

Tabular short cuts to network design 82
Logic circuitry offers 10 stable states 102
Tips for starting your own company 110

\$1.00 A McGraw-Hill Publication

August 18, 1969

Electronics®

A semiconductor whodunit!

The failure detectives

142 K55956 4486
R MISLER
JISB

They're on our shelf



The "special" audio transformers you need are "standard" at UTC.

When you're ready to specify transformers and inductors, before you turn to costly *specials*, check UTC. Chances are there's a *standard* unit that fits your special electrical and mechanical requirements exactly.

UTC has over 500 audio types in stock, ready for immediate delivery. And UTC engineers are constantly adding to the line. Microwatts to kilowatts. Less than $\frac{1}{4}$ Hz to greater than 1 MHz. MIL-T-27 or industrial. Metal-encased or open frame. Input, output, mixing, matching, modulating, phase shifting, hybrid,

baluns, ring modulator. All in continuous production for sample or high-volume requirements.

If the specific unit you need isn't on our shelf, we'll tailor a standard unit to your special requirements—saving the time and costs of starting from scratch. Check your local distributor for immediate off-the-shelf delivery. For catalog, write: United Transformer Company, Division of TRW INC., 150 Varick Street, New York, N.Y. 10013.

TRW
UNITED TRANSFORMER COMPANY

When you buy a low-cost electronic counter from us, you get a unique bonus. Us.

With 55 service offices in the United States and Canada and 86 offices worldwide, we're always close by if you need help. And we give the same complete, dependable back-up to customers who spend a few hundred dollars for a counter as we do to those who spend a few thousand. That's a good thing to keep in mind when you're looking for an inexpensive way to solve your counting problems. And when you add the price and service to the performance you can expect from these counters, you know you're onto a real bargain.

For instance the Hewlett-Packard

5321A counts frequencies up to 10 MHz, has a 100 mV sensitivity and 1 M Ω /30 pF input impedance, 4-digit readout with display storage, zero blanking for easier, faster reading. All this is \$425.

The more versatile and more accurate Hewlett-Packard 5321B gives you BCD recorder output, 5-digit readout, frequency ratio and pulse duration measurement, additional gate times and a quartz crystal time base. Yet the price is just \$775.

The Hewlett-Packard 5221A/B Counters are the same in everything but shape. They're higher, narrower and not as long as the 5321A/B.

If you need greater capability, the Hewlett-Packard 5216A will provide it for \$985. This counter will totalize, measure

frequency, period, multiple period averages, ratio, multiple ratios and pulse duration. It has a 7-digit readout, gate times of 0.01 to 10 seconds, 10 millivolt sensitivity, BCD recorder output, and a maximum count rate of 12.5 MHz.

So when you need a low-cost counter, talk to the people who can deliver the goods *and* whatever service you need, whenever you need it. Call your local Hewlett-Packard field engineer for all the details. Or write to Hewlett-Packard, Palo Alto, California 94304; Europe: 1217 Meyrin-Geneva, Switzerland.

HEWLETT  PACKARD

ELECTRONIC COUNTERS

02912

Circle 1 on reader service card

**Count on us
for as little as
\$425.**

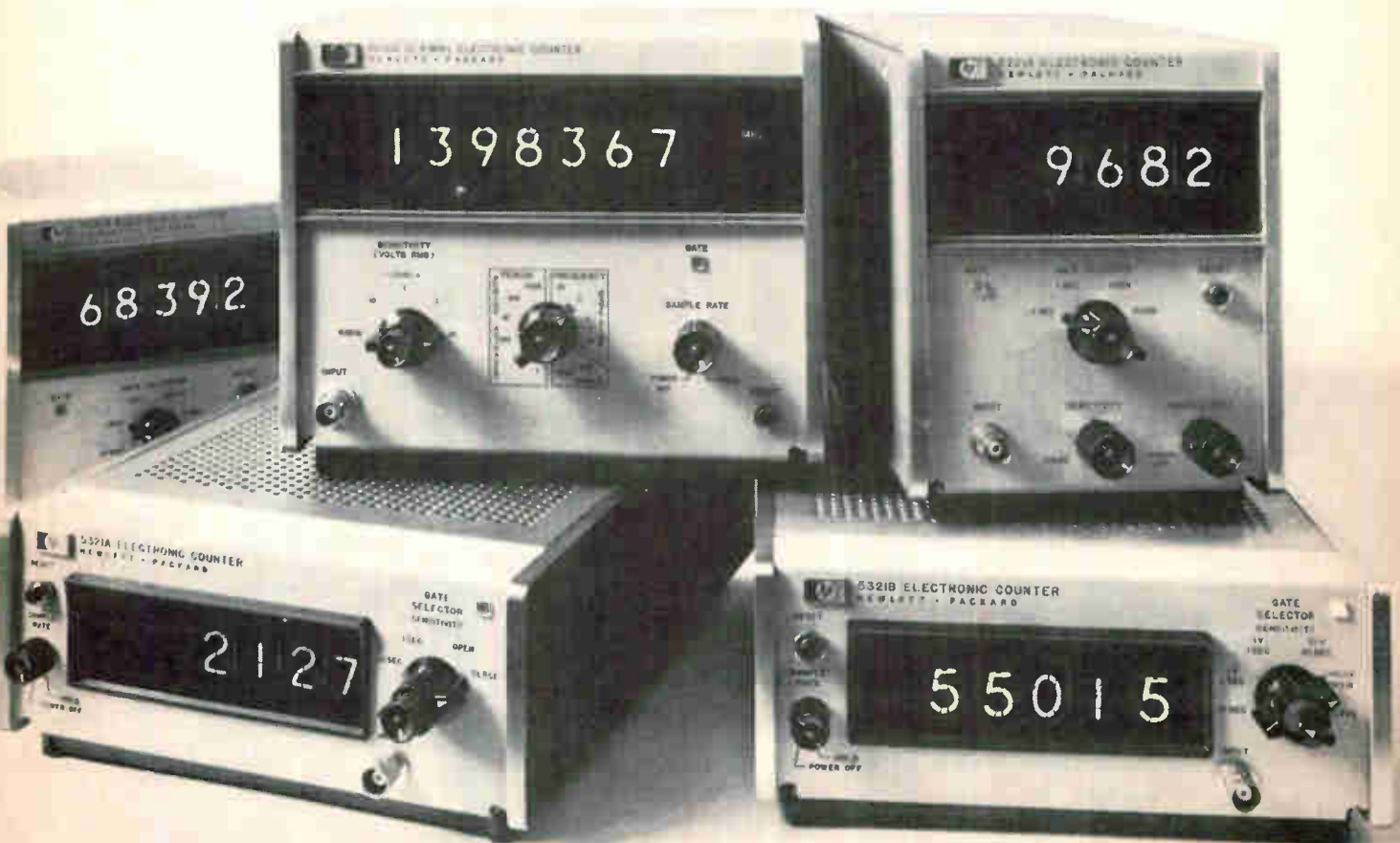

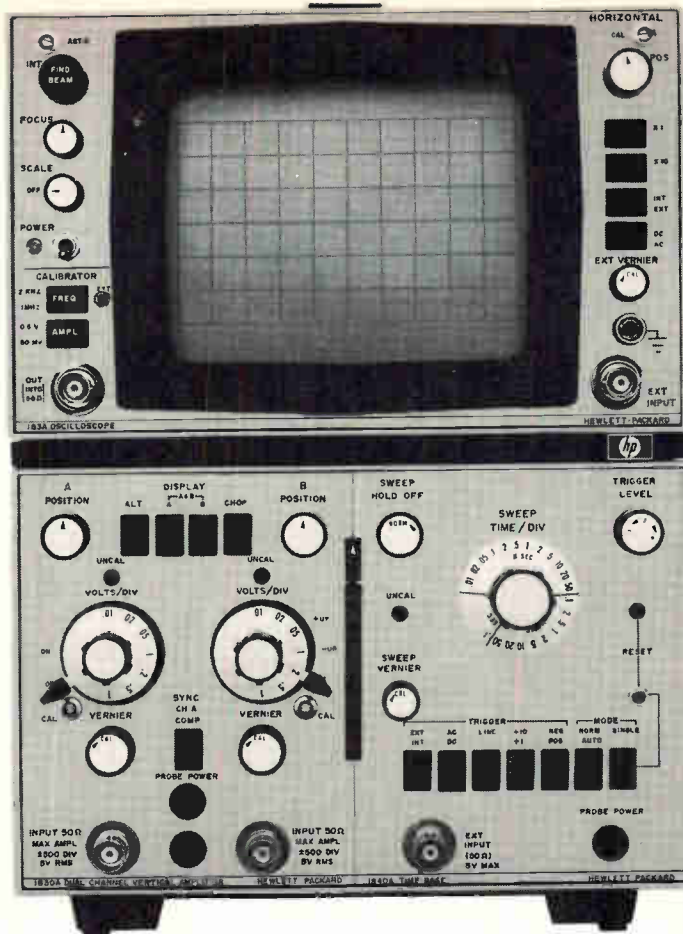

250 MHz Real Time With 10 mV Input

New to the 180 System—for the first time you can get a 6 centimeter vertical display of repetitive wave-forms or single-shot transients in frequencies from dc to 250 MHz. And, you can see these displays with only 10 mV/division input.

A major breakthrough in CRT technology provides the 183A with a high sensitivity CRT compatible with solid-state circuitry and bandwidths above 500 MHz. This capability will prevent the mainframe from limiting future advances in vertical plug-ins. The new CRT design also gives you a fast writing rate of 4 cm/ns, so you can have bright displays of low rep-rate, narrow pulses.

With the HP resistive dividers or active probes and the 50 Ω inputs you can make accurate measurements, regardless of your source impedances. Capacitive effects on rise time and CW amplitude have been minimized—VSWR is < 1.35:1 at 250 MHz, 10 mV/cm.

Since the 180 scopes first appeared in 1966, the all-solid-state concept has proved that service and maintenance are minimized. All-solid-state design also lends itself well to the versatile plug-in concept. Packed in small plug-in modules are such capabilities as dual-channel,

four-channel, 7 ns 50 MHz, 3.5 ns 100 MHz, 12.4 GHz sampling, 35 ps calibrated TDR, mixed sweep, delayed sweep, variable holdoff, differential/dc offset—to cover only part of the growing list of field-proven plug-ins, all of which are compatible with the new 183A. This versatility is possible because all 180 scope mainframes contain only the CRT and its power supply—you will not be mainframe-limited in the future selection of advanced plug-ins.

When your job depends on your measurements, when your reputation rests on your purchases, when you want maximum performance per dollar invested, **step forward with the growing HP 180 Scope System.**

For price and availability of the HP 183A 250 MHz Oscilloscope (cabinet or rack model), and other mainframes and plug-ins in the HP 180 Scope System, call your nearest HP field engineer. Or, write Hewlett-Packard, Palo Alto, California 94304. Europe: 1217 Meyrin-Geneva, Switzerland.

HEWLETT  PACKARD

OSCILLOSCOPE SYSTEMS

News Features

Probing the News

- 131 **Solid state:** Mil Std 883—a real test case
138 **Transportation:** Road open for highway automation

U.S. Reports

- 47 **Advanced technology:** New delay line
48 **Computers:** IBM's System/3
49 **Space:** Mariner's landfall
50 **Integrated electronics:** Interfacing system house, IC maker
51 **Patents:** Weaker legislation
52 **Medical electronics:** Computerized ECG system
54 **Communications:** Field-replaceable modules
56 **Government:** Proposed Cabinet science department
59 **Air traffic control:** Industry proposals
60 **Air traffic control:** Near misses
61 **Companies:** Computer exports
61 **For the record**

Electronics International

- 195 **Japan:** Read-only memory can be customized yet mass produced
196 **West Germany:** Computer family to control traffic
197 **Japan:** More minicomputers; yttrium-oxide thin films
198 **Sweden:** Rough time for color tv

New Products

- 145 **In the spotlight**
145 With 253 gates on a chip, analyzer is unquestionably LSI
149 Tester zips through complex logic
153 **New components**
153 Hybrid op amp designed for speed
157 **New instruments**
157 Wattmeter covers d-c to 1 Ghz
161 **New subassemblies**
161 Converter samples at 80-Mhz rate
163 Ferrite dots create displays
165 Op amps speed cockpit control
168 Equipment timer plugs into line
171 **Data Handling**
171 Remote data terminal is portable
174 7-beam crt gives brighter display

Technical Articles

- Circuit theory** 82 **Active filters: part 12**
Short cuts to network design
Tables of normalized element values for different filter responses and a slide rule for simple calculations add up to a quick design of a complete active filter
Robert R. Shepard, Genisco Technology Corp.
- Circuit design** 93 **Designer's casebook**
▪ Transmit-receive switch exceeds 60-db isolation
▪ Positive or negative pulses trigger one-shot multivibrator
▪ IC flip-flops accurately control motor rotation
▪ Stable f-m oscillator offers sensitivity and linearity
▪ Control current slows pulse's leading edge
- Solid state** 98 **Semiconductor whodunit:**
Who's to blame for failures? (cover)
Associate Editor Owen Doyle finds failure sleuths faulting quality control at the vendor level; often, easily detected flaws somehow slip by unnoticed—in some cases, supposedly good devices fall short of their specifications
- Circuit design** 105 **Multistable logic simplifies man-machine interface**
Based on the phased-pulse principle, circuitry that assumes 10 stability levels instead of just two is not only more efficient but also far less complex
L.S. Sitnikov and L.L. Utyakov, Tochelectropribor, Kiev, USSR
- Opinion** 110 **Before you start your own company . . .**
. . . make sure you've got an engineering-management team, good lawyers, backing, and a product that doesn't imitate another already on the market
Dale Samuelson, Electro-Metrics Corp.
- ### Departments
- | | | | |
|----|--------------------------|--------------------------|------------------------|
| 4 | Readers Comment | 35 | Electronics Newsletter |
| 8 | Who's Who in this issue | 71 | Washington Newsletter |
| 14 | Who's Who in electronics | 178 | New Books |
| 24 | Meetings | 181 | Technical Abstracts |
| 33 | Editorial Comment | 184 | New Literature |
| | 193 | International Newsletter | |

Electronics

Editor-in-Chief: Donald Christiansen

Senior Staff editors

Technical: Stephen E. Scrupski
News: Robert Henkel
International: Arthur Erikson

Art director: Gerald Ferguson

Senior associate editors: Joseph Mittleman, Harry R. Karp
Assistant managing editors: H. Thomas Maguire, Howard Wolff,
William Bucci, Richard Gundlach, Frederick Corey
Special projects editor: Roger Kenneth Field; Senior staff writer: John Johnsrud

Department editors

Communications: John Drummond, Raphael Kestenbaum
Computers: Wallace B. Riley, George Weiss
Design theory: Joseph Mittleman
Industrial electronics: Harry R. Karp
Instrumentation: Owen Doyle
Military/Aerospace: Alfred Rosenblatt; Paul Dickson (Aerospace)
New products: William P. O'Brien
Solid state: George Watson, Stephen Wm. Fields

Field bureaus

Boston: James Brinton, manager; Gail Farrell
Los Angeles: Lawrence Curran, manager; Ralph Selph
New York: Peter Schuyten
San Francisco: Stephen Wm. Fields
Washington: Ray Connolly, manager; Paul Dickson, Robert Westgate, Lois Vermillion
Bonn: John Gosch
London: Michael Payne
Paris: Arthur Erikson
Tokyo: Charles Cohen

Copy editor: Edward Flinn

Assistant art director: Charles Ciatto
Production editors: Susan Hurlburt, Arthur C. Miller

Editorial research: Virginia Mundt

Editorial secretaries: Lorraine Longo, Claire Goodlin, Barbara Razulis, Vickie Green,
Bernice Pawlak, Patricia Bispham

McGraw-Hill News Service

Director: Arthur L. Moore; Atlanta: Fran Ridgway; Chicago: Robert E. Lee
Cleveland: Arthur Zimmerman; Dallas: Marvin Reid
Detroit: James Wargo; Houston: Barbara LaRoux
Los Angeles: Michael Murphy; Pittsburgh: Louis Gomolak
San Francisco: Margaret Drossel
Seattle: Ray Bloomberg; Washington: Charles Gardner, James Canan,
Herbert W. Cheshire, Seth Payne, Warren Burkett, William D. Hickman

McGraw-Hill World News Service

Bonn: Robert Dorang; Brussels: James Smith; Hong Kong: Kate Mattock
London: John Shinn; Mexico City: Gerald Parkinson; Milan: Ronald Taggiasco, Jack Star
Moscow: Jack Winkler; Paris: Robert E. Farrell, Stewart Toy
Rio de Janeiro: Leslie Warren; Tokyo: Marvin Petal

Reprints: Gail Niles

Circulation: Isaaca Siegel

Publisher: Gordon Jones

Associate Publisher: Dan McMillan

Assistant to the publisher: Wallace C. Carmichael

Electronics: August 18, 1969, Vol. 42, No. 17

Published every other Monday by McGraw-Hill, Inc. Founder: James H. McGraw 1860-1948.
Publication office 99 North Broadway, Albany, N. Y. 12202; second class postage paid at Albany, N. Y.
and additional mailing offices.

Executive, editorial, circulation and advertising addresses: Electronics, McGraw-Hill Building,
330 W. 42nd Street, New York, N. Y. 10036. Telephone (212) 971-3333. Teletype TWX, N.Y., 710-581-4235.
Cable address: MCGRAW-HILL N.Y.

Subscriptions solicited only from those professionally engaged in electronics technology. Subscription rates:
qualified subscribers in the United States and possessions and Canada, \$8.00 one year, \$12.00 two years,
\$16.00 three years; all other countries \$25.00 one year. Non-qualified subscribers in the U.S. and
possessions and Canada, \$25.00 one year; all other countries \$50.00. Air freight service to Japan \$50.00
one year. Single copies: United States and possessions and Canada, \$1.00; all other countries, \$1.75.

Officers of McGraw-Hill Publications Company: Joseph Allen, President; John R. Emery, J. Elton Tuohig,
Senior Vice Presidents; Gordon L. Jones, Jr., Group Vice President; Vice Presidents: John R. Callahan, Editorial;
Paul F. Cowie, Circulation; John M. Holden, Marketing; David G. Jensen, Manufacturing;
Jerome D. Luntz, Planning & Development; Robert F. Marshall, Administration; Robert M. Wilhelm, Finance.

Officers of the Corporation: Shelton Fisher, President and Chief Executive Officer; John L. McGraw, Chairman;
Robert E. Slaughter, Executive Vice President; Daniel F. Crowley, Donald C. McGraw, Jr., Bayard E. Sawyer,
Senior Vice Presidents; John J. Cooke, Vice President & Secretary; Gordon W. McKinley, Vice President &
Treasurer.

Title registered in U.S. Patent Office; © Copyright 1969 by McGraw-Hill, Inc. All rights reserved. The contents
of this publication may not be reproduced either in whole or in part without the consent of copyright owner.

Subscribers: The publisher, upon written request to our New York office from any subscriber,
agrees to refund that part of the subscription price applying to copies not yet mailed.
Please send change of address notices or complaints to Fulfillment Manager; subscription
orders to Circulation Manager, Electronics at address below. Change of address notices
should provide old as well as new address, including postal zip code number. If possible,
attach address label from recent issue. Allow one month for change to become effective.

Postmaster: Please send form 3579 to Fulfillment Manager, Electronics,
P.O. Box 430, Hightstown, New Jersey 08520

Readers Comment

Tolerating the intolerable

To the Editor:

After watching color-tv pictures of the Apollo 11 recovery—representing uniform transmission of an amplitude-modulated signal over a bandwidth of 4.5×10^6 hertz across a distance of 40,000 miles—I am appalled at the quality of audio

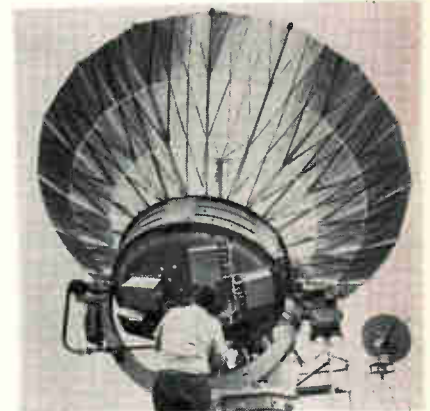

Relaying splashdown from Hornet.

transmission that requires only 3,500 hz and travels only 20 miles.

I think it is amazing that, in this day and age, both military and commercial aviation tolerate audio quality so poor as to require a trained ear to decipher and understand it. Too much is at stake; human life depends on the quality of these transmissions.

Perhaps an investigation should be called to determine why this state of affairs continues.

Richard G. Devaney
Kingsport, Tenn.

Pcm, Italian-style

To the Editor:

William Bucci's article on the worldwide status of pulse-code modulation [June 23, p. 94] is excellent, concise, and accurate. But the article wasn't as complete as we at Telettra would have expected. Mr. Bucci mentioned neither the pioneering pcm work in Italy nor that done by Telettra.

To our knowledge, Telettra is the first European firm to develop, manufacture, and install com-

Buy resistors with built-in dependability...

Vitreous-enamel **BLUE JACKET[®]** **POWER WIREWOUND RESISTORS**



INFORMATION RETRIEVAL NO. 517

All-welded end-cap construction eliminates moisture along the leads, also anchors leads securely to resistor body. Expansion coefficients of vitreous enamel coating, ceramic core, and end caps are closely matched. Standard wattage ratings include 1, 2, 2.5, 3, 5, 7, 10, and 11 watts. Also available with radial tab terminals in ratings from 8 to 230 watts.

45R-9145

Tiny in size...Giants in volume efficiency!

Type 160D, 161D **Solid-Electrolyte Tantalex[®] Capacitors** for hearing aids and ultra-miniature circuits

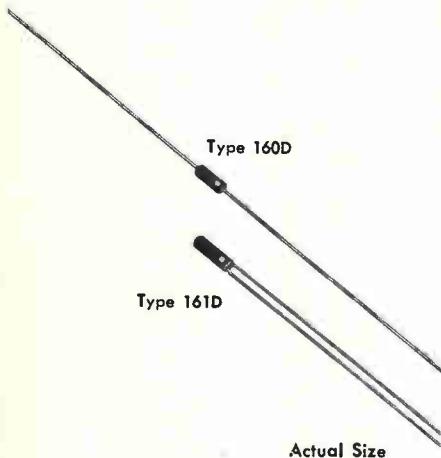

INFORMATION RETRIEVAL NO. 518

Tiny Type 160D/161D Tantalex Capacitors are sealed within a polyester film tube with tightly-bonded epoxy fill, so the assembly is both electrically insulated and highly resistant to moisture. They are available with axial leads as well as in single-ended construction.

Offering extremely high capacitance per unit volume (for example: 0.25 μ F @ 20 VDC in a case only .065" D. x .125" L.), Tantalex Hearing-aid Capacitors let you select from a broad range of ratings in five different case sizes.

For information on Blue Jacket Resistors, request Engineering Bulletin 7410D. For the full story on Type 160D/161D Capacitors, write for Engineering Bulletin 3515D. Address Technical Literature Service, Sprague Electric Co., 35 Marshall St., North Adams, Mass. 01247.



Sprague' and '®' are registered trademarks of the Sprague Electric Co.

THE BROAD-LINE PRODUCER OF ELECTRONIC PARTS

Diagnose noise in an instant



1921 Real-Time Analyzer with 1921-P1 Storage Display Unit.

This is the fastest, most accurate 1/3-octave noise analyzer available today. It reduces the time previously taken to do a complete noise analysis from as much as one week to 45 minutes — and the results are more reliable. At the push of a button, GR's Type 1921 Real-Time Analyzer preshapes the noise spectrum, segments it into 30 to 45 1/3-octave frequency bands, digitally detects the *true* rms levels in all bands *simultaneously*, and processes up to 45,000 samples of data in a single measurement. You can pick one of nine measurement periods (from 1/8 to 32 seconds), select the desired reference level, and get right answers in both analog and digital form. With the 1921 you can analyze noise at least 30 times faster than with existing serial systems.

APPLICATIONS

As part of an analyzer/computer system, or as an individual instrument using appropriate input and output equipment, the 1921 can perform a wide variety of on-line calculations of, for example, spectrum comparisons, loudness, perceived-noise-level, speech-interference-level, noise-criterion levels, ARI ratings, AMCA ratings, ASHRAE measurements, and STC ratings.

STANDARD MODELS

The 1921 is a combination of two new GR instruments: the 1925 Multifilter and the 1926 Multichannel RMS Detector. Models are available for bench use or rack mounting, with or without calibrated channel attenuators.

Frequency range (1/3-Octave Center Frequencies)	Price in USA	
	With Attenuator	Without Attenuator
25 Hz to 20 kHz	\$9275.00	\$8925.00
12.5 Hz to 10 kHz	9355.00	9005.00
3.15 Hz to 2.5 kHz	9455.00	9105.00
100 Hz to 80 kHz	9225.00	8875.00

Optional Type 1921-P1 Storage Display Unit, \$1345 in U.S.A. (bench model).

For complete information, write General Radio Company, W. Concord, Massachusetts 01781; telephone (617) 369-4400. In Europe: Postfach 124, CH 8034 Zurich 24, Switzerland.

GENERAL RADIO

Readers Comment

mercial 24-channel systems. As of now, more than 2,000 Telettra channels are operating in Italy's public telephone network, with the first system [experimental] installed in 1963. There are 3,000 other Telettra channels now operating in Yugoslavia, Norway, Switzerland, Ireland, Spain, Greece, Finland, and Brazil.

Moreover, the company believes it is the first to develop, produce, and install fully-integrated solid state microwave radio-relay equipment (13 gigahertz) specifically designed for 24-channel pcm systems. More than 120 of these terminals are operating in Italy—the first was installed two years ago—and about 100-or-so others are operating in other countries.

Telettra will soon manufacture 30-channel systems and their related microwave terminals. The systems will be designed to the specifications set down by the Conference of European Postal and Telecommunications Administration.

In August 1967, the company installed an experimental all-IC 120-channel pcm multiplexer. Thus far, the unit has worked satisfactorily with Telettra's experimental time-division switching system in the Italian telephone network.

Three years earlier, the company successfully field tested a pcm satellite exchange—Sintel 1.

Federico Brando

Laboratori di Telefonia
Elettronica e Radio (Telettra)
Milan, Italy

Tenfold better

To the Editor:

In your photo caption describing Dynalex Inc.'s ADX analog-to-digital converter [June 23, p. 183], a minor typographical error produced a monumental understatement of performance. Rather than 20,000 15-bit conversions per second, the ADX provides a throughput of 200,000 conversions per second.

Paul K. Harris

Market manager
Dynalex Inc.
Burbank, Calif.

A case for lower case

To the Editor:

Mr. Hildebrand's comments [July 21, p. 4] concerning your reply to Mr. Soane's letter on standards and style [July 7, p. 7] are the most asinine ever. Technical accuracy first, then aesthetics, bah! Perhaps the recognized national standards should be reexamined in the light of what is readable.

What are standards for if not to make symbols and the like clearer more readable, and universal? I would much rather see h than H, and μf instead of μF . Because abbreviations are derived from men's names isn't reason enough for capitalization; readability comes first.

D.J. Rhoads

New Brunswick, N.J.



Wide Band, Precision CURRENT MONITOR

With a Pearson current monitor and an oscilloscope, you can measure pulse or ac currents from milliamperes to kiloamperes, in any conductor or beam of charged particles, at any voltage level up to a million volts, at frequencies up to 35 MHz or down to 1 Hz.

The monitor is physically isolated from the circuit. It is a current transformer capable of highly precise measurement of pulse amplitude and waveshape. The one shown above, for example, offers pulse-amplitude accuracy of +1%, -0% (typical of all Pearson current monitors), 20 nanosecond rise time, and droop of only 0.5% per millisecond. Three db bandwidth is 1 Hz to 35 MHz.

Whether you wish to measure current in a conductor, a klystron, or a particle accelerator, it's likely that one of our off-the-shelf models (ranging from 1/2" to 10 3/4" ID) will do the job. Contact us and we will send you engineering data.

PEARSON ELECTRONICS INC

4007 Transport St., Palo Alto, California 94303
Telephone (415) 326-7285



Circle 7 on reader service card

7

SUBSCRIPTION SERVICE

Please include an Electronics Magazine address label to insure prompt service whenever you write us about your subscription.

Mail to: Fulfillment Manager
Electronics
P.O. Box 430
Hightstown, N.J. 08520

To subscribe mail this form with your payment and check new subscription renew my present subscription

Subscription rates: qualified subscribers in the U.S.: 1 year \$8; two years, \$12; three years, \$16. Non-qualified: 1 year \$25. Subscription rates for foreign countries available on request.

CHANGE OF ADDRESS

ATTACH
LABEL
HERE

If you are moving, please let us know five weeks before changing your address. Place magazine address label here, print your new address below.

name

address

city

state

zip code

Who's Who in this issue



Shepard

Skills in two specialties—filter design and computer programming enabled Robert Shepard to design, simulate, and test the active filters discussed in the article beginning on page 82. Holder of a master's degree from the University of California (Berkeley), Shepard joined Genisco in 1964. Initially in charge of programming, he was named project engineer when the firm started work on hybrid IC active filters.



Samuelson

Practicing what he preaches, Dale S. Samuelson has done very well for himself. Author of the advice-packed piece on how an engineer can go about starting his own company (page 110), he's vice president for marketing at the Electro-Metrics Corp., a subsidiary of Fairchild Camera & Instrument. Samuelson was a key man in the founding, organization, and development of the firm, which set up shop in 1963. Before casting his lot with Electro-Metrics, Samuelson, who earned a B.S. at Virginia Poly and a master's degree at NYU, had a varied career in marketing and sales promotion.



Sitnikov



Utyakov

Two of Russia's top engineers, L.S. Sitnikov and L.L. Utyakov, are responsible for the article on multistable logic circuits that begins on page 105. Both men are graduates of the Polytechnical Institute of Lvov in the western Ukraine; they hold candidate of science degrees—the equivalent of the western world's doctorates. (Sitnikov was recently awarded a doctor of science degree, a follow-on honor accorded him for the work he has done in the multistable circuit field since completing his normal graduate studies.) Until 1964, Sitnikov and Utyakov were on the engineering staff at the Automation and Electrometry Institute of the Siberian branch of the USSR Academy of Science; here, they did research and development work aimed at applying multistable circuits in digital measuring systems. In 1964, they were appointed to the Tochelectropribor works in Kiev—Sitnikov as chief of the research department and Utyakov as chief of the multistable circuits laboratory. For their work, the two have been awarded the S.I. Vavilov prize—the Soviet Union's highest accolade for electronics—in 1967, as well as the Lenin Komsomol (Young Communist League) prize for 1968.

A frequent byliner in *Electronics*, associate editor Paul Dickson will take a nine-month leave of absence beginning in September. Paul, whose most recent effort—a takeout on the important role to be played by the electronics industry in the Federal Government's attempts to automate highways—starts on page 138, has been awarded a graduate-study fellowship by the American Political Science Association. He'll be studying advanced areas of science and technology at universities in the Washington, D.C. area with an eye to exploring the relationship between these fields and politics. A Wesleyan graduate and a veteran of the Navy where he served aboard a carrier as a communications officer and cryptologist, he joined the magazine in 1966. A year later, Paul was assigned to Washington where he specialized in space reporting.

COS/MOS

RCA's unique approach to digital design
—at new low prices

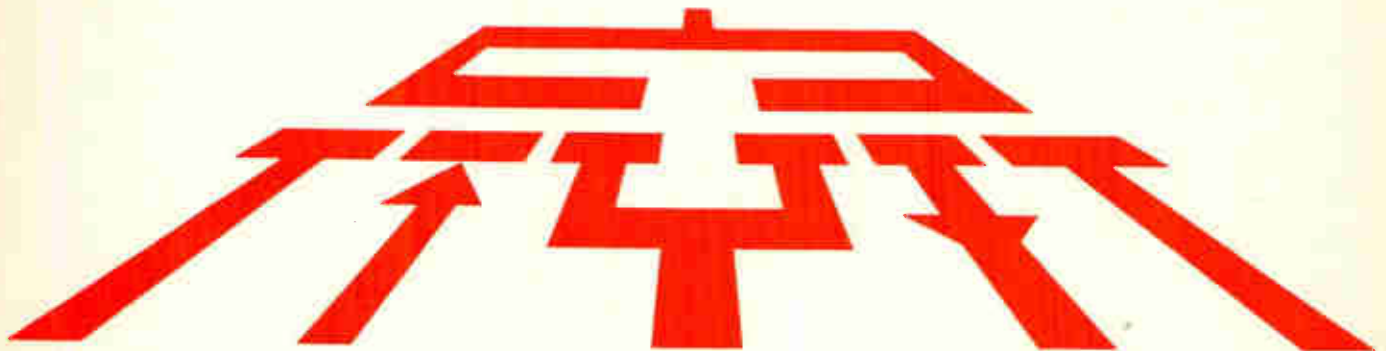

For practical circuit designs...

High performance and new low prices combine to make COS/MOS—RCA's unique Complementary Symmetry MOS integrated circuits—an even greater value for a broader range of digital equipment designs. Now you can re-evaluate—and find even more advantages in—these COS/MOS features that no other logic circuitry has matched to date:

- Quiescent power dissipation in nanowatts
- Noise margin—4.5 volts
- Fanouts up to 50
- Single power supply required—6 to 15 V, positive or negative
- Logic level swing—"0" to power supply voltage
- Compatible gate level and MSI functions
- Frequency capabilities from DC to 5 MHz
- Single-phase clocking
- Full military operating temperature range—from —55°C to +125°C
- Hermetic packages—DIC or ceramic flat pack

To get acquainted with COS/MOS, see your RCA Distributor for the COS/MOS Sampler QK2201, yours for only \$50.00 (optional distributor resale price).

For new economy...

Effective now, new low prices—combined with unrivalled application advantages—put COS/MOS squarely in the picture for all your digital designs. Check the list of device numbers, descriptions and prices. Then ask your local RCA Representative or your RCA Distributor for details. For specific circuit data, write RCA Electronic Components, Commercial Engineering, Section ICN8-3, Harrison, N. J. 07029.

CD4000D	Dual 3-Input Gate and Inverter (DIC)	NOW \$ 4.00
CD4001D	Quad 2-Input Gate (DIC)	NOW \$ 4.75
CD4002D	Dual 4-Input Gate (DIC)	NOW \$ 4.50
CD4003D	Dual "D" Type Flip-Flop (DIC)	NOW \$ 8.00
CD4004T	7-Stage Counter-Divider (12-lead TO-5)	NOW \$10.00
CD4005D	16-Bit NDRO Memory (DIC)	NOW \$10.00
CD4006D	18-Stage Static Shift Register (DIC)	NOW \$17.25
CD4007D	Dual Complementary Transistor Pair and Inverter (DIC)	NOW \$ 3.00

(All prices at 1,000 unit level. These COS/MOS IC's also available in ceramic flat-pack at slightly-higher prices.)

Consider the systems advantages to be provided by these developmental types, soon to be added to the growing COS/MOS series. See your local RCA Representative.

	Dev. Type No.	Description
Buffers	TA5660	Hex Inverting Buffer
	TA5668	Hex Non-Inverting Buffer
MSI	TA5519	4-Bit Full Adder
	TA5578	8-Stage Synchronous Parallel-Input/Serial-Output Register
	TA5579	Dual 4-Stage Serial-Input/Parallel-Output Register
	TA5684	Decade Counter
	TA5971	5-Stage Binary/Decade Counter
	TA5580	Presetable Divide by "N" Counter

RCA
Integrated
Circuits

BURROUGHS DEVELOPS . . . DOT MATRIX

Burroughs 

the most
significant development
in electronic display

SELF-SCAN

Burroughs, the originator of NIXIE® tubes, now revolutionizes display technology with the first commercially practical dot matrix display system. It took self-scan, the remarkable Burroughs invention that takes the electronics out of the present electronic displays...reducing costly drive circuitry up to 90%.

With a minimum number of leads and drivers, Burroughs' system automatically scans data input into in-plane readout characters formed by glowing dots...making possible a totally new combination of readability, minimal packaging and cost advantages.

The new flat-panel display is basically a matrix of small gas discharge cells hermetically sealed between heavy glass plates in a sandwich configuration. The matrix itself, formed of insulating material, has small grooves on its top surface to allow positioning of information anode wires which intersect each hole. Cathode conductors behind the center sheet intersect at each cavity with a second set of anode wires.



By utilizing the phenomena of preferential glow transfer and glow shifting, the initial glow caused by cathode ionization in the dot matrix may be moved through selected holes to a visible position on the top surface. A sequential flow of light is thus achieved without separate drivers for individual columns and rows.

Burroughs' alphanumeric self-scanning dot matrix displays are available with or without memory for any application requiring 16 or 18 digit readout.

Write today for descriptive brochure, Burroughs Corporation, Electronic Components Division, P. O. Box 1226, Plainfield, New Jersey 07061. Tel.: (201) 757-5000.

See us at Wescon --- Booths 4224 - 4225

Staggered-finger heat sink design is more efficient, saves space and weight

Unique design is causing circuit designers to re-think their thermal theory.

Design engineers are learning daily that power ratings of power transistors are often not at all what they appear to be at first glance. For example, the data sheet on a transistor may state, "maximum power dissipation — 50 watts." But the fine print — if there is any — says, "at 25°C case temperature." Actually, the transistor alone will dissipate only 3 to 4 watts before the maximum allowable junction temperature is reached!

Obviously, something must be done to maintain the specified case temperature when more than 3-4 watts are to be dissipated. This is normally accomplished by mounting the transistor case to a dissipator or heat sink, but dissipator state-of-the-art has been such that these devices are too bulky, too heavy — just plain inefficient. Now you needn't tolerate these size and weight penalties in your design because IERC has achieved a major breakthrough in heat sink design: The IERC Staggered Finger Dissipator.

International Electronic Research Corporation has developed a broad line of these smaller, lighter, much more efficient heat dissipators based on the unique, multiple staggered finger design which has proven to be 30% more efficient overall, and in some

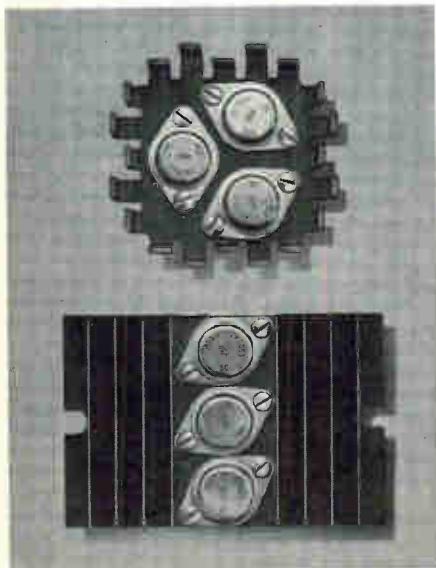

FIGURE 1

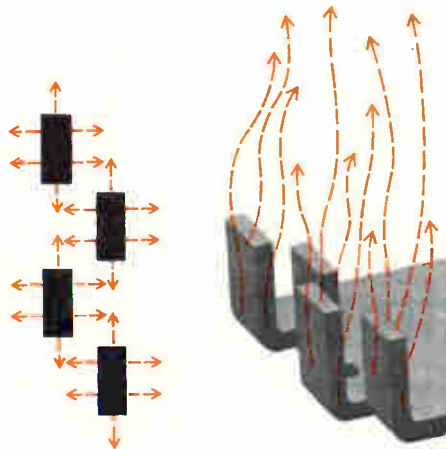

FIGURE 2

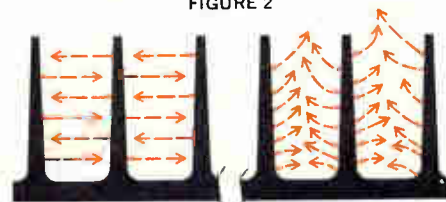

FIGURE 3

cases up to 500% more effective than many conventional designs now in wide use. An example of the staggered finger design is shown in Figure 1. This is an IERC HP3 Heat Dissipator. To show how efficient this device is, it is shown compared to a common finned extrusion. The HP3 and the extrusion are virtually equivalent in their heat dissipating ability; however, the HP3 is only 1/3rd the weight and 2/3rd the volume of the extrusion.

The secret to the efficiency of the new dissipators is the staggered fingers. (Figure 2) Note how the fingers are positioned so they do not radiate to each other and the configuration is so arranged that natural convection takes place very readily.

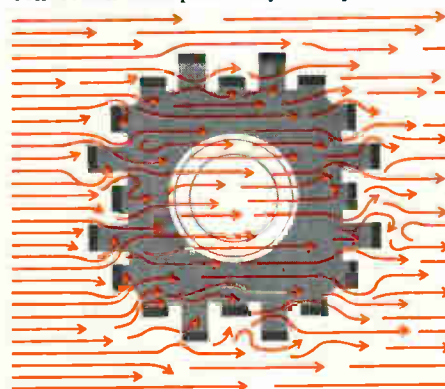

FIGURE 4

In a finned extrusion the fins radiate to each other and it is difficult for natural convection to take place in the confined area between the fins. (Figure 3)

In a forced air environment the staggered finger configuration is even more effective. The air can be from any direction. (Figure 4) As it hits the fingers, turbulence causes it to move around each of the fingers, striking many surfaces in its flow past the part. The turbulent air against these surfaces disturbs their surface barrier and is the principal reason for the significant improvement in the forced air heat dissipating properties of these parts.

Compare this turbulent air flow over the staggered fingers of the IERC part with the air flow conditions when directed at a finned extrusion. Here laminar air flow, rather than turbulent air flow, takes place. The air must be directed in one direction only, (Figure 5) parallel to the fins. The air enters the space between the fins; but because of this restricted space, it immediately tries to leave. Shortly after entering, it is not flowing against the bottom of the fin surfaces. Since the air flow is laminar, not turbulent, and it is not disturbing the surface barrier at the bottom of the fins shortly after entering, the surface areas of the fins are only partially effective.

The old rule-of-thumb which considers only the surface

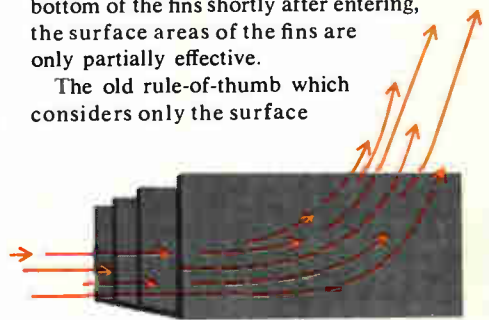

FIGURE 5

area relative to heat dissipation is not valid. The effectiveness of the area must also be considered. The staggered finger concept is a significant breakthrough in heat dissipating devices and is the first improvement in heat dissipator design since the flat fin or extrusion design.

Broad line accommodates all lead and case mounted semiconductors.

During the past several years, IERC has developed numerous heat dissipating devices

using the staggered finger configuration.

The UP style (Figure 6) is just 1.78 inches square and is available in various heights up to one inch. It was designed particularly to accommodate a single power transistor such as a TO36, TO3, TO15, etc. However, it will also accommodate more than one smaller semiconductor, including the newer plastic case power transistors.

To really appreciate the efficiency of the UP, refer to the temperature vs. power



FIGURE 6

curve (Figure 7) showing a 2N1208 power transistor mounted in a UP-TO15-B dissipator. Remember, now, that this UP part weighs *less than one ounce*. Considering a maximum case rise of 100°C, the 2N1208 by itself will dissipate only 3 watts. When mounted in the UP dissipator in natural convection, it will dissipate 14 watts, or

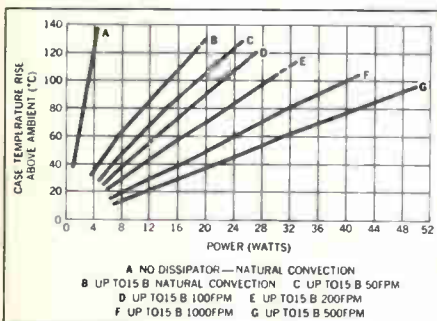

FIGURE 7

more than four times more power at the same case temperature. In a forced air environment of only 200 FPM, 28 watts can be dissipated — more than nine times the power at the same case temperature. With 1000 FPM, the remarkable light weight UP will allow 50 watts of dissipation from the transistor — *seventeen times more power at the same case temperature*.

Think now. You must limit the case temperature rise of a power transistor to 100°C. You need to dissipate 14, 28 or 50 watts. You have three cubic inches of space and are limited to adding one ounce of weight. And you can't spend more than 40 cents for a dissipator or sink in medium quantities. What would your present thinking lead you to do?



FIGURE 8

Another IERC dissipator, the HP1, is a companion to the HP3 shown in Figure 1. The HP1 is 2½ inches square, slightly larger than the UP. At the same case temperature rise of 100°C, it will dissipate 23 watts in natural convection; in a forced air flow of 200 FPM, it will dissipate 33 watts; and 65 watts with 1000 FPM. The HP3, which is 3½ inches square, will dissipate 28 watts in natural convection, 42 watts with 200 FPM, and 74 watts with 1000 FPM. When the HP1 and HP3 are nested, Figure 8, more than 100 watts can be dissipated at the same 100°C case temperature rise with 1000 FPM.

Stop and contemplate the sizes of heat dissipating devices which would have been required to dissipate these powers before the advent of the staggered finger design, and you will appreciate the savings of space and weight which the UP and HP make possible.

The staggered finger design has also been used in heat dissipators for TO5 and TO18 metal case transistors. Models in the LP Series, Figure 9, are available in three lengths and two heights and to accommodate one or two transistors. These parts are so efficient that when a TO5 transistor is mounted in the largest model



FIGURE 9

LP dissipator (only 2.31 x 1.12 x ½"), the dissipator is virtually an infinite heat sink. The case temperature rises only 65°C when 5 watts are being dissipated. When 1000 FPM of air is used at 5 watts dissipation, the case temperature rise is phenomenally low — less than 15°C.

In addition to their thermal efficiency, LP parts are extremely versatile. Almost any application problem where a conduction plane is not available can be solved with these simple, low cost devices.



FIGURE 10

The staggered finger concept is also available in dissipators for plastic case power transistors and integrated circuits and microcircuit packages as shown in Figure 10.

The staggered finger concept of heat dissipation is the most significant breakthrough in heat sink technology since the advent of the power transistor. Get specific technical and pricing information on those IERC heat dissipators most applicable to your needs. Write on your company letterhead for Technical Bulletin 149 for more detailed information on the PA and PB series and Technical Bulletin 151 for the LB series. Technical Bulletin 134 and Test Report 172A detail the UP series; Technical Bulletin 139 and Test Report 198 cover the HP series; and for the LP series, ask for Technical Bulletin 135 and Test Report 182. You'll be surprised how substantially these advanced new heat sinks will contribute to the efficiency of your design and your equipment.

International Electronic Research Corporation, a corporate division of Dynamics Corporation of America, 135 West Magnolia Boulevard, Burbank, California 91502.



HEAT SINKS/DISSIPATORS

LOWEST COST . . . FULL WAVE BRIDGE RECTIFIERS & ASSEMBLIES

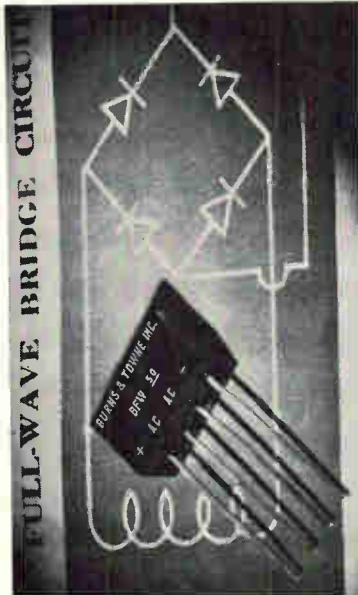

Burns & Towne pre-packaged rectifier circuits represent a significant cost savings over individual components used in multi-rectifier units. Yet, you are always assured of quality and reliability. The low cost BFW family of single phase full wave bridges . . . features high current capability of up to 2.0 amps.

Part No.	Max. PRV (volts)
BFW-50	50
BFW-100	100
BFW-200	200
BFW-300	300
BFW-400	400
BFW-500	500
BFW-600	600
BFW-800	800
BFW-1000	1000

Call or write for full specifications and price data.

BURNS & TOWNE INC.
18-36 Granite St.
Haverhill, Mass. 01830, Tel (617) 373-1333

Who's who in electronics



Brain trust. DISC's founders at a staff meeting. Seated at head of table is Roland Boisvert; standing beside him is Steven A. Lambert.

Small computers have become big business; so manufacturers are spinning off new firms the way semiconductor houses do. One of the latest spinoffs is DISC—for the Digital Information Storage Corp., Berlin, Mass. DISC is in the low-cost-peripherals business, and its first product will be a disk-memory system designed with a mechanical approach to electronics.

The founders come from the Digital Equipment Corp. Roland Boisvert, president, was manager of DEC's magnetic tape systems. Steven A. Lambert, DISC's vice president, was special project engineer for disk memories at DEC. Both men came away with strong opinions about the proper development of low-cost peripherals—and at least the tacit approval of DEC management, which may view DISC as a future supplier.

The score. "At almost every maker of computer peripheral equipment, the computer engineers outnumber the mechanical engineers by about 5 to 1," says Boisvert. "This isn't only frustrating, it's often like the tail wagging the dog; in the quest for better electrical performance, mechanical design suffers—and in the end, elec-

trical performance does too. We are going to let mechanical engineers decide mechanical questions."

Vibration of disks, lost bits, false bits, "crash landing" of flying heads, and damaged disks—all can crop up in the quest for better electrical performance, Lambert and Boisvert claim. And if they're right, all could be prevented through the proper mix of mechanics and electronics.

Having set up their company with the backing of Wang Laboratories, Boisvert and Lambert have reversed the ratio: on their staff the mechanical engineers outnumber the logic types 5 to 1.

Innovations. And they're coming up with a new, low-cost (about \$15,000) memory which uses many ideas rare or unique in disk stores. To prevent crash landings, damaged disks, and data dropout, they'll use fixed heads—but disks will be interchangeable. To damp wobble, they'll use beefed-up mechanical parts and, possibly, air bearings. For sensing and control without electrical noise, the relays and switches may be replaced with fluidic elements.

Meanwhile, DISC's chief backer, Wang Laboratories, seems to have faith in this mechanical approach to electronics. It has insisted on getting the first system off DISC's production line.

If the DISC-1 proves itself, says Wang's President, An Wang, his firm could exercise options to buy control of DISC. A prime reason for his financial interest is a new small computer under development at Wang Laboratories that could appear in 1970. The computer would need disk stores, especially for business applications.

Though America's military professionals like to consider themselves apolitical, this does not automatically protect them from becoming embroiled in politics—especially when they become general officers. The latest evidence of this will come September 1 when Maj. Gen. Walter E. Lotz Jr. takes over the Army Electronics Command from

RELAYS

NEW MIL-R-6106

- One-Inch Cube
- 4PDT-10 Amps
- 28VDC-115VAC
- All Welded

IT'S BABCOCK'S BR30

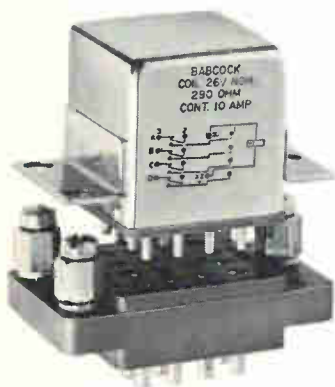

Babcock's new Model BR30 is a miniature, all-welded, 4PDT relay . . . designed specifically to meet the requirements of MIL-R-6106 (MS-27400)—and to be completely interchangeable with other models of this type. Characterized by reliable op-

eration in environmental extremes, this new relay is the first developed by Babcock to meet the needs of airframe applications. Performance is outstanding . . . to 200g's shock, 30g's vibration, over a temperature range of -70°C to $+125^{\circ}\text{C}$, for a minimum of 100,000 operations. All welded construction, inside and out, assures a contaminant-free unit. Plug-in and solder-hook versions are offered; qualified relay sockets also available.

The Model BR30 is a new relay for new applications . . . and it carries the same mark of proven Babcock dependability. Your assurance that it's better because it's Babcock.

The Babcock Model BR30 is a brand new MIL-R-6106 relay . . . featuring a new symmetrical magnetic circuit. Utilizing two permanent magnets, this system provides a positive holding force, undisturbed by shock and vibration extremes . . . and

dependable switching action throughout the life of the relay.

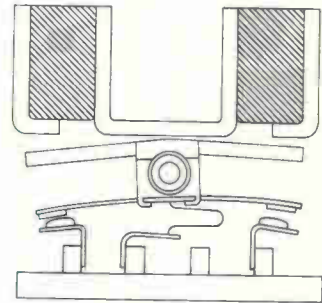

Coil design has also undergone some innovation. AC versions have been fabricated such that coil frequency is operational from 60 Hz to 400Hz, without degradation of ratings.

SPECIFICATIONS

Contact Rating (@28VDC, 115/208VAC 400Hz).....	Resistive: 10 amps. Inductive: 8 amps.
Overload.....	D.C. 40 amps. A.C. 60 amps.
Rupture.....	D.C. 50 amps. A.C. 80 amps.
Coil Voltages.....	6, 12 and 28VDC, 115VAC
Shock.....	200g's (6ms.)
Vibration.....	30g's, 70-3000Hz
Operation Temp.	-70°C to $+125^{\circ}\text{C}$
Pull-In Power.....	600mw
Operate/Release Time.....	15ms, max.
Bounce Time.....	1ms, max.
Life.....	100,000 operation, min.

Get complete information on the new Model BR30 . . . contact Babcock Electronics Corp., Relays Division, Subsidiary of Esterline Corp., 3501 Harbor Blvd., Costa Mesa, Calif. 92626. CALL COLLECT (714) 540-1234 or TWX 910-595-1517.

Challenging opportunities for relay-switch engineers.



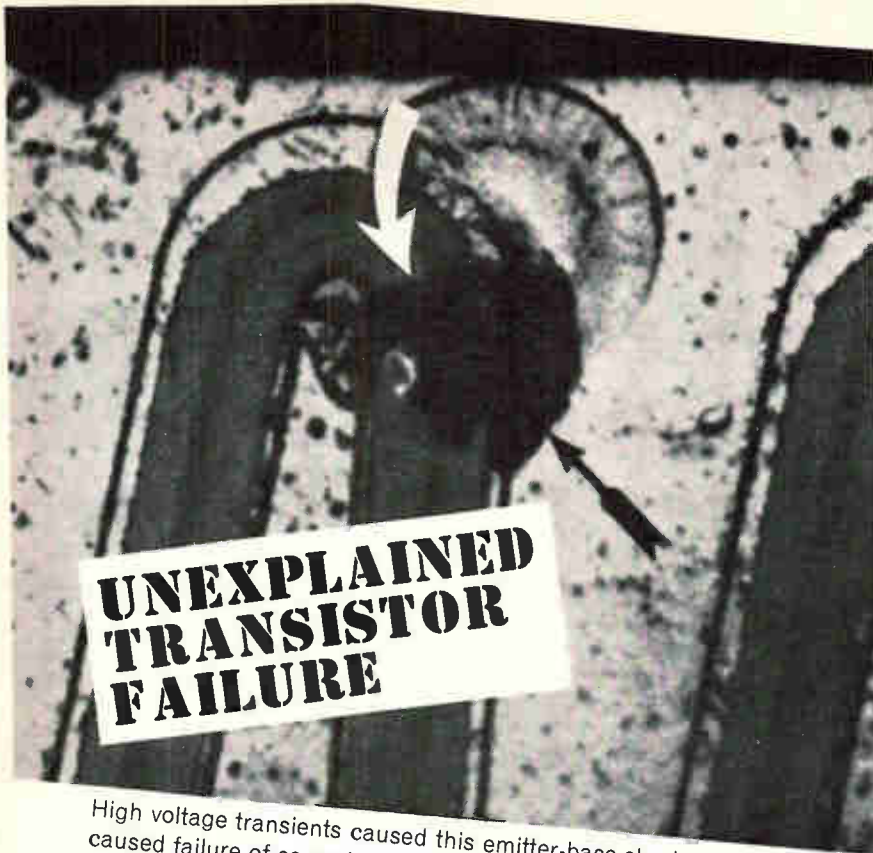

**UNEXPLAINED
TRANSISTOR
FAILURE**

High voltage transients caused this emitter-base short which later caused failure of several power transistors.

And how you can prevent it.

Whether it was caused by a technician with a wayward probe, or a piece of heavy equipment starting up nearby, or "strays," the origin of a high-voltage transient is of no consequence.

In every case, the results are the same: immediate—or eventual—failure of costly semiconductors.

Even though it may not fail immediately, the punctured device is left with a path, analogous to scar tissue, along which subsequent failures take place.

Eventually, under thermal stress or load conditions, the semiconductor gives up. Often without apparent cause.

Protection against transients

The Heinemann JA/Q™ electronics protector prevents high voltage spikes, or overvoltages of any kind, from ever reaching your semiconductors. (JA/Q undervoltage protectors are also now available.)

The JA/Q provides protection against transients and overvoltages by sensing them before they reach the vulnerable portions of the circuit. It responds to dangerous conditions

by shunting them from the line and signaling a trip mechanism to open the line.

Transient response time of the JA/Q is within 500 nanoseconds. Trip time is 10 milliseconds.

And overcurrent protection

Transient/overvoltage protection is combined in the JA/Q with hydraulic-magnetic overcurrent protection, which may be specified with or without time delay, depending on your circuit requirements. Time delays for typical overcurrent faults have no effect on the trip time of the protector under transient or overvoltage conditions.

To learn more about the JA/Q, write for Bulletin 3370. We're as interested in preventing failures as you are. Heinemann Electric Company, 2600 Brunswick Pike, Trenton, N.J. 06802.

HEINEMANN



Who's Who in electronics

his West Point classmate, Maj. Gen. William B. Latta. What happens to Latta? He will take over Lotz's old job, heading the Strategic Communications Command.

In this way, Gen. Latta may find it warmer at his new Ft. Huachuca, Ariz., outpost than at Ft. Monmouth, N.J.—but the heat should be far less than that coming from Washington. There, Rep. William H. Harsha (R., Ohio) has been sharply critical of what he calls enormous waste in Electronics Command procurements during Latta's tenure [*Electronics*, June 9, p. 58]. When Harsha made his first assault upon Ft. Monmouth a few weeks earlier, he said, "The enormity of the waste is so incredible to me that it would seem to border on criminal action."

Latta, of course, has been charged with nothing. In fact, a number of his colleagues resent Harsha's implication. Nevertheless, the Pentagon high command got the message.

Commonality. Though the names and faces may be different, Generals Latta and Lotz have more in common than most of their colleagues, according to the men in government and industry who know them. After graduating from West Point in 1938, both men moved immediately to what was then called the Signal Corps. They are alumni of the Industrial College of the Armed Forces, and both received outside graduate training as they rose through the ranks. Latta took an M.B.A. with distinction at Harvard's Business School, while Lotz pursued science, receiving a Ph.D. in physics from the University of Virginia.

If there is something more than a political advantage to be gained in the switch of the two men, the Army isn't saying. Indeed, it is described officially as a routine assignment change—a description that produces some wry smiles among Pentagon managers. Putting Gen. Lotz in charge of the Electronics Command, where he once served as deputy, is expected to give the Army a man in the post who, as one colonel puts it, "gets along on the Hill."

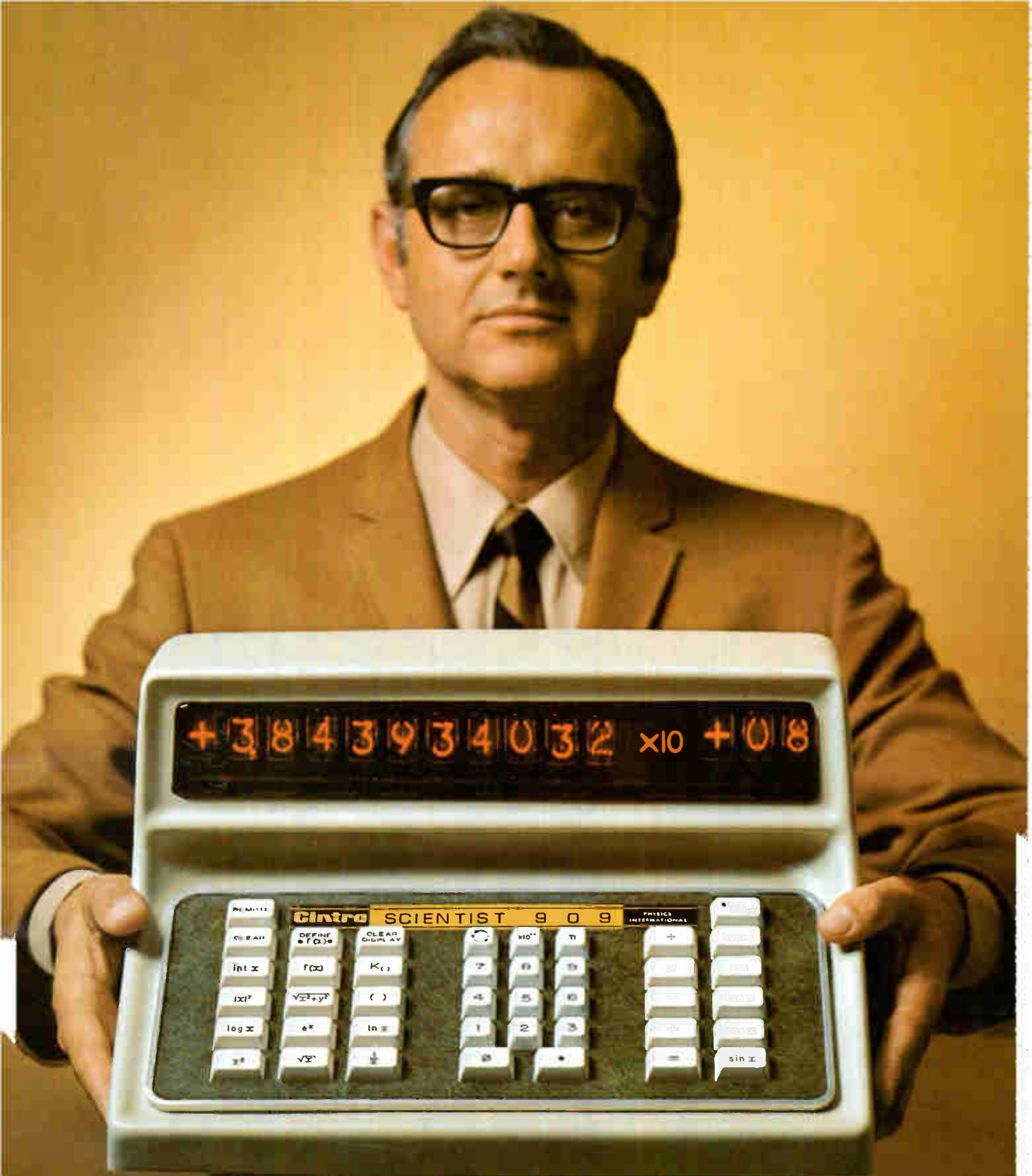

Presenting the Cintra Scientist.

The MOS/LSI Instant Mathematician. Write your equations directly on its keyboard. See the answers as quickly as you press the keys.

Mathematics! That's the language of the Cintra Scientist 909. To see how effortlessly you can communicate with it, turn the page.

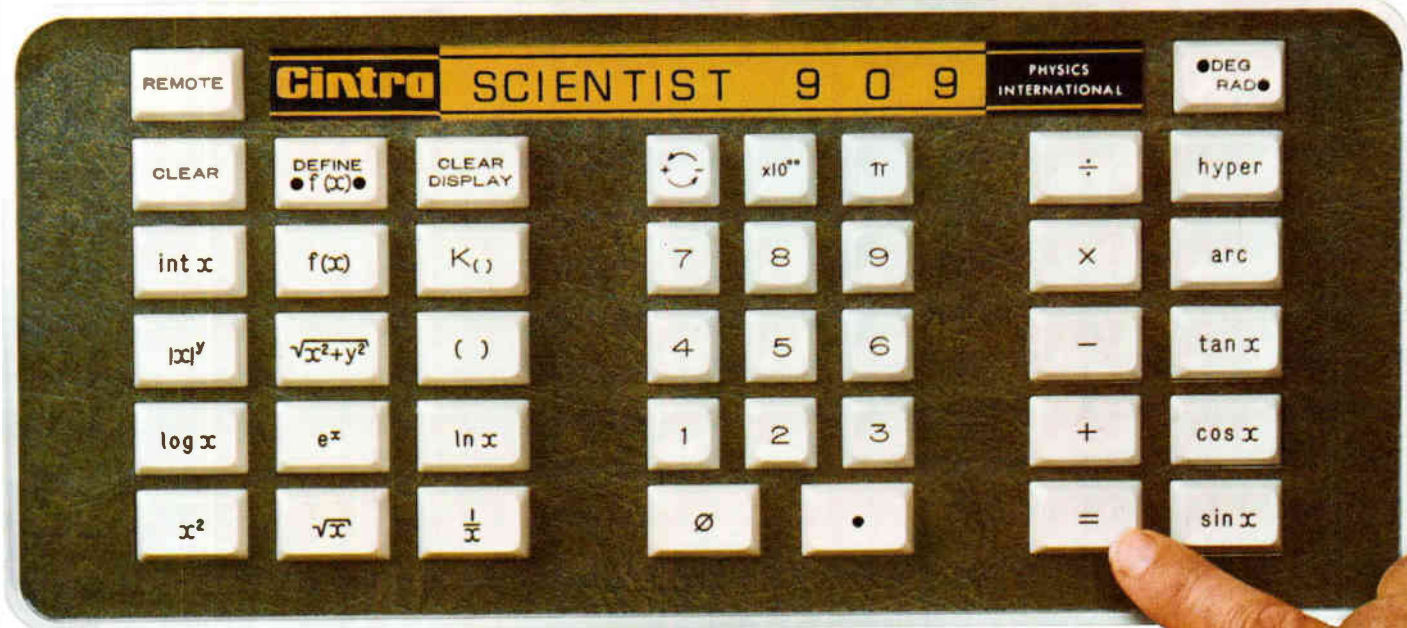

Talk to me, Cintra Scientist.

What should I ask you?

Ask a lot. Ask, for example, the solution to $(A + B \times C)^{(D+E \times F)} =$, where A, B, C, D, E and F can be data or any combination of keyboard functions such as $\sin X$, $\log X$, e^x , etc. Just key it in exactly as written and you'll have the answer by the time your finger is off the equals key. The Scientist's dynamic range is 200 decades with 10 significant figure accuracy.

Try it yourself. Take an everyday slide rule operation such as $286.4 \times 10^{20} \div .004612 \times 10^{12} =$. The answer is immediate! Your entered data can be in scientific notation, floating point or combinations of both. The Scientist will keep track of decimal points and exponents for you. All keys are hardwired, and note how logically they're arranged. Power? **Ultra-power** is more like it.

Storage registers? You get 26 with the basic model, up to 122 optional.

No machine language to learn! The Cintra Scientist talks your language. And it won't take you but 5 minutes to confirm it.

Behind the keyboard? Hermetically-sealed MOS/LSI and integrated circuitry assures reliable, trouble-free performance.

Can you operate as a computer, too? Certainly. With the Cintra Model 927 Programmer, up to 25,600 consecutive steps can be performed automatically in addition to loops, branches and subroutines. Further-

more, the modular design allows expansion into a mini-computer with peripherals such as the Cintra 941 Printer, plotters, and A to D converters for on-line/off-line applications.

Just \$3,780 puts the power of the Cintra Scientist at your fingertips. Now ask yourself a question. Shouldn't I find out more about the Cintra Scientist?

Look at these unique keys

|x|^y **Ultra-powerful.** Includes all non-integer values of y and X.

x10^n An **order of magnitude** more versatile. Enter floating point and scientific notation, or any combination interchangeably.

= **Equate the value.** Press the key and immediately see the result of a long complicated expression.

() **In a bracket by itself,** this key allows any other key to operate on a group of terms.

DEFINE f(x) Use this **highly functional** 31-keystroke programmer for series expansions, transcendental equations, operational analysis, etc. Define f(X) as any function up to 31 consecutive steps; thereafter execute this defined function with one f(X) keystroke.

K(i) **Constantly works for you.** Set constants equal to K₁, K₂, etc. To reuse any constant in any equation, simply key K₀ and the subscript thereafter. Stores up to 26 (122 optional) 12-digit constants including exponent and signs.

sqrt(x^2+y^2) **Statistically proven** most useful for least square sums, RMS, and vector magnitudes, etc.

DEG RAD View your data from a **better angle.** Keylight shows which trigonometric units you are using.

REMOTE This **far out** key lets you communicate with up to 99 instruments: printers, plotters, computers, A to D converters, etc.

Physics International Co.

440 Logue Avenue
Mountain View, California 94040
(415) 969-9230

WESCON Booths 5512-13

Ask the Cintra Scientist



Dual Transistors



17 tight trackers

Tight thermal tracking. Low drift. High stability. All essential in circuits which process matched signals. They're yours when you design with TI dual and matched-pair transistors.

Use them for high and low current applications in your operational and differential amplifier designs...as flip-flops, emitter-followers, gates and counters in your switching and logic circuits...and for audio, compound and pulse amplifiers.

From its line of 73 standards and hundreds of specials, TI has selected 17 dual and matched-pair transistors that meet the majority of multi-channel circuit needs.

†Matched-Pairs
 **Trademark of Texas Instruments



TI Preferred Dual and Matched-Pair Transistors					
Type	Polarity	Package	Type	Polarity	Package
TIS92*	NPN	TO-18 SILECT**	2N2920	NPN	TO-77
TIS92M*	NPN	TO-18 SILECT**	2N2977	NPN	TO-71
TIS93†	PNP	TO-18 SILECT**	2N2979	NPN	TO-71
TIS93M†	PNP	TO-18 SILECT**	2N3350	PNP	TO-77
2N2060	NPN	TO-77	2N3680	NPN	TO-77
2N2223	NPN	TO-77	2N3838	NPN/PNP	FLAT PACK
2N2639	NPN	TO-77	2N4854	NPN/PNP	TO-77
2N2642	NPN	TO-77	2N5045	N-CH.FET	TO-71
2N2643	NPN	TO-77			

They're part of TI's line of preferred semiconductors, selected after months of computer demand analysis to save you time and money in specifying discrete devices.

To obtain data and specifications on preferred dual and matched-

pair transistors, write for TI's *Preferred Semiconductors and Components Catalog*: Texas Instruments Incorporated, PO Box 5012, MS 308, Dallas, Texas 75222. Or just circle reader service card number 196.



TEXAS INSTRUMENTS
 INCORPORATED

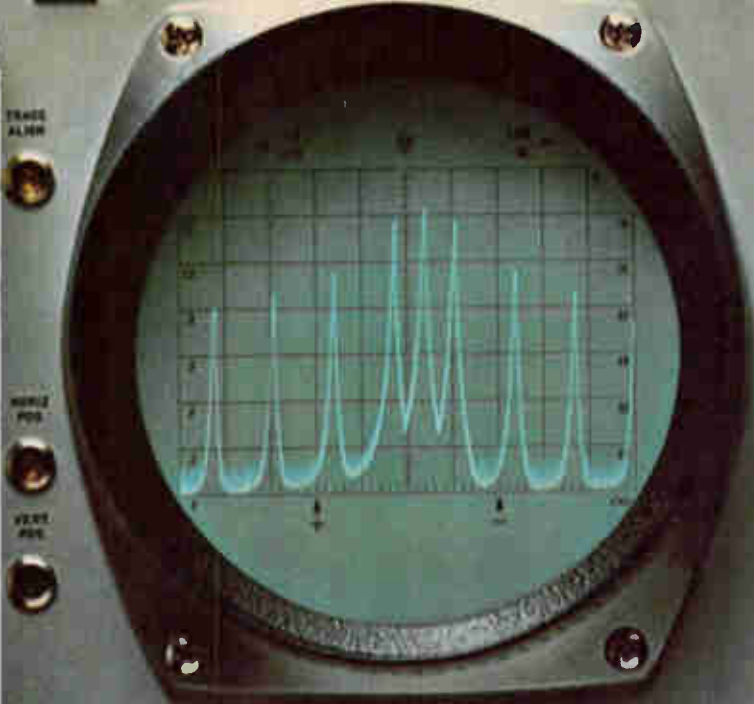

FOCUS SYNC VERT DISPLAY I. F. E

SINGLE SWEEP LINE INT EXT 90 LIN 100 100 3KC 1KC

BASE-LINE CLIPPER INTENSITY SWEEP TIME VERNIER MILLISECS/CM I. F. VERNIER I. F.

EXT 3 10 30 100

hp 8551B SPECTRUM ANALYZER w/ HF SECTION
HEWLETT PACKARD

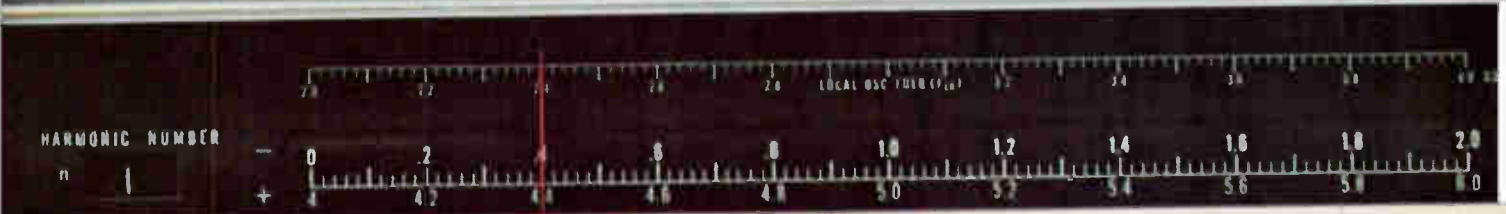

FREQUENCY (GC) SPECTRUM WIDTH VERNIER STABILIZATION PNE STAB BAL

300 MC IF 10-40 REF/CM 100 50 30 10 5 2 1 PNE STAB BAL STABILIZED FINE TUNE UNSTABILIZED PNE/SQUARE TUNE OBS TRACK

4-10 8-10 12-20 16-40 REDUCE SPECTRUM WIDTH CAL

ATTENUATOR (DB) SENSITIVITY SIGNAL IDENTIFIER (F_s)

30 40 50 60 1000 MAX INPUT REFERENCE OFF SET SPEC WIDTH 1000/CM REF CHECK - PUSH F_s = 2 F₀ = 200

INPUT 0VLE-400 MIXER DIODE EXT. MIXER INPUT 0-4000 SPECTRUM CENTERING STAR. TUNE SIG. IDENT CAL



In the past 5 years, spectrum analyzers have come and gone.

This is the one that came and stayed.

When the HP 8551B/851B Spectrum Analyzer came on the scene, it turned a theory into technology. This one instrument not only could do more than any spectrum analyzer could do before. It can still do more than any other spectrum analyzer available today.

This spectrum analyzer opened up whole new areas for spectrum measurement—areas like circuit design, systems performance and semi-conductor evaluation. And it continues to be the overwhelming favorite: it's easy to use, accurately calibrated and lets you observe harmonics on broad spectra, modulations on narrow band, or compare low-level signals with high-level carriers.

It has a swept first LO and high frequency first IF that lets you view wide 2 GHz spectra, free from images, spurious and residual responses. It has a calibrated 60 dB display range to give you an accurate comparison of signals vastly different in amplitude. Its RF attenuator permits level setting without overdriving the input. And its wideband mixer provides extremely flat response over the full range from 10.1 MHz to 12 GHz, with -100 to -85 dBm sensitivity.

These and other state-of-the-art advances put our spectrum analyzer in a class by itself. That's why it came and stayed.

Price of the 8551B RF Section is \$7950; the 851B Display Section costs \$2475. An alternate display unit, Model 852A with variable persistence and storage, costs \$3475. Your Hewlett-Packard field engineer will give you all the details on the 8551B/851B's full range of performance. Or write to Hewlett-Packard, Palo Alto, California 94304; Europe: 1217 Meyrin-Geneva, Switzerland.

HEWLETT  PACKARD

SIGNAL ANALYZERS

04904

Circle 21 on reader service card

Circle 23 on reader service card →

Custom(er) Cable Constructions by Chester

Proof of Chester's ability to produce plastic coated multi-conductor cable construction to customer requirements is reflected in part by the production samples shown on these pages. Though only representative of the thousands of "specials" made for our many customers they graphically prove Chester's ability to translate a wide range of special multi-conductor needs into dependable and practical cable constructions.

When standard cable constructions will not suffice, Chester's vast resources, technical skills and manufacturing facilities are placed at your disposal to manufacture conductors, insulations and jackets to meet your most exacting requirements.

Whatever your multi-conductor cable needs, check first with Chester. We know you'll be more than pleased with the expeditious and thorough handling of your request.



A. RECORDING STUDIO: Audio sound cable: 25 shielded pairs, stranded copper conductors, low loss insulation, twisted with uninsulated drain wire, isolated aluminum tape shields, cabled, PVC jacket.

B. TV CAMERA MFR.: Camera control cable for Audio and Video signals: a composite of PVC and polyethylene insulated conductors, cabled, overall braid shield, PVC jacket.

C. AIRCRAFT SIMULATOR MFR.: Control cable: 12 shielded jacketed, stranded copper conductors, PVC insulated, individual shield jackets color coded, cabled, overall PVC jacket.

D. ELEVATOR MFR.: Control cable: 35 conductors, stranded copper, PVC insulated, conductors coded by colors and printed numbers, cabled with open binder; individual conductors U/L listed.

E. INTERCOM EQUIPMENT MFR.: 250 conductor inter-office communication and signaling cable: solid bare copper, PVC insulation, paired, cabled, PVC jacket; U/L listed.

F. ELECTRIC UTILITY CO.: Station control cable for general use: 37 conductors, stranded, polyethylene and PVC insulated, color coded, cabled, overall tough PVC jacket; per NEMA/IPCEA Specifications.

G. LARGE CITY: Communication cable: 50 pairs, polyethylene insulated, cabled, continuous layer of copper shielding tape, PVC jacket; per spec. IMSA-19-2, 600 volts.

H. LEADING SHIPBUILDER: shipboard cable: stranded conductors, nylon-jacketed PVC insulation, pairs shielded and jacketed, cabled, PVC jacket, and aluminum braid armor overall; per spec. MIL-C-915.

I. U. S. GOVERNMENT: Coaxial cable: type RG-218/U, solid copper conductor, polyethylene insulated, copper braid shield, PVC jacket; per spec. MIL-C-17/79.

J. BROADCASTING COMPANY: Remote control broadcasting cable: stranded conductors, polyethylene insulation, pairs & triples shielded and jacketed, cabled, PVC jacket overall.

K. COMPUTER MFR.: Computer control cable: 55 conductors, stranded copper conductors, PVC insulated, formed into 7 groups of 7 conductors, cabled, PVC jacket; U/L listed.

MACHINERY MFR.: Bus drop cable: 3 PVC insulated stranded conductors, with split uninsulated grounding conductor, cabled, overall PVC jacket; U/L listed; per NEC.



CHESTER CABLE CO.

DIVISION TENNESSEE CORPORATION
CHESTER, NEW YORK • 10318

PHONE: (914) 469-2141 TWX (914) 469-9901

A SUBSIDIARY OF CITIES SERVICE COMPANY

TODD

cost
cutting
system
power
supplies!

More watts/in³/°C/\$

\$69⁰⁰
M
SERIES



FEATURES:

- No external heat sink required
- 71 Degree C Operating Temperature
- .5 MV RMS Ripple
- .01% Regulation
- Short Circuit & Overload Protection
- 5 year warranty
- Meets MIL Environment Specifications
- OverVoltage Protection option

Available:

- "M" Series to 1.1 amps \$69
- "A" Series to 3.7 amps \$99
- "B" Series to 5.0 amps \$115
- "C" Series to 7.5 amps \$135
- "D" Series to 13.1 amps \$205
- "E" Series to 22.0 amps \$265
- "F" Series to 33.0 amps \$315

Full OEM
custom capability

PTC

TODD PRODUCTS CORP.

28 Laurel Street
Hicksville, N.Y. 11801

Meetings

Getting the lowdown on MIC's

What's available, and what's practical now in microwave integrated circuits. These questions might well be the theme of this year's Microelectronics Symposium to be held September 10 and 11 at the Colony Motor Inn, St. Louis, Mo. The organizers, determined to keep the conference down to earth included only those papers that dealt with existing passive and active components and devices, and with their system applications. The program excludes all academic, purely tutorial, or blue-sky prediction papers.

Possibly the most intriguing session of the symposium is the Wednesday evening panel discussion: "Microwave Integrated Circuits—Tell It Like It Is." If preceded by a cocktail party, it might prove either a boon or bane to MIC's. The panel will consist of systems and components people, essentially representing two opposing views. Previous jibes by components people that they've outstripped systems people will surely provoke some stimulating conversation. On the other side of the coin, the components people can expect to be slapped with the claim that they're not goal oriented, that they're developing new devices for nonexistent needs. In any event, there should be answers to such questions as: What kind of MIC's do systems people really want, and where should or shouldn't these devices be used?

During the kickoff session, a paper dealing with design considerations of microstrip is expected to give more insight into the problem of losses in such structures. Earlier papers on the losses have dealt mainly with the transverse electromagnetic approach to loss analyses and haven't really helped. Other papers in this session will discuss ultrabroadband components in microstrip, provide a look at a microstrip diplexer using band-stop filters, and report on a broadband MIC mixer and on microwave lumped-element networks.

In a session on active devices, one paper will take on the ambitious task of providing a realistic look at what's available now in small-signal and power-microwave transistors. Following this, one of the meeting's more interesting papers will reveal some realistic performance data on high-resistivity silicon substrates for MIC's. Gunn devices in MIC's and a fully integrated electronically tunable Ku-band avalanche-diode oscillator will also be covered.

Ferrites will be the subject of two papers. One will discuss the advantages and disadvantages of ferrite films and bulk ferrite as MIC substrates. The other paper looks at the advances in planar-ferrite devices.

The meeting will conclude with a systems-oriented session. An attempt will be made to set the facts straight about solid state radar, and two other papers will discuss MIC's for active aperture radar and a solid state phased array for electronic countermeasure applications.

For further information, contact Henry Guckel, chairman of the program committee, Department of Engineering and Applied Science, Washington University, St. Louis, Mo. 63130.

Calendar

Symposium on Programing Languages Definition, Association for Computing Machinery; San Francisco; Aug. 24-25.

Defects in Electronic Materials for Devices, Metallurgical Society of the American Institute of Mining, Metallurgical, and Petroleum Engineers; Statler-Hilton Hotel, Boston; Aug. 24-27.

ACM National Conference and Exposition, Association for Computing Machinery; San Francisco Civic Center; Aug. 26-28.

Cornell Biennial Conference on Engineering Applications of Electronic Phenomena, IEEE; Cornell University, Ithaca, N. Y.; Aug. 26-28.

(Continued on p. 26)

- Four full digits plus "1" for 20% overranging
- Rechargeable battery operation optional
- Measures ac and dc volts in four ranges to 1200 volts
- Measures ohms in five ranges to twelve megohms
- Active 2 pole switchable filter
- Automatic polarity indicator
- All functions push-button selectable



The digital multimeter you can believe

Announcing the Fluke 8100A, a completely portable 0.02% digital multimeter for \$695.

The only way to build a multimeter with no last digit uncertainty is to add an "extra digit." That's exactly what we've done with the new Fluke 8100A. Here is an instrument with nine times the accuracy of three digit units selling at only half the price of comparable four digit multimeters.

How?

We've used an A to D conversion technique new to the DVM field. The result is an instrument with low power drain, simplicity of circuitry, troublefree oper-

ation and the uncommon accuracy you expect from Fluke.

Standard features include ac measurement accuracy of 0.2% and resistance, 0.1%. For real portability, batteries will operate the multimeter continuously up to eight hours without recharging. Battery operation, the only option, is priced at \$100. Accessories available include high frequency and voltage probes, switched ac-dc current shunts and a ruggedized case.

FLUKE

Fluke, Box 7429, Seattle, Washington 98133. Phone: (206) 774-2211. TWX: 810-440-2650. In Europe, address Fluke Nederland (N.V.), P.O. Box 5053, Tilburg, Holland. Phone: (04250) 70130. Telex: 884-50237. In the U.K., address Fluke International Corp., Garnett Close, Watford, WD2 4TT. Phone: Watford, 27768. Telex: 834583.

The Grayhill "Excellent 50's"

Here is an entirely new generation of miniaturized rotary switches that allows you to select your own specifications from all these options:

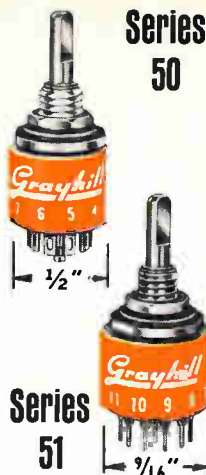

NUMBER OF POLES:

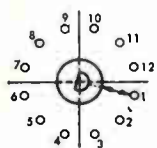

1 pole

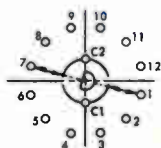

2 poles

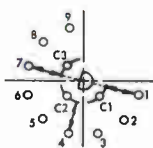

3 poles

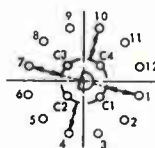

4 poles

ANGLES OF THROW:

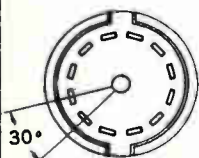

30°

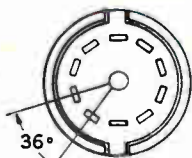

36°



45°

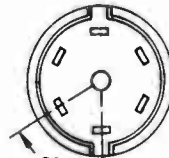

60°

TERMINALS:



Solder Lugs



Printed Circuit

CONTACTS:



Shorting or Non-Shorting



STOPS:



Factory Set

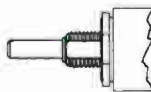

Adjustable

SEAL OPTIONS: Shaft and Panel

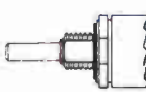

Sealed

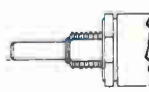

Unsealed

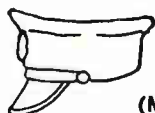

Military
(MIL-S-3786/20)



Commercial

Write for "Excellent 50's" technical data — Switches are available from stock — contact your Grayhill Representative or local Distributor.



523 Hillgrove Avenue
LaGrange, Illinois 60525
Area Code 312, Phone 354-1040

... the Difference Between Excellent and Adequate

Meetings

(Continued from p. 24)

Education and Training Technology International Convention, IEE; London, England; Sept. 2-6.

Electrical Insulation Conference, IEEE; Sheraton-Boston Hotel & War Memorial Auditorium, Boston; Sept. 7-11.

European Microwave Conference, International Symposium on Man-Machine Systems, IEE; St. John's College, Cambridge, England; Sept. 8-12.

Convention of the Society of Logistics Engineers; Cape Kennedy Hilton Hotel, Cape Kennedy, Fla.; Sept. 9-10.

Petroleum & Chemical Industry Tech. Conference, IEEE; Statler Hilton Hotel, Los Angeles; Sept. 14-17.

International Telemetry Conference, International Foundation for Telemetering, Sheraton Park Hotel, Washington, D.C.; Sept. 15-17.

Conference on Trunk Telecommunications by Guided Waves, IEE; London, England; Sept. 15-17.

Electro-Optical Systems Design Conference, Industrial and Scientific Conference Management Inc.; Chicago; Sept. 16-19.

Solid State Devices Conference, IEE; University of Exeter, Exeter, Devon, England; Sept. 16-19.

Symposium on the Biological Effects and Health Implications of Microwave Radiation, Biophysics Department of the Virginia Commonwealth University, Bureau of Radiological Health, Environmental Control Administration, and U.S. Public Health Service; Richmond, Va.; Sept. 17-19.

Annual Broadcasting Symposium, IEEE; Mayflower Hotel, Washington, D.C.; Sept. 18-20.

Joint Power Generation Conference, IEEE, American Society for Mechanical Engineers; Charlotte, N.C.; Sept. 21-25.

Annual Intersociety Energy Conversion Engineering Conference, IEEE, American Society for Mechanical Engineers; Statler Hilton Hotel, Washington, D.C.; Sept. 21-26.

Ultrasonics Symposium, IEEE; Chase Park Plaza Hotel, St. Louis, Mo.; Sept. 24-26.

International Electronics Conference, IEEE; Automotive Building, Exhibition Park, Toronto; Oct. 6-8.

(Continued on p. 28)



less
than
\$1.00*

for new high performance
A-B solid hot-molded
variable resistor...

A-B Type W
variable resistor
shown about 5 times
actual size

The QUALITY is Allen-Bradley—the price is COMPETITIVE! This new Type W variable resistor is a commercial version of the Type G control.

This Type W variable resistor features a solid, hot-molded resistance track for long operating life. Life tests show less than 10% resistance change after 50,000 complete cycles. Noise level is low initially and actually becomes less after normal use. Furthermore, the resolution is essentially infinite, and the low inductance permits operation at high frequencies where wirewound controls are useless.

The Type W control, while only $\frac{1}{2}$ inch in diameter, is immersion-proof. The shaft is sealed with an "O" ring, making it watertight at that point.

Rated $\frac{1}{2}$ watt at 70°C, the Type W can be operated at 120°C ambient with zero load. Nominal resistance values are from 100 ohms to 5.0 megohms.

For complete specifications on tolerances, tapers, and options, please write Henry G. Rosenkranz and request Publication 5212. Allen-Bradley Co., 1201 S. Second St., Milwaukee, Wis. 53204. Export Office: 1293 Broad St., Bloomfield, N.J. U.S.A. 07003. In Canada: Allen-Bradley Canada Ltd.

EC69-1



ALLEN-BRADLEY
QUALITY ELECTRONIC COMPONENTS

© Allen-Bradley Company 1969

*Standard unit with plain bushing and hardware, 20% tolerance in 1,000 piece quantities. Price subject to change without notice.

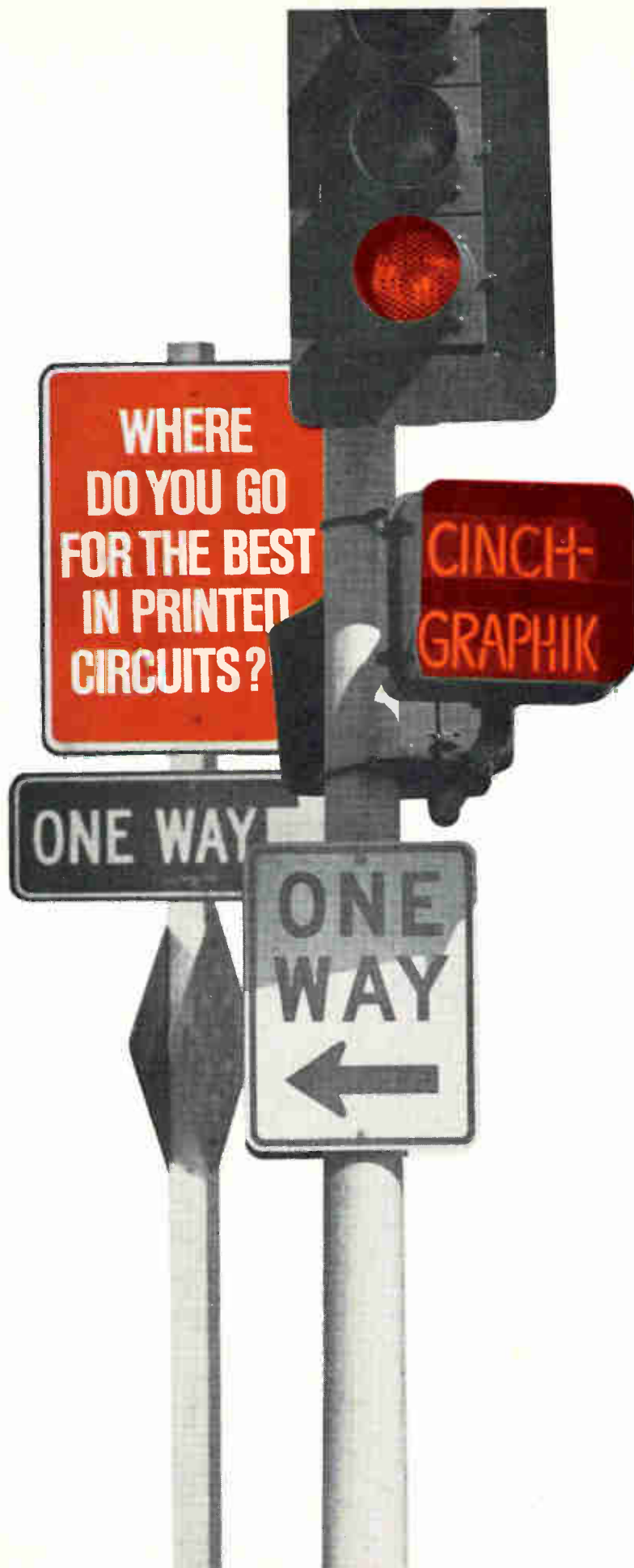

Meetings

(Continued from p. 26)

Annual Conference of the American Institute of Ultrasound in Medicine; Winnipeg, Manitoba, Canada; **Oct. 6-10.**

IGA Group Annual Meeting, IEEE; Statler Hilton Hotel, Detroit; **Oct. 12-16.**

Annual Symposium on Switching and Automata Theory, IEEE; Waterloo, Ontario, Canada; **Oct. 15-17.**

International Symposium on Remote Sensing of Environment, The Center for Remote Sensing Information and Analysis; University of Michigan, Ann Arbor; **Oct. 14-16.**

Engineering Management Conference, IEEE; Montreal, Quebec, Canada; **Oct. 9-10.**

Joint Materials Handling Engineering Conference, IEEE, American Society of Mechanical Engineers; Sheraton Motor Inn, Portland, Ore.; **Oct. 27-29.**

Short courses

Laser Fundamentals and Applications, Polytechnic Institute of Brooklyn; Long Island Graduate Center, Farmingdale; **Sept. 8-12.** \$275 fee.

Digital Process Control Systems, Purdue University, Lafayette, Ind.; **Sept. 15-24.** \$250 fee.

Active Filter Design: Theory and Practice, University of California at Los Angeles; **Sept. 22-26.** \$275 fee.

Call for papers

International Solid-State Circuits Conference, IEEE; Sheraton Hotel, Philadelphia, Feb. 18-20, 1970. **Oct. 17** is deadline for submission of abstracts and papers to Mr. L.D. Wechsler, General Electric Co., Electronics Park, Building #3, Syracuse, N.Y. 13201.

Transducer Conference, IEEE; National Bureau of Standards, Gaithersburg, Md., May 4-5, 1970. **Nov. 1** is deadline for submission of summaries to Dr. Robert B. Spooner, IMPAC Instrument Service, 201 E. Carson Street, Pittsburgh, Pa. 15219.

Geoscience Electronics Symposium, IEEE; Washington, D.C., April 14-17, 1970. **Dec. 1** is deadline for submission of abstracts to Mr. Ralph Bernstein, Chairman, Technical Program Committee, IBM Corp., 18100 Frederick Pike, Gaithersburg, Md. 20760.

"ALLEN BRADLEY HOT-MOLDED RESISTORS ENHANCE THE QUALITY STANDARD OF OUR DATA-RECORDERS"

Mohawk Data Sciences Corporation

MDS The time reduction achieved by the MDS Data-Recorder method of computer input preparation demands continuously reliable operation. And this in turn demands the highest standards of performance from each and every component.

Allen-Bradley fixed composition resistors were a natural selection. Made by an automatic hot-molding technique—developed and used exclusively by Allen-Bradley—A-B resistors afford the ultimate in uniformity. From resistor to resistor—year in and year out—physical and electrical properties are unvarying. Predictable. Always of the highest order.

Performance records are equally excellent. For example, Allen-Bradley hot-molded resistors meet the requirements of the new MIL-R-39008A Established Reliability Specification at the *highest* level—the S level. And this is true for *all* three ratings—the 1 watt, ½ watt, and ¼ watt—and over the *complete* resistance range from 2.7 ohms to 22 megohms.

For complete specifications on this quality line of hot-molded resistors, please write to Henry G. Rosenkranz, and request a copy of Technical Bulletin 5000. Allen-Bradley Co., 1201 S. Second St., Milwaukee, Wis. 53204. Export Office: 1293 Broad St., Bloomfield, N.J., U.S.A. 07003. In Canada: Allen-Bradley Canada Ltd.

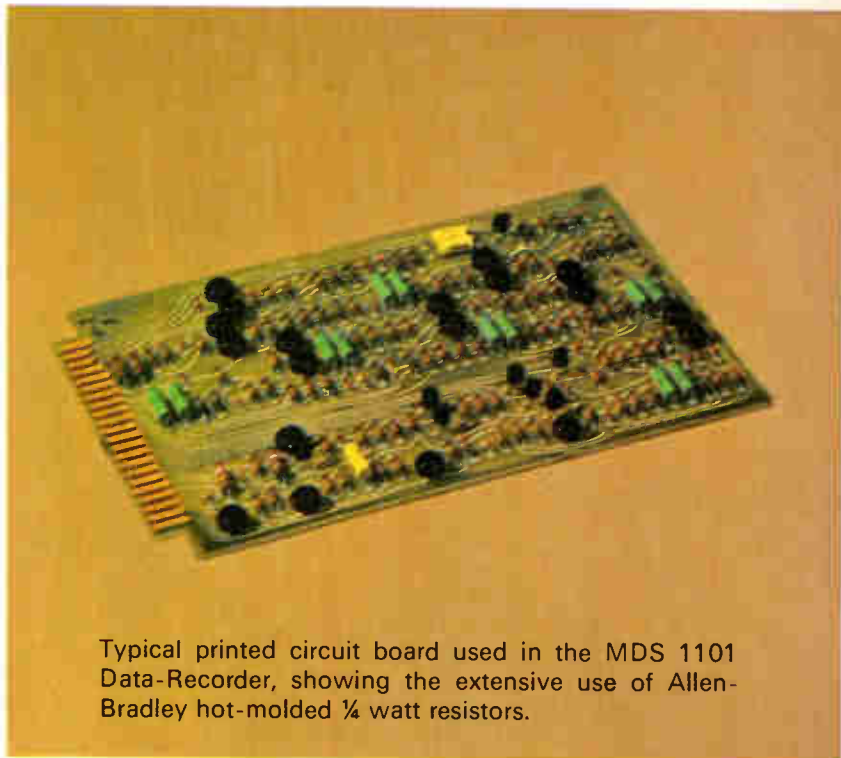

Typical printed circuit board used in the MDS 1101 Data-Recorder, showing the extensive use of Allen-Bradley hot-molded ¼ watt resistors.

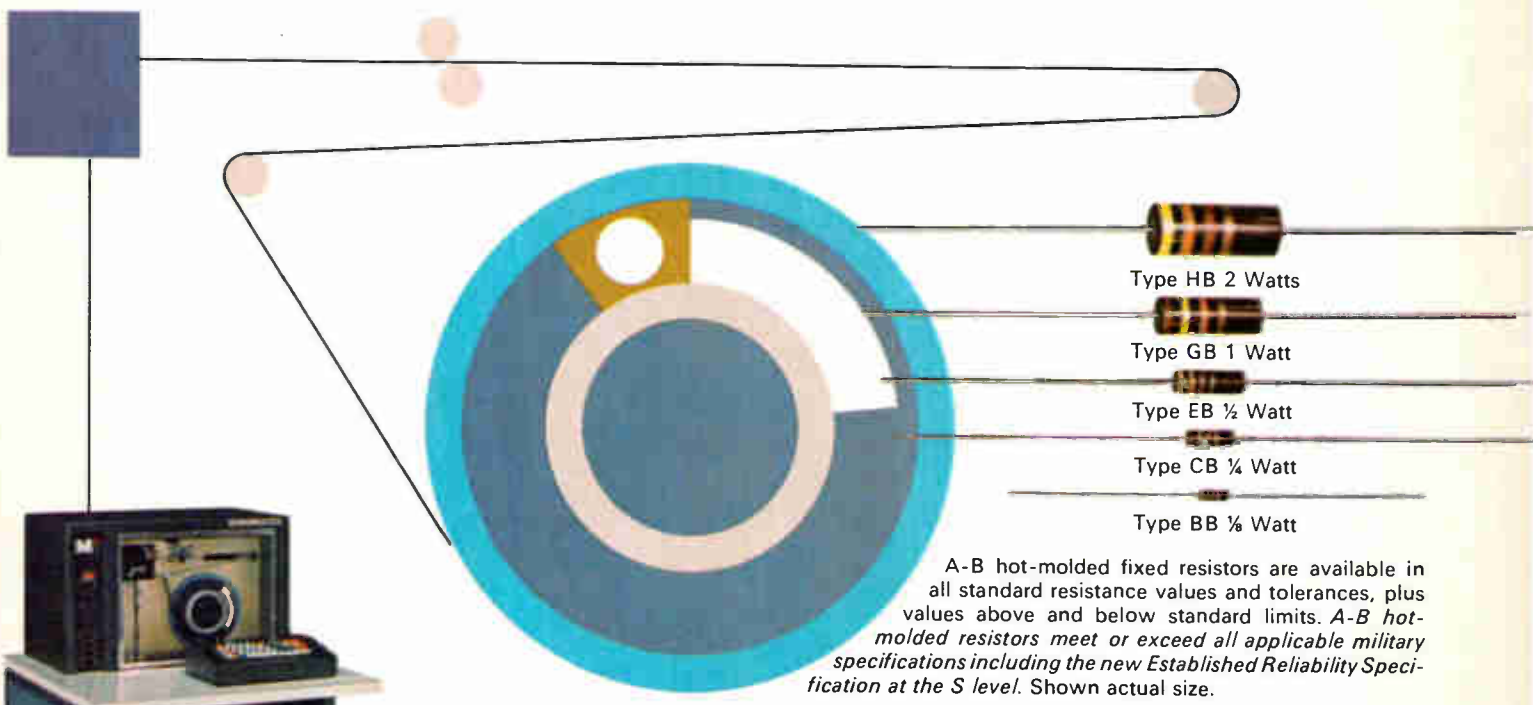

A-B hot-molded fixed resistors are available in all standard resistance values and tolerances, plus values above and below standard limits. A-B hot-molded resistors meet or exceed all applicable military specifications including the new Established Reliability Specification at the S level. Shown actual size.



Mohawk 1101 Data-Recorder permits transcribing of data from source documents direct to ½" computer magnetic tape.

©Allen-Bradley Company 1968

EC69-61



ALLEN - BRADLEY
QUALITY ELECTRONIC COMPONENTS

Circle 29 on reader service card

The better point-to-point WIRE, SPACE,

Use stranded as well as solid wire. And use less of it. Our TERMI-POINT★ Technique uses 25% less wire for the connection than other techniques. Wire is not destroyed in testing, routine maintenance and circuit changes . . . can be re-used.

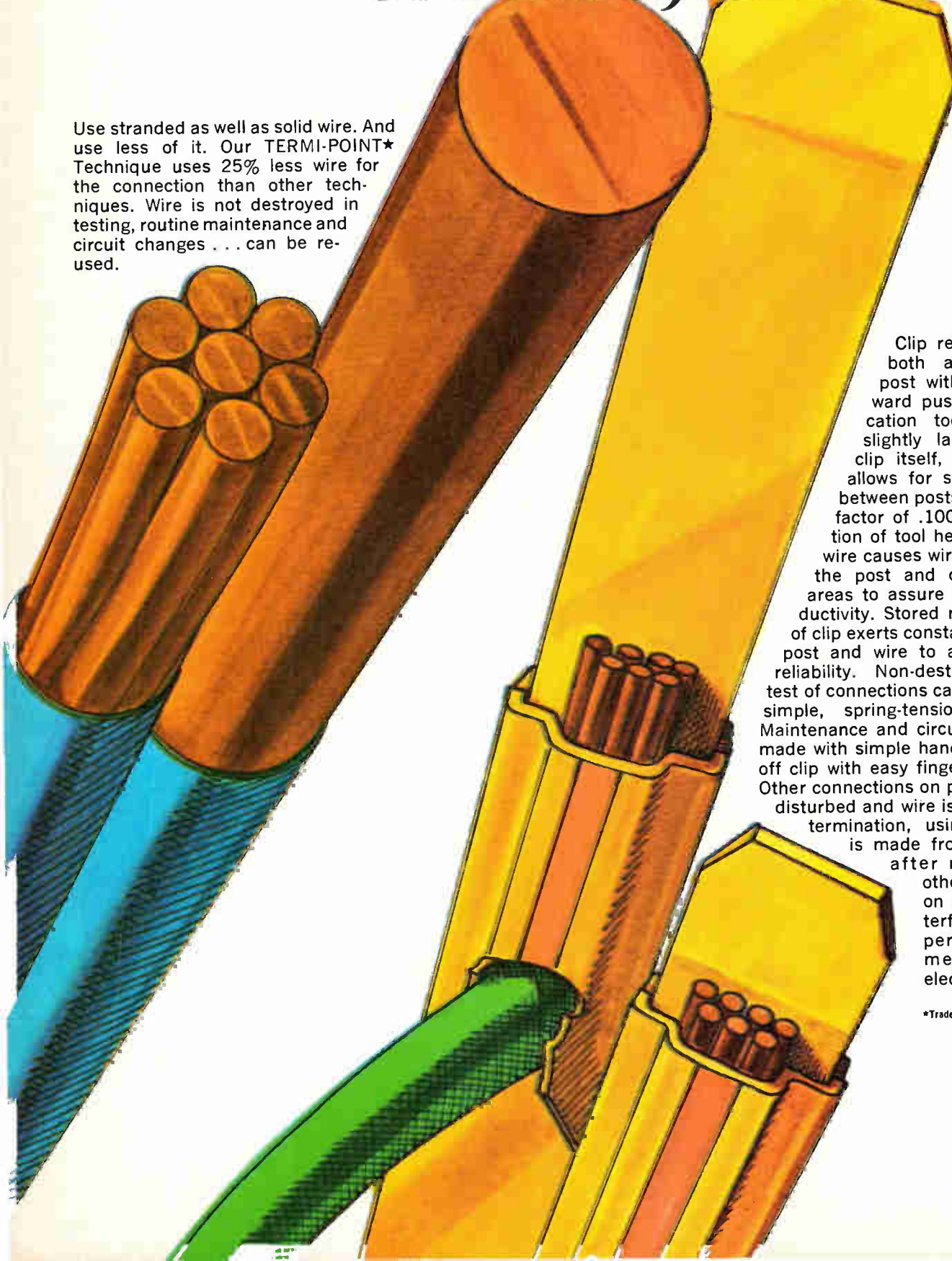

Clip retains wire and both are affixed to post with straight, forward push of the application tool head. Only slightly larger than the clip itself, the tool head allows for smaller spacing between posts with a density factor of .100". Forward action of tool head on clip and wire causes wire to wipe along the post and create "clean" areas to assure maximum conductivity. Stored memory design of clip exerts constant pressure on post and wire to assure long-life reliability. Non-destructive tensile test of connections can be made with simple, spring-tension hand tool. Maintenance and circuit changes are made with simple hand tool that flips off clip with easy finger-twist motion. Other connections on post are left undisturbed and wire is reusable. New termination, using same wire, is made from top of post after repositioning other connections on post without interfering with their performance and mechanical and electrical stability.

*Trademark of AMP Incorporated

wiring technique saves you **TIME, MONEY**

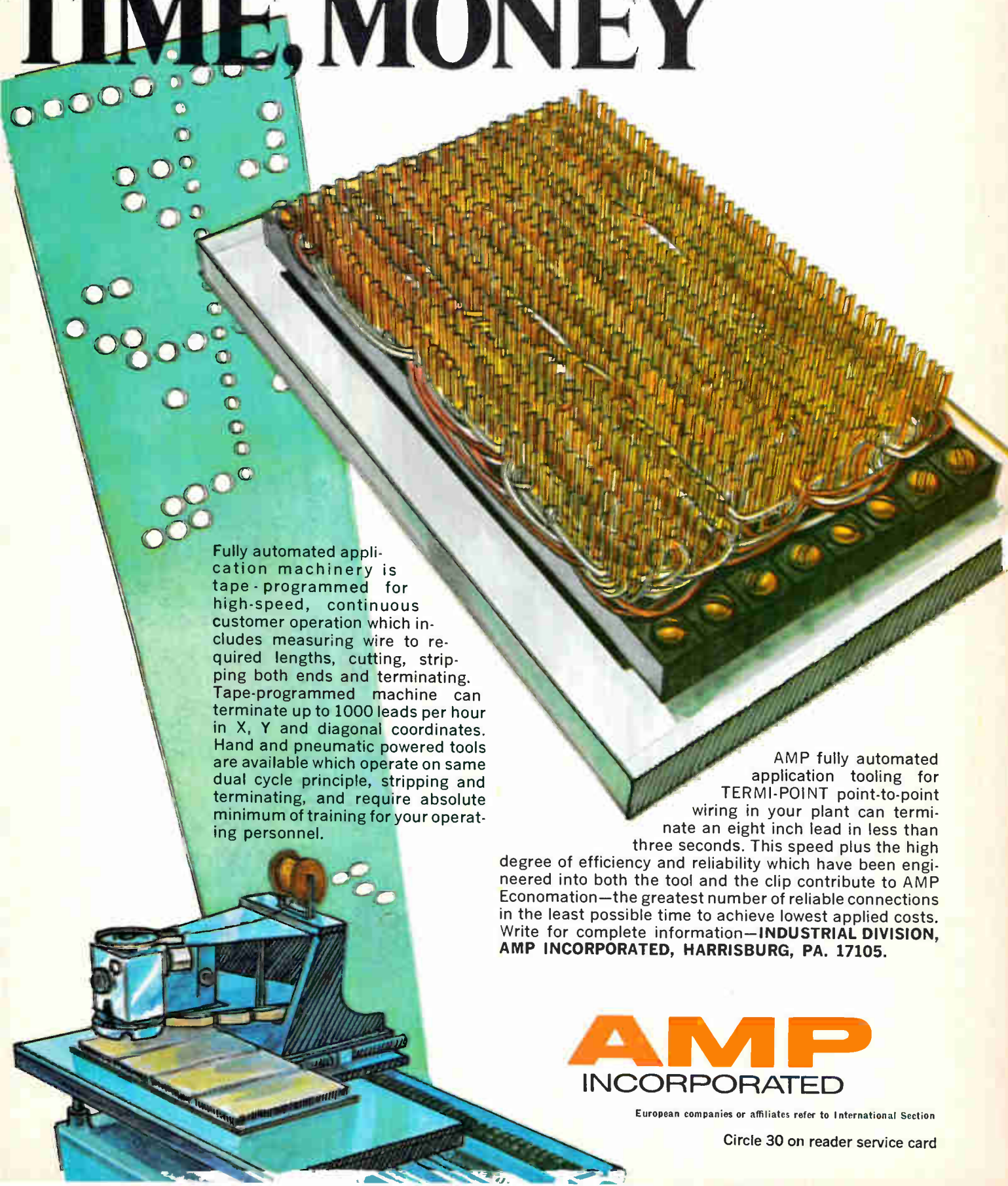

Fully automated application machinery is tape-programmed for high-speed, continuous customer operation which includes measuring wire to required lengths, cutting, stripping both ends and terminating. Tape-programmed machine can terminate up to 1000 leads per hour in X, Y and diagonal coordinates. Hand and pneumatic powered tools are available which operate on same dual cycle principle, stripping and terminating, and require absolute minimum of training for your operating personnel.

AMP fully automated application tooling for TERMI-POINT point-to-point wiring in your plant can terminate an eight inch lead in less than three seconds. This speed plus the high degree of efficiency and reliability which have been engineered into both the tool and the clip contribute to AMP Economotion—the greatest number of reliable connections in the least possible time to achieve lowest applied costs. Write for complete information—**INDUSTRIAL DIVISION, AMP INCORPORATED, HARRISBURG, PA. 17105.**

AMP
INCORPORATED

European companies or affiliates refer to International Section

Circle 30 on reader service card

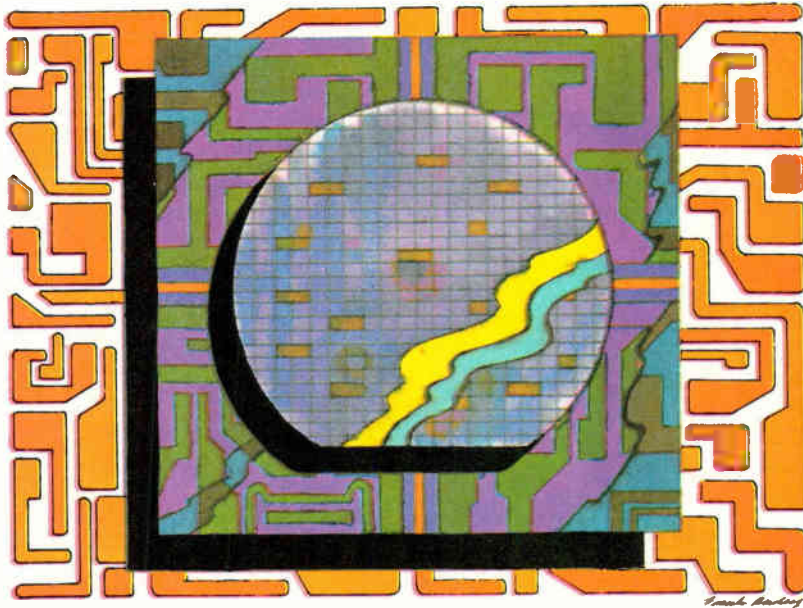

MOS/LSI WAFERS

Here's your opportunity to take advantage of MOS/LSI in new equipment designs without getting involved in lengthy negotiations, high costs, design compromises and next year deliveries!

If you're doing microelectronics design, MOS/LSI implementation can be easier than you think... without building a semiconductor facility within your plant you perform the tasks that best enable you to add value to your final product.

Cartesian's MOS/LSI lets you re-assume design responsibility and perform those manufacturing operations which you can easily handle. We take care of mask-making and wafer fabrication.

From your layout, we prepare masks and produce prototype wafers in quantities of ten for about \$100 each plus cost of mask-making... production-run quantities for less. We guarantee integrity. Turn-around time is normally five weeks, less if you provide masks. No design compromises unless you make them.

No subordination to the demands of semiconductor companies, no loss of proprietary design rights, and no staggering costs. Sound interesting? Write for a free copy of our MOS/LSI Implementation Guide and see how easily you can take advantage of the opportunities in MOS/LSI!



CARTESIAN, INC.

10432 NORTH TANTAU □ CUPERTINO, CALIF. 95014 □ PHONE (408) 257-0481

Editorial comment

Japan: Land of rising exports

Japan faces a dilemma. Should it continue its import restrictions—particularly in such areas as computers and computer components, IC's, and electronic telephone exchanges—and tight rules governing foreign investment, or should it relax them? Despite the mounting pressure from the U.S., Japan still isn't quite ready to choose the latter course of action. This is an unfortunate state of affairs, for the Japanese have prospered so greatly with the help of U.S. technology and markets that the island nation has become a formidable competitor. Last year, Japan's trade balance with the U.S. was close to \$560 million on exports of more than \$4 billion and imports of about \$3.5 billion. And according to U.S. representatives at recent trade talks in Tokyo, the U.S. trade deficit could reach \$1.5 billion this year.

Japan's electronics sales have soared beyond \$6 billion, with exports well over \$500 million annually. And the No. 1 customer for many Japanese products is the U.S.—nearly 60% of Japan's radio exports go to the U.S.

Nevertheless, Japan seems determined to follow a path of "gradualism." This is based on the theory that the longer Japan restricts imports, the longer it maintains a healthy economic posture. Fear, real or imagined, of U.S. "big business" is an important factor, too. Some Japanese contend that liberalization of foreign-investment rules could lead to U.S. firms taking over domestic companies. As the result, Japan continues to restrict imports of 120 items, and thus protects budding Japanese industries or those that would otherwise find it difficult to compete on an open market. But what about Japan's computer industry—does it really need stringent government protectionism? The government helped get the industry off to an auspicious start by limiting the number of companies that could produce business computers. Moreover, the government set up a private agency to buy computers from manufacturers and lease them to users. Under this setup, and abetted by computer research undertaken by government laboratories, Japan was producing a broad range of computers by the mid-1960's using basic IBM patents and other imported technology. The domestic industry has grown so much that computers now account for 12% of the nation's total electronics production. By the end of 1968, domestic computers accounted for one-half the dollar volume of installations in Japan; last year, Japan found it necessary to turn to imports to fill only 20% of its computer needs. Unquestionably, Japan's computer industry has grown to the point at which it can stand on its own feet. And its growth continues.

Generally, Japanese imports fall into three categories

ranging from stringent to liberalized. Items falling into the stringent category are subject to severe import quotas; government sanctions are necessary before items in this category can be imported. A second category, somewhat less severe, is characterized by automatic import quotas. Applications in this category are merely monitored (machinery is available to limit these imports if they get out of hand). The third category, the most liberal of all, comes under the heading of automatic allocation. This means the importer need only make arrangements for currency conversion. Items in the most stringent category include digital computers, desk calculators, electronic telephone exchanges, receiving tubes, and IC's. Items in the automatic quota category include passive components, switches, and consumer electronics products.

Before Japan agrees to ease import restrictions, it wants first to build up what Kenichiro Komai, president of Hitachi, calls "creative technology." Komai says Japan has prospered by exploiting technology developed elsewhere [mostly in the U.S.], but needs to develop its own technology before it can put up an "even fight." Up to now, Japanese developments have been mostly in tape recorders, f-m radio, and specialized computer components.

Japan now permits foreign holdings of no more than 50% in companies that manufacture radio and tv sets, and tape recorders. But when it comes to semiconductor and IC firms, the government must review all requests for foreign investment. Where marriages of U.S. and Japanese firms have taken place, they haven't always run smoothly. Problems stem mainly from differences in the traditional ways of doing business. Japanese managers are used to slow, methodical decision making. They rebel at short-cut management techniques and profit isn't always uppermost in their priorities. Nevertheless, U.S. businessmen are seeking greater opportunities to invest in Japanese firms. And it can be said that changes in Japanese methods are imminent, not for the sake of U.S. companies, but for the sake of the Japanese companies themselves. Executives like Koji Kobayashi, president of Nippon Electric Co., are calling for the overhaul of top-level Japanese industrial management to cope with the problems of the 1970's.

The days of the U.S. dominating Japan's economy are gone. Yet, the U.S. undoubtedly will continue to be Japan's best customer. It behooves the Japanese to take heed of advice from the U.S. They must convert their talk of mutual understanding and common goals to action. An undesirable alternative would be for the U.S. to erect counter barriers and hence further stifle trade between the two free nations. ■

Get sine, square and triangle functions—and positive and negative going pulses, positive and negative going ramps—in the new HP 3310A. And there's more! You'll have these seven functions over a decade of decades—0.0005 Hz to 5 MHz.

All this capability is packed into a package only 7¾" wide, 4½" high, 8" deep! With the 3310A Function Generator performing many of the functions of the pulse generator, ramp

generator, bias box and amplifier on your bench—think about the clutter you eliminate... the instant access you'll have to all these signals.

With the dc offset capability of the 3310A, you can put any of the functions where you want them—easily and without biasing. And, with the choice of high or low level output, you can get clean low level signals without an external attenuator. You get a maximum of 15 V peak-to-peak into 50 Ω—and that's plenty of power to eliminate most needs for external amplification.

Add to this the external frequency control capability which allows you to sweep over a 50 to 1 range or tie the 3310A into a system—the price

of only \$575—solid-state reliability—and you know the HP 3310A is more than a function generator!

Order your HP 3310A today from your nearest HP Sales Office. For full specifications, write to Hewlett-Packard, Palo Alto, California 94304. Europe: 1217 Meyrin-Geneva, Switzerland.

HEWLETT *hp* PACKARD
S I G N A L S O U R C E S

099/9

Circle 34 on reader service card

This One Is More Than A Function Generator!

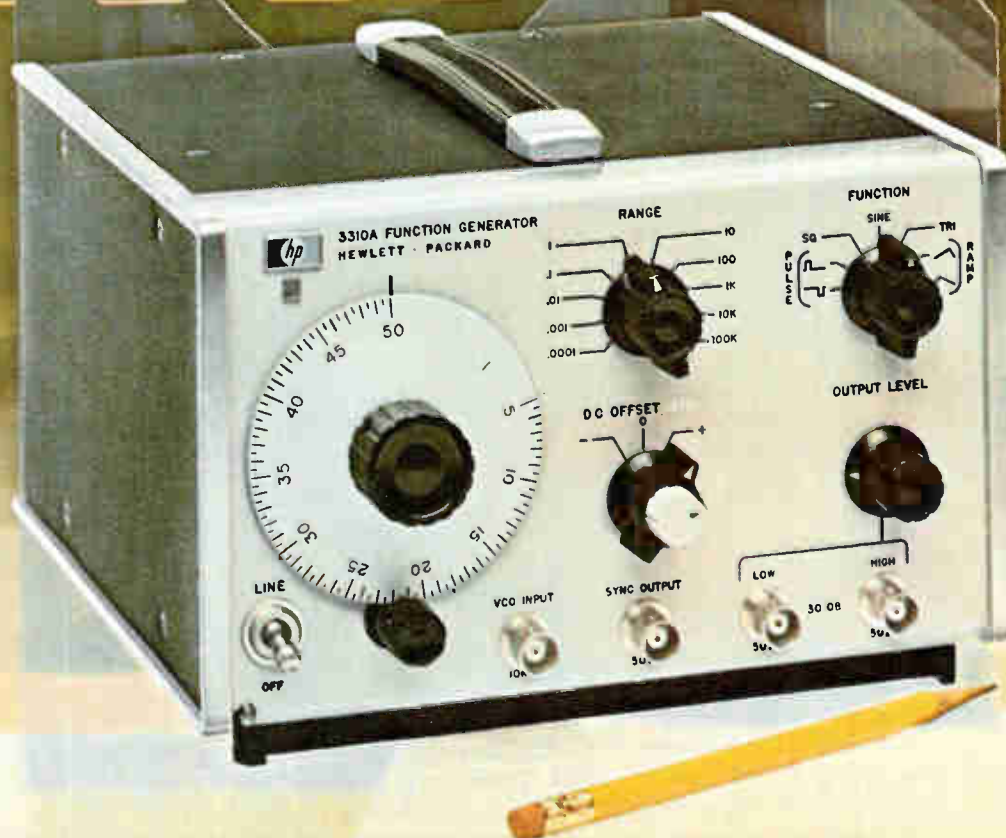

Electronics Newsletter

August 18, 1969

Motorola packages nitride in plastic

The argument by backers of silicon-nitride-passivated semiconductors that such devices needn't be housed in hermetically sealed packages has gained some added punch. Motorola is offering nitride-passivated MOS FET's in a plastic package.

The dual-gate devices are available in sample quantities now, though no price data is available. The transistors are popular ones aimed at consumer applications such as r-f amplifiers, and mixers in f-m receivers, television sets, and a-m car radios. Motorola had to develop a four-pin package before putting nitrided parts in plastic because the dual-gate transistors require four leads, while other Motorola plastic packages for MOS FET's have three leads. The new package looks like a shortened dual in-line package.

Proposals sought for noise radar

The Air Force soon is expected to request proposals aimed at perfecting its so-called noise radar. The name arises from one of the radar's advantages: it uses a cheap gas discharge random-noise source as a transmitter rather than a costly microwave tube. Other advantages include immunity from jamming and mutual interference, high range and azimuth accuracy even at very short ranges, and a simple receiver design for low cost.

The basics of the scheme were developed by the Air Force Cambridge Research Laboratory, which would be contracting agency for further work. Since the noise radar was made public [*Electronics*, July 22, 1968, p. 41], several companies have made unsolicited proposals for funds to develop the system.

Called by one observer "an almost perfect battlefield radar scheme," the radar is said to be potentially economical enough for the private aircraft market, in either radar or collision avoidance applications.

Rivals see System/3 as foot in door

On the whole, the competition seems to be happy about the introduction of IBM's System/3 [see p. 48]. Several expect the advent of the \$40,000 small computer to boost small-computer sales across the board, with one spokesman estimating 30% sales increases due to IBM's opening of new markets. "IBM is so great at selling a concept," says another, "that many potential buyers can envision electronic data processing only in terms of an IBM trademark."

But with a small IBM computer available, customers who had never imagined a place for data processing in their operations will find one, it's thought. Also, it's felt that most of these new customers are going to be comparison shoppers, meaning that companies like Digital Equipment, Data General, Varian, Lockheed, and others with \$5,000-to-\$12,000 basic prices will find themselves competing effortlessly. "Our system can do the same jobs at half the System/3's price," says one executive, "and that includes peripherals."

GE unveils pair of space spinoffs

A new General Electric organization, set up to turn space technology into products, is about to announce its first two devices: a light detector and a radiation detector. The organization, called Space Technology Products, is part of the Space division in Valley Forge, Pa.

Electronics Newsletter

The light detector, with immediate application as a receiver in a laser communications system, will sell for about \$900 with the buyer supplying his own recording device or display. The radiation device will come in two versions: a hand-held portable and a large type to measure low-energy isotopes. **Top price is expected to be less than \$3,000.**

Both detectors are built around a contoured silicon diode, basically a planar diode of p-doped n material with the internal characteristics of an avalanche diode. It can detect light from 0.9 micron to 1.1 microns; those avalanche characteristics enable it to amplify the radiation an average of 200 times. **Thus, in effect, the diode is a solid state substitute for the photomultiplier tube.** The radiation detector, a Geiger-counter-type device, has different circuitry behind and different filters in front of the diode.

Hughes readies silicon vidicon

Hughes Aircraft expects to have evaluation versions of a vidicon tube with a silicon target available within six months. George Smith, a Hughes vice president and research lab director, says that work on the tubes, which hold promise for military and commercial low-light-level television systems, will be transferred to the Vacuum Tube Products division in Oceanside, Calif., as the tubes approach the product stage. Says Smith, "We intend to have a catalog item, but most such tubes have been custom to date, and we still haven't defined what the catalog item will wind up looking like."

A silicon diode matrix is substituted for the antimony trisulfide target used in conventional vidicons. Smith says the silicon vidicon has some significant advantages over conventional vidicons: silicon is more easily reproducible than antimony trisulfide, and it has good sensitivity out to about 1 micron, while conventional vidicons can't deliver any sensitivity in that region—one of particular interest for military 111tv systems. Smith expects silicon vidicons to be more rugged and less expensive than secondary electron conduction tubes [*Electronics*, May 12, p. 75]. Bell Telephone Laboratories and Texas Instruments [*Electronics*, Jan. 6, p. 56] are also making vidicons with silicon targets.

Monsanto, Fisher sign merger

The Federal Trade Commission notwithstanding, Monsanto and Fisher Governor officials have signed a merger deal. **Both companies feel certain there will be no violation of the antitrust laws, a specter raised by the FTC when the companies first indicated their intention to merge.**

The deal will give Monsanto a strong edge in the industrial electronics and control business. More than likely Fisher Controls, as the industrial enterprise will be called, will be attached to Monsanto's recently formed Electronic Products and Control division.

Addendum

A strong move into computer time-sharing services and data management systems, with commercial sales totaling \$25 to \$30 million by 1974, has been projected by System Development Corp. officials following a change from nonprofit to for-profit status. Commercial business represented less than 3% of \$61 million in fiscal 1969 corporate sales. SDC entered the commercial market only a year ago, but expects to expand activity in that field to 25% of total sales over the next 5 years. About 80% of the software firm's current contracts are military.

CRTs

Multibeam tubes are now a complete family.

These computer terminal readout tubes can be supplied in a range of standard sizes and configurations.



A few months ago we introduced our first multibeam tube, a seven-beam job designed to give brighter and faster readouts for computer terminals. Now we've expanded the line to give you a wide choice of tube sizes, configurations, and phosphor colors. In fact, we can put our multibeam gun in many standard tubes.

Our multibeam approach is a new and unique way of getting more out of a CRT. In conventional single-gun CRTs, brightness and writing speed are intimately related. The higher the writing speed the lower the brightness level. Our seven-beam multibeam tube actually allows you to increase writing speed seven times without loss of brightness. Or conversely, you can get a brightness increase of up to seven times without loss of writing speed.

As an example of what multibeam can do for you, take a look at our 12" SC-5299 seven-beam CRT. Seven separate electron beams are controlled by a common focus coil. Typical written character size is $5/32$ ", but size can be varied by changing the position of the focus coil on the neck of the tube. Line width of individual spots is typically less than 0.010 ". Each beam may be individually modulated and all may be simultaneously varied in intensity with a single variable control grid bias. These multiple electron sources increase the brightness potential of the tube by a factor of seven.

Typically, this tube may be used to great advantage in alphanumeric displays, graphics or mapping. The advantages are even greater where high writing speed or viewing in a high ambient is required.

Since alphanumeric character writing is done in this tube simply by scanning lines across the screen and blanking and unblanking at appropriate points, the high speed

"diddle" or write-through yoke requirement is eliminated. The yoke current for the horizontal line scan, normally a step function, now becomes a simple ramp. Thus, you eliminate the step-settling time problems usually associated with single-beam operation.

Among the many applications we see for this new family of tubes are air traffic control systems, military identification systems, stock market quotation units, teaching machines, electronic test equipment and airline status boards.

CIRCLE NUMBER 300

This issue in capsule

Integrated Circuits

How to design with fast adders.

Television

Add economy and versatility to your new portable TV designs.

Circuit Boards

Is multilayer your best bet?

Microwaves

Meet our full-line PIN diode family.

Microelectronics

Fast custom service solves your interface problems.

Manager's Corner

Hybrid microelectronics . . . where does it go from here?

INTEGRATED CIRCUITS

How to design fast adders.

Four basic adder systems give you maximum flexibility in operating speed and package count.

When integrated circuits are used to build an adder there are many design considerations—cost, speed, power drain, etc.—that must be weighed to arrive at the optimum system.

Our fast adder series—SM-10, -20, -30, -40—makes it easy to devise the optimum system. The SM-10 full adder is useful for low cost, low power systems where the delays of ripple carry techniques can be tolerated. Only one package is used per bit and only one carry wire is needed per package.

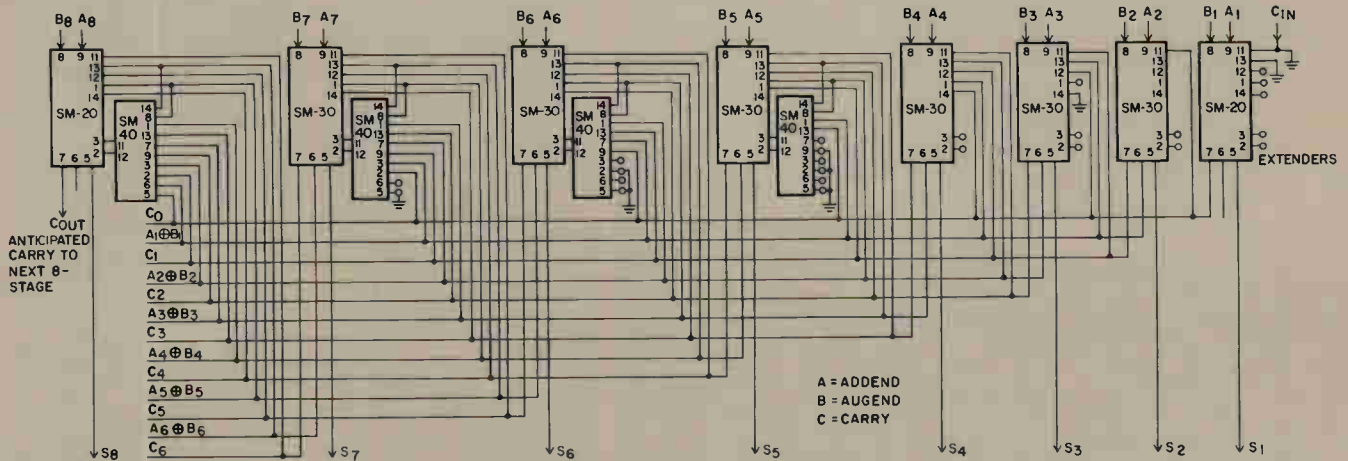

Fig. 1. Anticipated carry adder is up to 4.5 times faster than adder systems using ripple carry propagation.

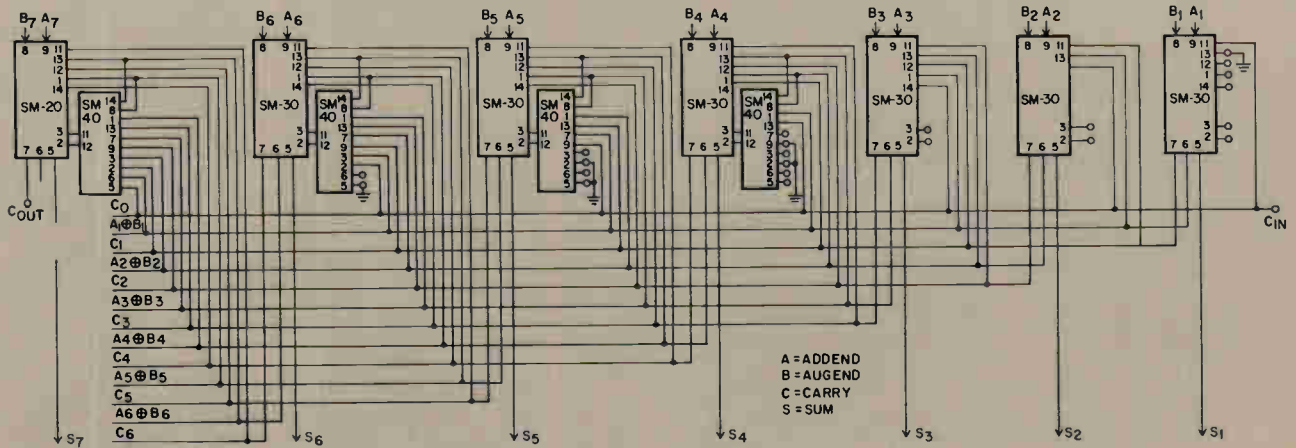

Fig. 2. Seven-bit section can be used to expand 8-bit unit shown in Fig. 1.

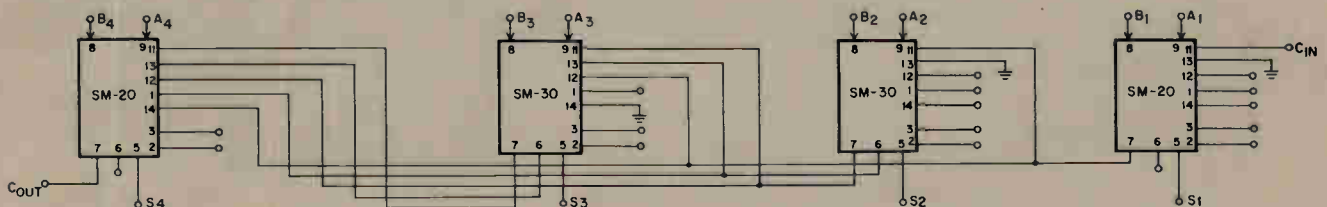

Fig. 3. Four-bit adder is based on first four stages of 8-bit adder.

If higher speed is required, the anticipated carry adders SM-20, -30, -40 can be used in several different configurations. For maximum speed, the 8-bit adder section shown in Fig. 1 should be used. This system will add two 8-bit numbers in 65 ns, and two 16-bit numbers in 105 ns. (These figures are based on the specified maximum propagation delays.) This approach uses 1½ packages per bit and power drain is typically 135 mW per bit.

For any word length greater than 8 bits but not equal to 16 bits, the fastest addition is obtained by adding 7-bit sections (Fig. 2) to the basic 8-bit adder sections. The 7-bit section is similar to the basic 8-bit section except that the SM-20 dependent carry adder is not used for the least significant bit. The ripple carry out from the preceding stage is connected to all 7 bits in parallel. Each added section must wait 20 ns for the carry out from the SM-20 of the preceding section, so the total addition time is 65 ns for the basic 8-bit section plus 20 ns for each added 7-bit section.

When slightly longer addition times can be tolerated, but ripple carry is still too slow, the anticipated carry adders can be connected in 3- and 4-bit sections to reduce package count and wiring complexity. This is accomplished by reducing the need for the SM-40 expander packages.

The basic 4-bit adder section (Fig. 3) is similar to the first 4 bits of the 8-bit adder except that an SM-20 has been substituted for the SM-30 at the fourth bit. This change provides single wire ripple carry to the next section. Anticipated carry is used to add 4 bits in 65 ns. Two of these 4-bit sections can be connected together to add two 8-bit numbers in 105 ns, as compared with 65 ns for the 8-bit section.

For any word length greater than 4 bits but not equal to 8 bits, 3-bit sections should be added to the basic 4-bit section as shown in Fig. 4. This arrangement adds 20 ns to the basic 65 ns addition time for each 3-bit section added. Two 16-bit numbers can be added in 145 ns. Note that this configuration uses only one package per bit. This is a good way to get the speed advantages of anticipated carry with the same package count as a ripple carry system. Power drain is typically 125 mW per bit.

Slightly faster addition times can be achieved by using the system shown in Fig. 5. Here an SM-40 expander package is used so that 4-bit sections can be added to the basic 4-bit section of Fig. 3. This adds 20 ns to the basic 65 ns add time for each 4-bit section. Two 16-bit numbers can be added in 125 ns using this system. Performance of the four basic adder systems is shown in Fig. 6.

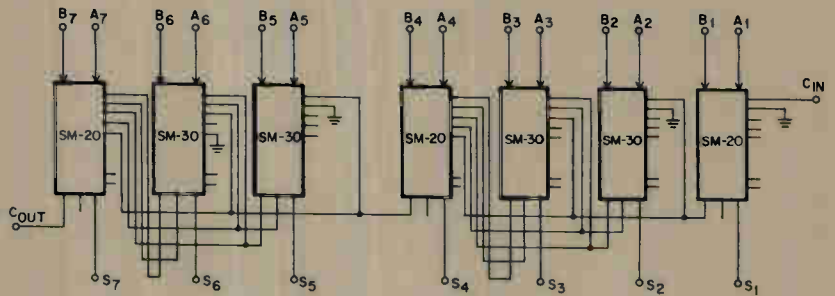

Fig. 4. Three-bit section can be used to expand 4-bit adder.

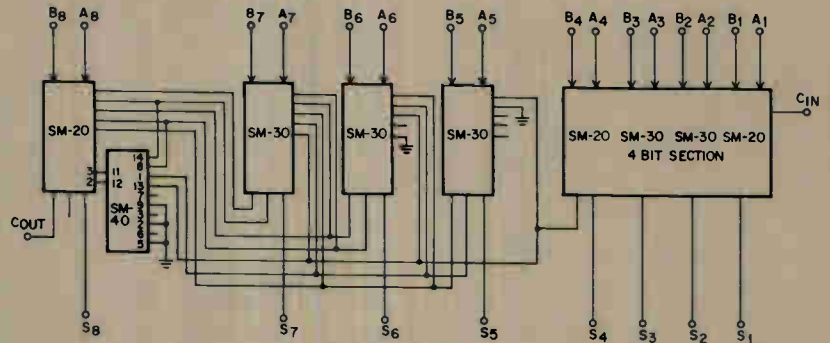

Fig. 5. Somewhat faster addition times can be obtained by using SM-40 expander to add 4-bit sections to basic 4-bit system.

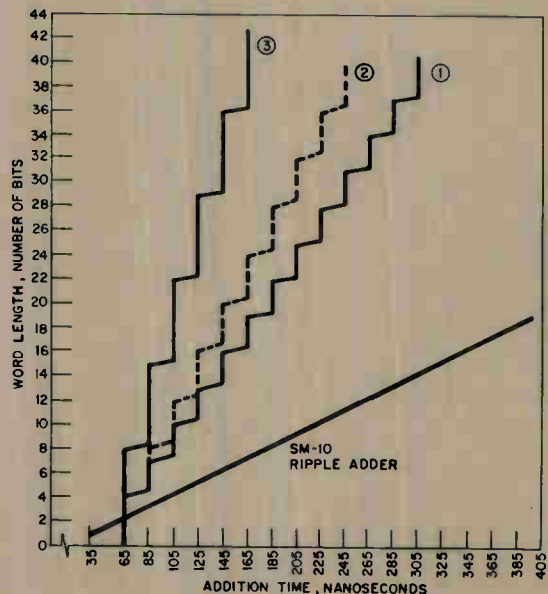

Fig. 6. Operating speed for (1) 3-bit stage added to 4-bit stage, (2) 4-bit stage with SM-40 expander added to 4-bit stage, and (3) 7-bit stage added to 7-bit stage.

TELEVISION

Add economy and versatility to your new portable TV designs.

Four-tube family fills the needs of compact small-screen portable B & W television sets.

We have the answers to your design problems in small-screen B & W sets. Our family of 8", 10", 12", and 15" picture tubes will cover most of your needs to give the advantages of Sylvania's superior design to your new systems.

All of the tubes are of the rectangular glass type with a gray filter glass faceplate. They feature electrostatic focus and do not require an ion-trap magnet. Deflection angles of 85° and 110° give you that short overall length so necessary in compact designs.

The small diameter neck and low G₂ voltages of these tubes give you possibilities for extra design economies by reducing power supply requirements. All of the tubes use the T-band implosion protection system.

And perhaps best of all is the pricing structure. Quantity prices are directly competitive with foreign imports. And look at what you get for that price. You get a full range of field engineering services and technical assistance that only a domestic manufacturer can provide. There's no long wait for delivery.

You also get all of the advantages of Sylvania's latest advances in tube design, materials and production techniques that assure high quality at minimum cost.

Why not investigate our new portable picture tube line. You'll be able to market an all "MADE IN USA" set at a price that will meet the foreign competition.

CIRCLE NUMBER 302

Portable TV monochrome picture tubes

Size	Type No.	Defl. Angle	Approx. Screen Area (Sq. in.)	Heater Voltage (V./Ma)	G ₂ Voltage (Volts)	Neck. Diam. (In.)	Overall Length (In.)	Safety Protection
8"	ST-4744B	85°	27	6.3/450	100	0.788	7.78	T-Band
10"	ST-4750A	85°	43	6.3/450	100	0.788	8.88	T-Band
12"	12DFP4	110°	74	6.3/450	200	0.788	8.81	T-Band
15"	15ADP4	110°	100	6.3/450	50	1.125	10.75	T-Band

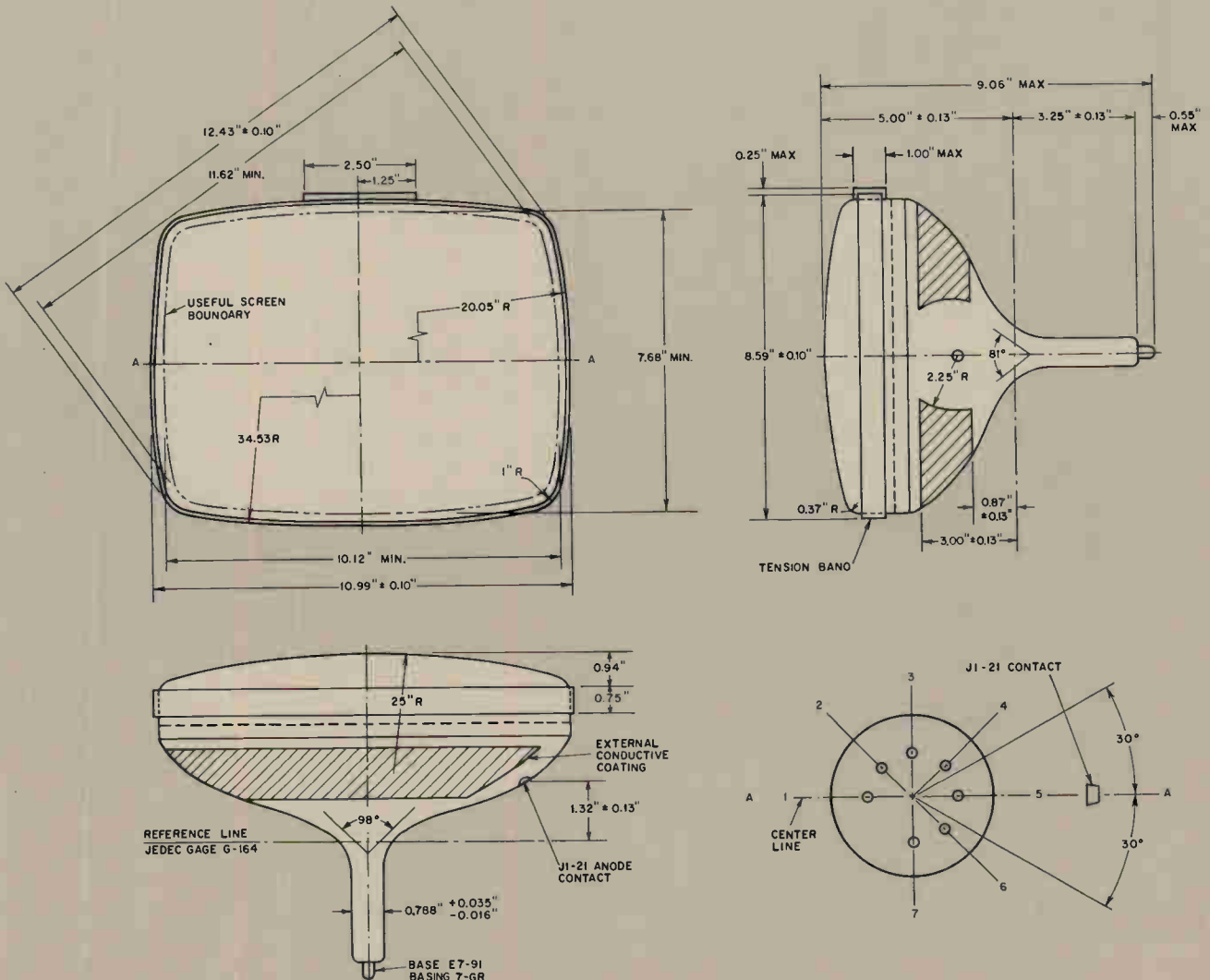

CIRCUIT BOARDS

Is multilayer your best bet?

As makers of all types of boards—single, double, and multilayer—Sylvania can help you make the right choice.

Are you looking for a high-speed circuit board? If you need high-density packaging, high-speed operation and low noise levels, multilayer boards may be your answer. Sylvania is especially equipped to aid you in making the right decision. Since our printed-circuit board facilities make all types of boards, our engineers can aid you in choosing the right one for your application.

Sylvania has been producing multilayer boards for over nine years and has made boards with up to 19 layers. Our multilayer operation is a modern 10,000-square-foot facility. Most of this space meets class III clean-room standards. Rigid process controls allow us to meet standards set by the Institute of Printed Circuits, military specifications and varied customer requirements.

Capacity of the plant is presently 1,400 one-foot-square boards per shift with plans now under way to increase this capacity to 2,800 boards per shift.

To provide highest-quality production we continue to use a plan written to meet the requirements of MIL-Q-9858A Quality Program Requirements, and specification NSA No. 68-8, NSA Specification for Printed Wiring Boards.

This plan is a working document, detailing and referencing procedures that will provide a total quality system. This assures compliance with all company and customer reliability and quality requirements.

Incoming raw materials are inspected and tested to meet standards established at the time of purchase. Testing and inspection are carried out at every step of manufacture and assembly.

Our multilayer facility is capable of handling boards in sizes from 4 to 350 square inches on a regular production basis. We can hold layer to layer tolerances which meet the demands of today's multilayer board requirements. Our boards can be made in thicknesses up to seven times the diameter of the smallest plated-through hole with a minimum tolerance of $\pm 0.005"$.

Our engineering staff is ready and willing to help you solve your printed circuit board problems. Why not talk to them soon.

CIRCLE NUMBER 303

Large-size multilayer board illustrates complexity of designs that can be handled by Sylvania.

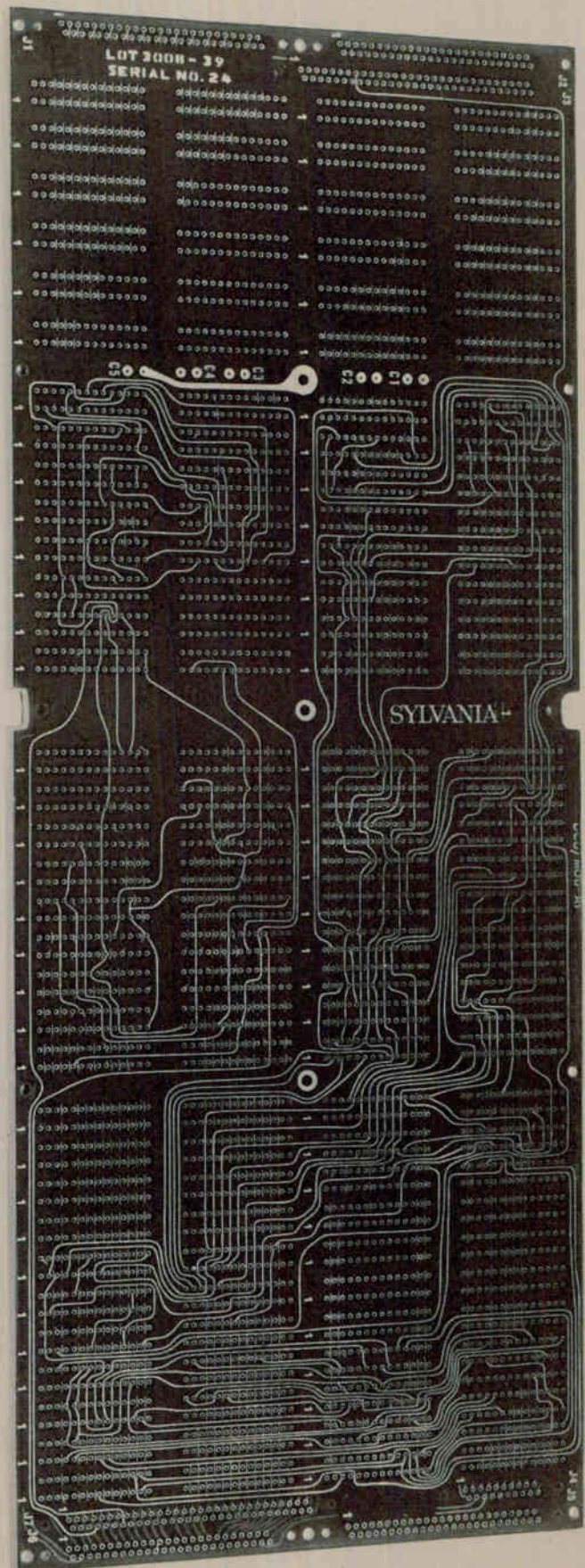

MICROWAVES

Meet our full-line PIN diode family.

Both epitaxial and non-epitaxial types are available in a wide-ranging line of devices.

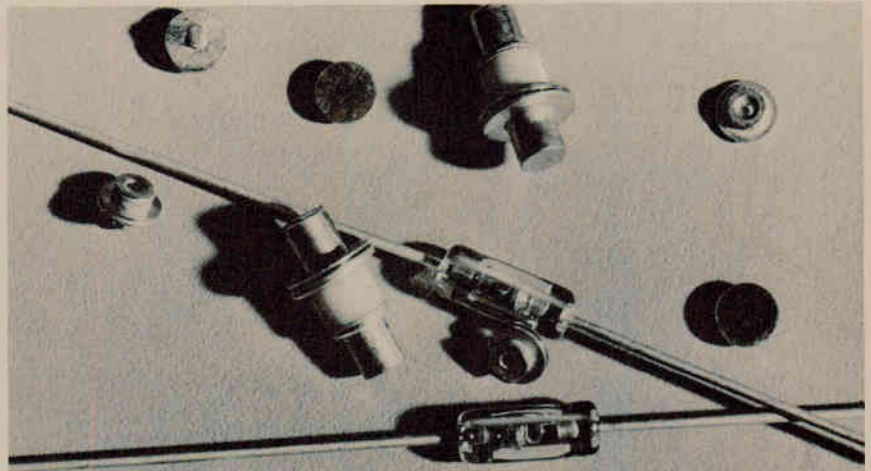

Variation of series resistance of PIN diode with forward current.

One of the industry's broadest lines of PIN microwave switching diodes is available from Sylvania. The unique properties of these devices make them suitable for such applications as low- and high-power switches, limiters, phase shifters, voltage-controlled attenuators and modulators.

A PIN diode is made by diffusing P and N type impurities into opposite sides of a wafer of pure intrinsic silicon that has high resistivity. This intrinsic layer provides the PIN diode with its unique properties at microwave frequencies. At low frequencies, a PIN diode exhibits rectification properties similar to an ordinary PN junction. However, at higher frequencies charge storage in the intrinsic region prevents rectification.

Thus, when a forward bias is applied to the device it operates as a voltage-dependent variable resistance. A slight increase in series resistance is observed up to a bias current of 10 μ A. This change occurs because the width of the depletion layer in the intrinsic region decreases; therefore, the thickness of the intrinsic layer increases slightly. As the forward current is increased beyond 10 μ A, the series resistance decreases rapidly because carriers are being injected into the intrinsic region.

When a reverse bias is applied to the device, a gradual decrease in series resistance is observed since the depletion layer is widened. This widening of the depletion layer continues until breakdown occurs and conduction increases

rapidly. Fig. 1 shows the small-signal equivalent circuit of a PIN diode in the forward and reverse biased conditions.

One of the most common applications for PIN diodes is as a high power digital phase shifter for phased array radars. The three major types of shifters are shown in Fig. 2.

The switched-line phase shifter uses two line lengths and two SPDT switches per bit. This means it can switch in either a reference line or a particular length of line depending on the amount of phase shift wanted. As many bits as needed can be added to obtain the accuracy desired in phase shift. The loss for each bit is identical and good accuracy can be obtained.

The periodically loaded line phase shifter uses the PIN diode as a switch. The diodes switch in load susceptances spaced a quarter wavelength apart on a transmission line. Phase shift per diode is small; thus it requires many more diodes to do the same job as the switched line phase shifter.

The hybrid-coupled-bit phase shifter uses a 3-dB hybrid junction with balanced phase shift bits connected to the coupled arms. This type uses fewer diodes than the switched line and has less loss. The problem with this approach, however, is that its loss varies with bits and it has only half the power-handling capacity of the switched line.

If you have an application where PIN diodes can be used, why not discuss it with Sylvania. We're sure to have the right diode for you. **CIRCLE NUMBER 304**

Typical PIN diode specifications

	D5964B	D5964C	D5964D	D5964E	Outline 075
Breakdown Voltage	100	100	100	100	Volts Min.
Total Capacitance, 50V	0.15-0.20	0.20-0.30	0.30-0.40	0.40-0.50	pF
Series Resistance, 100 mA	1.0	0.7	0.5	0.4	ohms typ.
Series Resistance, 10 mA	2.5	2.0	1.5	1.3	ohms Max.
Thermal Resistance	400	400	400	400	$^{\circ}$ C/W

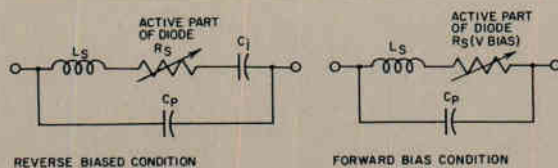

Fig. 1 Small-signal equivalent circuit of PIN diode.

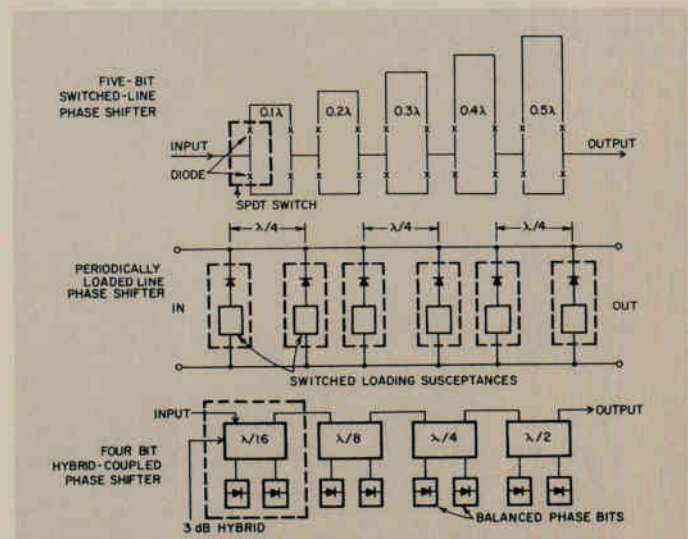

Fig. 2 Three types of phase shifters used in phased-array radars.

MICROELECTRONICS

Fast custom service solves your interface problems.

Our standard circuit submodules let us tailor an interface circuit to your specs and get it to you within two weeks.

Using our advanced hybrid circuit techniques, Sylvania can give you high reliability and proven designs, and we can do it fast, too.

The secret is in our standard circuit submodule approach. By combining these standard input and output submodules into one 12-lead TO-8 can, we can give you an interface driver circuit that will handle your specific application. Since all the design work has already been done, we can promise delivery in two weeks after receipt of order.

Input circuit functions available (see table) include voltage and current detection, level shifting, gating, inversions and pulse shaping. Schmitt trigger circuits are used for voltage and current detection and to provide a clearly defined output threshold. Logic functions are being added to make the family even more universal in its application.

In the output section, a thyristor, a medium current transistor and a high current transistor driver is available. Our thyristor circuit can handle up to 300 Volts at one Ampere. The medium current output circuit gives you 360 mA at 6 Volts or can be used to drive your own power transistor and load. The high-current transistor driver can be used to drive power transistors and is capable of switching 10 Amperes.

Our interface drivers are now available for positive and negative supply voltages ranging from 4 to 24 Volts. Input voltages can be either positive or negative over a range from 0 to ± 25 Volts.

CIRCLE NUMBER 305

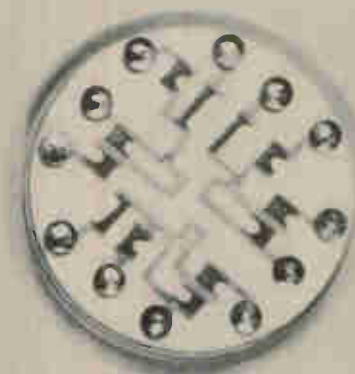

General Characteristics of interface driver submodules

Input sections

Schmitt trigger:

On at +3V, Off at 0V

+ or - current sense

User supplies 1 resistor selected to sense in a range of 1 mA to 1A.

+ or - voltage sense

Standard levels 1, 2, 5, 10, 15, 20, 25 Volts or user can add resistor for any specific level from 1 Volt up.

+ or - logic

Switches at 1V nominal

+ or - high noise immunity logic

Switches at 2.5V nominal

Output sections

Thyristor

Load current to 500 mA. Voltage ratings of 50, 100, 200 and 300V.

Medium-current transistor

Load current ratings of 150 and 500 mA. Voltage ratings of 20, 30 and 50V.

High-current transistor driver

To drive power transistors switching up to 10A.

SEE OUR SPECIFICATIONS IN
VSMF
MICROFILM CATALOG FILE

Use Sylvania's "Hot Line" inquiry service, especially if you require full particulars on any item in a hurry. It's easy and it's free. Circle the reader service number(s) you're most interested in; then fill in your name, title, company and address. We'll do the rest and see you get further information by return mail.

BUSINESS REPLY MAIL

No Postage Stamp Necessary if Mailed in the United States

FIRST CLASS
Permit No. 2833
Buffalo, N. Y.

POSTAGE WILL BE PAID BY

Sylvania Electric Products Inc.
Sylvania Electronic Components
1100 Main Street
Buffalo, New York 14209

D 6 6

MANAGER'S CORNER

Hybrid microelectronics...where does it go from here?

Reading any of the design electronics magazines, an engineer can get the feeling that he is "out of it" unless he is committed to several active hardware designs using film hybrid microelectronics. Scarcely an issue goes by that a new technical advance or new utilization is not described.

Is there sufficient justification for all this technical publicity? Has the technology really arrived yet? Where will it develop from here?

The apparent popularity of hybrid technology, coupled with the relatively low dollar investment required, has led to upwards of 500 hybrid film facilities being started within the last 12 to 18 months. Of course, some of these facilities were formed to support in-house engineering groups, but many are oriented toward industry sales activity.

EIA statistics for 1968 certainly do not justify all of this activity in hybrid film technology. In 1968, sales were about \$54.6 million in "non-captive" markets (not including in-house usage of self-manufactured circuits). Half of this sales level is in "passive-only" film circuits. The remainder is in film circuits with active components added.

The accelerating interest in hybrid films comes from a growing accumulation of successful applications. Engineers have found that hybrids can solve design problems not readily resolved by available monolithic circuits and/or printed circuit approaches.

With increasing usage of hybrid circuits the vendor-user engineering liaison loops have become more workable and more efficient. The initial strangeness of working with a new technology has worn off. Engineers who have been suc-

cessful in their first applications are now confidently designing hybrid films into future jobs where they meet the economic and technical requirements.

For this reason, we at Sylvania believe that the growth of film circuit technology will be explosive in the next 12 to 18 months. By 1971, we see engineers designing systems using such devices as multiple beamleaded, nitride passivated integrated circuits arrayed on multi-level alumina substrates. The whole device will be hermetically sealed in a 1"-square flat pack.

To obtain this level of technology by 1971, certain developments are required. These developments include fine-line, low-cost film registration to accommodate beamleads; availability of a broad range of beamlead devices at reasonable prices; and a reliable multi-level substrate interconnect capacity. All of these factors should be available by 1971.

At Sylvania we're similarly confident of the future place of film circuits in the industry picture as a packaging technology. Hybrid films will complement single chip monolithic devices and printed-circuit board approaches. Each technique will find its proper application through economic and technological review.

Sylvania's program in hybrid film technology is oriented toward supplying analog and digital circuits in module form. These modules incorporate our own solid-state devices using advanced technologies in design and packaging. Our ten years of film circuit and packaging experience, our in-house source of beamleaded chips, and extensive new developments in film processing techniques allow us to offer broad design and production support to the user of film circuits.



W. D. Hogan

This information in Sylvania Ideas is furnished without assuming any obligations.

SYLVANIA

GENERAL TELEPHONE & ELECTRONICS

NEW CAPABILITIES IN: ELECTRONIC TUBES • SEMICONDUCTORS • MICROWAVE DEVICES • SPECIAL COMPONENTS • DISPLAY DEVICES

D6

NAME _____

PLEASE PRINT

TITLE _____

COMPANY _____

ADDRESS _____

CITY _____ STATE _____ ZIP _____

Circle Numbers Corresponding to Product Item

300 301 302 303 304

305

Please have a Sales Engineer call



HOT LINE INQUIRY SERVICE

Need information in a hurry? Clip the card and mail it. Be sure to fill in all information requested. We'll rush you full particulars on any item indicated.

You can also get information using the publication's card elsewhere in this issue. Use of the card shown here will simplify handling and save time.

**A major
breakthrough!**

**Buckbee-Mears
research has
found a way to
produce small
holes in thick
metal!**

*Our secret is to
lamine metal*

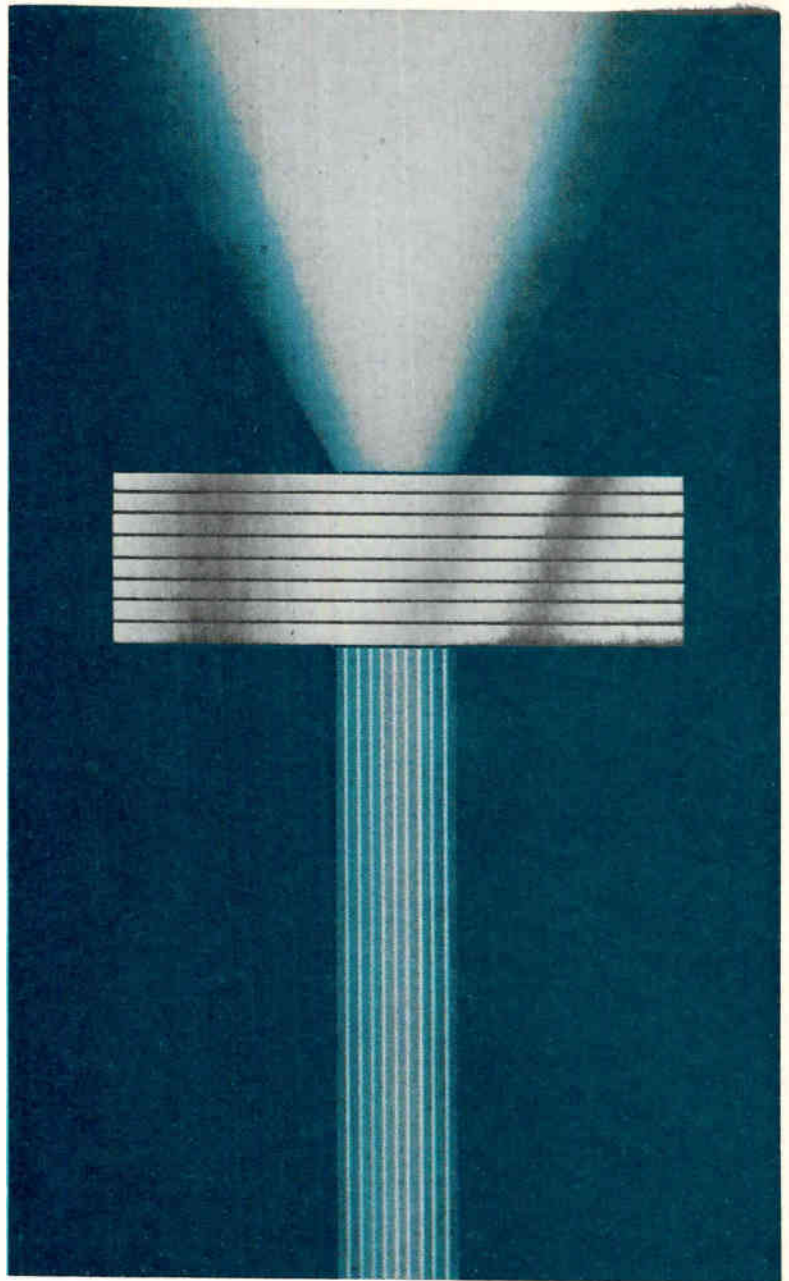

Until now, no one has been able to produce holes in thick metal at anything smaller than a one-to-one ratio. We put our world leading technology in photomechanical reproduction to work and came up with a way to laminate sheets of etched metal in perfect register. We can produce sharply cornered holes of any design in metal much thicker than the width of the hole.

The trick was to eliminate the radii in the corners caused by the laminating process. Our scientists succeeded so well that Buckbee-Mears can accurately register 10,000 holes per square inch over an 11" by 11" area. We can even register up to 40,000 holes per square inch if you need it!

Tolerance on registry is $\pm .0005$ ". Tolerance on hole size

is $\pm .0002$ ". We are able to laminate up to 1,000 layers of .005" thick material in accurate collimation.

There are countless applications for small holes in thick metals. A few examples might be core nests, fluid amplifiers and collimator screens. Buckbee-Mears can produce masters and the actual laminated metal parts. Either or both.

If you need small holes at better than a one-to-one ratio in any type of metal, any thickness, talk to Buckbee-Mears. We've got a capability to solve your problem.

Solving people's problems is the way we became the world's leader in photomechanical production. Call or write Bill Amundson, our industrial sales manager, and tell him what you need. His number is 612-227-6371.

PRECISION METAL AND GLASS ETCHING • ELECTRO FORMING • AUTOMATED DESIGN
bmc BUCKBEE-MEARS COMPANY
SAINT PAUL, MINNESOTA 55101



RS 00 Model 110 Wave analyzer
 It permits adjustment of Q from 1-100
 (bandwidth to 1.0%) over a frequency
 range of 1 Hz - 110 kHz. For distortion
 analysis, you can measure levels of
 distortion as low as 0.1%. Or combine
 two Model 110's in tandem for meas-
 urements down to 0.001%.

Why the "PLUS"? Because the Model 110
 can also serve you in so many other
 ways. Use it as a Stable low-distortion
 oscillator providing up to 5 volts rms
 into 600 ohms and capable of synchro-
 nization by an external signal. Flat as
 selective ac voltmeter with sensitivity
 ranging from 10 microvolts to 5 volts
 rms full scale. Low noise amplifier
 with a voltage gain from 3 to 10,000
 and a typical noise figure of 1 dB.
 Notch filter with 40 db frequency rejec-
 tion in excess of 100 db. Allpass delay
 phase shifter with an amplitude re-
 sponse flat with frequency, and a
 phase lag which increases monoton-
 ically with frequency.

Price of the Model 110, complete with
 all its PLUSES, is \$1,350. For addi-
 tional information or a demonstration,
 write Princeton Applied Research
 Corporation, Box 585, Princeton, New
 Jersey 08540, or call (609) 924-8225.

PAR PRINCETON APPLIED RESEARCH CORPORATION

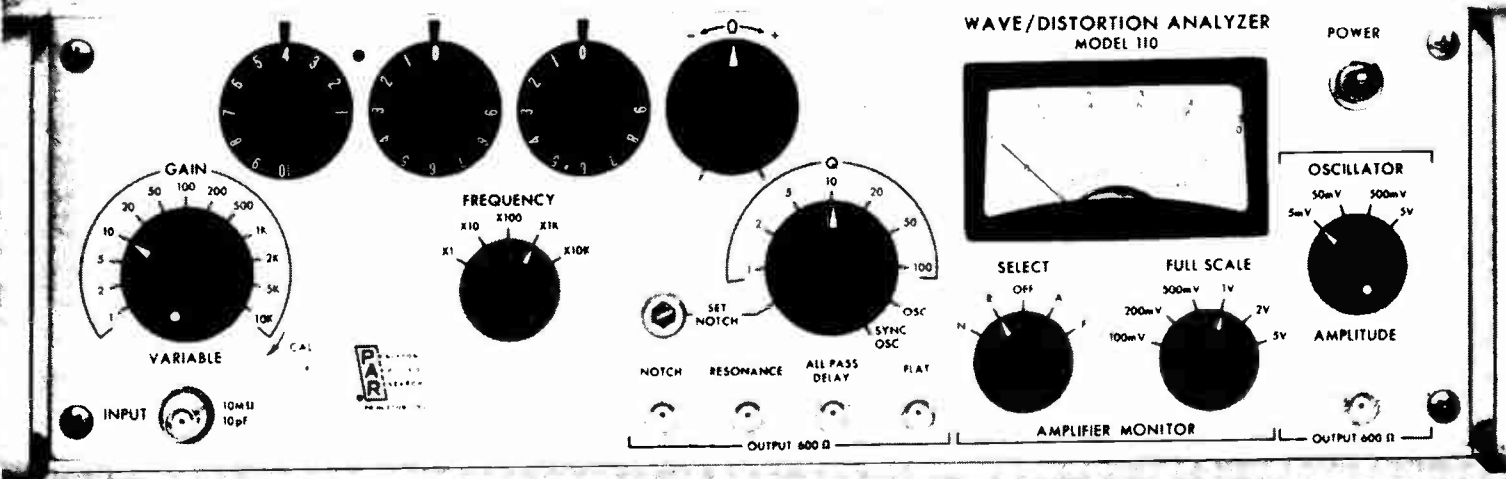

Bulk delay line reveals its secrets

Serendipitous technique perfected by Air Force spots transverse and longitudinal waves, acoustic-energy scatter

Delay lines are used in all kinds of equipment: from tv sets to radar systems. But the light and tiny acoustic delay lines so attractive for microwave signal processing, in use more than five years, still have flaws: attenuation in bulk delay lines is often high, and the reason often isn't understood. Nor, for that matter, are the loss mechanisms at work inside the delay lines easy to study in the first place. And despite advances in surface-wave delay lines, frequencies above 3 gigahertz to 4 GHz remain the sole province of bulk delay lines.

Scientists at the Air Force Cambridge Research Laboratories, Hanscom Field, Mass., have developed a new sort of delay line—and in the process, a new tool for getting inside bulk delay lines. Paul H. Carr, chief of the labs' microwave acoustics branch, developed the technique along with research physicist Alan J. Budreau.

Long and short. In conventional bulk delay lines, a transducer such as cadmium sulphide is deposited at one end of a rod of a crystal-like magnesium oxide. Electromagnetic waves (photons) are converted by the CdS into acoustic waves (phonons) which travel the rod's length far more slowly than would electromagnetic waves; thus, a short rod gives a long delay compared to that of an ordinary microwave transmission line of equal length. Another CdS transducer at the rod's output end converts the energy back into electromagnetic form for more processing.

Rather than detecting the signal at the rod's output end, the Air Force team measures attenuation, but not in the rod. The new delay line consists of a crystal rod with a transducer; but instead of just lying in series with a transmission

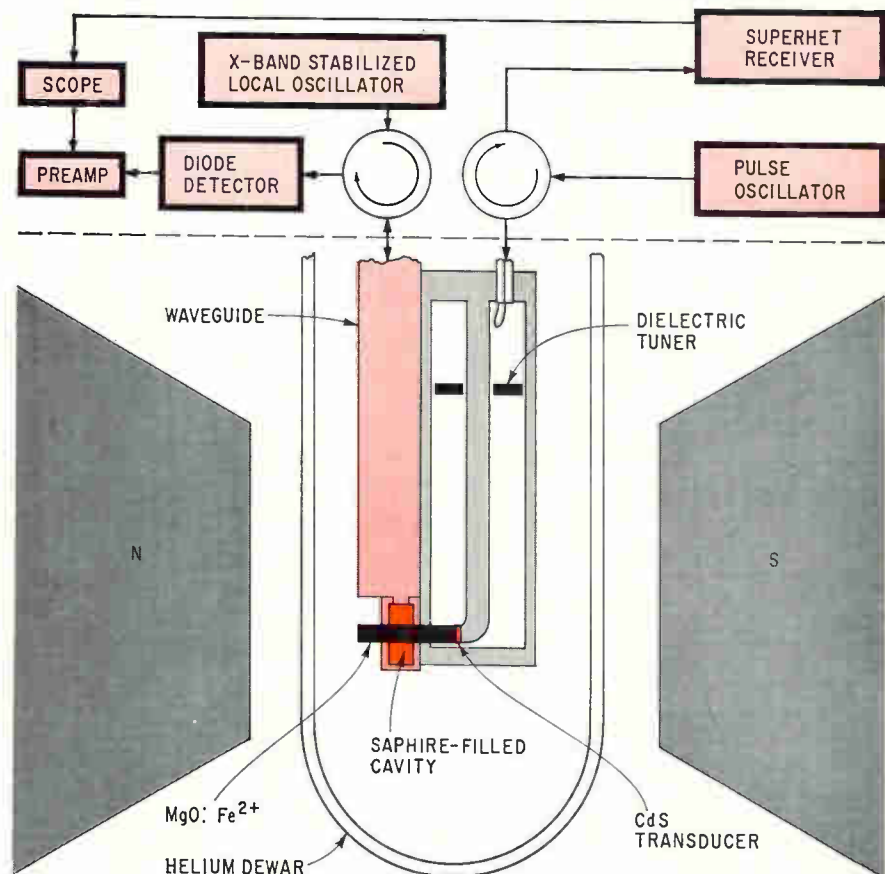

And it comes out here. Energy from microwave launcher, top of right waveguide, excites transducer and is converted from electromagnetic to acoustic waves. Combined with energy from the c-w oscillator, it soaks up microwave energy in sapphire-filled cavity.

line, the delay line is built into one end of a sapphire-filled, tuned microwave cavity with continuous output of an 8.7-GHz oscillator.

When an 8.7-GHz pulse is applied to the transducer, an acoustic wave is launched in the rod and interacts with the 8.7-GHz continuous electromagnetic wave in the cavity, attenuating it. A simple diode detector monitors this.

"With this approach it's possible to detect both transverse and longitudinal waves as they propagate within the rod," says Carr. Piezo-

electric transducers only convert pure longitudinal waves.

But the labs' researchers have found that by applying a magnetic field at 45° to the rod's axis, they can selectively detect longitudinal waves. With the magnetic lines of force either along, or at right angles to, the rod's axis, they can pick out transverse waves. Therefore, by studying the proportions of the two types of waves, they can spot scattering of acoustic energy inside the rod. Scattering can be due to doping peculiarities, bubbles, stresses

U.S. Reports

in the crystal lattice, or other reasons.

Carr cites the case of a delay-line rod which passed visual inspection, but which later was found to have inordinately high attenuation. The new technique spotted a peculiar sort of scattering, and the rod was found to have a mosaic-like defect in its lattice arrangement which soaked up acoustic energy like a sponge.

Thus, the application of the technique to research and materials perfection is obvious. It could be used as a quality-control tool as well. But Carr feels that the new technique may become a popular delay line format in its own right, especially at the frequencies above 30 Ghz—so attractive to military radar and communications planners.

"Piezoelectric transducers for operation at such frequencies are hard to build," he says, "and the parallel end surfaces that are a must for low attenuation are even harder to achieve." Since no piezoelectric output transducer is needed in the Air Force approach, and since the rods' ends needn't be absolutely parallel, the system should work with less costly rods.

Right now, as a diagnostic tool, the scheme requires liquid helium cooling, but Carr hopes for room temperature operation. "We could experiment with doping levels in the rods, find more sensitive directors, reduce confusing f-m noise by using a more tightly controlled local oscillator, and raise cavity-Q to boost attenuation," he says.

For now, though, he and Budeau are content just to be able to find out what's going on inside an acoustic delay line.

Computers

A shoe drops

It's been known for some time that IBM has been holding at least two machines in readiness, waiting for the appropriate moment to announce them [*Electronics*, March 17, p. 51]. On July 30 it showed one of them, System/3, the company's long-awaited entry into the

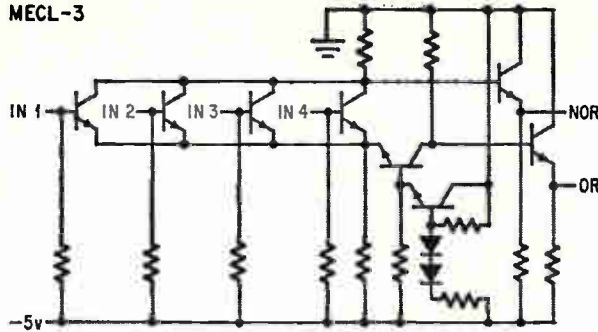

Cousins. Motorola's MECL-3 propagates in 1 nanosecond while . . .

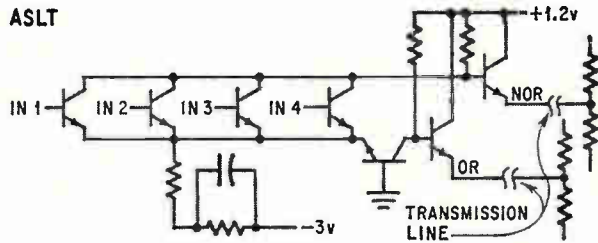

. . . IBM's discontinued ASLT took 5 nsec . . .

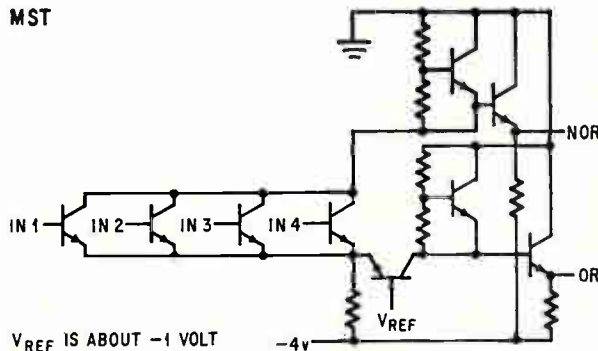

. . . and the new MST takes 10 nsec. Also, it has wiring on two sides, chips on top only. ASLT, with its two substrates in tandem, had wiring and chips on all four sides.

minicomputer market.

The new machine has two obvious characteristics—one positive, one negative. Its positive feature is a new small punched card, about a third the size of the conventional card and containing 20% more information. The negative feature is the machine's complete incompatibility with the five-year-old System 360—in language, conversion techniques, or data-communication attachments. There won't even be any accessories for the 360 or other conventional machines to enable them to process the small cards.

Crazy like a fox. On the surface, these characteristics might be confusing to users and competitors alike. Aren't new punched-card systems a step backward? Didn't IBM nearly fall on its face with the 360's, which were incompatible with their predecessors? Isn't data communication the coming thing in computers?

But on second thought, IBM's

reasons for incorporating these designs in the System/3 are crystal clear. It's aiming the machine at the small business—the corner grocer, so to speak; and the corner grocer who buys a System/3 and thrives on it will find, when he's ready to expand, that he can't buy anything but another System/3. He'll have too much invested in his first machine and in files of small punched cards to switch either to a small model of the 360 or to a competitive machine.

This marketing strategy is exactly the kind of thing that over the years has put IBM at the top of the list of the nation's largest electronics companies and No. 6 among companies in all fields. It's also caused the U.S. Justice Department to regard the company with a jaundiced eye.

Of particular interest to electronics engineers is IBM's use of monolithic integrated circuits, dubbed MST, for monolithic sys-

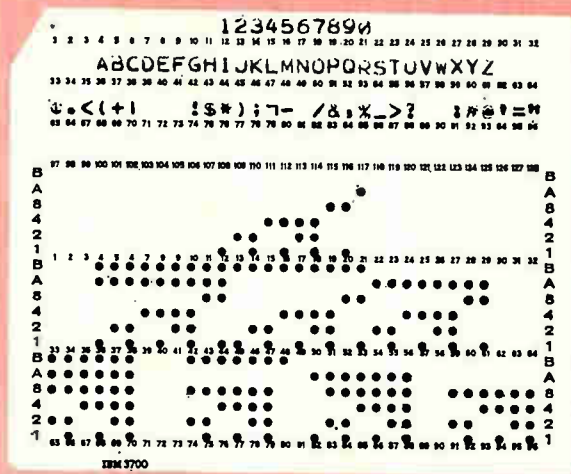

Cut. Old IBM card, 3 1/4 by 7 3/5 inches, provides background for the System/3 version, a svelte 2 5/8 by 3 1/4 inches.

tems technology—its first application of them throughout a new machine. Previously, monolithic IC's have appeared in isolated spots without much fanfare—notably in the System 360 model 44, in the model 25, and in the model 85.

In the System/3, IBM uses current-switching circuits that are somewhat similar to the emitter-coupled logic (ECL) now being marketed by several semiconductor firms, and that are descendants of the advanced solid logic technology circuits that were tried out in the new defunct System 360 model 91. Each individual chip, measuring 43 by 63 mils, holds four or five complete circuits—the exact number depends on the circuit's complexity. Several chips, in turn, are mounted on 16-pin modules similar to the circuit modules of solid logic technology, or SLT, that the company uses in its System 360.

The chips are unusually small; IBM is probably thinking of combining functions on chips that would wind up about twice as large.

IBM hinted at its plans to use monolithic circuits last fall when it described a compliant solder process that permits simultaneous bonding of many contacts to a substrate [*Electronics*, Oct. 28, 1968, p. 50]. Use of the new circuits confirms what was suggested then.

Click. Switching time of the new circuits is about 10 nanoseconds.

They are similar to, but not identical with, the circuits in the high-speed buffer memory in the System 360 model 85, which are generally understood to be ECL-like but which switch in 2 or 3 nsec.

MST's principal contribution to the System/3 is small size, not speed; each thumbnail-sized module holds on the average about five times more logic than the System 360 modules. For that matter, the System/3 won't be famous for its speed; its memory cycle time is 1.52 microseconds, which is pretty snappy for a small machine but not fabulous, and it loafs along for 26 μ sec just to add up two 5-digit numbers. The System 360 will continue to be built with the older SLT modules; eventually MST will find its way in, to be sure, but IBM isn't talking about such plans.

Now IBMologists will be waiting for the other shoe to drop—a new large machine in the 360 line, probably somewhere between the model 50 and the model 85, or perhaps a beefed-up 85.

Space electronics

Smooth sailing

Despite minor hardware problems, Mariner project scientists are jubilant over the performance of their two spacecraft. In fact, the six sci-

entific experiments aboard Mariners 6 and 7 poured out so much data that officials expect it will be several months before all the information—as well as 200 near- and far-encounter photos—can be completely combed for all significant details.

As for the flaws, they turned up early in both craft. On Mariner 6, a failure in the hydrogen-nitrogen cooling system for the infrared spectrometer resulted in loss of the 4-to-14-micron channel instrument. For reasons still undetermined, the gas system failed to cool the channel's solid-state sensor. However, the lower channel, covering the 1.5-to-6-micron region, functioned well, taking readings at 10-second intervals with 60-by-50-mile resolution.

Unlocked. Several tense hours also resulted when Mariner 7, prior to far encounter with Mars, lost its lock on the star Canopus. The lock was regained 5 hours later, and scientists speculate that a small meteor may have struck the spacecraft, temporarily knocking it off lock.

The ultra-violet spectrometer on Mariner 6 failed to detect nitrogen in the upper atmosphere, but did observe ionized carbon dioxide and carbon monoxide. Measurement of surface temperatures by the infrared radiometer in the 10-to-20-micron range will be correlated later with surface features visible in photographs.

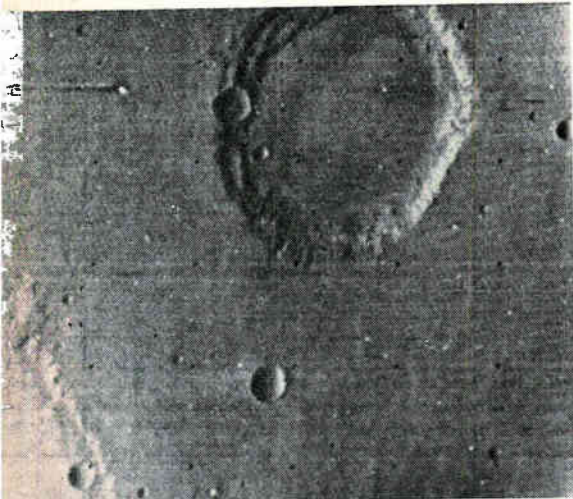

Original. Mariner 6 picture 18 looked like this when it was first received. It is marred by a general softness and an overall basketweave pattern.

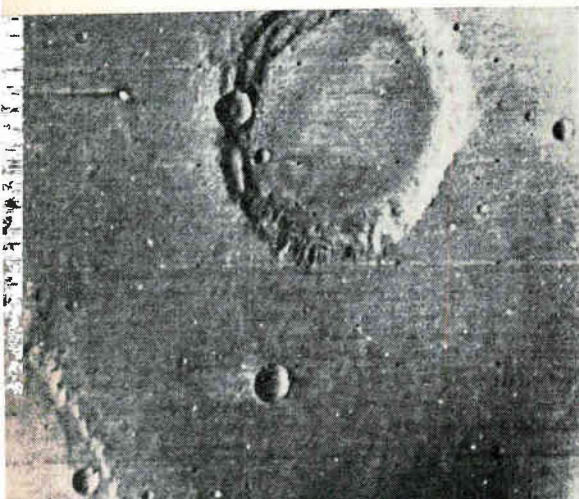

Enhancing. The basketweave, caused by "pickup" in the camera's preamplifier, was analyzed by computer and then subtracted to give a sharper image.

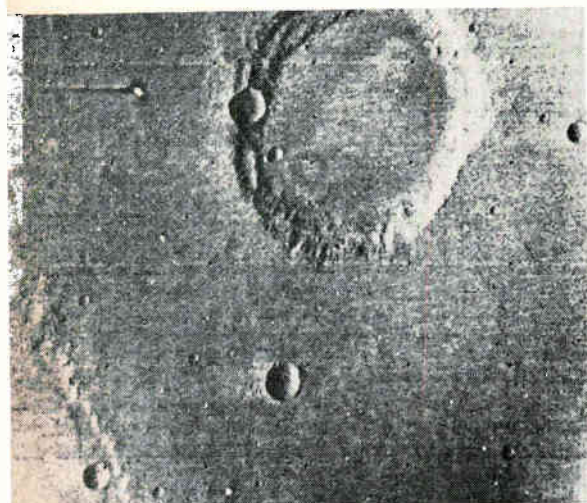

Enhanced. Then two computer programs cleared up the softness, which came from the vidicon's limited resolution.

According to John A. Stallkamp, Mariner project scientist, the television cameras on both Mariners operated well, although the Mariner 7 photographs showed superior contrast. Some officials speculate that this may have been due, in part, to the fact that Mariner 6 operated 10° cooler than optimum, reducing sensitivity and placing the signal still closer to the noise level.

Two cameras, one with a wide-angle lens and one a narrow-angle instrument equipped with a Schmidt cassegrain telescope, took pictures at 42.5-second intervals from 6,000 to 2,000 miles during the fly-by. The Mariner 6 cameras were turned on two days before encounter; Mariner 7, three days. The wide-angle camera used red, green, and blue filters to show color differences, while the narrow-angle camera employed a yellow filter to reduce haze, and covered an area as small as a large city block at nearest approach. Because of improved data storage and the high-rate data transmission system (16.2 kilobits per second vs. 8.3 bits per second for Mariner 4), officials estimate that about 150 times more data will be retrieved than was obtained from the Mariner 4 project in 1965.

Filling a vacuum. Preliminary examination of that data from Mariner 6 was sufficient to fill a number of gaps in knowledge about atmosphere and surface on Mars. A peak electron density of 1.5 by 10⁵ at 130 kilometers above the surface was recorded, about 7 orders of magnitude higher than at the surface. Readings were about 50% higher than those observed by Mariner 4 because of greater sun activity. Significantly, atmosphere pressure measurements confirmed Mariner 4 findings and indicate that design concepts for the Viking soft lander are correct. X-band occultation experiments indicate an atmospheric pressure of about 6.5 millibars at a point 9 kilometers above the Martian surface. Measurements ranged from 3 millibars in high equatorial regions of the planet to 8 millibars in lower equatorial areas.

The classical canals of Mars

weren't observed except as irregular low-contrast splotches, but several other striking features were revealed. Nix Olympica, a 300-mile-diameter crater that appears to brighten perceptibly as the Martian day progresses, was clearly visible even in far-encounter photographs. Using a blue filter, the Mariner 6 wide-angle camera indicated that a blue haze sometimes seen over dark areas of Mars with earth-bound telescopes is illusory. Wide-angle photographs taken at near encounter covering a 450-by-450-mile area showed numerous craters ranging from 150 miles down to 30 miles diameter. One narrow-angle photograph revealed a 25-mile-wide crater with slumped terraces on the sides similar to those observed on the moon.

Gravity measurements, using direct measurement through relativity mechanics, doppler and ranging data, indicate that the earth has 81.3011 times more mass than Mars. The mass-ratio from Mariner 7 was 81.2997, giving close correlation to the Mariner 6 figures. Although no ammonia, methane, or nitrogen were observed, investigators still say it's possible that nitrogen might be present in the planet's interior.

Stallkamp says the Martian moon, Phobos, hasn't been detected in photographs, but may yet be seen after further processing to remove electronic interference.

Integrated electronics

Solo road

Determining just where the system house interfaces with the complex-circuit vendor is a problem that's keeping many engineers awake nights. One company that has made up its mind has gone to the extreme, keeping everything but the diffusion in-house.

Four-Phase Systems, a California company formed late last year, has rounded the first turn and is pounding down the stretch, showing every indication that its approach is superior to the traditional method of letting the vendor design and manufacture the circuits.

One good example of the traditional approach is that of Viatron Computer Systems [*Electronics*, June 23, p. 141], which farms out both MOS chip design and manufacture, and even some subassembly operations, concentrating in-house on system and design assembly.

Do it yourself. On the other hand, Four-Phase does everything, even designing and making the masks; it then gives the masks to the semiconductor device maker for manufacture. The contractor returns undiced wafers, and Four-Phase does the rest.

Four-Phase has now achieved prototype production with a large scale integrated circuit that outclasses anything else now on the market. It's a 1,000-bit random access memory, made with MOS technology, on a silicon chip 150 mils square. The chip includes all decoding circuitry, yet is 20% smaller in area than any currently available 1,000-bit shift register—which, of course, has serial, not random, access. And it's being produced with excellent yield.

But the company doesn't plan to offer the memory for sale—at least not right away. It will be stockpiled as a component for a computer, most of which is still being developed. The computer will be com-

pletely packaged on nine chips plus enough of the memory chips to make a suitably large memory. By contrast, Viatron's design calls for 35 different kinds of chips, and Viatron's computer isn't nearly as powerful as the Four-Phase design promises to be.

The high-density design for the memory combines the virtues of static MOS flip-flops for random access with those of dynamic MOS storage cells for small size. It depends on a circuit design that, although not unheard of in the industry up to now, is unique in any production design, according to company officials.

Patents

Patently weaker

Last spring, when William E. Schuyler Jr. was appointed to replace Edward Brenner as U.S. Patent Commissioner, proponents of a four-year-old measure to reform patent laws feared the worst [*Electronics*, May 26, p. 14]. After all, Schuyler, a Republican (Brenner was a Democrat) in private patent law practice in Washington, had been leading the opposition against a thorough-going reform of patent

regulations.

Nor were these fears exaggerated, for although still alive and likely to receive Congressional approval, the patent reform bill as reworked to conform with Schuyler's views is now just a shadow of its former self. In fact, it might endanger the highly touted international patent cooperation treaty.

Americans first. For example, gone and long forgotten is a provision which would have specified that patents be issued to the first applicant who files for one, a change that would have brought U.S. patent law into step with that of other countries. Instead, the new bill—designated S.2756—retains the old concept that the true inventor is the one who can prove through lab notes and articles in professional journals that the idea occurred to him first.

This also means that foreign inventors, who are accustomed to a first-come-first-served system of patent approval, will continue to be discriminated against in the U.S., which is what places the patent treaty in jeopardy. Patent officials hint, however, that they might go back to Congress and seek repeal of that provision in return for some concessions from the foreigners.

The new bill also drops a provision making disclosure of a patent

Follow the bouncing bubble

Pressing their never-ending search for new technology making possible low-cost, low-power, all-digital data processing and switching, Bell Laboratories scientists think that minute magnetic bubbles may be the answer. Locally magnetized areas that can move about in thin plates of magnetic material, the bubbles can be created, erased, and moved anywhere without interconnection.

The bubbles are formed from orthoferrites—magnetics materials composed of rare-earth iron oxides. When a magnetic field of critical value is applied, magnetic domains that are almost perfectly cylindrical are formed. These are the bubbles. They may be controlled either

by programing electric currents in an overlaid pattern of conductors or—with no connecting wires—by controlling the surrounding magnetic field.

In the first picture below, bubbles are placed in a photo-lithographed printed-circuit conductor array and moved in a shift register mode at data rates of 3 million bits a second. The second picture shows how the bubble moves (top to bottom) one period of the pattern for each clockwise rotation of the in-plane rotating field that has generated poles in a Permalloy pattern. Finally, the pulsating domain interacts with Permalloy wedges and rings to produce inchworm motion.

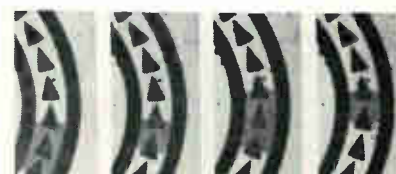
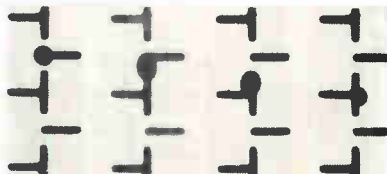
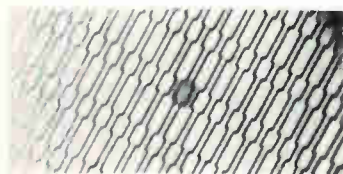

U.S. Reports

award mandatory after 18 months. Such a provision would help to speed new technology into the economic mainstream; disclosure now takes from 24 to 30 months—even longer for complex electronic and chemical patents.

Senator John McClellan (D., Ark.), chairman of the subcommittee on patents, trademarks, and copyrights, who traditionally has favored strong reform measures, said he agreed to drop the provision after getting assurances from Schuyler that new administrative practices would cut the time between application and disclosure to 18 months.

Solidity. In softening his position on patent reform, Sen. McClellan indicates that he believes the new bill will at least enhance the validity of patents because it offers some language to clarify Section 103 of the patent act dealing with the conditions of patentability and the "nonobvious" test—a major part of the patent law. It also offers guidelines for patent examiners and the courts to help them in determining which inventions are truly patentable. McClellan and others have bemoaned the fact that the courts have overturned patents in 72% of the challenges in the past 2½ years.

As it stands now, the Senate is almost certain to approve the bill before adjournment this fall. And although House approval is expected to follow, there is less certainty that time will permit final passage during the current session.

Medical electronics

Fingering the ailment

Analyzing electrocardiograms for heart abnormalities can be a long and laborious process for cardiologists. Programming a computer to take over this task has long tantalized hospitals but the high cost of developing the software to do the job prevented it from happening.

Now coming to the rescue, however, is the Medical Systems Laboratory of the Public Health Service, which developed the software

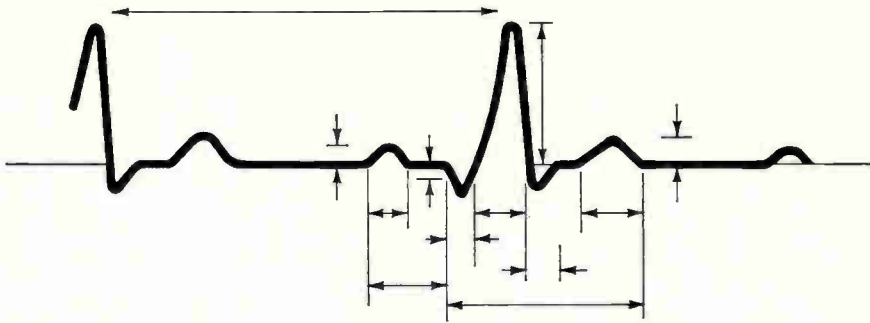

Pattern recognition. For a typical electrocardiogram the computer calculates and analyzes the amplitudes, slopes and durations of the various waves and segments of the signal. Diagnosis is performed by comparing this data with data for various known defects.

for a computerized ECG system that a community hospital can afford. But it took \$3 million and 100 man years of work to do it.

Another problem was interesting a computer maker in putting together hardware. The laboratory had little success, partly due to the limited size of the potential market, until it talked to the Analog-Digital Systems division of Control Data in La Jolla.

The initial unit, costing \$125,000, was recently delivered to Hartford Hospital, Hartford, Conn., and CDC is now ready to market the system.

In for tests. A modified CDC 1700 computer with a 24,576 word (16-bit) memory, peripherals, and software, the system comes in three configurations capable of accepting an input of from 100 to 1,000 electrocardiograms per day. Built into the system is an analog input subsystem that accepts analog data, converts it, and stores it in memory. Kent Booth, CDC engineer, points out that most general-purpose computers can't read analog signals, digitize them, and store them with any amount of ease except where the digitizing is done by data acquisition. Such external units often require a lot of time and money for debugging and interfacing.

Dr. Robert Dobrow, in charge of the Hartford ECG system, said that while the system could be run in real time, the hospital decided it would be more economical to use batch processing. At present Hartford is processing only 15 ECG's per hour, about one-fourth of capacity.

The computer generates a printed report containing the patient's identification and vital statistics, ECG lead measurements, pattern recognition information, and a diagnosis. Typically, the machine would tell the physician if the patient had an enlarged heart, heart attack, was normal, or had any one of a number of other afflictions.

The computer's diagnosis is as good as, or sometimes even better than, a cardiologist's diagnosis, according to Dr. Cesar Caceres, former head of the Medical Systems Development Laboratory and now chairman of the Department of Clinical Engineering at George Washington University. But the cardiologist is not replaced by the computer. He will still review, correct if necessary, comment, and sign the diagnosis.

The unit proves that a medical-information system is economically feasible for small hospitals, Dr. Caceres believes. Ultimately, it will be part of a much larger system encompassing all hospital applications such as record keeping, monitoring, scheduling, plus analysis of all types of electrical signals originating from a patient. Some of the necessary software is now being developed by the Public Health Service, but work is being slowed by a lack of funds. Like the software being used with the CDC system, all future development in software will be available to anyone who wants it.

No guessing. The CDC system can accept data on a real-time basis or from digital or analog tape. From either source, the data goes to a pattern-recognition program



and now...
UNITRODE
 invents the 12 amp
UCR-
 the industry's first
 fused-in-glass SCR.

It has so many superior features it
 deserves to be called "something else".

- Ideal for pulse modulator applications
- Smallest medium-power SCR
- Efficient switching of high pulse currents
- Peak repetitive pulse current 150A in high frequency modulators
- Anode voltage 100 to 600V
- Low forward voltage drop
- Forward current 12A
- Peak gate current 100A
- 3.5°C/watt thermal impedance

TAKE A LOOK AT THE WAY IT'S BUILT

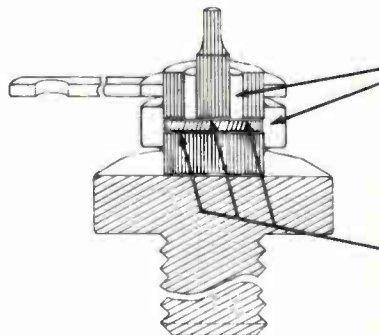

Two fused-in-glass seals melted, wetted and fused to both silicon and metal surfaces permanently protecting and stabilizing the SCR die in a voidless Unitrode package.

Thermal coefficients of glass, pins, and silicon are matched to withstand extremes in temperature shock and cycling.

True metallurgical bonds from terminal pins to the silicon provide rapid heat transfer and high current capability.

580 Pleasant Street, Watertown, Mass. 02172 (617) 926-0404

UNITRODE



Check off the reply card now for a really comprehensive set of specs, charts, graphs, and curves. Or if you want really fast service, call John McCusker collect at (617) 926-0404.



HEAT-SHRINK MYLAR* TUBING

Having an extremely high dielectric strength, HS "Mylar" may be specified in very thin wall thicknesses to reduce space requirements. It is shrinkable as much as 50% to provide an immovable, tight fit. *TM-DuPont Co.

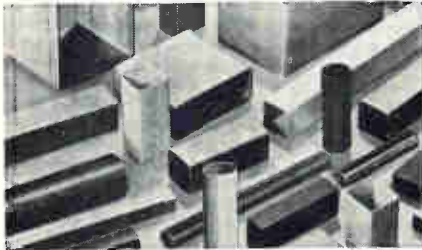

DIELECTRIC KRAFT TUBING

Meets general dielectric requirements for a variety of applications including; coil and transformer forms, capacitor covers, light shields, spacers, etc. Can be produced in almost any wall thickness and tubing dimension.



RESINITE PHENOLIC TUBING

This phenolic impregnated kraft tubing is mechanically stable, non-corrosive and reasonably priced. Resinite tubing may be punched, slit, cut and have lugs applied for a large number of applications such as coil forms, spacers and shafts.

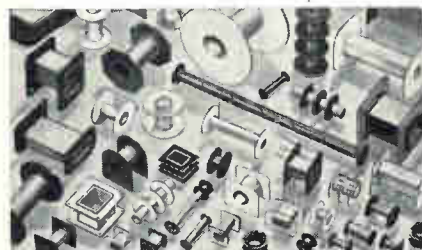

FABRICATED BOBBINS

A wide range of materials and the largest inventory of tooling in the industry allows you to have your choice of high quality bobbins at reasonable prices. Precision's patented "Plas-tilokt"® process assures positive affixing of flanges.

Precision

Paper Tube Company

1033 So. Noel Avenue, Wheeling, Ill. 60090
Phone: (312) 537-4250, Chicago: 631-1445

U.S. Reports

that calculates, tabulates, and analyzes the amplitudes, slopes, and durations of the various waves and segments of the ECG. These results are then routed to a criteria program that compares this data with preestablished norms. It gives false negative diagnosis less than 1% of the time, Control Data claims. The typical cardiologist misinterprets ECG's about 5% to 10% of the time.

The electrocardiogram analysis system ranges in price from \$120,000 to \$300,000 or can be rented for \$4,000 to about \$8,500 per month, depending on the size and options desired.

Communications

Utopia

Picture this: the sergeant, informed that his platoon's radio isn't working, growls to the complaining radio operator: "Find which circuit-fault indicator is on, then replace the conked-out module with a spare from that bag in the corner."

A New York firm, Microwave Power Devices, not only has an idea to make that picture a reality, but actually has the hardware to do it: field-replaceable modules requiring no installation alignment that can be used individually or combined to produce 1, 10, or even 50,000 watts in the future.

These modules—a few could be used for a wide variety of gear—would also provide smooth incremental control of the output power from as low as 1 watt to well over 100 watts. And when used with low-level modulation and loop comparator circuitry for low distortion, they would be able to provide a-m, f-m, single sideband, and pulse modulate the c-w carrier power. Right now, the maximum power is limited by losses in the power combiner and dividers, and the upper frequency is limited by the available transistor's gain and power-handling capability.

Here and now. Microwave Power Devices has put together several modules, four of them identical r-f

power amplifiers, capable of producing 125 watts of c-w power. The equipment is capable of 125 watts of peak effective power; with an additional circuitry module it can control the output power from 125 watts to below 10 watts. In addition, this module, with the power input, provides low-level amplitude modulation of the output to 90% with less than 7% distortion. Although the modules have a 10% bandwidth in the uhf region, the manufacturer feels that better than 50% bandwidths are just around the corner.

Long awaited. While the equipment is headed for the Army Electronics Command, the maker sees wider potential. The military, of course, must stock many components just to maintain manpack-communications equipment, and the shortage of skilled repair personnel adds to equipment downtime. Additionally, oil companies that rely on radio equipment to maintain communications along their many miles of pipeline need modules that are reliable, easily maintained, and require minimum spare parts. And the Federal Aviation Administration and other agencies insist on redundant communications systems. It also would seem that the modules are fore-runners of the small high-power solid state vhf/uhf transmitter.

There is another advantage: failure would mean loss of power rather than shutoff because several standard modules would produce total power in the first place; if one should fail, only 1 or 2 decibels of power would be lost. A 100-watt transmitter would therefore still put out at least 80 watts. But where several high-power transistors linked in parallel provide the 100 watts, a transistor failure would force others to carry an additional load they were not designed to carry, and pretty soon they would also fail.

Until now, r-f components were thought of as transistors, capacitors, chokes, resistors, and the like. Microwave Power Devices combines them in a still bigger component—sort of an r-f power op-amp, a black box that has an input and output terminal, a lead for d-c

PHYSICS, ELECTRONICS, OPTICS, CHEMISTRY

WE'RE TAKING THE FAT OFF LASERS.

One of our new portable lasers puts out several million watts of peak power. But you don't have to haul it around in a truck. It weighs, in fact, just 25 pounds, powerpack included. To slim down a laser, you've got to do pretty fancy footwork in physics, microelectronics, optics, chemistry, materials and power generation. Our people did. *Martin Marietta Aerospace Group. Headquarters: Friendship International Airport, Maryland. MARTIN MARIETTA*



Measure
150 kG
at **4.2 K**
with the
**NEW BELL
HALL-PAK®**
PROBE



A high performance field measuring system using the new Bell Hall-Pak (Model 660 Gaussmeter & HFT 6600 Probe).

The development of a new Hall Generator now makes it possible to offer with the Bell Gaussmeter a new series of high performance Hall probes.

- **HIGH FIELD PROBES (HF Series)**
 - Measure Fields to 150 kG
 - ± 1.5% Accuracy (Model 660)
 - 50 PPM/°C Temperature Stability
- **LOW TEMPERATURE PROBES (LT Series)**
 - Measure Fields at 4.2 K
 - Indefinite Probe Life
 - Small Sensing Package
- **HIGH LINEARITY PROBES (HL Series)**
 - ± 0.1% Linearity to 30 kG
 - 15 PPM/°C Temperature Stability
 - No External Temperature Compensation

A most dynamic feature of this new Hall-Pak Probe Series is the temperature stability. It has been accomplished without the need for external compensation of the Hall voltage or the use of a temperature controlled package. For the latest breakthrough in Hall Effect technology write Bell — Hall Effect Headquarters.

Leaders in Hall Effect Components,
Instruments and Systems

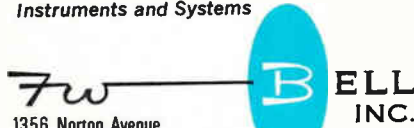

1356 Norton Avenue
Columbus, Ohio 43212
614-294-4906 TWX: 810-482-1716

See us at Wescon—Booth No. 1704-1705

U.S. Reports

power, and a terminal that is used either to provide Class AB bias or is grounded.

Plan ahead. One of the first military services to realize the potential of these ideas was the Electronics Components Laboratory at Ft. Monmouth, which expects to fund the programs next year. Based on its own field studies, the Army is convinced that the field-replaceable building-block approach is the way to go. According to Octavius Pitzalis Jr., technical area leader in advanced circuit techniques at the lab, just about every preproduction communication-set failure, regardless of power or frequency range, has been in the r-f transmitter section. And he thinks that the cure is the building block concept—using standard amplifier modules that have been debugged, optimized, and stabilized.

He says that these standard broadband linear power amplifiers should be used for all frequency bands of interest; the use of filters will give a narrower frequency band if desired.

Government

Science secretary?

The issue of centralized control of Federally sponsored scientific activity is an old one that has never been resolved to anyone's satisfaction. The first serious proposal to create a Cabinet-level Department of Science came in 1881, only to die aborning.

Yet the issue is a recurring one and is now before Rep. Emilio Q. Daddario's science and astronautics subcommittee. It seems to have gained stronger support over the years.

Voice needed. One factor adding to its growth is the attempt by the academic scientific community to counter declining—and in many cases unacceptable—research and development appropriations from the Department of Defense.

However, the R&D community sees a downward trend in other Federal agencies as well, and fears that the pragmatic bent of the

Nixon Administration—eager to match every dollar spent with something more than paper studies—does not offer much support. "Researchers don't make good lobbyists," says one Capitol Hill staff man bluntly. "They are generally highly individualistic; not coordinated like industry, for example. Most of them are reluctant to lobby and their budgets are easily cut."

The individualism coupled with a reluctance to lobby, are also being cited as being key factors behind the R&D community's doubt whether to push for the consolidation of Federal science support into one body. Nevertheless, the community is not happy with the way things are now.

Split personality. "An argument for continuing the present diffuse science organization is the uncertainty and lack of agreement which exists regarding the composition of a centralized science body," observes Congressman Daddario (D., Conn). "Should it be a department for science, education, and cultural affairs; or a department of research and education? Each title denotes somewhat different components," he points out.

The arguments against centralization are essentially that big government's overemphasis on coordination could stifle creativity, and restrict diversity and plurality of scientific judgment and replace it with narrow orthodoxy, and—in terms of gut economics—present a bigger budgetary target for Congress to cut.

Similarly, those favoring the present diffuse structure believe it leads to a multitude of funding opportunities; is more like the present diffuse structure of Congress and its committees, which weigh appropriations on an agency-by-agency basis; and permits coupling basic research closely to mission-oriented applications.

Arguments favoring centralization contend that creativity and efficiency would increase though a decrease in administrative burdens and overhead in a Department of Science. Such a department could also rapidly exploit new areas of study, provide science with funding continuity by establishing pri-



When you're under pressure (8,000 psi) to get facts fast . . .

Composite Histogram showing 4 oceanographic parameters. Photograph by Anthony Balogny.

bring ERIE in early.

Current speeds and directions . . . temperatures . . . pressures . . . salinities. Essential data if Oceanography is to achieve its predicted \$9 Billion potential by 1978. Geodyne Division of EG & G International makes instruments combining multiple sensor packages . . . each capable of measuring up to eight such parameters. And, through new high-speed digitizing systems, all parameters are recorded almost simultaneously. From the start, Geodyne has relied on ERIE TECHNOLOGICAL for the Thick Film Hybrid Circuitry so vital to these new systems. Our unique single-source capability assures total control of substrates, precious metal formulations, components and encapsulants. Proof, once again, that it pays to bring ERIE in early.

ERIE TECHNOLOGICAL PRODUCTS, INC.
644 West 14th Street, Erie, Pennsylvania 16512
(614) 456-0392

Better solutions come from Weatherford

Try these for starters: TTL. Military Transistors. Discretes.

The Trend is TTL. And we've got just what you need to stay out in front of this fast-moving game: Texas Instruments' new TTL brochure – the most detailed handbook yet on these increasingly-popular devices. In its 80 pages is complete data on industry's broadest TTL family, some 166 different circuits, many of them in a choice of packages and temperature ranges. You'll also find loading tables and informational guidelines on the application and use of leading MSI functions. As an extra convenience, it is color-coded for easy reference and simpler device selection. We've got a free copy waiting for you. Or circle 150 on the Service Card.

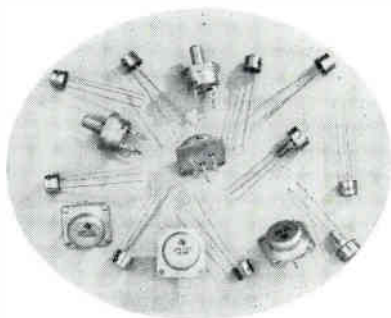
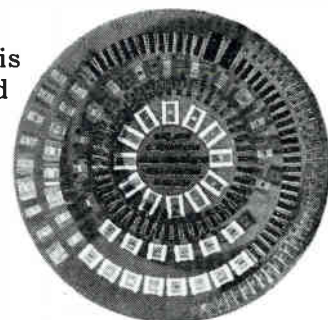

Only TI's military-qualified power transistors qualify for off-the-shelf delivery. If you now go directly to a manufacturing source for military-qualified power transistors and still wait weeks for delivery, come to us. We can get them to you fast! Availability is excellent because inventories are in great shape. And your choice is broad, 16 devices: JAN 2N497, JAN 2N498, JAN 2N656, JAN 2N657, JAN 2N1714-JAN 2N1717, JAN 2N1049A, JAN 2N1050A, JANTX 2N1724, JAN 2N1724, JANTX 2N1722, JAN 2N1722, JAN 2N389, JAN 2N424. TI makes many other planar and epitaxial planar power devices which, while not military-qualified, can meet stringent military requirements. So stop marking time – shoot an order our way. Or for pricing and delivery data on all TI power transistors, check with us.

TI's discrete dual transistors: proven, reliable, ready to go. When applications—like operational or differential amplifier designs—demand extremely high stability, take a close look at TI's dual transistors. They provide better thermal tracking with extremely low drift and a stability that just can't be achieved with a matched pair of separate transistors. TI's dual transistors are available for high and low current applications in NPN duals, PNP duals and complementary pairs in TO-5, TO-18 and dual flat packs. Pick what you need from this broad selection: 2N2639-2N2644, 2N2802-2N2807, 2N2913-2N2920, 2N2972-2N2979, 2N3347-2N3352 and 2N3806-2N3811. Contact us for data sheets on TI's discrete dual transistors or circle 151 on the Service Card.

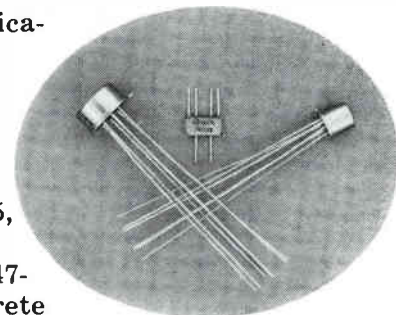

For better solutions, call your authorized TI distributor



R. V. WEATHERFORD CO.

DISTRIBUTORS OF ELECTRONIC COMPONENTS AND EQUIPMENT

ANAHEIM, CALIFORNIA
1550 Babbitt Street
714-532-6741
714-547-7521

GLENDALE, CALIFORNIA
6921 San Fernando Road
213-849-3451

PALO ALTO, CALIFORNIA
3240 Hillview Drive
Stanford Industrial Park
415-321-5373

PHOENIX, ARIZONA
1917 North 25th Drive
Carson Industrial Center
602-272-7144

POMONA, CALIFORNIA
1095 East 3rd Street
714-623-1261
213-966-8461

SALES OFFICES: San Diego, California, 714-278-7400 • Seattle, Washington, 206-762-4200

NON-ATTN. CUSTOMER COMPONENTS
**WEATHERFORD
SERVICE
PLUS**

orities, cut duplication of effort and increase technology transfer, and provide better public communications and visibility for scientific achievements.

Daddario is among the first to concede that no one has any firm answers on which direction to take, although there is a strong tendency at the moment to give cabinet-level status to science and technology, with a secretary functioning more as a spokesman than a czar.

Watch for Niras. Should a stronger organization be proposed, however, Daddario already has a prototype before him: the National Institutes of Research and Advanced Studies (Niras). It would include, at most, the National Science Foundation, NASA, the AEC—shorn of its weapons-development programs, which would be transferred to the Defense Department—the National Institutes of Health, the National Bureau of Standards, HEW's Bureau of Higher Education, and the Smithsonian.

Air traffic control

Industry side

The air traffic control crisis which occurred in major cities during the summer of 1968 did more than touch off angry letters from passengers: it got both the airlines and the Federal Government to set up separate task groups to try to make suggestions to prevent the '68 event from becoming an annual or never-ceasing thing.

Under the aegis of the Air Transport Association, an air traffic control system planning group was established, and the Department of Transportation put together a task force to look for solutions to the problems of air traffic control in the 1980's. The report of the Department of Transportation is due within the next 30 to 40 days.

Machines. The final report of the Air Transport Association has just been finished, and it offers 21 broad long-ranging recommendations as well as some comments on the present situation, and situation as it will evolve unless something is

done. In a nutshell, the report gives an unqualified boost to the use of electronic data processing and "automation" in the all-too-human air traffic control system. Most of the 21 individual recommendations will require electronic answers; one of the conclusions of the group states, "There is no apparent alternative to the application of automation to the ground and in the air, with humans undertaking a passive and supervisory role."

According to a spokesman for the Air Transport Association: "One of the most significant aspects of the report is that the airlines have come up with their philosophic stance on air traffic control and that stance advocates a much greater commitment to automation than is currently being thought of by the Federal Aviation Administration." He adds, "It comes out strongly for digital communications and automation in both the cockpit and on the ground. The Government has been pushing for automation on the ground. We want it both places."

The plan, in calling for a heavy electronics commitment, would provide the electronics industry with a major market and a tough challenge if implemented. In calling for a "very sophisticated airborne guidance-and-control system" the panel admits there would be design difficulties. It envisions small solid state computers, linked to the plane's automatic flight-control system, as the operational heart of the airborne side of the plan. Airborne and ground computers would relate via digital data links. On the ground, a sophisticated system, based around a data-processing complex, would be required to receive and handle all data required to monitor traffic and generate the displays and information needed by controllers. Also called for is advanced navigation for aircraft. This could be a boost for any of a variety of navigation schemes, including satellites, now on the drawing boards.

Waiting. The program would cost both the airlines and Government a great deal of money, and the report in itself constitutes a commitment by the airlines to the

The Wizards of OZ

Like magic — vector impedance instruments read out complex impedance in an instant.

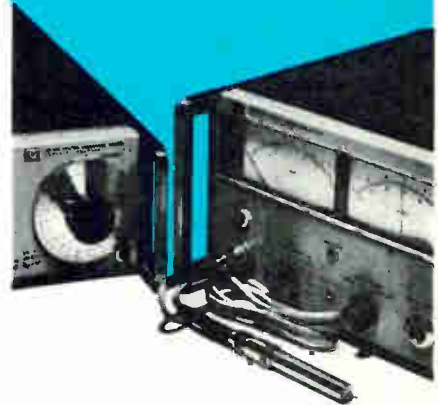

Bench or production line measurements involving impedance magnitude, Z , and phase angle, θ , no longer require tedious test procedures. These measurements are now as easy to make as voltage readings. No nulling . . . no balancing . . . no calculations to make. The wizardry of these HP instruments provides direct readout in terms of Z (in ohms) and θ (in degrees) over a continuous frequency range.

HP 4800A Vector Impedance Meter covers the 5 Hz to 500 kHz range. You set the frequency, select the impedance range and read: Z from 1 ohm to 10 Megohms, and θ from -90° to $+90^\circ$. \$1650.

HP 4815A RF Vector Impedance Meter covers 500 kHz to 108 MHz. Measures, via a probe, active or passive circuits directly in their normal operating environment. Z from 1 ohm to 100 K ohms; θ from 0° to 360° . \$2650.

Application Note 86 describes many applications of the 4800A and the 4815A Vector Impedance Meters including the measurement of Z , R , L , and C . For your copy and complete specifications, contact your local Hewlett-Packard field engineer or write: Hewlett-Packard, Green Pond Road, Rockaway, New Jersey 07866. In Europe: 1217 Meyrin-Geneva, Switzerland.

HEWLETT **hp** PACKARD

IMPEDANCE INSTRUMENTS

1093

Jack-in-the-box HF antenna

Goes up in 2 hours.

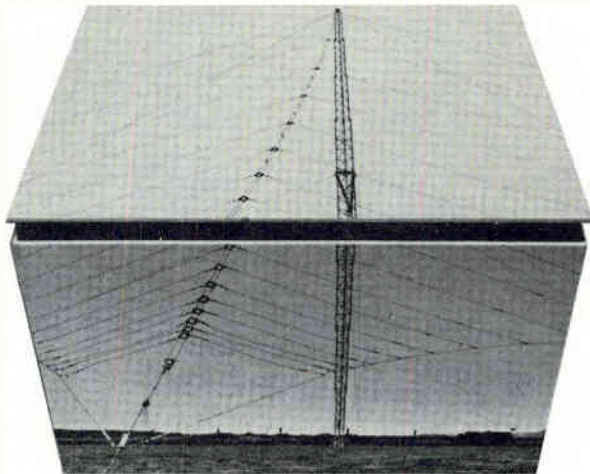

Transport it by air . . . or store it for emergency standby. You'll have reliable performance even after repeated field use.

Granger's 747CA antenna comes out of storage and sets up fast as a 0-to-2000 mile communications back-up if a hurricane knocks out a fixed antenna. Or, move it by air or surface wherever you need quick communications. The 747CA is a compact package, and five men can set it up in 2 hours. With gain of up to 13db from 4 to 30 MHz, VSWR under 2.1:1, and no lobe splitting, it performs as well as a permanent installation. A Delta extension kit adds omnidirectional coverage from 2 to 4 MHz for close-in communication.* The 747CA antenna withstands harsh environments. . . winds up to 100 mph. Its rigid, nested tower and all materials are corrosion resistant. Available in models from 1 to 20 kw average (2 to 40 kw PEP), this high-performance portable or stowable antenna is a good package deal. Write for complete data.

*The Delta Kit is included with antenna Model 747CB. The Kit is also available as a retrofit for 747CA's. CA/CB models are available for fixed installations.



GRANGER
ANTENNA AND TRANSMISSION
DIVISION

1360 Willow Rd., Menlo Park, Calif. 94025 / 1601 Calif. Ave., Palo Alto, Calif. 94304
1 Brooklands Rd., Weybridge, Surrey, U.K. / 1-3 Dale St., Brookvale, NSW, Australia

U.S. Reports

expensive automated program. Those who have prepared the report await Government recommendations while unabashedly trying to get the Transportation Department to pick up their program. When the Government decides to move, the ATA report may come in handy—it offers a 15-step program to the FAA and the airlines to serve as a transition between the present system and the one envisioned.

Hits and misses

Understandably displeased to have to report 2,230 near mid-air collisions over the U.S. in 1968, the Federal Aviation Agency accompanied its latest statistical study with a 20-point program to combat the problem.

Noting that the number of unreported near misses was probably five times that high—over 10,000—and the number of actual collisions a grisly 35, the FAA started pushing for a wide-ranging improvement in collision-avoidance techniques. Its program included, for the most part, procedure training and operation reviews, publication of more data, continuation of ongoing FAA programs and suggestions for the future—for example, “recognize the need for improved cockpit visibility in the development of all future aircraft.” In short, the list was less than dynamic. However, tucked in as the 19th point was the suggestion: “direct an extensive effort toward the development of an airborne collision-avoidance system, with cockpit displays, as a prime solution to the near midair collision problem.”

Works in progress. As a promoter of the development of suitable collision-avoidance hardware, the FAA is a latecomer. The two major efforts in this area right now are being conducted by the Air Transport Association and NASA—albeit both with cooperation from the FAA. Currently three CAS systems are being tested by Martin-Marietta in Baltimore [*Electronics*, July 21, p. 62] for eventual installation by private air carriers.

NASA is taking several approaches. One is proximity-warn-

U.S. Reports

ing indicators which it hopes will eventually be available for a few hundred dollars a unit for all aircraft (its Langley Research Center is at work on a PWI based on the doppler transponder concept); also its Electronics Research Center is requesting proposals for a prototype xenon light anticollision device; and several studies are now being conducted on lasers. It has also just signed a contract with McDonnell Douglas to define a CAS for general aviation. The system will be based on the company's EROS (eliminate range zero system) which has been used on the F-4.

While all of these approaches offer promise, they are all a distance down the road and, regrettably, the major news in the air collision area for some time to come will probably be more statistics.

Companies

Feast—or famine

United States exports of computers and parts will show a sharp 44% rise to \$700 million this year if first-half figures are any indication. The total last year: \$486.5 million.

In the first 1969 half, overseas demand—particularly in the European Common Market—far exceeded the ability of foreign producers, including U.S. subsidiaries, to meet demand. The result was that shipments jumped to \$318.2 million from the \$219 million recorded in the first six months of last year, according to data from the Commerce Department. The increase of nearly \$100 million far exceeded that recorded in 1968 when computer exports rose only \$3.4 million in the first six months and \$54 million for the year when compared with 1967.

Despite this, speculation still exists that the American computer makers' export feast will eventually turn to near-famine as Europeans continue to develop their own capabilities. West Germany, for example, continues to be America's largest computer customer by far, yet a number of U.S. manufactur-

ers—led by IBM—are working feverishly to get new German plants on stream to meet local demand.

In addition to the Common Market, whose computer imports from the U.S. rose 47% to \$115.1 million in the first half, other buyers of American hardware in the period include: United Kingdom—\$47 million, an increase of 27%; Canada—\$46.3 million, up 48%; and Japan, which went for \$39.8 million worth of systems, 40% more.

For the record

Performance monitor. The prototype performance and failure assessment monitor (Pafam) for installation in the McDonnell Douglas DC-10 airbus will be delivered by the Honeywell Aerospace division in January 1970. Honeywell received orders totaling \$10 million through 1974 for Pafam, at a unit cost slightly under \$35,000. Competitors were Bendix, GE, and United Controls. The system can assess overall performance of the automatic landing system, and also can be made to monitor any manually flown approaches, since it is completely independent of the landing system.

The unit has a dual input-output signal path constant self-testing, and is equipped with two small 2-color cathode-ray tube displays. Sixty-one analog and 140 discrete validity and mode status indicators are monitored. Quality of the instrument-landing system beam is constantly monitored by studying the noise and beam-bending characteristics. Wind shear and turbulence conditions are also evaluated through real-time modeling. A serial computer including two central processing units, 8,192 words of read-only memory, and a 2,048-word scratchpad memory is used. In addition to the standard crt displays, the unit has outputs permitting installation of electronic attitude director indicators, head-up displays, or modified attitude indicators. There is also provision for incorporating independent monitoring schemes such as low-light-level television, high-penetration radar, and infrared devices.

EG&G SILICON DIFFUSED PHOTODIODE

- HIGH QUANTUM EFFICIENCY
- WIDE SPECTRAL RANGE • FAST RESPONSE TIME • LOW NOISE



SINGLE CELL



BI-CELL



QUAD-CELL

SGD-444 SERIES

The SGD-444 Series complements the versatile EG&G SGD-100A Photodiode. Improved diffused guard ring construction permits higher sensitivity, lower noise and faster response factors than ever before available in large (1 cm² active) area diodes.

Bi-cell and quadrature cell configurations with isolations of greater than 20 to 1 are standard. The photodiodes are oxide-passivated and hermetically sealed in a TO-36 package.

Sensitivity 0.5μA/μW @ 0.9μ
(70% Quantum Efficiency)
Spectral Range 0.35 to 1.13μ
Leakage 0.5μA @ 100 volts
Rise Time 10 nanoseconds
NEP 1.0 x 10⁻¹² watts
Linearity of Response Over 7 decades

Applications include CW, pulsed light and laser detection and measurement, star tracking, optical navigation and guidance, and range-finding systems. The SGD-444 series is in quantity production for fast delivery at low price.

For information, write EG&G Inc., 166 Brookline Avenue, Boston, Massachusetts 02215. Or phone 617-267-9700. TWX: 617-262-9317. On West Coast, telephone 213-464-2800.



ELECTRONIC PRODUCTS DIVISION

**TTL.
PDAQ.**

RSVP: Your National distributor

Gates

DM8000N (SN7400N)	Quad 2-Input, NAND gate
DM8001N (SN7401N)	Quad 2-Input, NAND gate (Open Collector)
DM8003N (SN7403N)	Quad 2-Input, NAND gate (Open Collector)
DM8010N (SN7410N)	Triple 3-Input, NAND gate
DM8020N (SN7420N)	Dual 4-Input, NAND gate
DM8030N (SN7430N)	Eight-Input, NAND gate
DM8040N (SN7440N)	Dual 4-Input, Buffer
DM8050N (SN7450N)	Expandable Dual 2-Wide, 2-Input AND-OR-INVERT gate
DM8051N (SN7451N)	Dual 2-Wide, 2-Input AND-OR-INVERT gate
DM8053N (SN7453N)	Expandable 4-Wide, 2-Input AND-OR-INVERT gate
DM8054N (SN7454N)	Four-Wide, 2-Input AND-OR-INVERT gate
DM8060N (SN7460N)	Dual 4-Input expander
DM8086N (SN7486N)	Quad Exclusive-OR-gate

Flip Flops

DM8501N (SN7473N)	Dual J-K MASTER-SLAVE flip flop
DM8500N (SN7476N)	Dual J-K MASTER-SLAVE flip flop
DM8510N (SN7474N)	Dual D flip flop

Counters

DM8530N (SN7490N)	Decade Counter
DM8532N (SN7492N)	Divide-by-twelve counter
DM8533N (SN7493N)	Four-bit binary counter
DM8560N (SN74192N)	Up-down decade counter
DM8563N (SN74193N)	Up-down binary counter
DM8520N	Modulo-n divider

Decoders

DM8840N (SN7441N)	BCD to decimal nixie driver
DM8842N (SN7442N)	BCD to decimal decoder

Shift Registers

DM8570N	Eight-bit serial-in parallel-out shift register
DM8590N	Eight-bit parallel-in serial-out shift register

Miscellaneous

DM8200N	Four-bit comparator
DM8210N	Eight channel digital switch
DM8220N	Parity generator/checker
DM8820N	Dual line receiver
DM8830N	Dual line driver
DM8800H	Dual TTL to MOS translator
DM8550N (SN7475N)	Quad latch

Drivers

NH0006C	High voltage, high source current driver
NH0008C	High voltage, high source current driver
NH0011C (SH2002)	High voltage, high sink current driver
NH0011CN (SH2002P)	High voltage, high sink current driver

TTL devices for industrial applications. Stocked in depth—available immediately, through National distributors. For our TTL Specification Guide and pricing, write or call National Semiconductor, 2975 San Ysidro Way, Santa Clara, California 95051. (408) 245-4320. TWX: 910-339-9240. Cables: NATSEMICON.

National/TTL

P.S. We've got low power TTL too. Meets 883 mil standards; off-the-shelf availability.

In 10 days we can teach you how to design your own MOS/LSI arrays.

Engineering Design Workshop uses standardized equations and procedures to assist systems engineers in the evaluation and design of their own MOS/LSI circuitry.

The systems designer who understands the advantages, limitations, costs, and performance of LSI will be able to translate existing designs or meet new systems objectives with greater speed, efficiency, and profit to his company and to himself.

This is the purpose of the course of study and work sessions developed by Integrated Systems Technology Inc., a company which has made a specialty of assisting others to acquire design and/or fabrication capabilities.

The MOS/LSI Engineering Design Workshop is presented by the Integrated Systems Technology staff and has achieved international recognition as a highly effective, practical way for equipment designers to become familiar with the LSI technology in a relatively short period of time.

Combining lectured material with IST's "topological" rules and private engineering consultation,

each attendee will design an LSI array or library of standard functions. The IST design approach permits multiple sourcing. Design experience will include system partitioning, calculation of array performance, and generation of an array plan diagram. A number of computer programs has been prepared to facilitate calculation of array performance, and a computer terminal will be provided as a design aid.

Each attendee will also receive a complete, 220-page set of notes detailing IST's design equations, circuit forms and analyses, and topological design rules.

The MOS/LSI Engineering Design Workshop will be in session from September 15-26, 1969 under the sponsorship of Electronics/Management Center. It will be held

at IST facilities in Santa Clara, California. Fee for individual registrant is \$3000. Special rates for multiple company registrations. To register, or for additional information, call Mr. Samuel Weber, at 212-971-3485 or write to Electronics/Management Center, 330 West 42nd Street, New York, N.Y. 10036.

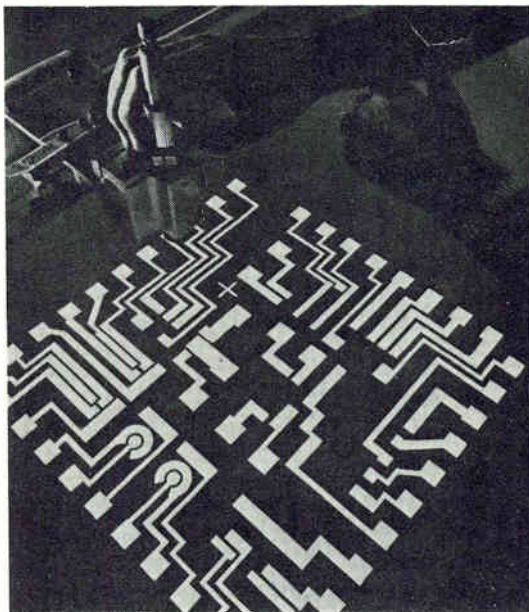

**The MOS/LSI Engineering Design Workshop
September 15-26, 1969**

Presented by Electronics/Management Center
in cooperation with Integrated Systems Technology, Inc.

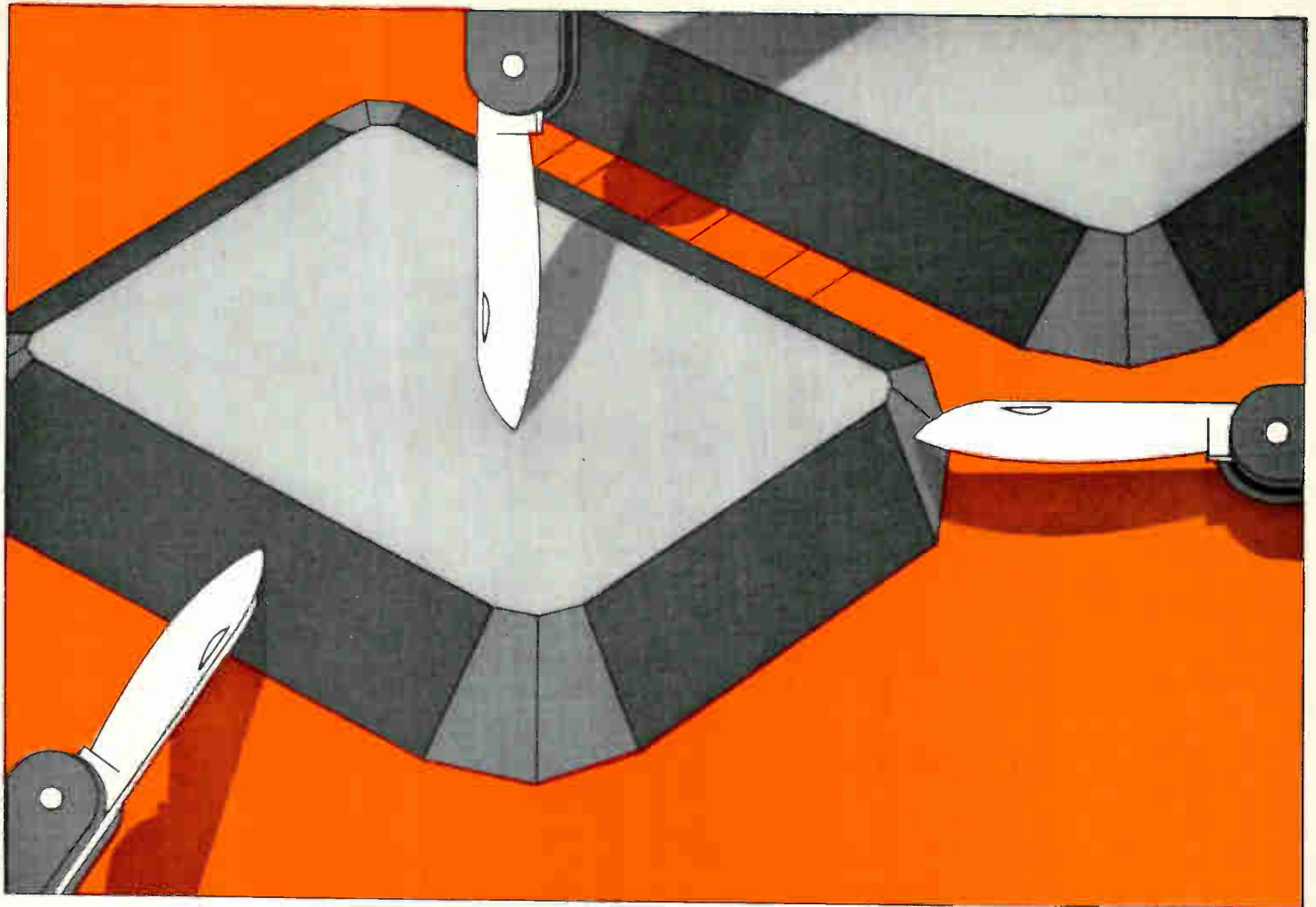

We sharpen a chemical knife.

We make many integrated circuits at a time . . . on a single wafer of silicon crystal. Then, we divide the wafer into individual circuits (and, sometimes, the circuits into electrically isolated components) by etching narrow slots through the silicon.

But conventional etchants don't cut downward only. They cut sideways, too, making a slot that's wide as well as deep. So, for safety, we have had to leave plenty of space between circuits. Then, Bell Laboratories scientists Herbert A. Wagner, Roger C. Kragness, and A. Lamont Tyler discovered a means of "one-directional" etching.

The new technique makes wedge-shaped slots, separating the circuit elements along precise lines. It depends on a "preferential" etchant, which most strongly attacks the semiconductor perpendicular to a particular crystal-lattice plane. The slot is wedge-shaped

because its walls are other planes toward which the etchant is almost inert.

The process is self-limiting; once a slot goes through a wafer, there is very little further etching. So, we can leave the wafer in the etchant long enough for complete separation of the parts without the careful thickness control formerly required. And, because of the fixed slope of the slot walls, minimum slot width can be much less than wafer thickness.

In the drawing, the light, medium, and dark surfaces represent three crystal-



lographic planes in silicon. The solution etches perpendicular to each of these at different rates. The surface shown light, for example, etches away most rapidly. To cut out an area, a mask is applied onto the fastest—"light"—plane, with the mask edges parallel to the slowest—"dark"—planes of the crystal.

In one example of the new technique, hundreds of 1-mm-square circuits, each with 10 transistors, 14 diodes, and 12 resistors on nine air-isolated areas, were etched at once on a single wafer. Slots were about 17 microns wide with strong "beam leads" for structural and electrical connections. The slot in the photo is only 6 microns wide.

This technique is another step toward making ever better and smaller integrated circuits.

From the Research and Development Unit of the Bell System—



Bell Labs

Semtech introduces...the "METOXILITE*" Rectifier.

Metoxilite is fused to the metallurgically bonded junction-tungsten pin assembly forming a "tough" sub-miniature package. A "state-of-the-art" rectifier that can be used anywhere — you'll see them used in stringent military and space environments, industrial and commercial applications. The Metoxilite rectifier is the result of over three years of applied research and extensive testing. Available in two current ratings — 6 amps / MIL-STD-750A (3 amps @ 55°C / no heat sink) and 3 amps / MIL-STD-750A (1 amp @ 55°C / no heat sink) — the Metoxilite rectifiers feature PIV up to 1000 volts and extremely low reverse leakage with Medium (t_{rr} 2 μ sec) or Fast (t_{rr} 150 nsec) Recovery characteristics.

NEW

3 AMP SERIES
Fast Recovery
IN5415 thru 19
Medium Recovery
IN5550 thru 54

Exceeds all MIL and space requirements
Electrically approaches theoretical
Available in production quantities
Immediate delivery



Sock it to me

*"METOXILITE" — fused metal oxides.

San Francisco—941 E. Charleston, Suite 10, Palo Alto, California 94303 / (415) 328-8025
Chicago—140 N. La Grange Road, La Grange, Illinois 60525 / (312) 352-3227 / TWX: 910-683-1896
Dallas—402 Irving Bank Tower, Irving, Texas 75060 (214) 253-7644
New York—116-55 Queens Blvd., Forest Hills, New York 11375 / (212) 263-3115 / TWX: 710-582-2959
European Sales—Bourne A. G. Alpenstrasse 1, Zug, Switzerland / (042) 4 82 72/73



SEMTECH
CORPORATION

652 Mitchell Road, Newbury Park, California 91320
(805) 498-2111, (213) 628-5392 / TWX: 910-336 1264

HF DUAL FETs

for wideband diff amps,
and balanced RF circuits



Wideband Differential Amplifier Ideal for a preamplifier where high input impedance and low noise over a wide frequency range is desired. At 25 MHz the input impedance is approximately 250K in parallel with 3 pF.

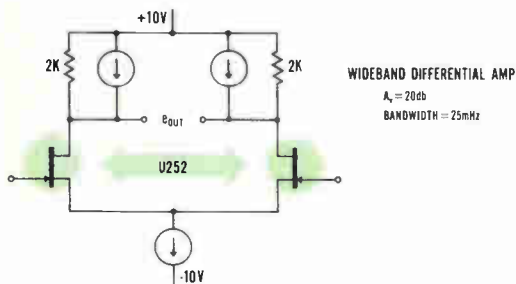

CHARACTERISTIC	SYMBOL	MIN	MAX	CONDITIONS
Transconductance	g_{fs}	5,000 μ mho		$V_{DG} = 10V$ $I_D = 5 mA$
Input Capacitance	C_{iss}		5 pF	
Offset Voltage	$ V_{GS1} - V_{GS2} $		10 mV*	
Differential Voltage Drift	$ V_{GS1} - V_{GS2} /\Delta T$		20 μ V/ $^{\circ}$ C*	

* The U253 has an offset of 20 mV and a differential drift of 40 μ V/ $^{\circ}$ C Max.

Balanced Mixer The FET's square law characteristic allows this mixer to handle large dynamic signal power while producing low spurious products. Oscillator power drive requirements are extremely low, thanks to the FET's high input impedance.

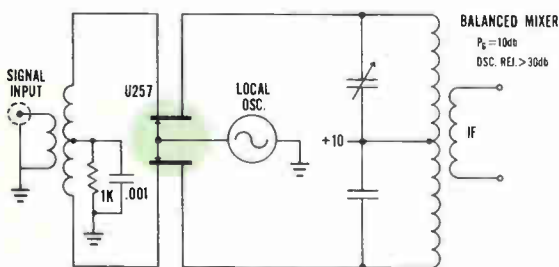

CHARACTERISTIC	SYMBOL	MIN	MAX	CONDITIONS
Transconductance	g_{fs}	5,000 μ mho		$V_{DG} = 10V$ $I_D = 5 mA$
Input Capacitance	C_{iss}		5 pF	
Offset Voltage	$ V_{GS1} - V_{GS2} $		100 mV	

These high frequency duals may be used up to 450 MHz depending upon the application and performance desired. If your present design situation is VHF or UHF, if you want instant applications information, call the number below. It's a direct line to our applications group. *That's applications power.

... in Europe Siliconix Ltd.
Siliconix House
Sketty Park
Saunders Way
Swansea, U.K.



Our new address . . .

Siliconix incorporated

2201 Laurelwood Road • Santa Clara, Calif. 95054
Phone (408) 246-8000 Ext. 201 • TWX: 910-338-0227

The
Choice
is **TTL.**

TI announces the “one-shot” heard 'round the world.



(Listen. It could revolutionize your designs.)

The pulse width of this new monolithic TTL monostable multivibrator is variable from 40 nanoseconds to 40 seconds. Stability is $\pm 0.2\%$. Tagged SN74121, it is primed to trigger off 50 nanosecond pulses or from slow ramps up to one volt per second. Full fan-out to 10 loads and fully compatible with all Series 54/74 ICs. The new “one-shot” comes in a choice of packages: flat-pack and plastic or ceramic dual-in-line. Immediate delivery and

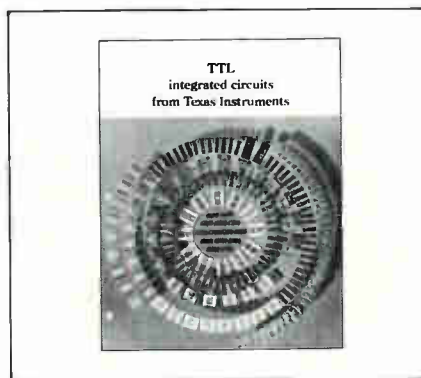

reasonably priced. In 100-999 quantities, the plastic dual-in-line is \$4.40.

Deploy the SN74121 and start your own revolution. For data sheet, application report and a copy of our new 80-page TTL brochure, circle 182 on the Reader Service Card or write Texas Instruments Incorporated, P. O. Box 5012, M. S. 308, Dallas, Texas 75222.



TEXAS INSTRUMENTS
INCORPORATED

- To sweep 5 to 1500 MHz**
- **you don't switch ranges**
 - **or change plug-ins**
 - **or use a second instrument**

YOU JUST SWEEP

The 3305 plug-in oscillator lets you operate over this entire range, using either end point or center frequency calibration, at widths as narrow as 200 kHz, as wide as 1495 MHz.

The 3305, in fact, makes the Telonic 2003 Sweep Generator "every man's" instrument while still permitting total flexibility if your requirements change. All functions of the instrument are on plug-in units — there are 7 oscillators including a new one covering audio frequencies, 6 different attenuators, fixed and variable markers, detectors, and other plug-ins regulating sweep rate and display processing. Complete 2003 Sweep/Signal Generator Systems start as low as \$1396.00. Price will depend on plug-ins selected.



Catalog 80A contains a comprehensive description of the 2003 and specs on all plug-ins. Send for a copy.

TELONIC INSTRUMENTS  TM
 A Division of Telonic Industries, Inc.
 60 N. First Avenue
 Beech Grove, Indiana 46107
 Tel: 317 787-3231 • TWX 810 341-3202

MICROWAVE IC MODULES PROGRESS REPORT #8: PRODUCTION

Sperry Rand's PACT (Progress in Advanced Circuit Technology) program has moved microwave integrated circuits and modules out of the laboratory and onto the production line. As far as we know, Sperry Rand is the first company in the industry to take this revolutionary step.

Our functional assignment was to design the world's first radar performance analyzer for end-to-end testing of doppler radars. For a Navy program, our customer wanted a portable tester that could exercise navigation radar without radiating energy and without making any interconnection with the aircraft. Since size, weight and power consumption are critical, all the microwave functions were integrated. The result: three microwave integrated modules replacing 32 conventional microwave components.

At one time or another, Sperry Rand had produced fully integrated versions of every microwave component in the test set. Why not reduce the whole circuit to integrated modules? First, integrated modules have fewer interconnections, and are therefore more reliable. Second, integrated modules cost less to produce than present day collections of discrete components. Third, by making all of the circuit elements ourselves, we sidestepped a lot of procurement problems.

Development of the microwave integrated circuit modules for the doppler test set proved to be well within Sperry Rand's capability.

The unit works well. In the old days (last month) the microwave section would have occupied 90 cubic inches. Today it takes up 3 cubic inches. Our ferrite-

substrate modules have a low-pass filter, 6 circulators, 11 attenuators, 5 diodes, 2 mixers, 2 converter and 4 thermistors. The old way would have required 25 more flange connections than the integrated modules use. The microwave circuit functions within the same tight tolerances that it would have under the older technology.

Now that we're delivering integrated modules, you can't afford to pass up our experience. In fact, if we're not helping design your microwave system it's probably obsolete.

A letter will start us working on your next system improvement. Write: Sperry Microwave Electronic Division, Sperry Rand Corporation, P. O. Box 464 Clearwater, Fla. 33518 or call us at (813) 784-1461

ABOVE RULER: The old way. Thirty-two conventional microwave components.

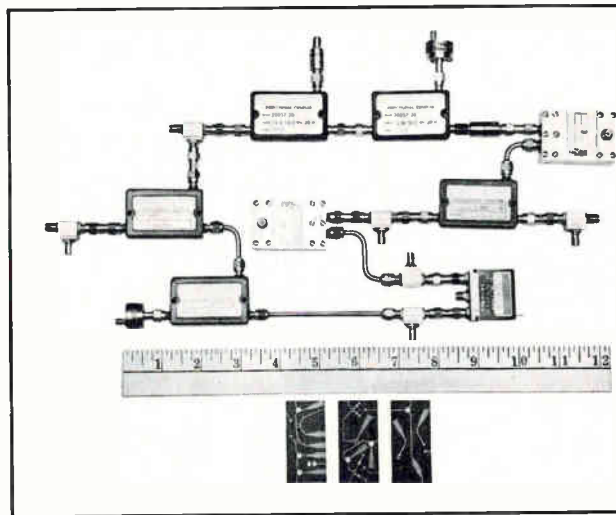

BELOW RULER: Sperry's new way. Three integrated modules. Lighter, expensive, more reliable.

*For faster microwave progress,
make a PACT with people
who know microwaves.*

SPERRY
MICROWAVE ELECTRONICS DIVISION
CLEARWATER, FLORIDA

Washington Newsletter

August 18, 1969

DCA's money cut: can't decide on computer specs

The Defense Communications Agency is still unable, for the second year in a row, to specify what kind of computer hardware it wants for the Worldwide Military Command and Control System. A major obstacle is getting agreement on system requirements from the three services, which will operate most of the computers. **So, the Budget Bureau has cut a \$6.4 million DCA request earmarked for the system's first two computer purchases and deferred it to fiscal 1971 for competitive procurement.**

The agency's role in the system would be to interconnect the National Military Command System with computers in other military commands. The 150-computer network—estimated last year to cost between \$300 million and \$400 million—would be the largest computer procurement ever [*Electronics*, June 23, 1968, p. 69].

Other services, like the Army, are also having trouble with the Budget Bureau now that the Nixon Administration has given the bureau new authority to control spending levels. The Army wanted \$5.7 million for operations and maintenance of its portion of the worldwide system but got only \$3.5 million. **The Budget Bureau says the Army doesn't need the money since the holdup in computer specs precludes the service getting hardware to operate and maintain this year.**

Air pollution net may be in the wind

A nationwide network to monitor air pollution may be set up by the National Air Pollution Control Administration, an agency of the Department of Health, Education, and Welfare. **As the first step, the agency has awarded the Mitre Corp. a \$200,000 systems engineering study to design and specify "an optimal air-quality data acquisition and monitoring system."** Mitre will take a year to examine, among other things, the most cost effective hardware for implementing such a national network.

The agency already operates several monitors, as do various local governments. However, neither the existing monitors nor the data they provide are adequate for the system.

Northrop picked for Jifdats job

Reliable sources say that Northrop's Electronics division has been picked by the Navy to develop the triservice, joint in-flight data acquisition and transmission system (Jifdats). **Northrop's all-digital proposal won out over partially analog systems proposed by Hughes Aircraft and by Motorola's Government Electronics division.** No official announcement is expected to be made until a contract has been negotiated, which could be next month.

There are indications that Hughes and Motorola might protest the award on the ground that the scope of the oft-delayed and reoriented program [*Electronics*, July 21, p. 62] changed even after the most recent proposals were in.

Stiff review plan rides with ABM

While the electronics industry wonders just what it can expect in the way of contracts from the Safeguard antiballistic-missile program, **potential contractors might do well to keep an eye on an amendment to the Senate's ABM legislation, approved by one vote, that would subject major defense contracts to quarterly review and independent audits** [*Electronics*, July 21, p. 61]. The amendment now goes to the House.

Washington Newsletter

The plan, submitted by freshman Sen. Richard Schweiker (R., Pa.), lacks support from senior members of the powerful Armed Services Committee. It would broaden the power of the **General Accounting Office**, which now may audit books only of negotiated contracts, to permit audits of bid contracts and subpoenas of contractors' records. Only the committee has subpoena power now.

Contractors also would be required to supply quarterly updated estimates with explanations of changes in prices, delivery, or performance schedules, and a list of procurement options and their costs.

Now Air Force says it wants Corsair 2

Gen. John D. Ryan, recently confirmed Air Force Chief of Staff, may have made some friends at General Precision, Hamilton Standard, IBM, and other A-7 Corsair 2 avionics subcontractors. But in the process he probably lost some at Bendix, Collins Radio, and Litton—all F-4 Phantom subs—and embarrassed not only himself but his boss, Defense Secretary Melvin Laird.

The reason: Ryan has asked the House to restore \$479 million to the Air Force budget for 155 A-7's, already canceled by the Senate Armed Services Committee [*Electronics*, July 21, p. 38]. Furthermore, it was Ryan's predecessor, Gen. John P. McConnell who, in closed hearings, downgraded the A-7's performance and suggested that the committee replace the craft with 120 more F-4's.

For its part, the Armed Services Committee is peeved. In fact, its chairman, Sen. John Stennis (D., Miss.) charges that the Air Force is arguing for the A-7 with "the same set of facts it used to knock the plane."

Reports urge new look for FAA

Those advocating changes in the FAA's National Airspace System are fast becoming a chorus and the result may be a whole new look for the agency.

A report from the Electronic Industries Association, for one, urges the FAA to adopt a systems engineering organization along with a research department and an operations department to implement the results of the research. The Air Transport Association, for another, has just offered a broad plan for systematizing air traffic control [see p. 59], and within the next two months the FAA's administrative parent, the Department of Transportation, will offer its own report on the future of air traffic control. **Insiders say transportation's report will recommend "systems thinking and better long-range planning."**

Taken as a whole, the reports deplore the FAA's poor showing in such areas as air traffic control, communications, and all-weather landing operations—a position that shouldn't surprise anyone.

Addenda

NASA's \$400,000-study award to General Dynamics—to come up with three or four multipurpose designs for National Space Station modules—makes the company the favorite to be named architect for the total system, most likely as a subcontractor to McDonnell Douglas or North American Rockwell, whichever is named prime. . . . It was bound to happen: Lloyd's of London is about to add the Comsat satellites to the list of unique insurables that has included Betty Grable's legs and Liberace's fingers. Because of several satellite losses, Comsat has had to line up a syndicate of insurers made up of Lloyd's and a group of U. S. companies to get its coverage.



Two best sellers with the same silly problem



When your 1969 model looks the same as your 1968 model—getting across the engineering advances and improvements that are on the *inside* is a problem.

For instance, in 1966 we started using fully-annealed Armco steel for all Guardian Solenoid plungers . . . an "inside" improvement. Then, to compound the problem, we covered up this improvement with copper/nickel plating.

In 1968 we did it again. We took those

long-life plungers and started running them in a cavity lined with low-friction phenolic. This alone increases operating life by maybe half a million operations.

And there's more: The new acetate-yarn-sealed coil cover that's standard this year means better protection, complies with U/L construction at no extra cost.

Our "bug" changes. Inside. Where an engineering advance makes for a better solenoid. Write for Bulletin G2, TS.

NEW! TUBULAR SOLENOIDS



Eleven new Guardian Tubular Solenoids to fit every application. Practically install themselves. Just insert threaded bushing through installation hole and tighten furnished nut.



**GUARDIAN[®]
ELECTRIC**

MANUFACTURING COMPANY 1550 W. Carroll Ave., Chicago, Illinois 60607

Circle 73 on reader service card

**Reliability is six things we do
that nobody else does.**

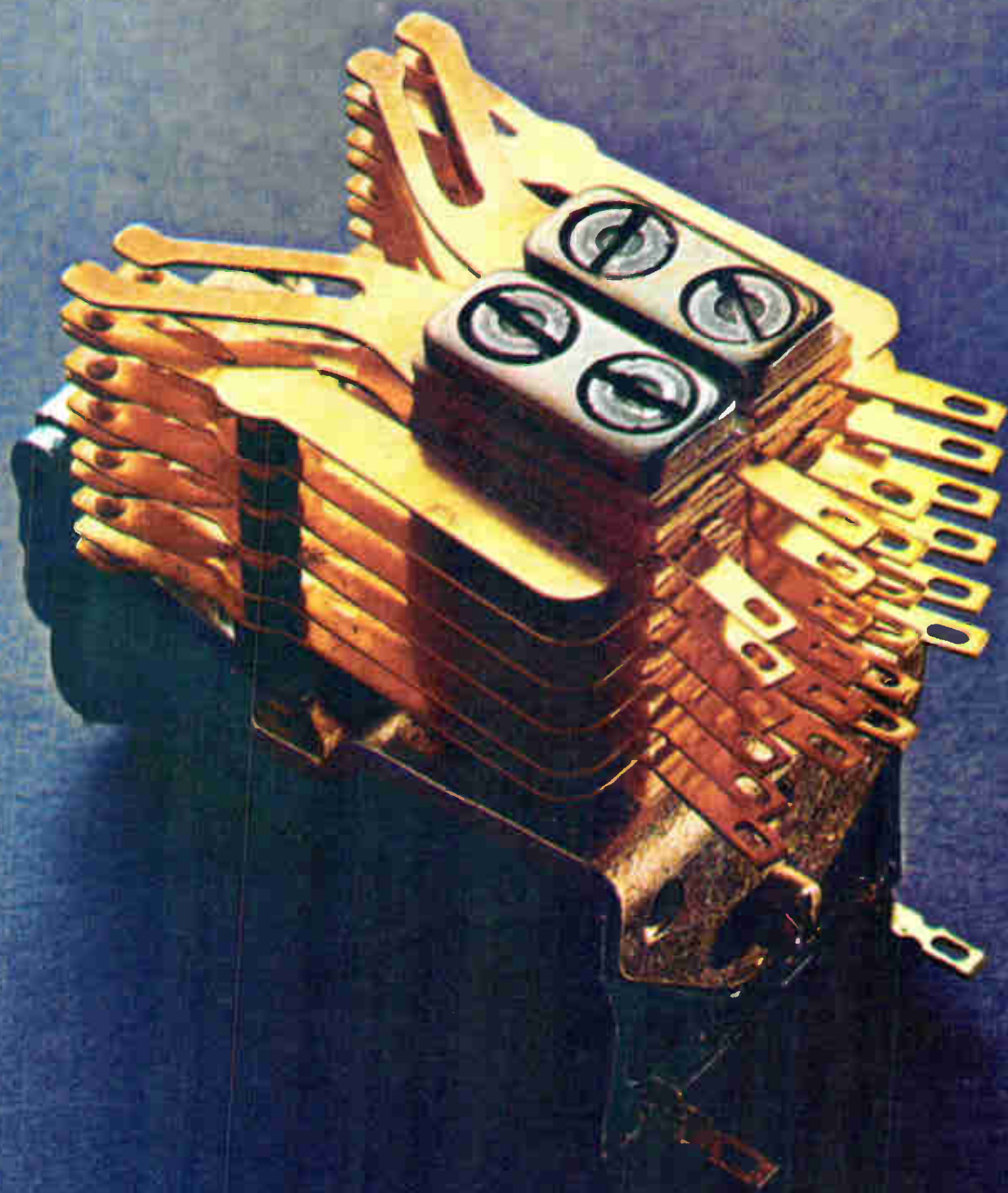



We're fanatics.

We build our relays stronger than we have to. That way, they last longer than they ever have to. Our Class E relay (shown on the opposite page) is a good example of our way of thinking.

The industry's strongest heelpiece.

We make the strongest heelpiece in the industry. A gigantic machine bangs them out extra fat and extra flat.

Extra fat to carry a maximum of flux. To handle big loads. Extra flat so that once an AE relay is adjusted, it stays adjusted.

Since our backstop is part of the heelpiece, it's just as thick and flat. But, tough as it is, the slightest wear here would throw the entire contact assembly out of whack. So, to be safe, we weld two tiny, non-magnetic pads where the armature arms meet the backstop. You might say we created the no-stop backstop.

Three parts that'll wear like crazy.

When you build a relay like a small tank, you have to think of everything. We try. Right down to the tiniest part. For example, we make our armature arms and bearing yoke extra thick.



Thicker than years of testing and use say they have to be. Then, to make sure they don't cause wear problems, we insert a hardened shim between the hinge pin and the frame. The pin rides on the shim, instead of wearing into the heelpiece. (You can forget the bearing, it's permanently lubricated.)

Buffers with lots of muscle.

We make our buffers of a special tough phenolic material that lasts. And lasts. And lasts. All without wear or distortion. Another reason why our relays stay in whack.

To make sure our buffers stay in place, we weld the buffer cups to the armature arms. We weld, instead of using rivets, because our lab found that rivets have a habit of falling out.

For the very same reason, we weld buffer cups to the contact springs. And also use the same special tough phenolic buffers.



No, we didn't forget the contact springs.

We have some strong feelings as to what makes a contact spring reliable. Our sentiment is that two contacts are better than one. So, we bifurcate all the springs, not just the make and break. This slotting and the addition of another contact to each spring means you get a completed circuit every time.

We make each set of contact points self-cleaning. The bad stuff doesn't have a chance to build up.

Now, what's different about our bobbin?

Our bobbin is one piece—molded of glass-filled nylon. This provides the maximum in insulation resistance.

Because our bobbin is nylon, we don't have to impregnate with varnish. Moisture and humidity have no effect on the stubborn nylon material. No effect means no malfunctions for you to worry about.



What all this means to you.

What this all adds up to is reliability. The kind of toughness no one else can give you. It means an AE relay works when it's supposed to, longer than it has to.

Isn't this the kind of reliability you really need? Automatic Electric Company, Northlake, Ill. 60164.

AUTOMATIC ELECTRIC

SUBSIDIARY OF GENERAL TELEPHONE & ELECTRONICS

Circle 31 on reader service card



Forget your ordinary light couplers. These Light-Coupled Data Amplifiers by Develco are something else. They pipe those tenuous incoming signals through a fiber-optic light guide over distances of 40 feet or more. This assures total electrical isolation between input transmitter and receiver. Major benefits:

- 100 dB common-mode rejection at 50 MHz
- Complete ground-loop immunity
- Operation of transmitter or receiver at common-mode voltages to 50 kv

All this adds up to a major advance in the art of data acquisition, a claim easily supported by the specs (sampling below).

	6110 Data Amplifier	6120 Data Amplifier	6153 Scope Plug-In †
Frequency Response	0-20 kHz 0-80 kHz	0-50 MHz *	0-50 MHz
Input Range	±1, 10, 100 mv ±1, 10 v	500 mv to 10 v	500 mv to 200 v
Typical SNR	50 dB	30 dB	30 dB
Input Impedance	1 megohm paralleled by 20 pf	1 megohm paralleled by 20 pf	1 megohm or 50 ohms paralleled by 20 pf
Drift	±0.025% full scale/°C	0.5% full scale/°C	1 cm/12 hrs./10°C
Output	±10 v @ 10 ma	1 v p-to-p, 50 ohms	full scale deflection
Operating Temperature Range	← +15°C to 40°C →		
Price	\$890.00	\$1050.00	\$1450.00

**Cord-of-light amplifies data
in total electrical isolation**

For complete specifications, or a demonstration at your facility, write us at 2433, Leghorn St., Mountain View, Calif. 94040. Or call (415) 969-1600.

* 100 MHz available on special order † Tektronix 544, 546 or 547

DEVELCO, INC.

COS/MOS—RCA's technological breakthrough breaks through in economics, too!

New design flexibility! New operating features! RCA-CD4006D brings both to digital circuits with MSI complexity! Newest in RCA's growing line of COS/MOS integrated circuits, this Complementary Symmetry MOS 18-Stage Static Shift Register gives you:

Flexibility. It provides multiple register sections of 4, 5, 8 and 9 stages or single register sections of 10, 12, 13, 14, 16, 17, and 18 stages. And outputs are available from both fourth and fifth stages. Here's real flexibility—in both design and operation.

Low Power. Take advantage of COS/MOS low power requirements. Quiescent dissipation is only 100 nanowatts (typical). Even in dynamic operation, the dissipation is only 2 milliwatts at 1 MHz with input of

alternate "ones" and zeros.

Workability. CD4006D operates with a single power supply and with a single-phase clock. Clock amplitude is the same as logic swing. No need to supply an additional voltage level. And you won't lose stored information if the clock is interrupted. No information recirculation required.

Economy to Match

CD4006D—at \$17.25 (1,000 units)—provides full military temperature range operation and 18 flip-flops for less than \$1.00 each. That means you get the design and operating advantages of RCA's unique COS/MOS technology with real-world economics.

Check these device design innovations:

- -55° to +125°C operation
- 100 nanowatt quiescent dissipation (typ.)
- Static to 2 MHz shift rate
- Single 6- to 15-volt positive or negative power supply
- 4-V noise margin (10-V logic)
- Large fanout—up to 50

CD4006D is only one of the new circuits that are ready now to prove the practicality and economy of COS/MOS. Order now from your local RCA Representative or through your RCA Distributor. For technical data, write to RCA Electronic Components, Commercial Engineering, Section ICN8-3, Harrison, N. J. 07029.

RCA-CD4006D 18-Stage Static Shift Register. MSI density with design flexibility.

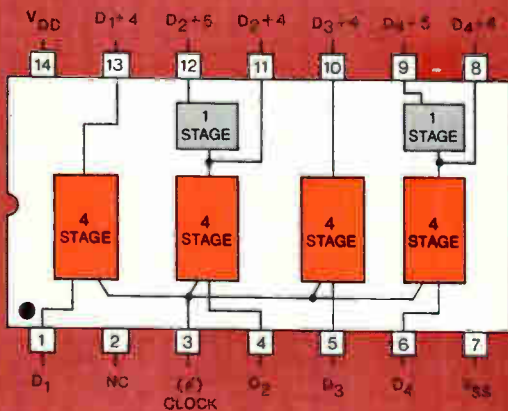

RCA-CD4006D in DIC, \$25.00 (1-99 units).
RCA-CD4006 in ceramic flat pack is \$26.50 (1-99 units).

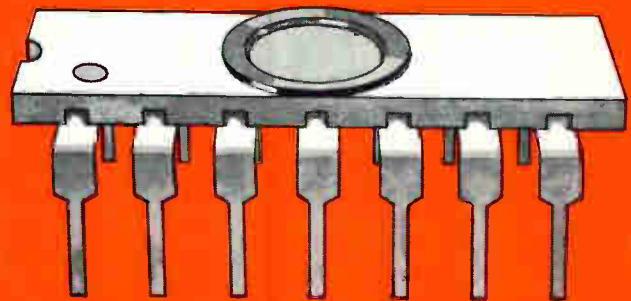

Design with these other COS/MOS Circuits—ready now:

Dual 3-Input Gate and Inverter	CD4000D	7-Stage Counter/Divider	CD4004T*
Quad 2-Input Gate	CD4001D	16-Bit NDRO Memory	CD4005D
Dual 4-Input Gate	CD4002D	Dual Complementary Transistor Pair and Inverter	CD4007D
Dual "D"-Type Flip-Flop	CD4003D		

*12-lead TO-5 Style Package

RCA Integrated Circuits

Never before

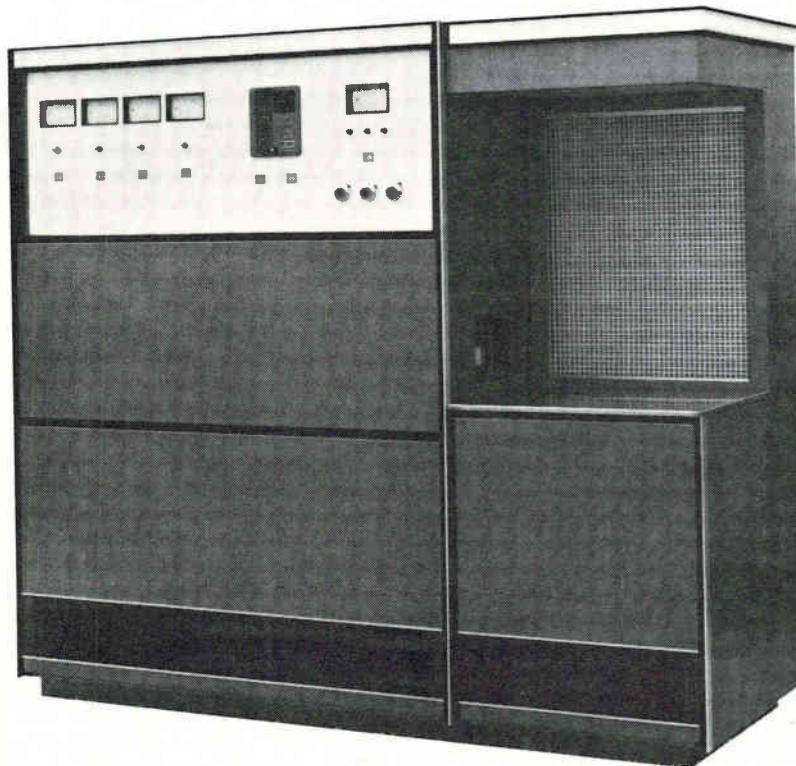

silicon nitride without RF power

The AMN-700 series of vapor phase passivation systems are the first non-RF powered high temperature, cold wall reactors for deposition of silicon nitride and silicon dioxide dielectric films. Typical film thickness uniformity is $\pm 5\%$ wafer to wafer within a run. Operating temperatures range from 650 to 900°C. AMN-700s can handle up to twenty 2" wafers per station with stations operating

independently or simultaneously for maximum throughput. The Si_3N_4 and SiO_2 films are of the highest quality.

A unique system design minimizes cycle times. There is no RFI noise and they are therefore completely compatible with diffusion process operations. All work stations are provided with laminar flow for the assurance of high integrity films.



applied materials

Applied Materials Technology, Inc. 2999 San Ysidro Way,
Santa Clara, California 95051 (408) 738-0600

In Europe: Advanced Semiconductor Materials Wokingham, U.K. Biltoven, Netherlands München, West Germany In Japan: Kanematsu-Gosha, Tokyo

Relax!
MDS has done your
digital strip printer
homework for you.

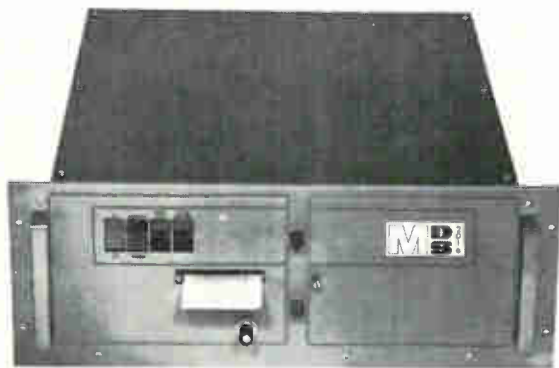

The MDS 2016 prints 8 to 20 columns. Size is 7"H x 19"W x 17"D



Printed circuit boards, with easily accessible switches permit unusual flexibility for Programmable Zero Suppress.

Specify the MDS 2016
Digital Lister Printer.

It incorporates, as standard, most features you ordinarily order as extra-cost options.

If you're sweating out specifications for Digital Strip Printers . . . up to your neck in options, trying to get everything you need in a single unit . . . drop the whole business and call MDS.

Chances are good that our new 2016 Digital Lister Printer has everything you want . . . in the *standard* unit . . . at a price much lower than you'd expect.

You'll get Full Buffering; Programmable Zero Suppress; Asynchronous Operation; 50 or 60 cycle, user-controlled; External Paper Advance; Out-of-Paper Status Line; Format Control; Positive Logic; Operate/Inhibit Switch.

PROGRAMMABLE ZERO SUPPRESS: The variable zero suppress fields within a line of print, or the number of zero suppress positions in a field, are programmable by switches.

BUFFER provides control for lock-out, activated upon receipt of a print command. An instruction is stored, and printer is inhibited until the instruction is executed. Lock-out also is generated by out-of-paper signal, external paper feed, manual paper advance, print test and printer off-line status.

Phone or write for literature. Your Man from MDS will gladly help you make your decision. Ask about other MDS Digital Strip Printers: 120A, 800, 1200, 1600, 2200, 3200, 2015.

HELP FOR OEM
DECISION-MAKERS

MOHAWK **MS**
DATA SCIENCES CORPORATION
OEM MARKETING
 P. O. Box 630 • Palisade St., Herkimer, N. Y. 13350
 Tel. 315/866-6040

REGIONAL MANAGER OFFICES:

Orlando, Fla., Phone 305/841-3091 • Waltham, Mass., Phone 617/891-5870 • Des Plaines, Ill., Phone 312/298-4141 • Los Angeles, Calif., Phone 213/685-5165

BUFFERED TAPE UNITS • DIGITAL STRIP PRINTERS • LINE PRINTERS • CARD PUNCHES AND READERS • PAPER TAPE PUNCHES AND READERS



Pat Paulsen takes time out from his expert advice on politics, philosophy, and physical fitness to say something important about connector manufacturing:

“Some people say that Cinch has limited design capabilities just because they don’t announce a new connector every few weeks.

Picky, picky, picky!

What hamburger decided that a company noted for quality production innovations *doesn't have capable design engineering?* Stop to think about it. You can't have one without the other!

When Cinch designs a connector, they know they can build it—and deliver it.

Call Cinch when you need expert connector design assistance. They'll produce a connector that will knock your eye out. What's more, the price will surprise you.

You don't like surprises?

Call anyway. You'll be a better man for it.”

Cinch Manufacturing Company, 1501 Morse Avenue, Elk Grove Village, Illinois 60007, (312) 921-6151



CINCH MANUFACTURING, CINCH-GRAFIK, CINCH-MONADNOCK, CINCH-NULINE AND PLAXIAL DIVISIONS OF UNITED-CARR INC., A SUBSIDIARY OF TRW INC.

C-6918



DIVISION OF UNITED-CARR

Technical Articles

Active filters: part 12
Short cuts
to network design
page 82

Active filters, unlike passive units, can be easily built with off-the-shelf components and require no special construction techniques. Active-filter design tables can help put users on the right design road; they serve as a convenient guide to the normalized element values for the three basic filter responses—maximum cutoff rate, pass-band amplitude flatness, and time-delay flatness. With these values, which are in a handy foldout accompanying the article, a designer can calculate the actual element values of the desired filter.

Semiconductor whodunit:
Who's to blame
for failure
page 98

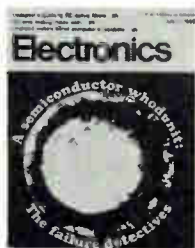

Semiconductor suppliers are apparently waging their price wars at the cost of device reliability. Customers' systems continue to fail as a result of defective componentry. All too often, it develops, device shortcomings could be avoided by vendors thoroughly testing electrical parameters or making simple eyeball checks. Users are no longer to be mollified by replacement parts, and many are establishing their own failure-analysis labs to develop new ways of analyzing components. One such is Raytheon, which supplied the cover picture of an IC covered with a liquid-crystal solution. When the device is activated, it heats up, producing different colors; the bluer the area, the hotter the spot.

Multistable logic
simplifies
man-machine interface
page 105

Bistable logic—on-and-off switching of electronic devices—leaves something to be desired as an efficient way of handling information at the man-machine interface. What's needed is multistable logic in which the components can assume any of 10 states. Engineers in the Soviet Union have developed a practical form that's being used in pulse counters, time-interval meters, and related apparatus.

Before you start
your own company . . .
page 110

The list of requirements for going into business for yourself is lengthy, but the prospects of a payoff under certain conditions are good enough to justify taking the gamble. For openers, you'll need technical talent, knowledge of some area of the electronics market, something new or different to offer, persistence, patience, guts, and financing—not necessarily from your own funds. When you're staking the future of your venture on a new product, it should be innovative. Otherwise, you could wind up with an item that's simply a carbon copy of what's being offered by others in the marketplace.

Surveying
low-light-level tv

Coming

Electronics' recent coverage of the military's low-light-level television programs has sparked a good deal of controversy. The article will take a close look at work in progress in this crucial area of reconnaissance that's still longer on promise than performance.

Active filters: part 12

Short cuts to network design

Tables of normalized element values for different filter responses and a slide rule for simple calculations add up to a quick design of a complete active filter

By Robert R. Shepard

Genisco Technology Corp., Compton, Calif.

Chebyshev, Butterworth and Bessel aren't names to be found on roadmaps, but they are on active-filter tables that serve a like purpose—putting the user on the right road. They serve as a handy guide of the normalized element values for the three basic filter responses—maximum cutoff rate (Chebyshev), passband amplitude flatness (Butterworth) and time-delay flatness (Bessel). With these values, a designer can calculate the actual element values of the desired filter. Underlying the value of these tables (see foldout, opposite page) is the fact that interest in active filters has been on the upswing in the last few years.

Unlike passive filters, active filters may be built easily on a printed-circuit board and requires no special construction techniques. Their advantages stem from their reduced size and weight, particularly at low frequencies, good voltage linearity, and, depending upon application, lower cost. Since they use only resistors, capacitors and semiconductors—inductors aren't required—components are normally readily available. And with the availability of linear amplifiers in integrated-circuit form, active filters become even more desirable.

Today, there are many approaches to active filtering, including those using operational amplifiers, fixed-gain amplifiers, gyrators, negative-immittance converters, and state variables. All perform as well, if not better, than their passive RLC counterparts.

Consider, for example, a fixed-gain amplifier approach. Such a configuration offers good stability, requires a minimum number of elements, and has low output impedance—important for cascading filters with four or more poles. In IC form, the material cost per pole could be as low as \$2.50.

In a passive RC network, such as on the opposite page, the transfer function has poles that lie solely on the negative-real axis of the complex-frequency

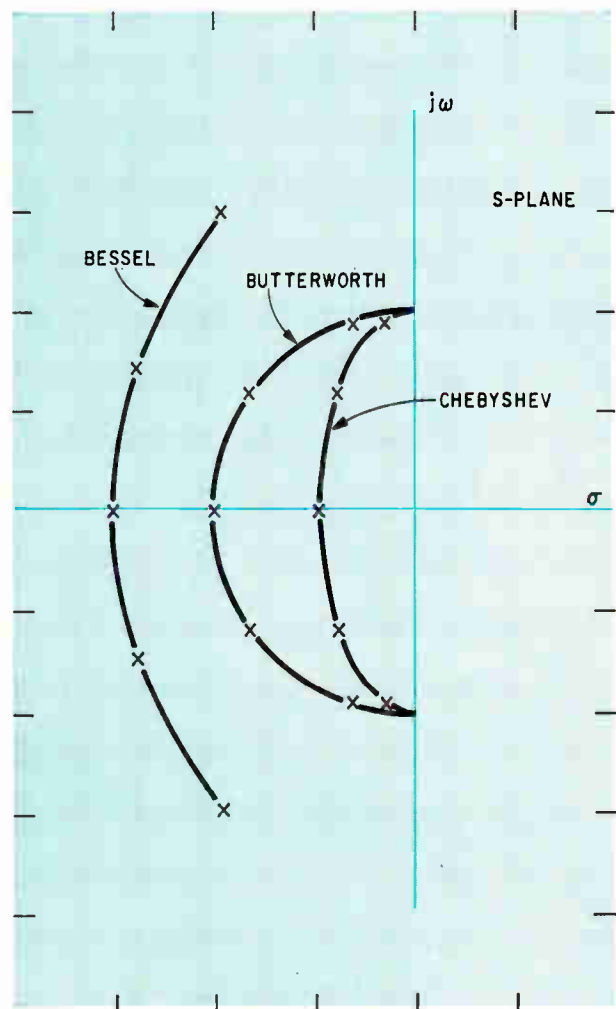

S-plane responses. Be it a Bessel, a Butterworth, or a Chebyshev filter, only one pole is on the negative-real axis. Other poles are in conjugate-complex pairs.

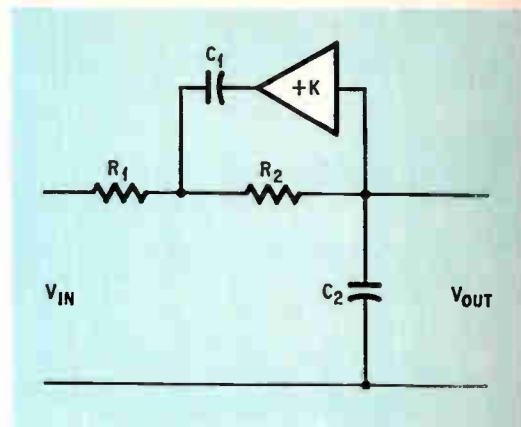
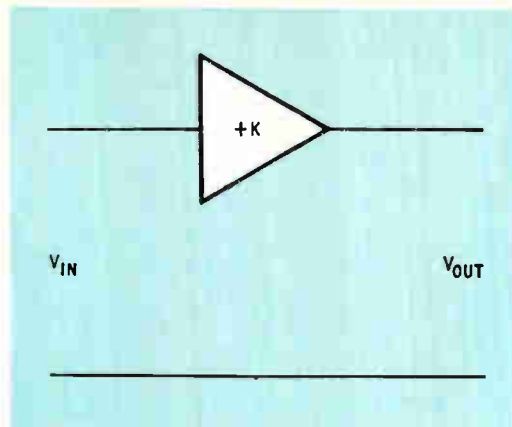
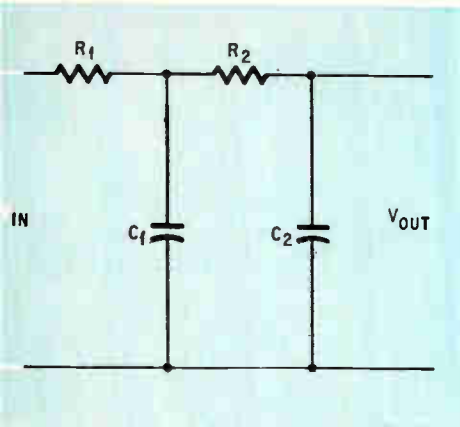

The ideal: From left, an RC passive network and an op amp are combined to form a general active filter . . .

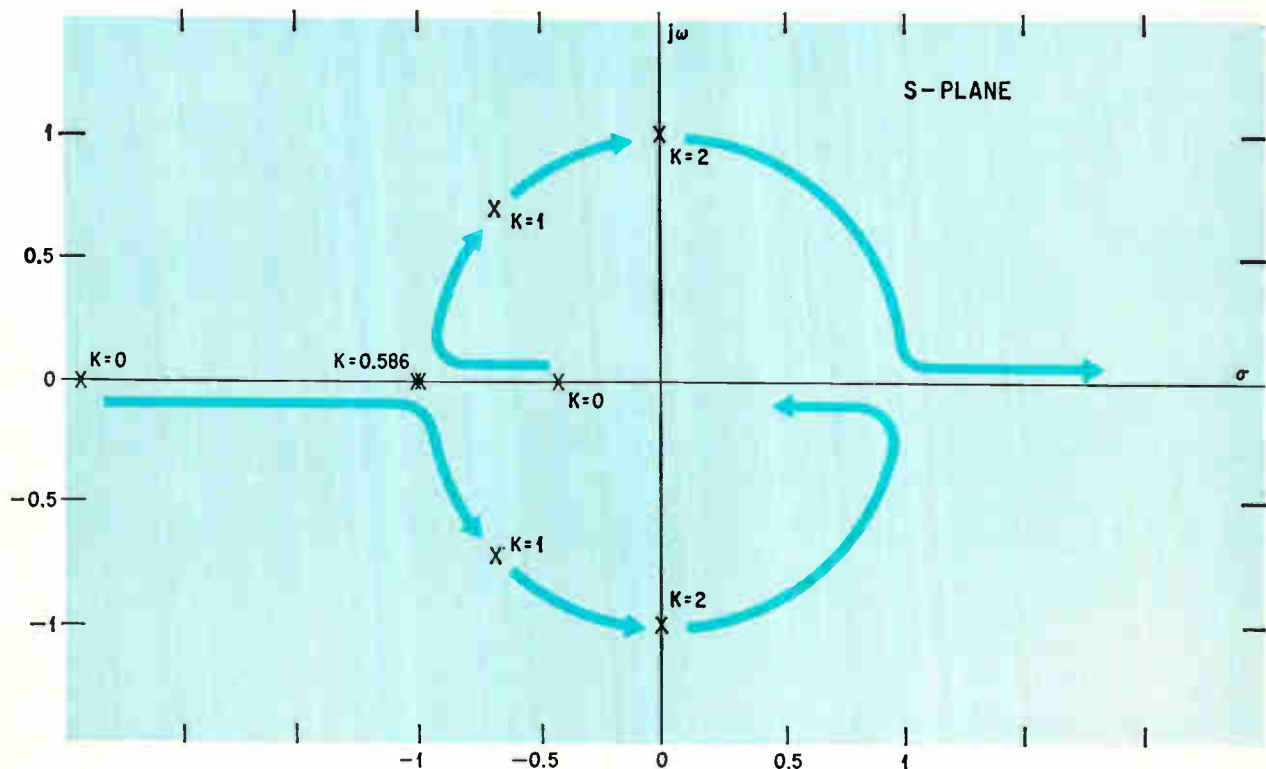

. . . when the gain, K, is varied throughout the s-plane, the response with respect to pole positions is obtained . . .

plane. Since the poles of an optimized transfer function occur in complex-conjugate pairs, it is impossible to produce such a function with a passive RC network. This can be achieved, however, by adding an active device to the network.

For the active element, an ideal voltage amplifier can be used. And since the device is ideal, its characteristics are a gain of K, zero phase shift, infinite input impedance and zero output impedance. Adding the amplifier to the RC network is best achieved in a feedback configuration, though there are several ways from which to choose. The transfer function of one such configuration, at the top right, is

$$\frac{V_{out}}{V_{in}} = \frac{1}{s^2 C_1 C_2 R_1 R_2 + s [C_2 (R_1 + R_2) + C_1 R_1 (1 - K)] + 1} \quad (1)$$

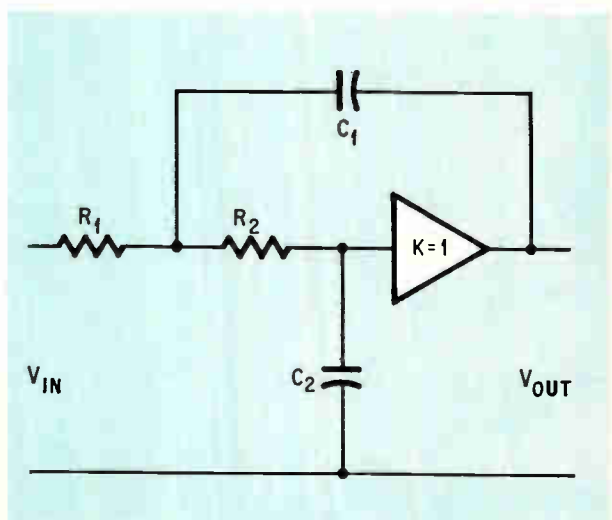

. . . with K=1 the ideal unity-gain amplifier is constructed.

which reduces to the transfer function of the RC network itself when $K = 0$. The poles are

$$s = \frac{-b \pm \sqrt{b^2 - 4ac}}{2a}$$

where $a = C_1 C_2 R_1 R_2$, $b = C_1 R_1 (1-K) + C_2 (R_1 + R_2)$, $c = 1$.

With $C_1 = 1/\sqrt{2}$, $C_2 = 1/2\sqrt{2}$, $R_1 = R_2 = 1$, and $K = 0$, the poles are on the negative real axis—one pole at -2.41 and the other at -0.414 ; see previous page. As the value of K increases the poles move towards each other until, at $K = 0.586$, both poles converge at -1 . As K is increased further, the poles go different ways and follow the circular paths of unit radius. At $K = 2$, the poles cross the $j\omega$ axis at $\pm j1$. The behavior in the right half-plane for larger values of K is then analogous to that in the left half-plane, with right half-plane characteristics representing unstable network behavior.

Butterworth response

Of interest are the network characteristics at $K = 1$. In this case, the poles are located at $s = -0.707 \pm j 0.707$, which is the same as that of a two-pole Butterworth low-pass filter. Hence, the simple unity-gain amplifier causes a two-pole RC network to behave in the same manner as a two-pole LC network. And since the poles of any normalized Butterworth low-pass filter lie on a unit circle, the pole distribution could be achieved with several active networks. All that's required is an adjustment of K for each section.

Another approach is based on an amplifier gain of unity in which the pole positions can be varied by adjusting the values of the passive components. Fixing the gain at unity provides low output impedance and allows sections to be cascaded without having the over-all filter gain increase as each new section is added. Since the amplifier does not introduce gain, the output terminal may be moved to provide low network-output impedance. This approach, at bottom of previous page, is the basic configuration for the filters listed in the tables.

Finalizing the result

Explicit expressions are now derived for the element values. Since there are four unknowns— R_1 , R_2 , C_1 and C_2 —there must be an equal number of conditions. Two of these are that the network have poles at $s = x \pm jy$, and the other two, for normalization purposes, are that $R_1 = R_2 = 1$. Using equation 1, these conditions yield

$$C_1 = -1/x \quad (2)$$

$$C_2 = \frac{-x}{x^2 + y^2} \quad (3)$$

Although it is impossible to use this network by itself to achieve a low-pass filter having an odd number of poles—such filters require a single pole on the negative real axis—it can be achieved when

used in conjunction with a single passive RC circuit. Three poles can then be produced, as at top right of page 89, as one on the negative real axis and a complex-conjugate pair.

Formulas for the element values in the three-pole circuit though rather cumbersome when in explicit detail, can be derived without much difficulty. First, since there are now six values, six conditions are now required for a solution. Three of these are that the poles occur at $s = x \pm jy$, and $s = z$ (a real number).

Also, for normalization, let $R_1 = R_2 = R_3 = 1$. Next, three new variables are defined based on the pole positions.

$$w_1 = \frac{x^2 + y^2 + 2xz}{-z(x^2 + y^2)}$$

$$w_2 = \frac{2x + z}{z(x^2 + y^2)}$$

$$w_3 = \frac{1}{-z(x^2 + y^2)}$$

If a fourth variable is now introduced, where

$$T = \sqrt[3]{-\frac{b}{2} + \sqrt{\frac{b^2}{4} + \frac{a^3}{27}}} + \sqrt[3]{-\frac{b}{2} - \sqrt{\frac{b^2}{4} + \frac{a^3}{27}}} + \frac{w_1}{3}$$

where

$$a = \frac{3}{2} w_2 - \frac{1}{3} w_1^2$$

$$b = \frac{1}{2} w_1 w_2 - \frac{2}{27} w_1^3 - 3w_3$$

it can be shown that the required solutions are given by

$$C_1 = \frac{3w_3}{T(w_1 - T)} \quad (4)$$

$$C_2 = \frac{3w_3}{(w_1 - 1)} \quad (5)$$

$$C_3 = \frac{w_3}{T} \quad (6)$$

Only one three-pole circuit may be used per filter because no more than one pole may occur on the real axis. Hence, if the required number of poles is N , the total number of active circuits needed would be $N/2$ for N even, and $(N-1)/2$ for N odd.

Similar equations can be derived for high-pass filters. This is unnecessary, however, because the transformation from low-pass to high-pass shown on page 89 does the job. Hence, by merely taking the reciprocal of the low-pass element values, the equivalent high-pass values are obtained.

Continued on page 89

Low pass

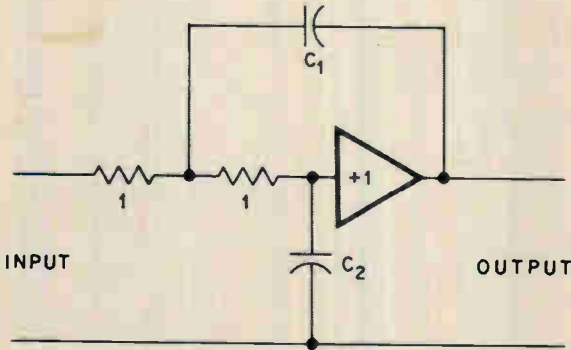

SECTION TYPE 1

Low pass

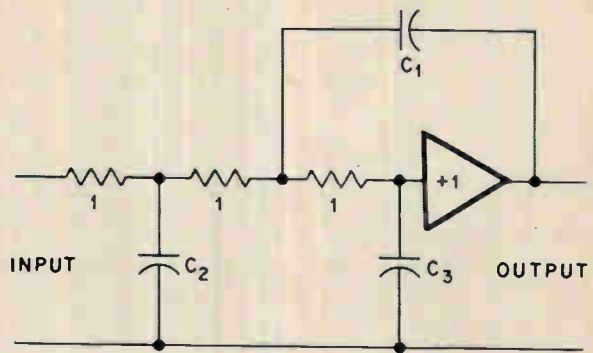

SECTION TYPE 2

Four fundamental resistor-capacitor networks form the basis for active-filter synthesis.

High pass

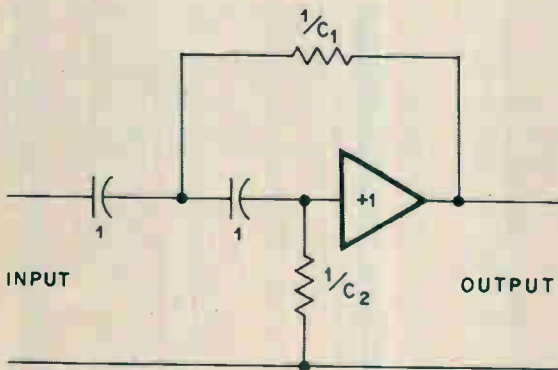

SECTION TYPE 1

High pass

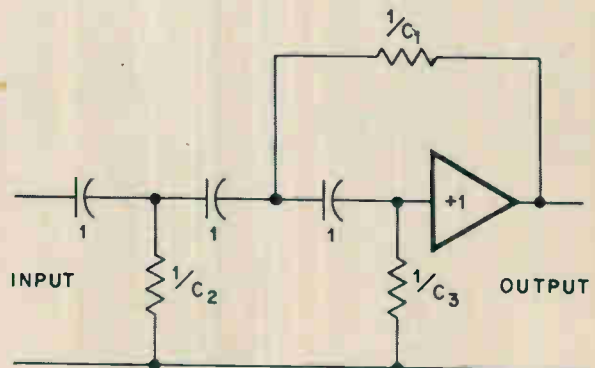

SECTION TYPE 2

One approach to designing active filters, whether Chebyshev, Bessel, or Butterworth is to use an operational amplifier of unity gain coupled to resistor-capacitor networks. By so doing, the designer is able to create an inductorless filter that can be built in integrated-circuit form, that offers good voltage linearity and low cost, and that has small size and weight.

A basic active filter is in fact a combination of low-and high-pass networks joined in some manner; for example, parallel or cascade. In this way, the wave shape response is the algebraic sum of the individual networks.

On the reverse side of this foldout appear four charts arranged in tabular

Keys for active-filter designs

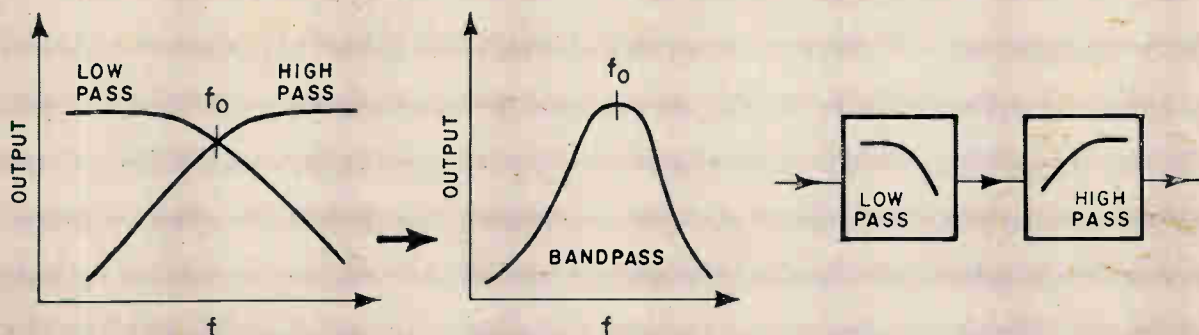

Two ways of combining low- and high-pass networks for different bandpass characteristics.

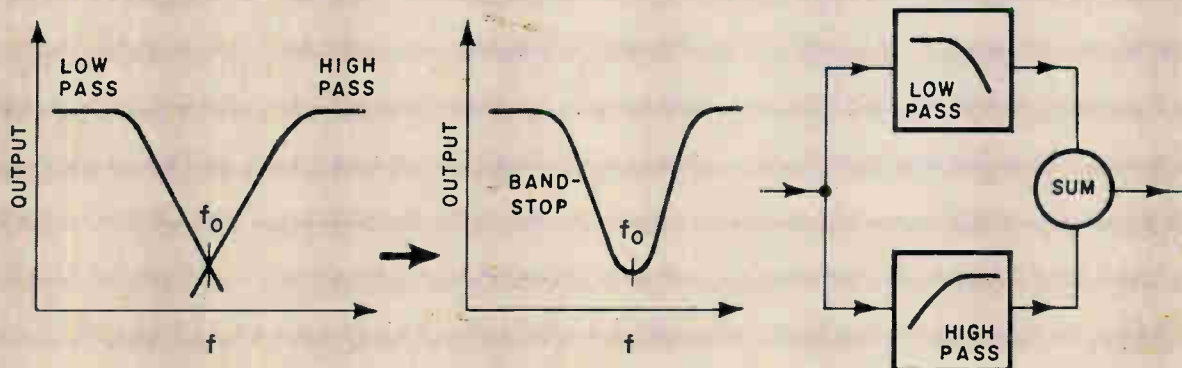

form. The numbers found in these tables give the normalized values for the elements of the low- and high-pass networks. After the designer decides on the configuration for the network he wants, he can frequency scale and impedance scale these values to obtain a final design. The resultant network is then combined with a unity-gain operational amplifier, such as the model 741 that appears on this foldout, to produce a desired frequency response. Typical of the networks developed are those that exhibit good temperature stability. For example, resistors of 120 ppm/°C provide adequate compensation for polystyrene capacitors of -120 ppm/°C.

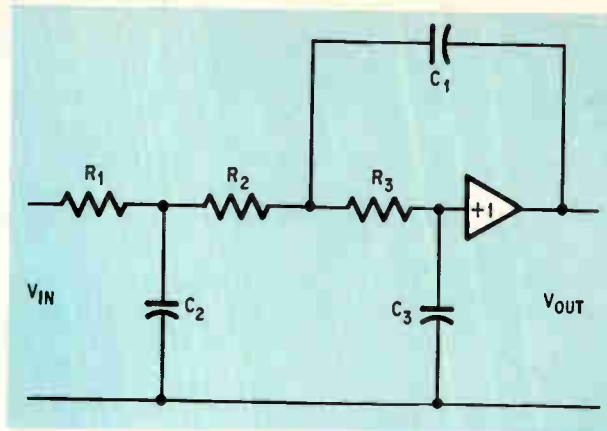
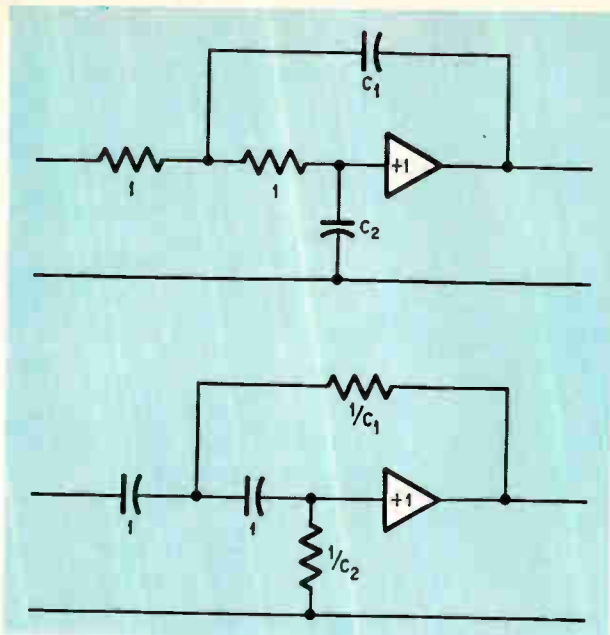

Two plus one. Two RC networks are combined with an ideal voltage amplifier to yield a three-pole filter response.

Transformation. A low-pass filter, top left, can be converted into a high-pass network, bottom, by substituting capacitors for the circuit's resistors and vice versa.

Continued from page 84

In the filter tables, which serve as design guides, appearing in the foldout, the values given are all normalized for a 3-decibel cutoff frequency of 1 radian per second and are expressed in farads and ohms. Filters are built in sections which are cascaded to achieve the desired over-all response. Two types of sections are required, one of which is used only in filters with an odd number of poles. Type 1 (two pole) are always used except when a value for C_3 is given, which requires a type 2 (three pole) section. Connected in the same order as listed in the tables, with the first section at the input, all the sections comprising the entire filter should be driven from a voltage source. Regardless of what the source is, its impedance should be negligible in comparison to the first section's input impedance. A d-c path to ground, typically 10,000 ohms or less, must be provided when the source in a low-pass filter includes a blocking capacitor. The load impedance may be any value that doesn't overload the output-section amplifier.

Pointing the way

In designing a low-pass filter, the engineer must first select the type of filter desired and the number of poles required. Then he looks up the appropriate tables values and divides all capacitor values by $2\pi f_c$ to achieve frequency scaling where f_c is the desired 3-db cutoff frequency. Next, he multiplies resistor values by M , and divides the capacitor values by M to achieve convenient element values. (M is an arbitrarily selected impedance scaling factor and may be different for each section.) Since all amplifiers have unity gain, the gain of the over-all filter will likewise be unity at d-c.

Consider, for example, a five pole 1-db Chebyshev low-pass filter in which the desired 3-db frequency is 100 hertz. Over-all size considerations call for capacitor values of 0.1 microfarad or less.

Initial values are selected from the table and frequency scaled. The next step is to find the impedance scaling factor, M , for each section. Since the largest capacitor in the final design is to be no more than $0.1 \mu\text{f}$, M is chosen to scale the largest capacitor—14, 140, 18, and $380 \mu\text{f}$ —for the three-pole and two-pole sections.

A prototype of this Chebyshev filter was built using accurately bridged component values. Measured results, as well as a computer-predicted curve, agree, within measurement error.

In designing a high-pass filter the engineer follows a procedure much like that followed for the low-pass filter. First, he selects the type of filter desired and the number of poles required, and then he calculates the normalized element values by finding the reciprocal of the table values. To achieve frequency scaling, he then divides all capacitor values by $2\pi f_c$ where f_c is the desired 3-db cutoff frequency. Impedance scaling is then achieved by multiplying each resistor value by M and dividing each capacitor value by M . As is the case for low-pass filters, M may differ for each section.

Cascading different sections

A bandpass configuration consisting of cascaded low and high-pass filter sections, as shown on the foldout, enables the designer to choose different rates of cutoff for the two filter types. Thus, he can satisfy specific design requirements but not without one drawback. The loss of the over-all filter at the center frequency, f_c is equal to the sum of the losses of the high-pass and low-pass sections. This approach, therefore, is far from satisfactory for narrow bandwidth filters—bandwidths less than $0.1 f_c$.

For a band-reject filter, a parallel configuration serves the purpose more than adequately. This configuration, as in the case for cascaded sections, enables the designer to choose different cutoff rates

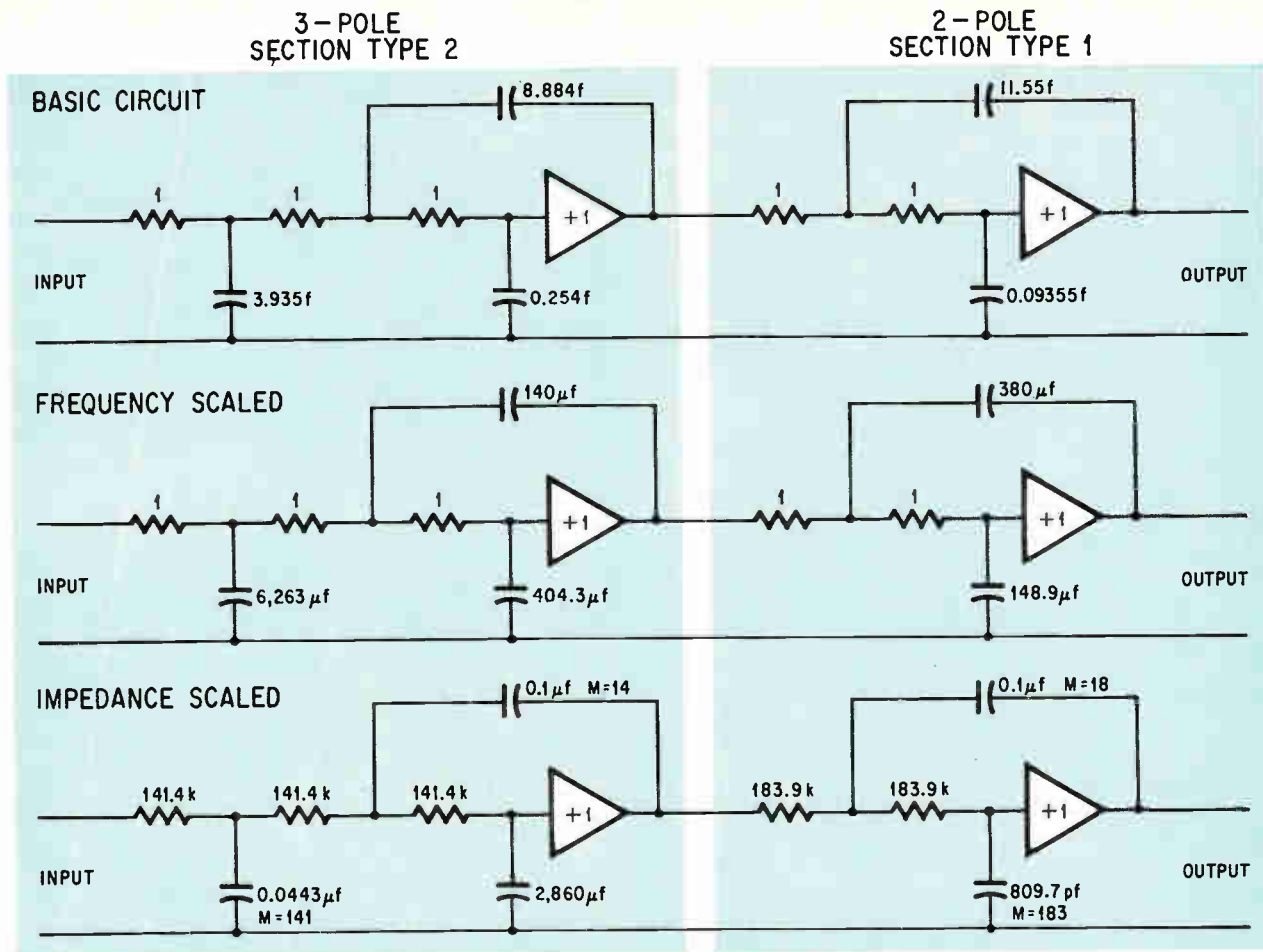

Filter design. Component values for a five-pole Chebyshev, top, are selected from the tables; frequency scaled in center drawing and impedance scaled in bottom schematic. Measured response coincides with the computer-

for the two filter types. Attenuation at the center of the notch is no better than either section at that specific value of frequency.

The active low-pass tables are arranged so that the input section has a gradual rolloff while following sections have increasingly sharp peaks in their responses. The combination of the responses produces the desired flat passband and sharp cutoff. This illustrates why the order of section placement is important. If a sharply peaked section were placed at the input, the unity-gain amplifier could be easily overdriven since peak gains of 20 db and more are not uncommon in these situations.

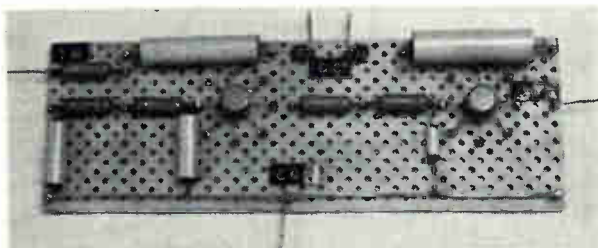

Active filter. Unity gain amplifier coupled to RC networks makes it possible to mount design on a p-c board.

Giving rise of late to a new wave of interest in active filters is the availability of small, low-cost, high-performance operational amplifiers in IC form. Typical is the 741, which is available in a TO-5 case with eight axial leads.

Unity gain of the 741 shown on the foldout is assured by the direct connection between the output and the inverting input. Since the open-loop gain of the device is in excess of 80 db, its closed-loop gain is stable. The circuit's feedback boosts the input impedance well into megohm region—typically 1,000 megohms—while causing the output to behave virtually as a voltage source. The device provides the characteristics for an active filter.

There are limitations

Although there are no theoretical limitations on the maximum frequency and impedance level at which an active filter may be employed, there are several practical ones. Probably the most severe limitation is that imposed by unity gain amplifiers that fall short of the ideal.

With type 1 sections, if the following inequalities are valid, the accuracy of the filter isn't affected:

$$A \gg C_1/2 C_2 \quad (7)$$

Basic building blocks for active-filter designs

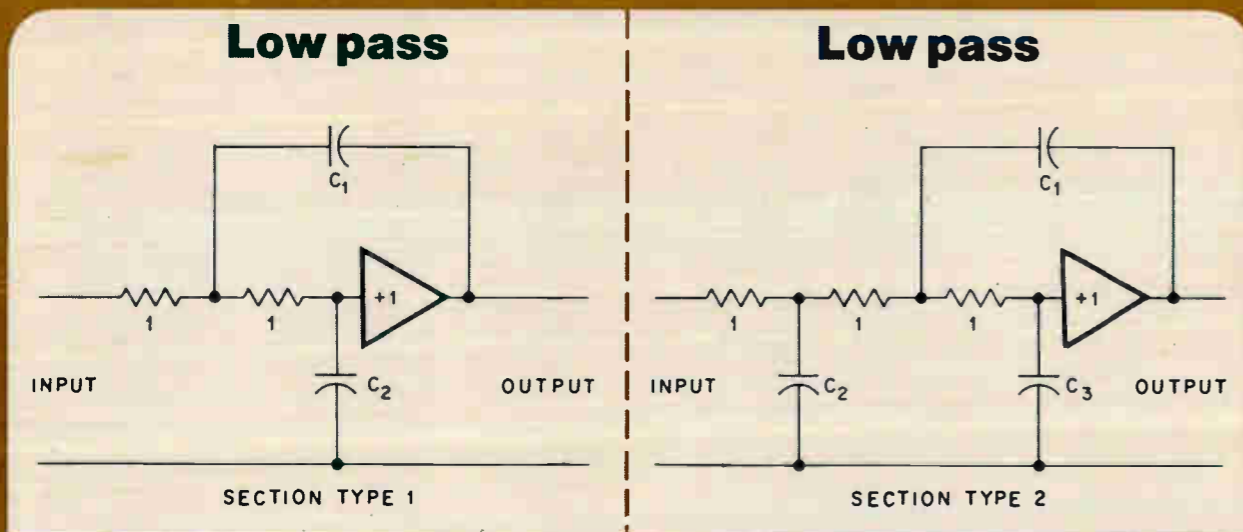

Four fundamental resistor-capacitor networks form the basis for active-filter synthesis.

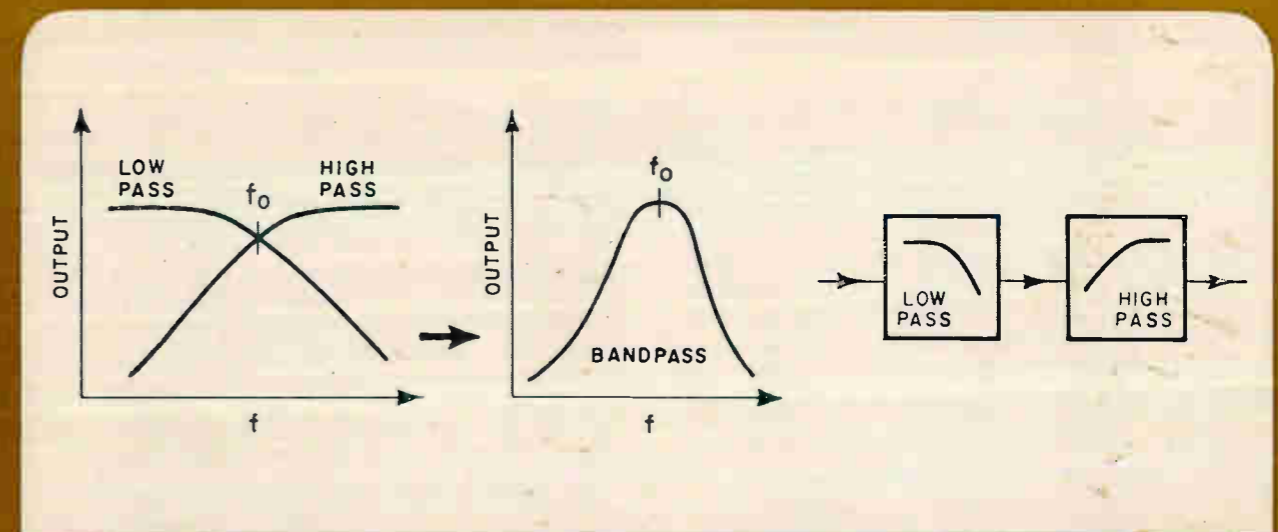
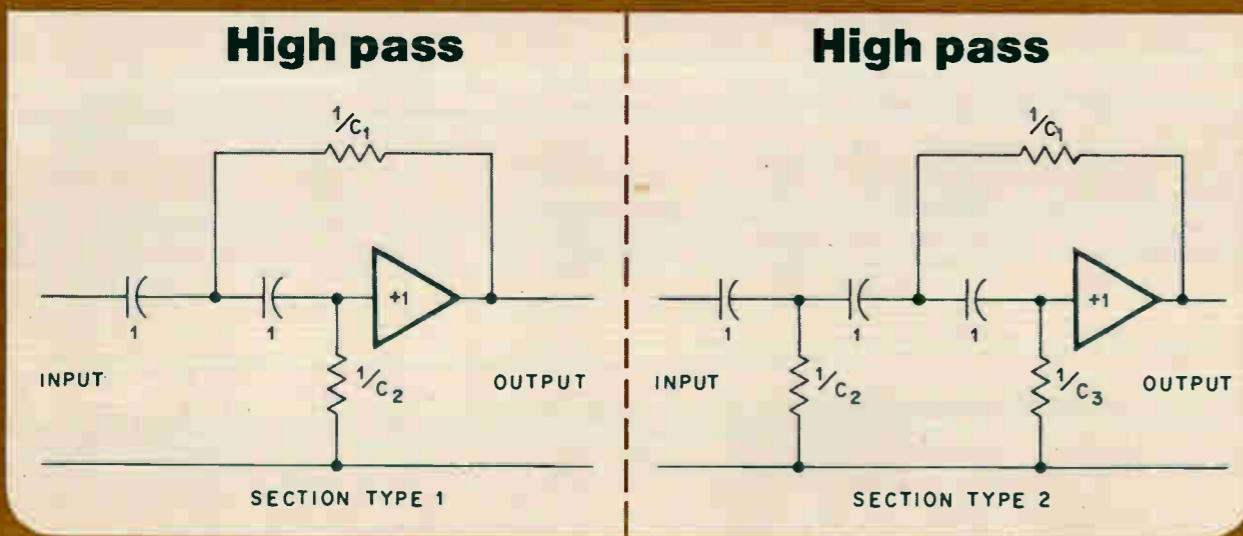

Two ways of combining low- and high-pass networks for different bandpass characteristics.

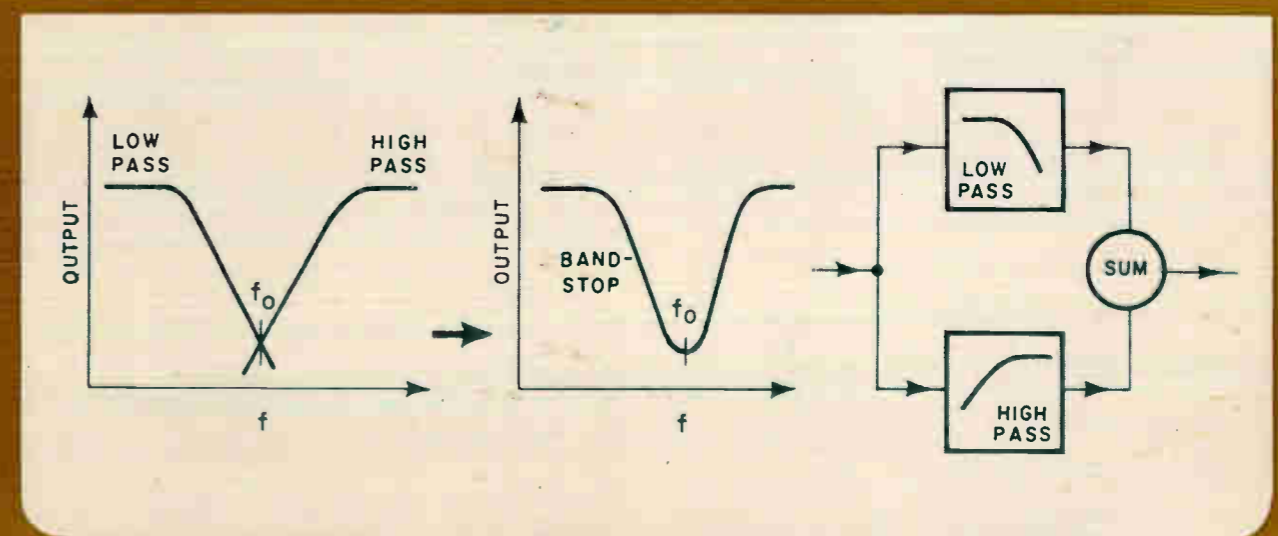

One approach to designing active filters, whether Chebyshev, Bessel, or Butterworth is to use an operational amplifier of unity gain coupled to resistor-capacitor networks. By so doing, the designer is able to create an inductorless filter that can be built in integrated-circuit form, that offers good voltage linearity and low cost, and that has small size and weight.

A basic active filter is in fact a combination of low-and high-pass networks joined in some manner; for example, parallel or cascade. In this way, the wave shape response is the algebraic sum of the individual networks.

On the reverse side of this foldout appear four charts arranged in tabular

form. The numbers found in these tables give the normalized values for the elements of the low-and high-pass networks. After the designer decides on the configuration for the network he wants, he can frequency scale and impedance scale these values to obtain a final design. The resultant network is then combined with a unity-gain operational amplifier, such as the model 741 that appears on this foldout, to produce a desired frequency response. Typical of the networks developed are those that exhibit good temperature stability. For example, resistors of 120 ppm/°C provide adequate compensation for polystyrene capacitors of -120 ppm/°C.

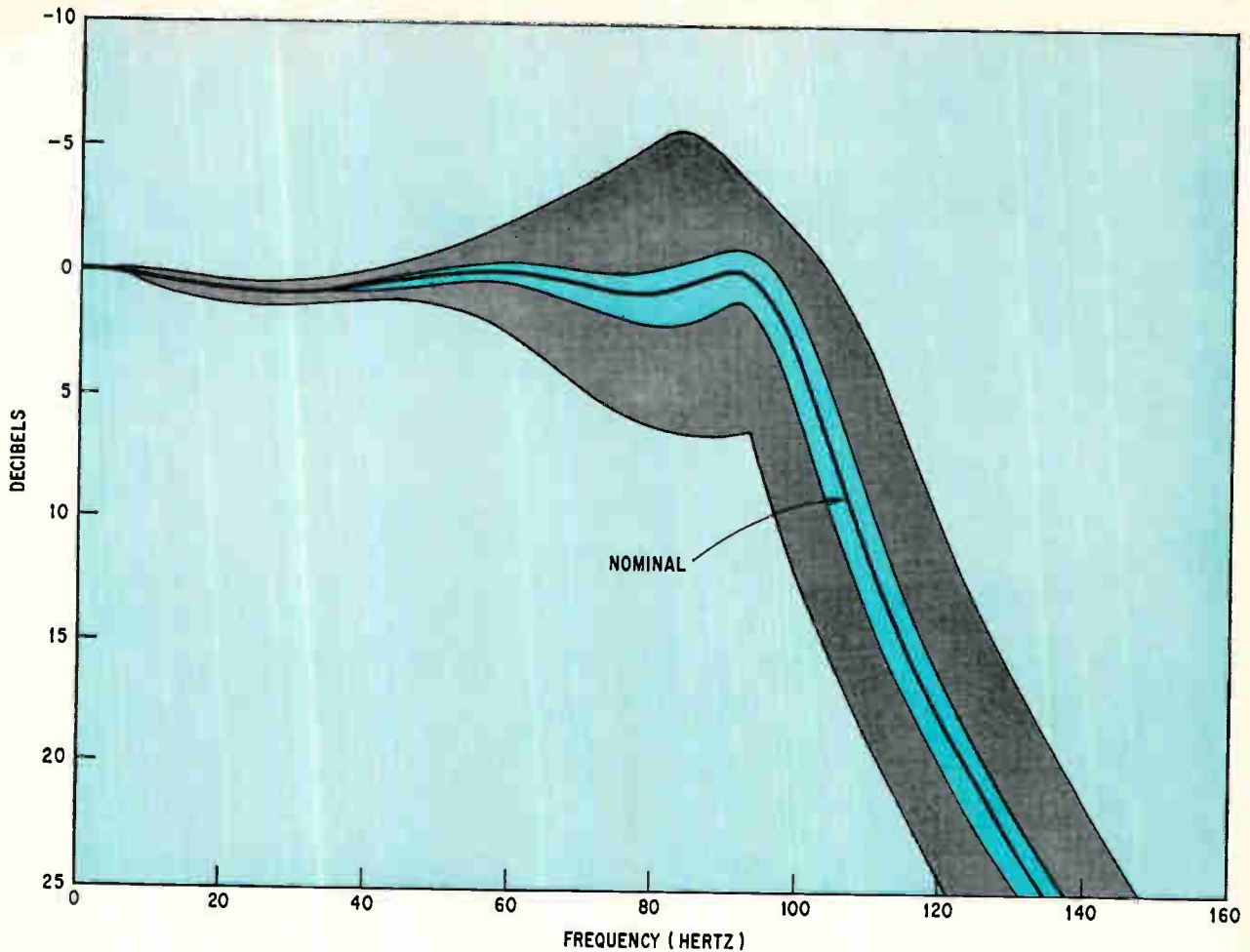

predicted values as indicated by the nominal curve. Component tolerances are varied $\pm 5\%$, curves at the ends of the red area, and $\pm 1\%$, curves at the ends of the grey areas, from nominal value to get attenuation response.

$$M \ll 2 \frac{C_2}{C_1} R_{in} \quad (8)$$

where A is the open-loop gain of the active device, M is the impedance scaling factor used, C_1 and C_2 are the table values for the section, and R_{in} is the closed-loop input resistance of the active device. As a point of reference, if each quantity is unequal by a factor of 100, the greatest deviation from nominal should be about 0.2 db. The inequalities should also be observed in type 2 sections for which C_3 substitutes for C_2 . For high-pass filters, equation 7 remains the same, but equation 8 becomes

$$M \ll C_2 R_{in}$$

Probably the most difficult area to analyze is that of filter stability—changes in element values lead to changes in filter characteristics. Many types of active filters tend to oscillate. With the unity gain approach, however, oscillation is theoretically impossible. When oscillation does occur, it usually stems from inadequate power-supply decoupling, stray pick-up, wiring errors, or a defective IC.

Although theoretically stable, unity gain active filter characteristics will shift when actual element values differ from design values. As a general rule,

follow the maxim: the sharper the rate of cutoff, the tighter the element tolerance.

An envelope of attenuation deviations would go a long way in helping the designer determine a filter's tolerances.

Temperature stability is also important particularly for sharp-cutoff filters. Since impedance scaling doesn't affect the performance of the device, resistors and capacitors having equal but opposite temperature coefficients achieve the necessary compensation. For example, if polystyrene capacitors having a temperature coefficient of approximately $-120 \text{ ppm}/^\circ\text{C}$ are used, resistors having a temperature coefficient of $+120 \text{ ppm}/^\circ\text{C}$ would provide compensation. But the effect of the tolerance on these coefficients must be weighed when estimating the over-all shift with temperature. ■

Bibliography

Reference Data for Radio Engineers, 4th ed. International Telephone and Telegraph, 1957.

Ernst Guillemin, *Synthesis of Passive Networks*, John Wiley & Sons, 1957.

Louis Weinberg, *Network Analysis and Synthesis*, McGraw-Hill, 1962.

Handbook of Operational Amplifier Active RC Networks, Burr-Brown Research, 1966.

Buy a Polycarbonate capacitor today and six months from now you won't recognize it.

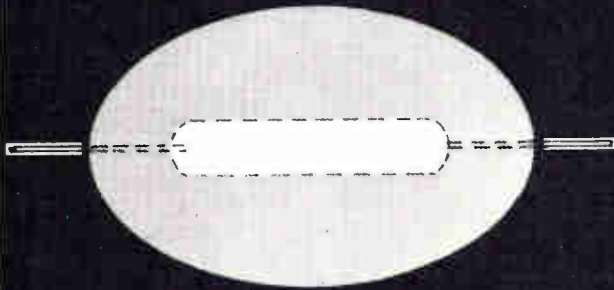

It'll change that much.

On the other hand, the KEMET® Flat-Kap remains electrically stable indefinitely—for years and years.

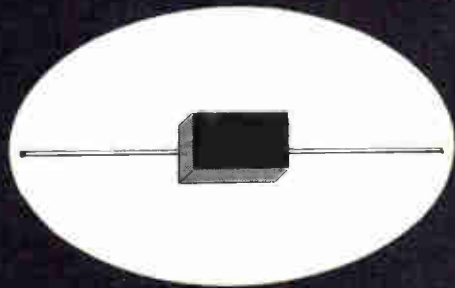

WITH KEMET FLAT-KAPS TIME IS ON YOUR SIDE. Because they're made with Union Carbide developed Parylene. That's why they can eliminate production problems frequently experienced with Polycarbonate capacitors. Examples: variations in temperature coefficient, instability on-shelf life, shorts, or even *delayed deliveries*.

Capacitance range: .001 μF to
.1 μF
Voltage rating: 50 VDC
Standard tolerances: $\pm 10\%$,
 $\pm 5\%$, and
 $\pm 1\%$

(Custom tolerances available on special order)

Temperature range: -55°C to
 $+125^{\circ}\text{C}$
Insulation resistance: 100,000
megohms
at 25°C
Dissipation factor: .35% max.
at 25°C ,
1KHz

Environmental test performance
per MIL-C-55514

Stability is the key...it's built-in...because Parylene is not subject to the dimensional changes and capacitance changes caused by stress-oriented plastic film (like Polycarbonate). And Union Carbide makes Parylene right here in the U.S.A. ...so you don't have to worry about long lead-time foreign deliveries.

Available off-the-shelf in three temperature coefficients, 0 ± 50 PPM, 0 ± 100 PPM, and -200 ± 30 PPM, in space saving epoxy cases with either radial or axial leads for your filter and tuned circuit applications. For complete information see your local Union Carbide representative, or write to P. O. Box 5928, Greenville, S. C. 29606.

**ELECTRONICS DIVISION
COMPONENTS DEPARTMENT**

P.O. Box 5928, Greenville, South Carolina 29606 • Tel: (803) 963-7421/TWX: 810-287-2536

Union Carbide's Electronics Division is a total supplier to the Electronics Community through its Semiconductor Department, Components Department, Crystal Products Department, KORAD® Department, and Instrument Department.

**UNION
CARBIDE**

THE DISCOVERY COMPANY

Designer's casebook

Designer's casebook is a regular feature in Electronics. Readers are invited to submit novel circuit ideas and unusual solutions to design problems. Descriptions should be short. We'll pay \$50 for each item published.

Transmit-receive switch exceeds 60-db isolation

By Paul V. Wanek

Warwick Electronics, Niles, Ill.

A diode bridge electronically couples an antenna to a transmitter, or a receiver. When the antenna is switched to the transmitter, the transmitter is isolated from the receiver by over 60 decibels. When it is switched to the receiver, the antenna's insertion loss is 0.2 db. The switch can operate at frequencies from 30 to 76 megahertz with a 50-watt transmitter.

The transmit-receive switch is shown in the receive mode in which a current of 30 milliamps

from a constant current source flows through the diode bridge, forward biasing the diodes at about 1.2 volts. Under this setup, the diode's forward resistance is about 1.2 ohms. And, since the diodes are in a series-parallel combination, the total resistance from the 50-ohm antenna source to the 50-ohm receiver load is also 1.2 ohms.

When the switch is placed in the transmit mode, diodes D_5 and D_6 conduct placing a low resistance across the receiver input; diodes D_1 through D_4 are reverse biased and are therefore effectively open circuited.

For operation from high transmitter power levels, inductors L_1 , L_2 , and L_3 may be replaced with resistors if a high level switching voltage is used. For operation at other frequencies, the inductors can be replaced with values suitable for the frequencies desired. They must, however, show a high reactance at the frequencies used.

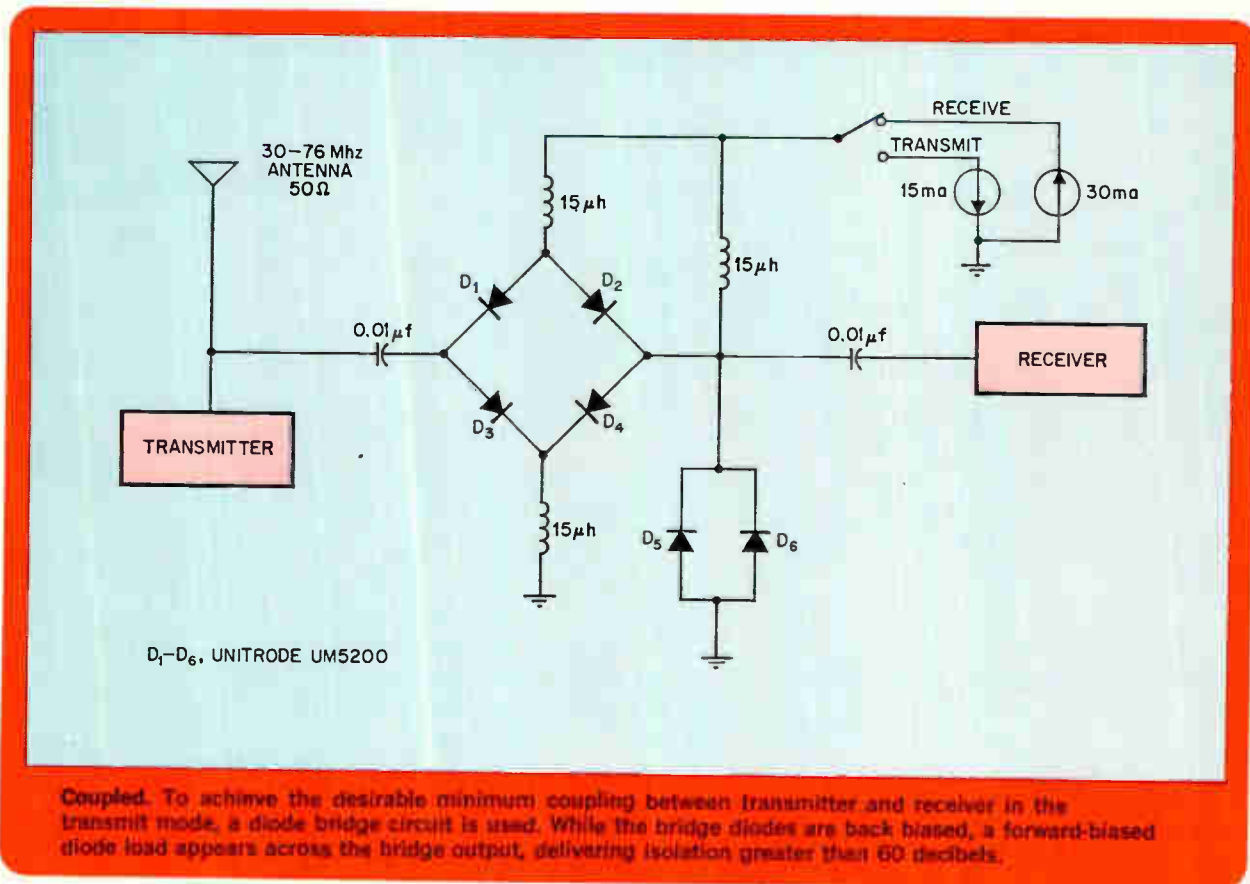

Positive or negative pulses trigger one-shot multivibrator

By Wolfhart Muller

Wentorf, Germany

Using two complimentary transistors it is possible to make a one-shot multivibrator that can be triggered by either positive or negative pulses. Complementary transistors allow pulses of one polarity to be transferred with no phase shift, while pulses of the opposite polarity are transferred with 180° of phase shift.

Both transistors are normally conducting and each is connected in series with an emitter resistor. The symmetry of voltage divider provides each resistor with half the supply voltage, which re-

sults in the reverse biasing of both diodes. When a positive pulse is applied to the input, the base of Q_1 is driven positive and the transistor is cut off. On the other hand, a negative input pulse will cut off Q_2 while Q_1 remains unaffected. Since the transistors are connected in series, only positive pulses will appear at the upper emitter resistor, while only negative pulses will show up at the lower emitter resistor.

The circuit becomes a monostable multivibrator with the addition of Q_3 , which is connected to the emitter of Q_1 via the zener diode D_3 . To insure that Q_3 cuts off completely, the voltage across the zener diode must be higher than the voltage between the emitter and ground of Q_1 . A positive or negative voltage, with an amplitude of at least 2 volts, is necessary to trigger the multivibrator. Neglecting the leakage currents and the saturation voltages of the transistors, the duration of the output pulse is approximated by $(R_b)(C)(\ln 2)$. A single rectangular input pulse will cause a double output pulse.

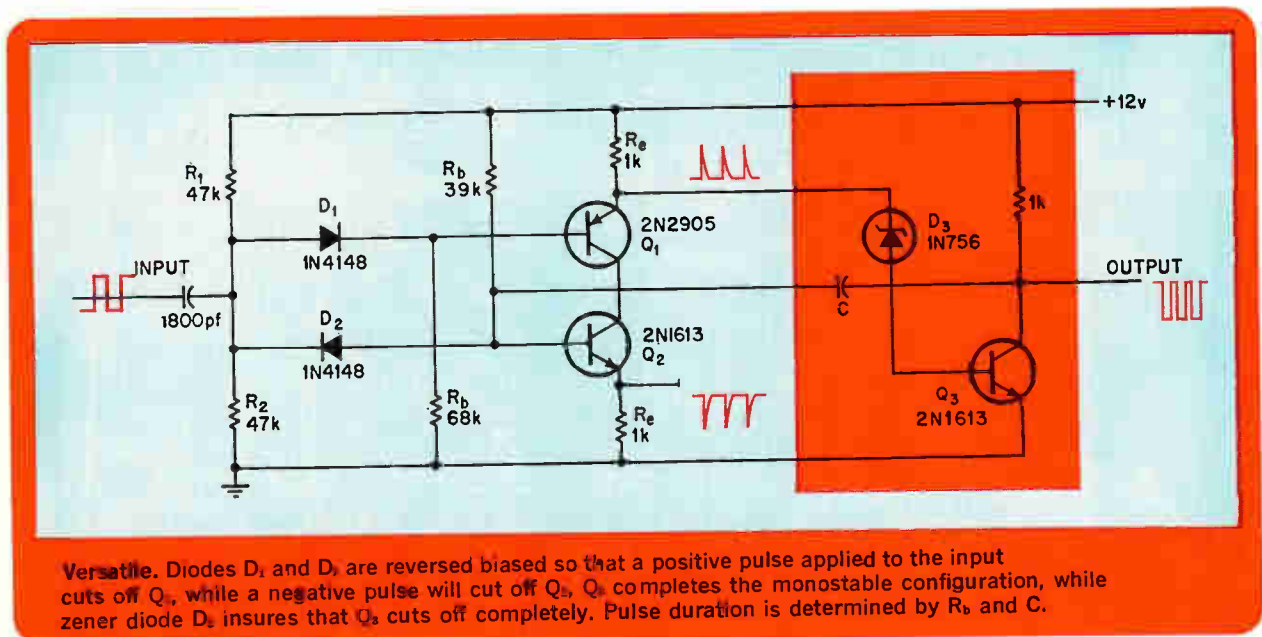

IC flip-flops accurately control motor rotation

By Irwin Math

Great Neck, N.Y.

Industrial applications often require a motor to turn for a fixed, predetermined, number of revolutions. However, with a heavy load, it is often difficult to control the number of revolutions. One method of overcoming this problem uses a flip-flop counter. Each rotation of the motor activates a switch that pulses the motor once. When the counter reaches its maximum, it resets and shuts the motor off.

A cam on the motor shaft activates switch S every time a turn is completed. Initially all flip-flops—FF₁, FF₂, FF₃, and FF₄—are in their zero state. A pulse turns FF₄ on, which causes Q₁ to saturate and which starts the motor turning. Every time a turn is completed, S supplies a pulse to FF₁. Since four flip-flops count up to a binary 16, after 16 pulses (turns), FF₄ turns off and the motor

stops. Should the motor slow down because of abnormal loading, or low voltage, it will always complete the required number of turns. By adjusting the cam to activate the switch more than once per turn, various degrees of rotation can easily be obtained. In addition, by increasing the number of flip-flops used in the circuit, it is possible to increase the number of turns that the motor makes.

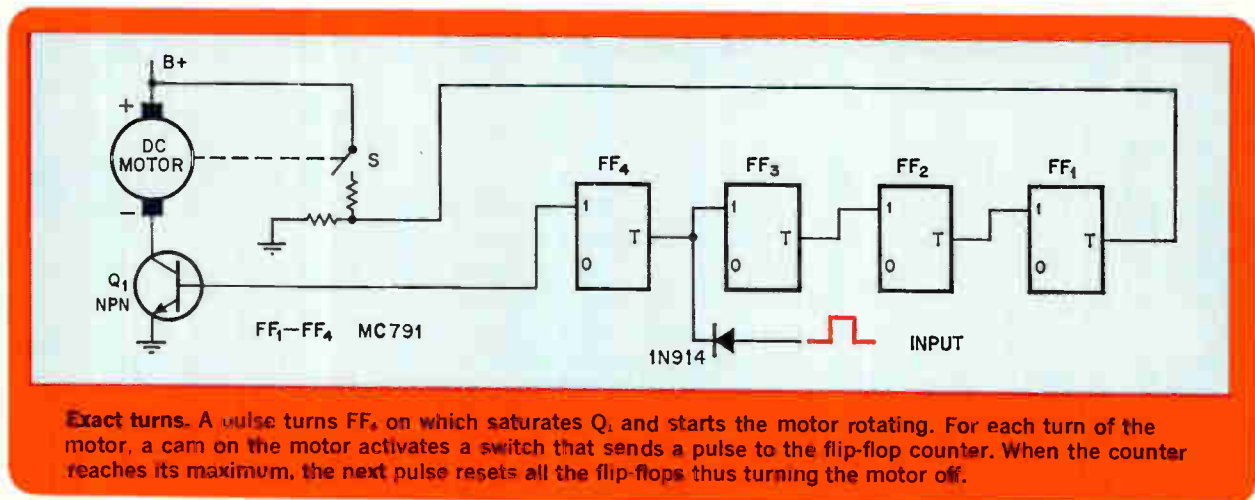

Stable f-m oscillator offers sensitivity and linearity

By Roland J. Turner

General Atronics Corp., Philadelphia, Pa.

Good linearity and small deviation from its center frequency can be obtained from a Hartley-type oscillator by modulating both the emitter current and collector voltage of its transistor.

As the emitter current of the radio-frequency oscillator varies at an audio or video rate, the input resistance of the transistor changes. This causes the phase in the feedback path—L and C₂—to be altered. Because the net phase shift must remain at zero for the circuit to sustain oscillations, the frequency of the oscillator is shifted. As a result of using a collector load that is bypassed for radio frequencies, the collector voltage of the transistor varies at the audio modulation frequency. This variation causes the collector capacitance to change at the same rate and thus provide additional f-m action.

Frequency-modulation produced using this dual

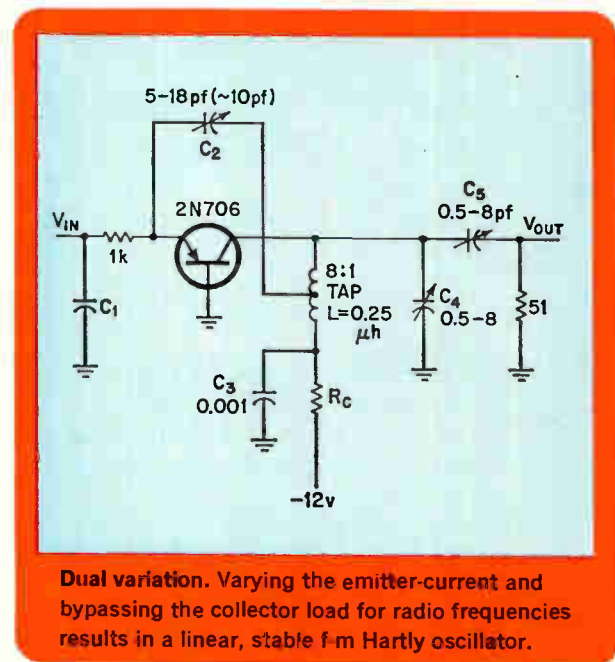

modulation technique produces a deviation sensitivity of from 1.0 to 2.5 megahertz/volt. This deviation has better than 3% linearity at 100 Mhz and is stable from 25° to 75°C.

Control current slows pulse's leading edge

By Thomas Hornak

Hewlett-Packard Co., Palo Alto, Calif.

Continuous control over the delay in the leading edge of a pulse can be achieved by regulating a d-c current as it flows through a tunnel diode located in series with an inductor in the collector of a transistor circuit. The inductor's nearly linear current response to an applied step voltage allows delays from zero to a few microseconds.

The input current pulse applied to the base of transistor Q_1 activates the circuit. However, it is the leading edge of the pulse that actually turns the transistor on and that causes the positive supply voltage to appear across the parallel combination of R_1 and inductor L , thus neglecting the voltage drop across the tunnel diode and transistor. The value chosen for R_1 must allow the current step drawn through the resistor to equal the peak current of the tunnel diode.

The current through the inductor increases linearly by the expression $E_1(t - t_1)/L$, where t_1 is the time at which the leading edge of the input

pulse occurs. The d-c resistance of the inductor is assumed to be negligibly small.

The reverse biasing of diode D_2 keeps the current through R_2 equal to zero and creates an essentially open circuit. The total current through the tunnel diode consists of the current step through R_1 , the increasing current through the inductor, and the d-c control current I_c .

When the total current through the tunnel diode exceeds the peak current, I_p , the diode changes to its high voltage state, delivering the negative leading edge of the output pulse. A delay proportional to the control current appears between the leading edges of the input-output signals.

Thus, if the control current is zero, the expression for the delay, $(t_2 - t_1) = LI_c/E_1$, is zero. The trailing edge of the input pulse turns the transistor off; the current through the tunnel diode returns the diode to its lower voltage state, and generates the rising trailing edge of the output pulse.

The current in the inductor cannot decay instantaneously to zero, and therefore the circuit's recovery time depends on the time constant, $L/(R_1 // R_2)$. For quick recovery, R_2 should be large.

To prevent inadvertent damage to the circuit R_3 and D_3 are chosen with a negative supply voltage $-E_2$ so the current through the transistor never exceeds the transistor's maximum rating. During normal operation, D_3 conducts.

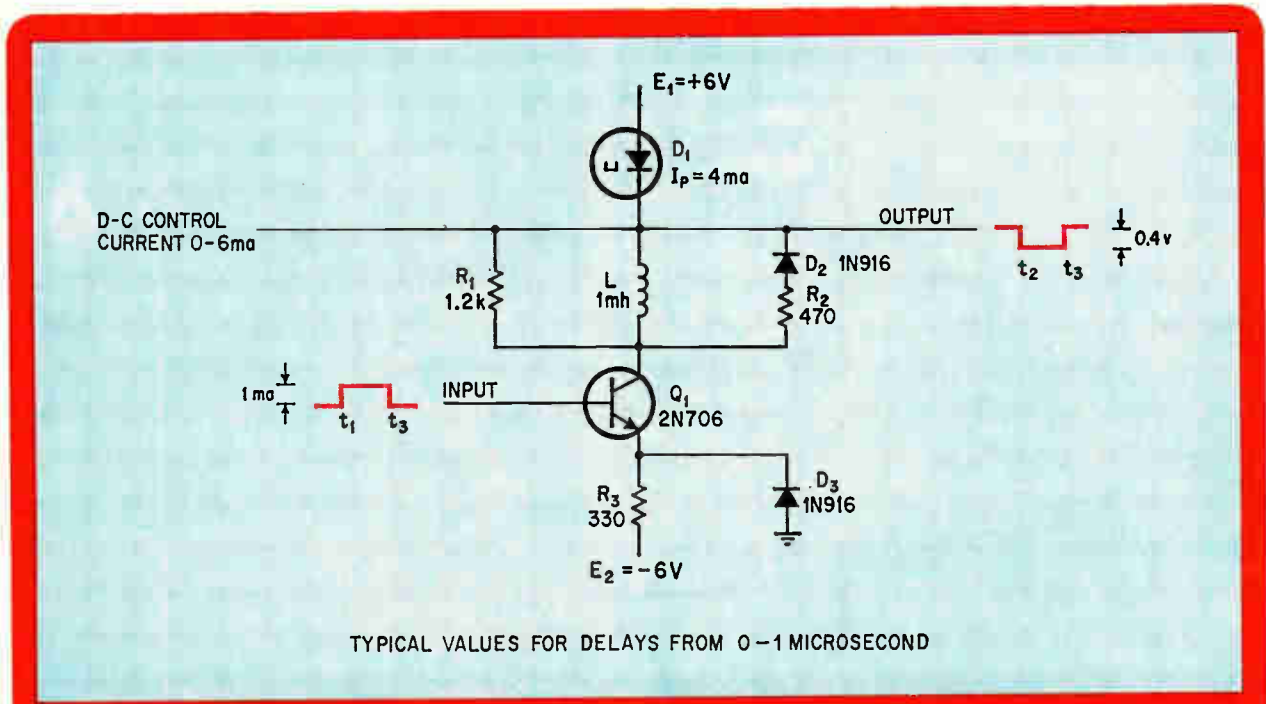

Smooth adjustment. The current in the inductor increases linearly until the tunnel diode's peak current is reached. At that point, the diode changes to its high voltage state. The delay between the leading edges of the input and output signals is proportional to the control current.

100PPM/°C

Ω ± 100 PPM/°C *

* Our diagram signifies Bourns now offers ± 100 ppm/°C TC over the entire temperature and resistance range of all its 12 cermet models

*Once you've said that,
you've said it all...*

...except Bourns said it first!

Complete data on this breakthrough in Trimpot® cermet potentiometers is available from your local Bourns Sales Office, representative of the factory.



BOURNS, INC., TRIMPOT PRODUCTS DIVISION • 1200 COLUMBIA AVE., RIVERSIDE, CALIF. 92507

Semiconductor whodunit: Who's to blame for failures?

Associate editor *Owen Doyle* finds failure sleuths faulting quality control at the vendor level; often, easily detected flaws somehow slip by unnoticed—in some cases, supposedly good devices fall short of their specification

● Caught up in a price war, semiconductor makers are apparently waging it at the expense of reliability. Systems are still failing because of defective semiconductor devices. And too often, the defects are of the type that vendors could spot by either looking at the devices under microscopes or thoroughly testing the devices' electrical parameters.

No longer satisfied with vendors simply replacing bad parts, some system makers are going so far as to set up their own failure-analysis laboratories. They intend telling their vendors: "This is what you're doing wrong; now fix it."

Some system makers are even going further by developing new ways to analyze components. The Raytheon Co.'s Reliability Analysis Laboratory in Sudbury, Mass., for example, is among those studying the use of liquid crystals in failure analysis. When an integrated circuit is put into a liquid-crystal solution and then turned on, the solution turns a bright blue over hot spots [see front cover].

The detective work isn't being done only by systems makers. A great deal of the work is being carried out by the military, which has a large stake in systems that rely heavily on semiconductors. The QRC (quick reaction capability) group was formed two years ago at the Rome Air Development Center because too many failures in Air Force systems were traced to defective semi-

conductor devices. Any time a high-priority system has a rash of failures that are caused by defective semiconductors, the devices are shipped to the center. The QRC group tears apart the bad components to find out why they went wrong.

Since its start, the group has seen devices from just about every manufacturer—big and small—who does business with Air Force contractors. And the systems involved include just about every type of airborne electronic gear. These range from automatic checkout equipment to transceivers, from radars and recorders to displays, and the like. Even data processors used for air-traffic control have been involved.

Some of the semiconductor devices have had obvious physical defects—such as scratches or the presence of contaminants—or just had poor geometry; others have had voids between the header and the chip. And some, as it turned out, simply were never tested electrically by the vendor.

The question that comes to mind immediately is: Why do these faulty devices get out of the vendor's hands in the first place? Unfortunately, there is no simple answer. Obviously, money is an important factor—perhaps, the most important.

The semiconductor industry is highly competitive. And unlike most other industries in which their products are becoming increasingly costly, the semiconduc-



The ups and downs. Using the Talysurf profilometer the QRC inspector measures the thickness of an oxide or a metalization layer. As the instrument's stylus moves up and down across an exposed surface of an IC or transistor, the pressure on the stylus changes. A transducer converts the pressure into an electrical signal whose magnitude is proportional to the relative height of the surface. The instrument shown resolves 250 angstroms. Shown in the foreground is another of the QRC group's tools, a dual-beam interferometer.

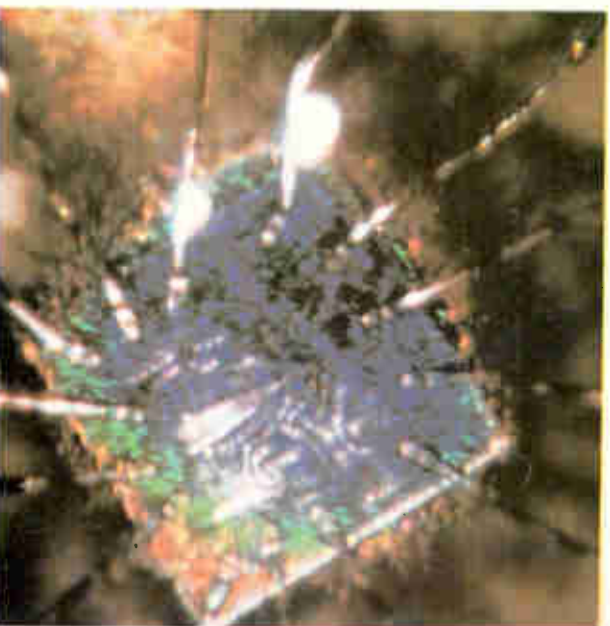
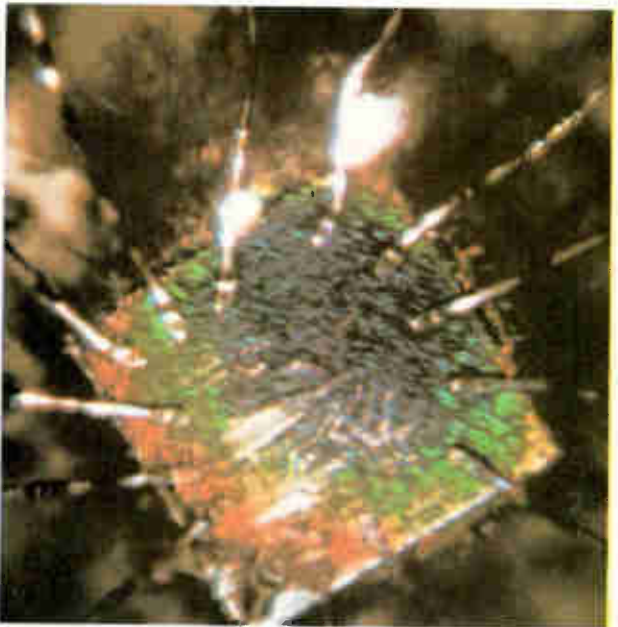
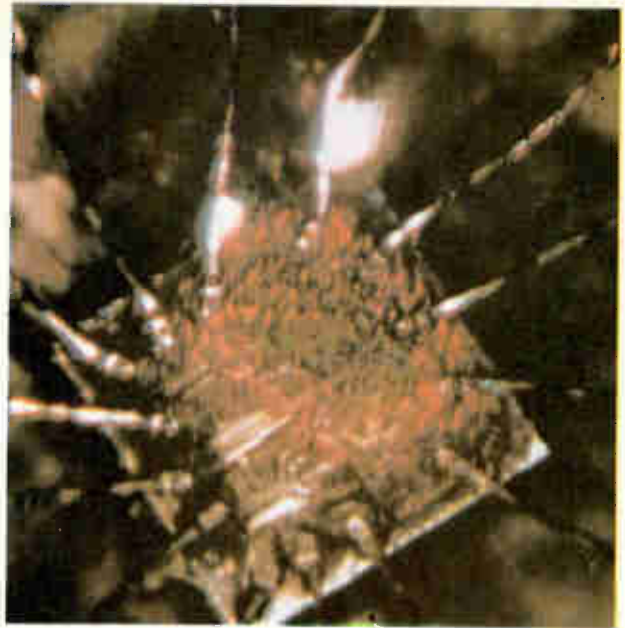

tor industry's products—diodes, transistors, and IC's—are getting cheaper. The more a manufacturer tests and inspects his product, the more expensive it will be. And the size of the purchase also can effect how much and how well a device is tested.

"Nobody questions the cost of adequate screening when you're buying 10,000 logic circuits," says Edgar Doyle, head of the QRC group. "But this isn't the case when you're buying the 60 power transistors to drive these circuits."

"The vendor is and has to be guided by the profit motive," points out John Gaffney, head of Raytheon's reliability lab. "It's hard to convince the maker to put in good quality control because this means reduced yields and that hurts profits."

Eventually, Gaffney points out, a vendor could come up with a simpler process that, with improved quality control, results in a better and less expensive product. "But, again, he's thinking about tomorrow's profits. As long as his products are going out the door, he's not going to worry."

Doyle agrees. "I don't believe any manufacturer wants to deliberately supply components that have processing problems incorporated into them," he says. "But some outfits have the policy: 'Ship it out the door and let the user life-test it and tell us what's wrong. If nothing happens, fine! If something goes wrong, we'll replace

A clue from the color. When the integrated circuit submerged in the liquid-crystal solution is turned on, the liquid crystals take on color. The hotter they are, the bluer they glow. Therefore, as the input to the IC goes up, the hottest regions turn a darker blue, and the blue-colored region grows larger. One use of liquid crystals then is to find hot spots. And any place a semiconductor device gets too hot is a place where the device is likely to fail.

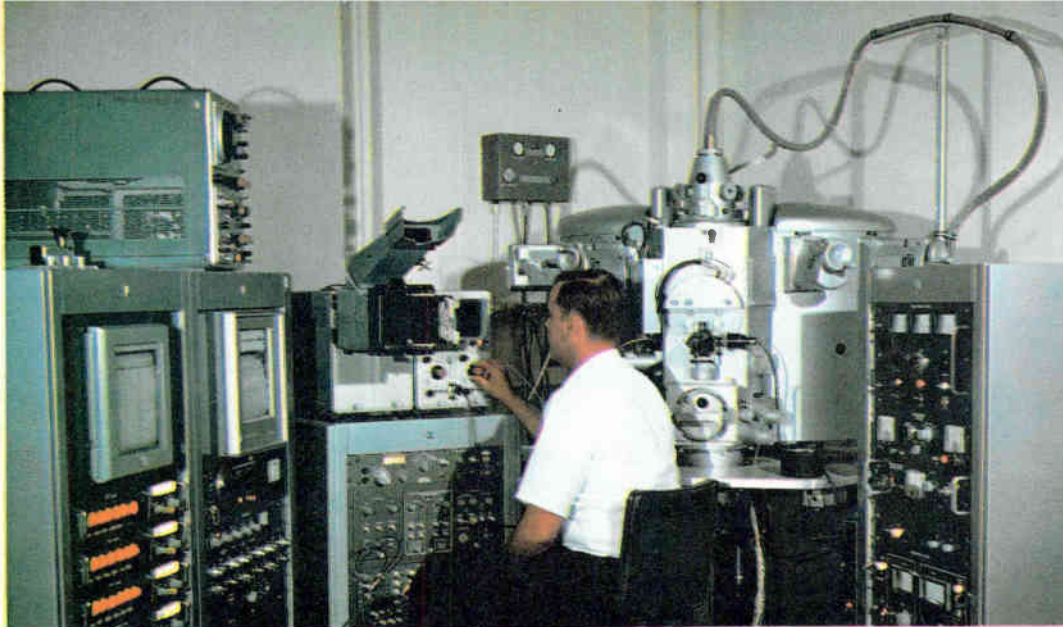

The seeker. The gold contaminating the junction FET was found by this Electron Beam Micro-analyzer, made by Applied Research Laboratories. The instrument shoots a beam of electrons at the device being tested. By analyzing the X-rays generated, the Microanalyzer finds out what material and how much of it is in the region the beam strikes.

the component free of charge.' This attitude doesn't hurt the vendors because they sell so many, but it sure hurts us when we're banking on reliability and don't get it."

All companies, regardless of size, have their problems. And, says Doyle, buying from a large manufacturer doesn't necessarily ensure getting a better product—even though the big companies have the technical talent available. "As far as small companies go," he says, "the quality depends largely on the type of people they have."

Progress, too, creates problems. "People always want to use the newest off-the-shelf parts," says Doyle, "and we just can't generate reliability data fast enough."

Although a vendor wouldn't deliberately ship bad components, there are cases in which the defects can be attributed directly to the design. One such case, uncovered by Doyle's QRC staff, involved a number of ultrahigh-frequency transistors that shorted out during stress testing. The transistors had a gold base contact, a silver collector contact, and a ceramic substrate separating the base from the collector.

The faulty devices were first tested electrically by the QRC engineers at ambient temperature and pressure. When the humidity was raised and the transistors tested again, the devices shorted—silver had left the collector and moved to the base. This didn't surprise Doyle. "Silver migration," he says, "occurs when silver is exposed

to a high electric field and a great deal of humidity. The manufacturer could have partially gotten around the problem by plating the silver with some other noble metal." In other words, the device was poorly designed.

Other cases, perhaps more than one would like to believe exists, involve poorly designed IC's. Says Doyle: "We still find IC-producing companies that don't control the ratio of oxide thickness to metalization-layer thickness, which could result in metal at oxide steps and at contact cuts. This is an obvious design deficiency." And strangely enough, according to the QRC chieftain, it's some of the major semiconductor makers who are guilty of this, not some obscure companies.

One of the most difficult things for Doyle to swallow is a manufacturer not bothering to test his device, particularly the major electrical parameters. But it has happened. "We once received what were supposed to be good transistors for comparison with transistors that had failed," he says. "But we found that the breakdown voltage of the supposedly good devices was only half of the specified value."

In almost every case, the failure itself is fairly obvious, but why it failed is another matter. One such case involved junction field effect transistors from prototypes of an intrusion detector that had failed shortly after installation. The systems maker did some analysis of his own and found the FET's were shorted by either overloads or

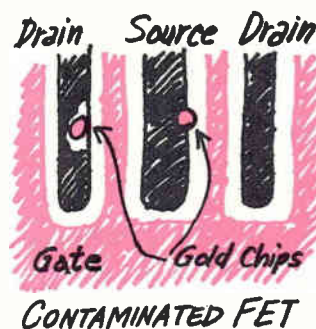
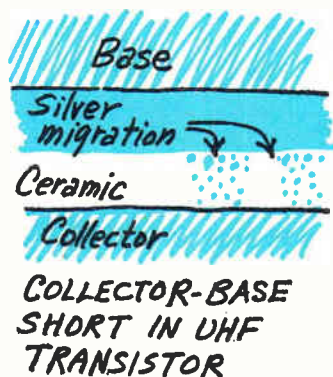

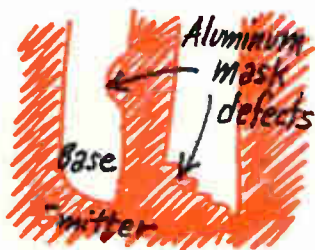

EMITTER-BASE SHORT
IN HIGH-POWER
TRANSISTOR

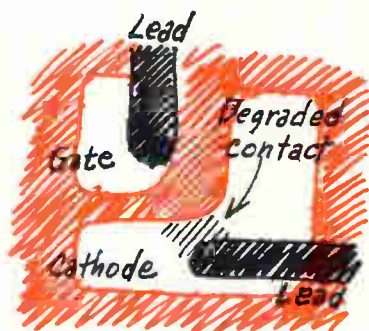

NEW, UNUSED SCR

transients. Finding out why the transistors were so susceptible to this failure mode was the task facing the QRC group.

First, some unused FET's from the original shipment were analyzed. By measuring the thickness of the metalization layer over the surface of the transistor, the QRC people found evidence of poor process control. There were large variations in the thickness of the layer; flakes of gold and silver—two metals not part of the device—were found inside the transistor; and the drain fingers varied in size, as did the source fingers.

Doyle's engineers then looked at the FET's that failed. The intrusion-detector maker supplied five of these devices, four of which failed because of shorts between the drain and the substrate, and the other because of an open between the drain fingers and the drain contact.

Of the four shorts, three were caused by aluminum diffusion and the fourth by gold diffusion. Each transistor, however, broke down in just one area along a single drain finger, due to excessive heating. In each case of aluminum diffusion, the faulty drain finger was easily spotted because the silicon near the hot spot had recrystallized.

Finding the cause of the short in the fourth case was somewhat more difficult. "There was no visual defect that would cause a short," says Doyle. "When we stripped away the aluminum, we found gold, a contami-

nant, in the drain finger contact."

Where did it come from? "Contamination from the bell jar, maybe," he points out. "They [the vendor] could have been doing gold evaporation earlier and didn't clean the jar, so when they were evaporating aluminum some of the gold flaked off onto the chip."

What probably happened in every case is fairly obvious. When an overload or transient appeared, the site of the defect heated and caused the metal diffusion to the substrate.

Both Doyle and Raytheon's Gaffney have come across cases where vendors could have spotted flaws with microscopes. Raytheon, when building the guidance computers for Apollo command modules, screened every component. Most of the IC's that failed the screening, says Gaffney, did so because of "cosmetic flaws"—such as scratches—that could be seen under a microscope.

Doyle can go on and on about similar situations. One, for example, involves a high-power mesa transistor used in a display's power supply.

Says Doyle: "After we stripped off the passivation layer, we could see a dimple in one of the emitter fingers [A dimple is a place where the emitter's border is concave instead of straight.] and a poor job of masking. As a result, the transistors kept burning out. These visual defects could have been caught."

As far as Doyle is concerned, there are too many cases—such as the mesa transistor—in which visual inspection is less than adequate at the vendor level, if not nonexistent. As if to underscore his point, he cites yet another example, this one involving silicon controlled rectifiers.

"The Air Force was having a problem with a certain SCR burning out," says Doyle. "We wanted to perform some high-current pulse tests on them, so we asked the contractor to send us some unused devices that he had received in the same shipment with the ones that had burned out. What surprised us was that of 12 unused SCR's one was partially degraded around one of its contacts. And another shorted out during low-power testing. We could see no way for an overvoltage or an excess current to get it to the rectifier. This device turned out to be partially degraded, too."

What worries Doyle the most is that the vendors are shipping devices, such as these SCR's, that are already partially destroyed. And once they're placed in critical equipment, system failure is just about guaranteed. ●

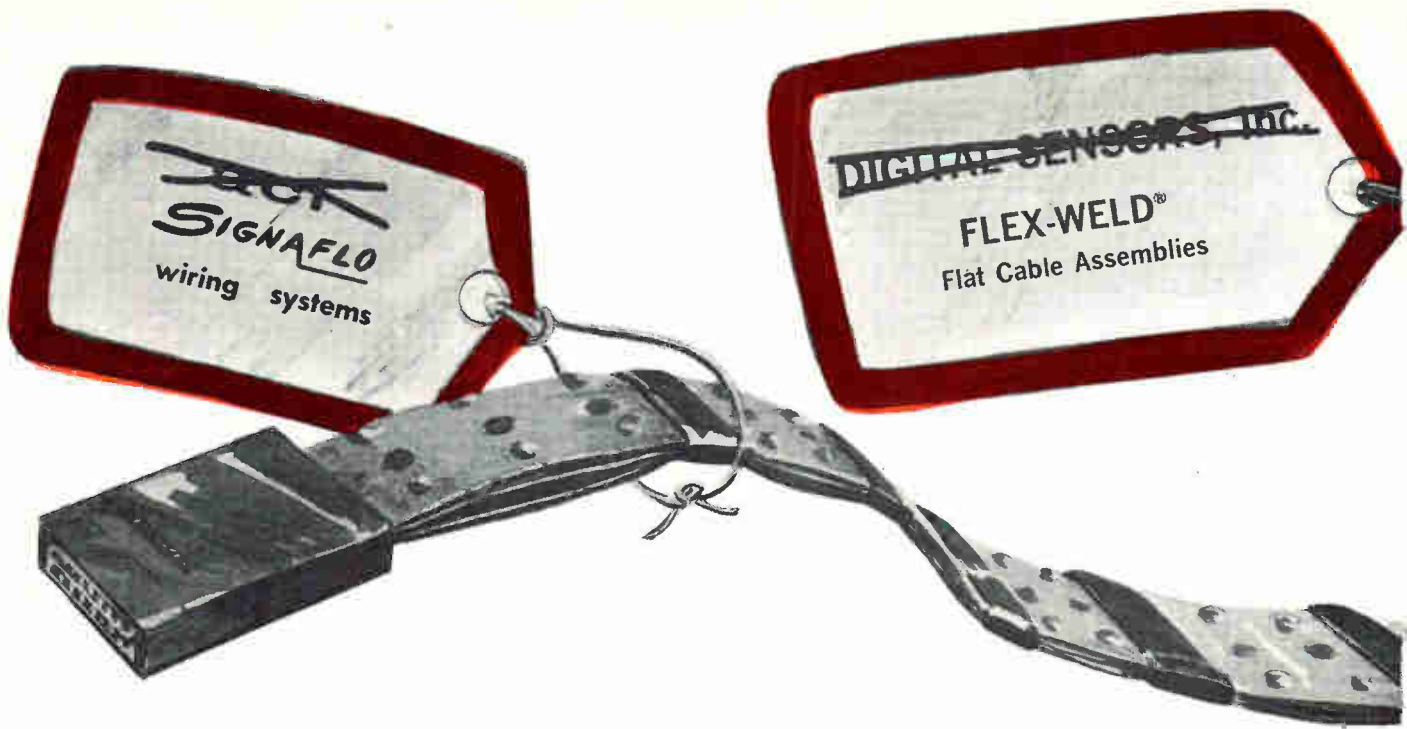

Ansley is our to make your

Division of Thomas & Betts Corporation

The old company names will disappear . . . but you'll continue to see our product trademarks . . . from now on prefixed by Ansley!

aci INCORPORATED

- SIGNAFLO wiring systems
- SIGNAFLO transmission line wiring systems
- Interconnection and structural systems for memory devices
- Laminar bus bars

DIGITAL SENSORS, Inc.

- Flex-Weld® flat cable assemblies for aerospace, military avionics and ground support equipment utilizing the patented flat cable welded pin interconnection.

ANSLEY MFG. CO.

- FREE-FLEX® flexible etched circuitry
- PERMA-FLUSH™ switch decks and code wheels
- ROTO-REED® switches
- Chemically created circuitry . . . multilayer, fine line etching, plated-through holes, etc.

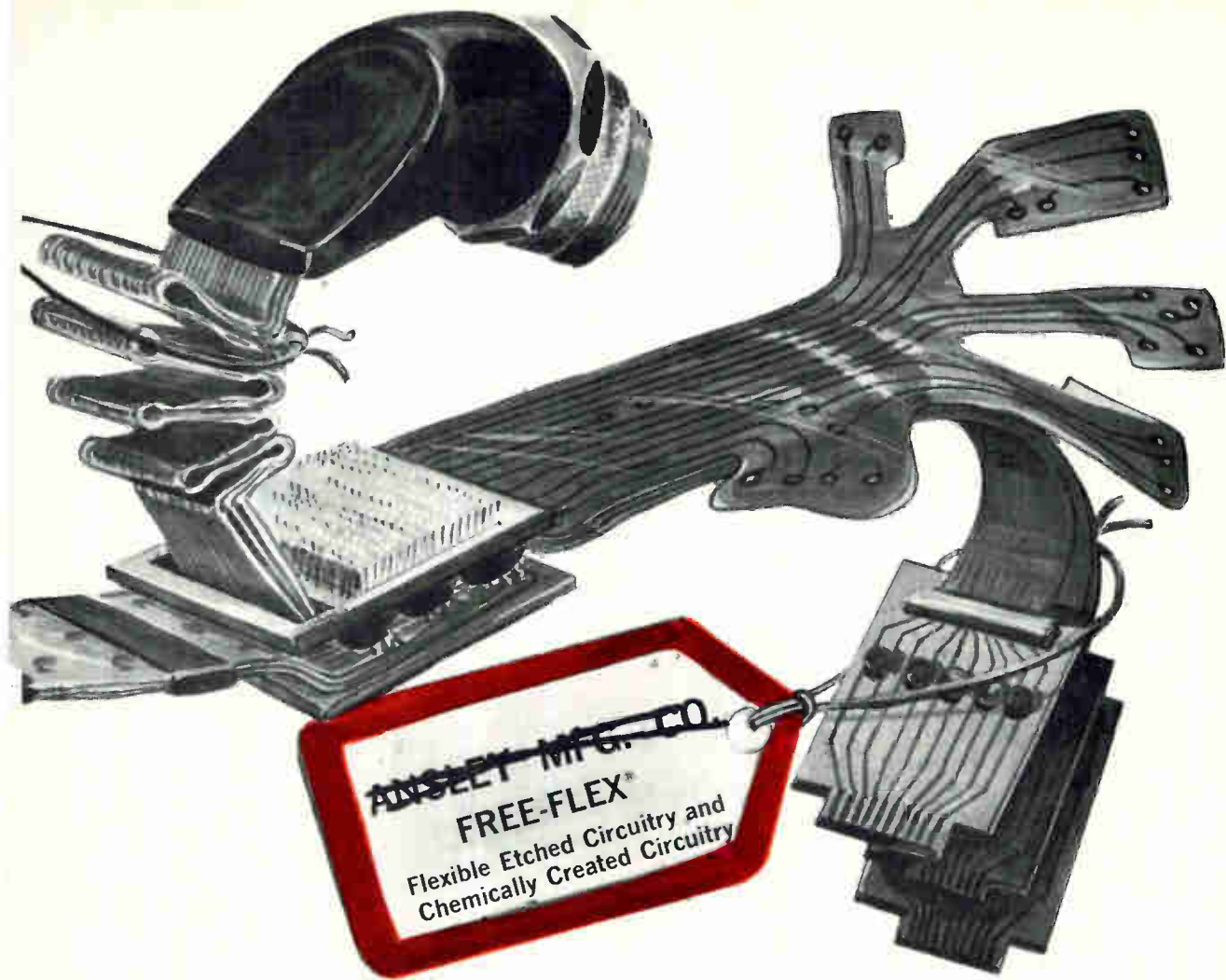

new name life easier..

Interconnective wiring for today's electrical/electronic packaging engineers requires many answers. Some are met simply. For others it takes many technologies to produce a meaningful state-of-the-art approach. Who knows? Your next interconnective wiring system may require just such a combination of technologies and facilities.

From now on it's Anasley . . . your one source.

Anasley

Division of Thomas & Betts Corporation 

Production facilities are located with geographic advantages to best serve our customers.

Anasley —east Corporation

Old Easton Road, Doylestown, Pa. 18901
Telephone 345-1800 area code 215

Anasley —west Corporation

4127 N. Figueroa St., Los Angeles, Cal. 90065
Telephone 223-2331 area code 213

*WESCON/69
Circle 103 on reader service card
BOOTH 2815-16

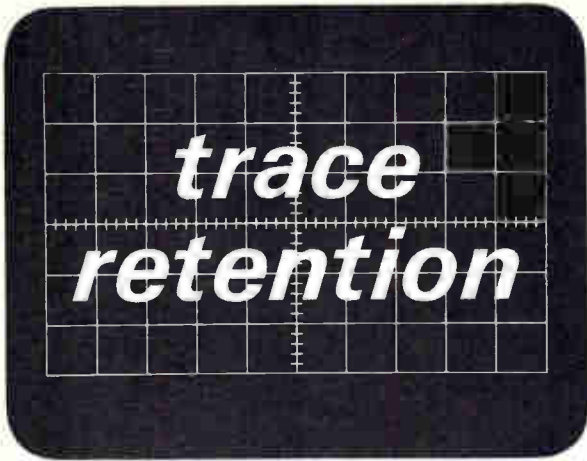

the convenience feature

Most waveform measurements are easily made with today's instrumentation. Signals are usually repetitive, medium frequency, sufficient in amplitude, easily triggerable, etc.—usually, but not always. Some signals persist in being single event or low frequency, aperiodic or absolutely random, and even untriggerable. There are three ways to approach these problem measurements: (1) great operator patience, (2) waveform photography, (3) trace retention (storage). The storage technique is pure convenience by comparison.

The Tektronix Type 549 Oscilloscope offers all the advantages and versatility of a conventional plug-in instrument—plus storage. It easily handles those normal Real-time (DC to 30 MHz), Sampling (DC to 1 GHz), or Spectrum Analysis (10 Hz to 40 GHz) measurements. And when you are confronted with a tedious measurement, simply call up the storage feature by pushing a button.

The result is solid bistable storage with 5 cm/ μ s writing speed and half or full screen displays. Viewing time and erase controls provide the flexibility for many different applications. The erase command is either manual (viewing time 1 hour without degradation), automatic (after-sweep or periodic) with variable viewing period up to ≥ 5 s, or remote. After automatic erasure the single-sweep circuitry is reset to complete the hands-off operation.

Call your local Tektronix Field Engineer for a demonstration of the Type 549 in your application. He can show you how storage lets you concentrate on the results of the measurement rather than making it.

For complete technical specifications on the Type 549 Oscilloscope and letter series or "1" series plug-ins, consult your current Tektronix catalog, circle the reader service number, or write Tektronix, Inc., P.O. Box 500, Beaverton, Oregon 97005.

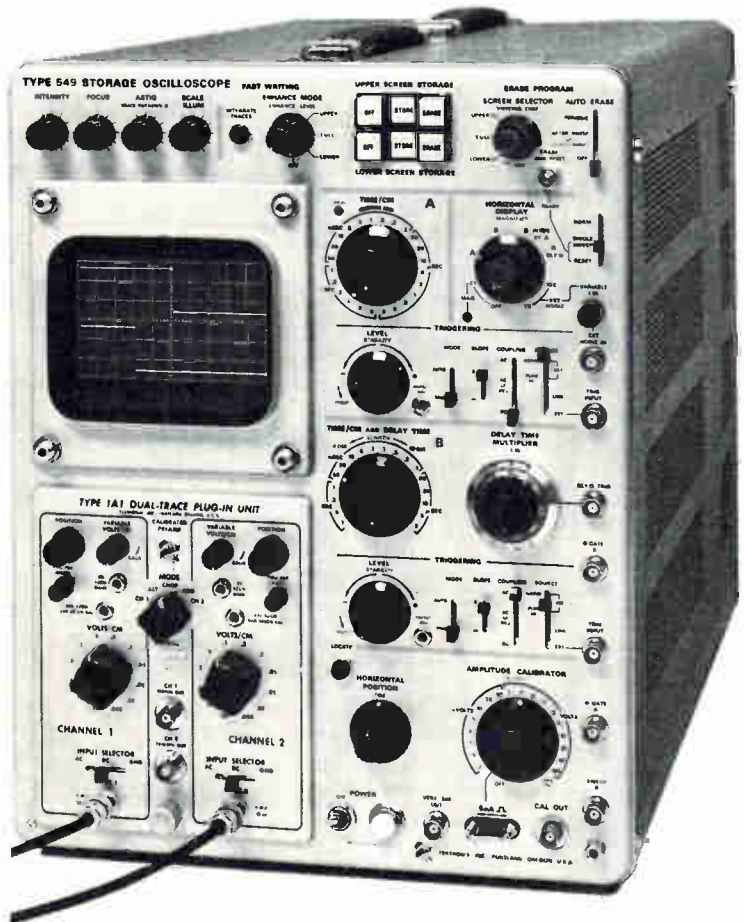

The Type 549 Storage Oscilloscope has DC to 30 MHz bandwidth (depending on plug-in unit); full delaying sweep horizontal operation; conventional or storage displays; accepts all "letter" or "1" series vertical plug-in units.

TYPE 549 STORAGE OSCILLOSCOPE \$2,625.00

Vertical plug-ins available cover single channel, multi-trace, differential, sampling, TDR, spectrum analysis, and other special purpose applications.

TYPE 1A1 DUAL-TRACE UNIT (shown) \$650.00

U.S. Sales Prices FOB Beaverton, Oregon



Tektronix, Inc.

committed to progress in waveform measurement

Multistable logic simplifies man-machine interface

Based on the phased-pulse principle, circuitry that assumes 10 stability levels instead of just two is not only more efficient, but is far less complex as well

By L.S. Sitnikov and L.L. Utyakov

Tochelectropribor, Kiev, USSR

The power and simplicity of bistable logic—on-and-off switching of electronic devices—has somewhat obscured the fact that it's really not the most efficient way of handling information at the man-machine interface. Converting the binary code that machines use to the decimal code that humans understand—and vice versa—calls for some complicated circuitry when the components can assume only two states.

What's needed is multistable logic in which the components can assume any of 10 states. Engineers at the Soviet Union's Tochelectropribor have developed a form of multistable logic that's not only practical in theory, but that is now used in pulse counters, time-interval meters, frequency meters, tachometers, desk-top calculators, and other equipment.

Tochelectropribor's multistable logic is based on the phased-pulse principle: count pulses are combined with clock pulses and passed through a frequency divider whose output is then compared with the clock pulses after they have been similarly processed through another frequency divider. The phase difference between the two pulse trains is proportional to the accumulated value of the count pulses.

Thus far, only discrete components have been used to implement the multistable technique. But size reductions have been impressive nonetheless. For example, Tochelectropribor has built a decade-counter module with a gas-discharge alphanumeric tube readout in a package that measures 20 by 20 by 65 millimeters. This module uses only half the number of components that would be needed if flip-flops were used. Moreover, these components require less power. As a result, the estimated mean time between failures is three to four times that of the equivalent bistable circuitry.

Capable of operating over a wide temperature range, the multistable circuits can tolerate supply voltage fluctuations of $\pm 10\%$. Component values need not be precise—a spread of 10% or more is acceptable in certain capacitors, while other components are even less critical.

Big boost for IC's

The multistable techniques employed for discrete circuits have much to offer to integrated circuits too. Although fewer components isn't necessarily an advantage with the latter, multistable techniques mean fewer internal and external connections per function. And this means increased IC yields and improved reliability.

For example, to stay within the constraints of the 16-pins on the popular dual in-line package, elaborate provisions are necessary to drive an alphanumeric readout with (bistable) transistor-transistor-logic IC's. Thus, with a series 7400 TTL decade counter, the binary-coded-decimal-to-decimal decoder that it drives must be far more complex internally; extra inverters must be provided so that there are four output pins, not eight. In addition to this internal complexity to achieve the four input pins, a typical series 7400 decoder requires 10 output pins to drive the display and two power-supply pins.

Similarly, a multistable IC decoder would require two power-supply pins and four input pins—but only one output pin. Actually, two such multistable decoders could be placed on the same chip and still need only 12 active pins—well within the constraints of the 16-pin dual in-line package. And the internal metalization for this two-cell circuit would be simpler than that for a single-cell TTL decoder.

With suitable partitioning—placing counters and

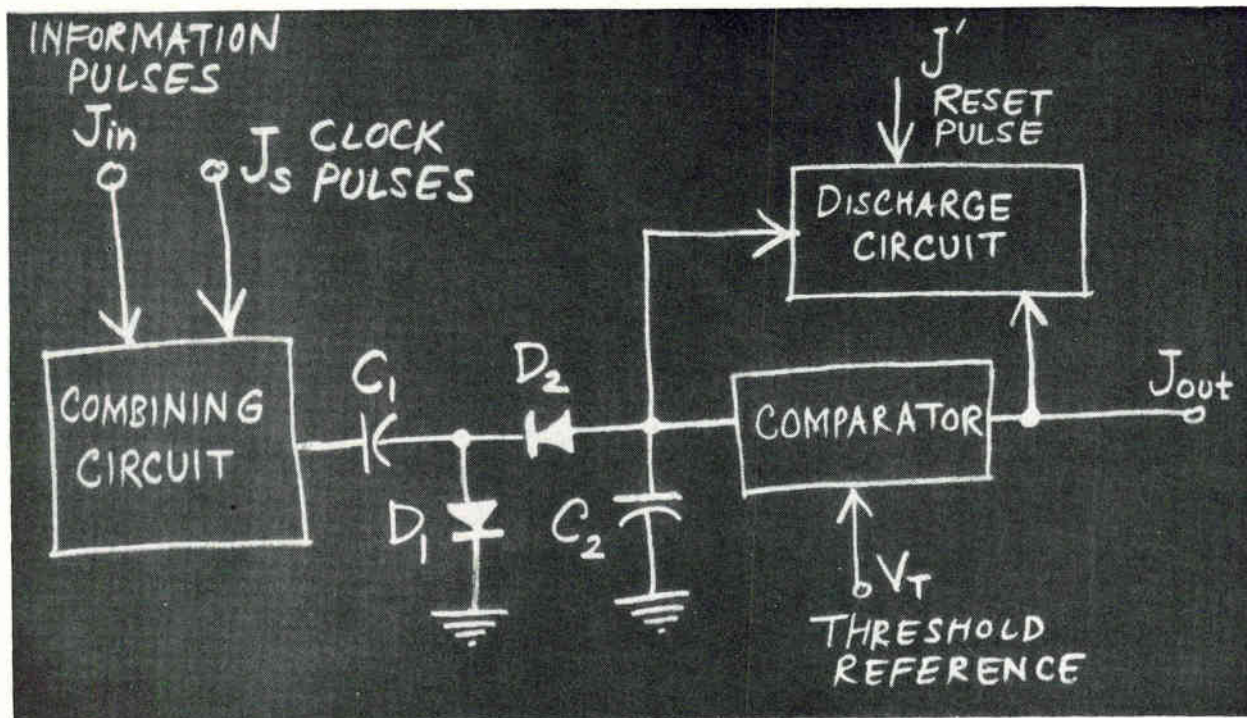

Phased pulses. In a multistable counter, the time difference between an output pulse and a reference pulse represents the accumulated count.

decoders on the same chip—multistable logic can reduce the pin connections to drive a multidigit alphanumeric display by as much as 75% that of binary logic and still maintain the 16-pin configuration. If one accepts the number of pins as an inverse figure of merit for reliability, this would increase reliability by as much as fourfold.

To understand the principle of the multistable circuit, consider the counter shown above in block diagram form. J_s is the clock, a train of synchronizing pulses from an external source. For the moment, disregard the “combining circuit.” Each pulse turns on diode D_1 and charges capacitor C_1 . (The charging time of the capacitor is independent of the pulse duration; it is determined only by the time constant of the C_1 - D_1 circuit.)

When the charge on C_1 reaches a certain level, D_2 becomes conductive and C_1 then discharges into C_2 . With each pulse J_s , then, the voltage V_{C_2} on C_2 increases in a staircase fashion, as on next page. The height of each step is $\Delta V_{C_2} = (V_a - V_{C_2(n-1)}) C_1 / (C_1 + C_2)$, where V_a is the pulse amplitude at the output of the combining circuit, and $V_{C_2(n-1)}$ is the voltage across C_2 at the moment of the n th pulse arrival.

After the arrival of a preset number of clock pulses, V_{C_2} reaches a certain threshold level (determined by voltage V_T applied to the comparator), the comparator triggers the discharge circuit, and V_{C_2} drops to its initial value.

The storage, comparator, and discharge circuits act as a pulse-frequency divider. They produce one output pulse, J_{out} , for every n input pulses.

Controlling division factor n are the pulse height at the output of the combining circuit, the discharge threshold, V_T , and the properties of the diode-capacitor circuits.

The period of the output pulses J_{out} is $\tau = nT$, where T is the clock-pulse period. Each output pulse coincides with an I_s pulse.

Adding an input

What is the effect of feeding the combining circuit an additional pulse train, one containing information? Then J_{out} pulses wouldn't necessarily coincide with clock pulses but the phase difference between pulses would relate to the information contained in the new input.

The combining circuit adds the new input—a series of count pulses, J_{in} —to the clock-pulse train J_s . And these $J_{in} + J_s$ pulse trains have the same effect on the storage capacitor, C_2 , and the discharge circuit. All pulses look alike to the output circuitry; there is no discrimination between the sources. When enough pulses have accumulated to exceed the threshold voltage, C_2 discharges.

All that remains is a comparison of the information-bearing output pulse train, J_{out} , with a “slow” clock J_{ref} (actually the same clock used for J_s , but with its frequency divided by n —achieved with a similar frequency divider). An I_{out} pulse train will appear shifted with respect to J_{ref} by a time interval $t_i = iT$ ($i = 0, 1, 2, \dots, n - 1$). This phase difference, or time shift t_i , represents the information contained in J_{in} .

Resetting for a new count sequence is achieved

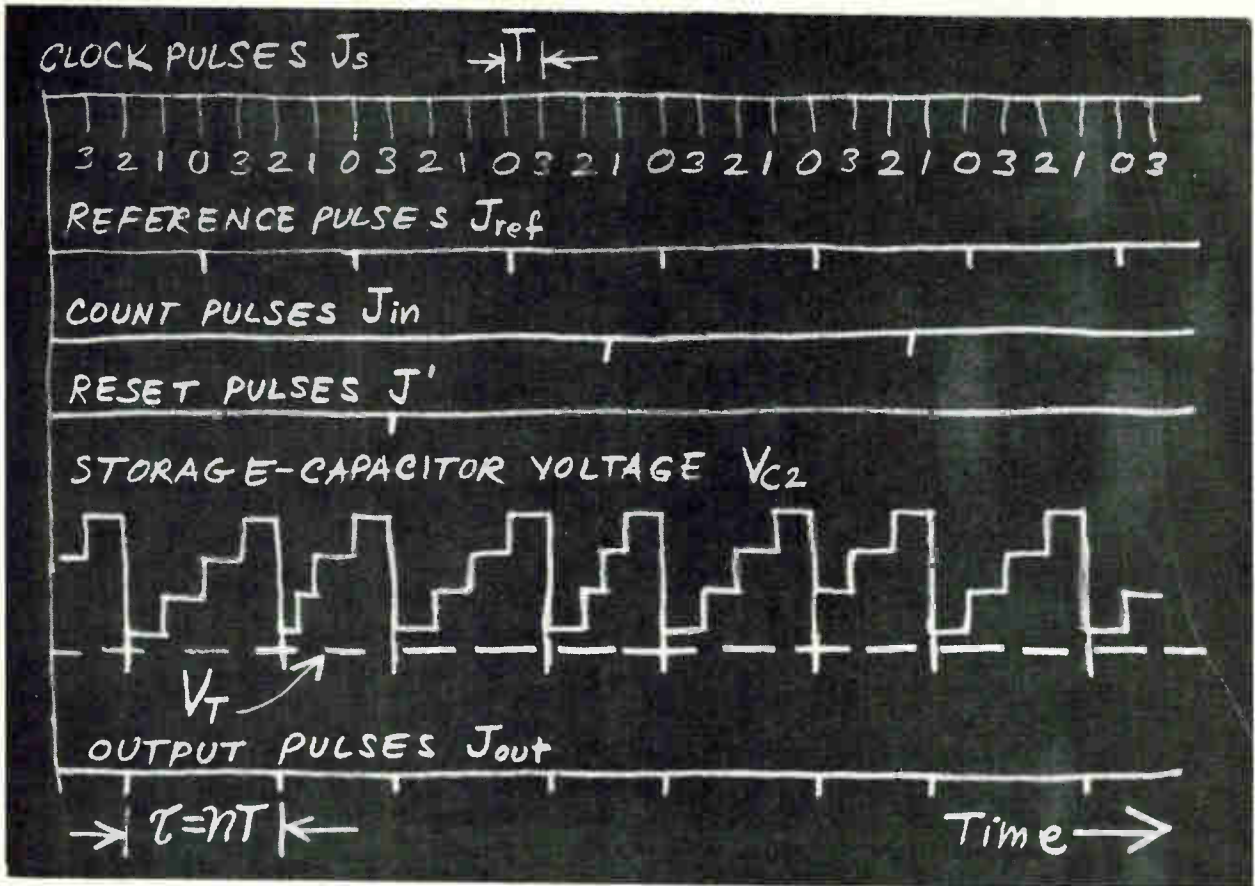

Staircase. The voltage on the storage capacitor increases in steps. Each step is the result of a clock pulse or a count pulse. Here, n is equal to 4 for simplicity; in a decade counter, n would be equal to 10.

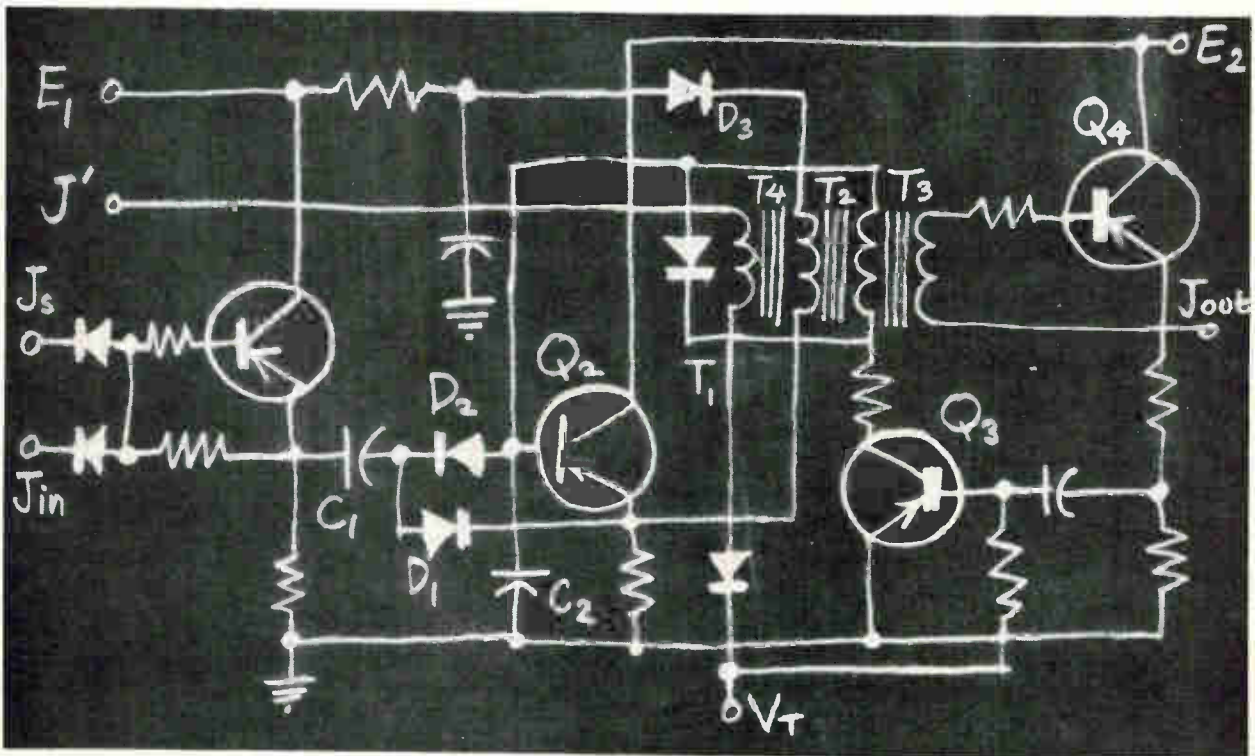

Discrete count. Several resistors, transistors, capacitors, and inductors are needed in a discrete-component multistable decade counter, but these are far fewer in number than that needed in a bistable version.

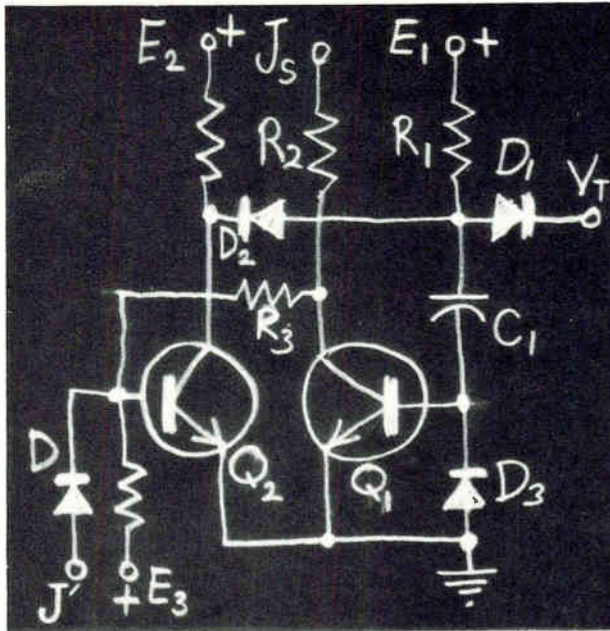

Compatible. An IC version of the multistable counter needs no inductors. The value of the single capacitor is low enough to be compatible with monolithic techniques.

by applying a pulse J' to the discharge circuit. V_{C2} is thus instantly raised above the threshold level, discharging C_2 , and starting a new counting sequence.

Using the time shift t_1 to drive an alphanumeric readout tube is a simple matter. A "constant generator" applies a voltage to each character (0,1,2, ...) in sequence, clocked by the synchronizing pulses J_s . Meanwhile, the J_{out} pulses from the counter circuit are applied to the readout tube's other electrode and the energized character lights up. Thus, if the count is zero, the J_{out} pulse coincides with the pulse on the 0 electrode, which then lights up.

The greater the time shift t_1 , the longer it takes for the constant generator to step through its sequence before a J_{out} pulse arrives. When the voltage does come—it may be at position 2, 5, or whatever, depending on the elapsed time—the tube immediately discharges and lights up the appropriate number.¹

A practical discrete-component circuit for performing the functions of frequency division and count storage is on page 107. The threshold voltage V_T is the same as supply voltage E_1 , to simplify power supply requirements. A reset pulse applied to transformer winding T_1 excites the blocking circuit (transistors Q_3 and Q_4), forcing the storage capacitor, C_2 to discharge.

Transistor Q_2 is part of a linearizing circuit that assures a linear envelope for the step voltage at C_2 .

Eliminating inductors

Designing an integrated version of the multistable circuit isn't difficult. From an IC viewpoint, the multistable technique has a lot going for it: few external leads, few internal connections, low

power consumption, and wide parameter tolerances, for instance.

First, of course, the inductive elements must be eliminated. One possible multistable circuit minus these elements, shown left, employs a synchronizing capacitive relaxation oscillator.

Only one capacitor is needed. It is charged from supply voltage E_1 (with time constant R_1C_1). The charge current flows through the base and emitter of transistor Q_1 , keeping it open until saturation. When the potential on the upper plate of C_1 reaches the threshold voltage V_T , diode D_1 turns on; this discontinues charging of C_1 and causes Q_1 to turn off.

The next clock pulse turns on Q_2 by way of B_2 and R_3 . C_1 can now discharge through D_2 , D_3 , and Q_2 , which it does almost instantly. Then Q_2 turns off and the charging of C_1 begins anew. And until the voltage across C_1 again reaches the threshold level, clock pulses are shunted through the collector and emitter of Q_1 . Since the R_1C_1 time constant determines the charging time, it also determines the number of clock pulses that are shunted. For example, the resistance and capacitance can be selected so that each 10th clock pulse turns on Q_2 .

The required value of C_1 decreases with increasing output frequency and with decreasing charging current I_1 , according to the relation $C_1 = I_1\tau/V_T$, where τ is the output pulse-repetition period. For $\tau = 10^{-5}$ second, $I_1 = 10^{-4}$ ampere, and $V_T = 10$ volts, the capacitance would have to be 10 picofarads. This means that the low capacitance that an IC chip provides is adequate, as long as the charging current, I_1 , is low. This can be assured by substituting a Darlington amplifier for Q_1 to give high impedance and gain.

The circuit values in the relaxation oscillator don't have to be precise. In fact, $\pm 20\%$ variations in I_1 , C_1 , and R_1 are acceptable.

In addition to counters, multistable circuits should find application in memories and in multi-level logic. Work is being done toward this end at Tochelectropribor. Meanwhile, the Licensintorg agency in Moscow is licensing the multistable technique. ■

Reference

1. L.S. Sitnikov and L.L. Utyakov, "Compteurs Decimaux Elements d'Impulsions de Phase (d'Impulsions en Position) Multistable," International Congress Mesucora 67, Paris, 1967.

Bibliography

- W.A. Edson, "Frequency Memory in Multimode Oscillators," IRE Trans. on Circuit Techniques, CT-2, 1955.
- R.L. Wigington, "New Principle in Computer Technology," Cybernetics Review, No. 2, 1961.
- L.S. Sitnikov and L.L. Utyakov, "On the Employment of Frequency Response Curves in the Design of Multistable Cells," Priborostroenie, No. 9, 1964.
- L.S. Sitnikov and L.L. Utyakov, "Multifrequency Flip-Flops with Magnetized Cores," Magnetic Elements Review, "Naukova Dumka", Kiev, 1964.
- L.S. Sitnikov and L.L. Utyakov, Counting circuit, USSR Patent No. 172130, cl. 42m, 140z, Invention Bulletin, No. 12, 1965.
- V.I. Kornytchuck, A.M. Romankevitch, L.S. Sitnikov and L.L. Utyakov, "On the Realization of K-Valued Logic," Izvestiya Vuzov, Radiophysica, Vol. X, No. 3, 1967.

The little things that count.

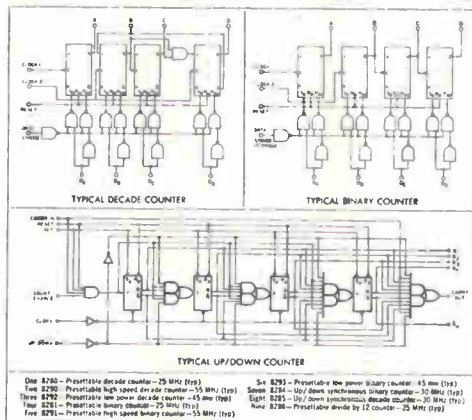

The magic number is nine.

Because that's how many MSI counters we make at Signetics — more than anybody else. Which lets you choose exactly the counter that's right for you. (No more buying too much. Or, worse yet, too little.)

You want high-speed counters? We've got 'em. Medium- or low-power counters? Take your choice. Binary, decade, divide-by-12 modes?

Just say the magic word. And all are

available in either flat packs or DIP's.

In short: each Signetics counter gives you more complex magic, dollar for dollar, than any other counters in the industry.

And, when you get right down to it, isn't that the one thing that really counts?

P.S. Coming to WESCON? Look us up in Unit F, and we'll tell you about a number of these numbers. Or write for specs on the whole line. We'll rush them to you.

Count on it.

More complex magic from

Signetics MSI

Signetics Corporation / 811 E. Arques Ave., Sunnyvale, Calif. 94086 / A subsidiary of Corning Glass Works

Before you start your own company...

... make sure you've got an engineering-management team, good lawyers, backing and a product that doesn't imitate another already on the market

By Dale Samuelson

Electro-Metrics Corp., Amsterdam, N.Y.

Before you change jobs, why not consider generating a new position for yourself instead. There's no surer way of becoming your own man than by starting your own company. But it won't be easy, not if you want to succeed; you have to work at success.

For starters, you'll need technical know-how, technical talent, a grasp of some segment of the electronics market, something new or different to offer, persistence, patience, guts and financial backing—though it needn't be your own money. And, you have to be willing to gamble. With a little help from Lady Luck, you can be on your way. If you're staking your venture on a new product, it should incorporate technological innovation. You could wind up behind the proverbial 8-ball should you place your hopes on a product that's simply a carbon copy of somebody else's.

Assuming you do have a product—or at least a good idea for one—a good time to start thinking of starting your own company is when your present employers announce they're merging with a larger company. This often means that qualified engineers and managers are either fired or forced to move to other parts of the country; there are many instances when relocation is frowned upon. Why not take advantage of the available talent and use it to form the backbone of a new company? A half dozen engineers with complementary backgrounds and who have worked well together before could make an unbeatable team.

Birth of a company

As a case in point, take the experience of several of us who found out six years ago that our employer, Empire Devices, was being taken over by the Singer Co. We faced the prospect of moving our families from Amsterdam, N.Y., to Bridgeport, Conn., a move we didn't care to make, and coping with the thorny problem of relocating an entire production facility.

Production line people learn a lot of techniques

that never get written down. Since these workers usually don't move with a company, there's no way of passing their skills on. Not only can a shakedown period be aggravating, it could be costly as well.

We weren't sure that Singer, new as it was to our end of the electronics business, realized the extent of this problem. And we had doubts about the company's grasp of wage scales for electrical engineers. Then, too, the radio-interference measuring equipment manufactured by Empire used tubes and was crying for redesign. It wasn't likely that a company new to the business would immediately spend the money to develop solid state products.

Eleven of us started to think seriously about forming our own firm. We were sure that even by starting from scratch, we could give the competition a run for their money. We were so confident of this that we were willing to take the gamble.

From the talking stage, we moved on to the planning stage. Our first step was to contact a group of attorneys—a must for anybody thinking of incor-

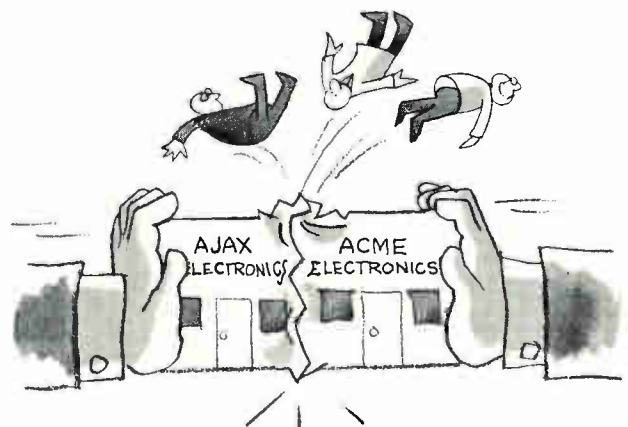

Squeeze play. Company mergers often squeeze out qualified engineers and managers.



Get to work. Even before your company gets going, put your design engineers to work—if necessary in somebody's basement.

porating. Most lawyers, as we were soon to discover, are adventurous and are business minded. They'll help you incorporate, write a prospectus, set up a stock issue, and they'll even lend you a desk and a telephone. As for paying for their services, you can take one of two routes. You can either pay them a fee or give them a piece of the action—anywhere from 5% to 15% ownership, depending on yourself and the kind of company you're forming. And if it is the latter route you are taking, make sure you don't give away too much of the action—even if your attorneys want to invest their own money—or you could conceivably find yourself on the outside, looking in. Besides, there will be others who will want to invest in your company.

And on the plus side, legal assistance is invaluable. You're certainly going to need it once you get your business rolling.

While you're looking for lawyers, you better get an accountant, too. Potential investors will want to know your plans for the future, particularly since your company has no past. Your prospectus, for example, should include projected profit and loss reports and balance sheets, say, for the next five years. An accountant will probably cost you another slice of the action, about a percent or two.

I heartily recommend that you be highly optimistic in your projections. Don't be conservative; investors tend to shy away from slow-moving companies. Besides, would-be investors will cut your forecasts by half anyway. Being realistic may ease your conscience, but it won't encourage takers.

Don't fret for lack of investors. They abound. They may be local men who opt for a home-grown business, professional investors, business people, and bankers. Although bankers probably won't invest their own money, they can arrange loans on terms that could be favorable to you.

A wise move would be not to sell stock at first. Instead, accept informal subscriptions. Holding the money without finalizing the stock transaction gives

you a legal escape hatch if either the stock sells too slowly or you decide not to issue it. In the case of my company—the Electro-Metrics Corp.—my partners and I never issued our stock. Eventually, my company became a subsidiary of the Fairchild Camera & Instrument Corp.

Facing the issue

But even if you do issue stock, keep some of it off the market. The stock that is held back gives you a good hedge should you decide later on to raise additional capital. This stock could also be used later on to increase the holdings of earlier investors or, if you prefer, be given to employees whose contribution to the company's growth overshadows all others.

Both your lawyer and accountant will help you decide how much founders should pay for the stock and what the public should pay. Experience with new companies suggest that it's a lot easier to sell 500,000 shares at \$1 a share than it is to sell 10,000 at \$50. And although you add to your paper work, you get a much wider distribution of shareholders.

It would help if either yourself or others in your group could invest money in your venture. It makes fund raising a lot easier, particularly when would-be investors are novices when it comes to a technical product. They invariably ask whether you are risking your own money.

Once you decide to issue stock, the next decision is whether to distribute your stock interstate or intrastate. The best bet, with limited personal finances, is an intrastate issue. That way you don't become involved with the Securities Exchange Commission and you avoid legal headaches. But this approach isn't without a drawback. If you're limited to one state you may have a hard time getting backers. This is particularly true if the state isn't affluent.

And when you're looking for investors, keep your eyes peeled for wealthy backers who are willing to

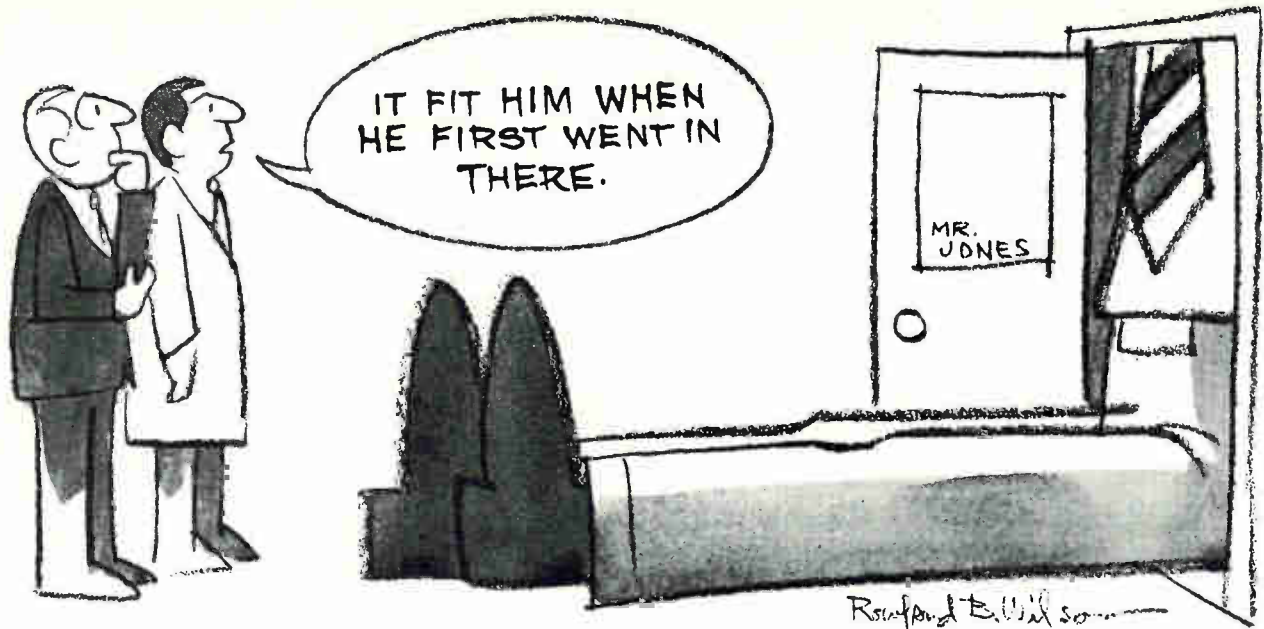

Pot of gold. Better plan on bonuses and other incentives. People overlooked when you founded your company and parceled out the shares of stock can turn out to be tigers.

buy part of the company. You'll probably have non-experts in your hair after you get started, but they're easily groomed and well worth the bother.

But don't concern yourself only with nonexperts; get your story across to industry leaders. If you have a real story, it would make good copy for the trade press. This certainly helped us and led to the phone call from Fairchild. Our conversation with Fairchild is an example of the kind of imaginative thinking that can go on in industry.

"Do you have a going operation," Fairchild asked.

"We haven't anything but talent," we replied.

"That's all we're interested in."

That's how our negotiations started. At the time all we had were a chief engineer, a marketing manager, four engineers, two production people, an instrument maintenance technician, a draftsman

and a purchasing agent. The rest was confidence in ourselves. We were convinced we could develop and sell an all-solid state line of radio-interference measuring equipment. With Fairchild's backing we went on to design products we might not have otherwise if we only sold stock. True, we could have designed good products, but they wouldn't have been nearly as sophisticated. Coming under the wings of a larger company pays both financial and technical dividends.

However, what worked to our advantage may not for others. Don't be too hasty to accept backing from another firm without first gaining a special incentive contract. The more specific the agreement is, the better for you. Generally, you furnish the talent and the parent company supplies the money, and perhaps, some additional management people. Your payoff comes after, say, a five-year period when your actual worth is determined by your profits, growth, potential, and other factors.

Before you sign the contract, make sure you've investigated similar actions—if any—the company has taken with other divisions or subsidiaries. And until you sign on, continue to take orders for stock. It will at least give you a hedge in the event the agreement falls through.

A way of life

Once you decide to go into business for yourself, you had better brace yourself for a law suit by your former employer. It may not happen. But if it does, and as long as you haven't stolen his trade secrets, your chances of winning are good. Surprisingly enough, law suits tend to help new companies rather than hurt them. Everything hinges on your being on sound footing.

Take our experience, for instance. When Singer



Path to success. Equipment begging for redesign can give you the product idea you need.

sued, it charged us with conspiring to make off with trade secrets. The suit alleged that we were the only ones in the corporation with full knowledge of the basic line. Despite the furor, our negotiations with Fairchild continued. When our agreement was reached, Fairchild stepped in and Singer eventually dropped its action against us. The law suit certainly didn't hurt us. The one thing you should remember is that legal actions are part and parcel of the business world. And as such, they shouldn't dissuade you from starting out on your own.

Don't waste talent

Your most important asset is engineering talent. Don't waste it. Put your design engineers to work before your company gets off the ground. If necessary, they can use someone's basement to make preliminary sketches, write technical components data, and begin planning your new product line.

Once you start work in your temporary quarters, you'll find yourself making important contacts and exploring new design approaches that you somehow never had time for before. This will pay off when your new company really starts rolling.

When there are several partners involved in a



Look ahead. Get an accountant to project profit and loss reports and balance sheets.

new venture, the problem crops up of how to divide the stock equitably. There would be no problem if everybody's contribution were equal; each would get the same amount of shares. But that's unusual. Accordingly, those who often get the lion's share are those who plan to carry the greater burdens and be most active in forming the company. And this, as we found out, causes problems.

Several years after a company's founding, you will find that some people who received relatively little stock are the most valuable. Little can be done, save floating additional stock for the purpose of remunerating these people, after the fact. Therefore, you should plan on incentives, such as bonuses, from the outset.

Think ahead

Try to avoid—although this is difficult—losing sight of long-term objectives when you're preparing the original partnership. If financial rewards depend on how close you come after five years to making a certain profit, for example, you're liable to neglect research and development. And R&D simply cannot be overlooked. Flexibility is essential in working out any kind of stock plan or financial arrangements among several members in a group.

Since engineers are fond of conclusions, here are four things to keep in mind about striking out on your own:

- All you really need is a few weeks to find out whether you can get backing. Even under the worst financial conditions, many engineers and managers can go that long without income.
- Try to keep the inevitable pessimists in your group muffled long enough to get started.
- If you try diligently enough, someone either inside or outside your group will come up with the money needed to keep your team together.
- You may spread your ideas and plans around to get backing. Despite tight money markets, investors are plentiful when it comes to financing new ventures. ■

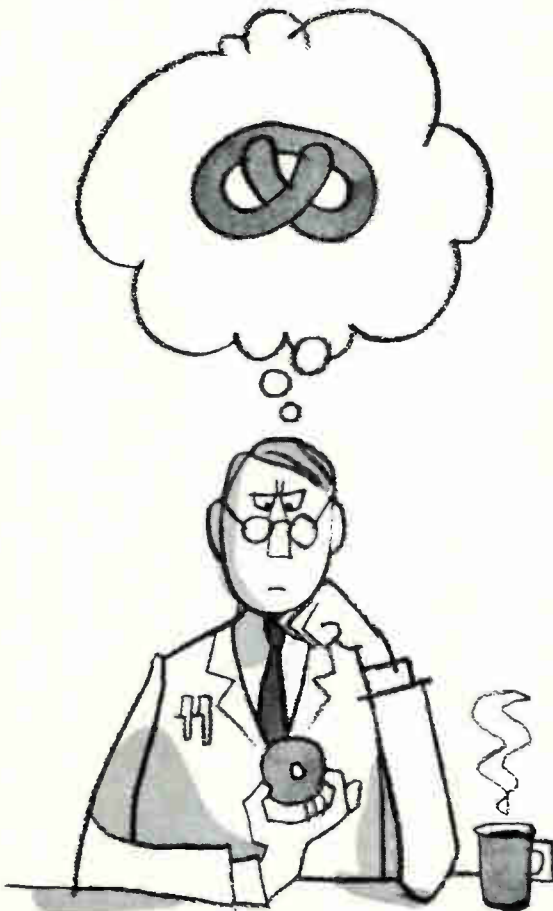

Innovate! If you're staking your venture on a new product, it should incorporate technological innovation. If it's simply a carbon copy of somebody else's, you could wind up behind the proverbial 8-ball.

**TEFLON: all by itself
the most thoroughly proven,
high-reliability
insulation**

**But look at the
extra performance
you can get
with TEFLON plus
mineral fillers**

Insulations of Du Pont TEFLON fluorocarbon resins have proven their reliability for more than 20 years, particularly in demanding aerospace applications. But did you know there are also mineral-reinforced constructions of TEFLON, whose extra toughness and abrasion resistance protect against cut-through and installation damage?

These mineral-reinforced insulations of TEFLON are available in a wide range of colors and are rated for use over a wide temperature range—up to 260°C. They offer the nonflammability, resistance to chemical corrosion and the optimum dielectric quality you expect from insulations made with TEFLON.

Consider composite insulations of TEFLON plus mineral fillers (or composites using polyimides or polyvinylidene fluorides plus TEFLON) for your next design.

For additional information, write us and let us know about the specific application you have in mind. Write: Du Pont Company, Room 7296G, Wilmington, Del. 19898.



TEFLON[®]
fluorocarbon resins



When the chips are down, they ought to be on our IC packages.

It's not just because we want to sell our products (which we do).

Or because we're proud of them (which we are).

We think you should buy our IC packages for a number of reasons.

First of all, we make all our own parts. (Many of our competitors must buy frames and ceramics for assembly.)

We assemble the packages ourselves.

We test our packages for insulation, thermal shock resistance, hermeticity, lack of internal shorts, excess glass-ceramic flow.

And if one of our growing line of packages

doesn't fit your requirements, we'll design one that will.

One more thing. Just because you're getting the best IC package money can buy, don't think it takes a lot of money. In fact, ours probably costs less than any others.

Isn't that where you should put your chips? Sylvania Metals & Chemicals, Parts Division, Warren, Pennsylvania 16365.

SYLVANIA
GENERAL TELEPHONE & ELECTRONICS

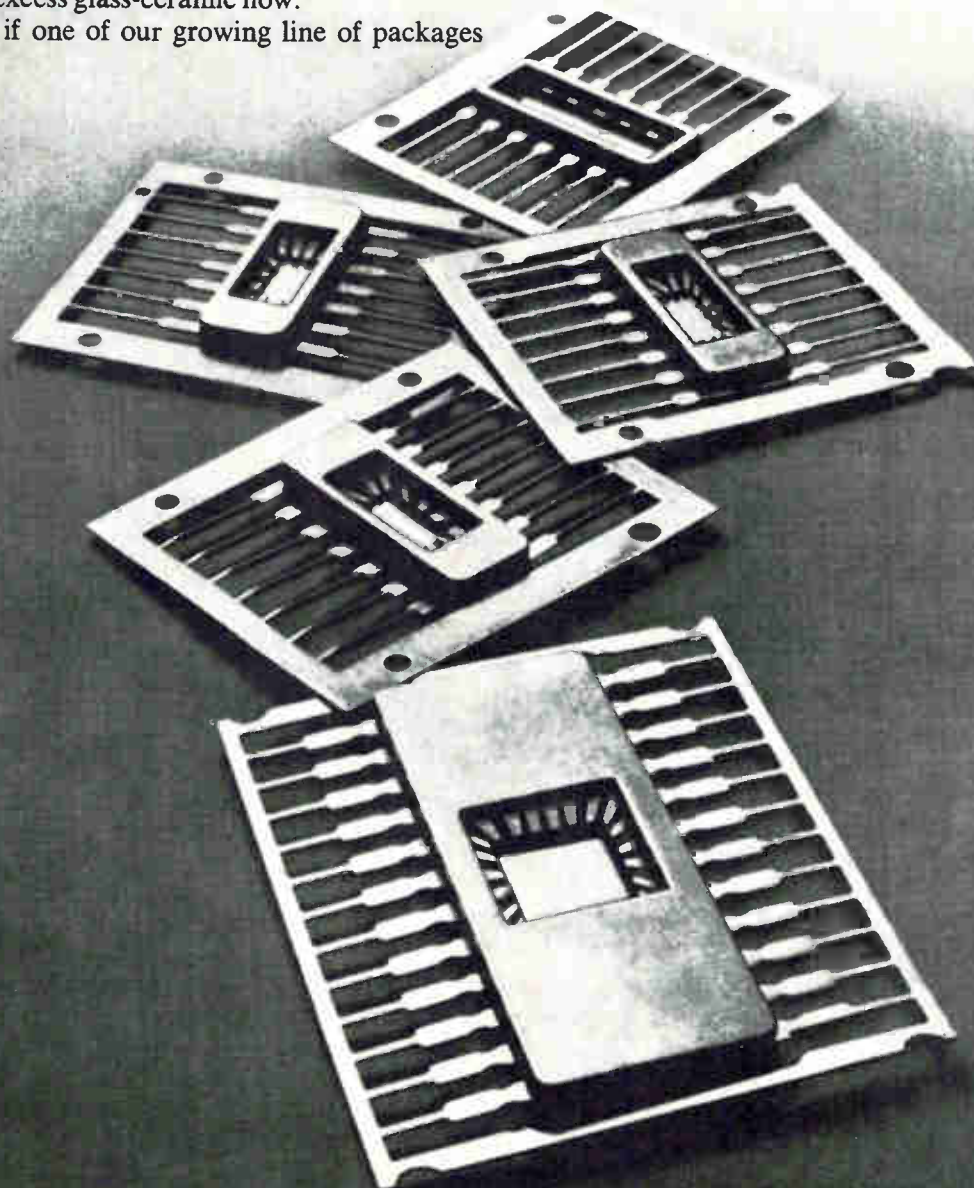

For high speed harnessing
with continuous lacing...

HERE IS THE WORK SPEEDING - MONEY SAVING -

GUDEBROD SYSTEM "C"

GUDEBROD FLAT TAPE BOBBINS—This special packaging of Gudebrod Flat Braided Lacing Tape is highly popular in the harness shop. Whether used in all hand tying or with the Cable-Lacer (for which it was designed) the bobbin makes conveniently available, high quality Gudebrod Tape in most of its many types—all engineered to lie flat, tie tight.

GUDEBROD CABLE-LACER®—This unique harnessing hand tool has proved a production speeder and harness improver. Makes up to 30 knots per minute. While making firmer harnesses with tighter, more uniform knots, it eliminates wear and tear on operator's hands because special brake takes strain of knot setting. Holds bobbin of Gudebrod Tape in handle.

LONGER WIRE HOLDING PINS—They make wire threading much easier, quicker (no repeated wire redressing between pins). In harness tying they preserve the layout while using the Gudebrod Cable-Lacer. Special case hardened pins, nail better, stay straight, no nailheads.

GUDEBROD SWIVEL-TILT HARNESS BOARD MOUNT—Two dimensional balanced mobility puts every section of the cabling within easy, natural reach of the operator. Work done in this unstrained manner goes faster, is better, all day through.

There it is, the Gudebrod System "C" solving the cable making problems in a speedy, economical, profit improving way. Ask about System "C" (If you use intermittent tying, ask about Gudebrod System "S").

Gudebrod's
Special, Longer
Case Hardened Pins

®T.M.—UNION SPECIAL
MACHINE CO.

GUDEBROD
Electronics Division

Gudebrod Swivel-Tilt Harness
Board Mounts available
in several sizes

GUDEBROD BROS. SILK CO., INC. Founded 1870, 12 South 12th Street, Philadelphia, Pa. 19107

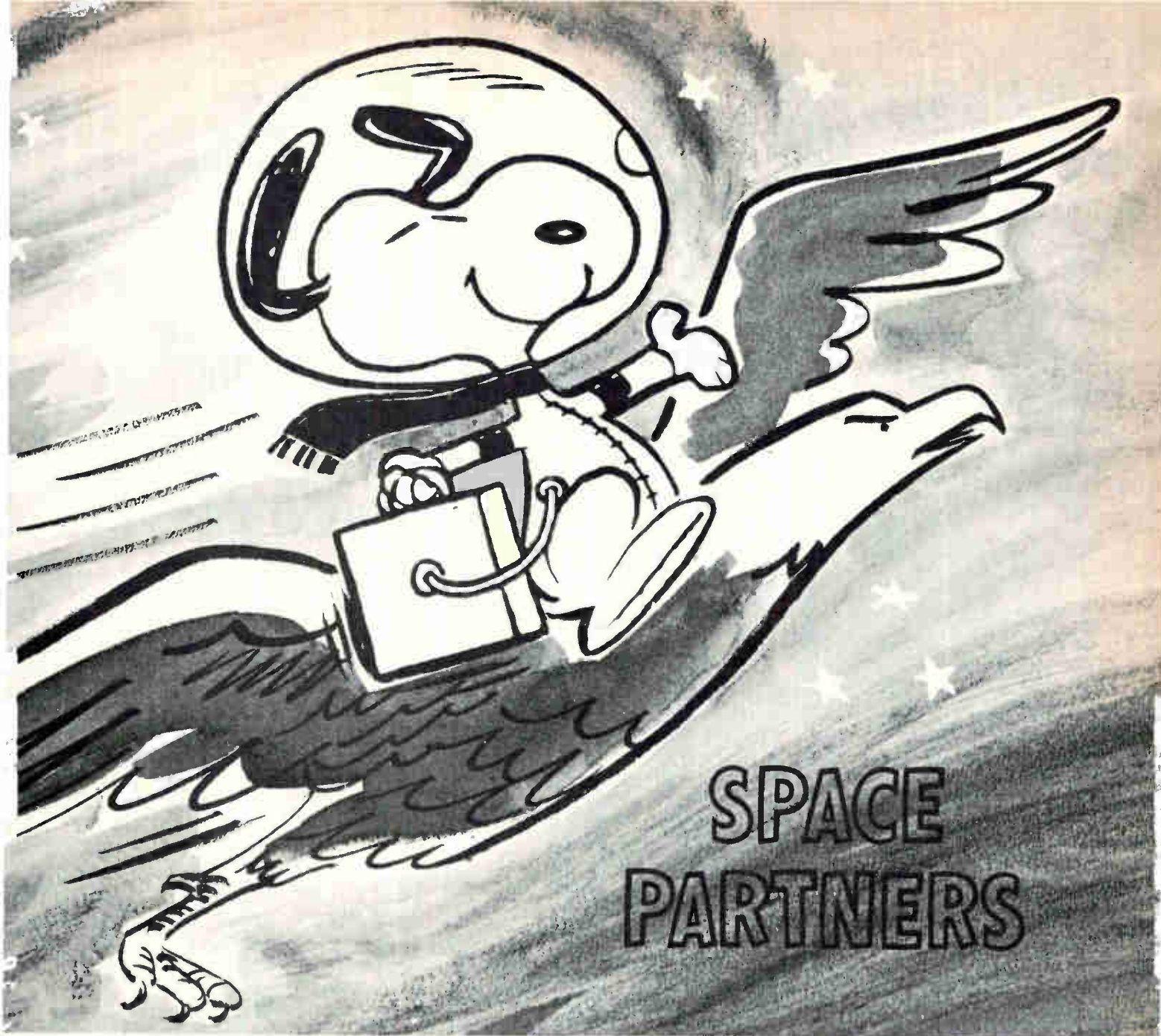

SNOOPY from "Peanuts" © United Features Syndicate—1968

"Thanks, Snoopy, for your famous NASA award."

"Thank you, Lola Fawcett, for completing 7,000 solder joints without a single defect.

They were moon-bound solder joints, many of them used in 14 Eagle time delay relays aboard the Apollo 11 command module. They had to be perfect, for they insured that our astronauts could dump their fuel in case of a pad or low-altitude abort.

Eagle timers and space craftsmanship have soared aloft in every manned and unmanned flight since the start of our moon program.

They all performed perfectly.

Maybe that's why an eagle was chosen as the symbol of Apollo 11. We don't know. Snoopy's not talking.

GW Eagle Signal Division
A GULF + WESTERN COMPANY

Davenport, Iowa 52803

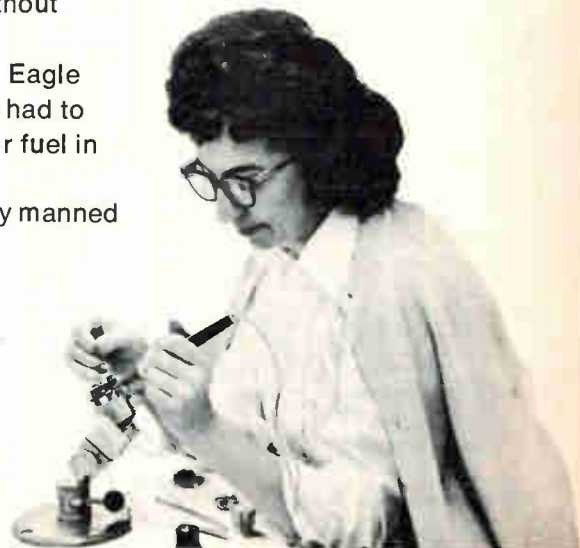

Circle 117 on reader service card

SOME ENGINEERS DON'T KNOW WHEN TO QUIT

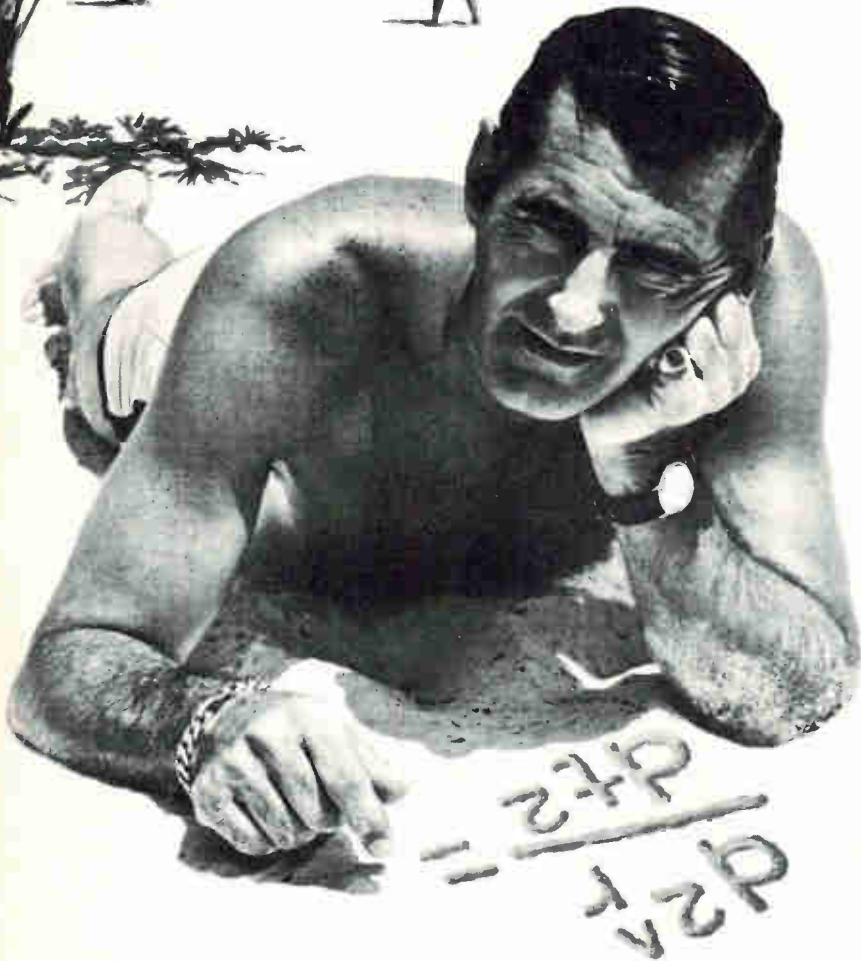

Give a guy a mile of sandy beach as a blackboard and you might find him doing equations from here to the moon . . . thinking about navigation and guidance systems.

At Honeywell-Florida we've got a lot of people who think engineering is an adventure. They create some of the world's most sophisticated equipment . . . computers . . . monolithic subsystems . . . plated wire memories . . . precision

components. We give 'em room to think . . .

provide a stimulating environment and then recognize their creative individuality.

We can't promise you can do all your engineering on the beach but we can promise an atmosphere where you'll always have the engineering freedom you need to do something significant. Of course while you're relaxing on the white sand beaches of the Gulf of Mexico you may get some of your best ideas.

If you and your family fit into the Florida picture tell us about your qualifications today. We have great opportunities for engineers with experience in logic, components, integrated circuits, computer memories, circuit or programming analysis, advanced packaging, manufacturing or industrial engineering, materials or quality assurance.

Write now to Mr. Owen S. Spring, Honeywell Inc.
13350 Highway 19, St., Petersburg, Florida 33733.

Honeywell-Florida

An equal opportunity employer

To investigate professional openings in other Honeywell facilities,
send resume to F. F. Laing, Honeywell, Minneapolis, Minnesota 55408.

A 1-minute look at what's new in relays



THE PARELCO R10 RELAY
2 times more pull force

Optimum distribution between magnetic core and pole piece cross sections and coil volume, and a low reluctance armature bearing produces a force-displacement product of 140 gm/mm at .050". The result is higher contact pressure and greater overtravel. Sensitivities to 20 mw/pole.

Contacts: From 2 to 8 Form C. 6 types from heavy duty 10A silver cadmium oxide to bifurcated cross bar gold — platinum — silver for dry circuits.
Coils: 3 to 115 vdc. UL listed.

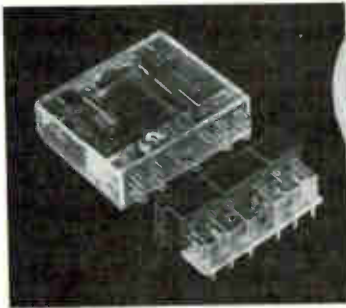

THE PARELCO R40 SLIMLINE®
.43" max. thickness

Lowest profile industrial relay available. Higher switching density: .18 cu. inches/Form C. Easy pc board layout. Lower cost, wider switching range (dry circuit to 10A) than dry reed packages. 5 mounting options.

Contacts: 2 and 4 Form C. 5 types from heavy duty 10A silver cadmium oxide to bifurcated cross bar gold — platinum — silver alloy for dry circuits.
Coils: From 3 to 115 vdc.



THE PARELCO R12 VARIABLE TIME DELAY RELAY

1/3rd the size of the relay you're now using!

All the R10 features plus a superior delay circuit using silicon transistors throughout. No false operations. Critical timing capacitor meets MIL-specs. Measures only 7.35 x 1.187 x 1.375 (2 pole) or 1.580 (4 pole). Delay range from .1 to 120 seconds — specials to 300 seconds. High resolution, 15 turn pot. The *only* 4 Form C time delay currently available. Three mounting choices.

Contacts: 6 types from dry circuit to 10 amps.
Coils: 12, 24 and 48 vdc.

COME SEE US, BOOTH 4809

WESCON/69



OTHER STANDARD MODELS

R11 guarded, low capacitance relay for instrumentation.

R30 magnetic latching relays.
R10-T octal base relays. *Custom Coils and contacts* — various mounting modes — special engineering.

Quick Delivery — 110 standard models always in stock. Prototypes in 3 days — production quantities in 3 weeks!

EVALUATION SAMPLES TO QUALIFIED DESIGNERS!

GIVE US:

Time delay range, secs. _____

Input voltage _____

Contact characteristics _____

I'll use _____ relays in the next 12 months. Application _____

Name _____

Title _____ Phone _____

Company _____

Street _____

City _____ State _____ Zip _____



PARELCO, INC.

28181 Avenida Aerojuaerto

San Juan Capistrano, California 92675

Phone (714) 492-4587 TWX (910) 556-1411 New HEM Series 4500

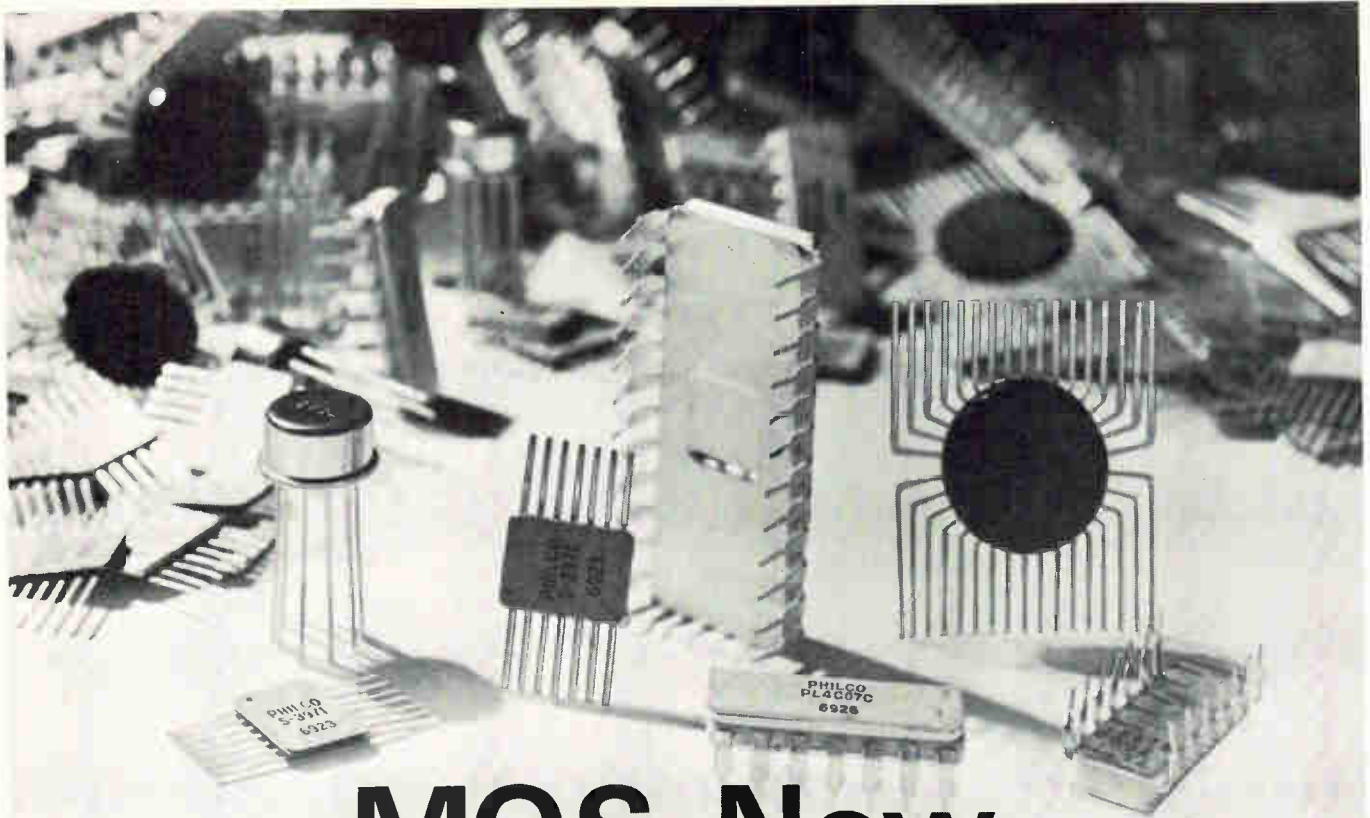

MOS. Now.

20 standard Philco types are ready to ship from stock.

Our line of standard production MOS integrated circuits keeps growing broader every day. From our Lansdale plant, one of the largest MOS facilities in the country, you can now get instant delivery of many of the devices that you'll need for your next generation designs. For example:

- Shift registers; including the longest (256 bits) and the fastest (5MHz clock) commercially available in production quantities.
- Compatible gates, up to 2MHz clock, in a variety of configurations.
- Binary counters . . . 16-channel sequential/random access multiplexer . . . 1024-bit dynamic read-only memory, programmed to your bit pattern; off-the-shelf model is a sine look-up table.

Many more are being readied for production. When you want MOS *now*, we're the people to see. Write or call MOS Marketing, Philco-Ford Microelectronics Division, Blue Bell, Pa. 19422. (215) 646-9100.

the better idea people in MOS

PHILCO 

Device	Description
pL4C07C	7-stage binary counter
pL4C07AC(1)	7-stage binary counter
pL4G10C	Hex 2 input NOR + 2 inverters
pL4G10AC(2)	Hex 2 input NOR + 2 inverters
pL4G11C	Dual 4 input NOR + dual 5 input NOR
pL4G11AC(2)	Dual 4 input NOR + dual 5 input NOR
pL4G12C	Dual 9 input NOR
pL4G12AC(2)	Dual 9 input NOR
pL4S16C	16 channel multiplexer
pL5R32C	Dual 8/16-bit shift register
pL5R40C	Dual 20-bit shift register
pL5R100C	Dual 50-bit shift register
pL5R96C	Dual 48-bit shift register
pL5R128C	Dual 64-bit shift register
pL5R128AC(3)	Dual 64-bit shift register
pL5R250C	250-bit shift register
pL5R250AC(3)	250-bit shift register
pL5R256C	256-bit shift register
pL5R256AC(3)	256-bit shift register
pM1024C	1024-bit read-only memory

(1) Clock rate 500KHz (2) Clock rate 2MHz
(3) Clock rate 5MHz

Off-the-Shelf Recorder Order Guide



PI-7100 Video/Instrumentation
Captures video, radar, RF, multiplex, telemetry . . . any broadband data up to 1.5 MHz, or video up to 3.5 MHz. Operates for 90 minutes on a 10½" reel of tape using helical scan transport. Includes VariScan™ and StopScan™ playback.

PI-1387 High Environment Digital
Write only, IBM compatible; 200 BPI, 7 track formats. Inexpensive, compact, lightweight (less than 17# without tape). Operates in virtually any environment. Uses single 12 VDC power source.

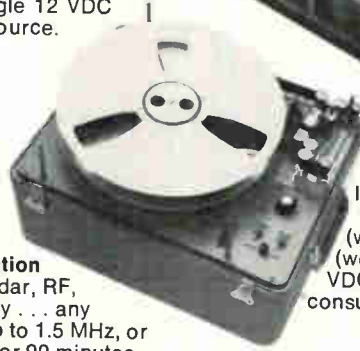

PI-5100 Long Term Monitor
IRIG formats. Two models—1" tape (weighs 60#); ½" tape (weighs 35#). Uses 12 VDC source; low power consumption.

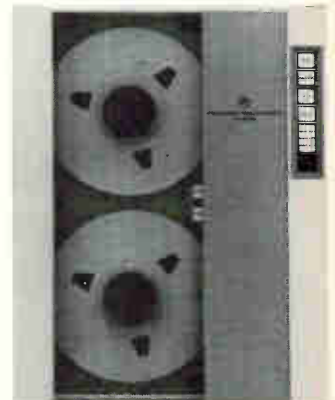

PI-1200 Digital
Read/Write, IBM compatible: 7 or 9 track formats. Three modes: high speed, slow, and incremental.

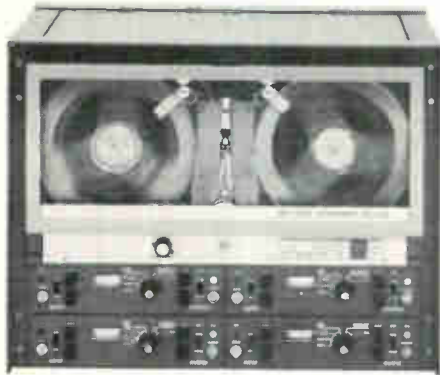

PI-6200 Portable Instrumentation
Lab quality. Pushbutton operation. Low-cost ¼" tape. Up to 8 channels with three switchable FM or Direct record/reproduce speeds—0.375, 3.75, 37.5 ips—provide time contraction or expansion in 1:10:100 ratio. Optional loop adaptor and remote control. Operates on any power: 105 to 125 or 210 to 250 VAC; 48 to 400 Hz + and -12 VDC.



PI-2100 IRIG Portable
Records/reproduces up to 14 tracks of FM or Direct data. Snap-on reel or loop magazines, vibration isolation mounts, and many more accessories available "off-the-shelf" to increase versatility.

And that's not all...

We can supply virtually any kind of special recorder, or modified standard models to meet your unique requirements. We also make the first practical, on-line trillion bit mass memory, Unicon 690®, a totally new laser recording system.

What's more, because we make all kinds of tape recorders, we can recommend the one that's best

for you — objectively, professionally. And, we'll provide all the engineering, documentation, training, and service support you need. Just send the coupon to 3170(A) Porter Drive, Palo Alto, Calif. 94304. Or call (415) 321-5615.

Worldwide sales and service representatives.



TO: **PRECISION INSTRUMENT COMPANY**
3170 (A) Porter Drive, Palo Alto, California 94304.

I want to know more about:

- 6200 7100 5100 1200 1387 2100
 Unicon 690 Other _____

My application is _____

Name _____ Title _____

Company _____

Address _____

City _____ State _____ Zip _____

Call me immediately at _____

***For measurement
of out-of-roundness, concentricity,
circular flatness and a
lot more... or less...
call Clevite***

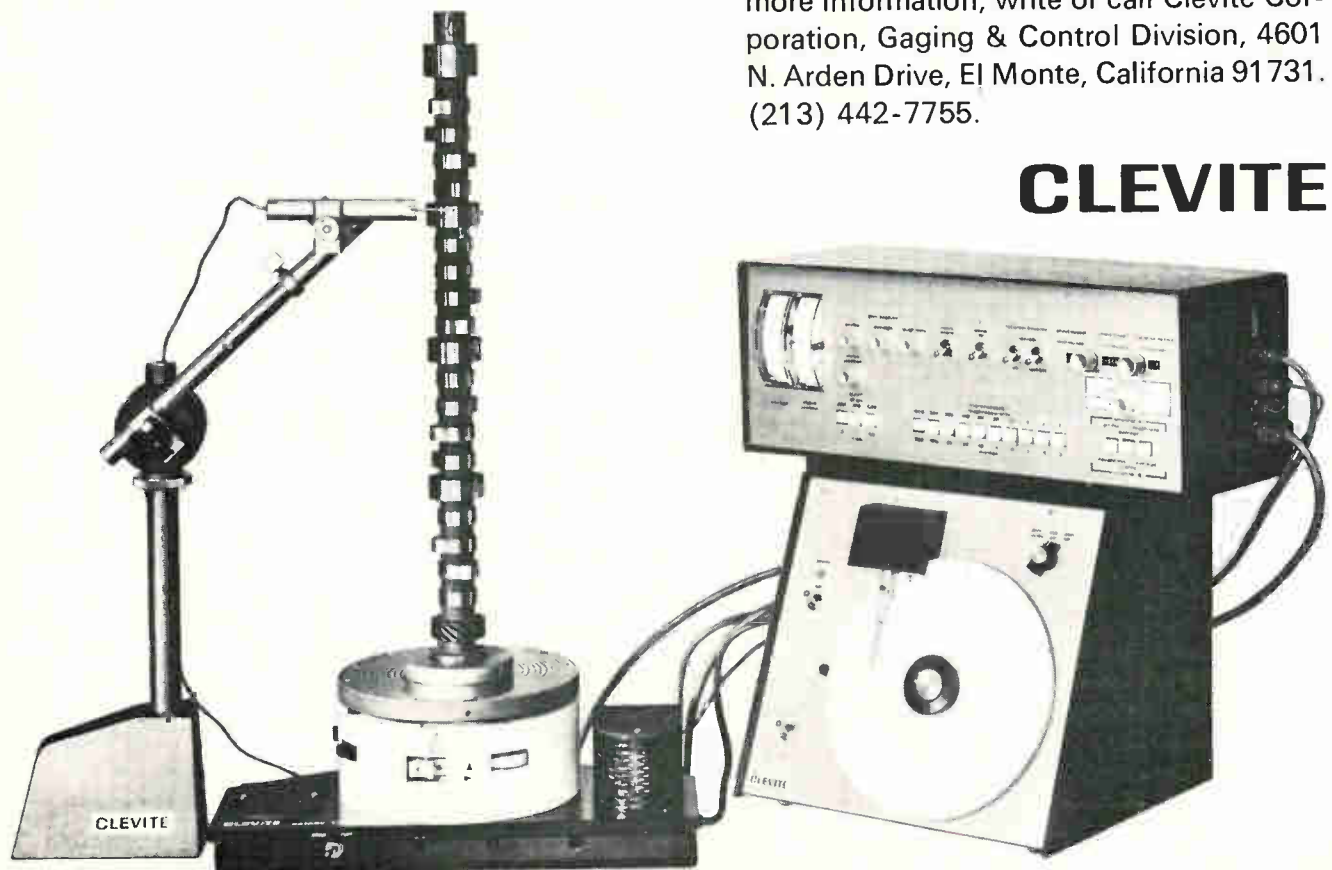

Our new Surfanalyzer 236 can handle them all. It's a superior instrument for surface analysis, plus the measurement of geometric relationships like roundness, squareness to axes, flatness, parallelism, concentricity and axes alignment.

You can measure ID's down to .050" and any size OD, as long as the part and fixturing weigh 250 pounds or less. Spindle accuracy is 2½ microinches. Basic system linearity is 1%, with extremely high frequency response.

The complete package consists of a polar recorder with an 8¾" chart, height stand, control, rotary drive and spindle, and your choice of probes.

But maybe you already have some of this equipment.

OK. The Surfanalyzer is modular, so you can order just as much of it as you need. If you want only one component, you can get just that. And add on the rest when and if you need them.

All connections are electrical and easy to make.

The portable, modular Surfanalyzer 236. It's got a lot more to offer you. Or less. For more information, write or call Clevite Corporation, Gaging & Control Division, 4601 N. Arden Drive, El Monte, California 91731. (213) 442-7755.

CLEVITE

The cheaper sweeper.*

The Model 134 gives you clean, continuous or triggered sweep over a 1,000:1 range, plus trigger, tone burst and voltage control. Clean waveforms, too: sine, square, triangle and sawtooth, from 0.2 Hz to 2 MHz, with flat frequency response and low sine distortion. At \$495, the price won't clean you out.*

WAVETEK®

9045 Balboa Ave., San Diego, Calif. 92123; Tel. 279-2200
P.O. Box 651, San Diego, Calif. 92112; TWX 910-335-2007

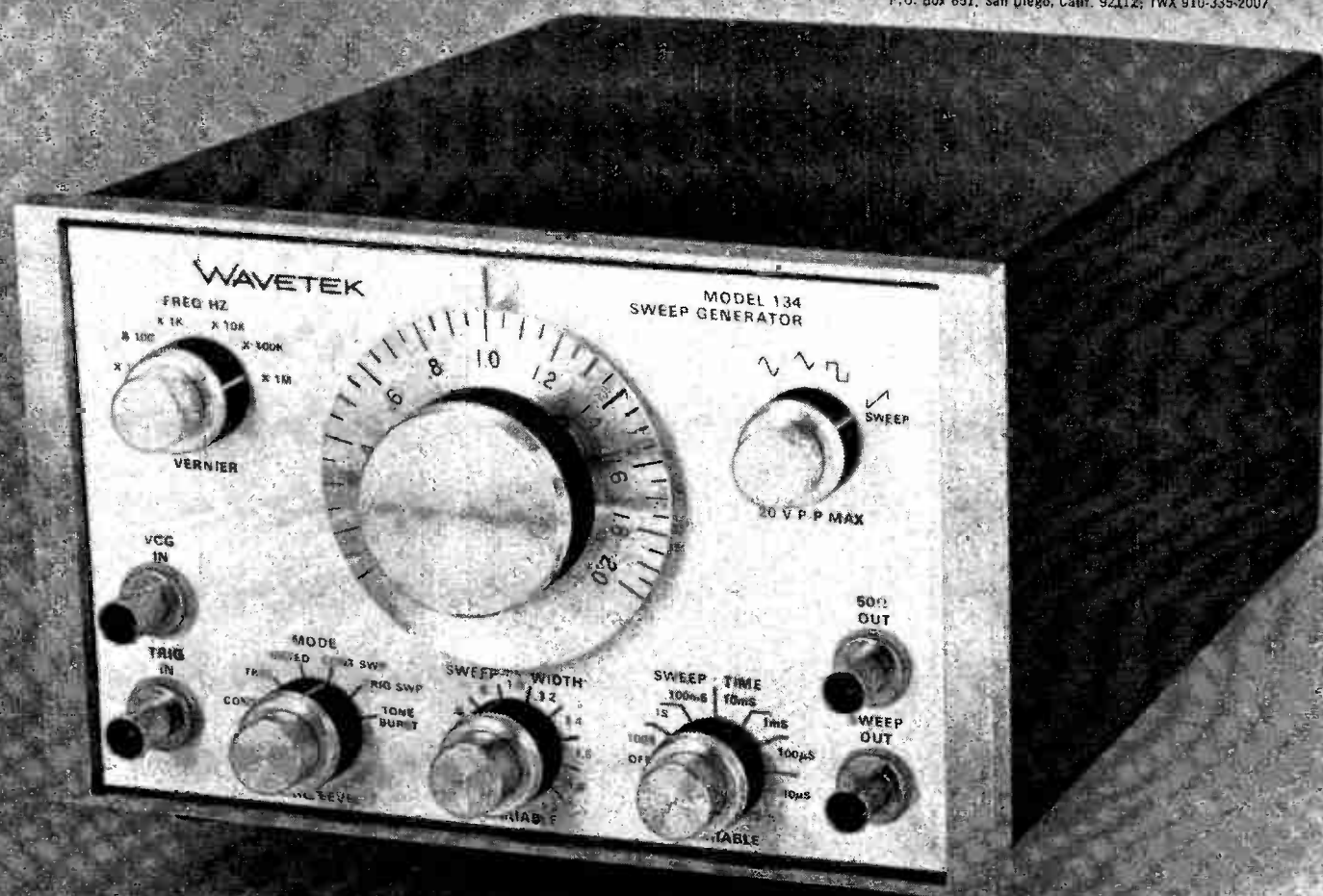

Ask about our Model 130 Oscillator Function generator (\$295) and our Model 131 VCG (\$345).

Tantalum Foil



3 ways better
than solid in
non-polar
applications

- smaller than solid tantalum
- more reliable than solid tantalum
- delivers more microfarads than solid tantalum

Design is the big difference between General Electric's Type 29F non-polar tantalum foil capacitor and an equivalent solid tantalum capacitor. A design that's specifically for **non-polar** applications.

GE Type 29F non-polar tantalum foil is about half the case size of an equivalent solid, yet accepts voltage and current variations in either direction. And from one small, single roll that in no way impairs the inherent reliability characteristics of tantalum foil. (Totally unlike its bulky solid counterpart that requires two slugs connected back-to-back and, in most cases, within a single case.)

The difference doesn't end with just size and reliability. Consider microfarads. GE tantalum foil delivers 50 percent more microfarads per case size, in practically all cases, when compared with solid tantalum.

So for your next non-polar application, contact your General Electric Sales Representative and ask to see the Type 29F tantalum foil capacitor. It could make a big difference. In size. In reliability. In microfarads. Electronic Capacitor and Battery Dept., Irmo, S.C.

430-36

GENERAL  ELECTRIC

MSI

MSI/LSI Circuit Seminar For Equipment And Systems Designers

MSI

Presented by Electronics/Management Center. An Information Service of McGraw-Hill
New York – September 29-October 1, 1969, Statler Hilton Hotel
7th Avenue & 33rd St., New York, N.Y.
California – December 1-3, 1969, Airport Marina Hotel
8601 Lincoln Blvd., Los Angeles, Calif.

Program

1. Evolution of Large Scale Integration (LSI)

1.1 Unique Properties of MOS

- self-isolation
- no voltage offset
- bilateral switching
- clocked load resistors
- temporary memory via gate storage
- design through mask topology
- second layer interconnect through diffused crossunders

1.2 Limitations of MOS

- lower speed than bipolar
- surface sensitivity – charge control, traps, radiation susceptibility
- gate oxide vulnerability
- low output current drive
- interface problems
- parasitic capacitive coupling

2. MOS Device Structure and Characterization

2.1 Basic Geometry of MOS Device

2.2 Device Design Parameters

- V_{GST} , K , body effect, BV_{DSS} , BV_{OX} , I_{DSS} , C_{GS} , C_{PN} , etc.
- parameter temperature sensitivity

2.3 Basic Device Model

- drain current in SAT and NONSAT regions
- R_{ON} and g_m
- body effect
- voltage dependent capacitive loading

3. Basic MOS Circuit Techniques

3.1 Circuit Solution Using the Basic Device Model

- DC solution with active load resistors
- clock power relationships
- transient solution – speed, power, speed-power product

4. Topological Design and Layout

4.1 Examples of Logic Gate Mask Layout

- 2 ϕ ratio shift register layout
- logic gate layout
- design rule considerations and limitations

5. Advanced Circuit Techniques

5.1 Circuit Evolution

- early 4 ϕ , modern 4 ϕ , ratioless 2 ϕ , precharged 2 ϕ , capacitive pullup

- interrelationships between circuit forms
- circuit models and their solutions for each circuit form – charge, discharge, power dissipation, speed-power product, charge sharing and parasitics
- clock requirements – timing relationships, amplitudes, drive requirements

5.2 Suitability of Circuit Forms to Given Applications

- shift registers
- general logic
- memories

5.3 Use of Circuit Forms in Combination

6. LSI Artwork Generation

6.1 Design Approaches

- handcrafted layout
- standard array
- discretionary wiring
- building block (library of functions)

6.2 Comparison of Design Approaches

- development cost
- turnaround time
- error susceptibility
- chip size and yield
- performance tradeoffs

7. Logic Implementation with LSI

7.1 Advantages of Multiphase Logic

- master-slave avoidance
- ease of delay implementation
- area, power and speed advantages

7.2 Conversion of System Logic into Form Suitable for LSI Implementation

- availability of multiple AND-OR capability at a single logic node
- minimization of logic levels
- power and propagation delay minimization

7.3 Comparison of 2 ϕ and 4 ϕ Logic Systems (Ratio vs. Ratioless)

- timing problems and their solutions
- logic level limitations
- speed, power, area and speed-power product comparison

8. Design Examples

8.1 System Partitioning Techniques

- multiphase logic implementation

Purpose

This seminar is designed to give the systems designer the knowledge he needs to deal effectively with MSI and LSI circuits as basic subsystems.

Through lecture, panel discussion, and hands-on sessions, the systems designer will be exposed to all phases of the newest and most popular circuit techniques, their design, manufacture, and application.

He will achieve a broad, realistic, and authoritative approach to: realizing the systems parameters made possible by MSI/LSI; achieving maximum cost-performance ratio; maintaining a competitive edge; getting the most out of off-the-shelf units; improving communications with vendors; using multiple sources; developing in-house capabilities; establishing realistic schedules, and meeting production deadlines.

Faculty

Presentations, discussions, and work sessions are under the direction of the staff of Integrated Systems Technology, Inc. of Santa Clara, California. Each member of the staff has wide experience in the areas of circuit design, systems application and semiconductor research and development.

Donald E. Farina – President, Integrated Systems Technology, Inc. One of the contributors to the design of the first micrologic integrated circuit families. Served as head of the R&D department in digital circuits for Fairchild Semiconductor, responsible for both digital circuit and bipolar device structure development.

For the microelectronics division of Philco-Ford Corporation Mr. Farina served as Director of R&D and was responsible for device and research devoted to MOS large scale integration. He received his BSEE at New York University in 1953.

8.2 Artwork Generation

- composite plan – logic cell placement, minimization of interconnect length and crossunder
- chip area estimating
- computation of cell loading in order to determine device geometry
- array performance calculations

9. MOS/Bipolar Interface Techniques

9.1 Requirements for Interface Circuits

- voltage level translator bipolar \leftrightarrow MOS
- low impedance output driver MOS \rightarrow MOS
- power supply compatibility
- low power dissipation on chip
- small area on chip
- minimum number of discrete components off chip

9.2 MOS Output Buffers on Chip

- scaled ratio type inverter
- push-pull driver
- push-pull with bootstrap driver
- dual load buffer
- series-sampled buffer
- diffused NPN emitter follower
- lateral PNP
- discrete load resistor

9.3 MOS Output Buffers off Chip

- NPN inverter – clamped and nonclamped
- NPN emitter follower
- PNP inverter
- complementary inverter

9.4 Input Buffer Techniques

- lateral PNP
- biased substrate
- lateral coupling device
- PNP inverter

10. Low Threshold Technology

10.1 Low Voltage Circuit Design

- speed, power, area and speed-power product of ratio circuits
- speed, power, area and speed-power product of ratioless circuits
- direct output compatibility with bipolar IC's
- direct input compatibility with bipolar IC's
- system and array power tradeoffs

11. Cost Considerations for LSI

11.1 Chip Size and Complexity vs. Cost per Function

11.2 Distribution of Fabrication Costs

- materials cost
- labor cost – process labor, sorting, dicing, packaging, testing, etc.

11.3 Array Development Costs

- handcrafted array
- standard matrix
- building block
- discretionary wiring

11.4 System Cost Factors

- system overhead – clock generation, interface circuitry, assembly cost, power supplies, etc.
- systems cost examples – discrete IC vs. LSI

12. Computer Aided Design

12.1 Logic Verification

12.2 Array Topological Design

- minimization of area, interconnect, crossunders and loading

12.3 Array Performance Prediction

- calculation of propagation delay, power dissipation, operating speed, etc.

12.4 Computer Artwork Generation

- library of standard functions
- computer controlled coordinatograph, photo exposure head, CRT

12.5 Test Sequence Generation

- test requirements
- algorithms
- test hardware

13. MOS Structures and Fabrication Techniques

13.1 Substrates and Preparation

13.2 Mask Sequences and Variations

- oxidation and diffusion
- field oxide and crossunders

13.3 Gate Structures

- surface preparation
- dielectric: homogeneous and composite
- metallization and delineation
- annealing and alloy

14. Process Constants and Minimum Design Rules

Ronald Pasqualini – Vice President, Engineering. Widely experienced in R&D on MOS memory systems for Philco-Ford Corporation. Performed initial logic design, circuit analysis, and composite layout of a monolithic read-only memory. Was responsible for the interface between R&D processing and R&D design.

Systems design experience in integrated circuits includes shared responsibility on an Air Force large scale array navigation computer, and Ranger spacecraft. Also designed a monolithic 2-MHz binary/BCD converter employing 4-phase circuit techniques.

Mr. Pasqualini holds a BS in Aeronautics from M.I.T., 1962, and an MSEE from U.S.C., 1966.

Richard Craig – Vice President, Technologies. Mr. Craig has devoted the major portion of his career to the semiconductor. With three major semiconductor manufacturers his experience includes such early developments as planar and epitaxial processes and structures. More recent experience includes responsibility for the development of advanced MOS LSI techniques, including multilayer and minimum size structures, oxide and interface charge control, and MOS circuit innovation and evaluation.

Mr. Craig received his BA in Physics from Fresno State College in 1958.

Richard Aladine Carberry – Senior Design Engineer. Presently involved in the logic and circuit design of complex MOS devices, and the design of digital equipment utilizing bipolar and MOS IC's. As a project engineer for Philco-Ford Corporation he was involved in the design of MOS memory and arithmetic chips for a guidance computer, as well as a sequencer and other control circuitry utilizing bipolar IC's.

For Lockheed Missiles and Space Company he designed analog circuits for a guidance system, switches, modulators and demodulators, active and passive filters, and various operational amplifier circuits.

Mr. Carberry holds BSEE and MSEE degrees from the University of California at Berkeley.

MSI/LSI Circuit Seminar

14.1 MOS Gate Capacitance

- dielectric constant and thickness
- gate dimensions and overlap capacitance

14.2 MOS Field Capacitance and Crossover Capacitance

14.3 Junction Depth, Capacitance and Resistivity

14.4 K values — t_{ox} , μ_m , ϵ_0 , W/L

14.5 Metallization Width, Spacing and Thickness

14.6 Area/Performance Optimization

- minimum length/width structures

14.7 Discussion of a Complete Set of Topological Design Rules

15. Yield Factors and Process Control

15.1 Processing Variables and Design Tolerances

- alignment uncertainties
- photoresist limitations
- working plate constraints

15.2 Threshold Control

- oxide thickness
- fixed charge (Deal's triangle) — crystal orientation and cooling ambient
- mobile charge — gettering, contamination sources

15.3 Test Devices and Patterns

- MOS capacitor (C-V evaluation)
- gate threshold device $V_{TH} = f(I_D)$
- field threshold device
- alignment marks, sizing marks and critical dimensions
- process development test vehicles

15.4 Gate Oxide Vulnerability — Protection Techniques

- MOSSAB and zener diodes

15.5 Wafer and Device Attrition

- in-process testing and rejection criteria
- probing, assembly, packaging and final testing

16. Facilities and Equipment Requirements for LSI

16.1 Requirements for a Prototype Facility

- personnel
- mask making equipment
- process equipment
- assembly, packaging and test equipment

16.2 Available Products and Services

17. Applications and Product Types Most Suited to LSI

17.1 The following examples will be discussed:

- desk calculator
- input/output peripheral equipment
- scratchpad memory
- read-only memory
- airborne computer — GP and DDA
- associate memory
- correlator applications
- multiplexers
- A/D and D/A converters
- industrial controls
- medical electronics

18. Currently Available MSI/LSI Products

18.1 Bipolar MSI

18.2 MOS MSI/LSI

19. Advanced Technology Trends

19.1 Contributors to Improved LSI Technology

- smaller geometries
- multilayer interconnect
- MOS-bipolar in same array — internal clock generation, high speed decoders
- array passivation
- multichip assembly

19.2 Contribution of Advanced Technology to Cost, Performance and Density

- memories
- delay lines
- general logic
- reliability

20. Technological Controversies

20.1 Semiconductor Developments

- complementary N and P MOS
- other MOS structures — SOS, TFT, self-aligning gate, MNS and MNOS and epitaxial
- isolation techniques — dielectric isolation, etch and back-fill

20.2 Custom vs. Standard Products

- memories
- logic
- production volume considerations

Fee

The registration fee for all sessions, a complete set of notes, and luncheons — \$385.

Registration

Register now for either the New York or Los Angeles program. Use the registration form below. Make checks payable to Electronics/Management Center. You must register in advance. We will be happy to bill you or your company, but only fully paid-up registrants will be permitted to attend the seminar.

Hotel reservations should be made directly with the hotel. A number of rooms is being held for seminar attendees. When you make your reservations, identify yourself as an attendee of the MSI/LSI seminar.

Samuel Weber, Mgr.
Electronics/Management Center
330 West 42nd Street, N.Y., N.Y. 10036

MSI/LSI Circuit Seminar for Equipment and Systems Designers

___ Please register me in your three day seminar at \$385

___ New York session ___ Los Angeles session.

___ Check enclosed

___ Bill me

___ Bill company PO# _____

Name _____ Title _____

Address _____

Company _____

City _____ State _____ Zip _____

IBM announces a new 4 Pi computer feature.

You no longer have to wait a year or more for a mil spec computer. IBM offers quick delivery of System/4 Pi Model CP 2 computers for government applications.

CP2's are the same mil spec (AN/AYK-6) computers in production and in operation for the Air Force. They're ready now, along with a support programming system, for almost any job you've got. From navigation and weapons delivery to signal processing.

System/4 Pi Model CP 2's come in a compact,

50 lb. package. Storage is 16,896, 16-bit words expandable in 16,896 word increments. Speed capacity is more than 150,000 operations per second.

If IBM's CP 2 won't do the job for you, ask about our other System/4 Pi models, from low cost tactical computers to powerful multiprocessors. Their capacities range from 60,000 to more than 500,000 operations per second.

We don't want to keep you waiting.

IBM, Federal Systems Division, Gaithersburg, Md. 20760.

Quick delivery

IBM Marketing Information
18100 Frederick Pike
Gaithersburg, Maryland 20760

Please send me more facts about
System/4 Pi Model CP 2 computers.

Name _____

Title _____

Company _____

Address _____

City _____ State _____ Zip _____

H001101

IBM®

Circle 129 on reader service card



SPEED WINS THE BALLGAME!

In computers, too, time is money; and the lowest computer time often wins the ballgame. So if speed is important to you, why settle for typical TTL times of 13 nanoseconds when you can have typical ECL II times of 4 nanoseconds?

At Stewart-Warner, the high-speed logic of the future is available today. We are now announcing another 14 new ECL II's in both the industrial series (1000) and military series

(1200). We have previously announced 14 circuits in these two ultra-high-speed series, as well as 11 ECL's in the high-speed 300 and 350 series.*

Since ECL's offer the designer the same functional capability and design freedom as he has with the slower TTL logics, there's no longer any need to compromise when speed is important...especially when Stewart-Warner ECL prices may be lower than what you have been paying for TTL's.

For more information, send for our ECL data sheets. And, for off-the-shelf delivery, call your local Stewart-Warner Microcircuits Distributor.

*All Stewart-Warner ECL's interchangeable with Motorola MECL and MECL II units.

STEWART-WARNER 
COMPANIES

STEWART-WARNER MICROCIRCUITS, INC.
730 EAST EVELYN AVENUE, SUNNYVALE, CALIFORNIA 94086
PHONE 408/245-9200 TWX 910-339-9210

Circle 130 on reader service card

Mil Std 883—a real test case

Air Force spec, which covers IC workmanship and performance checks, has nonplused industry, particularly linear houses; many of them believe document can be misinterpreted

By James Brinton

Associate editor

Military Standard 883 is a mixed bag. The man who drafted it—Joseph Brauer, head of the solid state applications group at the Air Force's Rome Air Development Center considers certain parts "the cleanest and most complete job" yet done to clarify and specify quality, workmanship, and performance tests for integrated circuitry. But while there are those in industry who agree with him, a number of others attack the spec on the grounds that there's a lot in it which will be misinterpreted to the detriment of order volume and device price levels.

A partial list of tests and definitions linear IC suppliers dislike includes common-mode rejection ratio, power-supply rejection ratio, open-loop gain, bias current and voltage, drift specs and checks, noise figure, and power gain. Digital IC makers don't care for the pre-cap visual inspection and gross leak tests called for in 883.

The motives behind 883 are above reproach. Some years ago, members of the Aerospace Industries Association and the Electronics Industries Association realized that identical, or at least interchangeable, IC's were being tested differently with varying results. They figured that if specification procedures and tests could be standardized, users would save million of dollars.

A leader in the effort to achieve this was Edward Keonjian, chief of microelectronics at Grumman Aerospace. Head of both the AIA Microelectronics Committee and the EIA Microelectronics Characterization Committee, he says that when the industry became aware

of the discrepancies between devices and test methods, the problem was called to the attention of the National Aeronautics and Space Administration and the military; the eventual result was 883 and several other documents.

Groundwork. The EIA committee had drafted specs covering some of the more controversial areas now included in 883—namely, definitions and test techniques for linear integrated circuits. Accord-



Flexible. Air Force's Joseph Brauer believes Mil Std 883 is a good spec, but is willing to consider a rewrite.

ing to Brauer, EIA members not only identified 883's linear IC parameters, as well as their definitions, but also worked up the bulk of the test circuits. "We (the Air Force) mostly sat in to assure uniformity of symbolism, format, and the like," he says. "We did, however, provide data from about \$1 million

worth of contracts aimed at developing test and screening procedures; Fairchild, Motorola, Texas Instruments, Philco-Ford, and others worked on these." Right now, however, it's the producers of linear IC's—both hybrid and monolithic—who are most vocal in their criticism of 883. The question thus arises as to why they should be complaining, if their views, as members of the industry's leading trade group, were reflected in the basic document.

The answer seems to center on the fact that EIA group may not have heard from all interested linear houses. "The EIA committee was formed of men from member firms such as Texas Instruments, Boeing, Fairchild, Motorola, Lockheed, and others," says Keonjian. Thus, smaller outfits of the size of, say, Analog Devices or Philbrick-Nexus weren't represented. But he notes: "If a company asked for a spot on the committee and had a man with a suitable engineering background, we asked them to join us." But to work on the committee, a firm has to be an EIA member; this provision effectively barred some small nonmember op amp and hybrid IC houses. From this viewpoint then, the EIA work that resulted in the document later used by the Air Force as the basis for the linear IC portions of 883 was potentially flawed.

At least three drafts of the standard were circulated to industry for comment in March, July, and November of 1968. "I sent copies to 22 members of my AIA Microelectronics Committee," says Keonjian. "Brauer sent copies to other firms." Brauer says as many as 5,000 cop-

GLASS ENCLOSED Thermostatic DELAY RELAYS



by **AMPERITE**

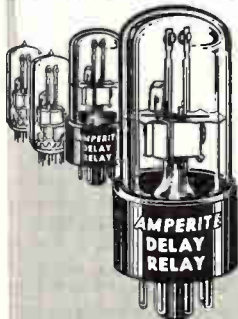

Offer true
hermetic
sealing —
— assure
maximum
stability
and life!

Delays: 2 to 180 seconds

Actuated by a heater, they operate on A.C., D.C., or Pulsating Current... Being hermetically sealed, they are not affected by altitude, moisture, or climate changes... SPST only — normally open or normally closed... Compensated for ambient temperature changes from -55° to $+80^{\circ}$ C... Heaters consume approximately 2 W. and may be operated continuously. The units are rugged, explosion-proof, long-lived, and inexpensive!

TYPES: Standard Radio Octal and 9-Pin Miniature... List Price, \$4.00
PROBLEM? Send for Bulletin No. TR-81.

AMPERITE

BALLAST REGULATORS

Hermetically sealed, they are not affected by changes in altitude, ambient temperature (-50° to $+70^{\circ}$ C.), or humidity... Rugged, light, compact, most inexpensive.

List Price, \$3.00

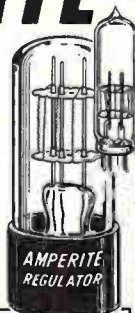

Write for
4-page
Technical
Bulletin
No. AB-51

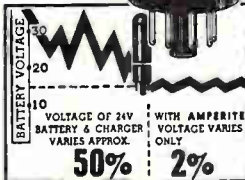

AMPERITE

600 PALISADE AVE., UNION CITY, N.J. 07087

Telephone: 201 UNion 4-9503

In Canada: Atlas Radio Corp., Ltd.,
50 Wingold Ave., Toronto 10

ies may have been mailed.

There's a difference of opinion, however, as to whether the draft was common knowledge in the industry until it circulated. Many sources claim never to have heard about 883 until the first draft was issued in May 1968. Others found out about it informally and requested a copy from Brauer, who answered all such requests. "By the November draft, my mailing list had about 1,000 names," he says.

Open to question

Thus, it may be possible that industry participation in the writing of 883 and the predecessor spec was limited by membership either in the EIA or AIA—as well as to smaller groups of firms within those organizations—and the right of criticism limited by inclusion on the Air Force mailing list.

It's impossible to say that any company was left out intentionally, just as it's hard to figure out why any should have been. As it happens, some sources reviewing the 1966-67 period of 883's drafting and circulation suspect that they may, in fact, have dealt themselves out.

For example, Fairchild Semiconductor, top dog in the op amp field industry at that time, didn't comment on the draft of 883 which was apparently sent to it. In retrospect, this is a puzzling response for a company with what was then probably the largest corporate stake in such standards because of its 709 series.

By the boards. Jim Morgan, Manager of Fairchild Semiconductor's high reliability programs, says he only became aware of the spec when it was published last May. Nor did he see it at Sprague where he worked during 1967. Morgan guesses the company was overtaken by the events that led to the hiring of C. Lester Hogan, and 883 got lost in the shuffle.

Clifford McCarroll, marketing manager of Fairchild Control, also claims he was unfamiliar with 883 and had never seen a copy until it was published last May. McCarroll is said to be trying to mobilize industry opinion to work for changes in the linear IC portions of 883, but he won't confirm this. Fairchild, a member both of EIA and AIA, should definitely have re-

ceived a draft copy for comment and taken the thing seriously. But now, it seems, nobody on the premises remembers getting the chance.

Follow-up. Transitron also got a draft. But a spokesman notes that he found out about the spec informally and wrote for a copy. He isn't sure that he would have received one without doing so.

Richard McCoy, supervisor of Government marketing at Signetics, says that his company got a copy and made about 25 change recommendations, of which about 90% were incorporated in the final document. "I don't know who got



Lead man. Grumman's Edward Keonjian heads the EIA and AIA committees that did preliminary work on Mil Std 883.

drafts," he says. "But it appeared to me that they were public knowledge and should have been available to anyone in the industry."

Brauer wonders why industry feels uninformed; he points to at least half a dozen articles and interviews on 883 in trade magazines before and during the drafting that invited industry participation and comment. He personally gave papers at the 1967 Reliability Symposium held in Washington, D.C. (the paper, "The Numbers Game and Who Wins," stated that 883 was being written because industry hadn't offered to police its own specs), as well as at the 1967 Product Assurance Symposium in New York. Brauer, with some justice, can't understand why industry shut itself out of the drafting process and then compounded the error by failing to comment.

Majority report. Of the more than 1,000 addressees who are supposed to have been mailed drafts, only about 26 appear to have answered back. Only 16 firm names appear on an RADC summary of comments on the July 1968 draft. They are: AC Electronics, Autonetics, Collins Radio, General Electric, General Precision, Grumman, IBM, Motorola, Ryan, Signetics, Sperry, RCA, Texas Instruments, Transitron, TRW, and Westinghouse. Ten others checked in late; their suggestions were used but not published, and they are not named in the officially published records.

Amelco, Fairchild, and ITT are conspicuous by their absence as are smaller firms like Philbrick-Nexus, Analog Devices, Burr-Brown, and others. "We were a reservoir of talent when 883 was written, but nobody asked our help; we saw nothing before a draft spec and that was passed on to us from another company," says a onetime staffer at P-N, Daniel H. Sheingold—now Analog Devices' marketing director. Along with other bypassed or overlooked concerns, P-N has a sizable stake in linear circuits and how they are specified.

Industry then is apparently as culpable for the snafu—if such it was—as the nominal drafters and distributors. "Looking back, we should have beaten them to it," says Ray Stata, vice president of Analog Devices. "This linear circuit business has been a rat's nest of conflicting specifications, definitions, and test procedures for years. And if we had agreed among ourselves what such terms as common-mode rejection, input bias current, and the like meant, as well as how to test for them, we could have avoided the difficulties now encountered with 883.

"You can't expect the Government to set standards for an industry," he continues. "Brauer's group may have done a poor job, but they were handicapped by lack of an industry consensus."

Opposing forces

Divisiveness and specmanship still are facts of life in the linear circuit business. Input bias current, for instance, can be quoted: as the average of the bias currents

at the two input terminals of an op amp, or, as the worse of the two measurements. Obviously, if the reading differs widely at the two inputs, the averaging route can not only make a poor amp look better but also mislead a buyer. Stata and others would like to see adoption of a single standard, preferably the worst-case figure.

But the averaging method is used in 883, and while this makes builders of monolithic op amps happy—since their devices look a little better—hybrid assembly suppliers who can select components, trim resistors, and adjust circuits in ways not possible for their monolithic rivals would rather see a worst-case standard.

The upshot is that a lack of self-imposed standards and just plain inertia has resulted in linear circuit makers being presented with a set of specification definitions that none of them can go for in toto. "About the only good thing you can say about the section of 883 devoted to specifying and testing linear IC's is that it's there," says one source. "Even if we have to go all the way back to square one and change it completely, we at least have the incentive to do so now. There are some things we just can't live with in that spec."

Discussions of the spec's supposedly intolerable provisions typically lapse into jargon, suggesting that some personal or corporate ox is being gored. There are, however, enough general criticisms to make a pretty good overall case.

Diversity. For example, Alan R. Risley, P-N's op amp product manager, says: "The linear IC tests and definitions try to cover too much ground. There doesn't seem to be much awareness of the differences among the many types of circuits. Consequently, the section includes specifications, definitions, and tests for parameters like power gain—I refuse to spec an op amp for power gain—and noise figure. None of these has across-the-board importance; yet there's no attempt to note which checks are important to what circuit types. It would have been less confusing if this part had been broken down into subsections for each linear circuit type."

Analog's Stata is even blunter: "883 doesn't tell what checks are needed when; nor does it give de-

your best buy in D.C. . . .



from any angle

For the mini-price of \$90, you can choose from three compact, well regulated, constant voltage/current limiting laboratory power supplies. And, for only \$25 more, 3 additional models are available with constant voltage/constant current. We call them BENCH supplies.

These stable battery substitutes are packaged in molded, high-impact plastic cases with an interlocking feature for stacking. They can be rack mounted with an accessory kit.

Check the following specs for proof of quality at no sacrifice in performance.

Outputs 0-10V @ 0-1A, 0-25V @ 0-4A, 0-50V @ 0-2A
Regulation 4 mV, Load or Line
Ripple 200 μ V rms/1mV p-p (DC to 20 MHz)
Stability 0.1% +5 mV for 8 Hours
Size 3 1/4 "H x 5 1/4 "W x 7 "D

HEWLETT  PACKARD

POWER SUPPLIES

112 Locust Avenue
Berkeley Heights, New Jersey 07922 21901

GREAT NEW WAY TO BUY DC POWER



ERA's Wide-Range, Variable, All-Silicon DC Power Modules at Low, Low Prices

ERA's new Value-Engineered DC Transpac® power modules provide all-silicon, DC power in a wide-range, variable, low cost module.

Stocking problems are reduced to a minimum and power module obsolescence is practically eliminated. Design changes are easily accommodated since all units can be set to desired voltages by a simple external tap change.

Output Voltage (DC)	Current (71°C)	Model	Price
4-32	0-750 ma	LC32P7	\$ 89.00
4-32	0-2 amps	LC322	\$115.00
4-32	0-5 amps	LC325	\$179.00
4-32	0-10 amps	LC3210	\$215.00
30-60	0-1 amp	LC601	\$145.00

Over-Voltage Protector Option: Add \$35.00 to above prices and Suffix V to Model No. (i.e. LC325V, etc.).

SPECIFICATIONS

Input: 105-125 VAC, 50-400 cps
 Ripple: Less than 800 microvolts RMS or .005%, whichever is greater
 Line Regulation: Better than $\pm 0.01\%$ or 5 mv for full input change
 Load Regulation: Better than 0.05% or 8 mv for 0-100% load change
 Voltage Adjustment: Taps and screwdriver adjustment
 Short Circuit Protected: Automatic recovery
 Vernier Voltage: External provision
 Transient Response: Less than 50 microseconds
 Operating Temperature: -20°C to + 71°C free air, full ratings
 Maximum Case Temperature: 130°C
 Temperature Coefficient: Less than 0.01% per degrees C or 3 millivolts
 Long-Term Stability: Within 8 millivolts (8 hours reference)

Write Today for Catalog #147



ELECTRONIC RESEARCH ASSOCIATES, INC.

Dept. E-869, 67 Sand Park Road
 Cedar Grove, N. J. 07009 • (201) 239-3000
 Subsidiaries: ERA Electric Co. • ERA Acoustics Corp.
 ERA Dynamics Corp. • ERA Pacific, Inc.

cent tests to begin with."

Douglas R. Sullivan, sales manager for linear integrated circuits at Transitron, says: "883's test circuits can include enormous capacitors (several farads) which sometimes must be matched at various frequencies—almost an impossibility outside the lab and tough even there. Other tests seem to confuse a-c with d-c methodology."

Dilemma. Sullivan reports that Transitron now is receiving about 10 requests a week for linear IC's "per 883". "Although I'm sure our circuits will pass tests set forth in the standard," he says, "I'm forced to no-bid if the buyer applies the spec literally. There's almost no room for profitable production if the tests in 883 are used; even at high speed, it could take ten minutes to test a circuit using some of these lash-ups."

The time factor is going to cost users money. How much depends on the company. Signetics, which advertises compliance with 883 on its digital IC line may have to ask an average of \$2.50 more per circuit, according to McCoy. Transitron's Sullivan anticipates a 40% price hike for linears tested to 883. National Semiconductor's Edward Thompson, director of quality assurance and reliability, believes it will cost from 50 cents to a dollar more to produce circuits the 883 way.

Another IC maker believes that users are beginning to write in "per 883" on their requests as a crutch. "It saves them a lot of time in proposal writing and makes them look good to Air Force men reading the proposal. But when they include it in requests to subcontractors it's trouble," he says. "I can see successive requests for waivers stretching from subcontractor levels through the prime contractors to the Air Force just because the user didn't take time to think through his needs, or to familiarize himself with 883."

Way out

To avoid this, several companies are trying to comply with the spirit, if not the letter, of 883. National Semiconductor, for example, says Thompson, gives prospective customers a so-called slash sheet that spells out exactly what the company means when talking about



Concession. Analog Devices' Ray Stata admits linear IC makers should have been more alert to 883's implications.

the standard. A case in point he notes is Collins Radio, which buys about 70,000 circuits weekly; all are gross leak tested to 883 standards—as interpreted by both companies.

Thompson concedes the test philosophies in the linear IC section of 883 appear weak; he calls this area a dangerous pitfall. None of the test limits are adequately defined, he says, and this is the big idea behind National's slash sheets which define tests and specs for each product.

Fairchild's Morgan also is manager of what the firm calls the Unique 883 program—another interpretive marketing effort which applies 883 (or 883-like) criteria selectively to a degree determined by the purchaser. The controversial linear IC electrical tests aren't mentioned, however.

Transitron sends buyers requesting 883 testing a statement of their philosophy. "Transitron favor d-c testing of linear IC's wherever possible since it is faster and more accurate," says the document, "... 883 requires that many tests ... be performed with a-c techniques ..." which the statement calls "cumbersome, time consuming, and not adaptable to automatic test techniques."

Transitron's Sullivan believes the IC maker and user could lose much of the cost advantage of batch processing by using 883's tests, which are at best suited to the lab. Moreover, he says quality could suffer; in his opinion, a-c tests are less accurate than his company's automated d-c tests. Transitron was

one of the first companies to get a Teradyne J263 computer-operated linear IC test system, which leans heavily on d-c techniques to measure performance.

Horse's mouth. William A. Attridge, the Teradyne project engineer who designed the J263, because of his background has a more than casual interest in the 883 situation. He believes that the standard, as written, is inadequate not only because some of its definitions are invalid, but also because tests can't be automated. In addition, Attridge considers the measurement of open-loop gain too tough to make outside a lab; and since this value is important for other measurements, additional difficulties are introduced.

"Anyone using 883 in production testing must be literal," he says. "But test systems must lend themselves to broad user bases. Some want automatic equipment, others manual gear; the range of tests and accuracy needed vary too. The industry needs different circuitry to optimize testing at different levels of sophistication. But 883 pins its users to standard test circuits few of which can be automated."

Attridge believes it's time to go back to basics, rather than amend 883. "My sole aim in writing a standard would be valid definitions of specifications," he says. "Even asking for a definition of d-c gain produces arguments among engineers; if a simple parameter like that is subject to interpretation, how valid can test circuits, designed around one definition, be?"

Looking backward. Now, with the benefit of hindsight, most IC engineers and salesmen agree that their companies should have gotten together long before 883 was drafted and agreed upon definitions for the specifications they touted. There are also schools of thought to the effect that test techniques should or shouldn't have been frozen at the same time. A standing committee charged with keeping standardized test technology abreast of circuit performance would perhaps have been an answer.

If it is as serious as its more vocal elements suggest, the industry will get together on proposals for improving 883—particularly provisions involving linear IC's, visual

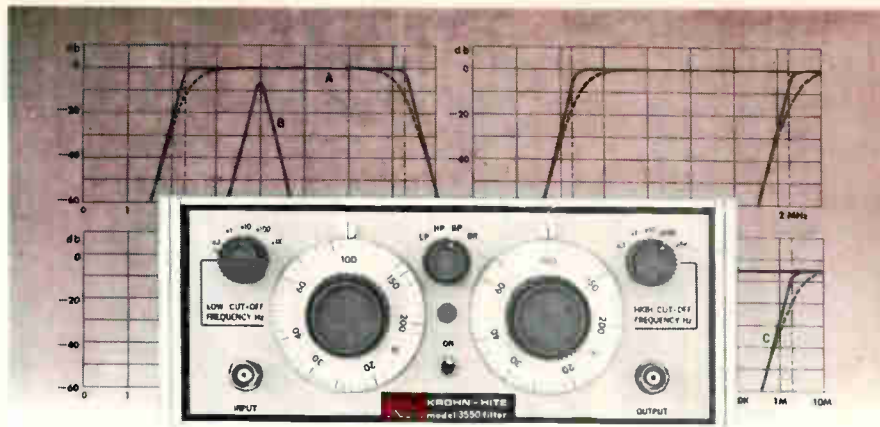

New, low priced all solid-state variable filters

cover 2 Hz to 200 KHz

MODEL 3550 — a new, all solid-state multifunction variable filter covering the 2 Hz to 200 KHz frequency range. Functions include band-pass, high-pass, band-reject and low-pass with 24-db-per octave attenuation slopes extending greater than 60 db. Frequency response can be switched from Butterworth to Low Q (transient free). Low hum and noise (200 μ v rms). Dynamic range of greater than 80 db. Insertion loss 0 db. Bench model: 8 $\frac{5}{8}$ " wide x 3 $\frac{1}{2}$ " high x 13 $\frac{1}{2}$ " deep. Rack model: 19" wide x 3 $\frac{1}{2}$ " high x 13 $\frac{1}{2}$ " deep. Price: \$525

MODEL 3500 — a new all solid-state variable band-pass filter covering the 20 Hz to 200 KHz range. Switches from Butterworth to Low Q. Attenuation slopes: 24-db-per octave extending to greater than 60 db. Hum and noise: 200 μ v rms. Dynamic range greater than 80 db. Insertion loss 0 db. Size: same as above. Price: \$395

See for yourself why these new Krohn-Hite solid-state variable filters make "do-it-yourself" filter design a relic of the past. Write for complete specifications.

OVERSEAS SALES OFFICES: BELGIUM, C. N. Rood s. a. DENMARK, SC Metric A/S; FRANCE, Antares; GERMANY, Nucletron Vertriebs-GMBH; HOLLAND, C. N. Rood n. v.; ITALY, Dott. Ing. Mario Vianello; SWEDEN, Teleinstrument; ISRAEL, R.D.T. Elect. Eng. Ltd.; JAPAN, Shoshin Shoji Kaisha, Ltd.; AUSTRALIA, Sample Electronics (Vic.) Pty., Ltd.; G. B., B & K Inst. Ltd.

KH KROHN-HITE CORPORATION

580 Massachusetts Ave., Cambridge, Mass. 02139, U.S.A.
Phone: (617) 491-3211 TWX: 710-320-6583

Oscillators / Filters / AC Power Sources / DC Power Supplies / Amplifiers

In Upstate New York . . .



our greatest fringe benefits cost you nothing

There's more to living than working — and Upstate New York has the kind of leisure-time living you and your employees will both enjoy. Extra hours for close-to-home golf or tennis . . . taking the kids to a Little League game . . . spending a summer evening at a nearby lake . . . or winter evenings and weekends at a nearby ski slope.

And when you consider Upstate New York, keep in mind that we serve 35% of the entire New York State area. Our information on available industrial sites, existing plants, cost, ownership, zoning, transportation and the labor market is immediate and up-to-date. So — instead of living on the big-city fringe, why not join us where the living's great . . . Upstate. For confidential, professional assistance . . .

Contact: W. K. Lampman, Manager of Area Development, New York State Electric & Gas Corp., 4500 Vestal Parkway E., Binghamton, N.Y. 13902.

Phone:
607/729-2551.

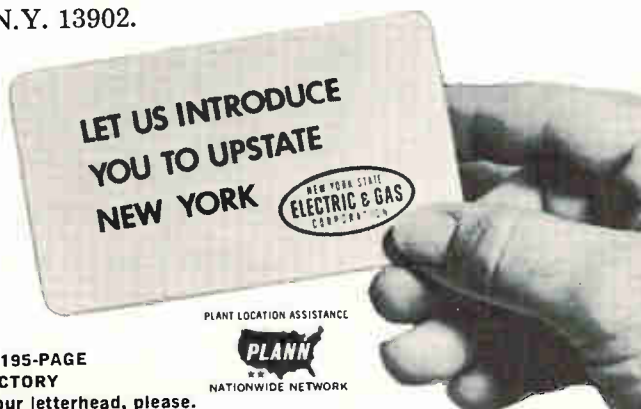

WRITE FOR FREE 195-PAGE
INDUSTRIAL DIRECTORY
of our area — on your letterhead, please.

inspection, and gross leak testing.

Brauer admits that there's room for improvement, and says that one of his priorities is development of easy-to-use d-c linear test procedures to replace some of the criticized a-c checks called out in the standard. But an important question centers on whether industry will do anything at all. Brauer is ready to go on industry-suggested revision, having arranged for standing Defense Supply Agency approval of a partial 883 rewrite—if suppliers will only stop grumbling privately and talk to him.

Sadly. "Somehow, when the time comes to form committees and get things like this done," says Attridge, "the best people don't seem to have the time to serve." He believes that the most talented would rather engineer than serve on committees—a conviction shared by others.

Things may be different this time, Analog's Stata says that he plans to have his best people available, and this attitude is common among the companies most critical of 883. With the stimulus of costly test requirements, potentially lower profit margins, and frustrating performance definitions staring them in the face, most suppliers seem ready to get their experts out of the lab to the conference table.

But they'll have to be quick about it. Mil-M-38510 ("general specifications for microcircuit quality and reliability assurance") may well represent a set of teeth for 883; and though this document is still being reviewed by industry, its advent promises to strengthen rather than weaken 883. Brauer says that when the spec is activated it will require those firms that want to be qualified Government suppliers to show that they meet 883's provisions. In addition, 883 criteria would appear in any Government-generated data used to flesh out 38510.

In the meantime the EIA has quietly formed another Microelectronic Devices Committee to specify parameters for linear circuitry. This group is already well along in its work under chairman Richard Linder of the Bell Telephone Laboratories Allentown, Pa., facility. The IC industry's response to MED-20 may foreshadow its success or failure with 883.

IRRAVINTM

INSULATED WIRE

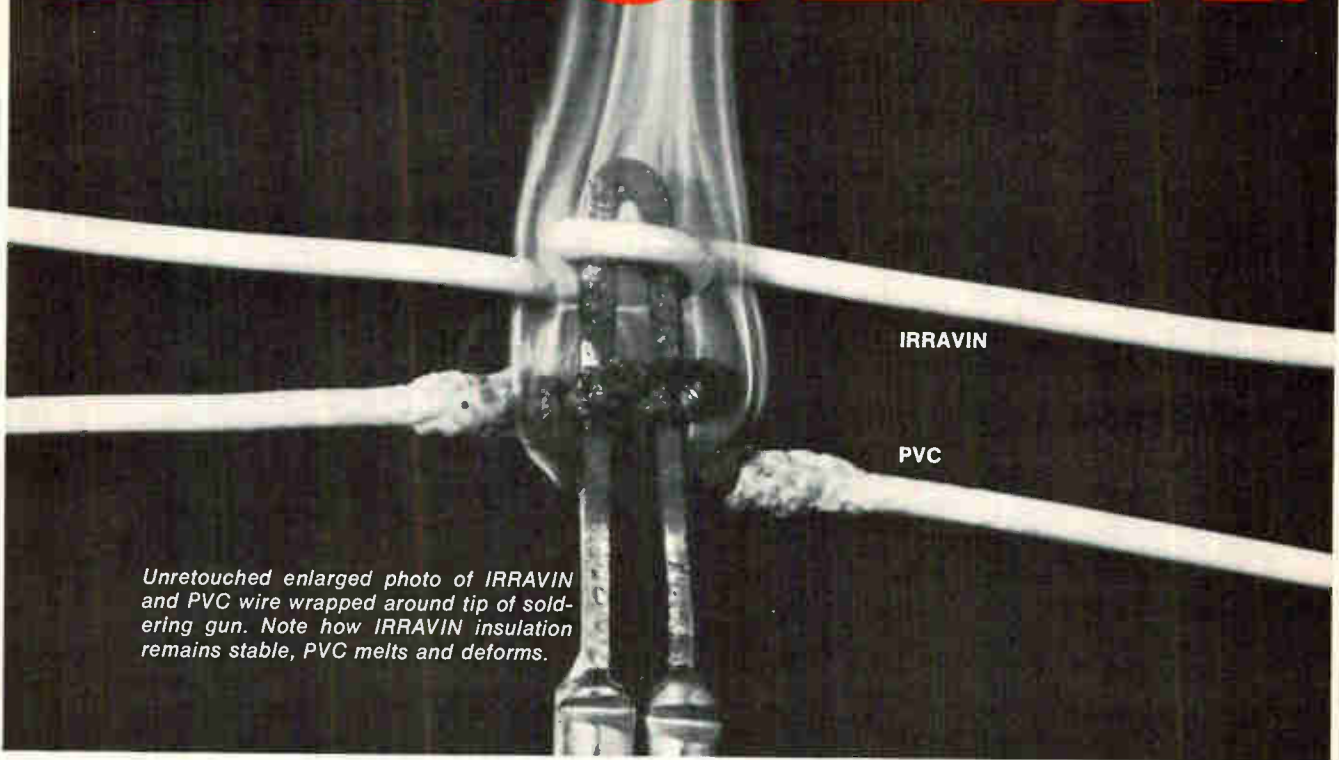

Unretouched enlarged photo of IRRAVIN and PVC wire wrapped around tip of soldering gun. Note how IRRAVIN insulation remains stable, PVC melts and deforms.

Hot problem...cool solution.

IRRAVIN insulation won't melt, flow or shrink back.

This photo was made to demonstrate the solder iron resistance of IRRAVIN insulated hook-up wire, compared with ordinary PVC insulated hook-up wire. It's proof that low-cost IRRAVIN wire suits applications where heat, even direct hot solder iron contact, is encountered. IRRAVIN insulation won't shrink back, or deform. It stays in place to maintain insulation integrity.

IRRAVIN wire can be soldered in snug spaces, even when terminals are

closely set. This, in addition to a small O.D., means space-savings, reduced rework and production time, less scrap.

To get the same product advantages of IRRAVIN wire you would have to specify wire that costs a lot more, two to three times more in fact! With IRRAVIN wire you not only save on time, space and waste. . . . you save on the initial cost too!

Don't just take our word for it. See for yourself with a sample.

It's yours FREE! Write ITT Wire and Cable Division, Surprenant Products, International Telephone and Telegraph Corporation, Pawtucket, Rhode Island 02862. In Europe: ITT Europe-Components Group, Lister Road, Basingstoke, Hants, England.

IRRAVIN—the wire that stops the grumbles.

SEE IRRAVIN Wire at
WESCON August 19-22
Cow Palace, San Francisco Booth 3808

WIRE AND CABLE **ITT**

Road open for highway automation

Federal agencies, along with state governments, are allocating sizable chunks of money; electronic route-guidance system is being readied for initial tests

By Paul A. Dickson

Associate editor

Realizing the popular concept of automated 20-lane highways—complete with coffee-drinking motorists zooming along at 200 miles per hour in self-controlled vehicles—is the ultimate development goal of officials directing Federal research efforts on high-speed ground transportation. For the moment, however, those involved would be willing to settle for a bridge between

the immediately practical and the frankly visionary. And in building such a bridge, they're interested in seeing what they can do about solving the two troublesome problems of highway safety and congestion.

Charged with the job of innovating fruitfully in this crucial area is the Office of Research and Development of the Federal Highway Administration's Bureau of Public

Roads. Four years ago this organization was directed to take on urgent highway problems in a long-range effort designated "a national program of research and development for highway transportation." This undertaking encompasses a score of major projects, ranging from the determination of reliable forecasting techniques for highway use through development of new materials for road building.

But according to Carl F. Izzard, acting director of R&D for the Bureau of Public Roads, the electronics industry is getting an increasingly larger piece of the action as it checks in with solutions to problems. "The electronics orientation of our program is apparent in that about \$4 million of our \$5.6 million R&D budget in the fiscal year just ended was concentrated on electronics work," he says.

Promising. The interest in electronics expressed by the R&D office augurs well for industry despite the smallish Federal budget. For one thing, outlays could rise to over \$7 million this year. For another, the influence of this spending is greater than the dollar figures suggest. A clause in Federal highway aid programs stipulates that states must also ante up something for R&D, thus adding almost \$30 million to the pot. While states do initiate their own projects, the direction of the overall effort does follow the Government's lead. In addition, the Federal R&D people are quick to turn their early electronics work over to other directorates within the highway apparatus for large-scale experimentation and installation.



Helping hand. GM-developed elements for electronic route-guidance system include encoder with wheels for dialing destination and dashboard display.

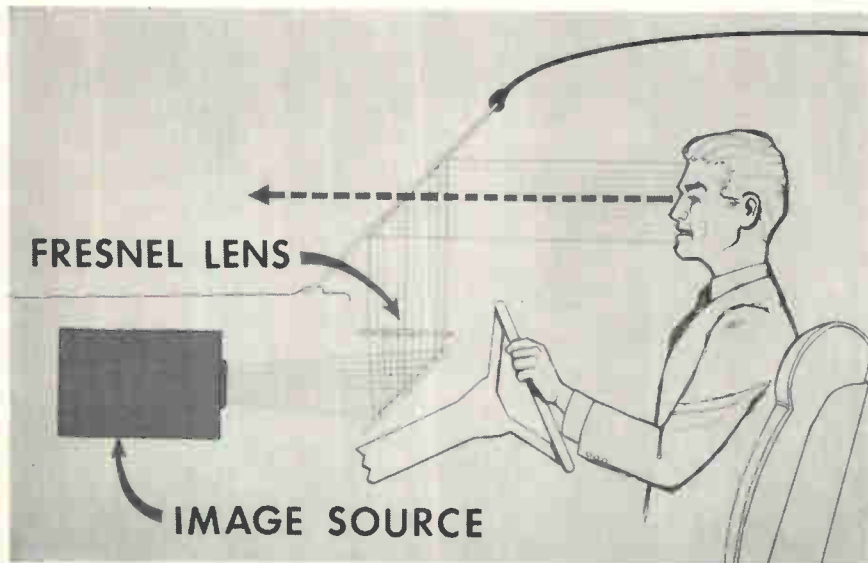
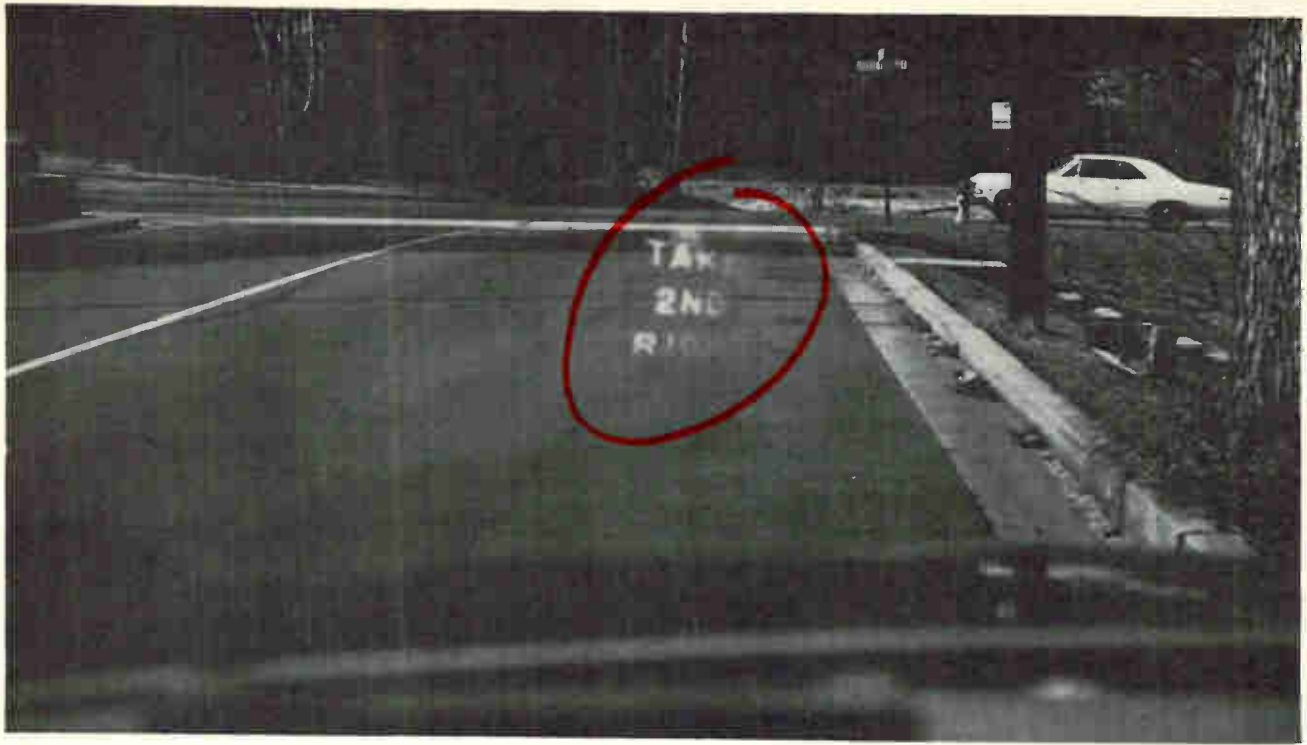

Looking good. The Standard-Kollsman Instrument Corp., along with General Motors, has been working on displays for electronic route-guidance systems under contract from the Bureau of Public Roads. This experimental unit from Kollsman has been tested to prove the feasibility of head-up configurations similar to those used in aircraft. Instructions are flashed, on command, on car's windshield.

In short, there is a large and fast-growing market for electronics in the highway program.

Izzard's office cites five development programs which are moving into test and evaluation that will become realities for drivers in the 1970's. The most ambitious and furthest advanced project, which Izzard describes as having the "greatest potential," is the electronic route-guidance system. (ERGS). The other programs involve: control of on-ramp merging; passing aids for two-lane roads; aids for distressed motorists; and improved urban traffic control.

At the moment, electronic route guidance is about to get its first

large-scale checkout. The system itself is a navigation aid with direct communication links into the vehicle; it is based on the assumption that traditional road signs are not satisfactory information media. The highway people are putting a lot of stock in ERGS as a viable substitute, believing it will serve the motorist better and, in the long run, cut down on accidents caused by improper and confusing signs.

In its current form, the system is supposed to work this way: a driver at the start of a trip dials the predetermined 6-letter code for his destination into a small control box mounted on the car's dashboard. The driver then starts in the general

direction of his destination; every time he comes to an intersection outfitted with ERGS gear, an antenna loop in the pavement interrogates the control box through the car's antenna. It is given the code which has been programed by the driver.

A roadside unit, incorporating a transceiver and a decoder computer gets the signal, searches its store of information, and returns a signal indicating what the driver should do at the intersection. An instruction is displayed; at the same time a beep alerts the driver to the fact that he is being directed. The instruction—turn right, go straight, or whatever—remains displayed for several seconds. Should



Semiconductor Burn-in

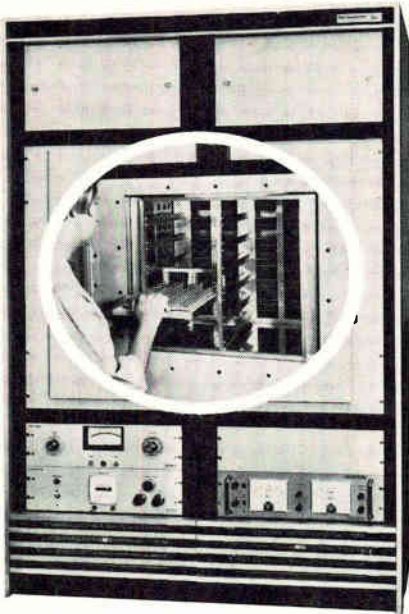

Economical TEC power aging and life test systems save you time and money

Test Equipment Corporation has for years designed and developed sophisticated environmental test equipment. This experience plus total "in-house" capabilities offers both manufacturer and user significant time and cost savings for semiconductor burn-in and life test.

Total "in-house" TEC manufacturing capabilities range from printed circuit boards, fixturing and socketing to NASA-approved machine shop, electrical assembly and micro-welding facilities. This makes possible extremely fast turn-around, thus saving valuable time and money.

In addition, TEC develops, builds and operates for customers complete "in-house" power aging and test facilities capable of meeting the most stringent requirements.



To discover how TEC burn-in systems and "in-house" facilities can help you, please write for this descriptive brochure.

Test Equipment

CORPORATION
P.O. BOX 20215, DALLAS, TEXAS 75220 • 214/357-6271

the driver miss his instruction or turn, he can continue and be rerouted at the next intersection.

Widespread. ERGS could eventually become a massive program. The Highway Administration anticipates versions will be installed on roads ranging from multilane highways to urban intersections. Hardware development is now well beyond the breadboard state; environment-hardened equipment has been installed in several test locations; and a national code scheme has been worked out.

A number of electronics firms are now preparing bids for an upcoming equipment purchase that will rig 100 intersections and 50 vehicles for a large-scale test to begin in the Washington, D. C., area next year. A top official in the Highway Administration reports interest by electronics firms and systems houses is running high; as many as 25 outfits are expected to submit bids on the system next month.

Burton Stephens, leader of the ERGS task group at the Bureau of Public Roads, says: "This phase will be important step for electronic route guidance; it will give us 18 months of concentrated test and evaluation and allow us to refine software, as well as accomplish the other tasks needed before wide-scale implementation."

Who's who

The General Motors Corp. has done the largest share of the work in developing the prototype hardware, producing both the roadside and vehicle equipment. Both GM and the Standard-Kollsman Instrument Corp. are developing car display units for the system.

Kollsman has proven the feasibility of a head-up display which appears on the windshield of the car—an adaptation of the units now in use in military aircraft. The GM display is a back-lighted panel with a repertoire of 16 graphic and verbal symbols which together offer about 100 possible instructions; this unit is dashboard mounted.

Besides displays, the major components of the system include: similar road and vehicle wire loop antennas; identical car and roadside solid-state transceivers; a modulation-demodulation system; a vehicle logic unit (encoder); and

roadside logic equipment.

Who will buy? The Bureau of Public Roads is not willing to be pinned down on the costs of the system. But, on the most general level, officials insist that a vehicle unit for the system will be comparable to other car "option costs." The cost of equipping an intersection, they say, will not be "far in excess" of the current expense of outfitting a corner with traffic-actuated lights.

Serendipity Associates of McLean, Va., which won a \$150,000 contract to study the human engineering aspects of the system, conducted a survey of visitors to the Smithsonian Institution to find out what they thought of the system and whether or not they would buy it. The results: 43% indicated they would buy; 39% were undecided; and 18% said no. Those who were willing to buy would be prepared to pay around \$150.

Despite the fact that much still has to be done to get the public tied into the program, Izzard is optimistic about electronic route guidance as an operational nationwide system. "It is conceivable," he says, "that ERGS could be operating on a nationwide basis by the end of the 1970's." He points out matching Federal highway grants are planned to get the system installed in various states. The evidence to date suggests that the states are very interested. "It will take us a while to get vehicles outfitted," says Izzard. "I think that within 10 years it will cost only between \$50 and \$100 to equip a car with ERGS; it will probably take another seven years, however, before enough new cars are bought to have really widespread use of the system."

Meanwhile Izzard's office is looking to future applications of ERGS, as well as meshing it with other developing programs. He says, "We're taking the systems approach towards highway development. While it may not be apparent on the surface, all of our programs are related to each other and to the same goals. We have one group at work here that concentrates on marrying one system to another."

Among the other ideas being investigated for electronic route guidance are: collecting traffic

data; directing traffic to the best route depending on circumstances (accidents, congestion, and the like); directing lane shifts on major highways; handling special detours; giving priority routing to emergency vehicles; and locating vehicles in distress.

Four other funded electronics aid programs in the works at the Bureau of Public Roads are, or will shortly go, into some form of test installation.

Plans now call for the first operational check of the passing-aid system (PAS) to be conducted on a 15-mile stretch of highway in Maine. Bids for furnishing and installing the hardware for the estimated \$1.5 million project have just been received and the system is expected to be fully operational in 1971. The PAS concept, which started at the bureau, was developed by the Raytheon Co.; it uses computers and sensors to tell motorists when they can pass other vehicles on two-lane roads.

Safety first. The system is designed to cut down head-on collisions on relatively heavily trav-

eled two-lane roads with poor lines of sight. The bureau estimates that there are 15,000 or more miles of road which fit this description; all are ultimate candidates for PAS.

In the Maine installation, sensors will be embedded in the pavement every 200 feet to detect the presence and direction of vehicles. The sensor system will consist of wire loops which sense by induction, feeding information to a simple roadside computer, which figures the relative velocities and distances of the vehicles and transmits passing time available to the motorist either through a receiver/display unit in the car or to a large roadside display. In the Maine operation both the vehicle display and the roadside display will be used.

Breakdowns

Another program aimed at solving a commonplace problem for motorists is aid for stranded motorists. While there have been many experimental installations of aids ranging from television surveillance to push-button phone booths located along stretches of highway

Way down the road

Both the Federal Highway Administration and the Federal Railroad Administration's Office of High Speed Ground Transportation are underwriting automated highway studies. The most ambitious was recently delivered to the latter by trw Systems as part of a \$5 million investigation of future automated ground systems.

While the results of the study will not be officially published until November, trw has briefed Federal Officials on the scheme. As a first step, it calls for longitudinal and headway controls built into highways to create a "guideway" or control system. The next two phases involve vehicles. After a given date, all automobiles produced will have sensor connectors attached to brakes, accelerators and steering. Outfitting cars with sensor capability would cost an estimated \$50 to \$100 per car. Once the vehicle is so predisposed it can be outfitted with black boxes (controls and sensors) which could be bought outright or leased upon entering an automated road. The car, complete with black box would enter the highway in an assigned slot. The driver would wait behind a gate and would get up to a predetermined speed once it opened letting him through. The driver would then put the system on automatic and proceed.

As is the case with other projects of this nature, those describing it preface most of their remarks with "if and when . . ." A senior engineer with Office of High Speed Ground Transportation says: "One of our biggest problems in implementing the idea is that somebody will have to take a first step. An automated highway is no good unless you have cars outfitted and vice versa. The thing we do have going for us is that there is a lot of enthusiasm for the project, and equipment needs are all within the state of the art." At present, transportation officials are deciding which agency—highway or railroad—will take the idea beyond the study stage. But whichever organization picks up the ball, it will have plenty of documentation to support its work. Among others, Ohio State University, the Battelle Memorial Institute, Michigan State University, RCA, General Motors, and Ford have done, or are doing, studies in this area.

PROBLEM:

Labor pains disrupting production

SOLUTION:

UTAH!

Expand WEST for . . . unspoiled labor in stable communities where you can find a cohesive work force ready to go to work for you NOW!

Where the average education is 12.2 years. This means flexible, trainable workers.

We'll guarantee the engineers and technical talent and will help you recruit—FREE. Or we'll train workers to your skills. You'll get the lowest absenteeism, lowest turnover, and the highest productivity from Utah workers.

Put YOUR plant in the heart of the fast-growing West. Put YOUR plant in UTAH where you can forget labor pains and concentrate on Growing Pains!

Write:

Calvin L. Rampton, Governor
State Capitol, Dept. 119
Salt Lake City, Utah 84114



SMALL BARGAIN!

**BARNES LOW-PROFILE
DIP SOCKETS...
SMALL SIZE!
SMALL PRICE!**

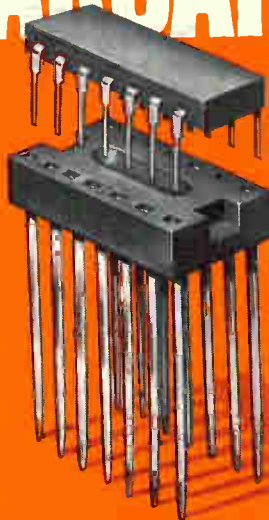

Wish you could squeeze more dual-in-lines onto a P.C. board—for production mounting or breadboarding? Try the low-cost, low-profile Barnes Series 041 DIP sockets. Designed for easy device insertion, yet excellent lead retention, the sockets are only a little larger than the device itself... and fit on the same centers. The low body height (only .135") gives you greater packing density between boards. Write or call for more data, and ask for a free sample. Lansdowne, Pa. 19050 • 215/MA2-1525

barnes
CORPORATION

barnes / THE FIRST WORD IN CARRIERS, CONTACTORS AND SOCKETS FOR I.C.'S

CIRCLE 205 ON READER SERVICE CARD

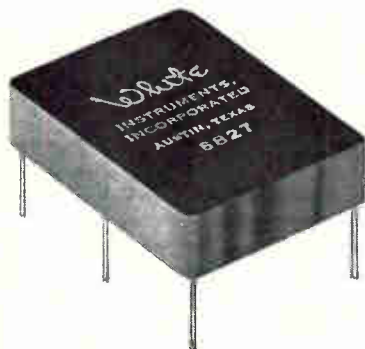

ACTIVE FILTERS PACKAGED FOR PRINTED CIRCUIT BOARD MOUNTING

Integral transistorized amplifier—network packages—Low, high, band pass and reject responses at audio and sub-audio frequencies for use over a wide range of source and load impedances and power supply voltages.

Ask for literature.

Write for quotations on individual problems.

Moderate prices, early deliveries.



instruments, incorporated

PHONE AREA 512 / 892-0752

P. O. BOX 698

AUSTIN, TEXAS 78767

in out-of-the-way areas, the Bureau of Public Roads is pursuing a new approach, which it feels will be more effective and practical than earlier efforts. The concept is based on the assumption that motorists will cooperate when they see another motorist in distress. A \$750,000 system is now being installed on a 50-mile stretch of highway in Florida. The system, called Flash (for flash lights and send help), was developed by Cutler-Hammer's Airborne Instrument Lab. In the test installations, if a motorist sees another in distress he continues on to the nearest Flash sign at which time he is told to blink his bright headlights on and off three times. The flashes are detected by a roadside sensor—a filtered photoelectric cell—and a signal is sent to the nearest police dispatcher. He sends the nearest patrol car to investigate.

The bureau's preliminary studies of the Flash scheme indicate that it will cut motorist waiting time by 50%, will cost less than other assistance schemes, and make more efficient use of police time. Variations on the Flash idea are being investigated, including a system that can be triggered by the beeping of a horn. Cost estimates for Flash on a large scale are about \$100 per year per mile.

Proposed mergers. Based on the premise that cars merging onto urban freeways are the single biggest cause of accidents in that environment, the bureau is involved in an effort to guide them on safely and quickly. Its on-ramp merging program is also aimed at controlling the flow of traffic on such arteries, thus accommodating a larger volume of traffic at higher speeds, as well as lowering the accident rate.

Two experimental installations, in Chicago and Houston, have demonstrated the effectiveness of computer-controlled traffic lights to give motorists a go for clear freeway access. The bureau is also investigating more sophisticated techniques. Two schemes which will be tested on a Boston expressway this year are designed to pace the motorist along the access road to synchronize himself with a gap in the traffic. One, called the pacer concept, has a series of lights along the access road which go on in sequence for the driver to follow

into a gap. The other test will involve a slight variation, called the green-band concept, in which the driver positions his car in line with the lighted portion of a long series of translucent panels. In both tests the gaps in traffic will be determined by a loop detector in the highway with the sequencers directed by computer. This work is being conducted by Raytheon.

Final approach. The bureau is also embarked on a major research effort in flow control concepts and programs under its urban traffic control system. While there have been a variety of traffic control systems proposed tested and implemented [Electronics, April 15, 1968, p. 157], the bureau is taking its own approach which features coordinated control concepts that would be practically applicable to a widespread network. The bureau believes that many of the earlier starts concentrate only on major arteries, thereby leaving out cross streets, or pay inordinate amounts of attention to major intersections.

The bureau's approach is to use real-time traffic data sensing and control systems to achieve advanced traffic control techniques. The ultimate would be digital computer control of traffic signals over an entire city. The bureau plans to test its ideas in a grid imposed on a large segment of the District of Columbia. Currently Sperry Rand and TRW Systems are developing specifications and suggesting hardware for the first installation. The bureau is also checking the feasibility of integrating the test traffic-control system with the developmental electronic route-guidance system in Washington for optimum routing along the least congested route.

According to Izzard, one of the key terms around the Bureau of Public Roads these days is "corridor control." It refers to the distribution and welfare of all the vehicles in a given area, whether on highways or streets. All of the programs now underway hark back to the concept which involves the old standbys of congestion and safety. For this reason, Izzard sees the program as a system for the future with all the elements, along with others which will emerge, as the bridge to an automated highway concept.



Photo courtesy Electronic Tube Division Westinghouse Electric Corporation

All NEW Bausch & Lomb STEREOZOOM[®] 7

establishes a new level of performance

We're getting glowing reports of the exceptional performance of StereoZoom 7, latest addition to the matchless line of Bausch & Lomb Stereomicroscopes. Eleven years' experience in StereoZoom building is bringing results where it counts the most . . . in actual use.

New StereoZoom 7 offers you the widest zoom range, sharpest images, highest magnification/resolution, simplest photographic set-up, plus proven reliability. That's a performance package that can't be equalled anywhere.

But, you be the judge. Write for catalog 31-15 and our free demonstration offer. Bausch & Lomb, Scientific Instrument Division, 99720 Bausch Street, Rochester, New York 14602.

BAUSCH & LOMB 
SCIENTIFIC INSTRUMENT DIVISION

Don't blow a fuse because your semiconductors aren't properly protected.

The new Airpax CEL-GARD® semiconductor fuses make fault-current protection easy for you! Now you can be sure that your rectifiers, thyristors, silicon-controlled rectifiers, and power transistors are properly protected . . . even in the face of short circuit disaster . . .

by using the easy steps outlined in our new catalog.

CEL-GARD® fuses are designed specifically for the semiconductor. The fastest arc-quenching techniques available are used to insure the **shortest possible** total fault-clearing time. In addition, CEL-GARD® fuses offer more mechanical durability when subjected to frequent switching of maximum rated currents. This means **longer CEL-GARD® life and increased circuit reliability.**

Protect your semiconductor properly. Send today for your catalog. Then you can be sure you're safe!

AIRPAX ELECTRONICS

Phone: (301) 228-4600

Telex: 8-7715

TWX: (710) 865-9655

Cambridge Division

Cambridge, Maryland 21613



Send for your AIRPAX CEL-GARD fuse catalog today!

NAME _____
TITLE _____
COMPANY _____
ADDRESS _____
CITY _____ STATE _____ ZIP _____
PHONE _____

Mail to: AIRPAX ELECTRONICS, Cambridge Division, Cambridge Md. 21613

Unquestionably LSI

With 253 gates on a chip, digital differential analyzer is most complex standard bipolar circuit on the market

A numbers game that integrated circuit manufacturers sometimes play is contained in the question: How many gates do you put on a chip before you call it large-scale integration? However, there's no doubt as to where Texas Instruments' digital differential analyzer stands. Containing the equivalent of 253 gates, it's unquestionably LSI and far and away the most complex bipolar IC that is commercially available.

The TA-00077 DDA occupies a whole 1½-inch silicon wafer and is enclosed in a 2⅜-inch-square ceramic package with 156 leads. Essentially, it's a special-purpose computer for the solution of dif-

ferential equations. For example, two TA-00077's can be cross-connected and used to find the sine and cosine pairs in 1-milliradian angular increments from pulses representing a radar antenna azimuth. The DDA's can perform a complete calculation of this type in 1 millisecond or less.

Bill Wickes, manager of advanced integration programs for TI, foresees applications for the TA-00077 in many kinds of navigational computation—tracking, beam steering, trajectory prediction—in civilian as well as in military aerospace systems.

The TA-00077 is fabricated with discretionary wiring, a technique

that TI advocates as the fastest route to true, practical LSI. Individual cells on the wafer are tested, and the location of defective cells is remembered by a computer. Then, when it comes time to interconnect the cells to form a functional circuit, the computer routes the metalization so that only good cells are used.

The metalization patterns are generated by the computer on the face of a cathode-ray tube. Photolithographic masks are made of the two levels of discretionary-wired metalization, and reproduced to interconnect the desired elements on the LSI wafer into a final circuit.

The DDA slice contains 128 J-K

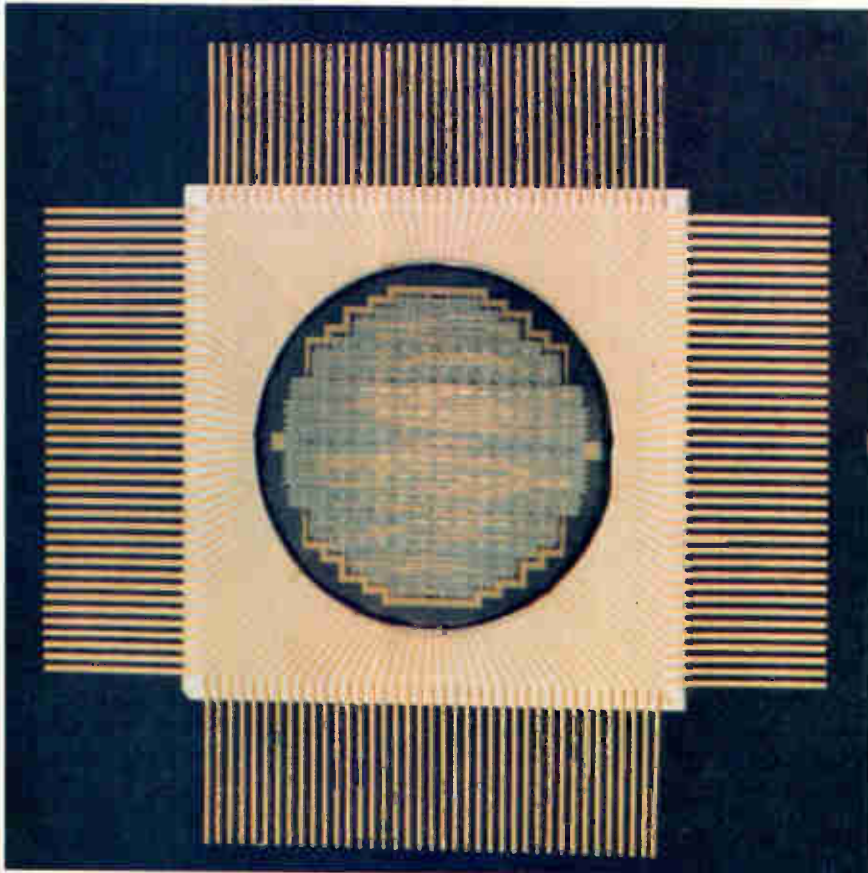

Circle in the square. Digital differential analyzer, containing 253 equivalent gates, is mounted in a ceramic package 2⅜ inches square with 39 leads, on 0.050-inch centers, on each edge. Computer-designed gold metalization on silicon wafer connects good cells only.



What is Bunker-Ramo doing aboard the EA-6A?



Receiving/Recording



RFI Measurement



DF Antennas

Sharpening the effectiveness of the Marine Corps' frontline combat aircraft, the Grumman A-6 intruder . . . *that's* Bunker-Ramo's role on the EA-6A.

Sophisticated electronic countermeasures equipment provides the EA-6A with multiple capabilities to gather electronic intelligence and perform tactical jamming . . . opening windows for A-6 missions around the clock and in all weather conditions. The tactical capability of the EA-6A is just one example of

Bunker-Ramo's competence in electronic warfare systems featuring unique data acquisition and data handling techniques at our Eastern Technical Center, Silver Spring, Maryland. Its capabilities cover a broad spectrum of communications . . . electronic data systems . . . electronic counter measures . . . simulation systems . . . microwave systems.

If *your* avionics/communications requirements call for integrated systems engineering with quick response capability — contact Bunker-Ramo.

 **THE BUNKER-RAMO CORPORATION**
DEFENSE SYSTEMS DIVISION

8433 FALLBROOK AVENUE • CANOGA PARK, CALIFORNIA 91304 • (213) 346-6000

2121 INDUSTRIAL PARKWAY • SILVER SPRING, MARYLAND 20904 • (301) 622-3100

AN EQUAL OPPORTUNITY EMPLOYER

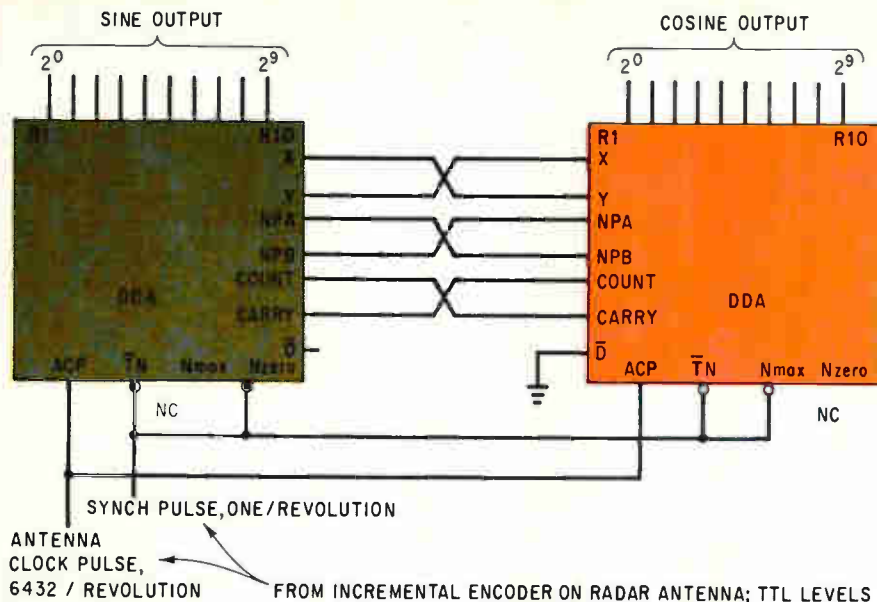

Sine and cosine. Two DDA's can be hooked up to compute the sine and cosine functions pertaining to radar antenna position. Navigation is the prime field of application for the DDA-on-a-chip.

flip-flops and 646 one-, three-, five-, and seven-input NAND gates. TI describes the unmetallized IC as a "general-purpose logic slice" that can be used to implement any logic function of up to 250-gate complexity. Besides the DDA, it can be used for a 20-bit up-down synchronous counter and an eight-bit adder with look-ahead entry, for example.

The DDA is an outgrowth of a program that TI conducted for the Air Force to develop an LSI computer [*Electronics*, April 14, p. 56]. It's only the first in a series of LSI circuits that TI will introduce commercially [*Electronics*, Aug. 4, p. 33]. Although the company's marketing men believe that almost all LSI circuits will be custom designed, they're introducing standard LSI products anyway. The reason: experience has taught them that before users will order custom designs, they want the reassurance provided by standard, commercially available circuits.

With a 90-day delivery time, TI isn't claiming "off-the-shelf" availability. This lead time, however, is shorter than for custom-designed circuits. Price is \$750 for quantities of one to four. Because the manufacturer is marketing the circuits as design samples, it does not expect many orders in excess of this quantity.

The TA-00077 includes as built-

in features a 10-bit up-down binary counter and a 10-bit add-subtract accumulator. It has direction control inputs, a sign-bit input (which also feeds the direction control internally), and a false-count suppression circuit that prevents cumulative error resulting from rounding-out.

The DDA utilizes high-speed parallel-transistor logic, and operates at a clock rate of 2 megahertz. Recommended supply voltage V_{CC} is 4.5 to 5.5 volts; at 5 volts, power dissipation is 2.5 watts. Operating case-temperature range is -55° to $+125^{\circ}\text{C}$.

The low output voltage, at -8 milliamperes and 5.5-volt V_{CC} , is no more than 0.4 volt. High output voltage, at 4 ma and 4.5-volt V_{CC} is at least 2.4 volts. With a "load" defined as 1.6 ma, the circuit can fan out to at least 5 loads.

The antenna count pulse (ACP) fan-in, the external directional control (\bar{D}) fan-in, and the internal directional control fan-ins (X and Y) are two loads each.

Fan-ins are 1 load each for Count, Nmax and Nzero (which set the up-down counter to all 1's and all 0's, respectively), "true north" synchronizing pulse \bar{TN} , and accumulator synchronizing pulses NPA and NPB.

Texas Instruments, 13500 North Central Expressway, Dallas, Texas 75222 [338]



Come Aboard & Advance The State-Of-The-Art

Bunker-Ramo — the ideal professional environment for applying skills and developing potential in electronic warfare — is recruiting highly qualified systems and techniques engineers with experience in DF microwave, and digital/analog signal processing.

You'll join teams generating new concepts, evaluating their effectiveness in meeting customer needs, and implementing the overall system.

Our salary/benefit packages are excellent; our suburban Maryland location attractive.



THE BUNKER-RAMO CORPORATION
DEFENSE SYSTEMS DIVISION
2121 INDUSTRIAL PARKWAY, SILVER SPRING, MARYLAND 20904 • PHONE (301) 622-3100

An Equal Opportunity Employer

**HIGH ELECTRIC STRENGTH,
LOW FRICTION SURFACE.**

**OPERATIONAL TO +500 F.
OPERATIONAL TO -100 F.**

**USED IN OUTER SPACE,
USED IN INNER SPACE.**



TEMP-R-TAPE OF TEFLON.*

Because Teflon has one of the slipperiest surfaces known, everything slides off Temp-R-Tape. Temp-R-Tape withstands severe environmental conditions. The electrical characteristics are excellent and remain constant through a temperature range of -100 F. to +500 F. It has excellent conformability and the silicone polymer pressure-sensitive adhesive makes it easy to apply and remove.

CHR's Temp-R-Tape line offers the industry's widest variety of types and sizes of pressure-sensitive Teflon tape.

Stocked by a national network of CHR distributors capable of technical assistance and fast delivery. Look in the Yellow Pages under "Tapes Industrial" or in major industrial directories and micro-film catalogs under CHR. Or write for a free sample to The Connecticut Hard Rubber Co., New Haven, Connecticut 06509.

*TM of DuPont



Subsidiary of U.S. Polymeric, Inc.

Circle 148 on reader service card

Analyzer zips through complex logic

Computer-controlled checkout instrument can handle 4,000 tests a second; adapters, simple programming make it suitable for wide range of tasks



Test station. Logic module analyzer system includes computer (lower right), alphanumeric display, and teletypewriter printout.

The checkout requirements for the printed circuit boards making up today's instruments, computers, and other devices have become awesome—a result of the use of more complex integrated circuitry in these machines.

The General Radio Company's model 1790 logic module analyzer grew out of the instrument company's more than two-year hunt for a solution to its own testing problems, and thus comes as close to being field-tested before announcement as any such complex system can.

A digital computer lets the 1790 perform up to 4,000 functional or diagnostic tests per second on logic complexes with as many as 240 pins. The new system can test any-

thing from a 14-pin IC to a 240-pin large-scale IC (eventually), or a circuit board with up to 96 inputs and 144 outputs.

The 1790 is built around a PDP-8L computer and an interfacing system which connects it to power supplies for the device under test, input drivers and output read-in gates, a Tektronix 601 storage tube alphanumeric display, a Teletype and high speed optical tape reader for programming, and what the company calls a "device adapter."

Flexible. The simplest device adapter is a box, a set of connectors and wires mating the device under test to the input-output electronics. As the circuits or circuit boards being tested grow more complex, so does the adapter. Var-

ious adapters allow the 1790 to test logic assembled from any of the four major families: diode-transistor, transistor-transistor, resistor-transistor, and metal oxide semiconductor logic.

Assemblies as complex as a module containing an 8-bit accumulator, eight read-in gates, an 8-bit memory buffer, two 4-bit full-binary adders, eight 48-bit shift registers, and 76 other parts can be tested in only about 150 milliseconds. Inputs and outputs total 31, and the number of tests total 650, for this board which is a part of GR's 1921 real-time analyzer.

With an appropriate adapter, the 1790 even tests whole instruments. GR's 1192 counter, for example, now is given a post-assembly check by a 1790. The 1790 operates a little like a comparator in that it runs through the gamut of inputs an assembly will experience, and checks the resulting outputs against data in memory. Robert E. Anderson, marketing engineer for the 1790, says, "This makes it unnecessary to have a working subassembly to use as a reference as is the case with 'pure' comparators. Nor does the user need to worry about performance changes in the 'master' subassembly."

Autoprogrammers. He admits that in some cases it might be easier to plug in a reference than to punch test programs, but counters with what he calls the 1790's autoprogramming feature. "Instead of writing a full test program, we write only the input side. It's then possible to use what we call the autoprogramming translator to store the responses of a device in the adapter. If it's a known good assembly, its outputs can be used as the gage against which similar units are compared. Thus we've

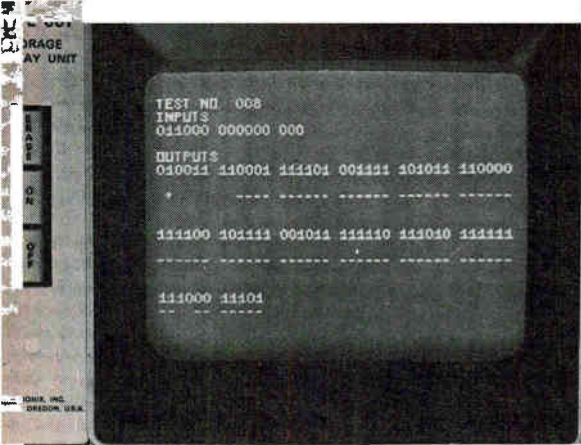

Flaw spotter. On storage tube display, cross indicates flawed output.

tried to combine the ease of the comparator technique with the flexibility of programed testing.”

But flexibility isn't much good to a user who needs a flock of programmers and systems analysts to take advantage of it. For this reason, General Radio's development engineer on the 1790, Matthew L. Fichtenbaum, has tried to come up with a simple programing technique, one so direct that a technician can program the 1790 to test highly complex assemblies.

“The longest program yet written for the 1790 contains about 800 complex tests,” he says, “and it was written by a test technician.”

“One of our original goals was to do away with the arcana which made programing difficult,” he says. “We use terms more relevant to the 1790's users than to the computer.”

“We went through several generations of refinement determining what commands were necessary—input, output, and control commands, loops, and transfers.

“While this was underway,” he says, “we had the aid of groups using prototype 1790's on actual production lines. They came up with many ideas which were incorporated.

“To write a program from scratch,” says Fichtenbaum, “a technician would envision a sub-assembly in terms of its functions, then exercise each function in terms of its inputs and the appropriate outputs, then exercise the functions as they relate to one another.”

“The average test technician would know pretty well what a failure at a certain point could mean,” he says. “And to aid fault

isolation he could insert instructions like, ‘probe point 34—check for oscillation,’ an instruction which would appear on the scope.”

Works quickly. Testing of the real-time analyzer board took 16 hours to program—only twice as long as it took to equip the device adapter to receive the module.

Once the program tape is cut, total setup time for the 1790 is about two or three minutes; this includes plugging in the device adapter, loading the PDP-8L's operating system, loading the test tape into memory, and beginning the test.

The 1790 usually operates as a go/no-go tester. But in the case of a no-go, the user either can troubleshoot the bad board with the aid of diagnostic software or ask for a Teletype printout of the failed test, to be set aside for later work.

Anderson estimates that about 15 minutes suffice to locate a bad part, replace it, and retest the board. “Without the 1790? Well, maybe two hours or so if one had a working device into which to put the board for an operational test—and even this won't check all contingencies.”

“The system is fast enough to leave plenty of time for troubleshooting after shorting out the rejects,” says Anderson. “A technician can sequence through tests, skip others, request sync pulses at certain tests, stop on failed tests or continue beyond them, and so on. Often the test program itself will be written to suggest probable failure areas or can be rewritten to do so on the spot to save time in the future.”

Cuts test time. “It's also possible to restart at or just before the failed test, and run through the sequence repeatedly to view the dynamic operation of the circuit before and during failure,” he adds. “And if needed, operation can be viewed on a scope slaved to the 1790's sync pulse.”

The typical 1790 system will sell for \$32,500. Anderson says this is “a quarter to a third the cost of competitive systems, and that for a system with many more inputs and outputs—240 versus only 14 to 16 in some cases.”

Anderson notes that other testers perform both functional and d-c tests. “The 1790 can't do d-c tests,”

he says, “but we are aiming at markets that don't really need such high-powered static test routines.”

Anderson expects most sales to come from builders of logic modules for in-house use, users of logic modules purchased outside, and the smaller manufacturers of logic modules.

Robert G. Fulks, GR's chief engineer, points out what may be both a fringe benefit and an additional market for the 1790. “Even though IC makers must make extensive d-c tests because they guarantee their d-c specifications, GR may find makers of large-scale integration using the 1790 in probe testing to eliminate bad circuits as early as possible. This would save testing time on more costly d-c testers in the manufacturing process.”

Shouldering in. The fringe benefit may put GR into competition with Teradyne and some of its IC testers. “Although we don't push the fact, the 1790 is by nature a fast IC tester. We don't expect it to replace the J-259, because—once again—the 1790 can't make d-c tests. But we have been using it for about two years as an incoming test system for the IC's we use,” says Peter H. Goebel, product engineer.

Out of more than 110,000 IC's tested, the 1790 caught all except about 200 bad circuits—and many of these failed during assembly because of heat shock and faulty insertion. These were spotted in board tests. By comparison, almost 3,500 were rejected in incoming inspection and returned for credit to their makers. Thus more than 75% of the bad IC's were spotted by the 1790 before use (another 800 were storage devices that failed 70°C speed tests).

Anderson plans to sell the 1790 almost like a catalog item. “We'll be scheduling three-month deliveries when we announce the system at Wescon,” he says. “Also, we'll deliver the 1790 with a wired adapter and test program for the customer's initial device. In addition, the price includes a two-day use and programing course at the customer's plant, installation, a logic probe, three unwired device adapters, and a system test adapter and program to self-test the 1790.”

The General Radio Co., West Concord, Mass. 01781 [339]

Our 5-band carbon comps are cats of a different stripe



Okay, so the other leading brand is also great on military specs. But our Speer resistors have still more to offer. They provide superior soldering characteristics. They're backed by the first and most sophisticated on-line computerized resistor quality control system. They're delivered in an exclusive foil pack. And they're accompanied by written documentation. Another helpful note—both our ½-watt and ¼-watt types qualify under the new Established Reliability Specification at the S level. Our 4-band carbon comps are something special, too—particularly now. They offer all of our traditional quality features—plus competitive prices. To learn more about our resistors—and the reliable customer service that backs them up—write AIRCO SPEER ELECTRONIC COMPONENTS, St. Marys, Pennsylvania 15857. Five “stripes” or four—you may even decide we're a whole new breed.

The passive innovators at **AIRCO Speer**

Speer resistors Resistor and conductor paste Jeffers JC precision resistors Jeffers JXP precision resistors and networks Jeffers inductors Jeffers capacitors PEC variable resistors and trimmer potentiometers.

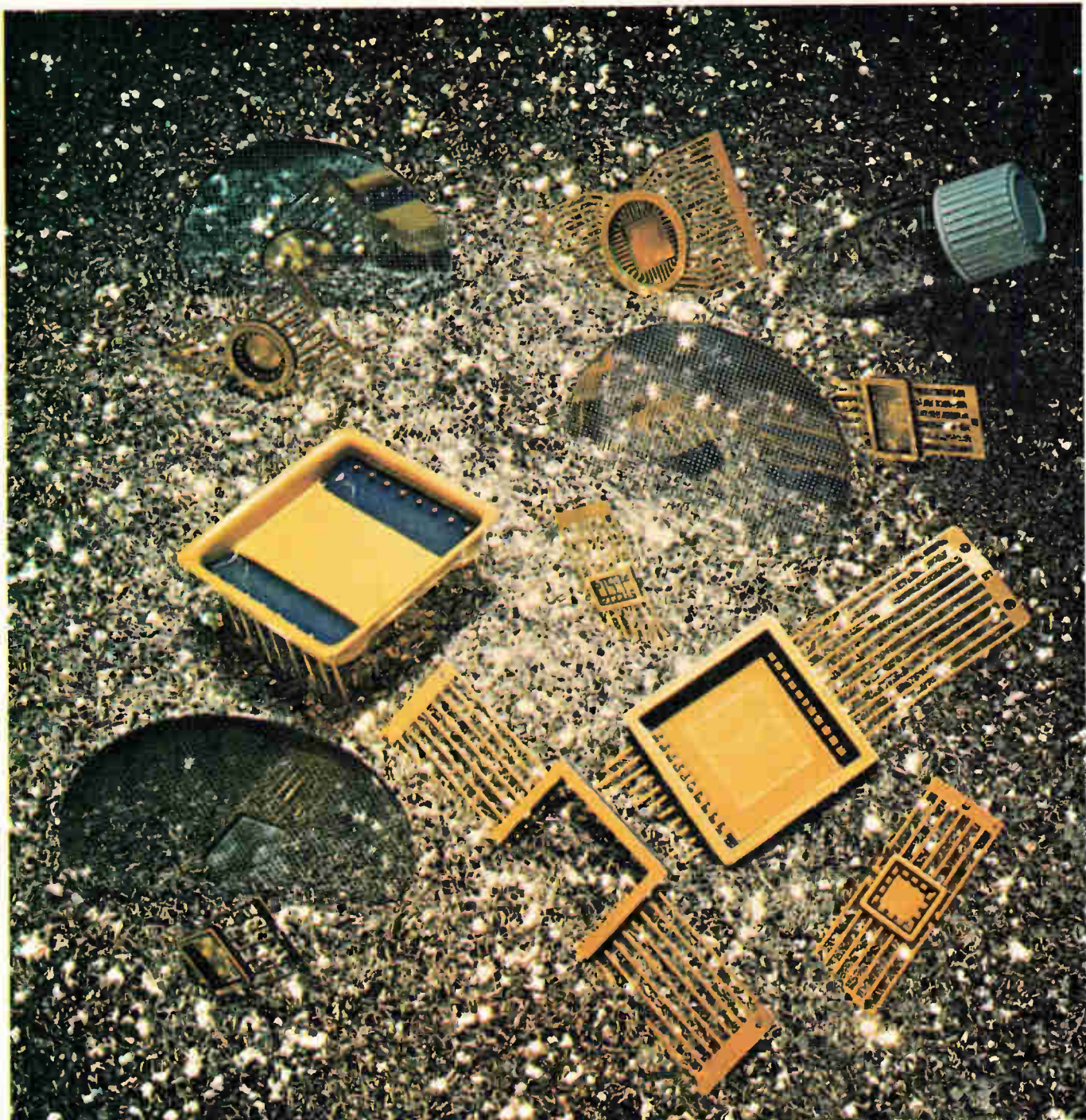

Sprague Semiconductor Chips and Packages. Illustration: 3 wafers, 8 packages, many chips

Semiconductor chips. Packages. One source. Sprague.

Every device in the Sprague Semiconductor line is available in chip form. Transistors. Integrated circuits. Even precision nickel-chromium resistor networks. Just about everything you need to build your own hybrids.

And from the Hermetic Seal Department, flatpacks to put them in. From $\frac{1}{4}$ " x $\frac{1}{4}$ " to 1 inch square. From

6 leads to 40. Standard and ready for off-the-shelf delivery. Your custom package design can be made to order, too.

Make Sprague your one source when you're making your own hybrids. If you're going to put down our chips, put them in our packages.

Call Sprague Info-Central (603) 224-1961 extension 255

Get data on Sprague's chips and packages. Write to: Semiconductor Division, Sprague Electric Co., Pembroke Road, Concord, N.H. 03301.

Or circle the reader service number below.

455-9130R1

152 Circle 207 on reader service card



Electronics | August 18, 1969

Hybrid op amp challenges the discretes

Called the fastest of its kind, dual-in-line device is designed to match the performance and stability of the bigger op amps

"It's the fastest op amp in a dual in-line package." That's what Alan R. Risley, operational amplifier product manager at Philbrick/Nexus Research, says of his company's newest device. Called the model 1405 field-effect-transistor input operational amplifier, the device was designed to have the performance of a discrete component, but in a form that fits a dual in-

line IC package.

Hybrid integrated-circuit technology is used for the 1405 in a combination of thick and thin films on separate substrates. This allows optimization of resistor characteristics, power dissipation, and thermal effects, says Risley, while retaining the ability to trim components and select values. Few tradeoffs are necessary, because an operation on

one substrate won't necessarily affect performance of the components on another.

Specification for specification, the 1405 pretty much holds its own with the company's discrete version, the model 1011. And, according to Risley, the 1405 outdoes some discrete devices now on the market. Open-loop gain for the hybrid is guaranteed to be 100,000

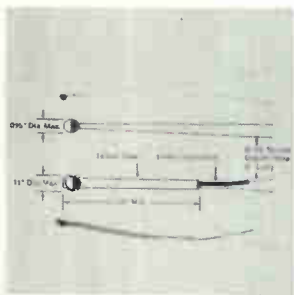

Three thermistors have values of 5,000 ohms at 25°C and a temperature-resistance range of 3,685 kilohms at -80°C to 92.70 ohms at +150°C. All P/N44007 and 44107 thermistors are interchangeable to within $\pm 0.2^\circ\text{C}$ and all P/N44034 units are interchangeable to within $\pm 0.1^\circ\text{C}$ over most of their usable range. Yellow Springs Instrument Co., Box 279, Yellow Springs, Ohio. [341]



Vacuum ultraviolet photomultiplier tubes SBX-860 and SBX-762 are calibrated as secondary standard detectors in the 2,000 to 1,150 angstrom wavelength range. Both have extremely uniform and stable characteristics when operated in the pulse-counting mode, which permit them to be used for fluxes from 1 to 10^9 photons/sec/cm². Bendix Research Labs, Southfield, Mich. [342]



Audio output transformers provide isolation and impedance matching for popular power integrated circuits in 1/2 to 1 watt power output range. A choice of single-ended or push-pull input is offered. The epoxy encapsulated units are for plug-in on standard 0.1-inch grid spacing. Magnetic Circuit Elements Inc., Del Monte Research Park, Monterey, Calif. [343]

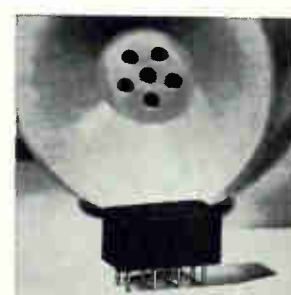

Solid state photocell relays can be furnished to switch up to 300 v a-c or d-c at low current levels directly with the photocell, or switch high current levels with built-in transistors. Off-on resistance ratios are obtainable from 100 to 1 to greater than 1,000,000 to 1. Control voltages may be selected from 6 to 120 v a-c or d-c. Electro-Tec Corp., Ormond Beach, Fla. [344]



Crystal oscillator model JKT0-77 for p-c board applications is suited for computer clocks and other timing devices. A frequency range of 5 Mhz to 20 Mhz is available. Measuring 1 x 1 x 3/8 in., the unit withstands shock and vibration per MIL-STD-202. Input supply requirement is +5 v d-c $\pm 5\%$ at 20 ma max. CTS Knights Inc., Sandwich, Ill. 60548 [345]

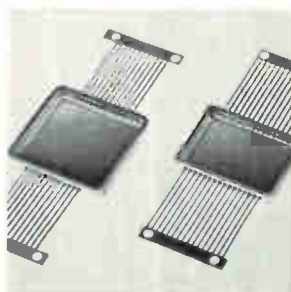

All-metal IC enclosure meets requirements of specification MIL-STD-883, including 3-hour helium bombardment at 90 psi. Designated the Butterfly case, it is intended for monolithic and hybrid IC's in high reliability applications. It is offered in 2 sizes: 0.750 x 1 in. and 1 x 1 in. Flat covers are available for each. Tekform Products Co., 2780 Colorado St., Anaheim, Calif. [346]



Coaxial transfer switch series 09-51 has a vswr at 12.4 Ghz of 1.25:1, and provides high interchannel isolation from 0 to 18 Ghz. Remote actuation is of the latching type, requiring no holding current. Actuating current is 53 ma at 26.5 v at 25°C. for latching and 177 ma for fail safe operation. Electronic Resources Inc., 4561 Colorado Blvd., Los Angeles 90039 [347]



Differential comparator relays combine integrated circuit technology with reed relay life, speed, and reliability. Applications include temperature controllers, precision analog gates, sample-and-hold circuits, overvoltage protection circuits, sorter/classifiers, go/no-go controls and limit controls. Phipps Precision Products, 7749 Densmore Ave., Van Nuys, Calif. [348]

Control/alarm shortcut.

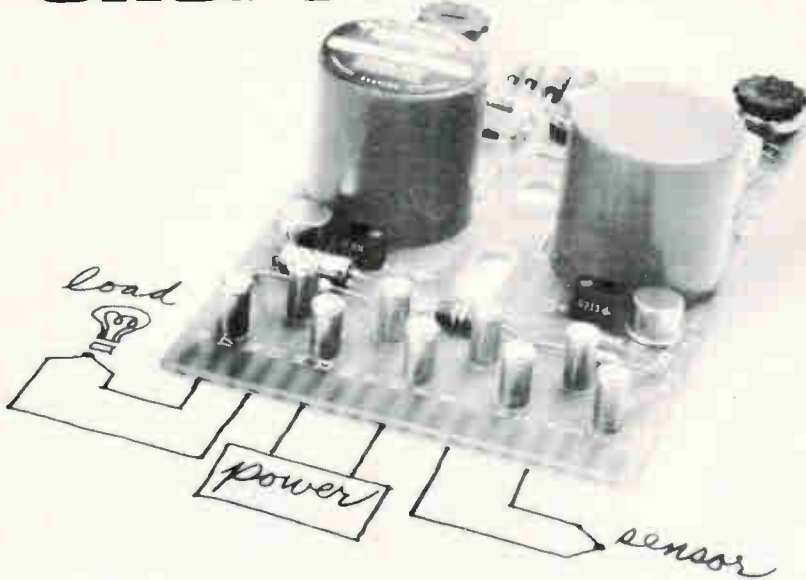

MAGSENSE

control/alarm for temperature, pressure, speed, flow

Here's the fast, low-cost way to solve control/alarm problems. Hook up sensor, load and power source to a MAGSENSE® module and adjust the setpoint (or dual setpoints). That's it. No time and money wasted designing and debugging a circuit. And you've got proven-in-service performance and reliability.

Capabilities. MAGSENSE modules offer 100-billion power gain, accept inputs as low as 10 microvolts or 1 microamp directly *without* preamplification. Completely isolated inputs are *unaffected* by common mode voltages as high as 110vac, 60 Hz or overloads as large as 1000-times full scale. And they operate from a *single* 28v or 12v power source.

Flexibility. Standard models offer a wide range of options including single, dual and remote setpoints, adjustable hysteresis, choice of output action, transducer excitation voltage, and cold junction and copper compensation on thermocouple models. And, in the off-chance a standard model won't fit your precise application, we can custom-build one quickly, inexpensively.

Take the short cut. Write or call for your free copy of the MAGSENSE Application Manual. It has all the specifications and prices. And all the shortcuts.

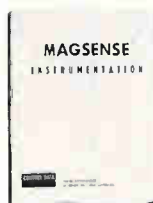

CONTROL DATA
CORPORATION

Magnetic Products Operation, Dept. 302
Control Data Corporation
775 Colorado Avenue So.
Minneapolis, Minnesota 55416
Phone 612/544-8851

versus 150,000 for the 1011—but the 1405's gain is typically 500,000. Output voltage and current range of the 1405 are the same as those of the discrete unit, ± 10 volts at up to 20 milliamperes—guaranteed.

Where the 1405 really shines are in frequency response, bias, and input impedance. Unity-gain, open-loop frequency response is typically 12 megahertz for the device, which has a 6-decibel per octave rolloff.

Input bias current is guaranteed at 30 picoamps or better—typical performance is about 10 picoamps. Bias changes with power supply voltage at the rate of about 5 picoamps per volt, and tracks at either input to within 10 picoamps. Because of the FET input stage, both common-mode and differential-input impedance are 10^{11} ohms.

Stability plus. Risley likes to point to the 1405's combination of speed and stability. Minimum slew rate is 50 volts per microsecond, and settling time is only 3 μ sec. Peak-to-peak frequency response at full output is 1 Mhz, and 10 Mhz for small-signal applications. "This is due to the rolloff," he says. "We've traded a little bandwidth for stability." If instability does appear, he points out, it could be handled with a simple resistance-capacitance network in parallel.

How good is the 1405? Says Risley:

"The worst operating condition for a high-speed amplifier is in the noninverting sense, as a follower. And the 1405 gives no trouble there; it is fully differential and the response using the noninverting input is equivalent to the minus output."

According to the company, the 1405 will most likely find applications in digital-to-analog converters and digital function generators for test gear. Also possible are pulse applications—perhaps to amplify photodiode output in digital isolators or optical communications systems.

The 1405's price is \$55 each in lots under 10 (compared to \$50 for the 1011), and \$45.50 each in lots of from 100 to 249.

Although large quantities require a 60-day wait, samples will be shown at Wescon.

Philbrick/Nexus Research, Allied Drive, Dedham, Mass. 02026 [349]



**We
redesigned
the cost
but not the
performance.**

Now you can buy a precision connector for \$7.00 (in quantities of 1,000 pieces) that meets cost/performance requirements of systems applications. We call it our APC-7S. The S stands for sexed. It's the key to our new design: a sexed coupling mechanism available in plug and jack configurations.

More importantly, we've reduced manufacturing costs without affecting electrical and environmental performance standards of the precision connector. We guarantee 1.039 SWR to 18 GHz. For a complete performance table, write Amphenol RF Division, The Bunker-Ramo Corporation, 33 E. Franklin St., Danbury, Conn. 06810.



AMPHENOL
THE BUNKER-RAMO CORPORATION

Circle 209 on reader service card

The 5104 knows . . . and tells . . . automatically. The new Philbrick/Nexus Model 5104 performs 15 different tests in under 3 seconds. Programmable GO/NO GO limits. Readout in engineering units. Maximum input/output flexibility for interface with handling equipment and data acquisition

peripherals. Test conditions, supply voltages, and meter scaling front panel control or programmable. Test IC, hybrid or discrete op amps through versatile plug-in sockets. To remove any shadow of doubt from your op amp testing, get the full report on the Philbrick/Nexus Model 5104 Op Amp

Tester. Price \$4,500
Contact your local Philbrick/Nexus field engineering representative or write, Philbrick/Nexus Research, 22 Allied Drive at Rt. 128, Dedham, Mass. 02026



PHILBRICK/NEXUS RESEARCH

A TELEDYNE COMPANY

Who knows what evil lurks in the heart of that \$1 Op Amp?



Eout
Ecm
Gain
Stability
Eos
CMRR
Ios
Icc
PSRR
Ibias

A wattmeter for r-f and another for light

One new instrument handles inputs up to 1 Mhz, and a second can measure a laser's output

Competition usually springs up when two companies introduce instruments of the same type—for example, wattmeters—on the market. However, with wattmeters, what they measure makes a big difference.

Although both Marconi Instruments Ltd. and Coherent Radiation Laboratories are introducing wattmeters, they will not be competi-

tors. The reason: one instrument will measure radio frequencies, the other visible light.

Marconi's 2501 measures up to 3 watts with 5% accuracy over a range of d-c to 1 gigahertz. Therefore engineers can use it for testing and adjusting antennas, transmitters and receivers.

The 2501's chief feature is that it does its job twice, once for speed

and once for accuracy. It has two separate sensors. A diode network, which instantaneously tracks the instrument's output, measures amplitude. If this input were always a pure sine wave, the diode detector would be enough, since the power in a sinusoidal signal is proportional to the signal's amplitude.

However, the sine waves that communications people deal with



Linear sweep generator LSG-6 is a source of highly accurate fixed or sweep-frequency signals in the range of 0-50 Mhz. The sweep end-points are digitally selectable. Spectrum of the output signal is exceptionally pure and permits signal-arrival-time measurements to an accuracy of 100 nsec. Unit is 28 x 16¾ x 18¾ in. Barry Research, E. Meadow Dr., Palo Alto, Calif. [361]



Servo system analyzer model 199 is for analysis and test of servo-mechanisms and complex control systems by observing phase and amplitude response with respect to various frequencies and wave shapes. Harmonic distortion is less than 0.5%. Phase accuracy is ±1° from 0 to 360°. Frequency accuracy is ±1%. Servo Corp. of America, 111 New South Rd., Hicksville, N.Y. [362]



An industrial version, called model 900, of the CAT (computer of average transients) is capable of separating data in 1,024 channels into signals and eliminating background noise. Repetition rates are from about 60 per sec to once in 31 msec. Memory capability is 999,999 in each channel. Price is \$6,490. Technical Instruments Inc., 441 Washington Ave., North Haven, Conn. [363]

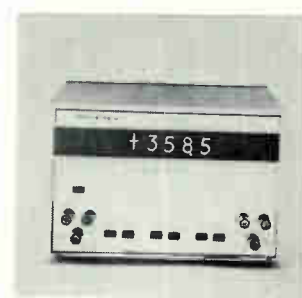

Precision digital phase meter model 750 features closed-loop design that insures stable, long-term phase measurements in a varying temperature environment. Four-digit Nixie readout gives 0.1° resolution with a plus or minus sign indicating the lead/lag relation. Accuracy ±0.1% full scale. Price is \$1,500; delivery, 30 days. Wavetek, 8159 Engineer Rd., San Diego, Calif. [364]



Sweeper/signal generator model M402S provides an all-electronically-swept output of up to 100 watts at any frequency, or over any band of frequencies, from 200 khz to 220 Mhz. Unit is designed for laser research, rfi testing, nuclear magnetic resonance work, and electronic countermeasures. Instruments For Industry Inc., 151 Toledo St., Farmingdale, N.Y. [365]



Digital panel meter model 1260 is available in voltage ranges of from 0-199 mv to 0-1 kv and in current ranges of from 0-19.9 µa to 0-199 ma. Features include ±0.5% full scale ±1 digit accuracy, 25% over-range, and a circularly polarizing window filter. Price is under \$100 in quantities of 25. Weston Instruments Inc., 614 Frelinghuysen Ave., Newark, N.J. 07114 [366]



General-purpose d-c recorder 1522 is self-programmable to serve as an output device and program source for automatic systems. It features maximum sensitivity of 2 mv/in. and 0.2 µa/in., 65 in./sec writing speed, 0.25% linearity, 0.5% accuracy. Price for bench models is \$1,950; rack models, \$1,915; plus plug-in pre-amp at \$250. General Radio Co., West Concord, Mass. 01781 [367]



Generator model F323A is a 10 hz to 10 Mhz unit that serves not only as a low distortion sine wave oscillator but also as a sine and square wave function generator. Square wave output is provided simultaneously and has a rise time of less than 10 nsec. Extremely flat frequency response is also featured. Price is \$660. Data Royal Corp., 8014 Armour St., San Diego, Calif. [368]



Look what \$325 buys in a 1 μ V Full Scale

DC Null Detector/Microvoltmeter

It buys you a portable performer with 0.15 microvolt resolution. It's handy and convenient to use. It's rugged, too—works more than 1000 continuous hours on four carbon-zinc batteries. It's the Keithley Model 155—the lowest-priced electronic null detector on the market today.

The 0.03 μ V rms input noise is quieter than any other in its price class. Coupled with better than $\frac{1}{2}$ μ V per day stability and 1 megohm input resistance at 1 μ V full scale, the 155 is ideal as a null detector for potentiometers, bridges, ratio devices and comparator circuits.

When the Model 155 isn't working as

a null detector, it doubles as a 1 μ V to 1000 volt microvoltmeter with 19 zero center ranges. Use it for measuring thermocouple and thermopile potentials, contact resistance, making Hall Effect studies, or whatever.

See this little giant perform. Call your Keithley Sales Engineer for your demonstration. Or contact Keithley Instruments, Inc. for complete details—28775 Aurora Road, Cleveland, Ohio 44139. In Europe: 14, Ave. Villardin, 1009 Pully, Suisse. Prices slightly higher outside the U.S.A. and Canada.



KEITHLEY

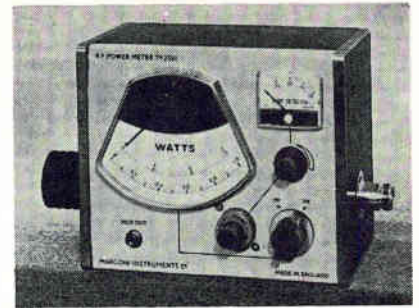

Two looks. The small meter is connected to a diode sensor, the larger one to a thermocouple.

are rarely pure. That's why the 2501 also has a slower, but surer, thermocouple sensor.

The instrument has two meters; the bigger one shows the reading of the thermocouple, and this is the measurement that's accurate to within 5%. Full scale is either 1 watt or 3 watts.

The other meter on the 2501 is scaled without dimensions from 0 to 100 and connected to the diode network. When, for example, the user is adjusting an antenna, he will use this meter to get an instantaneous peak-power reading.

The 2501 is 5 by 9½ by 5 inches, weighs 3 pounds, and costs \$1,200. The 2502, is a similar instrument but with 3- and 10-watt scales, is also available now and costs \$1,500. Delivery time is 60 days.

Light work. The 212 from Coherent Radiation measures the power of visible light over a range of from 100 nanowatts up to 300 milliwatts with 5% accuracy. An optional attenuator changes the range to 100 microwatts up to 10 watts.

The company says the instrument can help determine exposure times in holography and photography, measure the output of lasers, and determine the characteristics of optical components.

The sensing head on the 212 has a photodetector that sends a signal to the measuring section where the signal is amplified and scaled into a power reading.

Price for the 212 is \$875, and for the attenuator \$100. Delivery time is 90 days.

Marconi Instruments Ltd., 111 Cedar Lane, Englewood, N.J. 07631 [370]

Coherent Radiation Laboratories, 932 E. Meadow Dr., Palo Alto, Calif. 94303 [371]

When you need

RF CAPACITORS,

Centralab designs them

Need dependable ceramic dielectric capacitors to replace vacuum, oil-filled or mica units? **Centralab designs them.** Need capacitors that are stable at high temperatures? **Centralab designs them.** Need capacitors to handle high voltage and high current? **Centralab designs them.** Need small size capacitors with high capacitance? **Centralab designs them.** Need capacitors to operate at medium current and voltage? **Centralab designs them.** Need transmitting capacitors for plate blocking with high power transmitting tubes? Or high transmission line coupling? Or bypassing in high voltage circuits? Or neutralizing? **Centralab designs them, too.** In fact, Centralab custom engineers transmitter capacitors for industrial equipment, commercial and military transmitters of all kinds.

And ceramic capacitors from Centralab offer more custom-design features, last longer and are backed by more comprehensive application engineering skill than any other capacitor you can use. Don't let lesser capacitors shut down your equipment. Stay operational with Centralab.

To put the reliability of Centralab's ceramic RF capacitors to work for you, send reader service card today. Centralab's Application Engineering Department will contact you to discuss your design requirements. Or, if you prefer, send drawings and requirements directly to Application Engineering Department 2X0 at the address below.

M-6828



CENTRALAB

Electronics Division
GLOBE-UNION INC.

5757 NORTH GREEN BAY AVENUE
MILWAUKEE, WISCONSIN 53201



Header or Double Cup



Monolithic



Feed Through



Single Cup,
including water cooled

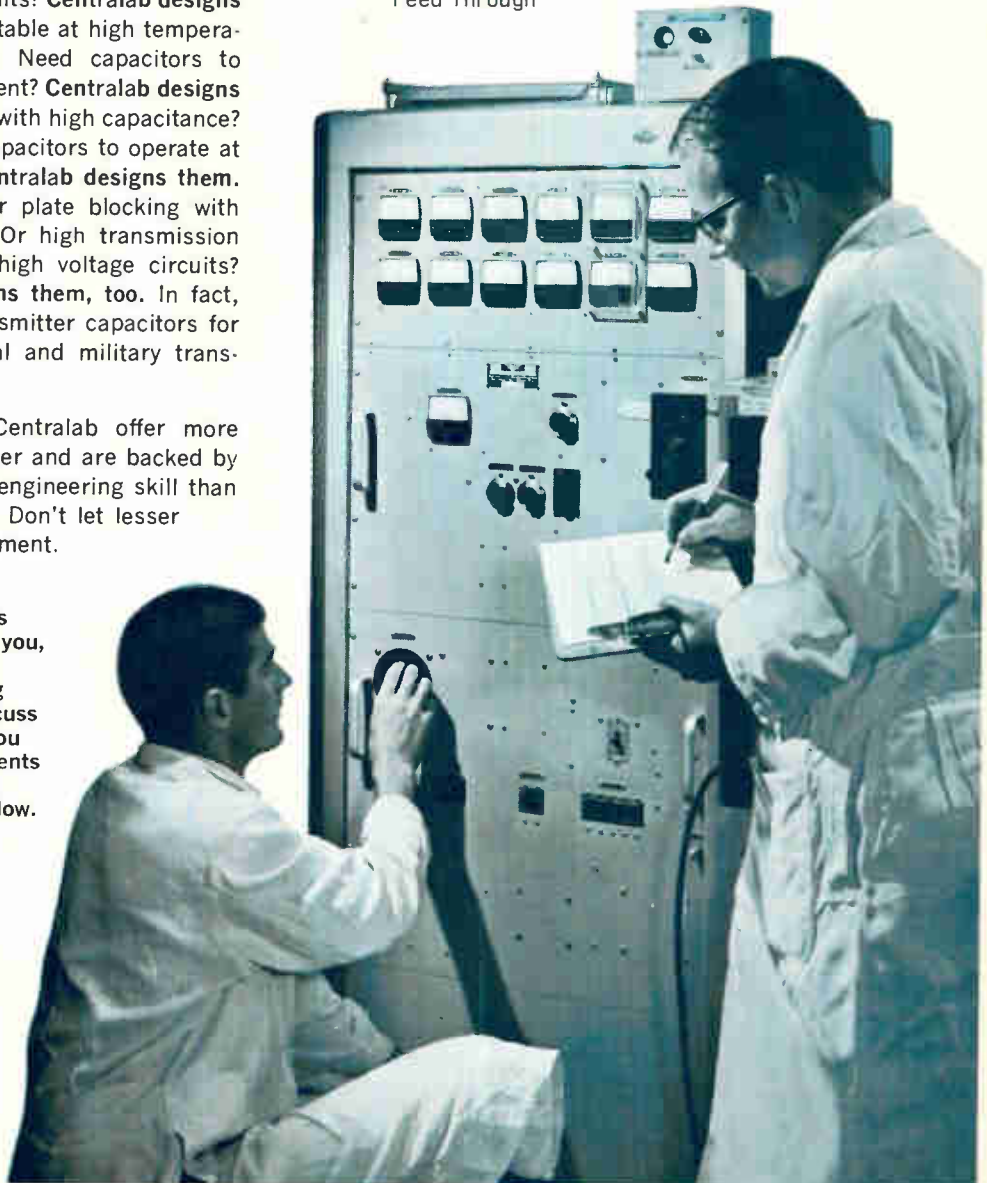

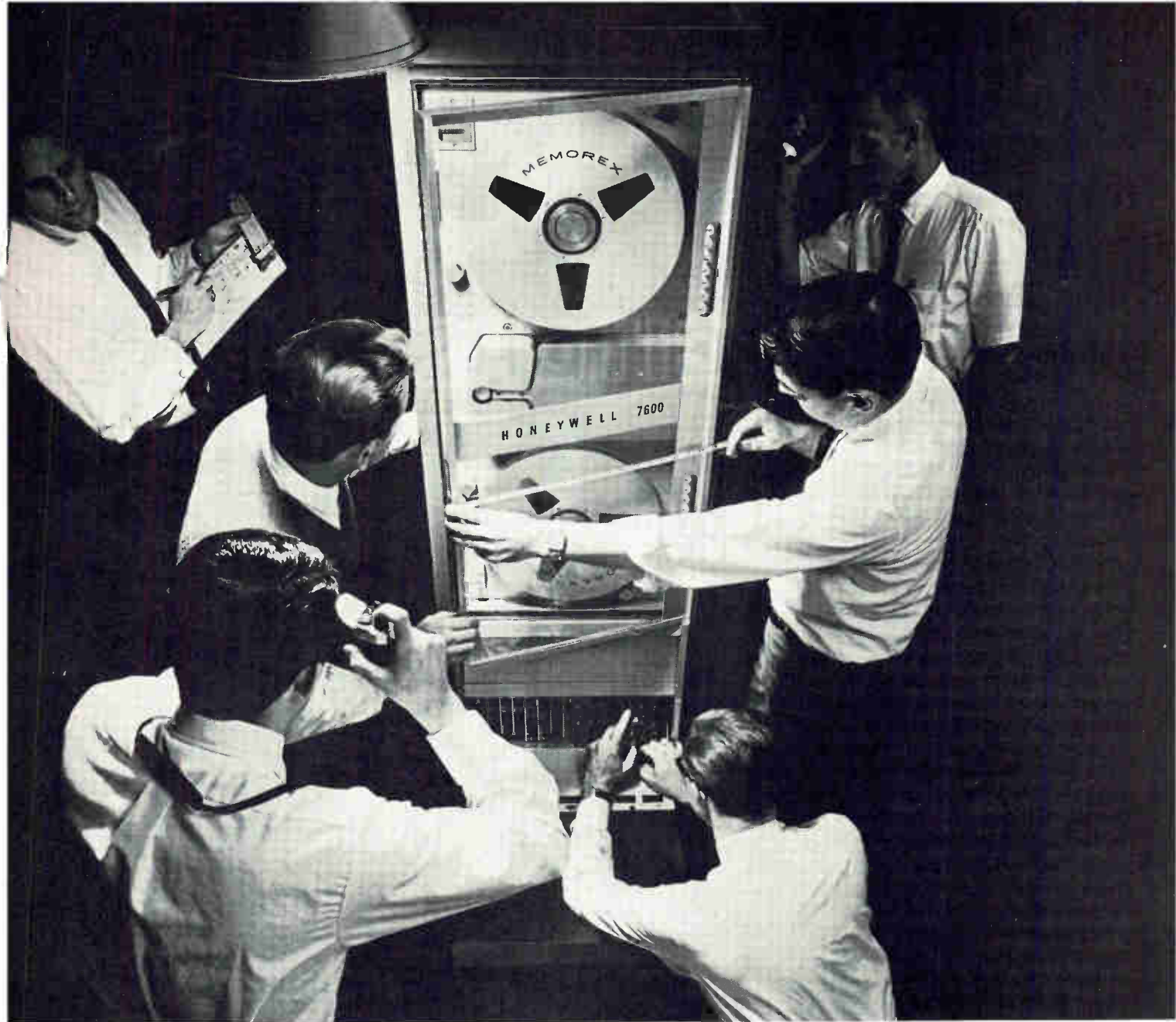

No matter how they measure it, the Honeywell 7600 checks out as the best value in the tape field!

From the way people are trying to copy it, you'd think our 7600 is the hottest tape system around. It is!

Compare the specs on our 7600 with those of some recent competitive machines and you'll notice something very interesting. A small revolution is taking place in the magnetic tape system industry. We started a trend. And now, others are following!

The Honeywell 7600 Series bears copying. Its modular design lets you specify the system you need now, and permits future expansion without costly modifications as your requirements grow. Easily maintained plug-in electronics give you a wide selection of bandwidths, and mechanical options include a choice of 10½" or 15" transport.

With its low flutter, skew, and time base error and high S/N ratios, the 7600's signal fidelity can't be matched by comparably priced units. And, due to its mechanical simplicity (no belts, pulleys, gears, or pinchrollers) and inherent reliability, our com-

petitors are going to have a rough time building a machine that will operate as economically as the 7600. It's priced lower than you'd expect, too, giving you more performance for your money than any other tape system!

The great 7600 Series is another example of how Honeywell's broad line, backed by local sales and service, can provide the *precise* solution to your instrumentation problems. For a demonstration, call your local Honeywell Sales Engineer. For technical literature, write: Honeywell Inc., Test Instruments Division, P.O. Box 5227, 4800 E. Dry Creek Rd., Denver, Colorado 80217.

Honeywell

Honeywell engineers sell solutions

Getting from a to d in less time

Converters sample at 80-megahertz rate with 4-bit resolution; can be used for processing MTI data and for radar sweep integration

It's going to be easier to process radar and wide-bandwidth video signals digitally—because of an analog-to-digital converter that can sample at an 80-megahertz rate. The unit, which encodes with 4-bit resolution, belongs to a new line of wideband converters developed by Inter-Computer Electronics. It is about three times as fast as other commercially available converters,

according to James J. Connolly, vice president. And it can be readily applied, he says, to processing data from high-resolution moving-target indicator radars, and for radar sweep integration.

Inter-Computer builds two types of a-d converters. One type, designed for laboratory use, has a sample rate, variable by an internal source, which is shown on

command on an 8-digit Nixie-tube display panel.

These units range from the model IAD-1104V, which can vary its conversion speed from 2 to 80 Mhz, with 4-bit resolution, down to the IAD-3108V, with conversion speeds from 0.1 to 3 Mhz and 8-bit resolution. These sampling rates take into account the total time that elapses between the encode com-



Digital precision angle transmitter model 2500T is used to transmit and indicate an angular position of a potentiometer, synchro or resolver. It has 360° for angular position with 0.2° resolution. The digital indicators which prevent parallax can be read in tenths of a degree or in minutes or seconds (as specified). Occo Mfg. Corp., 8 Romanelli Ave., South Hackensack, N.J. [381]

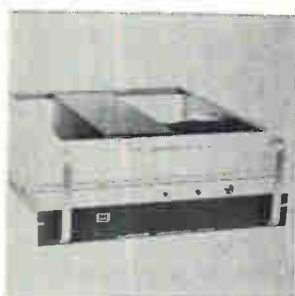

Line regulator model 3131 has an output power of 1 kva maximum. Output voltage is 115 v rms nominal, adjustable 110 to 120 v rms. Regulation is $\pm 0.01\%$ for a ± 10 v line change; $\pm 0.04\%$ no load to full load. Output distortion is 0.25% max. Response time is 50 μ sec nominal. Operating frequency is 60 hz ± 3 hz. NH Research Inc., 1510 S. Lyon St., Santa Ana, Calif. [382]



Power supplies series IC5N can deliver from 2 amps to 100 amps in six different models. All models feature 0.05% regulation providing precision power for computer, instrumentation and communication equipment applications. Output voltage is adjustable from 4.75 to 5.25 v. Prices range from \$98 to \$835. ACDC Electronics, 2979 N. Ontario St., Burbank, Calif. [383]

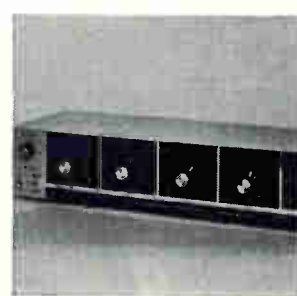

Programmer SP101 is a versatile and accurate time-sequence generator. It consists of a series cascade of 5 individually adjustable time function modules, each having an isolated spdt output contact. Each timing function is available with one of two scales, 0.1 to 1.6 or 0.3 to 5.0 seconds with multipliers of X1, X10, or X100. Chronologics Inc., 24 Martin St., Webster, N.Y. [384]



Power amplifier series 1100J is a fully-professional plug-in unit designed for the most exacting control room and sound reinforcement applications. It is equipped with input transformer and pre-amplifier. Output is conservatively rated at 75 w rms at less than 0.5% harmonic generation. United Recording Electronics Industries, 11922 Valerio St., N. Hollywood, Calif. 91605. [385]



Bench model power supply PM429 has a case size of 1.63 x 2.88 x 4 in. Its binding posts are spaced to accept a standard BNC to banana plug adapter. Output is 5 v d-c at 250 ma. Line and load regulation is $\pm 0.05\%$ each and ripple and noise is 0.5 mv rms. Price (1-9) is \$45.60, (100-299) \$34.40. Computer Products Inc., 2709 N. Dixie Highway, Fort Lauderdale, Fla. [386]



Miniature silicon power supplies series PMA feature self-restoring overload or short circuit protection by a solid state, cutback, current-limiting circuit. Standard units have outputs from 10 v/1.5 amp to 100 v/0.2 amp. Load regulation is 0.02%; line regulation, 0.01%; ripple, less than 1 mv rms. Mid-Eastern Industries, 660 Jerusalem Road, Scotch Plains, N.J. 07076 [387]



Power converter PS-274 is designed to provide 5-v d-c power for aircraft instrument lighting systems. Operating from the 28-v aircraft power source, this unit provides an output that may be remotely adjusted from 0 to 5 v. The output current capacity of 7.5 amps nominal provides power for 125 60-ma lamps or 65 115-ma lamps. EMP Electronics Inc., Box 2346, Phoenix. [388]

However, these are used with the special sample and hold circuits, and high speed amplifiers.

Cost of the variable sample-rate instruments, with display, internal reference supplies, and self-test features, ranges between \$6,850 and \$15,550. The fixed bit-rate converters cost \$2,850 to \$8,850. Delivery time is stock to 90 days.

Inter-Computer Electronics Inc., 1213 Walnut St., Lansdale, Pa. 19446 [389]

New subassemblies

Ferrite dots create displays

Array of electromagnets
moves across plastic screen
to generate characters

The magnetic properties of ferrite powder are used to produce a passive display that will remain intact indefinitely without power consumption, and can be read under ambient light conditions.

Developed by Peripheral Data Machines Inc., the display screen is made of honeycomb-molded thermoplastic. It measures 36 by 48 by 2 inches. Resolution is 120 by 170 lines, and erase-write time is 30 seconds. However, a time delay is usually added to permit reading, resulting in a normal full cycle of about 1 minute for display change.

The unit, designated the Magnyx-3401, uses voltages compatible with transistor-transistor logic, and will accept input from any digital data source, including computers, keyboard character generators, and the company's own optical page reader, the Magnyx-3420, which is designed for use with the screen.

Contrasting colors include black-on-white, two-color day-glow combinations, or fluorescent colors with an ultraviolet light for special effects.

To create a display, the scanning bar, containing a linear array of 120 electromagnets, is moved

Meet the Members of The Board...

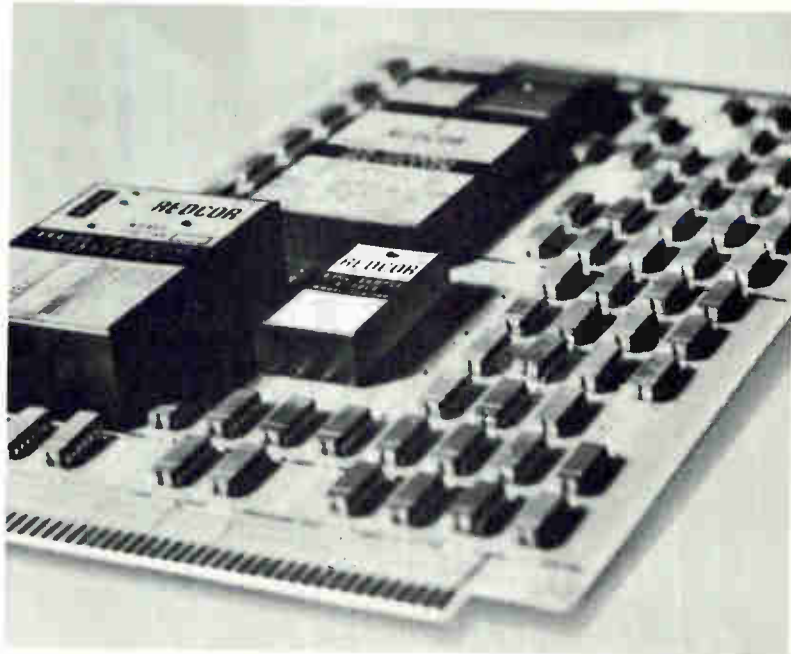

...Dual In-Line Conference

For the successful management of analog circuit design, the designer's board members must have background characteristics based upon dynamic response specifications and a proven performance with known sources and loads. The designer's board members must also have the ability to "fit in" with the others whether they be dual in-lines, discrete or flat-pack components. Our packaging configuration allows the designer this freedom.

The guaranteed performance of REDCOR's closed loop module concept frees the system designer from the concern, risk and expense normally experienced with other analog modules.

To support those special circuit and system design requirements, REDCOR can supply not only the modules, but the boards, chassis, and power supplies.

Analog-to-Digital Converters	BUF-FET Ultra Fast Settling Amplifiers
Digital-to-Analog Converters	Dynamic Bridge Amplifiers
Multiplexers	REDIREF Voltage Reference Supplies
Sample and Hold Amplifiers	Comparators
TRICON Fast Settling Amplifiers	

REDCOR's board members come prepared to meet any situation. For a complete catalog listing specified performance, write or call:

R
C **REDCOR**
CORPORATION

Complete Systems Capability / 7800 Deering Avenue, P.O. Box 1031,
Canoga Park, California 91304—(213) 348-5892



What makes low-cost Dialight readouts so reliable and easy-to-read?

Reliable because of simple module construction and long life lamps. Designed for use with neon or incandescent lamps to meet circuit voltage requirements. Easy-to-read from any viewing angle. 1" high characters are formed by unique patented light-gathering cells, and may be read from distances of 30 feet. Sharp contrast makes for easy viewing under high ambient lighting conditions.

Dialight Readout Features

1. Operate at low power.
 2. 6V AC-DC, 10V AC-DC, 14-16V AC-DC, 24-28V AC-DC, 150-160V DC or 110-125V AC.
3. Non-glare viewing windows in a choice of colors.
 4. Available with RFI-EMI suppression screen.
5. Available with universal BCD to 7 line translator driver.
 6. Can be used with integrated circuit decoder devices now universally available.
7. Caption modules available; each can display 6 messages.

Send for catalog

Catalog-folder contains complete specifying and ordering data on numeric and caption modules, translator drivers, mounting accessories. Dialight Corporation, 60 Stewart Avenue, Brooklyn, New York 11237. Phone: (212) 497-7600.



DIALIGHT

DT-126

across the screen. To minimize power requirements, the solenoids are energized sequentially in groups of 12, with each successive group being pulsed for 8 milliseconds. When a cycle of 10 pulses is completed, the sequence is repeated. Each solenoid group represents a 12-bit word.

Over the hump. The honeycomb matrix across which the scanner moves is made up of 0.1 inch cells, each containing a small amount of ferrite powder. Front and back portions of the cell are separated by a small hump, or barrier. When an energized solenoid passes over a cell, the powder is moved over the barrier by the electromagnetic field to the front, or display, side of the cell. Each solenoid draws a one-quarter-inch dot, exciting three ferrite cells at a time.

On the erase scan, the ferrite powder is attracted and returned to the back, or non-visible, portion of the cell by a magnetic strip. This strip travels across the back of the screen parallel with, and ahead of, the front-screen scanning bar containing the electromagnets.

During scanning only, the system uses 200 watts, with peak power pulses of 15 watts per solenoid. After a display is deposited, power consumption is zero.

The screen and electronics will rent or lease for "less than \$2 per day," according to Peripheral. Combined with the Magnyx-3420 page reader, the display will lease for less than \$95 per month. The reader is a data source for the display, using a linear array of photocells to scan photographic, printed, or hand-drawn transparencies up to 8½ by 11 inches.

Two other versions of the reader, to be marketed later this year, will include acoustic couplers and modems to permit sending and receiving display signals by telephone at up to 1,000 baud. Peripheral says the high rate is possible because bit errors up to 1 part in 10⁴ are selected-out by the eye, and can therefore be tolerated by the system.

Delivery time for the page reader and display screen is 60 days after receipt of order.

Peripheral Data Machines Inc., 1546 E. Chestnut St., Santa Ana, Calif. 92701 [390]

New subassemblies

Op amps speed cockpit control

Synchro-to-digital converter made to replace electromechanical encoders

Electromechanical shaft encoders have been used for many years to indicate position of rudders, flaps, nose wheels and other aircraft systems and controls.

But the complexity of control, weapon, data, and display systems in modern aircraft projected the need for a device capable of rapid multichannel synchro-to-digital-conversion in a single, compact, lightweight package.

Dynalex Inc. has combined fast operational amplifiers with a new conversion technique in producing its SDX series solid state converter to meet these requirements. Conversion time is 40 microseconds per channel with 13 bits parallel output. The SDX accommodates one to eight input channels with independent reference voltages, reference frequency 50 hertz to 500 hz; and can take any mix of 90- or 11.8-volt synchro or resolver inputs. The unit measures 5½ by 7 by 1¾ inches, and contains three 5 by 7 inch plug-in cards that comprise the converter, logic, multiplexer, and solid state Scott-tee networks. Price for the basic converter and control logic is \$2,500, and each channel costs \$400. Optional plug-in converter cards provide conversion speeds to 5 microseconds, with resolution to 39 seconds of arc, for about 25% more than the standard converter price. Other options are an input reference frequency to 5 kilohertz, and a multiplexer expansion in 8 channel increments.

By comparison, the fastest conversion time for a machine produced by a competitor is 100 microseconds, and the price is more than \$10,000.

Dynalex says electromechanical shaft encoders can't really be compared with the SDX, despite pricing in the \$2,000 to \$4,000 range. They

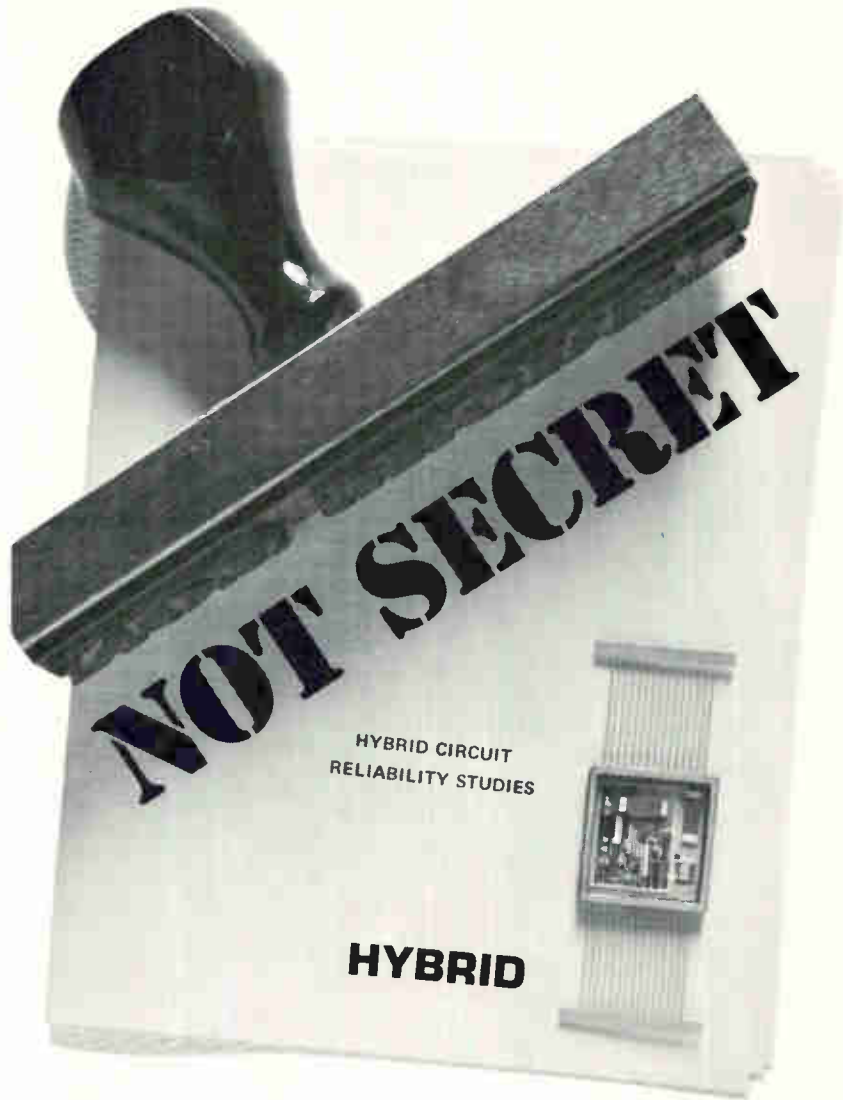

Come see for yourself!

At WEMS we have no secrets. Our vast microelectronic packaging experience is yours-for-the-asking.

Working together we can produce the best hybrid circuits for your applications. Your engineers know the system requirements; our engineers know hybrid technology and how to meet those requirements.

Write or call for further information.

Wescon booths 4816, 4817 ■ An equal opportunity employer.



WEMS, INC. 4650 WEST ROSECRANS AVENUE

HAWTHORNE, CALIF. 90250 ■ TELEPHONE (213) 679-9181

DL 620A

A COMPLETE 18-CHANNEL DIGITAL DATA ACQUISITION SYSTEM

for only
\$3,900

The compact and lightweight design, plus low power requirements, makes the DL 620A an extremely versatile unit. Ideal for general purpose recording of analog or digital data on magnetic tape both in the laboratory and remote installations... or portable airborne applications.

This complete 18-channel data acquisition system weighs only 18 lbs. and needs minimal power of 35 watts. Features include a presettable crystal controlled clock; ability to accept either analog or direct digital data; high Z differential analog input stage; selectable recording rates; cartridge magnetic tape system with associated drive; plus all necessary logic and power supplies. Data recovery options include; tape-to-tape, tape-to-computer, and real-time.

For the complete story on the Model DL 620A and associated equipment write MetroData Systems, Inc., P. O. Box 1307, Norman, Oklahoma 73069.



point out that each encoder is dedicated to a single function, can't be multiplexed, and provides serial output, which is a disadvantage with modern parallel computers. Encoders also have mechanical backlash problems and are sensitive to vibration.

The use of op amps instead of transformers, to get the sine and cosine, eliminates the problems of frequency sensitivity. Input impedance is 100 kilohms; with the optional converter, 500 kilohms. The high impedance prevents loads from being placed on gyros and avoids transients to the gyro platform which result from transformer multiplexing.

Fairchild's advanced model 3705 integrated-circuit MOS FETs are used in the multiplexers to get a fast switching time—1 microsecond. In the standard unit, with 40 μ sec conversion, 30 op amps with slew rates of 20 volts per μ sec, and settling time of 300 nanoseconds are used. The optional 5- μ sec converter, uses new hybrid op amps with 100 nsec settling time and 8 megacycle full power bandwidth. Dynalex says the slew rate is very high. Both units employ a feed-forward algorithm conversion technique that doesn't require the usual successive approximation methods.

The 5 μ sec conversion rates are attained both by using faster op amps, and through hand selection of components, including hand assembly and matching of gains and resistances, according to Dynalex.

Component aging in the converter, with resulting comparator level shifts that require maintenance adjustment, are avoided by using patented bulk-film Vishay resistors with .005% resistance and a pulse rise time of 1 nsec. Stability of the resistors is ± 1 part-per-million per $^{\circ}$ C. This compares with 25 ppm/ $^{\circ}$ C stability, and 30- to 40-nsec pulse rise time for wire-wound resistors.

Rack-mountable enclosures with binary or decimal display and integrated power supplies are optional. Direct computer interface options range in price from \$800 for a single card for the PDP-8 computer to \$3500 for five or six cards for the Univac model 4183 or 1108.

Dynalex Inc., 885 Front Street, Burbank, Calif., 19502 [391]

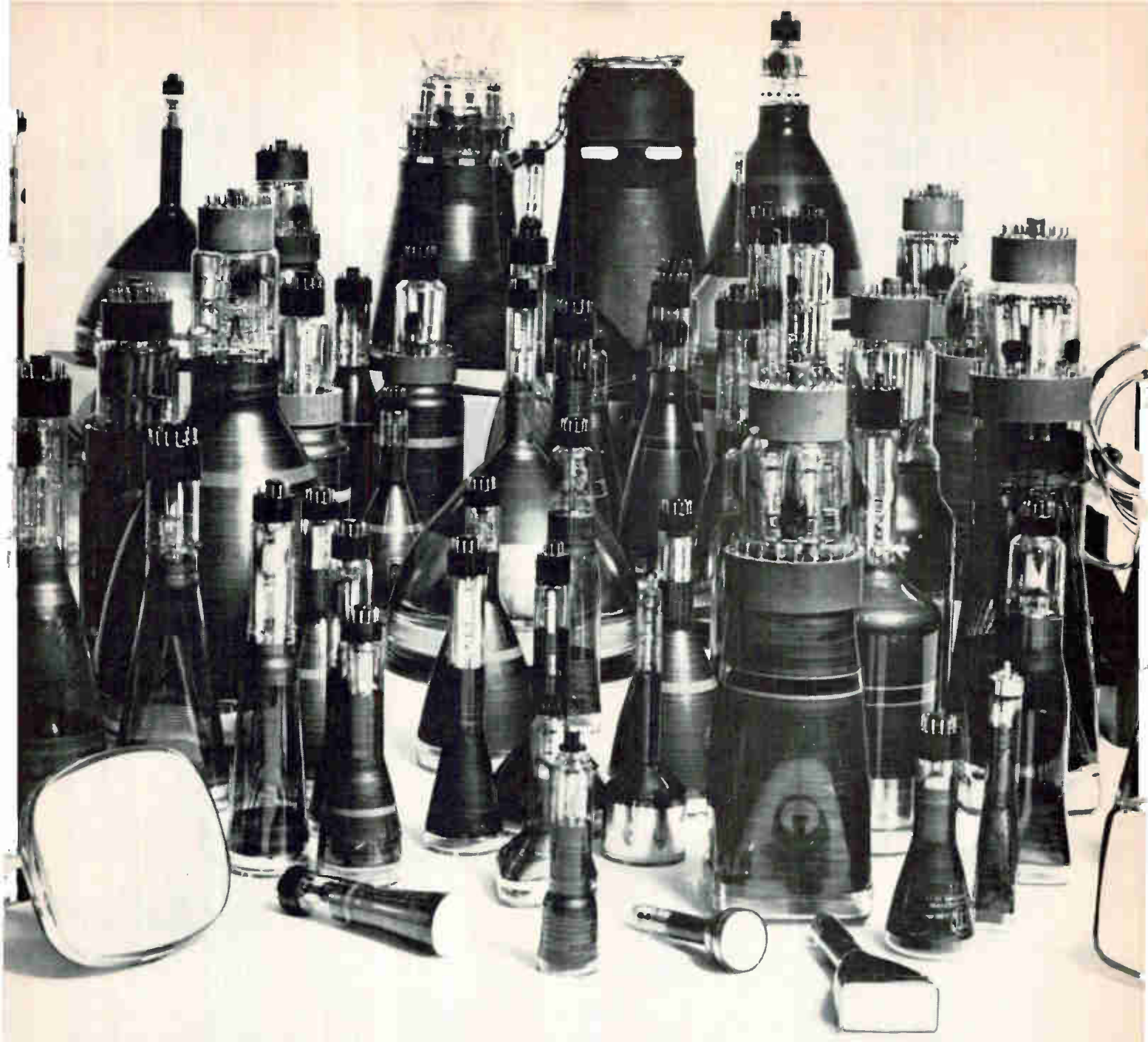

98 million to 1 we have what you need in a CRT

Try us. Just pick up the phone and call. Do it now, before your design is locked in. Or write if there's time.

Your problem is no problem at all to us. We've got 98,112,000 different ways to go. That's our capability in producing cathode ray tubes. We've made over two hundred different versions, and they're available . . . practically off-the-shelf.

Our ETC tubes come in any one of 511 shapes and sizes. Use any one of 40 different phosphors. One to twelve electron guns. A choice of four filaments. They can be ruggedized or not. And

include fiber optics faceplates (something we pioneered in the industry), rear windows and optically ground faceplates.

So . . . feel free to call for exactly what you want. Not a modification. Or add-to. But something that specifically fits your design and answers your total read-out requirement.

There's only one way to find out. Call us. Anytime. (215) 248-3700. Or write: Electronic Tube Division ETC®, General Atronics, Philadelphia, Pennsylvania 19118. A subsidiary of Magnavox Corp.



GENERAL ATRONICS

Convert any X-Y scope into a curve tracer: \$655*



Now U-Tech's plug in and console units are all your oscilloscope needs to become a curve tracer. Save 1/2 to 1/3 the cost!

For the price of one curve tracer, you can now buy two to three of these U-Tech units that use the facilities of your present scope to display the dynamic characteristics of both NPN and PNP transistors, N Channel and P Channel junctions, FETs, MOS-FETs, bipolars, uni-junctions, diodes, tunnel diodes and SCRs.

Ask your distributor about these U-Tech curve tracer units or order direct from:

*Prices apply to purchase and shipments within U.S.A. fob Salt Lake City, Utah

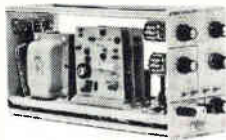

U-Tech plug-in Model 681: \$655.00*. For use with Tektronix 560 series Oscilloscopes.

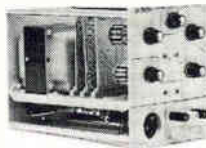

U-Tech plug-in Model 682: \$675.00*. For use with Tektronix 530, 540, 550, 580 series Oscilloscopes.



U-Tech Console Model 683: \$685.00*. For use with any X-Y Oscilloscope.

New subassemblies

Equipment timer plugs into line

Usage monitor can measure up to 5,000 hours on 100-1,800 watt loads

A running-time monitor that plugs into the power line of any 115-volt a-c equipment to measure operating hours has been developed by the Bissett-Berman Corp.

Designated the OTM-1, the unit requires no installation wiring to adapt it to most electrical instruments. It was designed for spot-checking equipment usage patterns, conducting special studies of equipment workloads, and helping with calibration, maintenance, and warranty programs. It is also expected to be used in failure analysis, collection of data on equipment lifetime, and in productivity analysis.

The instrument can measure up to 5,000 operating hours on loads from 100 to 1,800 watts. Its operation is not affected by line load or by frequency and voltage variations.

The OTM-1 is designed around an E-Cell micro-coulometer, which plates one of its electrodes with a precise amount of silver that is equivalent to the current-time integral passing through the unit. Since the current is constant, the amount of plating is directly proportional to time. Plating occurs only when current is passing through the unit, so it measures operating hours of the equipment in real time.

Readout is accomplished by reversing the process by means of the OTR-300, which measures the time required to deplate the OTM-1 unit. Readout time is 3,600 times as fast as real time, the company says. One OTR-300 readout will serve several monitors.

The monitor is priced at \$13.75 each, and the readout instrument sells for \$375.

Components Division, Bissett-Berman Corp., P.O. Box 655, Santa Monica, Calif. 90406 [392]

U-TECH

A Division of Industrial Physics and Electronics Company

4190 South State Street, Salt Lake City, Utah 84107 Tel. (801) 262-2663

Yes, send me curve tracer model.....

Enclosed is: Check P.O. Bill me Send literature

NAME _____ TITLE _____

COMPANY NAME _____

COMPANY ADDRESS _____ PHONE _____

CITY _____ STATE _____

Photoconductive Cells

This listing represents less than half of the Clairex standard and special photocells available. A 16-page design manual is available on request.



Photocell ordering abbreviation	Diam. X Length (inches)	Resistance @ 2 fc ± 33 1/3%	Minimum resistance ratio from 2 fc to Dark within 5 sec.	Maximum voltage	Power Dissipation @ 25°C (mw)
CL5M2	.55 X .18	55K	1:100	250	2000-500 ¹
CL602	.25 X .5	1 meg.		300	75
CL702	.36 X .18	1 meg.		300	125
CL902	.21 X .15	1 meg.		250	50

Type 2 CdS (photosensitive material designated by last number in ordering abbreviation, i.e. CL5M2). Peak spectral response 5150 angstroms, bluest response photosensitive material, high stability, lowest temperature error.

CL503	.5 X .5	7.2K	1:10,000	250	500-250 ¹
CL5M3	.55 X .18	7.2K		250	2000-500 ¹
CL603	.25 X .5	133K		300	75
CL603A	.25 X .5	75K		300	75
CL603AL	.25 X .5	3.5K		170	75
CL703	.36 X .18	133K		300	125
CL703A	.36 X .18	67K		300	125
CL703L	.36 X .18	2.7K		100	125
CL903	.21 X .15	133K		250	50
CL903A	.21 X .15	67K		250	50
CL903L	.21 X .15	6.0K		100	50

Type 3 CdSe, peak spectral response 7350 angstroms, fast response, and very high light-to-dark resistance ratio. Can be used for high speed switching or counting. Sensitive to near infra red. For use with incandescent or neon lamps.

CL504	.5 X .5	1.5K	1:1000	250	500-250 ¹
CL5M4	.55 X .18	1.5K		250	2000-500 ¹
CL504L	.5 X .5	0.25K		170	500-250 ¹
CL5M4L	.55 X .18	0.25K		170	2000-500 ¹
CL604	.25 X .5	30K		300	75
CL604L	.25 X .5	1.5K		170	75
CL704	.36 X .18	30K		300	125
CL704L	.36 X .18	0.6K		100	125
CL904	.21 X .15	30K		250	50
CL904L	.21 X .15	2K		100	50

Type 4 CdSe, peak spectral response 6900 angstroms, lowest resistance photocells available. Can be used for "on-off" applications when low resistance is desired. For use with incandescent or neon lamps.

CL505	.5 X .5	9K	1:100	250	500-250 ¹
CL5M5	.55 X .18	9K		250	2000-500 ¹
CL505L	.5 X .5	1.5K		170	500-250 ¹
CL5M5L	.55 X .18	1.5K		170	2000-500 ¹
CL605	.25 X .5	166K		300	75
CL605L	.25 X .5	7.5K		170	75
CL705	.36 X .18	166K		300	125
CL705L	.36 X .18	3.3K		100	125
CL905	.21 X .15	166K		250	50
CL905L	.21 X .15	10K		100	50

Type 5 CdS, peak spectral response 5500 angstroms (closely matches the human eye), most stable, lowest memory photocell available. Can be used in light measuring applications and precision low speed switching. For use with incandescent, fluorescent or neon lamps.

CL705HL	.36 X .18	28K	1:1000	100	125
CL905HL	.21 X .15	100K		100	50
CL905HN	.21 X .15	700K		100	50

Type 5H CdS, peak spectral response 5500 angstroms (closely matches the human eye). Combines high speed, stability, linearity, and uniform color temperature response.

Photocell ordering abbreviation	Diam. X Length (inches)	Resistance @ 2 fc ± 33 1/3%	Minimum resistance ratio from 2 fc to Dark within 5 sec.	Maximum voltage	Power Dissipation @ 25°C (mw)
CL507	.5 X .5	7.2K	1:1000	250	500-250 ¹
CL5M7	.55 X .18	7.2K		250	2000-500 ¹
CL607	.25 X .5	133K		300	75
CL707	.36 X .18	133K		300	125
CL707L	.36 X .18	2.7K		100	125
CL907	.21 X .15	133K		250	50
CL907N	.21 X .15	66K		100	50

Type 7 CdS, peak spectral response 6150 angstroms, moderate speed and ratio. Can be used in general beam breaking applications. For use with incandescent, neon or fluorescent lamps.

CL707H	.36 X .18	500K	1:1000	300	125
CL707HM	.36 X .18	100K		250	125
CL707HL	.36 X .18	10K		100	125
CL907H	.21 X .15	600K		250	50
CL907HN	.21 X .15	300K		100	50
CL907HL	.21 X .15	24K		100	50

Type 7H CdS Peak Spectral response 6200 angstroms. Very fast decay time coupled with low resistance and high linearity. Ideal for beam breaking applications.

Photocell ordering abbreviation	Diam. X Length (inches)	Resistance @ 2 fc ± 33 1/3%	Minimum resistance ratio from 2 fc to Dark within 5 sec.	Maximum voltage	Power Dissipation @ 25°C (mw)	Type
CL703/2	.36 X .18	50K	1:10,000	300	125	3 CdSe
CL703L/2	.36 X .18	6.5K	1:10,000	100	125	3 CdSe
CL704/2	.36 X .18	17K	1:1000	300	125	4 CdSe
CL704L/2	.36 X .18	1.5K	1:1000	100	125	4 CdSe
CL705/2	.36 X .18	166K	1:100	300	125	5 CdSe
CL705L/2	.36 X .18	7.5K	1:100	100	125	5 CdS

DUAL ELEMENT

Photocells contain two separate elements with two separate leads and one common lead.



PHOTOMOD®

PHOTOCELL-LAMP ASSEMBLIES

Part No.	Rated Lamp Voltage	Resistance (Max. Ohms) @ Rated Lamp Voltage	Max. Allowable Cell Voltage @ Peak AC
CLM3006A	6	160	120V
CLM4006A	6	55	120V
CLM4012A	12	30	120V
CLM3012A	12	160	120V
CLM5H10A	10	3000	120V
CLM7H16A	16	550	170V
CLM3120A	120	1150	120V
CLM4120A	120	160	120V

FOOTNOTE: ¹ With and without heat sink.

CLAIREX ELECTRONICS, INC.

1239 BROADWAY, NEW YORK, N.Y. 10001 • WRITE FOR NAME OF YOUR NEAREST CLAIREX REPRESENTATIVE OR DISTRIBUTOR.

Sweep Diagraph ZWA

measures impedances, admittances, attenuation and phase

on two- and four-terminal networks (semiconductors, filters and diplexers, feedback amplifiers, antennas, components with negative impedances, cables); sweeps the entire range from 10–480 MHz or any subrange.

Display: complex (Smith chart); magnitude, linear/logarithmic; or phase over a range of 60 dB.

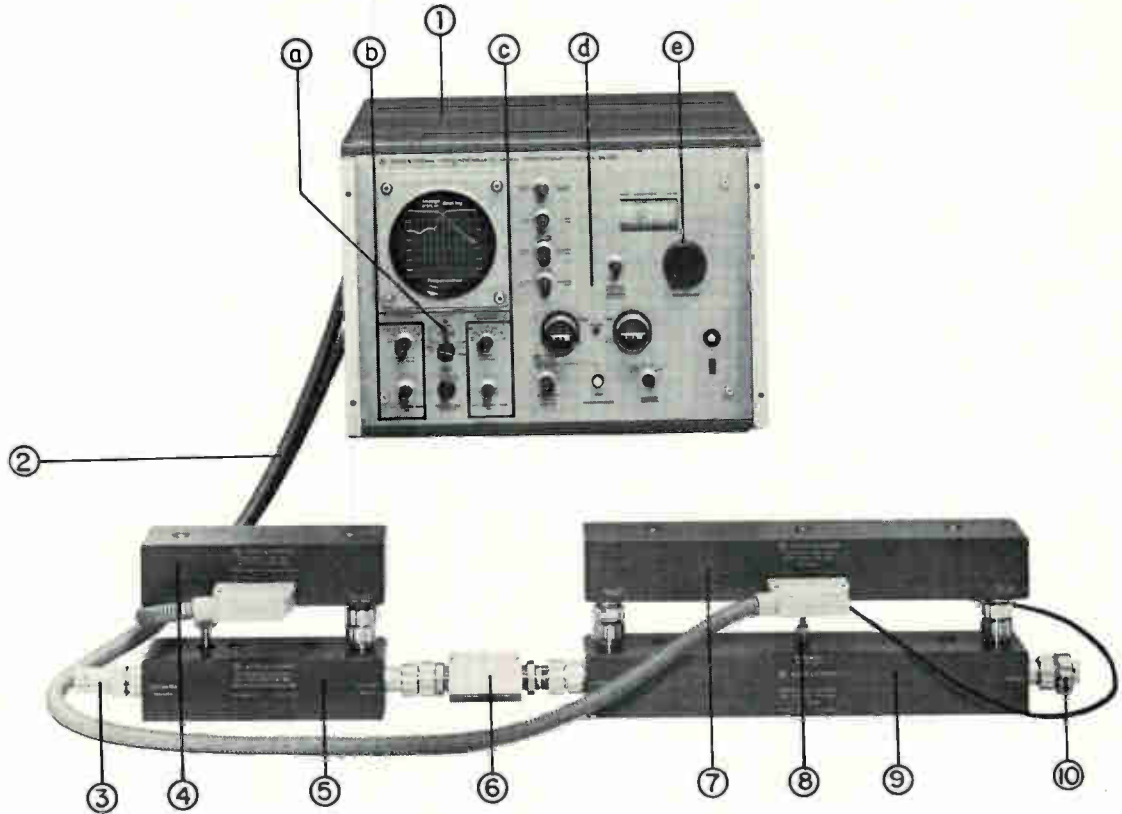

All items (except for 6) supplied with set

1 Basic unit: a Function selector, b Reflection channel, c Transmission channel, d Start and stop frequencies, centre frequency and sweep width, e Marker generator; 2 Connecting cable (up to 10 m), 3 termination, 4 Mixer head II (transmission), 5 Directional coupler II (transmission), 6 Test item, 7 Mixer head I (reflection and reference), 8 Test-voltage input, 9 Directional coupler I (reflection and reference), 10 Short-circuit (reference).

Simultaneous display of reflection coefficient and transmission factor; phase measurement with 0.1° resolution; exchangeable directional couplers for $50\ \Omega$, $60\ \Omega$ or $75\ \Omega$

Built-in sweep generator — adjustable sweep frequency $1/100 - 20$ Hz, frequency markers can be superimposed; reference voltage variable up to 20 dB (range extension)

Voltage across matched test item $< 3 - 30$ mV (depending on frequency); $2\ \mu\text{V}$ for full-scale deflection in most sensitive range; synchronization is possible with an external frequency synthesizer

Switch-selected bandwidth (1 Hz and 10 kHz). All essential functions of the ZWA are programmable; output for connection of XY recorder

Get The Extra Capability,
Greater Reliability, and
Longer Useful Life . . .



ROHDE & SCHWARZ
111 LEXINGTON AVENUE, PASSAIC, N. J. 07055 • 201 - 773-8010

Inquiries outside the U.S.A. should be made to: Rohde & Schwarz, Muehlendorfstrasse 15, Munchen 8, West Germany.
Western Office: 510 South Mathilda Ave., Sunnyvale, Calif. 94086 408-736-1122

See this and other R&S instruments at WESCON Booth Nos. 1417-18

Remote computer terminal is portable

Special keyboard placed over Selectric typewriter plus carry-along electronics make input-output station

Pack up your remote data terminal like a portable typewriter and take it with you—that's the option that Computaumatation is offering. The terminal consists of an IBM Selectric typewriter with a specially designed keyboard that fits over the standard keyboard, and a portable unit called Computamate III that houses the necessary electronics.

A telephone line links the Selec-

tric to the Computamate III. This portable unit can be connected to other terminals or to a central computer and operated as a time-sharing terminal. Information can be transmitted or received between remote terminals, or it can be sent to and from the central processor of a digital computer.

The new keyboard enables the operator to transmit in half- or

full-duplex mode in either ASCII or EBCDIC. The Computamate system can thus take the place of bigger and bulkier teletypewriter machines or of data terminals like the IBM 2741.

For hard-copy printout of voice communications, the operator picks up the receiver and places it inside the Computamate, near the magnetic acoustic coupler. As the



Data keyer model 3865 is capable of keying nonsynchronous data transmitters over wide ranges to facilitate adjustment and maintenance of data systems. Keying speeds from 2 dot cycles to 22K dot cycles are obtainable. The unit is housed in a case 4.7 x 6.6 x 4.3 in. Weight is approximately 2 lbs with a-c power supply. RFL Industries Inc., Boonton, N.J. [421]

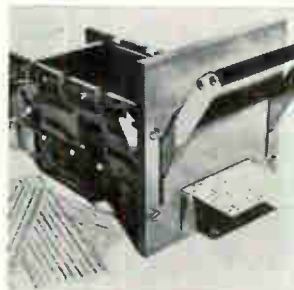

Static punched card reader SCR128cc provides a means of reading simultaneously every hole position in a 12 row, 80 column Hollerith coded tabulator card. Units have wide applications for converting pre-punched holes in a standard tabulator card to useful electrical information. Uses include data collection and process control. Sealectro Corp., Mamaroneck, N.Y. [422]



Automatically equalized, high-speed data modem ADS-448 provides optimum performance between a data source and its terminal equipment. It transmits and receives data at 4,800 bps over Belt System series 3002 telephone data lines. Error rate is 1 in 5 million bits, depending on line conditioning. American Data Systems, 20747 Dearborn St., Chatsworth, Calif. [423]



Communication terminal system model DF33ASR-0 is suited to a wide range of applications such as time sharing, terminal to terminal communications and computer access. It transmits and receives at 100 words per minute. It uses a fully filtered transmitter and receiver data set that rejects harmonic and spurious signals. Data Access Systems, P.O. Box M418, Landing, N.J. [424]



Digital printers series DP-600 provide print-out of up to 21 columns of numerals and symbols with the legibility of an electric typewriter. Unit has long life of over 5 million cycles without adjustment. A field replaceable print mechanism is utilized. Input data storage and floating decimal point are featured. Anadex Instruments Inc., 7833 Haskell Ave., Van Nuys, Calif. [425]



Coincident-current core memory system VersaStore IV operates asynchronously with a full cycle time of 900 nsec and an access time of 350 nsec. One model has a storage capacity of 4,096 words of 40 bits, or 8,192 words of 20 bits, and a larger model can store up to 8,192 words of 40 bits or 16,284 words of 20 bits. Varian Data Machines, 2722 Michelon Dr., Irvine, Calif. [426]



Punched card programmers and translators series P413 are designed for programming any instrument that can be controlled by variable resistance. Features include repeatability of programmed resistance of $\pm 0.0025\%$, typical temperature coefficient of ± 25 ppm/ $^{\circ}\text{C}$., and operating range of $+10^{\circ}$ to $+40^{\circ}\text{C}$.. Program Electronics Co., 1733 West End Ave., New Hyde Park, N.Y. [427]



Direct connected modem DCM-151 provides serial data transmission up to a 150 baud rate. It connects directly to private or leased voice grade telephone lines up to a distance of 5 miles. The data input/output levels comply with EIA RS-232B, and the fsk tones are transformer coupled to the transmission lines. Anderson Jacobson Inc., 2235 Mora Dr., Mtn. View, Calif. [428]

Lean on...



Permag

for all your magnet and ferrite needs.

Depend on Permag to have just the right magnet or ferrite for your particular application. We stock magnets in all sizes, all shapes, all grades—all ready for 24-hour delivery. And our inventory of ferrites is unique... as is our ability to grind this material to extremely fine tolerances required by the computer industry. Look to Permag for special precision grinding and cutting. And magnetizing and engineering facilities. Lean on Permag, at any of the following facilities.

PERMAG SIERRA CORP.

3721 HAVEN AVE., MENLO PARK, CALIF. 94025 • (415) 369-0303

PERMAG PACIFIC CORP.

5441 WEST 104th ST., LOS ANGELES, CALIF. 90045 • (213) 776-5656 • TWX [910] 328-6547

PERMAG SOUTHWEST CORPORATION

2720 TAYLOR STREET, DALLAS, TEXAS 75226 • (214) 748-6909

PERMAG CENTRAL CORPORATION

1213 ESTES AVE., ELK GROVE VILLAGE, ILL. 60007 • (312) 956-1140

PERMAG MAGNETICS CORPORATION

(formerly EMPIRE MAGNETICS) 3130 SOUTH AVE., TOLEDO, OHIO 43609 • (419) 385-4621

PERMAG NORTHEAST CORPORATION

50 THAYER ROAD, WALTHAM, MASSACHUSETTS 02154 • (617) 484-0550

PERMAG CORPORATION

88-06 VAN WYCK EXPRESSWAY, JAMAICA, N.Y. 11418 • (212) 657-1818 • TWX [710] 582-2952

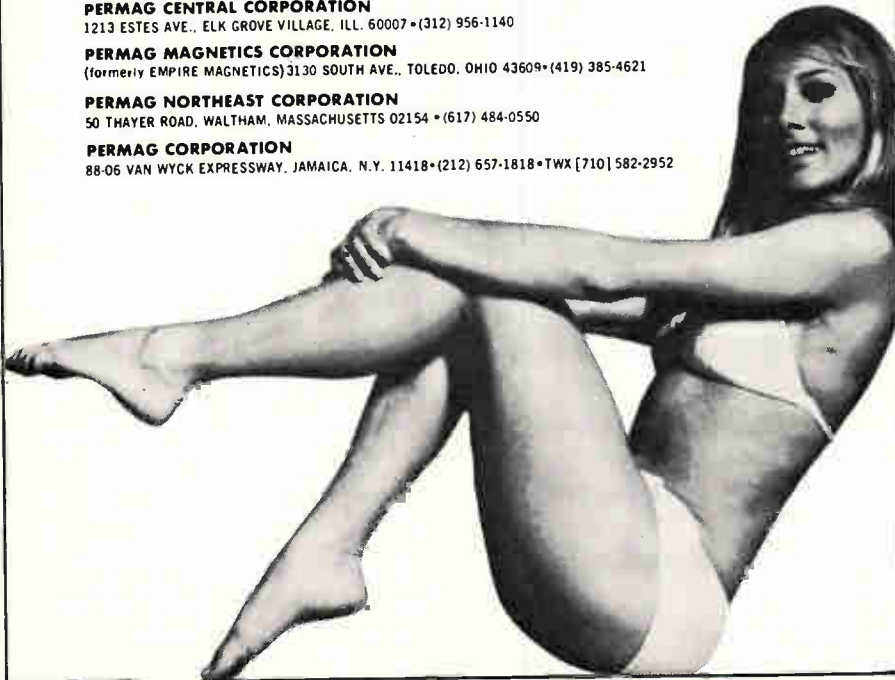

voice message is received, it is printed by the Selectric.

Besides an acoustic magnetic coupler, the Computaumat consists of the decode and drive electronics necessary for transmission, and a power supply.

One of the unusual features of the remote terminal is the design of the keyboard: it is only 2 inches high compared to the 5-inch height of standard keyboards. This reduced height gives the typist a better view of the keys.

Instant signal. The keyboard uses a proximity transducer, made by Transducer Systems Inc., that results in instantaneous transmission of signals when the key has been depressed. The proximity transducer depends only on the distance that a ferromagnetic key has moved. When a threshold is reached, based on the distance the key has moved, the signal is transmitted. A variable-reluctance transducer, on the other hand, generates a signal that depends upon the speed with which the key is depressed. This type contains an inherent delay of about 150 milliseconds before the signal is generated.

The proximity transducer is excited with a specific voltage at the carrier frequency. Attached to the spindle of the key is the piece of ferromagnetic material. When the key is depressed, this material moves closer to the transducer and as the air gap becomes smaller, the signal generated across the load increases until it triggers a threshold detector, producing a desired output pulse or waveform.

Computaumat's keyboard differs significantly from Viatron's logic-driven metal oxide semiconductor solenoid pack, which also fits over the IBM Selectric typewriter [*Electronics*, Oct. 14, 1968, p. 193]. The Viatron keyboard is strictly a one-way affair—generating printout only. Computaumat's keyboard is an input-output device that prints hard copy for both incoming and outgoing messages.

The Computaumat III and the converted Selectric will sell for \$2,000. Warranties on the Selectric will not be affected by the new keyboard.

Computaumat Inc., Newtown, Conn. [429]

Honeywell is out to clear the air in a lot of dirty businesses.



Stale smoke, dust, grease particles, pollen and other airborne filth are the enemies of all businessmen, from restaurant managers to machine shop operators. So, Honeywell has developed a new business machine that fits into your heating or cooling system and removes up to 95% of the impurities from the circulating air.

We call our self-washing electronic air cleaner a business machine because we sell it on a very business-like basis. **IT CAN SAVE YOU MONEY.**

In a retail business, the relationship between cleaner air, less maintenance, cleaner merchandise (or food) and more customers is pretty obvious. But it's hard to measure. So, here's a more measurable saving that applies to *any* type of business.

Business machine cuts heating, cooling, ventilating costs. Any ventilation system uses outside air—often polluted. A regular ventilating system must run almost continuously to replace stale inside air with only partially filtered outside air—a substantial operating expense. The Honeywell Electronic Air Cleaner cleans and reuses more inside air . . . the air you've already heated or cooled. That's a saving anyone can measure.

No maintenance on the machine, either. After it cleans the air, it cleans itself . . . automatically. Businessmen don't need more maintenance problems.

If you'd like to know more about Honeywell's new business machine, the self-washing electronic air cleaner, just mail the coupon. If we can't make a businessman's case for saving you money, we'll just leave quietly.

Mail to:
Honeywell, Dept. 118
Minneapolis, Minnesota 55408

I'm interested in more information about your Automatic Wash Electronic Air Cleaner.

- Please send new brochure.
 Please have a representative call.

Name _____

Business _____

Address _____

City _____

State _____ Zip _____

Honeywell
A U T O M A T I O N



A new lightweight wheel did big things for our instrument counters

Our new counting wheel gives you two important high-performance options in "D" Series instrument counters.

Operate your "D" at standard speeds and you'll have substantially longer counter life. Or run it at a speed 50% higher than was possible with the old wheel (3000 rpm vs. 2000 for the old) and you'll have the same counter life as before.

These benefits are the direct result of a breakthrough in molding techniques and materials that let us reduce the standard Delrin wheel's weight by 30%. This means the new wheel has 20% lower torque requirements, lower inertia, and creates far less radial load and strain on the counter mechanism. And that a counter equipped with it operates 30% more quietly, regardless of speed.

The new Delrin wheels are available in two styles. One has a bronze bushing. Use this if you need exceptionally high performance or very long counter life. The other style has no bushing, and is ideal for standard applications.

Both styles are fully interchangeable with wheels supplied on previous "D" models. Figures are permanently impressed into the Delrin, and meet Mil specs for readability. Dull instrument finish is standard. For full information write for Instrument Counter Catalog, 622 N. Cass St., Milwaukee, Wis. 53201.

Versatile "D" series 3, 4, 5, or 6-figure model without case. 3000 rpm. 1/4" Delrin wheels, special unit wheels available. 44 different models.

Compact "Y" series Small. Speeds to 1500 rpm continuous, 2000 rpm intermittent. Open or closed design. Some models resettable, all add and subtract.

Sub-miniature "S" series 3, 4, or 5-figure sub-miniature model without case. For use where space and weight are limited. 2500 rpm intermittent. 1/8" figures, 12 different models.

See the difference! Wheel samples free with request for information.

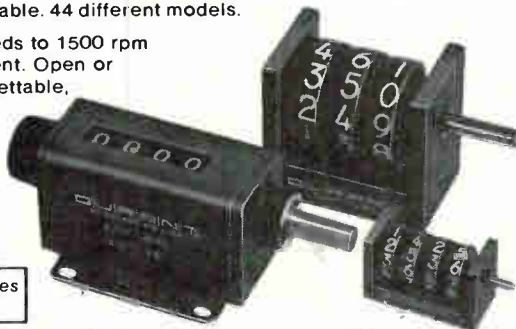

DURANT®
DIGITAL INSTRUMENTS

A CUTLER-HAMMER COMPANY

In Europe: Durant (Europa) N.V. Barneveld, Netherlands

Data handling

7-beam crt gives brighter display

Faster writing speeds also can be obtained for computer terminals

Displaying alphanumeric on a computer terminal's cathode-ray tube involves a lot of work for the console's drive electronics. The tube's electron beam not only is continually scanned in x and y axes, but is intensity-modulated as well. For a given writing rate, the beam must race across the tube face, pausing for very short periods—just long enough to excite phosphor dots. These short pauses, however, take a toll in brightness. Allowing the beam to linger a longer time at a given phosphor dot would brighten the display, but it would also slow the tube's writing speed.

The Electronic Tube division of Sylvania Electronic Components has an answer to the problems that may well lead to solving the brightness-speed dilemma: the use of several electron beams in one assembly.

Sylvania's new 12-inch (diagonal) crt, the model SC-5299, uses seven electron beams to write alphanumeric in the standard five-by-seven matrix. Each beam in the tube can be individually intensity-modulated.

But all seven sweep vertically and horizontally as a unit, with each beam having better than a 10-mil resolution. Unlike a raster-type display in which a single beam scans back and forth seven times to generate one character, the multi-beam unit scans but once at 1/7 the speed. Thus, at present writing rates, brightness can be greatly enhanced. Moreover, since a single sweep does what seven sweeps of a single beam accomplishes, the cost of sweep circuitry can be reduced.

Thus the new tube offers several tradeoffs in the design of computer terminal displays and other types

If Newton had General Electric Computer Time-Sharing Service . . .

. . . gravity might have been discovered painlessly.



The real pain, of course, was doing the tedious, manual calculations, not the bop on the noggin. Using his tree-side terminal (you can put one anywhere), he could have spent his time creatively. Fortunately, you don't have to waste man-hours on computational work when solving your business problems.

Today—whether your problem is *mathematical calculations* (like Newton's), *engineering design*, *sales forecasting* or *market research*—if it involves costly, time-consuming calculations, GE Time-Sharing Service can help you get the right answers faster and easier than any other method. How? By offering you immediate access to a problem-solving computer.

. . . It's easy to learn (GE does the training). It grows with you (we have hundreds of ready-to-use computer programs). It's inexpensive (you only pay when you use the service). And, it is from General Electric, world leader in Time-Sharing Service—already serving over 100,000 people like you.

More facts? Call toll-free: 800-243-0355 [In Conn: Call collect 853-3600] or write General Electric, Box 291-52, Schenectady, N. Y. 12305. Outside U.S.A. write: Canadian GE Information Systems Dept., 214 King St. West, Toronto 1, Ont./Australian GE Pty. Ltd., 103 York St., Sydney, NSW 2000/European Information Service Operation, G.E.T.S. Co., 42 Ave. Montaigne, Paris 8e, France.

Information Systems

World Leader
In Time-Sharing
Service

GENERAL ELECTRIC

Circle 175 on reader service card

Power Supplies

More than 400 most-wanted models available from stock.

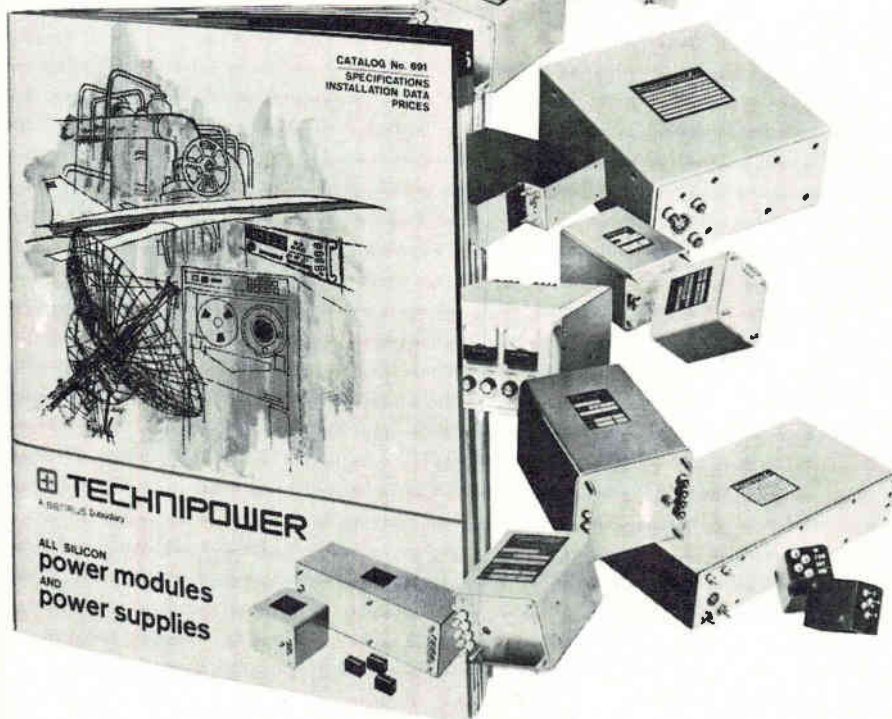

64-page Catalog and Design/Data Book
Send for your free copy.

See our representative at Wescon — Booth 4921

TECHNIPOWER, INC. 

A **BENSUS** SUBSIDIARY

Bensus Center, Ridgefield, Conn. 06877 Phone 203-438-0333 TWX: 710-450-3631
In Europe contact:
TECHNIPOWER, Bensus Technical, 20 Avenue des Planches, 1820 Montreux, SWITZERLAND

176 Circle 176 on reader service card

... may help cut cost of display refreshment ...

of crt readouts.

At present brightness levels, the new tube can write seven times faster than single-gun crt's: the pause at a given dot is at least as long as that of beams operating at 1/7th the speed. Thus it is possible to trade off speed and brightness.

Offers bonus. Sylvania spokesmen see the new tube helping to reduce the cost and complexity of character generators. "You no longer need odd waveforms to write 'through' a deflection yoke," says one company official. There's even an outside chance that the tube could help cut the cost of display refreshment.

Since display brightness is higher for a given writing rate, the

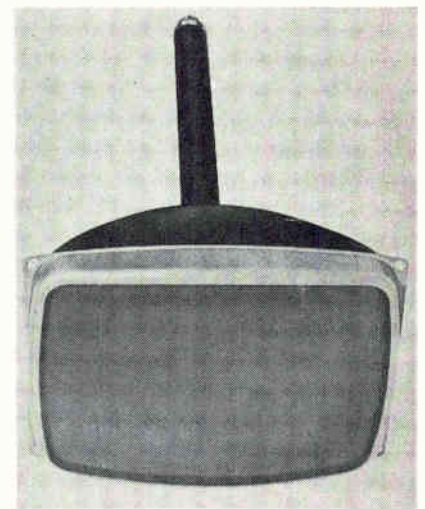

Multibeam scan. Seven beams in tube sweep phosphor dots as a unit.

use of slow-decay phosphors could minimize the need to refresh the display. And if the computer is used to refresh the display, this could mean a savings in machine time.

There is a cost penalty, however, in using the new tube. A video amplifier is needed for each electron beam—seven in all. Single-gun crt's require but one such amplifier.

Sylvania, which will display the tube at Wescon, is taking sample orders. Delivery time is about four weeks.

Electron Tube Division, Sylvania Electronic Components, Seneca Falls, N. Y. 13148 [430]

Electronics | August 18, 1969

hand us your A/D converter requirements,

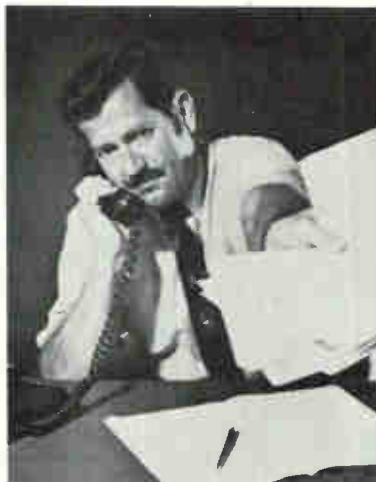

Like this BR-850 A/D Converter, engineered and manufactured by Bunker-Ramo Corporation as the world's most practical Cyclic A/D Converter.

The BR-850's Capabilities . . . full 8-bit resolution . . . 1-MHz word rate . . . power: maximum $7\frac{1}{2}$ watts . . . weight: approximately 2 pounds . . . size: occupies less than 125 cubic inches . . . price: \$1,595.

But Bunker-Ramo's demonstrated high-speed conversion capabilities extend well beyond the remarkable BR-850.

If you have a specification, we will be happy to include it in our planning and notify you of price and availability. If you would like to know more about the BR-850, as well as our capabilities, circle the number on the inquiry card or contact: Mr. J. A. Crist direct at (213) 346-6000.

and we'll hand you your A/D converter



THE BUNKER-RAMO CORPORATION
DEFENSE SYSTEMS DIVISION
8433 FALLBROOK AVENUE • CANOGA PARK, CALIFORNIA 91304





ANCRONA CORP.

OFFERS THIS TINY

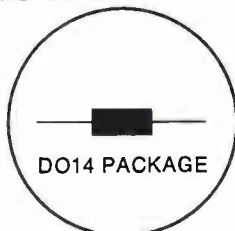

DO14 PACKAGE

MINIATURE SILICON RECTIFIER

WITH OUTSTANDING FEATURES

75A

DC FORWARD

1.1A

PEAK SURGE

1100V

PEAK INVERSE

PRICES

	PEAK REVERSE	1-99	100up
A1N4001A	50V	.35	.20
A1N4002A	100V	.36	.21
A1N4003A	200V	.41	.24
A1N4004A	400V	.50	.28
A1N4005A	600V	.66	.32
A1N4006A	800V	.90	.40
A1N4007A	1000V	1.30	.70

LARGE QUANTITIES FROM STOCK

ANCRONA CORP.

65 E. 55th Street, NEW YORK, N. Y. 10022
(212) 688-6285 TWX (710581/5413)

New Books

How to do it

Real-time data-processing systems
Saul Stimler
McGraw-Hill Book Co., 259 pp., \$13.50

As a whole, this book gives reasonably good descriptions of such things as what is in a real-time system and how it works. But the reader must be willing to plow through examples and descriptions that often make him do quite a lot of guessing about just what the author is trying to say. In Chapter 2, for example, the author, in describing an operational model of a real-time system, attempts to show how a message-switching system operates in the interrupt mode, which he defines as the way to get the quickest response with the least memory space, at the expense of throughput.

Having been interrupted by an incoming message, "A buffer is assigned from a buffer pool to the active input line, and the proper table is updated." Buffer pool? Table?—they're not explained. The author has inserted a typical table in one of the appendixes, with an explanation of its contents, but it doesn't throw much light on the message-switching example.

The message is 400 characters long and is to be processed as four 100-character segments. The first of these is presumably preceded by a string of start-of message characters; the last is followed by end-of message characters. The author doesn't make it clear in context whether these special characters are part of their respective segments or not.

In any case, after the first hundred characters, there's another interrupt, which turns out to have been caused by a midmessage segment. "The midmessage segment is processed" (the first segment wasn't processed, in spite of the author's earlier statement that in message-switching systems, start-of-message and end-of-message characters are processed but the intervening text is not) "and the segment is queued in the random-access device write queue." Aside from syntax, which leaves something to be desired, one wonders

where that random-access device came from and why it is required. It wasn't previously mentioned in the example; following the example to its end reveals that all 400 incoming characters are stored in this random-access device—which is either a magnetic disk or drum—before any of them are routed to an outgoing line.

Mr. Stimler never explains why this procedure is desirable or necessary; it's possible to conjure up a plausible explanation, but this guesswork shouldn't be needed. Good exposition, based on a knowledge of the reader's probable background, doesn't depend on the reader's conjuring up anything. Similarly, several rather dubious explanations are found throughout.

Also covered are such topics as data communications networks, terminal subsystems, systems costs, and examples of automated stock brokerage subsystems.

Basic to filter design

Analysis and Synthesis of
Linear Active Networks
S.K. Mitra
John Wiley & Sons Inc., 565 pp., \$15.95

By examining active-filter elements for small-signal applications via several linear equivalent circuits, the author has geared the book to both the practicing engineer as well as the graduate student. The book is perhaps the most up-to-date work on the subject of active filters, an area where the literature has generally lagged the technology.

By and large, the author has done a good job of compiling a set of basic tools for designing inductorless filters; mathematics is kept to a minimum and examples are used throughout the text. Although each chapter is self-contained, the first three also provide the basic reasoning that makes the rest of the book easily understandable.

The only requirement on the part of the reader is that he be, to some degree, familiar with complex variables and matrix theory, and knows the properties of LC, RC, and RLC one-port and two-port networks. Perhaps the author would have done better to explain them. But

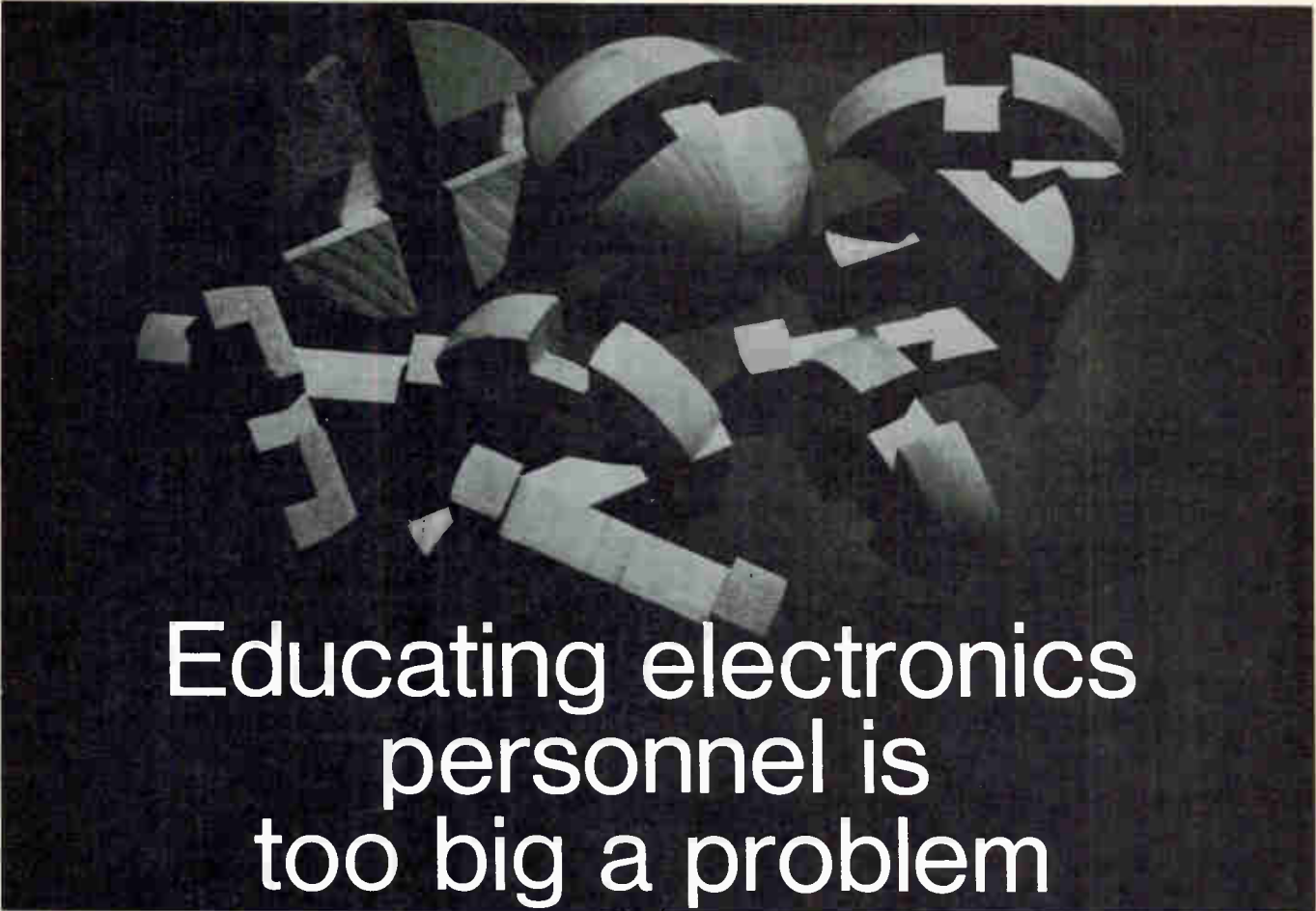

Educating electronics personnel is too big a problem to have only one solution.



Of course, you're sold on the importance of providing continuing education for your electronics personnel. So rapidly do new developments take place in electronics that knowledge begins to lose its value almost as soon as it is acquired. Valuable men can become outmoded and unproductive almost overnight. And the shortage of technical manpower at both the professional and supporting levels makes it imperative that you utilize fully every man you have.

Perhaps your company conducts in-plant programs of instruction. Or pays all or part of the cost

of evening classes in nearby technical institutes, colleges and universities. Whatever your educational program, we believe it will be more flexible and more effective if you supplement it with CREI Home Study Programs in Electronics.

We've prepared a brochure that tells how CREI Programs can help you update, upgrade and reorient electronics personnel. Use coupon below to send for a copy today.

Founded 1927



Accredited Member of the National Home Study Council



CREI, Home Study Division, McGraw-Hill Book Company

Dept WT6-07, 3224 Sixteenth Street, N.W.
Washington, D.C. 20010

I want more information on CREI Programs in Electronics and how they can supplement our educational program for electronics personnel. Please send me, without obligation, your descriptive brochure.

Name _____

Title _____

Firm Name _____

Address _____

City _____ State _____ Zip _____

Never use less than the safest High- Voltage leads



For example: a quick connect/disconnect 20 KVDC connector feeding two CRT tubes from a single terminal 20 feet away. It's a compact lead assembly with glass and epoxy receptacles and silicone insulated leads that can be mated safely by hand, yet it's rated 25 KVDC at 70,000 feet!

- Lightweight, flexible assembly
- Meets applicable MIL specifications
- RFI shielding available
- Rated at 10 amps
- No exposed high-voltage
- Corona and radiation resistant
- Foolproof assembly

Let us design an assembly that meets or exceeds your requirements. We're the leading maker of high-voltage, high-altitude custom lead assemblies. Whatever your connection problem, write or call today.

Capitron Division
Elizabethtown, Pa. 17022
717-367-1105 TWX: 510-657-4561

AMP
INCORPORATED

New Books

the lack of this explanatory matter doesn't hurt the book that much.

The first chapter is basically an introduction to the major aspects of active-network design. Discussed are the advantages and disadvantages of linear active networks, along with the limitations of passive RLC networks. One design of an inductorless active filter is also included.

Properties of linear active elements, their inter-relationships, and how they are used to form equivalent circuits are discussed in the following chapters. Several stability concepts, and network theorems are reviewed, and parameter sensitivity also is described.

The remaining chapters deal mainly with synthesis aspects—the use of negative resistance, controlled sources, negative-impedance converters, and the gyrator.

Recently Published

Avionics Navigation Systems, Myron Kayton and Walter Fried, Editors, John Wiley & Sons, 666 pp., \$24.95

Principles and practices of modern aircraft navigation systems are presented for the systems engineer, whether user or designer. The state of the art is discussed as well as the developmental status of new systems likely to be introduced within the next five years. Chapters deal with topics such as navigation equations, system mechanizations, and multisensor navigation; digital and analog computers; traditional aeronautical radio aids and the newer radio systems; electronic trackers; inertial navigators; attitude and heading references; use of earth satellites as navigation aids; autopilots; and instrument landing systems.

The Technology of Computer Music, M. V. Mathews, The MIT Press, 183 pp., \$12

This book is intended for those who plan to use computers for sound generation and processing but presupposes a working knowledge of Fortran and the general functioning of a computer. Using the computer as both a generator and processor of sound music is discussed and a detailed description of the structure and operation of a particular sound-generating program is included. Also, a training course in the use of this program and special mathematical sections should give the interested reader some idea of the main mathematical relationships.

AIR TRAFFIC CONTROL



**TOTAL ELECTRONIC
SYSTEMS CAPABILITY.
SPECIALISTS IN
TIME/FREQUENCY,
RADAR AND
DATA SYSTEMS
OFFERING RAPID
GROWTH.**



RESEARCH CORPORATION
an equal opportunity employer

P.O. BOX 222, BUFFALO, N.Y. 14225

Technical Abstracts

Monitoring the heart

An automatic diagnostic cardiac waveform detector
Charles W. Ragsdale
Army Material Command
Washington

An automatic cardiac monitor senses the electrical activity of the heart and sounds an alarm when the heart rate is too high or too low, when cardiac arrest or ventricular fibrillation occurs, and when excessive electrical noise is present.

The monitor's heart-rate alarm levels are adjustable and preset for each patient. An electrocardiograph noise discriminator prevents false rate information—caused by noise and heart-muscle signals—from registering on the monitor's meter. In the discriminator, the absolute value of a preamplified signal is applied to two threshold detectors, whose outputs are then routed to pulse width discriminators. The discriminators' outputs depend on both the amplitude and the pulse width of the incoming signal. When the noise level is above normal, the meter displays a high noise reading and the alarm is sounded.

Cardiac arrest is easily detected because there is no electrical signal present. Ventricular fibrillation, however, is difficult to detect because the waveform it produces is an erratic sinusoidal type similar to other waveforms that do not necessarily indicate abnormalities of the heart. By analyzing frequency spectrum, average value, duty cycle, erraticism, and filtered-signal repetition rate—and automatically relating them to the shape and rate of occurrence—the heart monitor detects the fibrillation.

Presented at the Conference on Engineering in Medicine and Biology, Chicago, July 20-25.

Reading by touch

A reading aid for the blind using integrated electronics
J.D. Meindl, J.D. Plummer,
P.J. Salisbury and J.S. Brugler
Stanford University
Stanford, Calif.

A small optical-tactile reading aid allows a blind person immediate access to virtually all printed ma-

**NOW AVAILABLE
FOR IMMEDIATE DELIVERY:**

**FAST
SWITCHING**

**2 AMP and 5 AMP
TRANSISTORS**

from **Solitron**

Solitron has expanded its line of ultra-fast switching transistors with the introduction of 2 AMP and 5 AMP devices. These new units are the fastest switching transistors in the industry now available for "off the shelf" immediate delivery. Features include planar construction and rise time less than 10 nanoseconds.



TO-5



TO-60

2 AMP SERIES

Type Number TO-5	Type Number TO-60	BV_{CBO}	BV_{CEO}	t_{ON} max.	t_{OFF} max.
SDT6101	SDT6104	65	30	50 ns	50 ns
SDT6102	SDT6105	65	40	50 ns	50 ns
SDT6103	SDT6106	65	50	50 ns	50 ns

5 AMP SERIES

Type Number TO-5	Type Number TO-60	BV_{CBO}	BV_{CEO}	t_{ON} max.	t_{OFF} max.
SDT6110	SDT6113	65	30	65 ns	65 ns
SDT6111	SDT6114	65	40	65 ns	65 ns
SDT6112	SDT6115	65	50	65 ns	65 ns

Dial 1-800-327-3243 for a "No Charge" telephone call and further information

Solitron
DEVICES, INC.

1177 BLUE HERON BLVD. / RIVIERA BEACH, FLA. / (305) 848-4311 / TWX: (510) 952-6676

3.999 REASONS WHY



4000 COUNT DIGITAL PANEL METER \$23600*

Computer Products' new DP400 series digital panel meter measures DC voltage with extreme accuracy: .05% \pm 1/2 count and with 4000 count resolution. It's priced with the DPMs and performs with the DVMs. Using revolutionary encoding techniques, it offers 8 voltage ranges (200 mV to 400 V) with internally selectable decimal point position, and the electronics are removable and repairable.

The DP400 series' styling will enhance the appearance of your system. All this, and behind-panel space required is only 2.5" x 3.0" x 4.2". Compact, wouldn't you say?

As if that weren't enough, DP400s have remote display capabilities.

The temperature coefficient of the DP400 series is .005%/°F and the operating temperature range is 30° to 140°F. Tube life expectancy is 200,000 hours.

In quantity orders, the DP400 series is available for measuring current and resistance.

Call or write for complete specifications and/or OEM prices.

SHIPMENT 15 TO 30 DAYS ARO

Prices	1-3	4-9	*10-29
	\$328	\$267	\$236

Computer Products, Inc. • P.O. Box 23849, Ft. Lauderdale, Florida 33307 • 305-565-9565



COMPUTER PRODUCTS™
FORT LAUDERDALE

Circle 217 on reader service card



NEW HERMETIC TINY PAK™ 201 & 741 OP AMPS

For Hybrids and
Conventional
Circuit Boards.

New TINY-PAK™ OP AMPS by MINI-SYSTEMS, INC. provide guaranteed electrical performance in a miniature hermetic flat pack much smaller than any now available in the industry. The diameter of this package is approximately twice the maximum dimension of I C OP Amp dice.

This package has been perfectly tailored to the die, thus maintaining its "size advantage" and at the same time providing ideal environmental protection. Standard Lead spacing of .050" eliminates the need for special equipment and skills in handling, testing and mounting. Each TINY-PAK™ OP Amp is thoroughly tested for compliance with device specifications and further screened for abnormally high noise and capacitive loading instability. This provides a bonus in performance and reliability.

Applications include all those of conventional "101" and "741" types, plus those now made possible and practical by the miniature size of the TINY-PAK™. TINY-PAK™ "101/201" and "741/741C" I C OP Amps are available from stock. Other types are available on special order. e.g.: 100, 101A, 102, 107 & 108.

Price: \$9.50, "201" or "741C", quantity 1-24.
f.o.b. North Attleboro, Massachusetts.

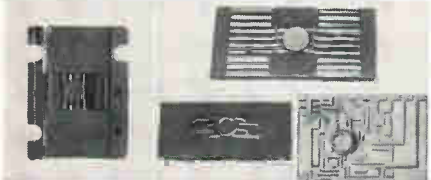

TINY-PAK™ op amps are handled and tested in standard Barnes carriers. Leads can be bent for insertion into PC boards or soldered or welded to ceramic substrates.



Note standard .050" spacing between .017" x .005" TINY-PAK™ leads.



For further information, write or call:

MINI-SYSTEMS, INC., P.O. Box 429, North Attleboro, Massachusetts 02761 (617) 695-0206

Technical Abstracts

terial. With arrays of phototransistors and piezoelectric tactile stimulators, a direct conversion from an optical image to a tactile facsimile is made.

An image of a printed character is focused by a simple optical system onto the phototransistor array, whose output provides the control voltages for the piezoelectric stimulators or bimorphs. The tips of a pattern of vibrating bimorphs extend slightly through perforations in a plastic plate. By placing a finger on the plate, a reader can sense the tactile facsimile of a printed character.

An IC multiplexing shift register is used to interrogate the phototransistor array and control the bimorph array. Because the sensor matrix is asymmetrical, one-dimensional y-multiplexing reduces hardware, improves sensitivity, and minimizes switching noise. Temporary memory of a phototransistor's previous output during its integration time is achieved with the self-capacitance of its associated bimorph. The logical AND function, which controls a given bimorph, is performed by the bimorph's corresponding driver transistor. Six matched IC comparators enhance circuit uniformity and sensitivity; an automatic comparator-threshold control adjusts for changes in paper finish—from dull to glossy—and increases accuracy for poor contrast ratios.

Presented at the Conference on Engineering in Medicine and Biology, Chicago, July 20-25.

Minireceiver

An implantable monolithic command receiver
P.H. Hudson, J.D. Meindl and
W.S. Foletta
Stanford University
Stanford, Calif.

A command receiver with a micro-power silicon integrated circuit provides control for implantable electronic systems. Such a receiver prolongs the life of an implantable telemetry system by turning off the d-c power when it's not in use.

Fabricated on a single chip, the unit consists of an r-f amplifier, a detector, an audio amplifier, and a power switch; a two-stage amplifier

Technical Abstracts

is the basic building block of the receiver linear section.

Only a bipolar transistor is used to provide four distinct circuit components. Collector load resistors are provided by using the transistor as a field-effect or "pinch" resistor. Forward-biased diode-connected transistors supply active transistors with base bias, thus eliminating the need for large-value resistors. Reverse-biased diode-connected transistors serve as coupling capacitors. With appropriate element values for its resistors and capacitors, the two-stage amplifier can be used as either an audio or r-f amplifier, or as a detector.

At a center frequency of 500 kilohertz and an r-f bandwidth of 2 khz, it has a minimum power drain of 20 microwatts. The bandwidth reflects a compromise between good selectivity, and small coupling capacitors.

Presented at the Conference on Engineering in Medicine and Biology, Chicago, July 20-25.

Four in one

A four-channel telemetry system for intensive care
J.R. Trummer and W.N. Reining
Medtronix Inc.
Madison, Wis.

A small four-channel telemetry system, developed for use in intensive care situations, can continuously monitor a patient without interfering with his normal activities. The four channels of data are used for the pulse-position modulation of a small f-m transmitter.

Monitoring electrocardiographic, temperature, respiration signals, and the condition of the battery pack, the unit consumes less than 50 milliwatts. EGG and temperature signals are amplified by operational amplifiers, while respiration data is coupled to a single transistor high-gain amplifier. The ppm multiplexer, consuming 10 mw, also provides synchronization signals to assure proper demodulation of the data.

Another unit, with four high gain channels, was developed for applications such as EKG and EEG.

Presented at the Conference on Engineering in Medicine and Biology, Chicago, July 20-25.

What happened when doctors and engineers got together.

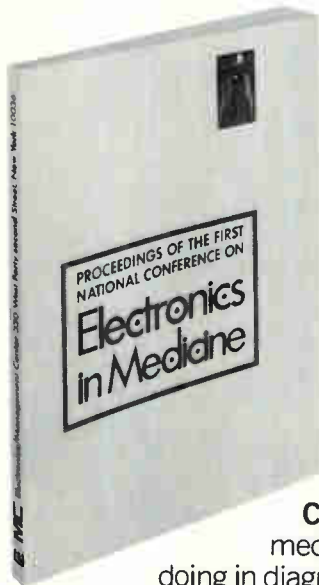

Doctors told engineers how they were using electronics and revealed their most urgent needs. Engineers described and demonstrated their newest equipment for diagnosis, treatment, and prevention. And hinted at things to come.

Their complete dialogue, with illustrations, makes pretty informative reading on a vital and growing market.

Here are some of the things it contains:

Computers: How they're joining the medical team. What computers are doing in diagnosis. In communications. The small computer as a paramedical aid.

Instrumentation: What's needed. What's available. Patient management. Protection. Standards and safety.

Electronics in the Hospital: The surgeon, the hospital, the instruments. What the administrator wants. Prescription for large-scale health care. The surgery department.

Electronics/Management Center
330 West 42nd Street, New York, N.Y. 10036

Enclosed is \$12 for a copy of the Proceedings of the First National Conference on Electronics in Medicine.

Send the Proceedings and bill me later. P.O. # _____

Name _____

Company _____

Address _____

City _____ State _____ Zip _____

PLUGMOLD

MULTIOUTLET ASSEMBLIES

FOR ELECTRICAL CONVENIENCE IN ELECTRONIC INSTALLATIONS

In electronic cabinets at the Kennedy Space Center, Plugmold 2000 multioutlet sections provide outlets at each side for test equipment, lamps, etc. For similar convenience in *your* installation, choose from the complete line of Wiremold surface wiring systems.



THE WIREMOLD COMPANY / HARTFORD, CONN. 06110

Circle 219 on reader service card



Every Engineer or Draftsman should have the **NEW BY-BUK** **CROSS REFERENCE GUIDE P-45**

(supersedes By-Buk Catalog No. P-42)



to better printed circuit
drafting.

This **FREE** 24 page booklet contains color-coded standard MIL-SPEC SIZES and design standards . . . plus a newly added numerical index for easy reference to over 2000 pre-cut tapes, pads, shapes, transistor tri-pads, spaced IC

terminal pad sets and other drafting aids for faster, more accurate, distortion-free printed circuit master drawings.

Send for your **FREE** guide today!

BY-BUK COMPANY

4326 West Pico Blvd. • Los Angeles, Calif. 90019 • (213) 937-3511



184 Circle 184 on reader service card

New Literature

Product reference guide. PEK Inc., 825 E. Evelyn Ave., Sunnyvale, Calif. 94086, has published a 12-page product reference guide covering its line of high intensity light sources, electronic accessories and related products. Circle **446** on reader service card.

Magnetic tape systems. Tri-Data Corp., 800 Maude Ave., Mountain View, Calif. 94040. Increased data processing capability for PDP-8, PDP-8/S, PDP-8/I and PDP-8/L is described in a brochure covering CartriFile digital magnetic tape systems. [**447**]

Data transmission resolvers. Weston-Transicoil, Worcester, Pa. 19490, has issued a folder describing representative size 11 data transmission resolvers. [**448**]

Thin film hybrids. Sensor Technology, Inc., 7118 Gerald Ave., Van Nuys, Calif. 91406, has released a 12-page brochure entitled "The Structure of Thin Film Hybrids" as a service to advanced circuit designers. [**449**]

Crystal units. Reeves-Hoffman Division of DCA, 400 W. North St., Carlisle, Pa. 17013. Specification sheets on the company's crystal units, hitherto available only as separate leaflets, have been bound together in the 16-page bulletin XS-16. [**450**]

Magnetic core memory. Ampex Corp., 401 Broadway, Redwood City, Calif. 94063. Description and specifications of the model 3DM-2000 magnetic core memory are contained in brochure C104. [**451**]

Pressure measuring systems. MB Electronics, Box 1825, New Haven, Conn. 06508, offers bulletin 500S describing its complete line of systems and components for measuring pressure electronically with high accuracy transducers. [**452**]

Frequency reference. Beukers Laboratories Inc., 1324 Motor Parkway, Hauppauge, N.Y. 11787, has issued a two-page data sheet describing the Bewco model 112 low-cost frequency reference. [**453**]

TTL IC specifying guide. National Semiconductor Corp., 2950 San Ysidro Way, Santa Clara, Calif. 95051, has available a TTL integrated circuit specifying guide on its 54/74 series. [**454**]

Synchronous controllers. Victory Engineering Corp., Victory Rd., Springfield, N.J. 07081. A four-page illustrated brochure describes the company's new synchronous controllers and synchronous proportional temperature controllers. [**455**]

Time delay relays. Industrial Solid State Controls Inc., 435 W. Philadelphia St.,

Electronics | August 18, 1969

STATE OF THE ART SEMINARS FOR ENGINEERS AND SCIENTISTS

Here's an opportunity to engage in short programs that will review many of the latest advances and engineering techniques in your field . . . presented by RCA Institutes.

LOGIC DESIGN	Washington, D. C.	10/6-10
	Montreal	10/20-24
	Rochester	11/10-14
	St. Louis, Mo.	11/17-21
	San Francisco	12/1-5
	San Diego	12/8-12
DIGITAL SYSTEMS ENGINEERING	Boston	10/6-10
	Huntsville, Ala.	10/27-31
	Chicago	11/10-14
	Washington, D. C.	11/17-21
DIGITAL COMMUNICATIONS	Dallas	10/6-10
	New York	10/27-31
	Boston	11/17-21
	Palm Beach, Fla.	12/8-12
MODERN OPTICS	New York	10/20-24
	San Francisco	11/3-7
	Washington, D. C.	12/8-12
INTEGRATED CIRCUITS (Technical Bulletin on Fabrication of ICs available on request)	Minneapolis	10/29-31
	San Francisco	10/20-22
	Los Angeles	10/27-29
	Houston	11/17-19
	Phoenix	12/1-3
	New York	12/8-10

Above schedule subject to change.

RCA

RCA Institutes, Inc. Dept. E-89
Institute for Professional Development
Central & Terminal Avenues, Clark, N. J. 07066

For free descriptive brochure, please check the seminar in which you are interested.

- Logic Design Modern Optics Integrated Circuits
 Digital Communications Digital Systems Engineering
 Please send me technical bulletin on ICs.

Name _____ Title _____

Company _____

Address _____

City _____ State _____ Zip _____

Circle 250 on reader service card



Oceanographic applications module with tape recorder, analog-to-digital converter, output register, programmer and multiplexer.

Braincon Corporation's new line of digital tape recorders for data acquisition systems upstages the others where low cost and high performance count.

Braincon's recording artists.

Going places.



Typical portable tape recorder for in-field data logging of industrial and scientific parameters.

- Flexible recorder programming to suit customer format and data rate
- Models for analog or digital input
- High capacity (up to 1/2 million characters)
- Lightweight all-weather models
- Convenient, re-useable tape cartridge
- Low cost per data point
- Self-contained, rechargeable battery pack
- Optional visual display for recorded data
- Unprecedented low system cost

For additional information, contact:

BRAINCON

a subsidiary of **GENERAL TIME**
Progress in the World of Time

MARION, MASSACHUSETTS 02738 / (617) 748-1085

Circle 185 on reader service card **185**



Medium Current Silicon Rectifier Stacks...

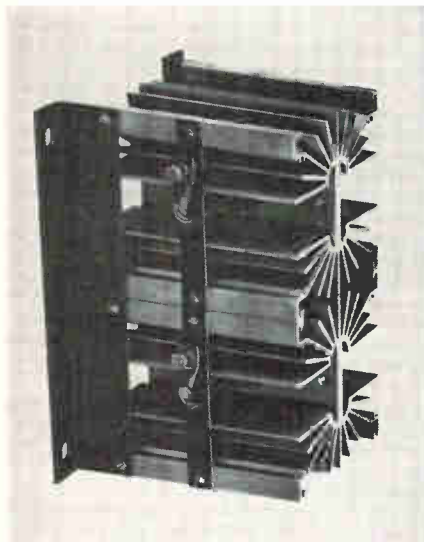

Typical Tung-Sol high efficiency medium current silicon rectifier stack.

Bantam stacks with a heavyweight punch

Exclusive extruded aluminum radiator design, combined with silicon rectifiers of low thermal impedance, achieves outstanding efficiencies in size, weight, and power output for Tung-Sol's medium current silicon rectifier stack assemblies. Installation flexibility is built in, with bolt grooves and interlock channels incorporated in the radiator extrusions. This design simplifies assembly; enables mounting in any plane.

Detailed specifications are given in Catalog T-484, which describes single phase center tap, single phase bridge, three phase bridge, and six phase star assemblies. Write for your free copy today. Tung-Sol Division, Wagner Electric Corporation, 630 W. Mt. Pleasant Avenue, Livingston, N. J. 07039. TWX: 710-994-4865. Phone: (201) 992-1100.

TUNG-SOL®
HELPS YOU DO MORE
...WITH LESS

©Reg. T.M. Wagner Electric Corporation
See us at booth 4710, WESCON Show, August 18-21

New Literature

York, Pa. 17405. Solid state time delay relays are described in a brochure complete with time function diagrams and other comprehensive data. [456]

Reed relays. General Reed Co., 19 Walnut Ave., Clark, N.J. 07066. Bulletin GR-11 covers the 300 series of multi-circuit reed relays. [457]

Electronic packaging. 3M Co., 3M Center, St. Paul, Minn. 55101, offers a six-page brochure on its electronic cable and connecting concepts for electronic packaging applications. [458]

Custom hybrid circuits. Motorola Semiconductor Products Inc., Box 20924, Phoenix 85008. A 16-page booklet discussing the advantages of custom hybrid IC's may be obtained by request on company letterhead.

Variable attenuators. Quindar Electronics Inc., 60 Fadem Road, Springfield, N.J. 07081, has available product data sheet PDS-2-9 describing the QVA-series variable attenuators. [459]

Crystal filters. CTS Knights Inc., Sandwich, Ill. 60548. Engineering bulletin 014-4001-0 illustrates and describes the crystal filter types most often utilized by designers for frequency selection applications. [460]

Rfi filters. Hopkins Engineering Co., 12900 Foothill Blvd., San Fernando, Calif. 91342. Four catalog sheets cover design specifications on rfi filters for data processing equipment. [461]

High voltage resistor. CTS Corp., 1142 W. Beardsley Ave., Elkhart, Ind. 46514. Data sheet 3680 describes the series 680 Cermide high resistance, high voltage resistor. [462]

Sealed connectors. Amphenol Connector Division, The Bunker-Ramo Corp., 2801 S. 25th Ave., Broadview, Ill. 60153. A complete line of hermetically sealed connectors, including a receptacle family offering less than 0.01 micron cu ft leakage per hour, is described in 20-page catalog HSC-2. [463]

Power supplies. Powercube Corp., 214 Calvary St., Waltham, Mass. 02154, has released a 24-page designers' aid catalog for help in specifying subminiature high power supplies. [464]

Crystal can relay. Hi G Inc., Spring St. & Route 75, Windsor Locks, Conn. 06096, has published a brochure on the Mini-G miniature crystal-can relay that is rated at 1 amp (2 amps for 50,000 operations). [465]

A-c line voltage stabilizers. General Electric Co., Corporation Park, Scotia, N.Y. 12302. Booklet GEA-8236A de-

Wanted design engineers by Murata to work with

MICROFORK

Model EFM



Subminiature Piezoelectric Tuning Forks

As low as **\$2.00** per unit

APPLICATIONS:

Page systems; selective call systems; mobil communication; security and fire alarm systems; remote controlled tone operated systems.

SPECIFICATIONS:

Frequency: 360 to 2,900 Hz
Freq. Accuracy:
below 1,000 Hz: $\pm 0.5\text{Hz}$
1,000 Hz & over: $\pm 1.0\text{Hz}$

Input/Output impedance 300K Ω
Insertion Loss: 10 dB max.
TC of frequency: $3.5 \times 10^{-5}/^\circ\text{C}$ max.

DELIVERY:

Pilot run qty...from our NY shelf
Production qty...3 weeks

For further information call or write to:

muRata

Murata Corp. of America
2 Westchester Plaza, Elmsford,
New York 10523
Telex: MURATA EMFD 137332
Phone 914-592-9180

engineers with good connections keep up their contacts



They use MS-230 Contact Re-Nu to maintain full electrical continuity on relays, connectors... all types of contacts where dirt, erosion dust and greasy films can lead to erratic operation. MS-230 is formulated especially

for cleaning contacts. Make it a part of your regular preventive maintenance program.

Write on your company letterhead for a free 16-oz. sample. For literature only, use bingo card.



miller-stephenson chemical co., inc.

Route 7, Danbury, Conn. 06813

Circle 222 on reader service card

Make your own break.

You can take a lot of the chance out of your future by including yourself in the Electronics Manpower Register.

When you do, your experience and talents become part of a nationwide computerized placement service.

Our computer is programmed to give every registrant the same look for every opening. With your prior approval, you'll be considered for every opportunity that matches your resume.

All you have to do is send one to:

Electronics Manpower Register
Electronics
330 West 42nd Street
New York, N.Y. 10036

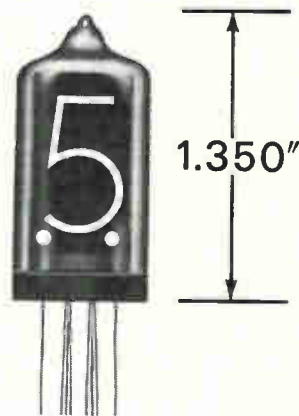

NEW NL-950 READOUT TUBE

Replaces: B-5750 B-5855 B-5859

- made in Geneva, Illinois U.S.A.
- request bulletin

NATIONAL
ELECTRONICS, INC.

a varian subsidiary

PHONE: (312) 232-4300 • GENEVA, ILLINOIS 60134



... offers an overall light gain of 10^6 with a typical background of 10^{-10} lumens/cm². (light equivalent input.)

Typical operating voltage for these conditions is 40kV. The background indicated is for a tube having alkali photocathodes, — tubes are also available with a range of S-20 cathodes for use out to 8,000 Angstroms. Input and output windows are flat Zinc crown glass, 50 mm diameter. Type 9693 is available with sapphire input window for use in the UV. Developmental types are now being made with fibre optic windows. All present types are furnished with P-11 phosphors throughout although other types of phosphors are under investigation. □ Tubes are normally supplied potted in silicon rubber and a number of variations are available. A complete package, including electromagnet, divider chain, high voltage power supply and magnet supply is offered. A permanent magnet is also available. □ An extensive technical manual, as well as useful application notes, are available on request. Write on your company letter-head to:

GENCOM DIVISION
varian/EMI

80 EXPRESS STREET, PLAINVIEW, N. Y. 11803
TELEPHONE: (516) 433-5900

New Literature

scribes a selection of unfiltered and harmonic-filtered enclosed a-c line voltage stabilizers. [466]

Short form catalog. Transformer Electronics Co., P.O. Box 910, Boulder Industrial Park, Boulder, Colo. 80302. Short form catalog 469 covers several products new to the company line, including an a-c/d-c prime power pack, a d-c/d-c converter toroidal transformer, and a hybrid voltage regulator. [467]

MATV system products. JFD Electronics Co., 15th Ave. at 62nd St., Brooklyn, N.Y. 11219, has issued a 16-page guide to master antenna tv system products. [468]

Digital angle indicators. Astrosystems Inc., 6 Nevada Drive, Lake Success, N.Y. 11040, offers data file 115, a four-page two-color brochure describing a series of digital angle indicators—solid state, all electronic devices for measuring and displaying angle inputs from remote synchros or resolvers. [469]

P-c board drilling machines. Digital Systems Inc., 1078 E. Edna Place, Covina, Calif. 91722. A 16-page brochure illustrates and describes a line of numerically controlled printed-circuit board drilling and programing machines. [470]

Antenna catalog. Antenna Products Co., Box 9588, Austin, Texas 78757. An abridged catalog contains several new products developed by the company, and depicts a broad line of h-f, vhf, and uhf antennas. [471]

Custom hybrid IC's. Lansdale Microelectronics Inc., Colmar, Pa. 18915, has available a 12-page brochure describing its facilities and capabilities in custom hybrid IC's and special mask-making services. [472]

Ultrasonic transducers. Branson Instruments Co., Progress Drive, Stamford, Conn. 06904, offers an illustrated, 35-page catalog describing a full line of ultrasonic nondestructive testing transducers. [473]

Hook-up wires. Brand-Rex Division, American Enka Corp., Willimantic, Conn. 06226. Twenty-four page catalog 169 describes a line of military specification hook-up wires. [474]

Instrument cabinets. Beechwood Mfg. Corp., 411 S. Ritter Ave., Indianapolis 46219. A four-page catalog covers a complete line of multipurpose instrument cabinets. [475]

TTL IC's. Sylvania Electric Products Inc., 1100 Main St., Buffalo, N.Y. 14209. A pocket-size brochure lists all of the monolithic TTL integrated circuits included in the company's SUHL I and SUHL II families. [473]



NORTON®
MAGNETIC
HEADS

MULTITRACK
ERASE
RECORD
PLAY

Send now for complete technical literature.

NORTON
ASSOCIATES, INC.

10 Di Tomas Court, Copiague, N. Y. 11726
Phone: 516 598-1600

Circle 224 on reader service card

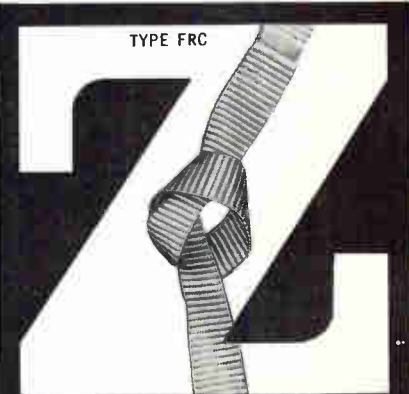

ZIPPERTUBING®
FAB-RI-CABLE

Spirals, folds, knots, tacks without change in characteristics! Custom woven to your specifications.

FRC, a flat tightly woven yet flexible ribbon cable does the job of heavy, bulky cables, yet fits in tight spaces or along edges. Breakouts do not disturb insulation of adjacent conductors.

Specify 4 to 100 conductors with any type insulation in any combination of colors. breakouts or conductor sizes.

Available woven in synthetic fibers such as Kapton, Teflon, Nylon, Nomex, as well as cotton or linen.

For full information on specialized high-performance Fab-Ri-Cable and ZT Jacketing, contact:

THE ZIPPERTUBING® CO.

CORPORATE HEADQUARTERS
13000 S. BROADWAY
LOS ANGELES, CALIF. 90061
Los Angeles Phone: (213) 321-3901
New Jersey Phone: (201) 256-4980



BALTIMORE • BOSTON • CHICAGO • CLEVELAND • DALLAS
NEW YORK • ORLANDO • PHOENIX • SAN FRANCISCO • WEST GERMANY

Looking for a better job?



Ask Electronics' computer all about it

Electronics magazine feels an obligation to help its readers find positions in the electronics technology which will make the greatest contribution to their profession and to society — jobs in which electronics men themselves will be happiest.

Electronics has joined with a nation-wide talent search company—National Manpower Register, Inc.—to form the computerized Electronics Manpower Register.

Your qualifications and job requirements will be pro-

grammed into a GE 265 computer, direct-linked to the Manpower Register's offices in New York. The computer, once your resume form (bottom of page and following page) is received, will continuously compare all your data with the specific manpower needs of electronics companies. When a match is made, you will be contacted directly or through an affiliated agency. The company and you will be brought together on a confidential basis.

Continued on next page

<p>Resumes acceptable only from applicants residing within the United States</p>	<h3>Electronics Manpower Register</h3> <p>It is important that your information be complete and that you type or print legibly</p>	<p>Resumes acceptable only from applicants residing within the United States</p>
<p>IDENTITY</p>		
Name	Date	PRESENT OR MOST RECENT EMPLOYER
Home address		Parent company
City	State	Your division or subsidiary
	Zip	Location (City/State)
Home phone	Do you subscribe to Electronics <input type="checkbox"/> or see a library or pass-along copy <input type="checkbox"/>	
<p>GEOGRAPHICAL PREFERENCE (Check appropriate boxes and complete all blanks)</p>		
<p>I will NOT relocate <input type="checkbox"/> I will consider opportunities in: <input type="checkbox"/> North East <input type="checkbox"/> Mid Atlantic <input type="checkbox"/> South <input type="checkbox"/> Midwest <input type="checkbox"/> Southwest <input type="checkbox"/> Calif. <input type="checkbox"/> Northwest</p>		
<p>Prefer: <input type="checkbox"/> Metro. area <input type="checkbox"/> Medium town <input type="checkbox"/> Rural area <input type="checkbox"/> Other: _____</p>		
<p>EDUCATION</p>		
Degree	Major field	Year
		College or University
<p>FOR OFFICE USE ONLY</p>		
		<input type="checkbox"/>
		<p>REGISTRATION NUMBER INITIAL OF LAST NAME</p>
<p>EMPLOYMENT INFORMATION</p>		
Position desired		
Present <input type="checkbox"/> or most recent <input type="checkbox"/> position	From	To
		Title
Duties and accomplishments		
<p>HAVE YOU REGISTERED WITH THIS SYSTEM PREVIOUSLY? Yes <input type="checkbox"/> No <input type="checkbox"/></p>		
<p>CONTINUED ON OTHER SIDE</p>		

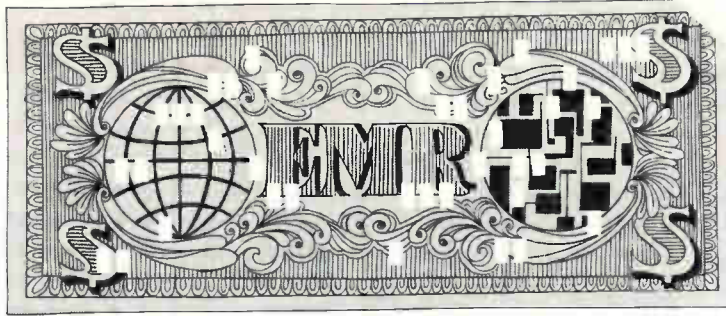

The cost of all this to you? Absolutely nothing. No fees or charges at any time.

Other advantages of EMR:

- Your resume is sent only to those companies that have a genuine requirement for your particular skills.
 - There is no general "broadcasting" in the hope "someone will be interested."
 - Your identity is protected because your name is released only according to your prior instructions. Your name can be deleted on request.
 - EMR's service is nationwide. You may be considered for job opportunities anywhere in the U.S.
- The Electronics Manpower Register is a powerful tool and should be considered when you are seriously seek-

ing a new position. And, although you may be reasonably happy in your present position, chances are that you might have that ideal job in mind.

This is why EMR makes good sense for you. If that job does turn up, you'll be there.

To get your name in the EMR file, just fill out the resume form and return to:

Electronics Manpower Register
330 West 42nd Street
New York, N. Y. 10036

Please enclose a copy of your resume if you have one. A detailed brochure further describing EMR will be sent to you.

⊕ Electronics Manpower Register

A computerized employment opportunity service

CONTINUED FROM OTHER SIDE				
Previous Position	Employer	City/State	From	To
Duties and accomplishments				
Previous Position	Employer	City/State	From	To
Duties and accomplishments				
GENERAL INFORMATION				
(Summarize your over-all qualifications and experience in your field. List any pertinent information not included above.)				
Current annual base salary				
Total years of experience		Date available (within four months)		U.S. Citizen <input type="checkbox"/> Non U.S. Citizen <input type="checkbox"/>
My identity may be released to:	Any employer <input type="checkbox"/>	All but my present employer <input type="checkbox"/>	Have you security clearance?	Yes <input type="checkbox"/> No <input type="checkbox"/> If yes, What level
Mail (with a copy of your resume, if you have one) to:				
Electronics Manpower Register			NO FEES OR CHARGES	
ELECTRONICS			EMR-17	
330 West 42nd St.				
New York, N. Y. 10036				

In electronics it's Electronics magazine to sell used equipment!

Your advertisement will produce Results in Electronics. Engineers turn to Electronics magazine for the latest technical developments — and for the latest buying information. You can reach them inexpensively in Electronics Searchlight Section.

For information:
Searchlight Section
Classified Advertising Dept.
Post Office Box 12
New York 10036



EMPLOYMENT OPPORTUNITIES

Product Manager

ELECTRONIC COMPONENTS

Well known manufacturer has exceptional opportunity for marketing oriented application engineer. Will provide leadership & direction to marketing in expanding non-military industrial sales.

QUALIFICATIONS

- Degree EE, ME, or Physics—MBA preferred
- Experience in application engineering
- Good understanding of solid state circuitry and controls application.

Send resume — replies will be acknowledged. Show current compensation. Our employees know of this ad.

P-8871, Electronics

645 N. Michigan Ave., Chicago, Ill. 60611

An equal opportunity employer

CIRCLE 967 ON READER SERVICE CARD

ELECTRONICS DESIGN ENGINEER

An opening exists in a university laboratory for an electronics engineer capable of assuming the design and development responsibility for instrumentation to be used in the fields of cosmic rays and space physics. The instrumentation will involve photomultipliers, image tubes, data digitization, digital and analog signals, and telemetry.

Experience with logic and fast pulse circuitry as well as knowledge of the latest integrated circuit technology is necessary.

Contact

R. W. Huggett or S. D. Verma,

Physics Department,

Louisiana State University,

Baton Rouge, Louisiana 70803.

An equal opportunity employer

CIRCLE 966 ON READER SERVICE CARD

CLASSIFIED ADVERTISING
SEARCHLIGHT SECTION
BUSINESS OPPORTUNITIES
USED OR SURPLUS EQUIPMENT

RADAR SYSTEMS GROUND AND AIRBORNE. AUTOMATIC TRACKING ANTENNA SYSTEMS. NIKE AJAX. NIKE HERCULES. M-33. MSQ-1A. MPS-19. MPS-9. SCR 584. TPS-1D. TPS-2B. FAA-ASR-2. AIRBORNE SYSTEMS. APN-84. APN-102. APS-20. APS-27. APS-45. DFN-19. DIGITAL COMPUTERS. IBM 650. IBM 704.

LARGEST INVENTORY OF RADAR AND MICROWAVE EQUIPMENT IN THE WORLD.
RADIO RESEARCH INSTRUMENT CO.
45 WEST 45TH ST. N. Y. 10036 212-JU 6-4691

CIRCLE 969 ON READER SERVICE CARD

Sold!

"Please discontinue our ad in 'Searchlight' as we have sold the equipment through this advertising."

Can "Searchlight" Serve You?

free catalog
POTTING APPLICATORS
MANUAL AND DISPOSABLE

6cc 12cc 30cc

FOR POTTING, ENCAPSULATING, AND SEALING OF MINIATURE COMPONENTS

PHILIP FISHMAN COMPANY
7 CAMERON ST., WELLESLEY 81, MASSACHUSETTS

CIRCLE 970 ON READER SERVICE CARD

The Scientists and Engineers served by Corcoran in the last year have found the difference between "a job" and "the job."

- Nationwide. Fee paid.
- Please airmail background to:

JOSEPH P. CORCORAN
Personnel Consultants

505 B Germantown Pike
Lafayette Hill, Pa. 19444
(215) 825-0848

CIRCLE 968 ON READER SERVICE CARD



We have been placing B.S., M.S. and Ph.D. **ELECTRONIC ENGINEERS** in fee paid positions throughout the U.S. since 1959. Send resume today or request confidential application. We are graduate engineers, working full time . . . for you.

ATOMIC PERSONNEL, INC.
Suite L, 1518 Walnut St., Phila., Pa. 19102
AN EMPLOYMENT AGENCY FOR ALL TECHNICAL FIELDS

Don't forget the

BOX NUMBER

When answering the classified advertisements in the magazine don't forget to put the box number on your envelope. It's our only means of identifying the advertisement you are answering.

How a little Rexolite® helps Amphenol plug leaks in microwave lines.

Amphenol RF Division knew they had a tiger by the tail when they set out to come up with a new 7 mm precision connector. And they say their choice of Rexolite 1422 dielectric material had a lot to do with their success.

The challenge — Microwave test equipment and air lines had advanced to the point, particularly in low-signal-strength applications, where equipment manufacturers were calling for a new, stable connecting link that would have almost no loss at all! Current coaxial connectors, producing VSWR's of about 1.35 at 10 GHz wouldn't do.

The solution — Working within parameters established in an IEEE subcommittee, Amphenol developed the precision coaxial connector shown here. It operates to 18 GHz with a maximum VSWR of 1.039.

WHY REXOLITE —

1. The **dielectric constant** of this Brand-Rex material, chosen for the insulation, proved "just right for a coaxial design of 7 millimeters inside diameter" according to Amphenol engineers.
2. Rexolite's **consistency** of properties, piece-to-piece and batch-to-batch was found better than that of other materials considered.
3. And it provided better **stability**, particularly where temperature variations were involved.
4. Finally, Amphenol found Rexolite 1422 **machines beautifully**. The disk is cut from rod stock to within .0002" tolerance on thickness, I.D. and O.D. And sharp shoulders (.002" max. radius) are held.

Can you use a real, problem-solver dielectric like this? Write for the facts on REXOLITE clad, rod and sheet stock.

American Enka Corp., Brand Rex Division,
Willimantic, Conn. 06226, Phone: 203 423-7771.

BRAND-REX

Circle 192 on reader service card

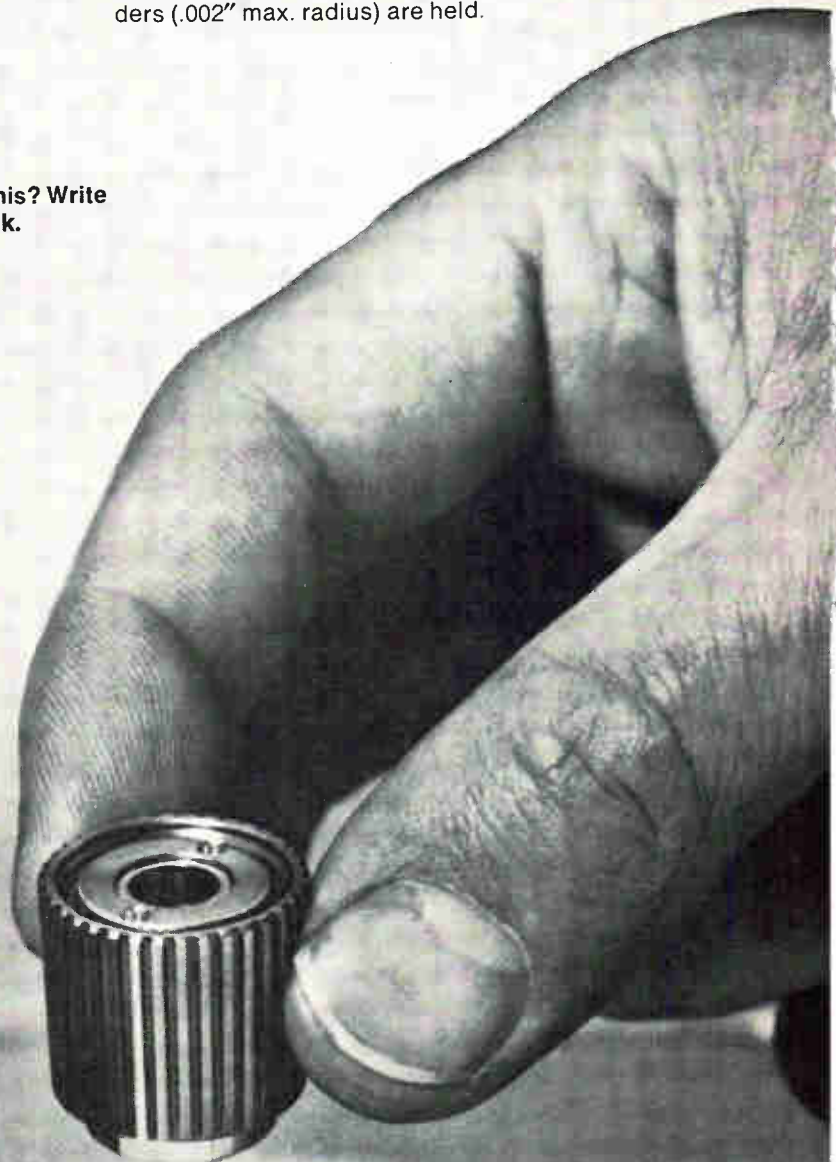

International Newsletter

August 18, 1969

**A new New Franc—
French to benefit . . .**

France's currency devaluation should boost French electronic exports and help French firms beat back the wave of Italian radios and other consumer electronic products that have been flowing into France because of their lower price tags.

But, the benefits will not be across the board. That's because French producers will have to pay more for every component they have to import. What's more, they face new labor negotiations this fall, and, with devaluation forcing import prices higher, the unions can be counted on to toughen their wage demands, expected to approach 10% even before devaluation. Higher wages could completely nullify the advantages of devaluation.

There's another factor, too, which limits the impact of devaluation. "In electronics," says Edouard Guigonis, sales vice-president of Thomson-CSF, "price isn't always the most important element." Technological advantages are more crucial than cost in such areas as defense electronics and advanced components.

The cut in the value of the franc is not expected to have any serious immediate effects on Britain, whose currency is considered about the weakest among the leading nations. True, there will be some slowing of British exports to France, especially in such sensitive areas as instruments, standard components and computers. But, there is not expected to be any significant increase in French sales in Britain because in the most price-sensitive areas—mass-produced components—British prices are comfortably below French prices.

**. . . but others
may gain more**

It looks like the biggest gainers by the devaluation will be American and other foreign companies producing in France. Their prices in France will stay about the same for now, but their export prices will be as much as 12.5% less. For example, Motorola Semiconductor Products Inc. is "delighted" to have based its first Common Market plant in France, says sales director Murray Duffin. Devaluation will certainly induce Motorola officials to step up French production and accelerate its plans to diffuse IC chips in its Toulouse plant. It was planning to import them from the United States, but U.S. chips are suddenly 12.5% more expensive.

**The sums are rising
in Japan . . .**

The fast growth of the Japanese electronics industry, which worries many American producers, may actually be underestimated. That's one sobering conclusion of a special study soon to be released to the membership of the Electronic Industries Association.

Take the field of IC's for an example. The report says that total consumption of IC's in Japan will almost double this year from 56.6 million units last year. For 1969, that figure will be 90 million. Imports from the United States during the same period will be nearly static, rising only from 8.6 to 9.5 million units.

And the Japanese are leaping forward with MOS IC's. They produced 6.5 million in 1968 and should make 7.4 million this year. This compares with the U.S. production of MOS IC's of 400,000 during 1968. Three-quarters of the total number of MOS IC's will be used in the fast growing electronic calculator industry, which went from 163,399 units in '68 to a projected 285,000 in '69.

International Newsletter

... as electronics industry booms

The Japanese are now looking for the same growth in the industrial/commercial area as they enjoyed previously in consumer electronics. And the big gun is computers. The upcoming EIA study reports that production of computers and associated equipment spurted from \$13.1 million in 1961 to \$455.0 million last year. Based on first quarter figures, it predicts a 1969 total production of between \$550 and \$575 million.

This phenomenal growth in the computer area was boosted by the Japanese Government. Its "Large-Scale Projects" (LSP) program in 1966 started federal funding for six technical objectives of pressing national urgency. One of the six—the only electronics goal in the pack—called for development of electronic computers. As of 1969 the total spent on computers has exceeded the total spent in the other five areas put together. What's more, the EIA report says this pattern of spending the most on computers will continue.

Telesat to gain from bad luck of other satellites

Technical failures experienced by international and U. S. military satellites have led to changes in the design for Canada's telecommunications satellite—Telesat—scheduled for launching in 1971.

RCA Ltd., which has the prime contract for Telesat, says the body of the satellite will have to be changed from cylindrical to a more squat shape. That means the satellite body will be more expensive than originally planned because it will now have to be custom made. However, it is not expected that the redesign will delay Telesat's launch, still two years off.

The Telesat antenna system which is specially designed to fit Canadian broadcast equipment will be built in Canada. TWR Inc. has been named to supply know-how on overall systems engineering and some subsystems of Telesat.

U.S. seeks to involve others in space effort

The U. S. Government is moving to offer greater participation in American space technology to other nations. An effort is growing in Congress to include money in the U. S. foreign aid program for space programs. One bill now being drafted calls for the Agency for International Development to establish a department which would help emerging nations set up satellite education television systems.

Meanwhile Secretary of State William Rogers has concluded an agreement with the Japanese which will allow U. S. firms to supply the Japanese with the assistance they need for an experimental synchronous communications satellite to be launched in 1973.

And in South America at a conference to iron out disputes over national fishing rights, the U. S. has offered to give three nations—Chili, Ecuador, and Peru—the use of a satellite to track the movements of schools of tuna in the South Pacific.

Czechoslovakia contracts for more Western hardware

Western technology continues to be attractive to East Bloc countries. In Prague, government officials have just approved a deal under which a Czech company will build teletypewriters under license from Siemens AG, the big West German electrical-electronics producer. Details of the agreement still have to be worked out. However, it is expected that the Czech firm will produce the teletypewriters—a Siemens model 100 which is widely used in Western Europe—primarily for the Czech domestic market. Production is likely to start next year.

Mass-produced read-only memory is custom wired after assembly

Diode matrix developed by engineers at Japan's Oki Electric Industry stores data at crosspoints by selective destruction of one of an opposed diode pair

One dream of equipment designers is a universal read-only memory that can be mass produced and, therefore, inexpensive, yet capable of being custom wired for many different low-volume applications.

These seemingly incompatible attributes are combined in new read-only memory circuit developed by engineers at Japan's Oki Electric Industry Co. In fact, the customizing of each circuit in the Oki approach is done after all fabrication steps, including packaging. That's because the memory content is completely independent of production stages. Instead, the contents of the memory are added by sending a writing current through the circuit at some later time, perhaps just before assembly in a finished device.

Grid. Oki's new memory consists of a diode matrix, in which the individual diodes are made like the base emitter diodes of IC transistors. At each crosspoint of the x and y lines of the matrix there are two back-to-back diodes. Back-to-back, the diodes will not conduct current in either direction between the x and y lines. Thus each crosspoint is electrically open—corresponding to 0.

To write a 1 into a given crosspoint, a pulse of about ten volts is connected with negative polarity on the x line and positive polarity on the y line. This voltage pulse breaks down and short circuits one of the diodes, to which it represents a reversed polarity. After writing, selected crosspoints, which correspond to 1, have a single diode with a reverse voltage rating of at least 6 volts between the x and y lines. Unselected cross-

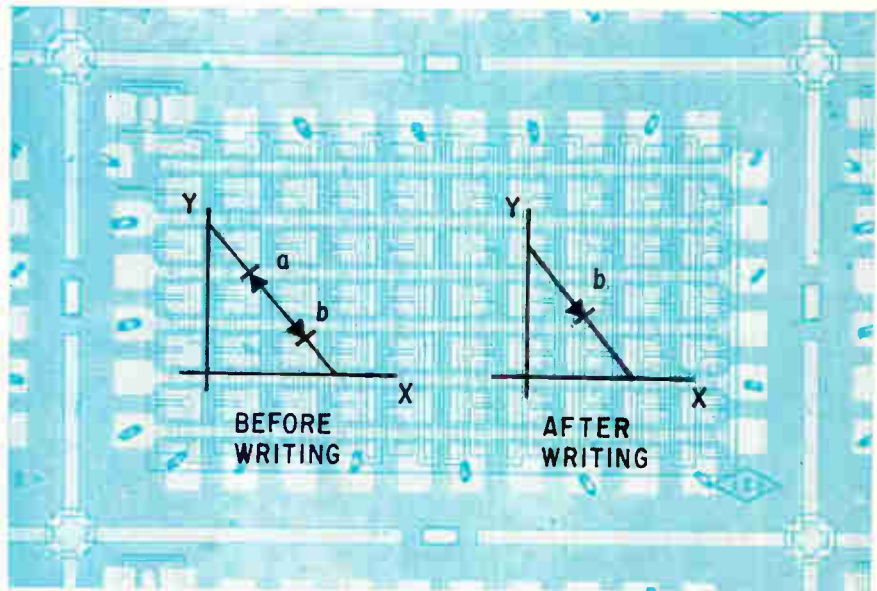

Breakdown. Grid with back-to-back diodes at each crosspoint can be made in quantity. Costly custom masks are not needed to adapt the array to low-volume applications. Electrically an open circuit, a crosspoint is changed to a closed circuit by destroying one diode with a 10 volt pulse.

points, which correspond to 0, are essentially open circuits for voltages under 6 volts of either polarity.

The writing process is simplified by charging a capacitor of 5 to 10 microfarads to 10 volts and then connecting it to each crosspoint where a 1 is required. And this process can be performed at high speed using the IC handlers incorporated in many IC testers. Oki's semiconductor plant is now doing the writing, but it expects customers to take care of their own customizing and is developing writing equipment for this purpose.

High level. Because the diode matrix can operate with signals of up to 6 volts, no sense amplifier is

required. Thus, the memory can directly drive transistor-transistor logic, such as Texas Instruments series 74; diode transistor logic; and similar circuits. In the first finished equipment using these memories, the clock rate is 5 megahertz, but the memories are capable of operation at much higher speeds. The response of the diodes, including stray capacitance in small memory arrays, is 20-nanosecond rise time and 5-nanosecond reverse-recovery time.

Oki's first memory product is a 6 by 10 matrix on a 1.3 by 2.0 millimeters silicon chip. These are mounted in a 14-lead package and connected as a 5 by 8 memory which uses up 13 of the pins. Oki

next will build a higher density 16 by 16 matrix with memory capacity of 256 bits in a pin package.

For larger memories, for example, one with 1,024 bits, the number of pins required would be too large for efficient fabrication. For these units Oki expects to include address circuits on the chip to reduce the number of pins required. With address circuits, information can be written into memory—just as with a simple matrix—if the safe working voltage of the address-circuit transistor is greater than the breakdown voltage of the diodes that are shortcircuited during writing. This should be easy to implement although Oki has not yet built circuits of this type, because collector junctions of transistors normally have much higher reverse-breakdown voltage ratings than junctions of the base-emitter type that are used for memory diodes.

On display. The memory circuit is being used initially for character patterns in a small remote computer terminal display unit. These memories are used to hold the characters for 96 different patterns, including the Roman alphabet, Arabic numerals, Japanese katakana characters, punctuation marks, and other symbols. A total of 72 characters can be displayed on the unit's 4-inch cathode-ray tube. Applications of the display include retrieval of stock prices from a computer and seat-reservation data handling.

In the same data terminal, another 23 types of these read-only memories are used for decoding inputs from the keyboard. Thus in the data terminal, a total of 119 different read-only memories with different contents are used.

Oki has just introduced the display unit and has great hopes for sales, but there is no guarantee that large numbers will be sold. Thus the company would not have been able to develop a unit with a semiconductor read-only character-pattern memory if separate diffusion masks were required for each of the 96 different characters patterns. The unit also has a greater versatility because it is possible to easily and rapidly exchange a standard character or symbol for any charac-

ter or symbol desired by the customer: each new character is represented by a different pattern of dots generated by the 5 by 8 matrix.

West Germany

Streamlining the flow

For untangling traffic, West German cities are going all out for electronic data-processing systems.

The chief supplier—and profit beneficiary—is Siemens AG, the country's No. 1 electrical-electronics producer. Indeed, Siemens has sold so many traffic-control computers that it already has become the leader among European computer firms competing in the traffic-control market.

From April 1965, when its first traffic-control computer made West Berlin the first European city with computerized traffic control, Siemens has put into operation no less than 28 such systems in West Ger-

many alone. Thirteen more, for installation there, are on order.

From Hamburg in the north to Freiburg in the south, the company's VSR 3000 and VSR 16000 machines are unsnarling traffic. Medium-sized German towns, such as Braunschweig, Heidelberg, and Mannheim, have one machine. Some bigger cities, like West Berlin, Frankfurt, and Hamburg, have several Siemens traffic computers either already in use or on order. And Siemens computers are easing traffic flow outside Germany, in places like Vienna, Utrecht, Helsinki, and soon in Ankara, Turkey.

Convertible. Now Siemens, to make sure it keeps its dominant position in the field, has expanded its work horse VSR 16000 machine into a traffic-control computer family that includes four different models. All are of modular construction so that one model can easily be converted into the next larger one by substituting or adding appropriate central units, storage devices or peripheral equipment. For a central unit, each model uses a computer of Siemens 300 series.

The four models range in price from below \$100,000 to more than \$250,000 depending on the number and type of peripheral devices externally connected. The smallest version can handle at least 70 intersections. The storage capacity of the four models ranges from 16,000 words to 65,000 words.

The four models differ from one another in their storage capacity and also in the number of machine commands and peripheral devices they can handle. But common to all four is their 24-word-bit code and command structure and the interface unit design. Furthermore, all can be used with one programming language, called Prosa 300, a machine-oriented language developed by Siemens for its 300 series.

The two smallest models, the 16002 and 16004, each have one central control computer and one or more signaling elements. The control computer stores all the required light-signaling data such as the typical amount of traffic at a particular time of day, say rush hour, and the switching intervals and on-off durations for the green,



Under control. Traffic flow is analyzed and directed by Siemens computer. Display helps in simulation.

yellow and red lights required to insure optimum traffic flow. The signaling element is an external unit containing circuitry for receiving the detector outputs and for switching the traffic lights.

The two larger systems, the 16013 and 16014, consist of two computers each—the control computer and a signaling computer. For the 16013 the control computer is a Siemens 303 process-control computer while the 16014 uses a Siemens 304. The signaling computer, especially developed for traffic-control purposes, is made up of fixed-wired control logic and a core store for the traffic-detector output data. The control-logic circuitry directs a periodic scan and evaluation of the core store's data content and, with the traffic-light control programs stored in the control computer, produces the switching commands for the lights at the intersections.

Japan

Thinking small

Now the Japanese electronics industry is off and running after the minicomputer market. Three more companies have joined early starters Fujitsu and Hitachi [*Electronics*, March 17, p. 199] and more are expected to enter the race.

All three new entries—the Nippon Electric Co., the Oki Electric Industry Co., and the Matsushita Communication Industrial Co.—have based their computers on transistor-transistor logic. TTL is well developed in Japan due, among other things, to competition for European supply contracts.

One. By next year, Nippon Electric—one of Japan's big three computer manufacturers, with Fujitsu and Hitachi—expects to be selling 50 of its new NEAC M4 computers a month. The computer is designed to be a system component or a data terminal. It contains its own power supply and can be installed in standard racks or on a desk-top cabinet.

The M4 has a 1.5 microsecond memory cycle and an add time for

an 8-bit word of 4.5 msec. It has, however, a variable word length feature that shortens add time per bit for longer words. Thus for 16 bits the add time is 6 msec, and for 32 bits the add time is 9 msec. While the arithmetic time is similar to that of other computers in its class, provision for 66 basic instructions—more than 600, counting register instructions—greatly speeds processing time. The computer has two internal and 11 external interrupts. Up to 8,000 words can be stored in internal memory and up to 32,000 words all together. Price of the computer with basic 4,000 word memory is \$9,772.

Two. Oki Electric's entry is the Okitac-4300. It is made by Oki itself, rather than by Oki Univac Kaisha Ltd., the company's joint venture with Sperry Rand, which makes bigger Univac-type machines.

The Okitac-4300 is designed for scientific computation, process control, measurement control, and data terminal applications. It is built around a word of 16 information bits plus a parity bit. Cycle time is 1.5 msec and add time is 3.84 msec. Four levels of interrupt are provided. Not counting input and output instructions, the 4300 has 39 instructions available.

The computer can hold up to 8,000 words in its main frame, with a maximum core memory capacity of 16,000 words. Oki has set a price of \$10,000 for the basic computer with 4,000 words memory. The company plans to produce about 100 units a year.

Three. Matsushita, a general-purpose computer dropout, is reentering the field via minicomputers. The company says it needed its own computers for use in traffic-control and broadcast-equipment control systems.

The Matsushita computer has a 16-bit word length, a cycle time of 2.1 msec, and add time of 4.2 msec, and two levels of interrupt. In addition to an internal power supply, it has many other internal components that the company feels are necessary for control applications. These include a photoreader power supply, a crystal clock, two slow-speed digital input channels

and one digital output channel. All this, of course, makes for a more expensive machine. Its price, including 4,000 word memory, is \$15,555.

Film making

Thin film resistors and conductors can be deposited with little difficulty on hybrid integrated-circuit substrates, but a simple fabrication technique for capacitors have proved illusive.

Now engineers at the Research and Development Center of the Tokyo Shibaura Electric Co. have been successful in harnessing the oxide of the rare earth yttrium to the vacuum-deposition process, the same process used to deposit other materials for making thin-film hybrid circuits. Thin films of Y_2O_3 are not only adaptable to present production methods, but also allow the use of capacitors as small as 15% of the size needed with silicon-based dielectric materials, and a 100-fold increase in effective capacitance.

Obstacles. The most widely used dielectrics for thin-film capacitors on hybrid IC substrates are silicon oxide (SiO_2) and tantalum oxide (Ta_2O_5). Toshiba says that disadvantages of the silicon oxide include poor reproducibility and low capacitance per unit area. Hand-in-hand with poor reproducibility goes poor stability. A major reason for poor reproducibility is that silicon oxide is incompletely

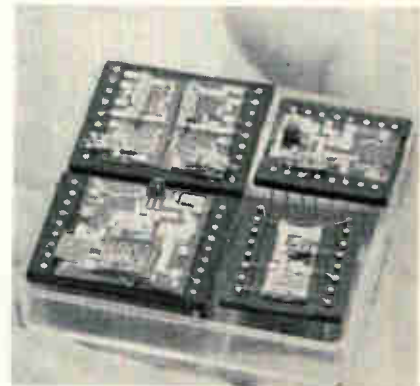

Handful. Hybrid circuit for tv tuner has yttrium-oxide capacitors.

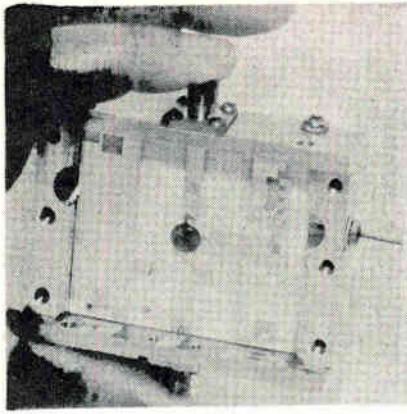

High frequency. Thin-film material is used in microwave amplifier.

oxidized and the actual film includes some silicon dioxide. A film completely composed of silicon dioxide would be more stable, but cannot be economically produced by the fabrication methods that are now in use.

Disadvantages of the tantalum-oxide film includes complexity of the fabrication process. Films of tantalum oxide cannot be deposited because they decompose into metal and oxygen. Thus it is necessary to deposit the metal and then anodize it electrolytically to obtain a film of the oxide.

Because of the difficulties of these two well known methods of producing capacitors on substrates, most hybrid circuits now use capacitor chips that are attached to the circuit rather than being formed on the substrate.

In a vacuum. Toshiba says that it is able to deposit a yttrium-oxide dielectric for capacitors by vacuum deposition and that repeatability has been excellent. Dielectric constant of the film is 15 and breakdown voltage is about 5 million volts per centimeter. Capacitors using yttrium oxide can be fabricated in layers for increased capacitance. Capacitors as large as 0.1 microfarads, which is about 100 times the limit for silicon-oxide capacitors, can be made.

Capacitors fabricated by the new process and placed on life test have shown a capacitance change of less than 0.5% in 1,000 hours. Temperature coefficient of capacitors fabricated with this film is about 300 parts per million. Resistivity is 10^{16}

ohm-centimeters. Compared with other materials the incidence of pinholes is small, so it is possible to make relatively large-area films. In addition to its use as a capacitor dielectric, the new material can also be used as a protective film over other thin-film elements.

The new yttrium-dielectric film does not require special conductors. It can be used with conventional conductors, such as gold and aluminum, and conventional resistance materials, such as Nichrome, to form a complete circuit.

Prototypes. Two experimental applications using capacitors with the new yttrium film have been tried to test its circuit performance in hybrid integrated circuits.

One of these applications is a hybrid IC circuit for a contactless varactor-diode tuned vhf tv tuner for Japanese channels 1 to 12. The tuner circuits are divided into four blocks—high frequency amplifier, mixer, coupling circuits, and local oscillator. Channels are selected by changing bias on varactor diodes. Toshiba says that by changing pattern design it should also be possible to build a tuner.

An experimental microwave thin-film hybrid IC, equivalent to an S-band transistor amplifier, has also been developed. Its maximum gain is 6.4 decibels at 2.1 gigahertz, and bandwidth for drop in gain of 1 db is 400 megahertz. The noise figure is 5.4 db. By use of a proprietary design it should be possible to make IC's that operate at frequencies as high as 9 Ghz.

Sweden

Dimming the color

Color television in Sweden is having some growing pains. While the Swedes have been broadcasting in color for about two years, color programing still only amounts to about 15 hours a week. Next year, though, a second channel will begin colorcasting, and the number of hours will double. What's more, public demand for color sets is booming. In 1967, when in anticipation of the 1968 Olympics the

first color tests were held, 3,000 sets were sold. In 1968, 42,000 more were sold. And this year, early estimates put sales at 100,000 to 120,000 sets.

This breathless pace, however, was noticeably slowed by recent Government anti-inflationary measures that have made borrowing all but impossible. Yet the relatively high cost of color television sets—about \$700 for a 22-inch set—has meant that some kind of financing is necessary.

Thus, in what should be a seller's market with fixed, high prices, discounting, the traditional hallmark of a buyer's market, has come to color television. In fact, price differences across Sweden for the same set amounts to as much as 30%, according to a just-released study by the Swedish Price and Cartel Agency.

Guideline. The study has now become the bible for wise color-tv set shoppers. It lists the highest and lowest prices of the 15 most popular models, gathered from retailers in eight of the largest cities.

The agency found a \$125 price tag difference between shops in Stockholm for a 22-inch Swedish-made set, with prices ranging from \$675 to \$800. Another Swedish-made 22-inch set was tagged at \$660 in a Stockholm shop, but was priced at \$850 in a shop in Malmoe, in south Sweden. Dagens Nyheter, the nation's leading morning paper, which played up the story on page one, noted that shop expenses such as rents and services are much higher in Stockholm, yet Stockholm prices were generally lowest for all makes and models.

Only one make, the Luma made by Koerting of West Germany and sold by the Consumer Cooperative Federation, had the same—and cheapest—price nationwide.

This make, however, has a small share of the market, with Philips and an AGA subsidiary holding the largest shares. Philips and AGA have a joint production agreement, with all sets, sold under a half-dozen trade names, being made in one Philips factory in Sweden. Imports, 77% of which were from West Germany, accounted for 41% of the color-tv sales.

Electronics advertisers

August 18, 1969

Alrco Speer Electronic Components Hazard Adv. Co., Inc.	151	E G & G, Inc. Culver Adv., Inc.	61	MetroData Systems, Inc. Robert V. Freeland & Assoc.	166
Airpax Electronics, Inc. Tech Communications, Inc.	144	Elco Corp. Schaefer Adv., Inc.	202	Miller-Stephenson Chemical Co., Inc. Michel-Cather, Inc.	187
Allen-Bradley Co. Fensholt Adv. Agcy.	27, 29	E/MC Electronics/ Management Center	64, 125 to 128, 183	Mini-Systems, Inc. John F. Norris & Co., Inc.	182
AMP Europe Allardyce Palmer, Ltd.	3E, 4E	Ries Cappiello Colwell, Inc.		Mohawk Data Sciences Corp./ OEM Marketing	79
AMP, Inc. Garceau, Hallahan & McCullough, Inc.	30, 31, 180	Electronic Research Associates, Inc. Josephson Cuffari Co.	134	MacFarland Assoc., Inc. Monsanto Co.	200
Amperite Co. H.J. Gold Co.	132	Erie Technological Products Co., Inc. Arthur Schmidt International, Inc.	57	Michel Cather, Inc. Murata Mfg. Co., Ltd. AMO, Inc.	186
Ancona Corp./Neumuller and Co. Wilhelm Bacher Werbung	178				
Ansley Richard L. Renner Industrial Adv.	102, 103				
Applied Materials Hall Butler Blatherwick, Inc.	78	Fluke Manufacturing Co., John Bonfield Assoc.	25		
Automatic Electric Co., Sub. of General Telephone & Electronics Corp. Marsteller, Inc.	74, 75				
				National Electronics, Inc. Connor-Sager Associates	187
Babcock Relays Div. of Babcock Electronics Corp. Jansen Assoc., Inc.	15			National Semiconductor Corp. Hall Butler Blatherwick, Inc.	62, 63
Barnes Corp. Industrial Public Relations, Inc.	142	Gencom. Division—Varian/EMI A.D. Adams Adv., Inc.	188	New York State Electric & Gas Corp. Rumrill-Hoyt, Inc.	136
Bausch & Lomb, Inc. Wolff Assoc., Inc.	143	General Atronic Corp. Garceau Hallahan & McCullough, Inc.	167	Norton Associates, Inc. J.J. Coppo Co.	188
Bell, Inc., F.W. Wheeler, Kight & Gainey, Inc.	56	General Electric Co., Capacitor Div. Robert S. Cragin, Inc.	124		
Bell Telephone Laboratories N.W. Ayer & Son, Inc.	65	General Electric Co., Information Services Dept. Robert S. Cragin, Inc.	175	Oltronix Svenska	10E
Bourns, Inc., Trimpot Div. The Lester Co.	97	General Radio Co. Horton Church & Goff, Inc.	6		
Braincon/General Time Alden Adv. Agcy., Inc.	185	Granger Associates West Associates	60	Parelco, Inc. Van Der Boom, McCarron, Inc.	119
Brand-Rex Creamer, Trowbridge, Case & Basford, Inc.	192	Grayhill, Inc. Merchandising Adv., Inc.	26	Pearson Electronics William E. Clayton & Assoc., Inc.	7
Buckbee-Mears Co. Midland Assoc., Inc.	45	Guardian Electric Mfg. Co. K & A Advertising	73	Permag Corp. Schneider, Allen, Walsh, Inc.	172
Bunker-Ramo Co. Diener & Dorskind, Inc.	146, 147, 177	Gudebrod Brothers Silk Co., Electronics Div. Ramsdell-Bickley & Co.	116	Philbrick/Nexus Research Renaccio Adv., Inc.	156
Bunker-Ramo Corp., Amphenol Div. Marsteller, Inc.	155			Philco-Ford Corp. Hal Lawrence, Inc.	13E
Burns & Towne, Inc. Hall-Karmatz Assoc., Inc.	14	Heinemann Electric Co. Thomas R. Sundheim, Inc.	16	Philco Ford Co., Microelectronics Div. The Aitkin-Kynett Co., Inc.	120
Burrough Corp. Electronic Components Div. Conti Adv. Agcy., Inc.	10, 11	Hewlett Packard, Colorado Springs Div. Tallant/Yates Adv., Inc.	2	Phillips N.V. PIT/EMA Div. Marsteller International S.A.	2E
By-Buk Co. Albert Frank Guenther Law Adv., Inc.	184	Hewlett Packard, Frequency & Time Div. Lennen & Newell, Inc.	1	Precision Instrument Co. Hal Lawrence, Inc.	121
		Hewlett Packard, Loveland Div. Tallant/Yates Adv., Inc.	34	Precision Paper Tube Co. T.W. Blackeslee Adv.	54
		Hewlett Packard, Microwave Div. Lennen & Newell, Inc.	20, 21	Princeton Applied Research Corp. Mort Barish Assoc., Inc.	46
Cartesian, Inc. Miller/Stoll Adv.	32	Hewlett Packard, New Jersey Div. McCarthy, Scelba and DiBiasi Adv. Agcy., Inc.	133		
Centralab Div. of Globe Union, Inc. The Brady Co.	159	Hewlett Packard, Rockaway Div. Culver Adv., Inc.	59	Radio Corporation of America Al Paul Lefton Co.	4th Cover, 9, 77, 185
Chester Cable Corp. Lewis Adv. Agcy.	22, 23	Honeywell, Commercial Div. Campbell Mithum, Inc.	173	Redcor Corp. Management Communication Consultants, Inc.	163
Cinch Manufacturing Co. Sral Adv. Co., Inc.	80	Honeywell—Florida Bradley Yeager & Assoc., Inc.	118	Rohde & Schwarz Fletcher-Walker-Gessell, Inc.	170
Cinch Graphik Div. of United Carr Fastener Co. Reach McClinton & Co.	28	Honeywell Test Instruments Div. Campbell Mithum, Inc.	160		
Cintra Bonfield Associates	17, 18	IBM—Federal Systems Div. Marsteller, Inc.	129	SDSA Public Service, Neuilly	5E
Clairax Corp. Michel-Cather, Inc.	169	International Electronic Research Corp.	12, 13	Semtech Corp. Burruss Advertising	66
Clevite Corp./Gaging & Control Div. Carr Liggett Adv., Inc.	122	ITT Components Group Brockie Haslam Chinery & Allon, Ltd.	6E, 7E	SGS Lonsdale Italia S.P.A.	8E
Computer Products, Inc. Grenman Assoc., Inc.	182	ITT Wire and Cable MacManus, John & Adams, Inc.	137	Sierra Research Corp. B.P. Myer Assoc., Inc.	180
Connecticut Hard Rubber Co. Chirurg & Cairns, Inc.	148			Signetics Corp., Sub. Corning Glass Works	109
Control Data Corp./Magsense Barnes-Champ/Advertising	154	Keithley Instruments, Inc. Bayless-Kerr Co.	158	Cunningham & Walsh, Inc.	
CREL, Home Study Div. of the McGraw-Hill Book Co. Henry J. Kaufman & Assoc.	179	Kikusui Electronics Corp. General Adv. Agcy.	12E	Silec Electronique Publicite Y Ch. Lambert	15E
		Krohn-Hite Corp. L.K. Frank Co., Inc.	135	Siliconix, Inc. Graphics West	67
Dale Electronics, Inc. Sub. of Lionel Corp.	3rd Cover			Solitron Devices Inc., Transistor Div. Haselmire Pearson Adv., Inc.	181
Develco, Inc. Hal Lawrence, Inc.	76	Marconi Instruments, Ltd. Taylor Adv., Ltd.	16E	Sperry Rand Corp., Sperry Microwave Electronics Div.	70
Dialight Corp. Michel Cather, Inc.	164	Martin Marietta Corp. Redmond Marcus & Shure, Inc.	55	Neals & Hickok, Inc.	
DuPont de Nemours Co., Teflon Div. Batten, Barton, Durstine & Osborn, Inc.	114	Metrimpond Hungexpo	11E	Sprague Electric Co., The Harry P. Bridge Co.	5, 152
Durant Digital Instruments Franklin Mautner Advertising	174			Stewart Warner Microcircuits, Inc. Jones, Maher, Roberts, Inc.	130
				Sylvania Electric Products, Inc., Electronic Components Group	37 to 44
Eagle Signal Div. of Gulf & Western Co. Feeley & Wheeler, Inc.	117			Doyle Dane Bernbach, Inc.	
				Sylvania Electric Products, Inc., Parts Div.	115
				Doyle Dane Bernbach, Inc.	
				Synthane-Taylor Corp. Gray & Rogers, Inc.	201



Our visible solid state light sources are being delivered in commercial quantities.

Very bright, typically 1000 ft/L @ 50 mA.

Long life: our tests indicate over 1,000,000 hours.*

Happily compatible with your IC circuitry.

Needs only 10 mW for 50 ft/L @ 6300-7000Å.

Instantly available in package shown or TO-18 header.

Ask Kierulff, Schweber, K-Tronics, or Semiconductor Specialists for our data sheets on the MV-10 series.

Monsanto ESP, 10131 Bubb Road, Cupertino, California 95014. Phone (408) 257-2140

* $T_A = 25^\circ\text{C}$, $I_f = 50\text{ mA}$. Result of step-stress testing with end of life projections.

Monsanto

■ Technipower	176
S & S Creative Services	
■ Tektronix, Inc.	104
Dawson, Turner & Jenkins, Inc.	
Telonic Instruments	69
Jansen Assoc., Inc.	
Test Equipment Corp.	140
Dean & Bain Adv., Inc.	
Texas Instruments Incorporated,	19, 58, 68
Components Group	
Albert Frank-Guenther Law, Inc.	
Todd Products Corp.	24
Ira Levine Adv. Assoc., Inc.	
■ Transformer Electronics Co.	162
Wolff & Weir	
■ Tung-Sol Div., Wagner Electric Corp.	186
Feeley & Wheeler, Inc.	
Union Carbide Co.	92
Windfield, Inc. Adv.	
United Transformer Co.,	
Div. of TRW, Inc.	2nd Cover
Fuller & Smith & Ross, Inc.	
■ Unitrode Corp.	53
Silton Brothers, Inc.	
Utah Industrial Promotion Commission	141
David W. Evans & Associates	
U-Tech, Industrial Physics and	
Electronics Co. Div.	168
Ross Clay Advertising	
Wavetek	123
Chapman, McQuiston Michetti	
Advertising	
Wems, Inc.	165
Nova Advertising	
■ White Instruments, Inc.	142
Wilson & Assoc., The Art Studio,	
Graphic Studios Div.	
Wiremold Co., The	184
Charles Brunelle Co.	
Zippertubing Co.	188
Edward S. Kellogg Co.	

Classified & Employment Advertising

F.J. Eberle, Manager
212-971-2557

EMPLOYMENT OPPORTUNITIES ... 190-191

Corcoran, J.P. 191
Louisiana State University 191

EQUIPMENT (Used or Surplus New) For Sale

Fishman, Philip Co. 191
Radio Research Instrument Co. 191

- For more information on complete product line see advertisement in the latest Electronics Buyer's Guide
- Advertisers in Electronics International

Electronics Buyers' Guide

George F. Werner, Associate Publisher
[212] 971-2310

Robert M. Denmead,
Midwest Regional Manager
[312] MO 4-5800

William A. Capuzzi,
New York, New England District Manager
[212] 971-3793

Regina Hera, Directory Manager
[212] 971-2544

Thomas M. Egan, Production Manager
[212] 971-3140

Carol Gallagher,
Assistant Production Manager [212] 971-2045

Circulation Department

Isaaca Siegel, Manager [212] 971-6057

Research Department

David Strassler, Manager [212] 971-6058

Advertising Sales Staff

Frank E. LeBeau [212] 971-6464
Advertising Sales Manager

Wallis Clarke [212] 971-2187
Advertising Sales Service Manager

Donald J. Austermann [212] 971-3139
Promotion Manager

Warren H. Gardner [215] LO 8-6161
Eastern Advertising Sales Manager

Atlanta, Ga. 30309: Michael H. Miller, 1375
Peachtree St., N.E.
[404] 892-2868

Boston, Mass. 02116: William S. Hodgkinson
McGraw-Hill Building, Copley Square
[617] CO 2-1160

Cleveland, Ohio 44113: William J. Boyle, 55
Public Square, [216] SU 1-7000

New York, N.Y. 10036
500 Fifth Avenue

James R. Pierce [212] 971-3615
John A. Garland [212] 971-3617

Michael J. Stoller [212] 971-3616
Philadelphia, Pa. 19103:

Jeffrey M. Preston
Warren H. Gardner,
6 Penn Center Plaza,
[215] LO 8-6161

Pittsburgh, Pa. 15222: Jeffrey M. Preston,
4 Gateway Center, [412] 391-1314

Rochester, N.Y. 14534: William J. Boyle,
9 Greylock Ridge, Pittsford, N.Y.
[716] 586-5040

Donald R. Furth [312] MO 4-5800
Midwest Advertising Sales Manager

Chicago, Ill. 60611: Kenneth E. Nicklas
Raiph Hanning 645 North Michigan Avenue,
[312] MO 4-5800

Dallas, Texas 75201: Richard P. Poole, 1800
Republic National Bank Tower,
[214] RI 7-9721

Houston, Texas 77002: Robert Wallin,
2270 Humble Bldg. [713] CA 4-8381

Detroit, Michigan 48226: Raiph Hanning,
856 Penobscot Building
[313] 962-1793

Minneapolis, Minn. 55402: 1104 Northstar
Center [612] 332-7425

St. Louis, Mo. 63105: Kenneth E. Nicklas,
The Clayton Tower, 7751 Carondelet Ave.
[314] PA 5-7285

James T. Hauptli [415] DO 2-4600
Western Advertising Sales Manager

Denver, Colo. 80202: David M. Watson,
Tower Bldg., 1700 Broadway
[303] 266-3863

Los Angeles, Calif. 90017: Ian C. Hill,
Bradley K. Jones, 1125 W. 6th St.,
[213] HU 2-5450

Portland, Ore. 97204: James T. Hauptli,
Don Farris, 218 Mohawk Building,
222 S.W. Morrison Street,
Phone [503] 223-5118

San Francisco, Calif. 94111: James T. Hauptli,
Don Farris, 255 California Street,
[415] DO 2-4600

Pierre Braude Tel: 225 85 88: Paris

European Director

Paris: Denis Jacob
88-90 Avenue Des Champs-Elysees, Paris 8

United Kingdom and Scandinavia

London: Oliver Ball, Tel: Hyde Park 1451
34 Dover Street, London W1

Milan: Robert Saidel, Roberto Laureri Jr.
1 via Baracchini Phone 86-90-656

Brussels: Denis Jacob

27 Rue Ducale Tel: 136503
Frankfurt/Main: Hans Haller

Elsa-Brandstroem Str. 2

Phone 72 01 81

Geneva: Denis Jacob

1 rue du Temple Phone: 31 95 60

Tokyo: McGraw-Hill

Publications Overseas Corporation,
Kasumigaseki Building 2-5, 3-chome,
Kasumigaseki, Chiyoda-Ku, Tokyo, Japan

[581] 9811

Osaka: Akihiko Kamesaka, McGraw-Hill

Publications Overseas Corporation, Kanda

Bldg., 163, Umegae-cho Kita-ku [362] 8771

Business Department

Stephen R. Weiss, Manager

[212] 971-2044

Thomas M. Egan,
Production Manager [212] 971-3140

Maury D'Gongora,
Assistant Production Manager [212] 971-2045

Dorothy Carmesin, Contracts and Billings

[212] 971-2908

Frances Vallone, Reader Service Manager

[212] 971-2865

FLEXIBLE

Taylor is your only source for Riegel Monotherm® copper clad polyimide film. It offers unmatched reliability and ease of fabrication. Basic properties of the film and a high temperature thermoset adhesive permit the use of high pressure without "swimming" or rupture. Retains dimensional stability and resists normal soldering temperatures. Withstands 180° creases without cracking or separating.

For specialized flexible circuit applications, Taylor can offer a wide range of dielectric films and metallic foils.

RIGID

Taylorclad FIREBAN 1011E is a premium glass-epoxy copper clad for critical circuit needs. It combines all of the basic properties of NEMA G-10, G-11, FR-4, and FR-5 grades. Heat resistant, flame retardant, it meets MIL-P-13949 and takes precision drilling, punching and shearing.

Taylor also has three other glass epoxy grades of copper clad, plus Teflon glass to meet your circuit needs.

Only Taylor offers total service for all your copper clad needs

All Taylor copper clad laminates are trouble-free for faster, easier processing.

Help you meet MIL-P-55110.

Write for data, prices and samples.

ULTRATHIN

Composites of copper foil glass epoxy laminates that save space and weight. Thicknesses range from .003 through .031 inches. GEC 550 meets NEMA G-10. FIREBAN 650 is flame retardant—meets NEMA FR-4. Both can be readily processed with standard equipment and solutions.

Taylor's controlled flow prepreg systems have low gel time—30-second range—resulting in minimal circuit displacement during the pressing cycle.

Taylor corporation

A subsidiary of Alco Standard Corporation

Valley Forge, Pa. 19481 • 215-666-0300
La Verne, Calif. 91750 • 714-593-1341
In Canada: Small Fibre Stampings, Ltd. • Scarborough, Ont. 416-751-6655

Manufacturer of Tayloron® Laminated Plastics, Taylorite® Vulcanized Fibre, Tayloron Prepregs, Taylor Fabricated Parts



How our Variplate™ connecting system keeps your fifty-cent IC's from becoming four-dollar headaches.

IC's don't cost much. Until you use them. You can buy, say 20,000 IC's for the innards of a compact computer, packed in the transistor cans, flat packs, or Dual-in-Line (DIP) packages, for a unit cost of less than fifty cents.

Great.

But then you have to connect them.

Not so great.

Because those 20,000 IC's have anywhere from 200,000 to 280,000 leads waiting to be connected. Fine leads. Closely spaced. And, of course, you want to pack the IC's as densely as possible. So it's really no surprise that your *in-place* cost of an IC can climb to \$4.00.

Fortunately, we have a system that can keep your in-place cost down: the Variplate interconnection system.

With the Variplate system, you can pack those IC's—and all the pc boards and other components you have—as densely as the application demands. You can do it on automated equipment—and we'll even do the wiring for you.

All the components you need.

The system begins with the base plate, a self-supporting structural member. It carries the insulated contact modules, accommodates secondary components and hardware, and provides for mounting to support framework.

The plate can be a single metal sheet that provides a ground plane, or it can be a sandwich that provides both volt-

age and ground planes for common bussing.

For the next layer in your electronic sandwich, we have all the header plates, card-edge receptacles and guides, and bushings you're likely to require. (For unlikely requirements, we'll come up with something new.)

And the connectors. Of course. Our own respected Varimate™, Varicon™, and Varilok™ connectors, or standard fork-and-blade, terminal stud, card-edge, or bus strip contacts. Your choice.

No holes barred.

We put all these components together in any size, any shape, and almost any density of package you require. Plates can be any size. Contacts can be spaced on .100", .125", .150", or .200" centers, in square or offset grids—on non-standard configurations where you need them.

What you get is a solid electrical and mechanical foundation for your electronic network, so precisely made that any automated assembly equipment can take over from there.

However.

You'll save time and money if you let us go one step further and wire your network for you. Our

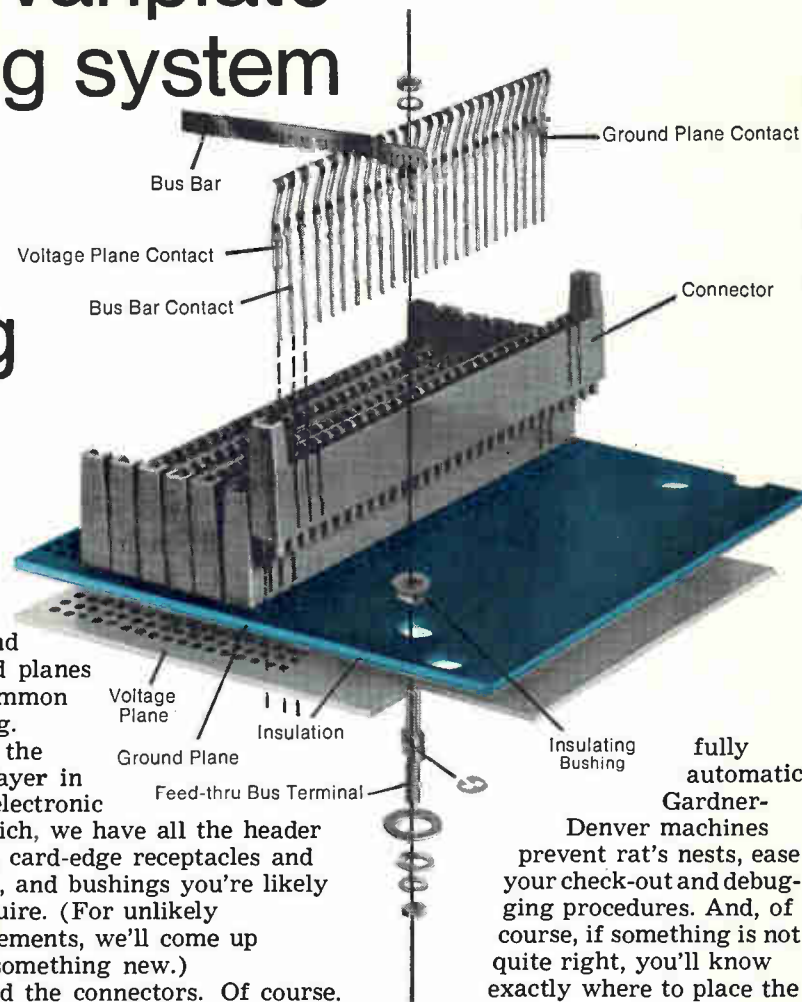

fully automatic Gardner-
Denver machines prevent rat's nests, ease your check-out and debugging procedures. And, of course, if something is not quite right, you'll know exactly where to place the responsibility.

Altogether, it's quite a system. And worth all the work we've put into it. Because if we can save you just a nickel on the cost of installing each of your 20,000 IC's you can add a thousand dollars to

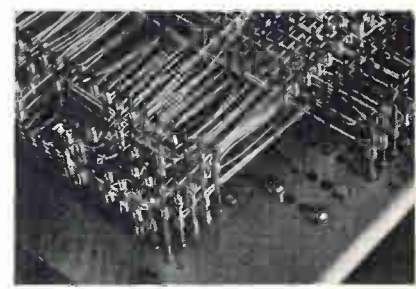

your company's profits. We're sure we can save you that nickel, and more. For more information, write, wire, call, or TWX us for our Variplate interconnecting systems catalog. Elco Corporation, Willow Grove, Pa. 19090. 215-659-7000; TWX 510-665-5573.

ELCO Variplate Connectors

Electronics reader service

Warning: The Post Office now requires your ZIP CODE on all mail. Please include your ZIP CODE number when filling out your reply card.

Use these handy post cards for more detailed information on: products advertised, new products, new literature.

Circle the number on the Reader Service post card that corresponds to the number at the bottom of the advertisement, new product item, or new literature in which you are interested.

Please print clearly. All written information must be legible to be efficiently processed.

If someone has beaten you to the post cards, you may obtain the needed information by writing directly to the manufacturer, or by sending your name and address, plus the Reader Service number, to Electronics Reader Service department.

All inquiries from outside the U.S. that cannot reach Electronics before the expiration dates noted on the Reader Service post card, must be mailed directly to the manufacturer. The manufacturer assumes all responsibilities for responding to inquiries. Electronics merely provides and clears requests for information from inquirer to manufacturer.

Correct amount of postage must be affixed for all mailings from outside the U.S.

To subscribe to or to renew Electronics

Fill in the "For Subscriptions" area on the card if you desire to subscribe to or renew your present subscription to Electronics. Send no money. Electronics will bill you at the address indicated on the Reader Service post card.

Multi-product advertisements

For information on specific items in multi-product advertisements which do not have a specific Reader Service number indicated write directly to manufacturer for information on precise product in which you are interested.

17 *For employment inquiries fill in home address. August 18, 1969 Card Expires October 18, 1969 14

Name _____ title _____
 Company* _____
 Address _____
 City _____ State _____ Zip Code _____

For Subscriptions
 new renewal
 3 years \$16.00
 1 year \$8.00

1	20	39	58	77	96	115	134	153	172	191	210	229	248	267	286	305	324	343	362	381	400	419	438	457	476	495	514	962
2	21	40	59	78	97	116	135	154	173	192	211	230	249	268	287	306	325	344	363	382	401	420	439	458	477	496	515	963
3	22	41	60	79	98	117	136	155	174	193	212	231	250	269	288	307	326	345	364	383	402	421	440	459	478	497	516	964
4	23	42	61	80	99	118	137	156	175	194	213	232	251	270	289	308	327	346	365	384	403	422	441	460	479	498	517	965
5	24	43	62	81	100	119	138	157	176	195	214	233	252	271	290	309	328	347	366	385	404	423	442	461	480	499	518	966
6	25	44	63	82	101	120	139	158	177	196	215	234	253	272	291	310	329	348	367	386	405	424	443	462	481	500	900	967
7	26	45	64	83	102	121	140	159	178	197	216	235	254	273	292	311	330	349	368	387	406	425	444	463	482	501	901	968
8	27	46	65	84	103	122	141	160	179	198	217	236	255	274	293	312	331	350	369	388	407	426	445	464	483	502	902	969
9	28	47	66	85	104	123	142	161	180	199	218	237	256	275	294	313	332	351	370	389	408	427	446	465	484	503	951	970
10	29	48	67	86	105	124	143	162	181	200	219	238	257	276	295	314	333	352	371	390	409	428	447	466	485	504	952	971
11	30	49	68	87	106	125	144	163	182	201	220	239	258	277	296	315	334	353	372	391	410	429	448	467	486	505	953	972
12	31	50	69	88	107	126	145	164	183	202	221	240	259	278	297	316	335	354	373	392	411	430	449	468	487	506	954	973
13	32	51	70	89	108	127	146	165	184	203	222	241	260	279	298	317	336	355	374	393	412	431	450	469	488	507	955	974
14	33	52	71	90	109	128	147	166	185	204	223	242	261	280	299	318	337	356	375	394	413	432	451	470	489	508	956	975
15	34	53	72	91	110	129	148	167	186	205	224	243	262	281	300	319	338	357	376	395	414	433	452	471	490	509	957	976
16	35	54	73	92	111	130	149	168	187	206	225	244	263	282	301	320	339	358	377	396	415	434	453	472	491	510	958	977
17	36	55	74	93	112	131	150	169	188	207	226	245	264	283	302	321	340	359	378	397	416	435	454	473	492	511	959	978
18	37	56	75	94	113	132	151	170	189	208	227	246	265	284	303	322	341	360	379	398	417	436	455	474	493	512	960	979
19	38	57	76	95	114	133	152	171	190	209	228	247	266	285	304	323	342	361	380	399	418	437	456	475	494	513	961	980

17 *For employment inquiries fill in home address. August 18, 1969 Card Expires October 18, 1969 14

Name _____ title _____
 Company* _____
 Address _____
 City _____ State _____ Zip Code _____

For Subscriptions
 new renewal
 3 years \$16.00
 1 year \$8.00

1	20	39	58	77	96	115	134	153	172	191	210	229	248	267	286	305	324	343	362	381	400	419	438	457	476	495	514	962
2	21	40	59	78	97	116	135	154	173	192	211	230	249	268	287	306	325	344	363	382	401	420	439	458	477	496	515	963
3	22	41	60	79	98	117	136	155	174	193	212	231	250	269	288	307	326	345	364	383	402	421	440	459	478	497	516	964
4	23	42	61	80	99	118	137	156	175	194	213	232	251	270	289	308	327	346	365	384	403	422	441	460	479	498	517	965
5	24	43	62	81	100	119	138	157	176	195	214	233	252	271	290	309	328	347	366	385	404	423	442	461	480	499	518	966
6	25	44	63	82	101	120	139	158	177	196	215	234	253	272	291	310	329	348	367	386	405	424	443	462	481	500	900	967
7	26	45	64	83	102	121	140	159	178	197	216	235	254	273	292	311	330	349	368	387	406	425	444	463	482	501	901	968
8	27	46	65	84	103	122	141	160	179	198	217	236	255	274	293	312	331	350	369	388	407	426	445	464	483	502	902	969
9	28	47	66	85	104	123	142	161	180	199	218	237	256	275	294	313	332	351	370	389	408	427	446	465	484	503	951	970
10	29	48	67	86	105	124	143	162	181	200	219	238	257	276	295	314	333	352	371	390	409	428	447	466	485	504	952	971
11	30	49	68	87	106	125	144	163	182	201	220	239	258	277	296	315	334	353	372	391	410	429	448	467	486	505	953	972
12	31	50	69	88	107	126	145	164	183	202	221	240	259	278	297	316	335	354	373	392	411	430	449	468	487	506	954	973
13	32	51	70	89	108	127	146	165	184	203	222	241	260	279	298	317	336	355	374	393	412	431	450	469	488	507	955	974
14	33	52	71	90	109	128	147	166	185	204	223	242	261	280	299	318	337	356	375	394	413	432	451	470	489	508	956	975
15	34	53	72	91	110	129	148	167	186	205	224	243	262	281	300	319	338	357	376	395	414	433	452	471	490	509	957	976
16	35	54	73	92	111	130	149	168	187	206	225	244	263	282	301	320	339	358	377	396	415	434	453	472	491	510	958	977
17	36	55	74	93	112	131	150	169	188	207	226	245	264	283	302	321	340	359	378	397	416	435	454	473	492	511	959	978
18	37	56	75	94	113	132	151	170	189	208	227	246	265	284	303	322	341	360	379	398	417	436	455	474	493	512	960	979
19	38	57	76	95	114	133	152	171	190	209	228	247	266	285	304	323	342	361	380	399	418	437	456	475	494	513	961	980

17 *For employment inquiries fill in home address. August 18, 1969 Card Expires October 18, 1969 14

Name _____ title _____
 Company* _____
 Address _____
 City _____ State _____ Zip Code _____

For Subscriptions
 new renewal
 3 years \$16.00
 1 year \$8.00

1	20	39	58	77	96	115	134	153	172	191	210	229	248	267	286	305	324	343	362	381	400	419	438	457	476	495	514	962
2	21	40	59	78	97	116	135	154	173	192	211	230	249	268	287	306	325	344	363	382	401	420	439	458	477	496	515	963
3	22	41	60	79	98	117	136	155	174	193	212	231	250	269	288	307	326	345	364	383	402	421	440	459	478	497	516	964
4	23	42	61	80	99	118	137	156	175	194	213	232	251	270	289	308	327	346	365	384	403	422	441	460	479	498	517	965
5	24	43	62	81	100	119	138	157	176	195	214	233	252	271	290	309	328	347	366	385	404	423	442	461	480	499	518	966
6	25	44	63	82	101	120	139	158	177	196	215	234	253	272	291	310	329	348	367	386	405	424	443	462	481	500	900	967
7	26	45	64	83	102	121	140	159	178	197	216	235	254	273	292	311	330	349	368	387	406	425	444	463	482	501	901	968
8	27	46	65	84	103	122	141	160	179	198	217	236	255	274	293	312	331	350	369	388	407	426	445	464	483	502	902	969
9	28	47	66	85	104	123	142	161	180	199	218	237	256	275	294	313	332	351	370	389	408	427	446	465	484	503	951	970
10	29	48	67	86	105	124	143	162	181	200	219	238	257	276	295	314	333	352	371	390								

Reprint service

All Electronics editorial matter available in reprint form:

For reprints of special reports and feature articles see list on right side of this page. Send your order to Electronics Reprint Department at the address indicated. To expedite mailing of your order for single reprints please send cash, check or money order with your order. Allow 3-4 weeks for delivery.

Bulk reprints of editorial matter can be ordered from current or past issues. The minimum quantity is 100 copies. Prices quoted on request: call 212-971-2274, or write to address below.

Warning: The Post Office now requires your ZIP CODE on all mail. Please include your ZIP CODE number when filling out your reply card.

3

Business reply mail

No postage stamp necessary if mailed in the United States

Postage will be paid by

Electronics
Reader service department
Box 444
Hightstown, N. J. 08520

First class
Permit no. 42
Hightstown, N. J.

2

Business reply mail

No postage stamp necessary if mailed in the United States

Postage will be paid by

Electronics
Reader service department
Box 444
Hightstown, N.J. 08520

First class
Permit no. 42
Hightstown, N. J.

1

Business reply mail

No postage stamp necessary if mailed in the United States

Postage will be paid by

Electronics
Reader service department
Box 444
Hightstown, N.J. 08520

First class
Permit no. 42
Hightstown, N. J.

To order reprints or for further information, please write to: **Electronics Reprint Department, 330 West 42nd Street, New York, N.Y. 10036.**

To expedite mailing of your order for single reprints please enclose payment with your order.

You may order any of the below listed reprints by key number. Discounts on quantities over 10.

- Key no. R-01 **Computer-aided Design: Part I, The Man-machine Merger.** 16 pages. \$1.25.
- Key no. R-04 **Multilayer Circuit Boards: Sharpening An Imperfect Art.** 7 pages. 50¢.
- Key no. R-05 **Topology Cuts Design Drudgery.** 12 pages. 50¢.
- Key no. R-06 **Report on Japanese Technology: Sony.** 20 pages. 50¢.
- Key no. R-010 **Special Report on Large Scale Integration.** 54 pages. \$1.50.
- Key no. R-011 **Medical Electronics (1967).** 8 part series, 44 pages. \$1.25.
- Key no. R-012 **Special Report on Gallium Arsenide** 17 parts. 32 pages. \$2.00
- Key no. R-016 **Special Report on The Transistor: Two Decades of Progress.** 48 pages. \$1.50.
- Key no. R-017 **Special Report on Ferrites.** 16 pages. \$1.00.
- Key no. R-018 **European Electronics Markets 1969** 20 page forecast report with a 6 page foldout. \$1.00
- Key no. R-019 **U.S. Electronics Markets 1969** 32 page forecast report with 4 page foldout. \$1.00
- Key no. R-020 **1968 Electronics Index to Technical Articles and Authors Free.**
- Key no. R-021 **Infrared Detector Characteristics.** 23 x 11 inch fold-out chart. 50¢
- Key no. R-022 **Active Filters: Part II, Varying the Approach.** 8 pages \$1.00
- Key no. R-79 **MOS Integrated Circuits.** 12 pages. 50¢.
- Key no. R-78 **The Overlay Transistor.** 15 pages. 50¢.
- Key no. R-75 **Biotelemetry.** 2 part series, 16 pages. 50¢.
- Key no. R-64 **Field Effect Transistors. Parts I, II, and III.** 64 pages. \$1.00.

Circle 901 on reader service card →

METAL FILM SOURCERY

MIL-R-55182

MIL-R-10509

MIL-R-22684

Three performance levels—one basic source. No trick at all when you call Dale.

Don't buy tin oxide resistors just to get power at a low price. Dale's molded MF styles match these needs with the precision stability and tolerance of metal film. Designers and buyers alike know it's a better deal and dozens of companies are profiting from it. Many are consolidating their MIL-R-22684, 10509 and 55182 buys at this one broad, dependable source. Whether you want established reliability or prices as low as pennies per part — Dale can give you action.

*Here's Metal Film versatility
across the board*

Dale epoxy-molded MF resistors are available to meet the following specifications. For complete information, write for Catalog A.

<u>MIL-R-55182</u>	<u>MIL-R-10509</u>	<u>MIL-R-22684</u>
RNR 55 thru 65	RN-55 thru	RL-07,
RNC 55 thru 65	RN-80	RL-20

Call today 402-564-3131

DALE

DALE ELECTRONICS, INC.

1300 28th Ave., Columbus, Nebr. 68601
In Canada: Dale Electronics Canada, Ltd.

A subsidiary of the Lionel Corporation

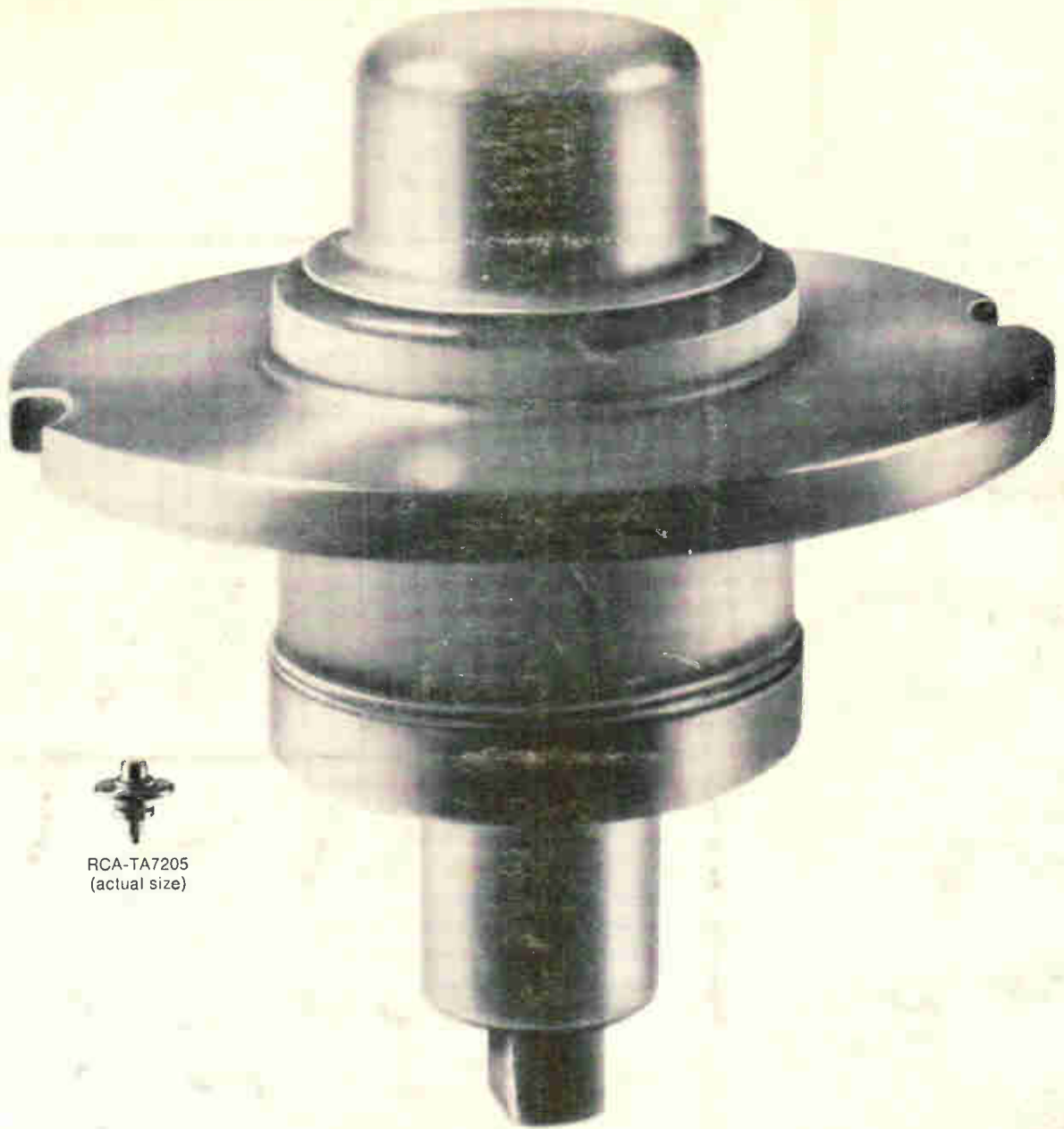

RCA-TA7205
(actual size)

Here—available—is the world's highest power, highest gain, highest efficiency transistor for operation at 2 GHz. In addition to the features above, this silicon n-p-n "overlay" transistor also offers 11-W output with 11.5-dB gain at 1.2 GHz at 60% efficiency.

The package is all new: hermetically-sealed, ceramic-metal, coaxial type that can be used in large signal applications in coaxial, stripline, and lumped-constant circuits.

RCA's multiple-emitter-site "overlay" construction is a feature recently patented.

The RCA-TA7205 is intended for reliable performance in such applications as microwave communications, S-band telemetry, microwave relay link, phased-array radar, distance measuring equipment, and collision avoidance systems.

Ask your local RCA Representative or your RCA Distributor for more detailed information. For technical data, write: RCA Electronic Components, Commercial Engineering, Section 1, Harrison, N. J. 07029.

**5.8-W (typ.) output,
7.6-dB gain,
45% efficiency,
at 2 GHz,
in common-base circuit.
New and now—
RCA-TA7205**

Visit the RCA Electronic Components Exhibit at WESCON, Unit C, in the Cow Palace Arena.

Circle 902 on reader service card