

# Electronics<sup>®</sup>

Using preleaded semiconductors: page 88

Op amps in active filters: page 98

Assessing the Russian market: page 126

December 9, 1968

\$1.00

A McGraw-Hill Publication

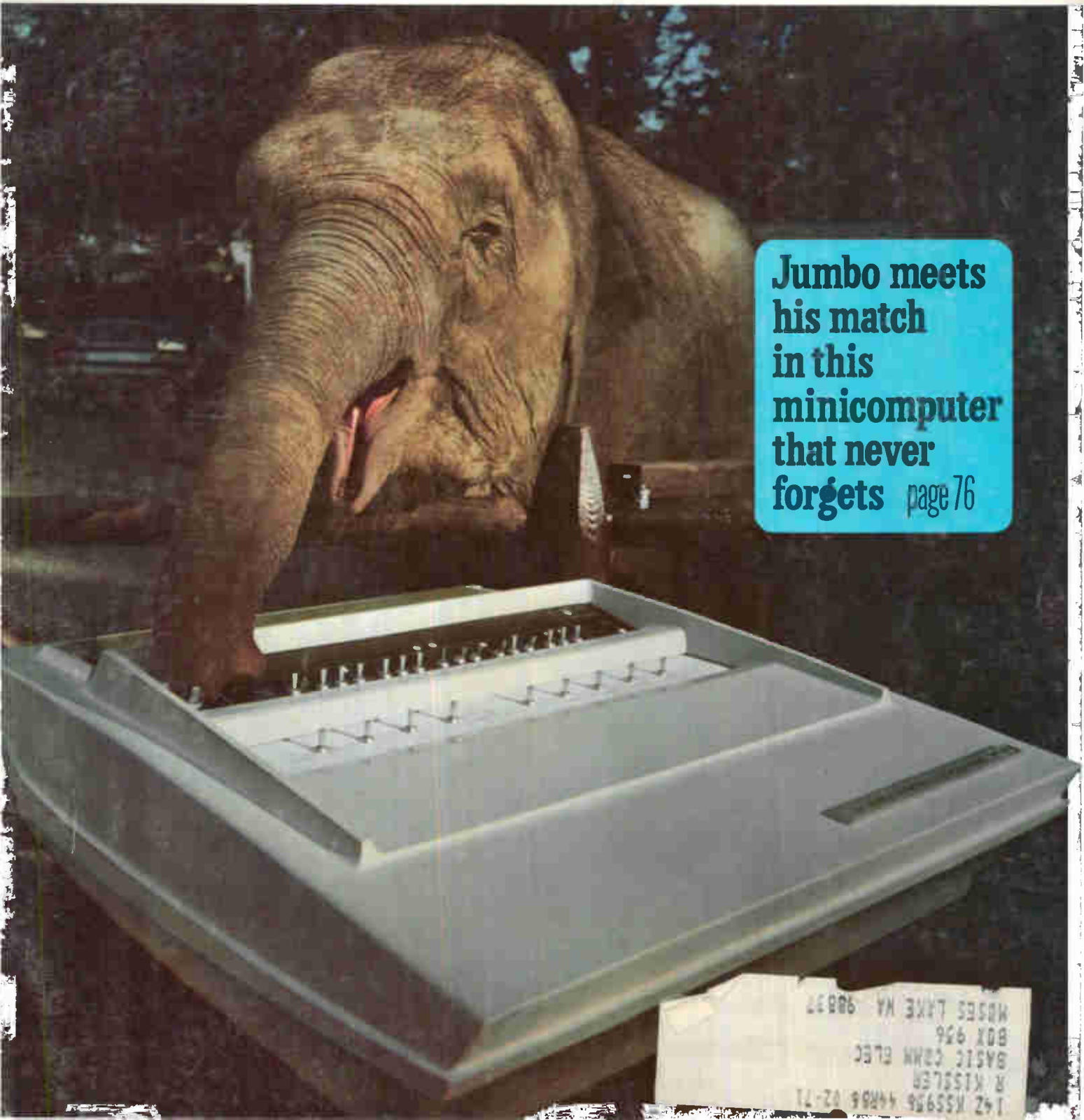

**Jumbo meets  
his match  
in this  
minicomputer  
that never  
forgets** page 76

142 K53956 44066 02-71  
R. KISSELEN  
BASIC COMM ELEC  
BOX 926  
MOSES LAKE WA 98837

# Pulsepower

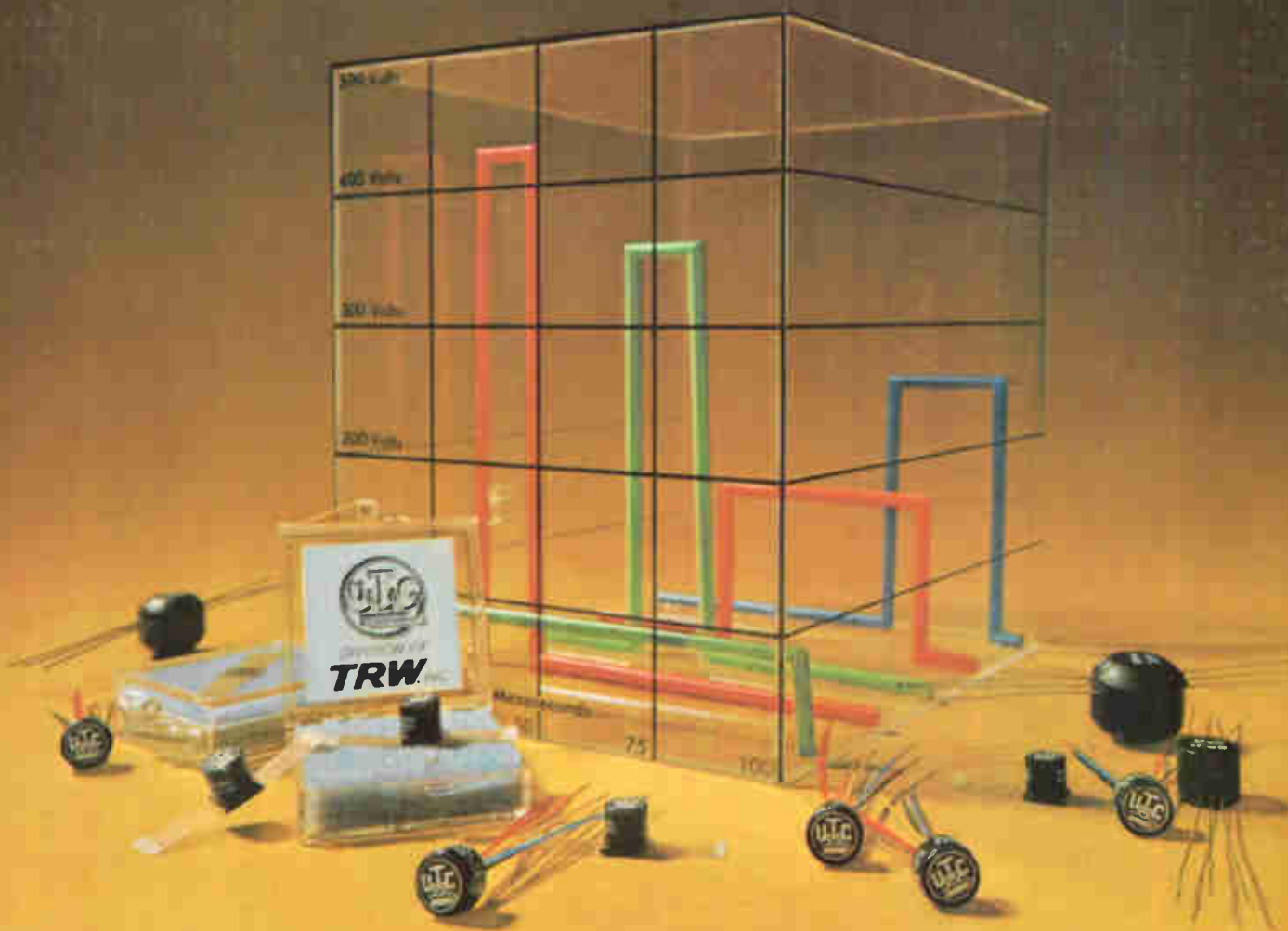

## UTC miniature transformers assure high pulse integrity at ET constants exceeding 7500 volt-microseconds

The high ET constants of UTC miniature pulse transformers give you fast rise time plus low droop at highest peak-power for size in the industry. That's pulsepower.

UTC's BJT-P and PIP standard lines are the smallest metal-encased pulse transformers made. Unique structures, plus manufacturing controls, enable UTC pulse transformers to achieve high flux densities and unrivalled temperature stability. All units are individually adjusted in a standard blocking oscillator circuit, assuring parameter uniformity unavailable elsewhere.

UTC's broad lines cover most pulse applications. Note particularly: use in high-gain, low-level, high-density packaged circuits made possible by high shielding of units; SCR di/dt failure reduction due to fast rise time and high pulse-

energy capability. The units are also suitable for wide-band applications of 1 kHz to 100 MHz.

UTC's metal-encased standard lines exceed MIL Grade 6 (MIL-T-21038B). They're ruggedized, hermetically sealed, and electromagnetically shielded. Molded units to MIL Grade 7, Class S temperature (+130°C), are available with a dielectric strength of 1250 volts. Where special parameters are needed we'll tailor them to your circuits.

When your design calls for pulsepower—high pulse integrity—UTC has the answer. Check your local distributor for immediate off-the-shelf delivery, or contact United Transformer Company, Division of TRW INC., 150 Varick St., New York, New York 10013.

**TRW**  
UNITED TRANSFORMER COMPANY

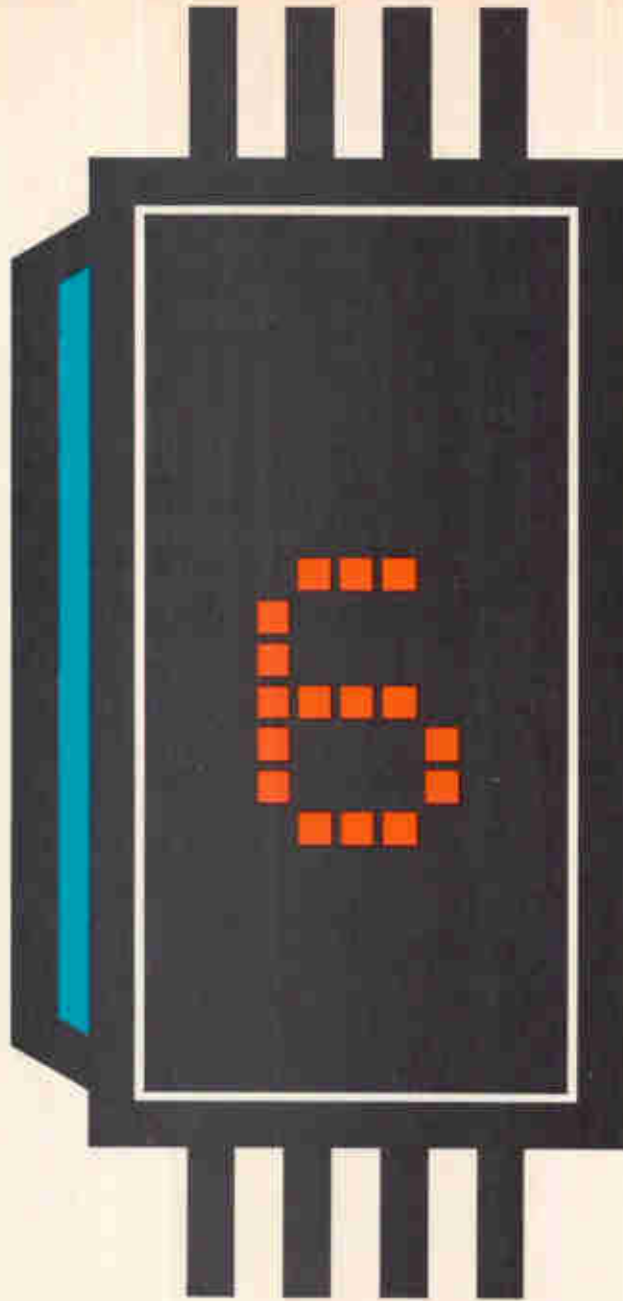

## Surprise package (1" x 1/2" x 1/10")

It's a completely new way to display digital information. The Hewlett-Packard solid state numeric display packs everything in one, small unit only 1" x 0.5" x 0.16". Gallium arsenide phosphide diodes and an IC driver/decoder chip deliver bright red numerals—bigger than life, visible for yards.

This new "total package" also gives you the edge on cost. You don't have to buy driver elements, or anything else. No special interfacing is needed. Only four line 8-4-2-1 BCD input and less than five volts to drive it. The modules are available in three-character packages, too.

The Hewlett-Packard solid state numeric display is ideal for instruments requiring smaller, tighter display panels. Or any ap-

plication demanding either low power or resistance to shock and vibration, without catastrophic failures.

Get more information about the new technology for numeric indicators. Call your local HP field engineer or write Hewlett-Packard, Palo Alto, California 94304; Europe: 1217 Meyrin-Geneva, Switzerland.

**HEWLETT**  **PACKARD**

SOLID STATE DEVICES

01810

# The Engineering World Is Full Of Great Ideas, But...

What you do with your ideas is a measure of your progress. Getting an idea is not always easy. Transforming that idea into reality — and proving it — that's where the work really begins!

At HP, we're using the best of our ideas and years of experience in design and production of measurement instrumentation to make the job of turning your ideas into realities easier and faster.

Take the HP 180 Scope System as a case-in-point. It now has a sampling system that allows you to see 12.4 GHz. This sampling system circuitry contains step recovery diodes which produce nanosecond rise times with high power. Dr. Frank Boff was using the first practical gigahertz sampling scope—the HP 185—to analyze the effects of different combinations of "p" and "n" material when he dis-

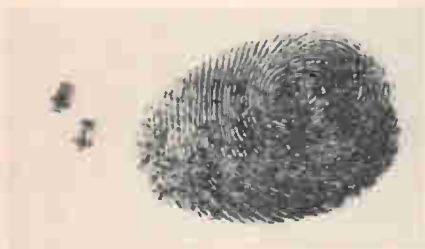

covered the step recovery diode. Other research by Hewlett-Packard Associates produced the hot carrier diode that made the 12.4 GHz system practical, provided an extremely fast sampling gate, simplified circuitry and gave greater reliability.

The engineering world has been plagued for years with inaccuracies caused by capacitance when measuring high frequencies and nanosecond rise times. We fought this

problem, also. HP Microwave Division's experience with high frequency 50  $\Omega$  transmission systems led to development of the 50  $\Omega$  input system for the 100 MHz 180 scope, so you have a near-perfect termination — regardless of your signal frequencies.

A few years back, to design connectors, circuits, antennas, strip lines, and similar component parts, you had to measure all around the problem. Then to get where you needed to be—to find out what, where, and how much, you had to interpolate or extrapolate to find your answer. Now all you need for a direct measurement is the 180 and the TDR plug-in—another HP idea that came from experimentation with microwave circuitry.



CRT size is another example. Early scopes—and even some of the modern scopes—had CRT's that were so small you had to squint to see them. We took the post-accelerator technique and the mesh dome technique ideas and combined them to produce larger, easier-to-read and more accurate CRT's. This combination requires lower driving potentials so the CRT can be driven directly by the plug-in. Driving the CRT from the plug-in gives you a mainframe that is not limited by its internal components and allows a choice of 50 MHz, 100 MHz, four channels, differential offset...

Vacuum tube scopes have a difficult time settling down to the point where accurate measurements can be made consistently — time after time. Signals often drift all over the face of the CRT! All-solid-state com-

ponents (which reach operating level almost immediately) and field effect transistors in the 180 scope system amplifier plug-ins virtually eliminate drift in both ac and dc measurements!

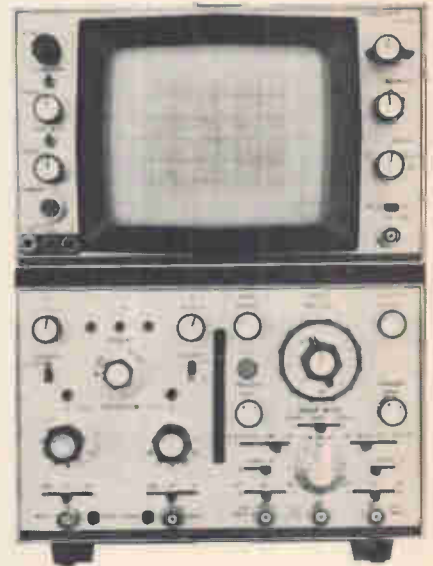

Speed your great ideas into realities. Step forward with the state-of-the-art new-idea-packed 180 scope system! It's no johnny-come-lately. It's been proven by more than two years in the field.

Consult your Hewlett-Packard Instrumentation Catalog for specifications and prices on the 180 Scope System mainframes and plug-ins, then contact your nearest HP field engineer. (He's an instrumentation specialist who can furnish information on a *complete* measurement system using the HP 180 as the core.) Or, write to Hewlett-Packard, Palo Alto, California 94304. Europe: 1217 Meyrin-Geneva, Switzerland.

STEP FORWARD

HEWLETT  PACKARD

OSCILLOSCOPE SYSTEMS

## News Features

### Probing the News

- 119 **Government electronics:** Federal outlets tough for foreigners
- 126 **Electronics abroad:** Russia—an open market

### Electronics Review

- 45 **Computers:** Control Data's new machine
- 46 **Space electronics:** Magnetic logic attracts NASA
- 47 **Industrial electronics:** One-tube color tv camera
- 48 **Instrumentation:** Induced electron emission spectrometer
- 52 **Patents:** Computer programs ruling reversed
- 54 **Components:** IC gyrators
- 56 **For the record**

### Electronics International

- 199 **France:** Franc crisis brings gloom to electronics industry
- 199 **Switzerland:** Schottky FET oscillates at 12 Ghz
- 200 **Japan:** Thick-film FET with wider forbidden band; facsimile system transmits page in half the time
- 202 **Western Europe:** Fairchild prepares invasion
- 204 **Great Britain:** Switch to metric system should be smooth
- 206 **Around the world**

### New Products

- 141 **Computer conference features**
- 141 **Graphics terminal displays** alphanumeric and vectors
- 144 **Complete memory on one board**
- 148 **A quick-change read-only memory**
- 152 **Tape system uses nine tracks**
- 157 **Instrument review**
- 157 **X-y graph displays medical data**
- 160 **Tester handles IC's, discretes**
- 165 **Semiconductor review**
- 165 **IC regulator delivers 0.5 amp**
- 169 **Hermetically sealed power case**
- 170 **Light fires Schmitt trigger**

## Technical Articles

### Computers 76

**Nova can't lose its instructions**  
Program can be debugged in main memory and wired into read-only form for fail-safe operation in this very small multiregister machine  
Edson D. de Castro, Henry Burkhardt, and Richard G. Sogge, Data General Corp.

### Circuit design 83

**Designer's casebook**

- Squelch gate reduces amplifier's standby drain
- Transistor circuit cancels the effects of inductive loads
- Multiplier stages eliminate the need for a second power-supply transformer

### Solid state 88

**Rival preleading schemes head for a market showdown**  
Flip chips have arrived and beam leads are on the way, with production quantities expected next year; the outcome of the battle may well hinge on the relative compatibility of the two techniques with medium- and large-scale integration  
Lawrence Curran, Los Angeles bureau manager

### Design theory 98

**Active filters: part 5**  
**Applying the operational amplifier**  
These devices, cheap and readily available in integrated form, make it possible to drive other networks without an isolating stage  
George S. Moschytz and Ralph W. Wyndrum Jr. Bell Telephone Laboratories

## Departments

- |    |                          |     |                          |
|----|--------------------------|-----|--------------------------|
| 4  | Readers Comment          | 46  | Index of Activity        |
| 8  | Who's Who in this issue  | 59  | Washington Newsletter    |
| 14 | Who's Who in electronics | 172 | New Books                |
| 22 | Meetings                 | 176 | Technical Abstracts      |
| 31 | Editorial Comment        | 182 | New Literature           |
| 33 | Electronics Newsletter   | 193 | International Newsletter |

# Electronics

Editor-in-Chief: Donald Christiansen

## Associate managing editors

Technical: Stephen E. Scrupski  
News: Robert Henkel  
Copy: Sally Powell

## Senior associate editors

Joseph Mittleman, Harry R. Karp

## Department editors

Avionics & Space: Alfred Rosenblatt  
Computers: Wallace B. Riley  
Communications: William Bucci  
Components: George Watson  
Consumer electronics: John D. Drummond  
Design theory: Joseph Mittleman  
Industrial electronics: Harry R. Karp  
Military electronics: Richard Gundlach  
Special projects: Raphael Kestenbaum

## Domestic bureaus

Boston: James Brinton, manager  
Chicago: Frederick Corey, manager  
Los Angeles: Lawrence Curran, manager  
New York: Howard Wolff, manager  
San Francisco: Walter Barney, manager; Peter Vogel  
Washington: Robert Skole, manager; Paul Dickson, William F. Arnold

## Foreign bureaus

Bonn: John Gosch  
London: Michael Payne  
Tokyo: Charles Cohen

## Copy editors

James Chang, Larry Miller

## Graphic design

Art director: Gerald Ferguson  
Assistant art directors: Valerie Betz, Susan Hurlburt  
Production editor: Arthur C. Miller

Editorial secretaries: Lorraine Longo, Claire Goodlin,  
Patricia Gardner, Barbara Razulis, Terry Kraus, Vickie Green

## McGraw-Hill News Service

Director: Arthur L. Moore; Atlanta: Fran Ridgway; Chicago: Robert E. Lee  
Cleveland: Arthur Zimmerman; Dallas: Marvin Reid  
Detroit: James Wargo; Houston: Barbara LaRoux  
Los Angeles: Michael Murphy; Pittsburgh: Louis Gomolak  
San Francisco: Margaret Drossel  
Seattle: Ray Bloomberg; Washington: Charles Gardner, Daniel B. Moskowitz,  
Herbert W. Cheshire, Seth Payne, Warren Burkett, William Small, William D. Hickman

## McGraw-Hill World News Service

Bonn: Robert Dorang; Brussels: James Smith; Hong Kong: Wes Perry;  
London: John Shinn; Mexico City: Gerald Parkinson; Milan: Ronald Tagliasco, Jack Star;  
Moscow: Jack Winkler; Paris: Robert E. Farrell, Stewart Toy  
Rio de Janeiro: Leslie Warren; Tokyo: Marvin Petal

Reprints: Susan Nugent

Circulation: Isaaca Siegel

Publisher: Gordon Jones

Electronics: December 9, 1968, Vol. 41, No. 25

Published every other Monday by McGraw-Hill, Inc. Founder: James H. McGraw 1860-1948.

Publication office 99 North Broadway, Albany, N.Y. 12202; second class postage paid at Albany, N.Y.

Executive, editorial, circulation and advertising addresses: McGraw-Hill Building, 330 W. 42nd Street  
New York, N.Y. 10036. Telephone (212) 971-3333. Teletype TWX N.Y. 710-581-4235. Cable address:  
MCGRAWHILL N.Y.

Subscriptions solicited only from those professionally engaged in electronics technology. Subscription rates:  
qualified subscribers in the United States and possessions and Canada, \$8.00 one year, \$12.00 two years,  
\$16.00 three years; all other countries \$25.00 one year. Non-qualified subscribers in the U.S. and  
possessions and Canada, \$25.00 one year; all other countries \$50.00. Air freight service to Japan \$50.00  
one year. Single copies: United States and possessions and Canada, \$1.00; all other countries, \$1.75.

Officers of McGraw-Hill Publications: Joseph H. Allen, President; J. Elton Tuohig, Executive Vice President;  
David J. McGrath, Senior Vice President-Operations; Vice Presidents: John R. Callahan, Editorial; Paul F. Cowie,  
Circulation; John R. Emery, Administration; John M. Holden, Marketing; David G. Jensen, Manufacturing;  
Jerome D. Luntz, Planning & Development; Robert M. Wilhelmy, Controller.

Officers of the Corporation: Shelton Fisher, President and Chief Executive Officer; John L. McGraw, Chairman;  
Robert E. Slaughter, Executive Vice President; Daniel F. Crowley, Donald C. McGraw, Jr., Bayard E. Sawyer, Senior  
Vice Presidents; John J. Cooke, Vice President & Secretary; Gordon W. McKinley, Vice President & Treasurer.

Title © registered in U.S. Patent Office; © Copyright 1968 by McGraw-Hill, Inc. All rights reserved. The contents  
of this publication may not be reproduced either in whole or in part without the consent of copyright owner.

Subscribers: The publisher, upon written request to our New York office from any subscriber,  
agrees to refund that part of the subscription price applying to copies not yet mailed.  
Please send change of address notices or complaints to Fulfillment Manager; subscription  
orders to Circulation Manager, Electronics at address below. Change of address notices  
should provide old as well as new address, including postal zip code number. If possible,  
attach address label from recent issue. Allow one month for change to become effective.

Postmaster: Please send form 3579 to Fulfillment Manager, Electronics,  
P.O. Box 430, Hightstown, New Jersey 08520

## Readers Comment

### Blood and thunder

To the Editor:

Concerning your article about an impedance cardiograph to measure blood flow [Sept. 2, p. 46], there have been no new electronic methods advanced in this field since Jan Nybor's early days. As co-authors of a paper critical of the assumptions made by many researchers, we find the expenditure of masses of money on electrical impedance plethysmography highly wasteful.

Of all electrode configurations, the system described in the article would be the one most prone to error signals. There must be a less expensive and cumbersome way to prove that the heart is beating.

Jerold C. Jansen  
James L. Fling

Custom Systems Associates Inc.  
Portland, Ore.

R.V. Hill, M.D.

■ The developer of the instrument in question, William G. Kubicek of the University of Minnesota Medical School, replies: "Such a harsh attack seems out of proportion when none of the three critics has ever taken a look at our technique. Moreover, it implies that no one at NASA knows what he's doing. Even Nybor is satisfied. He spent more than a day scrutinizing our work, and remarked to me that he wished he had the kind of engineering support I have."

### Same league

To the Editor:

You announced that an oscilloscope with a bandwidth extending to 300 megahertz will soon be introduced by the Matsushita Communications Industrial Co. [May 13, p. 192]. You omitted to mention that an oscilloscope with similar features made its appearance at the Salon des Composants in Paris in April of this year.

This scope, the OCT 590 manufactured by my firm, is a solid state instrument with a bandwidth of 250 Mhz at 3 decibels. It has interchangeable plug-in units and a

# Two new Series 54/74 AND gates.

The 54/7408—a Quad 2-input AND.

The 54/7411—a Triple 3-input AND.

Choice of flat pack  or DIP. 

Full of  
features.....

- High Speed— $t_{pd} = 13$  nsec.
- Low Power—25 mW/gate
- Full Fan-out of 10
- Input Diode Clamping
- Reduce Package Count

Available now from Sprague—  
the broad line Series 54/74 supplier.

SERIES 74N	FUNCTION	SPRAGUE PART NO.*	SERIES 74N	FUNCTION	SPRAGUE PART NO.*
SN7400N	Quad 2-Input NAND	USN-7400A	SN7473N	Dual J-K Master Slave Flip Flop: Single chip, pin 11 GND	USN-7473A
SN7401N	Quad 2-Input NAND (No Collector Load)	USN-7401A	—	Single chip, pin 7 GND	USN-74107A
SN7402N	Quad 2-Input NOR	USN-7402A	SN7474N	Dual D-Type Edge-Triggered Flip Flop	USN-7474A
—	Quad 2-Input AND	USN-7408A	—	Dual J-K MS Flip Flop with Preset and Clear	USN-7476B
SN7410N	Triple 3-Input NAND	USN-7410A	—	Dual AC Clocked J-K Flip Flop	USN-7479A
—	Triple 3-Input AND	USN-7411A	<b>COMPLEX ARRAYS</b>		
SN7420N	Dual 4-Input NAND	USN-7420A	SN7441N	BCD-To-Decimal Decoder/Driver	USN-7441B
SN7430N	Single 8-Input NAND	USN-7430A	SN7475N	Quadruple Bistable Latch	USN-7475B
SN7440N	Dual 4-Input NAND Buffer	USN-7440A	SN7480N	Gated Full Adder	USN-7480A
SN7450N	2-Wide 2-Input Expandable AND-OR-INVERT	USN-7450A	SN7482N	2-Bit Binary Adder	USN-7482A
SN7451N	2-Wide 2-Input AND-OR-INVERT	USN-7451A	SN7483N	4-Bit Binary Adder	USN-7483B
SN7453N	4-Wide 2-Input Expandable AND-OR-INVERT	USN-7453A	SN7490N	Decade Counter	USN-7490A
SN7454N	4-Wide 2-Input AND-OR-INVERT	USN-7454A	SN7491AN	8-Bit Shift Register	USN-7491A
SN7460N	Dual 4-Input Expander	USN-7460A	SN7492N	Divide-By-Twelve Counter	USN-7492A
SN7470N	D-C Clocked J-K Flip Flop	USN-7470A	SN7493N	4-Bit Binary Counter	USN-7493A
SN7472N	J-K Master Slave Flip Flop	USN-7472A			

\*0 to 70 C dual in-line circuits. Standard devices also available in flat pack, as well as Series 5400 full-temperature-range equivalents in flat pack or DIP.

For complete technical data on Series 54/74 circuits, write to Technical Literature Service, Sprague Electric Company, 35 Marshall Street, North Adams, Mass. 01247



\*Sprague and ® are registered trademarks of the Sprague Electric Co.

**THE BROAD-LINE PRODUCER OF ELECTRONIC PARTS**

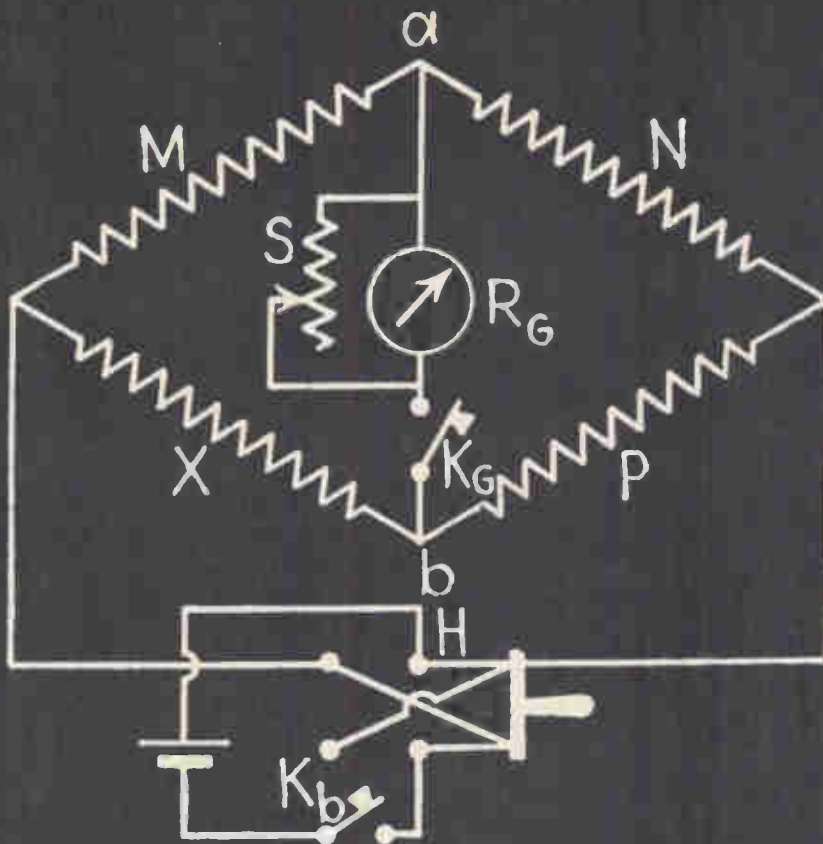

## A new bridge?

Redesigning something as basic as an R-L-C Bridge is like reinventing the wheel. What more can be done beyond just a face-lifting? A lot. You can always improve on basic old concepts by adapting them to meet today's needs. This is what happened to the new GR1650-B Impedance Bridge. After all, what did Wheatstone, Maxwell, and Hay know about transistors?

Oh sure, we're guilty of face-lifting too — we gave the 1650-B a new, light look; but we also added features that adapt the bridge to today's and tomorrow's needs. For example:

Access has been provided to the bridge arm opposite the unknown. An external capacitance decade may be connected here to make a reactive balance of inductive resistors. This is often useful when measuring an amplifier's input impedance.

A conductance bridge has been added. It permits direct readout in micromhos of parameters such as  $h_{oe}$ . A simple test jig allows you to measure all the transistor  $h$  parameters including input and output capacitance.\*

A convenient external DQ jack simplifies inserting a dc blocking capacitor for incremental inductance measurements of inductors carrying direct current.

A slow-motion dial drive has been added to ensure fine accurate balances. The drive comes into use during the final stages of balance.

DC sensitivity for low resistance has been improved and the bridge transformer has been redesigned to permit low-frequency measurement with less drive power.

With all these additions, you probably wonder about subtractions. There is one and it's in the price.

The 1650-B sells for \$450 in the USA. That's \$25 less than the price of its predecessor, the 1650-A.

\*See General Radio Experimenter.

Circle 6 on reader service card

## What's old about this new bridge?

The features that made the 1650-A Bridge so versatile have been maintained and strengthened:

- Wide measuring ranges: C from 1pF to 1100 $\mu$ F, series or parallel; L from 1 $\mu$ H to 1100H, series or parallel; R from 1 m $\Omega$  to 1.1 M $\Omega$ , ac or dc; G from 1 nanomho to 1.1 mhos, ac or dc; D (at 1 kHz) for C, from 0.001 to 1, for  $C_p$  from 0.1 to 50; Q (at 1 kHz) for L, from 0.02 to 10, for  $L_p$  from 1 to 1000.
- $\pm 1\%$  accuracy for G, C, R, and L measurements holds on all ranges, is not reduced at range extremes, and holds from 20 Hz to 20 kHz. Accuracy is only slightly reduced at 100 kHz.
- Exclusive Orthonull<sup>®</sup> balance finder avoids false nulls when measuring lossy components. The bridge's DQ dial has now been color coded to indicate when Orthonull should be switched in.
- High DQ resolution and accuracy make for accurate determinations of equivalent circuits and network modeling for computer analysis. You could almost call the 1650-B "computer software".
- Battery operation for portability and isolation from the power line . . . Solid state 1-kHz oscillator and selective null detector . . . External biasing provision . . . Useful for both two- and three-terminal measurements . . . Flip-tilt case provides protection and doubles as an adjustable stand.

For complete information, write General Radio Company, W. Concord, Massachusetts 01781; telephone (617) 369-4400. In Europe: Postfach 124, CH 8034 Zurich 34, Switzerland.



**GENERAL RADIO**



## Readers Comment

helical deflection tube. And we are now developing a double-beam oscilloscope with the same characteristics.

Jean Toutain  
Constructions Radioelectriques  
et Electroniques du Centre  
Saint-Etienne, France

### Paper pileup

To the Editor:

Regarding your editorial on the Mansfield amendment [Oct. 28, p. 31], which would have limited overhead charges on Government research contracts to 25%, that ceiling is historically too low and 150% is almost certainly too high. In 1948, when I monitored some R&D contracts as a Navy engineering employee, 100% overhead was common. In 1966, the industrial firm for which I was working charged 125% overhead, some of this for bookkeeping and record-keeping that would have been unnecessary but for formal Government requirements. The rest of it went for managerial and other "service" costs, some of them also unnecessary.

There has been a tendency at both industrial and Government organizations for overhead costs to increase at the expense of the engineering work done. Much of the work covered by these costs—management, marketing, accounting, and administration—does not contribute to results. In industry, the cost of just getting the contract—formulating proposals and such—

is very high because of Government usages and regulations.

There is a growth in what we might call "concealed" overhead—requirements that force working engineers and scientists to spend more and more of their time on paperwork. This condition is brought about by dividing a project into smaller and smaller pieces that have to be performed by more and more organizations—both Government groups and contractors. Each such division creates another interface, and each interface calls for more documentation. Both industry and Government have fostered this kind of fragmentation over the years. And it has run up the costs of R&D.

L. Fleming

President  
Innes Instruments  
Pasadena, Calif.

### Added touches

To the Editor:

The cover of your Sept. 30 issue features a picture of an IBM input-output terminal display. It has been retouched, however, and suggests that the IBM 2550 is capable of handling color displays. It is not.

Walter Keeshen Jr.

International Business  
Machines Corp.  
White Plains, N.Y.

▪ Electronics overlaid two additional colors to brighten its own product. We had no intention of distorting IBM's image.

Application For

# FET VIDEO SWITCHES

**PROBLEM:** High OFF attenuation  
— Low ON loss

**SOLUTION:** Grounded gate FET —  
controlled at the drain and  
source.

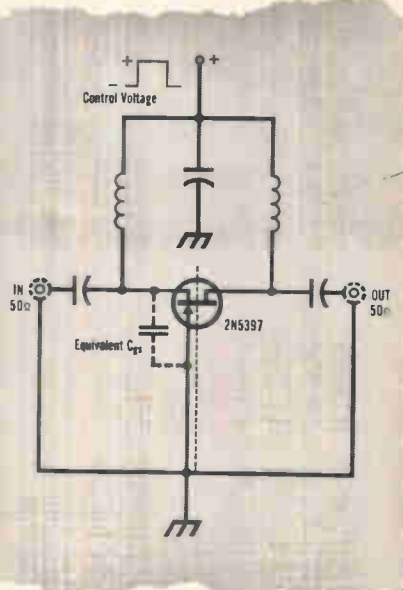

Turn this circuit off and the RF is shunted to ground through the FET's equivalent  $C_{gs}$ . OFF attenuation is greater than 65 dB for small signals. ON loss is less than 6 dB. With the 2N5397 these figures hold true around 200 MHz.

Write today for complete information on this and five other RF circuits that function best with high-performance Siliconix FETs. We'll include complete data on all RF FETs, too. Just ask for the Siliconix RF FET Data Packet.



**Siliconix Incorporated**

1140 W. Evelyn Ave. • Sunnyvale, CA 94086  
Phone (408) 245-1000 • TWX: 910-339-9216

## SUBSCRIPTION SERVICE

Please include an Electronics Magazine address label to insure prompt service whenever you write us about your subscription.

Mail to: Fulfillment Manager  
Electronics  
P.O. Box 430  
Hightstown, N.J. 08520

To subscribe mail this form with your payment and check  new subscription  renew my present subscription

Subscription rates: qualified subscribers in the U.S.: 1 year \$8; two years, \$12; three years, \$16. Non-qualified: 1 year \$25. Subscription rates for foreign countries available on request.

## CHANGE OF ADDRESS

ATTACH  
LABEL  
HERE

If you are moving, please let us know five weeks before changing your address. Place magazine address label here, print your new address below.

name

address

city

state

zip code

## New Victoreen MOX Resistors Now values to 2500 megohms in a compact package only 1/4 OD x 5" long

Now — by specifying new Victoreen metal oxide glaze resistors — you can buy resistance by the inch.

Based on our standard 1/4" OD size, Victoreen Series MOX resistors, per inch of lineal length, give up to 7.5 kv ratings . . . 500 megohms resistance . . . 2.5 watts power dissipation. Tolerances are  $\pm 2\%$  or  $\pm 5\%$  right across the board up to the 5" size . . .  $\pm 1\%$  and  $\pm 0.5\%$  in some sizes. Stability is exceptional, too — less than 1% full-load drift in 2000 hours . . . shelf life drift less than 0.1% per year.

Victoreen MOX Resistors are available right now in sizes and ratings that make them near-perfect — for HV probes with DVMs, meter multipliers, HV plate load resistors and similar circuits. And still more new sizes and ratings are on the way, too.

A-1962

**VICTOREEN INSTRUMENT DIVISION**  
10101 WOODLAND AVENUE · CLEVELAND, OHIO 44104  
IN EUROPE: GROVE HOUSE, LONDON RD., ISLEWORTH, MIDDLESEX, ENGLAND



## Who's Who in this issue



Burkhardt

de Castro

The founders of the Data General Corp. have a lot of experience in designing small computers; they're all ex-employees of the Digital Equipment Corp. The president of the new company, Edson D. de Castro, and his vice presidents, Henry Burkhardt and Richard G. Sogge, are co-authors of the article

The brain drain, that one-way transatlantic current, numbers George S. Moschytz among its passengers. The European-born engineer, co-author of the article on active filters on page 98, received his schooling in Switzerland, earning a doctorate in 1960 from the Institute of Technology in Zurich. In 1963 he was attracted to the U.S. by Bell Labs, where he's now



Wyndrum



Sogge

on page 76 about the firm's first computer. As head of small-computer design at DEC, de Castro developed the PDP-5, -8, -8/I, and -8/S. Burkhardt was in charge of small-computer applications programming and Sogge was in charge of DEC's memory and circuit development.

a supervisor of the data systems and circuits group.

Ralph W. Wyndrum Jr., the other author, is a native of New York. He received his Sc.D. degree in 1963 from New York University and joined Bell Labs the same year. He is now supervisor of exploratory circuit applications and has investigated thin-film circuit development, including active RC filters.



Moschytz

# Here's a new direct- reading broad range capacitance meter



MODEL 2W1  
**\$197.<sup>00</sup>**

This new instrument covers the range from 300 pF to 10,000  $\mu$ F. An easy-to-read scale on a large 4" meter gives you readings to  $\pm 3\%$  accuracy.

Impressed voltage is only 1 volt a-c, thus low voltage electrolytic capacitors may be safely measured.

Solid-state circuitry provides drift-free measurements without warm-up, makes the 2W1 small and lightweight. Only 6" high x 8½" wide x 5" deep, it fits neatly into inspection stations!

Put this versatile capacitance meter to work at incoming inspection, on the production line, in the lab, or out in the field.

For complete technical data, write for Engineering Bulletin 90,020 to the Technical Literature Service, Sprague Electric Co., 35 Marshall Street, North Adams, Mass. 01247.

44C-8133

**SPRAGUE**<sup>®</sup>  
THE MARK OF RELIABILITY

# How do you improve on an Op Amp like the LM 101?

COMPARISON OF THE TYPICAL INPUT OFFSET CURRENT OF THE LM101A WITH THE 709 AND LM101.

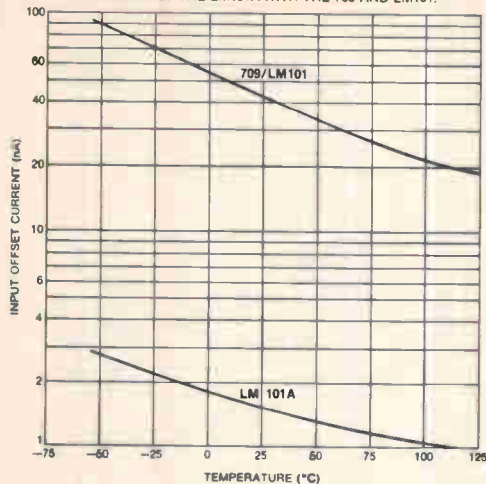

COMPARISON OF THE TYPICAL INPUT BIAS CURRENT OF THE LM101A WITH THE 709 AND LM101.

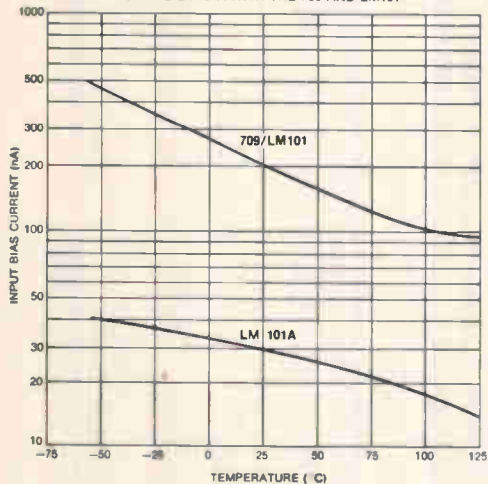

An order of magnitude improvement. The LM 101A has every advantage of the LM 101, but with 20 nA offset current and 100 nA bias current guaranteed over a  $-55^{\circ}$  to  $125^{\circ}\text{C}$  temperature range.

With this device, we also guarantee offset voltages of 3 mV, offset voltage drifts of  $15\mu\text{V}/^{\circ}\text{C}$  and offset current drifts of  $0.2\text{ nA}/^{\circ}\text{C}$ . Again over the  $-55^{\circ}$  to  $125^{\circ}\text{C}$  mil range. The offsets are specified over the common mode range and both the common mode and supply rejection have been improved. A new processing technique gives the LM 101A lower noise and input currents, and the input stage biasing has been changed to reduce temperature drift.

None of the other 101 basics have changed. You still get frequency compensation with just one 30 pF capacitor. Insensitivity to oscillations with capacitive loads or loose supply by-passing. Overload protection on the input and output. No latch up modes. All the good things. Completely interchangeable with old LM 101.

The price is right, too. \$30.00 from 100 pieces. And \$12.00 in the commercial/industrial version. LM 201A.

Write for the details. National Semiconductor Corporation, 2975 San Ysidro Way, Santa Clara, California 95051 (408) 245-4320.

**National Semiconductor**

# the LM 101A

## HP 3450A Multi-Function Meter:

The basic HP 3450A digital multi-function meter measures dc voltage and true four-terminal dc ratio. From there you make up your own unit with options to fit your needs now—then add other field-installable capabilities later to make your unit a complete “dodecameter” with five digit plus overrange digit readout for dc, ac and ohms measurements. Full autoranging capability for all functions is standard.

Add the AC Option and you can make true RMS ac measurements from 45 Hz to 1 MHz—and true four-terminal ac ratio. Add the OHMS Option for six four-wire ohms ranges including a 100  $\Omega$  range and ohms ratio. Put in the LIMIT TEST Option and you have HI GO LO and digital readout with two pre-selected limits for dc, ac and ohms — and ratio limit tests for ac, dc and ohms. That gives you a total of twelve measurement functions. But, that's not all! Add the DIGITAL OUTPUT Option for nine columns of digital output to a printer. With the addition of the REMOTE CONTROL Option, you have added full programmability for systems use. The only option that must be factory-installed is the REAR INPUT Option for isolated front and rear input capability! All this capability is contained in a rack-mountable cabinet only 3½ inches high. All-solid-state construction—including more than 220 integrated circuits—gives you increased reliability and lower maintenance. Turn the instrument on, and in seconds it's ready to operate. Call your nearest HP Sales and Service Office to learn how you can save time and reduce bench clutter with the one multi-function meter with twelve measurement capabilities. For

full specifications, write to Hewlett-Packard, Palo Alto, California 94304. Europe: 1217 Meyrin-Geneva, Switzerland.

### DC VOLTAGE and DC RATIO

DC voltage and dc ratio capabilities are contained in the basic unit.

The 3450A uses a dual-slope integration technique and is fully guarded for excellent noise immunity at 15 readings per second on

all five dc voltage ranges (100 mV to 1000 V). Input resistance is  $>10^{10} \Omega$  on the lower three ranges and  $10^7 \Omega$  on upper ranges to minimize the effects of resistive loading of your sources. The four-terminal ratio on the 3450A gives you complete isolation between X and Y inputs so you can measure the ratio of two independent dc voltages. Four ranges (1:1 to 1000:1) of true four-terminal dc ratio are provided. Price of basic 3450A, \$3150.

### AC VOLTAGE and AC RATIO (Option 001)

The 3450A with ac option is the only true RMS digital voltmeter with five-digit resolution for ac measurements



from 45 Hz to 1 MHz. This greatly increases the capability previously available in a digital meter. You get true RMS responding measurements on four ranges (1 V to 1000 V). And the 3450A has a  $\pm 0.05\%$  midband accuracy!

Adding the ac converter (Option 001) to your basic 3450A provides ac voltage and true four-terminal ac ratio. Price Option 001, \$1250.

# THE INCREDIBLE DODECAMETER

Start with the basic meter... Order what you *need* now...  
Add what you *want* later!



dc ratio limit test

dc limit test

ohms ratio limit test

ac limit test

## OHMS and OHMS RATIO (Option 002)

Six ranges (100  $\Omega$  to 10000 k $\Omega$ ) of four-wire ohms measurements at 15 readings/sec are available when you add the ohms converter to the 3450A basic unit. A maximum of 1 mA signal current reduces self-heating in the resistor under test. The ohms converter also adds four ranges of ohms ratio. Price Option 002, \$400.

## LIMIT TEST (Option 003), DIGITAL OUTPUT (Option 004)

Install the limit test converter in your 3450A. Then you can use contact-

closures-to-ground to preset two four-digit limits (with an additional digit for 20% overranging) and polarity for dc and dc ratio limit tests. When your 3450A has ac and ohms capability, plus the limit test option, you have ac limit and ac ratio limit tests, ohms limit and ohms ratio limit tests. HI, GO, LO front panel lights clearly indicate results of a test.

With the digital output (Option 004), you get 9 columns of information including HI, GO, LO limit test decisions in 1-2-4-8 "1" state positive BCD form. Buffered BCD output stores previous reading until printer can record it and allows DVM to immediately make another reading. Price Option 003, \$350; Option 004, \$175.

## REMOTE CONTROL (Option 005)

For systems applications, remote control option installed in the 3450A allows full programmability. All programmable front panel controls can be locked out in remote operation. Price Option 005, \$225.

## REAR INPUT TERMINALS (Option 006)

Addition of this option provides a set of rear input terminals and a FRONT/REAR INPUT selector switch on the front panel. Price Option 006, \$50.

HEWLETT  PACKARD

DIGITAL VOLTMETERS

# Small Space, Large Range



The Hewlett-Packard 3200B VHF Oscillator, in small space, offers continuous coverage of frequencies from 10 to 500 MHz. The 3200B provides  $\pm 0.002\%$  frequency stability over a 5-minute period, a high RF output level and an output attenuator. It is ideal as a general purpose source of CW signals and will also accept external pulse or amplitude modulation. The 3200B may be used with an accessory doubler probe to extend the frequency coverage to 1000 MHz. Size: 7 $\frac{1}{2}$ " wide, 6 $\frac{1}{2}$ " high and 13 $\frac{1}{8}$ " deep. Price: \$525. For more complete information, contact your local Hewlett-Packard field engineer or write: Hewlett-Packard, Rockaway Division, Green Pond Road, Rockaway, New Jersey 07866.

HEWLETT *hp* PACKARD

SIGNAL SOURCES

1083

## Who's who in electronics



O'Connor

One of the first actions that Douglas J. O'Connor took upon becoming group director of marketing at Fairchild Semiconductor was to lay down the law to the sales staff: in the future, Fairchild personnel will be known as professionals who help the customer solve his problems. Those present at the meeting say that O'Connor and Joseph Van Poppelen, corporate vice president of marketing, were severe in their evaluation of Fairchild's present marketing image. O'Connor, who'll discuss only the positive aspects of his talk, says there will be no major change in his department.

But O'Connor himself is certainly a change from the ebullient supersalesman, W. Jerry Sanders, who was his predecessor. Sanders, colorful of dress and speech, during one period sported a Mississippi riverboat gambler's mustache. O'Connor likes dark suits, wears black shoes and socks, a plain tie, and a buttondown shirt, and has mannerisms to match this quiet fashion. Yet at 37, he has been a paratroop officer (82nd Airborne) and has served as director general of Texas Instruments Deutschland and as marketing director of TI's Semiconductor Components division. And the Fairchild sales staff can testify that there is nothing quiet about the way he does business.

'Sock it to 'em.' Ever since C.

Lester Hogan & Co. took charge of Fairchild in August, there had been speculation that Sanders' days as marketing director were numbered. Sanders himself said later that Hogan clearly wanted to change Fairchild's marketing image and that bringing in a new man was the easiest way. Still, O'Connor's arrival was something of a surprise because it was so sudden: Sanders was reportedly informed of the change at a luncheon with Van Poppelen and Hogan only an hour before Fairchild made the announcement. Sanders was offered a post as assistant vice president of marketing under Van Poppelen and said he would accept it, but he hasn't yet taken up his duties.

O'Connor manages to talk about how he plans to run Fairchild's marketing without ever conceding that there will be a change in the old "sock it to 'em" style. "Today we can solve the customer's design problems," he says, "but we can't deliver on some high-volume standard products. We will have to ask for indulgence and patience until we get into a position to meet volume demands."

'Unique team.' O'Connor notes that integrated-circuit technology has shortened a product's lifetime considerably. "In 1960, the life cycle of a transistor was 4 to 7 years," he says. "Now, DTL and TTL have been around for only 2 or 2 $\frac{1}{2}$  years and medium-scale integration is already coming in as a replacement technology." O'Connor feels that Fairchild is in an extremely strong position in DTL and linear circuits and thus ready to reap the high profits that come at the end of a product's lifetime. And he adds that it will make a strong effort for deep market penetration in MSI and memory products.

O'Connor concedes that Motorola dominates the domestic semiconductor market and TI the foreign market but says, "Fairchild seems to have put together a unique team—the old Fairchild personnel and technology plus a management group consisting of the top business executive and a group of men who know how to manufacture. I don't see that anywhere else; that's





## Guide to Machlett Electron Tubes

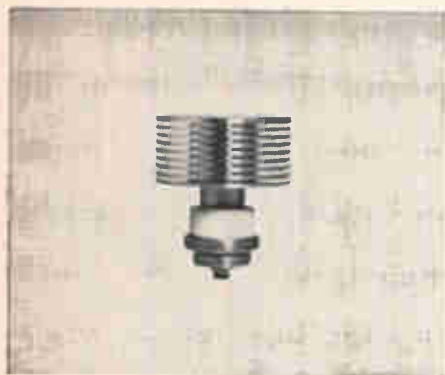

### Planar Triodes.

Grid pulsed to 1 kw at 6 Gc. To 35 kw in pulse modulator service. For communications, radar beacons and navigation.



### Magnetic Beam Triodes.

Pulsed ratings to 6 Mw with only 2.5 kw drive. CW ratings to 200 kW with only 0.7 kW drive.



### Heavy Duty Tetrodes.

Forced air cooled, water cooled and vapor cooled for broadcasting and communications.



### Pulse Modulators.

Shield grid triodes (oxide cathode) to 4.5 Mw, 80 kv peak. High voltage triodes (thoriated tungsten cathode) to 20 Mw with plate voltages to 200 kv peak.



### Heavy Duty Triodes.

Includes vapor cooled triodes, to 440 kW CW.



### Vacuum Capacitors, Variable.

RMS amperes to 75A; voltage to 15 kv peak. Capacities from 5-750 pF to 50-2,300 pF.



### High Power Tetrodes.

Vapor cooled tetrodes to 350 kw CW for communications.

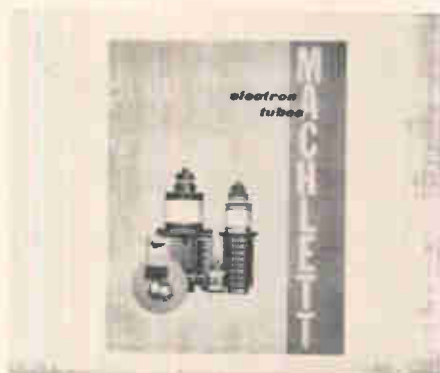

### Send for latest condensed catalog

covering the entire line of Machlett electron tubes. Write: The Machlett Laboratories, Inc., 1063 Hope Street, Stamford, Conn. 06907



# THE MACHLETT LABORATORIES, INC.

A SUBSIDIARY OF RAYTHEON COMPANY

From any Angle...

## Atec's New

# SLIM LINE

1 1/4" (H) x 17" (W) x 12" (D)

## 2802 Electronic Counter/Timer

gives you more capability for less money than any other model available . . . and in a compact configuration. ■ Compare these features with other counter-timers ■ measures frequency from DC to 12.5 MHz and time intervals to 1  $\mu$ sec ■ measures ratio ■ totalizes ■ BCD 1-2-4-8 output available on rear chassis for driving printers and punches ■ input sensitivity of 10 mV DC to 5 MHz, 30 mV DC to 12.5 MHz ■ remote programming ■ pushbutton switching ■ dual input channels ■ IC circuitry ■ illuminating overflow indicator. Now compare the price . . . \$455! ■ The 2802's plug-in, modular design allows the following options to be added at any time ■ additional digits (seven maximum) ■ display storage ■ 1 MHz, crystal-controlled time base. For complete specifications or a free demonstration, call your local Atec engineering-sales representative or contact Atec directly.

# Atec, Inc.

P. O. Box 19426 / 1125 Lumpkin Street, Houston, Texas 77024  
Telephone: (713) 468-7971

## Who's who in electronics

why there is an opportunity for us to become the dominant world-wide supplier." That's Hogan's goal; the timetable is 3 to 5 years, and with the addition of O'Connor, the team seems to be shaping up.



Beaton

Paradoxically, General Electric's Electronic Systems division has been anything but systems oriented: it's neither produced systems nor used a systems-engineering approach. But this is changing, according to Roy H. Beaton, who recently became general manager of the division and a GE vice president.

Beaton, 52, is no stranger to systems engineering; he was formerly general manager of GE's Apollo Systems division in Daytona Beach, Fla. Beaton says his mission at the Syracuse, N.Y., facility "is to integrate a large number of separate entities within the division to produce total systems from a systems-engineering viewpoint, especially in the military sector."

"Before this," Beaton explains, "the division was primarily a supplier of military equipment and subsystems. Now we're trying to bring in systems engineering at the division level and work down from there." He cites the military trend toward total-systems procurement as a reason for the approach.

**Study group.** Among the innovations already under way is the creation of an advanced systems and requirements operations group, which will study coordination of the division's diverse activities and report directly to Beaton.

# *Cermet*

AND THE

## *Model 3082*

POTENTIOMETER

**Microminiature Size - Only .5" x .1" x .15"**

**TC 150PPM/°C\* over entire resistance range 10Ω to 1 Meg.**

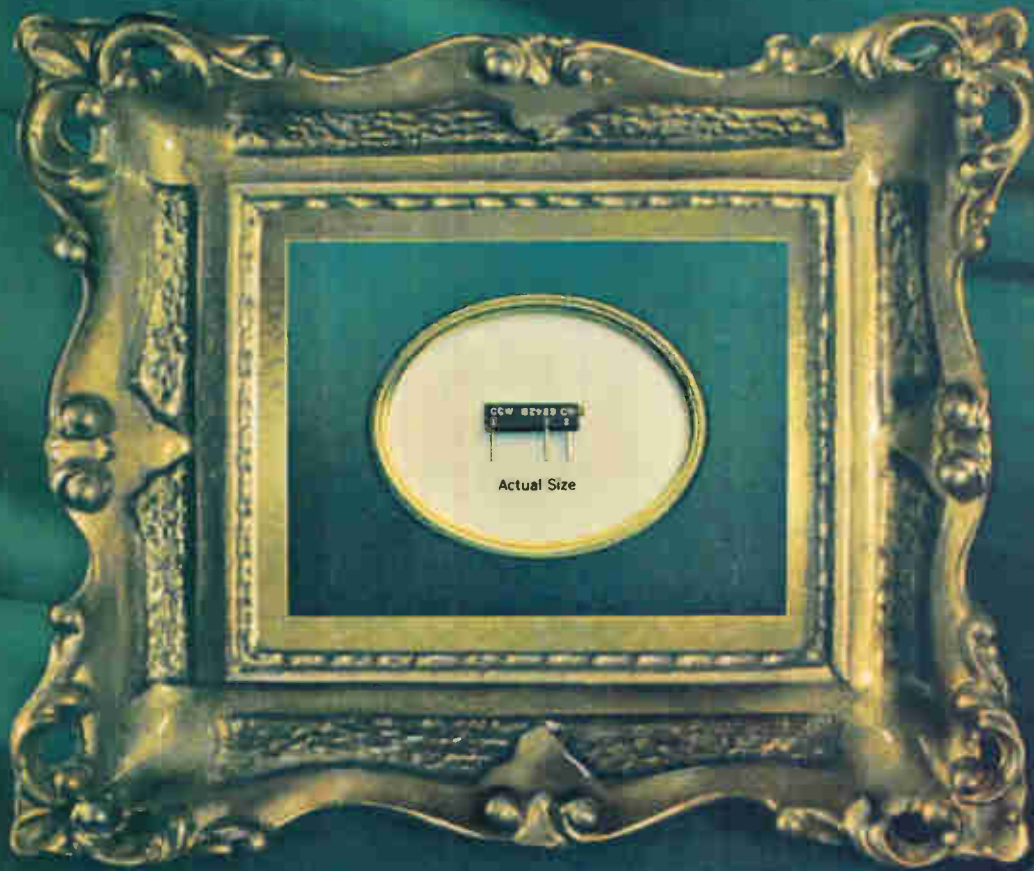

Designed and manufactured to meet your exacting requirements in the highest tradition of quality — by Bourns . . . the leader in adjustment potentiometers. Write or call the factory, your local field office or representative today for complete details!

\* 100PPM/°C AVAILABLE



BOURNS, INC., TRIMPOT PRODUCTS DIVISION • 1200 COLUMBIA AVE., RIVERSIDE, CALIF. 92507

# Fairchild can make more hybrids in

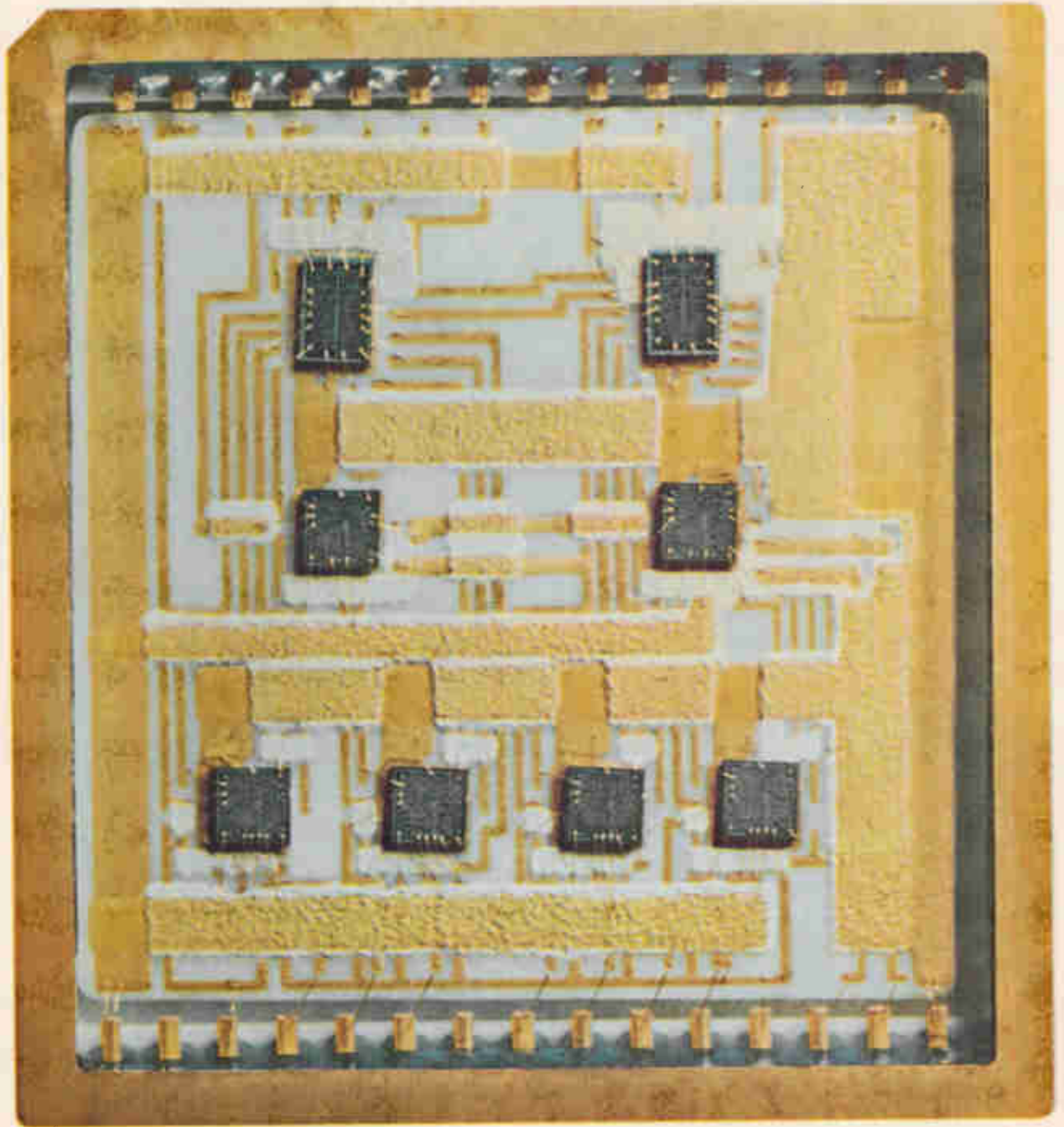

# an hour than you can use in a month.



*We can make any hybrid, in any quantity, using any method: Thick film. Thin film. Thin film on silicon.*

*We can make them faster than anyone in the industry. And deliver them quicker to anyone in the world.*

*We'll take any functions you need and package them any way you want. Our list of hybrid components has everything from a simple diode to a complex LSI array.*

*For your less complex applications, we have a line of off-the-shelf standard hybrids priced like discretes.*

*If this commitment makes sense in general, we'd like to send you the whole story in detail. Our brochure is called Fairchild Hybrid Microcircuits. It can give you more ideas in an hour than you could use in a year. Write for it.*

Fairchild Semiconductor/A Division of Fairchild Camera and Instrument Corporation/313 Fairchild Drive, Mountain View, California 94040 (415) 962-5011 TWX: 910-378-6435

**FAIRCHILD**  
SEMICONDUCTOR

# How to select the best DVM in the medium price range:

	HP 3440 SERIES	FAIRCHILD 7000 SERIES
<b>TO MEASURE DC VOLTS</b>		
price	\$1295	\$1275
ranges	3	4
overranging	5%	20%
accuracy—		
24 hours	.05% r. ± .01% f.s.	.01% r. ± .01% f.s.
3-month stability	.05%	not specified
noise rejection		
common mode, 60 Hz	30 - 70 dB	not specified
normal mode, 60 Hz	30 db	30 dB
input resistance—10-volt range	10.2 megohms	1000 megohms
<b>TO MEASURE MILLIVOLTS</b>		
price	\$1610	—
accuracy—100 mV	.10% r. ± .05% f.s.	—
3-month stability	.05%	—
input resistance	10.2 megohms	—
common mode noise rejection	100dB	—
autoranging—100 mV to 1000 V	yes	—
<b>TO MEASURE AC VOLTS (100 kHz)</b>		
price	\$1775	\$1725
ranges	3	4
basic accuracy	.10% r. ± .02% f.s.	.10% r. ± .02% f.s.
auto ranging	no	yes
common mode noise rejection	not specified	not specified
<b>TO MEASURE OHMS</b>		
price	\$1525 (incl. mV and current)	\$1385
ranges	5	5
basic accuracy	.30% r. ± .01% f.s.	.05% r. ± .02% f.s.
max. voltage across unknown	1.0v	1.2v
<b>MULTIMETER CAPABILITY</b>		
price	—	\$1895
functions	—	dc, ac, mV, ohms, current
source of data	catalog—1968	#7000 - 8/67

NLS X2 SERIES

DANA 4400 SERIES

\$1180  
3  
20%  
  
.02% r. ± .01% f.s.  
not specified  
  
100 dB  
30 dB  
10 megohms

\$1150  
4  
20%  
  
.01% r. ± .01% f.s.  
.01%  
  
100 dB  
60 dB  
1000 megohms

\$1630 (incl. ohms)  
.06% r. ± .05% f.s.  
not specified  
100 megohms  
not specified  
no

\$1395  
.01% r. ± .01% f.s.  
.01%  
100 megohms  
100 dB  
yes

\$1480  
4  
.05% r. ± .02% f.s.  
yes  
not specified

\$1450  
4  
.10% r. ± .02% f.s.  
yes  
60 dB

\$1630 (incl. mV)  
5  
.02% r. ± .06% f.s.  
16v

\$1795 (incl. mV and ac)  
5  
.01% r. ± .02% f.s.  
1.2v

\$2230  
dc, ac, mV, ohms,  
current, ratio

\$1795  
dc, ac, mV, ohms

#002 - 6/67

catalog - 1968



The rest of the series 4400 specs are in our new brochure along with those on all the Dana DVM's. A letterhead request will get you a copy.

Dana Laboratories, Inc., 2401 Campus Drive, Irvine, California 92664.

**DANA**

Circle 21 on reader service card

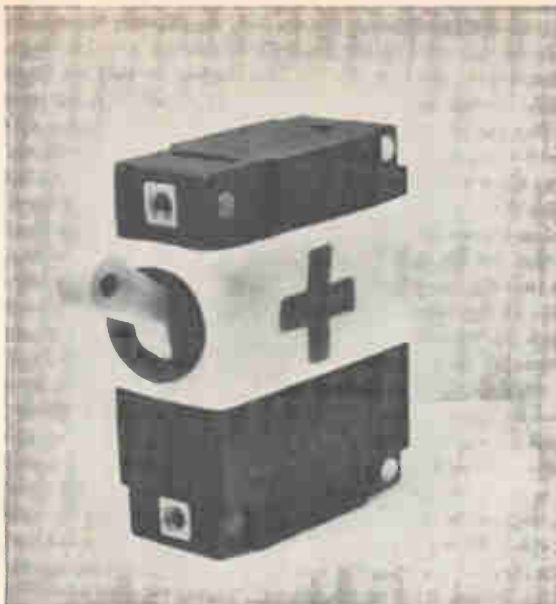

## Nurse's aide?

Sure. And medical technician's.  
And doctor's, too, for that matter.

Anybody who has to operate medical instrumentation sooner or later will appreciate the advantages of our circuit breakers over the usual fuse arrangement.

You don't have to keep replacements on hand. Or worry about having the right size. Or remember where you put the spares in an emergency.

(It may sound melodramatic to say so, but under certain circumstances, a breaker could save a life.)

As a designer, you naturally have to worry about cost. But, with OEM discounts, our Series JA breaker is quite reasonable. Particularly when you consider

the kind of premium protection it provides:

- ultra-precise current ratings, from 0.020 to 30 amp
- response characteristics job-matched to the specific needs of your equipment
- special-function internal circuits: (like relay-trip, for example) that can greatly simplify equipment circuitry
- color-codability for instant recognition
- five year warranty

Our Bulletin 3350 will provide you with all the details you'll need to prescribe the right JA breaker for your next medical instrument. It's yours for the asking. Heinemann Electric Co., 2600 Brunswick Pike, Trenton, N.J. 08602.



# HEINEMANN

4032

## Meetings

### Reliability symposium

The formal trappings of the reliability business—manuals, specifications, standards—have been a feature of military and space electronics programs for the past decade. And they're now being applied to the non-Government field. This extension of reliability technology will be the theme of the 15th Annual Symposium on Reliability, to be held in Chicago, Jan. 21 to 23.

An indication of the theme is that the two keynote addresses will be given by consumer-industrial men—Thomas Morrow, vice president of Chrysler, and Thomas Wands, vice president of Sears, Roebuck.

Included in the range of reliability topics on the agenda: marine products, consumer electronics, manufacturing, welding and soldering, lasers, software, and, of course, military and space systems.

**Broad view.** Nondestructive electronic testing is included in the symposium for the first time. In the one-day session on nondestructive testing the topics again reflect diversity: shipbuilding, bridges, and building construction will be included.

Another session included for the first time is on medical instrumentation. Among the papers: safety and reliability in medical electronics by Prof. Jesse Crump of the Polytechnic Institute of Brooklyn and "Hazards in Hospital Instrumentation" by J. A. Hopps of the National Research Council of Canada. Other items on the agenda for the first time are a panel on reliability and cost and a panel on reliability in consumer electronics.

One session that has always proved controversial in past years and gives every indication of remaining true to form is on math and prediction techniques. For example, R. E. Myers of Honeywell in his paper "How Meaningful Are Reliability Predictions?" will assert that most of them are based on premises which are suspect.

For further information write 1969 Annual Symposium on Reliability, c/o C.M. Bird, registration vice chairman, 26 Yawl Dr., Cocoa Beach, Fla. 32931.

(Continued on p. 24)



# first at the SUMMIT

Allen-Bradley hot-molded resistors are the *first* resistors to meet the requirements at the *S level* of the new MIL-R-39008A specification, which covers the general requirements for established reliability for Insulated Fixed Carbon Composition Resistors. ■ And Allen-Bradley provides this "peak" performance in *all three ratings*—the 1 watt, 1/2 watt, and 1/4 watt—and over the *complete resistance range* from 2.7 ohms to 22 megohms! ■ This conclusively demonstrates the superiority of Allen-Bradley's exclusive hot-molding technique. Completely automatic machines developed, built, and used only by Allen-Bradley produce such uniformity from

resistor to resistor—billion after billion—that long-term performance can be accurately predicted. And Allen-Bradley hot-molded resistors have no known incident of catastrophic failure. ■ For complete specifications on this quality line of resistors that afford tops in performance, please write to Henry G. Rosenkranz and request Technical Bulletin 5000.

Allen-Bradley Co., 1201 S. Second St., Milwaukee, Wis. 53204. Export Office: 630 Third Ave., New York, N.Y., U.S.A. 10017. In Canada: Allen-Bradley Canada Ltd.



**ALLEN-BRADLEY**

QUALITY ELECTRONIC COMPONENTS

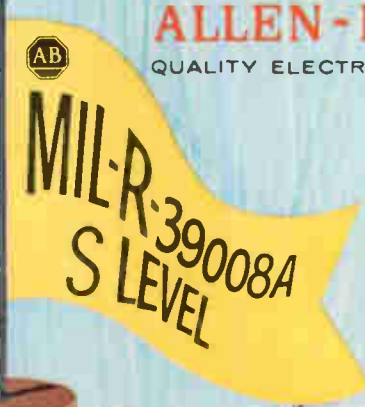

Type GB  
1 WATT



Type CB  
1/4 WATT



Type EB  
1/2 WATT

1/8" Shank  
Solid Carbide  
Circuit Board Drill

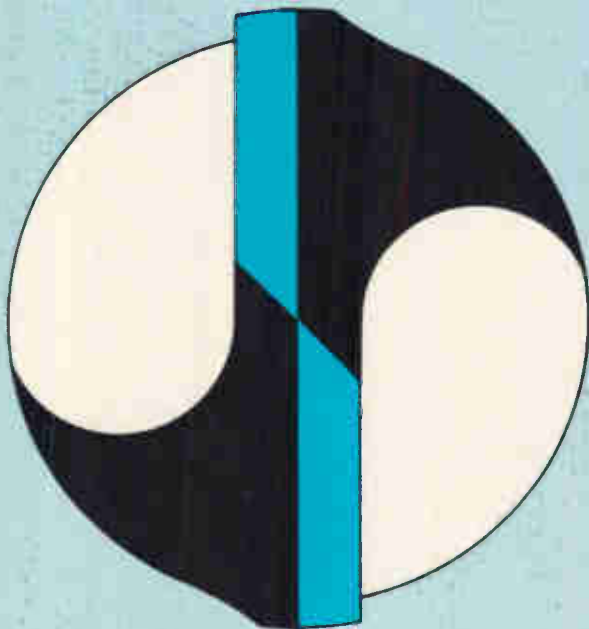

## 4 FACET POINT

for bur-free  
no smear holes

any questions?



### THE METAL REMOVAL COMPANY

1859 W. Columbia Avenue • Chicago, Illinois 60626  
Plants located in CHICAGO / LOS ANGELES / SAN JUAN

MASTER TOOL AND WHEEL MAKERS FOR THE WORLD  
END MILLS / DRILLS / REAMERS / BURS / SPECIAL TOOLING

## Meetings

(Continued from p. 22)

### Calendar

**Symposium on Adaptive Processes**, IEEE and UCLA; University of California at Los Angeles, Dec. 16-18.

**Winter Institute in Computer and Information Sciences**, University of Florida; Gainesville, Dec. 17-21.

**American Association for the Advancement of Sciences**; Dallas, Dec. 26-31.

**Symposium on Reliability**, IEEE; Palmer House, Chicago, Jan. 21-23.

**Second Hawaii International Conference**, Department of Electrical Engineering, University of Hawaii, Honolulu, Jan. 22-24.

**Winter Power Meeting**, IEEE; New York, Jan. 26-31.

**International Symposium on Information Theory**, IEEE; Nevele Country Club, Ellenville, N.Y., Jan. 28-31.

**PMA Meteorology Conference**, Precision Measurements Association; The Ambassador, Los Angeles, Feb. 3-5.

**Winter Convention on Aerospace and Electronics Systems (Wincon)**, IEEE; Biltmore Hotel, Los Angeles, Feb. 11-13.

**International Solid State Circuits Conference**, IEEE; University of Pennsylvania and the Sheraton Hotel, Philadelphia, Feb. 19-21.

**Particle Accelerator Conference**, IEEE; Shoreham Hotel, Washington, March 5-7.

**International Convention & Exhibition**, IEEE; Coliseum and Hilton Hotel, New York, March 24-27.

**Conference on Lasers & Optoelectronics**, IEEE; Southampton, England, March 25-27.

**Semiconductor Device Research Conference**, IEEE; Munich, West Germany, April 11-14.

**Joint Railroad Conference**, IEEE; Queen Elizabeth Hotel, Montreal, April 15-16.

**International Magnetics Conference (Intermag)**, IEEE; RAI Building, Amsterdam, Holland, April 15-18.

**International Geoscience Electronics Meeting**, IEEE; Twin Bridges Marriott Hotel, Washington, April 16-18.

(Continued on p. 26)



All components shown actual size



## Only the new Allen-Bradley Type S cermet trimming resistors have all these features

**Type S**  
shown twice actual size



for side adjustment



for top adjustment

The Allen-Bradley Type S is a one turn cermet trimmer in which you will find incorporated a wider range of features than in any other trimmer now on the market. Here are a few of the more important features.

- **COMPACT**—body is  $\frac{3}{8}$ " dia.
- **BUILT FOR EITHER TOP OR SIDE ADJUSTMENT**
- **50 OHMS THRU 1 MEGOHM**
- **THE SEALED UNIT** is immersion-proof
- **TEMPERATURE COEFFICIENT** less than 250 ppm/ $^{\circ}$ C over all resistance values and complete temperature range
- **UNIQUE ROTOR DESIGN** provides exceptional stability of setting under shock and vibration
- **SMOOTH CONTROL**, approaches infinite resolution
- **PIN TYPE TERMINALS** for use on printed circuit boards with a  $\frac{1}{10}$ " pattern

- **VIRTUALLY NO BACKLASH**
- **WIDE TEMPERATURE RANGE** from  $-65^{\circ}$ C to  $+150^{\circ}$ C
- **RATED  $\frac{1}{2}$  watt @  $85^{\circ}$ C**
- **EXCEPTIONAL STABILITY** under high temperature or high humidity
- **MEETS OR EXCEEDS ALL APPLICABLE MIL SPECS**
- **COMPETITIVELY PRICED!**

You'll find the new Type S trimmer equal to the traditional Allen-Bradley quality. You really ought to know more about the Type S. Won't you write for detailed specifications? Allen-Bradley Co., 222 W. Greenfield Ave., Milwaukee, Wis. 53204. In Canada: Allen-Bradley Canada Limited. Export Office: 630 Third Ave., New York, N. Y., U.S.A. 10017.



**ALLEN-BRADLEY**  
QUALITY ELECTRONIC COMPONENTS

# WE'VE JUST MADE THE INDUSTRY'S BROADEST LINE OF TEFLON<sup>®</sup> TAPES A LITTLE BROADER

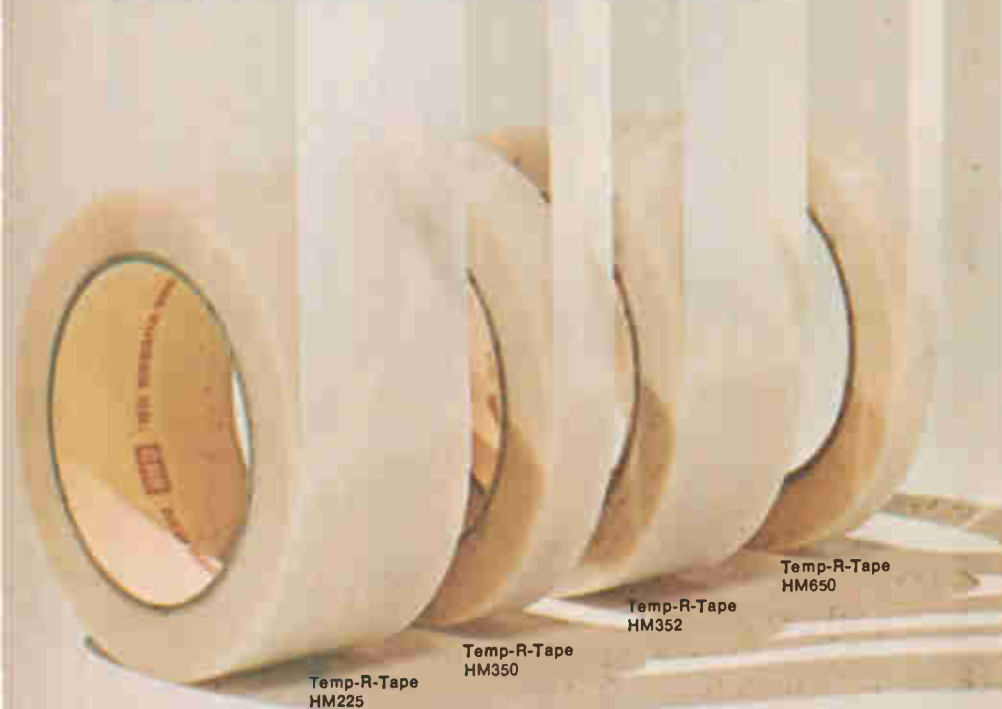

## By about a thousandth of an inch.

That's the thickness of the Teflon film used in our new HM225 Temp-R-Tape<sup>®</sup>. With its silicone polymer pressure sensitive adhesive it mikes out to only .00225".

Along with the super-slipperiness of Teflon, HM225 has low elongation, high strength, easy no-curl handling, outstanding electrical properties and a -100 to +500 F operating range.

You can't buy a thinner Teflon tape that offers this combination of unique qualities.

CHR has a tape of Teflon to match just about any design requirement you may come up with. And with the other new high modulus tapes (see box) CHR has the broadest line in the industry. \* TM of DuPont

### NEW CHR TEMP-R-TAPE OF TEFLON

Four HM series tapes are available with silicone polymer pressure sensitive adhesive: HM225—2¼ mils, HM350—3½ mils, HM650—6½ mils and HM352—3½ mils with the Teflon surface treated to promote adhesion of varnishes.

For the widest selection of tapes of Teflon in the industry see your nearest CHR distributor for technical assistance and prompt delivery. Look in the Yellow Pages under "Tapes Industrial" or in major industrial directories and microfilm catalogs under CHR. Or write for details and sample. The Connecticut Hard Rubber Company, New Haven, Connecticut 06509.



Subsidiary of U.S. Polymetric, Inc.

Circle 26 on reader service card

## Meetings

(Continued from p. 24)

Conference on Switching Techniques for Telecommunications Networks, IEEE; London, April 21-25.

Southwestern Conference & Exhibition, IEEE; Convention & Exhibition Center, San Antonio, April 23-25.

Electrical & Electronic Measurement and Test Instrument Conference, Instrumentation & Measurement Symposium, IEEE; Skyline Hotel, Ottawa, Canada, May 5-7.

Rocky Mountain Bioengineering Symposium; University of Wyoming, Laramie, May 5-6.

Frequency Control Symposium, Electric Components Laboratory, Army Electronics Command, Shelburne Hotel, Atlantic City, N.J. May 6-8.

## Short courses

Modern on-line process analysis and control, University of Wisconsin, Madison, Wis., Dec. 12-13; \$70 fee.

Evaluation technology, University of Calif., Los Angeles, Jan. 20-24; \$285 fee.

Winter institute in computer and information sciences, University of Florida, Gainesville, Fla., Dec. 17-21; \$250 fee.

## Call for papers

Geoscience Electronics Symposium, IEEE; Marriott Twin Bridges Motor Hotel, Washington, D.C., April 16-18. Jan. 1 is deadline for submission of abstracts to M.E. Ringenbach, director, Equipment Development Lab, U.S. Weather Bureau, Room 201, Gramax Building, 8060 13th St., Silver Spring, Md. 20910.

Electrical and Electronic Measurement and Test Instrument Conference, IEEE; Skyline Hotel, Ottawa. Jan. 15 is deadline for submission of abstracts to Dr. George E. Schafer, Institute for Basic Standards, National Bureau of Standards, Boulder, Colo. 80302.

Conference on Laser Engineering and Applications, IEEE; Washington Hilton Hotel, Washington, D.C., May 26-28. Jan. 17 is deadline for submission of abstracts and summary to Dr. William B. Bridges, Hughes Research Laboratories, 3011 Malibu Canyon Rd., Malibu, Calif. 90265.

Circle 27 on reader service card →

Syston-Donner worked till we could give you a line of DVM's clearly superior to any others on the market today. Take the tiny Model 9000 you see here:

We gave it a clean, modern design and pivoted the display so you can adjust it to be read without frowning and craning your neck.

We gave it a quick response input amplifier to eliminate hunting and enable it to track varying inputs. That means you don't have to wait while the digits flicker every time you tweak a pot.

We used the best conversion technique—dual

slope integration—to give it 80 db noise rejection and maximum long-term accuracy.

We made it read current and resistance as well as voltage to broaden its utility.

We made it show polarity, decimal point and unit of measurement so just about anyone can use it without risk of error.

And we gave it a price tag you can afford: \$39.95.

Little Model 9000 is but the smallest of an elegant new family that includes .01% DVM's and multimeters in easy-to-carry cases or flat Thin Line configurations that take only 1-3/4" of rack space.

**We perfected the imperfect DVM  
—and gave it class too.**



SYSTRON  DONNER

# New connectors. New standardization.

## JT concepts have really branched out at Bendix.

Now—to the thousands of JT users who like the advantages of rear-release crimp contacts—Bendix offers the opportunity to standardize. It'll ease operation, installation and maintenance problems in the field. Cut back on spares and application tools. And you'll enjoy the inherent benefits of size and weight savings, reliability and extended connector life. You liked rear-release crimp contacts so well, we're putting them in all kinds of connectors in all kinds of shapes. Rectangular connectors, cylin-

dricl connectors, printed circuit connectors, r and panel connectors. All with solder or filter contact options. A full variety of shell sizes and ty Many insert patterns with 12-, 16-, 20-, 22- : 22M contacts. Double-density models with up to contacts. Plus some entirely new designs com your way soon. If you haven't tried them by r you should. They'll grow on you. Write Electr Components Division, The Bendix Corporat Sidney, New York 13838.

**Bendix**  **Electronics**



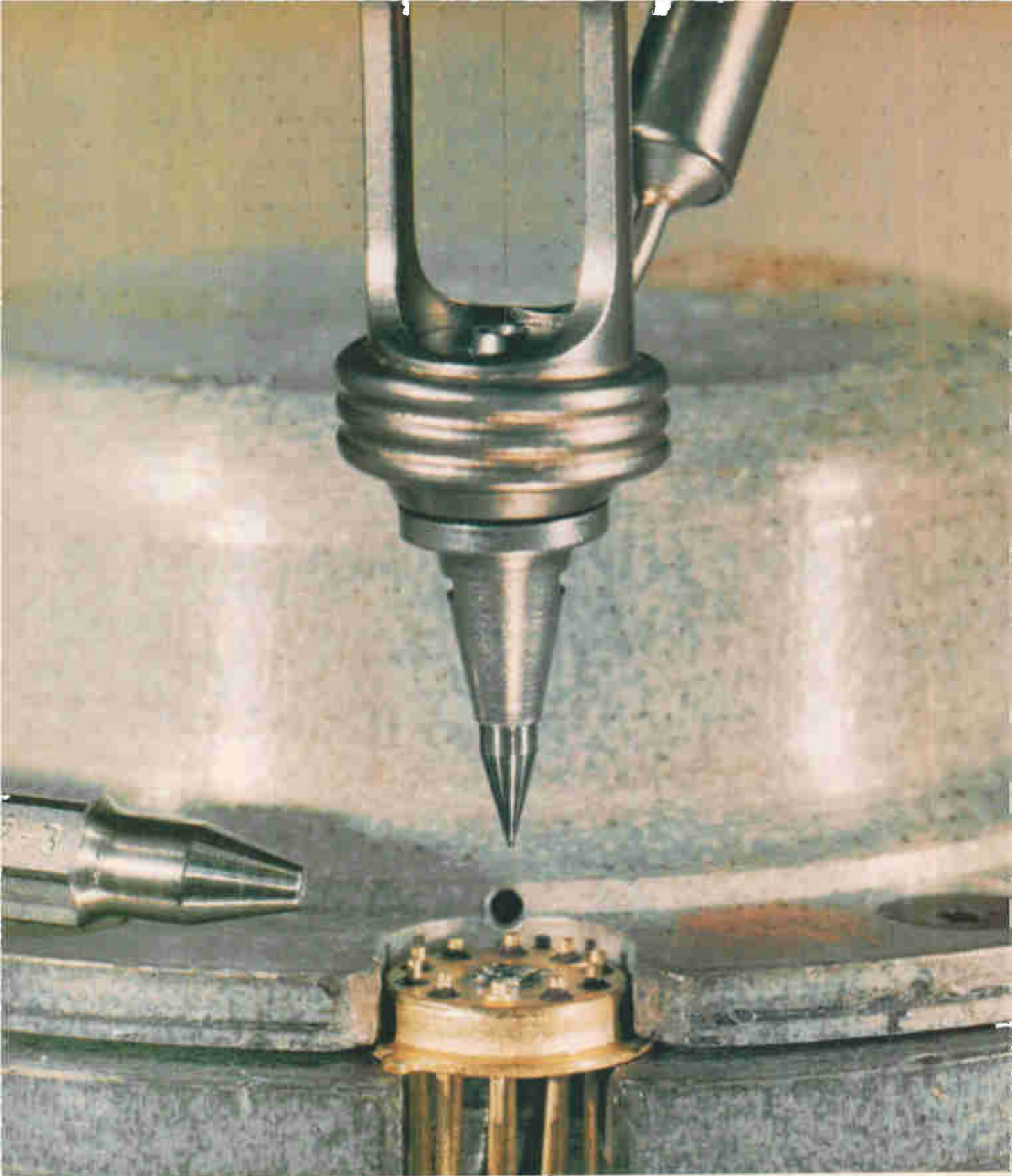



---

**Editorial comment**

---

## Vintage year in Europe?

It may seem foolhardy to predict how electronics in Europe will fare during the coming year. The repercussions of last month's international monetary crisis have hardly subsided and the experts are far from agreed that the steps taken to stabilize the world's currencies will work. Added to this uncertainty is the chance of strikes and political unrest.

Nevertheless, it's possible to make some predictions based on the situation in three European countries: West Germany, France, and Britain. Together they account for the bulk of Europe's total electronics output. And with these nations as indicators, the outlook is favorable.

**West Germany.** If the crisis involving the mark and the franc did nothing else, it confirmed that the dominant economy in Western Europe is West Germany's. While financial specialists fretted, the mark grew steadily stronger, attracting speculators' francs in anticipation of a revaluation of the mark that hasn't materialized. Instead the German government has held fast, agreeing to a 4% to 6% indirect revaluation through import-export tax modifications.

Just how did Germany reach its current position of national strength and prosperity? Much of the credit must go to the industrialists who a year ago laid careful plans to pull the economy back from its 1967 doldrums. They anticipated an expanding economy this year and invested heavily in new plant. Much of the money went for equipment aimed at boosting productivity, an investment that was reflected in more demand for instrumentation and industrial electronics gear. Unemployment dropped to virtually zero and a labor shortage sharpened the need for even more automation. The installation of process-control computers alone is expected to jump next year by 25% to 50%.

The prosperous German consumer is expected to continue to spend more on electronics, a trend that began in this year's second quarter. The more optimistic forecasters are predicting sales of 400,000 color tv sets in 1969. And the industry expects to sell another 1.5 million black-and-white sets as well.

Meanwhile, the German post office intends to continue its massive spending for communications gear. During the next year it will evaluate four competitive pulse-code-modulation systems that have been installed in local exchanges.

The rosy outlook in West Germany is reflected by optimism in Holland, Belgium, and Luxembourg—all of whom look to Germany as an important outlet for their electronics wares.

**France.** While Germany prospers, France hopes to recover from lost opportunities and economic setbacks. Most damaging were last spring's strikes, which cost the country \$3 billion in lost output and brought a wave of inflationary wage increases. President de Gaulle has opted for austerity rather than devaluation to protect the faltering franc. To slash the expected deficit, there'll be a cutback in government spending, so that a number of formerly sacrosanct defense projects will be stretched out during 1969. But although the government is holding down its direct expenditures, it will encourage plant expansion and improved productivity through tax incentives. French process-control and industrial electronics firms could profit handsomely.

The wage rises may have slowed the French economy as de Gaulle says they did, but they've also put the French worker in a spending mood. Despite austerity, consumer electronics firms could have a good year.

**Britain.** The British are generally optimistic about the prospects for the year ahead. The government, through its Industrial Reorganization Corp., has encouraged mergers to create companies that can compete favorably with U.S. electronics firms. In addition, there's a trend to develop those markets in which Britain holds an advantage over its U.S. competition—Russia and Eastern Europe, for instance. Like its German counterpart, the British post office will spend money to enhance its communications system and will evaluate pcm system installed by four firms.

Unfortunately, the British consumer may adopt a more conservative stance next year. Deliveries of items such as color tv sets are expected to slow in the wake of government actions to freeze wages and restrict consumer credit. The Briton who intends to buy will find prices high. Color tv sets average \$700 (and most are rented); tape recorders, previously tax free, are now subject to a sales levy of about 20%.

If the bellwether countries are any indication, electronics in Europe should enjoy a profitable year. In the next issue, *Electronics* will publish a comprehensive country-by-country analysis of Europe's 1969 electronics markets. ■ ■



## If your TWTs don't play because of coercive force problems, our HyCo Alnico 8 is the solution.

What can HyCo do for your traveling wave tubes that no other alnico can?

Offer you the highest coercive force of any alnico, for one thing: 1900 oersteds, in our HyCo 8H. From samples to production quantities, HyCo is consistent in high coercive force, resistance to demagnetization, and temperature stability.

Want to avoid the exacting process of calibrating your magnets and stacks? We're the only manufacturer

offering production quantities of calibrated TWT assemblies (and we'll even sell you a calibrator).

When it comes to residual induction, our HyCo 8B is the highest among all the alnico 8 types. Look to HyCo 8 materials to save weight and space in applications like klystrons, BWOs, reed switches, relays, motors, generators, meters and instruments. Write for

all the HyCo details to Mr. C. H. Repenn, Manager of Sales, Indiana General Corporation, Magnet Division, Valparaiso, Indiana.

Typical Properties	HyCo 8B	HyCo 8H
Residual Induction ( $B_r$ ) gauss.....	8500	7000
Coercive Force ( $H_c$ ) oersteds.....	1600	1900
Energy Product ( $B_dH_d$ ) max.....	$5.00 \times 10^4$	$5.00 \times 10^4$
Peak Magnetizing Force—oersteds.....	6000	6000
Permeance Coefficient at ( $B_dH_d$ ) max.....	5.25	4.25

# INDIANA GENERAL

Making Magnetics Work



---

# Electronics Newsletter

---

December 9, 1968

## Autonetics unveils all-MOS computer

The D-200 general-purpose avionics computer Autonetics will show at this week's Fall Joint Computer Conference is a mockup of the first such machine to use only metal oxide semiconductor large-scale integrated arrays in its central processor, control unit, and memory. MOS has heretofore been limited to a few special-purpose computers.

A breadboard of the Autonetics design is operating now. The prototype will measure 5 by 6 by 7 inches, and will be ready in March. It will be suitable for aircraft navigation applications, although officials say it could also handle such other functions as fuel management in jet engines.

The computer, which consumes 10 watts, has been proposed to at least one of the military services. Its central processor has 24 arrays of eight different types, ranging in complexity from 142 MOS field effect transistors to 1,053. The unit has a 108-microsecond multiply time, a 112- $\mu$ sec divide time, and a 4- $\mu$ sec memory cycle. Most other instructions take 8  $\mu$ sec. A 1- $\mu$ sec memory cycle time is in the offing when the present 250-kilohertz clock rate is boosted to 1 megahertz.

## Electronics makers woo phone concerns

Electronics firms, especially those producing communications gear and semiconductors, have flocked to the annual meeting of the Independent Telephone Association in Miami this week. The reason: with the Carterphone decision opening the way for independent firms to produce phone equipment, electronics companies are eagerly wooing their potential customers. Currently, most phone gear is produced by the Bell System's Western Electric Co. or its licensees.

## One-tube tv camera for medicine draws military attention

A one-tube color tv camera developed for the medical market is being considered by the Navy and Air Force for reconnaissance and remote-control operations. Military experience with color tv systems has been none too good, but the two services want to take a look at the CBS Laboratories' camera because it weighs only 12 pounds and is considerably less complex than three-tube units. And while the conventional cameras require a high ambient light level, the CBS camera uses a secondary electron conduction vidicon that can record pictures at levels as low as starlight.

The tube, operating with a synchronous color filter wheel, utilizes the field sequential video principle developed years ago. In reconnaissance applications, camouflaged or man-made objects could be easily detected if the primary-color filters were replaced by those of other colors.

A prototype of the medical system is now being field tested at the Army's Fitzsimmons Hospital in Denver. CBS plans to market the unit next spring for \$15,000.

## CBS presses EVR on tv set producers

For the past several months, executives have been trying to get television set producers around the country to design CBS's electronic video recording (EVR) units into their receivers [Electronics, Sept. 4, 1967, p. 25]. Most of the set makers confirm that talks have been held, but they decline to say whether any accords have been reached. It's understood, however, that at least one U.S. set producer has already agreed to build

---

# Electronics Newsletter

---

the CBS equipment into some of its sets. It's estimated that EVR would add \$120 or less to the price of a receiver. CBS marketing plans are to be disclosed this week in New York.

Technical details of EVR haven't yet been disclosed by CBS, but this much is known: the system will be able to play back up to an hour of black-and-white programming directly on the set, and the recording film will fit into a small cartridge that's plugged into the set.

The current EVR design is limited to black-and-white pictures, but CBS is understood to be working on a color system.

## Government may make Navy's Cains an in-house project

Industry reports indicate that the Navy hasn't come up with sufficient funds to have a contractor build its Carrier Aircraft Inertial Navigation System (Cains), a ship-borne unit that would quickly align, via radio link, the inertial systems of carrier-based planes using the ship's inertial navigation system [Electronics, Oct. 30, 1967, p. 44]. One source says the system could wind up being furnished by the Government itself by modifying existing equipment.

Specs for the fast-reaction system have been sent to potential builders of both the VSX antisubmarine-warfare aircraft and the VFX fleet defense fighter to serve as a guide to navigation requirements. For the VSX, the fast-alignment inertial system is clearly labeled an industry-furnished item. For the VFX, Cains was originally spelled out as Government-furnished, but an amendment to that specification calls for an alternative bid from industry.

"It's still up in the air," says one observer, who believes that if industry is called upon to build the Cains equipment, the leading contenders will be AC Electronics, General Precision, and Litton Industries. Eight firms answered the Navy's request for proposals for six prototypes [Electronics, Sept. 30, p. 63].

## DuBridge will back more science funding

Lee A. DuBridge, who is retiring as president of California Institute of Technology to become Nixon's science adviser, will probably push for increased Federal funding of scientific research, particularly at universities. He can also be expected to oppose any moves to combine civilian and military space efforts. His attitude towards an expansion of the antiballistic-missile program isn't known, but there's some speculation that he may oppose it on scientific grounds.

## Addenda

Control Data's new giant computer, the 7600, is expected to cost about \$5 million (for details, see page 45). However, a source at Lawrence Radiation Labs says that facility is buying two machines for about \$3.8 million each. . . . Two impending airline decisions are being eagerly awaited by AC Electronics and Litton, who both have commercial inertial navigation systems. United Air Lines is expected to decide early next year—probably in March—whether it will retrofit the stretched-out DC-8's on its Hawaiian run. And Eastern Airlines is also considering a retrofit for its big jets, according to industry sources. United would want its DC-8 systems by June. . . . Indiana General is about to start selling quantities of plated wire for computer memories. Currently, firms producing plated-wire memories—including Univac, Honeywell, and Electronic Memories [Electronics, Oct. 14, p. 216]—have to make the wire themselves.

From the leader in

# Epitaxial Reactors and Cold Wall Furnaces



Only Hugle Industries offers you this large range of models, then makes them available in either semi-automated or fully automated modes. The automatic units feature our exclusive HI integrated circuit process controller. Soft-ware and installation are furnished free with these models.

Choose the model and mode that suits your operation.

HIER I	14-1" wafers or 4-2" wafers	HIER IV	60-1" wafers or 12-2" wafers
HIER II	25-1" wafers or 4-2" wafers	HIER VI	85-1" wafers or 18-2" wafers
HIER III (Thin Film)	14-1" wafers or 4-2" wafers	HIER VII	108-1" wafers or 27-2" wafers
<b>And Our Newest Addition . . .</b>		EPI GRANDE (Barrel)	140-1" wafers or 40-2" wafers

Other Hugle Industries' products include: Diffusion Doping Systems D100 Series Epitaxial Doping Systems Model 100 Infrared Microscope Model 1300 Ultrasonic Wire Bonder Model 1400 Beam Lead Bonder Model 2000 Flip Chip Bonder PCD Process Controller.

Call Mr. Dave Davis, Marketing Manager, at (408) 738-1700 for further information.



## HUGLE Industries

750 NORTH PASTORIA AVENUE

SUNNYVALE, CALIFORNIA 94086

# FLEXIBLE CABLE PRINTED CIRCUIT APPLICATIONS

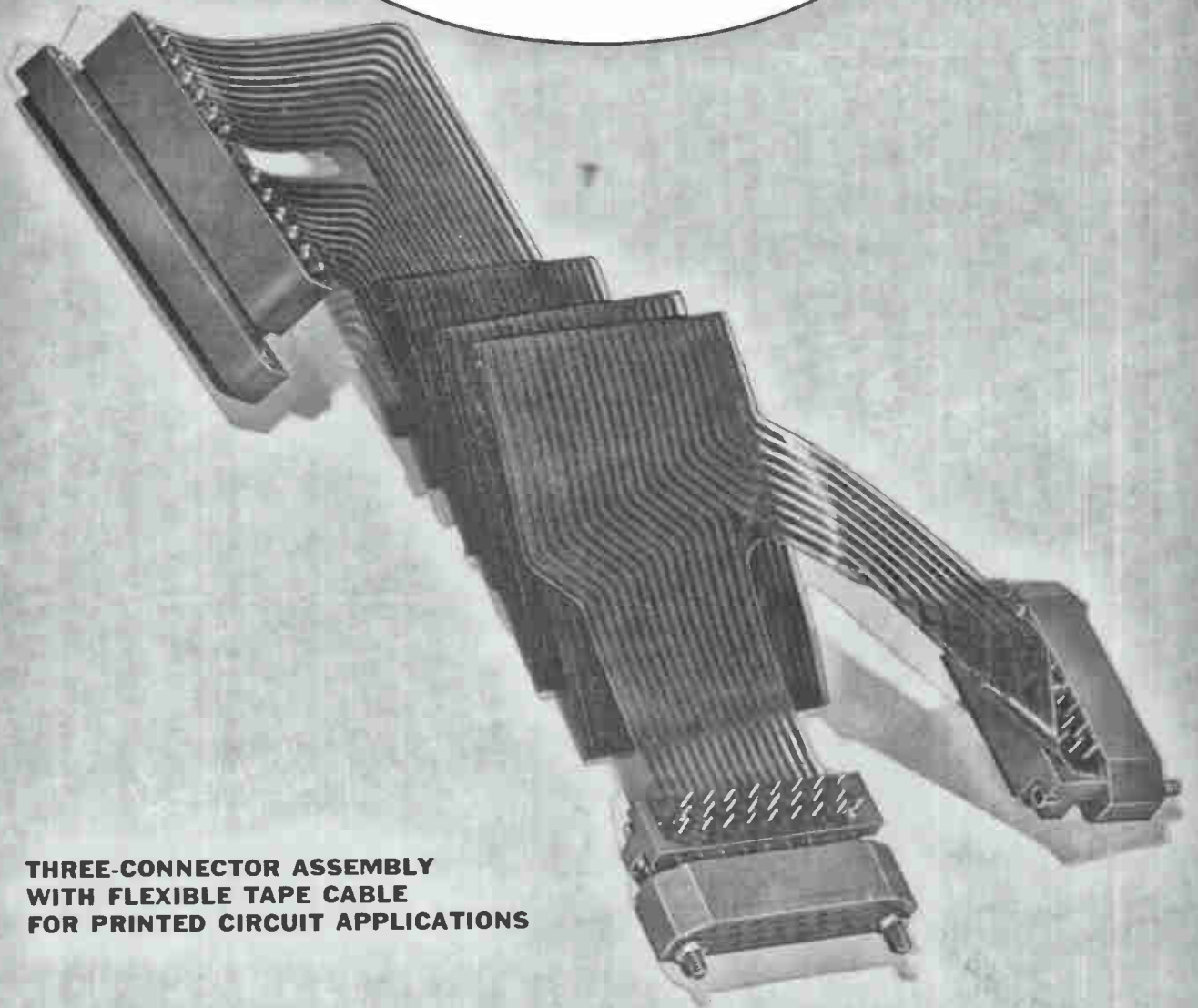

**THREE-CONNECTOR ASSEMBLY  
WITH FLEXIBLE TAPE CABLE  
FOR PRINTED CIRCUIT APPLICATIONS**

Connect... with a Continental Connector

# CONTINENTAL CONNECTORS

**CONTINENTAL CONNECTOR CORPORATION ■ WOODSIDE, NEW YORK 11377**

For the Sales Representative Nearest You, See Our Listings in EEM and VSMF Directories

# Who can make your precision resistors take up less space?

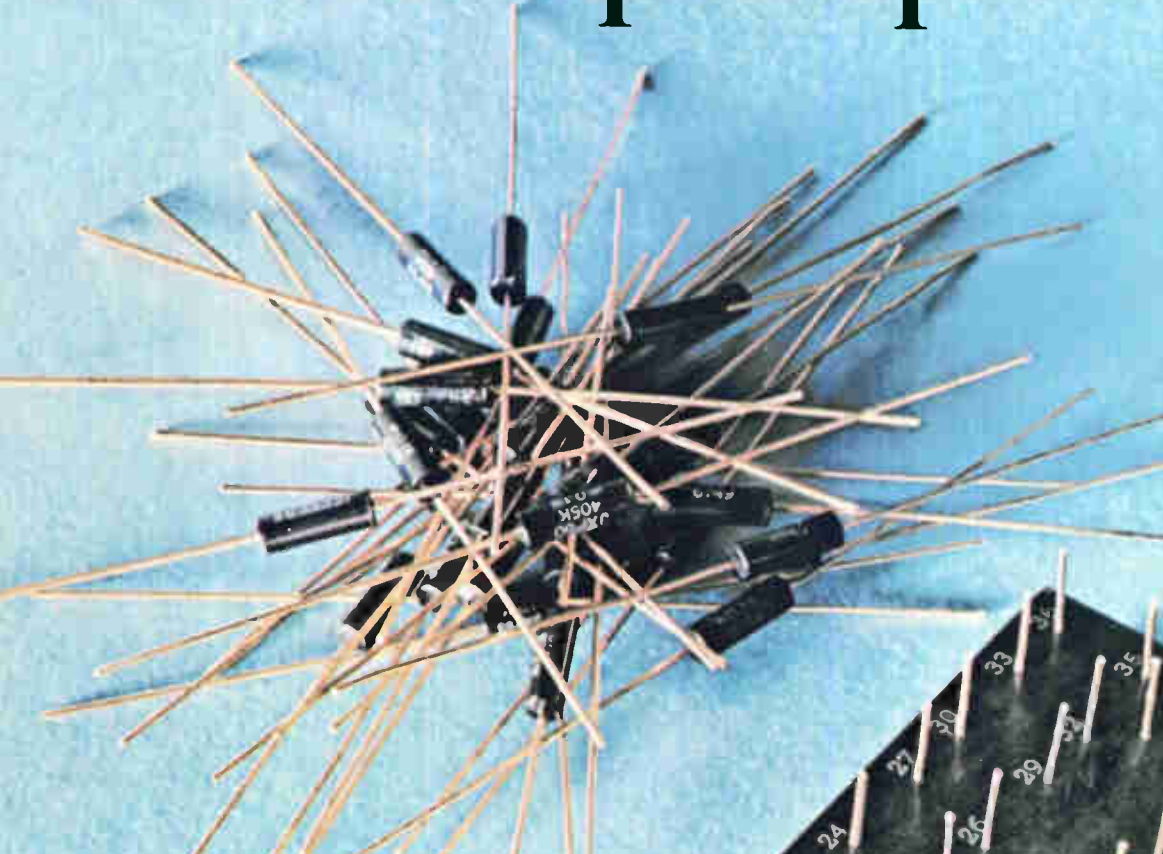

And not just less space than they take up separately. But less space than they'd take up if transformed into wire-wound resistor networks. We can accomplish this . . . by supplying you with our "second-generation" Jeffers JXP metal film networks. These highly reliable packaged resistor assemblies can deliver volume savings of up to 80% — while reducing your costs, too. Drop us a line for details. And ask about our ability to custom-tailor our networks to your precise needs. It's all part of our package.

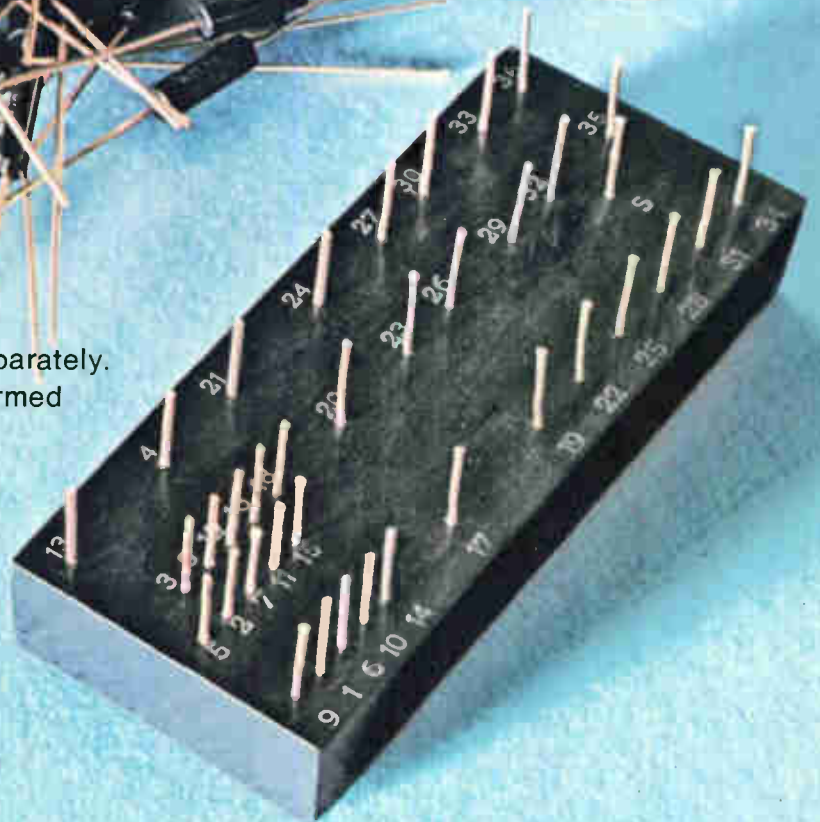

## The passive innovators at Airco Speer.

**AIRCO** Speer Electronic Components include Speer resistors, Jeffers JC precision resistors, Jeffers JXP precision resistors and networks, Jeffers inductors and capacitors and PEC variable resistors and trimmer potentiometers. St. Marys, Pa. 15857 • Bradford, Pa. 16701 • DuBois, Pa. 15801 • Toronto 15, Ontario.

# 20,000,000 customer-proven TI plastic ICs are doing their job...

more are available now to do yours...  
from Kierulff

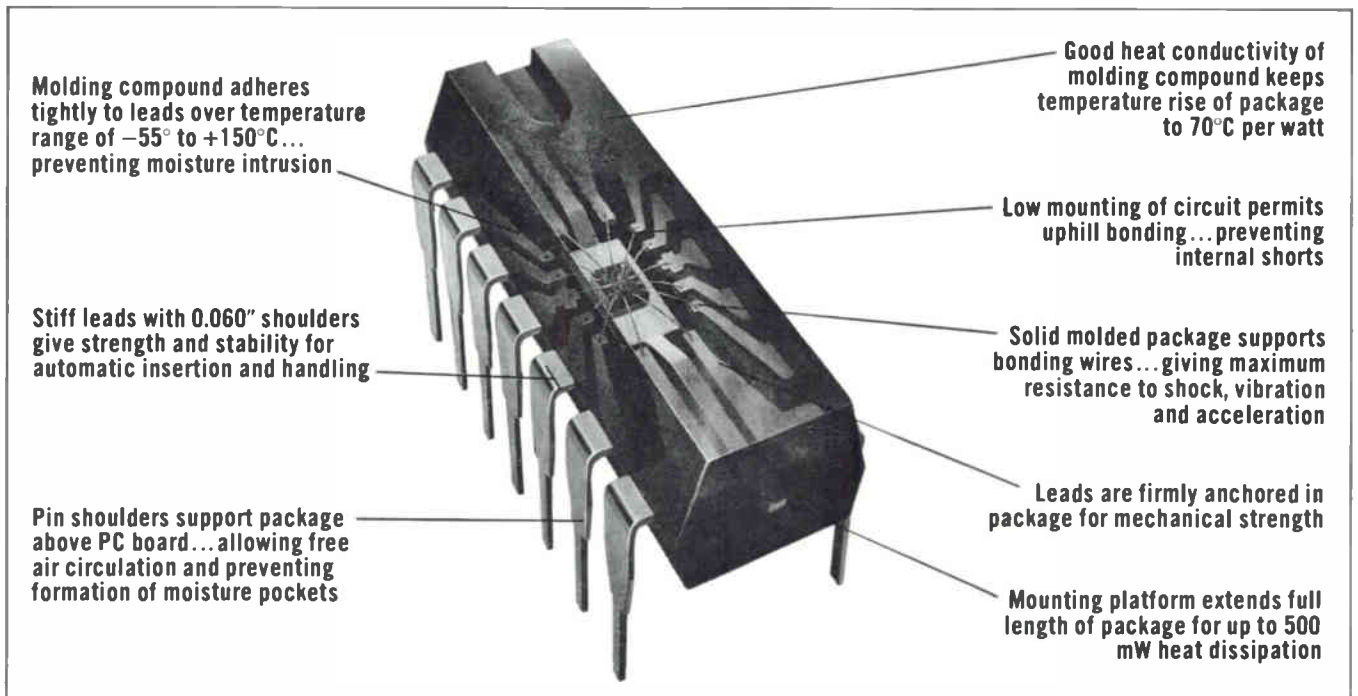

If your plans call for economical, reliable plastic integrated circuits, don't settle for substitutes...get TI plastic. We carry large stocks of TI plastic ICs—TTL, DTL, and linear—so we can fill your orders promptly.

You don't have to worry about reliability when specifying TI plas-

tic. Over 1500 customers have purchased more than 20 million circuits in three years. This user experience has been so satisfactory that TI plastic is the industry's fastest growing package design.

Ideal for industrial/commercial applications and preferred for a growing number of military/avi-

onic projects, TI plastic ICs are stocked in depth for industrial and military temperature ranges.

If you need prices or delivery information, call us direct and get quick answers to your questions. For a documented report on plastic IC reliability, circle 230 on the reader service card.



**ALBUQUERQUE**  
2524 Baylor Drive S.E.  
Albuquerque, New Mexico 87108

**PHOENIX**  
2633 E. Buckeye Road  
Phoenix, Arizona 85034

**PALO ALTO**  
3969 East Bayshore Road  
Palo Alto, California 94303





**NOTICE TO READER:**



**What's happening tomorrow  
in keyboards has just happened**

What's inside the little black box shown above has advanced keyboards into the next generation, overnight. For more on this major breakthrough, and what it can mean to you, turn the page.

# What's inside this little black box?

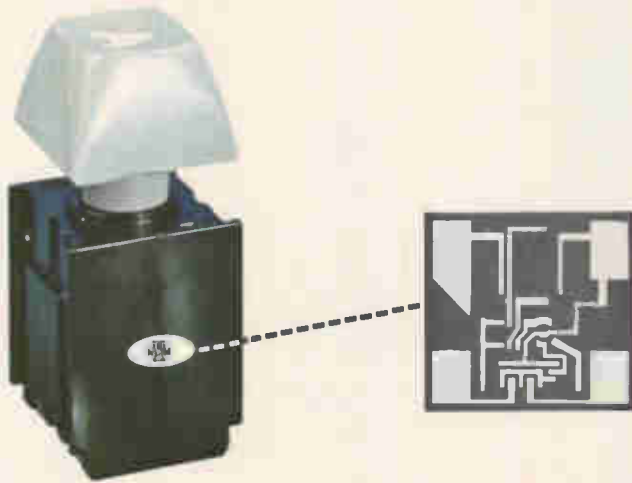

## A breakthrough in keyboard technology from MICRO SWITCH

Inside this key is a new discovery. Using the Hall effect, MICRO SWITCH has developed the world's first practical application of an integrated circuit as a keyboard switching element. An integrated-circuit chip (only .040" square) is actuated with a magnet mounted on a plunger. Thus, MICRO SWITCH has combined integrated circuitry with manual actuation to bring you an all solid state keyboard, unlike any other ever made.

It is called SSK. A keyboard unmatched in reliability, flexibility and low cost!





# It makes possible this all solid state keyboard... SSK... the first of its kind

SSK is a keyboard that is compatible with your present *and* next generation communications and data preparation equipment. Assembled, wired and encoded—ready to plug into your equipment.

#### **A breakthrough in keyboard reliability**

From key to connector, every unit of the new SSK keyboard is all solid state. The only moving mechanical part is the plunger. There are no mechanical linkages and no moving contacts to wear or fail. The result is unequalled reliability.

#### **A breakthrough in keyboard economy**

You get triple economy. First, the initial cost is less, tailored to your high production commitments. Second, the bounce-free output of SSK requires no special interface circuitry to adapt it to your equipment; just plug it in. Finally, being solid state, SSK is practically maintenance free; cuts your service costs to the bone.

#### **All in a completely flexible package!**

**For more facts on MICRO SWITCH SSK, turn the page.**

# SSK...a completely flexible package...

MICRO SWITCH solid state keyboard flexibility adapts to your format and encoding needs. All standard key arrays and custom arrays, block or offset. Encoding of any 8-bit code (or less); hexadecimal; Baudot; BCD; USASCII mono-mode, dual-mode and tri-function; plus EBCDIC and custom codes.

You may choose from a complete selection of customized legends and colors. Let us know the control functions you require—we'll match your needs to the letter. There's no reason anymore to compromise for any less—or pay for more—than what you want.

## Featuring the latest human factors considerations...

- A. Two-Key Rollover permits typing at burst speeds without causing a system error output.
- B. Universally accepted truncated keys combined with standard typewriter offset arrangements between rows, permits accurate high-speed typing without hindering the natural flow of operation.
- C. SSK offers sloped key or stepped key rows.
- D. Custom molded-in legends are integral part of button, cannot be obscured by wear.

## Backed by MICRO SWITCH Capabilities

Through advanced design concepts, complete engineering facilities, innovative assembly techniques, and unique quality assurance procedures, MICRO SWITCH is prepared to supply your every keyboard need. This means new reliability and flexibility in mass-production quantities with attractive customized appearance giving new sales appeal to your equipment.

**Make no decisions on keyboards until you see what's happening at MICRO SWITCH. Send the coupon today.**



### SSK MICRO SWITCH

Freeport, Illinois 61032

Dear Sir,

I would like further information about MICRO SWITCH SSK solid state keyboards.

Name & Title \_\_\_\_\_

Company \_\_\_\_\_

Address \_\_\_\_\_

City \_\_\_\_\_ State \_\_\_\_\_ Zip \_\_\_\_\_

Please have a field engineer call. Phone \_\_\_\_\_

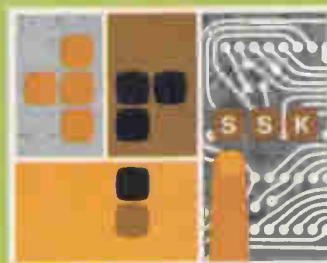

## MICRO SWITCH

FREEPORT, ILLINOIS 61032

A DIVISION OF HONEYWELL

Circle 42 on reader service card

# Help Yourself To Better Power Circuit Systems With This All-New Designer's Handbook!

Two hundred and fifty information-packed pages that will help you make the best use of the best of today's power transistors, rectifiers, thyristors and regulator diodes — with proven circuits springboarding auxiliary ideas for your future requirements!

"How-to-do-it" is the keynote. Nearly 150 bread-boarded and tested designs — many of them unique and up-to-now-unpublished — point the ways to a great variety of state-of-the-art power semiconductor applications. Even for a given power system, such as dc-ac conversion multi-faceted approaches are described: low and high voltage inputs and high power outputs, 60 Hz to 15 kHz switching frequencies, unregulated and regulated output with and without overload protection and using SCR's and transistors.

Specific titled sections include:

- Motor Speed Controls
- Inverters and Converters
- Regulated Power Supplies
- Static Switching
- Servo & Audio Power Amplifiers
- Thyristor & Transistor Switches

The first of many section highlights illustrates excellent control of ac induction motors through two unique designs followed by dc motor speed controls featuring control of rotation direction, compensation for load changes and optical feedback. Other chapters are equally engrossing spotlighting series, parallel and impulse-commutated thyristor inverters; overload circuit protection with automatic reset with no series resistance to power source; triac-relays with no contact bounce or arcing; low-distortion, transformerless, load-protected power amplifiers and much, much more.

**Learn the latest in power circuit designs with this invaluable technical library addition. Send for your copy today!**

(To receive "Semiconductor Power Circuits," send check or money order for \$2.00 payable to Motorola, Inc., to Box 20912, Phoenix, Arizona 85036.)



**MOTOROLA**  
Power Semiconductors  
*- where the priceless ingredient is care!*

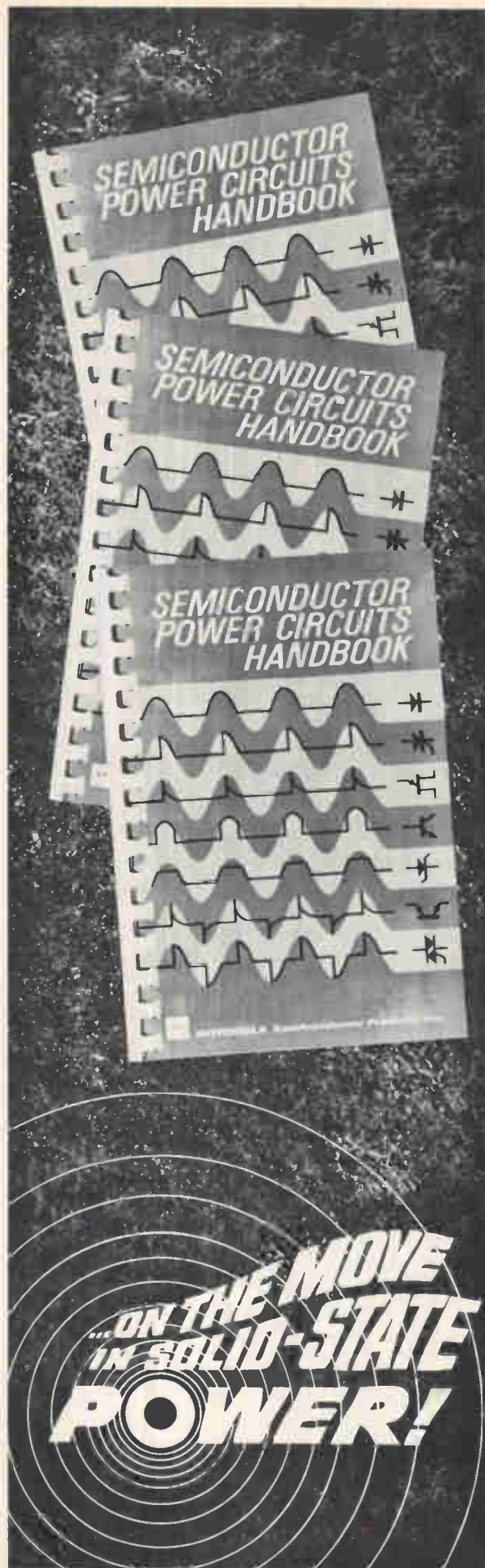

# Noisy Signal?

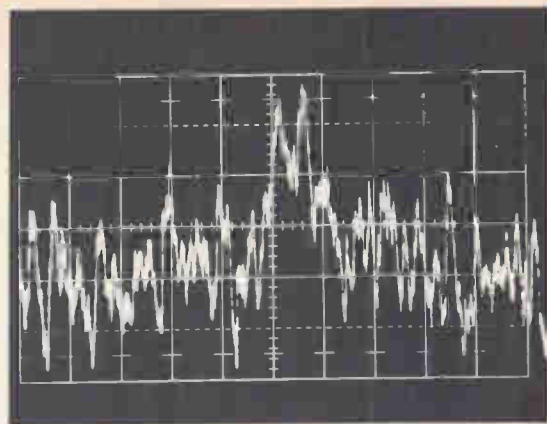

## Extract it with a PAR Waveform Educator™

The PAR Waveform Educator is a signal averager used to extract repetitive signals from noise. For complete information or to arrange a demonstration of this instrument, which is priced at only \$4,200, write Princeton Applied Research Corporation, P.O. Box 565, Princeton, New Jersey 08540, or call (609) 924-6835.

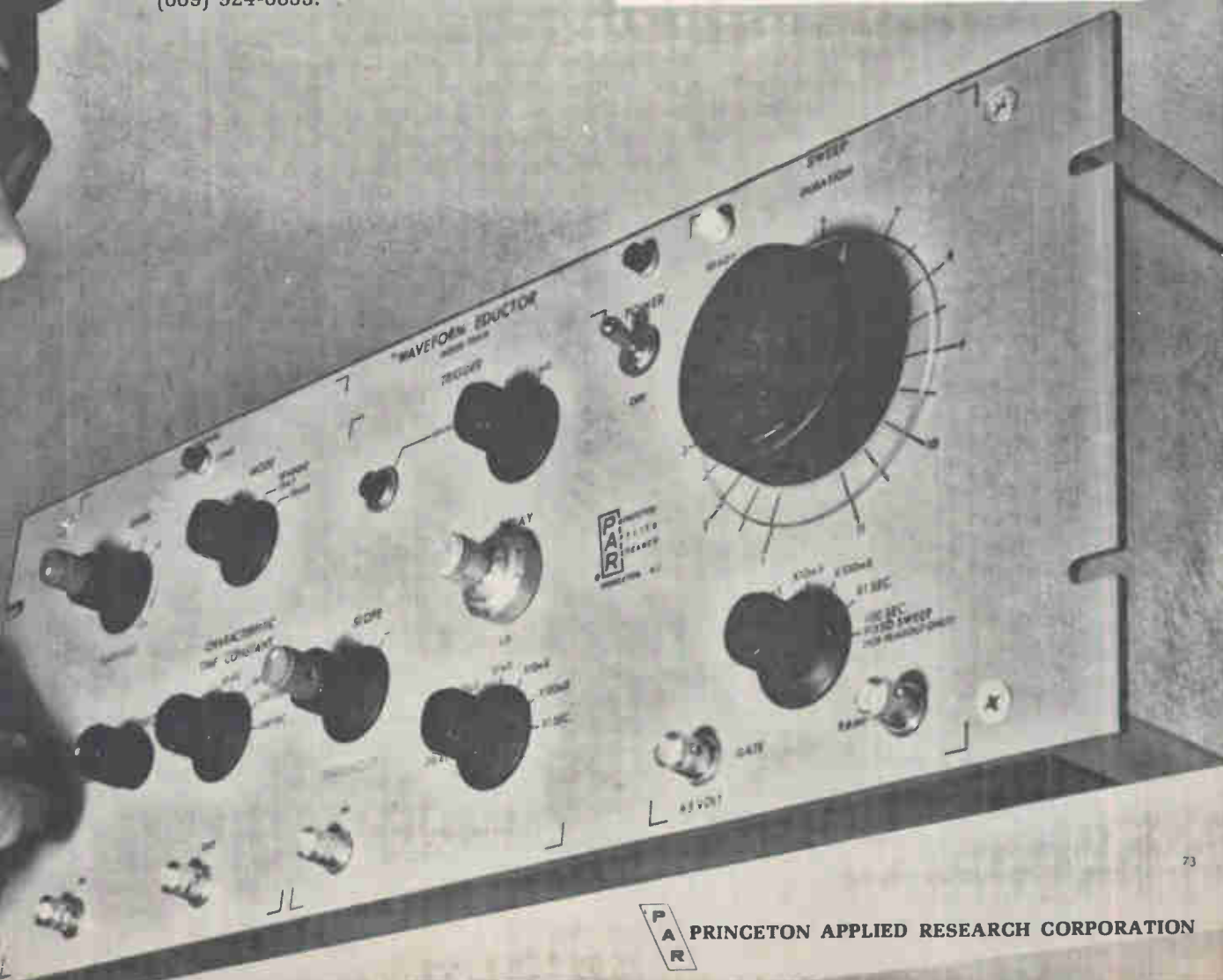
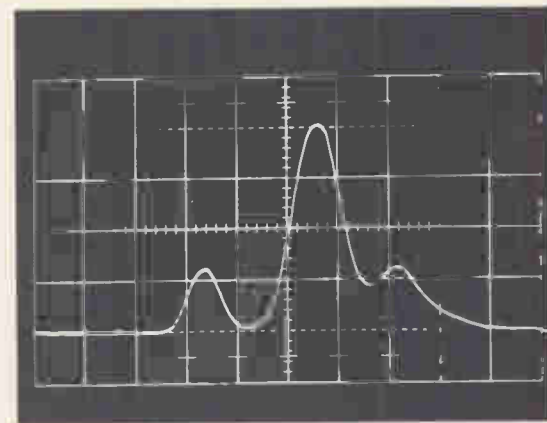

## Computers

### Walk-in model

Not since 1951, when Univac 1 was built, has anyone designed a computer big enough for a man to walk into. Univac's 1's performance is far surpassed today by a small unit sitting on a desk top, but its shape has been resurrected by the Control Data Corp., which bills itself as the builder of the world's largest computers. The new machine [Electronics, Sept. 30, p. 34], the CDC 7600, exceeds the performance of even the biggest machines previously built by the company.

The most important hardware features in the new machine are the small core memory that serves as a buffer between the large main memory and the processor, the maintenance control unit, and discrete circuits. The small core memory consists of 32 banks of 2,048 words each. Each bank—a conventional 3-dimensional, 4-wire unit—can cycle in 275 nanoseconds, storing or fetching one 60-bit word in that time.

The banks are capable of 10-way overlapping; in other words, independent cycles can be initiated in each one at 27.5-nsec cycle time. This 27.5-nsec interval matches the cycle time of the circuits in the machine.

**Simple arithmetic.** Even so, its 275-nsec cycle is fast for a core memory—especially a coincident-current unit. Control Data uses hand-wired arrays of 16-mil toroidal cores—instead of today's standard 20- to 22-mil cores—in the small memory because they can switch faster. The memory banks also dissipate quite a lot of power for their size—exact figures aren't yet available—suggesting that the cores may be made of a new type of ferrite material that requires more wallop to switch. It's understood that the cores are also only partially switched—a high-speed technique that switches only the material around the hole, instead of the entire core. Noise problems usually preclude partial switching in 3-D arrays, but a new material or an unusual sense winding pattern could reduce these problems to a manageable level.

The main memory contains eight banks of 65,536 words each and operates at 1.76 microseconds. Words, usually instructions, can be individually fetched from the large memory for use in the central processor, or large blocks, usually data, can be transferred into the small memory.

The 7600's central processor contains nine independent arithmetic units, each for a narrowly restricted class of operations and therefore relatively simple in design. These nine units, being separate, can operate in parallel, thus speeding up the system's throughput. A similar approach was used in the CDC 6600, announced in 1964.

Connected to the central processor are a number of peripheral processing units, which control input-output equipment. Each peripheral processor has a self-contained memory of 4,096 words of 12 bits each and eight data channels for connecting input-output devices—either local or remote—or additional peripheral processors. This approach permits an indefinitely large number of input-output units to be connected to a given central processor; the penalty is only in the number of times data has to be transferred from memory to memory through a string of peripheral processors.

**Unique unit.** The 7600 is the first computer with a maintenance control unit. This is a specialized processor that monitors the other components of the system without interfering with the system's performance and permits engineers to diagnose and exercise some components of the system off-line while other components continue running normally. To the system, the maintenance control unit has the same characteristics as a peripheral processor. The maintenance and diagnostic hardware that is some-



**Big and small.** Control Data's new computer, the 7600, is big enough for a man to step inside. And it uses tiny (16-mil) hand-wired arrays of toroidal cores in its memory. Despite its use of cores, the machine has a 275-nsec cycle speed.

times distributed throughout other systems is pulled together into a single unit in the 7600.

Strange as it may seem, the 7600 attains its extraordinary level of performance even with discrete components. Cordwood packaging of the components achieves the extreme packing density that the machine's high speed requires, while still retaining what CDC designers feel is the reliability that integrated circuits haven't quite achieved yet.

And stranger still, Control Data won't disclose the price of its new machine. It was formally introduced last week, and at that time the company declined to say why it kept the price secret. But it is known that the first machine is to be delivered in January to the Lawrence Radiation Labs.

## Space electronics

### Drawn to magnetics

Researchers at the Ampex Corp. in Redwood City, Calif., under a NASA contract, have revived the dream of attaining completely reliable, low-power magnetic logic structures.

Ampex has produced a multi-stage logic structure that can be wired to an identical structure to act as a four-stage shift register or an eight-stage ring counter. The key to the company's work is a proprietary process that permits the fusion of two ferrite materials.

Magnetic logic circuits can resume operation after a power shut-down without starting a job over.

This minimizes power requirements, since circuits need not be kept on to preserve logic states, and maximizes reliability. NASA thus viewed such circuits as especially suited to three- to five-year space shots.

**Uncompetitive.** Herbert Heckler Jr., Ampex materials-devices section engineer, notes that industry interest in magnetic logic peaked in the 1950's, diminishing with the advent of the transistor and almost dying after the development of fast integrated circuits, which magnetic logic could never compete with.

Magnetic-logic speed reaches its maximum at 100-kilohertz clock rates. However, for specialized functions, such as long space shots, where reliability and power rather than size and speed are prime considerations, magnetic logic may be the solution, the engineers believe.

The real stumbling block to developing magnetic logic structures, says Heckler, was that most work has been done with ferrite materials developed for magnetic core memories, and most magnetic structures have used only one ferrite material. The ideal device, he adds, would have different coercive forces for various magnetic paths so that the magnetomotive force ratio would be equal to the product of the ratio of path lengths and the ratio of coercive forces.

**Cut into sheets.** The addition of regions of high coercive force would allow high ratios of magnetomotive force for a structure of a given size. The ratios of magnetomotive force are vital in obtaining controlled switching of specific amounts of flux around the various paths—the fundamental consideration for the procession of binary logic states through the circuit. Two flux conditions are equivalent to binary 1 and binary 0.

The Ampex logic structures are formed, basically, of magnesium-manganese and cadmium-magnesium-manganese, each of which is "doctor-bladed" into small sheets; after drying, each material is punched into specific shapes, which are then compression-bonded in patterns that determine the relative placement of low and high coercive

## Electronics Index of Activity

December 9, 1968

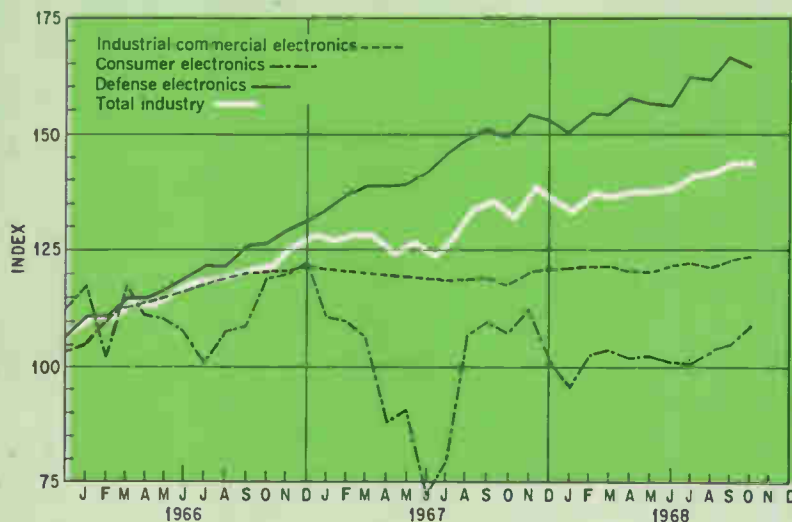

	Oct. 1968	Sept. 1968*	Oct. 1967
Consumer electronics	109.8	105.3	107.3
Defense electronics	1164.5	166.1	149.4
Industrial-commercial electronics	123.9	122.9	116.7
TOTAL INDUSTRY	143.3	143.1	132.7

Electronics production edged up 0.2 point in October from September but was up 10.6 points from October 1967. The consumer electronics index climbed 4.5 points in the month and 2.5 points in the year, while industrial electronics output rose 1 point in the month and 7.2 points in the year. Defense electronics slipped 1.6 points from the previous month but was still 15.1 points above the year-earlier level.

Indexes chart pace of production volume for total industry and each segment. The base period, equal to 100, is the average of 1965 monthly output for each of the three parts of the industry. Index numbers are expressed as a percentage of the base period. Data is seasonally adjusted.  
\* Revised



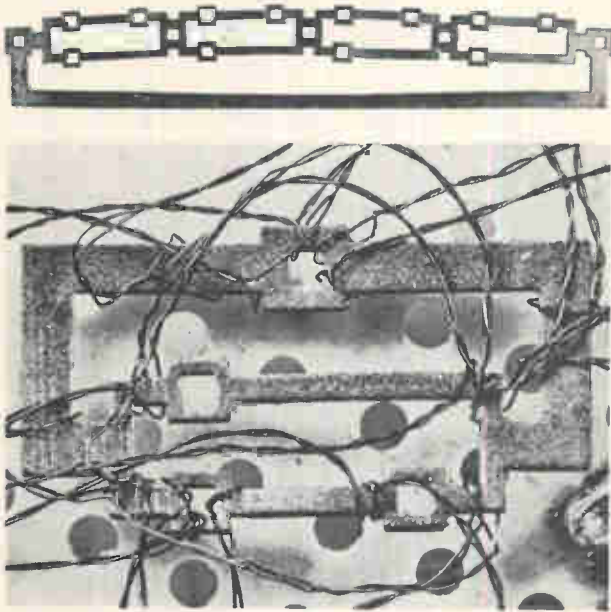

**Magnetic logic.** Four-stage logic structure (top) is building block of magnetic memory being developed for NASA. Lower photo shows how structure is wound.

force regions. This final structure is then sintered at high temperature, typically 1,300°C, to make the ferrite denser and develop the desired magnetic properties.

The present multistage structure, which is about 2½ inches long, offers the possibility of mass production, and such techniques are now being developed at Ampex. Efforts to halve the size of the structure without altering the circuit parameters are also under way.

## Industrial electronics

### One-tube color camera

A sizable share of the educational, industrial, and cable-television markets eludes color tv because the cameras and associated equipment cost too much. And camera makers haven't been able to lower their prices much because they've had to use three pickup tubes, one for each primary color.

Last month, however, RCA introduced a single-tube color camera that considerably enhances the outlook for those markets. Priced between \$6,500 and \$10,000, the camera systems cost from a third to a half less than competitive cameras.

Resolution of the new color systems is about 200 lines, adequate

for most educational purposes but far short of the 525-line broadcast quality. RCA engineers think higher-resolution systems may be developed within five years, however. This would probably also reduce prices of broadcast-quality equipment. To improve resolution for broadcast quality, RCA could take a number of approaches, among them bigger vidicon tubes or different tubes altogether.

**Primary principle.** In developing the one-tube color camera, RCA focused on a principle developed in the 1950's but then discarded. Nobody worked on it because the electronics—considering the state-of-the-art at that time—was unwieldy. The idea was resurrected a few years ago, when semiconductor technology seemed to permit an inexpensive, compact design.

Since primary colors leave a signature even on black-and-white patterns, RCA's Commercial Electronics Systems division began working on methods to extract the values of two of the primary colors from a black-and-white picture. By subtracting the known two, the third can be derived.

They devised a basic design whereby dichroic optical filters in a sandwich configuration identify the red and blue before the light reaches the vidicon. The red-blue-green image is then carried whole to the tube, where it is converted

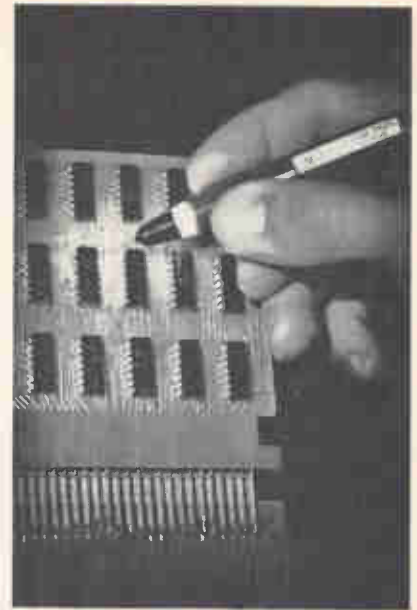

## This probe lights up when a pulse goes by.

Even a pulse as short as 30 ns—positive or negative—will cause this logic indicator to flash a signal. You can trace pulses, or test the logic state of TTL or DTL integrated circuits, without taking your eyes off your work. In effect, the probes act like a second oscilloscope at your fingertips.

No adjustments of trigger level, slope or polarity are needed. A lamp in the tip will flash on 0.1 second for a positive pulse, momentarily extinguish for a negative pulse, come on low for a pulse train, burn brightly for a high logic state, and turn off for a low logic state.

The logic probe—with all circuits built into the handpiece—is rugged. Overload protection: —50 to +200 V continuous; 120 V ac for 10 s. Input impedance: 10 kΩ. Price of HP 10525A Logic Probe: \$95, quantity discounts available.

Ask your HP field engineer how you could put this new tool to work in logic circuit design or troubleshooting. Or write Hewlett-Packard, Palo Alto, Calif. 94304; Europe: 54 Route des Acacias, Geneva.

02825A

**HEWLETT  PACKARD**

# PROGRAM VOLTAGE OR PROGRAM CURRENT WITH KEPCO AUTO-CROSSOVER POWER SUPPLIES

By PROGRAM, we mean the exercise of intentional control over the output of your power supply — a regulated supply that remains quiescent — unmoving, stable until it receives your command signal.

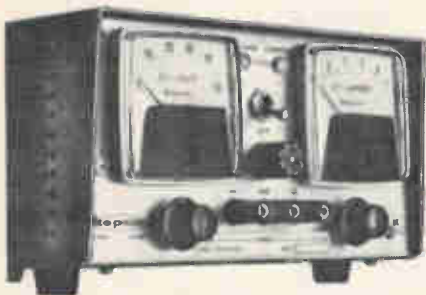

Model CK-36—1.5M voltage/current regulator showing Kepco's exclusive mode indicator lights—VIX®. This half-rack power supply delivers 0-36V @ 0-1.5A.

You can signal with analog voltage or current or resistance or conductance. Or, you can get fancy and use digital control. Kepco's 6 CK models offer complete control over both voltage (0-2V to 0-60V) and current (0-8A to 0-0.5A) the half-rack design may be bench mounted or installed in a single or dual 19" rack adapter. Write Dept. C-14 and we'll tell you about the 16 programming terminals available on all models.

**with KEPCO  
IT'S CONTROL!**



131-38 SANFORD AVE. • FLUSHING, N.Y. 11352  
(212) 461-7000 • TWX #710-582-2631

## Electronics Review



Two down. RCA's new color television camera has one pickup tube instead of the conventional three.

into electrical signals.

These signals go from the camera to a control console in which a proprietary arrangement of integrated circuits and discrete transistors on a 5-by-12 inch printed-circuit board identifies the primaries and enhances them. Standard colorplexing techniques fuse them into NTSC color signals. One control console can handle three cameras.

The beauty of the system is that "it's basically a standard black-and-white camera," says Henry Ball, chief engineer. "The tube doesn't see color. All it sees are black and white values." Also, the basic image is never taken apart, he explains, so there are no registration problems of bringing together three pictures as there are with three-tube cameras. This is the chief cost-cutting factor.

**Fewer controls.** Another is the use of an ordinary \$130 1-inch 8507A vidicon. Since the average user will be a nontechnical person, RCA was able to eliminate many of the fine adjustment controls a studio technician would require. The color filters automatically set the color values, for example.

The studio camera, with viewfinder, costs \$9,850. It's 10 inches high, 11 inches wide, and about 25 inches long, and it weighs about 45 pounds. A camera without viewfinder for static uses will cost

\$6,500, and a complete tv color-film system will go for the same price as the studio camera.

Once it knew it could produce the system, RCA quickly chose to announce it at last month's National Association of Educational Broadcasters convention in Washington, the first convenient showcase. It seems Japanese companies have also been experimenting with single-tube color tv. "We don't know what they're going to do," says one RCA executive. "So we decided to announce first and get as many orders as we can."

## Instrumentation

### Energetic identification

Two researchers at Varian Associates have applied a technique used for studying radioactive decay to the analysis of chemical compounds, and in doing so have developed a new type of spectrometer. Varian says the unit, called an induced electron emission spectrometer, is 10 times more sensitive than present analytical instruments, and will complement or supplant infrared, ultraviolet, X-ray emission, mass, and nuclear magnetic resonance spectrometers.

The new technique uses low-energy X-rays to knock electrons loose from the inner shells of the atoms in the compound. The energy required to shake the electrons free depends on the element and is determined by sending the electrons through an electrostatic field, where they're dispersed according to their energy levels. They then enter a detector slit and pass through a 15-stage dynode that multiplies the number of electrons 100,000 to 1 million times.

**Taking the pulse.** Which electrons are entering the detector slit is determined by sweeping the strength of the electrostatic field. In addition, the electron multiplier produces a series of electrical pulses, which, when counted, indicate the number of electrons knocked loose at each energy level, and hence the amount of each ele-



Do you need  
**MIL Type Rectifiers?**  
(JAN or JANTX Types)

1 amp Fast Recovery Rectifiers  
MIL-S-19500/359A (USAF)  
1N4942, 1N4944, 1N4946,  
1N4947 and 1N4948

1 amp General Purpose Rectifiers  
MIL-S-19500/286B  
1N4245, 1N4246, 1N4247,  
1N4248 and 1N4249

3 amp General Purpose Rectifiers  
MIL-S-19500/367 (USAF)  
1N5197, 1N5198, 1N5199,  
1N5200 and 1N5201

High Voltage Sub-miniature Rectifiers  
MIL-S-19500/279 (NAVY)  
1N3644, 1N3645, 1N3646  
and 1N3647

Semtech has extensive environmental and power burn-in facilities available to process your military and high reliability requirements.

Contact your local representative for immediate delivery —

San Francisco — 941 E. Charleston, Suite 10, Palo Alto, California 94303  
(415) 328-8025  
Chicago — 140 N. La Grange Road, La Grange, Illinois 60525  
(312) 352-3227 / TWX: 910-683-1896  
Dallas — 402 Irving Bank Tower, Irving, Texas 75060 / (214) 253-7644  
New York — 116-55 Queens Blvd., Forest Hills, New York 11375  
(212) 263-3115 / TWX: 710-582-2959  
European Sales — Bourne A. G., Alpenstrasse 1, Zug, Switzerland  
(042) 4 82 72/73



**SEMTECH**<sup>TM</sup>  
CORPORATION

652 Mitchell Road, Newbury Park, California 91320  
(805) 498-2111, (213) 628-5392 / TWX: 910-336-1264

# BUNKER-RAMO'S NEW A/D CONVERTER SIMPLIFIES YOUR SYSTEM, LOWERS COSTS.

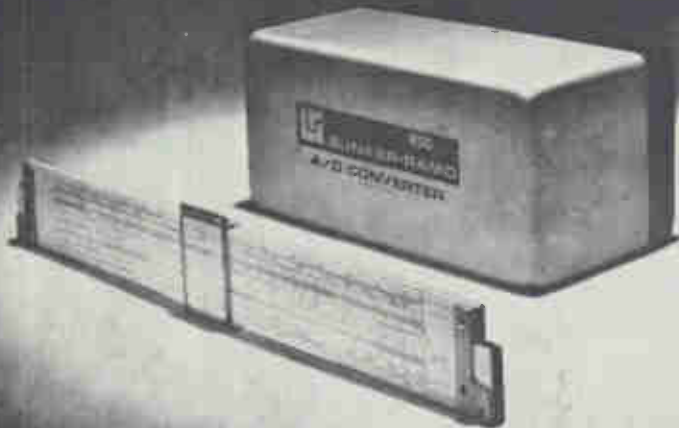

Recent technical breakthroughs at Bunker-Ramo enable us to offer an extremely versatile, yet simple A/D converter at a price of \$1,348.

Designed for incorporation into *your* system, the BR-850 uses  $\pm 15$ -vdc system power at less than 7.5 watts, weighs less than 2 pounds and occupies less than 125 cubic inches.

The BR-850 provides full 8-bit resolution, 1-MHz *word* rate, fully buffered input, continuous or clocked readout or asynchronous operation to your system speed, internal register, output either in parallel Gray code or serial binary—plus many additional features designed to simplify *your* system application.

For more information about the BR-850 and how it can help you with your specific application, contact W. G. Garner. Phone: (213) 346-6000 or write:

 **THE BUNKER-RAMO CORPORATION**  
DEFENSE SYSTEMS DIVISION  
8433 FALLBROOK AVENUE • CANOGA PARK, CALIFORNIA 91304

ment that is present.

John Helmer and Norbert Weichert, the developers of the new spectrometer, report that binding energy varies with an element's structural environment, so that carbon in a methyl group exhibits a slightly different binding energy than carbon in a carboxyl group. Identification and measurement of these chemical shifts will provide a new body of chemical information.

Induced electron emission was pioneered by Kai Siegbahn, a professor at the University of Uppsala, Sweden. But Siegbahn needed large magnetic fields to detect fast electrons; he had to use huge coils to create a magnetic field equal and opposite to the earth's to prevent magnetic perturbations. The equipment was housed in a non-magnetic building containing no steel. Similar gear built at other universities requires several rooms full of equipment.

Siegbahn used magnetic fields because he couldn't get electrostatic fields of sufficient energy in a vacuum to operate with fast particles. But high energy isn't a requirement for spectroscopy, and so Weichert and Helmer were able to design an electrostatic analyzer and shield it in a double-walled Mu-metal cylinder only 4 feet tall and a foot in diameter. And this has enabled Varian to produce a desk-size instrument.

The spectrometer accepts samples in their natural form—solid, liquid, or gas. When the chamber has been evacuated to a pressure of  $1 \times 10^{-7}$  torr, the sample is bombarded with soft X-rays at an energy level of 1,500 electron-volts. The electronic energies are resolved to 0.1 ev, or one part in 10,000.

**In-house rivals.** Announcement of the spectrometer was made last month at the Pacific Conference on Chemistry and Spectroscopy in San Francisco, and Varian plans to start selling the instrument in mid-1969 at a price of \$60,000. Once on the market, it will compete with Varian's own mass and nuclear magnetic resonance spectrometers, but the company figures it's time to act on the new technology. "In the first place, the technology will need acceptance in the marketplace,"

# winning form

from the  
form-factor  
specialists  
at Damon

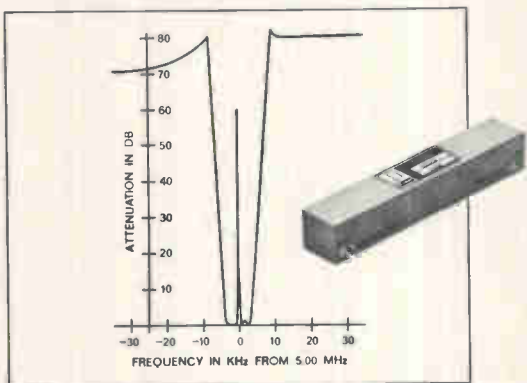

When it comes to rejecting clutter in a Doppler radar system, or the carrier in a suppressed-carrier communications system, the **Damon Model 5200A Bandpass-Notch Filter** gives you a double edge. It provides at least 50 db of clutter or carrier rejection — plus crystal bandpass filtering to eliminate unwanted sidebands.

Specifications: Notch frequency ( $f_R$ ): 5.00 MHz. Reject bandwidth (>50 db):  $f_R \pm 70$  Hz min. Passbands: Flat within  $\pm .75$  db from  $f_R \pm 450$  Hz to  $f_R \pm 3570$  Hz. Insertion loss: typically <5 db. Out-of-band rejection: 60 db min. Operating temperature range:  $-15^\circ\text{C}$  to  $+65^\circ\text{C}$ .

Whatever your signal-shaping needs — from a sharp rejection notch to a broad bandpass — you can rely on the form-factor specialists at Damon. Write: Electronics Division, Damon Engineering, Inc., 115 Fourth Avenue, Needham, Mass. 02194, or call (617) 449-0800.

## DAMON

Circle 51 on reader service card

# INFO-SCOPE

PAT. PENDING

MARK I



Can increase your production output by **TWO to TWENTY TIMES!** Yes, this revolutionary **NEW** instrument—the McBain INFO-SCOPE by Olympus will increase production dramatically, lessen operator fatigue and practically eliminate costly errors.

The INFO-SCOPE introduces information into the operator's field of view. What formerly was outside the microscope is now inside the optical system. This information in the form of written instructions or diagrams is superimposed on the work piece. The operator can devote his attention entirely to assembly and testing without the necessity of raising his eyes to read schematics or other information. The information can be inserted or removed at the flick of a switch. Our MARK II model INFO-SCOPE allows the operator to read digital voltmeter displays in the field of view.

Priced at \$685 the McBain INFO-SCOPE is no more expensive than many standard zoom stereo microscopes. *For information about this exceptional new optical instrument, write or telephone:*

## McBAIN INSTRUMENTS, INC.

14753 ARMINTA ST. • VAN NUYS, CALIFORNIA 91402 • (213) 873-2205

## Electronics Review

says Jerome Holcomb of the Analytical Instruments division. "In the second place, we have a strong feeling that we're not the only instrument company that's been working on it."

### Patents

#### Upsetting decision

The Patent Office, which ruled in October that computer programs aren't patentable, was reversed last month when the Court of Customs and Patent Appeals overturned an examiner's ruling that prohibited a patent for a device using a program.

The Patent Office, however, hasn't conceded defeat. Patent Commissioner Edward J. Brenner said he interprets the decision as meaning that programs are patentable subject matter and that patents should be granted if the software meets the other criteria of patentability.

Brenner said that he was planning to file a petition for reconsideration by the court and that he may take the matter to the Supreme Court.

The court's decision came only 29 days after Brenner said his office planned to continue its policy of refusing patents on programs [Electronics, Oct. 28, p. 58].

The court ruled that Charles D. Prater and James Wei of Mobil Oil's computer center in Princeton, N.J., were entitled to a patent on a device used for spectrographic analysis of gases. The device requires an analog computer and its associated software.

**Wait a minute.** Two days before the court announced its decision Brenner petitioned the court for a delay, saying the appeal "involves broad fundamental questions of whether certain process claims fall within the statutory definition of a process."

Brenner further warned the court that "important legal issues are involved, which may affect the business community active in a new field of technology." He said the decision "will undoubtedly be

Looking for a PCM Bit Synchronizer and Signal Conditioner with four digit bit rate selection, crystal controlled accuracy, and stability of one part in  $10^5$ ? Need to accommodate all PCM Codes, exhibit no bit slippage at 0 db SNR and regenerate data to within 1 db of theory? Want optional computer and remote programming capability?

Well, Norden has it in stock.

It's the Vector Model 975 PCM Bit Synchronizer and Signal Conditioner, part of Norden's full line of ground digital data acquisition and reduction equipment. For more information, or a demonstration, write or call Communications Products Department, Norden Division, United Aircraft Corporation, Trevose, Pa. 19047. Phone (215) 355-5000.

**Norden** DIVISION OF UNITED AIRCRAFT CORPORATION  
**U  
A**



# now...

## Reliable-Versatile *low-cost* Reed Pushbutton Switch by CLARE-PENDAR



actual size

- Sealed-In-Glass, SPST-NO contacts provide contamination-free service.
- Long Life: Ten million cycles at 12 vdc, 1/8 amp... longer at reduced levels.
- Gold Alloy Contacts: Assure initial 200 milliohm contact resistance.
- Durable: Specially selected plastics used for critical components. Diallyl phthalate terminal header and PCB adapters.

### MOUNTING CHOICES:

Standard threaded neck... PCB base stud or solder lugs... or 10° angle adapter base.

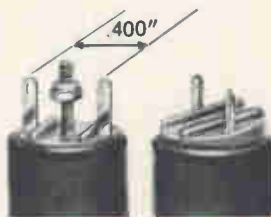

■ Here is the switch designed to meet your needs... to complement your package as "made-to-order"... at off-the-shelf prices! Controlled contact bounce... assured by the Clare PICOREED—"make" less than 500 microseconds and a consistent clean "break". Rugged... tested in accordance with MIL-STD-202C... meets shock to 35G... temperature -65°C to 85°C. Feather touch 4 oz. pressure... choice of lens shapes and colors certain to please.

Circle Reader Service Number or write for complete information

## Electronics Review

treated as a precedent for a number of other appeals" currently before the court involving the same or similar issues.

## Components

### Reluctant inductance

It's not often that an R&D contract is the result of a chance meeting between two men. But that's just what happened with Philip R. Geffe, a Westinghouse research engineer, and Charles E. Holland, a senior engineer in the Naval Electronics Systems Command.

Holland has been convinced that integrated-circuit gyrators promise a breakthrough in achieving inexpensive, versatile filters for communications networks and systems. This would include teletypewriters, sonar filter banks, and extremely-low and very-low frequency receivers.

However, there just aren't any such inexpensive off-the-shelf filters because semiconductor manufacturers, uncertain of the market, haven't invested in their development.

It turned out that while Holland was considering a gyrator contract, Geffe was tinkering with the gyrator problem during his work on active filters for Westinghouse. He had even built a few rough ones on his own but couldn't get any in-house money to pursue the problem.

**Small stuff.** One result of the chance meeting, then, was that—to spur commercial interest—the command awarded Westinghouse's Defense & Space Center a small (a little more than \$100,000) 18-month contract to develop a monolithic IC gyrator [Electronics, Oct. 28, p. 69]. Of course, the development could eventually give all the services cheap, small, mass-produced filters.



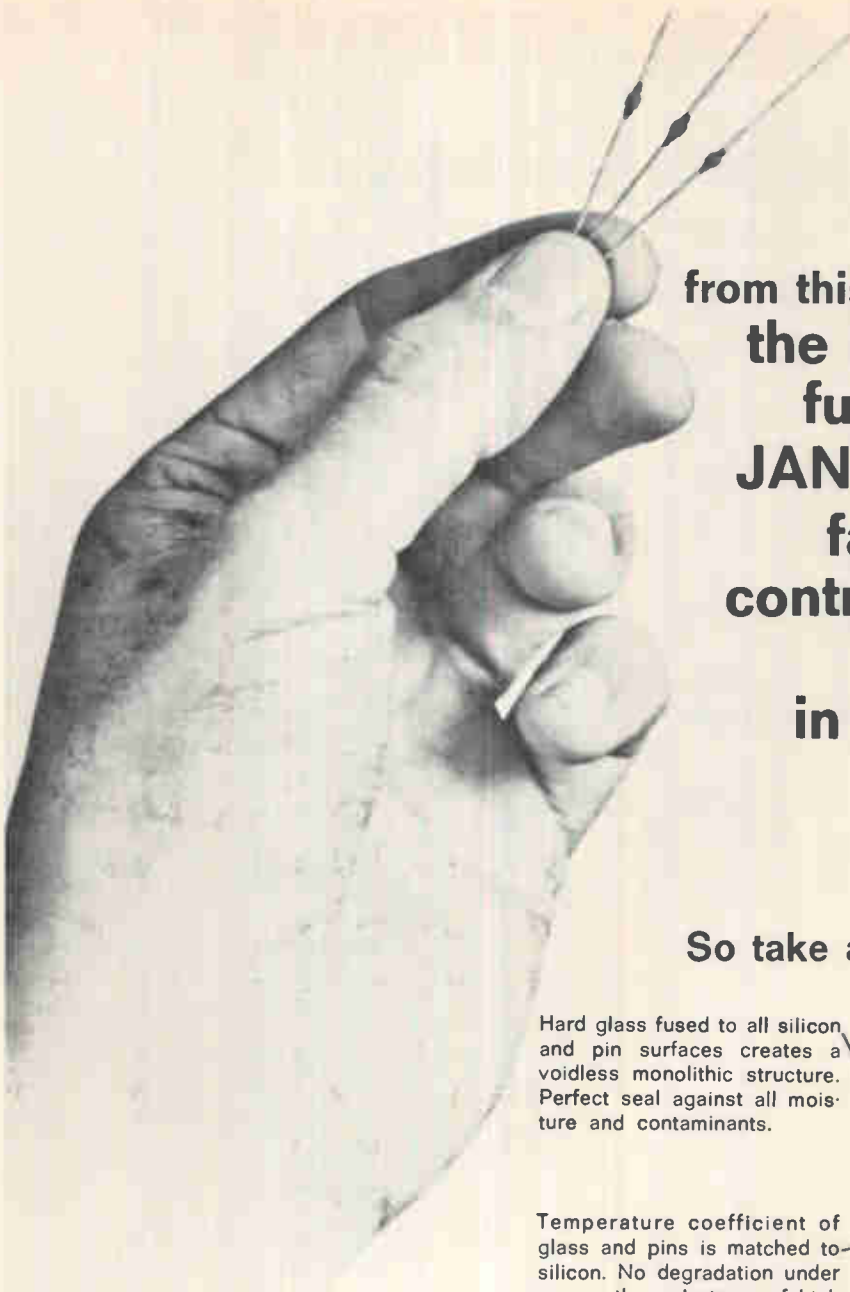

**You can't tell  
from this picture that these are  
the only monolithic  
fused-in-glass  
JAN TX type 1N4942  
fast recovery  
controlled avalanche  
rectifiers  
in the business.**

**So take a look at this actual section**

Hard glass fused to all silicon and pin surfaces creates a voidless monolithic structure. Perfect seal against all moisture and contaminants.

Metallurgical bond of pins to die faces at 1000°C allows extremely high surge capability, low thermal resistance. Virtually indestructible construction.

Temperature coefficient of glass and pins is matched to silicon. No degradation under severe thermal stress of high transients or repeated temperature shock even from -195°C to 300°C.



Controlled avalanche and permanently stable surface leakage characteristics. Hyperclean silicon surface fused only in hard glass. No oxides, silicones, or varnish are used.

ACTUAL SIZE



JAN and JAN TX-1N4942 Series  
I<sub>o</sub> @ 55°C 1.0 Adc  
Surge 15 A

JAN 1N4942 200V  
JAN 1N4944 400V  
JAN 1N4946 600V

Recovery Time 150 nsec

And you can't tell by looking at the picture that Unitrode not only makes them, but has them on the shelf, ready to ship, no waiting, 3 ratings. So . . .

If you're in a real hurry, why not call Dave Greene collect, at (617) 926-0404.

If you're not in that much of a hurry, we'll be glad to send you our data sheet, with all the specs.

Samples anyone? Just call Compar or Daniel & Co. . . . or drop us a line.

580 Pleasant Street, Watertown, Mass. 02172 (617) 926-0404

**UNITRODE**



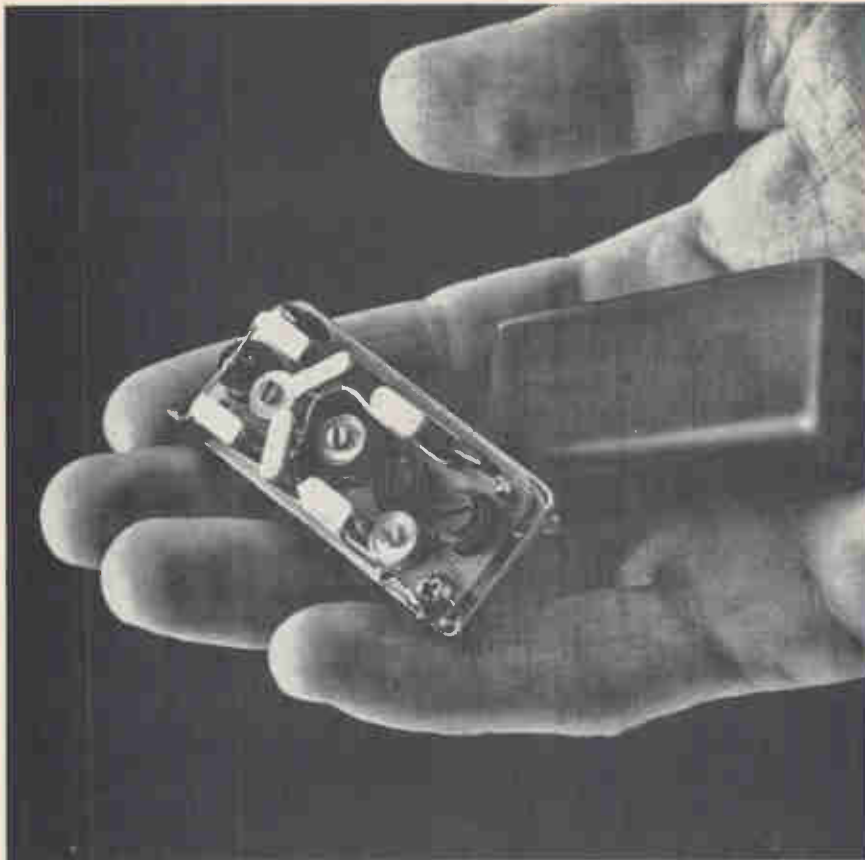

## Does Sherold produce more crystal filters than any other source?

### Clearly.

In fact, we're the largest single independent source for both crystal filters and discriminators. And we've built more PRC and VRC filters than any other company. Plus, we've got the widest range of models in production. But . . . biggest doesn't necessarily mean best, although it's a good indication. Sound out our crystal technology capabilities and you'll find Sherold has a solid reputation for being able to produce top-quality frequency selection devices in the full range from 1 to 150 megaHz. For commercial and military applications. The real proof, though, is to let Sherold tackle your frequency selection application. Send us the electrical and mechanical characteristics of your problem and we'll put our Filter Technology Department to work on it. Quickly. Write Sherold Crystal Products Group, Tyco Laboratories, Inc., 1510 McGee Trafficway, Kansas City, Missouri 64108. Or phone (816) 842-9792. TWX 910-771-2181.

# TYCO

## Electronics Review

is far from the only reason the Navy is looking at such components. Since a gyrator with a capacitor acts like an inductor, a designer can connect a communications circuit with his present knowledge of inductors. With other approaches to active filters, such as amplifiers, the designer would have to learn a new technology. What's more, IC gyrators mounted on printed-circuit boards could also lead to modular equipment assembly, making maintenance much easier. And large-scale integration promises further benefits.

**Other devices.** Although the Navy sees the contract as the start of an "evolutionary type of development which will eventually evolve into a wide range of devices," according to Holland, it also wants Westinghouse to devise filters that can be readily made mass produced.

The Navy also wants high Q and stability. "We would like to have the maximum possible Q of thousands," Holland says. "We'll probably get 400," Holland adds, and it seems he would be happy with that.

## For the record

**Top man.** The IEEE has elected F. Karl Willenbrock president for 1969. Willenbrock, a provost at the State University of New York, succeeds Seymour Herwald.

**Light music.** Hughes Aircraft has been awarded a \$12 million contract by McDonnell Douglas to develop a multiplexed entertainment system that will eliminate 400 pounds of wiring from the DC-10 airliner [Electronics, June 10, p. 25].

**Purchase.** The Data Automation Co., a computer service firm, has bought a 45% interest in the Carterphone Communications Corp. of Dallas. Carterphone successfully challenged AT&T's ban on attaching customer-owned equipment to phone lines [Electronics, Sept. 16, p. 55].

# Flicker-Free CRT Storage

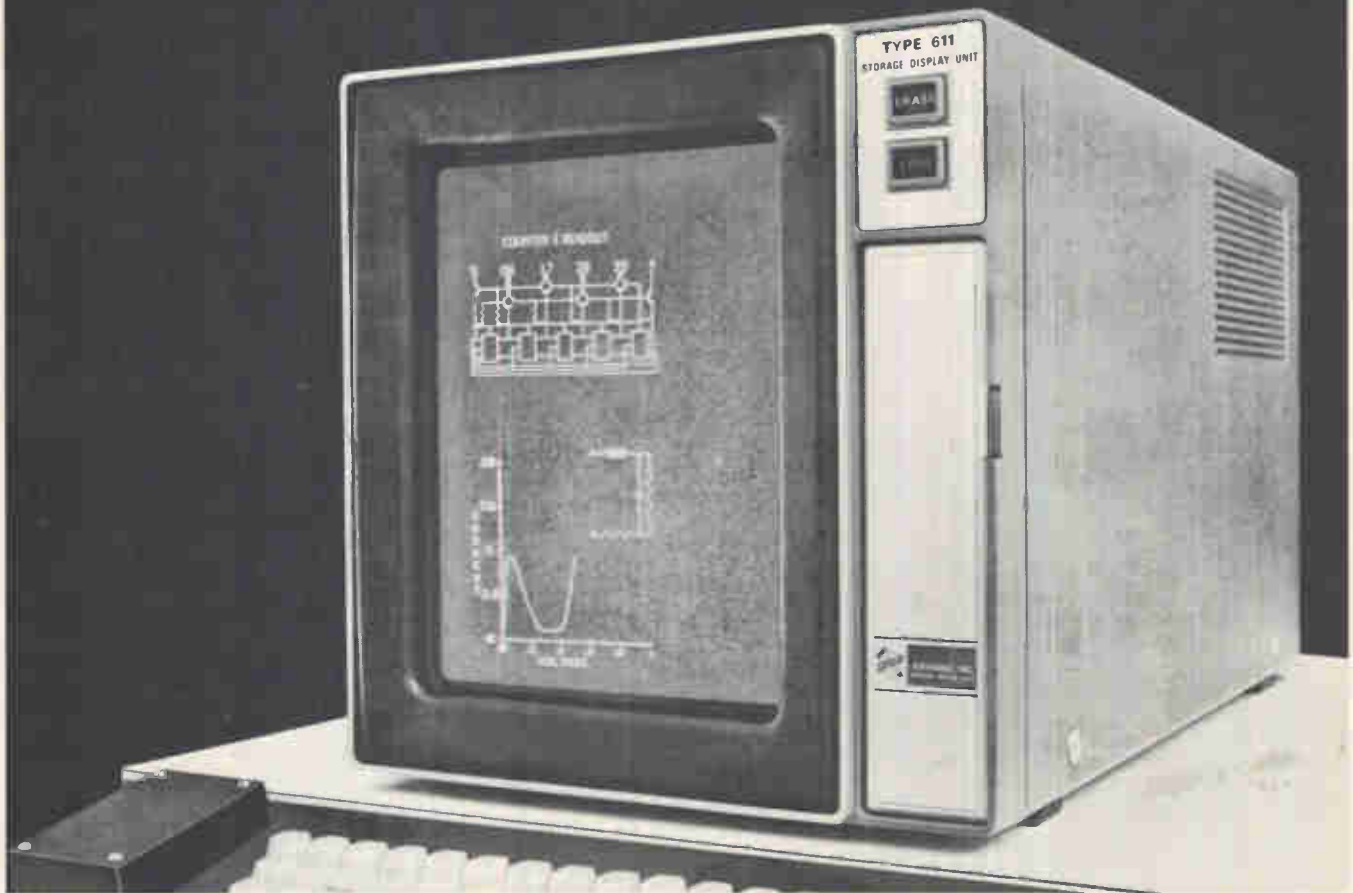

## NEW Storage Display Unit from TEKTRONIX®

*The Type 611 Storage Display Unit is designed to function as a computer console and remote terminal readout device. With X, Y, and Z inputs provided by peripheral equipment, this new instrument presents flicker-free displays of alphanumeric and graphic information without refreshing.*

The Type 611 Storage Display Unit features an 11-inch, magnetically deflected, bistable storage display tube. This new storage tube offers high information density and excellent resolution on a 21-cm x 16.3-cm screen. 4000 characters, 90 x 70 mils in size, may be clearly displayed with good spacing. Resolution is equivalent to 400 stored line pairs along the vertical axis and 300 stored line pairs along the horizontal axis. Dot settling time is  $3.5 \mu\text{s}/\text{cm} + 5 \mu\text{s}$  and dot writing time is  $20 \mu\text{s}$ . Time required to erase and return to ready-to-write status is 0.5 seconds. Operating functions are remotely programmable through a rear-panel connector. A "Write-Through" feature provides an index to the writing beam position without storing new information or altering previously stored information.

Type 611 Storage Display Unit ..... \$2500  
U.S. Sales Prices FOB Beaverton, Oregon

For a demonstration, contact your nearby Tektronix field engineer or write: Tektronix, Inc., P.O. Box 500, Beaverton, Oregon 97005.



*Nearly half of our effort devoted to development and production of specialized components*



*... part of the Tektronix commitment to technical excellence*

**MICROWAVE IC  
PROGRESS  
REPORT #5**

# PACT proves microstrip is compatible for MIC mixers, filters, hybrids

Before microwave integrated circuits can become a reality this important question must be answered — can present stripline technology be converted to microstrip without a prohibitive performance penalty? Engineers and scientists engaged in Sperry's PACT (Progress in Advanced Component Technology) Program have found the answer, and the answer is yes!

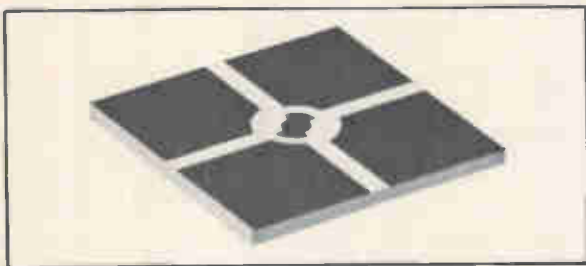
**TWO-BRANCH MICROSTRIP 3 DB COUPLER**

PACT investigations have already produced couplers, balanced mixers and a number of hybrid circuits, all utilizing the basic microstrip technology. Performance penalties have been negligible, and all indicators point to production availability of entire subsystems deposited on a single substrate.

Like other PACT activities, this effort has depended heavily on the proper selection of materials. For multi-function substrates, such as those capable of carrying entire subsystems, Sperry's choice is a composite of ferrimagnetic and alumina substrates. In some cases all-ferrimagnetic substrates are recommended.

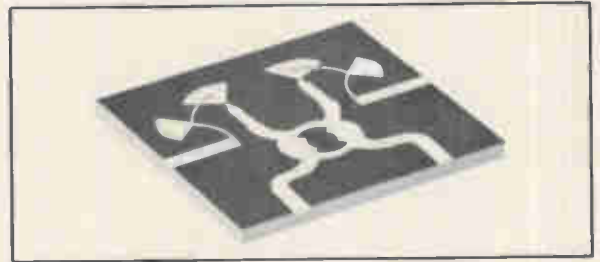
**MICROSTRIP BALANCED MIXER CIRCUIT**

This approach provides maximum size, weight and cost savings, along with significant increases in thermal and mechanical stability.

PACT has also benefited from the use of the computer as a design aid. For example, the computer was programmed to calculate the electrostatic potentials around a microstrip circuit and determine its impedance. Options were then added to the program to obtain a print-out of actual potentials around the microstrip and to plot equal potential lines.

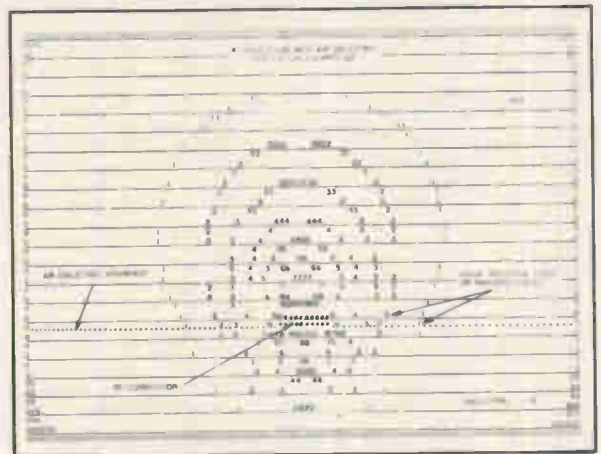
**COMPUTER PLOT OF EQUAL-POTENTIAL SURFACES  
(RF MAGNETIC FIELD) AROUND MICROSTRIP LINE  
WITH  $\epsilon = 9$** 

The result is optimum configuration for microstrip circuits prior to their fabrication.

To learn more about Sperry progress in design and fabrication of multi-function MICs for your applications, ask your Cain & Co. representative or write Sperry Microwave Electronics Division, Sperry Rand Corporation, Clearwater, Florida.

*For faster microwave progress,  
make a PACT with people  
who know microwaves.*

# SPEYRY

MICROWAVE ELECTRONICS DIVISION  
CLEARWATER, FLORIDA

---

# Washington Newsletter

---

December 9, 1968

## House unit says agencies withhold data despite law

A freer flow of information from Government agencies in such areas as procurement—details on contractor evaluations and unclassified bids, for example—was expected to result from the Freedom of Information Act. But this isn't happening, according to the House subcommittee on foreign operations and Government information. It's finding that many agencies, including the armed forces and intelligence gathering groups, aren't obeying the act. The subcommittee plans to schedule hearings next spring to find out why and force compliance with the law, which has been on the books since July 1967.

One area of concern to the subcommittee staff: the armed forces haven't been making contractor evaluation reports available to the public. The Army is currently revising its procedures, but the other services have not yet done anything to alleviate the situation. Something else irritating the subcommittee is that the armed services are still using procurement rules that the panel says are inconsistent with the law. For example, information on unclassified bids has been repeatedly withheld.

## Post Office alliance with Western Union will be recommended

The Post Office may eventually get involved in facsimile mail transmission—conceivably in partnership with Western Union—if a proposal by the President's Task Force on Telecommunications is adopted. The task force, which is still applying final touches to its report, will recommend that a deal be worked out to allow Western Union to use Post Office facilities and personnel. For example, special delivery mailmen would deliver telegrams and Western Union would open windows at Post Offices.

Western Union would also like to offer a new cooperative service it calls "mail gram"—an overnight telegram delivered with the morning mail. If Congress goes along with such a service, the next step could easily be facsimile mail services—handled jointly by the Post Office and Western Union. This obviously would open up a large market for such equipment. Post Office researchers have long followed facsimile developments but have hesitated to recommend their use by the Post Office because of the many legal and political objections that would be raised. A cooperative effort with Western Union might sidestep these hurdles.

## LBJ may hand GOP sharply pared budget

President Johnson may be cooking up a hot potato to pass on to the incoming Nixon Administration—a very tight and balanced Federal budget to be sent to Congress in January. By chopping the budget requests of Government departments, the present Administration would be leaving it up to the Republicans to restore projects cut in its fiscal 1970 budget.

One Congressman who sees evidence of this is Rep. Melvin Laird (R., Wis.). After getting a rare glimpse of the budget, which is now going through its final appeals in the Budget Bureau, he reports that the Consumer Protection and Environmental Health Service, for example, is down for only a \$9 million increase from its present \$222.3 million outlay—a rise of less than 5% and not even enough to cover increasing costs due to inflation.

Budget Bureau officials who have been pulling together the 1970 budget see similar patterns elsewhere. William D. Carey, assistant direc-

---

# Washington Newsletter

---

tor of the bureau, says R&D is in "a holding pattern that is probably going to last for a while."

## Government plans computer-based education system

The Office of Education's research bureau is moving ahead with a computer-based education system that will cost only a projected \$12 to \$15 per student annually. The system will do administrative work and teach students how to work with computers, but will not include computer-aided instruction. Called Cues (for Computer Utilities for Education Systems), it is an outgrowth of studies performed by IBM and the General Learning Corp. [Electronics, May 29, 1967, p. 59].

Within the next few months, the Office of Education will ask for industry proposals for Cues software and curricula. The research bureau is currently drawing up specifications for hardware, but it won't ask quotes from computer firms for about a year. The system will be built around a large time-shared computer.

Though the location hasn't yet been decided, Cues may be installed in the Washington area to serve 200,000 high school and junior college students at 100 schools in a 100-mile radius. The cost per student is low because there will be only one or two terminals at each school. These terminals will include moderate-speed card readers and printers. The students, who'll be offline, will either mark or punch cards, which will then be batch processed.

## Figures on midair near misses could spur work on CAS

Congress may step up or even expand work on pilot warning indicators and collision avoidance systems (CAS) after it sees the FAA's report on the number of near midair collisions in 1968.

If reports of near misses continue to come in at the present rate, the number of instances rated "hazardous" this year will total at least 1,000, with more than 700 of them in the area of terminals. During January and February—considered "slow" months because flights are frequently grounded by poor weather conditions—the agency got reports of 436 near misses; of the 186 deemed hazardous, 117 were in terminal areas.

## NASA to ask funds for Mariner-Mars 'soft landers' in '70

NASA has decided to ask for money in its fiscal 1970 budget to build "soft landers" for its two Mariner-Mars 1973 missions. The soft lander would be ejected from the mother craft as it passes Mars, and would be designed to send back data from the Martian surface. Still undecided, however, is the number and complexity of experiments on the missions. The space agency would like to have eight, and it is currently fighting with the Budget Bureau to include all of them in its budget. The battle may result in a compromise. One NASA insider says, "We may end up with six experiments or with eight scaled-down ones."

## Outlook dimmer for aeronautical services satellite

The proposed vhf aeronautical services satellite, which has always had shaky prospects [Electronics, Oct. 28, p. 33], has suffered another setback. At last month's closed-door meeting of the International Civil Aviation Organization's Astra (for applications of space techniques relative to aviation) panel in Montreal, foreign delegates refused to discuss, let alone endorse, the U.S. plan for satellite relay of aircraft-to-ground communications. Though the U.S. didn't expect other members to foot part of the bill, it had hoped for some international support.

# TAKE THE SKILL OUT OF PHASE MEASUREMENTS

• No Meter • No Ranging • No Operator Manipulation

SAVE TIME WITH AN EASY TO READ DIGITAL READOUT



DIGITAL PHASE METER  
MODEL 355 \$2200

- Ideal for phase linearity and critical measurements where best commercial accuracy is required. Phase reading accuracy:  $0.2^\circ \pm 0.3\%$  of phase angle.
- Obtain accurate and continuous phase readings in the midst of large signal amplitude fluctuations.
- With one instrument and without the need for accessories you have the flexibility of measuring phase at signal levels from 1 mV to 100 V on either channel over the range 10 Hz to 2 MHz.
- For plotting or for external circuit control, phase information is available from three separate outputs: 4 digit NIXIE tubes • Analog of phase • BCD 1248 for computer tie-in.
- For direct phase measurements on balanced transmission lines, lattice networks etc., the input circuits can be switched to differential or single ended.
- Phase reference switchable from  $0^\circ$  to  $180^\circ$  for maximum accuracy at small and large phase angles.



930 East Meadow Drive, Palo Alto, Calif.  
Phone (415) 321-7428

# You can tell a company

"We rarely perform miracles. We never promise them. We make over a million integrated circuits a month. And no apologies."

RICHARD F. KRUGER  
VICE PRESIDENT  
OPERATIONS



**SIGNETICS INTEGRATED CIRCUITS**  
SIGNETICS CORPORATION - THE RESPONSIBLE ABILITY COMPANY

"Sure, we've made a major breakthrough in the integrated circuit world. Our customers say we're the first company in this circus industry to operate like a responsible business."

WILLIAM A. BERG  
MARKETING  
MANAGER



**SIGNETICS INTEGRATED CIRCUITS**  
SIGNETICS CORPORATION - THE RESPONSIBLE ABILITY COMPANY

"The difficulties of speaking foreign languages are no barrier to selling integrated circuits overseas. You have to know how to listen, not talk, to meet a customer's needs."

GEORGE H. DIDINGER  
MANAGER,  
INTERNATIONAL  
DEPARTMENT



**SIGNETICS INTEGRATED CIRCUITS**  
SIGNETICS CORPORATION - THE RESPONSIBLE ABILITY COMPANY

"We admit that competitive integrated circuits are sometimes equal, but problems never are. That's why we put stress on solving our customers' problems. We sell more integrated circuits that way."

JACK HALTER  
MANAGER,  
SALES  
DEPARTMENT



**SIGNETICS INTEGRATED CIRCUITS**  
SIGNETICS CORPORATION - THE RESPONSIBLE ABILITY COMPANY



# by the men it keeps.

"Some people think integrated circuit reliability programs are part of the game 'How to Lie With Statistics.' More than 11% of our people work exclusively on such programs. We wouldn't spend money like that just to play a game."

TIMOTHY M. de SILVA  
PRODUCT  
RELIABILITY  
MANAGER



**SIGNETICS INTEGRATED CIRCUITS**  
SIGNETICS CORPORATION THE RESPONSIBILITY COMPANY

"We must be able to tell our integrated circuit customers not only where we are, but where we're going. That's why our researchers keep one foot in today's problems and the other in tomorrow's key technologies."

DR. DAVID KLEITHAN  
DIRECTOR OF R & D



**SIGNETICS INTEGRATED CIRCUITS**  
SIGNETICS CORPORATION THE RESPONSIBILITY COMPANY

"We don't want our customers to be surprised by what we deliver in integrated circuits—just satisfied that they got what we both know will meet tomorrow's competition."

ORVILLE BAKER  
VICE PRESIDENT  
TECHNICAL  
DEVELOPMENT



**SIGNETICS INTEGRATED CIRCUITS**  
SIGNETICS CORPORATION THE RESPONSIBILITY COMPANY

"Some people say we're the most conservative company in the integrated circuit business. I prefer the word responsible, because it implies as much concern for our customers' problems as it does for our own. And besides—it's a proven way to make profit."

JAMES F. RILEY  
PRESIDENT

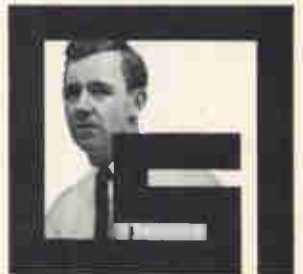

**SIGNETICS INTEGRATED CIRCUITS**  
SIGNETICS CORPORATION THE RESPONSIBILITY COMPANY

SIGNETICS CORPORATION, 811 EAST ARQUES AVENUE, SUNNYVALE, CALIFORNIA 94086. A SUBSIDIARY OF CORNING GLASS WORKS

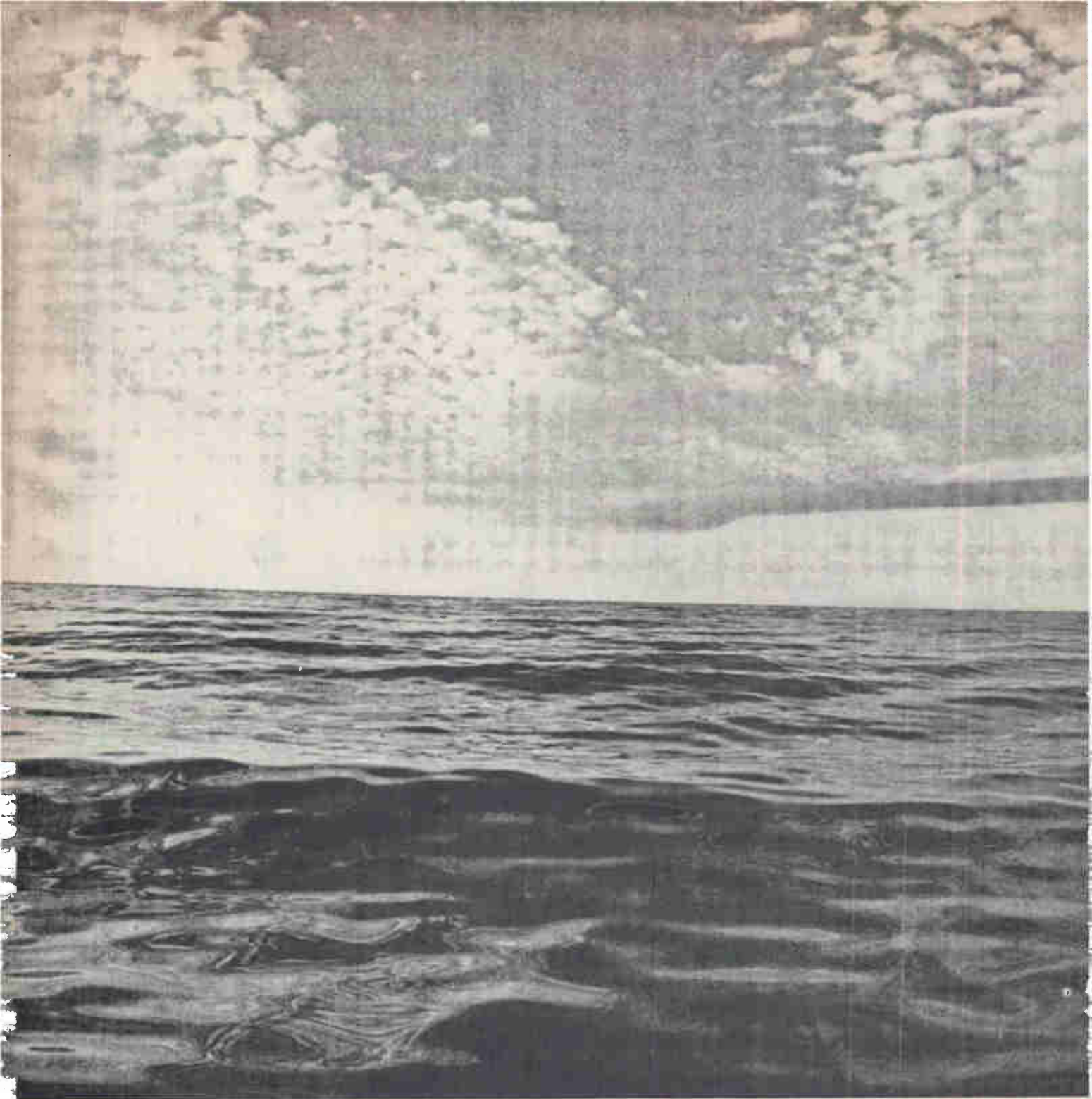

**We're taking all the fun  
out of getting lost at sea.**



Sea captains spend a lot of their time trying to figure out where they are.

Especially when it's been cloudy for days — no sun to shoot at noon, no stars at dusk.

Even the most experienced captains sometimes feel the thrill of being lost.

The spoilsport U.S. Navy is about to take most of the excitement out of navigation with a system called Omega.

There will soon be eight Omega stations spaced around the globe (four have already been built) that will cover the earth with low-frequency

radio waves. Ships will have receivers on the bridge that will compare the signals from three or four stations and tell the captain where he is, within a mile or two.

Simple as that.

Omega won't just belong to the Navy. It will be used by everybody, everywhere. Passenger liners, tankers, fishing boats, yachts. Any vessel with an inexpensive Omega receiver on the bridge.

We make the Omega receivers. We developed the shipboard Omega receiver for the Navy, and we're now manufacturing them for the first installations in the fleet. Eventually

all the Navy's seagoing vessels will be equipped with Omega receivers. Thousands more will go aboard ships of all nations.

Airplanes will have Omega too. We've almost finished developing an airborne receiver.

Before long there'll be Omega street signs all over the earth. That may sound like the end of romantic adventure, but to a navigator it's simply the end.

That's why it's called Omega.

**NORTHROP**  
*We also build airplanes.*

Circle 65 on reader service card

NEW from LAMBDA

# A totally new concept in

The FIRST AC-DC power supplies using an integrated circuit regulation system:

## Lambda COM-PAK MARK II™ power supplies

- First all-silicon AC-DC Power Supply using integrated circuits to provide regulation system exclusive of input and output capacitors, rectifiers and series regulation transistors.
- 3-5/32" x 3-9/32" x 3-5/16" with single or dual outputs.
- 3-5/32" x 3-9/32" x 1-11/16" with single output.
- More current per cubic inch.
- Guaranteed for five years material and labor.
- Increased reliability through use of Integrated Circuit which replaces 32 discrete components from conventional designs.
- Convection cooled—no external heat sinks.
- Regulation Line or Load .01% + 1mV.
- Ripple and Noise 250  $\mu$ V rms; 1mV p to p.
- Wide Input Voltage and Frequency Range 105-132 VAC, 57-63Hz.
- Wide Temperature Range - 20°C to + 71°C.
- Temp. Coeff. .01% +300 $\mu$ V/°C External Programming Resistor .015% + 300 $\mu$ V/°C Internal Resistor.
- Lightweight—Only 1 lb.

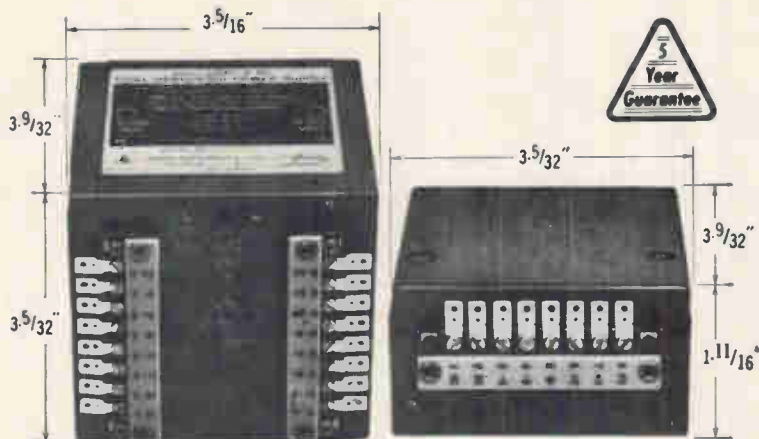

- Rugged die-cast aluminum construction.
- Mounting flexibility—four mounting surfaces.
- Overvoltage Protection—available as accessory up to 70 VDC.
- Multi-Current-Rated • Complete Serviceability all components replaceable.
- Remote sensing.
- No overshoot on turn-on, turn-off or power failure.
- Remote Programming 1000 ohm/V nominal or Volt/Volt.
- Series/Parallel operation with similar single or dual units.
- Completely Protected—automatic current limiting.

### Features of Dual Output Models

- Independent Operation.
- Independent Remote Sensing.
- Independent Remote Programming
- Series Parallel Operation (Master/Slave)
- Each Supply Electrically Isolated and Floating with Respect to Ground.

### LCD-2 DUAL OUTPUT MODELS

3 5/32" x 3 3/32" x 3 5/16"

Model	VOLTAGE RANGE (EACH SIDE)	MAXIMUM CURRENT (MA) AT AMBIENT TEMPERATURE (1)				Price (2)
		40°C	50°C	60°C	71°C	
LCD-2-11	0-7 VDC	300ma	240ma	175ma	115ma	\$155
	0-7 VDC	300ma	240ma	175ma	115ma	
LCD-2-12	0-18 VDC	160ma	130ma	100ma	65ma	155
	0-7 VDC	300ma	240ma	175ma	115ma	
LCD-2-13	0-32 VDC	120ma	95ma	70ma	45ma	155
	0-7 VDC	300ma	240ma	175ma	115ma	
LCD-2-22	0-18 VDC	160ma	130ma	100ma	65ma	155
	0-18 VDC	160ma	130ma	100ma	65ma	
LCD-2-23	0-32 VDC	120ma	95ma	70ma	45ma	155
	0-18 VDC	160ma	130ma	100ma	65ma	
LCD-2-33	0-32 VDC	120ma	95ma	70ma	45ma	155
	0-32 VDC	120ma	95ma	70ma	45ma	
LCD-2-44	0-60 VDC	65ma	52ma	37ma	23ma	170
	0-60 VDC	65ma	52ma	37ma	23ma	
LCD-2-55	0-120 VDC	30ma	30ma	22ma	14ma	170
	0-120 VDC	30ma	30ma	22ma	14ma	

### LCS-2 SINGLE OUTPUT MODELS

3 5/32" x 3 3/32" x 3 5/16"

Model	VOLTAGE RANGE	MAXIMUM CURRENT (MA) AT AMBIENT TEMPERATURE (1)				Price (2)
		40°C	50°C	60°C	71°C	
LCS-2-01	0-7 VDC	550ma	455ma	350ma	240ma	\$90
LCS-2-02	0-18 VDC	330ma	275ma	210ma	140ma	90
LCS-2-03	0-32 VDC	240ma	205ma	155ma	95ma	90
LCS-2-04	0-60 VDC	145ma	115ma	87ma	57ma	100
LCS-2-05	0-120 VDC	50ma	50ma	45ma	30ma	100

### LCS-1 SINGLE OUTPUT MODELS

3 5/32" x 3 3/32" x 1 11/16"

Model	VOLTAGE RANGE	MAXIMUM CURRENT (MA) AT AMBIENT TEMPERATURE (1)				Price (2)
		40°C	50°C	60°C	71°C	
LCS-1-01	0-7 VDC	200ma	200ma	150ma	100ma	\$85
LCS-1-02	0-18 VDC	95ma	95ma	95ma	80ma	85
LCS-1-03	0-32 VDC	65ma	65ma	65ma	40ma	85
LCS-1-04	0-60 VDC	35ma	35ma	35ma	25ma	95
LCS-1-05	0-120 VDC	12ma	12ma	12ma	12ma	95

#### NOTES:

(1) For operation at other than 57-63 Hz, consult factory for ratings and specifications.

(2) All prices FOB Melville, N. Y. All prices and specifications subject to change without notice.

### OVERVOLTAGE PROTECTION

FOR USE WITH	Model	VOLT ADJ. RANGE	Price (2)
LCD-2-11, LCD-2-12, LCD-2-22, LCS-2-01, LCS-2-02, LCS-1-01, LCS-1-02	LC-OV-10	3-24 VDC	\$20
LCD-2-13, LCD-2-23, LCD-2-33, LCS-2-03, LCS-1-03,	LC-OV-11	3-47 VDC	20
LCD-2-44, LCS-2-04	LC-OV-12	3-70 VDC	25

Write, wire, or call to order direct, for information, or for new Lambda Power Supplies catalog. LAMBDA Electronics Corp., 515 Broad Hollow Road, Melville, L. I., New York 11746, TEL. 516-694-4200, TWX 510-224-6484.

# power systems design

The **FIRST** complete power supply assembly systems using standard Lambda component power supplies and accessories...make custom power supply systems obsolete!

**COM-PAK MARK II**  
integrated  
circuit LC  
power module  
with  
overvoltage protector

**1 3/4" H x 19" W x 14" D**  
LC Power Supply Assembly System

Standard Systems Cables

Systems  
Power Control  
Panels  
SP-1 for LRA-9 Price: \$20.00  
SP-3 for LRA-8 Price: \$20.00

5  
Year  
Guarantee

Rack Adapters  
LRA-8 is 3 1/2" high Price: \$60.00  
LRA-9 is 1 3/4" high Price: \$60.00

Systems  
Metering Panels  
SMP-1 for LRA-9 Price: \$90.00  
SMP-3 for LRA-8 Price: \$100.00

**3 1/2" H x 19" W x 14" D**  
LC Power Supply Assembly System

Chassis Slides  
LRA-9-CS Price: \$50.00  
LRA-8-CS Price: \$50.00

● Lambda's dramatically new Power Supply Systems Concept eliminates the need for costly custom-designed multiple output power supply systems. You can order from the component power supplies and assemble your system with these standard accessories:

- Overvoltage protectors ● Rack adapters
- Systems power control panels ● Systems metering panels
- Standard systems cables ● Chassis slides
- Assemble the system yourself or if you prefer, Lambda will assemble your power system from 18 standard power supplies and 36 accessories. You will receive the system ready to plug in.
- Up to 8 separate outputs in a 1 3/4" high rack adapter.
- Up to 16 separate outputs in a 3 1/2" rack adapter.
- Use of standard mass-produced power supplies and accessories gives lower unit costs.
- Fast delivery. No waiting for custom design.

● Substantial discounts are available to Original Equipment Manufacturers under the Lambda Commercial Purchase Plan.

- Maximum flexibility for later design changes.
- Guaranteed 5 years whether you assemble or Lambda assembles.

SEND FOR THIS  
**New 56 Page  
Lambda  
Catalog**

It gives complete information  
about all Lambda Power  
Systems, Power Instruments  
and Power Supplies

 **LAMBDA** ELECTRONICS CORP.

515 BROAD HOLLOW ROAD, MELVILLE, L.I., NEW YORK 11746 TEL. 516-694-4200, TWX: 510-224-6484 CABLE: VEECOVAC PLAINVIEW NY

A  SUBSIDIARY

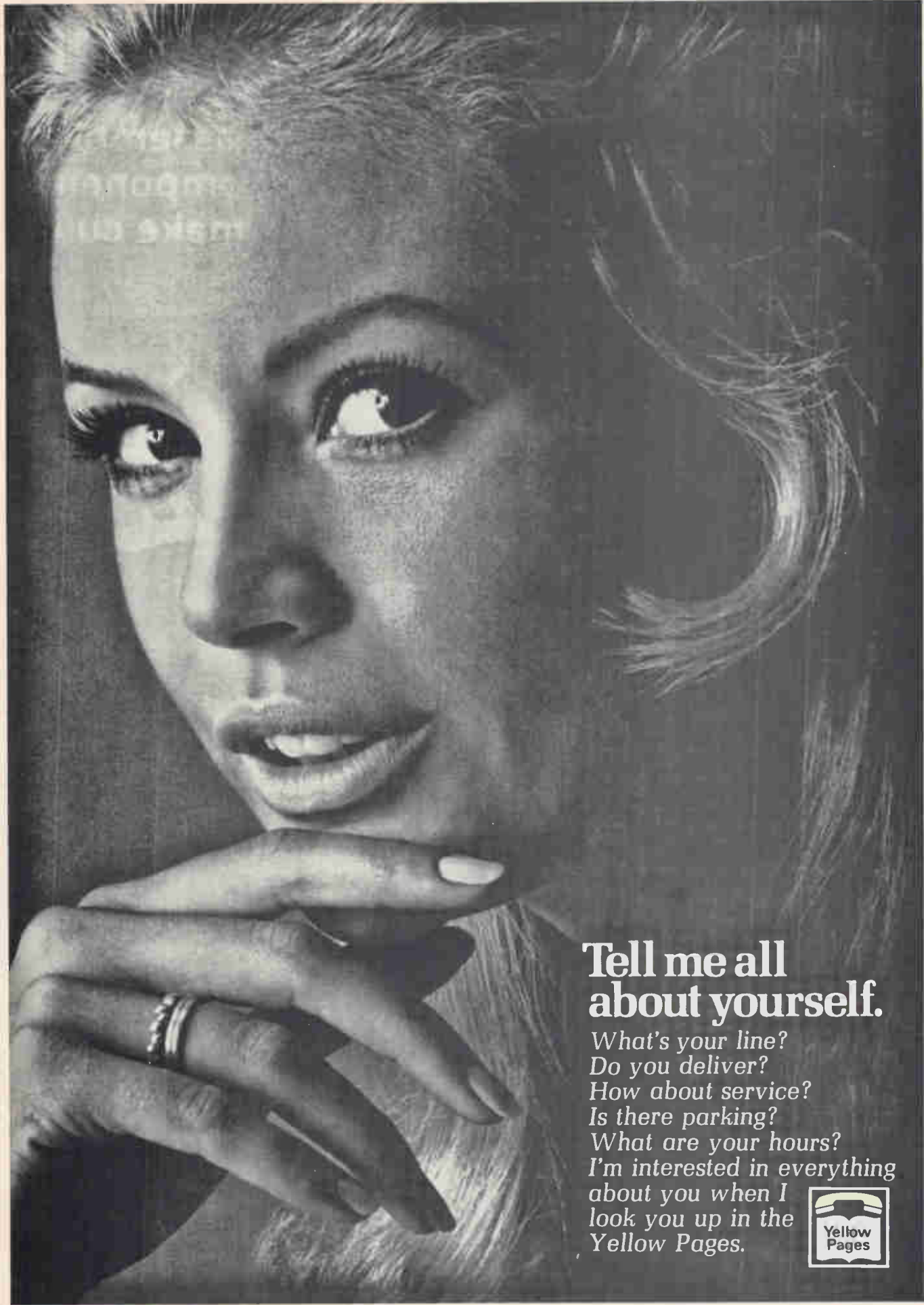

**Tell me all  
about yourself.**

*What's your line?  
Do you deliver?  
How about service?  
Is there parking?  
What are your hours?  
I'm interested in everything  
about you when I  
look you up in the  
Yellow Pages.*



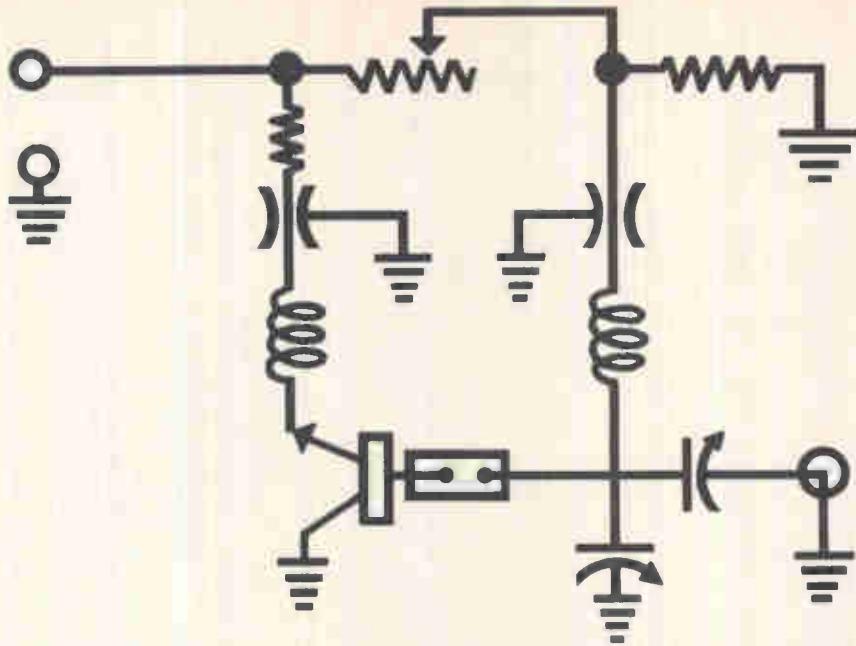

A Microwave  
Fundamental  
Frequency  
Oscillator  
Circuit is as  
simple as  
RCA-TA7403  
"overlay" can  
make it



TA7403 is a new configuration... designed especially to simplify oscillator circuitry. Featuring 0.5 watt output at 2 GHz (at 21 V operation), this all-new RCA epitaxial silicon n-p-n transistor will be especially attractive to designers looking for a device that acts as a superior self-excited oscillator at L-band and higher microwave frequencies.

Incorporating all the advantages of the RCA-developed "overlay" structure, RCA developmental type TA7403 is a compact unit in a hermetically-sealed ceramic-to-metal coaxial package... a package that features very low inductances and low parasitic capacitances. This is the industry's first unit that lends itself to cavity, stripline, and "lumped" constant circuits.

Here, then, is definitely a transistor intended primarily for simple oscillator circuits. TA7403 will find applications in such areas as: local oscillator for receivers, microwave power source—low power klystron replacement, sonde oscillator.

For more information on RCA-TA7403, see your RCA Representative. Ask him, too, about RCA-2N5470 for your UHF and microwave amplifier applications. For technical data, write: RCA Electronic Components, Commercial Engineering, Section P-N-12-1, Harrison, N.J. 07029.

RCA

# Here's something you should look into

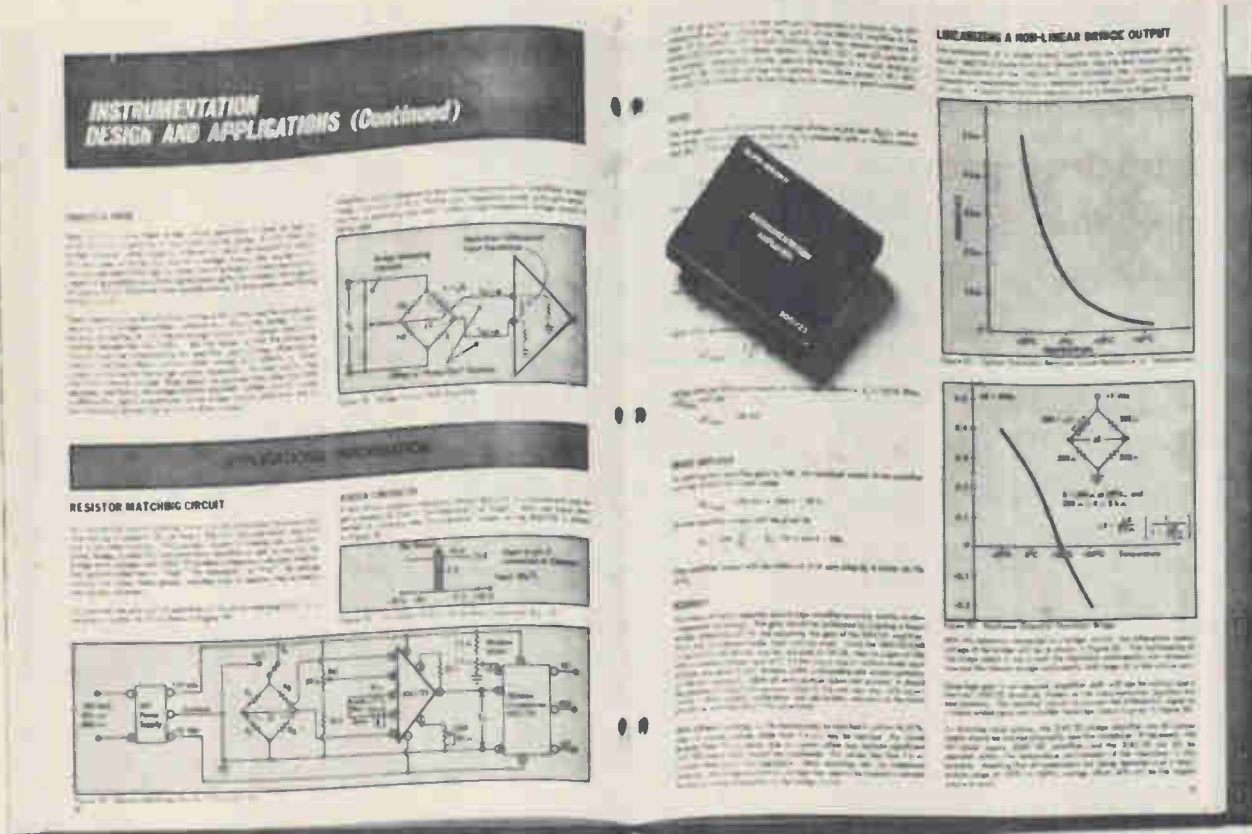

## New Burr-Brown handbook and catalog of Instrumentation Amplifiers

This new 32-page publication is one you'll refer to again and again. It contains IN-DEPTH INSTRUMENTATION DESIGN AND APPLICATIONS INFORMATION including: transducers and bridge circuits; sources of error; a resistor matching circuit; linearizing a nonlinear bridge output; a power measurement circuit; a buffer-amplifier tester; and a review of instrumentation system power supply requirements. There's also a fundamental discussion of the various considerations involved in the selection of amplifiers for instrumentation applications.

In addition, the catalog section contains DETAILED SPECIFICATION AND TEST DATA on Burr-Brown's broad line of standard instrumentation amplifiers. All units are covered including new high-performance, encapsulated devices with prices as low as \$95 in single unit quantity.

### IT'S YOURS FOR THE ASKING

Simply check this publication's reader service card, or phone the nearest Burr-Brown Engineering Representative listed below.

## BURR-BROWN

RESEARCH CORPORATION

International Airport Industrial Park • Tucson, Arizona 85706  
TELEPHONE: 602-294-1431 • TWX: 910-952-1111 • CABLE: BBRCORP



Operational Amplifiers  
Instrumentation Amplifiers  
Function Modules  
Active Filters  
Power Supplies

ENGINEERING REPRESENTATIVES: ALABAMA, HUNTSVILLE (205) 534-1648 / ARIZONA, PHOENIX (602) 254-6085 / CALIF., LOS ANGELES (213) 665-5181, SAN DIEGO (714) 232-2017, SAN FRANCISCO (408) 244-1505 / COLO., DENVER (303) 399-4391 / CONN., EAST HARTFORD (203) 874-9222 / D.C., WASHINGTON (SEE MARYLAND) / FLORIDA, ORLANDO (305) 425-2764 / ILLINOIS, CHICAGO (312) 286-6824 / LA., NEW ORLEANS (504) 888-2266 / MD., SILVER SPRING (301) 588-8134 / MASS., BOSTON (617) 245-4870 / MICH., DETROIT (313) 358-3333 / MINN., MINNEAPOLIS (612) 781-1611 / MO., ST. LOUIS (314) 524-4800 / N.C., GREENSBORO (919) 273-1918 / N.J., CAMDEN (215) 925-8711 / N.M., ALBUQUERQUE (505) 255-1638 / N.Y., ALBANY

(518) 489-4777, BINGHAMTON (607) 723-9661, MT. VERNON (914) 664-0080, NEWBURGH (914) 561-4510, NEW HARTFORD (315) 732-3775, ROCHESTER (716) 473-2115 / OHIO, CINCINNATI (513) 761-5432, CLEVELAND (216) 237-9145, DAYTON (513) 277-8911 / PENN., PHILADELPHIA (SEE CAMDEN, N.J.), PITTSBURGH (412) 243-6655 / TEXAS, DALLAS (214) 357-6451, HOUSTON (713) 774-2568 / UTAH, SALT LAKE CITY (801) 466-8709 / VIRGINIA, (SEE MARYLAND) / WASH., SEATTLE (206) 767-4260 / CANADA, DOWNSVIEW, ONT. (416) 636-4910, MONTREAL, QUE. (514) 739-6776, OTTAWA, ONT. (613) 725-1288, VANCOUVER B.C. (604) 291-7161



# What could you do with a T0-5 size commercial relay?

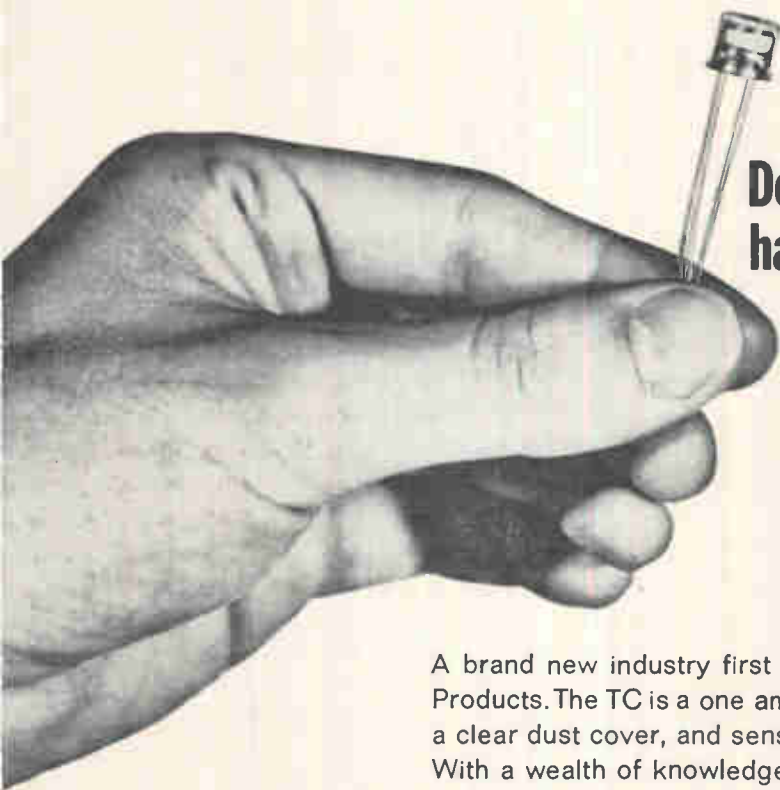

**Deutsch-Filtors  
has one.**

A brand new industry first from Deutsch-Filtors Industrial Products. The TC is a one amp, DPDT commercial relay with a clear dust cover, and sensitivity as low as 235 milliwatts. With a wealth of knowledge in relay design to back it up.

Are the ideas already coming to you? We'll see to it that a sample does too. Just drop us a line on your letterhead. And then see what you can do.

"Available Immediately from COMPAR STOCK"



Circle 71 on reader service card

**PICK THE  
BEST**

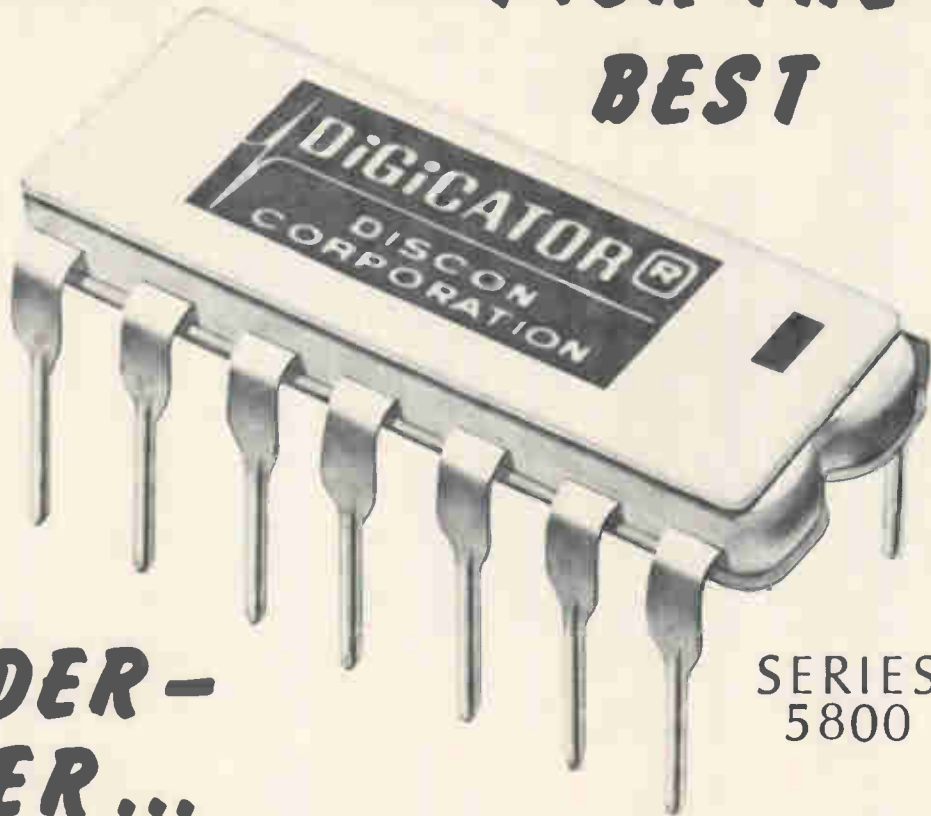

**DECODER-  
DRIVER...**

**SERIES  
5800**

**HIGH CURRENT LAMP DRIVER - UP TO  
80 MA PER LAMP**

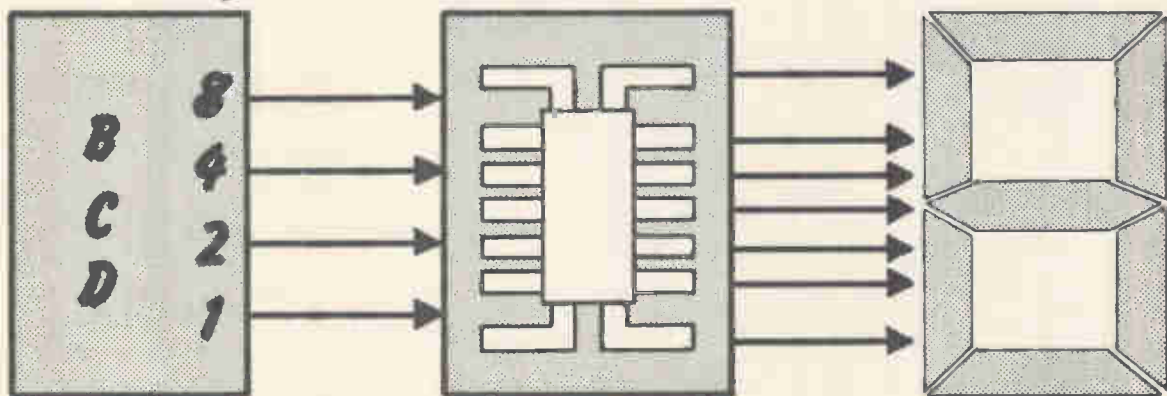

**DiGiGATOR®** REGISTERED TRADE MARK

A complete line of display readouts and decoder/drivers

**DISCON CORPORATION**

P.O. BOX 9355 \* FORT LAUDERDALE, FLORIDA 33310

PHONE: (AREA CODE 305) 565-5511

# Jack-in-the-box HF antenna. Goes up in 2 hours.

**Transport it by air... or store it for emergency standby.  
You'll have reliable performance even after repeated field use.**

Granger's 747 CA antenna comes out of storage and sets up fast as a 0-to-2000 mile communications back-up if a hurricane knocks out a fixed antenna. Or, move it by air or surface wherever you need quick communications. The 747 CA is a compact package, and five men can set it up in 2 hours. With gain of up to 13 db from 4 to 30 MHz, VSWR under 2.1:1, and no lobe splitting, it performs as well as a permanent installation. A Delta extension kit adds omnidirectional coverage from 2 to 4 MHz for close-in communication.\* The 747 CA antenna withstands harsh environments... winds up to 100 mph. Its rigid, nested tower and all materials are corrosion resistant. Available in models from 1 to 20 kw average (2 to 40 kw PEP), this high-performance portable or stowable antenna is a good package deal. Write for complete data.

\*The Delta Kit is Included with antenna Model 747 CB. The Kit is also available as a retrofit for 747 CA's. CA/CB models are available for fixed Installation.

*Granger*  

---

*Associates*

Circle 73 on reader service card

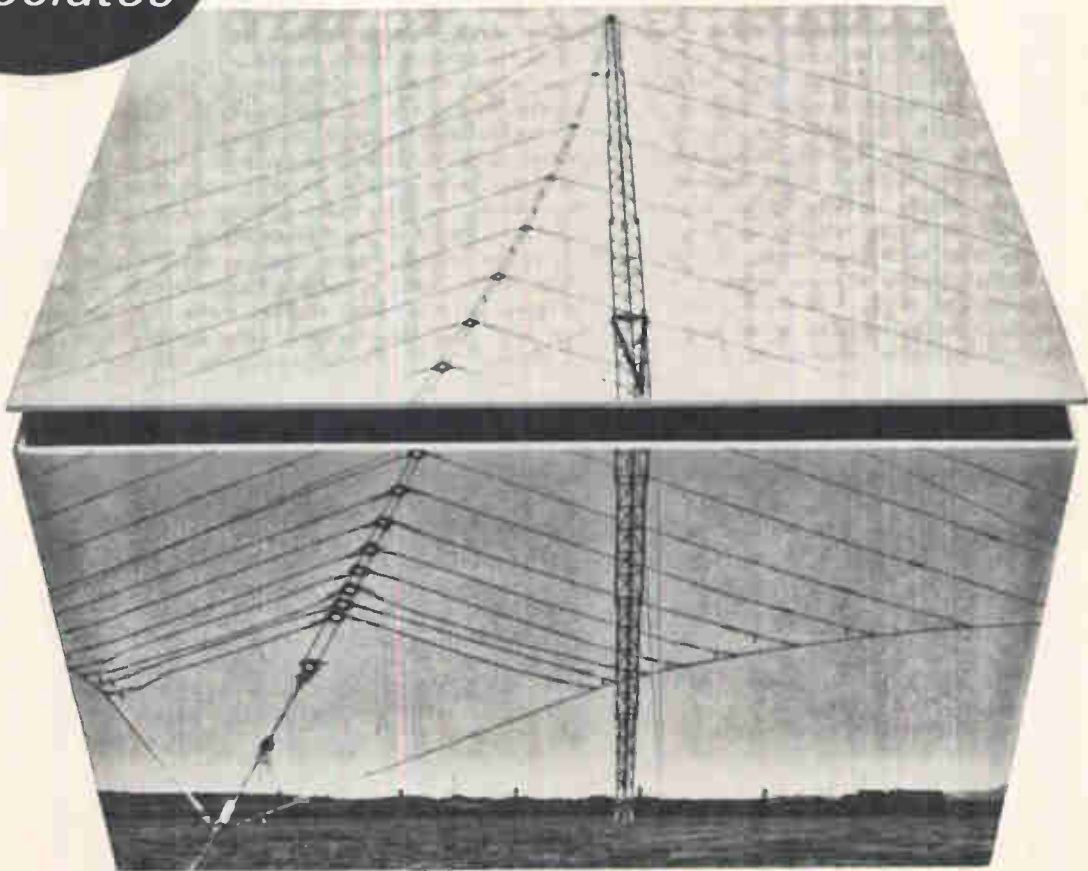

# 4 breakthroughs: new NIXIE® tube

1

## size

.530" dia. x 1.5" for IC compatibility — largest numeral height provides best readability.

2

## anode strobing

new design permits all like-numerals to be driven in parallel for time sharing operation with improved brightness.

3

## pin spacer

simplifies both PC board layout and tube insertion.

4

## price

in quantities of 1,000 — only **\$395** each.



ACTUAL SIZE

This new tube, type B-5750, has been engineered to achieve all these outstanding breakthroughs in a single design. The new slim-line tube not only has two internal decimal points but also has an "in-line" lead arrangement which is compatible with dual in-line IC's. In addition, the numeral aspect ratio has been designed to provide the optimum in readability and viewing distance.

The movable pin spacer — standoff, which is used to align the tube pins for ease of PC layout and insertion, is part of the tube assembly.

The anode strobing time sharing operation permits substantial reduction in driver costs for many multi-digit display applications. For more information on these and other features contact your nearest Burroughs representative or sales engineer, or write: *Burroughs Corporation, Electronic Components Division, P.O. Box 1226, Department N6, Plainfield, New Jersey 07061 TEL: (201) 757-5000.*

Burroughs

December 9, 1968 | Highlights of this issue

# Technical Articles

---

**Computer can't forget  
its program**  
page 76

## Electronics



Compared to this minicomputer, the elephant has a memory like a sieve. The machine's program can be stored in a read-only memory that can replace a conventional read-write memory module. The Nova computer also has multiple accumulators—a feature characteristic of many third-generation computers, but only larger machines. Medium-scale integration is the secret. The Nova is shown on the cover, along with a resident of Boston's Franklin Park Zoo, who wasn't really as interested in the computer as in the peanuts the photographer scattered over it. He'd just polished off the last one when the picture was snapped.

**Preleaded semiconductors  
are hitting the market**  
page 88

A survey of semiconductor makers shows that flip chips are becoming readily available and beam-lead devices are on the way. Most of the big companies should be offering production quantities of both next year. Keeping step with the semiconductor firms are the makers of automatic handling and welding machines for batch fabrication and bonding of the devices. This article concludes a two-part series begun in the last issue.

**Active filters:  
part 5**  
page 98

The designer of inductorless filters has many circuit choices; two examples are the gyrator and the negative-impedance converter. However, when such devices are built with discrete components it's sometimes hard to control their frequency stability. By using operational amplifiers in these circuits, the designer not only obtains a stable circuit but minimizes the number of additional passive components.

---

## Coming

**The annual forecasts  
for European markets**

How the markets stack up on the Continent and in Britain for 1969, with reports from a dozen countries and charts estimating sales of 82 product categories.

# Nova can't lose its instructions

Program can be debugged in main memory and wired into read-only form for fail-safe operation in this very small multiregister machine

By Edson D. de Castro, Henry Burkhardt, and Richard G. Sogge

Data General Corp., Hudson, Mass.

**An architectural approach**, the key to many large third-generation computers, has been applied for the first time to a small computer. As in the designs of large-scale processors, the principal guidelines here are customer requirements and general trends in hardware technology.

Ideally, the availability of specific components does not influence an architectural design, but it is, of course, a factor in implementing the design. In this case, an economic advantage has been realized by employing integrated circuits. However, since the approach stresses function rather than hardware, the usefulness of the basic design is not limited by the economic life of a particular set of components. The computer has an intrinsic order and utility that are impervious to the quirks of some components.

One of the foremost characteristics of many modern computer designs is a multiaccumulator organization—the system's central processor contains a number of active general-purpose registers. Arithmetic and logic operations are executed more simply by manipulating data in these registers than they could be by transferring the data to and from the computer's memory.

Up until now, such registers have been considered impractical in small general-purpose computers, but medium-scale integration has changed all that. More than half the gates and flip-flops in the new machine are MSI circuits; this serves to reduce the number of interconnections and thereby shaves packaging costs.

Besides embodying an architectural design and featuring multiple registers, the new computer can have a braided read-only memory for program storage. This unit is made of wires preformed into a braid and dropped over U-shaped ferrite cores, which are then capped. It's unique in that it is homogeneous with the alterable main memory—that is, 1,024-word modules of read-only memory are directly interchangeable with main-memory mod-

ules made of conventional toroidal ferrite cores.

The user writes a program, debugs it in the alterable main memory, and orders it wired into read-only modules, which then replace the corresponding portion of alterable memory. From that point on, it is as immune to bugs as a program can be.

## Targets

The computer described here is the Data General Corp.'s Nova, one of the growing class of so-called "minicomputers" that sell for under \$10,000. Within the architectural framework, several rather unusual goals were set for the Nova design:

- A price of \$5,000 or less in quantity for a complete system containing processor, power supply, and console, and having a full input-output capability and a memory comprising 4,096 words of 16 bits each.
- An absolute minimum number of interconnections, in the interest of reliability.
- No custom-designed components; all parts used must be produced in volume by a reputable manufacturer.

Besides these, several more or less conventional design objectives were established:

- A full cycle, including a memory cycle and accumulator access or indexing, in less than 3 microseconds.
- An input-output facility capable of both single-word transfer under program control and independent direct access to the memory by external devices, as well as a priority interrupt system that identifies the interrupting device.
- Room for expansion of either memory or input-output device controllers.
- Reliable operation over the entire commercial temperature range, 0° to 55°C.
- Minimum use of adjustable components.

All central processors consist of data paths, which are regular and repetitive, and the controls

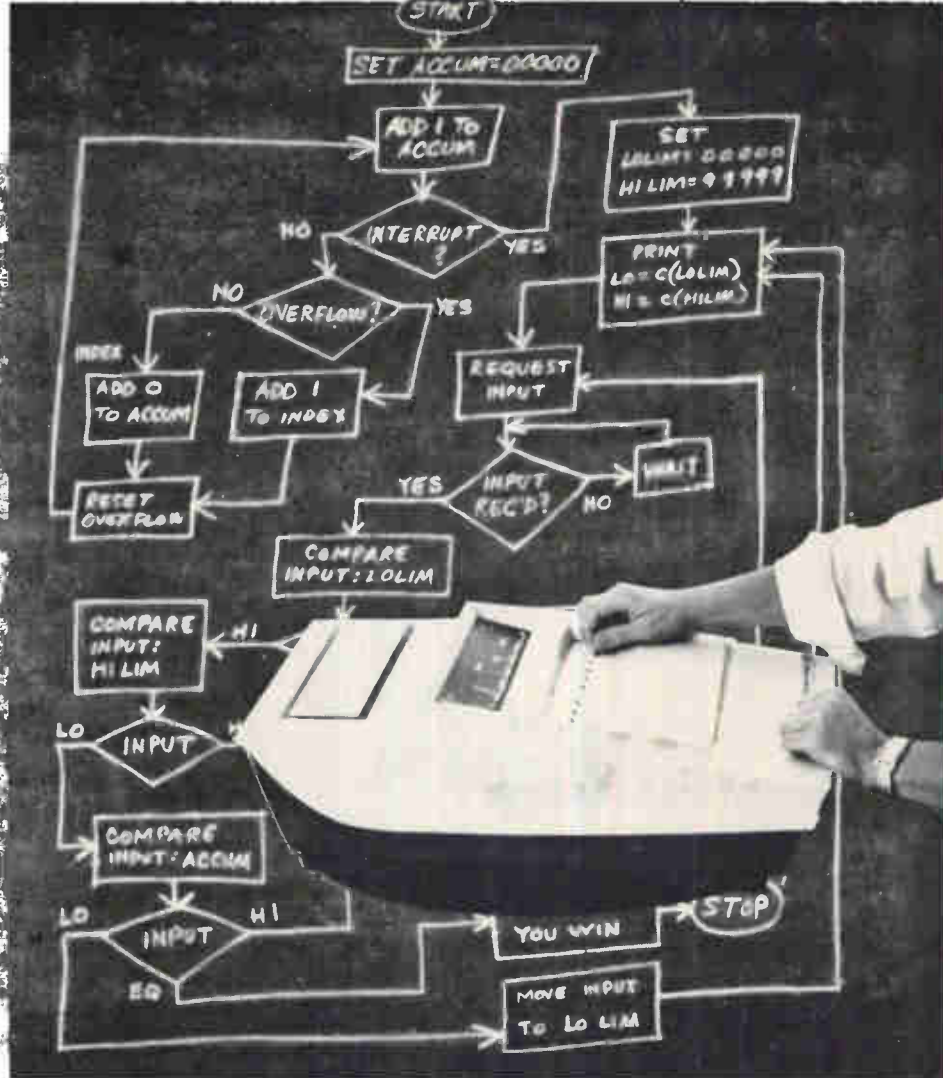

Mighty midget. Small though it is, the Nova has all the characteristics of a much larger computer, as the flow-chart in the background indicates. The chart itself represents the stored-program concept, the diamond-shaped decision blocks indicate conditional branches, and the operations at the upper left show how the program can modify itself. Strictly speaking, the read-only memory prevents direct modification, and current programming practice frowns on it, but the concept is still valid.

—the irregular and hard-to-describe parts of the machine.

The regular portion consists of registers, adders, multiplexing gates, and the like. Its components, being common to all machines, represent a mass market for integrated-circuit manufacturers. The controls, on the other hand, are usually unique to a specific machine and therefore aren't economically feasible as large integrated chunks unless vast quantities of a single type of computer are being produced.

For instance, 16 flip-flops in a single package are available for use in regular registers, but only two flip-flops can be put in the same package for random control applications. Likewise, a four-bit adder containing 42 gates is available off the shelf, but four gates is the maximum available for individual use. Internal interconnections make the difference.

The Data General designers took into consideration that although regular components are being offered at ever-increasing densities and decreasing costs as technology progresses, the trend is much slower in the case of irregular parts. They therefore structured the Nova computer to utilize as few irregular logic groupings as possible. In practical

terms, this was accomplished by keeping the instruction set straightforward—reducing the amount of irregular random control logic—and by designing the instructions' execution algorithms to operate efficiently in multiple general registers—sometimes at the expense of additional instructions in the set. By using an instruction format in which each bit has its own function, much irregular decoding logic was avoided.

For example, comparing two numbers in many small computers means complementing one of them, adding a 1 to it, adding the other number to it, and then testing the result—which is zero if the two numbers are equal. Any halfway decent computer needs all three of these instructions—complement, add (used twice here), and test. But the Nova achieves the same result with a single instruction—compare—in much less time; the one instruction covers the same four steps, but by whipping the numbers through the registers, it requires very little extra irregular logic.

For another example, one instruction in the Nova can subtract and shift the result to the left. This instruction, which is used in programmed division, necessarily supplements an ordinary subtraction, but the logic to implement it is much less complex

and irregular than a hardware divide would require.

Several such instructions make the Nova's set unusually efficient and easy to use.

### Logical choice

To achieve the needed regularity in the processor's design, an IC logic family had to be selected. The designers considered several factors: breadth of line, cost, availability from several sources, noise immunity, and speed. They evaluated four lines and established the ranking diagrammed at the right.

This diagram indicates that emitter-coupled logic is fastest of the the four and has the best noise immunity, and that resistor-transistor logic is the least expensive circuit form. Diode-transistor and transistor-transistor logic are quite close to one another in speed and cost—although TTL has a small but distinct advantage in breadth of line and in its availability from several sources.

Several other factors were also considered, especially as they affected cost. For example, the number of new designs appearing in RTL and DTL is declining; thus the production of these lines may drop and prices increase. And because the cost of the printed-circuit board, its connector, and the wiring is often several times the cost of the component itself, the availability of complex functions in a single component could result in real savings in packaging costs.

Speed affects cost because it permits different levels of parallelism or seriality; a given level of performance can be achieved with a smaller number of relatively faster components.

With all these factors in mind, the designers decided on TTL.

Even the most complex functions Data General chose to buy for the Nova were available in off-the-shelf circuits. These circuits have many applications, and the company believes this is a more useful definition of medium-scale integration than any arbitrary number of transistors or gates per chip.

MSI's major contribution is not low cost per function but rather a reduction of interconnections and a consequent improvement in reliability. It is true, though, that cost per function is usually somewhat lower with MSI components than with discrete gates and flip-flops.

### Nibbling away

The Nova processes all data in groups of four bits, called "nibbles" because they're larger than a bit and smaller than a byte. This partly parallel organization represents a better choice than either a serial organization with a few fast components or a fully parallel organization with a larger number of slower parts. It's obviously only one of many possible choices; any submultiple of 16 bits—the word length—could have been used, each with its own advantages in cost and performance. But all in all, the four-bit path has more advantages and fewer disadvantages than any of the others.

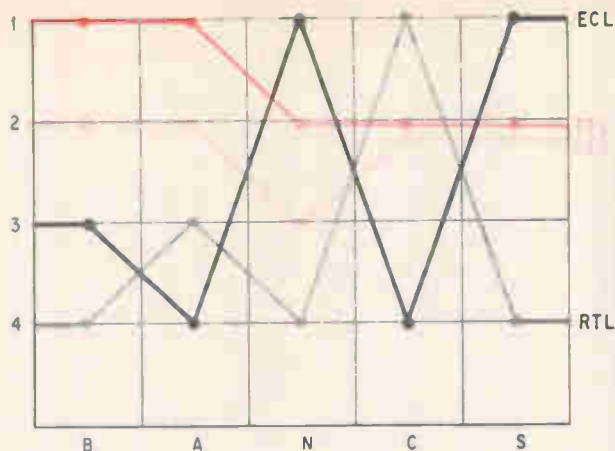

B = BREADTH OF LINE  
A = MULTISOURCE AVAILABILITY  
N = NOISE IMMUNITY  
C = COST  
S = SPEED

Optimum choice. TTL circuits have the best combination of characteristics desirable for a small computer.

Among the advantages is the availability of standard off-the-shelf MSI circuits for several applications in the Nova. For instance, the accumulators consist of four 16-bit monolithic registers selected and sequenced by two MSI decoders. Each register unit contains 16 flip-flops addressed as a four-by-four matrix. One line from each of two groups of four selects the bit in a particular position in all four registers—four bits, or a nibble, in parallel.

As each register contains four bits from each of the accumulators, one of four control lines selects a particular accumulator. The other four lines are then brought up in sequence to access an entire accumulator four bits at a time. The output of the accumulator is gated into a four-bit adder—another MSI circuit in a single package. A full 16-bit addition is completed in four clock times as data passes through the adder a nibble at a time.

All the other machine registers are MSI four-bit shift registers. These include the memory address, memory buffer, and instruction registers, and the program counter. Data enters these registers from the adder output or passes from them to the adder input. An individual IC shift register will contain bits 1, 5, 9, and 13, for instance, instead of four adjacent bits of a word, so that a single shift operation is equivalent to a shift of four bit positions. Thus, four data entries and four shifts are involved in the transfer of a complete word.

Another interesting use of MSI is in the timing and control section. The entire machine's timing is locked to a single crystal controlled oscillator running at 10 megahertz.

The waveforms driving the memory system come from two MSI shift registers connected as an eight-bit, switched-tail ring counter, that is, as a single



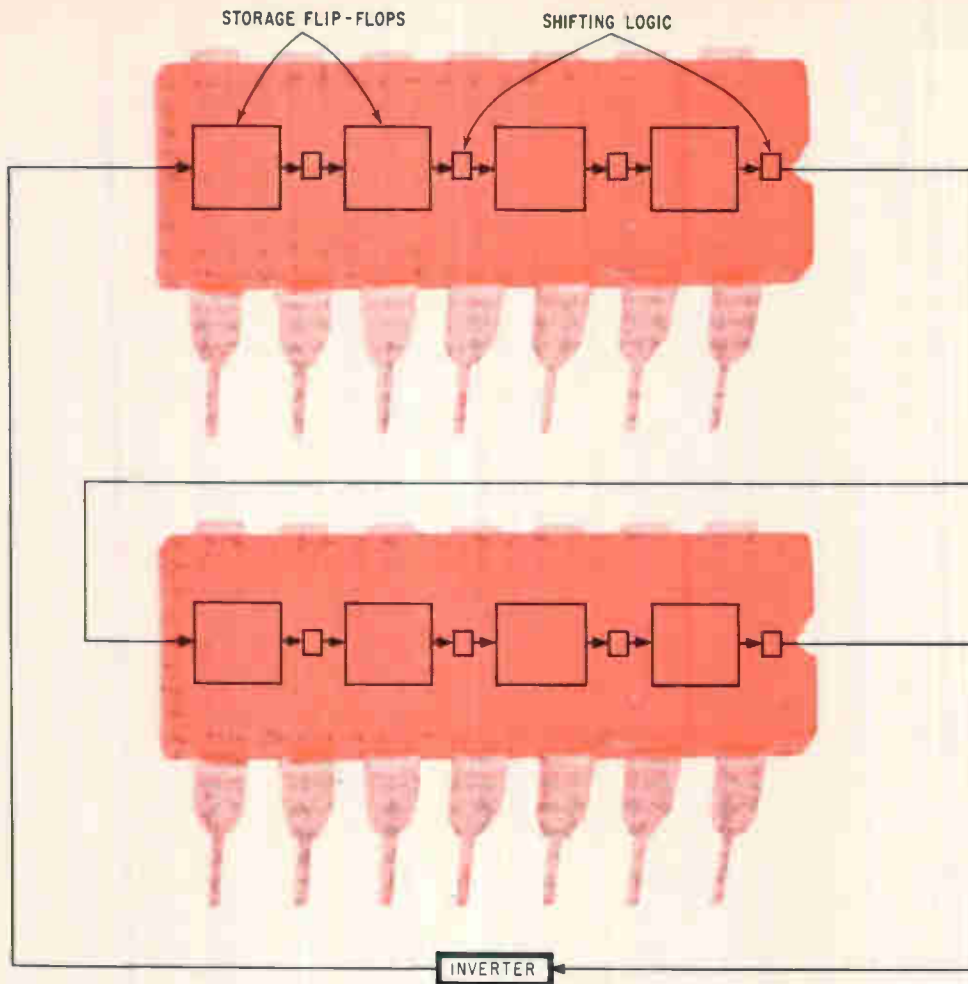

**Timing.** These two shift registers feeding one another, plus the inverter, generate all the waveforms needed for the memory system in the Nova. The configuration is called a switched-tail ring counter.

shift register with an output that's inverted and fed back to the inputs, as shown above. Every time the counter shifts, one and only one bit changes state, so that the register as a whole has 16 different states.

Connecting various combinations of these eight bits to logic gates generates a wide variety of waveforms; those for the memory system are obtained from two-input AND gates.

### Cores and stacks

As with the rest of the Nova design, the approach taken to the core memory was aimed at holding down both cost and physical size. A decision on the core size was easy to make. The required speed could be realized with a 30-mil core, a type now in high-volume production.

The question of stack organization was much thornier. So-called 2½-D arrays have become quite popular because they require only three wires through each core and are therefore inexpensive. But their associated electronic circuits are expensive, especially in small systems. The more common three-dimensional organization employs less electronics, but four wires must be strung through each core, increasing the array's cost.

The three-wire, 3-D scheme offers the best of

both worlds in a small system. In this organization, the sense and inhibit functions share the same wire. In a conventional 3-D memory, the sense line is used for readout only and thus is active during only the read portion of the cycle. Conversely, the inhibit line is functional only during the write half of the cycle. The inhibit line requires a balanced drive and it's important that the sense line not be too noisy, but there's no logical reason why a single wire cannot be time-shared to perform both of these functions.

This sharing requires an unusual sense winding pattern, as shown on page 80. The basic pattern takes the form of a bow tie and gives first order cancellation of noise induced from the parallel selection line. The center-tapped winding is brought out as a twisted triplet; one wire from the center tap is connected to the inhibit driver, and one wire from each end of the bow-tie winding is connected to a transformer in a balun configuration. With this setup, any tendency of the current in one half of the winding to increase causes the impedance in that side of the balun to increase, blocking the current, and causes the impedance on the other side to decrease. The currents in the two halves are thus kept equal. And the maintenance of this approximate balance of current in the winding

serves to reduce differential noise at the input of the sense amplifier.

The circuit not only provides balanced drive but allows the use of a low supply voltage for the memory because the inhibit driver sees the winding in two parts, each with half the total inductance of the array. These halves, in parallel, present only a quarter of the inductance to the driver, which, however, must provide twice as much current as it would if it were connected to the end of the winding.

During a write operation, the balun presents a very low impedance to common-mode signals and a very high impedance to differential signals. This forces the inhibit current to be equal in both halves of the winding and keeps the differential noise small at the input to the sense amplifier. When reading, the balun is effectively out of the circuit because the sense voltage is much too small to forward-bias the two diodes.

### Plane and simple

The Nova's complete 4,096-word memory system, including sixteen 64-by-64 core mats and all the peripheral electronic circuits, is mounted on a single printed-circuit board 15 inches square, as shown on page 81. The system has 32 switches in its drive arrangement—eight at each end of the x and y windings, which thread all the mats in series. Four switches, one from each set of eight, select a single core in each of the 16 mats to read 16 bits in parallel. The core array, fabricated in a single plane, is soldered directly to the board.

Compared with the usual stack of individual planes, this arrangement offers many advantages in terms of cost and reliability. Interconnections are at a minimum because all lines are soldered directly to the main p-c board, all cores are directly accessible and can be repaired without disassembling the array, and lead lengths are short, reducing noise, stray capacitance, and inductance. Best of all, the entire memory is only a half-inch high, leaving plenty of room for more memory or other circuitry in the standard frame, which is 5¼ inches high.

A similar scheme using 32-by-32 mats didn't appear to offer the best packaging arrangement for smaller memories. Of course, smaller arrays cost less, but their use doesn't have much effect on the cost of the associated electronics. For example, chopping the array size from 4,096 to 1,024 words and retaining the 16-bit parallel readout would reduce the number of switches required from 32 to 24—not a very impressive saving.

But the fact that the processor handles bits four at a time affords an opportunity to cut costs by a significant margin. The 1,024-word memory need only be four bits wide instead of 16, and it uses four of the same 64-by-64 mats and the same 32 switches as the larger size. But it has only four inhibit drivers and four sense amplifiers, instead of 16 of each, and this results in a 15% greater saving than the elimination of eight switches and a

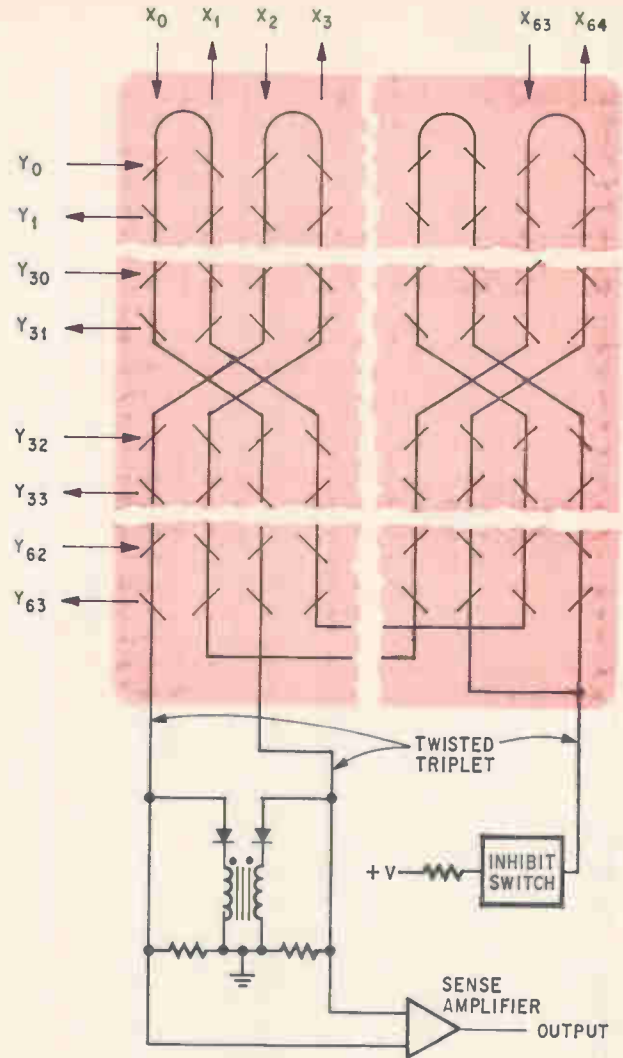

Bow tie. This sense winding pattern loads the driver symmetrically, and cancels most noise.

handful of diodes with 32-by-32 mats and a 16-bit-wide memory.

There's a catch, of course. With the larger memory, one memory cycle takes out 16 bits that the processor processes in four cycles. The four-bit-wide memory matches the processor speed cycle for cycle, meaning that equivalent jobs are executed more slowly by the machine with the smaller memory than by one with the larger.

### Malleable memory

Because of its unique application, the Nova's read-only memory presented its designers with some requirements not ordinarily associated with this form of storage. Read-only storage has generally been used mainly for microprogram control in fairly complex processors. These memories have to be very fast, but they're also mass-producible because all computers of a given model usually have identical microprograms.

The Nova read-only memory, on the other hand, is a storage medium for the operating program.

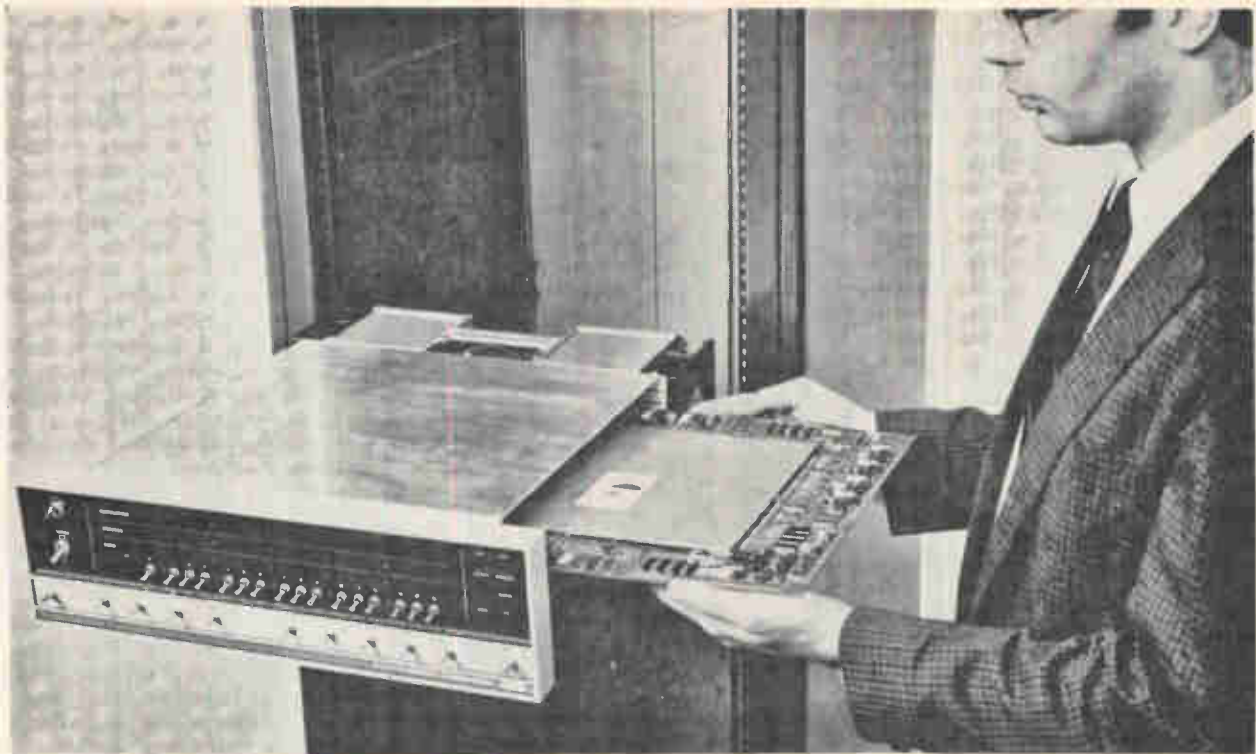

Memory board. A complete memory containing 4,096 words and all drivers, decoders, and sense amplifiers, fits on this 15-inch-square board. Design is easily cut back to 1,024 words on a similar layout.

With it, a user can convert a general-purpose processor into a hard-wired control element without having to load new programs. The machine can thus be operated by unskilled workers in electrically noisy areas without affecting the program.

Only a very flexible system could satisfy the needs of this application. Because many of the programs wired into the read-only memory would be one of a kind, high setup or tooling costs couldn't be tolerated. Also, the designers felt that it should be possible to make changes in the field with ordinary tools and techniques. Last but not least, the user should be able to debug his program thoroughly before committing it to the read-only memory.

These requirements are met in the Nova's 1,024-word memory module. It contains 16 of the U-shaped cores with their multiturn sense winding, which functions as the secondary winding of a transformer. A wire for each word is strung through all the cores, passing through a particular core from right to left to store a 1, or from left to right to store a 0. When a current pulse passes through any of these wires, which function as the transformer primary windings, it induces a signal in the secondary winding, the phase of this induced signal depending on the direction of the primary wire through the core. The sense amplifier detects the phase of the output signal to determine whether the bit is a 1 or a 0.

In practice, a user initially loads his program into an alterable core storage and debugs it using

normal procedures. After operationally checking the program's correctness, he simply dumps it on a paper tape and sends it to Data General. This tape serves as the basis for manufacturing the read-only memory and for verifying its contents. The assembled read-only memory can then be plugged into the user's machine in place of that part of the storage that originally contained the program.

If field modifications are required, a technician simply cuts out the wire corresponding to the word to be changed, inserts a new wire in the desired pattern, and solders it to the same parts the old wire was connected to.

### Accessibility

There's room for many standard and custom-designed input-output interfaces within the Nova's standard frame. For example, the interfaces for the teleprinter, a high-speed paper-tape reader and punch, and a real-time clock are all mounted on a single board 15 inches square.

Nova's input-output interfaces provide for direct access to the memory, programed data transfers, the status testing of devices, priority interruptions, and identification of the device requesting interrupt service. With the input-output system, which is standard in the basic machine, the program can address up to 64 devices. A single instruction can transfer a word between an accumulator and a device and at the same time control the operation of the device.

A high-speed device such as a magnetic-tape unit

or disk can gain direct access to the memory through a data channel and transfer a great many words following the execution of only one instruction. Likewise, a free-running external device such as a process-control sensor or pulse-height analyzer can store or fetch data in a reserved block of memory at any time without executing any instructions at all. In either case, the program simply pauses as access is made. The data channel logic can transfer data to or from the memory, increment the memory word, or add external data to a word already in the memory.

The interrupt system is particularly useful in process control applications. Several types of interrupt service may be employed by the central processor program depending upon the nature of the data rates and service time required by the input-output devices connected to the system. Each device's interface circuitry includes a flip-flop that enables or disables its interrupt signals.

A single processor instruction called Mask Out can change the flip-flops in all of the device interfaces simultaneously. This instruction, one of the first in a routine to which the computer branches when an external device interrupts it, is accompanied by a 16-bit word on the output data bus. The 1's and 0's of this word turn on or off the flip-flops for the various devices. Since each device's priority is established by the bit in the data bus to which its flip-flop is connected, the computer can enable or disable a particular device's interrupt but cannot change its priority rank.

When a device interrupts the computer, the Mask Out instruction disables the interrupts of all lower-priority devices. If a high-priority interrupt is received while another is being processed, the computer shifts its attention to the higher-priority device but later returns to the lower.

The key to this hierarchical scheme is Mask Out, the kind of instruction usually found only in computers much larger than the Nova.

Another instruction reduces the overhead time required to identify the device causing an interrupt. By transferring the selection code of the interrupting device from the interface to an accumulator, this instruction allows the interrupt service to branch quickly to the routine appropriate to the device.

### No weak links

In devising a packaging scheme that minimizes the number of interconnections between components, the Nova's designers sidestepped some cost and reliability problems associated with earlier small computers. In the past, packaging has typically accounted for 40% of the manufacturing cost of small computers. This is true even of some machines using integrated circuits, because their designers simply replaced the discrete components on small printed-circuit boards with IC's, leaving the rest of the system unchanged. In such modules, every circuit connection is made through pins on the back panel; the circuit board functions only as a

carrier for the IC. This technique multiplies the number of interconnections and thus reduces reliability. It also increases the cost of boards, the number of connectors, and the amount of back-panel wiring and cabinet space.

In the case of the Nova, one of the first decisions taken was to use higher-level components to reduce the number of parts. Each integrated circuit in the Nova is of a level of complexity equal to or higher than that found in a conventional logic module circuit card carrying discrete components.

The designers also decided to use only those levels of interconnection that increased the complexity of the system. In other words, they determined to avoid wasteful circuit carriers.

Putting high-level components on printed-circuit boards reduced wire lengths and increased reliability. The size of the printed-circuit board itself wasn't too important. With the conventional module replaced by the IC, boards could contain whole subsystems.

The conductors on the Nova's p-c boards replace almost all conventional back-panel wiring, while what back-panel wiring there is replaces cables. Thus the traditional level of connection complexity for this kind of system has been escalated one degree. Even when small IC modules are required for special device interfaces, connecting them on larger boards is better than accumulating nonfunctional connections in back-panel wiring.

Board size isn't limited by the capacity of existing cameras, copy plates, etchers, solderers, or other production equipment. Even those firms that are using small modules are building big boards and cutting them apart. Nor is yield a problem. Poor yield results from an inability to control process variables; lines are either etched through or short-circuited. The wider the line and the greater the spacing, the less likely are defects, and the Nova's boards have wide lines and wide spaces between them.

If a customer wants to configure his own system from the various memory sizes and peripheral devices available, or wants to interface special devices of his own, he'll find the Nova design accommodating.

The computer's basic rack mount unit holds seven 15-inch-square circuit boards. The central processor takes up two of these cards, so the other five are available for any combination of memory boards and input-output boards.

Interface boards are available for a complete line of standard computer peripherals, including teleprinters, card readers, line printers, displays, and magnetic tape. The customer can build special interfaces by mounting IC's on standard plug-in socket boards purchased from Data General. These boards contain eight interface areas, each with space for 12 standard 14-, 16-, 24-, or 36-pin IC's, either soldered or plugged in.

The user can also buy special circuit boards containing certain kinds of high-current drivers that have to be assembled from discrete components. ■

# Designer's casebook

## Squelch gate reduces amplifier's standby drain

By A.T. Lehmann

Polytechnic Engineering Co., Mountain Lakes, N.J.

The push-pull type of audio output stage not only costs more than the single-ended stage but also suffers from crossover distortion at low current drains as class B operation is approached. For receivers operating mostly in the squelched condition, such as police and emergency receivers, the solution is simple: use a single-ended output stage and a squelched audio gate.

The three-stage, direct-coupled amplifier draws a fraction of a milliampere when squelched. When a positive control voltage is fed to the input of the squelch gate, the gate removes the supply voltage from the first stage. This, in turn, removes the bias from the second stage and thus from the output stage. The standby current is therefore only the leakage current of the transistors, which, with the silicon transistors used, is insignificant.

The circuit contains d-c feedback for stability. This cancels out the effects of temperature variations and assures constant operation with changing transistor parameters.

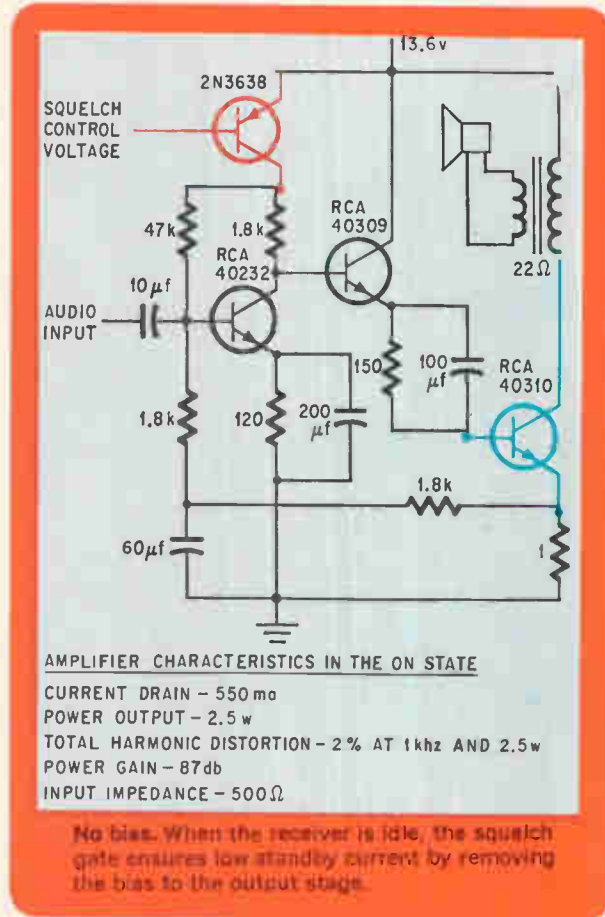

## Transistor circuit cancels inductive load effects

By Thomas E. Skopal

Burroughs Corp., Plainfield, N.J.

Overshoots develop in pulses delivered by coaxial cables to inductive loads. To compensate for the inductive reactance, a capacitor could be shunted across the inductor, but this might lead to ringing in the LC network, and the capacitor's leakage would bleed current from the pulse. The problem can be solved simply and efficiently by a one-tran-

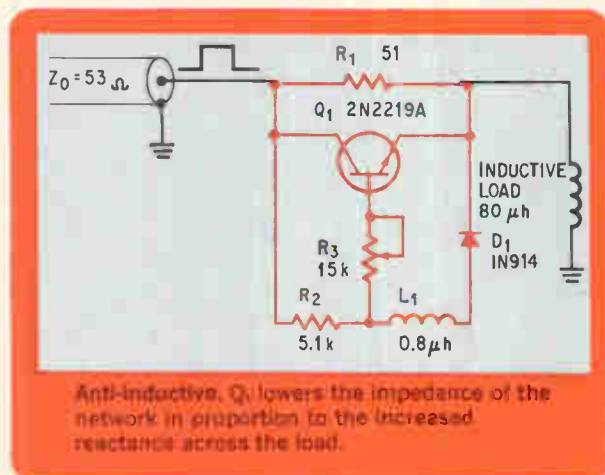

sistor circuit inserted between the cable and the load.

At the pulse's d-c level, no reactance is developed by the 80-microhenry load inductor, and the total load impedance is  $R_1$ , which with some inductive resistance is about equal to the characteristic impedance of the coaxial cable.  $Q_1$  is just biased on by  $D_1$ .

The pulse's leading and trailing edges generate a voltage drop across both  $L_1$  and the inductive load. The voltage at  $L_1$  turns  $Q_1$  on and lowers the impedance of the network to offset the increased reactance developed by the inductive load. The

network's net effect is to terminate the cable in its characteristic impedance and cancel the inductive load's effect on pulse transitions. The exact characteristic impedance of the cable is found by adjusting potentiometer  $R_3$  which controls the current flowing through  $Q_1$  and thus the network's impedance.

For best compensation, the product of  $R_1$  and the inductive load must be equal to the product of resistor  $R_2$  and the inductor  $L_1$ . Another restriction is that  $R_2$  must be large enough to avoid loading  $R_1$  yet small enough to allow for enough transistor base current.

## Multiplier stages replace power-supply transformer

By Merle E. Converse

Southwest Research Institute, San Antonio, Texas

A dual-output d-c power supply can provide a high voltage output of between 100 and 200 volts and a low one of less than 50 volts without employing a separate transformer or a second winding and separate rectifier. A capacitor-diode multiplier con-

nected to the same transformer and bridge rectifier that supplies the low voltage can develop the high voltage as an isolated output. Voltages of either polarity can be obtained.

Capacitors  $C_1$ ,  $C_2$ , and  $C_3$  couple the negative half-cycles of the transformer secondary to multiplier diodes  $D_5$ ,  $D_6$ ,  $D_7$ , and  $D_8$ ; positive half-cycles are clamped by the bridge rectifiers,  $D_2$  and  $D_4$ . The no-load voltage developed at the output of each stage of the multiplier is the d-c output of the previous stage plus 1.4 times the rms voltage at the transformer secondary. The output voltage is thus determined by the number of multiplier stages and by the load current.

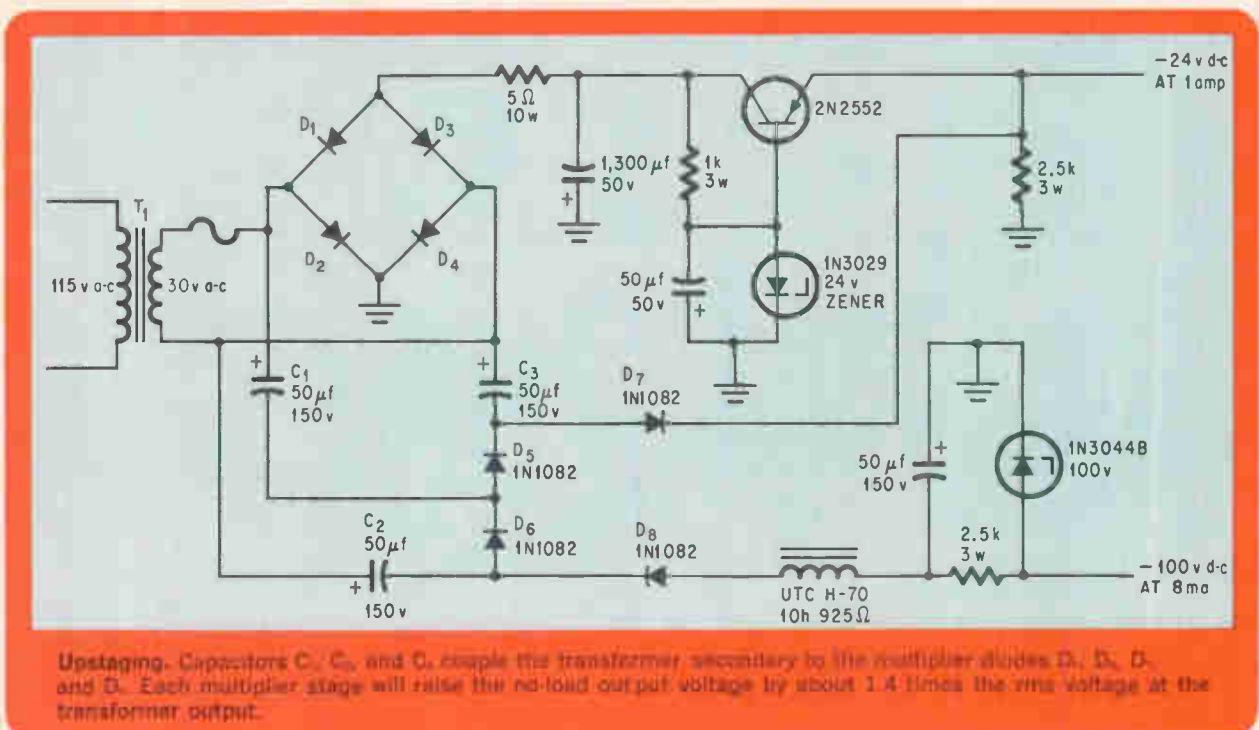

Upstaging. Capacitors  $C_1$ ,  $C_2$ , and  $C_3$  couple the transformer secondary to the multiplier diodes  $D_5$ ,  $D_6$ ,  $D_7$ , and  $D_8$ . Each multiplier stage will raise the no-load output voltage by about 1.4 times the rms voltage at the transformer output.

# EMI FILTER *BREAKTHROUGH*

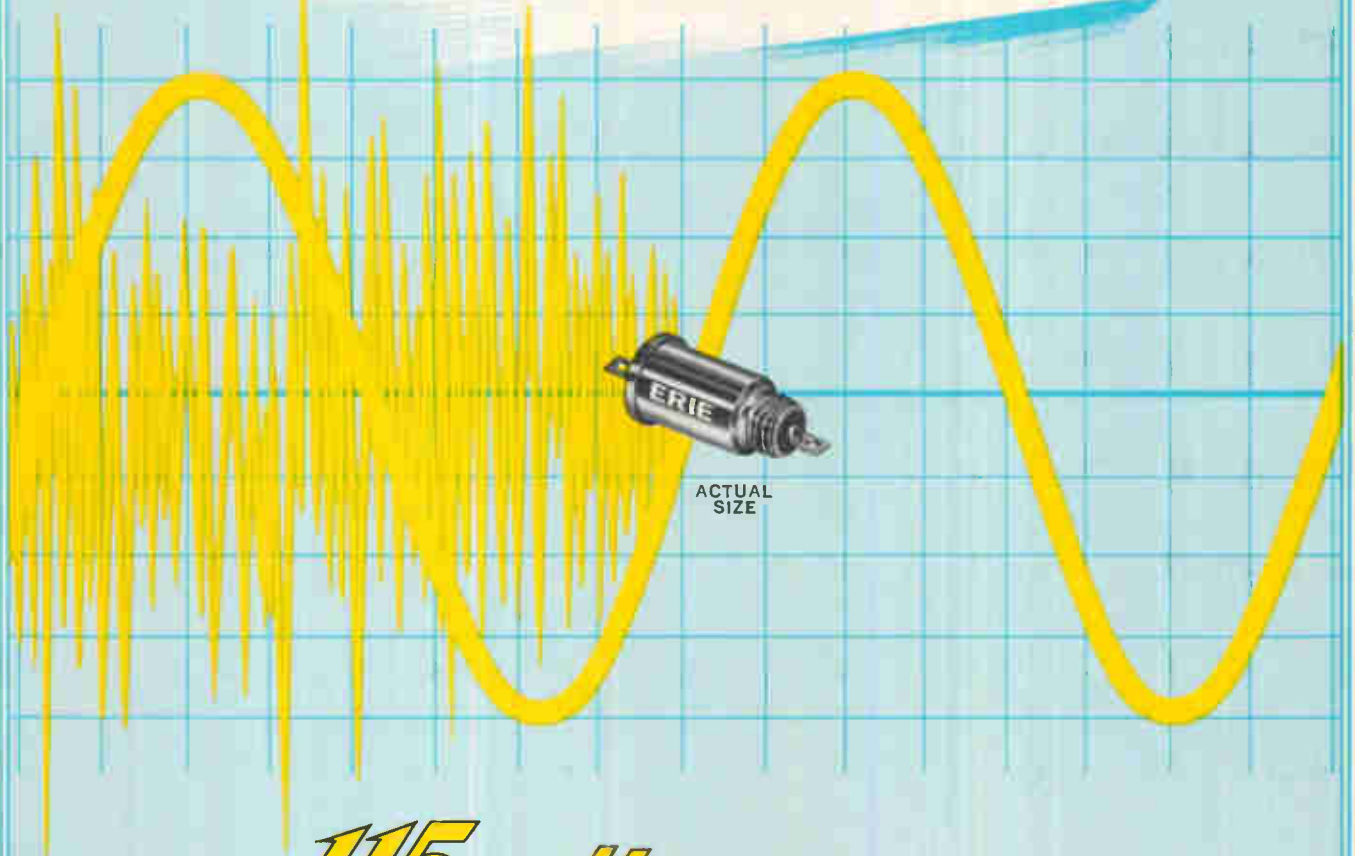

## ERIE *115 volt ac* LINE FILTERS

**SMALLER and LIGHTER THAN ANY OTHER  
LINE FILTER AVAILABLE!**

- **DESIGNED FOR OPERATION IN . . .**  
400 Hz lines @ 85°C  
60 Hz lines @ 125°C
- **INSERTION LOSS GUARANTEED FROM . . .**  
-55°C to +125°C @ rated current
- **TYPICAL INSERTION LOSS . . .**  
30 db @ 150 kHz  
80 db @ 1 MHz and up



These hermetically sealed ERIE EMI Power Line Filters represent a substantial reduction in size and weight without sacrifice in performance through the use of a sophisticated state of the art dielectric. Most measure less than 1 inch long and weigh less than 10 grams, making these tiny Filters perfect for power supply applications where reliability, size, and weight are design considerations.

The broad line of ERIE EMI Filters economically provides optimum performance for virtually any environment. For detailed specs see your local ERIE applications engineer or write for Catalog 9000.



Erie, Pennsylvania



Introducing  
**THE THERMAL MAGICIANS**





Magicians? Yes. That's the word our customers have for TI's amazing new electronic and electromechanical thermal controls and the men who conjure them up. They all work wonders. Like what? Like creating customized semiconducting materials to stabilize temperatures without separate sensors, thermostats and heaters. Like controlling

temperatures within  $\pm 0.050$  C with interchangeable solid state sensors and switches. Like monitoring several temperatures in several locations simultaneously with Hi-Rel electronic circuitry. Like squeezing an SPDT electromechanical switch into a miniature SPST frame. Like using a unique piggy-back technique to package two snap-acting thermo-

stats in a single hermetically sealed case. There's no end of magic in TI's bag of tricks. Next time you have a tricky temperature control problem, you can rely on TI to work wonders for you too. Write to TI Control Products Div., Attleboro, Mass. 02703, or tel. (617) 222-2800. Ext. 318



**TEXAS INSTRUMENTS**  
INCORPORATED

Circle 87 on reader service card

# Rival preleading schemes head for a market showdown

Flip chips have arrived and beam leads are on the way, with production quantities expected next year; the outcome of the battle may well hinge on the relative compatibility of the two techniques with MSI and LSI

By Lawrence Curran

Los Angeles bureau manager

**Prospective buyers** of preleaded devices—whether bumped flip chips or beam-lead components—are getting restless. They know what the devices promise; they're questioning what the suppliers promise. Specifically, they're asking whether the semiconductor makers can deliver the goods. Increasingly, the answer is yes.

Texas Instruments and Sylvania, for example, are delivering discrete beam-lead diodes for microwave systems customers [see panel, p. 90], and Autonetics is getting some beam-lead IC's and discrettes from Raytheon, although the volume isn't great. Members of the Bell System are getting beam-lead IC's from their Allentown, Pa., facility's pilot production line, but volume output there appears at least a year away. Flip chips, on the other hand, are farther along at most semiconductor houses making them, and some firms have been delivering production quantities for a couple of years.

Signetics is making some of its old triple-diffused series 100 diode-transistor logic in beam-lead form for use by Autonetics in the Minuteman missile program, and it expects to be shipping production quantities in the first quarter of next year. Signetics' R&D director, David Kleitman, says the firm wants to have beam leads available "as soon as possible for customers," but notes that "for in-house use—in our own IC lines—the whole effort is flip chip."

Donald Thompson, department chief of manufacturing development at Western Electric, the manufacturing arm of the Bell System, says that more than 30 different types of beam-lead IC's are either in pilot production or nearing it at Allentown. The roster includes counters, gates, and drivers—devices slated for duty in the ESS (electronic switching system), touch-tone telephones, traffic service

precision consoles, PBX's, data sets, and carrier systems. Thompson predicts mass production of many of these circuits in a year to 18 months.

The plant is also turning out developmental quantities of monolithic and multichip beam-lead circuits, and is tooling up for LSI. The circuits in this category typically have about 100 elements per chip, and one device being developed has 1,000 elements on a 90-by-100-mil die. Multichip circuits have up to 200 chips on a hybrid substrate.

## Conversion

Raytheon is laying out all its circuits with beam leads, according to Rudolph Thun, microelectronics manager at the company's radar and electronics lab. For conventional circuits already announced, the firm is going to standard chip sizes and standard chip-to-chip spacing to allow beam-lead attachment. Thun says the "retrofit" masking program already covers the series 200 and 930 DTL lines, the series 1,000 transistor-transistor logic, and Ray I and Ray II lines (corresponding to Sylvania's SUHL I and II TTL), plus all linear devices.

Raytheon's IC product manager, Paul Sullivan, observes that the firm isn't anxious to supply companies other than its sponsors—Autonetics plus two in-house operations—with beam-lead devices just yet. "But by mid-1969 we hope to have well over 50% of what we make commercially available in beam-lead form."

Autonetics expects Raytheon to start producing in volume the devices it has ordered early next year, according to Richard Bucheister, an Autonetics purchasing agent. This is essentially a production contract, but deliveries to date can't be considered production quantities. Autonetics is also

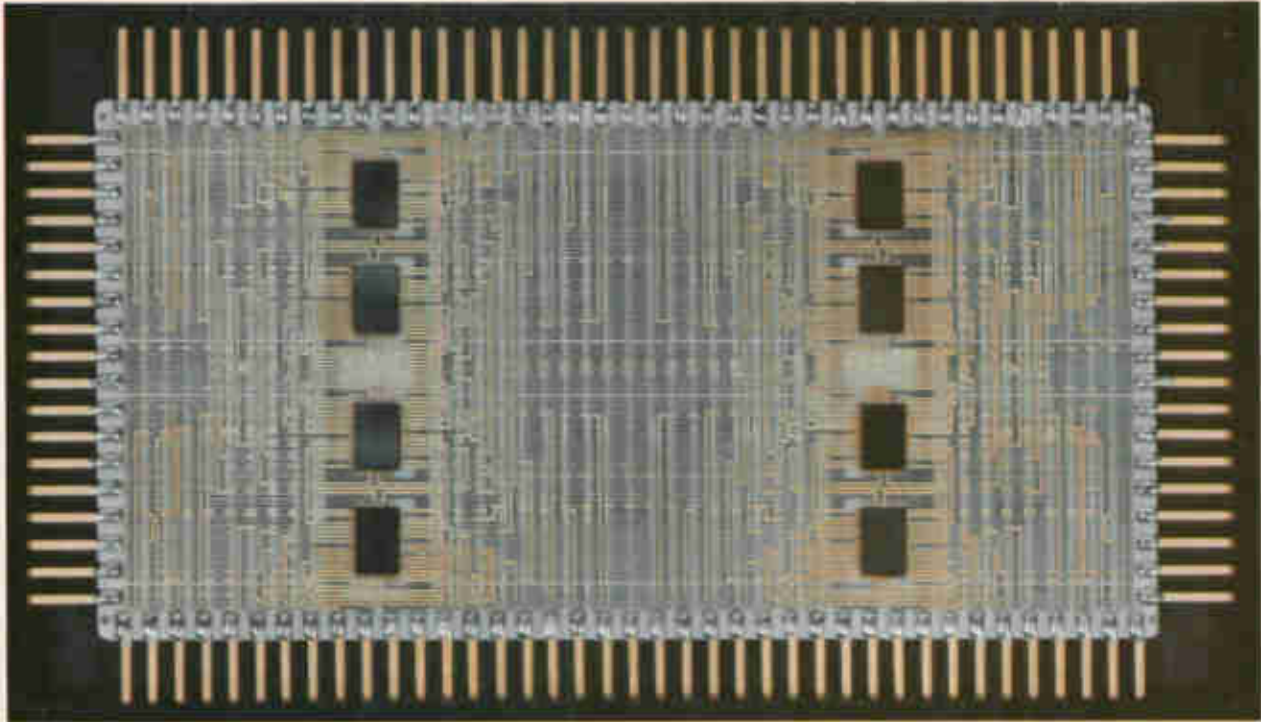

Leading somewhere. Experimental module built by Raytheon's Missile Systems division uses eight 40-gate TTL modules with beam leads. The top layer of the metalization pattern on the substrate sets up the circuit configuration.

attempting to qualify other suppliers of beam-lead devices for the FB-111A and F-111D aircraft. Barring drastic changes in these programs, Bucheister expects a follow-on to the Raytheon contract late next year, but he says that in all likelihood it won't be a sole-source procurement. The competition will be thrown open again at that time.

Motorola isn't giving out much information about the specific devices it has slated for beam leads. Richard Abraham, director of advanced IC programs, will say only that Semiconductor Products division will be ready to introduce beam-leaded products by the middle of 1969. "Just what products they'll be depends on which of our customers ask for beam leads," Abraham explains.

Brian Dale, chief engineer at Sylvania's Semiconductor division, expects his operation to bring out a line of beam-lead devices in early 1970, including 12 to 14 IC's to begin with. Meanwhile, Sylvania will continue to seek custom work in this field, and will sharpen its technology by working with discrete microwave beam-lead components. Dale says that while Bell Labs has put up to 56 leads on a beam-leaded chip, Sylvania's maximum figure to date is 40 on an array of 1,024 diodes.

Beyond this in-house work, Sylvania has an Air Force contract to investigate "means of building hybrid circuits without wire bonds." The award, received this summer and slated to run almost two years, doesn't specify beam leads, but Sylvania is applying that technology to its feasibility circuit—a four-bit, 12-chip shift register. The firm is also working on a beam-lead interdigitated transistor

that's supposed to reach 5 watts at 2 gigahertz.

At Sprague Electric's Semiconductor division, Robert Pepper, director of research, development, and engineering, says production rates will depend on the beam-lead device market, which he doesn't see maturing for at least a year. "For the present, Sprague is going to settle for 'preproduction' volumes. But when the full market appears, we'll be geared for it," he adds.

Pepper says Sprague uses a straightforward Bell Labs cook-book format: gold or gold-molybdenum beams and silicon nitride passivation. The division tackled the beam-lead task head on, starting with a dual four-input NAND gate from its Super-Speed Logic (SSL) line. Explains Pepper: "We figured if we could solve the problems with this, one of our toughest-to-build IC's, we'd find other circuits easier. This circuit, like most high-speed TTL, has small device and contact geometries and is hard to build with ordinary aluminum metalization, much less with beam leads."

Sprague engineers had to overcome three problems with the initial circuit, one of them being the small geometries. "Fussy mask making solved this one," Pepper says, "but another hurdle was a problem no one has said much about—the fact that metalization in beam-lead IC's can easily short out to the substrate. This may also be the reason you don't hear much happy talk about beam-lead IC yields." Pepper won't say how Sprague got around this problem, but he does relate that it took about four months to isolate the problem, but only a week to add the solution to the production

## Microwave beams

Integrated circuits aren't the only subjects of beam-lead research and development. The technique has much to offer microwave devices; for one thing, the wide leads reduce parasitic effects. Among the firms making microwave beam-lead devices, Texas Instruments and Sylvania appear to be the leaders, with both claiming to be number one.

Ti's microwave beam-lead work got started about four years ago, with much of it stimulated by the Air Force's MERA (molecular electronics for radar applications) program. The company has put beam leads on such MERA components as mixer and varactor diodes, pin switching and detector diodes, and capacitors and resistors. Beam-leaded microwave transistors have also been built, but not for MERA.

Sylvania has been selling beam-lead Schottky-barrier diodes and mixers incorporating the diodes. And Marvin Groll, marketing manager for microwave semiconductors, says that before year's end the firm will be ready to introduce a redesigned Schottky diode with broad flat beams. Slated to bow later are Schottky diodes that will extend Sylvania's capability beyond its present Ku-band limit, and farther down the road are pin switching and varactor diodes and silicon-oxide capacitors.

**The reason why.** Arthur Solomon, head of the solid state microwave components department at Sylvania's Semiconductor division, says he backs beam-lead devices because they're easy to mount with automated techniques, because the **uniformity**

of the active devices allows preselection of matched diode pairs after only sample testing, and because they promise greater packing densities than chip-and-wire components.

"There's no good way to make a demountable test circuit for unpackaged chips," Solomon says, "but with beam-lead diodes, we can use lot sampling from the same wafer of about 1,000 chips. Because the boundaries of the semiconductor area and the beams are uniform, you get uniformity of parasitics."

Solomon also notes that with most nonactive material etched away, the devices can be mounted closer together on a stripline than would be possible with conventional diodes. "We've made multidiode switches using beam-lead pin diodes 8 to 10 mils on a side and put them side by side on a 20-mil-wide microstripline only one-quarter wavelength apart at Ku band and with only 25 mils between centers," he says. "This would be tough to do with conventional devices because chip pin diodes are about 20 mils a side. You need about 50 by 125 mils to mount two in parallel, against 20 by 50 mils for two beam-lead pin diodes."

Although his department hasn't investigated flip chips, Solomon is quick to observe that they don't afford the advantages of air isolation and lead shaping. "I don't know of any flip-chip work in the microwave area," he adds.

**The heat's off.** One of the advantages of beam-lead devices at lower frequencies works against them in

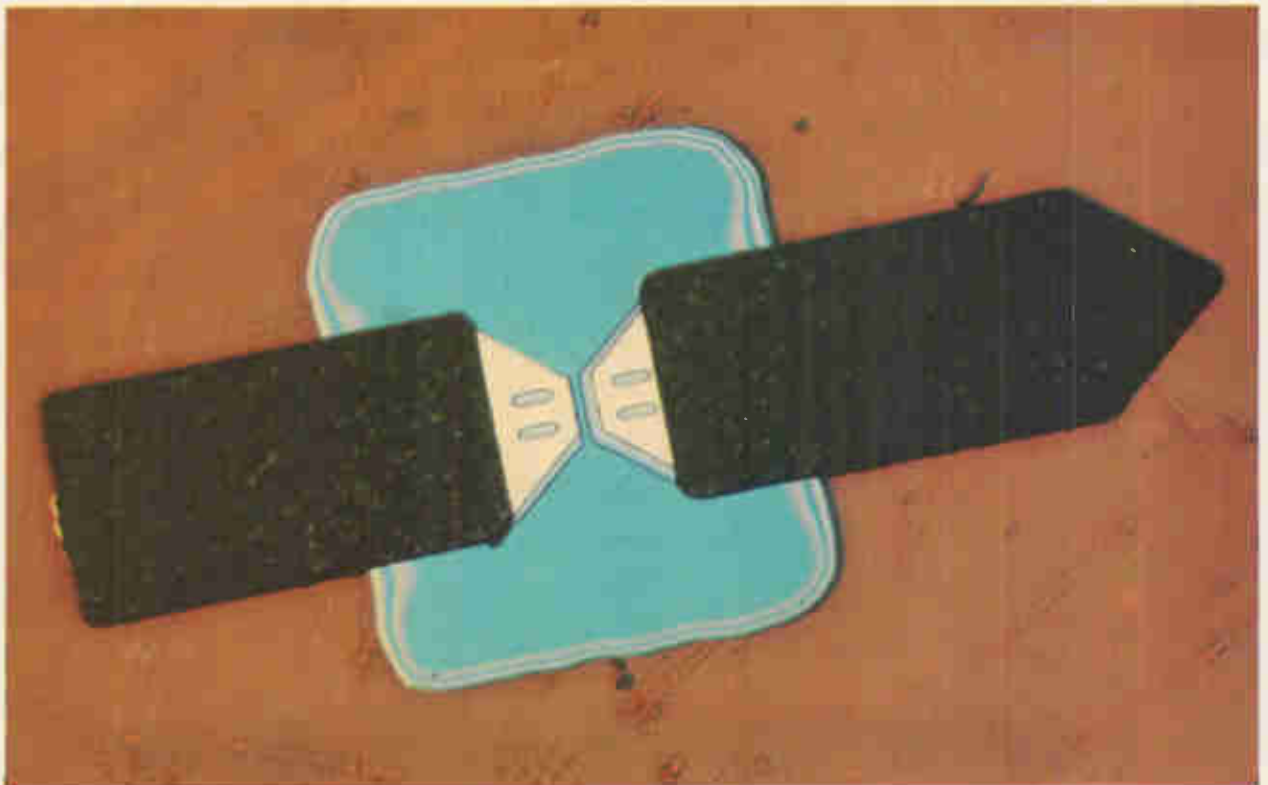

**Isolationist.** This surface-oriented pin diode, developed by Texas Instruments for use in the MERA program as a transmit-receive switch, has beam leads and provides better than 20-db isolation with an insertion loss of less than 0.5 db. Total capacitance is 0.1 pf and series resistance is 3 ohms.

microwave systems. They're virtually isolated from bonding heat because the leads dissipate the heat before it reaches the active regions. This limits their power-dissipation capabilities, Solomon says, because there's no intimate contact between the device junction and a heat sink. Thus, he says, the upper limit for switches with beam-lead varactor or avalanche diodes is several hundred milliwatts, compared with a few watts for the same devices using similar conventional diodes.

Developmental devices made with beam-lead components by Solomon's group include a 13.3-gigahertz integrated balanced mixer employing Schottky diodes, and an experimental i-f amplifier that uses the mixer and is centered at 450 megahertz.

The Army's SAM-D surface-to-air missile system has lent impetus to Raytheon's work in Bedford, Mass., on microwave components. Robert Chinchillo, a design engineer at the company's Missile System division—prime contractor for the program—says he's found that "beam leads give you some of the smallest devices available. They sit tight to the substrate and present much smaller obstacles to microwaves than other kinds of diodes."

Beam leads permit the fabrication of Schottky's as small as 0.005 inch in diameter, Chinchillo goes on. "Before beam leads, we couldn't specify a matched pair of diodes and be sure we would get one. We can now pick diodes that were side by side on the wafer. It's as comfortable as you can get before ac-

tual testing at microwave frequencies."

SAM-D will have a phased-array radar, and Chinchillo notes: "We like beam leads for microwave mixers and phase shifters. One phased-array radar may have 5,000 or 6,000 elements with up to 40,000 diodes, so if beam leads get the nod, it will be a strong nod."

On the West Coast, Hewlett-Packard Associates is making a beam-lead, X-band, Schottky-barrier mixer diode that operates at 10 Ghz. Because it's batch processed, the diode sells for about \$20 in small quantities.

**Limited field.** This is the only device Hewlett-Packard has shown in beam-lead form and there are no plans to introduce others soon. The argument at H-P is that only planar devices are compatible with beam leading, and this precludes the application of the technique to the firm's varactor and step recovery diodes. The Palo Alto, Calif., concern has also ruled out beam leads for power devices because of the leads' limited heat dissipation.

Hewlett-Packard isn't interested in flip chips. Donald Flynn, product marketing engineer, explains: "Our business is principally in microwave. The solder bumps on flip chips involve too much capacitance for devices in the 10-Ghz range in which we chose to work." Flynn says the firm uses sapphire as a substrate material because it has a uniform surface, and because it dissipates power better and has a more uniform dielectric constant than silicon.

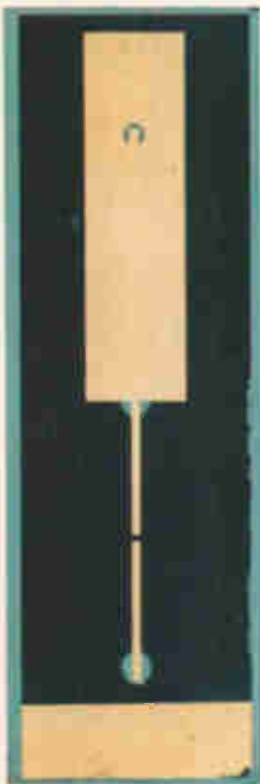

Pulser. This beam-lead microwave pulse generator was built at MIT.

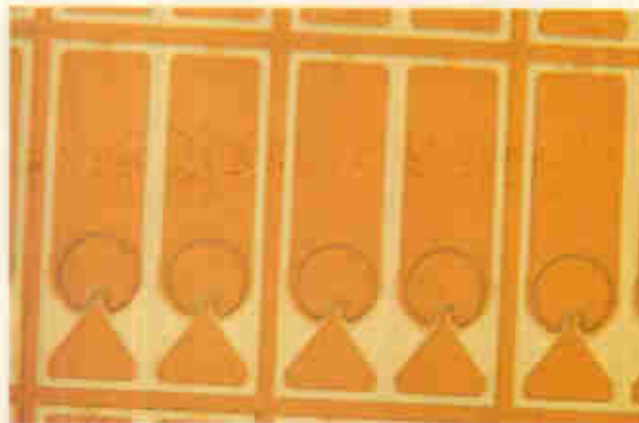

**Broad beams.** A group of Schottky-barrier beam-lead diodes from Sylvania's semiconductor division are lined up in the upper photo, while the lower shows a single diode placed in the center of the "tails" side of a penny. The devices are intended for use at about 13.3 gigahertz.

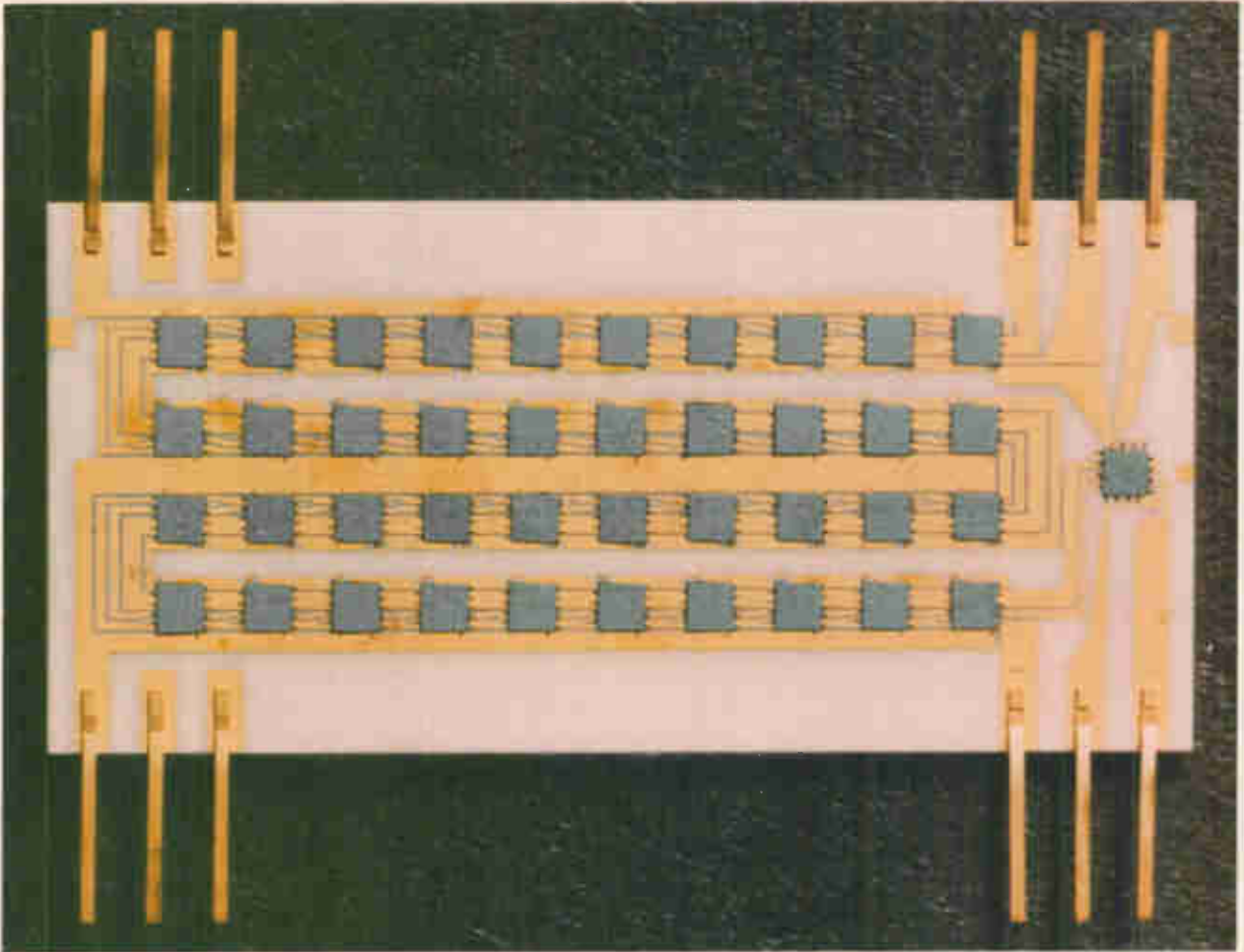

**Big shift.** Built by Bell Labs, this shift register has beam-leaded, insulated-gate FET stages with a single bipolar stage as a buffer. The substrate measures 0.625 by 1.3 inches.

technique. With this addition, yields doubled.

A third problem was gold segregation associated with nitride passivation. "Normally our SSL IC's are loaded with gold to cut storage time," Pepper says. "Unfortunately, this gold metalization isn't fully compatible with silicon nitriding. At some of the high temperatures needed for nitriding, the gold precipitates, doubling or tripling storage time. Our NAND gate initially ran at 15 nanoseconds, but we eventually worked out a way to use gold and silicon nitride together without degradation." Again, the solution is proprietary.

"With this first circuit, we knew we were in business and we went on to other IC's." That was last spring, and since then Sprague has been making twin mask sets for each new digital IC—one for bonding pads and the other for beam leads. The firm has beam-lead mask sets for such forthcoming additions to its lines as a quad double-input NAND gate, a 60-megahertz, charge-control flip-flop, a high-noise-immunity gate, an up-down counter, and a right-left shift register, all of them scheduled for introduction next spring. The company is also developing the capability to retrofit beam leads to older products.

James Hubbard, an IC manager at TI, says his firm is just getting started in beam-lead integrated circuits, although it's been working on discrete beam-lead microwave devices for about four years. "The microwave region was a natural for a beginning," says Hubbard. But outside that region, TI is putting both beam leads and bumps on silicon transistors and diodes and on DTL, TTL, and some emitter-coupled-logic IC's. "We have developmental contracts with a number of customers covering both beam-lead and flip-chip approaches," Hubbard says, "and I couldn't say at this point which method seems better. In the next few months we should have a lot more data from our two work groups and know a lot more."

#### Out into the world

While beam leads are probably at least a year away from volume production, flip chips have been on the market for as long as two years. Herbert Evander, assistant microelectronics manager at Hughes Aircraft, goes to the heart of the flip-chip advocates' argument when he says: "The Sentinel [missile] contract will help people get into commercial production with beam-lead devices, but

it will be a long time before we see beam leads in competition. Flip chips are here today and beam leads are not, and flip chips are a proven process."

And even after beam-leads get into commercial production, Evander doesn't see them squeezing out flip chips. "There will always be flip chips," he declares.

Hughes has been putting bumps on discrete devices on a production basis for more than two years. Device families available from Hughes in flip-chip form include the 1N3602, 1N917, 1N918, and 1N4149 computer switching diodes, the 1N898, 1N4824, and 1N483 core driver switching diodes, and the 1N458A and 1N459A signal diodes. Transistors Hughes supplies with bumps are chiefly npn devices—2N2369 switching transistors, 2N915 and 2N916 amplifiers, 2N2221, 2222, and 2223 high-current switches, and the 2N930, 2N2484, and 2N918 transistors. The firm also supplies two pnp transistor types, the 2N2605 and 2N2907; the latter is a high-current switching transistor. In addition, Hughes' Newport Beach, Calif., plant is turning out a complete line of flip-chip zener diodes with an operational range from 6.6 to 33 volts.

Evander says he expects Hughes to be producing a variety of flip-chip IC's now in development by early next year. The logic families are the series 930 DTL and series 5400 TTL, and there are also some linear operational amplifiers scheduled for the flip treatment.

The small geometries of some TTL devices, particularly Sylvania's SUHL II line, present problems in bump spacing similar to those encountered by Sprague in trying to apply beam leads. "You can't put 14 bumps on a 40-mil-square chip and expect to get good bonding to the substrate," says Evander. The problem prompted Hughes to propose a standard flip-chip bump spacing of 5 mils to the Electronic Industries Association. SUHL II allows only about 1-mil bump spacing because of the closeness of bonding pads.

Hughes is anxious to share the wealth of knowledge it has acquired in applying bumps to chips in the hope that flip-chip bumping will become the most widely accepted face-down bonding technique in the semiconductor industry. The firm has selected another manufacturer as a second source for the Hughes process. "We helped them design the masks and we'll be talking about a license with them," Evander says. "This company looked at beam leads and rejected them. We're trying to promote several sources and we're completely open to licensing arrangements."

Siliconix first marketed flip-chips about a year ago after two years of development work. The company says almost all its conventional packaged circuits are available in flip-chip form, including MOS FET's junction FET's and IC's, the latter chiefly multichannel drivers and switches or driver-and-switch combinations. The firm also offers a line of flip-chip DTL and linear IC's—for example, the LM101 and 201, and LH101 and 201.

Prices for the bumped components are about the

same as those for their packaged counterparts, according to the company (all Siliconix flip-chips are sold in chip form, but the firm is negotiating to sell bumped unscrubbed wafers).

It would be hard to prove that flip chips have arrived if your only evidence was the experience of the Big Three in the semiconductor business. Fairchild jumped in with the Fairpak process last year, but has now abandoned it. Texas Instruments like the Fairpak idea so much that they adopted it with little variation, but the firm's IC package development manager, Ross Schraeder, describes both the ceramic-and plastic-packaged flip-chip efforts as still developmental after 2½ years of effort. He says TI will market in next year's fourth quarter a standard line of bumped DTL and TTL IC's in ceramic packages with 14 to 16 leads. He also says the firm is looking at flip-chip packages with up to 64 leads.

Eventually, TI's plans call for making available in flip-chip form all IC's that don't have power dissipation limitations. "We are working hard to overcome power dissipation problems," says Schraeder. "If we can do this, the market for these devices would really mushroom." He feels there will be future requirements for higher-power devices that could give TI trouble, but for the present, DTL and TTL devices don't dissipate enough power to preclude bumped versions in standard packages. The official sees the flip-chip market beginning to open up next year, "but the real speedup won't come until 1970. We expect to be in high-volume production by then. The main problem now is market development rather than insurmountable technical production difficulties."

Meanwhile, Motorola continues to pour out spider-bonded IC's. Officials at the company's Phoenix, Ariz., plant are shy about describing production rates, but they do say that the technique is at least 20 times faster than chip-and-wire bonding. Two more spider-bonding machines are being built, so the firm will have two lines going early next year. Each reel of aluminum spider leads contains up to 25,000 piece parts, and considering Motorola's penchant for high-volume manufacturing, the peak production levels are probably eye-popping.

But spider bonding is suited only for monolithic IC's. How compatible, then, are the different approaches with the automatic assembly lines of their users, who are mainly making hybrid circuits?

The IBM solid logic technology (SLT) process—a form of flip chipping—is obviously highly automated, and its apparent successor—"controlled collapse"—may be, too. But arguments rage about the relative degree of automation of conventional flip-chip bonding and beam-lead bonding.

IBM and Bell Labs officials appear to see things differently and there's even disagreement within the Bell System itself about the bonding rates users of beam leads might expect. IBM executives point out that automatic handling and automatic etching techniques for beam-lead devices aren't in hand

yet. At least one Bell Labs official agrees, noting that beam-lead bonding rates are now as low as 90 devices an hour, which he concedes is unacceptable for use today. This same source says bonding rates of 400 an hour might be acceptable to users, but that's a far cry from the 2,000-per-hour rate claimed by Aerojet-General for flip-chip bonding and the 1,800-per-hour pace expected by Evander once Hughes' automatic bonder reaches the market next year.

Other Bell officials, however, maintain that Western Electric will have automatic handling and etching mastered in a year to 18 months. There's no indication, however, of how many devices a beam-lead user might reasonably expect to be able to bond per hour.

### Brighter side

Automation is a way of life at Motorola, and Abraham remains undismayed about the problems faced in speeding up the beam-lead bonding process. "The first wire bonder wasn't very fast, you know," he says. "Once the dice are separated from the wafer and mounted on a carrier, and once the backs of the beams are probed the same way an IC die is probed, the dice are arranged on a substrate in the same pattern they had on the wafer. You can align a pickup tool so the chips line up in an outline in the reticule of the optics, and then orient the header to the same outline. You can then pick up the chip and put it down for bonding automatically."

Autonetics officials foresee no major obstacles to automating beam-lead bonding in their hybrid thin-film MICRA (microelectronic integrated circuit replaceable assembly) packages. The company's thin-film superintendent, Kenneth Pascoe, says Autonetics made its decision to go the beam-lead route about 18 months ago after considering—and rejecting—flip chips. "We wanted to automate as much as possible, and the blind interconnect associated with flip chips made us uncertain of the bump location and orientation in relation to the contact pads," Pascoe explains.

He further states that the scribing and breaking of flip-chip wafers creates rough edges that make the chips difficult to handle automatically. In contrast, he says, back-etched beam-lead dice have smooth, symmetrical edges.

One flip-chip advocate has solved the rough-edge problem by sawing the dice apart instead of scribing and breaking the wafer. Walter Chin, assistant manager of the microelectronics department at Aerojet General's Electronics division, says the saw is used to produce a square pattern compatible with the company's automatic equipment.

### Seeing is relieving

Another advantage of beam leads cited by Autonetics' Pascoe is that unlike flip-chip bumps, the overhanging beams are visible after the devices are turned face down, providing an orientation refer-

ence. "We want to locate the dice to a tolerance of 1 or 1.5 mils in bonding them to the contact pads so we need the orientation," he says.

Compatibility with thin films appears to be a beam-lead feature that flip chips may not be able to match. "We don't want to subject the films to more than 150°C in bonding," Pascoe says. This, he asserts, rules out flip chips because they have a substrate that has to sit on a platform heated up to 300°C during bonding.

Raytheon ships etched-apart dice to Autonetics oriented the same way they were on the wafer and held on a flat surface by a proprietary adhesive. Autonetics' Bucheister says bad devices will either be marked or removed from the adhesive backing. Pascoe would rather they were removed to facilitate automated assembly because he says it's easier to automatically sense a vacant space on the surface than it is to sense a marked die.

Sylvania's Dale is another who likes the prospects for automated assembly of beam-lead devices. He explains that because etch separation preserves the geometrical orientation present in the photo-mask, each die in a matrix of devices will be in a known location and orientation. "This makes it possible to program a pickup tool for repetitive assembly," he says. Further, "because the positions of the leads are in known positions for the same reasons, beam leads look good for automated bonding. We have a hand-operated compliant bonder in our lab now that should be operating late this year or early next."

According to Dale, Sylvania has had in mind the retention of the matrix geometry. "At first we used a foil of gold that acted as a grid within which we laid out our IC's. Then we tried Bell's wax, screen, and sapphire approach. Now we feel we've improved on it in our most recent work." The nature of that improvement is proprietary, but Dale says that with it, chips are laid out "within a mil or two" of each other.

But users assembling multichip circuits can't live on promises about automated bonding of beam-lead devices. Aerojet-General shelled out some \$150,000 to Bulova for two machines that give the firm possibly the most highly automated hybrid, thin-film, flip-chip assembly operation anywhere. Aerojet-General buys bumped discrete dice—junction FET's, npn and pnp bipolar transistors, and some diodes—principally from Hughes, Amelco, and Intersil. Gordon Carville, a marketing engineer in Aerojet-General's microelectronics department, explains the company's fondness for flip chips in one word—automation.

The Bulova equipment consists of a flip-chip sorter and classifier connected to a Teradyne IC tester. This combination automatically classifies flip chips fed from a vibrating spiral trough into one of eight categories, probes them, and automatically loads them into cartridges for transfer to the bonding machine. The equipment has a top speed of 3,000 dice an hour. As the bumped chips slide from the vibratory feeder, they pass down a



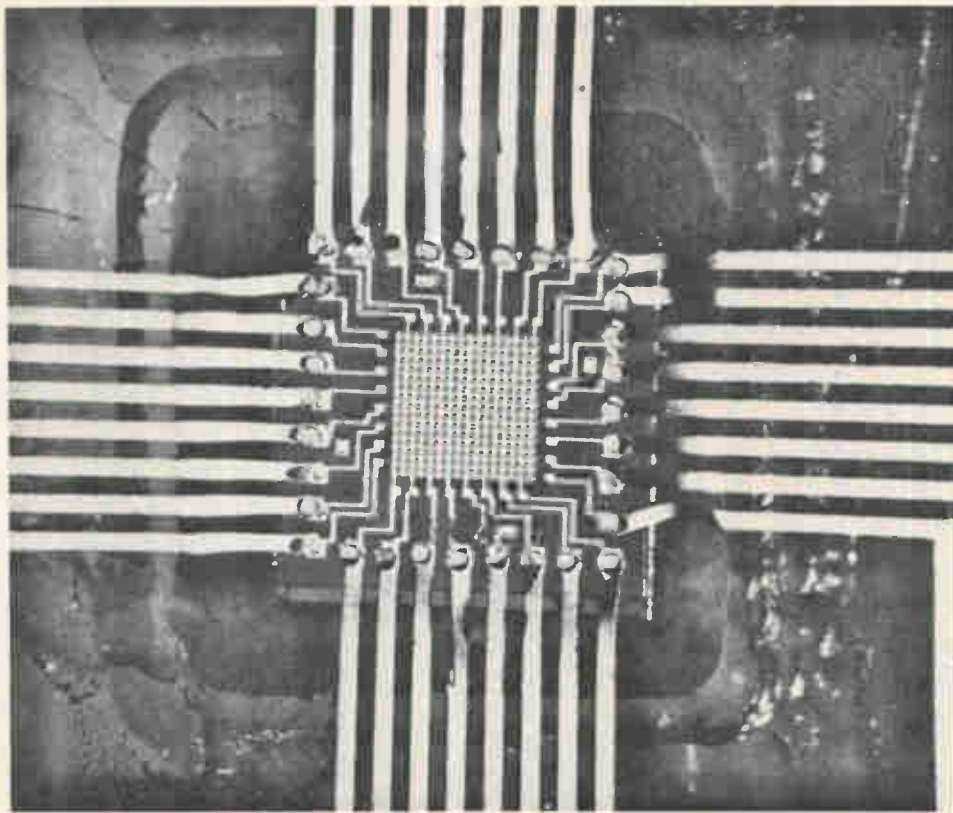

Over the edge. In this read-only memory from MIT's Lincoln Lab, the beam leads are formed on the substrate overhanging the cavity into which the chip is inserted.

section in the trough that's scored with grooves parallel to the axis of dice movement. Unless the dice are properly oriented and have their bumps down to catch in the grooves, they slide back down to the bottom of the vibratory feeder for recycling.

After the dice are moved to the ultrasonic bonder, which incorporates a Hughes bonding head, the magazines in which they're loaded are placed in the machine. This unit is driven by punched paper tape and has rotating vacuum pickup tools that take the dice from the cartridge in the rear of the machine, turn 180°, and place them on one of two thin-film substrates on tables in the front of the machine. The tape program dictates which dice will be selected from which cartridge, and also controls the indexing of the tables bearing the substrates so that the right die is bonded to the right substrate. The bonder handles up to 2,000 four-bump flip-chip dice an hour.

Hugle Industries is now designing an automated system that will be delivered to a large flip-chip user in 1970. William Hugle, president, says it will sell for \$50,000. Describing its operation, he says the dice will be loaded into a notched tape in their wafer orientation. They will already have been wafer-probed and sorted. When the dice are unloaded face down, they'll be set into a square hole in an arm that extends from the bonder. The bumps will fit into small depressions inside the hole, and a-c tests will be made there. Alignment will be done by vibration.

Hugle says the arm must be exactly aligned with the substrate below because a vacuum needle picks

up the dice after they're tested and places them on the substrate for bonding. System accuracy is about 2 mils, which Hugle admits isn't outstanding. However, he says the key consideration is to maintain the same chip orientation from wafer to wafer. The system will be required to bond 24,000 dice per day.

Hughes Aircraft's Evander, while promising a flip-chip bonder capable of handling 1,800 devices an hour next year, says 250 devices an hour is a more realistic rate for most present machines. "Some of our customers are doing that well now, and the beam-lead people would settle for those rates. Some technique for handling and sorting will have to be found before anyone can talk about bonding rates of 1,800 an hour for beam leads."

Texas Instruments' Schraeder notes that the company has automated its flip-chip production line for monolithic IC's slated for ceramic packages, "and we see no reason why we can't come up with workable gear for the plastics." He observes that most of the problems with plastic-packaged flip chips arise before the molding operation. "If you can get them through molding, the main problems are licked," he says. "To keep your manufacturing operation together until molding makes it almost mandatory that you have automated machines to do the job. We are now designing machines to do this for us."

At MIT's Lincoln Laboratory in Bedford, Mass., the sparse supply of beam-lead devices led researchers to find a new way to put the leads on devices [Electronics, Aug. 19, p. 52]. They're put-

ting the beam leads down on substrates—either ceramic or silicon—and then bonding standard IC dice to them. In this “beam-lead substrate” approach, holes the size of the IC die are cut in the ceramic substrate and filled with an easy-to-etch material. A layer of metalization is then added and etched to create interconnection patterns.

The holes in the substrate are etched out, too, and the IC dice (resistor-transistor logic and TTL have been used) are deposited in the holes with their bonding pads aligned with the ribbon-like beam leads overhanging the windows. A modified ball bonder completes the electrical connections.

An oxide layer is grown over the silicon substrate before the metalization pattern is put down. After the interconnection paths have been etched on top of the slice, windows for the dice are etched into the back of the substrate. With this approach, the monolithic chip can be placed directly on a heat sink, which should mean that higher-power devices can be made.

### Testy arguments

Supporters of the beam lead raise some points that the flip-chip advocates, on balance, can't seem to explain away. One of these is the testing and inspection problems inherent in the “blind” bonding of flip chips. Another is the need for high heat and pressure levels in flip-chip bonding. But possibly the clincher in deciding future trends will be the relative compatibility of the two processes with medium- and large-scale integration.

Looking at inspection and testing problems first, these appear to be the most important reasons for Autonetics' choice of beam leads for its F-111 programs. Says Bucheister, “As far as we know, Raytheon is the first firm that has shown an ability to do 100% testing—a-c and d-c—over the temperature range of uncased devices at the wafer level.”

Because Raytheon can do 100% wafer testing, Autonetics isn't overly concerned about inspection. Pascoe says, however, that in the final look at devices after they've been bonded into the package, bad beam-lead bonds “jump right out” at an inspector.

Evander of Hughes dismisses the “invisibility” of flip-chip bonds as more a psychological hazard than a real problem. “The answer I give the reliability people when this argument comes up is that you can't tell anything about beam-lead bonds either unless you X-ray them. I don't really have a good defense, but I don't think the fact that you can see the beam-lead bonds is a good offense either. You still have to stress the part to see if it's sound.”

Roger Murray, a senior projects engineer at Amelco, lines up with Evander on this issue. “Visual inspection sounds good, but it really tells you nothing more than whether the upper side of the lead is dented. You still have to use some other method to find the bad bond.” Murray says that “to find that die is a monumental problem,

but once you do, you can repair flip-chip hybrid circuits much more quickly than circuits with beam leads.”

### Under stress

Regarding the heat and pressure applied to flip chips during bonding, Raytheon's Thun says that this may be no problem with DTL devices, but it could degrade the higher-speed TTL circuits.

Evander discounts the heat and pressure stresses, asserting that the wafer never sees more than a few hundred degrees in bump applications, and that these levels don't interfere with diffusion. Bump formation imposes no pressure on the chip because the bumps are grown, he says. “The bumps do take some pressure in bonding to the substrate, but this is in a peripheral area, not an active area of the chip. Besides, beam leads also take some pressure in bonding to the substrate.”

As to the question of compatibility with MSI and LSI, even some flip-chip boosters point out that there is a lower limit on the number of bumps or balls that can be applied to a chip than there is to the number of beam leads. “The key question,” says Signetics' Kleitman, is whether a flip chip with as many as 40 leads can be made reliable. “We think it can.” Huggle agrees, noting that Autonetics has bonded as many as 50 to a flip chip. “We think the number is certainly more than 20,” he says. “The limiting factor is the amount of force needed to deform the bumps plastically.”

However, John Hall, a senior engineer at Intersil, says there may be a point at which customers will ask for beam leads. He believes that point may be reached when devices have to have more than 14 leads. “Beyond that number,” he says, “there would be too much force required to squash the bumps into acceptable bonds. The chip would probably suffer.” Intersil, one of a few companies doing a substantial business in flip chips, is preparing to meet that demand by developing its beam-lead technology, also.

Evans of Siliconix believes that alignment problems become so complex somewhere between 10 and 20 bumps that flip chipping isn't feasible at that point. Evans, a flip-chip backer, concedes that “when the theoretical limit of flip chipping is reached, beam leads might become more practical.”

On the other side of the fence, Bell Labs doesn't foresee any mechanical limitation on the number of beam leads that can be put on a chip. One engineer there says, “we're regularly making beams spaced 4 mils apart center to center.”

This article concludes a two-part series on methods of eliminating wire bonds. The first article covered the basic fabrication of prelead chips.



# Would a 15W power IC audio amplifier be music to your ears?

Listen to what the new Bendix Model BHA-0002 audio amplifier can do for you.

This 1" x 2" x 5/16" package actually costs less to use than discrete components—and outperforms them as well. It has 25Hz-20KHz frequency response, a voltage range of 14 to 40 volts, power gain of 55db, THD less than 1%, high-power operation to 100°C case temperature, and 350 mV input for  $P_o = 15$  watts.

The BHA-0002 offers some exciting possibilities for stereo amplifiers, transceivers, PA systems, phonographs, musical instrument amplifiers, intercoms and movie projector/sound systems.

It's one of a whole new family of thick-film power circuits from Bendix. These additions include two more audio amplifiers, 2W and 5W (see chart), plus a new Darlington, bridge rectifier and power driver module for industrial applications.

It's a lot of power for a lot of applications. From the real power in power: Semiconductor Division, The Bendix Corporation, Holmdel, New Jersey 07733.

## POWER AUDIO AMPLIFIER CIRCUITS

Part Number	Maximum Power Output (W)	Voltage Range (V)	Input Voltage (mV)	Frequency Response (Hz)
BHA0001	2	11 to 16	5	40 to 10K
BHA0004	5	11 to 20	20	25 to 20K
BHA0002	15	14 to 40	350	25 to 20K

**Bendix** **Electronics**



Chicago—(312) 637-6929; Dallas—(214) 357-1972; Detroit—(313) 548-2120; Great Neck, N.Y.—H. V. Sales Co. (516) HU 7-1142; Greenwich, Conn.—(203) 869-7797; Holmdel, N.J.—(201) 946-9400; Lexington, Mass.—(617) 861-8350; Los Angeles—(213) 776-4100; Minneapolis—(612) 926-4633; Orlando, Fla.—(304) 241-6559; Rochester, N.Y.—(716) 266-5550; Runnemede, N.J.—(609) 933-2550; Seattle—Ray Johnston Co., Inc. (206) LA 4-5170; Export—Cable: "Bendixint," 605 Third Avenue, New York, (212) 973-2121; Ottawa, Ont.—Computing Devices of Canada, P.O. Box 508 (613) 829-1800; San Juan, Puerto Rico—Southern International Sales Co. 723-3879.

Circle 97 on reader service card

# Active filters: part 5

## Applying the operational amplifier

These devices are cheap and readily available in integrated form, and make it possible to drive other networks without an isolating stage

By George S. Moschytz

Bell Telephone Laboratories, Holmdel, N.J.

and Ralph W. Wyndrum Jr.

Bell Telephone Laboratories, Murray Hill, N.J.

**Operational amplifiers** with their inherent high input and low output impedances offer the designer of inductorless filters several advantages over circuits built from negative-impedance converters or gyrators. For example, a negative-impedance converter is used to provide the difference of two large numbers in the denominator of the transfer function. This results in the desired complex poles; however, these are highly sensitive to variations in network elements. Furthermore, it is difficult to d-c stabilize the network.

When a single gyrator configuration is used, a wide spread of capacitor values may be required. And although a gyrator can readily simulate a grounded inductor, a floating inductor is much more difficult to achieve. Low loss capacitors must be used to get high Q values, and at present no integrated circuit gyrators are available. With op amps the filter's pole and zero locations are determined by the op amp's gain and by the added RC passive networks. Appropriate techniques are available to make the pole locations relatively stable and independent of changes in the active elements.

Basically, the op amp is defined as a voltage-controlled voltage source (VCVS) of high input impedance, low output impedance, wide bandwidth, and very high gain. For typical applications, requiring high-quality units, the input impedance may be several megohms, but the output impedance only fractions of an ohm. Such amplifiers can simulate

In the nonideal operational amplifier, shown on the facing page in the inverting and noninverting modes with corresponding equivalent-circuit diagrams,  $R_i$  and  $R_o$  are the open-loop input and output resistances,  $R_b$  is the intrinsic-feedback resistance, and  $A_o$  the open-loop differential voltage gain of the op amp by itself. Although these parameters are frequency-dependent, they're treated as constants for the purpose of this analysis. The remaining three resistors,  $R_G$ ,  $R_F$ , and  $R_n$ , are outside the amplifier. Resistors  $R_G$  and  $R_F$  determine the closed-loop gain;  $R_i$  is required to minimize offset voltage at the output. The voltage at the inverting input terminal is  $V_i$ , and that at the noninverting terminal  $V_n$ .

### D-c characterization of the op amp

The gain of the op amp in either mode of operation can be written in the form

$$G = \frac{V_{OUT}}{V_{IN}} = \left( \alpha \right) \left( \frac{A\beta}{1 + A\beta} \right) \quad (1)$$

where the forward gain  $A$  is proportional to  $A_o$  but smaller. The reduced value results because of the input and output impedances of the op amp. The term  $\alpha$  is the closed-loop gain for an ideal op amp, defined by

tween the inverting and noninverting modes

$$\alpha_I = -\frac{R_F}{R_G} \quad (3)$$

$$\alpha_N = \frac{R_F + R_G}{R_G} \quad (4)$$

For the inverting mode,  $A$  corresponds to the output voltage when a 1-volt signal is applied to the input of the op amp—terminals 2 and 5—and  $V_{IN}$  is set equal to zero. For the noninverting mode,  $A$  corresponds to the output voltage when 1 volt appears at the amplifier input—terminals 2 and 3—and the signal source  $V_{IN}$  is removed. The feedback factor is  $\beta$ .

In the inverting mode,  $\beta$  corresponds to the voltage fraction at the input when a 1-volt signal is applied across the output terminals and the input signal source,  $V_{IN}$ , is short-circuited. In the noninverting mode,  $\beta$  corresponds to the voltage fraction appearing across input terminals 2 and 3 under the same conditions. At low frequencies, the feedback factor  $\beta_o$  for both types of an ideal op amp in either mode of operation is given by

$$\beta_o = \frac{R_G}{R_G + R_F} \quad (5)$$

The ratio of actual to ideal closed-loop gain is

$$\frac{G}{\alpha} = \frac{1}{1 + \frac{1}{A\beta}} \quad (6)$$

The term  $A\beta$ , the amplifier's loop gain, must be much larger than unity for low-gain sensitivity. To verify the effects of this term, equation 6 is expanded in a Taylor series as follows

$$\frac{G}{\alpha} = 1 - \frac{1}{A\beta} + \left(\frac{1}{A\beta}\right)^2 - \left(\frac{1}{A\beta}\right)^3 + \dots = 1 - E \quad (7)$$

where  $E$  is the gain error. For  $|A\beta| \gg 1$ ,  $E$  can be approximated by the linear term,  $1/A\beta$ , in equation 7.

By assuming a minimum closed-loop gain,  $R_F/R_G$ , of unity and inserting this value into equation 5, an upper limit for  $\beta_o$  is established as 0.5. When  $R_F/R_G$  equals infinity, the lower limit for  $\beta_o$  becomes zero. Thus, the limits on  $\beta_o$  are:

$$0 \leq \beta_o \leq 0.5 \quad (8)$$

To minimize d-c offset, the external resistor  $R_n$  must satisfy the condition

$$R_n = R_G \parallel (R_F + R_G) \quad (9)$$

Expressions for the forward gain,  $A$ , and feedback

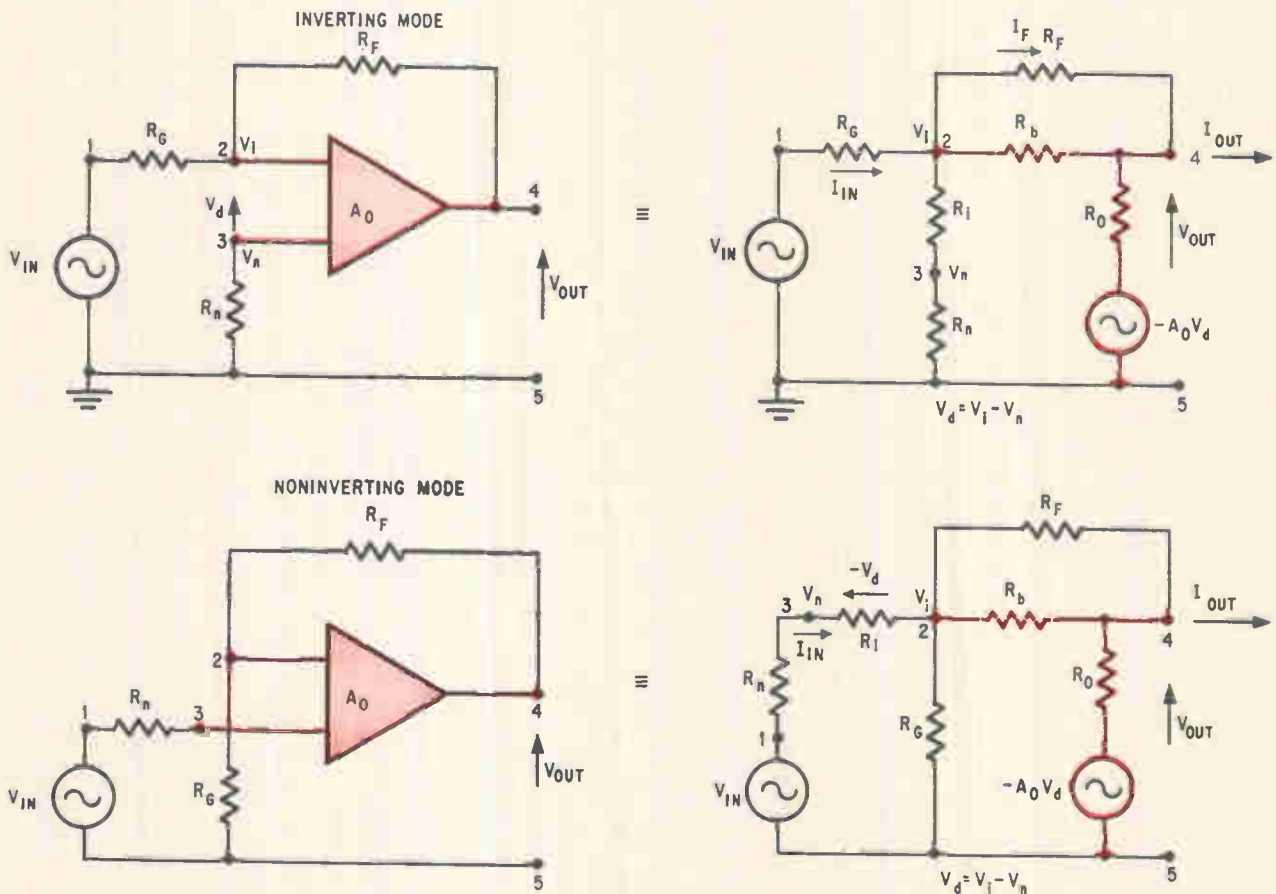

Operating modes. Terminal connections are indicated for both the inverting and noninverting modes of operation of an operational amplifier. At the right are the respective equivalent circuits for both modes.

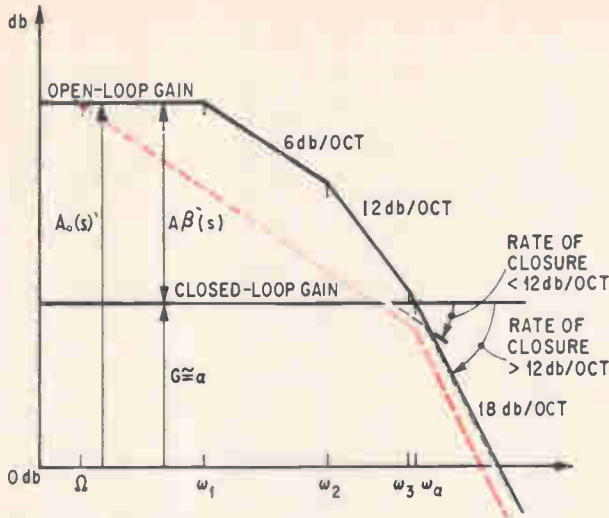

Graphing the gains. Bode plots for the open-loop and closed-loop gains of a typical operational amplifier. Dashed line represents the gain response of a modified op amp whose stability is assured by added RC components.

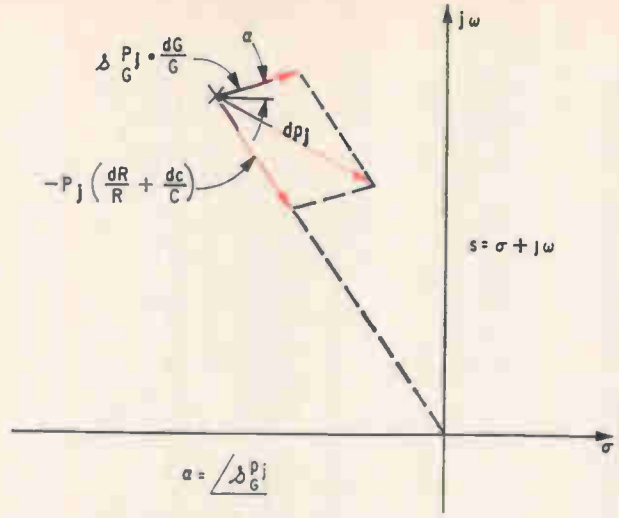

Pole displacement. The vector diagram represents the pole displacement for an active RC feedback network consisting of an active device  $G$  and resistors and capacitors. These passive components must track closely.

factor,  $\beta$ , of the op amp can then be obtained from the equivalent diagrams. Since

$$A_o \gg 1 \quad (10)$$

and

$$\frac{R_o}{R_F} \ll 1 \quad (11)$$

the resulting expressions can be simplified considerably.

The feedback loop is proportional to  $\beta_o$ , but is only adversely affected by a finite amplifier input impedance. The loop gain,  $A\beta$ , is proportional to  $A_o \beta_o$  and decreases with nonideal input and output impedances. Thus, the more ideal an amplifier is, the higher the available loop gain in either mode of operation.

In any application, this available loop gain characterizes the performance of an amplifier. In the inverting mode, the larger the loop gain the closer a designer comes to obtaining the desired virtual ground at the input. In the noninverting mode, the desired high input impedance is directly proportional to loop gain, and in both cases the desired low output impedance is inversely proportional to the loop gain. As indicated by equation 7, the gain error,  $\bar{E}$ , decreases with increasing loop gain, and the closed-loop stability improves in either mode.

### A-c characterization of the op amp

Although  $A_o$ , the open-loop differential voltage gain of the amplifier, was previously considered independent of frequency, it is not. It can be approximated by a rational function of poles and zeros as follows:

$$A_o(s) = \frac{A_o}{(s + \omega_1)(s + \omega_2)(s + \omega_3)} \quad (12)$$

This representation corresponds to the Bode plot of the open-loop gain, where  $\omega_1$ ,  $\omega_2$ , and  $\omega_3$  are the corner frequencies in the band of interest and the slope is increased by 6 decibels per octave at each corner. A typical representation of the Bode plot for the open-loop gain corresponding to equation 12 and the closed-loop gain corresponding to equation 1 is shown at the above left. This plot shows the open-loop gain,  $A_o(s)$ , the closed-loop gain,  $G$ , and the loop gain,  $A\beta$ . As long as  $A\beta$  is large the closed-loop gain is approximately equal to  $\alpha$ , and the error,  $E$ , is negligible.

The loop gain is now frequency dependent and decreases to 0 db at the frequency  $\omega_\alpha$  where the two plots intersect. To satisfy Bode's criterion for absolute stability of a feedback amplifier, the op amp's frequency response must usually be limited still further by external frequency-stabilizing RC circuits. This is shown for a typical situation by the dashed lines. The loop gain has been modified to roll off at the frequency  $\Omega$  that is lower than  $\omega_1$ . The value of  $\omega_1$  represents the first natural break frequency of the amplifier.

There are various methods of incorporating frequency-stabilizing RC networks to ensure the required 6 db/octave rate of closure.<sup>1-3</sup> One approach is to modify the frequency response of the open-loop gain by putting lead-lag networks in the forward path of the amplifier. Alternatively, the response of the closed-loop gain can be modified by putting frequency-dependent networks in the feedback network. Either way, the resulting loop gain usually has a single-frequency pole and can be expressed in the form

$$A\beta(s) = A\beta \frac{\Omega}{s + \Omega} \quad (13)$$

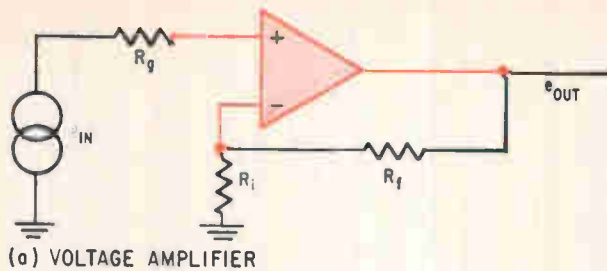

(a) VOLTAGE AMPLIFIER

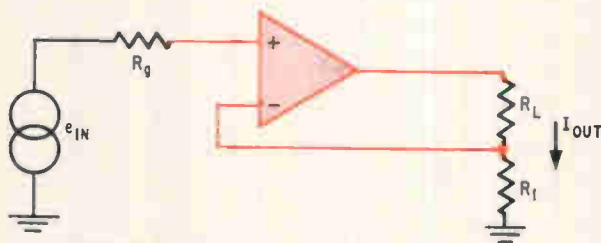

(b) VOLTAGE-CONTROLLED CURRENT SOURCE

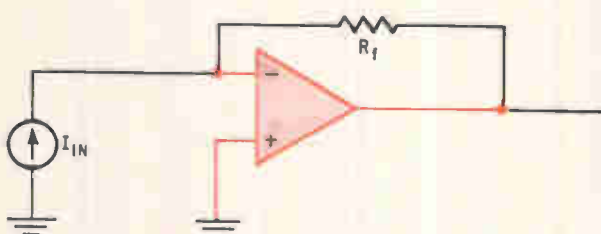

(c) CURRENT-CONTROLLED VOLTAGE SOURCE

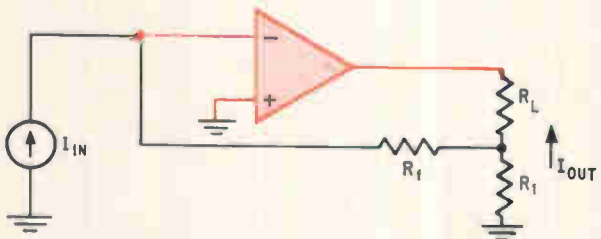

(d) CURRENT AMPLIFIER

Applying controlled sources. Four basic types of controlled sources that use operational amplifiers are shown above. When combined with RC passive networks the system can be used to provide desired transfer functions, having adjustable complex poles.

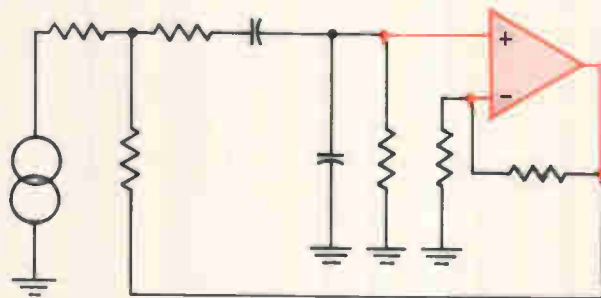

Second-order transfer functions. A typical circuit that can be used to produce second-order transfer functions is this one proposed by Sallen and Key. It assures stable frequency operation and is easily built with a small number of components.

The corresponding loop-gain magnitude thus becomes

$$|A\beta(j\omega)| = (A\beta) F\omega \quad (14)$$

where

$$F\omega = \frac{1}{\sqrt{1 + \left(\frac{\omega}{\Omega}\right)^2}} \quad (15)$$

$A\beta$  is real, then, below  $\omega = \Omega$ .

### Gain stability

Op amps are popular in active-network synthesis because their high open-loop gain can provide highly stable closed-loop gain. Gain stability depends mainly on the amount of available loop gain and the stability of the feedback network.

In terms of the sensitivity of a network function  $\psi$  with respect to an element  $x$  as defined by

$$S_x^{\psi} = \frac{d\psi}{dx} \left( \frac{x}{\psi} \right) \quad (16)$$

the relative variation in closed-loop gain with small variations in amplifier characteristics is given by:

$$\frac{dG}{G} = S_{A_o}^G \frac{dA_o}{A_o} + S_{\beta_o}^G \frac{d\beta_o}{\beta_o} + S_{R_i}^G \frac{dR_i}{R_i} + S_{R_o}^G \frac{dR_o}{R_o} \quad (17)$$

the relative variation in closed-loop gain with small similar for both the inverting and noninverting modes. Assuming that the available loop gain is much larger than unity—one reason for using an op amp in a feedback mode—the sensitivity functions in equation 17 turn out to be very simple. The sensitivity to variations in open-loop amplifier characteristics—gain, input and output impedance—is inversely proportional to the available loop gain. The actual functions can be approximated by the gain error,  $E$ , given by equation 7.

The sensitivity to variations in the external feedback network varies from 1 to 2 for the inverting mode and is approximately equal to 1 in the non-inverting mode. This relatively high sensitivity, which isn't reduced by loop gain, can be made by selecting sufficiently stable components for the feedback network.

In practice, it's useful to consider finite differentials rather than derivatives when evaluating equation 17. Thus,  $\Delta A_o/A_o$  represents the relative tolerance and drift due to temperature changes of the open-loop gain. This is usually specified by the manufacturer;  $\Delta\beta_o/\beta_o$  gives a measure of the stability and tracking capabilities of the external feedback network. Similarly,  $\Delta R_i/R_i$  gives a measure of input-impedance drift and  $\Delta R_o/R_o$  of output-impedance drift.

It is well known that one of the major problems in active RC network synthesis is that of minimizing the network sensitivity. The two main reasons for this are that the individual network elements, espe-

cially the active ones, may drift appreciably with ambient variations, and that active networks, unlike passive ones, are only conditionally stable. The location of active-network transmission poles isn't limited to the negative s-plane, and drift may cause severe underdamping or even oscillation. Thus, to ensure the stability of an active RC network, it's especially vital that the sensitivity of the dominant poles be minimized.

### Pole displacement

Assuming uniform passive-component variations, such as those available from integrated circuits, and the effects of the active elements lumped into those of a single equivalent active device, the drift of the  $j$ th pole due to drift in all capacitors, resistors, and the active element,  $G$ , is given by

$$dp_j = S_G^{p_j} \frac{dG}{G} - p_j \left( \frac{dR}{R} + \frac{dC}{C} \right) \quad (18)$$

The pole displacement given by this expression can be represented by a vector diagram in the s-plane, as shown on page 100. It can be easily verified that the displacement due to the passive elements, RC products, takes place in a radial direction, but the displacement due to the active element has the same direction as the pole sensitivity with respect to that element.

Active-network synthesis with op amps works especially well in two of the many methods of minimizing this pole displacement. One technique

seeks to minimize pole sensitivity with respect to the active elements, the other to minimize variations in their gain. In both, the second term on the right side of equation 18 is minimized by using resistors and capacitors with equal but opposite temperature coefficients. The first method can be represented by

$$S_G^{p_j} \rightarrow 0 \quad (19)$$

and the second by

$$\frac{dG}{G} \rightarrow 0 \quad (20)$$

Typical networks that permit the realization of equation 19 are negative-feedback configurations with infinite gain and positive-feedback configurations with unity forward gain. In both, the pole sensitivity to  $G$  can be minimized by using amplifiers with sufficiently high loop gain. And the op amp, obviously, is very suitable for this approach.

The second method stabilizes the performance of the active elements by local negative feedback around each element, using passive components with tight tracking properties. Op amps are also ideal for this process, because it's all the more effective the higher the available open-loop gain is for each active element. Because this means that the available closed-loop gain of each amplifier is reduced by individual feedback, more than one amplifier is often required in high-Q applications.

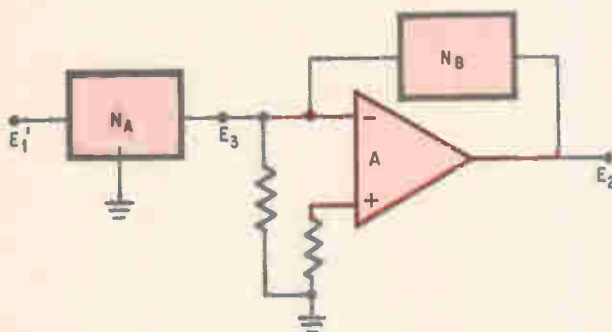

**Simultaneous operation.** A single operational amplifier is used to provide both the zeros and poles of a desired transfer function. It accomplishes this result through externally connected RC networks.

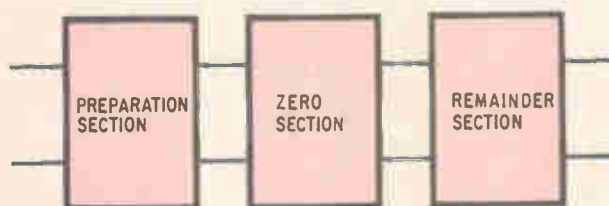

**Cascading.** Transmission zeros and driving-point admittance can be achieved simultaneously with a three-section arrangement connected in cascade.

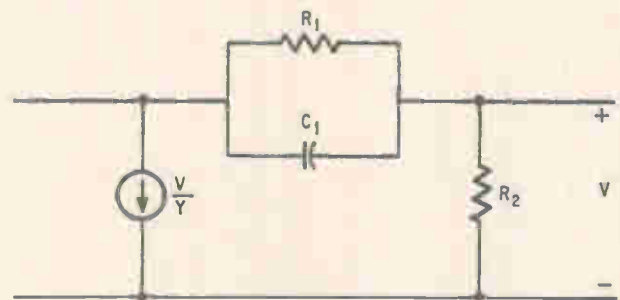

**Zero section.** A single transmission zero is produced in the right-half plane with this typical active-zero section.

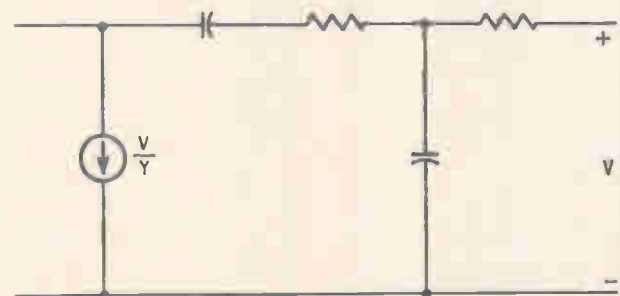

**Pairing.** Several groups of zero transmissions, including complex pairs, can be achieved with this active network. A controlled source is required for the transmission zero.



Active-network design with op amps was first proposed by H.H. Scott.<sup>1</sup> He foresaw the usefulness of the twin T as a parallel ladder-network capable of producing complex transfer-function zeros. These then produce complex poles by imbedding the passive network in the feedback loop of a high-gain vacuum-tube amplifier. The poles of such a configuration are then determined by the rejection frequency of the twin T. If the twin T gives a transfer function  $A(s)/B(s)$ , the configuration has a voltage transfer function given by  $B(s)/A(s)$  when the forward amplifier's gain is large enough.

Some amplifier-oriented active networks require amplifiers with very high gain, while others use lower, but carefully controlled, gains. Both use op amps, but the latter type usually require controlled sources.

Four categories of controlled sources that use op amps are identified on page 101. Most of the synthesis procedures developed in recent years use controlled sources with passive RC networks to provide transfer functions. The passive twin T, however, remains particularly attractive when complex zeros of transmission or readily adjustable complex poles are needed. Algorithms such as those derived by W.H. Orr<sup>2</sup> have ensured the continued survival of the twin T in modern network design. These algorithms make it possible to design networks for prescribed, and independently switchable, notch depths and center frequencies.

A classical active-network approach using controlled sources is that of R.P. Sallen and E.L. Key.<sup>3</sup> Their technique is useful for producing second-order transfer functions of the form

$$G(s) = \frac{a_2s^2 + a_1s + a_0}{b_2s^2 + b_1s + b_0} \quad (21)$$

Higher-order transfer functions, whether voltage or current gains, or transfer impedances or admittances, are best achieved by cascading second-order sections. This approach improves sensitivity and simplifies design and adjustment by ensuring control of a single conjugate pole pair by a single active circuit.

Sallen and Key compiled a catalog of 18 basic networks used to produce complex or real poles or zeros, or both, for voltage-gain functions. All their results were frequency-normalized to  $\omega_0$ , so they could be conveniently denormalized for any application. The networks require two or three capacitors, one or two op amps (as controlled sources), and two or more resistors. Critical pole frequencies depend on the RC products of passive networks; their damping, or bandwidth where appropriate, is a function of the amplifier gain.

This catalog provides alternate means of achieving a  $G(s)$  and lists criteria for choosing a network. One factor is the range of RC values needed. High-Q poles tend to need larger ratios of element values—the ratio of the largest to the smallest—and the most appropriate circuit might be one that minimizes this range. The designer must include not only the

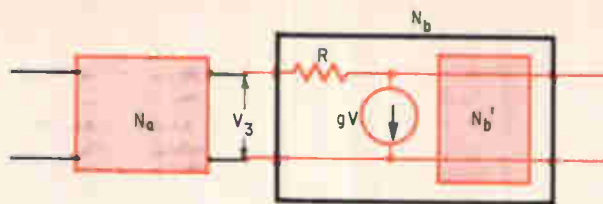

Horowitz' synthesis. This cascaded arrangement achieves its RL transfer function from the zeros developed in the  $N_a$  and  $N_b'$  networks.

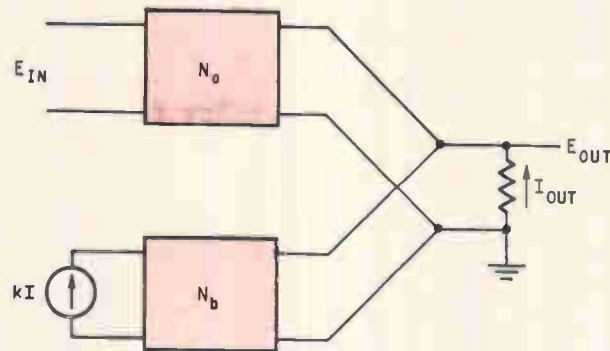

Kuh's method. An open-circuit voltage transfer function within a constant multiplier is made possible with a single control source and a few RC elements.

R's and C's required for the Sallen and Key design but also the bias resistors and compensation capacitors that help to make up the entire circuit.

Another criterion is the network's sensitivity to changes in the passive and active elements. Some configurations provide for low sensitivity because they have unity gain and positive feedback. Finally, the complexity of the biasing and stabilization circuitry required by the various gains must be considered. A typical Sallen and Key configuration is shown on page 101.

Norman Balabanian and B. Patel<sup>4</sup> extended the work of Sallen and Key to include simultaneous realization of transmission zeros and poles located more independently of one another.

The most common op-amp network with a single loop and infinite gain is shown in the upper left network on the previous page. Assuming that  $N_B$  is a passive-feedback network with the voltage transfer function

$$G_B(s) = \frac{P_B(s)}{Q_B(s)} \quad (22)$$

then the function

$$\frac{E_2}{E_3} = \frac{A}{1 + AG_B} \quad (23)$$

as  $A \rightarrow \infty$ ,

$$\frac{E_2}{E_3} \rightarrow \frac{1}{G_B} = \frac{Q_B(s)}{P_B(s)} \quad (24)$$

Thus, the poles and zeros of  $G_B$  are inverted by placing the network in the feedback path of  $A$ . Roots  $Q_B(s)$  must lie on the negative real axis. Since  $N_B$  is passive, the zeros of  $P_B(s)$  can be complex. Ratio  $E_2/E_1$  can thus have complex poles and negative real zeros. The network is now cascaded with  $N_A$ . The impedance levels are intentionally mismatched to minimize interaction between networks. The over-all transfer function becomes

$$\frac{E_2}{E_1} = \frac{P_A}{Q_A} \cdot \frac{Q_B}{P_B} \quad (25)$$

if  $G_A = P_A/Q_A$ .

The roots of  $Q_A$  are chosen to cancel those of  $Q_B$  on the negative real axis, so

$$\frac{E_2}{E_1} = \frac{P_A}{P_B} \quad (26)$$

Thus, with the help of a single op amp, it was possible to provide both the poles and zeros of the transfer function by taking advantage of the flexible zeros of the passive RC networks.

### The Horowitz procedure

Isaac Horowitz<sup>5</sup> suggested a cascade synthesis arrangement to realize transmission zeros and driving-point admittances simultaneously. Because a voltage transfer function is given by the ratios of a transfer and driving-point immittance (each assumed to have the same denominator or poles), Horowitz's procedure makes it possible to achieve a voltage transfer function to within a constant. That is,

$$G(s) = \frac{E_2}{E_1}(s) = \frac{y_{21}}{y_{11}} = \frac{\frac{N_{21}}{D}}{\frac{N_{11}}{D}} = \frac{N_{21}}{N_{11}} \quad (27)$$

The zeros of  $N_{21}$  specify  $y_{21}$  to within a constant, and  $y_{11}$  is realized exactly. The zeros of  $N_{21}$  can be complex (they can even be on the positive real axis). Those of  $N_{11}$  must be negative and real, however.

To realize a single transmission zero in the right-half plane, an active zero section is used. For pairs of zeros, including complex pairs, the active network shown on page 102, bottom right, may be used (notice the controlled source in each case).

In the same report, Horowitz outlined a procedure for realizing an open-circuit transfer impedance of a two-port network by using a single voltage-controlled voltage source. Here

$$z_{21} = \frac{Z_{21}^a Z_{21}^b}{Z_{22}^a + Z_{11}^b} = \frac{N}{D} \quad (28)$$

where  $Z_{21}$  can be related to the two driving-point functions in its denominator. One is RC, the other RL; possible expansions for the denominator  $D$  are

$$Z_{22}^a = \sum \frac{k_i}{s + \sigma_i} \quad \text{and} \quad Z_{11}^b = R_1 - \sum \frac{k_j}{s + \sigma_j}$$

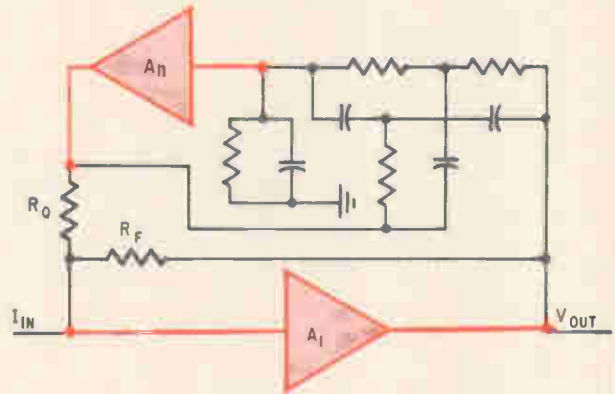
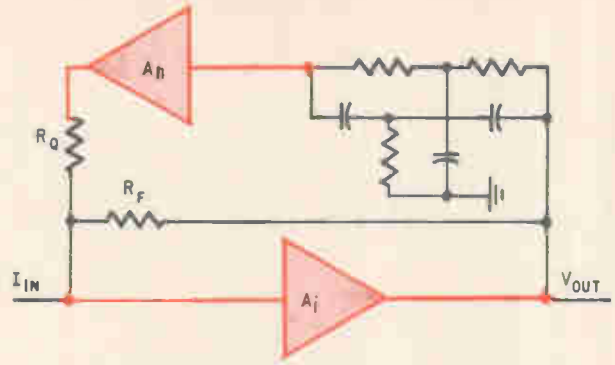

Frequency emphasizing networks. Circuit on top provides medium  $Q$  transfer functions; for high selectivity the bottom network is used.

The circuit at the top of the previous page can be used to realize the RL function with an active RC network. At the same time, the transmission zeros are developed from  $z^{a_{21}}$  and  $z^{b_{21}}$ . Standard ladder-type passive networks usually meet the needs.

### Kuh's approach

Another approach was proposed by E.S. Kuh.<sup>6</sup> It provides for the realization of a prescribed open-circuit voltage transfer function within a constant multiplier. The method requires one controlled source and a few passive RC components. The configuration is shown in the lower drawing on page 103, where the load impedance is assumed to be resistive and normalized to 1 ohm.

For this configuration

$$\frac{E_2}{E_1} = \frac{y^{a_{21}}}{y^{a_{22}} + y^{b_{22}} + 1 + ky^{b_{21}}} = H \frac{N(s)}{D(s)} \quad (29)$$

The designer can arbitrarily choose a polynomial  $q(s)$  with distinct zeros on the negative real axis. Depending on the technique chosen, the degree of  $q(s)$  should be equal to or one less than that of  $D(s)$ . Then

$$-y^{a_{21}} = H \frac{N(s)}{D(s)} \quad (30)$$

and

$$y^{a_{22}} + y^{b_{22}} + 1 + ky^{b_{21}} = \frac{D}{q} \quad (31)$$

Taking a Foster expansion of  $D/q$  yields,

$$\frac{D}{q} = k_0 + k_\infty s + \sum_i \frac{k_{1i}s}{s + \sigma_i} - \sum_j \frac{h_j s}{s + \sigma_j} \quad (32)$$

and

$$y^{b_{22}} = -y^{b_{21}} = G + \sum_j \frac{h_j^* s}{s + \sigma_j} \quad (33)$$

If  $(k-l)G + k_0 - 1 \geq 0$  and  $(k-l)h_j^* - h_j > 0$  for all  $j$ ,  $y^{a_{22}}$  can be realized as an RC admittance. This completes the synthesis.

Many other synthesis procedures are available for active networks. Some use two op amps to produce the appropriate active filter characterizations.

### Filter building blocks

If integrated filters are to become economically feasible, a method of network synthesis that allows circuit standardization must be used. This has been proven in the field of digital integrated circuits, where complex systems are broken down into small families of logic building blocks; high production quantities mean low cost. Two methods of designing filter building blocks with op amps have been advanced recently. The first uses frequency-emphasizing networks (FEN's), the second the Miller integrator.

The FEN technique was developed to synthesis general second-order transfer functions of the form

$$T(s) = K \frac{s^2 + \frac{\omega_z}{Q_z} s + \omega_z^2}{s^2 + \frac{\omega_p}{Q_p} s + \omega_p^2} \quad (34)$$

Higher-order transfer functions are obtained by cascading second-order sections. The synthesis method consists of decomposing  $T(s)$  into the product of two functions. The first function is the transfer admittance of a passive RC network that provides the asymptotic characteristic of the function  $T(s)$ , namely

$$(y_{21})_R = K_R \cdot \frac{s^2 + \frac{\omega_z}{Q_z} s + \omega_z^2}{s^2 + \frac{\omega_p}{Q_R} s + \omega_p^2} \quad (35)$$

where

$$Q_R < 0.5 \quad (36)$$

for a passive network. The second function is the transfer impedance of an active correcting network. Such a network is cascaded to the passive network to provide the prescribed characteristic  $T(s)$  by pole-zero cancellation, thus:

$$(z_{21})_A = K_A \cdot \frac{s^2 + \frac{\omega_p}{Q_R} s + \omega_p^2}{s^2 + \frac{\omega_p}{Q_p} s + \omega_p^2} \quad (37)$$

Regardless of the nature of  $T(s)$ ,  $(z_{21})_A$  defines the response of a FEN. The filter type to be synthesized is therefore determined by  $(y_{21})_R$ . There are many techniques for producing specified RC short-circuit transfer admittances.

The circuit configurations on the opposite page provide a transfer impedance with FEN characteristics;  $A_I$  is an inverting and  $A_N$  a noninverting op amp. For medium-selectivity transfer functions—those with  $Q_p$  values of less than 50—the top configuration is used. For high-selectivity realizations, this configuration is modified to that of the bottom one, which has a second feedback loop. This approach can yield high-selectivity filters with closed-loop gain values of  $A_N$  that are close to unity. The closed-loop gain of  $A_I$  is restricted only by the loop gain necessary to maintain a specified degree of  $Q$ -stability. For absolutely stable high- $Q$  filters, the bandwidth of  $A_N$  must exceed that of  $A_I$ . To obtain perfect pole-zero cancellation between  $(y_{21})_R$  and  $(z_{21})_A$  in high-selectivity filters,  $(y_{21})_R$  must also be active in the form of a Sallen and Key network. With only modest  $Q_R$  values for the Sallen and Key networks, stable high  $Q$ -transfer functions  $T(s)$  can be realized.

The FEN's are stabilized by minimizing the gain variations of the active elements. Thus, by distrib-

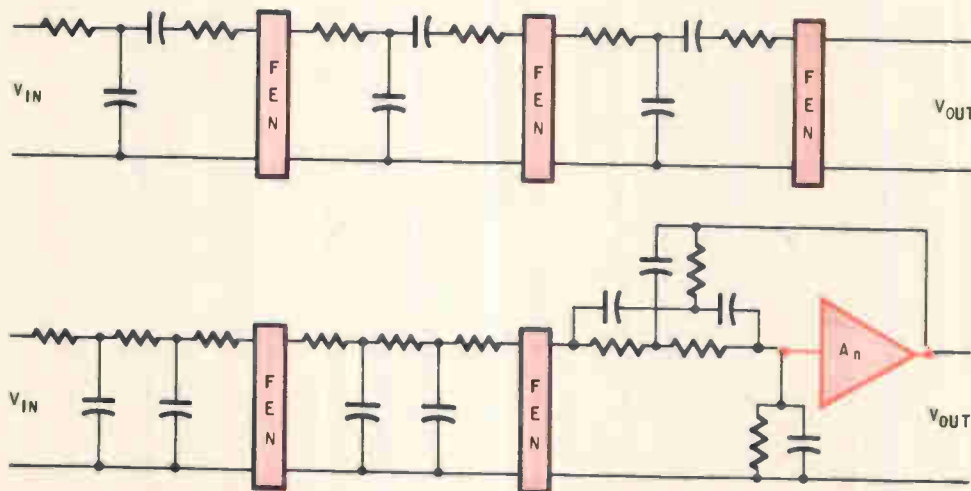

FEN filter synthesis. A sixth-order bandpass filter (top drawing) and a sixth-order elliptic lowpass filter (bottom drawing) are built with frequency emphasizing networks (FEN's). These units provide the RC networks with resonance properties similar to those of LC networks.

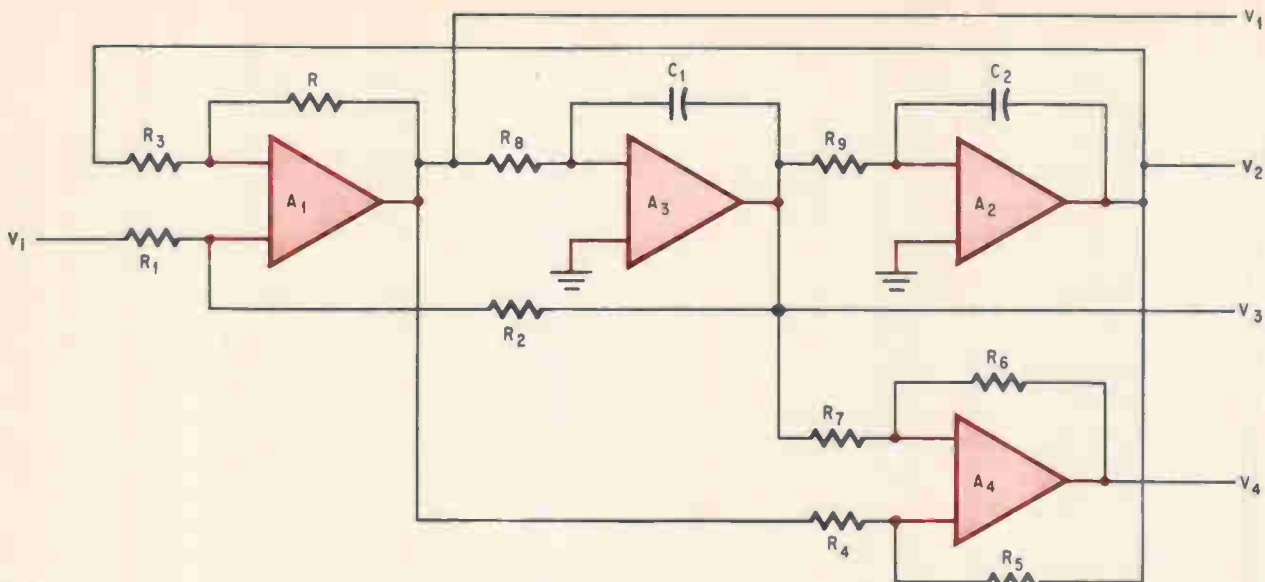

Miller integrator. One approach to achieving a desired transfer function is to use a basic Miller integrating network consisting of amplifier and RC network. Several such units are employed here to produce second-order transfer functions.

uting the gain of the active feedback loop between two op amps, each can be sufficiently stabilized by local negative feedback to ensure high-Q stability. Frequency is stabilized by matching the temperature coefficients of the resistors and capacitors of the frequency-determining twin T in the feedback loop. Two typical filter configurations using FEN's are on the bottom of the previous page. The top drawing shows a sixth-order bandpass filter, the other a sixth-order elliptical low-pass filter. Note that here transmission zeros aren't obtained by cascading an RC null network (twin T) with a FEN. The active feedback loop of a high-selectivity FEN is used instead, because it contains an appropriate active frequency rejection network. This economizes on components and twin-T tuning, but it's feasible only for medium-selectivity filtering.

### The integrator method

Active-filter realizations using the Miller integrator as a building block are as old as the analog computer. Familiar synthesis methods use the integrators to simulate the reactances in a passive filter on a one-to-one basis. A modification of the leapfrog filter has recently been suggested for the design of tunable low-frequency filters and stable high-Q bandpass filters. A similar configuration shown above has recently been suggested as an all-purpose filter building block that provides any second-order transfer function, depending on which output terminal—or combination of output terminals—is used.

The resulting transfer functions of interest are

$$\frac{V_1}{V_i} = K_1 \frac{s^2}{as^2 + bs + c} \quad (38)$$

$$\frac{V_2}{V_i} = K_2 \frac{1}{as^2 + bs + c} \quad (39)$$

$$\frac{V_3}{V_i} = -K_3 \frac{s}{as^2 + bs + c} \quad (40)$$

Complex zeros are obtained at the output of the summing amplifier, A<sub>4</sub>, which adds weighted quantities of the outputs V<sub>1</sub>, V<sub>2</sub>, and V<sub>3</sub>.

The constants, K<sub>1</sub>, K<sub>2</sub>, and K<sub>3</sub>, and the coefficients, a, b, and c, depend only on the passive-circuit components provided the open-loop gain of the four op amps A<sub>1</sub> to A<sub>4</sub> is high enough.

Stability is obtained here by minimizing the pole sensitivity with respect to the active elements. Except for some negligibly small terms that depend on the passive components, the pole-sensitivity functions with respect to the active devices depend primarily on terms that are inversely proportional to the respective open-loop gain values. If these are large enough, high-Q stability results. As in the FEN technique, frequency is stabilized by matching the temperature coefficients of the passive components. ■

### References

1. H.H. Scott, "A New Type of Selective Circuit and Some Applications," *Proc. IRE*, February 1938, p. 226.
2. W.H. Orr, "Precision Tuning of a Thin-Film Notch Filter," *ISSCC*, February 1964.
3. R.P. Sallen and E.L. Key, "A Practical Method of Designing RC Active Filters," *IRE-CT Trans.*, March 1955, p. 74.
4. Norman Balabanian and B. Patel, "Active Realization of Complex Zeros," *IEEE Trans. on Circuit Theory*, June 1963, pp. 299-302.
5. Isaac Horowitz, "Synthesis of Active RC Transfer Functions," *PIB (MRI) Res. Rpt. R-507-56*, PIB-437, November 1956.
6. E.S. Kuh, "Transfer Function Synthesis of Active RC Networks," *IRE T-CT*, vol. 7, supplement, August 1960, pp. 3-7.

# 16 FET SOLUTIONS TO CHOPPER PROBLEMS



focus on Motorola for  
FET TECHNOLOGY

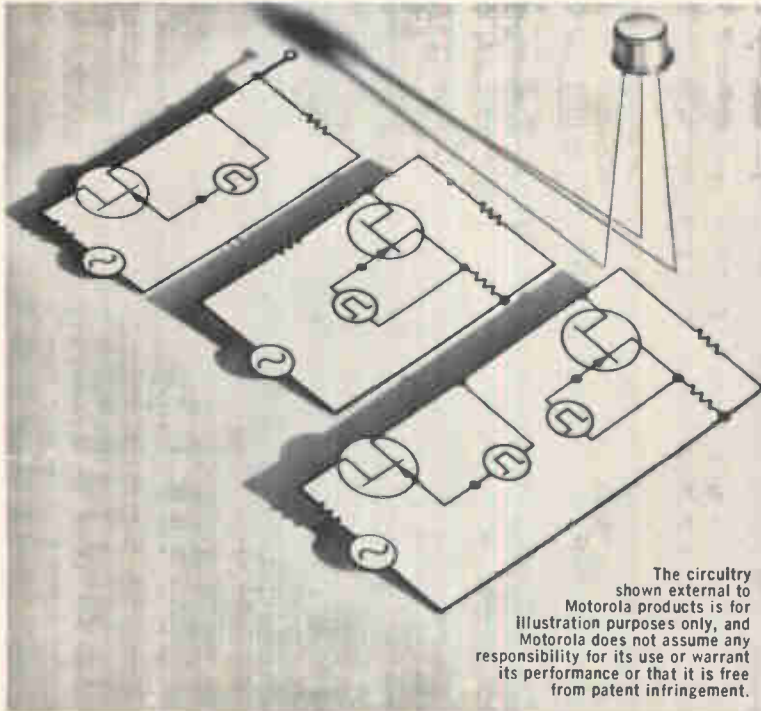

The circuitry shown external to Motorola products is for illustration purposes only, and Motorola does not assume any responsibility for its use or warrant its performance or that it is free from patent infringement.

Remember when the best way to convert a dc signal to ac was by using a relay as the chopper element? Although suitable for low dc levels the mechanical choppers required high-drive power, were subject to wearout, and performed poorly under extreme environmental conditions. Along came the transistor which required lower drive power, had no moving parts, operated at higher frequencies, and sustained environmental extremes in stride. But even the transistor had disadvantages. Compensation was needed for the inherent offset voltage and floating drive circuits were required for isolation. Introduction of FET choppers combined the best features of mechanical and transistor choppers. FETs offered the advantage of no inherent offset voltage and did not require isolated drives.

Motorola now introduces 16 new N-Channel JFETs in the TO-18 package. These devices are tailor-made for chopper applications as mentioned above and also in demodulator, gating and sampling circuits. Circuit designers concerned with switching speed and output levels will appreciate the low drain-source "on" resistance (as low as 10 ohms, max.). Leakage currents as low as 0.2 nA produce minimum error voltages in output circuits.  $C_{iRR}$  and  $C_{TRR}$  characteristics are minimal insuring optimum chopper action. Check the specs for the type that best fits your particular application.

TYPE	$r_{ds(on)}$ OHMS (max)	$C_{iss}$ (pF) $f = 1 \text{ MHz}$	$C_{oss}$ (pF) $f = 1 \text{ MHz}$	$V_{(BR)GSS}$ Vdc	$I_{loss}$ mA	$V_{DS(on)}$ Vdc	Price (100-up)
MFE2004	80	16	5	30	8	0.4	\$2.00
MFE2005	50	16	5	30	15	0.4	2.70
MFE2006	30	16	5	30	30	0.4	3.70
MFE2007	40	30	15	25	8	0.75	2.80
MFE2008	30	30	15	25	20	0.75	3.50
MFE2009	20	30	15	25	50	0.75	4.50
MFE2010	25	50	20	25	15	0.75	3.50
MFE2011	15	50	20	25	40	0.75	5.00
MFE2012	10	50	20	25	100	0.75	6.50
2N4091	30	16	5	40	30	0.2	4.10
2N4092	50	16	5	40	15	0.2	3.10
2N4093	80	16	5	40	8	0.2	2.30
2N4391	30	14	3.5	40	50-150	0.4	4.30
2N4392	60	14	3.5	40	25-75	0.4	3.30
2N4393	100	14	3.5	40	5-30	0.4	3.80
2N5555	150	5	1.2	25	15	1.5	0.80

Send for a complete data sheet of one or all of the above types. We'll also include our Application Note on Field-Effect Transistors in Chopper and Analog Switching Circuits.

*P.S.* Your nearby franchised Motorola Semiconductor distributor has these "chopper problem solvers" available and waiting. Call him.

- where the priceless ingredient is care!



**MOTOROLA**  
Field-Effect Transistors

MOTOROLA SEMICONDUCTOR PRODUCTS INC., P.O. BOX 20912 / PHOENIX, ARIZONA / 85036

# *How bright is a bright light?*

*We make  
a reflector  
precise  
enough  
to light  
a football  
field*

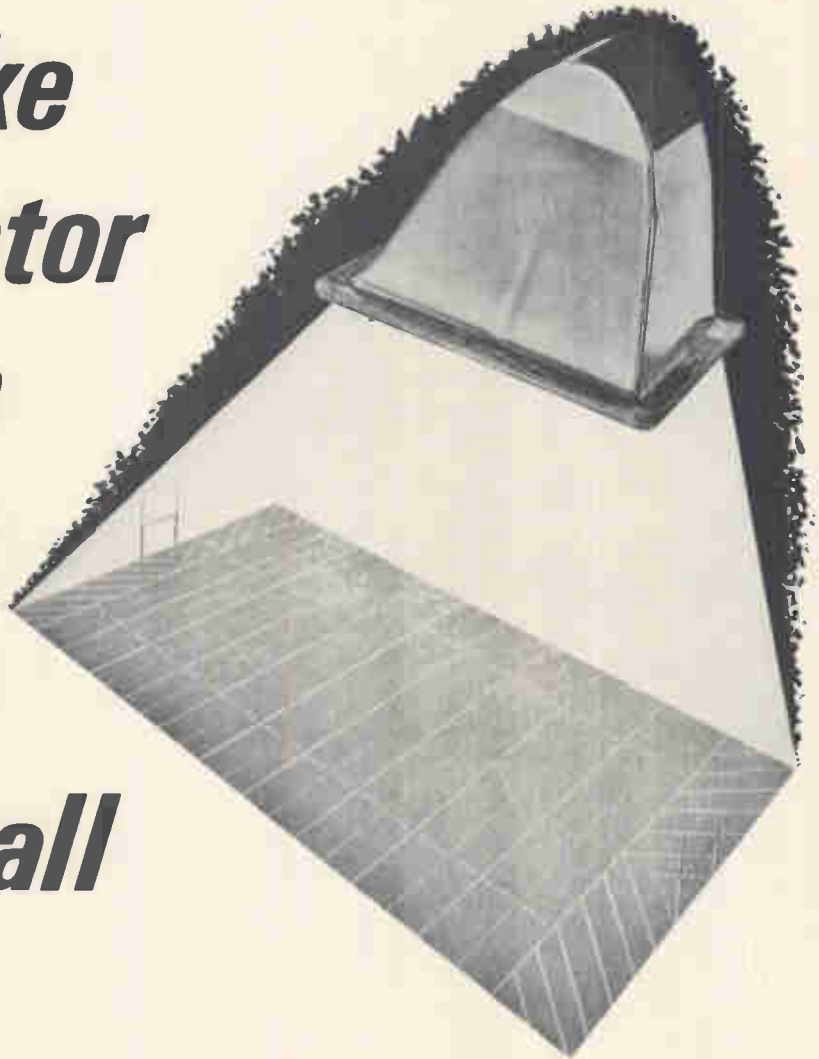

Chicago Aerial Industries didn't ask us to invent a better way to illuminate football games. What they wanted was a three-dimensional, electroformed reflector head formed to incredibly precise specifications for a military contract. They decided we were the only people with the capabilities to produce what they needed.

They were right. No one can match Buckbee-Mears in the field of two or three dimensional precision electro-forming. Our mesh screens, for example, go down to four million holes per square inch with perfect accuracy. Line width tolerances of  $\pm .0001$  are common.

A few of our standard products include evaporation masks, pin hole apertures, micro-mesh sieves, electron microscope

grids, optical wedges, zone plates and a variety of micro-miniature parts.

We're equally adept at electroforming gold, silver, copper and nickel. Any shape you want. Besides the reflector, we produce seamless tubing to a thickness of .005 inches for housing intricate electronic packages used in space vehicles. We make the carefully angled exhaust pipes for aircraft jet engines.

If it requires an intricate two or three dimensional shape with precision tolerances, just ask us. Call Bill Amundson, our Industrial Sales Manager, and tell him what you need.

If we can help one bulb light a football field, just think what we might be able to do for you!

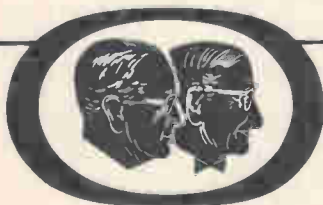

## **BUCKBEE-MEARS CO.**

245 E. 6th St., St. Paul, Minnesota 55101 / (612) 227-6371

*The world leader in precision photomechanical reproduction*

# Why buy only photocells from us,

## When you can buy the whole assembly —and save money to boot.

Whether or not it uses a photocell, let Clairex quote on your next requirement for electronic assemblies. We supply electronic assemblies to some of the best names in photography, business machines and automated machinery.

Our assembly operations are set up to supply low-cost, high-quality assemblies in the quantities you need. To have us quote on your specific requirements, call Clairex (212) 684-5512 or write 1239 Broadway, New York, N. Y. 10001.

### CLAIREX ELECTRONICS, INC.

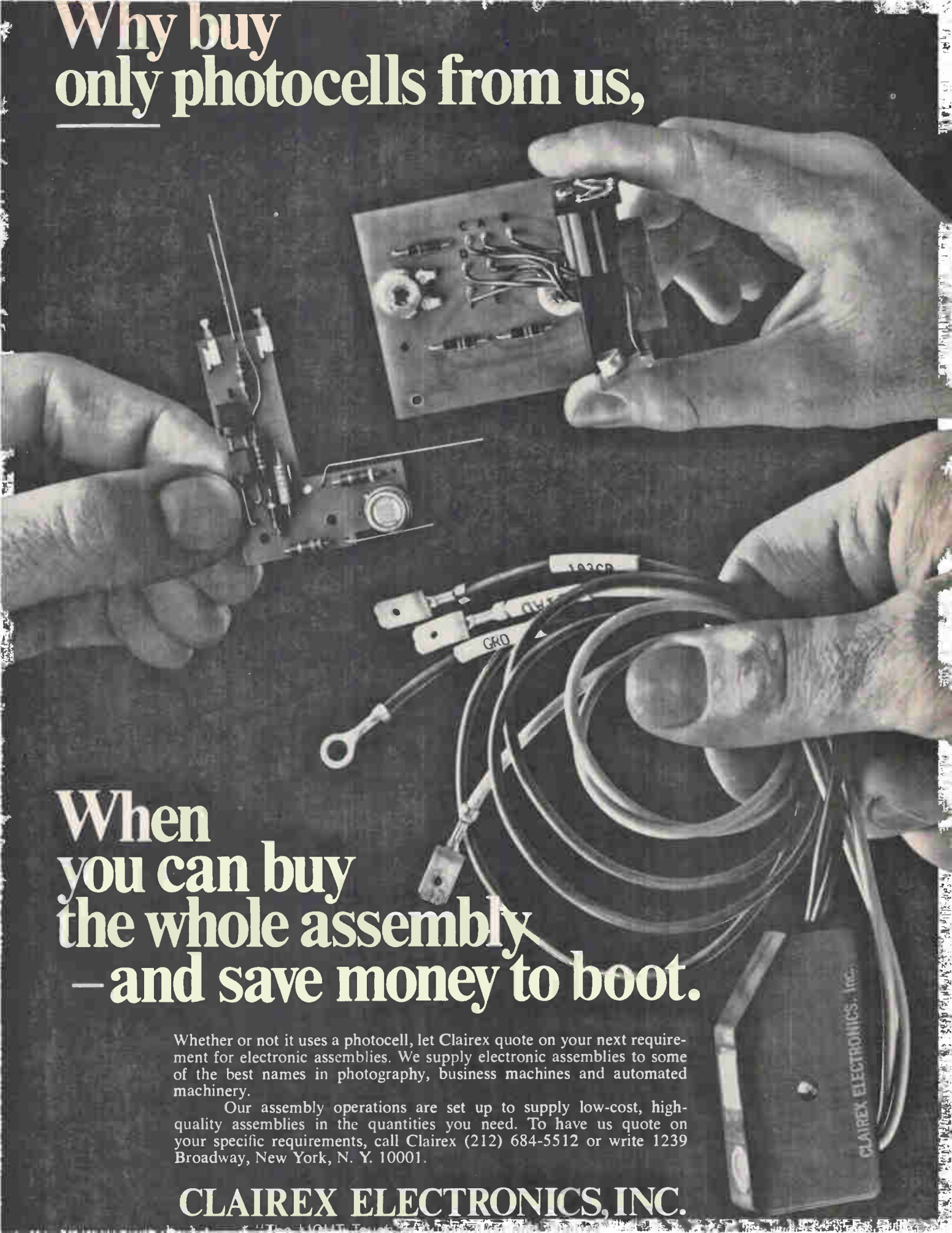

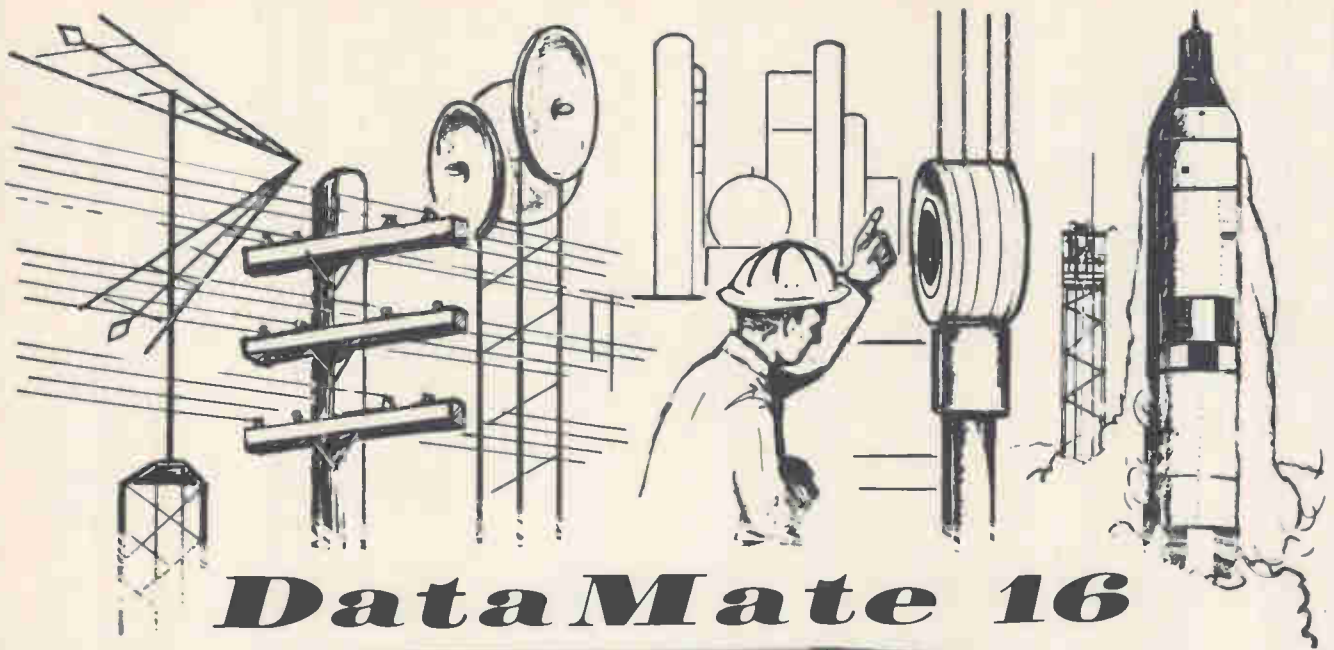

# DataMate 16

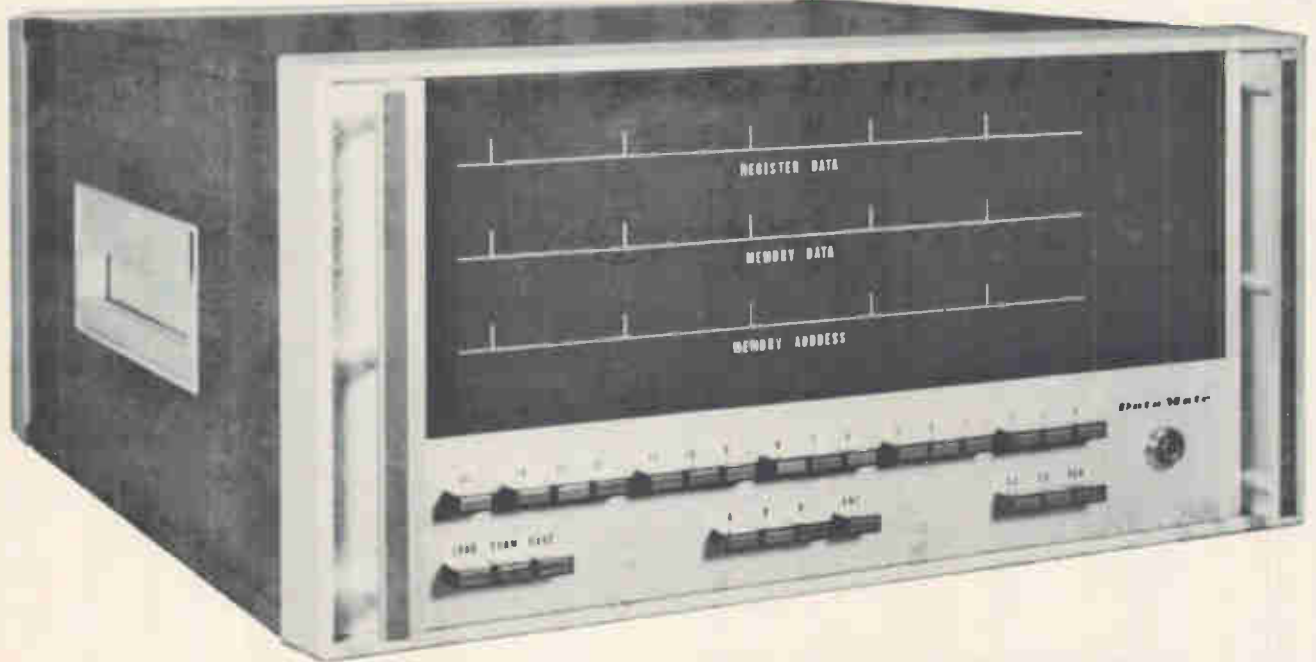

## 16 BIT - ONE MICRO SECOND SYSTEM COMPUTER YOUR APPLICATION DEMANDS THE BEST DIGITAL COMPUTER MONEY CAN BUY.

The new DataMate 16 provides big machine processing at small machine price. It's flexible I/O Bus accommodates up to 64 peripherals with priority interrupt. An optional DMA channel is available.

DataMate solves your problems fast . . . . Average Speed 5.6  $\mu$  sec multiply; 6.6  $\mu$  sec divide; 2.0  $\mu$  sec add. Byte, word, double word processing; indexing and multi-level indirect addressing. Memory expansion to 32,768 words.

IC's and MSI devices throughout.

Table top or rack mounted.

DataMate has built in features that give added performance at no increase in price.

- Hardware Multiply and Divide N/C
- 8 Channels I/O priority interrupt N/C
- Power Failure protection N/C
- Hardware Index Register N/C
- DATAMATE 16 4 K memory - 1.0  $\mu$  sec. systems computer \$13,900.00

SEE IT AT FJCC - BOOTH 113

DataMate Computer Systems

P.O. Box 1911 Big Spring, Texas 79720

Phone 915/267 9744





# Why waste time on bypass/filter capacitors?

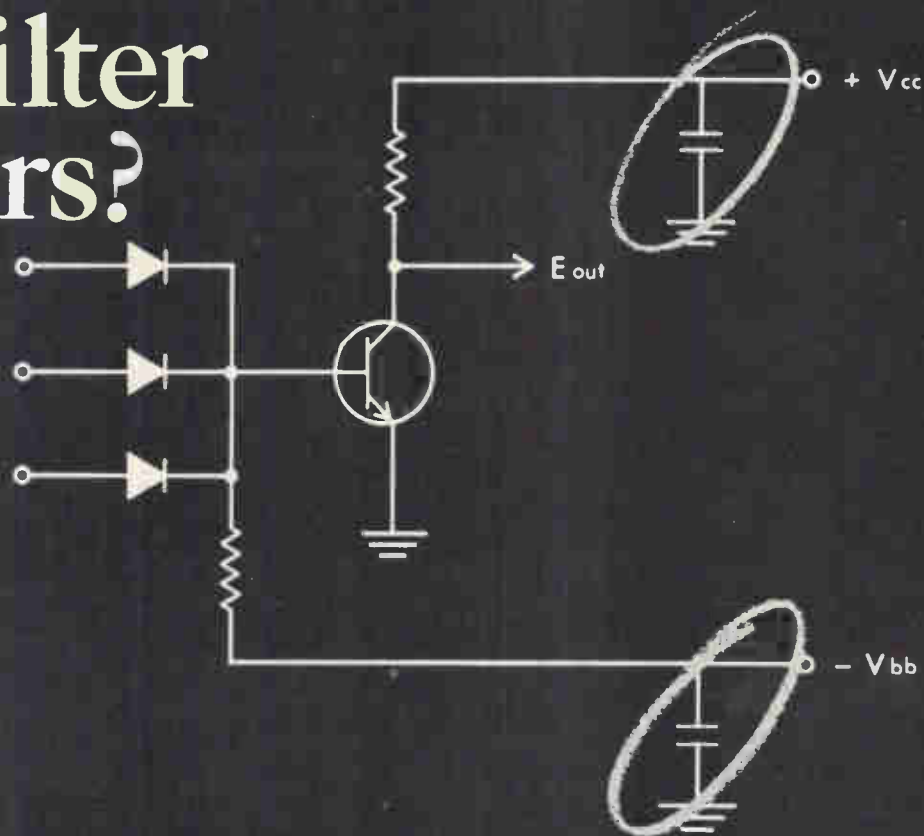

Specify CORNING® Glass-K Capacitors, and move on.

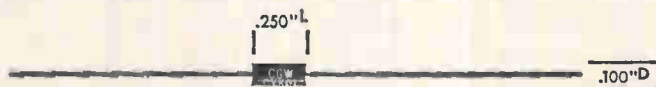

There's only one real concern with a bypass/filter capacitor. If it goes, your circuit will probably follow. Specify the guaranteed reliability of CORNING Glass-K Capacitors and forget it.

You can forget it for the same reason we can guarantee it:

1. Large capacitance in minimum case size, 1000 to 51,000  $pf$  in  $.250'' \times .100''$  or 12,000 to 100,000  $pf$  in  $.250'' \times .140''$ .
2. Low power factor and low DC leakage.
3. Adaptability to cordwood, printed circuit, and point-to-point packaging and automatic insertion.
4. Tight end-of-life design with guaranteed stability.

Get this confidence at a competitive price, and inside two weeks for standard items. Get complete data by writing to: Corning Glass Works, Electronic Products Division, Corning, New York 14830.

**CORNING**  
ELECTRONICS

Circle 111 on reader service card

Using spot ties for  
wire harnessing?

HERE IS THE  
**GUDEBROD  
SYSTEM "S"**

**—SPEEDS THE WORK—SAVES MONEY, TOO!**

**GUDE-TIES CUT LENGTHS**—Specifically produced for spot knotting these handy cut lengths of Gudebrod Flat Braided Lacing Tape are dispenser packaged for one hand, speedy withdrawal. Available in 6", 8", 10", 12", 15", 18", 20" and 22" lengths (other lengths on order). Meet or exceed MIL-T Specs, no-slip knots hold firmly without cutting insulation.

**GUDE-SNIPS**—These palm-of-the-hand snips cut cleanly, easily. For right or left hand use, spring action, DuPont Teflon bearing. Allow operator to have free use of fingers without constant reaching for knife or shears. Save motion, save time.

**GUDEBROD SWIVEL-TILT HARNESS BOARD MOUNT**—Balanced, two dimensional action brings every section of the harness within easy reach. No stretching, no straining. Knots are tied in an easy, natural position. Cuts fatigue—speeds work.

Here you have the Gudebrod System "S" for spot tie lacing, based on the high quality, high speed Gudebrod Lacing Tape—if you're interested in saving money while speeding the harness work, get in touch with us. (For continuous tying, ask about System "C".)



Available also in other types  
of Gudebrod Lacing Tapes

**G**UDEBROD  
*Electronics Division*

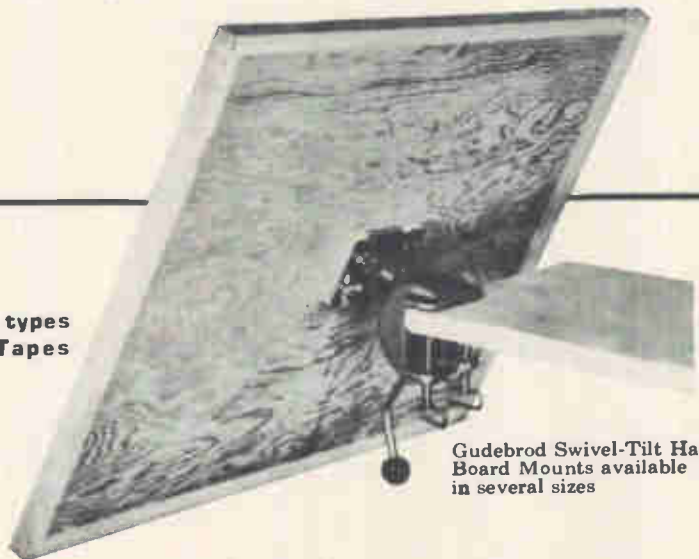

Gudebrod Swivel-Tilt Harness  
Board Mounts available  
in several sizes

For electrical contacts, as in medicine,

# It pays to go to a specialist

A major operation requires a whole team of specialists. So too, it takes a team of specialists to design contacts. Configuration, materials, electrical performance, contact design and manufacture is complex.

That's why Deringer believes it takes 100% concentrated effort to give our customers the best in electrical contacts, contact sub-assemblies and assemblies.

Let Deringer be the doctor. Contact us today. We'll send one of our contact specialists right away.



**D E R I N G E R**

**METALLURGICAL CORPORATION**

1250 Town Line Road (Rt. 60) Mundelein, Illinois 60060

Circle 113 on reader service card

When it comes to being wanted...

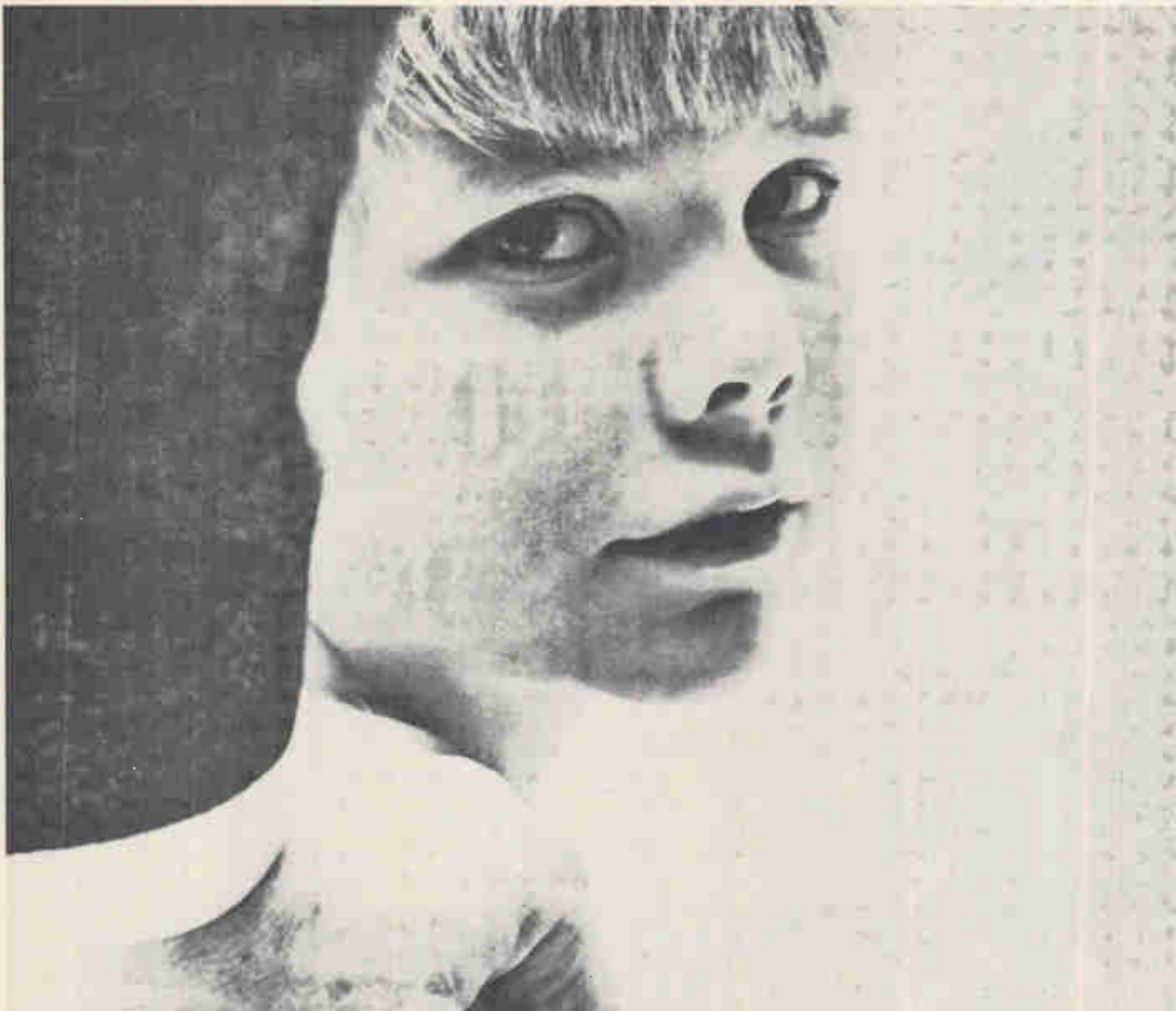

## Colorado is choice country for a growing boy.... or a growing business

Kids and businesses thrive on the same things. Being wanted, for instance.

In Colorado there's not a shadow of a doubt how people feel. Their elected representatives earmark 30% of the State's yearly budget to support Colorado's outstanding school systems. And communities throughout the State go out of their way to make sure there are plenty of choice parks, playgrounds, and recreational areas for their children.

Recent bi-partisan laws passed by the State legislature prove that business and industry are wanted in Colorado too. For example, the valuation for assessment of finished goods going to out-of-state markets was

reduced to 5%; the valuation of all inventory—raw materials, goods in process and finished goods for use in Colorado—will be reduced in 5% per-year steps from the current 25% to 5% in 1972. On a local level fully improved industrial development areas in many Colorado communities provide a warm welcome for business.

If you'd like to find out more about a state where people encourage progressive growth, we'll send you a complimentary copy of our 66 page "Industrial Colorado." Address inquiries to Dwight E. Neill, Director, Division of Commerce and Development, 1039 State Services Building, Denver, Colorado 80203.

## Make Industrial Colorado Your Choice

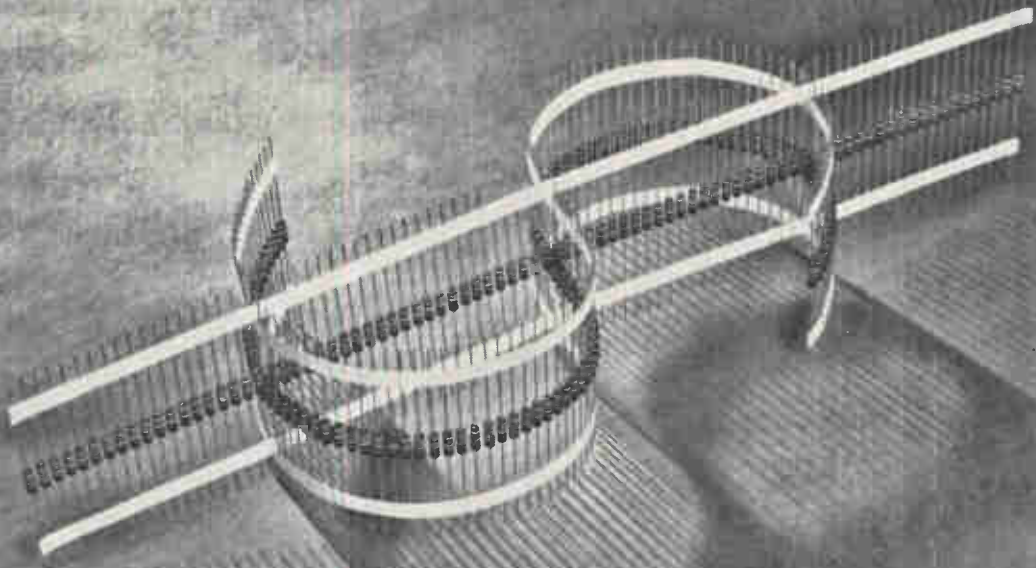

## Why buy price at any cost

To pay too little is to obviously speculate. To spend too much is to be foolishly extravagant. The real value of any purchase is determined in performance, not price. Resistors are like this also.

For years, Stackpole fixed composition resistors have been the standard of value for many leading manufacturers of electrical and electronic equipment. Engineers have become familiar with the testing and evaluation that go into each Stackpole resistor order. Purchasing people know they can expect prompt delivery. And management is assured of complete, in-depth service backed by sixty years of experience.

It's for reasons like these that Stackpole resistors are selected to maintain top performance on so many established products and on a growing number of brand new ones. Such confidence and loyalty cannot be based on price alone, but instead come from the kind of dependability that builds a reputation for your product.

Uniformity is a known characteristic of Stackpole resistors. Unique production methods coupled with thorough testing assure you absolute performance. You can rest assured that the Stackpole resistors you order today will be identical in every way, order after order.

Are you getting what you pay for in a resistor? Why not investigate the value Stackpole resistors can give you. Quality, economically priced and backed by the recognized name . . . Stackpole. There are four sizes to choose from: 2, 1, ½ and ¼ watts.

For samples or a copy of our new booklet, "How to spot a quality resistor", write: Stackpole Carbon Company, Electronic Components Division, Kane, Pa. 16735. Phone: 814-837-7000 — TWX: 510-695-8404.



**STACKPOLE**

ELECTRONIC COMPONENTS DIVISION

A CLARE  
EXCLUSIVE!

Minimum Noise over  
 $22 \times 10^9$  Operations...  
Mercury-Wetted  
Contacts

Type HGS2MT  
Highly sensitive,  
low contact noise

Type HG2MT  
Switches 5 amp  
with minimal  
thermal emf

NEW Type HGR2MT  
Only .4" high, 50  $\mu$ s  
common open time  
1.25 ms response time



High Reliability in  
Environmental Extremes  
... Clare Crystal Can Relays

Type FT Standard crystal can size, meets  
MIL-R-5757D requirements for  
shock, vibration, heat, cold

Type LFT Magnetic latching, polarized,  
bi-stable, 1 or 2 coil operation

Fast Switching...  
MicroClareed Relay

Type MR2MT  
Switches 125 ma  
in 1.5 ms at nominal  
voltage

All relays actual size



# thermal noise? contact noise?

## Clare can help clean up your signal!

Thermal noise and contact noise can  
cause big headaches in instrumenta-  
tion and control circuitry...but not  
when you choose the *right* Clare relay.

With the addition of the new Type  
HGR2MT, Clare now offers the indus-  
try's most versatile line—all highly re-  
liable, with a variety of speeds, sensi-  
tivities, and contact characteristics  
matched to your most demanding de-  
sign requirements.

For complete data, Circle Reader Serv-  
ice Number...or write Group 12N12.

C. P. Clare & Co., Chicago, Ill. 60645  
...and worldwide



a GENERAL INSTRUMENT company

CLARE Low Level Relays

Relay Type	Contact Arrangements	Typical Low Level Characteristics	
		Thermal EMF @ 100% Duty	Contact Noise @ 10ms after close*
HGS2MT	2 Form C	15 $\mu$ v max.	5 $\mu$ v max., P-P
HG2MT	2 Form A, 2 Form B 2 Form D (ext. wiring)	10 $\mu$ v max.	5 $\mu$ v max., P-P
HGR2MT	2 Form C	25 $\mu$ v max.	5 $\mu$ v max., P-P
MR2MT	2 Form A	10 $\mu$ v max.	5 $\mu$ v max., P-P
FT	2 Form C	25 $\mu$ v max.	5 $\mu$ v max., P-P
LFT	2 Form C	—	5 $\mu$ v max., P-P

\*.06—600 HZ Bandwidth



### CLARE RELAYS FOR LOW LEVEL SWITCHING

serve data logging, process control, and instrumentation applications

## Performs more tests with no adjustments than any other IC or discrete op amp tester

Philbrick/Nexus Model 5102 Integrated Circuit Tester performs all tests automatically without calibration or manual programming. The only time you touch a dial is to select the desired test and for a minimum of scale changing for offset voltage and current measurements. Everything else is automatic, including offset zeroing. What's more, it is the only tester that performs CMRR and PSRR tests.

For only \$1400 you get all these additional features in a single instrument: direct reading meter displaying values of all parameters including large signal DC gain, external terminals for displaying IC output, selection of output resistors to match load, oscillation indicator, internal supply of  $\pm 15$  VDC programmable for  $\pm 6$  VDC — plus many more features. Contact your Philbrick/Nexus sales representative for complete details and specifications. Or write Philbrick/Nexus Research, 22 Allied Drive at Route 128, Dedham, Mass. 02026.



**PHILBRICK/NEXUS RESEARCH**

A TELEDYNE COMPANY

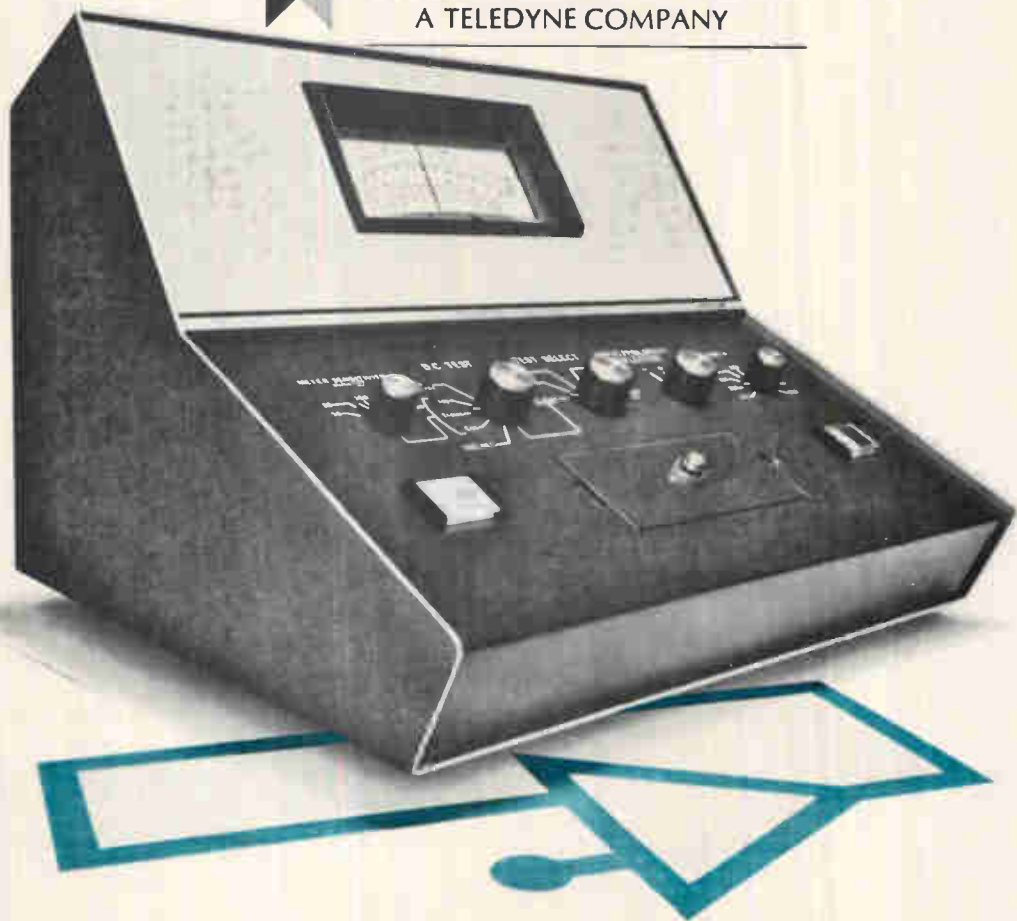

# A NOTE ABOUT . . .

# ANTENNA PERFORMANCE

This pattern\* demonstrates the low side lobes, high front to back ratio and symmetrical radiation of our Series 20 Log Periodic Antenna. Design parameters selected for optimum performance, excellent mechanical engineering and rigid manufacturing control result in an antenna which approached theoretical limits of performance. The specialists in electromagnetics, mechanical design and manufacturing which produced this antenna, work as a team to provide antennas which meet the most exacting requirements. The latest laboratory instrumentation and several completely equipped antenna ranges are available to test new designs and verify performance of production models. Apply this technology to your antenna problems. Call Boyd Lyons at Scientific-Atlanta, Inc. P.O. Box 13654, Atlanta, Georgia 30324. Tel 404-938-2930.

\*E-Plane radiation pattern of Model 20-1 Log Periodic Antenna measured at 137 MHz.

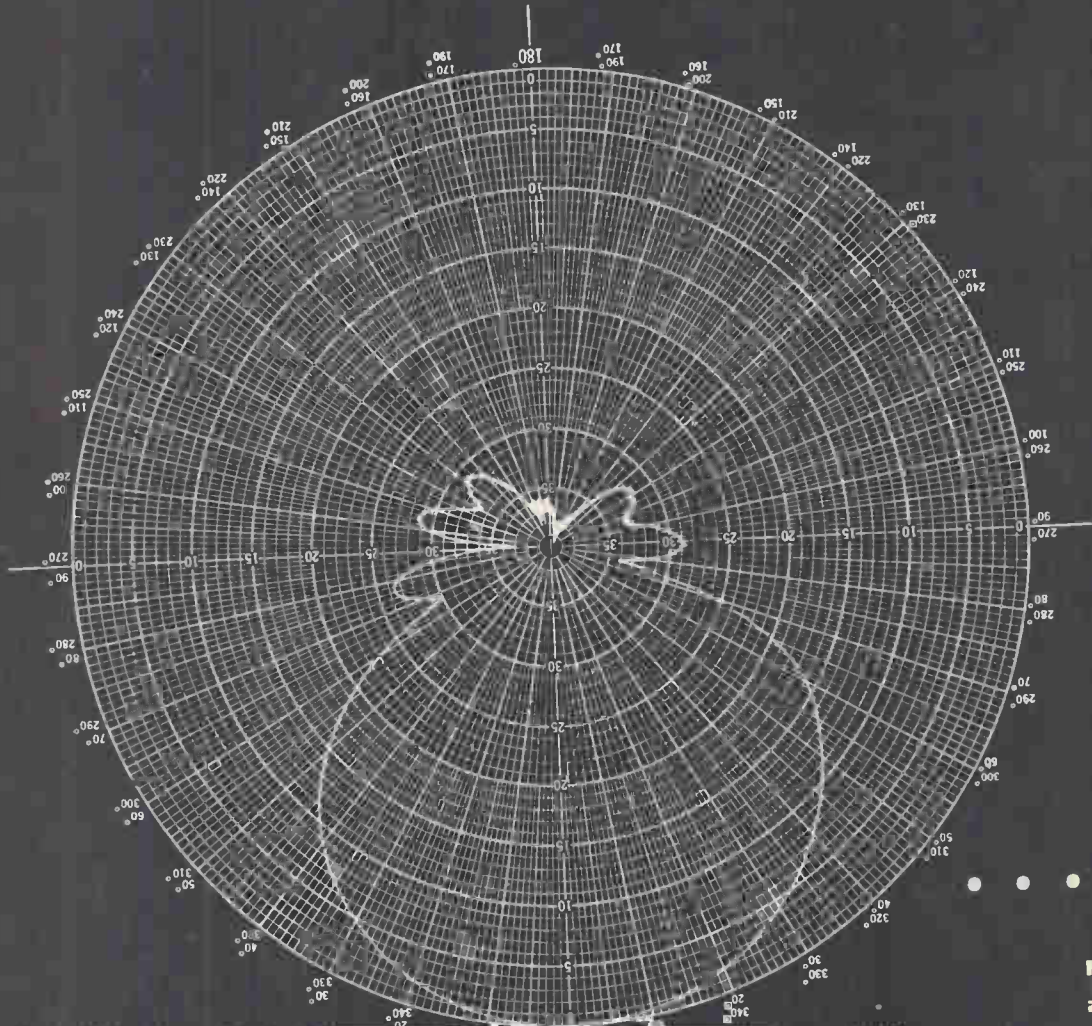



# Probing the News

Government electronics

## Federal outlets tough for foreigners

The world's largest electronics customer prefers to deal with U.S. concerns, but firms with unique products can do well, particularly at civilian agencies

By Robert Skole

Washington bureau manager

Many foreign electronics firms have all but given up trying to sell the U.S. Government, especially military outlets. But some have tackled this market and done surprisingly well. The situation, of course, is of more than passing interest to the domestic electronics industry—parts of which have proved extremely vulnerable to competition from imports.

At first glance, the problems in doing business with the world's biggest customer appear almost insurmountable for an overseas concern. For one thing, there's the Buy-American act, which gives preference to domestic manufacturers competing for Government contracts. Although each Federal department and agency works out its own specifics for implementing the law, the upshot is that foreign firms must be willing to bid at least 6% under the lowest American company to get a job on a competitive basis. If small businesses or firms based in depressed areas are involved, foreign bids must be at least 12% under the lowest American bid.

The Department of Defense, on orders from former Secretary McNamara, has made it even tougher for foreign firms to compete. Armed services procurement regulations established last year provide that foreign bids must be "adjusted" by upping the bid 50% exclusive of duty. The "best" foreign figure is then rated against the lowest American bid. Finally, all cases of foreign bidding are decided by senior officers rather than lower echelon procurement officials. And the Sec-

retary of Defense must approve all foreign contracts exceeding \$100,000.

McNamara made it quite clear that he thought it was a long-run waste to buy foreign equipment unless it was unique and unavailable from American firms. He figured the administrative cost of supervising quality control abroad and ensuring an adequate supply of spare parts and ready service was simply too high. And the same philosophy permeates the Pentagon now that McNamara's gone.

### Overcoming the odds

Nonetheless, some foreign electronics products have been sold—and are being sold—to the military. On the whole, however, overseas firms have less trouble selling civilian agencies, which use only the 6% and 12% penalties and often encourage foreign competition "to

keep American suppliers' pencils sharp."

Foreign firms that sell the military normally do so through competitive negotiation or as sole sources of supply. Only 11.5% of all military contracts are actually awarded through competitive advertised bidding; 30.6% are let through competitive negotiations, and 57.9% by single-source negotiation. When a foreign firm is a sole supplier on a contract that is negotiated, there's no 50% penalty.

"Competition with the 6% and 12% penalty is possible," says one British trade official. "We don't like it, but it doesn't stop business. But the 50% impost does stop us, and I guess that's what it's intended to do."

British manufacturers got a chance to enter the American military market on a no penalty basis under the terms of the sale of \$2.5

### Caught in the act

If President-elect Nixon is protection-minded on the subject of trade, he might consider ordering some American-made tape recorders. Last year, when President Johnson announced that the Government would reduce its purchases of imported goods to help stem the flow of gold from the country, his words were being preserved on Swiss tape recorders.

The White House Communications Agency, a branch of the Army, has about 30 tape recorders manufactured by Nagra of Switzerland. Price at around \$1,000 each, these machines have been storing LBJ's utterances for several years now. A White House sound technician asked about the use of Nagra, rather than American-made machines, answers: "They're the best ones made." Nagra, however, is not cashing in on this "testimonial." Like most other firms selling Uncle Sam, it prefers to let well enough alone.

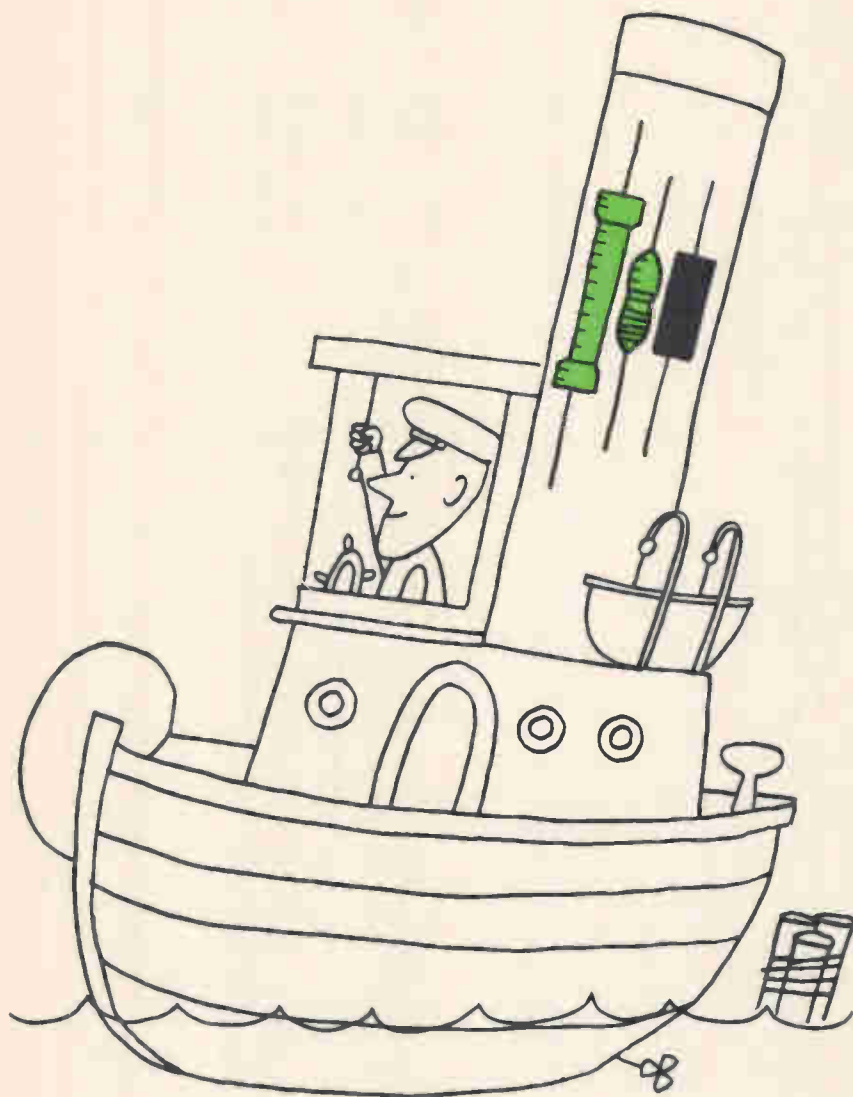

## Our films cover the watt-er front

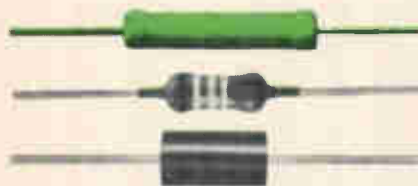

From  $\frac{1}{8}$  watt to 7 watts, Mallory gives you fast delivery on a wide range of metal alloy and metal oxide film resistors. For high precision, Type MAF  $\pm 0.25\%$ ,  $\pm 0.5\%$  and  $\pm 1\%$  in  $\frac{1}{8}W$  and  $\frac{1}{4}W$ . For semi-precision,

Type MAL  $\pm 2\%$  and  $\pm 5\%$  in  $\frac{1}{2}W$ . And for premium performance at low cost, Type MOL,  $\pm 10\%$  2W to 7W. All Mallory film resistors are 100% inspected. For details, write or call Mallory Controls Company.

**MALLORY**

**MALLORY CONTROLS COMPANY**

a division of P. R. MALLORY & CO. INC.  
Box 231, Frankfort, Indiana 46041

## ... foreign firms do better going after subcontracts ...

billion worth of F-111 aircraft to the Royal Air Force. The 1966 agreement which lapsed a few months ago allowed British concerns to sell about \$300 million of goods, including Rolls-Royce engines, Jetstream aircraft, survey ships, and Elliott Automation's head-up display.

**Caveat vendor.** "We learned that even if the Buy-American act was waived, it was no piece of cake to get prime contracts from the Department of Defense," the trade official says. "It's fairly obvious to us now that the best way to break into this market is to go in for subcontracting, and that's what we're encouraging our manufacturers to go after."

He points out that under normal procurement regulations overseas firms can serve as subcontractors without running into Buy-American obstacles as long as the value of foreign components is less than half the total. British concerns supplied some important electronic equipment for the C-5A transport—including monitoring gear and an "artificial feel" device that provides the pilot with proper stick tension and play.

But the American services don't necessarily beat paths to the doors of manufacturers with better mousetraps. A classic example is the mortar locating radar manufactured by EMI of Great Britain. Although this equipment has been used by British forces and several NATO countries for almost 10 years and this type of apparatus is at the top of the priority lists for service in Vietnam, the Army has turned thumbs down on it. One reason given by the brass is that it wants 300° radar; the EMI equipment scans only 180°.

A Pentagon source familiar with the situation says that if EMI had been more aggressive in marketing its equipment it probably would have been able to sell some. "Hell, if I were them, I'd put units into the hands of the Australians in Vietnam," he says. "Get a few good news stories about the sophisticated equipment the Australians have—and the American don't—and some Congressmen would start

squawking. Then you'd see how fast doors open around here."

**Walk softly.** "One of the secrets of selling to the Government is never get so big that you are hurting an American firm," says one representative of a foreign company. "And it also helps if your American competition is active in your own home country. You'd never hear IBM complain about a Dutch computer sold to the American Government, would you?" As a matter of fact, the Dutch giant, Philips, has been successful in selling computer-based equipment to the Federal Aviation Administration for use in message switching.

Another company in the same field, Addo-X, of Sweden, has been selling to both civilian agencies and the military. The company makes equipment for capturing data on punched tape; one feature of this gear is that errors are detected before they go into the computer. Addo-X has sold a \$75,000 installation to the Federal Housing Administration, for use in field offices' data collections, and has also done business with the Department of Agriculture and the Internal Revenue Service.

#### Inside jobs

Some foreign companies have cracked the Government market through licensing or U.S. manufacturing subsidiaries. Decca, for example, does both and imports equipment from Great Britain. The basic Decca Mark 8A navigation equipment is made under license by the Laboratory for Electronics, while the company's Houston plant manufacturers marine navigation equipment. The Decca Omnitrac system is made in Britain. "Some of our products are 100% British made, while others are 99% American made," says a Decca official.

Racal, a British communications equipment company, has established a plant in Rockville, Md., near Washington, with an eye to being close to the big military buyers. Racal officials say they have no problems selling to the Government even though they must often demonstrate new equipment that has been manufactured in Britain. The company makes gear that's commonly used for monitoring by the "spook shops"—the Defense Intelligence Agency and the

# From A to V\* about SSL's!

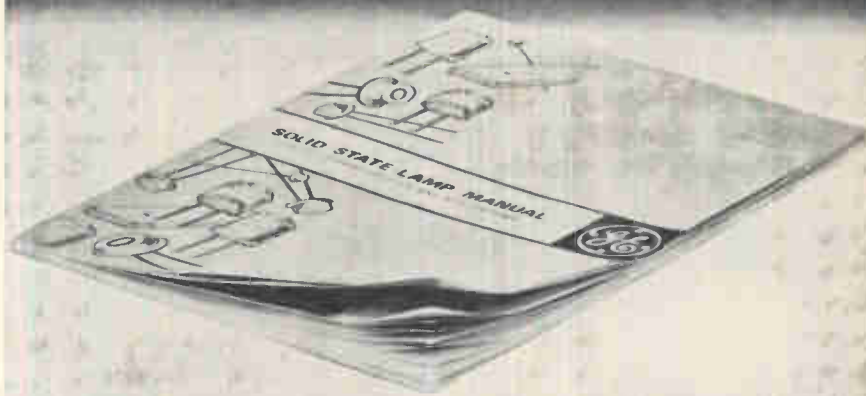

## first complete SOLID STATE LAMP MANUAL, now from General Electric

Here are 64 pages cram-packed with facts, figures and formulae about GE's growing SSL family. Over 80 diagrams, illustrations and graphs. An indispensable source book for engineers, scientists, technicians and students working with the exciting new field of solid state optics.

New *Solid State Lamp Manual* suggests dozens of immediate and future SSL applications, with particular attention to modulation, detection and control circuits. It explores solid state lamp theory and characteristics.

Also, there's a 22-page section on optoelectronics and a helpful glossary of terms. Plus, complete specifications on all GE SSL lamps.

Months in preparation by a team of General Electric scientists and engineers, this comprehensive SSL manual is now off the press. Copies are two dollars each. But supplies are limited, so mail your order today.

*\*from "acceptor" to "valence band"*

Please send me \_\_\_\_\_ copies of General Electric's new *Solid State Lamp Manual*. I enclose \$2 for each copy.

Name \_\_\_\_\_

Company \_\_\_\_\_

Address \_\_\_\_\_

City \_\_\_\_\_ State \_\_\_\_\_ Zip \_\_\_\_\_

To: General Electric Company  
Miniature Lamp Department, #381S  
Nela Park, Cleveland, Ohio 44112  
Attn: C. R. Dougherty

MINIATURE LAMP DEPARTMENT

GENERAL  ELECTRIC

# Crimp. Crimp.

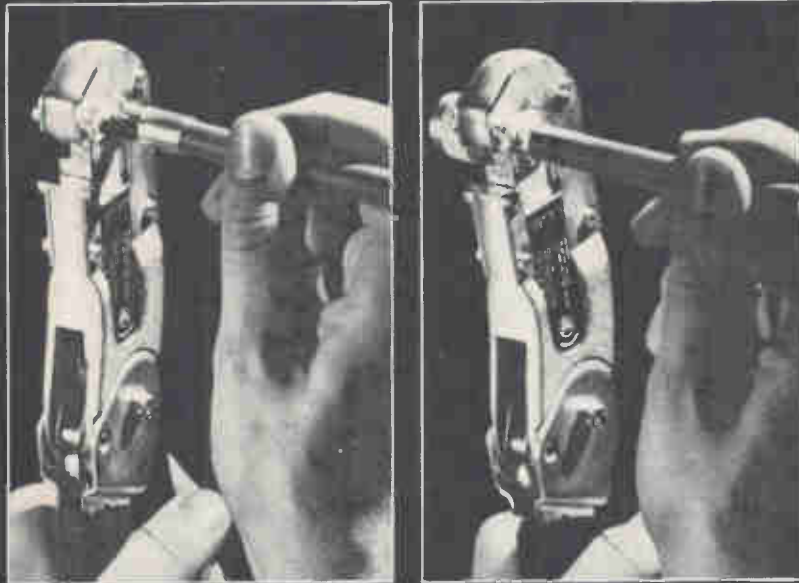

## A short story on savings.

**In time.** Amphenol MIL-Crimp N connectors assemble in 30 seconds. Simply crimp the contact to the center conductor, then crimp the connector to the cable. That's all there is to it.

**In money.** Assembly costs can be cut as much as 50¢ per connector over the conventional field-serviceable UG connectors.

**In trouble.** No special-assembly techniques are required. Every assembly is identical and perfect.

**In performance.** Quality and performance levels are guaranteed and meet MIL-C-39012, the specification that supersedes MIL-C-71 for N connectors.

**In price and delivery.** Amphenol MIL-Crimp N's are priced competitively with conventional UG's and are available as straight or angle plugs; straight, bulkhead or panel jacks and receptacles. Most are stocked on distributors' shelves.

BNC's too. MIL-Crimp BNC's to MIL-C-23329 are also available.

**FREE OFFER.** With every order for 500 or more MIL-Crimp N's received by February 28, 1969, Amphenol will supply a free crimp tool. Act now. Amphenol RF Division, 33 E. Franklin St., Danbury, Conn. 06810.



**AMPHENOL**  
THE BUNKER-RAMO CORPORATION

... the Buy-American act  
doesn't apply overseas ...

Central Intelligence Agency. The fact that it is designed in Britain is evidently no deterrent to sales. But a source at the Air Force Electronics Systems division points out that security is a major consideration when it comes to dealing with foreign suppliers. "We might need cryptographic equipment, for instance," he says. "And we wouldn't want to compromise our security by letting the specifications out of the country."

The ESD says several overseas electronics companies have bid for some of its work but only one—Japan's Nippon Electric—has succeeded. Nippon is now installing a microwave communications network in Japan for use with the service's Pacific area communications system. The contract, worth \$13 million, was granted in December 1966. Buy-American act provisions don't apply to equipment to be used abroad, and the Air Force says it was logical to award the contract to a low-bidding Japanese firm.

**Business is business.** Some large American firms such as Raytheon report that they rarely if ever subcontract abroad. But others, such as Sylvania Electric Products, like to operate there—albeit on a selective basis. "Many distributors of foreign products call on us, and often foreign firms' salesmen come over. On occasion, we'll send representatives to trade shows in Germany or Great Britain and other countries to get the feel of the market or look for certain items," says an official.

The Sylvania spokesman gives several reasons why his firm is willing to buy abroad. "Perhaps an American company can't deliver soon enough because he has so many orders or can't quite meet specs," he says, "and a foreign firm might do custom work to fulfill the contract. In a high-volume situation, a foreign company might give us a better price. We always try to have two or three sources for a product, and one might be overseas."

But, he points out, there are problems involved in buying out-

side the U.S. "Prices are not always better abroad; they may look good there, but the cost of shipping, plus tariffs, may make the items more expensive than U.S. parts." Spare parts can also cause difficulties. "We must have continuity. A foreign firm that does just one run for a specific order will not be able to help when we come back a year later for more parts."

**Better pickings.** Although the Pentagon is the most tempting target for electronics salesmen from overseas, it's a lot easier for them to grab the much smaller fruits found in the civilian agencies. One of the most receptive to foreign companies these days is the Post Office. The Assistant Postmaster General for Research and Engineering, Leo Packer, makes it clear that he's ready to buy the best postal equipment available—no matter where it comes from. He even has one contracting specialist, a linguist, assigned to dealing with foreign suppliers.

Until a few years ago, whenever there was an international postal conference, top political figures would attend as representatives of the U.S. Foreign agencies, however, send technical specialists who spend most of their time discussing the latest developments in mechanization, automation, or whatever with their counterparts from other lands. Now the situation is quite different: the American Post Office assigns specialists with orders to see what they can learn.

The Government's number two electronics purchaser, NASA, isn't a particularly happy hunting ground for foreign firms. NASA has let only a few contracts to foreign firms—largely for on-site work at overseas tracking stations. But the agency will buy equipment from foreign companies when it is unavailable in the U.S.; on this list are special optical gear, electron microscopes, and cameras.

"Foreign businessmen should not be discouraged," says one space agency procurement official. "Aside from the Buy-American act, they face the same problems as domestic companies. It's a matter of ringing doorbells and wearing out shoe leather." He adds that NASA definitely wants to see foreign firms in the bidding. "Who knows?"

# No Crimp.



## Another short story on savings.

**In time.** Amphenol field-serviceable MIL-Clamp N connectors assemble in half the time it usually takes with conventional UG connectors. Simply solder the contact and place the braid clamp over the exposed braid (no combing required). Assemble into the rear of the connector and tighten the clamp nut. That's all there is to it.

**In money.** Assembly costs can be cut as much as 35¢ per connector over the conventional UG connectors.

**In trouble.** No special tools or assembly techniques are required. Every assembly is identical and perfect.

**In performance.** Quality and performance levels are guaranteed and meet MIL-C-39012, the spec that supersedes MIL-C-71 for N connectors.

**In price and delivery.** Amphenol MIL-Clamp N's are priced competitively with conventional UG's and are available as straight or angle plugs; straight, bulkhead or panel jacks and receptacles. Most are stocked on distributors' shelves.

BNC's too. Field-serviceable BNC's to MIL-C-39012 are also available.

**FREE OFFER.** With every order for 500 or more MIL-Clamp N's received by February 28, 1969, Amphenol will supply a free lab kit of 25 assorted field-serviceable N connectors. Act now. Amphenol RF Division, 33 E. Franklin St., Danbury, Conn. 06810.



**AMPHENOL**  
THE BUNKER-RAMO CORPORATION

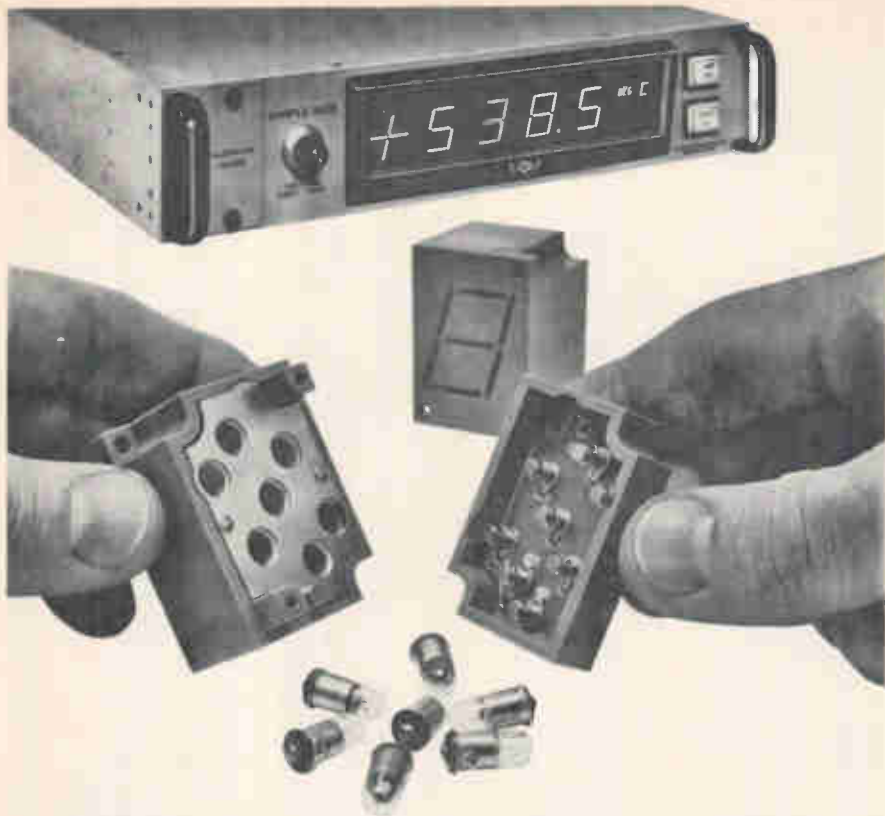

## *What makes low-cost Dialight readouts so reliable and easy-to-read?*

Reliable because of simple module construction and long life lamps. Designed for use with neon or incandescent lamps to meet circuit voltage requirements. Easy-to-read from any viewing angle. 1" high characters are formed by unique patented light-gathering cells, and may be read from distances of 30 feet. Sharp contrast makes for easy viewing under high ambient lighting conditions.

### **Dialight Readout Features**

1. Operate at low power.
  2. 6V AC-DC, 10V AC-DC, 14-16V AC-DC, 24-28V AC-DC, 150-160V DC or 110-125V AC.
3. Non-glare viewing windows in a choice of colors.
  4. Available with RFI-EMI suppression screen.
5. Available with universal BCD to 7 line translator driver.
  6. Can be used with integrated circuit decoder devices now universally available.
7. Caption modules available; each can display 6 messages.

## *Send for catalog*

Catalog-folder contains complete specifying and ordering data on numeric and caption modules, translator drivers, mounting accessories. Dialight Corporation, 60 Stewart Avenue, Brooklyn, New York 11237. Phone: (212) 497-7600.



# **DIALIGHT**

DT-126

**... Government sales can be made in unlikely outlets ...**

They could very well come up with something we need. And more bidders keep things competitive."

On the other hand, a trade official of one foreign embassy says, "On the whole, the only firms that are ever going to sell here are those that have established a presence and that follow the market. That is one of the major advantages the American firms enjoy—they have built-in protection."

**Specialties.** A broad range of Government agencies are potential markets for companies that specialize. Although by American standards many of these outlets seem small in terms of dollars, the volume is significant abroad. For example, AGA, of Sweden, developed a laser geodimeter for the U.S. Coast and Geodetic Survey, under a contract worth about \$78,000. The company made no profit on the job, but took on the project to get experience in the field. As a result, AGA now has commercial orders for about \$150,000 worth of these surveying instruments and expects to get more Government work. American parts in the AGA laser equipment account for more than half the cost, so the gear doesn't fall under the Buy-American act.

Another example of successful specialization is the measuring equipment being made by Bruel and Kjaer Precision Instruments of Denmark for the National Bureau of Standards. The gear, which costs about \$70,000, will monitor sound and vibration so standards can be set for homes underwritten by the Federal Housing Authority.

The Government market is so big—and sales, like that of the Danish measurement gear, can be hustled in such unlikely places—that covering all possible outlets can be a problem for foreign firms. The British are tackling this difficulty systematically. The commercial section at the embassy is studying the market—department by department and agency by agency. "At least we'll know what they are looking for and we'll be able to contact the right people," says an official. "That's often a major problem in itself for a foreign businessman."



# SOLID STATE BROADBAND AMPLIFIERS HIGH LEVEL, LOW NOISE

FEATURES: Standard Line of all Solid State Broadband Amplifiers offering  
 FLAT GAIN RESPONSE • EXCELLENT PHASE LINEARITY • MULTI OCTAVE  
 • LOW NOISE FIGURES • HIGH LINEAR OUTPUT • Applications: ECM  
 • LINE AND WIDEBAND IF AMPLIFIERS • FREQUENCY SYNTHESIS  
 PULSE • RFI MEASUREMENTS • TELEMETRY • TV • LABORATORY

TYPICAL CHARACTERISTIC CURVES  
 MODEL ESN 5001 LOW NOISE BROADBAND AMPLIFIER

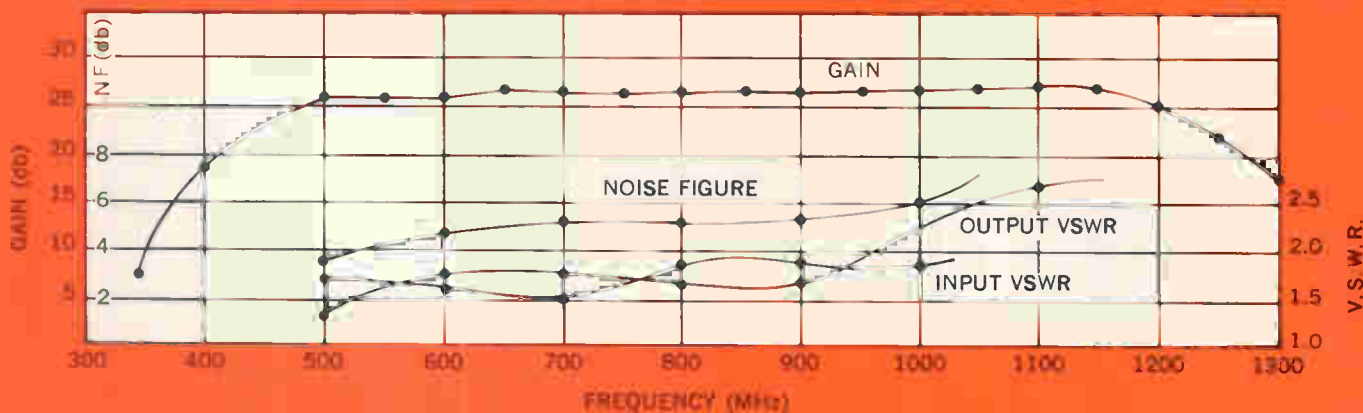

## HIGH LEVEL BROADBAND AMPLIFIERS

Frequency MHz	Noise Figure db Max.	Gain db Min.	Gain Flatness ±db	Power Output dbm.		VSWR Max.		Model Number
				Min.	Input	Output	Input	
10-400	8	20	0.5	+20	2.5	2.0	EBA1001	
10-400	8	20	1.0	+27	2.5	3.0	EBA1002	
50-100	8	25	1.0	+27	2.5	2.5	ESK5010	
50-100	5	25	1.0	+20	2.0	2.5	ESH5010	
100-200	8	25	1.0	+27	2.0	3.0	ESK1020	
100-200	5	25	1.0	+20	2.0	2.5	ESH1020	
150-300	8	25	1.0	+27	2.0	3.0	ESK1530	
150-300	6	25	1.0	+20	2.5	2.5	ESH1530	
200-400	6	25	1.0	+20	2.0	2.5	ESH2040	
200-400	8	25	1.0	+27	2.5	3.0	ESK2040	
250-500	8	25	1.0	+27	2.0	3.0	ESK2550	
250-500	7	25	1.0	+20	2.0	2.5	ESH2550	
500-1000	8	25	1.0	+10	2.0	2.5	ESN5001	

## LOW NOISE BROADBAND AMPLIFIERS

Frequency MHz	Noise Figure db Max.	Gain db Min.	Gain Flatness ±db	Power Output dbm.		VSWR Max.		Model Number
				Min.	Input	Output	Input	
10-450	2.5	25	0.5	0	2.5	2.0	EBG1005	
50-100	2.0	25	1.0	0	2.0	2.0	EGM5010	
50-100	3.5	25	1.0	+7	2.0	2.0	ESL5010	
100-200	2.0	25	1.0	0	2.0	2.0	EGM1020	
100-200	3.5	25	1.0	+7	2.0	2.0	ESL1020	
150-300	2.5	25	1.0	0	2.0	2.0	EGM1530	
150-300	3.5	25	1.0	+7	2.0	2.0	ESL1530	
200-400	3.0	25	1.0	0	2.0	2.0	EGM2040	
200-400	4.0	25	1.0	+7	2.0	2.0	ESL2040	
250-500	3.0	25	1.0	0	2.0	2.0	EGM2550	
250-500	4.5	25	1.0	+7	2.0	2.0	ESL2550	
500-1000	5.0	25	1.0	0	2.5	2.5	ESM5001LN	
500-1000	4.0	25	1.0	-5	2.5	2.5	EGR5001LN	



**E & M  
LABORATORIES**  
 DIVISION OF STERLING ELECTRONICS

7414 GREENBUSH AVENUE, NORTH HOLLYWOOD, CALIF. 91605 - TELEPHONE (714) 825-1484

COMPLETE DATA  
 AVAILABLE  
 UPON REQUEST



## Measuring low light levels

...requires extremely low dark currents coupled with maximum useful sensitivity. The EMI 6256, a 13-stage venetian blind 2" photomultiplier tube has the essential characteristics that are necessary for low light level applications. The unique 10mm cathode-DI geometry, together with the ultra-stable EMI venetian blind design, has resulted in its widely successful use in astronomy, biology and spectrophotometry. The EMI 6256B has a quartz window and the S-11 cathode (S-13) which has a peak quantum efficiency of 17% at 4,200 Å. The EMI type 6256S has 5 to 10 times lower dark current than the 6256B, and should be used when system performance is dark current limited. This type is also available for visible light applications as 9502B/9502S, or with 11 dynodes as 6094B/6094S. Many other EMI photomultiplier tubes are available for special applications from stock in sizes from 1" to 12". EMI photomultiplier tubes are available through qualified engineering representatives located in major marketing areas throughout the United States. A request on your company letterhead will bring you the name of your nearest representative as well as a copy of our latest catalog.



**W**hittaker  
CORPORATION  
**GENCOM** DIVISION

80 Express St., Plainview, L.I., N.Y.  
S16-433-5900 TWX S16-433-8790  
\*EMI ELECTRONICS, LTD.

## Electronics abroad

# Russia—an open market

Soviets give preference to foreign electronics suppliers since domestic industry can't handle all of nation's needs

By Jack Winkler

Moscow news bureau

Western electronics firms interested in the expanding Russian market have a better chance for quick success than their counterparts in other industrial fields. Automated instrumentation and control systems, medical equipment, and integrated circuits are high on the Kremlin's list of priorities, and the Soviet industry is admittedly weak in these areas. So prospects in this \$50 million or so market look good for some time to come.

One possible limiting factor on exports to Russia might be the extent of its willingness to spend foreign exchange on electronics rather than other goods. But in view of the USSR's 1967 trade surplus of \$1.2 billion—including \$700 million from hard-currency capitalist nations—and government pronouncements stressing the need for automated production, improved information processing, and computer-based systems for a variety of applications, the outlook for continuing purchases is bright.

**Guessing game.** Just what this means in dollars, however, is a very moot point. Experienced traders put the current import market for electronic goods at anywhere from \$15 million to \$100 million. However, a check of all trade classifications that are nominally electronic suggests that last year's volume was about midway between.

Apart from the money involved, businessmen repeatedly report that the USSR is atypically receptive to pitches for electronic wares. In general, the Russians are considered fair but tough trading partners. Companies exhibiting electronic goods at collective trade shows seem to sell a higher percentage of the equipment they display than firms in other industries.

And more important, the representatives of electronics concerns are more likely to be asked to arrange private showings of their lines.

As a rule, companies interested in selling the Soviets must make repeated appearances at large, highly competitive exhibitions, and their representatives must work hard to wangle an invitation to put on a lucrative solo show. The advice of the experienced is that most newcomers should be prepared to hoe a long, hard row to build their sales in Russia.

### Shopping list

The preference accorded electronics firms doesn't result from naiveté. Soviet engineers know very well what's available and where it stands technologically. The USSR's generally excellent technical intelligence service is particularly strong in electronics. Every month, a volume running to 600 or 700 pages carries abstracts in Russian of reports on basic and applied research from all over the world.

Another advantage for electronics salesmen in Russia is a lack of competition. Most of the giant American electronics firms avoid Russia because of the U.S. embargo on strategic exports. And, among the continental firms Philips and AEG-Telefunken, for example, do very little business with the USSR. The leading seller of medical electronic equipment is a small Japanese firm, Nihon Kohden. Its gross sales are only \$9 million but 10% are to Russia.

**Rx for growth?** Though the medical electronics field is wide open, surprisingly few foreign companies have made a play for it. Last July, on the 50th fiftieth anniversary of



**HERE'S A DIGITAL  
STRIP PRINTER  
THAT SPLITS IN TWO ...**



Stack 'em, rack 'em  
or mount 'em anywhere

This Series 800 MDS Digital Strip Printer . . . only 5¼" rack height ordinarily . . . is designed with the print-head in one chassis, and another chassis containing the solid-state electronics and power supply, thus permitting half-rack mounting, remote operation or other configurations.

Featuring a standard 8 columns (9, 10 or less than 8 columns available) and a 12 lines per second speed, the 812 D-8 has a 10 decimal-digit printout, plus a choice of one of three sets of additional symbols which can be easily changed by changing print-drum indexing.

This model is supplied ready for operation with all the required electronics, integral power supply, attractively-styled cabinet with satin-finish aluminum trim and even a roll of paper. Just plug it in!

The printing mechanism slides forward on full-suspension, ball bearing glide rails for complete inspection and quick, easy paper loading. Series 800 units are uniquely flexible, with great capability in small space. The price is lower than for other printers that are a generation behind!

These units feature simple maintenance with "down-time" the exception, rather than the rule. Warranty: 120 days.

ASK FOR: The MDS folder-file on Series 800 . . . gives general specifications and more complete information.

**FOR MORE — MEET YOUR MAN FROM MDS**

**MOHAWK<sup>MS</sup>**  
DATA SCIENCES CORPORATION  
**OEM MARKETING**

122 EAST RIDGEWOOD AVENUE • PARAMUS, N.J. 07652  
Telephone 201/265-7333

Every MDS office is an OEM Marketing office

DIGITAL STRIP PRINTERS • BUFFERED TAPE UNITS  
HIGH-SPEED AND LOW-SPEED LINE PRINTERS  
CARD PUNCHES AND READERS  
PAPER TAPE PUNCHES AND READERS

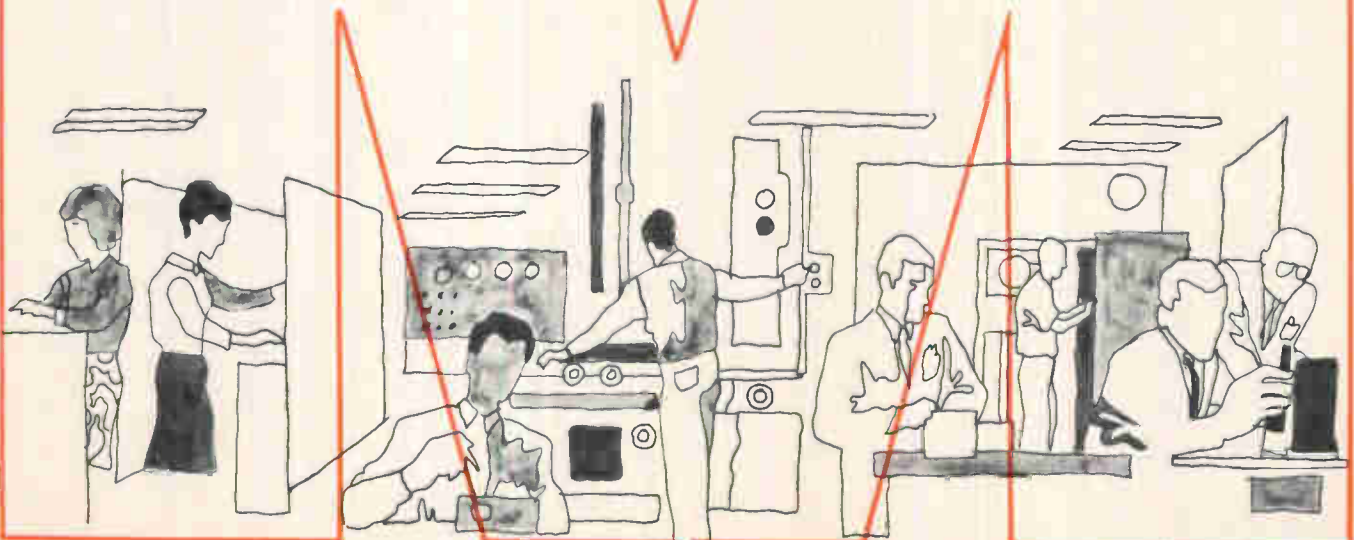

# No.

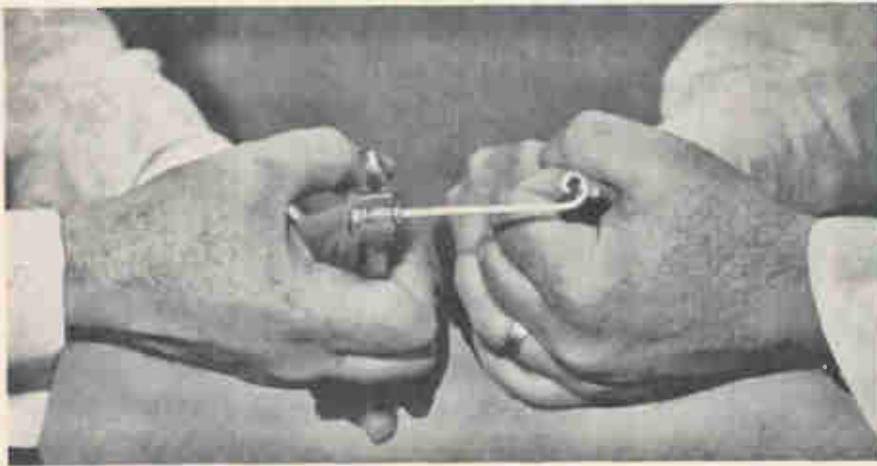

## You cannot pull the cable out of our Emlock<sup>®</sup> connectors.

No tricks. Our claim is that it is impossible to pull the cable out of one of our Emlock<sup>®</sup> compression fit, miniature connectors. Disengagement will be caused only by failure of the braid, not pullout of the compression. We believe this extraordinary capability beats crimped type connectors all hollow. Yes, and competitive compression types, too.

Prove it to yourself. Have one of our Technical Representatives call on you. He'll attach any one of our stock Emlock<sup>®</sup> connectors to a section of braided cable. Then, as he holds the connector body with a pliers, he'll hand you the chain nose, and you pull! The assembly will break away, of course. He will then disassemble the

connector and show you that there is still enough wire trapped to prove that Emlock<sup>®</sup> compression held and the braid failed!

Here's your chance to gain a new concept in miniature connector reliability. Remember, only Emlock<sup>®</sup> connectors offer this basic capability and only we have Emlock<sup>®</sup>.

Write for the name of our Technical Representative in your territory. He'll phone for an appointment and give you a chance to prove it to yourself. *While you are about it, why don't you ask for Bulletin MMC, Issue 1 describing the complete line of Emlock<sup>®</sup> connectors? Phelps Dodge Electronic Products Corporation, 60 Dodge Avenue, North Haven, Connecticut 06473.*

### ... Russia lags the West in measurement techniques ...

the Soviet Health Service, Minister Boris Petrovsky made so many exhortations for putting electronics into medicine that only the deaf could not have heard. He covered virtually every level—from setting up a nationwide computer network for medical data to equipping hospitals with the latest patient-monitoring equipment. How many of his proposals will eventually be realized is questionable, but the will—and presumably the money—is clearly there.

One American firm that has just entered Russian markets thinks process analysis equipment, particularly for the chemical field, is a good bet. The company, seeking a quick return on its investment, investigated a number of high-potential outlets before choosing to concentrate its merchandising efforts on this sector.

**Fair play.** Electronic measuring equipment is also a potentially lucrative area, according to knowledgeable sources. The bandwagon has already begun moving. Being held simultaneously at the end of last month, for example, were: a seven-day private show of measuring instruments by Hitachi in Moscow; a joint exhibit by 25 French firms in Novosibirsk, and a Moscow show with participation by nine electronics firms. The last was nominally for the automotive industry, but a substantial section was devoted to measuring and control equipment.

Firm after firm dealing with Russia reports that in every measuring area Soviet industry is years, if not decades, behind advanced Western practices. The Soviets know this, and a series of nine highly specialized invitation-only exhibitions this winter will deal with production applications. In every case the welcome mat is out only for firms with expertise in relevant measurement and control equipment and systems.

Soviet researchers frankly admit their shortcomings in integrated circuits. And, they concede, they can't even get into production with such technology as they have. Attempts to establish cooperative technical liaisons with American

**PHELPS DODGE** ELECTRONIC PRODUCTS CORPORATION 



# King Radio needed: capacitors that stay reliable even with extreme cold, humidity and vibration. So King Radio chose: capacitors of MYLAR.

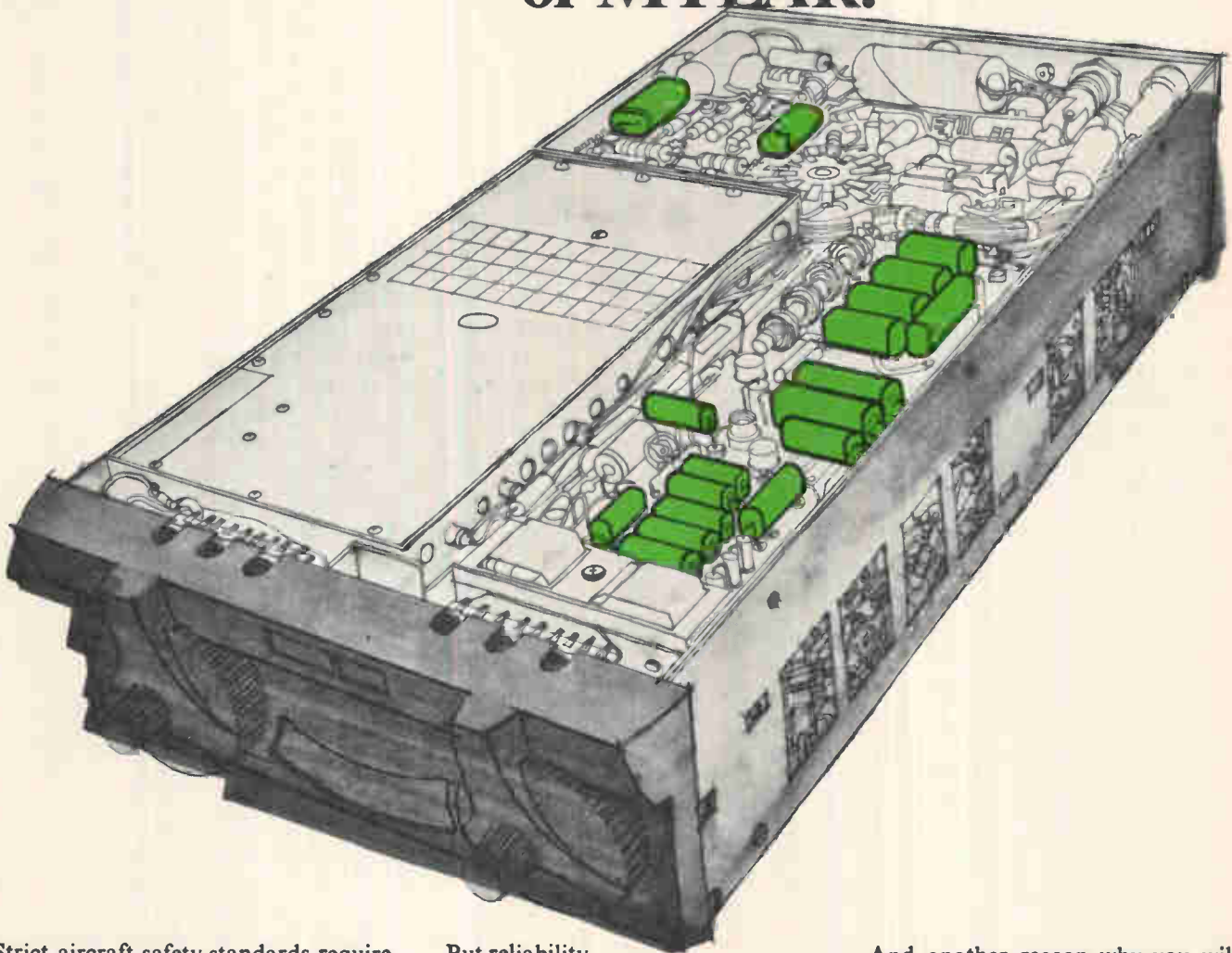

Strict aircraft safety standards require the most reliable navigation equipment available. That's why King Radio Corporation uses capacitors of MYLAR\* for their Distance Measuring Equipment. MYLAR can take temperature extremes from  $-60^{\circ}$  to  $+150^{\circ}\text{C}$ ; MYLAR remains constantly stable under humid conditions.

But reliability isn't the only reason King Radio chose MYLAR. The extremely high dielectric strength of MYLAR permits its use in thinner film, thus helping King Radio to build the lightest and most compact distance measuring unit on the market. MYLAR is available in films as thin as 15 gauge.

And another reason why you will want to investigate using capacitors of MYLAR: they usually cost no more than others. Write for complete technical data to DuPont Company, Room 4960A, Wilmington, Delaware 19898. (In Canada, for information write Du Pont of Canada Ltd., Post Office Box 660, Montreal, Quebec.)

 **MYLAR<sup>®</sup>**

DU PONT'S REGISTERED TRADEMARK FOR ITS POLYESTER FILM.

## You can selectively transfer 216 circuits with these two Ledex switches and only 10 wires

As you can see from the diagram, our Selector Switches can do a lot of work in a small space. And they'll do many different jobs, some smaller, some larger. That's why they are known by many different names.

To some engineers a Ledex Switch is a programmer or a batch accumulator. To others it's a light dimmer or binary-to-decimal converter. To you it might be a sequencer, a thermo-couple scanner, a memory pulse decoder, a destruct switch or an intervalometer.

We have 36 stock models, 28 and 100 VDC, to give you a quick start on your prototype. Or, if you've got a special problem, our engineers will come up with a custom model.

Our 36-page catalog tells all about Ledex Switches. For your copy just drop us a note. Or, call and we'll talk about your special application.

Write for catalogs on Rotary Solenoids, Push-Pull Solenoids, Stepping Motors and Rectifiers. Also check our "Package Control Service" for black box and timed switching solutions.

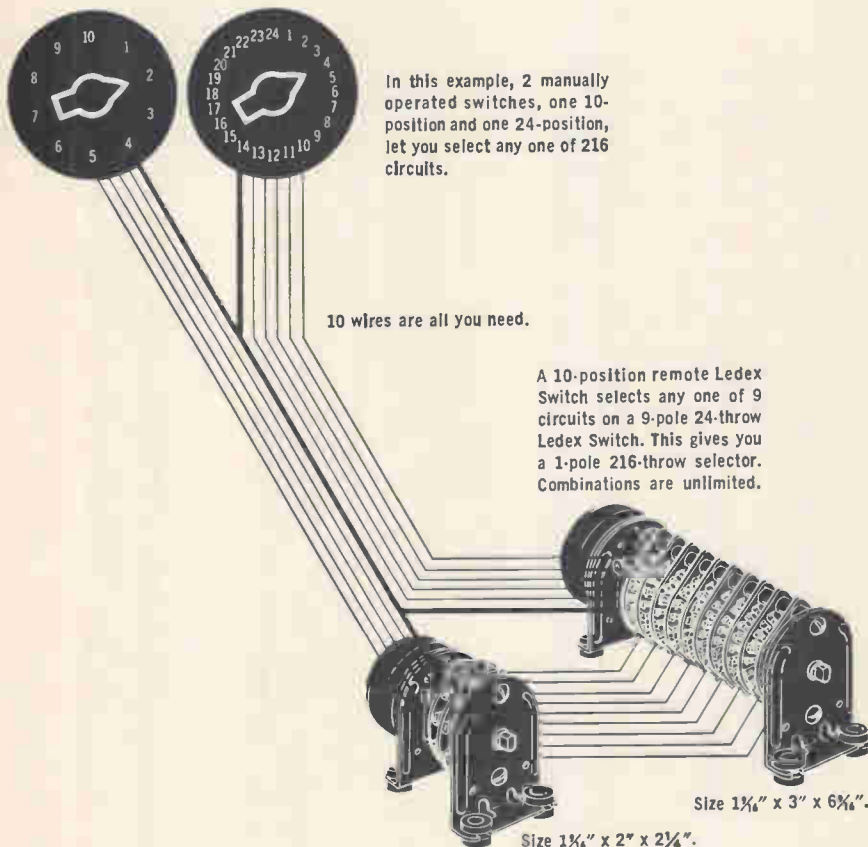

**LEDEX DIVISION, LEDEX INC.**  
123 Webster Street, Dayton, Ohio 45402 • phone (513) 224-9891  
Custom Circuitry & Controls

## ... Russia's economy suffered a third-quarter slump ...

firms have generally failed.

As a result, Moscow will sponsor a show in February and March by as many as 100 firms whose exhibits will be devoted entirely to IC's. This will be followed by an even bigger exposition in May that will be devoted to automation equipment.

### Home front

The Soviets' concentration on buying foreign technology persists despite the buoyancy of their domestic electronics industry; with output running 18% ahead of 1967, it's the fastest-growing sector of the Soviet economy. Moreover, the consumer sector is finally being emphasized as a matter of policy. Television production, 15% ahead of last year after 10 months, should reach the ambitious target of 5.7 million sets. Radio and phonograph outputs were close to the 6-million level after 10 months, up about 8% from 1967.

The Soviet Union's economy suffered a third-quarter slump largely as a result of the invasion of Czechoslovakia. Over the longer term, however, there will be pressure from shortfalls in investment funding. Electronics obviously has some priority in the competition for capital, but it still isn't getting enough. Thus, the country should continue to welcome overseas firms.

Western visitors often observe that the USSR isn't getting the productive fallout from its space electronics programs that the U.S. is. But at least part of Russia's backwardness in electronics centers on getting advanced theoretical developments into mass production. This has led to some ludicrous situations. For example, the Soviets recently achieved a notable research breakthrough: theoretical development of phased-pulse multistable circuits that can work directly on a decimal system instead of a binary code and can be integrated. But the USSR is now trying to license its development abroad because, as one engineer discreetly puts it: "The industry is too weak here, and it would take us so long to get into production."



## Helipot's new, economy dc voltage regulators are only \$10<sup>80</sup> (100 piece quantity)

Helipot's new *positive* (Model 809) and *negative* (Model 859) *self-contained* hybrid *cermet* units are designed to give you high performance at budget prices.

- 5 to 28 volts fixed outputs
- 0.003%/ma maximum load regulation
- 2 volt minimum  $\Delta V$  across regulator
- 750 ma load capability
- 34 db ripple attenuation to 100 kHz
- $-55^{\circ}$  to  $+125^{\circ}\text{C}$  operating temperature range
- Add-on capabilities include: short circuit protection with an external transistor, loads over 5 amps with an external pass transistor, and adjustable outputs with an external resistor.

These regulators are small (1" x 0.5" x 0.170" high), fully sealed ( $1 \times 10^{-7}$ ) and compatible with flat pack and dual in-line packaging. And, they're available from local stock. For more information, call your local Helipot sales representative or circle the reader service number.

**Beckman**

INSTRUMENTS, INC.  
HELIPOT DIVISION  
FULLERTON, CALIFORNIA • 92634

INTERNATIONAL SUBSIDIARIES: GENEVA, MUNICH, GLENROTHES, SCOTLAND,  
TOKYO, PARIS, CAPE TOWN, LONDON, MEXICO CITY, STOCKHOLM, VIENNA



# If you can't find it here, you can't find it.

This is just part of the broadest, most complete line of rectangular rack and panel connectors made.

The one you need is here somewhere among the hundreds of industry favorites, old standbys, newer double density and environ-

mental types, subminiatures and microminiatures. Whatever your industry and wherever your application, ITT Cannon makes the rack and panel connectors you need.

And they're available in quantity right now from your nearby ITT

Cannon factory authorized distributor. If he doesn't have exactly what you need, he can get it for you. ITT Cannon Electric, 3208 Humboldt St., Los Angeles, California 90031. A division of International Telephone and Telegraph Corporation.

Circle 132 on reader service card

**CANNON ITT**



**TRW**  
**Metallized**  
**Mylar Capacitors**

**are different**

**The little things set them apart.**

Things like superior electrical properties. Better environmental properties, too.

Things like variety. Tape-wrap, epoxy or hermetically sealed. Axial or radial leads. Voltages from 50 volts to 600 volts. Values from .001 mfd. to 10.0 mfd. And

tolerances to 1%.

And not so little things like unequalled experience in metallized mylar\*. And the technical know-how to meet special requirements. They all add up to a big difference!

Contact any TRW distributor, or TRW Capacitors, Box 1000

Ogallala, Nebraska. Phone (308) 284-3611. TWX 910-620-0321. TRW Capacitors is a Division of TRW INC. \*DU PONT REGISTERED TRADEMARK

**TRW**

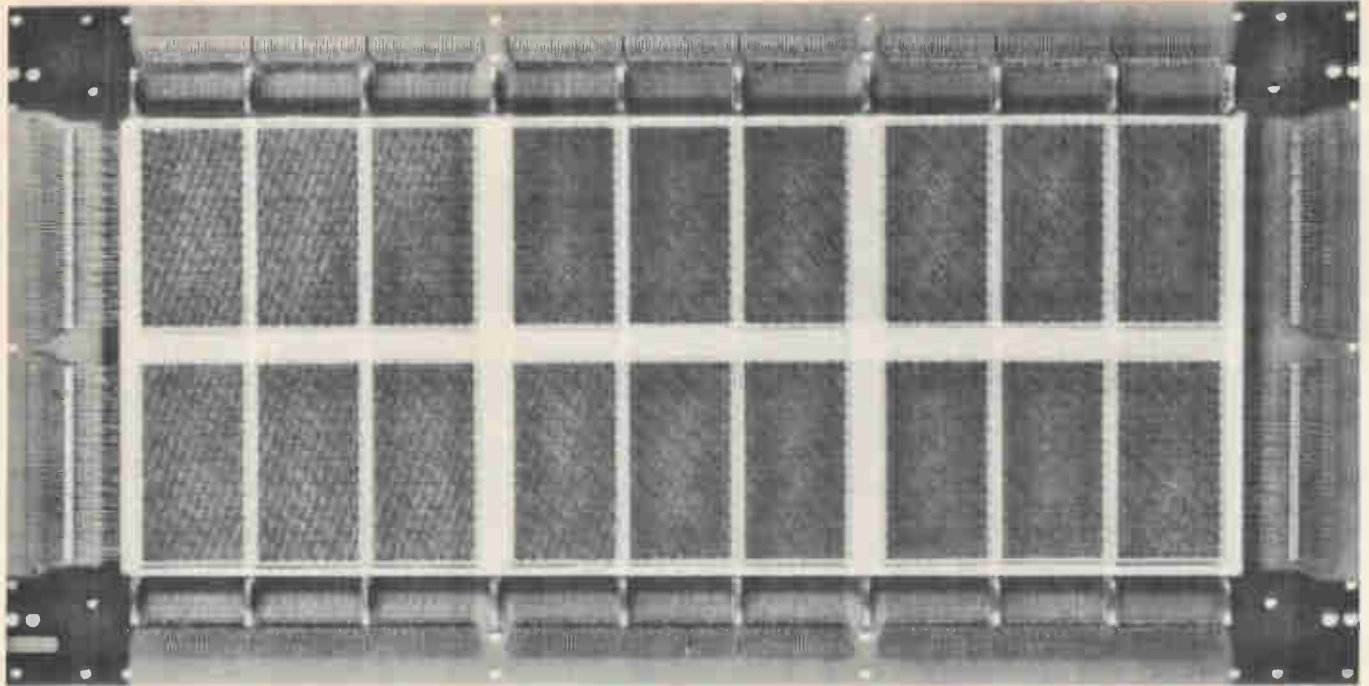

# THE BEST OF BOTH DIMENSIONS

Here's a 2½D core memory array that combines the advantages of 2D and 3D types. It makes possible a whole new generation of computers. Advanced manufacturing techniques developed by Hitachi produce the tiny 16-mil cores. This assures high reliability coupled with low cost. Hitachi's PE0903 Memory Array features a memory cycle of only 420 nano-seconds. It consists of HFC158 cores arrayed 128x64x18 and is intended for use in memory systems operating in an ambient temperature range of 0 to 45°C. It's designed to permit direct plane-to-plane stacking. And it's available right now. Other types are in production and special-purpose memory arrays may be ordered.

## RESPONSE CHARACTERISTICS:

Temperature .....	25 ± 1°C
"Read" Pulse .....	400 mA
"Write" Pulse .....	400 mA
Strobe "1" (min.) .....	30 mV
Strobe "0" (max.) .....	8 mV
Peaking Time (av.) .....	90 nsec.
Switching Time (max.) .....	170 nsec.

## HITACHI MEMORY CORES (Coincident Current Type)

Core Material Classification	OD (mils)	Core Type	Typical Operating Conditions at 25°C						
			Drive Current Conditions			Output Signals			
			$I_r/I_d$ (mA)	$t_r$ (μ sec)	$t_w$ (μ sec)	$DV_1$ (mV)	$DV_2$ (mV)	$t_p$ (μ sec)	$t_s$ (μ sec)
Conventional Standard	50	H 5031	360/180	0.200	1.000	53	10	0.50	1.10
	30	HFC 338	520/260	0.100	0.300	54	7	0.20	0.35
	30	HFC 330	520/260	0.100	0.300	52	7	0.19	0.34
	30	HFC 308	680/340	0.100	0.320	60	6	0.20	0.35
	20	H 5020	680/340	0.050	0.180	46	6	0.11	0.20
Medium Temperature Range	50	H 5033	550/275	0.200	3.500	55	7	0.450	0.900
	30	H 5006	550/275	0.100	0.350	51	7	0.240	0.460
	18	H 5009	520/260	0.100	0.280	38	2.2	0.19	0.315
	18	H 5015	750/375	0.050	0.200	54	4.5	0.12	0.21
	16	H 5022	700/350	0.030	0.120	60	8	0.07	0.120
Wide Temperature Range	30	HFC 354	740/370	0.100	0.400	56	6	0.21	0.45
	20	HFC 258	894/447	0.050	0.160	42	4.8	0.11	0.19
	16	HFC 158	800/400	0.030	0.120	52	7.5	0.073	0.13



Write Hitachi for full information and specifications.

Hitachi Sales Corporation: 333 N. Michigan Ave., Chicago, Ill. 60601, U.S.A. Tel: 726-4572/5  
Hitachi Düsseldorf Office: 4 Düsseldorf, Graf Adolf Strasse 37, West Germany Tel: 10846





This new cathode-ray projection tube offers more light, higher resolution, and longer life than is available with other such tubes. With it, any conventional type of CRT display can be projected for viewing by large or small groups.

The tube features small packaging, conventional circuitry require-

ments, and rugged construction. Using a beaded viewing or rear-projection screen, a brightness of 50 foot lamberts can be achieved on a 3' x 4' display. Resolution exceeds 600 lines. And the tube's life expectancy—under high brightness conditions—exceeds 500 hours.

Projectoray's advanced technical features are the result of these major developments:

1. The use of an optically clear, thermal conductive face panel that cools the phosphor with a rim-mounted heat exchanger. This new concept in phosphor cooling inhibits electron beam damage to the phosphor, greatly reduces the saturation effect

on light output, and increases tube life.

2. A tube design that permits the use of a highly efficient lens system, which provides focusing over various projection distances for large or small groups.

For a demonstration of the Projectoray in operation at our plant, call or write: *Raytheon Company, Industrial Components Operation, 465 Centre Street, Quincy, Massachusetts 02169. Tel: 617-479-5300, Ext. 337.*

**RAYTHEON**

## New Projectoray™ CRT brings long life and high light output to large screen displays.



# More MSI from Transitron

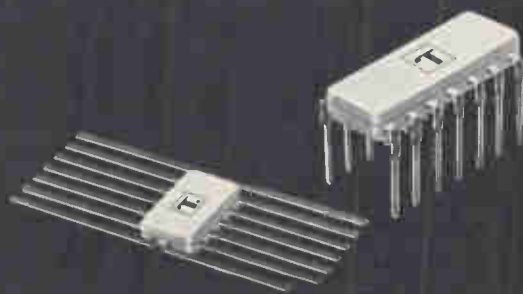

Now available for immediate shipment — 2 new complex circuits with industry's best performance

## BCD-to-Decimal

### DECODER-DRIVER

- High breakdown voltage — 70V min.
- High sinking current capability — simplifies power supply filtering requirements
- No background glow, no oscillation
- Low power consumption — typically 10mA @ 5V
- Compatible with TTL and DTL levels
- Only decoder-driver available in 16-pin hermetically-sealed ceramic dual in-line package
- Also available in 22-lead ceramic flat pack and 16-pin epoxy dual in-line package

## Industry's Fastest (60 MHz)

### 4-BIT RIPPLE COUNTER

- High speed — typically 60 MHz
- Low power consumption — typically 180mW @ 5V
- High output current drive — typically 20mA
- Master-slave flip-flops provide application versatility
- Internal buffers provide low input current loading
- Buffered outputs prevent false output signals
- Full TTL compatibility (easily interfaces with other logic)
- Available for industrial or military temperature range operation
- Available in 14-lead flat package (suffix G) or 14-lead dual in-line package, ceramic (suffix P) and plastic for 0-75°C (suffix E)
- Both binary and BCD versions available in two pin configurations:
  - 4/10 { TRC 2511-14, Binary Ripple Counter  
TRC 2515-18, BCD Ripple Counter
  - 7/14 { TRC 2521-24, Binary Ripple Counter  
TRC 2525-28, BCD Ripple Counter

Send for complete data on these and other Transitron MSI functions. Available without charge.

**Transitron**  
electronic corporation  
168 Albion Street Wakefield, Massachusetts 01880

# The only recognized\* thermosets are Durez.<sup>®</sup>

*\*Recognized under the  
Component Program of  
Underwriters' Laboratories, Inc.*

These are the molding compounds that can save you time and money on end-product evaluation.

For detailed data sheets, simply check the numbers you're interested in and mail us the card. Durez Division, 9012 Walck Road, North Tonawanda, N. Y. 14120.

 **hooker**  
durez DIVISION

Guide No. 1819 N16.16-C. July 8, 1968 E39252.  
Component—Plastic Materials.

Hooker Chemical Corp., Durez Plastics Div.,  
North Tonawanda, N. Y. 14120

Durez phenolic molding compounds, Nos. 1308, 1328, 18975, 19089, 21426, and 22262; minimum thickness  $\frac{1}{8}$  in. for use at temperatures not exceeding 155 C.

Durez phenolic molding compound, No. 11864; minimum thickness  $\frac{1}{8}$  in. for use at temperatures not exceeding 170 C.

Durez phenolic molding compound, No. 791; minimum thickness  $\frac{1}{8}$  in. for use at temperatures not exceeding 150 C.

Alkyd molding compound, No. 24480; minimum thickness  $\frac{1}{8}$  in., for use at temperatures not exceeding 155 C.

Alkyd molding compound, No. 24525; minimum thickness  $\frac{1}{8}$  in. for use at temperatures not exceeding 170 C.

Alkyd molding compound, No. 24150; minimum thickness  $\frac{1}{8}$  in. for use at temperatures not exceeding 180 C.

Identification: Company name and number designation on container.

Reexamination Service—See General Information Card of above guide number.

For use only in equipment where the acceptability of the combination is determined by Underwriters' Laboratories, Inc.

Reports: July 16, 1968; July 16, 1968; July 16, 1968; July 16, 1968; July 16, 1968; July 16, 1968.

PRINTED  
IN  
U.S.A.

This card is issued by Underwriters' Laboratories, Inc. ®

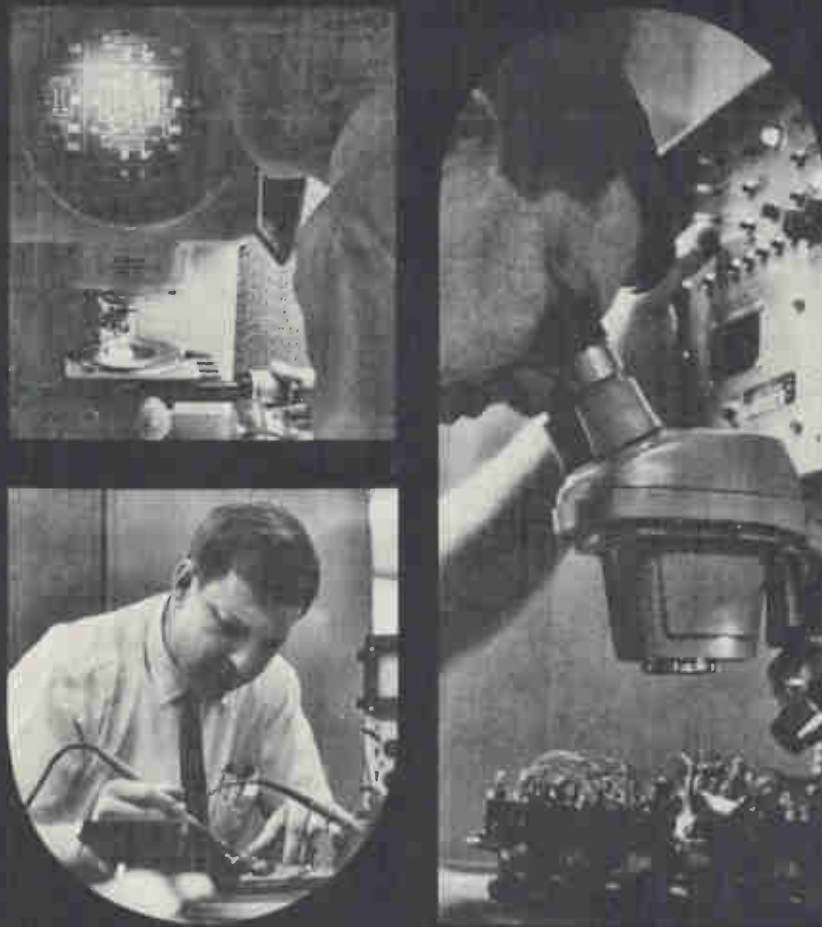

## Which discipline will Ed Whitaker use tomorrow

When Delco says multi-disciplinarian, they mean it. Just ask Ed Whitaker. And the solid professionals who have helped him grow into jobs like developing the microcircuits for a fire and overheat detection computer for jet aircraft. Twenty-five hundred components in a package 4" x 2" x 1/2". From concept to hardware in eight months flat. And then a fast hop to Air Force testing. From beginning to final delivery, Ed was a full member of the team. The question is . . . does your job permit you this kind of growth? Take a good look at how your career shapes up, compared with Ed Whitaker's and his colleagues at Delco. You might even call us collect. Or, write: Mr. C. D. Longshore, Supervisor, Salaried Employment, Dept. 604, Delco Radio Division of General Motors, Kokomo, Indiana.

**DELCO  
RADIO**



MARK OF EXCELLENCE

AN EQUAL OPPORTUNITY EMPLOYER  
DIVISION OF GENERAL MOTORS  
KOKOMO, INDIANA

Suppose you need to see a sequence of pictures within seconds after you make the exposure.

But you are in a remote location.

You have no facilities or means to process conventionally.

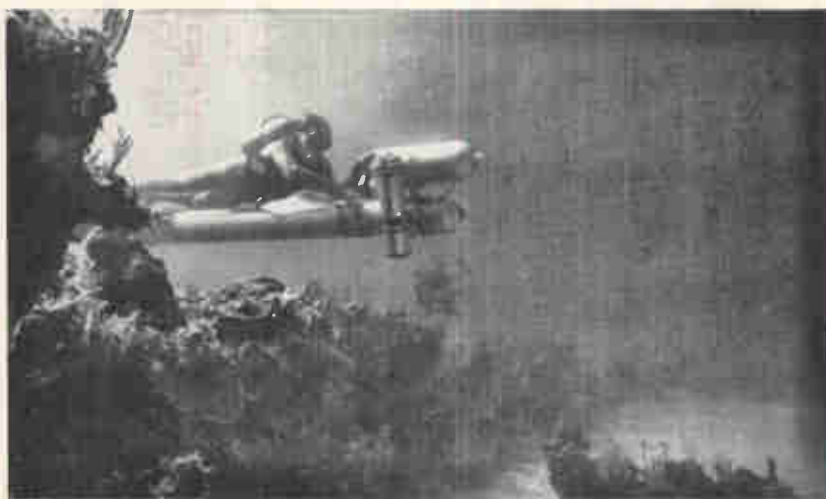

## You might do it easily with new Kodak Bimat Transfer Film.

Difficult data-collection problems are everyday fare at Kodak. Photography is extremely adept at gathering and recording data that escape other methods.

KODAK BIMAT Transfer Film is an example. Still under development for its total potential, but already able to serve well in situations such as the one illustrated here. The oceanographer needs his positive pictures (and negatives) just minutes after releasing the shutter. He gets both simultaneously with a system using KODAK BIMAT Transfer Film. He knows he has his data before leaving the surface area.

Fast, convenient, dependable. Qualities you expect from Kodak. Now applied to the advancing sciences.

You may not need to study the ocean floor. But, if your needs include data collection where the location is remote, when conventional processing is impossible, and playback of sequential information is needed immediately, you might do it easily with new KODAK BIMAT Transfer Film.

To learn more about new KODAK BIMAT Transfer Film and how it might serve you, or to learn if some other problem you face might respond to a Kodak solution, use the coupon below.

Department 412L  
EASTMAN KODAK COMPANY, Rochester, N. Y. 14650  
Please send me information on KODAK BIMAT Transfer Film and liquid-free, rapid-access processing.

Name \_\_\_\_\_

Position \_\_\_\_\_

Company \_\_\_\_\_

Address \_\_\_\_\_

City \_\_\_\_\_

State \_\_\_\_\_ Zip \_\_\_\_\_

1248

Kodak

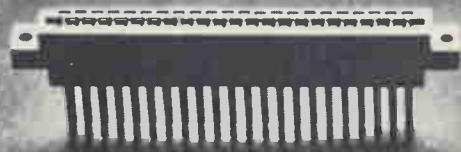

## After 17 years Sylvania breaks with custom.

You probably never knew it, but Sylvania is one of the biggest makers of precision-built circuit-board connectors. For years we have been supplying the biggest names in the computer and communications fields. But strictly on a custom basis.

Some of our custom designs have become industry standards. And now we are making them available as off-the-shelf items. This means you can now get the benefits of cus-

tom design without tooling or set-up charges.

And it means you can buy in small quantities at low prices.

You get Sylvania's special welded gold-dot contact design that puts the gold only where it's needed for low contact resistance (less than 50mV drop at 5A). And less gold means less expense.

You also get Sylvania's precision construction that puts wire-wrap terminals exactly in the right posi-

tion for programmed wiring systems.

Formats available include: 44-pin single position, 20-pin single position, 212-pin eight position, and 220-pin five position. Contact ratings up to 5 Amperes.

If these types won't fill your needs, remember we're still one of the biggest names in custom designs. Call us. Sylvania Metals & Chemicals, Parts Division, Warren, Pa. 16365.

CONNECTORS BY  
**SYLVANIA**  
A SUBSIDIARY OF  
GENERAL TELEPHONE & ELECTRONICS

# New Products

Peripheral equipment

## Graphics terminal displays attractive figure: under \$10,000

Unit with storage crt handles alphanumeric and vectors; it's being unveiled at Fall Joint Computer Conference

By Walter Barney

San Francisco bureau manager

When Tektronix Inc. introduced last year a storage cathode-ray tube suitable for use in a graphic-display computer terminal [Electronics, Oct. 16, 1967, p. 165], many figured that it was only a matter of time before the company followed up with a complete terminal. They were right. At the Fall Joint Computer Conference in San Francisco, Tektronix is unveiling its type 4002 graphics computer terminal, including storage crt, terminal control, character generator, and keyboard. The terminal provides full alphanumeric and graphic display of data entered from a keyboard or auxiliary input, at a price which the company says will be under \$10,000.

The storage tube, which doesn't require refreshment to maintain its display, is most suitable for time-shared computer systems, because it can operate at the end of a 2,000-bit-per-second telephone line. The first terminal has been tailored to the Digital Equipment Corp.'s PDP-8 computer; the terminal control inputs and outputs operate with standard DEC software. Tektronix has indicated that the terminal may be marketed through DEC or other computer manufacturers as well as through Tektronix' own

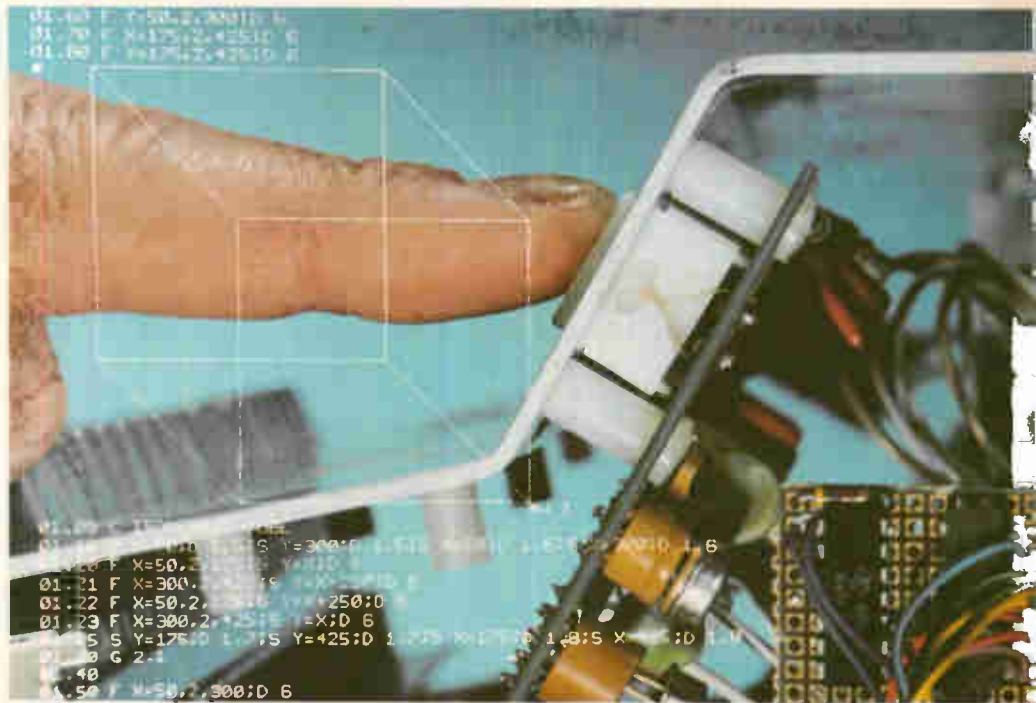

Controller. Pushbutton switches just above terminal keyboard use integrated circuits for switching and logic functions.

sales force and field offices.

Keith Williams, vice president and marketing manager, expects the 4002 to appeal to some users who are now making manual plots from computer data. He concedes that the popular x-y plotter made by California Computer Products

Inc. does provide a kind of low-cost graphics, but he indicates that Tektronix thinks of the Calcomp plotter as complementary equipment to the 4002. Williams also says that the 4002's faster writing means using less computer time than either an x-y plotter or a teletypewriter



Loner. Terminal reads out alphanumeric and vectors, retains display without recycling of information by computer.

is likely to use.

**Blank buttons.** The terminal won't be available until next August. John Griffin, manager of the electronics section of Tektronix' Information Display division, says the advance peek during the conference will "give computer people time to start thinking about graphics software." Three buttons that will be blank on the terminal shown at the conference will have a function that relates to one of the major drawbacks of the storage tube when used for computer display: the inability to erase selectively. Neither Williams nor Griffin will give details, but the terminal that will be available next summer will have some sort of off-line editing capability.

Meanwhile, Tektronix has doubled its ceramic tube production, indicating that it expects the storage tube to grab a good share of the terminal market. The 611 display unit introduced a year ago is already going into a rival computer terminal built by Computer Displays Inc. [Electronics, Feb. 19, p.

50]. It is priced at \$12,750.

The 4002 has these features:

- Flicker-free display covering more than 50 square inches on an 11-inch diagonal.
- The ability to retain traces indefinitely; however, erasure after an hour is recommended.
- The ability to plot lines, points, and characters in any format.
- A writing speed of 1,000 characters per second and a line-drawing speed of 200 inches per second.
- The capacity to display 2,800 characters.
- The ability to generate the full ASCII code of 96 characters and 32 commands.

The terminal consists of the display unit, a character generator, a control unit that contains plotting logic and a digital-analog converter, an input/output module to interface with a computer or a data modem, and a keyboard. All but the last were designed and built by Tektronix; the keyboard is purchased from the Micro Switch division of Honeywell Inc. [Electronics, Sept. 16, p. 169].

**Discrete memory.** The tube is a modified version of the direct-view, bistable 611. The screen will present up to 35 lines of alphanumeric characters (with 80 characters per line) any kind of graphics, or both graphics and alphanumerics.

The graphics can be preplotted by subroutines, plotted incrementally, or drawn by linear interpolation, in which the computer plots a line between two addressed points on the crt. The interpolator, says Griffin, is a high-speed integrator consisting of two current sources to charge separate capacitors that deliver voltages to the x and y deflection plates.

Characters are generated in the usual way by a read-only memory built with 1,600 diodes. The ASCII code—seven bits from the computer—for a character is decoded into one of 96 lines that address the read-only memory. Simultaneously, x and y counters set the beam to stepping through a 7-by-9-dot matrix; these x and y lines are also two of three inputs to three-way AND gates in a scanning sense array; if it indicates that a given dot is in the character pattern, the gate opens and the signal unblanks the beam.

Griffin says that Tektronix may at some point integrate the read-only memory but that at present monolithic memories can't compete in price with the discrete types. There are, however, Tektronix-designed integrated circuits in a new type of pushbutton on the front panel. One such switch, for example, changes the terminal from keyboard to magnetic or paper tape operation.

The switches were designed to be shallow yet to permit multiple functions and be lighted from multiple sources. The button travels only 1/16 of an inch to operate the switch, and thus is unlikely to get out of trim. The IC has a flip-flop to establish its binary state and multiple outputs to send logic signals to the rest of the circuitry and to light the switch lamp. Eight packages perform the switching, logic functions, and lamp-driving for all 13 special switches on the front. Griffin says the new switches will undoubtedly show up in other Tektronix instruments.

Tektronix Inc., P.O. Box 500, Beaverton, Ore. 97005 [338]



**Goldilox™ built-in protection system gives even greater Mil Spec reliability to linear ICs.**

**And that's no fairy tale.**

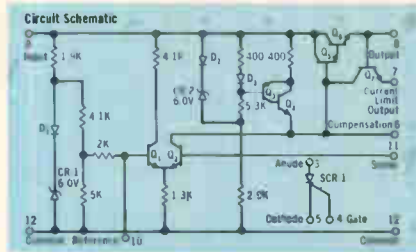

**WC 109 voltage regulator** — Today's standard of commercial product reliability. This device in the TO-5 package meets the most severe environmental testing available. Priced at \$3.60 in lots of 1000 or more.

Exclusive Goldilox protection extends mil spec reliability even further. It's built

right into the circuit at critical points. A glass-over layer seals out moisture at interconnects. Devices have been operated under water for over one hour, without packaging. Other Goldilox features guard against heat damage, inversion and current leakage.

That's why Goldilox protection is being added to many Westinghouse linear devices: audio, video, operational and differential amplifiers; voltage regulators; SCR packages. For full data, call our local sales office or Westinghouse Molecular Electronics Division, Elkridge, Maryland (301) 796-3666.

J-09151

You can be sure... if it's **Westinghouse**



# Goldilox ICs thwart moisture.



# get

TOP CRYSTAL TECHNOLOGY

INSTANT STABILITY

LOW AGING

LOW POWER DRAIN

LOW VOLUME PACKAGING

with

# new Bliley TCCO's

[TEMPERATURE COMPENSATED CRYSTAL OSCILLATORS]



## TYPICAL DESIGN SPECS

Frequency Range: 1-20 MHz  
Stability:  $\pm 2 \times 10^{-7}$  over 0°-50° C range  
Input: 12Vdc or 5Vdc  
Output: Sine/Square/Logic Options  
Size: Under 2.5 cu. in.  
Request Bulletin 549 for complete details

**Bliley** If you buy quality

# BLILEY ELECTRIC COMPANY

Data handling

## Total recall on one board

Core memory for small computers and peripheral equipment has its own drive, decode, and power monitoring circuits

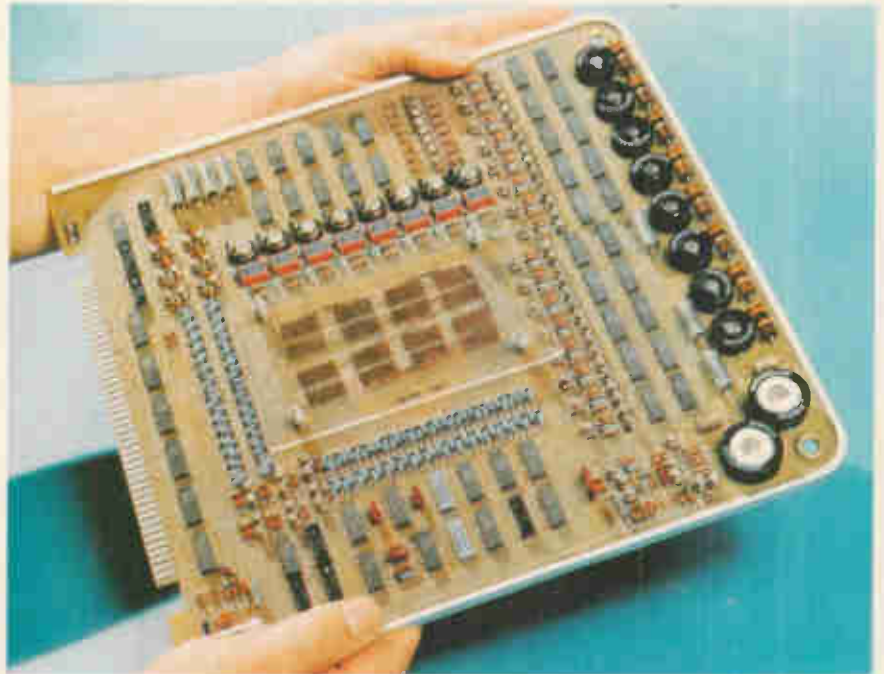

All together. Arrayed around mats of memory cores in center are the drive and decode electronics that make this assembly a complete memory.

Half a memory may be better than none, but equipment makers are primarily interested in complete memories that can be plugged into their small computers, peripheral equipment, or numerical control directors.

That's how Sanders Associates sees the market for memories, and that's why it developed Memcard, a series of core memories complete with drive and decode electronics.

These complete memories for the digital equipment market also have to be inexpensive. The first of the Memcard series, to be introduced at the Fall Joint Computer Conference, is a 1,024-word, 8-bit-per-word random access memory that will sell for about \$650 in 100-unit lots. It is a 3-D, three-wire memory of coincident current design.

The price is \$50 to \$150 less than for competing equipment, according to Melvin W. Thompson, marketing

the Nashua, N.H., firm.

**Fast cycle.** Prices are figured in many ways in the memory business, so it's tough to tell whether \$650 is good or bad unless it's known what it buys. In this case, it buys core mats, address, digit, and decode registers, a built-in clock, and a feature usually reserved for main-frame power supplies: a power monitoring circuit that helps preserve the stored data if power fails.

The memory is on a printed-circuit board 12 by 11.375 by 0.75 inches—a format used in the special circuit boards developed for the Data General Corp.'s Nova computer [Electronics, Sept. 30, p. 147]. According to John R. Gillespie, senior staff engineer at Sanders, the devices Memcard would compete against use three or more cards, and are 30% to 50% bulkier. "We wanted to build something a main

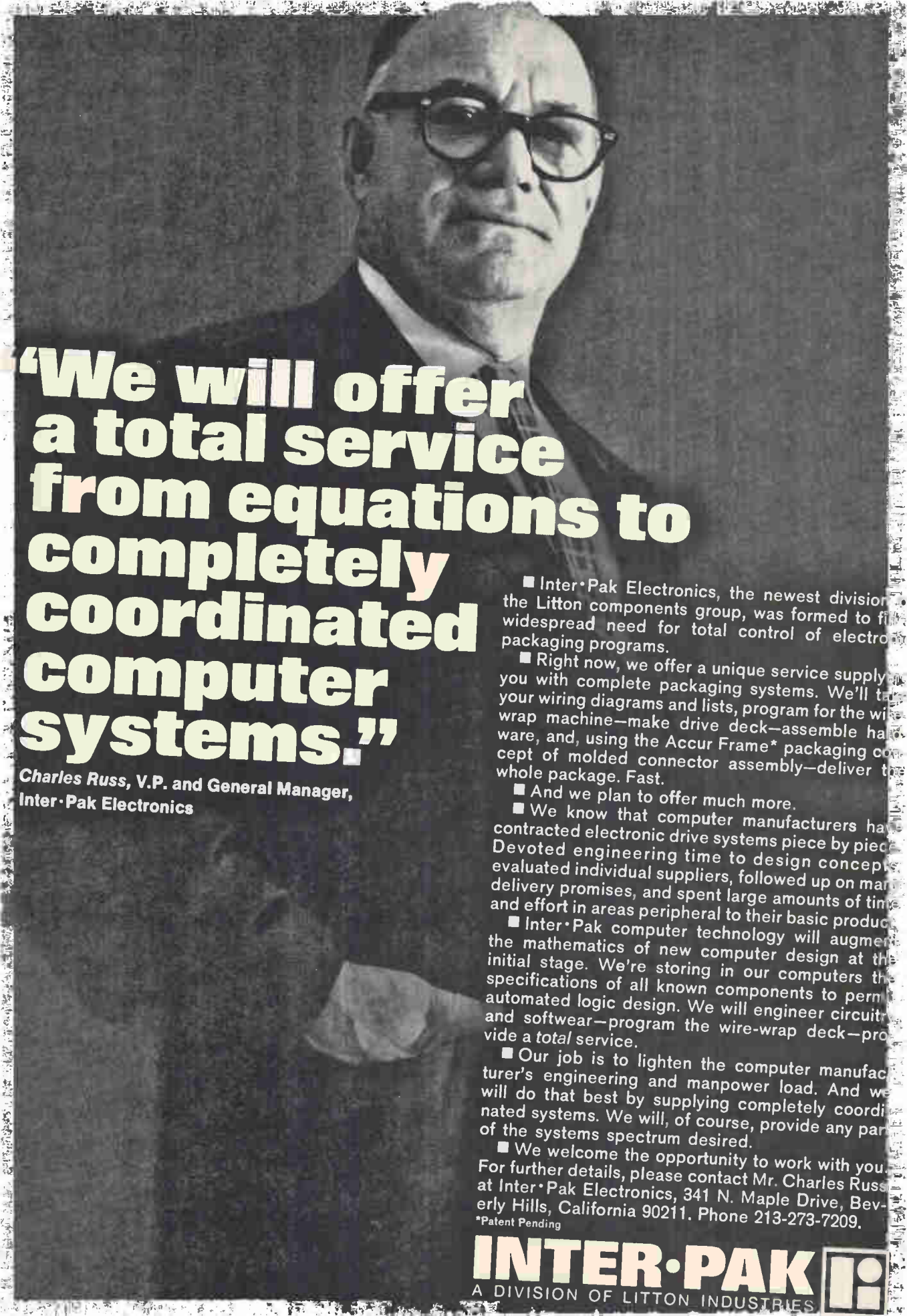

**"We will offer  
a total service  
from equations to  
completely  
coordinated  
computer  
systems."**

**Charles Russ, V.P. and General Manager,  
Inter-Pak Electronics**

■ Inter-Pak Electronics, the newest division of the Litton components group, was formed to fill the widespread need for total control of electronic packaging programs.

■ Right now, we offer a unique service supply you with complete packaging systems. We'll take your wiring diagrams and lists, program for the wire-wrap machine—make drive deck—assemble hardware, and, using the Accur Frame\* packaging concept of molded connector assembly—deliver the whole package. Fast.

■ And we plan to offer much more.

■ We know that computer manufacturers have contracted electronic drive systems piece by piece. Devoted engineering time to design concepts, evaluated individual suppliers, followed up on manufacturing delivery promises, and spent large amounts of time and effort in areas peripheral to their basic products.

■ Inter-Pak computer technology will augment the mathematics of new computer design at the initial stage. We're storing in our computers the specifications of all known components to permit automated logic design. We will engineer circuitry and software—program the wire-wrap deck—provide a total service.

■ Our job is to lighten the computer manufacturer's engineering and manpower load. And we will do that best by supplying completely coordinated systems. We will, of course, provide any part of the systems spectrum desired.

■ We welcome the opportunity to work with you. For further details, please contact Mr. Charles Russ at Inter-Pak Electronics, 341 N. Maple Drive, Beverly Hills, California 90211. Phone 213-273-7209.

\*Patent Pending

**INTER-PAK**   
A DIVISION OF LITTON INDUSTRIES

**The BIG INCH Series 31000 3-Wire Stepper . . .** Unique principle drives rotor 360° for each pulse cycle. Other step angles available through integral gear reduction. An economical solution whenever compact unidirectional stepper drives are needed.

**The BIG INCH Series 31600 Reversible Step Servo . . .** Bi-directional operation is obtained by energizing four coils in sequence or can be driven by simple logic circuitry up to 200 steps per second. Ideal for instrument drives.

**The HSI BIG INCH™ line is truly revolutionary.** No brushes, commutators or ratchets to limit life; an almost infinite variety of ways to actuate and drive. Send for catalog with complete details on features, applications and circuitry.

## **HAYDON SWITCH & INSTRUMENT, INC.**

1500 Meriden Rd., Waterbury, Ct. 06720 Tel: (203) 756-7441

**Two  
great new  
steppers  
from H·S·I**

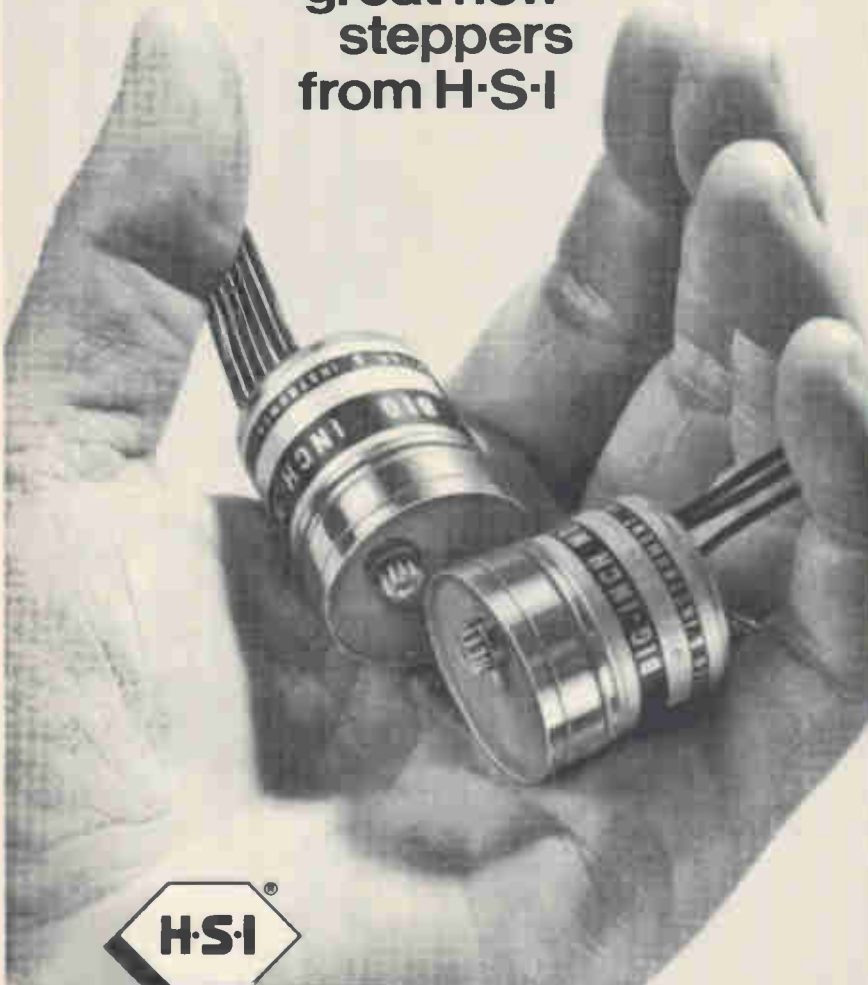

**. . . display refreshment  
is one sales target . . .**

connector without having to worry about connector adapters or interfacing logic. We've tried to put all in one piece," Gillespie says.

Memcard's cycle time is from 1 to 1.5 microseconds; competing units average about 4 microseconds. Access time for the Memcard's 1,024-word memory is 450 to 600 nanoseconds, Gillespie says.

Much of the savings in Memcard result from volume purchase of parts and the resulting low unit prices. Also, Sanders' production is fully automated. "It takes only 45 minutes to make one of the 1024's," says Freeman. "Besides, we were already in this business, having sold core memories for avionics systems, for electronic-counter-measure systems, and even some for large commercial computer applications. It was just a case of borrowing the expertise from other parts of the company."

This expertise has resulted in a system with what Gillespie calls "a more than adequate waveform." The user who takes care with mainframe lead dress won't even need to use baluns" (costly and bulky devices for load matching).

**Refreshing job.** According to Gillespie, the inexpensive core system may compete with delay lines for the job of refreshing computer displays.

"Memcards organized on a one-bit-per-word, 8,000-odd word basis could sell for about \$300 to \$350," he says. "Delay lines are only \$50 or so cheaper and offer no random access capability. Memcard could offer not only random access but sequential character generation."

Sanders' own model 720 display console may be the first system to use this inexpensive refreshment system. Coming up in January is a larger Memcard module, this one 4-kilobit, 18-bit-per-word module that will be expandable to 32 kilobits. It will take two cards, but Freeman says other devices need from four to seven p-c boards to do the same job.

Delivery time for the first Memcard is 30 days.

# Corning introduces the 2½ cent bit.

In the newest CORNING® Low Cost Digital Memory Modules for serial storage.

Each bit costs 2½ cents, for 4096 bits @ 16 MHz, in the 1000-module bracket.

More modules—less cost. And even for 100 units, your total cost is less than a nickel per bit.

CORNING modules plug in. TTL interface circuitry has been done for you. The medium is proven zero-TC glass from Corning. Stable. Rugged.

These modules are available now, off the shelf.

Specials on request.

For specs and to see a sample, write Corning Glass Works, Electronic Products Division, Advanced Products Dept., Raleigh, N.C. 27604. Telephone (919) 828-0511, Ext. 262.

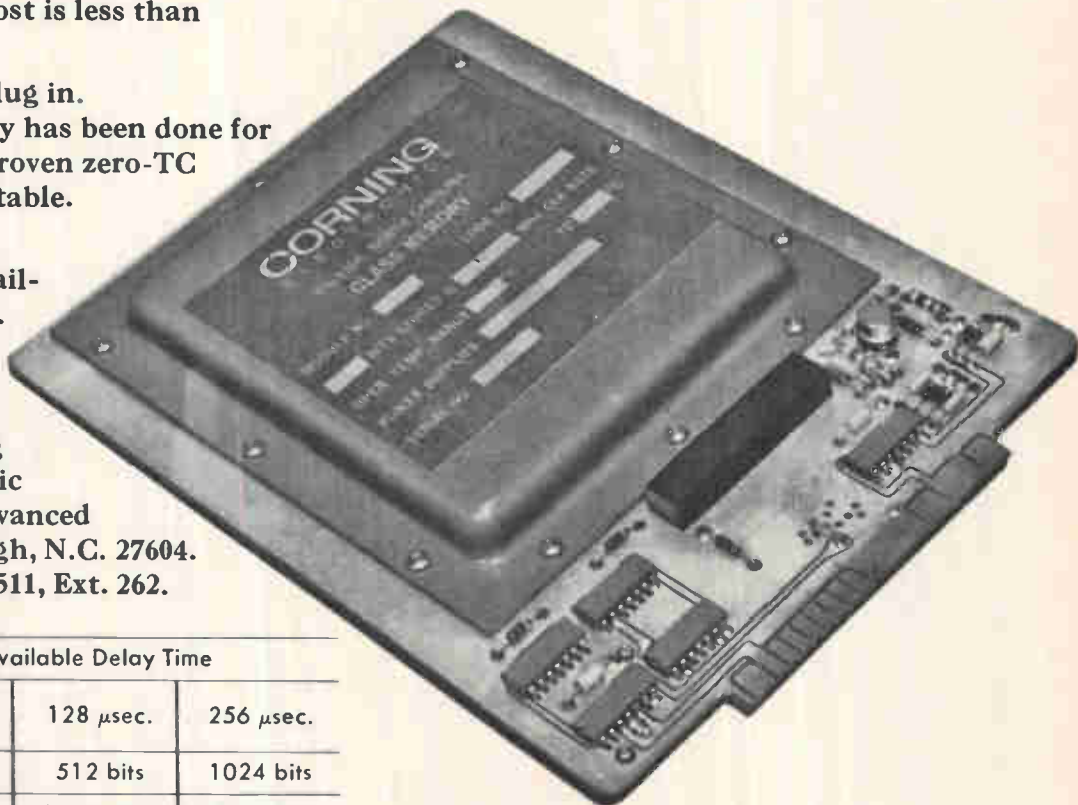

Available Frequencies	Available Delay Time		
	64 μsec.	128 μsec.	256 μsec.
4 MHz	256 bits	512 bits	1024 bits
8 MHz	512 bits	1024 bits	2048 bits
16 MHz	1024 bits	2048 bits	4096 bits

**CORNING**  
ELECTRONICS

This is the most powerful, yet easiest to use, calculating/computing system available. It's also the most versatile. You can create your own individualized system by selecting true building block modules from a family of peripheral devices larger than all competitive calculating products combined. Start with a basic 300 Series calculator if you like; add accessories as needs grow without worrying about compatibility, obsolescence, retraining or special program languages. The 370 will loop, branch, perform subroutines and manipulate arrays. You can have up to 480 steps of program storage and up to 64 separate data storage registers, also automatic typewriter or teletypewriter output. CRT graphic display and time-sharing basic keyboards for your associates.

**The 370 solves these problems . . .**

for Engineers and Scientists:

**Inversion of 6 x 6 Matrices,  
Roots of Equations,  
Up to 7 Simultaneous Equations,  
Fourier Analysis.**

for Statisticians:

**Mean, Variance and Standard Deviation,  
2nd-order Regression Analysis,  
Distributions such as:  
Binomial, Normal Probability, etc.**

And also:

**General Nth-order Regression,  
Multiple Regression,  
Analysis of Variance,  
Factorial Design.**

These and many other highly-useful programs are furnished free in a 250 page program library. Three volumes of basic calculator programs and a two-volume 370 reference manual are also offered. Call now for complete details.

**Solves problems  
ordinary calculators can't,  
full-scale computers  
shouldn't.**

**Wang 370**



**WANG**

Data handling

## A quick-change braid memory

Potted-core module  
can be replaced  
in 15 seconds

**One of the advantages** of braided-wire read-only memories, which are sold principally by Memory Technology Inc., is the ease with which a user can rewire their contents. Merely looping fine wire around U-shaped cores in a given pattern can change the binary content of a stored word.

Often, however, a word or a bit isn't enough, and a new read-only memory is needed. For example, if a programmed machine tool is to stop making nuts and start making bolts, the difference is enough to require a new set of data.

Now such new sets can be supplied in as little as 10 or 15 seconds. Memory Technology has developed a quick-change version of its braided memory and will announce both military and commercial versions this week at the Fall Joint Computer Conference.

**Four boards.** "In many ways, our new braid system is similar to our standard small-braid system; both can hold up to 20 kilobits of data," says John J. Marino, MTI president. "The differences lie in the shape and size of the new memory and the ease with which it can be changed—and exchanged."

The standard system is bolted to a single printed-circuit board about 9 by 11 inches, but the new memory contains the same circuitry on four boards in a package 10.5 by 6 by 2 inches. One board contains the solid, potted array of cores and the interconnection wire called the



TO-3



TO-66

# rugged! low cost!

## SINGLE DIFFUSED INTERMEDIATE FREQUENCY SILICON POWER TRANSISTORS

TYPE NO.	PACKAGE	CURRENT	V <sub>CEO(SUS)</sub>
2N3441	TO-66	3.0A	140V
2N3054	TO-66	4.0A	55V
2N4347	TO-3	7.0A	120V
2N3442	TO-3	10.A	140V
2N4348	TO-3	10.A	120V
2N3055	TO-3	15.A	60V
2N3773	TO-3	15.A	140V
2N3772	TO-3	20.A	60V
2N3771	TO-3	30.A	40V

Rugged reliability. Superior performance. That's what you'll get with Solitron's single-diffused NPN silicon power family. They're ideal for power supplies, audio power stages, series and shunt regulators, inverters . . . for every intermediate frequency application. All of these transistors are low priced and are available for immediate shipment.

*Dial 1-800-327-3243 for a "No Charge" telephone call and further information.*

from **Solitron**, of course!

**Solitron** SEMICONDUCTOR DIVISION

**DEVICES, INC.** / 1177 BLUE HERON BLVD. / RIVIERA BEACH, FLORIDA 33404 / TWX: 510-95266

# Low cost way to sensitive AC Null-Sensing

(servo/differential control)



## Sensitak® Solid-State / Dry Reed Relays

- Isolated dry reed load contacts
  - 1, 5, or 500 mV ac signals
  - -20°C to +70°C ambient
  - Epoxy encapsulated
  - Many applications

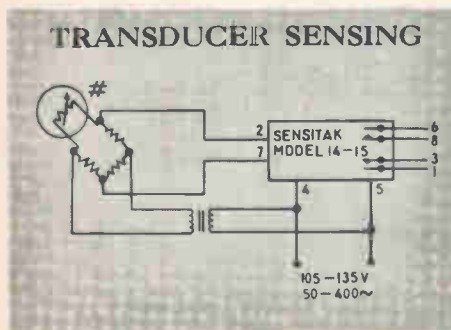

A four-arm resistance bridge may be used with a variety of transducers, to translate variations in temperature, pressure, etc., into proportional changes in resistance. The transducer, with or without auxiliary series resistance, forms one "leg" of the bridge. One or more of the other arms may be variable "set" type resistances for adjusting settings and ranges.

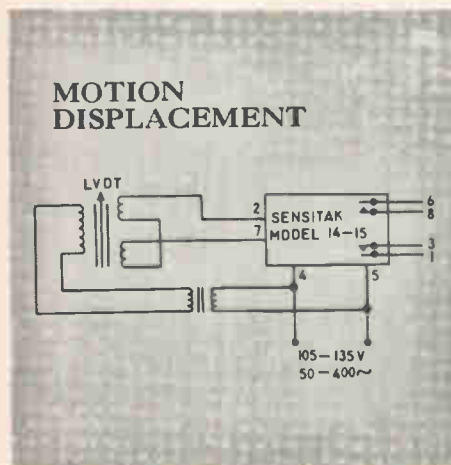

Linear variable differential transformers (LVDTs) can be used to provide the same type of signal system phase reversal.

Using LVDTs as shown, opposing secondary windings balance out when a magnetic core is centrally positioned between them, thus forming a null range. Externally-initiated core movement in one direction induces one signal, while movement to the other side of null produces a phase reversed signal. Thus, one Sensitak reed switch contact or the other closes when the LVDT core is positioned to either side of null.

Get 4-page bulletin B110714. Write to:



**SENSITAK INSTRUMENT CORP.**

A WHOLLY-OWNED STRUTHERS-DUNN SUBSIDIARY  
531 Front Street, Manchester, N.H. 03102

Telephone: 603-627-1432

ing, or subroutine control. Equipment makers could offer libraries of subroutines to suit their equipment to divergent applications. The new braids would also serve as easily changed look-up tables.

▪ Makers of numerical-control devices who want as much flexibility in their controller's capabilities as possible. A library of read-only memories could contain a variety of repetitive control programs.

▪ Manufacturers of process-control equipment who need long programs that are usually reserved for tape input but must operate in damaging environments. The potted braid is nearly impervious to damage and as easy to change as a reel of tape.



Alteration. Pluggable contents board is being removed from read-only memory.

▪ Makers of computer typesetting equipment who need to change fonts quickly.

One manufacturer of computer peripheral equipment plans to make the plug-in braid memory available. "If not the braids themselves, at least sockets for them," says Robert H. Stotz, president of Computer Displays Inc., Waltham, Mass. His partner and vice president, Thomas B. Cheek, says, "We have often had calls for display fonts in other than ASCII standard styles—everything from Greek letters to chemical and military symbols. Certainly, the plug-in braid would be a simple way of making such changes quickly."

The quick-change braid also offers the advantage of being user-proof. The equipment maker would state each braid's content and Memory Technology would supply it to specification. This approach differs from such designs as the



General Electric introduces a faster, more convenient and less costly technique for production line encapsulating and potting. And the RTV's used in the process are as tough as any previously available.

Called the RTV-800 series, the new liquid silicone rubbers do not need a catalyst to activate them, so no premixing is needed.

They cure at temperatures ranging from 200°F to 450°F, so pot life is far longer than is customary with RTV's. A typical deep section cure would be one hour at 300°F. For really rapid cure, components can be preheated and dipped into the RTV.

These three new products are supplied in both opaque and clear grades, with viscosities ranging from very pourable to pourable. They can be blended with one another to suit your particular encapsulating job.

For more information about these new encapsulating RTV silicones (they also make good short-run molding-

materials), write Section 300, Silicone Products Dept., General Electric Company, Waterford, N.Y. 12188.

#### TYPICAL PROPERTIES

Uncured	RTV-815	RTV-830	RTV-835
Color	Clear	Beige	Beige
Consistency	Easily pourable	Pourable	Easily pourable
Viscosity, cps	3500	200,000	8000
Specific Gravity	1.02	1.28	1.18
Solids, %	100	100	100
Shelf Life, months	4	4	4
Cured, ±1 hr. @ 150°C	RTV-815	RTV-830	RTV-835
Hardness, Shore A durometer	35	50	35
Tensile Strength, psi	700	800	500
Elongation, %	150	250	200
Tear Strength, lb/in.	15	100	20

**GENERAL**  **ELECTRIC**

Now. Heat-curing,  
no-mixing, high-strength  
RTV silicones.

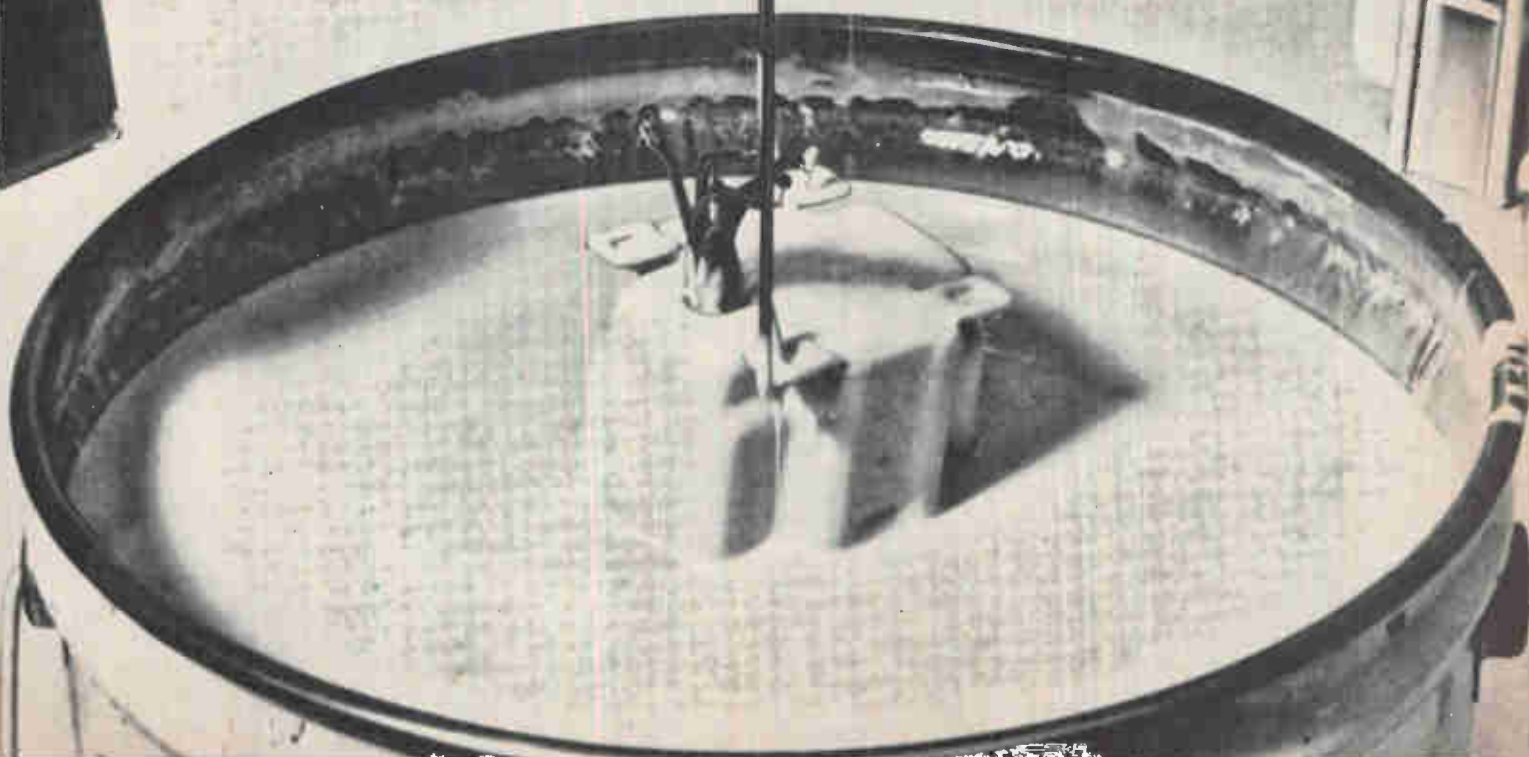

# If your electronics problems are... PEOPLE, PRODUCTION, and PROFITS UTAH has the answers

Utah offers you GUARANTEED BRAINPOWER... an inventory of more than 4000 hard-to-find specialists, experienced people of all kinds, eager to work for you in Utah.

An adequate and stable labor force of women and trainable people with the vocational training facilities to prepare them to meet YOUR needs.

**One major electronics firm now in Utah reports:**  
Increased productivity 2.5 to 3 times.  
Decreased labor turnover  $\frac{2}{3}$  to  $\frac{3}{4}$ .  
... and that spells PROFITS...

That is why such firms as Univac, Litton, Sperry, General Instrument, Signetics, and others are sold on the fact that "This Is the Place" for profitable electronics operations.

In addition to an unlimited source of low cost raw materials, Utah offers you:

- Many trained people in the electronics field.
- An outstanding and stable labor supply at reasonable wages.
- Training aid and research help.
- Low-cost plant sites.
- Favorable freight rates.
- Freeport-Export Exemption laws.
- An ideal distribution location in the middle of a market of 30 million.
- Recreation, culture, scenery... a wonderful place to live and work.

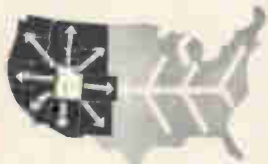

Win the WEST.. from  
**UTAH!**

For information write:  
UTAH INDUSTRIAL PROMOTION BOARD  
167 Social Hall Avenue,  
Salt Lake City, Utah 84111 Dept. 119

Name

Company

Type of Business

Address

City

State

Zip

Honeywell read-only memory, which can be altered by the manufacturer only. The quick-change braid would allow the user to exchange one subroutine for another without damaging the central processor's operation.

**Mylar retrofit.** Marino also points out that users can change the memory by gluing down copper circuit strips on a Mylar overlay. He says, "This would make possible speedy field alterations of existing equipment, using plastic sheets sent out from the manufacturer's home office."

The memory shown at the conference will have the speed characteristic of braided systems: a 650-nanosecond cycle time and a 300-nsec access time for the mil-spec version, and a 500-nsec access time and sub-microsecond cycle time for the civilian model.

Prices haven't been set but Marino says they shouldn't be too far from those of present braided memories: for a 1,000-word memory with 10 bits per word, about \$900 each, or \$580 in quantities of 100. Delivery takes about a month.

Memory Technology Inc., 223 Crescent St., Waltham, Mass. 02154 [340]

Data handling

## Widetrack trend is accelerated

Nine-channel tape system  
transmits or records data  
at 800 bits per inch

Between the Spring and Fall Joint Computer Conferences this year, one company switched tracks to steer its efforts toward the data communications market created by the latest computers.

In San Francisco this week, the Communitytype Corp. will demonstrate a nine-track magnetic-tape system that records data at a density of 800 bits per inch, making the equipment compatible with all IBM System 360 computers. Only last spring, Communitytype introduced a similar system that reads

## HERE'S HOW...

### THE ELECTRONIC INDUSTRY IS USING THESE FAMOUS ULANO FILMS IN ULTRAMINIATURE MASK TECHNOLOGY AND COMPLEX PRINTED CIRCUITRY

Cut a piece of the desired film large enough to cover area to be masked. Tape it down firmly at the top with dull-side up.

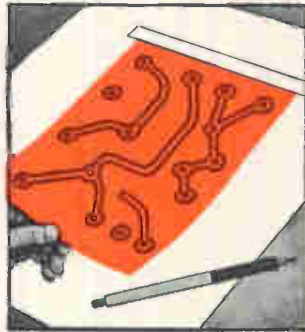

With sharp blade, outline the areas to be masked. Do not cut through the backing sheet. The Ulano Swivel Knife does the job quickly, easily.



Using the tip of the blade, lift up a corner of the film thus separating it from the backing sheet.

Now carefully peel off the film as outlined leaving a completed mask, positive or negative, that corresponds exactly to the desired pattern.

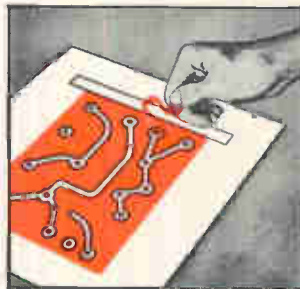

"Ulano"—"Rbylith"—"Amberlith" are registered trade marks of the Ulano Companies.

# Ulano<sup>TM</sup>

## RUBYLITH<sup>TM</sup>

## AMBERLITH<sup>TM</sup>

HAND CUT MASKING FILMS FOR THE GRAPHIC ARTS

ULANO RUBYLITH... a revolutionary knife cut red film is laminated to a stable transparent plastic backing sheet. The red film is "light safe" so that when contacted to a sensitized emulsion and exposed to a suitable light source, light passes through the cut-out portions only... not through the red film. ■ The polyester backing is absolutely stable... insures perfect register. ■ Special effects such as crayon tones, paste ups, benday sheets, and opaquing are easily combined with versatile ULANO RUBYLITH.

ULANO AMBERLITH... a companion to Rubyolith serves as a color separation medium used as the master on camera copy board to secure negatives or positives.

*A wide variety of Ulano films—in rolls and sheets—is readily available*

## Designed FOR YOUR PARTICULAR NEEDS

Ulano offers the most versatile line of hand-cut masking films, including:

.0075—RUBYLITH 75 DR\* .005—RUBYLITH 5 DR†

.005—AMBERLITH 5 DA†

Where exact register assures a critical importance, you will find these new, thick, polyester based films the positive answer.

\* Available in sheets only, cut to your specifications

† Available in rolls and sheets



**WRITE TODAY**

on your letterhead for free special sample kit 1748

# ulano

610 DEAN STREET, BROOKLYN, N.Y. 11238

In Europe: ULANO A.G., Untere, Heflibachstrasse No. 22, Kusnacht, Zurich, Switzerland

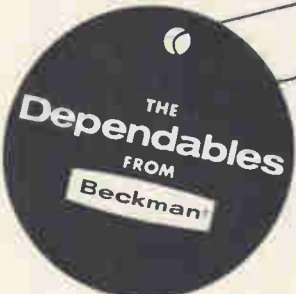
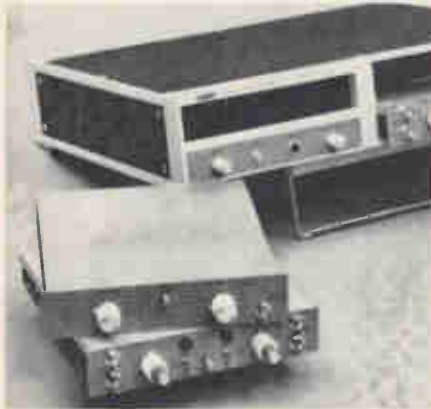
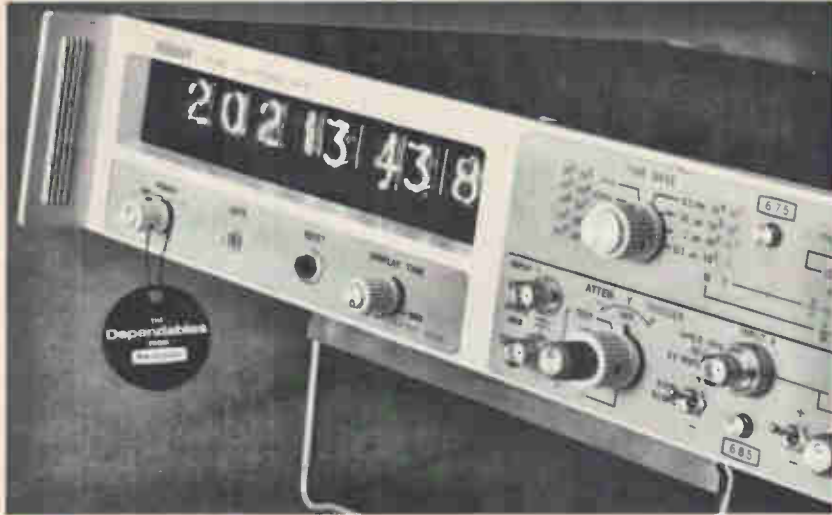

## 200 MHz Direct Count

Today's super-speed IC counters designed for tomorrow's needs. Here is another of the Dependables—the Beckman 6300 series of counters are the fastest (200 MHz direct count) and are available as either six-, seven-, or eight-digit instruments. A choice of three function and three input modules will deliver all the capability needed in today's applications. For future requirements, expand by "custom building" an instrument with newly developed modules. Save money now by purchasing only the capability you need today—save money later through modular expansion, rather than new instrument buying. • These modular counters provide C<sup>3</sup> (Cross Channel Calibration), which facilitates accurate trigger and slope control adjustment and eliminates the need for external support equipment normally used in making precise timing measurements... no other instrument has it. In addition, a new visual trigger level control concept eliminates typical ambiguities in setting attenuator and trigger level... another Beckman exclusive. • Features of the 6300 series include: modular construction; integrated circuit design; four visual indicator aids for maximum operator convenience; no fans; 3½ inch height; computer compatible 1-2-4-8 BCD output; and fast (30 μs) recycle. • For complete detailed information, or a demonstration, contact your local Beckman sales representative or the factory direct.

The Electronic Instruments Division develops and manufactures precision electronic measurement and test instrumentation for science and industry. Major product lines include: electronic counters, IC testers, oscillographic recorders, panel meters, system components, signal sources, time standards, and data acquisition systems.

**Beckman**

INSTRUMENTS, INC.  
ELECTRONIC INSTRUMENTS DIVISION  
RICHMOND, CALIFORNIA • 94804

International subsidiaries: Geneva, Munich, Glenrothes, Scotland, Tokyo, Paris, Capetown, London, Mexico City, Stockholm, Vienna

and writes on seven-channel tapes at 556 bpi. But "there's a clear-cut trend in industry to 800 bpi, nine-track equipment," explains Communitytype's president, Robert N. King.

The new system, designated the 850, can send and receive computer-generated data at high speed over direct-dial telephone circuits. Its primary use will be on the receiving end of the company's 100SR Data Communication System, an input-output data terminal employing a standard-keyboard IBM Selectric typewriter. A single unit at a computer center could serve widely dispersed 100SR installations.



Data central. Unit at computer site records data from many locations.

Data received by the 850 is translated into code compatible with 360-type computers and recorded on compatible tape. The 10½-inch tape reel holds 20 million characters at 800 bpi. The system will also transmit computer-generated data to 100SR units in remote locations by reading it block by block into a 160-character buffer memory consisting of metal oxide semiconductor field effect transistors.

Delivery of the 850 will start next spring. The unit will sell for \$24,000 and will rent for a price the company says could be "as low as \$528 a month."

Communitytype Corp., 292 Madison Ave., New York, N.Y. 10017 [341]

# EECoLogic<sup>2</sup> expands...

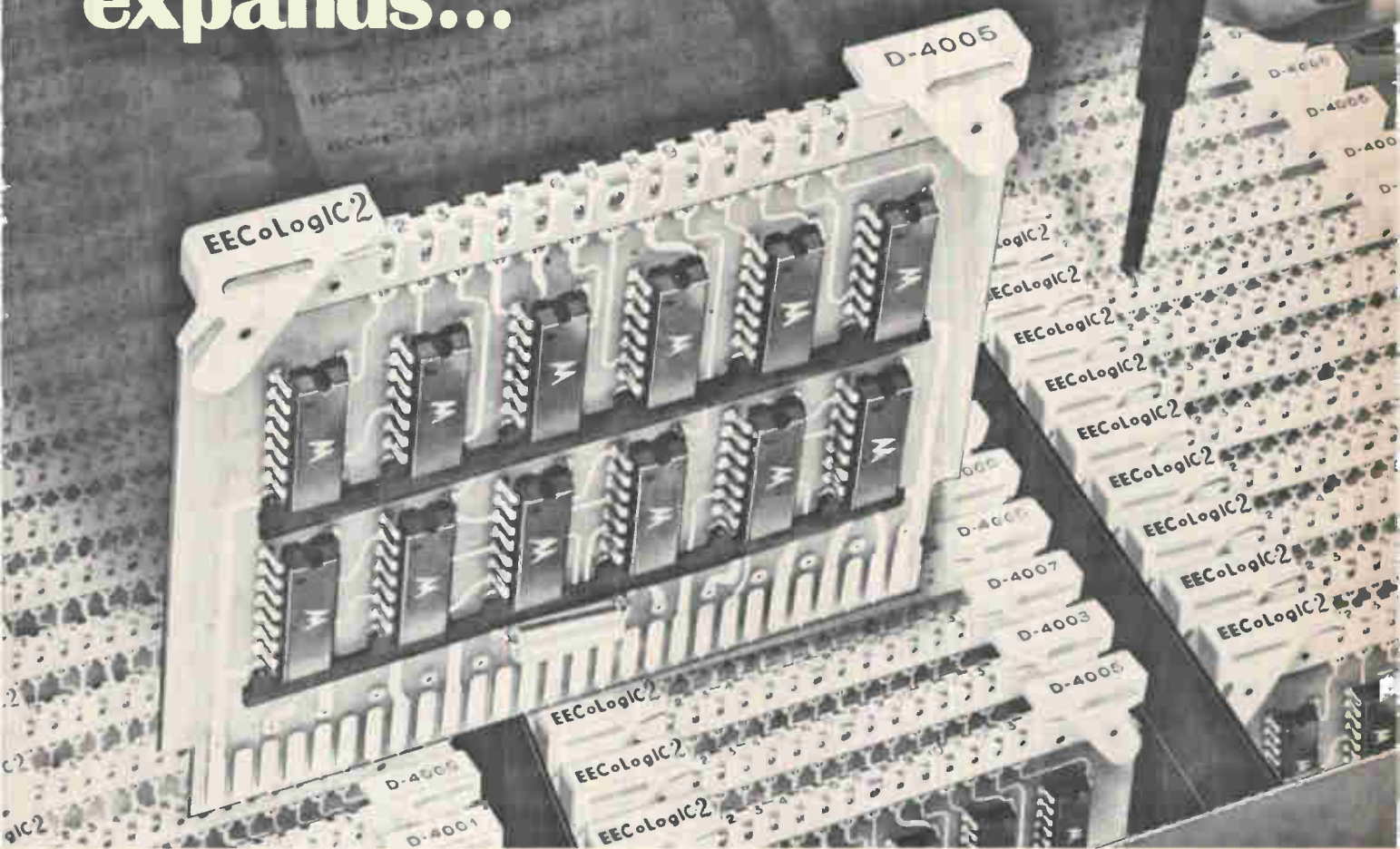

## to make digital system design easier

EECoLogic<sup>2</sup> Digital Logic Card Series expands with 11 new DTL types... 13 new TTL types... 11 new analog types. EECoLogic<sup>2</sup> now provides:

- 40 DTL card types
- 13 TTL card types
- 11 Analog card types

Plus these outstanding advantages:

- 13 test points
- Integral locking/extractor handles
- High density – over 6,000 connections per drawer
- Laminated power busses on cards and in chassis hardware
- Automatic machine-wired hardware ... "Termi-Point," "Wire-Wrap," as well as soldering

Send for your catalog of specifications and applications today.

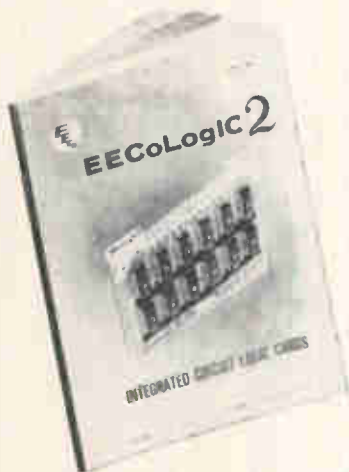

Ask about our machine wiring service.



### **COMPONENTS DIVISION**

ELECTRONIC ENGINEERING COMPANY OF CALIFORNIA

1441 EAST CHESTNUT AVENUE · SANTA ANA, CALIFORNIA 92701 · (714) 547-5651

# DOUBLE THRESHOLD TIME DELAY

Magnetic circuit breakers permit accurate and reliable control circuits. The circuit shown allows an adjustable time delay responding to the average, (average, not rms) value of an overload, no trip below rated current, a time delay between 100% and 200% of rating, essentially zero delay above the adjustable limit. A 1/2 volt input corresponds to 100%. 1 volt input corresponds to about 200%. Between these limits time delay is furnished by C1-R2. R1 adjusts the first threshold, the 100% point.



Double Pole Breaker  
Type APL 14-R

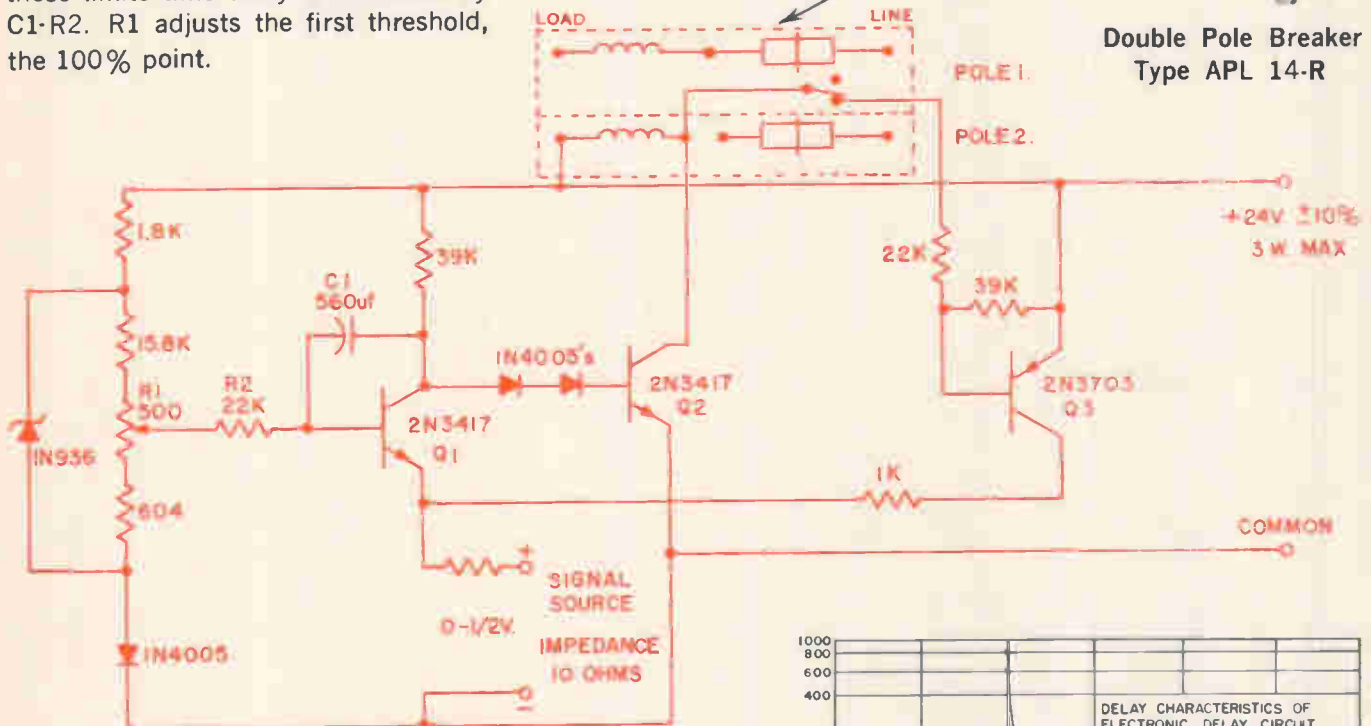

Electronic time delay circuit

Double threshold characteristic curve

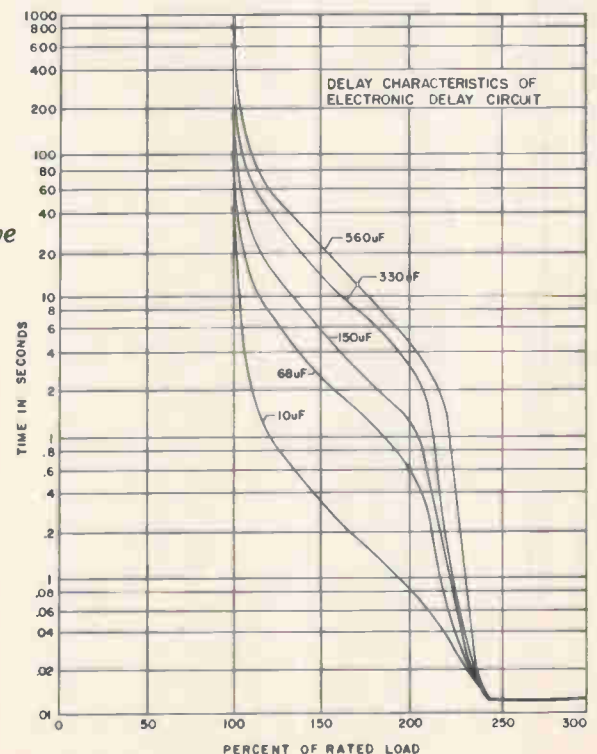

For further information on Airpax breakers, contact

**AIRPAX  
ELECTRONICS**

Cambridge Division, Cambridge, Maryland 21613

Phone (301) 228-4600

TWX 710 865-9655

TELEX 8-7715

## New Instruments Review



Power meter 6863-1 provides information on conducted EMI, displaying corrected EMI current, line impedance and calculated EMI power values. Current probes couple to the unknown impedance and measure impedance magnitudes from 0.3 to 1,000 ohms and phase angles  $\pm 180^\circ$  from 15 khz to 30 Mhz. Solar Electronics Co., 901 Highland Ave., Hollywood, Calif. [361]



General purpose pulse generator type 1340 features wide ranges of pulse repetition frequency and pulse duration (both  $10^0/1$ ). Prf is as high as 20 Mhz or as low as 0.2 hz and pulse duration can be varied from 25 nsec to 2.5 sec. Ground-based positive and negative pulses are available simultaneously. Price \$395. General Radio Co., West Concord, Mass. 01781. [362]



Pulse generator model 605P can provide 20 kw of power in pulse widths from 0.05 to 1,000  $\mu$ sec. Pulse repetition rates can be varied from a single shot to 1,000,000 pps. Pulse amplitude is continuously variable to a maximum of 2,000 v. Standard rack mounted units are \$3,890; bench-top, \$3,990. Cober Electronics Inc., 9 Gleason Ave., Stamford, Conn. [363]



Solid state photometer, for use with photomultipliers, has an electrometer type current meter with a FET input for measuring currents from 300  $\mu$ a to 3 na. It has a 6-inch meter readout as well as a 5-v output with  $\pm 2\%$  accuracy. The built-in h-v supply is adjustable from 400 to 600 v and operates a load up to 2 ma. Schoeffel Instrument Corp. Westwood, N.J. [364]



Model 222 Maxi-Max voltmeter accepts input transients and stores the peak value for reading on the built-in meter, or for plotting using the external output. It can describe the larger of the plus or minus peaks of a given transient. The voltmeter has a dynamic range of  $-50$  db from 10 v. Price is \$1,500. Marshall Research and Development Corp., 15A St., Burlington, Mass. [365]

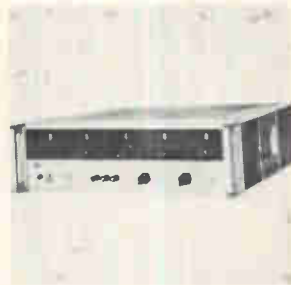

A-c calibrator 6921A has a 25-w output and supplies either a calibrated voltage or current to its load. The rms amplitude of its output is within  $\pm 0.25\%$  of selected value. The unit has 4 voltage ranges: 0 to 1.4, 14, 140, or 280 v rms. It has 5 current ranges: 0 to 1.4, 14, or 140 ma rms, or 0 to 1.4 or 5 amps rms. Hewlett-Packard Co., Locust Ave., Berkeley Heights, N.J. [366]



Solid state electrometer 610C will measure 81 ranges of d-c voltage, current, resistance and charge. It has: 11 ranges from 1 mv full scale to 100 v; 28 ranges from  $10^{-11}$  amp full scale to 0.3 amp; 25 ranges from 100 ohms full scale to  $10^{14}$  ohms; 17 ranges from  $10^{-18}$  coulomb full scale to  $10^{-5}$  coulomb. Price is \$585. Keithley Instruments Inc., Aurora Road, Cleveland. [367]



Seven ranges, covering resistances from 0.0001 ohm to 1 megohm, are offered in the model 8103-421 digital ohmmeter. One ohm minimum full scale is displayed as 1.0000 ohm to an accuracy of 0.1%. A large, illuminated digital readout provides a full 4-digit presentation with 10% over-ranging to the 5th digit. California Instruments Corp., 3511 Midway Dr., San Diego, Calif. [368]

### New instruments

## How are you? x-y plotter will tell

Compact recorder displays eight channels of medical data on 8¼-by-11-inch paper and runs for as long as 9 hours

The intensive-care section of a hospital isn't an R&D laboratory. Hospital people are understandably reluctant to handle the rolls of recording-chart paper needed to monitor critically-ill patients, and they're equally reluctant to allocate much space to bulky recording

equipment. Designers in the Hewlett-Packard Co.'s Moseley division, however, are betting that the medical technicians won't mind changing a sheet of 8½-by-11-inch paper once in awhile.

H-P's new recorder, the 7597A medical monitoring instrument, is

19 by 10½ by 6¼ inches and handles eight channels of data.

H-P has adapted x-y recorder techniques for the 7597A. Instead of handling rolls of strip chart, technicians need only place the standard-size sheet of paper in the recorder, which will plot data for nine hours on one sheet. The compactness of the presentation makes trends easier to spot and interpret. And the price is about \$1,200. The recorder can plot eight parameters for one patient or one parameter for eight patients.

**No ink.** H-P hopes that the instrument, with different papers and in a slightly different package, will

# Crisp Bacon in 90 Seconds

with INTERNATIONAL'S  
MICROWAVE OVEN



The culinary wonder of space age cooking moves to your kitchen with this new International countertop oven that cooks with radar-spawned microwave power.

People on the go will welcome an oven that makes cooking chores a pleasure. Imagine a "piping hot" TV dinner (frozen) in 3½ minutes\* instead of 20 to 50 minutes. Bake a potato in 5 minutes instead of 60 minutes. Warm a chilled baby bottle in 60 seconds. Fry crisp bacon in 90 seconds on a paper plate. Great for those leftovers.

International Microwave Oven is truly remarkable. No more waiting for the oven to reach cooking temperature.

Countertop designed for the home, mobile home, or the galley on your boat. No special wiring required. Works on 115 vac house circuit. Comes in baked vinyl white with attractive trim. **\$545.00**

Available direct from International or through your local appliance dealer.

*\*Times listed are approximate and vary with size of item.*

Write for folder



**CRYSTAL MFG. CO., INC.**  
10 NO. LEE • OKLA. CITY, OKLA. 73102

also be used in nonmedical applications. Trend measurements from transducers or instruments such as voltmeters and power meters are possibilities.

The recorder sweeps over the 9½-inch length of the recording area, continuously sampling the channels. A complete sampling cycle takes about a minute. The device can be programed to bypass any combination of channels in the scanning sequence. The sensitivity of each channel is adjustable between 0.5 and 3 volts per inch; the input impedance is 100 kilohms. Accuracy depends on the y-axis span of each channel; for a 1-inch span it's 1.5%, for a 3-inch span 0.5%.

The writing is done electrically; an ink pen would require too much attention from hospital personnel. A separate reed switch in each

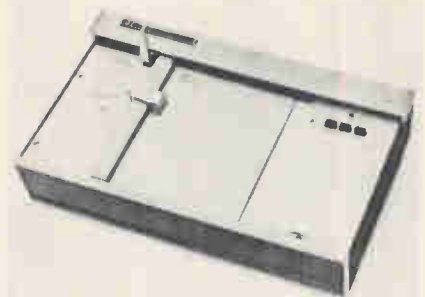

On record. The sensitivity can be set between 0.5 and 3 volts/inch.

channel actuates the pen. When the reed is closed, a pair of transistors apply 28 volts to the pen's tip, creating a dot in that channel. A series of such dots forms the trace. The electro-sensitive paper, 7 inches high, is held on the instrument electrostatically.

**Anatomy.** The servo loop circuit that drives the pen includes a dual field effect transistor, an integrated-circuit operational amplifier, and complementary output transistors in a Darlington configuration. The input signal is applied to one gate of the FET and the other gate is connected to the slidewire wiper. The FET is connected as a source follower, so that when the two gates are at the same voltage, the voltage differential between sources is zero and the system is in balance. But if the gate voltages are unequal,



# We've submini-priced subminiature switches

## and the deal's OFF...

Or on. Or off-again-on-again-off-again. Or on-again-on-again-on-again. Now, you can order both subminiature push button switches and subminiature toggle switches at the tiniest prices on the market. How mini? Submini! Now how many?

### SubMini-Price List of Pushbutton and Toggle Switches

TOGGLE-SWITCH MODELS	1-24	29-99	100-499	500-999
7101	\$ 1.65	\$ 1.10	\$ .96	\$ .82
7103, 5, 7, 9	1.95	1.30	1.16	.97
7201	2.15	1.43	1.28	1.07
7203, 5, 7, 9	2.55	1.70	1.52	1.27
7211	2.85	1.90	1.70	1.41
7213	3.15	2.10	1.87	1.55
7215	3.45	2.30	2.06	1.71
7301	3.85	2.57	2.30	1.92
7303, 5, 7, 9	4.80	3.20	2.87	2.38
7401	4.85	3.28	2.90	2.43
7403, 5, 7, 9	6.05	4.10	3.61	3.00
7411, 13, 15	6.90	4.30	4.11	3.41

PUSHBUTTON SWITCH MODELS	1-24	25-99	100-499	500-999
P8121	\$ 2.55	\$ 1.70	\$ 1.52	\$ 1.27
P8221	3.45	2.30	2.06	1.71
P8321	4.80	3.20	2.87	2.38
P8421	6.05	4.10	3.61	3.00

Call or write for quantity prices:

**CK** COMPONENTS, INC.  
103 Morse Street,  
Watertown, Mass. 02172 tel.: (617) 926-0800

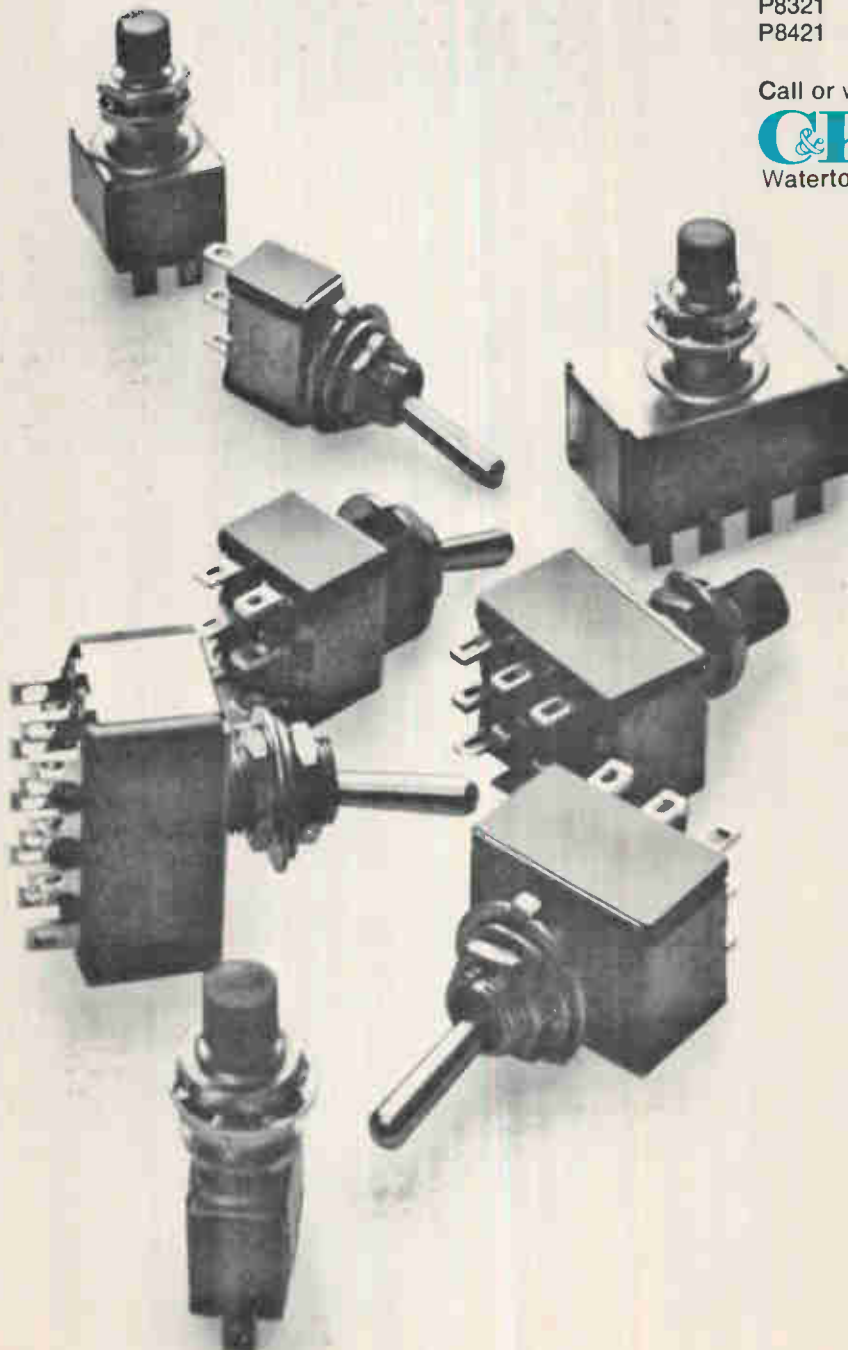

1  
2  
3  
4 Poles!

# A New X-Y Recorder...

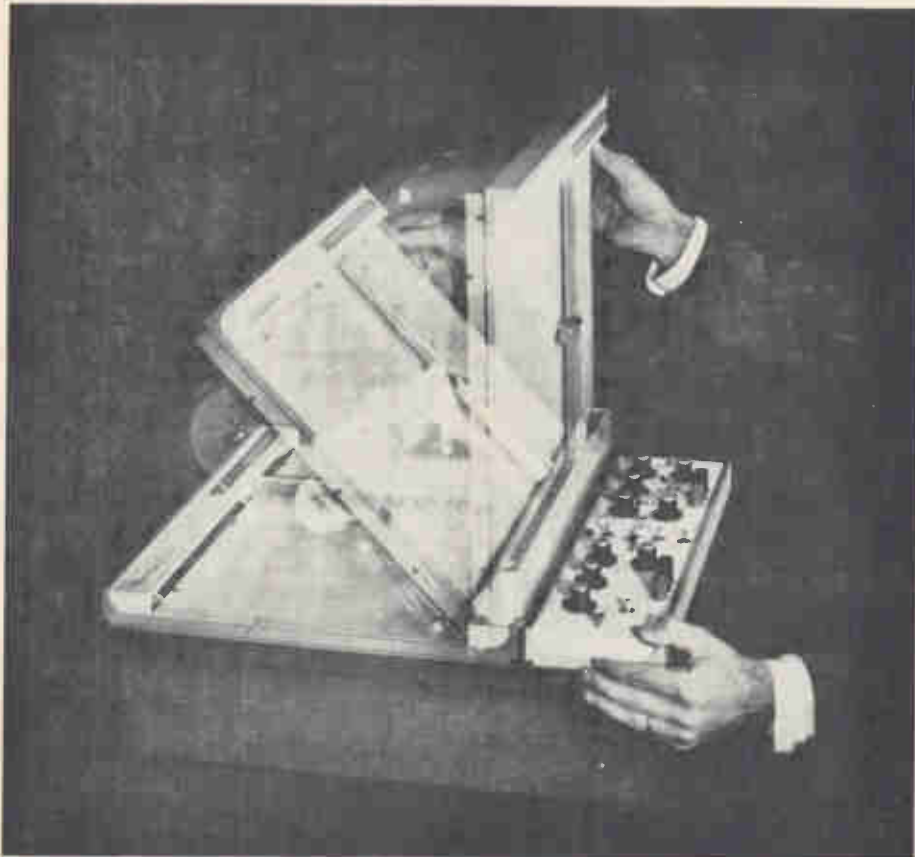

## That's Easier To Operate

Easier to operate . . . easier to position . . . and meets top performance requirements. The *function/riter*\* recorder is more convenient than other X-Y plotters. You can operate this new TI recorder in five different positions to suit any application. Mount it in a 19-inch rack without adapters, stand it upright on a benchtop or position it flat with the writing surface horizontal, at a 45° or 90° tilt angle so you see the plot, even when you're sitting.

It's easy to change applications too. Three types of plug-in "function modules" allow you to plot inputs from 100 $\mu$ v to 50v, with time sweeps from 0.1 second/inch to 100 seconds/inch. All modules are interchangeable between X and Y axes. *Signal Input* module permits single-range millivolt recording. *Signal Control*

module offers 16 calibrated scale factors. *Time Base* module gives 10 time or voltage factors.

For more than four years, the servo system of the *function/riter* recorder has been use-proved in thousands of other TI instruments. Quieter operation of the vacuum hold down (for either 8½ x 11-inch or 11 x 17-inch paper), solid-state electronics, 20 inches/second slewing speed and accuracy of 0.2% of full scale are some of the other features that make this X-Y recorder an outstanding instrument to solve your plotting problems.

There's more to the story too. Find out by asking for complete data or a demonstration from your TI representative or the Industrial Products Division, P. O. Box 66027, Houston, Texas 77006 (713-349-2171).

\*Trademark of Texas Instruments

**TEXAS INSTRUMENTS**  
INCORPORATED

a differential voltage exists between the two sources.

The d-c op amp amplifies the differential source voltage (with a gain of approximately 2,000). The next stage is the motor driver—the Darlington amplifier. The npn transistors conduct and drive the motor in one direction for positive-going signals and in the opposite direction for negative-going signals. The voltage gain of this stage is one. The Darlington configuration increases the current gain and reduces the load on the op amp.

Hewlett-Packard Moseley Div., P.O. Box 791, Pasadena, Calif. 91102 [369]

New instruments

## Circuit tester does double duty

Versatile device handles  
op amps and digital IC's  
manually or automatically

Equipment manufacturers who use integrated circuits in small or moderate quantities look for versatility in a tester; they can't afford special-purpose apparatus. The model 716 circuit tester developed by Microdyne Instruments Inc. goes a long way toward meeting this requirement. The instrument will test both discrete and monolithic operational amplifiers, as well as all digital logic IC's on the market, the manufacturer says. It can be manually operated or programed, by means of prewired patch plugs, as a functional tester.

The 716 takes about 30 seconds, typically, to make a complete set of d-c and functional tests on a circuit in the programed mode. It can accommodate as many as 36 device terminals. Measured values are displayed on a three-digit read-out or a high-low indicator.

On op amps, the Microdyne instrument can measure voltage gain, input voltage offset, input bias current, input differential current, output voltage under full load, total current drain, and gain-bandwidth



# Psst!

# Wanna buy some nice crystals?

## Motorola's Precision Crystals are on the market.

We've been making them for thirty years. Precision, high-tolerance crystals that had to be good enough to use in our own products. But we found out something. You can't keep

a great thing to yourself forever.

Now, our wide range of precision crystals, including temperature compensated varieties, are available to designers and manufacturers in the electronics industry. Characteristics like tight tolerances and low-aging are Motorola specialties. You can choose from types of holders too—glass, solder seal and cold weld.

Crystals, oscillators, filters, and tone modules: the list of Motorola

components currently in production is a mile long, but the way things are going that may not be long enough. If you need something special, just call. Our designers are ready to go to work on projects for you alone.

For additional information on existing products and on design potentials, write to Motorola Communications & Electronics Inc., 4501 West Augusta Boulevard, Chicago, Illinois 60651.

Ask for Bulletin TIC-3401.



**MOTOROLA**



## Counting Relay



Siemens Counting Relay  
measures only 2.6" x 1.32" x .53"

- Static readout feature provides instantaneous electrical readout . . . can be used as decimal memory unit.
- Accessory contacts for logic function.
- Plug-in type.
- Low in price.
- Functions as a one digit indicator or part of a multiple counting module.
- Available in either forward or reverse counting direction.

Sample quantities available from New York stock

**SIEMENS AMERICA INCORPORATED**  
Telecommunications Division  
350 Fifth Ave., New York, N.Y. 10001 • Tel. (212) 564-7674

Circle 235 on reader service card

## NATIONAL® Regenerative Gate\* SCR

# lowest switching losses

Operates to 20 KHz with switching losses lower than any other high power SCR available. Ideal for inverters, choppers, DC to DC converters, cycloconverters. Only the Regenerative Gate\* SCR gives 600 amperes/ $\mu$ sec. di/dt with low power gate drive. 110 ampere rating available with 200 volts/ $\mu$ sec. minimum dv/dt and 10  $\mu$ sec. maximum turn-off time.

\*A NATIONAL® exclusive.  
Patent Pending.

**NATIONAL**  
ELECTRONICS, INC.

a varian subsidiary

PHONE: (312) 232-4300 • GENEVA, ILLINOIS 60134

REQUEST BULLETIN



162 Circle 162 on reader service card

product.

On DTL, RTL, TTL, and ECL circuits, the 716 can measure input load currents, shorts between inputs, thresholds, input leakage, output 0 under load, output 1 under load, output short-circuit current, and total current drain. It can also clock flip-flops.

The accuracy of the digital readout is 0.25%. The meter voltage ranges are 1, 10, and 100 volts, with 0.1 volt optional. The current ranges are 1, 10, and 100 milliamperes, with 0.1 ma optional.

**Hand work.** The 716 comes with four constant-voltage supplies, ca-

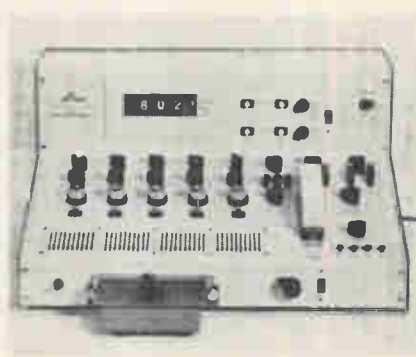

Choice. Operator can set conditions with patch panel or manual adjustment.

pable of sourcing or sinking current regardless of output polarity, a sweep-voltage supply, a constant-current supply, a pulse generator with repetition rates from 10 hertz to 1 megahertz and adjustable amplitude, and selectable circuit loads, both resistive and capacitive.

A 10-by-40 matrix selector switch is used for manual operation. By adjusting the slider positions, the operator can connect power supplies, grounds, output voltage comparators, pulse generators, output displays, and loads to the device in any configuration.

The patch plug provides a semi-automatic mode of functional testing. The plug is wired to connect the terminals of the device under test to the appropriate components of the instrument. An operator inserts the device, rotates the test selector switch, and observes a high or low indication on the comparator lamps.

The tester sells for \$2,195.

Microdyne Instruments Inc., 225 Crescent St., Waltham, Mass. 02154 [370]

Electronics | December 9, 1968

# MEET A NEW GENERATION OF ELECTROMETERS



All New, Line Operated DC Laboratory



Vibrating Capacitor Electrometer



Portable, Battery-operated Multimeter

## Keithley sets the design pace for highly stable all solid-state electrometers

***Keithley multi-purpose electrometers extend your dc measurement capabilities with widest choice of models, functions, sensitivities, stability and price. Can you really afford to buy less?***

Keithley has over twenty years of electrometer design experience and a reputation for the highest product integrity in the industry. More models to choose from, more kinds and variety of electrometer accessories, give you more measuring capability for every instrument dollar.

*If you're looking for the fastest, most sensitive and stable electrometer ever made, see our*

Model 640 Vibrating Capacitor model. It resolves 2 microvolts,  $10^{-17}$  ampere and  $5 \times 10^{-16}$  coulomb. It features stability of 20 microvolts per day,  $10^{16}$  ohms input impedance and 10 milliseconds response on mv ranges. A breakthrough in price, as well as design, at only \$1875.

*If you're looking for superior stability and economy, check our mos fet Models 602 and 610C. Both offer stabilities better than 1 mv per 24 hours. Both measure voltage, current, resistance and charge over broader ranges than any other dc multimeter. Buy the battery operated 602 for \$675. Or the line operated 610C for only \$585.*

*If you've thought about simplifying the search for low level*

currents, here's a second thought. Investigate Keithley picoammeters. Different models offer choices of fast response, automatic or remote ranging, long-term stability, calibrated zero suppression and prices that will delight you.

See Keithley electrometers and picoammeters in action. Call your experienced Keithley Sales Engineer for demonstrations and full technical details.

Or contact us direct. Keithley Instruments, Inc., 28775 Aurora Road, Cleveland, Ohio 44139. In Europe: 14 Ave. Villardin, 1009 Pully, Suisse. Prices slightly higher outside the U.S.A. and Canada.



KEITHLEY

# NEW TUNG-SOL® DIGIVAC S/G

TRADE MARK

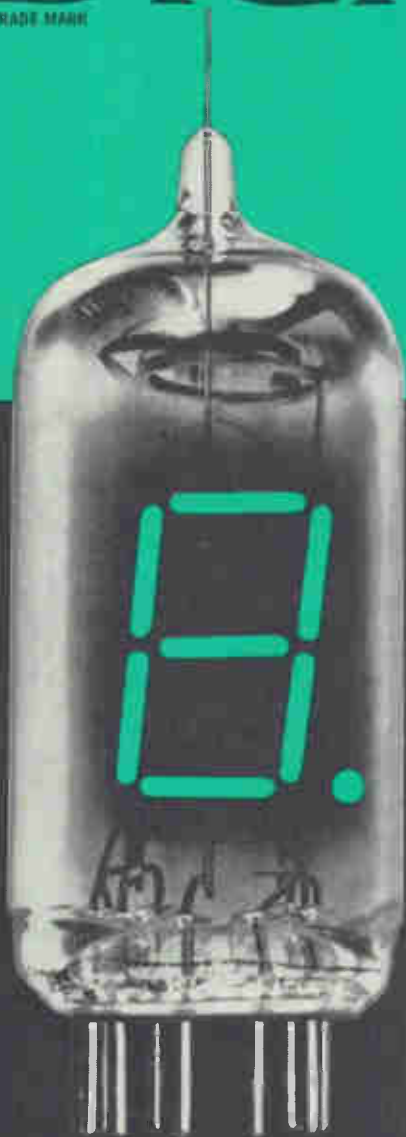

Vacuum Fluorescent  
Readout with  
Matching Logic

## A Significant Second Generation Readout

1. Low cost
2. Single plane display
3. 150° viewing angle
4. Standard 9-pin base
5. High brightness
6. Low power
7. Low voltage
8. Simplicity of design
9. I.C. compatibility
10. Optional decimal
11. 10 numerals; 13 letters
12. Variety of colors with appropriate filtering

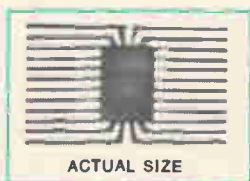

## LOGIC FOR TUNG-SOL DIGIVAC S/G

This is a monolithic integrated MTOS circuit. It contains (1) decade counter, (2) storage register, (3) decoder/driver, and (4) appropriate input, output, and command terminals. Two important features are provision for leading zero blanking and false count indication.

Write for complete information.

**TUNG-SOL DIVISION**  
**WAGNER ELECTRIC CORPORATION**  
One Summer Avenue, Newark, N.J. 07104 • Telephone: (201) 484-8500

© T.M. Wagner Electric Corporation

## New Semiconductor Review



Bidirectional triode thyristors series BTV0400 handle up to 3,600 w and provide their own built-in electrical isolation. The case is fully insulated from the mounting stud. Five types are available for use with peak off-state voltages of 100 to 600 v. All types handle up to 10 amps of on-state rms current. Solitron Electronic Corp., 168 Al-bion St., Wakefield, Mass. [436]



Monolithic voltage comparator model 5501 provides a maximum comparison error of  $\pm 1$  mv including gain and offset errors. Features include 80 db minimum voltage gain,  $\pm 25$  ma minimum output current,  $\pm 10 \mu\text{v}/^\circ\text{C}$  maximum input voltage drift. The unit is packaged in a 5-lead TO-5 low profile can. Price (1-9) is \$27 each. Optical Electronics Inc., Box 11140, Tucson 85706. [437]

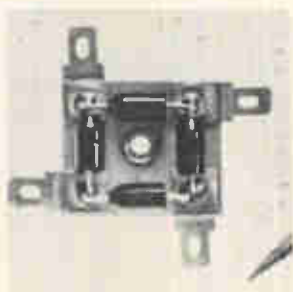

Industrial bridge rectifiers series B786-QD are now available with four quick-disconnect terminals that can be mounted simply and quickly into equipment by a 6-32 screw and push-on-terminals. The rectifiers use controlled avalanche devices. They are stocked in 2-amp and 4-amp types with piv up to 1,000 v. Solitron Devices Inc., 256 Oak Tree Road, Tappan, N.Y. 10983. [438]

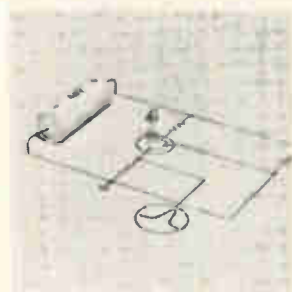

Unijunction transistor type 2N5431 is characterized for operation on source voltages as low as 4 v. Fabricated by a process similar to that used on silicon Annular transistors, it has an emitter leakage current of only 10 na maximum. Maximum reverse emitter voltage is 30 v; maximum emitter current, 50 ma rms. Motorola Semiconductor Products Inc., Box 20924, Phoenix. [439]

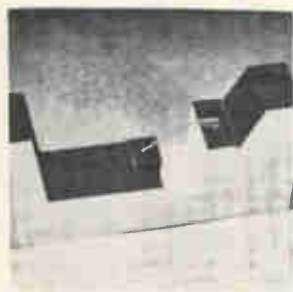

Schottky barrier mixer diode type CAY13A is a gallium arsenide device with an over-all noise figure of 6.5 db at X-band frequencies. Vswr is 2 max. I-f impedance is 350 ohms. Temperature range is  $-55^\circ$  to  $+155^\circ\text{C}$ . The unit is mounted on a ceramic carrier 1.9 x 0.8 x 0.35 mm. Metalized lands simplify bonding to substrate. Mullard Ltd., Mullard House, Torrington Place, London WC1, [440]



Silicon Schottky barrier photo-diode PIN-25 has an active area of 7  $\text{cm}^2$ . Response time is 5 nsec or less. Capacitance at 90 v is less than 100 pf/ $\text{cm}^2$ . Linearity of response extends over 8 decades. Noise equivalent power is  $10^{-13}$  w in a 1 hz bandwidth. Reverse leakage current is less than  $10^{-7}$  amps  $\text{cm}^2$ . United Detector Technology, 1732 21st St., Santa Monica, Calif. [441]

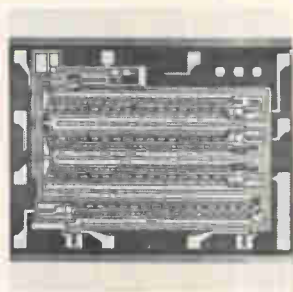

Two 64-bit shift registers, each with a single-phase clock, provide high speed operation from d-c to 1 Mhz and power consumption of less than 3 mw per bit. The MOS products are the 3305 quad 16-bit unit in a dual in-line package, and the 3306 dual 16-bit/single 32-bit unit in a TO-100 container. Fairchild Semiconductor, 313 Fairchild Dr., Mountain View, Calif. 04041. [442]

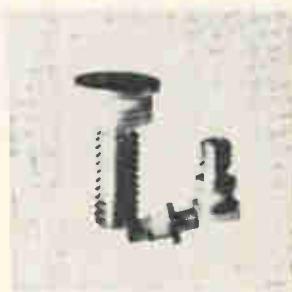

P-i-n diode series MA-47000 is a complete family of 27 diodes designed for control applications such as r-f switching, limiting, duplexing phase-shifting, modulation and pulse forming. They feature peak power to 3 kw, switching speed of 100 to 500 nsec. Minimum breakdown voltage ranges from 500 to 800 v. Microwave Associates Inc., Burlington, Mass. 01803. [443]

### New semiconductors

## IC voltage regulator delivers 0.5 amp

Regulator-within-regulator design of monolithic device keeps output impedance low over a wide voltage range

Motorola's Semiconductor Products division says it's ushering in the third generation of monolithic voltage regulators with the MC1560, a linear integrated circuit with an output current of up to 500 milliamperes—more than three times that of its nearest IC competitor.

Clay Tatom, manager of linear IC product planning, points out that National Semiconductor introduced a monolithic regulator more than a year ago, "but it can't be used much over 15 milliamperes, and it's designed to go with a couple of external transistors to get to 5

amps. Then Fairchild introduced the  $\mu\text{A}723$ ." And at 150 milliamperes, Tatom says, this is the MC1560's nearest monolithic competitor. He adds that with the addition of one external transistor, the Motorola device can regulate a 10-amp load current.

The TO-66 package, a nine-pin variation of the widely used power transistor case, enables the regulator to dissipate 10 watts at a case temperature of  $65^\circ\text{C}$  and 17.5 watts at  $25^\circ\text{C}$ . This model carries the designation MC1560R; the other military version, the MC1560G, housed in a 10-pin TO-5 can, will dissipate 1.8 watts at  $25^\circ\text{C}$  and

# VOLTAGE SENSITIVE RELAY DRIVER

Am I wild? Adjustable trip point variable continuously thru zero with no discontinuity. Trip point range  $\pm 20v$ .



0.002% f.s./ $^{\circ}C$  trip point stability!

Want to check my hysteresis all you smart engineers? When you start specifying, remember that I told you that the new Model 525 precision voltage relay driver has less than 0.01 hysteresis; less than 4 millivolts.



About external connections: Designed for PC card mounting. All leads on standard 0.1" grid spacing and are a

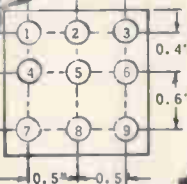

nominal 0.033" Dia. x 0.45" long. (Model 520 and Model 525 have same lead assignments so are interchangeable). Bottom view is shown.

VoltSensor can be used for motor speed alarm, transducer monitor, battery or power supply monitor, medical transducer, etc.



I'm really encapsulated! Operating temp range  $-40^{\circ}$  to  $+75^{\circ}C$ . Shock: 100 G any axis 10 ms. Vibration: 15G p-p any axis. Humidity, altitude and other env. specs per MIL-E-5272 Airborne Equipment.



Talk about fast operators! Operating time less than 10 microseconds. Infinite resolution! Output rise & fall time 2 microseconds. The repeatability better than 1mv. Power:  $\pm 25v$  to  $\pm 15VDC$ ; VDC @ 12ma (25v) to 7ma (15v) + load. Output 20v 50ma nominal with 25v supply down to 12v @ 15ma with 15v.



More vital statistics? Wt. 1.75 oz. and dimensions 1.5x1.5x0.7.

CALIF ELECTRONIC MFG CO., INC.

CALIFORNIA ELECTRONIC MANUFACTURING COMPANY, INC. PO BOX 555 \* ALAMO, CAL. 94507 \* TEL. 415 932 3911

Circle 213 on reader service card

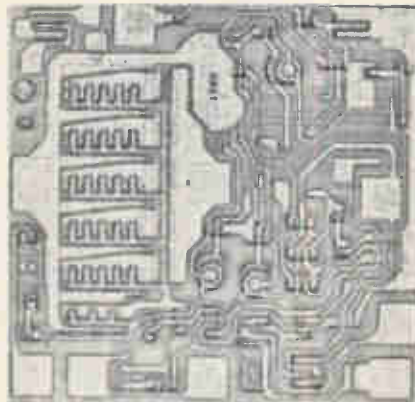

Steady climate. Compensation circuits keep drift down to  $\pm 0.002\%/^{\circ}C$ .

the output impedance of all the other IC voltage regulators they know of varies widely with output voltage.

With the regulator-within-a-regulator feature, the reference voltage for the output stage is the output of another regulator. The reference for the second regulator is a temperature-compensated zener. Tatom explains, "Each stage of the MC1560, then, has a temperature-compensated bias to give better performance over the temperature range. We don't get bias drift with temperature changes in the differing stages." The typical change in input voltage is just  $\pm 0.002\%$  per degree centigrade.

Two other features Tatom says are important are the regulator's shut-down control and its transient-

GRC<sup>®</sup>



die cast ZINC ALLOY



molded PLASTICS



Coil Bobbins Gears & Pinions



GET THIS SAMPLE KIT OF GRC TINY PLASTIC MOLDINGS

Gries' special methods and Value Engineering are combined to give highest functional value. Imaginative engineering ideas are turned into precise, uniform tiny parts. You save every step of the way . . . basic part through final assembly.

NO SIZE TOO SMALL! MAXIMUM SIZE FOR PLASTIC MOLDINGS: 1/32", .05 oz. Write today on company letterhead for your kit.



GRIES REPRODUCER CO. Division of Coats & Clark Inc.

World's Foremost Producer of Small Die Castings 151 Beechwood Ave., New Rochelle, N.Y. (914) 633-8600 Plants In: New Rochelle, N.Y.; Warren, R.I.; Toccoa, Ga.



1 1/2 in. AM-1 (actual size)

Distinctively Styled high torque, self-shielded panel meters

Smart, sophisticated styling . . . easy reading scale . . . sizes 1 1/2 to 4 1/2". Rugged, high torque mechanism offers 1% linearity, 2% accuracy and sensitivity to 20 ua. Completely shielded to eliminate error from magnetic panels. Mounts bezel-to-bezel on any material without interaction or effect on calibration. Choice of colors or finishes, custom dials — ASA/MIL 4-stud mounting.

AMMON

AMMON INSTRUMENTS, INC. 345 Kelley St., Manchester, N.H. 03105



# NEW

## TWO LOW COST LOW RIPPLE REGULATED DC POWER SUPPLIES



These new low cost ELECTRO power supplies offer excellent load (.01%) and line (0.01 + 2mV) regulation, and only 100 microvolts RMS max. ripple.

Features all solid state circuitry with regulation through Zener diodes and integrated circuit components. Automatic current limiting. Lightweight—only 7 lbs.

Ideal for transistor circuit design, development and experimental use, also as a general purpose laboratory supply, as a bias supply or battery substitute.

**PSR-12-25** output 0 to 25 VDC 0 to 500 mA

**PSR-12-50** output 0 to 50 VDC 0 to 250 mA

Input: 105-125 VAC, 60 HZ  
Rack-mount accessory for up to 4 units available.

Write for specifications.

Sold exclusively through Electronic Distributors.



### ELECTRO POWER SUPPLIES

ELECTRO PRODUCTS LABORATORIES, INC.  
6125-Y Howard St., Chicago, Illinois 60648 • 312/775-8744

Circle 240 on reader service card

If you missed the  
**JAPAN ELECTRONICS SHOW in TOKYO**

Pick up the official  
**EXHIBITORS  
DIRECTORY\***

at Booth 1403  
Conrad Hilton Hotel, Chicago  
during the

**NATIONAL ELECTRONICS  
CONFERENCE • Dec. 9 to 11**



\*over 100 pages listing  
manufacturers' names,  
addresses, product categories,  
overseas agents and American  
representatives.



**ELECTRONIC INDUSTRIES  
ASSOCIATION OF JAPAN**

Electronics Division  
Japan Light Machinery Information Center  
437 5th Ave., New York, N.Y. 10016 • (212) MU 6-0731

Circle 224 on reader service card

# mechanical refrigeration to ~~-85°F~~ -100°F for only \$745



## Only Associated Gives You Full Range Military Testing At This Low Price!

Associated's Model SW-5101 Temperature Chamber offers a new concept in mechanical refrigeration that enables you to perform 90% of all military low-high temperature tests at equipment cost-savings of up to \$200.

### SPECIAL FEATURES OF THE SW-5101:

- full 1 cubic foot test area
- temperature range from -100 to +350°F.
- all solid state controller with  $\pm 1/2$  °F stability
- delivery from stock
- adjustable high-temperature fail-safe with signal lamp
- indicating thermometer in door
- combination hinged and removable door
- bench-top design, can be modified for stacking
- stainless steel feed-through port, 3/4" diameter

Check the SW-5101 specifications against your testing requirements. You'll find they add up to outstanding performance at a down-to-earth price — without sacrifice of quality or reliability.

*The new Associated catalog of environmental chambers is yours for the asking. Write for your free copy today.*

**ASSOCIATED  
TESTING  
LABORATORIES  
INC.**

200 Route 46, Wayne, New Jersey • (201) 256-2800

West Coast Office:

6100 Wilmington Ave., Los Angeles, Calif. 90001 • (213) 589-9196



Circle 167 on reader service card

167

## Build New Schober Music Kits

### DYNABEAT RHYTHM

If you want rhythm Schober's got it—10 real trap sounds in a small carrying case. Add bass drum, snare drum, cymbals, and 7 other great rhythm effects to your combo, piano, or organ playing, each at the touch of a button the instant you want it—or have a ball playing traps along with records and radio! The Schober Portable Dynabeat connects to any guitar, hi-fi, or p.a. amplifier, makes you an instant drummer. Kit \$139.50, all built \$169.50. Special Dynabeat for all Schober Organs (not other brands) synchronizes the sounds you want with manuals and pedals. \$150 for the kit.



### TUNESMITH MELODY INSTRUMENT

The Schober Tun Smith makes the one-finger artist an instrumental soloist. Produces one note at a time on the 2½-octave keyboard while you control tone color (6 voices), vibrato, pitch, volume, as you play. Carry the melody for a combo or play with piano or organ accompaniment—or along with records and radio. Easily portable (13 lbs.), connects to any amplifier. Easy to build kit \$149.50; assembled, ready to plug in and play \$189.50.



Send right now for the full-color Schober catalog, with all details on Dynabeat and Tun Smith as well as Schober's five kit organ models and unique reverberation system. No charge, no obligation. If you like music, you owe yourself a Schober instrument!

THE *Schober* ORGAN CORP., Dept. EL-12  
43 West 61st Street, New York, N.Y. 10023

- Please send me a Schober Organ Catalog.  
 Enclosed is 50 cents for 7-inch LP demonstration record of DYNABEAT and Portable TUNESMITH.

NAME \_\_\_\_\_  
ADDRESS \_\_\_\_\_  
CITY \_\_\_\_\_ STATE \_\_\_\_\_ ZIP \_\_\_\_\_

... recovery from transient effects takes 50 nsec ...

response characteristics. Application of a control voltage to the shutdown terminal turns off both the load and the regulator bias current, reducing system power consumption. "If you want to shut the power supply off with a logic signal, you just supply the signal and it will cut the regulator off," Tatom says. This can't be done with most other IC regulators, he says, except the Fairchild device. Shutdown can be triggered in the MC1560 by logic levels of resistor-transistor, diode-transistor, transistor-transistor, and high-threshold logic for all possible regulator output voltages, with no damage to the circuit. The shutdown feature can also act as a dissipation control to protect the regulator during sustained short-circuits.

**Quick recovery.** As for transient response, Tatom says that for a large change in input voltage, there's little change in output voltage. "The input can change in 20 nanoseconds and you don't get a big spike in the output. For a 5-volt input change taking place in 20 nsec, the typical change in the output is just 3 millivolts. You can also adjust the short-circuit limiting current easily—to make sure you never draw too much current into the load—by adding a very small external resistor, and this doesn't appreciably affect the output impedance."

Typical recovery time for the MC1560 for a drop in load current from 100 to 50 milliamps is 50 nsec, compared with the microsecond recovery times typical of other regulators, either discrete or monolithic. This feature is said to be particularly important for digital systems in which switching causes large current changes in a short time. The device also offers high ripple rejection, typically 0.002% per volt.

Tatom says the MC1560 will be applicable in any system using a power supply that has a 20-volt input and a 17-volt output. A device to handle inputs up to 35 volts will be ready in a few months.

Motorola Semiconductor Products,  
Phoenix, Ariz. 85036 [444]

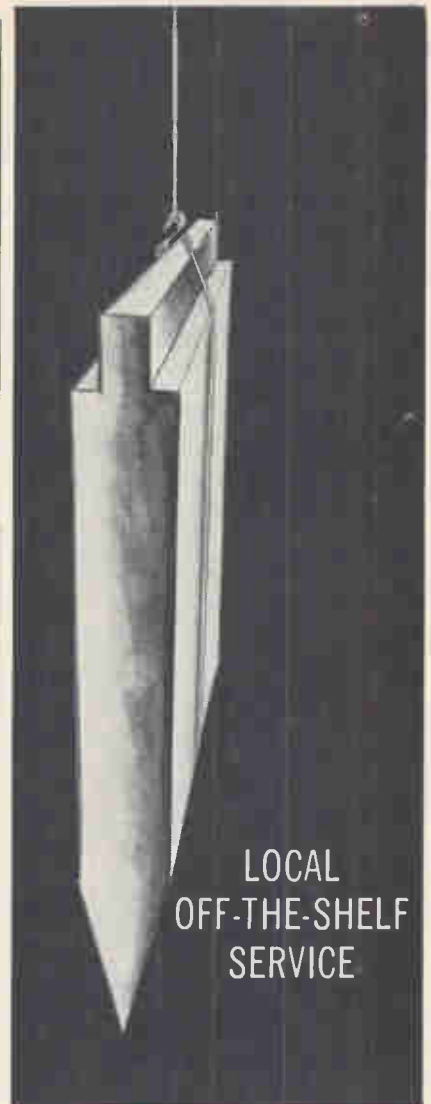

LOCAL  
OFF-THE-SHELF  
SERVICE

## DI-ACRO PRESS BRAKE DIES

There is a Di-Acro distributor near you with a stock of forming punches and dies in standard sizes and lengths up to 150 inches. Gooseneck dies, offset dies and other specialties also available from factory and distributor stocks.

Di-Acro dies fit all press brakes. They are ready for immediate delivery to cut costly tooling time for you. In addition to standards, special shapes can be made to your specifications.

Write us for the name of your local stocking distributor and your copy of the new Di-Acro complete press brake catalog. Take advantage of Instant Inventory on your press brake dies now.



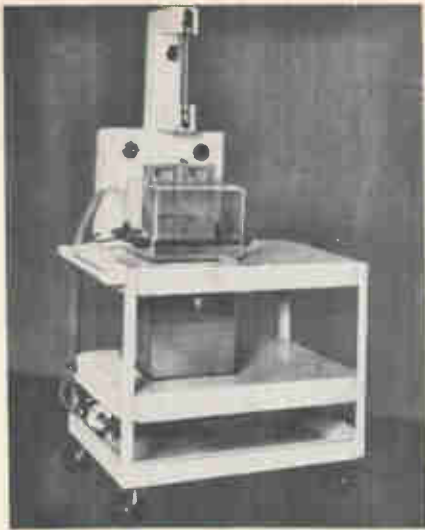

## "fine line" etcher

for prototypes—limited runs

Model No. 201 (illus.), etches two  
11" x 14" one-sided  
boards or one 11" x 14"  
two-sided board: **\$795**  
Pat. applied for

**ETCH YOUR OWN  
P C BOARDS  
AUTOMATICALLY**  
(in less than 5 minutes)

from this →  
to 11" x 14"  
Shown Actual Size



- No cooling or venting required!
- Etches as fine as .001"!
- Cuts costs in half—saves time!
- Complete photo processing instructions!
- Work is illuminated while etching!
- No patterning . . . minimum undercutting!

### NOW IN USE BY:

AMP, Inc.  
Ampex Corp.  
Atomic Energy Com.  
Bendix  
Charles Bruning  
Esso Research  
General Dynamics  
General Electric  
IBM  
ITT  
Lear Siegler  
Magnavox  
Micro Switch  
NASA  
Owens-Illinois

Sprague Electric  
Union Carbide  
U.S. Air Force  
Western Electric  
Whirlpool  
M.I.T.  
Oklahoma State U.  
Purdue Univ.  
Washington Univ.  
Univ. of Calif.  
Univ. of Chicago  
Univ. of Colorado  
Univ. of Georgia  
Univ. of Hawaii  
Univ. of Penn.

## CYCLO-TRONICS, INC.

3858 N. CICERO — CHICAGO, ILL. 60641  
TELEPHONE: (312)-282-6141

### New semiconductors

## Power sealed in TO-3 case

Package for transistors  
has low leak rate  
for military jobs

In the brief period between its abandonment of the industrial power-transistor business and the decision of the new management to re-enter power in a big way, Fairchild Semiconductor continued producing power devices for the military, at a rate of about 70,000 per month.

To further exploit this market, the company has developed what it says is the first hermetically sealed TO-3 package.

The TO-3 is a low-profile package in which the power-transistor chip is mounted on a steel or copper plate and lead-bonded to two pins. The pins are sealed with glass where they pass through the plate, and since the coefficient of expansion of glass is different from that of copper or steel, the seal isn't hermetic.

Fairchild switched to Kovar pins, with glass seals, and found that hot-welding the pins to steel weld rings produced a package that meets hermetic standards (a leak rate of  $10^{-8}$  cubic centimeter of helium per second).

Expansion rates have also contributed to failures in mounting chips. To spread heat in a power device, the silicon chip is normally mounted on the base plate with lead-tin, lead-silver, or lead-indium solder a mil or two thick. As the silicon expands it deforms the solder, so that eventually, after many cyclings, the bond will fail like a solder wire bent once too often.

Fairchild solved this problem, says Thomas J. Moutoux, manager of power transistor and silicon controlled rectifier engineering, by putting a relatively thick (30-to-40 mil) disk of molybdenum, beryllia, or silicon-tungsten between the chip and the plate. The silicon expands at the same rate as the disk,

# LOW COST AUTOMATION takes many forms

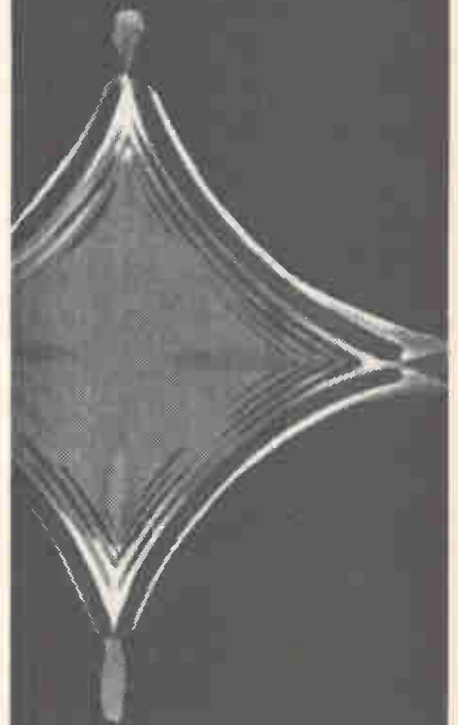

Our MP Repeat Cycle Timers inexpensively control up to 12 SPDT, 10 amp 120 VAC circuits from a common time base. Catalog 15 explains this and 560 other forms of low-cost automation. Send for it.

**BLISS**  **EAGLE SIGNAL**

A GULF + WESTERN COMPANY  
DAVENPORT, IOWA 52808

Service-In-Depth...  
Local Engineering, Stock, Repair

# AMPERITE

## GLASS ENCLOSED Thermostatic DELAY RELAYS



Offer true  
hermetic  
sealing —

— assure  
maximum  
stability  
and life!

### Delays: 2 to 180 seconds

Actuated by a heater, they operate on A.C., D.C., or Pulsating Current . . . Being hermetically sealed, they are not affected by altitude, moisture, or climate changes . . . SPST only — normally open or normally closed . . . Compensated for ambient temperature changes from  $-55^{\circ}$  to  $+80^{\circ}\text{C}$ . . . Heaters consume approximately 2 W. and may be operated continuously. The units are rugged, explosion-proof, long-lived, and inexpensive!

TYPES: Standard Radio Octal and 9-Pin Miniature . . . List Price, \$4.00  
PROBLEM? Send for Bulletin No. TR-81.

# AMPERITE

## BALLAST REGULATORS

Hermetically sealed, they are not affected by changes in altitude, ambient temperature ( $-50^{\circ}$  to  $+70^{\circ}\text{C}$ .), or humidity . . . Rugged, light, compact, most inexpensive.

List Price, \$3.00

Write for  
4-page  
Technical  
Bulletin  
No. AB-51

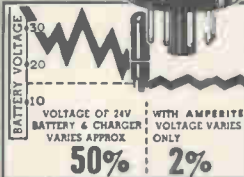

# AMPERITE

600 PALISADE AVE., UNION CITY, N.J.  
Telephone: 201 UNion 4-9503  
In Canada: Atlas Radio Corp., Ltd.,  
50 Wingold Ave., Toronto 10

which is thick enough to expand within the elastic limits of the material, thus acting like a spring.

The disk and the steel weld rings for the pins are braised to the base plate. The disk has a gold surface and the chip is coated with silicon-doped gold; when heated, the gold and silicon form a melt which, as it cools, forms a gold-silicon eutectic interface.

Fairchild, which has been providing samples of the TO-3, is ready to do the same with a hermetic version of the TO-66 that's essentially a smaller version of the TO-3.

Fairchild will put seven circuits into its new TO-3 and TO-66 cans: the 6207 2-amp npn amplifier/switch and its pnp complement, the 0403; the 7207 5-amp npn amplifier/switch and its pnp complement, the 0400; the 8207 10-amp npn amplifier/switch and its pnp complement, the 0402; and the 2N5264 180-volt 7-amp npn switch.

Moutoux says the new packages will cost slightly more than their non-hermetic forerunners.

Fairchild Semiconductor Division, Mountain View, Calif. [445]

New semiconductors

Nordic trigger  
pulled by light

Schmitt device is made  
with photosensitive FET;  
handles up to 20 watts

Photoelectric control almost always involves a photoresistor. But the people of the fjords have shown a way to get along without one.

Norway's A.S. Akers Electronics has built a Schmitt trigger whose firing level can be fixed by light intensity. The company says that its device, called the UH 3011, can be used in counters, readers, smoke detectors, and lamp drivers; it may also have a place in long-time delay lines, optical-logic devices, and process controllers.

Built into a TO-5 can, the UH 3011

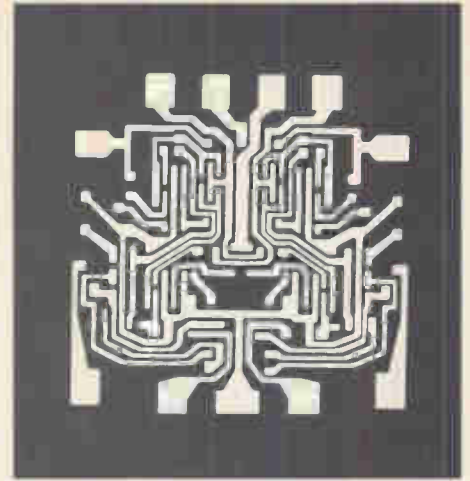

## Precision plotting.

That's what our new Micro/Plotter coordinatograph offers you — precision plotting to  $\pm .001$  inch.

Now you can produce highly accurate master layouts for printed circuits, optical resolution targets, maps, charts, graphs, and tool templates.

Micro/Plotter features rack and pinion motion, ultra-flat work surface, and abscissa rail pivots. And it's available with a special hardwood or backlighted translucent glass top — rectangular or rotary. An optical electronic digital display unit eliminates scale dials and tapes, increases operating speed and efficiency. And a new electrostatic top prevents movement of drafting films, minimizes air pockets, and improves accuracy.



Write today for complete information.  
Consul & Mutoh, Ltd., 519 Davis St.,  
Evanston, Illinois 60201  
Eastern Regional Office: 7601 Castor Ave.  
Philadelphia, Pa. 19152

# MUTOH

MICRO PLOTTER

**TONE TELEGRAPH BANDPASS TRANSMIT FILTER**  
Size: 2-15/16" x 2-1/16" x 2-9/16"

**EIA LAND MOBILE LOW PASS VOICE FILTER**  
Size: 3/4" x 5/8" x 1-1/4"

**RF20, CONTACTLESS RESONANT REED FILTER**  
Size: .395" x .620" x 1.100"

**RADIO RECEIVER LOW PASS FILTER**  
Size: 2-3/4" x 1-29/32" x 31/32"

**TONE TELEGRAPH BANDPASS RECEIVE FILTER**  
Size: 3-1/4" x 2-1/4" x 1-1/4"

**Bramco Custom Designed LC and Electromechanical Filters Operate from 0 to 200 kHz**

At Bramco we specialize in custom engineering LC and electromechanical filters. We offer experience and speed. And our computer synthesis program makes sure you get optimum design and performance.

Write for helpful literature and data sheets...or outline your special requirements.



**BRAMCO CONTROLS DIVISION, LEDEX INC.**

542 South Street, Piqua, Ohio 45356  
Phone (513) 773-8271

Circle 218 on reader service card

is a thin-film hybrid integrated circuit. The key element is a light-sensitive field effect transistor. The Schmitt trigger can be fired by either raising the control voltage or shining light of sufficient intensity on the IC.

**Lead on.** Four wires come out of the device. The first one is for control voltage, which can go from 4 to 10 volts; the second lead is connected to the TO-5 can. In most applications, a gate resistor, grounded at one end, is attached to lead three. The load and the sup-

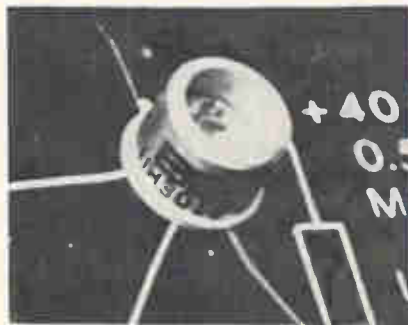

Norwegian hybrid. The trigger is a thin-film IC made for counters and readers.

ply voltage—40 volts maximum—are connected to lead four.

The minimum intensity at which the trigger fires is a linear function of control voltage. For example, if a 10-megohm gate resistor is attached, if the wavelength of the illumination is 9 microns, and if the control voltage is 5 volts, the device fires when the illumination intensity exceeds 200 lumens per square meter and turns off when the intensity falls below 150 lumens. If the control voltage is raised to 9 volts, 525 lumens are needed to turn on the trigger, and it doesn't shut off unless the intensity drops below 350 lumens.

The UH 3011 switches up to 20 watts with a 10-megohm gate resistor attached, and its trigger level stays the same for shifts in the 0°-to-85° range. If the gate resistor is only 1 megohm, the operating range goes out to 120°C.

In the off state the switch draws 1 milliamp from the control supply if the control input is 4 volts, and 2.6 ma at 10 volts. If the device is on, the current ranges from 2.5 to 8.0 ma.

A.S. Akers Electronics, Horten, Norway [446]

# LOW COST AUTOMATION takes many forms

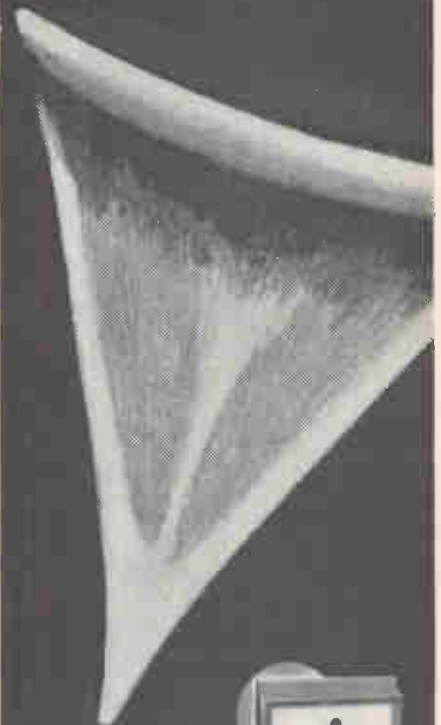

New plug-in Cycl-Flex 2 & 3 digit totally solid state I/C counters. 100% accurate. Up to 1200 counts per minute. Available in higher count rates. Easy-to-set thumb wheels.

Get Catalog 15, describing these and 560 other forms of low-cost automation.

**BLISS**  **EAGLE SIGNAL**

A GULF + WESTERN COMPANY  
DAVENPORT, IOWA 52808

**Service-In-Depth ...  
Local Engineering, Stock, Repair**

Circle 171 on reader service card

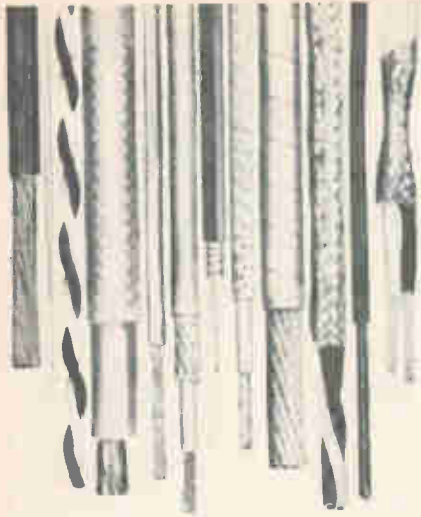

**if we haven't  
made it . . .  
nobody has  
asked for it**

We make not only a wide variety of standard cable constructions, including all the standard RG/U Coaxial cables, but also a tremendous number of special constructions to customers' specifications. These special *Flexlead* cables are precisely engineered to meet the exacting requirements of high and low temperatures, corrosive atmospheres, repeated flexure, abrasion, excessive corona, weathering, and many other severe conditions. Whatever your requirements, Markel will make a cable to meet them. In fact, the chances are good that we've already made one like it . . . and that could save you both time and money! Your letterhead request will bring a copy of our complete *Flexlead* catalog.



**L. FRANK MARKEL & SONS, INC.**  
Norrstown, Pa. 19404 • Phone: 215/272-8960  
INSULATING TUBINGS AND SLEEVINGS  
HIGH TEMPERATURE WIRE AND CABLE

## New Books

### Bifocal and bright

Applied Optics: A Guide to Modern  
Optical System Design  
Leo Levi  
John Wiley & Sons Inc.  
620 pp., \$18.95

Many recent developments in optics have resulted from the application of principles from theories of communication, amplifiers, oscillators, and feedback. This has been especially true in the areas of image analysis, holography, and coherent light. Levi's volume is thus intended for engineers attempting to straddle several technological disciplines as well as for those working with optical systems. Doing a good job for both these groups is a formidable task, but Levi has succeeded amazingly well.

Three major sections deal with fundamentals and with generators and modifiers of light. A second volume will deal with detectors. The fundamentals section discusses principles of radiometry, photometry, and colorimetry; the wave nature of light; communications-theory aspects of optical images, and the quantum nature of light. However, the chapters on modifiers, such as lenses and prisms, are the most extensive and best presented. Also included are pages of tables, which will be especially useful to practicing optical engineers.

Levi stresses the areas of practical importance, giving academic or theoretical topics only brief treatment. This emphasis leads to the inclusion of subjects bordering on optics, such as incandescence and discharge lamps, photoluminescence, roetgenoluminescence, cathodoluminescence, electroluminescence, cathode-ray-tubes, image tubes, and X-ray viewing and recording systems. Similarly, the tables—many computed especially for this volume—include detailed data on black-body radiation, extensive tables of  $\sin x/x$ , precise values of maxima and zeros of  $(\sin x/x)^2$  and  $J_1(x)/x^2$ , and modulation transfer functions of diffraction-limited lenses. Finally, the references are abundant and relevant.

The volume's faults are few but annoying. The author devotes 84



**By George . . .  
Captor sure  
makes small  
EMC Filters!**

Captor subminiature EMC filters are the industry's smallest . . . 25% to 37% more compact than other popular miniatures. Volumes and weights are correspondingly reduced . . . as light as 4.9 grams for many units. Captor EMC filters maintain high published performance over full temperature range to 125° C. Their performance is equal to or better than the competition's, yet they truthfully cost less! Let Captor bid on your next EMC filter or filter assembly requirement, by George! Write for Catalog F-104 and prices today.

**Captor Corporation manufactures miniature filters . . . communications and security filters . . . custom-design filters, and other electronic components.**

**CAPTOR CORPORATION**  
APPLICATION ENGINEERING DEPT.  
5040 Dixie Highway, Tipp City, Ohio 45371

**FREE SAMPLE  
RFI GASKET  
ECCOSHIELD® SV**

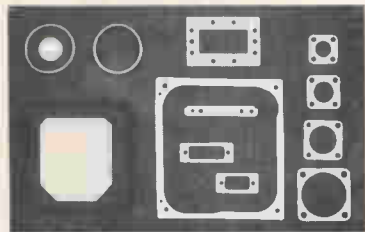

Eccoshield® SV is the flexible, compressible plastic with the conductivity of metal—available in many physical forms—for RF and hermetic seals. Insertion loss has exceeded 100 db.

Circle 516 on reader service card

**ECCOSHIELD®  
RF SHIELDING  
MATERIALS**



**NEW FOLDER**

Electrically conductive self-sticking tapes, metal foils, conductive fabrics, sealers, spray-on coatings, lubricants and adhesives to combat EMI/RFI. All are fully described. Send for FREE copy.

Circle 517 on reader service card

**ECCOAMP  
ELECTRICALLY CONDUCTIVE  
ADHESIVES & COATINGS**

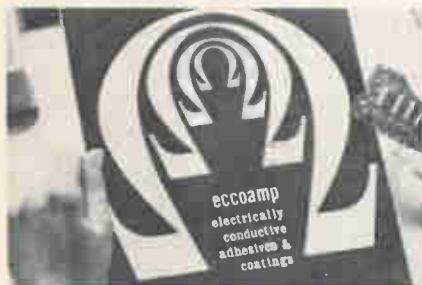

New four page folder describes materials from 0.0001 to 100 ohm-cm. Adhesive pastes to replace hot solder, thin liquids, silver lacquer in aerosol spray, glossy coatings, etc.

Circle 518 on reader service card

**Emerson & Cuming, Inc.**



CANTON, MASS.  
GARDENA, CALIF.  
NORTHBROOK, ILL.  
Sales Offices  
in Principal Cities

EMERSON & CUMING EUROPE N.V., Devel, Belgium

**New Books**

pages to prisms but only 42 to the much broader topic of lasers and related devices. Holography gets only two short paragraphs and non-linear optics three pages. And this section stirs further disappointment when it accepts as formal fact the long-standing joke among some laser researchers of calling a laser oscillator a loser, for light oscillation by stimulated emission of radiation.

A.J. DeMaria

United Aircraft Research Laboratories  
East Hartford, Conn.

**Doing a model job**

Computer-Aided Integrated  
Circuit Design  
Gerald J. Herskowitz  
McGraw-Hill Book Co.  
423 pp., \$15

Designing a new integrated circuit—linear or otherwise—or determining which types of IC's will work best in a system requires accurate mathematical models of the components and their interactions.

To study a circuit's response and sensitivity as parameters and environmental conditions change, the engineer feeds into a computer a model that can represent a variety of conventional IC's substituted at will into larger circuit or subsystem models. Models can also be employed to describe the operation of a proposed IC. Before the device is manufactured and tested, it can be evaluated and modified through simulated operation in the computer.

The problem is that it's difficult to model an integrated circuit element by element. The elements may be fabricated by a wide variety of techniques, some of which can encourage interactions that are difficult to describe. For example, a single integrated circuit might contain both diffused and thin-film resistors, which require different models. And models for diffused transistors may vary depending upon how the devices are to be isolated from other elements in the circuit.

Further, the choice of an active-device model may depend on

**LOW  
COST  
AUTOMATION  
takes  
many  
forms**



EAGLE control relays last longer! There are over 3000 models in our catalog RGC-1, ready to prove their superiority in your application. See them all. Send for your copy.

**BLISS**  **EAGLE SIGNAL**

A GULF + WESTERN COMPANY  
DAVENPORT, IOWA 52808

**Service-In-Depth...  
Local Engineering and Stock**

# TRYGON HAS THE POWER

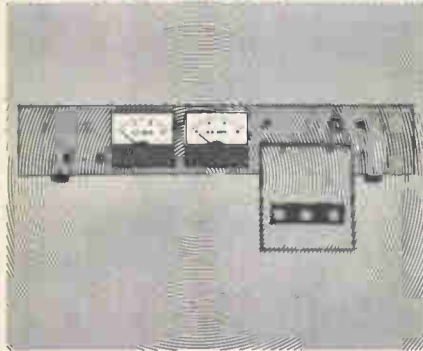

**to deliver wide slot range performance in ratings to fit every system... from \$119.**

- Rack mounted and modular.
- Meter and control options, Integral.
- All silicon design—precision performance.
- Adjustable current limiting—optional overvoltage protection.
- Remote sensing and programming.

LIBERATORS from TRYGON...the ultimate in IC and transistor system power in minimum size at lowest possible cost. Specs like 0.5mV ripple, 3mV P-P noise, MIL Spec. performance and overvoltage protection.

**FULL-RACK MODELS:** voltages to 160V; output currents up to 40 A (3½") and 70 A (5¼"), 0.005% regulation and 0.01% stability, plus load share automatic paralleling.

**SUB-RACK MODULAR MODELS:** voltages to 160VDC, output currents from .25 A to 25 amps, 0.01% regulation and 0.03% stability. Write today.



## TRYGON POWER SUPPLIES

111 Pleasant Avenue, Roosevelt, L.I., N.Y. 11575  
Trygon GmbH 8 Munchen 60, Haldelweg 20, Germany  
Write for Trygon 1968 Power Supply Handbook.  
Prices slightly higher in Europe.

## New Books

whether the studies are being made for small-signal operation or for switching applications.

In some cases, IC elements can be represented by the same models used for their discrete counterparts. The model for a transistor fabricated on a substrate and ideally isolated from the remainder of the circuit is identical to the one for the comparable discrete transistor, for instance.

These are the subjects covered in Herskowitz's book. The focus in this work is on three broad areas, the first involving modeling procedures—including the experimental determination of model parameters—the second relating network and system computer techniques, and the third dealing with the use of modeling to achieve specific IC designs with the aid of a computer.

Herskowitz describes specific methods and outlines seven operating programs that have been applied to the design of currently available IC's. Included are three on-line optimization programs for use with time-shared computer systems.

### Recently published

**Introduction to the Basic Computer**, Donald Eadie, Prentice Hall Inc., 430 pp., \$11.50

Covering the fundamentals of computers, this book reviews number systems, logic schemes, and solid-state circuits. An up-to-date chapter on peripheral equipment precedes the concluding chapter on analog and hybrid techniques. For engineers unfamiliar with digital techniques.

**Digital Computations in Basic Circuit Theory**, Lawrence P. Huelsman, McGraw-Hill Book Co., 203 pp., \$6.95

Designed for use in undergraduate circuit theory courses. Illustrates how digital-computation techniques can solve engineering problems. Subroutines are developed to solve both linear time-invariant and time-varying non-linear networks, partial-fraction expansions, inverse Laplace transforms, Nyquist plots, and root-locus plots. Included are two subroutines that use the computer's printer to plot the data from the problem's calculations.

**Time-Sharing Computer Systems**, M.V. Wilkes, American Elsevier Publishing Co., 102 pp., \$4.95

Surveys a rapidly expanding field, covering problems that have been solved and those that remain to be solved. Describes essential elements of systems, including swapping, scheduling, multiprogramming, paging, multiplexing, segmentation, and memory lockout. Discusses satellite computer system communication problems, graphic display systems, and managerial aspects. Intended for both the software and hardware designer.

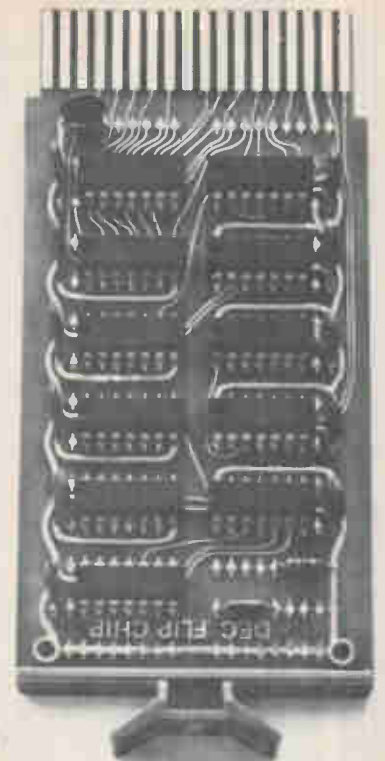

**Complete  
10 MHz IC  
shift register  
at \$10.50  
per stage**

M-208 is an 8-stage digital logic shift register, complete. It, like all 25 modules in the M Series, works at 10 MHz. And it, like all other modules in the series, is designed for a cost/performance ratio that is the best in the industry. The M-208 sells for \$84, unless you buy large quantities. Then it's less.

M-208 control lines are buffered, eliminating complex loading rules. Provision is made for parallel loading of bits. TTL integrated circuits, the latest and best available, are used exclusively. Typical dc noise margin is 1 volt at either logic 1 or logic 0 levels.

M Series modules, including the M-208, and several other series of compatible modules, are fully described in the new Logic Handbook. Write for a free copy.

**digital**  
MODULES · COMPUTERS  
Maynard, Mass.,



# Give our PC connectors an unfair shake.

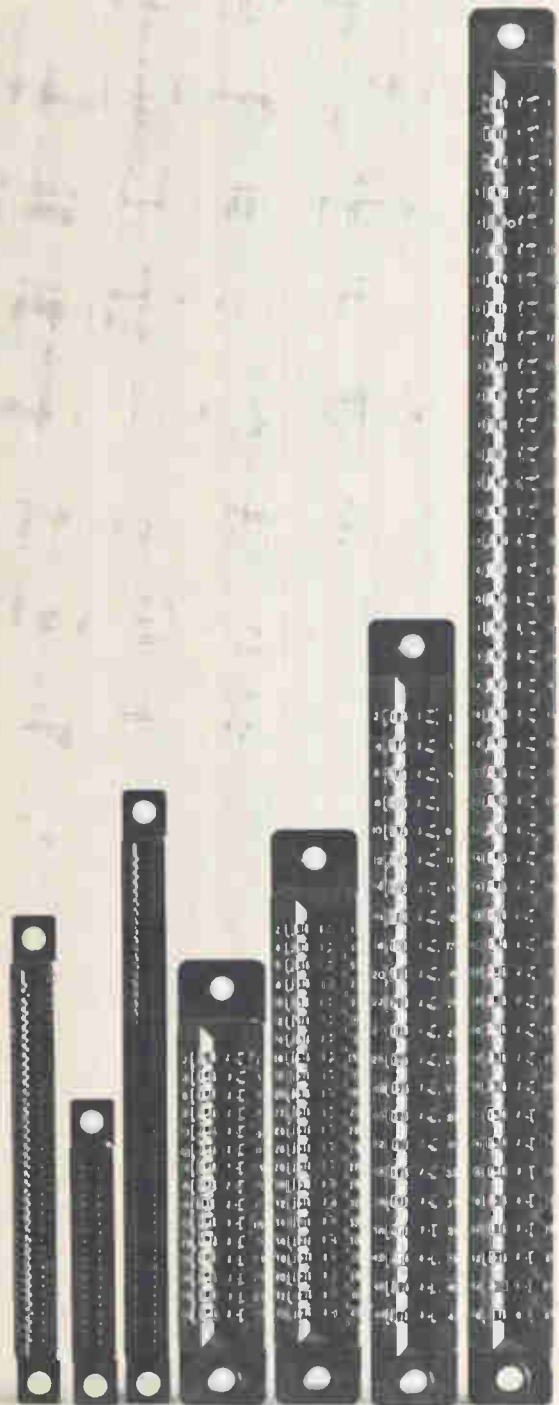

## They can take it.

Vibration.

Shock.

Warping.

That's what printed circuit boards have to put up with nowadays.

So we designed PC connectors that can take it.

Not even an unfair shake (or warp) can jar them loose.

In fact, they can withstand shaking no matter how widely deflected the linear direction of the contact force.

The secret's a bifurcated dual-socket contact that uses a double-cantilever principle.

Once contact is made, it stays made unless you want to reposition it. And when you do, Hughes' exclusive JacPin construction lets you do it easily

and quickly.

Hughes PC miniature and subminiature connectors are available off-the-shelf in 10 sizes with 10 to 96 contacts.

Order some. And give 'em an unfair shake.

Write Hughes Aircraft Co., Connecting Devices, 500 Superior Ave., Newport Beach, Calif. 92663. Phone (714) 548-0671. TWX (714) 642-1353.

☐☐ Connecting Devices, part of Hughes Circuit Technologies. Including: Contour™ Cable; Semiconductors; Flip Chips/Equipment; Frequency Control Devices; Microelectronic Circuits; MOSFETs.

**HUGHES**

HUGHES AIRCRAFT COMPANY

If it's happening in connectors  
it probably started at Hughes

# Delay Lines

**MAGNETOSTRICTIVE**  
DELAY LINES

**SOLID**  
DELAY LINES  
(Glass or Quartz)

**LC and DC**  
DELAY LINES

**DISPERSIVE**  
DELAY LINES

**DIGITAL**  
DELAY LINES

for proven  
reliability in  
Delay Lines and  
Serial Memory Systems  
for military and  
commercial  
applications, it's...



**MICROSONICS, INC.**  
60 Winter Street  
Weymouth, Mass. 02188  
Tel: 617 337-4200

A subsidiary of the Sangamo Electric Company

## Technical Abstracts

### Reverberations

Amplified ferrimagnetic echoes  
G.F. Herrmann, R.M. Hill, and  
D.E. Kaplan  
Lockheed Research Lab  
Palo Alto, Calif.

A new solid state effect may permit the development of a new class of microwave devices. Called a ferrimagnetic echo, the effect can be used to amplify, delay, or change the shape of short pulses of microwave energy.

The word echo is used here in a special way. In the simplest form of the effect, a microwave signal pulse is stored in the resonances of a medium such as yttrium iron garnet. After a waiting period, a second pulse—a recall pulse—is applied to the garnet at the same frequency. The two disturbances are then mixed so that an output signal or echo is radiated by the garnet at times determined by the period between pulses.

The discovery is part of a continuing study that has resulted in the finding of echoes in ionized plasmas (cyclotron echo) and molecular gases.

The echo effect is improved when irregularly shaped crystals biased by inhomogeneous magnetic fields are used. The conditions under which these echoes can be produced are particularly suitable for applications in new devices.



Microwave pulse-delay devices can now be exceedingly small and light because they can operate efficiently without either cryogenic cooling or a very homogeneous magnetic field. Delays of 2 microseconds are possible with a single recall pulse; with multiple recall pulses, delays may exceed 10 microseconds. The echo pulses are amplified by as much as 50 decibels in relation to the signal pulses.

Time compression or expansion of microwave pulses is also possible using a modified pulse sequence. To compress a microwave pulse by this method, the input and recall pulses are both frequency modulated. If the duration of the recall pulses is adjusted to be half that of the signal pulse, the echo pulse is very much shorter than the



**miniature**  
**DC-18 GHz motorized**  
**programmable**  
**stepattenuators**  
**0-129 dB**



New  Miniature Motorized Programmable Stepattenuators come with values as high as 129 dB in 1 and 10 dB steps. These 50 ohm  series 96, 97 and 98 Stepattenuators come in a choice of 8 standard RF connector options (coaxial or waveguide); 5 standard frequency ranges; 17 standard insertion loss ranges; and single, double or triple drum assemblies internally connected in series with low reflection adapters to minimize mismatch errors.

They feature  switching life exceeding 1,000,000 steps  excellent repeatability  high stability under wide range of environmental conditions  low leakage  low VSWR  and low minimum insertion loss. In addition, they are motorized and easily programmable.

Switching time is typically 2 seconds. Repeatability exceeds  $\pm 0.01$  dB/drum up to 10 GHz. Maximum VSWR for all  series 96 units is held to less than 1.50 and to 1.8 GHz and to below 1.15 for lower frequencies.

The ease with which these models are programmable makes them especially useful in systems employing automatically controlled levels. These stepattenuators can be switched more than one million times without deterioration and without in-between maintenance.

Designers and  
Manufacturers of Precision  
Microwave Equipment

**WEINSCHEL**  
**ENGINEERING**

Gaithersburg, Md. 20760  
Tel: (301) 948-3434  
TWX: 710-828-9705



## Happiness is an Acopian power supply . . . because it's shipped in only 3 days.

Whether your application is op amps, ICs, logic circuits, relays, lamps or electronic measuring equipment, look to Acopian to meet your needs for AC to DC plug-in power supplies. Acopian's new catalog lists over 62,000 different supplies . . . all available for shipment within 3 days. Get your 16 pages of happiness by writing or calling Acopian Corp., Easton, Pennsylvania (215) 258-5441.



Circle 177 on reader service card

# IC SEALING PROBLEMS SOLVED

WITH WILLIAMS' IMPROVED ALLOYS FOR MICROELECTRONIC DESIGN.

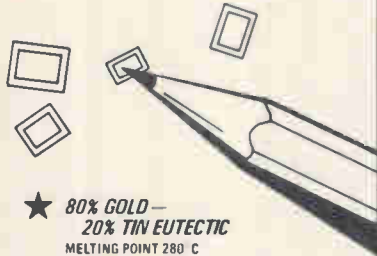

- ★ **80% GOLD — 20% TIN EUTECTIC**  
MELTING POINT 280 C
- ★ **88% GOLD — 12% GERMANIUM EUTECTIC**  
MELTING POINT 356 C
- ★ **SOLDER PREFORMS FOR SEALING INTEGRATED CIRCUIT PACKAGES**
- ★ **TOOLING AVAILABLE ON MOST STANDARD SIZES**  
4 to 6 Weeks Delivery on New Tooling

## PARTIAL LIST OF AVAILABLE ALLOYS & SOLDER PREFORMS

88% Gold 12% Germanium (Eutectic Alloy)  
Strip and solder preforms in all sizes

80% Gold 20% Tin (Eutectic Alloy)  
Strip, wire and solder preforms in all sizes

Gold with .1 to 1.2% Antimony  
Wire, strip and solder preforms all sizes

Gold — .05% Min. Phosphorous  
Wire, strip and solder preforms all sizes

95% Gold 5% Nickel  
Wire, strip and solder preforms all sizes

Gold and up to .5% Arsenic  
Strip and solder preforms all sizes

Silver with .1 to 1.2% Antimony  
Wire, strip and solder preforms all sizes

Silver — .1% Min. Phosphorous  
Wire, strip and solder preforms all sizes

95% Silver 5% Nickel  
Wire, strip and solder preforms all sizes

Silver and up to .5% Arsenic  
Strip and solder preforms all sizes

Special alloys produced on request at minimum charge.

Precious Metals in 99.9% Pure, 99.99% Pure, and 99.999% Pure.

Modern, up-to-date refining of precious metals and complete spectrographic facilities available

### HIGH PURITY METALS USED ON ALL ALLOYS

WRITE FOR COMPLETE PRECIOUS METALS CATALOG AND SPECIFICATION SHEETS. PHONE 716-834-7204

OVER 50 YEARS OF PRECIOUS METALS EXPERIENCE

**WILLIAMS PRECIOUS METALS**



2978 MAIN ST. BUFFALO, NEW YORK 14214  
Division of Williams Gold Refining Co., Inc.

## Technical Abstracts

signal. Compression ratios in excess of 250:1 have been achieved, so the pulse compression techniques may extend into the nano-second range.

In a radar application this would permit the resolution of target features that vary over little more than a foot in depth with transmitter pulses more than a thousand feet long. As an added dividend, the technique amplifies weak radar-return echoes at the same time that it compresses the pulses.

The Lockheed development relies upon restricted mutual coupling between the oscillatory modes of the ferrimagnetic system. This is done with inhomogeneous internal magnetic fields that allow a given oscillator, or spin mode, to make exchanges of energies close to its own. As a consequence, a nonlinear energy flow process induced by the recall pulse causes certain groups of spin modes to be rapidly pumped up in amplitude with energy derived from their neighbors.

These highly excited modes eventually unite to form a large radiating magnetic moment at a time determined by the interval between the signal and recall pulse. The disturbance initially impressed upon the system by the signal then reappears as a strongly amplified echo.

Presented at the 14th Annual Conference on Magnetism and Magnetic Materials, New York, Nov. 18-21.

### Small strain

IGFET strain transducers utilizing piezoelectric materials  
James Conragan  
Electronics Research Laboratory  
University of California, Berkeley

Insulated-gate field effect transistors fabricated from piezoelectric semiconductors can be used as small and fast thin-film transducers. The IGFETS produce a d-c response when they're strained and they don't need the external amplification required by conventional piezoelectric strain transducers. The twin functions of strain sensing and amplification are built into the device.

Any insulating material, from

**NEW**

# "Tray biens" most versatile of all nutdriver sets

Handy "Tray Bien" sets lie flat or sit up on a bench, hang securely on a wall, pack neatly in a tool caddy.

Lightweight, durable, molded plastic trays feature fold-away stands, wall mounting holes, and a snap lock arrangement that holds tools firmly, yet permits easy removal.

Professional quality Xcelite nutdrivers have color coded, shockproof, breakproof, plastic (UL) handles; precision fit, case-hardened sockets.

Hangs up

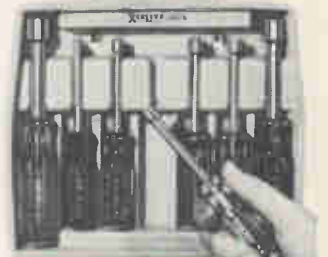

Stands up



Holds tools securely



No. 127TB "Tray Bien" set — 7 solid shaft nutdrivers (3/16" thru 3/8" hex openings)

No. 137TB "Tray Bien" set — 5 solid shaft nutdrivers (3/16" thru 3/8" hex openings) and 2 hollow shaft nutdrivers (1/2" and 9/16" hex openings)

No. 147TB "Tray Bien" set — 7 hollow shaft nutdrivers (1/4" thru 1/2" hex openings)

WRITE FOR BULLETIN N666

**XCELITE**

XCELITE, INC., 130 Bank St., Orchard Park, N. Y. 14127  
In Canada contact Charles W. Pointon, Ltd.

# evening classes won't fit your schedule?

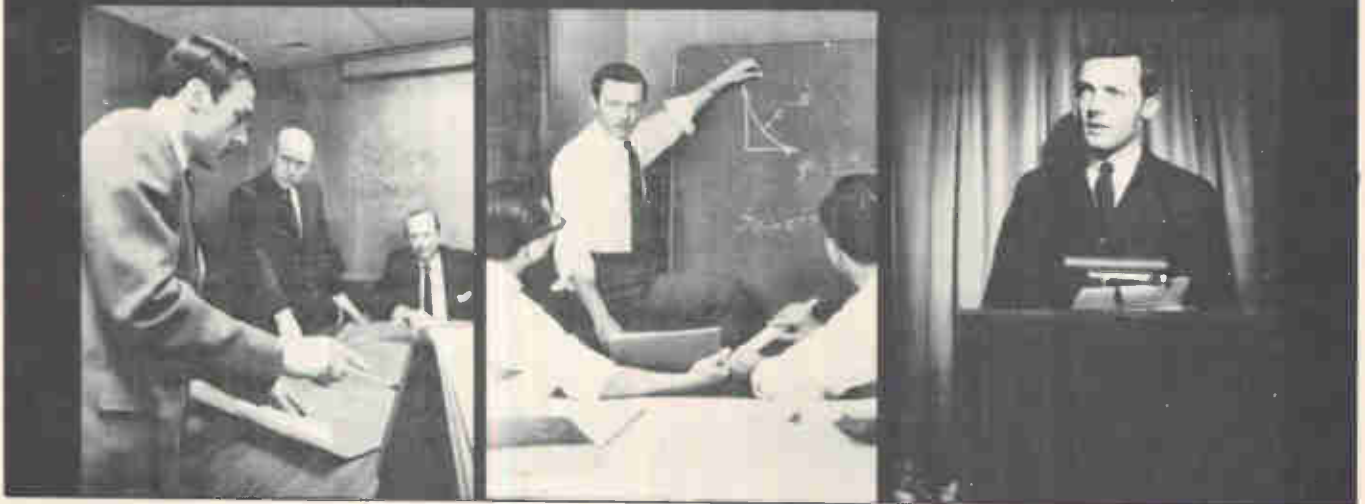

## here's a practical way to keep up with new developments

Are irregular hours, travel and family obligations keeping you from attending classes—even though you worry about becoming technically obsolescent? Check into the Special Programs in Electronics for Engineers developed by CREI, the Home Study Division of the McGraw-Hill Book Company.

These are not simply courses, but comprehensive programs in advanced electronics offering major electives in such fields as:

Communications Engineering, Aeronautical and Navigational, Television Engineering, Automatic Control Engineering, Missile and Spacecraft Guidance, Radar and Sonar Engineering, Nuclear Instrumentation and Control, Computers.

Industry-recognized CREI Programs make it possible for you to catch up on new developments in electronics through study in your own home, at your own pace,

your own schedule. Free book gives complete information and details of technical material covered. For your copy, mail coupon below or write: CREI, Home Study Division, McGraw-Hill Book Company, Dept. 1846G, 3224 Sixteenth St., N.W., Washington, D.C. 20010.

Founded 1927



Specialist Member of the National Home Study Council



CREI, Home Study Division, McGraw-Hill Book Company  
Dept. 1846G, 3224 Sixteenth St., N.W.  
Washington, D.C. 20010

Send me free brochure describing CREI Programs in Electronics for Engineers.

NAME \_\_\_\_\_ AGE \_\_\_\_\_

ADDRESS \_\_\_\_\_

CITY \_\_\_\_\_ STATE \_\_\_\_\_ ZIP CODE \_\_\_\_\_

COMPANY \_\_\_\_\_

TITLE \_\_\_\_\_

# NEW

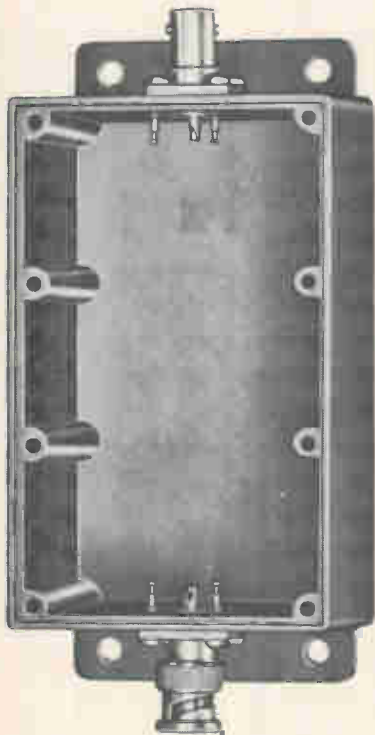

**MODEL 2903**  
Shown  $\frac{3}{4}$  Actual Size

## LARGER SHIELDED "BLACK BOXES"

Useable inside space: 4" long x 2" wide x 1½" deep. Large enough to permanently protect and shield custom test circuits. Six models, with four connector combinations. Rugged die-cast aluminum boxes supplied with aluminum cover.

Featured in our 1968 general catalog.  
Write for your free copy.

## POMONA

**ELECTRONICS CO., INC.**  
1500 E. Ninth Street, Pomona, Calif. 91766

## Technical Abstracts

comparatively rigid glass to a highly flexible polyamide film, can be used as the substrate. Cadmium sulfide shows the greatest piezoelectric activity among the semiconductors that are suitable. Cadmium selenide and tellurium are two other materials that have been used. The insulating layer is made of silicon monoxide, and aluminum is used for the electrode material.

When the thin-film IGFET is strained, a piezoelectrically induced field is produced in the semiconductor. This field is neutralized by carriers within the semiconductor itself, a process that takes place at a rate determined by the dielectric relaxation time of the semiconductor. This produces a change in the charge distribution within the IGFET's channel, causing a corresponding change in the drain current. Because this change in charge distribution remains as long as the strain is applied, the result is a d-c response to the strain.

Cadmium sulfide's piezoelectric activity is due primarily to the high crystal orientation of its deposited film. Film thickness is approximately 10,000 angstroms, while the channel depth ranges from 100 to 1,000 Å. Resistivity of the sulfide material must be on the order of  $10^4$  ohm-centimeters to reduce unwanted bulk currents between source and drain. This gives a dielectric relaxation time of about 10 nanoseconds and represents the upper limit of response to an applied strain.

The transducers have a typical stress sensing area of 100 square mils or less. So far, only these fairly large-area devices have been studied; response time is limited to 1 microsecond.

The thin-film IGFET can also be used as a current source or a voltage source if an additional load-resistor is deposited and a second IGFET is used as a source follower.

Work is currently underway to improve the sensitivity and stability of the devices, which can also be used in microphones and surface acoustic wave detectors.

Presented at the 35th convention of the Audio Engineering Society, New York, Oct. 21-24.

## Opportunities for CIRCUIT DESIGNERS

Expanding activity on long-range programs and advanced projects has created many stimulating growth-assignments for Circuit Designers at Hughes.

Some of our most urgent requirements exist in the following areas:

- Development of high-power airborne radar transmitters, the design of which involves the use of the most advanced components
- Design of low-noise radar receivers using parametric amplifiers and other advanced microwave components
- Design of digital radar signal processing subsystem circuits, including range and speed trackers, doppler filter banks and a variety of display circuits
- Design of high-efficiency power supplies for airborne and space electronic systems
- Development of telemetering and command circuits for space vehicles and communications satellites

Requirements: an accredited Engineering degree, a minimum of two years of directly relatable experience and U.S. citizenship.

For immediate consideration, please airmail your resume to:

**MR. ROBERT A. MARTIN**  
Head of Employment  
Hughes Aerospace Divisions  
Dept. 10  
11940 W. Jefferson Blvd.  
Culver City, Calif. 90230

## HUGHES

HUGHES AIRCRAFT COMPANY  
AEROSPACE DIVISIONS

An equal opportunity employer—M & F

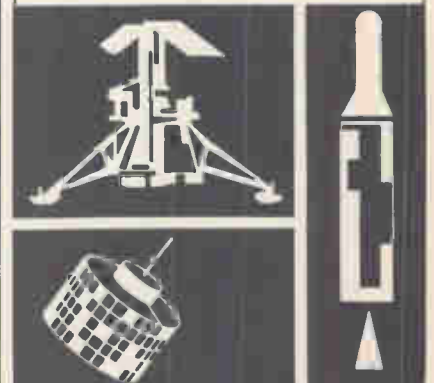

# We Sound Best Under Water...



Bunker-Ramo's advanced BR-441 Acoustic Projector, for example, is a highly efficient sound source at any depth. The BR-441 is the latest projector in a series of deep-operating projector developments that began nearly 10 years ago.

Our extensive knowledge of the ocean's inconstant properties related to propagation, reverberation and ambient noise as well as its effects on materials enable us to keep pace with new developments — from concept formulation to installation and operation.

In the past 10 years our ASW/Oceanographic Laboratory has developed a wide range of products and services. Miniature hydrophones, airborne avionics systems, distance measuring equipment, transponder buoys, checkout instrumentation, data displays, signal processing techniques, deep-ocean sonar, advanced airborne sonar and pressure-insensitive electronic components.

Our knowledge and "in-depth" experience may be of assistance in your program. Contact Jim Caldwell in Washington, D.C. at (202) 337-1500 or write to:

**THE BUNKER-RAMO CORPORATION**  
DEFENSE SYSTEMS DIVISION  
8433 FALLBROOK AVENUE • CANOGA PARK, CALIFORNIA 91304

Circle 223 on reader service card

## PLAY IT SAFE: Start now to save their hearts

Help your children form good health habits now to reduce risk of heart attack later:

- Maintain normal weight; obesity in youth may persist throughout life
- Encourage regular physical activity
- Serve them foods low in saturated fats;
- Teach them that cigarette smoking is hazardous
- Make medical check-ups a family routine

Do as a good parent should. Set a good example. Follow the rules yourself, and guard your heart, too.



**GIVE ...SO MORE  
WILL LIVE**



**HEART FUND**

Here's a little something that will save more time, space and money in circuit design than anything else.

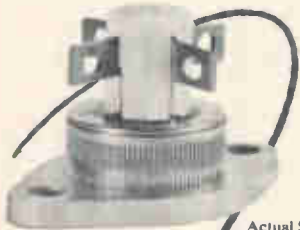

IBR® from Varo.

Actual Size



Varo's Integrated Bridge Rectifier requires just one-half to one-twentieth as much space as its competition. Saves design and installation time and reduces error.

Our IBR® is available as a 10-Amp, 10 Amp fast recovery and 25-Amp full-wave bridge rectifier. 200V, 400V and 600V controlled avalanche ratings. Electrically insulated case for direct chassis mounting. Three mounting options: Press mount, TO3 flange, single stud.

**25-Amp IBR® only**  
**\$3.05\***

**10-Amp fast-recovery IBR® only**  
**\$4.75\***

**10-Amp IBR® only**  
**\$2.35\***

\*In 200V rating and quantity of 1,000 (press mount).

Write for complete information on Varo IBR® products. It could solve problems you didn't even know you had. Available now from Allied Electronics.

®Registered trademark of Varo, Inc.



VARO

SEMICONDUCTOR DIVISION  
2203 WALNUT STREET, GARLAND, TEXAS 75040  
(214) 272-3561

## New Literature

Power conversion equipment. Topaz Inc., 3802 Houston St., San Diego, Calif. 92110, has released a 12-page catalog describing solid state power conversion equipment.  
Circle 446 on reader service card.

Dual in-line packaging. Scanbe Mfg. Corp., 1161 Monterey Pass Rd., Monterey Park, Calif. 91754. Dual in-line packaging is described in a 20-page designer's catalog. [447]

Rfi filters. U.S. Capacitor Corp., 2151 N. Lincoln St., Burbank, Calif. 91504, has published bulletin No. 2000 covering a new line of 50 vwdc, L-section rfi filters. [448]

Panel meter catalog. Voltron Products Inc., 403 S. Raymond Ave., Pasadena, Calif. 91101, offers catalog DA68 giving complete information on the DA series 2½-, 3-, 3½- and 4-inch panel and switchboard instruments. [449]

Data generator. Datapulse Division of Systron-Donner Corp., 10150 W. Jefferson Blvd., Culver City, Calif. 90230. Advance specification 212 describes a 75-Mhz, 16-bit data generator with simultaneous +5 v and -5 v NRZ outputs and ±2 v baseline offset. [450]

Flat ribbon cable. Spectra-Strip Corp., P.O. Box 415, Garden Grove, Calif. 92642, has published a data sheet describing Spectra-Twist flat ribbon cable, which consists of twisted pairs of round conductors, bonded. [451]

Germanium detectors. Laboratory Products Division, Isotopes, a Teledyne Co., 50 Van Buren Ave., Westwood, N.J. 07675. A six-page brochure covers a full line of lithium drifted germanium detectors. [452]

Broadband detectors. I-Tel Inc., 10504 Wheatley St., Kensington, Md. 20795. Bulletin 1929-21 contains dimensions, performance specifications, and prices for a line of broadband detectors. [453]

Desktop modem. Ultronic Systems Corp., Mt. Laurel Industrial Park, Moorestown, N.J. 08057, has available a technical bulletin on the series 2400 Data Pump, a 2400 bits/sec desktop modem. [454]

Power supplies. Technipower Inc., Benrus Center, Ridgefield, Conn. 06877. Catalog 691 gives complete electrical and mechanical specifications and prices of thousands of power supplies. [455]

Videotape recorder. Ampex Corp., 2201 Lunt Ave., Elk Grove Village, Ill. 60007, has issued a brochure containing a description and specifications of the VR-5100 portable, closed-circuit videotape recorder. [456]

WITH **KH** ALL-SILICON  
MULTIFUNCTION  
VARIABLE FILTERS  
**YOU GET MORE**  
THAN HIGH-PASS and LOW-PASS  
**PERFORMANCE**

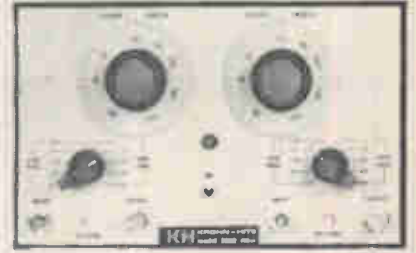

MODEL 3202 provides continuously adjustable high-pass, low-pass, bandpass and band-reject functions over frequency range of 20 Hz to 2 MHz. Two-channel bench unit shown; 5¼" x 8½" x 15¼" rack units available.

The unlimited flexibility of the K-H Multifunction Variable Filters is essential for complex frequency- or time-domain measurements. Don't settle for limited single-function capability when you can take advantage of K-H's two-channel Model 3202 or the one-channel Model 3200. See functions, below.



These responses are fully adjustable and may be set independently. This performance typifies the extra value you get from modern Krohn-Hite electronic instruments. Other values increase user confidence further by providing simpler, faster and lower-cost operation.

**Functions:** Low-pass — direct coupled with low drift. High-pass — upper 3 db at 10 MHz. Bandpass — continuously variable. Band rejection — Variable Broad Band or Null.

**Two Response Characteristics:** (1) fourth-order Butterworth or (2) simple R-C (transient free)

**Zero-db Insertion Loss:** all-silicon amplifiers provide "lossless" passband response. Steep (24 or 48 db per octave) attenuation slopes extend to at least 80 db.

**90-db Dynamic Range:** Low hum and noise (100 microvolts) eliminates costly preamplifiers.

**Output Impedance:** 50 ohms, or lower. There's more in K-H Data Sheet 3200/3202. Write for a copy.

**KH KROHN-HITE CORPORATION**  
580 Massachusetts Avenue, Cambridge, Mass. 02139  
Telephone: 617/491-3211



HERE'S HELP FOR YOUR  
COST-REDUCTION PROGRAM

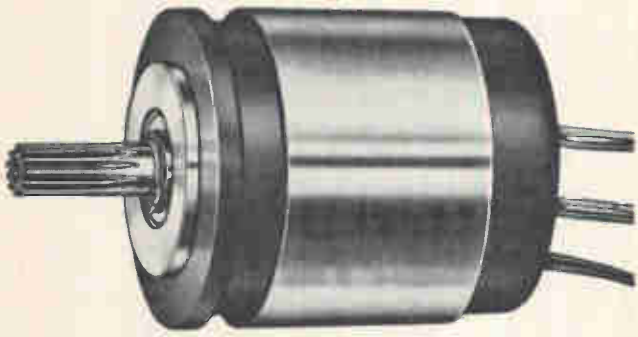

Cedar's new  
**JETLINE**  
Servo Motor

With Cedar's traditional high  
quality and performance but  
at far less cost  
than conventional motors

The new Jetline motors are a family of standard motors available from stock for quick delivery. Modifications and special designs on request. Size 8, 10 and 11 servo motors and Size 8 and 10 motor-tachs are available for both 26-volt and 115-volt applications.

These new motors are an extension of Cedar's more than 10 years experience in the transfer-molding of stators. Molded plastic replaces the case and end cap resulting in fewer parts. Efficiency is maximized through the use of larger stator laminations. The larger flanged bearings fit against the molded plastic, run cooler and provide greater reliability.

Thorough testing of these motors has proven them to meet traditional Cedar quality standards. Our normal warranty applies. Jetline motors have, however, demonstrated over 3500 hours at 100°C ambient.

The important difference to you when you specify Cedar's Jetline motors is that they cost less. For example, a standard Size 10 Servo Motor costs only \$16.50 in quantities up to 1000. To get all the facts on how Cedar's new Jetline servo motors can help in your cost-reduction efforts, write or call today.

**CEDAR** CONTROL DATA  
DIVISION CORPORATION

5806 West 36th Street, Minneapolis, Minnesota 55416  
Phone: 612/929-1681

Circle 225 on reader service card

# Dependable binding posts

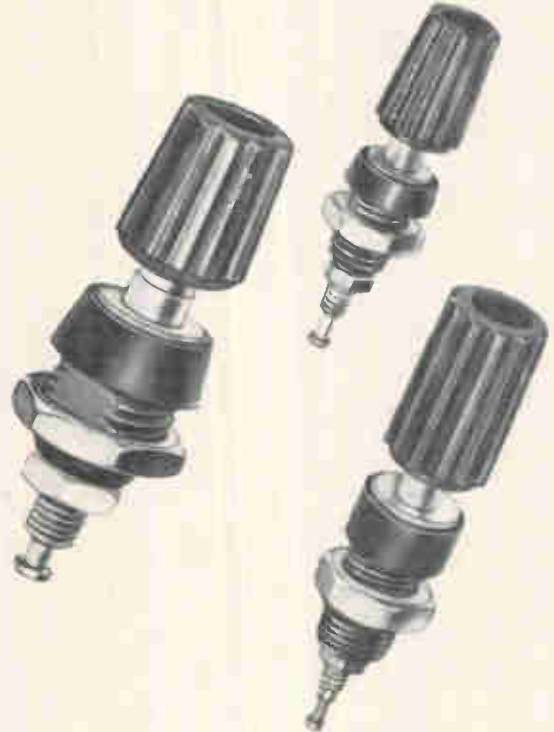

Compact, pre-assembled design offers convenient single nut mounting. Saves time and money on the production line.

Available in three sizes, Johnson pre-assembled binding posts are molded of tough low-loss polyamide. Studs are brass, silver plated and Iridited. Fluted thumb nuts are self-captivated. Connections made at solder terminal or lug may be slipped over threaded portion and secured with a nut. Miniature post accepts single tip plug. Other sizes accept standard banana plug. Insulation resistance greater than 200 meg. after MIL-T-5422B humidity test. Six colors.

**NEW, FREE CATALOG** brings you up to date on these and other high-quality E. F. Johnson components—with detailed specs and prices. See your Johnson representative or write for your copy today.



**E. F. JOHNSON COMPANY**

3062 Tenth Ave. S. W., Waseca, Minnesota 56093

Providing nearly a half-century of communications leadership

Circle 183 on reader service card

183

# NEW O.E.M.

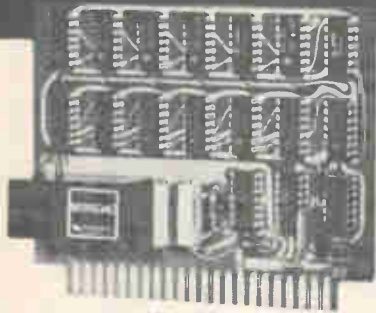

3 3/4" x 4 1/2" x 1/2"

## A-to-D Converter

Pastoriza offers the first utility converter for systems applications . . . priced for quantity sales.

Having first introduced the modular A-to-D and D-to-A converter, Pastoriza Electronics now offers an unprecedented innovation: A printed circuit card A-to-D converter featuring . . .

### High Performance

- 12 bits conversion in 8 microseconds.
- 10 bits conversion in 4 microseconds.
- 8 bits conversion in 2 microseconds.

### Low Cost

Priced competitively with any ADC available today, and designed for volume production.

### Open Book Concept

No black magic in the design — circuitry is accessible and repairable.

### User Confidence

Design and component information is supplied to insure ease and confidence in customer application.

This complete single-card A-to-D converter includes reference supply and comparison amplifier, using dual in-line integrated circuit logic with a MINIDAC D-to-A module. It accepts 0 to +10 volts input range, and provides up to 12 bits resolution.

Write for eye-opening facts on this newest modular A-to-D utility converter.

**PASTORIZA**  
ELECTRONICS, INC.

385 Elliot St., Newton, Mass. 02164 • 617-332-2131

## New Literature

**Electronic readout.** Endeeco Corp., 1675 Stierlin Rd., Mountain View, Calif. 94040, offers a data sheet on a portable, low-cost electronic readout for use with pressure, force, and acceleration measuring transducers. [457]

**D-c voltage standard.** Cohu Electronics Inc., Box 623, San Diego, Calif. 92112. Technical data sheet 15-76 covers a d-c voltage standard with 0.001% accuracy. [458]

**Analog building blocks.** Dana Laboratories Inc., 2401 Campus Dr., Irvine, Calif. 92664. Series 2600 analog building blocks for high-performance instrumentation and data-processing systems are described in a four-page brochure. [459]

**Power supplies.** Elgin Electronics Inc., P.O. Box 1318, Erie, Pa. 16512. A four-page technical data folder for design engineers deals with low-voltage power supplies for integrated circuits. [460]

**Modular instrumentation systems.** New London Instrument Co., 153 California St., Newton, Mass. 02158. A six-page folder covers modular instrumentation systems for modulation analysis, calibration, and testing. [461]

**U.S. and foreign computers.** Auerbach Info Inc., 121 N. Broad St., Philadelphia 19107, has released a four-page brochure providing a comprehensive guide to American, European, and Japanese computers. [462]

**Solder flux.** Micro Co., Box 543, Easton, Pa. 18042, offers bulletin No. 12 on Microflux-A, a water-soluble solder flux for p-c boards and other soldering applications. [463]

**Data set.** Sangamo Electric Co., Box 359, Springfield, Ill. 62705. A data set that transmits and receives asynchronous serial digital data over direct distance dialing networks at rates from 0 to 1,200 bps is described in bulletin 5305. [464]

**Gallium arsenide semiconductors.** Monsanto Co., 10131 Bubb Rd., Cupertino, Calif. 95014. Performance and physical characteristics of III-V light-emitting semiconductors are detailed in a short-form catalog. [465]

**Components catalog.** James Electronics Inc., 4050 N. Rockwell St., Chicago 60618, offers a general catalog outlining a line of electromechanical and solid state devices. [466]

**Push-button switch.** Micro Switch, a division of Honeywell, 11 W. Spring St., Freeport, Ill. 61032. A two-page product sheet describes the 15PB miniature unlighted push-button switch. [467]

## Announcing



## NEW LOW PRICE

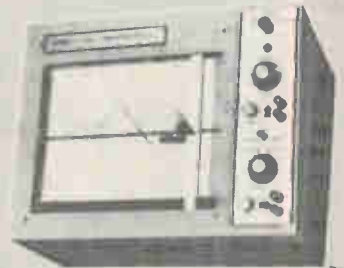

Model  
HR-96

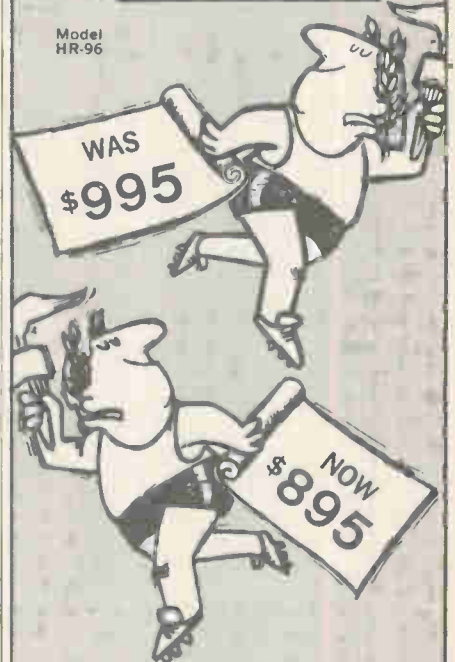

Now you can save \$100 and enjoy the speed and ease of plotting data with Model HR-96 X-Y recorder. Long a laboratory favorite, it features:

- 0.25% accuracy
- 1 mv/in. maximum sensitivity, switch selectable in 5 steps to 10 v/in.
- Electric pen lift
- Electronic time base optional
- 8 1/2" x 11" chart size (11" x 17" size available at slightly higher price)

**houston instrument** DIVISION OF BAUSCH & LOMB

4950 Terminal Avenue, Bellaire, Texas 77401  
(713) 667 7403 Cable HOINCO

Momentary or Push On, Push Off

# MINIATURE Push Button Switches



Exceptionally high current. Positive snap-action with fast make and break contacts. SPDT, DPDT & 4PDT, useable as either a Normally Open or Normally Closed switch. Silver contacts and terminals.

**FREE**  
12-PAGE  
CATALOG  
WRITE!

## ALCOSWITCH

DIV OF ALCO ELECTRONIC PRODUCTS INC. LAWRENCE, MASS

Our Newest Series

# MINIATURES



Outperforms Competitive Models

This advanced "A" Series is a modified version of the original Alcoswitch with the case improvements of our top-of-the-line "E" Series. Case design has double high voltage barriers, and low-loss, high impact, high temperature materials. Wide silver contacts. Available in 1-2-3-4 pole configurations, all in compact unitized bodies. 6 Amps @ 125 VAC.

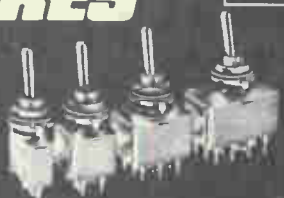

**FREE**  
12-PAGE  
CATALOG  
WRITE!

## ALCOSWITCH

DIV OF ALCO ELECTRONIC PRODUCTS INC. LAWRENCE, MASS

Circle 228 on reader service card

# MODERNIZE the Easy Way With HIGH POWER ADD-ON AMPLIFIERS

- 40 to 18,000 Mhz • 100 Watts to 2.5 KW
- CW or PULSE OPERATION

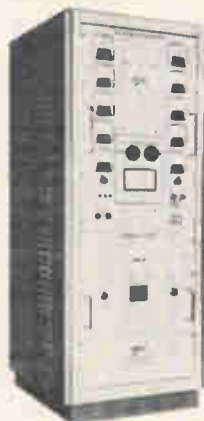

An exclusive MCL advancement in self-contained, rack-mounted amplifier systems which affords quick and economical conversion of older installations to modern and efficient high power operation. Contributes to work area efficiency by eliminating clutter of multi-unit, multi-cable lashups otherwise required for comparable power and frequency ranges. Complete with power supply, cooling source, sequential circuitry, protective interlock and fusing. Built to standard 19" rack mounting dimensions for use as complete subsystem to your specifications.

## CW TETRODE AMPLIFIER SYSTEMS

Model	Freq. Range MHz	Power Output	Gain db.	Bandwidth at 3 db.
10038	200-260	125 watts	13	5 MHz
10039	220-400	125 watts	13	5 MHz
10270-11043	40-200	1.0 KW	13	1 MHz
10270-11044	200-400	1.0 KW	13	5 MHz
10270-11045	400-800	1.0 KW	13	6 MHz
10270-11046	800-1000	1.0 KW	12	4 MHz
11017	400-450	2.5 KW	13	6 MHz

## KLYSTRON AMPLIFIER SYSTEMS

High Gain, High Efficiency  
Or Broad Band Tuning Modes

Model	Tube Type	Freq. MHz	Power Output	Max. Gain Tuned		Max. B.W. Tuned	
				Gain db.	BW MHz	Gain db.	BW MHz
10282	4K3SJ	1700-2400	1.0 KW	47-45	4-6	—	—
10283	4K3SL	1700-2400	1.0 KW	41-38	9-12	38.3	13-14
10284	4K3SK	2400-2700	1.0 KW	43-42	10-15	—	—
10285	4K3SN	2850-3050	1.0 KW	45	7	—	—
10276	VA888	4400-5000	1.0 KW	51	6-8	41	13-19
10233	VA834B	4400-5000	1.0 KW	51	5.5-7.5	41	11-17
10277	VA834D	5500-5850	1.0 KW	51	5.5-7.5	41	11-17
10278	VA861	5900-6400	1.0 KW	58	7-8	48	11
10286	VA866	7100-8500	1.0 KW	59	12	50	20
10287	VA930	15000-18000	0.5 KW	50	12	40	20

Additional standard models available at other power levels and frequencies.

Write for complete MCL Catalog describing triode and tetrode cavities, accessories, test equipment, subsystems and custom capabilities.

See MCL "MICROWAVE MARKETPLACE" Spread,  
1969 Electronics Buyers' Guide

# MICROWAVE CAVITY LABORATORIES, Inc.

10 North Beach Avenue  
La Grange, Illinois 60525  
Phone: (312) 354-4350  
Western Union Telex 25-3608

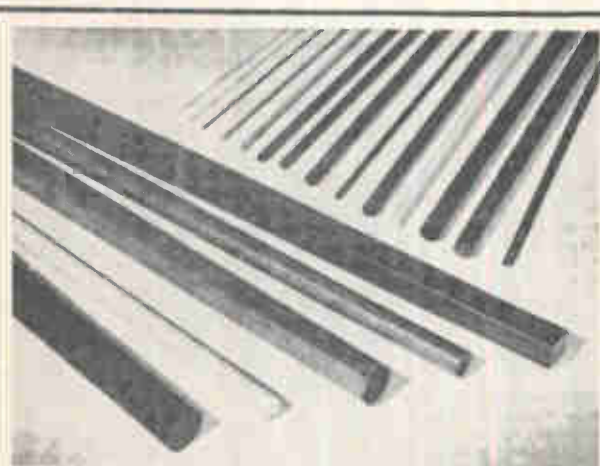

## Laminated plastic rods— convolute wound and molded

Synthane laminated plastic rods with paper, fabric, asbestos, glass and nylon reinforcements; phenolic, melamine, epoxy and other resin binders. Wide variety of shapes, sizes and grades. Ground, polished, varnish-coated. Order direct from mill. Big ready-to-ship inventory. Let us fabricate rods for you—largest fabrication facilities in the U.S. Write for information—Synthane Corporation 36 River Road, Oaks, Pa. 19456—or call (215) 666-5011.

## SYNTHANE

CORPORATION S OAKS - PA 19456  
Laminated Plastic Sheets, Rods, Tubes, and Fabricated Parts.

Circle 229 on reader service card

Circle 185 on reader service card

185

Now Cover the

## ULTRASONIC SPECTRUM

with the new  
MULTISONS® series  
of BROAD BAND  
POWER GENERATORS

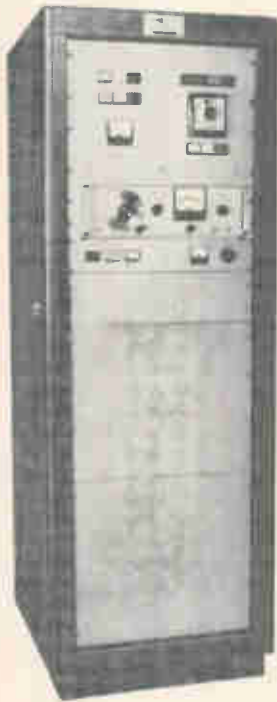

- Bandwidth 10 kcps to 1 mcps
- Average standard power outputs available: 100, 250, 500 and 1 KW (within 3 db)
- Choice of four impedances: between 18 and 2400 ohms
- Push-pull low harmonic distortion driver and output stages
- Standard parts used exclusively
- All power circuits fuse protected
- Maximum accessibility to all sections for ease of servicing tubes
- Variable D.C. bias for magnetostrictive transducers
- Plug in 60 min. timer for automatic programming

Write for Bulletin 105



### MACROSONICS CORPORATION

880 Elston Street, Rahway, New Jersey  
Phone: 201-382-2030

**FRENCH REPRESENTATIVE:**

Societe Luziesia, 70 Rue J. P. Timbaud,  
75 Paris XI. Tel: 023.48.22

## New Literature

**Laser systems.** Korad Department, Union Carbide Corp., 2520 Colorado Ave., Santa Monica, Calif. 90406. Series K-1 pulsed, solid state laser systems are described in a four-page brochure. [468]

**Low level limiters.** DeMornay-Bonardi, division of Datapulse Inc., 1313 N. Lincoln Ave., Pasadena, Calif. 91103. Technical data sheet DB-359 covers precision low-level limiters using silicon epitaxial devices combined with a filter structure. [469]

**Semiconductor bases.** The Nippert Electric Products Co., 801 Pittsburgh Dr., Delaware, Ohio 43015. Bulletin TR-368 describes semiconductor mounting bases produced with integral weld rings by a process of cold extrusion and coining. [470]

**Display and control.** Transistor Electronics Corp., Box 6191, Minneapolis 55424. A complete line of information display and control components, assemblies, and systems are described in catalog 629. [471]

**Concentration converters.** Beckman Instruments Inc., 2500 Harbor Blvd., Fullerton, Calif. 92634. Digital and standard concentration converters are discussed in bulletin 7139. [472]

**IC parameter definitions.** IC Metrics Inc., 121-03 Dupont St., Plainview, N.Y. 11803, has available a 32-page text on linear IC parameter definitions. [473]

**Adjustable toroids.** Vanguard Electronics, a division of Wyle Laboratories, 930 W. Hyde Park Blvd., Inglewood, Calif. 90302. Applications and operating characteristics of miniature high-frequency adjustable toroids, called Varoids, are described in a specifications brochure. [474]

**Data handling.** Tally Corp., 1310 Mercer St., Seattle 98109, has published Tech Topics No. 3, entitled "Data Handling in a Transmission Network". [475]

**Filter catalog.** TT Electronics Inc., Box 180, Culver City, Calif. 90230. The 1968-69 filter catalog lists highpass, lowpass, bandpass and band-reject types. [476]

**Rotary pulse generators.** Trump-Ross Industrial Controls Inc., 265 Boston Rd., North Billerica, Mass. 01862. Bulletin 808A contains revised data on the type 10 and type 11 Tru-Rota rotary pulse generators. [477]

**Holographic systems.** Jodon Engineering Associates, 145 Enterprise Dr., Ann Arbor, Mich. 48103. Two complete systems for holography and nondestructive testing are described in an illustrated brochure. [478]

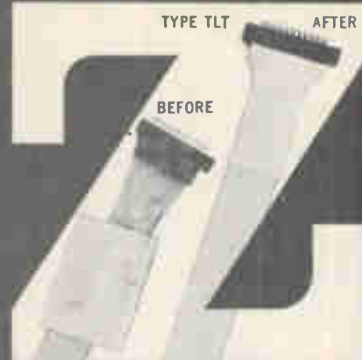

### ZIPPERTUBING® TEMPLOCK THINWALL SHRINKTUBING

provides low cost, light weight PVC with better dielectric properties!

TLT is a thin wall, low cost shrink tubing of especially compounded polyvinyl chloride with a shrink capability of 45% to 55%.

Standard colors: Clear, black, white.

For full information on specialized, high-performance jacketing, contact

### THE ZIPPERTUBING® CO.

CORPORATE HEADQUARTERS  
13000 S. BROADWAY  
LOS ANGELES, CALIF. 90061  
Phone (213) 321-3901  
TWX 910-346-6713



BALTIMORE • BOSTON • CHICAGO • DALLAS • NEW YORK  
PHOENIX • SAN FRANCISCO • WEST GERMANY

Circle 232 on reader service card

### Digilog: first with NON-LINEAR POTS

—custom wirewound under  
direct punched tape control

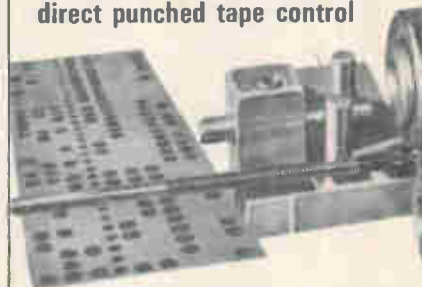

Production can start in hours from the time you tell us your custom requirements.

(1) Design alternatives are analyzed by time-sharing computer, which then punches control tape for best design;

(2) Unique punched tape control directly actuates coil winding machine. No delays to prepare cams or strip charts; an order-of-magnitude improvement in wire position accuracy;

(3) Finished potentiometers, to your exact specifications, are delivered in as little as 10 days, and at reasonable cost.

See your Digilog rep or contact

### Digilog electronics corporation

701 Third Ave. No., Seattle, Wash. 98109  
Phone (206) 284-6811; TWX 910-444-1665

Precision potentiometers, linear or non-linear  
"Mechatrim" and "Differatio" trimmers

Circle 233 on reader service card



localized areas of electronic components can now be Dalic Brush Plated with most metals—without dismantling!

### DALIC SOLVES YOUR PLATING PROBLEMS

Dalic portable brush plating is used by electronics manufacturers and repair shops to spot plate gold, rhodium, silver or other metals directly onto conductive surfaces by utilizing advanced, specially engineered Dalic tools and solutions—in the shop or field. Dalic brush electroplates all areas, without immersion tanks, masking, dismantling, and rewiring. Thickness of deposited metal is accurately controlled to .000010". Quickly learned—no special skills required. Small capital investment. 43 metal coatings available.

**DALIC  
POWER PACK  
Type 200/25-25G**

Input: 110, 240 or 440 volts single phase, 60 cycle A.C. Output: 0-25 amps at 0-25 volts. Forward-off-reverse output switch. Automatic D.C. and A.C. cut-out switches protect work and rectifier. Extremely accurate D.C. type ampere-hour meter for thickness deposit control.



**Sifco Metachemical**  
Division of Steel Improvement & Forge Co.  
935 EAST 63rd ST. • CLEVELAND, OHIO 44103  
PHONE: 216-881-8600

Circle 234 on reader service card

**The only total portable,  
laboratory quality  
oscilloscope.**

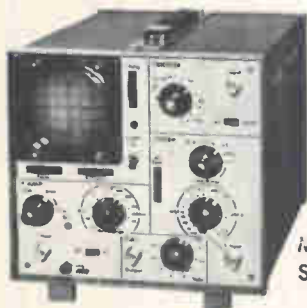

Model  
S1301A

**And only \$665.**

Goes anywhere you need it. And at \$665,\* there's no need for scope sharing. Operates from optional internal battery or 110/220 vac 50 to 400 Hz line. Compact 8½" x 9" x 15" size, weighs less than 20 lbs.

Features include: 20 MHz bandwidth; 17 nsec rise time; 18 sweep speeds; internal voltage calibrator; and triggering stability over 30 MHz.

Write for Bulletin TIC 3316 to Motorola Communications & Electronics Inc., 4501 W. Augusta Blvd., Chicago, Ill. 60651.

\*Exclusive of options.



**MOTOROLA**  
Precision Instrument Products

Circle 231 on reader service card

## Going to IC's? Or Higher IF's?

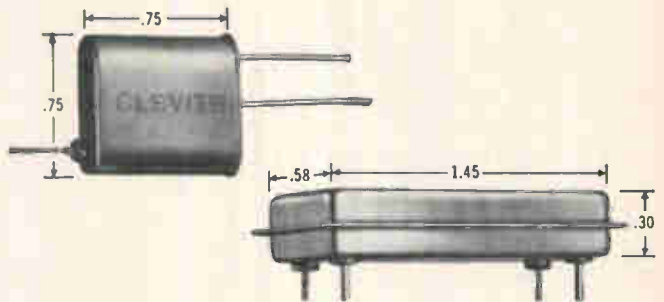

### Go two ways with Monolithic Clevite Uni-Wafer Filters

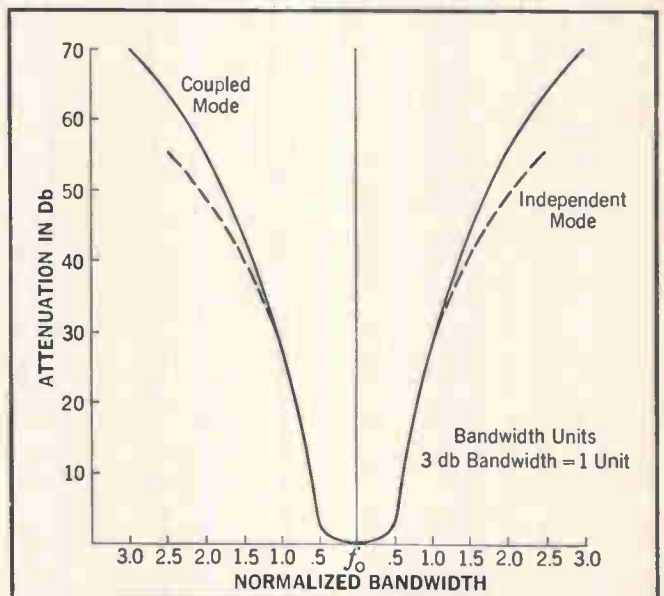

Go independent mode. Go coupled mode. You can go either mode with monolithic Clevite Uni-Wafer filters. They're smaller and more reliable (fewer interconnections) than conventional filters.

Clevite Uni-Wafer filters are ideal for matching IC circuitry in communications receivers operating in the VHF and UHF frequency ranges as well as in telemetry, radar and aerospace systems.

They are four-pole crystal filters with a choice of center frequencies ranging from 8 MHz to 75 MHz. They've been developed using Clevite's advanced engineering techniques and Clevite's original thin film approach to quartz filters. In this concept, arrays of resonators are achieved on a single quartz wafer with resonator isolation and spurious suppression controlled by the trapped energy principle.

So if you're going to IC's or higher IF's, go Clevite Uni-Wafer filters. They're available in both independent and coupled mode.

For more information and complete specification data, write: Clevite Corporation, Piezoelectric Division, 232 Forbes Road, Bedford, Ohio 44146.

# CLEVITE

Circle 187 on reader service card

187

# It's nice to have enough money to retire on.

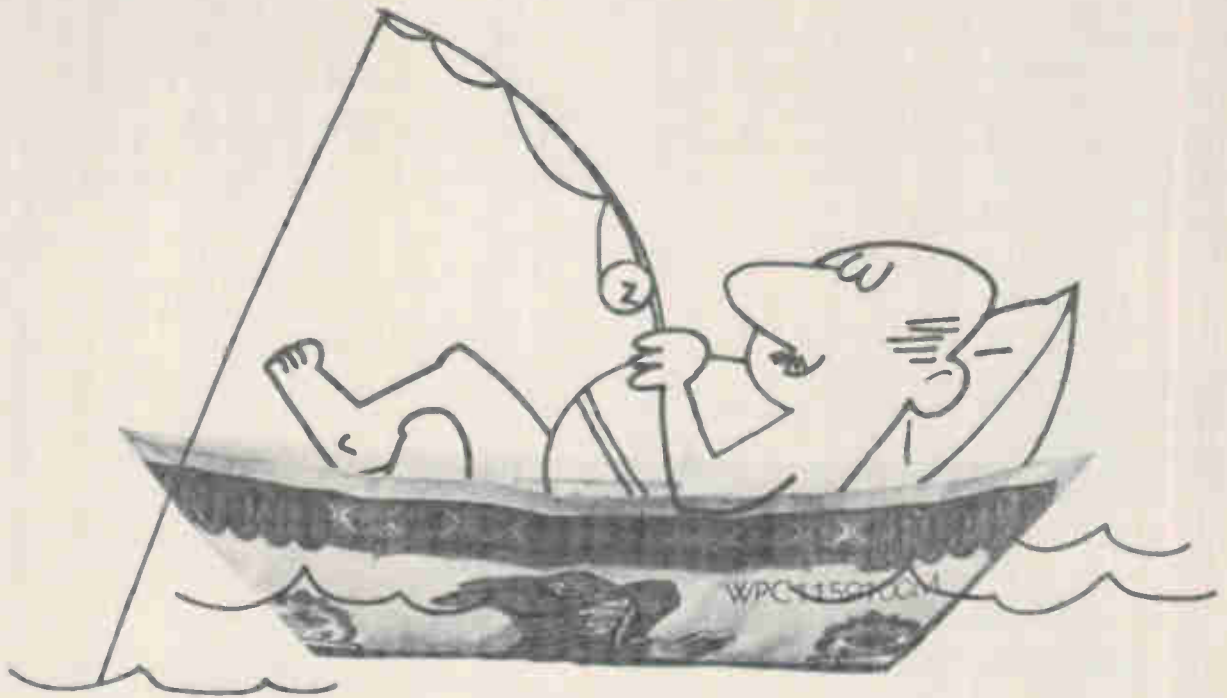

## It's also nice to be around when it's time to retire.

You want to save a nest egg to retire on? Fine. All we suggest is that you be here to enjoy it. What to do? See your doctor for a thorough health checkup once a year, including a procto. And for women, also a Pap test. In short, the works.

Because most cancers are curable if spotted in time. But your doctor won't be able to spot anything—unless you give him the chance.

If you do, you'll improve your chances of enjoying your retirement. To a ripe old age.



THIS SPACE CONTRIBUTED BY THE PUBLISHER AS A PUBLIC SERVICE

# Looking for a better job?

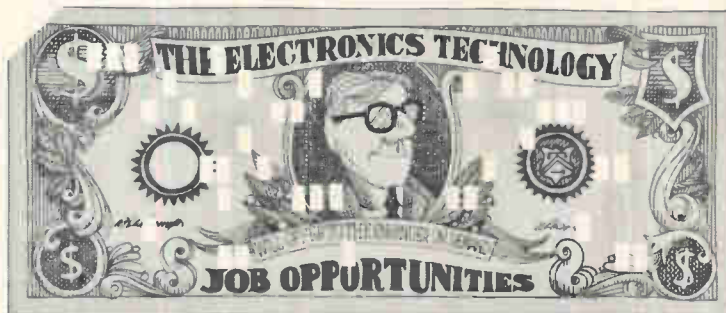

## Ask Electronics' computer all about it

Electronics magazine feels an obligation to help its readers find positions in the electronics technology which will make the greatest contribution to their profession and to society — jobs in which electronics men themselves will be happiest.

Electronics has joined with a nation-wide talent search company—National Manpower Register, Inc.—to form the computerized Electronics Manpower Register. Your qualifications and job requirements will be pro-

grammed into a GE 265 computer, direct-linked to the Manpower Register's offices in New York. The computer, once your resume form (bottom of page and following page) is received, will continuously compare all your data with the specific manpower needs of electronics companies. When a match is made, you will be contacted directly or through an affiliated agency. The company and you will be brought together on a confidential basis.

*Continued on next page*

### Electronics Manpower Register

It is important that your information be complete and that you type or print legibly

#### IDENTITY

Name	Date	PRESENT OR MOST RECENT EMPLOYER	
Home address		Parent company	
City	State	Zip	Your division or subsidiary
			Location (City/State)
Home phone	Do you subscribe to Electronics <input type="checkbox"/>		or see a library or pass-along copy <input type="checkbox"/>

#### GEOGRAPHICAL PREFERENCE (Check appropriate boxes and complete all blanks)

I will NOT relocate  I will consider opportunities in:  North East  Mid Atlantic  South  Midwest  Southwest  Calif.  Northwest  
 Prefer:  Metro. area  Medium town  Rural area  Other: \_\_\_\_\_

#### EDUCATION

Degree	Major field	Year	College or University

#### EMPLOYMENT INFORMATION

Position desired	FOR OFFICE USE ONLY	
Present <input type="checkbox"/> or most recent <input type="checkbox"/> position	REGISTRATION NUMBER	INITIAL OF LAST NAME
Duties and accomplishments	From	To

HAVE YOU REGISTERED WITH THIS SYSTEM PREVIOUSLY? Yes  No

CONTINUED ON OTHER SIDE

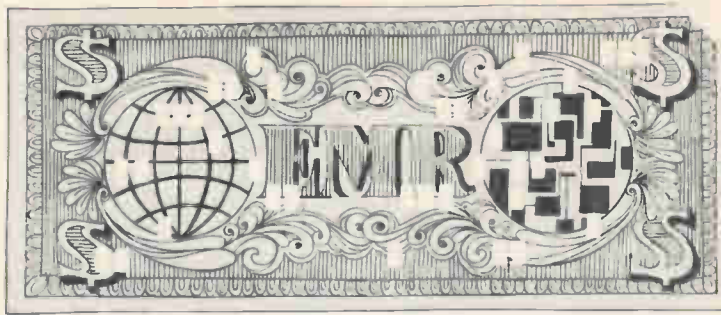

The cost of all this to you? Absolutely nothing. No fees or charges at any time.

Other advantages of EMR:

- Your resume is sent only to those companies that have a genuine requirement for your particular skills.
  - There is no general "broadcasting" in the hope "someone will be interested."
  - Your identity is protected because your name is released only according to your prior instructions. Your name can be deleted on request.
  - EMR's service is nationwide. You may be considered for job opportunities anywhere in the U.S.
- The Electronics Manpower Register is a powerful tool and should be considered when you are seriously seek-

ing a new position. And, although you may be reasonably happy in your present position, chances are that you might have that ideal job in mind.

This is why EMR makes good sense for you. If that job does turn up, you'll be there.

To get your name in the EMR file, just fill out the resume form and return to:

Electronics Manpower Register  
330 West 42nd Street  
New York, N. Y. 10036

Please enclose a copy of your resume if you have one. A detailed brochure further describing EMR will be sent to you.

## **Electronics Manpower Register** A computerized employment opportunity service

CONTINUED FROM OTHER SIDE					
Previous Position	Employer	City/State	From	To	
Duties and accomplishments					
Previous Position	Employer	City/State	From	To	
Duties and accomplishments					
<b>GENERAL INFORMATION</b> (Summarize your over-all qualifications and experience in your field. List any pertinent information not included above.)					
Current annual base salary	Total years of experience	Date available (within four months)	U.S. Citizen <input type="checkbox"/>	Non U.S. Citizen <input type="checkbox"/>	
My identity may be released to:	Any employer <input type="checkbox"/>	All but my present employer <input type="checkbox"/>	Have you security clearance?	Yes <input type="checkbox"/> No <input type="checkbox"/>	If yes, What level
Mail (with a copy of your resume, if you have one) to:					
<b>Electronics Manpower Register</b> <b>ELECTRONICS</b> <b>330 West 42nd St.</b> <b>New York, N. Y. 10036</b>			<b>NO FEES</b> <b>OR</b> <b>CHARGES</b>		
EMR-9					



## SURPLUS BARGAINS!

### 0.01% SORENSEN Line Voltage Regulator

#1001 regul. against load changes 0-1 kva & line changes 95-130 v. 1 ph. 55 65 cy; adj. output 110-120 v. holds to 0.01%. Distortion max. 3%. Response 0.1 sec. Regularly \$570.00. From us, OK

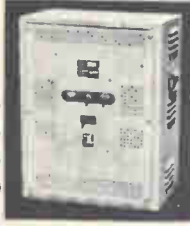

grd. only . . . . \$275.00  
#2501 is same but 0-2.5 kva. . . . \$375.00  
#5005 is same, 0.5 kva. 0.1% . . . \$89.50  
#10005 is same, 1 kva. 0.1% . . . \$99.50  
#20005 is same, 2 kva. 0.1% . . . \$179.50

Sup. Electric #IE-5102 is same spec. electronic regul., but 2 1/2 kva, 0.1% . . . \$199.50  
Sup. Elect. IE-20060: 3 kva. Same specs as above but MIL-spec built, all potted xfrms, etc. Behind rack panel 21" h. 14 1/2" dp; no cabinet. Regular \$960. NEW export boxed, 330 lbs for Utica, N.Y. (Cabinet for above \$30 for Utica.) . . . \$279.50  
Sorensen R5010 all-solid-state, zero reference, 0-5 kva, 90% efficient . . . . \$450.00  
Sup. Elect. IE-5105: Same specs as Sorensen "S" series. 0-5 kva. . . . \$349.50  
Sorensen 10,000S: Same specs as all but 0-10 kva . . . . \$695.00

ALL ABOVE are 1 ph 95-130 v. Here are 1 ph 190-250 v in. 220 240v out, 0-5 kva. Choose Sorensen 5000-2S or Sup. IE-5205P . . . \$349.50

Above are electronic. Following are electromech.:

Gen. Radio #1570AL: 0-8 kva. . . . \$199.50  
Sup. Elect. EM-4106: 0-8 kva. . . . \$199.50  
Sup. Elect. EM-4115: 1 ph 0-15 kva. . . \$295.00

Above are all 95-130 v; 190-260 v follows:

Sup. Elect. EM-4228. 1 ph. 0-27 1/2 kva. . \$495.00  
EMT 6220 Y (transistorized) 3 ph 20 kva \$450.00

L&N #4725, .05% Wheatstone Bridge, 1.1's thru K's, X,0001 thru X10K. . . . \$227.50

WE PROBABLY HAVE THE BEST INVENTORY OF GOOD LAB TEST EQUIPMENT IN THE COUNTRY, BUT PLEASE DO NOT ASK FOR CATALOG! ASK FOR SPECIFIC ITEMS OR KINDS OF ITEMS YOU NEED! WE ALSO BUY! WHAT DO YOU HAVE?

### R. E. GOODHEART CO. INC.

Box 1220-E, Beverly Hills, Calif. 90213  
Phones: Area 213, office 272-5707, messages 275-5342

CIRCLE 972 ON READER SERVICE CARD

Director of progressive British Co. visiting U.S.A. 1969 including Packaging Exhibitions Chicago April & Detroit October wishes to meet Companies interested in selling electronic components, instruments and industrial electronic equipment in the United Kingdom and Europe. Ten years' exp. in selling these items for American principals. We offer an H.Q. in a new office block, engineering & sales staff, full representation and the determination to sell and expand. Please write Hird-Brown Electronics Limited, Bolton, Lancashire, England. Telephone Bolton 27311. Telex: 63478

CIRCLE 973 ON READER SERVICE CARD



## EMPLOYMENT OPPORTUNITIES

ADDRESS BOX NO. REPLIES TO: Box No. Classified Adv. Dept. of this publication. Send to office nearest you. NEW YORK, N. Y. 10036: P. O. Box 12 CHICAGO, Ill. 60611: 645 N. Michigan Ave. SAN FRANCISCO, Cal. 94111: 255 California St.

### POSITION VACANT

**Challenging Opportunity for Electronics Engineer** with strong industrial experience to teach in 2 year Associate Degree electronics technology program in a comprehensive community college. Attractive salary and fringe benefits. Graduate study available nearby. Write or call Mr. Leddy, Illinois Central College, P. O. Box 2400, East Peoria, Illinois 61611, phone 309-694-1421.

### EMPLOYMENT SERVICES

Florida/Nationwide EEs, MEs, IEs . . . Electronic, Aerospace, Industrial, Sales & Mfg. \$9-18,000. Tech Div Brodeur Personnel Service, Inc., 3947 Blvd., Center Drive, Jacksonville, Fla. 32207

Sales Specialist Res. Welding B.A.E.E. Electronics \$13,000. Baker Employment, Danville, Ill.



## SEARCHLIGHT SECTION

• CLASSIFIED ADVERTISING • BUSINESS OPPORTUNITIES  
• USED OR SURPLUS EQUIPMENT

### AUTOTRACK MOUNT



360 degree azimuth, 210 degree elevation sweep with better than 1 mil. accuracy. Missile velocity acceleration and slewing rates. Amplidyne and servo control. Will handle up to 20 ft. dish. Supplied complete with control chassis. In stock—immediate delivery. Used world over by NASA. USAF. MP-61-B. Type SCR-584. Nike Ajax mounts also in stock.

### PULSE MODULATORS

#### MIT MODEL 9 PULSER 1 MW—HARD TUBE

Output 25kv 40 amp., 30kv 40 amp. max. Duty cy .002. 25 to 2 microsec. Also 5 to 5 microsec. and 1 to .5 microsec. Uses 6C21. Input 115v 60 cycle AC. Mfg. GE. Complete with driver and high voltage power supply. Ref: MIT Rad. Lab. Series, Vol. 5, p. 182.

#### 2 MEGAWATT PULSER

Output 30 kv at 70 amp. Duty cycle .001. Rep rates. 1 microsec 600 pps. 1 or 2 msec 300 pps. Uses 5348 hydrogen thyratron. Input 120/208 VAC 60 cycle. Mfr. GE. Complete with high voltage power supply.

#### 250 KW HARD TUBE PULSER

Output 18 kv 18 amp. Duty cycle .002. Pulses can be coded. Uses 5D21, 715C or 4PR60A. Input 115 v 60 cy. AC \$1200 ea.

#### 18 MEGAWATT PULSER

Output 150KV at 120 amps. Rep rate: 50-500 PPS. Pulse length: 5 msec. 15KV 120 amp. into pulse transformer. Rise time 1.5 msec. Filament supply 5V 80 amp. Incl. 17.5KV 1.5 amp DC power supply. Input: 220V 60 cy AC.

#### INDICATOR CONSOLES

AN/SPA-4A. PPI 10", range to 300 ml.  
VJ-1 PPI 12", range to 200 ml.  
VL-1 RIII 12" to 200 ml. 60K ft.

#### HIGH VOLTAGE POWER SUPPLIES

100 KV, 200MA, DC, \$5500; 27 KV, 100MA, DC, \$2200; 15KV, 2 amp, DC, \$3800; 12KV, 1200MA, DC, \$1400; 8KV, 800MA, DC, \$375.

#### SCR 584 AUTOTRACK RADARS

Our 584s in like new condition ready to go, and in stock for immediate delivery. Ideal for telemetry research and development, missile tracking, satellite tracking. Fully Desc. MIT Rad. Lab. Series, Vol. 1, pps. 207-210, 223, 284-286. Comp. Inst. Bk available \$25.00 each.

### SONAR SYSTEMS IN STOCK

AN/FQS-1A. AN/UQS-1B, QHLBa scanning sonars. Rochello salt hydrophones 6 ft.

### MICROWAVE SYSTEMS

#### 200-2400 mc. RF PKG

Continuous coverage, 30 Watts Cw nominal output. Uses 2C39A. Price \$575.

#### L BAND RF PKG.

20 KW peak 990 to 1040 MC. Pulse width .7 to 1.2 micro sec. Rep. rate 180 to 420 pps. Input 115 v. incl. Receiver \$1200.

#### 200-225 mc RADAR SYSTEM

1 Megawatt output, 200 nautical mile range for long range detection of medium and high altitude jet aircraft as well as general search. AN/TPS-28.

#### SURVEILLANCE DRONE RADAR SYSTEM

X-Band tracking system with plotting boards. Type AN/MPQ-29. Drone also in stock.

#### 5 MEGAWATT C-BAND

Klystron RF package delivering nominal 5 megawatt pulse HF. Complete with pulser and power supply.

#### 500 KW L BAND RADAR

500 kw 1220-1359 msc. 160 nautical mile search range P.R.I. and A scopes. MIT thyratron mod 5728 magnetron. Complete system.

#### AN/GPG-1 SKY-SWEEP TRACKER

3 cm. automatic tracking radar system. Complete package with indicator system. Full target acquisition and automatic tracking. Input 115 volts 60 cycle New. In stock for immediate delivery. Entire system 6' long, 3' wide, 10' high. Ideal for Infrared Tracker, Drone Tracker, Missile Tracker, R. & D.

#### C Band Autotrack

1 Megawatt 10 ft. Parabola. Sperry.

RADAR SYSTEMS GROUND AND AIRBORNE AUTOMATIC TRACKING ANTENNA SYSTEMS NIKE AJAX NIKE HERCULES M-33 MSO-1A MPS-19 MPS-9 SCR 584 TPS-1D TPS-78 FAA-ASR-2 AIRBORNE SYSTEMS APN-84 APN-107 APS-70 APS-27 APS-45 DPN-19 DIGITAL COMPUTERS IBM 650 IBM 704

LARGEST INVENTORY OF RADAR AND MICROWAVE EQUIPMENT IN THE WORLD  
**RADIO RESEARCH INSTRUMENT CO.**  
45 WEST 45TH ST N. Y. 10036 212-JU 6-4691

CIRCLE 969 ON READER SERVICE CARD

**Minifluid DISPENSER**  
AIR OPERATED  
for miniature potting and encapsulating  
Available in 3 sizes  
6cc - 12cc - 30cc  
\$34.00 UP  
**PHILIP FISHMAN COMPANY**  
7 CAMERON ST., WELLESLEY, MASSACHUSETTS 02151

CIRCLE 970 ON READER SERVICE CARD

### ELECTRON TUBES

KLYSTRONS • ATR & TR • MAGNETRONS  
SUBMINIATURES • C.R.T. • T.W.T. • 5000-  
6000 SERIES  
• SEND FOR NEW CATALOG A2 •  
**A & A ELECTRONICS CORP.**  
1063 PERRY ANNEX  
WHITTIER, CALIF.  
656-7544

CIRCLE 971 ON READER SERVICE CARD

## Mr. Used Equipment Dealer:

When you advertise in the Searchlight Section . . . You have hired your most persuasive salesman:

He's efficient . . . He thrives on long hours . . . His territory is the entire nation . . . and overseas . . . He doesn't see buyers of used and new surplus equipment: They see him—regularly. They depend on him.

He is Searchlight—The section of this publication where wise dealers advertise and list their stocks for sale.

### SEARCHLIGHT SECTION

Classified Advertising Dept.  
Post Office Box 12 • New York, N. Y. 10036

# THE GREAT MOS-FET "HANG UP"

The listing below is the broadest line of single and dual MOS-FETs available anywhere. It is another example of our great "hang up" — which is to constantly extend General Instrument's recognized leadership, not only in complex integrated circuitry and LSI, but in MOS-FETs.

TYPE	CHANNEL	MODE OF OPERATION	DESCRIPTION	TEMP RANGE	CASE #	V <sub>GS(max)</sub> (VOLTS TYP)	I <sub>DS(on)</sub> (mA TYP)	I <sub>CS</sub> (mA TYP)	V <sub>DS</sub> (VOLTS)	Y <sub>f</sub> (μmhos TYP)	C <sub>iss</sub> (pF TYP)	R <sub>DS(on)</sub> (Ω TYP)	G <sub>fs</sub> (dB TYP)	NF (dB TYP)	PRICE 1-99 100-999
MEMS11	P	Enhancement	General Purpose MOS-FET†	-65 to +125°C	TO-72	-4.0	-6.0	-0.2	-30	2,500	2.0	150	*	*	8.00 5.35
2N4353	P	Enhancement	General Purpose MOS-FET†	-65 to +125°C	TO-72	-4.0	-6.0	-0.2	-30	2,500	2.0	150	*	*	10.00 6.70
MEMS11C	P	Enhancement	General Purpose MOS-FET†	-50 to +100°C	TO-72	-4.0	-6.0	-1.0	-25	2,500	2.0	150	*	*	1.98 1.30
MEMS17	P	Enhancement	Power MOS-FET†	-65 to +125°C	TO-33	-3.5	-60	-0.3	-30	12,000	10	30	*	*	19.00 12.75
MEMS17A	P	Enhancement	Power MOS-FET†	-65 to +125°C	TO-5	-3.5	-60	-0.3	-30	12,000	10	30	*	*	19.00 12.75
MEMS17AC	P	Enhancement	Power MOS-FET†	-50 to +100°C	TO-5	-3.5	-60	-1.5	-25	12,000	10	30	*	*	3.98 2.70
MEMS17B	P	Enhancement	Power MOS-FET†	-65 to +125°C	TO-72	-3.5	-60	-0.3	-30	12,000	10	30	*	*	19.00 12.75
MEMS17BC	P	Enhancement	Power MOS-FET†	-50 to +100°C	TO-72	-3.5	-60	-1.5	-25	12,000	10	30	*	*	3.98 2.70
MEMS17C	P	Enhancement	Power MOS-FET†	-50 to +100°C	TO-33	-3.5	-50	-1.5	-25	12,000	10	30	*	*	3.98 2.70
MEMS20	P	Enhancement	MOS-FET	-65 to +125°C	TO-72	-4.0	-6.0	-0.2	-30	2,500	2.0	150	*	*	8.00 5.35
MEMS20C	P	Enhancement	MOS-FET	-50 to +100°C	TO-72	-4.0	-6.0	-1.0	-25	2,500	2.0	150	*	*	1.98 1.30
MEMS50	P	Enhancement	Dual MOS-FETs†	-65 to +125°C	TO-77	-4.0	-5.0	-1.0	-30	1,400	1.1	250	*	*	17.50 11.30
3N151	P	Enhancement	Dual MOS-FETs†	-65 to +125°C	TO-77	-4.0	-7.0	-0.2	-30	2,000	1.1	250	*	*	17.50 11.30
MEMS50C	P	Enhancement	Dual MOS-FETs†	-50 to +100°C	TO-77	-4.0	-5.0	-0.5	-25	1,400	1.1	250	*	*	3.98 2.70
MEMS51	P	Enhancement	Dual MOS-FETs†	-65 to +125°C	TO-77	-4.0	-5.0	-0.2	-30	1,400	1.1	250	*	*	17.50 11.30
MEMS51C	P	Enhancement	Dual MOS-FETs†	-50 to +100°C	TO-77	-4.0	-5.0	-1.0	-25	1,400	1.1	250	*	*	3.98 2.70
MEMS54	N	Depletion	VHF Cascode	-65 to +150°C	TO-72	-1.5	10	*	20	13,000	.02	50	20 @ 200 MHz	2.8 @ 200 MHz	8.00 5.35
MEMS54C	N	Depletion	VHF Cascode	-50 to +125°C	TO-72	-1.5	10	*	20	11,000	0.2	50	18 @ 200 MHz	3.5 @ 200 MHz	1.50 1.10
3N140	N	Depletion	VHF Amplifier	-65 to +150°C	TO-72	-1.5	10	*	20	11,000	0.2	50	18 @ 200 MHz	3.2 @ 200 MHz	1.60 1.15
3N141	N	Depletion	VHF Converter	-65 to +150°C	TO-72	-1.5	10	*	20	11,000	0.2	50	17	1.50	1.10
MEMS56	P	Enhancement	High Voltage MOS-FET†	-65 to +125°C	TO-72	-4.0	-7.0	-0.1	-50	950	0.3	700	*	*	10.00 6.70
MEMS56C	P	Enhancement	High Voltage MOS-FET†	-50 to +100°C	TO-72	-4.0	-7.0	-0.5	-45	950	0.3	700	*	*	2.98 2.00
MEMS57	N	Depletion	VHF Triode	-65 to +150°C	TO-72	-2.0	8.0	*	20	10,000	.32	200	19 @ 200 MHz	2.5 @ 200 MHz	5.35 3.60
MEMS57C	N	Depletion	VHF Triode	-50 to +125°C	TO-72	-2.0	8.0	*	20	8,000	.32	200	17 @ 200 MHz	3.0 @ 200 MHz	1.60 1.00
MEMS60	P	Enhancement	General Purpose Switch†	-65 to +125°C	TO-72	-2.0	-20	0.5	-40	3,500	3.0	100	*	*	8.00 5.35
MEMS60C	P	Enhancement	General Purpose Switch†	-50 to +100°C	TO-72	-2.5	-15	1.0	-35	3,000	3.5	175	*	*	1.98 1.30
MEMS62	N	Enhancement	General Purpose Switch	-65 to +125°C	TO-72	1.5	15	0.5	20	4,000 @ 10 mA	0.3	150	*	*	5.85 3.80
MEMS62C	N	Enhancement	General Purpose Switch	-50 to +100°C	TO-72	1.5	15	3.0	20	4,000 @ 10 mA	0.3	150	*	*	1.65 1.10
MEMS63	N	Enhancement	High Gain Switch	-65 to +125°C	TO-72	1.5	40	1.0	20	7,000 @ 10 mA	0.3	50	*	*	8.00 5.35
MEMS63C	N	Enhancement	High Gain Switch	-50 to +100°C	TO-72	1.5	40	5.0	15	7,000 @ 10 mA	0.3	50	*	*	1.98 1.30
MEMS64C	N	Depletion	VHF Cascode†	-50 to +125°C	TO-72	-1.5	10	*	20	12,000	0.2	50	17 @ 200 MHz	3.5 @ 200 MHz	1.65 1.25
MEMS71C	N	Depletion	VHF Triode†	-50 to +125°C	TO-72	2.0	8.0	*	20	10,000	.32	200	17 @ 200 MHz	3.0 @ 200 MHz	1.75 1.15

†With Gate Protection \*Not Applicable

Contact your authorized GI distributor for complete information on General Instrument's full line of MOS-FETs.



GENERAL INSTRUMENT CORPORATION • 600 WEST JOHN STREET, HICKSVILLE, L. I., NEW YORK

Start solving your FET "hang ups." — Send for your copy of General Instrument's free, colorful MOS-FET wall chart. Write to General Instrument Corporation, 600 West John Street, Hicksville, L.I., N.Y. 11802. (In Europe, to General Instrument Europe S.P.A., Piazza Amendola 9, 20149 Milano, Italy.)

---

# International Newsletter

---

December 9, 1968

## Northern Electric leads race to build Canadian satellite

The feeling in Ottawa is that a consortium headed by the Northern Electric Co. has the inside track on the contract for Canada's proposed communications satellite system. Subcontractors would be Canadair Ltd. of Montreal and the Hughes Aircraft Co. The recent selection of Northern Electric to manufacture Intelsat 4's \$1 million repeater subsystem as a Hughes subcontractor strengthens the feeling that it will get the big order.

If legislation to set up a Crown corporation with private participation is presented to the current session of Parliament, 1971 should see two 6,000-channel Canadian-designed birds in stationary orbit at about 95° longitude. Besides the Northern Electric group, a consortium headed by RCA Ltd. (with Spar Aerospace Products Ltd. of Toronto and TRW Inc.) has submitted a proposal. Both groups have suggested that one 1,000-pound satellite be launched by a U.S. rocket to cover all of Canada from the Arctic to the U.S. border, and that a second be orbited about 3° away to take care of solar transit interference. A third satellite would stand by on the ground.

No cost figures have been disclosed, but it's estimated that the three satellites, plus launching by Thor Delta or Atlas rockets, would cost about \$45 million. Officials of Canada's Department of Industry will discuss the proposals with both consortiums in mid-December, then turn them over to the newly formed Communications Department, which will be responsible for development of the program.

## New Hitachi IC for fast computers

Engineers at Hitachi Ltd. have built a new family of diode-emitter-coupled logic IC's for extremely fast computers. The nonsaturating circuits are intended for large machines with an addition time on the order of 50 nanoseconds.

The Hitachi IC's, described in a paper given at this week's National Electronics Conference in Chicago, are designed to eliminate the disadvantages of conventional current-mode logic IC's—easy oscillation, a high density of elements per gate, and a high propagation delay-power product when used in registers. Diode gates at the circuit's input suppress oscillation and provide an additional logic stage, decreasing both the number of elements per gate and the propagation delay-power product.

Most of the delay in Hitachi's DECL circuit is in the current switch. The switches described at the conference gave a delay of nearly 2 nsec—the figure for conventional CML—but the company says its latest units are providing a delay of 1.34 nsec per logic stage, close to the 1 nsec claimed for Motorola's MECL-3.

## NEC unveils Japan's biggest computer

That Nippon Electric Co. computer destined to be the largest commercial machine developed in Japan [Electronics, April 1, p. 144] has finally been officially announced by the company, which says the first one will be delivered in March 1970. The computer, the Neac Series 2200 Model 700, was first mentioned last spring when Fujitsu introduced its Facom 230-60, at the time the biggest domestic machine and the first featuring multiprocessing.

The 700, which also has two central processors, will be the first Japanese computer to have an associative memory. It will also have a

---

# International Newsletter

---

main core memory with a capacity of 2,097,000 characters per central processor. Fixed-point calculations will be done in 0.5 microsecond, floating addition in 0.8  $\mu$ sec. This compares with the 230-60's fixed-point addition time of 1.26  $\mu$ sec. The 700's cycle time will be 0.5  $\mu$ sec per 48-bit word; the 230-60's is 0.92  $\mu$ sec per 42-bit word.

Nippon Electric claims that the only machines more powerful than its 700 are IBM's 360/85, Control Data's 6600 and 7600 [see p. 45], and perhaps Burroughs' 8500.

## ELDO undismayed by rocket fizzle

Failure of its three-stage Europa 1 to carry a test satellite into orbit hasn't left the European Launcher Development Organization distraught. As a matter of fact, some observers are calling the shot a limited success. The reason: one of the prime purposes of the launch was to check separation and ignition, and these processes went without a hitch.

What failed in the Woomera, Australia, test was the third stage. Made by a group of German firms, it was supposed to deliver full thrust for 6 minutes, pushing the 550-pound Italian-made satellite into a polar orbit. Instead, the stage delivered full thrust for just 7 seconds. German space officials suspect a loss of pressure in the helium supply due to a line break or a malfunctioning valve in the system designed to reduce pressure from 700 pounds per square inch to 280 psi.

The next test shot—the eighth of a total of 11—is scheduled for next May at Woomera. But the last two shots will probably take place at ELDO's new space range in French Guiana.

## German firm expects some Phantom work

At least one West German avionics firm—Fluggeraetwerk Bodensee GmbH—stands a pretty good chance of building some of the electronics for the 88 McDonnell Douglas RF-4E Phantom jets being purchased by the Bonn government [Electronics, Nov. 11, p. 308]. A General Electric Co. spokesman has indicated that his firm is willing to give a contract to Fluggeraetwerk to produce and maintain the GE-designed automatic flight control system used in the Phantom. The German government, however, has the final word on which company will get the contract.

## Addenda

Australia's overseas telecommunications commission has awarded contracts totaling \$1.7 million to two affiliates of Japanese firms for work on a second satellite communication station at Carnarvon. Mitsubishi Australia will supply \$900,000 worth of antenna systems, while Sumitomo Shoji Australia will receive \$800,000 for microwave and multiplex installations. Upon its completion in about a year, the station will take over the NASA functions of the present Carnarvon station, which will then be used to handle international telecommunications. . . . Jeumont-Schneider of France is negotiating for the sale of an "important interest" to Westinghouse. Jeumont appears to be seeking technical aid in its competition with such European giants as Siemens and English Electric-GEC, while Westinghouse may be demanding capital participation in exchange for such aid. The French company has been in the red since it was formed in a 1964 merger. . . . At the same time, Westinghouse's decision to stop manufacturing television sets has been met with interest by Japanese set makers. For some time, the company has been importing small-screen models from Japan; from now on the 20- and 23-inch models also will come from across the Pacific.

# Electronics New subscription application

Please start my one year subscription — 26 issues — for only \$8!

CHECK HERE FOR 3 Years \$16 — Saves me \$8!

- Payment Enclosed  
 Bill Me  
 Bill My Company

**SUBSCRIPTION INCLUDES 1,200-PAGE ANNUAL BUYERS' GUIDE ISSUE**

Name \_\_\_\_\_ Title \_\_\_\_\_

Please Fill In All Spaces

Company \_\_\_\_\_

Company address \_\_\_\_\_

City \_\_\_\_\_ State \_\_\_\_\_ Zip code  \_\_\_\_\_

Specific Product \_\_\_\_\_ or Service performed \_\_\_\_\_  
manufactured \_\_\_\_\_

Are you involved in the specification of electronic or allied products?  Yes  No

**Please check your department or function:**

Design  Research, development  Production, operation, maintenance

Other (please describe) \_\_\_\_\_

Above rates apply only to those professionally engaged in electronics technology.  
All others, \$25 per year.

14-50680

# Electronics New subscription application

Please start my one year subscription — 26 issues — for only \$8!

CHECK HERE FOR 3 Years \$16 — Saves me \$8!

- Payment Enclosed  
 Bill Me  
 Bill My Company

**SUBSCRIPTION INCLUDES 1,200-PAGE ANNUAL BUYERS' GUIDE ISSUE**

Name \_\_\_\_\_ Title \_\_\_\_\_

Please Fill In All Spaces

Company \_\_\_\_\_

Company address \_\_\_\_\_

City \_\_\_\_\_ State \_\_\_\_\_ Zip code  \_\_\_\_\_

Specific Product \_\_\_\_\_ or Service performed \_\_\_\_\_  
manufactured \_\_\_\_\_

Are you involved in the specification of electronic or allied products?  Yes  No

**Please check your department or function:**

Design  Research, development  Production, operation, maintenance

Other (please describe) \_\_\_\_\_

Above rates apply only to those professionally engaged in electronics technology.  
All others, \$25 per year.

14-50680

First Class  
Permit No. 42  
Hightstown, N. J.

# Business reply mail

No postage stamp necessary if mailed in the United States

Postage will be paid by McGraw-Hill, Inc.

## Electronics

P. O. Box 514  
Hightstown, N. J. 08520

Subscription department

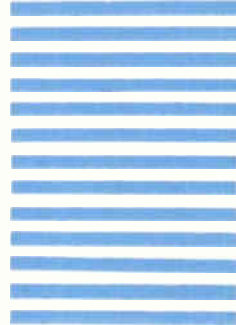

First Class  
Permit No. 42  
Hightstown, N. J.

# Business reply mail

No postage stamp necessary if mailed in the United States

Postage will be paid by McGraw-Hill, Inc.

## Electronics

P. O. Box 514  
Hightstown, N. J. 08520

Subscription department



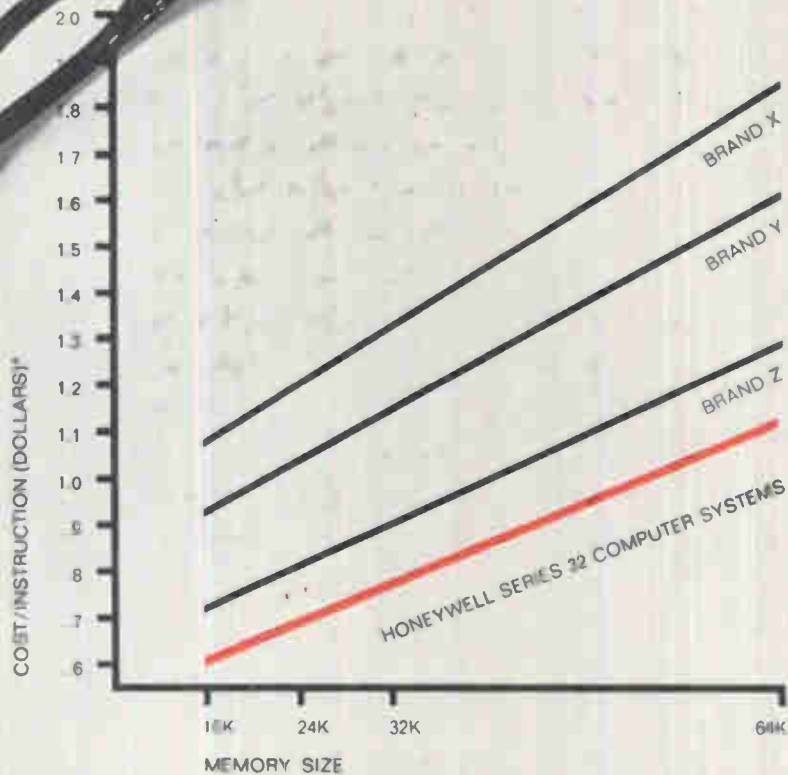

## Now...for all the other reasons why you should go with Series 32 Computer Systems

When a real-time systems man like you looks for a computer, you want the most performance for the fewest dollars. And H632 — first member in the Honeywell Series 32 family of medium-scale computer systems — has the others beaten by anywhere from 15 to 50%.

But you want a lot more, too.

You want software tools for easy program development. H632 software package includes a basic operating system, powerful macro assembler, extended USASI FORTRAN IV compiler, and many more.

You want expandability. H632 memory can grow from 8K to 132K words using plug-in modules. There can be as many as four central and four I/O processors in a single system. Floating-point hardware is available.

You want reliability. H632 is a compact I/C computer — the fifth I/C line we've built. Calculated MTBF is 1,740 hours.

You want a complete line of peripherals and subsystems. H632 offers everything from discs to displays, communications subsystems, and analog-digital I/O systems.

You want fast delivery. We're quoting typical systems as six months A.R.O.

You want full support services. We offer them all . . . world-wide.

Series 32 systems offer an advanced concept of modular integration and coordination which permits special processor capabilities in multiprocessor configurations. By being able to work with various-size data elements, Series 32 systems make optimum use of available memory

space. They also provide a systems-oriented instruction set, including an extensive set of bit, boolean, and halfword operations.

Whatever your requirements for real-time applications, check into Series 32 computer systems. They give you all you could ever want . . . at the lowest cost. Our new Series 32 summary brochure is yours for the asking.

Honeywell, Computer Control Division, Old Connecticut Path, Framingham, Mass. 01701.

\*System cost ÷ instructions per second using a modified Gibson mix.

Come see the H632 system at the Fall Joint Computer Conference.

# Honeywell

**COMPUTER CONTROL**  
DIVISION

**Our new  
high energy  
silicon power  
transistors.  
15 Amperes.  
80 to 120 Volts.**

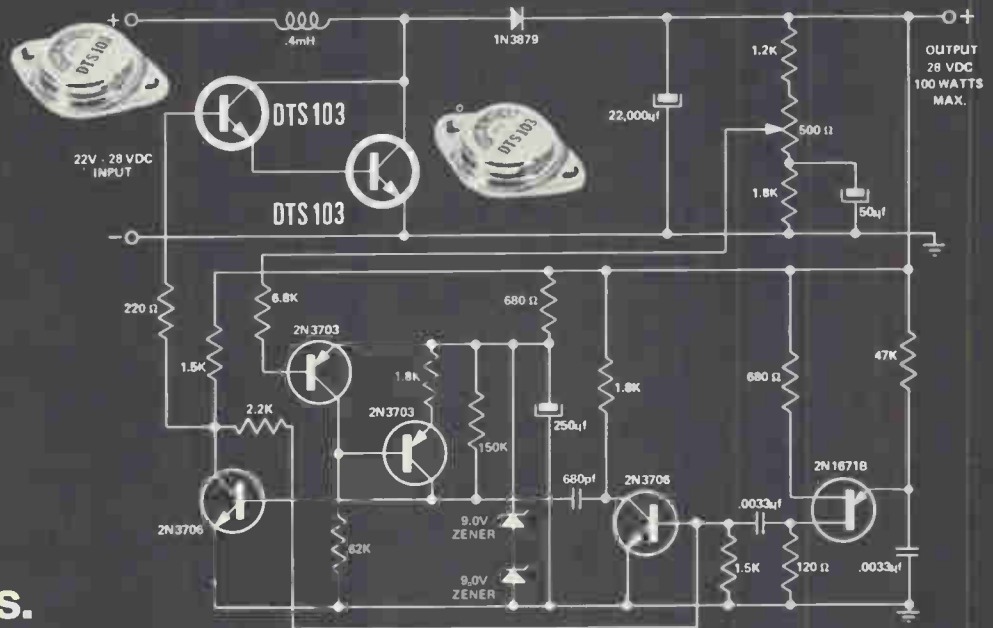

**For Switching.**

The Delco Radio DTS-100 series. NPN. Triple diffused. Rugged.

All the experience gained from our very high voltage silicon power line has gone into the development of these new transistors.

They were especially designed for the extreme under-the-hood environment of our I.C. voltage regulator. We found these devices ideal for applications requiring high efficiency switching or high power amplification.

The Delco triple sequential diffusion gives the DTS-100 series the high

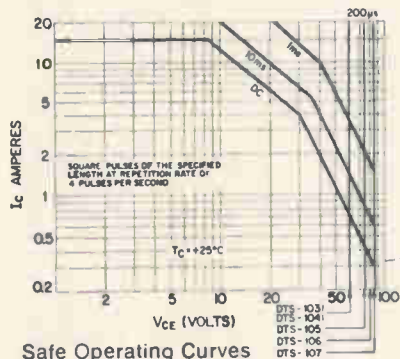

energy reliability that's needed for very tough switching jobs—resistive or inductive. The 28-volt shunt regulator above, for example, is amply handled by the DTS-103 ( $V_{CEX}$  of 80 volts). For complete data on this circuit, ask for our application note No. 42.

In the direct coupled audio amplifier above right, the DTS-107 displays the excellent frequency response, gain linearity and transconductance of this family. This circuit is covered in our application note No. 43.

Our solid copper TO-3 package provides maximum thermal capacitance to absorb peak power pulses. Its low thermal resistance ( $0.75^{\circ}\text{C/W}$  Max.) assures the extra reliability you expect from Delco.

Like more information? Just call us or your nearest Delco Radio distributor. All our distributors are stocked to handle your sample orders.

**SEMICONDUCTOR DISTRIBUTORS: EAST**—BALTIMORE, MO. 21201, Radio Electric Service Co., 5 North Howard Street, (301)-539-3835 BINGHAMTON, N.Y. 13902, Federal Electronics, Inc., P. O. Box 1208, (607)-748-8211 CLIFTON, N.J. 07015, Eastern Radio Corporation, 312 Clifton Avenue, (201)-471-6600 NEWTON, MASS. 02195, The Greene Shaw Co., Inc., 341-347 Watertown St., (617)-969-8900 NEW YORK, NEW YORK 10036, Harvey Radio Co., Inc., 2 West 45th St., (212)-582-2590 PHILADELPHIA, PENN. 19123, Almo Industrial Electronics, Inc., 412 North 6th Street, (215)-922-5918 PITTSBURGH, PENN. 15206, Radio Parts Company, Inc., 6401 Penn Ave., (412)-361-4600 WOODBURY, L. I., N.Y. 11797, Harvey Radio Company, Inc., 60 Crossways Park West, (516)-921-8700 **SOUTH**—BIRMINGHAM, ALA. 35233, Forbes Distributing Company, Inc., 1416 Fourth Ave., South, (205)-251-4104 MIAMI, FLORIDA 33142, Mountain Electronics, Division of Mountain National Co., 3730 Northwest 36th St., (305)-634-4556 RICHMOND, VA. 23220, Meridian Electronics, Inc., 1001 West Broad Street, (703)-353-6648 WEST PALM BEACH, FLA. 33402, Mountain Electronics, Division of Mountain National Co., 1000 N. Dixie Highway, (305)-833-5701 **MIDWEST**—CINCINNATI, OHIO 45237, United Radio, Inc., 7713 Reinhold Drive, (513)-761-4030 CLEVELAND, OHIO 44125, The W. M. Pattison Supply Co., Industrial Electronics Division, 4550 Willow Parkway, (216)-441-3000 INDIANAPOLIS, INO. 46225, Graham Electronics Supply, Inc., 122 South Senate Avenue, (317)-634-8486 KALAMAZOO, MICH. 49005, Electronic Supply Corp., P. O. Box 831, (616)-381-4626 KANSAS CITY, MO. 64111, Walters Radio Supply, Inc., 3635 Main



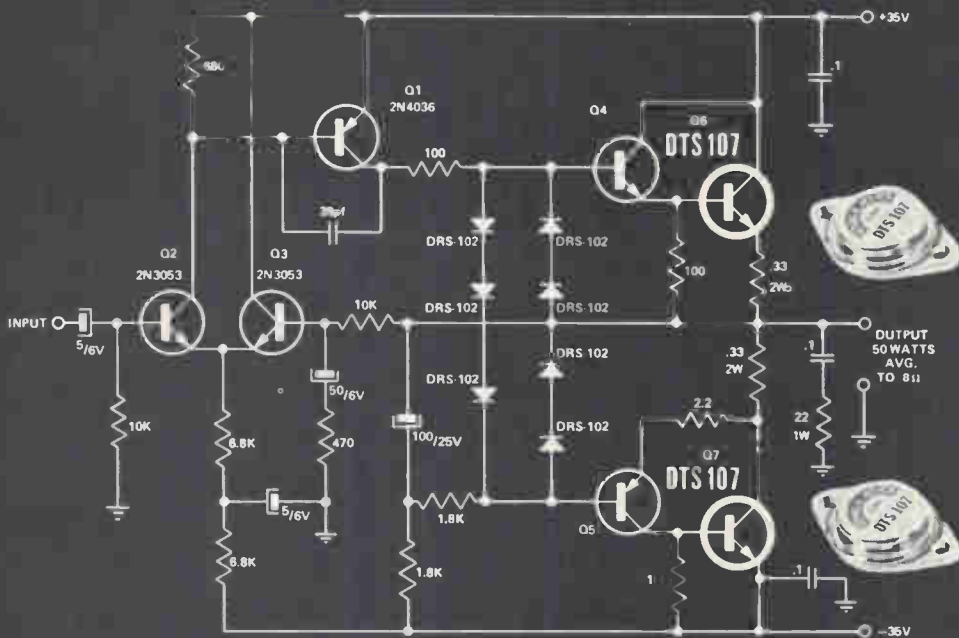

**For Audio Amplification.**

	I <sub>c</sub> Cont. Amps.	I <sub>c</sub> Pulsed Amps.	V <sub>CEX</sub> @ .5mA Volts	V <sub>CEO</sub> @ .25mA Volts	V <sub>CEO(SUS)</sub> @ 250mA Volts	h <sub>FE</sub> @ 5A	h <sub>FE</sub> @ 20A (Min.)	V <sub>CE(sat)</sub> @ 10A (Max.)	f <sub>t</sub> MHz (Min.)	P <sub>t</sub> Watts (Max.)
DTS-103	15	20	80	60	60	20-55	5	1.8	4	125
DTS-104	15	20	80	60	60	50-120	10	1.5	4	125
DTS-105	15	20	100	80	75	20-55	5	1.8	4	125
DTS-106	15	20	110	90	80	20-55	5	1.8	4	125
DTS-107	15	20	120	100	85	20-55	5	1.8	4	125

**FIELD SALES OFFICES**

Union, New Jersey\* 07083  
Box 1018 Chestnut Station  
(201) 687-3770

Syracuse, New York 13203  
1054 James Street  
(315) 472-2668

Santa Monica, Calif.\* 90401  
726 Santa Monica Blvd.  
(213) 870-8807

Detroit, Michigan 48202  
57 Harper Avenue  
(313) 873-6560

Chicago, Illinois\* 60656  
5151 N. Harlem Avenue  
(312) 775-5411

Kokomo, Ind. 46901  
700 E. Firmin  
(317) 459-2175 Home Office

\*Office includes field lab and resident engineer for application assistance.



MARK OF EXCELLENCE



**DELCO RADIO**  
DIVISION OF GENERAL MOTORS  
KOKOMO, INDIANA  
*THE KOKOMOANS ARE IN POWER*

Street, (816)-531-7015 MINNEAPOLIS, MINNESOTA 55401, Stark Electronics Supply Co., 112 3rd Ave., North, (612)-332-1325 SKOKIE, ILL. 60076, Merquip Electronics, Inc., 7701 N. Austin Ave., (312)-282-5400 ST. LOUIS, MO. 63144, Electronic Components for Industry Co., 2605 South Hanley Road, (314)-647-5505 WEST—ALBUQUERQUE, N. M. 87103, Sterling Electronics, Inc., 1712 Lomas Blvd., N. E., (505)-247-2486 DALLAS, TEXAS 75201, Adleta Electronics Company, 1907 McKinney Ave., (214)-742-8257 DENVER, COLO. 80219, L. B. Walker Radio Company, 300 Bryant Street, (303)-935-2406 HOUSTON, TEXAS 77001, Harrison Equipment Co., Inc., 1422 San Jacinto Street, (713) 224-9131 LOS ANGELES, CAL. 90015, Radio Products Sales, Inc., 1501 South Hill Street, (213)-748-1271 LOS ANGELES, CAL. 90022, Kierulff Electronics, Inc., 2585 Commerce Way, (213)-685-5511 OKLAHOMA CITY, OKLAHOMA 73102, Radio, Inc., 903 North Hudson, (405)-235-1551 PALO ALTO, CAL. 94303, Kierulff Electronics, Inc., 3969 East Bayshore Road, (415)-968-6292 PHOENIX, ARIZ. 85005, Sterling Electronics, Inc., 1930 North 22nd Ave., (602)-258-4531 SAN DIEGO, CAL. 92101, Milo of California, Inc., 2060 India Street, Box 2710, (714)-232-8951 SEATTLE, WASH. 98108, Kierulff Electronics, Inc., 5940 6th Ave., South, (206)-763-1550 TACOMA, WASH. 98402, C & G Electronics Company, 2502 Jefferson Ave., (206)-272-3181 TULSA, OKLAHOMA 74119, Radio, Inc., 1000 South Main Street, (918)-587-9124 CANADA—SCARBOROUGH, ONTARIO, Lake Engineering Co., Ltd., 123 Manville Rd., (416)-751-5980

# 3 way winner:



## New sweep oscillator from AIL.

Looking for a really new sweeper that wraps up all of the advanced features you've been wanting? Now it's yours in Airborne Instruments Laboratory's new Type 210. Just check these benefits of our triple-crown design:

### 1. Operating simplicity

- Human-engineered front panel.
- Easy-to-read pushbutton operation.
- Plug-in RF power units; snap-in frequency scales.
- Uniquely visible linear frequency readout scales.
- Leveling light.

### 2. Superior performance

- PIN-diode leveling to 18 GHz; BWO Grid above 18 GHz.
- Greater than 30 dB dynamic leveling range.
- Peak and average power meter leveling to  $\pm 0.1$  dB.
- Marker width constant 1% of swept width.

### 3. Greater versatility

- 0.5 to 40 GHz range.
- 15 highly accurate  $\Delta F$  widths available.
- Two independently adjustable broadband sweeps— $F_1$  to  $F_2$  and  $M_1$  to  $M_2$ .
- Choice of four CW frequencies.

But this is just the start. For all of the facts, write for our new Type 210 brochure. Or better still, ask your local AIL Sales Representative for a demonstration of the new Type 210.

### SPECIFICATIONS—TYPE 210 SWEEP OSCILLATOR

#### FREQUENCY:

Plug-in modules cover from 500 MHz to 40 GHz.

#### SWEEP FUNCTIONS:

$F_1$  to  $F_2$  or  $M_1$  to  $M_2$  direct reading accuracy  $\pm 1\%$ . External sweep from 0 to +20V source for full band coverage.  
Response DC to 10 KHz.

#### SWEEP MODES:

**FAST:** Recurrent sweep adjustable from 10 msec to 1 second.  
**SLOW:** Single sweep from 1 to 100 seconds.  
**MANUAL:** Single knob control of frequency.

#### LEVELING:

Internal, External or Power Meter  $\pm 0.1$  dB.

#### MARKERS:

Width constant 1% of swept width.  
Accuracy  $\pm 1\%$ . Resolution 0.05%

#### CW/ $\Delta F$ OPERATION:

Four CW frequencies available, accuracy  $\pm 1\%$ . Fifteen  $\Delta F$  widths available.

#### AMPLITUDE MODULATION:

Internal: Square wave variable from 900 to 1100 Hz.  
External: Pulse or Linear.

#### PEN LIFT:

Protects external recorder during flyback.

#### PRICE:

Main Frame: \$1600  
RF Plug-Ins: PIN Leveled units from \$1950.



AIRBORNE INSTRUMENTS LABORATORY  
DEER PARK, LONG ISLAND, NEW YORK 11729

# Electronics International

## France

### Gathering clouds

President de Gaulle's austerity measures are making the electronics sales outlook quite gloomy.

By further reducing the 1969 budget in an effort to slow inflation, the Gaullist regime probably will strangle all but the most urgent capital investment projects. For example, Jean-Marie Fourier, finance director of Thomson-Houston-Hotchkiss Brandt, expects more reductions next year in government equipment purchases. The military establishment and such state-owned utilities as Electricité de France and the phone system will be under strong pressure to postpone expansion projects. Sums up Fourier: the consequences for the electronics industry could be "very hard." Even France's 1969 contribution to the Concorde SST has been cut and her nuclear tests canceled.

**Less to spend.** Industry sources also assume that government plans to hold down wages will cut into consumer demand. The prospect is particularly galling because the consumer sector was expected to be one of the few bright areas in a generally mediocre 1969. Another round of wage increases—promised last July for next March—is presumed dead.

On the other hand, electronics exports will almost certainly rise. The combination of French export incentives and Germany's decision to give imports a 4% price advantage will speed French electronics equipment across the Rhine and make competition easier elsewhere. Germany, which buys 20% of France's exports, is her biggest electronics customer.

Finally, many observers fear the austerity measures will increase Leftist discontent and fuel new student and worker unrest.

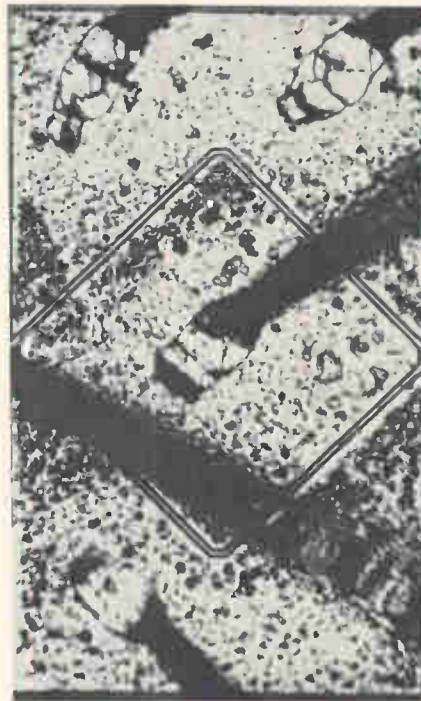

Up there. IBM's experimental MES FET has gate enclosing central drain. Gate width is only 1 micron; oscillation frequency can go to 12 gigahertz.

## Switzerland

### Microwave FET's?

Circuit designers may soon have a new component to work with—a Schottky-barrier field effect transistor operating well up in the microwave range.

At its present stage of development at IBM's research labs near Zurich, the new transistor, christened MES (for metal semiconductor) FET, has a maximum oscillating frequency of 12 gigahertz. That's considerably higher than the 9 GHz reported so far for conventional insulated-gate FET's or bipolar types. And power gain for the new device is about 2 db at 10 GHz, dropping to 0 db at 12 GHz; gain-bandwidth product is up to 3.5 GHz.

Karsten E. Drangeid, head of the Swiss research team, says the main goal of the work is to find out how

far FET frequencies can be pushed into the microwave range, but he also hints at some applications for MES FET's. For example, they could be used as low-pass, wideband amplifiers in small-signal applications or as input stages in microwave systems. They might also serve as switches in digital circuits or replacements for low-power traveling-wave tubes.

**A square pad.** Basically, the high oscillating frequency is attained by reducing the width of the Schottky gate to about 1 micron. Since a Schottky element is structurally simpler than a MOS FET, it's easier to narrow that gate. As a result, says Drangeid, IBM's new MES FET can be mass-produced without too much trouble.

The device is made of a high-resistivity silicon substrate covered with an n-type epitaxial silicon film. That film, between 0.2 and 0.3 micron thick, is the conducting channel. The 0.2-micron gate contact is a gold-chromium-nickel sandwich enclosing the central drain. The source and drain pads are of alloyed gold-antimony.

Another major difference between the new device and MOS FET's is the absence of an insulating layer between the gate and the semiconductor material. A rectifying contact is formed directly at the metal-semiconductor junction below which the Schottky effect produces a charge-free, or depletion, region. The region's depth depends on the applied voltage. The substrate's resistivity is between 10 kilohm-centimeters and 50 kilohm-centimeters; that of the silicon film is about 0.1 kilohm-centimeters.

In one of Drangeid's MES FET versions, the drain is a square pad; each of the four legs surrounding the drain is 100 microns long, in effect making the transistor a parallel connection of four gates with a total effective length of 400 microns. This cuts the gate resistance caused by the small cross-section

# NEW

\* Designed to be used with either upright or inclined panel Series Sixty racks, but they have many applications when used individually.



\* In this position, the convertible may be placed on a bench, table, or cabinet to provide easy viewing from above.



\* In the reverse position, the convertible fits on an inclined panel Series Sixty rack, may be fastened to a wall, or placed in any other location where viewing from below is preferred.

\* The new convertibles are built on the same design and engineering principles that have made the Series Sixty line of enclosures preferred by most people. They are ideal housings for delicate instruments and systems. Maximum access to interior for installation of components or service is provided through sides, top, rear, bottom, and front. Standard Bud 19" aluminum or steel panels fit these units. Choice of types and sizes.

Write for prices and descriptive literature.

BUD Series Sixty . . .  
The Growth Line



BUD RADIO, INC.  
Willoughby, Ohio

your product  
Belongs in a BUD cabinet

## Electronics International

of the gate legs. And to minimize the losses and parasitic capacitances to which high-impedance FET's are very sensitive, the Swiss researchers have used a high-resistivity substrate and enclosed the drain.

**Shaving it down.** The narrow gate is made by a projection masking technique developed three years ago by AEG-Telefunken. The mask is reduced about 40 times by

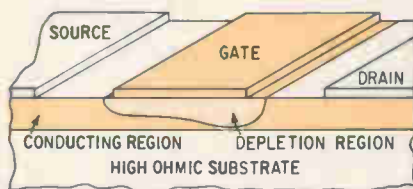

View. Cross-section of MES FET shows 1-micron gate. It's in the form of legs paralleling the sides of drain.

conventional methods. Then a high-resolution microscope lens is used to shrink the mask still further by a factor of 25, and the mask is projected onto the wafer. Finally, holes are etched into the silicon oxide layer.

A sequence of evaporation and resist-stripping methods is used for metalization. Gold is then deposited on the contacts to reduce resistance, and 8-micron wires are bonded to them.

### Japan

#### Forbidding FET

Two Japanese researchers have used a semiconductor material they first investigated for their work on photocells to develop a thick-film field effect transistor. The material is sintered cadmium silicon sulfide ( $Cd_4SiS_6$ ); it promises more reliable FET's, say the researchers, Miyoshi Haradome and Hirokuni Kawashima of Nihon University.

Because of the high electric potential applied to the semiconductor layer in FET's, a wide forbidden band is desirable. (The forbidden band is the energy gap just below the conduction band.) The wider

the band, the more reliable the device. One commonly used semiconductor material, for example, is cadmium sulfide, which boasts a forbidden-band width of 2.4 electron volts. The cadmium silicon sulfide in the new FET, on the other hand, has about 2.8 electron volts. What's more, the material shows little tendency to decompose during sintering.

There also are manufacturing advantages. Inexpensive thick-film techniques—compatible with those for passive components—are used, and the transistors are on the same substrate as passive components.

**No vacuum.** The transistor is an inverted structure on an alumina substrate. Gold paste is deposited with a silk screen to form the gate electrode, source, and drain. The remainder of the structure can be made in the same way, so a vacuum isn't required. After the gate and insulator are deposited—and fired at a low temperature—the semiconductor is put on with paste that's a mixture of cadmium silicon sulfide powder, cadmium chloride, and ethylene glycol. The semiconductor is sintered at 500°C for 10 minutes.

A typical device has a transconductance of 500 micromhos at a gate bias of +5 volts. D-c input resistance is more than  $10^{10}$  ohms, and input capacitance with bias applied is about 100 picofarads. Gain is constant at about 500  $\mu$ mhos up to 10 kilohertz; the gain-bandwidth product is 1.2 megahertz.

Using the earlier evaporated thin-film electrodes, transistors can be made with source-to-drain spacing of 50 microns. With deposited paste electrodes, transistors can be made with 500-micron spacing.

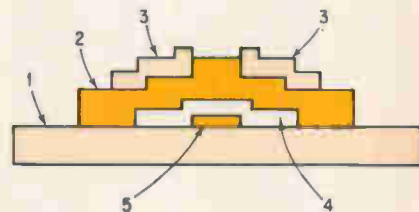

Parts. Thick-film FET's elements are substrate (1), semiconductor layer (2), source and drain (3), dielectric layer (4), and gate (5).

One application that appears to offer promise is use of the FET, with a threshold bias of zero volts, as a diode; this is because it would be easier to make a diode array with thick-film techniques than to interconnect conventional diodes. For diode operation, source and gate are connected to serve as one electrode; the drain is used as the other electrode.

### Twice the fax

Japan's fiercely competitive national newspapers have made facsimile reproduction a potent circulation weapon. Stories are written and set in type in Tokyo, made up into pages, and faxed to the provinces. There, pages of local news are added, plates are photolithographed, and the newspaper is printed. Thus, news is available from one end of Japan to the other within hours.

But as newspapers prosper they add pages, and it takes eight minutes to fax each page. So about two years ago the nation's leading financial sheet, the Nihon Keizai Shimbun, asked two professors at the University of Tokyo to develop a band-compression method for fax. The two, Tamiya Nomura and Yasuhiko Yasuda, specialize in space communications; the newspaper figured that anyone who could develop communication and telemetering systems sophisticated enough for space could certainly do something to cut the time needed to fax a newspaper page.

**Half as long.** The newspaper figured right. The Tokyo team devised a system that cuts transmission time to four minutes a page—by trading signal-to-noise ratio for speed. Still, the 6-decibel loss—to 39 db—is acceptable because 45 db is more than is needed for facsimile.

The old system used a two-level analog signal (one for black, the other for white) amplitude-modulated onto a carrier, passed through a sideband filter, and transmitted over a phone channel 48 kilohertz wide. Scanning density is about 12 lines a millimeter; for the fine lines



## You save DOLLARS when you buy SERIES 60 CABINETS

... actually, a Series 60 Cabinet Rack costs you less in the long run because you don't have any assembly costs ... you use it right out of the carton.

Now you have a wider choice than ever in the most rugged, most practical cabinet rack on the market. It is the overwhelming choice of manufacturers of electronic gear and instrumentation systems. That's because it meets their stringent requirements and is immediately shipped from stock. Series 60 cabinets are now made to accommodate both standard 19" and 24" relay rack panels. All together, there are 136 types and sizes. Such accessories as desk tops, turrets, drawers, sloping panel supports, slides and blowers are available.

Ask your Authorized Bud Distributor to tell you all about the Series 60 line. Comprehensive literature is available.

The new line of 15° and 45° Wedge Sections are compatible in size and style with every Series 60 Cabinet either upright or inclined panel. They are ideal for building a wide variety of consoles.



BUD Series Sixty... *The Growth Line*



**BUD RADIO, INC.**  
Willoughby, Ohio

your product *Belongs* in a BUD cabinet.

# HICKOK

## PR 4900 DIGITAL PRINTER



From  
**\$760**

This professional printer provides print-out of up to 10 columns of digital information from one or two independent sources. It is a companion unit to the Hickok DMS 3200 Digital Measuring System; however, it may be used with any device which provides 10-line decimal or BCD coded data outputs. Voltage, frequency, time period, resistance, capacitance or event counts are examples of data which may be recorded in printed form on paper tape for storage and future reference.

- Direct print-out on ink-impresion or pressure-sensitive paper
- 4 to 10 column print-out, fully modular for field expansion
- Operates directly from DMS 3200 Digital Measuring System — just interconnect and operate
- Will operate from other 10-line decimal or BCD sources
- Built-in timer for pre-set print cycle
- Fast, convenient push-button selection of command mode
- All solid state logic circuitry
- Gives 4-digit print-out of DMS Digital Measuring System 3-digit display through print-out of "overrange" digit
- Two print wheel types — decimal and symbol data
- Selectable print command — Auto, Timer, External, or Manual
- Plug-in printed circuit boards and print modules
- Will print from two independent sources
- Low-voltage, low-power data inputs
- Uses either ink-impresion or pressure-sensitive paper
- Long-life ink cartridge easily replaceable without finger smudge
- Small — 9 $\frac{5}{8}$ " W, 6 $\frac{7}{8}$ " H, 14 $\frac{3}{8}$ " D; 21 pounds

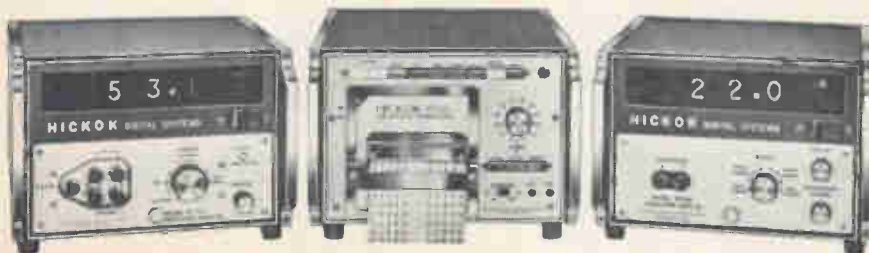

Printer will print the output from two independent  
DMS 3200 Digital Measuring Systems.

HICKOK ELECTRICAL INSTRUMENT COMPANY, 10514 Dupont Ave., Cleveland, Ohio 44108

### Electronics International

—about 50 microns—in Japanese characters the transmission rate approaches 150,000 bits a second.

Many efforts to speed transmission use digital systems, but new problems crop up in these more complex circuits. Nomura and Yasuda avoided these difficulties by sticking with the analog signal. At the same time, though, they took the same general road as other researchers—the tradeoff of signal-to-noise ratio for speed.

**One more.** Their system transmits three signals instead of two. The center level is used for black, the lowest and highest for white. Simple logic circuits select which white level is to be used alternatively. This either reduces the maximum frequency by half or doubles the transmission speed for the same bandwidth. And since the signal is still analog, no synchronizing circuits are needed at the receiver. The professors developed improved phase compensation and synchronous detector circuits for the receiver; otherwise, transmission is the same as for conventional fax.

Commercial equipment using the new system is being made by the Nippon Electric Co. Interestingly enough, Nippon was one of two companies — the other is Toho Denki — to develop sampling systems for increasing transmission rate at the expense of signal-to-noise ratio. However, printout is degraded by serrations at black-to-white transitions, lines that are actually a series of dots, and moire patterns in halftones. Also, more complex signal processing and synchronization techniques are required, because loss of sync means complete loss of signal.

### Western Europe

#### Coming back

Freed of a marketing agreement that kept it from competing effectively in Europe, Fairchild Semiconductor is readying a new assault on a market that President C. Lester Hogan thinks is potentially as

# HICKOK

## DMS 3200

DIGITAL MEASURING SYSTEM  
(Fully solid state with IC's)

big as that of the U.S. "By 1973-75," says Hogan, "the total semiconductor market in free Europe could equal that of the U.S.; even if the curves don't intersect, the European market will certainly be 80% of that in the U.S."

For that reason, says Hogan, "We're going to go into Europe and we're going to build a factory." Exactly where that factory will be is yet to be determined, but it will be in one of the Common Market countries. After his thorny experience with the de Gaulle government at Motorola Inc., Hogan will probably steer clear of France; the best bet at the moment seems to be Germany or Belgium (though Hogan will not even speculate that far).

The decision will be made by Christmas, and will depend in part on the fresh light on European manufacturing that can be shed by Douglas J. O'Connor, the new Fairchild marketing director. O'Connor spent two years in Germany, first as European marketing director for Texas Instruments and then as director general of Texas Instruments Deutschland.

"He knows more than any of us about how to obtain government cooperation and what the availability of labor is," Hogan says. "I listen carefully and attentively when he talks."

**In—but out.** It will take all the expertise that Hogan can command—and that is considerable—plus large expenditures of cash, to put Fairchild back in the European market. Profitable though it was, the agreement under which Societa Generale Semiconduttore SpA marketed Fairchild products in Europe put the continent off-limits to Fairchild's own aggressive sales and marketing staff.

Meanwhile, Motorola and TI had built plants, and Signetics and National Semiconductor have reached advanced planning stages for doing so. But Hogan doesn't think that Fairchild will have even the shell of a finished building in Europe until March 1970. "The negotiation phase can't be too quick," he says, "or you give up some advantages. I don't see how we can start build-



This all-solid-state precision measurement system offers unlimited expansion capability through plug-in additions, resulting in a specialized instrument for each type of measurement. New plug-ins now broaden the measurement capability of this field-proven unit. Over 10,000 are in use at present.

Scaling controls make possible resolution of up to seven digits on the three-digit display by utilizing the overrange capability of many of the plug-ins, thus providing high resolution and accuracy with minimum investment. Companion devices such as the PR 4900 Digital Printer and 1050 Digital Set-Point Controller further extend the utility of the DMS 3200 System.



- DC VOLTMETER PLUG-IN DP 100 **\$175**  
00.1 mv to 999. volts  
± 0.1% rdg ± 1 digit
- DC MICROVOLTMETER PLUG-IN DP 110 **\$450**  
0.001 mv to 999.9 volts  
± 0.05% rdg ± 1 digit  
4-digit resolution
- AC VOLTMETER PLUG-IN DP 130 **\$375**  
0.01 mv to 999. volts  
± 0.1% rdg ± 1 digit  
22 Hz to 1.0 MHz
- EVENT COUNTER/S�AVE PLUG-IN DP 140 **\$90**  
Up to 1,000,000 counts/sec  
Cascade with second DMS to obtain 6-digit display
- 1 MHz COUNTER PLUG-IN DP 150A **\$230**  
00.1 Hz to 999. kHz  
± 0.0005% rdg ± 1 digit  
7-digit resolution
- 80 MHz COUNTER PLUG-IN DP 160 **\$395**  
00.1 Hz to 80.0 MHz  
± 0.00005% rdg ± 1 digit  
7-digit resolution
- OHMMETER PLUG-IN DP 170 **\$275**  
.001 ohm to 999. megohms  
± 0.1% rdg ± 1 digit  
Microamp test current
- CAPACITY METER PLUG-IN DP 200 **\$275**  
.001 picofarad to 9,999 mfd  
± 0.1% rdg ± 1 digit  
Low DC test voltage
- TIME INTERVAL METER PLUG-IN DP 210 **\$230**  
0.01 ms to 999. seconds  
± 0.0005% rdg ± 1 digit  
Period or time interval
- DC CURRENT METER ADAPTER D 310 **\$90**  
.0001 microamp to 9.99 amps  
± 0.15% rdg ± 1 digit

HICKOK ELECTRICAL INSTRUMENT COMPANY, 10514 Dupont Ave., Cleveland, Ohio 44108

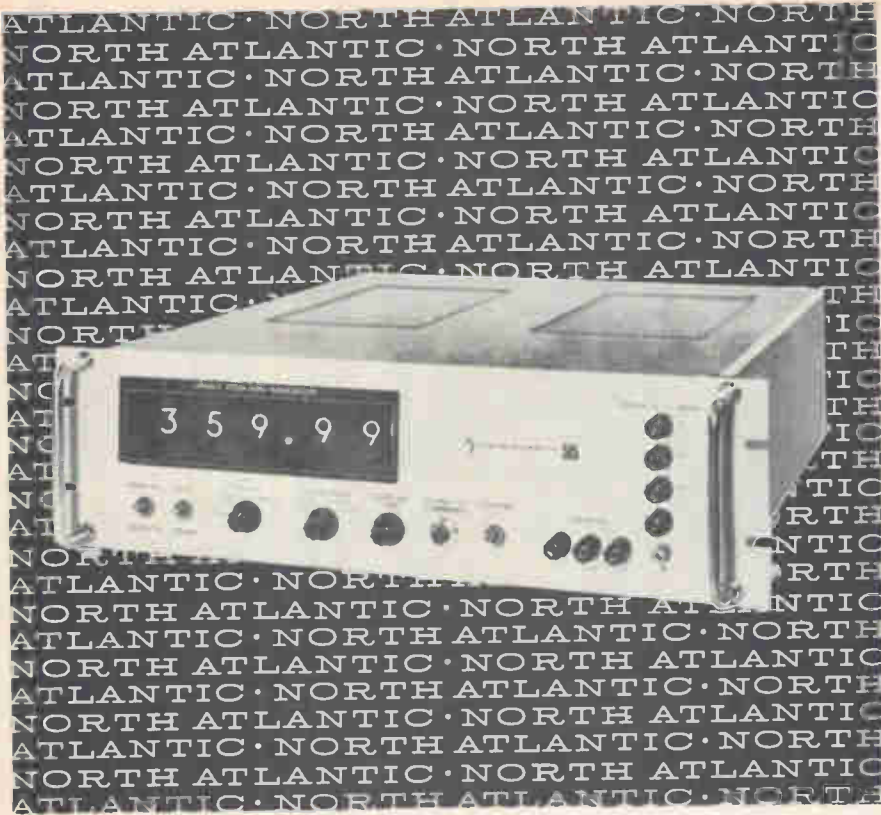

## resolver/synchro to digital conversion

~~20,000~~... **.01° accuracy**  
~~20,000~~ **2000°/sec. tracking**

North Atlantic now brings you a new generation of solid-state analog-to-digital converters for resolver and synchro data. They offer major advances in high-speed precision tracking as required in modern antenna readout, ground support, simulation, and measurement systems.

For example, the Model 545 provides conversion of both resolver and synchro data at rates to ~~2000~~ <sup>20,000</sup>°/second, and accommodates 11.8v to 90v 400Hz line-line signals. For multiplexed applications, acquisition time is less than 50ms. Digital output data is visually displayed and simultaneously available on rear connectors. All modes are programmable as well as manually controlled. Optional features include .001° resolution with 10 arc second accuracy, data frequencies from 60Hz to 4.8KHz, data freeze command for digital readout at a critical instant, and programmed mode where difference angle computation is required.

Your North Atlantic representative (see EEM) has complete specifications and application information. He'll be glad to show you how these converters can answer critical interface problems in your system.



**NORTH ATLANTIC industries, inc.**  
TERMINAL DRIVE, PLAINVIEW, NEW YORK 11803 • 516-681-8600

ing before March, and construction itself will take a year."

In the interim, then, Fairchild will establish sales offices throughout Europe and maintain an inventory there, set up distributors, and provide applications engineering and customer service. It will have 100 to 150 employees stationed on the Continent. Hogan doesn't believe that he will be at too much of a disadvantage with TI and Motorola during this period. "You have a higher profit margin on an incremental basis for U.S.-manufactured parts," he explains, "and you don't have the extra factory overhead, so you can afford to pay some duty."

"In any case," he adds, "my guess is that from 30% to 50% of what TI sells in Europe is made in the U.S. anyway."

**A start.** Initially, Fairchild's European plant will do only assembly and final testing. It will be a 40,000-square-foot expandable "module." By the time it's ready, Fairchild may already be building another plant in Europe, possibly in the United Kingdom or another European Free Trade Association country. But the debate now, Hogan says, is whether to add onto the first module or build three or four in different places. "About 600 to 1,000 employees, living off Fairchild technology, could run a satellite plant [with complete fabrication] in Europe," Hogan says. "If you want a totally integrated factory, you'd better go to 2,000 employees. We aren't making that decision now."

Because Fairchild must reestablish itself in Europe, its sales there will probably be less than 10% of the total next year. But eventually, says Hogan, "if we do an adequate job, we could do 40% of our business in Europe. That's the kind of investment we're thinking of."

### Great Britain

#### Reading the meter

As Britons warily eye the approaching end of traditional coin values and a switch to the decimal



system—it's to be completed by February 1971—engineering and systems companies are preparing for the accompanying change to the metric system. The government would like to see all manufacturers working in metric units by 1975, but it'll probably take the entire decade for all of Britain's industry to drop the feet-and-inches system.

However, at least some of the electronics houses are meeting the challenge of change head-on and experiencing no great problems. Welcoming it with relish are the makers of desktop calculators. Sales of ordinary decimal machines have been restricted in Britain because they're no good for computations involving money, weight, or distance unless the operator can convert all his figures to decimals before using the machine. Volume is estimated at only \$10 million to \$12 million, a figure that could triple within three years as U.S., Continental, and Japanese firms intensify sales efforts.

**One plus one.** The parade has already started. First with a third-generation integrated-circuit machine is Burroughs Machines Ltd., whose C3000 was introduced recently at a price of \$1,000 to \$1,500. Addo Ltd., British offshoot of the Swedish company, and Sunlock Comptometer, the only indigenous British manufacturer, will soon be selling British-designed IC machines in the same price range. Addo's will use 400-transistor metal oxide semiconductor chips supplied by General Instrument (UK) Ltd., a subsidiary of the U.S. company.

So far as component and system designs are concerned, the electronics manufacturers will find it easier than other industries to make the adjustment and should meet the target date easily. For one thing, the more important parameters of most hardware—frequency, current, resistance, and so on—will be counted as they always have been.

Harry Lightfoot, who studied the problems involved for the Marconi Co., sums it up: "The changeover will not be difficult in the electronics industry, provided a company does good solid prep work." Ferranti Ltd. has run a pilot project

## Transistor Controlled INDICATORS/SWITCHES

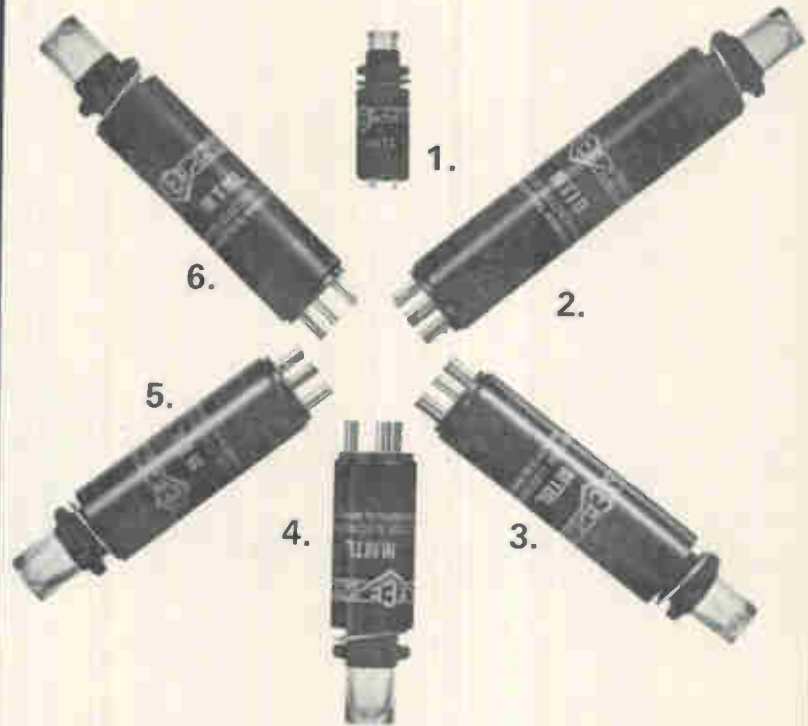

### 1. MSTL Series

Extra small .360" dia. body. Neon or incandescent lamp controlled from low level I-C signals. As low as \$6.75.\*

### 2. MTIB Series

Offers integral, isolated switch with MTIL functions. As low as \$5.10.\*

### 3. MTBL Series

Adds integral, isolated switch to MMTL Series. As low as \$4.25.\*

### 4. MCTL Series

Controls neon lamp from signals as small as 1 volt. Price: As low as \$5.35.\*

### 5. MTIL Series

Replaceable incandescent lamp controlled by signals as low as .5 ma. As low as \$4.15.\*

\*in 500 quantity

### 6. MMTL Series

Turns on with a 2  $\mu$ sec pulse. Remains on until cleared. Integral switch available. As low as \$8.75.\*

## Complete range . . . operate directly from typical integrated circuit logic levels

Solid-state circuitry within the device uses low level outputs of your I-C system. Transistor control means high voltages and currents for lamps are confined to indicator and panel area. Lamp control logic is inside indicator. Mount on 19/32" centers except MSTL Series which mount on 3/8" centers. Wide range of terminals available. Also available for discrete component circuitry.

TEC has designed thousands of *special* display and control devices to be compatible with customer's logic levels. For information about TEC's complete line of INDICATOR/SWITCHES • READOUTS • DISPLAY PANELS

• DATA ENTRY KEYBOARDS • CRT DISPLAY TERMINALS,  
call (612) 941-1100 or write:



**Transistor  
Electronics  
Corporation**

Box 6191 • Minneapolis, Minnesota 55424

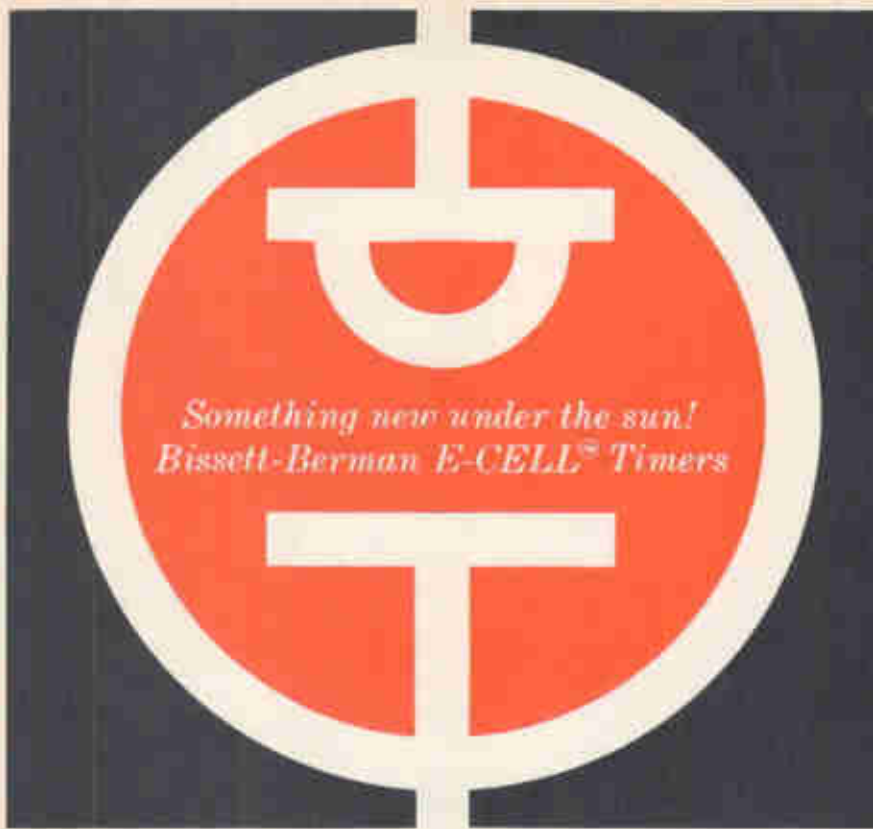

## UNDETECTABLE E-CELL\* TIMER WON'T TICK, HUM OR RADIATE

Problem: Arm or safe an ordnance device using self-destruct or self-sterilize methods with precision components that emit no sounds or electromagnetic energy. Solution: Use an E-CELL timing component in an all solid-state circuit (see schematic) and your timer will have no moving parts, mechanical functions, or energy radiation. When the pre-set interval has elapsed (it could be anywhere from seconds to months), the E-CELL will deliver an output signal in the 1-volt range. Your complete timer will occupy less than one-half cubic inch of space, will consume only microwatts of power, will work in hostile environments, and will work every time!

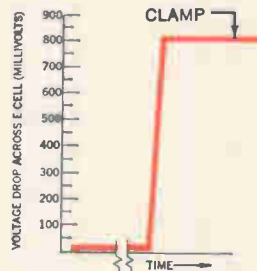
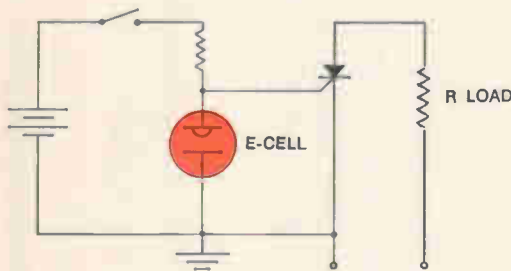

\* E-CELL timers are used in many of today's advanced ordnance weapon systems. E-CELL timers are also ideally suited for scuttling sonobuoy transmission, in addition to many industrial control applications. Patents applied for.

**Environmental Tolerance**  
E-CELL devices have been tested and approved by users for severe shock and vibration tolerance, and are designed to meet or exceed the following requirements:

- Altitude: MIL-STD-202C, Method 105C Test Condition B.
- Ordnance: MIL-STD-303A, 304, 306, 314, 358, 828, etc.
- Airborne: MIL-E-5400, MIL-E-5272, Procedures I, II, VIB, etc. and air drop, hi-shock service.
- Marine: Requirements for air-dropped sonobuoy use.

For technical information and application notes, contact: Component Division, The Bissett-Berman Corporation, 3860 Centinela Avenue, Los Angeles, California 90066; Phone (213) 390-3585.

**BISSETT  
BERMAN**

in which everyone from senior engineer to junior draftsman worked in metrics; the company found that it was far more difficult to get them to return to the old illogical Imperial units than to use the metric versions.

**Thinking right.** Of course, many companies already work partly in metrics. These include the component divisions of Mullard Ltd., a Philips subsidiary, and ITT's Standard Telephones & Cables, which are part of large international organizations that demand interchangeability of parts, specs, and drawings. And companies that export have had to consider metric requirements even when those requirements haven't influenced design. Finally, the heavy scientific content of electronics means that most designers habitually think metrically even though their specs are in feet and inches.

However, throughout Europe printed-circuit boards are designed to the 0.1-inch module. The biggest problem in this area could occur in the computer field: American dominance is so marked that if there should be a conflict between inch-sized and metric-sized components, the Yankee inch is almost sure to win. This could force British firms to make similar components to two standards if they want to retain the business of U.S. companies manufacturing in Britain.

### Around the world

**Italy.** The embattled Elsi plant in Palermo, formerly owned by Raytheon, finally has a new owner. The Italian state holding company—Istituto per la Ricostituzione Industriale—has taken over the plant and appointed its communications and telephone subsidiary, STET, to run it. The component factory was the focal point of an ugly battle between Raytheon and Italian authorities during a general election earlier this year when the American company decided to close the money-losing operation and lay off its workers.

# Electronics advertisers

December 9, 1968

■ <b>Acopian Corp.</b> 177	<b>Deringer Metallurgical Corp.</b> 113	<b>Keithley Instruments, Inc.</b> 163
Mort Barish Associates	R.B. Advertising	Bayless-Kerr Co.
<b>Airborne Instruments Laboratory</b> 198	<b>Deutsch-Filtors Industrial Products</b> 71	■ <b>Keppo, Incorporated</b> 48
Campbell-Mithum, Inc.	Muller Jordan Herrick, Inc.	Weiss Advertising
<b>Airco Speer Electronic Components</b> 37	<b>Di-Acro Corp., Div. of</b>	<b>Krohn-Hite Corp.</b> 182
Hazard Adv. Co., Inc.	Houdaille Industries, Inc.	L.K. Frank Co., Inc.
<b>Airpax Electronics, Inc.</b> 156	Charles E. Brown Adv. Agcy.	
Welch, Mirabile & Co., Inc.	<b>Dialight Corp.</b> 124	■ <b>Lambda Electronics Corp.</b> 66, 67
<b>Alco Electronic Products, Inc.</b> 185	Michel, Cather, Inc.	Michel Cather, Inc.
Marketronics Advertising	<b>Digilog Electronics Corp.</b> 186	Ledex, Inc.
<b>Allen-Bradley Co.</b> 23, 25	Pollock & Loth, Inc.	Yeck & Yeck, Inc.
Fensholt Adv. Agcy.	<b>Digital Equipment Corp.</b> 174	Ledex, Inc., Bramco Controls Div.
<b>American Telephone &amp; Telegraph Co.</b> 68	Kalb & Schneider, Inc.	Yeck & Yeck, Inc.
Cunningham & Walsh, Inc. Adv.	■ <b>Discon Corp.</b> 72	<b>Litton Industries, Inc.,</b>
■ <b>Ammon Instruments, Inc.</b> 166	Al Woodbury, Jr. & Assoc's.	<b>Inter/Pak Electronics</b>
Culver Adv., Inc.	<b>DuPont de Nemours Co., Mylar Div.</b> 129	MacManus, John & Adams, Inc.
■ <b>Amperex Electronics Corp., Div. of North</b>	Batten, Barton, Durstine & Osborn, Inc.	
<b>American Phillips Co.</b> 209		<b>McBain Instruments, Inc.</b> 52
Sam Groden, Inc.	■ <b>Eagle Signal Div. of</b>	Hershberger Advertising
■ <b>Amperite Co.</b> 170	<b>E.W. Bliss Co.</b> 169, 171, 173	■ <b>Machlett Laboratories, Div. of</b>
H.J. Gold Co.	Feeley & Wheeler, Inc.	<b>Raytheon Co.</b> 15
■ <b>Amphenol Corp.</b> 122, 123	<b>Eastman Kodak Co.,</b>	Fuller & Smith & Ross, Inc.
Marsteller, Inc.	<b>PCIM Market Development</b> 139	<b>Macrosonics Corp.</b> 186
<b>Associated Testing Laboratories, Inc.</b> 167	Rumrill Hoyt, Inc.	Carpenter, Matthews & Stewart, Inc.
Murray Heyert Associates	<b>Elco Corp.</b> 210	■ <b>Mallory &amp; Co., P.R., Mfg. Div.</b> 120
<b>Atec, Inc.</b> 16	Fien and Schwerin, Inc.	Aitkin-Kynett Co.
Helme Assoc., Inc.	<b>Electro Products Laboratories, Inc.,</b>	Markel & Sons, L. Frank
	<b>Transducer Div.</b> 167	George Moll Adv., Inc.
■ <b>Beckman Instruments, Inc.,</b>	Grant, Schwenck & Baker, Inc.	<b>Metal Removal Co., The</b> 24
<b>Electronic Instrument Div.</b> 154	<b>Electronic Engineering Company of</b>	Advertising Producers Associates
Hixson & Jorgensen, Inc.	California	■ <b>Microsonics, Inc.</b> 176
■ <b>Beckman Instruments, Inc., Helipot Div.</b> 131	Jansen Associates	S. Gunnar Myrbeck & Co.
Hixson & Jorgensen, Inc.	<b>Emerson &amp; Cuming, Inc.</b> 173	<b>Micro Switch</b>
<b>Bendix Corp.,</b>	Edwin F. Hall	Div. of Honeywell 39, 40, 41, 42
<b>Electrical Components Div.</b> 28, 29	<b>E &amp; M Laboratories</b> 125	Batten, Barton, Durstine & Osborn, Inc.
MacManus, John & Adams, Inc.	Brewer, Betancourt & Moisselle, Inc.	■ <b>Microwave Cavity Laboratories, Inc.</b> 185
<b>Bendix Corp.,</b>	<b>Erie Technological Products Co., Inc.</b> 85	Art Brown Writing Service
<b>Semiconductor Products Div.</b>	Altman-Hall Associates	<b>Mohawk Data Sciences Corp./OEM</b>
MacManus, John & Adams, Inc.		Marketing 127
<b>Bissett-Berman Corp.</b> 206	<b>Fairchild Semiconductor, Inc.</b> 18, 19	MacFarland Assoc., Inc.
S F Associates	Faust/Day, Inc.	■ <b>Motorola Communications &amp;</b>
<b>Bliley Electric Co.</b> 144		<b>Electronics, Inc.</b> 161, 187
Barber & Drullard, Inc.	<b>Gamco Industries, Inc.</b> 110	The Griswold-Eshleman Co.
<b>Bourns, Inc., Trimpot Div.</b> 17	Creative Advertising	<b>Motorola Semiconductor Products,</b>
Lester Co., The	■ <b>Gencom Division—Whittaker Corp.</b> 126	Inc. 43, 107
■ <b>Buckbee-Mears Co.</b> 108	A.D. Adams Adv., Inc.	Lane & Bird Adv., Inc.
Midland Assoc., Inc.	■ <b>General Electric Co.,</b>	
<b>Bud Radio, Inc.</b> 200, 201	<b>Miniature Lamp Div.</b> 121	■ <b>National Electronics, Inc.</b> 162
Allied Adv. Agcy., Inc.	Batten, Barton, Durstine & Osborn, Inc.	Connor-Sager Associates
<b>Bunker-Ramo Co.</b> 50, 181	■ <b>General Electric Co.,</b>	<b>National Semiconductor Corp.</b> 10, 11
Diener & Dorskind, Inc.	<b>Silicone Products Div.</b> 151	Hall Butler Blatherwick, Inc.
■ <b>Burr Brown Research Corp.</b> 70	Ross Roy of New York, Inc.	<b>Norden Division of United Aircraft Corp.</b> 53
N.A. Winter Adv. Agcy.	■ <b>General Instrument Corp.,</b>	Cunningham & Walsh, Inc.
■ <b>Burroughs Corp.,</b>	<b>Semiconductor Products Div.</b> 192	■ <b>North Atlantic Industries, Inc.</b> 204
<b>Electronic Components Div.</b>	Norman Allen Associates	Ross Roy of New York, Inc.
Conti Adv. Agcy., Inc.	<b>General Radio Co.</b> 6	<b>Northrop</b> 64, 65
	Horton, Church & Goff, Inc.	Doyle, Dane, Bernbach, Inc.
<b>California Electronic Mfg. Co., Inc.</b> 166	Granger Associates	
Alpha Adv. Assoc.	West Associates	<b>Pastoriza Electronics Co.</b> 184
■ <b>Captor Corp.</b> 172	<b>Gries Reproducer Co.</b> 166	L.K. Frank Co., Inc.
Weber, Geiger & Kalat, Inc.	Harold Marshall Advertising	<b>Phelps Dodge Electronics Products</b>
<b>Cedar Engineering Div.,</b>	■ <b>Gudebrod Brothers Silk Co.,</b> 112	<b>Corp.</b> 128
<b>Control Data Corp.</b>	<b>Electronics Div.</b>	Smith, Dorian & Burman, Inc.
Colle & McVoy Adv. Agcy., Inc.	Ramsdell-Buckley & Co.	■ <b>Philbrick/Nexus Research</b> 117
<b>C &amp; K Components, Inc.</b> 159		Culver Adv., Inc.
Van Cristo Associates	■ <b>Haydon Switch &amp; Instrument, Inc.</b> 146	<b>Philips Eindhoven, Nederland</b>
■ <b>Clalrex Corp.</b> 109	Reynolds & Foster, Inc.	<b>Media International</b>
Michel-Cather, Inc.	<b>Heinemann Electric Co.</b> 22	■ <b>Pomona Electronics Co.</b> 180
<b>Clare &amp; Co., C.P.</b> 54, 116	Thomas R. Sundheim, Inc.	Buxton Adv. Agcy.
Reincke, Meyer & Finn Adv., Inc.	■ <b>Hewlett Packard, H.P. Associates</b> 1	<b>Princeton Applied Research Corp.</b> 44
■ <b>Clevite Corp., Piezoelectric Div.</b> 187	Lennen & Newell, Inc.	Mort Barish Assoc., Inc.
Carr Liggett Adv., Inc.	■ <b>Hewlett Packard, Colorado Springs Div.</b> 2	
<b>Colorado, State of,</b>	Tallant/Yates, Adv., Inc.	<b>Radlo Corporation of America 4th Cover,</b> 69
<b>Industrial Development Div.</b>	■ <b>Hewlett Packard, F &amp; T Div.</b> 47	Al Paul Lefton Co.
Buchen Adv., Inc.	Lennen & Newell, Inc.	<b>Raytheon Co., Components Div.</b> 135
<b>Connecticut Hard Rubber Co.</b> 26	■ <b>Hewlett Packard, Loveland Div.</b> 12, 13	Fuller & Smith & Ross, Inc.
Chirurg & Cairns, Inc.	Tallant/Yates Adv., Inc.	
<b>Consul &amp; Mutoh, Ltd.</b> 170	■ <b>Hewlett Packard, Rockaway Div.</b> 14	<b>Schober Organ Corp.</b> 168
Drew & Carr, Inc.	Culver Adv., Inc.	Harry C. Waterston, Inc.
<b>Continental Connector Corp.</b> 36	■ <b>Hickok Electrical Instrument Co.</b> 202, 203	■ <b>Scientific-Atlanta, Inc.</b> 118
Dunwoodie Associates	Parsells Advertising Service	NOW
<b>Control Products Division,</b>	Hitachi, Ltd. 134	■ <b>Semtech Corp.</b> 49
<b>Texas Instruments Incorporated</b> 86, 87	Dentsu Advertising	Burress Advertising
Horton, Church & Goff, Inc.	<b>Honeywell, Computer Control Div.</b> 195	<b>Siemens America</b> 162
<b>Corning Glass Works Electronic Div.—</b>	Creamer, Trowbridge, Case & Basford, Inc.	Clinton E. Frank, Inc.
<b>Capacitors</b> 111	Hooker Chemical Corp., Durez Div.	<b>Sifco Metachemical, Div. of</b>
Warner, Bicking & Fenwick, Inc.	Rumrill-Hoyt, Inc.	<b>Steel Improvement &amp; Forge Co.</b> 187
<b>Corning Glass Works Electronic Div.—</b>	■ <b>Houston Instrument, Div. of</b>	Creative/3
<b>Glass Memories</b> 147	<b>Bausch &amp; Lomb</b> 184	<b>Signetics Corp., Sub. Corning</b>
Warner, Bicking & Fenwick, Inc.	Ray Cooley & Assoc., Inc.	<b>Glass Works</b> 62, 63
<b>CREI, Home Study Div. of the</b>	<b>Hughes Aircraft Co.</b> 175, 180	Cunningham & Walsh, Inc.
<b>McGraw-Hill Book Co.</b> 179	Foote, Cone & Belding	<b>Siliconix, Inc.</b> 7
Henry J. Kaufman & Associates	<b>Hugle Industries, Inc.</b> 35	Graphics West
<b>Cylo-Tronics, Inc.</b> 169	Tom Jones Advertising and Packaging	<b>Solitron Devices, Inc., Transistor Div.</b> 149
Bernard J. Hahn & Associates		Haselmir Pearson Adv., Inc.
	■ <b>Indiana General Corp., Ferrites Div.</b> 32	<b>Sperry Rand Corp., Sperry</b>
■ <b>Dale Electronics, Inc.,</b>	Griswold & Eshleman	<b>Microwave Electronics Div.</b>
<b>Sub. of Lionel Corp.</b> 3rd Cover	■ <b>International Crystal Mfg. Co.</b> 158	Neals & Hickok, Inc.
Swanson, Sinkey, Ellis, Inc.	Robert V. Freeland & Associates	<b>Sprague Electric Co., The</b> 5, 9
<b>Damon Engineering, Inc.</b> 51	■ <b>ITT Cannon Electric</b> 132	Harry P. Bridge Co.
L.K. Frank Co., Inc.	MacManus, John & Adams, Inc.	■ <b>Stackpole Carbon Co., Electronic</b>
<b>Dana Laboratories, Inc.</b> 20, 21		<b>Components Div.</b> 115
<b>Dana Laboratories, Inc.</b>	<b>Japan Lite Machinery Information</b>	Meek & Thomas, Inc.
Smith-Klitten, Inc.	<b>Center</b> 167	<b>Struthers-Dunn, Inc.</b> 150
<b>Delco Radio Div. of</b>	Pace Advertising	Harry P. Bridge Co.
<b>General Motors Corp.</b> 196, 197	<b>Johnson Company, E.F.</b> 183	<b>Sylvania Electric Products, Inc.,</b>
Campbell-Ewald Co.	Midland Associates	<b>Parts Div.</b> 140
<b>Delco Radio Div. of</b>		Doyle, Dane, Bernbach, Inc.
<b>General Motors Corp.</b> 138		
Macbill/Ross, Inc.		

# EUROPE'S STRONGEST GROUP IN SOLID STATE DEVICES CAN DELIVER THESE IC'S RIGHT NOW



## LINEAR INTEGRATED CIRCUITS FOR TV

Philips integrated TV circuits are a practical and economical proposition for today's receivers. So much so that they are already widely used by top-line setmakers in both the U.S.A. and Europe. Philips strong links with the setmaking industry ensure up-to-date circuits that combine a full understanding of TV receiver design with complete IC capability. Why not check Philips range of specific integrated TV circuits for your latest designs?

Our application laboratories are ready to assist you

Philips are studying more TV receiver circuit functions, to realize them in integrated circuit form. Why not ask us about the integrated circuits for TV you want to use? We may have designed them already!

## PHILIPS WIDE RANGE OF IC'S FOR AUDIO

Philips also make linear IC's for all kinds of audio-frequency applications, as well as circuits for telecommunication and instrumentation.

# PHILIPS

PHILIPS ELECTRONIC COMPONENTS  
AND MATERIALS DIVISION  
EINDHOVEN, THE NETHERLANDS

## TUNERS

Designed for varactor diode tuners, the TAA550 out-perform any stabilizing circuit using discrete components. It stabilizes a 33 V supply with a temperature coefficient of 50 p.p.m. / °C.

## SOUND IF

TAA350 gives you a straight, wide-band, FM IF amplifier with high AM suppression (50 dB), suitable for a simple tuned-circuit detector.

TAA570 is the same circuit, extended with a simple quadrature detector and audio pre-amplifier, for driving tube or semiconductor audio stages.

TAA380 is a wide-band FM IF amplifier (compatible with the CA3013/14), comprising a ratio detector and audio amplifier. TAA450 is the same circuit, with a higher audio output for driving tubes or semiconductors directly.

So you can choose an IC for the IF part only, or a complete IC channel up to and including the audio driver stage.

You also have the choice of either a simple detector circuit or a conventional ratio detector.

## SIGNAL PROCESSING

TAA700 is a higher-order linear circuit which combines the following signal processing functions in a TV set:

- video pre-amplifier
- AGC detector for IF control
- AGC amplifier for tuner control
- noise gate
- sync separator
- automatic line synchronization
- frame sync pulse separator

The circuit is designed to work with tubes or transistors in video output, line sync, and frame sync stages.

## COLOUR SYNCHRONOUS DETECTOR

TAA630 is designed to serve as synchronous detector for colour receivers, driving either colour difference output transistors or RGB matrix TAA470.

The TAA630 comprises the detector circuit, plus the PAL switch flip-flop and 90° phase shifting network for the reference signal. It is designed for PAL system receivers, but the detector circuit itself is also suitable for use in the NTSC system.

## RGB MATRIX

The TAA470 is an RGB matrix pre-amplifier to drive cathode or grid of a colour picture tube.

This integrated circuit, with its inherent thermal matching of R, G, and B channels, makes RGB drive an attractive solution compared with the colour difference method.

distributed and sold in the U.S. by: AMPEREX ELECTRONIC CORPORATION Providence Pike, SLATERSVILLE, Rhode Island  
230 Duffy Avenue, HICKSVILLE, New York 11802 • 801 E. Charleston Avenue, PALO ALTO, California 94303 • 360 E. North Avenue, NORTHLAKE, Illinois 60164.

...and Amperex,  
**your American  
source for  
Philips IC's has  
IC specialists as  
close to you as  
your telephone:**

on the East Coast,

Phone: Cranston, R.I.  
401-737-3200,  
or  
Hicksville, N.Y.  
516-931-6200

in the Midwest,

Phone: Northlake, Ill.  
312-261-7878

on the West Coast,

Phone: Palo Alto, Calif.  
415-327-0461

Available from these Amperex distributors:

CALIF., Glendale, R V Weatherford Co  
CALIF., Hollywood, Hollywood Radio  
CALIF., Los Angeles, Kieruff Electronics  
CALIF., Redwood City, Fortune Electronics  
CALIF., Riverside, Electronic Supply  
CALIF., San Francisco, Zack Electronics  
COL., Denver, Newark-Denver Electronics Supply  
FLA., Orlando, Hammond Electronics, Inc  
ILL., Chicago, Newark Electronics  
IND., Indianapolis, Graham Electronics Supply Inc  
IND., Indianapolis, Ra-Dis-Co  
KY., Louisville, P I Burks Co  
LA., New Orleans, Southern Radio Supply  
MO., Rockville, Pioneer Washington Electronics  
MASS., Newton, Cramer Electronics  
MICH., Detroit, Radio Specialties Co  
MICH., Kalamazoo, Electronic Supply Corp.  
MINN., St. Paul, Gopher Electronics  
MO., St. Louis, Van Sickle Radio Electronics  
N.J., Springfield, Federated Purchaser, Inc  
N.Y., New York City, Milgray  
N.Y., New York City, Terminal-Hudson, Inc  
N.C., Winston-Salem, Kirkman Electronics  
OHIO, Columbus, Hughes-Peters  
OKLA., Tulsa, Oil Capitol  
ORE., Portland, United Radio Supply  
PA., Allentown, A A Peters Inc  
PA., Pittsburgh, Cameradio Co  
TEXAS, Dallas, Adleta Electronics  
UTAH, Salt Lake City, Ballard Supply Co  
VA., Arlington, Arlington Electronics Wholesalers  
WASH., Seattle, Robert E. Priche Co



Synthane Corporation	185
Arndt, Preston, Chaplin, Lamb & Keen Inc.	
■ Systron-Donner Corporation	27
Bonfield Associates, Inc.	
■ Tektronix Inc.	57
Dawson, Turner & Jenkins Inc.	
Tempress Research Co., Inc.	30
Hal Lawrence Inc.	
Texas Instruments Incorporated	
Components Group	38
Don L. Baxter, Div. of	
Albert Frank-Guenther Law, Inc.	
■ Texas Instruments Incorporated	160
Industrial Products Group	
Robinson-Gerrard	
Transistor Electronics Corporation	205
Stevenson and Associates Inc.	
Transitron Electronic Corporation	136
Larcom Randall Advertising Inc.	
TRW Electronics Capacitors Division	133
Fuller & Smith & Ross Inc.	
■ Trygon Electronics Inc.	174
Kameny Associates Inc.	
■ Tung-Sol Division, Wagner Electric	164
Corporation	
Feeley & Wheeler Inc.	
Tyco Laboratories—Solar Systems	56
Division	
Kenyon & Eckhardt, Inc. Adv.	
Ulano Graphic Arts Supplies Inc.	153
Lory Roston Associates	
■ United Transformer Co., Division of	2nd Cover
TRW Inc.	
Fuller & Smith & Ross Inc.	
■ Unitrode Corporation	55
Silton Brothers Inc.	
Utah Industrial Promotion Commission	152
David W. Evans & Associates	
■ Varo, Inc.	182
Tracy-Locke Co., Inc.	
Victoreen Instrument Co.	8
Palm & Peterson, Inc.	
Wang Laboratories	148
Impact Adv., Inc.	
■ Weinschel Engineering Co.	176
E.G. White Adv., Inc.	
Westinghouse/MED	143
Pritchard Wood Assoc., Inc.	
■ Williams Gold Refining Co., Inc.,	178
Precious Metal Div.	
Stahlka, Faller & Klenk, Inc.	
Wilton Co.	61
Tom Jones Advertising and Packaging	
Xcelite, Inc.	178
Harold Warner Adv., Inc.	
Zippertubing Co.	186
Edward S. Kellog Co.	

### Classified Advertising

F. J. Eberle, Manager

EMPLOYMENT OPPORTUNITIES 188-190  
Memorex Corp. 188

EQUIPMENT  
(Used or Surplus New)  
For Sale

A & A Electronics Corp.	191
Fishman, P., Co.	191
Goodheart, R. E., Co., Inc.	191
Hird-Brown Ltd.	191
Radio Research Instrument Co.	191

■ For more information on complete product  
line see advertisement in the latest Elec-  
tronics Buyer's Guide

### Electronics Buyers' Guide

George F. Wemer, General Manager  
[212] 971-2310  
Robert M. Denmead,  
Midwest Regional Manager  
[312] MO 4-5800  
Regina Hera, Directory Manager  
[212] 971-2544  
Thomas M. Egan, Production Manager  
[212] 971-3140

### Circulation Department

Isaaca Siegel, Manager [212] 971-6057

### Research Department

David Strassler, Manager [212] 971-6058

## Advertising Sales Staff

Frank E. LeBeau [212] 971-6464  
Advertising Sales Manager

Wallis Clarke [212] 971-2187  
Assistant to sales manager

Donald J. Austermann [212] 971-3139  
Promotion Manager

Warren H. Gardner [215] LO 8-6161  
Eastern Advertising Sales Manager

Atlanta, Ga. 30309: Michael H. Miller, 1375  
Peachtree St., N.E.  
[404] 892-2868

Boston, Mass. 02116: William S. Hodgkinson  
McGraw-Hill Building, Copley Square  
[617] CO 2-1160

Cleveland, Ohio 44113: William J. Boyle, 55  
Public Square, [216] SU 1-7000

New York, N.Y. 10036  
500 Fifth Avenue  
James R. Pierce [212] 971-3615  
John A. Garland [212] 971-3617  
Michael J. Stoller [212] 971-3616

Philadelphia, Pa. 19103:

Jeffrey M. Preston  
Warren H. Gardner,  
6 Penn Center Plaza,  
[215] LO 8-6161

Pittsburgh, Pa. 15222: Warren H. Gardner,  
4 Gateway Center, [412] 391-1314

Rochester, N.Y. 14534: William J. Boyle,  
9 Greylock Ridge, Pittsford, N.Y.  
[716] 586-5040

Donald R. Furth (312) MO 4-5800  
Midwest Advertising Sales Manager

Chicago, Ill. 60611: Kenneth E. Nicklas  
Ralph Hanning 645 North Michigan Avenue,  
[312] MO 4-5800

Dallas, Texas 75201: Richard P. Poole, 1800  
Republic National Bank Tower,  
[214] RI 7-9721

Houston, Texas 77002: Robert Wallin,  
2270 Humble Bldg. [713] CA 4-8381

Detroit, Michigan 48226: Ralph Hanning,  
856 Penobscot Building  
[313] 962-1793

Minneapolis, Minn. 55402: 1104 Northstar  
Center [612] 332-7425

St. Louis, Mo. 63105: Kenneth E. Nicklas,  
The Clayton Tower, 7751 Carondelet Ave.  
[314] PA 5-7285

James T. Hauptli [415] DO 2-4600  
Western Advertising Sales Manager

Denver, Colo. 80202: Joseph C. Page, David  
M. Watson, Tower Bldg., 1700 Broadway  
[303] 255-5484

Los Angeles, Calif. 90017: Ian C. Hill,  
John G. Zisch, 1125 W. 6th St.,  
[213] HU 2-5450

Portland, Ore. 97204: James T. Hauptli,  
Thomas McElhinny, 218 Mohawk Building,  
222 S.W. Morrison Street,  
Phone [503] 223-5118

San Francisco, Calif. 94111: James T. Hauptli,  
Thomas McElhinny, 255 California Street,  
[415] DO 2-4600

Pierre Braude Tel: 225 85 88: Paris  
European Director

Paris: Denis Jacob

88-90 Avenue Des Champs-Elysees, Paris 8

United Kingdom and Scandinavia

London: Oliver Ball, Tel: Hyde Park 1451  
34 Dover Street, London W1

Milan: Robert Saldel  
1 vln Baracchini Phone 86-90-656

Brussels: F.I.H. Huntiens  
27 Rue Ducale Tel: 136503

Frankfurt/Main: Hans Haller  
Elsa-Brandstroem Str. 2  
Phone 72 01 81

Geneva: Denis Jacob  
1, rue du Temple Phone: 31 95 60  
Tokyo: Takeji Kinoshita 1 Kotohiracho  
Shiba, Minato-Ku Tokyo [502] 0656

Osaka: Ryoji Kobayashi 163, Umegae-cho  
Kita-ku [362] 8771

### Business Department

Wallace C. Carmichael, Manager  
[212] 971-3191

Stephen R. Weiss, Production Manager  
[212] 971-2044

Thomas M. Egan,  
Assistant Production Manager [212] 971-3140

Dorothy Carnesin, Contracts and Billings  
[212] 971-2908

Frances Vallone, Reader Service Manager  
[212] 971-2865

**Amperex**

For immediate action, data sheets, etc., write:  
AMPEREX ELECTRONIC CORP.,  
SEMICONDUCTOR & MICROCIRCUITS DIV.,  
SLATERSVILLE, R. I. 02876

Use This Giant "Economy-Size" Coupon at Once.

# SAVE TIME and MONEY ON WIRE WRAPPING

Connector Panels. Yours or Ours.

Please tell me how I can close the time-and-cost gap by letting you wire wrap our connector panels, or having you furnish your panels completely wrapped and ready for installation.

Name \_\_\_\_\_

Company \_\_\_\_\_

Address \_\_\_\_\_

\_\_\_\_\_

\_\_\_\_\_

Mail to Elco Corporation, Fort Washington, Pa. 19034

Now, under one roof, Elco wire wraps connector panels via fully-automatic, semi-automatic, or hand-wrapping methods. We will wrap your panels, or Elco metal plates—ready for installation. We can assure you of saving both time and money plus giving you the added benefit of greater reliability. So for your current or contemplated prototypes or production runs—contact your Elco Sales Office. Or call, wire, TWX or write ELCO Corporation, Fort Washington, Pa. 19034; 215-646-7420; TWX 510-661-0363.



GARDNER DENVER'S FULLY-AUTOMATIC MACHINE WRAPPING



SEMI-AUTOMATIC MACHINE WRAPPING



PRECISION HAND WRAPPING

**ELCO**  
 Corporation

Competitively priced

# Dale Econo-Trims

let you choose wirewound or film T-Pots in both 3/4" and 1" styles – sealed or unsealed!



**3/4"**  
**ECONO-TRIM**

**2400 SERIES/WIREWOUND**  
**8400 SERIES/FILM**

**SPECIFICATIONS**

**Dimensions:** .31" H x .16" W x .75 L

**Standard Resistance:** 2400 = 10 ohms to 50K ohms; 8400 = 10 ohms to 2 Megohms

**Resistance Tolerance:** 2400 = ±10%;  
8400 = ±10% 100 ohms thru 500K ohms,  
±20% all other values

**Power Rating:** 2400 = 1 watt at 40° C;  
8400 = .75 watt at 25° C

**Operating Temperature Range:** –55° C to 125° C

**Mechanical Adjustment:** 20 turns nominal

**Mechanical Stops:** None. Clutch permits overtravel without damage

**Models:** Sealed or unsealed with gold-plated PC terminals

**DALE ELECTRONICS, INC.**

1300 28th Avenue, Columbus, Nebr. 68601  
In Canada: Dale Electronics Canada, Ltd.



**1"**  
**ECONO-TRIM**

**2300 SERIES/WIREWOUND**  
**8300 SERIES/FILM**

**SPECIFICATIONS**

**Dimensions:** .36" H x .28" W x 1.00" L

**Standard Resistance:** 2300 = 10 ohms to 50K ohms; 8300 = 10 ohms to 2 Megohms

**Resistance Tolerance:** 2300 = ±10%;  
8300 = ±10% 100 ohms thru 500K ohms,  
±20% all other values

**Power Rating:** 2300 = 0.5 watt at 25° C;  
8300 = .75 watt at 25° C

**Operating Temperature Range:** –55° C to 105° C

**Mechanical Adjustment:** 15 turns nominal

**Mechanical Stops:** None. Clutch permits overtravel without damage

**Models:** Sealed or unsealed. Gold-plated PC terminals or gold-plated hook type solder lugs

**DALE ELECTRONICS, INC.**

1300 28th Avenue, Columbus, Nebr. 68601  
In Canada: Dale Electronics Canada, Ltd.

**You can do more with**  
**Dale T-Pots...call 402-564-3131 today**



## Power for any socket... new or old

There's a wide selection of RCA Power Tube types — all meeting the challenge of modern, high-power RF design — all with the same built-in reliability — all made to the same exacting standards.

You already know the RCA-6146 "family." Its new RCA-6146B type sets new marks for reliability and performance. Like all RCA RF power tube types, it's built for service. Carefully-shielded getters reduce RF losses. Grid side rods are high dissipation copper. Plates? Pure nickel inside the low-loss lead-glass bulb. Regular life tests at full rated RF input and frequency prove our point — RCA-6146B — and every other RCA power tube — will give you and your customer maximum reliability and RF performance in new or old equipments.

Now meet the RCA-8794 — latest example of RCA Power Tube innovation in design. A 10-kW tube, designed and priced for HF, FM and VHF-TV sockets, it is capable of full performance throughout the military UHF band! This 400-MHz capability makes it a cinch to operate in lower frequency and linear applications, and the high-gain CERMOLOX® tube construction pays off in performance and reliability wherever you use the RCA-8794.

See your RCA Representative or your RCA Distributor for more information on the more than 100 RCA Power Tube Types to meet your exact requirements. For technical data on specific RCA Power Tube types, write RCA Electronic Components, Commercial Engineering, Section L-19-Q-1, Harrison, N. J. 07029.



# RCA

