

# Electronics

Advances in wave analysis: page 62

Computer-controlled circuit testing: page 72

Solid gains for solid-state displays: page 95

July 22, 1968

\$1.00

A McGraw-Hill Publication

Below: Digital computer navigates aircraft, page 78

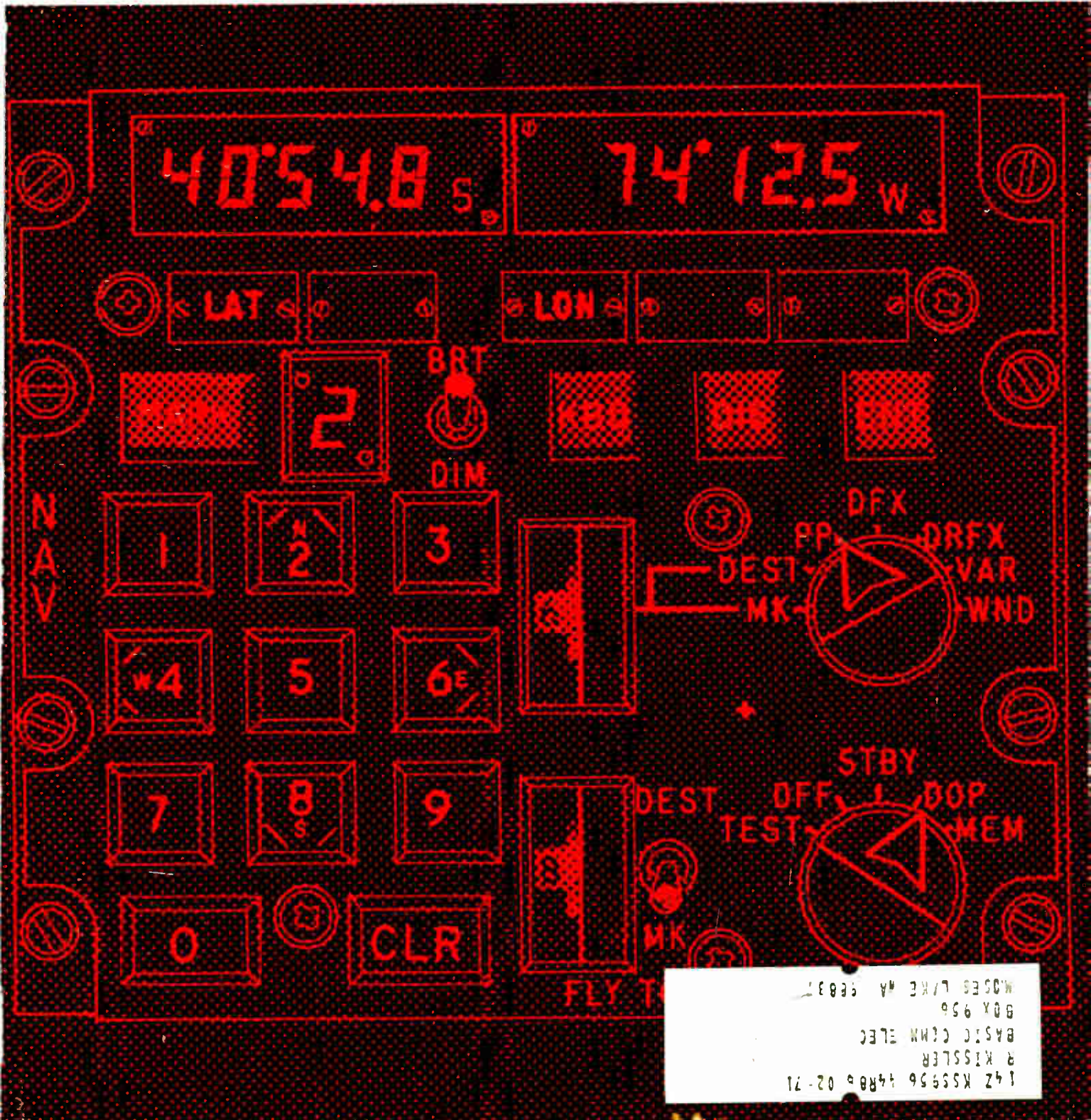





## NEW BIT-250™ LINE

### SMALLEST METAL-ENCASED TRANSFORMERS AVAILABLE!

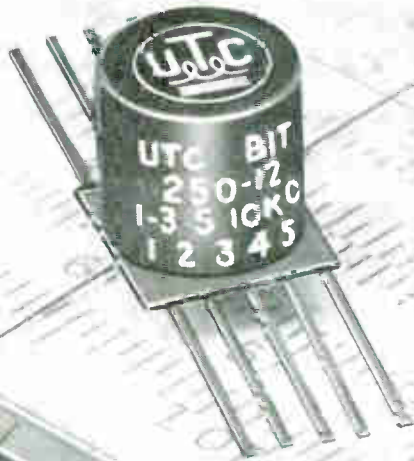

BIT-250's achieve outstanding reliability, in a profile compatible with Flat Packs and IC's, while maintaining response and power levels found only in larger units. MIL-T-27B, Grade 4, completely ruggedized. Seventeen items immediately available from stock, plus specials to your requirements. Dimensions: .250" high x .250" diameter. Power to 80 mw. Patent applied for.

Write for descriptive brochure depicting ranges and capabilities.

**UNITED TRANSFORMER CO. TRW**  
DIVISION OF TRW INC. • 150 VARICK STREET, NEW YORK, N. Y. 10013

# BEST SHORT-TERM STABILITY IN A RUBIDIUM FREQUENCY STANDARD... \$7500.

That says it.

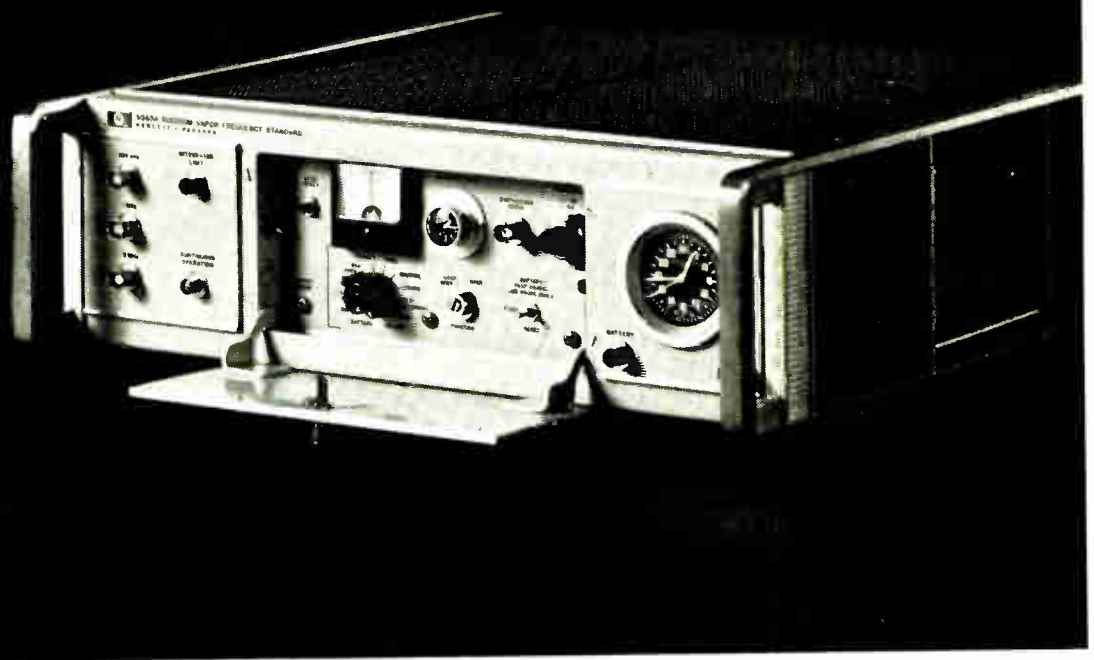

No if's, and's or but's. Just the facts. The Hewlett-Packard 5065A sets a new mark for short-term stability (rms) in a rubidium frequency standard: less than  $7 \times 10^{-12}$ , 1 second averaging;  $2.2 \times 10^{-12}$ , 10 sec. avg.; and  $7 \times 10^{-13}$ , 100 sec. avg.—verified against the HP hydrogen maser. Yet this 37-pound, portable atomic standard costs you only \$7500.

More facts. The 5065A has a built-in frequency synthesizer that lets you change time scales as much as  $1 \times 10^{-7}$  by convenient thumbwheel dialing—no extra cost. Fine frequency control resolution is  $2 \times 10^{-12}$ . Signal-to-noise ratio is greater than 87 dB.

Long-term stability is better than 2 parts in  $10^{11}$  per month. And the standard has passed environmental tests for humidity, magnetism, vibration, shock and electromagnetic compatibility under military specifications.

Options featured: Option 01 is a Time Standard which has a clock pulse rate of 1 pulse/second, a rise time of less than 50 nsec and jitter of less than 20 nsec. Clock movement is 24 hours. Option 02 is a Standby Power Supply.

The price—again—of this portable, rugged Rubidium Standard is only \$7500. Option 01 costs \$1500;

Option 02, \$300. Or you can get Option 03, shown above, which combines both for \$1800.

Now you can get all three frequency standards from Hewlett-Packard—quartz, cesium or rubidium. Get more facts by calling your HP field engineer, or writing Hewlett-Packard, Palo Alto, California 94304; Europe: 54 Route des Acacias, Geneva.

HEWLETT  PACKARD

FREQUENCY STANDARDS  
02805

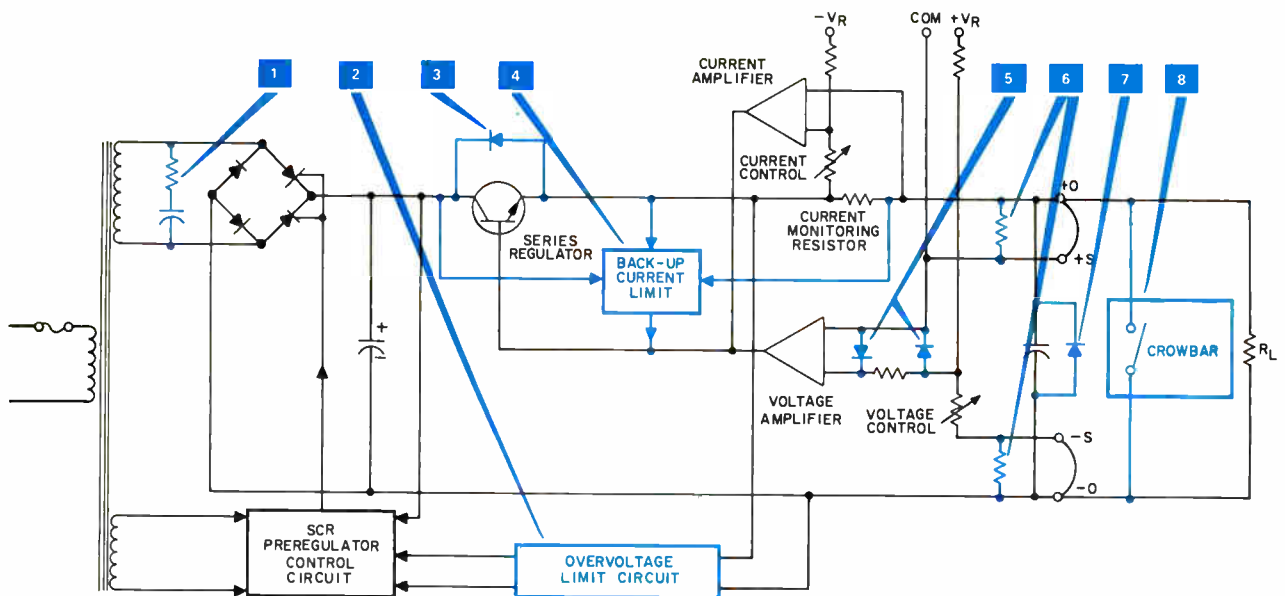

# 8 ways hp protects dc power supplies

## ... and your load

1. **Rectifier Damping Network** . . . Protects downstream elements against short duration input line transients.
2. **Preregulator Overvoltage Limit** . . . Protects load against excessively high output voltage.
3. **Series Regulator Diode** . . . Protects series regulator against reverse voltage from external source (active load or parallel power supply).
4. **Back-up Current Limit** . . . Protects load by providing back-up current limit, in case primary current limit fails or series regulator voltage becomes excessive.
5. **Amplifier Input Clamp Diodes** . . . Protects voltage amplifier by limiting its input to less than 1 volt during violent output changes.
6. **Sensing Protection Resistors** . . . Protects load from receiving full rectifier voltage if remote sensing leads or straps are accidentally open-circuited.
7. **Output Diode** . . . Protects the power supply against reverse output voltage from external source (active load or series power supply).
8. **Crowbar Circuit\*** . . . Protects independently of any other power supply malfunction by providing fast clamping of undesired overvoltage.

\*Standard on some hp supplies—optional on most others

A Constant Voltage/Constant Current supply with automatic crossover inherently protects by providing adjustable current limiting in constant voltage operation and adjustable voltage limiting in constant current operation. The diagram shows eight *additional* protective features used in hp MPB-5 Series medium power bench supplies.

These protective features, in fact, are typical of those found in all hp DC power supplies. If you want to know more about the hp approach to power supply design, we'll be glad to send you our 1968 Handbook and Catalog combination. For the copy, call your local hp field representative or write Hewlett-Packard Company, 100 Locust Avenue, Berkeley Heights, New Jersey 07922; Europe: 54 Route des Acacias, 1211 Geneva 24.



HEWLETT **hp** PACKARD  
POWER SUPPLIES



## News Features

### Probing the News

- 95 **Integrated electronics:** Solid-state display nears market  
103 **Federal electronics:** Census Bureau depends on electronics to make its 1970 national nose count

## Electronics Review

- 39 **Displays:** Plasma display;  
**Advanced technology:** Projection crt's; Random noise radar  
42 **Oceanography:** Tv periscope  
42 **Computers:** Shockproof memories  
46 **Military electronics:** No metric for Maverick; Waiting for Awacs  
48 **Space electronics:** Gravity-gradient test  
50 **For the record**

## Electronics Abroad

- 161 **West Germany:** Portable landing aid works with Tacan receivers  
162 **Japan:** Busy signal for DEX-II electronic exchange; nationwide network clears checks by computer  
163 **France:** Magnetic passports may one day check travelers; French-built transceiver has inside track  
164 **Great Britain:** Quadruplicated electronic system could replace mechanical linkages in planes  
164 **Around the world**

## New Products

- 121 **Six-week delivery promised on 96-gate chip**  
127 **Components review**  
127 Latching relay doesn't need shunt  
128 Chip capacitor has flat contacts  
133 **Semiconductors review**  
133 MOS IC's move into color tv's  
134 Flasher, driver, pulser in one IC  
137 **Instruments review**  
137 H-P introduces its third-generation wave analyzer  
141 **Production equipment review**  
141 Splicer joins wire to almost anything

## Technical Articles

- Instrumentation** 62 **Wave analyzers: a bright future**  
They've been around a long time but continuing improvements have made wave analyzers superior for some jobs and have led to new applications  
William T. Beierwaltes, Hewlett-Packard Co.
- Circuit design** 69 **Designer's casebook**  
■ Power multivibrator gives linear motion to control rods  
■ Transistor and relay regulate high voltages  
■ Zeners and SCR fire gas discharge tube
- Computers** 72 **Computer-oriented system speeds testing of circuits and components**  
Hardware specifically designed for machine control eliminates the need for an oscilloscope, making the test setup 1,000 times faster and far simpler to program and operate  
Thomas F. Blakeslee, Scientific Data Systems Inc.
- Avionics** 78 **Doppler navigation system is redesigned from a to d**  
Replacing an analog computer with a general-purpose digital machine that fits into the same space improves performance and allows a greater number of functions to be handled  
Richard C. Warner  
General Precision Systems Inc.
- Solid state** 84 **Getting beneath the surface of multilayer integrated circuits**  
It's done with a test pattern technique that evaluates processing parameters of high density IC's during fabrication, and provides design and reliability data to both the user and maker of multilevel devices  
Frank J. Barone and C. Frank Myers,  
Motorola Semiconductor Products Inc.
- ## Departments
- |    |                          |     |                        |
|----|--------------------------|-----|------------------------|
| 4  | Readers Comment          | 40  | Index of Activity      |
| 8  | Who's who in this issue  | 53  | Washington Newsletter  |
| 14 | Who's who in electronics | 144 | New Books              |
| 22 | Meetings                 | 148 | Technical Abstracts    |
| 31 | Editorial Comment        | 152 | New Literature         |
| 33 | Electronics Newsletter   | 159 | Newsletter from Abroad |

# Electronics

Editor-in-Chief: Donald Christiansen

## Associate managing editors

Technical: Stephen E. Scrupski  
News: Robert Henkel  
Copy: Sally Powell

## Senior associate editors

Joseph Mittleman, Harry R. Karp

## Department editors

**Avionics & Space:** Alfred Rosenblatt  
**Computers:** Wallace B. Riley  
**Communications:** William Bucci  
**Components:** George Watson  
**Consumer electronics:** John D. Drummond  
**Design theory:** Joseph Mittleman  
**Industrial electronics:** Harry R. Karp  
**Military electronics:** Richard Gundlach

## Domestic bureaus

**Boston:** James Brinton, manager  
**Chicago:** Frederick Corey, manager  
**Los Angeles:** Lawrence Curran, manager; Burton Bell  
**New York:** Howard Wolff, manager  
**San Francisco:** Walter Barney, manager; Peter Vogel  
**Washington:** Robert Skole, manager; Paul Dickson, William F. Arnold

## Foreign bureaus

**Bonn:** John Gosch  
**London:** Michael Payne  
**Tokyo:** Charles Cohen

## Copy editors

James Chang, Larry Miller

## Graphic design

**Art director:** Gerald Ferguson  
**Assistant art directors:** Valerie Betz, Susan Hurlburt  
**Production editor:** Arthur C. Miller

## Editorial research:

Kay Fontana

## Editorial secretaries:

Lorraine Longo, Claire Benell, Patricia Gardner, Barbara Razulis, Stina Colombo

## McGraw-Hill News Service

**Director:** Arthur L. Moore; **Atlanta:** Fran Ridgway; **Chicago:** Robert E. Lee  
**Cleveland:** Arthur Zimmerman; **Dallas:** Marvin Reid;  
**Detroit:** James Wargo; **Los Angeles:** Michael Murphy  
**Pittsburgh:** Louis Gomolak  
**San Francisco:** Margaret Drossel  
**Seattle:** Ray Bloomberg; **Washington:** Charles Gardner, Daniel B. Moskowitz, Herbert W. Cheshire, Seth Payne, Warren Burkett, William Small, William D. Hickman

## McGraw-Hill World News Service

**Bonn:** Robert Dorang; **Brussels:** James Smith; **Hong Kong:** Wes Perry;  
**London:** John Shinn; **Mexico City:** Gerald Parkinson; **Milan:** Ronald Taggiasco, Jack Star;  
**Moscow:** Jack Winkler; **Paris:** Robert E. Farrell, Peter Kilborn;  
**Rio de Janeiro:** Leslie Warren; **Tokyo:** Marvin Petal

Reprints: Susan Nugent

Circulation: Isaaca Siegel

## Publisher: Gordon Jones

Electronics: July 22, 1968, Vol. 41, No. 15

Published every other Monday by McGraw-Hill, Inc. Founder: James H. McGraw 1860-1948.

Publication office 99 North Broadway, Albany, N.Y. 12202; second class postage paid at Albany, N.Y.

Executive, editorial, circulation and advertising addresses: McGraw-Hill Building, 330 W. 42nd Street, New York, N.Y. 10036. Telephone (212) 971-3333. Teletype TWX N.Y. 710-581-4235. Cable address: MCGRAWHILL N.Y.

Subscriptions solicited only from those professionally engaged in electronics technology. Subscription rates: qualified subscribers in the United States and possessions and Canada, \$8.00 one year, \$12.00 two years, \$16.00 three years; all other countries \$25.00 one year. Non-qualified subscribers in the U.S. and possessions and Canada, \$25.00 one year; all other countries \$50.00. Air freight service to Japan \$50.00 one year. Single copies: United States and possessions and Canada, \$1.00; all other countries, \$1.75.

Officers of McGraw-Hill Publications: Joseph H. Allen, President; J. Elton Tuohig, Executive Vice President; David J. McGrath, Senior Vice President-Operations; Vice Presidents: John R. Callahan, Editorial; Paul F. Cowie, Circulation; John R. Emery, Administration; John M. Holden, Marketing; David G. Jensen, Manufacturing; Jerome D. Luntz, Planning & Development; Robert M. Wilhelmy, Controller.

Officers of the Corporation: Shelton Fisher, President and Chief Executive Officer; John L. McGraw, Chairman; Robert E. Slaughter, Executive Vice President; Daniel F. Crowley, Donald C. McGraw, Jr., Bayard E. Sawyer, Senior Vice Presidents; John J. Cooke, Vice President & Secretary; Gordon W. McKinley, Vice President & Treasurer.

Title © registered in U.S. Patent Office; © Copyright 1968 by McGraw-Hill, Inc. All rights reserved. The contents of this publication may not be reproduced either in whole or in part without the consent of copyright owner.

**Subscribers:** The publisher, upon written request to our New York office from any subscriber, agrees to refund that part of the subscription price applying to copies not yet mailed. Please send change of address notices or complaints to Fulfillment Manager; subscription orders to Circulation Manager, Electronics at address below. Change of address notices should provide old as well as new address, including postal zip code number. If possible, attach address label from recent issue. Allow one month for change to become effective.

**Postmaster:** Please send form 3579 to Fulfillment Manager, Electronics, P.O. Box 430, Hightstown, New Jersey 08520

## Readers Comment

### On the defensive

To the Editor:

In "Patent bill not pending" [May 27, p. 52], discussing the new "defensive" publication procedure recently inaugurated by the Patent Office, it is stated "Lawyers who profit from full patenting fees are unlikely to advise its use." This is a charge that patent lawyers may give erroneous advice for personal gain. Research would have avoided this unfortunate assumption and innuendo.

There will be circumstances in which a lawyer may advise his client to use the new "defensive" publication procedure. Many, however, may not recommend its use for two major reasons:

1. The so-called "defensive" publication practice requires the applicant to request publication by the Patent Office and abandon his application before the Office has acted upon and communicated to the applicant its conclusions as to the relevant prior art. It seems most unlikely that any substantial number of informed applicants who have taken the time and gone to the expense of having an application prepared and filed will find it desirable to abandon the application before receiving a first response from the Patent Office which response would be forthcoming without any further effort or expense on their part.

2. The early filing date is important for defensive purposes. The Patent Office notice inaugurating this procedure indicates that the applicant will receive the benefit of the application filing date under 102(a) as evidence of prior knowledge. However, many lawyers question whether statutory authorization may not be necessary to insure this effect and that without it being certain there is the question as to whether the advantages of publication are justified in view of the risk of losing the filing date.

While, of course, there may be disagreement with respect to these points of view, they are entirely valid reasons why patent lawyers may not and did not recommend to their clients substantial use of the



270,000  $\mu$ F

in a

3" x 5<sup>5</sup>/<sub>8</sub>" case

(This is a standard rating.  
Even higher capacitance values  
are possible on special order.)

## POWERLYTIC® CAPACITORS ARE PACKED WITH CAPACITANCE!

### Improved Capacitance Capability

Type 36D aluminum electrolytic capacitors now have as much as 60% more capacitance in a given case size than previously available.

### Higher Operating Temperature

Improved Powerlytic capacitors may now be operated at 85 C.

### High Ripple Current Capability

Ideal capacitors for use in "brute-force" filtering and pulse discharge applications. Single capacitors are capable of handling up to 20 or more amps rms at 25 C, 120 Hz.



### Superior Seal and Safety Vent

Beaded aluminum can is crimped onto a rubber gasket recessed in a rigid molded cover, providing an expected operating life in excess of ten years. Pressure-type safety vent employs silicone rubber for reliable, predictable release of excess pressure.

### Choice of Insulating Tubes, Terminal Styles

In addition to the standard bare case, Type 36D capacitors are available with a clear plastic tube or with a Kraftboard tube. Tapped terminals in two different heights, as well as solder lug terminals are available.

For complete technical data, write for Engineering Bulletin  
3431B to Technical Literature Service, Sprague Electric Co.,  
35 Marshall Street, North Adams, Mass. 01247

### SPRAGUE COMPONENTS

CAPACITORS  
TRANSISTORS  
RESISTORS  
INTEGRATED CIRCUITS  
THIN-FILM MICROCIRCUITS

PULSE TRANSFORMERS  
INTERFERENCE FILTERS  
PULSE-FORMING NETWORKS  
TOROIDAL INDUCTORS  
ELECTRIC WAVE FILTERS

CERAMIC-BASE PRINTED NETWORKS  
PACKAGED COMPONENT ASSEMBLIES  
BOBBIN and TAPE WOUND MAGNETIC CORES  
SILICON RECTIFIER GATE CONTROLS  
FUNCTIONAL DIGITAL CIRCUITS

45C-8130



Sprague® and ® are registered trademarks of the Sprague Electric Co.

We put the  
squeeze  
on counter size  
—and price.

Systron-Donner used modern integrated circuits to create a new breed of counters, smaller and less expensive than ever before.

**12.4  
MHz  
\$395**

Only \$395 buys the all-new Model 114, a simple digital frequency meter that anyone can operate. It displays frequency from 1 Hz to 12.4 MHz — complete with decimal point and unit of measurement. This tiny, handsomely styled instrument is designed for long, troublefree service with no maintenance attention. To use it as a panel meter you simply remove the tilt stand and insert the counter in a 3" x 7" hole. The sturdy faceplate supports the chassis.



For \$750 you can get Model 7014, a truly sophisticated instrument that packs extraordinary precision and versatility into an easily carried cabinet. This counter offers a 20-MHz range, crystal-controlled time base, 10 millivolt sensitivity, and precise determinations of very low frequencies by multiple period measurement. Optional extras include a super-stable oscillator with an aging rate of 3 parts in  $10^{10}$  per 24 hours, and 8-digit or 9-digit readouts for ultra-high resolution.

**20  
MHz  
\$750**



**SYSTRON  DONNER**

888 Galindo Street, Concord, California 94520 Phone (415) 682-6161

**See us at WESCON, Booths 1726-29**

Circle 6 on reader service card



defensive publication procedure.

We believe that patent lawyers are due an apology for the implication of unprofessional actions by them.

Eben M. Graves

President  
American Patent Law Ass'n.  
Washington

### Wrong company

To the Editor:

In "Mexico nears finish line in the first Olympic event" [April 1, p. 95], there is a statement that Matsushita Electrical Industrial Co. is one of the companies working on the program. Although this firm is one of the biggest manufacturers of home appliances and other light machinery, it is not Matsushita but Mitsubishi Electric Corp. that has engaged in the design, manufacturing, and installation of the antenna under a subcontract with Mitsubishi TRW, a joint venture with TRW Inc.

S. Itoh

Mitsubishi Electric Corp.  
Tokyo

### Keeping the recorders straight

To the Editor:

"Color television scores big gains with small screens" by John Drummond [June 10, p. 136] was interesting and informative. I particularly appreciated the straightforward statements identifying the real manufacturer of a product that is marketed under some other name. This silly, clandestine sort of misrepresentation has always been a pet peeve of mine as a consumer. I say "silly" because this information can usually be exhumed (it's not really a secret);

the ploy only makes the task of comparing, appraising, and buying more difficult, confusing, and distasteful.

Please excuse the "Naderistic" digression. I would like to point out an apparent oversight in the video tape recorder section of the article. The May, 1968, issue of High Fidelity displays a stationary head vtr for sale, conflicting with the statement in your article that such machines are not being produced at the present time. The price of this unit, sold by Akai of Japan, is quite low at around \$500, far below normal and hence worthy of note.

James C. Trescott

Automatic Sprinkler Corp.  
Cleveland

▪ Akai's fixed-head vtr was reported earlier by Electronics [Nov. 27, 1967, p. 187]. The reference in the June 10 story was to domestic production.

### More light on photocell

To the Editor:

The Clairex ultraviolet photocell [June 24, p. 163] has a resistance of 1 megohm or less when exposed to 3650Å radiation of 5 milliwatts/cm<sup>2</sup>. Its resistance in the dark and at 50 foot-candles of incandescent light is 100 to 1,000 megohms. It exhibits a linear increase in resistance from 5 milliwatts/cm<sup>2</sup> to 50 microwatts/cm<sup>2</sup> of 3650Å radiation.

This is not the first commercial application of zinc sulfide thin film, but the first as a photoresistor.

Joseph Malgiolio

Director of research  
Clairex Corp.  
New York, N.Y.

## SUBSCRIPTION SERVICE

Please include an Electronics Magazine address label to insure prompt service whenever you write us about your subscription.

Mail to: Fulfillment Manager  
Electronics  
P.O. Box 430  
Hightstown, N.J. 08520

To subscribe mail this form with your payment and check  new subscription  renew my present subscription

Subscription rates: qualified subscribers in the U.S.: 1 year \$8; two years, \$12; three years, \$16. Non-qualified: 1 year \$25. Subscription rates for foreign countries available on request.

## CHANGE OF ADDRESS

ATTACH LABEL HERE

If you are moving, please let us know five weeks before changing your address. Place magazine address label here, print your new address below.

name

address

city

state

zip code

Application For

# LAMP DRIVERS

**PROBLEM:** Find integrated circuit to drive two lamps... must be dual.

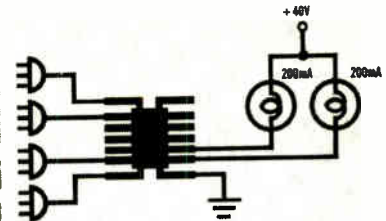

**REQUIRED:** Drivers must be controlled by 5 volt logic... and must latch.

**GIVEN:**

Input swing ...

Logic 0 ... +0.5 V

Logic 1 ... +4 V

Lamp rating ... 40 V; 200 mA

Available power supplies ... +5;

+40 V

Both lamps are never ON at same time (exclusive OR)

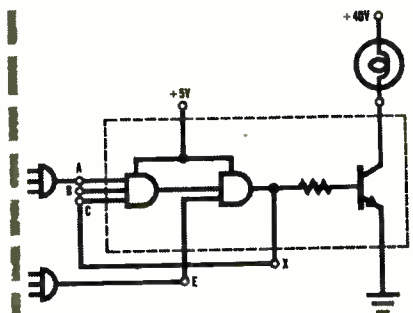

**SOLUTION:** SI 4002... Integrated dual lamp driver with 3 logic inputs... and latching capability (one of a series of 3 drivers).

Max output current ... 250 mA

(can withstand surges up to 1 amp)

Max output voltage ... 42 V

Power Dissipation ... 600 mW

Lamp drivers keeping you in the dark?  
Contact us for applications help and data sheets.



Siliconix incorporated

1140 W Evelyn Ave. • Sunnyvale, CA 94086  
Phone (408) 245-1000 • TWX: 910-339-9216



## Fast action on custom-design EMC Filters from Captor!

If your EMC problem is unique, Captor is the supplier with the fastest action on custom-design EMC filters and filter assemblies. Our application engineers will go to work immediately to evolve a prototype that fulfills your mechanical and electrical requirements and conforms to applicable MIL specifications. Captor has the manufacturing capability to produce in volume economically — cylindrical or rectangular electromagnetic interference filters for all commercial or military compliances. Also Captor offers many cataloged EMC filters ready for immediate delivery. Contact Captor today on your EMC problem!

**Captor Corporation manufactures miniature filters . . . communications and security filters . . . custom-design filters, and other electronic components.**

**CAPTOR CORPORATION**  
APPLICATION ENGINEERING DEPT.  
5040 Dixie Highway, Tipp City, Ohio 45371

## Who's Who in this issue



Warner



Beierwaltes

**A big city boy** who finds the country to his liking, Dick Warner lives in the mountains of Morris Plains, N.J. The Bayonne, N.J. born physics major at Brooklyn Polytechnic has been in engineering since 1951.

Warner is a project manager in the Aerospace Digital Computer department of the Kearfott Products division of General Precision Systems, Inc., where he designed the Micro-Minac computer described on page 78. Dick's first exposure to logic was at Bell Telephone Laboratories, followed by a tour as senior engineer at the Ford Instrument Co. He also worked at Digital Electronics Inc.

**Computer-controlled** automatic testing with wave analyzers is not far off, says William Beierwaltes, author of the article on page 62. Beierwaltes sees new wave analyzers as being computer-oriented, with programmable functions, digital readout of amplitude and frequency, and automatic ranging, so they can operate under the complete control of a computer.

Beierwaltes has bachelor's degrees in mathematics and electrical engineering from the University of Michigan. He has been active in wave analysis at Hewlett-Packard's Loveland, Colo., division as a design engineer.

Myers

Barone

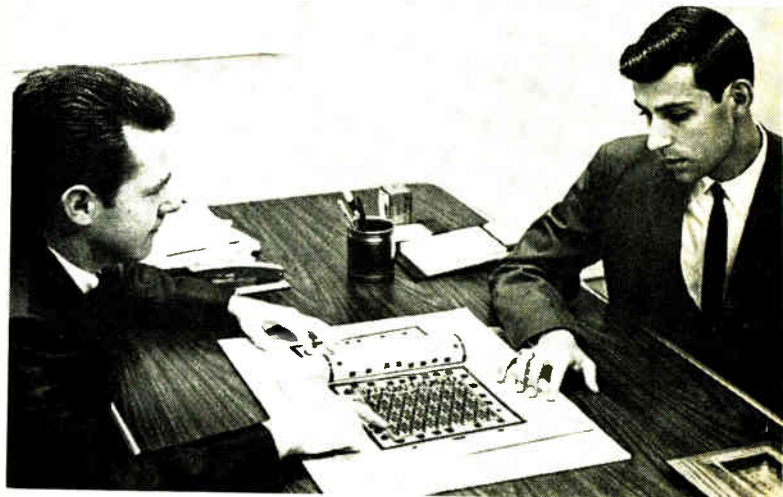





Blakeslee

In the late spring of 1967, Tom Blakeslee, then working in test equipment engineering, noticed that a substantial proportion of the logic modules that passed production-line tests turned out to be bad during the debugging of the machine in which they were installed. Each card was subjected to about 10 tests that took about 30 seconds, using the sampling oscilloscope approach outlined in the article on page 72. During practically all 30 seconds, the computer that controlled the test was idle.

Tom is now in the advanced development group at Scientific Data Systems. He has been with the company four years, coming from Scantlin Electronics, where he designed a display board for stock prices. He is a graduate of California Institute of Technology.

The combined backgrounds of Frank Barone and Charles Myers led to the article on test patterns on page 84. Myers received his bachelor's degree in electrical engineering from the University of Arizona in 1963. He then joined Motorola's Semiconductor Products division, and is now manager of the IC process R&D division.

Barone received his B.S. in electrical engineering and his masters in materials science from Marquette University in 1963. He joined Motorola in 1965 and is now a project engineer in the IC process R&D division.

# Add Sprague Series 7400A to your prints for Series 74N TTL circuits. They're pin-for-pin identical.

SERIES 74N	FUNCTION	SPRAGUE PART NO.
SN7400N	Quad 2-Input NAND	USN-7400A
SN7401N	Quad 2-Input NAND (No Collector Load)	USN-7401A
SN7402N	Quad 2-Input NOR	USN-7402A
SN7410N	Triple 3-Input NAND	USN-7410A
SN7420N	Dual 4-Input NAND	USN-7420A
SN7430N	Single 8-Input NAND	USN-7430A
SN7440N	Dual 4-Input NAND Buffer	USN-7440A
SN7450N	2-Wide 2-Input Expandable AND-OR-INVERT	USN-7450A
SN7451N	2-Wide 2-Input AND-OR-INVERT	USN-7451A
SN7453N	4-Wide 2-Input Expandable AND-OR-INVERT	USN-7453A
SN7454N	4-Wide 2-Input AND-OR-INVERT	USN-7454A
SN7460N	Dual 4-Input Expander	USN-7460A
SN7470N	D-C Clocked J-K Flip Flop	USN-7470A
SN7472N	J-K Master Slave Flip Flop	USN-7472A
	Dual J-K Master Slave Flip Flop:	
SN7473N	Single chip, pin 11 GND	USN-7473A
—	Single chip, pin 7 GND	USN-74107A
SN7474N	Dual D-Type Edge-Triggered Flip Flop	USN-7474A
—	Dual AC Clocked J-K Flip Flop	USN-7479A

Series 5400, full-temperature-range equivalents in 14 pin flat-packs, are also available for rapid delivery from Sprague.

## Don't spend another week without calling Sprague.

For complete technical data on Series 5400 and 7400A circuits, write to Technical Literature Service, Sprague Electric Co., 35 Marshall St., North Adams, Mass. 01247



### SPRAGUE COMPONENTS

INTEGRATED CIRCUITS  
CAPACITORS  
TRANSISTORS  
RESISTORS  
THIN-FILM MICROCIRCUITS  
PULSE TRANSFORMERS

INTERFERENCE FILTERS  
PACKAGED COMPONENT ASSEMBLIES  
FUNCTIONAL DIGITAL CIRCUITS  
MAGNETIC COMPONENTS  
CERAMIC-BASE PRINTED NETWORKS  
PULSE-FORMING NETWORKS



'Sprague' and '®' are registered trademarks of the Sprague Electric Co.

# Let's take the mystery out of MOS!

## ...design your own large-scale MOS arrays with the new Philco Building Block Program

- Stay in the design loop
- Get a proprietary design
- Estimate performance and cost before committing design
- Get quick turnaround
- Optimize economics with help from Philco specialists

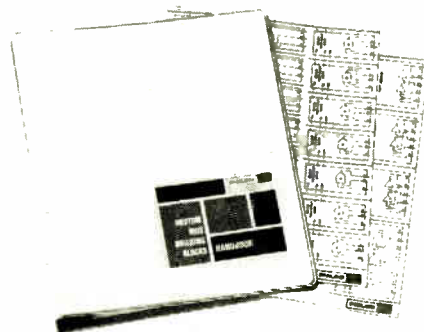

### Here's what the program includes:

Definitive handbook, adhesive-backed decals, help in optimization from the most experienced MOS staff in the industry.



**Here's how the program works:**

Follow the Philco handbook—Contents include everything you need: design fundamentals, partitioning the system, layout, performance calculations, testing, ordering, and sample specification sheet. More than 70 illustrations and tables.

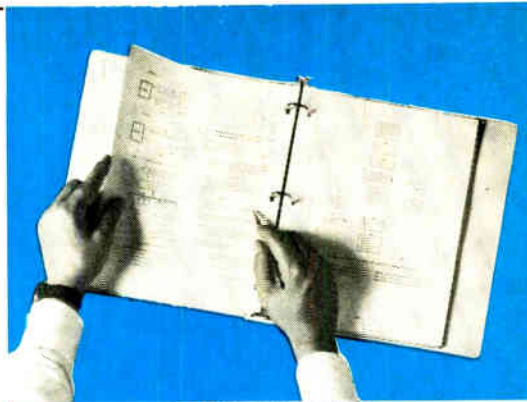

Paste up decals — Partition your system using the scaled replicas of proved digital functions such as gates and flip-flops (nearly 100 to choose from). Lay the decals on scaled paper representing the chip, 250 times size. Draw interconnections. Determine power requirements, predict performance.

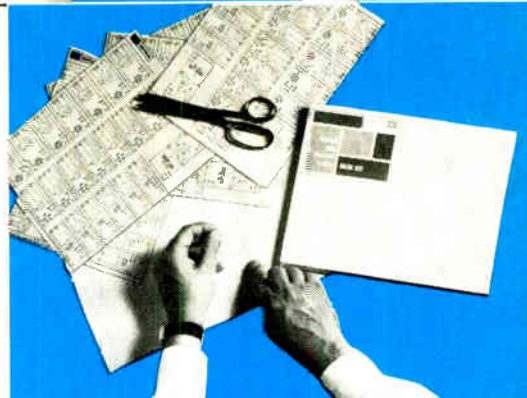

Turn your layout over to us for optimization—We'll evaluate and optimize your layout for economic use of chip area.

Turnaround time will be short and costs will be economical.

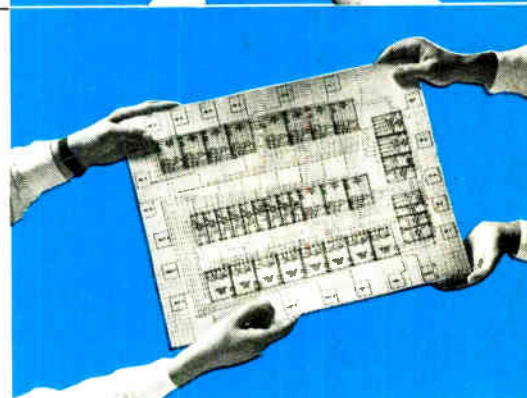

**PHILCO-FORD CORPORATION**

Microelectronics Division, Santa Clara, California 95051

**Bipolar • Hybrid • MOS • Discrete Devices/Electro-Optical & Microwave Products**

**Start today** — For additional information on the Philco MOS Building Block Program, fill in and mail coupon. Philco-Ford Corporation, Microelectronics Division, Marketing Dept., 2920 San Ysidro Way, Santa Clara, California 95051.

Name \_\_\_\_\_  
Title \_\_\_\_\_  
Company \_\_\_\_\_  
Address \_\_\_\_\_  
City \_\_\_\_\_  
State \_\_\_\_\_ Zip \_\_\_\_\_  
Application \_\_\_\_\_  
\_\_\_\_\_  
\_\_\_\_\_

# Bravo!

Yesterday's success in TTL's was worth repeating.

We	They	Description	Modest Engineering Advantages
SN 5400/7400	SN 5400/7400	Quad 2-input Gate	Input voltage clamps
SN 5410/7410	SN 5410/7410	Triple 3-input Gate	Input voltage clamps
SN 5473/7473	SN 5473/7473	Dual JK Flip Flop	15ns clock skew, clock line clamp
SN 5474/7474	SN 5474/7474	Dual D Flip Flop	Tight hold time specification
DM 7800/8800	— none —	Dual TTL/MOS Translator	Up to 33V output swing
NH 0006	— none —	Lamp/Relay Driver	250mA output drive capability



# Encore!

So we've added these to our line.

We	They	Description	Modest Engineering Advantages
SN 5420/7420 SN 5440/7440 SN 5441/7441	SN 5420/7420 SN 5440/7440 SN 5441/7441	Dual 4-input Gate Dual 4-input Buffer Nixie Driver	Input voltage clamps Input voltage clamps No oscillation, over-range counting, "excess 3" decoding
SN 5475/7475 SN 5476/7476 SN 5490/7490 SN 5492/7492 SN 5493/7493 DM 7200/8200	SN 5475/7475 SN 5476/7476 SN 5490/7490 SN 5492/7492 SN 5493/7493 — none —	Quad Latch Dual JK Flip Flop Decade Counter Divide-by-Twelve Counter Four-Bit Binary Counter Four-Bit Comparator	Input diodes Preset and clear inputs 20 MHz input frequency 20 MHz input frequency 20 MHz input frequency A > B, A < B, A = B outputs, 20 nsec propagation delay
DM 7210/8210 DM 7220/8220 DM 7520/8520	— none — — none — — none —	8-Channel Digital Switch Parity Generator/Checker Modulo-N Divider	Parallel/serial converter Odd or even parity 20 MHz input frequency, divides by any number from 2-15, no external gating
DM 7570/8570	— none —	8-Bit Serial in/Parallel out Shift Register	20 MHz input frequency
DM 7590/8590	— none —	8-Bit Parallel in/Serial out Shift Register	20 MHz input frequency
DM 7820/8820	— none —	Line Receiver	Differential input, single 5V power supply, 15V common mode rejection
DM 7830/8830	— none —	Line Driver	Differential output, single 5V power supply
NH 0008	— none —	Lamp/Relay Driver	3A output drive (pulse) capability

We take our bows with a hermetic package for the -55 to +125°C mil-temp versions, and a silicone molded package for the 0 to 70°C industrial/commercial units. Complete behind-the-scenes information from: National Semiconductor Corporation, 2975 San Ysidro Way, Santa Clara, California 95051 (408) 245-4320.

## National Semiconductor



# this skinny device measures thermal energy

A NEW CONCEPT in determining thermal energy transfer. RdF MICRO-FOIL™ Heat Flow Sensors are self-generating transducers. Their output is directly proportional to the amount of thermal energy received per unit area per unit time (such as Btu/ft<sup>2</sup>-sec).

Thin (0.003") and flexible, the sensors can be attached to flat or curved surfaces. Simply connect the leads to a millivoltmeter and you can make accurate measurements of convective, conductive or radiant energy. It's as simple as that! Send for complete bulletin #36614

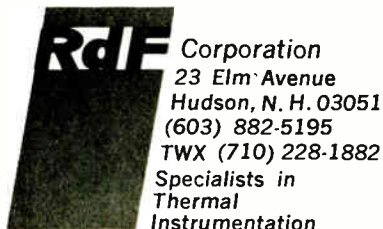

## Who's who in Electronics

**Resignations** of a number of Fairchild Semiconductor's top officers recently have sparked rumors suggesting dramatic changes in company operations. However, at least in the research and development arena, the selection of Louis Jack Kabell as director of R&D guarantees that current practices and directions will be continued.

Kabell explains that he and departing R&D director, Gordon Moore, had a very close working relationship and adds that both assisted in the reorganization of Fairchild's R&D over the last year; in that reorganization, conventional product engineering was moved out of R&D into the appropriate departments.

**Looks promising.** "What we are now doing, and will continue to do in R&D," Kabell says, "is to work in areas where 'technology' is the major consideration. Naturally we will continue to be product-oriented; our experimental work will be with MOS, bipolar, and other technologies that look promising, but require



Kabell

had been responsible for the development of discrete devices, optoelectronic devices, linear integrated circuits, and device and packaging support for digital IC's. However, in the shuffle to get mundane product engineering out of R&D, that job and its associated functions have been transferred to the solid state physics department under the direction of Charles Bittman.

**Background.** During the last eight years, Kabell has worked for Fairchild in the device development department and also coordinated the establishment of the company's photo-transistor line. Prior to his employment at Fairchild, he was senior research engineer at the Stanford Research Institute, Menlo Park, Calif.

**If the Laboratory** for Electronics Inc. weren't in the electronics business, it would probably be in the black. The Waltham, Mass., firm lost \$4.8 million in the year ended April 26, despite sales of \$52.8 million. And the Electronics division has been blamed for most of the loss.

Named recently to turn this red ink into black is a new management team headed by Herbert N. Roth Jr., president and chief executive officer, and his chief aide, Robert L. Francisco, vice president for the Electronics division.

Roth—who nursed sickly Anelex Inc. back to health and then into

a profitable merger with Mohawk Data Sciences Inc.—succeeded Henry Harding, who is now chairman of the LFE board.

Francisco came from Western Union; his appointment was one of Harding's last major acts as president.

**Pull-ups.** Now Roth and Francisco hope to pull LFE out of a six-year slump and are getting out of unprofitable areas and cutting losses and inventories as rapidly as possible. "If we don't make a profit," Roth says, ". . . you can meet a new president next summer."

In one move to cut losses, LFE



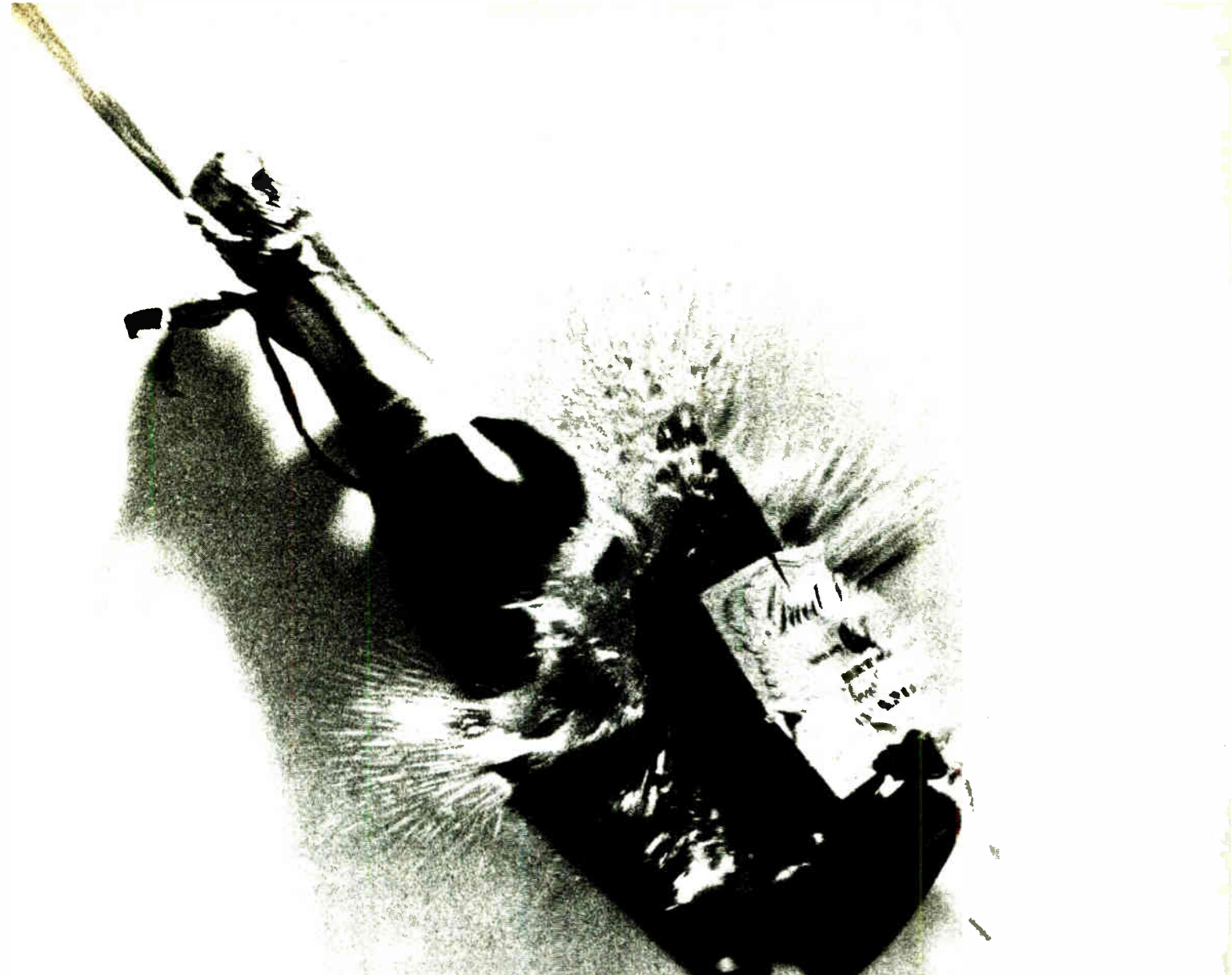

# IGC LAUNCHES A NEW ERA IN FERRITES

New shapes, new materials, and new processes are ready for engineers and designers who are bold enough to use them.

New techniques let us make shapes never possible before, providing you with virtually complete design freedom.

Our Pulse Rated Toroids are another IGC first. We've calculated toroid parameters like pulse inductance, pulse magnetizing current, and ET constant and listed them in black and white, for guaranteed per-

formance on each and every part.

We've stretched size limits in both directions to open new applications. From the world's smallest pot core (0.125" O.D., 0.035" thick), to ferrite plates as large as 1"x2"x6".

Products already using ferrites are being improved. And new ferrite applications are springing up all over. Success stories include: omnidirectional antennas, micro-miniature transformers, transistorized ignition

systems, fluorescent lighting, read-only memories. And more.

Discover it all. Our bulletins on ferrite materials, shapes and applications are a great place to start. If you have something specific in mind, send your requirements. Write Mr. K. S. Talbot, Manager of Sales, Indiana General Corporation, Electronics Division/Ferrites, Keasbey, New Jersey.



**INDIANA GENERAL**

Making Magnetics Work

SERIES  
260  
AND  
265

1/8"  
SHANK

# SOLID CARBIDE CIRCUIT BOARD DRILLS

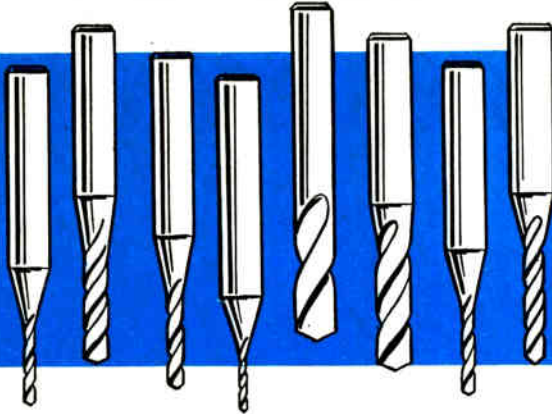

Choice of 58 drill sizes from No. 80 to 1/8"  
ALL WITH COMMON 1/8" DIAMETER SHANKS

## for precision drilling with every drill size!

You can now maintain location and hole size tolerances to extremely close limits . . . at drill feeds up to 15 feet per minute! The unequalled rigidity of solid carbide plus the added support of 1/8" shanks gives maximum deflection-free performance in drilling all diameter circuit board holes. All drills precision ground with unique four facet drill point configuration. Common 1/8" shank design eliminates need for collet and bushing inventory for each drill size. Your Metal Removal distributor provides vital sales and engineering liaison . . . call him or write for Catalog D67.



**THE METAL REMOVAL COMPANY**  
1859 West Columbia Avenue • Chicago, Illinois 60626  
Plants Located in CHICAGO/LOS ANGELES/SAN JUAN

MASTER TOOL AND WHEEL MAKERS FOR THE WORLD  
END MILLS / DRILLS / REAMERS / BURS / SPECIAL TOOLING

## Who's who in Electronics

sold the Electronics division's delay-line business to the Sangamo Electric Co. The delay-line operation posted sales of about a million a year, but was profitless.

Under scrutiny are the division's mass computer memory, instrument, and microwave oscillator lines. They have been warned to "make money . . . or else."

The division is holding on to its domain-tip-propagation logic devices. The magnetic logic units are chalking up good sales as shift registers and memory devices find

Roth



Francisco

applications in army ordnance and communications gear.

Another asset is LFE's license agreement with Decca Radar Ltd. of Great Britain. LFE is already building Decca navigation gear for military use, and may take on other Decca lines, according to Roth. Also, he adds, Decca soon may market LFE products in Great Britain.

**Salvage.** Francisco also hopes to keep alive the sophisticated analog to digital converters and advanced control and display systems it developed for Sperry Gyroscope's moribund Integrated Light Aircraft Avionics System. He's hunting for applications aboard other military planes.

And there'll be a change in the Electronics division's approach to business and proposals. Rather than underbid to get large contracts, Francisco would have the division become a quality producer of small quantities of specialized electronics gear.



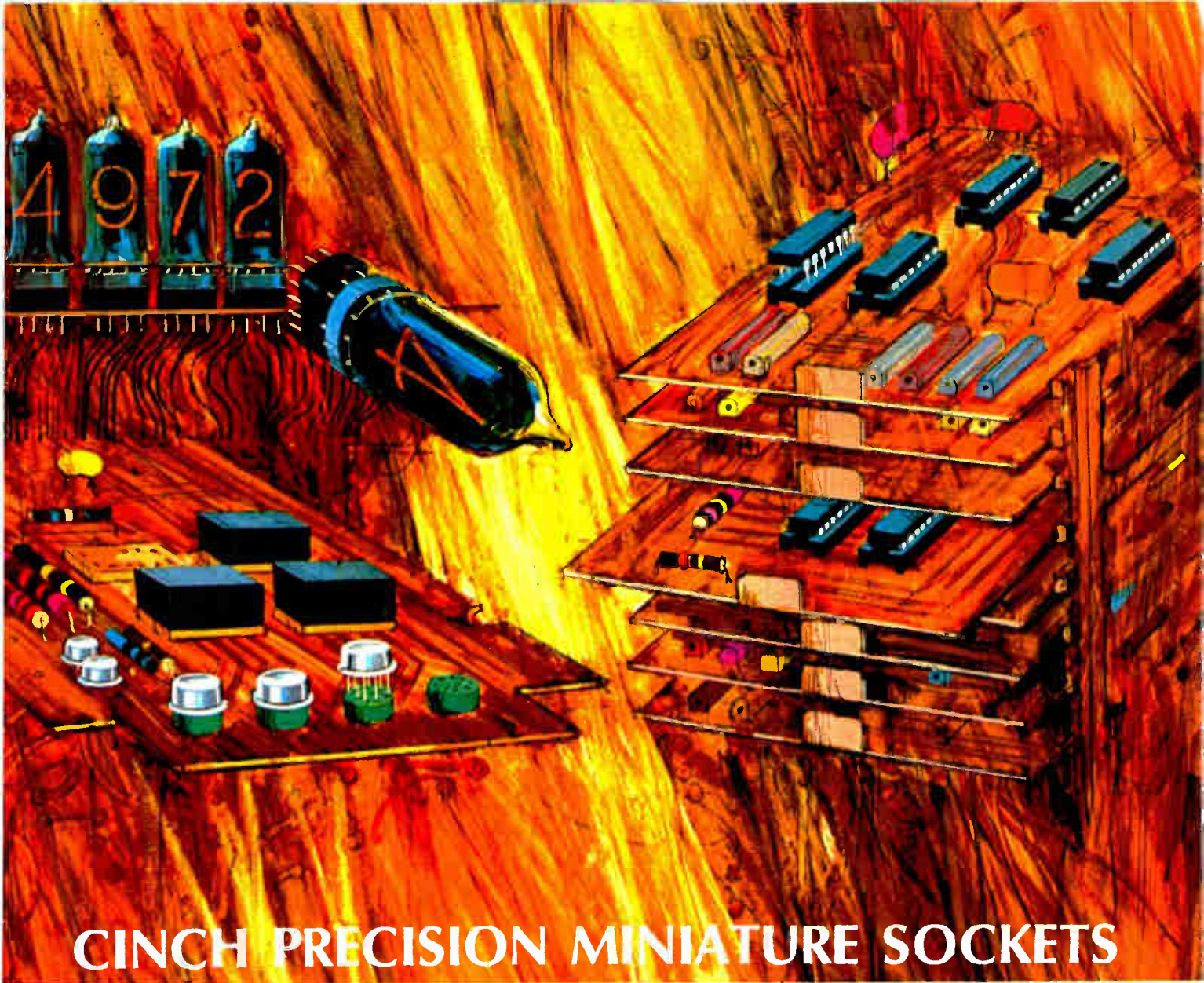

# CINCH PRECISION MINIATURE SOCKETS

## INSURE EQUIPMENT DEPENDABILITY

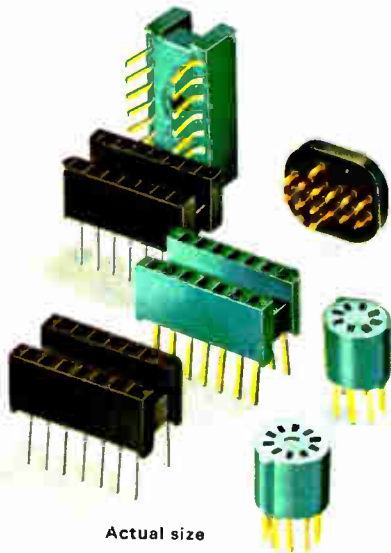

Actual size

Equipment design frequently involves problems of field maintenance or circuit updating. Cinch component sockets provide inexpensive and effective solutions without compromising reliability.

*DIP* sockets for 14 and 16 lead DIP's are typical of Cinch specialized miniature sockets. Available in GP black phenolic or SDGF diallyl phthalate, they have extremely high resistance to shock, vibration, humidity and corrosive atmospheres. Contacts are gold or cadmium plated beryllium copper with low contact resistance.

*IC* sockets for 6, 8 and 10 pin TO-5 cased devices, miniature *NIXIE Tube* sockets and *Subminiature relay* sockets are just a few of the other component sockets Cinch manufactures.

For information on *DIP* sockets and other Cinch interconnection devices, write to Cinch Manufacturing Company, 1501 Morse Avenue, Elk Grove Village, Illinois 60007.

C-6818



DIVISION OF UNITED-CARR



CONSISTING OF CINCH MANUFACTURING COMPANY, CINCH-GRAPHIK, CINCH-MONADNOCK, CINCH-NULINE, UCINITE (ELECTRONICS) AND PLAXIAL CABLE DEPT.

Circle 17 on reader service card

# How to select the best DVM in the medium price range:

	HP 3440 SERIES	FAIRCHILD 7000 SERIES
<b>TO MEASURE DC VOLTS</b>		
price	\$1295	\$1275
ranges	3	4
overranging	5%	20%
accuracy—		
24 hours	.05% r. ± .01% f.s.	.01% r. ± .01% f.s.
3-month stability	.05%	not specified
noise rejection		
common mode, 60 Hz	30 - 70 dB	not specified
normal mode, 60 Hz	30 db	30 dB
input resistance—10-volt range	10.2 megohms	1000 megohms
<b>TO MEASURE MILLIVOLTS</b>		
price	\$1610	—
accuracy—100 mV	.10% r. ± .05% f.s.	—
3-month stability	.05%	—
input resistance	10.2 megohms	—
common mode noise rejection	100dB	—
autoranging—100 mV to 1000 V	yes	—
<b>TO MEASURE AC VOLTS (100 kHz)</b>		
price	\$1775	\$1725
ranges	3	4
basic accuracy	.10% r. ± .02% f.s.	.10% r. ± .02% f.s.
auto ranging	no	yes
common mode noise rejection	not specified	not specified
<b>TO MEASURE OHMS</b>		
price	\$1525 (incl. mV and current)	\$1385
ranges	5	5
basic accuracy	.30% r. ± .01% f.s.	.05% r. ± .02% f.s.
max. voltage across unknown	1.0v	1.2v
<b>MULTIMETER CAPABILITY</b>		
price	—	\$1895
functions	—	dc, ac, mV, ohms, current
source of data	catalog—1968	#7000 - 8/67



**NLS X2 SERIES**

**DANA 4400 SERIES**

\$1180  
3  
20%  
  
.02% r. ± .01% f.s.  
not specified

\$1150  
4  
20%  
  
.01% r. ± .01% f.s.  
.01%

100 dB  
30 dB  
10 megohms

100 dB  
60 dB  
1000 megohms

\$1630 (incl. ohms)  
.06% r. ± .05% f.s.  
not specified  
100 megohms  
not specified  
no

\$1395  
.01% r. ± .01% f.s.  
.01%  
100 megohms  
100 dB  
yes

\$1480  
4  
.05% r. ± .02% f.s.  
yes  
not specified

\$1450  
4  
.10% r. ± .02% f.s.  
yes  
60 dB

\$1630 (incl. mV)  
5  
.02% r. ± .06% f.s.  
16v

\$1795 (incl. mV and ac)  
5  
.01% r. ± .02% f.s.  
1.2v

\$2230  
dc, ac, mV, ohms,  
current, ratio

\$1795  
dc, ac, mV, ohms

#002 - 6/67

catalog - 1968



The rest of the series 4400 specs are in our new brochure along with those on all the Dana DVM's. A letterhead request will get you a copy.  
Dana Laboratories, Inc., 2401 Campus Drive, Irvine, California 92664.

**DANA**

Circle 19 on reader service card

# We build connectors around filters, so you won't have to build filters around connectors.

Used to be, you had to build a filter around connectors to keep out EMI (electromagnetic interference.) Now Bendix is building its connectors around filters to settle the problem once and for all.

New Bendix® filter-connectors are an entirely new concept. Each pin is surrounded with its own miniature ferrite filter. The benefits of making the filter an integral part of the connector are obvious. You save space, weight and production costs. (A Bendix filter-connector costs about a third less than a filter-box setup.) You eliminate two out of three solder joints. And you wind up with a superior mechanical structure. That's important for improving the performance and reliability of today's highly complex electronic equipment.

Readily available filter-connectors include those intermatable with the Bendix Pygmy® Series (Mil-C-26482), Bendix JT Series and Bendix LJT Series (Mil-C-27599 and Mil-C-38999). Others are on the way. We'll design filter-connectors to meet your specific requirements, of course. For details, write: Electrical Components Division, The Bendix Corporation, Sidney, N.Y. 13838.

**Bendix**  
  
**Electronics**





# Rent INSTRUMENTS FOR ANY EMERGENCY Rent INSTRUMENTS TO SAVE CAPITAL

You can save time and money and satisfy your short term equipment requirements by renting almost any kind of electronic instrument or small computer from Rentronix. Our rates are low . . . Our service is fast and easy to use. You simply select the instrument you want from our complete catalog, confirm its availability by a collect phone call or quotation request, and send us your purchase order for 30 days rental or more.

Your calibrated, fully maintained instrument will be on its way to you, transportation prepaid, anywhere in the United States within hours.

Get full information now at no obligation. Fill out the coupon or call collect, (301) 933-6655 for even faster service.

## Rentronix

A DIVISION OF INMARK, INC.

11501 Huff Court  
Kensington, Maryland 20795

Send me full information   
I would like to rent a Model \_\_\_\_\_

from you for \_\_\_\_\_ months.  
How much would it cost?

Name \_\_\_\_\_ Title \_\_\_\_\_

Company \_\_\_\_\_

Address \_\_\_\_\_

City & State \_\_\_\_\_ Zip \_\_\_\_\_



## Meetings

### United Nations space forum set for launch

Although its main purpose is to show developing nations how to get into the space race, the United Nations Conference on the Exploration and Peaceful Uses of Outer Space promises a certain amount of just plain showing off when representatives from more than 60 nations assemble in Vienna, Aug. 14 to 27. Not unnaturally, the two leading participants in the space race—the United States and the Soviet Union—are among the biggest contributors to the conference.

Proud of its achievements with the Molniya-1 spacecraft, the Soviet Union will describe the use of narrow-beam antennas for increased signal strength and a 40-watt on-board relay transmitter. The Orbita communications satel-

lite ground network will also be the subject of a paper and will include a description of a noise-free f-m signal receiver having a synchronous phase demodulator with frequency feedback.

Other papers from Russia cover a system for automatic docking in space and the use of high-resolution television cameras for recording cloud formations.

Among the U.S. contributions will be papers by NASA officials and scientists on topics ranging from aerospace applications in agriculture, forestry, cartography, and oceanography to descriptions of the world weather watch program.

For more information write Marcia Cooper Pinchas, Room 388, United Nations, New York, N.Y.

### U.S. plays large role at IFIP

Computer specialists from 22 countries will present a total of 245 papers in Edinburgh, Scotland, next month when the International Federation of Information Processors convenes for its triennial conference. As in the past, the conference, scheduled for Aug. 5 to 10, will divide its attention equally between hardware and software. Over 100 of the papers are from the United States, with Britain contributing 48, followed by France with 17.

Among the U.S. contributions will be a description of a computer-controlled mechanical arm currently under development at the Stanford University's artificial intelligence project. A two-part system, a vidicon camera scans the contours of an object and provides

input to a PDP-6 time-shared computer that controls the arm.

In a paper on high-speed plated-wire memory, Sigurd Waaben, a researcher with the Bell Telephone Laboratories, will discuss a way to improve performance by changing, for example, from read-write to read-only mode and back at logic speed as the processor goes along in its sequence of instructions.

Other U.S. papers include one on a new approach to real-time memory disk design developed at the Western Union Telegraph Co. and an approach to real-time display of computer-generated half-tone perspective drawings using a hidden line algorithm.

For further information write the IFIP Congress '68, 23 Dorset Square, London, N.W. 1, England.

## Calendar

Congress of the International Federation for Information Processing, British Computer Society; Edinburgh, Scotland, Aug. 5-10.

United Nations Conference on the Exploration and Peaceful Uses of

Outer Space, United Nations General Assembly; Vienna, Aug. 14-27.

Conference on Radar Meteorology, American Meteorological Society; Montreal, Aug. 19-23.

(Continued on p. 24)

# Just because we built them to NASA standards doesn't mean they're priced sky high!

PHILCOLOGIC® Micromodules were designed originally for manned space programs, that's true. And it's true they've proven their mettle under demands as stringent as any a logic module is ever likely to face. However, if you have the idea they're priced too high for industry, that's not true!

A few representative prices from our list of more than 300 micromodule types should lay that myth to rest:

NG-01 Nand Gate, 4-input . . . . .	\$ 16.45
FF-03 Flip-Flop . . . . .	16.45
DU-09 12-Bit DAC . . . . .	215.00
MU-01 16-Channel Multiplexer . . . . .	350.00
HU-02 25-psec sample-&-hold . . . . .	149.85

Our 300+ micromodule inventory bulges with a wide variety of both digital and analog functions, including multiplexers, operational amplifiers, D-to-A and A-to-D circuits, and the industry's widest selection of computer interfaces. They employ compatible logic to 40 MHz in standard DTL, T<sup>2</sup>L, and MOS circuits. Unique three-dimensional design accepts all existing monolithic ICs.

PHILCOLOGIC micromodules are easy to work with, simple to service. Color-coded labels reveal logic family and type at a glance. Clearance holes in the cover provide front-panel access to all input / output terminals. No more trouble-shooting from the back-plane wiring!

For complete technical information on PHILCOLOGIC micromodules, including our down-to-earth prices, request Data File 152. Write Product Sales Manager, WDL Division, Philco-Ford Corporation, Mail Station C-41, 3939 Fabian Way, Palo Alto, California 94303. Or call (415) 326-4350, extension 5981.

® Trademark of Philco-Ford Corporation



PHILCO-FORD CORPORATION  
WDL Division • 3939 Fabian Way  
Palo Alto, California • 94303

\*Prices shown for 11 or more modules. Liberal discount schedule (up to 40%) applies to volume purchases.

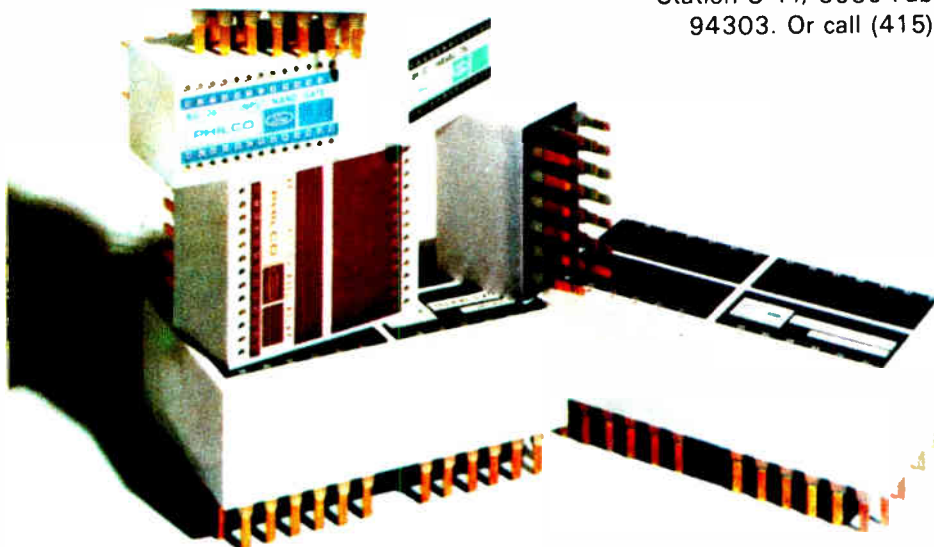



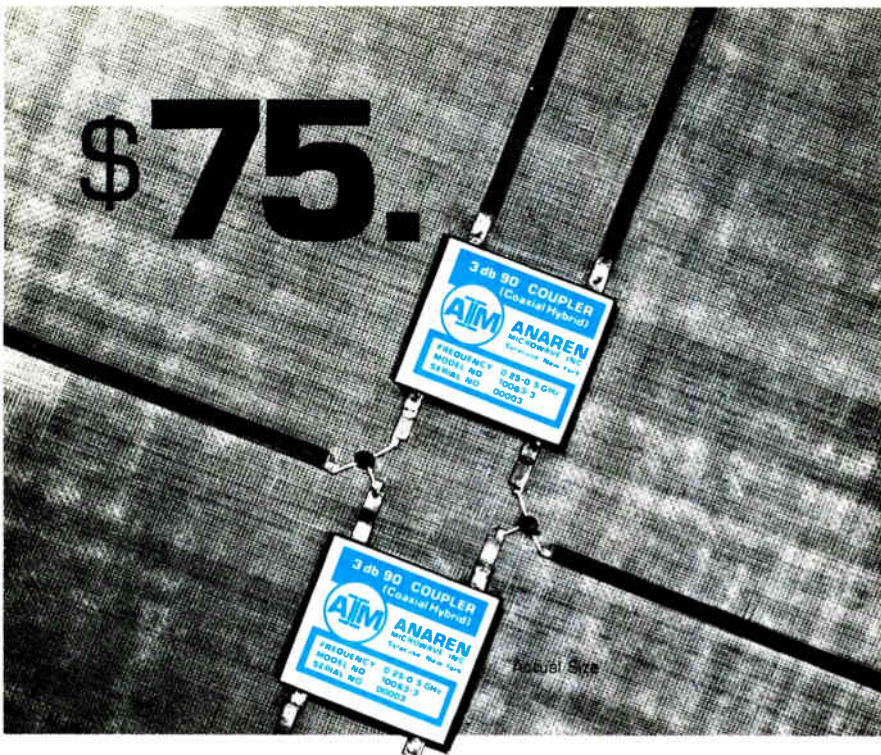

## Plastic Encased 3 db 90° Coupler

ANAREN's series 10060-3 plastic-encased 3 db 90° coupler (coaxial hybrid) is specifically designed for use in stripline applications. Fitted with stripline terminals and ground plane mounting holes, this low cost, compact, rugged coaxial hybrid utilizes advanced strip transmission line techniques to provide superior electrical performance across octave bandwidths. Encapsulated solid body construction assures extremely high reliability under severe environmental conditions.

Order directly from this ad, or send for detailed electrical and physical specifications and application information.

### SPECIFICATIONS

MODEL NO.	FREQUENCY RANGE (GHz)	MINIMUM ISOLATION	MAIN LINE VSWR	WEIGHT (GRAMS)
10061-3	0.0625-0.125	20 db	1.25	22
10062-3	0.125-0.25	20 db	1.25	14
10063-3	0.25-0.5	20 db	1.25	10
10064-3	0.5-1.0	20 db	1.25	6
10065-3	1.0-2.0	20 db	1.25	4
10060-3	0.225-0.40	20 db	1.25	10

Maximum deviation from mean output on all models is  $\pm 0.5$  db. Coupling is 3 db + 0.2 db - 0.0 db.



**ANAREN  
MICROWAVE, INC.**

478 EAST BRIGHTON AVE., SYRACUSE, N.Y. 13210  
Phone: 315-475-1621 TWX 710-541-1507

©TM Anaren Microwave, Inc.

## Meetings

(Continued from p. 22)

**International Symposium on Nuclear Electronics**, Societe Francaise des Electroniciens et des Radioelectriciens; Versailles, France, Sept. 10-13.

**Meeting of the Union Radio Scientific International**; Northeastern University, Boston, Sept. 10-12.

**Symposium on Computer Control of Natural Resources and Public Utilities**, International Federation of Automatic Control; Haifa, Israel, Sept. 11-14.

**Solid State Sensors and Transducers Symposium**, IEEE and Instrument Society of America; Leamington Hotel, Minneapolis, Sept. 12-13.

**Joint Power Generation Conference**, IEEE and American Society of Mechanical Engineers; Jack Tar Hotel, San Francisco, Sept. 15-19.

**Space Simulation Conference**, American Institute of Aeronautics and Astronautics; Seattle, Sept. 16-18.

**International Symposium on Analog and Hybrid Computation Applied to Nuclear Energy**; Versailles, France, Sept. 16-18.

**International Conference on Microwave and Optical Generation and Amplification**, IEEE and the University of Hamburg; University of Hamburg, West Germany, Sept. 16-20.

**Conference on Measurement Technology**, Scientific Apparatus Makers Association and the National Bureau of Standards; National Bureau of Standards Laboratories, Gaithersburg, Md., Sept. 17-18.

**Conference on Tube Techniques**, IEEE; United Engineering Center Auditorium, New York, Sept. 17-19.

**Technical Association of Pulp and Paper Industry Engineering Conference**; Regency-Hyatt House, Atlanta, Sept. 18-21.

**Broadcast Symposium**, IEEE; Mayflower Hotel, Washington, Sept. 19-21.

**Aerodynamic Deceleration Systems Conference**, American Institute of Aeronautics and Astronautics; El Centro, Calif., Sept. 23-25.

**Electronics Design Conference**, IEEE; University of Cambridge, England, Sept. 23-27.

**International Congress of Cybernetic Medicine**; Naples, Italy, Sept. 23-27.

**Ultrasonics Symposium**, IEEE; Statler Hilton Hotel, New York, Sept. 25-27.

(Continued on p. 26)





## Compliments of a friend – a complete multimeter at less than \$3000

We think you'll agree that it's pretty friendly of Cimron to put out such a flexible instrument for so little. But it's typical of the philosophy that has always guided Cimron – customer concern. You need the most sophisticated instruments to do your work under a variety of changing conditions. And the Model 6653 gives you a great sendoff for both systems applications and laboratory or production testing. You get 5-digit readout including overrange, with an accuracy of  $\pm 0.01\%$  f.s.  $+0.01\%$

of reading for six months or longer. You'll save on calibration costs. Sample rates up to 300 per second; automatic polarity and automatic ranging; AC, ohms, millivolts. And look! You also get auto ranging through six millivolt and DC ranges. It's especially hard to beat all those Cimron customer concern features like remote control and printout, maintainable plug-in pc boards, and accessible calibration and test points. Write Cimron®, Dept. B-117, 1152 Morena, San Diego, Calif. 92110.



LEAR SIEGLER, INC.

CIMRON DIVISION



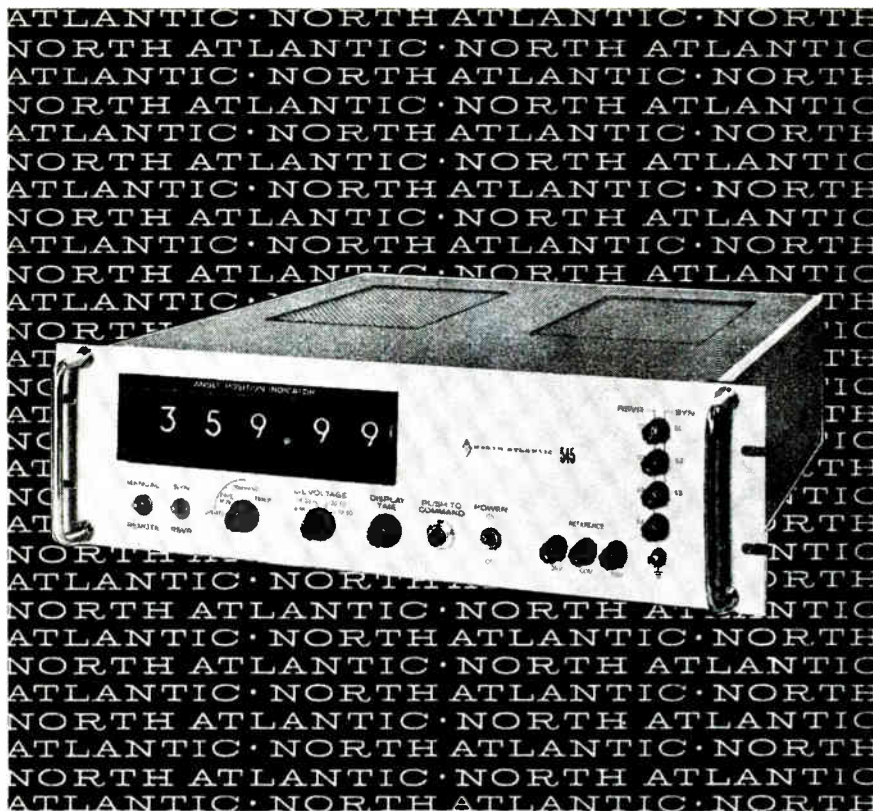

## resolver/synchro to digital conversion

~~20,000°~~ <sup>20,000°</sup> .01° accuracy  
~~20,000°~~ /sec. tracking

North Atlantic now brings you a new generation of solid-state analog-to-digital converters for resolver and synchro data. They offer major advances in high-speed precision tracking as required in modern antenna readout, ground support, simulation, and measurement systems.

For example, the Model ~~545~~ <sup>20,000°</sup> provides conversion of both resolver and synchro data at rates to ~~2000°~~ /second, and accommodates 11.8v to 90v 400Hz line-line signals. For multiplexed applications, acquisition time is less than 50ms. Digital output data is visually displayed and simultaneously available on rear connectors. All modes are programmable as well as manually controlled. Optional features include .001° resolution with 10 arc second accuracy, data frequencies from 60Hz to 4.8KHz, data freeze command for digital readout at a critical instant, and programmed mode where difference angle computation is required.

Your North Atlantic representative (see EEM) has complete specifications and application information. He'll be glad to show you how these converters can answer critical interface problems in your system.



**NORTH ATLANTIC** industries, inc.  
TERMINAL DRIVE, PLAINVIEW, NEW YORK 11803 • 516-681-8600

See us at WESCON — Booths 2325 and 2326 Sports Arena

## Meetings

(Continued from p. 24)

**Joint Engineering Management Conference, IEEE; Marriott Motor Hotel, Philadelphia, Sept. 30-Oct. 1.**

**Allerton Conference on Circuit and System Theory, IEEE; Allerton House, Monticello, Ill., Oct. 2-4.**

**Symposium on Applications of Ferroelectrics, IEEE; Catholic University, Washington, Oct. 10-11.**

**System Science and Cybernetics Conference, IEEE; Towne House, San Francisco, Oct. 14-16.**

**International Electron Devices Meeting, IEEE; Sheraton Park Hotel, Washington, Oct. 23-25.**

**Nuclear Science Symposium, IEEE; Bonaventure Hotel, Montreal, Quebec, Oct. 23-25.**

**Machine Tools Industry Technical Conference, IEEE; Wagon Wheel Lodge, Rockford, Ill., Oct. 28-30.**

**Seminar in Depth—Image Information Recovery, Society of Photo-Optical Instrumentation Engineers; Benjamin Franklin Hotel, Philadelphia, Oct. 24-25.**

**Symposium of the American Vacuum Society; Pittsburgh Hilton Hotel, Oct. 30-Nov. 1.**

## Call for papers

**International Conference on Medical and Biological Engineering and Conference on Engineering in Medicine and Biology, International Federation for Medical and Biological Engineering, IEEE, the Instrument Society of America, the American Society of Mechanical Engineers, and American Institute of Chemical Engineers; Palmer House, Chicago, July 20-25, 1969. Oct. 1 is deadline for request for author kits to program chairman, 8th International Conference on Medical and Biological Engineering, P.O. Box 1969, Evanston, Ill. 60204.**

## Short Courses

**Computer-aided analysis and design workshop, University of Missouri's Department of Electrical Engineering, Columbia, Mo., Aug. 12-16; \$150 fee.**

**Theory and application of symmetrical components, Texas A&M University's College of Engineering, College Station, Texas, Aug. 12-23; \$150 fee.**

**Lens design, University of California, Los Angeles, Aug. 12-23; \$375 fee.**



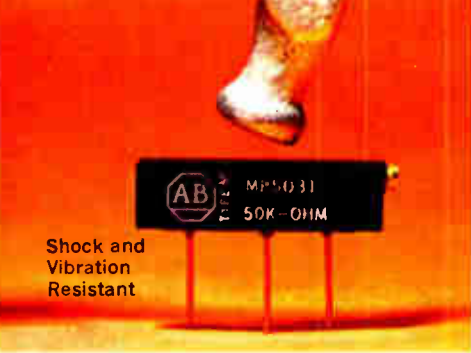

Shock and  
Vibration  
Resistant

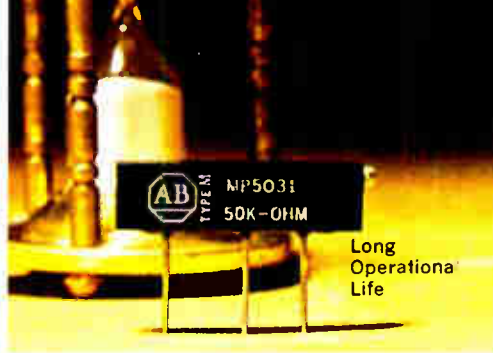

Long  
Operational  
Life



Low  
Temperature  
Coefficient

Shown  
actual size



New Allen-Bradley  
Cermet Trimmers give you

# superior "all-round" performance

*Allen-Bradley's new Type M Cermet trimmer provides very fine multi-turn adjustability in a rugged package for severe environmental conditions.*

This latest addition to the line of trimmers features the same high performance cermet resistive material—developed by A-B—which has enabled the Type S trimmer to gain such widespread popularity.

Sturdy structural design resists impact—a unique rotor design ensures smooth adjustment and stable setting. Resolution is essentially infinite. Leads are permanently anchored and bonded. Attachment exceeds lead strength—opens cannot occur.

The Type M trimmer is dust-tight and watertight. The entire unit is immersion-proof and can be potted. The enclosure has mounting pads to prevent moisture migration and also to prevent post-solder washout.

For more details on the Type M cermet trimmer, please write Henry G. Rosenkranz, Allen-Bradley Co., 110 West Greenfield Avenue, Milwaukee, Wisconsin 53204. Export Office: 630 Third Ave., New York, N. Y., U.S.A. 10017. In Canada: Allen-Bradley Canada Ltd.

#### Type M Specifications

Rating: 1 watt @ 85°C

Temperature Range: -55°C to +150°C

Resistances: 50 ohms thru 1 megohm. Lower resistances available.

Load Life: Less than 3% total resistance change after 1000 hours, 1 watt at 85°C.

Tolerances: ±10% standard, ±5% available.

Temp. Coef.: Less than ±250 PPM/°C for all resistance values and over complete temperature range.

Rotational Life: Less than 2% total resistance change after 200 complete cycles.

CE681



## ALLEN-BRADLEY

QUALITY ELECTRONIC COMPONENTS

Circle 27 on reader service card



**FASTEST!  
SMALLEST!**

**...and built for  
100,000,000  
OPERATIONS**



**NEW**  
**PICOREED**  
**REED RELAYS FROM CLARE**

**A STATE-OF-THE-ART ADVANCE IN HARD-CONTACT  
SWITCHING... EXCLUSIVE WITH CLARE!**

# Exclusive new Clare Picoreed relay operates in $500\mu\text{s}$ ; permits .250" pcb mounting centers; completely compatible with IC solid-state devices

Maintenance-free, hermetically-sealed contacts in molded-epoxy modules provide positive on-off switching for 100,000,000 operations at low-level loads

The fastest and smallest reed-contact relay made, the Picoreed is completely compatible with IC solid state devices. Response time, physical size, sensitivity, and reliability characteristics are superior to any ever before available. The Picoreed's one Form A contact solves important problems of economical and reliable input-output isolation buffering. Outstanding characteristics of the Picoreed are:

- **High speed.** 500  $\mu\text{s}$  operate time (including bounce) and 667 Hz repetition rates at nominal coil power. Capable of following 1000 Hz with appropriate coil drive. (See response curves and scope traces.)

- **Low profile mounting.** Your choice of terminal pins for through-board connections, or axial leads for aperture mounting. Pcb mounting on .250" centers is feasible. Relays are not position sensitive.

- **Minimal size.** .187" high, .250" wide, .781" long.

- **Positive on-off switching.** ON impedance (contact resistance) 0.1 ohm initially; 1.0 ohm maximum after life. OFF impedance (insulation resistance) 10 KM ohms minimum with 0.5 pf open contact capacitance.

- **Inherent reliability.** Maintenance-free, hermetically-sealed contacts are built for 100,000,000 operations at low-level loads, 5,000,000 at 28 vdc, 0.125 amp.

- **Environmental.** Withstand vibration 0 to 5 KHz at 20g; shock 100g. Temperature range:  $-40^{\circ}$  to  $+85^{\circ}\text{C}$ .

## TYPICAL RESPONSE TIMES

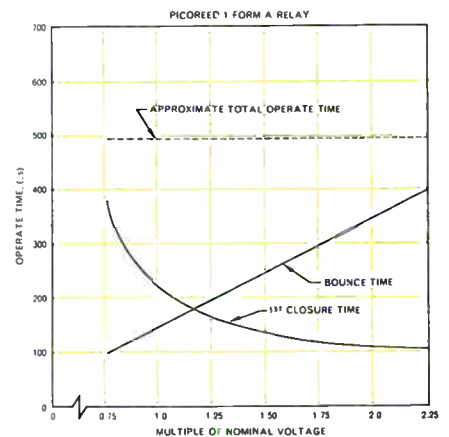

### NOTES:

1. Response time measurements made at 50 Hz, 50% duty cycle square-wave coil drive.

2. With diode coil suppression (1N914 or equivalent) release time approximately 100  $\mu\text{s}$ , with nominal voltage zener diode clamping release time approximately 50  $\mu\text{s}$ .

## REPETITION RATE CAPABILITIES

Oscillograms below illustrate the ability of the Picoreed to operate at 667 Hz (operate time including bounce typically 500  $\mu\text{s}$ ) and to follow 1000 Hz with an appropriate coil drive.

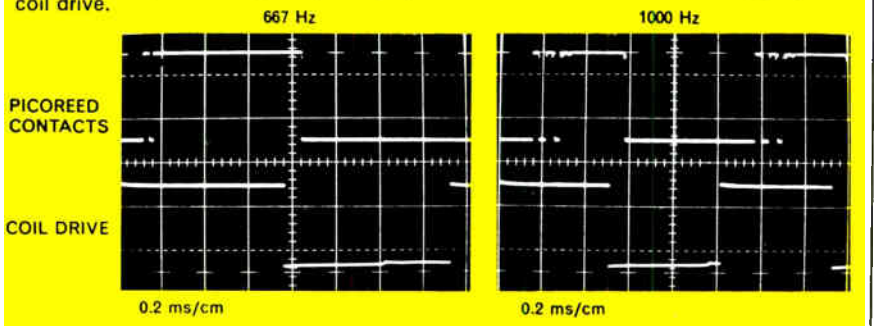

For a sample Picoreed relay, call your nearest Clare Sales Engineer:

**East.** Needham, Mass. (617) 444-4200; Great Neck, N. Y. (516) 466-2100; Syracuse, N. Y. (315) 422-0347; Philadelphia, Pa. (215) 386-3385; Baltimore, Md. (301) 377-8010; Silver Spring, Md. (Government liaison) (301) 593-0667; Orlando, Fla. (305) 424-9508

**Central.** Des Plaines, Ill. (312) 827-0151; Minneapolis, Minn. (612) 920-3125; Overland (St.

Louis) Mo. (314) 429-7372; Cleveland, Ohio (216) 221-9030; Xenia, Ohio (513) 426-5485; Cincinnati, Ohio (513) 891-3827; Columbus, Ohio (614) 486-4046; Mission, Kansas (913) 722-2441

**Southwest.** Dallas, Texas (214) 357-4601; Houston, Texas (713) 528-3811

**Pacific Coast and Mountain States.** Burlingame, Cal. (415)

697-8033; Encino, Cal. (213) 981-3323; Phoenix, Arizona (602) 264-0645; Seattle, Wash. (206) 455-2410 & 2411

For complete data, circle Reader Service Number, or write Group 7N9, C. P. CLARE & CO., 3101 Pratt Blvd., Chicago, Illinois 60645...and worldwide.

a GENERAL INSTRUMENT Company

# From Monsanto: 130,000,000 discrete frequencies with almost perfect purity.



**Computer-aided design and integrated-circuit construction in this new Frequency Synthesizer bring a new level of perfection to signal generation.**

The new "4th generation" Model 3100A Digital Frequency Synthesizer obsoletes just about every current concept of general purpose signal sources. Pick your frequency from 0.01 Hz to 1.3 MHz in 0.01 Hz steps. The result—signal purity you can get only from Monsanto, with a stability of 1 part in  $10^9$  day. Other refinements include: internally supplied rapid or slow sweep and provision for

external sweep; dc coupled output permitting internally supplied offset; continuous control of output level over a 90 dB range; provision for amplitude modulation; and, in the remotely programmable version, switching time of less than 20 microseconds. Best of all, you can put this *better way* of signal generation to work for you for only \$3,950\*. Call our field engineering representative in your area for full

technical details, or contact us directly at: Monsanto Electronics Technical Ctr., 620 Passaic Ave., W. Caldwell, N.J. 07006. Ph. (201) 228-3800; TWX 710-734-4334.

\*U. S. Price, FOB West Caldwell, N. J.



ELECTRONICS

Circle 30 on reader service card



---

**Editorial comment**

---

## Good business: an international approach

**The bright outlook** for the electronics industry's domestic sales could seem pale in the light of its prospects in the international marketplace. Although predictions are a risky business, even when confined to limited time periods and areas, C. Lester Hogan, Motorola Semiconductor's general manager, confidently asserts that in 10 years the company's total sales will be divided equally between American and foreign markets. Moreover, he says, by the end of the next decade one-quarter of the company's output will be manufactured abroad. To meet this goal Hogan believes that Motorola—which already has plants in Korea, France and Mexico—must plan carefully. For example, Hogan is determined not to start any new manufacturing process abroad until all the kinks have been worked out of it here and good yields are assured.

In their rush to exploit opportunities abroad, not all U.S. electronics firms have been as judicious. Wooed by low labor costs, freedom from government interference in setting up new businesses, and ease in repatriating profits, they've flocked—some without adequately considering the disadvantages—to places like Hong Kong, Korea, and Taiwan. (In Taiwan, teenage girls can be hired for light assembly work for about 13 cents an hour, and in Hong Kong, for about 20 cents).

But political unrest in Southeast Asia has caused many businessmen to reexamine locations in Europe. Labor may cost more, but the odds against a bombed-out plant and terrorized workers are better. The strikes, rioting and terrorism of last year dampened the enthusiasm of U.S. electronics companies who were thinking of following the leaders—Fairchild, Teledyne, Oak Electro/Netics, GE, Sylvania and Arvin—to Hong Kong. Interestingly, one international electronics company rates Europe over Southeast Asia because the costs of relocating managers and technicians are lower. It might cost \$10,000 to settle a man in Taiwan, for example, compared to half that in Portugal. Moreover, the relocated personnel are less inclined to want to return prematurely to the U.S. The turnover is about three times as great in Taiwan.

U.S. firms usually find it necessary to retain

Americans to manage their overseas plants, although nationals do well as middle-managers and foremen. Understandably, it takes time to train Europeans in the ways of U.S. business.

A most sought-after manager is the returning native—the German engineer, for example, who has completed a tour of duty with a U.S. company. He spreads the gospel of American business techniques and is respected by his colleagues. A case in point is Volkswagen, which puts promising young men to work for its American branch, then returns them to Germany to spread the word on cost-consciousness and American competitiveness.

As American electronics companies become more firmly entrenched overseas, their motives and goals change. Success encourages greater investment in the overseas community. Because they have an advantageous position to protect, such companies accept social responsibilities and introduce programs to improve the health, education, and welfare of their employees.

Although some U.S. laboratories abroad are little more than window dressing, many U.S. firms expect to conduct basic R&D abroad with the aim of eventually helping to train foreign scientists and engineers.

Well established American firms that are international in scope raise much of their capital overseas—a procedure that helps put them into partnership rather than competition with foreign investors. Companies like ITT and GE have little trouble in raising money abroad. Motorola plans the sale of convertible debentures overseas to finance its expansion there. Lesser-known U.S. firms may have a tougher time getting conservative foreign investment houses to risk the necessary capital.

If American productivity sets the pattern abroad, workers will turn from agriculture and fishing to the factories. The past indicates the future—the rising affluence of the new industrial society will enable its workers to become consumers of electronics products, too. Taiwanese, for example, are buying five times as many tv sets as they did in 1963. The end result could be an important narrowing of the gap between the have and have-not countries.

**4½-Digit DVM.  
Compact flexibility:  
\$1150.**

We've packed a lot of flexibility into our Model 7000 DVM. It's only half-rack size (5¼" x 8¾" x 12"), but has five big options: auto-ranging, AC volts, resistance, DC current and BCD output. Options are contained on convenient plug-in circuit boards. A front-panel function switch controls all options. The 7000 is built with integrated circuits and provides a reading accuracy of 0.01%. Resolution is 100µV. Input impedance is greater than 1000 megohms. You also get dual slope integration, automatic polarity and display storage. Low power operation means no fan and no noise. A 7000 DVM can be yours in 15 days. You can get our data sheets even faster. Write today.

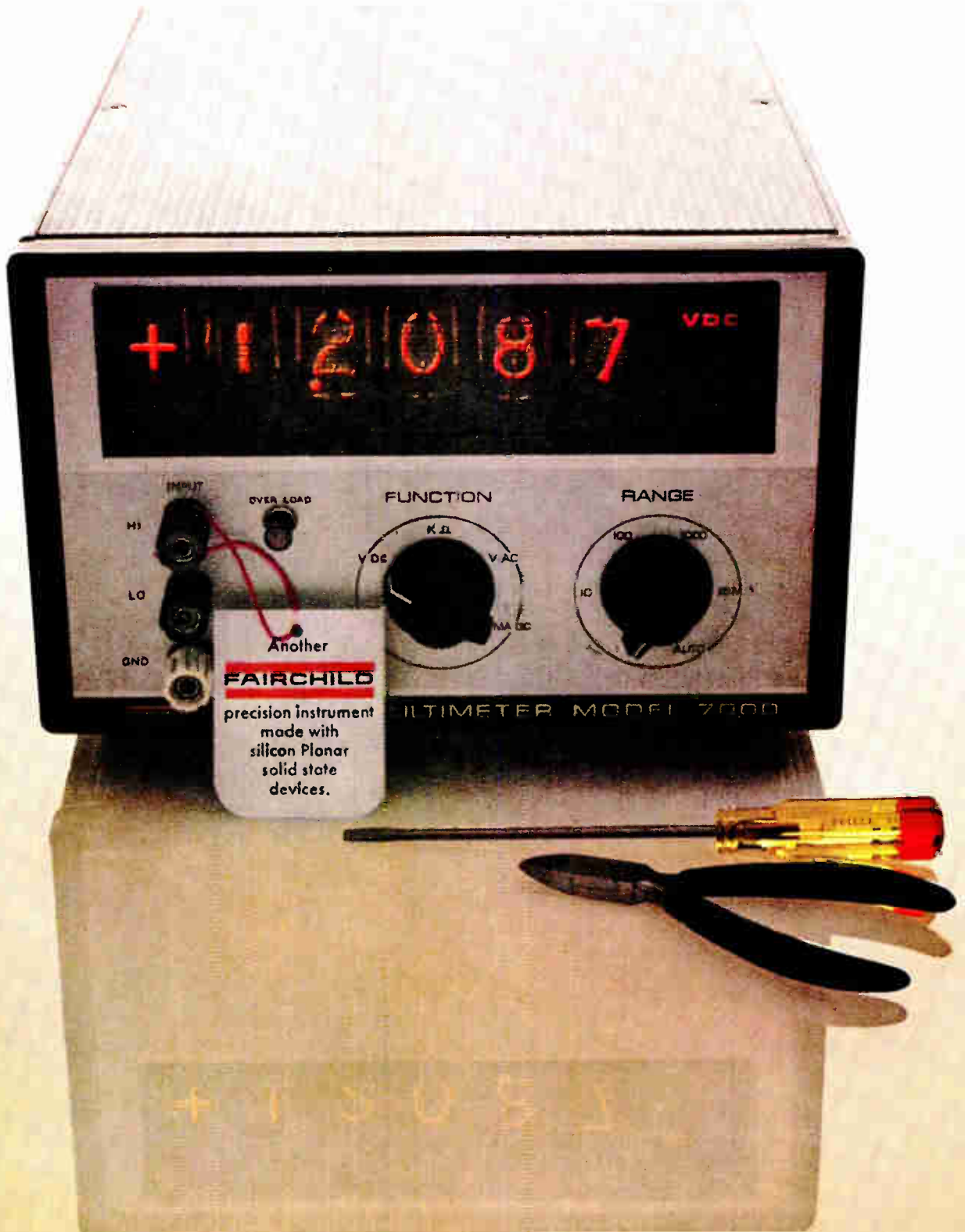

---

# Electronics Newsletter

---

July 22, 1968

## Hughes out front for Intelsat 4

Final decision on the contractor for the Intelsat 4 satellite will be made at the September meeting of the Interim Committee of the International Telecommunications Satellite Consortium in Washington. In a meeting earlier this month, the committee voted to proceed with the Intelsat 4 program and instructed Comsat to negotiate with Hughes Aircraft. But this doesn't mean that Hughes has the order wrapped up. Lockheed was given until Aug. 5 to submit a revised proposal. Comsat wants Lockheed to lower its price and to change delivery penalties and performance incentives.

At this point Hughes is the odds-on-favorite to win the contract for the estimated \$80 million program. The bid from TRW was dropped.

## Analog devices' first IC

A 709-type operational amplifier with only 1 nanoampere input offset current and as little as 2.5 nanoamperes bias current is the first integrated circuit from Analog Devices of Cambridge, Mass. By contrast, even so-called "improved 709's" are rated at 500 nanoamperes for the same specifications. The IC is to be shown for the first time at Wescon.

According to an Analog spokesman, the lower currents will permit the 709 type to be applied for the first time to low-level current amplifiers, high-accuracy capacitor-charging circuits like some analog-to-digital converters, and will allow high-input impedance circuit designs.

## Monsanto eyes process control

Monsanto, which dropped work on data-acquisition systems earlier this year, may rechannel its efforts toward process control and instrumentation. The tipoff: the recent hiring of Barry Saper from Hewlett-Packard, where he was involved in the marketing of instrumentation systems.

Saper's title at Monsanto is director of industrial electronics. But he is minister without portfolio—the company isn't currently doing any work along these lines. One of Saper's primary tasks will be to see how to blend the company's know-how in data systems with his know-how in instrumentation.

Monsanto is also considering acquiring an instrumentation firm, which could trigger the launching of a separate electronics division. Presently, the company's electronics effort comes under the jurisdiction of the New Enterprise division, which is headquartered in St. Louis, Mo. The division is a conglomerate of several enterprises that Monsanto considers promising.

## Space radar comes down to earth

A terminal descent radar originally slated for possible use in NASA's Voyager planetary soft-landing program may be applied in vertical and short takeoff and landing aircraft (V/STOL) and helicopters. The radar, built by Autonetics, will be developed under a \$250,000 contract from NASA's Langley Research Center.

The radar design is unique in that it combines two techniques: a continuous-wave frequency-modulated Bessel sideband mode for low-altitude approaches and an interrupted continuous-wave technique that operates half the time during descent from altitudes as high as 30,000 feet down to 20 feet.

Previously, two transmitters and two receivers were needed to do these



---

# Electronics Newsletter

---

jobs. The Autonetics radar will accomplish its mission by phase-modulating a stable intermediate-frequency oscillator to produce a continuous-wave f-m signal and then modulating it. **The interrupted continuous-wave modulation is achieved by bypassing the phase modulator and pulsing the multiplier chain directly.**

The radar—called the R146A—will be flight tested by February 1969. It will weigh less than 60 pounds and operate at 13.3 gigahertz.

## **Microwave transistor: 30 watts at 2 Ghz**

Gains in power and frequency for microwave transistors continues. **Watch for TRW Semiconductors to introduce a set of three microwave transistors late this fall that deliver 30 watts at 2 gigahertz.** Currently, record outputs for commercially available microwave transistors are no more than 5 watts at 2 gigahertz.

## **Year delay likely for 621B project**

The Air Force's 621B navigation satellite, now being studied by two industry teams in the project-definition phase, **most likely will be held back for one year.** The Pentagon is mum on the subject, but finding money in next year's budget was believed to be the major stumbling block.

Original plans were to pick a contractor in fiscal 1969 to build the satellite system which would be operational 1971-72. **But the Air Force has only \$500,000 in the 1969 budget, an amount included primarily to keep the program alive.**

Hughes and TRW started work May 1 on two 621B studies, worth \$500,000 each; they will deliver most of their studies to the Air Force by next January. The companies are planning a secure worldwide system, made up of from 16 to 18 stationary satellites; it would provide positions for high-performance aircraft accurate to within less than a mile using the signals from three to four satellites.

Meanwhile, RCA has held informal discussions with the Air Force's Space and Missile Systems Organization to use the \$500,000 for a series of tests with the tactical communications satellite (Tacsat) now being built by Hughes. RCA would take one of its tactical ground terminals being built for the Tacsat program and would determine the feasibility of using Tacsat communications signals to derive position fixes.

## **Awars delayed by money woes**

Money problems may cause some slippage in the Air Force's Airborne Weather Reconnaissance System (Awars), although Electronic Systems Division sources earlier believed their funding was secure [Electronics, June 24, p. 151]. The request for proposals for the definition phase will go out later than originally slated—probably in one or two months. The delay is attributed, at least partly, to Pentagon budget paring. **Award of the two definition contracts for the \$44 million program will probably slip from December into 1969.**

## **Litton plans avionics division**

Litton Industries will soon announce the formation of a new division—probably named the Commercial Avionics division—to develop, manufacture, and market such products as the LTN-51 inertial navigation system now made by the firm's Guidance and Control Systems division in Woodland Hills, Calif. The unit will also market hardware made at other divisions, such as the radar altimeters now produced by the Amec division.

Our  
roof  
is  
proof...

CHESTER  
N.Y.

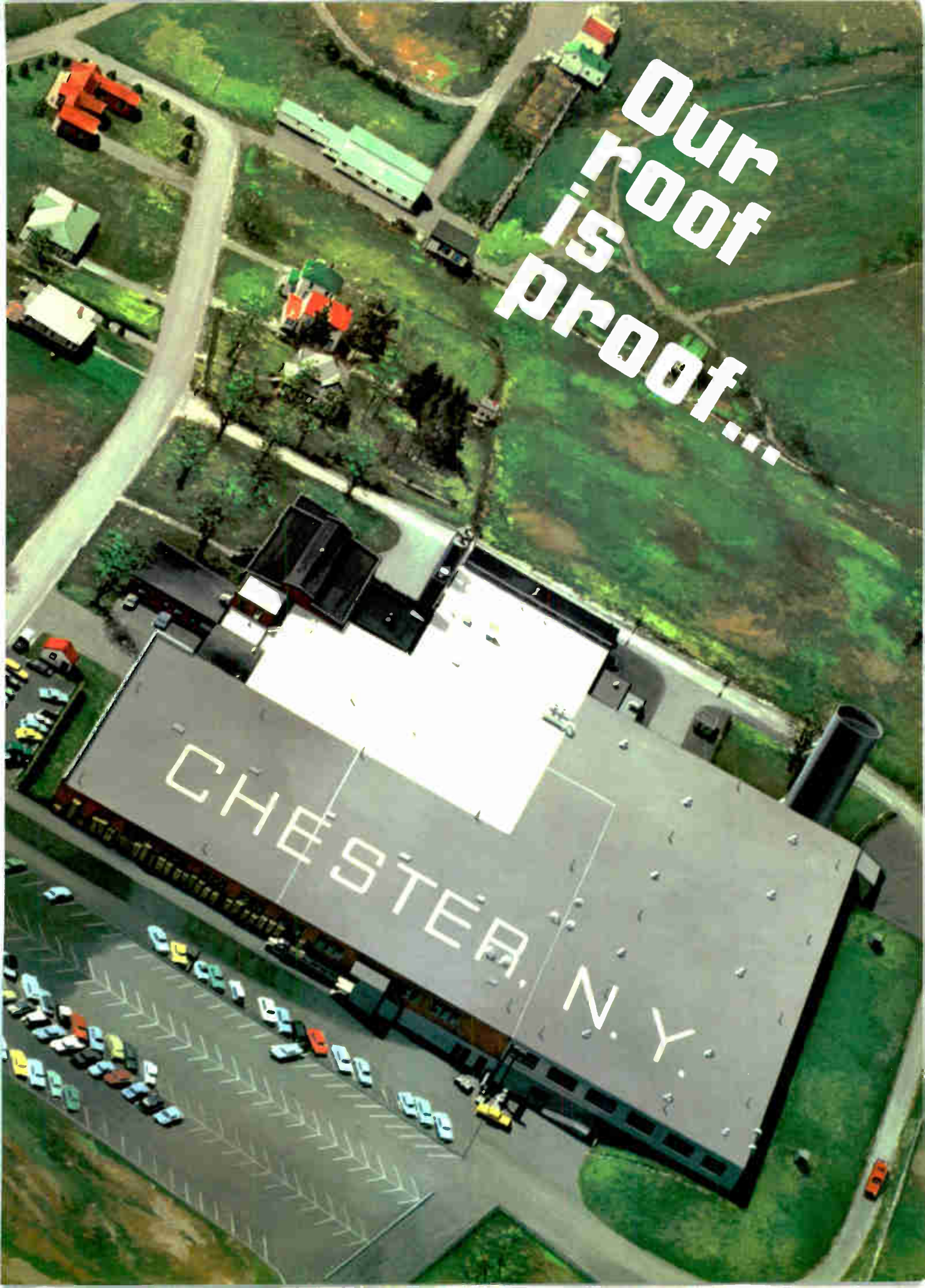



# Chester's growth through service

We can't think of a more graphic way to portray "Growth Through Service", than the illustration on the preceding page. The dark roof area represents Chester's plant expansion during the past ten years . . . expansion made necessary by the increasing requirements of our many valued customers in the electrical and electronic industries.

Actually, though, it's what's under the roof that counts: — The newest and most advanced production machinery . . . expanded research and test facilities . . . exacting quality control techniques . . . modern materials handling systems . . . and most important — experienced people, skilled in the manufacture of Plasticote® Wire and Cable.

Today . . . while we plan for the future . . . we still continue to meet industry's present requirements with unequalled service. The ultimate ingredient of this service is the most important facet of Chester's story of growth . . . the close, personal attention to each customer's requirement.

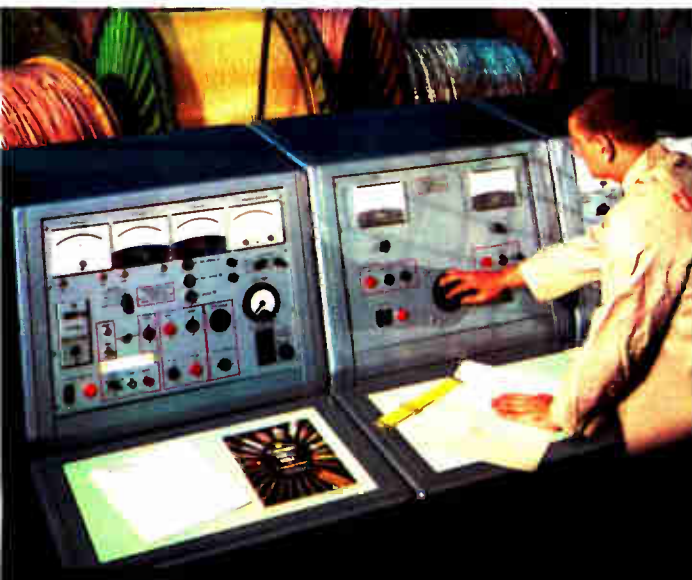

**CHESTER CABLE CO.**

DIVISION TENNESSEE CORPORATION, CHESTER, NEW YORK 10918

A SUBSIDIARY OF CITIES SERVICE COMPANY

PHONE: (914) 469-2141



TWX (914) 469-9801

Printed in U.S.A.



# Hi-Rel POWER in ISOLATED packages from **Solitron**

Now Solitron has the industry's widest selection available of Hi-Rel planar transistors in Isolated collector packages. These devices include nearly all of Solitron's NPN and PNP diffused power silicon transistors. They offer low leakage currents, a uniform gain over wide current ranges and low saturation voltages.

<p><b>TO-5</b></p>  <p><b>NPN 10 AMP</b>  <math>V_{CE} = 60 - 120V</math>  <math>h_{FE} = 20 \text{ MIN}</math>          40 - 120</p>	<p><b>TO-111</b></p>  <p><b>NPN 5 AMP</b>  <math>V_{CE} = 40 - 120V</math>  <math>h_{FE} = 20 - 60</math>          40 - 120          100 MIN</p> <p><b>PNP 5 AMP</b>  <math>V_{CE} = 40 - 120V</math>  <math>h_{FE} = 20 - 60</math>          40 - 120</p>	<p><b>TO-61</b></p>  <p><b>NPN 10 AMP</b>  <math>V_{CE} = 40 - 120V</math>  <math>h_{FE} = 30 - 90</math></p> <p><b>20 AMP</b>  <math>V_{CE} = 40 - 100V</math>  <math>h_{FE} = 30 - 90</math></p> <p><b>30 AMP</b>  <math>V_{CE} = 25 - 120V</math>  <math>h_{FE} = 20 - 60</math>          40 - 120          100 MIN</p> <p><b>PNP 10 AMP</b>  <math>V_{CE} = 40 - 120V</math>  <math>h_{FE} = 30 - 90</math></p> <p><b>20 AMP</b>  <math>V_{CE} = 40 - 100V</math>  <math>h_{FE} = 30 - 90</math></p>
---	--	--

COMPLEMENTARY PAIRS AVAILABLE

Mail coupon now  
for data sheets and  
information.  
NO OBLIGATION.

## **Solitron** DEVICES, INC.

1177 BLUE HERON BLVD. / RIVIERA BEACH, FLORIDA / (305) 848-4311 / TWX: (510) 952-6676

For information on Solitron's Isolated collector power transistors, check appropriate boxes:

- |                              |                                       |                                      |                              |
|------------------------------|---------------------------------------|--------------------------------------|------------------------------|
| <b>5 AMP</b>                 | <b>10 AMP</b>                         | <b>20 AMP</b>                        | <b>30 AMP</b>                |
| <input type="checkbox"/> NPN | <input type="checkbox"/> NPN (TO-5)   | <input type="checkbox"/> NPN (TO-61) | <input type="checkbox"/> NPN |
| <input type="checkbox"/> PNP | <input type="checkbox"/> NPN (TO-111) | <input type="checkbox"/> PNP (TO-61) | <input type="checkbox"/> PNP |

Name \_\_\_\_\_ Title \_\_\_\_\_

Company \_\_\_\_\_

Address \_\_\_\_\_

Zip \_\_\_\_\_

# PAR Lock-In Amplifier Measures Signals in the Presence of Noise by Crosscorrelation

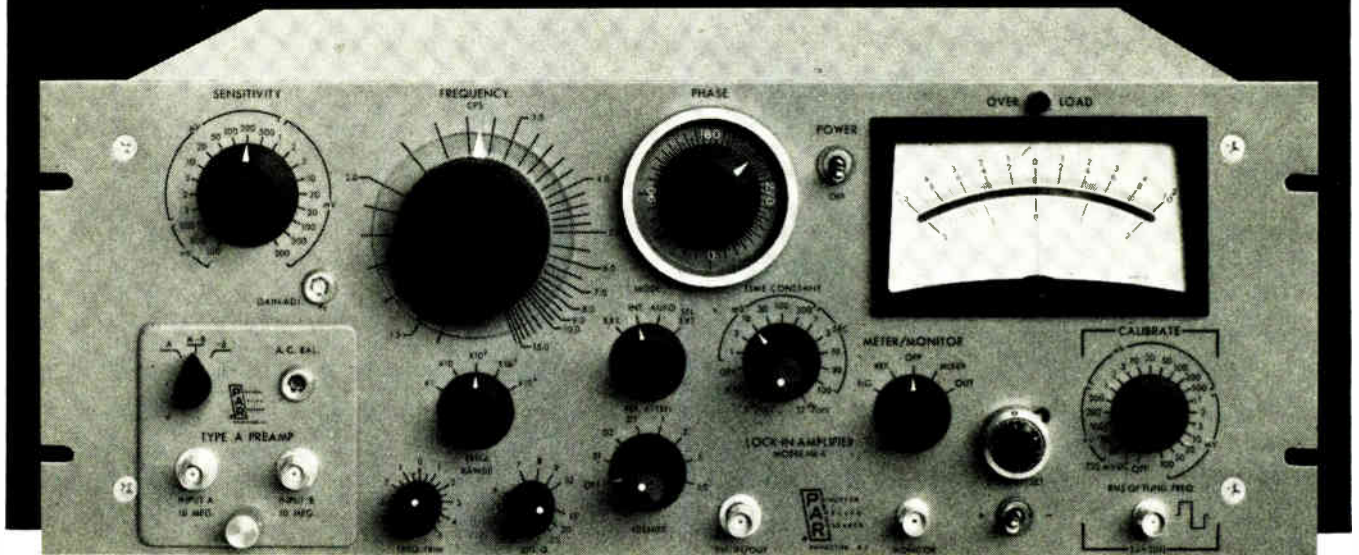

Transistorized Lock-In Amplifier — Model HR-8

The PAR Model HR-8 Lock-In Amplifier represents a significant advance in signal processing equipment for experimentalists who must measure low-level signal intensities in the presence of noise. It employs the theoretically optimum technique for signal recovery, and can be incorporated into a large class of experiments in which the signal of interest is, or can be made periodic, and in which a reference voltage related in frequency and phase to the signal can be obtained. The Model HR-8 first amplifies and bandlimits the input signal and then crosscorrelates it with the reference signal, suitably phase shifted and shaped. The crosscorrelation of input and reference signals yields a DC output voltage proportional to the signal of interest, while the crosscorrelation of the reference and noise results in no net DC voltage. The system can also be described as a continuously integrating, highly sensitive, phase conscious voltmeter, the response of which is "locked" to that particular frequency and phase at which the signal information has been made to appear.

## Technical Features:

**Frequency Range:** 1.5 cps to 150 KC continuously tunable in 5 ranges.

**Time Constants:** 11 values in 1-3 sequence extending from 0.001 to 100 seconds. Single or double section RC filtering.

**Pre-Amplifiers:** Interchangeable low-noise pre-amplifiers, operable either within the HR-8 or remotely, are used.

Type A: Differential 10 megohm input.

Type B: Low impedance transformer input for low source impedances.

**Sensitivity:** 21 calibrated full scale ranges in 1-2-5 sequence.

With Type A Pre-Amplifier: 100 nanovolts to 500 millivolts rms.

With Type B Pre-Amplifier: 1 nanovolt to 5 millivolts rms.

**Output:**  $\pm 10$  volts full scale, single-ended with respect to ground. Will drive galvanometric and servo recorders.

**Frequency Selective Amplifiers:** Notch network in negative feedback loop used in both signal and reference channel tuned amplifiers. Reference channel Q of 10. Signal channel Q adjustable from 5 to 25 with calibrated dial (no gain change with Q adjustment).

**Phase Adjustment:** Calibrated 360° phase shifter, providing continuous rotation as well as a four position quadrant switch which shifts phase in 90° increments.

**Price:** \$2,350 with either Type A or Type B Pre-Amplifier.

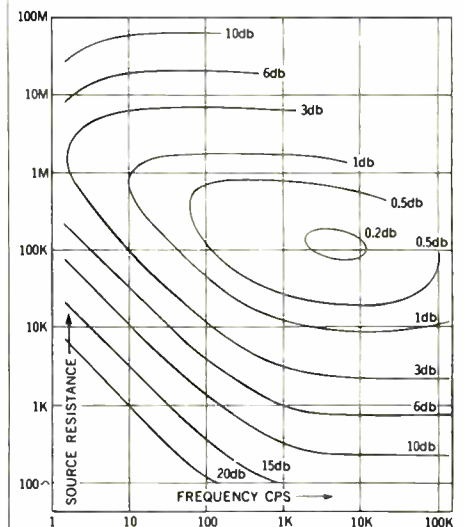

Contours of constant noise figure for a typical PAR Type A preamplifier plotted to show dependence on frequency and source resistance at 300° K. Amplifier operated single-ended.

Write for bulletin No. 120 on the HR-8 or ask for information on PAR's complete line of Lock-In Amplifiers and accessories.

**PAR** PRINCETON APPLIED RESEARCH CORP.  
Box 565, Princeton, N. J.  
Telephone (609) 799-1222

## Displays

### Plasma on display

A development described in a paper delivered in November 1966 has triggered a furious race by more than a dozen electronics firms toward a product that could change the face of much electronic gear. The paper, by University of Illinois scientists D.L. Bitzer and H.G. Slottow, described a plasma display panel with inherent memory.

The firms—among them are Bunker-Ramo, Burroughs, Control Data, Beckman Instruments, Owens Illinois, IBM, Westinghouse, Zenith, Japan's Fujitsu, and Holland's Philips Gloeilampenfabrieken—are aiming at instrument, computer, and, at least in Zenith's case, flat-screen television displays.

**Gas glow.** The panel is a three-layer glass sandwich; the center has rows of holes filled with gas—different gases have different light, speed, and life characteristics—and the outer slices have transparent electrodes on their exterior surface in register with the holes. A current applied to the gas changes it to plasma and a charge builds up along the wall of the hole. It is in this "wall voltage" that the inherent memory resides.

One of the major advantages is low manufacturing cost. Plasma displays also promise to be far more rugged than cathode-ray types. And, in the case of instruments or computers, there is a big cost saving in the elimination of the great bulk of interfacing electronics.

**Who's ahead?** Illinois' Bitzer, who now heads the university's computer-based Education Research Laboratory, believes that Control Data is in the vanguard. Most firms working on plasma are

consulting Bitzer and Slottow, but so far only Control Data has an option to incorporate the panels into computer-aided education systems and only Owen Illinois has a license to make and sell the panels—but not systems. Fujitsu, however, has negotiated an exclusive Japanese license to make the panels, incorporate them into systems, and sell the whole package. The Fujitsu deal, says the university, is the first commercial application of the panel as a display for a computer system.

Burroughs and IBM are negotiating licensing arrangements with the university, and exploratory talks have been held with Bunker-Ramo, Beckman, RCA, Westinghouse, and Zenith.

Westinghouse and Burroughs have built working models believed to be 4 inches by 4 inches—the same size as Control Data's which contains dots 20 mils in diameter and 33 mils apart. In charge of the work at Westinghouse is Robert H. Willson, who helped Bitzer and Slottow in their pioneer work at Illinois.

**Another picture.** While the outlook for plasma displays is bullish,

there are serious obstacles to its use as a thin-screen tv receiver—the area Zenith is exploring. For one thing, the on-off character of the panel means it doesn't have a gray scale; moreover, the problem of addressing is still far from solution. Another major drawback is that the panel requires relatively high voltage and a high-frequency a-c power supply for which a low-cost switching technique must be found. However, Zenith researchers believe the advantages—low-cost fabrication in a variety of sizes, inherent memory, and a life that may extend to several years—make their research effort worthwhile.

## Advanced technology

### Keeping cool

To get enough light on the screen, a projection cathode-ray tube's phosphor must be excited to the utmost brightness. This takes a very powerful electron beam; if power is pushed too far the phos-

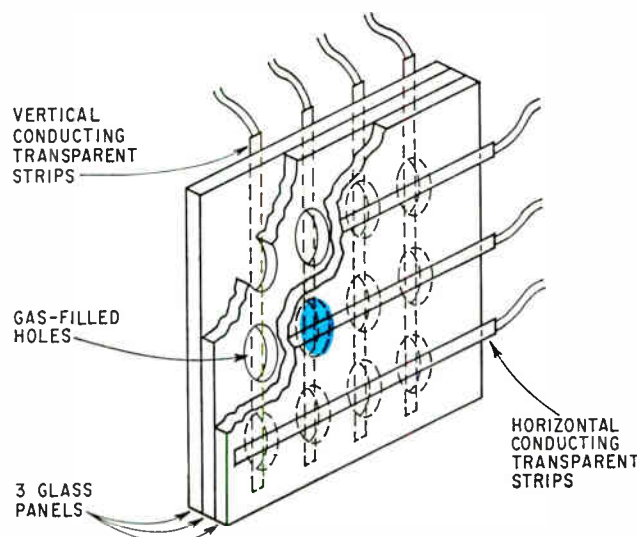

**Light up.** Plasma display, developed by two University of Illinois scientists, is under development at about a dozen instrument, computer, and tv firms in the United States and abroad. Display has built-in inherent memory function.



phor can break down or evaporate. So designing projection cathode-ray tubes comes down to figuring out how to operate them without frying the phosphor.

The Raytheon Co.'s Components division in Quincy, Mass., may have the answer in its projection crt, which promises bright displays with high resolution and tens or perhaps hundreds of times longer life than present commercial tubes [Electronics, June 24, p. 25].

**Bad shape.** The standard engineering answer to projection crt problems has been to cool the phosphor. Engineers have done it by designing some rather weird crt's. The best known is a saucepan-shaped tube in which a phosphor coats the bottom of the "pan"

and the electron gun (or pan handle) is offset from the vertical about 45°. Water runs over the bottom of the pan cooling the phosphor from the rear.

But because of the design of the saucepan, it's impossible to place the lenses closer than 4.5 inches from the phosphor; hence some light is wasted. Also, since the electron beam and the phosphor meet at a 45° angle, adjustment for proper beam deflection is tricky.

For this and other reasons, the saucepan tube's resolution is only 600 lines. Many commercial users find 600 lines adequate, and some of Raytheon's competitors sell tubes with only 200 lines resolution but 600 lines is not always enough for some military or com-

puter display systems.

**Cooling it.** Raytheon's tube looks like a 5-inch-diameter version of the crt in a television set. The faceplate is constructed of a clear heat-conducting material made by the Union Carbide Corp. that conducts heat away from the phosphor almost as quickly as stainless steel. Excess heat is transferred to a stream of water or air circling the rim of the faceplate. The phosphor is so cool that Raytheon expects tube life-times of more than 500 hours.

With the new tube shaped like an ordinary crt, its brilliant faceplate is up front and the light-gathering and focusing lenses are near the phosphor. This means that more generated light hits the screen. Resolution reaches 1,000 lines because the simple axial design permits easier beam collimation and deflection than the offset gun of the saucepan tube.

**Selling point.** What sells tubes, says Alvin S. Luftman, manager of display and storage tubes, is the amount of light reaching the screen. He claims that Raytheon's new tube doesn't need a powerful electron beam—because of its efficient cooling scheme—to generate a bright image. He says a 40-kilovolt, 1-milliamper beam generates enough light to illuminate a 3-by-4-foot screen to a level of 15 foot-lamberts—well above the minimum.

Though still in prototype form, the new tube works almost as well as 24-inch diameter crt's developed by Raytheon for the Navy. These monster tubes use Schmidt optics (a mirror-lens combination found in some astronomical telescopes) to gather maximum light for transmission to the screen, and they have a slightly brighter screen. But the smaller projection tubes are simpler to build and should cost less. Moreover, they're easier to handle than 2-by-4 foot crt's.

Luftman hopes the Navy will put the 5-inch diameter tubes in the Naval Tactical Data System, which now uses the larger Raytheon tubes. He adds that they would work well in large displays

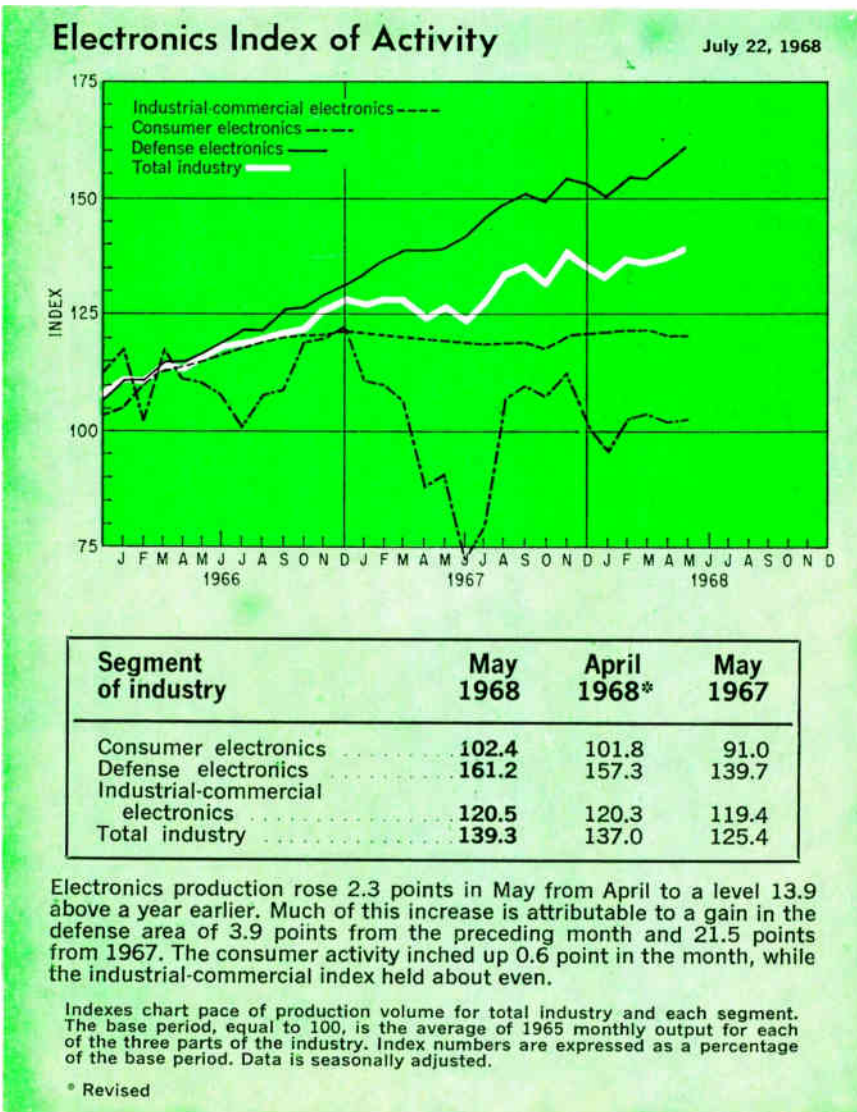

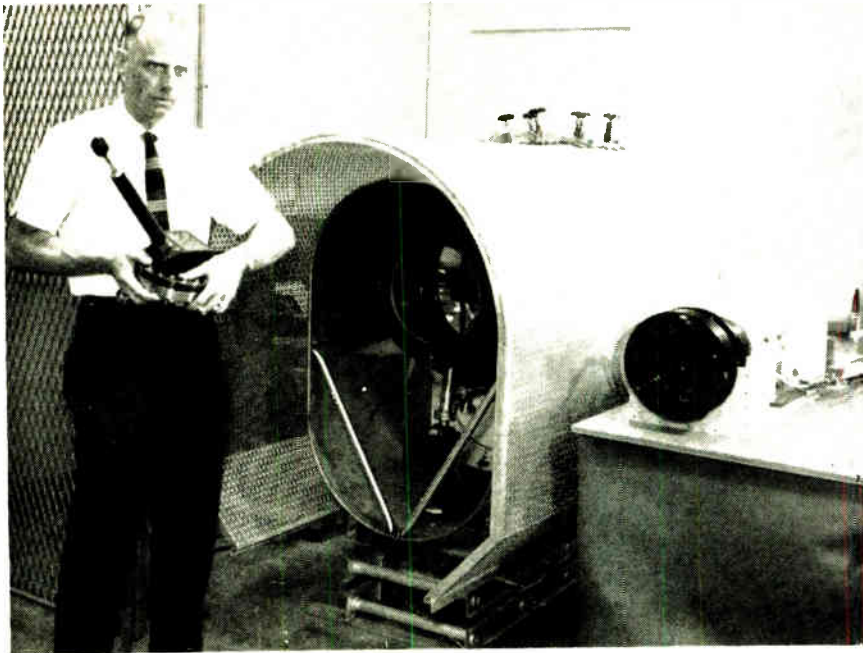

**Compare.** Raytheon's new projection cathode-ray tube (right) offers bright display and high resolution without resorting to the large, expensive Schmidt optics design (center) or the power-limited off-axis crt (left).

for aircraft carrier ready rooms. With his research program promising even brighter phosphor, he says that commercial computer displays are a probable market.

### Random radar

Although the idea of using random noise as radar pulses isn't new, the systems so far have been generally inaccurate or costly.

But a "noise radar" that's simple and possibly inexpensive enough for commercial applications has been developed by Joseph L. Poirier, a scientist at the Air Force Cambridge Research Laboratories, Hanscom Field, Mass. Range measurements are up to 88% more accurate than those obtained by a pulsed radar with the same average power spectrum and the new system should also prove almost impossible to jam.

Poirier says that he got the idea for his radar after reading some old papers on light coherence theory. He built a working model in his spare time, using old lab equipment.

**Rooftop view.** Even in the face of these difficulties, the system was able in tests to gauge the distance

between the roof of Poirier's office building and a structure 324 feet away to within a foot or so. And at least a third of the time the measurements were right on the button. (Accuracy is often harder to achieve at short distances than over longer ranges.)

Instead of the short, powerful pulses of radio energy sent out at a single frequency by most radars, Poirier's system transmits random r-f noise generated by a gas discharge and amplified to about 100 milliwatts by a traveling-wave tube. No elaborate pulse-forming networks or heavy-duty power supplies are needed, and there shouldn't be especially difficult power-source problems even at higher outputs.

Reception is almost as simple. A preamplifier sends returned energy into an arm of a coaxial T, where it's mixed with a small portion of the transmitter output. The electronic sum of the two signals is then viewed on spectrum-analyzer equipment to determine the distance to the target.

The display of the summed signals looks like a series of sine waves in a Gaussian, or bell-curve, envelope. The difference in frequency between the troughs, or nulls, is in-

versely proportional to range.

In his rooftop experiments, Poirier used a center frequency of 2.8 gigahertz and a bandwidth of 10 megahertz. He estimates that nulls for a target 100,000 feet away would be about 5 kilohertz apart under these conditions. The broader the range of output frequencies used with this system, the more accurate the determination of distance.

**Matchmaking.** The Gaussian envelopes of the transmitted and returned signals look almost exactly alike—as they would with almost any noise radar. Earlier noise systems had used such envelopes only to measure range, however. Instead of transmitting continually, these earlier radars sent out pulses of random noise while storing low-power copies of the pulses in a variable-delay line. The envelopes of returned pulses were matched against the copies, and the time between matchups was taken as proportional to range.

The delay lines employed had to be extremely accurate, and therefore costly, and the signal-processing electronics were about as complex as the innards of a special-purpose digital computer, according to Poirier. Even in the best of these designs, range accuracy and resolution were limited by output bandwidth—and the broader the bandwidth, the tougher and more expensive was the signal-processing problem.

"It was also wasteful," Poirier says. "By concentrating on the envelopes alone, designers of earlier noise radars lost phase information." One version of his system features two closely spaced antennas and uses phase data not only to gauge range but to produce angular measurements. By checking the frequency shift of the nulls, Poirier can determine the difference in the distances between each of the two antennas and the target. A little electronic trigonometry helps make his system's angular determinations far more accurate than any possible with a single-antenna radar.

**Job prospects.** Poirier sees a place for his radar in small boats or light planes and in a variety of



military applications. The design requires only part of a spectrum analyzer, he notes—a sweep local oscillator and the appropriate intermediate-frequency strip, plus a means of measuring the frequency separation of the nulls and of displaying range.

“If you wanted to be fancy, you could add a peak detector, a filter, and another swept i-f stage,” he says. “A cathode-ray-tube display of the output would be an ‘A-scope’ with pips along a horizontal line to indicate the presence of targets. Conversion to a plan position indicator or radial display would be cheap and easy,” he adds.

The system will work well even when surrounded by equipment using the same frequency spectrum. Because of the individual differences in the outputs of any two noise sources, two of these systems could just about be aimed at each other without experiencing interference or jamming. This is a tremendous plus in radar-dense environments like airports, or on the battlefield, where interference is intentional.

Poirier will publish a full mathematical explanation of his system in the September issue of *Radio Science Magazine*, a publication of the National Bureau of Standards.

## Oceanography

### Up camera

The propulsion and electronics systems on today's nuclear submarines use the most advanced designs available, but the periscope hasn't changed much since Von Luckner used one to hunt allied ships in the North Atlantic. Essentially, the periscope is a long tube that is hydraulically operated and needs careful alignment of prisms and lenses. As a result, it takes up precious room. Also periscopes are restricted in what they can view and are somewhat slow moving.

A small San Diego company proposes to bring the periscope up to

date by putting a television camera in the sail (conning tower) and eliminating the hydraulic system. Hydro Products, a newly acquired division of the Dillingham Corp., is trying to sell to the Navy its new compact (50 pounds, 28 inches long) PTC100 periscope television camera.

The video periscope would let a sub make one 360° sighting within nine seconds in hostile waters. It could then return to safer depths to replay the scene on video tape over the control room monitor for detailed scrutiny. In the future, the sub could remain at a safe depth and still view the surface by sending up the video periscope on a detachable module.

Furthermore, no large hull penetrations are required for the video periscope since it could be attached with one 12-pin waterproof socket.

Hydro uses a self-contained RCA 7262A vidicon; it features integrated-circuit video and sweep circuits, right-angle optics, and automatic solar shutter encased in a single 3/16 inch-thick stainless steel tube. The vidicon, with a horizontal resolution of 600 lines minimum, can withstand pressures down to 8,000 feet, below the operating depth of modern submarines.

A unique feature is that the periscope is motor driven and rotates within the housing. Video and power signals are carried through a slip ring, so the periscope can rotate in either direction. A bearing indicator lets the observer read the viewing position relative to the sub.

The \$20,000 video periscope follows the modularized packaging of Hydro's line of underwater television cameras, C.L. Strickland, project manager, says.

Besides the Navy, Hydro sees a market for the increasing number of research subs now being used by industry and institutions.

Last year, Strickland says, a third of Hydro's \$3 million business was in underwater tv cameras for such uses as inspection of offshore oil rigs, municipal sewer lines, harbor pilings, and fresh water fisheries.

## Computers

### Hardy memories

Because electromechanical mass memories—which work well in civilian life—do poorly in the field, the Army wants all-electronic random-access bulk memories for its tactical computers. One volunteer for military service is being developed by the Hughes Aircraft Co.; it's a mass-storage system based on the company's Dynabit memory element.

The Army insists not only that the memory be shockproof but also that the cost be “a few tenths of a cent per bit,” according to Donald Savitt, head of the advanced techniques section in the data processing products division at the Ground Systems group, Fullerton, Calif.

The Hughes effort is among those being supported by the Army Electronics Command, Fort Monmouth, N.J., in its block-oriented random-access memory (Boram) program. The goal is a memory that can store 4 million characters of eight bits each.

**Inside job.** Savitt says Hughes got its most recent \$250,000 award for its work last July. The firm is to deliver an engineering model that operates at 250 kilohertz this December. Meanwhile, Savitt's department continues an internal effort to build a prototype Dynabit memory of about 1.2 million bits operating at an information rate of 125 khz for use in internal computing facilities. This device, with an 18-bit word organization, should be ready about Nov. 15, Savitt says.

The basic Dynabit memory element in both efforts functions as a controlled shift register, Savitt explains. “You can put information in one bit at a time at one end and it comes out one bit at a time at the other end. But one of the big advantages it has over a shift register is that it's nonvolatile. The element can be made as long as 16,000 bits, and the cost per bit gets cheaper as the memory element gets longer.” But the delay in getting data out also becomes longer as the fine-alloy storage



# “Ministac”™

## A New High Voltage High Frequency SILICON RECTIFIER

“Ministac” is a fast-recovery, *silicon*, microminiature rectifier that can replace vacuum tubes and selenium sticks. Offering easier mounting and a smaller package, “Ministac” is competitively priced. Due to Semtech’s high-volume production techniques, “Ministac” is being produced without sacrificing quality or reliability.

“Ministac” operates efficiently with all types of wave forms. Applications include:

- R. F. Power supplies
- Focus rectifiers
- High-voltage devices for —
  - CRT’s
  - Image intensifier tubes
- Voltage multipliers for —
  - Data display systems
  - Multivision equipment
  - Television receivers

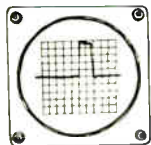

“Ministac” specifications:

Peak Inverse Voltage	..... 3 kV to 7 kV
Average Rectified Current	..... 10 mA
Leakage Current	..... 100 nA
Junction Capacitance	..... 1 pF max.
Recovery Time	..... 100 ns

“Ministac” is small measuring only .400 x .120.



Enlargement of “Ministac” with solid internal construction using high temperature bond

“Ministac” junctions are metallurgically bonded at *high temperature* producing a high-strength multi-junction unitary stack. This process allows Semtech to use the Supratalaxial junction (liquid phase epitaxial) proven to be superior for high-voltage, fast-recovery devices.

For more information, contact Semtech or your nearest representative and get your copy of “Ministac — Design Freedom with New High Voltage-Low Current Rectifiers.”

San Francisco — 941 E. Charleston, Suite 10, Palo Alto, California 94303  
 (415) 328-8025  
 Chicago — 140 N. La Grange Road, La Grange, Illinois 60525  
 (312) 352-3227 / TWX: 910-683-1896  
 Dallas — 402 Irving Bank Tower, Irving, Texas 75060 / (214) 253-7644  
 New York — 116-55 Queens Blvd., Forest Hills, New York 11375  
 (212) 263-3115 / TWX: 710-582-2959  
 Boston — P.O. Box 264, Woburn, Massachusetts 01801  
 (617) 935-5595  
 European Sales — Bourns A. G. Alpenstrasse 1, Zug, Switzerland  
 (042) 4 82 72/73



**SEMTECH**™  
CORPORATION

652 Mitchell Road, Newbury Park, California 91320  
 (805) 498-2111, (213) 628-5392 / TWX: 910-336-1264

1. RAW COPPER TUBE

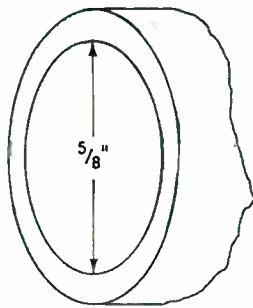

2. AFTER BROACHING AND APPLICATION OF INSULATOR

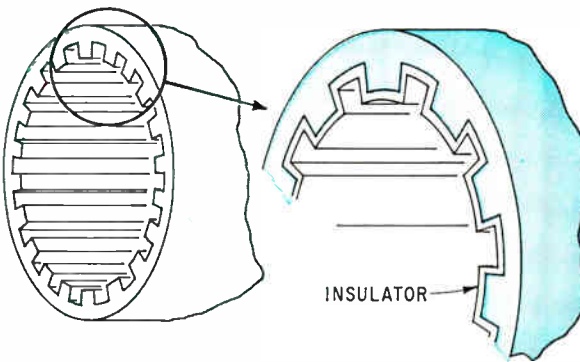

3. AFTER SWAGING AND SUBSTRATE INSERTION

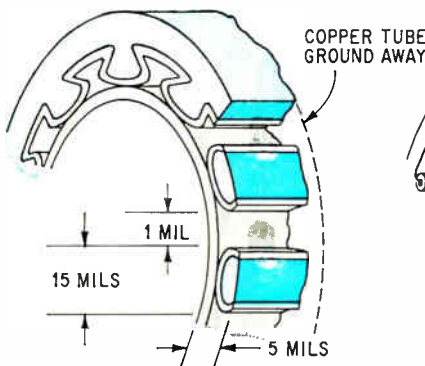

4. COMPLETED DYNABIT ELEMENT

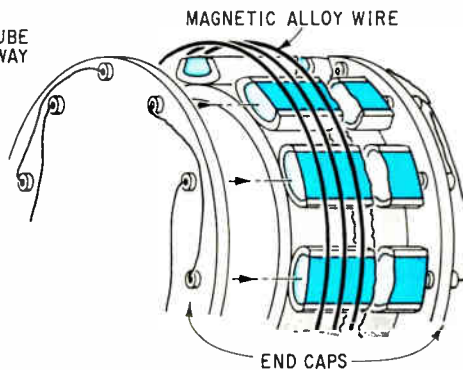

**Firm reminder.** Computer memory, fabricated from 7-inch copper tubes, being developed by Hughes Aircraft. In addition to its high capacity, the memory is easy to manufacture and can withstand severe shocks.

wire becomes longer.

The key to the Dynabit system's low cost is the simple technique for making the elements. A length of ordinary  $\frac{5}{8}$ -inch-diameter copper tubing is broached with a tool that looks like a splined shaft, leaving a set of inward-pointing splines inside the tube. These are coated with a relatively hard insulating material. Then the tube is swaged with a cylindrical tool; this flattens the tops of the splines into a mushroom shape. These flattened tops are prevented from touching each other by the layer of insulation.

Finally, a cylindrical substrate is secured inside the tube and all the copper except the flattened spline tops is ground away from the outside in, leaving a set of copper strips around the substrate parallel to its axis. The strips—60 in each tube—are 15 mils wide, 5 mils high, and 1 mil apart.

To make these strips into two

sets of propagating conductors, end caps are put on the substrate that connects the strips. A solid magnetic-alloy wire 0.3 mil in diameter and of proprietary composition is wound around the strips. Several such windings can be placed on a single substrate, spaced along its length.

**Moving domains.** Information is stored on the wire much as it was on wire recorders—a magnetic field is established in which the lines of flux are parallel to the length of the wire. This establishes a localized magnetic spot, or domain, which is either a 1 or a 0. The memory works as a moving magnetic domain memory because the wire has a property that allows propagation of the domain along its length at a field intensity that is considerably less than that required to establish the domain—write the data—in the first place.

The propagation conductors determine the direction of move-

ment of domains, acting much like the fields of a motor, and "dragging" the domains along the wire.

Each time the Dynabit element shifts, all domains are moved down the wire, so that if a sensing coil or read head is put at the opposite end of the wire to the write head, it will sense the edge of a domain passing under it. Information may be recirculated by connecting the sense amplifier at the read head to the write amplifier at the write head. Placing a memory register in this loop enables the information to be sent to a computer rather than being recirculated, in which case new information can be written in at the write end of the Dynabit element.

A guard band is required between bits of data to keep adjacent bits with opposing polarities from demagnetizing each other and causing a loss of data. The guard band, essentially a blank space on the wire, is produced by controlling the size of the written domain so that it is small enough in relation to the propagating conductors to prevent its interaction with the domain one bit behind it.

**Big advantage.** In its company-sponsored effort, Hughes is building an array of 32 Dynabit elements, each of which has 18 bands of wire; each band is 2,048 bits long. "This gives us random access to  $18 \times 2,048$  bits of information," says Savitt.

One of the big advantages of the Dynabit memory element, according to Savitt, is that its operation is asynchronous. It will move only when it's told to move, whereas a drum moves all the time and one must wait one-half revolution before getting data out; this is about 5 to 8 milliseconds of wasted computer time. With the Dynabit, data can be organized sequentially so a record or a whole file can be read out. This might take about as long as it does for a drum to access the first record; but after that, the access time can be reduced quickly—to about 1/100 of the time to get the first record out—if the data is organized sequentially.

Savitt says the user can also stop as long as he wants between records, and in this sense, the Dyna-

variable viewing time

5 cm/ $\mu$ s stored writing speed

# split-screen displays

## all in the Tektronix Type 549 Storage Oscilloscope

Waveform display showing train of pulses. Upper screen in the stored mode shows three pulses with falltime of the pulse trailing edge showing system deficiency. Lower screen in conventional display mode shows the same pulse train with corrections applied to provide a well formed pulse shape. Pulse width shown is 8  $\mu$ s with risetime of 0.1  $\mu$ s. Vertical deflection factor is 0.5 volts/cm. Horizontal deflection factor is 10  $\mu$ s/cm. Repetitive sweep used for both displays.

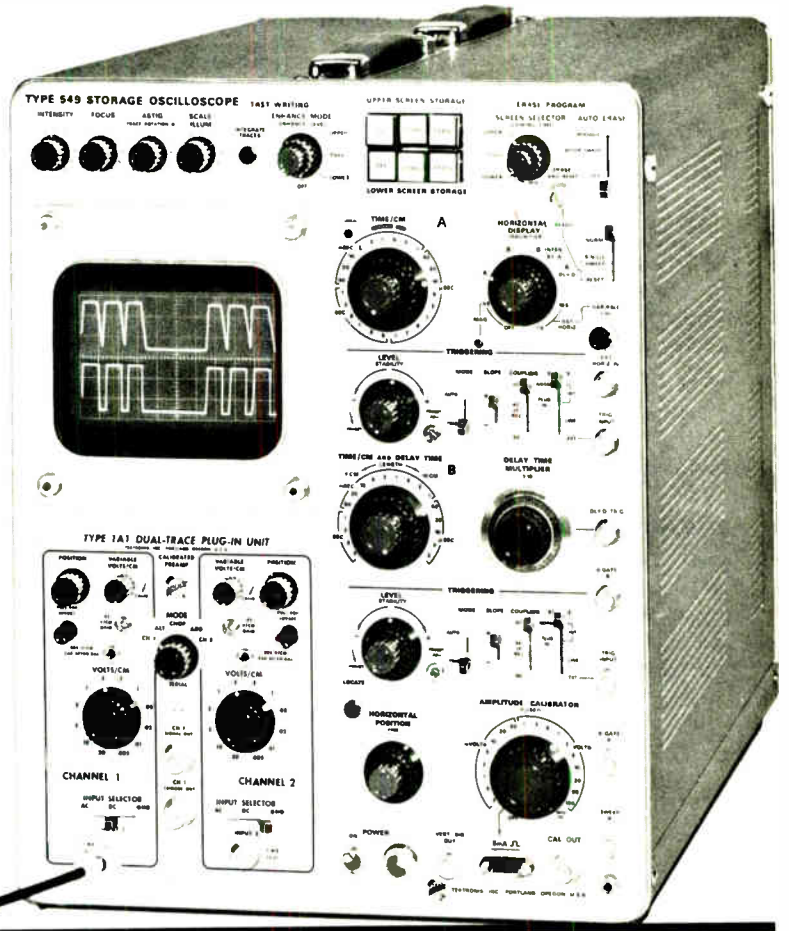

The Type 549 allows up to one hour of continuous visual storage, giving you ample time in most applications to measure and analyze stored waveforms. Stored displays can be erased in less than one-quarter of a second.

### Split-screen displays

Unique with Tektronix storage oscilloscopes, split-screen displays bring you many advantages in waveform-comparison applications. You can use either half of the 6 cm by 10 cm display area for stored displays, the other half for nonstored displays, with independent control of each half. You can also use the entire screen for either type of display.

### Variable viewing time

Variable viewing time — an outstanding feature of the Type 549 — allows you to automatically store displays, view them for a selected time, then automatically erase them on either or both halves of the screen. Two modes of operation are possible. In the After-Sweep Automatic Erase Mode, the selectable viewing time of 0.5 s to 5 s begins at the end of each complete sweep. After the viewing time, the display is automatically erased and the cycle begins again when the next sweep is triggered by a signal.

In the Periodic Automatic Erase Mode, the sequence of storing, viewing time and erasure is continuous and independent of the sweep or signal. In this mode, the viewing time can also be varied from 0.5 s to 5 s.

There is no degradation of stored traces during the selected viewing time, in either mode, and you can retain or erase displays manually whenever desired.

For a demonstration, contact your nearby Tektronix field engineer or write: Tektronix, Inc., P. O. Box 500, Beaverton, Oregon 97005.

### Bistable storage advantages

With bistable storage oscilloscopes, such as the Type 564 and Type 549, the contrast ratio and brightness of stored displays are constant and independent of the viewing time, writing and sweep speeds, or signal repetition rates. This also simplifies waveform photography. Once initial camera settings are made for photographs of one stored display, no further adjustments are needed for photographs of subsequent stored displays.

Tektronix bistable storage cathode ray tubes are not inherently susceptible to burn-damage and require only the ordinary precautions taken in operating conventional oscilloscopes.

### Plug-in unit adaptability

Vertical deflection characteristics of the Type 549 are extremely flexible through use of any of the Tektronix letter- or 1-series plug-in units. These include multi-trace, differential, sampling, and spectrum analyzer units. Depending upon the plug-in being used, bandwidth of nonstored displays extends from DC to 30 MHz.

Among other features of the Type 549 are 5 cm/ $\mu$ s stored writing speed, calibrated sweep delay from 1  $\mu$ s to 10 s, sweep speeds to 20 ns/cm, amplitude calibrator from 0.2 mV to 100 V and a locate zone for easy positioning of stored traces.

Type 549, without plug-in units . . . . . \$2475

Type 1A1 Dual-Trace Plug-In Unit . . . . . \$ 625

DC to 30 MHz at 50 mV/cm; DC to 23 MHz at 5 mV/cm.  
2 Hz to 14 MHz at 500  $\mu$ V/cm, single-channel.

U.S. Sales Prices, FOB Beaverton, Oregon



*Multi-trace, differential, sampling and spectrum analysis*

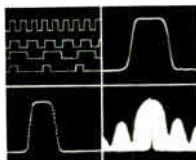

*. . . in all Tektronix 530-540-550-series plug-in oscilloscopes*



bit is somewhat analogous to a punched paper tape that can stop on a character (of course, it's much faster than a tape). One can also reverse the magnetic field, make a push-down stack, and get the last data entered out first. This is convenient for programmers who may want to modify a record. It's simple to back up instantaneously because there's no inertia to overcome, as there is with a drum.

The device's parallel operation is also an attractive feature, Savitt maintains. In a system, an array of Dynabit elements can be stacked like a cord of wood, and the number of parallel information streams one can get out depends on how many memory wires are energized. One can energize a number of wire loops on one element or a number of elements. "We see no physical limitation to the number of bits in parallel that come out," Savitt concludes.

---

### Military electronics

---

#### No metric Maverick

Ever since the United States bought French 75-millimeter cannons in World War I, bores of American artillery weapons have been measured in metric units. And after many years of haggling, the NATO nations agreed that the standard rifle bullet would be 7.62 mm—which happens to be the same size as the American .30 caliber. Outside of this, there hasn't been any definite moves to switch military hardware over to the metric system.

And now it appears that no such moves will come until—or unless—the United States as a whole switches to the metric system.

**Give an inch.** The Pentagon had asked the two prime competitors for the Maverick air-to-ground missile system—Hughes Aircraft and North American Aviation—to study how much it would cost to build the missile to metric units instead of inches. Pentagon brass gave serious thought to actually build-

ing the Maverick with metric measurements.

Now, in announcing award of the \$95 million Maverick contract to Hughes, the Pentagon said it would be built in inches. The major reason was that the Pentagon felt that a change to metric "must be a civilian decision . . . the Department of Defense should not adopt a system not adopted by the nation as a whole."

Finn J. Larsen, deputy director of defense research and engineering, initiated the Maverick metric studies. He said the Pentagon had heard so much about the problems involved, they decided to actually find out.

The studies disclosed "no unique problems associated with a change in the measurement system," a Pentagon statement said. However, it noted that there would be extra costs and more time needed for production because of additional training, conversion or procurement of machines, tooling, and test equipment.

At about the same time the Pentagon was releasing this statement, Congress was moving toward final approval of a three-year study to determine the problems involved in switching over to the metric system. The study will be carried out by the U.S. Bureau of Standards, which will explore the advantages and disadvantages in such a move. The United States and Canada are the big hold-outs in the metric system world. The study will try to calculate, among other things, how our exports could be expanded by the switch—and at the same time, how a switch might help European firms to market in the United States.

**Switch-over.** The reports by the two Maverick contractors on the switch-over will be made available to Government agencies interested in this subject—and particularly the Bureau of Standards, which is likely to use it as a starting point for its study.

The award of the Maverick contract to Hughes came almost two years after contractors submitted initial proposals. The Maverick will be a tactical missile carried on the F-111, A-7D, and F-4 series of air-

craft. The medium-range rocket will use an electro-optical guidance system.

#### Waiting for Awacs

Though there's disagreement over whether the overland radar is developed to the point where the 411L airborne warning and control system (Awacs) can move to project definition, the program manager, the Air Force's Electronic Systems division, insists the key Awacs subsystem is ready to go.

More overland radar tests are unnecessary, maintains an official of the division, which has been after the Pentagon for months to move ahead with Awacs. But he adds, "There's always somebody in Washington who wants to make one more test." While both airframe companies competing for the job—Boeing and McDonnell Douglas—are anxious to move along, others involved want more overland radar tests, including initial systems tests [Electronics, June 24, p. 54].

**Expected.** In any event, there's Awacs money available this year, and almost everyone connected with the program is waiting impatiently for the word to come down from the Pentagon. Approval is expected "momentarily," but momentarily has been the word for the last six months.

About \$35 million is authorized in fiscal 1969 for phase I, or contract definition. This money would be split between the two airframe companies, which would define and select a detailed system. They would submit proposals in six months, and after about four months of evaluation, the Air Force would pick the winner.

Actual work on the system is expected to begin about a year after the contract-definition approval is given. But Electronic Systems officials, who have seen previous Awacs timetables go out the window, say that these estimates are only goals.

The way it looks now, Awacs will be purchased under a total-package procurement; that is, the prime contractor would be respon-

PRECISION MOLDED  
MONOBLOCS



PHENOLIC COATED MONOBLOCS



HERMETICALLY  
SEALED-IN-GLASS MONOBLOCS



"NEW FLAT-PACK MONOBLOCS"  
Five 10,000 pF. capacitors in one  
package



NEW HIGH VOLTAGE MONOBLOCS  
1400 pF. at 3 K Volts...  
in only .003 cu. in.



NEW BUTTON-TYPE  
MONOBLOC FILTER-CAPACITORS



MONOBLOC CHIPS  
Any SIZE and shape available



WORLD'S MOST COMPACT  
TRIMMER CAPACITOR...  
5 to 25 pF. 100 WVdc



**UNMATCHED for  
VOLUMETRIC EFFICIENCY,  
STABILITY and RELIABILITY**

In today's microcircuitry, Erie's unique MONOBLOC Ceramic Capacitors provide the answer to difficult packaging problems... particularly where high capacitance, demanding stability, great reliability and severe environmental conditions are deciding factors.

Monobloc Subminiature Capacitors are available now for a wide variety of microcircuit applications. Currently, Monoblocs are used extensively in aerospace and military control equipments, communications computers and other areas requiring the reliability of performance so characteristic of Erie Monoblocs.

*You name the capacitance problem and Erie will provide a Monobloc Capacitor with better reliability... in a smaller package.* Write for Monobloc Ceramic Capacitor literature.

Another Series of Components in Erie's Project "ACTIVE"  
Advanced Components Through Increased Volumetric Efficiency



**IF YOU NEED  
SMALLER**

**Quality  
CAPACITORS...  
Specify**

**ERIE  
MONOBLOCS**®

ERIE

TECHNOLOGICAL

PRODUCTS, INC.

ERIE

Erie, Pennsylvania

One approach. Boeing design for Awacs flying command post is dominated by 30-foot-diameter rotodome housing main radar antenna. Craft would carry \$20 million worth of radar, computers, and communications gear.

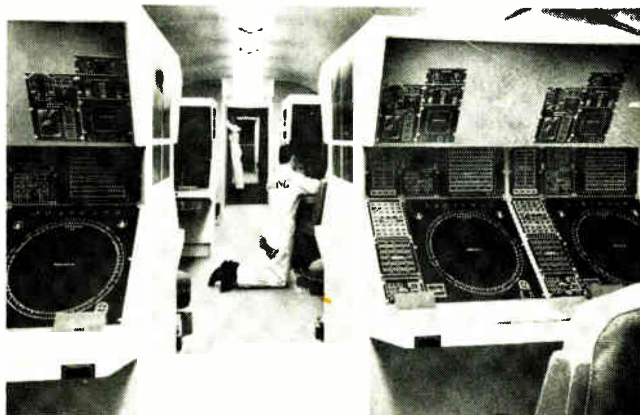
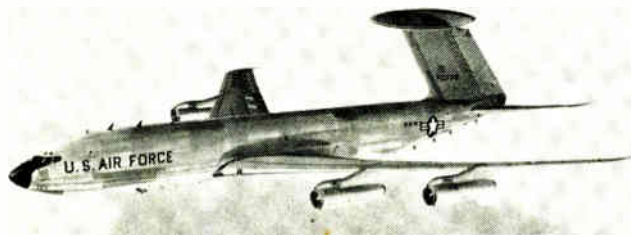

sible for everything from design to maintenance of the operating systems, which would fly in either a DC-8 or 707 transport. Under this approach, the prime contractor would also select the subcontractors, including the overland-radar builder.

The word also is that \$7 million to \$8 million is authorized and will be spent in fiscal 1969 for more overland radar testing. Results of these tests would go to the competing prime contractors, which will evaluate the two or three competing radars. The Air Force wants the airframe companies to pick a radar that they feel will work with their systems.

**One delay.** One radar contractor has a number of proposals covering more testing. This work alone would cost more than the \$7 million expected to be made available this year for tests; a total of about \$2 million was spent in fiscal 1968. The radar is the only Awacs subsystem to cause any real delay, an Air Force spokesman says. An official for one prime contractor asserts: "The delays in Awacs are due to everyone's doing his homework." For example, Boeing kept the 200 people on its Awacs pro-

gram at work with its own money for two additional months going over their studies again to see if anything was left out.

Despite its Congressional critics, Awacs is expected by many to move into the hardware stage in fiscal 1970. One reason is its dual role: as a survivable early-warning command and control center to detect and track enemy aircraft and to direct interceptors; and as a command and control system for rapid deployment and initial operation of tactical aircraft. Best of all, at least to those dedicated to cost effectiveness, is that Awacs will have a "substantially lower operating cost" than present systems. Bmews, for example, costs at least \$40 million a year just to operate and maintain.

Despite the argument by many that Awacs needs an electronics company as a systems integrator, Boeing won't team up with another firm. Instead, it will use subcontractors, since it feels teaming would be more costly to the program. It estimates that with its approach 60% of the Awacs money it would receive would go to subcontractors.

**Team plans.** On the other hand, Douglas and Litton Industries are

understood to have decided on a teaming arrangement. Litton received a letter contract from Douglas in January authorizing it to begin work connected with the contract-definition phase. Litton's Data Systems division will get 10% to 20% of Douglas' share of the money. If Douglas is awarded Awacs, the Litton division would handle the following: onboard data processing, including that required for the identification-friend-or-foe subsystem and mission displays. In addition, it probably would also assist Douglas with the over-all systems analysis and design formulation task.

To date, the Litton division has received about \$1 million for studies of the command, control, and communication parts of Awacs, about \$625,000 from the Air Force in a parallel study with IBM, and the rest in later studies for the two airframes.

---

## Space electronics

---

### Unspun

Later this week, Applications Technology Satellite-D will be launched from Cape Kennedy to test three-axis gravity-gradient stabilization. In April 1967 NASA launched ATS-A, which was to be the first test of three-axis gravity gradient stabilization, but that satellite failed to achieve a proper orbit.

Project officials at Goddard Space Flight Center are concerned, however, that the gravity-gradient system may limit the life of ATS-D because of what is called thermal flutter. They fear that the heat of the sun acting on one side of the 123-foot-long booms will cause them to bend and, eventually, resulting yaw and pitch will cause the satellite's orbit to degrade and put it out of commission.

One Goddard official puts it this way, "Air Force, Navy, and DOD Dodge satellites have deteriorated in orbit after periods ranging from one to 10 months because of what we feel is thermal flutter." He adds that some people don't go along



# 27 seconds from now you'll know whose JAN 1N3611 you want to use . . . and why

## This is an actual section of a conventional plastic JAN 1N3611 rectifier

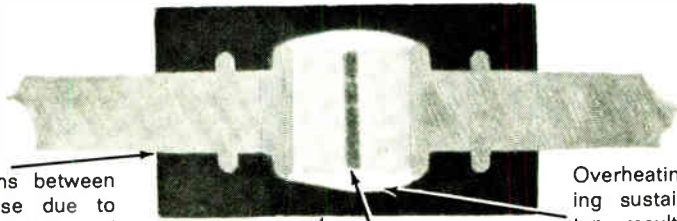

Possible moisture paths between leads and plastic case due to unequal thermal coefficients of expansion and shrinkage of plastic from leads during cure.

Overheating of silicone rubber during sustained power overload often results in long-term leakage degradation.

Relative porosity of plastic allows penetration of moisture over extended period, creating possible electrical degradation.

Usually not controlled avalanche. Conventional passivation by oxides, varnish, or silicone rubber (as shown) allows possibility of surface leakage degradation.

## This is an actual section of a Unitrode glass 2 amp JAN 1N3611 rectifier



Hard glass fused to all silicon and pin surfaces creates a voidless monolithic structure. Perfect seal against all moisture and contaminants.

Metallurgical bond of pins to die-faces at 1000°C allows extremely high surge capability, low thermal resistance. Virtually indestructible construction.

Temperature coefficient of glass and pins is matched to silicon. No degradation under severe thermal stress of high transients or repeated temperature shock — even from -195°C to +300°C.

Controlled avalanche and permanently stable surface leakage characteristics. Hyperclean silicon surface fused only in hard glass. No oxides, silicones, or varnish are used.

And by the way . . .

Glass doesn't always cost more than plastic. Not when you get the economies of making 250 thousand at a time. So don't be shocked at how low our prices are. And . . . you can buy a 100 thousand right off the shelf.

For fast action, call Dave Greene COLLECT at (617) 926-0404.



Part #	PIV	Rating
JAN1N3611	200V	2A
JAN1N3612	400	2
JAN1N3613	600	2
JAN1N3614	800	2



Our catalog sheet is loaded with charts, graphs, and all kinds of detailed specs you'll want to have, so circle the reply card number now.

580 Pleasant St., Watertown, Mass. 02172, (617) 926-0404

# UNITRODE

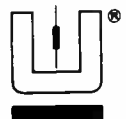

# EMC

## simplified

BY USE OF

# New FI-601

FROM **ACL**



14 KHz to 1.0 GHz

- Modular Construction; plug-in R. F. Tuners; I. F., Audio and Video Amplifiers; power supplies and detectors
- Completely Solid State Circuitry
- Internal, Rechargeable Battery Pack
- Built-in Spectrum Display for I. F. Monitoring
- Selectable I. F. Bandwidths (4 provided)
- Designed for testing in accordance with such specifications as:

MIL-STD-461, 462, 463.

MIL-STD-826

MIL-STD-449

FED-STD-222

To be demonstrated during  
GEMC SYMPOSIUM  
Seattle, July 23-25, 1968

## ACL

**ASTRO  
COMMUNICATION  
LABORATORY**

A Division of Aiken Industries, Inc.

9125 GAITHER ROAD  
GAITHERSBURG, MD. 20760

Phone: (301) 948-5210 TWX 710-828-9706  
RF Equipment for The Systems Engineer

## Electronics Review

with the thermal flutter theory, but that Goddard scientists are generally agreed that the evidence points to flutter as the culprit.

**Damper.** The ATS-D will have a tv camera monitoring the booms. If they bend too much, a damper boom will be activated to alleviate flutter.

Officials hope that this will be enough to keep the satellite alive should flutter occur. But they concede that it may only serve to stave off the inevitable foundering of the satellite for a few months.

**Zip up.** Robert Darcey, ATS project chief, believes gravity-gradient satellites are here to stay because they hold the promise of much longer space life and are cheaper than active-stabilization schemes. Darcey explains that if flutter is causing the deterioration of such satellites it may be solved shortly. He points out that the ATS-E satellite, which will be launched next May, will employ a new "zippered" boom for the first time in a stabilization system. Similar booms were launched earlier this month for the Radio Astronomy Explorer-A. The ATS-E booms are perforated to allow the sun's heat to dissipate and they have serrated edges that interlock like a zipper when the booms unfurl.

### For the record

**Listening.** NASA's Radio Astronomy Explorer (RAE-A), launched early this month, is now operating in its planned circular orbit. The spacecraft's unique radio receiver antenna system is designed to monitor signals from outer space below 10 megahertz. It will also provide astronomers with their first low-frequency radio map of the Milky Way. The antennas are designed to be unfurled gradually in space to an eventual length of 750 feet. They will form a 1500-foot X pattern.

**Second chance.** The Nimbus B satellite, which was destroyed moments after a faulty launch in May from the Western Test Range, will

be replaced, as expected, by a second satellite dubbed B2 [Electronics, June 24, p. 69]. Costing an estimated \$20 million, the mission is tentatively scheduled to get under way next spring.

**Dils.** As expected, Litton Industries' Guidance and Control Systems division has won a \$4.2 million contract to develop and test a prototype doppler-inertial-loran navigation system for the Air Force [Electronics June 24, p. 25]. Claiming it'll be the first to use Kalman filtering in conjunction with large-scale integration, company officials have already asked for bids on both bipolar and metal oxide semiconductor LSI devices for the system's auxiliary computers.

**Moral victory.** Texas Instruments nosed out Lockheed-Georgia in the big race for the Adverse Weather Aerial Delivery System (Awads) but the winning stakes were not as big as expected. Originally planned as a \$300 million, 448-plane system that was to include the C-5, the Awads contract, first cut down to include 156 aircraft, now covers only 39 older C-130E's with multi-mode radar and stationkeeping gear at a total cost of only \$30 million. Development of the system is scheduled for next year, with first production starting a year later.

**Pit stop.** IBM has joined the ranks of those building computerized automobile diagnostic centers. The center, a joint effort by IBM and Mobil in East Meadow, N.Y., is built around a modified IBM 1130. A complete set of tests, including ratings on some 112 systems and components on the car, usually take about 25 minutes.

**Outside help.** The FCC has finally decided to make use of outside consultants in dealing with pressing communications problems. The commission has awarded a \$500,000 contract to Stanford Research Institute to study land mobile radio channel-sharing and frequency assignment, and to look into policy problems of computers and communications.

# No other 100W silicon power transistor in the industry can match this performance point

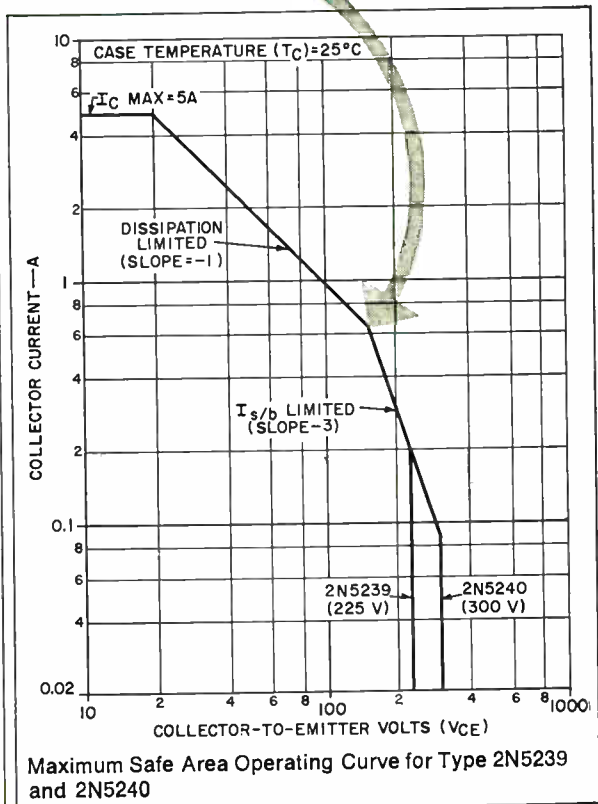
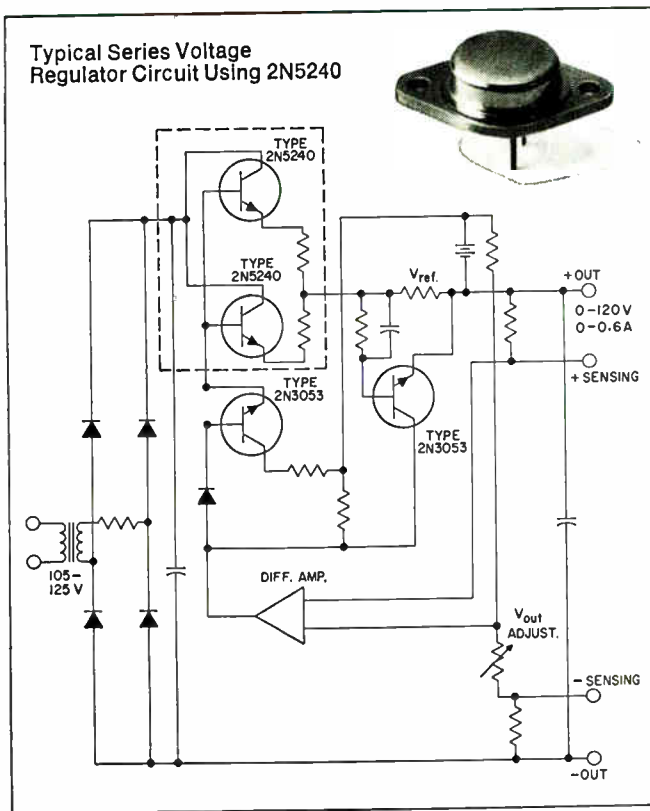

Now, full second breakdown protection up to 100 W dissipation and 150 volts, plus safe area rated up to 300 volts! That's a brand new level of power performance and reliability for high-voltage silicon transistors.

We made this capability possible by creating a unique pellet construction technique—multiple diffusion combined with the multiple emitter concept made famous by RCA "overlay." To you, this means better performing, more reliable circuits for high-voltage regulators, series regulators, high-speed inverters for off-the-line operation, switching bridge amplifiers for servo motor controls, and ultrasonic power amplifiers.

Depending on your circuit requirements, you can choose between the 2N5240 with a  $V_{ce(r)}$  (sus) of 350 volts or the 2N5239 with a 250 volt rating. Both transistors have an  $I_c$  (max.) of 5A and  $P_c$  of 100 W.

For more information consult your RCA Representative or your RCA Distributor. For technical data, write: Commercial Engineering, RCA Electronic Components and Devices, Section IN7-2, Harrison, N. J. 07029.

# RCA





## MICROWAVE IC PROGRESS REPORT #2

### PACT program circulators prove power handling ability up to 8.5 kW

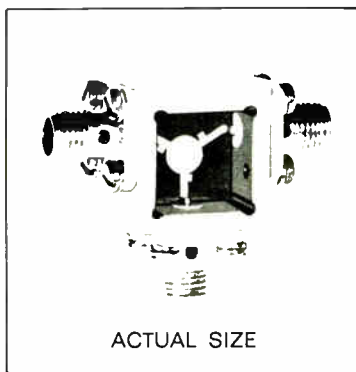

Sperry's PACT (Progress in Advanced Component Technology) program has achieved outstanding results in the development of microstrip ferrite circulators. PACT engineers report considerable progress in loss reduction, bandwidth, and power handling capability.

In the power area, laboratory work has already demonstrated Sperry circulators' ability to handle as much as 8.5 kW at X band. Improved power levels are achieved by doping the YIG substrate with small quantities (2%-5%) of dysprosium. While the higher power levels are achieved at the expense of somewhat higher insertion loss, PACT engineers feel that dysprosium doping offers great promise for high power applications.

Improvement in bandwidth/loss relationships has been equally gratify-

ing. Isolation of 20 db or better with insertion loss of .5 db or less has been achieved with a single device across a 40% (6.5-9.5 GHz) bandwidth.

PACT engineers feel that the reasons for such improvement are about

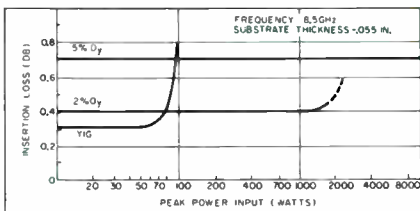

**POWER CURVE**

equally divided between selection and handling of substrate material and improved design of the microstrip conductors.

Substrate selection has been approached on a lowest possible loss basis; no other circuit parameters are considered at that stage. As a result, Sperry has learned that a thicker substrate is useful. Instead of the 25 mil substrate common in earlier microstrip work, PACT designers have gone to a 55 mil substrate and the added thickness contributes to demonstrably lower insertion loss.

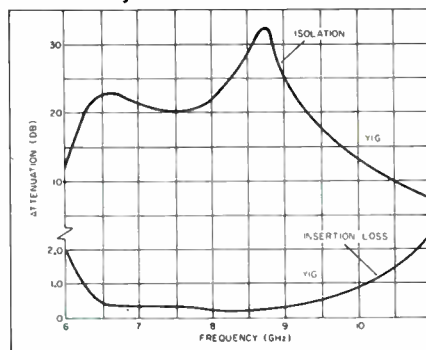

**BANDWIDTH CURVE**

Bandwidth has been substantially increased by the addition of matching

stubs to the deposited microstrip structure. Considerable work has gone into determination of optimum size and location for the stubs, and these efforts have been extremely rewarding.

PACT efforts have resulted in a number of microstrip circulator designs which cover a combined frequency range from 1.5 to 13.0 GHz. All circulators in the group share the desirable bandwidth and low loss

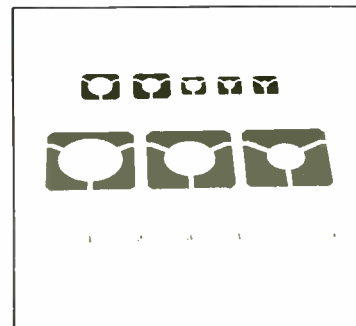

**VARIOUS CIRCULATOR SIZES AND DESIGNS COVER 1.5 TO 13.0 GHz**

characteristics described above. To date, PACT has concerned itself primarily with fixed bias devices, but recent technical evidence indicates that the program will shortly produce latching circulators with comparable capabilities.

If you would like more information about progress in microwave integrated circuit modules, contact your Cain & Co. representative or write Sperry Microwave Electronics Division, Sperry Rand Corporation, Clearwater, Florida.

*For faster microwave progress,  
make a PACT with people  
who know microwaves.*

**SPERRY**  
MICROWAVE ELECTRONICS DIVISION  
CLEARWATER, FLORIDA

# Washington Newsletter

July 22, 1968

## ATS-E will carry L-band transponder

There'll be an L-band transponder aboard the ATS-E for the first tests of aircraft-to-ground communications via satellite relay at frequencies of 1,540 to 1,660 megahertz. NASA's decision to add the transponder to the fifth Applications Technology satellite, scheduled for launching next May, will be announced soon.

Test results could help resolve one of the major hangups in the Comsat-proposed Aeronautical Services Satellite: whether to transmit on the very high frequency channels now being used, go higher to L-band where gear is not now available, or both [Electronics, May 27, p. 48].

The change came after meetings between the space agency and the FAA, which urged that the tests be made. When NASA decides where the transponder will fit on the satellite and completes specifications for it, Hughes Aircraft—ATS prime contractor—will either build the unit or subcontract the work.

The FAA is now hard at work on plans to equip an aircraft with L-band equipment, including the all-important antenna, to carry out ATS tests.

## Radiation bill unlikely this year

There is now a strong possibility that the well-publicized radiation protection bill might not get through Congress this year. If the bill fails to pass this session, the entire legislative process will have to be rerun with the 91st Congress.

Time is running short before the summer recess for the conventions, and congressmen aren't expected to spend much time in the Capitol before final adjournment this fall prior to the elections.

Complicating things are seven Administration-backed amendments that the Senate Commerce Committee tacked on to the weak bill passed unanimously by the House [Electronics, April 29, p. 52]. Because of this, the Senate-House conference on the final version might drag out. The Senate bill has one more stop to make before conference—the Senate Labor Committee's subcommittee on health—but no new hearings or changes in the bill are expected there.

## Two ways of telling what Air Force wants

Defense contractors soon may have an easier alternate approach to the Air Force's controversial 375-5 system engineering management procedure, a detailed list of instructions on how to document the development of a complex system. A draft of the new procedure has been completed by a joint industry-Air Force Systems Command committee, which was formed after a host of complaints were received from industry and parts of the Air Force that 375-5 generated more documentation than anyone could keep track of in its first real tryout—the C-5A.

If the second standard is adopted, an AFSC evaluation committee will screen a company's systems engineering at the contract definition stage. If it passes muster, the contractor can use the easier standard; if not, the company will have to go with 375-5.

The easier format would be a general guide telling contractors what steps the Air Force wants to see in the development of complex systems, while 375-5, on the other hand, "not only tells a company what we want, but how we want it," says an AFSC official.

AFSC's plan to have the new format available in three-to-six months

# Washington Newsletter

could be delayed, however, by recent Pentagon activities. Defense department push for a tri-service systems engineering standard within a year could delay things; and a Pentagon policy statement put out last month will mean some modification of both 375-5 and the new format draft. Most likely the new format will be tried on a new contract or two before it is seriously considered.

## Contest for VFX-1 starts to heat up

The Pentagon's decision to stop work on the Navy's F-111B intensifies the battle by five airframe companies to land the contract for the replacement, the VFX-1. The field will be narrowed to two or three this fall, and a winner chosen at year-end.

Soon to receive study awards to define the aircraft are General Dynamics, Grumman, Ling-Temco-Vought, McDonnell-Douglas, and North American Rockwell. The VFX-1, to be lighter and more maneuverable than the F-111B, will be built in two versions: an interceptor carrying Hughes' Phoenix missile and a fighter carrying an advanced version of Raytheon's Sparrow missile. The Navy will use as much of the F-111B avionics as possible on the new aircraft.

## Instant terminals look like winners

Two portable ground stations, being tested in the Applications Technology Satellite program, are arousing considerable interest, here and overseas. Comsat and several foreign countries—including Australia and Canada—want complete technical details from Goddard Space Flight Center. Their interest stems from the possibility of using such stations in remote areas and for temporary locations.

One terminal, operating at standard satellite microwave frequencies, is being tested with the shf transponder aboard the ATS-3. It is being carried in the back of a station wagon and can be set up in less than an hour by two men. It uses a GE-built, 15-foot diameter honeycomb Mylar antenna which is erected like an umbrella. The station handles one two-way voice channel, but also will be used in tests to transmit digital data and facsimile. In production, this terminal would cost less than \$50,000, with about \$35,000 going for the antenna.

A Goddard-built vhf unit is also being tested and has produced high-quality voice in tests so far. It requires 300 watts, weighs 75 pounds and fits in a suitcase.

## Federal agencies eye SDC software system

Developing interest by Federal agencies in a new user-oriented system of computer programs—called Adept-50—could trigger a miniboom in random-access mass memories. The software system, developed by System Development Corp. under a two-year, \$3 million Defense Department contract, fills over 256,000 bytes of memory.

With the SDC software, a single time-sharing system serves a variety of facilities, users, and applications. One important feature: the operator can be trained in just a few hours to ask questions in simple English and get back answers not specifically programmed into the computer.

The nonprofit software house demonstrated its system to 500 Pentagon and other Government agency officials earlier this month. SDC already has two orders for test and evaluation of Adept-50; one from the National Military Command System Support Center and another from the Air Force Command Post. Three more contracts from Defense agencies are expected within a year.



# 3,000,000 VOLTS/SEC.



The scope photo illustrates the QRD40-.75's high-speed response to 10KHz square, sine and triangular waves. Amplitudes are 20V peak-to-peak.

## ***New Sorensen QRD:***

- A High-Speed Programmable Power Supply with a "Slewing Rate" Greater than 3,000,000 volts/second.**
- A Versatile Laboratory Supply Featuring  $\pm 0.005\%$  Regulation.**

This new precision power supply leads two lives! In the high-speed programming mode, its performance is unmatched—only 10 microseconds programming time from  $E_{max}$  to 0 Volts. Capable of being programmed by resistance, voltage, or current to 100KHz. The oscilloscope photo vividly illustrates the QRD's high-speed capability which makes the QRD unequaled in digital, microcircuit testing, and servo system applications. The QRD also serves as a precision general-purpose instrument featuring  $\pm 0.005\%$  voltage regulation, 200 $\mu$ V r.m.s. (3mV p-p) ripple, automatic crossover between constant volt-

age and constant current operation, and overload/short circuit protection.

Sorensen QRD's are available in seven off-the-shelf models ranging from 0-15v @ 2.0 Amps. (QRD15-2) to 0-60v @ 1.5 Amps. (QRD60-1.5). Prices start at \$178.00.

Contact your local Sorensen representative or: Raytheon Company, Sorensen Operation, Richards Avenue, Norwalk, Connecticut 06856 TWX 710-468-2940.

**RAYTHEON**

for more data on this versatile instrument . . . **Call Sorensen: 203-838-6571**

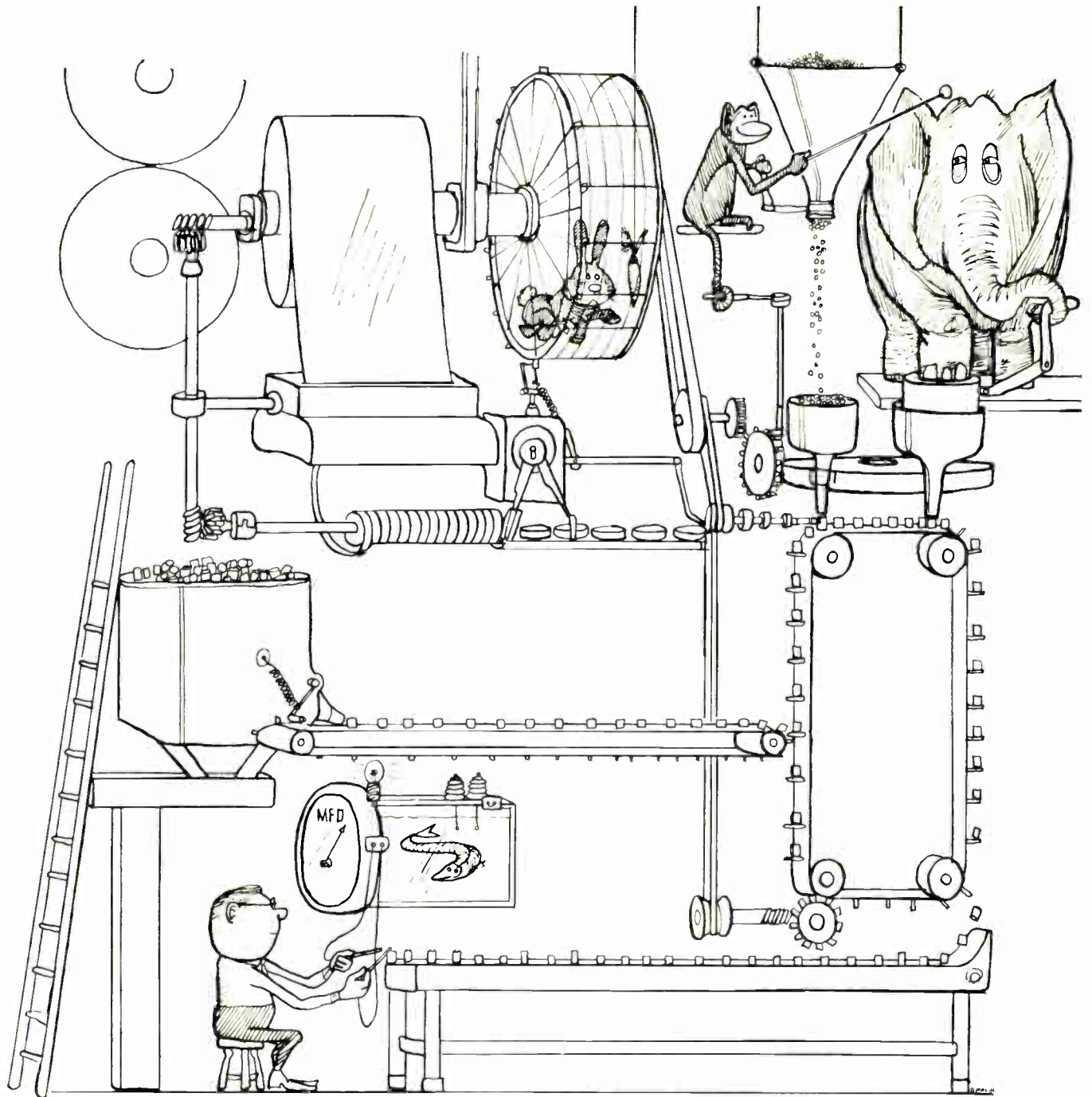

## How to Get More Microfarads in That Little Bitty Can

Republic announces new etched aluminum foils which provide up to 50% greater capacitance per unit area. These products yield more microfarads per \$ than anything now available. Republic's new Electro-Etch high-gain—low voltage etched foils, produced under U. S. Patent No. 3,351,442, are now available in .0034" and .0028" gauges in 1199 and 1193 alloys to meet the needs of electrolytic capacitor designers.

Write for Specifications EF 342, 343 and 344.



# REPUBLIC<sup>®</sup> FOIL INC.

General Offices, Danbury, Conn. 06810: Tel. 203-743-2731

BRANCH SALES OFFICES • Chicago, Ill. 312-545-2142 • Salisbury, N. C. 704-633-6020 • Cleveland, Ohio 216-871-6268 • WEST COAST — Electrical Specialty Co., 213 E. Harris Avenue, So. San Francisco, Calif. • 2820 E. 12th Street, Los Angeles, Calif. 90023 • PLANTS • Danbury, Conn. • Salisbury, N. C. • Somerville, Mass.



**They're new, Molex edge connectors. For printed circuit boards. Terminals crimped to wires automatically. We have straight-in and right-angle types. With and without mounting ears. It's another giant step by Molex in helping create high-speed, low-cost devices that simplify circuitry. Reliable? You bet. The connector has bifurcated terminals that provide solid contacts. Yet you can slip the connector on and off many times without damaging printed circuits. And it's not a preloaded unit. Carries only contacts required. From nine to twenty-one.**

**If you want to save assembly time, steps and money, take a close look at this new Molex edge connector. For free samples, write or you can make connections by calling (312) 969-4550.**

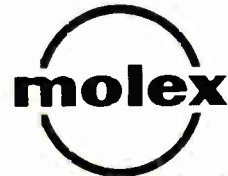

**MOLEX PRODUCTS  
COMPANY**  
Downers Grove, Ill. 60615



# HeNe GAS LASERS

Together with extreme reliability and low cost, ENL Models LS-30 and LS-32 feature:

- Advanced coaxial plasma tube design
- Compact, lightweight laser head for easy mounting
- Simple to operate
- Mechanically rugged design for industrial, laboratory, and classroom applications
- Needs no adjustment, except in the case of multimode operation
- Requires no alignment or maintenance
- Excellent output stability, exceptionally long life
- Fast delivery from stock

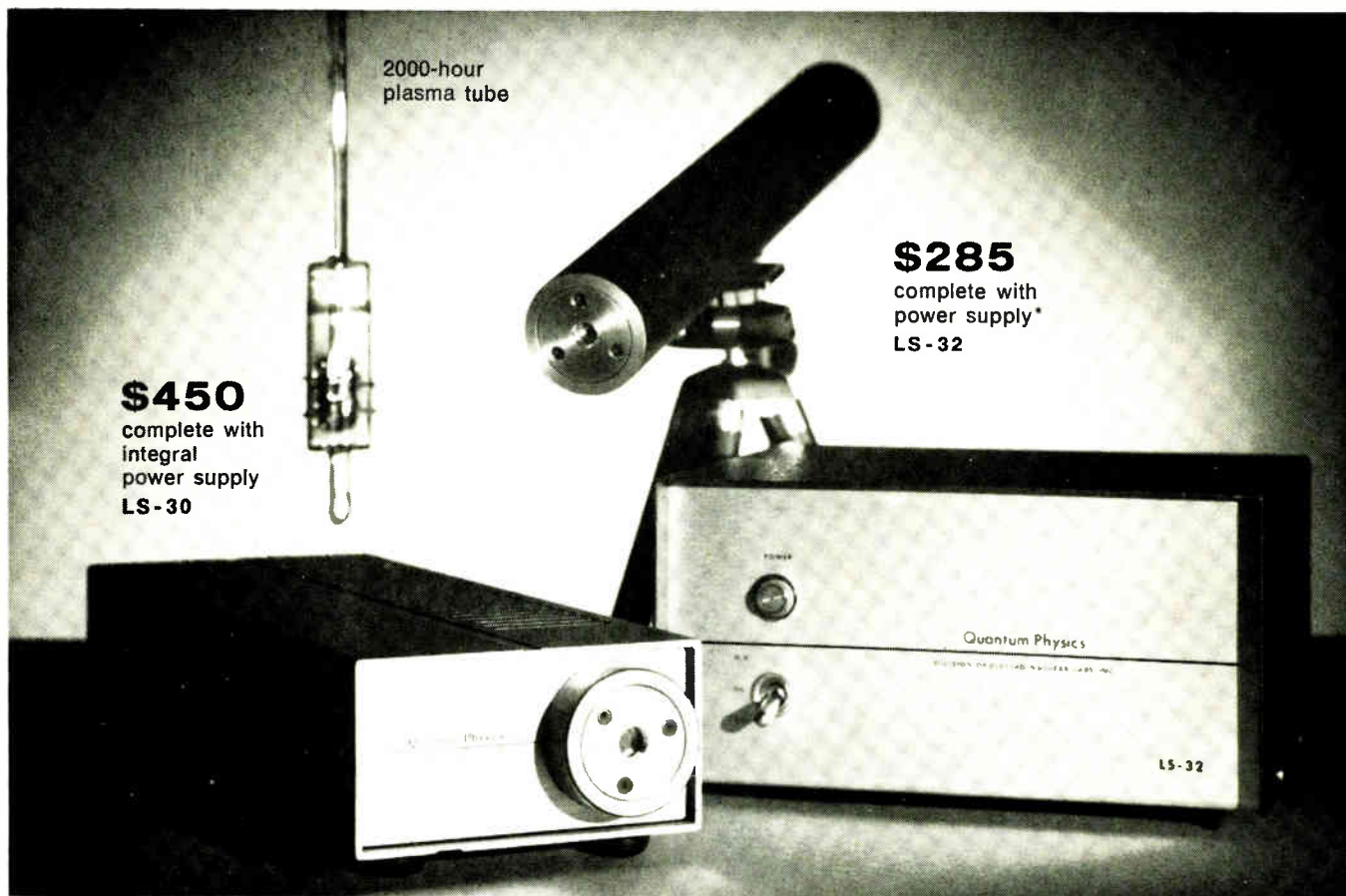

\*Tripod extra

**LASER MODEL LS-30** Extremely compact, low noise CW gas laser with 1% regulated integral power supply. Portable, easy to operate. Features, in common with the entire Quantum Physics laser line, sealed interferometer mounts that require no adjustment, but have the capability for tuning all of the Fabry-Perot interferometer modes. Optical power at 6328 Å, single mode 2.0 mw.

**LASER MODEL LS-32** Educational / laboratory HeNe gas laser of exceptional quality and performance at minimal cost. A complete laser system (including 2% regulated dc power supply). Designed for ease of operation, mounting, stability, ruggedness, and long life. Serves as an excellent source of highly collimated optical radiation at 6328 Å. Output power, single mode 1.5 mw.

**Guaranteed operating life, both models, 2000 hours or one year shelf life.**  
**Ask also for information about ENL's ultra-fast laser and infrared detectors.**  
**Literature available on request.**



**QUANTUM PHYSICS DIVISION**  
**ELECTRO-NUCLEAR LABORATORIES, INC.**

115 Independence Drive, Menlo Park, California 94025 • (415) 322-8451

**Which data sets did  
Computer Sciences Corporation  
select for their recent  
data communications expansion?**



# MODEM 4400/48

## **Result: maximum throughput... always**

Computer Sciences Corporation, Richland, Washington, serves twelve remote batch terminals over regular communication facilities throughout the Pacific Northwest, and Western Canada. All terminals requiring 4800 bps transmission have been updated with dependable MODEM 4400/48 data sets on existing communication facilities without interfering with normal operations.

CSC can also expand their services to customers with remote locations . . . no longer limited by the lack of availability and reliability of highly conditioned lines.

Many other users have updated their data communications with MODEM 4400. You, too, can benefit from maximum throughput at either 2000 bps, 2400 bps or 4800 bps over **any** data line. Interested? Contact Milgo for information.



Data Communication Division  
**Milgo Electronic Corporation**  
7620 N.W. 36th Avenue, Miami, Florida 33147

patents applied for

# How to use the SINGER Model MF-5 Family of Spectrum Analyzers for Audio, Telemetry and Broadcasting Band Analysis

Singer Instrumentation's Model MF-5 Spectrum Analyzer main frame accepts three interchangeable plug-in spectrum analyzer modules, ranging in frequency from 20 Hz to 27.5 MHz.

Since interchangeability of the modules is effected in seconds, many users buy only the module they need, adding other modules as their requirements change.



The spectrum analyzer with an **AL-2** module is often used in audio distortion measurements. Amplitudes of all frequency components in the scanned spectrum are simultaneously displayed for rapid analysis. Typical of its applications are measurement of IM distortion in transducers such as phonograph cartridges. IM products are displayed as side bands on a recorded carrier.

The display shows the side bands down 23 dB and 26 dB from the carrier level. This simple spectrum analyzer method is much faster than using IM analyzers, which require several adjustments for each measurement and which can not supply continuous, graphic displays of distortion.

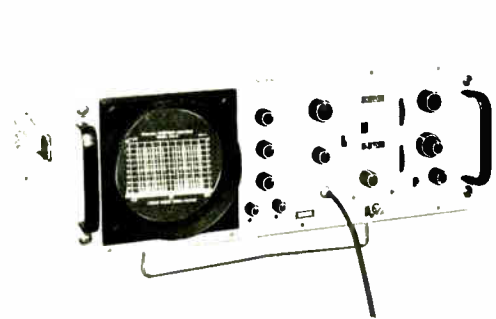
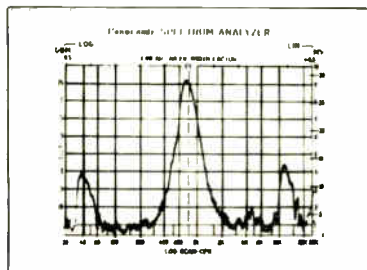

A **UR-3** module (100 Hz to 700 KHz) is ideal for applications in telemetry systems. This module is shown here scanning all 21 constant bandwidth IRIG telemetry channels.

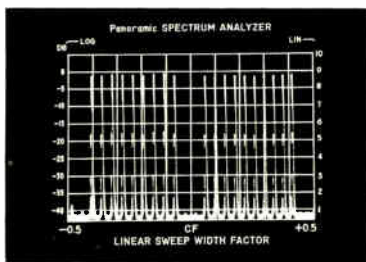

When two channels drop away, their absence shows up instantly on the spectrum analyzer's CRT display. The analyzer is also used for checking signal to noise ratio, the amplitude taper of a telemetry system, or distortion. Besides scanning all the channels, it can provide an expanded display of any one of them.

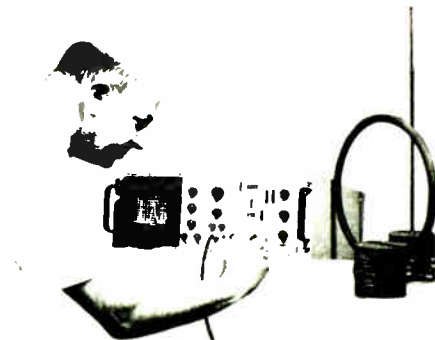
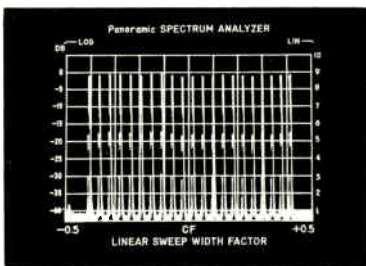

The **VR-4** module (1 KHz to 27.5 MHz) can be used to survey the entire communication frequency spectrum. For this and other applications, Singer provides a full range of accessories, including both antennas shown in this picture.

Shown below is a typical display of the broadcast band. When we want to examine one station's channel occupancy, or a station's average program modulation, the analyzer sweep width is reduced and this display is presented on the CRT. The spectrum analyzer is set for a 20 KHz sweep width (2 KHz/division) in this application. The modulation sideband occupancy at 12 KHz bandwidth is clearly visible as is the carrier of a weaker station (far left of the CRT).

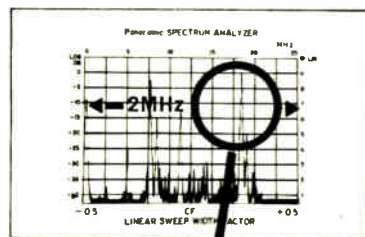

Expanded View of One Channel

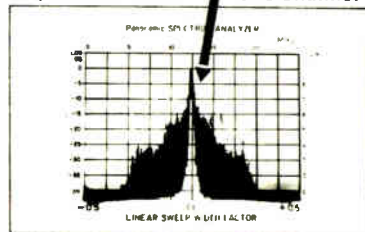

**Panoramic SINGER INSTRUMENTATION**

The Singer Company Metrics Division, 915 Pembroke St. Bridgeport, Conn. 06608 (203) 366-3201



# Technical Articles

---

**Wave analyzers survive  
the test of time  
page 62**

Although some of its functions have been taken over by other instruments, the wave analyzer is still superior for some applications, such as measuring the characteristics of coaxial cables. And newer units are easier to operate because they have automatic ranging, x-y recorder outputs, full dynamic display range, electronic sweep, and electronic counter readouts for frequency measurements.

**Comparator speeds  
computer testing  
page 72**

Using computer-oriented hardware for computer-controlled testing is faster and more efficient than requiring the computer to work with people-oriented hardware. The new hardware is designed around a high-speed comparator circuit that replaces a sampling oscilloscope. The comparator uses conventional logic and can switch in less than two nanoseconds. A special language simplifies programing.

**Navigational computer  
goes digital  
page 78**

## Electronics

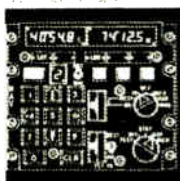

A digital replacement for an airborne analog navigational computer not only works with analog sensors but also fits into the same space and has the same pin configuration. The new computer, called the Micro-Minac, is easier for a pilot to operate and more accurate than its predecessor. And its mean time between failures could approach the duty tour of the plane.

**Test patterns monitor  
IC fabrication  
page 84**

With integrated circuits growing from single level to multi-level structures, most old methods of testing are useless. The test pattern—a circuit, component, or a group of components on the wafer—checks the progress of an IC at various stages of fabrication and provides a means of determining yield and the quality of the product.

---

## Coming

### Large-screen multicolor displays

Computer-directed system gathers operational data and projects it on a screen virtually in real time.

# Wave analyzers: a bright future

Instruments have been around a long time, but continuing improvements have made them superior for some jobs and have led to new applications

By William T. Beierwaltes

Hewlett-Packard Co., Loveland, Colo.

The wave analyzer is almost elderly as electronic instruments go, but its versatility is keeping it young and active. Some of its functions have been taken over by newer devices—distortion and spectrum analyzers—but improvements have made it superior for some applications and have led to new ones.

The instrument is a finite-bandwidth tunable window that can be moved across a frequency range to measure signals as they're framed by the window. Invented in the early 1930's to measure harmonic components, wave analyzers—sometimes known as frequency-selective voltmeters—can also measure frequency response and characteristics of noise and coaxial cables. And new units not only perform these customary functions but also have automatic ranging, x-y recorder outputs, full dynamic display range on the meter, electronic sweep, and electronic counter readouts for frequency measurements. [One such new device is described in detail on p. 137.]

However, designers of wave analyzers must still improve sensitivity and operating ease. The sensitivity problem is made apparent by a statement of Nyquist's noise equation,  $E_n = (4kTBR)^{1/2}$ , where  $E_n$  is noise voltage in volts,  $k$  is Boltzmann's constant,  $T$  is temperature in °K,  $B$  is window width (bandwidth) in hertz, and  $R$  is the input resistance.

## Four tradeoffs

This equation shows that the maximum sensitivity, which is set by the noise level, is proportional to the square root of the input resistance; lower input resistance means lower noise and thus better sensitivity. For example, one manufacturer uses an input impedance of 1 megohm and gives 10-microvolt full-scale sensitivity, while another has 3- $\mu$ v full-scale sensitivity but 100-kilohm input impedance for the same window width.

A second tradeoff is between window width and sensitivity. Nyquist's equation shows that noise

level is proportional to the square root of window width, so sensitivity can be improved by narrowing the window.

A third design tradeoff, which applies to an analyzer in a swept-frequency mode, involves the relationship between window width and maximum sweep rate. A rather complex mathematical derivation describes this relationship; the result is essentially:  $S_{max} \propto B^2$ , where  $S_{max}$  is the maximum sweep rate in hertz per second, and  $B$  is the window width (bandwidth) in hertz.

Although this relationship holds true for only a special type of window, it can be used in approximate form for wave-analyzer windows. It indicates that the sweep rate can be increased as the square of the window width. For example, the sweep rate could be increased 100 times if the window width is increased by 10.

Tuning ease versus window width is a fourth tradeoff. If the window is made narrow to improve selectivity, operating the controls to set the signal in the window can sometimes be frustrating and time-consuming. Widening the window would simplify tuning but reduce selectivity. The solution is to have selectable window widths; an easily tuned wide window is used when selectivity isn't important, and vice versa.

## Other considerations

Of the other considerations, window shape is among the most important. Ideally, the window's bandpass characteristic should be tall, with straight sides and a flat top. However, because the window is usually formed by either passive or active filtering, the ideal remains just that. Today, the best shape factor (ratio of window spread at -60 decibels to the window spread at -3 db) is approximately 2. However, shape factors up to 3.5 are considered good.

Erroneous readings can result from a poor shape factor because of differences in selectivity. If

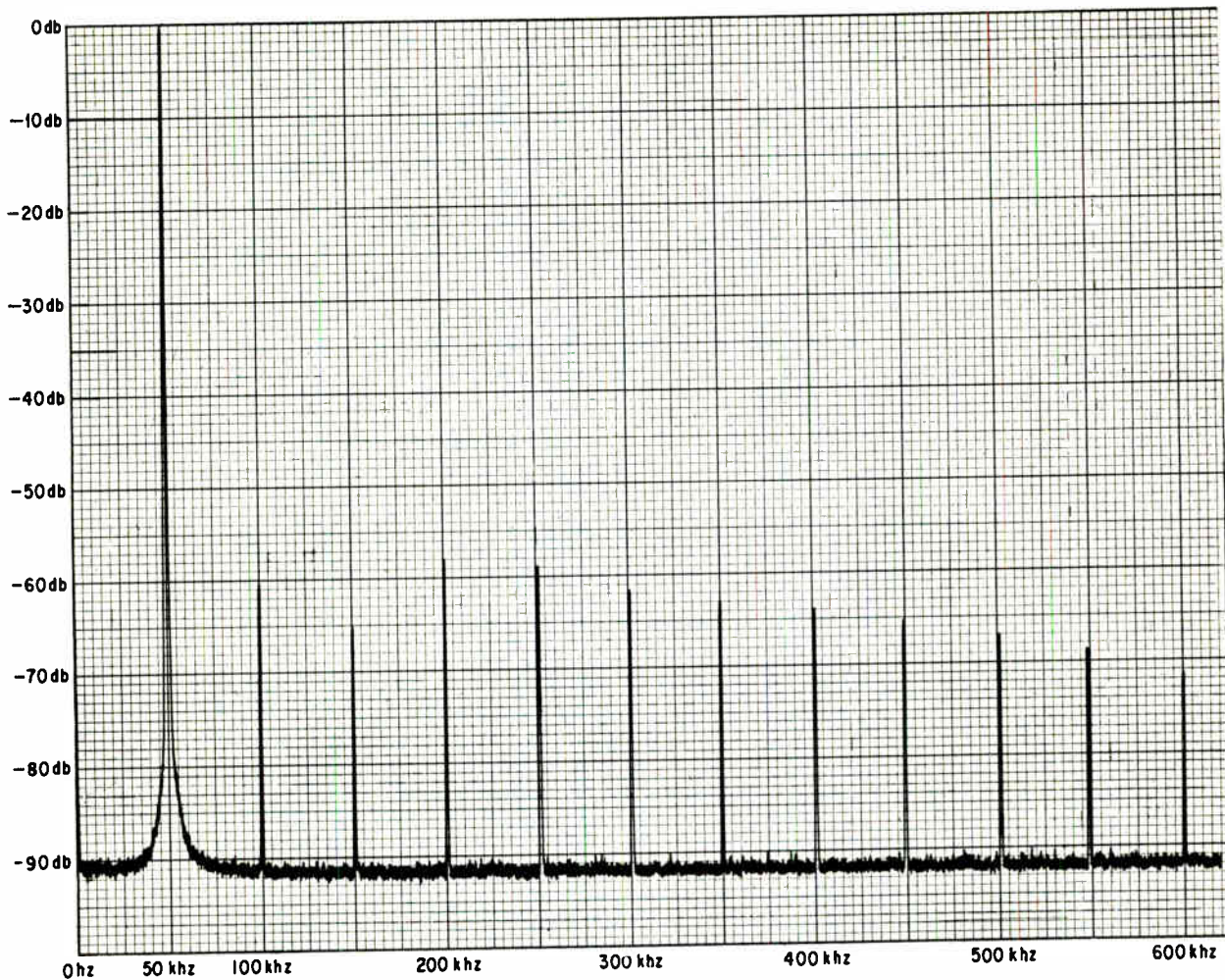

Wide range. New wave analyzers can provide recordings with 90 decibels dynamic range. This plot is of an oscillator output with the analyzer set at 1-kHz window, sweeping at 1 kHz per second

the window's skirts are wide, the analyzer may combine and measure undesired signals, but where the skirts are steep (a lower shape factor), the analyzer will detect and measure only the one signal of interest. Because the operator often needs to separate closely spaced signals to measure each independently, designers are providing better shape factors and narrower windows.

They're also trying to make the window top as flat as possible. A rounded top can result in measurement error, depending on where the signal lies within the window. To help eliminate this problem, some instruments use active filtering to produce tops as flat as  $\pm 1\%$  for more than half the window width. Another approach is to use crystal filters, which cost less than active filters but don't work as well. Active filtering allows shaping to be designed into the window form, but crystal filters can't be easily shaped to compensate for the rounded top and higher shape factor, although three staggered, closely spaced crystal filters can be used to simulate a flat top.

#### To notch or not

Most active filters have a center frequency notch, but crystal filters don't. The notch—at most a few

hertz wide, regardless of window width, and theoretically infinitely deep—is caused when the signal is heterodyned down to about d-c and is blocked by a-c coupling in the active filter. One analyzer manufacturer using active filters has produced notchless windows by d-c coupling in the filter and keeping the analyzer frequency range relatively low.

One advantage of having the notch is that the operator can read the frequency very accurately by tuning the analyzer so the signal of interest is in the notch; the signal's entry there is indicated by a sudden drop in amplitude. A disadvantage is that when the operator uses a narrow window, the notch represents a larger part of the window, so the signal could be lost in the notch. Even so if the wave analyzer is equipped with automatic frequency control (afc), the signal can easily be kept out of the notch by switching to the afc mode.

Afc is useful for measuring the amplitude of a drifting signal or tuning to signals when using narrow windows. Special afc amplitude- and phase-detecting circuits monitor signals filtered through the window. If the signal passing through the window isn't centered in it, an automatic tuning correction will approximately center the window about



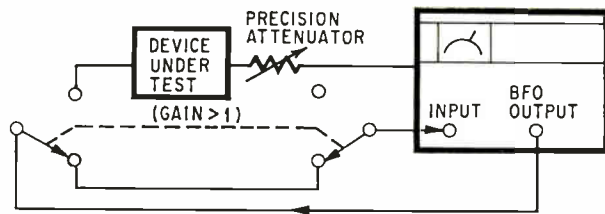

**Amplifier gain.** A wave analyzer can be used for precise gain measurements with a comparison technique.

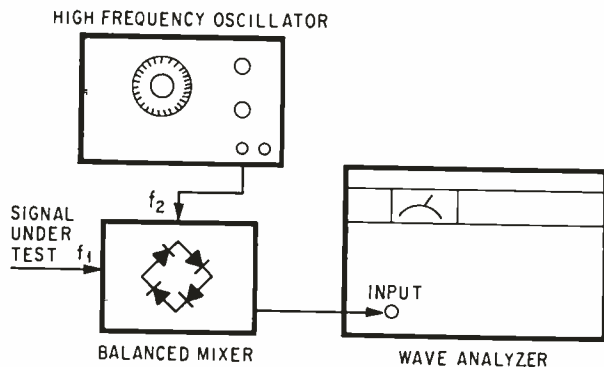

**Extending range.** With a pre-mixing technique, the wave analyzer's upper frequency limit can be raised.

the signal. If the signal is centered in the window but is drifting, the afc will tune the window over a limited range to keep the signal centered.

Other possible modes of operation include restored signal, beat-frequency oscillator (bfo), upper sideband, lower sideband, and amplitude modulation.

The restored-signal mode uses the analyzer's a-c output, which produces a signal whose frequency is identical to that of the signal passing through the window and whose level is proportional to the meter deflection. On units where an electronic digital counter isn't available, the restored output is often sent to an external counter to measure the exact frequency of the signal under study.

### Using the bfo mode

The bfo output mode is the most commonly used. The a-c output produces a signal of constant amplitude and essentially of the tuned frequency. In many applications, the bfo output is used to drive a device under test; output is then monitored by the wave analyzer's input. The bfo output signal, therefore, is given a frequency that will make it pass through the window when monitored by the analyzer. The constant output level is necessary so that the frequency response of the device under test can be measured directly.

Analyzers with a bfo output but no window notch produce a bfo output signal of exactly the same frequency as the tuned frequency. In notched analyzers, the bfo output signal frequency is slightly offset from the tuned frequency; if it wasn't, the output signal would always be centered in the window's notch and couldn't be detected by the analyzer. The frequency offset must be large

enough to keep the signal away from the notch, but small enough to keep the signal on top of the flat part of the window.

Upper and lower sideband modes are used almost exclusively by line communications operators to demodulate multiplexed voice channels down to audio frequencies. In this application, the user tunes the analyzer to the middle of the voice channel of interest after switching to either sideband, depending on the signal. He can then attach ear-phones or a speaker to the a-c output and listen to a demodulated test conversation.

In the a-m mode, the signal must pass through the window before it is detected in the meter circuit, so the sideband excursions can't be greater than the window width. The frequency range presented at the a-c output, then, can't be greater than the widest window available.

Dynamic range, an important wave-analyzer specification, defines how small a signal can be measured in the presence of larger ones. An analyzer with 80 db of dynamic range can measure a small signal in the presence of signals up to 80 db larger. The best dynamic range available today is about 85 db.

A key to good dynamic range is often the input amplifier, which must be able to handle a range of amplitudes as large as, or larger than, the analyzer's dynamic range.

### Input attenuation

The wave analyzer input has an attenuator preceding the amplifier for overload protection. Proper use of input attenuation is usually a trivial consideration with voltmeters, but not with wave analyzers. Voltmeters are broadband and will indicate a reading for all signals applied at the input, but wave analyzers will indicate only the amplitude of the signal coming through the window. While an analyzer is tuned to a small signal, there might be a large undetected signal at the input.

This situation can produce problems. The input level of the large unseen signal could exceed the maximum and cause distortion in the input amplifier. The distortion products appearing at the output of the amplifier could be detected by the analyzer, leading to erroneous readings.

The operator has four ways to protect himself against such input pitfalls. He can sweep over the entire frequency range of the analyzer to find the largest signal and adjust the attenuator accordingly. Another approach would be to apply the signal to an internal or external broadband voltmeter to determine the maximum input level. The input attenuator can then be adjusted with confidence that the input won't be overdriven by a large signal.

A third approach, effective but somewhat frustrating, entails switching of the input attenuator and the dynamic range attenuator. The procedure is to first tune to a signal of interest and adjust the input attenuators to obtain an up-scale meter reading, which is noted. The input attenuator is

now increased by 10 db and the dynamic range attenuator reduced by 10 db. If the meter reading changes by more than about 6%, an overload is indicated.

The fourth method of protection is an overload indicator triggered by a broadband level detector circuit integrated into the analyzer. The light warns the operator if the input is being overloaded so he can adjust the attenuator.

Local-oscillator stability is also vital, since it dictates how well the analyzer will stay at its tuned frequency. If the signal from this oscillator drifts with temperature or time, the window frequency will also drift. Some makers gain stability by phase-locking the high-frequency local oscillator to a very stable crystal-oscillator signal of lower frequency. Another approach is to use an oven-controlled environment for the local oscillator. By controlling the ambient temperature in which the oscillator operates and by pre-aging critical components, good short- and long-run stability can be obtained.

When long-term measurements are being made, afc helps overcome analyzer instability. With afc, the signal will be kept centered in the window even though the local oscillator may drift over the longer period of time. The operator could expect to keep a signal centered in even a very narrow window all day. With afc, this measurement stability would be difficult to achieve with even the most stable local oscillators.

### Zero response

Zero response limits the low-frequency usefulness of all wave analyzers. It's characterized by a meter indication as an analyzer is tuned to 0 hertz, though no input signal may be present. At 0, the indication can be as high as 20 db below the reference permitting a dynamic range of only 20 db. The two parameters affecting zero response are window width and shape factor; for wider windows and higher shape factors, the zero response will begin at a higher frequency. For some analyzers, zero response begins at 1,000 hertz, for others at 5 hertz. The analyzer has limited usefulness at frequencies at or below these points.

Zero response occurs as the local oscillator is tuned lower. When it approaches the i-f frequency, some signal leaks into the i-f strip through the first mixer, causing a signal to appear at the filter input. When this frequency is low enough, the filter will pass it as though it were an input signal. The narrower the filter, the lower the local oscillator must be tuned to be passed and metered.

A low shape factor can also help lower the start frequency of the zero response. As the local oscillator is tuned lower, narrower filter skirts will pass a smaller amount of the signal.

### Special recorder outputs

A relatively new advance in wave analyzers is the addition of special recorder outputs. There has always been a desire to have analyzers continuously

display their full dynamic range on x-y recordings. One technique uses an i-f detection scheme that requires a special detecting strip-chart recorder with a mechanical drive linkage.

In a new analyzer, plots can display up to 90 db of continuous dynamic range. At the same time, the x axis can be swept in either a linear or logarithmic fashion. This capability allows the operator to make spectral recordings when frequency components are of interest or direct Bode plots when filter or amplifier responses are of interest.

Normally, an analyzer will display its meter reading either linearly in volts or logarithmically in db. A new analyzer can be switched to also read decibels linearly from 0 db to -90 db on its meter by also using automatic attenuator ranging.

When in the linear db display mode, the analyzer conventionally detects an input signal, but the meter circuit now routes its d-c output signal to a logarithmic converting circuit instead of to the meter.

At this point, the d-c signal splits and goes in two directions; one part goes to the autoranging comparator, the other to a logarithmic amplifier. In the first direction, the signal triggers a comparator that automatically keeps the metered a-c signal within a 30-db range. In the other direction, the signal is logarithmically shaped over a 10-db range to give a linear db output. After the comparator also adjusts d-c step voltages, proportional to range, the step and logarithmically shaped voltages are summed. The resulting output is a linear db d-c signal that goes to the meter and the recorder output.

### Electronic sweeping

Electronic sweeping with voltage-controlled oscillators has also come of age. In the past, tuning was done with air-tuned capacitors; this meant that sweeping required electromechanical drive units. Some of these units produced satisfactory results, but they were cumbersome and hard to operate.

The voltage-controlled oscillator has other advantages besides convenience. Because frequency is a function of voltage, the analyzer can be swept externally. An even more important advantage is that an external d-c voltage can be applied to tune to a predetermined frequency.

Still another new feature of wave analyzers is the electronic counter. All first-generation analyzers used dials to indicate frequency. As the analyzers became more sophisticated, manufacturers provided mechanical digital counters. These provided 4- to 5-place resolution with fair accuracy, but the operator often attached an electronic counter to the restored output if he wanted high-frequency accuracy and resolution. The new analyzers containing electronic counters not only provide high resolution and accuracy but also display a running account of sweep frequency information.

Noise measurements can be made with a variety of instruments, but the wave analyzer's are frequently the most meaningful. And the device can

supply information that enables the operator to plot noise as a function of frequency. For example, a circuit designer can select low-noise transistors on the basis of low-frequency noise recordings. And an engineer designing an amplifier, by knowing the noise level distribution as a function of frequency, can concentrate on lowering the noise level in a particular frequency range to reduce broadband noise.

### Carrier-system tests

A common noise-measurement application is in testing telephone coaxial systems. Noise on coaxial telephone lines restricts dynamic range, which often must be as high as 70 to 90 db. The measurements are usually made with an analyzer that has a 200-hertz window. This reading is normalized to that of a 3-khz window, which covers the standard voice-channel width, adding a correction factor to compensate for the difference in bandwidths. However, even this correction factor must be adjusted to account for the lack of such things as C-message weighting—a filtering circuit used to compensate for nonlinearities in the receiver and human ear—rms response, and proper meter time-constant. The 200-hertz window is thus very time-consuming and the technique doesn't allow for noise level irregularities in the channel that aren't seen in the window.

It would be better to have a wave analyzer with a 3-khz window to measure noise. Until recently, however, this has been unsatisfactory, because such analyzers used filters with shape factors too large to eliminate error readings caused by the partially suppressed carriers. A 3-khz window with a shape factor of 2 for example, will result in only about 18 db of carrier rejection, which isn't enough. The carriers are originally suppressed only about 35 db.

Now, however, state-of-the-art development provides carrier-system operators with a filter that allows channel noise measurements to be made with a 3-khz window. Two notches are superimposed 2 khz away from the center frequency for

better carrier rejection. With the new filter design, adjacent carriers can be rejected more than 55 db. When this rejection is added to 35 db of suppression, the carrier is 90 db down. With the carrier rejected this far, noise can be measured down to 90 db below the reference using a wave analyzer with a 3-khz window. Filter spillover into the adjacent channels will cause negligible detected noise. Because the rebound peaks are less than 30 db and the noise is already 50 to 70 db down, the noise from the other channels will be rejected to 80 db or more.

No weighting formulas are necessary to compensate for the lack of C-message weighting, rms response, and proper meter-time constant, because the correction factors cancel out. A total of 1.5 db is subtracted from the reading to account for a lack of C-message weighting when the noise is approximated by uniform white noise, 1 db is added because the meter is average-responding rather than true rms, and about 1 db or less is added to compensate for a large meter time constant (the time constant should be 200 msec rather than 1 second). The reading is thus within 0.5 db of the true reading. And, since  $\pm 1$  db is the accepted noise measurement accuracy tolerated by the system operators, the analyzer reading can be made directly without normalization.

### Frequency-response measurement

The wave analyzer is too often overlooked by those measuring frequency responses. State-of-the-art innovations have made it possible to make x-y recordings of a device under test that even include direct Bode plots over three frequency decades, using the bfo output as a signal source. The operator can stimulate the circuit at the tuned frequency with the analyzer's bfo output signal while the circuit's output is being monitored. The analyzer can then sweep over its frequency range, and the circuit's output will always be at the analyzer's tuned frequency.

In many cases, bfo flatness at its best is about  $\pm 2\%$ , and input frequency-response error

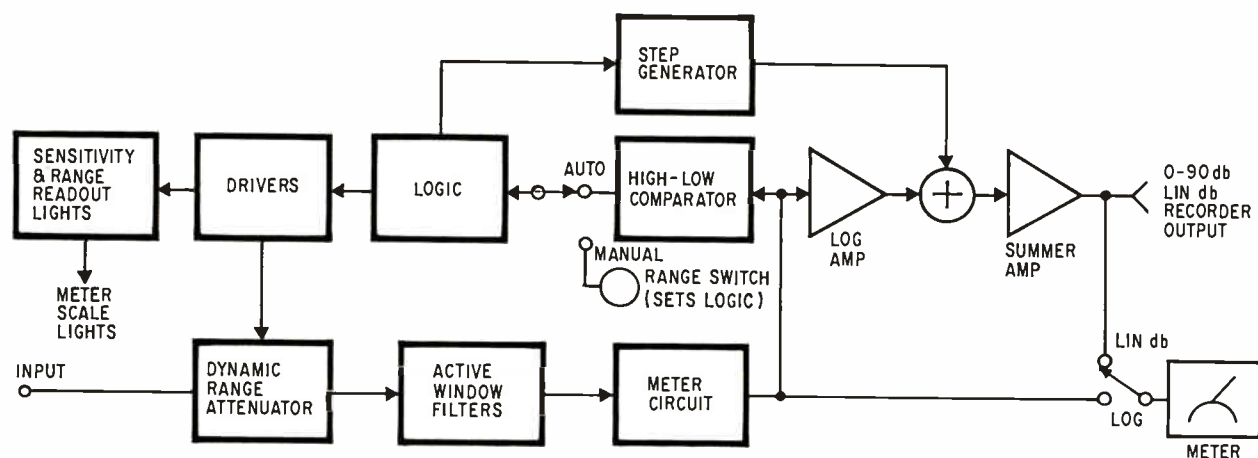

**Automatic ranging.** The new Hewlett-Packard 3590A wave analyzer provides automatic ranging of the signal amplitude and allows 0 to 90 decibels meter display and recorder output.



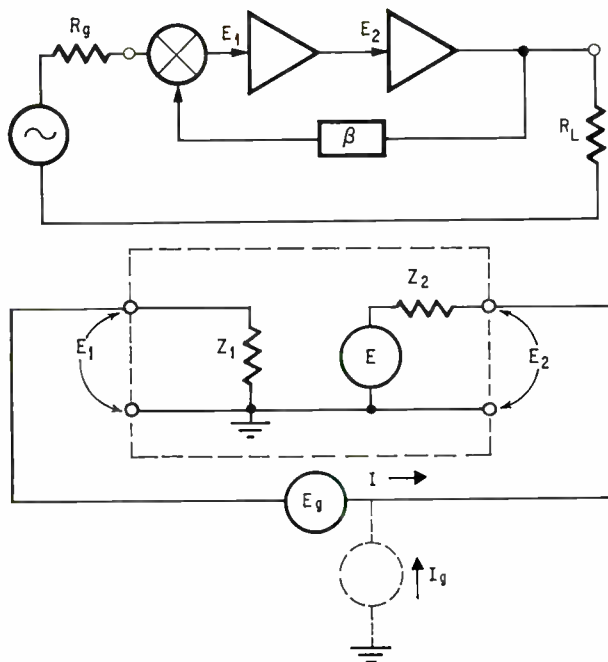

**Loop gain.** The wave analyzer can be used to measure an amplifier's loop gain by inserting a voltage with a current probe in the feedback loop, as shown in the equivalent circuit. The current source, shown dashed, can be used in an alternate scheme for different impedance levels.

can be another  $\pm 2\%$ . If more accuracy is desired, the operator can first make another frequency-response recording, with the bfo output connected directly to the analyzer input to record the analyzer's response. The deviation between this recording and the test recording indicate the test device's frequency response, since errors due to analyzer response have been compensated for.

Depending on application, a wave analyzer can give better frequency response accuracy than a broadband voltmeter because the analyzer won't allow source distortion to contribute to the reading; the analyzer will be tuned only to the fundamental frequency and will disregard all distortion components. And such things as 60-hertz hum and noise in the circuit can be tuned out. An oscillator-voltmeter combination may be less costly, but a special low-distortion oscillator may be needed; otherwise, the distortion components from the oscillator will limit the dynamic range of the measurement in some cases.

### Measuring loop gain

Another application is in measuring loop gain ( $A\beta$ ) in a feedback amplifier. The conventional way to measure  $A\beta$  is to open the feedback loop and measure the output obtained in response to a known input. The procedure must duplicate the impedance presented to the output stage when the loop is closed, and auxiliary bias sources must be added if d-c feedback is used.

However, the measurement can be made with the loop closed by using a current probe for signal injection and a wave analyzer with bfo output for signal measurement. The current probe can be made

to act as a coupling transformer by simply clipping it around a circuit lead. Values of  $A\beta$  over a wide range of frequencies and magnitudes—even less than unity—are readily obtained. And the phase angle of  $A\beta$  at frequencies near gain crossover is easily determined.

Insertion of an isolated ideal voltage source in series with the signal path of a feedback system doesn't alter the feedback loop's characteristics because the source has zero series impedance and no shunt conductances to ground. Voltages are established, however, to allow  $A\beta$  to be determined directly.

Consider the situation at the left. The loop is closed and a voltage source is connected in series with it. This represents the normally closed feedback loop, because no additional impedances have been introduced. The disturbance created by the presence of voltage  $E_g$ , however, causes voltages  $E_1$  and  $E_2$  to be established by the reaction of the feedback loop.

The voltage on the output side of the generator is:

$$E_2 = IZ_2 + E$$

The current may be expressed as:

$$I = E_1/Z_1$$

Combining equations yields:

$$E_2 = \frac{EIZ_2}{Z_1} + \frac{Z_1 + Z_2}{Z_1} A\beta E_1$$

If  $Z_2$  is much less than  $Z_1$ , then  $E_2 = A\beta E_1$ , even though  $E_g$  has been added to the circuit. Thus,

$$A\beta = \frac{E_2}{E_1}$$

Thus, the simple introduction of the voltage  $E_g$  in series with the loop establishes two voltages,  $E_1$  and  $E_2$ , that determine  $A\beta$  directly.

The voltage source  $E_g$  may be placed at any point in the loop where the signal is confined to a single path and where  $Z_2$  is much less than  $Z_1$ . The load and generator impedances normally used with the amplifier should be connected to the normal output and input terminals.

To determine whether the output impedance is much less than the input impedance, approximate calculations based on the particular feedback circuit would normally be made. However, there is an easier way. Because the impedances are the output and input impedances without feedback, it will be necessary to short the feedback loop to ground by grounding one of its large capacitors. Then, using the clip-on probe, a signal is injected into the loop. The resulting ratio of  $E_{out}$  to  $E_{in}$  is the ratio of  $Z_{out}$  to  $Z_{in}$ , since the same current flows through both impedances. Another way would be to apply a current; the ratio of  $I_{out}$  to  $I_{in}$  would be the ratio of  $Z_{in}$  to  $Z_{out}$ . The amplitude of  $E_g$  must be small enough to prevent saturation in any of the active elements, and consequently either  $E_1$  or  $E_2$  will be quite low.

Sensitive wave analyzers are excellent choices

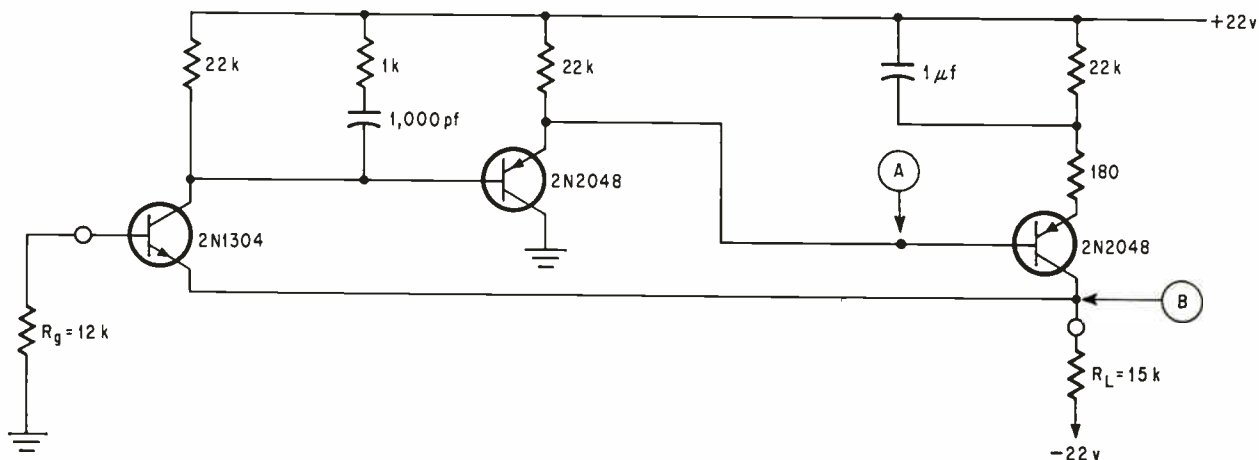

**Test circuit.** The loop gain of this amplifier was measured with a current probe and wave analyzer. The current probe inserts a voltage at point A, while point B is the current node.

for  $A\beta$  measurements involving such small signals, because narrow bandwidths ensure good rejection of noise and spurious signals. The signal available from the wave analyzer operating in the bfo mode can be used for  $E_g$ , so that source and measurement circuits are tuned simultaneously.

The series impedance introduced into the test circuit by the clip-on a-c current probe is approximately 0.01 ohm shunted by 1 microhenry and 2 picofarads. When driven by the wave analyzer, the voltage produced in the test circuit is about 10 millivolts, a convenient level.

### Using the technique

The loop gain of an amplifier, shown above, was measured with this technique.  $E_g$  was inserted at point A, where  $Z_2$  is calculated to be no more than 400 ohms and  $Z_1$  is about 10,000 ohms. The requirement that  $Z_2 \ll Z_1$  is satisfied here.

To read loop gain directly in db units,  $E_2$  is set to the 0-db level on the analyzer by adjusting the amplitude of  $E_g$ . Consequently,  $E_1$  is measured in negative db units, and when the sign is reversed, these readings represent  $A\beta$  in db.

Measurement of  $A\beta$  values of less than unity can be useful. For example, if the circuit isn't stable when the loop is closed, resistive attenuation may be introduced somewhere in the loop to avoid oscillations. The relative values of  $A\beta$  are measured, and when they're plotted the reasons for instability can be determined.

The phase-angle magnitude of  $A\beta$  is readily determined through construction of a simple vector diagram. This is merely a graphic depiction of the relationship  $E_2 = E_1 + E_g$ .  $E_2$  and  $E_1$  are measured directly, and  $E_g$  is measured by shorting the voltmeter input leads together and clipping the current probe around them. For negative feedback, the phase angle usually is measured from the  $-180$  degree reference.

It may not always be possible to find a point where  $Z_2$  is much less than  $Z_1$ . A similar measurement technique applies when  $Z_2 \gg Z_1$ . The amplifier is connected with a current source connected

from the signal path to ground, as shown on p. 67. As before, the feedback loop is closed, but current source  $I_g$  sets up  $I_1$  and  $I_2$ , where  $I_g = I_2 - I_1$ .

$$E_1 = -I_1 Z_1, \text{ and}$$

$$E_2 = I_1 Z_2 + E$$

Thus:

$$E_2 = I_2 Z_2 + \frac{Z_1 + Z_2}{Z_1} A\beta E_1$$

Since  $E_2 = E_1$ ,

$$-I_1 Z_1 = I_2 Z_2 - \frac{Z_1 + Z_2}{Z_1} A\beta I_1 Z_1$$

$$\text{If } Z_2 \gg Z_1, \quad A\beta = I_2 / I_1$$

### Another method

Currents thus replace voltages in the determination of loop gain. As in the voltage approach, the normal input and output load impedances should be connected. The temporary input and output again may be chosen at any point where the signal is confined to one path. A resistor is usually adequate for converting a voltage generator to a current source (a capacitor may be placed in series with the resistor block d-c). In this case, the resistance should be large with respect to  $Z_1$ .

This technique is also used to measure the loop gain of the amplifier shown above. Point B is selected as the current node.  $Z_2$ , about 1 megohm, is the output impedance of the amplifier; local emitter feedback, and the input impedance of the following emitter is about 270 ohms, meeting the requirement that  $Z_2 \gg Z_1$ .

A current source is simulated by connecting a 10-kilohm resistor ( $\gg Z_1$ ) in series with the wave analyzer's bfo output. The current probe senses each current,  $I_2$  and  $I_1$ , supplying a proportional voltage to the input of the wave analyzer (termination of the current probe isn't necessary, because only relative measurements are being taken). With this technique, the maximum deviation from the  $A\beta$  obtained by the voltage method is only 0.3 db.

# Designer's casebook

## Power multivibrator gives linear motion to control rods

By Robert S. Snyder and Arthur C. Eberle

Columbia Gas Systems Service Corp., Columbus, Ohio

**Eccentric cams mounted** on the shaft of an electric motor have been used in the past to give periodic linear motion to mechanical control rods. Now that fast power transistors are available, this expensive and troublesome arrangement can be replaced by a multivibrator-solenoid circuit. By alternately energizing and de-energizing two solenoids, the multivibrator gives sharp reciprocating motion to the

core common to the pair.

A positive pulse generated across  $R_3$  in the relaxation oscillator is coupled through  $C_1$  into a point common to the anodes of  $D_1$  and  $D_2$ . If  $D_1$  and  $Q_1$  respond first to this pulse—a factor that depends on a small difference in the turn-on times of  $D_1$  and  $D_2$ —then  $Q_1$ 's collector current flows through  $L_1$ . The magnetic field built up by the current pulls in the core of the solenoid and the rod to which it is attached.

The collector voltage of  $Q_1$  is close to ground potential when it is biased on. This voltage is coupled across  $R_2$  to the base of  $Q_2$  where it keeps that transistor off. Since no collector current is flowing through  $L_2$ , this coil has no effect on the core common to it and  $L_1$ .

The next pulse from the oscillator to the base of  $Q_1$  has no effect on the operation of that tran-

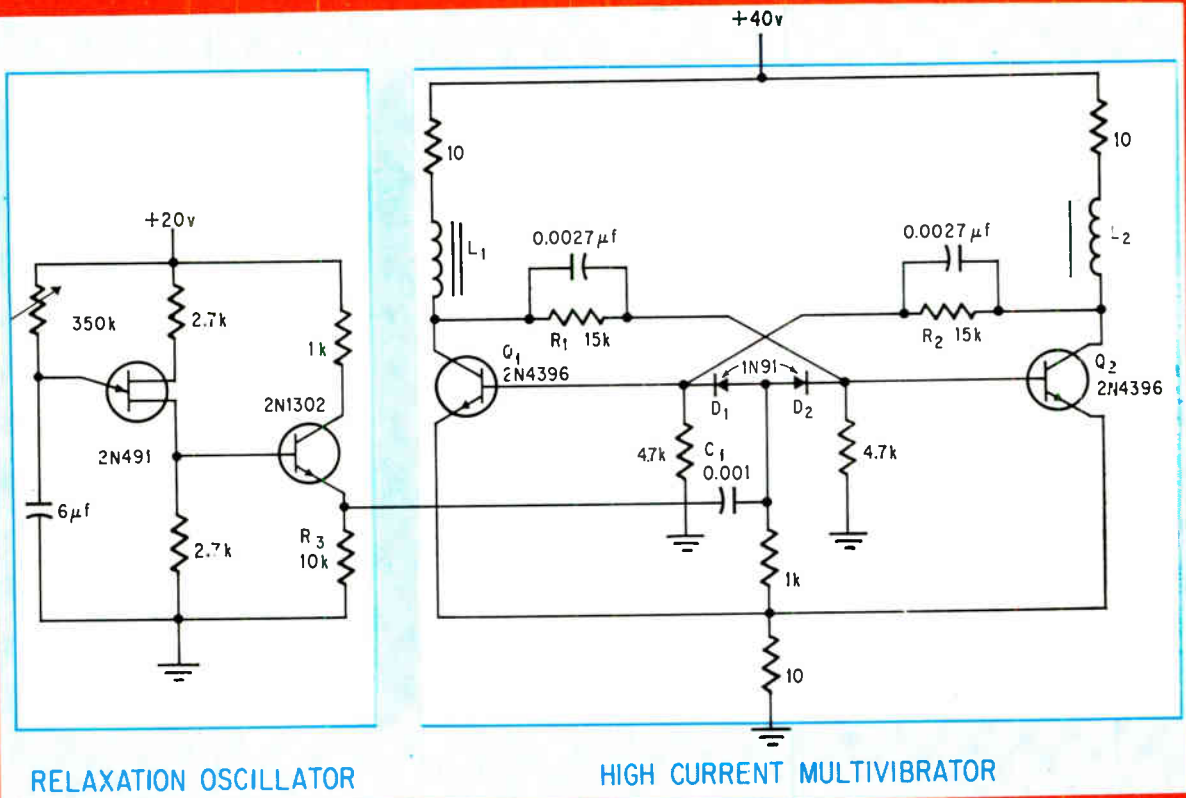

RELAXATION OSCILLATOR

HIGH CURRENT MULTIVIBRATOR

**Sharp thrusts.** Power transistors supplying energizing current to the solenoids have fast turn-on and turn-off times. Changes in the direction of core movement in the solenoid are therefore sharply defined.



sistor. It does, however, cause  $Q_2$  to start conducting, and the magnetic field built up by  $Q_2$ 's collector current starts pulling the core away from  $L_1$ 's magnetic field. Meanwhile, the low collector voltage of  $Q_2$  is coupled through  $R_2$  so that it biases  $Q_1$  into a cutoff state. The collapse of the mag-

netic field in  $L_1$  releases the core, which is pulled toward  $L_2$ .

Although the circuit shown here was designed to operate at 6 hertz, it can, depending on adjustment in the oscillator, be made to move control rods at a rate of 1 hertz.

## Transistor and relay regulate high voltages

By Tom Lamb

Tappan Co., Mansfield, Ohio

**Overcharge** in an electrolytic capacitor, a frequent occurrence in photo-flash power supplies, drastically shortens the capacitor's operating life. It can be avoided by adding a resistor to the supply circuit, but undercharging then becomes a problem at low line voltages. A regulator consisting of a relay and transistor, can be used to keep capacitor voltage at the proper level, however. A pilot light added to the regulator indicates when the capacitor is fully charged.

At the start of circuit operation, the electrolytic capacitor is uncharged, the relay in the primary circuit is not energized, and transformer primary current consequently flows. Voltage induced in the secondary is rectified by  $D_1$  and the electrolytic capacitor starts charging. When the capacitor voltage reaches about 300 volts, enough current flows

through the  $R_1$ ,  $R_2$ , and  $R_3$  divider to develop a forward bias for  $Q_1$ . Collector current through the conducting transistor then energizes the relay coil, opening the primary circuit and causing  $C_1$  to stop charging.

When the capacitor voltage drops to about 290 volts due to discharge through the divider, the voltage across  $R_2$  and the lower portion of  $R_3$  is too low to keep  $Q_1$  in conduction. The transistor moves into cutoff and collector current stops flowing.

The relay is de-energized, the primary circuit is closed, and  $C_1$  again receives charging current until the 300-volt level is re-established.

During the charging and recharging of the electrolytic capacitor, the pilot light across the primary flashes assuring the photographer that the unit is operating properly.

By placing a zener diode between the wiper of  $R_3$  and the base of  $Q_1$ , the difference between turn-on and turn-off voltage on the capacitor can be kept negligible.

The resistor in the primary circuit limits the inductive surges and prevents pitting on the relay contacts.

The 1100 $\mu$ f capacitor, shown as one component, is actually three capacitors in parallel.

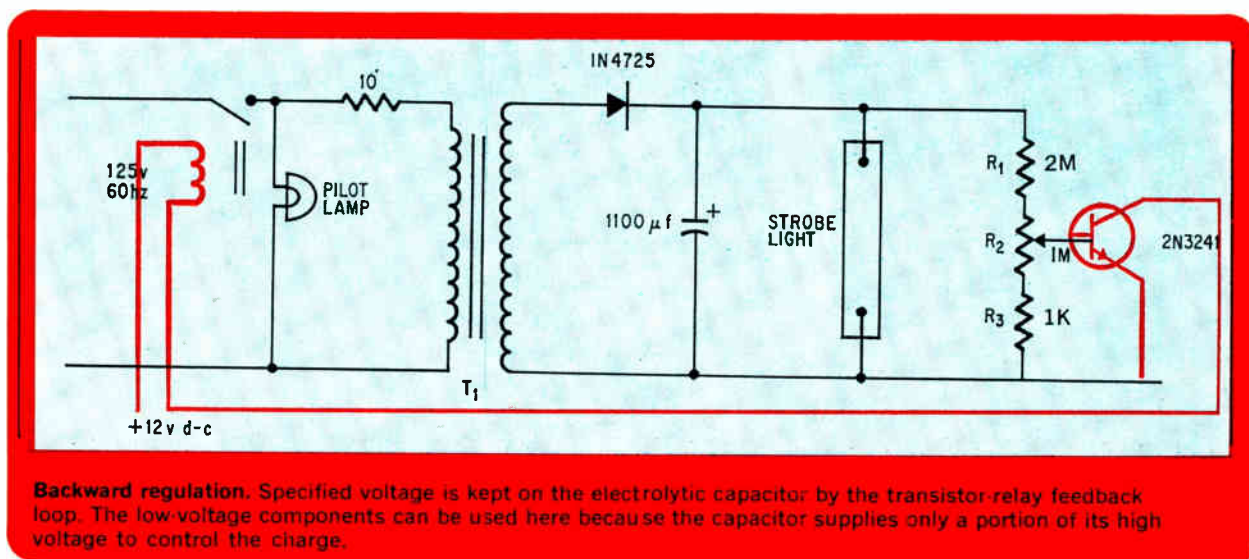

**Backward regulation.** Specified voltage is kept on the electrolytic capacitor by the transistor-relay feedback loop. The low-voltage components can be used here because the capacitor supplies only a portion of its high voltage to control the charge.

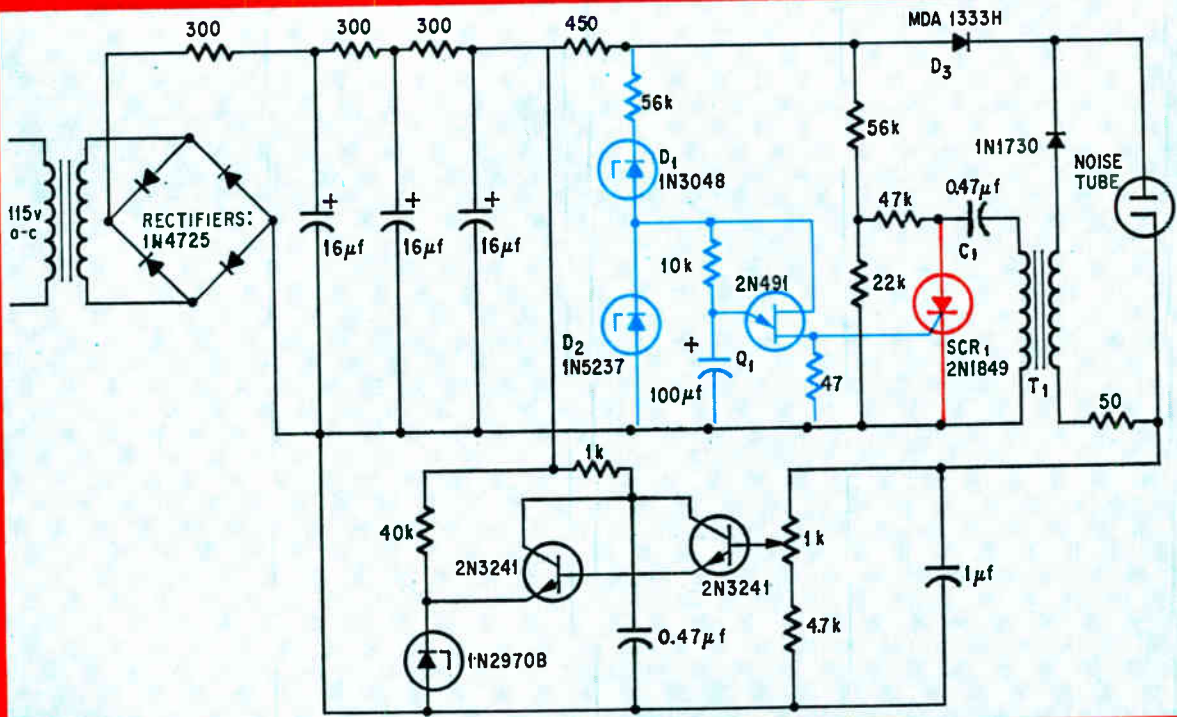

**Double duty.** The unijunction's triggering of SCR, causes a high voltage to develop in the secondary of  $T_1$ . This high voltage fires the gas tube. The filtered d-c voltage at the anode of  $D_3$  keeps the tube in conduction.

## Zeners and SCR fire gas discharge tube

By J.M. Payne

National Radio Astronomy Observatory,  
Green Bank, W. Va.

The gas discharge tubes used to calibrate and measure noise in radiometers must operate from two different voltages. A 7-kilovolt pulse ionizes the gas, and a 300-volt supply delivers high current to keep it ionized. One supply delivers both of these voltages. The high voltage is generated by opening and closing a switch in an inductive circuit—hardly a reliable method. However, a single circuit with a silicon controlled rectifier and a zener diode can generate the high voltage and then automatically switch to low-voltage operation after ionization.

When the circuit is switched on, a 350-volt d-c level is established at the anode of the zener  $D_3$ . Although this voltage is coupled across  $D_3$  onto the plate of the gas tube, it isn't high enough to start tube operation. Because zener diodes  $D_1$  has a reverse breakdown of 150 volts, the 350 volts make it avalanche, and zener current flows.

Current goes through  $D_1$  and starts charging the  $100\mu\text{f}$  capacitor. When the voltage on this capacitor reaches about 4 volts, the unijunction transistor fires. Capacitor  $C_1$ , which has charged to 350 volts through  $R_4$ , now discharges through the gated SCR $_1$  and the primary of  $T_1$ . The 7-kilovolt pulse, induced in the secondary of  $T_1$  by the primary's current surge, reduces the resistance of the gas by ionizing it. Now that a low resistance is present current flows through  $D_3$ . Because of the loading, the voltage at the anode of the zener  $D_3$  drops to about 80 volts. The zener diode is taken out of reverse conduction,  $C_1$  receives no charging current, and  $Q_1$  and SCR $_1$  become inoperative.

The noise output of the tube does depend slightly on current, so a shunt regulator consisting of  $Q_2$  and  $Q_3$  was added. The current may be set to values from 150 to 200 milliamperes by adjusting the 1-kilohm potentiometer in the regulator.

Probably any pulse transformer designed for triggering small spark gaps would be suitable for  $T_1$  operation. In the circuit shown, however, a pulse transformer type TR132 manufactured by EG&G Inc. was used, with success.

For the sake of clarity the rectifier  $D_3$  is given the designation MD1333H—an expensive pre-potted 1kv stack. It is possible when necessary to connect seven 1N4725s in series to perform the same function.

# Computer-oriented system speeds testing of circuits and components

Hardware specifically designed for machine control eliminates the need for an oscilloscope, making the test setup 1,000 times faster and far simpler to program and operate

By Thomas R. Blakeslee

Scientific Data Systems Inc., Santa Monica, Calif.

**The great advantage** of a computer is speed, but much of this speed goes to waste when the machine is used to control a rig that tests circuits or components. Even the smallest modern computer spends much of its time waiting, because the equipment it's controlling is designed to be monitored by human beings, who can't react in nanoseconds.

With a sampling oscilloscope, for example, the test is essentially completed in one or two samples. But because the scope is built to be monitored by a person, 2,000 samples are taken to draw a picture that he need not see. The wasted time of 1,998 extra samples can be eliminated by taking the human being out of the system and letting the computer do all the work, not just some of it.

By doing just this, and by reducing the output and decision-making hardware to the barest minimum, a new test system can work 1,000 times faster than conventional methods. The output test circuit makes a voltage comparison at a specified instant and leaves the rest up to the computer. The computer specifies the reference and required circuit voltages and how long to wait after the start of the test before making a comparison. In effect, the computer asks, "Is the output signal greater than voltage  $V$  at time  $T$ ?" and receives a yes or no answer.

By asking the question in various ways, the computer can verify any specification of the output signal. For example, the propagation time through a circuit is ordinarily measured as the interval between the two instants at which the input and output signals are half their nominal values. To check this parameter, the computer specifies half the nominal output voltage and the maximum allowable propagation time. For a rising output, a "no" reply thus means the module being tested is too slow;

for a falling output, a slow module would be indicated by a "yes" reply, because the test is keyed to the output voltage being greater than a reference voltage.

## Simplicity itself

A typical d-c measurement would be the saturation voltage of a transistor. The maximum allowable  $V_{sat}$  would be specified and the time would be any interval longer than the propagation time. A "yes" answer to this test would mean the module is bad, since  $V_{sat}$  should be less than the reference. Specific voltages or times can be measured by simply repeating the question over and over, obtaining the desired accuracy through successive approximations.

By contrast, the conventional automatic test system typically includes a programmable pulse and level generator, a digital-readout oscilloscope, and interface circuits between the computer and the test rig. The readout oscilloscope is an ordinary sampling scope with added circuitry to measure and record the maximum and minimum signal values and to measure the time between the input signal and points on the output signal that are 10%, 50%, or 90% of full value—the levels ordinarily used in measuring transition and propagation times. The system displays the resulting measurements on the oscilloscope and compares them to programmed minimum and maximum values.

The sampling scope may seem fast to the operator, but it's much slower than a computer. The scope circuitry strobos a fast repetitive signal, measures its amplitude at the time of the strobe, and displays this measurement as a bright dot on the scope screen. On successive sweeps, the strobe



pulse is delayed by successive increments, so that the signal's waveshape appears on the screen as a series of dots. Typically, 100 samples are taken for each centimeter of width in the scope's display area, or 1,000 samples for the entire display—1,000 sweeps to generate a single display.

During a manually controlled test, these 1,000 sweeps take only a fraction of a second, after which, as they are repeated, the operator can take the necessary measurements from the scope face. But when the sampling scope is part of a computer-controlled test, only the minimum and maximum values can be obtained from the 1,000 sweeps; another 1,000 must be made to take an actual measurement. During all this time, the computer is idling.

### Other advantages

In the new system, using equipment designed for automatic operation not only reduces the test time but also makes programing much simpler. What's more, the entire output test circuit, shown at right, fits on one printed-circuit card about four inches square. Still another advantage over the conventional methods is that additional equipment isn't needed for d-c tests.

In the output test circuit, as diagramed below, the signal being tested is compared with a computer-specified reference voltage from  $-4$  to  $+8$  volts. The computer loads a seven-bit register with a number corresponding to this voltage; this register drives a digital-to-analog converter connected to the signal comparator. If the output of the comparator is positive when the strobe pulse comes, the reply flip-flop is set, giving a "yes" reply to the computer interrogation.

The strobe pulse rises when a voltage ramp reaches the voltage from another d-a converter set by the computer and makes the output of the time comparator go positive. This signal is connected to a short-circuited delay line; the reflection from the short circuit creates a pulse at the comparator output whose width is twice the length of the delay line.

When the ramp control flip-flop turns on, the voltage ramp begins, generating a 4-nanosecond

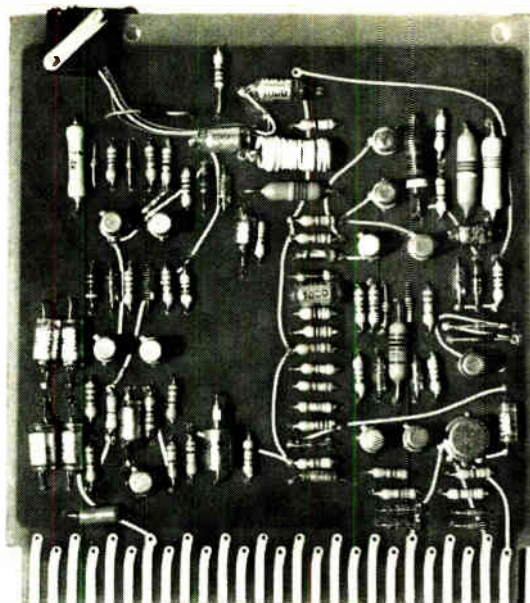

**Small but mighty.** This simple printed-circuit card replaces an expensive sampling oscilloscope.

strobe pulse as late as 127 nanoseconds after the start of the test. The seven bits give a 1-nanosecond resolution for the test interval. Test intervals of up to 32 microseconds are produced by an 8-megahertz crystal oscillator and an eight-stage counter that turn on the ramp control flip-flop at the end of the countdown.

All output test times are referred to an instantaneous input transition. The input pattern generators use the same basic ramp-variable delay circuit to produce programmable transition times of 0 to 127 nanoseconds on three-bit patterns specified by the computer.

### Fast comparator circuit

All the input signal generator circuits and output test circuits, including the flip-flops, are built around a basic high-speed comparator circuit, shown at the bottom of page 74—an improvement on the standard current-mode logic circuit.

Resistor R and the negative voltage are a source that drives current through either transistor Q<sub>1</sub> or

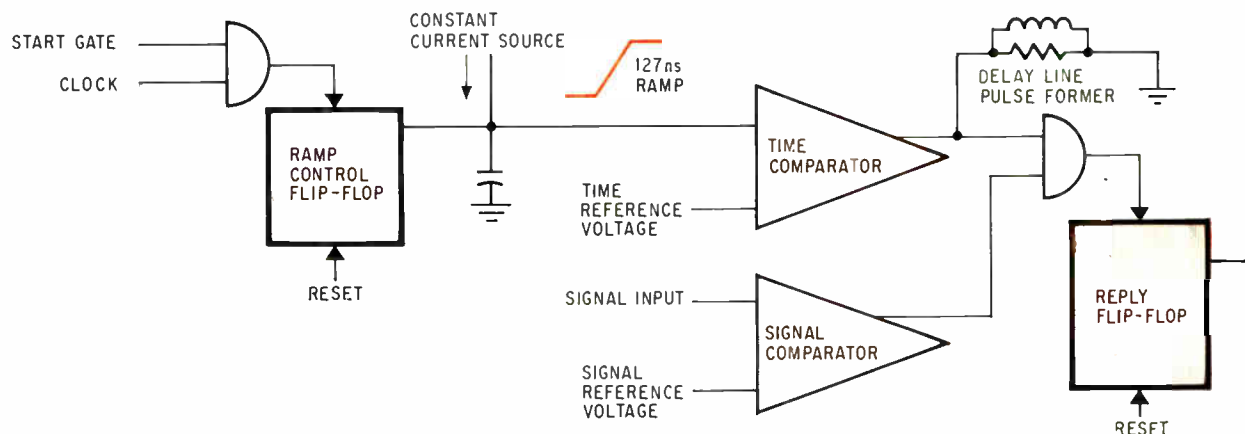

**Output test circuit.** Variable delay circuit produces a narrow strobe pulse 4 nanoseconds wide. The strobe sets the reply flip-flop if the signal is higher than the comparison voltage at the specified time.

$Q_2$ , whichever has the higher base voltage. Although these transistors don't saturate, they would cut off, reducing the operating speed, if resistors  $R_4$  and  $R_5$  weren't in the circuit; these "keep-alive" resistors prevent cutoff in the transistors. The current from  $R_1$  goes through either transistor, but the currents from  $R_4$  and  $R_5$  are kept from going to the opposite transistor by the two diodes. The minimum and maximum currents through the transistors are chosen from the constant gain-bandwidth product contours on the transistor manufacturer's data sheet so the transistor is always in a region of high gain-bandwidth product.

The "keep-alive" resistors' effect on the comparator circuit can be further illustrated by a transistor load line superimposed on a set of gain-bandwidth curves, shown on page 76. The curves show how quickly a transistor can change its operating point along the load line; each curve corresponds to the maximum frequency at which the transistor's gain is 1. For a voltage-step input at the base, the collector voltage follows a curve shaped like a flattened S; the steepest part of the curve corresponds to the highest frequency crossed by the load line.

In the simplest circuits, the transistor is either cut off or saturated; these conditions are represented by points on the load line near the intercepts. In conventional current-mode circuits, a source supplies enough current to turn on the transistor but not enough to saturate it; this pulls up the lower operating points on the load line to a higher frequency and further flattens the lower part of the S-shaped curve. In the new comparator circuit, the "keep-alive" resistors have the same effect on the upper operating point and the upper part of the S-shaped curve.

Since stored charges prevent the diodes from turning off immediately, both diodes conduct for a short time when the current switches from one side to the other. This improves the switching time of the circuit by causing an overdrive during this interval, sending all three currents through the tran-

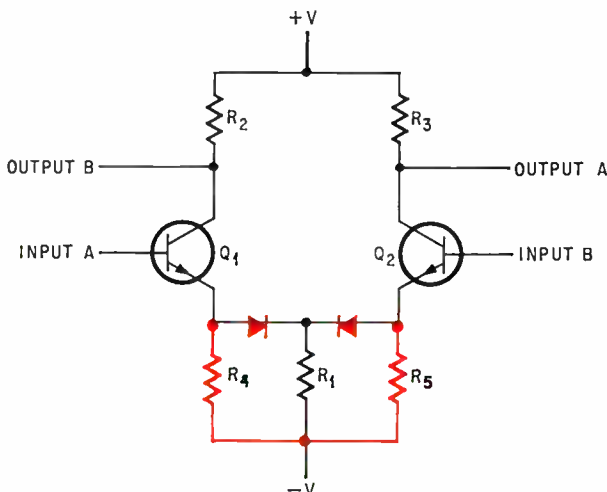

**Comparator.** Two extra resistors and two diodes (color) reduce turn-on delay of current-mode circuit.

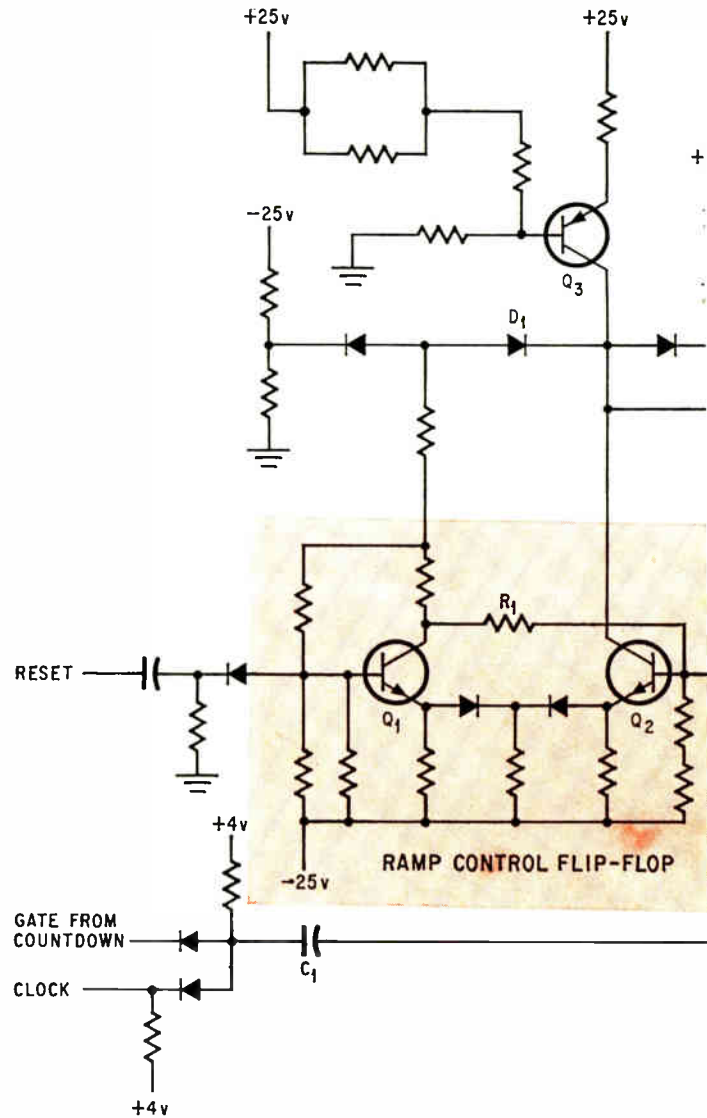

**All on one card.** In this output test circuit, the basic comparator turns on a linear ramp time function,

sistor that's just coming on. After the diode storage time elapses, the small keep-alive current returns to the "off" transistor.

In the tester, one comparator output is connected to the opposite input through a resistor to make the circuit a flip-flop.

### Details of operation

In the schematic diagram shown above, the voltage ramp is started when the flip-flop formed by  $Q_1$  and  $Q_2$ , with feedback through  $R_1$ , is set by the clocked output of the delay countdown circuit, pulling the base of  $Q_2$  negative through  $C_1$ . Before the flip-flop turns on, the constant current from  $Q_3$  flows into  $Q_2$  and the voltage on  $C_2$  is clamped to  $-0.5$  volt by diode  $D_1$ . When the flip-flop turns on, only a small current can pass through  $Q_2$ ; the remainder from the current source starts charging  $C_2$  linearly.

When the ramp voltage just exceeds the d-a converter voltage, which is between 0 and 5 volts, the

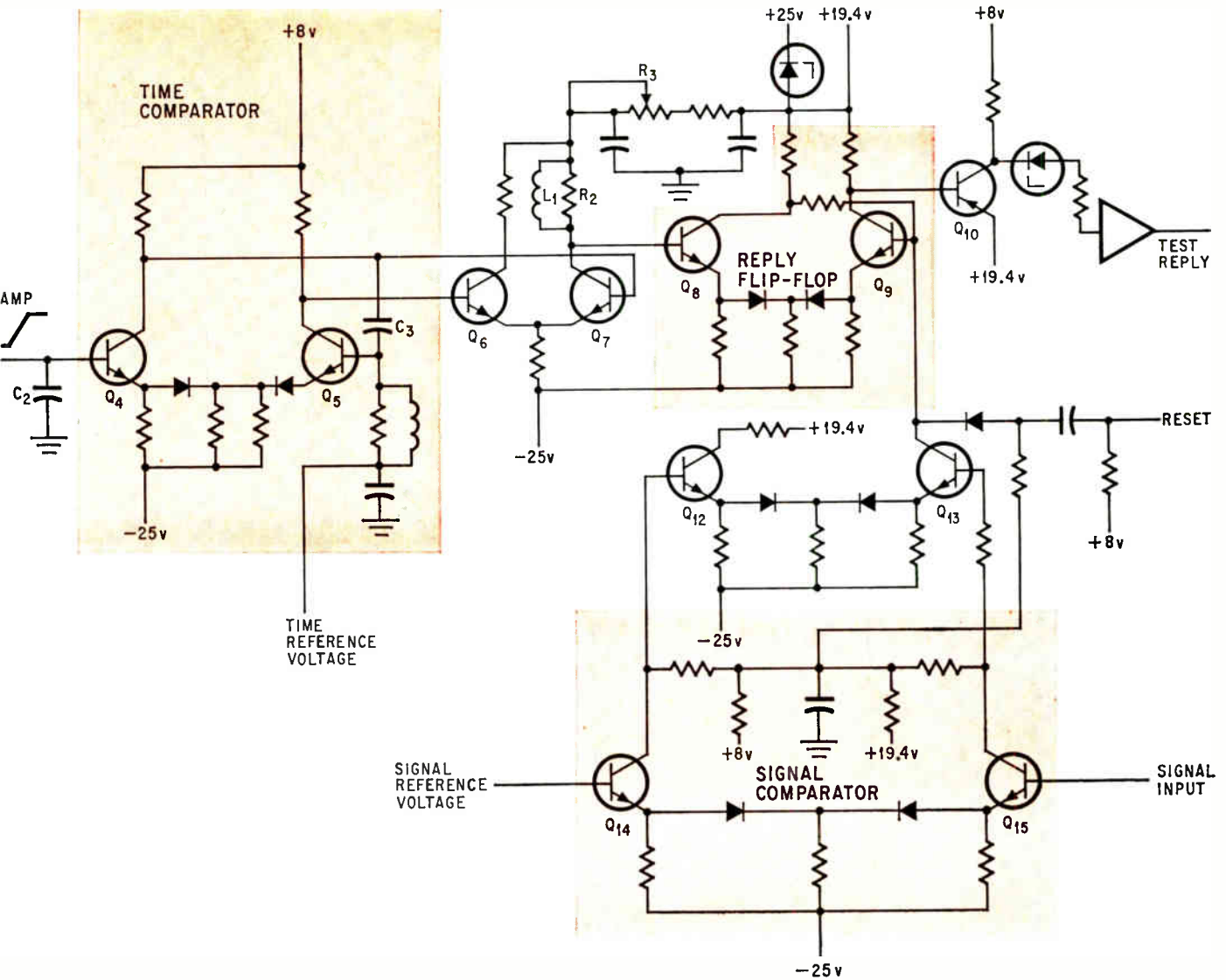

generates a strobe at the end of a specified time, compares a signal with a reference voltage, and

remembers whether the result was high or low. Tinted areas correspond to blocks in the diagram on page 73.

comparator switches. As it does,  $C_3$  provides positive feedback to speed the transition, and  $Q_6$  and  $Q_7$  amplify it. As  $Q_7$  stops conducting, its collector voltage increases; this signal travels through  $L_1$ , which consists of 18 turns of fine wire wound around  $R_2$  and acts as a 2-nanosecond delay line. At the end, it finds a-c ground and is reflected. Back at  $Q_7$ , the signal returns the voltage to its original value, giving a 4-nanosecond pulse. The pulse is triangular; its effective width as a strobe can be adjusted by shifting its baseline with potentiometer  $R_3$  to obtain the same calibration with both rising and falling signals.

The output signal of the module under test is compared with the test voltage from the d-a converter by transistors  $Q_{14}$  and  $Q_{15}$ . Then  $Q_{12}$  and  $Q_{13}$  amplify the comparison and present the result to the base of  $Q_8$ , which, with  $Q_9$ , is a comparator connected as a flip-flop. The strobe pulse is applied to the base of  $Q_8$  at the proper time. If the output voltage is higher than the output test d-a voltage,

the strobe pulse makes the base of  $Q_8$  higher than that of  $Q_9$ , setting the flip-flop.

Because the ramp starts at  $-0.5$  volt, and 0 nanosecond corresponds to a 0-volt d-a converter input, the first 15 nanoseconds of the ramp, which may be nonlinear, aren't used. Since all input timing is produced by similar circuitry, the delays cancel one another.

### Obtaining accuracy

Trimming potentiometers on the d-a converters shift their output levels to offset all circuit variations. A calibration program automatically makes connections to a special calibration board and tells the operator what to adjust. This permits the test equipment to be completely calibrated in about 30 seconds. The voltage test accuracy is within  $\pm 10$  millivolts of the voltage measured. Over the whole 12-volt range of the system, time accuracy is  $\pm 2$  nanoseconds.

This time accuracy is better than the one that



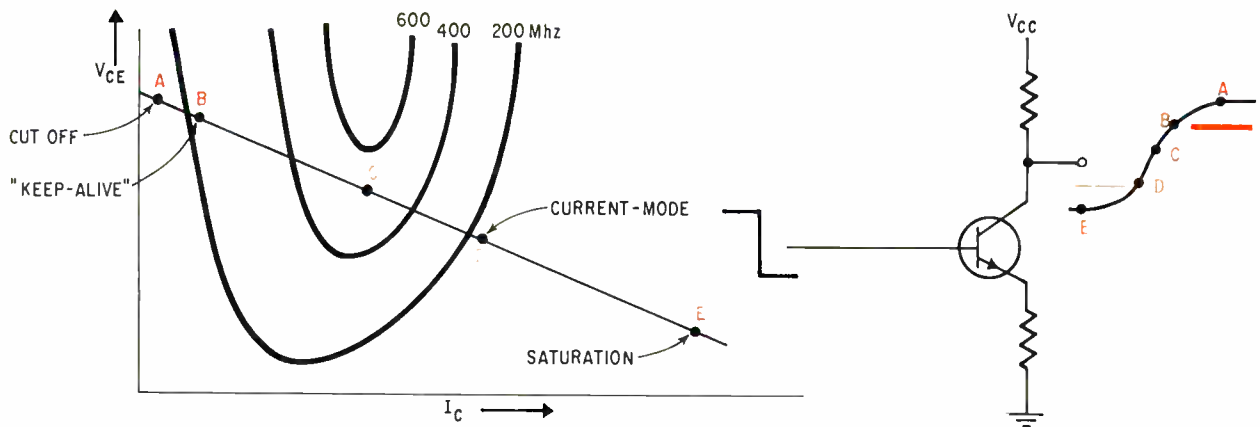

Gain-bandwidth contours. "Keep-alive" resistors hold transistors between points B and D on load line, speeding comparator circuit operation. Corresponding points are labeled on output curve at right; color shows restricted operating range.

would have been established by the 3-nanosecond rise time of wiring in the tester. The time accuracy of the test circuit could be improved into the picosecond range by using a sample-and-hold circuit ahead of the voltage comparator. An ordinary integrated-circuit logic flip-flop strobed after the sample time would then be adequate as a reply flip-flop.

### Using the system

This technique is used to test T Series circuit modules at Scientific Data Systems, Inc. The automatic tester, shown below, uses an SDS 910 computer with a magnetic tape unit that stores the test programs for more than 300 types of digital and analog modules. New programs are loaded in a few seconds by simply typing the module's type number on the keyboard. More than 500 tests are performed on a typical logic module in about three seconds. If the module fails, a high-speed strip printer produces an error message. The message, attached to the module when it's sent for reworking, identifies the component to be replaced or the location of any short circuits on the board.

The test programs also find and identify such

faults as open or shorted AND or OR diodes, incorrect resistor values, high saturation voltage, and overlong delays. All tests are made at worst-case power margins, input clock width, and skew.

All the troubleshooting has been written into subroutines that are called by simple programming statements using the standard SDS Meta-Symbol program. Programming of all input-gating tests on inverters and buffers requires only one statement followed by a table of input pins, diode numbers, and similar identifications. Special test-language statements facilitate writing programs for other types of modules. For example, to connect the output test circuit to pin 46, a line of the program would say, "OUTTO 46." To test whether the output is more than 300 millivolts at 30 nanoseconds, the programmer simply writes "OUTTEST 300, 30."

All error messages are punched on paper tape as well as printed. These tapes are periodically used off-line to generate a tabulation of failures and to help identify design or production problems.

At the start of the day, and after every 200th module test, a self-test program automatically checks the entire system for proper operation and calibration in about 10 seconds, using a calibration module in the test socket.

### Other applications

The test technique can be used for many other applications. Because circuit modules are largely just collections of IC's, an IC test system could be built on the same principles. Transistor testing would be even simpler, requiring only one input generator instead of three as in the SDS tester. Different collector-load and base resistors could be installed on a plug-in board for each transistor type.

Nor is the technique limited to computer-controlled testing. A very simple go/no-go transistor switching-time tester could be built with times and voltages specified by programming resistors on a plug-board. Since only one transition per measurement would be required, a mercury relay could generate fast rise and fall input steps without making the test time excessive.

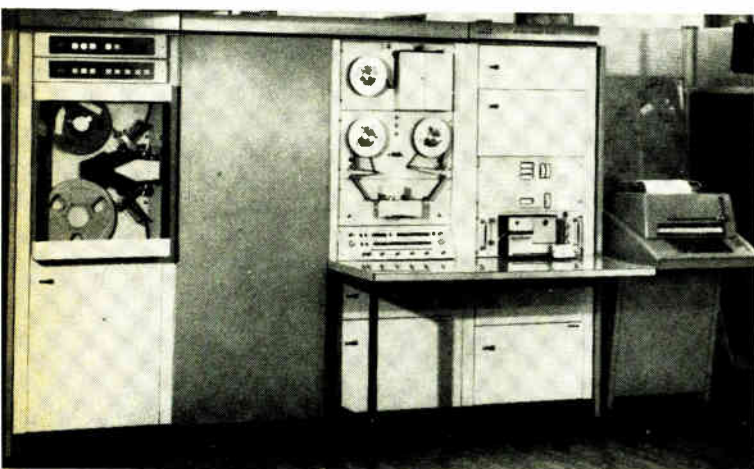

Automatic tester. Test programs are on tape; SDS 910 computer runs 500 tests in three seconds and prints results on strip of paper sent with module for rework.

**NEW**

# high-brightness NIXIE® tubes. designed for tomorrow, delivered today.

## TYPE B-5750

**LOW COST:**  
\$3.95 each in 1000 quantities.

**HIGH BRIGHTNESS:**  
time sharing up to 12 digits,  
or for DC operation.

**TUBE SIZE:**  
0.53" diameter; 1.5" height.



## TYPE B-5855

**LOW COST:**  
\$4.35 each in 1000 quantities.

**ULTRA-HIGH BRIGHTNESS:**  
time sharing more than 12  
digits, or for DC operation.

**MINI TUBE SIZE:**  
1.51" diameter; 1.35" height.



TUBES SHOWN ACTUAL SIZE

### TIME-SHARING OPERATION:

like numerals can be driven in parallel,  
reducing driver costs, and without sacrifice  
of brightness.

**IC-COMPATIBLE PIN CONFIGURATION:**  
dual-inline layout designed for IC de-  
coder/drivers.

**OPTIONAL PIN CONFIGURATION:**  
conventional plug-in type for socket  
mounting, or flying leads for direct  
soldering.

**COMB PIN SPACER/LEAD STRAIGHTENER:**  
simplifies PC-board and/or socket in-  
sertion.

**DECIMAL POINTS:**  
positioned left and right, independently  
operable.

**CHARACTER HEIGHT: 0.5"**

**MINI-SIZE, LOW-COST SOCKETS:**  
for DC or time-sharing operation.

**ULTRA-RELIABLE:**  
like all ultra-long-life NIXIE tubes.

**LONGEST STATIC LIFE:**  
for demanding applications.

**SPECIAL-CHARACTER TUBES:**  
— / — tubes available from stock. Alpha/  
special-character tubes made to order.

**MOST COMPLETE HARDWARE BACK-UP:**  
low-cost IC decoder/drivers available  
off-shelf. Custom assemblies at pro-  
duction costs through modular design.

**MOST COMPLETE APPLICATIONS BACK-UP:**  
design and applications assistance of  
the kind available only from Burroughs,  
the originator of NIXIE tubes. For a  
demonstration, application notes and  
full information call or write  
Burroughs Corporation,  
Electronic Components Division,  
Dept. N-17, P.O. Box 1226,  
Plainfield, New Jersey 07061  
TEL: (201) 757-5000.

**Burroughs B**

# Doppler navigation system is redesigned from a to d

Replacing an analog computer with a general-purpose digital machine that fits the same space improves performance and allows a greater number of functions to be handled

By Richard C. Warner

Kearfott Products Division, General Precision Systems Inc., Little Falls, N.J.

**Replacing analog machines** with their digital counterparts is now the principal means of upgrading avionics systems in military aircraft.

A prime example of this trend is the Micro-Minac digital doppler navigation computer developed by the Kearfott Products division of General Precision Systems Inc. The system has been designed as a pin-for-pin replacement for the completely analog Minac 5 (AN/ASN-41) navigation computer, a machine that's been flying for more than five years in such aircraft as the Navy's A-7A Corsair and the Air Force's A-4E Skyhawk.

The Micro-Minac, under the military designation of AN/ASN-41B, has been tested at the Naval air station in Johnsville, Pa., and could be used on several strike aircraft.

The solid state machine comes, like its predecessor, in two parts—a control-display unit and a general-purpose computer. It is, however, much more than simply a digital version of an analog machine. The Micro-Minac performs more operations than the analog unit and is easier for a pilot to work. Further, it handles its tasks with a higher degree of accuracy and with a mean time between failures that may approach the duty tour of the aircraft.

## Taking the hurdles

Of the many problems involved in developing the new system, the major one was posed by the fact that the digital machine had to fit exactly into the slot now allotted to its predecessor. The analog unit is to be pulled out and the new digital machine plugged in and turned on. The Micro-Minac must therefore have the same shape and be mounted in the same way as the Minac 5, and must interface

with existing analog transducers in the aircraft.

It's like putting a 100-watt light bulb in a socket formerly occupied by a 60-watt bulb—except that there's no problem when you're working with light bulbs. Besides building in this interchangeability, though, engineers had to design:

- A compact and efficient power supply that would fit into the computer box. Raw power to the unit—the same as that available to the analog machine—is only 1.5 amperes, nominal, at 115 volts and 400 hertz single phase.
- Highly accurate, solid state synchro-to-digital and digital-to-synchro converters.
- A new control-display console in which the synchro-driven engraved wheels of the analog Minac 5 are replaced by segmented displays lighted by incandescent lamps.
- A telephone touch-tone keyboard layout to replace the input slew controls of the display console. The keyboard speeds the input of information and the interrogation of the computer.

## Close quarters

All the digital machine's logic, memory, and converter circuits fit into the box that housed the analog components of the AN/ASN-41. The fit is, however, a tight one. Among the features the Micro-Minac adds to the system are:

- The ability to take the entered latitude and longitude coordinates of as many as eight destinations or intermediate points, and to automatically guide the aircraft to each of them in turn. The Minac 5 can handle only two points at a time.
- A tactical feature that allows the pilot to mark, with the press of a button, his position coordinates



when he sees an unexpected target such as a camouflaged truck or a suspicious wisp of smoke. Later in the flight, the digital computer will automatically guide the plane back to that target site.

- Automatic display of present position coordinates on the console, again at the touch of a button, and the ability to update positions stored in the computer with visual sighting of landmarks.

The Micro-Minac also has a self-test operating mode in which more than 95% of its components are checked automatically. If specific test data doesn't appear in the readouts when the machine is in this mode, the system isn't working properly.

It would have been impossible to put all these extra functions into the analog machine and still expect it to fit into the space available in the aircraft; the size of an analog computer is proportional to the number of functions it performs.

On the other hand, a digital computer's power supply and arithmetic, timing, and control circuitry don't have to be expanded to handle extra operations. The number of functions can be increased tremendously at the expense of only a minor increase in the size of the memory. More buffer circuits are needed only when more inputs are involved in the additional functions. If the length of the Micro-Minac computer box were increased by only  $\frac{5}{8}$  inch, for example, and two cards identical to the memory cards were added, the computational ability would be more than tripled.

### No comparison

To understand the problem of interchange-

ability, consider a block diagram, top of page 80, of the analog AN/ASN-41 navigation system. The aircraft's motion is detected by various sensors and fed into the analog computer. The loop is closed in this system by the pilot, who maneuvers his plane according to the bearing, distance, and heading indicator (BDHI). Inputs are all of the synchro type; outputs are all of the torque follower type.

Functionally, the analog system is broken up into separate modules, each of which perform specific portions of the navigation computations. Thus, there is a wind speed and direction module, the latitude and longitude modules, and a course angle and distance module.

Inputs to these modules can be conducted unbuffered into compatible rotating devices; outputs compatible with the BDHI are derived directly from the analog components in the course angle and distance module.

The functional block diagram of the Micro-Minac computer, bottom, page 80, indicates the tremendous difference between the digital and analog machines. No longer are there separate modules to handle distinct navigation equations. Most of the machine is now taken up with modules that perform analog-to-digital and digital-to-analog conversions, plus interface functions. Calculations are handled in the timing and control, arithmetic, and memory sections.

The digital computer is a 20-bit-per-word serial processor with a 1-megahertz clock and a wired-program, lithium-ferrite core memory.

Five 5-by-7-inch printed-circuit cards contain the

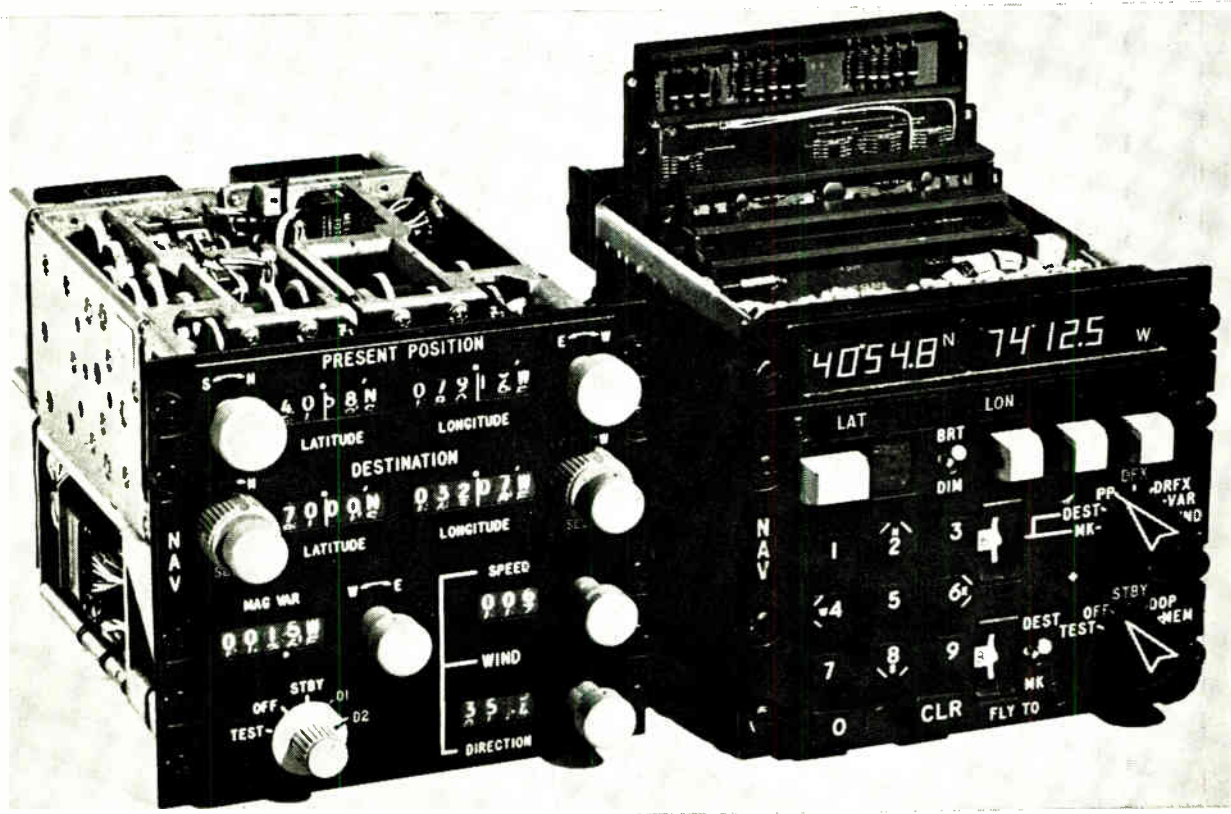

One for one. Control-display unit, right, is designed with digital techniques for doppler navigation system; it has a telephone-type keyboard and numerical readouts. It can be plugged into the place of the older analog unit.

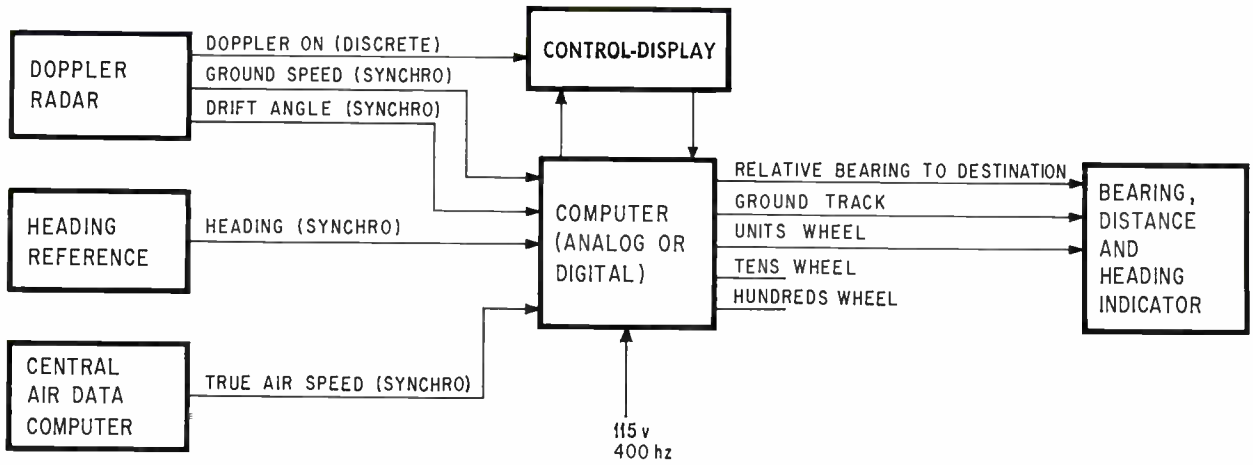

Line replacement. Doppler navigation system functions with either analog or digital computer control-display.

digital functions of the computer. Converter control and memory electronics are on three additional cards. The converters are on 13 cards, the ferrite-core memory on two. Each side of the card is made of x and y interconnection layers with feedthrough, and there's an aluminum frame in the center that acts as a combination heat sink and ground plane. The sides of the cards each carry from 45 to 50 integrated circuit flatpacks.

The digital sections of the computer actually account for only 14% of the total volume of the computer box. Most of the space—some 68%—is assigned to converter circuitry; the power supply takes up 15% and the input-output buffer cards the remaining 3%.

The problem of packaging all this circuitry in the Minac 5 box was solved, in part, by rearranging the circuit cards so that components nest with each other. Also, a blower incorporated into the initial design was eliminated in favor of additional heat-sinking on the cards.

The 10,240 bits in the memory stack are byte-oriented, with commands consisting of 1 to 4 five-bit

bytes. This arrangement leads to an extremely high-density utilization—98.4% in Micro-Minac—of the core locations. Generally, 80% is considered crowded. Cycle time is 2 microseconds.

The program is wired in to prevent memory loss, and it's rewritten each time the computer is entered. However, the computer can work with both nondestructive and destructive readout stacks.

### Complications

The power supply for the analog machine is a pretty simple affair. Most of the power is transformer-derived a-c, unregulated and unfiltered. In the digital unit shown on the next page, however, nine separate d-c supplies with a total nominal output of 175 watts must be carefully regulated against line and load variations. There are also three a-c outputs, one of which is regulated by a silicon controlled rectifier to adjust lamp brightness in the control-display unit. Over-all efficiency of the new 60-cubic-inch power supply is greater than 70%.

The supply operates continuously between 56

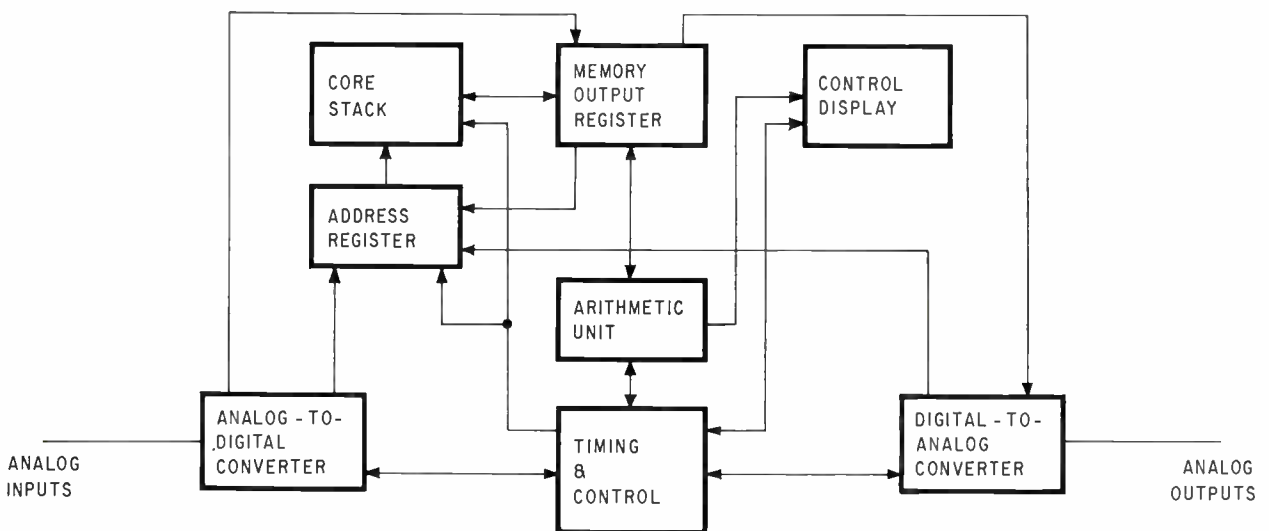

Analog in and out. Converters on input and output of the Micro-Minac digital computer make it compatible with the analog system already aboard the aircraft.

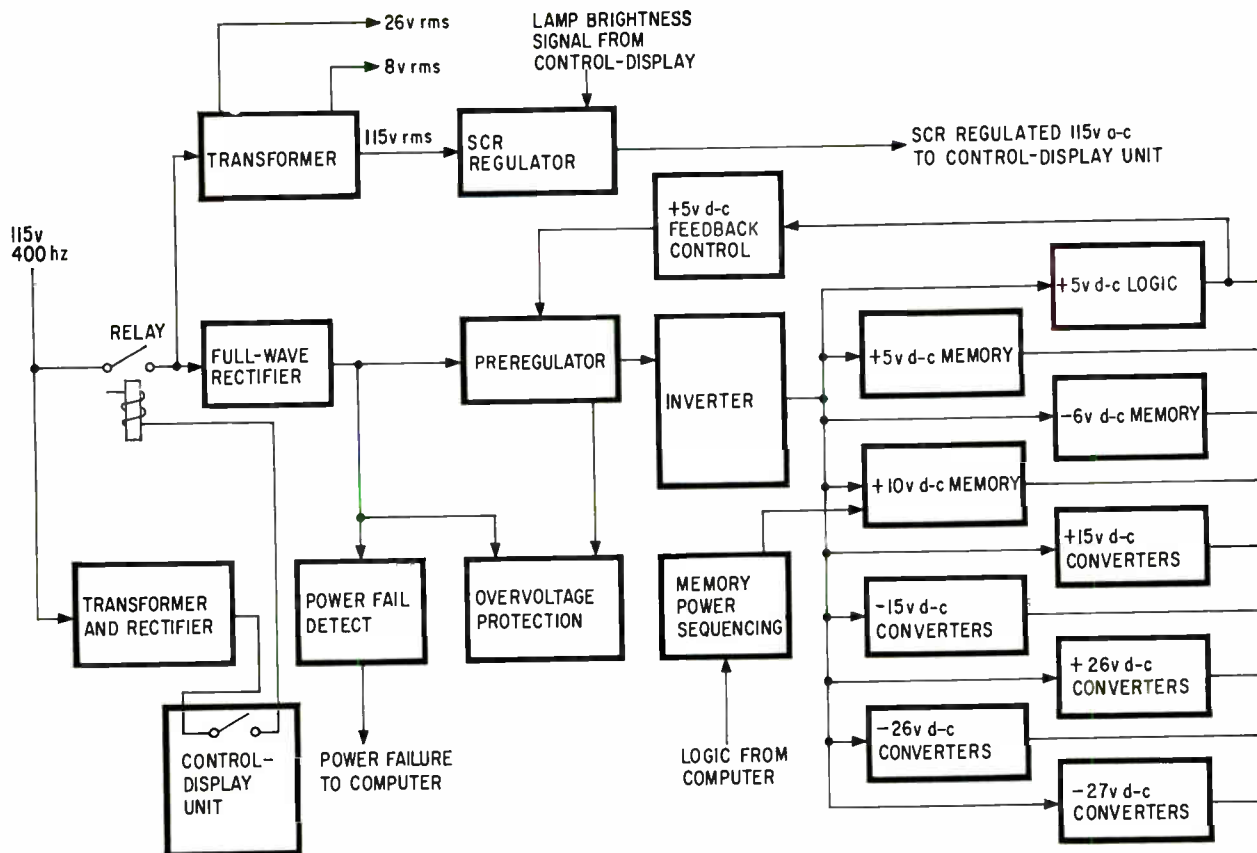

**Computer power.** Voltages supplied to the digital computer must be carefully controlled and regulated. Preregulation is used on line supplying 5-volt logic level because it's more efficient than using pass regulators only.

and 190 volts rms and between 380 and 420 hertz, far exceeding the requirements specified by limits 2 and 3 of Mil-Std-704. If input power falls below 56 volts, the supply notifies the computer of an incipient power failure and both units shut down. When input power returns to 85 volts, the computer and supply turn on again. Loss in accuracy—the equivalent of degraded performance—is determined by the distance the aircraft flies while the computer is off.

Except for the line supplying the 5-volt logic level, all the d-c supplies use relatively lossy pass regulators. A more efficient preregulating technique is used on the 5-volt logic supply because it supplies some 37% of the power. Feedback from the output controls a preregulator that adjusts the voltage applied to the inverter regulating the 5-volt line.

Keeping ripple down was difficult because the digital unit has to use the single-phase power available to the analog unit it's designed to replace. The job requires relatively large input capacitors—about 40 microfarads and able to withstand 300 volts peak. Smaller capacitors could be used if three-phase power were available.

Unlike the Minac 5, which conducts inputs directly to its functional modules, the Micro-Minac uses a four-channel field effect transistor multiplexer and converts all inputs through the same equipment. A linear charge-gated analog-to-digital converter samples the input field about 12 cycles per

second, a fast enough rate in an environment with slew rates of change. Conversion time is 20 milliseconds, and accuracy ( $3\sigma$ ) is to  $\pm 6$  minutes of arc.

The digitized values are stored directly in the core memory via an indirect method that doesn't cost the computer either time or programing.

On the output side, the d-a converter, with five synchro and two discrete flag channels, uses a linear pulsewidth and a nonlinear ladder technique. Output accuracy ( $3\sigma$ ) is  $\pm 0.5^\circ$  for three channels and  $\pm 3^\circ$  for the other two.

A multiplexing scheme is also used for the outputs to the bearing, distance, and heading indicator. Analog levels are individually synthesized by the computer for each stator lead. The sequential conversion rate, which is interleaved with the 20 msec periods required for input conversion, is high enough to assure that the analog levels won't deteriorate too much between updating.

### Wheeling and stepping

The converted outputs to the BDHI presented a special problem. In moving from 800 to 799 nautical miles, say, in the Minac 5, the analog-driven distance-to-go wheels tumble together—as in an auto odometer—keeping readings free of any ambiguity.

With the digital machine, it was originally decided to drive the tens and hundreds decades incrementally in steps of one full digit at a time, and to drive the "units" wheel continuously. As a result,



when distance decreased from 800 nautical miles to just a hair under that, say 799.99, the tens and hundreds wheels flipped from 80 to 79 while the units wheel hardly budged. The effect was an apparent 10-mile readout error. When the distance decreased to 799.5 miles the ambiguity was resolved.

While a 10-mile error at a distance of 800 miles isn't necessarily catastrophic, the same error at a distance of 10 miles could be. The problem has been solved by driving the Micro-Minac units wheel in half-mile increments.

The control-display console of the Micro-Minac

## Calculated course

The digital and analog versions of the doppler navigation system determine latitude and longitude, and wind speed and direction by solving the same basic equations.

Present position:

$$\dot{\lambda} = \frac{V_N}{r_N} = \frac{V_{GS} \cos(\tau + \delta)}{r_N}$$

$$\dot{\phi} = \frac{V_E}{r_E \cos \lambda} = \frac{V_{GS} \sin(\tau + \delta)}{r_E \cos \lambda}$$

where:

$$r_N = r(1 - e^2)(1 - e^2 \sin^2 \lambda)^{-3/2} = \text{Land radius north}$$

$$r_E = r(1 - e^2 \sin^2 \lambda)^{-1/2} = \text{Land radius east}$$

$V_N$  = velocity north

$V_E$  = velocity east

$\lambda$  = latitude

$\phi$  = longitude

$V_{GS}$  = ground velocity

$\tau$  = true heading

$\delta$  = drift angle

The differential changes in position,  $\lambda$  and  $\phi$ , resulting from each iteration of the computer, are added to the previous position coordinates.

Great circle course and distance:

$$\text{Course angle} = \alpha = \tan^{-1} \left( \frac{y}{x} \right)$$

$$\text{Distance to go} = \sigma = r_N \tan^{-1} \left( \frac{\sqrt{x^2 + y^2}}{z} \right)$$

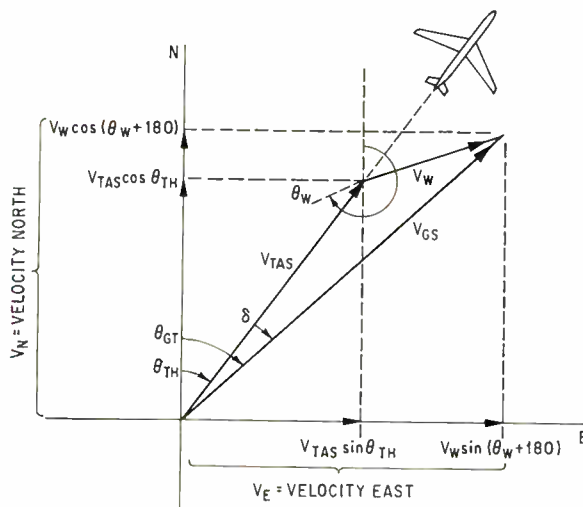

Wind speed and direction

where:

$$x = \cos \lambda \sin \lambda_D - \sin \lambda \cos \lambda_D \cos(\phi_D - \phi)$$

$$y = \cos \lambda_D \sin(\phi_D - \phi)$$

$$z = \sin \lambda \sin \lambda_D + \cos \lambda \cos \lambda_D \cos(\phi_D - \phi)$$

$\lambda_D$  = latitude of destination

$\phi_D$  = longitude of destination

Wind speed and direction (see drawing):

$$V_w = (V_{GS}^2 + V_{TAS}^2 - 2 V_{GS} V_{TAS} \cos \delta)^{1/2}$$

$$\beta_w = \tau + \pi - \sin^{-1} \left( \frac{V_{GS}}{V_w} \sin \delta \right)$$

where:

$V_w$  = wind speed

$\beta_w$  = wind direction

$V_{TAS}$  = true air speed

A significant part of the solution to these equations is concerned with either trigonometric or anti-trigonometric functions. Most digital computers solve these equations by evaluating an infinite series for the function or an approximation of the function. A subroutine can be written if the particular calculation is to be performed more than once. The trouble with this is that a series in the form

$$y = k_1x + k_2x^3 + k_3x^5 + k_4x^7$$

for example, requires no less than five multiply operations, which take a long time in a serial machine (time varies with the square of the number of bits in the word). If performed using trigonometric expansions, one iteration of the Micro-Minac program would demand about 25 such operations. At eight iterations per second, more than 14% of available computer time is taken up with this type of function. This includes 440 microseconds per multiply and 100 microseconds more for other arithmetic operations, plus up to 60 trigonometric operations per second for the processing of inputs and outputs through the converters.

This severe loading of the computer was reduced materially by giving the arithmetic unit the ability to perform operations in the Cordic algorithm.<sup>1</sup> The timing gates of the original Cordic arithmetic unit were replaced by secondary shift registers. This enabled the secondary registers to be used for time-keeping as well as for the execution of the Cordic algorithm. The presence of a real-time clock permitted a variable-length program to be used for the time-dependent navigation problem. And the use of the Cordic algorithm cut the loading time for trigonometric operations to about 3% of available machine time.

## Reference

1. J.E. Volder, "The Cordic Trigonometric Computing Technique," IRE Transactions on Digital Computers, September 1959, p. 330, and D.H. Dagggett, "Decimal-Binary Conversions in Cordic," *Ibid.*, p. 335.

must be able to enter and display three times as much information as can the Minac 5 unit. The slew controls on the older machine are relatively slow, and there isn't enough panel space for a separate display register for each item.

The new control-display unit has but two seven-digit readout registers, and it substitutes the keyboard for the slewing controls. A digit is made up of a combination of seven line segments, each illuminated by an incandescent lamp and each dissipating a whopping 280 milliwatts. There are 100 segments in the two displays.

In order to beat the heat, the lamp housing is built with major heat-conducting paths connected directly to the mounting flange.

Of the several reasons for using incandescent-lamp displays, the basic one is that they come closer than other types of displays to being compatible with solid state circuitry. The lamps operate on relatively little voltage (4 volts), they're fairly small, and they can be updated rapidly (four times each second). Fast update means there is no visible time lag between the time a pilot keys data in and the time it appears in the readouts.

### Key information

In selecting a touch-tone phone layout for the console, the Micro-Minac designers showed an eye for the future. The keyboard most familiar right now is the one on an adding machine, with the numeral "1" in the lower left corner. But the engineers reasoned that push-button phones will soon be in nationwide service and that their layout—with the "1" in the upper left corner—will be more familiar to the pilots and navigators who'll be using this upgraded avionics system.

The push buttons generate binary-coded decimal information in a mixed radix system—base six for minutes and seconds of arc, as well as base 10—and the computer reencodes the signals into a segment format for lighting the displays. Besides displaying the latitude and longitude of present positions and destinations, the control-display unit can also show magnetic variation, wind speed, and wind direction.

The cables that connect the Micro-Minac computer to the control-display unit are already in place in the aircraft and are the same ones that transmit analog signals in the Minac 5 system. Only a handful of the 90-odd wires are twisted and shielded, and the ambient noise conditions in and around the cable are unknown.

To escape the possible consequences of any reasonable amount of noise, it was decided to develop relatively high-voltage signals with low-impedance sources and sinks. Rise and fall times are controlled, and hysteresis is applied to the clock-line receiver. A similar system for transmitting digital information was proposed later in ARINC project paper 561; it's still under consideration as an airline standard.

Five lines in the existing cable are used to exchange all data and control signals between the computer and the control-display unit. Two of them

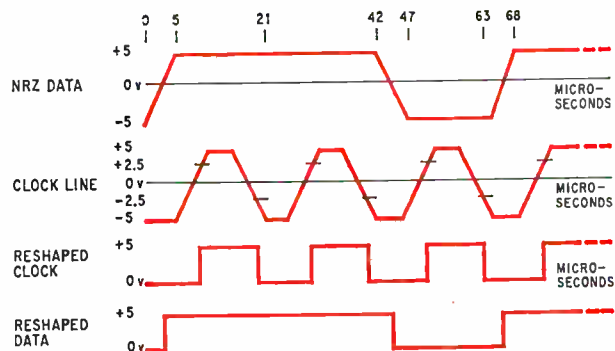

**Reshaped signals.** Data pulses are shifted relative to the clock pulses to keep the data stable during clocking. Clock triggers at  $\pm 2.5$  volts, data at zero-crossing points.

carry the commands to transfer data to and from the display, while two others carry the data, one for each direction of transmission. A clock line strobes the data at a frequency of about 47.6 kilohertz.

Rise and fall time for all clock and data signals is  $5 \mu\text{sec}$ , as shown above. The times are created in the driver circuits and driven into the lines by push-pull emitter followers with a 510-ohm source impedance. The receiver circuits have input impedances of 1 kilohm, and both the inputs and the outputs are shunted by 2,000 picofarads of capacitance. The resulting transmission paths are quite immune to noise, and the driving impedance is so low that as much as 6,000 pf more on the line has a barely measurable effect on the rise and fall time.

Without any hysteresis built into the receiver, the data lines are somewhat sensitive to noise when the signal is at the zero crossover level (which is also the trigger point of the receiver). The timing between the data and the clock is staggered in such a way that when the clock changes state, the data is stable and it takes 5 volts of noise to be upset.

The trigger points of the clock receiver are set at  $+2.5$  volts for turn-on and at  $-2.5$  volts for turnoff. Therefore, the clock line also has 5 volts of noise margin. However, this triggering scheme introduces an additional  $1.25\text{-}\mu\text{sec}$  shift relative to the data in the reshaped clock pulse in the control-display unit, a factor that had to be considered when the timing relationships were chosen.

Power for the control-display unit, excepting the lamps, is shipped up from the computer over the spare lines in the cable. There are quite a few of these, as the digital data system requires only a fraction of the number of wires installed for the analog system.

The lamps in the two displays are rated at 70 milliamperes at 4 volts. It's possible to light a minimum of three and a maximum of 100 segments, drawing a current variation of 6.8 amperes. Brightness is kept constant by applying to the lamps a full-wave rectified 4-volt-rms signal derived from a transformer that's driven by a 115-volt line. Rather than regulate the up to 7 amps on the 4-volt line, the system uses the SCR on the low-voltage line to control the 115-volt line, which is only pumping about 250 ma maximum.

# Getting beneath the surface of multilayer integrated circuits

It's done with a test pattern technique that evaluates processing parameters of high density IC's during fabrication, and provides design and reliability data to both user and maker of multilevel devices

By Frank J. Barone and C. Frank Myers

Motorola Semiconductor Products Inc., Phoenix, Ariz.

**Testing semiconductor devices** has been a major problem ever since manufacturers learned how to fabricate large numbers of components on a single chip of silicon. As integrated circuits become increasingly complex, with components buried under layers of alternately applied insulation and metal, visual inspection and evaluation of the process steps is impossible. Yet early feedback on process evaluations and yield indications is increasingly important in larger arrays because of the increasing value of each chip of the wafer, and will be essential for large-scale integration. In the event of low manufacturing yield, some method must be available for analyzing the defective circuits to determine the cause of the problem.

Since it is impossible to obtain this information directly from a highly complex circuit, it must be obtained by an indirect method that provides a close correlation and identification with the components and processes used in the actual circuit. Such a method is provided by a properly designed test pattern—an extra component formed on the slice that can be tested to reveal the quality of the circuitry on the slices.

## Process control feedback

The test pattern concept has become a key factor in the development and manufacture of high-density integrated circuits. When included on the circuit wafers, it can be used for component characterization and to provide in-process evaluations of each step used to fabricate complex circuits. It can also be used as a look-ahead indicator of the final yield for the circuits. It represents a vehicle for the development of new processes and process controls.

Although an IC fabrication sequence contains many controls to assure that the individual processes remain within the design tolerances, the complexity of the processes and their interactions may lead to difficulties. Since it is impossible to isolate the various processes in the actual circuits, the test pattern must provide access to these separate fabrication steps for individual evaluation. Typical information obtained from these patterns includes diffusion sheet resistance and depth, metalization sheet resistance, oxide stability and contact resistance. This information is directly translatable into such data as resistor values and tolerance, transistor gain and frequency response, and component interconnection integrity.

A circuit consisting of two or three levels of metal interconnects requires 25% to 50% more processing than a single-level interconnect circuit. Such complexity makes it impossible to locate or isolate failures on completed circuits. Simple defects, such as open or shorted metal runs, which were easily detected under a microscope on IC's employing single level metalization, are no longer visible.

Because of the large active die areas required for today's IC's, the circuit yield becomes a function of area. Since it's important to know both the density and the type of defect, the test devices on an efficient test pattern must isolate each process and determine the yield of that part of the total structure in terms of the total circuit area.

## Device evaluation

Actual circuit components are duplicated in the test pattern to evaluate critical device parameters.



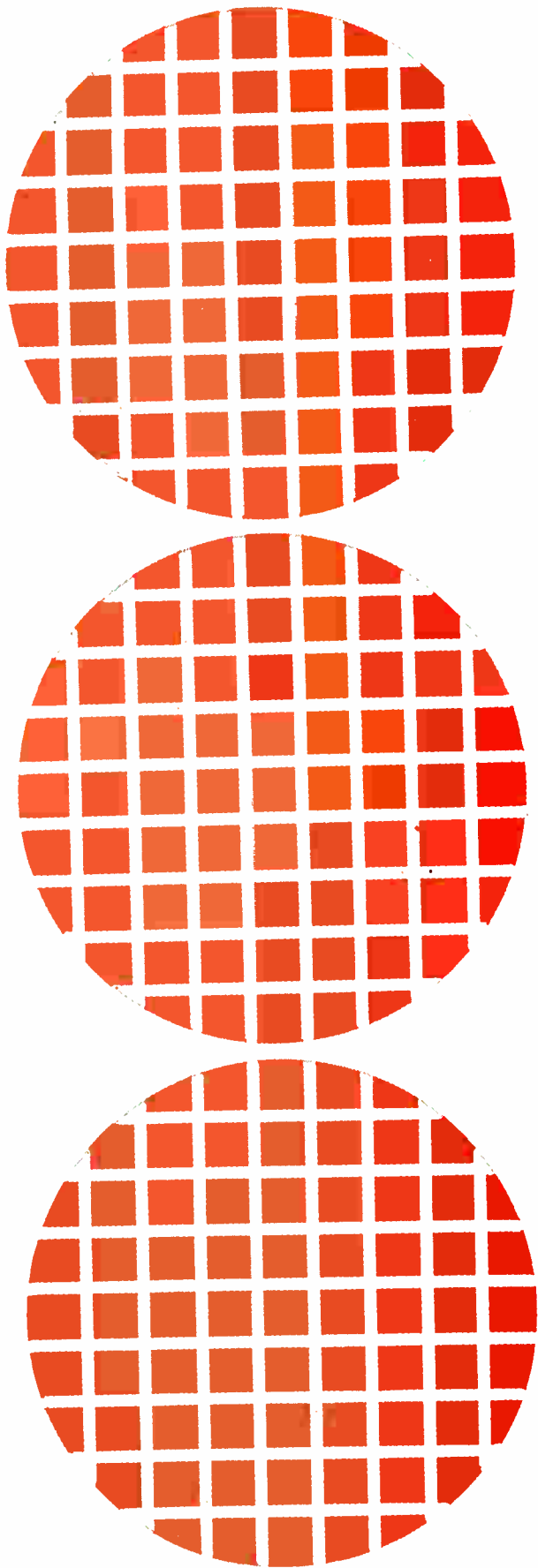

Where they go. Pattern positions are determined by use. For a new circuit, the top pattern is used. Others are for process evaluation and new process development.

Typical device parameters measured are saturation resistance, junction capacitance, forward voltage drops, and low and high-current beta. With high-density multilayered IC's it's neither practical nor economical to test circuit performance during processing. Transistor parameters, on the other hand, are more easily obtained, and are necessary to predict and eventually characterize circuit performance.

All test pattern devices are available after wafer dicing for extensive evaluation by the device designers. This allows both the device and circuit designer to correlate results of the process control tests with device parameters. This type of evaluation gives positive feedback for future designs of components for integrated circuits.

### Reliability indicator

In many cases the test pattern is used as a vehicle for reliability studies. When new processes are used, the test patterns from the first wafers are placed under step stress tests and provide a look-ahead indicator of the stability and reliability of the actual circuits. When test patterns are used to predict the reliability of a given process or product, it is extremely important that there be a one-to-one correlation of geometrical factors. Test pattern devices must be designed with the geometries and spacings used on actual circuit die in order to provide maximum sensitivity to each process step.

The test pattern is an integral part of the photoresist mask and can be positioned in the mask grid in various manners. In developing new circuits with new processes, more test patterns are used on the wafers to characterize the various steps, as shown at the left. When integrated circuits developed this way are placed in pilot production, fewer test sites are needed and they are used primarily for process evaluations and reliability studies. The number of test sites used on any given wafer is determined by the complexity of the system. In the limiting case, a mask composed entirely of test patterns can be used as a vehicle for new process development.

### Tracing the test steps

To demonstrate the value of the test-pattern technique in manufacturing and evaluating complex IC's, let's trace it during the production of an 8-bit adder consisting of 448 components on a 53 x 119 mil chip, that uses three layers of metalization for interconnections shown on page 87.

The processing sequence for this structure includes buried-layer diffusion, epitaxial growth, isolation diffusion, base diffusion, emitter diffusions, first metal deposition, first passivation, second metal deposition, second passivation, and finally, third metal deposition.

For the process evaluation test pattern, on page 86, used with 8-bit adder, the test devices were designed with the same layout rules used in designing the circuits. The rules specify minimum width and spacings of metal interconnects, device geometries, preohmic sizes and component density. There must be a good correlation between the devices and

structures on the test pattern and those on the circuit. For a customer who wants high reliability interconnections and needs thick metal, low-resistance leads, a metalization run on the test pattern would provide test data that could not be obtained from the actual circuit. The circuit layout and density dictate the ground rules for the test pattern.

### Early evaluation

The first major evaluation point in the processing sequence for the 8-bit adder is immediately before first layer insulation. At this point the wafer is either accepted or rejected. If it is accepted, it is sent on to the first layer insulation step; if it is rejected, it may have to be scrapped.

The resistivity of the epitaxial layer is monitored on the test pattern using breakdown voltage measurements on collector-base diodes. The diodes have no buried layer and, for maximum accuracy, are designed to provide breakdown voltages as close as possible to the bulk breakdown voltage of the epitaxial layer.

The multi-emitter test device, numbered 10 below, is a transistor consisting of 100 emitters connected in parallel, and spread out over a large

area. A single measurement on it gives an indication of yield for the transistors on the circuit.

The number and geometry of the emitters in this kind of test device corresponds to the number of active devices on the circuit chip. Defects in the epitaxial layer—such as diffusion pipes and stacking faults—caused by faulty materials preparation or processing, will show up as emitter-to-collector shorts. The large-scale transistor test can also give statistical information on device parameters such as punch-through voltage, emitter contact resistance, and alloyed emitter-base junctions. The metalization pattern has been designed so that the bad devices can be delineated for further analysis.

A wide, diffused resistor, numbered 2 below, evaluates the sheet resistance of the device base and resistor diffusion, and the emitter diffusion. The test resistor's width is made large to minimize end effects as well as variations caused by photoprocessing. This test allows the designer to correlate device performance and specifications with the process parameters.

### Sheet resistance

Two important device evaluations are the sheet

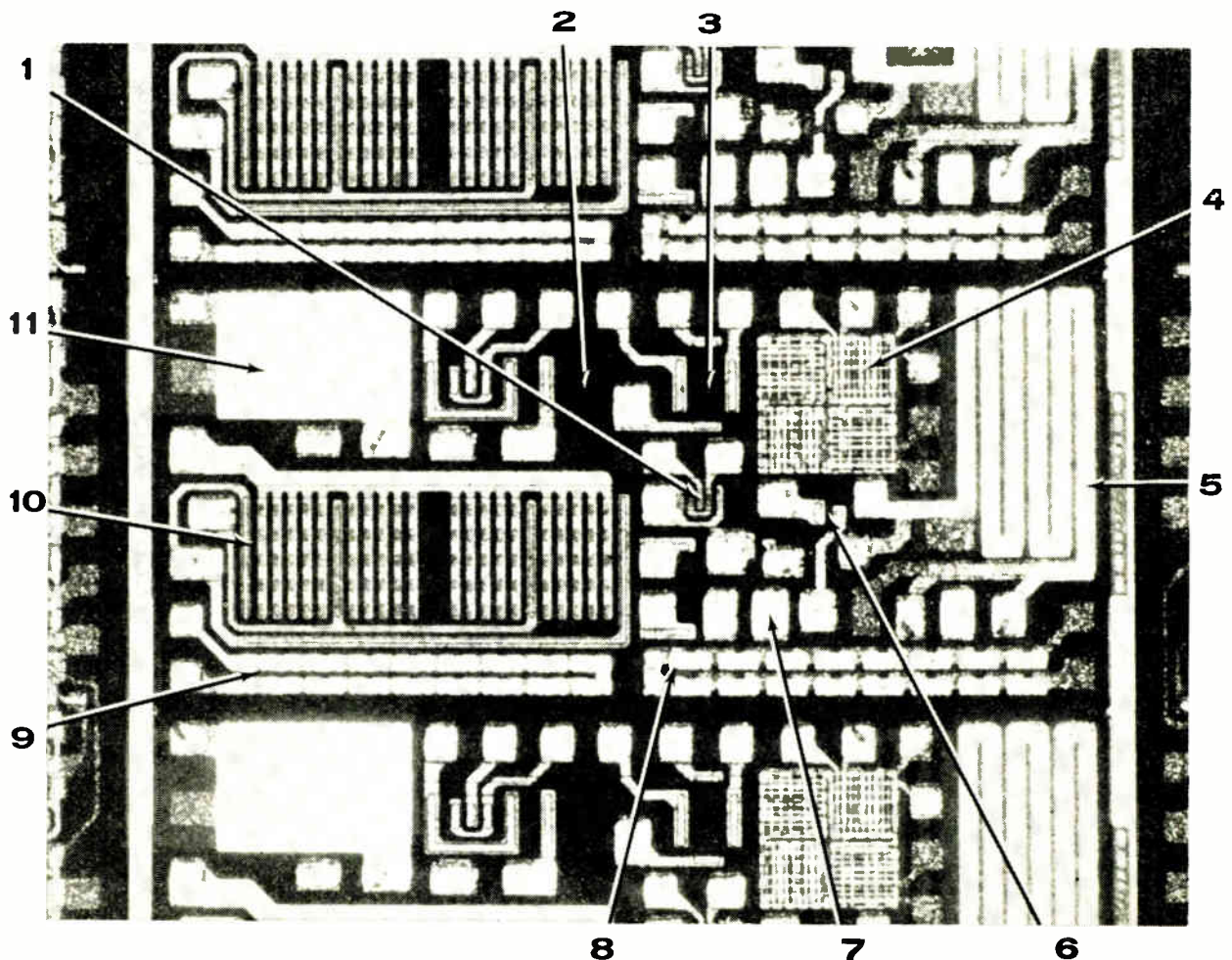

**Layout.** The test pattern for the 8-bit adder contains 11 sections. They provide such information as silicon-metal resistance, device parameters, metal sheet-resistance, and feedthrough resistance.



## Six of the test patterns for an 8-bit adder

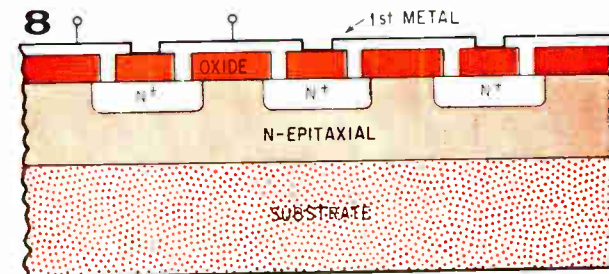
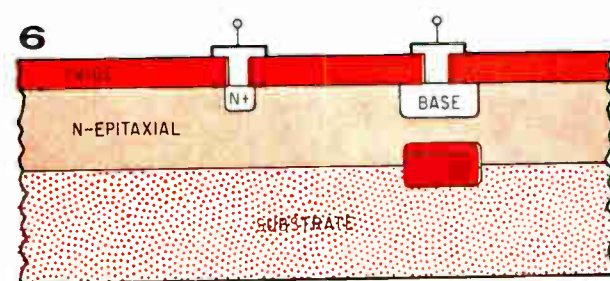
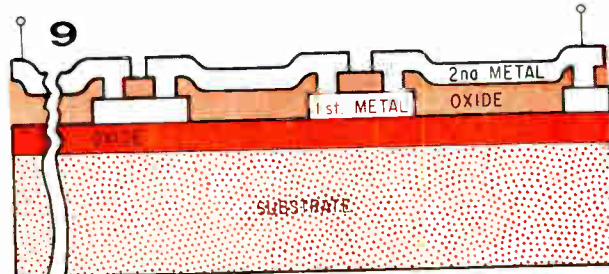
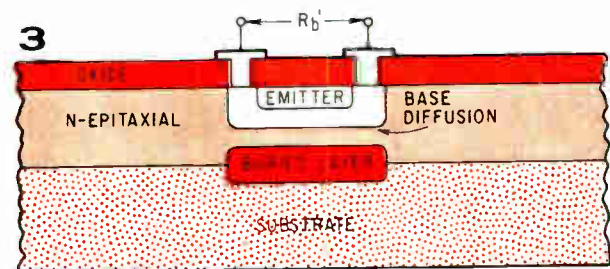
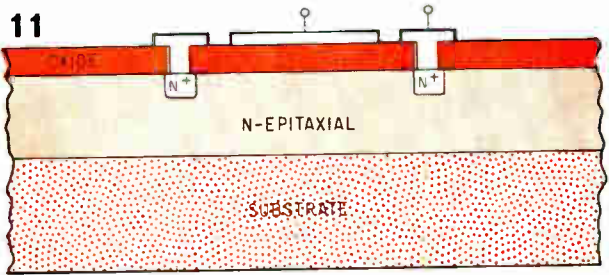
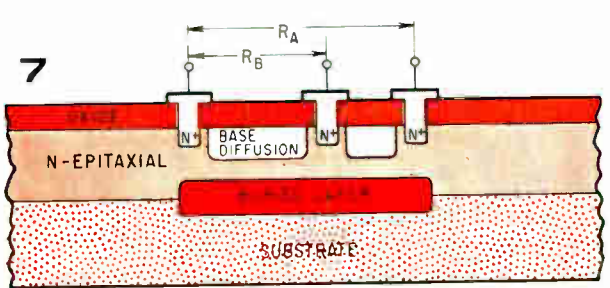
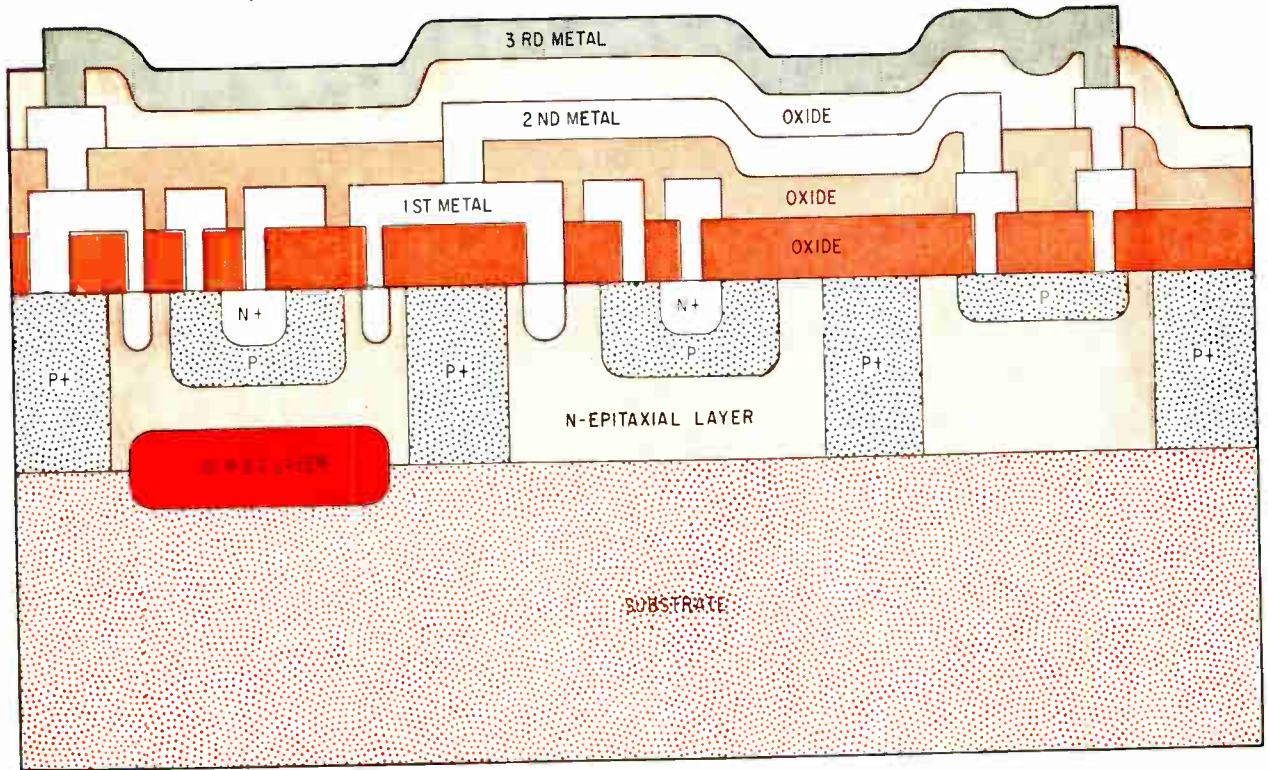

Through the chip. Test patterns are constructed to represent actual cross-sections of the 8-bit adder. The numbers on the sections refer to the chip layout on the facing page. Each pattern is designed to test a specific connection or device characteristic. The three tests, above left, are for evaluating buried-layer sheet resistance, transistor base width, and epitaxial layer resistivity. Those on the right are for testing surface stability, feedthrough resistance, and metal-semiconductor contacts. Other tests, not illustrated, are described in the text.



resistance of the buried layer and the sheet resistance of the base region under the emitter, or  $R_{b'}$ . Initially, the buried layer is diffused into the substrate, then the epitaxial layer is grown. During the subsequent diffusions, the buried layer "outdiffuses" from the substrate into the epitaxial layer, thereby decreasing the saturation resistance of the transistor. The final sheet resistance of the redistributed buried-layer region is evaluated using the three-terminal device, numbered 7 on page 87. Two resistance measurements are made on the test device and the sheet resistance is obtained by solving two equations with two unknowns.

With the test device, number 3, that evaluates the sheet resistance of the base region under the emitter, the resistance depends upon the emitter diffusion depth as well as the redistribution of the buried layer. A correlation curve can be made between beta and  $R_{b'}$  to isolate diffusion problems from surface problems when certain process cycles result in lower-than-expected beta values.

The actual breakdown voltage of the transistors can be monitored with a base-collector diode similar to the one used for the resistivity evaluation of the epitaxial layer. The only difference is that the  $BV_{CBO}$  diode (number 6, page 87) includes a buried layer.

The surface stability of the structure can be evaluated using a metal oxide semiconductor capacitor (number 11, page 87) included on the test pattern. Such a device is of considerable importance in the fabrication of MOS integrated circuits and can also be a valuable process-control tool in the manufacture of extremely stable bipolar devices.

The test pattern also includes one actual circuit device, numbered 1 on page 86, for device evaluations. Typical measurements include high-and-low-current beta, saturation resistance, junction capacitances, and breakdown voltages.

### Multilayer evaluations

The second and third evaluation points for the complex circuits are at the second and third layer metalizations following the delineation of the metal patterns. At these points the major evaluation emphasis is on the interconnections systems. On the basis of each evaluation the wafer is either accepted or rejected.

The structure for the 8-bit adder consists of three levels of interconnection metalization. One of the basic evaluations performed on the metalization process is the measurement of the metal sheet resistance, number 5 on page 86. Since each level of metalization is deposited separately, the sheet resistance of each level must be monitored. This is done by measuring the end-to-end resistance of a long metal run of known length and width, and converting the reading to sheet resistance. Both current-carrying capabilities and the reliability of the metal runs are functions of the cross-sectional area.

The second evaluation performed on the multilayer metal structure is the integrity of the insulating layers. This is usually done with large-area

capacitor structures. For this particular case, a three-layer capacitor was designed to evaluate each insulating layer. The area of the capacitor is large enough to statistically determine the pinhole density in the insulating layers. Using this number, the final circuit yield may be predicted.

### Feedthroughs

In the design of a multilayer interconnection system, many small holes, or feedthroughs, must be provided in the insulating layers to allow interconnections from one level to another. It is important that these feedthroughs, after metalization, be free from contact resistance to provide proper current and voltage distribution. Measurement of a large number of feedthroughs is necessary to predict yield in terms of this process.

The feedthrough resistance is monitored using the device numbered 9 on page 87. A series of feedthroughs is constructed in the form of a metal run of known length and width. All the feedthroughs in the line are identical in geometry and typically consist of 100 feedthroughs. The end-to-end resistance of the feedthrough line is measured and converted to an effective sheet resistance. This reading is then compared with the sheet resistance of an identical metal run containing no feedthroughs. This type of analysis gives the average feedthrough resistance. With three levels of metalizations, two types of feedthroughs are possible—a feedthrough between consecutive layers of metalization, and a feedthrough from the first layer directly to the third layer. Both of these types are monitored by the test patterns.

In high-density IC's, a large number of contacts between the metal and the silicon are required to produce functional circuits. The metal-semiconductor contact-resistance, monitored on a large number of devices for yield prediction, is determined by an arrangement similar to the feedthrough test. A series of metal-semiconductor contacts is designed in the form of a line (number 8, page 87). The end-to-end resistance of the line is measured, and the resistance of the interconnecting metalization and the  $n+$  areas is subtracted from the total resistance. Any remaining resistance can be attributed to the metal-silicon contacts in the line.

One final test that must be made on a multilevel metalization process evaluates metal coverage over "steps" in the insulating layers. A cross-hatch pattern numbered 4 on page 86 allows the second-level metal to pass at  $90^\circ$  over the first-level metal and the third-level metal to pass at  $90^\circ$  over the second-level metal. The length and width of the lines are known and therefore the metal sheet resistance can be determined by measuring the end-to-end resistance of the line on each level. This resistance can then be compared to the resistance obtained from the sheet resistance test for that level of metalization. Any significant differences can be attributed to a thickness variation over the steps. The integrity of the oxide layers over the steps in the metal can be evaluated by measuring the interlayer resistance.

# Utilogic II

## Read all about it!

### Free Handbook!



Signetics' new Utilogic II is the most flexible, reliable, economical line in the business. The entire series now comes in dual in-line silicone packages, which gives you convenience and ease of handling, in addition to the performance proven by over 10 million Utilogic elements in the field. Utilogic II also provides dual J-K binaries and triple and quadruple gates. The system is now simpler, faster, more flexible and requires fewer packages. On top of all that, Utilogic II is priced at RTL levels. Get the facts, plus our new Utilogic II handbook. It tells you everything you need to know about the specifications, usage rules and application for using Utilogic II. Write Signetics, 811 E. Arques Ave., Sunnyvale, Calif. 94086.

**SIGNETICS  
INTEGRATED  
CIRCUITS**



A SUBSIDIARY OF CORNING GLASS WORKS

**SIGNETICS SALES OFFICES:** Fort Lee, New Jersey (201) 947-9870; Syracuse, New York (315) 469-1072; Richardson, Texas (214) 231-6344; Beverly Hills, California (213) 272-9421; Garden Grove, California (714) 636-4260; Wakefield, Massachusetts (617) 245-8200; Silver Springs, Maryland (301) 946-6030; Collingswood, New Jersey (609) 858-2864; Clearwater, Florida (813) 726-3734; Rolling Meadows, Illinois (312) 259-8300; Sunnyvale, California (408) 738-2710.

**DISTRIBUTORS:** Compar at all locations listed below. Semiconductor Specialists, Inc. (312) 279-1000; Terminal Hudson Electronics (212) 243-5200; Wesco Electronics (213) 684-0880; Wesco Electronics (405) 968-3475; Hammond Electronics (305) 241-6601; Avnet Electronics Corp. of Massachusetts (617) 272-3060; Pioneer Standard Electronics Inc. (301) 427-3300; Kieruluff Electronics (206) RO 3-5510; G. S. Marshall (213) 684-1530; Milgray Delaware Valley (215) 228-2000; Universon Electronics Inc. (713) 781-0421.

**DOMESTIC REPRESENTATIVES:** Jack Pyle Company (415) 349-1266; Ozark Electronic Marketing, Inc. (314) 423-7200. A Compar Corporation at the following locations: Alabama (205) 539-8476; Arizona (602) 947-4336; California (213) 245-1172; California (415) 697-6244; Colorado (303) 781-0912; Connecticut (203) 288-9276; Florida (305) 855-3964; Illinois (312) 692-4125; Maryland (301) 484-5400; Massachusetts (617) 559-7140; Michigan (313) 357-5369; Minnesota (612) 922-7011; Missouri (314) 542-3399; New Jersey (609) 429-1526; New Mexico (505) 265-1020; New York (518) 436-8536; New York (607) 723-8743; New York (516) 921-9333; North Carolina (919) 724-0750; Ohio (216) 333-4120; Ohio (513) 878-2631; Texas (214) EM 3-1526; Texas (713) 667-3420; Washington (206) 763-1711.

**INTERNATIONAL SALES:** France, Germany, Italy, Belgium, Holland, Luxemburg, Spain—Sovcor Electronique, 11, Cherin de Ronde, Le Vesinet, (S.-&O.) France, United Kingdom, Ireland, Sweden, Denmark, Norway, Switzerland, Austria, Portugal—Electrosil Ltd., Lakeside Estate, Colnbrook-By-Pass Slough, Buckinghamshire, Great Britain. Australia—Corning, 1202 Plaza Building, Australia Square, Sydney, N.S.W. 27-4318. Canada—Corning Glass Works of Canada, Ltd., Leaside Plant, Ontario, Canada (416) 421-1500. Israel—Optronix, P.O. Box 195, Ramat-Gan, Israel 724-437. Japan—ASAHI Glass Co., Ltd., Corning Products Sales Dept. No. 2, 3-Chome Marunouchi, Chiyoda-ku, Tokyo, Japan.



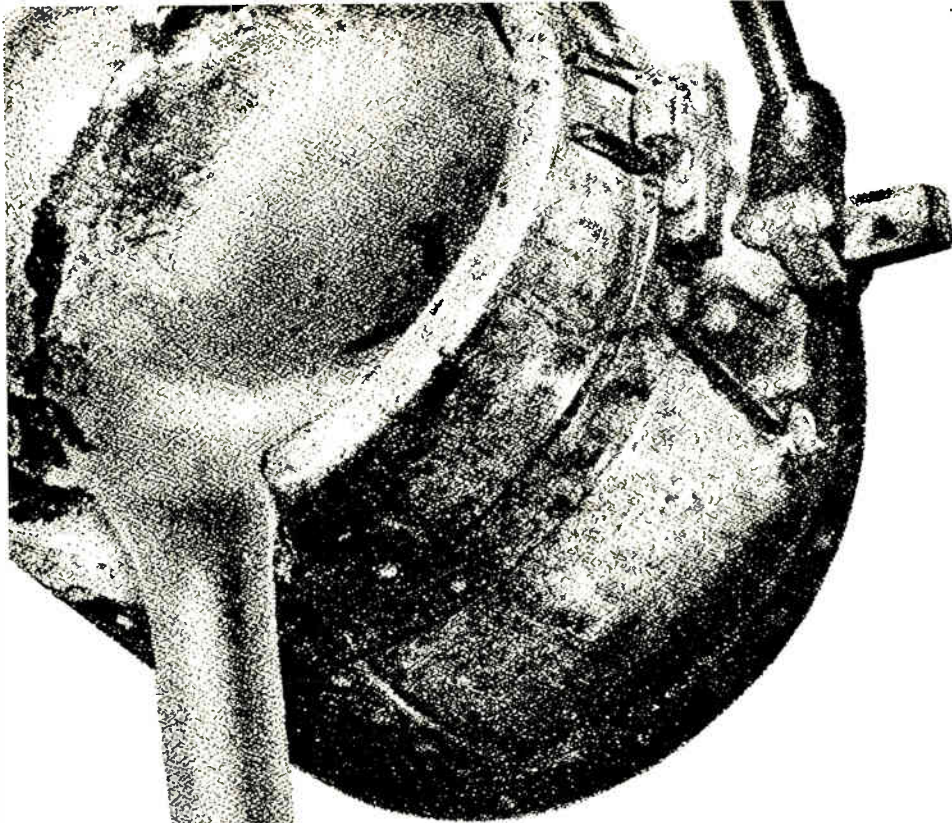

## Telemotive needed a battery husky enough to pour tons of molten steel. Mallory made it. What can we do for you?

Telemotive needed a battery. A battery to power its radio remote control system for cranes. A battery that could put out a strong, steady signal for months. A battery that could take extreme temperatures and the shocks and punishment that a steel mill dishes out. Yet a battery that would pack the most energy into the least weight—and provide the most performance for the least money.



Mallory made it. The battery—a Mallory mercury battery. It provides steady output in continuous or intermittent operation. It can take temperatures from below zero to +160° F. And penny for penny, pound for pound, it provides more energy than any battery in its class.

### TOUGH BATTERIES

High-class performers are often prima donnas. Not Mallory mercury batteries. Their

extremely long service and shelf life, their high operating efficiency and flat voltage doesn't mean they're delicate—in fact, the reverse is true. The construction and design of these cells are such that they have extraordinary resistance to extreme conditions. For example, high vacuum or pressures up to 5000 psi have no detectable effect on performance. Double jackets of nickel-plated steel provide protection against humidity and corrosion. And where extreme shock and vibration conditions are to be encountered the batteries can be potted in epoxy resin with no adverse effects.

### OVER 1000 DIFFERENT TYPES

Chances are Mallory has the battery you need already in production. Right now we're making over 1000 different types and sizes. And if we're not actually producing the one you need, we'll be glad to sit down with you to design one to your specifications.

For more information, please write Technical Sales Department, Mallory Battery Company, a division of P. R. Mallory & Co. Inc., South Broadway, Tarrytown, New York 10591. Or phone us at 914-591-7000. (In Canada: Mallory Battery Company of Canada Limited, Sheridan Park, Ontario.)

**MALLORY**

It's good business to do business with Mallory



## RJ11 space saver

(actual size)



**It's new! Helitrim® Model 76P cermet trimming potentiometer is the industry's first  $\frac{3}{4}$ " long trimmer with RJ11 style pin spacing.**

It's a space saver – saving 40% of the board space required by conventional  $1\frac{1}{4}$ " long models.

It's low-cost—only \$1.95 list.

And it's fully sealed.

Model 76P also provides essentially infinite resolution, setting ability to within  $\pm 0.05\%$  of required voltage

and maximum freedom from catastrophic failure. It's available from local stock in standard resistance values from 10 ohms to 2 megohms.

For all of Model 76P's specifications, call your local Helipot representative. He'll give you all the answers and an evaluation sample.

**Beckman**

**INSTRUMENTS, INC.**

**HELIPOT DIVISION**

FULLERTON, CALIFORNIA • 92634

INTERNATIONAL SUBSIDIARIES: GENEVA; MUNICH; GLENROTHES, SCOTLAND; TOKYO; PARIS; CAPETOWN; LONDON; MEXICO CITY

# Thinking big in communications systems?

## We'd like to have a part in it.

With 30 years' leadership in electronic stampings, we've been a part of the most advanced communications systems, computers and special-purpose tubes. In fact, we're right at home in just about anything that requires exacting tolerances and reliable delivery of parts in volume at the lowest possible cost.

Our unique engineering service, diemaking skills and production techniques could play an important part in your next big idea. Let us show you how. Write or call Volkert Stampings, Inc., Subsidiary of The Stanley Works, 222-35 96th Avenue, Queens Village, L. I., N. Y. 11429. Tel.: 212-464-8400.

***Volkert*** STAMPINGS, INC.

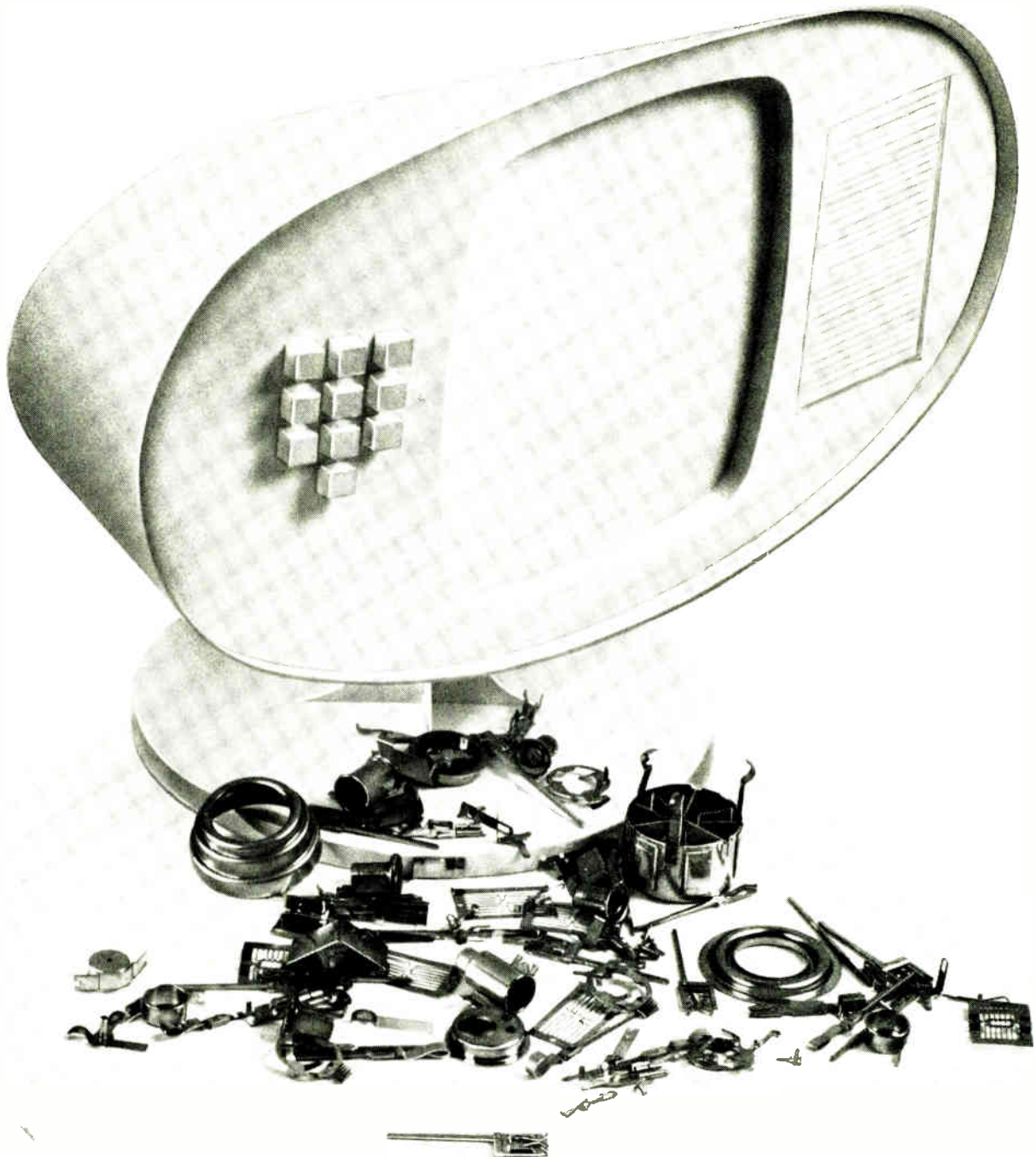

# To 150°C

CDE's Extended Temperature Range Aluminum Electrolytic Capacitors with Optimum Reliability and Low Cost.



Featuring the exclusive CDE continuous cold weld connection of section to rod...insuring superior mechanical and electrical reliability. With far superior ESR to temperature characteristics.

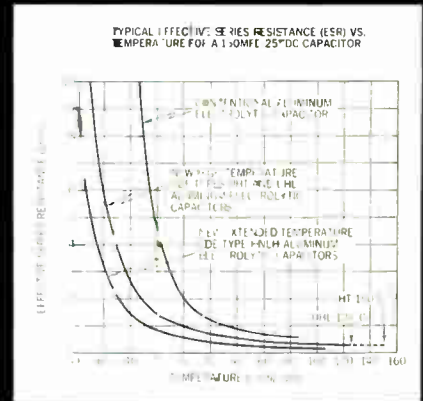

And with high ripple current capability, low DC leakage, Capacitance and DF stability. Low impedance, rugged design for vibration and shock endurance.

These units are now available for your design considerations.

- |             |   |                                  |
|-------------|---|----------------------------------|
| <b>UHT</b>  | Miniature Axial Lead Case Sizes: $\frac{3}{8} \times \frac{15}{16}$ to $\frac{3}{8} \times 2\frac{1}{16}$ ". Ratings: 3 mfd to 100 mfd, from 3 VDC to 100 VDC.  | <b>-55 to + 150° C OPERATION</b> |
| <b>UHL</b>  | Miniature Axial Lead Case Sizes: $\frac{9}{32} \times \frac{15}{16}$ to $\frac{3}{8} \times 2\frac{1}{16}$ ". Ratings: 3.3 mfd to 1000 mfd, from 5 VDC to 200 VDC, designed to meet and exceed Mil C-39013/1. (Already stock standards on our Distributor's shelves.) | <b>-55 to + 125° C OPERATION</b> |
| <b>UHR</b>  | Large Axial Lead Case Sizes: $\frac{5}{8} \times 1\frac{1}{8}$ to $1" \times 3\frac{5}{8}$ ". Ratings: 10 mfd to 12,000 mfd, from 5 VDC to 200 VDC, designed to meet and exceed MIL C-39018/3. (Also available in -55 to +85° C specifications.)                      | <b>-55 to + 105° C OPERATION</b> |
| <b>HNLH</b> | Miniature Axial Lead Case Sizes: $\frac{1}{4} \times \frac{5}{8}$ to $\frac{3}{8} \times 1\frac{1}{2}$ ". Ratings: 1 mfd to 600 mfd, from 3 VDC to 150 VDC. (Already stock standards on our Distributor's shelves.)   | <b>-80 to + 110° C OPERATION</b> |
| <b>UFH</b>  | Computer Grade Case Sizes: $1\frac{3}{8} \times 2\frac{1}{2}$ to $3" \times 8\frac{5}{8}$ ". Ratings: 5500 mfd to 300,000 mfd at 5 VDC 240 mfd to 3000 mfd at 150 VDC.  | <b>-55 to + 105° C OPERATION</b> |

For your design considerations, ask for details from your local CDE Sales Engineering Office. Or write:

Circle 93 on reader service card

**CDE** **CORNELL-DUBILIER**

50 Paris Street, Newark, N. J.



# INTERFACE

We've got solutions to problems you haven't even had yet.

Litton is a leader in matching sophisticated components in integrated equipment systems.

An outstanding example is our new Precision Pattern Generator used for the computer controlled generation of interconnect masks required in the production of large scale integrated circuit arrays. We used a high resolution cathode ray tube matched with an electronic control system to achieve a degree of speed, accuracy, resolution and repeatability never before attained in recording systems. Our single source responsibility for the system equipment

played a large part in achieving the outstanding performance.

This capability of Electron Tube Division to solve integrated equipment systems applications comprehends not only tube equipment interface but severe environmental, high density packaging and heat problems as well. Whatever your present problem in these areas there's a good chance we've been there before you, and are ready now with solutions. Contact the Microwave and Video Equipment Department of the Electron Tube Division, 960 Industrial Road, San Carlos, California 94070.

 **LITTON INDUSTRIES**  
**ELECTRON TUBE DIVISION**

# Probing the News

Integrated electronics

## Solid-state display nears market

Hewlett-Packard device with logic and readout in single small package set to challenge cold-cathode assemblies; most other firms see price a stumbling block

By Eric Aiken

Probing the News editor

**Solid-state technology** still has a few worlds to conquer. Displays, for example. Nonetheless, a number of electronics firms believe solid state represents the eventual shape of things to come. Indeed, next month in Los Angeles at the Western Electronic Show and Convention the Hewlett-Packard Co. will unveil working models of gallium-arsenide diode matrixes, which, says a spokesman, are designed to compete for choice with cold-cathode, gas-discharge displays like Burroughs' Nixie tube, electroluminescent devices, and related assemblies.

Other companies going the solid-state route—RCA, the Monsanto Co., and Texas Instruments, among others—are somewhat less sanguine than Hewlett-Packard in their estimates of the immediate impact of solid state upon the display market. And rivals are prone to pooh-pooh such developments as have been announced. Clearly, however, solid-state displays have reached a point where they must be considered as at least potential competitors of conventional assemblies.

### Product profile

Hewlett-Packard's preliminary version of a solid-state assembly appears to be a technologically viable competitor in the display field. The GaAs diode-matrix device has a 0.25-inch high numeral in a package only 0.162-inch thick. Packages can be assembled in an array, using

½-inch, center-to-center spacings. The display operates at full brightness (50 foot lamberts) from a 5-volt source. Brightness is voltage controllable over a range of 5 to 50 foot lamberts.

The assembly's light output is pure red (6700 angstroms). Sizes larger than the 0.25-inch version are possible, and prototypes have been built, says a Hewlett-Packard spokesman. However an optical phenomenon makes the displayed numbers seem at least twice their real size. The character can be easily read in daylight from several feet away and at extremely wide vertical and horizontal off-axis viewing angles. Electrical connection may be accomplished by soldering into printed-circuit boards, flexible lead, or conventional 100-mil center-to-center connectors.

**Division of labor.** Four of the eight connections on H-P's solid-state numeric indicator are directly driven from standard 4-line 8421 negative binary-coded decimal (BCD) sources. Other connections are: +5 v for light emitter power; +5 v for logic power; decimal point; and ground. The BCD inputs control selection of the character set 0 through 9. Display power requirement is about 0.5 watts per character, depending on the setting of the brightness level. Current consumption is 5 milliamps at 5 v.

The H-P numeric indicator package has 35 GaAs diodes arranged in a 5x7 matrix mounted on the

same ceramic substrate as two complex integrated circuits developed in-house. The IC's, which have more than 250 transistors apiece, decode the 4-line BCD input to the set of 10 drive points required for character selection, and then pick those to be eliminated from the

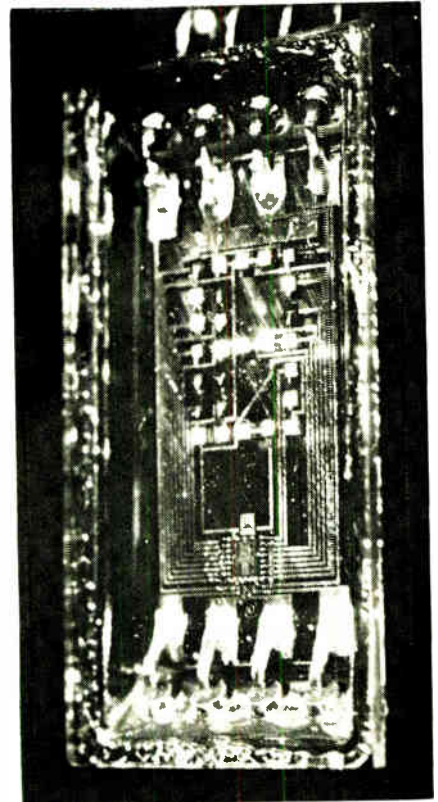

**Five spot.** The number five appears in the 5x7 diode matrix of this prototype solid-state display from Hewlett-Packard. Logic and display elements are incorporated in a single package only 0.162-inch thick.

# ORGANIZE!

**PLUGMOLD® MULTIOUTLET SYSTEMS** offer a versatile efficient way to organize electrical wiring and devices of all kinds. Build Plugmold into the products you design. Use it in lab and production areas.

Rugged, attractive Plugmold—in a variety of sizes—accommodates 14 to 2/0 AWG wire, devices to 60A, circuit breakers to 100A. U.L. listed. Send for bulletin.



THE WIREMOLD COMPANY / HARTFORD, CONNECTICUT 06110

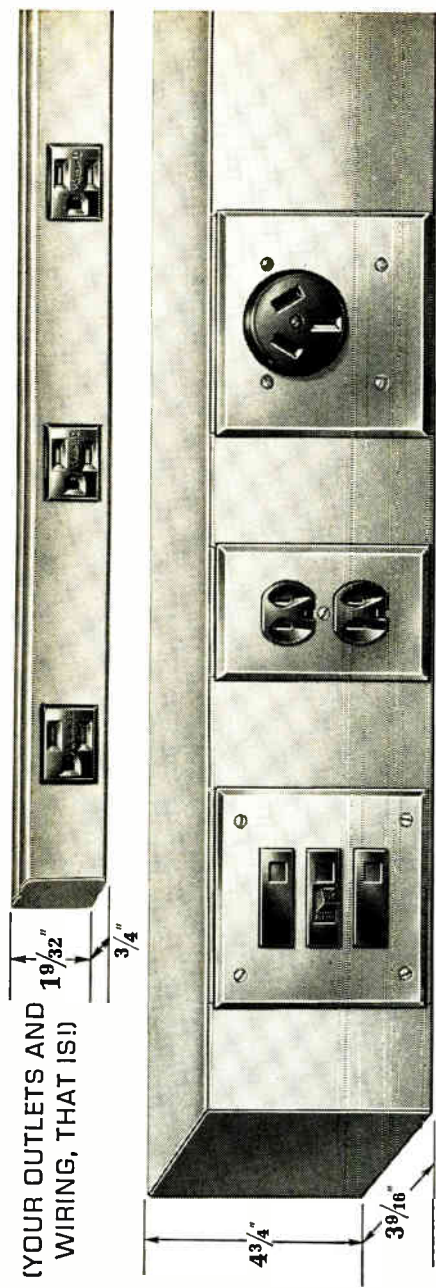

## ... makers of cold-cathode displays are conceding little to solid state ...

display. Incorporation of decoding circuitry in the display package gives Hewlett-Packard at least an interim technical edge over its rivals in the solid-state sweepstakes. The package is sealed in glass.

### Company coming

Solid-state displays are by no means the private preserve of Hewlett-Packard. Monsanto, for example, has fashioned a light-emitting diode array that's being used as the numerical readout in an experimental counter-timer [Electronics, April 15, p. 48]. Each element in the array lights when it is forward-biased with a current of from 10 ma to 100 ma at about 1.5 v; the display is compatible with IC's. And each light-emitting diode array can combine letters, numbers, or symbols—a capability beyond cold-cathode tubes and comparable readouts since they lack the depth to include 26 letters.

Monsanto says it is a year or two away from marketing an all solid-state display since costs are still too high. However, the company is selling discrete arrays of GaAs phosphide diodes on a custom basis. Monsanto supplies the arrays in a variety of configurations—3x5, 4x7, 5x7, and the like—so there are no hard-and-fast specs. However, on a ballpark basis, numeral height is 1 inch; package thickness is 0.8 inch on a 0.5-inch wide metal base; grouping is 100-mil center-to-center spacings; and brightness from a 5-v source is 50 foot lamberts.

**Helpmate.** The array is driven by a 16-gate, dual in-line IC, made by Monsanto. The circuit, which is compatible with transistor-transistor logic and diode-transistor logic, includes a decoder, 4-bit BCD memory, and clock line. This last permits users to apply almost any decade of their choosing. At the moment, Monsanto's light-emitting diodes come in three shades—red, infrared, and green.

Another contender in the solid-state display derby is Texas Instruments of Dallas. The company, which is playing it close to the vest on what its plans are, unveiled a prototype 3x5 diode array at the 1966 IEEE show. A compatible

metal oxide semiconductor chip was used to receive decimal inputs and convert them into signals to drive the array.

RCA's Electronic Components division, Somerville, N.J., is working on an experimental 5x7 light-emitting diode matrix as well as a 50x50 assembly. But Lawrence A. Murray, who heads the division, says there are no real plans to market these units any time soon. His group is simply doing its homework in the field with an eye to producing a million-bit picture tube some three or four years hence.

RCA, along with a dozen or so other electronics firms, is also investigating plasma display devices. These assemblies are not solid state in the accepted sense of the term since they are gas operated. However, such units could eventually give tube, electroluminescent, and even alphanumeric displays a run for their money. [For more on this subject, see page 39.]

### Parting of the ways

At the moment, makers of cold-cathode, gas-discharge displays and electroluminescent devices are conceding little, if anything, to solid-state partisans. John Pittman, product manager at Burroughs' Electronic Components division, which makes Nixie tubes in Plainfield, N.J., says: "I don't see solid state as an immediate threat. Potential purchasers' attitude will be 'it's cute, but who needs it?'" The situation reminds me of tunnel diodes' initial splash. Where are they now?"

Pittman emphasizes that Burroughs is not simply mesmerized by its own promotion; the company, he says, has examined the field closely and developed a solid-state capability. "Since Nixie tubes were first developed in 1955, the market was pretty well limited to instruments," says Pittman. "But now we've developed a low-cost IC driver that will enable us to increase our sales for applications like desk-top calculators."

**Three score.** Pittman ticks off three advantages of the Nixie that, he feels, competitors will be hard put to overcome. In the first place, he says, Nixies only cost around



Measure the world of motion in any direction...instantly, accurately, dependably, in any application, telemetry or control, with United Control's highly reliable servoed miniature accelerometers. You name the application and the environment, we'll provide the best accelerometer. For more information, call or write United Control.

**measure**

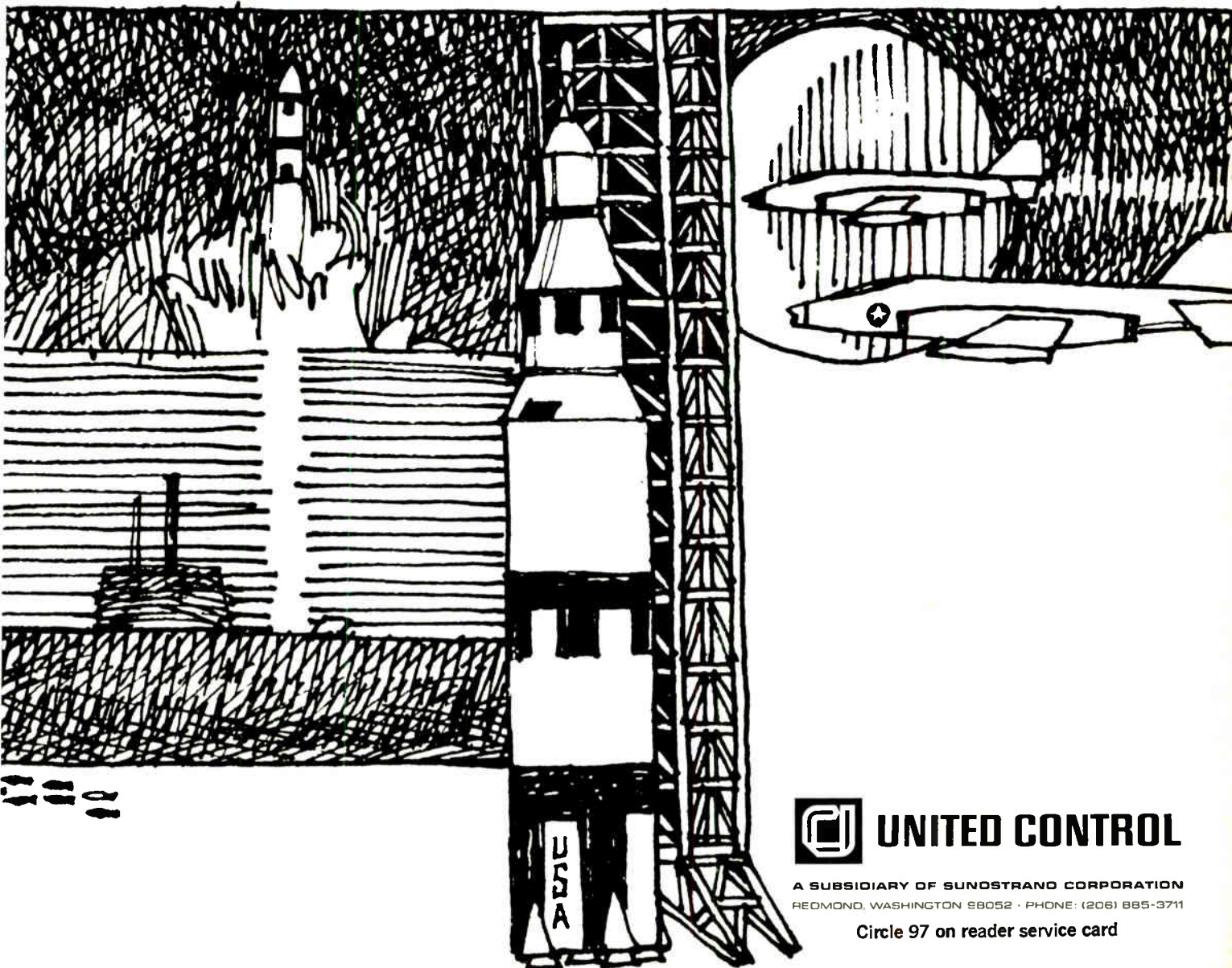

 **UNITED CONTROL**

A SUBSIDIARY OF SUNDSTRAND CORPORATION  
REDMOND, WASHINGTON 98052 · PHONE: (206) 885-3711

Circle 97 on reader service card

## Design Brochure

Cable Assemblies & Coaxial Delay Lines



This 4-page brochure details specifications and multiple design possibilities of cable assemblies and coaxial delay lines. It also follows through with evaluation, production and test procedure info.

For your copy write or phone:  
Times Wire & Cable, Wallingford, Conn. (203) CO 9-3381

Circle 502 on reader service card

## Seamless Metal Tube Sheathed Coaxial Cable



Times' new semiflexible coaxial cable with seamless aluminum tube sheath conductor is available in two standard versions:

1. ALUMIFOAM® — Foam polyethylene dielectric where pressurizing isn't practical.
2. ALUMISPLINE® — Air dielectric where pressurizing is practical. These cables offer more isolation—at 80 < db more than ordinary coax. Uniformity average — VSWR 1.1 or less. Stability — 10 times better. Lower loss — 30% less. Pulse reflection — less than 1%. Less distortion. Also avail. in solid dielectric and high temp. constructions.

For prices & data write or phone:  
Times Wire & Cable, Wallingford, Conn. (203) CO 9-3381

Circle 503 on reader service card

## Connectors for Solid Sheathed Cable

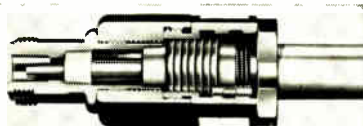

Only one step required to use the new one-piece TIMATCH® Connector with its own pat. CoilGrip® clamp—just unpack it. Its reusable and repeated assembly and disassembly does not impair either the RF or physical characteristics of the connector or the cable. Available in all popular sizes and fits all metal tube sheathed coaxial cables.

For prices & data write or phone:  
Times Wire & Cable, Wallingford, Conn. (203) CO 9-3381

Circle 504 on reader service card

## ... the military-aerospace market can't support two technologies ...

\$4 apiece in volume lots. Addition of driver-decoder electronic package brings the price tag up to about \$20-\$25 below Hewlett-Packard's \$25 target for solid-state devices. Secondly, availability is a consideration in Pittman's opinion. He notes Burroughs offers 15 kinds of standard Nixies, and has supplied customers with upwards of 2,000 custom versions. "And if an order warrants it, we can deliver in two weeks," he says. Finally, says Pittman, neon is a well-known and relatively stable element that's easy to handle. Gallium arsenide is difficult to deal with, must be batch processed, and has low yields.

Alvin S. Luftman, manager, display and storage tubes at the Raytheon Co.'s Industrial Components Operation, which second-sources Nixie tubes in Quincy, Mass., largely agrees with Pittman. The only real opening he sees for solid-state displays is in some aerospace applications where there are restrictions against using mercury tubes. "And here diode matrixes will be competing against electroluminescent indicators," says Luftman. "Tubes will continue to do well in original-equipment-manufacturing outlets, particularly instrumentation and test gear. High voltage requirements in such cases represent no particular drawback since such gear plugs into high mains anyway."

**Economics lesson.** Luftman notes that most original-equipment manufacturers produce their own driver-decoder circuitry, a situation that promises to limit the size of the market for solid-state displays incorporating such features. Raytheon has no plans to produce diode arrays. "We need more information on the behavior of GaAs, along with a dependable source of supply," says Luftman. "And even then, we'd want a clearly defined market before going ahead."

## Glowing retort

"If the guys pushing diode-matrix arrays think the military and aerospace display field is their meat, they've goofed. The market isn't big enough for two technologies,"

says a source at Sylvania Electric Products Inc. whose Electron Tube division makes electroluminescent devices in Emporium, Pa. "What you've got here is a new unproven technique going up against an established approach that's built into a number of operational systems."

**Off color.** This source says that red is not a particularly popular choice for numeric indicators in the military and aerospace fields. "Red stands for danger, and psychologists want to use it as seldom as possible in cockpit displays," he says. Sylvania's electroluminescent devices are a blue-green shade.

Sylvania is not alarmed at the reliability levels claimed for solid-state displays. An official notes that in the aerospace market a 1,000 hour half life is long enough for most purposes. In addition, electroluminescent devices degrade gracefully, he says.

Nor does the Dialight Corp., Brooklyn, N.Y., a producer of segmented neon and incandescent displays feel threatened by solid state. Richard Laken, the company's marketing manager, says price is the big stumbling block. "Hewlett-Packard can probably afford the \$25 for in-house use, but not as a loss leader," says Laken. "Wait'll they start making devices, they'll

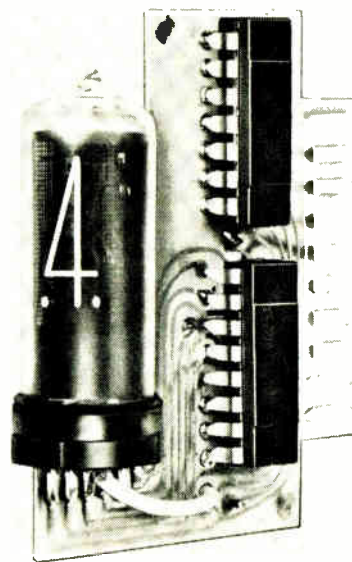

Package deal. A Nixie tube with drive circuitry from Burroughs goes for about \$20. The tube alone is listed at \$3.95.



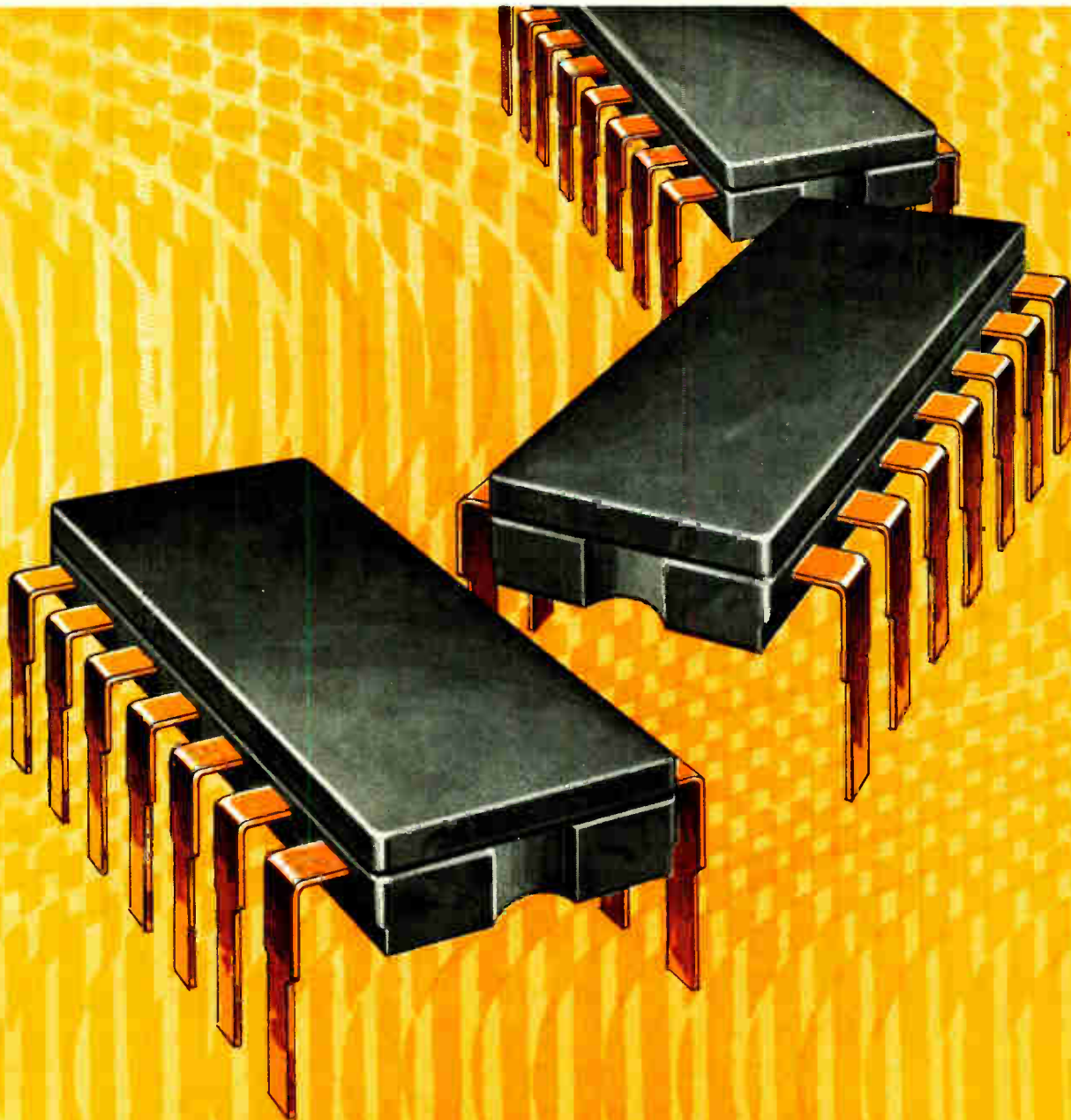

## Take the IC lead with a built-in heat sink

Power limitations due to the low thermal conductivity of lead frames is eliminated by employing silver-bearing copper's built-in high heat transfer capability. By reducing thermal resistance, the power ratings of integrated circuits can now match those of high power transistors.

White Pine Silver-Bearing Copper has a natural, uniformly dispersed silver content which gives it all the physical properties of ordinary copper plus superior characteristics at elevated temperatures.

Silver-bearing copper provides 100% IACS electrical conductivity . . . retains its original hard temper in leads when subjected to heat during manufacture, testing and service . . . resists oxidation better than ordinary copper . . . and enables packages to be lid-sealed by cold welding.

The next time you design or purchase integrated circuits, take the "lead" and specify White Pine Silver-Bearing Copper containing 25 ounces of silver/ton (Copper Number 116).

Want application assistance? Our product development engineers will welcome the opportunity to tell you more about White Pine Silver-Bearing Copper. Please contact I. B. Elman or W. J. Jenkins at 212/586-0300.

---

# COPPER RANGE COMPANY

---

630 FIFTH AVENUE • NEW YORK, NEW YORK 10020



# Circuit Boards inspected 7 times faster



That's right! The new Bausch & Lomb Comparascope will save 86% of your visual inspection time on circuit boards—and assure greater reliability, too.

This unique inspection device compares a production panel with an approved master. It instantly shows up missing components, reversed diodes, broken track, and missing holes, reversed polarity, bridging, wrong values, misplaced resistors, rotated transistors.

Operator fatigue is minimized. Comparascope images are bright and clear, eye strain is eliminated, viewing position is comfortable and relaxed—all making for increased accuracy and reliability . . . and done 7 times quicker. Remember?

Ask for the intriguing story and where you can see the Comparascope. Write for catalog 42-2273. Bausch & Lomb, 61407 Bausch Street, Rochester, New York 14602.

**BAUSCH & LOMB** 

SCIENTIFIC INSTRUMENT DIVISION

Circle 100 on reader service card

find that price pretty unrealistic.”

But George M. McLeod, director of Monsanto's Electronic Special Products Group, feels the marketing battle may be more imaginary than real. “It's something like the presumed death struggle between transistors and vacuum tubes,” he says. “Look at 1967, it was one of the best years yet for tubes. Nixies will be around for a long time to come. However, we see solid-state displays ushering in a host of new applications—a whole new generation of counters, for example, and perhaps even a pocket-size computer.”

Hewlett-Packard continues to display confidence in the market prospects of its solid-state numeric indicator. A spokesman proudly lists the device's pluses as seen through corporate eyes:

- The assembly is small in size, with logic and display in a single package.
- The readout's brightness is on a par with that of the Nixie, and characters are easily visible in daylight.
- Brightness is voltage controllable.
- The device has wide-angle readability since all characters are produced in the same plane.
- Only a 5-v d-c power source is required to drive the display. In addition, the matrix is compatible with IC or other solid-state drives.
- Half life is currently estimated at 10,000 hours, so durability compares favorably with competitive assemblies.
- Costs are comparable.

**Next steps.** Marketing plans for the solid-state numeric indicator are still in a formative stage, say Hewlett-Packard officials. However, it now appears likely that devices will be sold for avionics applications before they're incorporated into catalogued company instruments.

When they finally make it to market, the display packages will sell in small quantities for about \$50 each. Various combinations of logic and display could run anywhere from \$39 to \$144.50 in small quantities. In lots of 1,000 or more, the company believes, unit cost could drop to \$25 or so. Eventually, with low-cost drivers supplied by the bigger IC makers, postings could be reduced to the \$20 range.

When you rate a crystal oscillator—or when you use stabilized VLF transmissions for any other precision-time application—you will be interested to know that the TRACOR 599J VLF Receiver/Comparator will provide

***continuous tracking round-the-clock anywhere in the world!***

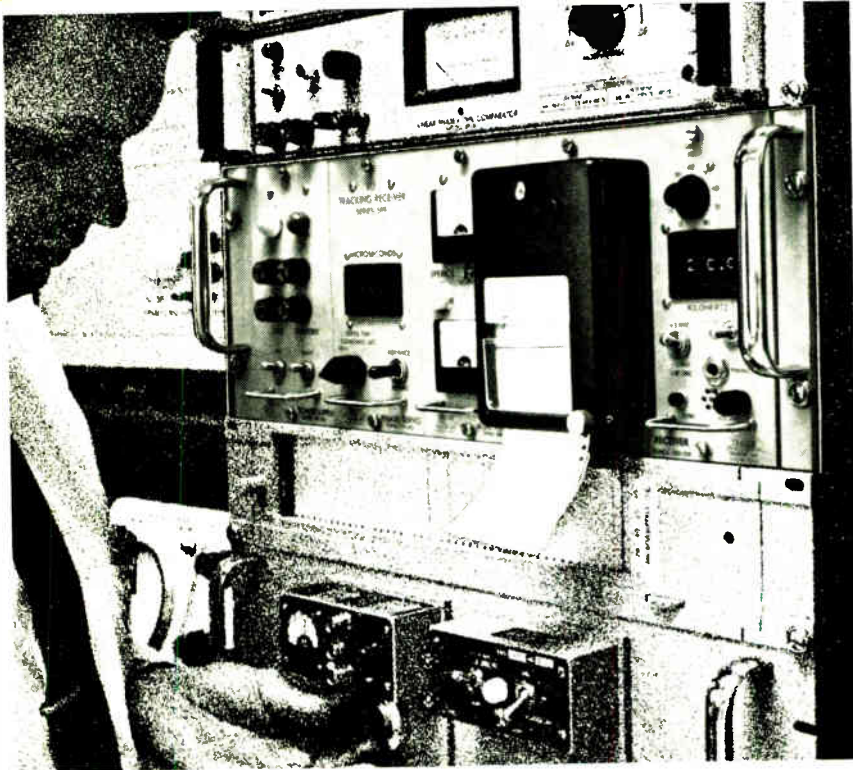

He may be in Australia, Norway, or South Africa. His problem is to rate a crystal oscillator to parts in  $10^{12}$  per day. Wherever he is, anywhere in the world, he needs to be able to track continuously a selected stabilized-VLF transmission for 24 hours or more. He can with the 599J because this receiver/comparator gives him:

- 5 nanovolt typical sensitivity *in actual use* (10 nanovolt guaranteed)
- 3.0 to 99.95 kHz continuous tuning in 50 cycle steps to cover *new* stabilized LF stations
- proportional blanking to keep noise *off the record*
- single sideband noise-rejection techniques to *eliminate* the need for filters.

*Do you have a similar problem? Get full information on TRACOR's complete line of VLF equipment and its performance record for more than seven years of use. Contact: Tracor, Inc., Industrial Instruments Div., 6500 Tracor Lane, Austin, Texas 78721, 512-926-2800.*

VISIT US AT WESCON BOOTH 2030-2031

IA-109

***Specialized instruments from*** **TRACOR** ***to meet your specific needs***

# bench accuracy at system speed

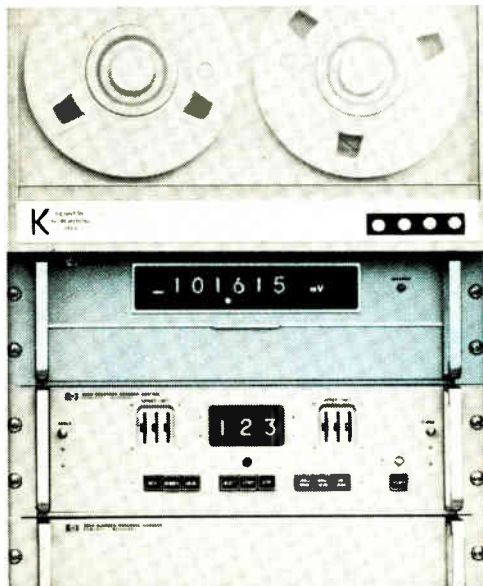
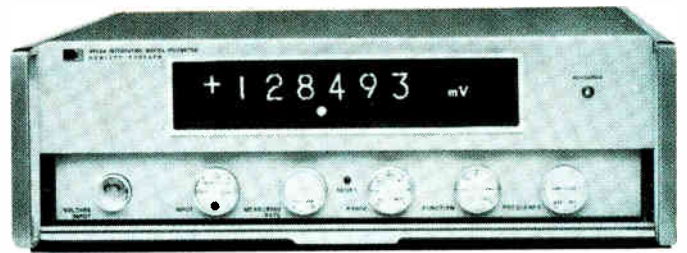

Cover protects 2402A controls for systems use.

Both in an  
integrating DVM  
with 1 microvolt  
resolution.

Take 40 readings per second, integrate and resolve the answers to a microvolt with the new Hewlett-Packard 2402A IDVM... get resolution never before available in this speed range. With the accuracy of a lab instrument (0.01% of reading  $\pm 0.003\%$  of full scale), the 2402A is excellent for system applications... with full programmability and all the features you'd expect from a systems voltmeter. (Of course, it's an excellent lab instrument, too.)

Guarding and integration permit accurate measurement of low-level signals in the presence of common mode and superimposed noise—over 120 dB effective common mode rejection... even at 40 readings per second. Designed for low-cost multimeter expandability: AC, resistance and frequency measurement capabilities can be added easily with optional plug-in circuit cards. Five ranges

to  $\pm 1000$  Volts, including a 0.1 Volt range for high-accuracy millivolt measurements.

The 2402A: \$4800. Plug-in options are reasonably priced—AC, for example, only \$450.

For more information, call your local HP field engineer or write Hewlett-Packard, Palo Alto, California 94304; Europe: 54 Route des Acacias, Geneva.

HEWLETT  PACKARD

DIGITAL VOLTMETERS



# Census Bureau depends on electronics to make its 1970 national nose count

Agency's job will be complicated by more paperwork, the need for speed and accuracy, and plans to make summary tapes available to local agencies

By Paul A. Dickson

Washington regional editor

On April 1, 1970, the Federal Government will again begin its decennial task of counting and profiling the population of the United States. Notwithstanding the kickoff date, the job is no joke. It's going to be bigger and more difficult than ever before. And electronic systems are even now being assembled and tested at the Bureau of the Census to process the vast amounts of data turned up in the course of a national nose count. Fortunately, the bureau has a proven track record in the field of automation.

To begin with, at least 70 million forms—enough to fill 256 boxcars—will be required to get the raw facts and figures on such items as the age, race, income, and housing situation of about 210 million Americans. But collection of information is the least of the worries of the Census Bureau, an arm of the Department of Commerce. The agency must sort, tabulate, and publish its findings by autumn so the data can be funneled into the tortuous bureaucratic maze in time for the President to use it in his 1971 State of the Union message. In addition, there's at least an equal premium on accuracy; the statistics will guide businessmen plotting sales strategies, legislators contemplating reapportionment, securities analysts checking market trends, administrators responsible for urban planning, and scholars interested in demographic patterns.

## Microcensus

The 1970 census will be the most complex and challenging task yet undertaken by the bureau; it will, for example, go far beyond pre-

vious norms and offer detailed analyses of the population of specific local areas. To this end, summary computer tapes containing demographic and housing data on single city blocks, groups of blocks, and census tracts (statistical divisions of metropolitan areas that usually contain about 4,000 people) will be turned out.

**Missing out.** The bureau devised the summary-tape scheme after it discovered that "microinformation," or fine local detail, was being lost when the national census was boiled down for listing in publications. The 1960 census produced about 140,000 pages of published statistics. In theory, the new proj-

ect will get every scrap of useful information into the right hands. The bureau recently set up the Data Access and Use Laboratory, under the direction of John C. Beresford, to oversee the dissemination and use of the summary tapes.

In addition, the System Development Corp., Santa Monica, Calif., has been hired to create software to accommodate the tapes; it is, for example, developing analytical programs to ensure that maximum amounts of data can be squeezed from such media. The company will also see to it that the tapes are suitable for use with the computers that will be in general use when

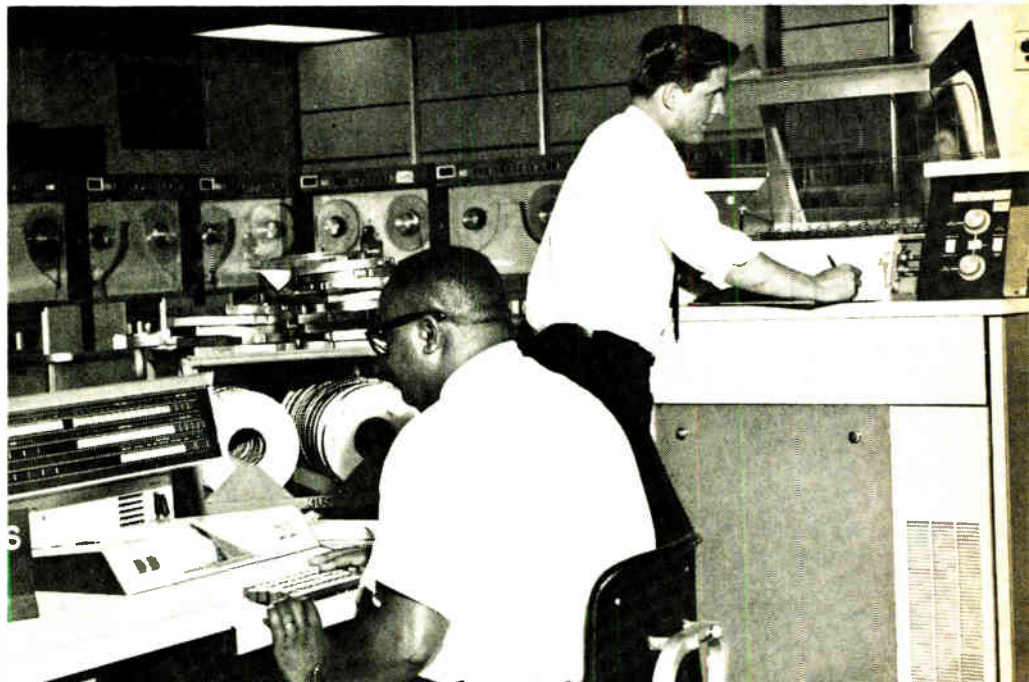

1970. Among the new systems that the Bureau of the Census will be using to tally the next population check is a high-speed Univac 1108 computer.

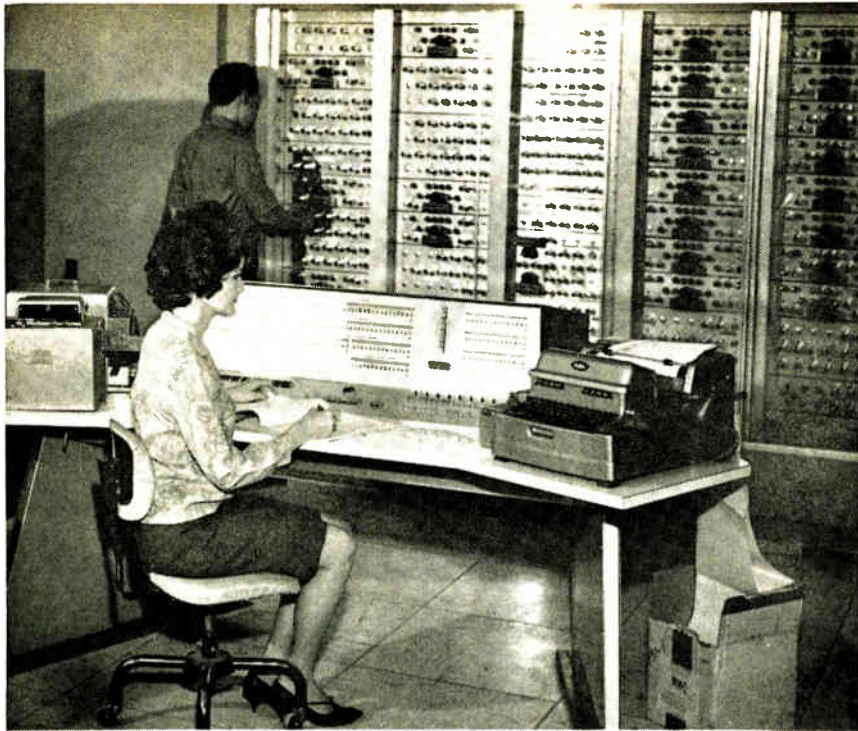

1960. Census Bureau's film optical-scanning device for input to computers (Fosdic) was first used in 1960; an updated version will be used in 1970.

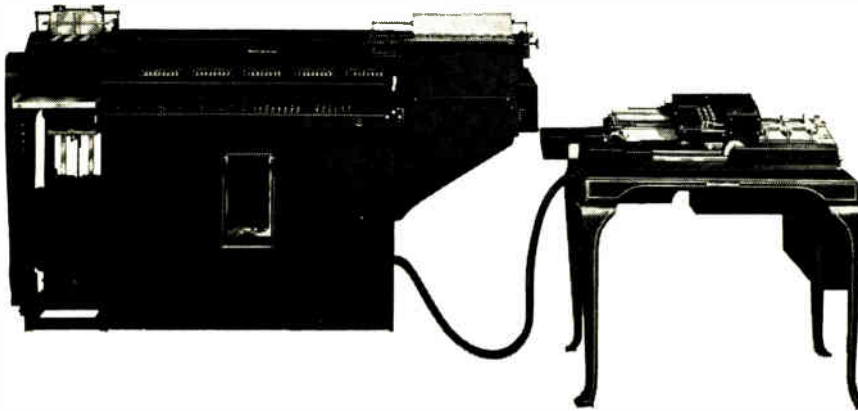

1930. This electric accounting machine with its automatic summary punch was an important part of the Census Bureau's automation arsenal in 1930.

the 1970 data becomes available. To accomplish this, SDC will perfect tape information to enable local researchers to use the data quickly.

### Program promotion

The bureau is now lining up contacts who will be prepared for the wealth of local information that will be available in late 1970. According to a census official, more than 70 administrators have already accepted assignments as regional coordinators for local operations. He says: "This is just the beginning. During 1969 we will hold summary-tape workshops in

100 to 200 locations across the country to instruct local users on what they can expect from the tapes."

An experimental session was held in Madison, Wisc., in May to test the procedures and problems that might be involved. The bureau hopes that future workshops will encourage users to integrate census information with locally gathered data and stimulate development of hardware and software for such innovative applications as computer-generated socioeconomic maps. The bureau is now planning to follow up the workshops with regional seminars for last-minute briefings

on summary tapes and their uses. In addition, the computer industry is now being advised by the Data Access and Use Laboratory about developments expected for the 1970 census so it can anticipate the hardware and software needs of its customers.

**Test bed.** Summary-tape techniques are now being checked in New Haven, Conn., where one of several dress rehearsals for the 1970 census was run off in April 1967. Studies were conducted there to determine just what services can be generated from summary tapes. One development is called DIME (Dual Independent Map Encoding), a technique for encoding geographic features for computer input and subsequent coupling with census information. The DIME file contains complete coding information on such urban geographical features as railroads, intersections, parks, and streets. The DIME system has produced maps of data for both New Haven and West Haven, Conn. According to a bureau source, work is now under way on a half-dozen cartographic schemes ranging from crude city maps, shaded to indicate population density, to detailed map overlays above numerical data displayed on cathode-ray tubes.

This official says the applications available for cities are numerous: maps and charts on housing conditions can be provided for fire departments; educators can have access to children's ages; traffic officials can see transportation patterns; and businessmen can get marketing data.

An official at a large computer manufacturer says his firm is hoping that the 1970 census tapes will induce state and local governments to avail themselves of more sophisticated data-processing systems and techniques. He maintains that the tapes will also afford users in the private sector a better data base for their operations. This source notes that the tapes could play a significant role, for example, in advertising.

**Addressing an issue.** The key to using the tapes without getting to a level that would arouse passions on the question of privacy is the use of address codes, composed of the zip code, street name, and house numbers for a single city



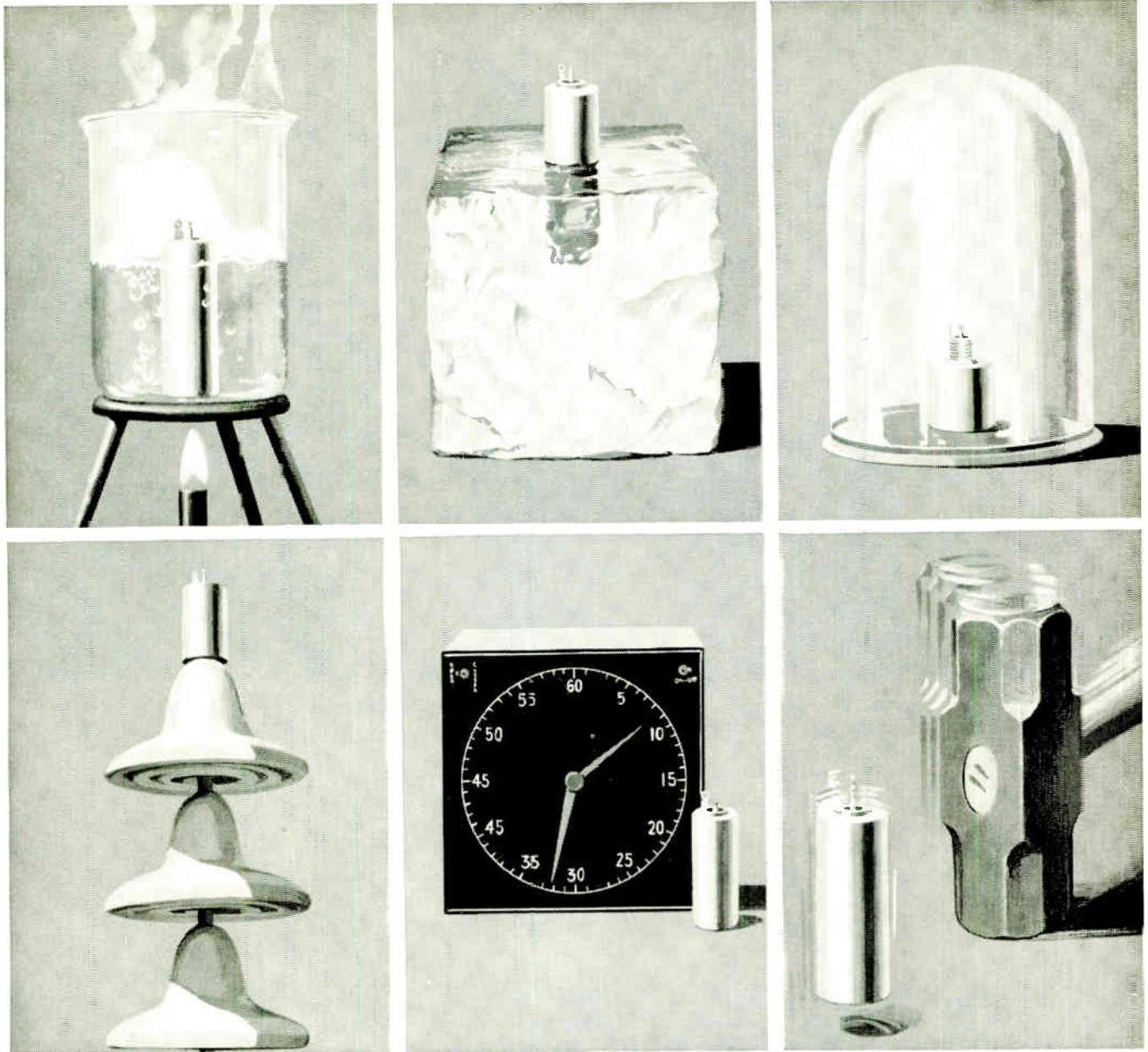

# The incredible capacitor

Sometimes you need a capacitor for requirements that seem impossible. One that's so good it's specified for missiles and airborne electronics. A design that has high capacitance at high voltage (up to 630 volts) in a small size. Temperature capability from  $-55^{\circ}\text{C}$  to  $+200^{\circ}\text{C}$ . Leakage current so low that you get exceptional performance in energy storage or timing circuits. Extreme ruggedness.

Hermetic seal. And on top of this, documented reliability in the order of MTBF of  $5 \times 10^6$  hours at 90% confidence.

The name of the capacitor is Mallory XT... the original wet slug tantalum family. The one you use when nothing else does the job so well. Write for specs. Standard Mallory capacitors are also available from authorized Mallory distributors throughout the United States.



**MALLORY CAPACITOR COMPANY**

a division of P. R. MALLORY & CO. INC.  
3029 E. Washington St., Indianapolis, Indiana 46203

electrical and electronic components • sequence timers • metallurgical products • batteries



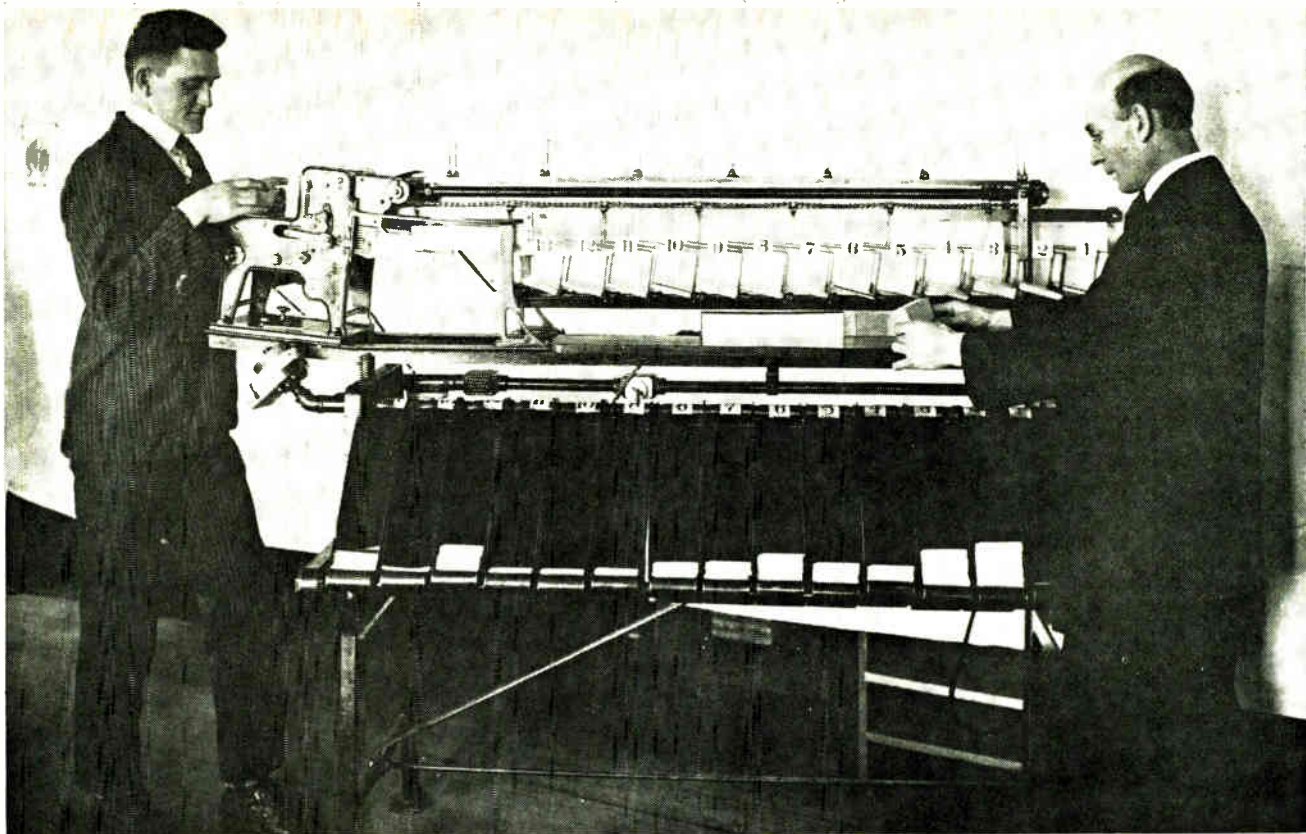

1920. Automatic sorting machines like this were pioneered by the Bureau of the Census; the first units were used during the 1920 population study. Such equipment was the precursor of that routinely used in modern data-processing systems.

block. Thus information about a block can be gathered without specific reference to families living there. The bureau feels that this will safeguard privacy and still give authorities access to detailed infor-

mation. For example, someone studying transportation problems could determine where people from a certain block work without knowing the identity of each individual. However, a master tape register

of addresses will be kept confidentially by the bureau to compile mailing lists and draw up population samples.

#### Business as usual

The first summary tapes, to be issued from late 1970 through mid-1971, will depend on the actual taking of the census. The forms are more detailed, but otherwise this job hasn't changed appreciably since the original census in 1790. It is, of course, done a lot faster. Says Masey Volk of the bureau's systems division: "What it took a keypunch operator eight hours to do in 1950 was done in one minute in 1960, and will take only 20 seconds in 1970." At the moment, the final census form is being readied, new equipment is being built and installed, and daily tests are being performed to ensure that everything will go smoothly in 1970.

Most of the 1970 census forms will, for the first time, be mailed to families; the tedious and costly process of having enumerators knock on doors will be all but eliminated. As during previous censuses, every fourth household will be given the "long form" which

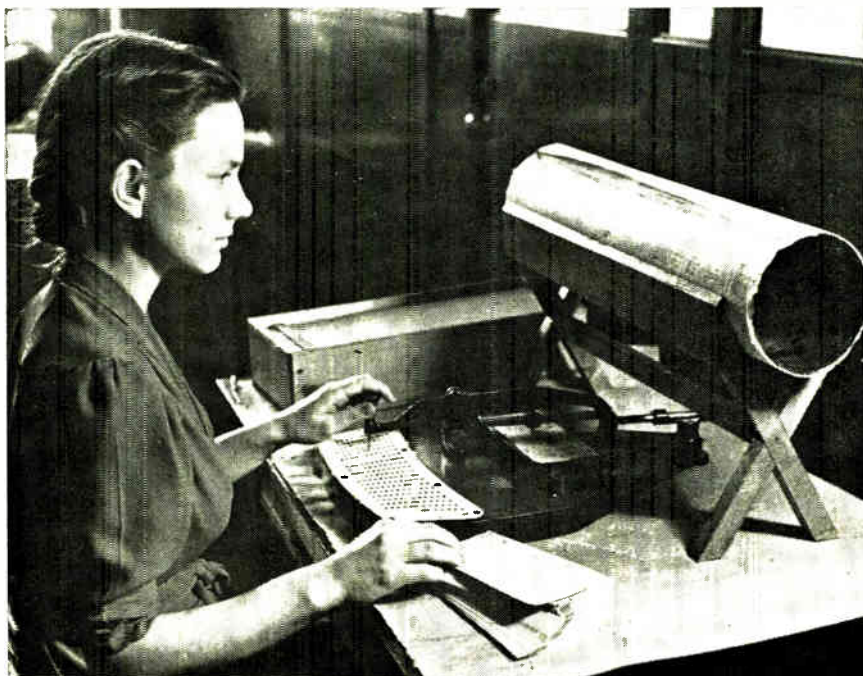

1890. The Census Bureau pioneered punch-card equipment in 1890 to speed tabulation of such statistical data as population's age, race, and sex.

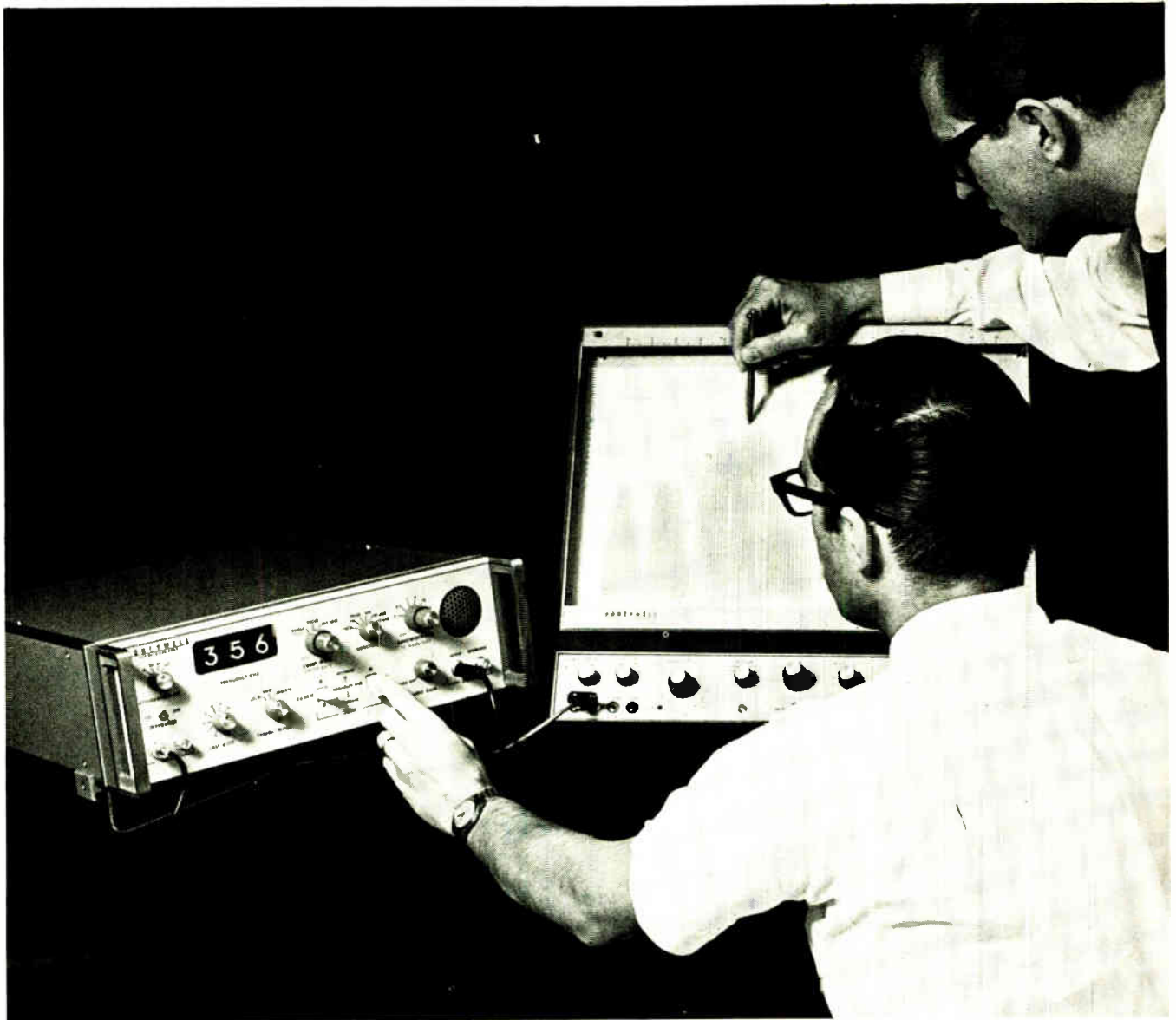

Automatically obtaining a graphic record of RF spectrum from 1-500 kHz.

## Here's Honeywell's solution to RF spectrum analysis: a compact, automatic analyzer with 15" permanent record readout!

This versatile system brings a new ease to surveillance and spectrum analysis. It's our new VLF Receiver – the first in a series of automatic sweep receivers – coupled to an X-Y recorder with 15" display for maximum spectrum resolution.

**Electronically tuned**, the receiver covers the 1 to 500 kHz range in one band. Manual coarse or fine tuning is quick and precise, thanks to lever-actuated switches. In addition, the receiver may be tuned through single or recurring internal sweep, or externally programmed with a DC voltage.

**Digital frequency readout** is four-digit display, plus a fifth digit with front panel switch. For digital recording, BCD outputs are provided. Other features include: choice of AM, FM, NFM, Pulse, AM-USB, AM-

LSB, CW, and FSK, all front-panel selectable; choice of six bandwidths, selected by front panel or remotely; high sensitivity with low noise figure, and image rejection greater than 70 db.

**Useful in a wide variety** of analysis and measurement problems, this compact spectrum analyzer is another example of how Honeywell's broad line, backed by local sales and service, can provide the *precise* solution to your instrumentation problems. For full details on this new system, call your local Honeywell Sales Engineer, or write: Honeywell, Test Instruments Division, P. O. Box 391, Annapolis, Maryland 21404.

**Honeywell**

Honeywell engineers sell solutions



## ... the bureau's efforts have left a mark on data processing history ...

goes into great detail on such items as education, income, employment, and Government service. However, doing the census by mail will increase paperwork; in 1960, as many as eight families could be included on one form in an enumerator's notebook.

"We will start receiving large quantities of returns about May 15 and will have to finish processing them by Sept. 15," says Volk. "This adds up to 70 million forms, containing some 140 million pages, or camera frames, to prepare in 120 days. This means we must process about 1,200,000 frames a day."

The automated input of the 1970 census will be done by a two-part electronic system. The first, high-speed feeder and photographing apparatus, is being built in the bureau's engineering development branch. There will be 35 to 40 of these units. Forms, fed onto Mylar belts, will be held flat by vacuum units. The machines will be able to handle long and short forms—long forms will have their pages turned by an arm with a rolling suction head. Anthony Berlinsky, chief of the engineering development branch, says that the system, called Camera 3, will be able to process two census documents per second. Four designs were considered before the Camera 3 configuration was adopted.

**Private eye.** Once the forms have been photographed, 200-foot rolls of film will be processed by one of six solid-state Fosdic 70 (for film optical-scanning device for input to computers) units. The first Fosdics were fearlessly introduced during the 1960 census. Developed jointly with the National Bureau of Standards, these machines have scanned a number of special censuses the bureau conducted for its own use and for such agencies as the Veterans' Administration and the Public Health Service.

The Fosdic units scan the rolls of film with a crt beam that triggers a photocell and records impulses from the film forms on magnetic tape. The processing speed is expected to be better than 300 photographic frames per second, more

than twice that of Fosdic 60. To handle the extra number of frames generated by the 1970 census, the Fosdics will work a long, hard, schedule: three shifts a day, seven days a week, through the summer of 1970.

Fosdic 70 will produce tapes for the bureau's one Univac 1107 and two 1108 computers, which will help tally the census. The bureau will also have an IBM 360/40 for certain tasks. The Fosdics will be used for some of the preliminary editing required before the tapes

### Fuel for the fire

The perennial issue of computers and invasion of privacy can be expected to direct fire toward the census bureau before, during, and after the 1970 study. Several Congressmen have already voiced concern lest the census provide too much information to the Government.

In rebuttal, the bureau says that privacy is protected by law and that citizens shouldn't fear the census. Officials point out that only the bureau can use the information on individual forms; data can be used only for statistical purposes, they say—not for taxation, investigation, or regulation. All census employees with access to forms must take an oath not to disclose information; violators can be penalized with up to two years in jail or a fine of up to \$1,000.

can be rewritten for use in the computers.

**Next case.** Once tallying is completed and the series of summary tapes produced and sent to local users, the bureau won't lack for work. The agency's operations have been studied by other nations, and talks are now in progress with several that want the U.S. to handle the automated parts of their censuses. The bureau will also continue to do censuses for other agencies, make its own test and research runs, and do a number of

other related odd jobs.

In addition, information from earlier censuses as well as the 1970 check will be required by Federal agencies, scholars, and others. Currently, an average of 400 programs and searches are written or conducted each week to gather data from the 160,000 reels of magnetic tape in the bureau's files.

The bureau is called upon to perform many fast-turnaround tasks that result in data-processing curiosities. For example, when Medicare went into effect, millions of elderly people had to prove their ages to be eligible to receive aid, and many went to the bureau. The result was formulation of an automatic data-retrieval system in which the 1890 censuses were microfilmed, coded, and recorded so that citizens' ages could be quickly checked.

### Achievements

Even as the innovative 1970 census approaches, specialists in the bureau are thinking of the 1980 study and the techniques that can be tested and examined during the next decade. The bureau's past efforts have left their mark on the course of data-processing history. Among the agencies more signal accomplishments:

- The punch card was developed by an employee named Herman Hollerith for the 1890 census—the first data-processing job handled by such a medium.

- Follow-on punch-card equipment and techniques were developed at the bureau—for example, keypunch devices as well as floating-point and multiple-program punching.

- The first electronic computer designed for statistical work was put in operation by the bureau in 1951. The computer concept developed from discussions with the Army, which was having the Eniac computer built. The bureau issued a study contract along with the National Bureau of Standards. This led to a contract for a system in 1948, and the delivered machine was the first Univac I, which helped finish the 1950 census. The first Univac I and the thirteenth were used during the 1960 census, with number one eventually being honorably retired to the Smithsonian Institution.



(another wei first)  
repeatable  
susceptibility testing



... automatically  
MIL-STDS-826A, 461/2

The WEI 320 Systems will automatically provide high power outputs over the frequency range of 15 Hz to 20 GHz. The Systems scan automatically from the lowest present frequency to the highest, producing a hard copy plot of frequency vs. test specimen malfunctions at calibrated power levels. Any single band may be scanned or locked out of the program with 60 dB of programmable attenuation per band.

A complete set of matched and calibrated antennas is provided with each 320 System for the direct performance of tests to MIL-STD-826A, 461/2, 220A, 285 and others.

Three separate systems cover the frequency spectrum. The 320A scans from 15 Hz to 1.0 GHz; the 320AH from 1.0 GHz to 12.4 GHz; and the 320AVH from 12.4 GHz to 20 GHz.

FOR COMPLETE INFORMATION CONTACT

656 Lotstrand Lane  
Rockville, Maryland 20850  
Phone: (301) 424-2900



WHITE  
ELECTROMAGNETICS  
INCORPORATED

# We have quite a thing about transmission capacity. 108 50-baud channels. Like RECTIPLEX.

This new carrier telegraph system commenced service between Tokyo (KDD) and San Francisco (RCA) June 1968 and revolutionized transmission capacity and transmission rates.

The development of this brilliant innovation posed quite a few problems. We had to increase speed and capacity, and, at the same time, battle the high costs of for-hire cables and new-cable installation. In cooperation with K.D.D. we found the answer: RECTIPLEX, in which

a unique phase-modulation transmits 108 standard telegraph channels over a single voice band. The resulting transmission capacity is five times that of conventional multiplex systems, and combines economical capacity expansion with faster data transmission.

RECTIPLEX I lived up to the highest expectations. So will RECTIPLEX II, when it revolutionizes cable transmission between Tokyo (KDD) and New York (ITT) this September.

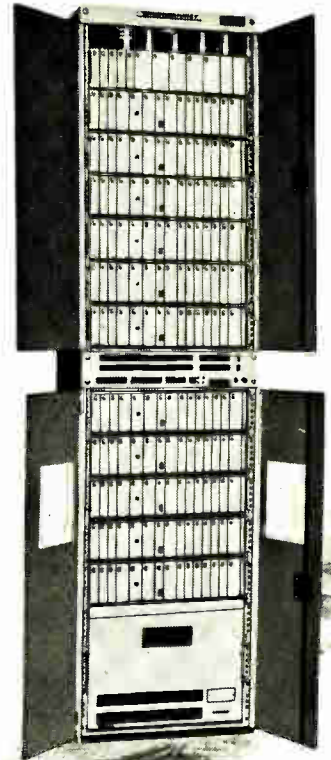

**FUJITSU LIMITED**

*Communications and Electronics*

Marunouchi, Tokyo, Japan

**Main Products:** Telephone Exchange Equipment  Telephone Sets  Carrier Transmission Equipment  Radio Communication Equipment  Space Electronics Equipment  Data Communication Equipment  Telemetering and Remote Control Equipment  Computers (FACOM) and Peripheral Equipment  Automatic Control Equipment (FANUC)  Electric Indicators  Electronic Components and Semiconductor Devices.



# How do most companies move a fast-thinking, precision-built, time-saving computer?



They choose a calmly efficient, utterly trustworthy, nerve-saving van line. Allied Van Lines carefully moves more computers than any other van line.

Call the utterly trustworthy Allied Agent in your town.



**ALLIED VAN LINES**

Circle 111 on reader service card





# Educating electronics personnel is too big a problem to have only one solution.



Of course, you're sold on the importance of providing continuing education for your electronics personnel. So rapidly do new developments take place in electronics that knowledge begins to lose its value almost as soon as it is acquired. Valuable men can become outmoded and unproductive almost overnight. And the shortage of technical manpower at both the professional and supporting levels makes it imperative that you utilize fully every man you have.

Perhaps your company conducts in-plant programs of instruction. Or pays all or part of the cost

of evening classes in nearby technical institutes, colleges and universities. Whatever your educational program, we believe it will be more flexible and more effective if you supplement it with CREI Home Study Programs in Electronics.

We've prepared a brochure that tells how CREI Programs can help you update, upgrade and reorient electronics personnel. Use coupon below to send for a copy today.

Founded 1927



Accredited Member of the National Home Study Council



#### CREI, Home Study Division, McGraw-Hill Book Company

Dept WTC-01, 3224 Sixteenth Street, N.W.  
Washington, D.C. 20010

I want more information on CREI Programs in Electronics and how they can supplement our educational program for electronics personnel. Please send me, without obligation, your descriptive brochure.

Name \_\_\_\_\_

Title \_\_\_\_\_

Firm Name \_\_\_\_\_

Address \_\_\_\_\_

City \_\_\_\_\_ State \_\_\_\_\_ Zip \_\_\_\_\_

# be Wisconsin's guest: in your own home!

read our newspapers, **FREE** for **60** days

If you have an industrial-site decision to make, you must have facts and figures, and we'll send you Wisconsin's. But there's more to site selection than cold figures or hot claims. Most importantly, there's the emotional and intellectual climate that makes so much difference in operating a business.

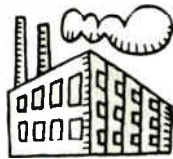

Imagine the most honest way to help you evaluate the people-factor in Wisconsin. Short of actually living with us for a while, we believe you would like to read our newspapers... from a different city every day or two, for 60 issues. Not slanted editions. The same papers that are delivered to our own doors.

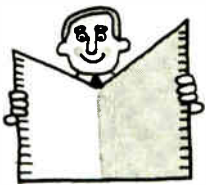

We'd like you to learn firsthand about our citizens support of law and order and our low crime rate. See how our editors are at odds, or in agreement, on points of state-wide policy, what our labor-industry situation actually is today. (A month of reading just our "classifieds," for example, could tell you more about that than most surveys.) We'd like you to see what we charge for a dozen eggs. Or a house. Or a theater ticket. How we feel about and use our northern crown of deep woods,

our lakes and streams, our inland sea ports. Look at our fashions. Enjoy our sports. Shop our stores.



So ask your secretary to fill out the coupon. Or write us a note on your business letterhead, mentioning your title and telling us whether you'd like to have your 60 different issues of Wisconsin newspapers mailed to your home or office. We'll acknowledge promptly, with some interesting statistics and an official map so you can see where each newspaper comes from. The papers themselves should start arriving in two or three weeks. Soon you should have a pretty clear picture of what Wisconsin is—and whether you'd like it here.

We do.

**This invitation is open to all industrialists everywhere, except those now living in Wisconsin. (Sorry, neighbors.)**

## WISCONSIN !

### 8 Good TAX-REASONS Why "You'll Like It Here"

- Wisconsin did not raise tax rates or add new taxes for fiscal 1967-69. All adjoining states raised taxes and/or altered tax systems.
- Property tax *credit* on inventories is now up to 60%.
- Industry realizes an average of 22.7% *relief* on personal and real property tax.
- We have *no* capitalization tax.
- Corporate income tax provides for *two-year net loss carry-forward*... no "poor year" burden.
- Our average unemployment compensation tax rate was 1.5%... national average 2.0% (1966).
- Per capita sales tax of median state among those having sales tax was \$42.35... ours only \$22.14 (1966).
- Wisconsin returns 61% of its revenues to local governments.



Division of  
Economic Development  
746 State Office Building  
Madison, Wisconsin 53702

I think you're right. A 60-issue look at Wisconsin's daily newspapers should be most revealing. Please send me your free papers. I understand there is no obligation whatever.

Name.....Title.....  
 Firm Name.....  
 Kind of Business.....  
 Address.....  
 City.....State.....Zip.....

If you would prefer that papers be sent to your home, please include following information:

Home Address.....  
 City.....State.....Zip.....  
 (If different from that of your company)

# The product improvers.

## TI dual FETs help Zeltex cut the cost of high performance

The Zeltex Model 133 differential amplifier costs only \$30, yet it features typical input bias current of 15 pA and 10,000 megohm input impedances. This combination of price and performance results in large measure from the use of TI's 2N5045 dual N-channel FETs at the input.

These "product improvers" helped Zeltex realize dramatic savings by avoiding the selective matching, stocking, handling, and testing previously required with individual FETs.

Furthermore, use of matched duals in a single package virtually eliminated thermal gradient problems, assuring low drift and outstanding long-term stability.

The excellent electrical characteristics of TI's 2N5045s have also helped Zeltex upgrade performance in all FET-input models. Other units feature dc voltage gains as high as two million, slew rates to 100 V/ $\mu$ s, and input bias currents as low as 5 pA. *And all units cost far less than chopper-stabilized amplifiers.*

You, too, can improve performance — while cutting design effort and manufacturing costs — by using dual FETs. Remember...TI offers industry's broadest choice, including singles or duals, N-channel or P-channel, plastic or metal can. In total, more than 75 different types are available. Let your local TI sales engineer or distributor help you choose the right product improver for your circuit design. For data sheets, drop a letter to



Texas Instruments Incorporated, P.O. Box 5621, MS 980, Dallas, Texas 75222.

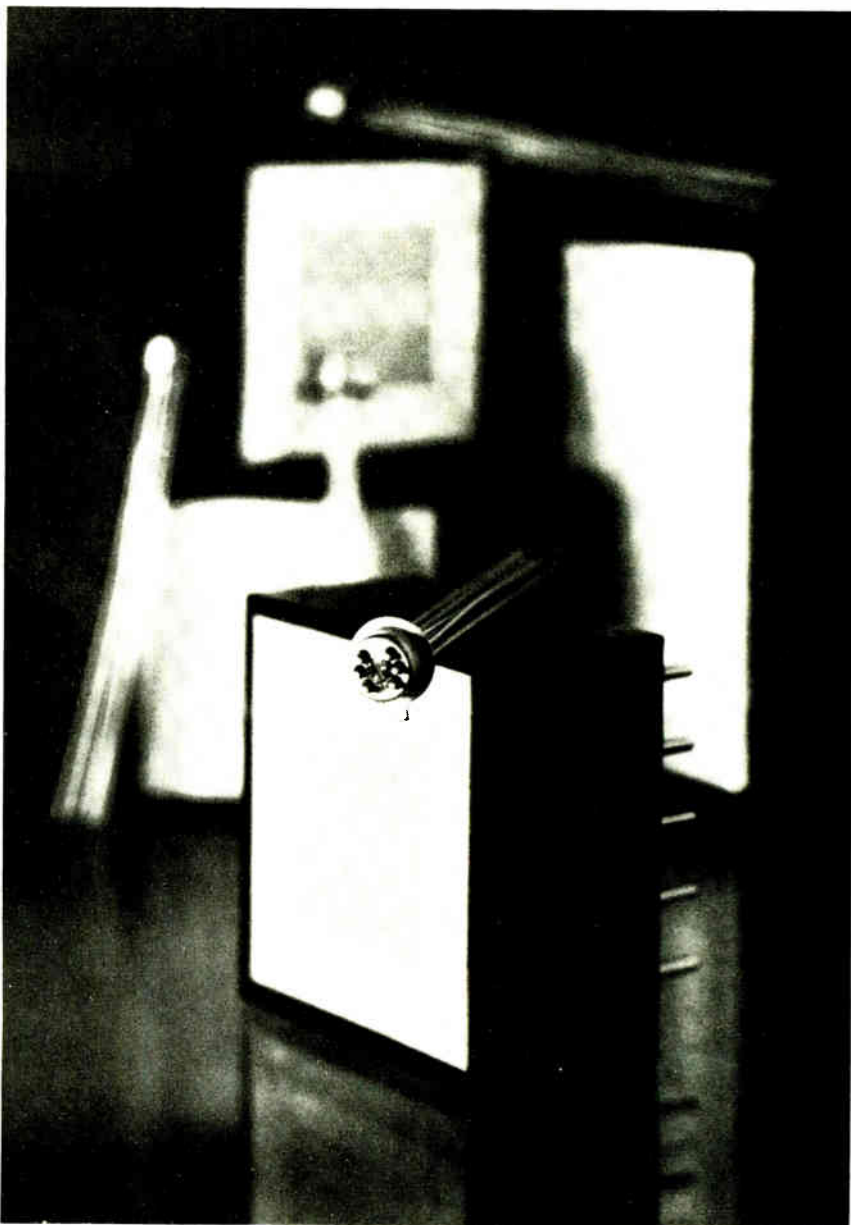

**TEXAS INSTRUMENTS**  
INCORPORATED



# Peace Core

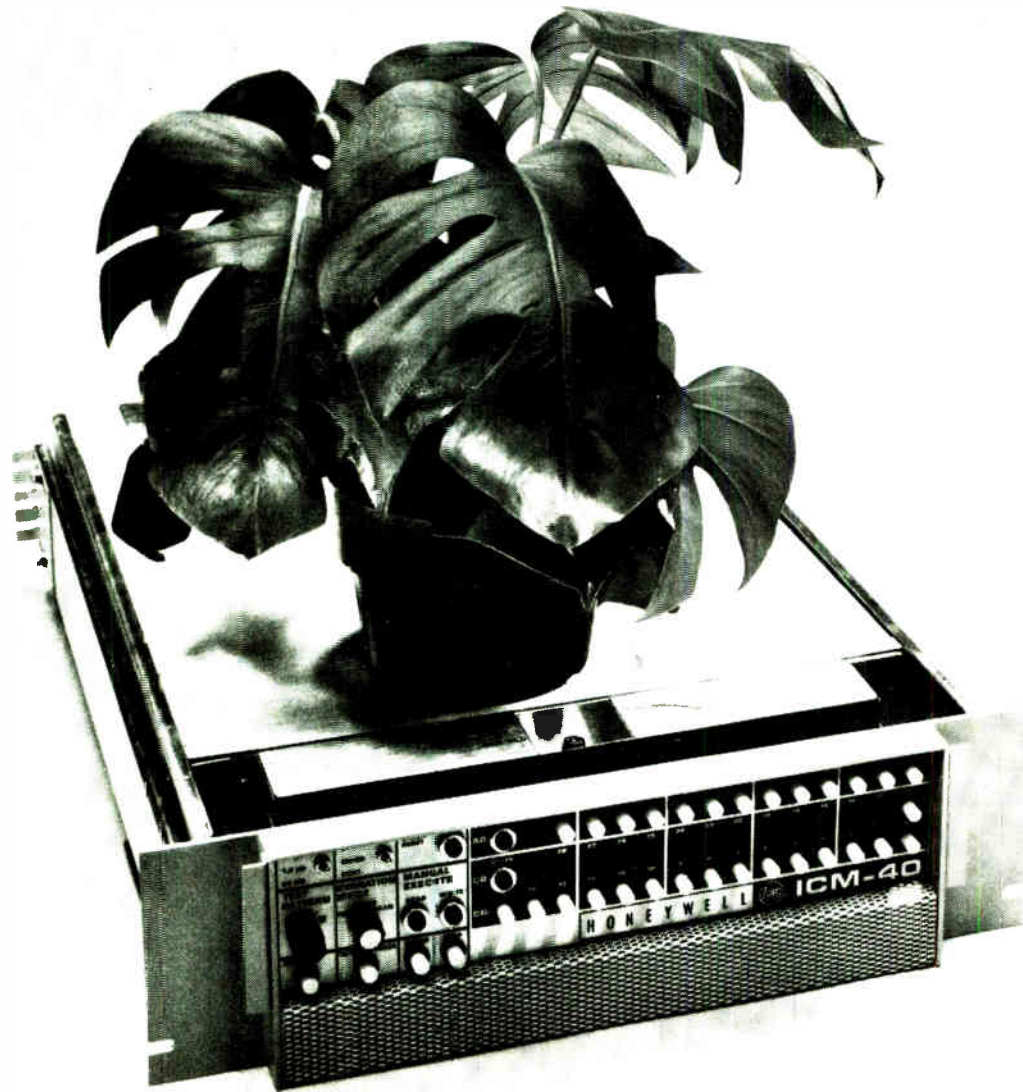

Slow deliveries getting your customers up in arms? Try the peace core — Honeywell's ICM-40 core memory system. With our Certified Fast Shipment (CFS) plan the ICM-40 will help make life in the production jungle a little easier. Memories will be shipped within 3 weeks of the time we receive your order — assuring you of low-cost inventories with no risk of production delays.

Whether you're an OEM buyer, or a custom designer, you'll like joining forces with the peace core. The ICM-40 features: *Fast operating speed* — full cycle time of one microsecond, *Wide capacity range* — up to 32,768 words in a single 5½ inch high memory module, *High reliability* — MTBF exceeding 10,000 hours, *Wide temperature range* — 0° C to + 50° C, *Proven performance* — over 400 installations.

For more information, call your local Honeywell core man, or write for our summary brochure. Honeywell, Computer Control Division, Old Connecticut Path, Framingham, Massachusetts 01701

## Honeywell

 **COMPUTER CONTROL**  
DIVISION

(205) 881-2711 Ext. 2100  
(212) 275-6200 Ext. 770  
(213) 278-1901 Ext. 32  
(214) 363-5441 Ext. 0219  
(215) 943-2210 Ext. 2214  
(304) 841-1570 Ext. 2400  
(312) 671-1800 Ext. 73  
(313) 836-7170 Ext. 7171  
(314) 862-1000 Ext. 135  
(315) 463-4535 Ext. 1177  
(408) 241-5650 Ext. 1041  
(505) 268-6714 Ext. 2954  
(617) 893-2610 Ext. 2710  
(703) 524-8200 Ext. 227  
(713) 622-2461 Ext. 322  
(714) 276-4162 Ext. 2017

# RESEARCH AND ENGINEERING

## Function

The Research and Engineering organization is the principal source of all programs that originate at the Fort Worth Division of General Dynamics. R&E personnel undertake the basic and applied research which leads to the definition and design of new aerospace systems. The broad scope of the R&E functional responsibility includes the continuous development of new programs and the technical management of major hardware projects from the conceptual stage through the operational phase.

## Organization

Research and Engineering is organized essentially in terms of principal engineering functions. Each of the five departments is responsible for the tasks which fall within its technical surveillance whether this task entails research, development, design or production. As a result of this functional organization structure, individual engineers have an opportunity to be familiar with a variety of programs simultaneously. The diversity of experience not only prevents overspecialization but it allows the individual to benefit from a fertile flow and interchange of ideas. When technical management activities must be coordinated across the functional departmental lines, project offices are established within the R&E organization; this project management experience provides another dimension to professional growth.

## Activities

Engineering resources are being utilized on the complex tasks associated with preparing the F-111 A and B airplanes for their operational roles and with designing and developing other members of the 111 family. Engineering skills are being used, also, in the formulation of completely new aircraft product lines and space surveillance systems.

To accomplish these activities, R&E personnel research, analyze, design, integrate, test, plan, implement, manage, monitor, administer, and support. Methods and techniques have to be updated, unique capabilities have to be expanded, facility needs have to be identified and enlarged, expertise has to be enhanced, experimental and analytical data has to be added to—all a continuing set of activities. And a purposeful set of activities that an engineer finds technically rewarding.

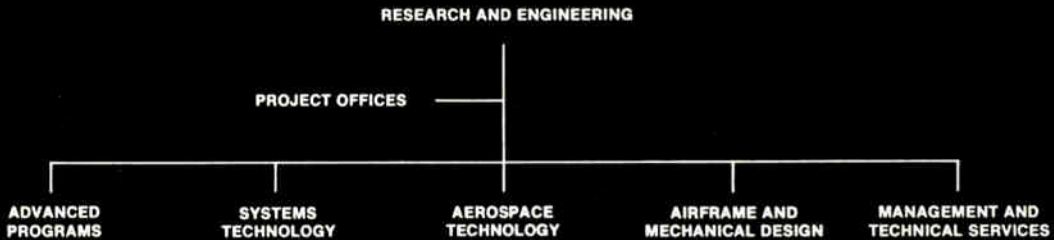

## RESEARCH AND ENGINEERING DEPARTMENTS

DISCIPLINES	Advanced Programs	Systems Technology	Aerospace Technology	Airframe and Mechanical Design	Management and Technical Services
Aeronautical	■	■	■	■	■
Electrical	■	■	■	■	■
Mechanical	■	■	■	■	■
Civil	■	■	■	■	■
Physics	■	■	■	■	■
Mathematics	■	■	■	■	■
Industrial	■	■	■	■	■
Other	■	■	■	■	■

The upper levels of opportunity in research, development, design, test and evaluation await your creative engineering or scientific capabilities in the many advanced aerospace projects at the Fort Worth Division of General Dynamics. You'll live and work where there's room to grow. Fort Worth's uncongested freeways connect the plant with superior residential areas, and you'll enjoy a broad range of cultural, recreational, and upper level educational facilities. Smog-free air, a mild climate and low living costs make a further contribution to your career satisfaction. Call Collect—817-732-4811, Extension 3551; or send a resume of your training and experience to Mr. J. B. Ellis, Industrial Relations Administrator-Engineering, General Dynamics, Fort Worth Division, P. O. Box 748E, Fort Worth, Texas 76101. An equal opportunity employer.

# GENERAL DYNAMICS

## Fort Worth Division



## In hope of doing each other some good

### In the old fish-oil plant



It's like the observation windows in hospital nurseries where the daddies get the first glimpse of the babies. The windows look in on the inner core of the building where an infant industry, born of printed circuits and the photo technology of the microelectronics revolution, is hard at work earning its keep. While observers observe, the interplay of light-sensitive resists with etchants is turning out parts for Kodak's own products and parts for the machines that make the products, like the heating elements for the equipment that seals the protective wrapper on our film for the home movie trade.

The man holding the photofabricated element and being shown how it was made typifies the observers we invite. After a walkthrough they are invited to go beyond mere observing and get their gloves wet. Some of them are managerial or financial types, just getting interested. More of them are already running photofabrication operations for their firms. The more they

stimulate each other to expand scope and improve efficiency, the better our sale of Kodak photoresists and companion products, and the better for the companies that have geared themselves to serve the photofabricators with equipment for generating the master "artwork" and reducing it to masks, for dip-coating, spray-coating, or roller-coating the resists, for exposing, and for chemical treatment.

The new Kodak Photofabrication Center was rebuilt from a plant we put up years ago to distill vitamin A from fish liver oil. As a result of the interest this plant kindled in vitamin A for pharmaceuticals, then foods, and later feeds, demand for vitamin A soared to a level that required better means of production than fish.

Some day, when the need is outlived to kindle interest in photofabrication and to develop new applications for photoresists, we may rebuild once more.

*Meanwhile, all who have decisions to make about photofabrication or employees to train in it are urged to communicate with Eastman Kodak Company, Industrial Photo Methods, Rochester, N.Y. 14650.*

### Is the laser in tune?

Photography is indeed the principal basis of our position in the world, but that doesn't qualify us as expert in all scientific applications of photography. For nothing more than following our directions for use of our products few engineers add lustre or publications to their names.

Directions and suggestions for use are framed from patterns of inquiry in

the mail, on the phone, and face to face. An instance: the many who ask how to see the modes of an infrared laser with photographic help. They have struck forth a pamphlet entitled "Photographing Phosphor Displays of Laser Patterns." The idea is simply:

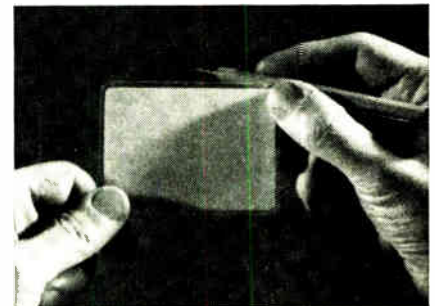
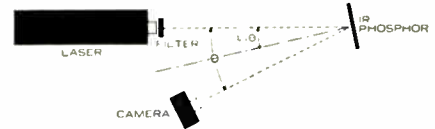

"IR PHOSPHOR" refers to a Kodak product that looks like a white card (available in 2" x 3", 4" x 5", 8" x 10", 14" x 17", and 20" x 24") and contains a substance that can be stimulated at 0.7 to 1.3 microns to release as orange light the energy it soaks up while lying around in white light.

*If you need the pamphlet for the details or if you have already figured out some details and just want to order a KODAK IR Phosphor\*, get in touch with Kodak Apparatus Division, Special Products Sales, Rochester, N.Y. 14650 (phone 716-325-2000, ext. 2339).*

\*Also said to be useful as an optical memory device. Fast, too. See *Proceedings of the IEEE* 54, 425 (1966).

### NOTE TO MILITARY READERS PLANNING RETURN SOON TO CIVILIAN LIFE

You may feel a certain small disquiet as you flip the pages of this magazine if you find that the articles that were appearing a couple of years ago were easier to follow in full detail than the ones in this issue. It's a fast changing technology. Indeed it is.

Such disquiet does one credit. It may indicate an attractive trait of mere modesty. On the other hand, if the modesty is justified, worrying is smarter than

not worrying. Here is a constructive suggestion:

*Drop a note about yourself, your engineering education, your engineering experience (if any) to Business and Technical Personnel Department, Eastman Kodak Company, Rochester, N.Y. 14650. No blanket promises, of course, but you may find you have nothing to worry about. We have ways to bring smart people up to date.*

EASTMAN KODAK COMPANY An equal-opportunity employer



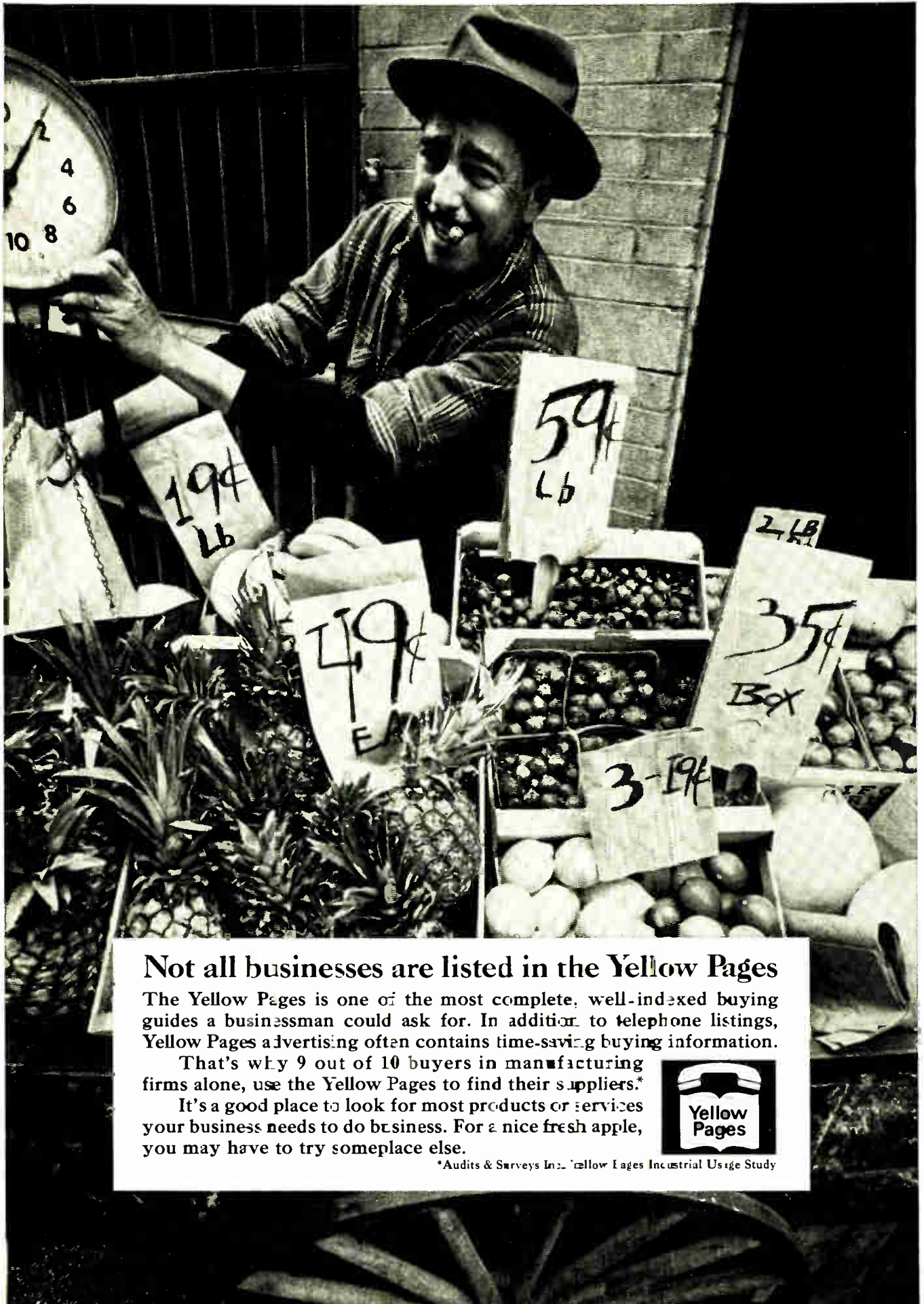

## Not all businesses are listed in the Yellow Pages

The Yellow Pages is one of the most complete, well-indexed buying guides a businessman could ask for. In addition to telephone listings, Yellow Pages advertising often contains time-saving buying information.

That's why 9 out of 10 buyers in manufacturing firms alone, use the Yellow Pages to find their suppliers.\*

It's a good place to look for most products or services your business needs to do business. For a nice fresh apple, you may have to try someplace else.



\*Audits & Surveys Inc., Yellow Pages Industrial Usage Study



# Polysulfone I.C. Carriers help make integrated circuits what they are today.

The Barnes Corporation, producers of the largest, most complete line of integrated circuit carriers, uses only BAKELITE Polysulfone.

BAKELITE Polysulfone's resistance to high temperatures is vital for successful I.C. temperature testing, which ranges from minutes to months at 150°C.

This thermoplastic won't shrink, grow, or gas. Because of these capabilities, efficient handling and testing of up to 50,000 packages an hour happens every day at leading I.C. manufacturers.

For other applications, here's why BAKELITE Polysulfone beats other thermoplastics, even some metals:

- Non-conductive
- Retains its physical properties from -150°F. to well over 300°F.
- Has a 150°C. U.L. temperature rating
- Is self-extinguishing
- Has a very low mold shrinkage for exceptional precision in molding
- Can be easily metal plated, threaded, painted
- Costs less than many metals
- Holds close tolerances and provides dimensional stability



BAKELITE is a registered trade mark of Union Carbide Corporation.

THE DISCOVERY COMPANY

For detailed information about BAKELITE Polysulfone, write: Union Carbide Corporation, Dept. EM-7, 270 Park Avenue, New York, N.Y. 10017

Circle 119 on reader service card



# DUMP CIRCUITS

Magnetic circuit breakers lend themselves to SCRAM circuits, panic button circuits, or any such application where it is desired to quickly and reliably remove the load from the power source.

APL type breakers can be had with standard 50 ma AC coils which have about 420 ohms impedance. Operated directly from 115 volts AC the coil current of Pole B will reach 275 ma for a few milliseconds. (Pole A is in the other side of the line and provides time delayed protection against overloads.) Somewhat lower pushbutton currents can be obtained, if necessary, by the use of circuit breakers with impedances up to 11K ohms. These would be non-standard, but our non-standard costs are modest indeed.

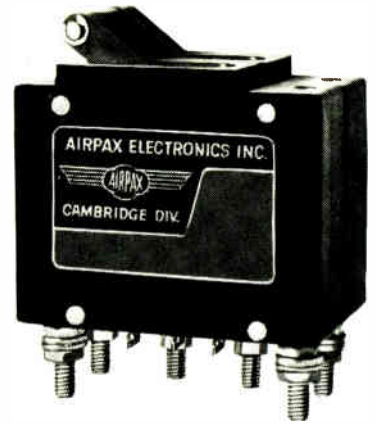

**APL  
MAGNETIC  
CIRCUIT BREAKER**  
Double Pole with  
auxiliary signal contacts

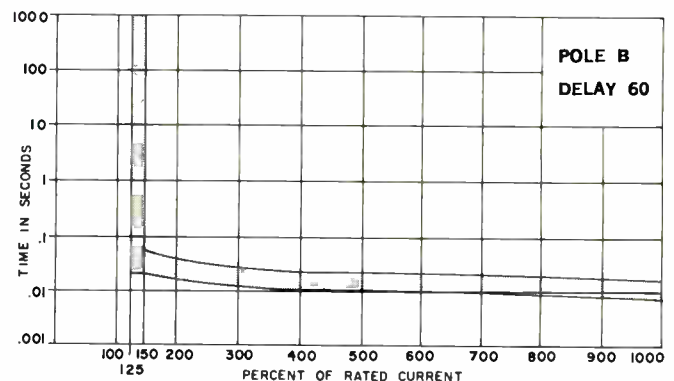
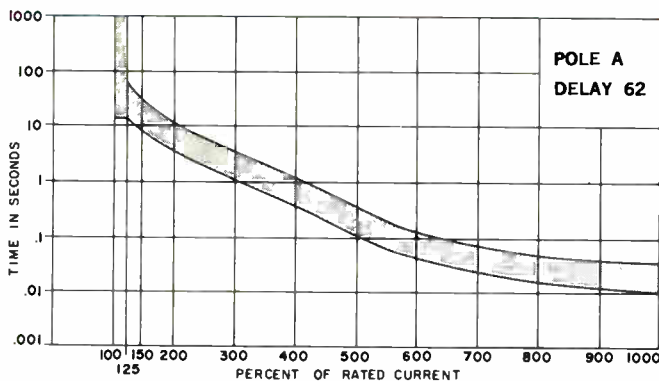
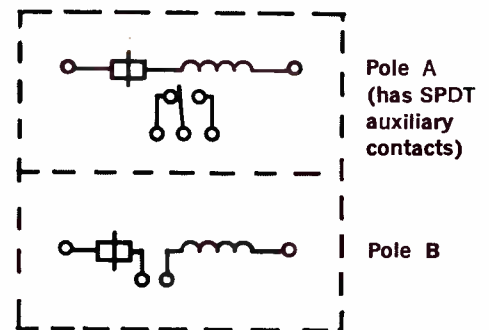
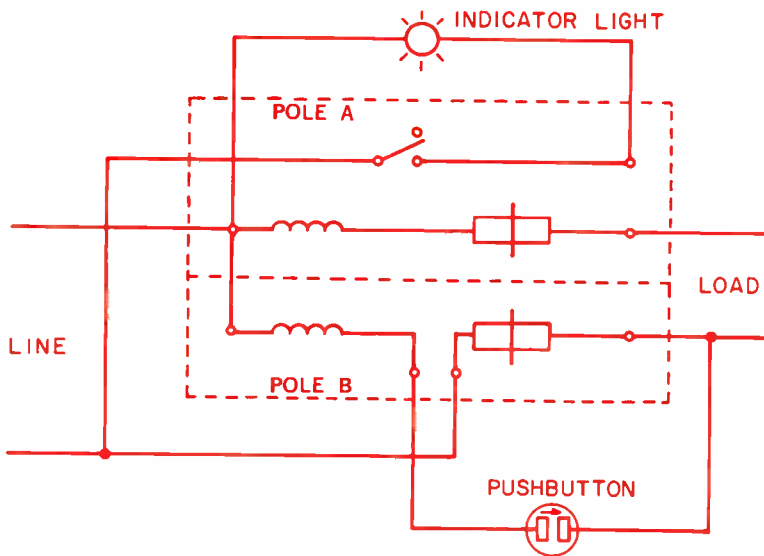

## AIRPAX ELECTRONICS

CAMBRIDGE DIVISION, CAMBRIDGE, MARYLAND 21613

Phone (301) 228-4600

TWX 710 865-9655

TELEX 8-7715



# New Products

---

Semiconductors

## Need an LSI array with 96 gates? Orders filled in six weeks

Giant chip is one of two large-scale integrated TTL circuits from Fairchild; application determines the intraconnections

By Walter Barney

San Francisco bureau manager

**To minimize design** and production problems in developing its first large-scale integrated array, the Fairchild Semiconductor division went with an approach with which it has had years of experience and success—diode-transistor logic. That first circuit, the 4500, was a four-by-two array of cells, each of which consisted of a quartet of four-input NAND gates [Electronics, Feb. 5, 1968, p. 45].

For its second venture in bipolar LSI, Fairchild has switched to the much faster transistor-transistor-logic scheme, and has increased both the number of gates and the complexity of the logic. The basic quarter-cell for the 4600 and 4700 will be two four-input AND gates connected as OR gates and then inverted. The 4600 will have six full cells (48 gates), and the 4700, on a monstrous chip of silicon 145 mils square, will have 12 cells and 96 gates. Yields are usually disastrous with such a large chip, but Ben Anixter, integrated-circuit marketing manager at Fairchild, claims that the complexity of the 4700 is such that the circuit can be sold with yields as low as 1%.

Fairchild will stockpile the 4600's and 4700's after they've been

through the final diffusion step. Customer requirements will determine the final metalization patterns, which will be deposited in two layers. Richard Kors, marketing manager for proprietary integrated circuits, says that if the customer breadboards his own circuit and provides a logic diagram, Fairchild will produce the circuit

in six and a half weeks. The work still required at the breadboard stage consists of three masking steps—for the two metalization layers plus an insulation layer—and testing.

**Ins and outs.** There are actually two types of quarter-cells, one for use when the signal is going off-chip and the other when it is to

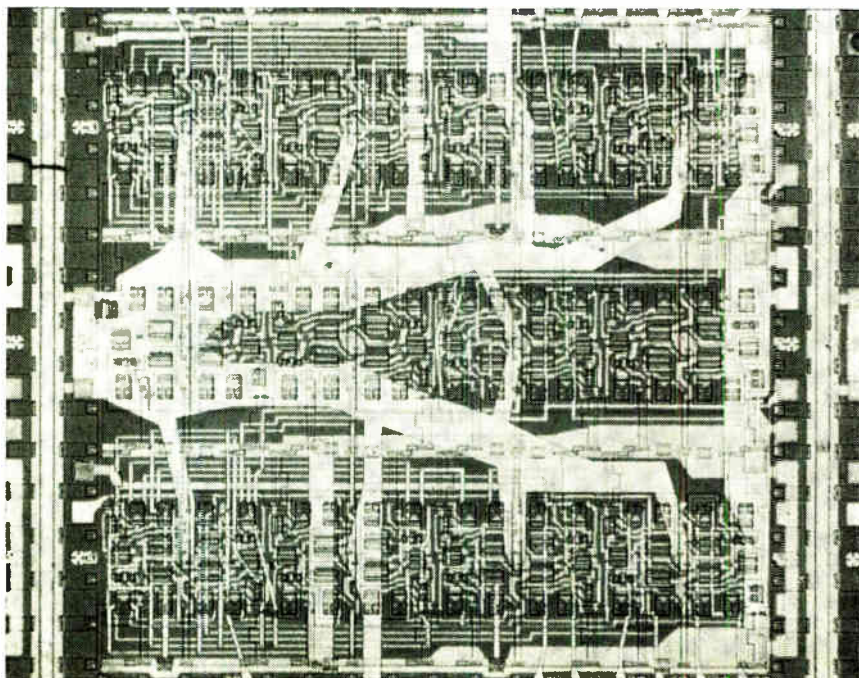

IN JUST

3

DAYS

ACOPIAN WILL SHIP ANY OF 62,000 DIFFERENT POWER SUPPLIES

This catalog lists 62,000 models of AC to DC plug-in power supplies available for shipment in just three days. Choose the exact outputs you need. Singles or duals, regulated or unregulated. Write or phone for your free copy.

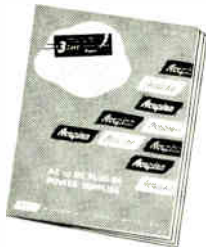

Name \_\_\_\_\_  
Title \_\_\_\_\_  
Company \_\_\_\_\_  
City \_\_\_\_\_  
State \_\_\_\_\_ Zip \_\_\_\_\_



Acopian Corp., Easton, Penna. 18042  
Phone: (215) 258-5441

## ... arrays are best suited for handling specific and repetitive functions ...

remain on. The external gate uses a transistor at the output as an active pullup that drives high external capacitance; the internal gate uses a diode as a resistive pullup. The active pullup has a fan-out of 10 when used either on- or off-chip. This transistor does have a drawback: it causes occasional current spikes and dissipates 2 to 3 milliwatts more power than the diode. The resistive pullup has a fan-out of seven on-chip and four off-chip.

There are four of each type of gate per cell, though Fairchild found that it could get along with far fewer external than internal gates.

How the array is used is more or less up to the customer. The 4700 was intended, Kors says, to handle specific, repetitive functions, such as occur in a decoder or counter. Or it can be used to integrate "random logic" left over when a system is designed with functional building blocks.

Fairchild calls these blocks medium-scale integrated arrays regardless of their size or number of gates. (The company has introduced a family of such MSI circuits, which are characterized by single-layer metallization.)

**Possible uses.** To demonstrate possible uses for the arrays, Fairchild has connected the 4600 as a dual two-variable function generator. In it, two identical circuits are operated by a four-bit control word to provide any possible Boolean function of two variables. The unit, useful in self-adapting digital systems, was designed for a 16-pin package.

Another circuit, a four-bit arithmetic logic unit, was built with the 4700 array. It's a combinatorial device that performs any of eight parallel operations on two four-bit operands. The operations include add, subtract, and several Boolean functions. The unit's look-ahead carry logic provides high-speed addition and subtraction; look-ahead capacity is eight bits with no ripple carry. When it's operating in the subtract mode, the circuit can function as a four-bit comparator. It's

designed to fit in a standard 24-pin package.

Fairchild will provide a customer with 48 IC packages, each corresponding to a quarter-cell, so that he can breadboard his 4700 circuit. The intraconnect patterns are laid out much as one would lay out interconnections on a two-sided printed-circuit board. The metal pattern follows an x-y grid, with the bottom layer for horizontal connections and the top for vertical. Specialization bars to connect or disconnect certain sections of a quarter-cell may be used to customize the cells in the first layer of metalization.

Because the dielectric between the layers insulates the active regions from the top layer of metal, line segments in the top layer can be run right over the active devices. But even this extreme flexibility doesn't guarantee that every theoretical 12-cell function can be intraconnected. Fairchild says any given function could be implemented if enough silicon area were assigned to intraconnection paths. But in the case of the 4600 and 4700, the designers chose to increase logic capability at the expense of connectability; if most of the chip were reserved for intraconnections, there would be scant room for gates.

Fairchild declares that it has never seen a design for the 32 quarter-cells of the DTL 4500 that it could not implement, but it concedes that designs employing a high percentage of cell inputs or prespecified bonding-pad locations might not be practical on the 4700 array.

**Computer aid.** To help the user in this regard, the firm is providing a layout sheet and a book of rules for intraconnections. Fairchild is currently debugging a computer program that will take logic diagram inputs and generate an optimum intraconnection scheme; this program may be available by the end of the year.

Fairchild already has computer-design capability in network coding—in which logic equations are converted to a format compatible



# EMC CONTROL

## 5 SOLUTIONS TO MAGNETIC SHIELDING PROBLEMS

1. Use flexible Netic Co-Netic Foil. It can be cut easily with ordinary scissors and shaped quickly to any desired configuration. One or more layers may be used as needed. Stock delivery in any required length. Widths: 4", 15" and 19 3/4". Other widths available. Several convenient thicknesses.



Netic Co-Netic Foil



Adhesive-Backed Foil

2. Order Netic Co-Netic Sheet Stock for fabrication in your plant into any desired configuration. Conveniently available in lengths of 15", 30", 60" and 120" in widths of 24", 26" and 30" and in thicknesses from .095 to .014.

3. Specify Netic Co-Netic fabricated component shields made to your exact specification by our magnetic shielding specialists.



Miniature Component Shielding



Transformer Cans

4. Protect your vital programming records by storing and transporting them in specially designed rugged Netic containers.

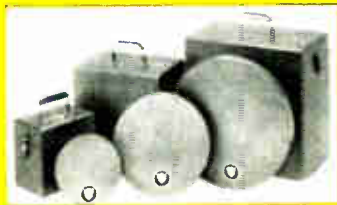

Stock Items



Multiple Stacked Tape Storage Cabinets

5. To reduce magnetic field pickup or radiation in vital wires or cables, select Unique Inter-8 Weave Cables. Available in plain, copper shielded or Co-Netic shielded.



Inter-8 Weave Cable—Plain, Copper Shielded, or Co-Netic Shielded

### YOURS FOR THE ASKING:

The most complete literature available on magnetic shielding.

West Coast Stocking Reps  
Tech Rep Distributor Co.  
10606 W. Pico Blvd.  
Los Angeles, Calif. 90064  
213, 836-6806  
213, 871-0055

Frauman Associates  
P.O. Box 969  
Menlo Park, Calif. 94026  
415, 322-8461



## MAGNETIC SHIELD DIVISION

PERFECTION MICA COMPANY

1322 NORTH ELSTON AVENUE • CHICAGO, ILLINOIS 60622

PHONE: 312, EV 4-2122

TWX 910 221-0105



# High Current Regulated Power Supply

## Adjustable Output Voltage, 27-28 V.D.C.

## 1% Regulation

## 50-60 Cycle Operation

## Substantial Overload Capability

Designed for communications equipment and available in 25 amp. stages from 25 to 150 amps, this unit can be operated in parallel, has remote sense feature, inverse time circuit breaker and internal fan cooling. Overload capacity is 200% for 5 minutes; 400% for 4 seconds. Environmental capability range from  $-20^{\circ}$  to  $+130^{\circ}$ F. This equipment is designed for standard rack mounting.

If you are interested in this, or a power supply to meet other specs, we would like the opportunity to demonstrate that a Tung-Sol designed unit would be your best buy.

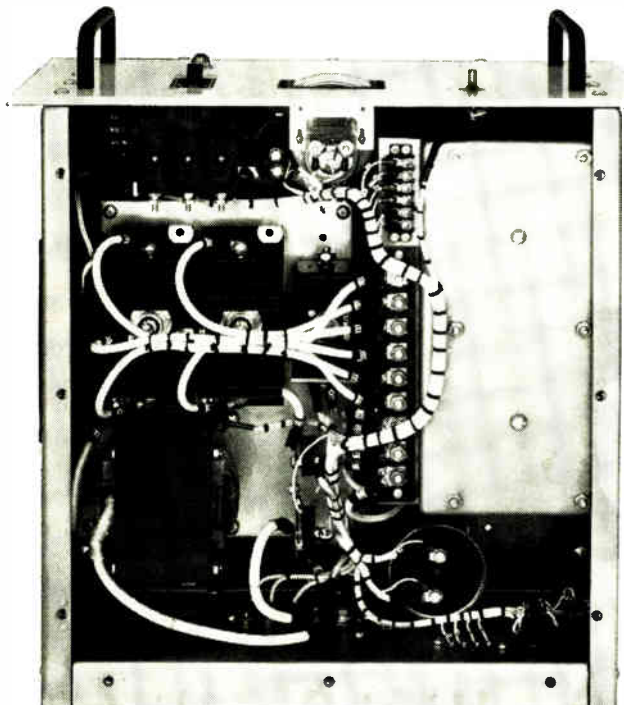

**TUNG-SOL<sup>®</sup>**  
**POWER SUPPLIES**

Tung-Sol Division, Wagner Electric Corporation  
Livingston, N.J. 07039. TWX: 710-994-4865. PHONE: 201-992-1100

... computer-aided design  
reduces engineering cost ...

with computer-aided design—and in logic simulation, cell placement, and test generation. The company says computer techniques are a necessity to keep their engineering costs low and production lead times short.

Testing the large arrays, which will come in 16-, 24-, and 36-lead flatpacks, dual in-line packages, and a new 50-lead dip, won't be as difficult as the large number of outputs might suggest, Kors notes, because testers will be concerned only with what the circuit will see in its particular application. The tests will be computer-generated from the logic equations provided by the customer. Only 300 or 400 tests might be needed for a given circuit. But more tests usually won't cause any big problems.

**Check out.** Fairchild recommends these acceptance tests for the arrays:

- Double-pass d-c functional testing, the first pass with power supply voltage and signal thresholds at their worst-case high limit, and the second pass at the worst-case low limit.

- D-c parameter testing of all input and output pins.

- At least one propagation-delay measurement through the worst-case logic chains specified by the customer.

The double pass through the functional tests using both high and low bias-voltage limits is intended to eliminate marginal gates and ensure that there is enough a-c drive at nominal bias voltage (so that the entire array can be categorized with just a few measurements).

Fairchild will have the 4700 on the market in August, but may introduce it as the 4711—the four-bit arithmetic unit with carry look-ahead.

In custom versions, prices will run about \$10,000 for engineering, plus about \$30 per package in lots of a thousand. The full price will depend on the specific circuit and on the share of the engineering burden the customer takes on himself.

Fairchild Semiconductor, Mountain View, Calif. 94040 [444]

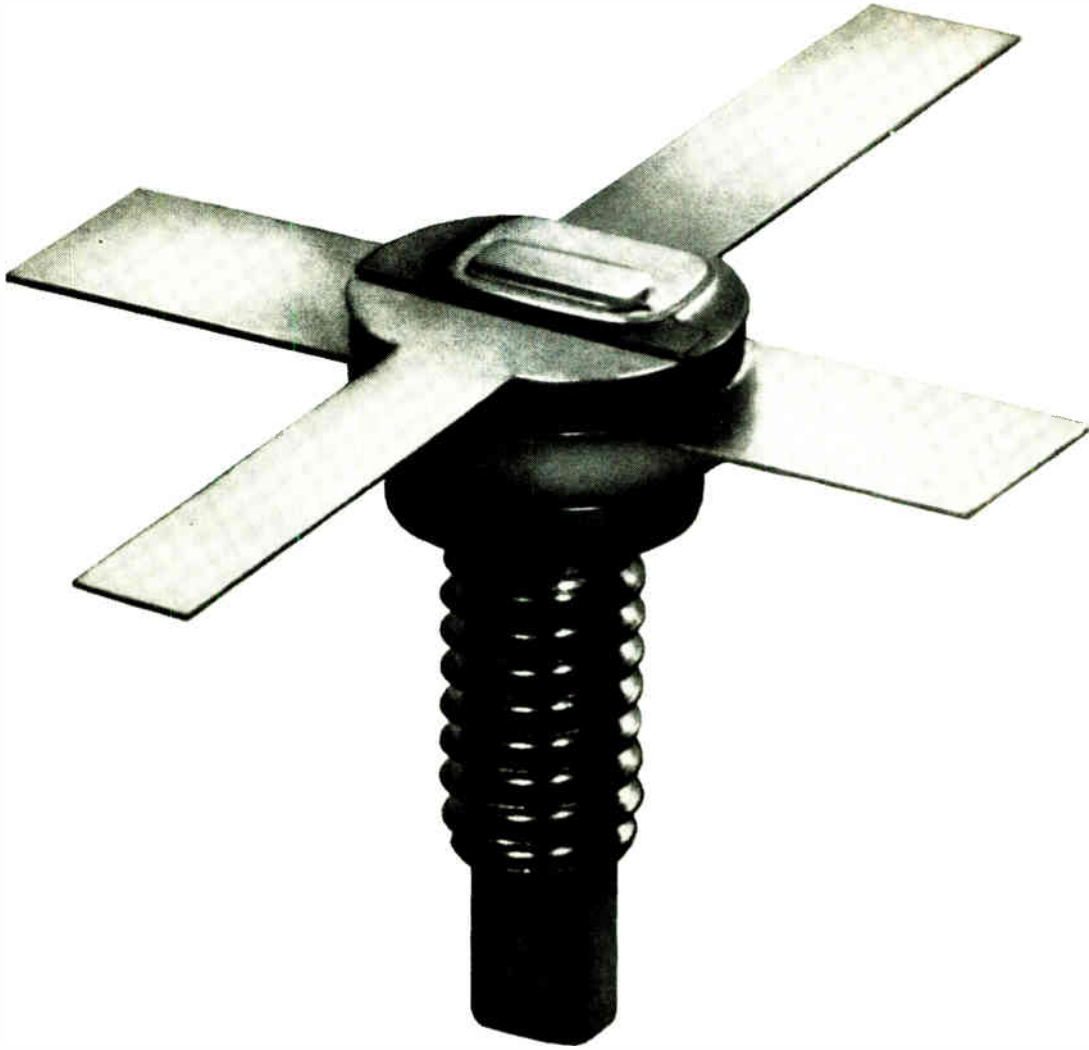

## What A Shape RCA TA7344 Is In!

It's hermetic. It's ceramic-to-metal. It's "overlay."  
It's radial lead stripline. It's the most reliable transistor  
of its kind in the industry. And it's an RCA first.

That's the shape developmental type TA7344 is in.  
Once again, RCA leads the way with new packaging  
for new power performance in VHF/UHF. In TA7344,  
RCA's famous "overlay" pellet is sealed in hermetically—  
with reliability built in, not tested in.

Here's a package with very low input and output parasitic  
lead inductance. Low capacitance, too. The wide leads are  
uniquely "sandwiched" between ceramic layers for  
unusual mechanical strength.

The TA7344 with a 28-volt input provides 16 W (min.)  
power output at 400 MHz with 6 dB gain. At 225 MHz,  
the device is capable of 20 W power output (typ.)  
with 10 dB (typ.) gain.

An excellent direct replacement for plastic stripline types,  
TA7344 is intended for large signal, high power,  
broadband linear RF amplifiers for military and industrial  
communications equipment operating at VHF/UHF  
frequencies.

For more information on this and other "overlay" silicon  
n-p-n transistors, see your RCA Representative or your  
RCA Distributor. For technical data, write:  
RCA Electronic Components, Commercial Engineering,  
Section PN-7-2, Harrison, N.J. 07029.

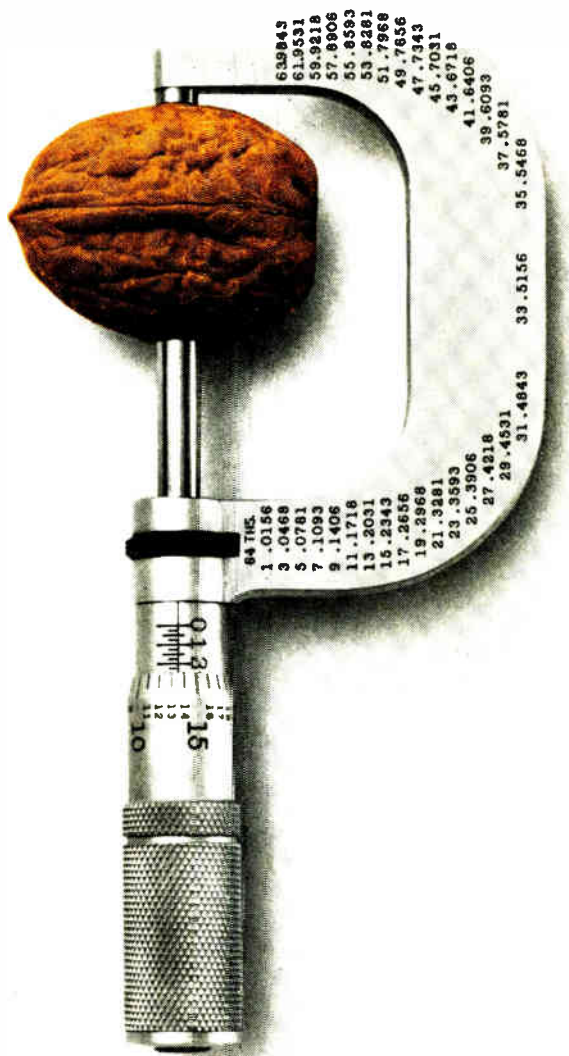

# Are you a nut for accuracy?

## Cohu's new Model 355 DC Voltage Standard is accurate to within 0.001%—that's a precedent.

The 355 has all the qualifications you would expect from a great precedent. Its solid-state design includes modular plug-in construction with unmatched reliability due to redundant switch sections. Its method of voltage pre-regulation protects output stage transistors while special low-noise amplifiers provide for minimum drift and off-set. Outside, a functionally designed front panel includes in-line read-out and human engineered controls. Calibration is made easy by a flip-up top—which you needn't touch for a month.

Not just anyone can develop a precedent like the 355, especially one priced at \$2750. We know. We've been developing them for years. *If you are a nut for accuracy, you will ask for the new...*

355 from **COHU** the Precedent Makers  
ELECTRONICS, INC.  
SAN DIEGO DIVISION

Box 623 • San Diego, Calif. 92112 • Phone: 714-277-6700

See us at WESCON Sports Arena Booths 1601-1602 August 20-23

126 Circle 126 on reader service card

Electronics | July 22, 1968



## New Components Review



Solid tantalum capacitors series K are available in cap/voltage ratings from 3.9  $\mu\text{f}/75\text{ v}$  to 60  $\mu\text{f}/6\text{ v}$ . Maximum d-c current capability is 5 amps at 85°C, 2 amps at 125°C. Leakage current need not be less than 1  $\mu\text{a}$ , or 0.02  $\mu\text{a}$  x  $\mu\text{f}$  x working voltage. Maximum dissipation factor at 25°C and 120 Hz is 6%. Dickson Electronics Corp., P.O. Box 1390, Scottsdale, Ariz. 85252. [341]



Vidicon tube type 2000, sensitive in the range from 3,500 to 18,000 Angstroms, is suitable both for tv camera operation in infrared light and for observing hot bodies at temperatures over 250°C. The tube has a very low photoelectric lag and a high sensitivity to infrared illumination. The electron gun is provided with a separate mesh. Epic Inc., 150 Nassau St., New York 10038. [345]

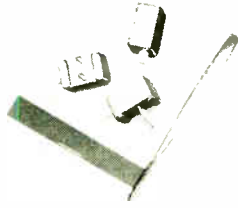

Pushbutton switch B8000 is for circuit checkout use in the crowded p-c boards of data processing equipment and industrial and military instrumentation. Its non-snap action provides low contact bounce and long life. Molded of impact resistant plastic, the switch measures 0.580 x 0.280 x 0.27 in. exclusive of terminals. Controls Co. of America, 1420 Delmar Dr., Folcroft, Pa. [342]



Subminiature rotary switches series PSA have an index assembly with fully adjustable stop devices for extra switching arrangements. The mechanism uses a double ball and star wheel geometry for lateral thrust which furnishes excellent torque control and "feel". Rotational life is 25,000 cycles minimum. Centralab, Div. of Globe-Union Inc., 5757 N. Green Bay Ave., Milwaukee. [346]

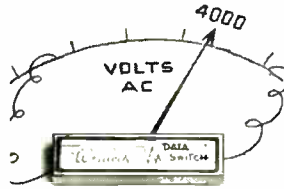

Glass reed relay switch series 3033 is capable of withstanding 4,000 v rms across the H7 switch or 2,000 v rms across the H6 switch. It has a vacuum switch atmosphere and molybdenum contacts. Units feature an initial contact resistance of 0.520 ohm, and provide  $10 \times 10^6$  operations at rated load. Wheelock Signals Inc., 273 Branchport Ave., Long Branch, N.J. 07740. [343]



Subminiature rectangular electrical connectors type D308 are designed to MIL-C-24308. They have rear release contacts and accommodate up to 50 gold plated crimp contacts in 5 shell sizes. Operating voltage is 1,000 v a-c at sea level, and current rating is 7.5 amps per contact. They use diallyl phthalate insulators. Matrix Science Corp., 435 Maple Ave., Torrance, Calif. [344]

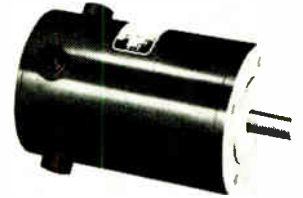

D-c permanent magnet motor type 3100 is a 0.3 h-p unit that will deliver its rated continuous output at any speed selected in the range of 4,400 to 10,000 rpm. It is designed for industrial and aerospace applications requiring a precision lightweight d-c motor in conformity with applicable portions of MIL-M-8609. Diehl Division, Singer Co., 2221 Barry Ave., Los Angeles. [348]

Wirewound resistors in the Econistor series 8E16 feature accuracies of  $\pm 0.1\%$ , 0.025%, 0.01% and 0.005%. They have typical temperature coefficients of  $\pm 3$  ppm/°C with a 3-year stability of better than 50 ppm and are qualified to MIL-R-93D. Power rating is  $\frac{1}{4}$  w at +125°C and  $\frac{1}{3}$  w at 85°C. General Resistance Inc., 430 Southern Blvd., Bronx, N.Y. 10455. [347]

## New components

### Latching relay stays in shape

Two-coil reed device isn't bothered by stray magnetic fields so units working side by side don't need protective shunts

**Yugoslavs invented it**, Danes built it, and both are hoping that Americans will buy it. "It" is a latching reed relay that doesn't need a bulky shunt to protect it from stray magnetic fields.

The device was developed by August Belic and Janez Erzen,

scientists at Yugoslavia's Institute za Elektroniko in Automatiko in Ljubjana. Like other reed relays, it's a thin elongated glass tube that's closed and has a lead inserted at each end.

In their relay, Belic and Erzen weld a steel leaf spring to a lead

and then bond a ferrite reed to the spring. At the tip of the reed they deposit a material that is conductive but nonmagnetic (gold is the usual choice).

The two reeds overlap at the tube's center, and a magnetic field



**Pulse to close.** A pulse in the longer coil, on right end, closes the relay, and a pulse in shorter coil opens it.

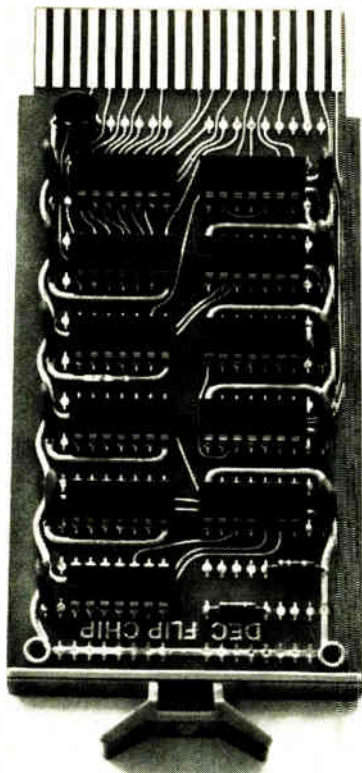

## Complete 10 MHz IC shift register at \$10.50 per stage

M-208 is an 8-stage digital logic shift register, complete. It, like all 25 modules in the M Series, works at 10 MHz. And it, like all other modules in the series, is designed for a cost/performance ratio that is the best in the industry. The M-208 sells for \$84, unless you buy large quantities. Then it's less.

M-208 control lines are buffered, eliminating complex loading rules. Provision is made for parallel loading of bits. TTL integrated circuits, the latest and best available, are used exclusively. Typical dc noise margin is 1 volt at either logic 1 or logic 0 levels.

M Series modules, including the M-208, and several other series of compatible modules, are fully described in the new Logic Handbook.

Write for a free copy.

**digital**

MODULES • COMPUTERS  
Maynard, Mass.,

can pull them together, closing the relay. The magnetic field must always be present to keep some kinds of relays closed. But the latching relay needs just a pulse of magnetic energy to close it and another pulse to open it.

**Protection.** In applications such as memories and telephone switching systems, designers want to use banks of latching reed relays. But when used close to one another, the relays usually need individual magnetic shunts to prevent them from being opened or closed by stray fields. And these shunts can double the relay's width.

In Belic and Erzen's device though, two coils, each the width of a single winding, are bonded to the glass tube. One carries the pulse that closes the relay, the other the opening pulse.

When a pulse passes through the closing coil, pulling the reeds together, the remanent magnetism of the reed is sufficient to keep the contact closed. When an off-pulse is applied, the reeds repel each other, breaking the contact.

**Farmed out.** Iskra, a Yugoslavian engineering firm that holds production and marketing rights to the relay, is having the devices built in Denmark by Tempress Electronic. The relays will be available in the U.S. early in the fall, but prices haven't been established yet. Iskra does say that its device won't cost any more than other latching relays now available.

Besides aiming the units at memory and telephone applications, Iskra hopes to sell them as control and safety switches for elevators and rotating machinery, change-over switches for measuring devices, isolating elements, and pulsing devices for counters.

The relay is 84 millimeters long, 4.5 mm in diameter, and weighs 2 grams. If the user wants to close the relay with a 2-millisecond pulse, he'll need 80 to 120 ampere-turns. If the closing pulse is from 30 to 50 microseconds wide, there must be 200 to 250 amp-turns; for d-c operation, 60 to 100 amp-turns are needed. The switch can be opened by only a third the energy required to close it.

The energy in either coil can go to three or four times the amount needed to close or open the relay and still not damage the coil.

The inventors say that this insensitivity to changes in pulse amplitude make the relays very useful when they're cascaded, as they would be if used as cross-bar switches in telephone exchanges.

Switching time is 500 msec for closing and 0.3 msec for opening. Contact resistance is 100 milliohms. And when the relay is open, there's  $10^{12}$  ohms and 0.5 picofarads between the contacts.

### Specifications

Dielectric strength	500 v
Operate bounce	0.3 ms
Release bounce	0
Resonant frequency of reed	500 hz
Lifetime	$10^9$ operations
Temperature range	-50 to +150° C

Iskra Representatives Inc., Suite 1111,  
509 Madison Ave., New York 10022  
[349]

### New components

## French chip in leadless capacitor

Metal contacts allow this tantalum device to be easily used with IC's

**A little-known** French company, Tekelec Airtronic, appears to be first to reach the market with a tantalum-chip capacitor that's both encapsulated and leadless. Instead of wire terminals, the capacitor has a pair of flat metal contacts, making the device easy to use in hybrid integrated circuits.

Unit cost is now between 50 cents and \$1, but Tekelec is switching over to an automated manufacturing process with volume production that could sharply lower the price to 10 cents within two years.

Explains Jean-Claude Asscher, Tekelec's president and the inventor of the device: "We'll be able to make them in-line like integrated circuits. Without leads, these chips can be soldered on ceramic or any other hybrid substrate simply while going through an oven."

Asscher's technique has been patented in France, and he is now discussing licensing agreements

# Code and Program Your Attenuation As You Go Along ...in Milliseconds

You can switch attenuation while operating . . . as you need it . . . for fast signal sampling and measurement. Switch in less than 100 milliseconds over a frequency range of DC to 1 GHz in 1 db steps from 0 to 139 db.

## DC TO 1 GHz PROGRAMMABLE ATTENUATOR MODEL 2163/1M2

**AUTOMATICALLY SETS** attenuation levels in response to 9-line binary coded decimal input signals . . . 1-2-4-8 . . . 10-20-40-80 . . . 100. Make before break logic ensures that at no time while switching is the attenuation less than the starting or final programmed value.

**DYNAMIC RANGE** covers from 0 to 139 db in 1 db increments. At 1 KHz, the programmer is accurate to  $\pm 0.5\%$   $\pm 0.1$  db up to 120 db ( $\pm 1$  db up to 130 db) . . . at 1 GHz, it's accurate to  $\pm 1\%$  and  $\pm 0.2$  db up to 100 db (with additional 0.5% at 130 db).

**VSWR** loss does not exceed 1.10 below 100 MHz . . . 1.25 below 500 MHz . . . or 1.50 below 1 GHz. Insertion loss 0.35 db per 100 MHz.

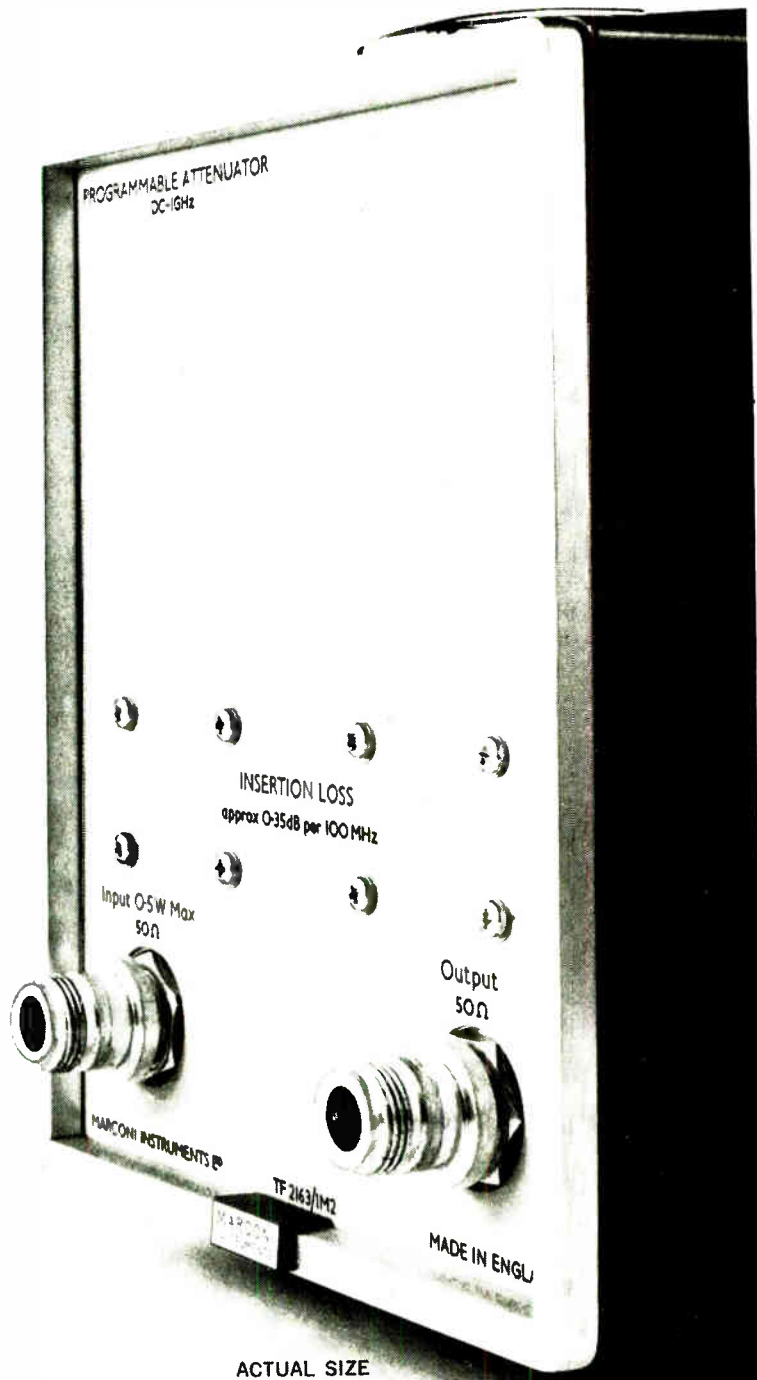

**MARCONI INSTRUMENTS**  
Division of English Electric Corporation

111 CEDAR LANE • ENGLEWOOD • NEW JERSEY 07631 • TELEPHONE: 201-567-0607



# The Non-Competitive Plug-in

\$450\*

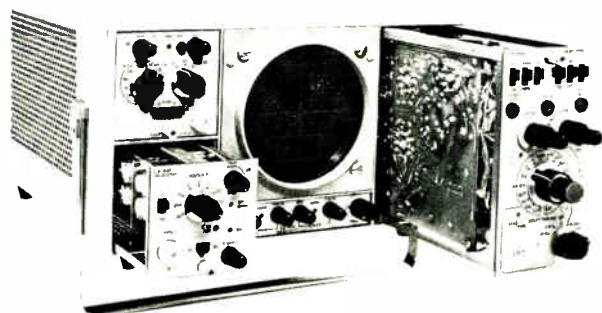

\*for main frame

This is Data Instruments CD1400. And the purpose of this ad is to clear up a misunderstanding. The CD1400 is not intended to compete with that other 15MHz, 8 x 10cm display, plug-in scope. Perhaps, it is natural to assume this since the bulk of their applications are identical. But we must insist that they are different breeds altogether.

In the first place, the CD1400 is far better looking. And this, we think is important since it indicates that the CD1400 design is pointed to the future. Secondly, the CD1400 has a true dual beam, PDA tube with individual focus and brilliance controls for each gun. The other has the disadvantages of a chopper. Thirdly, that other scope accepts only Y axis plug-ins; the time base is fixed. The CD1400 accepts plug-ins on both axes allowing flexibility in triggering, sweep control and X amplifiers. To be fair, though, that other scope does have an endless array of amplifiers and what nots, some of which the CD1400 will never have. This undoubtedly gives it greater prestige, although it doesn't seem sensible to us to produce a plug-in when one can build the entire scope for the same price.

At any rate, here are the current CD1400 plug-ins. Others are coming:

	VERTICAL AMPLIFIERS				TIME BASES		
	CX1441	CX1442	CX1449		CX1443	CX1444	CX1448
Bandwidth	DC-15MHz (-3db)	DC-75KHz (-3db)	DC-10MHz (-3db)	Sweep/cm	.5μs-200ms 18 pos	.5μs-200ms 18 pos	.5μs-1sec 20 pos
Sensitivity	100mv/cm 10mv/cm (10X)	1mv/cm 100μv/cm (10X)	10mv/cm	Trigger	Int, Ext, Norm, Auto, +, -, HF sync	Int, Ext, Norm, Auto, +, -, HF sync	Int, Ext, Norm, Auto, Single Shot
Type	Wide Band Single Channel	High Gain Differential	Wide Band Differential	Features	General Purpose	3 sweep delays 0-100ms variable	Single Shot DC trigger
Price	\$91	\$155	\$246	Price	\$142	\$300	\$265

Of course, Price is the real difference. The CD1400—complete with plug-ins for 15MHz single and double beam operation and also for use as a 1° matched X-Y instrument—costs 30% less than the main frame of that other scope.

But don't take our word for it. Call us for a demonstration and see for yourself. At \$450 you'll find there is no competition at all.

Data Instruments Division • 7300 Crescent Blvd. • Pennsauken, N.J. 08110

... devices are rated from  
2 up to 50 volts ...

with some U.S. and German component houses.

**Strip and fold.** To make the chip capacitors, Tekelec engineers start with a long thin strip of nickel. Rectangular holes are punched down the length of the strip, whose sides are then folded up at right angles. A tantalum chip is dropped over one of the holes with one end of the chip being soldered to a folded side and the other end welded to the opposite side. A plastic cap is then placed over the tantalum and the encapsulated segment is cut from the nickel strip. The excess nickel is trimmed from the edges, leaving just enough metal to form the two electrodes.

The chips, called rectangular series CM, come in five package sizes, from 3.2 by 1.8 by 1.1 millimeters up to 12.1 by 9.5 by 3.8 mm. The tantalum contacts extend 0.55 mm

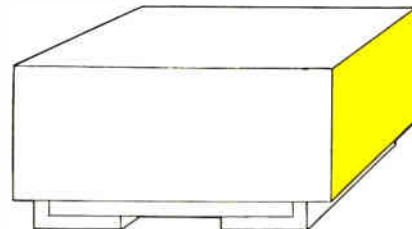

**Tinted side.** The metal contacts are on the bottom of the capacitor, which is tinted on the anode side.

from the underside of the smallest package and 0.8 mm from the biggest. The smallest contacts are 0.7 by 1.4 mm in surface area and the largest 3.0 by 8.4 mm.

Capacitance ranges from 0.001 to 220 microfarads at 50 volts d-c. Ascher says the devices operate up to 125°C and have low current leakage and dissipation factors.

The company is offering nine voltage ratings, from 2 to 50 volts. The smallest package has a tolerance of +40% and -20%, while the figure for the four others is ±20%. Chips with ±5% and ±10% tolerances are also available.

Each capacitor is color-coded to indicate its capacitance, tolerance and voltage rating.

Tekelec Airtron, Rue Carle Vernet, Sevres, France [350]

# Two new additions to the BURR-BROWN family of solid-state MULTIPLIERS\*

## MODEL 4029/25

New \$195† Multiplier makes hundreds of applications more economical.

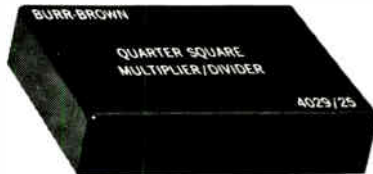

This new, low-priced, encapsulated Burr-Brown quarter-square multiplier is a precision analog function module capable of performing accurate four-quadrant multiplication, two quadrant division as well as square and square root functions. Accuracy is  $\pm 0.5\%$  max. Bandwidth at 1% abs. error is 5kHz. Rated input:  $\pm 10V$ . Rated output:  $\pm 10V$ ,  $\pm 5mA$ . Module size: 2.4" x 1.8" x .60".

†\$195.00 in 100 quantity (\$260.00 unit price) makes use of pre-engineered Burr-Brown modules even more attractive.

Use this publication's reader service card for your copy of new application-oriented product bulletin. For immediate applications assistance, phone (602) 294-1431, and ask to talk to your Burr-Brown Applications Engineer.

## MODEL 4012/25

New encapsulated quarter-square multiplier-divider packs high performance in small package.



The 4012/25 is a high-speed, fully encapsulated quarter-square multiplier containing three wide-band operational amplifiers and two precision diode squaring circuits. It performs precision four-quadrant multiplication and two-quadrant division as well as square and square root functions. Accuracy is  $\pm 0.25\%$  max. Bandwidth at 1% abs. error is 40 kHz. Rated input is  $\pm 10V$ .

Rated output:  $\pm 10V$  at 10 mA. Module size: 2.4" x 1.8" x .60". Also available in rack-mount package. Unit price: \$495.00 (\$375.00 in 100 quantity).

Use this publication's reader service card for your copy of new application-oriented product bulletin. For immediate applications assistance, phone (602) 294-1431, and ask to talk to your Burr-Brown Applications Engineer.

**\*Use 'em like building blocks to save time and money in systems requiring dynamic gain control, trigonometric computation, power measurement, correlation computation, RMS measurement, linear modulation and many other system functions.**

# BURR-BROWN

RESEARCH CORPORATION

International Airport Industrial Park • Tucson, Arizona 85706  
TELEPHONE: 602-294-1431 • TWX: 910-952-1111 • CABLE: BBRCORP



Operational Amplifiers  
Instrumentation Amplifiers  
Function Modules  
Active Filters  
Analog Simulators  
Geophysical Instruments

ENGINEERING REPRESENTATIVES: ALABAMA, HUNTSVILLE (205) 534-1648 / ARIZONA, PHOENIX (602) 254-5085 / CALIF., LOS ANGELES (213) 665-5181, SAN FRANCISCO (408) 244-1505 / COLO., DENVER (303) 388-4391 / CONN., EAST HARTFORD (203) 874-9222 / D.C., WASHINGTON (SEE MARYLAND) / FLORIDA, ORLANDO (305) 425-2764 / ILLINOIS, CHICAGO (312) 286-6824 / LA., NEW ORLEANS (504) 888-2266 / MD., SILVER SPRING (301) 588-8134 / MASS., BOSTON (617) 245-4870 / MICH., DETROIT (313) 358-3333 / MINN., MINNEAPOLIS (612) 781-1611 / MO., ST. LOUIS (314) 524-4800 / N.C., GREENSBORO (919) 273-1918 / N.J., CAMDEN (215) 925-8711 / N.M., ALBUQUERQUE (505) 255-1638 / N.Y., ALBANY (518) 436-9649, BINGHAMTON (607)

723-9661, MT. VERNON (914) 968-2200, NEW HARTFORD (315) 732-3775, ROCHESTER ((716) 473-2115 / OHIO, CINCINNATI (513) 761-5432, CLEVELAND (216) 237-9145, DAYTON (513) 277-8911 / PENN., PHILADELPHIA (SEE CAMDEN, N.J.), PITTSBURGH (412) 243-6655 / TEXAS, DALLAS (214) 357-6451, HOUSTON (713) 774-2568 / UTAH, SALT LAKE CITY (801) 466-8709 / VIRGINIA, (SEE MARYLAND) / WASH., SEATTLE (206) 767-4260 / CANADA, DOWNSVIEW, ONT., (416) 636-4910 — MONTREAL, QUE., (514) 739-6776 — OTTAWA, ONT., (613) 725-1288 — VANCOUVER, B.C., (604) 298-6242

# TWO NEW CERAMAG<sup>®</sup> 90° COLOR YOKE CORES FROM STACKPOLE

## THE COMPACT

(Part No's 52-437, 52-506)



## THE MINI

(Part No's 52-488, 52-489)

With deflection yoke cores that are 25% smaller, consider the savings in copper, hardware, labor and shipping costs, too. Both the Compact and Mini yoke cores are moulded from Stackpole's standard 7B ferrite material. Even though you benefit from smaller, more compact yoke size and appreciably lower prices, there is no sacrifice of nickel content with Ceramag<sup>®</sup> 7B. Curie is 160°C.  $\pm 10^\circ\text{C}$ . For specifications, samples, prices and delivery, call: D. L. Almquist, Electronic Components Division, Stackpole Carbon Company, St. Marys, Pa. 15857. Phone: 814-781-8521. TWX: 510-693-4511.



**STACKPOLE**  
ELECTRONIC COMPONENTS DIVISION

ALSO A LEADER IN THE MANUFACTURE OF QUALITY FIXED COMPOSITION RESISTORS



## New Semiconductors Review

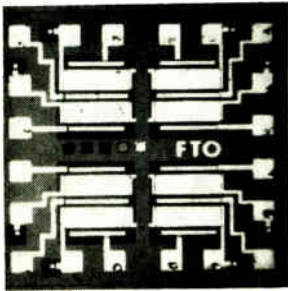

MOSFET array HRM2206 consists of four pairs of MOSFET switches. Each pair has a common source, independent drains and independent gates. Each switch has similar electrical characteristics, with nominal threshold voltages of  $-2$  v, and channel resistances of 250 ohms when biased with a negative 10 v gate drive. Hughes Aircraft Co., Newport Beach, Calif. [436]

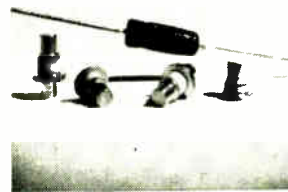

Step-recovery diodes series 5082-0200 are characterized for pulse and digital applications. They feature specification of two new parameters: ramping and rounding. These are measured as a percent of total transition amplitude, typically 10% to 20%. The epitaxial surface-passivated silicon diodes meet MIL-S-19500. Hewlett-Packard Co., 1501 Page Mill Rd., Palo Alto, Calif. [440]

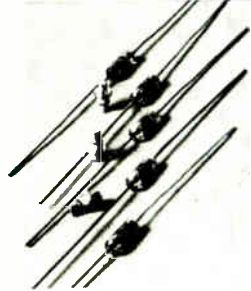

Medium and low power silicon p-i-n switching diodes are designated MA-47027 through 47047. Typical performance is represented by the MA-47030 which has a peak power of 1 kw with switching speed of 50 to 200 nsec. Minimum breakdown voltage is 200 v. Units are suited for r-f switching and phase shifting. Microwave Associates Inc., Burlington, Mass. [437]

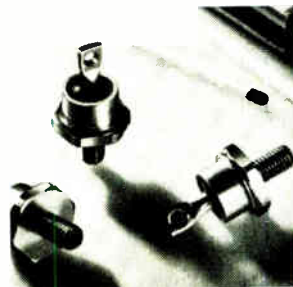

Transient voltage protected silicon rectifiers series ST-11 are 70-amp avalanche units with piv ratings from 100 to 1,000. They are hermetically sealed in stud-mounted cases measuring  $\frac{1}{8}$  in. high, exclusive of stud. Uses include computers, speed controls, power supplies, variable drives, motors and generators. Sarkes Tarzian Inc., 815 College Ave., Bloomington, Ind. [441]



NPN silicon power transistors 2N5250 and 2N5251 are capable of controlling and/or switching a collector current of 100 amps. They can dissipate up to 350 w. Sustaining voltages are 100 v for 2N5250 and 150 v for 2N5251. Minimum cut-off frequency is 10 Mhz. Total switching speed at 70 amps is 4  $\mu$ sec max. Solitron Devices Inc., 1177 Blue Heron Blvd., Riviera Beach, Fla. [438]

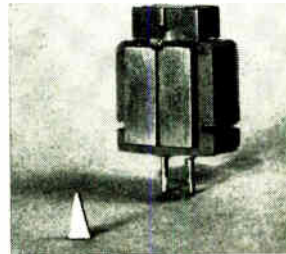

Gallium arsenide laser diodes come in 4 types providing peak power of 10, 14, 18 and 30 w. The triangular diode package pictured next to a heat/sink mount measures  $\frac{1}{4}$  in. in height. Peak wavelength is 9,160 angstroms. Half-power width is 50 angstroms. Emission angle is 0.1 steradian. Pulse repetition rate is 3,000 pps. Sperry Rand Corp., Marcus Ave., Great Neck, N.Y. [442]

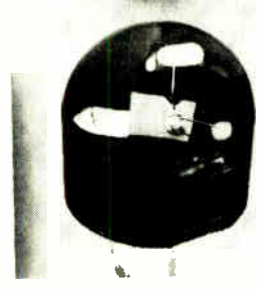

Plastic NPN photo transistor FP-T100 features 3 terminals for flexibility and control in circuit design. A transparent resin encapsulation makes it stable under high humidity conditions. High illumination sensitivity is based on a light sensitive area of 35 x 35 mils. The unit costs 50 cents in lots of 10,000. Fairchild Semiconductor, 313 Fairchild Dr., Mtn. View, Calif. [439]

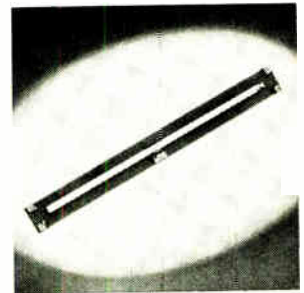

Metal semiconductor silicon photo-diodes offer response times under 25 nsec, and sensitivity variations over 4 sq in. are under 3%. Up to 70% of the incident light photons are converted into electric current, and spectral response is 3,000 to 11,000 angstroms. Units measure from 3 x 10<sup>-2</sup> cm<sup>2</sup> to 1.25 cm<sup>2</sup>. United Detector Technology, 1728 21st St., Santa Monica, Calif. [443]

### New semiconductors

## MOS IC's process color video signals

Price and performance may be superior to those of bipolars; fewer and cheaper external discrete components required

Everyone's aware of the qualities that metal oxide semiconductor integrated circuits offer in digital equipment. Not so with linear applications, however. So the General Instrument Corp. developed four IC's to demonstrate the usefulness of MOS technology in color-

tv receivers. GI will start selling the circuits in sample quantities next month.

The four IC's are:

- Type 8103 burst separator with three amplifier stages. One stage functions as the first chroma band-pass amplifier and drives the other

two stages, a keyed chroma band-pass amplifier and a keyed burst amplifier.

- 8104 dual demodulator, a switching type with built-in bias supplies.

- 8102 matrix version of the three-triode cathode-coupled x and z matrix commonly used in color receivers.

- 8105 color synchronizer, containing a two-stage amplifier operating at 3.58 megahertz, a locked oscillator, and a limiter stage.

General Instrument is not ready to quote a price for the four IC's, because the partitioning of the circuits hasn't been completely re-

## ... one bipolar dissipates as much as four MOS IC's ...

solved. GI may, in fact, combine the circuits in two chips instead of four.

Although most IC manufacturers are developing bipolar IC's for color, or already have them for sale, GI is the first to offer MOS IC's for this application, according to Muni Mitchell, head of the group that designed the circuits. They have many advantages over bipolar IC's. Mitchell says. They require fewer and cheaper peripheral components. They are compatible with either solid state or tube circuits without interface circuitry and their power drain is very slight. Because of their high impedance, all four IC's draw a total of only about 300 milliwatts; a single comparable bipolar IC might dissipate just as much. Probably the most important advantage of MOS IC's is their noise immunity. No d-c is drawn by gates as it is in bipolars, so the d-c operating point isn't changed by noise pulses. Such noise-induced changes have been a serious problem in color synchronization.

**How they work.** In GI's demonstration circuitry, composite chroma video from the color take-off transformer is applied to the first stage of the 8103 through an external 47-pf coupling capacitor. This stage is coupled to the second and third stages by a chroma bandpass transformer and another 47-pf capacitor. The second stage, another chroma bandpass amplifier, is keyed off during the retrace intervals. Chroma output is taken from the output of stage 2 through a chroma-level-control potentiometer. Stage 3 is keyed on during the retrace, permitting the removal of a 3.58-Mhz burst signal from the composite chroma signal. The output transformer should have high impedance to drive the automatic chroma control.

In the 8104, chroma signals are applied to both demodulators. Internal d-c bias establishes the Q. An external phase-shift network produces 10 volts peak-to-peak continuous wave r-f signals of the proper phase for the demodulation system (an x and z system

requires a 63° phase difference). These signals switch the demodulators on and off, producing two demodulated chroma video signals at the outputs of the 8104.

The demodulators are highly linear and can handle large signals (as much as 6 volts peak-to-peak). The 8104 requires a 10-kilohm external resistance as a load and as a termination for the filters that limit the video bandwidth and remove any 3.58 Mhz components.

The 8102 matrix is designed so that blanking pulses can be added to the chroma signals for blanking the cathode-ray tube and setting its bias. The demodulated output signals from the 8104 are fed through lowpass filters to two input terminals of the 8102. Because of the high input impedance of the 8102, 0.01- $\mu$ f capacitors give adequate low-frequency response. Blanking pulses enter through a 100-pf capacitor.

The G - y signal is derived internally from the x and y signals, which are predominantly R - y and B - y, respectively. External load resistors of 3.3 kilohms will provide a peak-to-peak video signal of 6 volts, suitable for driving high-level amplifiers.

**No ripples.** The input to the 8105 is the 3.58-Mhz signal containing the burst information. This signal is amplified and limited in the 8105, with external 47-pf capacitors coupling the signal from stage to stage. L-C circuits tuned by 47-pf capacitors provide load impedance. Hue is controlled by varying the impedance of one of these load circuits.

A single coil tuned by a 300-pf capacitor is the frequency-determining network for the 3.58-Mhz reference oscillator. A 47-pf feedback capacitor maintains oscillation, and another 47-pf capacitor couples sync signals to the oscillator. The limiter stage in the 8105 removes any ripple from the oscillator waveform to ensure that the 3.58-Mhz sine wave is pure; output from the limiter is 10 volts peak-to-peak.

Power-supply voltage to all circuits is 20 volts. The 8103 draws 1.5 milliamperes, and the 8104, 8102, and 8105 draw 2 ma, 7 ma, and 4.5 ma, respectively.

General Instrument Corp., Hicksville, N.Y. 11802 [444]

## New semiconductors

### Single IC drives, flashes, and pulses

Thick-film hybrid package  
mounts on lamp housing;  
configurations can vary

**A lamp driver, flasher, and a single-shot pulse generator** have all been put in a 1-by- $\frac{3}{4}$  inch package that can be connected directly to the lamp housing with spring clips on the back of the package. Varadyne is making this three-in-one device, which is a thick-film hybrid integrated circuit.

Charles Tobias, president, says this is the first time all three functions are available from one snap-on package. Mounting the package at the lamp housing eliminates the need for a good deal of wiring, he points out.

The driver's input can range from 2.5 volts to 28 volts d-c, and its energizing signal is 2.5 volts d-c or more. Input impedance is 25 kilohms and output load rating 100 milliamps. Tobias says the driver will operate two General Electric 327 lamps.

**Discrete prices.** The flasher needs 28 volts d-c  $\pm 4$  volts, and produces an energizing signal of the same value. For a 50% duty cycle, the flashing rate ranges from 70 to 120 per minute. The flasher draws up to 2.5 ma and consumes a maximum of 100 milliwatts.

The generator's output is a single pulse whose amplitude is 5 volts and whose width can be specified anywhere between 1 microsecond and 10 milliseconds. Input is 28 volts d-c, output impedance is 500 ohms minimum, and the rise and fall times are both 1/10 the pulse width.

More than one flasher or driver can be put in one package. The components are integrated on the chip but discrete on the price tag; in quantities up to 24 packages, two drivers cost \$46.48, four drivers \$81.70, two flashers \$65.45, and one generator costs \$22.89.

Varadyne Inc., 1805 Colorado Ave., Santa Monica, Calif. 90404 [445]

# What's the difference between Midwestern's new Alpha 434 and any other instrumentation tape recorder?

**About \$4,000.** Compare the Alpha 434's average price tag of \$2,500 for a complete 4-channel Direct record/reproduce system and \$3,500 for a 4-channel FM record/reproduce system

And compare the features you get on the Alpha 434: ■ 4 Channel ¼-inch Tape ■ 3 Speed Electrically Switchable ■ Separate FM or Direct Record and Reproduce Modules ■ Direct Response from 100 Hz to 60 KHz @ 15 ips ■ FM Response from DC to 5 KHz @ 15 ips ■ Speed Ranges from 15/16 ips to 15 ips ■ Portable Carrying Case ■ Built-in Calibration Voltages ■ Maximum Weight — 46 pounds ■ Many options, such as: Rack Mount, Remote Control, etc.

For full details on options and costs, contact your nearest **Midwestern Instruments Representative . . . vive la difference!**



**Walk off with a winner!**  
See it at WESCON booth 1709!  
L.A. Sports Arena

FREE ILLUSTRATED  
BROCHURE ON  
REQUEST



**MIDWESTERN  
INSTRUMENTS / TELEX**

DATA SYSTEMS DIVISION

A SUBSIDIARY OF THE TELEX CORPORATION  
6422 E. 41st STREET TULSA, OKLAHOMA 74135  
PHONE 918 - 627-1111 TWX 918 - 627-6030 TELEX 49-2489



# LOOKING FOR LOW-COST AUTOMATION?

Here's a **NEW** way:

## Eagle's all-solid-state count controls

### 100% Accurate up to 1200 Counts per minute\*

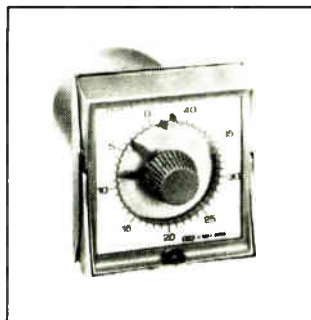
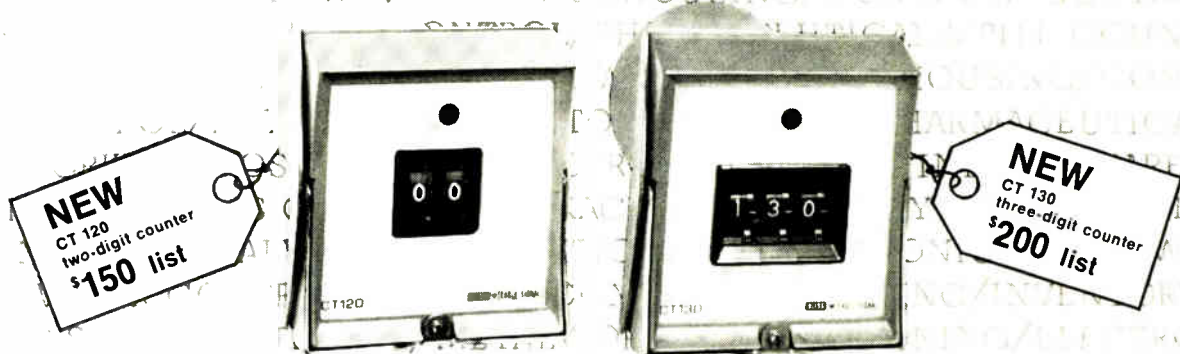

HZ170 PREDETERMINING COUNTER

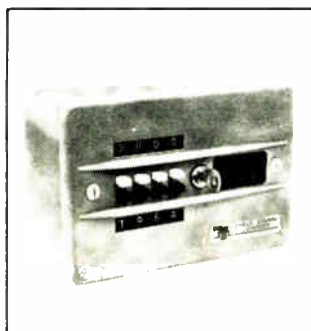

HZ760 CONTINUOUS BATCH COUNTER

Eagle continues to expand its reliable count-control products . . . always compatible with its complete line of proven solid-state or electromechanical time controls. Our two, new transient-protected integrated circuit counters above offer 100% accuracy from a wide variety of inputs of specified voltages and frequency . . . at low cost. With flexible solid-state control output, easy-to-set binary thumbwheels and easy-to-see integral indicator lights, these counters are particularly well suited for machine tool and process control duty. Eagle's famous Cycl-Flex® plug-in cases cut down-time . . . can be replaced without tools in 5 seconds or less.

Eagle solid-state count controls are also available in electromechanical models, as those shown at the left.

*\*Count speed based on counter input from electromechanical sources. Higher counts to 30,000 per second limited only by input accuracy.*

### For complete information

on these new counters and all 56 basic types of Eagle time/count controls, circle the number below on the Reader Service Card. Or write: Eagle Signal Division, E. W. Bliss Company, 736 Federal Street, Davenport, Iowa 52808.



In Canada: Eagle Signal Division,  
E. W. Bliss Company  
(Canada) Ltd.,  
Georgetown, Ontario.

**BLISS**



**EAGLE SIGNAL**

A DIVISION OF THE E. W. BLISS COMPANY  
A GULF + WESTERN COMPANY

## New Instruments Review

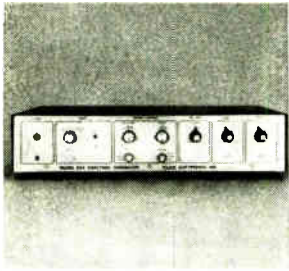

Function generator model 504 features unitized construction and integrated circuitry, with three separate signal amplifiers to provide square, pulse, ramp, reverse ramp, sine and triangle waveforms at frequencies from 0.0001 hz to 1.0 Mhz. Dimensions are 16¾ x 3½ x 14¾ in. Price is \$525; availability, from stock to 3 weeks. Exact Electronics Inc., Box 160, Hillsboro, Ore. [361]



Frequency meter model 460 has a crystal time base aging rate of 2 parts in 10<sup>6</sup> per month ±9 parts in 10<sup>6</sup> (0° to 50°C). Designed with gate times in decades from 1 msec to 10 sec, it makes 4 digit measurements with 8 digit resolution, covering 5 hz to 10 Mhz with input sensitivity of 100 mv to 150 v rms. Darcy Industries Inc., 1723 Cloverfield Blvd., Santa Monica, Calif. [362]



Solid state, 20 Mhz pulse generator model 300A provides a wide range of operational advantages, including individually adjustable rise and fall time, d-c offset independent of attenuator setting and pulse polarity, and voltage programming of pulse period, delay and width. Price is \$1,100; delivery, from stock. Monsanto Co., 620 Passaic Ave., West Caldwell, N.J. 08091. [363]



Logarithmic null meter model 5101 operates on regular line voltage and will null to 10 μv. It features 5 decades and reacts to decreased voltage with increased sensitivity while establishing the null balance. The 5 zero-center full scale range provided is: 30 mv, 300 mv, 3 v, 30 v, and 300 v. Philbrick/Nexus Research, Allied Dr. at Route 128, Dedham, Mass. [364]

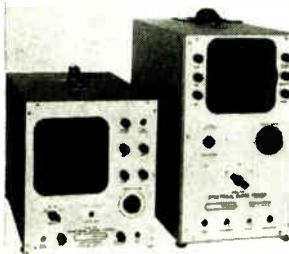

Two high-voltage surge testers are for checking 3-phase electrical motors. Model 325 makes tests to 6,000 v; model 202, to 10,000 v. All tests for a motor require only one switch setting of a front panel control. Price of the model 202 is \$2,450; model 325, \$1,625. Delivery takes approximately 90 days after receipt of order. Greve Electronics, 1215 West Clay, Houston 77019. [365]

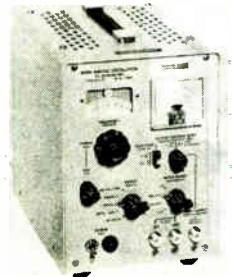

Sine and square wave generator RCO11 is for general lab and production use. It features broad frequency coverage, precise attenuation, and meter monitoring of its 50 ohm, 600 ohm and direct (low impedance) outputs. It delivers a low distortion sine wave or a square wave, with 50 nsec rise and fall time, from 10-hz to 1-Mhz. London Co., Sharon Dr., Cleveland. [366]



Portable instrument model 31121 is for rapid on-site calibration of moving coil temperature indicators and potentiometer-type pyrometers. Called MultiMite, it also gives direct readings from up to 6 thermocouple or millivolt inputs quickly selected with a rotary switch. Current for the unit is supplied by two 1.5 v flashlight batteries. Thermo Electric, Saddle Brook, N.J. [367]



Charge amplifier model 5072 will accommodate a wide range of transducer sensitivities and excitation. It will also absorb large instantaneous overloads without blocking. Plug-in filters provide bandwidth limiting when desired. Frequency response is flat from 2 to 20,000 hz, and noise referred to input is 0.009 picocoulomb Matrix Instrument Co., P.O. Box 36501, Houston. [368]

### New instruments

## Wave analyzer has 85-db dynamic range

'Third-generation' unit features automatic ranging, linear and log meter display, digital frequency readout

The generation gap yawns wider and deeper with the introduction of a "third-generation" wave analyzer that incorporates advances in measurement and display capability.

The first generation, according to Hewlett-Packard, appeared in the

1930's and was first used to measure distortion in audio signals. The second generation, in the late '50's, was all solid state and had greater dynamic range and simpler tuning. The latest generation has automatic ranging, elaborate x-y recorder outputs, full dynamic

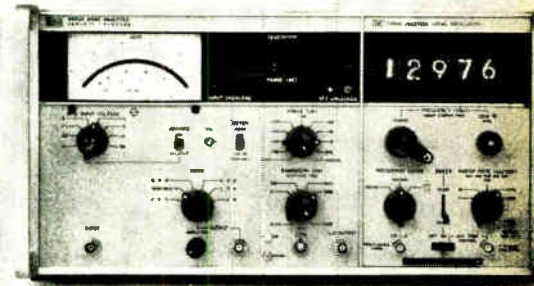

# New RFI Filters Especially for DATA PROCESSING EQUIPMENT

Save Time!  
Save Money!  
Speed Production!



## Look for RECOGNITION

\* NOW HOPKINS BRINGS YOU 38 DIFFERENT RFI FILTERS, ALL  
RECOGNIZED UNDER THE COMPONENT PROGRAM  
OF UNDERWRITERS' LABORATORIES, INC.

ONLY Hopkins Engineering Company offers you such a wide selection of RFI Filters for data processing equipment... filters which have been recognized under the Component Program of Underwriters' Laboratories, Inc.

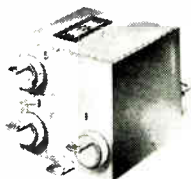

Hopkins Filters will save you both time and money in design and manufacture of your data processing equipment because they are already included as recognized components.

The 38 different Hopkins RFI Filter designs range from 1 amp to 75 amps in a wide selection of case styles... tubular, rectangular and bathtub. Attenuation covers the frequency ranges of most concern to data processing equipment manufacturers.

### These Hopkins RFI Filters are Off-the-Shelf Items!

Take advantage of Hopkins' more than 20 years of experience in designing and manufacturing filters. Our filter specialists are as close as your telephone. Just call (213) 361-8691.

Write today for DATA-LOG 113 on RFI Filters for data processing equipment.

Telephone (213) 361-8691

**HOPKINS**  
Engineering Company

A Subsidiary of Maxson Electronics Corporation  
12900 Foothill Boulevard • San Fernando, California 91342

... with the log outputs,  
Bode plots are easy ...

range display on the meter, electronic sweep, and integrated counter readout [see p. 78].

The new arrival is Hewlett-Packard's model 3590A. Over the frequency range of 20 hertz to 620 kilohertz, it can:

- Analyze complex waveforms
- Measure intermodulation and harmonic distortion
- Measure frequency response of filters, amplifiers, and transmission lines
- Analyze sonar signals
- Measure loop gain
- Make Bode plots

For displays, the 3590A has an optional direct digital readout of frequency and a meter indicating signal level in volts and decibels. It also has outputs for an x-y recorder; the y signal is proportional to the meter indication (either linear or logarithmic), and the x signal is proportional to the frequency, which can be swept over the instrument's range at rates of 10, 100, 1,000, and 3,100 hertz per second.

**Wide-ranging.** The signal-level meter has an over-all range of 3 microvolts to 30 volts full-scale, composed of 15 ranges. Dynamic range is 85 decibels, with 0-db range reference. At the log and linear outputs to the recorder, 10 volts corresponds to full scale on the meter. Like the db meter scale, the log output provides an 85-db range.

A logarithmic frequency output is also available for the x axis of the recorder. This output, combined with the log signal level output, permits Bode plots to be made directly.

Frequency can be tuned continuously; no band switching is necessary. Frequency can be generated internally or externally or programed by an external d-c voltage.

Signal components can be located within 20 hertz with the 3592A plug-in, which has a five-place digital readout.

**Autoranging.** Provision for automatic range changing makes measurement of widely different values fast and convenient. The wave analyzer automatically moves up to



the next higher range at 100% of full scale, and moves down to the next lower range at approximately 30% of full scale. With autoranging, the meter pointer is always in the upper two-thirds of the scale, its most accurate region. To prevent any possibility of the operator reading from the wrong scale, the correct range is indicated by an illuminated 15-place annunciator.

**Oscillator.** There are four bandwidths, which are selected with a front-panel control. Closely spaced signals can be resolved with the 10-hertz or 100-hertz bandwidths. The 1-khz bandwidth makes tuning easier in less critical measurements, and the 3-khz bandwidth is wide enough to pass voice signals. The wave analyzer has a carrier reinsertion oscillator so upper or lower sideband signals can be demodulated at the 3-khz bandwidth. This demodulated signal is available for listening or recording.

An automatic frequency control mode allows the analyzer to lock on and follow an input signal, even when it drifts and the bandwidth setting is only 10 hertz. By using the autoranging while the instrument is operating in the afc mode, signals can be measured quickly and easily just by tuning to within the afc lock-in range.

The basic 3590A costs \$3,200. Three plug-ins are available. The 3594A is a frequency sweeping plug-in with five-digit electronic readout; cost is \$1600. The 3593A is identical except that its frequency display is a three-digit mechanical counter; it costs \$1100. When the frequency source is external, the 3592A, a \$80 adapter is used.

**Accurate.** With either the 3593A or the 3594A plug-ins, frequency can be swept over the ranges of 20 hz to 62 khz and 20 hz to 620 khz. The frequency at which the sweep starts is adjustable. Accuracy of the mechanical readout version is  $\pm(1\%$  of indication,  $+20$  hz) for the larger sweep, and for the electronic readout it's  $\pm 20$  hz.

A balanced-input version of the wave analyzer, model 3591A, provides terminating or bridging operation for measurements of communication channels in dbm. It is calibrated for impedances of 75, 135, 150, and 600 ohms. Cost is \$3350.

Hewlett-Packard Co., Loveland, Colo. [369]

# wanted: "big" insulator problems

Solving "big" insulator problems is Lapp's specialty. Wherever insulator requirements call for high strength, special electrical specifications, maximum dependability and long service . . . Lapp is the company to contact.

Lapp has been designing, testing and making insulators for communications installations for almost a half century. On many special jobs, our experience provides the basic engineering and design, which enables us to deliver the job quicker, and save you money.

How "big" are the jobs we've done? How about tower base insulators to 9 million lbs. ultimate strength with 500 kv peak wet flashover. Or, compression cone guy insulators to 620 thousand lbs. strength and in strings with grading rings giving wet flashover to 700 kv peak.

Lapp also made 3 of the world's largest RF feed through bushings with wet flashover of 600 kv peak, for continuous operation at 2545 amperes at 140 kv rms at 14-30 kc. Our double-yoked strain insulators have been made to 240 thousand lbs. ultimate strength with a wet flashover rating of 700 kv peak.

From drawing board to delivery, you can count on Lapp when it comes to "big" insulator problems. Write for additional information, Lapp Insulator Co., Inc., LeRoy, N.Y. 14482.

**Lapp**

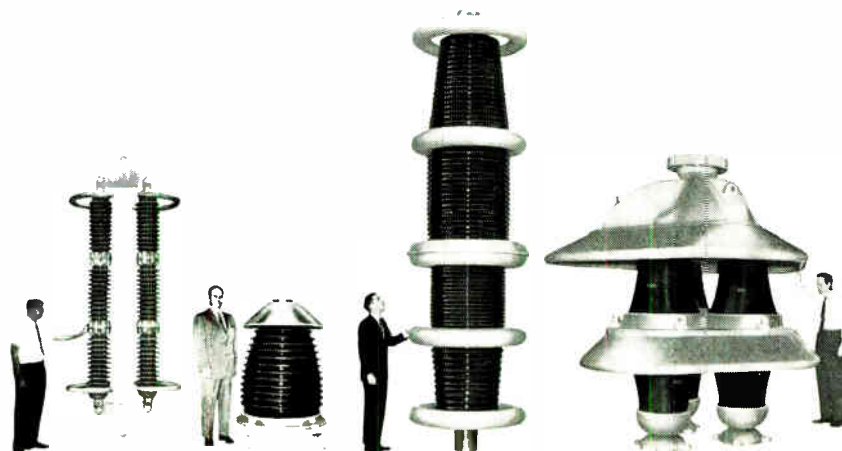

LOOK!  
we just invented  
the  
**electromechanical sequential switching device**

we just invented  
the word, that is.  
Not the product.  
It's been around for  
a long time.

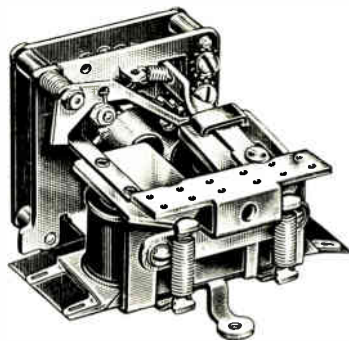

We usually call them stepping relays, or steppers for short. There's no need to re-invent them through costly scratch-design using a series of relays or circuitry. That costs lots more, and you've no guarantee of performance.

Guardian steppers are simple. They've been around for years performing all manner of sequential switching functions. And with all of the different types of steppers we offer, there's bound to be one that will do exactly what your design is attempting to do: but cheaper and perhaps better.

The types at your disposal include sequence selecting, automatic resetting, continuous rotation, circuit selecting, pulse multiplying, and counting. Also, slave and master, automatic homing, add and subtract and remote homing. They are available with up to 52 positions . . . up to 8 undivided circuits.

Ripe old engineers in dozens of equipment fields are familiar with Guardian stepper applications. We're counting on the bright young engineers to think up new ones. It helps to have our catalog F32. Why not write for it today.



**GUARDIAN<sup>®</sup>  
ELECTRIC**

**MANUFACTURING COMPANY** 1550 W. Carroll Ave. • Chicago, Illinois 60607

## New Production Equipment Review



Two Stripall thermal strippers remove outer coverings from single or multiple-conductor and coaxial cables. Operating at a blade temperature of 1,700°F, the TW-6 is for removal of Teflon, Kapton and Kel-F. The temperature-controlled TWC-6 is for removal of nylon, neoprene, silicone rubber and thermoplastic insulations. Kinetics Co., Solana Beach, Calif. [421]

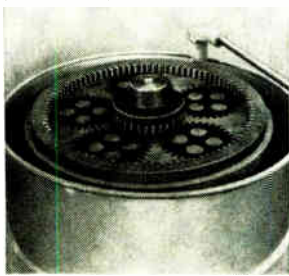
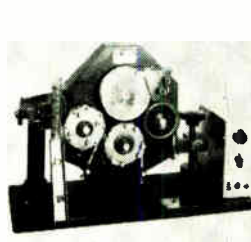
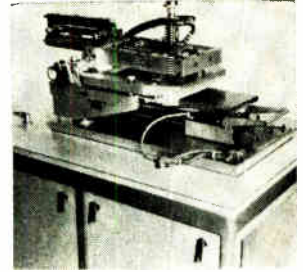

Table-model planetary finishing machine model PR-2-32T laps and polishes silicon wafers, germanium wafers, quartz crystals and other electrical components to a repeatable accuracy of 0.000005 in. Parts ranging in size from 1 3/4 in. diameter (5 per load) to 1/4 in. diameter (40 per load) or smaller can be processed. P. R. Hoffman Co., 325 Cherry St., Carlisle, Pa. [422]



High speed, bench-type offset industrial printer model 6756 is composed of the standard model 6306 printing head and a pin style escapement feed track. The precision printer is capable of printing two lines of small lettering, a line at a time, around the body of a TO-18 transistor, and similar parts or products. Jas. H. Matthews & Co., 6515 Penn Ave., Pittsburgh, Pa. [423]



Screen printer model 150 enables users to produce integrated circuits on a laboratory or pilot plant scale using a full size production screen on a small size printer. The 8 x 10 in. screen which provides a 6 x 6 in. work area is suited for large size parts, high screen-to-pattern ratios, or multiple circuit printing. Precision Systems Co., P.O. Box 148, Somerville, N.J. [424]

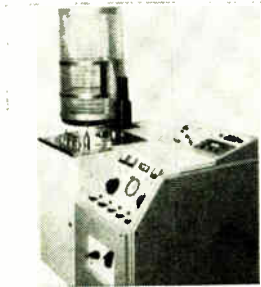

High vacuum 6 in. evaporator gives completely automatic cycling by a push-button start. The system will pump down an 18-in.-diameter, 30-in.-high bell jar from atmosphere to  $5 \times 10^{-7}$  torr in 3 minutes, 70 microns to  $5 \times 10^{-7}$  torr in 7 sec when clear, dry and empty and backfilled with dry nitrogen. Davis and Wilder Inc., 717 Stierlin Road, Mountain View, Calif. [425]

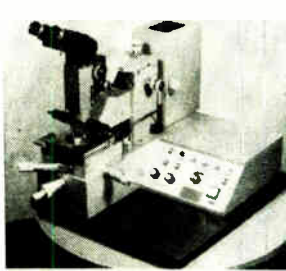

Compact mask aligner can process wafers in 50 sec while maintaining accuracies of 0.000040 in. It enables split field optics magnification to be changed from 80X to 160X instantly with one finger. Features include a self-aligning chuck that accommodates to various wafer and mask thicknesses. Unit occupies 1 1/2 ft of bench space. Axion Corp., Danbury, Conn. [426]

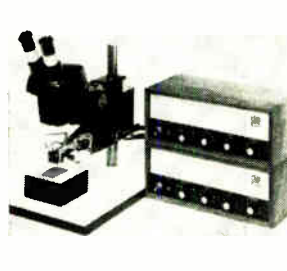

Dual soldering system called MDS attaches 14 or 22 lead flat packs to p-c boards in a single joining cycle. A magnetic transfer arm positions the flatpack beneath the electrodes for soldering. The complete process can be viewed through a 10X microscope, which may be used to aid in aligning the p-c board. Development Associates Controls, 725 Reddick Ave., Santa Barbara, Calif. [427]

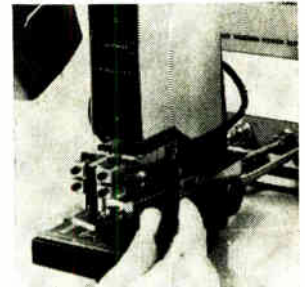

Reflow soldering head VTA-67 is for "all lead" soldering of IC packages. It utilizes 2 heater bars, adjustable to conform to most standard flatpack sizes. The heater bars are independently suspended to adjust to uneven printed circuits. The head has a loading "nest" for positioning the IC package under the heater bars. Hughes Welders, Oceanside, Calif. [428]

### Production equipment

## Hooked on anything

Fast and economical splicing machine joins wires to lugs, terminals, or even to flexible sheets

For all the technological advances incorporated in a piece of electronic equipment, successful operation often comes down to a question of connections. A wide variety of techniques has been developed to join components, and to this number the General Staple Co.

has just added the Splicemaster, a machine the firm says can be used to connect "virtually any two conductors".

To prove the statement, General Staple has shown that the machine can connect wires to the terminals of a reed switch, the lugs

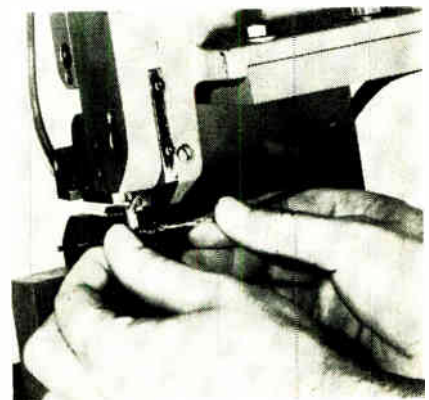

**Accessible.** Parts can be inserted from three sides, so operator works quickly and efficiently.



# MITRE NEEDS MORE TOP SYSTEMS PEOPLE

**MITRE has immediate openings  
in Bedford, Mass., and Washington, D.C.**

## ■ Communications Engineers

MITRE's responsibility in Bedford includes technical direction on such current communications systems as 490L Overseas Autovon, TACSATCOM, and Integrated Communication Navigation and Identification (ICNI). There are also openings for communications engineers on 407L, Tactical Air Control System, and related tactical communications projects.

Interest and background are desired in systems analysis; design, installation and checkout of communications networks; modulation and signal processing techniques; switching systems; voice and data transmission and satellite communications and associated airborne and ground terminal hardware.

## ■ Systems Engineers

A number of openings exist in Bedford for engineers with a broad systems engineering background, with emphasis on system design and system analysis. Fields of knowledge should include data processing, communications, display, and information storage and retrieval. These positions involve extensive command and control system design, data analysis and software functional design.

MITRE's Washington Operations also has unusual new openings for systems engineers in: Weather Systems, Defense Communications Systems, and Information Systems. We are also conducting independent

research in transportation systems, educational technology, medical data systems and urban planning.

## ■ National Range Support Systems Development

MITRE needs scientists and engineers in Washington to assist the Air Force Systems Command in its development of the future systems requirements and instrumentation plans for the Eastern and Western Test Ranges. Systems-oriented planning and research activities include studies of range functional subsystems categories: radar, telemetry, optics, communications, and data processing.

If you have two or more years' experience and a degree in electronics, mathematics, or physics, write in confidence to Vice President — Technical Operations, The MITRE Corporation, 3907 Middlesex Turnpike, Bedford, Massachusetts 01730. Persons interested in Washington openings should write directly to Vice President — Washington Operations, The MITRE Corporation, P. O. Box 1202 BC, Bailey's Crossroads, Va. 22041.



An Equal Opportunity Employer (M & F)

of an on-off switch, the terminals of a soft asbestos-backed mesh heating element, and the terminals of a film resistor on a flexible plastic sheet.

**Step on it.** Machine operation is simple. The operator positions the conductors on the work surface and steps on a pedal to start the Splicemaster which then feeds flat wire from a reel, cuts it, wraps it around the conductors, and compresses the assembly. The binding wire is flat copper, brass, tinned brass, silver, or aluminum with one side knurled so that it grips the conductors.

The operator doesn't have to be skilled; inexperienced workers can become adept at making the connections in four to six hours.

When coated magnet wire rather than the standard copper type is used, the binding wire is serrated longitudinally instead of knurled so it can penetrate the insulating coating.

The Splicemaster will compete with machines that use preformed connectors fed from a hopper or a coil. The connectors for these machines cost about \$4 per thousand, while the binding wire for the Splicemaster costs only about 80 cents per thousand connections, according to Irwin Zahn, president of General Staple. Zahn estimates that this 78% cost saving means that the Splicemaster can pay for itself in two years if as few as 880 connections are made each working day.

**Labor saving.** General Staple supplies the work-holding fixture on a custom basis, since its form depends on the parts to be connected. The company can also provide an indexing table or a conveyor to feed parts automatically; production rates as high as 300 connections per minute are claimed. With manual feed, the Splicemaster can save 25% in labor compared with other equipment because the work pedestal is accessible from three sides.

The Splicemaster is priced at \$1,185, with delivery in three to four weeks. The machine can be tried for one week without charge and can be leased for \$41.48 a month over a three-year term, with a purchase option.

General Staple Co., 28 E. 22 St., New York 10010 [429]

*Formed in 1958 . . . pioneer in the design and development of command and control systems . . . MITRE serves as technical adviser and systems engineer for the Electronic Systems Division of the Air Force Systems Command and provides technical assistance to other Government agencies, including the Department of Defense, the Department of Commerce, the Federal Aviation Administration and the Office of High Speed Ground Transportation of the Department of Transportation, and the National Aeronautics and Space Administration.*

# 60A, 1400V Controlled Avalanche Thyristors..

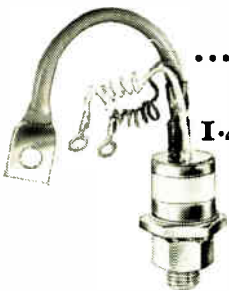

...part of a range covering  
1.0 to 62.5A, 100V to  
1.4kV in 4 different series

Standard types, high temperature types, avalanche types and inverter grades—all readily available from Mullard at competitive prices.

Here are the details—

**Avalanche Types**  
Rated: 85°C Stud

Average Current Ratings Up to 60A  
Min. Avalanche Voltage Up to 1400V

**High Temperature Types**  
Rated: 110°C Stud

Average Current Ratings Up to 11.5A  
Max. Crest Reverse Working Voltage Up to 400V

**Inverter Types**  
Rated: 85°C Stud

Turn off time (up to 10A) 10 μs  
(up to 62.5A) 15 μs

**Standard Types**  
Rated: 85°C Stud

Average Current Ratings Up to 62.5A  
Max. Crest Reverse Working Voltage Up to 1000V

Every designer should have a copy of the Mullard Quick Reference Guide containing information on thyristors, rectifiers, stacks and modules.

Also ask to be put on the mailing list of the Mullard Bulletin—a regular publication which gives details of new components and applications . . . the result of extensive research and development programs in the Mullard laboratories in England. Mullard employ 1,000 qualified scientists and engineers and have six major plants, with over 3 million square feet of floor space.

Write today for information on Mullard thyristors, and for the name of your local Distributor.

Mullard Limited, Mullard House, Torrington Place, London WC1, England.

U.S.A. enquiries to Mullard Inc., 100 Finn Court, Farmingdale, Long Island, New York, 11735 U.S.A.  
Telephone: (516) 694-8989 Telex: 961455

**Mullard** LIMITED

# Delay Lines

**MAGNETOSTRICTIVE**  
DELAY LINES

**SOLID**  
DELAY LINES  
(Glass or Quartz)

**LC and DC**  
DELAY LINES

**DISPERSIVE**  
DELAY LINES

**DIGITAL**  
DELAY LINES

for proven  
reliability in  
Delay Lines and  
Serial Memory Systems  
for military and  
commercial  
applications, it's...



**MICROSONICS, INC.**  
60 Winter Street  
Weymouth, Mass. 02188  
Tel: 617 337-4200

A subsidiary of the Sangamo Electric Company

## New Books

### Working Text

Solid State Physical Electronics,  
Second Edition.  
Aldert van der Ziel, Prentice-Hall Inc.,  
633 pp., \$13.75

A lot has happened in the 10 years since the first edition of this text appeared—Schottky barrier diodes, Gunn effect devices, and planar processing, to name a few advances. Although van der Ziel takes note of all these developments and includes the theory of new devices, his treatment is often sketchy.

Starting with wave mechanics and solid-state theory, he moves on to electron emission, semiconductor devices, and ends with topics such as nonlinear optics, piezoelectrics, magnetics, cryogenics, and lasers.

While van der Ziel didn't intend to write a processing book but rather a theoretical text of the operation of various solid state devices, readers would probably have welcomed at least an appendix on device fabrication.

Though the author has aimed his book primarily at undergraduates, engineers can use it for basic information or just to understand an article in a professional journal.

### Illuminating

Electro-Optical Photography at  
Low Illumination Levels  
Harold V. Soule  
John Wiley & Sons  
392 pp., \$15.95

In describing a relatively new and sophisticated area of optics, the author has managed to cover all the important topics and has presented them in a manner that should make the book useful to engineers as both a reference and a guide to the design of low-illumination systems.

His organization is logical and easy to follow. For example, a historical discussion of electro-optical imaging is followed by a chapter on night illumination. Then come chapters on image intensifiers, lens systems, camera systems (electronography), and television. Other top-

ics include recording techniques and their applications, the physics of components, imaging sensors, image evaluation, and the military uses of passive night imaging.

Particularly useful is a comprehensive table of the present and future applications of low-light-level instruments.

On the other hand, Soule is sometimes guilty of looseness of definition and even technical errors. For example, his definition of sine condition is incorrect. He confuses gamma with density of film, continually uses the American Standards Association's film-speed ratings under conditions not defined by the ASA, and writes mean root square when he means rms. The most irritating error is the persistent substitution of illumination for luminance or illuminance, and radiation for radiance or irradiance. Such errors have been made by other writers in this field, which seems to suffer from confusion between radiometric and photometric terminology. Authors would do well to follow the U.S. standard nomenclature and definitions for illumination engineering.

W. A. Miller

Sanders Associates Inc.  
Plainview, N.Y.

### Still timely

Correlation Techniques  
F.H. Lange  
D. Van Nostrand Co.  
464 pp., \$13.50

In writing this book eight years ago at the University of Rostock in East Germany, Prof. Lange brought the powerful tool of correlation analysis to bear on signal design, transmission, and reception. He bridged the gap between the statistical and spectral characterizations of signal sources with an approach both comprehensive and practical.

Since then, others have written texts weaving the probabilistic understanding of information transfer into communications engineering. Yet, remarkably, this first English edition—basically the original book with one additional chapter on recent trends—is timely and in some ways unique.

Essentially an introduction to mathematical correlation theory, it also describes applications of the



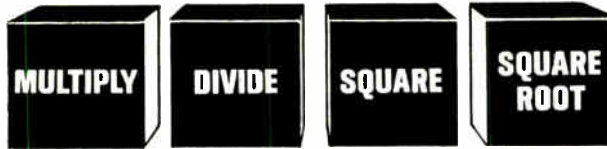

# INTRONICS

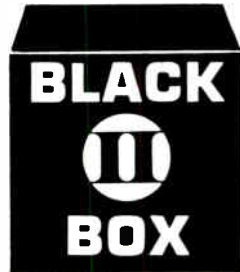

## FUNCTION MODULES PROVIDE THE ANSWER

### ALL MODELS FEATURE:

- Linear operation at all input voltage levels. No distortion through zero volts.
- High input impedance.
- Low output impedance (also short circuit proof)
- High thermal stability.
- High stability with respect to supply voltage variation.
- MIL quality construction.
- -25°C to +85°C operation standard, with -55°C to +125°C optional.
- Accuracy specifications include all linearity, offset, and gain errors.

### *New* M401 ECONOMY MULTIPLIER

- 2% full scale four quadrant accuracy
- 0.5% full scale single quadrant accuracy
- DC to 25kHz full output
- 100kHz small signal response
- ±10V inputs and output
- Input impedance >20K ohms
- Output impedance <1 ohm
- Size: 1.5" x 1.5" x 0.625"

\$95.00 (1 - 9)  
\$75.00 (100 level)

### HIGH ACCURACY M300 SERIES MULTIPLIER

		Typical	Worst Case
• Four quadrant full scale accuracy:	M301	0.5%	1.0%
	M302	0.25%	0.5%
	M303	0.1%	0.2%
• Multiply / Divide / Square / Square Root Operation			
• Pulse modulation technique provides >0.1% linearity all models.			
• No external amplifiers or adjustments required.			
• ±10V inputs and outputs.			
• Input impedance >10K ohms			
• Output impedance <1 ohm			
• Bandwidth 1000Hz 400Hz	M301, M302 M303		
• Size: 2" x 3" x 0.625"			
	M301	\$245.00	(1 - 9)
	M302	\$275.00	(1 - 9)
	M303	\$325.00	(1 - 9)

### *New* M501 HIGH FREQUENCY MULTIPLIER

- DC to 1 Megahertz full output bandwidth
- 1% full scale four quadrant accuracy
- 500nsec step response
- Multiply / Divide / Square / Square Root Operation
- No external amplifiers or adjustments required.
- ±10V inputs and output
- Input impedance >10K ohms
- Output impedance <1 ohm
- Size: 2" x 3" x 0.625"

\$295.00 (1 - 9)

Other solid state function modules available for: impedance buffering, voltage amplification, sample and hold, precision voltage reference and A to D conversion.

Contact our applications engineering department to discuss your requirements. Phone: 617-332-7350, TWX.: 710-335-6835



# intronics

57 Chapel Street • Newton, Massachusetts 02158

# Can you

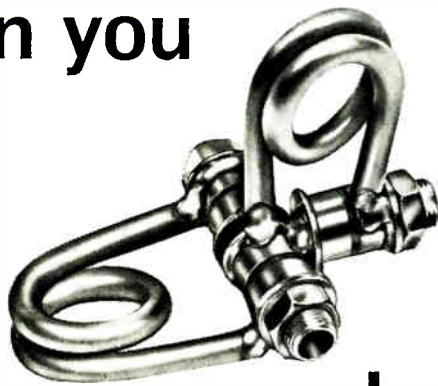

# do this?

These new Johanson glass capacitors are designed to bridge the gap between conventional trimmers and high frequency air capacitors. They have high Q—low inductance; they have high RF current characteristics, they can be soldered together with components to simplify circuitry and they are strong.

#### Models include:



**Series II:** High RF voltage low cost units with  $Q > 1200$  and TC;  $0 \pm 50$  ppm.



**Johanson 7168:** High voltage quartz capacitors which feature 7000 VDC; 2500 V peak RF at 30 mc and current capacity  $> 2$  amps.

#### Also available are:

- Tuners and ganged tuners; linear within  $\pm 3\%$
- Differential capacitors
- Mil spec capacitors
- Microminiature capacitors .075" diameter and .1-1 pf

Write today for full catalog.

**Johanson MANUFACTURING CORPORATION**

400 Rockaway Valley Road, Boonton, N. J. 07005 (201) 334-2676

*Electronic Accuracy Through Mechanical Precision*

Circle 146 on reader service card

## Our little black book has over 100,000 phone numbers.

You never had a black book like it. Over 1,500 pages. And those phone numbers! More than 100,000 telling you who to call/where to go, for the over 4,000 different product categories listed and advertised in the yellow pages of the Electronics Buyers' Guide.

It's the industry's one-stop shopping center that lets you find the products and services you need quickly. You can depend on EBG.



### Electronics Buyers' Guide

A McGraw-Hill Market Directed Publication, 330 West 42nd Street, New York, N.Y. 10036

## New Books

theory to communications, measurement, and control systems and is crammed with examples and practical techniques.

Practicing communications or control engineers will appreciate the clear presentation and extensive references. However, some may quarrel with the multiplicity of examples, and theorists may not find the book rigorous enough. It might be used as a third- or fourth-year engineering text, though the lack of problems and breadth of subject matter are drawbacks in this application. The book may find its proper niche as an interdisciplinary reference. The writing is occasionally tedious and clumsy—perhaps because of the translation—and the combination of small print and long sentences can try one's eyes and patience.

But anyone in communications or control who takes his engineering seriously shouldn't overlook this book.

David S. Dayton  
Synergistic Technology Inc.  
Acton, Mass.

## Recently published

**Magnetic Recording in Science and Industry**, edited by Charles B. Pear Jr., Reinhold Publishing Corp., 453 pp., \$19.50.

Covers basic magnetic-recording principles as well as analog and digital recording procedures and systems, and computer applications.

**Mathematical Methods for Physicists and Engineers**, Royal Eugene Collins, Reinhold Book Corp., 385 pp., \$12.50

Discussion includes vector calculus and matrix algebra, methods for analytically solving linear boundary problems, and approximation methods based on perturbation and variational calculus. Emphasizes practical mathematical approaches to the solution of physics and engineering problems.

**Junction Field-Effect Transistors**, Carl David Todd, John Wiley & Sons Inc., 285 pp., \$10.50

Describes operation of junction FETs, their major characteristics, and how they can be used. Intended as a design guide, handbook, and text for design engineers, educators, and graduate students.

**Transistor Circuits and Applications**, Laurence G. Cowles, Prentice-Hall Inc., 323 pp., \$14.60

Highlights of this treatment of both junction and field-effect transistors include discussions of active filters and tuned amplifiers, the transistor gain-impedance relation, single-stage FET amplifiers and practical feedback considerations.



# A Kokomoan power with mettle of honor.

Type	$I_c$	$V_{CE0}$	$V_{CE\theta}$	$hFE$ @ $I_c$ amps	$V_{CE(sat)}$ @ $I_c$ Volts	$\theta_c$ @ $I_c$ Amps
DTS-423	3.5	400	40C	30/90 1.0	0.8	1.0
2N3902	3.5	700*	40C	30/90 1.0	0.8	1.0
JAN 2N3902	3.5	700*	400	30/90 1.0	0.8	1.0

\* $V_{CEX}$

It started out as the DTS-423. Then, with EIA registration, it became the 2N3902. And now it has JAN approval.

At 700v., 100w., the JAN 2N3902\* gives you the full benefit of Delco high energy silicon power: ruggedness, reliability and reduction of circuit weight, size and component cost.

Delco silicon power transistors are serving in high energy circuits including DC to DC converters, ultrasonic power supplies, VLF class C amplifiers, off-line class A audio output and magnetic CRT deflection.

Put this one to work for you.  
Just call your local Delco Distributor  
or Delco sales office.

\*Mil-S 19500/371 (USAF)



**DELCO RADIO**  
DIVISION OF GENERAL MOTORS  
**KOKOMO, INDIANA**



#### Kokomoans' Regional Headquarters

Union, New Jersey\* 07083  
Box 1018 Chestnut Station  
(201) 687-3770  
Chicago, Illinois\* 60656  
5151 N. Harlem Avenue  
(312) 775-5411

Syracuse, New York 13203  
1054 James Street  
(315) 472-2668  
Santa Monica, Calif.\* 90401  
726 Santa Monica Blvd.  
(213) 870-8807

Detroit, Michigan 48202  
57 Harper Avenue  
(313) 373-6560  
Kokomo, Ind. 46901  
700 E. Firmin  
(317) 459-2775 Home Office

\*Office includes field lab and resident engineer for application assistance.



# FOR Chemicals

Think  
**GC**

Solve all electronic chemical needs quickly and economically... simply specify GC!

GC manufacturers and stocks cleaners, solvents, cements, lubricants, lacquers and varnishes for in-plant servicing and maintenance needs on all office and production equipment. Packaged, or in bulk, all are available for immediate shipment.



**FREE!**



Write today for the big GC Electronic Chemical Handbook — \$1.50 value — yours **FREE** when applied for on your Company letterhead. It's your solution to all chemical problems.

**GC Electronics**

400 South Wyman Street  
Rockford, Ill. 61101

A Division of  
GC Hydrometals, Inc.  
Shipping warehouses in:  
Hicksville, L.I., N.Y.  
Los Angeles, California



Circle 171 on reader service card

## Replace Costly AC/DC Circuits!

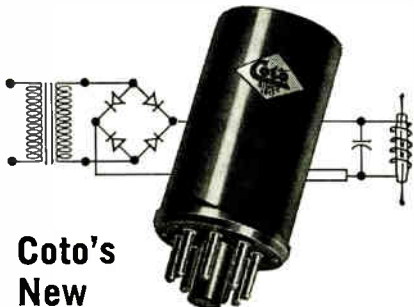

**Coto's  
New**

# A.C. Reed Relay

**Designed to Operate on  
Standard 60 Hz input**

**Contacts:** Forms A, B, C with single or multiple poles.

**Ratings:** To 3 amperes or up to 5000 volts D.C.

**Inputs:** 50-400 Hz voltages available.

**Physical:** Available in steel or plastic octal base housings for plug-in mounting.

Write for complete specifications. For special requirements, give complete details for quotation.

**Coto-Coil** COMPANY, INC.  
61 Pavilion Ave.  
Providence, R. I. 02905  
Phone (401) 941-3335

148 Circle 148 on reader service card

## Technical Abstracts

### Demodulation by gating

Stereo and color signal demodulation with integrated circuit techniques  
Francis H. Hilbert, Gildo Cecchin, and James Feit  
Motorola Inc.  
Franklin Park, Ill.

The key to greater use of integrated circuits in consumer products is the ability of semiconductor makers to design low-cost circuits that, with various external components, can perform many different functions. The IC designer must consider such factors as processing costs, density yields, and die size on the one hand, and cost advantages to the user on the other. Cost aside, the design approach must be flexible and must offer at least the potential for improving the performance of the user's product.

The alternatives available to the IC manufacturer are demonstrated by designs of a chroma demodulator for a color television receiver and a stereo signal demodulator for a stereo receiver. In both designs, a gate-type demodulator was selected because it offers the lowest cost. Demodulation by gating also offers the user greater circuit design flexibility, because it allows the preservation of the original frequency spectrum, which could be useful in other parts of the circuit. Furthermore, the stringent linearity requirements of the chroma demodulator can be easily met by the good component-matching features of monolithic IC's.

Another advantage is that the color signal can be demodulated by the difference method with gain or by the direct method—bringing the luminance components through the demodulation process—also with gain. The gating signals are removed from the demodulator output by a cross-coupled gating arrangement. Also, an IC demodulator allows retrace blanking and brightness control and can develop a signal of the level required to directly drive the external transistor output circuitry.

For stereo demodulation by gating, a single chip can be made to include all active devices and most of the passive devices necessary for multiplex demodulation. The func-

tions include amplification of the basic 19-hertz; pilot; frequency doubling to produce the 38-hertz pilot; audio and 19-hertz muting switch with hysteresis, and stereo lamp driving.

Presented at the IEEE Spring Conference on Broadcast and Television Receivers, Chicago, June 17-18.

### Looking back in time

Operability of computer-controlled plants

A. Maarleveld  
Koninklijke/Shell Laboratorium  
Amsterdam, Holland  
J. Barth

Bataafse Internationale Petroleum  
Maatschappij N.V.  
The Hague, Holland

The digital process control computer in the refinery has provided the opportunity to examine the role of operating personnel and, where necessary, to redistribute their workload in a rational manner. What's more, a cathode-ray-tube display, driven by the computer, simplifies the tasks assigned to the operators.

How operators respond to normal and emergency conditions has been studied at Shell's Pernis, Holland, refinery. The refinery installed a Honeywell H620 process control computer system that includes a cathode-ray tube to display trend information on 80 process variables.

The computer system contains both core and drum memories, with historical process-variable data read in and out via the core but stored on the drum. Each drum track, with a capacity of 165 24-bit words, contains the records of two variables. That is, each variable is allotted 80 words. Further, each word contains two data points, so the total number of data points for each variable is 160.

Once every second, one track (two variables) is transferred to the core memory to be updated with new measured values. During this interval the oldest data points are deleted and new data points are added. Then the records are transferred back to the drum. In this manner, a new track is updated in each succeeding one sec-

# EIMAC

zeroed in on some grid problems so you can get higher power gain.

Want up to 20 times power gain in a cathode driver circuit? Try one of the tubes in our complete zero-bias power triode line. While you're solving problems, throw out the bias power supply. Forget some of the associated circuitry. And don't worry about destroying the tubes if you lose grid voltage. They don't need any.

These triodes are designed for use as Class B or C amplifiers in audio or radio-frequency applications. We've got zero-bias triodes ranging from 400 watts to 10,000 watts—the most complete range of zero-bias triodes available.

Contact your nearest distributor or the Varian Field Office for further information. Offices are located in 16 major cities. Ask Information for Varian Electron Tube and Device Group.

	TYPICAL OPERATION					
	CLASS B RF LINEAR POWER AMPLIFIER, GROUNDED GRID					
	GLASS			CERAMIC		
	3-400Z	3-500Z	3-1000Z	3CX1000A7	3CX3000A7	3CX10000A7
Plate Voltage, Vdc	3000	3000	3500	2500	5000	7000
Max Signal Plate Current, A	0.332	0.333	0.75	0.800	1.56	5.0
Drive Power, W	32	35	85	60	215	1540
Output Power, W	655	644	1770	1170	5500	24,200
Filament Voltage, V	5.0	5.0	5.0	5.0	7.5	7.5
Filament Current, A	14.5	14.5	21.5 23.0	28/33	51	94/104

**EIMAC**  
Division of Varian  
San Carlos, California 94070

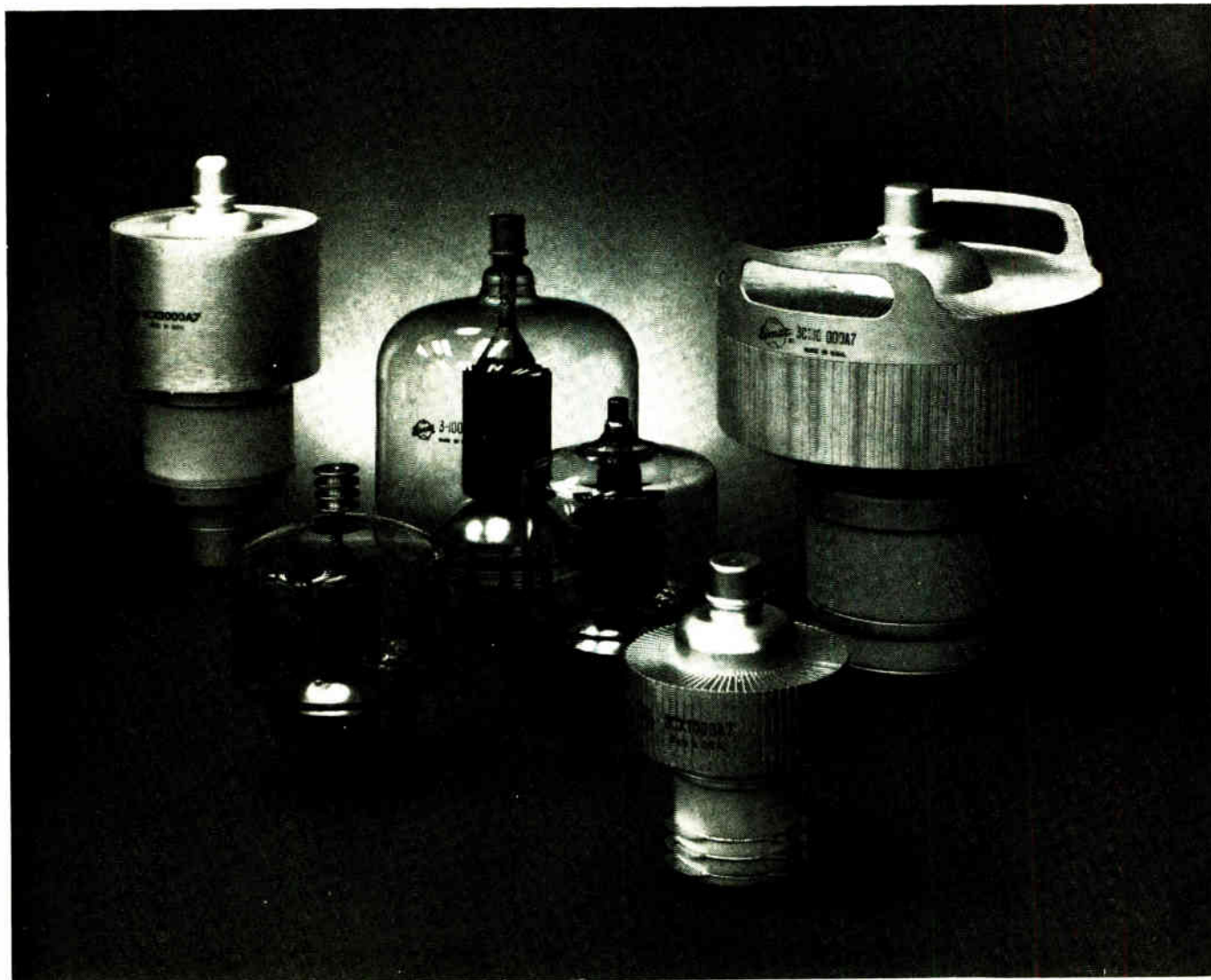



# WHICH DEFLECTION YOKE FOR YOUR DISPLAY ?



Consult **SYNTRONIC**

## YOKE SPECIALISTS

Syntronic's team of experts knows more about yoke design, engineering and quality control than anyone else. A solid 10-year record of leadership—acknowledged throughout the industry. Benefit from it.

***syntronic*** **INSTRUMENTS, INC.**  
100 Industrial Road, Addison, Illinois  
Phone: Kingswood 3-6444

Circle 172 on reader service card

**NEW!**



**read angular position  
to .0001 degree**

### **synchro/resolver standards and bridges**

- 2 seconds of arc accuracy
- 200-800 Hz frequency range
- cabinet or rack mount
- complete isolation
- high input impedance
- fully switched, 7 decades

**asi**

advanced instrumentation

**astrosystems, inc.**

6 Nevada Drive, New Hyde Park, New York 11040 516-328-1600

## Technical Abstracts

ond interval.

When the operator wants to see past information about processing conditions, he selects a desired primary variable for display on any one of four traces on a wide-screen crt display tube. Three other related variables can also be shown, so four variables can be correlated on a common time base.

Normally, each trace on the scope consists of 160 dots, spaced 40 seconds apart. However, the operator has the option of selecting a five-second interval between data points, thus giving him "fast trend" information display.

Presented at the IFAC/IFIP Symposium on Digital Control of Large Industrial Systems, Toronto, June 17-19.

### Choosing a filter

Design of high performance f-m receivers using high-gain integrated circuit i-f amplifiers  
T.J. Robe and L. Kaplan  
RCA Electronic Components,  
Somerville, N.J.

Now that the semiconductor industry has begun to offer integrated circuits with gains as high as 60 to 80 decibels, and with good limiting characteristics at 10.7 megahertz—the f-m i-f frequency standard—the design of high-performance f-m receivers is being revolutionized.

However, a major problem is that the i-f filter becomes much harder to design, because fewer gain blocks are required for the amplifier—perhaps only two—and selectivity must be provided in complex blocks. The pass-band requirements are dictated by the a-m frequency, and the deviation of the transmitted carrier from the center frequency.

Crystal filters offer a possible solution to the selectivity problem, if used with one or more inductance-capacitance tuned circuits, but cost too much for most applications. Another choice is the use of ceramic filters, which show promise of good performance in f-m systems. Still another is the use of conventional L-C filters, which can now be designed with the aid of computers and the application of modern network theory.

Presented at the IEEE Spring Conference on Broadcast and Television Receivers, Chicago, June 17-18.



# Our little black book has over 100,000 phone numbers.

You never had a black book like it. Over 1,500 pages. And those phone numbers!

More than 100,000 telling you who to call/where to go, for the over 4,000 different product categories listed and advertised in the yellow pages of the Electronics Buyers' Guide.

It's the industry's one-stop shopping center that lets you find the products and services you need quickly. You can depend on EBG.

## Electronics Buyers' Guide

A McGraw-Hill Market Directed Publication, 330 West 42nd Street, New York, N.Y. 10036



## How Small is Big Enough?

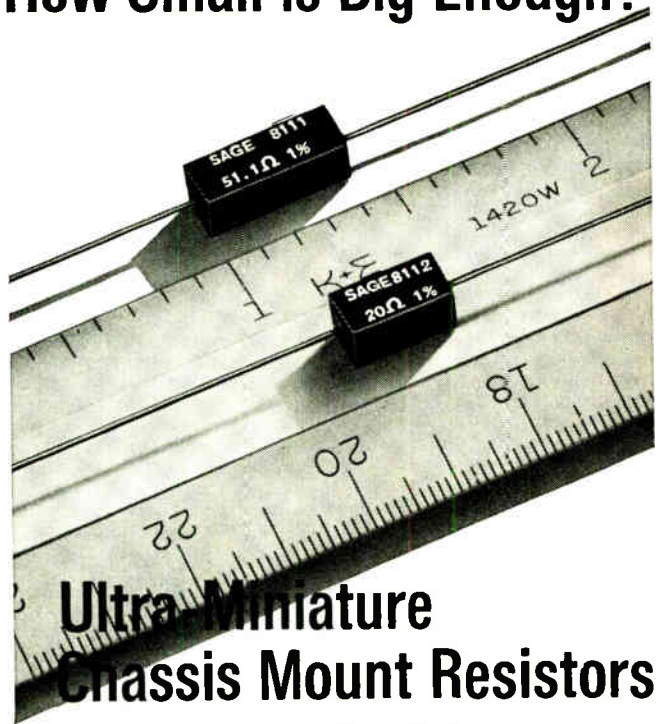

## Ultra-Miniature Chassis Mount Resistors NEW from SAGE!

**PROBLEM:** To produce, for aerospace application, out-board resistive components for use with hybrid and/or integrated circuits which combine minimum size with maximum efficiency and reliability; also to provide mounting ease and flexibility using component clips, clamps or high temperature epoxy bonding materials

**SOLUTION:** The new Sage Ultra-Miniature Chassis Mount Resistors shown here!

**STYLE 8111:** 7 WATTS CHASSIS MOUNTED—3.5 WATTS FREE AIR—LESS THAN 0.015 IN<sup>3</sup> VOLUME

**STYLE 8112:** 5 WATTS CHASSIS MOUNTED—2.5 WATTS FREE AIR—LESS THAN 0.009 IN<sup>3</sup> VOLUME

Part	Length	Width	Height	Standard Ranges Resistance
8111	0.430" ± 0.015"	0.156" ± 0.005"	0.165" Max.	.05Ω-13KΩ
8112	0.305" ± 0.015"	0.156" ± 0.005"	0.165" Max.	.05Ω-6KΩ

**ACCURACY:** Tolerance to ± 0.05%

**PERFORMANCE:** Meet or exceed all applicable requirements of MIL-R-18546

Free air rating is based on maximum surface hot spot temperature of 275° C.

Chassis mount power rating is based on maximum surface hot spot temperature of 150° C when mounted on 4" x 4" x 0.040" aluminum chassis.

For complete engineering data on these new Sage achievements in miniaturized electronic products, write



**SAGE**

## SAGE ELECTRONICS CORP.

Subsidiary of Gulton Industries, Inc.

BOX 3926 ROCHESTER, N. Y. 14610

Phone: (716) 586-8010

**TRANSIENTS  
IN THE AC INPUT LINE  
WON'T HURT YOUR PRODUCT  
DESIGNS IF YOU SPECIFY  
JOSLYN AC PROTECTORS**



For ultra fast precision response   
clamping at extremely low levels   
any kva rating with line voltages up to  
650 v rms max.  life expectancy that  
exceeds that of your product  no power  
interruption and no line insertion loss  
(exc. 1201-02).

Call or write now for full information on  
1200 single-phase, 1400 three-phase  
60-cycle Series Protectors. Just two  
of many surge arrester lines.



**JOSLYN**  
ELECTRONIC SYSTEMS

Division of Joslyn Mfg. & Supply Co.  
SANTA BARBARA RESEARCH PARK  
P.O. BOX 817, GOLETA, CALIFORNIA 93017  
Tel. (805) 968-3551.

Circle 173 on reader service card

Cartoon by Whitney Darrow, Jr.



**Be a buddy!**

**One gift works many wonders  
THE UNITED WAY**

**New Literature**

**Clips and insulators.** Mueller Electric Co., E. 31st St., Cleveland 44114. An eight-page catalog describes materials, sizes, characteristics, and capacities of all clips and insulators made by the company.

Circle 446 on reader service card

**FSK data set.** General Electric Co., P.O. Box 4197, Lynchburg, Va. 24502, has published bulletin ECD-16 on the DigiNet TDM-210 frequency-shift keyed data set. [447]

**Voltage variable capacitors.** Computer Diode Corp., Pollitt Drive, Fair Lawn, N.J. 07410. Four-page bulletin 371 contains technical data on voltage variable capacitors and catalogs over 400 of the most frequently used types. [448]

**Nickel-cadmium batteries.** Sonotone Corp., Elmsford, N.Y. 10523. Bulletin BA-204 is a reprint of a paper, "The Sealed Rechargeable Nickel-Cadmium Battery." [449]

**Ultrasonics capability.** Redford Corp., 968 Albany-Shaker Rd., Latham, N.Y. 12110. A four-page brochure illustrates and describes the company's capability in applied research, development, applications, and production of ultrasonic equipment, components, and systems. [450]

**Teflon tubing.** Zeus Industrial Products Inc., 195 Nassau St., Princeton, N.J. 08540. A 28-page catalog describes line of Teflon TFE tubing. [451]

**Vacuum capacitors.** ITT Jennings Division of International Telephone & Telegraph Corp., P.O. Box 1278, San Jose, Calif. 95108, has available its 52-page catalog 101, covering a variety of vacuum capacitors. [452]

**Delay-invert amplifier.** Hamner Electronics Co., 1945 E. 97th St., Cleveland 44106. A technical bulletin describes the NA-19 delay-invert amplifier that is used either to introduce a fixed delay for linear signals or to invert signal polarity. [453]

**Resistance pastes.** Methode Development Co., 7447 West Wilson Ave., Chicago 60656, offers a booklet designed to acquaint engineers, designers, and manufacturers with its Blend-Ohm resistance pastes. Copies can be obtained by writing on company letterhead.

**Crystal orientation unit.** General Electric Co., 4855 Electric Ave., Milwaukee 53201. A four-page technical bulletin describes a crystal orientation test unit for rapid and accurate production alignment of crystals used in the electronics industry. [454]

**IC logic cards.** Computer Logic Corp., 1528 20th St., Santa Monica, Calif. 90404, offers a 24-page catalog of IC logic cards for a wide variety of functions. [455]

**Data sets.** General Electric Co., P.O. Box 4197, Lynchburg, Va. 24502, has published bulletin ECD-11 on the DigiNet family of data modems for voice channel, group and supergroup digital Communications. [456]

**Power supply.** Lambda Electronics Corp., 515 Broad Hollow Road, Melville, N.Y. 11746. A high-precision power supply with plug-in differential voltmeter is described in a 12-page brochure. [457]

**Vacuum relays.** High Vacuum Electronics Inc., 538 Mission St., South Pasadena, Calif. 91030. A 20-page, full-color brochure covers the design, specification and use of Kilovac vacuum relays. [458]

**Solid state control.** Lehigh Valley Electronics Inc., Box 125, Fogelsville, Pa. 18051, has released a brochure on a new line of solid state logic and control modules. [459]

**Laser components.** Laser Optics Inc., Mill Plain Rd., Danbury, Conn. 06810. A four-page components brochure is directed to users and makers of CO<sub>2</sub> lasers. [460]

**Coaxial connectors.** Phelps Dodge Electronic Products Corp., 60 Dodge Ave., North Haven, Conn. 06473. A 16-page technical bulletin describes the company's lines of Taperlok and Wirelok coaxial connectors. [461]

**Tunable oscillator.** Solid State Electronics Corp., 15321 Rayen St., Sepulveda, Calif. 91343, has available a single-sheet bulletin on the model S-300 silicon transistor tunable oscillator. [462]

**Counters and timers.** Beckman Instruments Inc., 2200 Wright Ave., Richmond, Calif. 94804. Bulletin 2238-A describes the 6300 series of modular electronic counters and timers. [463]

**Induction motors.** Eastern Air Devices, 385 Central Ave., Dover, N.H. 03820, has released a data sheet covering a line of miniature (less than 1.5 cubic inches) induction motors with outputs up to 1/100 horsepower. [464]

**Spectral analysis.** Signal Analysis Industries Corp., 12 Di Tomas Court, Copiague, N.Y. 11726, has available data sheets describing a real-time spectrum analyzer with companion digital integrator for power spectral density analysis. [465]

**A-c power conditioner.** Wanlass Electric Co., 1540 E. Edinger Ave., Santa Ana, Calif. An eight-page folder covers the Parax 400-hertz a-c power conditioner model P4-1405. [466]



# Free! Latest data on our electronic products.

New Catalog 52 gives you comprehensive, up-to-date information on Superior Electronic Products. Includes data on cathode designs, materials and chemical composition, physical properties, and special features. Also describes the major characteristics of each cathode material. And Superior's capability in fabricating tubular parts for electronic applications.

Write for your free copy. It will help you evaluate and select the best cathode design and material for your specific application. Or fabricated parts. Superior Tube Company, Electronic Sales Department, 2500 Germantown Avenue, Norristown, Pa. 19404.

 **Superior Tube**  
Norristown, Pa. 19404



Circle 153 on reader service card

**WORLD'S FIRST! NEON T-1 $\frac{3}{8}$**

## MINIATURE Brite Glo Lamps

TRADE MARK



An unusual ring-electrode construction glows on the entire surface for maximum brightness. The unobstructed glass allows the illuminated elements to be placed close to the top where it may be viewed to advantage. 3 styles: with short bare leads; with 10" insulated leads; with 10" insulated leads and metal base.

**FREE**  
12-PAGE CATALOG WRITE!

**ALCO<sup>®</sup> ELECTRONIC PRODUCTS, INC.**  
LAWRENCE, MASSACHUSETTS

**COMPACT**

## NUMERIC READOUTS

AT REASONABLE PRICES



Displays 0-9 numerals by illuminating miniature lamps. Combination of lamps can be controlled with a matrix circuit (not supplied). Decimal points can be used as colon when 2 units are placed together. Indicator provides high illumination with a low voltage and current. Colored filters available. 6 & 12V. Figures 25/32" high. 20,000 hr. bu b life.

**ALCO<sup>®</sup> ELECTRONIC PRODUCTS, INC.**  
LAWRENCE, MASSACHUSETTS

PRICES start at \$9.95  
Quantity prices available

Circle 175 on reader service card

## WITH INSERTS, THE SAVINGS ARE IN THE HOLE

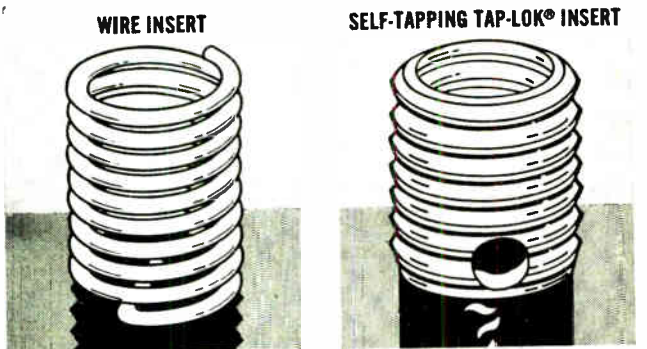

For the real bargain in inserts, look into the hole. You'll get a new view of what really counts—final installed costs. Check these approximate installation figures:

(Estimated Costs*)	Do Our Costs Agree With Yours? If Not, Fill In Your Own	(Estimated Costs*)
Wire-Type Inserts		Self-Tapping Tap-Lok <sup>®</sup> Inserts
Insert Cost	5¢	Insert Cost
Drill Hole	5¢	Drill Hole
Tap Hole	7¢	Tap Hole (Not Req.)
Gage Hole	3¢	Gage Hole (Not Req.)
Install Insert	8¢	Install Insert
Remove Tang	5¢	Remove Tang (Not Req.)
Per Finished Hole	33¢	Per Finished Hole
		4.4¢
		5.3¢
		—
		—
		8.0¢
		—
		17.4¢

\*Estimated cost for wire-type 4-40, .224" long, 25,000 quantity; Tap-Lok 4-40, .234" long, case-hardened steel, 25,000 quantity. Estimated average costs will vary with user, equipment, overhead, and labor rates. Self-tapping Tap-Lok inserts eliminate three operations which alone amount to about triple the cost of the insert itself. With Tap-Lok you need only one inexpensive installation tool. Wire inserts require special taps, gages, and a tang removal tool. Tap-Lok inserts conform to MS 35914-101 thru 166. Write for data—Groov-Pin Corp., 1121 Hendricks Causeway, Ridgefield, N.J. 07657, (201) WH 5-6780.

FASTENER DIVISION **GROOV-PIN CORP.**

Circle 174 on reader service card 153



# Valuable new and recent books from McGraw-Hill

**1 SOURCEBOOK OF ELECTRONIC CIRCUITS.** By JOHN MARKUS. **New.** Over 3,000 circuits, complete with values of all components, are arranged in 100 chapters for easy reference. With each circuit is a concise description of its significant features, performance data, and operating characteristics. **888 pp., \$18.50**

**2 SIMULATION: The Modeling of Ideas and Systems with Computers.** By JOHN McLEOD. **New.** From aerospace to the design of models for various technical and engineering situations, this series of articles covers a wide range of topics in this field. This book will be of immediate value to all who are interested in applying simulation to actual problems. **352 pp., \$15.00**

**3 THE PROGRAMMER'S PL/I: A Complete Reference.** By CHARLES P. LECHT. **New.** This detailed reference source is especially useful to professional Systems Analyst/Programmer personnel in the preparation of applications utilizing the PL/I language repertoire. It is also extremely valuable to beginners learning to use the language since it concentrates on each PL/I language available. The book has been carefully planned for quick and easy use. **427 pp., \$11.95**

**4 ELECTRONIC DIGITAL TECHNIQUES.** By PAUL M. KINTNER. **New.** This down-to-earth, how-to-do-it approach to digital systems is geared to the needs of the practicing engineer. Algebra or other mathematical formulations are used only when they contribute specifically to a design technique. **315 pp., \$11.95**

**5 MATHEMATICAL HANDBOOK FOR SCIENTISTS AND ENGINEERS.** 2nd Edition. By GRANINO A. KORN and THERESA M. KORN. Designed specially for engineers, scientists, and others whose work involves mathematics and its methodology, this authoritative handbook provides reliable reference to helpful definitions, theorems, and formulas, and conveniently outlines the mathematical methods essential for accuracy and speed in today's exacting applications. **1,130 pp., \$25.00**

**6 PRINCIPLES OF DATA COMMUNICATION.** By R. W. LUCKY, J. SALZ and E. J. WELDON, JR. A thorough coverage of channel characterization, fundamental bounds on performance, pulse transmission and systems, optimization, automatic and adaptive equalization, linear and nonlinear modulation techniques, coding theory and error-control techniques. **433 pp., \$14.50**

**7 MICROELECTRONIC PACKAGING: Interconnection and Assembly of Integrated Circuits.** By GEORGE SIDERIS. **New.** These 35 recent articles cover that portion of circuit and system design that is concerned with device and circuit interconnection, functional division of the system into subassemblies that are convenient to produce and maintain, and the design and fabrication of the circuit and system interconnection structure, mechanical hardware, and cooling methods. **299 pp., \$12.50**

**8 MODERN ELECTRONIC CIRCUIT DESIGN.** By JAMES D. LONG. **New.** A simple, lucid introduction. From analysis to design, applications is stressed, with a wealth of worked out examples of typical job problems. **286 pp., \$12.50**

**9 MODERN CONTROL PRINCIPLES AND APPLICATIONS.** By JAY C. HSU and ANDREW U. MEYER. **New.** Covers two main areas of automatic control—stability and performance. Theory is introduced only where necessary to show math's role in given problems. **704 pp., \$24.50**

At your bookstore or direct from publisher

## 10 DAYS FREE EXAMINATION

McGraw-Hill Book Co., Dept. 23-L-722  
330 West 42nd Street, New York, N.Y. 10036

Send me the book(s) circled below for 10 days on approval. In 10 days I will remit for book(s) I keep, plus a few cents for delivery costs, and return others postpaid. Include local sales tax if applicable.

1 40443-4      2 45433-0      3 36959-5      4 34750-0      5 35370-6  
6 38960-1      7 57343-6      8 38670-6      9 30635-7

Name \_\_\_\_\_

Address \_\_\_\_\_

City \_\_\_\_\_

State \_\_\_\_\_

Zip Code \_\_\_\_\_

For prices and terms outside U.S. write McGraw-Hill Int'l, N.Y.C.

23-L-722

## New Literature

**Process controller.** Louis Allis Co., 427 E. Stewart St., Milwaukee 53201, has released bulletin 209A on Dyna-Mite 500 process controller for use in digital counting applications. [467]

**P-c board registration.** Bishop Industries Corp., 11728 Vose St., North Hollywood, Calif. 91605, offers a brochure describing a method to achieve absolute registration for two-sided printed-circuit boards. [468]

**SCR power controllers.** Loyola Industries Inc., 155 Arena St., El Segundo, Calif. 90245, has released a catalog sheet illustrating and describing a series of SCR power controllers for tungsten-element incandescent lamps. [469]

**Remote reset protectors.** Airpax Electronics Inc., Cambridge, Md. 21613. Bulletin 16E-11 describes the RRP series of remote reset circuit protectors. [470]

**Ruggedized computer.** Computer Control Division, Honeywell Inc., Old Connecticut Path, Framingham, Mass. 01701, has available a brochure describing the ruggedized DDP-516, a low-cost computer for real-time, on-line uses. [471]

**Precision cold plates.** Lytron Inc., 71 Pine St., Woburn, Mass. 01810. An engineering bulletin describes precision cold plates and thermal panels manufactured by the company. [472]

**Beam breakers.** Clairex Electronics Inc., 1239 Broadway, New York 10001. Industrial applications for beam breakers that use photoelectric cells are described and illustrated in an eight-page publication. [473]

**Power driver modules.** Bendix Semiconductor Division, Bendix Corp., South St., Holmdel, N.J. 07733, has available a four-page engineering data sheet on its line of thick-film power driver modules. [474]

**Subcarrier discriminator.** Defense Electronics Inc., Rockville, Md. 20854. Model SCD-5 phase-lock subcarrier discriminator is described in a six-page bulletin. [475]

**Electromagnetic delay lines.** Microsonics Inc., 60 Winter St., Weymouth, Mass. 02188. A brochure on electromagnetic delay lines covers definitions and measurements for both lumped-parameter and distributed-parameter networks. [476]

**P-c connectors.** Amphenol Industrial Division, Bunker-Ramo Corp., 2875 S. 25th Ave., Broadview, Ill., has available a 24-page printed-circuit connector catalog. [477]



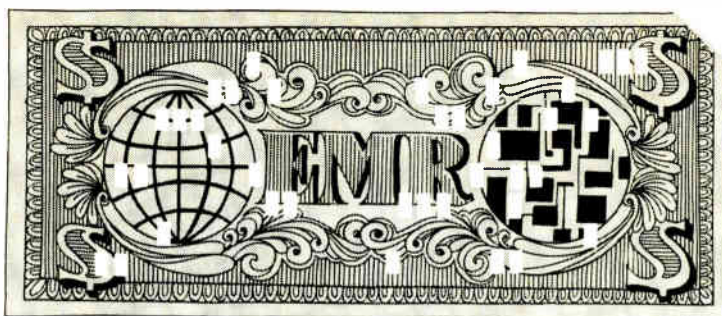

The cost of all this to you? Absolutely nothing. No fees or charges at any time.

Other advantages of EMR:

- Your resume is sent only to those companies that have a genuine requirement for your particular skills.
- There is no general "broadcasting" in the hope "someone will be interested."
- Your identity is protected because your name is released only according to your prior instructions. Your name can be deleted on request.
- EMR's service is nationwide. You may be considered for job opportunities anywhere in the U.S.

The Electronics Manpower Register is a powerful tool and should be considered when you are seriously seek-

ing a new position. And, although you may be reasonably happy in your present position, chances are that you might have that ideal job in mind.

This is why EMR makes good sense for you. If that job does turn up, you'll be there.

To get your name in the EMR file, just fill out the resume form and return to:

Electronics Manpower Register  
330 West 42nd Street  
New York, N. Y. 10036

Please enclose a copy of your resume if you have one. A detailed brochure further describing EMR will be sent to you.

## Electronics Manpower Register

A computerized employment opportunity service

CONTINUED FROM OTHER SIDE				
Previous Position	Employer	City/State	From	To
Duties and accomplishments				
Previous Position	Employer	City/State	From	To
Duties and accomplishments				
<b>GENERAL INFORMATION</b>				
(Summarize your over-all qualifications and experience in your field. List any pertinent information not included above.)				
Current annual base salary	Total years of experience	Date available	U.S. Citizen <input type="checkbox"/>	Non U.S. Citizen <input type="checkbox"/>
My identity may be released to: Any employer <input type="checkbox"/>	All but my present employer	Have you security clearance? Yes <input type="checkbox"/> No <input type="checkbox"/>	If yes, What level	
Mail (with a copy of your resume, if you have one) to:				
<b>Electronics Manpower Register</b> <b>330 West 42nd Street,</b> <b>New York, N. Y. 10036</b>			<b>NO FEES</b> <b>OR</b> <b>CHARGES</b>	



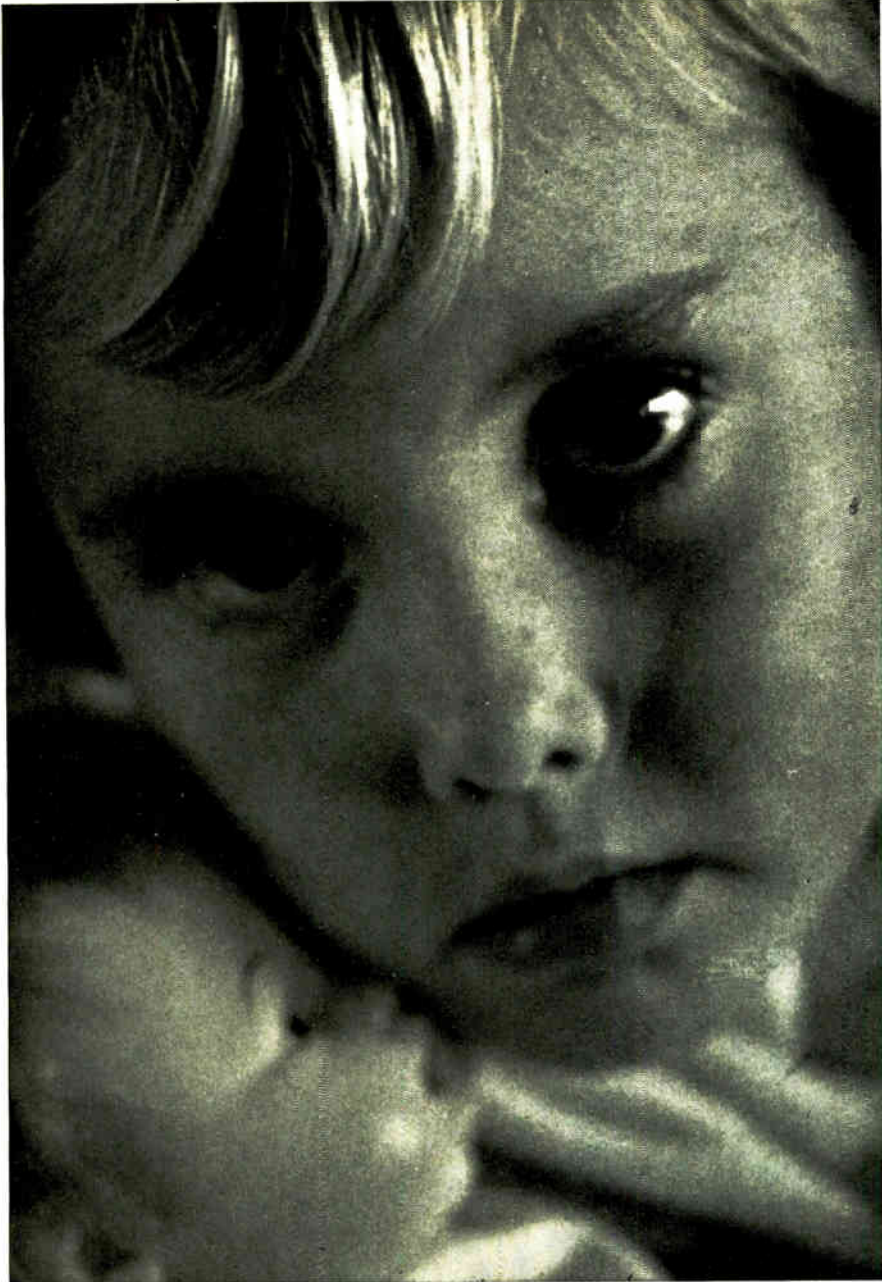

# You can give her hope.

How? Can you find loving parents for her, give her good health, adjust her to the realities of normal living, remedy any physical or other problems troubling her? Probably not.

But you can do this: give the United Way. Support the regular community agencies which provide help for all, all at once, all year long — for the young and old, the ill and troubled, the poor and neglected, for members of the Armed Forces and their families, and for victims of disaster.

Your voluntary United Way gift is your way of being a good neighbor and friend in your community. It is your way of saying you want to help make your community a better place for all families, including your own, through your United Fund or Community Chest.



Your fair share gift works many wonders  
**THE UNITED WAY**



27 million families benefit by child care, family service, youth guidance, health programs, disaster relief and services for the Armed Forces from 31,000 United Way agencies.

**CLASSIFIED ADVERTISING**  

**SEARCHLIGHT SECTION**  
 BUSINESS OPPORTUNITIES  
 USED OR SURPLUS EQUIPMENT

RADAR SYSTEMS GROUND AND AIRBORNE. AUTOMATIC TRACKING ANTENNA SYSTEMS. NIKE AJAX NIKE HERCULES. M-33 MSD-1A MPS-19 MPS-5 SCR 584 TPS-1D TPS-28 FAA-ASR-2 AIRBORNE SYSTEMS APN-84 APN-102 APS-20 APS-27 APS-45 DPN-19 DIGITAL COMPUTERS IBM 650. IBM 704

LARGEST INVENTORY OF RADAR AND MICROWAVE EQUIPMENT IN THE WORLD.

**RADIO RESEARCH INSTRUMENT CO.**  
 45 WEST 45TH ST. N. Y. 10036 212-JU 6-4691

CIRCLE 953 ON READER SERVICE CARD

**FOR SALE**



When you have used electronics equipment to sell, advertise in Electronics Searchlight Section for fastest results.

For information:  
**Searchlight Section**  
**Classified Advertising Division**  
 Post Office Box 12  
 New York 10036

# DEMAND PROOF

Hewlett-Packard's 3950 Series of Analog Tape Recorders gives you the *best slot signal to noise ratio* available in the industry. To

prove it, we'll present you with verified data for any tape speed from 3 3/4 to 120 ips. HP knows how important this information is in pinpointing signal to noise ratios for multiplexed subcarrier channels in your telemetry recording—so we invite you to demand proof of the 3950 Series' high performance.

But superior performance with up to 2 MHz capability isn't the whole story. To people with critical deadlines

and government contracts to meet, price and delivery are of the utmost importance. HP can deliver, and at a price that fits comfortably into your budget.

Here's an example of what we mean: a 3950 Recorder with cabinet, up to 15-inch reels, switch panel, 6-speed transport, 3-speed equalization, meters, 14-track direct record/reproduce—at 1.5 MHz. All for \$19,700.

You can't afford *not* to check further on these high-reliability, low-maintenance recorders. And while you're at it, don't forget—*demand proof*.

Call your local HP field engineer for specifications, or write Hewlett-Packard, Palo Alto, California 94304; Europe: 54 Route des Acacias, Geneva.



MAGNETIC RECORDERS

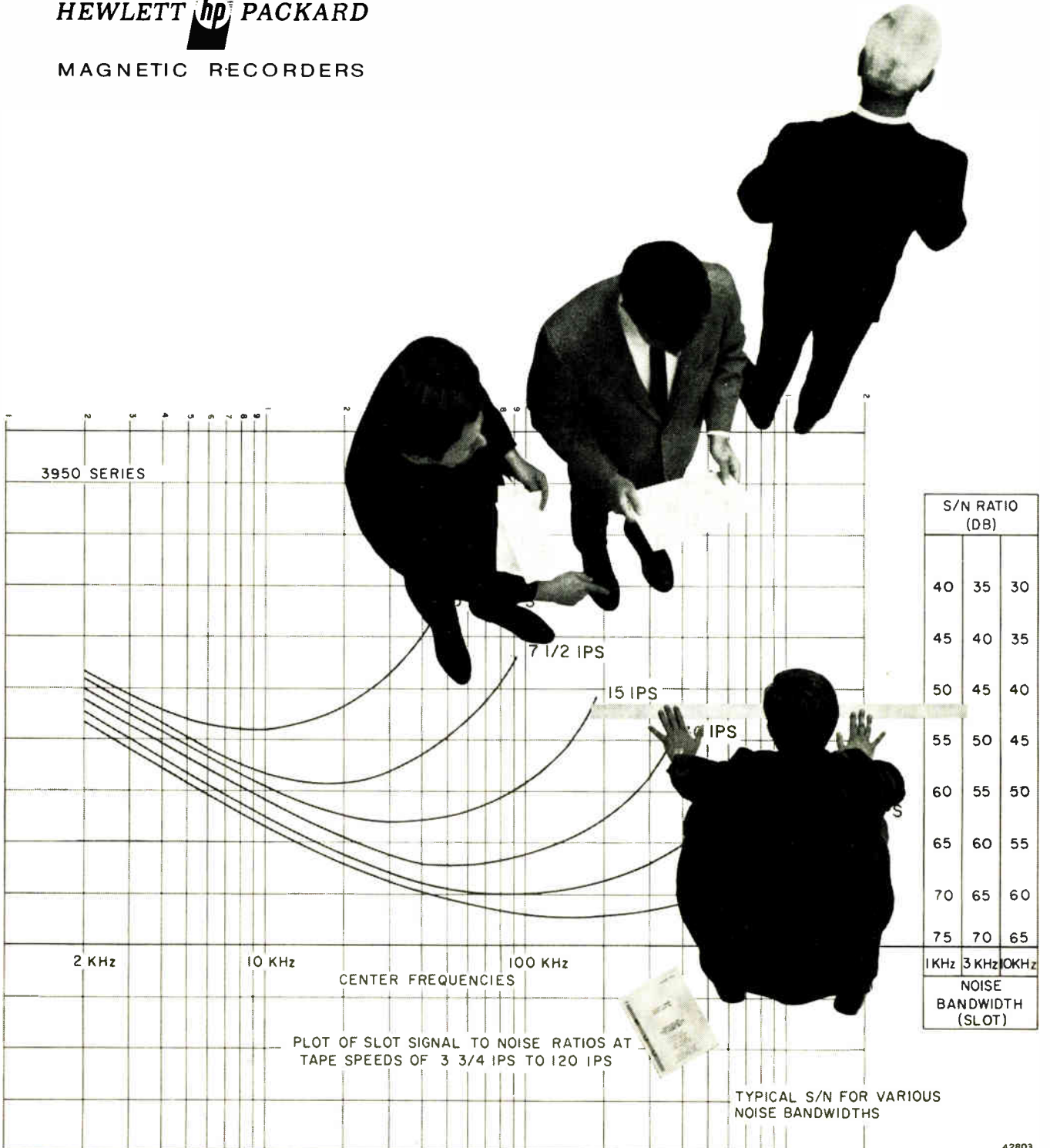

42803

# Newsletter from Abroad

July 22, 1968

## French still count on computer plan

President de Gaulle isn't slackening the pace of programs he considers vital to France's long-term economic growth.

At a time when budget woes have forced a stretchout of prestige military programs like the force de frappe, the government has earmarked another \$24 million for the Plan-Calcul. Previously, \$180 million was allotted Compagnie Internationale pour l'Informatique (CII) the "national" computer company.

Most of the additional money—\$20 million—will go to Societe Sperac, set up under the plan to develop peripherals for computers. The other \$4 million is destined for the Compagnie des Semiconducteurs (Cosem), an affiliate of Compagnie Francaise Thomson Houston-Hotchkiss Brandt. Cosem will use the money to develop integrated circuits for CII's central processors.

The government agency running the plan had promised aid for Sperac and an integrated-circuit producer long ago but the deals had not been signed when the "revolution" hit France in May. The fact that the deals went through, observers say, is a clue to the new priorities that have been assigned government programs as a result of the May-June turmoil.

## Red China to get Siemens computer

West Germany's top electronics producer, Siemens AG, has picked up a few drops of the trickle of trade between Red China and the Western countries.

Siemens has just sold a process-control computer to an Austrian company that has a contract to build a steel plant in China. The computer, a Siemens 303 machine, will be part of the plant's control equipment.

Siemens officials expect no embargo troubles from the sale. The 303 has been on the market for slightly more than three years, has no integrated circuits, and has limited storage capacity.

## Italian set makers press for color tv

Receiver manufacturers in Italy continue to chip away at the government's order putting off color-tv broadcasting until the end of 1970.

The industry now plans to present color-tv productions at three major trade shows scheduled early in September at Milan. All three are sponsored by the Associazione Nazionale Industrie Elettrotecniche ed Elettroniche (ANIE), which is trying to convince the government that the country's industry can produce the hardware needed for color tv. One main reason for the government's reluctance to move to color tv is a fear that imports of components and sets will upset Italy's balance of trade.

## Magnets improve brushless motors

Small brushless d-c motors with efficiencies of 75%—double that of existing types—are in the offing for aerospace and like applications where cost is not the prime consideration.

The new motors, developed by Wolfgang Radziwill of the Aachen research facility of Philips' Gloeilampenfabrieken, use magnetic amplifier principles to sense rotor position for speed control. Radziwill says no tachometer is needed for precision control.

Rotor position is spotted by tiny ferrite cores embedded in the stator



---

# Newsletter from Abroad

---

and fed with a high-frequency signal between 20 and 100 kilohertz. As the permanent-magnet rotor spins, the field around the cores changes and modulates the h-f signal. It controls the stator's drive circuits.

Radziwill has concentrated on small fractional-horsepower motors with outputs between 0.1 and 10 watts. But he says **the technique will work for outputs up to 80 watts or so.** There's scant chance the motors will find their way into consumer products. Even in serial production, they will cost at least \$20 each.

## Three groups vie for big NATO job

Competition is emerging for the Eurocan consortium, which late this spring offered to build for \$30 million the 13 ground stations for the satellite communications network of the North Atlantic Treaty Organization.

Earlier it looked as if Eurocan, led by Siemens, AEG-Telefunken, and Philips' Gloeilampenfabrieken, had a clear field [Electronics, June 10, p. 245]. Now two challengers have appeared, both formed around **British companies that have built terminals for the U.K. Skynet system, on which NATO's satellites are patterned.**

**One of the British group leaders is the General Electric Co.** [no connection with its U.S. namesake] builder of Skynet's ground stations. **The other group leader is the Plessey Co.,** whose Skynet contribution was the shipboard terminals.

## Germans protest French trade moves

The West German electrical-electronics trade association has filed a strong protest with the Kiesinger government about the import restrictions imposed by France last month to protect her strike-beset economy.

France is one of the biggest export markets for West German producers of radios, television sets, audio equipment, antennas, and components. But even more than a setback in the French market, **the Germans fear a backlash effect at home. Foreign producers, they figure, will step up their sales efforts in Germany to offset the lackluster French market.**

## IBM to moderate price rises in U.K.

At the Wilson government's behest, IBM United Kingdom Ltd. very likely will pare down its across-the-board 10% rise in computer rentals announced at the end of 1967, shortly after the pound was devalued.

**The government's Prices and Incomes Board has told IBM that it should limit the 10% rise to IBM 360 computers installed after January 1 this year.** For earlier 360 installations, the Board thinks 7% more would be enough. For older computers, the rise would be 5%.

Although the Board cannot force IBM to hew to these "recommendations," IBM almost certainly will. If IBM balked, the government could freeze the rentals at current levels for nearly a year by invoking legislation already on the books.

## Addenda

The Nippon Electric Co. has been tapped to build Peru's ground station for the Intelsat 3 network. Hughes Aircraft was the low bidder for the job but withdrew when it couldn't arrange satisfactory financing, [Electronics, March 4, p. 307] . . . Sweden's AGA will supply 14 surveying lasers to the U.S. Coast and Geodetic Survey. The Swedish company, whose hardware uses Perkin Elmer lasers, won the contract with a price of \$5,600 per unit.

## West Germany

### Glide guide

High on the "most wanted" list of military aviation people is an all-weather landing system that works with standard airborne navigation instruments and can be set up on an airstrip in a hurry.

So far, there's no such system. Portable landing aids, to be sure, there are. But they require special receivers. And while military planes often do carry instrument-landing-system (ILS) gear, the associated ground equipment can't be hustled from place to place easily—it's bulky and needs time-taking alignment.

A way around these drawbacks is in the offing from Standard Elektrik Lorenz AG, a subsidiary of the International Telephone and Telegraph Corp. SEL engineers have developed a landing system that works with Tacan receivers, found on most military aircraft flown by the armed forces of the North Atlantic Treaty Organization (NATO) countries.

Just as important, the new system can be set up and aligned in a hurry. SEL won't cite a setup time, but it's a safe bet it's well under an hour.

**Restrictive.** Like Tacan, SEL's system gives the bearing and distance to pilots flying near airfields. But where a Tacan installation covers a full 360° sweep, Setac—the German equipment—covers only a 36° sector centered on a runway. (The name is a contraction of sector and Tacan.) What's more, Setac can give elevation angles as well as bearings and distances. But for elevation information an adapter unit is needed on the plane.

Several experimental Setac systems are undergoing tests under a study contract let by West Germany's Ministry of Defense. Manfred Boehm, chief design engineer

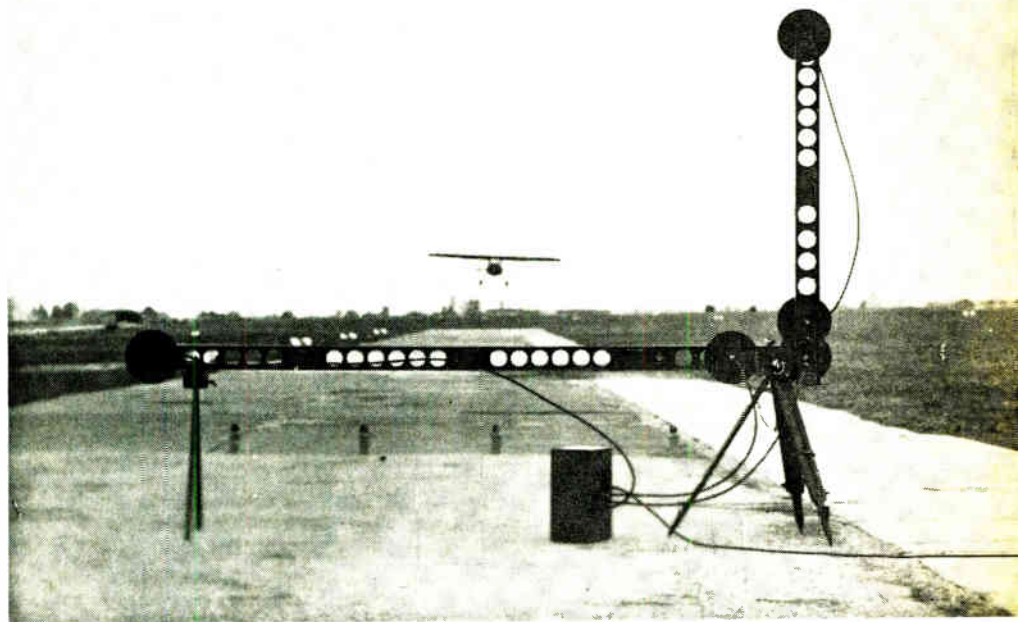

**Handy guide.** Setac landing equipment sets up in a trice at any airstrip. Three antennas on horizontal beam handle azimuth pattern. Elevation angle pattern comes from antenna pair on vertical beam.

for the project, says the system should eventually be accurate in azimuth to at least  $\pm 0.1^\circ$ , 10 times better than an ordinary Tacan installation. As for distance, Setac errs no more than 60 feet at ranges up to 3 miles. The accuracy for elevation readings will be  $\pm 0.2^\circ$  when the system is perfected, Boehm maintains.

SEL now hopes to get a follow-on contract that would lead to production of Setac-A, an azimuth-only version of the system. If the ministry gives the go-ahead soon, Setac-A could become standard gear for West Germany's armed forces by 1971, according to Peter Weyersberg, sales manager for the company's radio navigation division. Setac-E, the elevation half of the system, will probably come much later.

**Patterns.** Setac is based on ideas first proposed by Ernst Kramar, a SEL board member and a consultant to the company on radio navigation.

Kramar's scheme works much like normal Tacan. Two antennas spotted close together are fed with a radio-frequency signal of the same frequency but out of phase. This produces a four-lobe radiation pattern whose position depends on the phase relationship between the signals.

The pattern will rotate if the phase varies at a constant rate, a situation easily obtained by making the frequency of one input signal slightly higher—15 hertz in this case—than the other. To a Tacan receiver, then, the pattern appears as an amplitude-modulated signal whose phase—compared to a reference—indicates the bearing from the antenna.

**Close.** In a typical Setac-A setup, the horn-parabola or helical antennas are spaced 40 centimeters apart. This spacing makes for a sector 36° wide and improves the azimuth accuracy by a factor of 10 compared to a Tacan (full-circle) pattern. This is because a 10°

change in phase now corresponds to a geographical angle of  $1^\circ$ . As a result, the Tacan receiver shows a  $10^\circ$  deviation when the plane slips off  $1^\circ$  from the approach base line, which bisects the sector.

This setup would be good enough for all-weather landing purposes. However, Tacan gear sounds an alarm if the normally present 135-hertz modulation signal is missing. To prevent an alarm, Setac superimposes onto the 15-hertz envelope a 135-hertz pattern by feeding an appropriate signal ( $f_0 + 135$ ) to a third antenna. The result is a pattern with nine minimum-maximum points that rotate at 135 hz. The a-m signal pattern within the Setac sector thus resembles the radiation pattern produced by a normal Tacan antenna system.

**On high.** For measuring elevation angles with Setac-E, signals are applied to a second set of antennas, installed one above the other. A similar radiation pattern is then produced, but it's off by  $90^\circ$  from the azimuth pattern. If the antenna spacing remains the same, elevation angles can be determined with the same accuracy  $\pm 0.1^\circ$ —as azimuth.

However, if a somewhat lower accuracy will do, the height of the Setac-E antenna support structure can be kept small. For instance, the antenna separation could be halved and the accuracy in elevation would still be  $\pm 0.2^\circ$ .

Distance determination with Setac is accomplished in the same manner as with normal Tacan, that is, by measuring the time it takes for a single to go from the aircraft to the ground station and back.

---

### Japan

---

#### On call

Planners at the Nippon Telegraph & Telephone Public Corp. (NTT) expect to log a major technological milestone toward the end of the year.

By then, NTT should get the hardware for the first electronic

exchange that will actually be used in the country's telephone network. NTT's goal is to have the prototype—designed to handle 32,000 subscriber lines—in service by 1970. Getting there will cost NTT and a quartet of communications-equipment producers an estimated \$30 million. The quartet, though, can count on a handsome return on its research and development spending when the phone system starts replacing over-age electromechanical crossbar equipment with production versions of electronic exchanges starting in the mid-1970's.

**Time out.** Like the Bell System in the U.S., the Japanese phone system will use space-division techniques for its initial excursion into electronic switching. The technique, as its name implies, employs a physical contact for each pair of phones it connects. NTT also is looking into time-division switching but so far has no definite plan to put equipment using the technique into central exchanges.

NTT's space-division hardware, however, will get its field trial at the Ushigome exchange in downtown Tokyo. Actually, there'll be two identical prototypes: one working at the exchange; a second at NTT's laboratories for backup and special testing. Both prototypes will be designated DEX-II since they're offshoots from NTT's first pair of DEX-I experimental exchanges. (The "D" is for Dendenkosha, NTT's name in Japanese.)

**On the program.** The DEX-II in many respects resembles Bell's pioneering No. 1 ESS equipment [Electronics, Oct. 19, 1964, p. 71]. Both switch under computer control and both have a stored control program. This makes it possible to adapt the hardware—by changing the program—to new services like automatic call-back on busy signals, conference calls, three-digit dialing, and picture-phones.

However, there are noteworthy differences. For one thing, the central control unit of the DEX-II is built mainly of monolithic integrated circuits; the Bell equipment uses discrete components. For another, NTT and its partners opted for a miniaturized crossbar assem-

bly for speech-path switching where Bell chose ferrite switches. And instead of ferrite sheets, the DEX-II has ferrite cores for its call memory. There's a big difference, too, in the control-program store: Bell's uses twistors; NTT's has both metal card memory units and magnetic drums.

**Four-in-hand.** The production versions NTT has in mind will differ only slightly from the DEX-II prototypes. Instead of joint efforts, though, the production units will be built by individual manufacturers. NTT orders exchanges complete from one manufacturer and will continue the practice when the electronic gear is standard.

NTT split up the development work among the Nippon Electric Co., Fujitsu Ltd., Oki Electric Industry Co., and Hitachi Ltd. Nippon, for example, is responsible for the switching matrixes, the central control, the call store and the channel control. Oki is involved in the program store and switching. Fujitsu is working on the call store and the central control. Hitachi is handling the trunk circuit and the magnetic drums. Since the split-up covers two prototypes, responsibilities overlap. What's more, the cooperation among the four is close enough that NTT figures any one of them will be able to build a complete exchange by the time it starts ordering them in quantity.

#### Fast check

In data transmission, at least, 62 members of the All-Japan Local Bank Association will get themselves on an even footing this fall with such giants as the Fuji, Sumitomo, and Mitsubishi banks.

The equalizer will come from the Nippon Telegraph and Telephone Public Corp., which has begun testing a nationwide check-clearing facility that will link the 62 head offices. Clearing operations will take seconds instead of days.

NTT put the network together by connecting data terminals at the banks to a Fujitsu Ltd. Facom 240-50 central processor. The terminals handle 200 bits per second; the printers and tape punchers



operate at 1,200 characters per minute.

Rates haven't been established yet. The system will probably lead to similar "public" data-transmission setups for other trade groups. What the banks pay will weigh heavily when the tariffs are set for similar services.

France

Travelers' check

The scene at major airports around the world almost always includes long lines of voyagers waiting to have their passports checked. All too often, immigration police have to check passport numbers against long lists of "wanted" people. With air travel generally on the rise and 300-passenger airbuses in the offing, the lines will almost certainly get longer.

Many makers of data-handling equipment have proposed ways to speed passenger flow through airports. But where most have touted optical readers for conventional passports, the Compagnie Générale d'Automatisme has designed a magnetic-card system.

The company's systems salesmen currently are talking to the Ministry of Interior (whose policemen are charged with keeping undesirables out of the country), Air France,

and airport authorities. CGA is also angling for customers in Montreal and Frankfurt, where the equipment has been demonstrated.

**In the cards.** Under CGA's scheme, travelers would be issued a plastic card with magnetic tape tracks on one side and the usual photograph and descriptive data on the other. The passengers would slip their cards into a reader after showing them to the checkpoint officials to verify that the card user is the person to whom the card was issued.

The reader would have stored in its small memory the passport numbers of wanted persons and would signal whenever it read one. The official then would take passenger and card to a second reader for verification. This reader would be tied to a computer storing details on why the voyager is on the wanted list.

**Count off.** CGA, a joint venture of CSF-Compagnie Générale de Télégraphie sans Fil and the Compagnie Générale d'Electricité, doesn't expect its plastic cards to supplant conventional passports any time soon. But there's a chance the cards, which cost about 10 cents each, will be issued along with passports by West European countries.

The nine magnetic tape tracks on the back of the cards can store up to 3,000 bits of information. Using the cards, CGA points out, would give travel officials an easy way to gather statistics; the readers

could be set up to store entries and exits and later dump them into a large computer for processing.

Less elaborate magnetic-card systems, CGA thinks, may find a market in industry for personnel control. CSF already uses one at a plant where it produces classified military hardware.

Inside job

In an all-comers market, Le Matériel Téléphonique would be hard put to snatch avionics business away from the Collins Radio Co., a top producer of airborne radio equipment.

But LMT is confident it can best Collins—or for that matter any other U.S. producer—when the French defense establishment next orders a batch of transceivers for its helicopters. The reason is quite clear, according to Christian Loeffler, manager of radio communications products for LMT, a subsidiary of the International Telephone and Telegraph Corp. Whenever there's a chance that a French-based company can develop equivalent hardware, imported equipment faces what adds up to an embargo by French military men.

**Market tactics.** Spotting a likely opening in its domestic avionics market, LMT put together—purely on its own hook—two prototypes of a high-frequency transceiver. LMT will offer them to the French army for testing. Unless a hitch develops in the normal course of contracting for hardware, French style, LMT should have an order in from three to five years.

In production quantities, Loeffler pegs the transceiver's price at about \$15,000 a copy.

For the money, the army will get a state-of-the-art set. The kingpin unit—the exciter-receiver—is built mainly around integrated circuits, 85 of them. Linear IC's are used for the i-f amplifier, the automatic gain control, and the audio amplifier; emitter-coupled-logic and transistor-transistor-logic digital circuits handle frequency switching and like functions.

The other three black boxes that make up the system—a 400-watt h-f

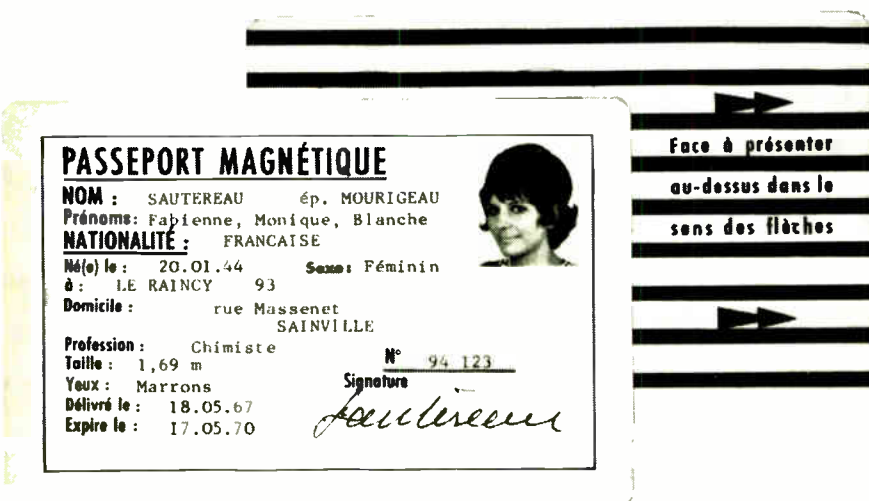

Front and back. Magnetic passport looks like ordinary ID card on one side. Data for card reader is coded onto tracks on other side.

amplifier, an antenna coupler and the control unit for the pilot—use discrete components.

**The numbers.** LMT's transceiver covers a frequency range of 2 to 30 megahertz in 28,000 channels each 1 kilohertz wide. The set is crystal stabilized to hold frequency errors to a maximum of 4 hertz over the entire range.

Output of the exciter-receiver is 40 watts peak-to-peak; this goes up to 400 watts when the transmitter amplifier is cut in.

### Great Britain

#### Missing link

Complex power-assisted ailerons, elevators, and rudders are the rule for fast modern aircraft, but the control inputs to the assists almost always are straightforward mechanical linkages.

The reluctance of aircraft designers to spare the rod for control of spoilers and like surfaces is easy to understand. Although the rod runs may be long and may flex along with the airframe, they cost considerably less than an electronic system that can match their reliability.

All the same, the rod may be on the way out. Researchers at the Royal Aircraft Establishment are working on a quadruplicated control system that will get a tryout in a Hawker Hunter Mk 12 fighter before the end of the year.

**Pros and cons.** To be sure, the four-times redundant system won't match mechanical linkages in cost. But it may be the best all things considered, say its developers, Geoff Howell and Pat Fullam. Feedback in the electronic system will vary the control surface movements to match the flying conditions. Thus, the plane will always respond in the same way to movements of the joystick.

With a mechanical linkage, the control surfaces always move the same distance for a given stick movement and the plane's maneuvers aren't the same at high speeds and high altitudes as they are at low ones.

**Matched.** Howell and Fullam use gain changers in their control system to keep control surface movements pegged to the plane's speed and the dynamic pressure. The changers—two for each control loop—act on the signals fed to servo amplifiers for the valves that control the hydraulic actuators for the elevators, ailerons, and the like.

For each control surface, there are four complete loops. All four work all the time and there's a logic voting system to sort out failures. If one loop fails, the logic operates on a three-out-of-four basis. If there's a subsequent failure the logic shifts to two-out-of-three voting.

**Compared.** Each loop in a group of four gets two basic inputs and compares them to get an error signal for the servo amplifier. The first input is picked off the joystick and in essence indicates what the pilot wants the plane to do. Since the effect of stick movements changes with speed, this input signal is corrected by a gain changer set by a pair of air-speed data computers.

This corrected signal is then compared with a gyro-originated rate signal that represents the plane's actual movements. The resulting error signal gets further correction in a second gain changer. This one's control input is the dynamic pressure on the control surface.

The twice-corrected error signal is one of two applied to the servo amplifier. The other is a conventional servo feedback signal.

**Mostly d-c.** Direct-current signals are used throughout the loops, except for the pickoffs at the joystick and the servo itself. The reason for eschewing square waves is that the signals must travel the length of the aircraft and back, a situation that invites distortion.

RAE opted for a-c for the joystick pickoff to avoid the moving parts in the potentiometers that would have been required for a d-c pickoff. The a-c pickoff operates at 2.4-kilohertz, stabilized by a 4.8 khz clock. This clock also controls the oscillator for the servo pickoff and the logic for the rate gyro.

### Around the world

**Great Britain.** Pilkington Brothers Ltd., whose main business is making glass, has turned the laser into an eavesdropping device. Pilkington aims a helium-neon beam at a window behind which people are talking. The slight vibrations of the pane caused by the talking vary the angle at which the beam bounces back. The variations are sensed by a photomultiplier and converted into an a-m audio signal.

Pilkington's laser eavesdropping system has a range up to 60 yards. But the range drops if there's wind or if the window is double-hung.

**Australia.** Information Electronics Ltd. apparently will become the first Australian-owned computer company to get into production. The company, formed last month, plans to start turning out early next year a small machine designed by a research team at the University of New South Wales. The computer is intended as a monitor for large computers.

**The Netherlands.** Philips' Gloeilampenfabrieken has landed the first export order for its \$1-million system that handles data on passengers and freight at airports. The computer-controlled "Airlord" will be used at both of Milan's main airports. It can store data for 55 flights and up to 100 destinations, enough to take care of 1,700 passengers an hour.

The Milan installation will be the second for Airlord; one is now operating at the Amsterdam airport.

**Italy.** Selenia S.p.A sold its 80th meteorological radar system last month. The \$300,000 contract came from the Environmental Science Services Administration of the Department of Commerce.

**Taiwan.** TKD Electronics Co., a leading Japanese manufacturer of ferrite components, will set up a wholly owned subsidiary in Taiwan. The company intends to produce about 5 million ferrite forms monthly for Taiwan plants producing radios.



# 90-second look at IEE's wonderful world of readouts

Readouts are our special craft. Using any characters you want. Any colors or color combinations. Any input, BCD or decimal. Any input signal level. Any mounting, vertical or horizontal. Five sizes.

up to 3 3/8". Many configurations, options and accessories. Long lamp life (to 100,000 hours; up to 175,000 hours at reduced voltage). If it doesn't exist and you need it, we'll build it.

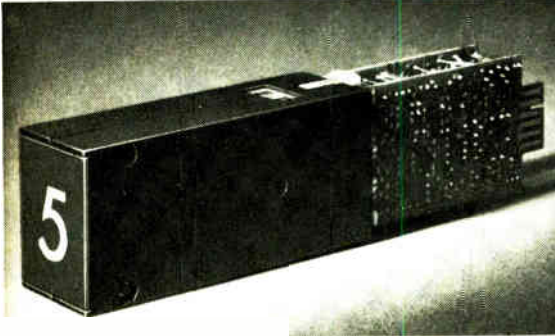

**10H**—World's most popular readout. And we've improved it. Double condensing lens provides exceptional character brightness. Greater clarity at wider angles and longer distances, even under high ambient light. .937" sq. viewing area. Mil-spec version available.



**160H**—Exceptionally large viewing area (1.56"H x 1.12"W) for overall size. 45 FL character brightness with a 6.3V S.20 lamp. Displays messages simultaneously with symbols.

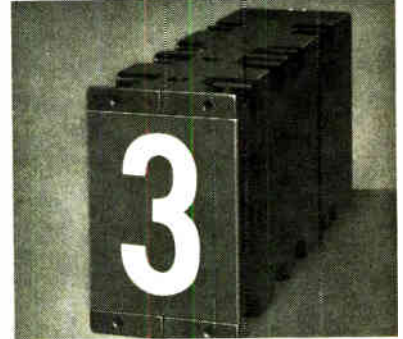

**80**—Large screen unit suited for annunciator applications such as factory call systems and production control. 3 3/8" character height can easily be read at 100'. 160° viewing angle.

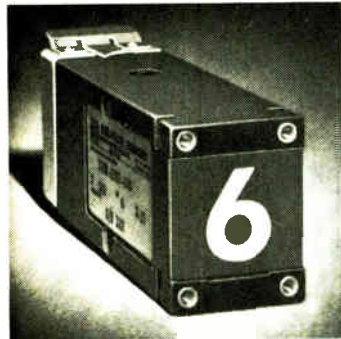

**120H**—Miniature rear-projection readout (.62" sq. screen) easily read from 30' under high ambient light. Quick-disconnect lamp assembly speeds lamp replacement.



**nimo™**—First 10-gun CRT single-plane display. Projects numbers, letters and words onto a fluorescent screen. No image ambiguity. No external focusing required. No ambient light worries. Exceptionally wide viewing angle. Ideal for instrument application.

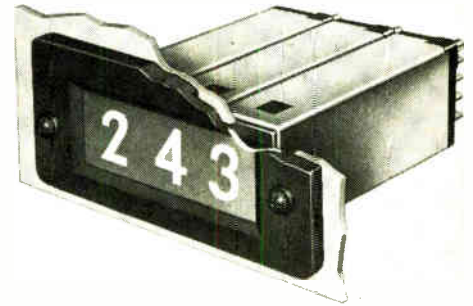
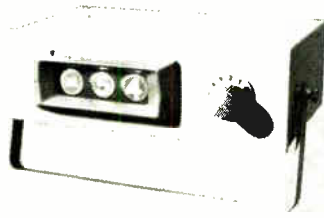

**875**—Miniature 24-position readout assembly with a cost per display of only \$1.45 each. .620 sq. in. viewing area with overall case size of 1.39"H x .90"W x 3.095"D. Exceptional brightness, clarity. Front panel access.

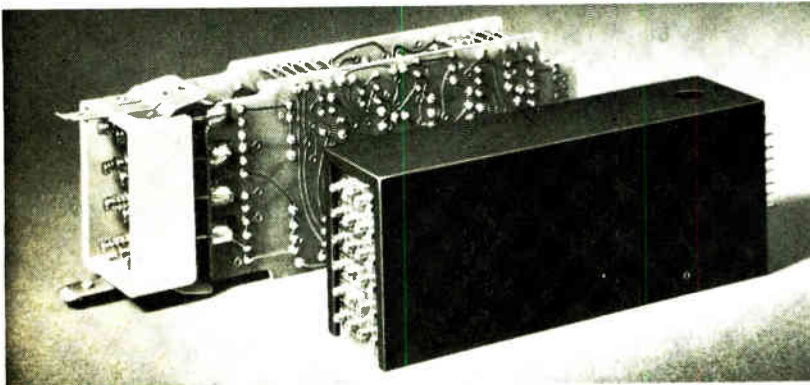

**IC Driver/Decoders**—Small, reliable units for driving IEE readout incandescent lamps ranging from 250 ma @ 6V to 40 ma @ 28V. Fully compatible with modern IC's. Accept a variety of binary codes for decimal conversion. Require normal signal V., draw less than 2 ma per data input. Internal data storage for pulsed oper.

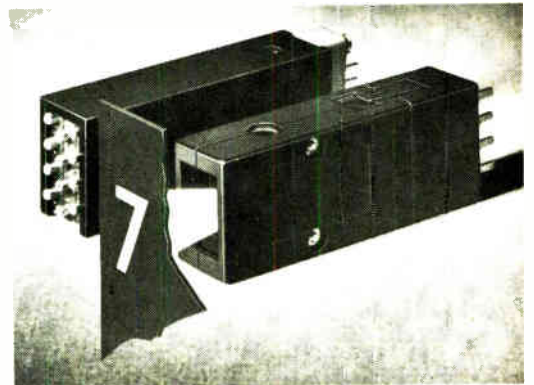

**345**—IEE's smallest rear-projection readout. Viewing area .38"H x .34"W. Based lamps. Low cost. Individual readouts plug into perm. wired housing for quick message change. Easy front panel access.

Industrial Electronic Engineers, Inc.



7720 Lemona Ave., Van Nuys, California





## Advertising Sales Staff

Frank E. LeBeau [212] 971-6464  
Advertising Sales Manager

Wallis Clarke [212] 971-2187  
Assistant to sales manager

Donald J. Austermann [212] 971-3139  
Promotion Manager

Warren H. Gardner [215] LO 8-6161  
Eastern Advertising Sales Manager

Atlanta, Ga. 30309: Michael H. Miller, 1375  
Peachtree St., N.E.  
[404] 892-2868

Boston, Mass. 02116: William S. Hodgkinson  
McGraw-Hill Building, Copley Square  
[617] CO 2-1160

Cleveland, Ohio 44113: William J. Boyle, 55  
Public Square, [216] SU 1-7000

New York, N.Y. 10036  
500 Fifth Avenue  
Donald R. Furth [212] 971-3615  
James R. Pierce [212] 971-3616  
John A. Garland [212] 971-3617

Philadelphia, Pa. 19103:

Jeffrey M. Preston  
Warren H. Gardner,  
6 Penn Center Plaza,  
[215] LO 8-6161

Pittsburgh, Pa. 15222: Warren H. Gardner,  
4 Gateway Center, [412] 391-1314

Rochester, N.Y. 14534: William J. Boyle,  
9 Greylock Ridge, Pittsford, N.Y.  
[716] 586-5040

Chicago, Ill. 60611: Kenneth E. Nicklas  
Ralph Hanning, 645 North Michigan Avenue,  
[312] MO 4-5800

Dallas, Texas 75201: Richard P. Poole, 1800  
Republic National Bank Tower,  
[214] RI 7-9721

Houston, Texas 77002: Robert Wallin,  
2270 Humble Bldg. [713] CA 4-8381

Detroit, Michigan 48226: Ralph Hanning,  
856 Penobscot Building  
[313] 962-1793

Minneapolis, Minn. 55402: 1104 Northstar  
Center [612] 332-7425

St. Louis, Mo. 63105: Kenneth E. Nicklas,  
The Clayton Tower, 7751 Carondelet Ave.  
[314] PA 5-7285

James T. Hauptli [415] DO 2-4600  
Western Advertising Sales Manager

Denver, Colo. 80202: Joseph C. Page, David  
M. Watson, Tower Bldg., 1700 Broadway  
[303] 255-5484

Los Angeles, Calif. 90017: Ian C. Hill,  
John G. Zisch, 1125 W. 6th St.,  
[213] HU 2-5450

Portland, Ore. 97204: James T. Hauptli,  
Thomas McElhinny, 218 Mohawk Building,  
222 S.W. Morrison Street,  
Phone [503] 223-5118

San Francisco, Calif. 94111: James T. Hauptli,  
Thomas McElhinny, 255 California Street,  
[415] DO 2-4600

Pierre Braude Tel: 225 85 88: Paris  
European Director

Paris: Ken Davey  
88-90 Avenue Des Champs-Elysees, Paris 8  
United Kingdom and Scandinavia

Brian Bowes Tel: Hyde Park 1451  
34 Dover Street,  
London W1

Milan: Robert Saidel  
1 via Baracchini Phone 86-90-656

Brussels: F.I.H. Huntjens  
27 Rue Ducale Tel: 136503

Frankfurt/Main: Hans Haller  
Elsa-Brandstroem Str. 2  
Phone 72 01 81

Geneva: Ken Davey  
1, rue du Temple Phone: 31 95 60

Tokyo: Takeji Kinoshita  
Shiba, Minato-Ku [502] 0656

Osaka: Ryoji Kobayashi 163, Umegae-cho  
Kita-ku [362] 8771

## Business Department

Wallace C. Carmichael, Manager  
[212] 971-3191

Stephen R. Weiss, Production Manager  
[212] 971-2044

Thomas M. Egan,  
Assistant Production Manager [212] 971-3140

Dorothy Carmesin, Contracts and Billings  
[212] 971-2908

Frances Vallone, Reader Service Manager  
[212] 971-2865

1968 impartial Government tests show:

# Aging Rate of Coldwelded Crystals nearly 1/2 that of glass-enclosed units

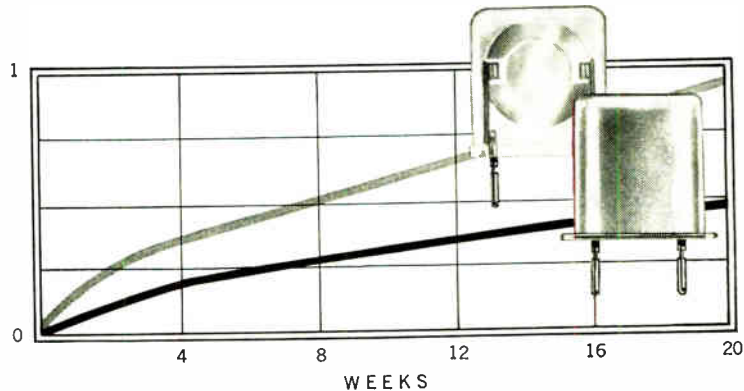

Tests were made to compare aging rates of crystals in soldersealed HC-6/U, coldwelded HC-6 equivalents, and glass HC-27/U holders. Here are excerpts from the test report:

Concerning tests made on 36 general-purpose crystal units: "In the case of the coldwelded units, the average frequency shift was slightly more than 2 ppm over the six-month period. Average frequency changes in the glass-enclosed and solder-sealed units over this period were a little more than 4 ppm."

Concerning single sideband crystals, one group in glass and one in coldwelded holders: "... the average frequency change and deviation of the vacuum-baked and coldwelded sealed units is about 1/2 that of the HC-27/U (glass) units."

After concluding that coldwelding improves aging, the report adds a significant qualification: "... if necessary precautions are taken to assure that hermetic seals are obtained. The number of crystal manufacturers having this capability at present is limited."

Reeves-Hoffman has this capability. A coldwelding pioneer, R-H is an experienced, volume producer of coldwelded crystals in numerous configurations meeting diverse military and commercial requirements. We invite your inquiry.



## REEVES-HOFFMAN

DIVISION, DYNAMICS CORPORATION OF AMERICA

400 WEST NORTH ST., CARLISLE, PENNSYLVANIA 17013 • 717/243-5929



# We're not afraid to say it out loud: 'Value.'

AND HOW IT APPLIES TO OUR METAL PLATE CONNECTIONS.

To us, "value" means giving you the most-for-your-money. Across the entire spectrum. From design expertise to on-time delivery. The packaging flexibility enabling you to convert from p.c. connectors to metal plates without changing your cards. Voltage plane, grounding, bussing features. The choice of any applicable contact nose. Terminations for stranded or solid wire. Grid spacing at .100" to .250". All of this, and more . . . to give you the inherent savings and reliable performance of back panel automatic wiring. That's "value." That's us. Elco Corporation, Willow Grove, Pa. 19090; 215-659-7000.



WESCON BOOTHS 243-244





Look  
what's  
under  
a dollar...

## New Dale film element 3/4 watt Econo-Trim!

Now, there's a film element in Dale's fast-growing *Econo-Trim* line. For less than a dollar, our new 8300 Series delivers:

- Infinite resolution.
- Interchangeability with competitive models 3067, 3068, 77, 5067 and 5068.
- Sealability – for only pennies more 8300 trimmers can be fully sealed to withstand fluxing and automatic soldering processes.

Dale's *Econo-Trim* line is the right match for your commercial needs – 3/4 watt film element models and 1/2 watt wirewounds at prices that are more than competitive. For a quick quote, call Dale – 402 – 564-3131 or write for complete Econo-Trim data.

### FOUR MODELS Sealed or Unsealed

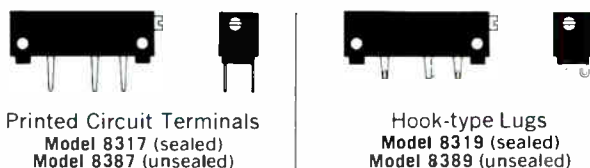

### SPECIFICATIONS

Standard Resistance Range: 10  $\Omega$  to 2 M  $\Omega$   
 Resistance Tolerance:  $\pm 10\%$  100  $\Omega$  thru 500K  $\Omega$   $\pm 20\%$  all other values  
 Resolution: Essentially infinite  
 Power Rating: .75 watt at room temperature to 0 watt at 105 C  
 Operating Temperature Range: - 55 C to 105 C  
 Mechanical Adjustment: 15 turns nominal  
 Mechanical Stops: None. Clutch mechanism permits overtravel without damage  
 Dimensions: 1.0" L x .36" H x .28" W



**DALE ELECTRONICS, INC.**  
 1300 28th Avenue, Columbus, Nebr. 68601  
 In Canada: Dale Electronics Canada, Ltd.



Circle 901 on reader service card

# Detect single photons with RCA Bialkali photomultipliers

These RCA Bialkali Photomultipliers represent a whole new generation of light-sensing devices—designed for OEM applications that go beyond present-day requirements. They employ the RCA Bialkali Photocathode, first introduced with the 8575.

The low-cost RCA-4516, -4517, and -4518, for their size, offer truly sophisticated performance in photon and scintillation counting, high energy physics, and those applications where pulse counting and low-light-level detection and measurement are important.

For more information and technical assistance on these and other RCA Photomultipliers, see your RCA Representative. For technical data on specific types, write: Commercial Engineering, Section G 19P-4, RCA Electronic Components, Harrison, N.J. 07029.

Also available from your RCA Industrial Tube Distributor.

Tube	Gain (min.)	Dynamic Range	Quantum Efficiency (%)	Dark-Current (Photocathode) (electrons/cm <sup>2</sup> -sec)	Anode Peak Current (μA)	Operating Voltage (V)	Gain (min.)	Gain (max.)
4516	10 <sup>6</sup>	10 <sup>3</sup>	20	1.0 × 10 <sup>-11</sup>	1.8	1500	10 <sup>6</sup>	10 <sup>7</sup>
4517	10 <sup>6</sup>	10 <sup>3</sup>	20	1.0 × 10 <sup>-11</sup>	2.3	1500	10 <sup>6</sup>	10 <sup>7</sup>
4518	10 <sup>6</sup>	10 <sup>3</sup>	20	1.0 × 10 <sup>-11</sup>	2.3	1500	10 <sup>6</sup>	10 <sup>7</sup>
4519	10 <sup>6</sup>	10 <sup>3</sup>	20	1.0 × 10 <sup>-11</sup>	2.3	1500	10 <sup>6</sup>	10 <sup>7</sup>
4520	10 <sup>6</sup>	10 <sup>3</sup>	20	1.0 × 10 <sup>-11</sup>	2.3	1500	10 <sup>6</sup>	10 <sup>7</sup>

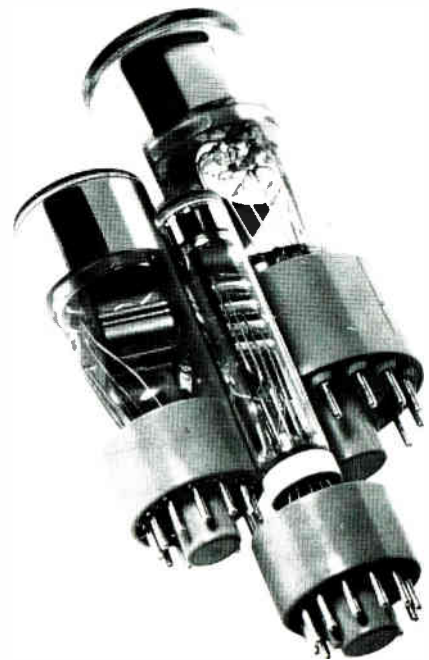

# RCA