

Electronics

Computer design of transmission lines: page 76

Op amp in integrated form: page 84

Chirp improves data transmission: page 104

November 27, 1967

\$1.00

A McGraw-Hill Publication

Below: Aviation's VOR goes digital with IC's, page 95



142 K55956 44R94 11-67
R KISSLER
BOX 956
MOSES LAKE WA 98837

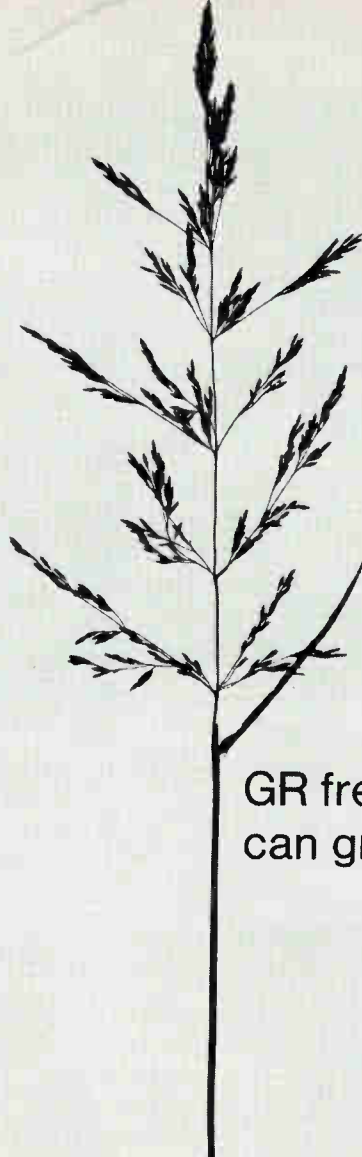

GR frequency synthesizers can grow on you.



Start with the basic package . . . a 3-digit synthesizer . . . in a 70-MHz, 12-MHz, 1-MHz, or 100-kHz model for as little as \$3640 . . .



add additional digits (\$455 each) as you need them for up to 7-digit resolution and . . .



at any time add a continuously adjustable decade (\$550) for 2 extra figures of resolution or for continuous, manual control of frequency . . . sweep it electrically with your own external sweep signal or . . .



get the sweep, and frequency markers too, by adding our new sweep and marker generator (\$495).



Want to go programmable? . . . use programmable decades (\$545-\$575) . . . new units now provide stepped programming up to 12 MHz . . . programming can be controlled by simple switch closures . . .



or, if you'd rather not flip switches, add our new preset-frequency programmer (20 channels for \$1000; 40 channels for \$1825) with a storage capability of up to 40 preset 7-digit frequencies per tray. Actual storage capability is unlimited if you don't mind switching trays . . .



and, if you need exceptional long-term stability, add an external frequency standard (\$2050) and improve it by three orders of magnitude to better than 1×10^{-10} . . .



or, if you're bothered by growing pains, why not outline your needs and we'll recommend the right system . . . at off-the-shelf prices. Write General Radio Company, W. Concord, Massachusetts 01781; telephone (617) 369-4400; TWX (710) 347-1051.

GENERAL RADIO

Circle 900 on reader service card

Here's the best solution.



Now show us your worst recording problem.

It doesn't matter that Hewlett-Packard hasn't seen your toughest problem yet — either the HP 7030A or 7001A X-Y Recorder is the best solution you'll find—the ultimate in recording performance.

The 7030A (8½" x 11") and the 7001A (11" x 17") combine the latest advancements with the versatility and reliability of the most sophisticated X-Y recorders available. Solid-state, and featuring the exclusive AUTOGRIP paper holddown, these recorders can meet your most demanding application requirements. High sensitivity, 100 $\mu\text{V}/\text{inch}$, 1 megohm input impedance and adjustable time base for either axis... automatic reset of

time sweeps, 0.1% linearity, guarded input, extended zero offset in calibrated steps... and more. Price: 7030A, \$1895; 7001A, \$2175. (Also available, the 7000A with AC/DC Converter, \$2495.)

For more information, call your local HP field engineer or write Hewlett-Packard, Palo Alto, California 94304; Europe: 54 Route des Acacias, Geneva.

1807

HEWLETT  **PACKARD**
GRAPHIC RECORDERS

Rugged, Reliable and Versatile!

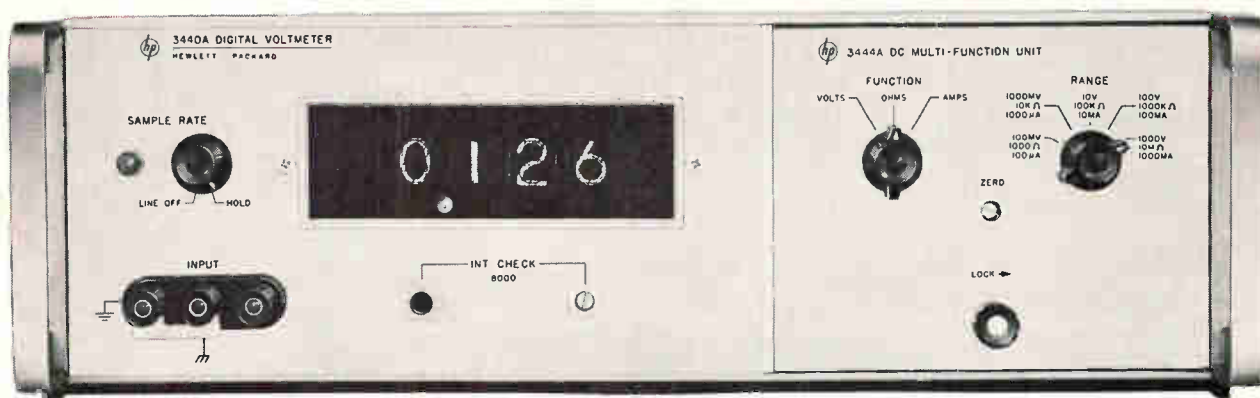

USE THIS hp DVM ANYWHERE!

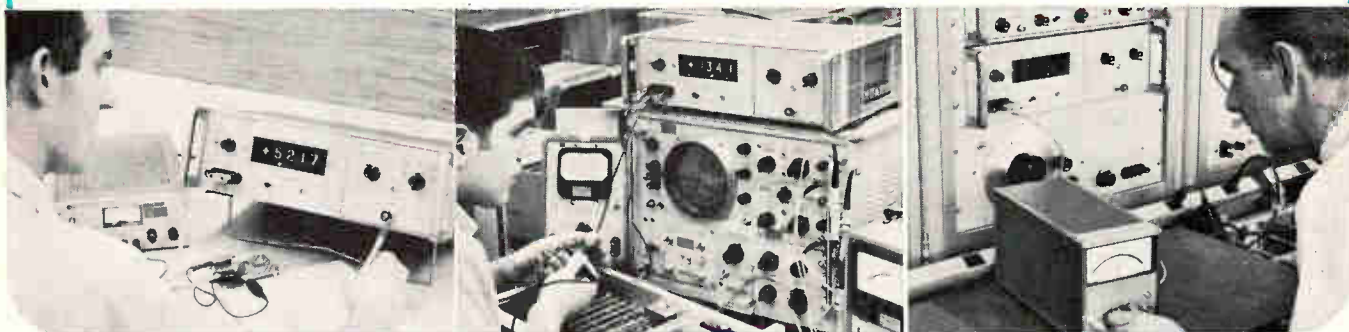

LABORATORY

PRODUCTION

SYSTEMS

The hp Models 3439A and 3440A Digital Voltmeters are compact, accurate, rapid, multiple function instruments—built rugged, reliable and versatile! With the appropriate plug-in, you get automatic ranging, remote or manual operation with an accuracy of 0.05% of reading on a four-digit readout; 50 Hz to 50 kHz bandwidth with 10 μ V; 10 nA sensitivity!

Rugged!—Models 3439A and 3440A are built with solid-state circuitry and reed relays to provide a rugged instrument. Use of solid-state components also gives a lighter weight for easy portability. These units are test operated at temperatures from 0°C to 50°C with relative humidities of 0 to 95%, vibration tested at 10 to 55 Hz at 0.010" peak-to-peak excursion, and drop-tested four times from four inches. Construction and testing assure you of a rugged instrument—ideal for bench or systems applications.

Reliable!—With either the 3439A or 3440A, you get an internal calibration source with a TC better than 0.002%/°C and a stability typically better than $\pm 0.005\%$ over a three month period. You can verify accuracy of these models simply by pressing a front panel button. You get digital readout on large rectangular display tubes which hold the previous reading until the input voltage is changed. Long-term reliability is assured with solid state components—but, if something should happen, the easy-to-service plug-in circuit cards mounted in the modular enclosure can be quickly replaced to minimize down-time.

Versatile!—You get a dc accuracy of better than $\pm 0.05\%$ of reading ± 1 digit. Specified accuracy is retained to 5% beyond full scale. The ac filter has a rejection of 30 dB at 60 Hz. Response time to a step change is 450 msec to read 99.95% of final value. The 10 M Ω impedance presents a constant load on all voltage ranges.

Add the capability of six plug-ins to these features and you have a truly versatile instrument! *But—that's not all!* You can make true RMS measurements using the dc output of the hp Model 3400A RMS Voltmeter and either the 3439A or 3440A. The 3440A has a BCD recorder output to operate with the hp

Model 562A Digital Recorder to produce a printed, six-column readout.

Plug-in*	3441A	3442A	3443A	3444A	3445A	3446A
AC volts 10V to 1000V	**	**	**	**	X	X
DC volts 10V to 1000V	X	X	X	X	X	X
DC volts 100mV to 1000V			X	X		
DC amps				X		
Ohms				X		
Manual ranging	X	X	X	X	X	X
Auto-ranging		X	X		X	
Remote ranging		X	X		X	X
Remote function						X
Floating input	X	X	X	X	X	X

*3439A and 3440A require a plug-in to operate

**Average response measurements: 100 μ V to 300 volts, 50 Hz to 500 kHz—hp-457A or 1 mV to 300 volts, 10 kHz to 10 MHz with -hp-400E/EL. True RMS measurements: 1 mV to 300 volts, 10 Hz to 10 MHz use -hp-3400A.

Get the full story on the rugged, reliable, versatile hp Model 3439A or 3440A Digital Voltmeter from your nearest hp field engineer. Or, write to Hewlett-Packard, Palo Alto, California, 94304. Europe: 54 Route des Acacias, Geneva. Price: hp model 3439A, \$950.00; hp Model 3440A, \$1160.00, plus plug-ins (\$40.00 to \$575.00).

097/9

HEWLETT  **PACKARD**
An extra measure of quality

News Features

Probing the News

- 127 Service—color tv's black eye
135 Fairchild's fine Italian hand

Electronics Review

- 45 **Communications:** Point of view; Tiny waves for Navy
46 **Medical electronics:** Spark of life
47 **Space electronics:** Milestone . . . ; in a busy week
48 **Optoelectronics:** Get the picture
50 **Computers:** On second thought
50 **Solid state:** LSI off the shelf
52 **Industrial electronics:** A sense of safety
52 **Avionics:** Hot on the trail
54 **For the record**

Electronics Abroad

- 187 **Japan:** Headed to market
187 **Great Britain:** Triple-threat IC
188 **Sweden:** Video highway
189 **West Germany:** Double exposure
189 **France:** Cross-channel link
190 **International:** Shifts at sea
190 **Around the world**

New Products

- 143 Recorder takes little time to pinpoint troublemakers
147 **New components review**
147 **New components:** Magnet finds a logical domain
151 **New semiconductors review**
151 **New semiconductors:** Toshiba—on the mark and ready
155 **New instruments review**
155 **New instruments:** Gamma particles measured in a flash
159 **New subassemblies review**
159 **New subassemblies:** Wiring machine clips price
163 **New microwave review**
163 **New microwave:** Signal paths that never cross
167 **New industrial electronics review**
167 **New industrial electronics:** Do-it-yourself kit for analog control

Technical articles

I. Design

- Design theory** 76 **Computer-aided design: part 12**
Smoothing the flow of data traffic
Reflected pulses in a transmission network raise havoc; they're minimized with the help of a computer
A.W. Rich, B.M. Vaughan and C.J. Cant
Christchurch, New Zealand
- Circuit design** 80 **Designer's casebook**
▪ Large-signal sampling without a transformer
▪ Cascoded transistors couple logic gates
▪ Null output detects square-wave duty cycle
▪ Cathode follower boosts output impedance
▪ Feedback eliminates noise in telephone circuit
▪ Single-shot multivibrator has zero recovery time
- Integrated electronics** 84 **Linear IC's: part 5**
Ins and outs of op amps
The road to better equipment design is based on a sound understanding of an operational amplifier's insides
Jack F. Gifford and Michael Markkula
Fairchild Semiconductor Division
- 87 **The power of negative feedback**
Picking the best feedback network tailors the IC to the job

II. Application

- Avionics** 95 **Steering a course to safer air travel (cover)**
New vhf omnirange receiver provides accurate bearing data in digital form
Edwin M. Drogin, Airborne Instruments Laboratory, Cutler-Hammer Inc.
- Communications** 104 **Coming to grips with multipath ghosts**
Waveform compression makes efficient use of bandwidth, cuts errors
David S. Dayton, Technical Communications Corp.
- Instrumentation** 110 **Stop-action recording of fleeting signals**
Transients lasting split seconds are captured by radiation-resistant recorder
Raymond J. Arndt, IIT Research Institute

Departments

- | | | | |
|----|-----------------|-----|------------------------|
| 4 | Readers Comment | 25 | Electronics Newsletter |
| 8 | People | 59 | Washington Newsletter |
| 14 | Meetings | 175 | New Books |
| 16 | Meeting Preview | 176 | Technical Abstracts |
| 23 | Editorial | 178 | New Literature |

183 Newsletter from Abroad

Electronics

Editor-in-Chief: Lewis H. Young

Associate managing editors

Technical: Donald Christiansen
News: Robert Henkel
Copy: Sally Powell

Senior associate editors

John F. Mason, Joseph Mittleman, Stephen E. Scrupski, Harry R. Karp

Department editors

Advanced technology: Stephen E. Scrupski
Avionics & Space: Alfred Rosenblatt
Computers: Wallace B. Riley
Consumer electronics: John D. Drummond
Design theory: Joseph Mittleman
Industrial electronics: Harry R. Karp
Instrumentation: Carl Moskowitz
Military electronics: John F. Mason
New Products: William P. O'Brien, Stephen Fields
Solid state: Mark B. Leeds
Staff writer: Howard Wolff

Section editors

Electronics abroad: Arthur Erikson
Electronics review: Stanley Zarowin
New Products: H. Thomas Maguire
Probing the news: Eric Aiken

Regional bureaus

Domestic

Boston: James Brinton, manager; Robin Carlson
Los Angeles: Lawrence Curran, manager; June Ranill
San Francisco: Walter Barney, manager; Mary Jo Jadin
Washington: Robert Skole, manager; William D. Hickman, Paul Dickson, Patricia C. Hoehling

Foreign

Bonn: John Gosch
London: Michael Payne
Tokyo: Charles Cohen

Copy editors

James Chang, Frederick Corey

Graphic design

Art director: Saul Sussman
Assistant art directors: Ann Mella, Valerie Betz
Production editor: Arthur C. Miller

Editorial secretaries: Claire Benell, Lynn Emery, Kay Fontana, Patricia Gardner, Lorraine Longo

McGraw-Hill News Service

Director: John Wilhelm; Atlanta: Fran Ridgway; Chicago: James Rubenstein;
Cleveland: Arthur Zimmerman; Dallas: Marvin Reid;
Detroit: J. Wirgo; Houston: Robert E. Lee; Los Angeles: Michael Murphy, Gerald Parkinson
Pittsburgh: Louis Gomolak
San Francisco: William F. Arnold
Seattle: Ray Bloomberg; Washington: Arthur L. Moore, Charles Gardner,
Herbert W. Cheshire, Seth Payne, Warren Burkett, James Canan, William Small

McGraw-Hill World News Service

Bonn: John Johnsrud; Hong Kong: Don Kirk; London: John Shinn;
Mexico City: Bruce Cross; Milan: Ronald Taggiasco;
Moscow: Howard Rausch; Paris: Peter Kilborn;
Rio de Janeiro: Wes Perry; Tokyo: Marvin Petal

Reprints: Susan Nugent

Circulation: Milton Drake

Publisher: Gordon Jones

Electronics: November 27, 1967, Vol. 40, No. 24

Published every other Monday by McGraw-Hill, Inc. Founder: James H. McGraw 1860-1948.
Printed at 99 North Broadway, Albany, N.Y. 12207; second class postage paid at Albany, N.Y.

Executive, editorial, circulation and advertising addresses: McGraw-Hill Building, 330 W. 42nd Street
New York, N. Y. 10036. Telephone (212) 971-3333. Teletype TWX N.Y. 710-581-4235. Cable address:
MCGRAWHILL N.Y.

Subscriptions solicited only from those professionally engaged in electronics technology. Subscription rates:
qualified subscribers in the United States and possessions and Canada, \$8.00 one year, \$12.00 two years,
\$16.00 three years; all other countries \$25.00 one year. Non-qualified subscribers in the U.S. and
possessions and Canada, \$25.00 one year; all other countries \$50.00. Air freight service to Japan \$50.00
one year. Single copies: United States and possessions and Canada, \$1.00; all other countries, \$1.75.

Officers of McGraw-Hill Publications: Joseph H. Allen, President; Bayard E. Sawyer, Executive Vice-President;
J. Elton Tuohig, Senior Vice-President-Operations; Vice Presidents: John R. Callahan, Editorial;
John M. Holden, Marketing; Paul F. Cowie, Circulation; Angelo R. Venezzian, Production; Jerome D. Luntz,
Planning & Development; Robert M. Wilhelm, Controller.

Officers of the Corporation: Donald C. McGraw, Chairman of the Board; Shelton Fisher, President;
L. Keith Goodrich, Robert E. Slaughter, Executive Vice Presidents; Donald C. McGraw, Jr.,
Senior Vice-President; John J. Cooke, Vice-President & Secretary; John L. McGraw,
Vice-President & Treasurer.

Title © registered in U.S. Patent Office; © Copyright 1967 by McGraw-Hill, Inc. All rights reserved. The contents
of this publication may not be reproduced either in whole or in part without the consent of copyright owner.

Subscribers: The publisher, upon written request to our New York office from any subscriber,
agrees to refund that part of the subscription price applying to copies not yet mailed.
Please send change of address notices or complaints to Fulfillment Manager; subscription
orders to Circulation Manager, Electronics at address below. Change of address notices
should provide old as well as new address, including postal zip code number. If possible,
attach address label from recent issue. Allow one month for change to become effective.

Postmaster: Please send form 3579 to Fulfillment Manager, Electronics,
P.O. Box 430, Hightstown, New Jersey 08520

Readers Comment

Color blind

To the Editor:

The article "Color for computers" [Oct. 16, p. 233], states "Sperac maintains that no other company in Europe offers a color crt display".

At the same show another French company, T.R.T. (Télécommunications Radio-électriques et Téléphoniques) exhibited a color crt display whose development appears to be rather more advanced than Sperac's. At the International Office Equipment Show in Paris this month, the same equipment was presented with several of its capabilities, and visitors could display, modify, and memorize words and diagrams made of color preset symbols.

For instance, by merely pushing a button on a keyboard, parts of block diagrams of existing supervisory networks were displayed.

With this equipment, it is possible to display on any 625-line tv set, a combination of alphanumeric characters (up to 64) and graphic symbols (up to 64), in 16 different colors.

A. Angot

Scientific director

T.R.T.

Paris, France

■ Both Sperac's engineers and Electronics' man in Paris missed the T.R.T. tube at the Sicob show because it was not operating.

No reason for delay

To the Editor:

The editorial, "Frightening testimony" [Aug. 7, p. 23], clearly delineates the unsatisfactory state of our air traffic control and the far too slow approaches made towards its correction.

However, permit me to point out that the collision avoidance radar system proposed by the ATA is not likely to involve the expense and weight of an atomic clock in each aircraft. High stability crystal oscillators, now available, provide aging characteristics and, even more important, short term stability quite adequate for this purpose, in

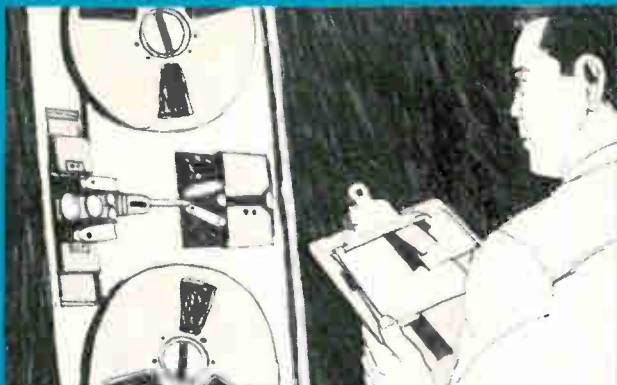

How much trouble are you
having with
flutter and drift?

Here's the only sure way to find out:

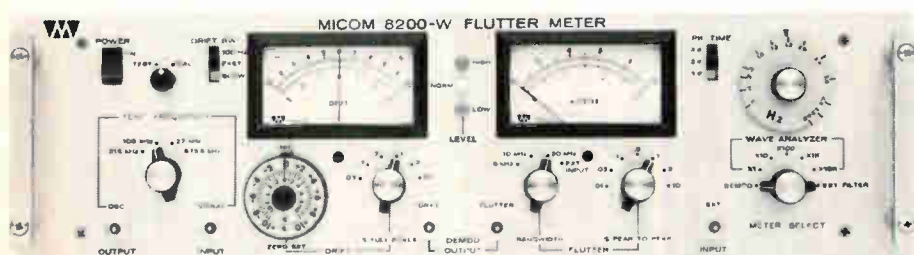

The Micom solid-state flutter meter provides direct drift and flutter measurement with *constant* $\pm 2\%$ accuracy...an accuracy never before available. Measurements are read out simultaneously on *separate* front-panel meters, drift from $\pm 0.03\%$ to $\pm 10\%$ and flutter from 0.01% to 10%.

Models are available for use with both instrumentation recording equipment and audio equipment. The 8200 meets or exceeds IRIG standards; the 8100 measures to NAB and DIN standards.

These instruments are automatically self-calibrating, making them trouble-free and easy to use. The operator just selects the range and reads the measurement. Their sensitivity is accurate enough for precise lab work yet easy enough to use on the production line.

Why not put these meters to work for you...on your tape transport, phonograph turntable, motion picture equipment...any rotational apparatus. Write Micom for complete information.



MICOM

855 COMMERCIAL STREET
PALO ALTO, CALIFORNIA 94303

TEL. (415) 328-2961

A CALIFORNIA CORPORATION

**Simplify night vision
systems dramatically
with exclusive
Westinghouse SEC
camera tubes... in
quantity production now.**

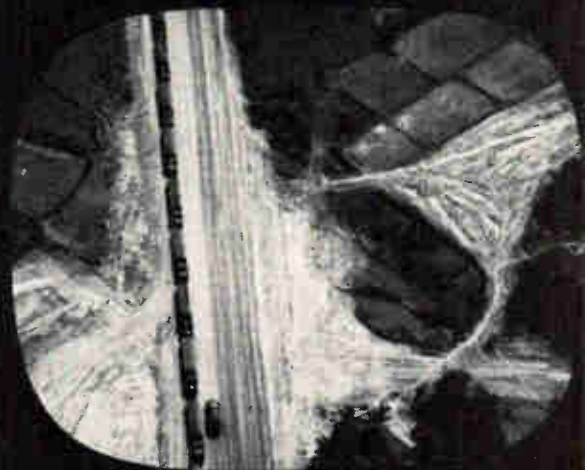

The Westinghouse Secondary Electron Conduction Camera Tube does everything image orthicons can... but without a mass of complex circuitry to compensate for motion-blurring, halo effects, and changes in light level.

Result: the SEC tube makes possible more compact, rugged, and economical night vision systems. Ones that outperform orthicon-based systems in important ways.

And Westinghouse production lines have been turning out SEC's for over two years. They're off-the-shelf items! Write for the data you desire. We have over 400 vacuum electronics engineers who want to help you. Westinghouse Tube Division, Elmira, New York 14902.

ET-4002

Circle 6 on reader service card

You can be sure if it's Westinghouse



a package of moderate price, weighing less than one pound.

Such precision oscillators change frequency as a result of aging by less than 2 parts in 10^{10} per day. Short term stability measured over 100 microseconds sampling time can be as low as 3 parts in 10^9 rms. The gradual frequency change (aging) inherent in all crystals, small as it is, can be corrected automatically by the ground stations as an aircraft enters the area covered by a ground station. There is no technical reason for delaying action now since such a system has been in operation in St. Louis for several years, protecting McDonnell-Douglas aircraft.

J.F. Tuke

Precision Instrument Products
Motorola Communications and
Electronics Inc.
Chicago

Bilateral switching

To the Editor:

I read with interest the article by James A. Perschy [July 24, p. 74], "On the threshold of success: glass semiconductor circuits." There indeed seems to be a real place for a bilateral switching device in memory systems. I am curious, however, if Perschy has considered the Silicon Bilateral Switch (i.e., 2N4992) for this application. The sbs would seem to have attributes superior to those of the device discussed in this article.

The sbs, while sharing the glass semiconductor's bilateral characteristic, offers superior parameters and uniformity. In addition, its "gating" lead may be used to further simplify addressing a matrix of these devices.

Although the sbs is actually a monolithic integrated circuit, its processing is identical to that of an ordinary silicon planar transistor. Thus the sbs combines the low cost and reliability of planar processing with the superior performance of a multi-element integrated circuit.

It seems logical in a "ground-to-space communications link" to make use of the reliable technology of integrated circuits. Especially when the ic is as economical as ordinary transistors!

Walter R. Spofford Jr.

Applications Engineering
Semiconductor Products Dept.
General Electric Co.
Syracuse, N.Y.

■ The 2N4992 is a versatile discrete bilateral switch, and does have several superior attributes. But part of this research study was to explore a new device that is potentially cheaper and just as reliable.

Picture credit

To the Editor:

You may be interested to know that the photographer who spent more than five hours taking the four-color pictures for the cover of your Sept. 18 issue, as well as most of the photographs used with the text, was Joe Bond. He is the project engineer for the PICOMM, Potter's new electronically sophisticated coordinate measuring machine, as well as the mechanical engineer responsible for the value-engineered mechanical parts of the PICOMM II.

Daniel J. Priscu

Potter Instrument Co.
Plainview, N.Y.

...now add 5MHz AC capability to your digital voltmeter

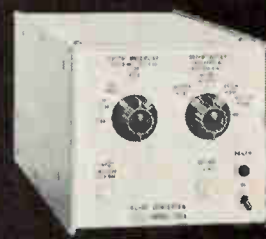

with PM's new AC/DC Converter

A unique rectifying detector circuit* employing MOS FETs provides a frequency range of 5 Hz to 5 MHz, 70 dB dynamic range and 300 microvolt sensitivity.

DC output is the RMS value of the AC signal.

In addition to its usefulness with DVMS, the analog output is ideal for swept frequency measurements where plots of filter characteristics are needed.

Add the companion PM Logarithmic Converter for direct measurements in dB.

PM 1008 AC/DC Converter: \$900

*PATENT PENDING

For details on this and other intriguing new PM instruments, write or call:

PM PACIFIC
MEASUREMENTS
INCORPORATED

940 INDUSTRIAL AVENUE,
PALO ALTO, CALIFORNIA
(415) 328-0300

SUBSCRIPTION SERVICE

Please include an Electronics Magazine address label to insure prompt service whenever you write us about your subscription.

Mail to: Fulfillment Manager
Electronics
P.O. Box 430
Hightstown, N.J. 08520

To subscribe mail this form with your payment and check new subscription renew my present subscription

Subscription rates: qualified subscribers in the U.S.: 1 year \$8; two years, \$12; three years, \$16. Non-qualified: 1 year \$25. Subscription rates for foreign countries available on request.

CHANGE OF ADDRESS

ATTACH
LABEL
HERE

If you are moving, please let us know five weeks before changing your address. Place magazine address label here, print your new address below.

name

address

city

state

zip code

re Technipower's
CM-95 Series
power modules...
**they're
loaded!**

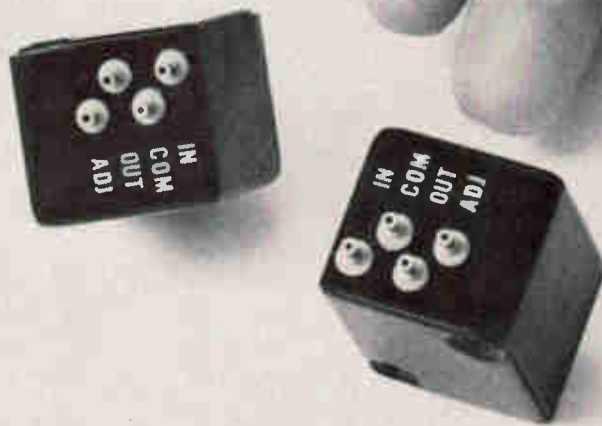

Technipower's miniature DC-DC power modules are packed with extras not found in other point-of-load regulators.

E.g.:

- Full 1.5 ampere capability with simple chassis mount or specially designed heat sink;
- Fully operational without adding external components;
- Complete line of output voltages, with either positive-common or negative-common versions;
- Easily mounted — input and output terminals are insulated from case;
- Protected against output shorts;
- \$30 each — much less in quantity!

Specifications include $\approx 200:1$ input ripple attenuation, $\pm 0.5\%$ regulation for a full 30% input or full load change, output voltage adjustment $\pm 5\%$, and operation to 95°C case temperature.

Write or call for information.



TECHNIPOWER

A BENRUS Subsidiary

Benrus Center, Ridgefield, Connecticut 06877

Phone: (203) 438-0333 TWX: 710-450-3631

People

"Like many other companies which deal largely with the military, LFE has come to realize the need for a commercial operation," says

Francis E. Vinal, the new manager of the applied research section of the Laboratory for Electronics Inc.'s Electron-



Francis E. Vinal

ics division. Toward this end, the Boston firm has created an applied products department, which includes Vinal's section as well as the division's instrument section and magnetic products section.

"A commercial operation brings everything into one ball of wax," says Vinal. "We hope within a year or two to achieve a 40%-60% breakdown between commercial and military sales."

One of LFE's major new efforts is in domain tip propagation logic for use in computer memories. The company has already developed a series of shift registers using the new techniques [see p. 147], and is working on two new products, a first-in, first-out memory and a push-down list memory. Both should appear in the near future. Also on the drawing boards, but further away, are other logic elements and a large-capacity mass memory, which will be produced by batch fabrication.

"I envisage domain tip logic utilized in markets that now use active digital devices," says Vinal. It should also compete with metal oxide semiconductor devices, he believes.

Blue sky. Currently in the lab is a display technique using magnetic films. "The goal is to be able to read and write into a magnetic film memory, which produces a character display and can then be photographed, video-recorded, or projected," he notes. Even further up the research trail, still "in the thinking stages," is work with neuron and neuristor studies.

Before joining LFE, Vinal spent about a year with Acra-Mation Inc., of which he was a cofounder, and nine years as operations man-



Guide to Machlett Electron Tubes



Planar Triodes.

Grid pulsed to 1 kw at 6 Gc. To 35 kw in pulse modulator service. For communications, radar beacons and navigation.



Magnetic Beam Triodes.

Pulsed ratings to 6 Mw with only 2.5 kw drive. CW ratings to 200 kW with only 0.7 kW drive.

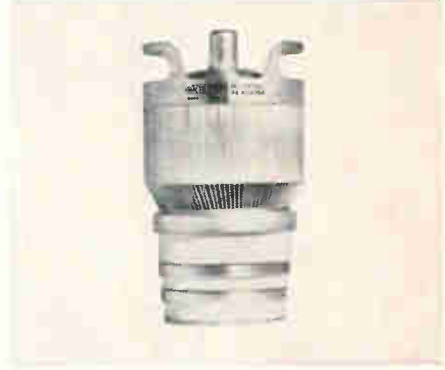

Heavy Duty Tetrodes.

Forced air cooled, water cooled and vapor cooled for broadcasting and communications.



Pulse Modulators.

Shield grid triodes (oxide cathode) to 4.5 Mw, 80 kv peak. High voltage triodes (thoriated tungsten cathode) to 20 Mw with plate voltages to 200 kv peak.



Heavy Duty Triodes.

Includes vapor cooled triodes, to 440 kW CW.



Vacuum Capacitors, Variable.

RMS amperes to 75A; voltage to 15 kv peak. Capacities from 5-750 pF to 50-2,300 pF.



High Power Tetrodes.

Vapor cooled tetrodes to 350 kw CW for communications.

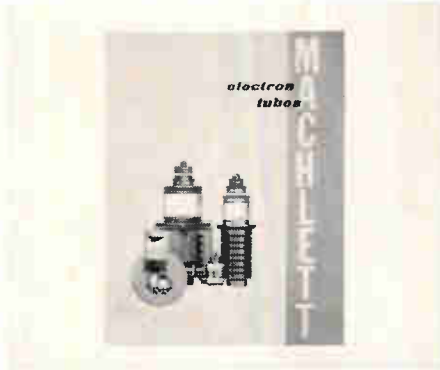

Send for latest condensed catalog

covering the entire line of Machlett electron tubes. Write: The Machlett Laboratories, Inc., 1063 Hope Street, Stamford, Conn. 06907



THE MACHLETT LABORATORIES, INC.

A SUBSIDIARY OF RAYTHEON COMPANY

Sprague delivers Tape Cores



Our Tape Cores come in thirty sizes from $\frac{5}{8}$ to 6 inch O.D., offer a choice of core materials, and have standard phenolic or hermetically-sealed epoxy-coated aluminum cases. Most are available for off-the-shelf delivery. Shouldn't you wind up with Sprague?

For complete technical data, write for Bulletin Series 51000 to Technical Literature Service, Sprague Electric Company, 35 Marshall Street, North Adams, Massachusetts 01247

SPRAGUE COMPONENTS

MAGNETIC COMPONENTS
CAPACITORS
TRANSISTORS
RESISTORS
THIN-FILM MICROCIRCUITS
INTEGRATED CIRCUITS

INTERFERENCE FILTERS
PACKAGE COMPONENT ASSEMBLIES
FUNCTIONAL DIGITAL CIRCUITS
PULSE TRANSFORMERS
CERAMIC-BASE PRINTED NETWORKS
PULSE-FORMING NETWORKS



Sprague and '®' are registered trademarks of the Sprague Electric Co.

People

ager for the Memory Products division of the Radio Corp. of America. He holds an Sc.D from the Massachusetts Institute of Technology.

Before the advent of large-scale integration, a circuit manufacturer thought he was doing his job by teaching his customer how to apply a new circuit to a product. This situation is about to change, and Texas Instruments Incorporated is antici-



Glenn Penisten

patating it. As part of its recent reorganization [Electronics, Oct. 2, p. 26], TI has established a business development post within its components group. Named to head this department was 35-year-old systems engineer **Glenn Penisten**.

Penisten's job will be to establish a task force of systems engineers and circuit designers who will work with customers before and during the design of a product. The aim is to design an LSI circuit for a particular customer's need, not to find an application for an existing circuit.

The problems. Penisten concedes there will be pitfalls. "We'll have to be very careful about proprietary matters," he says. "We'll also have to sell ourselves not only to the customer's technical specialists but to top management as well. Management people may be reluctant to let in outsiders."

Also, once decisions are reached with a customer, Penisten believes his group will have to turn the ideas into products in weeks instead of months or years. "We will have to make heavy use of computer-aided design to do this," he says.

TI market forecasters see integrated circuits and systems accounting for 50% of the more than \$1 billion semiconductor market by 1973 (compared with about 22% now). "We have to develop new market areas because discrete component sales are going to be hit harder and harder," Penisten says.



Model QRE 7.5-10



Model QRE 10-3.7

Sorensen Off-the-Shelf Power Supplies Designed for Integrated Circuits:

Sorensen has provided stock availability of the new QRE Series. This series was designed specifically for use with integrated circuits, micro miniature chips, and digital logic circuitry. QRE provides overvoltage protection within 10 microseconds, voltage regulation, line and load combined, is $\pm 0.005\%$ or $\pm 0.01\%$.

All QRE units include these Sorensen features, series/parallel operation, remote sensing, remote programming and high stability. Designed as a space saving system the QRE Series may be selected from either modular or $3\frac{1}{2}$ " high rack units.

MODEL	V/A RANGES	PRICES
QRE 10-2.2	0-10V, 0-2.2A	\$135
QRE 10-3.7	0-10V, 0-3.7A	155
QRE 7.5-10	0-7.5V, 0-10A	295
QRE 7.5-20	0-7.5V, 0-20A	465
QRE 7.5-50	0-7.5V, 0-50A	595

For QRE details, or for information on other stock or custom DC power supplies, AC line regulators, frequency changers, or for our free catalog #662A, contact your Sorensen rep., or Raytheon Company, Sorensen Operation, Richards Ave., Norwalk, Conn. 06856. Tel: 203-838-6571.



Every day, in almost every lab, important measurements are being neglected because people think they're difficult to make.

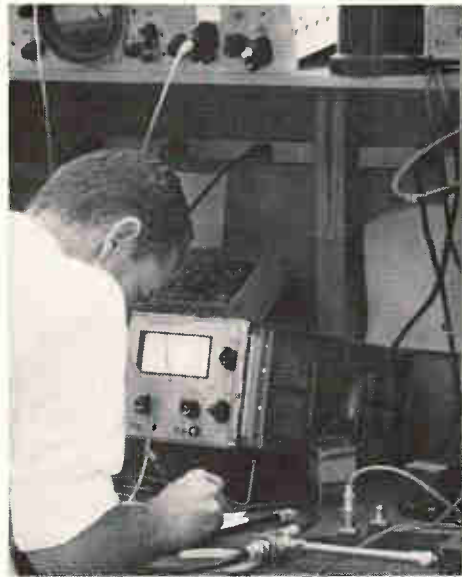

This RF vector voltmeter proves they're wrong.

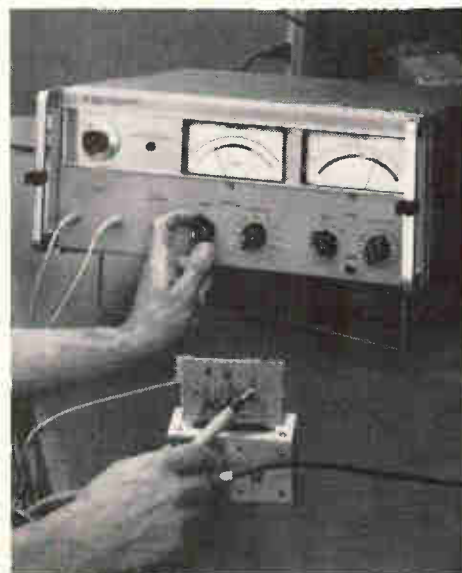



From 1 to 1000 MHz, this 2-channel rf millivoltmeter-phasemeter provides simultaneous measurement of voltage and phase. Just think of the numerous situations where these measurements will enable you to evaluate your design efforts quickly, easily and thoroughly.

What measurements? Well, take open-loop gain of feedback amplifiers. The Hewlett-Packard 8405A Vector Voltmeter makes it easy to design feedback amplifiers because it can give you both amplitude and phase of open-loop gain *simultaneously* and *fast*. The wide frequency range of 1 MHz to 1000 MHz, 100 μ V full-scale sensitivity and 95 dB dynamic range all contribute to simplicity in these important measurements. Just connect the probes to your circuit, the 8405A *automatically* tunes and locks to the test signal, and your measurement results are presented on the meters.

Or take measurement of electrical lengths such as cable matching or phase-tracking between signal paths. The 8405A, used as a phasemeter, does each simply and quickly with 10° offset steps permitting high resolution of 0.1° on the $\pm 6^\circ$ scale. And this same capability can easily be applied to making group delay measurements.

In filter design and evaluation, phase characteristics readily disclose resonances—and the 8405A Vector Voltmeter's high sensitivity and wide dynamic range permit measurements in the filter's *rejection* band, as well as in the pass band.

Though wideband in coverage—1 to 1000 MHz—the 8405A is nevertheless a *tuned* or frequency-selective voltmeter with 1 kHz measurement bandwidth which makes it especially valuable for accurate measurement of fine-grain phenomena such as "notches," filter skirts, etc.

Price: 8405A, \$2750.

Many other examples of the 8405A's applications for what previously were considered awkward or complex measurements are available. The ubiquitous nature of the 8405A as a fundamental design tool is fully described in HP Application Note #91, "How Vector Measurements Expand Design Capability—1 to 1000 MHz."

Get it and more information about the Vector Voltmeter by calling your local HP field engineer or writing Hewlett-Packard, Palo Alto, California 94304; Europe: 54 Route des Acacias, Geneva.

HEWLETT  PACKARD

RF TEST EQUIPMENT

04722

- There always has to be a winner—and when it comes to all-purpose sweep signal generators, the Jerrold Model 900-C is a shoo-in.

Measure a *narrow* band circuit (sweep-width down to 10 kHz) or check the *entire coverage* of broad band units such as mixers, amplifiers, or filters (sweepwidths up to 400 MHz). Design, test or measure a variety of VHF, UHF, narrow and wide band devices in the frequency range 500 kHz to 1200 MHz... and do it with incomparable ease and accuracy. Here is convenience only an all-purpose sweeper can provide.

The 900-C and ultra-reliable Measurement-by-Comparison techniques permit accurate and simple measurement of gain, loss, and VSWR. You can disregard variables such as nonlinearity of detectors, oscilloscope drift, and line voltage variations.

If you need more convincing, send for complete data—or contact us for a demonstration. Write Government and Industrial Division, Jerrold Electronics Corporation, 401 Walnut St., Philadelphia, Pa. 19105.

JERROLD

clean sweep!

IN TEST,
MEASUREMENT,
AND
DESIGN

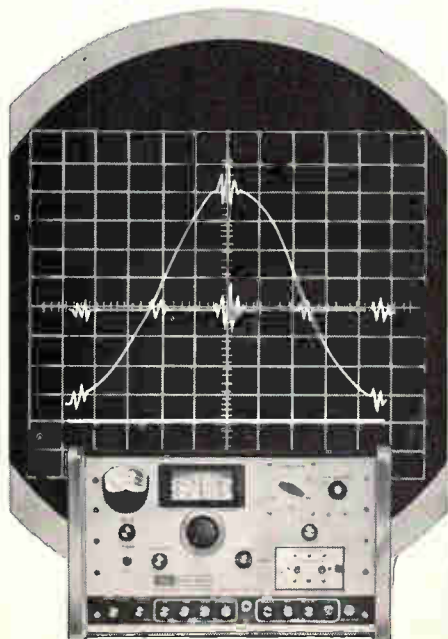

Meetings

Missile System Meeting, American Institute of Aeronautics and Astronautics; Monterey, Calif., Dec. 4-6.

Symposium on Theory and Measurement of Atmospheric Turbulence and Diffusion in the Planetary Boundary Layer, Atmospheric Sciences Laboratory of the Army Electronics Command; Sandia Base, Albuquerque, N.M., Dec. 5-7.

Vehicular Conference, IEEE; New York Hilton, New York, Dec. 5-7.

Symposium on Reliability, IEEE; Sheraton-Boston Hotel, Boston, Jan. 16-18.*

Power Meeting, IEEE; Statler-Hilton Hotel, New York, Jan. 28-Feb. 2.

Aerospace and Electronic Systems Convention, IEEE; International Hotel, Los Angeles, Feb. 13-15.

International Solid-State Circuits Conference, IEEE; Sheraton Hotel, Philadelphia, Feb. 14-16.

Scintillation and Semiconductor Counter Symposium, IEEE; Shoreham Hotel, Washington, Feb. 28-March 1.

International Convention and Exhibition, IEEE; New York Coliseum and New York Hilton Hotel, New York, March 18-21.

Symposium on Microwave Power, International Microwave Power Institute, Statler Hilton Hotel, New York, March 21-23.

Joint Railroad Conference, IEEE; Conrad Hilton Hotel, Chicago, March 27-28.

International Magnetics Conference, IEEE; Sheraton Park Hotel, Washington, April 3-5.

Business Aircraft Meeting and Engineering Display, Society of Automotive Engineers, Broadview Hotel, Wichita, Kan., April 3-5.

Telemetry Conference, IEEE; Shamrock Hilton Hotel, Houston, April 9-11.

International Pulse Symposium, International Federation of Automatic Control; Budapest, Hungary, April 9-11.

Symposium on Law Enforcement Science and Technology, Illinois Institute of Technology Research; Chicago, April 16-18.

Southwestern Conference and Exhibition, IEEE; Sheraton Lincoln Hotel, Houston, April 17-19.

Short Courses

Creativity at work—advanced, University of Wisconsin's College of Engineering and College of Applied Science and Engineering, Madison, Dec. 4-5, \$50 fee.

Electronic circuit analysis program workshop, University of Wisconsin, Madison; Jan. 25-26, \$65 fee.

Unified approach to measurement engineering, Arizona State University, Tempe, Ariz.; Jan. 29-Feb. 2, \$225 fee.

Call for papers

Seminar on Holography, Society of Photo-Optical Instrumentation Engineers; San Francisco, May 23-24. Jan. 1 is deadline for submission of abstracts to Holography Seminar Committee, Society of Photo-Optical Instrumentation Engineers, P.O. Box 288, Redondo Beach, Calif. 90277

International Television Conference, IEEE; London, Sept. 9-13, 1968. Jan. 5 is deadline for submission of abstracts to R.G. Cox, The Institution of Electrical Engineers, Savoy Place, London, W.C. 2, England.

Instrument Society of America Conference, New York City, Oct. 28-31. Feb. 1 is deadline for submission of abstracts to O. W. Williams, Conference Program Coordinator, Instrument Society of America, 530 William Penn Place, Pittsburgh, Pa. 15219

* Meeting preview on page 16.

The Model 335A measures and supplies DC voltages from 0 to 1100 volts with an output of 0 to 50 milliamperes. As a source and as a differential voltmeter, absolute accuracy is within 0.003% of setting. Resolution for any voltage range is 0.1 ppm. Only 7 inches high, the compact functionally styled solid state Model 335A needs no fan for cooling. □ Stability of the Model 335A is $\pm(0.0025\%$ of setting $+ 10 \mu\text{v})$ per six months. Overcurrent protection automatically limits output current at any preset level between 1 ma and 60 ma. Any voltage within the range of the instrument can be selected as an overvoltage trip point. Ripple and noise are less than $40 \mu\text{v rms}$ on the 1000 v range. □ The null detector, which can be used at the same time the Model 335A is being used as a voltage source, offers an accuracy of 3% of end scale on all ranges. An output meter allows the operator to read voltage or current at a glance. Now if you can find any comparable device at any price (let alone the modest \$2,485 we'll let you have the Model 335A for), **buy** it. We **remain** confident. So, when you want a demonstration or more information, please call your full service Fluke sales engineer (listed in EEM) or write directly to us at the factory if you prefer.

Circle 15 on reader service card

Multi-function instruments

aren't new. But multi-function instruments
in which no single function degrades
the others are! Sounds suspiciously like a
description of the new Fluke Model 335A DC Voltage
Calibrator, Differential Voltmeter
and Null Detector.
Elementary. . .



FLUKE

Fluke: Box 7428, Seattle, Washington 98133. Phone: (206) 774-2211 • TWX: (910) 449-2850
In Europe, address Fluke International Corporation, P.O. Box 5033,
Ledeboerstraat 27, Tilburg, Holland. Telex: 844-50237.

Discover SONY® Portable Data Recording



The new Sony PFM-15 gives you accuracy and flexibility in the field... same as it does in the lab.

Weighing only 37 lbs., it operates anywhere, from any power source: 100-240V AC, 50-400 HZ ■ 12V DC, battery or converter ■ even from your car's cigarette lighter! ■ Its modular, circuit-board construction is extraordinarily rugged and easy to maintain ■ while its all-transistor circuitry provides high stability and low power-drain.

The PFM-15 uses standard ¼" instrumentation tape and records simultaneously on any combination of four channels through four high-impedance FM recording inputs ■ accepts audio input for running commentary ■ output impedance 600 ohms ■ footage counter ■ individual input/output level meter on each channel ■ closed-loop servo drive for tape speed uniformity over an extreme range of ambience. Write or call today and discover SONY data recording.

The new SONY PFM-15 Instrumentation Recorder is rugged, versatile and \$2900.

SONY

For more information call or write:
Instrumentation Data Products Inc.
2 Maud Graham Circle, Burlington, Mass. 01803/Tel: 617/272-5997

Meeting preview

Reliability

Following a course set three years ago, this year's Symposium on Reliability will focus on the relationship between reliability and product costs and performance. The meeting, scheduled for Jan. 16 to 18 in Boston, will cover a broad range of topics—in both military to consumer fields—from this angle.

Integrated circuits will be spotlighted in a session moderated by Al Phillips, general manager of ic's at Sylvania Electric Products. Two reliability specialists from Autonetics, D.A. Hausrath and D.C. Fleming, will discuss a technique for reducing the uncertainties in failure-rate predictions based on experiences with the Minuteman 2 program. Two RCA product-assurance specialists, D.I. Troxal and Bernard Tiger, will describe a method of assessing ic reliability without performance tests. And a paper on the relation of reliability to manufacturing processes will be presented by three General Electric engineers: E.A. Herr, manager of reliability engineering, and D.W. Baker and Albert Fox.

Computer help. The application of computers to reliability studies will also be investigated. Clint Purdue of the Sandia Corp. will lead a panel analysis of the economics and limitations of computer-aided studies based on such CAD programs as Sceptre, Circus, ECAP, and NET.

This year the symposium will initiate a program on the special reliability problems encountered in medical electronics. Here, Dr. Samuel Fine, a professor of biomedical engineering at Northeastern University, will head a panel of physicians, medical scientists, and engineers.

Driver's seat. A session on reliability in the automotive industry will be moderated by Alex Haynes, associate director of the Ford Motor Co.'s testing laboratory. Among the speakers will be representatives from the University of Michigan and TRW Inc.'s Automotive Products division.

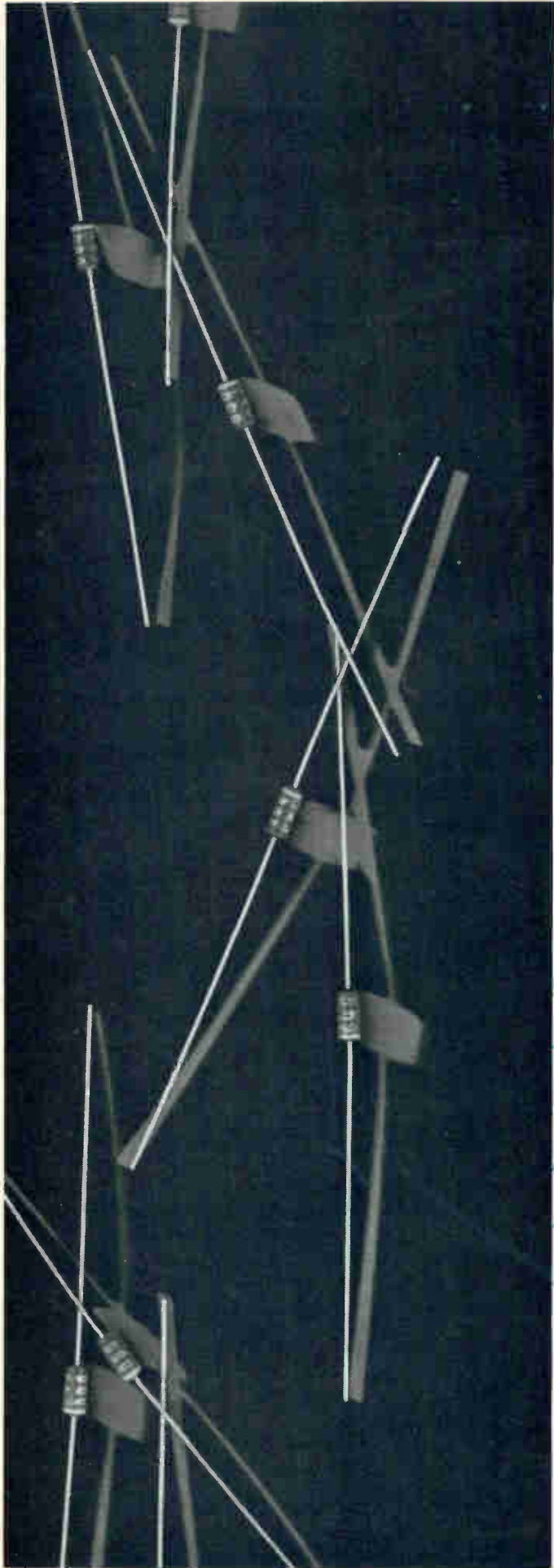

HOT CARRIER DIODES...

- Negligible charge storage
- Low leakage, high forward conductance
- Available in matched pairs and quads
- Low cost

...from HPA

The performance specifications and prices in the table below show why the HPA 2900 is ideally suited for commercial applications requiring ultra-fast switching, RF/UHF mixing, detecting and limiting. Call your local HP field engineer or write direct for your data sheet. HP Associates, 620 Page Mill Road, Palo Alto, California 94304.

Typical specifications		
Forward Current I_F		Breakdown Voltage V_{BR}
20 mA min. @ $V_F=1.0$ V 1.0 mA min. @ $V_F=0.4$ V		10 V @ $I_R=10$ μ A
Leakage Current I_R	Lifetime τ	Price
100 nA @ $V_R=-5.0$ V	120 ps	1 to 99, \$1.50 100 to 999, \$1.10

HEWLETT
PACKARD  HP
ASSOCIATES

2585

The end of the non-portable portable

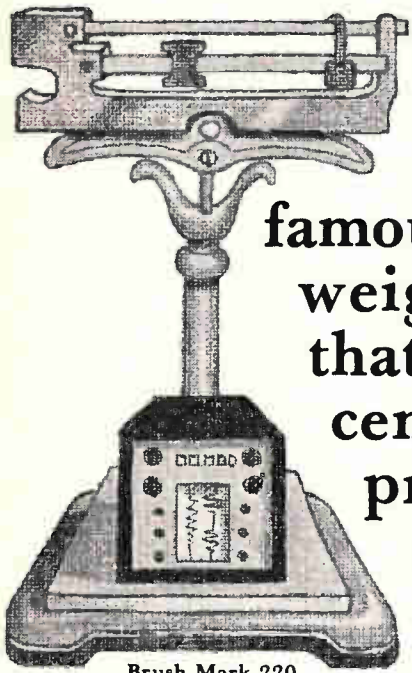

Brush Mark 220 weighs in at 25 pounds.

Mark 220 by Brush . . . a brand new recorder with a 25,000-channel pedigree. Behaves like its famous granddaddy, the Mark 200, but weighs only 25 pounds. Delivers traces that are unbelievably sharp, 99½ percent accurate. Solid state electronics provide position feedback pen control . . . no springs, no strings. The new Mark 220 has two channels for analog recording, two for

events. Maximum sensitivity is one millivolt per chart division, but the recorder is electrically protected from overloads as high as 500 volts. Pressurized writing

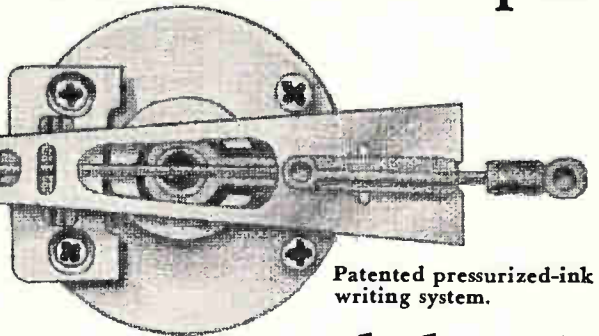

Patented pressurized-ink writing system.

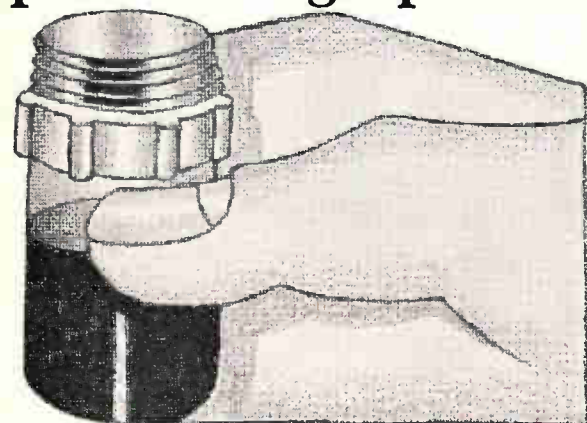

Throw-away ink cartridge—1000 miles between changes.

puts smudge-proof traces into paper, and there's enough ink in the throw-away cartridge to last for about a thousand miles. Less than \$1700 will put you in business with this fine instrument. Call for a demonstration of the remarkable Mark 220,

and if you wish to keep the unit . . . we'll swap it for a P.O. number. Clevite Corp., Brush Instruments Division, 37th & Perkins, Cleveland, Ohio 44114.

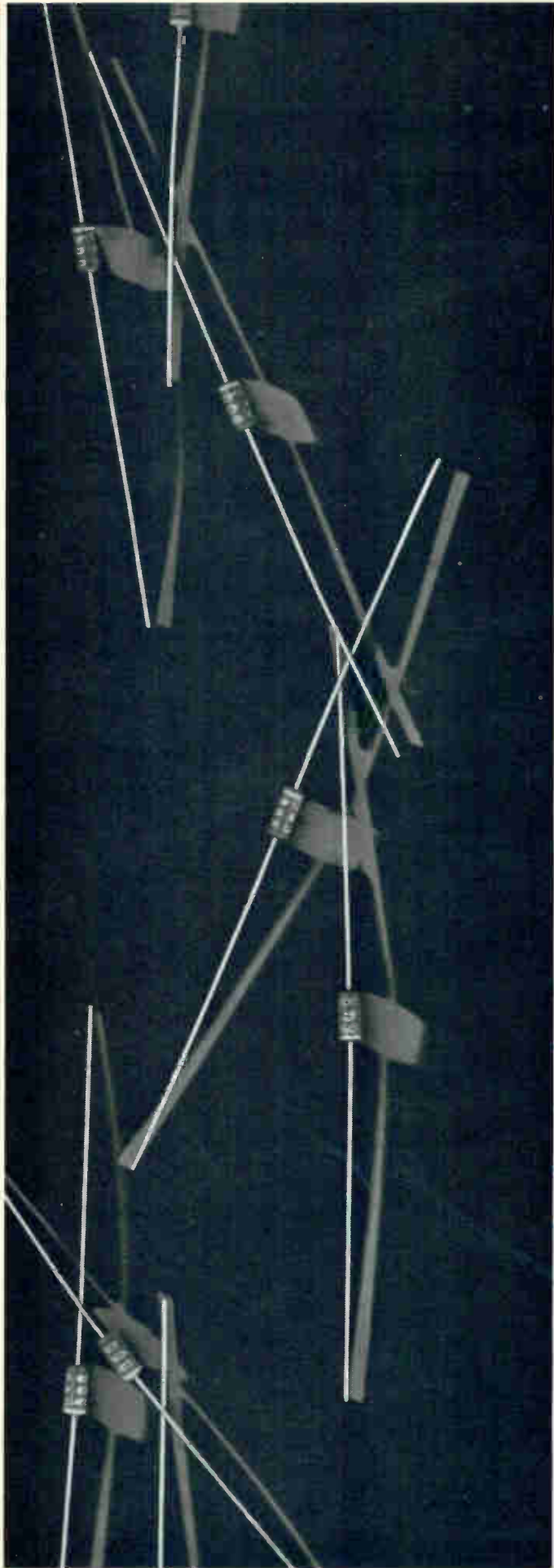

HOT CARRIER DIODES...

- Negligible charge storage
- Low leakage, high forward conductance
- Available in matched pairs and quads
- Low cost

...from HPA

The performance specifications and prices in the table below show why the HPA 2900 is ideally suited for commercial applications requiring ultra-fast switching, RF/UHF mixing, detecting and limiting. Call your local HP field engineer or write direct for your data sheet. HP Associates, 620 Page Mill Road, Palo Alto, California 94304.

Typical specifications		
Forward Current I_F	Breakdown Voltage V_{BR}	
20 mA min. @ $V_F=1.0$ V 1.0 mA min. @ $V_F=0.4$ V	10 V @ $I_R=10$ μ A	
Leakage Current I_R	Lifetime τ	Price
100 nA @ $V_R=-5.0$ V	120 ps	1 to 99, \$1.50 100 to 999, \$1.10

**HEWLETT
PACKARD**  **HP
ASSOCIATES**

2585

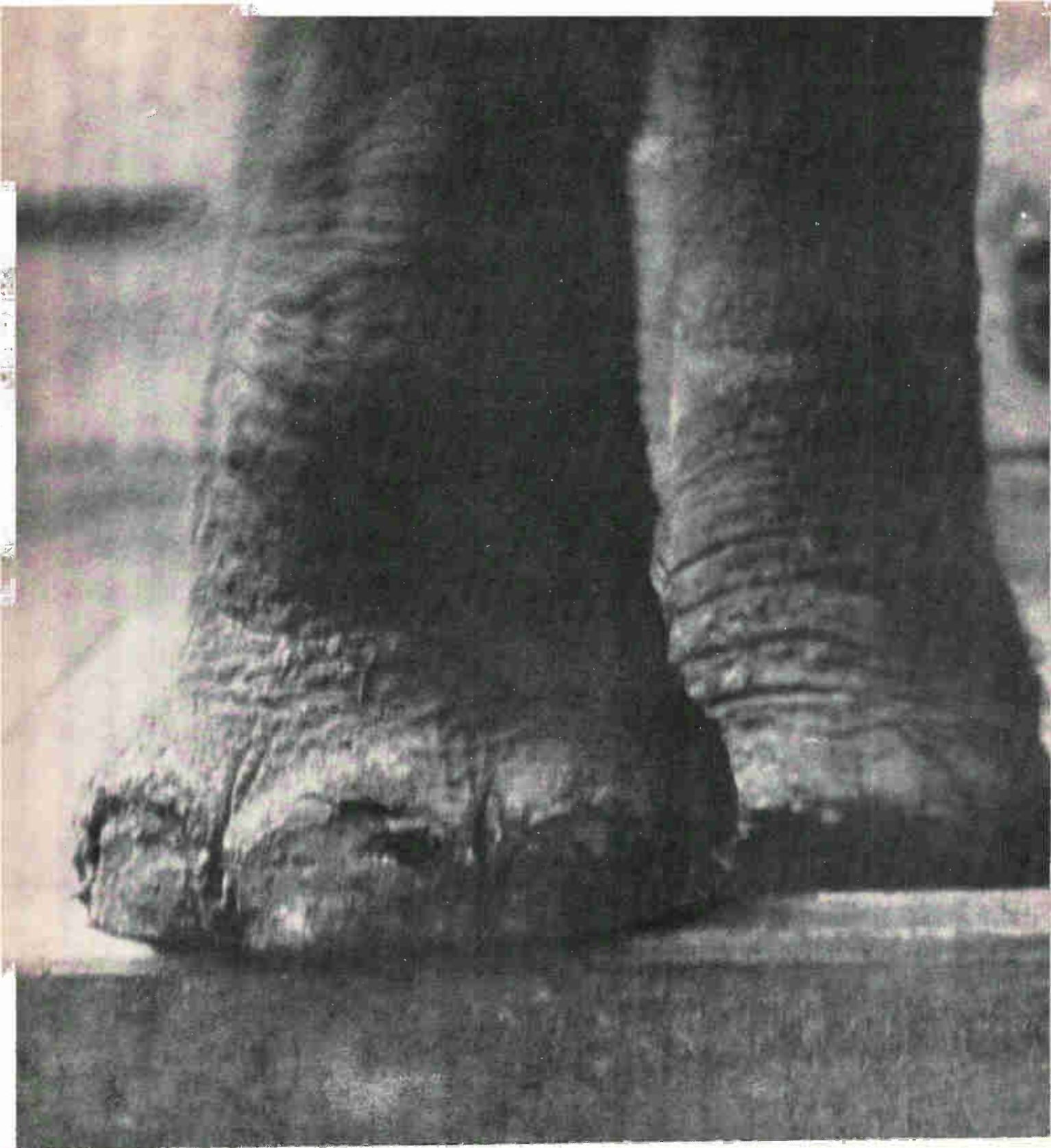

**Amphenol has 7000
different coaxial connectors.
Good thing we don't sell elephants.**

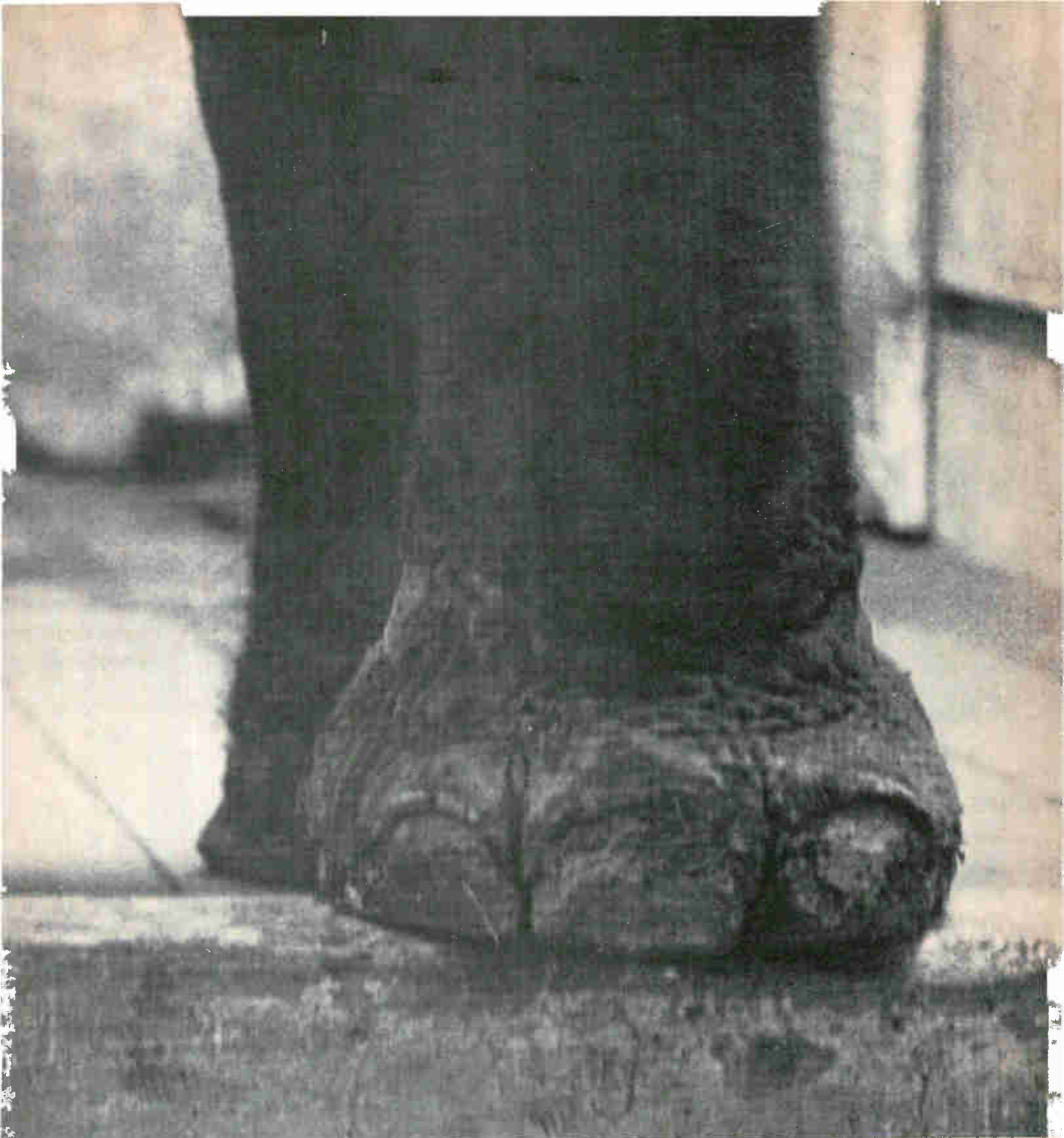

We have an existing design to fill every need.

From low-cost UHF types to the highly sophisticated 7mm precision connector. Connectors in all common series, including the new ones to meet MIL-C-39012. Subminiature connectors to MIL-C-22557. Crimp connectors in BNC, TNC, and N se-

ries. And adapters of all sorts.

You'll find these connectors in our complete, cross-indexed catalog—or on Amphenol distributors' shelves.

If you need a connector that's not in this wide range of products, our engineers will create one to meet your specific needs.

Get the full story from our sales

engineers or distributors. Or write us. (Unless you need elephants.) **Amphenol RF Division**, 33 E. Franklin Street, Danbury, Conn. 06810.



AMPHENOL

Specify Amphenol . . . the leading name in cable, connectors, assemblies, RF switches, potentiometers, microelectronics

Circle 19 on reader service card

The end of the non-portable portable

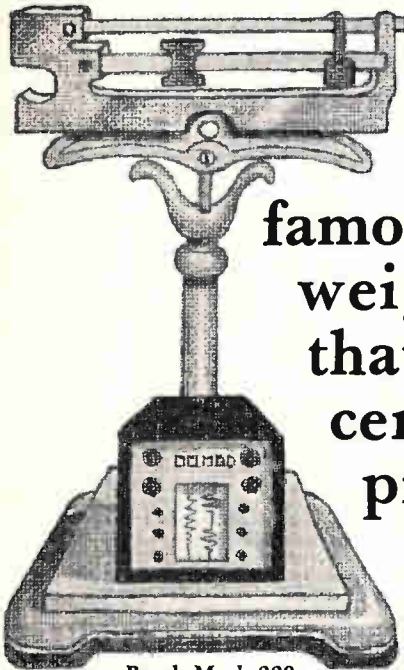

Brush Mark 220
weighs in at 25 pounds.

Mark 220 by Brush... a brand new recorder with a 25,000-channel pedigree. Behaves like its famous granddaddy, the Mark 200, but weighs only 25 pounds. Delivers traces that are unbelievably sharp, 99½ percent accurate. Solid state electronics provide position feedback pen control . . . no springs, no strings. The new Mark 220 has two channels for analog recording, two for

events. Maximum sensitivity is one millivolt per chart division, but the recorder is electrically protected from overloads as high as 500 volts. Pressurized writing puts smudge-proof traces into paper, and there's

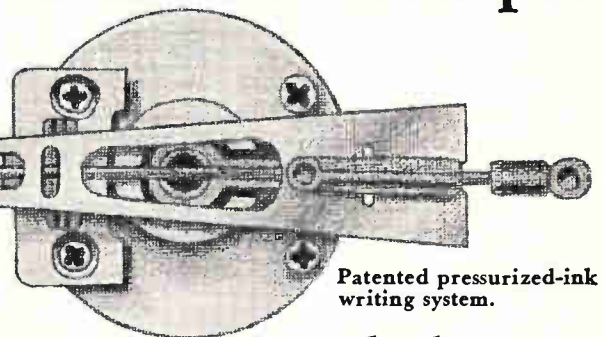

Patented pressurized-ink writing system.

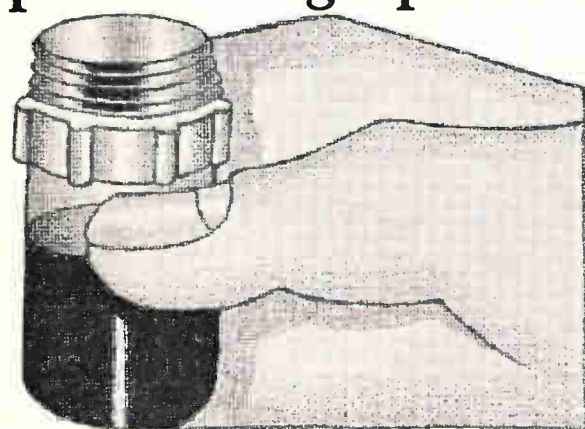

Throw-away ink cartridge—1000 miles between changes.

enough ink in the throw-away cartridge to last for about a thousand miles. Less than \$1700 will put you in business with this fine instrument. Call for a demonstration of the remarkable Mark 220,

and if you wish to keep the unit . . . we'll swap it for a P.O. number. Clevite Corp., Brush Instruments Division, 37th & Perkins, Cleveland, Ohio 44114.

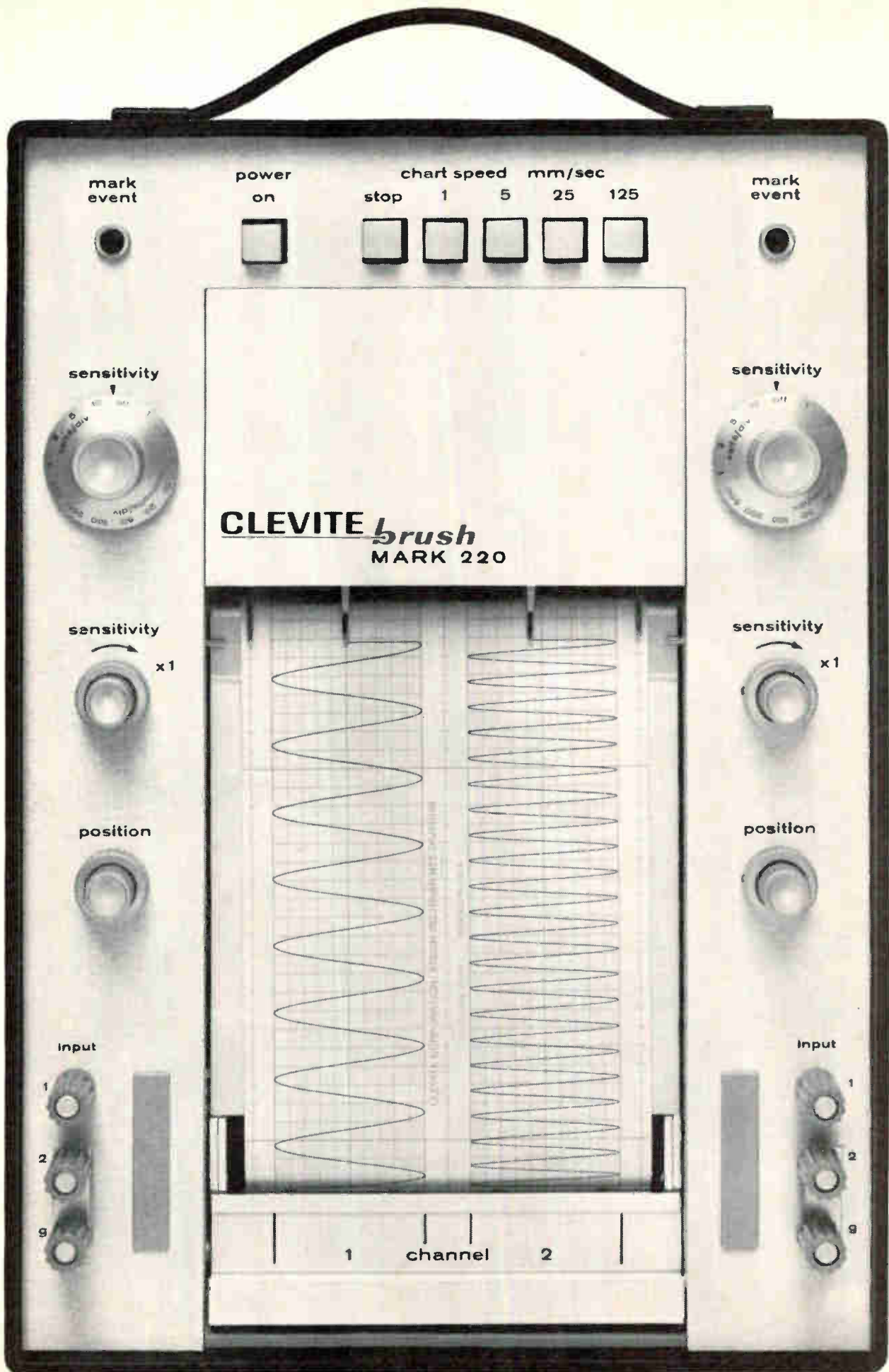

Shown 71% of actual size.

Circle 21 on reader service card

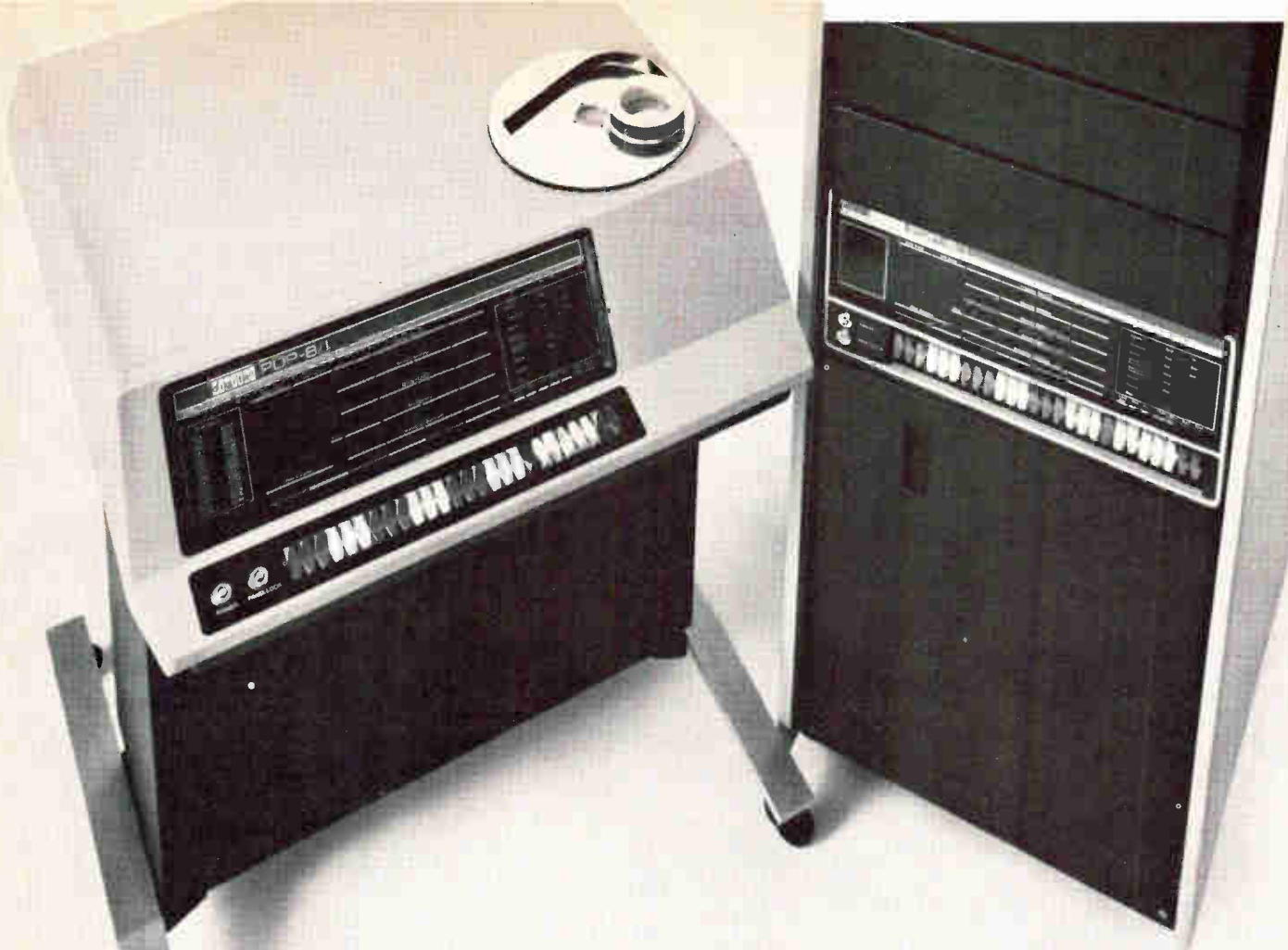

All time winner, move over- the new PDP-8/I computer is here

The integrated circuit PDP-8/I is a brand new computer, but behind it are the two most successful small computers ever built. Over 1,000 PDP-8 systems are already installed — an all time high for real-time, on-line small general purpose machines. Nearly 1,000 PDP-8/S computers are installed — all sold and delivered within the last 15 months. Built into instrumentation. On-line in process control.

So, PDP-8/I starts with a history and goes on from there. It has all the features of the PDP-8 plus a new ease of interfacing, expanded software and new options. It is more compact. PDP-8/I has a faster multiply-divide option (multiply 6.0, divide 6.5 microseconds). Its standard 1.5 microsecond 4K core memory expands to 32K (first extra 4K plugs into the basic configuration without further interfacing). PDP-8/I comes as a stand-alone console or mounted in a standard 19-inch rack. The processor is pre-wired so that it will accommodate a high-speed paper tape reader and punch, a 100 card-per-minute reader,

an incremental plotter, and a scope display also without further interface.

And software. The same proven software that runs the PDP-8, drives the PDP-8/I. Auto-indexing. MACRO. FORTRAN. On-line editing and debugging. But that is not all. New systems software is available which takes full advantage of 32K or more of DECdisk or DECtape memory. Thousands of the most active computer users in the world exchange PDP-8 programs and techniques.

Peripherals that go with the PDP-8 and PDP-8/S go with the PDP-8/I. Hundreds of logic-compatible modules make interfacing easy. Peripherals are field-installed by an applications engineering and field service group second to none.

And the crusher. PDP-8/I sells for \$12,800 complete. Quantity discounts reduce that price. Deliveries in the spring. PDP-8 and PDP-8/S available now. Write for brochure. We'll throw in our new Small Computer Handbook free.

digital
COMPUTERS • MODULES

DIGITAL EQUIPMENT CORPORATION, Maynard, Massachusetts 01754. Telephone: (617) 897-8821 • Cambridge, Mass. • New Haven • Washington, D. C. • Parsippany, N. J. • Princeton, N. J. • Rochester, N. Y. • Long Island, N. Y. • Philadelphia • Huntsville • Pittsburgh • Chicago • Denver • Ann Arbor • Houston • Albuquerque • Los Angeles • Palo Alto • Seattle • Carleton Place and Toronto, Ont. • Montreal, Quebec • Reading, England • Walkden Manchester, England • Paris, France • Munich and Cologne, Germany • Noordwkerhoot, Holland • Sydney and West Perth, Australia • Modules distributed also through Allied Radio

Editorial

Television rerun—in color

Shortly after black-and-white television won wide consumer acceptance, when World War II ended, a hue and cry arose about servicing. It wasn't until manufacturers were able to design in high reliability that the anguished cries from consumers died down. History is about to repeat itself in color television.

Complaints from consumers over the performance and servicing of television are growing louder and larger. In California, a state law has been passed requiring tv servicemen to pay a \$35 fee and register with the state. [See story on p. 127.] New York is talking about requiring servicemen to be licensed. More and more consumers are accusing tv repairmen of being charlatans, thieves, or worse.

The reaction is showing up in a slowing of sales of color-tv receivers. This summer, the Consumer Research Corporation in Philadelphia asked a group of consumers why they had not purchased color-tv sets. Many replied that they worried about reliability.* Although the sample was small, some of the comments made by these reluctant buyers are illuminating:

“. . . what's involved is really not only the repair of it, but there are so many things more that can go wrong with a color television set . . .”

“. . . the first thing is the amount of trouble you have. Something's always going bad on a color set.”

Manufacturers could well argue that these consumers were misinformed about the reliability of color television. But there is a problem here that has to be identified and a senior vice president at a set maker spelled it out recently. “We're making the best color-tv sets we have ever made,” he said, “but a small portion of them, like any kind of product, come off the assembly line and don't work. The core of the problem is that the average serviceman cannot fix these sets and they never get repaired properly. These lemons are ruining the reputation of all color-tv.”

At another set maker, an executive reached the same conclusion, though he put it differently. “I don't think the average serviceman is a crook,” he argued. “I just think he's inept. He does the best he can, but repairing a color-tv set is over his head.”

Investigating the servicing of color-television sets has uncovered some strange practices that tv servicemen have resorted to to make up for their lack of technical knowledge. “If your set is gone for two or three weeks,” one tv executive observed, “chances are good that your serviceman is taking it around from one repair shop to another trying to find somebody who

can fix it. What probably happens is that he'll finally take it to a factory service center, if the manufacturer has one, to get it fixed. You'll end up paying for all that moving around.”

Another executive said, “Sometimes when a serviceman can't find the real trouble, he starts replacing components in all the spots he thinks he could be causing the trouble. You could end up paying an \$80 repair bill when it should have cost you only \$15.”

Industry executives agree that when such an experience occurs, the average consumer is not likely to take the time to draw the line between fraud and ineptitude. As far as the set owner is concerned, he's been had.

The solution to such problems clearly lies in the manufacturers' hands, not the repair shop. Because of the increased complexity of the color-tv set (compared to a black-and-white set) and the added investment in instrumentation required for service, a few training lessons will not be enough. The manufacturer may have to go whole hog and assume all the responsibility for servicing his sets at factory-operated centers. Most makers have resisted this approach because in the past the tv repair shop has always worked best as a small business. But the need for factory-operated service seems clear now: General Electric, Zenith, Philco and RCA have long had factory-operated service organizations. Sylvania Electric Products and others are starting to move in this direction.

Next, the manufacturers will have to redesign color-tv circuitry for easier troubleshooting and maintenance. That demands a switch to aerospace-type packaging; putting components on modularized circuit boards, troubleshooting the modules, and then replacing troublesome modules which are returned to the factory for repair.

Although this is clearly the trend—and Motorola has already initiated it with its newly announced all-transistor color-tv—most companies feel they will require five years to accomplish such a changeover. The major reason is that aerospace-style packaging is so much more expensive than the “rats-nest wiring” still being used on many sets.

Still, manufacturers are going to have to make these two changes. The adoption of solid state components and integrated circuits in consumer products is only going to make this situation worse by obsoleting a lot of servicemen whose sole capability is testing tubes and replacing them. The answer to the repair problem for consumer electronics will have to be found in the engineering department of the manufacturers, not in the local tv repair shop.

* One other major point of buyer resistance reported by the survey is the difficulty in adjusting sets. Some typical comments: “I've seen a set change just by somebody walking across the room.”; “All the getting up and down, changing the knobs, apologizing for the fact that there's one shade of green and another shade of green made me lose interest in the football game”; “It's frustrating, constantly popping up and adjusting the color and it's very disruptive to good entertainment.” Clearly, set makers need to design some additional circuits to overcome these objections from color-tv holdouts.

CLIFTON HAS A WHOLE RAFT OF QUALITY AMPLIFIERS



Clifton is rapidly becoming known as an amplifier house. And why not, since we are designing and building a wide variety of amplifiers—and here's the best part—to stringent Clifton QUALITY standards.

For instance, Clifton has a new state of the art, low cost, high reliability servo amplifier for position

Our booster amplifier-resolver chains are another area in which Clifton excels. The amplifiers (single or dual channel) are built to MIL-E-5400 (as are all our amplifiers) and feature an overall loop gain of 66db. min. They are completely interchangeable within a system.

Additional Clifton amplifiers include frequency modulator isolation amps, summing isolation amps, resolver buffer amps and many more servo types.

Clifton also builds a number of power supplies and related servo system components. Look to Clifton for all your electronic module needs.

Contact Clifton Division of Litton Industries, Clifton Heights, Pa., 215 622-1000, TWX 510 669-8217, or our local Sales Offices.

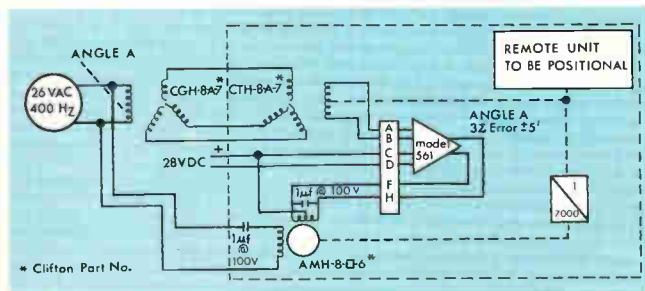

servo systems. It is Model 561. See the typical diagram above. Note also that Clifton rotating components are recommended in this system for their excellent matching qualities with our servo amplifiers (and vice versa).

CLIFTON 
DIVISION OF LITTON INDUSTRIES

Electronics Newsletter

November 27, 1967

Price cut may spur data transmission by satellites

By next year companies that operate internationally may start using communications satellites to relay engineering and financial data between their far-flung plants. The major holdback so far has been channel cost. **But within the next few months the FCC should rule on a proposal of the National Association of Manufacturers to divide some voice channels into six or seven data channels, thereby slicing the cost of a channel.**

Within two years, Washington insiders say, **satellite rates may be cut another 30% to 50%**, as satellites with more circuits go into orbit.

Major U.S. companies are anxious to get onto satellite circuits. An official of Eaton Yale & Towne says: "We're dying to hook up. Right now we have to make do with Telex hookups that allow us to move only the most important data between centers."

Some major companies, like IBM, have already used satellites for computer-to-computer talk, sending engineering data between the U.S. and France, and termed the experiments highly successful. None have yet put the system on an operational basis. **And within the next few weeks, a small computing firm, University Computing, Dallas, will try computer-to-computer tests via satellite.**

Astronauts may get a bigger launch role

Space agency insiders say NASA may soon give astronauts a more active role in the launch phase of future manned space flights. Although launch control will remain under the direction of automatic equipment and ground crews, an astronaut will receive enough information—both current and predictive—to take control of certain systems should failures in the automatic gear occur. A minor failure, in a noncritical gyroscope, for example, would not in itself scratch a launch.

Transitron raises state of op amp art

The widespread belief that monolithic bipolar integrated-circuit operational amplifiers can be substantially improved only by going to something like field effect transistor input arrangements has been shattered by the Transitron Electronics Corp. The company, a late starter in the linear IC field, has developed an op amp with features comparable to those found in far more expensive hybrid and discrete arrangements.

The concern says the monolithic, designated the TOA7709, has a minimum input impedance of 50 megohms, a bias current of 200 nanoamperes, an offset current of 50 na, and "other features that are at least an order of magnitude superior to the standard 709 op amp," currently the kingpin of IC linears. Transitron engineers developed higher-gain transistor elements, and modified the surface technology and oxidation and deposition processes to obtain these parameters.

The new device, due for introduction within the next few weeks, will be priced competitively with 709's, according to Stanley Harris, Transitron's sales manager. A lower-priced commercial version, the TOA8709, will also be offered.

Air navigation sales seen soaring in '68

Sales of inertial navigation systems for commercial and general aviation planes will spurt next summer, according to planners at Litton Industries. The company expects to deliver "just over 100" of its LTN-51 units next

Electronics Newsletter

year. Litton figures that American Airlines, now its biggest commercial customer for inertial systems, will get Federal Aviation Administration approval next July or August to use the LTN-51 as the primary means of navigation aboard its Boeing 707 planes—dispensing with human navigators—and other airlines will fall into line.

Marketing officials expect 80 to 85 LTN-51's to go to commercial airlines, at \$99,000 apiece, and the remainder to general aviation users, who will pay \$123,000.

Extending lives of big, small planes

New and old control methods are helping the aircraft industry solve problems that have harassed plane makers and pilots for years. One Honeywell project, using a complex theory developed about a decade ago, should make planes last longer. And another project, sponsored by NASA to reduce pilot workload, aims to provide better flight control systems for small private aircraft.

In its Load Alleviation and Mode Stability project, Honeywell Systems and Research division scientists have developed for the Air Force the first practical application of the highly regarded Kalman quadratic-techniques filter theory. A controller based on Kalman's optimization theory extends aircraft life, depending on structure, wind, and passenger-comfort conditions. It could lead to thinner skins, less hefty frames.

The system manipulates control surface reaction to wind disturbances, thus limiting flexures (bends or twists) so as to reduce metal fatigue. The less fatigue, the more chance the plane has to survive potentially catastrophic wind gusts.

Honeywell has analyzed and simulated the optimal control. A prototype, now being built, will be flight-tested early next year.

For the first time, NASA has tested in a wind tunnel a complete general aviation aircraft, a Piper PA-30 Cherokee. During a six-week test, completed about a month ago, NASA engineers obtained the plane's aerodynamic coefficients. One finding, for example, was that the autopilot had a 0.3-hertz bandwidth, the aircraft a 10-hz bandwidth—that is, the autopilot may limit the plane's dynamic response.

Military favoring mechanically despun satellite antennas

The larger, higher-powered stationary satellites that will be developed to upgrade the Defense Communications Satellite Program [see p. 60] will probably carry mechanically despun antennas despite the success of an electronically despun version aboard the Despun Antenna Test Satellite (DATS) launched in July.

Engineers at Aerospace Corp., systems manager for the DATS test, say a mechanically despun antenna promises a gain of 15 decibels—up to 1½ to 2 db better than the electronic version—for the planned military satellites. A mechanically despun antenna, developed at Hughes was first flown this month on the Applications Technology Satellite 3, and one also is being developed by Sylvania for Comsat's Intelsat 3 satellite that is scheduled to be launched next year.

Raytheon hits snags in air control gear

Raytheon is having technical problems with the computer display channel gear slated for use in the FAA's air traffic control system [Electronics, July 24, p. 141]. Washington sources say the FAA is planning to meet with company officials to discuss the difficulties and find out whether there will be delays in delivery, now scheduled for May 1968.

IDEAS

from SYLVANIA

INFORMATION DISPLAY

Think how much more useful this display would be in 2 colors

It IS 2 colors—red and green...

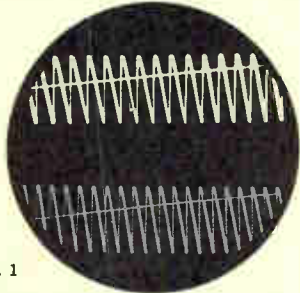

Fig. 1

... and it's not a split screen. Both colors are available — visually simultaneously — over the entire raster area. Thus Sylvania's new 2-color CRTs can display two entirely different sets of information with complete visual distinction between each.

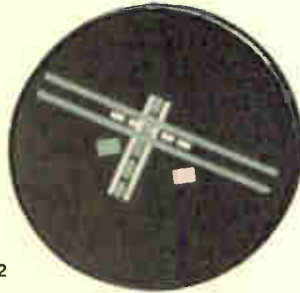

Fig. 2

Air-traffic control display. Here east-west airplanes and aircraft can be shown in red (lighter lines), while north-south information is shown in green (darker lines). This is typical of information-display versatility of our new one-gun, two-color CRTs.

CRT employs only one electron gun, with two layers of phosphor (red and green). Low voltage electron beam actuates the red phosphor; high voltage activates the green. By rapid switching from high to low voltage, red and green information appears visually simultaneously over full screen. And there is no shadow mask to reduce brightness or resolution.

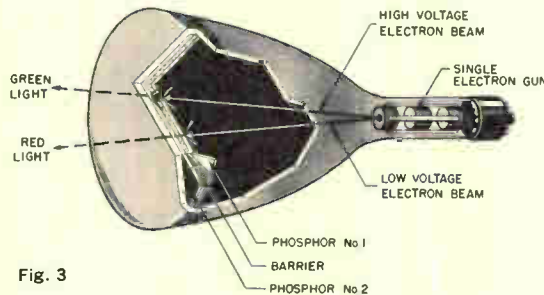

Fig. 3



Fig. 4

Tubes are currently being produced in 5" size (SC-4689, left, with electrostatic focusing and deflection) and a new 10" size (SC-4827, right, with electromagnetic focusing and deflection). On special order we can make them in any size from 1" screen diameter to 27".

Here, we think, is one of the most versatile information display concepts ever devised: an industrial/military-quality CRT that presents information simultaneously in two colors. Two types are available: a 5" size with electrostatic focusing and deflection, and the new 10" size shown, with electromagnetic focusing and deflection.

Extra two guns and three-dot phosphor used in conventional color CRTs aren't needed in our one-gun tube. This eliminates the precise shadow-mask control and alignment procedures normally used in color CRTs. And because dots of three different phosphors are no longer required for each information point, the new tube has very high resolution. This means more information can be displayed in a given area, increasing display space efficiency.

(Continued on next page)

This issue in capsule

Integrated Circuits — A TTL binary-to-decimal averager with SUHL™ circuits and functional arrays

Readouts — Random-access EL panels provide alphanumeric or pictorial information displays

Microwave Components — Schottky diodes lower 1/F noise and microphonics in doppler radars

Manager's Corner—Advancing the state-of-the-art in industrial and military cathode ray tubes

Diodes — Voltage-variable capacitors for automatic frequency control systems

Television — New lighter weight, lower cost color picture tube in 22" rectangular size

Elimination of the three-dot phosphors means there's no chance of misalignment which can cause the wrong phosphor to be activated by the wrong gun.

Our tube, on the other hand—using a red-and-green multi-layer phosphor combination and no shadow mask—provides the brightness, resolution and image quality of a monochrome tube...but in two separate and distinct colors. It's a 2-color image display in green and red (or other color combination) from a single gun, with the gun producing red from low voltage and green from high voltage.

These tubes are available in 5" and 10" round-face diameters (see Fig. 4), but other faces can be designed on special order. Both use a bright green and Sylvania's "rare earth" europium-activated red phosphor selected for contrast and high light output.

We recommend them for:

- Air traffic control systems
- Military identification systems
- Bio-medical equipment
- Stock market quotation units
- Teaching machines
- Electronic test equipment
- Computer displays

- Airline and other transportation-status boards
- Any application requiring discrete-color information display.

In air-traffic control displays, for example, these CRTs could be used to provide quick and positive information on different altitudes or stacked aircraft problems. Different colors could be used to indicate various runways, holding patterns or air traffic lanes (see Fig. 2).

In computer displays, color can be used to indicate particularly significant data or newly changed, added or deleted data. For alphanumeric stock quotation displays, red could be used to indicate a stock which has declined since the last quotation, and green a stock which has gone up.

Switching requirements and circuits

The speed at which color selection is required determines the type of switching circuits needed. System requirements should be analyzed to determine if field sequential rates satisfy the ultimate need. For example, all information to be displayed in one color may be presented, the voltage switched, and all information of the

second color presented. Such an arrangement may help to reduce transients and the need for extremely rapid switching.

5" electrostatically deflected CRT

Relatively fast switching speeds can be achieved with the basic circuit shown in Fig. A. This mode of operation is typical for our 5" electrostatically deflected CRTs. The second anode is at ground potential and the cathode is operated below ground by 6 KV. It is only necessary to switch the final anode between ground and +6 KV to select color.

With V_1 conducting, essentially the entire 6 KV is dropped across R_1 . The speed at which it is dropped is determined by C_x and the parallel resistance of R_1 and R_p of V_1 . When V_1 is cut off, the capacitance C_x charges through R_1 . For rapid switching, the RC product of $C_x R_1$ should be as small as possible, consistent with the available power source. The values shown are typical.

Since the time constant is considerably different from one state to the other, switching in one direction is considerably faster than in the other. Consideration should be given to the addition of shunt or series "peaking" to increase the charging speed of C_x through R_1 .

It should also be noted that, since the final anode of the CRT is changing potential, its effect on other parameters must also be considered. For example, the deflection sensitivity or deflection factor is different under the two modes of operation and, therefore, should be altered at the same time the final anode is switched. It may be advantageous to increase the beam current at the time the anode is switched to the lower voltage in order to maintain relatively constant brightness under the two operating conditions.

10" electromagnetically deflected CRT

The switching circuit for our 10" tube (Fig. B) operates with the cathode at ground potential. The final anode is switched over a range of from +6,000 volts to +12,000 volts. In this circuit arrangement, the 6BK4 stands off the entire anode voltage. During the interval that the 6BK4 is nonconducting, the anode of the cathode ray tubes is essentially at the supply potential.

During the time that the 6BK4 is conducting through R_1 , the final anode of the CRT is reduced in potential to a value whose product is equal to $R_1 p$. The maximum lp is limited to a value which is adjustable by the bias applied to diode D_1 .

Fast-switching requirement for 10" CRT
Fig. C illustrates the basic circuit for a fast-switching requirement. This shunt-series control arrangement virtually eliminates the $R_1 C_x$ time constant associated with Figs. A and B.

CIRCLE NUMBER 300

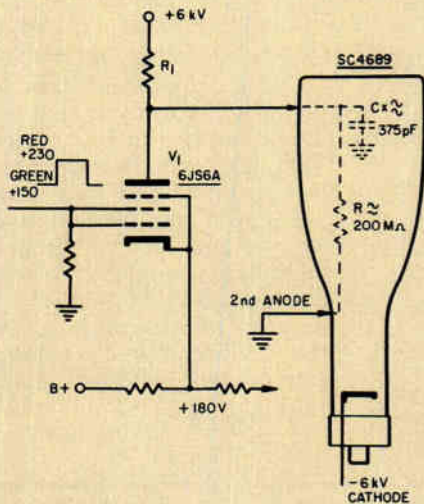

Fig. A

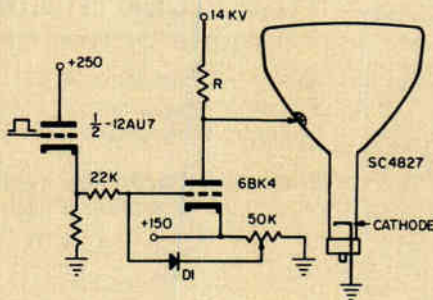

Fig. B

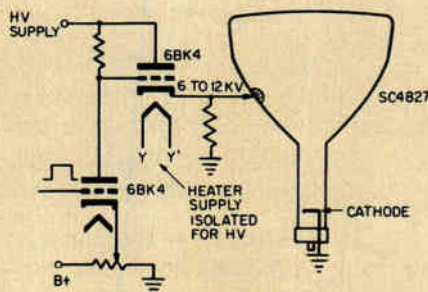

Fig. C

High-speed TTL binary-to-decimal averager using SUHL™ and functional arrays

This binary decimal averaging converter, designed by Sylvania for a specific customer application, illustrates again the range, capability and versatility of Sylvania integrated circuits. It also demonstrates the complete compatibility of Sylvania's SUHL line of TTL integrated circuits; here four different IC types work together in a TTL system with absolutely no special interfacing required.

This custom-designed circuit simultaneously accepts an 8-bit binary addend, an 8-bit binary augend, adds and averages them and provides an output coded for all forms of visual readout. And this system is open ended: by adding IC packages, larger numbers can be easily processed.

How it works

The system shown employs four SM-60 4-bit storage registers to accept addend and augend information; eight SM-10 full adders in an 8-stage parallel adder; four SG-140 NAND/NOR gates and seven SF-50 J-K flip-flops in a shift-left register that feeds into a binary to BCD converter made up of standard SUHL gates and flip-flops.

The SM-60 storage registers and the SM-10 full adders require true input only, thereby simplifying wiring requirements. But where necessary, an internal inverter in each SM-10 provides inverted output, which in this case the SF-50's require. By using these internal gates, only four SG-140 NAND/NOR gates are needed.

Addend and augend data are entered in the A and B registers simultaneously. An enable pulse gates the contents of the A and B register simultaneously into the 8-stage parallel adder, which then computes the sum.

A Logic # 1 on the inhibit line permits the sum to be asynchronously

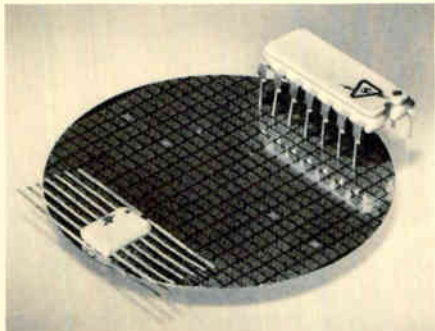

Fig. 1. Sylvania ceramic-packaged TTL SUHL integrated circuits used in binary-to-decimal averaging converter. System employs SM-60 four-bit storage registers, SM-10 full adders, SG-140 dual 4-input NAND/NOR gates and SF-50 AND-input J-K flip-flops. All are available either in Sylvania's 14-lead dual in-line plug-in package or TO-85 flat pack.

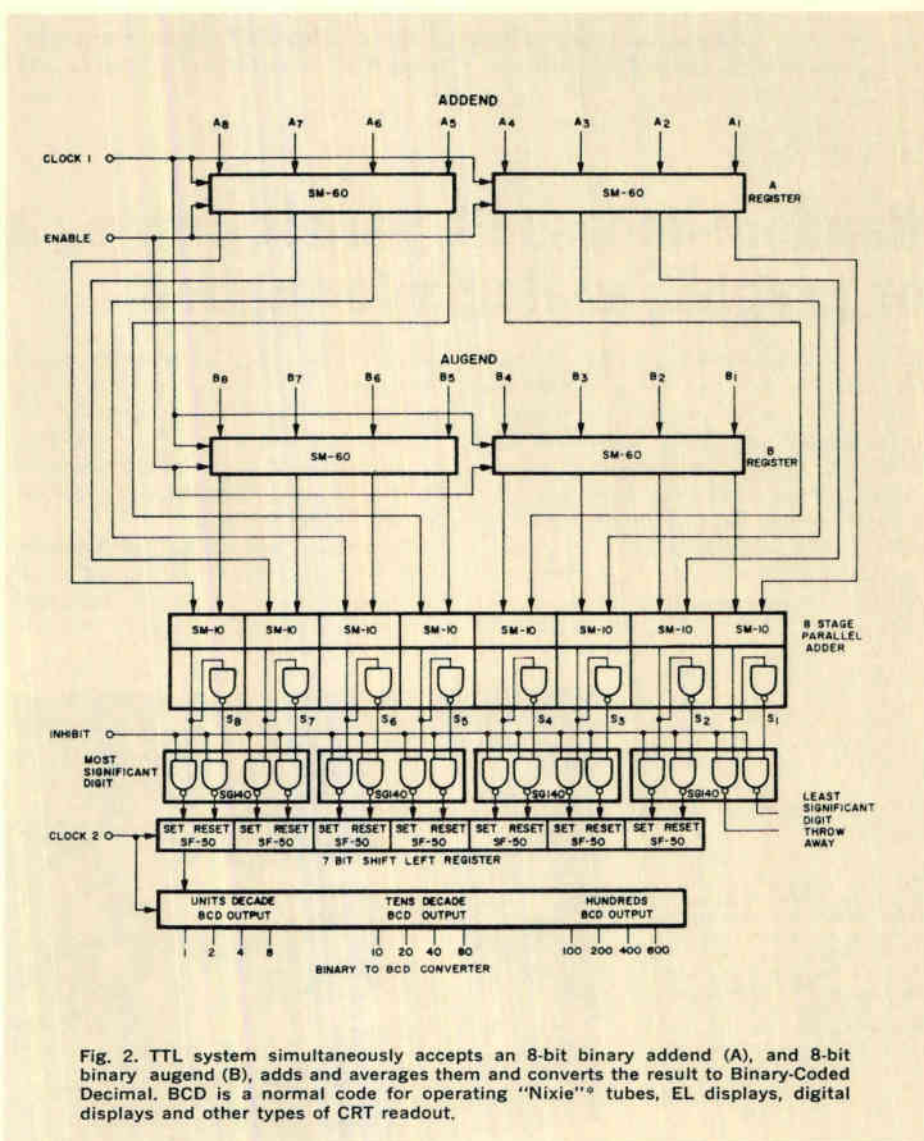

Fig. 2. TTL system simultaneously accepts an 8-bit binary addend (A), and 8-bit binary augend (B), adds and averages them and converts the result to Binary-Coded Decimal. BCD is a normal code for operating "Nixie" tubes, EL displays, digital displays and other types of CRT readout.

*Registered Trademark, Burroughs Corp.

entered through the inverting gates into a 7-bit shift-left register. Since the most significant 7 bits from the parallel adder are entered in the shift register, with the least significant digit being dropped, the sum is effectively divided in half to provide the average. The average is accurate to ± 1 binary bit; higher accuracy can be obtained if the least significant digit is used.

After 7 pulses on the Clock #2 line, the information in the shift register is entered in the binary to BCD converter. Total time from parallel input to BCD output: approx. 1.5 μ s based on a 5 MHz clock rate. You have to take it from there, depending on your system requirements.

Component Characteristics

The ICs used in this system are Sylvania's Monolithic Digital Func-

tional Arrays (SM-10, SM-60) and SUHL gates and flip-flops (SG-140, SF-50). These quality ICs offer complete compatibility, high noise immunity, high logic levels, proven reliability with low power consumption, and operations over both military and industrial temperature ranges.

SM-60 storage registers, one of the Monolithic Digital Functional Arrays, are saturated logic devices providing high-output drive capability from a single 5-volt power supply. It stores a "1" in 20 ns, a "0" in 25 ns, with 4-bit parallel read-in and read-out. Output current is 20 ma noise immunity ± 1 v, with a power drain of 30 mw/bit.

SM-10 full adders, also one of the Monolithic Digital Functional Arrays, are recommended for ripple-carry adder subsystems. This array will sum 2 digits in 25 ns and provide a carry in 13 ns. Only one package is

(Continued on next page)

required per stage, thereby reducing interconnections. A 64-stage ripple-carry adder subsystem built with SM-10s can add two 64-digit numbers in less than a microsecond.

Each SG-140 NAND/NOR gate contains four gates consisting of a 2-input AND gate followed by an inverting amplifier. They are extremely useful where multiple inverting functions are needed, or where multiple

drivers with fan-out capability of up to 15 are required as in clock distribution systems. The SG-140 series features high-capacitance drive (up to 600 pF), high logic swing ("0" = 0.26 v typ., "1" = 3.3 v typ.), low power consumption, and integral short-circuit protection.

The SF-50 J-K flip-flop is designed to implement high-speed logic systems with a minimum of gates and

interconnections. Three J and three K data-input connections provide the AND function right in the flip-flop, assuring high speed and reduction in system package counts. And the unit is raceless; the inhibiting action of the clock input also directly inhibits the J and K terminals to prevent any internal racing problem. And they're all designed to work together in one big compatible SUHL family.

CIRCLE NUMBER 301

EL READOUTS

Random-access EL panels display alphanumeric or graphic/analog information

How many different types of information display systems are available to you today? CRT digital or analog readouts and printouts, neon-bulb indicators, charts, pen-and-ink paper graphs, fast-switching bar graphs, meters, ticker tape, computer printouts . . . the mind boggles.

Here we plan to show you that our new electroluminescent random-access panels might provide more useful

output than other systems in many industrial, commercial and military applications and—hopefully—why.

Everyone has seen moving character displays such as the sign around the old Times Tower Building in New York's Times Square.

Now Sylvania has applied the same principle to electroluminescent readout systems—but with all the inherent superiority that EL displays provide.

Such as: light weight . . . ruggedness . . . low power drain . . . flat configuration . . . wide viewing angle . . . compactness . . . and those all-important Sylvania exclusives: hermetically sealed all-glass construction, high contrast, and high luminosity (to 15 fL, so the display is readily visible even in high ambient-light conditions).

Depending on switching circuitry, units can be made bi-stable or mono-stable. In bi-stable units, any "on" remains "on" till pulsed "off"; in mono-stable units, an "on" remains "on" so long as actuating current is applied. Using Sylvania computer technology, our engineers will help you achieve optimum switching design.

Each square on the grid is essentially a flat capacitor containing the EL phosphor material in a dielectric sandwich between two conductors, one electrode being common to all capacitors. Squares are switched "on" or "off" by solid-state digital integrated or magnetic circuitry for trouble-free operation and long life.

Squares can be switched in any combination or sequence to present letters, numbers, curves, maps, symbols . . . or moving displays such as air-traffic patterns.

As in the air traffic pattern at left (Fig. 2.), different shapes and symbols may be used to differentiate between aircraft. Direction of flight travel or wind direction may be indicated by arrows or other appropriate symbols. An aircraft symbol may be accompanied by a numeric readout to indicate flight number and altitude as well as position. There's literally no limit to what you can do.

These flat, compact, wall-type units are ideal for spacecraft, aircraft, submarine, shipborne or industrial instrumentation, meeting or exceeding military specifications. With versatility virtually unlimited, we consider them one of the most advanced concepts for visual information display available today.

We'll be glad to custom design our EL readout panels to meet your specific needs.

CIRCLE NUMBER 302

Fig. 1. Typical Sylvania high-brightness, high-contrast random-access electroluminescent panel element. Panel consists of a grid of EL squares with resolution as fine as 10 squares per inch. Any pattern of squares may be illuminated at random to produce alphanumeric or analog readout.

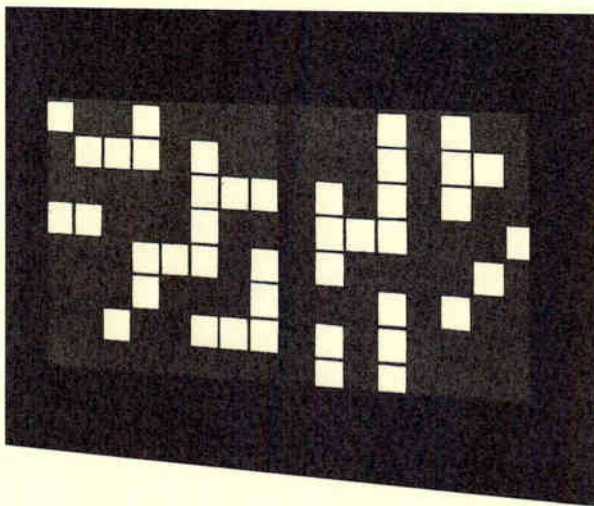
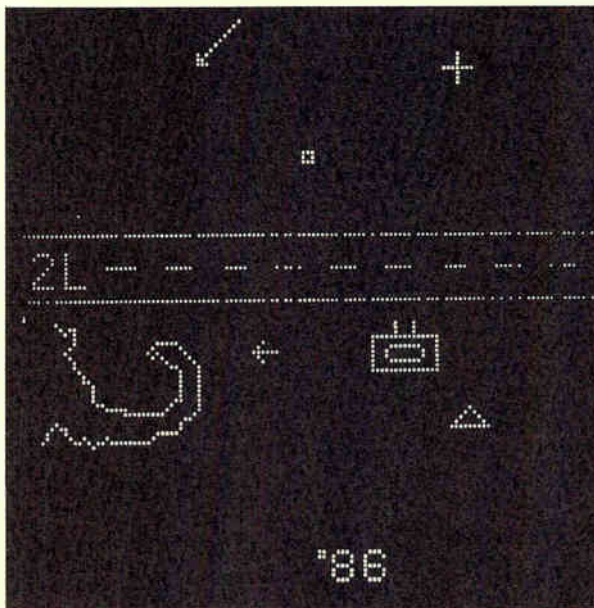

Fig. 2. Any number of elements may be combined into an uninterrupted large-board display like this air-traffic control pattern of an area of the Atlantic Ocean just east of Cape Cod. The outline of the Cape, airplanes and various aircraft in the vicinity are readily visible.



How to lower 1/F noise and microphonics in doppler radar systems

Traditionally, microwave mixer diodes used in cw doppler radar systems employing audio-range i-f frequencies have been of the point-contact type. But in point-contact diodes, 1/F noise levels and microphonics can cause spurious responses and excessive noise in the doppler radar receiver. Now Sylvania has developed Schottky barrier diodes for microwave mixer applications with 1/F noise levels as much as 12 dB less than levels obtained with conventional point-contact diodes. And they cover the entire microwave spectrum from L through Ka-bands.

The Noise Problem

Unwanted audio noise is generated in a diode due to the local oscillator action, or by outside disturbances such as shock.

The reduction of af noise that can be realized when using a Schottky rather than a point-contact diode is demonstrated in Fig. 1.

The Microphonics Problem

Microphonics — noise generated by mechanical motion of internal parts within a device—can also be a problem in doppler systems using low frequency i-fs. Figure 2 shows comparative microphonics output of a typical point-contact diode when subjected to shock, and a Sylvania Schottky diode when subjected to an equivalent shock. The figure speaks for itself: essentially no microphonics with the Schottky diode.

MQM Construction

Only Sylvania offers Schottky barrier diodes in the low-capacitance MQM package. The MQM package (only 0.08" x 0.20" overall) utilizes a low dielectric glass body hermetically sealed to precision mounting pins, providing a package capacitance of only 0.08 pF. This construction is ideal for broadband systems.

Beam-lead Construction

Beam-lead Schottky barrier diodes are bonded directly onto a non-conductive ceramic substrate which provides a convenient mount for use in stripline or microcircuits. This configuration provides an extremely strong, stable and vibration-resistant component.

Full Microwave Spectrum Coverage

Sylvania Schottky barrier diodes in the MQM package cover the microwave spectrum as follows (see Fig. 4) :

D5503	L to S bands
D5506	X-band
D5507	Ku-band
D5509	K through Ka bands

As an example of performance ca-

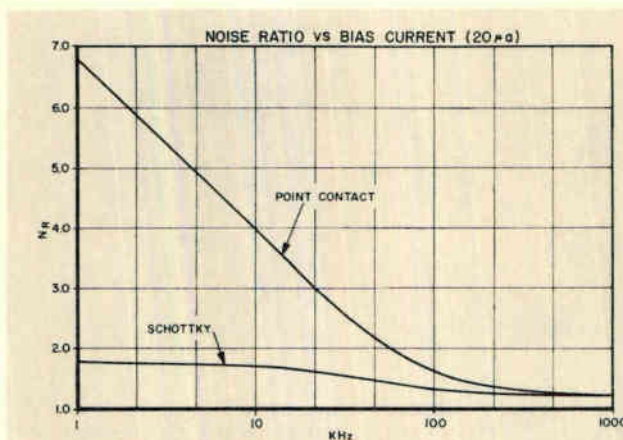

Fig. 1. Sylvania Schottky barrier diodes exhibit much lower noise-figure levels at low, doppler-type 1/F frequencies than point-contact diodes.

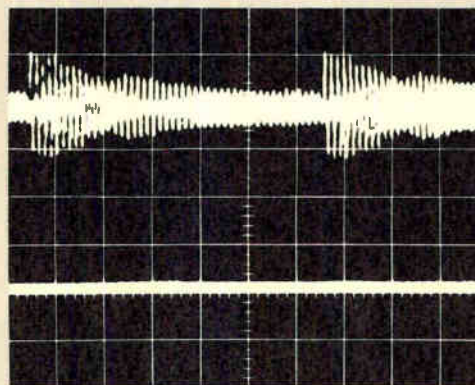

Fig. 2. Sylvania Schottky barrier diodes exhibit much lower microphonics than point-contact diodes. Upper trace is microphonic response of a point-contact diode when subjected to a shock; lower trace shows the lack of microphonic response of a Sylvania Schottky D5503 when subjected to the same shock.

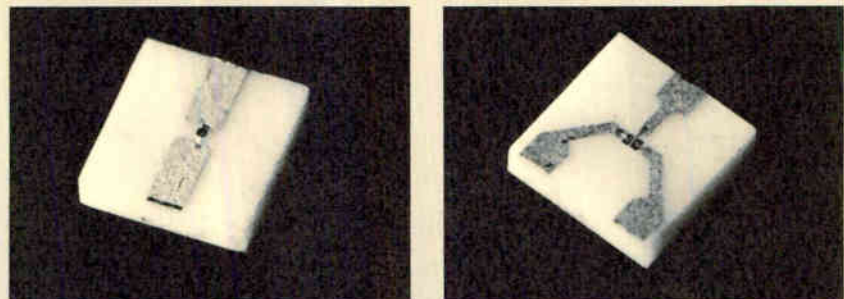

Fig. 3. Beam-lead construction. Beam-lead diodes are bonded directly to ceramic substrate.

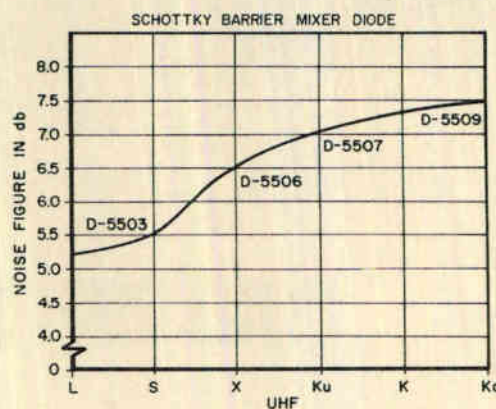

Fig. 4. Noise figure levels from L to Ka bands.

pability, our millimeter D5509C exhibits an overall noise figure of 8 dB. This low noise figure results from the low series resistance of the diode, which is achieved by keeping the epitaxial layer extremely thin, on the order of 1 micron.

Doppler radar systems will benefit from the use of Schottky diodes because of the inherently low 1/F noise. Prime examples of such systems are DME, altimeters, proximity fuses and police radars.

CIRCLE NUMBER 303

"A million of those, and half a dozen of these"

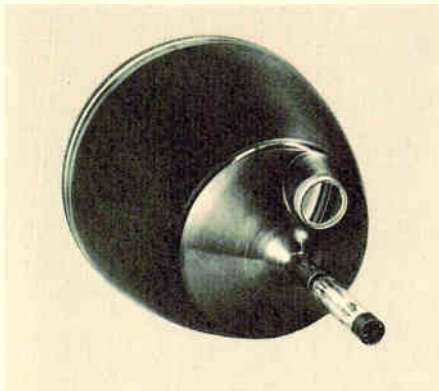

SC3875 — A rear ported CRT, 19" in diameter, allowing full optical access to the rear of the phosphor display... either to photograph the electronic image or to superimpose optical information with the electronics.

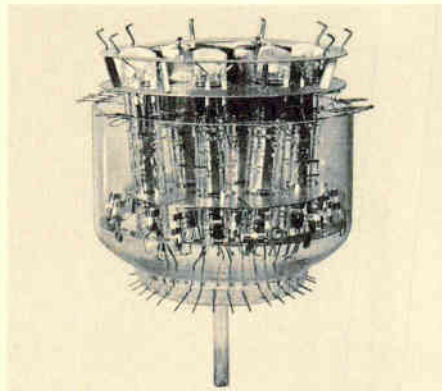

SC3814 — 6-gun tube assembly providing tremendous versatility in spectrum analyzer applications.

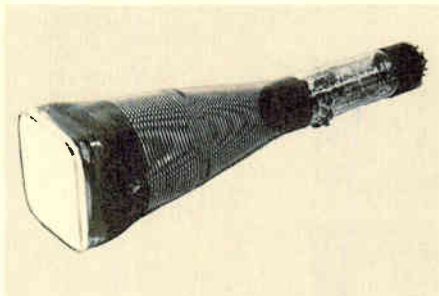

SC3511 — One of several CRTs which incorporate the exclusive low power heater cathode... If you have to carry around a battery for your portable displays, you should use a heater/cathode design that uses only 0.22 watts, rather than commonly used 4-watt units.

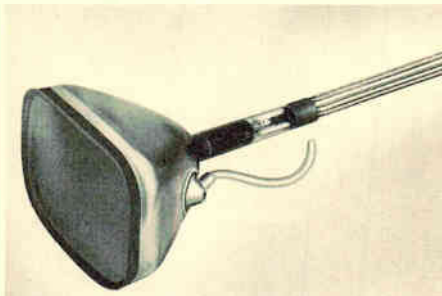

SC4649 — Developed to display 1000 lines at 1000 fL of brightness... for sophisticated cockpit displays in fighter aircraft.



SC4082 — A new fiber optics tube with a full 3"x 5" face... the largest fiber optics tube being made in quantity.

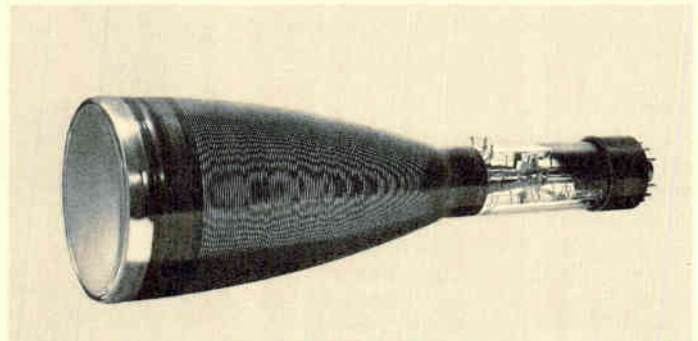

SC4689 — Provides, for the first time, a practical 2-color display capability to the display systems engineer.

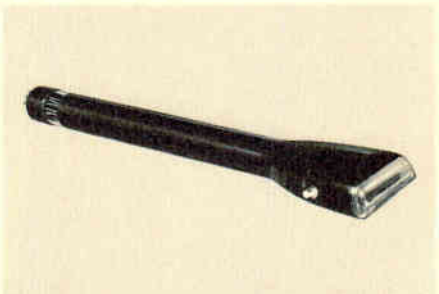

SC2795 — 3" electrostatic charge printing tube, allowing publisher to print address labels at the rate of over 120,000 per hour. Tubes are also in use with 5" and 8" matrix for very fast recording on hard copy.

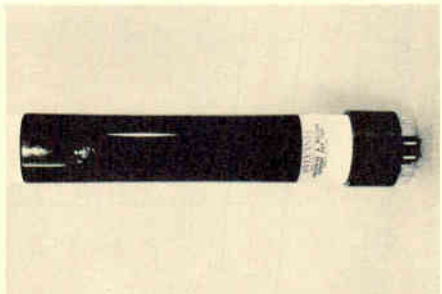

SC4648 — Monoscope with a library of 64 characters affording one of the lowest cost methods of character generation.

Most of our production facilities at Sylvania are geared to volume production... the manufacture of a broad line of electron tubes, semiconductors, phosphors, plastic parts, lighting products in the millions.

But in the midst of all this mass-production activity is Sylvania's Industrial and Military Cathode Ray Tube Department. Here an order for a half dozen tubes can be of major significance.

The purpose of this department is to design and build specialized cathode ray tubes. In most cases they are built to special order because they don't exist at the time. Our job is to make them exist. This requires a close relationship among customer, sales engineer and the tube design engineer.

That's how our Sylvania I and M CRT department can prototype a device which, someday, may be moved into mass production. Yet even in this prototyping operation, the foremost experts in glass, ceramics, heater and cathode processing from our Division Engineering Organization are available to solve problems.

Since we are primarily a prototype department, one of our jobs is to advance the state-of-the-art. That's why an order for even a half dozen tubes can be important... to you, to us and to the industry.

The types shown here give you an idea of our department's contributions... plus an indication of ways in which we might help you in the future.

These I and M CRTs are but a few of our designs... but none were developed just to put a new tube on the market. Sylvania designed them to meet specific display system needs.

ALFRED D. JOHNSON
MANAGER,
INDUSTRIAL AND MILITARY CATHODE RAY TUBES

If you don't need any of the display devices shown here, by all means call Sylvania. We'll help you develop the one you do need.

VVC's for automatic frequency control

Voltage-variable capacitance diodes offer designers an attractive alternative to mechanically restrictive methods of tuning. With these new solid-state devices, designers can now integrate the tuning function where it can best serve the electrical performance considerations, and exploit the new freedom from mechanical linkages to improve styling. Sylvania has just introduced the first of a line of voltage-variable capacitance diodes to reduce frequency control problems in automatic fine tuning adjustments in color and monochrome television, and fm receivers.

Sylvania's new D6743 voltage-variable capacitance (VVC) diode simplifies the design of automatic frequency control into electronic equipment. Utilizing the dynamic relationship of diode capacitance to applied voltage,

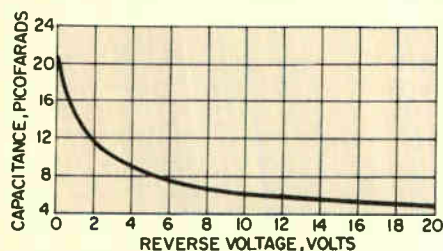

Capacitance vs V_R

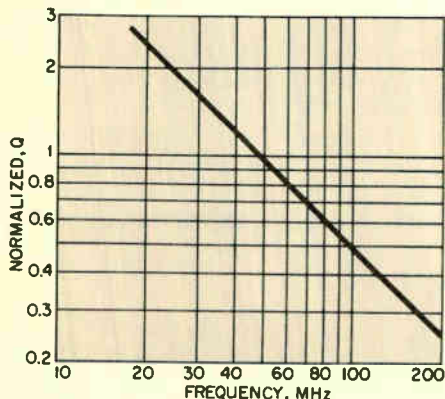

Normalized Q vs Frequency

these devices permit precise electronic tuning for automatic frequency control as desired in applications such as automatic fine tuning in color television sets. This effect can also be used advantageously in modulators for fm equipment, voltage-variable oscillators and sweep generators.

The VVC diode offers the physical advantages of small size, light weight, absence of microphonics, and inherently high reliability for electronically fine tuning with no necessity for additional mechanical complexity. Accordingly, these devices complement traditional, manual tuning methods to open new opportunities for remote tuning concepts.

The Quality Factor (Q) of the D6743 is greater than 200 at 50 MHz and with a reverse bias of four volts. Typical capacitance at these conditions is nine picofarads. The minimum capacitance change ratio is 1.25 over

an operating bias of four to ten volts. Operable over the temperature extremes of -65 to $+175^\circ\text{C}$, these new units are rated to dissipate 250mW, and handle reverse voltages to 20 volts.

The Sylvania D6743 unit is designed to minimize circuit complexities arising from series lead inductance. Featuring whiskerless construction, the DO-35 package retains wire-in flexibility, and still permits a low series inductance of 1.5 nanohenries.

The D6743 device, the first unit of Sylvania's line of voltage-variable capacitance diodes, is to be followed by the D6750 VVC diode for tuning the fm band. More sophisticated devices suitable for performing the total tuning functions in equipment designed for frequencies from uhf television through the a-m broadcast band are now in development.

CIRCLE NUMBER 304

D6743 RATINGS AND CHARACTERISTICS

ABSOLUTE MAXIMUM RATINGS AT 25°C:

Reverse Voltage, V_R	20 volts
Power Dissipation, P_T	250 mW
Operating Temperature, T_{oper}	-65°C to $+175^\circ\text{C}$
Storage Temperature, T_{stg}	-65°C to $+200^\circ\text{C}$

ELECTRICAL CHARACTERISTICS AT 25°C (except as noted)

	Conditions	Min	Max	Units
Breakdown Voltage, V_{BR}	$I_R = 1 \mu\text{A}$	20		V
Reverse Current, I_R	$V_R = 10 \text{ V}$		50	nA
Capacitance, C_{SH}	$V_R = 4 \text{ V}$ $f = 50 \text{ MHz}$	7.0	11.0	pF
Capacitance Change Ratio, C	$V_R = 4\text{V}/10\text{V}$ $f = 50 \text{ MHz}$	1.25		
Quality Factor, Q	$V_R = 4 \text{ V}$ $f = 50 \text{ MHz}$	200		
Temperature Coefficient, T_C	$V_R = 4 \text{ V}$ $f = 50 \text{ MHz}$	140	260	ppm/ $^\circ\text{C}$



Use Sylvania's "Hot Line" inquiry service, especially if you require full particulars on any item in a hurry. It's easy and it's free. Circle the reader service number(s) you're most interested in; then fill in your name, title, company and address. We'll do the rest and see you get further information by return mail.

BUSINESS REPLY MAIL

No Postage Stamp Necessary if Mailed in the United States

POSTAGE WILL BE PAID BY

Sylvania Electric Products Inc.
Sylvania Electronic Components
1100 Main Street
Buffalo, New York 14209

Dept. B99

FIRST CLASS
Permit No. 2833
Buffalo, N. Y.

Lighter weight, lower cost **color bright 85**[®] picture tubes in 22" rectangular size.

Sylvania has expanded its line of color bright 85 color picture tubes with the new integral tension-band and rim implosion protection system to include 22" types: the RE-ST4570 and the RE-ST4563A. This brings to three the sizes we offer with this new, improved system: a 15" size (T-Brand), a 19" size (Kimcode) and the 22" size (Kimcode). Both Kimcode construction sizes may be provided with optional mounting lugs on the tension band to simplify mounting the tube in the set by eliminating

harnesses and similar devices.

Our new 22" Kimcode-protected color picture tubes are shadow-mask rectangular types with almost straight sides, 90° diagonal deflection angle, employing Sylvania-developed rare-earth red phosphors to produce pictures of maximum brightness. They are lighter than bonded tubes of the same size, cost less, and—with optional integral mounting lugs (Type RE-ST4570) — can cut time and cost of set assembly.

The new tubes have a minimum

FEATURES	
Implosion protection.....	Kimcode
Minimum useful screen dimension	17.466" x 13.640"
Minimum useful screen area	227 sq. in.
Overall length	19.012 ± .375"
Neck length	6.693 ± .188"
Weight (approximate)	29 pounds
Deflection angle (diagonal)	90 degrees
Anode voltage (max)	27,500V
Phosphor	Includes Sylvania rare-earth Europium red

useful screen dimension of 17.466" by 13.640", producing a minimum projected area of 227 square inches. They are to be used in sets marketed as 20" units. They are electrically interchangeable with our familiar and popular RE-22KP22 (non-bonded) and our RE-22JP22 and RE-22LP22 types which have an integral protective window bonded directly to the faceplate. Each features a spherical, dark-tint, 42%-transmission faceplate, aluminized screen, electrostatic focus, magnetic convergence and deflection. Electron guns, spaced 120° apart, have axes tilted toward the tube axis to facilitate convergence of the three beams at the shadow mask. Internal magnetic pole pieces are provided for individual radial convergence control of each beam. Masks and face panels of each tube are aligned automatically by a computerized process which precisely establishes an optimized relationship.

CIRCLE NUMBER 305

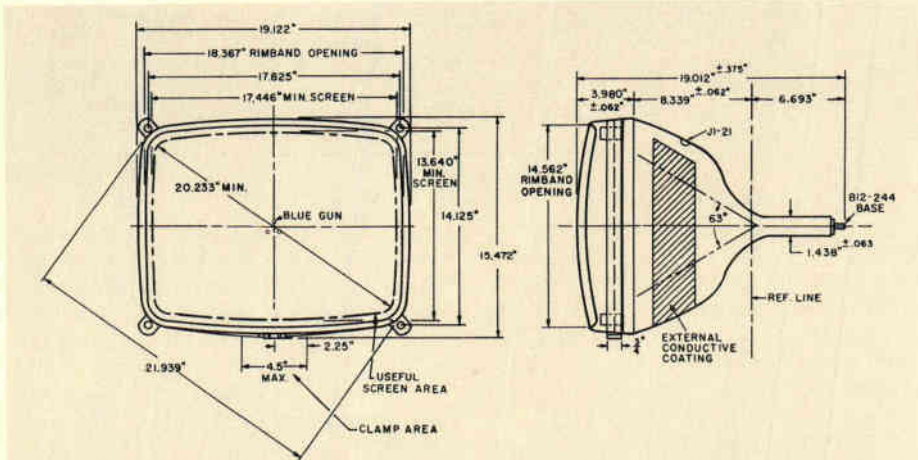

New Sylvania 22" color bright 85 color picture tube with integral Kimcode tension-band and rim-type implosion protection. Tension band may be provided with integral mounting lugs as shown (Type RE-ST4570) to speed and simplify set assembly... or without (as Type RE-ST4563A). It's the first domestically produced 22" color picture tube with rim and tension-band protection system and integral mounting lugs.

*Registered Trademark, Sylvania Electronic Products

SYLVANIA

A SUBSIDIARY OF
GENERAL TELEPHONE & ELECTRONICS

NEW CAPABILITIES IN: ELECTRONIC TUBES • SEMICONDUCTORS • MICROWAVE DEVICES • SPECIAL COMPONENTS • DISPLAY DEVICES

This information in Sylvania Ideas is furnished without assuming any obligations.

NAME _____

TITLE _____

COMPANY _____

ADDRESS _____

CITY _____ STATE _____

Circle Numbers Corresponding to Product Item

- 300 301 302 303 304
305

Please have a Sales Engineer call



HOT LINE INQUIRY SERVICE

Need information in a hurry? Clip the card and mail it. Be sure to fill in all information requested. We'll rush you full particulars on any item indicated.

You can also get information using the publication's card elsewhere in this issue. Use of the card shown here will simplify handling and save time.

Small wonder:



Our new "4th-generation" 12.5 MHz universal counter/timer. Wonderful versatility in a wonderfully small package — at an even more wonderfully small price.

With the new Model 100A you can measure average frequency, frequency ratio, single period or time interval, or count total events. It has a crystal-controlled clock, Monsanto integrated circuit construction, and built-in compatibility with a rapidly growing assemblage of accessory modules.

With its \$575* price tag (accessory modules are pegged at comparably modest rates) you can have big-league counter/timer performance at

costs never before possible. Small wonder we are selling (and delivering) Model 100A's just as fast as we can build them.

Call your local Monsanto field engineering representative for full technical details, or contact us directly at: Monsanto Electronics Technical Ctr., 620 Passaic Avenue, West Caldwell, New Jersey 07006. Phone (201) 228-3800; TWX 710-734-4334.

*U.S. Price. FOB West Caldwell, New Jersey.



ELECTRONICS

Circle 35 on reader service card

Plenty of customers told us what we could do with them.

Your ideas, your designs, your suggestions. These are the things that have made Bendix® JT connectors what they are today: Customer-engineered for numerous applications.

This means that among the thousands sold to date, there's bound to be a Bendix JT connector that's just made for your application.

Choose from crimp or solder terminations. Nine shell sizes—8 through

24. Eight shell styles. 40 different insert patterns with 16-, 20-, 22- and 22M-contact sizes that will accept a wire range of 16 through 28 gage. Included are Double-Density models with up to 128 contacts. Potted, grommeted and hermetic versions, too. All have improved environmental sealing and resistance to pin splaying and bending. Fewer components. Lot control for sensitive items.

Alternate keying to eliminate cross plugging. Better electrical characteristics through rigid, glass-filled epoxy inserts. Temperature capabilities to 392°F. continuous operation.

If we still haven't mentioned a feature you need, tell us. We might make it part of a Bendix JT connector for you. Contact The Bendix Corporation, Electrical Components Division, Sidney, N. Y.





- ✓ Complete selection and versatility
- ✓ Lighter, smaller
- ✓ Latest design improvements
- ✓ Jobber availability
- ✓ Proven acceptability



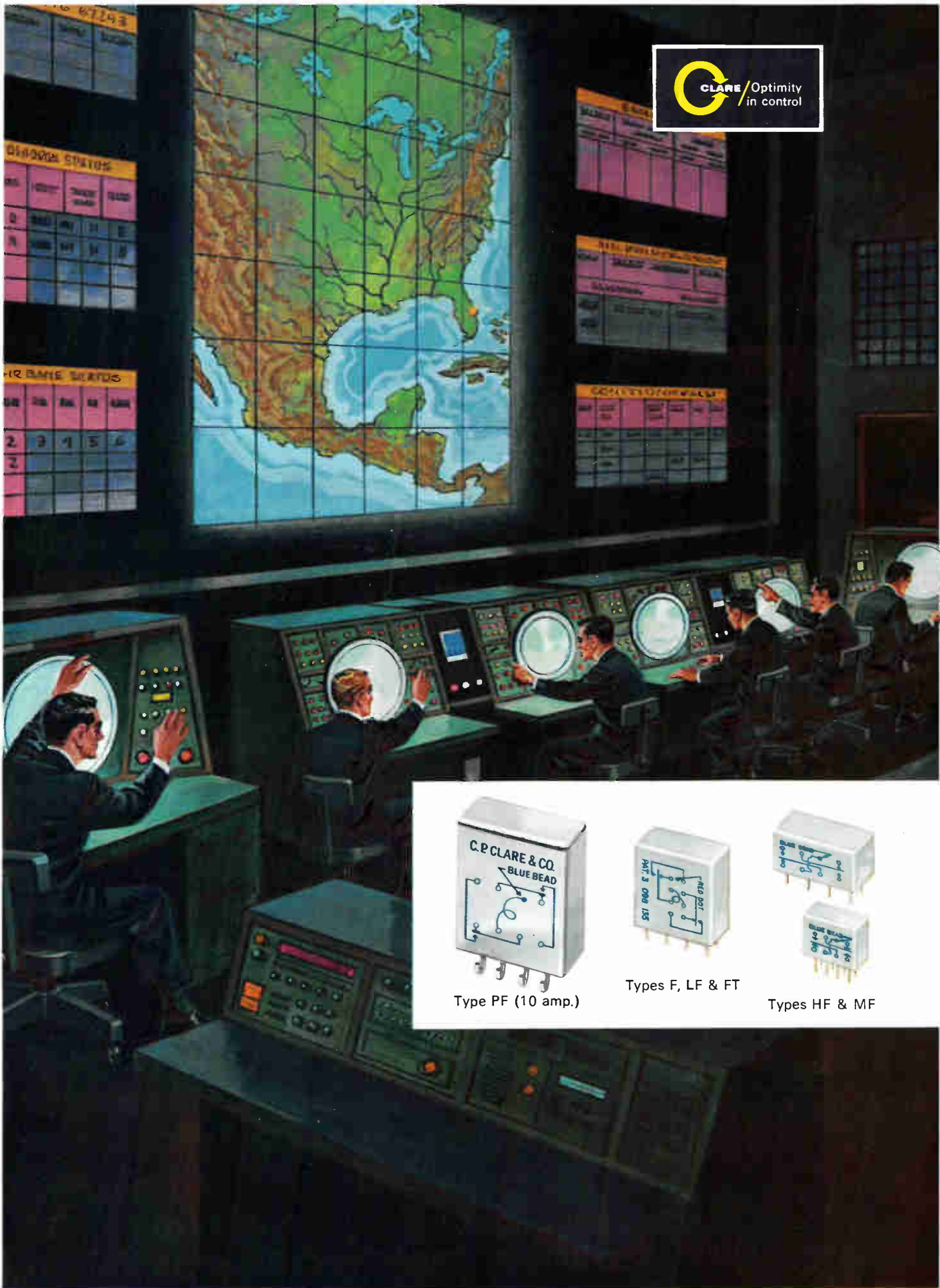

Type PF (10 amp.)

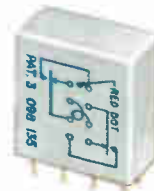

Types F, LF & FT



Types HF & MF

on the spot,

shaken, shocked, exposed to extremes of hot and cold, Clare Military-Type relays keep on working dependably!

Even the little Clare MF, at .046 cu. in., delivers full-size performance—fills low profile pcb's with high-density switching you can depend on. In fact, the whole Clare F relay family is tough, reliable—built for action!

Optimum performance is expected in environmentally demanding military and industrial circuits. Deliver it with the highly reliable, crystal can size Clare F, the latching LF, the half-size HF and the one-sixth size MF. If your system calls for 10-ampere capability, specify the new PF. Where noise and thermal voltage problems exist, use the Clare FT. All satisfy appropriate requirements under MIL-R-5757D.

Aim for new highs—in switching density and in reliability. Circle Reader Service Number, or ask Clare for current Bulletins . . . write Group 11N7,



C. P. Clare & Co., Chicago, Illinois 60645

a GENERAL INSTRUMENT company

- Long electrical and mechanical life under extreme conditions of shock, vibration and linear acceleration, and temperatures from -65°C to $+125^{\circ}\text{C}$
- Sensitivities ranging from 40 milliwatts
- Versatile contact capabilities . . . low level to 10 amp. Gold-plated contact areas, with high contact pressures and positive wiping action. Bifurcated contacts (F, FT, LF, HF)
- Welded cases available

CLARE MILITARY-TYPE (crystal can) RELAYS

for airborne, aerospace and ground support equipment, industrial and commercial control systems

Nothing Can Test MECL, ECL, TTL, DTL and Linear IC's Automatically

(except the 553)

Make us prove it! Call Test Systems collect in Houston at 713-349-2171 for information on the 553 Dynamic Test System. Or write TI, P.O. Box 66027, Houston, Texas 77006.

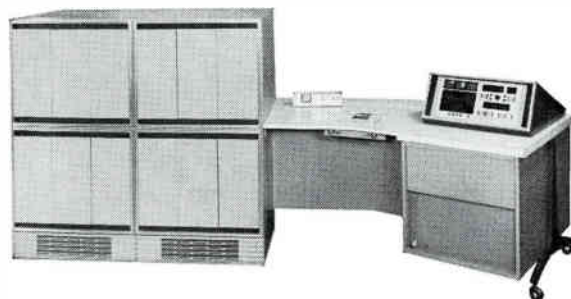

TEXAS INSTRUMENTS
INCORPORATED

947

These 5 blowers

belong



to the

world's

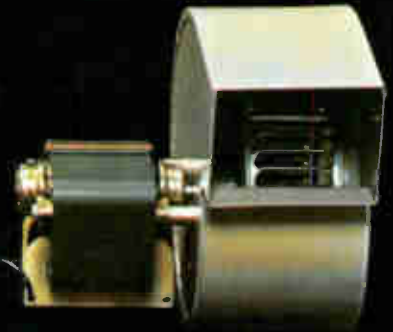
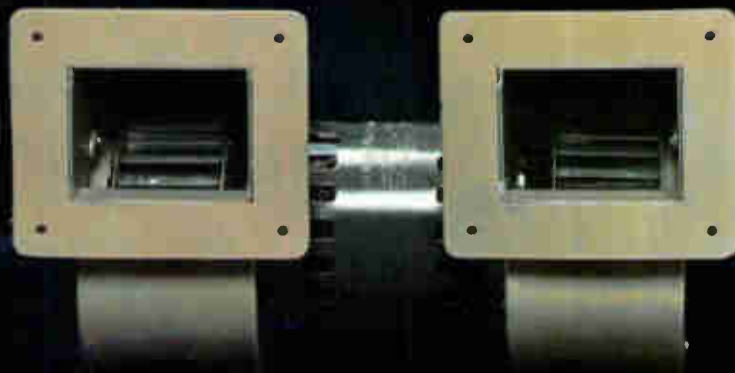

biggest

fan club.

TORRINGTON

Despite any resemblance, no two centrifugal blowers shown above are alike. For that matter, neither are any of Torrington's 67 other in-stock blowers identical. Except for one outstanding fact.

All 72 of these blowers are immediately available "off-the-shelf" units . . . models designed to lend themselves to a variety of adaptations. By merely interchanging standard parts these in-stock units have produced 216 different models for Torrington customers, and the end is nowhere in sight.

Whatever your specifications, whether high or low air flow, A.C. or D.C. motors, high or low resistance, single or double inlet, Torrington can make the centrifugal blower you need — faster, more economically, and in any quantity you desire, from mere dozens to the thousands.

We can't illustrate every type of blower produced in our plant. But if you'd care to see how far we'll go to meet your needs, write today for our catalog "Centrifugal Blowers by Torrington." Address your request to Torrington Manufacturing Company, Torrington, Connecticut.



*The more complex
the data system gets,
the simpler Cimron
can make it for you!*

Let's face it. You shouldn't have to be an electronics genius just to understand a system like the one shown here. You don't have to *design* the system to know what you want it to do—or to use it. That's where Cimron comes in. And the more complex the problem, the simpler Cimron can make it for you. That's what we're here for. To provide the expertise in this specialized field so you don't have to do it yourself.

The Model 1130 Production Test Applications System shown here monitors 100 channels of input signals, measures and records the data. It happens to employ a Cimron DVM with converters, a scanner, a serializer and a digital recorder. It could have been designed to solve your special problems as easily. For help, call Cimron collect at (714) 276-3200, or write Department A-112, 1152 Morena Boulevard, San Diego, California 92110.



The hope of doing each other some good prompts these advertisements

Send for man to squeeze mystique out of film

If you need the fastest film Kodak offers, order KODAK 2485 High Speed Recording Film (ESTAR-AH Base).

If you need a film that can run through an instrument wherein light from a glow tube or c-r tube will draw on it and then you want the results ready to look at as soon as possible, order KODAK 2491 RAR Film (ESTAR-AH Base).

Call for a Kodak Instrumentation Products Technical Sales Representative before actually ordering. Individual guidance is provided.

Instrumentation talk isn't quite the same as photography talk. There is less mystique in the selection of the medium. Sensitivity is considered to be a characteristic of the film, not the customer, and he doesn't mind our saying so, though it isn't true.



2485 is the same film you may have seen dramatized a few months ago with a picture taken by the light of a match of three men trying to stir up interest in the film on which they were photographed. They succeeded to a degree that necessitates dropping the tentative designation "SO-166." Supplied in 16mm, 35mm, 70mm, and various other widths of roll, as required for serious instrumentation.

Big feature is the *adjustability* in processing to the conditions of exposure and nature of subject. ASA Speed as defined in American Standard PH2.5-1960 is only 1000, as based on elaborate studies of public preference in contrast rendition for pleasurable pictures. This film can be processed and used that way. It is then difficult to distinguish from previous films of similar speed. With more intense development, *those* would only get murky; this one rises to new levels of light sensitivity. We can supply the required chemicals and advice.

Big problem is keeping unwanted light from reaching this film. Equipment and darkroom facilities must be tip-top. To prevent light from reaching emulsion by internal reflection from edge of film, optical density has been introduced into the film base. Base is of polyester for minimizing dimensional effects of temperature and moisture changes. Its strength permits thickness of only 0.1mm.

2491 has the same ESTAR-AH Base. It is probably even more desirable here. The relatively few (like geophysicists) who need 2491 need a lot of it. They need the dimensional stability for their measurements, and they need the comparative toleration of worklight and insensitivity to wavelengths longer than blue. Designed for almost instantaneous access to results through the KODAK SUPERMATIC PROCESSOR.

Call for the man through Instrumentation Products, Eastman Kodak Company, Rochester, N.Y. 14650 (phone 716-325-2000, ext. 3170).

Other fish to fry

We are selling out our PbS and PbSe infrared detectors. If neither "state-of-the-art" performance characteristics nor continued availability nor conformance to Kodak standards of predictability matters for the 1-5 μ application you have in mind, but cost does, and if you act while this page is still fresh from the press, you may be in luck. Action consists of sending for "Close-out Price List of Detectors" to Special Products Sales, Eastman Kodak Company, Rochester, N.Y. 14650. Therein a reader who has or can pick up a little grounding in infrared technology will find enough frank technical information to do better than merely reach into a grab bag. As these words were written, detectors were still available at prices from \$2.30 to \$110, f.o.b. Rochester, N.Y., minimum order \$25.

A successful, constantly growing business is constantly deciding in what directions to grow. Decisions represent judgments on where the particular set of talents that have been attracted into the fold can make their best contribution, as compared with the talents that other organizations have attracted. The men who could have kept us out front in development and manufacture of photoconductive detectors were needed in other work for which Kodak was uniquely well fitted. So the lead in the photoconductive art passed elsewhere. We pulled over, waved the new leaders past, and leave it to you to discover their names and addresses.

Meanwhile, note on the bargain counter: D* from 10⁸ to 8 \times 10¹⁰, time constants from a millisecond to 2 μ sec, resistance per square in range of 0.2 to 2 megohms, sensitive

areas from 0.02 x 2.0mm to 20 x 10mm, room temperature or to be cooled, some resistant to heat and high humidity and some resistant to permanent high vacuum, plug-in mounted or just with leads from the low-sodium glass or KODAK IRTRAN 3 Optical Material substrate that passes infrared to 6 μ .

D* is expressed in units of cm/watt-sec^{1/2} by the equations $D^* = \frac{V(\Delta f)^{1/2}}{JNA^{1/2}} = \frac{(A\Delta f)^{1/2}}{[NEP]}$

where V = rms value of signal in volts
 Δf = frequency bandwidth in cycles/sec
 J = rms value of radiant energy flux density in watts/cm²
 N = rms noise in volts
 A = sensitive area of detector in cm²
 [NEP] = noise equivalent power, the rms value of minimum radiant energy flux in watts necessary to give signal-to-noise ratio of unity

Imbibing apparatus ready

Lunar Orbiter is finished. Some people met in a big auditorium last month for the final summation that marked the transition from a project to just an entry in the history of technology. Pleasant it is for us to contemplate how well it worked: image-motion-compensated pictures on conventional film of the entire lunar surface; processing in an aqueous medium in circumlunar orbit by an operator who gets to sleep in his own bed each night; translating the image on the film into a video signal and that back into finished photographs of anything bigger than a card table.

To go a step beyond self-congratulation we have spread upon the record in *Journal of the SMPTE* (August '67) five papers full of detail about the over-all Lunar Orbiter photographic system, about our camera, about our eminently portable process-dryer into which the camera fed, about our readout, and about our ground reconstruction assembly.

Not the least important engineering accomplishment was the demonstration of what a nice job of processing fairly conventional film can be done by bringing it into contact with imbibed KODAK BIMAT Transfer Film, viz.:

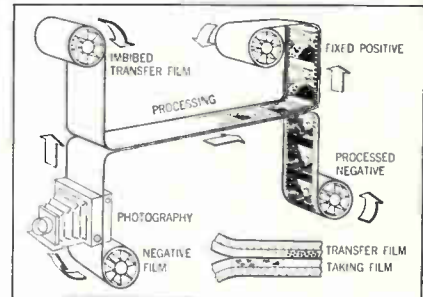

Clicking away inside Lunar Orbiters, this principle turned out work like the view of Copernicus:

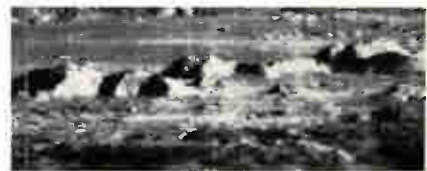

Heartened by these and less widely publicized triumphs of imbibed BIMAT Transfer Film, we have placed our imbibing apparatus in a state of quick readiness. Other apparatus for working with BIMAT Transfer Film, including some for those who prefer to do their own imbibing, is waiting in the shops and warehouses of other manufacturers.

Delighted to send you their names. Also word on possibility of seeing the positive within 15 seconds after contact. Inquire of Industrial Photo Methods, Eastman Kodak Company, Rochester, N.Y. 14650.

Kodak

Bendix Autosyn 08 Synchronos.



For weight-conscious engineers.

The average weight of Bendix® size 08 Autosyn® synchronos is only 1.3 ounces. And their maximum diameter is 0.750". That's a great combination for trimming down servo systems.

There are 16 standard 08 units to choose from. Some are radiation-resistant. Some will perform accurately at sustained temperatures up to 800°F. All have flexible 12" leads, corrosion-resistant construction and aluminum housings.

Stainless-steel housings are avail-

able too. So are hundreds of other Autosyn types in 10, 11, 15 and 22 sizes. As well as Mil-Spec synchronos up to size 37. You're almost certain

From Catalog 25	Function	Voltage	Max. Error
AY080AA-40-A1	Transmitter	26/11.8	7'
AY080AA-42-A1	Receiver	26/11.8	—
AY080AA-36-A1	Control Transformer	11.8/22.5	7'
AY083AA-43-A1	Control Differential	11.8/11.8	7'
AY082AA-53-A1	Resolver	26/11.8	7'

to find exactly what you need. And if you don't, we can design one for you. We've been doing it for 40 years. No wonder so many engineers rely on Bendix synchronos for performance and dependability. And why you find them in the 747, C-5A and F-111, to name a few. There's no better value anywhere. Ask for our catalog and see for yourself. The Bendix Corporation, Flight & Engine Instruments Division, Montrose, Pennsylvania. Phone: (717) 278-1161.



**Aerospace
Products**

Electronics Review

Volume 40

Number 24

Communications

Point of view

Today's broadcast television signals require a bandwidth of about 4 megahertz. This is necessary for commercial tv, but for the American Telephone and Telegraph Co.'s Picturephone, or relay of tv signals from surveillance systems, satellites, or space probes, it's too broad; aside from taking up so much frequency spectrum, it requires costly broadband circuitry and gobbles up power.

The Bell System, the International Business Machines Corp., and others have for some time sought to reduce the bandwidth needed for tv.

An answer has been found at the Air Force Cambridge Research Laboratories, Hanscom Field, Mass. The technique makes possible a reduction to about 160 kilohertz with some picture degradation, and to 800 khz for high-quality pictures.

Rather than using bandwidth-greedy interlaced raster scanning, as in broadcast tv, the scientists at Hanscom Field's data sciences laboratory use what they call pointwriting. The technique takes advantage of the integrative property of human vision, which makes movies appear flicker-free, to reduce scan rates and thus to slash bandwidth.

Little distraction. Pointwriting divides the cathode-ray tube's surface into an arbitrary pattern of rectangles. It does the same for the vidicon tube. Each area is then randomly scanned for picture content in a sequence designed for the least possible viewer distraction.

Finding the best pseudorandom scanning sequence was one of the problems encountered in development of pointwriting. Air Force en-

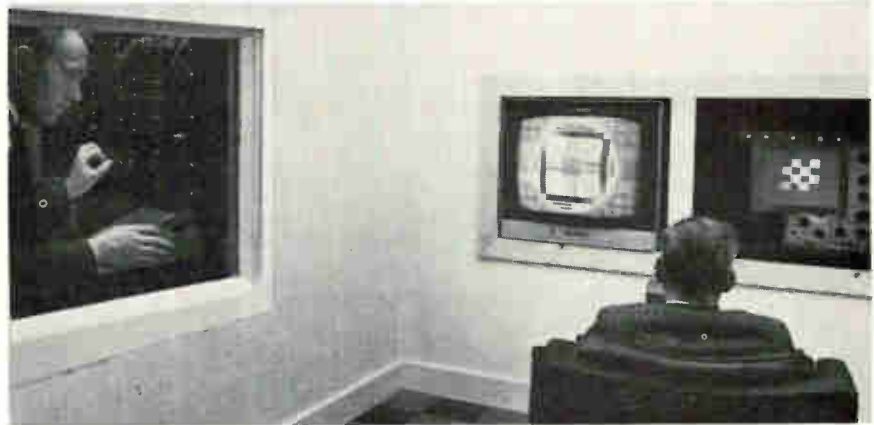

Picture judging. Subject evaluates tv picture as engineer trims bandwidth to as little as 160 kilohertz, compared with the 4 megahertz used on broadcast tv.

gineers were forced to construct a variety of scanning circuits and then try out each one in viewer tests. It took them two years to come up with a system which yields a picture whose quality appears high to an observer, while using only about one-fifth the standard tv bandwidth.

As in broadcast tv, the entire picture is scanned and transmitted frame by frame, but in dotted sections, not in interlaced raster lines. The frame rate is far slower than that of commercial tv.

In viewer experiments, the time it takes to update the entire picture was varied from as little as 1/60 of a second to as much as once every 6 seconds. Depending on picture contrast and image motion, the system worked well at either rate.

With an almost totally gray picture (very low contrast), the scan rate had to be high for adequate perception: first, because the picture was hard to see in general, and second, because crt phosphor decay made it impossible to store the picture long enough for it to be seen clearly.

High-contrast pictures, approaching all black or white, required the slowest scan rates—the picture was easily visible and phosphor

decay rate was less troublesome.

Drawbacks. Phosphors are still a problem in any case, however, especially if the picture is that of a moving object. A fast-decaying phosphor makes the picture flicker; one with slow decay causes blurred images.

An optimum decay rate for a crt phosphor would be about 1/10 of a second, according to the head of the data sciences laboratory, Robert Alexander. But nobody builds a crt with such a phosphor, so the lab has had to use a variable memory storage tube to simulate the proper decay rate in its experiments.

As yet, no operational system is due to come out of these experiments, but the Bell System has asked for briefings on the technique, as has IBM—perhaps with computer displays in mind. Next step for the Air Force will be to investigate a variety of other bandwidth reduction techniques, says Alexander. He hints that even further reductions may be possible.

Tiny waves for Navy

One answer to the unending sos from users of the crowded frequency spectrum in marine and mobile land communications is to

go to millimeter waves. The Navy has heard the message; it will accept delivery in January of the first millimeter transceiver ever put to work. Designed and built by Sylvania Electric Products Inc. for line-of-sight operations, the device will operate between 36 and 38 gigahertz at up to 15 nautical miles.

The all-transistor transceiver puts out 100 milliwatts of power—state of the art for transistor devices at those frequencies—in a narrow beam that insures privacy. Ships would be able to replace that venerable guardian of maritime privacy, the blinker light. Carrier-to-noise ratio in the frequency-modulated transceiver, a superheterodyne type, is about 27 decibels.

Talk for two. Though built for single-channel operation—it handles a two-way telephone conversation—the transceiver easily could carry more bandwidth. It also includes a call-alert channel that indicates when another station is attempting to reach it. A rotating horn antenna scans the horizon for incoming signals.

Transmission is barely hurt by fog or moderate rain, Sylvania found in tests. In medium-to-heavy rain, however, range may drop to

a little more than five miles.

Reflections, and reserve signal strength permitting operation from side lobes, make it possible to talk through obstacles like ships, low buildings, and trees, at certain ranges.

The Navy will test the transceiver on standard signal light mounts and operators will aim the beam in the right direction. Sylvania has already done just that in recent tests between shore stations, amphibious crafts, and a command ship in choppy waters off the Pacific Coast.

Medical electronics

Spark of life

As heart patients who wear pacemakers well know, when the device stops, death is only moments away. And medical electronics engineers gloomily concede that premature battery failures constitute the greatest single threat. Unfortunately, since the battery, like the pacemaker, is surgically implanted in the patient's body, the power

source can't be examined without an operation. Now two teams of researchers—one from Boston and another from Newark, N.J.—have worked out a way to check a battery's performance by measuring the pacemaker's pulse by taking the patient's electrocardiogram (EKG).

The Boston technique was developed by G. W. Sandberg, a student at the Harvard Medical School, during his summer recess; he was aided by researchers from Massachusetts General and Boston City hospitals.

If the team's preliminary results are borne out in subsequent tests, a clinic may be established to conduct routine, periodic checkups.

Beyond the test. The Newark program, undertaken at Beth Israel Hospital, has gone one step further. There, a small clinic has already been set up for periodic examinations. What the researchers are seeking in their EKG studies are very small aberrations in the received signal. For example, in the Boston test the EKG signal is read out on a dual beam oscilloscope; one scope trace provides the pacemaker rate, the other displays an expanded pulse waveform. With this information, data is gathered on pulse repetition rate, width, amplitude, and other parameters.

Researchers say that very slight changes in the battery's performance or in the interface between the battery leads and the patient's heart show up as subtle changes in the pacemaker's signal.

In the Newark program, an electronic counter is used in addition to an oscilloscope. With the counter, the researchers say, more exact data can be collected.

Not all researchers agree on the efficacy of this technique. One medical electronics expert, David Geselowitz, a professor of electrical engineering at the University of Pennsylvania's Moore School, says his investigation of the technique failed to determine a clear correlation between pacemaker pulses and impending failures.

His criticism was voiced this month at the Boston Conference on Engineering in Medicine and Biology.

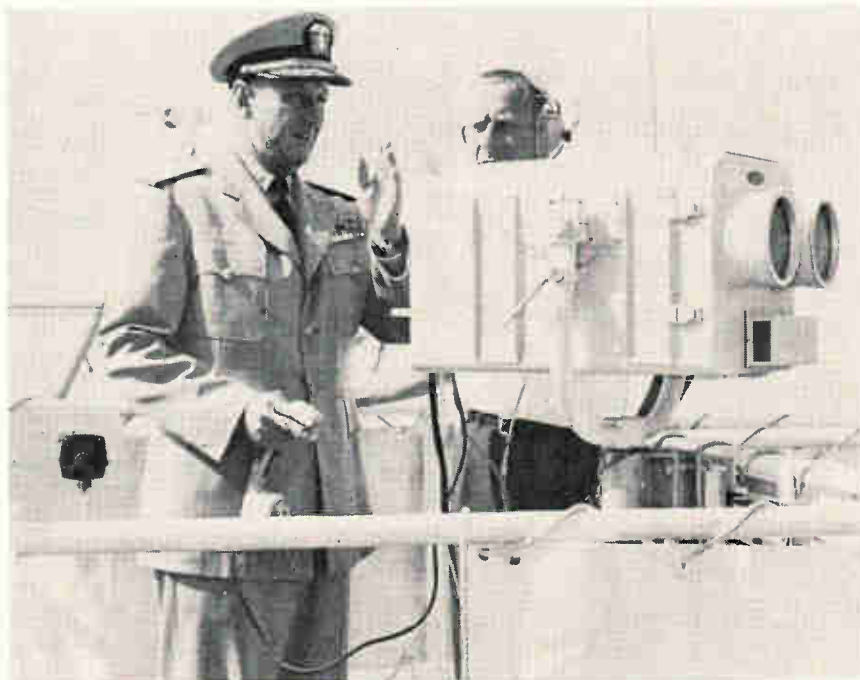

Private conversation. Millimeter-wave communication system from Sylvania will offer the Navy secure communications over short ranges.

Space electronics

Milestone . . .

"I think we have a 50-50 chance of putting men on the moon in 1969," says Presidential space adviser Edward S. Welsh in the light of this month's successful launch of Apollo 4 by a giant Saturn 5 rocket.

The Nov. 9 launch marked a strong comeback for the Apollo program, which had been plagued by delays since the fiery tragedy that claimed the lives of three astronauts last January. The capsule slammed back into the atmosphere at 25,000 miles per hour—the approximate speed at which a manned capsule would return to earth.

Shortly after the mission, NASA reported its latest Apollo schedule: six shots for 1968, ending with the first manned flight, and five manned launches in 1969.

Laud RCA. Space agency officials, after a week of post-flight evaluation, were jubilant over the performance of the electronics. George C. White, Apollo reliability and quality director, says, "As far as we can determine right now, electrical and electronic problems were minor—very minor." Electrical connectors and circuit solder, which proved troublesome earlier [Electronics, Oct. 16, p. 139], didn't create any problem. White singled out the Radio Corp. of America's 110A control computer for particular praise.

Besides the Saturn 5's baptism, the unified S-band communications system went through its first comprehensive space test without serious fault. Says Henry Thompson, who directs tracking and data systems at Goddard Space Flight Center: "There were a few small hardware problems that one would expect with any system in its first operation, but there were no design problems." Thompson says a fuse blew out in the Bermuda tracking station, and a few printed-circuit boards had to be replaced.

Program locked in. Although it will probably be a month before evaluation of all data is completed, no major changes are planned for the system. More tracking stations,



Thrust ahead. Saturn 5 blasts off pad in Cape Kennedy, raising the hope of placing a man on the moon before 1970.

however, will be added. "Before the next Apollo mission," says Thompson, "the tracking ship Redstone will be in the system and so will new land tracking stations."

Thompson points out that "Apollo 4 represents the greatest dependency we have ever seen on computers in space communication. We think that that part of the mission went off especially well. There were no bugs in the computer operation and the software passed the test with flying colors."

Guarded optimism. Despite the success of Apollo 4, the outlook for getting a man on the moon by 1969 may be somewhat less than 50-50. Although the soundness of the design of the rocket vehicles and ground-control procedures have been proved, there still is hardware yet to be tested in space. This includes the lunar module and the Apollo craft designed for the manned lunar flight, with its new type of escape hatch.

Leaks discovered last month in the module's control engines led to a redesign of the plumbing seals, which are still untested in flight.

. . . in a busy week

While the Soviet Union still basked in praise for its October space spec-

taculars, the U.S. quietly grabbed the spotlight with a show of its own.

The week of Nov. 5 was one of the busiest ever in space. On Sunday, the Applications Technology Satellite 3 was placed in stationary orbit over Brazil; on Tuesday, Surveyor 6 was launched; on Thursday, Saturn 5 blasted off in a shot heard around the world when it lifted an unmanned Apollo capsule into orbit, and Surveyor 6 made a soft landing on Sinus Medii, the plain that is almost smack in the center of the sunlit side of the moon; and on Friday, the sixth Tiros satellite—Essa 6—was launched.

Landing preparations. At week's end, Surveyor 6 was transmitting photographs and conducting alpha-scattering experiments for soil analysis at "a likely spot" for the first manned lunar landing. Space agency officials now plan to send Surveyor 7, the last in the series, to the moon in the first weeks of 1968.

Meanwhile, ATS-3 has successfully transmitted color photographs of the earth back to earth. According to project manager Robert Darcey, instrumentation on the satellite is working perfectly in preparation for nine major experiments. These include:

- An experiment to determine

whether mechanically despun antennas can be used for high-quality communications. According to Darcey, the antenna had been in operation over 99% of the time sending pictures that he termed "just beautiful." The Sylvania Electric Products Inc. antenna is designed to provide highly directional transmissions; receiving gain figures reached 18 decibels.

▪ A variety of very-high-frequency experiments to be conducted by domestic and foreign airlines. One, planned within the next six months, is Ople (Omega position locating experiments), which will test a method of locating fixed or moving surface and air platforms via synchronous satellites. Ople will use signals from the Navy's Omega surface-to-air navigation system, which will be received by the platform and relayed to an ATS ground station.

▪ A self-contained navigation system, to go into operation next February, will eject baseball-size steel balls while sensors on board observe their position against a star background. An on-board computer will be able to determine the spacecraft's orbit to within 10 seconds of arc. The Control Data Corp. built the navigation system.

Optoelectronics

Get the picture

When the laser was first developed, engineers quickly realized its potential in radar. Without the need for massive antennas, laser radars could achieve resolution hitherto undreamed of—but they lacked the muscle to reach out several hundred miles.

Now, at Autonetics, a 4,000-watt continuous-wave laser radar system is being developed that's expected to have a range of as much as 400 miles and a minimum resolution of 1 foot in 50,000 feet—sharp enough to register a clear picture of a target, not just a blip on the radar screen. By comparison, a radio-frequency radar with a 10-foot antenna produces a resolution of about 900 feet in 50,000 feet at the same range. For an r-f radar to come even close to the resolution promised by the laser, an antenna the size of a football field would be required.

Skylight. R. A. Brandewie, manager of the North American Rockwell Corp. project, says the carbon-dioxide laser under study would have an aperture of only 3 inches.

In addition to high resolution, the Air Force radar, a doppler type, will provide both the range and speed of a moving target. The choice of carbon dioxide was no accident: the atmosphere, save for thick fog, heavy rain, and snow, provides a "window" for the laser's 10.6-micron output. Furthermore, it's the only laser that can generate power levels sufficient for long-range radar.

At present, Autonetics is working with a 35-watt, single-mode laser. Eventually, the 4,000-watt model will be used, says Brandewie. Both lasers are flowing-gas systems.

At the company's lab, the beam from the 35-watt laser is sent through a hole in the roof and directed at a rough aluminum target about a foot square that's about a mile away. The beam is frequency modulated so that it has a maximum shift of about 3.5 megahertz; this is achieved by feeding sawtooth signals to a piezoelectric ceramic mounted on one of the laser-cavity mirrors. Return signals are picked up by a heterodyne-detector system. The detectors are copper-doped germanium crystals operating at 4°K.

On beam. Target angle is measured by noting the position of the beam; velocity is measured by the doppler shift, and range is calculated from the frequency modulation of the beam.

"This is an extremely sensitive system," Brandewie says. "We find we are within a factor of 2½ of the theoretical quantum limit in signal-to-noise ratio."

Development of the receiver was sponsored by the Air Force's Rome, N.Y., Air Development Center. Funding for the rest of the development was by Autonetics, explains Brandewie.

The 35-watt laser is about 4 feet long by ½ inch in diameter. The 4,000-watt laser, consisting of a 30-foot-long oscillator with an inner diameter of 3 inches and a 120-foot-long amplifier tube of the same diameter, is situated in an underground tunnel, one end of which terminates beneath the building housing the 35-watt system. When it is connected to the radar system, mirrors will be used to reflect the

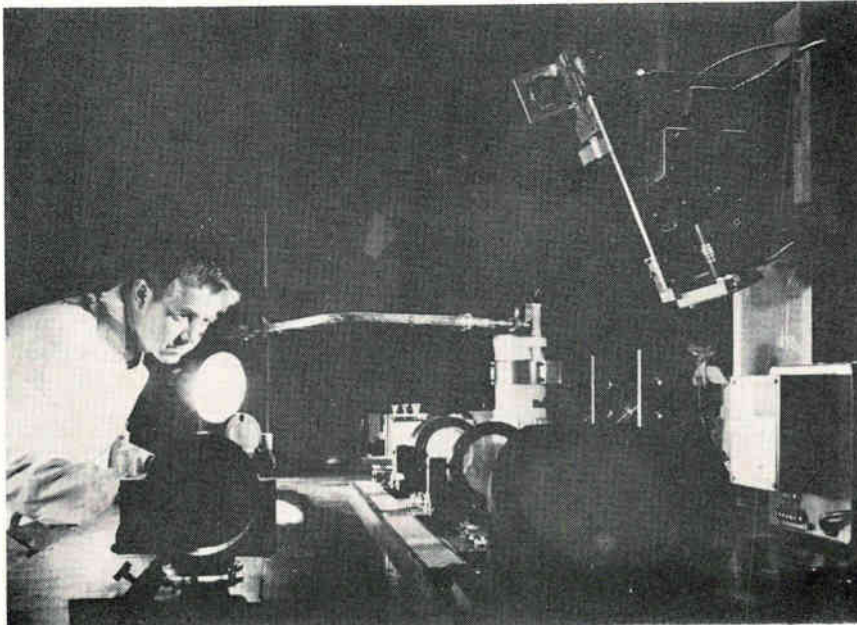

Light aim. Autonetics' laser radar will be able to generate detailed pictures of targets up to 400 miles away.

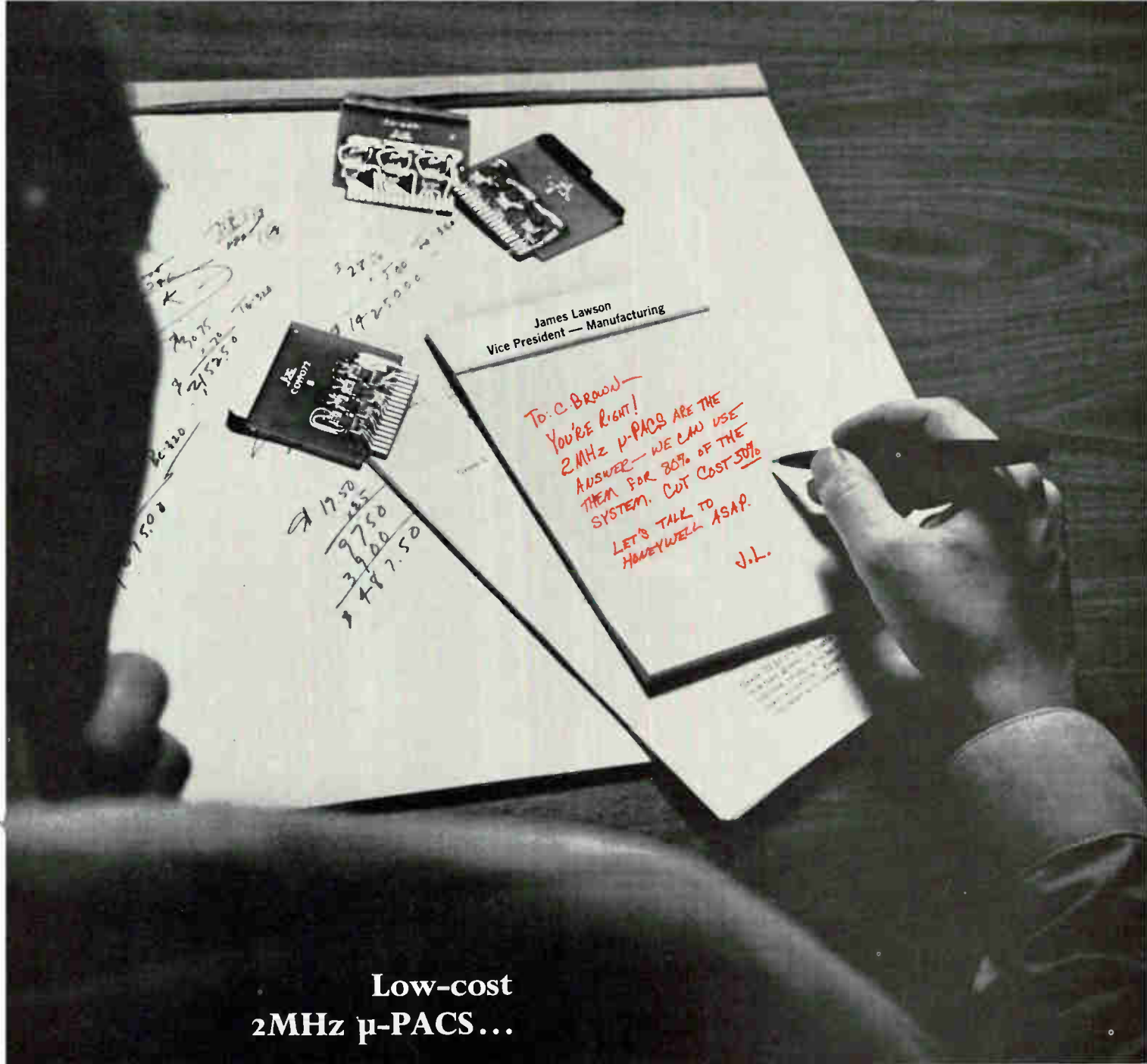

**Low-cost
2MHz μ -PACS...**

**...let you save
up to half the cost
of system logic.**

If you face a make-or-buy evaluation for system logic, maybe you've considered μ -PACS. Now, you can use new I/C 2MHz μ -PACS for up to 80% of your logic needs. Cut costs as much as 50%.

Take another look at your make-or-buy: Think μ -PACS at half the cost. Add more savings for volume discounts. Forget the people and equipment you'd need just to begin making your own. Remember μ -PAC quality and reliability. (Both 2MHz and 5MHz μ -PACS are compatible.) If this changes your cost analysis, write for new spec/price brochure. Honeywell, Computer Control Division, Old Connecticut Path, Framingham, Massachusetts 01701.

Honeywell

**AEC COMPUTER CONTROL
DIVISION**

Circle 49 on reader service card

beam out of the tunnel and through the roof of the building.

Thus far, the large system has not been operated at its capacity, but a 2,500-watt output has been achieved by amplifying a 300-watt output from the oscillator. Autonetics is modifying the oscillator to yield a 700-watt output, a spokesman said. The amplifier will boost this to 4,000 watts.

Autonetics has had several military contracts for carbon-dioxide laser radar work. Presently, the division has two classified contracts. Another contract, with the Rome center, is for a study of the phase coherence of 10.6-micron propagation and multiaperture techniques.

Computers

On second thought

Efforts to develop a "computer on a slice" at RCA Laboratories have caused extensive reconsideration of what it is that makes up a computer. And in the process, says scientist Henry S. Miiller, a remarkable thing has happened: systems designers and circuit designers are talking to each other—and using the same language. Their topic: RCA's proposed large integrated monolithic array computer (Limac).

RCA expects to deliver a breadboard Limac to the Air Force toward the end of 1968. Along with RCA's projects, Miiller says work on LSI computers at Texas Instruments and Philco-Ford Microelectronics division have been funded by the Air Force's Rome Air Development Center, N.Y. [Electronics, Jan. 24, 1966, p. 26]. RCA uses bipolar circuits for the computer logic, and complementary MOS techniques for the memory.

The Limac breadboard under construction uses standard third-generation emitter-coupled logic (ECL) with speeds in the 5-to-7 nanosecond stage delay range—"the same kind of logic that's in RCA's Spectra line of computers," notes Miiller. He explains that ex-

isting flat-pack IC's are being employed in the breadboard model now "so we won't have to debut software, logic, system design, and LSI arrays all at the same time."

Advance. Logic array development, declares Miiller, has progressed to the point where 150-gate arrays should be easily achievable by the end of next year. But he emphasizes that the Limac will be strictly experimental—a unit the Air Force can use to show off LSI technology. RCA engineers are now producing 36-cell, 72-cell, and 150-cell arrays that will be substituted next year for the IC logic currently employed. The 72-cell arrays are storage registers and associated gating networks, says Miiller, while the 150-cell arrays will form part of the add logic and some portions of the input-output logic. The experimental computer will consist of 3,000 gates, with a mixture of array sizes. As a measure of technological progress, the same kind of 180-mil-square wafer produced earlier in the program to hold 36 cells now carries 150.

Although the system is still in development, Miiller says simulations indicate that the Limac will be able to deliver algorithmic solutions with greater speed and accuracies than can present series-approximation systems. Accuracies for the 16-bit word unit have been pegged at one part in 2^{16} . The Limac will execute algorithms almost as quickly as third-generation computers perform multiplications and divisions.

The 150-cell array will replace about 70 ECL flatpacks, according to Miiller. Engineers estimated early in the program that the degree of logic shrinkage possible with LSI would allow them to put all the logic contained in two double racks of equipment in the second-generation RCA 301 computer on 10 circuit boards, each with four 100-gate arrays. The entire logic portion of the computer would measure 6 cubic inches.

Partitions. LSI, with its fewer interconnections, offers the designer greater reliability than does IC logic, but it also creates problems. Miiller says the number of connections per silicon chip in IC logic

works out to just a little more than one per gate, or 14 pins for 10 gates. Projecting that ratio, a 100-gate array would require 140 connections, "and that's impossible to do on a 180-mil-square chip," he says. The problem led to a rearrangement of logic, a functional partitioning that forced those doing packaging specifications to work with engineers writing system specs.

Instead of the usual sequence—system design followed by logic design followed by the assignment of gates to plug-in cards—the RCA cycle began with an analysis of the tasks the computer must do. Digit-by-digit algorithms of machine instructions were then written, and, as a final step, units that could execute a similar set of functions were built. "We've also applied functional partitioning to the computer control system," Miiller says, "making a distinction between control for the memory and control of a process such as addition."

He adds: "We've come up with a straightforward solution to LSI application by locking systems designers and circuit designers in the same room and forcing them to consider each other's problems."

The read-write memory won't present any partitioning problems, according to Miiller. "A reasonable demonstration of MOS memory technology in the Limac machine will be 16 words by 18 bits using very low power—in the microwatt range for the standby mode.

Solid state

LSI off the shelf

At least two entries in the new-product-a-week parade now being ballyhooed by the Semiconductor Division of the Fairchild Camera & Instrument Corp. will be standard bipolar large-scale integrated circuits. Marketing manager Jerry Sanders says flatly that the two IC's will be available in next year's first quarter. And to underline its

SPEER COMPONENT

COMMENTS

All about a new economical method for selecting the right precision industrial resistors...

It's called "looking for the particular precision resistors that deliver the exact functional characteristics you need at the lowest possible price."

Perhaps this highly sensible method isn't new to you. But it will be to a lot of people. We've been amazed to discover just how many design engineers specify their industrial precision resistors on the basis of arbitrary (and non-functional) labels—such as the fact that the resistors meet certain MIL specs or feature "wire-wound" construction.

Don't get us wrong. MIL-spec resistors are fine—for military applications. But is it really logical to pay a premium for a wider range of environmental adaptability—and more documentation—than your industrial application actually involves?

Wire-wound resistors are fine, too. Even when they're evaluated on a functional basis, they may prove to be better than metal film resistors for certain industrial applications. But if you still assume that wire-wounds are better for every application, you simply haven't been paying sufficient attention to what's been happening in precision resistor technology in recent years.

Thanks in part to important advances by the Speer research and development people, our JXP resistors now are competitive with wire-wounds as far as resistance-temperature stability is concerned. And their statistical reliability is greater. Ditto their power density, when performance is equivalent. And their prices are not only competitive but are in many cases even lower than wire-wounds.

Our JXP metal film resistors, because of our exclusive manufacturing process, can be produced to tighter tolerances than wire-wounds at sig-



nificantly less cost for most resistance ranges. Furthermore, they automatically incorporate faster response and settling times at no additional cost.

You can get JXP's with tolerances and TCs as low as $\pm 0.02\%$ and ± 2 PPM/ $^{\circ}$ C, respectively, upon request. These "white room" metal film resistors have other startling functional characteristics that you should also be aware of. Use the coupon, and we'll send you the full details.

...and the right industrial precision resistor networks

As we've just demonstrated, evaluating industrial precision resistors on the basis of functional characteristics rather than arbitrary labels may change your buying habits.

Well, the same goes for resistor networks.

Our JXP precision resistors are available in all kinds of packaged networks and assemblies, needless to say. In addition, we can furnish you

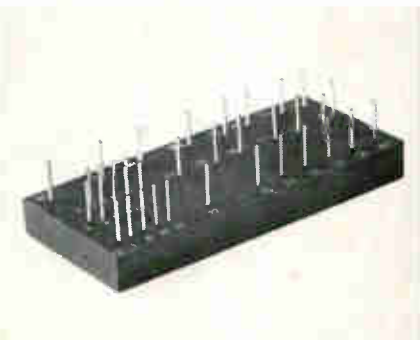

with any network engineering assistance you might need—from prototype preparation to testing and certification. For complete information, mail us the coupon.

How's your frequency on Typical Error #4 in inductor testing?

Continuing our review of the errors often made when measuring inductance and Q (see MIL-C-15305), error #4 is letting your test frequency become inaccurate.

Needless to say, preventing this particular lapse is easy. Just check it at regular intervals using accepted instruments of at least 0.1% accuracy.

For additional errors—and how to adjust for them—check with us.

AIRCO Speer Electronic Components

St. Marys, Pa. 15857

Rush details on just how functional your JXP precision resistors really are.

Ditto on your JXP precision resistor networks.

Name _____

Title _____

Company _____

Street _____

City _____ State _____ Zip _____

commitment to LSI, Fairchild has reshuffled its manufacturing command and come up with an LSI product manager, R.J. Schreiner.

Until the first of the year—and perhaps until Fairchild moves into its new headquarters in the spring—Schreiner will continue to report to Gordon Moore, the head of research and development. (Schreiner has been directing custom LSI work under Moore.) But by the time the LSI circuits are on the market, Schreiner and his staff will come under the command of John Sentous, Fairchild's manufacturing chief. There are said to be almost 100 men in the custom LSI operation.

Crowded calendar. Some 70% of the 52 new IC products slated for introduction next year will be digital devices, Sanders says, and of these more than half will involve medium-scale integration technology. Fairchild defines an LSI product as any circuit that requires two-layer metalization for interconnections laid out by computer-aided design.

The company is already supplying one LSI circuit to a classified customer, said by industry sources to be NASA. The two new circuits, Sanders indicates, will be standard—as opposed to customized—arrays.

LSI chip yields are now at the level of early integrated-circuit yields, Sanders says. But Ben Anixter, Fairchild's IC marketing manager, asserts that in terms of usable gates per wafer, the LSI yields are not out of line with present IC levels.

Packaging. The circuits will be marketed in a 36-lead, dual in-line ceramic package. Fairchild has already indicated that it will flip-chip all of its new transistor-transistor logic products, but plans for the LSI circuits aren't so clear.

"The area taken up by the logic function determines cost," Anixter says. "You want the package to be a small part of total cost, and there are ways to get small areas that are not diode-transistor logic and not TTL." Presumably, he's considering some current-mode arrangement like emitter-coupled logic.

Industrial electronics

A sense of safety

Anyone who's driven on a busy freeway during rush hour will be glad to know that the Raytheon Co. is trying to make it easier. Under an \$822,997 contract from the United States Bureau of Public Roads, the company's Equipment division in Waltham, Mass., will build a computer-controlled system to help cars entering a highway merge with traffic and to reduce congestion.

Raytheon has participated in control system tests on the Gulf Freeway in Houston, on Chicago's Eisenhower Expressway, and elsewhere. But the new study envisions the most complex instrumentation and sophisticated control yet.

Added capabilities. Raytheon's new contract calls for a system like that built for the Gulf Freeway—capacity versus demand for entry—but with the added capabilities of measuring the acceleration of merging cars and control of some off-freeway traffic.

Doppler ultrasonic sensors or inductive loops could be used to measure acceleration rate, and a stop signal would be flashed to the car moving too slowly to merge without disrupting traffic. A Raytheon 703 digital computer will process the data and call the signals.

In the beginning. The 1961 Eisenhower Expressway program attempted to speed net traffic flow by halting cars which would otherwise have entered the road. It used ultrasonic sensors to determine how crowded the freeway was, and induction coils to spot traffic waiting on the ramps. Thus, rather than merely counting the cars on the freeway and flashing a "go" signal at set intervals, the computer-controlled system made the rate of entry proportional to the difference between capacity and the number of cars waiting to enter.

Jack Sample, transportation systems engineer, says a key problem is development of an abort capability for cars that accelerate too

slowly to merge, or don't move fast enough in response to "go" signals.

To reduce side-street congestion, the new system will measure overall flow on the freeway and assign higher priorities to the entry ramps with the greatest demand.

Any market? "We haven't put any dollar signs on it yet," says Sample, "but we think the market will be viable in about two years." He adds that Raytheon has already gotten nibbles from interested customers—especially those who might wish to apply computer control to freeways which make up part of the interstate highway system. Eventually it may be necessary to add control to new roads in order for cities and states to get Federal construction funds.

Avionics

Hot on the trail

Now that the Autonetics division of the North American Rockwell Corp. has eliminated some of the bugs that showed up during last spring's flight tests of its infrared clear-air turbulence (CAT) detector, the device is flying again aboard a Pan American World Airways Boeing 707-321B on regular passenger runs.

Pan Am hasn't purchased the CAT detector system, but Autonetics officials term results of the May and June tests "very encouraging." The current flight test program, scheduled to last through next February, will add 140 hours of flying time to the 70 hours logged in that first phase of the cooperative project.

Before the first Pan Am tests, an engineering model of the Autonetics system installed in an Air Force C-135 detected CAT fronts at distances greater than 30 miles during 145 hours aloft.

Advance word. E. F. Flint, program manager at Autonetics, says the current tests are intended to determine the sensor settings that give pilots maximum notice that they are approaching turbulence; the goal is a warning of no more

40378
7A RMS current, 200V
(Surge current = 80A)
(2-lead TO-5)

2N3228
5A RMS current, 200V
(Surge current = 60A)
TO-66

2N3528
2A RMS current, 200V
(Surge current = 60A)
TO-8



These **3** RCA SCR's sell for only **98¢*** each

... and offer
circuit capability of
devices that
cost many times more!

ONLY FROM RCA... one low price plus a choice of current ratings *and* packaging... for a broad range of 120-V line-operated control circuits. For low-current power control without use of a heat sink, ask for the 2N3528... for medium-power loads with the lowest dollars per kilowatt ratio, ask for the 2N3228... and for a really small package adaptable to semi-automatic or batch mounting, ask for the 40378. They all offer cost and performance advantages that should be built into *your* control circuits!

400-volt versions of these SCR's are also available for as little as \$1.40°. Your RCA Field Representative will be happy to give you more details. *And ask him, too, about RCA's special heat-sinking techniques for TO-5 packages which gives you the power-handling capability of a press-fit without the added cost.* For additional technical data, write RCA Commercial Engineering, Section RN11-5, Harrison, N.J. 07029.

See your RCA Distributor for his price and delivery.

*Prices in quantities of 1,000 and up

RCA Electronic Components and Devices



The Most Trusted Name in Electronics

than four minutes.

During last spring's tests aboard the Pan Am aircraft, the i-r sensor was triggering warnings when the "chop" from CAT was too minor to disturb passengers. However, it was also picking up radiation from false heat sources on the ground, especially at low altitudes and often when the plane was making its landing approach. Autonetics officials say refinements have been made in the system to eliminate these false alarms.

The system consists of the passive i-r radiometer sensor mounted atop the fuselage near the cockpit, a data processor in the radio rack, and an indicator on the instrument panel. The sensor, in turn, consists of an i-r detector, an optical amplifier, a chopper, a black body reference, and a preamplifier. It has a 1.5° field of view in elevation, and scans in azimuth 60 miles ahead of the aircraft. Autonetics spokesmen say the system works day or night, and can detect turbulence in clear air or in cirro-stratus clouds.

Citations. The Flight Safety Foundation, a New York nonprofit group that evaluates air-safety equipment and standards, notes that the i-r radiometer has been around for a long time and that its capabilities and limitations are better known than are those of lasers. The foundation also points out that infrared CAT sensor optics and electronics are lightweight, relatively simple, and occupy little space.

The principal disadvantage of i-r sensors, according to the foundation, is limited range, especially in the presence of water vapor, which absorbs infrared radiation.

Infrared sensing isn't the only approach being pursued. The Boeing Co., for example, has been experimenting with long-wave radar (220 megahertz) and L-band radar (1.3 gigahertz). These systems detect the strong eddy currents in a turbulent airspace. Boeing thus far has used only ground-based equipment, confirming the existence of any CAT it's detected by flying a light plane through it. One of the systems will be flown aboard a Boeing 727 next January, the company says.

For the record

Maybe. Prototypes of a flat-screen display device—one report insists it's the long-awaited solid state version of the cathode-ray tube—are to be produced in Canada by Automatic Radio Corp. of Melrose, Mass., and an unidentified Canadian electronics firm.

Zip. First assignment for the Government Printing Office's ultra-high-speed Linotron 1010 typesetting system has been completed. It set the type for an 81-volume catalog—36,000 pages—listing supplies for all the armed services in six weeks. The Linotron, developed jointly by CBS Laboratories and the Mergenthaler Linotype Co., operates at a speed of 1,000 characters a second by setting type on film by area composition instead of the traditional line at a time.

Whoa. A House Commerce subcommittee has, in effect, rejected the FCC's assumption that it has the power to institute a nationwide pay television system and told the agency to wait for Congressional authorization. The full committee is expected to approve the action and the FCC is expected to agree to a delay pending further Congressional hearings next year.

Talk. People are often left mute and paralyzed as the result of a stroke or accident. And their rehabilitation is slowed by their frustration at being unable to communicate. A device that can help such patients "talk" has been developed by the biomedical engineering laboratory of Fairchild Hiller Corp.'s Republic Aviation division. The system consists of a display panel; a matrix of messages in pictorial form; groups of words ("I am hungry"), or the alphabet; a control unit, and a logic unit. The patient selects the message by inserting his finger in the control unit's transducer, moving a light through the display until it illuminates the desired message. Very little pressure up, down, or to either side is needed to move the light.

Guard. Lt. Gen. Alfred D. Starbird has been named manager of the Sentinel antimissile program.

Starbird, an electronics specialist who formerly directed the Defense Communications Agency, will have three main elements in his organization: the Sentinel System Office in Washington; the Sentinel System Command in Huntsville, Ala., which will develop, procure, and install the system; and the Sentinel System Evaluation Agency at White Sands Missile Range, N.M. Meanwhile, surveys of possible missile and radar sites for the \$5 billion program have begun.

End run. Solitron Devices Inc. plans to make an offer directly to stockholders of the Amphenol Corp. for shares in the Chicago-based electronics firm. This is an indication that Solitron's negotiations with Amphenol officials for the acquisition of the firm have reached an impasse. Paul Windels Jr., secretary of Solitron, says the offer will be one share of Solitron stock for five shares of Amphenol common stock.

Help! Motorola Inc. has developed a computer-operated system that it says can be used as an alarm to protect buses from holdups and to call for help in the event of an emergency. Each bus would have a two-way radio to store signals from transmitter "signposts" along the route and retransmit them to a computer at the dispatcher's headquarters. In an emergency, the driver would press a hidden foot pedal, transmitting an alarm signal that gives the location and identification of the bus. The dispatcher would phone for help.

Purchase. White Consolidated Industries Inc. of Cleveland plans to buy the Davidson division of Fairchild Camera and Instrument Corp. Davidson makes offset printing presses and equipment; sales volume is about \$10 million annually. Officials of both companies expect the deal to be completed before the end of the year.

Acquisition. F.W. Bell Inc. of Columbus, Ohio, manufacturer of electronic components and equipment with annual sales topping \$1 million, is being acquired by Allegheny Ludlum Steel Corp. Bell's principal products are instruments for the measurement of magnetic fields.

WIN A 1970 CAR FROM FAIRCHILD:



Please enter my name in your New Product sweepstakes.

NAME _____

TITLE _____

COMPANY _____

CITY _____ STATE _____ ZIP _____

Void wherever prohibited, licensed, taxed or in any other way restricted by law. Employees of Fairchild Camera and Instrument Corporation, its advertising and sweepstakes agencies and their families are not eligible.

FAIRCHILD SEMICONDUCTOR SWEEPSTAKES
P. O. Box 68 Los Angeles, California 90051

Now that we have your attention, we have a short announcement to make:

We're introducing our 1970 product line. All monolithic integrated circuits — MSIs, LSIs and new linears. There will be a new one every week for the next 52 weeks. In stock. At Fairchild distributors. Complete with data sheets and reliability information. And, they will be available in volume. (The first eight are on the following pages.)

Any week we fail to announce a new product, we'll hold a drawing. The winner gets a 1970 car. To keep. Any model he chooses (up to \$4,000) or the equivalent in cash. Fill in the coupon and return it to us. We'll enter your name in the sweepstakes. Enter now. By 1970 you'll need a new car, anyway.

FAIRCHILD

9300 FOUR-BIT UNIVERSAL REGISTER

1. Fairchild will introduce a new integrated circuit each week for the next 52 weeks. This is number 1.

The Fairchild 9300 is the first of a new line of highly versatile digital elements. It is an MSI (Medium Scale Integration) device which means greater complexity in less space, fewer external connection requirements and improved reliability. At the same time, the 9300 is extremely low cost and can be used in a number of applications. For example, it can function as either a high speed 8-bit register, a high speed counter or a high speed storage element. It features 20 MHz shift frequency, type D input followed by type J input, J and K inputs, gated synchronous parallel input, Q and \bar{Q} output, and complete compatibility with CMOS elements. The 9300 comes in a hermetic, ceramic dual in-line package with a 16-lead configuration. It is available in both military and industrial temperature ranges (-55°C to +125°C and 0°C to +70°C). The 9300 is available in volume quantities. Fairchild distributors have it in stock now. Write for complete specifications, applications information and descriptions of other Fairchild MSI elements.

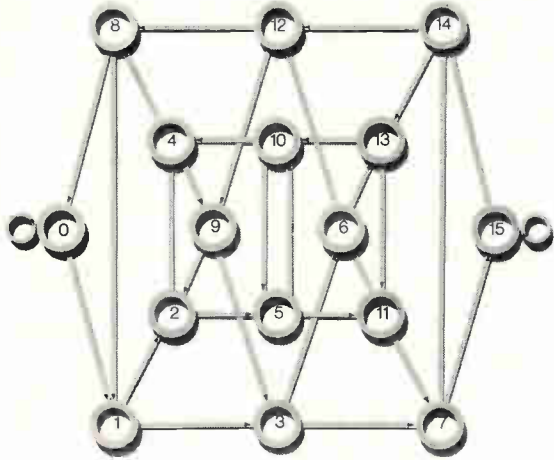

FAIRCHILD MANUFACTURING CORPORATION • Division of Fairchild Camera and Instrument Corporation • 111 Fairchild Road, Mountain View, California 94035 • (415) 961-1111 • Telex: 151 270 9125

CIRCLE READER SERVICE NUMBER 101

9304 DUAL FULL ADDER

2. Fairchild will introduce a new integrated circuit each week for 52 weeks. This is number 2.

Fairchild's 9304 is a highly flexible MSI (Medium Scale Integration) device with extremely fast carry propagation delay (typically 8 nanoseconds). It provides greater complexity in less space, fewer external connection requirements and improved reliability. Separate carry outputs allow the use of fast action—individually or together. The 9304 is fully compatible with Fairchild CMOS devices. It is also part of our new family of system building blocks. Others are shift registers, counters, decoders, interface devices, and it is applicable in any digital logic system. Its versatility means high volume production resulting in low unit cost. In addition to a dual full adder, the 9304 can also be used as a parity checker, an exclusive OR output, or for a number of other useful logic functions. It comes in a 16-pin hermetic dual in-line package. It is available in both military and industrial temperature ranges (-55°C to +125°C and 0°C to +70°C). The 9304 is at your Fairchild distributor now. Write for complete specifications, application information and descriptions of our other MSI devices.

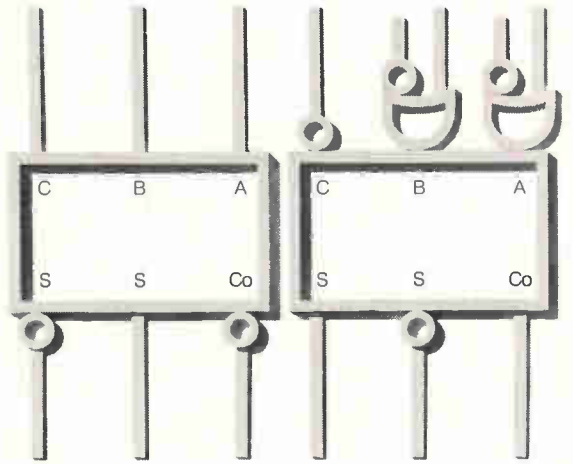

FAIRCHILD MANUFACTURING CORPORATION • Division of Fairchild Camera and Instrument Corporation • 111 Fairchild Road, Mountain View, California 94035 • (415) 961-1111 • Telex: 151 270 9125

CIRCLE READER SERVICE NUMBER 102

9020 DUAL JK FLIP-FLOP

3. Fairchild will introduce a new integrated circuit each week for 52 weeks. This is number 3.

The 9020 is a CMOS device in a dual in-line package. It consists of two JK flip-flops with a common clock, separate J and K inputs and a common \bar{Q} output. The joint JK input eliminates the need for gating to perform and can result in simplified logic designs and minimum dead time problems. The JK input also allows the 9020 to perform as a dual type D flip-flop by tying the J and K inputs together. Clock loading is reduced to a single clock buffer. The 9020 is fully compatible and hermetic. It comes in a 16-pin hermetic dual in-line package. It is available in both military and industrial temperature ranges (-55°C to +125°C and 0°C to +70°C). It can be operated as a type D flip-flop or as a standard JK. The 9020 is available in volume quantities now. Fairchild distributors have it in stock. Write for complete specifications, applications information and descriptions of our other new products.

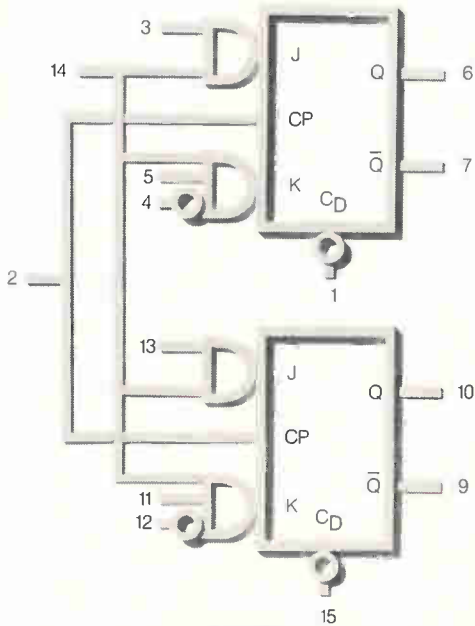

FAIRCHILD MANUFACTURING CORPORATION • Division of Fairchild Camera and Instrument Corporation • 111 Fairchild Road, Mountain View, California 94035 • (415) 961-1111 • Telex: 151 270 9125

CIRCLE READER SERVICE NUMBER 103

9301 ONE-OF-TEN DECODER

4. Fairchild will introduce a new integrated circuit each week for 52 weeks. This is number 4.

The 9301 is a CMOS, multi-emitter decoder in a 16-pin hermetic dual in-line package. It is particularly new for its system building blocks. (Others are shift registers, counters, adders, etc.) It is applicable in any digital logic system. The 9301 is designed to give added flexibility to Fairchild's Medium Scale Integration (MSI) devices. (MSI already offers operationally in less space, fewer external connection requirements, improved reliability, and an example of its versatility.) The 9301 can serve as an input/output decoder, a memory address decoder, a memory cell (8003) and dual full adder (9304). It can also be used as an expandable digital demultiplexer, minimum generator, and as a decoder for any BCD code. It is available in both military and industrial temperature ranges (-55°C to +125°C and 0°C to +70°C). The 9301 and other MSI devices mentioned above are available in volume quantities. Fairchild distributors have them in stock now. Write for complete specifications, applications information and descriptions of our other MSI devices.

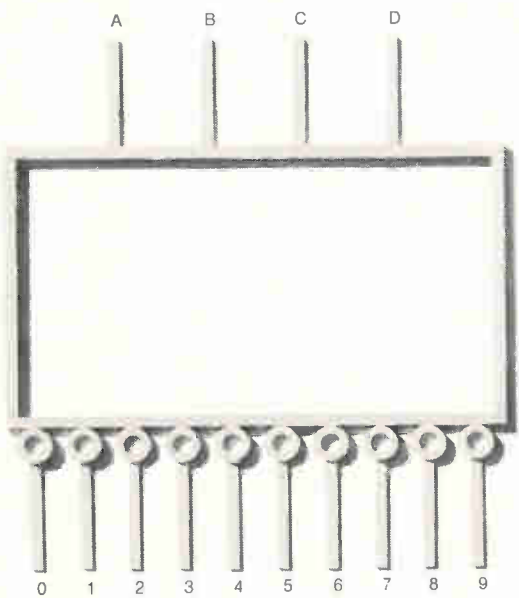

FAIRCHILD MANUFACTURING CORPORATION • Division of Fairchild Camera and Instrument Corporation • 111 Fairchild Road, Mountain View, California 94035 • (415) 961-1111 • Telex: 151 270 9125

CIRCLE READER SERVICE NUMBER 104

9109 HIGH LEVEL HEX CONVERTER

5.
Fairchild will introduce a new integrated circuit each week for 52 weeks. This is number 5.

The 9109 is a new member of a new high noise immunity integrated circuit family introduced by Fairchild. The DTL gates within the 9109 are designed to operate at 100 MHz. This is the highest operating frequency of any DTL gate available. The 9109 is a hex inverter. It can be used as a hex inverter or as a hex buffer. It is available in both 14-pin and 16-pin packages. The 9109 is available in both 14-pin and 16-pin packages. The 9109 is available in both 14-pin and 16-pin packages. The 9109 is available in both 14-pin and 16-pin packages.

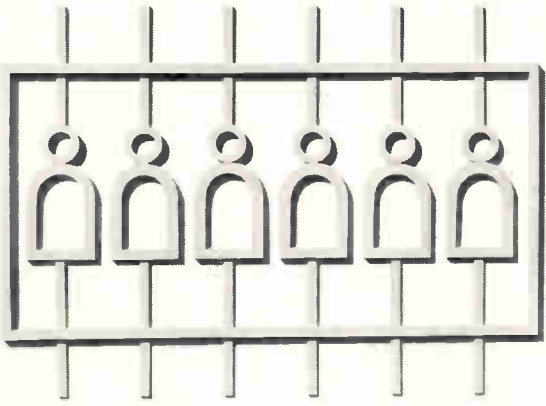

CIRCLE READER SERVICE NUMBER 105

9112 HIGH LEVEL HEX CONVERTER

6.
Fairchild will introduce a new integrated circuit each week for 52 weeks. This is number 6.

The 9112 is part of our new family of high noise immunity integrated circuits. It is designed to convert CMOS logic levels to high-level hex inverter operation. The 9112 consists of six high-level DTL gates arranged in a hex inverter. Each gate performs a single inversion operation. The 9112 can be used as a hex inverter or as a hex buffer. It is available in both 14-pin and 16-pin packages. The 9112 is available in both 14-pin and 16-pin packages. The 9112 is available in both 14-pin and 16-pin packages. The 9112 is available in both 14-pin and 16-pin packages.

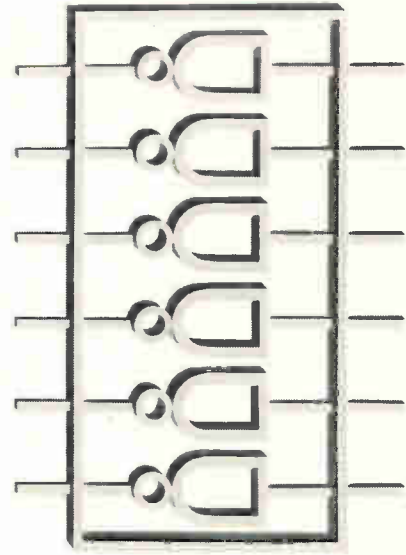

CIRCLE READER SERVICE NUMBER 106

9989 FOUR-BIT BINARY COUNTER

7.
Fairchild will introduce a new integrated circuit each week for 52 weeks. This is number 7.

The 9989 is a new member of a new high noise immunity integrated circuit family introduced by Fairchild. The 9989 is a four-bit binary counter. It is available in both 14-pin and 16-pin packages. The 9989 is available in both 14-pin and 16-pin packages. The 9989 is available in both 14-pin and 16-pin packages. The 9989 is available in both 14-pin and 16-pin packages.

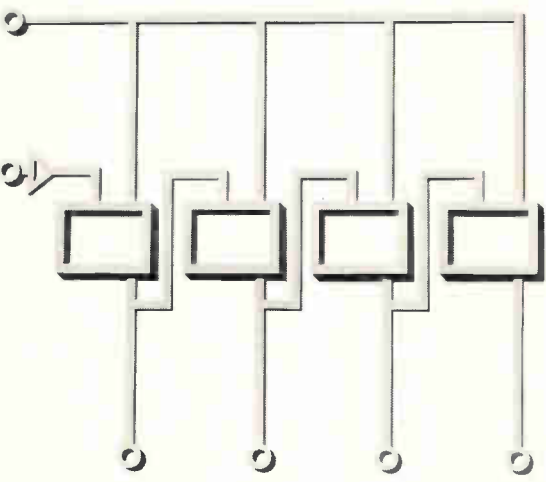

CIRCLE READER SERVICE NUMBER 107

μA719 HIGH FREQUENCY COMMUNICATIONS SYSTEM

8.
Fairchild will introduce a new integrated circuit each week for 52 weeks. This is number 8.

The μA719 is a new member of a new high noise immunity integrated circuit family introduced by Fairchild. The μA719 is a high frequency communications system. It is available in both 14-pin and 16-pin packages. The μA719 is available in both 14-pin and 16-pin packages. The μA719 is available in both 14-pin and 16-pin packages. The μA719 is available in both 14-pin and 16-pin packages.

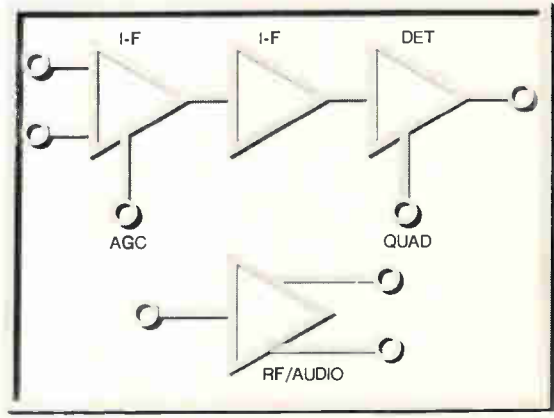

CIRCLE READER SERVICE NUMBER 108

*An important new addition
to the world's most complete
line of mercury relays*

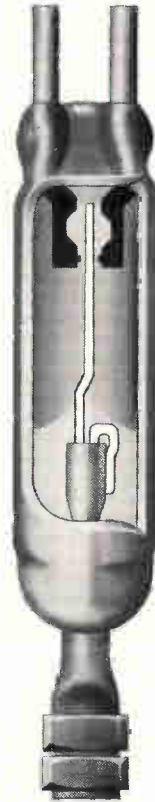

Adlake Presents The Series 15000 Form D Sensitive Relays

Complementing our extensive line of mercury wetted contact relays, the Series 15000 Form D Relays are available in several packages: plug-in styles (standard, miniature and sub-miniature), wax filled and epoxy molded for printed circuit boards, in addition—the newest concept in relay packaging—Adlake Type AW.

Typical of Adlake's proven-in-industry neutral

Form D and sensitive Form C Mercury Wetted Contact Relays, Series 15000 Form D relays are manufactured under strict supervision and quality control conditions.

To learn more about this quality product, its advantages and details of the entire line address your inquiry on company letterhead to Dept. RLL and ask for Bulletin 15000.



THE ADAMS & WESTLAKE COMPANY

A SUBSIDIARY OF ALLIED PRODUCTS CORPORATION

ELKHART, INDIANA 46514 • AC 219 • 264-1141

TRANSPORTATION EQUIPMENT • ARCHITECTURAL PRODUCTS • MERCURY RELAYS • DOORS AND ENTRANCES • CONTRACT MANUFACTURING

Washington Newsletter

November 27, 1967

Star-studded force fails to shine

In August the President set up a star-studded task force to prepare, in a year, a comprehensive study on a new U. S. communications policy. Now, almost a third of the way to deadline, the task force is still at anchor and without a staff director. The task force itself has only met once. Study assignments to be parceled out to various government agencies—framed by the staff working for the task force—haven't been approved or assigned.

Air Force moving on 621B program

The eagerly awaited request for proposals for the Air Force's 621B navigation-satellite program is about to see the light of day. Originally expected to be sent out to industry in September [Electronics, Aug. 21, 1967, p. 40], the proposal package for the highly accurate, secure system was held up by an extensive review at the Pentagon. With at least a dozen firms planning to bid, several are already working hard on in-house studies and lining up subcontractors.

The big money in the 621B will be in the user aircraft hardware—which could run as high as \$100,000 per plane. The program is expected to be operational in the early 1970's with a worldwide system of satellites in stationary orbit.

Sprint too hot for Sentinel?

There are growing doubts that the anti-Chinese antimissile program will be as extensive as Defense Secretary MacNamara first indicated. When he announced the Sentinel program go-ahead, the Pentagon chief said that Martin-Marietta Sprint missiles could be included to protect U.S. Minuteman ICBM bases at a "modest" additional cost. This meant that what is being billed as an anti-Chinese system would use "point-defense" to provide limited protection in the event of a Soviet attack. Now, however, the Pentagon says no firm decision has been made to include Sprint missiles along with the McDonnell Douglas Spartans, which provide area defense, in the \$5 billion Sentinel system. But the Defense Department insists that the decision doesn't have to be made at this time.

Pentagon firm on bonus-splitting

Despite many complaints from subcontractors, the Pentagon refuses to change its controversial policy of not requiring prime contractors to share incentive bonuses with subcontractors. The hands-off policy was reaffirmed after it had been reviewed at the request of the Senate Small Business subcommittee. The Pentagon argues that it cannot intervene in the relationships between prime and subcontractors because its contracts are with the primes only.

Military procurement officers do encourage prime contractors to make maximum use of competition in subcontracting, however. In that way the primes can, if they wish, share the incentives to motivate the subs to greater efficiency.

Paperwork delays airlines satellite

Prospects for an operational aeronautical services satellite will be pushed farther into the future by a U.S. position paper on the subject being drawn up by the Federal Aviation Administration. Until this document has been cleared through all interested parties, the FAA will not be able

Washington Newsletter

to render a favorable decision on Comsat's proposal for a \$40 million-to-\$50 million system [Electronics, Aug.7, p.65]. Comsat had indicated that it could get a satellite aloft by 1970 to relay vhf communications between transoceanic airliners and ground stations [Electronics, Sept. 18, p.67].

The paper, which aims to clear up considerable confusion about this country's position on this issue [Electronics, Nov. 13, p.179], will be presented next year to the International Telecommunications Satellite Consortium and the International Civil Aviation Organization after making the rounds of the Pentagon, NASA, the State Department, the FCC, the Office of Telecommunications Management, Comsat, and U.S. commercial airlines.

FCC may upset earlier rulings

Capital observers won't be surprised if the Federal Communications Commission upholds its hearing examiners in three precedent-setting cases. So important are these decisions that the FCC has bypassed its normal appeals procedure and will hear the cases without first submitting them to its review board.

Should the commission support the examiners, it will mean that Carter-phones—non-telephone-company devices—may be attached to telephone company equipment; that Microwave Communications Inc. can establish a common-carrier link between St. Louis and Chicago, and that San Diego CATV systems can continue to bring in Los Angeles tv signals. In the San Diego case, this would overturn the FCC ruling which prohibits bringing distant signals into the top-100 market. Regardless of how the commission decides these issues, prolonged court battles seem inevitable.

Military's upgrading of satellite network to be a long haul

Upgrading and expanding the military long-haul communications satellite network is going to take longer than expected. The Pentagon's decision to push ahead with the improvement program will be made by year's end, but the money to implement it will be cut back because of the budget squeeze brought on by increased Vietnam spending.

The Initial Defense Communications Satellite Program (IDCSP), which was shifted earlier from an R&D effort to an operational system [Electronics, Feb. 6, p. 48], will have its belt of small satellites in random orbit augmented by larger, higher-powered craft in stationary orbit. But procurement of these satellites will be delayed; just how long will depend on how deep the budget cuts are. Since the new satellites could be operational in two and a half to four years after a contract award, the delay could mean they won't be airborne for six years or longer.

As a result, more satellites similar to Philco-Ford's IDCSP model will be ordered. Replenishment launchings of these craft are already planned for next summer, and more may be added.

Avionics orders for SST on way

Boeing is putting together bid packages for prototype avionics equipment for its supersonic transport, and will start asking for proposals around the first of the year. The company expects to award \$15 million of subcontracts in 1968, including orders for an inertial navigation system, communications and radio navigation gear, weather radar, an air data computer and displays, an integrated data system, a flight data multiplexing system (to reduce the amount of cable in the SST), and integrated flight instrument displays.

AIRPAX ELECTROMAGNETIC TIME-DELAY CIRCUIT PROTECTORS SERIES APL



Sensitive - trip levels as low as 50 milliamperes

Rugged - withstand shocks of 50 g while operating

Powerful - trip levels as high as 50A at 50 v dc or 250 v ac

Reliable - rated for at least 10,000 operations

Stable - trip level unaffected by ambient temperature or past current history

Safe - handle is trip free so that a protector cannot be manually held closed in presence of overload

Versatile - instantaneous trip for protection of sensitive circuits - time delays of normal surges without tripping

Adaptable - units can be stacked for mechanical interlock, auxiliary contacts permit remote electrical interlocking and signalling

Dependable - designed and manufactured by Airpax

AIRPAX ELECTRONICS, Cambridge, Md. 21613

Phone 301 228-4600 • TWX 710 865-9655 • TELEX 8-7715

RCA "overlay" Transistors ... for Total RF Power

New Plastic Design for SSB Communications



TA2758
(Molded Silicone Plastic)

Circle 311 on reader service card

75 Watts PEP Output (Min.)
@ 30 MHz,
IMD—30 dB (Max)
Intended for 2- to 30-MHz SSB
power amplifiers operating from
a 28-volt supply, this high gain
transistor is encased in RCA's
new plastic package with
isolated pin-pad electrodes. It
uses an internally mounted
diode for temperature
compensation.

High Power Performance at 400 MHz



2N5016 (TO-60)
TA7036 (TO-60)

Circle 312 on reader service card

Both types are in the popular,
time-tested TO-60 package. The
RCA 2N5016 is designed for
Class-B and -C rf amplifiers and
offers 15 watts (min.) at 400
MHz. The TA7036 is a higher
power version and provides 20
watts (min.) at the same
frequency.

Microwave Coaxial Package



TA7003
(Coaxial Lead Package)

Circle 313 on reader service card

1 Watt Output with 5 dB Gain
@ 2 GHz
2 Watts Output with 10 dB Gain
@ 1 GHz
Low-inductance package for UHF
and microwave oscillator,
frequency-multiplier, and
rf-amplifier service.

High Gain UHF driver or oscillator



2N5108 (TO-39)

Circle 314 on reader service card

1 Watt Output (Min.)
@ 1 GHz, 5 dB Gain
High gain device for Class B or C
operation in final, driver, and
pre-driver amplifier stages in
UHF equipment and as a
fundamental frequency
oscillator at 1.68 GHz.
Specifically designed for L-Band
pulse radar, mobile, and
telemetry applications.

High-Reliability types available off the shelf



40577 (TO-5)
40578 (TO-39)

40577 is electrically similar to
RCA 2N3118; 40578 has as its
parent type RCA-2N3866. Both
devices add to RCA's expanding
high-reliability line which
includes 40305, 40306, 40307
(parent types 2N3553, 2N3375
and 2N3632).

Circle 315 on reader service card

JAN types with off-the-shelf availability



JAN-2N3553 (TO-39)
JAN-2N3375 (TO-60)

Circle 316 on reader service card

Tested to MIL-S-19500/341,
these RCA "overlay" types
conform to JAN specifications
and are available right now in
quantity.

Circuit Coverage

For Military and Industrial Applications



2N5070 (TO-60)
2N5071 (TO-60)

2N5070
25 Watts PEP Output with
13 dB Gain (Min.) @ 30 MHz and 28 V
2N5071
24 Watts Output with 9 dB Gain (Min.)
@ 76 MHz and 24 V
The RCA 2N5070 is designed
specifically for 2- to 30-MHz single-
sideband military and ham
transmitters. The 2N5071 is intended
as a high-power, Class B and C rf
amplifier for FM communications in
wideband and narrowband circuits.
Circle 317 on reader service card

Load Mismatch Protection for Aircraft Transmitters



2N5102 (TO-60)

15 Watts Output (Min.) @ 136 MHz
RCA-2N5102 is intended
as a high power device for
Class C, AM amplifier service
(for aircraft VHF) in the 108- to
150-MHz range. Each unit is
individually tested at worst-case
conditions (full modulation and
no current limiting) for complete
load mismatch protection.

Circle 318 on reader service card

Class A Linear Amplifier for VHF—UHF



2N5109 (TO-39)

$f_T = 1200$ MHz (Min.)
@ $I_C = 50$ mA, $V_{CE} = 15$ V
New generation "overlay"
transistor featuring low
distortion, low noise for
wideband applications in CATV,
MATV, Class A, or linear
amplifiers with large dynamic
range.

Circle 319 on reader service card

Famous 2N3866 Performance in TO-60 case



2N5090 (TO-60)

1.2 Watts Output (Min.)
@ 400 MHz, 7.8 dB Gain
1.6 Watts Output (Typ.)
@ 175 MHz, 12 dB Gain
Intended for Class A, B, or C
amplifier, frequency-multiplier,
or oscillator circuits, 2N5090
may be used in output, driver, or
pre-driver stages in VHF and
UHF equipment.

Circle 320 on reader service card

27-MHz Output Transistors for Citizens-Band Transmitters



40581 (TO-39)
40582 (TO-39)

These two new devices are
designed specifically for output
stages of 5-watt CB equipment.
The 40581 has an output of 3.5
watts at 27 MHz with $P_T =$
5 watts; the 40582 has an output
of 5 watts with $P_T = 10$ watts
and is equipped with a factory-
attached mounting flange for
improved heat-sinking.

Circle 321 on reader service card

For more information on these and other RCA
"overlay" transistors, see your RCA Repre-
sentative or your RCA Distributor. For tech-
nical data on specific types, write: Commercial
Engineering, Sec. IN11-4, RCA Electronic Com-
ponents and Devices, Harrison, N.J. 07029.



RCA Electronic Components and Devices

The Most Trusted Name in Electronics

announcing

... JFD

compactuner compactuner compactuner



JFD is pleased to announce a new line of miniaturized Long Life Modular Tuners, for both straight line capacitance and straight line frequency applications.

JFD has always featured a line of specially designed and built tuners to meet custom applications. Now available is a standardized tuner designed with all the versatility of the custom built units. This is made possible by two new mechanical packages that allow up to eight independent capacitor elements to be tuned simultaneously. This standardization results in a high quality, precision tuner at moderate cost.

Two basic models are available both featuring ten full turns of adjustment for precise tuning and excellent resolution. One model will accommodate up to four cylinders; the other from five to eight cylinders. These cylinders are available in a wide choice of dielectric materials and metalized patterns allowing almost unlimited design freedom. They can all be made as straight line capacitance, straight line frequency, special function, split stator, differentials, etc. or any combination can be specified on a single tuner.

The use of solid dielectrics with their inherent stability and high voltage ratings allow tuners to be built in smaller sizes than have even been achieved before. Wide capacitance ranges or frequency ratios can be achieved in packages that will withstand the severe environmental conditions that today's equipment requires.

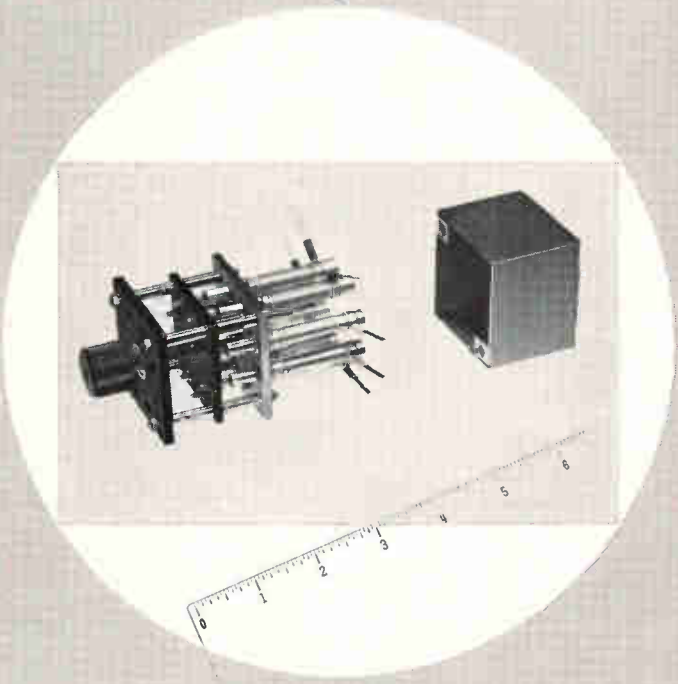

For additional information, write for catalog LLT-67.

"TODAY'S COMPONENTS BUILT FOR TOMORROW'S CHALLENGES"



JFD ELECTRONICS CO. / COMPONENTS DIVISION / 15th Avenue at 62nd Street / Brooklyn, New York 11219 / Phone 212-331-1000
Offices and subsidiaries in principal cities, world-wide.

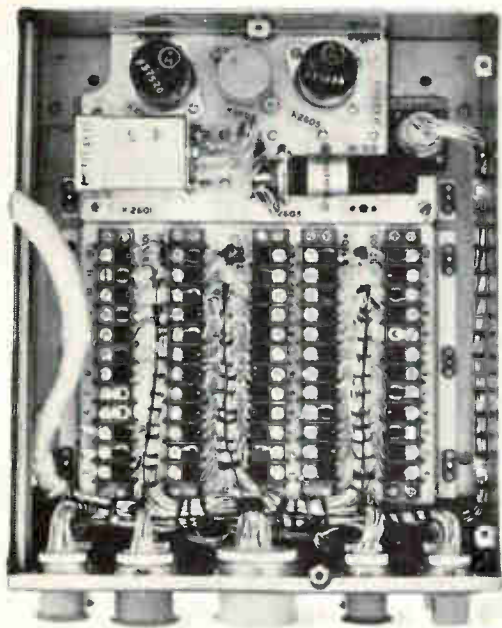

**Why load your equipment
with obsolete round wire...**

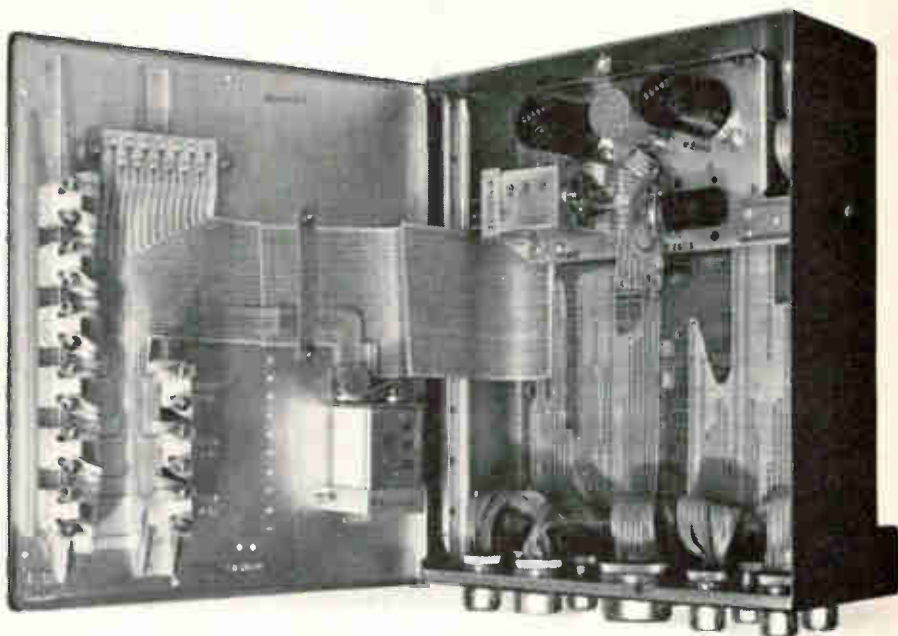

**when you can lighten it
with flexible printed wiring?**

Here's the logical solution to today's critical demands on electronic equipment: flexible cables and printed wiring.

And Cerro is the logical source for reliable, high-quality materials.

This breakthrough in electronic packaging reduces space requirements by as much as 75%...cuts overall wiring weight by up to 60%...increases reliability and uniformity...eliminates errors...reduces handling, installation, and inspection time...and cuts installed costs by up to 50%.

CERRO-FLEX* is ideal for missiles, rockets and satellite systems; computers and data processing equipment; defense and weapons systems; instruments and control systems; and telemetering and communication equipment.

Why not put our 50 years of experience in manufacturing Rockbestos® products to work for you? Write now for our free, authoritative 12-page design guide (CF-1/67-5M).



It'll show you how to reduce weight, save space, simplify assembly, increase reliability and uniformity and...cut costs.

Cerro Wire & Cable Co., Division of Cerro Corporation, New Haven, Conn.06504.

CERRO
WIRE & CABLE

*Trademark

FLEXIBLE

LEVEL-MEASURING SYSTEM PSM-5

10 kHz to 36 MHz

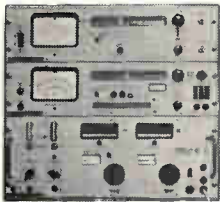
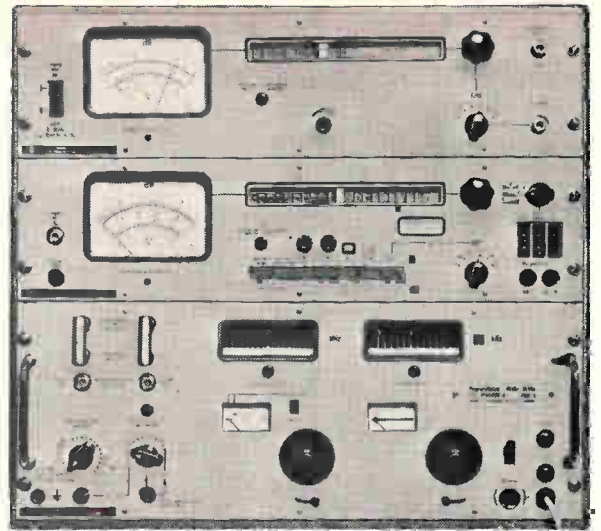

PSM-5

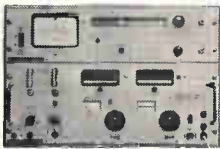

PSO-5

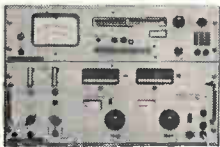

PMO-5

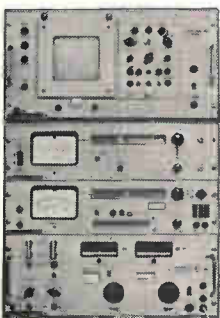

WM-50

Until now, it has been impossible to cover such a wide range of frequencies and applications as is possible with the PSM-5 family of measuring instruments. Accurate within ± 10 Hz at 1 kHz check points and ± 100 Hz at any frequency.

Level Generator and Receiver (combined or separate)

The PSM-5 level measuring system consists of a generator, a receiver and a tuning oscillator. The oscillator and generator may be combined to form a level generator, PSO-5. The oscillator and receiver may be separately combined to form a selective level meter, PMO-5. Any of these combinations can be provided.

Level Calibration Selectable

Both the generator and receiver may be set to measure either voltage level or power level, i.e. levels can be indicated either in dB or dBm. This is accomplished through a front panel switch which physically changes the attenuator scales and electrically compensates the meter circuits for the referenced impedance of the measurement.

Input and Output Impedances

Both generator and receiver portions of the PSM-5 can be switched to match impedances of 50, 60, 65, 75, 135, and 150 ohms. The receiver is equipped with a high impedance "bridging" input (30 pF input capacity) and an accessory high impedance probe (7 pF) is available.

Battery Operation

When normal AC power is not available, the PSM-5 can equally well be powered from a DC source in the range of 23 V to 30 V.

Point-to-Point or Sweep Measurements

The measuring system allows exact point-to-point measurements. With the addition of an oscilloscope display it can also be used for sweep measurements (WM-50). A wide range of sweep rates and ranges is already provided in the tuning oscillator unit.

Frequency adjustment: 10 kHz (2 kHz) to 36 MHz, phase locked to a crystal at 100 kHz points, phase compared at 1 kHz point; optically projected fine and coarse tuning scales, each virtually 8 ft. in length.

Built-in electronic sweep with common tuning of generator and receiver.

Sweep range ± 17.5 Hz to ± 17.5 MHz.

Sweep frequency: 0.1 to 50 Hz, manual and external.

Level measuring range: -130 dB to +20 dB.

Selectable bandwidth: 500 Hz and 3.5 kHz.

Meter scale linear (20 dB) and logarithmic (100 dB).

Calibration: Selectable dB or dBm.

Oscilloscope display unit with electronic calibration line and frequency markers.

Graticule markings, full scale (level): 2 dB to 100 dB.

Graticule markings, full scale (frequency): 35 Hz to 35 MHz.

Accessories: Expanded scale meter (± 1 dB), high impedance probe, dual trace switching unit, return loss bridge (50 - 150 ohms).

Wandel & Goltermann

West Germany

REPRESENTED IN U.S.A. BY

TEL-COM

INSTRUMENTS, INC.

6 Great Meadow Lane, Hanover, New Jersey 07936

Telephone: (201) 887-8700



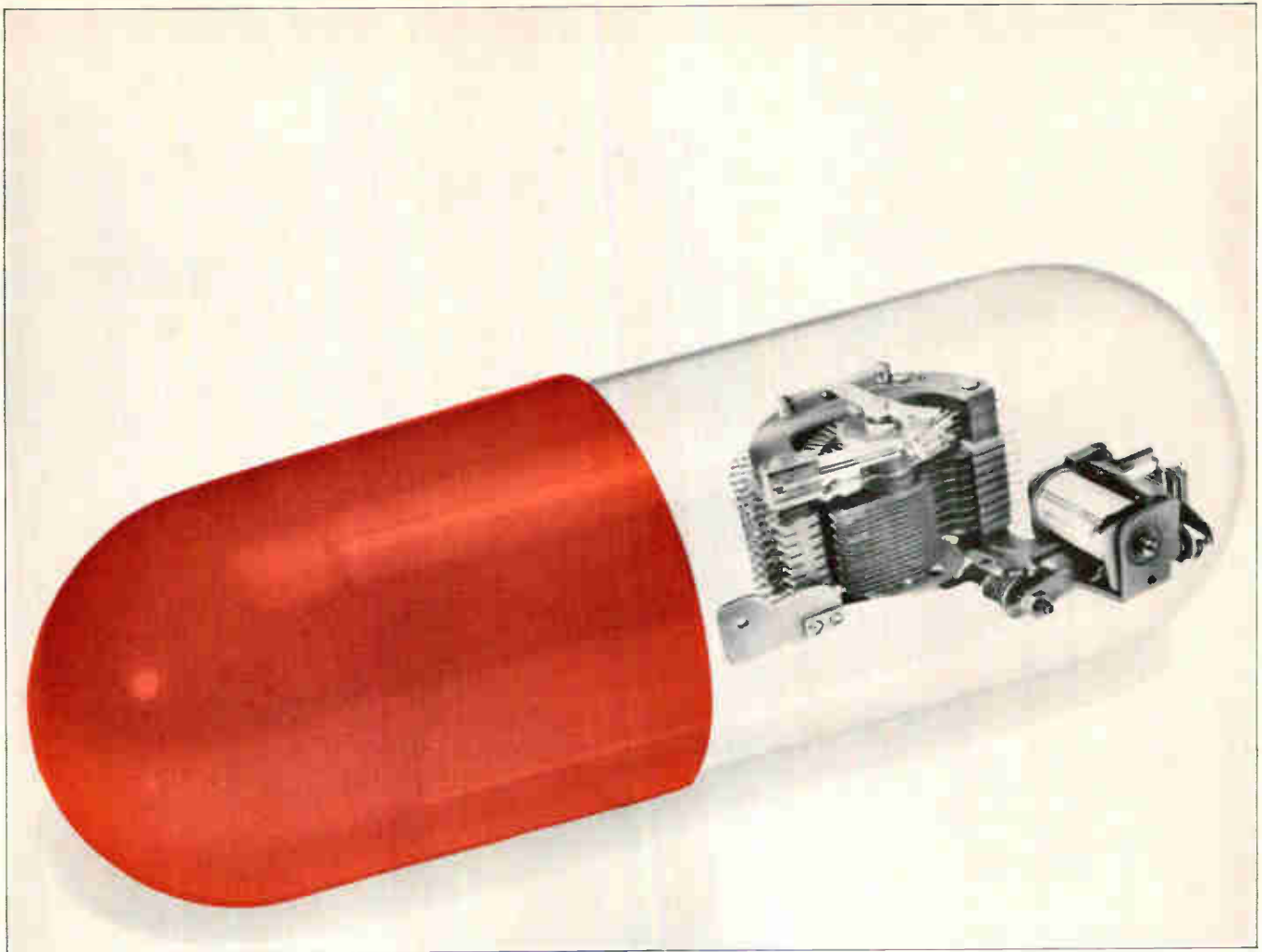

Remedy for nightmares: AE's Type 45NC stepping switch with "shorting" levels.

Many of today's complex switching circuits look like an engineer's nightmare. Why not simplify them? You can replace whole groups of components with an AE Type 45NC "stepper."

This switch has normally closed ("shorting") levels. It's designed so that pairs of contacts *open* successively when the rotor is stepped.

The Type 45NC can solve almost any circuit-transfer or testing problem.

It's ideal for self-interrupted hunting, and you don't need auxiliary relays.

You get one or two electrical levels of either 26 or 52 point normally-closed contacts. For extra versatility, you can specify addi-

tional levels of *normally-open* contacts—on the same switch.

Contacts are gold-plated phosphor bronze. Contact resistance: a maximum of 50 to 100 milliohms, measured at 6 volts 100 milliamperes.

When you specify AE rotary stepping switches, you get the benefit of our continuous research—in design, in metals and insulating materials. All this plus *positive positioning* — a unique AE design

feature that locks the rotor and makes overthrow impossible.

Find out more about AE rotary stepping switches—an economical, rugged and reliable way to simplify switching circuits. There's a lot of helpful application information in our new reference circular 1698-L. To get your copy, just ask your AE representative. Or write to the

Director,
Relay Control Equipment Sales,
Automatic Electric,
Northlake,
Illinois
60164.

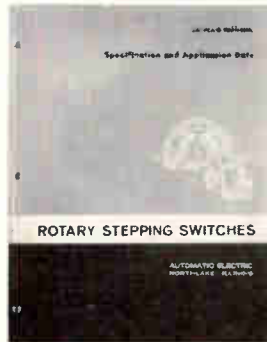

AUTOMATIC ELECTRIC
SUBSIDIARY OF
GENERAL TELEPHONE & ELECTRONICS **GTE**

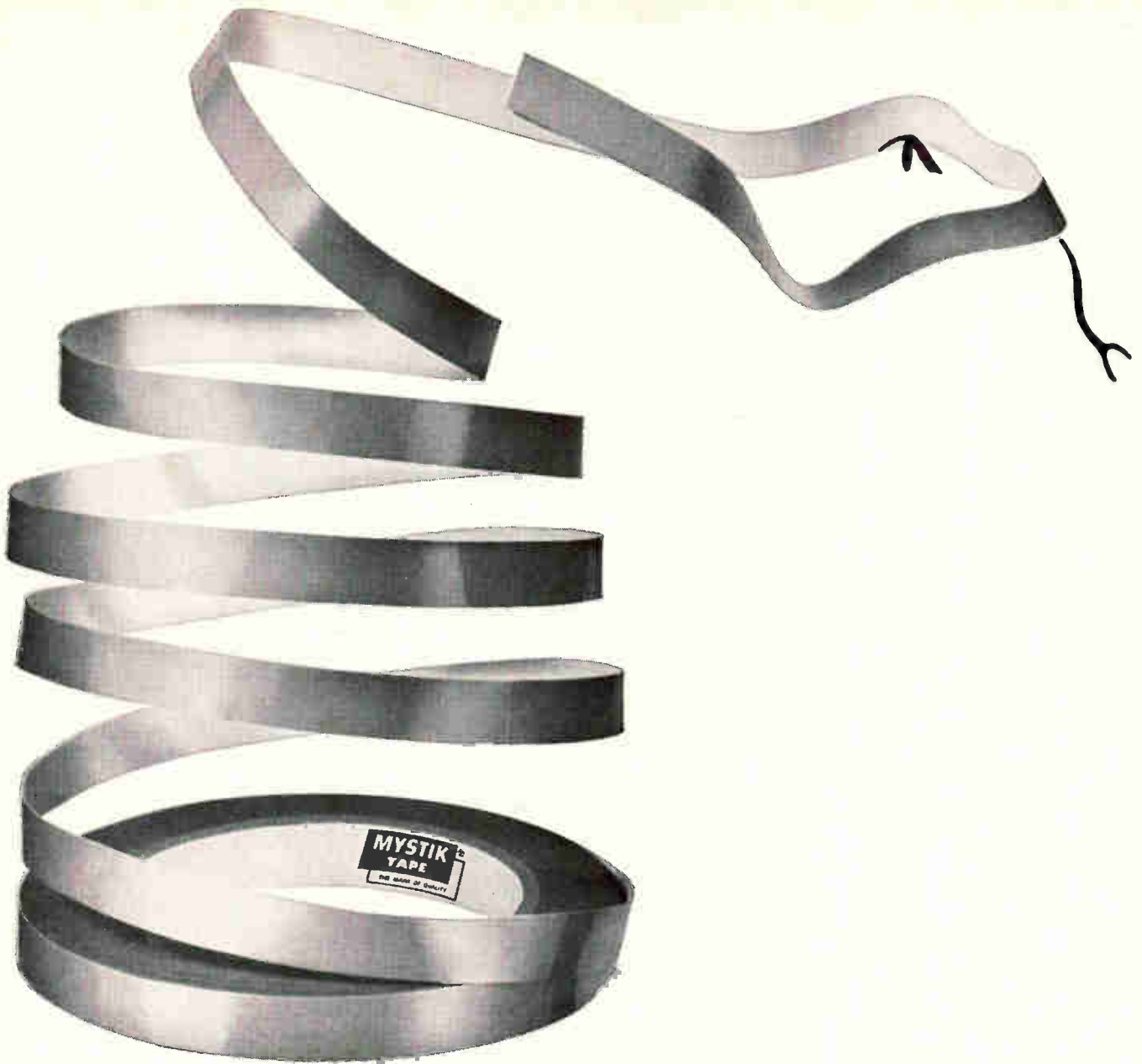

Reduce friction and keep cool with Mystik Teflon® Tapes

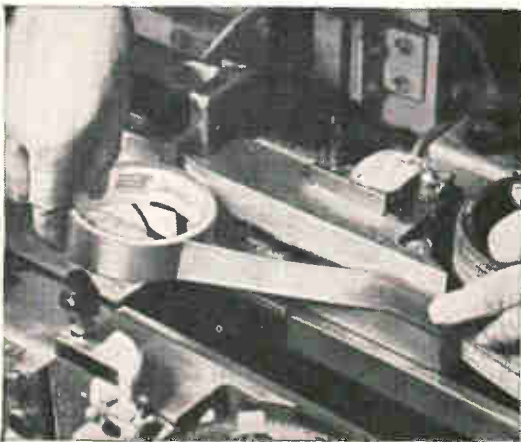

Mystik's Teflon tapes combine the advantages of TFE Teflon film with a silicone pressure-sensitive adhesive. As a result, they offer high dielectric strength, low coefficient of friction, and high performance within a temperature range from -100°F to $+450^{\circ}\text{F}$.

These remarkable tapes are particularly useful in reducing friction on high speed equipment and as insulators of electrical apparatus, but they have many other applications in the electrical and electronic industry.

Of course, Mystik Teflon Tapes represent only a few of the high quality paper, film, and glass cloth tapes available for special applications. For assistance in selecting the best ones for your needs, contact your local Mystik distributor. He's listed in the Yellow Pages under "Tape" or write The Borden Chemical Co., Mystik Tape Div., 1700 Winnetka Avenue, Northfield, Illinois 60093.



**BORDEN
CHEMICAL**

© TFC

Why waste time on bypass/filter capacitors?

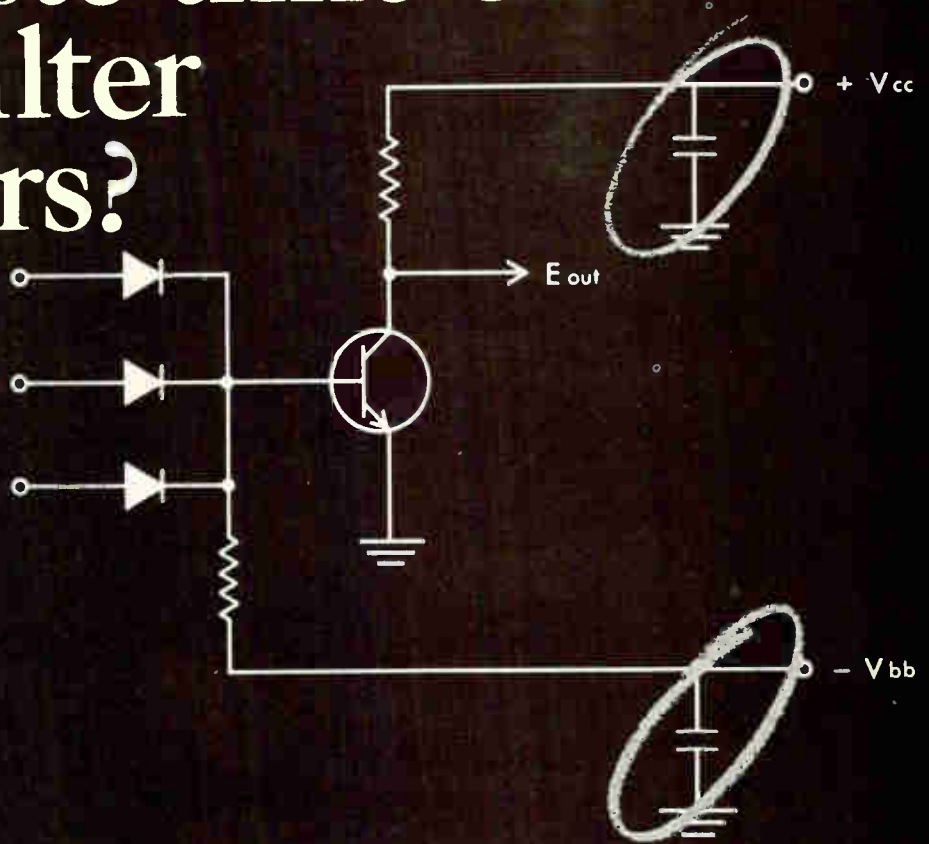

Specify CORNING® Glass-K Capacitors, and move on.



There's only one real concern with a bypass/filter capacitor. If it goes, your circuit will probably follow. Specify the guaranteed reliability of CORNING Glass-K Capacitors and forget it.

You can forget it for the same reason we can guarantee it:

1. Large capacitance in minimum case size, 1000 to 51,000 μf in $.250'' \times .100''$ or 12,000 to 100,000 μf in $.250'' \times .140''$.
2. Low power factor and low DC leakage.
3. Adaptability to cordwood, printed circuit, and point-to-point packaging and automatic insertion.
4. Tight end-of-life design with guaranteed stability.

Get this confidence at a competitive price, and inside two weeks for standard items. Get complete data by writing to: Corning Glass Works, Electronic Products Division, Corning, New York 14830.

CORNING
ELECTRONICS

Circle 69 on reader service card

How AO fiber optic light guides solve illumination problems.

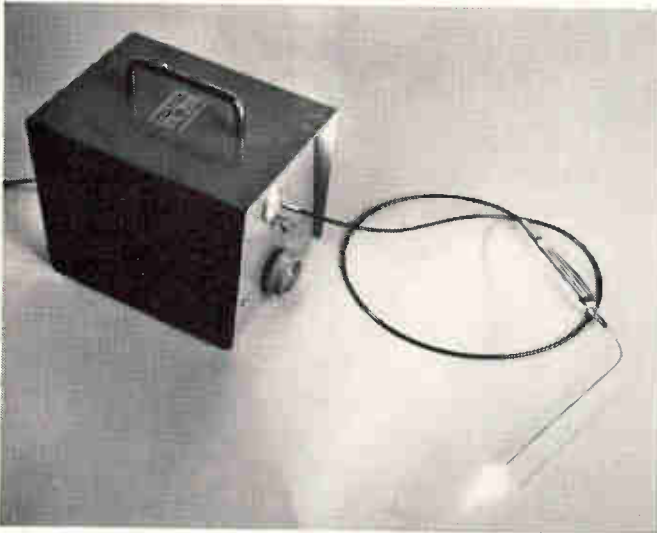

Transmit "cold" light like other forms of energy—by flexible routing to remote or inaccessible locations, hazardous areas, or any abnormal environment.

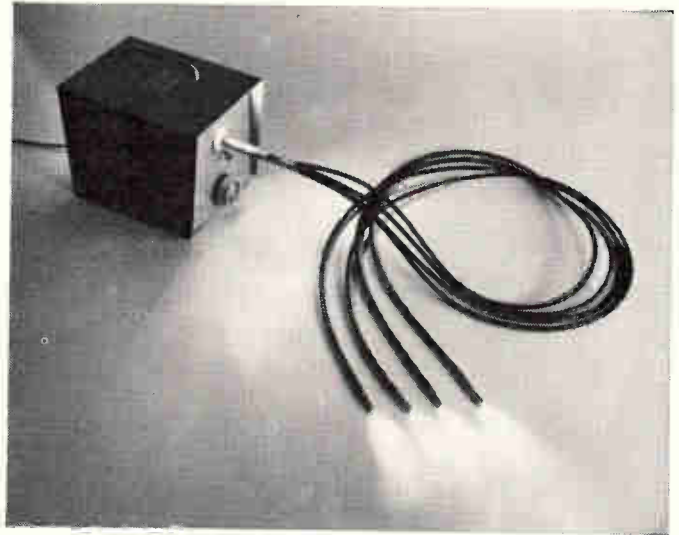

Supply multiple illumination from a single light source, with multi-branched light guides.

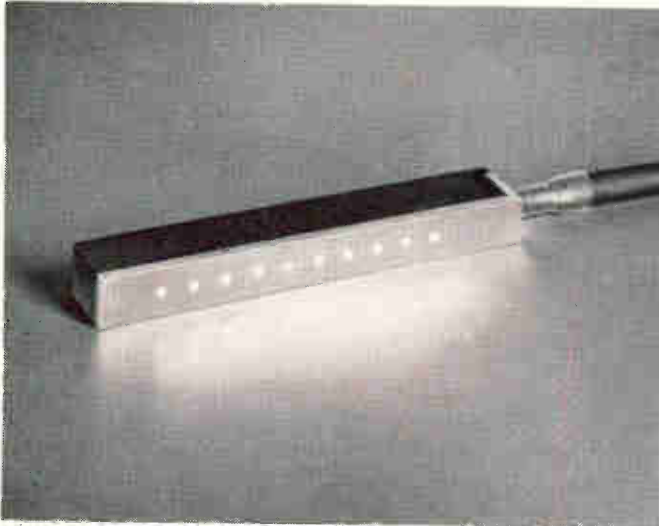

Simplify lighting problems by eliminating lens systems, multiple lamps, complex electrical circuitry.



Provide input-output geometry conversions such as round-to-square, round-to-slit, etc.

These are only a few of the ways in which American Optical fiber optic light guides are used to help solve illumination problems. Specific applications range from mark sense readout to electro-optical sensing in data processing, circuit verification, fire control, null detection, light pens, spot illumination, and many others.

Simple, reliable, economical. AO fiber optic light guides are simple, passive elements which remain extremely reliable under normal vibration, temperature or humidity changes, or other environmental fluctuations. This results in long service life with minimum maintenance.

Standard and custom light guides from American Optical have light transmission ranges from 400 to 1500 millimicrons. Standard light guides are

available in bundle sizes from .020" to 1/4", with 30 to 6000 fibers, lengths up to 72", plastic or stainless steel tips, and PVC sheaths. Custom light guides can be supplied in any length desired, with special end tips, sheaths, diameters, input-output face configurations, and branchings.

A leader in optics since 1833, American Optical Company brings a great breadth of related experience to the technology of fiber optics. Our versatility in fiber optics is unmatched by any other manufacturer. In fact, AO scientists already hold more than 200 important patents or patents pending in this relatively new field.

For Fiber Optics Data Kit, send reader service card, or write to Fiber Optics Department:



AMERICAN OPTICAL COMPANY
Space-Defense Division • Southbridge, Mass. 01550

The RCA-TA2628 solid-state laser with threshold current of less than 15A at room temperature needs only a simple solid-state circuit and a small battery for a typical power output of ... **3 crazy watts!**



There's nothing crazy or complicated about putting RCA's new GaAs injection laser to work in your circuits today! This tiny, highly efficient unit is one of the more practical laser diodes around.

It operates at room temperature and all you need to drive it is a low cost transistor or SCR, a couple of resistors and capacitors, and a triggering diode. No expensive or cumbersome cryogenic hardware or high-current power supplies.

The peak emission wavelength of the TA2628 is $9050 \pm 50 \text{ \AA}$ and you can get a typical output of 3 watts if you drive it with a pulse current of 30A. It is backed by life test data in excess of 1000 hours and its range of applications is limited only by your imagination.

We have just published a brand new Application Note (AN-3439) on this unit, which we would like to send you. At the same time we will forward you data sheets on RCA's other solid-state optical devices—the TA2930, a 50-watt laser, and the TA7008, IR emitting diode. Write: RCA Commercial Engineering, Section SN11-4, Harrison, N.J. 07029.

Also available through your RCA Distributor

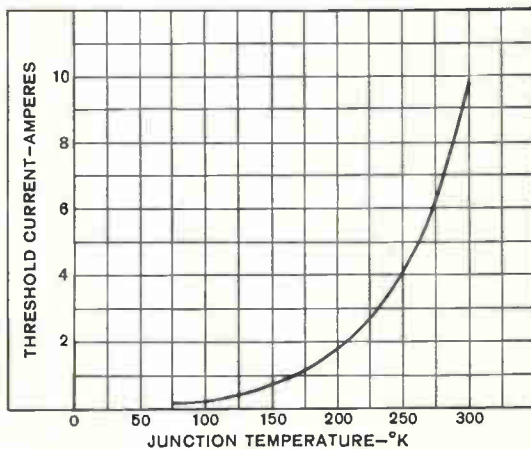

RCA Electronic Components and Devices

The Most Trusted Name in Electronics

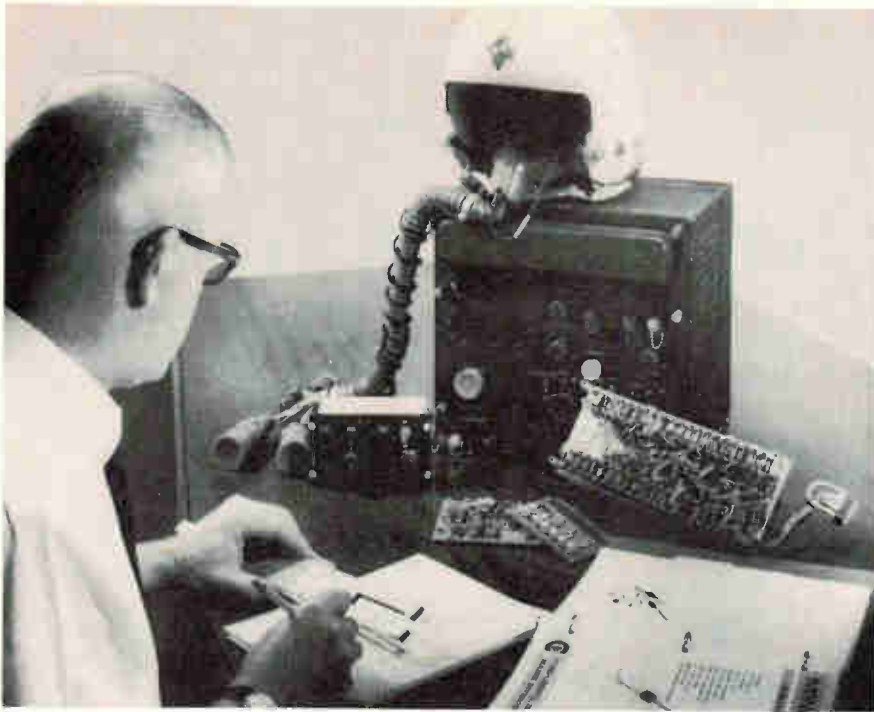

how to save space in avionics black boxes...

Application: Fire control system on our latest tactical fighter.

Problem: How to fit an analog/digital data processor, two servo systems, and a power supply into a 10" x 8" x 6" box and still not sacrifice reliability.

Solution: Thick film substrates utilizing Minitan solid tantalum capacitors.

Minitan subminiature solid tantalums are up to 75% smaller than equivalent CS13 styles — at no sacrifice in performance. That's why Minitans are specified on Poseidon, HARP, F-111, Apollo, Saturn V and dozens of other airborne and space systems.

Minitans operate reliably to 125°C, handle 130% voltage surges, and withstand Method 106 moisture testing. Standard tolerances are $\pm 20\%$, $\pm 10\%$, and $\pm 5\%$. DC leakage is typi-

cally less than .01 uA per mfd-volt. Impedance is below 10 ohms between 1MHz and 10MHz.

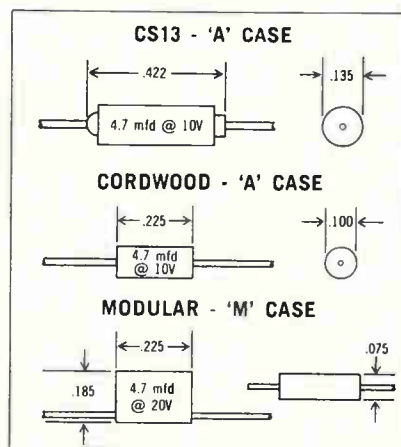

Not only are Minitans substantially smaller than CS13s, they come in both rectangular and tubular styles with either radial or axial leads. For maximum IC compatibility, gold plated ribbon leads are a standard option.

Minitan subminiatures are available in 11 case sizes, working

voltages to 35 volts, and capacitance values from .001 to 220 mfd. A full line of non-polar styles is offered for severe reverse DC bias applications.

Components, Inc. offers more subminiature case styles and ratings than anyone else. Our products are designed in, not added on. So we welcome requests for samples, performance and reliability data, and applications aid. Almost every catalog part can be shipped in prototype quantities within 24 hours.

**... with
Minitan®
solid tantalum
capacitors.**

COMPONENTS, INC.
MAINE DIVISION
SMITH ST. BIDDEFORD, MAINE 04005 TEL: 207-284-5956 TWX-710-229-1559

Why take pot luck for reliability?

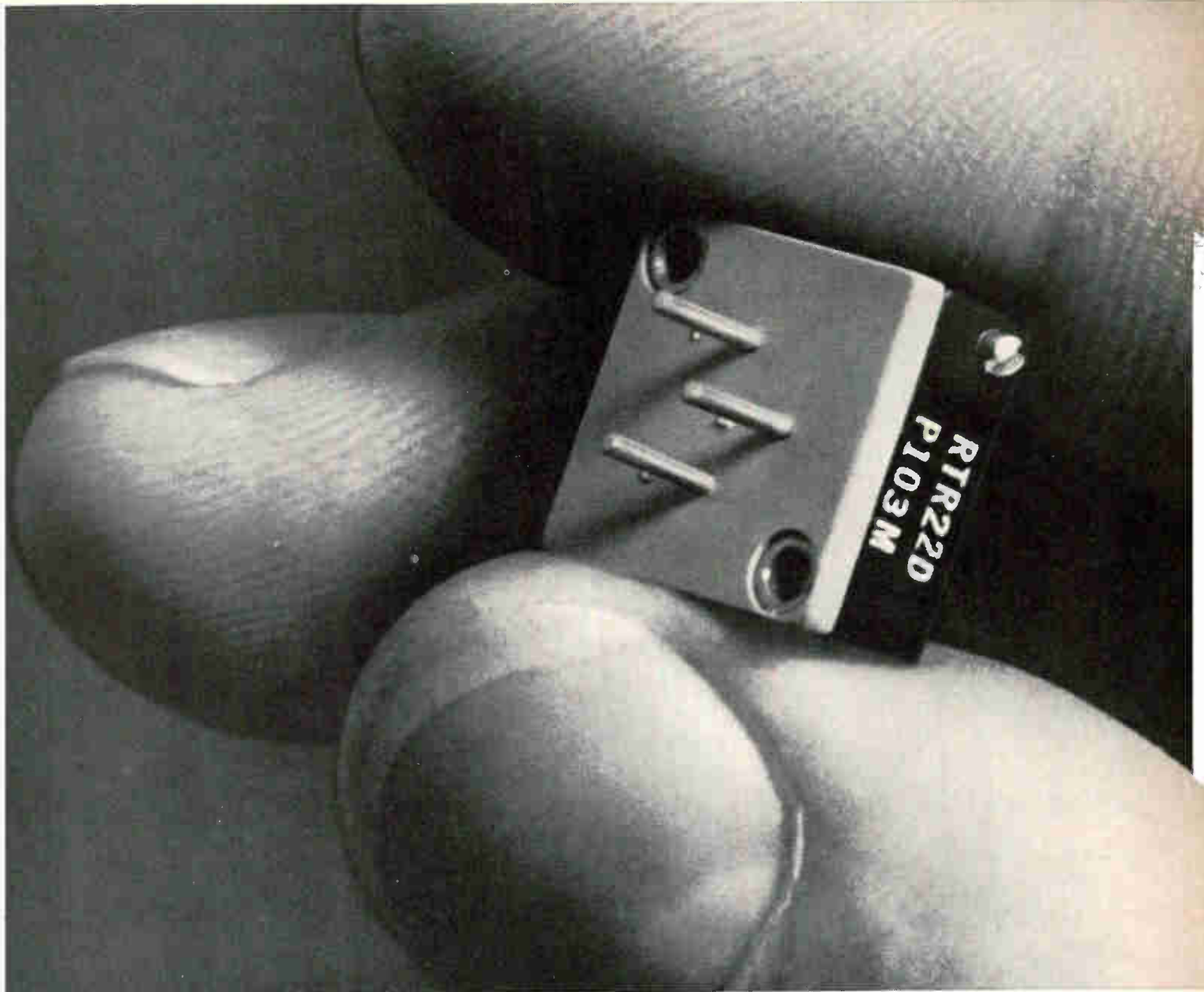

**DAYSTROM HI-RELIABILITY SQUARETRIM® POTS
ARE MANUFACTURED AND TESTED TO MIL-R-39015**

The Daystrom Squaretrim 318-160HS is designed, manufactured and tested in complete accordance with MIL-R-39015. This means you no longer have to resort to costly unmonitored programs when you need high reliability potentiometers.

The 318-160 Series Squaretrim potentiometers not only give you the best design and materials, but are manufactured with piece part traceability, in-process controls, and

the stringent QC program defined in this Specification.

So . . . don't trust to luck. Order Daystrom Hi-Reliability Squaretrim pots. They're available in values from 10 ohms through 20K. Prompt delivery on orders. Write or phone today.

Daystrom potentiometers are another product of: Weston Instruments, Inc. • Weston-Archbald Division, Archbald, Pennsylvania 18403 • Phone 717-876-1500

WESTON® *prime source for precision . . . since 1888*

WESTON-ARCHBALD • WESTON-HATBORO • WESTON-NEWARK • WESTON-POUGHKEEPSIE • WESTON-LEXINGTON • WESTON-TRANSICOIL • WESTON-GARWIN CARRUTH • WESTON-CANADA

Circle 199 on reader service card

Obviously from Sprague Electric!

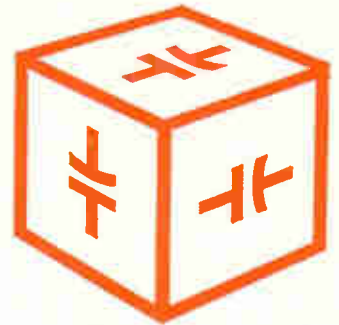

**Higher CV product per cubic inch
than any other solid tantalum capacitor!**

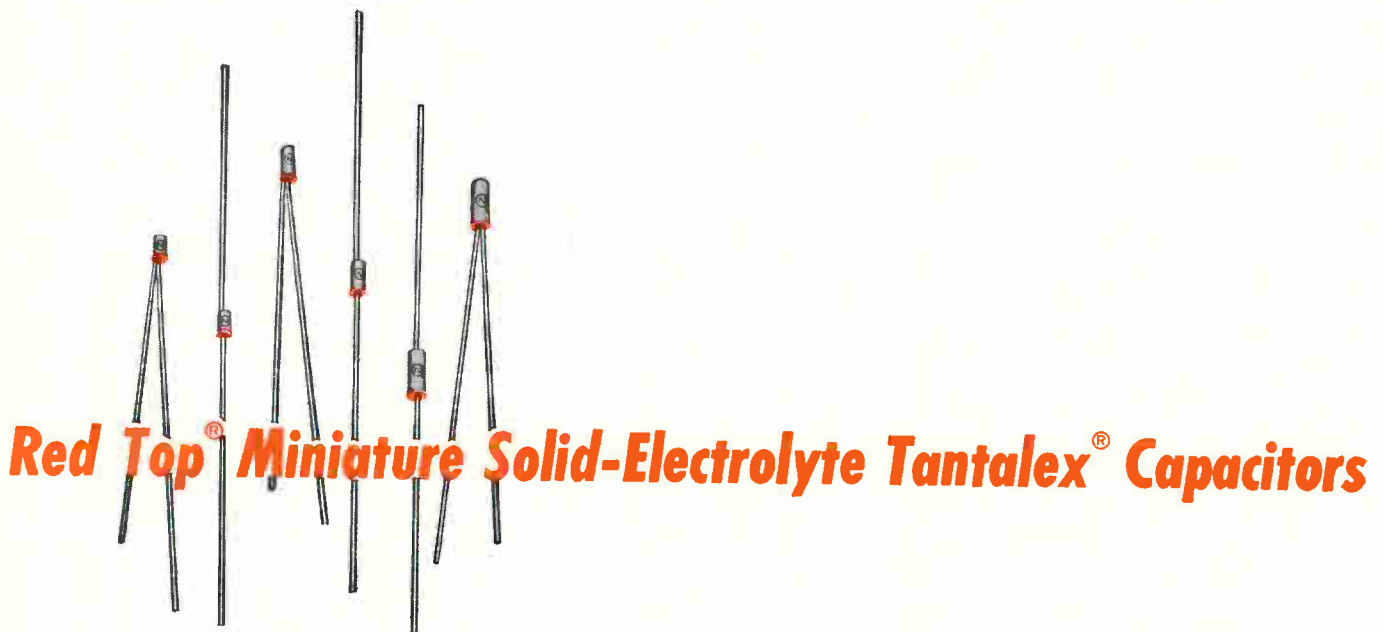

Red Top® Capacitors are TOPS when your circuit design calls for reliable, low-cost, commercial/industrial solid tantalums for printed wiring boards, packaged circuit modules, and other applications where miniaturization is a must.

Their special construction employs a metal case and plastic resin end seal, providing the price advantages but eliminating the mechanical disadvantages often associated with molded capacitors, such as "off-center" units with consequent "thin" walls, secondary cathode connection prior to molding, and limited humidity resistance.

Red Top® Capacitors are ideally suited for today's circuit design requirements which demand filtering at specific locations. Their small size permits "salting" or "sprinkling" wherever needed:

With capacitance values that range from 68 μF to .016 μF in voltage ratings from 2 to 100 WVDC, Sprague Red Top® Capacitors are available with axial or "single-ended" leads.

For complete technical data, write for Engineering Bulletin 3536A to Technical Literature Service, Sprague Electric Company, 35 Marshall Street, North Adams, Massachusetts 01247.

SPRAGUE COMPONENTS

CAPACITORS
TRANSISTORS
RESISTORS
INTEGRATED CIRCUITS
THIN-FILM MICROCIRCUITS
45C-7138

PULSE TRANSFORMERS
INTERFERENCE FILTERS
PULSE-FORMING NETWORKS
TOROIDAL INDUCTORS
ELECTRIC WAVE FILTERS

CERAMIC-BASE PRINTED NETWORKS
PACKAGED COMPONENT ASSEMBLIES
BOBBIN and TAPE WOUND MAGNETIC CORES
SILICON RECTIFIER GATE CONTROLS
FUNCTIONAL DIGITAL CIRCUITS



Sprague and '®' are registered trademarks of the Sprague Electric Co.

Technical Articles

Computer-aided design:
part 12, Smoothing the
flow of data traffic
page 76

Minimizing the effect of impedance mismatches in data systems gets to be an almost impossibly difficult job in a large system where the number of such mismatches can top 100,000. Still, these mismatches can slow the operation of transmission lines and adversely affect the system's performance. Now a computer program has been written so that fast machine help brings the problem down to manageable size.

Linear integrated circuits:
part 5, More on the
operational amplifier
page 84

Sales talk about how easy it is to design with integrated circuits often leads an engineer to do a superficial job. Comforted by such catchphrases as "systems approach" and "black-box theory," he will busy himself with external connections to the IC—input, output, biasing, feedback—and ignore what goes on inside the chip. But knowing how to exploit a circuit's innards can widen the device's range of application, lessen the chances of misoperation or failure, and permit the full exploitation of system design techniques.

**Steering a course
to safer air travel**
page 95

Electronics

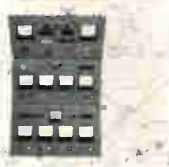

Very-high-frequency omnirange systems (VOR) are the backbone of the electronic direction-finding system pilots use in the United States to position themselves. But the complaint is raised regularly that VOR position information is not accurate enough. One part of the problem is that the VOR signals have been measured to a limited accuracy. Now digital VOR equipment has

been designed that will allow the Federal Aviation Administration to measure the signals from its VOR ground stations with an accuracy 10 times better than that of existing receivers. The design techniques, using off-the-shelf integrated circuits, may be the precursor of digital VOR equipment for all aircraft. For the cover, Vincent Pollizzotto superimposed a color photograph of the new equipment on an air chart of the kind pilots use for navigation.

**Coming to grips
with multipath ghosts**
page 104

Chirp, a technique developed to remove unwanted reflections from radar signals, is now being applied to high-frequency and very-high-frequency radio transmission. By compressing waveforms, the new method minimizes the effects of echoes, noise, crosstalk, and frequency shifts.

**Coming
December 11**

- **Special report on Japanese semiconductor technology**
 - Discrete devices
 - Optoelectronic devices
 - Bulk-effect devices
- **Programmable arrays for computers**

Computer-aided design: part 12

Smoothing the flow of data traffic

Programed to analyze a highway network in a digital data system before it is built, a computer determines how reflected pulses can be reduced to provide the system with maximum efficiency

By A.W. Rich, B.M. Vaughan and C.J. Cant

Christchurch, New Zealand

Head-on collisions are as dangerous to transmitted signals as they are to motorists—they're potentially destructive. One way to minimize the effect of such collisions in digital systems is to use a computer-aided approach to designing the transmission line.

Unlike the motorist, the designer of a data system can't avoid a collision by turning the signal off the highway. Collisions are actually caused by the highway scheme whereby one transmission line feeds several receivers in different units via spur connections.

Although highways reduce the number of lines in a large data system that would otherwise have upwards of 100,000, the impedance mismatches caused by spur connections partially reflect transmitted signals back to their source. With a single discontinuity, the amplitude of the reflected and transmitted pulses can easily be calculated. But most systems have several discontinuities, each generating spurious pulses.

Because the spurious pulses take considerable time to fade, the accumulative effect is a much longer delay time than the cable's basic propagation delay. Eventually, the myriad pulses in the system are absorbed by the many load resistors attached to the line.

Manually calculating all the pulses in a typical system is possible, but unlikely; keeping track of them is almost impossible. For a computer, however, performing the calculations is relatively simple. Before a system is actually built, the machine calculates their amplitudes, keeps track of their time progression, and plots the voltage waveform at any point in the network. This graph indicates the delay from the source to the receiver input. Knowing the threshold limits of the receiver's input volt-

age, the engineer easily determines the limits on the delay. He then adjusts the line lengths to improve the system timing so that the maximum possible efficiency is achieved, and then feeds the new data into the computer program, to test the new system.

It is also possible to correct for spurious pulses by connecting different terminations as the loads. If adjusting the line lengths or changing the loads does not offer much improvement then the engineer can reduce the clock-pulse frequency to allow time for the voltages to settle to steady state values. In essence, this adjusts the rate of data pulse transmission.

Computer program

Although written in Ferranti autocode—an elementary language—for a Ferranti Hermes F1600 computer having 8,000 words of core storage, the program can be rewritten in other languages, such as Algol (algorithmic language). Choice of language depends on the computer to be used. The program's running time is dictated by the digital plotter's speed. When a constant voltage persists on the output curve, the program is halted manually.

With most new digital-equipment designs, spur connections are usually made from printed-circuit tracks having a controlled width above a ground plane, twisted-pair wire, or coaxial cable. Since these have accurately controlled impedances, theoretical analysis is based on the assumption that a distributed network yields accurate results.

The energies in the voltage waveforms, before and after the incident wave reaches the discontinuity, determine the amplitude of both the transmitted and reflected voltages. When a spur is attached to a transmission line, a T junction is formed having

Designing a digital data system

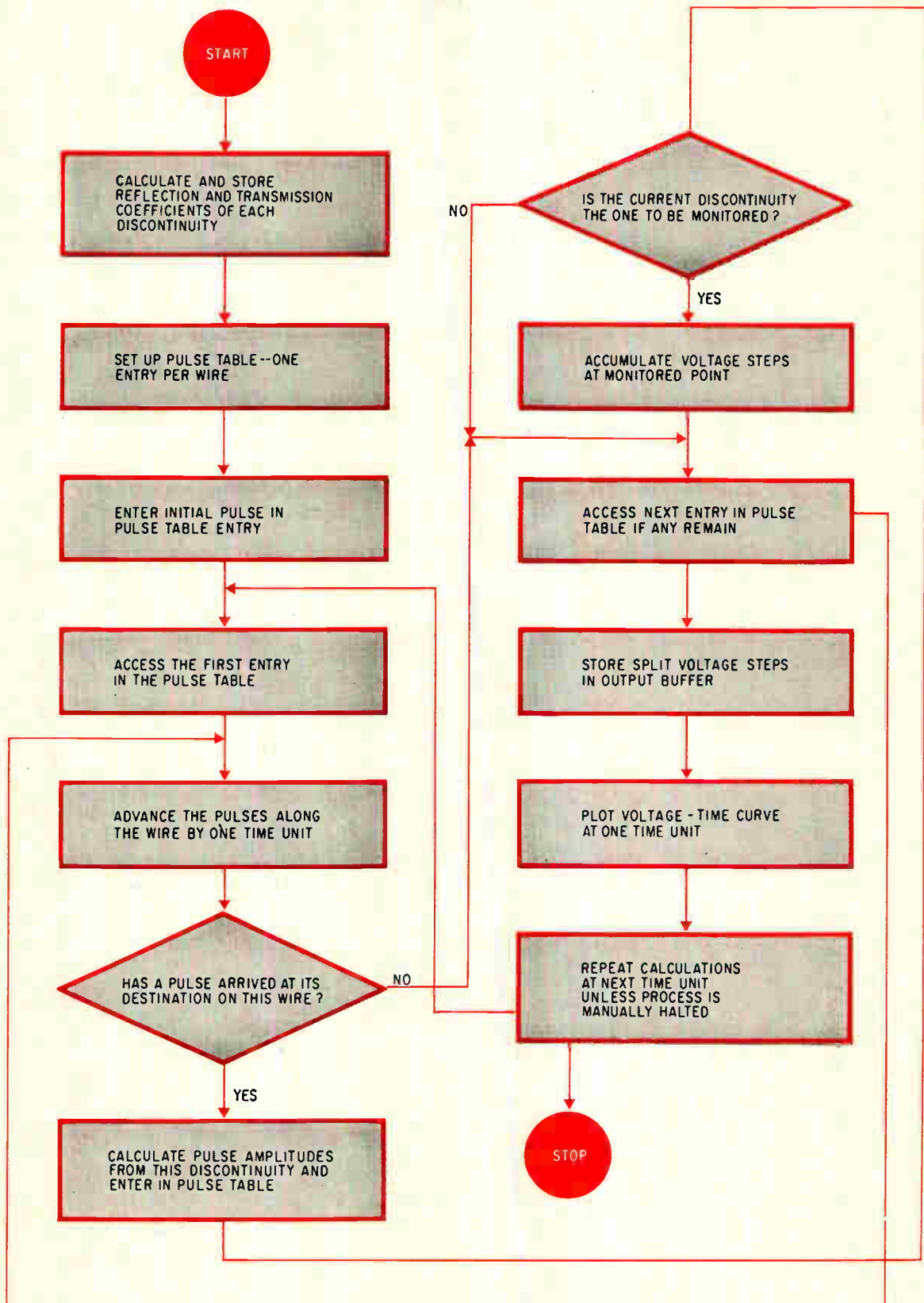

Program flow. Voltage amplitudes at each spur-wire connecting point are determined by the computer as it follows the program.

impedances Z_1 , Z_2 , and Z_3 . Lines AB and BC form the top of the T, and BD the leg. When a voltage wave traveling from A reaches B, voltages of equal amplitude are transmitted along BC and BD, and a voltage is reflected back along BA. The transmission coefficient, T , is expressed by

$$T = \frac{2Z_2Z_3}{Z_1Z_2 + Z_2Z_3 + Z_3Z_1}$$

and the reflection coefficient, r , by

$$r = T - 1$$

With a computer calculating coefficients, it is more convenient to work in terms of transmission-line admittances where

$$T = \frac{2Y_1}{Y_1 + Y_2 + Y_3}$$

In the basic analysis scheme, the program simulates the progress of the initial pulse and those derived from it. Using the Ferranti computer, the pulses were 1 nanosecond apart. Since absolute-voltage levels at all points in the network aren't stored, one point is singled out for monitoring. Each pulse arriving at this point causes an increment to be plotted on a voltage-time curve.

While the calculation is performed, two tables—line description and pulse—are stored in the computer's memory. During the data-input routine, the line-description table is formed. With each word containing the parameters of one branch and its terminating resistor, the table has as many words as the network has branches. Also, as the coefficients of transmission and reflection are computed for each discontinuity, they are added to the table.

During the computation, a dynamic pulse table is created in which all pulses presently within the network are recorded. This table contains a block of words for each branch and its resistor corresponding to each word in the description table. Each block contains $t+4$ words, t representing the propagation-delay time of the branch. The first three words provide a cross-reference to the description table, indicate the number of words in the block, and specify where to insert new pulses. Each remaining $t+1$ word contains a pulse amplitude.

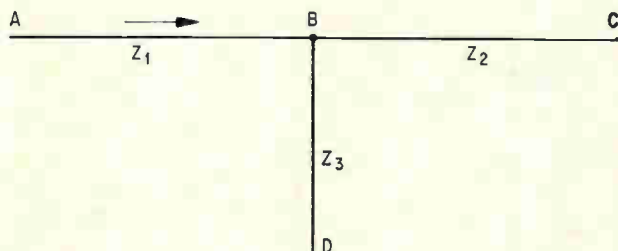

Spur connection. A typical spur connection takes the form of a T and is arbitrarily labeled A, B, C, D, so that it can be easily described to the computer. As the voltage is reflected up or down AB, amplitude changes are tracked and stored in the computer.

Word four represents a voltage at the discontinuity at time 0, and the last word is at the end of the branch's propagation time. At time 0, a pulse with zero-rise time is inserted at the network's driving point. This $t=0$ word is set to a normalized value. In all other blocks, the $t=0$ and first few words are cleared.

The first word that isn't cleared corresponds to the propagation delay between the driving point and the discontinuity for that block. Contents of this word represent the amplitude of the pulse when it reaches that discontinuity.

When analyzing a discontinuity, the program takes into account the reflections from all other discontinuities. With an iterative procedure, the computer adds up all the incident and reflected voltages that would have arrived.

Pulse shape doesn't matter

Any waveform can be approximated with several small voltage steps at different time intervals. The more steps that are selected, the smoother the curve, and, hence, the closer the result to the actual waveform. To implement this approach, the program's input voltage step is replaced by a series of smaller steps spaced at regular time intervals. For each step, the pulse calculations are applied. By summing all the pulses at each time interval, an accurate output graph results.

As advantageous as this may be, there's a price to be paid—a new entry is required for each time increment of the input waveform. How costly this technique is depends on the number of input steps: the more steps, the larger the program storage and the longer the total calculation time.

There is an alternate method, however, that provides the same results, but with much less calculation. This approach treats the pulses as single steps of zero-rise time. The pulses are then split into small steps at different time intervals when a plot is needed. The first increment is stored in an output buffer when the pulse arrives at a monitored discontinuity. All subsequent increments are stored successively. These are summed in the buffer before plotting.

Variable parameters such as the number of steps, the time duration, and the amplitudes—expressed as a fraction of the total pulse amplitude—are contained in the program on an initial data tape. (There is one tape for each pulse shape.) Thus, the resultant output is the same as that of approximating the required pulse shape via separate calculations. The initial pulse and the reflected or transmitted pulses are all treated as voltage steps.

Labeling the network

Each discontinuity is assigned a letter, with each line specified by two letters. A data tape is prepared for the entire system. It lists all lines with their impedance and propagation delay, the terminating input resistors, the source and its type, and the point to be monitored. By applying a scaling factor to the true line-propagation delay times, it is possible to

alter the graph's time scale. This permits studying short lines with delays of fractions of a nanosecond or long lines in the microsecond region.

A pulse source is specified on the data tape and can be either voltage or current.

A low impedance that applies a specified pulse to the transmission line is required for a voltage source. The impedance is listed on the tape to give the correct reflection coefficient for pulses returning to the source. A current source, on the other hand, is treated as an infinite impedance—the line is open circuited at the driving point. This causes a defined current to change in the line, making the propagated-voltage wave dependent on the line impedance.

High frequency a limitation

At present, the program cannot account for high-frequency loss in the transmission lines. Such losses usually degrade a pulse's rise time. Of the systems analyzed, most had cable lengths up to 50 feet and the pulses had rise times of 10 nsec, which caused high-frequency loss to be small. In systems having either longer lines or faster rise times, the loss is greater.

Another drawback is that the input capacitance of receiving elements aren't always known, therefore they cannot be treated precisely. But by specifying an input resistance at a point where a lumped capacitance is usually present, an approximation is possible that is accurate to within $\pm 10\%$.

Several highways have been constructed with twisted pairs for comparing measured and computed results. Because they affect the voltage characteristic of electrically short lines, program rise times were purposely selected to be less than those of actual circuits. The reason: to enable worst-case analysis. Damping resistors of 4,000 ohms have been used successfully at receiving-element inputs where a capacitance of 4 picofarads would normally be expected.

Achieving efficiency

To correct for delays caused by multiple spur connections, it is necessary to know the time at which reflections fall outside the receiving element's

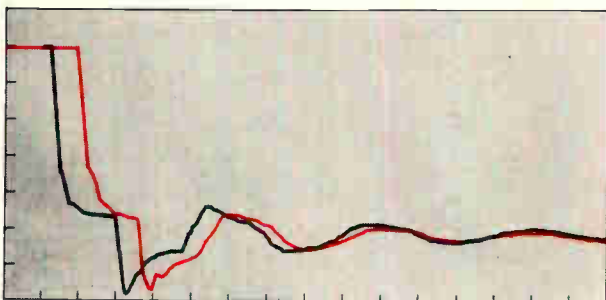

Waveform prediction. Accuracy of the computer program is proven with twisted-pair transmission line. Line in color represents measured voltage amplitudes, and curve represents computed values, which are within 10% of the measured results.

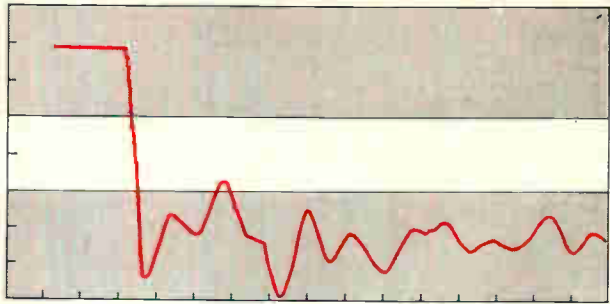

Connection delay. In the voltage waveform obtained at the end of a twisted pair connection, receiving element is switched after 62 nsec, but a reflected pulse breaks into threshold band at 113 nsec and lasts until 125 nsec. Worst-case design would allow for 125 nsec delay. Depending on actual threshold voltage, receiving element might produce stable output at 62 nsec.

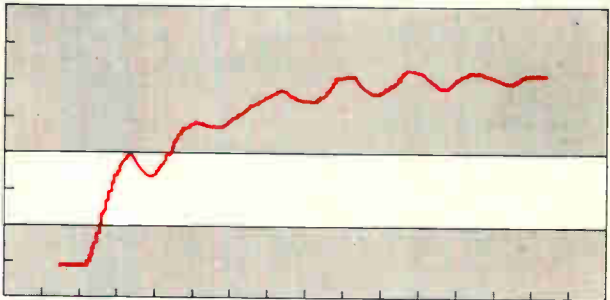

Bad termination. Exponential curve of voltage waveform obtained at the end of a printed-circuit connection indicates that the line was not terminated correctly. White area defines the upper and lower threshold limits.

threshold band. This is best provided by a voltage-waveform plot for each connection. With the accumulated data, the computer can determine the total connection delay time.

If desired, the connections and time delays between logic gates in a piece of equipment can also be analyzed to enable the engineer to predict the maximum clock speed.

In the plot directly above of a typical printed-circuit connection between logic gates, the line is incorrectly terminated, resulting in the waveform approaching an exponential curve. This indicates to the engineer that an alternate connection scheme is necessary.

The results of an analysis depends on the accuracy of the line impedance and propagation delay times. In printed-circuit assemblies, particularly multilayer types, this could require considerable sampling to specify the values for a given design of logic unit.

With additional development, it will be possible to alter the program to include the effect of input capacitance, and thus make this technique more valuable for designing equipment having high-speed logic gates. For these, the input characteristics are predominantly capacitive and multiple reflections exceeding the gate threshold limits usually cannot be tolerated.

Designer's casebook

Designer's casebook is a regular feature in Electronics. Readers are invited to submit novel circuit ideas, packaging schemes, or other unusual solutions to design problems. Descriptions should be short. We'll pay \$50 for each item published.

Large-signal sampling without a transformer

By D.J. Grover

Marconi Instruments Ltd., St. Albans, Herts, England

By eliminating the transformer usually found in a sampling circuit an engineer can monitor signals whose amplitudes are comparable with those of the power supply.

The conventional sampler employs a pulse transformer whose secondary drives a diode bridge. The buffer, between the low d-c resistance of the transformer and the diode bridge, causes considerable attenuation of driving voltage, thus limiting the amplitude of the sampled signal. With the modified circuit these disadvantages are overcome because a balanced drive to the diode bridge is achieved without a transformer.

Transistor Q_1 operates as a common-emitter amplifier driven by a 5-milliampere positive pulse

whose rise time is 50 nanoseconds. The emitter current is coupled directly to the emitter of complementary common-base stage Q_2 . Differentiating capacitors C_1 and C_2 receive an identical drive to reverse-bias diodes D_1 and D_2 for approximately 50 nsecs.

Constant-current generators Q_3 and Q_4 acting in the common-base mode receive current from resistors R_1 and R_2 for the 50-nsec period and are trimmed by R_3 to cause cancellation of the current fed to the sampled signal. The signal is applied to input 2 and the sample is stored on capacitor C_3 . Transistors Q_5 , Q_6 and Q_7 form buffer amplifiers.

The circuit can handle a ± 10 -volt signal; the store assumes the peak voltage in 50 nsecs and maintains the potential within 1% for 2 microseconds. In the event that a larger sampling time is allowed, C_3 , and therefore the storage time may be increased pro rata. Such a circuit may be used for progressive signal sampling, as in a sampling oscilloscope, where the change of stored potential need only be small per sample period. In this event C_3 and the storage time may be increased 10 to 100 times the values shown.

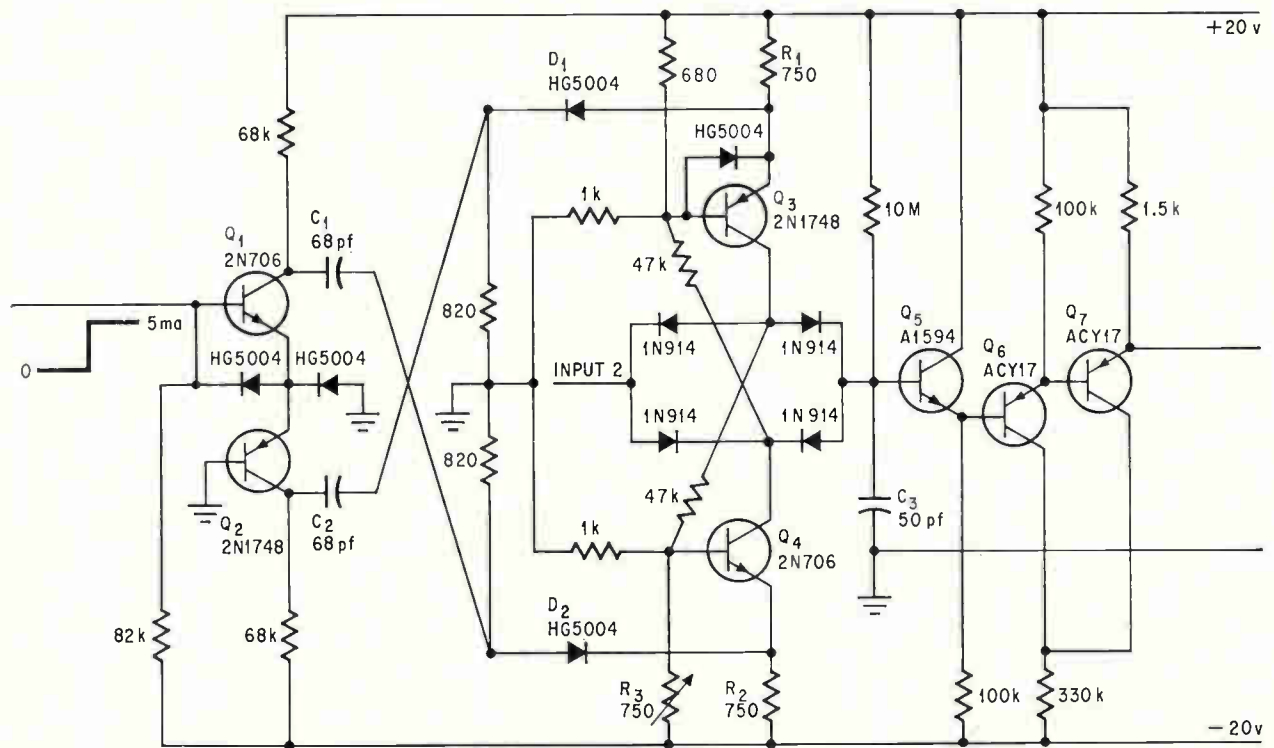

Transformerless. By eliminating the conventional transformer used to drive the diode bridge, signals comparable to those from the power supply can be monitored.

Cascoded transistors couple logic gates

By Ben Tripp

Northern Electric Co., London, Ontario

Two transistors in a cascode arrangement enable conventional circuits to be coupled to logic gates. The transistors insure that the output is in phase with the input, the output sinks the gate in the zero state, and the gate's noise immunity requirements are held constant or improved for the system.

Transistor Q_1 is biased to saturation using the gate's internal resistor as a load. Since the gate resistor is usually four kilohms, Q_1 may saturate at a low base-current value. When V_{in} is in the one state, Q_1 no longer saturates and V_{out} is also in the one state but at a slightly lower value than V_{in} . When V_{in} is in the zero state V_{out} is also in the zero state and does not recognize values of V_{in} below 0.5 v.

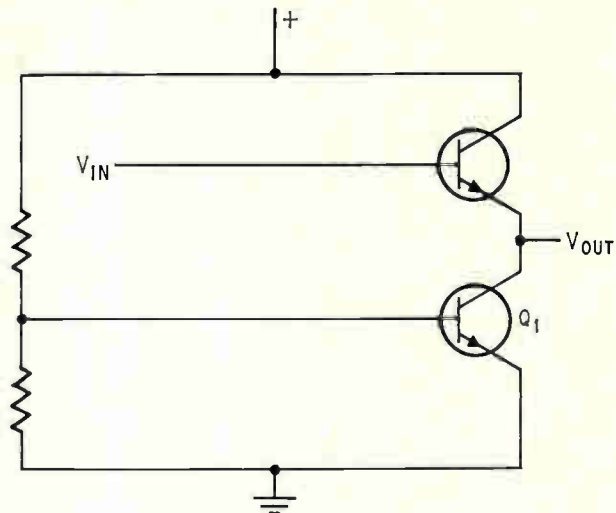

Logic coupler. Conventional circuits can be coupled to logic gates easily and efficiently with this cascode transistor arrangement. System's noise immunity is also improved. Cascading assures that the output signal is in phase with the input.

Null output detects square-wave duty cycle

By John E. Gersbach

International Business Machines Corp., Poughkeepsie, N.Y.

Developing a reference voltage and comparing it to the average value of an input signal is an easy way of detecting or measuring the duty cycle of a square wave. The circuit is widely applicable; component values are selected as appropriate for input voltage level.

Reference voltage, V_1 , is developed by charging capacitor, C_1 , to the peak value of the input voltage through diode D_1 . Then the resultant voltage is divided by R_1 and R_2 and becomes a constant fraction of the peak input voltage, $K = R_2 / (R_1 + R_2)$. This requires that the time constant $(R_1 + R_2)C_1$ be much larger than the input period.

The averaging circuit is a simple integrator whose output voltage is proportional to both the duty cycle and V_{peak} . Again, the time constant, in this case R_3C_2 , must be very large compared to the input period, and the value of R_4 must be much less than R_3 . Diode D_2 compensates for the forward drop of D_1 .

The following relationships then hold:

$$V_1 = (V_{peak} - V_{D1}) \frac{R_2}{R_1 + R_2}, \text{ if } (R_1 + R_2)C_1 \gg T$$

$$V_2 = (V_{peak} - V_{D2}) \frac{T_1}{T}, \text{ if } R_3C_2 \gg T$$

When $V_1 = V_2$, the difference output is zero and

$$\frac{R_2}{R_1 + R_2} = \frac{T_1}{T}, (V_{D1} = V_{D2})$$

Accuracy is determined by R_1 , R_2 and the difference in the diode drops and is independent of the amplitude of V_{in} and relatively insensitive to the capacitor values.

The output of the circuit can be connected to a null-reading meter or to a differential amplifier. In the second case, the output can be fed back to the generating source to act as a control to maintain a constant duty cycle.

When R_1 and R_2 are calibrated potentiometers,

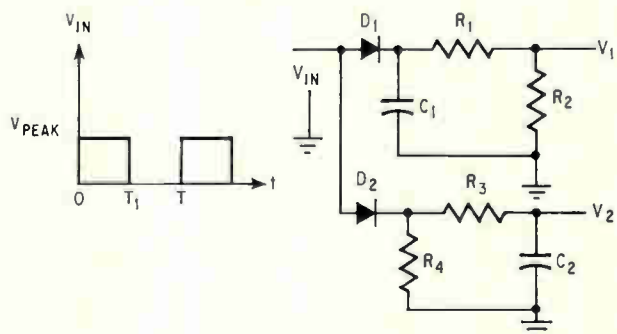

Detector. Reference voltage, V_1 , is proportional to the duty cycle of the applied square-wave input signal.

the circuit can be used to measure the duty cycle. When R_1 or R_2 is a thermistor and the output of the circuit is fed to a monostable multivibrator whose output pulse width is proportional to $V_1 -$

V_2 , the circuit forms a proportional temperature control. Efficiency of this temperature control is much higher than similar configurations using the conventional class A amplifier.

Cathode follower boosts output impedance

By T.P. Petrik

Slovak Polytechnical University, Bratislava, Czechoslovakia

Output impedances as large as five to six-megohms are obtained from a conventional pentode connected to a dual triode in a cathode-follower arrangement. Such large impedances are necessary in equipment that generates constant currents.

Conventionally, current generators rely on pentodes for supplying constant current, but to function correctly, the second grid must have the same alternating potential as its cathode bias. Therefore, a large capacitor, C , is needed. The dynamic impedance between nodes AB is then essentially the biasing resistance, R_b , and does not depend on the pentode characteristics. Hence, impedances larger than one or two megohms cannot be obtained.

By coupling a cathode follower to the pentode the engineer takes advantage of the large input impedance and unity voltage gain of the circuit. The combination replaces capacitor, C , and provides a five to six megohm impedance across terminals AB.

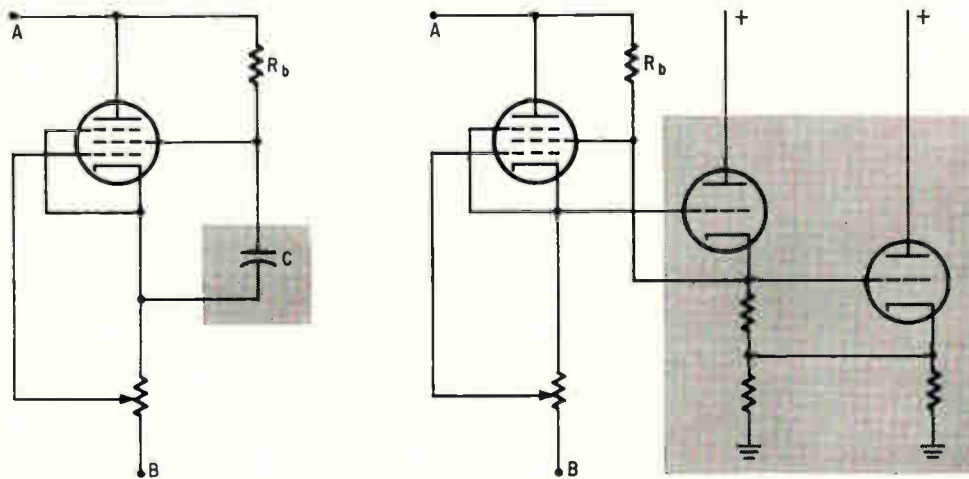

Impedance booster. Pentode at the left provides constant current, but capacitor, C , is required to maintain the second grid at the same potential as the cathode. Dual triodes replace C and provide five to six megohms between AB.

Feedback eliminates noise in telephone circuit

By Robert G. Stoneman

Wisconsin Telephone Co., Milwaukee

Power transmission and distribution lines frequently induce large, noise voltages in nearby telephone wires. These voltages can be eliminated by placing the feedback circuit on page 83 in the telephone line at a subscriber's station. The circuit cancels the noise voltage by sensing, amplifying

and reintroducing it into the telephone line 180° out of phase.

The noise voltages are longitudinal—voltages that set up currents in the same direction in both wires of a telephone pair and which use the earth as a return path. Longitudinal currents, however, do not generate noise signals directly, but create potential differences between individual wires in the telephone cable; these differences of potential—called metallic voltages—introduce noise directly into the voice/data channels.

Metallic voltages develop between conductors in a cable because the individual conductors do not have identical impedances and thus do not carry equal longitudinal currents. The unequal imped-

Single-shot multivibrator has zero recovery time

By J.L. Shagena and Aaron Mall

Bendix Radio Division, Bendix Corp., Baltimore

Giving the timing capacitor of a single-shot multivibrator two jobs—timing the output pulse and setting up the circuit to receive the next trigger pulse—reduces the circuit's recovery time to zero. A premature trigger will not produce a too-short output.

The duty cycle of the single-shot, or monostable, multivibrator is almost 100%. In comparison, the conventional monostable multivibrator is limited to a duty cycle of about 95%, even when the timing capacitor is quickly recharged from a low-impedance source. Thus, the premature triggering problem.

The input transistor, Q_1 , is normally biased off and its collector sets at approximately ground. When a positive pulse is applied at the input, Q_1 turns on, and transistors Q_2 , Q_3 and Q_4 turn off. Transistor Q_2 is turned off through capacitor C_1 for a time approximately equal to $0.7R_1C_1$.

After C_1 is charged through R_1 , Q_2 turns back on, and Q_1 turns off again. However, the collector of Q_1 does not return to ground immediately, but rises in potential while C_1 is recharging through R_2 . When C_1 is recharged, after a second time interval equal to $0.7R_2C_1$, Q_3 also turns back on. As Q_3 turns on, it turns on Q_4 .

The turn-on action is regenerative. At this time, the voltage across C_1 is equal to its initial value and the single-shot can be retriggered immediately.

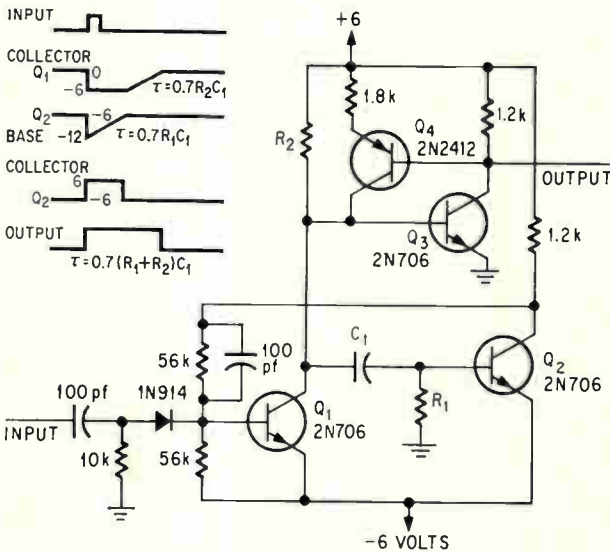

Double duty. Capacitor, C_1 , controls the timing of the output and delays the setting up for the next cycle.

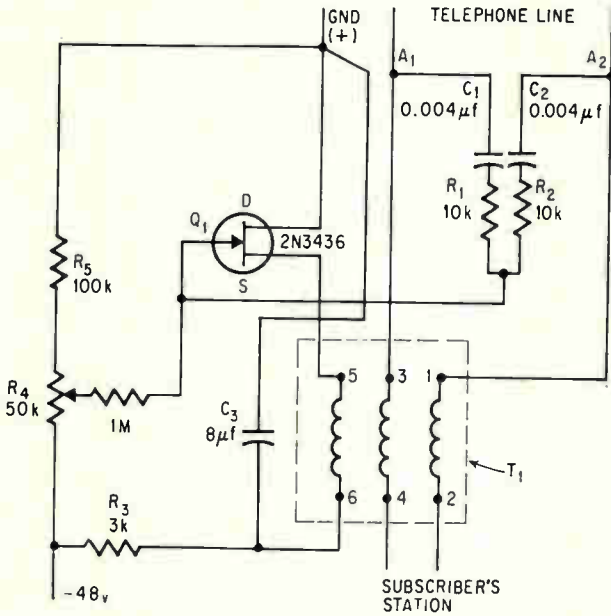

Feedback circuit. Longitudinal voltage is sensed at points A_1 and A_2 , applied to Q_1 , and reintroduced into the telephone line 180° out of phase via windings 3-4 and 1-2, effectively cancelling the longitudinal voltage.

ances are caused by small dissimilarities in construction that produce differences in each wire's capacitance with respect to ground, resistance to ground, and linear resistance.

Increases in longitudinal voltage produce a corresponding increase in metallic voltage. Longitudinal voltages occasionally reach levels as high as 200 volts, making voice communication difficult. Conversely, a reduction in longitudinal voltage yields a corresponding drop in metallic voltage, reducing the noise level in the communication channels.

When the circuit is installed at a subscriber's station, the longitudinal voltage is cancelled so that the metallic voltage and the noise are eliminated. The longitudinal voltage at the station is sensed at points A_1 and A_2 by the networks of C_1 , R_1 , C_2 , and R_2 respectively and applied to the gate of Q_1 , a field-effect transistor. The voltage at point 5 in the source branch tracks the signal at the gate of Q_1 in the usual source-follower manner. The secondary windings of transformer T_1 (the windings between points 3-4, and 1-2 on the schematic) are wound on the same core as the primary winding (between points 5 and 6) and have opposite polarity. Thus, a voltage that is almost identical in amplitude and waveshape to the signal sensed at points A_1 and A_2 is induced into the secondary windings of T_1 (3-4, 1-2), cancelling the longitudinal voltage.

Capacitor C_3 helps maintain the desired voltage across resistor R_3 . Potentiometer R_1 and resistor R_5 are biasing resistors for the FET.

Linear IC's: part 5

Ins and outs of op amps

Phrases like "systems approach" and "black box" too often obscure the importance of the circuit's innards; internal characteristics influence external component selection, and overall performance

By Jack F. Gifford and Michael Markkula

Fairchild Semiconductor Division, Mountain View, Calif.

Sales talk about how easy it is to design with integrated circuits often leads an engineer to do a superficial job. Comforted by such catchphrases as "systems approach" and "black-box theory," he will busy himself with external connections to the IC—input, output, biasing, feedback—and ignore what goes on inside the chip. But knowing how to exploit a circuit's innards can widen the device's range of application, lessen the chances of misoperation or failure, and optimize over-all system design.

The black-box concept saves design time but can be used to maximum advantage only when the ins—as well as the outs—of the circuit have been thoroughly examined.

This is particularly true for IC operational amplifiers, the most versatile and popular of the linear

circuits. In some cases, engineers will slavishly follow the op-amp applications given in data sheets and handbooks—not completely sure that the resulting design will work, only occasionally making full use of the circuit's capabilities, and even less frequently applying the IC to jobs it's suited for but which the books don't specify.

The application flexibility of the IC op amp stems from its configuration—usually a cascade of differential-amplifier stages followed by a push-pull output stage [Electronics, Sept. 18, p. 96]. In contrast to most discrete semiconductor versions of the circuit, the IC has a differential input mode rather than a single-ended input, a feature that affords the user greater freedom in selecting feedback networks.

The dual inputs, inverting and noninverting, respectively, may be used independently or simultaneously. Negative feedback is the normal operating mode, although positive may be used, for example, to provide a hysteresis effect in comparator applications. Another advantage of the dual configuration is that the IC can accommodate various source impedance arrangements. Finally, the inputs track one another because of the virtual ground between the terminals [Electronics, Oct. 16, p. 86].

Inverting mode

An IC operational amplifier connected in the inverting feedback mode is displayed on page 85, top. As a rule, load resistor R_L is much larger than the output impedance of the amplifier, R_o . Also, the resistance of the reference leg, R_{eq} is equal to the d-c impedance of the other leg, so that minimum offset voltage appears at the output. R_{eq} is the parallel combination of the signal source's impedance, R_s , with the series combination of the feedback imped-

The authors



Jack Gifford came to Fairchild in 1964, and has managed the linear IC department since 1965. A graduate of UCLA, his responsibilities include products, planning, and marketing. Gifford was previously an engineer with RCA and the Electronic Specialties Corp.



Michael Markkula is a senior engineer in the linear circuits department. The holder of BSEE and MSEE degrees from UCLA, he now specializes in applications and circuit development. Before joining Fairchild he was an R&D engineer at Hughes Aircraft.

ance, R_f , and the much smaller, and therefore negligible, output impedance, R_o . The inverting and noninverting terminals are labeled minus and plus, respectively; A_{vo} is the open-loop differential voltage gain of the entire circuit, and R_{in} is the differential input impedance.

The feedback factor, β , is defined as $R_s/(R_f + R_s)$, and α , the attenuation factor, is given by $R_f/(R_s + R_f)$. The inverting closed-loop gain, or transfer function, simplifies to $\beta A_{vo}/(1 - \beta A_{vo})$ if R_o is much smaller than R_f , and R_{in} is much greater than R_{eq} . If the open-loop gain is large enough to dominate the transfer function terms, the closed-loop gain becomes the classical ratio of impedance, $-R_f/R_s$ ($-Z_f/Z_r$ for the a-c case).

Loop gain, defined as the ratio of open-loop to closed-loop gain, is an index of how accurate the transfer expression is. Deviation, expressed by a percentage error, is $100/A_{vo}\beta$. Thus, an IC with an open-loop gain of 1,000, an input impedance of 50 kilohms, an output impedance of 200 ohms, and a R_{eq} of 1,000 ohms will have a loop gain of 20 db when $R_s = 1,000$ ohms and the feedback resistance is 100 kilohms; under these conditions, the percent difference between the ideal and actual closed-loop gains is $100/(1,000)(1,000/[10^5 + 1,000])$, or approximately 10%.

Input impedance of the inverting mode is R_s , and the closed-loop output impedance, R_{out} , is the ratio of the unloaded output voltage to the short-circuit output current—approximated by $R_o/A_{vo}\beta$.

Noninverting mode

The noninverting configuration, below, right—because of the tracking nature of the virtually grounded differential input—has characteristics similar to those of the inverting mode.

Typically, intrinsic output impedance R_o is negligible, load R_L is high, and differential input impedance R_{in} is much larger than R_{eq} , R_f , and R_s . The resulting transfer function, V_{out}/V_{in} , becomes $1 + (R_f/R_s)$, because A_{vo} is large and R_s dominates R_f . This expression for closed-loop gain indicates that this circuit mode provides at least unity gain even with no feedback ($R_f = \infty$).

As with the inverting mode, the difference between the ideal and nonideal transfer functions is small—usually 10% or less. The input impedance seen by an external signal generator is $\beta A_{vo}R_{in}$.

Users, then, should apply loads, feedback networks, and signal sources within the limits of the gain and impedance relationships developed for the two modes to achieve a closed-loop behavior that is strictly predictable by ratios of externally applied impedances.

Frequency compensation

The a-c open-loop response of an operational amplifier is an important circuit design consideration. Feedback theory holds that an amplifier will be unstable if its high-frequency loop gain, βA_{vo} , is equal to or greater than unity when its phase shift reaches 180° . Since the natural response of the am-

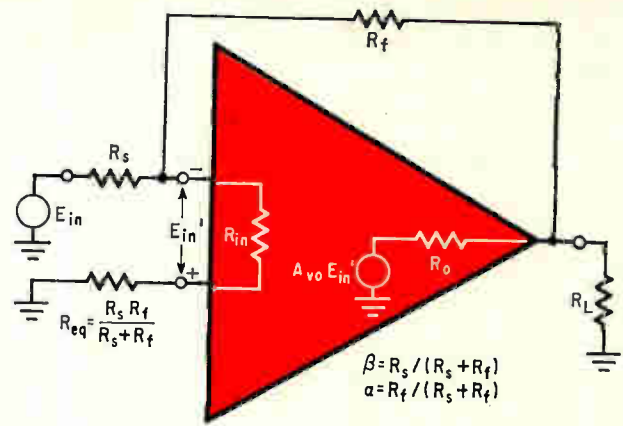

Inverter. Input signals applied to the inverting terminal of the op amp are flipped so that output has an opposite polarity. Transfer characteristic becomes the ratio of the feedback impedance, R_f , to the source impedance, R_s , providing gain A_{vo} is large, output impedance R_o is small, and input impedance R_{in} is much larger than R_f and R_s .

plifier is limited by internal capacitances, it's usually necessary to shape the gain-phase characteristics with external compensation networks to achieve stability for any amount of feedback. The most common procedure is to synthesize a rolloff characteristic approximating that of a single RC network; since the maximum phase shift associated with such a rolloff—20 db per decade—is 90° , the circuit cannot become unstable. With some IC amplifiers, large bandwidths can be obtained by using the natural rolloff of the amplifier (that due to the internal elements) to provide part of the compensation.

Consider, for example, the $\mu A709$ op amp. Because its gain falls off rapidly at a rate approaching 60 db/decade above 2 Mhz, it can't employ natural rolloff as part of its frequency compensation. Because of stray capacitance and high gain, the circuit, without compensation, may oscillate even when operated open-loop. The rolloff from the compensation networks, therefore, must begin at a low enough

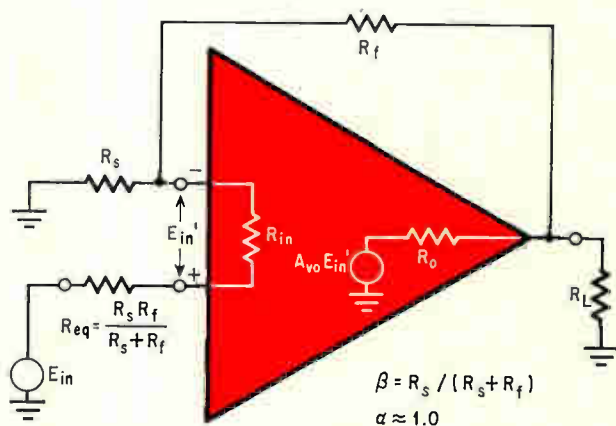

Noninverter. In this mode the polarity of the output matches that of the input. E_{in} is applied to the (+) terminal and feedback is applied to the inverting (-) input terminal. The transfer function, approximated by $1 + (R_f/R_s)$, is contingent upon A_{vo} and R_{in} being large, and R_o small.

Simple diode and resistor elements protect the IC from . . .

input breakdown . . .

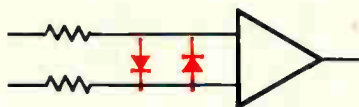

overload . . .

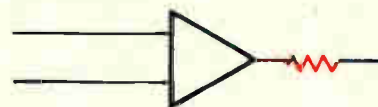

latchup . . .

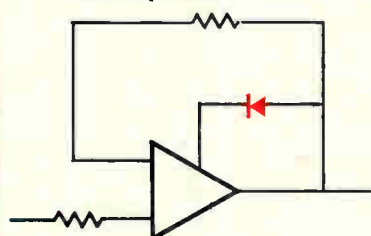

overvoltage

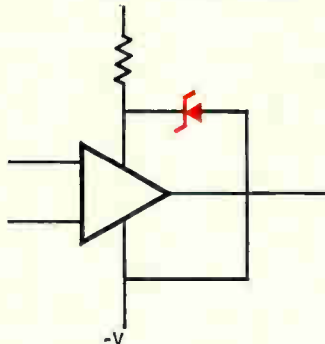

Shields. To prevent excessive input voltages from over-driving the input stage, shunting diodes are placed across the inverting and noninverting differential input pair (top: left and middle). Short-circuiting and general current overloading is limited by the insertion of a series resistor in the output lead (above). Inadvertent saturation of the circuit's output stage is prevented by a limiting diode (far left). And voltage transients in the power supply are limited by a zener diode (left).

frequency to ensure that the loop gain will be less than unity before the amplifier introduces additional phase shift.

Two sets of frequency compensation points have been provided for the $\mu A709$ because it's usually difficult to get more than 60 db of compensation at one node. Both points have high transfer resistances so the amplifier can be fully compensated with small external capacitors [Electronics, Oct. 16, p. 88].

Collector-to-base feedback around the second stage via one RC network provides the first 60-db rolloff, and another feedback loop around the output driver stage gives the remaining compensation. The transfer resistance of the input compensation terminals is about 1.4 megohm, and that of the output compensation is 36 kilohms. A 50-ohm external series resistor is used to isolate the output compensation from capacitive loads without affecting the output voltage swing significantly.

Recommended frequency networks used in a given application provide stability for any $\mu A709$, accounting for unit-to-unit variation of transfer resistance, open-loop voltage gain, high-frequency phase shift, and the effects of temperature and power supply voltage. A worst-case design for these parameters, however, would be unnecessarily conservative since they are correlated to some degree in an integrated circuit. The change of gain with supply voltage, for example, is partially compensated for by a change in transfer resistance.

Makers' data sheets usually recommend networks for frequency compensation of noninverting amplifiers having closed-loop gains of 0, 20, 40, and 60 db, and include the frequency responses obtained. Values for intermediate gains are found by interpolation. For inverting amplifier configurations, the capacitance values should be divided by the factor $1 + (R_s/R_f)$ to obtain the same bandwidths.

Words of warning

Mention must be made here of op amp data sheets. Specifications are often hazy and sometimes downright misleading; further, their meanings vary from maker to maker and even from product to product [Electronics, Oct. 16, p. 91]. Ambiguity is a problem not only with "maximum" and "minimum" values, but with the more commonly specified "typical" ratings.

"Typical" can be realistically defined as the value falling at the 50th percentile of a certain parameter's distribution. However, to some manufacturers it is a mean between the maximum and minimum, and to others it may be something else.

Besides, the probability that "n" independent parameters of a device will all be at their given typical value is 0.5^n . Thus, in the case of an IC with 10 parameters, chances are that only one in a thousand will have all parameters at their typical values.

Designers must therefore work on an ad hoc basis, using data-sheet values only as a very general guide. Also, when comparing the specs of two or more manufacturers, the designers must compensate not only for variations in definitions but for difference in test conditions.

For example, one data sheet may specify an input offset voltage of 5 millivolts maximum with ± 15 -volt supplies and a source resistance of 10 kilohms at 25°C . Another, applying the identical definition, may put the offset voltage at 5 mv maximum with ± 15 -volt supplies but with a source resistance of only 50 ohms at 25°C . The second circuit has a maximum 25°C offset current, I_{os} , of 150 nanoamperes, so that the total worst-case offset with a 10-kilohm source resistance would be $5\text{ mv} + I_{os}R_s$; $5\text{ mv} + (150 \times 10^{-9})(10^4)\text{ mv} = 6.5\text{ mv}$ maximum.

Also, parameters must be evaluated in relation to

the specific application. A designer may get an amplifier with a specified 10-megahertz bandwidth for a unity gain application that requires maximum sinewave output voltage swing at 20 kilohertz. But the unit in operation may appear to have a bandwidth of about 100 hz and almost no gain at 20 khz. The reason: it's slew-rate limited. The problem could have been avoided if the slew-rate parameters had been considered.

When comparing data sheets, engineers find that some makers specify bandwidth, others risetime, and that confusion between the two specs can lead to errors. The relationship between bandwidth and risetime for a single-pole system—one with a roll-off of 20 db per decade—is: 3-db bandwidth = $0.35/\text{risetime}$. Both specifications are useful as long as they're accompanied by a plot of the open-loop frequency response. The actual usable bandwidth of the amplifier depends on the open-loop gain at the frequency where the phase shift crosses 180° .

Specs for power dissipation and derating factors also vary among makers. Some even quote different maximum power ratings for identical packages. The apparent discrepancy is resolved when the derating factor is applied at the temperatures of concern. For example, if 95°C is chosen as the derating temperature, an ic's power rating may be 300 milliwatts. If derating were applied starting at $+25^\circ\text{C}$, the power dissipation for the same device could be quoted at 700 mw.

Protection

Although many ic's contain built-in limiting circuitry, few are protected against the long-term effects of overvoltage, overload, or latchup. The panel on page 86 outlines some typical external protective

measures recommended by ic makers; the integrated circuit involved is the $\mu\text{A}709$.

When complex system functions are mechanized, it's common to have one operational amplifier directly drive another. The input voltage range of most monolithic op amps is smaller than the available output voltage swing, so some form of input protection—usually in the form of shunt diode arrangements—must be provided for the driven amplifier.

The simplest way to prevent current overload when operating the ic into a very low impedance is to insert a resistor between the amplifier output and the load. A resistor of a few hundred ohms is usually sufficient.

Latchup occurs when the circuit is inadvertently saturated, and is fairly common in unity-gain, non-inverting amplifier applications. If the input stage of the amplifier is saturated by a slight overdriving, it will no longer invert the signal. The amplifier then has positive feedback, and if it's possible for the output voltage to hold the input stage in saturation through the feedback network, the amplifier will remain saturated even if the input is removed. The insertion of a limiting diode between the output and the input to the last internal stage of the ic prevents this.

Since the circuits can tolerate only a certain amount of voltage over a given period of time, a zener diode limiter should be placed across the bias supply terminals in situations where the supply can exceed the ic's voltage rating.

And since many ic's have electrical connections to the case, care should be taken to ensure that the case doesn't short to ground, chassis, or some other electrically energized point.

Integrated electronics II

The power of negative feedback

Selection of resistive, reactive, active, or combination networks fits the IC operational amplifier to a host of applications

Once the inner workings of the integrated-circuit operational amplifier are mastered, application becomes a matter of choosing the appropriate feedback network.

The ic can be operated with purely resistive feedback, active or reactive feedback, combinations of these, or with no feedback at all (open-loop). In general, the more sophisticated the application, the

more complex the feedback network.

In simple, open-loop roles, the ic functions as a multistage differential amplifier with a class-B output. This open-loop configuration is tailored to comparator applications—level detection, line receiving, impedance transformation, and the like—where feedback is not required to perform the function.

Keeping the loop open

Voltage comparator

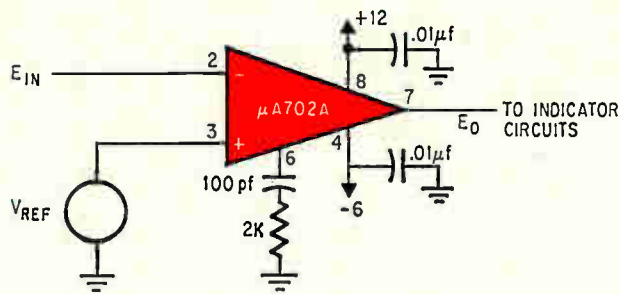

Operational amplifiers can be operated without feedback, functioning as multistage differential amplifiers. Typical open-loop applications are detection and signal conditioning.

Noise-immune line receiver

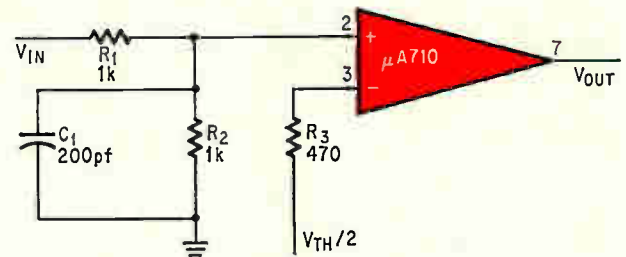

When connected as a comparator, as shown above, the IC amplifies the difference between an unknown signal and a reference source, and produces a fixed output with a polarity that indicates which signal is greater. For example, the output of a $\mu A702A$ is 5 volts when an input signal exceeds the reference by a margin of 2 millivolts (the offset error), and is -5 volts when the reference signal is that much larger. The 0.01-microfarad capacitors filter the bias supplies, and the RC network containing the 100-picofarad capacitor and 2-kilohm resistor provide frequency compensation that prevents oscillation from stray wiring and layout capacitance.

Some comparator applications require an impedance transformation to prevent loading of the input signal by the IC; this is fairly common with source impedances of a few kilohms or higher. To overcome loading problems, buffering transistor stages are placed between the operational amplifier and the input sources to increase the impedance levels by orders of magnitude. Since the transistors slow the speed of comparison somewhat, they should have low collector-to-base capacitances as well as high gains.

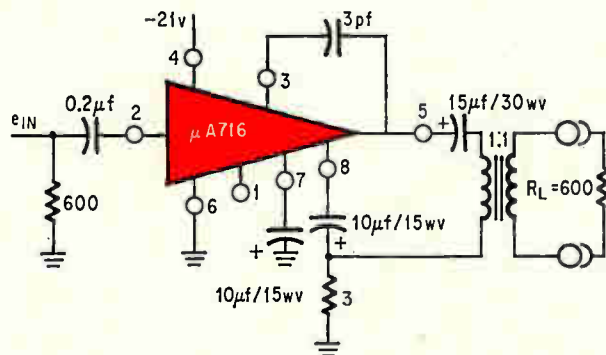

Match up. In a telephone-channel amplifier, the IC matches the 600-ohm line impedance and provides a flat gain response.

An alternative to employing external transistors is to use IC's with a higher input impedance. However, such IC's usually have slower response times.

In the typical line-receiver setup shown above, the amplifier is functioning merely as a preconditioner to improve signal-to-noise ratios. Its high noise immunity is a desirable characteristic in most long-line digital systems.

The divider formed by R_1 and R_2 permits the handling of large input signals (typically 14 volts), and C_1 shunts out fast noise spikes that would ordinarily be processed by the high-gain, fast-responding IC. The reference signal establishing the input threshold level is fed through a low impedance (R_3) so as not to load the other input leg. When the input exceeds half the threshold, a finite output is generated.

Resistive

Simplest of the closed-loop modes are those employing purely resistive feedback. Typical applications would be channel, transducer, and summing amplifiers, and buffer stages and regulators.

In a channel amplifier, voice frequencies are generally transmitted by an amplitude-modulated, suppressed-carrier system; the components of the modulating waveform are limited to the band of audio frequencies from 0.1 to 3.2 kilohertz. After demodulation at the receiving end, the voice frequencies are amplified, processed, and sent on to, say, a phone-system subscriber.

The channel amplifier's specifications call for low distortion, flat frequency response over the channel bandwidth, 600-ohm input and output impedances (to match the transmission lines and filters), and an output capability of 13 decibels above 1 milliwatt. Small size is also desirable, and extra savings accrue if d-c current in the output transformer is eliminated.

The channel amplifier at the left employs a low-distortion type operational amplifier, the $\mu A716$, to meet these requirements. Matching of the input and output impedances to 600 ohms is achieved by

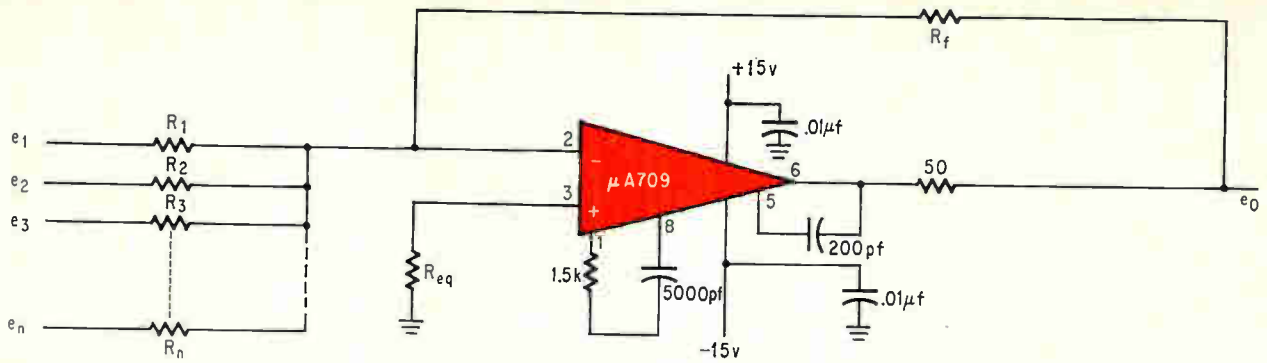

Adder. An op amp can sum many input signals easily when R_{in} is much larger than any of the source resistances.

placing the load in the feedback loop instead of across the output. The load's value is chosen to double the feedback factor, thereby halving the gain. Thus, for constant input signals, the output is reduced by two. The output, when load is applied, drops to half its no-load value, assuring that output impedance and load match. A single 3-ohm resistor can make $Z_{out} = 600$ ohms when this feedback arrangement is used with the $\mu A716$.

The high gain, stability, and high Z_{in} of ic operational amplifiers make them suitable for amplifying transducer signals, which are typically low level—often just a few millivolts. In the arrangement shown below, the ic is preceded by two differential amplifiers that stabilize temperature and, because of their very high input impedances, prevent loading of the high output-impedance transducer.

The first differential stage has a gain of 70; its collector current is set at 10 microamperes by the constant current source, Q_1 . The second stage is connected as a pair of emitter-followers that prevent temperature-dependent first-stage loading. Load resistors R_4 and R_5 —low-temperature-coefficient types—match to within 10 ppm/ $^{\circ}C$ to minimize drift.

The composite circuit has a gain of 3×10^6 , a 1-mv initial offset voltage, a 10-nanoampere offset current, a $0.2\text{-}\mu\text{v}/^{\circ}C$ offset voltage drift, and a $10\text{-picoamp}/^{\circ}C$ offset current drift over the range of -55 to $+125^{\circ}C$. Frequency compensation is provided by C_1 , R_6 , C_2 , R_{10} , and C_3 .

For jobs with less stringent stability requirements, the second differential stage and R_7 , R_8 , and R_9 can be eliminated. For proper biasing, resistor R_1 must be changed to 75 kilohms, R_4 and R_5 to 24.3 kilohms, R_6 to 300 ohms, and C_1 to $10\ \mu\text{f}$. The new cascade will have the same gain, a voltage drift of $1\ \mu\text{v}/^{\circ}C$, and an offset current drift of $30\ \text{pa}/^{\circ}C$.

Summing up

The ic's low drift and high input impedance and gain are key features in summing-amplifier applications. In the schematic above, R_{in} must be > 10 times the parallel combination of R_f and the source resistors. The output then is a sum given by $(R_f/R_1)e_1 + (R_f/R_2)e_2 + \dots + (R_f/R_n)e_n$. The maximum error due to offset current and voltage is given by $I_{os}R_f + V_{os}(n + 2)$.

For example, the maximum error is 30 mv when three inputs are processed and $R_f = 20$ kilohms =

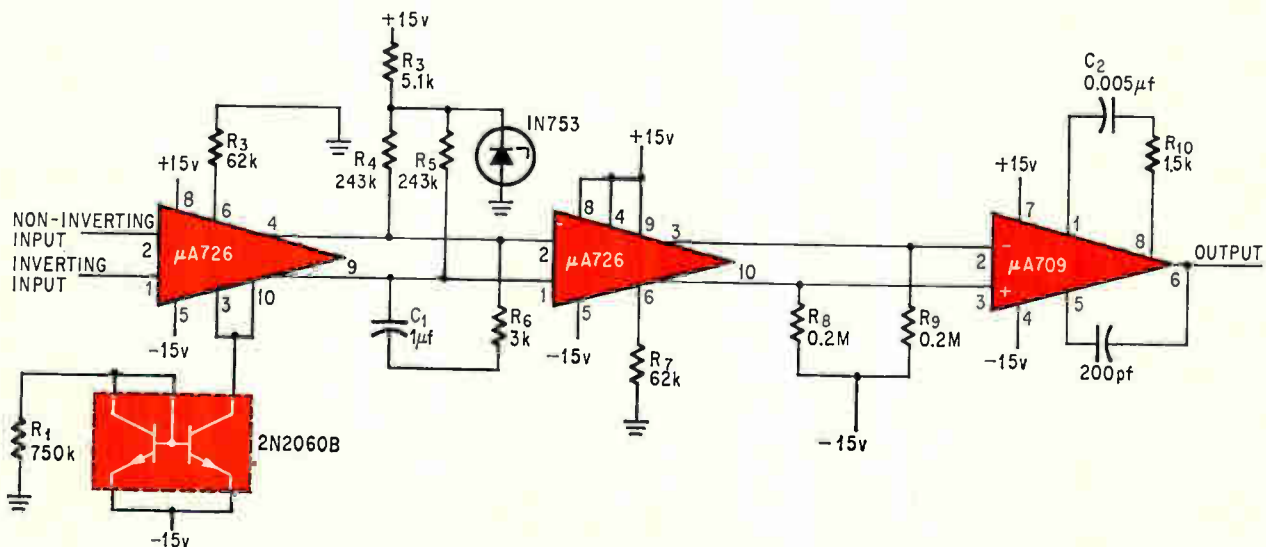

Chain. Three integrated circuits form a precise transducer-signal amplifier. The $\mu A726$'s give high input impedance and temperature stability, and the $\mu A709$ provides most of the gain.

Regulators

Greater than zener

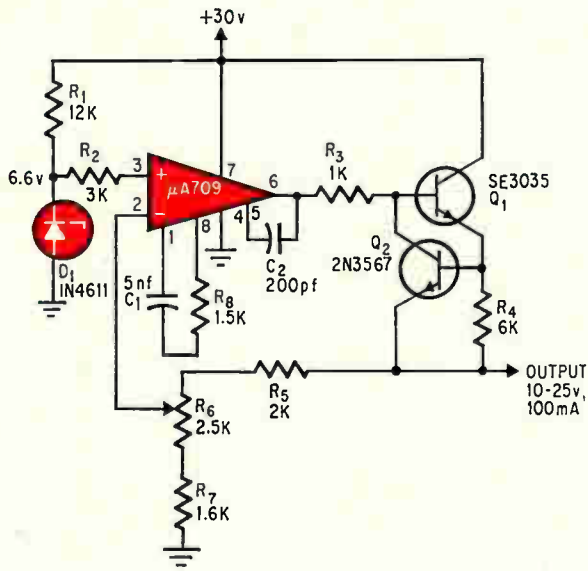

Less than zener

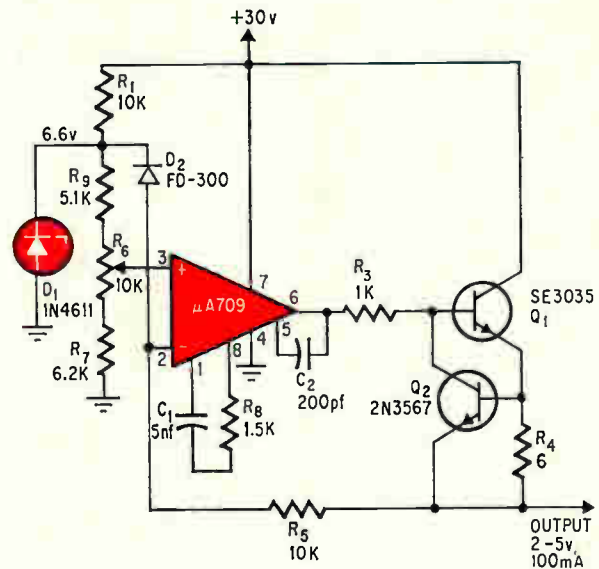

Line operated

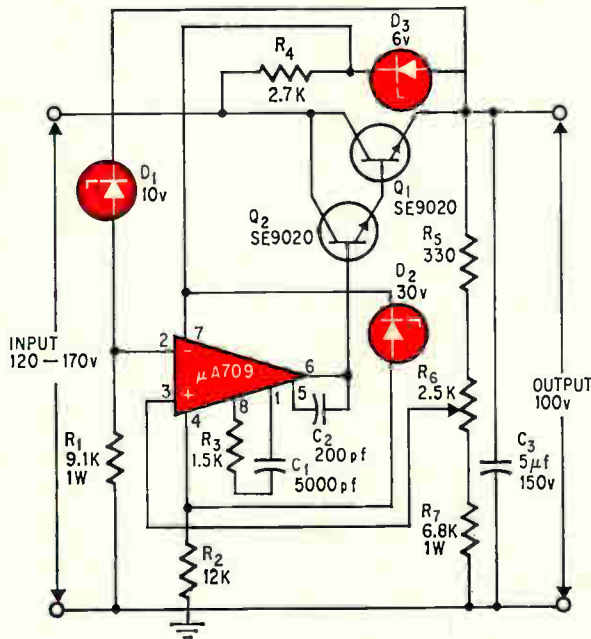

IC operational amplifiers can fill a variety of regulator jobs, particularly when a precision voltage supply is needed. For circuits requiring an output in excess of a temperature dependent zener reference, the zener signal is fed to the noninverting input terminal (top, left); for outputs below the zener level the input is coupled to the inverting leg (top, right). When power transistors and attenuators are added to the IC (left), a regulator circuit handling 100-volts output and operating directly off the a-c mains is formed.

$R_1 = R_2 = R_3$. The error of the summed output voltage—given by $100/\beta A_{v_o}$, where $\beta = R_1/(R_1 + R_f)$ —is 0.02% for the arrangement shown.

Buffer amplifiers, which provide gain without loading the source, must have high input impedance and adjustable gain. Buffer stages are commonly used in transducers, voltmeters, a-c-to-d-c converters, and instrumentation amplifiers.

The circuit, p. 91, top left, can provide any desired gain from unity to 25,000; closed-loop gain is given by $(R_1 + R_2)/R_1$. Equivalent input impedance, R_{eq} , presented to the source is $\beta A_{v_o} R_{in}$, where

A_{v_o} is the open-loop gain, and R_{in} is the differential input-impedance of the IC; it isn't difficult to achieve equivalent resistances of 10 megohms or greater.

Operational amplifiers are used as regulators in voltage supplies to minimize loading of temperature-compensated voltage reference diodes, permit full exploitation of the diode's precision temperature stability, and allow convenient adjustment over wide output voltage ranges.

Three representative circuits appear above. In the first configuration, a voltage-raising regulator (top left), the IC operates from a single, positive power

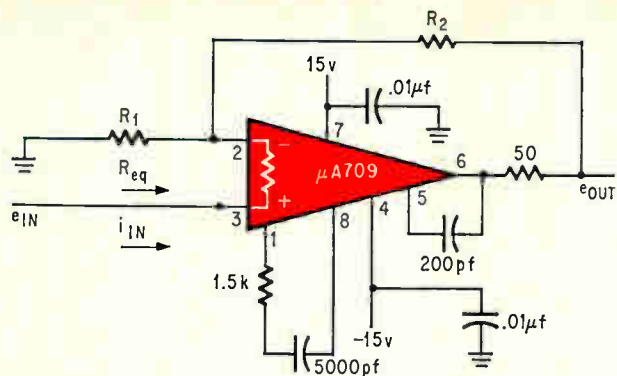

Buffer. High input impedance and adjustable gain result when the input signal, e_{in} , sees an impedance that's the product of the open-loop gain, the differential input impedance, and the feedback ratio set by $R_1 (R_1 + R_2)$.

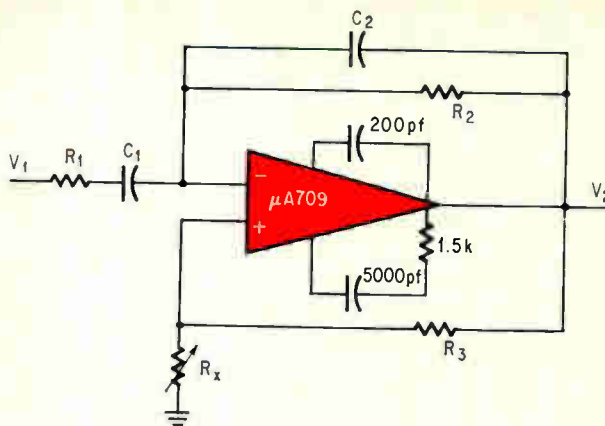

Band-pass filter. R_x establishes the Q of the circuit, and R_1-C_2 and R_2-C_2 set the limits of the pass band.

supply. The emitter-follower, Q_1 , at the circuit's output delivers a larger output current than the IC could supply alone. Transistor Q_2 limits the base drive to Q_1 when the output current exceeds 100 milliamps, thereby protecting against surges. The overload current can be adjusted by varying R_4 .

In the voltage-lowering regulator on p. 90, (top right) the amplifier operates at unity gain and has its input tapped across the reference diode. The feedback insures that the amplifier's output voltage is sufficient to keep the inputs within their operating common-mode range, in this case 2 volts.

The 100-volt d-c regulator on p. 90, middle left, uses a $\mu A709$ as the control element; the output adjustment range is 60 volts. The modified bootstrap configuration reflects the use of a 30-volt zener diode to stabilize and control voltage across the op amp. This circuit has a regulation of better than 0.01%, and nominal output voltages of up to 250 volts. Because the IC, nominally a 30-volt device, is not internally grounded, it is floated so it can

handle much higher voltages (as is done here).

Reactive

Op-amp applications in the areas of signal generation and shaping often require reactive feedback elements. Inductors and capacitors are needed with resistive elements for mathematical-function generation, integration, differentiation, filtering, averaging, and holding.

In the typical integrator circuit a feedback capacitor, C , in conjunction with an input resistor, R , establishes an integrating transfer function; if differentiation were called for, the R and C elements would be interchanged. For integration, the output is $1/RC$ times the integral of the input signal, e_{in} .

Operational amplifiers are used in active filter networks to provide both gain and frequency selectivity; bandpass and stopband filters are typical applications.

Transfer functions describing simple or multi-stage, maximally flat, linear phase-filter networks

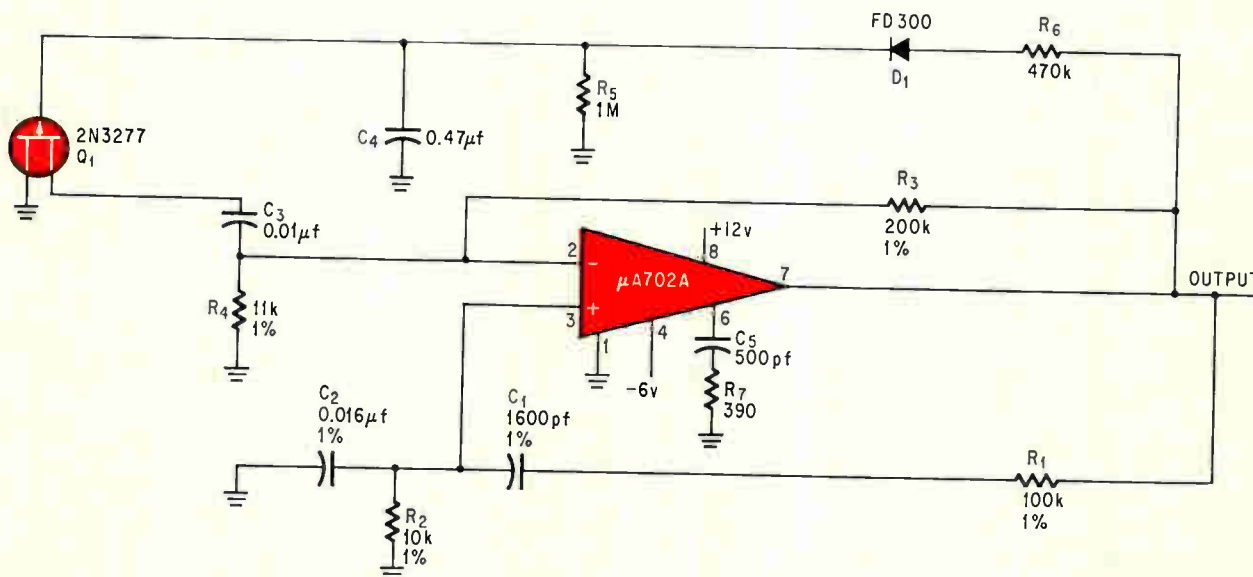

Making waves. In this 1-kHz oscillator, the field-effect transistor stage provides automatic gain control to hold down instabilities and avoid limiting.

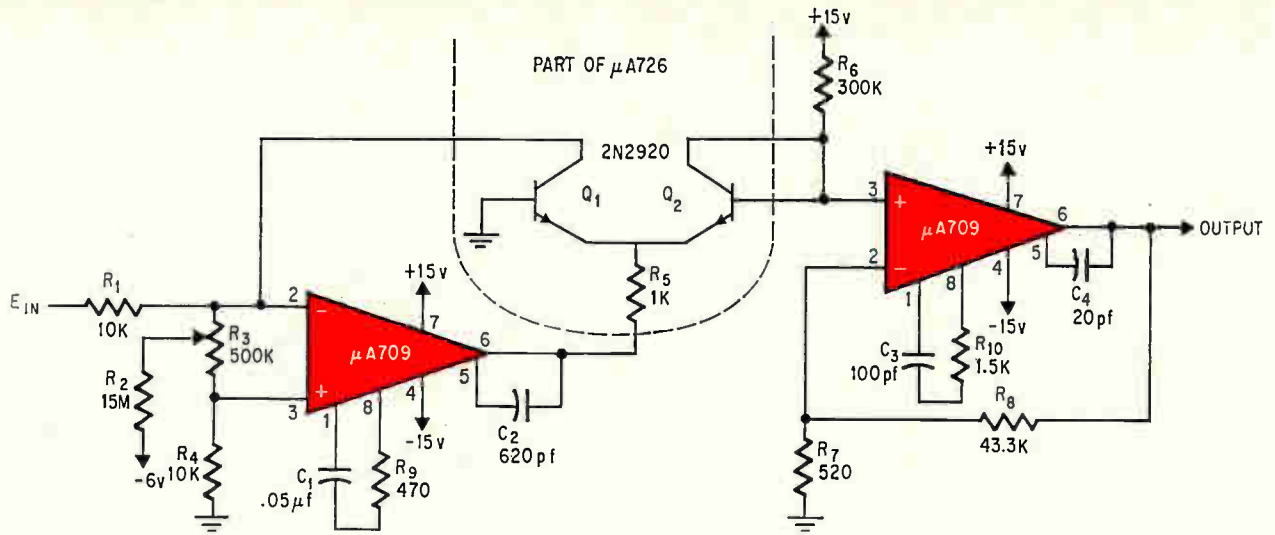

Log. A logarithmic amplifier is formed by two $\mu A709$ operational amplifiers and a transistor pair from the $\mu A726$ temperature-compensated differential amplifier. The 709's provide gain and broad bandwidth, while the 726, only connected as a feedback stage between the 709's, adds the two signal levels that are converted to log form.

require the high gain and Z_{in} of the ic op amp. Input-to-output-impedance transformation by the ic isolates filter stages so that a filter function with many poles can be represented by the product of simple, low-degree, fewer-pole functions.

The ic active filter can also operate without inductors at low frequencies using RC inductor-synthesizing feedback elements. Highly selective and capable of generating complex poles close to the imaginary axis, this filter is useful in f-m recording in the range from 1 hz to 1 khz, and in applications where the size, weight, tolerance, or magnetic nature of an inductor would create problems.

The stable, single-pole, band-pass filter circuit on p. 91, top, has a low output impedance and

affords independent control of filter Q and the center frequency. The circuit's transfer function is:

$$T(s) = V_2/V_1 = \frac{-sR_3}{(R_x + R_3)(R_1C_2)s^2 + s[\omega_1 + \omega_2 - (R_x/R_3)(1/R_1C_2)] + \omega_1\omega_2}$$

where $\omega_1 = 1/R_1C_1$ and $\omega_2 = 1/R_2C_2$.

Tight-tolerance capacitors aren't needed. With resistors chosen so that the RC products, R_1C_1 and R_2C_2 , are accurate to within 1%, the circuit Q can be trimmed to any value by adjusting R_x . For a Q of 20, a voltage gain of 7 is realized.

Active

Active elements—transistors, other ic's, diodes—are added to the feedback network to handle such

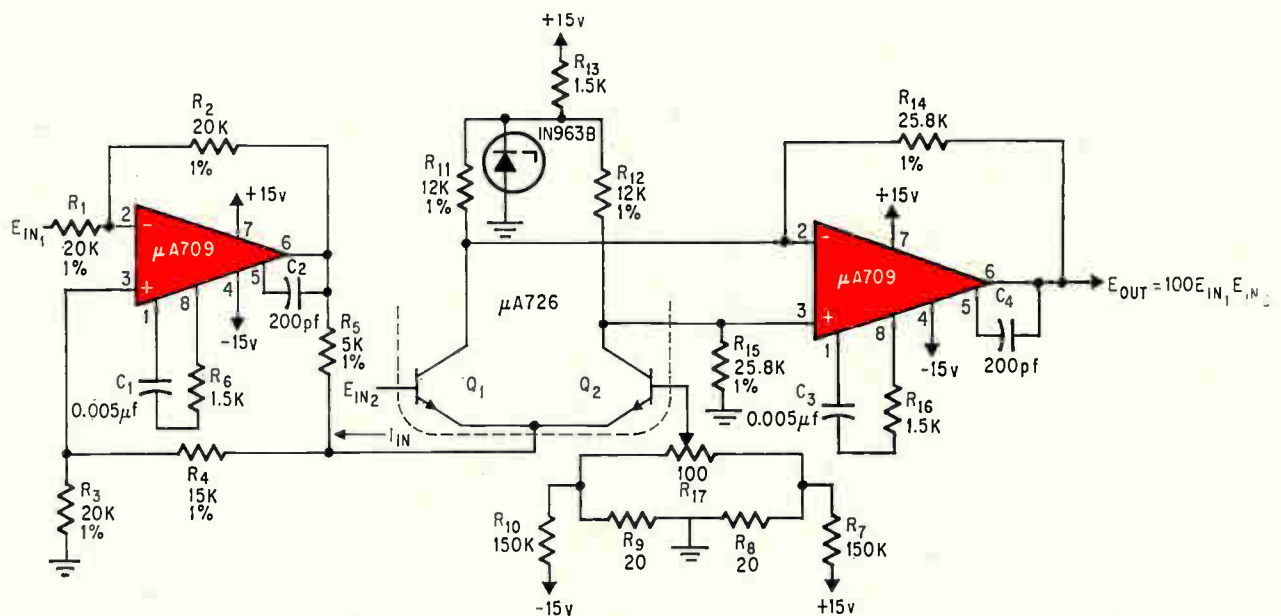

Finished product. Multiplier functions are also achieved with IC operational amplifiers and a differential pair. The first 709 stage is a current source, the 726 does the multiplying, and the second 709 amplifies.

complex jobs as waveform generating, multiplying, analog gating, and logarithmic amplifying.

The low-frequency, low-distortion sine-wave oscillator on p. 91 (bottom), for example, can be used for precise tone generation, computation, or timing.

Negative feedback, applied to the inverting input of the amplifier through R_3 , stabilizes the gain and makes it essentially independent of the integrated circuit's characteristics. At the same time, the RC network formed by R_1 , C_1 , R_2 , and C_2 applies positive feedback to the noninverting input. If the positive feedback is equal to or greater than the negative, the circuit will oscillate at the frequency at which the phase shift through the RC network is zero. Use of an automatic gain control circuit to equalize the positive and negative feedback yields an undistorted sine-wave output.

If $R_1C_1 = R_2C_2$, the frequency of oscillation is $1/2\pi R_1C_1$. Attenuation through the network at this frequency is $1/[1 + (2R_1/R_2)]$, and the amplifier gain must make up for this loss.

FET controls

The amplifier's output is rectified by D_1 , filtered by C_4 , and fed to the gate of the field effect transistor, where it controls drain-to-source resistance. The a-c output level is determined by the ratio, R_6/R_5 , plus the FET's resistance. Filter capacitor C_4 must be large to stabilize the agc loop. To change the oscillation frequency, C_1 , C_2 , C_3 , and C_4 should all be adjusted accordingly.

For the component values shown, the frequency of oscillation is 1 khz and the peak-to-peak output voltage is 8 volts. Stabilization time from turn-on is approximately 50 milliseconds.

Operational amplifiers can also be used to multiply and divide signals in true logarithmic fashion; the addition of two logarithmic analog functions gives a sum the antilog of which is the product of the two functions. In the circuit, page 92 (top), the emitter-base voltage differential between two matched transistors operating at different collector currents is $V_{BE} = (kT/q) \ln(I_{C1}/I_{C2})$. Transistor Q_1 is used as the feedback element around the operational amplifier; negative feedback makes the collector current of this transistor equal to the current flowing to the amplifier's summing node.

The gain of the second amplifier stage is $(R_7 + R_8)/R_7$, and the output voltage is given by:

$$E_{out} = -[(kT/qR_7)(R_7 + R_8)] \ln(R_6 E_{in}/R_1 V^+)$$

The expression indicates that the output voltage is proportional to the logarithm of the input voltage.

Resistance divided

Resistors R_2 and R_3 provide an offset adjustment that increases the dynamic range of small input signals, and R_5 limits the loop gain of the input amplifier so the device can be frequency compensated. R_7 matches the diode impedance of Q_2 to minimize the effect of the input bias current of the output amplifier. R_8 determines the slope of the log characteristic, and R_6 the zero crossing. The IC combination handles logarithmic conversion over an

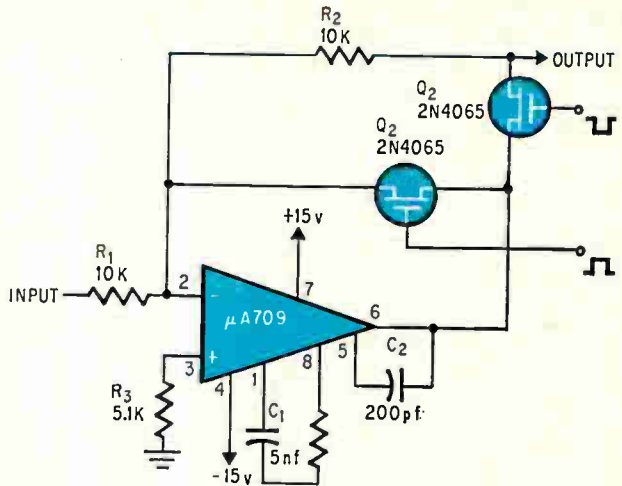

Gate. Addition of shunt and series MOS FET's in an op amp's feedback loop converts the circuit into a precision analog gate. Push-pull drive signals applied to Q_1 and Q_2 connect and disconnect the high-gain IC and the load.

80-db dynamic range, and at temperatures between -55 and $+125^\circ\text{C}$.

IC's used in multiplying applications provide a highly accurate product of two signals. In a typical arrangement, below, left, the basic multiplying element is transistor pair Q_1 and Q_2 .

The first op amp in the circuit supplies to the emitters of Q_1 and Q_2 a current proportional to the positive input voltage. The second input is fed directly to Q_1 's base. Since the relationship between the collector-current and emitter-to-base voltage of a transistor is logarithmic, the output current is proportional to the product of E_1 and E_2 . E_{IN2} can have any polarity but E_{IN1} must be positive.

The combination of R_{11} and the second op amp converts this current to a voltage and provides the desired scale factor. The μA709 output stage also presents a low output impedance to succeeding stages it drives.

A precision analog gate can be made with an operational amplifier and a pair of metal oxide semiconductor FET switches, as shown above. The gate is opened and closed by alternately switching Q_1 and Q_2 on and off. The circuit operates as a unity-gain inverting amplifier with essentially no on-gate resistance. If R_1 and R_2 are matched to within 0.01%, the effective closed resistance of the gate is 0.1 ohm when a 1-kilohm load is driven.

The gate is opened by switching Q_1 off and Q_2 on, an action that disconnects the amplifier from the load and connects its output to the summing junction. Near-perfect isolation is achieved between input signal and load.

Bibliography

Fairchild Camera & Instrument Corp., Semiconductor Division, "Linear Integrated Circuits Applications Handbook," Mountain View, Calif., 1967.

Actual photographs show the filtering effect of Stackpole ferrite beads on critical electronic circuits. Left — without beads, right — with beads.

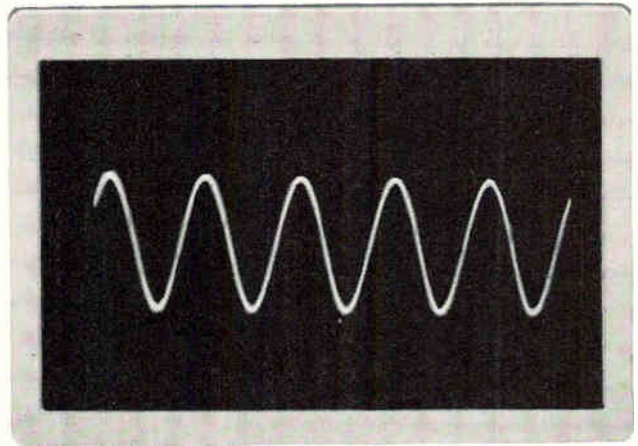
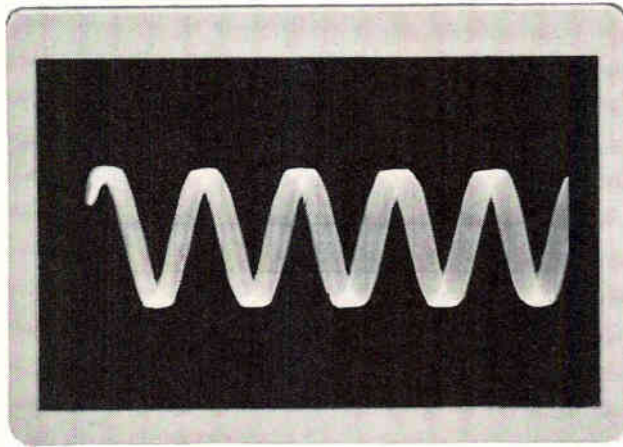

Stackpole Ceramag[®] beads solve noise and filter problems easily and economically



Ceramag[®] ferrite beads offer a simple, inexpensive, yet effective means of obtaining RF decoupling, shielding, and parasitic suppression without sacrificing low frequency power or signal level.

Unlike conventional RF chokes, beads are compact, have no DC losses, and will not couple to stray capacity and introduce detuning or spurious oscillations. Ceramag[®] beads offer an impedance which varies from quite low at low frequencies to quite high at noise frequencies. Beads need not be grounded; how-

ever, chassis contact is permissible when desired, as beads possess sufficiently high resistivity to preclude grounding.

Installation of Stackpole beads is easy. Simply slip one (or several) over appropriate conductor(s) for the desired noise suppression or high frequency isolation. Beads are available in sleeve form in a range of sizes starting at .025 ID, .060 OD, and .400 long. For special compact filtering applications such as cable connectors, beads can be supplied to tight mechanical tolerances.

Several ferrite grades provide a variety of attenuation characteristics. Inductance tolerance is normally $\pm 30\%$ as measured on an LC meter. The performance of a Ceramag[®] 7D bead as a parasitic suppressor is shown in Figure 1.

Other typical applications might include: decoupling in "B" circuitry; noise suppression; RF isolation in filament circuits; use in combination with capacitors to form "L" networks.

FIGURE 1

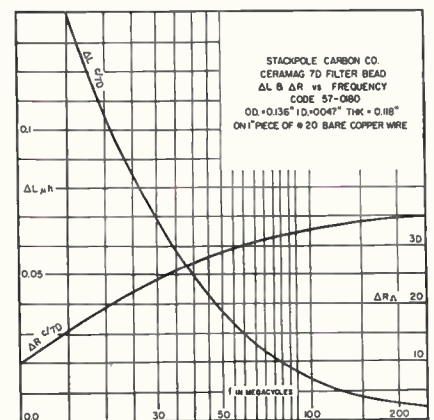

Sample quantities of Ceramag[®] beads are available without charge upon request. Send your requirements to Stackpole Carbon Company, Electronic Components Division, St. Marys, Pennsylvania 15857. Phone: 814-781-8521. TWX: 510-693-4511.



Steering a course to safer air travel

Digital techniques replace analog in a new vhf omnirange receiver that can help evaluate FAA ground stations

By Edwin M. Drogin

Airborne Instruments Laboratory, Cutler-Hammer, Inc., Deer Park, N.Y.

Airplanes flying at supersonic speeds have little time to react to mistakes. Faced with the prospect of faster aircraft and more of them in the air at the same time, both pilots and passengers welcome navigation aids that will tell the pilot more quickly and accurately where his plane is.

One very helpful instrument for enabling the pilot to stay on course is the very high frequency omnidirectional radio range (VOR) receiver which measures the bearing of his aircraft with respect to ground stations. A prototype VOR, designed and built by Airborne Instruments Laboratory as part of the Federal Aviation Administration's evaluation of its ground stations, provides accuracy that may be as much as 10 times better than can be obtained in existing receivers.

Unlike VOR's built during the past 20 years this one is digital, not analog. As a result it could interface with a digital onboard computer to speedily fix the craft's position. Onboard computers will be widely used for generating and plotting courses, displaying distance to destination and estimating time of arrival, and coupling into the autopilots of aircraft now on the drawing boards. Even now digital outputs are being specified for the avionics equipment aboard the U. S. supersonic transport. And airborne digital computers are being used in inertial navigation systems.

But with the AIL VOR navigation section, built entirely of digital circuits, an important step has

been taken in moving to all-digital techniques. Its bearing resolution of 0.01° is more than an order of magnitude greater than can be read from the best commercial omnibearing displays.

The potential of all-digital design is tremendous. Relatively large, power-consuming and expensive analog components can be replaced by the low-cost silicon monolithic integrated circuits. When large-scale integrated circuits are a bit more advanced, it's possible that a completely digital VOR navigation section could be built with only two or three chips of silicon.

Ground station evaluation

Next March, FAA's Signal Evaluation Airborne Laboratory system (SEAL), housed in a turboprop Convair, is scheduled to begin making low-altitude operational checks on the FAA's ground stations. The basic measuring equipment in the plane will consist of AIL's VOR, of distance-measuring equipment produced by Federal Laboratories, a division of International Telephone & Telegraph Corp., and a glide-slope instrument landing system produced by the Wilcox Electric Co. In the near future an inertial guidance system for locating the plane's position as the measurements are made will be placed aboard the FAA's Convair.

The digital outputs from these systems can be recorded and fed into ground-based computers for evaluation.

The FAA developed the SEAL system because it wanted to make as systematic and complete an engineering evaluation of the performance of its ground stations as possible. In particular, the FAA wanted to measure bearing with the greatest accuracy achievable. The best commercial type of VOR receiver, approved by Aeronautical Radio Inc., measures bearing to within $\pm 0.25^\circ$. Over-all, the FAA-maintained VOR systems usually provide bearing accuracy to within $\pm 1^\circ$.

The FAA also wanted outputs not supplied by

The author



Edwin M. Drogin is a consultant in the radar techniques and advanced development department of Airborne Instruments Laboratory. He designs special purpose computing systems for radar signal processing and has been concerned with programs for the Federal Aviation Administration's navigation facilities.

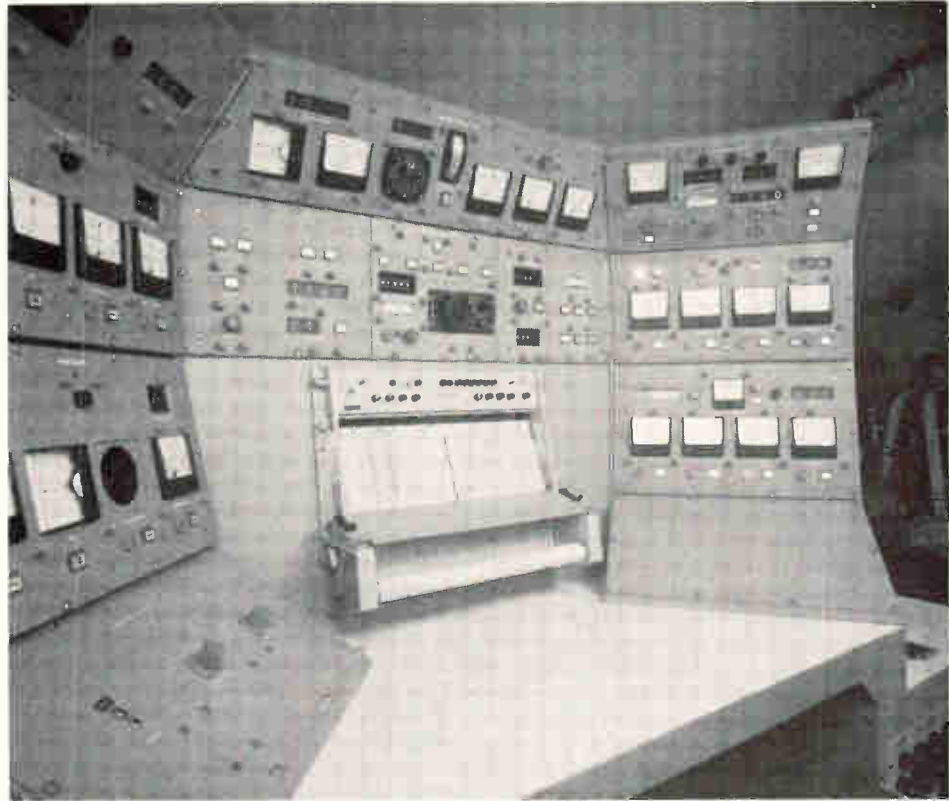

Control panel. Analog recorders in the SEAL system monitor selected outputs of VOR/localizer and TACAN units at the right and glide slope equipment at the left.

standard receivers. Thus the VOR in the airborne laboratory had to measure:

- Modulation frequency, or the deviation from the standard 30 hertz, of the rotating antenna pattern. Because the antenna is driven by a synchronous motor, this frequency depends on the frequency of locally supplied 60-hertz power.
- Wideband bearing error. There are rapid, momentary and unpredictable changes in bearing caused by anomalies in the radio-frequency propagation path. In a standard VOR receiver, this type of error is deliberately filtered out.
- Percentage modulation of the r-f carrier transmitted by the ground station at 30 and 9960 hertz.
- R-f signal level.

Just too expensive

These outputs are vitally important in making an accurate engineering analysis aimed at upgrading a ground station's performance. It's not enough to know that bearing errors occur. It's necessary to know why they occur.

Bearing errors could be caused, for example, by poor frequency control by the local company supplying power to the synchronous motors driving the VOR antenna. Or the modulation percentage could be off. Although signal strength is monitored at the ground stations, the airborne equipment provides a check on the signals as they are received by the user.

It would have been extremely expensive to provide all these outputs with an analog receiver. Each output would have required a separate analog-to-digital converter. In addition, analog-to-digital conversion techniques would have been taxed to yield

a bearing resolution of only 0.1° .

Phase-locked loop techniques were immediately considered for measuring the phase angle between the reference and variable detected sine waves. A phase-locked system could be implemented with digital techniques and would provide the high bearing resolution required.

But instead of using a conventional single-integrator phase-locked loop, it was decided to build a loop having two integrating elements. In such a digital double-integrator loop, precision square waves are generated by the equivalent of voltage-controlled oscillators. These waves are locked in both frequency and phase to the noisy detected input sine waves. A single-integrator loop provides only frequency lock because it requires a phase error to drive the integrating element—the voltage-controlled oscillator in the analog equivalent—to the input frequency.

Double integrator advantages

Some important advantages of the double integrator design over the single integrator are:

- Very narrowband filtering of the noisy reference and variable sinewaves is achieved without introducing phase shift errors.
- Aircraft maneuvering while orbiting the VOR station does not cause phase-lag errors.
- Output of the second integrator (the reference channel) is a measure of the frequency deviation from 30 hz (another output desired by the FAA).

In addition, the loop time constants don't drift—the elements either work or don't—so that the performance of the loop can be precisely simulated on a general purpose digital computer.

Single-integrator loop

The operation of digital phase-locked loops can best be understood by following the operation of their analog counterparts, on this page at the right. In a single integrator loop, an error signal, derived from a phase detector, is amplified to drive the integrator—a voltage-controlled oscillator (vco)—that is locked in frequency only to the incoming 30 hz signal. (In the schematic, K_1 , K_2 and K_3 are constants for the circuit elements and S is the Laplace representation of the time-varying function in the frequency domain.)

Once locked, zero phase error is maintained as long as the input frequency is equal to the vco idle frequency. However, if a constant frequency difference does exist, as a result of aircraft maneuvering or a modulation frequency error in the ground station, a constant phase error must be developed to drive the vco to the proper frequency. If this error is to be kept very small, the gain of the loop must be very high, thus making it difficult to achieve a desirable narrow loop bandwidth.

Double-integrator loop

By adding a second integrator—an operational amplifier with a feedback capacitor—gain may be reduced and the loop behaves as a very narrow band filter.

Any fixed phase error between the input and output signals will be integrated by the additional integrator—its transfer function is K_2/S —until its output builds up to the level of the error. At lock, the output of the phase detector will go to zero and the integrator will hold the error value necessary to keep the vco at the correct frequency. Thus, under steady-state conditions, a fixed frequency difference between the input and the vco idle frequency will not cause a phase error between the input and output signals.

There are other advantages of the double-integrator loop: the steady-state output of the K_2/S integrator is the input frequency error (provided the vco idle frequency is precisely 30 hz) and the error signal out of the phase detector is the wide-band difference between the input and the narrow-

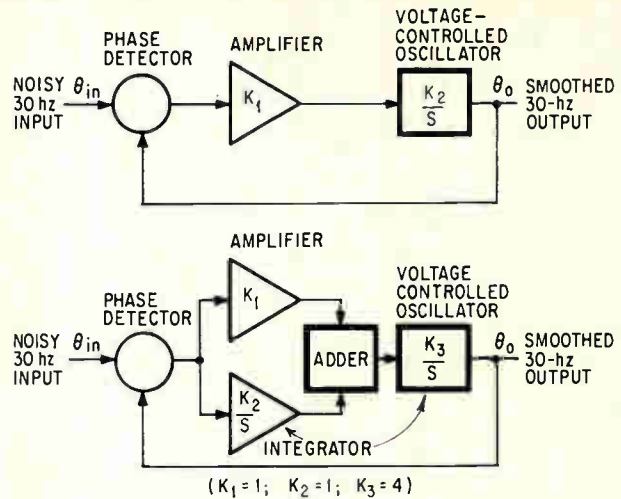

Locked loops. Double integrator phase-locked loop (bottom) locks the output in both frequency and phase to the input. Phase-locked loop with but a single integrator (top) provides only frequency lock.

band output. Both of these outputs were specified by the FAA.

Because of the second integrator, the loop gain can be made low to facilitate high smoothing (narrow bandwidth) without introducing phase error. Such a loop would be difficult to implement with analog techniques because the second integrator would have to be a servomotor or high-quality electronic integrator with low drift and other highly stable characteristics. In an all-digital loop, this problem does not exist.

The forward gain of the double-integrator loop is $G = (K_1 + K_2/S)K_3/S$. The ratio of output voltage to input voltage, or the transfer function of the loop is:

$$\begin{aligned} G/(1 + G) &= \frac{K_1 K_3/S + K_2 K_3/S^2}{1 + K_1 K_3/S + K_2 K_3/S^2} \\ &= \frac{K_1 K_3 S + K_2 K_3}{S^2 + K_1 K_3 S + K_2 K_3} \end{aligned}$$

The denominator of this expression is known as the characteristic equation. It is a quadratic and can be written in the form $S^2 + 2F\omega_0 S + \omega_0^2$ where

How a VOR works

A very high frequency omnidirectional radio (vor) range operating between 108 and 118 megahertz, provides aircraft with lines of bearing, or azimuth referred to a station on the ground. This is done in a vor receiver in the aircraft which compares the phase between two 30-hertz modulating signals. One is a reference signal whose phase remains constant around the ground station; the other's phase varies with azimuth

around the ground station.

The 30-hz reference signal frequency modulates a subcarrier of 9,960 hz which, in turn, amplitude-modulates the radio-frequency carrier. The combined signal is transmitted by an omnidirectional antenna so that the phase of the reference around the ground station is everywhere the same.

The 30-hz variable phase signal is provided by the equivalent of a cardioid-shaped antenna pattern rotating around the ground station at 30 revolutions per second. Proc-

essed by the vor receiver, this appears as a 30-hz sine wave whose phase, with respect to the reference sine wave, varies with bearing.

Received and detected by the receiver, the two signals are in phase when the receiving antenna on the aircraft is due north of the transmitting station. The phase of the variable signal lags the reference signal by the number of degrees the aircraft moves clockwise around the station. This difference is displayed as the bearing to or from the vor station.

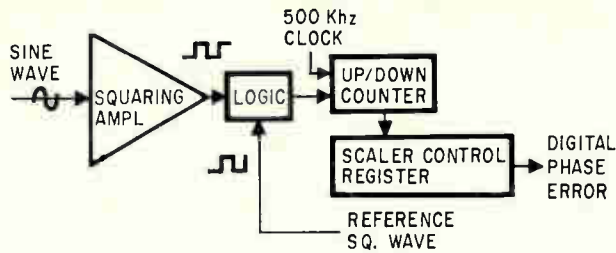

Digital phase detector. Squaring amplifier converts input 30 hertz sine wave into square wave, which is then summed with reference wave. Counter registers two counts for every phase difference of .01°.

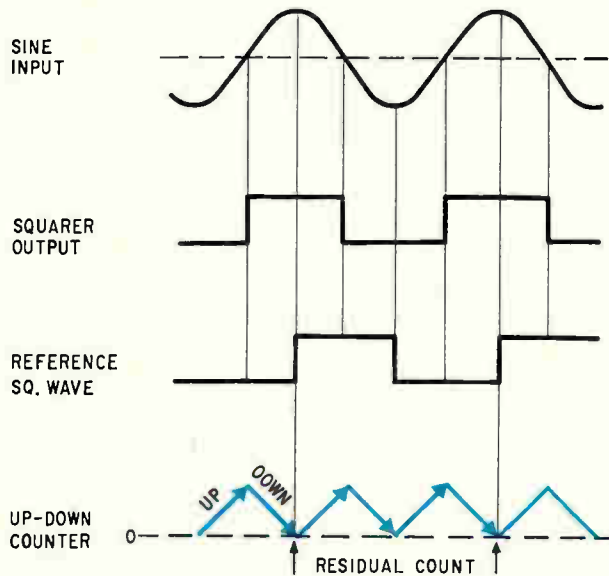

Counter action. Residual count at end of each cycle is zero when phase difference between reference and input is 90°.

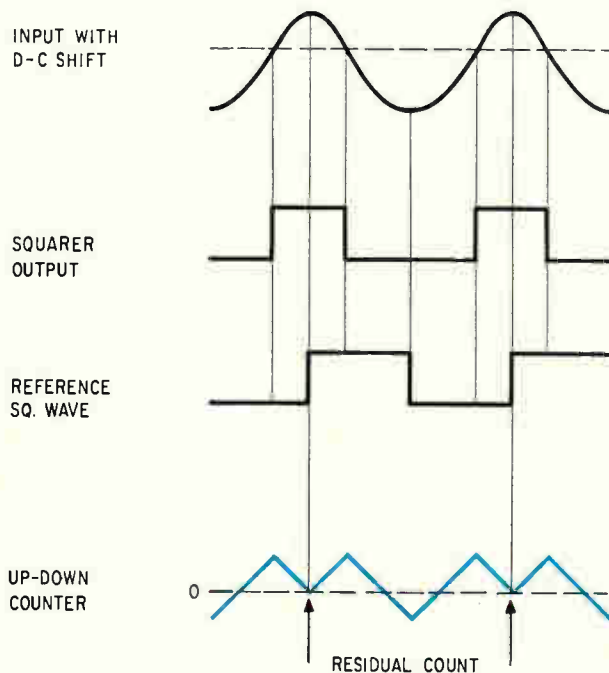

D-c drift. Total counts in the up/down counter are unaffected by d-c drift in the operational amplifier squaring the input wave. For 90° phase difference shown residual count is zero.

$f_0 = \omega_0/2\pi$ is the undamped natural frequency of the loop. F is the damping factor (equal to 1 for critical damping).

The response of the digital equivalent of this phase-locked loop was simulated on a digital computer. It was decided that an f_0 of approximately $\frac{1}{3}$ hz with a damping factor of one yielded desirable settling time and noise performance. The maximum initial frequency error that the loop could lock to was within requirements and could be readily implemented. Thus, with $\omega_0 = 2\pi F_0 = 2\pi(\frac{1}{3}) \approx 2$ and $F = 1$, the values of the constants K_1 , K_2 , K_3 can be selected and calculated to be:

$$\begin{aligned} K_1, K_2 &= 1 \\ K_3 &= 4 \end{aligned}$$

The ratio of the output to the input in Laplace notation is:

$$\left(\frac{4S + 4}{S^2 + 4S + 4} \right)$$

This is the transfer function that must be approximated by digital circuitry. The analog counterparts on the preceding page will be considered first.

Analog phase detector

The first element in the double integrator phase-locked loop is a phase detector. The difference in phase between the input sine wave and the vco sine wave produces a voltage, usually $E = AB \sin(\theta_{in} - \theta_{out})$, where A and B are the respective amplitudes of the sine waves, θ_{in} and θ_{out} .

Thus, the error voltage is not only a function of the phase difference between the signals but also the amplitudes of the two waves. Input sine-wave amplitude must be accurately maintained by a good automatic gain control if the gain of the loop is to be held constant.

Analog integrator

The error out of the phase detector is integrated in an operational amplifier and summed with a fraction of the unintegrated error (for loop stability) to drive the second integrator—a vco. In this way the vco is driven to match the input in frequency and phase. The error goes to zero as the integrator holds the correct voltage output.

Unfortunately, analog integrators drift with time and have stability problems. As the first integrator drifts the vco output will have to differ from the input sine wave in frequency and/or phase to maintain the loop in lock. These problems make the design of an analog double-integrator phase-locked loop difficult.

Voltage-controlled oscillator

The vco in the second integrator is, of course, a familiar component. If the center frequency of this oscillator is precisely 30 hz (zero-error frequency) the voltage out of the first integrator will be a measure of the input frequency deviation from 30 hz. It is difficult to design a low frequency vco with precise center frequency which does not drift

with temperature and component aging.

The digitally controlled oscillator eliminates the drift problems. Its center frequency is crystal-controlled to be the equivalent of 30 hz and the digital first integrator output is thus a precise measure of the input deviation from 30 hz.

Digital phase detector

In the digital equivalent of the analog phase detector, top, page 98, the input sine wave is squared in a high-gain integrated circuit operational amplifier wired as a comparator. The square wave is entered into an AND gate with a reference square wave produced by a digital vco. The logic is arranged so that when the two waves are both "plus" or both "minus" the up/down counter counts up at its clock frequency. When the square waves differ in sign, the counter counts down.

Thus, every time the reference square wave completes a full cycle, the number in the counter is a measure of the phase difference between the two waves, at the left. With the clock frequency at 500 khz (actually 504 khz), and a 30 hz input sine wave, two counts represent a phase difference of $.01^\circ$. As with an analog, full-wave phase detector, the allowable phase error range is $\pm 90^\circ$.

With the up/down techniques of counting through a full cycle of the input square wave, the effects of d-c drift in the operational amplifier doing the squaring is eliminated. This is shown by the waveforms, separated in phase by 90° , at the bottom of page 98. (The amount of shift expected from a good, high-gain operational amplifier has been grossly exaggerated to show the point more clearly.) Although the up/down counter curve is shifted, the total counts—the reading at the end of a cycle of the reference square wave—is still zero. Even harmonic distortion of the sine wave will not cause an incorrect count.

However, because of the nonlinear nature of the zero-crossing measurements, a combination of d-c shift and even harmonics will cause errors. These errors are proportional to the square of the

ratio of harmonic to fundamental amplitude, rather than directly proportional as with odd harmonics. They are, therefore, of secondary importance. Errors due to odd harmonics are eliminated by a pair of matched filters following the a-m and f-m detectors in the r-f section.

Digital integrator

The output from the up/down counter's register is integrated in a tapped shift register and binary adder, shown below. This subsystem takes the place of the first integrator, with a transfer function of $1/S$, shown in the schematic of the analog double-integrator phase-locked loop on page 97.

The contents of the shift register are circulated through the adder together with the phase-shift error "word" coming from the up/down counter. The register is circulated 30 times each second, at which rate the measurements are made. Thus, a one-count error causes a 30-count-per-second buildup of the number in the shift register. This is equivalent to saying that the integrator has a basic gain of 30.

To approximate the required $1/S$ transfer function, the gain must be divided by 30. This is done by tapping the output of the shift register five flip-flops from the lower order end, equivalent to dividing by 2^5 or 32.

Digital VCO

The digital equivalent of a voltage-controlled oscillator is obtained by adapting an old idea, that of a digital scaler in which a binary counter chain drives a set of capacitors whose outputs are summed, as shown next page. In a vco, frequency is controlled by a voltage change. Here, output frequency is controlled by opening or closing switches. This manipulation can be tied to a digital control word.

If the transition of each flip-flop from 0 to 1 produces a pulse, the table of binary output codes for the three flip-flops is as shown on the figure. Each row represents the output states of the flip-

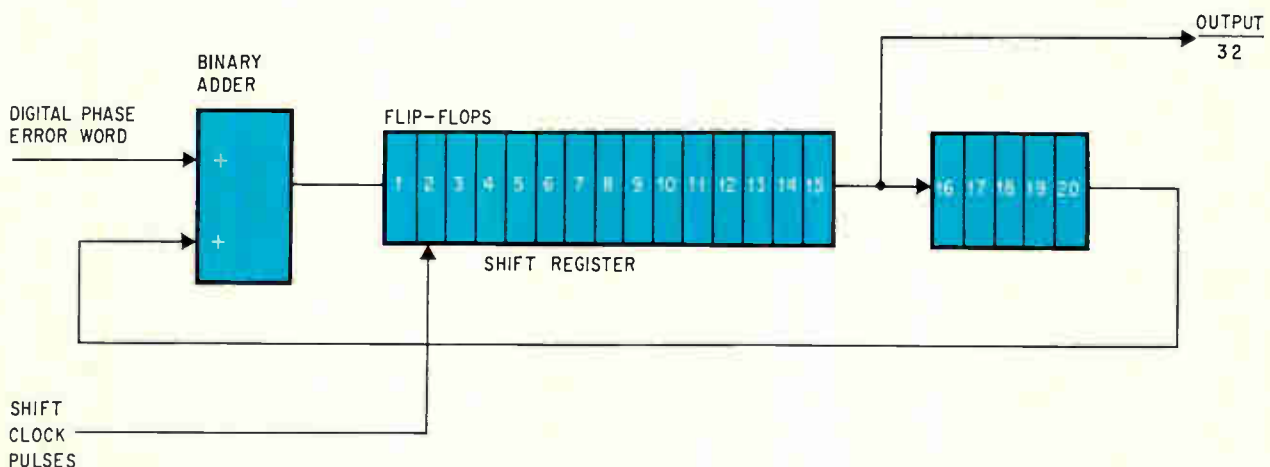

Digital integrator. Phase error word coming from up/down counter feeds into tapped shift register to produce transfer function of $30/(32S)$, which is approximately $1/S$.

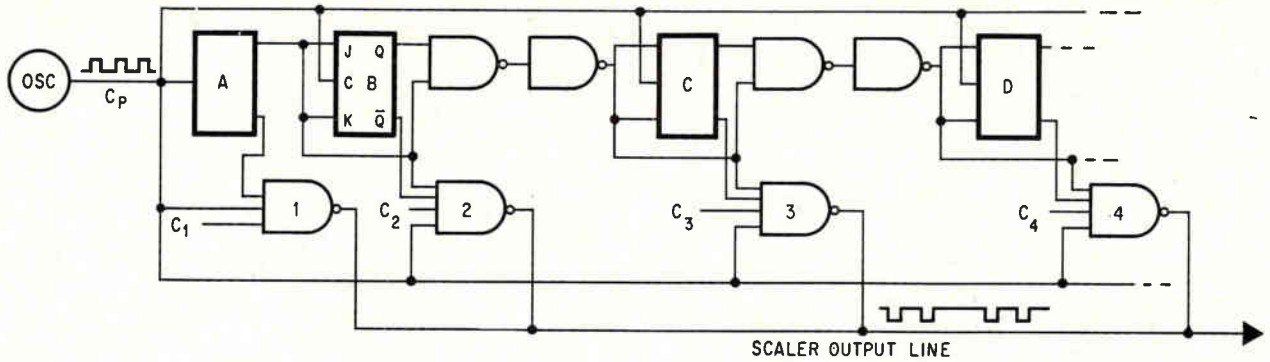

IC scaler. Pulse output in IC scaler is controlled by applying gate-enable signals on lines $C_1, C_2, C_3, C_4 \dots$ which come from digital control word.

Digital scaler. Binary counter chain and switches control pulse frequency by discharging capacitors into output line.

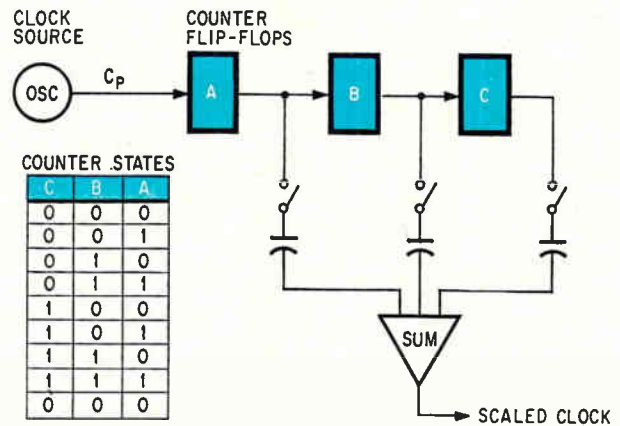

flops for each clock period. Note that only one flip-flop at a time changes from 0 to 1. Thus output pulses never occur simultaneously.

Depending on which switches are closed, from 0 to 7 output pulses are produced for each 8 clock pulses into the binary counter chain. In general, for an n -stage counter, any ratio of output pulses to input pulses from 0 to $(2^n - 1)/2^n$ can be obtained in integral steps.

Fortunately, it does not take capacitors to implement this scaler. The synchronous counter in the figure at the top is a scaler built of integrated circuits. According to the binary code table, a higher order flip-flop changes state at clock time when all lower order flip-flops are one.

For example, when flip-flops A, B and C are in their 1 states, a 1 will be on the J and K inputs of flip-flop D. If D is at a 0 it will change to a 1, the condition at which a scaler output pulse is desired. Thus, for example, gate 4 produces an output pulse when driven by A, B, C and \bar{D} , the clock pulse C_p and a gate-enable signal, C_4 .

The gate-enable signals are equivalent to the switches on the capacitor output circuit. They are generated by a digital control word that consists of the error output of the digital phase detector summed with the output of the first integrator. The gate-enable signal for C_4 is the fourth bit of this control word.

The trailing edge of the clock pulse causes the flip-flop to change state so that the pulse will pass through the gate before D goes to 1, provided C_4 is high. The integrated circuits used in this section may have their outputs tied together

to implement a NAND-OR function, thus summing the scaler outputs on one line.

The pulse train output of the scaler drives a bearing counter which cycles at a 30 hz rate when the control word represents zero error. The scaler rate is restricted to vary $\pm 1.5\%$ of the frequency needed to make the counter cycle at 30 hz.

Completing the loop

The complete digital double integrator phase-locked loop, next page, consists of:

- A digital up/down counter acting as a phase detector. This has a gain of 2 counts per $.01^\circ$ of phase difference.
- A digital serial integrator or velocity register whose output approximates a transfer function of $1/S$ (actually $30/32S$).

The output of the integrator and the up/down counter are summed together and stored in the scaler control register. The transfer function at this point, referred to the input, is $2(1 + 30/32S)$. However, the output of the control register is tapped to give an additional division of 16. Thus, the overall transfer function is now $1/16(2)(1 + 30/32S)$.

By controlling the scaler frequency, this register controls the pulse rate to the bearing counter. The combination of the bearing counter and scaler is equivalent to an analog vco. It has a transfer function of approximately $30/S$.

The bearing counter drives a flip-flop which generates the reference square wave, closing the loop back to the phase detector.

The crystal oscillator frequency is such that a

control word consisting of a 1 and all zeros to the scaler gates (corresponding to a zero frequency error) causes a 1.08 Mhz clock rate to the binary-coded decimal counter. The counter counts to 36,000 and therefore cycles at exactly 30 hz ($36,000 \times 30 = 1.08 \times 10^6$). Each count represents .01° of phase regardless of input clock rate. An all-ones control word will produce 30 hz + 1.5% and an all-zeros control word will produce 30 hz - 1.5%.

Because zero error from the up/down counter occurs when the input square wave is 90° out of phase with the reference square wave (as with most phase detectors), the reference square wave is derived from the BCD counter by a flip-flop triggered at counts equivalent to 90° and 270°. Thus, when the loop is locked, the counter will be going through zero degrees at the instant the input sine wave goes through zero degrees. The counts will be in exact phase with the sine wave.

The forward gain, G, of the loop can now be computed, using the gain values of each section.

$$G = (\text{Gain to the scaler}) \times (\text{gain of bearing counter})$$

$$= 1/16(2) \left(1 + \frac{30}{32S} \right) \left(\frac{30}{S} \right)$$

$$= \frac{3.8}{S} + \frac{3.5}{S^2}$$

The closed loop transfer function is:

$$\frac{\text{output}}{\text{input}} = \frac{G}{1 + G} = \frac{3.8S + 3.5}{S^2 + 3.8S + 3.5}$$

This expression doesn't exactly match the transfer function given on page 00 for the analog version of the double integrator phase locked loop:

$$\left(\frac{4S + 4}{S^2 + 4S + 4} \right)$$

But it's close enough. Thus, for the digitally implemented loop, the undamped natural frequency of the loop, $f_0 \cong 0.3$ hz; damping factor $F \cong 1$.

Joining the loops

Two digital phase locked loops connected as shown in the figure on page 102 plus auxiliary data registers complete the entire navigation section of the digital vor. Working together, the two loops measure the phase difference between the input reference and variable sine waves. This corresponds to the bearing of the aircraft.

For example, suppose the two loops are locked and the bearing to the ground station is 30°. The binary counter in the a-m section goes through a count of zero at the instant the BCD counter in the f-m section goes through a count of 30.00°. At the instant the binary counter goes through zero, a command is generated to load the contents of the BCD counter to the omnibearing display register. This register drives a digital display which contains built-in decoders for converting the 4-wire BCD code to decimal to drive the display lamps.

The register is updated 30 times per second in a fraction of a microsecond. The contents of the register can also be shifted serially into an external computer or recorder under the control of an external shift clock. At a megahertz shift rate the process takes less than 20 microseconds, so the output display is unaffected. During shift-out, updating of the register is inhibited.

The operator sets a desired course on a set of thumbwheel switches. These are equivalent to an omnibearing selector (obs). The switch outputs (BCD-coded thumbwheel wafers are used) are compared with the contents of the BCD counter. At coincidence, a trigger is generated which loads the contents of the binary counter into the bearing deviation display register. The contents of this register represent the difference between the desired course set in on the thumbwheels and the actual bearing of the aircraft. This is known as the course deviation.

For instance, if the bearing is 30°, the BCD counter will be at a count of 30.00 at the instant the binary counter is going through 0.00. If the

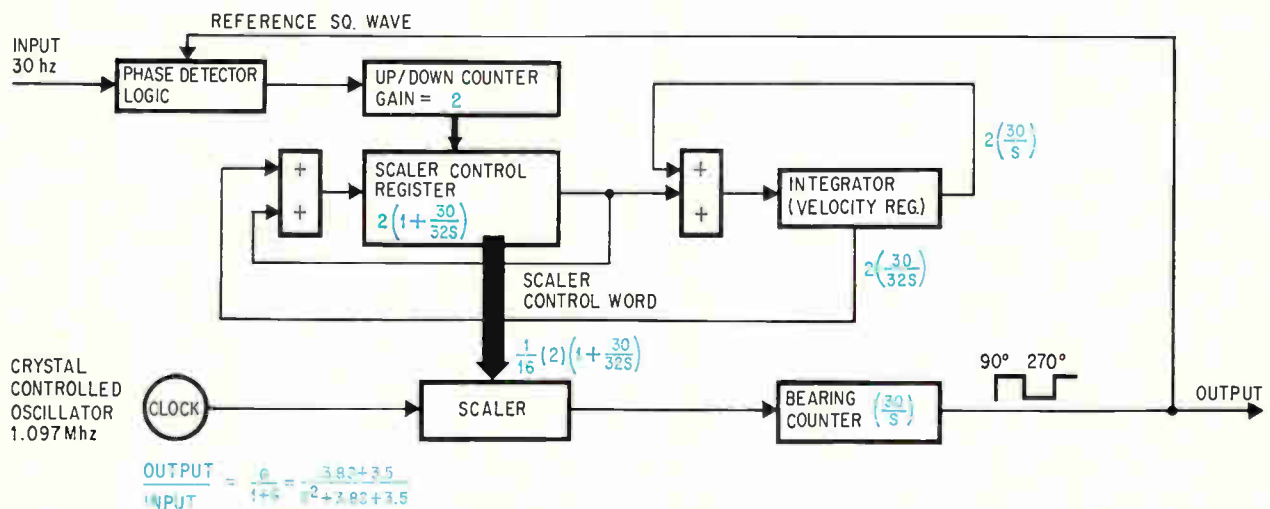

Double integrator loop. Complete digital phase-locked loop locks to frequency of 30 hertz ±1.5%, is critically damped and has undamped natural frequency of approximately 1/3 hz.

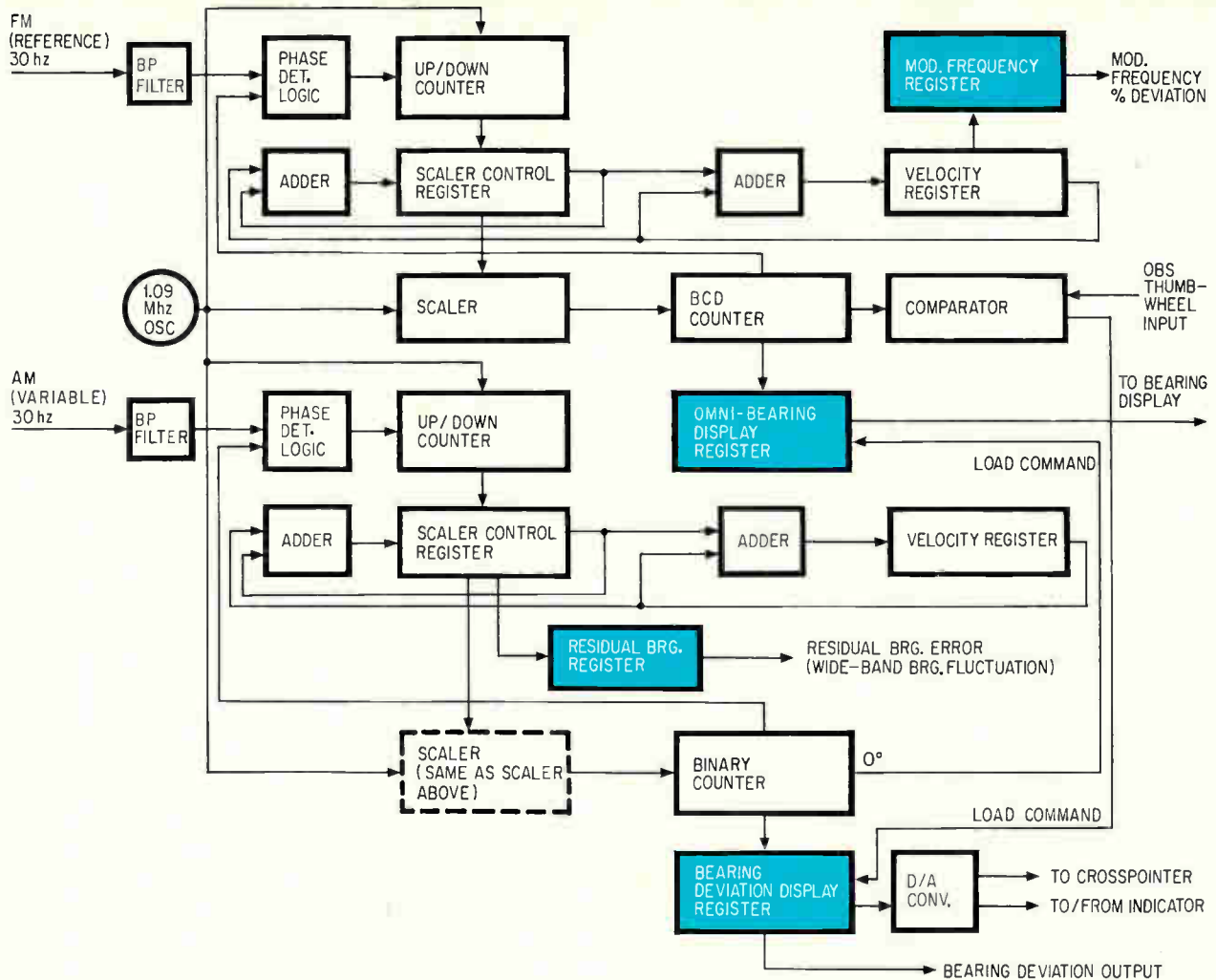

Digital VOR. Two separate double integrator loops, one for the reference and one for the variable wave, make up the complete navigation section. Blocks in color show outputs in digital form specified by FAA's Signal Evaluation Airborne Laboratory.

thumbwheels are set at 31° , the trigger will occur 1 degree later when the BCD counter reaches 31° and the binary counter is at 1.00° , which is the course deviation.

The course deviation in binary form is easily converted to an analog signal which drives a standard course deviation meter. Note that if the thumbwheels are set permanently at 0° , the course deviation register will contain bearing in binary form. This is sometimes the desired coding for input to a navigation computer.

The velocity register in the f-m loop contains the deviation from 30 hz of the input reference sine-wave. This is loaded in the modulation frequency register and can be shifted into an external recorder or computer. It is another output desired by the FAA.

Contents of the up/down counter in the a-m loop represent the instantaneous deviation of the input sine wave from the narrowband loop output. It's a measure of bearing scalloping or the rapid fluctuations in bearing which occur because of propagation anomalies near the vor antenna. This is still another output desired by the FAA which is

available in digital form because of the all-digital nature of the loops.

Miniaturized package

The entire navigation section was packaged, using ic flatpacks, in a standard miniaturized vor receiver chassis, replacing the original analog circuitry. In addition, the front end of the receiver, particularly the intermediate frequency and detector portions, was modified to improve the accuracy and linearity, and reduce cross-modulation effects.

All of the digital circuitry fits on 17 six-layer printed circuit boards, each measuring three inches square. Because many parts of the system are similar, only eight different board designs are needed. There are also four double-sided printed circuit boards for the squaring amplifiers, digital-to-analog converters, and various self-checking and alarm circuits.

Six different types of ic's are used: a J-K flip-flop, a driver module, and dual-, triple-, quad-, and eight-input-NAND gates. All are diode-transistor logic manufactured by Westinghouse.

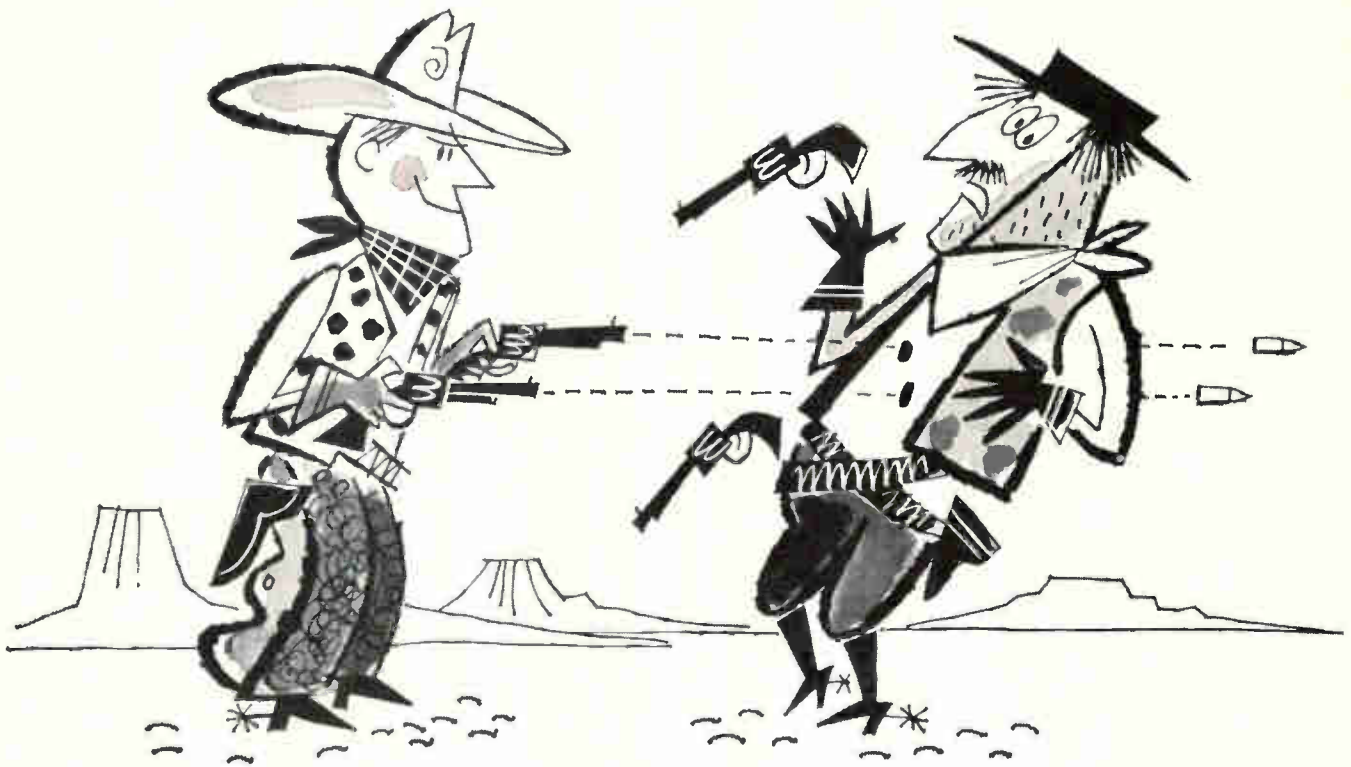

The Fastest S/D Converter in the West... or East!

Continuous Synchro-to-Digital Conversion

Tracks Data Up to 2000°/second.

The NEW solid-state North Atlantic 545 is a good deal faster than Black Bart...and more accurate too! Featuring .01° resolution and accuracy, it continuously converts 400 Hz synchro (or resolver) data to digital form—eliminates variable errors due to data staleness associated with previous conversion techniques.

In addition to the basic tracking mode, track/hold modes are provided to permit observation of slowly changing or jittery data. Drift-free performance is guaranteed through the use of solid-state switched precision transformers. Optional features include 50 Hz to 5 KHz data signals, .001° resolution, 2-speed inputs, and many other system-oriented options.



NORTH ATLANTIC TERMINAL DRIVE, PLAINVIEW, NEW YORK • (516) 681-8600
industries, inc.

Coming to grips with multipath ghosts

Widely used in radar, Chirp modulation makes the most of bandwidth in h-f and vhf radio transmission by compressing waveforms to minimize the effects of echoes, noise, crosstalk and frequency shifts

By David S. Dayton

Technical Communications Corp., Lexington, Mass.

Haunted by ghosts of radio waves that are either bounced off the ionosphere or relayed by satellites, long-distance communications systems can carry only a limited amount of information over the earth's curvature. Partially reflected by irregularities in the ionosphere—or by the land and ocean below—these waves return as echoes that either distort or cancel signals.

Engineers have battled these multipath effects by increasing transmitted bandwidth, a reluctant move considering that bandwidth is a highly precious commodity in free-space transmission. To take full advantage of the wider band, engineers are now turning to a technique borrowed from radar and sonar. When employed in digital high-frequency and very-high-frequency radio communication systems, this technique—called Chirp modulation—uses bandwidth and transmitter power efficiently, tolerates frequency shifts caused by oscillator drift or antenna motion (on either aircraft or satellites), and lowers interference from electrical noise and other radio channels.

Like a cricket's short, shrill blast, Chirp signals pack a lot of punch into a brief interval. An oscil-

lator at the Chirp transmitter sweeps linearly across a fixed band of frequencies for a set time period, producing a relatively long rectangular pulse. Each component frequency has virtually the same low amplitude.

At the receiver, dispersive filters make the first frequency to arrive wait the longest until the others in the pulse envelope catch up. These frequencies, piling on top of each other, add coherently, forming a short, high peak-power pulse that lasts as long as the reciprocal of its bandwidth. The pulse slope, W/T (the ratio of bandwidth to sweep duration), carries the information; for example, positive slopes—where the oscillator sweeps from lowest to highest frequency—could represent binary 1's and would be compressed in the positive matched filter. These signals spread out in time as they pass through the negative matched filter. A detector samples each filter every T second and selects the stronger output signal.

Of course, transmitting codes that are more complex than binary or sending many signals simultaneously over the same bandwidth requires more than two different slopes. This can be achieved by varying sweep rates, repeating sweeps, or shaping pulse envelopes.

Air and sea

Built by the Technical Communications Corp., the equipment used in Chirp modulation includes sweep generator, voltage-controlled oscillator, matched filters, synchronization circuitry, and signal detector. These are incorporated into the modulator-demodulator (modem) along with conventional associated circuitry.

The author



David S. Dayton is vice president and technical director of the Technical Communications Corp., which he helped found in 1962. He was formerly with the Raytheon Co. as system engineer, section chief, and corporate staff consultant.

Now being tested by NASA, Chirp modems are designed to send digital data and digitized voice to satellites for relay to commercial jet aircraft. As a jet flies above the ocean, Chirp signals fight both the doppler shifts caused by the moving aircraft and the multipath signals caused by reflections from the water.

Still another test is in the works for Chirp. Early next year the Navy intends to transmit meteorological data from distant oscillator-equipped ocean buoys to shore stations by bouncing the signals off the ionosphere. In this test, oscillator drift is expected to shift the transmitted frequencies. Because multipath signals bouncing off ionosphere irregularities can make several hops before arriving at the receiver, the Chirp equipment must identify these echoes and differentiate them from the primary signal. As long as the frequencies are within the bandwidth of the matched filters, it is possible to resolve the shift. And provided pulse bandwidth exceeds the reciprocal of the delay between the multipath and primary signals, it is possible to distinguish between the two.

The wider the bandwidth, the easier it is to spot multipath reflections; wider bandwidths mean narrower compressed pulses and, therefore, shorter intervals during which the detector samples the filter outputs. Usually the detector isn't scanning the filter at the time its output is the compressed multipath pulse, which comes hard on the heels of the compressed primary signal.

Combating noise

Fortunately, Chirp modulation wastes precious little of the bandwidth; the bandwidth of the rectangular pulse equals the swept bandwidth. Thus, engineers can design filters that remove wideband noise outside the Chirp bandwidth. By contrast, other leading wave-compression techniques transmit $\sin x/x$ -shaped spectra—that is,

From a short, sharp note . . .

Chirp modulation, developed at Bell Telephone Laboratories for radar applications, was first reported in an interoffice memo written in 1951 by Bernard M. Oliver, now a vice president at the Hewlett-Packard Co.

Oliver's memo, "Not with a bang but a chirp," described a new method of radar transmission that made it possible to clearly distinguish between closely spaced returns, thereby pinpointing the location of a moving target without sacrificing high peak power.

Communications applications of Chirp modulation follow from the similarities between target uncertainties and dispersive channels; multipath is analogous to range variations, and frequency dispersion to doppler effects.

their envelopes include a main band of frequencies plus several sidebands. As a result, more spectrum space must be allocated, and the matched filters designed to admit these sidebands also let in more noise.

Generally, wave-compression techniques offer a way around the peak-power limitations of transmitters. There's just so much power a transmitter can emit in a brief time before it either breaks down, ionizes the atmosphere around it, or causes other problems. Chirp modulation achieves the resolution and energy per bit of very-high peak powers by spreading the transmitted power across a long time interval and then adding it up in matched filters at the receiver.

At the same time, the matched filters delay interfering radio signals, but not selectively, and spread out the frequency components of impulse noise. Therefore, the peak power of continuous-wave signals remains the same during compression in the filters while the peak power of impulse

Up, up and aweigh

System	NASA application	Navy application
	Aircraft-ground communications	Sea-shore communications
Description	Digital data and voice transmitted from ground station will be relayed by synchronous satellite to commercial jet flying over ocean	Meteorological data transmitted from moored buoys will be bounced off the ionosphere and sent to shore stations
Terminals	Transmitter will be located at station in California's Mojave Desert, and receiver will be located on board jet	Transmitters will be located on buoys in Gulf of Mexico, and receivers will be located in mobile vans at various points in U. S.
Channels	Signal has 50-khz bandwidth with 150-Mhz center frequency	Signal has 3-khz bandwidth at 9-Mhz; 6-khz bandwidth at 15-Mhz.
Data rate	2,400 bits per second	75 and 150 bits per second

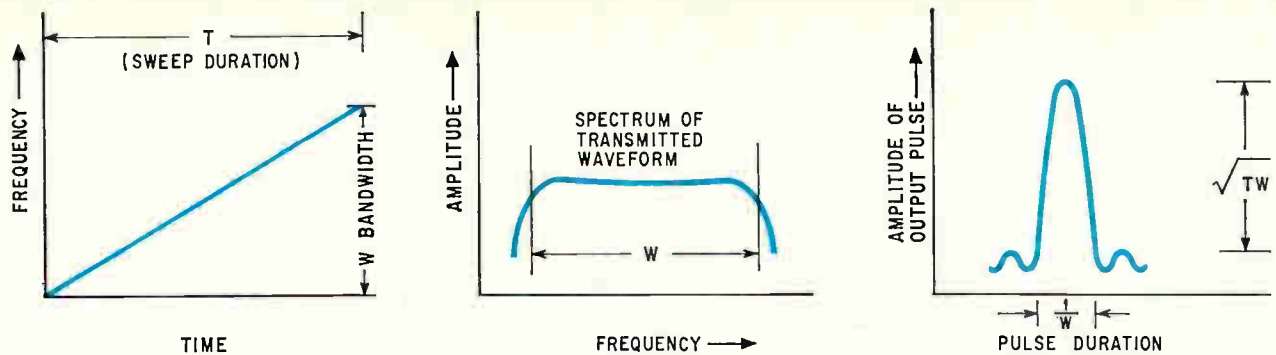

Swept and compressed. A linear sweep over a wide band of frequencies for a set time produces a long rectangular pulse that is compressed (at the receiver) into a short, high-peak power pulse.

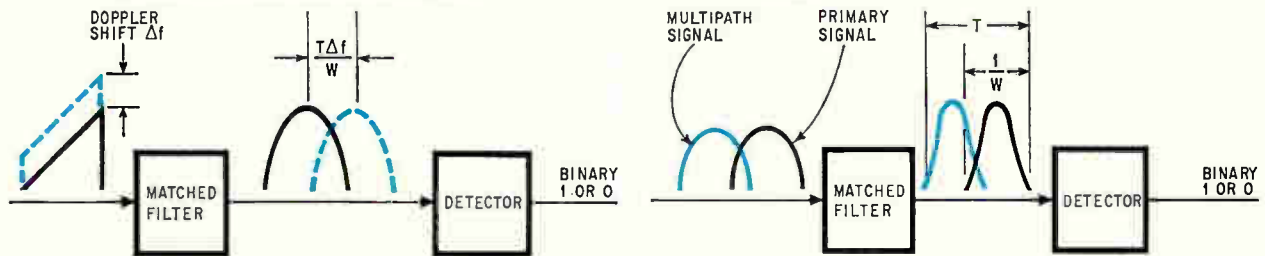

Doppler shift. Chirp pulses, shifted in frequency, are compressed in the filter slightly earlier or later than unshifted pulses. Amplitude is unaffected by the shift. The detector then samples the pulse peak at a different time and identifies signal as a binary 1 or binary 0.

Ignoring multipath. Both the primary and multipath signals are compressed in the matched filter into narrow high peak power pulses. The detector samples filter output every T second, identifies the primary signal and ignores its closely trailing echo.

noise drops. Since the detector samples the filter output for only $1/W$ second during each T second, both types of interference are discriminated against in favor of the Chirp signal.

This requires liberal use of bandwidth in an already pitifully crowded frequency spectrum. But unless communications engineers can pack many simultaneous signals into this bandwidth, they consider it wasted. The engineer's goal is to increase the number of channels to the point where mutual interference becomes intolerable. By stop-

ping short of a cluttered system, he reclaims most of the bandwidth expended in the battle against multipath and other interference.

Asynchronous vs synchronous

There are many ways of sending simultaneous signals, including assigning a specific slot to each channel. But most require system-wide synchronization. At first glance, synchronization appears attractive for satellites which, in addition to acting as relay stations, can also act as central clocks. Furthermore, in theory, the number of possible simultaneous signals could equal $2TW$, without adding to the errors caused by receiver or impulse noise, or c-w interference. Despite this, synchronous satellite-communication systems have one major drawback: they are very costly, especially for multiple access applications where many terminals must be locked together in phase.

A more practical system would be the asynchronous type. Such a system could transmit many signals simultaneously over the same bandwidth, recognizing each signal by its slope. For example, consider the transmission of a pulse envelope 400 microseconds long with a swept-frequency bandwidth of 50 kilohertz. Channel 1 could sweep through the band in 400 μ sec, channel 2 could take half the time to sweep and thus complete two sweeps while channel 3 could complete three sweeps in the same time. It's not hard to generate slopes like these with acceptable linearity. However, the more sweeps per signal, the more difficult it is to build a matched filter.

With many sweeps, the filter produces succes-

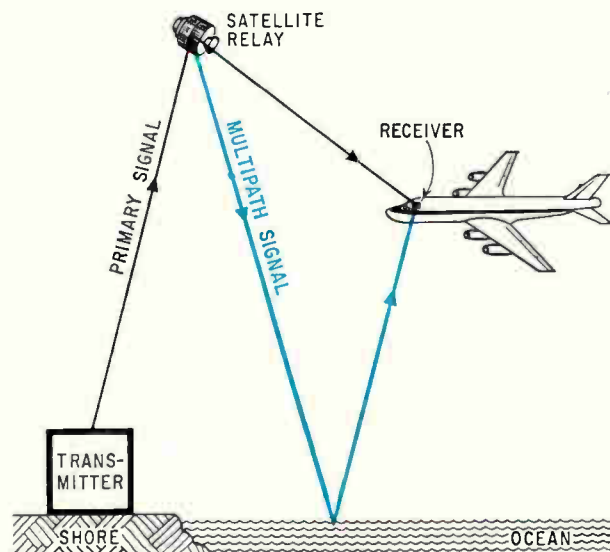

Multipath reflection. As satellite relays data from a land-based transmitter to an aircraft, multipath signals are reflected from the ocean to the plane.

sive outputs that must be delayed for different time periods so that they coincide at the detector. It turns out that the more pulse envelopes—the more sweeps per signal—the detector must recognize, the lower the final signal-to-noise ratio.

Evaluating filter output

To evaluate the number of permissible overlapping channels, engineers compute the response of the matched filters to all slopes transmitted in a system. The results tell whether the detector can distinguish between the outputs. Matched-filter output can be loosely approximated by

$$S_o = kS_1 \sqrt{\frac{T}{t}}$$

where S_o = peak output signal voltage; S_1 = rms input-signal voltage; T = sweep duration; t = filter output-pulse duration; and k = circuit constant.

Since the duration of the output pulse equals the reciprocal of the sweep bandwidth, then $S_o = kS_1\sqrt{TW}$ for the matched sweep. The filter lengthens unswept wideband pulses and doesn't compress narrowband signals. For c-w interference and impulse noise, $t = T$ and thus $S_o = kS_1$. A positive-matched filter doubles the duration of a negative-sloped signal so that $t = 2T$ and, therefore $S_o = 0.707 kS_1$.

If a matched-filter slope closely resembles a mismatched slope (say, if the signal slope is less than 1.5 times that of the matched-signal's slope) the detector may not be able to discriminate between the two. However, detectors easily distinguish between slopes varying by a factor greater than 1.5. Many simultaneous signals add up as noise power at one-half the sum of their total input voltages squared. Ultimately, the number of allowable simultaneous signals depends on the desired signal-to-noise-plus-interference ratio and, therefore, the error rate. For example, in a system having a 10-decibel signal-to-interference ratio, $TW/10$

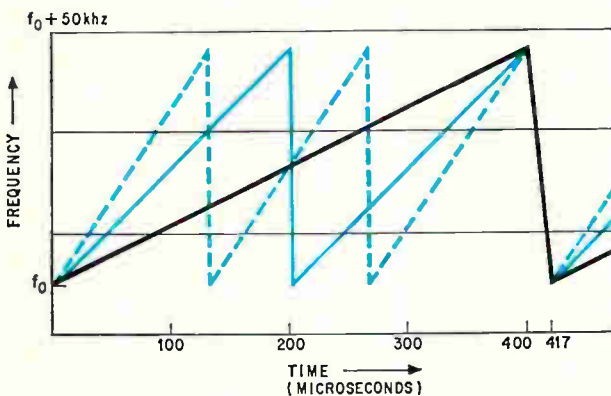

Asynchronous system. Many signals can be sent simultaneously over the same bandwidth by assigning a different slope to each. Here, three signals are sent, each taking a different number of sweeps. A 17-microsecond delay occurs before transmitting next set of signals.

Others making waves

Two other promising techniques using waveform compression are pseudonoise modulation and frequency hopping. Pseudonoise transmitters usually modulate the phase of a carrier wave with a fixed random sequence of bits, thereby generating a wide band of frequencies with a $\sin x/x$ shape. Each sequence of generated bits transmitted corresponds to one information bit.

Frequency-hopping systems generate one frequency after another over a fixed time period. But unlike Chirp systems, they do not sweep an oscillator over a band of frequencies.

channels can be transmitted simultaneously over the same bandwidth provided the signal level is well above the noise level.

Signal demodulation

Generating Chirp signals is no problem provided TW products aren't too high; voltage-controlled oscillators do the job nicely. The difficulty lies in demodulating the swept frequency-modulated signal. This can be achieved by using either dispersive-delay lines or correlation receivers.

Of the two, the most practical is the dispersive-delay line, using either lumped constant-electrical networks (such as cascaded resistance-inductance-capacitance sections) or ultrasonic lines. One lumped network consists of a linear delay line with bandpass filters in contiguous frequency bands at each tap, giving a staircase relationship between delay and frequency. Another approach with networks was taken by T.R. O'Meara of the Hughes Research Laboratories.

In the O'Meara filter, a series of networks—each having its own parabolic phase characteristic across a limited frequency range—passes all frequencies. The accumulative effect of the individual characteristics is to build up the desired slope. However, circuit requirements become strin-

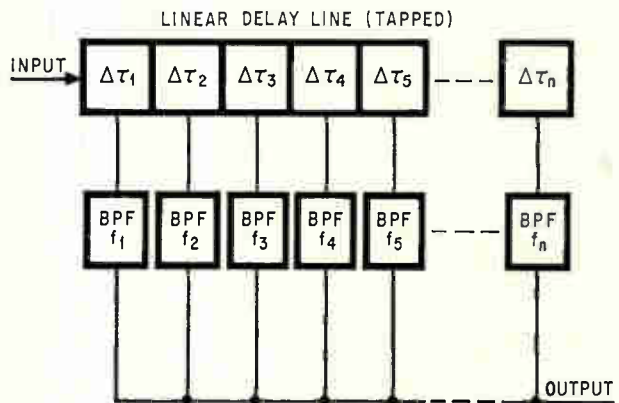

Compressive filter. All frequencies in the swept bandwidth pass through a linear delay line. Bandpass filters connected to successive taps in the line each pass only a small band of frequencies, selectively delaying the frequencies so that a compressed pulse is formed.

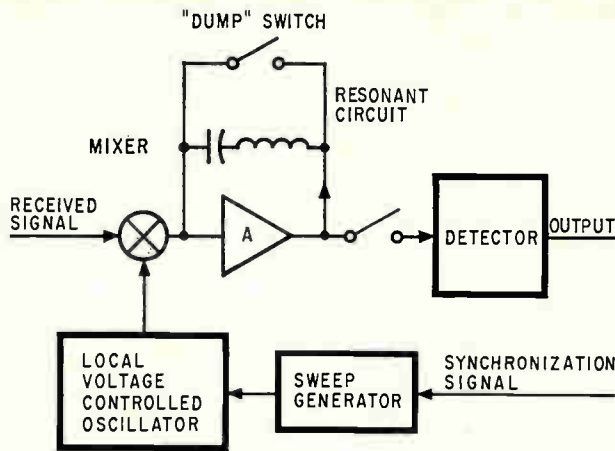

Correlation receiver. The synchronization signal constantly adjusts the frequency of a local VCO whose output combines in a mixer with the received Chirp pulse. The difference frequency between the two signals is amplified and sent back through a resonant circuit. Every T second, the circuit is shorted and the signal goes to the detector.

gent as the ratio of center frequency to bandwidth exceeds 5:1. Despite this, the O'Meara filter is extremely attractive for h-f radio and vhf systems transmitting wideband signals.

So attractive is this approach that the Technical Communications Corporation implemented it in its own filters. One such filter has a bandwidth of 50 kilohertz, a TW product of 20, and a center frequency of 150 khz. It weighs about 3 pounds, takes up about 0.16 cubic foot of space, and doesn't require sophisticated packaging. This filter is being used in the space agency's Chirp tests. A filter of the same type with a 100 TW product could be packaged in less than 0.5 cubic foot. An O'Meara filter built for the upcoming Navy Chirp tests has a delay versus frequency characteristic that is linear (within 2%) across the range of 4.5 to 7.5 khz.

Also holding promise as dispersive-delay filters are those using the ultrasonic approach—wire, quartz, or liquid delay lines—and electron-resonance techniques. Quartz lines offer TW products up to 10,000 with bandwidths of 50 megahertz. Although these take up less than 1 cubic foot of space, they also have characteristically high insertion losses—as much as 80 db.

Correlation receivers

With both large bandwidth and long sweep duration, correlation receivers become attractive. A local voltage-controlled oscillator sweeps across the same bandwidth and at the same rate to produce a signal similar to that received. Combining the two in a mixer gives a sum frequency, which is filtered out, and a difference frequency, which identifies the signal. Engineers offset the vco by a small amount of cycles so that the mixer output would be a constant low frequency, easily detectable in a simple resonance circuit.

Synchronizing the correlation receiver is a com-

plex process. One method compares the phase difference between the received signal and the local swept-oscillator signal. When a timing error occurs, a phase-lock loop output produces an error signal that readjusts the timing of the voltage-controlled oscillator.

Synchronizing delay-line systems, on the other hand, is relatively simple. No matter when it arrives, the swept waveform gets compressed. The only problem is to sample the compressed pulse at or near its peak. Once the system locks on to the transmitted signal, it easily tracks subsequent signals regardless of their delay. This is achieved with radar techniques, such as the split gate-tracking loop. Generally, compressed multipath pulses arrive when the filter isn't being sampled. But even if the pulses are closely spaced, synchronization signals make them readily identifiable.

Design requirements for both delay lines and correlation receivers soar as a system's time-bandwidth product increases. Particularly troublesome are slight nonlinearities of vco sweeps or irregularities in the parabolic phase response of the compressive filter. These severely distort the output signal. And as time-bandwidth products increase, the phase characteristic of the system's bandpass filters including that of the channel itself becomes increasingly significant.

Plus and minus

How Chirp modulation stacks up against other types of compressed-waveform modulation depends on the application. If time-bandwidth products are very high or if data rates are changed often, Chirp systems are far more difficult to instrument than pseudonoise or frequency-hopping systems—other promising types. And if transmitter power is low, Chirp's poorer discrimination against random noise may rule out its choice.

But in accommodating doppler shift or oscillator drift and in operating within tightly restricted r-f bandwidths, Chirp clearly has the edge. Moreover, the complexity and expense of gaining phase coherence and synchronization—required in pseudonoise and frequency-hopping systems—aren't economically justifiable for transmitting short bursts of data.

Bibliography

- J.R. Klauder, et al., "The theory and design of chirp radars," *Bell System Technical Journal*, 1960, pp. 745-303.
- F.R. Steel, A.E. Babbit, and F.P. Corr, "The design of frequency-time matrix Rada communications system," presented at IEEE International Conference on Communication, 1967.
- A.S. Griffiths, and W.H. Smith, "Communications Satellite Systems Technology," Academic Press, New York, 1966, page 159.
- T.R. O'Meara, "The synthesis of bandpass-all pass time-delay networks with graphical approximation technique," *Hughes Research Report No. 114*, 1959.
- W.B. Mims, "The detection of chirped radar signals by means of electron spin echoes," *Proc. of the IEEE*, 1963, page 1127.
- C.E. Cook, "Effect of phase modulation errors on pulse compressive systems," *IRE Convention Record*, 1962, page 174.
- S.A. Kramer, "Doppler and acceleration tolerances of high-gain wideband linear f-m correlation sonars," *Proc. of the IEEE*, 1967, page 627.

Semiconductor Report



ABOUT SPACE-SAVING MICRO-T TRANSISTORS FOR OPTIMUM DESIGN FLEXIBILITY

NEW MICRO-T TRANSISTORS SOLVE HIGH-DENSITY PACKAGING PROBLEMS

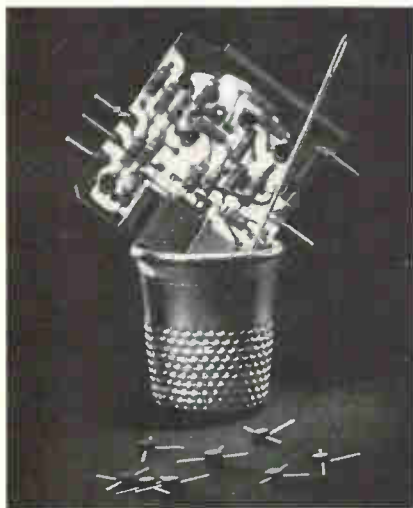

Motorola's Micro-T* molded Unibloc* plastic transistors now provide the ultra-small devices you've needed to make those high-density, miniaturized equipment designs a practical reality. The new Micro-T is only about one-tenth the volume of standard plastic or TO-18 packages. Handling problems disappear too . . . because the leads of the Micro-T radiate from the center, making it particularly well-suited to "drop-in" PC-board mounting.

The Micro-T is "at home" anywhere high-density packaging is required . . . electronic watches, hearing aids, satellites, high-frequency instruments and many, many more. In short, the Micro-T lets you design circuits that provide *discrete device* performance and design flexibility; while, at the same time, achieve the component densities and space reductions approaching that of integrated circuits. For example, it makes an ideal device for use in thick-film and unitized circuit assemblies.

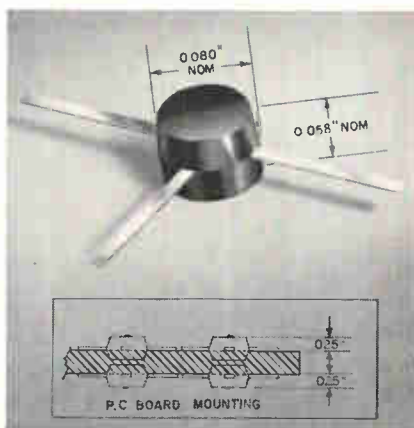

COMPLEMENTARY SWITCHING AND AMPLIFIER TYPES FIRST MICRO-T's AVAILABLE

MMT3903-04 (NPN) and MMT-3905-06 (PNP) Micro-T transistors boast a host of premium specs for general purpose switching and amplifier applications, as well as for complementary circuitry. In fact, the specifications are identical to those of their standard (TO-92) plastic-packaged counterparts—2N3903-06. Yet, you gain the added advantages of space-saving and handling-ease—available only with Motorola's Micro-T!

Here are the specs that make these Micro-T types an "evaluation must":

CHARACTERISTICS	TYPES			
	NPN		PNP	
	MMT3903	MMT3904	MMT3905	MMT3906
BV_{CE0}	40 V	40 V	40 V	40 V
$C_{ext-max}$	4 pF	4 pF	4 pF	4 pF
$P_D @ T_A = 25^\circ C$	225 mW	225 mW	225 mW	225 mW
$h_{FE} @ V_{CE} = 1.0 V_{dc}, I_C = 100 \mu A$	20 (min)	40 (min)	30 (min)	60 (min)
$I_C = 10 mA$	50-150	100-300	50-150	100-300

Operating and storage junction temperature range: -55° to $+135^\circ C$

Prices are moderate too — only \$1.45 for the MMT3903 and MMT-3905; \$1.80 for the MMT3904 and MMT3906 (1000-up). Production quantities are immediately available.

Circle 309 on readers service card

MOTOROLA Semiconductors

— where the priceless ingredient is care!

CHIP FROM FAMED 2N2369 SWITCH ALSO IN MICRO-T

For several years, the 2N2369 has been "a standard of the industry" for high-speed, low-current switching applications . . . *except* in micro-miniature equipment.

Today, the MMT2369 is "the standard of the industry." Period!

Now, in the reliable, space-saving Micro-T, Unibloc plastic package, you can have all the advantages you always had — plus! Plus what? Plus the cost-savings on layout, assembly, and even P.C. boards . . . It's also ideal for thick-film digital circuit applications.

In case you've forgotten, here are some of the specs that made the 2N2369 great and make the MMT-2369 even greater now:

CHARACTERISTIC	SYMBOL	MIN	MAX	UNIT
Collector-Emitter Breakdown Voltage	$B_{V_{CE0}}$	15	—	V _{dc}
Collector Cutoff Current	$I_{C_{CO}}$	—	100	nA _{dc}
DC Current Gain	h_{FE}	40	120	
Current-Gain Bandwidth Prod.	f_T	500		MHz
Turn-on Time	t_{on}	—	12	ns
Turn-off Time	t_{off}	—	18	ns

Immediately available in production quantities, the MMT2369 is moderately priced at \$.97 (1000-up). For complete details, send for the data sheet. Write P.O. Box 955, Phoenix, Arizona 85001.

Circle 310 on readers service card



*Trademark of Motorola Inc.

Stop-action recording of fleeting signals

Designed to detect nuances of nuclear detonations, a magnetic-drum system handles 48 data channels with 15-megahertz bandwidth; it contains no active devices, making it resistant to intense radiation

By Raymond J. Arndt

IIT Research Institute, Chicago

The human eye can catch a flicker of light lasting only 1/30th of a second. Quicker still is a recently developed magnetic-drum recording system that can pick up and store transient analog signals lasting but a fraction of a microsecond.

The recorder handles up to 48 data channels, each with a response from 400 hertz to 15 megahertz; wide bandwidth is a must because signals of short duration contain high frequencies. The system was designed to record signals produced by nuclear detonations, so the recording circuits were built without active semiconductor devices to make the equipment insensitive to radiation.

Besides its ability to record fast transients, the drum recorder offers several other advantages over conventional tape recorders in this rather specialized application. The rotating drum can record many more individual channels in a given space, and its repetitive playback makes for quicker examination and interpretation of transient data. Also, the frequency response of even the best instrumentation tape systems is limited by maximum tape speed to a few megahertz.

Photographic recording of cathode-ray-tube displays is another widely applied method of storing signals of short duration. But film needs further

processing, whereas high-speed transient data recorded on a magnetic drum is available immediately for electronic processing. Moreover, the storage capacity in a rotating drum is a hundred times greater for a given time resolution than that of a conventional still photographic system. And most important, a single drum recorder can process and retain as much useful information as an entire trailerful of oscilloscopes and cameras.

Whirling drum

The recorder, developed by the IIT Research Institute, is built around an aluminum drum 7½ inches in diameter and 2½ inches wide. The periphery of the drum is coated with an ultrathin film of a special nickel-cobalt alloy, the actual recording medium. A three-phase motor rotates the drum at 22,900 revolutions per minute, so that the recording surface passes the recording heads at a speed of about 9,000 inches per second. This recording technique utilizing a rotating drum, multiple heads, and a metal film is similar to the method used in the digital memories of many computers.

Designing the heads involved a juggling of tradeoffs. Contact between the heads and the rotating drum would provide high frequency response, but abrasion would quickly destroy both the heads and the smooth magnetic coating. Separation of heads and drum eliminates mechanical wear but reduces frequency response.

To get the best possible response while maintaining the necessary separation, it was decided to use aerodynamic flying heads. A cantilever spring moves each one toward the recording film. As the head approaches the drum, the thin layer of air carried along with the rotating surface counterbalances the spring force and establishes an

The author



Raymond J. Arndt is a research engineer in the Electronics division at IIT Research Institute. He has worked on compact, high-performance circuitry for audio-recording applications, flux-responsive playback systems utilizing both Hall-effect and modulator playback heads, and wideband recording techniques.

equilibrium that keeps the head just slightly above the drum surface. Skim spacing as small as 50 or 100 microinches has been consistently maintained in prototypes. A major advantage here is that the elasticity of the air suspension allows the head to follow such irregularities in the drum surface as runout and thus maintain a constant spacing.

Since the air bearing is effective only at the drum's rated speed, the heads are withdrawn during startup and slowdown to prevent accidental contact with the drum surface. After the drum has reached its operating velocity, a solenoid is energized to move the heads into position; it is deactivated to retract the heads when the recording is completed. Each of the retractors is capable of mounting up to 16 individual heads, so that with three retractors, a total of 48 data channels is accommodated.

Multimegahertz operation requires recording heads with a very low impedance. The ferrite heads used have an inductance of 10 microhenries, limiting the usable upper frequency to 20 Mhz. The track width of each head is 0.02 inch and the separation between adjacent tracks is 0.03 inch.

For the best possible signal level and high-

frequency response, the heads are built with a 100-microinch gap. The size of this gap represents another compromise: small gaps yield slightly better response but degrade the signal during playback; larger gaps improve output level but cut frequency response. The choice of a 100-microinch gap was a conservative one, as gaps of up to 250 microinches degraded high-frequency performance only slightly, reducing the upper frequency limit by about 10 or 15%.

Passive recording

Signals induced by the field in electromagnetic sensors are applied through a passive matching network—a tapped autotransformer—directly to the heads. The energy needed is thus supplied by the electromagnetic field being measured. No gating or control circuitry—other than that supplying power to the drum motor—is required. Thanks to the drum's inertia, even the motor's power can be interrupted a moment before a nuclear detonation without affecting the recorder's performance.

Since the recording system is entirely passive during recording, its radiation tolerance is limited only by the drum coating and associated wir-

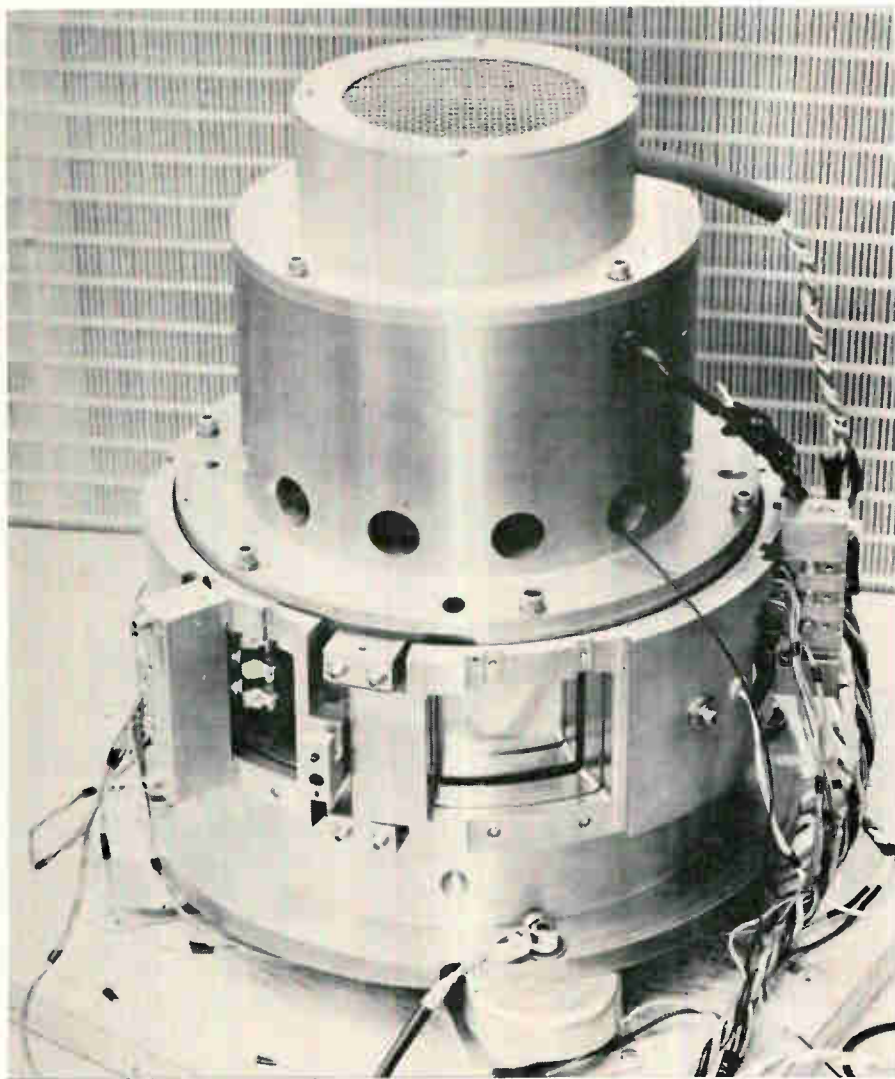

Small size. Drum recorder is only about a foot in diameter at its widest point. Thinner laced cables lead to banks of recording heads, heavier ones to motor drive.

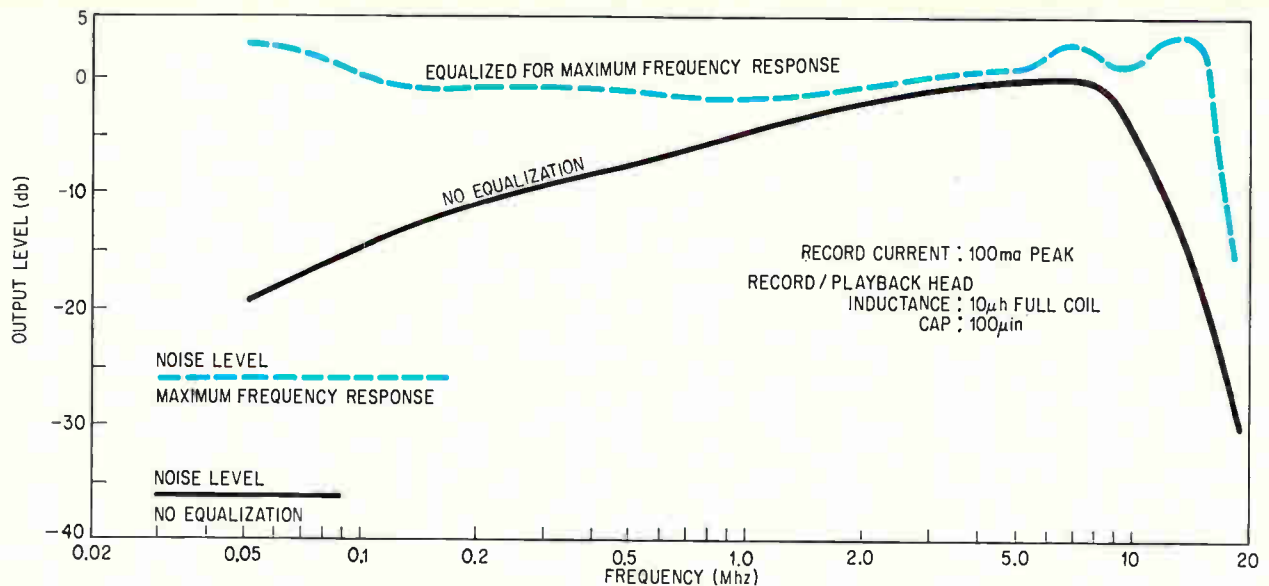

Flat response. Unequalized recorder frequency response is down 20 db at 50 khz and falls off sharply above 8 Mhz. With equalization, however, the curve is almost flat up to 15 Mhz.

ing. The recorder itself is capable of withstanding gamma irradiation levels of 10^8 roentgens per second and neutron exposures of 10^{15} neutrons per square centimeter. With radiation-insulating materials and shielding, the equipment's tolerance would be even higher.

In conventional tape systems, information is recorded along with an ultrasonic bias frequency to increase system linearity and thereby improve signal-handling capability. But this method is unsuited to passive recording applications. In fact, only two operating modes are possible with a passive recording system.

The first is direct recording of the input data on a previously erased drum; the stored signals are reproduced through a conventional playback amplifier. With the rotating drum, a virtually flat frequency response from 20 khz to 15 Mhz is attainable. But because no recording bias is available and because of the nonlinearity of the mag-

netic coating, the amplitude range of single-track signals that can be recorded faithfully is limited to between 6 and 10 decibels.

To improve the dynamic range, each autotransformer tap is connected to a separate channel. In this way, successively increasing voltages drive individual tracks. The recording range is thus multiplied by having each head handle a portion of the signal's amplitude range.

The second technique applicable to a passive system is carrier-erase recording. Incoming signals are applied to the drum over a previously recorded high-frequency carrier; the output level then depends on how much of the carrier is erased. Although the low-frequency response of a carrier-erase system can theoretically extend down to d-c, the wavelength of the recorded signals must not exceed the drum circumference. The practical lower boundary is therefore raised to 400 hz. Except for its extended low-frequency capability, the carrier-erase system offers about the same overall response and dynamic range as the direct technique.

When the equipment doesn't have to hold up under severe radiation, of course, active electronic components can be used and conventional recording techniques applied. With high-frequency recording bias, the present frequency response can be retained and the dynamic range boosted to 25 or 30 db.

The mechanical simplicity and flywheel effect of the high-speed rotating drum give the system a much lower level of wow and flutter than a conventional tape transport could provide. This should make the magnetic drum equipment especially useful for f-m recording, where slight variations in recording speed can result in spurious deviations in carrier frequency.

If used in an f-m system, the drum recorder should achieve high linearity, wide dynamic range, and a frequency response of up to about 5 Mhz.

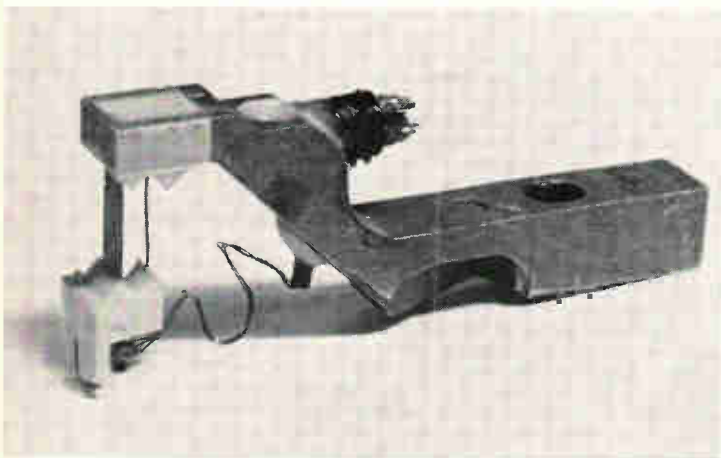

Flying heads. Aerodynamic ferrite heads have track widths of only 0.02 inch. Mounting the heads on cantilever springs maintains their spacing just above drum's surface.

This integrating DVM still offers better performance than any other of its kind.

Measure low-level signals even in the presence of extreme noise with Hewlett-Packard's 2401C Integrating Digital Voltmeter. It has a floating and guarded input for minimizing the effects of common mode noise; and integration averages out all noise superimposed on the signal.

But the 2401 DVM could do that when it was first introduced. Since then there have been two new models and many additional features to keep the 2401 the industry's most useful bench and system DVM.

Here's why:

5 ranges, 100 mV, 1 V and the 3 usuals; 300% over-ranging on the 4 most sensitive ranges, 6th digit for overrange display; integration through zero; full programmability; BCD output for systems use; independent internal calibrate source stable to 0.006% / 6 mo.; 300 kHz frequency counting ability; optional autoranger with 34 msec maximum change time.

If this isn't enough, a full repertoire of options and compatible systems instruments is available to satisfy your measurement needs.

Price: \$4100

Call your local Hewlett-Packard field engineer or write direct to Dymec Division of Hewlett-Packard, 395 Page Mill Rd., Palo Alto, California 94306, Tel. (415) 326-1755; Europe: 54 Route des Acacias, Geneva.

HEWLETT
PACKARD  DYMEC
DIVISION

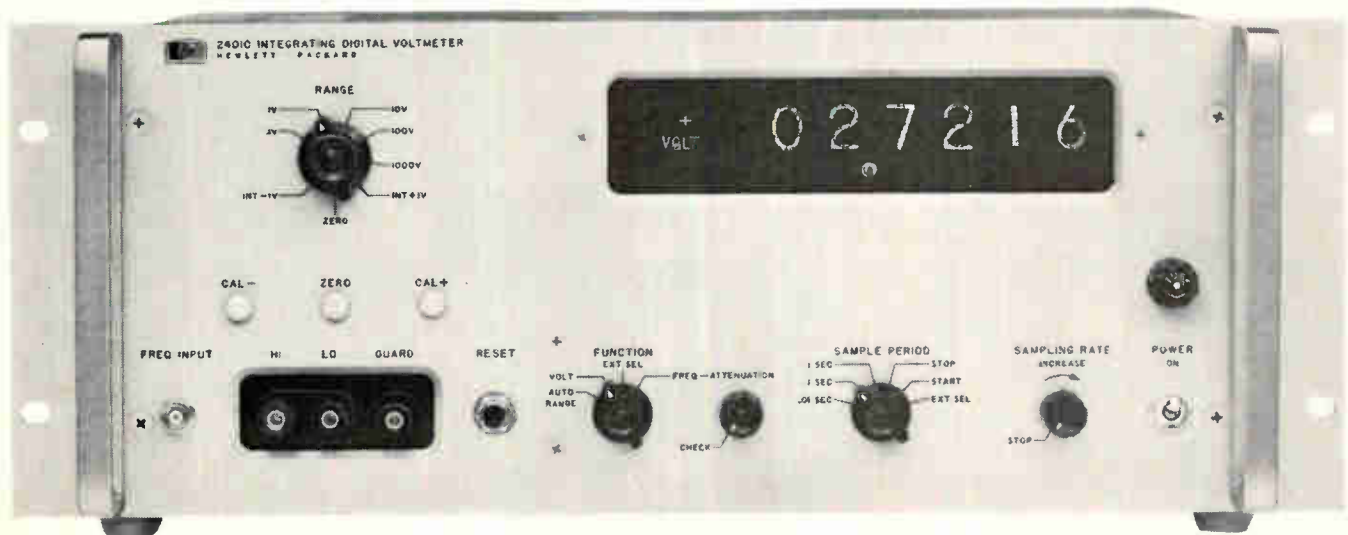

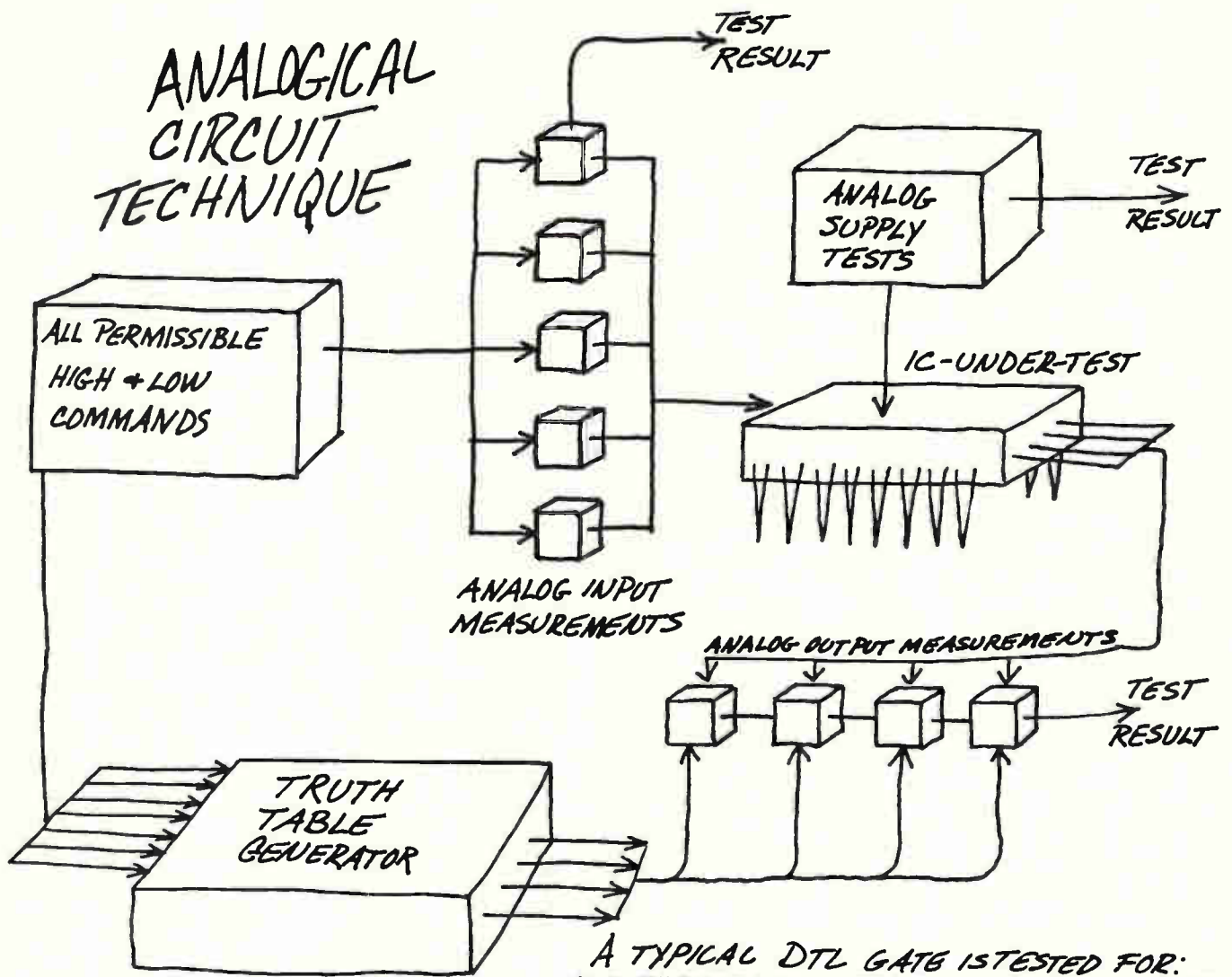

A TYPICAL DTL GATE IS TESTED FOR:

$I_{IN HI}$	5.1 mA MAX @ 4.1 V
$I_{IN LO}$	1.1 mA MAX @ 1.1 V
$V_{OUT HI}$	2.6 V MIN @ 0.12 mA
$V_{OUT LO}$	0.45 V MAX @ 12.0 mA
I_{CC}	16 mA MAX @ 5.0 V

Intriguing, isn't it, this new way of testing digital integrated circuits?

Now you can make sure ALL of your ic's will work — because you can make both parameter and functional tests simultaneously, and for all permissible combinations of inputs. □ It's done by exercising all the LOGICAL inputs on the ic-under-test and selecting the appropriate ANALOG measurements that should be made. 5,000 such measurements are made in 1/100 of a second.



□ Even more exciting, our Analogical Circuit Technique is available on a little machine that weighs only 25 lbs. It's a cinch to program, and costs only about \$5,000. □ We call it ACT 1 (because of the fortunate acronym). □ To learn more about analogical testing, just write: ACT 1, Teradyne, 183 Essex Street, Boston, Massachusetts 02111.

VSMF is a product supermarket

John Manning, Missiles Systems Division, Raytheon Company, Bedford, Mass., has installed 4 VSMF Files: Defense Design, Documentation, Mil Specs and Mil Standards.

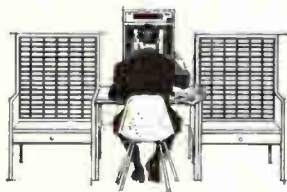

look into it!

Design engineers have been telling us for years that VSMF is much like a product supermarket. That's because Visual Search Microfilm Files contain more than 1,000,000 products from over 15,000 manufacturers—all arranged with design engineers in mind.

Of course, VSMF isn't exactly a supermarket. At Information Handling Services, we've collected 1¼ million pages of product data, indexed them, microfilmed them, put them in compact consoles, and combined them with the most modern microfilm retrieval equipment. VSMF has all the advantages of a product supermarket . . . complete, easy-to-use and up-to-date.

We know that when you design a product you want to use the best components and materials. And, to do this, you need to compare all that is available. VSMF can help you in this comparison because VSMF supplies the data on *all* products. You supply the judgment.

Manufacturers who place their data in VSMF know this and invite comparison. The constantly changing "state of the art" is reflected in the pages of VSMF.

More than 125,000 engineers in 500 great corporations now shop in the VSMF supermarket. If you have VSMF in your company, look into it. If you don't, you might look into that, too. Write for "Looking into VSMF."



Information

HANDLING SERVICES, INC.

Dept. E-1127

Denver Technological Center

Englewood, Colo. 80110

Circle 115 on reader service card

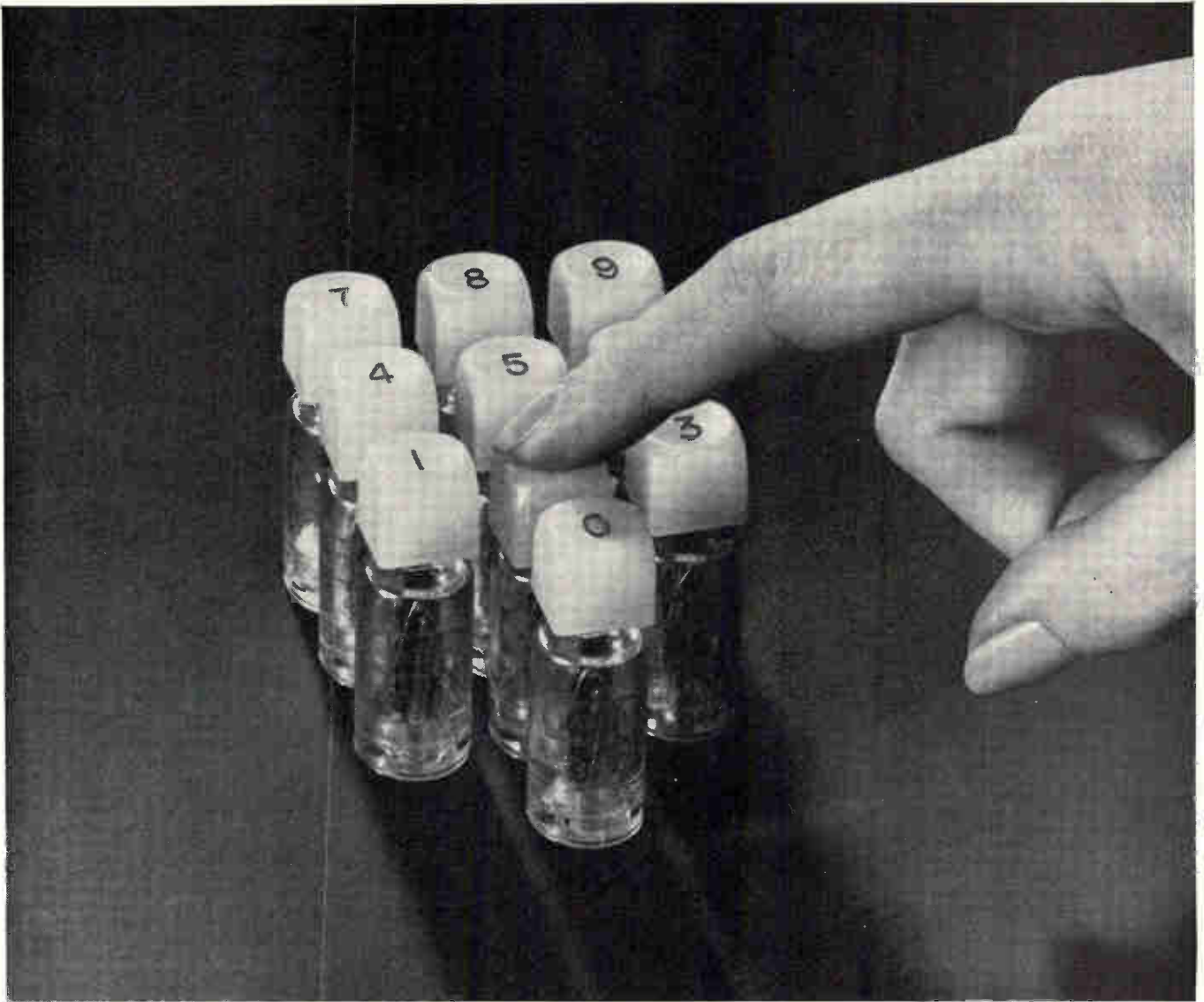

These new keyboard switches feature unusually precise action and low-cost mounting. See for yourself—write for samples.

These elegantly styled key switches are especially suitable for computers, learning and business machines, and other advanced control equipment.

Designed by Raytheon, they have a featherlight touch that is precise and reliable. Just a 3-oz. touch activates the switch. Because of the unique design, this action can be repeated more than 10 million times. Yet the switches cost as little as 60¢ in production quantities.

Raytheon key switches are available in a wide range of standard- and custom-cap shapes, sizes, colors,

and alphanumeric. The characters can be illuminated by backlighting. All switches are made of high-quality materials: stain-resistant caps; polycarbonate body parts; stainless steel springs; beryllium and stainless steel contacts. They are available in single- and double-level wipe-action types, and in dry-reed, hermetically sealed single- and double-level types.

Write for samples. For free samples, write on your letterhead describing your application to: *Raytheon Company, Industrial Components Operation, Dept. 2351-EL, Quincy, Massachusetts 02169.*



Simple, low-cost mounting. Raytheon switches plug into .125" PC board. Contact pins snap in, firmly lock switch in place for soldering. This permits you to use flow soldering techniques—cut keyboard assembly time and costs.



BIFURCATED CARD EDGE CONTACTS ARE REDUNDANT?

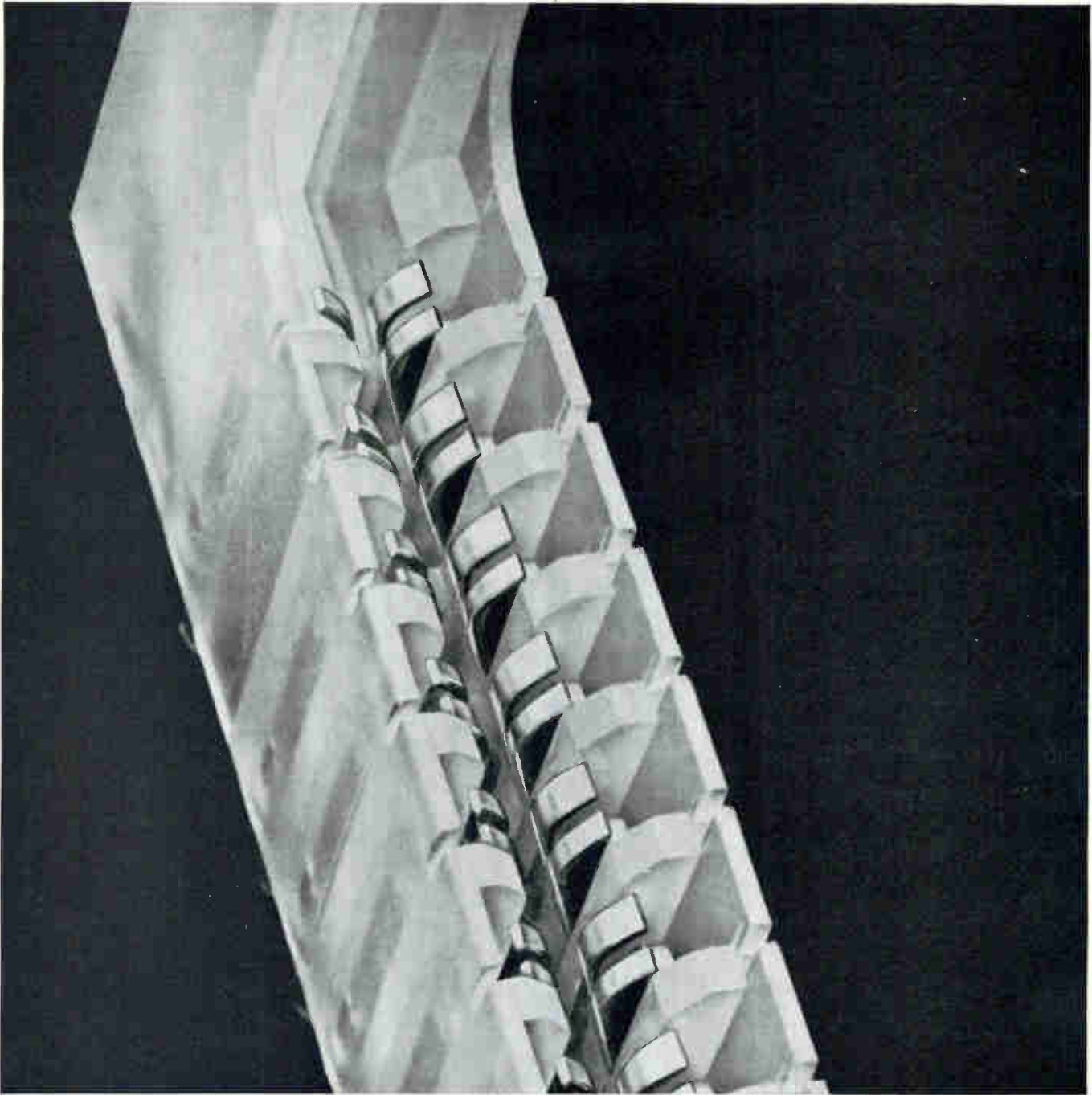

YOU'RE KIDDING!

No, we're not. It's just one of the many years ahead ideas from Elco.

So the contacts will remember their original "form," and always assure positive card edge connections, we bifurcate them. We do it to offer you that extra "no failure" capability. Even after countless insertions the contacts still mate with the boards, just like the first time . . . every time.

The biggest plus of all is Elco's complete line and total capability in card edge connectors. Available in a variety of sizes and contact configurations—including Elco Varicon* contacts at

.100", .125", .150", .156", and .200" centers.

Choice of terminations is just as varied—wire wrapping posts; wire hole; taper tab; and solder post. Optional card guides make circuit board insertion as easy and as positive as closing a window.

If you have a card edge connector need, get in touch with us. Elco Corporation, Willow Grove, Pa. 19090; (215) 659-7000, or your nearest Elco representative. When it comes to showing you the best in card edge connectors, we won't kid you. We can afford to be serious.

*TRADEMARK

*Elco
Connector
Technology . . .
20 years
young*



When you have an insulating problem that's "up in the air"

... ask LAPP.

LAPP ANTENNA INSULATORS



Shaped insulator

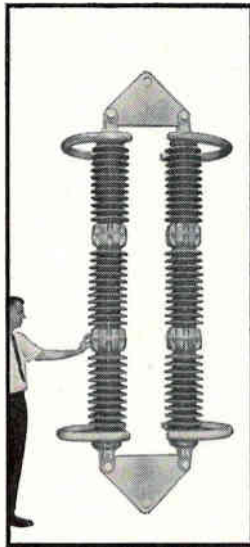

Double strain assembly



Rod-type with rain shield and corona ring

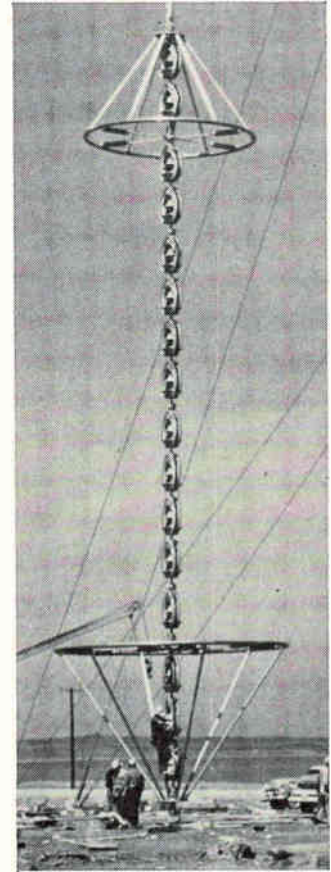

Special antenna insulator assembly with corona rings.

Lapp has been designing and producing antenna insulators for nearly a half century. We have delivered short ones, long ones, little ones, big ones, giant ones. Each met the customers' electrical and mechanical specifications with "room to spare".

Examples? The double-strain insulator assembly shown here tested to 240,000 lbs. ultimate strength. A similar triple yoke assembly tests to 360,000 lbs. Lapp has a compression cone guy insulator already designed that tests to 750,000 lbs! We also

have many smaller units and rod-type and shaped insulators.

Don't leave your antenna insulating problem "up in the air". Write or call Lapp Insulator Co., Inc., LeRoy, N. Y. 14482. We're down-to-earth people who get the job done.

Lapp

50
YEARS

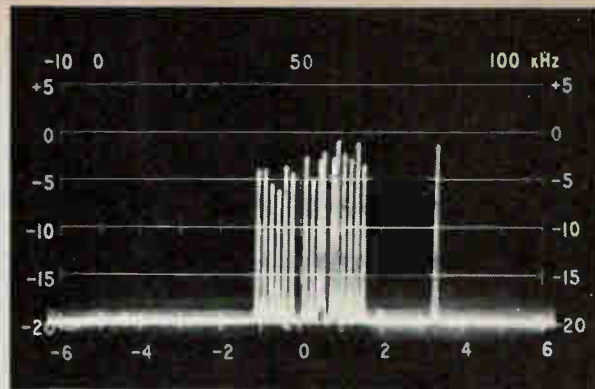

Three 4-kHz channels of L3 carrier multiplex system. Center channel has teletype subcarriers. Model 360A is in 12-kHz sweep width mode, sweeping from 6.780 to 6.792 kHz.



Switch-selected meter modes, normal or expanded scale, provide level measurement resolution of 0.05 dB. Signal generator level increments as fine as 0.01 dB can be readily resolved.



Frequency resolution to nearest 10 Hz in phase-locked tuning mode is displayed on flat-plane, high-brightness readouts. Alternative continuous tuning mode presents frequency resolved to nearest 100 kHz.

A Communications System Test Set (VLF to HF)...

engineered for humans (A to VB*)

From Sierra comes the most thoroughly human-engineered instrument for HF-radio and telephone-carrier applications in today's knob- and meter-ridden world: The Model 305/360 Communications System Test Set.

Model 305/360 gives you ultra-bright, unambiguous electronic digital readouts of frequency. Built-in counter automatically totals outputs of both the coarse and fine tuning oscillators, reads out tuned frequency with 10-Hz resolution. Attenuator levels appear in three-digit displays, with unique logic and switching circuits combining the levels of the 10-dB and 1-dB per step attenuators. Rear-projection meters with luminous pointers permit parallax-free viewing from any angle with easy resolution of fine-level increments.

Performance features include phase-locked tuning circuits, a single continuous tuning range covering voice frequencies through 32 MHz, and selective bandwidths of 250 and 3100 Hz. You can resolve signals separated by as little as 35-Hz.

Model 305/360 does everything humanly possible to keep foibles from fouling your readings. For the brochure, write Sierra, 3885 Bohannon Drive, Menlo Park, California 94025.

*Average to Very Bright



PHILCO-FORD CORPORATION
Sierra Electronic Operation
Menlo Park, California • 94025

Circle 119 on reader service card

Here's how to get more cooling with less size and weight: Use Garrett-AiResearch "ICE".

The Garrett-AiResearch systems approach to "black box" cooling is called Integrated Cooling for Electronics ("ICE"). It can save you development dollars, cut system weight, and reduce circuit enclosure size.

Simply give us your circuit design heat transfer problem and we'll do the rest: trade-off studies, interface details, heat transfer system design, and manufacturing.

You'll get an optimized system with minimum power consumption for maximum cooling, and a compact, lightweight chassis with an

integral or separate heat transport loop or heat pump.

If you're developing electronics circuits for space vehicles, weapons systems, aircraft or ground communications, or other critical applications, call in AiResearch while your package is being conceived; we'll work with you to match an "ICE" system to your specific needs. Contact AiResearch Manufacturing Company, 9851 Sepulveda Blvd., Los Angeles, California 90009.

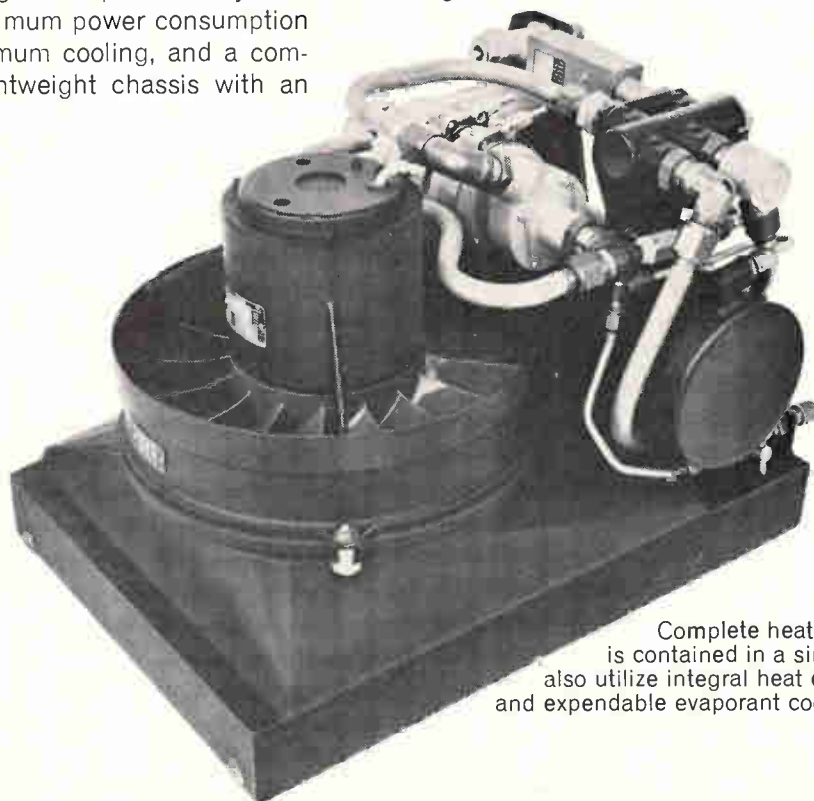

Complete heat transport system (left) is contained in a single, compact unit. We can also utilize integral heat exchangers, heat pumps, and expendable evaporant cooling methods.

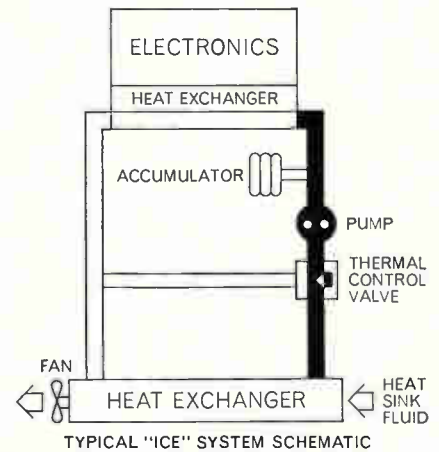

This AiResearch "ICE" system includes both the heat transport system and electronics enclosure with integrated heat exchanger.

GARRETT AiResearch
Heat
Transfer Systems

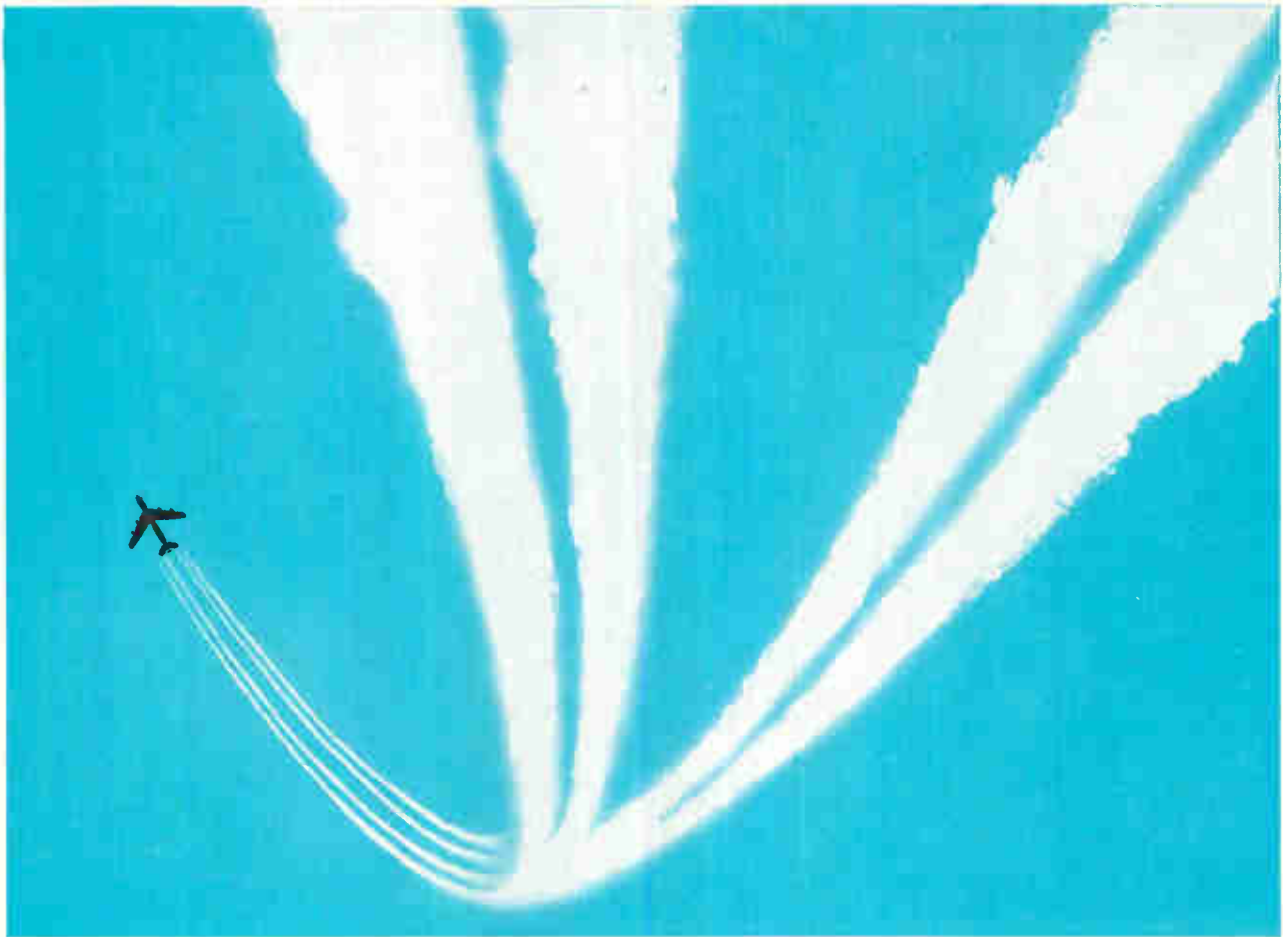

Our abrasion-resistant TFE wire keeps on flying after others call it quits.

Keeps flying up to 12 times longer, as proved in use on six leading types of commercial and military jets. Reason? It's 100% more abrasion resistant than other airframe wires. Because it has a tough insulation core of mineral-reinforced TFE bonded between pure TFE layers.

Our wire also averages 50% smaller in diameter and 60% lighter in weight than comparably rated wires. It can operate continuously at 500°F and remain tough at -450°F. It's nonflammable, nonhygroscopic, highly resistant to chemicals, has optimum dielectric properties and good flexibility.

Right now, it's reducing wire replacements in aviation, mining, refining, ground transportation and railroad equipment manufacturing. It can do the same for your application. For a free test sample and further data, write: ITT Wire and Cable Division, International Telephone and Telegraph Corporation, Clinton, Mass. 01510.

WIRE AND CABLE **ITT**

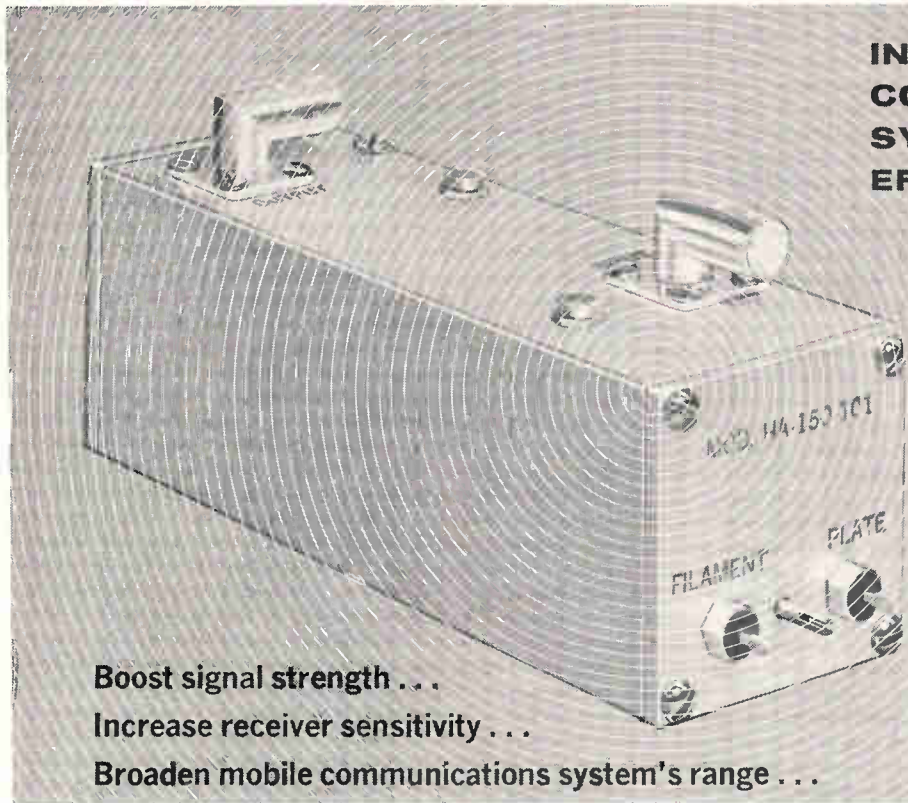

**INCREASE
COMMUNICATIONS
SYSTEM
EFFICIENCY
with
CAVAMP**

**Boost signal strength . . .
Increase receiver sensitivity . . .
Broaden mobile communications system's range . . .**

How? With Sinclair's Cavamp.

For use in compact duplex or multicoupler systems, Cavamp combines amplifier with filter to reduce noise while boosting signal strength.

Cavamp is capable of quieting receivers of .6 microvolt sensitivity with less than .2 microvolt signals, supplying gains of up to 14 Db at a 5Db noise figure. It incorporates a double-ended 8058 nuvistor that insures greater overload protection (1 milliwatt maximum input) and lower intermodulation product levels.

Cavamp incorporates a narrow band pass filter to increase receiver selectivity.

Transmission line losses are offset, or receiver front end sensitivity is increased, improving system performance.

Designed for the 150 and 450 MHz range, Cavamp is factory tuned to your specific frequency, however, can be easily field retuned to any frequency in the band by making two screwdriver adjustments.

Standard or Special assemblies are available to meet your requirements

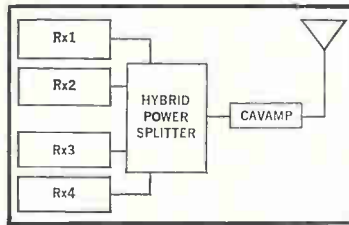

Receiver multicoupling for closely spaced receivers:

Four receivers, separated by 50 KHz, connected to a hybrid power splitter providing each with 25 Db isolation: power splitter loss of 6.5 Db offset by Cavamp with 12 Db gain. Band pass filter characteristic also protects receivers from nearby transmitters.

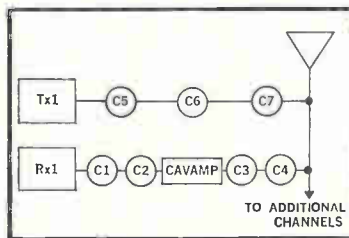

Receivers and transmitters connected to a common antenna with a passive multicoupler for an expandable system:

Transmitter, Tx1, separated from receiver, Rx1, by 500 KHz. Cavities C1,2,3,4 insert 6 Db loss at Rx1 frequency, 80 Db attenuation against Tx1. Cavities 5,6,7 insert 1.5 Db loss at Tx1 frequency, attenuate Tx1 noise at Rx1 frequency by 35 Db or more. 6 Db insertion loss not degrading to receiver operation: Cavamp offsets filter losses, provides 6.0 Db gain on Rx1.

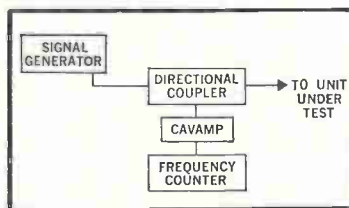

Increasing sensitivity of frequency measuring system:

Where frequency counter is used, high signal strength is often required to drive the counter. Cavamp increases counter sensitivity while the selectivity reduces false triggering from unwanted signals.

Clip the coupon and attach to your letterhead for full details and prices.

FREE LITERATURE

TO: SINCLAIR RADIO LABORATORIES, INC.
Dept. 101-P 523 Fillmore Avenue
Tonawanda, New York 14152

Name: _____
Title: _____
Company: _____
Address: _____
City: _____
State: _____ Zip: _____

SINCLAIR RADIO LABORATORIES, INC.

523 FILLMORE AVE. DEPT. 101-P TONAWANDA, NEW YORK

See us at booth #9 at the December 1967
IEEE Vehicular Communications Conference in New York City

You can record up to 1 million bits on 1 sq. in. of magnetic tape with our exclusive recording techniques and still get that same high guaranteed error rate. Tape speeds are reduced over 10 to 1, too.

In space you get the fastest data dump possible over a telemetry window. Airborne you store more in less. (For example 200 million bits in under 51 cu. in.). And on the ground "on line", your transfer rate's

so much faster you get closer to your computer's real-time capability.

We call the whole thing HDDR* high density digital recording.

You'll call it a necessity.

Ask us at Leach Corporation—Controls Division, 717 North Coney Avenue, Azusa, Calif.

91702 Telephone (213) 334-8211

LEACH



10 to 20k
bits/in./track
and errors
less than 1 in 10^8
This is a high
density recording.



EG&G IS IN A STATE OF EXCITEMENT!

More than ever Nevada is leading the Westward Movement... because Nevada offers more. More growth! More excitement! More personal and professional benefits! Dynamic Nevada . . . outstanding schools, facilities, services, entertainment and climate.

Engineers and Scientists . . . investigate assignments with EG&G, Las Vegas, working on projects of national importance involving nuclear rocket development and underground testing. Diversified projects, modern facilities, advanced equipment . . . in one of the most stimulating and challenging engineering and scientific environments in the West.

Inquiries and resumes invited. U.S. Citizenship Required. An Equal Opportunity Employer. Write EG&G, Personnel, 680 E. Sunset Road, Las Vegas, Nevada 89101.





EG&G
Las Vegas • Nevada



Get TI's
IC op amps
from us.

Op amps are in...

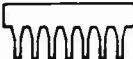
economical molded plastic packages from Texas Instruments.  New prices are so low you'll be using these dual-in-line integrated circuits in more equipment designs than ever—or substantially reducing costs of existing designs.  Call us for comparison quotes on TI's new "702", "709" and "710" IC operational amplifiers.  When you're out of op amps, remember our big stocks and call us. We'll help you fill the empty spaces  in your procurement schedules—fast.

For data sheets, circle reader service number 85.



R. V. WEATHERFORD CO.

DISTRIBUTORS OF ELECTRONIC COMPONENTS AND EQUIPMENT

NOW WITH CUSTOMIZED COMPONENTS
**WEATHERFORD
SERVICE
PLUS** 

ANAHEIM, CALIFORNIA
1651 State College Blvd.
714-532-6741
714-547-7521

GLENDALE, CALIFORNIA
6921 San Fernando Road
213-849-3451

PALO ALTO, CALIFORNIA
3240 Hillview Drive
Stanford Industrial Park
415-321-5373

SALES OFFICES
Albuquerque, N.M.
505-298-5593
Phoenix, Arizona
602-272-7144

Pomona, California
714-966-8461 714-623-1261
San Diego, California
714-278-7400

Put your fast pulse displays

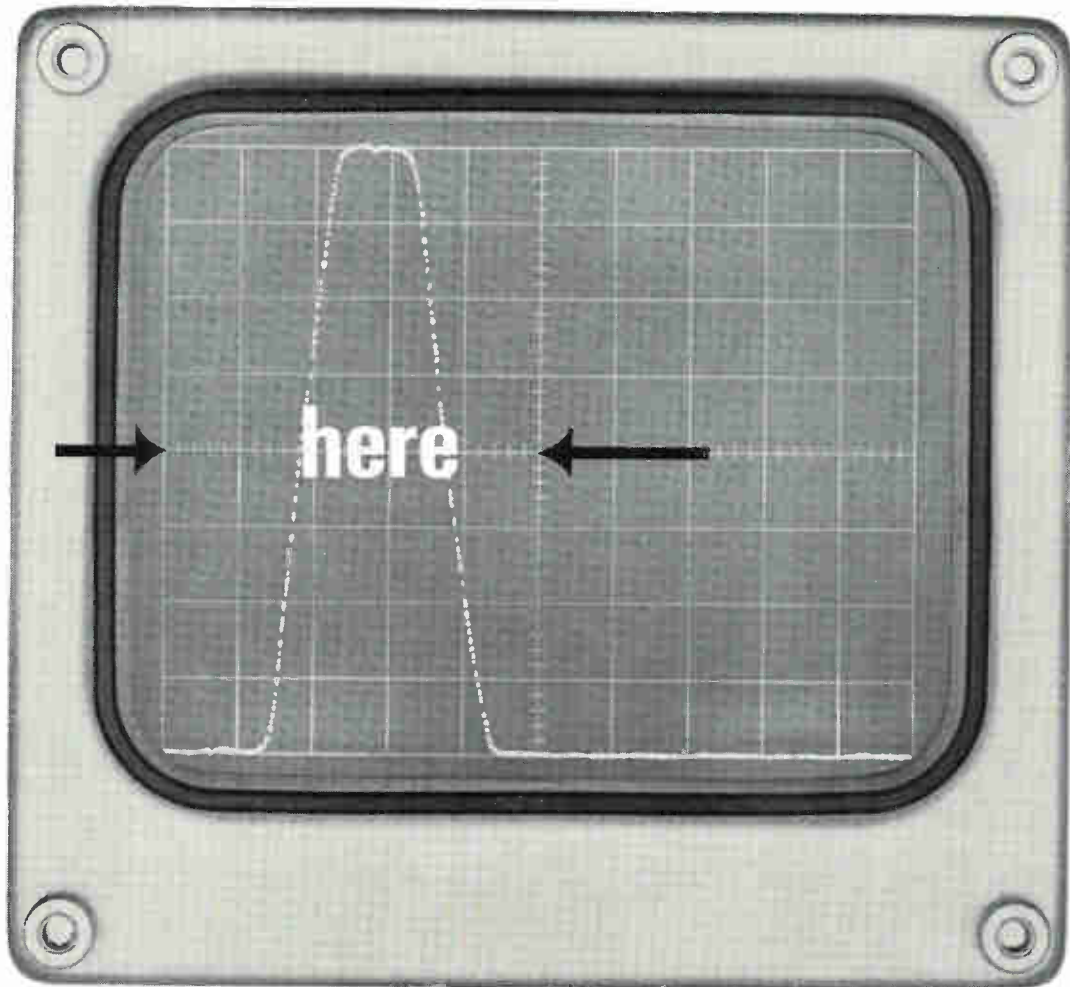

with Tektronix Random Sampling

The new Tektronix Type 3T2 Random Sampling Time Base Unit lets you position the leading edge of your fast pulse displays anywhere in the first five horizontal divisions at all sweep speeds from 20 ps/div to 100 μ s/div. Random sampling permits triggering before or after the displayed pulse, eliminating the need for delay lines or a pre-trigger.

The sample-taking process initiated by the Type 3T2 bears a statistical time relationship to the displayed waveform, while an exact correlation is maintained between the displayed pulse and a reference trigger. The random sampling technique eliminates display jitter caused by time differences of the pulse period.

The triggering signal may occur before or after the displayed pulse by as much as 50 ns at the fastest sweep speed, increasing to 500 μ s at the slowest sweep speed. Triggering frequency range is from 10 Hz to 3 GHz on pulses and from 100 kHz to 3 GHz on sine waves. A front

panel switch also permits the Type 3T2 to be operated as a conventional sampling time base.

The Type 3T2 with a sampling vertical plug-in may be used in your Type 561A, 564, 567 or 568 Tektronix Oscilloscope. Presently, the Type 3T2 offers most advantage when used in conjunction with the Type 3S3 or the new Type 3S1 Dual Trace Vertical Plug-In Unit.

The four display modes are single sweep, normal, manual and external horizontal. Other features of the Type 3T2 include direct reading of sweep time/div on a lighted panel, sweep output for driving recorders, continuously variable samples/div, and two external trigger inputs, 50 Ω and 1 M Ω .

Type 3T2 \$990
U. S. Sales Price F.O.B. Beaverton, Oregon

For a demonstration, contact your nearby Tektronix field engineer or write: Tektronix, Inc., P. O. Box 500, Beaverton, Oregon 97005.



Research and development



*. . . part of the Tektronix commitment
to progress in the measurement sciences*

Probing the News

Consumer electronics

Service—color tv's black eye

Shortage of ethical repairmen qualified to work on receivers is producing an increasing number of consumer gripes and leading to tough legislation

By John D. Drummond

Consumer electronics editor

Public outrage over unscrupulous and incompetent repairmen, particularly when it comes to servicing expensive color television receivers, is rapidly building to a crescendo—well ahead of the Christmas season when big-ticket items traditionally move best. Buck-passing dealers and sales-minded set makers have also earned a fair share of the blame.

Nationwide, one of five color-set owners will write a complaining letter to a manufacturer; one of eight will contact a local Better Business Bureau or government agency. Countless others will simply gnash their teeth and swear never again to buy the brand they're stuck with.

Regardless of who's at fault, the industry's image has been tarnished to the point where an increasing number of state and local governments have adopted, or are considering, legislation to protect consumers' interests.

Catch phrases. A good part of the problem is attributable to the promotional practices of set makers. They have come up with such misleading claims as: "miracle memory tuning . . . set it and forget it . . . automatically brings in your color programs without further adjustments" and "new electronic color control that eliminates fading and assures perfect color every time." The truth is no color set can be tuned automatically; each control—contrast, brightness, and color tint—must be carefully adjusted by the viewer. In addition, the fine tuning must be individually set for each station.

I. Going through the motions

But even if an owner masters the art of tuning his set, he may well find himself undone by a botched-up installation. As a rule, the serviceman delivering a set will simply connect it to whatever antenna is

available, check for the presence of color, explain the unit's operation, and make his escape—all within 15 minutes.

Unfortunately for the new owner, the chances are very good his set will require more than minimum attention to operate properly. For



Pursuit of a buck. Many independent tv repairmen are stymied by color sets so they seek the aid of factory shops—a practice that costs owners dearly.

The laws—at a glance

Clamor about the unscrupulous practices of television repairmen has caused a handful of states and cities to enact laws to safeguard the consumers' interests. Those turning to legislation include:

California. A registration law provides for the establishment of a bureau to license and police the industry. The agency's main objective is to obtain compliance from violators rather than prosecute them. Among other provisions, the law specifies customers must be told what parts were installed and the labor required. All replaced parts must be returned with the set and the customer must be told whether a replaced picture tube is new or rebuilt. Upon request, a written estimate must be provided before work begins. The cost estimate cannot be exceeded without the customer's approval.

Louisiana. The law establishes three licensing categories for radio and tv repairmen: apprentice, radio technician, and radio and tv technician. Written and oral exams are required before a license can be

granted. An apprentice program, funded by Federal and state agencies, is also provided. An 11-member board administers the law.

Massachusetts. Laws governing radio and television technicians require applicants pass a proficiency examination before they can be licensed. A seven-member board mediates disputes between servicemen and consumers.

Connecticut. The law provides a two-year grace period before a repairman is required to pass a qualifying exam. Three categories of licenses are issued: unrestricted, restricted for black-and-white tv servicing, and restricted for antenna installation. Two full-time inspectors police the law. By arrangement with technical schools, the state conducts training programs in both radio and tv repair.

Detroit. The law calls for certification of all tv repairmen. To be certified, a technician must have at least two years of formal technical training and two years of practical experience. The act also covers dealers, who are required to have at least one licensed repairman in their employ. Service deal-

ers are required to provide customers with itemized bills, and are prohibited from advertising their rates in newspapers or other mass media. The law is administered by a nine-member board, four of whom are dealers.

Kansas City, Mo. Ordinance requires the licensing of repairmen and provides for three categories: radio receiving equipment, tv receiving equipment, and radio and tv receiving equipment. Dealer must provide customer with an itemized bill, and all replaced parts must be returned to the customer. A seven-member board of examiners, six of whom are dealers, administers the law.

Madison, Wis. All radio and tv repairmen must be licensed and must post a \$1,000 bond.

Buffalo, N.Y. All tv repairmen must be licensed. Applicants must pass a written test and provide proof of at least 4,000 hours of practical experience, or have a technical school certificate and 1,000 hours of work experience. An apprentice license enables the applicant to meet the necessary minimums.

one thing, the narrow-band outdoor antennas and indoor rabbit-ear or built-in types that provide satisfactory black-and-white pictures generally lack the gain, bandwidth, and directivity required for good color reception. Few dealers intent on closing a sale dwell upon this point since an additional outlay of up to \$150 is involved.

From a service standpoint, an improperly oriented antenna that causes only a barely perceptible ghost on a black-and-white unit produces an intolerable displacement of images that results in smearing on a color set. In metropolitan areas where color signals are strong, a poor antenna installation can lead to picture distortion and color saturation. This situation can be rectified by using an attenuator pad at the receiver's antenna terminals. But most servicemen don't bother with either the antenna or attenuator when the set is delivered.

Odds against. Assuming the antenna system is in working order, the new owner must still worry about the receiver setup. While every color set is adjusted before leaving the factory, such work is

far from foolproof since it is completed under time constraints as the unit moves along a conveyor. Inspectors at the end of the production line reject a number of receivers because of poor performance, but many substandard sets still slip through. As a result, some touch-up adjustments are necessary to bring poorly aligned sets up to established performance levels. And some adjustment may be necessary to compensate for control settings that have been jarred out of specification during transit.

Setting up a color receiver in the home is a tricky and time-consuming job that requires a degree of technical competence and patience apparently beyond the reach of many practitioners drawing wages for such work. There are five separate steps involved:

Degaussing. In this operation, stray magnetism is removed from the picture tube and the metal hardware surrounding it. Most new sets are now equipped with an automatic degausser that operates whenever the set is turned on. So this step no longer has to be repeated when a properly equipped receiver is moved around the house.

Purity adjustment. Impure color areas are removed from the picture tube screen in this step. If done improperly, blotchy color will result.

Static and dynamic convergence adjustments. In these operations, the red, blue, and green electron-gun beams are aimed so they fall on the red, blue, and green phosphor dots in the center of the screen and around the edges. Improper convergence produces color fringing.

Gray-scale adjustment. Dominant color shades are removed from the screen in this operation so monochrome transmissions can be received in black and white.

Improper adjustment of any of the steps will lead to at best a poor picture and at worst an angry, frustrated owner. But largely as a result of the paucity of competence in the service field, little time or effort is invested in such preventive procedures—anywhere.

Perhaps the best evidence of this is found around the set-makers' flashy, big-city showcases. Any day of the week, consumers are free to inspect receivers carrying price tags from \$395 to \$1,200 that are

on display with wildly variant color-saturated, misconverged pictures. Much the same situation prevails at retail outlets. "Dealer showrooms where colors just run wild are our worst advertisement," says Nick DeFalco, sales manager at the Emerson Radio & Phonograph Corp., a subsidiary of the National Union Electric Corp.

The pros are not, of course, deliberately seeking to estrange potential customers with psychedelic color signals. But for all the skilled engineering that goes into their sets, they, too, have their woes with incompetent service personnel who either don't know or care very much about their jobs.

II. Party line

For the record, most executives in the color tv field profess not to be overly worried by the technical service situation at either the repair or retail levels. Jack Evans, general manager at Zenith New York, a service subsidiary of the Zenith Radio Corp., concedes the need for making fine adjustments in the customer's home but says this requires only a half-hour's work from a competent serviceman. An additional 15 minutes is required to explain the controls and warranty, he says.

Manny Frank, parts planning supervisor at the Panasonic division of the Matsushita Electric Corp. of America, goes Evans one better: "We have found that our sets require little or no adjustment in customers' homes, and we're seriously considering discontinuing the initial setup."

Minority report. However, the chief engineer at a Midwest consumer-goods house suggests both an initial and follow-up convergence is necessary. "For best results, a new set should be reconverged after about two weeks of use when the components have had a chance to stabilize," he says. "Even a change in the picture size resulting from low line voltage is enough to throw a receiver out of whack."

The existence of widespread incompetence and dishonesty in the service field gives the entire tv industry a black eye. But aside from the trend toward captive service organizations, most manufacturers are outwardly unconcerned about the less than ethical practices of

franchised dealers and repair outfits—as long as sales quotas are met. Set makers have made few overt moves to discourage misrepresentations of products and warranties or to crack down on unqualified servicemen.

III. Days of reckoning

In the absence of any effective industry policing, state and local governments have been forced to act. In California, for example, a Bureau of Electronics Repair and Dealer Registration was established four years ago to protect consumers. At the moment, the agency is investigating 20-odd outfits—both retail and repair—in Sacramento and 30 or so in Los Angeles.

In New York City, legislators are pressing for a law to license and bond tv repairmen and dealers. The measure would require proficiency tests before applicants could be licensed. Misleading advertising would be prohibited as would the prevalent practice of awarding bonuses to workers who install unnecessary replacement parts in sets under repair. In addition, licensees would have to post a \$2,500 bond to assure customers recourse in cases of fraud and incompetence. Joel J. Tyler, the city's license commissioner, places the onus of the proposed legislation on repairmen: "The serviceman has taken advantage—either innocently or by design—of the consumer for too long."

IV. Slow burns

Current information compiled by the New York City Better Business Bureau supports Tyler's stand. Over an eight-month period this year, the bureau logged 887 complaints against service and repair firms; over the same span, 127 complaints were leveled against retail outlets. More than half of the charges against servicemen involved overcharging and poor repair work; two-thirds of the complaints dealt with unkept promises or warranty disputes and an outraged 14% simply wanted their overdue sets back from overly enterprising repairmen.

On the retail side, just over half of the complaints concerned sales of allegedly defective or malfunctioning color sets; the balance centered on dealers' failure to deliver the agreed-upon merchandise or

Poor old Henry Adams He thought he found a goof in a Trygon silicon power module. But the laugh was on him.



Like any of the Twelve Cranks on Pleasant Avenue, Henry Adams feels fulfilled whenever he finds a goof. When he found two in a row, he was ecstatic—but the other Cranks wouldn't believe him.

They were right. The laugh was on Henry when they found an intermittent in his test equipment leads. One goofed Trygon could be possible (that's what we hire our 12 cranks to catch). But two? Impossible, Henry.

Trygon's silicon power supply modules are precision regulated units for unattended operation in military, industrial or commercial systems. Automatic reset short circuit protection and optional overvoltage protection. Voltage and current ratings from 3v to 200v, 150mA. to 5A. with single and dual outputs.

Highest quality components—generously derated and temperature aged power transistors—hermetically sealed rectifiers—temperature stabilized zener diodes—computer grade capacitors—the works.

Performance specifications match the componentry: 0.01% line regulation; temperature range from 0° to 71°C.; remote programming; remote sensing; or more. Much more. Four series of modules in a competitive price range. Write for literature.



Trygon Power Supplies

111 Pleasant Avenue, Roosevelt, L.I., N.Y. 11575
Trygon GmbH 8 Munchen 60, Haidehweg 20, Germany
Write for Trygon 1967 Power Supply Handbook.

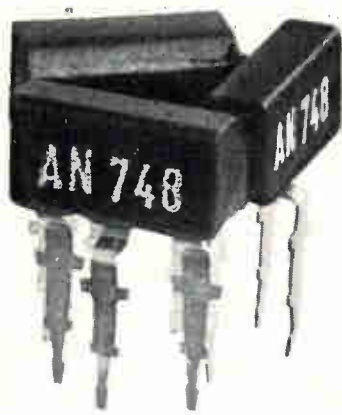

"Automatic insertion of transistors into the boards"—the major problem in mass-producing electronic circuits.

It might be solved by a transistor with fixed leads which allows a mechanized handling; it must fit the industry's standard circuit board hole-pattern and if once inserted it has to stick firmly without any other support.



Actual Size

The new ANCRONA "self-ert" is the answer. It meets all the requirements for self-acting and quick manual insertion without price increase or deterioration in quality.

The flexible wire leads are replaced by three rigid alloy leads which grant a firm sitting in the circuit board holes.

Transistors now available in the new "self-ert" configuration are: AN747, AN748, AN749 for general purpose and low level audio frequency application. The AN749 is a low noise unit with high gain.

Prices:	1-99	100 up	1000 up	10,000 up
AN747	0.59	0.40	0.36	0.34
AN748	0.48	0.33	0.29	0.27
AN749	0.63	0.42	0.38	0.36

For more details please apply to:

ANCRONA CORPORATION

65 East 55th Street
New York, N. Y. 10022
Phone: 688-6285

... the average tv repairman will fail an honesty test on a doctored set ...

install the receiver as promised.

Recently, Consumers Union collaborated with the Bureau of Consumer Frauds and Protection of the New York State Attorney General's Office and WCBS-TV the New York City television outlet of the Columbia Broadcasting System to test the validity of claims that the tv servicing business is dishonest. Twenty sets were doctored by burning out the third intermediate-frequency amplifier tube in each. Of the 20 repairmen who were called, only three charged a fair price—averaging about \$8—for replacing just the bad tube. One enterprising soul charged \$37.50 and "justified" the tab by replacing perfectly good parts. This entrepreneur even claimed that the tuner coils were missing and had to be replaced. Another bill claimed work on the automatic gain control—at a cost of \$25.65. The report submitted by CU concludes that a good two-thirds of the servicemen in the New

York metropolitan area, on the basis of those sampled, were downright cheats.

Land of Lincoln. In a similar test conducted in Illinois, 24 repair shops, selected at random, were checked with doctored sets. The State Attorney General's undercover investigators were presented with bills ranging from \$14.85 to \$45.70 for repairs that should not have cost more than \$5 to \$10.

The National Educational Television network reported recently that it called in three service shops to repair three doctored tv sets. The receivers had a defective tube and a blown fuse. The combined retail price: \$5.66. One repairman charged \$7.75 for the job, including \$3 for the service call, but instead of replacing the 91-cent fuse, he simply bypassed it with a piece of wire. The second craftsman, who also bypassed the fuse, installed enough unnecessary parts to jack up his bill to \$21. The third pre-



Black art. Factory serviceman makes so-called pincushion correction on a color set to assure the proper vertical and horizontal linearity; few technicians bother with this key adjustment during the initial setup.

sented a bill for \$18.75, but at least he replaced the fuse.

West Coast, too. Fraudulent repair is as prevalent in California as anywhere else. The state's repair and dealer bureau processes more than 3,000 tv complaints a year, many of which involve color sets, and turn up crooked repairmen through an undercover network of housewives and bureau personnel. A spokesman for the agency points out, however, that the bureau does not initiate its own checks. Only after it receives repeated complaints against a given service organization does the bureau act.

V. Fortune and men's eyes

Competent tv repairmen—and there are some—make far less interesting reading than the inept swindlers who pursue their petty, but nonetheless aggravating, thieveries. On a composite basis the typical incompetent's biography goes something like this:

Generally, he has had little formal technical training and would have difficulty passing a written proficiency test. The knowledge he possesses was gained originally on a factory production line, where he worked as a wireman or solderer. Eventually, he moved up the ladder and became a tester or troubleshooter. Here he learned to use a volt-ohmmeter and gained familiarity with color coding of components. Checked out on a signal generator, he probably never had occasion to use an oscilloscope. In time, he was able to identify vertical and horizontal deflection circuits and relate an unstable picture to synchronization problems. In addition, he perhaps learned to distinguish between video and audio functions.

On the road. By this time, our apocryphal hero began to think of himself as an expert because he knew what tubes to check when he lost high voltage and where to look when the picture rolled. Starting modestly, he worked on neighbors' sets, gaining a reputation as a "good man." Having built a lucrative moonlighting trade, he took the gamble and went into business.

Having taken the plunge, our man quickly learned he was in over his head. It was not that he was inherently dishonest, but survival proved difficult on his limited

Versatility and simplicity in variable, regulated power supplies

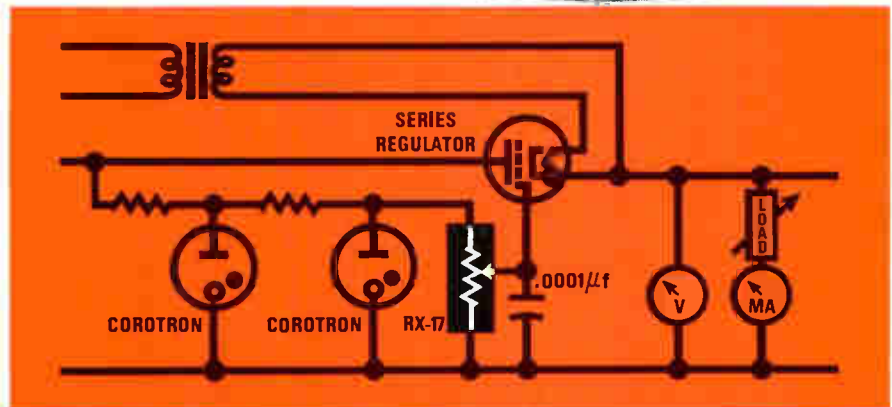
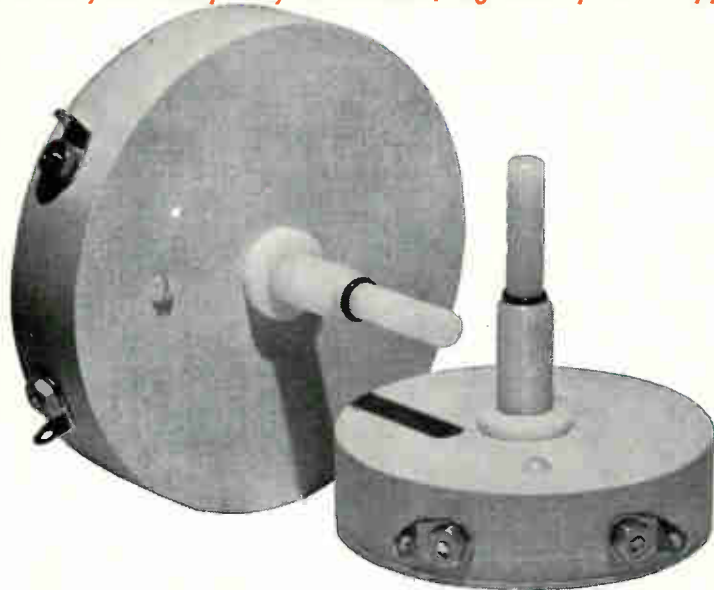

POTENTIOMETERS TO 10 KV

New Victoreen RX-17 series ceramic potentiometers, when used across a well-regulated high-voltage source, provide reference adjustment with a degree of simplicity never before available to circuit designers.

Long life, resistance stability and panel insulation capability to 20 kv make Victoreen RX-17 series potentiometers ideal for reference adjustment for variable, regulated HV supplies in CRT's, TWT's, Klystrons, GM tubes, proportional counters, etc.

Two RX-17 series are available: One for operation to 5 kv rated at 3 w, the other for 10 kv rated at 5 w. RX-17 series ceramic potentiometers are normally supplied with nominal resistance range of 1 Meg to 5000 Meg, with a linearity of $\pm 2\%$. Full technical details on request to Applications Engineering Department.

6976-A

VICTOREEN INSTRUMENT DIVISION
10101 WOODLAND AVENUE • CLEVELAND, OHIO 44104
IN EUROPE: GROVE HOUSE, LONDON RO., ISLEWORTH, MIDDLESEX, ENGLAND



DiGiGATOR^{T.M.}

A WHOLLY INTEGRATED PRODUCT LINE

ACTUAL SIZE

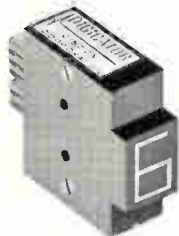

SERIES 10



SERIES 16



SERIES 13

NUMERIC READOUTS

Discon's DiGiGATOR Display Readout series are 7 segment, incandescent lamp, low voltage type readouts, featuring a host of exclusive design and performance characteristics. Here is a bright-white display, clearly readable under all ambient lighting conditions . . . a truly wide angle display without parallax or distortion. Its unique construction allows easy disassembly for quick replacement of lamps.

PLUG-IN
SERIES



CHASSIS MOUNTED
SERIES



DECODER/DRIVERS

Miniaturized DiGiGATOR Decoder/Driver Modules convert BCD or Decimal output signals into the input voltages necessary to drive 7 segment numeric displays. Integrated decoder circuitry, featuring the unique use of decoder flat-pack elements, controls high current incandescent lamps with signals as small as 2.0 milliamps. Through the use of separate logic and lamp supply circuits, high voltage lamps can be controlled with low logic voltage inputs. The entire series of drivers are now available with latching memory. These features, plus the complete compatibility of the DiGiGATOR Driver with most available 7 segment, bar type, numeric readouts, make DiGiGATOR a truly versatile line of components.

Pay scale

On the average, an experienced color tv repairman, working for a dealer or service firm, earns \$160 for a 40-hour week. Beginners make about \$110, and key men might be paid as much as \$200.

Working as an independent from his own shop, a serviceman is likely to take in upwards of \$300 a week—depending on his skill or gall.

knowledge. The gradual change-over from tubes to transistors effectively short-circuited trouble-free troubleshooting, and the popularity of color sets with their many tricky adjustments added greatly to his woes. Now, when he runs into trouble with a set that he can't handle on his own—an increasingly frequent occurrence—he has to take it to an established service organization with the technical resources and know-how to handle the problem. To make a profit on such a deal, he must either add unnecessary parts or pad the bill.

Next best. As a rule, factory service groups and the larger independent organizations with reputations to protect are more reliable than one-man operations—except in cases where employees are paid on a basis of salary plus parts commission. However, even these leading lights suffer lapses.

Many of the more reputable service outfits can only blame themselves for harboring incompetents. Because of the great shortage of qualified help, these organizations, of necessity, have had to hire repairmen who could barely hold their own. Some, still cling to undercover private practices.

Short supply. Ernest Khouri, until recently service manager at the Admiral Corp. and now Eastern regional service manager at Panasonic, deplores the poor technical background of the average tv repairman. However, he says: "As a practical matter, we prefer a job applicant with field experience, regardless of whether he has had formal technical training." Khouri says he gets few job-hunters from the technical schools anyway: "They go right into industry where they're well paid and are spared the hostile scrutiny of consumers who are tired of being taken."

DISCON CORPORATION
4250 NORTHWEST 10th AVE. • FT. LAUDERDALE, FLORIDA 33309
PHONE: (AREA CODE 305) 565-5511

At ECI in St. Petersburg, Florida . . .
RF Communications Opportunities

For a special breed of engineer

If you're one of that special breed of communication engineers who finds a challenge in projects beginning with applied research and advanced development and continuing through prototype and product design, you may well be the kind of person we're looking for.

Check this partial list of RF engineering activities at ECI. If you'd like to help push the state-of-the-art in any of these or other areas in communications, send us your resume. You'll design systems and equipment for satellite communications, multiplexing, electronic switching, command and control and advanced radio communications for some of the nation's major defense and space programs.

RF Communication Engineering Activities:

- Modulation and Demodulation
- Frequency Synthesis
- Solid State Power Amplification
- Hi Power Amplification
- Power Supply Technology
- Receiver Front End Design
- Packaging and Cooling
- Microelectronic Applications
- Reliability Techniques

CHALLENGE, GROWTH . . . and LOCATION TOO!

At ECI your job will be challenging. At ECI you'll find real opportunity for growth instead of just another confining groove — two-thirds of all advanced development is done in regular engineering development areas. And, at ECI you'll like where you're living just as much as you'll like your job. We'll match subtropical, sunny St. Petersburg against any location in the U. S. for stimulating, comfortable living.

SEND YOUR RESUME TODAY — in confidence —
to K. E. Nipper, Supervisor of Professional Placement,
Electronic Communications, Inc., P. O. Box 12248,
St. Petersburg, Florida 33733.
(An equal opportunity employer, M & F.)



ELECTRONIC COMMUNICATIONS, INC.
ST. PETERSBURG DIVISION

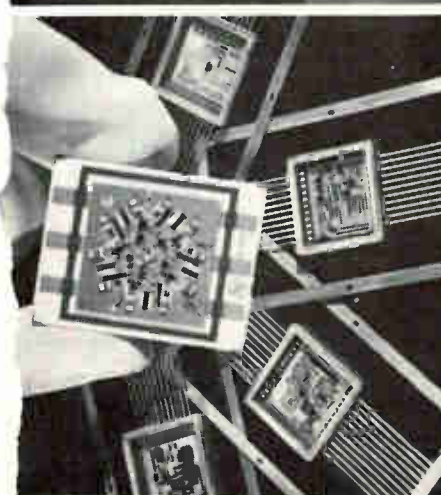

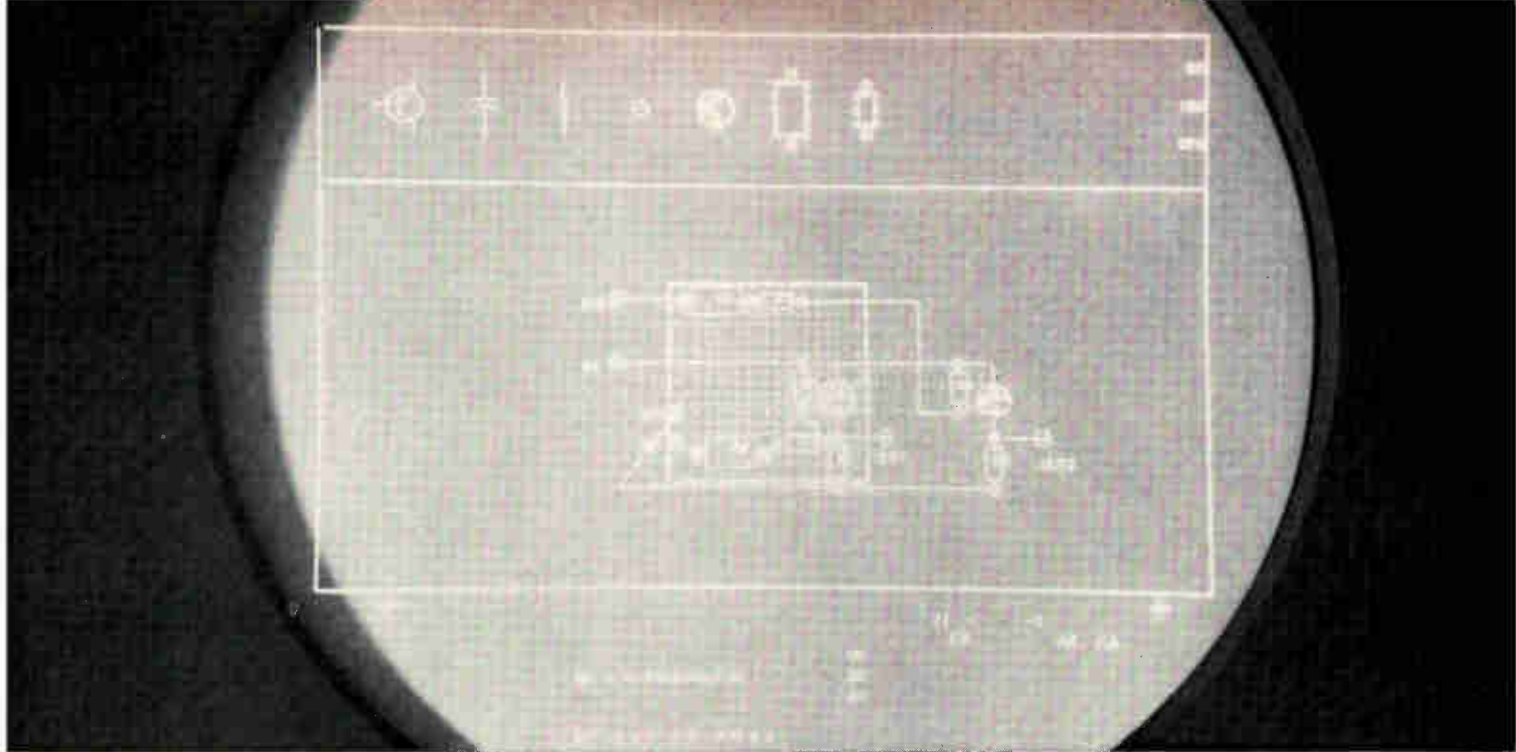

Readouts clear up problems.

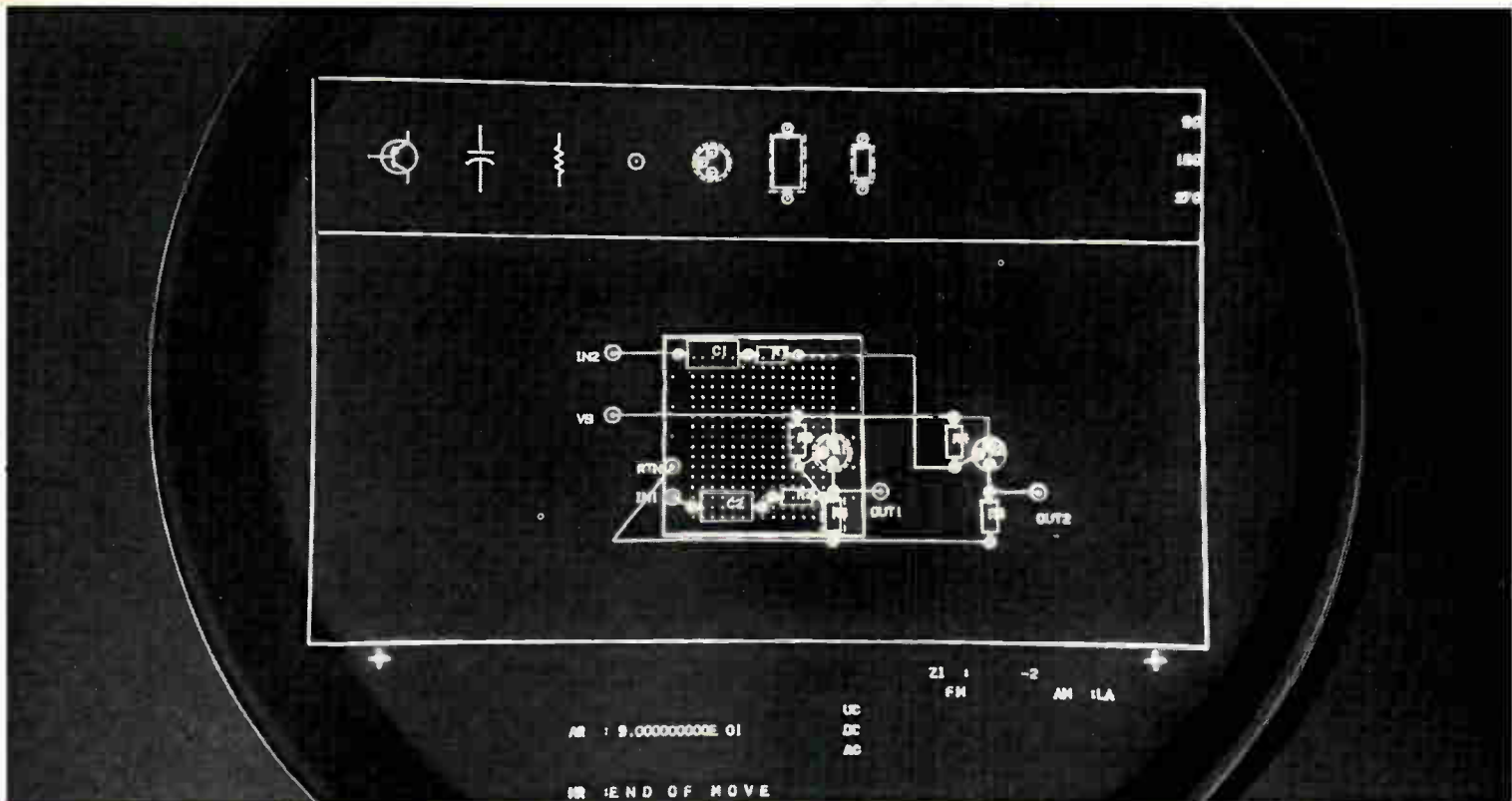

Polaroid circular polarizers clear up readouts.

It's never a problem to read readouts if they're equipped with Polaroid circular polarizers. Our polarizers improve readability from every angle by increasing contrast. In daylight. Or even in brightly lighted rooms.

But now you don't have to take our word for it. Send for our new brochure, and we'll include 3 samples of our circular polarizers (amber, neutral, and green). They'll help you see very clearly why many major display and

instrument manufacturers are now using Polaroid circular polarizers.

Write Polaroid Corporation, Polarizer Sales, Department 59, Cambridge, Massachusetts 02139.
Polaroid Circular Polarizers.

Fairchild's fine Italian hand

Minority interest in new semiconductor R&D lab near Milan could provide access to the European device markets so often overlooked by volume-minded U.S. firms

By Jack Star

Milan news bureau

Europeans maintain that their electronics firms can effectively partner American outfits—balancing the so-called technology gap with local market know-how. Later this week, SGS-Fairchild, a seven-year-old Italian company, will furnish symbolic support for this contention by formally dedicating a research and development laboratory. The year-old facility, located in Agrate, a suburb of Milan, was set up to design and develop semiconductor devices tailored to the needs of Continental markets. Results so far have proved encouraging and fruitful to interests on both sides of the Atlantic.

Pedigree. The Fairchild Camera & Instrument Corp. owns one-third of SGS-Fairchild. Controlling interest is held by Societa Generale Semiconduttori, a joint venture of Ing. C. Olivetti & Co. S.p.A., a manufacturer of office equipment and machine tools, and Telettra S.p.A., a producer of communications gear. Both Italian concerns are important customers of SGS-Fairchild.

The new lab is unique in research-hungry Italy; and knowledgeable observers rate it on a par with similar facilities run by NV Philips Gloeilampenfabrieken in the Netherlands and Siemens AG in West Germany. Exclusive of bricks and mortar, about \$1.8 million was invested in the lab during its first year, a sum representing 6.25% of SGS-Fairchild's 1967 revenue. Fairchild supplies most of the advanced technical know-how, and many of the lab's 150 staffers, spent a year in R&D residence at the American company's Palo Alto, Calif., facilities before the Italian operation got going. But on the other hand, market-wise Italians can channel development efforts

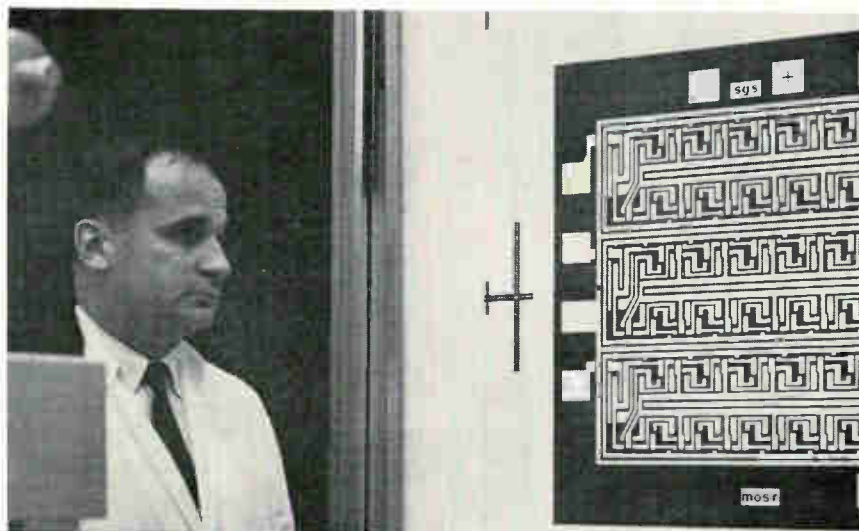

Left to his own devices. Canadian-born Paul J. Beneteau heads new lab built by the Italian concern, SGS-Fairchild, to develop semiconductor products tailored to European consumer and industrial-control markets.

into areas of greatest local promise, particularly those that might be overlooked by a volume-minded U.S. firm.

1. A world of difference

Canadian-born Paul J. Beneteau, the lab's director, is an articulate advocate of the cross-fertilization approach. "American-made semiconductor devices are not always suited to the European market," he says. Military, space, and computer applications provide the volume outlets for semiconductors in the U.S., but shopping lists in Europe are topped by high-speed devices for such consumer wares as tv sets, autos, and appliances, as well as assemblies for industrial control and computer applications.

These items are perhaps not as profitable as their more exotic counterparts, but they constitute an important source of secondary growth that can scarcely be ignored. And a big reason for setting

up the SGS-Fairchild lab was to get the American firm into the game on a solid footing. "Our approach is to start from scratch and develop totally new devices which we then share with Fairchild," says Beneteau.

Success stories. During the first year of operation, the lab's staff has been busy—and productive. In the entertainment field, for example, high-frequency transistors required for solid-state television receivers, including ultrahigh-frequency and very-high-frequency tuner devices and intermediate-frequency amplifier assemblies, were released for production.

Now, the lab is preparing production designs of integrated circuits for radio and tv sets. The first of 10 such assemblies, all of which will be manufactured by the spring of 1969, is a 2-watt audio amplifier with field effect transistor input that will be put into production next month. By the end of 1968,

New LEL WIDEBAND AMPLIFIERS



OFFER MAXIMUM
GAIN/BANDWIDTH
COVERAGE...

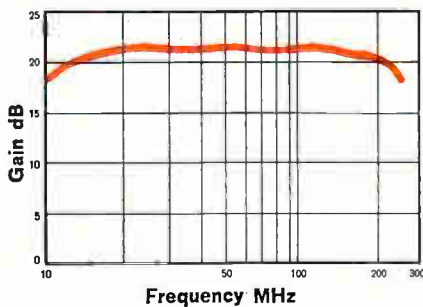

... and greater dynamic range in radar, broadband communications, multiplexers and similar applications. Small, light and rugged, these new solid state amplifiers deliver top performance over the 10 to 250 MHz frequency range. The units complement a broad range of LEL RF and IF receiver components.

SPECIFICATIONS:

Noise figure (at 25°C):4 dB (max.)
 Gain, midband:20 dB (min.)
 Impedance (in and out):50 ohms
 VSWR:2:1 max.
 Power output
 (1 dB compression):0 dBm (min.)
 Size:3" x 1½" x ¾"
 Connectors:OSM
 Temperature Range:-40° to +55°C
 Power required:-20 VDC 30 mA (max.)

Send now for full information.

LEL DIVISION
 VARIAN associates

AKRON ST., COPIAGUE, L. I., NEW YORK 11726
 (516) Amityville 4-2200/(516) Pyramid 9-8200
 TWX Code 510-224-6692

... there's no effort on high voltage in the U.S. because of low demand ...

Beneteau expects to have all the signal-handling circuitry in a tv set in ic form—barring the vhf and uhf tuner and horizontal and vertical output.

In the control sector, researchers recently put the finishing touches on a bipolar ic, designated the FA-1, aimed at the desk-top calculator and computer fields—both areas with good growth potential in Europe. The full-adder FA-1 is already being manufactured; mounted on a chip 1.56 millimeters square, it integrates 17 transistors, 24 diodes, and 34 resistors.

II. High, wide, and handsome

Power transistors, silicon controlled rectifiers, and medium-scale-integration (msi) assemblies are also being developed at the lab, says Beneteau. In Europe, where line voltages range from 220 to 380 volts, there is a need for high-power, high-voltage devices, he notes, citing an economical 50-watt transistor with perhaps a 500-volt breakdown as one R&D goal.

Donald B. Rogers, international marketing manager at Fairchild's Semiconductor division, concedes his company has made little headway in the high-voltage field. However, he says: "There's no effort on high voltage because there isn't much demand for it anywhere in the world. We try to stay in the mass markets." Success at Agrate would, of course, provide the means for Fairchild to go after such specialty outlets as exist.

Researchers at the lab are working on high-voltage techniques for both planar and mesa transistors. Planar assemblies have been limited to 400 volts, but Beneteau says the staff has come up with a way to achieve 1,000-volt ratings. He wants to stick with planar technology because he feels it will prove more economic than available alternatives.

Moderation. Beneteau is a fan of msi and considers himself something of a prophet without honor in this respect. "Everyone in the U.S. seems to be gunning for the largest circuit possible," he says. "It may be that technology is surpassing

systems, and that you can make devices too big to use."

Beneteau also believes that U.S. manufacturers may be reconsidering their once common practice of using production costs per gate as the sole measure of a device's economic feasibility. Engineering costs per gate rise more sharply than do production outlays, he says. "In practical terms, the economic optimum is between 25 and 50 gates—a far lower number than you would get using just production costs."

Way out. In addition to specific device work, the lab is experimenting with low-temperature deposition of various oxides and nitrides with an eye "to developing transistors fast enough for high-speed, high-frequency switching applications."

In another long-range project, researchers are trying to develop a dual-layer metalization process for both planar transistors and integrated circuits. Beneteau believes someone—hopefully SGS-Fairchild—will achieve a break through in this area within two years. "Of course, we started from a very high level of planar technology," he notes.

III. Fringe benefits

Beneteau says there is a free exchange of ideas, devices, drawings, and confidential progress reports between Fairchild and the Italian



Inside job. Vaporizing apparatus is used to metalize base materials at SGS-Fairchild's Milan research lab.

We're number one 2, 3, 4, 5, 6, 7, 8, 9...

No matter how it all adds up, we're the leaders in thumbwheel switches — in sales, in product features and quality... and in service. We like leading, and here's what it means to you:

■ Our switches — Digiswitch™ and Miniswitch® — are the simplest, most easily read, easiest to operate, smallest, biggest, and best looking for your panel. And they have both complex and simple electrical output capabilities.

■ Did we get to be number one because we are so smart? We like to think so. But being there first sure helped. We pioneered the thumbwheel switch. And we're the kind of engineers who continually improve our product. [Drives the competition crazy.]

■ But maybe our real advantage is that we like to sell things. This makes us easy to buy from. Send for our catalog. It's as easy as one, two, three.

THE DIGITRAN COMPANY

Subsidiary of Becton, Dickinson and Company 

855 S. Arroyo Pkwy./Pasadena, Calif. 91105

Tel: (213) 449-3110/TWX 910-588-3794

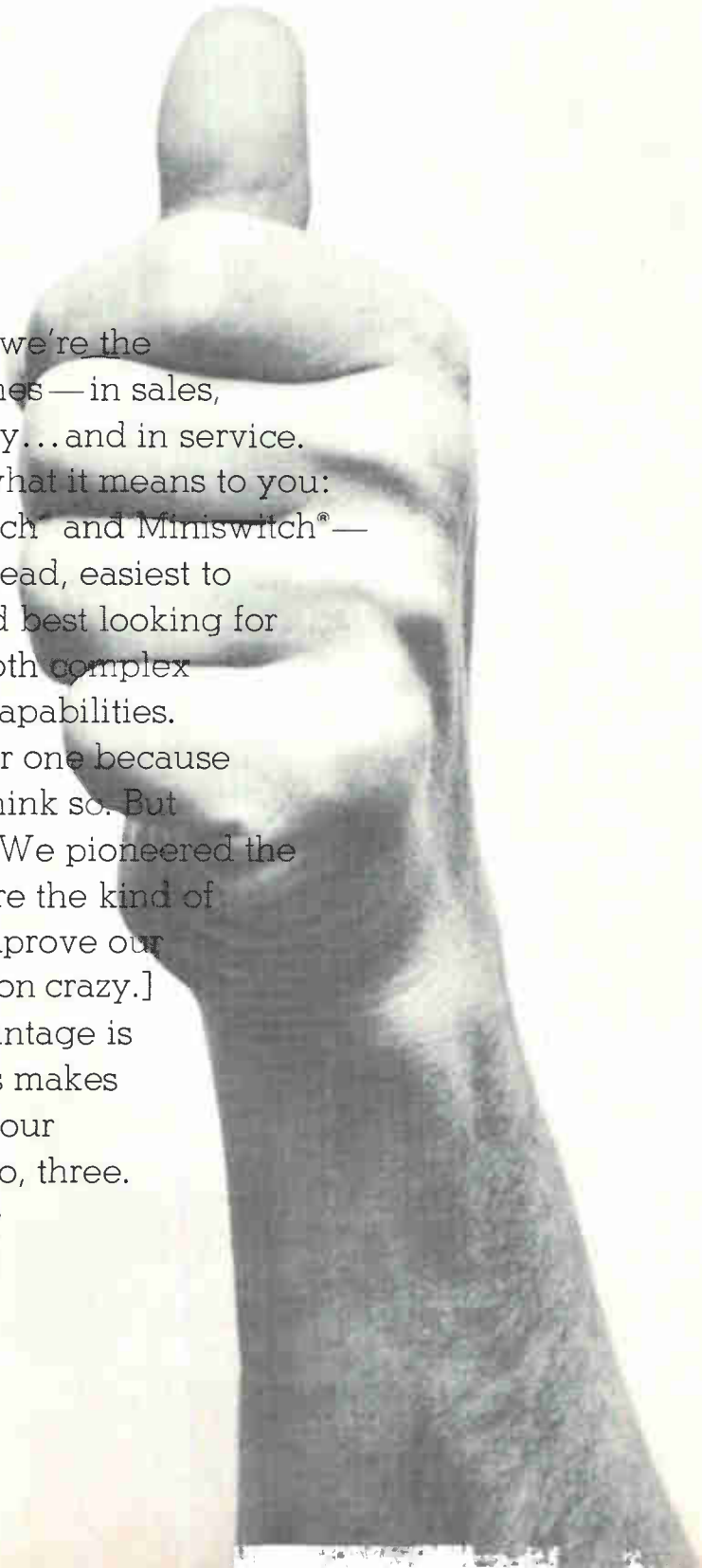

WANG Reports A Major Technological Advance . . .

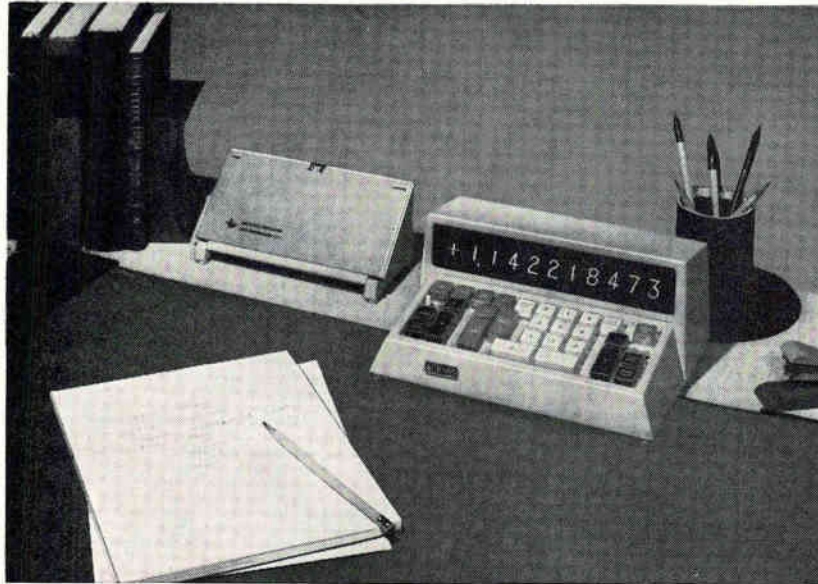

Now an ELECTRONIC CALCULATOR

based on a unique Digital Log Generator which has been designed into electronic circuits. With the DLG at its heart, the calculator uniquely enables you to use logs and exponentials digitally, at electronic speeds. It provides order-of-magnitude gains in numerical analysis.

Now you can solve $(2.3)^{13.5^*}$ or $1603.08^{\frac{1}{13.5}^{**}}$ by just touching four operational keys. Results are shown instantly to ten significant digits with a floating decimal point.

Ans: *76440.89906 **1.727444442

Working the WANG electronic desktop instruments is a delightful experience. You sit at your desk and "communicate" with it for instant data analysis — from simple arithmetic to exponential functions.

WANG's modular DLG calculating instruments provide another technological advance. You can start with a simple calculator and build it to a highly versatile personal computer system. Over 4000 other business leaders are already using theirs. Prices range from \$1690 to \$10,000 purchased outright.

For complete information call:

(203) 666-9433
 (212) 682-5921
 (213) 278-3232
 (215) 839-3345
 (312) 456-1542
 (415) 454-4140
 (713) 668-0275
 (716) 381-5440

WANG

LABORATORIES, INC.

Dept. N-11, 836 North Street, Tewksbury, Mass. 01876
 Tel. (617) 851-7311

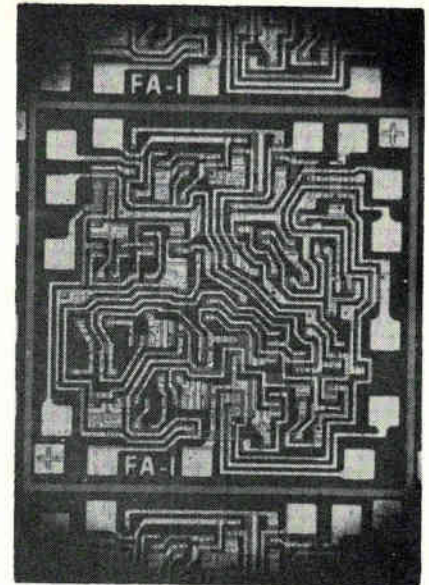

Homebred. Bipolar full adder, designed by lab, has 17 transistors, 24 diodes, and 34 transistors on a 1.56-mm chip.

operation. "We felt we had to give something back," he says. "Now, our activities here will permit Fairchild to enter new markets."

He admits that there was some resistance at the outset to locating the development lab in Italy rather than in an area with more important markets, more advanced technology, and a superior labor pool. These drawbacks were outweighed, however, by the proximity of the SGS-Fairchild headquarters complex, which includes application, testing, and production facilities. In addition, the firm was willing to take the time and trouble to train a locally recruited staff for the lab's R&D activities. "Italy has a wealth of competent people, including physicists and engineers, who learn quickly," says Beneteau.

Xenophobia. Beneteau is an enthusiastic booster of joint ventures by U.S. and European firms, even when the U.S. partner holds only a minority interest. "American companies may not realize how much European governments fear their ownership," he says. "Texas Instruments Incorporated, the International Business Machines Corp., and others have been successful so far in keeping total control. But in the long run, life may prove difficult for them."

European governments are beginning to come up with R&D financing, he points out, but "wholly or predominantly American firms are unlikely to see any of it."

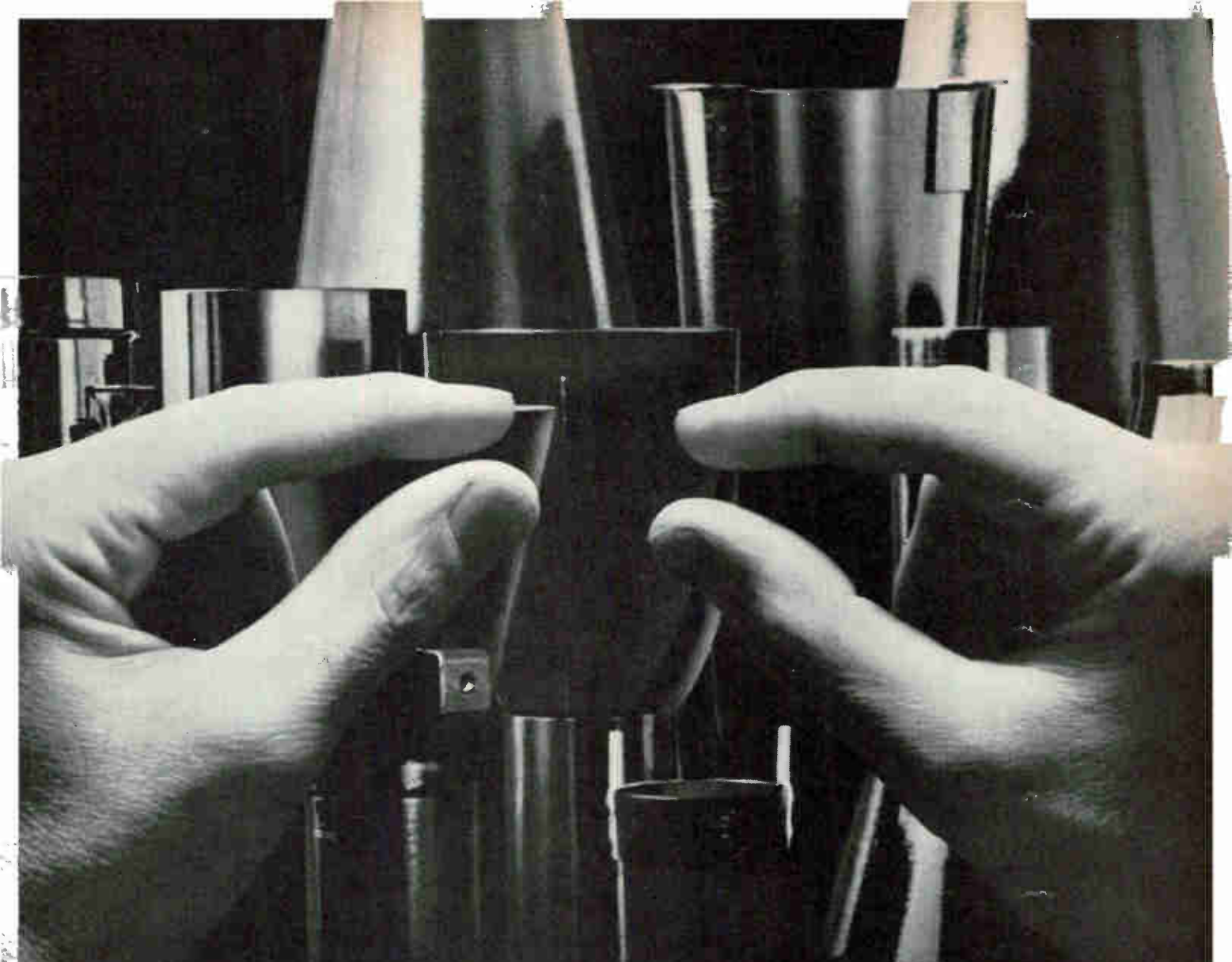

.020" of Hipernom[®] shields like .030" of the magnetic alloy you're probably using.

Hipernom meets the requirements of Federal Standard No. 222

It can keep your costs competitive in the 1970's.

Westinghouse Hipernom's high permeability lets you use thinner, lighter shielding against magnetic fields from DC to 10,000 Hz. That means easier fabrication, less material per shield. So if you use magnetic shielding materials, be sure to use Hipernom. Its premium performance gives you the shielding you need at the lowest possible

cost. And cuts needless weight from your products. Along with Hipernom, you get the services of the largest group of metallurgists specializing in magnetics. For 50 years, Westinghouse research has led in this field. You get the benefit. Want specific details? Call Bob Carroll at 412-459-9400.

Free 36-page book on magnetic shielding. It's a complete seminar in practical, easy-to-use form... tells you everything you must know to design and evaluate magnetic shielding. The only book of its kind. For your free copy, write for "Shielding Book." Address Westinghouse Metals Division, Box 868, Pittsburgh, Pennsylvania 15230.

You can be sure if it's Westinghouse

J-05014

Circle 139 on reader service card



PROBLEM: YOUR CIRCUITS NEED THE LOW COST OF HIGH VOLTAGE.

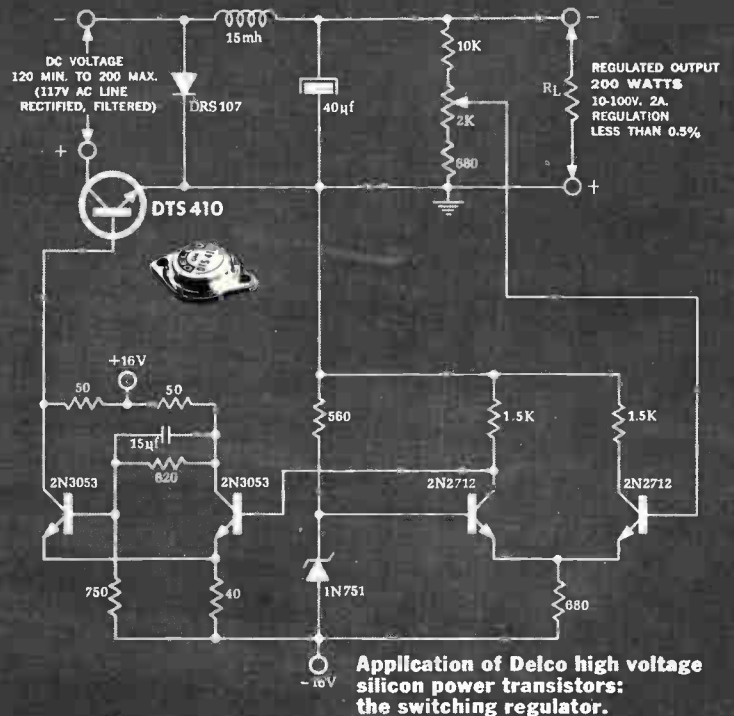

SOLUTION: DELCO SILICON POWER.

Delco high voltage silicon power transistors provide high energy capability at the lowest possible cost. Take the applications pictured above: switching regulators, DC to DC converters and DC voltage regulators. Unit prices? Just \$1.70 for the DTS-410*, \$4.95 for the DTS-423* and \$3.95 for the DTS-413*.

There are other cost cutting advantages to our high voltage silicon power transistors. You can reduce the number and complexity of input-output and filtering components, which means more compact circuitry. Greater reliability. Lower assembly costs.

Other high energy circuits where Delco silicon power transistors have proved capabilities include: ultrasonic power supplies, VLF class C amplifiers, off-line class A audio output, and magnetic CRT deflection (several major TV manufacturers are using them in big screen horizontal and vertical sweep circuits).

They're available in production quantities. For prices, delivery, data, or applications information, just give us a call. Or call your local Delco distributor.

With Delco silicon power transistors, everything's high powered but the price.

*When purchased in quantities of 1,000 and up. Prices subject to change without notice.

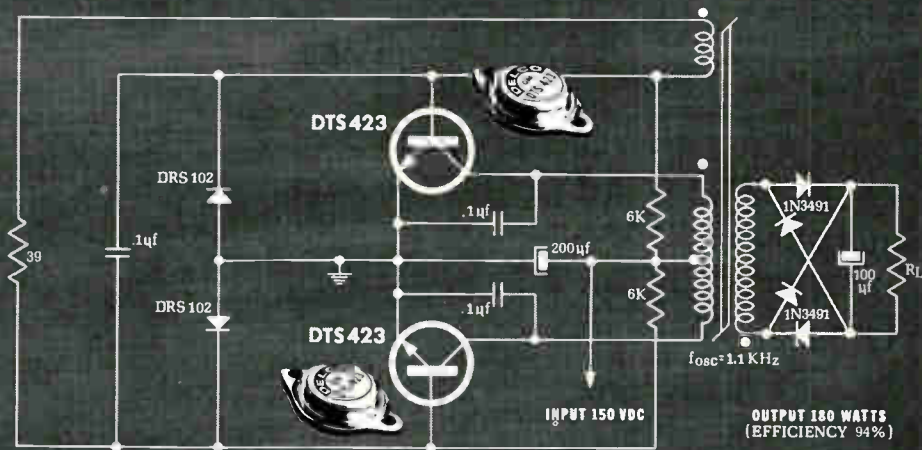

Application of Delco high voltage silicon power transistors: the DC to DC Converter.

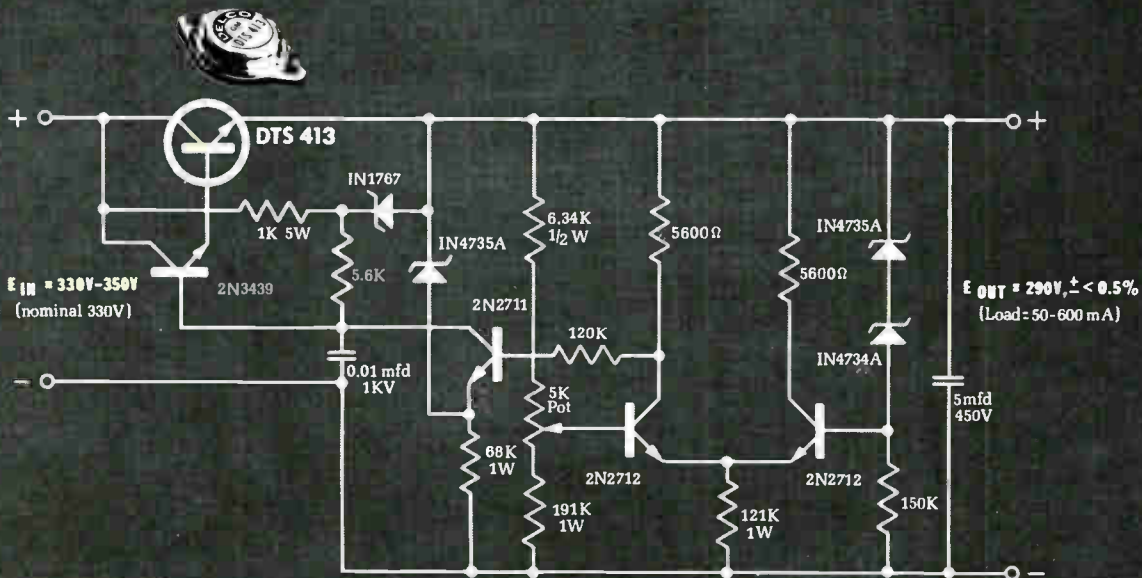

Application of Delco high voltage silicon power transistors: a DC voltage regulator.

TYPE	V _{CEX}	V _{CEO} (sus) min.	I _C max.	hFE min. V _{CE} =5 V @ I _C	P _D max.	PRICE 1000-and-up QUANTITIES
DTS-410	200V	200V	3.5A	10 @ 2.5A	80W	\$1.70
DTS-411	300V	300V	3.5A	10 @ 2.5A	100W	\$2.20
DTS-413	400V	325V	2.0A	15 @ 1.0A	75W	\$3.95
DTS-423	400V	325V	3.5A	10 @ 2.5A	100W	\$4.95
DTS-424	700V	350V	3.5A	10 @ 2.5A	100W	\$7.00
DTS-425	700V	400V	3.5A	10 @ 2.5A	100W	\$10.00
DTS-430	400V	300V	5.0A	10 @ 3.5A	125W	\$12.00
DTS-431	400V	325V	5.0A	10 @ 3.5A	125W	\$18.00

NPN silicon transistors packaged in solid copper TO-3 case.

Field Sales Offices: Union, New Jersey* 07083 Box 1018 Chestnut Station (201) 687-3770; Detroit, Michigan 48202 57 Harper Avenue (313) 873-6560; Santa Monica, Calif.* 90401 726 Santa Monica Blvd. (213) 870-8807; Syracuse, New York 13203 1054 James Street (315) 472-2668; Chicago, Illinois* 60656 5151 N. Harlem Avenue (312) 775-5411; General Sales Office: 700 E. Firmin, Kokomo, Ind. 46901 (317) 459-2175

*Office includes field lab and resident engineer for applications assistance.

DELCO RADIO

Division of General Motors, Kokomo, Indiana



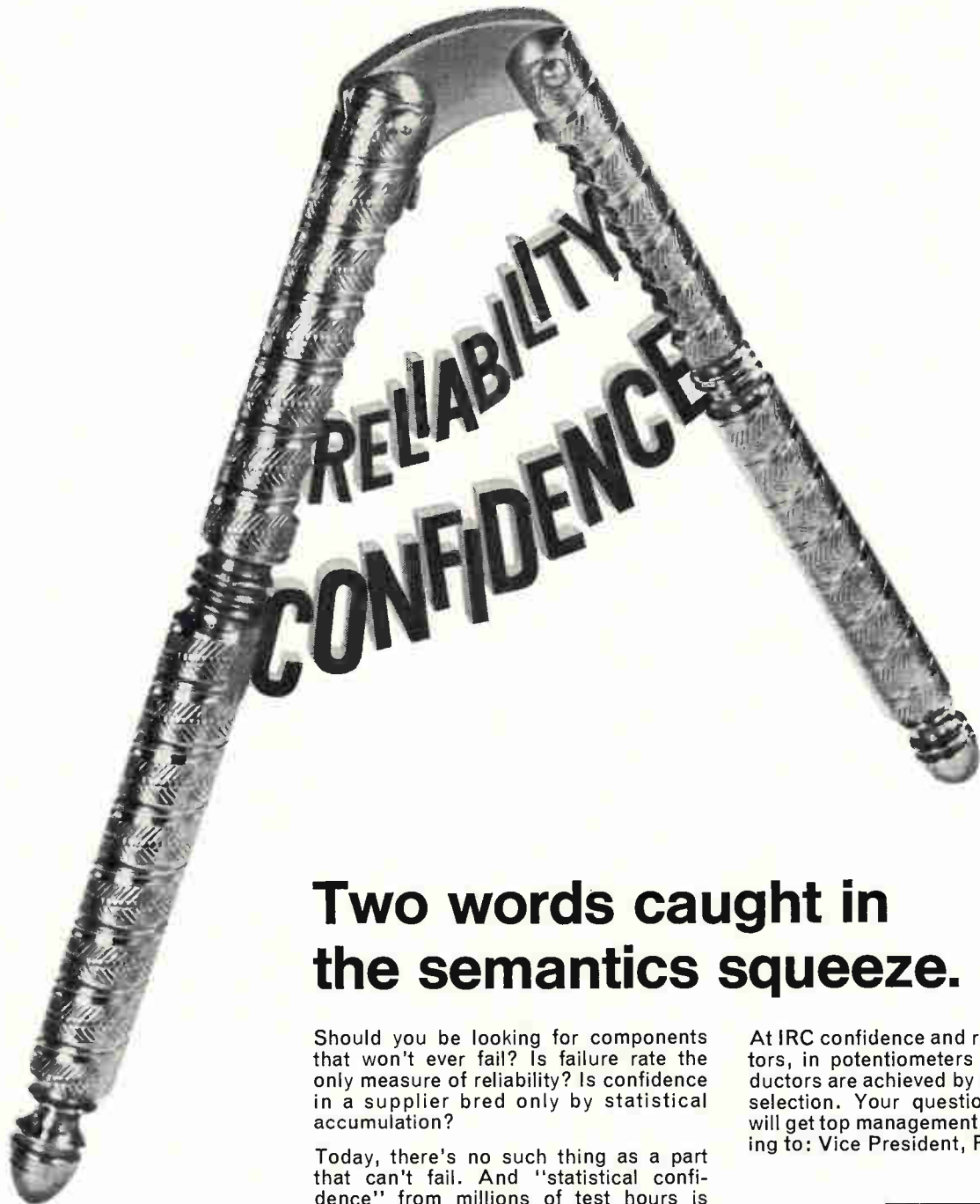

Two words caught in the semantics squeeze.

Should you be looking for components that won't ever fail? Is failure rate the only measure of reliability? Is confidence in a supplier bred only by statistical accumulation?

Today, there's no such thing as a part that can't fail. And "statistical confidence" from millions of test hours is economically prohibitive because as failure rates decrease, the cost-of-proof increases sharply.

It comes down to plain old confidence . . . in us and in our production system.

Call it reliability. Call it confidence. We think it's both. And our Director of Reliability makes sure you get it. He's involved in everything from basic designs to final inspection to assure you of homogeneity and performance repeatability.

At IRC confidence and reliability in resistors, in potentiometers and in semiconductors are achieved by discipline, not by selection. Your questions on reliability will get top management attention by writing to: Vice President, Reliability.

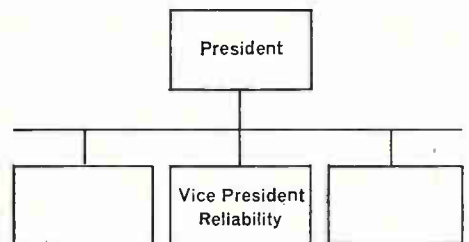

IRC, Inc., 401 N. Broad St., Philadelphia, Pa. 19108



New Products

New industrial electronics

Recorder takes little time to pinpoint troublemakers

All-IC annunciator for power and production lines is capable of monitoring 1,000 points and reading out occurrences that are as little as 0.01 second apart

When lightning strikes a transmission line, its repercussions can be felt throughout a power network—circuit breakers opening and generators shedding their loads. In seconds and in sequence, main and auxiliary distribution and generation equipment go into off-normal conditions.

To capture these fast-paced occurrences in their exact sequence, the Scam Instrument Corp. has come up with a digital system that can interrogate up to 1,000 on-off contact inputs every 860 microseconds. Called the Series 119 Event Recorder, it senses and memorizes up to 120 events separated by as little as 0.01 second. A teleprinter then reads out a point-identification code and occurrence time at a rate of 10 characters a second. During printout, the memory registers are freed to accept new on-off contact inputs.

Although Scam vice president Roscoe H. Garrett expects power plants to be the biggest users of the Series 119—one unit has already been shipped to such a facility—there are other applications. Three units have been ordered for monitoring factory conveyor lines, on which feelers sense positioning of parts to indicate whether the next machining operation can proceed.

English, too. The United States Steel Corp. bought one unit with an English-language printout op-

tion. Independent of the basic printout, this option provides readable information about the point and its condition. Thus, the readout for each stored event will have, in addition to the usual code and event printout, a legend like

BOILER TEMP 17 TOO HIGH.

I. Meeting different needs

The basic Series 119 recorder ac-

commodates 250 points and 30 lines of memory—four units make up the standard maximum of 1,000 points and 120 lines. The minimum configuration is 10 points and five lines, which can be expanded in increments of 10 points and five lines by installing plug-in cards. And the packaging lets the customer expand the system after installation.

Price depends on configuration and options. For a recorder with 100 points, 10 lines of memory, and a teleprinter, says Garrett, the price is about \$20,000; for 1,000 points and 30 lines, the cost is about \$35,000. The English-language readout option, which in its standard form types a 15-character line, adds about \$7,000 to the price.

IC's double capacity. Scam claims the Series 119 is the first all-integrated-circuit event annunciator. Kenneth C. Linder, chief engineer at Scam's Panalarm division, chose transistor-transistor-logic



Designer's choice. Chief engineer Kenneth C. Linder selected TTL integrated circuits for, among other reasons, better noise immunity.

VITREOSIL® PURE FUSED QUARTZ CLOTH

Vitreosil® Quartz fabrics offer the design engineer a combination of extreme heat resistance, exceptionally low coefficient of thermal expansion and excellent dielectric properties. Applications include plastic reinforcement for missile and aircraft parts, rocket nozzles, heat and exit shields and similar services. They are also recommended for screening and filtration of molten non-ferrous metals and high temperature gases. Also available are Vitreosil Quartz mat and wool of extremely fine diameter fibers which provide excellent thermal insulation barriers to 2000°F indefinitely with no degradation for fuel cells, jet engines, etc. Complete information and technical data are available from Thermal American Fused Quartz Company, Montville, N. J., 07045.



THERMAL AMERICAN
FUSED QUARTZ CO.
RT. 202 & CHANGE BRIDGE RD.
MONTVILLE, NEW JERSEY
ZIP CODE 07045

69

"... Higher speed results in precise acquisition of data and, thus, tighter control ..."

(TTL) circuits for both logic and memory functions. The 119 uses 3,450 Texas Instruments TTL integrated circuits.

Comparing the 119 with the company's discrete-component Series 109, Linder says designing with TTL reduced logic hardware costs by 66%, doubled monitoring capacity to 1,000 points, improved event-time resolution from 1,250 to 860 microseconds, and reduced size by more than 80%.

"Core logic was cheaper when bit-counts were lower," says Linder. "But special-purpose computers like the 119 have raised the bit-count to the point where IC's are about as inexpensive as core logic for our purposes. And recent reductions in IC cost have made them even more attractive as memory elements."

II. Improved reliability

Meaningful reliability increases are hard to trace, Linder notes, because discrete-component annunciators are reliable to the point of being failure-proof.

"However, reliability does go up with IC's because there's less point-to-point wiring," he says. "What we used to put on one chassis made up

of 20 boards we now put on one board with 20 different IC's. Inherently, then, the IC approach offers greater reliability."

Other advantages. By turning to IC's, Scam was able to reduce the over-all equipment in the 119 to 10% of that in the 109. "What we used to put in a three-bay cabinet," Linder points out, "we now put in a small instrument case, measuring 30 by 20 by 18 inches—an 80% space saving. This provides much more flexibility in system location."

"We tried resistor-transistor-logic (RTL) first," Linder says, "but its higher susceptibility to electrical noise meant that elaborate and expensive noise-shielding and suppression techniques would have been necessary to prevent false firing."

The high a-c noise immunity of the TTL's results from very low output impedance. Texas Instruments' Series 74 TTL, for example, has a logical 1 output impedance of only 70 to 130 ohms as opposed to 2,000 to 4,000 ohms for RTL. Typically, Series 74 IC's will tolerate 1.9 volts of noise in the 1 state and 1.2 volts in the 0 state without false triggering. Comparable noise figures for RTL are 0.3 and 0.4 volts, respectively.

"Another consideration in the choice of TTL," says Linder, "was the availability of more complex logic functions—like the Texas Instruments SN7491 eight-bit shift register we use in the memory area. The circuit complexity really means system simplicity."

Faster speed. "Another advantage of switching from discretely to IC's is higher speed," Linder says. "Earlier annunciators couldn't go much above 150 kilohertz. So when we went TTL, we decided to shoot for 5 megahertz—quite a jump for us. Higher speed results in precise acquisition of data and, thus, tighter control. For now, 5 Mhz meets our design needs, but with TTL we have the basic capability for even faster scanning speeds to meet future requirements."

Scam Instrument Corp., 7401 N. Hamlin Ave., Skokie, Ill. 60076 [338]



Self-contained. Basic event recorder package scans up to 250 points, types data on teleprinter.

Take me to RCA... your leader of traveling-wave tubes for advanced ECM systems

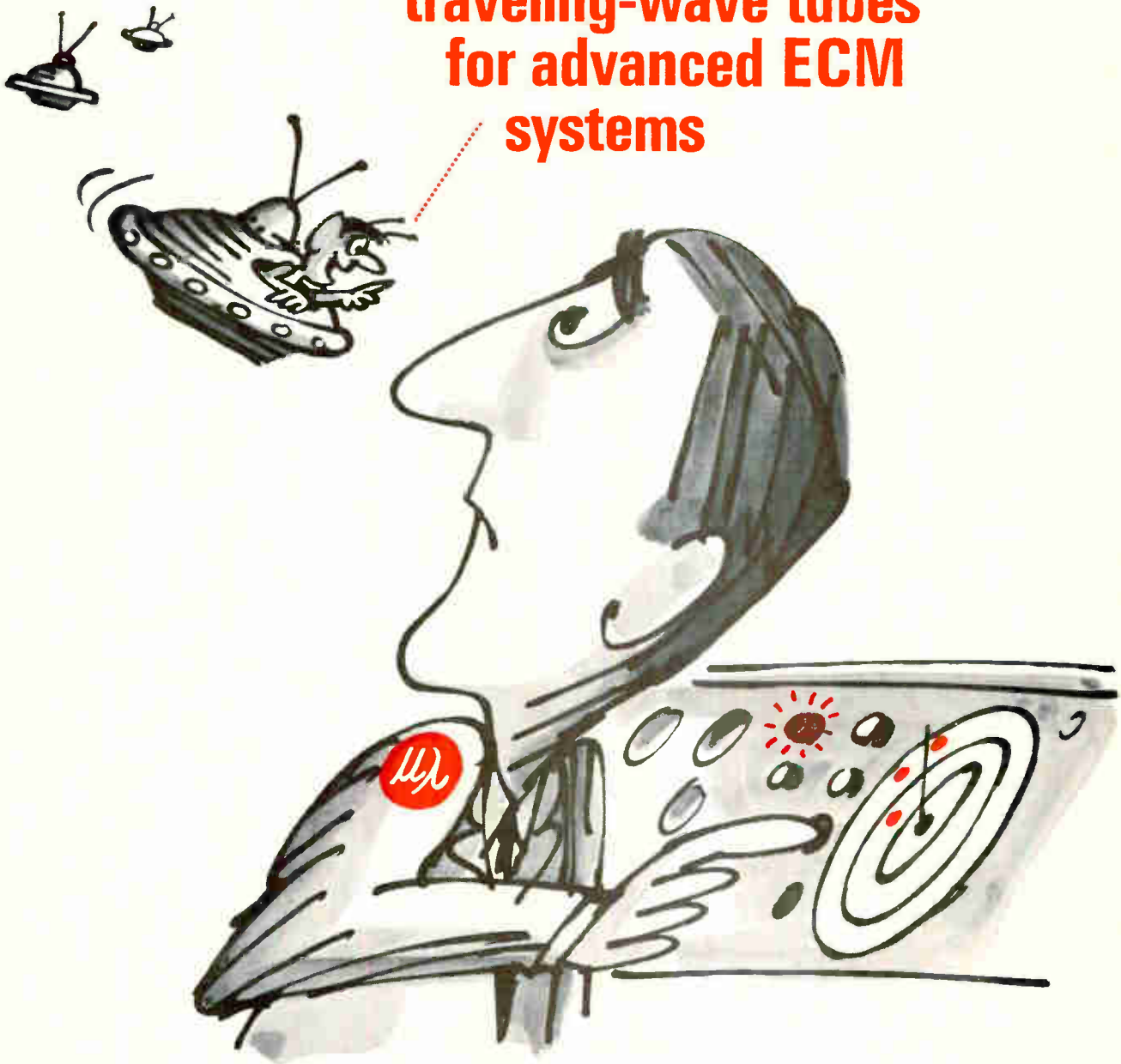

RCA Developmental Type A1383

From laboratory to commercial device, RCA has paced the progress of traveling-wave tube development. Since 1956, when the first commercial low-noise tube was announced, RCA TWTs have participated in every major ECM system. Adept in the application of PPM traveling-wave tubes operating in a memory storage loop over a full octave bandwidth, RCA has introduced:

- First practical PPM traveling-wave tubes for airborne applications.
- First ruggedized PPM traveling-wave tube for military airborne systems.
- PPM traveling-wave tubes with temperature compensation.
- First PPM traveling-wave tubes for commercial service.

- First PPM traveling-wave tubes operating in a memory storage loop over a full octave frequency.
- First reliable, long-life PPM traveling-wave tube in an orbiting communications satellite.
- First use of a high-sensitivity photocathode with a Helix structure in a traveling-wave tube.

Consult your RCA Representative for more information or write: Commercial Engineering, Section K19Q5, RCA Electronic Components and Devices, Harrison, N.J. 07029.



The Most Trusted Name in Electronics



Sharpest Breakdown Below 10 Volts!

The LVA™ is more than just a new diode: it represents a major breakthrough in low voltage regulators (patent pending). Wherever you need a zener below 10 volts, the LVA will significantly improve circuit performance with its avalanche breakdown characteristics.

With the LVA you can design better low current circuits, battery-operated circuits, and operational

amplifier clamping networks. And now for the first time, you can make zero TC reference below 5 volts!

The LVA is available in 10 values from 10 volts down to 4.3 volts. Delivery is off-the-shelf from factory or authorized distributors.

If you'd like to compare, write for test samples and applications data on company letterhead to

TRW Semiconductors, Ray Koch, 14520 Aviation Boulevard, Lawndale, California 90260. Phone (213) 679-4561. TWX 910-325-6206. *TRW Semiconductors Inc. is a subsidiary of TRW INC.*

TRW

New Components Review



Photocell/lamp assemblies for p-c board mounting use a 10-v, 0.015-amp incandescent lamp. Maximum illuminated photocell resistance is 100 ohms for type PL-1033-1, 400 ohms for PL-1036-1. Minimum dark resistance is 10 megohms and 100 megohms respectively. Speed of response is 50 msec turn-on, 75 msec turn-off. National Semiconductors Ltd., Ward St., Montreal 9. [341]

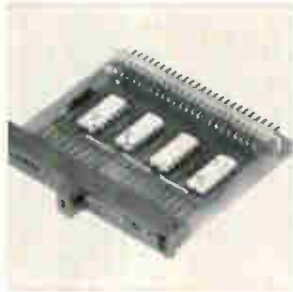

Test probe receptacle series 6505, incorporating 18 jacks on 0.125-in. centers, provides convenient multiple test points on a p-c board and facilitates monitoring and troubleshooting circuit operation. The jacks are rated at 5 amps. They accept 0.040-in.-diameter test probes. The insulator is 3 x 0.385 x 0.350 in. with 2 mounting holes. Elco Corp., Willow Grove, Pa. 19090. [342]



Coaxial-cable current viewing resistor series 600, offering in-line mounting and minimum degradation of electrical circuits, was developed to facilitate compatible current measurement of exploding bridge wire ordnance components. Nominal resistance is 0.050 ohm. The unit measures 0.590 x 1.890 in. Reynolds Industries Inc., 2105 Colorado Ave., Santa Monica, Calif. 90404. [343]

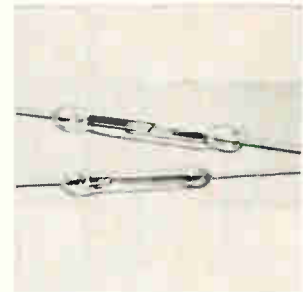

Magnetic reed switches for r-f signal switching come in 2 types. The MTRF-2's glass is 0.092 x 0.635 in. max., with 2 1/8-in. over-all length. It switches r-f from 30 to 100 Mhz. The MRMF-2, handling up to 30 Mhz, has glass size of 0.130 x 0.830 in.; over-all length, 2 1/4 in. Impedance levels are 52.5 and 70 ohms. Hamlin Inc., Lake & Grove Sts., Lake Mills, Wis. 53551. [344]

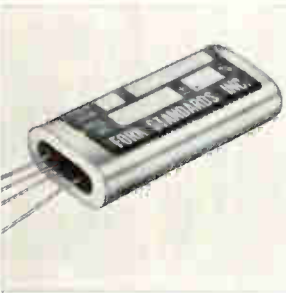

Tuning-fork oscillator model M0 is built in a 1 1/2 x 3/8 x 3/4-in. crystal can for mounting flat on a p-c board or in a spring clip. Frequency range is 1,000 to 15,000 hz with accuracy to 0.002% over a limited temperature range, or 0.01% from -55° to +85°C. Supply voltage is 3.5 to 12 v d-c. Price is from \$80 each. Fork Standards Inc., Box 177, West Chicago 60185. [345]

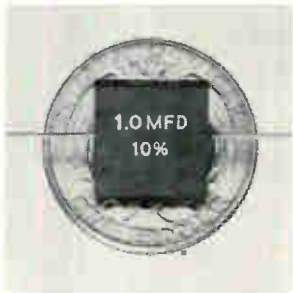

Axial-lead ceramic capacitors series C27 come in 50 or 100 v d-c versions. The 50 v units range from 0.01 μ f in a 0.200 x 0.200 x 0.100-in. package, to 2.5 μ f in a 0.500 x 0.500 x 0.250-in. package. The 100 v devices range from 0.01 to 2.5 μ f in slightly larger sizes. Standard tolerance is 10%. U.S. Capacitor Corp., 2151 N. Lincoln St., Burbank, Calif. 91504. [346]



Conductive plastic potentiometers known as Kelpots are for use in commercial instruments, components, and systems. Units come in standard resistance from 1,000 to 50,000 ohms, \pm 20% resistance tolerance, 2.0% linearity, and essentially infinite resolution. They will dissipate 1.5 w. Price is \$4 each in quantity. Keltron Corp., 225 Crescent St., Waltham, Mass. 02154. [347]

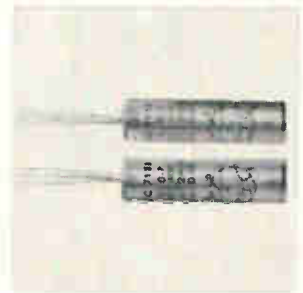

Polarized relays style SZC are for communications and switching systems, instrumentation and logic control functions. They provide up to 50 million electrical operations at 200 hz switching rates at a maximum of 60 v d-c, or 200 ma d-c. They withstand shock up to 20 g for 11 msec. Units measure less than 1.5 x 0.45 in. Price Electric Corp., Frederick, Md. 21701. [348]

New components

A magnet finds a logical domain

Thin-film magnetic shift register zigzags its way to success in a unique approach to logic design

Unable to achieve what it set out to accomplish, Laboratory for Electronics Inc. successfully turned a problem into a product—a magnetic 1,024-bit shift register. Based on magnetic domain tip propagation, the register is an outgrowth of the company's magnetic thin-

film research for the Air Force's Cambridge, Mass., Research Laboratories.

Called the model 1487, the register interfaces with standard logic formats, operates at a 0 to 250-megahertz bit rate, withstands voltage transients and nuclear radia-

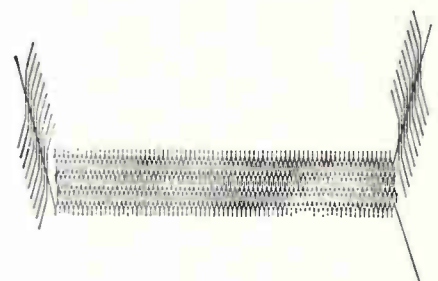

Logical zigzag. Domain tips propagate along fine etched lines.

tion, and doesn't consume power in the standby state or lose its memory if computer power fails.

During its experiments, the company's Electronics division found

Need fast action on servo amplifiers?

Try Bulova first! Chances are, we can solve your problem better and faster than anyone else. Here's why:

1. We have the most complete line of Servo Amplifiers in the business—hundreds of standard designs to solve your problems! From 3.5 to 40 watts output power; 60 and 400 Hz.

2. Bulova Servo Amplifiers are engineered to reduce the number of components, producing low cost, high quality, trouble-free units. This frees you to concentrate on systems, rather than components.



3. High-density packaging—down to just 0.3 cu. in.! For example, Model S21220101: A 3.5 watt Servo Amplifier with gains of up to 5000—in the smallest package of its type on the market!

Another example:

The smallest package ever for a stable solid state servo amplifier producing 40 watts of output power! Need a unit fast to put into a breadboard or prototype? We can probably supply it, meeting most military specs (MIL-E-5272, MIL-E-5400, MIL-I-26600, etc.) You'll get assembly by personnel trained and certified by NASA, if desired. You'll get amplifiers built for 10,000 hours of operating life! And perhaps equally important, you'll get the unit you need fast!



Write today for your free copy of our 8-page Bulletin No. 10, containing complete specifications and ordering information. Also ask about our Resolver Amplifiers, Demodulators, Quadrature Reject and AGC Amplifiers. Address: Dept. E-24.

Try Bulova First!

SERVO PRODUCTS

ELECTRONICS DIVISION
OF BULOVA WATCH COMPANY, INC.

61-20 WOODSIDE AVENUE
WOODSIDE, N.Y. 11377, (212) DE 5-6000

... a variety of logic functions are formed depending on the etched pattern ...

it difficult to magnetize films evenly. The unevenness has worsened by the presence of magnetic domain tip propagation. When the firm tried to reverse the sense of a film's magnetization by applying a field with the opposite sense of magnetization, it discovered areas of reverse magnetization propagated across the face of the film in long, thin spikes that are called domain tips.

Unable to prevent the domain tips, the company decided to turn the difficulty into an asset. It reasoned that if it could control the way the domain tips propagated, it should be possible to build useful devices with them.

Channeled effort. To keep the domain tips where they wanted, the researchers deposited a thin, ferromagnetic film on a sheet of aluminum on which thin lines (about 3 mils wide) have already been etched. Magnetization is easier where the aluminum has been etched away so the domain tips take the lines of least magnetic resistance—the etched routes. Thus a reversing magnetic field can send a stream of domain tips along the etched channels without reversal of polarity elsewhere—this is damped by the aluminum.

Depending on the etched pattern, a variety of logic functions can be formed. For example, the new shift register uses a zigzag pattern; data in the form of a domain tip or its absence is shunted along the zigzag lines by a sequence of magnetic fields.

Read-in occurs when simultaneous magnetic fields are applied for both inserting and storing information at a zigzag junction. Afterward, the domain tip can be shunted along the line by a shifting succession of magnetic fields. Information is read out when a domain tip passes over an etched copper inductor; the tip notes the sense of the induced voltage and the signal is amplified and time sampled.

Since both the basic film and inductor can be batch-produced much like printed-circuit boards or integrated circuits, the company

claims low production costs for the new system.

Standard diode-transistor-logic (DTL) IC's control timing and logic functions, and three bipolar current drivers connected to the etched copper conductors control the sequencing of the magnetic fields.

Measuring 5.5 by 8.625 by 1.25 inches, the register weighs only 19 ounces. Power requirements are also small, only 32 watts are required for the maximum bit rate. The device uses the ± 12 -volt and $+5$ -volt supplies found in almost all computers. Metal oxide semiconductor devices, on the other hand, require higher voltages. Operation of the register can be either synchronous or asynchronous and input-output can be either serial-serial or parallel-parallel.

More to come. The 1487 is the first of a series of registers to be marketed by the company. Soon to appear are 512-bit and 2,048-bit models. Other logic forms should appear later as LFE engineers have already experimented with mass memory, AND, NOR, OR, NAND, inverted exclusive OR, and inversion systems.

Immediate applications for domain tip propagation logic include data recording and communications buffering. Airborne flight recorders, machine-tool directors, and time-sharing computer terminals are also viewed as potential markets.

And, since these devices are resistant to nuclear radiation, there are potential markets in missile guidance computers, proximity fuses, and other military applications. The Army's Harry Diamond Laboratories is already trying to apply domain tip propagation logic to fuse timers that are used for artillery shells.

Specifications

Bit rate	0-250 khz
Bit capacity	1,024
Power supply tolerance	± 0.5 v
Standby power	0
Operating power	1.2 w min. 32 w max.
Interface	DTL and TTL
Temperature range	0° to +50°C
Price	About \$3,000

Laboratory for Electronics Inc., Electronics Div., Boston, Mass. 02115 [349]

PROBE
AND READ
IN-CIRCUIT
MEASUREMENTS



RF Vector Impedance Meter with direct readout simplifies testing

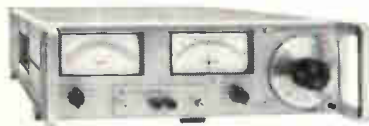

A COMPANION INSTRUMENT COVERS THE
5 Hz to 500 kHz RANGE

The Hewlett-Packard 4800A Vector Impedance Meter measures impedance in seconds. It does for AC measurement what the ohmmeter does for DC testing. Just plug it in and read it. Price: \$1,650.00. Complete specifications are yours on request.

The Hewlett-Packard 4815A RF Vector Impedance Meter provides fast, direct reading measurements of impedance and phase angle over the frequency range from 500 kHz to 108 MHz. The convenience of probe measurement and direct readout make the instrument equally useful for laboratory, receiving inspection or production line measurements. The 4815A reads complex impedance over its full frequency range without charts, data interpretation or a slide rule. As a result, it offers fast, accurate evaluation of the complex impedance of both active circuits and components.

The 4815A is an all solid-state integrated vector impedance *system* that reads out directly in Z and θ . Low-level signal strength minimizes circuit disturbance and prevents overloading the test component. Price: \$2,650.00. For complete specifications, contact your local Hewlett-Packard field engineer or write Hewlett-Packard, Green Pond Road, Rockaway, N. J. 07866.

HEWLETT  PACKARD

Circle 149 on reader service card

IMPEDANCE INSTRUMENTS

1072B

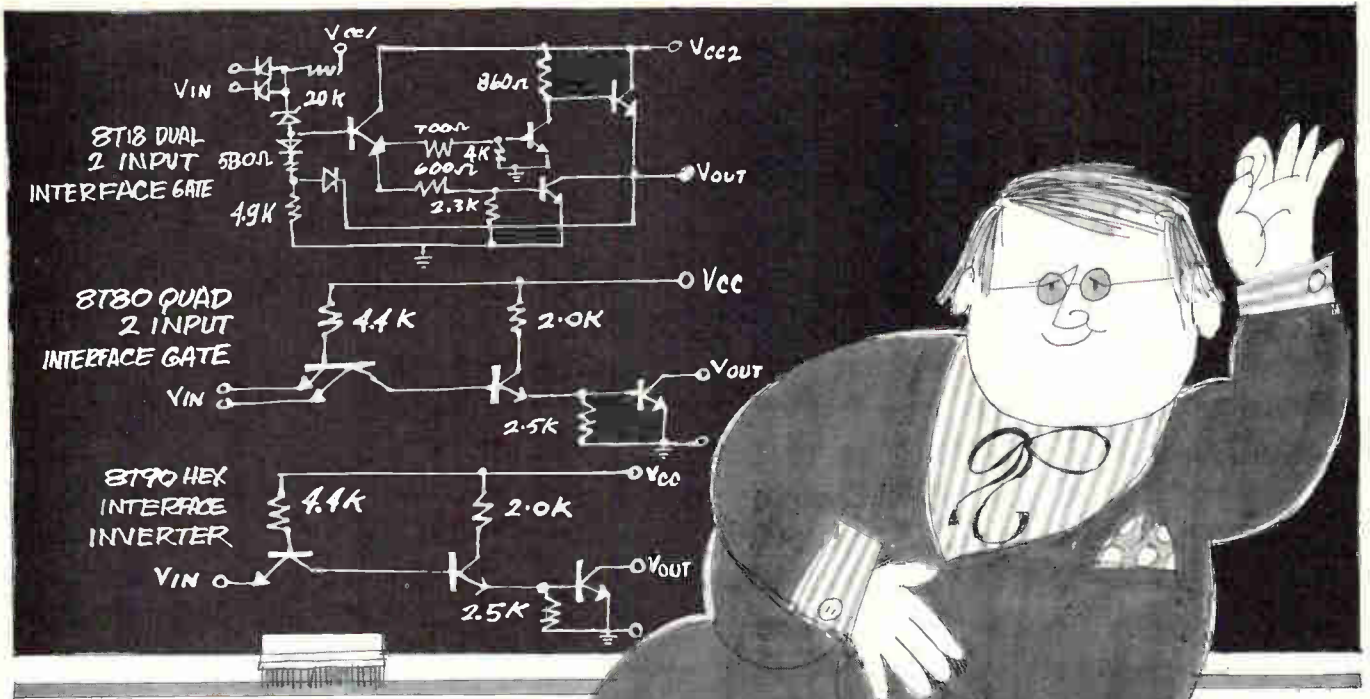

EUREKA! Signetics solves the IC interface problem.

We've just saved you time and money and simplified your system design procedures. There are three new interface elements in the DCL series. They are designed specifically to match system levels of up to 30 volts with DCL levels of 5 volts. In addition to their obvious application in level translation and buffering, they may be used as lamp, relay and line drivers.

Hooray! No more special discrete component designs at interfaces. Signetics has done it again! Just circle the number on the bingo card, or write, and we'll be happy to send you the data sheets on the 8T18 Dual 2-Input Interface Gate, 8T80 Quad 2-Input Interface Gate, 8T90 Hex Interface Inverter.

**SIGNETICS
INTEGRATED
CIRCUITS**

A SUBSIDIARY OF CORNING GLASS WORKS
811 East Argus Avenue
Sunnyvale, California 94086

SIGNETICS SALES OFFICES: Metropolitan New York (201) 992-3980; Upper New York State (315) 469-1072; Southwestern (214) 231-6344; Western Regional (213) 272-9421; Eastern Regional (617) 245-8200; Mid-Atlantic (609) 858-2864; Southeastern (813) 726-3734; Midwestern Regional (312) 259-8300; Northwestern (408) 738-2710.

DISTRIBUTORS: Compar at all locations listed below. Semiconductor Specialists, Inc. (312) 279-1000; Terminal Hudson Electronics (212) 243-5200; Wesco Electronics (213) 684-0880; Wesco Electronics (405) 968-3475; Hammond Electronics (305) 241-6601; Avnet Electronics Corp. of Massachusetts (617) 272-3060.

DOMESTIC REPRESENTATIVES: Jack Pyle Company (415) 349-1266. Compar Corporation at the following locations: Alabama (205) 539-8476; Arizona (602) 947-4336; California (213) 245-1172; California (415) 697-6244; Colorado (303) 781-0912; Connecticut (203) 288-9276; Florida (305) 855-3964; Illinois (312) 775-5300; Maryland (301) 484-5400; Massachusetts (617) 969-7140; Michigan (313) 476-5758; Minnesota (612) 922-7011; Missouri (314) 428-5313; New Jersey (609) 429-1526; New Mexico (505) 265-1020; New York (518) 436-8536; New York (607) 723-8743; New York (716) 684-5731; New York (201) 471-6090; North Carolina (919) 724-0750; Ohio (216) 333-4120; Ohio (513) 878-2631; Texas (214) EM 3-1526; Texas (713) 649-5756; Washington (206) 725-7800.

INTERNATIONAL SALES: France, Germany, Italy, Belgium, Holland, Luxemburg, Spain—Sovcor Electronique, 11, Chemin de Ronde, Le Vesinet, (S.-&D.) France. United Kingdom, Ireland, Sweden, Denmark, Norway, Switzerland, Austria, Portugal—Electrosil Ltd., Lakeside Estate, Colnbrook-By-Pass Slough, Buckinghamshire, Great Britain. Australia—Corning, 1202 Plaza Building, Australia Square, Sydney, N.S.W. 27-4318. Canada—Corning Glass Works of Canada, Ltd., Leaside Plant, Ontario, Canada (416) 421-150. Israel—Optronix, P.O. Box 195, Ramat-Gan, Israel 724-437. Japan—ASAHI Glass Co., Ltd., Corning Products Sales Dept. No. 2, 3-Chome Marunouchi, Chiyoda-ku, Tokyo, Japan.

New Semiconductors Review



Plastic-encapsulated power transistor D28C is a monolithic, Darlington amplifier featuring very high gain. Two voltage groups are available: D28C1-3, 25 v and D28C4&5, 40 v. Forward transfer ratio is typically 60K. Maximum collector current is 500 ma continuous and 800 ma at 50% duty cycle, 50-msec pulse width. General Electric Co., Schenectady, N.Y. 12305. [436]

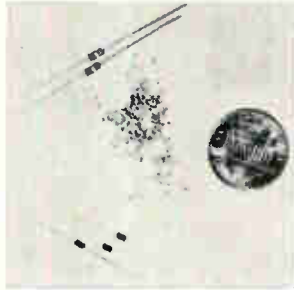

Temperature-compensated, zener reference microdiodes/pellets are for use as d-c voltage reference standards where great stability is required. The line has nominal voltages of 6.28 v, 7.65 v, and 8.71 v; temperature coefficients of less than 0.001%/°C, with dynamic impedance of less than 10 ohms. Micro Semiconductor Corp., 11250 Playa Court, Culver City, Calif. 90230. [437]



Three hybrid circuits (CDA1-1, 2 and 3) for D-to-A converters use all military-grade semiconductors and feature complete switch and interface functions in one compatible package. All feature low saturation resistance (5 ohms typical) and low offset voltage (1 mv max.) Unit price in 1-99 lots is \$44. Crystalonics Inc., 147 Sherman St., Cambridge, Mass. 02140. [438]



Silicon, point contact mixer diode type MO-2002G is for S-band use. Exhibiting a noise figure of 5.5 db, it is suited for plug-in stripline shunt and coaxial shunt or series designs. Test frequency is 3,060 Mhz; maximum vswr, 1.5; i-f impedance, 325 to 525 ohms; and burnout rating, 2.0 ergs. Alpha Industries Inc., 381 Elliot St., Newton Upper Falls, Mass. 02164. [439]

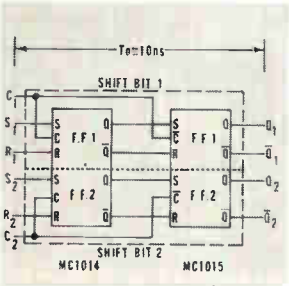

Positive-gated (MC1014P) and negative-gated (MC1015P) dual R-S flip-flops may be combined to form a 2-stage master-slave shift register. Propagation delay from clock input to output (2 levels of gating) is 6 nsec. Both circuits have power dissipation of 125 mw at an operating frequency of 80 Mhz. Motorola Semiconductor Products Inc., Phoenix, Ariz. 85002. [440]



A void-free diode with double hermetic seal meets all MIL-S-19500 requirements. The junction of the monolithic diode is passivated with hard glass at over 1,000°C. This, in turn, is completely encased by 800°C glass. The process excludes gases and extraneous material. Exposure to overload does not affect the diode. Solitron Devices Inc., 256 Oak Tree Rd., Tappan, N.Y. 10983. [441]



Silicon rectifiers in the RVP series have piv's from 5,000 to 50,000 v and forward currents of 600 to 800 ma at 50°C ambient. They feature 300-nsec recovery time measured from 500 ma forward current to 250 ma reverse current. Typical is the RVP10 rated 800 ma at 10,000 piv. Price is \$19.30 each for 100 lots. Electronic Devices Inc., 21 Gray Oaks Ave., Yonkers, N.Y. 10710. [442]

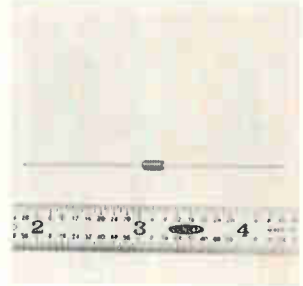

Military rectifiers series 1N3611 are encased in a polymerized silicone called Poly-Sil, which is made with a glass-filled, nonflammable resin that has high thermal and moisture resistance. They are rated 2 amps at 25°C and have voltage ratings of 200, 400 and 600 v. Typical price is 99 cents each in lots of 100. IRC Inc., 401 N. Broad St., Philadelphia, Pa. 19108. [443]

New semiconductors

Toshiba—on the mark and ready

It has a horizontal-output tv-transistor, rated at 1,500 volts and available now to U.S. buyers

What, Toshiba worry? Apparently not. The Japanese firm—its full name is Tokyo Shibaura Electric Co.—is striding purposefully, its new tv horizontal-output transistor in hand, into territory coveted by a family of giants: Amperex of the U.S., Matsushita Electronics of Ja-

pan, their affiliate, Philips of the Netherlands, and Delco Radio.

Amperex Electronic Corp. has come out with a high-voltage, horizontal-output transistor rated at 1,400 volts [Electronics, Oct. 30, p. 138]. But the company is marketing only prototypes now; the earliest

off-the-shelf deliveries of what Amperex has designated the A709 are slated for the end of January.

Matsushita's transistor is rated at 1,500 volts [Electronics, Oct. 30, p. 159]. The problem here is that Matsushita won't sell to outsiders until its own set division is marketing products equipped with the transistor. The company says that won't happen until sometime next year.

The Delco Radio Co., a unit of the General Motors Corp., offers a transistor [Electronics, April 17, p. 178], with a collector to base voltage rating of only 1,200 volts. The company says its device will be available to users in production

A BIG PUSH, PULL, TWIST OR TURN, IN A SMALL SPACE

Ledex solenoids can help you get a lot of work done in places where you don't have much room. We make both push/pull and rotary solenoids in a wide variety of shapes and sizes to solve just about any actuating problem you have.

PUSH/PULL

Our push/pull solenoids are designed for fast response and high force-to-size. Generally, the flat face is best for big loads and short strokes, and the conical gives you more force with longer strokes. Here's a performance comparison for a Ledex size 5 (1 $\frac{1}{8}$ " dia. x 1 $\frac{1}{16}$ "):

STROKE	FORCE flat-face plunger. 90 watts, 1/10 duty	FORCE conical plunger. 90 watts, 1/10 duty
.020 inch	96 pounds	35 pounds
.120 inch	12 pounds	27 pounds



Conical

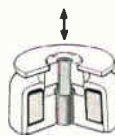

Flat Face

ROTARY

Ledex rotary solenoids are known best for their shock resistant ability and high torque-to-size rotary motion. For example, with a load that must be moved through a 25° arc, our smallest rotary solenoid (1" dia. x $\frac{5}{8}$ ") snaps 1.1 pound-inches, and our largest (3 $\frac{3}{8}$ " dia. x 2 $\frac{5}{16}$ ") moves a hefty 117 pound-inches.

Because Ledex rotary solenoids have a relatively flat output torque curve, they are often used to move linear loads. They are also used for linear loads when shock conditions exist or when stroke length is beyond the efficient range of push/pull solenoids.

Call Ledex when you need a lot of power in a small space to push, pull, turn, twist, step, index, hammer, punch or trigger. For a quick start on your prototype, choose from over 350 different stock model designs. Or, send details and we'll custom design a space-saving solenoid for you.

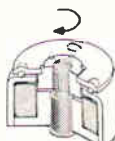

Standard Solenoid.
Life to 10 million
actuations.



Endurance Engineered.
Life to 100 million
actuations.

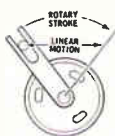

ROTARY
STROKE
LINEAR
MOTION

... for 19-inch and larger
television sets ...

quantities some time next year.

Here and now. Along comes Toshiba to challenge Amperex and Matsushita with a 1,500-volt-rated version of its 2SC643 unit. What's more, the transistor is ready for the U. S. market now and Toshiba says it will sell to anyone. The company won't disclose its pricing plans, but a spokesman says the device will sell for "somewhat below the \$2.50 of the Amperex unit." And Matsushita already has announced its intention of matching the Amperex price.

The Toshiba device is a triple-diffused silicon type with a collector to base voltage rating of 1,500 volts, which Toshiba says is sufficient for a 19-inch set. The company can also produce an 1,800-volt unit for larger sets.

The transistor has a maximum collector current rating of 2.5 amperes, a collector saturation voltage of 5 volts with a 2-amp collector current and 0.4-amp base current, and a dissipation rating of 50 watts with a case temperature of 25°C and a collector junction temperature of 150°C.

No damper. One of the problems in using high-voltage transistors in a tv set's output stage is that the damper—used in tube sets to prevent oscillation in the flyback circuit—must be eliminated. Toshiba hasn't yet used damperless circuits, but the company doesn't consider this a major hurdle. The ability to eliminate the damper is based on the fact that circuit voltages are high in relation to turnoff bias on the horizontal-output transistor's base, and that this causes a type of crossover distortion that Toshiba engineers think provides enough of a damping effect.

Toshiba also has a new vertical output transistor, designated 2SC-642. It has a maximum collector current of one ampere and a d-c current amplification factor of between 30 and 160. The collector saturation voltage is 2 volts with a collector current of 150 ma, and a 15-ma base current. Its collector dissipation rating is 50 watts in an ambient temperature of 25°C.

Tokyo Shibaura Electric Co., Tokyo, Japan [444]



LEDEX INC., 123 WEBSTER STREET, DAYTON, OHIO 45402
Custom Circuitry & Controls phone (513) 224-9891

Don't despair because
the company's
educational program
wasn't planned for
your electronics
support people...

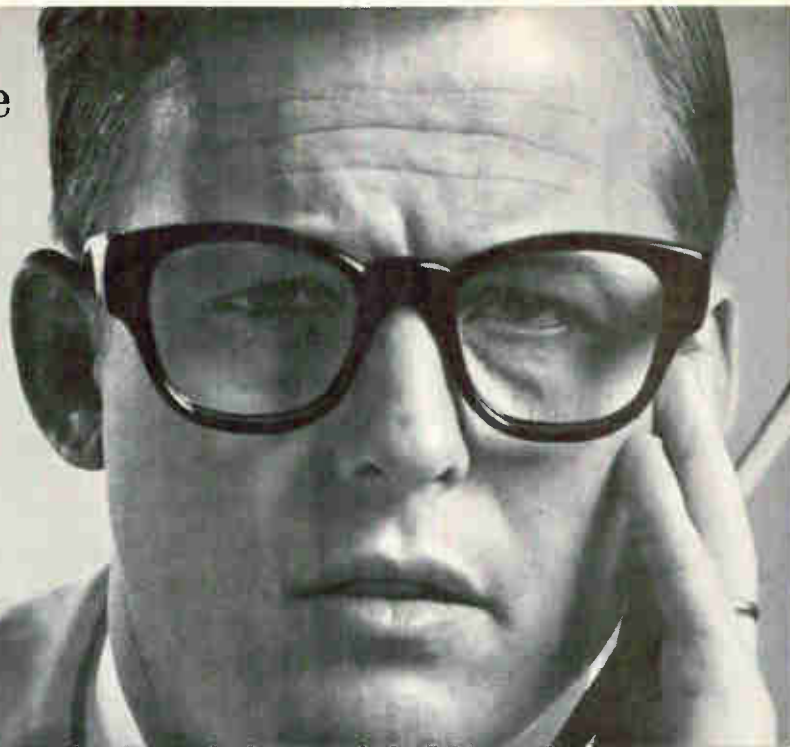

improvise

Look over your men. Pick out a few who are intelligent enough to profit from more education in electronics, ambitious enough to work hard to get it. Send us their names and addresses. We'll send them complete information about CREI Home Study Programs in Electronics, tell them how these programs have helped thousands of young men increase their value to their employers. We'll explain how they can study at home, at their own pace, on their own schedule without traveling

to classes. We'll give them the names of the more than 80 leading scientists and engineers who help us develop and update programs related directly to the needs of industry.

Yes, we'll do all that. If you're lucky some of your men may enroll. Why not give it a try? Fill out the coupon and get it in the mail today.



CREI Programs cover these specialized areas of advanced electronics:

- Communications Engineering
- Aeronautical and Navigational Engineering
- Television Engineering
- Computers
- Nuclear Instrumentation and Control
- Automatic Control Engineering
- Missile and Spacecraft Guidance
- Radar and Sonar Engineering
- Nuclear Engineering Technology
- Industrial Electronics for Automation
- Computer Systems Technology.

**CREI
THE CAPITOL RADIO ENGINEERING INSTITUTE**

A Division of McGraw-Hill, Inc.
Dept. 1848-E, 3224 Sixteenth Street, N.W.
Washington, D.C. 20010

Gentlemen: The men listed at right are high school graduates working in some phase of electronics. Please send them your FREE book, "How to Prepare Today for Tomorrow's Jobs" and complete information about CREI Home Study Programs.

And please send me the free brochure which tells how we can use CREI Home Study Programs to supplement our educational program for electronics personnel.

Name _____
 Title _____
 Company _____
 Address _____
 City _____ State _____ Zip Code _____

Name _____
 Address _____
 City _____ State _____ Zip Code _____

Name _____
 Address _____
 City _____ State _____ Zip Code _____

Name _____
 Address _____
 City _____ State _____ Zip Code _____

Name _____
 Address _____
 City _____ State _____ Zip Code _____

(Not enough room? Attach sheet of paper with additional names and addresses)

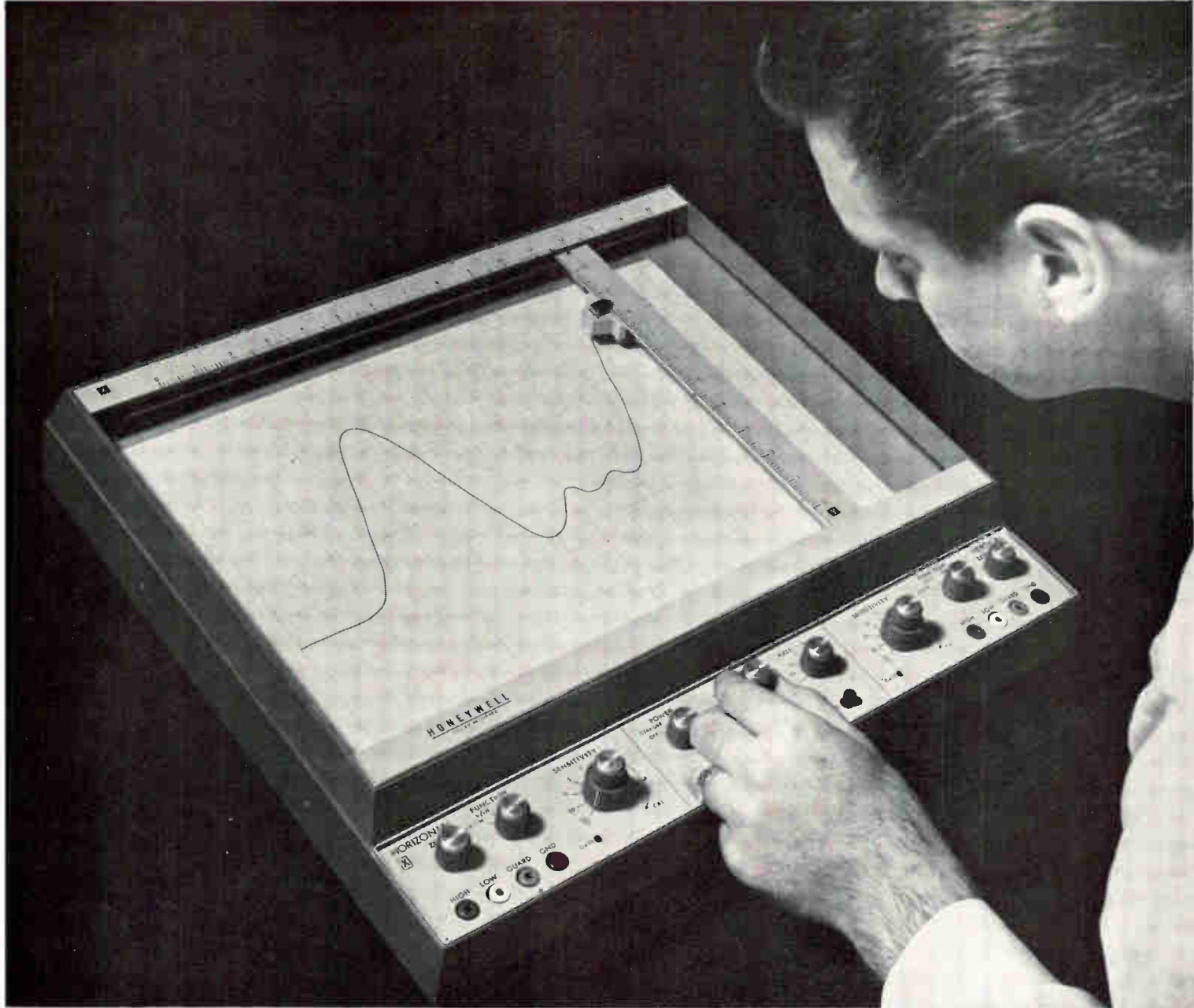

Self-supported at a 30° angle, the new Honeywell 550 offers convenient bench operation – converts to rack mounting easily.

It's rugged, portable, and it works when other X-Y recorders fail. Meet our new Model 550!

We've used X-Y differential recorders around our plant for years. Most have been mechanical dropouts, balking or clogging when we really needed a record. So we decided to build one ourselves. One that worked.

The result is the new Honeywell 550—a slim, crisply designed instrument that overcomes the mechanical problems that plague other X-Y's. Its built-in reliability is protected by a tough, molded base that seals working parts from dust and dirt, even when the 550 is rack-mounted. You get smooth, quiet operation, and you get it for a long, long time.

With true differential input, high sensitivity to 100 $\mu\text{v}/\text{in.}$, and accuracy of 0.15%, the dependable 550 takes a back seat to no one in the performance department. And, it's convenient to use — there's a standby position for quick, easy paper loading, a zero check position, and rear inputs and remote capability built in.

Circle 154 on reader service card

Other 550 features include: a stainless steel pen with non-clogging polished sapphire tip; sealed potentiometers for maximum field reliability; snap-on ink cartridges; a handy zero check, and a built-in event marker. There's lots more, yet the 550 is moderately priced!

If you've been bugged by your current X-Y recorder, look into the new 550. It's another example of how Honeywell's broad line, backed by local sales and service, can provide the *precise* solution to your instrumentation problems. For full details on the 550, call your local Honeywell Sales Engineer, or write: Honeywell, Test Instruments Division, 4800 East Dry Creek Road, Denver, Colorado 80217.

Honeywell

Honeywell engineers sell solutions

New Instruments Review



Spectrum analyzer MSA-1 is a real time 30-point recorder producing a contour write-out. Taking an input from a microphone or hydrophone amplifier, it records frequency versus time on dry, current-sensitive paper. Range is 5 to 19.5 khz. Tolerance of center frequency is ± 50 hz. Paper speed is 50 mm/sec. Listening Instruments, 6 Garden St., Arlington, Mass. 02174. [361]

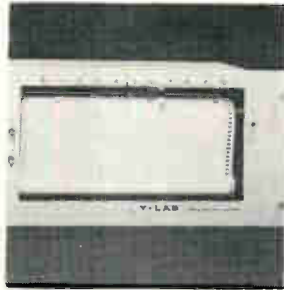

Servographic recorder model 28 is compatible with all equipment having recorder output. Circuitry is self-balancing potentiometric, chopper-stabilized, and employs solid-state components. Base price of \$295 makes it economically practical to record all data from research, analytical and process instruments. Yeiser Laboratories, 881 W. 18th St., Costa Mesa, Calif. 92627. [362]

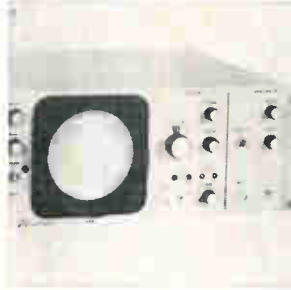

Five-inch oscilloscope model 950 is for use as an x-y display. It contains a crt with an accelerating potential of 2,600 v. The horizontal amplifier operates from an external drive. The vertical amplifier may be a-c or d-c coupled, and includes a base line clamp circuit that maintains a fixed zero reference point. Price is \$495. Sweep Systems Inc., Box 616, Indianapolis 46206. [363]



Portable laboratory power supply series LP comes in voltage ranges of 0-10, 0-20, 0-40, 0-60, 0-120, and 0-250 v d-c. It features remote programming, remote sensing, and constant voltage/constant current with automatic crossover. Convection cooling fins are internally mounted. Prices start at \$114. Lambda Electronics Corp., 515 Broad Hollow Rd., Melville, N.Y. 11749. [364]



Portable strip-chart recorder Vanlab offers MOSFET chopper and solid state circuitry with zener-controlled reference. Flip-top loading of the 8 1/2-in. chart paper is featured. The recorder operates at 1, 5, 10, 50, 100 and 500 mv with chart speeds of 1/2, 1, 2 1/2, 5 and 10 ipm. Response time is 0.5 sec. Van Waters & Rogers Inc., Box 3200, Rincon Annex, San Francisco 94119. [365]



Hall effect gaussmeter model 220 measures flux density from 0.2 to 20,000 gauss. Its a-c field capability up to 50 khz enables investigation and measurement of sine wave and pulsed magnetic fields with time base down to the μ sec region. The unit is self calibrating and has an accuracy of better than $\pm 3\%$. Price is \$540. RFL Industries Inc., Boonton, N.J. 07005. [366]



D-c transducers produce full-scale outputs from as little as 1 ma d-c signal levels. They fully isolate the output circuit from the input circuit in a manner similar to the isolation provided by instrument transformers used in metering a-c circuits. D-c in h-v circuits can be measured to an accuracy of $\pm 1\%$ of full scale. Airpax Electronics, Box 8488, Ft. Lauderdale, Fla. 33310. [367]

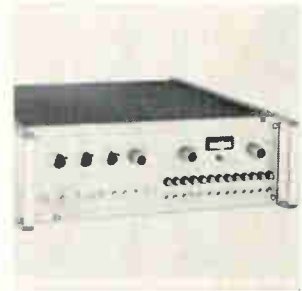

A/D converter model 461 can digitize nuclear pulse events with a resolution of 1 part in 8,192. It features a 50-Mhz digitizing rate and internal provisions for direct computer interface. Integral and differential linearities are $\pm 0.025\%$ and $\pm 1\%$, respectively, over 99% of the full input energy range. Technical Measurement Corp., 441 Washington Ave., North Haven, Conn. 06473. [368]

New instruments

Gamma particles measured in a flash

Dosimeter detects radiation from X-ray machine and provides a direct readout in roentgens

A product in search of a market is nothing new in nuclear instrumentation. For two decades, the promising but slow-moving technology has been cramped by limited marketability.

Among the latest such products is an instrument which measures

gamma radiation from large flash X-ray machines. The principal use of these machines is to simulate a nuclear weapons environment and measure the effects of gamma radiation on electronic devices in that environment. The X-ray equipment also has some applications in an-

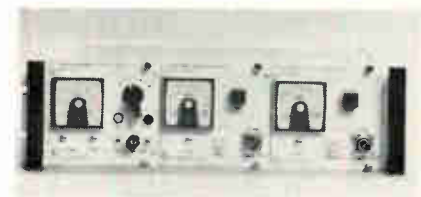

Discharge. By measuring the discharge rate, radiation level is determined.

alyzing chemical processes and in radiography.

Physics International, Inc., which makes some of the biggest X-ray machines, developed for its own use but now plans to market an instrument which measures pulsed gamma radiation faster than the

3 integrated bridge rectifiers with 3 mounting options

Each of these Varo Integrated Bridge Rectifiers is a controlled avalanche, full-wave bridge, and is electrically insulated for direct chassis mounting. Each offers three mounting options: Press mount. Single stud. TO-3 mounting adapter.



10 amp fast recovery IBR. Recovery time: 200 nanoseconds. 100V, 200V, and 400V ratings.

only \$4.75 *



10 amp IBR. 200V, 400V, and 600V ratings.

only \$2.35 *



25 amp IBR. 200V, 400V, and 600V ratings.

only \$3.05 *

* In 200V rating and quantity of 1,000 (press mount).

Write for complete information on Varo rectifier products.



SPECIAL PRODUCTS DIVISION
2203 WALNUT STREET, GARLAND, TEXAS 75040
(214) 272-3561

... not more accurate,
but much faster ...

conventional method and gives a direct readout. The technique may be applicable in other systems which monitor nuclear events.

Wide margins. Gamma-ray bursts are measured in tolerances much looser than electronics engineers expect. Measurement is usually by several dozen thermoluminescent dosimeters—lithium fluoride crystals which give off a flash of light when they are irradiated. The emissions must be statistically analyzed before a good final value can be arrived at, and this value is accurate only to $\pm 10\%$. The swing between two TLD crystals may be as much as 40%.

The company does not claim its pulsed gamma dosimeter is more accurate than the TLD; in fact, it specifies the new dosimeter as having root-mean-square accuracy to $\pm 20\%$ relative to the TLD. What it does say is that the dosimeter gives values repeatable from a machine that is considerably cheaper and immediately reusable.

A TLD package, including a radioactive calibration source, costs about \$5,000, versus an estimated \$1,500 for the gamma dosimeter, and TLD crystals must be carefully annealed for a week to 10 days after using, to get rid of residual radiation. The detector for the new dosimeter, a vacuum tube photodiode with a scintillation crystal, does not retain radiation.

The gamma dosimeter uses the gamma-ray burst, which may be from 15 to 100 nanoseconds in duration, to charge a capacitor. It then uses the time it takes for the capacitor to discharge as a measure of the size of the dose.

Squashed and amplified. The detector produces a pulse that looks something like a single squashed sine wave. This pulse is amplified and fed into the capacitor, which discharges exponentially into a comparator. The problem for the rest of the circuitry is to integrate the area under the ramp and decay curve of the capacitor. The output of the comparator is normally negative, but when the capacitor reaches a reference voltage, 5 volts, it switches to positive and stays there until the capacitor decays to



ECONOMY SOLID STATE POWER SUPPLIES

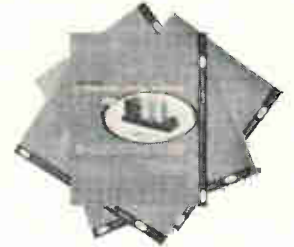

Write
for a
copy
today

Now ... A low cost Power Supply with 1% Line and Load Regulation, Minimum Ripple, 3% Output Voltage Adjustability, Frequency Insensitive with 47-63 Cycle Operation. 45 Standard Models. 4-240 vdc 0-25 Amps.

Three Lines Available

60-LX	60 watts output	\$85 each
120-LX	120 watts output	\$125 each
200-LX	200 watts output	\$170 each

WANLASS ELECTRIC CO.



A Subsidiary of American Bosch Arma Corporation
2175 South Grand Avenue/Santa Ana, California 92705

Circle 203 on reader service card

Cartoon by Whitney Darrow, Jr.



Be a buddy!

One gift works many wonders
THE UNITED WAY

ELGENCO Noise Generators



Model 632A

SOLID STATE NOISE GENERATORS

Model 602A 5 Hz to 5 mHz, 3 Ranges \$ 360

Model 603A 5 Hz to 5 mHz, 3 Ranges \$ 545

Model 610A 5 Hz to 5 mHz, 8 Ranges \$1,275

Model 632A Two outputs DC to 400 Hz and 10 Hz to 35 kHz. . . . \$2,595

Series 624 (Fixed frequency) 5 Hz to 500 kHz \$270 to \$600. Write for details on frequency ranges and spectral flatness.

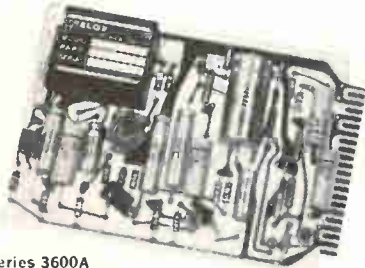

Series 3600A

NOISE GENERATOR CARDS

Series 3600 \$144 to \$409

Various frequency ranges and output flatness available. Write for details.



Model 312A

VACUUM TUBE NOISE GENERATORS

Model 301A DC to 40 Hz \$2,195

Model 311A Two outputs DC to 40 Hz and 10 Hz to 20 kHz. \$2,595

Model 312A Two outputs DC to 120 Hz and 10 Hz to 20 kHz. \$2,695

Model 321A DC to 120 Hz \$2,295

Model 331A 10 Hz to 20 kHz \$1,395

ENCAPSULATED NOISE SOURCE MODULES

Series 1600 \$95 to \$350

Various frequency ranges and output flatness available. Write for details.

For a more complete listing of Elgenco noise generators, write for short form catalog.

ELGENCO INCORPORATED



1550 Euclid Street
Santa Monica, California
Phone: (213) 451-1635
TWX: (213) 879-0091
Cable: Elgenco

DEMONSTRATOR MODELS AVAILABLE
See EEM or Write for Name of Nearest Rep.

below 5 volts again. In effect, the comparator squares up the pulse.

The comparator provides one input to a NAND gate; the other is a 17.5 megahertz crystal-controlled oscillator. When the comparator is negative, the gate is at 1; when the comparator goes positive, the NAND gate passes pulses from the oscillator. Since the capacitor reaches reference voltage level (turning the comparator positive) at the very lowest point of its voltage ramp, the oscillator is passing pulses for the capacitor's entire charge-discharge period.

These pulses are fed into seven flip-flops arranged in a ripple counter. Appropriately chosen resistors feed milliamp-level currents out of each flip-flop—1 ma for the 1 flip-flop, 2 ma for the 2 flip-flop, 4 ma for the 4 flip-flop, and so on through 8, 16, and 32 to 64 ma for the 64 flip-flop. These currents are summed into a d-c meter whose reading becomes proportional to the dose. Since the capacitor discharges exponentially, the reading is on a log scale.

When 123 counts have been stored in the binary circuits, the primary gate is locked out, and the meter indicates that the dose is over scale. Approximately 300 to 400 nsec after the output pulse has left, the input circuitry is locked out to any noise up to 5 volts by feedback circuitry which tries to ground the input. This is a protection against false triggering.

The readout, in three decades, can be in either of two ranges—0.1 to 100 roentgens, and 10 roentgens to 10 kiloroentgens.

At present, the instrument can only be used with the company's pulsed-radiation machines and those made by the Field Emission Corp. and Ion Physics Inc. Now under development is a dosimeter that could be used for long-duration nuclear testing.

Specifications

Range	0.1 to 100 r 0.01 to 10 kr
Power supply	2.5 kv max., unregulated +12, +5, and -6 v, regulated
Readout	3 decades logarithmic on 0 to 1 ma meter
Input impedance	50 ohms
Input signal current	1 amp/decade nominal, 8 amps max.
Accuracy	±20%

Physics International Inc., San Leandro, Calif. [369]

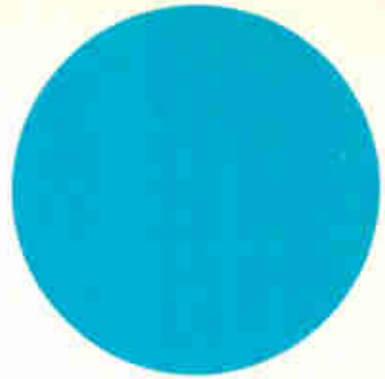

Atlas will put the blue bead anywhere you want it . . .



But the real value is the extra testing we do to save you trouble later. The point is, most manufacturers of custom hermetically-sealed test facilities that Atlas has . . . altitude, temperature, and humidity cycling chambers as well as Helium Mass Spectrometers for leak detection, and metallographic equipment for taking high-magnification photographs of glass-to-metal interfaces or plating thickness cross-sections.

These in-house test facilities allow Atlas to make . . . and test . . . your custom headers to your specs (or MIL specs, if you prefer), so that the rejects are weeded out before you get them. And when we say that a header with terminals spaced at ¼ inch will withstand 900 volts at 70,000 feet without flashover . . . WE CAN PROVE IT!

Call our marketing department today. Or send for more detailed technical information.

ATLAS
CHEMICAL INDUSTRIES, INC.
Aerospace Components Division
Valley Forge, Pa. 19481

NORTHERN SCIENTIFIC



DIGITAL MEMORY
OSCILLOSCOPES
and Pulse Height
Analyzers
Reader service #323

GENERAL TECHNOLOGY





PORTABLE RUBIDIUM
ATOMIC CLOCKS
5 x 10⁻¹²/100 sec avg
37 pounds!
Reader service #324

RUBIDIUM FREQUENCY
STANDARD
1 x 10⁻¹⁰ freq
2 x 10⁻¹¹ stnd dev/yr
Reader service #325

These are specialized TRACOR instruments designed for your specific needs. Interested in technical specs?...circle the reader service number found underneath each instrument:

ALLISON LABORATORIES



EQUALIZERS/SPECTRUM
GENERATORS
Up to 40 1/2-octave
increments
Reader service #326



CONTINUOUSLY-
VARIABLE
PASSIVE FILTERS
1 Hz-672 kHz
Reader service #327

SULZER LABORATORIES AND AUSTIN TIME/FREQUENCY



VLF/OMEGA
NAVIGATIONAL
SYSTEMS
For broad-area
navigation
Reader service #328



PHASE/TIME AND
FREQUENCY DIFFERENCE
METERS
Freq 10⁻¹¹; Time 0.1 x
10⁻⁶ sec; Phase 1 cycle
Reader service #329



FREQUENCY
DISTRIBUTION
UNITS
100 kHz, 1 MHz, 5MHz
Up to 16 outlets
Reader service #330



REFERENCE SIGNAL
GENERATORS
200 Hz-6.25 kHz
Reader service #331



TELEVISION PRECISION
SYNCHRONIZING SYSTEMS
Color and monochrome
Reader service #332



CRYSTAL STANDARDS
5 x 10⁻¹¹/24 hours
5 to 0.1 MHz
Reader service #333



CRYSTAL CLOCKS
2 x 10⁻⁶ secs
per day
Reader service #334



VLF TRACKING
RECEIVER/COMPARATORS
Continuous tuning
3.00 to 99.5 kHz
Reader service #335



CRYSTAL
CHRONOMETERS
Replace mechanical,
1 x 10⁻³ sec
per day
Reader service #336

Industrial Instruments Division



6500 Tracor Lane Austin, Texas 78721 (512) 926-2800

IA-107

New Subassemblies Review

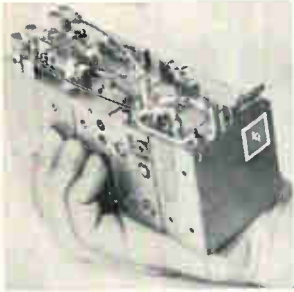

A solid state f-m telemetry transmitter produces 10 w at S band. With a volume of 40 cu in., and a weight of 37 oz, the unit consists of 7 modules, providing maximum flexibility in mounting installation in missiles or space craft. The modulation system provides a flat response from d-c to 1.5 Mhz. Electronic Communications Inc., Box 12248, St. Petersburg, Fla. 33733. [381]



Analog multiplier 384 is for multiplexing telemetry data, video signals, and scope presentation drives. It has a frequency response of d-c to 4 Mhz. Gain is flat to 0.8 db at 1 Mhz and 3 db at 4 Mhz. Phase is less than 1° at 1 Mhz and 30° at 4 Mhz. Input impedance is 10 kilohms resistive-shunted by 50 pf max. Transmagmatics Inc., 134-25 Northern Blvd., Flushing, N.Y. 11354. [382]



Tape degausser 3603A automatically erases magnetic tapes in 32 seconds and requires no cooling off between degaussing cycles. It erases to 90 db below the recorded level. It accepts reels from 3 to 15 in. in diameter with ¼- to 1-in.-wide tapes. It measures 16¾ x 8¾ x 16¾ in. Price is \$900. Hewlett-Packard Co., 1501 Page Mill Rd., Palo Alto, Calif. 94304. [383]



Crystal oscillator model 7003 is available at frequencies up to 100 Mhz. Hermetically sealed in a volume of 1/3 cu in., its output will drive integrated circuitry from d-c input voltages between 5 and 30 v. Frequency stability versus temperature is ±0.005% from -55° to +105° C; shock, 100 g's; vibration, 20 g's. Varo Inc., 402 E. Gutierrez, Santa Barbara, Calif. 93101. [384]



Ceramic filters in the 9- to 50-khz range combine ½% bandwidths and 90-db rejection in an HC-6/U crystal can with an over-all weight of less than ¼ oz. They use cascaded combinations of 4-terminal ceramic elements. The individual element is a split-ring filter with 1% bandwidth at 3 db and 13% at 20 db. Clevite Corp., 232 Forbes Rd., Bedford, Ohio 44146. [385]

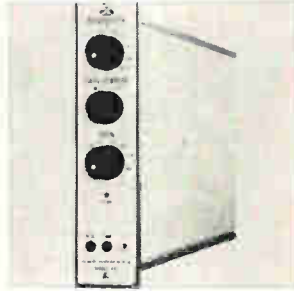

D-c differential amplifier series 889 is for instrumentation systems. The single-output model delivers a wideband signal of ±10 v at 100 ma for galvanometers, and the dual-output unit provides both the 100-ma output and ±10 v at 5 ma selectable bandwidth output for multiplexers, VCO's, and a-c converters. Astrodata Inc., 240 E. Palais Rd., Anaheim, Calif. 92803. [386]



Power supplies series SHU are for digital computers and solid state circuitry. The 40-w units can have up to 6 individual specified outputs. These static converters are rated up to 1,000 v d-c. Outputs are floating and as low as 10 pf to ground. Input is 26-30 v d-c. Price, about \$295, depending on outputs. Arnold Magnetics Corp., 6050 W. Jefferson Blvd., Los Angeles 90016. [387]



Moderate regulation, low ripple, and small size and weight characterize a series of SCR power supplies. All models are fully adjustable from zero to full rated output. Maximum output ratings are from 4 v to 600 v, 1.5 to 2,000 amps, 300 w to over 10,000 w. Prices are from \$360 to \$3,500. Hewlett-Packard Co., 100 Locust Ave., Berkeley Heights, N.J. 07922. [388]

New subassemblies

Wiring machine clips price

Working point to point or by path with clip-on or wrapped termination, it sells for only \$25,000

A numerically controlled unit that lays wire from point to point or by path to either clipped-on or wrapped termination has been developed for such applications as computer back-panel wiring. The semiautomatic machine puts the Product Improvement Corp. of

Santa Ana, Calif., on a new tack. Generally a manufacturer of custom automation equipment, the firm has designed this unit as a standard product.

Alan McMillen, president, says fully automatic wiring gear is limited at present to either wire-wrap-

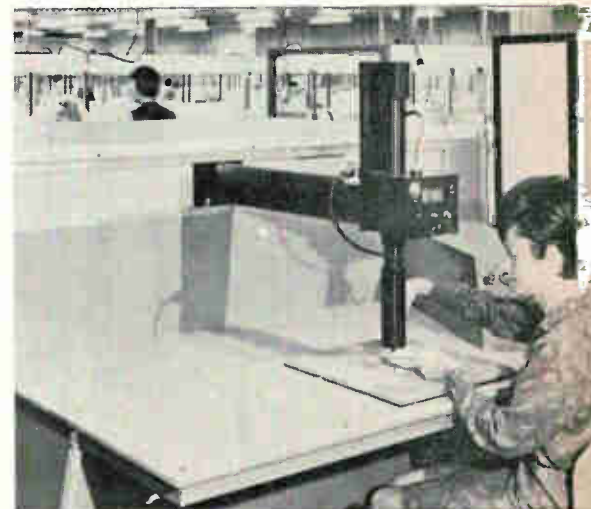

Hand held. Operator guides machine head to proper location.

The Customer said Cool It.

Special capabilities are big business with us. Case in point: the airborne air conditioner illustrated below. It was needed to cool electronic gear for missile guidance housed in a pod.

We plumbed our systems engineering and compact heat exchanger capabilities, and came up with this lightweight, efficient solution, the "AEA-4040." It dissipates 1300 watts and maintains 120°F when operating at ram air temperatures of 200°F.

Results: A more reliable missile system. Case Closed.

When you are faced with any heat transfer or refrigeration problem, let ECS solve it for you. Write or call for full information today.

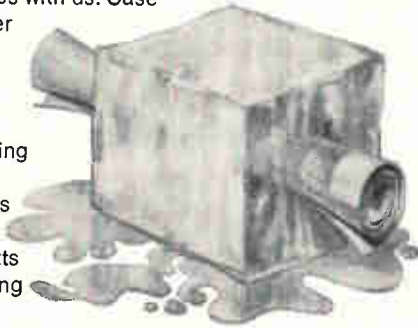

We Did.

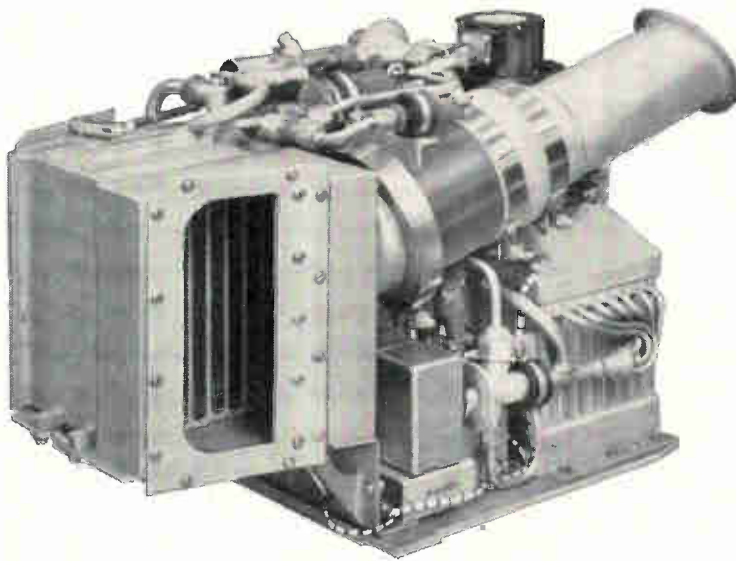

Environmental Control Systems

A DIVISION OF PALL CORPORATION

PALL

43-22 QUEENS STREET, LONG ISLAND CITY, NEW YORK 11101 • (212) 361-7575

... best feature
is price tag ...

ping or terminal clip-on operations. The Gardner-Denver Co. makes fully automatic wire-wrap machinery, and AMP Inc. makes automated clip-on equipment in its Termipoint line, he notes, but Product Improvement's wiring system combines both capabilities. In addition, the machine can work inside a 15-inch-deep chassis, which McMillen says the Gardner-Denver and AMP equipment cannot. Changeover from wrapping to clip-on termination takes only three minutes.

Still, the machine's main selling point is its \$25,000 price tag. The Gardner-Denver wire-wrap unit costs about \$150,000; the AMP equipment must be leased, and this entails an initial outlay of \$25,000 plus a fee.

Tradeoff. Of the sacrifices made to hold the unit's price down, the prime one is speed. McMillen says Gardner-Denver's equipment operates at about three times the new machine's rate of 200 wires per hour.

The only machines in the new system's price range in this field are wire-laying and terminating units built by the Hughes Aircraft Co.'s Industrial Systems division and selling for \$38,000 and \$37,300, respectively. Hughes also plans to market a \$25,500 system made up of the Product Improvement machine coupled to one of its own numerical control units. Product Improvement's system uses a modified Slosyn numerical control console supplied by Superior Electric Co., but the digital readout unit that indicates wire length is produced in-house.

Among other advantages cited for the system are: operation on any grid of more than 0.002-inch center distance, regardless of the incremental distance between pins; feed rates greater than 100 inches a minute; use with solid, stranded, tinsel and printed-wire twisted pairs; use with color-coded wires; a built-in tool float of 0.03 inch in any direction that leads to termination at bent pins; possible wire harness lay-up applications.

Product Improvement Corp., 150 Stevens Ave., Santa Ana, Calif. 92707 [389]

TALK ONE

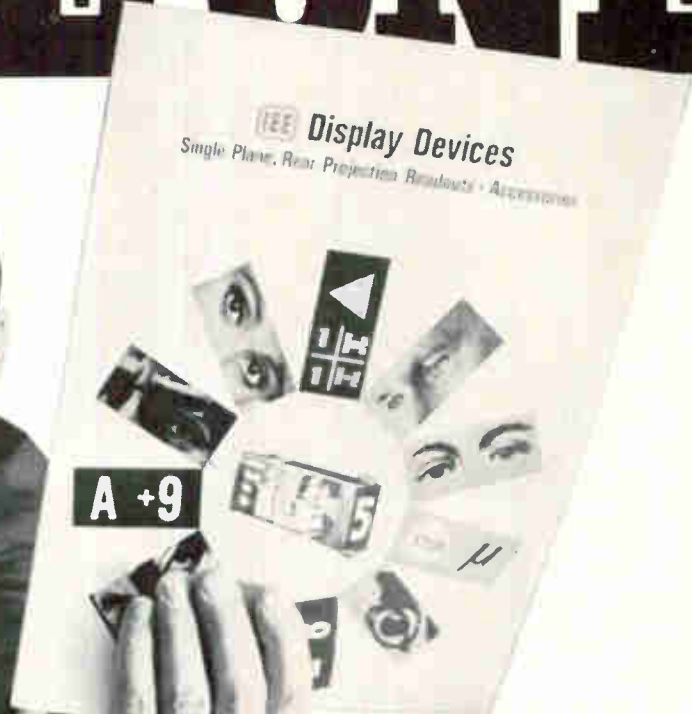
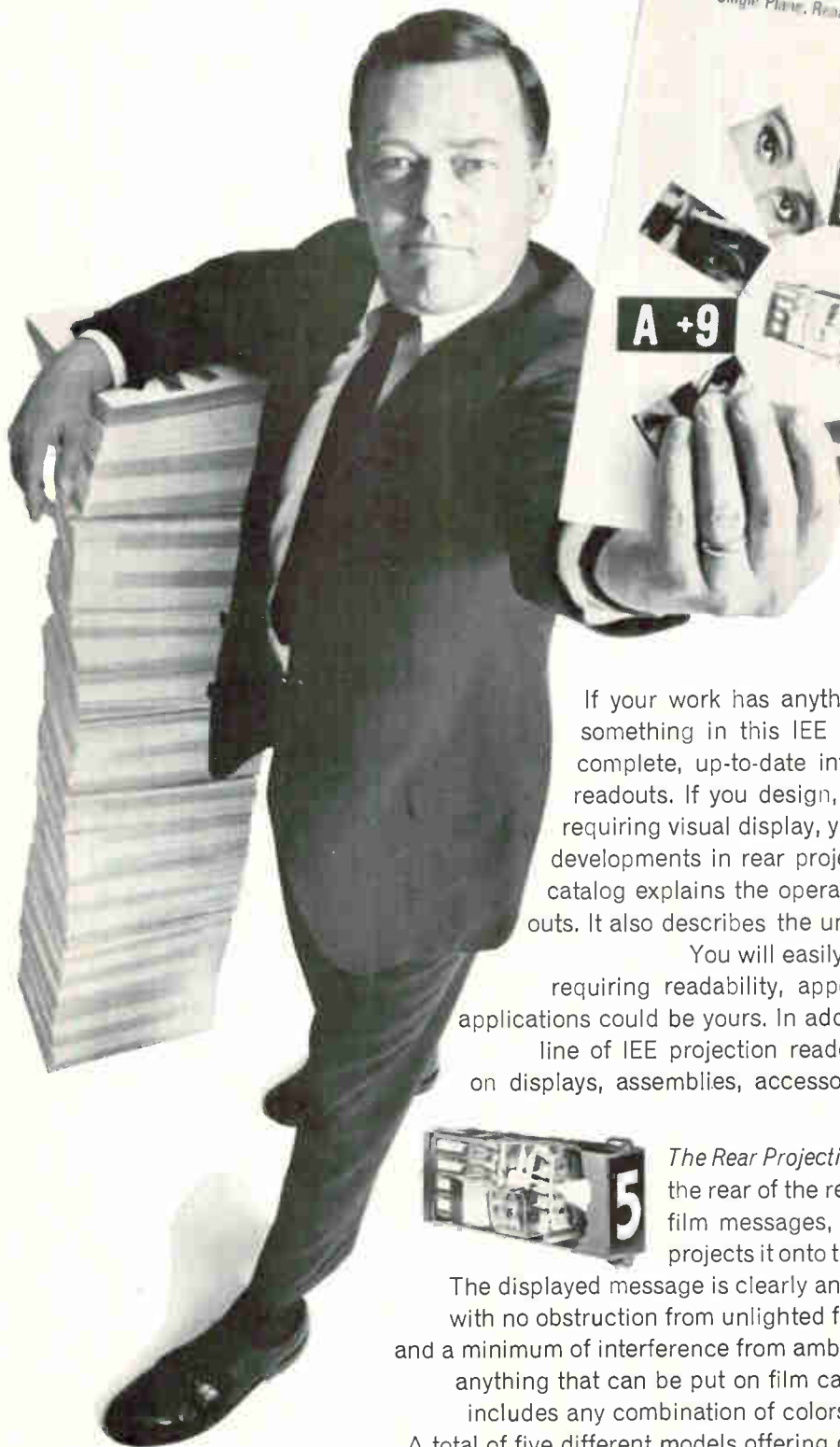

If your work has anything to do with visual readout, there's something in this IEE Catalog for you. It contains the most complete, up-to-date information available on rear projection readouts. If you design, manufacture, market or use products requiring visual display, you should become familiar with current developments in rear projection display. It's in this catalog. The catalog explains the operating principles of rear projection readouts. It also describes the unique results you get with this product.

You will easily see why it is specified for applications requiring readability, appearance and versatility. One of these applications could be yours. In addition to specifications on the complete line of IEE projection readouts, the catalog includes information on displays, assemblies, accessories, lamps and prices. It's complete.

Ask us for a copy now.



The Rear Projection Readout: When one of the 12 lamps at the rear of the readout is lighted, it illuminates one of 12 film messages, focuses it through a lens system, and projects it onto the non-glare viewing screen at the front.

The displayed message is clearly and distinctly projected on a single plane, with no obstruction from unlighted filaments. There is a wide viewing angle and a minimum of interference from ambient light. It is extremely versatile, since anything that can be put on film can be displayed on an IEE readout. That includes any combination of colors, symbols, numbers, letters and words. A total of five different models offering character sizes ranging from $\frac{1}{8}$ " to $3\frac{3}{8}$ ".

"I double-E," the world's largest manufacturer of rear projection readouts. Industrial Electronic Engineers, Inc., 7720 Lemona Ave., Van Nuys, Calif.



Design engineer Bob Alden searched for nearly an hour to find he didn't have the information he needed.

Chances are 10 to 1 he'd have found it in less than 5 minutes in the new Sweet's Industrial Information System*

Sweet's Industrial Information System is a vendor catalog file on microfilm. Because we make no charge to vendors, and microfilm everything they have in print, Sweet's has more than 600,000 pages of vendor data including application notes, reliability tests, price lists and names of distributors and reps. What's more, the Sweet's vendor catalog file on microfilm is updated every 60 days!

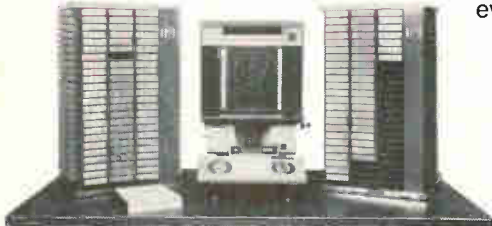

Small wonder.

In addition, the Sweet's system is tailored to your needs by adding the vendors you want – at no extra cost. We start with a basic file of the most wanted information. Update it regularly, and then—to top it off—“personalize” the file by adding the complete vendor information you request. It also reduces storage area by 98%, cuts redundancies in design efforts and increases sources and use of standard items.

You can install a Sweet's vendor catalog file on an annual subscription for less than the cost of a file clerk. Sweet's vendor catalog files are in use in plants with as few as fifty employees. The “user-orientated” idea not only provides current knowledge of the component state-of-the-art, but also expedites the purchasing function. Because of its complete coverage, more than 60% of our recent installations have replaced other microfilmed vendor catalog systems.



A new McGraw-Hill Information Service

* formerly IRI Information Retrieval Incorporated



It takes about 2 hours to demonstrate to your key people. But in much less time than that your design, standards, quality control, drafting, receiving, inspection and purchasing people will realize that a Sweet's Industrial Information System is the next best thing to a raise in pay! We have demonstration teams in most principal cities. To arrange a demonstration today, send the coupon, or call collect: George Stevens, (212) 971-3941.



Find it fast. Make a print-out in 6 seconds.

SWEET'S INDUSTRIAL INFORMATION SYSTEM
330 W. 42nd St., New York, N. Y. 10036
Dept. #B-58

- I'd like to see a demonstration of the Sweet's Industrial Information System. Have your representative call me for an appointment.
- I'm not ready for a demonstration at this time, but please send further information.

Name _____ Title _____

Company _____

Address _____

City _____ State _____ Zip _____

Telephone _____ Ext. _____

Number of employees at this location _____

We have have not had experience with a vendor catalog file on microfilm.

In addition to the Vendor Catalog File on microfilm we're interested in Mil Specs Mil Standards.

New Microwave Review



Diode switch model N412 has type N plug connectors that mate with conventional coaxial-to-waveguide adapters to form full waveguide range switches that cover 12 waveguide sizes. From 1.12 to 15.0 Ghz, the N412 features 45-db isolation, 2-db insertion loss, and 2 w c-w and 100 w peak power. Somerset Radiation Laboratory Inc., 2060 N. 14th St., Arlington, Va. 22216. [401]



Two-pole, two-throw fail-safe coaxial switches series SAN-522 cover d-c to 4 Ghz. Over the full range, insertion loss is less than 0.2 db and vswr is less than 1.3. Isolation is greater than 40 db from d-c to 2 Ghz, and greater than 20 db to 4 Ghz. Power capability is 50 w c-w and 3 kw peak. Weight is 9 oz. Sage Laboratories Inc., 3 Huron Drive, Natick, Mass. 01760. [402]

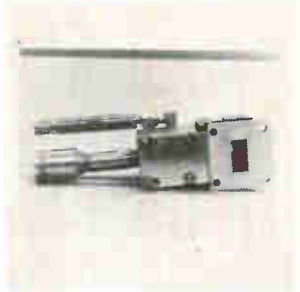

Frequency translator MS-111 accepts inputs from 2 to 6 Ghz and has outputs in the 8- to 12-Ghz range. No tuning is required. The unit also features inherent suppression of the 14 Ghz l-o frequency. Input vswr is 2.5:1 max., referenced to 50 ohms. The unit measures 5 x 1.75 x 1.50 in. with connectors. Raven Electronics, 101 W. Alameda Ave., Burbank, Calif. 91502. [403]



Crystal-controlled local oscillator LO-104, in a 24-cu. in. flatpack 0.9 in. high, is designed for full MIL X-band doppler missile use. Features include transistor circuitry to 1 Ghz with printed r-f and d-c circuits. Power output is 10 mw minimum, with all spurious output down 75 db over 0-20 Ghz. Applied Technology Inc., 3410 Hillview Ave., Palo Alto, Calif. 94304. [404]

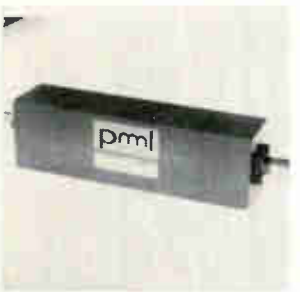

Telemetry filter F512A passes the 2.2-2.3 Ghz band with less than 0.35-db insertion loss, suiting it for use as a preselector with low-noise front ends. The 60-db/3-db form factor is less than 4.5 and the 60-db stop band extends through 10 Ghz. Vswr is less than 1.3. Units are 5.45 x 1.60 x 1.25 in. Peninsula Microwave Laboratories, 855 Maude Ave., Mountain View, Calif. 94040. [405]



Model 5705 Omegaline is a 5-kw r-f coaxial load resistor that uses water as both coolant and dielectric. Specs include 50-ohm impedance; a frequency range of 60 hz to 2.2 Ghz; vswr of 1.10 to 1 Ghz, 1.15 to 1.5 Ghz, and 1.20 to 2 Ghz. The unit measures 10 1/4 x 3 1/2 in., weighs 4 1/2 lbs. Price, \$355. Altronic Research Corp., 13710 Aspinwall Ave., Cleveland, Ohio 44110. [406]

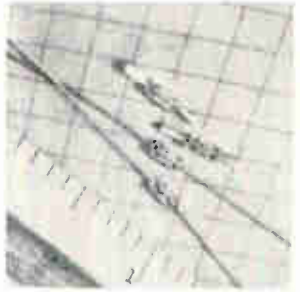

S-band, subminiature, glass micro-wave diode type MO-2301C has a 6.0-db noise figure. It is suited for strip transmission line applications, since the hermetically sealed case has flat ribbon leads. Test frequency is 3,060 Mhz; max. vswr, 1.6; i-f impedance, 350-450 ohms; and burnout rating, 5.0 ergs. Alpha Industries Inc., 381 Elliot St., Newton Upper Falls, Mass. 02164. [407]



Terminated circulator MA-7K275 is for operation in the frequency range between 7.5 Ghz and 10 Ghz. The X-band isolators handle power levels up to 10 w, with operation guaranteed from -40° to +75°C. Featuring 20-db isolation, 0.3-db insertion loss, the units are 1 1/4 x 19/32 x 27/32 in. Microwave Associates Inc., 999 E. Arques Ave., Sunnyvale, Calif. 94086. [408]

New microwave

Signal paths that never cross

Duplexer system for satellite tracker gives 125-db isolation between high-power transmit and low-level receive signals

An experimental ground station being built in Bouchette, Quebec, may be the key terminal in the proposed Canadian satellite system which will bring television programs to the Far North.

It is also the first commercial application of a novel mode-coupler

duplexer system that allows a tracking antenna to transmit at continuous power levels up to 10 kilowatts and simultaneously receive low-power signals. The duplexer also provides error signal data for precise operation of the antenna system when it is used in an auto-

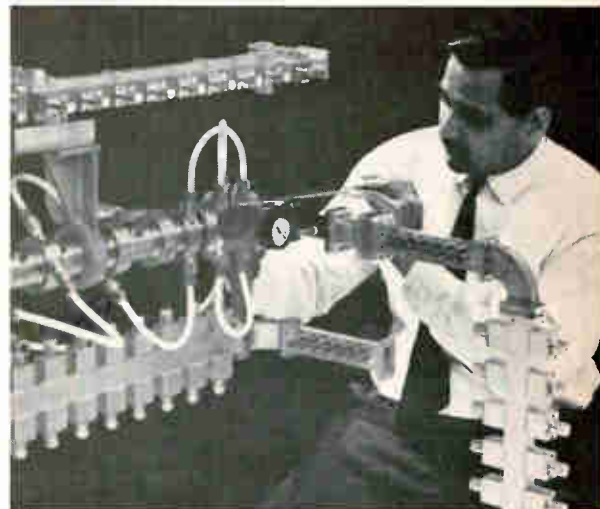

Plumber's dream. Waveguide filters provide 125 db isolation between transmitter and receiver.

Unbelievable! Unavailable!

Until now.

Next time someone walks up to you and asks, "Does Redcor/Modules' new 770-440 give you instrumentation amplifier performance at module amplifier prices?" look him right in the eye and say yes. You might also mention that its unique patented dynamic bridge design principle means great closed-loop specs like differential input impedance of 10 megohms; common mode input impedance of 1000 megohms, from dc to 60 cps;

differential gains of 20 to 1000; and a gain accuracy of $\pm 0.02\%$ FSR 20V. Then tell him all this performance costs less than one-fifth a kilobuck per each. There. You did a fine job. Now request complete data so you can really sock it to the next guy that asks.

REDCOR 7800 DEERING AVENUE
CANOGA PARK,
CALIFORNIA 91304
(213) 348-5892 • TWX 910-494-1228

Circle 206 on reader service card

Profit Center of the Southwest

Operating divisions of corporations located in Phoenix seem to rapidly get going and going and going — profitwise, particularly when compared to other areas. Some reasons for this profitable growth are indicated in the revised edition of "The Phoenix Story." Send for your copy.

For complete, confidential information, write Stanton Allen, Manager, Economic Development Department, Room E-3, Chamber of Commerce, Phoenix, Arizona 85004

PHOENIX
ARIZONA

164 Circle 164 on reader service card

SOLID STATE STANDARD SIGNAL GENERATOR Model SG-83B

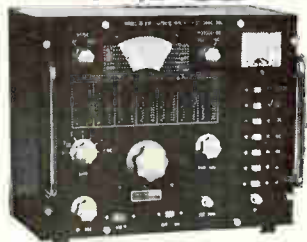

MADE IN U.S.A.

\$29500

- ✓ 50 Kc. to 54 Mc.; 1% accuracy; plus 1 Mc. crystal
- ✓ Calibrated output 0.6 to 160,000 microvolts
- ✓ Operates from 115 volts or internal battery
- ✓ Modulation 0-50%, read on meter. No FM!
- ✓ Send for complimentary copy of Instruction Book with Schematic and all details.

Immediate Delivery f.o.b. St. Louis



CLEMENS MANUFACTURING CO.
630 South Berry Road
St. Louis, Missouri 63122
Area Code (314) WD 1-7228

Circle 207 on reader service card

... high isolation
with low loss ...

tracking mode.

Developed by Northern Electric Co. for the Canadian Defence Research Board's Telecommunications Establishment, the system operates at 7.25 to 7.75 gigahertz in the receive band and 7.90 to 8.40 Ghz in the transmit band.

Unusual filter techniques were incorporated in the duplexer to achieve a 125-decibel isolation between the low-level receive signals and the high-power transmit signals. "Since the frequency separation of these two bands is about 150 megahertz," says designer Arvind Bastikar, "it's difficult to achieve proper isolation and still keep the losses of the system at a minimum." A reflection-type band reject filter was designed to solve the problem.

Smooth and resonant. The filter employs various pairs of resonant cavities; 11 pairs are used in the autotrack and receive filters, and nine pairs are inserted in the transmitter filter. The filter cavities are mechanically attached to the side walls of the oversized waveguide.

The full height of the waveguide is used to achieve proper coupling between the cavities and the waveguide channel, and provides a surface along the guide free of any sharp edges. This eliminates any chance of concentration of high-intensity electric field regions due to sharp protrusions, making the filter usable in high power applications. The high Q cavities, which are tuned to the rejection frequency, generate only very small internal potentials in the pass band, resulting in the extremely low losses.

Cavity pairs are stagger-tuned to obtain maximum bandwidth of rejection with a minimum number of resonators. Phase measurements on the filters revealed very small delay distortions, less than 0.25 nanosecond over any 20 Mhz band. A waffle iron harmonic rejection filter—essentially a corrugated variable impedance waveguide filter—is used in the transmit line of the system to achieve a filter response dependent on frequency rather than guide wavelength in the transverse electric and magnetic mode.

Electronics | November 27, 1967

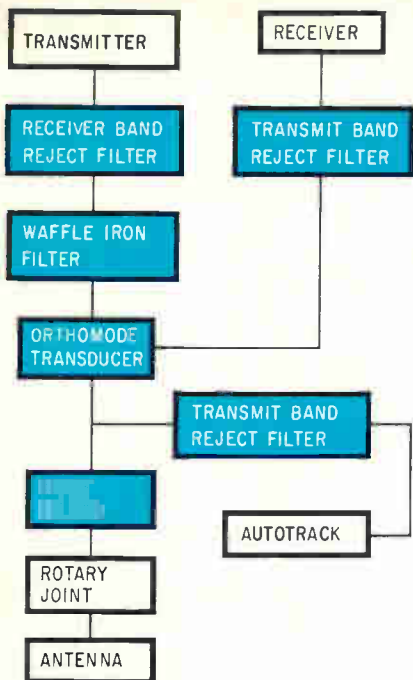

All for one. One antenna feed line serves both transmitter and receiver.

The waffle iron filter also meets the very low insertion loss specifications and wide stop-band characteristics.

Free to move. Since a satellite tracking antenna must move in elevation and azimuth, a rotary joint and circular waveguide window arrangement was developed to provide for multimode high power and broadband characteristics while preserving the integrity of the terminal's pressurized nitrogen system. The waveguide window was made nonresonant in the oversized circular waveguide by using a transverse sheet of Teflon dielectric material.

Signals then pass through a coupler that allows angle errors to be extracted for autotracking information. This also feeds directly into an orthomode transducer which combines transmit and receive signals in a common port. Completing the arrangement are various band-pass and harmonic-rejection filters in the transmit and receive signal paths.

For better signal-propagation properties, the entire duplexer system is plated in silver and flashed with gold. The waveguide is cooled with a mixture of glycol and water through an external finned jacket.

Northern Electric Co., Ottawa, Canada
[409]

Hi-voltage, hi-fly leads solve tough design problem

Customer needed a quick connect/disconnect feature on a 20 KVDC connector which would feed two CRT tubes from a single terminal 20 feet away. We designed a compact assembly using glass epoxy receptacles and silicone insulated leads that features hand mating with complete safety, yet is rated at 25 KVDC at 70,000 feet! Here are some added features:

- Lightweight, flexible assembly
- Meets applicable MIL specifications
- RFI shielding available
- Rated at 10 amps
- No exposed high-voltage
- Corona and radiation resistant

Let us design an assembly that meets or exceeds your requirements. We're the leading maker of high-voltage, high-altitude custom lead assemblies. For immediate action, write or call today.

AMP INCORPORATED

CAPITRON DIVISION

155 Park Street • Elizabethtown, Pa. • 717-367-1105

Some people think FANUC is high-hatted. Because we refuse to *make* inexpensive n/c systems.



We tailor them.

We designed the FANUC 200 series to meet *specific* demands and fit into existing lay-outs. They are compact, economical models for simplified installation, programming, operation and maintenance. Our choice combination of 7 stepper motors (4 EHPMs and 3 EPMs) assures highest performance and accurate open-loop

control. Here's what we can do for you—reduce new-design lead-time, convert conventional processes, lower machining costs and increase "make" capabilities. We think a lot about our clients and their need for a wide range of accessories. We think it's worth while to *tailor* n/c.

Find your FANUC.

Automatic cutter offset?	Yes	No	FANUC 220:	Contouring; 3 axes (2-axis simultaneous control); for grinders, millers; workpieces—cam gauges, forging dies, metal moulds, etc.
Circular interpolation?	Yes	No	FANUC 240:	Contouring; 2-axis simultaneous control; for lathes, automatic drafters; workpieces—tapered shafts, etc.
	3-axis simultaneous control?	Yes	FANUC 230:	Contouring; for millers; workpieces—press and metal moulds.
		No	FANUC 260:	Positioning & straight cut; for millers, drillers, borers, lathes.
	2-axis simultaneous control?	Yes	FANUC 270:	Profiling; 2-axis copying function; for lathes; workpieces—tapered shafts, etc.
		No	FANUC 280:	Contouring; for lathes, grinders, automatic drafters; workpieces—cam shafts, etc.
	45° linear interpolation?	Yes		

Need non-n/c?—We have it: A new tracing system—► **FANUC 320:** 180°, 360°, 3-dimension tracing; unique tracer head with EHPMs or EPMs plus differential transformers, simple, fast and low-cost conversion into n/c.

*4 model series of EHPM (up to 6HP) and 3 model series of EPM (up to 0.46) are available for each FANUC model.

 **FUJITSU LIMITED**
Communications and Electronics
Marunouchi, Tokyo, Japan

Circle 166 on reader service card

Mail this coupon for information brochures

Please send me information brochures about FANUC models checked below.

*FANUC220 _____ *FANUC240 _____ *FANUC230 _____ *FANUC260 _____
 *FANUC270 _____ *FANUC280 _____ *FANUC320 _____

NAME: _____ TITLE: _____
 COMPANY: _____
 ADDRESS: _____

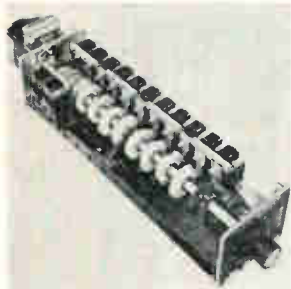

Program cam timers constructed of injection molded modules feature low cost and compact size. Two types are offered with up to 20 individual load circuits. Series AM is a continuous recycling type, series BR a single-rotation unit. Time cycles range from 2/3 sec to 72 hours. Prices range from \$23 to \$132. Industrial Timer Corp., U.S. Highway 287, Parsippany, N.J. 07054. [421]



Size 15 permanent-magnet stepper motor MSA-15-AS-2 is 1.535 in. long, weighs 7.2 oz, and has an inertia of 2.4 gm-cm². Index angle is 45° ±2° and rated voltage is 28 v d-c. Resistance is 120 ohms/phase, no load response rate is 300 pps, and no load slew rate is 450 pps. Clifton, Division of Litton Industries, Marple at B'way, Clifton Heights, Pa. 19018. [422]



Driver module model AD-1 provides high performance for 4-phase stepping motors. Utilizing high-current output transistors and conservatively rated dissipative elements, it minimizes the electrical time constant which normally limits the torque, maximum speed, and error-free starting speeds of most stepping motors. Icon Corp., 156 Sixth St., Cambridge, Mass. 02142. [423]



Digital pressure gauge 621A/B is for gas and liquid applications requiring remote location of the transducer up to 1,000 ft. from the servo-driven readout device. Accuracy is ±0.15%. Zero and span are temperature compensated to better than 1% per 1,000°F. Models span 0-0.2 to 0-1,000 psi. Price is \$1,225. Robinson-Halpern Co., West Conshohocken, Pa. 19428. [424]



Digital process controller series 101 provides precise rate or ratio control of speed and flow. It features closed loop digital feedback, solid state circuits, high speed electronic display up to 5 digits in operating units, thumbwheel command switches, adjustable gain and sensitivity, and control to 0.1%. Emerson Electric Co., 8100 Florissant Ave., St. Louis, Mo. 63136. [425]



A recycling timer programmer features a d-c timing motor for operation on 6, 12, or 24 v. The d-c drive can be supplied in 2 standard models that can control 10 or 19 electrically independent circuits. These models are equipped with a 60-position programming drum, offering up to 30 on/off sequences. Sealectro Corp., 225 Hoyt St., Mamaroneck, N.Y. 10543. [426]



Continuous duty, 28 v d-c motor, model M270020, measures 7/8 x 1.7 in. and weighs under 3 oz. It operates at a rated speed of 40,000 rpm and develops 0.5 oz-in. of torque. It can operate under sinusoidal vibrations of 5 to 2,000 hz at 26 g's peak, shock of 100 g's for 11 msec and 1,000 g's for 0.4 msec on each axis. Kinetics Corp., 410 S. Cedros Ave., Solana Beach, Calif. 92075. [427]



Digi-Master series 1836 electronic predetermining counter is for liquid batching use. It has a control that automatically slows delivery rate in anticipation of preset gallonage. Slow-down point may be set at 10 to 90 gallons in 10-gallon increments. The set stop model has 4-figure capacity; preset is accomplished by 4 push buttons. Veeder-Root, Danvers, Mass. 01923. [428]

New industrial electronics

Do-it-yourself kit for analog control

Low-cost family of modules allows inventive engineer to experiment with process, manufacturing methods

Long before digital computers became a factor in process and manufacturing plants, engineers were designing and buying special-purpose analog control systems.

They still are, partly because in-plant installations often pay for themselves quickly, in one day to

six months. Some companies order quantities of specially-designed analog systems, at about \$5,000-\$10,000 each, for installation on the production and inspection equipment they sell.

Sales of analog computer equipment for special-purpose instru-

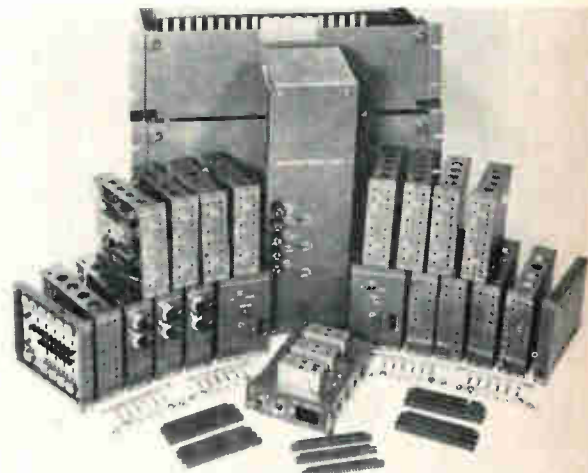

Build your own. PC-12 analog kit contains enough modules and support equipment to construct usable in-plant control systems.

Whatever your specialty, chances are TI has the opening.

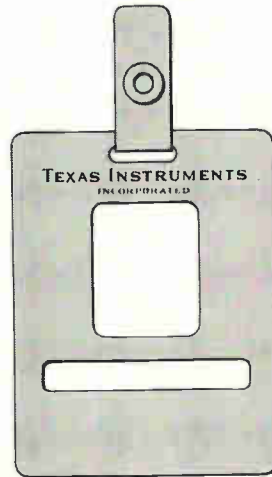

Now all we need
is your name.

We'll shoot the photo later. So just send us your name on the coupon.

Add anything you want about yourself.

Things like what your degree is. What you've been doing for the past two to five years. What you'd like to be doing for the next five or ten.

The adjoining column lists some of our current openings.

We can assure you of this.

Whatever your specialty, chances are we have an important job. Important to the company. Important to you as an individual. And when you look at our growth record, plus what we have planned for the future, you'll see why.

Since World War II, TI has grown 200-fold to a \$580-million annual billings level. Our present growth

goal is to reach \$3-billion in annual sales in the next decade.

Even though TI is a big, diversified company, with plans to get bigger, you won't get lost here.

One of the things that management is accomplishing is that you retain your individuality and can relate your own personal goals to those of the company.

How we achieve this retention of individuality is told in a comprehensive brochure. It's yours by return mail for the asking.

It gives you a look at what we do. It shows why we can offer you meaningful growth opportunities in a wide range of disciplines.

Don't be surprised to find that we have an opening with your name on it.

Tom Dudley
P. O. Box 5474
Dallas, Texas 75222

Please send me the story of TI.

Name _____

Address _____

City _____

State _____ Zip _____

My degree is: _____

My area of interest is: _____



An Equal
Opportunity Employer

TEXAS INSTRUMENTS
INCORPORATED

TI openings

SYSTEMS ENGINEER

Specifications and customer liaison for cryogenic cooler test equipment. BSME, EE, or Physics.

QA ENGINEER

Develop and implement QA disciplines. BS plus experience in quality engineering or design.

CHEMICAL ENGINEER

Control quality and process of chemical handling facility. BS plus related experience.

COMPUTER ANALYST

Experience in systems analysis, programming, diagnostic programming of monitors and arithmetic routines.

MECHANICAL ENGINEER

Design hydraulic test equipment. BSME plus experience in aircraft hydraulic design.

DESIGN ENGINEER

Engineer design and packaging for power sources. BSEE plus 3-5 years' design on low frequency power supplies.

MANAGEMENT SYSTEMS MANAGER

Direct implementation of advanced management information system. Broad operating and supervisory experience.

ELECTRICAL ENGINEER

Design circuits for space instrumentation. MS plus 1-5 years' experience.

TEST ENGINEER

Build radar systems. Experience in pulse compression and phased array.

PATENT ATTORNEY

LLB plus BSEE, Physics or Chemical Engineering. 3-5 years' electronic experience.

MARKETING ENGINEER

Manage marketing for product line. BSEE or equivalent technical marketing experience.

COMPUTING SYSTEM ANALYST

Design and execute programs for IBM 7074, 1401, 1440, 1460 and 360. BS plus 2-4 years' experience.

ELECTRICAL ENGINEER

Design and develop proximity fuze circuits and special test equipment. BS or MSEE plus 5 years' experience.

TECHNICAL WRITER

Write and edit technical manuals and reports. Coordinate print production. BSEE or Physics, plus 3-5 years' experience.

LOGISTICS ENGINEER

Prepare data relative to TI equipments. BA plus 3 years' logistics or related experience.

R&E ADMINISTRATOR

Help administer cost control, reporting, plans, and implementation of projects. Business and technical background.

WRITE FOR COMPLETE LIST OF CURRENT OPENINGS

An Equal Opportunity Employer



TEXAS INSTRUMENTS
INCORPORATED

... sometimes the control idea gets lost because the engineer won't recommend spending ...

mentation, control, and calculation run about \$100 million a year. Process-control systems, the largest segment of this market, account for about \$25 million. And in spite of competition from digital computers, John H. Licht, marketing manager of the Electronic Associates Inc.'s Advanced Development department, expects analog sales to rise.

To encourage greater use of analog computation systems, EAI is offering the PC-12 Experimenter's Kit at \$4,875. Priced individually, the modules in the kit would sell at about \$8,000. They are the same

as those used in PC-12 special purpose analog control systems that EAI supplies, all wired and packaged, to customers in process, manufacturing, and aerospace industries.

Licht's aim is to crack the latent market for analog control systems resulting from the fact that engineers have more control ideas than they can put into practice. Sometimes ideas get lost because the engineer won't recommend spending money for a complete system without a field trial first. Or perhaps he's not quite sure how the system should be designed, and

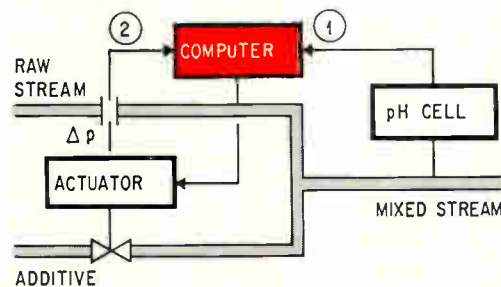
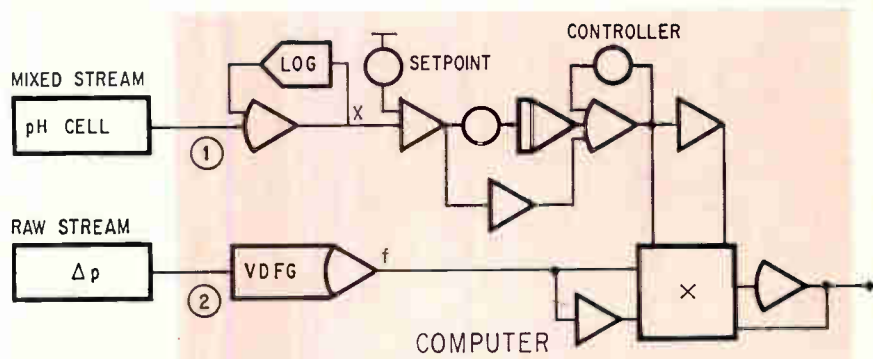

pH control system. Including linearizing of two sensors and appropriate controller, system uses 8 op amps, 1 integrator, 3 potentiometers, 1 function generator, 1 logarithmic module, and 1 quarter-square multiplier.

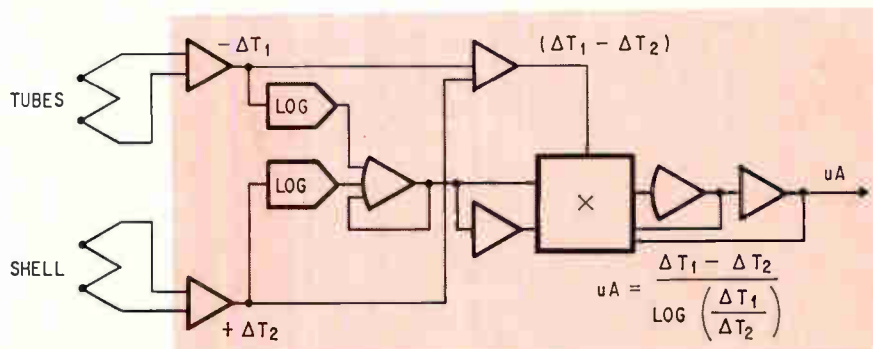

Inferential measurement. Coefficient to determine heat exchanger fouling is calculated using 7 op amps, 2 logarithmic elements, and 1 quarter-square multiplier.

... enough modules offered
for variety of equipment ...

doesn't have equipment to build a prototype.

Real system. With analog modules on the shelf, there is minimum delay in building a real system—not a paper design—which he can try in the plant in an attempt to convince himself first, and then plant operators and managers.

The Dow Chemical Co. and the Phillips Petroleum Co., whose engineers have extensive experience with analog computer control, have each bought a kit, principally because of the low price and the benefit of having a matched set of modules on the shelf. Thus, when an engineer spots a problem in the process, he can develop a suitable system control without delay.

According to EAI systems engineer Michael D. Harter, the variety of modules is large enough to build equipment for such applications as nonlinear control, inferential calculations, matrix calculations, feedback and feedforward control, and noninteractive multi-variable control.

Typically, with one kit, users can construct an analog system to control stream pH or to calculate a coefficient to measure fouling of a heat exchanger—and still have modules left over. "In fact," says Harter, "the kit can be used to build a calculator to determine optimum quantities and composition of two ingredients in a blend. And with one more amplifier, it is large enough to construct a 3 x 3 'recipe' blender."

Kit complement

In addition to such support equipment as a power supply, reference regulator, module connectors, bridge connectors, mounting units, and a manual, the PC-12 Experimenter's Kit contains:

- 6 potentiometers
- 12 operational amplifiers (uncommitted)
- 6 integrator networks (uncommitted)
- 4 wide-band amplifiers (uncommitted)
- 2 low-drift integrators
- 1 variable diode function generator
- 1 quarter-square multiplier
- 2 dual $\frac{1}{2}$ logs

In terms of mathematical functions, the kit provides:

- 6 variable coefficients
- 18 operational amplifiers
- 8 integrators
- 1 multiplication, division, square, or square root
- 1 exponential or logarithm
- 1 arbitrary function

Electronic Associates, Inc., West Long Branch, N.J. 07764. [429]

CL905 • CL905N • CL905L • CL905H • CL905HN • CL905HL • CL907 • CL907N • CL907L • CL907H • CL907HN • CL907HL • CL904 • CL904N • CL904L • CL904H • CL904HL • CL903 • CL903A • CL903N • CL903AN • CL903L • CL904 • CL904N • CL904L • CL904H • CL904HL • CL902 • CL902N • CL902L • CL902H • CL902HL • CL901 • CL901N • CL901L • CL901H • CL901HL

WIDEST RANGE OF MINIATURE (TO-18) PHOTOCELLS

Clairex now offers the broadest selection of miniature CdS and CdSe Photoconductive Cells available anywhere. 23 types of CL 900 series offer:

- Resistance values from 2K to 1.4 megohms at 2 ftc
- Voltage ratings from 100 to 250 volts
- All cells hermetically sealed in low-profile TO-18 transistor case. If you need a miniature, high-reliability photocell, send for new Photocell Design Manual.

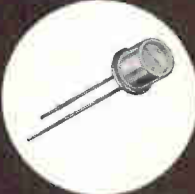

CLAIREX

"The LIGHT Touch in Automation and Control"
1239 Broadway, New York, N.Y. 10001
212 MU 4-0940

CL-108

Circle 208 on reader service card

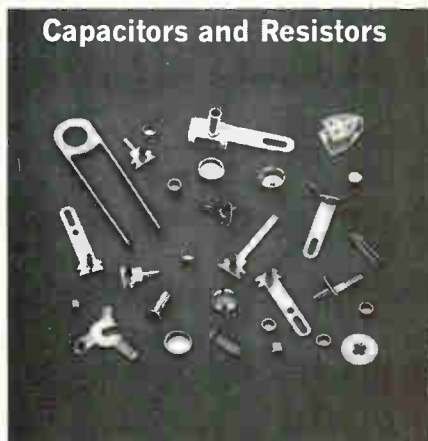

Capacitors and Resistors

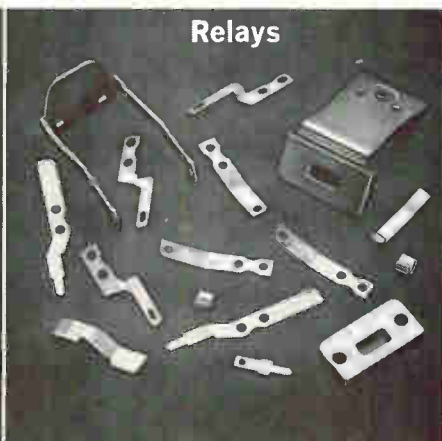

Relays



Connectors

Our parts go into everything electronic

Producers of *all types* of electronic components have their reasons for relying on Volkert Stampings. It comes out in the extra things Volkert does. Like converting a multi-piece design to a single stamping. Or consistently using high-speed equipment to reduce per-part costs.

Write or call Volkert Stampings, Inc., 222-35 96th Avenue, Queens Village, L.I., New York 11429. Telephone 212-464-8400.

Volkert

STAMPINGS, INC.

Subsidiary of The Stanley Works



It's never too early to start saving their hearts

Help your children form good health habits now to reduce risk of heart attack later:

- Encourage normal weight; obesity in youth may persist throughout life;
- Build body health through regular physical activity;
- Serve them foods low in saturated fats;
- Teach them that cigarette smoking is hazardous to health;
- Make medical check-ups a family routine.

Set a good example. Follow the rules yourself and guard *your* heart, too.

GIVE...
so more will live
HEART FUND

Contributed by the Publisher

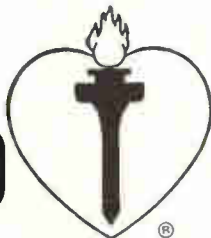

NEW, high visibility alphanumeric readout

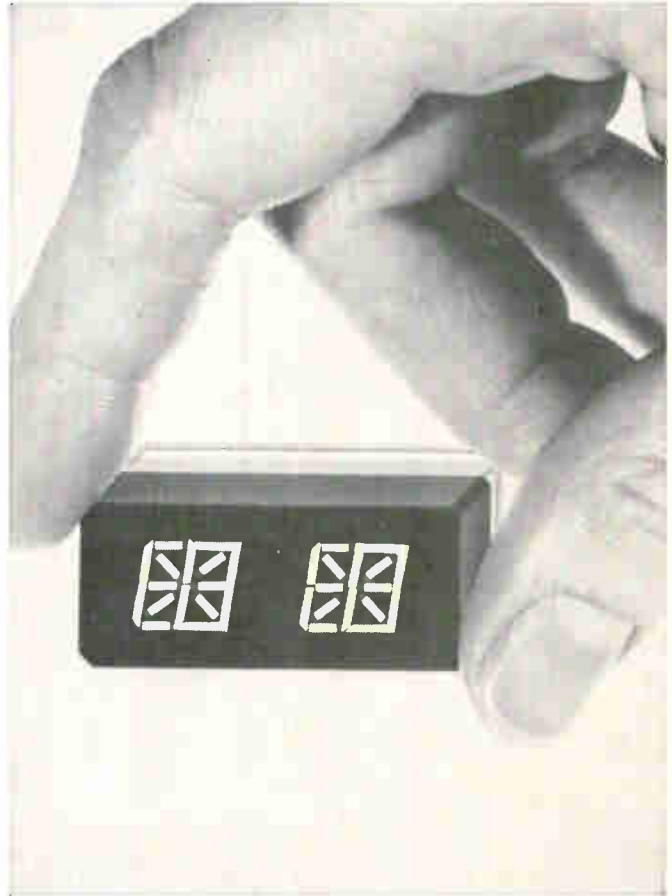

The 16-segment bar configuration of this new Tung-Sol readout, provides a potential of 65000 letter/symbol displays. This unit offers the same high visibility, clarity and sharp angle viewing that characterizes the Tung-Sol digital readout.



In addition to full alphanumeric display, fixed letter/symbol messages may be displayed in selected digit areas.

This new readout is compatible with the standard Tung-Sol digital unit. Use of the same lamp banks, voltages and mounting techniques, permits intermixing the readout blocks.

Write for detailed technical information. Tung-Sol Division, Wagner Electric Corporation, One Summer Ave., Newark, N.J. 07104.

TUNG-SOL

ALPHANUMERIC READOUT

© REG. T.M., WAGNER ELECTRIC CORPORATION

Send us a new LM 100 application send you an LM 100 to try it out on.

Here's the LM 100:

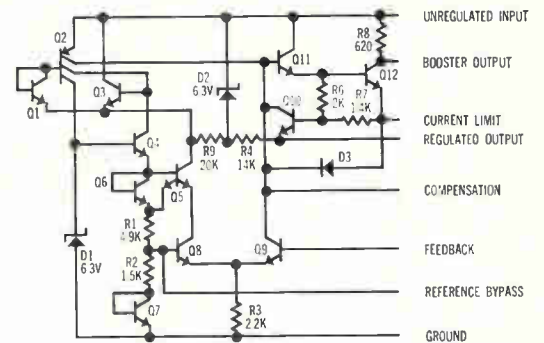

- Output Voltage: Adjustable from 2V to 30V
- Load and Line Regulation: 1%
- Operating Junction Temperature Range: -55°C to $+150^{\circ}\text{C}$
- Power Dissipation: 500mW
- Temperature Stability: 1%
- Output Currents: $>5\text{A}$ with External Transistors

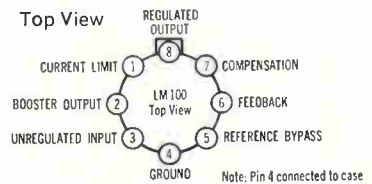

and we'll

And here are a few applications to start you thinking.

2A Regulator with Foldback Current Limiting

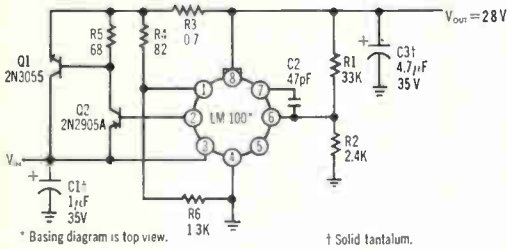

4A Switching Regulator

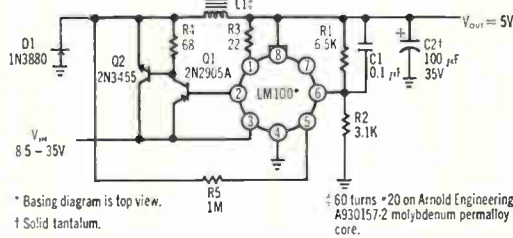

Basic Regulator Circuit

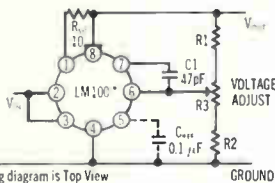

200mA Regulator

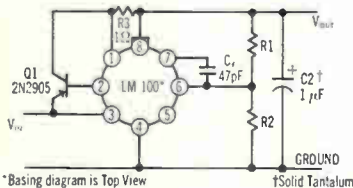

Your application goes here

Mail your drawings to Regis McKenna. (Isn't that a good name to mail things to?) He'll send you the 100, then review your drawing with Bob Widlar, the guy who invented the 100. They'll arbitrarily decide on the best one. (All entries must arrive by January 1.) We'll send a nice little portable color TV (brand undecided, but a good value) to the winner. A modest prize we agree, but then it's a modest contest.*

If you need more information before you can think up an application, write us at National Semiconductor, 2975 San Ysidro Way, Santa Clara, California 95051, and request our bulletin SC100.

*Contest void where prohibited by law.

National Semiconductor

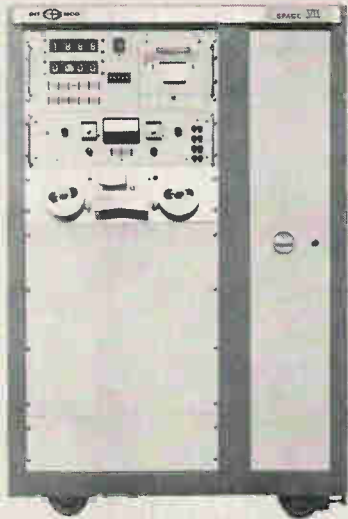

**IT TAKES A LOT
OF ADJECTIVES
TO DESCRIBE THE
SPACE VII...**

Adjectives like FAST, ACCURATE, FLEXIBLE, RELIABLE, VERSATILE, ECONOMICAL and MANEUVERABLE. If you doubt for one minute that a humble wiring system analyzer from the middle west can live up to these labels, then try testing this tester for yourself. It was designed and developed (after thorough lab and field testing) especially to meet today's demand for speed, accuracy, versatility and economy. DIT-MCO's Space VII operates on the fully automatic tape input and printout concept. Design and construction are of the highest quality. The "total

speed" function of the Space VII gives you faster overall test time because of adaptation and hookup ease, rapid tape feed, speed of test plus speed of fault determination time, scan time, error recording and printout. With this advanced system you can test up to 2,000 terminations at a rate of more than 400 per minute! Electronic engineers who've tried it, call DIT-MCO's Space VII the best intermediate size testing system on the market. We won't disagree.



DIT-MCO INTERNATIONAL
A DIVISION OF XEBEC CORPORATION
5612 BRIGHTON TERRACE
KANSAS CITY, MISSOURI 64130
TELEPHONE (816) 363-6288 TELEX 42-6149

IT'S NO WONDER APPROXIMATELY 90% OF ALL MAJOR MANUFACTURERS IN THE COMPUTER AND AEROSPACE INDUSTRIES ARE SATISFIED USERS OF DIT-MCO SYSTEMS.

Circle 209 on reader service card

New from Helipot

First \$1¹⁰ cermet trimmer sealed for board washing

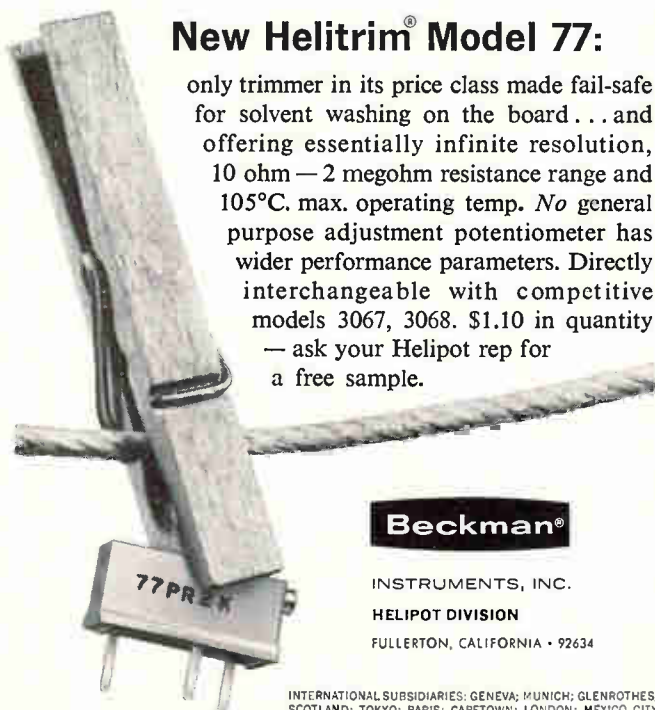

New Helitrim[®] Model 77:

only trimmer in its price class made fail-safe for solvent washing on the board... and offering essentially infinite resolution, 10 ohm — 2 megohm resistance range and 105°C. max. operating temp. No general purpose adjustment potentiometer has wider performance parameters. Directly interchangeable with competitive models 3067, 3068. \$1.10 in quantity — ask your Helipot rep for a free sample.

Beckman[®]

INSTRUMENTS, INC.
HELIPOT DIVISION
FULLERTON, CALIFORNIA • 92634

INTERNATIONAL SUBSIDIARIES: GENEVA; MUNICH; GLENROTHES, SCOTLAND; TOKYO; PARIS; CAPETOWN; LONDON; MEXICO CITY

174 Circle 174 on reader service card



New Plug-in Stepping Switch

Here's a printed-circuit stepping switch that can solve many of your remote control problems. You can use it for sequential circuit switching, pulse counting, and programming. It plugs into a standard printed circuit board connector so you can conveniently and easily mount the switch and make your electrical connections at the same time.

You can choose AC or DC operation, with or without homing. The step rate is up to 15 steps per second; switches are available with 3, 4, 5, 6, 10, or 12 positions. Life is over 6,000,000 steps at rated load. Send for technical data now.

AWHAYDON
THE COMPANY

232 North Elm Street
Waterbury, Conn. 06720
4060 Ince Boulevard
Culver City, Calif. 90231

REPRESENTATIVES THROUGHOUT THE U.S. (SEE EEM). IN EUROPE CONTACT POLYMOTOR, BRUSSELS.

Circle 210 on reader service card

New Books

On the fringe

High-frequency Communications
J.A. Betts
American Elsevier Publishing Co. Inc.,
98 pp., \$5.00

This is one of the few technical books published recently that can be read straight through without halts to puzzle over cryptic notations or trace long mathematical derivations. The second in a projected series of volumes on particular electronics fields, it's aimed at giving engineers on the fringe of the field a fundamental grasp of recent developments.

Covering, in only 98 pages, radio-frequency propagation, modulation, amplification, antennas, and error detection and correction, the book hardly offers an in-depth treatment of each subject. But presumably the readers who need the book won't be interested in secondary details.

The section on errors in high-frequency communications, for example, doesn't cover the latest developments described at technical meetings in the last year or so, but it does provide a basis for a better understanding by pointing out the important problem areas. Similarly, an 11-page chapter on frequency synthesis covers only the basic methods of deriving multi-frequency signals from a single stable oscillator.

The part on modulated signals puts the state of single-sideband systems in perspective with the prediction that the next 10 years will be a transitional period in which existing double-sideband systems will be phased out. The author notes that during this period there will be a need for equipment capable of double- and single-sideband transmission, and then discusses two systems with this dual capability.

The subject of h-f antennas, generally the most specialized in this field, is handled in a down-to-earth manner. Three types are covered: rhombic for long-distance uses; logarithmic arrays for short distances; and whip antennas and broadband monopoles for mobile use. Antenna feeders and switch-

ing systems also are covered.

There's a lot more information in the book than its sketchy index suggests—there are only about a hundred entries.

On Heaviside

Unified Circuit Theory in Electronics
and Engineering Analysis
J.W. Head and C.G. Mayo
Hilife Books Ltd., 174 pp., \$2.52
(18 shillings)

Here is an excellent review of the mathematics of transient analysis, stressing the Heaviside method of operational calculus. Although it cannot be recommended as an introduction to the subject, it could be helpful to an engineer now using transient analysis in his day-to-day work, or to a student who wants a different viewpoint.

In a reasoned appeal to intuitive understanding the authors discuss and explain new concepts. They write for the reader already familiar with circuit theory, impedance concepts, classical differential equations, and Laplace transforms.

The authors make the point that Heaviside's method can be used to find the complete response of an electrical network by straightforward partial-fraction expansions of immittance functions, without becoming enmeshed in the details of complex variables and the like.

Taking a practical view of such circuit analysis problems, they relegate special cases such as multiple poles (critical damping) to the appendix, pointing out that "these difficulties are a delight to pure mathematicians, but often a source of unsuspected error to students." However, they do cover the mathematics of convolution integrals, convergence theorems, vector space theory, and feedback system stability.

One minor point that American readers may find distracting is that British terminology, such as "230 volt mains tension" (rather than 230 volt d-c power line voltage) predominates.

R.C. Levine
Bell Telephone Laboratories
Murray Hill, N.J.



When You
Brush The
Other Names
Aside ...

MU
WE
MO
VA
SPRA
TE
CT
HAE
SP
FAIR
AME

One Company
Leads All Others
In Microcircuit
Production

Can you name it?

See if you're right...
Turn the page...

NEW Concept in Digital-Analog Converters

The use of Model DIC 2760 Digital-to-Current Converter with any operational amplifier provides the designer with a variety of high performance digital-to-analog converters with premium specifications.



3/4" x 3/4" x 1 1/2"

MODEL DIC 2760 converts TTL logic levels to weighted currents in less than 50 nanoseconds. This module contains reference supply, resistor network, and up to 12 high-speed precision switches.



1 1/8" x 1 1/8" x 1/2"

MODEL HSA X Digital Operational Amplifier with FET input provides current-to-voltage conversion for voltage outputs of up to ± 10 volts at ± 10 mas.

The combination of HSA X and DIC 2760 results in a very high performance digital-to-analog converter with:

- Input levels of up to 12 bits resolution at TTL logic levels.
- Total conversions in 1 microsec.
- Complete DAC, in two modules, requiring less than 2 sq. in. of P.C. card.

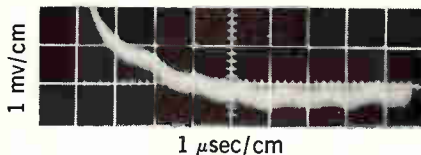

Response of D/A converter output to a full-scale change of 10 volts.

Write for detailed specifications and application data.

PASTORIZA
ELECTRONICS, INC.

385 Elliot St., Newton Upper Falls, Mass. 02164
(617) 332-2131

Technical Abstracts

Power play

A multidiode power combiner
W.J. Getsinger
MIT Lincoln Laboratory,
Lexington, Mass.

Combining power outputs from varactor diodes is successful if these four conditions are met: operate every diode at its maximum power capability; combine the generated signals in the same phase; operate at a useful impedance level; and provide a way to dissipate the diodes' heat. Previous methods for combining the diodes either failed on one of these counts or produced structures that were too large for convenient packaging.

A new method produces the desired result by stacking the diodes on an equiphase surface of a TEM transmission line and also gives a small package.

The scheme uses a coaxial-line structure and combines 18 diodes acting as a high-power doubler from 500 to 1,000 megahertz.

The combiner acts like a single diode of twice the impedance and many times the power capacity of a single diode. It can be used in any doubler, tripler or other type circuit as a single diode, with the function set by the external circuitry.

The model has three parallel-connected stacks of diodes of six series-connected diodes each, mounted in series with the center conductor of a 50-ohm transmission line. With the special structure the diodes can be liquid cooled. Thin copper disks are used between diodes to conduct the heat to the dielectric coolant and the diode columns are spaced widely enough to allow the free flow of cooling liquid around them.

At 1,000 Mhz, the length of the diode array is 0.06 wavelengths, short enough for low-frequency, lumped-parameter design methods, rather than transmission-line methods. The voltage across each diode is equally divided and in phase over each row of diodes—which would not be a proper assumption if the stacks were much longer. However, there is a limit to the frequency range in which the method is useful, since at higher frequencies, the diode stack makes up a much

larger fraction of a wavelength.

The efficiency of the power combiner is about equal to that of a single diode. A maximum efficiency of 53% was obtained with the doubler, including the effects of the tuner and diplexer. Maximum input power was about 40 watts.

Presented at NEREM, Boston, Nov. 1-3.

Cone cuts ringing

A new wideband antenna
receiving element
G.F. Ross
Sperry Rand Research Center,
Sudbury, Mass.

A long brass conical structure acting as an impedance transformer is the key component in a new wideband dipole antenna. When excited by a pulsed plane wave, this new element sharply reduces ringing and reaches steady-state performance in less than half an r-f cycle. It can be used from vhf to X band.

The antenna consists of a radiating element on a ground plane driven from the other side of the ground plane by a center conductor of a long, conical brass tube which matches 265 ohms at its wide end to 50 ohms at the narrow end, furthest from the ground plane.

A pulse launched into the brass cone toward the radiating element experiences an increasing impedance level toward the wider part of the cone. When the pulse reaches the base of the radiating element it meets a surge impedance of about 265 ohms. Since the ratio of the diameter of the cone to the diameter of the inner conductor is adjusted to also give 265 ohms, the pulse continues up the radiating element without reflection. When it reaches the open end of the element, it is reflected with the same sign back toward the base of the element, where it is absorbed because of the impedance match.

Typically, a 100-volt, 100 picosecond pulse is received with only one cycle of ringing, about 800 picoseconds long. If the brass cone were replaced with a direct connection to the radiating element, severe ringing would result.

Presented at NEREM, Boston, Nov. 1-3.

Centralab
leads the industry

459,700,000

Custom microcircuits produced to date

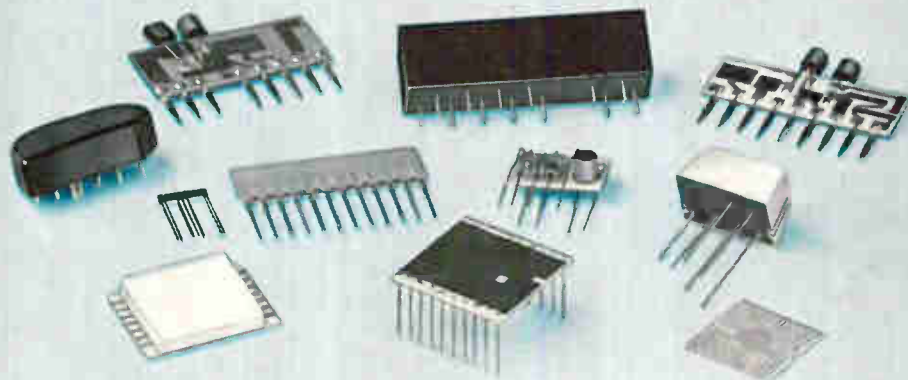

- 459,700,000:** With millions custom-designed for special applications in consumer entertainment, industrial and military markets.
- 459,700,000:** Every one a natural for communications, testing and measurement devices; for airborne control equipment, stereos, television sets, radios and computers.
- 459,700,000:** Manufactured by Centralab's unique technique that keeps costs low, reliability high.
- 459,700,000:** And the number keeps growing as more and more customers join the industry leader, not only in production, but in flexibility, cost and reliability.



CENTRALAB

Electronics Division
GLOBE-UNION INC.
5757 NORTH GREEN BAY AVENUE
MILWAUKEE, WISCONSIN 53201

Send your custom circuit requirement to Centralab Application Engineering today for prompt action.

M-6733

SIGNAL TO NOISE IMPROVEMENT OF 300:1

With EG&G's New
AV-102
Silicon Avalanche
Photodiode

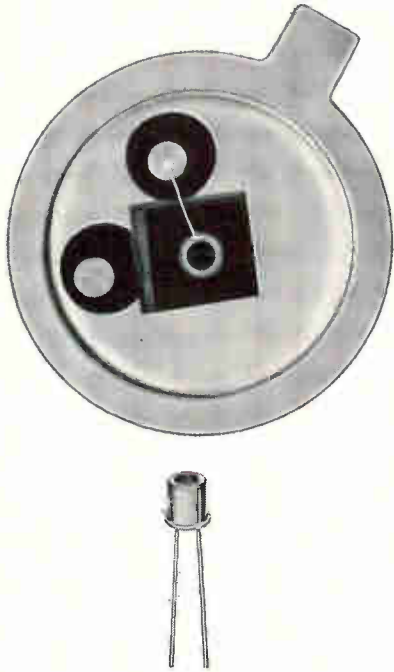

The new AV-102 Silicon Avalanche Photodiode is a state of the art device which features high internal gain resulting in typical signal to noise improvement of 300:1. It is designed primarily for high frequency applications up to 1 GHz.

Packaged in a TO-18 configuration, the AV-102 is specifically designed for the detection, characterization and measurement of low level light signals over the spectral range from 0.35 to 1.13 microns. Combining a high quantum efficiency (70%) and a high internal gain, the AV-102 permits measurement of signals which would normally be obscured by detector system noise.

With a typical operating voltage of 12 volts, the AV-102 is intended for many high frequency applications which now utilize S-1 photomultiplier tubes. It has obvious advantages of smaller size, lower operating power and higher reliability. Price is \$275 in small quantities.

For further information, contact EG&G, Inc., 166 Brookline Avenue, Boston, Mass. 02215. Phone: 617-267-9700. TWX: 617-262-9317.



New Literature

Engineering courses. Education for Career Advancement, 456 S. Franklin St., Hempstead, N.Y. 11550, offers a booklet outlining engineering graduate-level courses in the fields of control systems, digital computers and circuits. Circle 446 on reader service card.

A-c motor. A.W. Haydon Co., 232 N. Elm St., Waterbury, Conn. 06720. Bulletin CM803 contains detailed data on the 81300 series miniature reversible a-c motor. [447]

Magnetic ingot iron. Armco Steel Corp., Middletown, Ohio 45042. A 46-page booklet discusses applications, properties and characteristics of magnetic ingot iron in magnetic components. [448]

R-f generators. Westinghouse Electric Corp., P.O. Box 868, Pittsburgh, Pa. 15230. Radio-frequency generators with thyristor power controls for induction heating applications are described and illustrated in technical bulletin TD 28-160. [449]

IR thermistors. Victory Engineering Corp., 122-48 Springfield Ave., Springfield, N.J. 07081. A comprehensive discussion of current infrared detector technology is contained in Infrared Thinistors technical bulletin MFN 173. [450]

Reed relay. Solid State Electronics Corp., 15321 Rayen St., Sepulveda, Calif. 91343. A bulletin on the model 7001 Microreed relay, describes a single-pole, double-throw unit designed to be driven by transistors. [451]

Silicon power modules. Deltron Inc., Wissahickon Ave., North Wales, Pa. 19454, offers bulletin 111A describing the 300 models available in its silicon power module line. [452]

Pulse height analyzers. Technical Measurement Corp., 441 Washington Ave., North Haven, Conn. 06473. A set of five data sheets describes the company's expanded series of portable analyzers for nuclear spectroscopy. [453]

Wire strippers. Ideal Industries Inc., 5180 Becker Place, Sycamore, Ill. 60178. A full line of hand- and bench-mounted wire strippers is illustrated and described in bulletin No. 6. [454]

Selenium rectifiers. Syntron Division, FMC Corp., 241 Lexington Ave., Homer City, Pa. 15748. Twenty-four-page catalog 301000 covers the company's vacuum process selenium rectifiers. [455]

DTL IC's. Raytheon Co., Lexington, Mass. 02173. A 28-page catalog on the 930 series DTL integrated circuits de-

scribes flip-flops, gate expanders, multiple gates, dual buffers, a-c binary circuits, and monostable multivibrators. [456]

Planar thyristors. Fairchild Semiconductor Division of Fairchild Camera and Instrument Corp., 313 Fairchild Drive, Mountain View, Calif. 94041. Design engineers can obtain detailed information in an eight-page Planar thyristor selection guide. [457]

Static relay. Quindar Electronics Inc., 60 Fadem Rd., Springfield, N.J. 07081. Features, description, block diagram, and specifications for the QCB-1 isolated static relay are contained in bulletin 135. [458]

Disk pack. Memorex Corp., 1180 Shulman Ave., Santa Clara, Calif. 95050, offers a complete brochure on its Mark I disk pack, an advanced random access memory storage media for computers. [459]

Relay brochure. Leach Corp., 405 Huntington Dr., San Marino, Calif. 91108. An eight-page brochure provides technical data on the company's line of relays. [460]

Electronic mathematician. Wright Line, a division of Barry Wright Corp., 160 Gold Star Blvd., Worcester, Mass. 01606, has issued a brochure on the Mathatron, an electronic mathematician capable of solving algebraic equations keyed into the machine exactly as they are written. [461]

Trimming potentiometers. Mepco Inc., Columbia Rd., Morristown, N.J. 07960, offers a four-page bulletin on its Accutrim film trimming potentiometers. [462]

Film-thickness measurement. William J. Hacker & Co., P.O. Box 646, West Caldwell, N.J. 07006. A four-page folder describes an interference microscope for thin-film thickness measurements. [463]

Relay/lamp driver. National Semiconductor Corp., 2975 San Ysidro Way, Santa Clara, Calif. 95051. Bulletin D-111 discusses the NS7673 integrated relay/lamp driver. [464]

Drum memory systems. Vermont Research Corp., Box 20, Precision Park, North Springfield, Vt. 05150. Standard VRC drum memory systems are described in eight-page technical brochure SB6708. [465]

Digital data systems. Canoga Electronics Corp., 8966 Comanche Ave., Chatsworth, Calif. 91311, offers an eight-page brochure on a wide range of custom and standard digital data systems and components. [466]

lowest price DVM

reliability proven by
20,000 units in use

- Multi-Range DC Measurements from 1 MV to 1 KV
- 0.1% FS Accuracy
- Simple rugged design provides high MTBF
- 1 year warranty

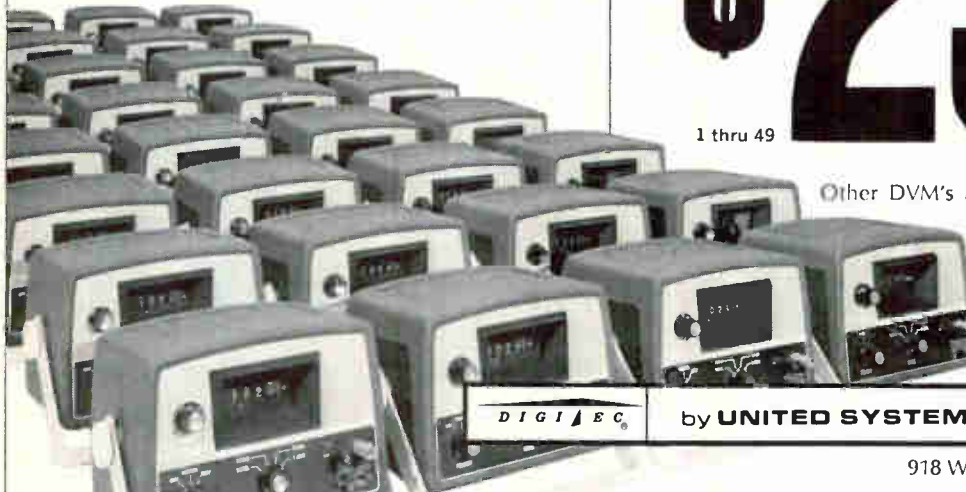

model 201

\$250

1 thru 49

Other DVM's and Thermometers comparatively priced. Send for NEW catalog and price list.



Stocked world wide for 24 hour delivery

DIGI-EC

by UNITED SYSTEMS CORPORATION

918 Woodley • Dayton, Ohio 45403

Circle 211 on reader service card

Our little black book has over 100,000 phone numbers.

You never had a black book like it. Over 1,500 pages. And those phone numbers! More than 100,000 telling you who to call/where to go, for the over 4,000 different product categories listed and advertised in the yellow pages of the Electronics Buyers' Guide.

There's never been a buyer's directory like it. The new '68 edition will be coming your way in October. Look for the book in the black box. EBG for '68... bigger, better and more useful than ever before.

Electronics Buyers' Guide

A McGraw-Hill Market Directed Publication,
330 West 42nd Street, New York, N.Y. 10036

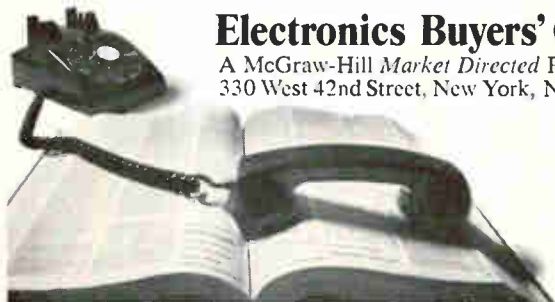

WITH INSERTS, THE SAVINGS ARE IN THE HOLE

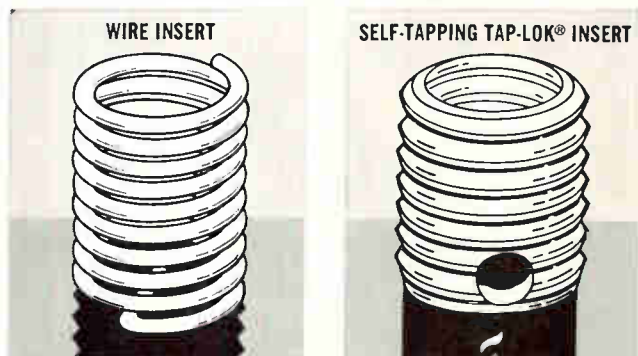

For the real bargain in inserts, look into the hole. You'll get a new view of what really counts—final installed costs. Check these approximate installation figures:

(Estimated Costs*)	Do Our Costs Agree With Yours? If Not, Fill in Your Own	(Estimated Costs*)
Wire-Type Inserts		Self-Tapping Tap-Lok® Inserts
Insert Cost .050¢	_____	Insert Cost .044¢
Drill Hole .070¢	_____	Drill Hole .070¢
Tap Hole .090¢	_____	Tap Hole Not Req.
Gage Hole .030¢	_____	Gage Hole Not Req.
Install Insert .080¢	_____	Install Insert .080¢
Remove Tang .050¢	_____	Remove Tang Not Req.
Per Finished Hole .370¢		Per Finished Hole .194¢

*Estimated cost for wire-type 4-40, .224" long, 25,000 quantity; Tap-Lok 4-40, .234" long, case-hardened steel, 25,000 quantity. Estimated average costs will vary with user, equipment, overhead, and labor rates. Self-tapping Tap-Lok inserts eliminate three operations which alone amount to about triple the cost of the insert itself. With Tap-Lok you need only one inexpensive installation tool. Wire inserts require special taps, gages, and a tang removal tool. Tap-Lok inserts conform to MS 35914-101 thru 166. Write for data—Groov-Pin Corp., 1121 Hendricks Causeway, Ridgefield, N.J. 07657, (201) WH 5-6780.

FASTENER DIVISION **GROOV-PIN CORP.**

NEW FROM EG&G
The HA-100 Hybrid
Op Amp designed for
use with SGD-100
and SGD-444
Silicon Photodiodes

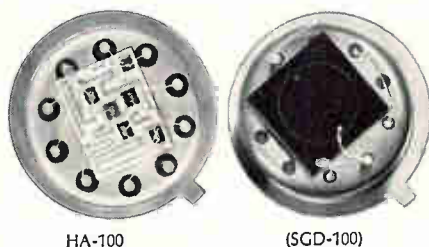

HA-100

(SGD-100)



HAD-130,
 combination amplifier
 (HA-100)
 and photodiode
 (SGD-100)

The new HA-100 is a truly functional operational amplifier intended to enhance the versatility of EG&G's SGD-100 and SGD-444 photodiodes. It provides low current/high gain (1500 minimum open loop gain) amplification with excellent linearity at low currents. The frequency range of the HA-100 extends from D.C. to 200 kHz. Provision for an external feedback resistor facilitates optimum resistance selection for each application. With a feedback resistance of 15 megohms, the HA-100 demonstrates high sensitivity (15V/ μ A) and a transient response of 15 μ sec. Packaged in a standard TO-5 configuration, the HA-100 is priced at \$175 in small quantities.

The HA-100 Op Amp is also available mounted in an integral package (TO-5) with the SGD-100 photodiode and is referred to as the HAD-130 Op Amp-Photodiode. Priced at \$295, it out-performs the commonly used S-1 photomultiplier tube in most low to medium frequency, low light level detection and measurement applications. Where size, power, reliability and/or cost are important factors, the EG&G silicon photodiodes and operational amplifiers offer an excellent alternative to photomultiplier tubes.

For further information, contact EG&G, Inc., 166 Brookline Avenue, Boston, Mass. 02215. Phone: 617-267-9700. TWX: 617-262-9317.



New Literature

Direct-reading attenuators. DeMornay-Bonardi Division of Datapulse Inc., 1313 N. Lincoln Ave., Pasadena, Calif. 91103. Bulletin DB-X-187 covers direct-reading attenuators for 7.05 to 90 Ghz. [467]

Tungsten wire mesh. Richard D. Brew & Co., Airport Road, Concord, N.H. 03302, has available a catalog on tungsten wire mesh that can withstand temperatures up to 3,000°C. [468]

Nickel cadmium cells. Gulton Industries Inc., 212 Durham Ave., Metuchen, N.J. 08840, has published a bulletin on a line of space-qualified nickel cadmium cells. [469]

Schottky-barrier diodes. Microwave Associates Inc., Burlington, Mass. 01803, has issued a technical bulletin describing a series of X-band, Schottky-barrier junction diodes. [470]

Power supplies. Power/Mate Corp., 163 Clay St., Hackensack, N.J. 07601. Bulletin No. 123 covers the UniTwin 164 dual-output module power supply. [471]

Counter-timers. Computer Logic Corp., 1528 20th St., Santa Monica, Calif. 90404, has available a four-page brochure outlining a complete series of integrated circuit counter-timers. [472]

Systems for pcm telemetry. RC-95 Inc., 9 E. 35th St., New York 10016. Bulletin 6791 deals with aerospace/weaponry systems for linking sensors to pcm transmitters in fixed and mobile applications. [473]

Time delay relays. Hi-Tek Corp., 2220 S. Anne St., Santa Ana, Calif. 92704, has released a catalog providing complete information for the evaluation and specification of a broad line of time delay relays. [474]

Telemetry modules. Solid State Electronics Corp., 15321 Rayen St., Sepulveda, Calif. 91343, offers a 40-page catalog describing its line of f-m/f-m telemetry modules. [475]

Ceramic capacitors. Gulton Industries Inc., 212 Durham Ave., Metuchen, N.J. 08840. Bulletin H31 covers the CT07 series of subminiature ceramic tubular capacitors with values to 10,000 pf. [476]

Laser driver. Sensor Corp., P.O. Box 967, Greenwich, Conn. 06830. Technical bulletin 6002 illustrates and describes IR photo/laser driver module 60102. [477]

Signal conditioner. Techni-Rite Electronics Inc., 65 Centerville Rd., Warwick, R.I. 02887, has released a catalog sheet describing model SST-10 strain gauge signal conditioner. [478]

Tight
schedules?
COLUMBIA
meets them
everyday!

Special cable problems have become routine at Columbia . . . we handle them daily for leading manufacturers across the country.

Chances are, we have just what you need in stock. If not, we have the production facilities and know-how to meet your specifications . . . exactly. Let us know your special cable needs—any order of 500 feet or more, any size up to 2" in diameter, any combination of conductors you require—we'll keep your production running smoothly and profitably.

Call Columbia Wire today . . . your order will be given prompt and careful attention. 312-267-3160

Write for fully illustrated catalog.



COLUMBIA
WIRE PRODUCTS COMPANY
 2850 Irving Park Road
 Chicago 60618

SALES AND MARKETING MANAGER

We are seeking a National Sales and Marketing Manager who has the desire and drive to get into a very high income bracket by way of his own effort and ability. Qualifications required: engineering degree in electronics, experience in selling electronic capital goods equipment, good knowledge of computers and allied equipment, plus some familiarity with programming, numerical control and software. If you have these qualifications and are looking for THE opportunity, send resume and starting salary requirements to

JOHN ROTTE ASSOCIATES

6100 Belleair Place,
Cincinnati, Ohio 45224.

CIRCLE 952 ON READER SERVICE CARD

DESIGN ENGINEERS

BSEE plus minimum of 2 years' experience in circuit design using semiconductor components. Commercial power supply and logic design experience preferred. Write, or call collect: Industrial Relations Manager, (214) AD 1-5111, Varo, Inc. Static Power Division, 1600 Dallas North Parkway, Plano, Texas 75074.

CIRCLE 953 ON READER SERVICE CARD

SALES ENGINEER

Real opportunity for young, energetic engineer who knows electronics, computers, and is familiar with programming, numerical control and software to move into high income bracket selling electronic capital goods equipment. Should have Bachelors Degree in engineering-electronics. Outline your qualifications in resume to John Rotte Assoc., 6100 Belleair Pl., Cincinnati, Ohio 45224.

CIRCLE 954 ON READER SERVICE CARD

CLASSIFIED ADVERTISING

SEARCHLIGHT SECTION

BUSINESS OPPORTUNITIES
USED OR SURPLUS EQUIPMENT

free catalog

POTTING APPLICATORS
MANUAL AND DISPOSABLE

6cc 12cc 30cc

FOR POTTING, ENCAPSULATING, AND
SEALING OF MINIATURE COMPONENTS

PHILIP FISHMAN COMPANY
7 CAMERON ST., WELLESLEY 81, MASSACHUSETTS

CIRCLE 961 ON READER SERVICE CARD

PROFESSIONAL SERVICES

Donald C. Harder, Inc.

Magnetic Component Engineers

Reactors—Transformers—Filters
Serving the Research Laboratory

2580 K Street, San Diego, Calif. 92102
Phone (714) 239-8021

R.U. 1

answering more than
advertisement? Then please send a
separate reply to each box number. It
will help you get an answer sooner.

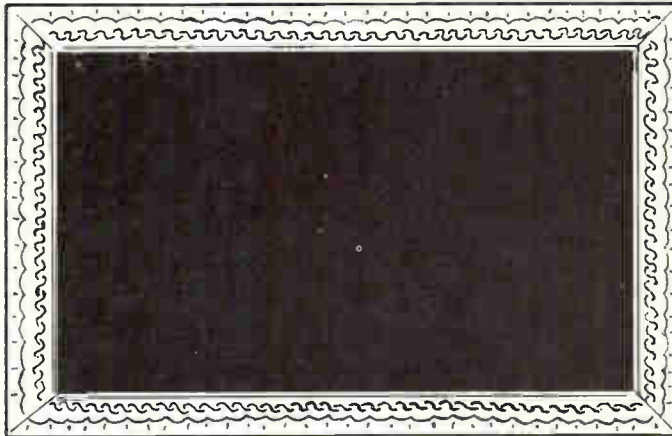

If you don't see 'Charley' in this night scene, join the group of Scientists and Engineers who have enough vision to to make this a reality.

New positions in advanced research and development projects are open at a unique laboratory with mission to accomplish applied research development and engineering of materials, methods and techniques; procurement of services; and design testing and test evaluation of night vision systems for the Army.

AT

NIGHT VISION LABORATORY

OF THE ARMY ELECTRONICS COMMAND

—IF YOU ARE A U.S. CITIZEN, HAVE A DEGREE AND AN INTEREST IN ANY OF THE FOLLOWING FIELDS . . .

OPTICS

PULSED CIRCUITRY
PHOTOEMISSION
VACUUM TECHNIQUES
LASER RESEARCH
LIGHT SOURCE RESEARCH
TRANSISTORIZED ELECTRONICS
AUTOMATIC PATTERN . .
RECOGNITION

VISUAL PERCEPTION

ATMOSPHERIC OPTICS
VISIONICS
IMAGE INTENSIFICATION . .
COMPONENTS & SYSTEMS
FAR INFRARED COMPONENTS
& SYSTEMS
ILLUMINATION SYSTEMS
TV SYSTEMS

SEND RESUME OR SF 57 TO . . .

CIVILIAN PERSONNEL OFFICE
Building T-2323, Room No. 1
Fort Belvoir, Virginia 22060

FORT BELVOIR IS LOCATED APPROXIMATELY 15 MILES SOUTH OF WASHINGTON, D.C. STARTING SALARIES RANGE FROM \$6,387 TO \$20,000 PER ANNUM. RELOCATION EXPENSE PAID. THESE ARE CAREER CIVIL SERVICE POSITIONS.

AN EQUAL OPPORTUNITY EMPLOYER

CIRCLE 951 ON READER SERVICE CARD

microwave problem?

talk to Andrew...the antenna systems specialist



Andrew microwave antenna systems are hard at work all over the world. Fixed, portable, and mobile installations, designed by Andrew, can be found wherever communications engineers demand the utmost in performance and reliability. ■ This new transportable 7 GHz system is a good case in point: used in a quick reaction microwave link, the unit packs broadband communications capability into a compact package. A 100 ft. aluminum telescoping mast pneumatically raises the 6 foot antenna, guy wires, and dual axis positioner in

less than 60 minutes. The flexible HELIAX® elliptical waveguide feeder goes up simultaneously, and the jacket includes control cables for the positioner. An automatic dehydrator-compressor, 1½ ton trailer, and AC power supply complete the package—all from Andrew. One source—one responsibility. ■ **Have a microwave antenna system problem?** Bring it to Andrew, most people do! Andrew Corporation, P.O. Box 42807, Chicago, Illinois 60642.

3-67



Newsletter from Abroad

November 27, 1967

Devalued pound to bolster British in export markets

Devaluation of the pound sterling will force the world's major electronics producers to rethink their global marketing strategies.

Although it will be weeks—and perhaps months—before the full import of the new valuation of British currency and the harsh austerity that goes with it will be known, the move should make British manufacturers tougher competitors in electronics export markets. The 14.3% cut in value of the pound in relation to the U.S. dollar—to \$2.40 from \$2.80—means British producers can now shave their export prices by about 12%. Increased interest rates and an end to export tax concessions account for the difference.

The 12% competitive edge, though, figures to dwindle somewhat in the months to come. Some inflation in the British economy will certainly follow the devaluation, and prices of imports will rise by 14.3%, too. These increases will filter back to electronics manufacturers, making their costs higher and thus offsetting some of the gains of the devaluation.

The electronics sector most affected by devaluation is computers. International Computers & Tabulators and English Electric, the two major British producers, will gain an advantage over IBM. Most IBM machines sold in Britain are imports, and the company must now either raise prices or slash its profit margin. Also, ICT, which exports about a third of its production, should do better in export markets, where its biggest competitor is IBM.

TI and Japanese believed near deal

Insiders say that Texas Instruments and the powerful Japanese Ministry of International Trade and Industry are close to an agreement on TI's entry into the Japanese market. TI had been insisting on 100% ownership of a Japanese subsidiary, while MITI had demanded a 51-49 deal and that TI share its knowhow with domestic firms. TI board chairman Patrick Haggerty denies that there's been any easing of the impasse.

GE seeks license for French tube . . .

Compagnie Francaise de Television and the General Electric Co. are believed to be close to an agreement licensing GE to make CFT's color television tube in the U.S. The French tube, touted since the early 1960's as the successor to RCA's shadowmask, hasn't been able to get out of the prototype stage because no manufacturers have wanted to make it. GE officials in Syracuse had no comment on reports of negotiations.

Paris sources also say that GE might try to get a minor interest in CFT, a company that has been experiencing financial difficulties. However, the French Finance Ministry would have to bless such a move and that approval might not come easily.

. . . as Admiral builds Italian plant

The Admiral Corp., with an Italian private company, Voxson, and a member of the state holding-company group, is building a plant outside Rome to make color television tubes. The name of the joint venture will be Argonne. Admiral officials declined to discuss the Italian move but did note that they signed a licensing agreement in July with "a European firm."

Though Italy won't have color tv broadcasting until 1970, Philco Italiana and a GE subsidiary already are making color sets there. In

Newsletter from Abroad

addition, RCA plans to build a color-tube plant near Rome, and Philips wants to make color components in Italy.

Soviets readying 24-hour satellite?

U.S. space officials believe the Soviet Union is planning a new Molnya communications satellite, probably with a synchronous 24-hour orbit. This would enable them to cover the entire USSR with one satellite. With previous Molnyas, which had 12-hour orbits, three were needed. One tip-off on the Russian plans is increased discussion among Russian scientists about the advantages of 24-hour satellites as work continues on the Orbita satellite communications network.

New British combine eyes postal orders

Heading Arnold Weinstock's list of projects now that his British General Electric Co. has won control of Associated Electrical Industries is a merging of the firms' telecommunications activities. The reason: Post Office orders will increase in the next few years, and, with open competition for orders expected, an efficient company offering the most advanced equipment can look forward to a bonanza. Also, the combined company will be strong in two areas attracting strong Post Office interest. One, the design of large electronic exchanges, is dominated by AEI; the other, microwave links, is one in which GEC has as much knowhow as any other British company.

Shiba develops a versatile vtr

The Shiba Electric Co. of Japan has developed a prototype fixed-head video tape recorder that audiophiles can convert into a high-quality stereo recorder simply by pushing a button. Tape speed is 60 inches per second as a vtr, 7.5 ips as a stereo. Shiba's success comes on the heels of a decision by the Akai Electric Co. to market a fixed-head vtr that operates at 45 ips [see p. 187].

Germans to widen train computer trial

West Germany's state-run railway system will soon begin large-scale trials of computerized train assembly and disassembly, freight rate calculation, and bookkeeping. The tests will create a \$4 million "cybernetic island" in the Hanover area, near the Siemens AG computer center in Brunswick.

It's estimated that from \$100 million to \$125 million worth of computers and related gear would be required to put the country's whole railroad system under computer control. But officials believe savings in operating costs would more than offset this big outlay.

Secondary role irritates Canberra

Insiders say the Australian government is quietly but firmly passing the word to foreign-owned electronics companies: do some R&D in Australia or you won't get your share of the swelling volume of government contracts. What's more, according to the Australian Financial Review, Japanese and American firms have been told they won't be welcome at all down under without local partners.

Two factors are behind the breeze of national self-interest blowing through the Australian electronics scene: growing official concern over the high rate of foreign ownership and the brain drain. Of the 13 top firms, only two do not have a substantial foreign equity; six are wholly owned subsidiaries of foreign companies and three are controlled from abroad. A recent survey shows 74 of 194 firms are run from abroad.

No need! Nearly twenty years of flight time on aircraft from the B-29 to the C-5A have proven the dependability of wiring insulated with TEFLON fluorocarbon resins. Lab tests are O.K.; we've got hundreds on record, but nothing tops the proof of use . . . and TEFLON has the proof

of millions of flying hours in scores of aircraft.

Ask for our brochure explaining in detail why there are no test flights for TEFLON. It may help you eliminate one unnecessary variable from *your* next test flight. Write Du Pont Company, Room 5617C, Wilmington, Delaware 19898.

*Reg. U.S. Pat. Off. for Du Pont fluorocarbon resins and films.

There are no test flights for Teflon*



REG. U.S. PAT. OFF.

Better things for better living
... through chemistry

TEFLON... the proven performer

Specify BRADLEY X-band Solid State Sources for Low Noise

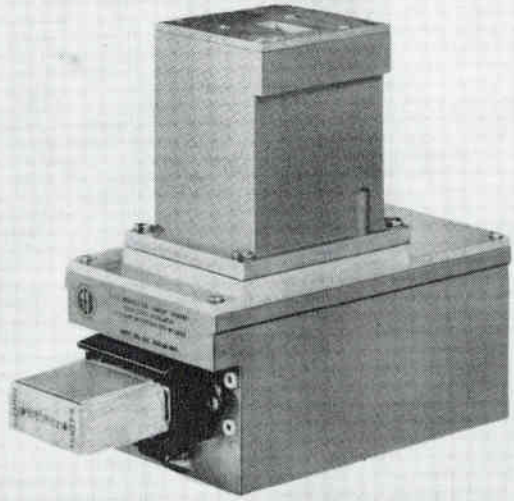
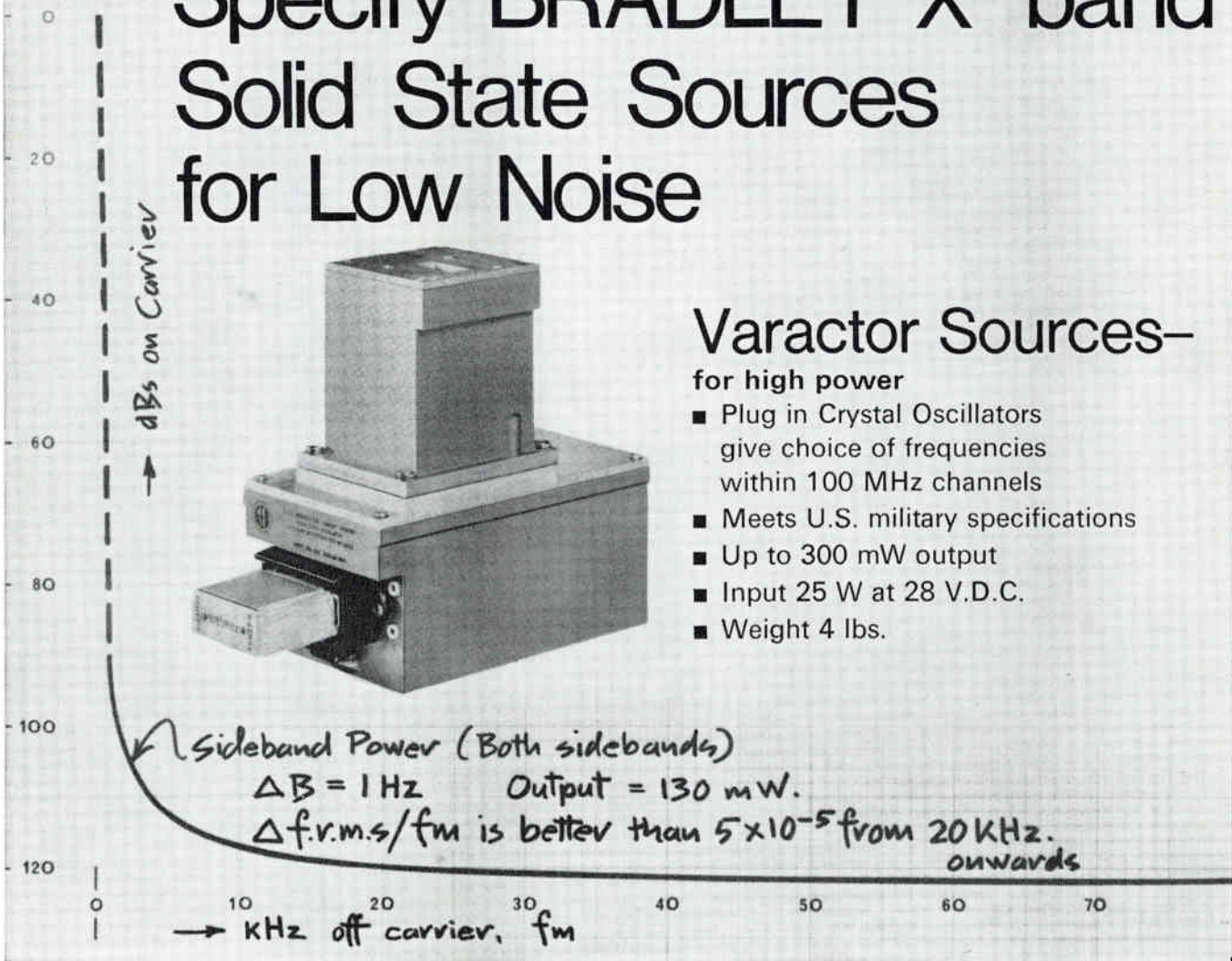

Varactor Sources— for high power

- Plug in Crystal Oscillators give choice of frequencies within 100 MHz channels
- Meets U.S. military specifications
- Up to 300 mW output
- Input 25 W at 28 V.D.C.
- Weight 4 lbs.

AND Step Recovery Sources -

for local oscillators

- Electrically tunable over 400 MHz
- 10 mW output
- 2 W input at 22 V.D.C.
- F.M. noise 80 d.B. per Hz at 50 KHz from carrier
- Low cost
- Meets U.S. military specifications
- Weight 5 ozs.

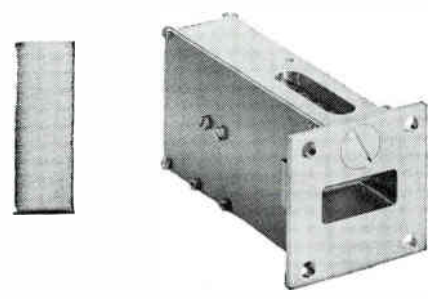

G. & E. BRADLEY LTD

ELECTRAL HOUSE, NEASDEN LANE, LONDON, N.W.10.
 TELEPHONE: 01-450 7811 TELEGRAMS: BRADELEC LONDON N.W.10. TELÉX: 25583
 In the United States—EDWIN INDUSTRIES CORP.,
 11933 Tech Road, Silver Spring, MD., 30904. Tel: 301 622 0700

Japan

Headed to market

So far, the technical trend in home video tape recorders has been to fast-spinning heads and slow-moving tapes.

The combination cuts tape costs, but the sophisticated synchronization circuits for the heads makes for expensive hardware. Aside from offbeat brands, home VTR's currently list at \$695 and up—mostly up.

A sharp change in the VTR price lineup, though, is on the way. Early in December, Akai Electric Co. will put a VTR ticketed at about \$300 on the U.S. market. The price doesn't include a receiver-monitor, which costs an additional \$150.

Well fixed. Unlike the popular VTR's now on the market, Akai's recorder has a fixed head; and its tape speed, 45 inches per second, is some five times faster. The company admits the picture quality of its fixed-head unit can't quite match that of rotating-head types. But Akai figures most buyers will notice the big difference in the price tags much more than they will the slight difference in the playback.

To keep tape costs within reason, Akai designed its VTR to play with ¼-inch instrument tape. A 10-inch reel with 7,200 feet of 1-mil tape gives 20 minutes playing time in one pass. Rotating-head recorders, by contrast, operate with either ½-inch or 1-inch tape.

Direct. Both the audio and video signals are recorded directly on the tape, which has a four-track stereo format. Rather than make the video track wider than the audio track, Akai chose the stereo format because it is considering a dual-purpose recorder that can handle both video and stereo. The company already has stereo recorders on the U.S. market. They are sold by the



Priced right. Akai fixed-head video tape recorder will go on U.S. market in December at list price of about \$300. Receiver-monitor adds \$150 to the price. The recorder uses ¼-inch tape.

Rheem Mfg. Co. under the "Roberts" label.

Although the signals are recorded without modulation, Akai does use some video-signal processing. Essentially, the negative-going synchronization pulses of the video signal are converted to positive pulses before they are recorded. The inversion, the company says, makes it easier to recover the sync pulses at playback and improves the signal-to-noise ratio of the reproduced signal. After playback, the signal is reprocessed to get a standard video format for the monitor.

A delay-line peaking circuit also turns up in the playback portion of the recorder. It helps sharpen the reproduced image, whose resolution is lower than normal because of the relatively limited passband—400 hertz to 1 megahertz—of the recorder. The circuit is much the same as those used in tv cameras for aperture correction.

Mechanics. Akai had to pay special attention to the tape head and tape drive. The head material is single-crystal ferrite, grown in-house. Akai started growing its own when it found it couldn't get the

performance it wanted with ferrites bought outside.

The tape drive incorporates a mechanical damper to cope with tape oscillation, a problem that plagues designers of fixed-head VTR's. Vibration is damped by three idler wheels that press against the tape. Without the wheels, there would be objectionable jitter in the playback picture.

Great Britain

Triple-threat IC

Like their counterparts in the U.S., Japan, and on the Continent, British semiconductor manufacturers are scrambling to stake claims in the fast-growing market for linear integrated circuits.

Mullard Ltd. and the Plessey Co. seem destined to get onto the British market first with linear IC's for a-m radio sets. Both plan to produce IC packages for radios by mid-1968.

Mullard's IC packs onto a single silicon chip the mixer, oscillator, i-f

amplifier, detector, audio preamplifier, and audio driver. Plessey carries integration a step further by including the audio output stage on its chip.

Versatile. But Mullard, a subsidiary of Philips' Gloeilampenfabrieken of the Netherlands, had its reasons for calling it quits at the next-to-last stage. After studying the range of portable receivers on the British market, it found that the main difference among them was their output power. So Mullard, aiming for the widest possible market, developed a circuit that enables set makers to select the output power through their choice of discrete transistors for the output stage.

What's more, the Mullard IC is not limited to use in a-m receivers. At the Microelectronics in Equipment conference in London this week, the company's B.E. Buckingham will show how the basic circuit can be rigged to function as a sound i-f amplifier in television sets or as a second i-f amplifier in communications receivers.

Blocks apart. On its chip, Mullard lays down three independent gain blocks. In an a-m radio, the first block functions as an oscillator and mixer, the second as an i-f amplifier and detector, and the third as an audio preamplifier-driver.

The mixer and oscillator functions of the first block are separate and d-c coupled, an arrangement that allows the automatic gain control signal to be applied to the mixer rather than the i-f amplifier. As a result, the i-f amplifier can be d-c coupled, too; this holds down the number of external connections to the IC package since there are no outboard coupling capacitors for the i-f amplifier.

A filter circuit built around a lead-zirconate-titanate ceramic filter is paired with the chip in the a-m receiver. Since the outboarded filter takes care of frequency selectivity, the chief job of the i-f stage in the IC is to provide gain. However, the last transistor in the stage serves as the detector and also develops the a-gc bias voltage that controls the output of the mixer; control range exceeds 60 decibels.

New roles. With a different set of outboard discrete components, the IC becomes an i-f amplifier for the f-m sound channel in a tv set. Here the input is fed to the second gain block, the one that serves as the i-f amplifier in the a-m receiver circuit. This stage yields a voltage gain of about 50. The output is fed back to the first gain block of the IC, which functions as a limiter with a-m suppression of 30 db or more. An external discriminator links the limiter and the audio stages on the chip.

When the IC sees service as a second i-f amplifier in communications receivers, a different set of outboard components is again needed. The first block of the IC becomes an oscillator-mixer that converts frequencies of 10.7 or 30 megahertz to a low second i-f of 100 khz. The second gain block is coupled to the first by a wideband interstage transformer and serves as an i-f amplifier. In this setup, the IC's third gain block works as a 100-khz limiter. Over-all voltage gain is 100 db.

Sweden

Video highway

Driving simulators—designed to teach or to gauge reaction time—attempt to provide the motorist with realism by projecting a moving picture of a road on his windshield. But the display is often unreal because it lacks the dimension of depth of the real world.

Engineers at Saab, the giant Swedish industrial complex, have managed to add the feeling of that third dimension to such a simulator. Adapting techniques used to design and test a new fighter plane, they've put together a simulator that uses a computer-generated arrangement of 16 straight lines and a collimating lens to replace the usual film.

The result, says Saab, is a driver-testing system that manages to give a remarkably realistic sensation of a road curving and twisting into infinity. What's more, the pattern

never repeats itself; with a movie it does.

Line drive. The display comprises a repeating series of "fence posts" that mark the edges of a "25-foot-wide road." Horizontal lines connect the bottoms of each set of posts. And a flashing vertical "obstacle" appears at irregular intervals about five feet from the side of the road. As the driver



Long look. Driver, seated before a collimating lens, sees unending line of "fence posts" stretching outward to infinity.

"steers," using a hood ornament as a reference point, the entire framework of the simulator moves from side to side up to 18 inches to give him the feel of real movement.

The lines are controlled by a Pace TR-10 analog computer made by Electronic Associates Inc. A program generator made by Saab adds nuances to the display by modifying the computer's signal. A punched paper tape produces the equivalent of three miles of road with an average of 16 curves per half mile, selected by random as the tape varies the signal from the generator.

The program also is equipped with five digital-to-analog converters that carry out five logic func-

tions—for example, making a new fence post appear when one disappears from the driver's field of vision. Finally, there's a diode matrix to add a random selection of obstacles, half of which appear at 160 feet, the rest popping up at 320 feet.

Strapped in. The driver is strapped into a regular driver's seat facing the windshield-like collimating lens. He views a display projected from a cathode-ray tube on a translucent screen about 20 inches away. Signals from steering wheel, accelerator, and brake pedal are transmitted through potentiometers to the computer. One signal goes back to the speedometer and the others are fed to an eight-channel pen recorder, then to tape punched on digital logging equipment. The tape can be processed to yield whatever information is desired.

Saab developed the simulator with the Swedish Traffic Safety Council.

West Germany

Double exposure

The electroencephalogram, a tracing of brain waves that can indicate vital changes in a patient's nervous system, also shows trivial changes that are of little value as clues for the physician. For example, an EEG signal might indicate severe trauma—or merely that the patient has blinked or swallowed.

Now something new has been added. A German doctor has developed a synchronized display system in which the EEG printout appears on a screen beside a picture of the patient. Thus, if the patient moves his head and the signal varies accordingly, whoever is monitoring the screen can see that the variation is of little significance.

Interpreter. The system is the brainchild of Dr. Heinz Penin, head of the electrophysiological department at Bonn's new University Clinic for Nervous Diseases. In the Penin setup, a fixed tv camera

installed just above the EEG recording equipment scans the curves as they're recorded, while another camera monitors the patient. The curves are displayed on the left side of the picture of the patient's head—or body—on a screen in the operator's room.

Image-orthicon cameras with remote-controlled optics and tilt and turn mechanisms are used to accommodate taking at low light levels. Synchronization is attained by feeding a timing pulse simultaneously to the EEG and the patient-image portions of the system.

Automatic warning. Penin has added an automatic alarm feature. If brain-current frequency falls below, say, 3 to 4 hertz, an optical or acoustical signal warns a hospital assistant that the patient needs immediate attention. Normally, these signals vary between 9 and 10 hz; they're about 0.5 microvolts in amplitude and must be amplified 1 million to 2 million times before an EEG curve can be recorded or an automatic alarm set off. Penin says such alarm techniques have been used before with electrocardiograms and devices measuring heart-beat rate, temperature, and other body parameters but never before with EEG's.

All patient and EEG displays at the clinic are recorded on video tape.

France

Cross-channel link

European computer makers long have felt they should join forces in giant supranational companies to counter the domination of U.S. firms in the European data-processing market. Until now, attempts to put together across-the-border joint ventures have fizzled.

This month, though, the embryo of a supranational computer company took shape as a British and a French firm signed a pact pooling much of their effort in process control. The two companies, Elliott Automation Ltd. and Compagnie pour l'Informatique et les Techniques Electroniques de Controle (Citec), will coordinate their research, development, and engineering in process automation. They also plan some joint sales efforts.

Fair share. Under the cross-channel deal, Elliott and Citec will continue to push development of central processors independently. But their process-control subsidiaries, Elliott Process Automation Ltd. and the Compagnie Générale d'Automatisme, will work closely together on peripherals and systems design.

If one of them, for example, produces a complex control system for



Together. Synchronized system displays picture of electroencephalogram curves alongside that of patient, enabling an attendant to tell immediately if wave variation is significant.

a refinery, its partner can tap it for refinery-automation knowhow, including software. The two parent firms point out that their control activities are for the most part complementary. The deal, they figure, nearly doubles the range of control business each can handle.

Doubling the market. And each company has, in a sense, added important new territory to its "domestic" market. As one Elliott official puts it, "This is the way we can lick the Americans. They've got a market of 200 million people. Now in process control we've doubled ours to 100 million."

Adding a West German partner, Elliott thinks, would put the venture on an almost equal footing with U.S. competitors. Elliott has been trying, with little luck, to lure Siemens AG into the fold. Unlike Elliott and Citec, Siemens has no process-control subsidiary that can be fitted easily into a supranational organization.

Robert Remillon, Citec's president, says there's a good chance that this month's deal will lead to others between the two companies, with binational ownership a possibility. In Remillon's view, supranational computer companies are inevitable. And he expects Citec to be among the first French firms to help set one up.

International

Shifts at sea

It looks as if there'll be years of good sailing ahead for makers of maritime radio equipment. Balmy trade winds were assured this month as the International Telecommunications Union scheduled a new series of regulations that eventually will make new hardware necessary in the radio shacks of most ships.

To be sure, the business won't come in a burst. The new regulations, most of them involving frequency allocations, won't take effect until April 1969. And there will be a long interim period as the changes go into force progressively.

But for the long run it means a whopping market for producers of marine radio gear.

Crowded. The ITU made the changes mainly to ease the overloaded frequency bands earmarked for communications at sea. To jam more channels into these bands, it has drawn up a timetable for a complete changeover to single-sideband transmission, which halves the bandwidth needed for a channel. At the same time, the ITU will narrow the separation between channels to get more working bandwidth.

Many ships and coast stations already have shifted to single-sideband, mostly in the high-frequency band of 4,000 to 23,000 kilohertz. Under the new regulations, everyone transmitting over h-f channels will have to shift to ssb by the end of 1977.

For the medium-frequency band—1,605 to 4,000 khz—the deadline for switching to ssb is Jan. 1, 1982. A year after that, a gradual changeover from 50-khz to 25-khz separation between channels in the vhf band will be completed.

New assignments. Although it will be years before the switch to ssb takes full effect, the ITU has already assigned slots in the h-f band for some new services. These include oceanographic data radioed from automatic buoys, narrow-band teleprinters, and data transmission systems. The ITU found room for them largely by reducing channel spacing, a solution made possible by improvements in transmitters and receivers since the maritime radio regulations were last revised in 1959.

Two other major decisions came out of the ITU's reworking of the regulations. One sets specifications for selective calling, the other assigns 121.5- and 243-megahertz frequencies for emergency radio-beacons.

Under the selective calling scheme, each ship will get a five-digit code, in a sense its "telephone number," for radio calls from shore stations. Automatic receivers would respond only to their own calls. The system adopted was developed by West Germany's Siemens AG. It won out over U.S. and Japanese sys-

tems [Electronics, June 13, 1966, p. 256].

In the Siemens system, the code signal consists of a combination of five audio-frequency tones taken from a series of 11 tones ranging from 1,124 to 1,981 hertz. The selective calling will be used mainly in vhf bands.

Around the world

Mexico. Anticipating an increase in the Mexican color television market from 10,000 sets this year to 50,000 by 1970, General Telephone & Electronics International Inc. has begun making color-tv picture tubes at its Mexican subsidiary, Sylva-mex Electronica SA. The firm has added 26,000 square feet to the 60,000-square-foot Monterrey plant to provide space for the manufacture of 19- and 25-inch tubes. Color-tv impetus is expected to be provided by the 1968 Olympics and the 1970 World Cup soccer championship.

Soviet Union. Russian scientists report that they can determine the mineral composition of a rock quickly and accurately by focusing a laser beam on it. The beam, trained on small specks in the rock, creates a flare that is photographed. By analyzing the photo, the Russians say, scientists can determine what elements are in a speck.

Japan. An American maker of switches and vhf television tuners and a Japanese maker of capacitors, resistors, and filters have formed a new firm to make and sell components in Japan. The Oak Electro/Netics Corp. of Crystal Lake, Ill., will have a 49% interest in Japan Electro Components; Murata Manufacturing Co. of Kyoto will own the rest. The joint venture's plant will be at Hachioji, 40 miles from Tokyo.

Taiwan. Honeywell Inc., the Taiwan Trading Corp., and the Yamatake-Honeywell Co. have set up a joint venture in Taipei. The new company will manufacture industrial instruments and temperature controls, first for the domestic market, later for export.

3 to get ready

COAXICON* BNC Connector—three parts. One crimp. One tool. 15 seconds from stripped cable to completed contact. Center conductor, braid and insulation crimped simultaneously. For all coaxial and shielded cable—even sub min. No guess work. Lowest applied cost.

*Trademark of AMP Incorporated

PUT YOUR IDEAS INTO ACTION WITH THE HELP OF AMP ENGINEERING . . . WORLDWIDE

AMP

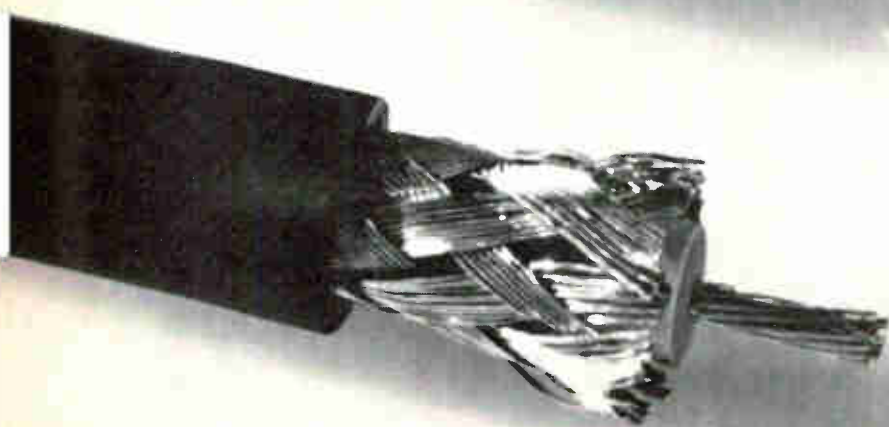

AMP INCORPORATED
Harrisburg, Pa. 17105

I'm ready. Please send me more information on COAXICON Connectors.

NAME _____
COMPANY _____
ADDRESS _____
CITY _____ STATE _____
ZIP _____

Adams & Westlake Co. Kasper & Assoc., Inc.	58	Eastman Kodak Co., Technical Corporate Adv. Rumrill Hoyt, Inc.	43	■ Leach Corporation Jay Chiat & Associates	123
Airco Speer Electronic Components Hazard Adv. Co., Inc.	51	EG & G, Inc.	178, 180	■ Ledex, Inc. Yeck & Yeck, Inc.	152
Airpax Electronics, Inc. Welch, Mirabile & Co., Inc.	61	EG & G—Las Vegas Robert Fenton Adv., Inc.	124	■ L E L, Div. of Varian Associates Snow & Depew Adv., Inc.	136
American Optical Co., Space-Defense Group Fuller & Smith & Ross, Inc.	70	Elco Corp. Fien and Schwerin, Inc.	117		
■ AMP, Inc.	165, 191	Electronic Communications, Inc. Neals & Hickok, Inc.	133		
■ Amphenol Corp., RF Div. Marsteller, Inc.	18, 19	Elgenco, Inc. Wesco Advertising	157		
Ancona Corp. Wilhelm Bacher Werbung	130	Environmental Control Systems, Div. of Pall Corp. Mohr & Co., Inc.	160	■ Machlett Laboratories, Div. of Raytheon Co. Fuller & Smith & Ross, Inc.	9
Andrew Corp. Fensholt Adv., Inc.	182			Micom Lennen & Newell, Inc.	5
■ Atlas Chemical Industries, Inc., Aerospace Components Div. Harris D. McKinney, Inc.	157	■ Fairchild Semiconductor, Inc. Faust/Day, Inc.	55, 56, 57	Monsanto Co. Foote, Cone & Belding	35
Automatic Electric Co., Sub. of General Telephone & Electronics Corp. Marsteller, Inc.	67	Fluke Manufacturing Co., John Bonfield Associates	15	Motorola Semiconductor Products, Inc. Lane & Bird Adv., Inc.	109
		Fujitsu, Ltd. Asia Adv. Agcy., Inc.	166		
				National Semiconductor Corp. Jay Chiat & Assoc.	172, 173
■ Beckman Instruments, Inc., Helipot Division Hixson & Jorgensen, Inc.	174	Garrett Corp., Airesearch Mfg. Div. J. Walter Thompson Co.	120	■ North Atlantic Industries, Inc. Murray Heyert Assoc.	103
Bendix Corp., Electrical Components Div. MacManus, John & Adams, Inc.	36, 37	G & E Bradley, Ltd. Hyde & Partners, Inc.	186		
■ Bendix Corp., Flight & Engine Instruments Div. MacManus, John & Adams, Inc.	44	General Radio Co. Horton, Church & Goff, Inc.	2nd Cover		
Borden Chemical Co., Mystik Tape Industrial Div. Conahay & Lyon, Inc.	68	Groov-Pin Corporation Feeley Adv. Agcy., Inc.	179		
Brush Instruments, Div. of Clevite Corp. Carr Liggett Adv., Inc.	20, 21			Pacific Measurements, Inc. Jack Herrick Adv., Inc.	7
■ Bulova Watch Co., Electronics Div. Frank Best Co., Inc.	148	Haydon Co., A.W. Chambers, Wiswell & Moore, Inc.	174	Pastoriza Electronics Co. L.K. Frank Co., Inc.	176
		■ Hewlett Packard Associates Lennen & Newell, Inc.	17	Phoenix Chamber of Commerce Jennings & Thompson Advertising	164
		■ Hewlett Packard, Colorado Springs Div. Tallant/Yates Adv., Inc.	3rd Cover	Polaroid Corp. Doyle, Dane, Bernbach, Inc.	134
		■ Hewlett Packard, Dymec Div. Lennen & Newell, Inc.	113	Powertec, Inc. Frost, Shaffer, Gauthier	193
Capitol Radio Engineering Institute Henry J. Kaufman & Assoc.	153	■ Hewlett Packard, Frequency & Time Div. Lennen & Newell, Inc.	194		
Centralab, Div. of Globe-Union, Inc. The Brady Co.	175, 177	■ Hewlett Packard, Loveland Div. Tallant/Yates, Adv., Inc.	2		
Cerro Wire & Cable, Div. of Cerro Corp. Marsteller, Inc.	65	■ Hewlett Packard, Microwave Div. Lennen & Newell, Inc.	12, 13		
Cimron, Div. of Lear Siegler, Inc. Phillips-Ramsey, Inc.	42	■ Hewlett Packard, F.L. Moseley Co. Div. Lennen & Newell, Inc.	1	Radio Corporation of America 4th Cover, 53, 62, 63, 71, 145 Al Paul Lefton Co.	116
■ Clairex Corp. Michel-Cather, Inc.	170	■ Hewlett Packard, Rockaway Div. Culver Adv., Inc.	149	■ Raytheon Co., Components Div. Fuller & Smith & Ross, Inc.	116
Clare & Company, C.P. Reincke, Meyer & Finn Adv., Inc.	38, 39	Honeywell, Computer Control Div. Franklin P. Folts, Inc.	49	Redcor Corp. Smith-Klitten, Inc.	164
Clemens Manufacturing Co.	164	■ Honeywell, Test Instruments Div. Campbell Mithun, Inc.	154		
■ Clifton Precision Products Co., Div. of Litton Industries Ivey Advertising, Inc.	24	Industrial Electronic Engineers Gumpertz, Bentley & Dolan, Inc.	161		
■ Columbia Wire Products Co. Sander Rodkin Adv. Agcy., Ltd.	180				
Components, Inc. Creative Adv. Agcy.	72	Information Handling Services Martz & Associates	115		
Corning Glass Works, Electronic Products Div. Rumrill Hoyt Co., Inc.	69	Instrumentation Data Products, Inc. Braun Advertising, Inc.	16		
		I R C, Inc. Gray & Rogers, Inc.	142	Sierra Electronics, Div. Philco Ford Hal Lawrence, Inc.	119
		ITT Wire & Cable West, Weir & Bartel, Inc.	121	Signetics Corp. Sub. Corning Glass Works Cunningham & Walsh, Inc.	150
				Sinclair Radio Labs., Inc. John E. Hayes Co., Inc.	122
Delco Radio, Div. of General Motors Corp. Campbell-Ewald Co.	140, 141	Jerrold Electronics Corp. Mohr & Co., Inc.	14	■ Sorensen Operation, Raytheon Co. James Advertising, Inc.	11
Digital Equipment Corp. Kalb & Schneider, Inc.	22	■ J F D Electronics Co., Components Div. Delphi Advertising, Inc.	64	Sprague Electric Co., The Harry P. Bridge Co.	10, 74
Digitran Company, The Smith-Klitten, Inc.	137			■ Stackpole Carbon Co., Electronic Components Div. Meek & Thomas, Inc.	94
Discon Corp.	132			Sweet's Industrial Information System Wank, Williams & Neylan, Inc.	162
Dit-Mco International, Div. of Xebec Corp. Martin Fromm & Assoc., Inc.	174			Sylvania Electric Products, Inc., Electronic Tube Div.	27 to 34
DuPont de Nemours Co., Teflon Div. Batten, Barton, Durstine & Osborn, Inc.	185	■ Lapp Insulator Co. Wolff Associates	118		



Advertising sales staff

		Frank E. LeBeau [212] 971-6464 Advertising sales manager Wallis Clarke [212] 971-2187 Assistant to sales manager
		Donald J. Austermann [212] 971-3139 Promotion Manager
	8	Atlanta, Ga. 30309: Michael H. Miller, 1375 Peachtree St., N.E. [404] TR 5-0523
	126	Boston, Mass. 02116: William S. Hodgkinson McGraw-Hill Building, Copley Square [617] CO 2-1160
	66	Chicago, Ill. 60611: Robert M. Denmead, J. Bradley MacKimm, Ralph Hanning, 645 North Michigan Avenue, [312] MO 4-5800
	114	Cleveland, Ohio 44113: William J. Boyle, 55 Public Square, [216] SU 1-7000
	168, 169	Dallas, Texas 75201: Richard P. Poole, 1800 Republic National Bank Tower, [214] RI 7-9721
	40	Denver, Colo. 80202: Joseph C. Page, David M. Watson, Tower Bldg., 1700 Broadway, [303] 255-5484
	125	Detroit, Michigan 48226: Ralph Hanning 856 Penobscot Building [313] 962-1793
	144	Houston, Texas 77002: Kenneth George, 2270 Humble Bldg., [713] CA 4-8381
	41	Los Angeles, Calif. 90017: Ian C. Hill, John G. Zisch, 1125 W. 6th St., [213] HU 2-5450
	158	Minneapolis, Minn. 55402: J. Bradley MacKimm, 1104 Northstar Center [612] 332-7425
	146	New York, N.Y. 10036 500 Fifth Avenue Donald R. Furth [212] 971-3615 James R. Pierce [212] 971-3616 Jeffrey M. Preston [212] 971-3617
	129	Philadelphia, Pa. 19103: Warren H. Gardner, 6 Penn Center Plaza, [215] LO 8-6161
	171	Pittsburgh, Pa. 15222: Warren H. Gardner, 4 Gateway Center, [412] 391-1314
	179	Portland, Ore. 97204: James T. Hauptli, 218 Mohawk Building, 222 S.W. Morrison Street, Phone [503] 223-5118
	156	Rochester, N.Y. 14534: William J. Boyle, 9 Greylock Ridge, Pittsford, N.Y. [716] 586-5040
	131	St. Louis, Mo. 63105: Robert M. Denmead The Clayton Tower, 7751 Carondelet Ave. [314] PA 5-7285
	170	San Francisco, Calif. 94111: James T. Hauptli, 255 California Street, [415] DO 2-4600
		London W1: Edwin S. Murphy Jr., 34 Dover Street, Hyde Park 1451
		Paris: Pierre Braude, European Director Iena Commercial Bldg., 33 rue Galilee Phone: 553-47-79
		Milan: Robert Saidel 1 via Baracchini Phone: 86-90-656
		Frankfurt/Main: Hans Haller Elsa-Brandstroem Str. 2 Phone: 72 01 81
		Geneva: Miko Zeynel 1, rue du Temple Phone: 31 95 60
		Tokyo: Nobuyuki Sato, 1, Kotohiracho Shiba, Minato-Ku [502] 0656
		Osaka: Ryoji Kobayashi 163, Umegae-cho Kita-ku [362] 8771

Business Department

Wallace C. Carmichael, Manager [212] 971-3191
Stephen R. Weiss, Production Manager [212] 971-2044
Thomas M. Egan, Assistant Production Manager [212] 971-3140
Dorothy Carmesin, Contracts and Billings [212] 971-2908
Frances Vallone, Reader Service Manager [212] 971-2865

Circulation and Research

Milton Drake, Manager [212] 971-3485
Isaaca Siegel, Assistant Circulation Manager [212] 971-6057
David Strassler, Assistant Research Manager [212] 971-6058
Chloe D. Glover, Research Associate [212] 971-6057

Electronics Buyers' Guide

George F. Werner, General Manager [212] 971-2310
Ray Smith, Eastern Regional Manager [212] 971-6538
Regina Hera, Directory Manager [212] 971-2544
Thomas M. Egan, Production Manager [212] 971-3140

Classified Advertising

F.J. Eberle, Manager	
PROFESSIONAL SERVICES	181
EMPLOYMENT OPPORTUNITIES	181
EQUIPMENT (Used or Surplus New) For Sale	181
ADVERTISERS INDEX	
Phillip Fishman Co.	181
R & D Procurement Office	181
John Rotte Associates	181
Varo, Inc.	181

■ For more information on complete product line see advertisement in the latest Electronics Buyers' Guide

NEW

mini-mod

I/C POWER SUPPLY

80% SMALLER!

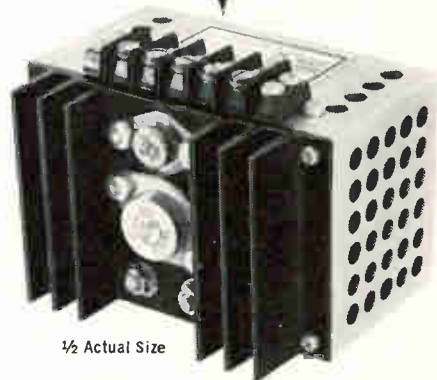

1/2 Actual Size

Powertec's new, ultra-miniature power supply is only 4"x3"x2 5/8" including heatsink.

Mini-mod is specifically designed for use in lightweight chassis with IC or other digital logic. Output voltages are available from 3 to 30 volts with .05% regulation.

INPUT: 115 Volts 47-440HZ

TYPICAL OUTPUTS:

3 V at 6 A
5 V at 5 A
15 V at 2 A

Mini-mod is currently available from stock. Detailed specifications and price are available upon request.

CUSTOM POWER SYSTEMS

Powertec's experts are capable of solving your most difficult power conversion requirements.

FOR MORE INFORMATION WRITE

POWERTEC

9170 Independence Avenue
Chatsworth, California 91311

HP Counters are now a better buy than ever before!



Hewlett-Packard's 5245 Series Electronic Counters, and their plug-ins, have steadily become the standard of quality and versatility wherever there is a need for precision electronic measurement. Always economical, always your best cost-for-performance buy, there are now more models and more plug-ins to choose from. And, with lower prices, they're a better buy than ever before.

5245L Counter: highly versatile instrument that measures frequency (0 to 50 MHz), period, multiple period average and frequency ratio. 8-digit readout and time base aging rate of <3 parts in 10^9 /day. Input impedance of 1 megohm 25 pF on all ranges. Accepts all HP counter plug-in accessories and has BCD output... NEW PRICE: \$2450.

5245M Counter: almost identical to the 5245L (above) but with a rapid warm-up ultra-stable time base with performance equalling that of many secondary standards: <5 parts in 10^{10} /day aging rate. Warms up to within 1 part in 10^8 of previous frequency in 1 hour (after 24 hours off)... NEW PRICE: \$2750.

5246L Counter: a stripped-down version of the 5245L, with only 6-digit readout and time base aging rate of <2 parts in 10^7 /month. Extra-cost options include 7- or 8-digit readout, BCD output; uses all 5245L plug-ins... NEW PRICE: \$1750.

5247M Counter counts directly to 135 MHz but, while it's similar to the 5245M, measures frequency only. Range can be extended to 18 GHz by means of the converter plug-ins; accepts prescaler plug-ins, too. Optional BCD output... NEW PRICE: \$2800.

5244L Counter: this counter doesn't accept plug-ins but has the basic measurement versatility of the 5245L—frequency, period and ratio. Range is to 50 MHz with 7-digit readout and BCD output. Time base aging rate is $<\pm 2$ parts in 10^7 /month... NEW PRICE: \$1850.

For more information on the lowest-priced deluxe counters you can buy, call your local HP field engineer or write Hewlett-Packard, Palo Alto, California 94304; Europe: 54 Route des Acacias, Geneva.

Plug-ins to use with these counters:

- | | |
|--|--|
| 5256A Heterodyne Converter, 8GHz to 18GHz (and 1 to 200 MHz), \$1750. | 5258A Prescaler, 1 to 200 MHz, 1 mV, \$825. |
| 5255A Heterodyne Converter, 3 GHz to 12.4 GHz (and 1 to 200 MHz), \$1650. | 5261A Video Amplifier, 1 mV RMS, 10 Hz to 50 MHz, \$325. |
| 5251A Plug-in Converter, 20-100 MHz, \$300. | 5262A Time Interval Plug-in, \$250. |
| 5252A Prescaler, DC to 350 MHz, \$685. | 5264A Preset Unit for normalized measurements, \$650. |
| 5253B Plug-in Converter, 50 to 512 MHz, \$500. | 5265A Digital Voltmeter, 6-digit presentation of 10, 100 and 1000 V full scale with 5% overrange capability, \$575. |
| 5254B Plug-in Converter, 0.2 to 3 GHz, \$825. | |

HEWLETT  PACKARD
ELECTRONIC COUNTERS

Electronics reader service

Warning: The Post Office now requires your ZIP CODE on all mail. Please include your ZIP CODE number when filling out your reply card.

Use these handy post cards for more detailed information on: products advertised, new products, new literature.

Circle the number on the Reader Service post card that corresponds to the number at the bottom of the advertisement, new product item, or new literature in which you are interested.

Please print clearly. All written information must be legible to be efficiently processed.

If someone has beaten you to the post cards, you may obtain the needed information by writing directly to the manufacturer, or by sending your name and address, plus the Reader Service number, to Electronics Reader Service department.

All inquiries from outside the U.S. that cannot reach Electronics before the expiration dates noted on the Reader Service post card, must be mailed directly to the manufacturer. The manufacturer assumes all responsibilities for responding to inquiries. Electronics merely provides and clears requests for information from inquirer to manufacturer.

Correct amount of postage must be affixed for all mailings from outside the U.S.

To subscribe to or to renew Electronics

Fill in the "For Subscriptions" area on the card if you desire to subscribe to or renew your present subscription to Electronics. Send no money. Electronics will bill you at the address indicated on the Reader Service post card.

Multi-product advertisements

For information on specific items in multi-product advertisements which do not have a specific Reader Service number indicated write directly to manufacturer for information on precise product in which you are interested.

24 Please Print Clearly *For employment inquires fill in home address. 14

Name _____ title _____ November 27, 1967
 Card Expires
 January 27, 1968

Company* _____
 Address _____

City _____ State _____ Zip Code _____

1	20	39	58	77	96	115	134	153	172	191	210	229	248	267	286	305	324	343	362	381	400	419	438	457	476	495	514	962
2	21	40	59	78	97	116	135	154	173	192	211	230	249	268	287	306	325	344	363	382	401	420	439	458	477	496	515	963
3	22	41	60	79	98	117	136	155	174	193	212	231	250	269	288	307	326	345	364	383	402	421	440	459	478	497	516	964
4	23	42	61	80	99	118	137	156	175	194	213	232	251	270	289	308	327	346	365	384	403	422	441	460	479	498	517	965
5	24	43	62	81	100	119	138	157	176	195	214	233	252	271	290	309	328	347	366	385	404	423	442	461	480	499	518	966
6	25	44	63	82	101	120	139	158	177	196	215	234	253	272	291	310	329	348	367	386	405	424	443	462	481	500	900	967
7	26	45	64	83	102	121	140	159	178	197	216	235	254	273	292	311	330	349	368	387	406	425	444	463	482	501	901	968
8	27	46	65	84	103	122	141	160	179	198	217	236	255	274	293	312	331	350	369	388	407	426	445	464	483	502	902	969
9	28	47	66	85	104	123	142	161	180	199	218	237	256	275	294	313	332	351	370	389	408	427	446	465	484	503	951	970
10	29	48	67	86	105	124	143	162	181	200	219	238	257	276	295	314	333	352	371	390	409	428	447	466	485	504	952	971
11	30	49	68	87	106	125	144	163	182	201	220	239	258	277	296	315	334	353	372	391	410	429	448	467	486	505	953	972
12	31	50	69	88	107	126	145	164	183	202	221	240	259	278	297	316	335	354	373	392	411	430	449	468	487	506	954	973
13	32	51	70	89	108	127	146	165	184	203	222	241	260	279	298	317	336	355	374	393	412	431	450	469	488	507	955	974
14	33	52	71	90	109	128	147	166	185	204	223	242	261	280	299	318	337	356	375	394	413	432	451	470	489	508	956	975
15	34	53	72	91	110	129	148	167	186	205	224	243	262	281	300	319	338	357	376	395	414	433	452	471	490	509	957	976
16	35	54	73	92	111	130	149	168	187	206	225	244	263	282	301	320	339	358	377	396	415	434	453	472	491	510	958	977
17	36	55	74	93	112	131	150	169	188	207	226	245	264	283	302	321	340	359	378	397	416	435	454	473	492	511	959	978
18	37	56	75	94	113	132	151	170	189	208	227	246	265	284	303	322	341	360	379	398	417	436	455	474	493	512	960	979
19	38	57	76	95	114	133	152	171	190	209	228	247	266	285	304	323	342	361	380	399	418	437	456	475	494	513	961	980

24 Please Print Clearly *For employment inquires fill in home address. 14

Name _____ title _____ November 27, 1967
 Card Expires
 January 27, 1968

Company* _____
 Address _____

City _____ State _____ Zip Code _____

1	20	39	58	77	96	115	134	153	172	191	210	229	248	267	286	305	324	343	362	381	400	419	438	457	476	495	514	962
2	21	40	59	78	97	116	135	154	173	192	211	230	249	268	287	306	325	344	363	382	401	420	439	458	477	496	515	963
3	22	41	60	79	98	117	136	155	174	193	212	231	250	269	288	307	326	345	364	383	402	421	440	459	478	497	516	964
4	23	42	61	80	99	118	137	156	175	194	213	232	251	270	289	308	327	346	365	384	403	422	441	460	479	498	517	965
5	24	43	62	81	100	119	138	157	176	195	214	233	252	271	290	309	328	347	366	385	404	423	442	461	480	499	518	966
6	25	44	63	82	101	120	139	158	177	196	215	234	253	272	291	310	329	348	367	386	405	424	443	462	481	500	900	967
7	26	45	64	83	102	121	140	159	178	197	216	235	254	273	292	311	330	349	368	387	406	425	444	463	482	501	901	968
8	27	46	65	84	103	122	141	160	179	198	217	236	255	274	293	312	331	350	369	388	407	426	445	464	483	502	902	969
9	28	47	66	85	104	123	142	161	180	199	218	237	256	275	294	313	332	351	370	389	408	427	446	465	484	503	951	970
10	29	48	67	86	105	124	143	162	181	200	219	238	257	276	295	314	333	352	371	390	409	428	447	466	485	504	952	971
11	30	49	68	87	106	125	144	163	182	201	220	239	258	277	296	315	334	353	372	391	410	429	448	467	486	505	953	972
12	31	50	69	88	107	126	145	164	183	202	221	240	259	278	297	316	335	354	373	392	411	430	449	468	487	506	954	973
13	32	51	70	89	108	127	146	165	184	203	222	241	260	279	298	317	336	355	374	393	412	431	450	469	488	507	955	974
14	33	52	71	90	109	128	147	166	185	204	223	242	261	280	299	318	337	356	375	394	413	432	451	470	489	508	956	975
15	34	53	72	91	110	129	148	167	186	205	224	243	262	281	300	319	338	357	376	395	414	433	452	471	490	509	957	976
16	35	54	73	92	111	130	149	168	187	206	225	244	263	282	301	320	339	358	377	396	415	434	453	472	491	510	958	977
17	36	55	74	93	112	131	150	169	188	207	226	245	264	283	302	321	340	359	378	397	416	435	454	473	492	511	959	978
18	37	56	75	94	113	132	151	170	189	208	227	246	265	284	303	322	341	360	379	398	417	436	455	474	493	512	960	979
19	38	57	76	95	114	133	152	171	190	209	228	247	266	285	304	323	342	361	380	399	418	437	456	475	494	513	961	980

Electronics New subscription application

Please start my three year subscription for only \$16 — I save \$8!

1 Year \$8 Bill Me Bill Company Payment Enclosed

Subscription Includes 1,200 Page Annual Buyers' Guide Issue

Name _____ Title _____
Please Fill in All Spaces

Company _____

Company address _____

City _____ State _____ Zip code

Product manufactured _____ or Service performed _____

Are you involved in the specification of electronic or allied products? Yes No

Please check your department or function:

Research Design, development Production, operation, maintenance

Other (please describe) _____

Above rates apply only to those professionally engaged in electronics technology. All others, \$25 per year.

L.
M.

Reprint service

All Electronics editorial matter available in reprint form:

For reprints of special reports and feature articles see list on right side of this page. Send your order to Electronics Reprint Department at the address indicated. To expedite mailing of your order for single reprints please send cash, check or money order with your order. Allow 3-4 weeks for delivery.

Bulk reprints of editorial matter can be ordered from current or past issues. The minimum quantity is 100 copies. Prices quoted on request; call 212-971-2274, or write to address below.

Warning: The Post Office now requires your ZIP CODE on all mail. Please include your ZIP CODE number when filling out your reply card.

3

Business reply mail
No postage stamp necessary if mailed in the United States

Postage will be paid by

First class
Permit no. 42
Hightstown, N. J.



Electronics
Reader service department
Box 444
Hightstown, N. J. 08520

2

Business reply mail
No postage stamp necessary if mailed in the United States

Postage will be paid by

First class
Permit no. 42
Hightstown, N. J.

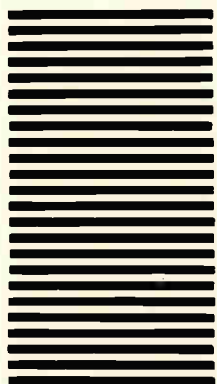

Electronics
Reader service department
Box 444
Hightstown, N.J. 08520

1

Business reply mail
No postage stamp necessary if mailed in the United States

Postage will be paid by

First class
Permit no. 42
Hightstown, N. J.



Electronics
P. O. Box 514
Hightstown, N. J. 08520

Subscription department

To order reprints or for further information, please write to: **Electronics Reprint Department, 330 West 42nd Street, New York, N.Y. 10036.**

You may order any of the below listed reprints by key number. Discounts on quantities over 10.

- Key no. R-01 **Computer-aided Design: Part I, The Man-machine Merger.** 16 pages. \$1.25.
- Key no. R-02 **Vietnam Communications Network Growing Into Southeast Asia's Best.** 3 pages. 25¢.
- Key no. R-03 **Sense Amplifier Fits Any Product.** 6 pages. 25¢
- Key no. R-04 **Multilayer Circuit Boards: Sharpening An Imperfect Art.** 7 pages. 50¢.
- Key no. R-05 **Topology Cuts Design Drudgery.** 12 pages. 50¢.
- Key no. R-06 **Report on Japanese Technology: Sony.** 20 pages. 50¢.
- Key no. R-07 **European Electronics Markets 1967.** 22 page forecast report with 4 page foldout chart. \$1.00.
- Key no. R-08 **U.S. Electronics Markets 1967.** 26 page forecast report with 6 page foldout. \$1.00.
- Key no. R-09 **1966 Electronics Index to Technical Articles and Authors Free.**
- Key no. R-010 **Special Report on Large Scale Integration.** 54 pages. \$1.50.
- Key no. R-011 **Medical Electronics (1967).** 8 part series, 44 pages. \$1.25.
- Key no. R-87a **The Packaging Revolution in Microelectronics. Parts I through VI.** 64 pages. \$2.00.
- Key no. R-86a **Computer Time Sharing. Parts I and II.** 32 pages. \$1.00.
- Key no. R-79 **MOS Integrated Circuits.** 12 pages. 50¢.
- Key no. R-78 **The Overlay Transistor.** 15 pages. 50¢.
- Key no. R-75 **Biotelemetry.** 2 part series, 16 pages. 50¢.
- Key no. R-74 **Unijunction Transistors.** 24 pages. 50¢.
- Key no. R-64 **Field Effect Transistors. Parts I, II, and III.** 64 pages. \$1.00.
- Key no. R-60 **Transistor Heat Dissipators.** 32 pages. 50¢.
- Key no. R-31 **Electromagnetic Spectrum Chart.** (22" x 30" foldout chart). \$1.00.

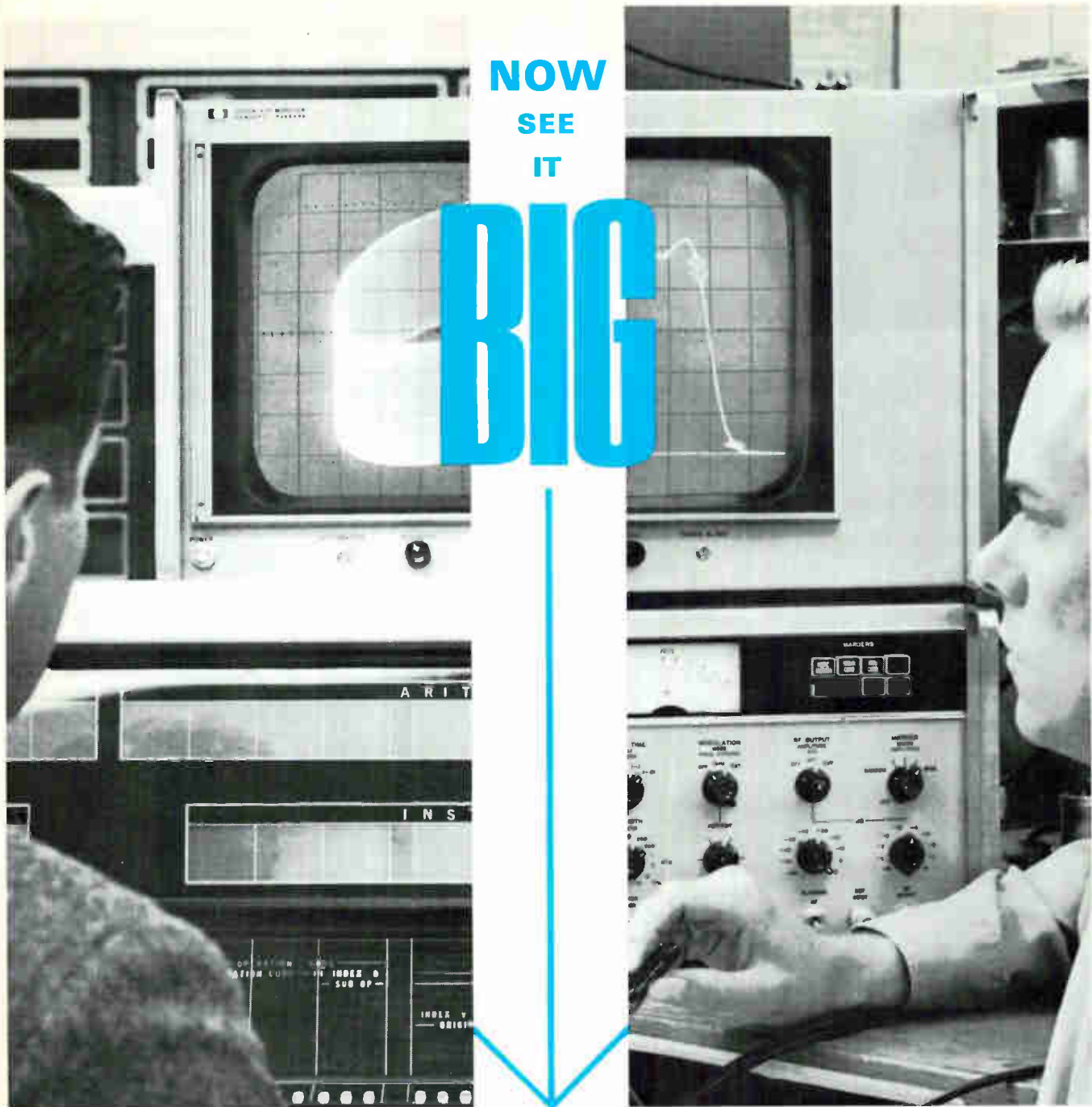

NOW
SEE
IT

BIG

New 20 MHz X-Y-Z Monitor

The extraordinarily wide dc to 20 MHz bandwidth on all three axes of the new hp 1300A provides an X-Y-Z capability not found in any other monitor. You get 20 times the bandwidth, twice the brightness found in other monitors—for only \$1900! Use it whenever you need extra large, accurate, easy-to-read displays. The internal graticule, 8 x 10-inch, 20 kV CRT gives you large, bright displays you can see across a big room—with no parallax error.

The 1300A Monitor writes at better than 20 inches/ μ sec for bright display of signals—even low duty cycle signals. Sensitivity of 100 mV/in provides large displays of low level signals. The compact 12" high rack space package weighs only 47 pounds, including self-contained power supply. All solid-state circuitry requires only 175 watts of power. Control and amplifier options available to increase versatility.

Get full details on the new hp 1300A X-Y Monitor from your hp field engineer. Or, write to Hewlett-Packard, Palo Alto, California 94304. Europe: 54 Route des Acacias, Geneva. Price: hp 1300A X-Y Monitor, \$1900.00.

087/31

HEWLETT  PACKARD

OSCILLOSCOPE SYSTEMS

Caught with their "ceramics" down

all similarly rated tubes are not equal

Construction of the high-gain Cermolox® RCA-4628 is far superior. For example, the G-1 and G-2 "cups" are locked together in a rigid assembly, then simultaneously electrically machined to produce grid wires precisely aligned with respect to each other. The result: a simplified, unitized construction. In SSB Communications and FM Broadcast service, particularly, the RCA-4628 delivers even more outstanding performance as a result of its compact coaxial structure, precision-aligned electronically-machined grids, and ceramic-to-metal seals.

RCA-4628, rated to 400 MHz, provides 10 kW PEP output in the 2 to 30 MHz range with lower distortion and better gain than its nearest counterpart. In FM Broadcast service, it offers higher gain with non-critical broadband neutralization techniques.

From now on, look "inside" as well as outside when you need tubes. In the RCA-4628, you'll find ruggedness, compactness, and long-life reliability. Mechanically-induced noise is very low and, because of UHF capabilities, you have no need for complex neutralization circuits at HF. The RCA-4628 is your obvious choice.

For more information on this and other RCA Cermolox® tubes, see your RCA Representative. For technical data on specific tube types, write: RCA Commercial Engineering, Section K19Q-2, Harrison, New Jersey 07029.

ALSO AVAILABLE FROM YOUR RCA INDUSTRIAL TUBE DISTRIBUTOR

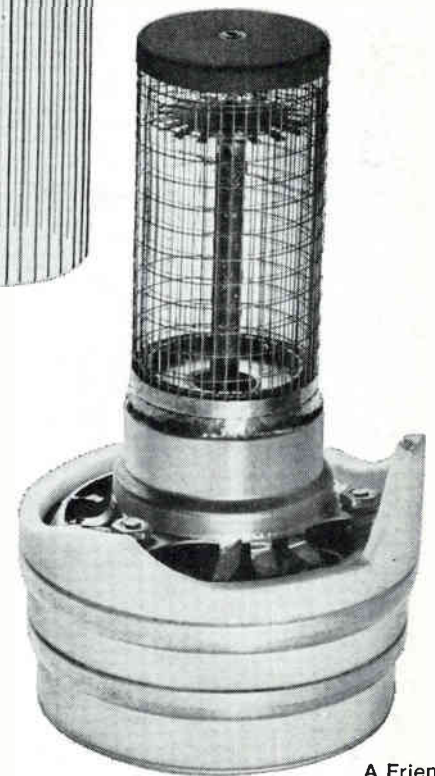
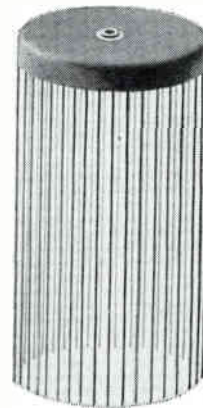
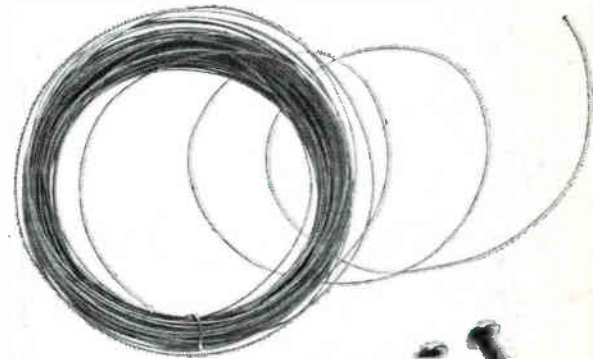

A Friend



G-2 "Cup"

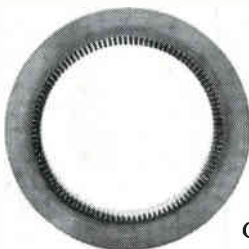

Electrical
Machining
Tool



G-1 "Cup"



RCA-4628



RCA Electronic Components and Devices

The Most Trusted Name in Electronics