

Electronics®

Computers help make circuits: page 70

Digitally controlled analog processor: page 99

Preview of IC's in entertainment goods: page 123

September 4, 1967

\$1.00

A McGraw-Hill Publication

Below: Map simulates circuit board to speed its layout, page 72

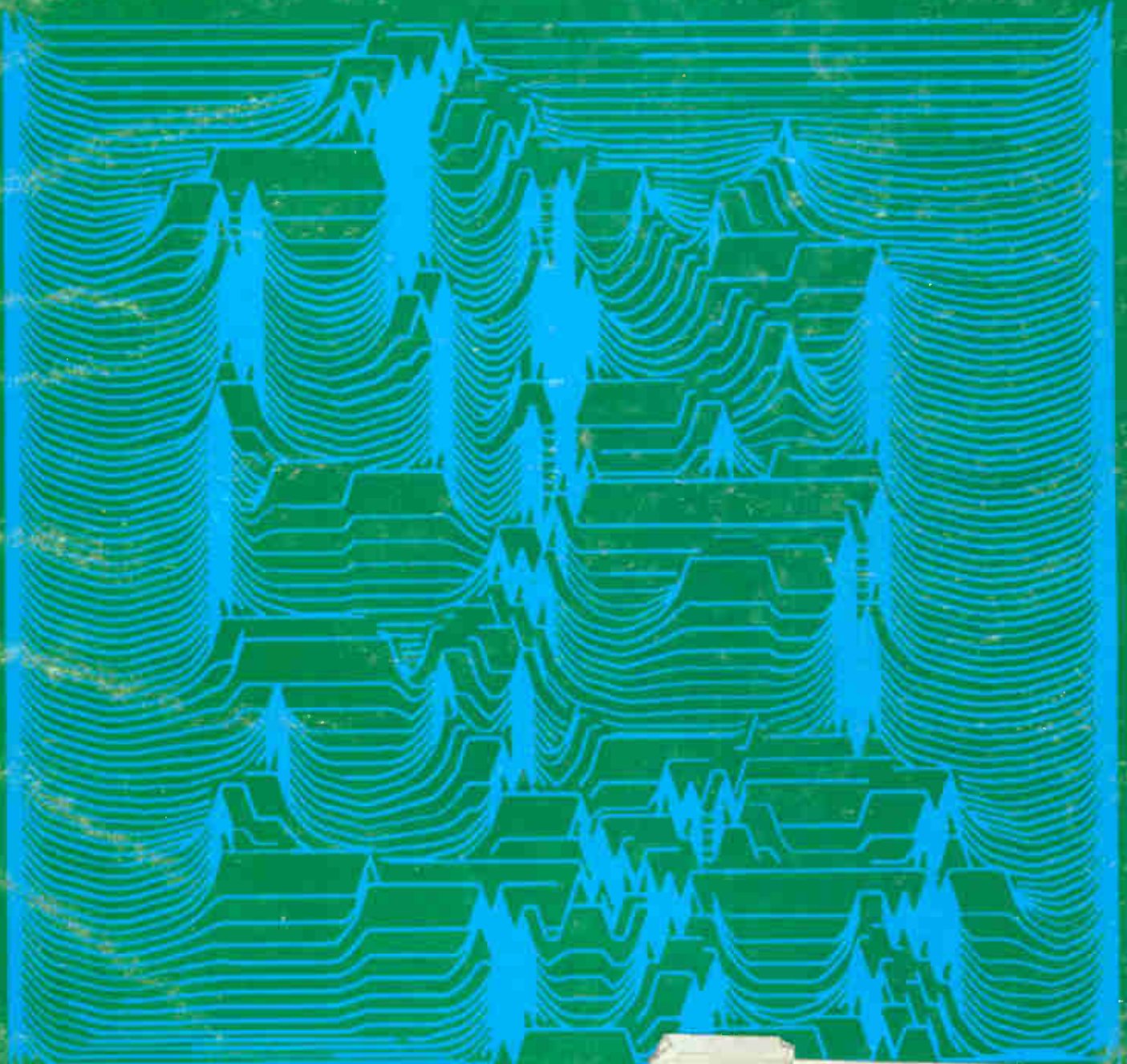

142 KSS936 44R94 11-67
R KISSLER
BOX 936
MAY 1967



Frequency synthesizers custom made... at off-the-shelf prices



Think you need a frequency synthesizer? A note of caution . . . it can be expensive. You can end up buying a lot more synthesizer than you really need or can use. Why not select one that's essentially custom built to your requirements?

With the GR series of 1160 Frequency Synthesizers you can do just that . . . your choice is not limited by a lack of variety. Start with any of four basic models; dc to 100 kHz, dc to 1 MHz, 30 to 12 MHz, or 10 kHz to 70 MHz. Next, select the amount of resolution you need; you can start with as few as three decades of resolution and add more later as your requirements expand, to give you up to nine significant figures. Need programmability? You can have that too, in up to 1-MHz steps. How about sweep and search func-

tions? Choose it if you need it. There are over 80 different combinations to select from, and the price of your "custom-built" synthesizer can be as low as \$3640.

For complete information or a demonstration, write General Radio Company, W. Concord, Massachusetts 01781; telephone (617) 369-4400.

GENERAL RADIO

bench accuracy at system speed

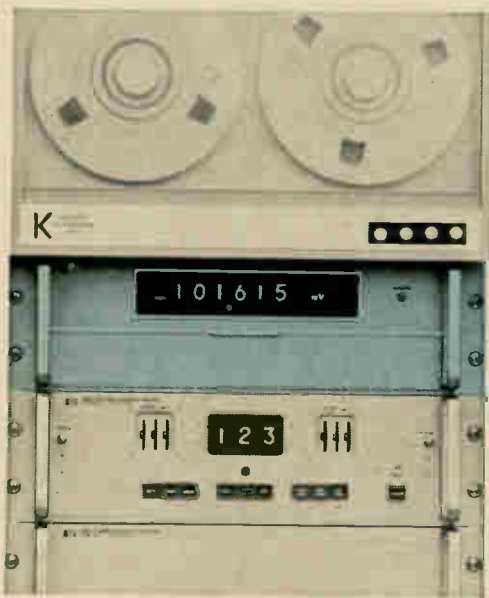

Cover protects 2402A controls for systems use.

Both in an
integrating DVM
with 1 microvolt
resolution.

Take 40 readings per second, integrate and resolve the answers to a microvolt with the new Hewlett-Packard 2402A IDVM... get resolution never before available in this speed range. With the accuracy of a lab instrument (0.01% of reading $\pm 0.003\%$ of full scale), the 2402A is excellent for system applications... with full programmability and all the features you'd expect from a systems voltmeter. (Of course, it's an excellent lab instrument, too.)

Guarding and integration permit accurate measurement of low-level signals in the presence of common mode and superimposed noise—over 120 dB effective common mode rejection... even at 40 readings per second. Designed for low-cost multimeter expandability: AC, resistance and frequency measurement capabilities can be added easily with optional plug-in circuit cards. Five ranges

to ± 1000 Volts, including a 0.1 Volt range for high-accuracy millivolt measurements.

The 2402A: \$4800. Plug-in options are reasonably priced—AC, for example, only \$450.

For more information, call your local HP field engineer or write Hewlett-Packard, Palo Alto, California 94304; Europe: 54 Route des Acacias, Geneva.

HEWLETT  PACKARD

DIGITAL VOLTMETERS

Here's *the* signal generator

for whatever microwave range...

...and here's why



8614A



8616A



8614B

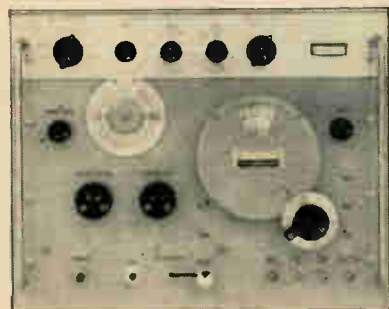

618C

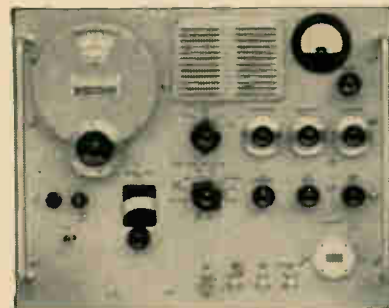

626A



938A



Hewlett-Packard microwave signal generators give you accurate, stable signals from 800 MHz—all the way to 40 GHz. These reliable, economical instruments provide direct reading frequency, output level controls and extremely flexible modulation capabilities.

- 800 to 2400 MHz: HP 8614A Signal Generator is user-oriented with digital dial frequency and output level setting and pushbutton selection of modulation functions. RF output is held constant with frequency by PIN diode modulator, residual and incidental FM are very low. RF output range is +10 to -127 dBm. Price, \$2200.

- 1800 to 4500 MHz: HP 8616A offers all the features of the 8614A, including low residual FM, negligible incidental FM, phase-lock capability. Price, \$2200.

- 800 to 4500 MHz: 8614B Signal Source (800-2400 MHz) and 8616B Signal Source (1800-4500 MHz) are economical, wide-range signal sources with digital dials for frequency and attenuation settings and pushbutton function selection. Precision RF output attenuator has >130 dB range. Units can be phase-locked. Prices, \$1450 each.

- 3.8 to 7.6 GHz: Model 618C Signal Generator has low (<15 kHz pk) residual FM, plus phase-lock capability. Versatile modulation includes internal pulse generator. Price, \$2250 (\$2270 rack mount).

- 7 to 11 GHz: Model 620B has same features as the 618C; residual FM <15 kHz pk. Price same as 618C.

- 10 to 15.5 GHz: Model 626A for SHF applications—easy to use, high 10 mW output level, especially versatile for its pulsing capabilities, \$3600 (\$3620 rack mount).

- 15 to 21 GHz: Model 628A, same features as the 626A, same price.

- 18 to 26.5 GHz: Model 938A Frequency Doubler Set doubles the output frequency of the driving source such as 626A Signal Generator. Driving signal can be CW, swept or modulated. Doubler has internal power monitor and precision 100 dB output attenuator. Price: \$1700 (rack mount \$1720).

- 26.5 to 40 GHz: Model 940A Frequency Doubler Set; driven by 628A Signal Generator. Same features as 938A, same price.

For more information on these broad-range, high-performance signal generators, call your local HP field engineer or write Hewlett-Packard, Palo Alto, California 94304. Europe: 54 Route des Acacias, Geneva.

HEWLETT *hp* PACKARD
SIGNAL GENERATORS

News Features

Probing the News

- 123 Consumer electronics firms entertain the possibility of using more IC's
131 Canada files claim on space sites

Electronics Review

- 39 Computers: Traveling memory; Real-time Fourier coefficients
41 Space electronics: Repair on the wing
42 Industrial electronics: Touch-tone testing
44 Avionics: In competition; On course
46 Instrumentation: Burning up the track
48 Advanced technology: GaAs packs more power
50 Government: The ups and downs
50 For the record

Electronics Abroad

- 205 Israel: Peeking at prizes
206 West Germany: Pointing the way
206 Great Britain: A step closer
207 Japan: What's cooking?
207 International: Discordant Symphonie
208 France: Shrug—in living color
208 Austria: Tv in waltz time
208 Soviet Union: Hard-to-get software
209 Around the world

New Products

- 141 Data processing in 3-D
146 New components review
146 New components: Diode chips for automatic tuning
147 New materials: Dichlorethane's in—and dirt's out; Ceramic magnet is 25% more permanent
153 New semiconductor review
153 New semiconductors: IC line is based on feedback; For stereo, two circuits in one
158 New instruments review
158 New instruments: Plug-ins make voltmeter a triple threat; Multimeter designer outdoes himself; Frequencies a la carte
167 New subassembly review
167 New systems: Computer analyzes memory performance
170 New subassemblies: Everyman's x-y recorder
175 New microwave review
175 New microwave: Harmonic mixer trims receiver
179 New production equipment review
179 New production equipment: Faster, safer packaging for semiconductors

Technical Articles

I. Design

- Circuit design 70 **Computer-aided design, part II: Shortcuts to IC's and p-c boards**
Computer helps design both printed and integrated circuits
Joseph Mittleman, senior associate editor
- 72 **Taking the puzzle out of p-c design**
A program helps design printed circuits by viewing them as 3-D maps
Clifford J. Fisk, David L. Caskey, and Leslie E. West, Sandia Corp.
- 83 **Drawing board for IC's**
Designer-computer dialogue begets better IC's faster
Arnold Spitalny and Martin Goldberg, Norden Division, United Aircraft Corp.
- 88 **Generating IC masks automatically**
The output for generating IC masks is provided by an experimental program
Harlow Freitag, Thomas J. Watson Research Center, IBM
- Circuit design 94 **Designer's casebook**
- Digital timing provides frequency-sensitive relay
 - Potentiometer turns flip-flop into an adjustable trigger
 - Transistor breakdown yields inexpensive thyristor trigger
 - Emitter peaking pushes bandwidth to 500 Mhz
 - Feedback loop stabilizes FET oscillator

II. Application

- Computers 99 **Paramatrix puts digital computer in analog picture**
Graphs and photographs are converted to digital signals by a fast new machine
W.J. Poppelbaum, Michael Faiman, and Edward Carr, Digital Computer Laboratory, University of Illinois

Departments

- | | | | |
|----|-----------------|-----|------------------------|
| 4 | Readers Comment | 25 | Electronics Newsletter |
| 8 | People | 53 | Washington Newsletter |
| 14 | Meetings | 183 | New Books |
| 16 | Meeting Preview | 189 | Technical Abstracts |
| 23 | Commentary | 194 | New Literature |
| | | 201 | Newsletter from Abroad |

Electronics

Editor-in-Chief: Lewis H. Young

Associate managing editors

Design: Donald Christiansen
Application: George Sideris
News: Robert Henkel
Copy: Sally Powell

Senior associate editors

John F. Mason, Joseph Mittleman, Stephen E. Scrupski

Department editors

Advanced technology: Stephen E. Scrupski
Computers: Wallace B. Riley
Consumer electronics: John Drummond
Design theory: Joseph Mittleman
Industrial electronics: Alfred Rosenblatt
Instrumentation: Carl Moskowitz
Military electronics: John F. Mason
New Products: William P. O'Brien, Stephen Fields
Solid state: Mark B. Leeds
Staff writers: James Brinton, Kay Sloman, Howard Wolff

Section editors

Electronics abroad: Arthur Erikson
Electronics review: Stanley Zarowin
Probing the news: Eric Aiken

Regional bureaus

Domestic

Boston: H. Thomas Maguire, manager; Robin Carlson
Los Angeles: Lawrence Curran, manager; June Ranill
San Francisco: Walter Barney, manager; Mary Jo Jadin
Washington: Robert Skole, manager; William D. Hickman, Paul Dickson, Patricia C. Hoehling

Foreign

Bonn: John Gosch
London: Michael Payne
Tokyo: Charles Cohen

Copy editors

Albert Tannenbaum, James Chang, Frederick Corey

Graphic design

Art director: Saul Sussman
Assistant art directors: Ann Mella, Valerie Betz
Production editor: Arthur C. Miller

Editorial secretaries: Claire Benell, Lynn Emery, Kay Fontana, Patricia Gardner, Lorraine Longo

McGraw-Hill News Service

Director: John Wilhelm; Atlanta: Fran Ridgway; Chicago: James Rubenstein;
Cleveland: Arthur Zimmerman; Dallas: Marvin Reid;
Detroit: N. Hunter; Houston: Robert E. Lee; Los Angeles: Michael Murphy, Gerald Parkinson
Pittsburgh: Louis Gomolak
San Francisco: William F. Arnold
Seattle: Ray Bloomberg; Washington: Arthur L. Moore, Charles Gardner,
Herbert W. Cheshire, Seth Payne, Warren Burkett, James Canan, William Small

McGraw-Hill World News Service

Bonn: John Johnsrud; Hong Kong: Don Kirk; London: John Shinn;
Mexico City: Bruce Cross; Milan: Ronald Taggiasco;
Moscow: Howard Rausch; Paris: Peter Kilborn;
Rio de Janeiro: Wes Perry; Tokyo: Marvin Petal

Reprints: Susan Nugent

Circulation: Milton Drake

Publisher: Gordon Jones

Electronics: September 4, 1967, Vol. 40, No. 18

Published every other Monday by McGraw-Hill, Inc. Founder: James H. McGraw 1860-1958.

Printed at 99 North Broadway, Albany, N.Y. 12207; second class postage paid at Albany, N.Y.

Executive, editorial, circulation and advertising addresses: McGraw-Hill Building, 330 W. 42nd Street
New York, N.Y. 10036. Telephone (212) 971-3333. Teletype TWX N.Y. 710-581-4235. Cable address:
MCGRAWHILL N.Y.

Subscriptions are solicited only from those actively engaged in the field of the publication. Position and company connection must be indicated on orders. Subscription prices: United States and possessions and Canada, \$8.00 one year, \$12.00 two years, \$16.00 three years; all other countries, \$25.00 one year. Single copies: United States and possessions and Canada, \$1.00; all other countries, \$1.75.

Officers of McGraw-Hill Publications: Joseph H. Allen, president; Bayard E. Sawyer, Executive Vice-President; J. Elton Tuchig, Senior Vice-President-Operations; Vice-Presidents: John R. Callahan, Editorial; John M. Holden, Marketing; Huber M. Gemmill, Circulation; Angelo R. Venezian, Production; Jerome D. Luntz, Planning & Development; Robert M. Wilhelm, Controller.

Officers of the Corporation: Donald C. McGraw, Chairman of the Board; Shelton Fisher, President; L. Keith Goodrich, Robert E. Slaughter, Executive Vice Presidents; Donald C. McGraw, Jr., Senior Vice-President; John L. Cooke, Vice-President & Secretary; John L. McGraw, Vice-President & Treasurer.

Title © registered in U.S. Patent Office; © Copyright 1967 by McGraw-Hill, Inc. All rights reserved. The contents of this publication may not be reproduced either in whole or in part without the consent of copyright owner.

Subscribers: The publisher, upon written request to our New York office from any subscriber, agrees to refund that part of the subscription price applying to copies not yet mailed. Please send change of address notices or complaints to Fulfillment Manager; subscription orders to Circulation Manager, Electronics at address below. Change of address notices should provide old as well as new address, including postal zip code number. If possible, attach address label from recent issue. Allow one month for change to become effective.

Postmaster: Please send form 3579 to Fulfillment Manager, Electronics,
P.O. Box 430, Hightstown, New Jersey 08520

Readers Comment

Laser hazard

To the Editor:

In connection with work on high-power carbon dioxide lasers, we have become aware of a practice apparently widespread throughout the industry: a standard firebrick is burned through to demonstrate the effectiveness of the laser beam or to terminate and dissipate the energy.

Since some firebrick material has a significant beryllia content, experimenters should know that the resulting vaporization of beryllium could represent a significant health hazard.

We use asbestos and recommend the use of materials guaranteed to be free of beryllia for such demonstrations.

Also, precautions are necessary whenever silica is heated to temperatures high enough to result in vaporization.

Richard G. Detro
Electro Optics Associates
Palo Alto, Calif.

Anglo-American problem

To the Editor:

Having worked four years in medical electronics in two hospitals in England, working in close association with doctors, I fully agree with your editorial "Partners in progress: doctor and engineer" [July 10, p. 23].

In the first hospital, the medical profession would not recognize my degree, which is in electrical engineering. They accepted only a degree in physics.

Since I had just finished college I finally decided to take a job there as a technician to gain experience in medical practice. In reality I was carrying out basic research in electronics as applied to surgery and at the same time lecturing the physics department which was supposed to be training me in semiconductor circuits as applied to hospital work.

Later, at a second hospital, I was suddenly told that it could not pay me an agreed-upon salary since I was under an age limit set by

Now from Sprague!

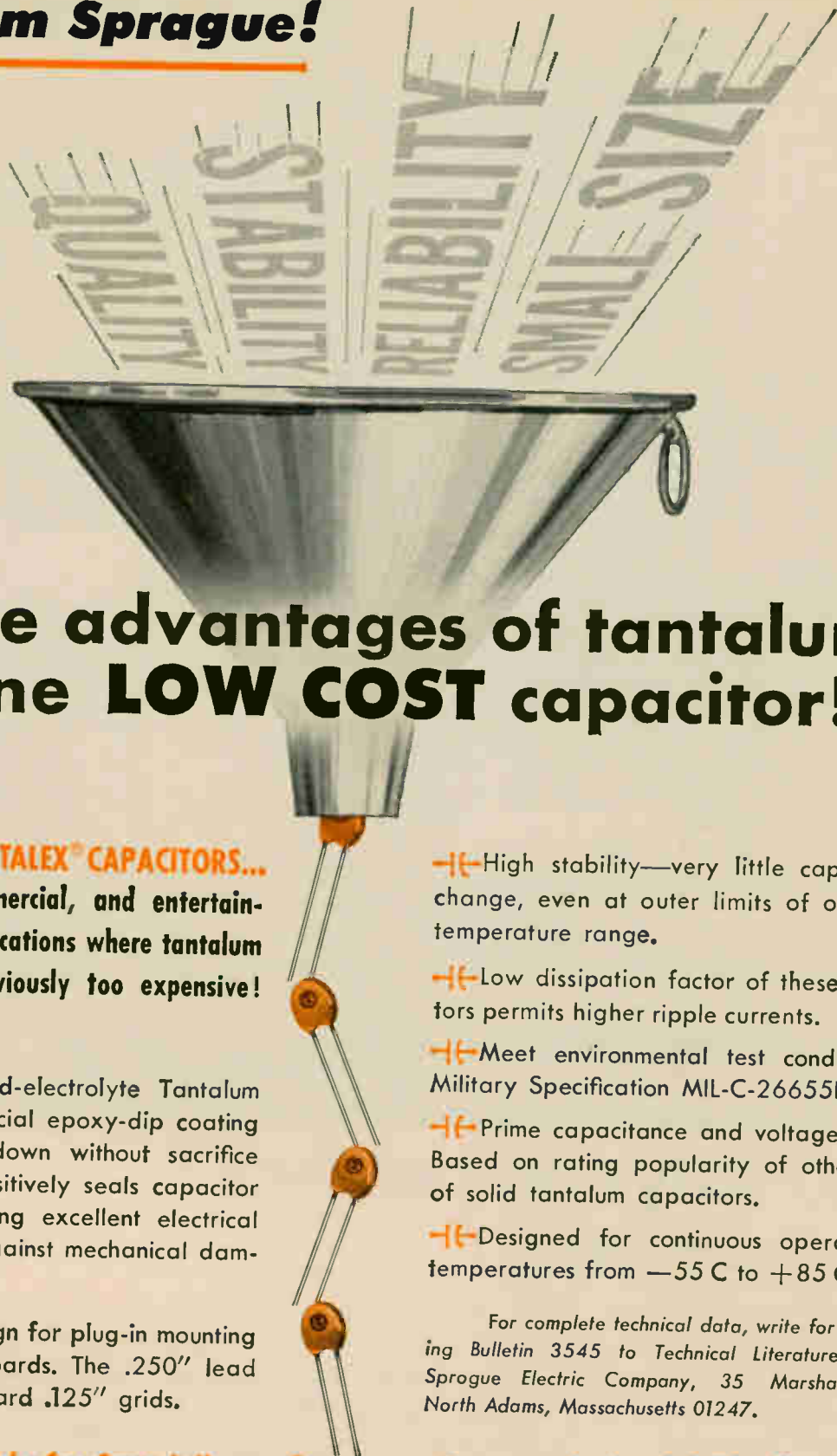

All the advantages of tantalum in one **LOW COST** capacitor!

EPOXY-DIPPED TANTALEX® CAPACITORS...

For industrial, commercial, and entertainment electronic applications where tantalum capacitors were previously too expensive!

—Type 196D Solid-electrolyte Tantalum Capacitors have special epoxy-dip coating which keeps costs down without sacrifice in dependability. Positively seals capacitor section while providing excellent electrical insulation. Protects against mechanical damage in handling.

—Radial lead design for plug-in mounting on printed wiring boards. The .250" lead spacing will fit standard .125" grids.

—High stability—very little capacitance change, even at outer limits of operating temperature range.

—Low dissipation factor of these capacitors permits higher ripple currents.

—Meet environmental test conditions of Military Specification MIL-C-26655B.

—Prime capacitance and voltage ratings. Based on rating popularity of other types of solid tantalum capacitors.

—Designed for continuous operation at temperatures from -55°C to $+85^{\circ}\text{C}$.

For complete technical data, write for Engineering Bulletin 3545 to Technical Literature Service, Sprague Electric Company, 35 Marshall Street, North Adams, Massachusetts 01247.

Now available for fast delivery from your Sprague Industrial Distributor

SPRAGUE COMPONENTS

CAPACITORS
TRANSISTORS
RESISTORS
INTEGRATED CIRCUITS
THIN-FILM MICROCIRCUITS
430-413081

PULSE TRANSFORMERS
INTERFERENCE FILTERS
PULSE-FORMING NETWORKS
TOROIDAL INDUCTORS
ELECTRIC WAVE FILTERS

CERAMIC-BASE PRINTED NETWORKS
PACKAGED COMPONENT ASSEMBLIES
BOBBIN and TAPE WOUND MAGNETIC CORES
SILICON RECTIFIER GATE CONTROLS
FUNCTIONAL DIGITAL CIRCUITS

SPRAGUE®
THE MARK OF RELIABILITY

Sprague and ® are registered trademarks of the Sprague Electric Co.

A black and white photograph showing a hand holding a funnel. The funnel is tilted, and a stream of coins is falling from it into a tall stack of coins. Some coins are scattered on the surface next to the stack. The background is dark.

**Knock off 35%
of shielding
material costs
with Hipernom[®]**

Hipernom meets the requirements of Federal Standard No. 222.

**...and stay competitive
into the 1970's.**

Of course you want to pay less for magnetic shielding against DC to 10,000 Hz. fields. Solution: Get Westinghouse Hipernom alloy.

Of all commonly used shielding alloys, Hipernom has the highest permeability. It lets you use thinner, lighter shields, allows easier, lower-cost fabrication. And you use less material per shield.

The 35% material cost saving per shield cited above is typical. Hipernom also brings you an important extra . . . the largest group of metallurgists specializing in magnetics. They'll put Westinghouse's 50 years of research leadership in magnetics at your service. Want specific details? Call Bob Carroll at 412-459-9400.

Free 36-page book on magnetic shielding

Any engineer who reads this book becomes one of America's foremost authorities on magnetic shielding. It is just that complete, practical and unique. For your free copy, write for "Shielding Book." Address Westinghouse Metals Division, Box 868, Pittsburgh, Pennsylvania 15230.

You can be sure if it's Westinghouse

J-05013



the hospital, so again I was paid as a technician. After I was married I decided to emigrate to the U.S. to work in industry.

It was my intention to return to medical work, eventually. However, it appears that the relationship between the medical profession and engineers is no better here than it is in England.

David W. Burgess

Engineer
Bendix Systems Division
Ann Arbor, Mich.

command many cities may experience a blackout.

While I wish the Marconi Co. prosperity, I submit that it would be better if they joined the other companies in supplying low-power single-side-band powerline carrier communications equipment.

P.F. Flynn

Systems Engineering
Arizona Public Service Co.
Phoenix, Ariz.

Warning

To the Editor:

The article "Blind to danger" [June 26, p. 47] described an incident in which a Fort Monmouth engineer allegedly suffered no ill effects from the direct viewing of the beam from a helium-neon laser. It is not clear whether this viewing was inadvertent or intentional. In either event, I would not encourage any of your readers to draw any unwarranted inferences from this isolated experience. Viewing of either direct or even reflected laser beams should never be undertaken unless a careful analysis of the potential ocular hazard has been performed for the particular situation at hand.

It would be regrettable if cavalier attitudes toward laser hazards are propagated either through bravado or ignorance. Those of us working with lasers have a special obligation to make sure that the tragic history of human injury, which occurred in the ionizing radiation field, is not repeated in this new area of advanced technology.

Leonard R. Solon

Vice president and
Technical Director
Biorad Inc.
New Hyde Park, N.Y.

Crowded frequencies

To the Editor:

The description of Marconi's new vlf transmitter [July 10, p. 162] says the 3- to 300-kilohertz frequencies are utilized by only a few government and military users.

How I wish this were true! As a matter of fact those frequencies are so crowded that in some instances there is zero hertz spacing between used frequencies. In the majority of cases a 2-khz guard band is a real luxury.

These frequencies are used extensively by power companies on their transmission lines for supervisory control, telemetry, relaying and voice communications. Recently I worked for three days with the Southwest Power Pool Frequency Coordinator, D. Martin, just to obtain frequencies for a new 500-kv transmission line. At the point where this line joins other lines there are 46 frequencies in use between 50 khz and 287 khz.

I might add that the supervisory control involved is not trivial. It controls the major electric power flows and when one of these transmission lines is tripped by a false

...now add 5MHz AC capability to your digital voltmeter



with PM's new AC/DC Converter

A unique rectifying detector circuit* employing MOS FETs provides a frequency range of 5 Hz to 5 MHz, 70 dB dynamic range and 300 microvolt sensitivity.

DC output is the RMS value of the AC signal.

In addition to its usefulness with DVMS, the analog output is ideal for swept frequency measurements where plots of filter characteristics are needed.

Add the companion PM Logarithmic Converter for direct measurements in dB.

PM 1008 AC/DC Converter: \$900

* PATENT PENDING

For details on this and other intriguing new PM instruments, write or call:

PM PACIFIC
MEASUREMENTS
INCORPORATED

940 INDUSTRIAL AVENUE,
PALO ALTO, CALIFORNIA
(415) 328-0300

SUBSCRIPTION SERVICE

Please include an Electronics Magazine address label to insure prompt service whenever you write us about your subscription.

Mail to: Fulfillment Manager
Electronics
P.O. Box 430
Hightstown, N.J. 08520

To subscribe mail this form with your payment and check new subscription renew my present subscription

Subscription rates: in the U.S.: 1 year \$8; two years, \$12; three years, \$16. Subscription rates for foreign countries available on request

CHANGE OF ADDRESS

ATTACH
LABEL
HERE

If you are moving, please let us know five weeks before changing your address. Place magazine address label here, print your new address below.

name _____

address _____

city _____

state _____

zip code _____

Add Sprague Series 7400A to your prints for Series 74N TTL circuits. They're pin-for-pin identical.

SERIES 74N	FUNCTION	SPRAGUE PART NO.
SN7400N	Quad 2-Input NAND	USN-7400A
SN7401N	Quad 2-Input NAND (No Collector Load)	USN-7401A
SN7402N	Quad 2-Input NOR	USN-7402A
SN7410N	Triple 3-Input NAND	USN-7410A
SN7420N	Dual 4-Input NAND	USN-7420A
SN7430N	Single 8-Input NAND	USN-7430A
SN7440N	Dual 4-Input NAND Buffer	USN-7440A
SN7450N	2-Wide 2-Input Expandable AND-OR-INVERT	USN-7450A
SN7451N	2-Wide 2-Input AND-OR-INVERT	USN-7451A
SN7453N	4-Wide 2-Input Expandable AND-OR-INVERT	USN-7453A
SN7454N	4-Wide 2-Input AND-OR-INVERT	USN-7454A
SN7460N	Dual 4-Input Expander	USN-7460A
SN7470N	D-C Clocked J-K Flip Flop	USN-7470A
SN7472N	J-K Master Slave Flip Flop	USN-7472A
SN7473N	Dual J-K Master Slave Flip Flop	USN-7473A
SN7474N	Dual D-Type Edge-Triggered Flip Flop	USN-7474A
—	Dual AC Clocked J-K Flip Flop	USN-7479A

Series 5400, full-temperature-range equivalents in 14 pin flat-packs, are also available for rapid delivery from Sprague.

Don't spend another week without calling Sprague.

For complete technical data on Series 5400 and 7400A circuits, write to Technical Literature Service, Sprague Electric Co., 35 Marshall St., North Adams, Mass. 01247



SPRAGUE COMPONENTS

INTEGRATED CIRCUITS
CAPACITORS
TRANSISTORS
RESISTORS
THIN-FILM MICROCIRCUITS
PULSE TRANSFORMERS

INTERFERENCE FILTERS
PACKAGED COMPONENT ASSEMBLIES
FUNCTIONAL DIGITAL CIRCUITS
MAGNETIC COMPONENTS
CERAMIC-BASE PRINTED NETWORKS
PULSE-FORMING NETWORKS



Sprague and ® are registered trademarks of the Sprague Electric Co.

People

"My first assignment," says NASA's new No. 3 man, "will be to develop an orderly, routine planning approach for the agency. The big problem, as I see it, is defining the major new objectives of the space program." The announcement of the appointment of 52-year-old Homer E. Newell as the agency's associate administrator came late last month in the midst of the National Aeronautics and Space Administration's worst financial setbacks in years. [For more on NASA's problem, see page 50.]



Homer E. Newell

Newell's credentials as a space planner and administrator go back to NASA's infancy. His first job was to plan and develop the space science program. That was back in 1958. For the last four years, he had been associate administrator for space sciences and applications, a job that included administration of a large parcel of program areas including lunar and planetary exploration, grants, space applications, physics, astronomy and bio-science, and research contracts. Before taking on the last assignment, Newell was deputy director of space flight programs and director, Office of Space Sciences.

Selling an idea. The soft-spoken Newell sees his new role as that of a communicator with those whom NASA serves and works with. "I will be in constant contact with the scientific community," he says, "and will work closely with the new missions boards being set up." He plans to help support other agencies in their space programs and mentions, as an example, helping Federal agencies that wish to study the earth's resources from space. An aide says Newell has the ability to explain and sell programs to Congress, and to communicate with the scientific community.

One program that has fallen victim to the House appropriation ax is Voyager, which was under Newell's jurisdiction in space sciences and applications.



AT WCBS-TV MACHLETT ML-5681 HIGH POWER TRANSMITTING TUBES HAVE JUST LOGGED 170,000 HOURS.

Where prime time requires prime performance specify Machlett transmitting tubes. Available now: The new Machlett short form catalog, from The Machlett Laboratories, Inc., 1063 Hope Street, Stamford, Connecticut 06907.



THE MACHLETT LABORATORIES, INC.

A SUBSIDIARY OF RAYTHEON COMPANY

(use time delay relays?)
CHECK AEMCO PRICES!

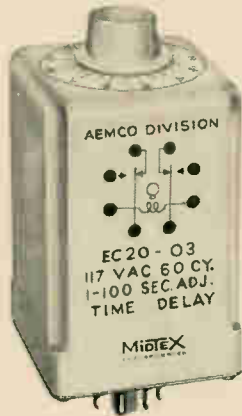

NEW!

electronic reliability
\$17.50

(1-24 quantity)

ELECTRONIC RELIABILITY

±5% REPEAT ACCURACY

1-100 SECOND ADJUSTABLE DELAY

PLUG-IN CONVENIENCE

DPDT OUTPUT RATED 10 A.

LOW PRICE! QUANTITY DISCOUNTS!

Budget priced with plug-in convenience where critical timing parameters are not required. Delay adjusted by convenient single knob. Remote adjustment by use of external potentiometer (special order). 117 VAC input. DPDT output rated 10 A. AEMCO type EC.



REPLACES MOTOR TYPES

\$15.50

(1-24 quantity)

ELECTRONIC RELIABILITY

REPLACES POPULAR MOTOR TYPES

±5% REPEAT ACCURACY

1-90 SECOND ADJUSTABLE DELAY

DPDT OUTPUT RATED 10 A.

LOW PRICE! QUANTITY DISCOUNTS!

Packaged to directly replace all popular motor type time delay relays... far more reliable than motor types. Budget priced—real savings when critical timing parameters are not required. 117 VAC input. DPDT rated 10 A. AEMCO type LC.

NEED SPECIALS? Other packaging? Longer timing ranges? Other voltages? DC? Remote adjustment? Write or call outlining your needs. We're eager to serve you, too!

AEMCO DIVISION

MANKATO, MINNESOTA 56001
 formerly TELEX/AEMCO
 PHONE A/C 507-388-6286



People

Says Newell: "My only hope is that we've sold Voyager and that we're just experiencing a delay because of war and problems on the homefront.

Newell concedes that the schedule for Voyager was so tight that without funds in fiscal 1968 the first shot to Mars cannot take place until 1975.

An electronics company with \$70 million in sales and a goal of \$100 million has two principal roads available: acquisition and diversification.



EC&C Inc. of Bedford, Mass., is going both ways: it acquired four small companies this year and last month named Norman L. Harvey general manager of its new Systems Development division to get that unit into high gear. The purchased firms work in the fields of oceanography, weather modification, instrumentation, and geophysical exploration.

"Systems have always been my major interest," says Harvey, who went to EC&C in 1965 from Varian Associates, Palo Alto, Calif. Harvey had headed a Varian venture into computer-based teaching systems, but when the company dropped the project Harvey quit and joined EC&C.

Bomb monitor. Since its founding 20 years ago, EC&C has been the prime Atomic Energy Commission instrumentation contractor. Of its \$70 million volume, EC&C currently gets nearly \$49 million under this contract. So the diversification is concentrated on non-AEC systems.

EC&C has already made its debut in digital facsimile systems [Electronics, Aug. 7, p. 42], and Harvey has plans for other graphic equipment, as well as flash systems for navigation and photography, weather modification techniques, and for custom-designed radiation-detection systems based on semiconductor technology.

AC line regulation problems ?

**—check
the
Sorensen
line.**

✓	Precision Regulation Required? —Need $\pm 0.01\%$...maybe only $\pm 0.1\%$?—Sorensen's broad line of 'off-the-shelf' regulators can provide it.
✓	Size and Weight Important? —ACR units are less than half the size and weight of conventional units.
✓	Stringent Distortion Requirements? —FR models maintain less than 0.25% — even with an input line having 10% distortion.
✓	Need Quick Response? —All models of our FR Series respond to line and load changes within 50 μ s—less than 1 cycle.
✓	Delivery/Price a Factor? —Each standard model is available off-the-shelf.

However demanding your AC regulator checklist, the Sorensen line can bear a good hard look. Whatever your needs, chances are Sorensen has a unit for your application. We offer a broad range of off-the-shelf line regulators to choose from in the range 150VA to 15kVA. Our ACR Series, for example, feature silicon controlled rectifier regulation, printed circuit maintainability, and require minimal rack space. The .01 Series provides high precision regulation, $\pm 0.01\%$, for applications demanding the strictest accuracy and stability. Where fast response is an important consideration, the FR Series is unsurpassed. Sorensen's magnetic-amplifier S Series offers excellent low-cost regulation for a variety of applications.

Each Series is a carefully designed combination of power, performance and packaging,—to fill your specific requirements. Sorensen's AC regulation capability spans 25 years of experience in the design and production of regulators. Our standard product technology provides the firm basis for an outstanding custom design capability. Whatever your AC regulator problems, — check with Sorensen.

For details on Sorensen AC regulators, or for standard/custom DC power supplies or frequency changes, contact your local Sorensen rep. or: Raytheon Company, Sorensen Operation, Richards Ave., Norwalk, Conn. 06856. Tel: 203-838-6571.



This **NEW G-V**

**QUICK
CONNECT**

**THERMAL
TIMING RELAY...**

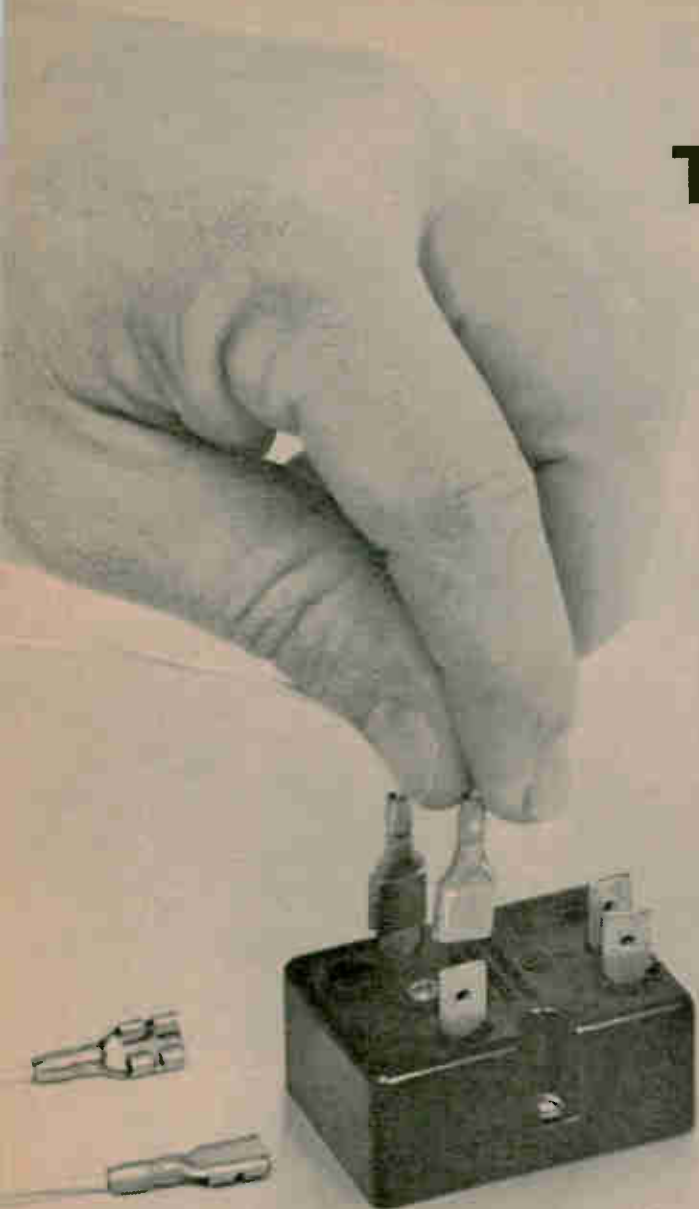

THERMAL TIMING RELAY
For PC board mounting



The JT Series is the only thermal relay designed to mount directly on PC boards without need for adapters or sockets. This design conserves space, reduces weight, allows greater packaging densities for PCB's. Features: time delays, 2 to 180 sec.; contacts, SPST, NO or NC; heater voltages, 5.3 to 230V, AC or DC; temperature compensated; operates in any position.

only from **G-V**

Circle 210 readers service card

**SUBMINIATURE THERMAL
TIMING RELAYS**



The LT Series relays provide hi-level performance in a subminiature hermetically sealed housing — space saving without loss of performance. Meets military standards. Features: height above mounting panel 40% of standard relays (7 pin flange mount); time delays, 2 to 75 sec.; operating temp., -65°C to +85°C; operating voltages, 6.3 to 115V, AC or DC.

G-V

Circle 211 readers service card

**HIGH PRECISION THERMAL
RELAYS**



The PT Series relays provide the most precise performance available in thermal relays. Meet the exacting military requirements for reliability under extreme operating environments. Features: ±5% tolerance over a temp. range of -55°C to +125°C; 2000 Hz vibration; 50g shock; time delays, 3 to 180 sec.; heater voltages, 6.3, 28 and 115V, AC or DC.

only from **G-V**

Circle 212 readers service card

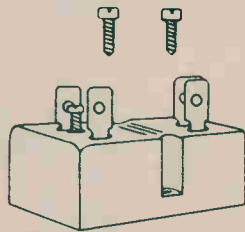

Recognized Under
The Components Program
Of Underwriter's
Laboratories Inc.

reduces installation time and cost!

**NEW PACKAGING FEATURES EASY MOUNTING . . .
PUSH-ON TERMINALS . . .** *it's from G-V*

The new G-V Quick Connect Thermal Timing Relays are rugged and versatile enough to withstand the most demanding industrial applications. They are a low cost series designed to reduce installation time and cost. Only two mounting screws are necessary, eliminating the need for special brackets, sockets or retainers. Push-on terminals provide flexibility of wiring, part location and equipment servicing. A dust-tight molded phenolic case houses a stainless structure with nickel-chromium heater winding, assuring long life and dependable service. The low profile Quick Connect thermal timing relays can be mounted in any position. Specifications include: Contacts, SPST, NO, NC; Resistive Rating, 2 amps 115V AC or 1 amp 28V DC; Heater Voltage, 6.3, 26, 115V AC or DC; Time Delays, 5-180 seconds; Time Delay Tolerance, $\pm 20\%$; Heater Power, 2½ Watts, nominal. Suitable for continuous operation to 160°F. Ambient compensated.



G-V CONTROLS INC.

LIVINGSTON, NEW JERSEY 07039
(201) 992-6200

Circle 216 on reader service card

THERMETTE 9 PIN RELAY



Metal enclosed thermal time delay is dust proof and shatter proof — designed for industrial applications requiring reliable operation and long life. Features: temp. compensated; time delays, 2 to 180 sec.; heater voltages, 6.3, 26, and 115V. AC or DC; contacts, SPST, NO or NC.

Recognized Under The Components Program
Of Underwriter's Laboratories Inc.



Circle 213 readers service card

INSTANT RESET THERMAL TIMING DEVICES



Instant reset during or after timing is available by combining G-V's unique instant reset timing element with a magnetic relay. Widely used in communication systems and data processing equipment. Features: delay time, 2 sec. to 5 min.; ambient operating temp., 32 F to 185 F.

only from 

Circle 214 readers service card

DIRECT-LINE FIELD ENGINEERING SERVICE



G-V assistance is always available to help you design and produce a better product. G-V Regional Field Engineers in your area will assist you and your design group in new applications and proper selection of your controls. G-V Product Engineers will help you with special applications. When you require experience, products and services in electro-mechanical and solid-state controls . . . call your man from G-V.



Circle 215 readers service card

There always has to be a winner—and when it comes to all-purpose sweep signal generators, the Jerrold Model 900-C is a shoo-in.

Measure a *narrow* band circuit (sweepwidth down to 10 kHz) or check the *entire* coverage of broad band units such as mixers, amplifiers, or filters (sweepwidths up to 400 MHz). Design, test or measure a variety of VHF, UHF, narrow and wide band devices in the frequency range 500 kHz to 1200 MHz... and do it with incomparable ease and accuracy. Here is convenience only an all-purpose sweeper can provide.

The 900-C and ultra-reliable Measurement-by-Comparison techniques permit accurate and simple measurement of gain, loss, and VSWR. You can disregard variables such as nonlinearity of detectors, oscilloscope drift, and line voltage variations.

If you need more convincing, send for complete data—or contact us for a demonstration. Write Government and Industrial Division, Jerrold Electronics Corporation, 401 Walnut St., Philadelphia, Pa. 19105.



clean sweep!

IN TEST,
MEASUREMENT,
AND
DESIGN

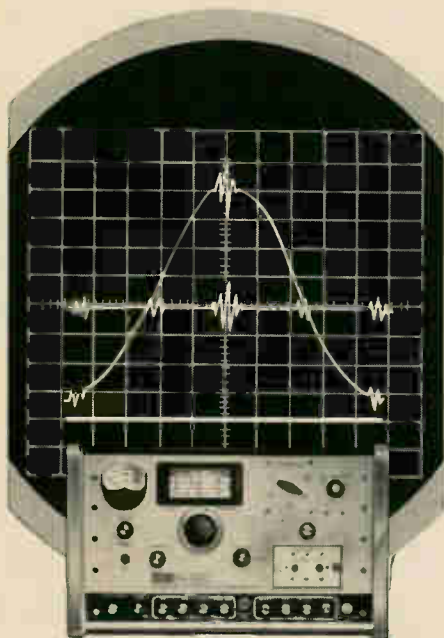

Meetings

Conference on Solid State Devices, IEEE; Manchester, England, Sept. 5-8.

Computer Conference, IEEE; Chicago, Sept. 6-8.

Electric Propulsion and Plasma-dynamics, American Institute of Aeronautics and Astronautics; Colorado Springs, Colo., Sept. 11-13.

Meeting on Space Simulation, American Society for Testing and Materials; Sheraton Hotel, Philadelphia, Sept. 11-13.

Symposium on Computer Control of Natural Resources and Public Utilities, International Federation of Automatic Control; Haifa, Israel, Sept. 11-14.

Instrument Society of America Conference and Exhibit, Instrument Society of America; International Amphitheater, Chicago, Sept. 11-14.

International Symposium on Information Theory, IEEE; Athens, Greece, Sept. 11-15.

Seminar on Mathematical Systems Theory, Pennsylvania State University; Pennsylvania State University's Residence Hall, Pa., Sept. 11-15.

International Congress on Magnetism, International Union of Pure and Applied Physics and American Institute of Physics; Boston, Sept. 11-16.

Symposium on Materials—key to effective use of the sea, Polytechnic Institute of Brooklyn and Naval Applied Science Laboratory; Statler Hilton Hotel, New York, Sept. 12-14.

Biennial Electric Heating Technical Conference, IEEE; Statler Hilton Hotel, Detroit, Sept. 13-14.

Society of Motion Picture and Television Engineers Conference; Edgewater Beach Hotel, Chicago, Sept. 17-22.

Conference on Electrical Insulation and Dielectric Phenomena; National Academy of Science; Pocono Manor Inn, Pocono Manor, Pa., Sept. 18-20.

Automotive Conference, IEEE; Howard Johnson's Motor Lodge, Detroit, Sept. 21-22.

Symposium on Microelectronics Applications, IEEE; Garden City Hotel, Garden City, Long Island, N.Y., Sept. 21-22.

International Electronics Conference and Exposition, Canadian Region of IEEE; Automotive Building, Canadian National Exhibition, Toronto, Sept. 25-27.

International Telemetry Conference, International Foundation for Telemetry; Marriott Twin Bridges Motor Hotel, Washington, Oct. 2-4.*

Short Courses

New directions in organic chemistry, Stevens Institute of Technology's Department of Electrical Engineering; Hoboken, N.J., Sept. 6-8; \$150 fee.

Seminar on the management of new developments: from basic sciences into profitable products, IEEE and Newark College of Engineering; Newark, N.J.; Sept. 7; \$25 for nonmembers of IEEE.

Calls for Papers

Electronic Components Conference, IEEE and Electronic Industries Association; Marriott Twin Bridges Motor Hotel, Washington, May 8-10, 1968. **Oct. 10** is deadline for submission of papers to technical program chairman, Frank Collins, Speer Research Laboratory, Packard Road and 47th St., Niagara Falls, N.Y. 14302

Intermag Conference, IEEE; Sheraton Park Hotel, Washington, April 3-5, 1968. **Dec. 15** is deadline for submission of abstracts to James M. Lommel, General Electric Research and Development Center, P. O. Box 1088, Schenectady, N. Y. 12305

International Quantum Electronics Conference, IEEE; Everglades Hotel, Miami, Fla., May 14-17, 1968. **Jan. 8** is deadline for abstracts to R.W. Terhune, technical program chairman, Physical Electronics Department, Ford Motor Co., P.O. Box 2053, Dearborn, Mich., 48121.

* Meeting preview on page 16.

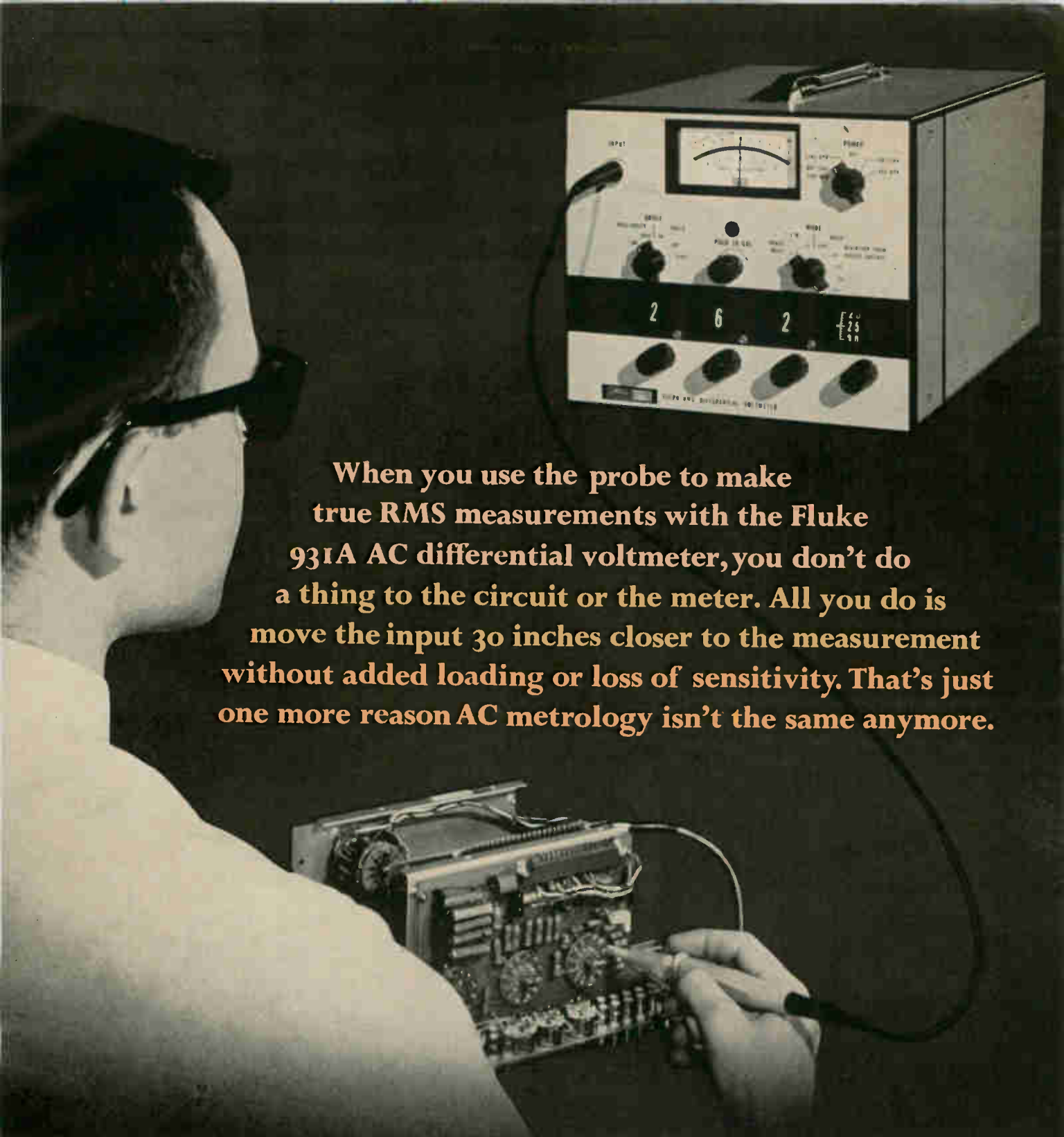

When you use the probe to make true RMS measurements with the Fluke 931A AC differential voltmeter, you don't do a thing to the circuit or the meter. All you do is move the input 30 inches closer to the measurement without added loading or loss of sensitivity. That's just one more reason AC metrology isn't the same anymore.

Use the new Fluke 931A to measure virtually any waveform within 0.05% from 30 Hz to 50 KHz. Make these measurements without losing null sensitivity as the voltage decreases. For in the Fluke 931A, the null meter indicates percent deviation from the dialed voltage. Overall frequency response is 10 Hz to 1 MHz. Range is 0.01 to 1100 volts. Ten to one crest factor takes care of effects caused by voltage spikes and pulse trains. Other features include low capaci-

tance, high resistance input, inline digital readout with lighted decimal point, all solid state design, and linear recorder output. Meets MIL-SPEC shock and vibration requirements. Ten percent overranging cuts down range changing. Available with or without probe in both line and combination line rechargeable battery powered versions. Base price \$895. Call your full service Fluke sales engineer (see EEM) for a demonstration or write us for full information.

Circle 15 on reader service card

Fluke • Box 7428, Seattle Washington 98133
Phone: (206) 774-2211 • TWX: (910) 449-2850 • In Europe,
address Fluke International Corporation, P.O. Box 5053,
Ledeboerstraat 27, Tilburg, Holland. Telex: 844-50237.



Now...



Cover a
Microwave Frequency Decade*
with ONE
LEL-Line
Directional Coupler...

New LEL-LINE series BBC Directional Couplers† now permits use of a single coupler over an entire microwave frequency decade. Take 0.5 to 5.0 GHz, for example. Any of 4 standard models will give you excellent symmetry, directivity and VSWR at any included frequency. Working in the 1-11 GHz range? Check these specs and performance curves for Model BBC 100-111.

SPECIFICATIONS

Frequency Range 1-11 GHz
Coupling 10 dB
Coupling Tolerance ±1 dB
Directivity 15 dB min.
VSWR 1.5:1 max.
Connectors OSM

*Ask us about
MICROWAVE DECADE COVERAGE
with 90° Hybrids,
Power Dividers/Combiners
and RF Mixers

† Patent applied for.

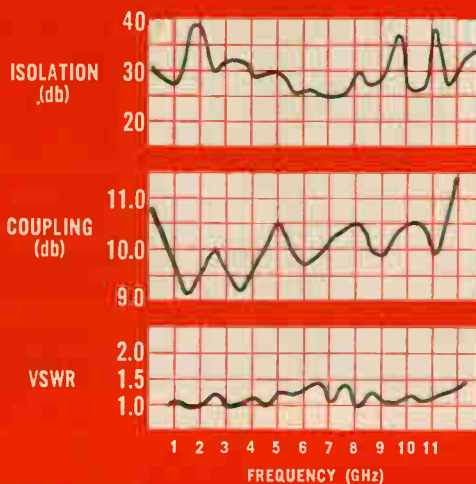

LEL DIVISION

varian / akron street / copiage / new york 11726

516 AM 4-2200 / 516 PY 9-8200 / TWX 516-691-5085

Eliminating redundancy

Three years ago when the International Telemetry Conference was initiated to supplement the well-established annual National Telemetry Conference, many telemetry engineers feared that two conferences would be redundant. That fear was justified in 1965 and 1966 when many of the papers and topics in one conference nearly duplicated those in the other. This year, the programs are sharply different, with the National Telemetry Conference, held last May, specializing in commercial topics and the International Telemetry Conference, scheduled in Washington, D.C., on Oct. 2 to 4, focusing much of its attention on military topics.

Conversion. One of the major topics will be the switch from X band to L and S bands, a switch that should be completed by the end of this decade. The problems associated with this conversion will be discussed by a panel under the direction of Brig. Gen. Clifford J. Kronauer Jr., commander of the Air Force's Western Test Range. Summaries will be presented covering airborne solid state r-f power generators, antenna design, ground-based L- and S-band systems, and signal search, detection, and acquisition. Representatives from the Pentagon, National Aeronautics and Space Administration, General Electric, TRW, and Aerospace Corp. will be on the panel.

The second area of emphasis will be methods of assuring the receipt of quality data. A panel on this subject will be chaired by Robert T. Merriam, head of an engineering group at the Navy's Ordnance Test Station at China Lake, Calif. Panel members include such prominent telemetry experts as E. J. Baghdadly, technical director of Adcom Inc., and Walter Larkin, manager of NASA's Goldstone facility. Another area to be explored is the growing use of microelectronics in telemetry gear. Representatives of Fairchild Semiconductor will describe how IC's can be applied to pulse-code-modulation, pulse-amplitude-modulation, pulse-duration-modulation and f-m/f-m systems.

There's a Tektronix Field Engineer in your area

He can help you with your
oscilloscope maintenance program

The same Tektronix Field Engineer who can help you with your measurement problems also is the man to see for assistance in setting up your oscilloscope maintenance program.

He can help you establish your own maintenance facility, conduct maintenance courses in your plant or arrange to enroll your personnel in a factory training course.

The field engineer also will make arrangements for repair, modification or recalibration of your oscilloscope at one of more than 20 Tektronix Service Centers in the U.S.

When you ask your field engineer to arrange such service, he will furnish a detailed quotation and get your oscilloscope back in operation as quickly as possible.

Call your nearby Tektronix Field Engineer for details.

Tektronix, Inc.

P O Box 500
Beaverton, Oregon
97005



*Tom Long of Dayton, Ohio—
One of the Tektronix Field Engineers
serving you from 43 U.S. Field Offices
and in more than 20 countries
around the world.*



Meet the Varian Statos I.

It records at 20,000 in./sec. without moving a muscle.

From the outside, the Statos™ I strip-chart recorder looks like any other recorder. But that's where the similarity ends. □ To record three data channels at 20,000 in./sec. full scale, Statos I uses a simple electrostatic recording "head" that never moves. It can't arc or burn and never needs adjustment or maintenance of any kind. It lets you forget about messy ink pens, expensive galvanometers, bothersome electric burning or heated styli, and noisy slidewires. □ Statos I simultaneously records two analog signals and one digital signal in exact coincidence—completely superimposed or separated. It records with an accuracy of 1.0% from dc to 1500 Hz at 10 cm full scale—with a rise time of 200 μ sec. full scale. □ Statos I has chart speeds from 0.2 cm/min. to 20 cm/sec.—continuously variable. It records full chart width time lines in perfect sync with the data at all speeds, and coded so you never lose track of data-to-data corre-

lation anywhere on the record. □ Statos I doesn't use expensive, preprinted chart paper—it prints its own! It gives you a permanent, high-contrast record on inexpensive white chart paper, without post-developing or further processing of any kind. And it lets you switch to either of two grid patterns that you originally specified. □ Statos I includes several bonuses: it interfaces directly with a computer—no extra hardware needed. It continuously displays trace amplitude on digital readout tubes. It has eight independent event-marker channels. □ All solid-state design—and reliable integrated circuits, of course. □ Send us the coupon for a comprehensive brochure. Or ask your Varian Recorder representative about the revolutionary Statos I.

And that's not all. Find out about the new Statos II 50-channel Event Recorder with the same outstanding design concepts as Statos I.



Varian, Recorder Division
611 Hansen Way, Palo Alto, California 94303

Send me your comprehensive brochure on Statos I and II.

Name _____

Company _____

Address _____

City _____

State _____

Zip _____

Design decisions belong in the hands of the systems designer.

DCL (Designers' Choice Logic) can start you on your way toward design freedom again. With Signetics' DCL you can optimize your system's performance without drawn-out calculations, expensive and time-consuming ground-plane designs or extensive use of outboard components. DCL is the only family that can offer all of these advantages:

WIDEST CHOICE OF FLIP-FLOPS—Four dual and two single flip-flops provide optimum choices in logic design and speed/power ratio. DCL offers the only dual low power RS/T binary in the industry, four flexible J-K types, and a dual high speed "D" type. The selection includes DC clocked, AC clocked, leading edge-triggered and trailing edge triggered binaries.

FULLY COMPATIBLE LARGE ARRAYS—Monolithic arrays (containing four binaries and thirteen gates) for counting and storage applications.

THREE RANGES OF GATE SPEED/POWER TRADE-OFFS—6ns/20mW, 10ns/15mW and 25ns/7mW.

FULLY COMPATIBLE INTERFACE ELEMENTS—Gates designed to match DCL levels to system levels up to 30 volts.

DTL FLEXIBILITY AND TTL SPEEDS—DCL includes high noise immunity DTL gates that are compatible with the high speed TTL members of the family. These gates provide a variety of AND-NOR functions to enhance design flexibility.

THE FIRST FULL MIL RANGE SILICONE DIP—All elements are available for either MIL or industrial temperature ranges in silicone DIPs or 14-lead glass/kovar flat paks.

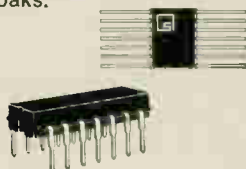

TYPICAL CHARACTERISTICS

TYPE NUMBER	DESCRIPTION	FAN-OUT FUNCTION	T _{pd} (ns) AND TOGGLE RATE	AVG. PWR. Function (mW) 50% Duty	DC NOISE MARGIN (V)
8162	MONOSTABLE MULTIVIBRATOR (delay from 80 ns to 2 seconds)	12	35	65	1.0
8280	DECADE COUNTER/STORAGE REGISTER	8	25 MHz	25	1.0
8281	BINARY COUNTER/STORAGE REGISTER	8	25 MHz	25	1.0
8415	DUAL 5-INPUT NAND GATE (bare output collector)	9	30	10.0	1.0
8416	DUAL 4-INPUT NAND GATE (input expansion node)	9	25	10.0	1.0
8417	DUAL 3-INPUT NAND GATE (expansion node and optional output resistor)	9	30	9.5	1.0
8424	DUAL, LOW POWER, RS/T BINARY (trailing edge triggered)	9	11 MHz	15.5	1.0
8440	DUAL AND-OR-INVERT GATE (2 AND Gates wide)	9	25	12.0	1.0
8455	DUAL 4-INPUT NAND GATE DRIVER	25	28	11.0	1.0
8470	TRIPLE 3-INPUT NAND GATE	9	25	7.0	1.0
8471	TRIPLE 3-INPUT NAND GATE (bare output collector)	9	30	7.0	1.0
8480	QUADRUPLE 2-INPUT NAND GATE	9	25	7.0	1.0
8481	QUADRUPLE 2-INPUT NAND GATE (bare output collector)	9	30	7.0	1.0
8731	QUADRUPLE 2-INPUT DIODE EXPANDER	—	—	—	—
8806	DUAL 4-INPUT EXPANDER	—	—	—	—
8808	8-INPUT NAND GATE	20	12	13	1.0
8816	DUAL 4-INPUT NAND GATE	20	12	13	1.0
8825	SINGLE PHASE, AND Input J-K BINARY (leading edge triggered)	20	25 MHz	90	1.0
8826	DUAL HIGH SPEED J-K BINARY (trailing edge triggered)	10	30 MHz	40	1.0
8827	DUAL HIGH-SPEED J-K BINARY (full asynchronous entry, trailing edge triggered)	10	30 MHz	40	1.0
8828	DUAL HIGH SPEED "D" TYPE BINARY (leading edge triggered)	20	25 MHz	55	1.0
8829	SINGLE PHASE AND INPUT J-K BINARY (trailing edge triggered)	20	20 MHz	90	1.0
8840	DUAL AND-OR-INVERT GATE (2 AND gates wide)	20	10	15	1.0
8848	AND-OR-INVERT GATE (4 AND gates wide)	20	10	30	1.0
8855	DUAL 4-INPUT POWER GATE	60	10	24	1.0
8870	TRIPLE 3-INPUT NAND GATE	20	10	15	1.0
8880	QUADRUPLE 2-INPUT NAND GATE	20	10	15	1.0
8H16	DUAL 4-INPUT NAND GATE (high-speed)	30	6	20	1.0
8H70	TRIPLE 3-INPUT NAND GATE (high-speed)	30	6	20	1.0
8H80	QUADRUPLE 2-INPUT NAND GATE (high-speed)	30	6	20	1.0
8T18	DUAL 2-INPUT NAND INTERFACE GATE (high voltage to low voltage)	9	15	45	7.0
8T80	QUADRUPLE 2-INPUT NAND INTERFACE GATE (low voltage to high voltage)	9	25	10.0	1.0
8T90	HEX INVERTER INTERFACE ELEMENT (low voltage to high voltage)	9	25	10.0	1.0

**SIGNETICS
INTEGRATED
CIRCUITS**

A SUBSIDIARY OF CORNING GLASS WORKS

So does this DCL* sampler from Signetics.



Signetics wants you to find out for yourself just how versatile you can be with DCL. So, we put a representative DCL selection together in an evaluation sampler, complete with a 46-page handbook and evaluator's guide. Then we cut the price in half, to make it even more attractive. The selection includes:

Type No.	Description	Quantity	Normal 1-24 Price
N8280A	Decade Counter	1	\$24.00
N8281A	Binary Counter	1	24.00
N8424A	Dual Lo Power RS/T Binary Element	2 at 5.90 ea	11.80
N8825A	Single Phase AND Input J-K Binary Element	2 at 4.00 ea	8.00
N8826A	Dual Hi Speed J-K Binary Element	2 at 5.90 ea	11.80
N8828A	Dual Hi Speed D-Type Binary Element	2 at 5.65 ea	11.30
N8416A	Dual 4-Input Expandable DTL NAND Gate	1	2.25
N8480A	Quad 2-Input Lo Power TTL NAND Gate	2 at 2.25 ea	4.50
N8440A	Dual AND-OR-INVERT Gate	1	2.25
N8455A	Dual 4-Input NAND Driver	1	2.50
N8880A	Quad 2-Input Hi Speed TTL NAND Gate	2 at 2.25 ea	4.50

17 \$106.90

SPECIAL INTRODUCTORY PRICE . . . \$45.00

YOU SAVE . . . \$61.90

DCL evaluation samplers are now available at all Signetics' distributors. Call or write right away, supply is limited.

* SIGNETICS TRADEMARK

SIGNETICS SALES OFFICES: Metropolitan New York (201) 992 3980, Upper New York State (315) 469 1072, Southwestern (214) 231 6344, Western Regional (213) 272 9421; Eastern Regional (617) 245 8200; Mid Atlantic (609) 858-2864; Southeastern (813) 726 3734, Midwestern Regional (312) 259 8300, Northwestern (408) 738 2710

DISTRIBUTORS: Compare at all locations listed below Semiconductor Specialists, Inc. (312) 279 1000, Terminal Hudson Electronics (212) 243 5200, Wesco Electronics (213) 684 0880; Wesco Electronics (405) 968 3475; Hammond Electronics (305) 241 6601, Avnet Electronics Corp. of Massachusetts (617) 272 3060

DOMESTIC REPRESENTATIVES: Jack Pyle Company (415) 349-1266, Compar Corporation at the following locations: Alabama (205) 539 8476, Arizona (602) 947-4336, California (213) 245-1172, California (415) 697 6244; Colorado (303) 781 0912; Connecticut (203) 288-9276, Florida (305) 855 3964, Illinois (312) 775 5300, Maryland (301) 484 5400, Massachusetts (617) 969-7140; Michigan (313) 476-5758; Minnesota (612) 922-7011; Missouri (314) 428 5313; New Jersey (609) 429-1526, New Mexico (505) 265 1020, New York (518) 436 8536, New York (607) 723 8743, New York (716) 684 5731; New York (201) 471-6090; North Carolina (919) 724-0750; Ohio (216) 333-4120; Ohio (513) 878-2631; Texas (214) EM 3 1526, Texas (713) 649 5756, Washington (206) 725 7800.

INTERNATIONAL SALES: France, Germany, Italy, Belgium, Holland, Luxemburg, Spain—Sovcor Electronique, 11, Chemin de Ronde, Le Vesinet. (S-8 0) France. United Kingdom, Ireland, Sweden, Denmark, Norway, Switzerland, Austria, Portugal—Electrosil Ltd., Lakeside Estate, Doinbrook By Pass Slough, Buckinghamshire, Great Britain. Australia—Corning, 1202 Plaza Building, Australia Square, Sydney, N.S.W. 27-4318. Canada—Corning Glass Works of Canada, Ltd., Leaside Plant, Ontario, Canada (416) 421 150. Israel—Optromix, P.O. Box 195 Ramat Gan, Israel 724 437. Japan—ASAHI Glass Co., Ltd., Corning Products Sales Dept. No. 2, 3-Chome Marunouchi, Chiyoda-ku, Tokyo, Japan.

Here's our best price yet for a high-gain, low-noise 200 MHz (MOS) FET

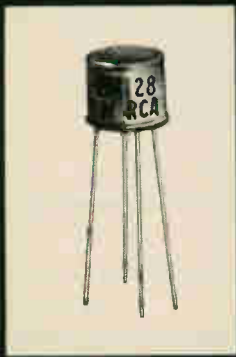

RCA
3N128
is now only
88¢ (1,000+)

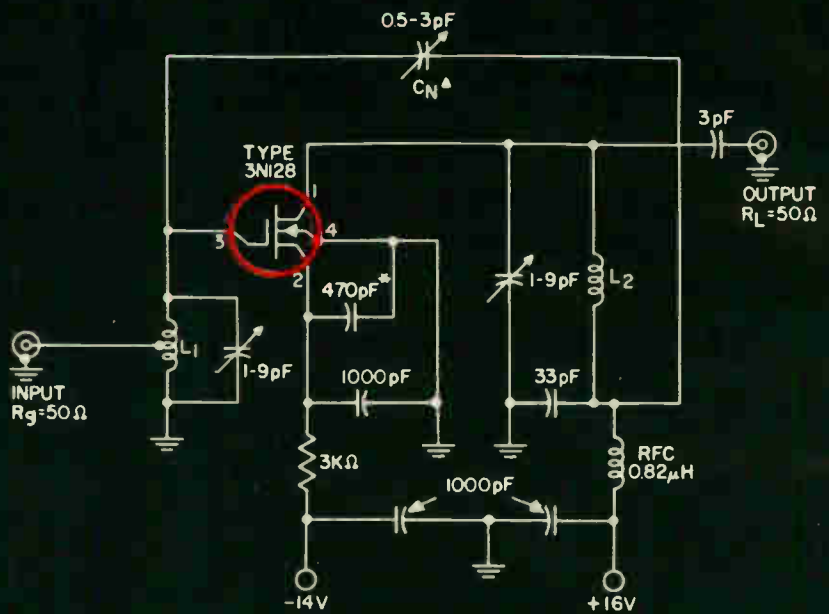

200 MHz RF Stage using RCA 3N128

RCA's 3N128 N-channel, depletion-type MOS field-effect transistor actually offers dynamic range 10 times greater than conventional bipolar transistors. Because of the resulting improvement in cross modulation and spurious response, the 3N128 is recommended as an RF amplifier and a mixer to further improve performance in these areas. You can use standard vacuum-tube-type biasing and AGC requires virtually no power.

Extremely low feedback capacitance (0.2 pF max.) and high transconductance (5,000 μ mhos min.) allow the 3N128 to deliver more useable VHF power gain without neutralization than a junction-gate FET can deliver with neutralization. Even more stable gain can be achieved with neutralization.

Operation over wide temperature ranges is possible because the extremely low gate leakage current (0.1 pA typ.) is not temperature sensitive. In fact, when you consider the combination of large signal-handling capability, exceptional performance characteristics, and low, low price, the 3N128 is an absolute necessity for critical front-end designs—and for a broad range of industrial, commercial and military applications in instrumentation, controls, and appliances, where high input resistance (10^{14} ohms typ.) is important.

So call your RCA Field Representative for complete information. For technical literature and application notes AN-3193 and AN-3341, covering RF amplifiers and mixers, write RCA Commercial Engineering, Section EN9-1, Harrison, N.J. 07029. Check your RCA Distributor for his price and delivery.

RCA 3N128 Features

- LOW FEEDBACK CAPACITANCE
0.2 pF max.
- HIGH TRANSCONDUCTANCE
5,000 μ mho min.
- HIGH POWER GAIN @ 200 MHz
18 dB typ.
- LOW NOISE FIGURE @ 200 MHz
4 dB typ.
- LOW GATE LEAKAGE
50 pA max.



RCA Electronic Components and Devices

The Most Trusted Name in Electronics

Commentary

The worrisome IC

The integrated circuit is cutting a wide swath in the electronics industry this summer, finding its way into systems ranging from sophisticated military computers to low-cost phonographs. But as the IC wins overwhelming acceptance, the concept of integrated electronics is frowning the brows of engineers at both makers and users. Almost everybody is at a crossroads; at stake for many firms is their future prosperity. For a few, guessing right will mean the difference between life and death.

It's the rapid acceptance of IC's that's at the root of the problem. The dizzying speed hardly gives firms enough time to consider all the factors. Makers fear they will miss the market if they don't act quickly; buyers want the competitive edge that the first IC-equipped gear will have. For the circuit user, there is a bewildering variety of choices: different kinds of logic, the linear-versus-digital question, hybrid versus monolithic, bipolar or monolithic. And beyond lies the promise of large-scale integration. For producers, there are similar decisions to make about new products—decisions complicated by erratic inventory situations and an enormous personnel turnover.

Take the inventory problem, for example. After almost a year of standing customers in line for diode-transistor logic—the most popular digital circuit today—production suddenly exceeded demand. And it happened with awesome speed. In July, Fairchild Semiconductor, the industry's largest producer, had customers on allocation. Thirty days later, the division had nearly 800,000 circuits in stock and was looking for buyers. Other producers of DTL also report burgeoning inventories.

The reason is simple. Every producer has been working overtime to increase yields, to improve profits. The work has suddenly borne more fruit than expected. Yields have improved so much, so fast, that the marketing men haven't had a chance to find new customers for all the circuits being turned out. At the same time, many producers went to a larger 2-inch-diameter slice of silicon in place of the traditional 1-inch slice, a move that also increased production. Some firms have added additional IC plants. And new second sources like Raytheon Semiconductor have cut into original suppliers' sales.

Traditionally, in such a situation semiconductor producers cut prices. So the industry is nervously awaiting what could be the sharpest price cuts in its history.

But oversupply affects only some products. Others are scarce. Customers for transistor-transistor logic, the newer, faster logic, complain bitterly about late delivery or nondelivery. Some makers of TTL have fallen far behind on promises because processing has turned out to be harder and yields much lower than expected. At this stage of production a slight error in estimated yields results in big errors in shipments.

In addition, many semiconductor producers have been slow getting TTL lines on the market. Development of Fairchild's second-generation line of low-power TTL is

behind schedule; Texas Instruments has been introducing its line piecemeal; and Philco-Ford Microelectronics won't have its first TTL products before autumn. Stewart Warner Microelectronics, on the other hand, thought there was a larger potential in DTL, and dropped its TTL line during a management reshuffle months ago.

Turnover of top personnel has plagued almost all the IC producers. After Ford Motor bought General Microelectronics Inc. last year, the two top marketing men of the latter company, the operations manager, the materials manager, and half the R&D staff left. Westinghouse's Molecular Electronics division has had three general managers in less than a year. Fairchild Semiconductor lost its general manager and five other key executives to the National Semiconductor Corp. And some executives at its Hong Kong facility have joined ITT Semiconductors' new plant in Portugal. Texas Instruments and ITT Semiconductors in West Palm Beach have changed division managers in the past seven months. Marketing managers have left Fairchild and Philco-Ford this summer. At Signetics, which underwent a major reorganization four years ago, James Riley, president, boasts he now has the senior management team in the industry.

Some of the customers—and potential customers—are having almost as worrisome a time. At consumer electronics firms, engineers are studying a variety of new IC products designed specially for consumer products, but they are going slow on ordering them [see page 123]. One reason is that there still is a question about reliability, and another is cost. But equally important is a reluctance on the part of consumer firms to use something so new they don't completely understand it.

The market for IC's in autos, considered only a few months ago to be potentially the second largest after computers, has foundered on the shoals of reliability and cost. The comedy of errors that marked the development of a voltage regulator [June 26, p. 46] over the past year has set the widespread adoption of IC's by car makers back at least two years—despite Pontiac's announcement of an optional IC regulator for 1968 models. Westinghouse, which started it all when it built a monolithic regulator for Ford in early 1966, has withdrawn from the auto market temporarily, and so has Fairchild. Development activity has cooled even at Philco-Ford's Microelectronics division, despite its tie to Ford Motor.

Among instrument companies and systems designers, the battle over whether to choose home-grown IC's or off-the-shelf units is raging furiously. Hewlett-Packard and many of the large systems companies feel they must have their own capability to protect proprietary secrets and to maintain their percentage of value added. There are reports of a small boom in sales of such machinery as bonders and microscopes (primarily to make hybrid circuits in small volume) to these companies. Other firms, however, like General Radio and Beckman Instruments, believe equally strongly that they can do everything they need to do with off-the-shelf circuits.

The companies looking for a single answer to all these problems are in for a big disappointment (there ought to be as many answers as there are companies). For how each company adapts to integrated electronics will depend on its management's strengths and weaknesses, its philosophy, its product lines and its resources.

Does Ford Make Automobiles?

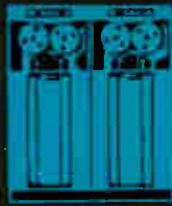

Does IBM
Make Computers?

Does Boeing Make Airplanes?

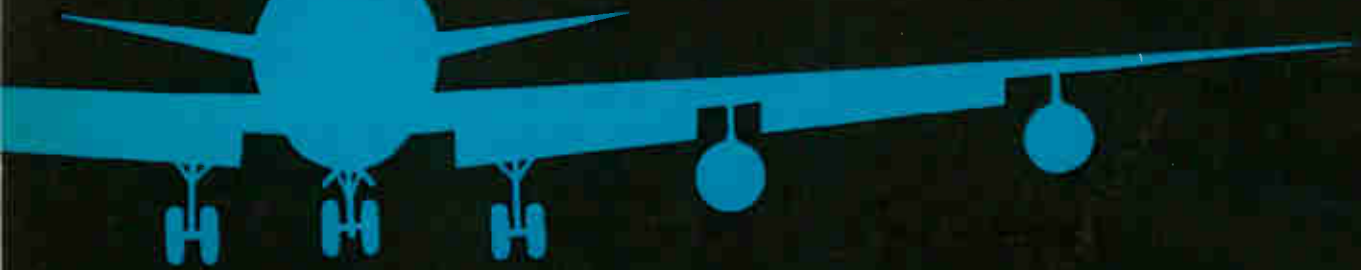

Does CLIFTON Make Servo Packages?

Sure, it's a Big part of our Business!

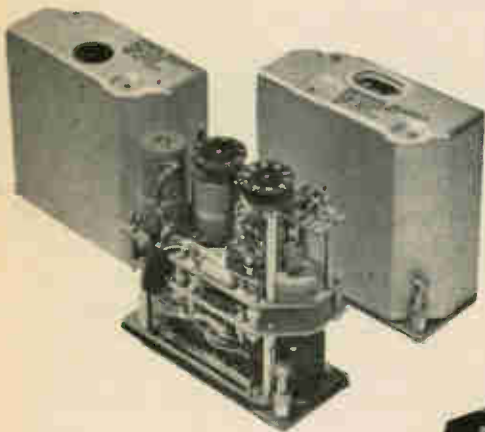

TACAN
RANGE AND
BEARING COUPLERS

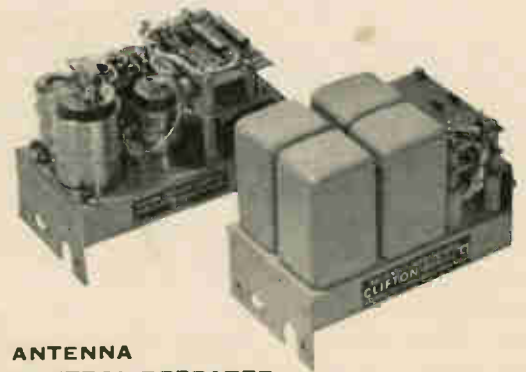

ANTENNA
CONTROL REPEATER
ELECTRO-MECHANICAL or SOLID STATE

DISCRETE MESSAGE INDICATOR
DATA LINK SYSTEMS

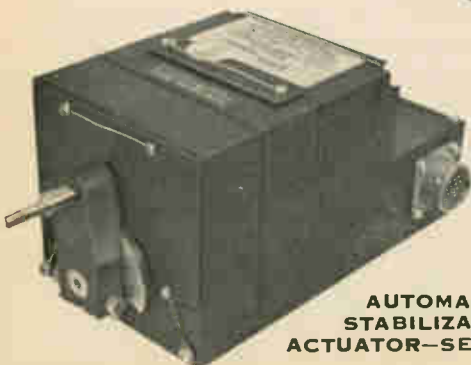

AUTOMATIC
STABILIZATION
ACTUATOR—SEA KNIGHT

Our Special Devices Group for the past 10 years has designed, developed, and manufactured an extremely wide variety of electro-mechanical and electronic packages for aircraft and ground support equipment. We are also well versed in the solid state technology which is replacing electro-mechanics in some instances. We are flying in the F-111, A7A, CH47A, 727 and dozens of our country's most important aircraft.

In your next "make or buy" situation, let Clifton engineering solve your problem—and with CLIFTON QUALITY built in!

For further information call your local Clifton Sales Office or Ed Fisher 215 622-1000; TWX 215 623-1183.

CLIFTON 
DIVISION OF LITTON INDUSTRIES

Electronics Newsletter

September 4, 1967

Monolithic IC's out of MERA radar

Texas Instruments, which has been plugging the monolithic microwave IC approach for its X-band phased array radar being developed for the Air Force under Project MERA, has now decided to use hybrid IC's instead. The reason: monolithic costs were too high, says Thomas Hyltin, an R&D manager at TI.

TI made a transmit-receive switch [Electronics, Jan. 23, p. 76], a 500-megahertz i-f preamplifier, and an X-band balanced mixer in monolithic form. Hyltin said they all worked well, but contained such elements as p-i-n diode switches, microwave transistors, and Schottky barrier diodes, which couldn't be fabricated simultaneously by monolithic processing. Since TI wanted to combine several circuit functions under a single, inexpensive fabrication process, hybrids won out.

Agonizing over the decision to switch to hybrids caused some delay in the Air Force program, according to some industry sources. The X-band array now is expected to be completed by next April.

New code technique thwarts snoopers

Programmable coding is one of the new techniques being demonstrated to law-enforcement agencies for voice-privacy radio systems. Requirements for riot control and stepped-up battles on urban crime have increased interest in squad car, aircraft, and portable radios which cannot be monitored by eavesdroppers with commercial receivers. Most scrambling systems invert the voice signal in a balanced modulator, transpose slots in the voice spectrum, or distort the signal in phase. The new technique, developed by Technical Communications Corp., Lexington, Mass., uses an encoder-decoder. The codes can be changed daily or even hourly, and the number of possible combinations is so large that the chances of breaking it are remote. In addition, the system's security is protected even if a unit is stolen or copied.

A-c tester challenges d-c wafer probes

The first commercial system for a-c testing of integrated circuits on the wafer has been demonstrated by E-H Research Laboratories in Oakland, Calif. Based on a switching-time converter for making nanosecond time-interval measurements and a strobing voltmeter for fast waveform measurements, the tester can be used with standard commercial wafer-probes. Its price ranges from \$28,775 to more than \$100,000 for fully automated versions with core-memory elements.

E-H is challenging the concept of d-c testing. Earlier a-c testers were designed to make tests on packaged IC's just prior to shipment; wafer testing was handled by d-c testers. But, says E-H applications engineer James E. Fisher, "except for leakage, we don't see any reason to make d-c tests at all."

The CBS playback: a revolution in data retrieval?

CBS Laboratories' Electronic Video Recording (EVR) development, which hit the entertainment and education market with a bang last week, may have an even heavier impact on information storage and retrieval. For example, EVR, a film process which allows the playback of television and motion pictures through conventional tv receivers, is a natural to be combined with CBS's Linotron electronic typesetter [Electronics, April 13, p. 113]. EVR developer Peter C. Goldmark, CBS Labs president,

Electronics Newsletter

acknowledges that the new recording and playback technique and Linotron would make a "perfect marriage."

By replacing the Linotron's cathode-ray tube, now used to generate letters and numbers for phototypesetting, with EVR's electron beam scanner, pages of text could be recorded as speedily as EVR records tv signals. An entire encyclopedia could be recorded on a single reel of film, says Goldmark, and any tv receiver could be used to view the filmed pages. CBS Labs undoubtedly has plans in this area, and probably will develop systems to compete with magnetic tape for computer data storage. EVR has a storage capacity 15 times that of magnetic tape.

In EVR, electron beam scanning exposes a special film (neither silver halide nor thermosetting plastic) and processing is required. The recording appears as two rows of frames down the 8.75-mm. film. For monochrome recording, each row carries a different program; for color, one row carries chrominance and the other luminance information.

First playback devices should be in schools by late 1968 playing canned educational tv programs. Shortly thereafter, playback units for home tv will go on the market at a price substantially below the originally quoted \$280, Goldmark predicts. Film cartridges will cost between \$7 and \$14.

On playback, the film passes before a flying spot scanner and the resulting amplitude-modulated light is picked up by a photomultiplier tube. The signal is then converted to a video waveform which modulates a tv carrier frequency; this is then piped into the home set directly through the antenna terminals.

Victory expected by backers of parameter shift

Manufacturers of high-frequency transistors who have been pushing revised semiconductor characterization parameters got stronger than expected support at last month's meeting of the Committee on Industrial Signal Transistors (JS-9). The upshot is that by early 1968 they'll likely have permission from the Electronic Industries Association to use either S, Y, or both parameters on their data sheets. This will benefit not only transistor manufacturers, but makers of high-frequency test equipment geared to S parameters as well.

Such device makers as Texas Instruments, KMC Semiconductor, and Raytheon have maintained [Electronics, July 24, p. 25] that S parameters are more realistic than Y parameters with devices operating at 500 megahertz and higher because they're geared to typical operating conditions, are easier to use and measure, and are compatible with Smith charts, the predominant high-frequency/microwave design aid.

TI gets new lead on heat sinks

A new heat-conducting technique, combining a silver-coated, copper alloy collector lead with a larger copper island on the printed circuit card, may gobble up a part of the transistor heat-sink market. Texas Instruments says it has been able to raise the power-handling capabilities of small-signal devices (less than a watt) to medium power levels of several watts with the new approach. This arrangement dispenses with costly, cumbersome heat-sink assemblies, TI claims.

The new lead material is incorporated on a new series of plastic-encapsulated transistors intended for consumer equipment. TI says the units, when used with the modified pc board, have about twice the heat-dissipating capabilities of higher priced, electrically comparable transistors in metal cans. TI plans to add the new lead material on more of its discrete semiconductor lines, including industrial units.

WHAT IS O/E/N?

O/E/N IS QUALITY COMPONENTS

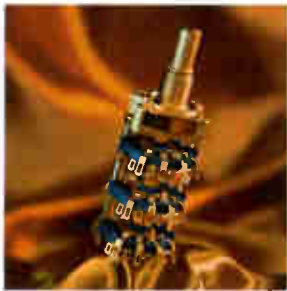

OAK MANUFACTURING CO.

... for over 35 years the leader in rotary switches, pioneer of many new advances including double-wiping contacts. Oak is also a leader in pushbutton, lever, slide and snap switches; rotary solenoids and choppers. Oak FM, VHF & UHF television tuners can be found in most major brand name sets.



MARCO-OAK

... serves our pushbutton world by showing "what's going on." Customers rely on Marco-Oak lighted pushbutton and matching indicator lights for applications far more complex than car radios. They're used in such applications as computers, missile ground controls, aircraft, utility and industrial instrument panels, TV broadcasting.



MCCOY ELECTRONICS CO.

... makes quartz crystals and assemblies to keep radio transmitters and receivers "on the beam." Such precise frequency control requires exacting manufacturing techniques—thickness accurate to .000001", cutting to 1/300 of 1° of angle accuracy, hermetic seals for protection. McCoy crystals are the highest quality available and perform in severe environments.



HART MANUFACTURING CO.

... "turns things on" with relays for household and commercial appliances, high-current relays for industry, and miniaturized relays for missiles and computers. Also thermostats, rotary and snap-in toggle switches, pilot lights. The complementary Phillips-Advance line of relays serves the electronics and communications industries.

O/E/N produces quality components...our customers build them into circuitry. We're their main source for an ever-widening variety of products. The one common denominator is engineering excellence, built into components produced by every O/E/N subsidiary or division described here. Write for Facilities and Capabilities brochure.



O/E/N

OAK ELECTRO/NETICS CORP.
CORPORATE OFFICE
CRYSTAL LAKE, ILLINOIS 60014

Don't sit there
wishing your
 support people
 knew more
 electronics...

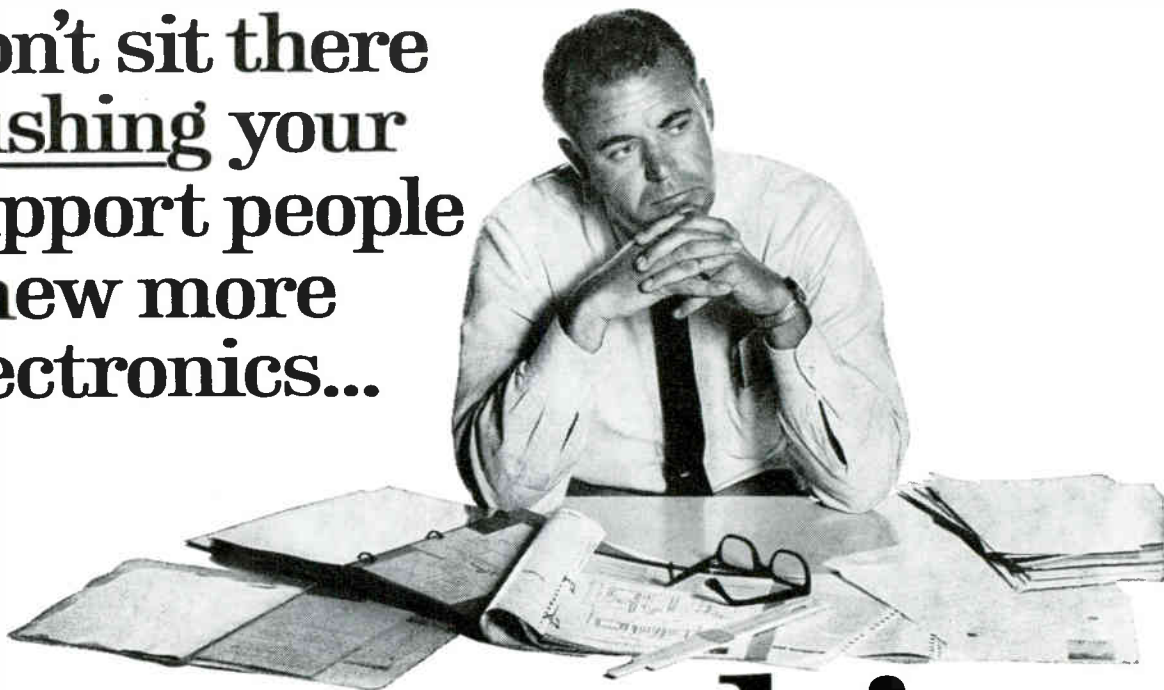

do something

Look over your men. Pick out a few who are intelligent enough to profit from more education in electronics, ambitious enough to work hard to get it. Send us their names and addresses. We'll send them complete information about CREI Home Study Programs in Electronics, tell them how these programs have helped thousands of young men increase their value to their employers. We'll explain how they can study at home, at their own pace, on their own schedule

without traveling to classes. We'll give them the names of the more than 80 leading scientists and engineers who help us develop and update programs related directly to the needs of industry.

Yes, we'll do all that. If you're lucky some of your men may enroll. Why not give it a try? Fill out the coupon and get it in the mail today.



CREI Programs cover these specialized areas of advanced electronics:

- Communications Engineering • Aeronautical and Navigational Engineering • Television Engineering • Computers • Nuclear Instrumentation and Control • Automatic Control Engineering • Missile and Spacecraft Guidance • Radar and Sonar Engineering • Nuclear Engineering Technology • Industrial Electronics for Automation • Computer Systems Technology.

CREI
THE CAPITOL RADIO ENGINEERING INSTITUTE
 A Division of McGraw-Hill, Inc.
 Dept. 1809E-1, 3224 Sixteenth Street, N.W.
 Washington, D.C. 20010

Gentlemen: The men listed at right are high school graduates working in some phase of electronics. Please send them your FREE book, "How to Prepare Today for Tomorrow's Jobs" and complete information about CREI Home Study Programs.

And please send me the free brochure which tells how we can use CREI Home Study Programs to supplement our educational program for electronics personnel.

Name _____
 Title _____
 Company _____
 Address _____
 City _____ State _____ Zip Code _____

Name _____
 Address _____
 City _____ State _____ Zip Code _____

Name _____
 Address _____
 City _____ State _____ Zip Code _____

Name _____
 Address _____
 City _____ State _____ Zip Code _____

Name _____
 Address _____
 City _____ State _____ Zip Code _____

(Not enough room? Attach sheet of paper with additional names and addresses)

WHAT IS O/E/N?

O/E/N IS QUALITY COMPONENTS



OAK MANUFACTURING CO.

... for over 35 years the leader in rotary switches, pioneer of many new advances including double-wiping contacts. Oak is also a leader in pushbutton, lever, slide and snap switches; rotary solenoids and choppers. Oak FM, VHF & UHF television tuners can be found in most major brand name sets.



MARCO-OAK

... serves our pushbutton world by showing "what's going on." Customers rely on Marco-Oak lighted pushbutton and matching indicator lights for applications far more complex than car radios. They're used in such applications as computers, missile ground controls, aircraft, utility and industrial instrument panels, TV broadcasting.



MCCOY ELECTRONICS CO.

... makes quartz crystals and assemblies to keep radio transmitters and receivers "on the beam." Such precise frequency control requires exacting manufacturing techniques—thickness accurate to .000001", cutting to 1/300 of 1° of angle accuracy, hermetic seals for protection. McCoy crystals are the highest quality available and perform in severe environments.



HART MANUFACTURING CO.

... "turns things on" with relays for household and commercial appliances, high-current relays for industry, and miniaturized relays for missiles and computers. Also thermostats, rotary and snap-in toggle switches, pilot lights. The complementary Phillips-Advance line of relays serves the electronics and communications industries.

O/E/N produces quality components...our customers build them into circuitry. We're their main source for an ever-widening variety of products. The one common denominator is engineering excellence, built into components produced by every O/E/N subsidiary or division described here. Write for Facilities and Capabilities brochure.



O/E/N

OAK ELECTRO/NETICS CORP
CORPORATE OFFICE
CRYSTAL LAKE, ILLINOIS 60014

Don't sit there
wishing your
 support people
 knew more
 electronics...

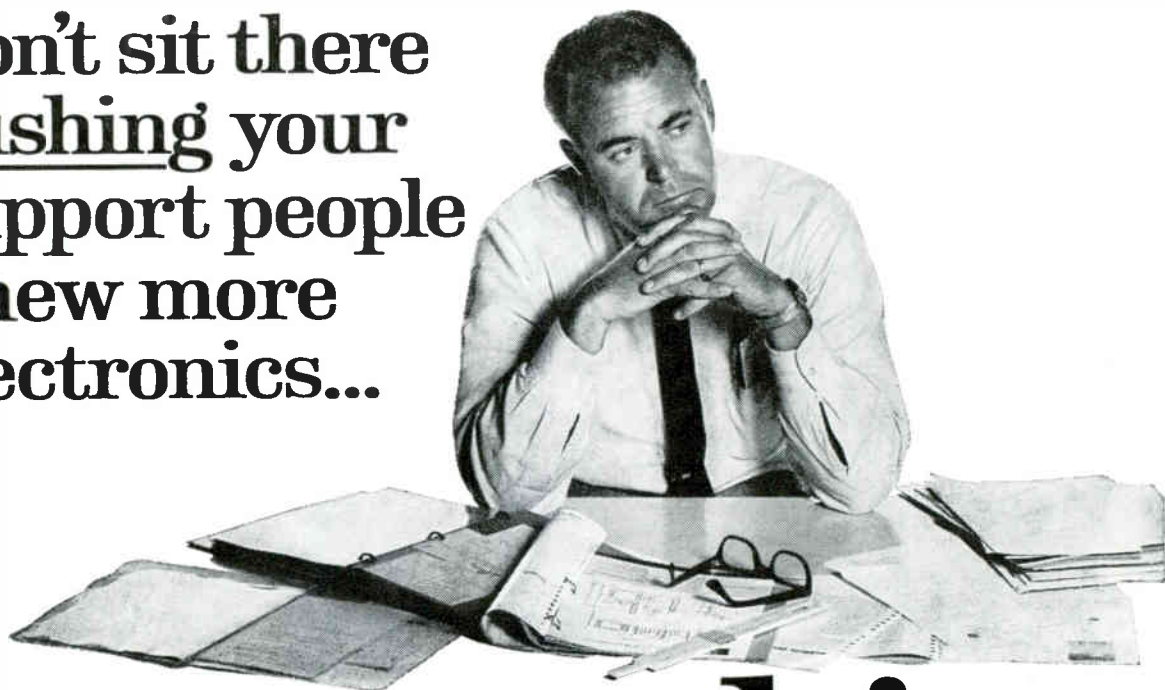

do something

Look over your men. Pick out a few who are intelligent enough to profit from more education in electronics, ambitious enough to work hard to get it. Send us their names and addresses. We'll send them complete information about CREI Home Study Programs in Electronics, tell them how these programs have helped thousands of young men increase their value to their employers. We'll explain how they can study at home, at their own pace, on their own schedule

without traveling to classes. We'll give them the names of the more than 80 leading scientists and engineers who help us develop and update programs related directly to the needs of industry.

Yes, we'll do all that. If you're lucky some of your men may enroll. Why not give it a try? Fill out the coupon and get it in the mail today.



CREI Programs cover these specialized areas of advanced electronics:

- Communications Engineering •
- Aeronautical and Navigational Engineering •
- Television Engineering •
- Computers • Nuclear Instrumentation and Control •
- Automatic Control Engineering •
- Missile and Spacecraft Guidance •
- Radar and Sonar Engineering •
- Nuclear Engineering Technology •
- Industrial Electronics for Automation •
- Computer Systems Technology.

CREI
THE CAPITOL RADIO ENGINEERING INSTITUTE

A Division of McGraw-Hill, Inc.
 Dept. 1809E-1, 3224 Sixteenth Street, N.W.
 Washington, D.C. 20010

Gentlemen: The men listed at right are high school graduates working in some phase of electronics. Please send them your FREE book, "How to Prepare Today for Tomorrow's Jobs" and complete information about CREI Home Study Programs.

And please send me the free brochure which tells how we can use CREI Home Study Programs to supplement our educational program for electronics personnel.

Name _____
 Title _____
 Company _____
 Address _____
 City _____ State _____ Zip Code _____

Name _____
 Address _____
 City _____ State _____ Zip Code _____

Name _____
 Address _____
 City _____ State _____ Zip Code _____

Name _____
 Address _____
 City _____ State _____ Zip Code _____

Name _____
 Address _____
 City _____ State _____ Zip Code _____

(Not enough room? Attach sheet of paper with additional names and addresses)

Good, old-fashioned, Scottish thrift.

We've become so thrifty at Honeywell that we've pared the prices of taut-band meters down even lower than the prices of pivot-and-jewel meters. (About 10% lower, on the average.)

Now, if your shrewd business sense tells you we've left something out, you're right.

We've left out half



the parts. (All the unnecessary ones.) Which doesn't make the meter less sophisticated. Just less complicated.

This taut-band meter is so ingeniously simple, there's hardly anything to go wrong.

There's no friction in the moving system, so the pointer doesn't stick. (Better readout accuracy and repeatability.) And the meter's self-shielded.



The low-cost taut-band meter from Honeywell. It comes in just about any style you'd like. Write Honeywell Precision Meter Division in Manchester, N.H. 03105 and we'll send you a brochure with all the sizes, styles and prices.



What's the secret of Honeywell's taut-band meter success?

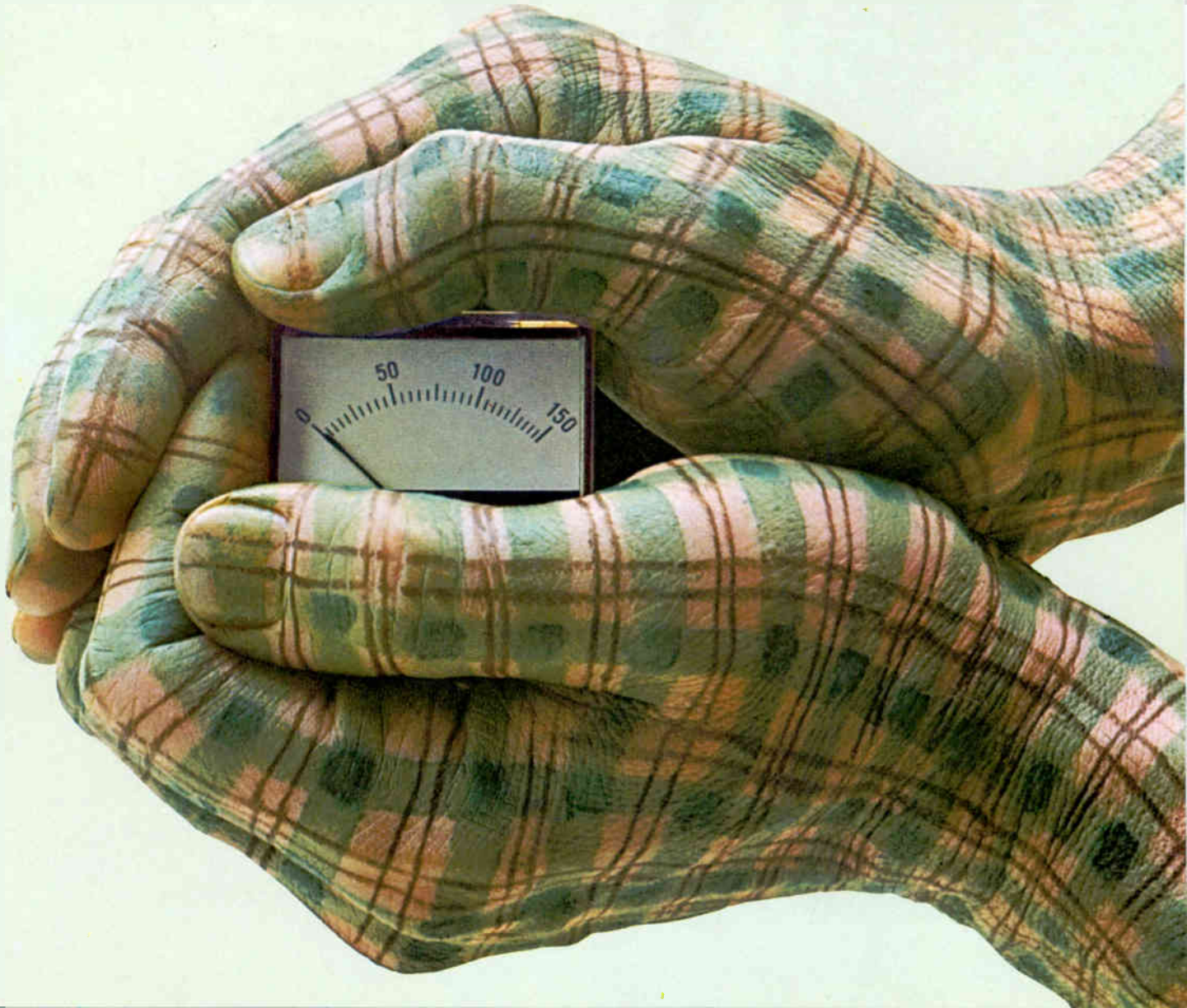



**\$1150 will get you
our Model 7000 DVM:
0.01% accuracy,
100 μ V resolution,
noise rejection,
stability, and 70%
integrated circuitry.
Reader Service
No. 71 will get you
full information.**

Free.

FAIRCHILD
INSTRUMENTATION

IF YOUR PLATES DON'T LOOK LIKE THIS . . .

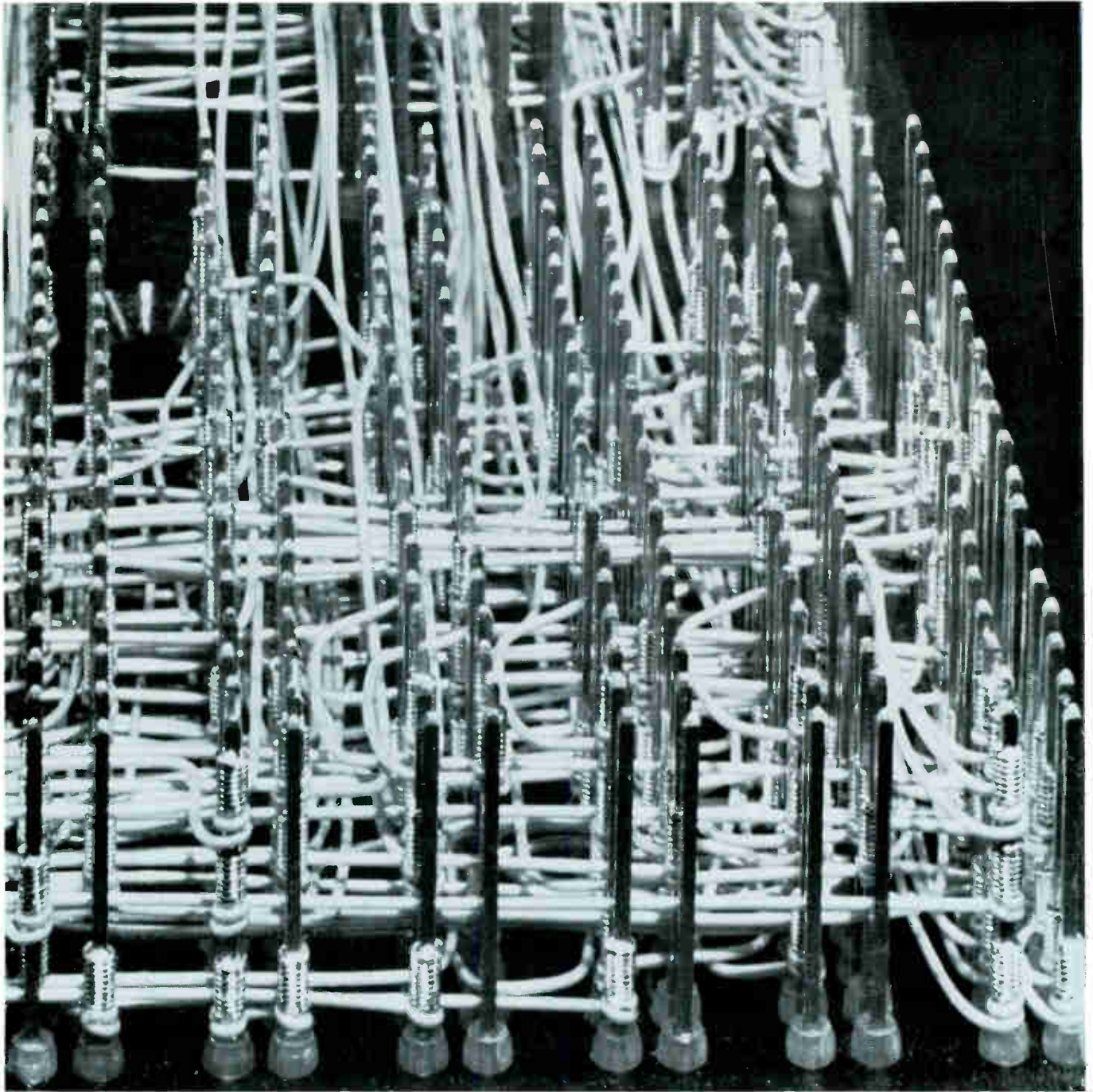

THEY SHOULD!

. . . and can, if they're Elco Variplates.*

The wired side of a plate doesn't just want to look pretty. It has to look pretty. Here's why.

The wire wrapping method of termination is mechanically stronger and far more economical than the old soldered method. Programmed wire wrapping machinery eliminates the possibility of human error. Wires can be dressed for maximum density and elimination of cross-talk. Three-level termination and ease of future wiring changes are more practical benefits.

Beauty is more than skin deep, and that's where Elco comes in. Programmed wrapping equipment demands tight tolerances. The plates must be

hole-punched accurately. When you're punching hundreds (or thousands) of holes, the metal expansion rate can be a large factor. Stand-offs must align perfectly and be pull-out proof. Our precision machining achieves guaranteed, micro-inch tolerances.

And Elco's complete line of component connectors offers you more design freedom than you need. Our vast array of connector styles, sizes and contact configurations can fill your functional needs.

So, if your plates don't look like ours, give us a holler. Elco Corporation, Willow Grove, Pa. 19090; (215) 659-7000. Where your design expectations take shape.

*TRADEMARK

*Elco
Connector
Technology . . .
20 years
young*



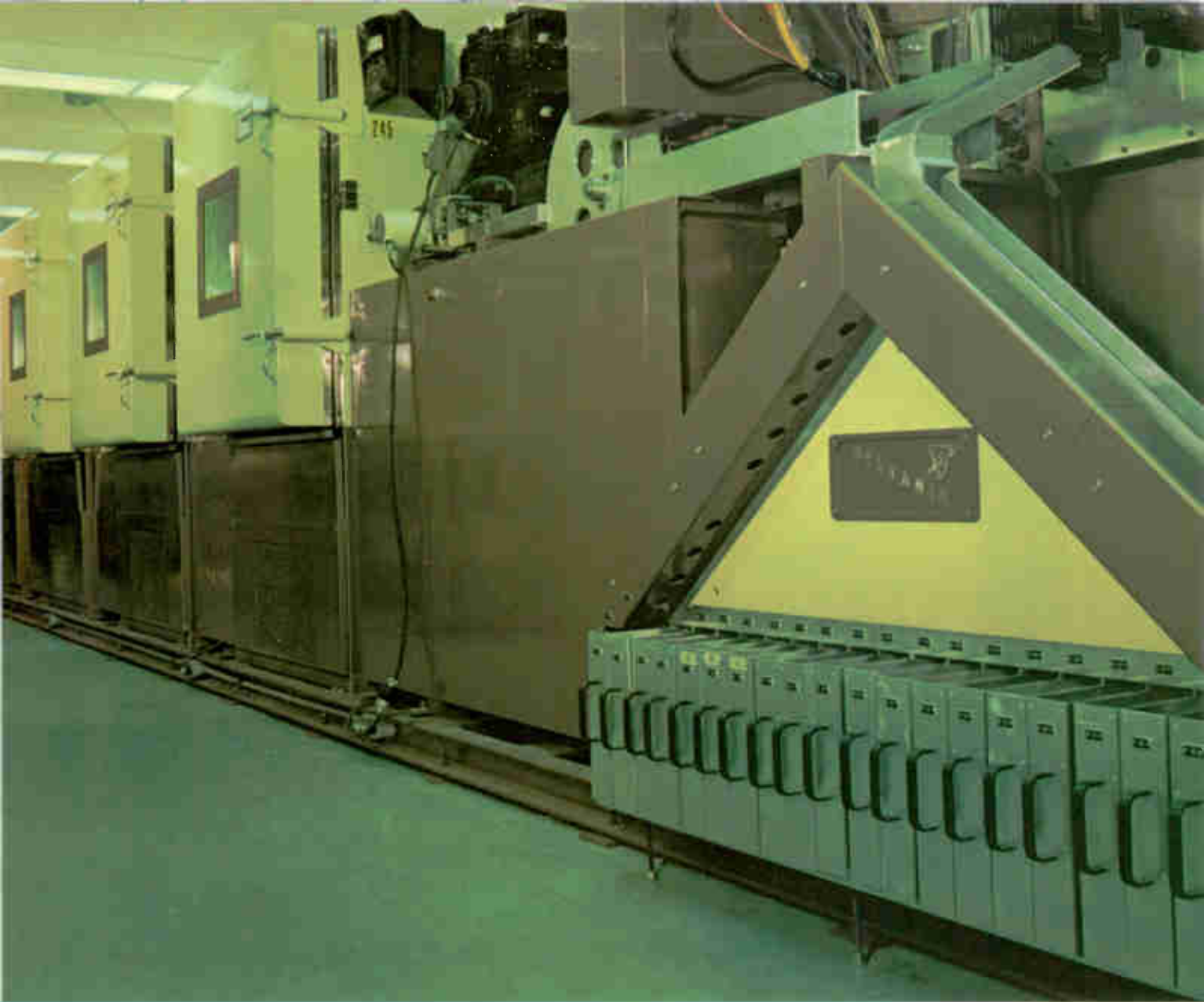

Every military IC must operate at temperatures from -55°C to 125°C in our test chambers.

In order to pass its final test, each Sylvania IC must operate in four consecutive temperature-controlled chambers while a computer records the parameters of each circuit. We call this ultimate testing equipment "Mr. Atomic"—a system with a capacity of about a quarter-million ICs a week.

In each "torture chamber," the ICs are automatically inserted in a wheel that rotates them to the testing point while they're stabilized at test temperature.

The temperature of the first chamber is 75°C . The second is 0°C . The next is 125°C . Then, -55°C . In these four chambers, up to 100 D.C. tests are automatically performed. A fifth testing station, maintained at 25°C , tests up to 30 switching parameters

accurately down to a few nanoseconds. (See inset). Each input is individually tested.

Then Mr. Atomic (for Multiple Rapid Automatic Test of Monolithic Integrated Circuits) directs the circuits to any of 20 bins, according to the computer's priority programs. You get only circuits that are fully guaranteed at temperature extremes—not at just room temperature only.

Sylvania Semiconductor Division, Electronic Components Group, Woburn, Massachusetts 01801.



SYLVANIA
SUBSIDIARY OF
GENERAL TELEPHONE & ELECTRONICS **GTE**

Circle 33 on reader service card

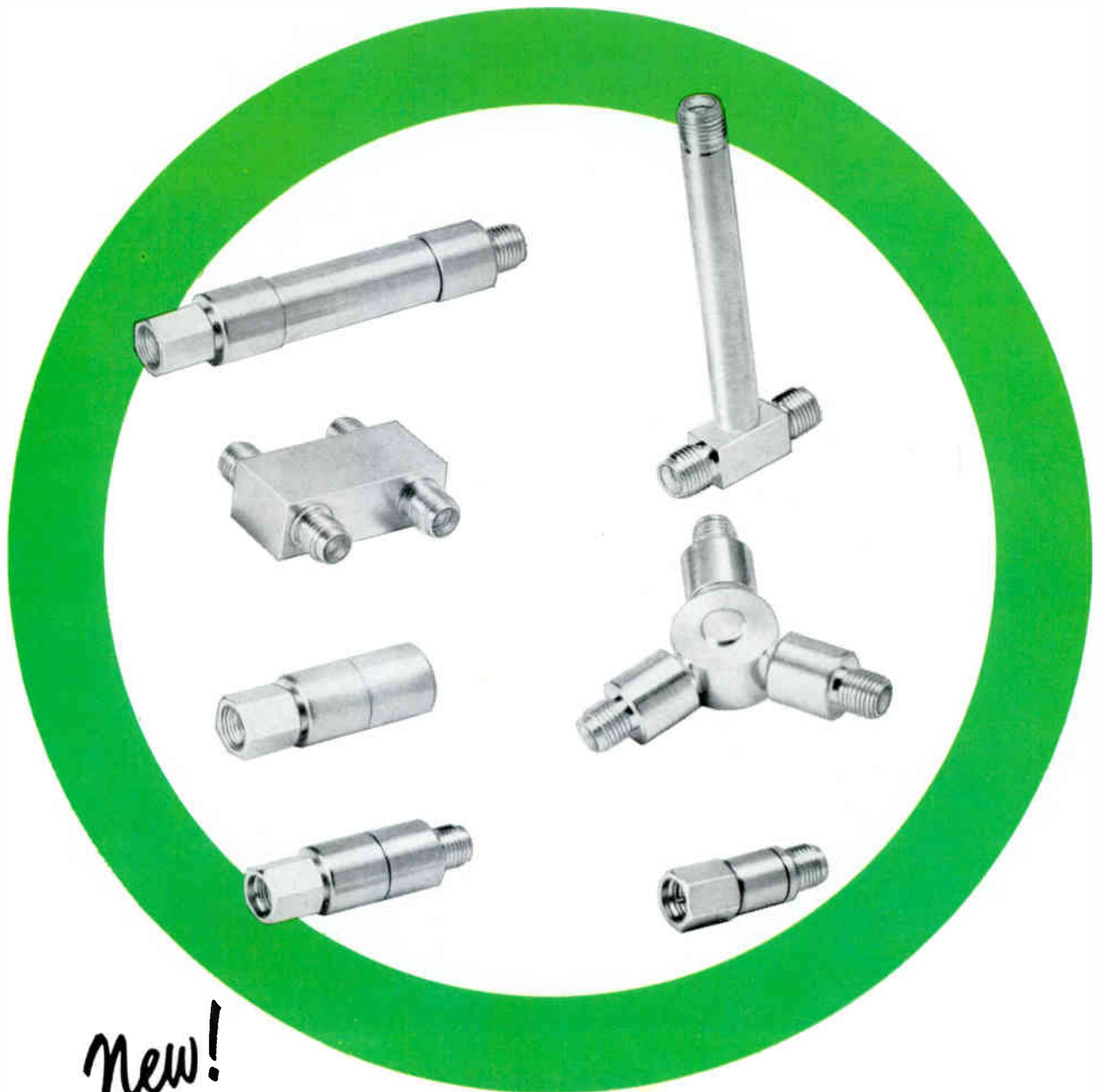

New!

A complete line of high-quality miniaturized coaxial devices—smaller, lighter, lower-priced!

Now available—off the shelf—from Microlab/FXR! A complete line of miniaturized attenuators, terminations, crystal detectors, resistive and reactive power dividers, low pass filters, hybrids, and directional couplers! All with MFM connectors! All useable to 12.4 Gc; some, to 18 Gc! All with specs that far exceed other, higher priced units!

For example, check these attenuator specs:

ATTENUATION (db)	ACCURACY (db)	MAX. VSWR	LENGTH (in.)	WEIGHT (oz.)	PRICE
3	0.75	1.5	1.4	0.5	55.00
6	0.75	1.5	1.4	0.5	55.00
10	0.75	1.4	1.4	0.5	60.00
15	0.75	1.4	1.4	0.5	60.00
20	0.75	1.4	1.4	0.6	60.00
30	1.00	1.4	1.8	0.6	65.00
40	1.00	1.4	1.8	0.6	65.00

Right now, 28 models of 8 basic product lines are available for immediate delivery; additional lines are on their way. What's more, wide use of interchangeable parts means that large-quantity orders can be filled readily and "specials" designed for you quickly. Write for complete information.



FREE! New Catalog 17—showing complete specs of these new miniaturized devices, plus thousands of other microwave products. Circle the Reader Service Card or write us. Address: Dept. E-59.

MICROLAB/FXR

Livingston, New Jersey 07039 Phones: (201) 992-7700; (212) 721-9000

Cable Address: MICROLAB



In contemporary data processing, Clare puts you in control

In every type of electrical/electronic operation, Clare capability can put you in control. Your responsibilities may involve high-speed data processing systems, or demanding industrial process control. Multi-channel communications networks, or instruments of utmost accuracy. Aerospace or ground support systems, where perfection is expected—and delivered.

Everywhere contact switching can optimize control systems—wherever long life, high reliability, advanced capability, and maximum economy are needed—let Clare put you in control.

C. P. Clare & Co.—worldwide.

Clare contact switching...for optimality in

Industrial Process Control Electronic Data Processing Aerospace and Ground Support Communications Instrumentation



simple direct measurements

1 mv to 3 v

10 kHz to 1 GHz



the first rf voltmeter to offer:

- 50 μ v readings with 20 μ v resolution
- $\pm 5\%$ measurements at 700 MHz (usable to 2 GHz)
- Linear scale, all ranges
- Recorder and "sample hold" outputs
- Probe with measurement retention
- Priced at only \$650!

The Hewlett-Packard 3406A RF Voltmeter provides greater accuracy and sensitivity over a broader frequency range than any comparable instrument available...and at only \$650!

The sampling technique employed in the voltmeter provides a "sample hold" output, which permits high-frequency peak measurements with a low-frequency scope, as well as true rms measurements, when you use the 3400A RMS Voltmeter. The 3406A/3400A combination costs just \$1175 for true rms measurements to 1 GHz. The 3406A, with a scope such as the HP 120B Oscilloscope, permits visual measurements over the same bandwidth for just \$1145!

Ideal for such applications as radar, high-frequency communications, telemetry and research and development labs, where measurements with this resolution and at these frequencies previously have been impossible.

Extra features include a front-panel calibrator, pushbutton range selection and the pushbutton probe which allows retention of a measurement. Accessories include the 11072A Isolator Tip, furnished with the instrument, plus these kits, which increase the flexibility of the 3406A:

11064A Basic Probe Kit (\$100)

11063A 50 Ohm "T"

11061A 10:1 Divider Tip

10218A BNC Adapter

(0950-0090) 50 Ohm Termination

11071A Probe Kit (\$185), same as 11064A

plus: 11073A Pen Type Probe

10219A Type 874A Adapter

10220A Microdot Adapter

11035A Probe Tip Kit

Ask your Hewlett-Packard field engineer for complete specifications. Or, write Hewlett-Packard, Palo Alto, California 94304. Europe: 54 Route des Acacias, Geneva.

1976R

HEWLETT  **PACKARD**
An extra measure of quality

Do All Low-Cost Medium-Current Plastic Transistors Offer Only Skeleton Specs?



Not These!

Scan all the data sheets — no other complementary plastic devices offer such complete specifications in the medium-current range as Motorola's UNIBLOC* 2N4400-03 switching & amplifier series at these low prices. Look at the design freedom you have!

- Gain guaranteed from as low as 100 μ A to 500 mA
- Complete h-parameters
- Switching times specified
- Saturation voltages at two operating levels

Your circuit possibilities multiply . . . you can simplify your circuitry . . . achieve new levels of performance efficiency . . . cut down on preliminary trial and error or lengthy test procedures . . . use one device in place of many.

What's more these silicon annular† transistors

	NPN		PNP	
	2N4400	2N4401	2N4402	2N4403
BV_{CE0} ($I_C = 1$ mA)	40 V min		40 V min	
h_{FE} ($I_C = 10$ mA) ($I_C = 150$ mA)	40 min 50 min	80 min 100 min	50 min 50 min	100 min 100 min
$V_{CE(sat)}$ ($I_C = 150$ mA)	0.4 V max		0.4 V max	
Prices (5,000-up)	28¢	35¢	28¢	35¢

have the rugged, solid, one-piece UNIBLOC plastic package to guarantee optimum reliability and performance . . . and easy-to-take low prices — 28¢ and 35¢ each in 5,000 - 9,999 quantities.

Check your franchised Motorola distributor. He has full stocks of the 2N4400-03 series. For production quantities, see your Motorola representative. Details available from Motorola Semiconductor Products Inc., Dept. TIC, Box 955, Phoenix, Arizona 85001.

*Trademark of Motorola Inc.

†Annular semiconductors are patented by Motorola Inc.

— where the priceless ingredient is care!



MOTOROLA
Semiconductors



Attitude, Temperature, Oil Pressure, Hydraulic Pressure, Fuel Flow,
Fuel Pressure, Flap Position, Trim-Tab Position, Radar Altitude,
Tachometer, Torque, Pressure Ratio, BDHI, RMI, Angle of Attack, etc.

Most of the world's best pilots won't make a move without checking our instruments.

U. S. military aircraft have more Bendix® instruments aboard than those of any other company. We think this says something about their technical excellence and reliability. How can we put this capability to work for you? Call or write the Flight & Engine Instruments Division, Montrose, Pa.

Bendix **Aerospace
Products**

Electronics Review

Volume 40
Number 18

Computers

Traveling memory

Few people—especially U.S. Customs officials—are startled by the contents of a traveler's overnight case, but how often does anyone see a computer memory tucked away in a 21-inch suitcase? That's how engineers at Bunker-Ramo's Defense System division packaged the 1,024-word, 30-bit low-power metal oxide semiconductor memory they built under contract to the Air Force Systems Command's Avionics Laboratory at Wright-Patterson Air Force Base.

The memory is significant for several reasons: it operates on much lower power and it's priced competitively with conventional memories. Although no applications have been spelled out by the Air Force or the company, M.E. Mohr, Bunker-Ramo's president, noted recently that completion of the project led to another Air Force award "to study the technology in implementing a low-cost inertial guidance computer for air-to-surface missiles."

George V. Podraza, an engineer for the Canoga Park, Calif., firm, says the nondestructive readout memory was put into a suitcase to simplify transporting it. Podraza is on a team headed by Samuel Nissim, manager of advanced computer technology, which developed the memory.

A feasibility model—including a breadboard exerciser that isolates faults down to the individual flat-pack level—was given a preliminary evaluation by the Air Force and is now back at Bunker-Ramo for further demonstrations. It faces extensive evaluation at Wright-Patterson in about a month. Dewey Brewer, a computer subsystems

project engineer at the avionics laboratory, described the memory's performance during initial tests as very good.

Could be smaller. The memory consists of 480 flatpack integrated circuits, each with 64 memory elements on an 80-by-100 mil chip. Podraza emphasizes that no attempt was made to shrink the size of the memory array, adding that the 480 chips, made by Philco-Ford's Microelectronics division, could be further reduced to a 1½-inch square thin-film substrate, if

the Air Force says it's necessary.

The objective is to develop a low-power random-access scratch-pad MOS memory priced competitively with other types of memories. The entire memory, excluding the exerciser but including the peripheral circuitry—address, write drivers, sense amplifiers, and timing circuits—consumes only 3½ watts; the MOS memory storage requires just 1 watt. The demonstration model uses a standard 115-volt a-c power supply.

One industry observer says that

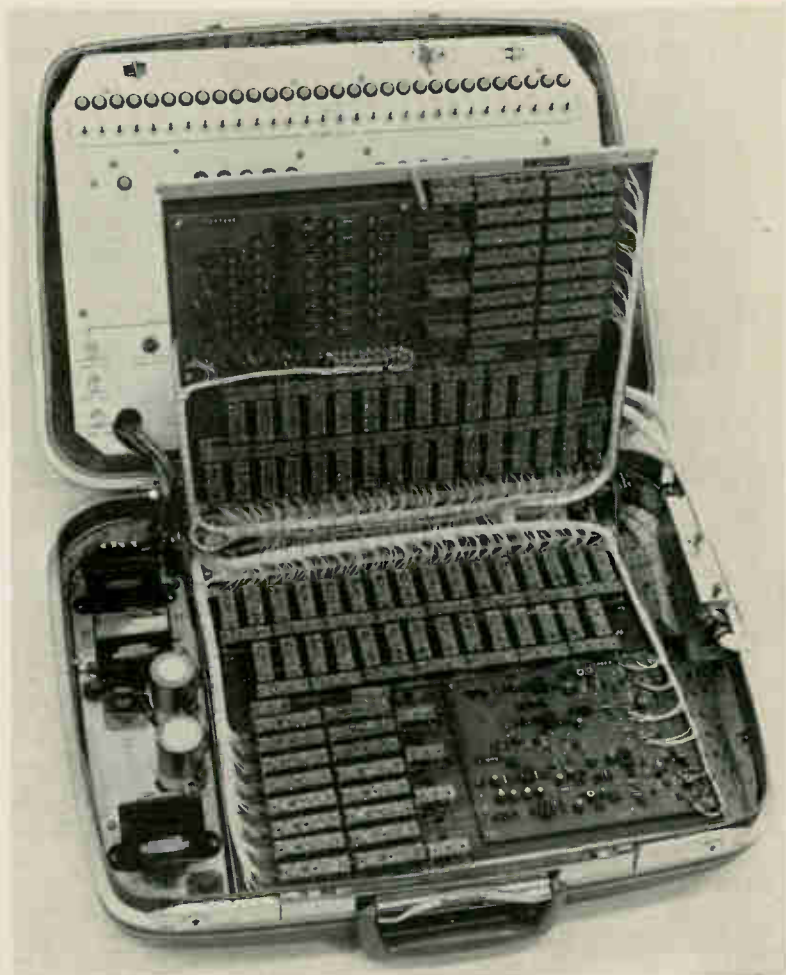

Suited for space. Bunker-Ramo's experimental memory, which fits into a 21-suitcase, operates on very low power.

comparable memories, using plated wire or magnetic cores, require power an order of magnitude greater than the Bunker-Ramo unit.

"This memory gets competitive with magnetic cores at small sizes," claims Podraza, "because we have a high-amplitude readout signal. We don't need very elaborate sense amplifiers." He says the chip cost works out to about \$1 per bit, but expects the cost per bit can be cut to 25 cents as yields and processing techniques improve. This compares with present costs of between 50 cents and \$10 per bit for registers and high-speed scratchpad memories.

Faster yet. Podraza explains that faster memories have been built, but that with a cycle time of 1 microsecond, the Bunker-Ramo memory speed is significant when

balanced against power dissipation. He says that core memories have been built with 100 nanosecond cycle times, but they require three times as much power as the suitcase memory.

Brewer notes that complementary MOS memories should be faster than Bunker-Ramo's p-enhancement unit, but nobody has built such a memory, as far as he knows. He says the suitcase memory could find application in scratchpad aerospace computers where extremely low power is important.

Bipolar technology is employed in the peripheral circuitry, with some bipolar IC's in the address decoder. The bipolar devices drive the large memory capacitance—several hundred picofarads—at fairly high speeds, says Podraza. But bipolar technology doesn't al-

low application of large-scale integration to the memory chips, says the Bunker-Ramo engineer. "We're getting three to four times as many memory cells on a chip with MOS techniques."

Real-time Fourier coefficients

About a year ago two scientists dreamed up a way to compute the Fourier coefficients of a complex waveform thousands of times faster than ever before [Electronics, Oct. 3, 1966, p. 52]. And engineers at Bell Telephone Laboratories subsequently asked themselves, "Why can't we build the Cooley-Tukey algorithm (named after the scientists who worked it out) into a machine that computes Fourier coefficients in real time?"

They could and they did. The processor, built for research in signal processing, generates the discrete Fourier transform for audio signals as fast as the signals come in.

It is connected to an IBM 1800 computer, a small machine generally used in process-control applications, but it is producing results as much as 20 times as fast as the laboratory's giant CE 635 computer.

Richard Shively, an engineer at Bell Labs, will describe the machine at the IEEE Computer Conference in Chicago this week.

Samples of segments. The processor divides up a waveform, which might be that of a voice on a telephone wire, for example, into segments a fraction of a second long. It then samples each segment at a frequency which is at least twice the bandwidth of the incoming signal. From the amplitudes measured at each sample the processor computes the Fourier coefficients for that segment while the following segment is being sampled.

The highest Fourier coefficient that the machine can generate is related to the sampling frequency and to the desired resolution. For example, if the input signal is divided into segments 1/25 second long, the machine will provide the Fourier coefficients for a funda-

Electronics Index of Activity

September 4, 1967

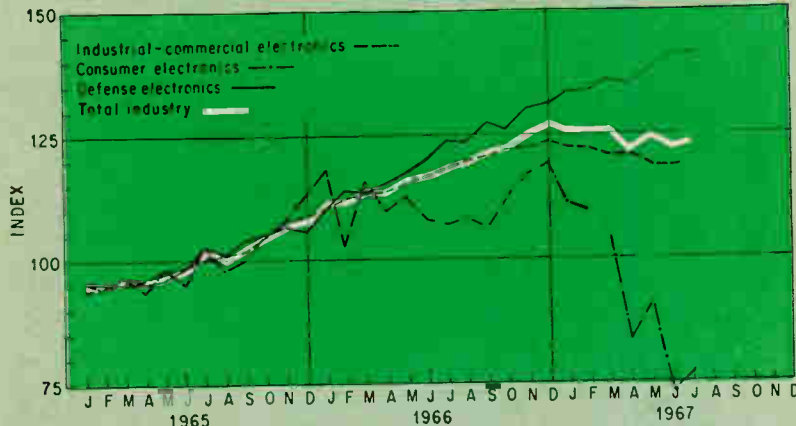

Segment of Industry	July 1967	June 1967*	July 1966
Consumer electronics	78.8	72.3	100.7
Defense electronics	140.9	141.4	124.1
Industrial-commercial electronics	119.7	118.3	118.3
Total industry	124.0	122.9	118.4

Volume of electronics production increased more than 1 index point in July and stands almost 6 points ahead of the July, 1966, level. Consumer production was the strongest gainer, surging more than 6 points in July but remaining more than 20 points below the year-ago pace. Output of defense electronics dropped half a point in July, but it still shows the strongest year-to-year gain of any industry segment, up nearly 17 points.

Indexes chart pace of production volume for total industry and each segment. The base period, equal to 100, is the average of 1965 monthly output for each of the three parts of the industry. Index numbers are expressed as a percentage of the base period. Data is seasonally adjusted.

* Revised.

mental frequency of 25 hertz and for multiples of 25 up to half the sampling frequency. If the signal has a bandwidth of 5 kilohertz, then the sampling frequency must be at least 10 khz; for that sampling frequency, the highest harmonic will be 5 khz.

Longer segments of the input signals will provide better resolution. Suppose a signal of 8-khz bandwidth is divided up into 1/10-second segments and sampled at 20 khz; the machine then generates the Fourier coefficients at 10 hz and multiples thereof up to 10 khz—a string of 1,000 numbers that defines the waveshape of the original signal with great fidelity. And this is nowhere near the capacity of the machine, which can process up to 8,192 samples of one segment.

Band aid. Bell Labs plans to use the new machine only as a research tool. But the Fourier coefficients of any kind of signal could be transmitted digitally as part of a frequency-multiplexing scheme, and the signal could then be reconstructed at the receiver. Or the coefficients could be transmitted directly in analog form, particularly where higher frequencies are involved. Either method of transmission would make more efficient use of the transmission bandwidth than direct transmission of the signal itself.

In another application the Fourier processor could be connected to a seismic monitoring system to produce a continuous string of coefficients for seismic noise. When a different signal arrives, masked to some extent by the noise, the changing coefficients would signal a distant mild earthquake or perhaps an underground nuclear blast—and the indication would be now, not tomorrow or next week.

Best route. The processor could also help achieve the best data-transmission rate on lines whose parameters vary from route to route. A telephone connection between two computers in New York and Los Angeles may be via Memphis in the morning and via Chicago in the afternoon, and the characteristics of the two lines may differ.

Space electronics

Repair on the wing

Computer designers, who are aware that there are no repairmen in space, are turning to machines that both diagnose and repair breakdowns without outside help and without significantly interrupting computations.

In one project, called STAR for self-testing and repair, Jet Propulsion Laboratory researchers are going one step further: they're developing a computer that performs most of its diagnosing work with hardware—not software—thereby cutting costs and saving computer-memory space.

Directed by Algirdas Avizienis, who is also on the engineering faculty at the University of California at Los Angeles, the project is funded by NASA. The goal is a computer unattended in a spacecraft for 10 years. As yet, a specific mission for the computer hasn't been chosen.

First step. So far, the arithmetic processor and one of the "bus checkers" vital in the system's concurrent diagnosis scheme—diagnosis during computation—have been breadboarded. The goal is to have the entire computer breadboarded by the end of 1968. "We felt the arithmetic processor had to be built first because it's the most demanding part of the task," says Avizienis.

Avizienis cites two critical design problems to be solved before an arithmetic processor can perform concurrent diagnosis: devising a way to indicate when a functional unit in service needs repair, and choosing the most reliable way to deactivate the faulty unit and activate a standby unit. The JPL researcher says his group chose to do all switching at the power source for each subsystem rather than on the wires that connect subsystems.

Three schemes. To achieve concurrent diagnosis, the JPL team employs conventional 32-bit binary numbers for all computer words. Three different error-detection

schemes are used. Arithmetic operands fed into the machine are 28 bits long and are multiplied by 15 as they are entered. Thus, all numbers being processed are multiples of 15. The multiplication adds four bits to the 28-bit word for a total of 32. The result of every operation is also a multiple of 15; a checking unit divides every such result by 15. If the remainder isn't 0, an error is signaled. The number 15 in binary form is 1111, and the choice of this particular number is related to the STAR computer's execution of arithmetic operations in four-bit bytes.

The computer's instructions are also 32 bits long, and comprise a 12-bit operation code and a 20-bit address. The 12 bits in the operation code are divided into four-bit bytes, each of which consists of two 1 bits and two 0 bits. If any byte is detected containing one or three 1 bits during the interpretation of an instruction, an error is signaled.

Addresses are specified by four 4-bit bytes, that are encoded by a multiplication process similar, but not identical, to that used for arithmetic operands, adding another four bits for a total of 20.

Avizienis maintains that the multiple-of-15 code will detect 14 out of every 15 errors that can occur. The probability of the 15th error occurring, he says, is very small and can be tolerated. Thus, there is no need for a special diagnosis program, allowing the diagnosis function to be implemented in hardware.

All units in the STAR computer that have been built use low-power, diode-transistor-logic integrated circuits from Fairchild Semiconductor's Micrologic line.

Standby system. Once an error is detected, it is directed to a control and diagnosis unit, which then momentarily interrupts the computation and attempts to restart it from a given point. If the fault reoccurs a standby subsystem is ordered into service. If a fault is detected in one of the three control and diagnosis units that run constantly and simultaneously, the other two deactivate the faulty unit

and a spare is put into service.

Avizienis says there might be one or two spare control and diagnosis units, depending on the duration and complexity of a spacecraft mission. He adds that each of these units has been designed as small as possible to compensate for the power drain caused by three running at the same time. The Fairchild ic's in the breadboard have typical power drains of less than 1 milliwatt per gate and less than 4 milliwatts per flip-flop.

The completed computer will employ a read-only braid memory to be supplied by MIT's Instrumentation Laboratory [Electronics, May 1, p. 88], and a braided read-write memory from General Precision's Librascope group, which has just been awarded a subcontract. Librascope's memory will have a nondestructive readout. These units, along with the control and diagnosis unit that is being designed by Stanford Research Institute, are the only subsystems of the STAR computer that aren't being built at JPL.

Industrial electronics

Touch-tone testing

A significant step toward automation of production processes will be taken this month by the Western Electric Co., manufacturing arm of the Bell System, at its Merrimack Valley works in North Andover, Mass. An on-line production information system—one of the first random-access computer-monitored process systems in the U.S.—will be put into operation in the crystal unit-fabrication shop.

Operators at 50 stations, equipped with frequency and resistance test sets, will have immediate access to a Honeywell H-21 process-control computer. Analog voltages representing crystal-resistance values, and digital signals for crystal frequencies will be fed into the computer through a multiplexer. The computer will then compare the readings with stand-

ards and generate reports on trouble spots.

"We hope to save about a half-million dollars a year in reduction of shrinkage," says William D. Watson, development engineer. A \$5 million-a-year operation, the crystal shop usually has 40,000 units in production and test stages at one time. The plant makes transmission equipment for telephone and television trunklines. Quartz crystals are used by the thousands in this equipment.

Western Electric's long-range goals include closed-loop computer control of the crystal shop's frequency-adjusting facilities. The first step is the real-time production information system with on-line monitoring of the testing function.

Finger tip control. A total of 250 work positions, including the 50 test stations, will also be equipped with small input stations for entering manual data into the computer. These are part of the Gates VIII system developed by the Western Electric Engineering Research Center in Princeton, N.J. The term Gates stands for the initials of the men who developed it.

The input keyboards are modified touch-tone dialers similar to those on many new telephones. The stations will accept information directly from production workers on all their significant activities—including movement of product lots, quantities, and observed defects.

The system will permit identification of production problem areas, control of inventory, improved scheduling of jobs and facilities, determination of operator efficiencies, and reduction of supervisors' paper work.

"I am convinced," says Watson, "that an effective shop-information system must not flood supervisors with information, but let them see quickly those things on which they must take action. It will give us a handle on what is going on in quality as well as inventory, and will speed the feedback time, so we can do something faster about production and inventory problems."

Unpunched. The real-time system replaces a punched-card technique used in the last three years.

In the first phase, only the test data will flow directly to the H-21 computer. The Gates VIII manual data will be punched onto paper tape for subsequent batch analysis by the plant's central computer. Eventually, the paper tape will be replaced by a direct connection to the H-21 computer. There, the data on the tape will be checked for errors and then compiled with data from the automatic test sets. The total data stream will be recorded on magnetic tape to be used by the central computer for more detailed off-line analysis.

Button pusher. The fully automatic input stations for the real-time system will be situated where operators adjust the crystals, perform fine tuning, and do final testing. A station consists of a Hewlett-Packard voltmeter and frequency counter combined by Western Electric engineers into a frequency-resistance test set. After the operator pushes a button, the computer takes less than 2 milliseconds to communicate with the set. The operator codes in the crystal type. Then the signals representing frequency and resistance values are sent to the computer through the multiplexer, made by Astrodata Inc.

The 50 test sets time-share the



Dialing trouble. Western Electric is computerizing its testing of crystals. Information is entered through a touch-tone dial system.

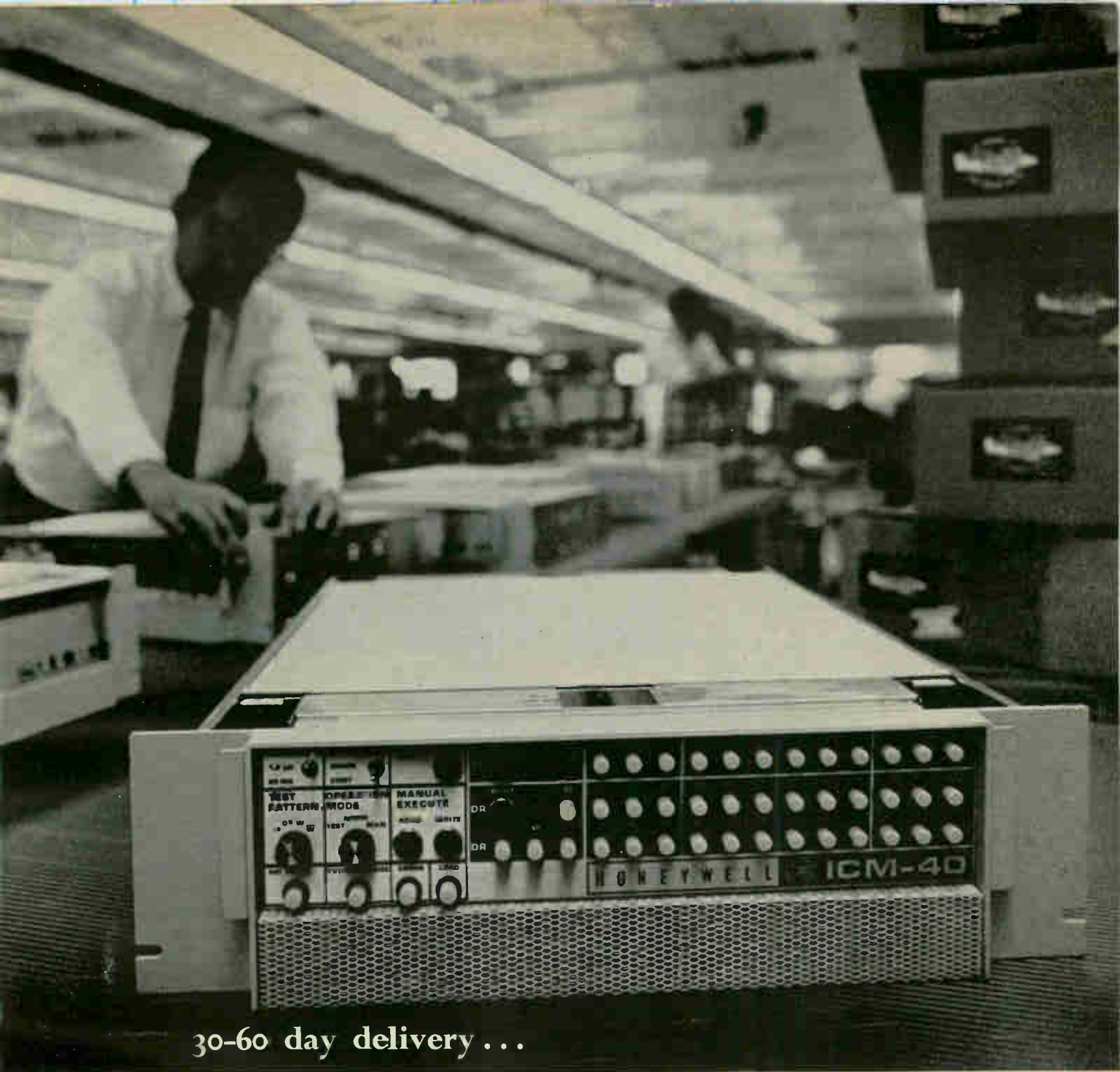

30-60 day delivery . . .

**...helps you
meet tight schedules
when you use I/C
 μ -STORE core memories**

Our one microsecond ICM-40 memories are ready now to meet your tightest delivery schedule — 60 days or less on standard models with capacities of 4,096, 8,192, 16,384 and 32,768 words.

If you've drawn a block marked "core memory" recently, let us show you μ -STORE speeds, capacities, and fast delivery capability. You'll find that both our ICM-40 and ICM-47 (670 nanosecond full cycle time) have been designed to offer a custom solution to your memory problems. Write for our new brochure. It sums up all the facts. Honeywell, Computer Control Division, Old Connecticut Path, Framingham, Massachusetts 01701.

Honeywell

 **COMPUTER CONTROL**
DIVISION

Circle 43 on reader service card

multiplexer and computer so that there is no noticeable wait for the operator after the button is pressed for a reading. It takes the system 5 milliseconds to perform the complete recording cycle. Meanwhile the computer has looked up the tables of standard values and average readings, which are updated daily.

Avionics

In competition

NASA isn't taking any chances.

At the agency's Electronics Research Center in Cambridge, Mass., work is stepping up toward the development of strapdown inertial guidance technology. Meanwhile, right across the street at MIT's Instrumentation Laboratory, work is also stepping up on its development of gimballed inertial guidance systems.

The two types of inertial systems—strapdown and gimballed—are competing for use on the supersonic transport and future space vehicles, and NASA has decided to bet its money on both.

Research into strapdown systems includes a \$500,000 contract with United Aircraft for the development of a modular-integrated circuit computer for such a system. And NASA is about to award a \$300,000 contract for the design and construction of a standard strapdown system.

The inventor. MIT's work—a three-year, \$7.9-million effort—is for the development of advanced gyroscopes and supersensitive solid state sensors for gimballed systems. The project is under the direction of C. Stark Draper, the founder and director of the lab and the man who's credited with designing and building the first inertial navigation system.

Gimballed systems—installed in the Apollo spacecraft and in Polaris, Minuteman, and other missiles—use a stabilized platform that isolates vehicle motion from the sensors and is initially aligned to

Father of inertial navigation

On Feb. 8, 1953, an inertial guidance system automatically guided a converted B-29 bomber from Bedford, Mass., to Los Angeles without radio aids or star sightings.

The electromechanical system was designed and built by C. Stark Draper at MIT's Instrumentation Laboratory. The flight proved inertial systems were practical for long-range navigation and guidance. Since then, inertial-guidance systems have been used in most U.S. long-range missiles.

Regarded as the father of inertial guidance, Draper, now 65 and retired from the MIT faculty, still heads the lab. He has personally taken charge of developing a new generation of sensors for gimballed inertial systems.

His goal: sensors that will keep inertial systems to a drift rate of only 10^{-5} ° per hour, 100 times better than today's performance and with a lifetime of 100,000 hours, at least five times better than present systems. The sensors would be electronically self-adjusting.

Draper founded the lab shortly before World War II to develop gyroscopic gunsights for the Navy's antiaircraft guns. By war's end, the laboratory chalked up gyro-stabilized gun-bomb-rocket sights for fighter planes among its developments. After the war, Draper began applying his knowledge of gyroscopic stabilization and feedback control to inertial navigation and guidance, leading to that historic 1953 flight.

inertial space—distant stars.

Strapdown systems are bolted directly to the body of the vehicle. As it moves, the gyros and accelerometers move with it. Thus, it must operate in a more severe environment and give measurements over a wide dynamic range. A newer technique, strapdown has been tested on Air Force experimental lifting-body vehicles and on a Lunar Orbiter flight. A strapdown system is the abort-guidance method on the Apollo landing module.

Most inertial-guidance specialists believe gimballed systems offer greater accuracy and performance because the sensors operate in a protected environment, but that strapdown systems offer weight, cost, reliability, flexibility, and maintainability advantages for some applications.

Open-minded. "We're not hard-nose about it, but there has been continuing work on gimballed sensors and not enough on strapdown," says Richard J. Hayes, the NASA center's assistant director for guidance and control research.

In theoretical studies sponsored by the center, analytical-error modes of new plug-in, self-aligning gyros are being established to make tools for design trade-offs.

"There isn't a gyro house in the U.S. today that can handle the whole problem," says Hayes. "The trouble is that the gyro design is done by mechanical engineers, and the electronics people are called in afterwards to design a signal pick-off loop around it. We're asking companies to reassess their organizations and capabilities, and work toward integrated mechanical and electronic design of new gyros."

Meanwhile, the laboratory will test and evaluate new sensor principles, including the laser gyros developed by Honeywell and Sperry Rand. Laser gyros don't require warm-up time, are relatively inexpensive and simple, and also produce digital output for computers.

On course

American Airlines is pushing ahead with its in-flight testing of an inertial navigation system, undeterred by Pan American World Airways' decision to drop the inertial system developed by Sperry Gyroscope [Electronics, July 24, p. 38]. A prototype of Litton Industries' LTN-51 system was installed last month on an American Boeing 707 used for

SPEER COMPONENT COMMENTS

How to get a real reading on a resistor's true function... resistance.



That's right, we mean plain old electrical resistance.

The problem with this particular parameter is that it's just too basic. It doesn't have the exotic intrigue of such items as temperature coefficient, moisture resistance or load life. As a result, almost everyone takes it for granted—and naturally neglects to verify whether or not the resistance is actually being properly measured.

For example, if you don't realize the importance of using the proper test voltage, you can get all kinds of remarkable results.

The culprit in this case is the coefficient, not the component you're measuring. You can decrease the measured resistance of a carbon composition resistor by simply increasing the voltage applied... and vice versa.

Now with low value resistors be-

low 100K improper applied voltage won't wreck your readings since the VC is comparatively insignificant. But if you're measuring resistors above 100,000 ohms this voltage coefficient can throw a real curve.

So what should your test voltage be? According to EIA Specifications RS-172, MIL-R-11, and MIL-R-39008, resistors above 100K must be tested at 80 to 100 volts.

Yet most commercial testing units used by receiving inspection departments and component evaluation laboratories apply, at most a mere 15 volts. So, unless compensation is made for this Voltage Coefficient, many lots of perfectly good resistors which are well within the parameters specified could be indicated as somewhat beyond the limit.

Needless to say, Speer tests and sorts all of its resistors at EIA/military voltages.

In addition, we've prepared an article that explores this entire subject in greater detail. This article has the appropriately basic title: "Resistance—How It Is Measured." If you'd like a copy, just mail the coupon.

Are you and your inductor supplier committing Typical Test Error #6?

If you've been purchasing any of the superb inductors manufactured by our Jeffers Electronics Division, we may well have warned you about this error already.

It consists of failing to obtain correlation between your supplier and your own incoming inspection, in cases where inductance tolerances of less than 5% are involved.

Ideally, this step should be completed before the actual manufacturing operation starts. Your supplier should measure and tag sample parts and then forward them to you for correlation.

There are seven other possible errors that you should also be aware of when you're using MIL-C-15305 testing procedures to measure inductance and Q. We've covered a number of these errors already. The others will be along shortly.

SPEER *Speer Carbon Co.*

St. Marys, Pennsylvania 15857

Speer Carbon Co. is a Division of Air Reduction Company, Inc.

Rush a copy of "Resistance—How It Is Measured."

Name _____

Title _____

Company _____

Street _____

City _____ State _____ Zip _____

Quietly reliable.

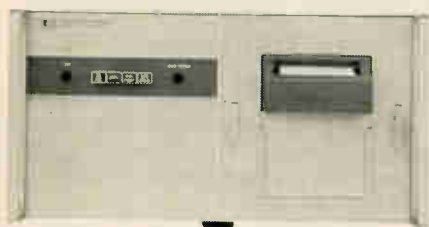

The measured noise level of the 20 lines/sec Hewlett-Packard 5050A Digital Printer is lower than an electric typewriter, making it quieter than other printers in its speed and price class. The removable plastic hopper folds records in a neat stack—seals in the noise.

Economical and rugged, the 5050A uses photo-electric decoding and a continuously rotating ink roller to reduce the number of moving parts. This results in less maintenance, more reliable operation.

Print cycle time is 50 msec asynchronous. It prints up to 18 columns of 4-line BCD data from one or two sources, even if they're in different BCD codes (by changing print wheel segments). Overall coding can be changed by replacing the code disc (\$2.50).

Fully compatible with other HP solid-state equipment, of course. Price: \$1750, plus \$35/column.

For more information, call your local HP field engineer or write Hewlett-Packard, Palo Alto, California 94304; Europe: 54 Route des Acacias, Geneva.

HEWLETT  PACKARD

02709

Electronics Review

military charter flights to Vietnam. Present plans call for the first of six production systems to be airborne starting in October.

No land marks. Eyeing new Pacific routes, American has an option to buy up to 25 of the systems, because the Pacific has few ground navigation aids.

There are still problems to be worked out in the system prototype, particularly with electrical connectors. The second test flight between Norton Air Force Base, Calif., and Anchorage, Alaska, was a washout. A wire came loose in a connector and the navigation system lost its memory.

Instrumentation

Burning up the track

Up until last year direct-writing event and graphic recorders put-putted along at about a few hundred hertz, while light-beam recorders pushed this speed up to a few kilohertz. Then last fall Honeywell broke the speed barrier with an oscillograph [Electronics, Nov. 14, 1966, p. 217] that pushed the state of the art to 1 megahertz—but at a price, \$20,000. Now, a small company in Norwood, N.J., Alpine Geophysical Associates Inc., has developed a machine that promises to boost this speed at least two orders of magnitude and it'll cost only about \$5,000 when it reaches the market within a year.

So far the Alpine recorder has attained speeds only equaling Honeywell's, but George Lehsten, the inventor and Alpine's chief engineer, says, "We haven't really opened it up; it'll eventually be able to record at up to several hundred megahertz."

Scratching the pen. The speed breakthrough, in both Honeywell's and Alpine's design, is achieved by eliminating the traditional moving pen, which has always been a drag on recorders.

Honeywell's recorder uses a cathode-ray tube to display the image of a signal's waveform. The

crt is connected, via fiber optics, to light-sensitive paper for recording the image. Alpine's machine, on the other hand, is much simpler. It uses the old-fashioned Lecher wire—the device that's used to measure wavelengths—to both measure a waveform and then literally burn the image onto a swift-moving roll of ordinary, inexpensive newsprint.

The Lecher wire is coupled to a very-high-frequency oscillator, which has a center frequency of 300 megahertz. The oscillator creates a voltage standing wave on the Lecher wire; then, when a signal from a sawtooth generator varies the oscillator's frequency by ± 100 Mhz, the wave sweeps up and down the length of the wire much the way an electron beam sweeps across the face of a crt.

The only mechanical function in the machine is the device that feeds the paper through the loop of Lecher wire; its speed is electronically servoed to the rate of recording. Consequently, the upper sweep frequency is based completely on the frequency of the printing oscillator and the paper's width. It's possible, therefore, to achieve sweep speeds in the range of 1 millisecond or even 1 microsecond. The low sweep frequency limitation is based on the recording paper itself.

High resolution. To record data, the input signal is coupled to the oscillator with a processor modulator. Details on the modulator are proprietary; obviously, it's upon the design of this device that the entire instrument is based.

The modulator boosts the energy level of the voltage wave when data is present, causing an electric

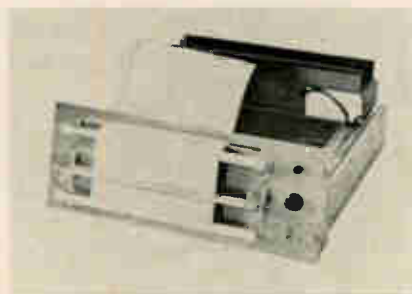

Zip. High-speed graphic unit may record at 100 Mhz.

An oscilloscope picture in 10 seconds: any longer is a waste of time.

Polaroid Land films don't make you wait to see if your trace zigged when it should have zagged.

They let you know in ten seconds.

They give you an oscilloscope picture you can study, attach to a report, send as a test record with a product shipment, or file for future reference.

You have a choice of 5 films for oscilloscope recording.

The standard film has an A.S.A.

equivalent rating of 3000. It comes in both roll film [Type 47] and pack film [Type 107]. They both give you 8 pictures $3\frac{1}{4} \times 4\frac{1}{4}$ inches. This emulsion is also available in 4 x 5 sheets [Type 57].

For extremely high-speed recording, there's Polaroid PolaScope Land film [a roll film, Type 410]. It has an A.S.A. equivalent rating of 10,000.

It can take pictures of traces too fleeting for the human eye: such as a scintillation pulse with a rise time of less than 3 nanoseconds.

One thing all these films have in common is a sharp, high-contrast image that's easy to read. Because the films are so sensitive, you can use small camera apertures and low-intensity settings.

To put these films to work on your scope, you need a camera that will take a Polaroid Land Camera Back.

Most oscilloscope camera manufacturers have one. For instance: Analab, Beattie-Coleman, BNK Associates, Fairchild, EG&G, General Atronics, Hewlett-Packard, and Tektronix.

You can get complete information by writing to Polaroid Corporation, Technical Sales Department, Cambridge, Massachusetts 02139, or by writing to one of the manufacturers mentioned above.

It will probably take a little longer than 10 seconds, but we promise the information won't be a waste of time.

"Polaroid" and "PolaScope"®

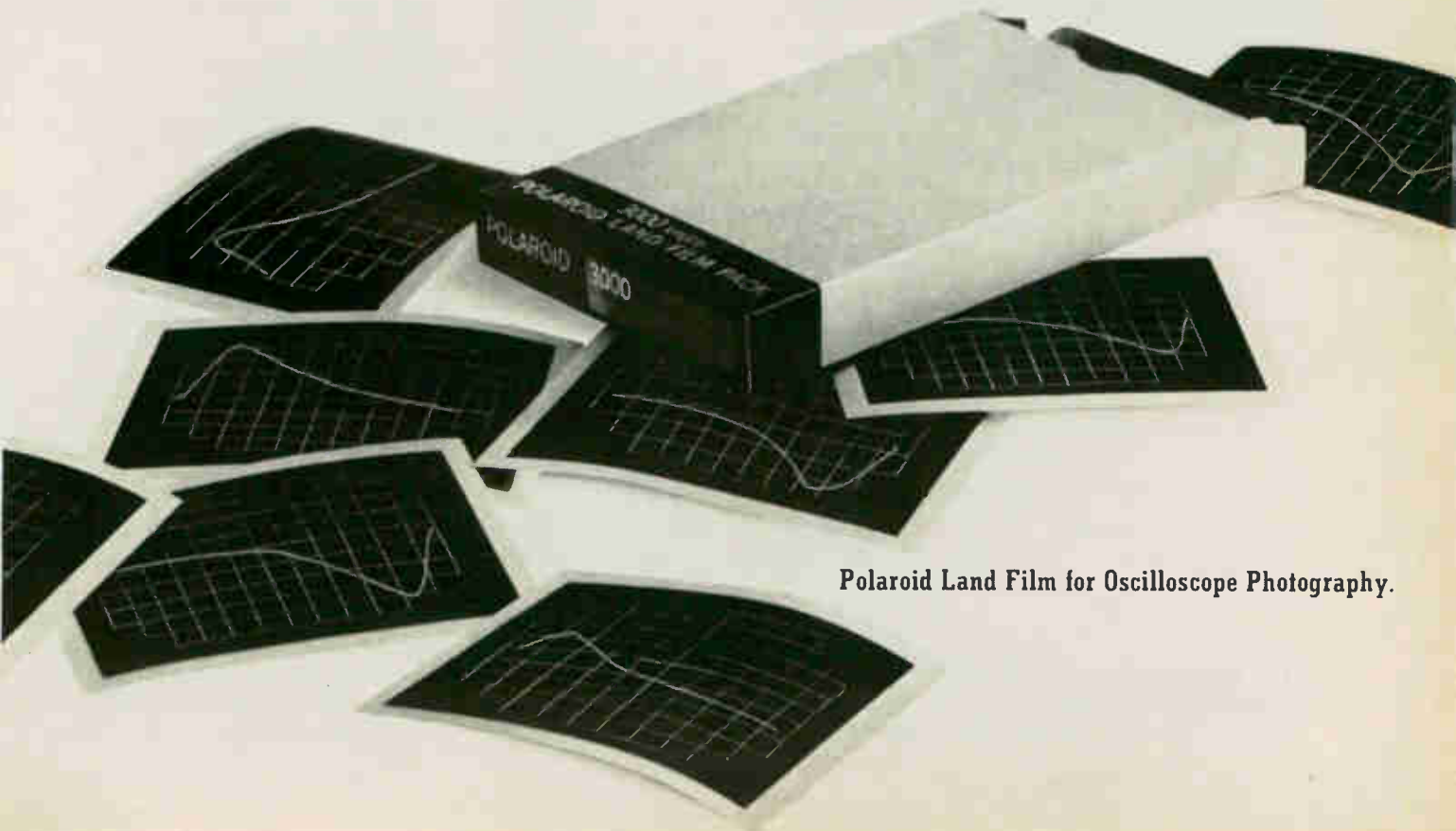

Polaroid Land Film for Oscilloscope Photography.

Free Samples

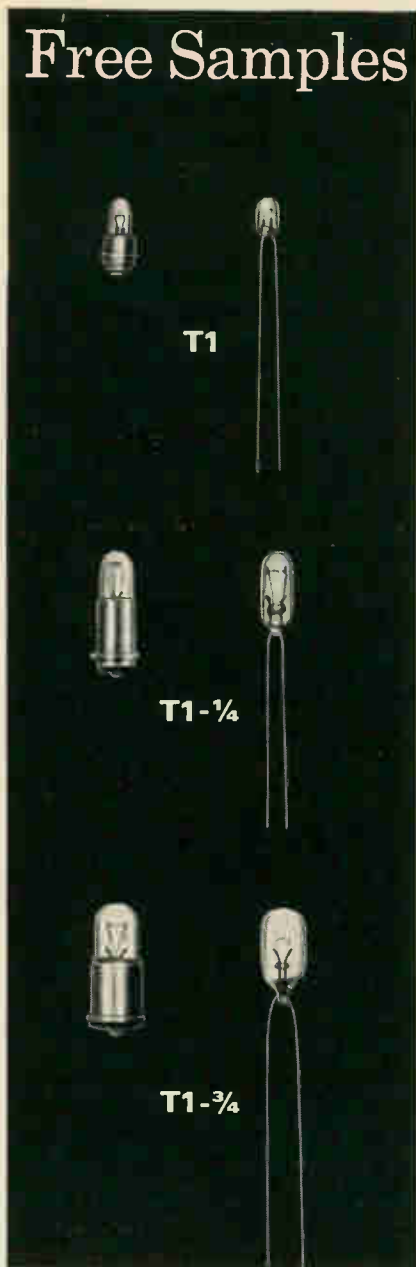

Miniature Lamps

Our miniature lamp prices are so low—about one-half the cost of competitive lamps—people sometimes wonder about their performance. So we're giving away samples to prove they are top quality, in spite of the low cost. In fact, most of our aged and selected lamps are priced lower than competitive lamps that are not aged and selected.

Simply drop us a line on your company letterhead, describing your application, and we'll send you a sample box of 10 IEE lamps. You select the lamp numbers. We'll do the rest.

We have a wide selection available in stock right now. So drop us a line and we'll send you some. Free.

IEE INDUSTRIAL ELECTRONIC
ENGINEERS, INC.

Dept. E 9, 7720 Lemona, Van Nuys, Calif

Electronics Review

arc to jump between the Lecher wireloop and burning a mark no wider than 0.005 inch in the paper. With such small marks, resolution of the recorder is high, exceeding that of the best oscilloscopes.

Antilog, too. Aside from speed, the recorder has another advantage that's available only on the most sophisticated custom-designed units: it can perform both log and antilog sweeps. Since the sweep is entirely an electronic function, any sweep wave within reason can be employed at the flick of a switch. These changes can be made without any loss of recording continuity.

Oddly, Alpine isn't in the instrumentation business. It's basically an oceanographic firm that performs research and engineering. Inventor Lehsten explains that the machine was developed only because Alpine needed such a unit for its work on ocean-bottom measurements, and couldn't buy a suitable machine. Because it's not in the instrumentation business, Alpine is going outside to have it built for the commercial market; it's already conducted negotiations with several potential producers, but no firm decision on who will build it has yet been made.

Advanced technology

GaAs packs more power

If there's any lingering doubt about the power or efficiency of gallium arsenide (GaAs) microwave power sources, it should dissipate fast. The microwave applied research group at the Radio Corp. of America's Princeton, N.J., labs, has built Gunn-effect devices capable of pulse powers up to 150 watts at 1 to 2 gigahertz with the highest Gunn-effect efficiency yet, 19% to 25%—about four times better than previous achievements.

RCA's next step will be a parallel array of Gunn diodes designed to reach kilowatt outputs. Such an array may eventually find its way into an airborne transponder RCA

is developing.

Meanwhile, researchers at Cornell University in Ithaca, N.Y., have squeezed 370-watt, 8-GHz pulses out of GaAs wafers operated in the limited space charge accumulation mode (LSA). This is the highest power ever achieved with LSA. Cornell researchers are investigating the mode for the Air Force, which would use it in radar.

Making waves. At the Bell Telephone Laboratories in Murray Hill, N.J., John Copeland is expected to achieve continuous-wave LSA generation of 0.7 to 1.0 watt at 150 GHz by autumn. In earlier work, he achieved tens of milliwatts of c-w power at 50 to 80 GHz—and detected output at 150 GHz. Copeland is now beefing up his instrumentation for millimeter-wave frequencies. He is also improving the heat-sinking capabilities of his crystal mount to boost output power.

Bell Labs is enthusiastic about LSA because it would enable the telephone companies to use the very broad bandwidths available at millimeter-wave frequencies. And solid state LSA devices could be far more reliable than tube oscillator.

The beauty of RCA's Gunn-effect achievement lies not only in high efficiency, but also in its repeatability. Industry sources say the company has found a doping profile for the semiconductor material that results in Gunn diodes with about 20% efficiency and that its epitaxial process control is close enough to assure repeating the profile time after time. RCA is patenting the profile.

Cornell's work is repeatable, too. Proof lies in the fact that the university's L.F. Eastman and G.C. Dalman, are forming a firm, Cayuga Associates, to market LSA-power sources for radar experimentation. The firm's first product will be unveiled in October, and will probably be capable of 350-watt, 8 GHz pulses about 100 nanoseconds long.

Won't make waves. Although RCA's Gunn-effect work has proven successful, LSA work has had problems in materials and plumbing.

"Mounting these things (LSA

INTERFACE

We've got solutions to problems you haven't even had yet.

Litton is a leader in matching sophisticated components in integrated equipment systems.

An outstanding example is our new Precision Pattern Generator used for the computer controlled generation of interconnect masks required in the production of large scale integrated circuit arrays. We used a high resolution cathode ray tube matched with an electronic control system to achieve a degree of speed, accuracy, resolution and repeatability never before attained in recording systems. Our single source responsibility for the system equipment

played a large part in achieving the outstanding performance.

This capability of Electron Tube Division to solve integrated equipment systems applications comprehends not only tube equipment interface but severe environmental, high density packaging and heat problems as well. Whatever your present problem in these areas there's a good chance we've been there before you, and are ready now with solutions. Contact the Microwave and Video Equipment Department of the Electron Tube Division, 960 Industrial Road, San Carlos, California 94070.

 **LITTON INDUSTRIES**
ELECTRON TUBE DIVISION

TAKE YOUR OWN X-RAYS

at your workbench with office-machine simplicity

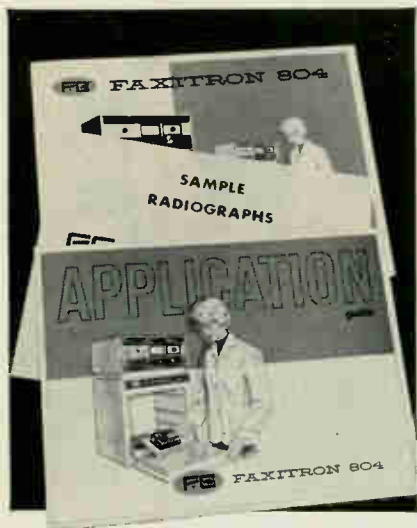

SEND FOR FREE APPLICATION KIT

X-ray machines are usually thought of as bulky, complex pieces of equipment operated in a lead-lined room by specialists.

The FAXITRON 804 now provides an invaluable new tool—a compact, self-contained X-ray unit for workbench, lab, production area which can be operated as easily as an office copying machine. Just place the object in the exposure chamber, select the voltage and exposure time, press a button. The image is recorded on film which processes on-the-spot in 10 seconds without a darkroom. Take them yourself—when and where you want them!

Built-in shielding allows the instrument to be operated safely in populated areas without an X-ray room. (Qualifies as an "exempt" installation per NBS Handbook 93). High resolution is provided by a small X-ray source (0.5 mm). Good contrast for a useful range of specimen thickness and densities is provided by a wide voltage range (10 to 110 kVP).

See for yourself how a "quick look inside" can help locate and define hidden problems, speed development of your project with X-rays you can take yourself.

Send for Free "Do-it-yourself" Application Kit—technical information on typical exposures and use of materials for on-the-spot X-rays of potted electronic components, multi-layer PC boards, integrated circuits, die cast parts, plastics, biological specimens—other research, design, production and quality assurance applications. Ask for a free radiographic sample of a product or object of your choosing.

FAXITRON 804, \$1970. f.o.b. McMinnville



Field Emission Corporation
McMinnville, Oregon 97128/A C 503, 472-5101

sources) and making them oscillate is a black art," says Martin Steel of the microwave research labs.

Ironically, it's the quality that makes RCA's GaAs good for Gunn oscillation that may be causing what Steel calls the company's "limited success" with LSA. Unlike LSA, which requires uniform doping throughout the GaAs crystal, the Gunn effect profits by graded variations in doping concentration along one dimension of the crystal. Using the very same crystal with which RCA first achieved 20% Gunn-effect efficiency, Steel's group got only weak, inefficient, 3% LSA output in K_u band at about 15 to 18 Ghz.

Government

The ups and downs

An economy-minded but defense-conscious Congress is playing seesaw with the defense and space budgets. While the House lopped \$516.6 million from the \$5.1 billion sought by NASA for 1968, Congress approved a \$70 billion defense appropriation—the largest in history and about the amount requested.

Unless unexpected restorations are made by the Senate, space spending for fiscal 1968 will be the lowest in five years. Hardest hit were "new start" programs. The Voyager program to send a craft to Mars was eliminated, as was the budget's "advance missions" item, which includes the mission study for the launch vehicle to be used after Saturn 5.

Two-year setback. Elimination of Voyager means there will be no lunar and planetary exploration programs beyond the launch of two Mariners now scheduled for 1969. NASA requested \$71 million for Voyager in its plan to land an unmanned spacecraft on Mars in 1973. Even if funded at a later date, the earliest possible landing on Mars will be in 1975, the next time the planet is close enough.

The Senate, which had earlier tried to scuttle Voyager when authorization hearings were held,

is not expected to appropriate money for the program. A request for \$40.2 million for electronic systems was trimmed by \$5.2 million.

The defense budget does include some cuts. The bill limits the Navy to purchasing eight test models of the controversial F-111B aircraft instead of the 20 requested by the Administration. The reduced number will cost \$147.9 million, roughly half the \$287 million requested for the 20 planes. The cut reflects Congressional unhappiness with the plane, which has grown so heavy that some critics wonder if it will be able to be used on carriers. Grumman Aircraft builds the plane under subcontract from General Dynamics.

More for Nike. The spending bill includes \$730 million for the Nike-X antiballistic missile system—increasing the amount available for the program to almost \$1 billion. About half of this amount is reserved for initial production once the Administration gives a green light.

Congress authorized \$47 million for the advanced manned strategic aircraft.

For the record

Narrow view. The National Science Foundation, recognizing that Federal funds are more likely to be spent on guns and ghettos than stargazing, has chopped a \$130-million package of six proposed radio and radar astronomy programs to a pair of projects costing \$18 million. The most ambitious of the six—\$52 million for an array of 36 dishes proposed by the National Radio Astronomy Observatory—has been returned for further study. Also deferred for study were bids by the Northeast Radio Observatory for a 42-foot fully steerable dish in a radome, and Caltech's steerable 330-foot dish. Projects that were recommended are Caltech's plan to add seven 130-foot dishes to its Owens Valley facility, and Cornell University's bid to improve the accuracy of the 1,000-foot spherical dish in Arecibo, Puerto Rico.

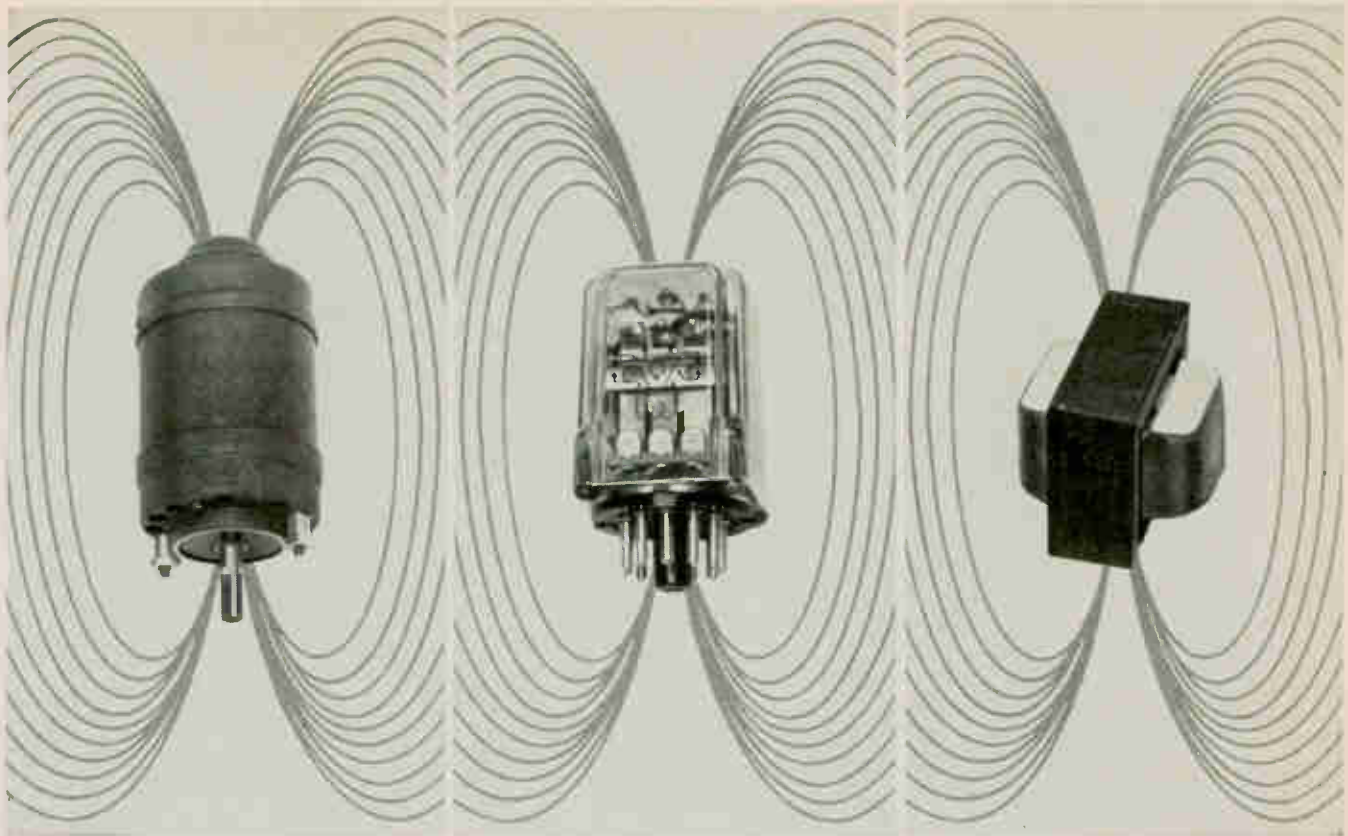

Now, Get 6 Volts Noise Immunity For Your Digital Control System With New MHTL Integrated Circuits!

You'll get the "right" signal every time in your numerical control, supervisory control and computer peripheral equipment with the new Motorola-developed high threshold integrated circuit logic series. Called MHTL, it's the first family of integrated circuits to offer a noise margin of 6 volts (typ) and a 15 volt ($\pm 1V$) operating voltage. And, it's priced, packaged, and specified for application in equipment designed for use in high noise industrial environments.

MHTL combines high noise immunity with a voltage swing of 13 volts, broad operating temperature range, large fan-out and a 35 mW power dissipation rating. In short, it offers you discrete circuit characteristics PLUS the price, size, and reliability advantages of integrated circuitry.

Here are some of the MHTL specifications:

CHARACTERISTICS	MHTL
Operating Voltage	15 \pm 1 Volts
Noise Immunity	6 Volts (typ)
Fan-out (Gate)	10 (min)
Clock Rate (Flip-Flop)	4 MHz (typ)
Operating Temperature Range	-30 °C to +75 °C

Offered in the 14-pin dual in-line plastic Unibloc* package, the circuit functions and prices for the MHTL family are as follows:

TYPE	DESCRIPTION	PRICE (1,000 UP)
MC660P	Dual 4-Input Gate	\$3.50
MC661P	Dual 4-Input Gate (Passive Pull-Up)	\$3.50
MC663P	Dual J-K Flip-Flop	\$6.10
MC664P	Master Slave R-S Flip-Flop	\$4.05

Other functions planned for the immediate future include a Dual 4-Input Line Driver, Triple Input Interface, Quad Output Interface, Dual Monostable Multi-vibrator, and Quad 2-Input Gate.

To find out how easily your designs can conquer high-noise-environments with MHTL, write for our data sheets. We'll also send you our latest application note on how MHTL solves your noise problems. For circuits you can try right now — call your nearby franchised Motorola Semiconductor distributor. He has high-noise-immunity MHTL in stock!

*Trademark of Motorola Inc.

— where the priceless ingredient is care!



MOTOROLA Semiconductors

MOTOROLA SEMICONDUCTOR PRODUCTS INC. / P. O. BOX 955 / PHOENIX, ARIZONA 85001 / (602) 273-6900 / TWX 910-931-1334

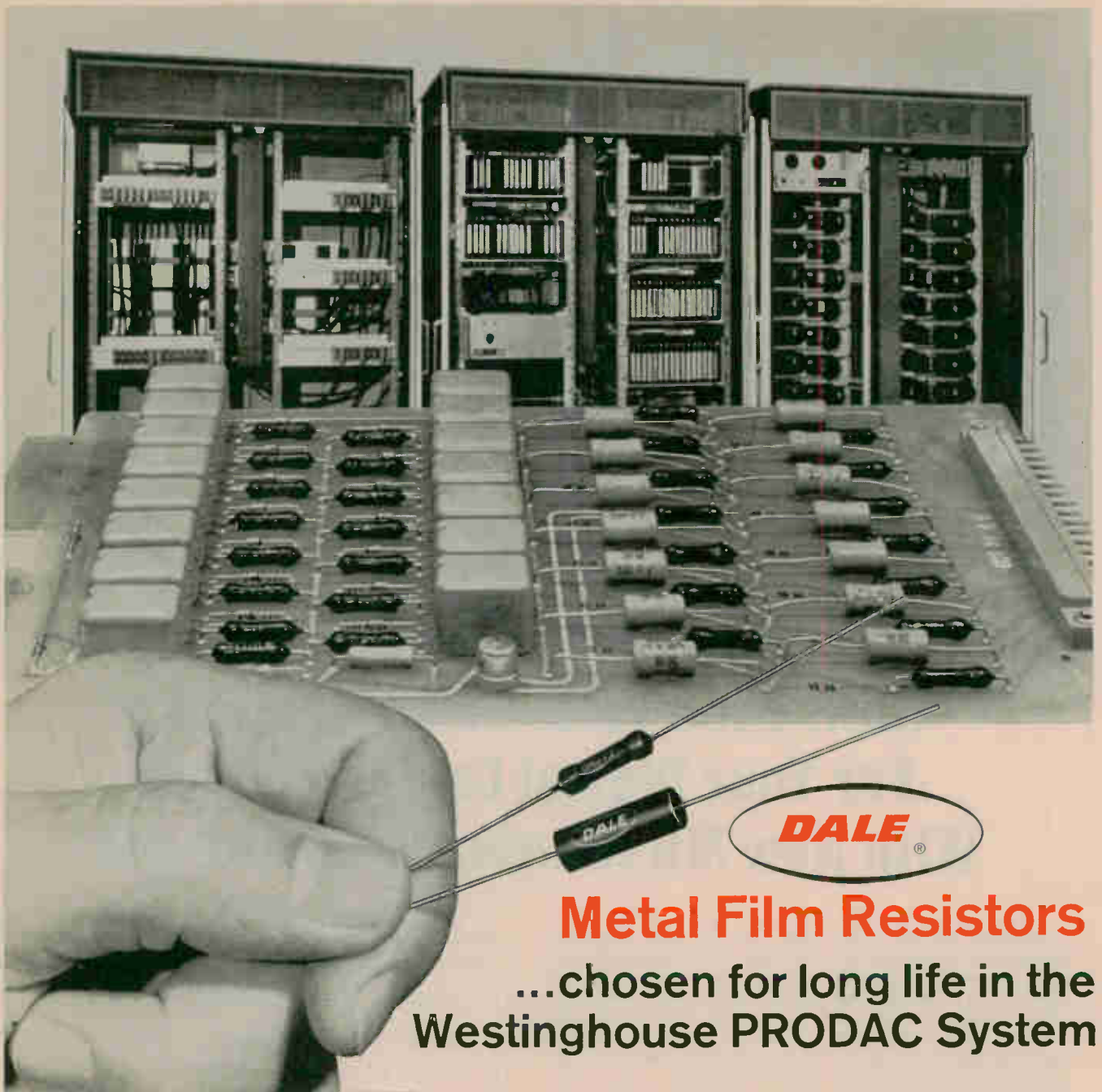

Metal Film Resistors ...chosen for long life in the Westinghouse PRODAC System

GENERAL SPECIFICATIONS TYPE MF^a MIL-R-10509F

DALE TYPE	MIL. TYPE	125° C RATING (Char. C & E)	70° C RATING (Char. D)	RESISTANCE RANGE (Ohms)
MF50	RN-50	1/20 w	1/10 w	30.1 to 80.6K
MF-1/10	RN-55	1/10 w	1/8 w	30.1 to 301K
MF-1/8	RN-60	1/8 w	1/4 w	10 to 1M Ω
MF-1/4	RN-65	1/4 w	1/2 w	10 to 1 M Ω
MFS-1/2	RN-70	1/2 w	3/4 w	10 to 1.5 M Ω
MF-1	RN-75	1 w	—	25 to 2.6 M Ω
MF-2	RN-80	—	2 w†	100 to 10 M Ω

^aAlso available in conformal coated (MFF) styles. †Char. B
Tolerance: $\pm 1\%$, $\pm 5\%$, $\pm 25\%$, $\pm 10\%$ standard.
Characteristics D, C, or E apply depending on T.C. required.

Computers for industrial process control demand long resistor life. To insure this, Dale Metal Film resistors are used extensively in the versatile Westinghouse PRODAC System. Value analysis dictated the choice — with the long life characteristics of metal film winning over the lower price of carbon and carbon composition types. Dale verifies this reliability with long-term load life tests (see below). Delivery is reliable, too. Expanded production facilities can put quantities up to 50,000 in your plant in 2 weeks (1% tolerance units). We'll prove it — call 402-564-3131 today.

NEW METAL FILM LOAD LIFE DATA

Dale MF resistors have undergone 16,320,000 hours of load life testing without a failure (100% rated power, 70°C; failure defined as $\Delta R > 1\%$). Based on these tests, the MF resistor has a proven failure rate of .004% per 1,000 hours (60% confidence at 50% power, 70°C ambient). Write Dale for complete test data.

WRITE FOR CATALOG A



DALE ELECTRONICS, INC.

1300 28th Avenue, Columbus, Nebraska 68601
In Canada: Dale Electronics Canada, Ltd.



Washington Newsletter

September 4, 1967

**IBM will make
Corsair deadlier . . .**

Avionics in the latest Corsair 2 aircraft—the Air Force A-7D and the Navy A-7E—will be integrated by IBM. Built by Ling-Temco-Vought, the new planes will differ from the Navy's A-7A primarily in avionics.

Although the new craft won't have complete all-weather and night attack capability, the improved avionics—an inertial platform, doppler navigation, a highly sophisticated radar, and IBM's 4 Pi computer—will enable it to hit large targets in zero visibility and within 50 feet of visible targets when flying at 5,000 feet. This is twice the accuracy of the A-7A's.

The IBM-integrated system will cost about \$700,000 compared to the \$500,000 for the A-7A avionics. The older system isn't integrated, although it has a Univac 1818 central computer. And, it doesn't include an inertial navigation system.

The new system will include an improved Texas Instruments radar for target-acquisition, navigation, terrain-following, and other functions. Kaiser Electronics will build the heads-up display and General Precision will supply the inertial platform and doppler.

Deliveries of the new Corsair models will begin in late 1968. The Pentagon is anxious to get the new series operational; one reason is that the Grumman-built A-6A intruder, the only all-weather attack plane in the U.S. inventory, is extremely difficult to maintain because of its complex electronics.

**. . . and Sperry feels
the bite on Ilaas**

Selection of IBM for the improved A-7 avionics system is another blow to Sperry Gyroscope, which has been trying hard to get its Integrated Light Attack Avionics System (Ilaas) on an aircraft and into production. Ilaas development originally was ordered by the Navy with the A-7's in mind, but has been stumbling badly because the military services refused to buy it, citing its high cost. But a Navy avionics official says: "As far as I'm concerned the Ilaas is alive and an on-going program."

Without a program the size of the A-7D and A-7E models, it is doubtful that Ilaas can be carried on beyond prototype. The Navy and Air Force haven't said how many Corsair 2's will be built, but estimates run about 800 for the Navy and about 600 for the Air Force. This is in addition to the 400 earlier A-7 models now flying or already on order.

**Post office delays
industry briefing**

Because of a lack of qualified technical personnel, the Post Office has been forced to delay a symposium to brief industry on its mechanization needs until Nov. 3. Nearing the end of his first year in office, Leo S. Packer, assistant postmaster general who heads the Bureau of Research and Engineering, has learned the hard way that Government agencies do not move as fast as private business. One of industry's biggest legitimate beefs in dealing with the Post Office, Packer has found, is the difficulty involved in finding technically oriented personnel to pass on proposals.

**Air traffic plan
may not take off**

Lack of both enthusiasm and money is expected to result in the rejection of an Air Transport Association proposal that the Government finance a five-year program to expand and improve the nation's air traffic control system. The industry group asked that \$100 million be appropriated in fiscal 1968 to launch the program, which calls for terminal radar at every

Washington Newsletter

airport with scheduled airline service.

The FAA is cool to the proposal because it could mean changing the agency's basic philosophy: airport improvements based on flight operations. The agency has always maintained that the busiest airports—regardless of whether they're used by airlines—should get priority in improved equipment. The second problem is funding. The FAA, along with other agencies, has been ordered to hold down spending.

NAACP seeks more white-collar jobs

Indications are that the electronics industry, among others, may come under renewed pressure to step up the hiring and training of Negroes. Applying the pressure will be the National Association for the Advancement of Colored People, which is expected to use a report from the President's Commission on Equal Employment Opportunity as ammunition.

The report, to be released late in the fall, is expected to show that electronics is lagging behind other industries in employing Negroes in white-collar positions. Included in the Government's white-collar category are sales, clerical, technical, and administrative jobs.

A commission spokesman says the report will be used by the Government to "encourage" industry to review hiring and in-house training practices. But the NAACP may go farther. NAACP counsel J.F. Pohlhaus says that if persuasion fails, court action may be taken.

150-computer deal may be yule gift

Having reaped a storm of protests with its first decision, the Air Force is in no hurry to reaward the contract for 150 computers for housekeeping at its bases. The new winner won't be named before December. The contract, for the biggest computer order ever, originally went to IBM for model 360-30/40's at a price of \$114 million, but at the insistence of losers Honeywell, Burroughs, and RCA, the General Accounting Office ordered new negotiations with all four companies [Electronics, July 24, p. 25]. Will IBM lose the deal? That's hard to figure; one thing that could be in the cards, though, is a lower price. Honeywell claims it can supply the machines at almost half IBM's bid.

Shrike replacement ready for flight

Only nine months after contracts were awarded [Electronics, Dec. 26, 1966, p. 36], and sooner than many expected, the Standard ARM (anti-radiation missile) will go through its first shakedown in the next two weeks. The missile, to replace the Air Force and Navy Shrike, will be tested on an A-6 Intruder all-weather attack aircraft. The final element, the TIAS (target identification and acquisition system) guidance unit, built by IBM, is now being installed. It uses IBM's 4 Pi airborne digital computer. General Dynamics Pomona division is prime contractor.

Antimortar missile? Army mum on bid

The Army, currently in a crash program to develop a radar that can speedily locate enemy mortars firing from any direction, has received an unsolicited proposal from the Marquardt Corp. that goes even farther. The proposed system would detect and destroy an incoming mortar shell before it hits. Although some Army R&D officials have discounted such a system, the Army promptly classified the Marquardt proposal. The office of the Chief of Army R&D acknowledged receiving the proposal, but would give no details. Such an antimortar missile system would have to have an extremely quick reaction time.

FET CHOPPERS ARE THE ONLY ANSWER

Part ELEVEN of a Series On The State of The Chopper Art.

MODEL 8000



Booze is the only answer at my house, but they frown down at the office when I suggest there is more than one way to solve problems. They should have my mother-in-law — they'd stick to booze, not electronics.

It turns out that an FET chopper is a distinct improvement over photo-choppers, what with 6 volts being enough drive instead of a couple hundred. Now the photo-chopper was better than the transistor choppers, because it looked like a resistor instead of a diode. So there ain't any voltage drops that have to cancel out. Mostly they don't. (Cancel, that is.)

As matters stand on noise and offset — and we sell choppers for only one purpose, which is to allow D.C. amplifiers with very little offset — the best of FET choppers are only two to three orders of magnitude worse than the best of mechanical choppers. Which is real progress. Last week it was three to four orders — before we invented this model 8000 FET chopper. The offset available is below 10 microvolts at 10,000 ohms, and would be lower if there weren't such wierd alloys inside the FET that have to come out eventually to copper.

So today's best mechanical choppers reach down below some 50 nanovolts, the FET chopper gets to about 5 microvolts. That's two orders of magnitude and crowding. Good thing we make solid-state choppers too.

Speaking only of offset, and anyway, what else is speakable about a chopper? I suppose you could say Mechanical Choppers << FET Choppers < Photo Choppers < Transistor Choppers.

AIRPAX ELECTRONICS
Cambridge, Maryland 21613

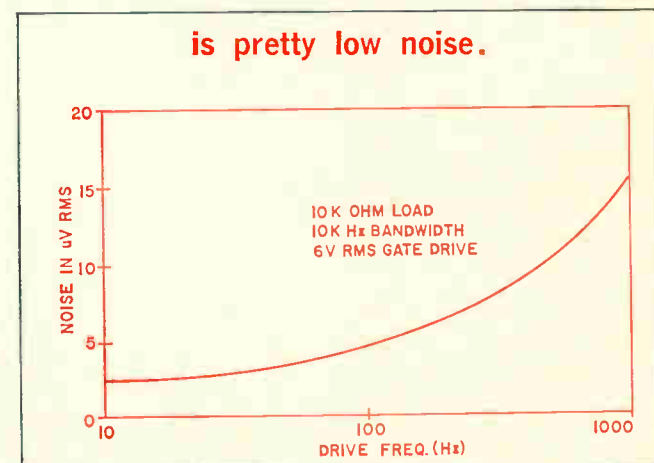
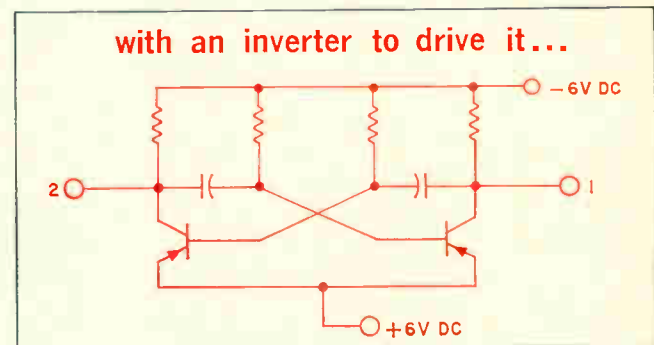
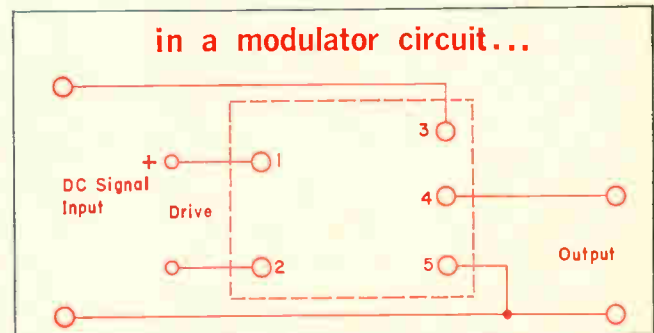
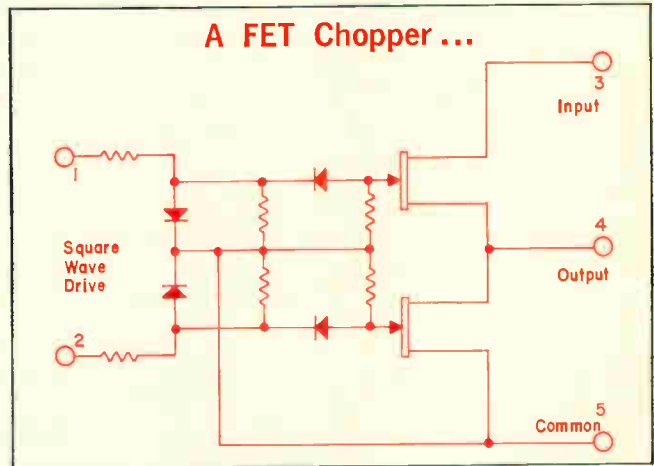

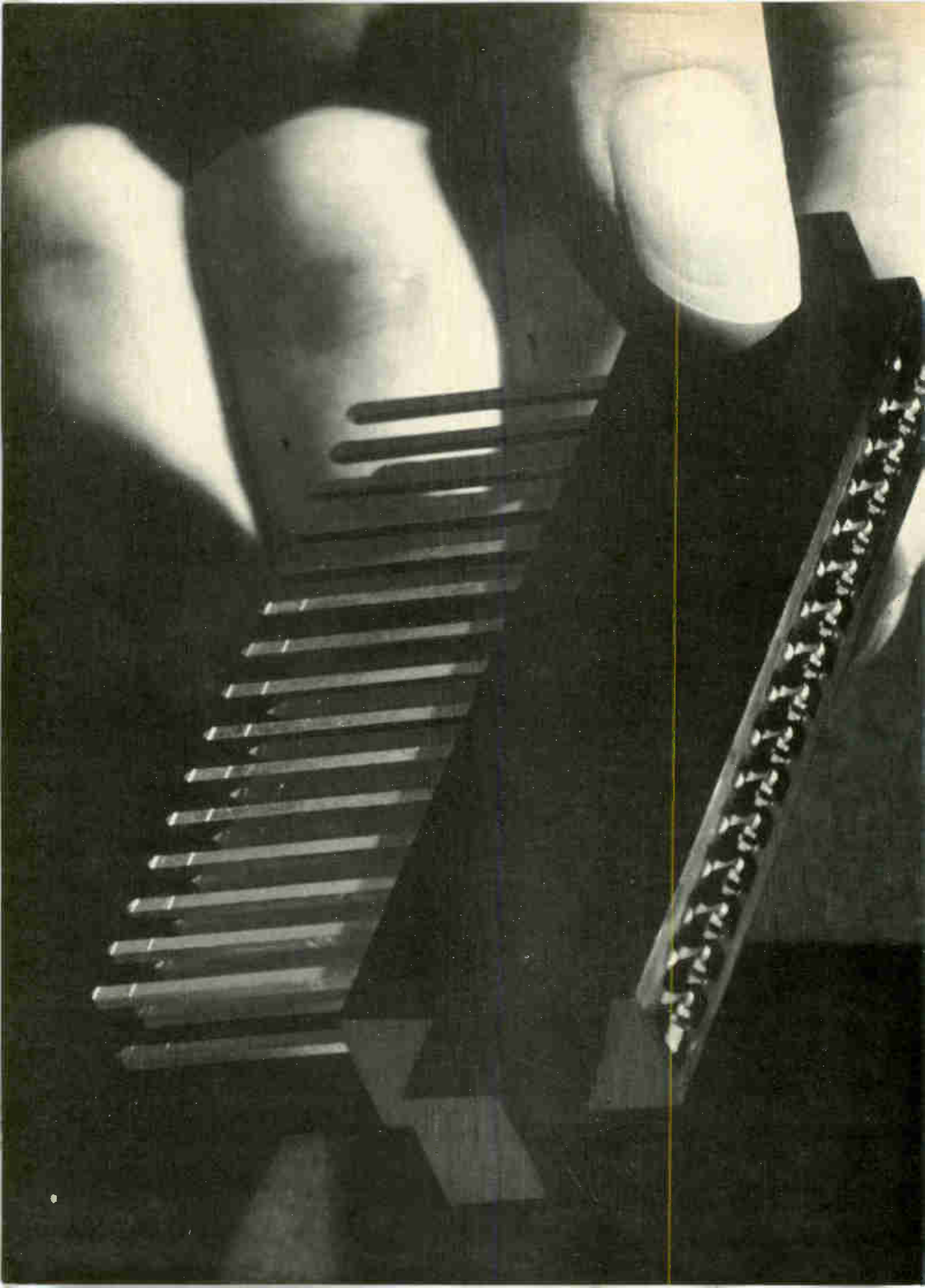

Off-the-shelf PMT from Amphenol

PMT means Precious Metal Tip, a wrought gold dot welded to printed circuit connector contacts. PMT is 100 times thicker than ordinary contact plating. We have 22 different PMT connectors that will work for 20 years, and they're all standard production items. Pre-tensioned contacts spring back to position insertion after insertion —without damaging P.C. boards. You'll pack about twice as many contacts in the same space, too: 56 in a No. 28 connector, 36 in a No. 18. PMT could be your best printed circuit connector buy. Call your nearest Amphenol Sales Engineer or write to **Amphenol Connector Division**, 1830 S. 54th Avenue, Chicago, Illinois 60650

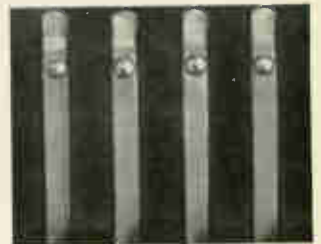

Cut-away Amphenol PMT connector shows welded gold dots on contacts



AMPHENOL

Circle 57 on reader service card

What did the president of National Semiconductor say to Ken Moyle upon learning that he had come up with a dual-50 shift register with the lowest operating voltage and the highest speed in the entire world?

“That’s nice. Where’s the dual-100?”

Everybody thought it would be impossible to take our dual-25 and double the capacity, yet extend the size by only one quarter, and still keep the specs intact. Everybody that is except Ken Moyle.

We’ve dubbed it the MM402.

It needs only 10 volt VDD and 16 volt clock pulse amplitude. This is 11 volts better than anything but our MM400, the dual-25 we introduced last month. It works at 1MHz at temperatures up to 125°C. And power dissipation is 1.0 mw/bit which is ideal for both ground instruments and airborne computers.

Each one goes for \$40 in 100 lots. You can pick up a lot at any of our distributors.

They’re stacking them on shelves right now.

Write or call National Semiconductor Corporation,
2950 San Ysidro Way, Santa Clara, California
95051. (408) 245-4320.



Ken Moyle, *Manager-Can't
Leave Well Enough Alone Dept.*

National Semiconductor

NEW RELAY

+ 100,000 OPERATIONS



AT 5 AMPS

The completely **NEW** Hi-G BN series meets all applicable requirements of Mil-R-5757, weighs .95 oz. in a .875" x .800" x .400" crystal can. All standard configurations and header styles are available for fast delivery.

Write or call Hi-G for new bulletins which provide full details on this high quality line of 5 amp. crystal-can relays. Test data and performance capabilities are available on request. Tel: 203-623-2481

**Hi
G**

INCORPORATED

SPRING STREET & ROUTE 75 / WINDSOR LOCKS, CONNECTICUT 06096

Now - An Applications Guide To Solid-State Power Control!

Want to know how to design low-cost solid-state power control circuits . . . how to improve high torque motor control by applying feedback signal . . . how to design a unique battery charger . . . or even how to understand the fundamentals of solid-state power control?

You'll find comprehensive answers to these — and many more questions about low-medium current SCR/trigger circuits — in this new applications-oriented brochure prepared especially for engineers who have a vital, day-to-day interest in solid-state power control and how to apply it most effectively to their new designs.

Full of useful, practical, "how-to-do-it" data like:

- Thyristor Trigger Circuits for Power Control Applications
- Solid-State High Torque Motor Speed Control
- SCR Power Control Fundamentals
- Suppressing RFI in Thyristor Circuits
- Designing SCR Circuits for High Inrush Loads . . . and much, much more!

You'll also get a new Selector Guide on Motorola preferred thyristor products . . . over 270 solid-state devices in 23 different cases and 14 voltage choices . . . that lead the industry in state-of-the-art performance, packaging and cost control. It will give you an overall look at the *broadest* up-to-35-ampere SCR/Triac/Trigger line in the industry!

**Scores of Ideas in This Power
Control Problem-Solver Will
Accelerate Your New-Design
Thinking... Send For Your
Head Start Now!**

For your copy, write on your company letterhead to:
Box 955, Phoenix, Arizona 85001



MOTOROLA
Semiconductors

-where the priceless ingredient is care!

These are some of the relatively unexciting components that make Trygon's new Liberator power supplies possible.

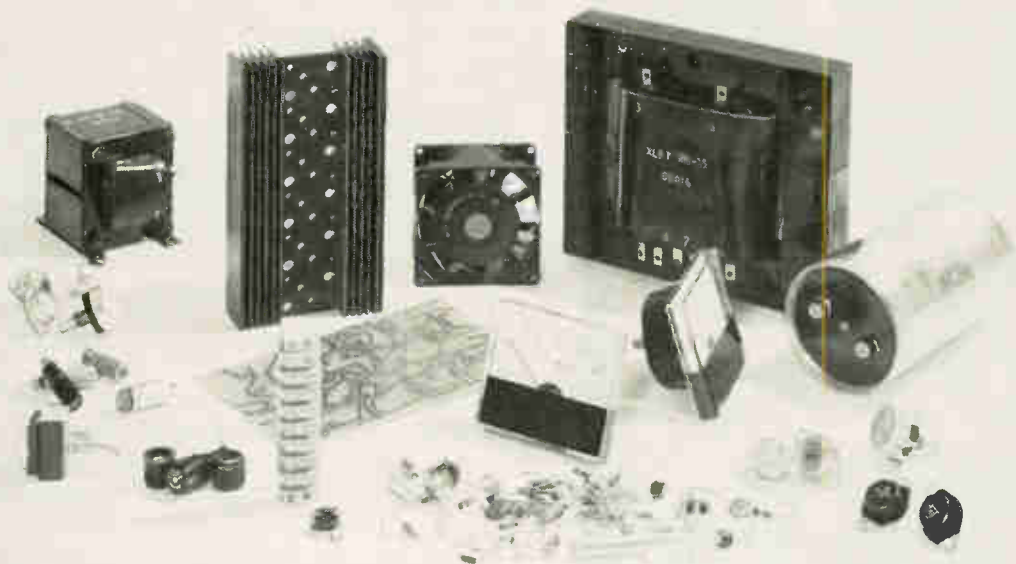

Here's the extraordinary, almost impossible system job it can do for you.

Trygon's Liberator Series is engineered to provide the ultimate in high power system performance, in a minimum size, at lowest possible cost.

Output current levels of 40 amperes (3½"), 70 amperes (5¼"). .005% regulation/.5mv ripple/3mv peak to peak noise/.01% stability/extremely low output impedance/MIL Spec. performance compliance/integral slide mounting/automatic load share paralleling/overvoltage protection/wide adjustable voltage range.

3½" units: 2.5-4.5V/40A; 4.8-6.8V/40A; 6.5-9.5V/25A; 8.5-11.5V/25A; 11-14V/25A; 13.5-19.5V/20A; 18.5-26.5V/15A; 24-32V/15A. Priced from \$420 to \$445. 0-8V/25A with overvoltage protection—\$525.

5¼" units: 2.5-4.5V/70A; 4.8-6.8V/70A; 6.5-9.5V/50A; 8.5-11.5V/50A; 11-14V/50A; 13.5-19.5V/40A; 18.5-26.5V/30A; 24-32V/30A. Priced from \$535 to \$550. 0-8V/50A with overvoltage protection; 0-15V/30A; 0-36V/15A; 0-60V/10A. Priced from \$550 to \$650.

LIBERATOR: the most precise system power supply available—at the highest possible power output—in the smallest possible package—at the lowest possible price. **MAKE US PROVE IT!**



TRYGON POWER SUPPLIES
PLEASANT AVE., ROOSEVELT, L.I., N.Y.

SEND ME PROOF OF LIBERATOR PERFORMANCE

NAME _____

COMPANY _____

ADDRESS _____

CITY _____ STATE _____ ZIP _____

TRYGON
ELECTRONICS, INC.,
Roosevelt, N.Y. 11575



now you can test
24 parameters of a
10-pin microcircuit
in 2 minutes flat...

with this new semi-automatic IC analyzer

**MICA
150**

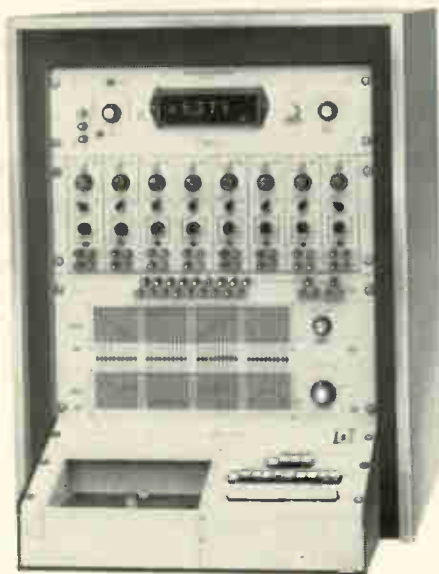

Now even a non-technical operator can speed through comprehensive DC tests on all types of IC packages with from 2 to 40 pins. Test conditions are easily set up on the programming switches of MICA-150 and pushbutton sequencing of the test from pin-to-pin of a device is simple and fast with test results indicated by direct digital readout. On a typical 10-pin, 5-input gate circuit, as many as 24 parameters of the device can be checked within two minutes without changing a single crossbar switch.

For additional information on applications of MICA-150 for DC or high frequency testing, contact W. Leo McBlain, (609) 424-2400

COMPUTER TEST CORPORATION
CHERRY HILL, NEW JERSEY



Circle 63 on reader service card

There's no faster delivery of Heinemann circuit breakers than across-the-counter...



...and we've got 43 counters:

AUTHORIZED HEINEMANN STOCKING DISTRIBUTORS

Alabama
Electro-Tech, Inc.
Huntsville
(205) 539-1250

Arizona
Kierulff Electronics, Inc.
Phoenix
(602) 273-7331

California
Wesco Electronics
Palo Alto
(415) 968-3475
Wesco Electronics
Pasadena
(213) 795-9161

Colorado
Kierulff Electronics, Inc.
Denver
(303) 825-7033

Connecticut
MarLe Company
Stamford
(203) 348-2645

Florida
McDonald Distributors
of Florida Inc.
Fort Lauderdale
(305) 563-1255

**Industrial Electronics
Associates, Inc.**
West Palm Beach
(305) 848-8686

Parts Service Corp.
Winter Park
(305) 647-5343

Georgia
Electro-Tech, Inc.
Hapeville
(404) 758-7205

Kansas
Hall-Mark Electronics
Kansas City
(913) 236-4343

Kentucky
E & H Electric Supply Co.
Louisville
(502) 587-0991

Marine Electric Co., Inc.
Louisville
(502) 587-6511

Louisiana
Poulan's Electrical Co.
Monroe
(318) 323-7701

Hall-Mark Electronics
New Orleans
(504) 242-7581

Maine
Stanley J. Leen Co., Inc.
Portland
(207) 774-6266

Maryland
Lee Electric Co.
Baltimore
(301) 752-4080

Pytronic Industries Inc.
Baltimore
(301) 727-5100

Massachusetts
Apparatus Service Co.
Allston
(617) 787-1300

Electrical Supply Corp.
Cambridge
(617) 491-3300

T. F. Cushing, Inc.
Springfield
(413) 788-7341

Mississippi
Ellington Electronic
Supply, Inc.
Jackson
(601) 355-0561

New Jersey
Valley Electronics, Inc.
Cherry Hill
(609) 662-9337

Federated Purchaser, Inc.
Springfield
(201) 376-8900

New Mexico
Kierulff Electronics, Inc.
Albuquerque
(505) 268-3901

New York
Federal Electronics Inc.
Vestal
(607) 748-8211

North Carolina
Electro-Tech, Inc.
Charlotte
(704) 333-0326

Ohio
Midwest Equipment Co.
Cincinnati
(513) 821-1687

Radio & Electronic Parts
Cleveland
(216) 881-6060

Oklahoma
Hall-Mark Electronics
Tulsa
(918) 835-8458

Oregon
Platt Electric Supply
Portland
(503) 222-9633

Pennsylvania
West Chester Electric
Supply Co.
West Chester
(215) 696-7500

Rhode Island
William Dandreta & Co.
Providence
(401) 861-2800

Texas
G. E. Jones Electric Co.
Amarillo
(806) 372-5505

Warren Electric Co.
Beaumont
(713) 833-9405

Hall-Mark Electronics
Dallas
(214) 231-6111

Nelson Electric Supply
Dallas
(214) 741-6341

Hall-Mark Electronics
Houston
(713) 781-0011

Warren Electric Co.
Houston
(713) 225-0971

Messner Electric Supply
Longview
(214) 753-4484

The Perry Shankle Co.
San Antonio
(512) 223-1801

Washington
Kierulff Electronics, Inc.
Seattle
(206) 725-1550

HEINEMANN ELECTRIC COMPANY



Trenton, New Jersey 08602

an invitation from 5,200 Manufacturers:

"look into VSMF"



5,200 manufacturers invite your judgment of their products in Visual Search Microfilm Files.

VSMF . . . 1,500,000 catalog pages, 5,200 manufacturers, millions of components and materials, indexed by product for side-by-side comparison. The VSMF Defense Design File, alone, contains over 250,000 pages from defense manufacturers. And, there's a file for OEM, too. In all, Information Handling Services produces 6 different VSMF files for industry and government.

We know that when you design a product you want to use the best components and materials. And, to do this, you need to compare all that is available. VSMF can help you in this comparison because VSMF supplies the data on all products. You supply the judgment.

Manufacturers who place their data in VSMF know this and invite comparison. The constantly changing "state of the art" is reflected in the pages of VSMF.

If you have VSMF in your company, look into it. If you don't, you might look into that, too. Write for "Looking into VSMF."



William H. B. Combs, Manager, Engineering Services, Relay Division, Leach Corporation, Los Angeles, uses the VSMF Defense Design File.



Information

HANDLING SERVICES, INC.
Dept. E-904

Denver Technological Center
Englewood, Colo. 80110

Circle 65 on reader service card

TEST YOUR E.Q.*

*EVALUATION QUOTIENT

in pots and trimmers

Check One of the Three Manufacturers For Each Question and Compare Your Answers with the Correct Answers Below

SPECTROL

Mfr. A

Mfr. B

1. Which manufacturer recently achieved an outstanding breakthrough in trimmer design — introducing the first cermet trimmer with a seamless construction that virtually eliminates leakage problems?

2. Which manufacturer built its reputation as a precision potentiometer and trimmer "spec house" and still welcomes your orders for those tough, hard-to-design specials?

3. Which manufacturer offers the best non-linear function capability to meet those "hairy" pot designs and still provides you with more than 200,000,000 options in its standard line of potentiometers and trimmers?

4. Which manufacturer offers the broadest line of quality precision potentiometers capable of meeting the stringent requirements of MIL-R-12934?

5. Which manufacturer has the newest, most up-to-date facility for the design and manufacture of potentiometers and trimmers?

Give yourself 20 points for each correct answer. A score of 80 or better means a very high E.Q. 60 is average. And below 60 means that you need more information to wisely specify or purchase precision or trimming potentiometers. (In case there's any doubt, the correct answer to all questions is "Spectrol.")

Whether your E.Q. is high or low, if you specify or purchase precision or trimming potentiometers, why not send for Spectrol's Short Form Catalog. We will also include complete information on the industry's first seamless trimmer — our remarkable new cermet — the Model 53.



Better Components
for Better Systems

Spectrol

SPECTROL ELECTRONICS CORPORATION 17070 East Gale Avenue City of Industry, California 91745

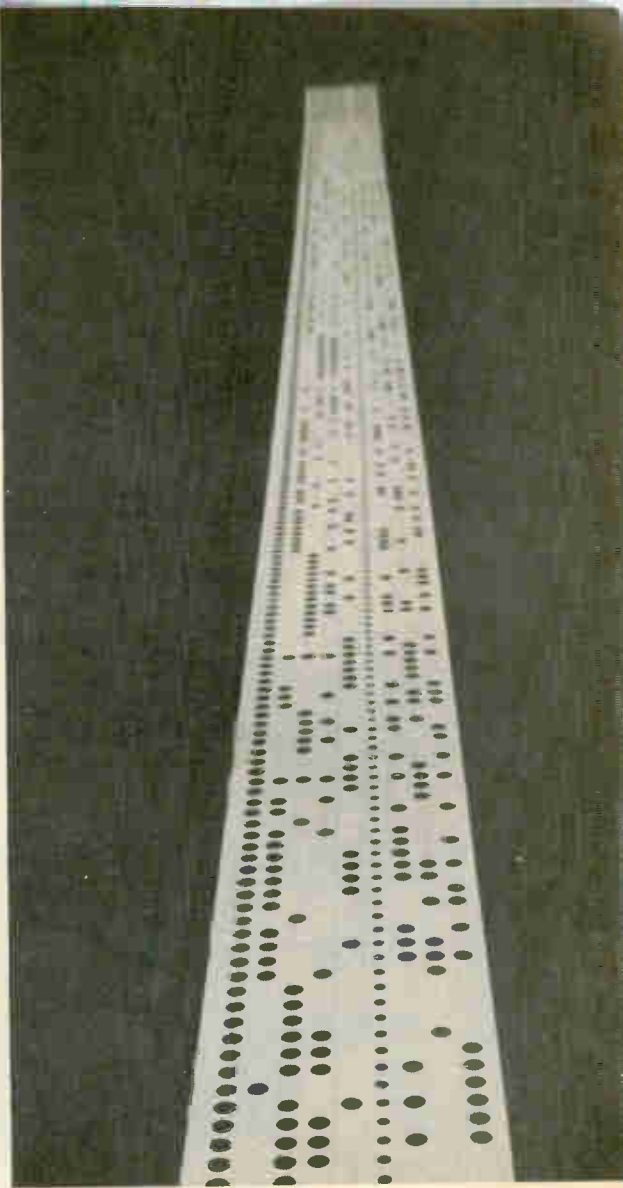
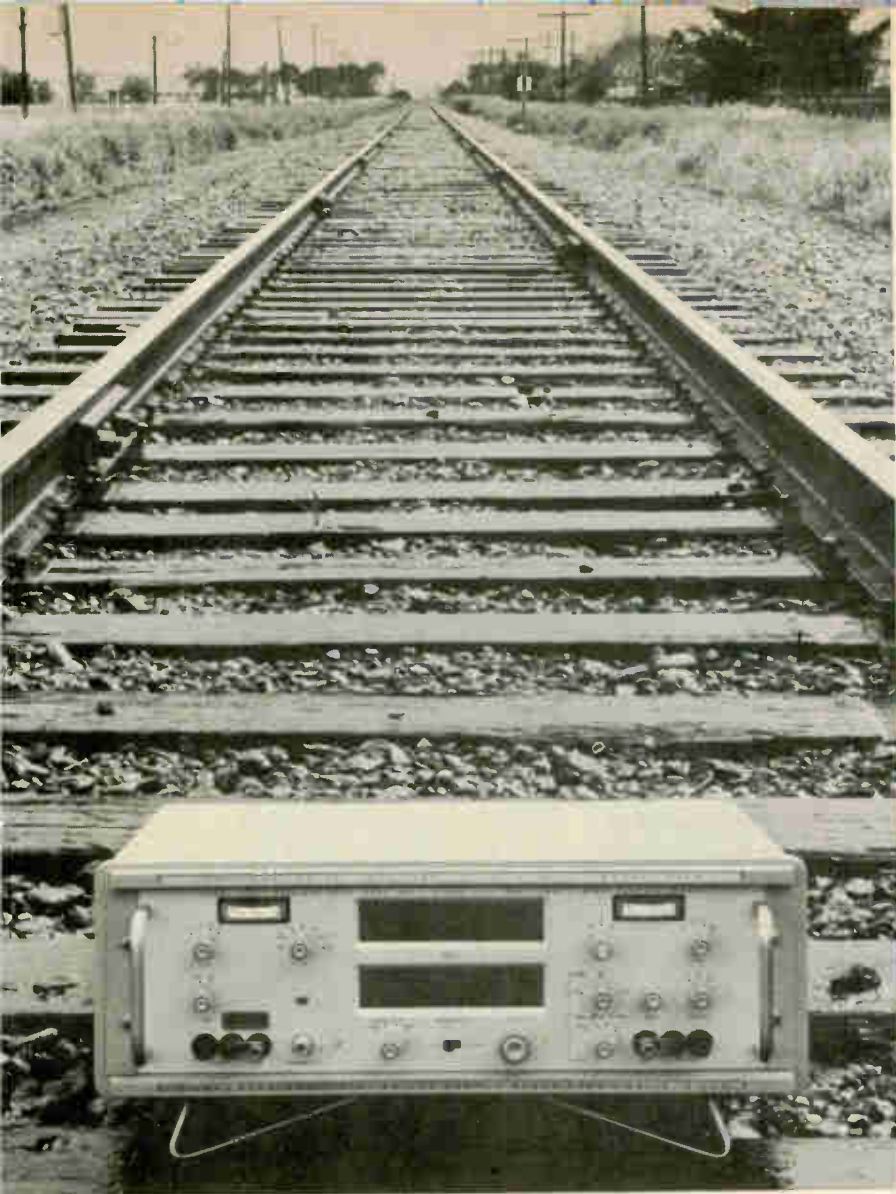

Tracks down envelope delay ...

Undetected envelope (or group) delay can easily derail a digital data transmission. Bit-by-bit that pristine formation crumples. Down the line, someone ends up with a mess instead of a message. To keep the data train properly coupled, you need precise information about phase-shift-versus-frequency characteristics of your carrier. The kind of information you can get express from a Sierra Model 340B Envelope Delay Test Set.

Model 340B pinpoints relative delay to $\pm 20,000 \mu\text{sec}$ on a big, direct single-range digital counter. Resolves it to $1.0 \mu\text{sec}$. On a second digital counter, it displays frequency with 10-Hz resolution. Range of 300 Hz to 110 kHz spans voice channel through group frequencies. Measurement modes include end-to-end, loop-back, or end-to-end with return reference path.

Modulation frequency of 25 Hz, usable over full range, resolves fine-grain deviations separated by as little as 50 Hz. Alternative 250-Hz modulation resolves delay to $0.1 \mu\text{sec}$. Price, with one modulation frequency, \$4,750.

Ask for more data, and watch us pour on the coal. Write Sierra, 3885 Bohannon Drive, Menlo Park, California 94025.

clears the track for digital data wave trains



PHILCO-FORD CORPORATION
Sierra Electronic Operation
Menlo Park, California • 94025

Circle 67 on reader service card

A NEW CONCEPT OF POWER

V_{CEO} (SUS)
30 TO 250 VOLTS



150 WATTS
 AT 45°C

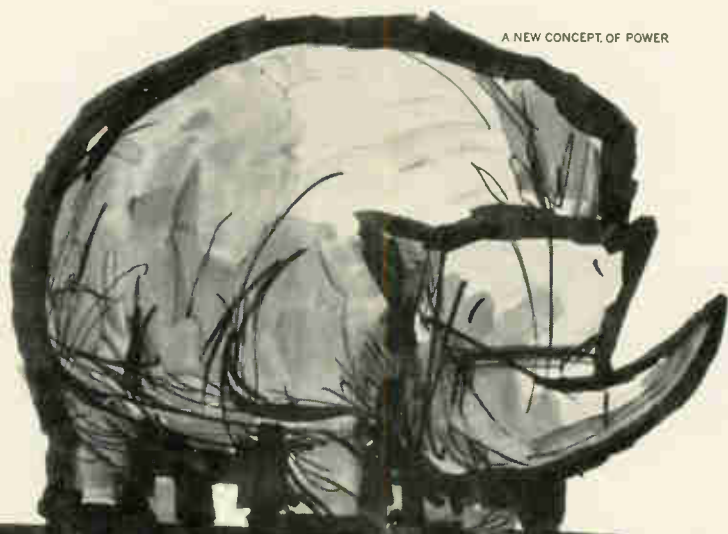

POWER

These high power diffused silicon transistors in the TO-82 package are also available as JAN devices for your military requirements.

ELECTRICAL CHARACTERISTICS
 (T_c=25°C, unless otherwise noted)

CHARACTERISTIC	TEST CONDITIONS	2N1015 SERIES		2N1016 SERIES		UNITS
		MIN.	MAX.	MIN.	MAX.	
Breakdown Voltage, Collector to Emitter, BV _{CEO} (SUS)	*I _c =100mA, I _B =0	30		30		Volts
		A-60		A-60		Volts
		B-100		B-100		Volts
		C-150		C-150		Volts
		D-200		D-200		Volts
E-250		E-250		Volts		
Collector Cutoff Current, I _{cEX}	V _{CE} =rated voltage V _{BE} =1.5V, T _c =150°C		20		20	mA
Emitter Cutoff Current I _{EBO}	V _{EB} =25V, I _c =0, T _c =150°C		20		20	mA
D.C. Forward Current Gain, h _{FE}	*I _c =2 Amps, V _{CE} =4V *I _c =5 Amps, V _{CE} =4V	10		10		
Saturation Resistance, r _{CE} (sat)	*I _c =2 Amps, I _B =300mA.	0.3	0.75			Ohms
	*I _c =5 Amps, I _B =750mA	Typical		0.2	0.5	Ohms
Base to Emitter Voltage, V _{BE}	*I _c =2 Amps V _{CE} =4V	1.5	2.5			Volts
	*I _c =5 Amps, V _{CE} =4V	Typical		1.7	3.5	Volts
				Typical		

*Pulse Cond. 300 μ sec., 2% duty cycle.

Available from stock.

For further information contact your local representative, distributor or

SILICON TRANSISTOR CORPORATION

EAST GATE BLVD., GARDEN CITY, N.Y. 11532 (516) Pioneer 2-4100, TWX 510-222-8258



Technical Articles

**Computer-aided design,
part 11:
Shortcuts to IC's
and p-c boards
page 70**

The physical design of electronic circuits need not be the haphazard process it once was. Both integrated and printed circuits benefit from the computer's aid in their layout and interconnection. Three important computer programs ease the designer's task.

**Taking the puzzle
out of p-c design
page 72**

Electronics



A computer program that views a printed circuit as a three-dimensional map (cover) speeds its efficient design. The program, developed under Atomic Energy Commission auspices, takes component descriptions and hand-drawn circuit schematics as its inputs and delivers complete specifications for wiring paths and component positioning.

**Drawing board
for IC's
page 83**

One problem in automatic IC design was that the designer had to give complete instructions to the computer, then sit back and wait for the results. They were sometimes far off base, forcing him to start from scratch. Now the designer and computer work as a team with continuous dialogue. As the design progresses, the designer views step-by-step results on a crt, making changes at will with a light pen.

**Generating IC
masks automatically
page 88**

Ideally, the engineer would like to describe a circuit to a computer and have it provide an output from which the art work for IC masks can be made. A program by IBM is doing just this on an experimental basis.

**Paramatrix puts
digital computer in
analog picture
page 99**

Graphs and photographs can be scanned electronically by a new machine, the Paramatrix, which can manipulate the image (enlarge it, shrink it, rotate it, or slide it) and digitize it for further manipulation or display. The Paramatrix can do this quickly and inexpensively because it links the input and output by digitally controlled analog circuits.

**Coming
September 18**

- IC's in a dimension checker
- Thermal management techniques
- A new braid memory

Computer-aided design: part 11

Short cuts to IC's and p-c boards

Three computer programs ease the designer's load by speeding and simplifying the building process

By Joseph Mittleman

Senior associate editor

Because high performance systems are increasing in complexity at an alarming rate, designers are under pressure to create faster and more compact circuits. But to make such designs economically, engineers have been forced to turn to computers to manipulate the many possible configurations needed to produce a usable circuit. Only computers can do the extraordinary computation required in the building of integrated circuits that can handle nanosecond switching speeds, and optimize component placing and wiring patterns—the kinds of problems that crop up in designing complex data-processing and analog systems.

In handling nanosecond speeds, lead lengths must be minimized to reduce pulse delay, eliminate crosstalk caused by these fast rise times, and reduce capacitance that could prevent circuits from operating properly.

Reducing pulse delay can be accomplished with new IC's having more components on a single chip. Thus, lead lengths are reduced. But cramming components on a chip tends to reduce yield and boost production costs. In addition, the chip may include high speed transistor elements that require finer resolution geometries in the IC mask design, thus complicating diffusion. To overcome this, better processing techniques are needed.

In large systems, each printed-circuit board contains many chips. Optimizing component placing and wiring patterns can be particularly troublesome. If each chip has a minimum of 40 leads, getting the leads to the p-c assembly's output is difficult. Thus, it becomes necessary to reduce the output wires. This is achieved by better placement of components, possibly interconnected IC's, and better wiring schemes.

These problems are best solved by a computer.

A major part of the IC and p-c board fabrication problem is the time gap between defining the circuit or layout and building it. The most difficult and time-consuming efforts in making integrated circuits are the design and manufacture of the masks from which the IC's are built. In printed-circuit boards, the difficulty lies in arranging and rearranging the layout and connections until a final set of drawings are prepared.

Programs help

The more complex the system, the greater the time and effort involved. It can reach the point where manual design becomes unwieldy and sometimes impossible to perform. The result: manufacturing costs skyrocket. Before the computer's aid could be enlisted to solve the problems, programs had to be devised to describe the conditions to the machine. Three such programs are now available. One automatically lays out a p-c board for a particular circuit based on its description and a listing of component shapes and sizes; another automatically designs an IC with optimum component placement given the circuit's components and how they are connected; the third automatically designs the fabrication masks from which the IC's are built once informed of component placement.

The three programs are:

- Accel (automatic circuit card etching layout), developed by the Sandia Corp., Albuquerque, N.M. [see p. 72].
- Cadic (computer-aided design of integrated circuits), developed at the United Aircraft Corp.'s Norden division, Norwalk, Conn. [see p. 83].
- Lager (layout generating routine), developed at the International Business Machines Corp.'s

Thomas J. Watson Research Center, Yorktown Heights, N.Y. [see p. 88].

An engineer who lays out p-c boards usually starts his design by selecting the components needed for the circuit and physically placing them on a board. He must be sure all conducting paths will fit between the components, which pairs of points should be connected, and, indeed, if two points can be connected at all. This last problem is solved by Lee's algorithm, but, unfortunately, this guide does not account for component spacing.

With Accel, the design task is simplified greatly. All the designer need do is tell the computer what components are in the circuit and how they are connected; the machine does the rest.

The technique simulates a topographic layout that represents component connector-pin locations by peaks, and the areas between the pins by combinations of slopes, plains, and valleys. In essence, the computer considers the circuit board as a large sheet of rubber. Terminals and nodes are fixed peaks, and the leads of the interconnected components are assumed to be elastic.

By stretching or depressing a point on the simulated rubber sheet, the designer is able to create a distorted terrain of hills and valleys, through which conductor paths are formed much as a mountain stream follows a natural raise. The advantage of the technique is that it can be altered mathematically to accommodate any set of laws—real or imaginary. For example, where real hills are up from a reference and valleys are down, with this technique a hill can be transformed into a valley simply by pushing it down on the sheet instead of pulling it up. In this way, new paths are created between peaks that may produce better board layouts.

Play as you go

When designing an integrated circuit, the engineer must be fully aware of component tolerance, shape, and size limitations. He must understand manufacturing processes, including thin-film, metal-oxide and isolation techniques. And, he must be able to prepare careful and detailed drawings that indicate an ic's structure.

Furthermore, if he uses a computer in a batch-processing mode, he is confronted with delays. For example, he specifies his input data on punch cards, waits until the cards are prepared, and waits again for a machine available for a run. He cannot visualize the result until the output data is plotted. Therefore, any errors—in the form of unused space, for example—are not immediately apparent. Plotting requires an additional set of data cards and is often further delayed by waiting for an available machine. If any changes are desired, a new card must be made and the run started from scratch.

A technique that enables the engineer to specify input, that enables the machine to provide an initial circuit, and allows the engineer to make visual changes easily and instantaneously as he goes along is preferred. All this is provided by a new system

that applies the Cadic program.

Cadic enables a designer to completely lay out an integrated circuit in minutes. To apply the program the designer uses a symbolic language, a cathode-ray tube, and a light pen. A circuit description, in the form of punched cards based on a schematic, is fed into the computer as input.

The machine determines, for every component, size and shape of the mask pattern, and supplies an initial layout with all components presented in true size and shape. The components are arranged in the same relative positions as on the schematic from which the input is taken. During the run of the program, instructions appear on the crt that indicate what the designer must do. For example, the screen may say select move part. The designer then points to the part with a light pen to move it as instructed. The program reduces both cost and time in producing a complete ic layout and relieves the designer from routine calculation and drafting.

Automatic artwork

Before an integrated circuit can be manufactured, masks must be prepared. The masks are an exact replica of the ic and are used to make the semiconductor device. Designing masks is a costly and time-consuming process. The engineer must design a mask for all manufacturing processes that may be required for a component. For example, if a transistor is made by diffusion process, and a capacitor on the chip is made by a metal-oxide technique, different masks must be prepared. In addition, not all parts of the chip will have equal spacing between the conductor paths. Any changes in the design usually requires a new mask, which is costly.

Lager comprises a three-part technique that automatically generates the artwork for such masks. A language to permit the designer to describe the patterns and structures required in the individual masks, a computer procedure for translating the language into commands, and the automatic equipment that acts upon the commands to generate the final masks.

The language is a convenient shorthand and symbolic way of describing the patterns a designer wishes to generate with a minimum likelihood of error. It defines individual structures and groups of structures on the mask and assigns a symbolic name to each group. This system is analogous to that found in programming where the variables are defined with mnemonic names. The programmer manipulates these names and leaves it to the computer to relate them to the actual items of data.

Any structure or groups of structures are defined with the language by means of substructures. For example, if the designer defines a structure that will generate the base of a transistor, this is then used as part of a set of structures that define the transistor. The transistor structures can then be used to define a still larger structure, a logic decision gate, for example.

Taking the puzzle out of p-c design

Simulated by a computer program, a contour map of the circuit helps complete a layout of a printed-circuit board in minutes

By Clifford J. Fisk, David L. Caskey and Leslie E. West

Sandia Corp., Albuquerque, N.M.

Laying out a printed-circuit board to perform a specific function can be likened to fitting together a jigsaw puzzle. In both, the challenge is basically the same—selecting the parts that mesh by trial and error. But unlike the jigsaw puzzle, which has only one solution, a p-c board can have several. And the designer of a p-c board, of course, has the advantage over the puzzle solver in that he's the one who determines the type, size, shape, and number of components that make up his particular puzzle.

To help the designer fit his pieces together, a computer approach has been successfully developed that combines a scheme for component placement with one for conductor-path routing to automatically produce a p-c board layout. The component phase, called force placement, is based on a set of simulated interacting forces. Conductor-path routing is achieved with a minimum path-length algorithm and a newly developed topographic-simulation technique. Called Accel, for automated circuit card etching layout, the method was developed at the Sandia Corp., Albuquerque, N.M., and the Thomas-Bede Foundation, Los Altos, Calif., under the auspices of the Atomic Energy Commission.

Makeup of the puzzle

Basically, a printed-circuit board is a thin, insulating board on which an assembly of electronic and electromechanical components are mounted. On the board's surface are several isolated copper conductive paths, each path attached to a component lead (the point of connection serves as the equipotential of the component). The junction of two or more paths is called a node. At one end of the board is either a connector or a set of printed contacts for electrical connection to the outside.

The paths are isolated to prevent shorting the circuitry. On two-sided p-c boards, where two surfaces are available, conductive paths may follow

the same route on opposite sides. Isolation in this case is achieved by the board's thickness.

The effectiveness of using the computer to take the puzzle out of design can best be measured in time. Where the conventional trial-and-error route takes as long as weeks, computer-aided design drastically shortens this to minutes. Fabricating the assembly starts with the circuit specifications that the designer generates and culminates in the physical construction of the board. This process includes:

- Converting the engineer's design into acceptable computer input data.
- Editing this data for validity.
- Retaining information on all components considered standard for the system.
- Handling nonstandard data that is entered at the time the board is constructed.
- Determining the location of the components on the layout after the data is accepted as valid.
- Positioning all the components and making the necessary electrical connections with routing paths that connect all common electrical nodal points.
- Generating, with the aid of the computer, a schematic of the input circuit, a parts-ordering list, an assembly drawing, a hole drilling list, and a mask required to etch the circuit board. Computer programs for all of the output information are independent subroutines written in Fortran 2 for the IBM 7090 series so that various plotters can be used for output. At Sandia, the current routines were written for the Stromberg Carlson Corp.'s SC4020 cathode-ray tube plotter. With this system, Sandia engineers can design up to 47 circuit boards per computer run.

The maximum size board that this system can handle is 90 square inches, with the standard 0.025-inch grid. Other size grids can be specified. Although conductors can be placed on one or both sides the board—or laminated if required—com-

ponents can be placed on only one surface. The system can accommodate up to 500 components and 300 nodes per board, and each component may have a maximum of four lead connections.

Input to the computer

The beauty of this approach is its simplicity. The designer checkerboards the schematic so that each element, crossover, corner, and connecting line is contained in separate squares. Each element in the circuit is assigned x-y coordinates. The x-y coordinates for resistor R_1 , in the example of a checkerboard circuit at the right, would be B1, and its part number is 855794. Although they would be acceptable, neither a predefined grid nor a machine-drawn schematic is required.

To eliminate the puzzle of which element or component to choose, every element in the circuit has a symbol assigned to it from a predefined glossary stored in the computer's memory. The symbols take into account the components parameters, physical orientation in the circuit, and stock part number. Thus the designer merely feeds the symbol number and x-y coordinates into the computer, which then analyzes the characteristics and location to determine a node component list.

Upwards of 100 symbols are included in the glossary, and additional entries can be included by allocating the required storage.

An assembly can be designed with components that aren't included in the parts table: the computer will do it for him. All the designer need do is feed into the machine data describing what is required and the board will be produced from it.

Layout of components

One of the system's features is the method that determines the locations of the components on the board. Because of the way in which the forces act on the components, the method is called force placement. Although based on an adaptive set of equations, this method doesn't guarantee optimum placement of components. The best introduction to force placement is an analogy based on the circuit on page 74.

Imagine that each of the components has elastic leads that are stretched into tension until they contract to some arbitrarily shorter length. The components are placed in an open box whose bottom surface is the size and shape of the printed-circuit board, and whose sides prevent the components from spilling over the edge. Points P_1 , P_2 , P_3 , and P_4 are stationary contacts that connect to the elastic leads of C_1 , R_2 , R_1 , and R_3 , respectively. Each component is confined so that it remains in contact with the bottom surface of the box. If the components are pinned arbitrarily to the bottom of the box, some or all of the elastic leads are strained in tension and each component is acted on by a set of forces. If the components are suddenly released from their pinned positions, each would accelerate according to the instantaneous force exerted on it. The components shift into

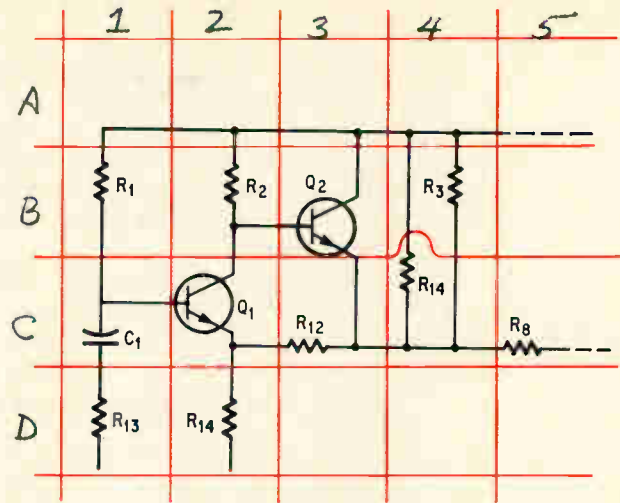

COMPONENT	DESCRIPTION	STOCK NUMBER
R_1	$\frac{1}{4}$ w, 5%	855794
R_2	$\frac{1}{4}$ w, 5%	855775
R_3	$\frac{1}{4}$ w, 5%	855784
\vdots		
C_1	3.5 μ f, 50v TANTALUM	
\vdots		
Q_1		873839

CONNECTOR BOARD IS STOCK NUMBER HHB5249/B5

Checkerboard. Key punch operator arbitrarily sections off the schematic so that each square contains one component. Component positions are then fed to the computer together with part numbers. Nodal points, representing pin locations, are fixed throughout a computer run.

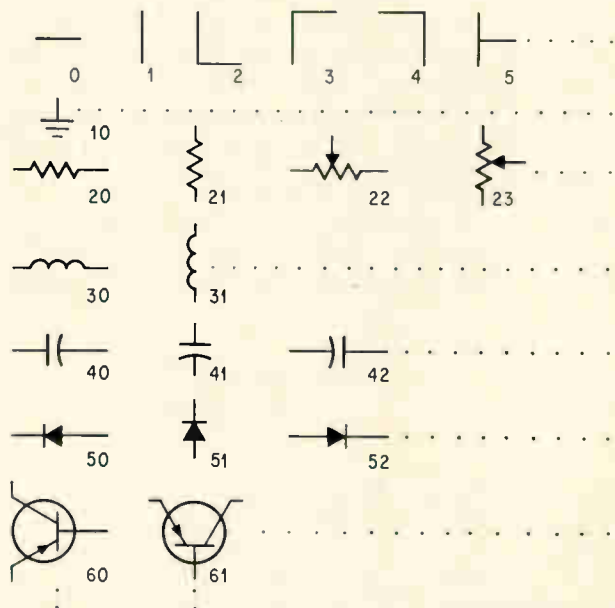

Symbol glossary. Components and wiring connections are assigned symbols from a table. A component may have several symbols to indicate different positions. By selecting the number corresponding to a particular element and its position, the designer can easily reconstruct the circuit as it appears in the schematic. Although there is a limit to the number of symbols, other elements can be described to the computer, which will then produce the layout. These additional descriptions can be stored in the computer's memory for future recall.

a cluster and stop moving only after the forces acting on each component are in opposing directions that cause a resultant of negligible magnitude. At this time, each elastic lead is either relaxed or stretched due to the static forces in the system. The motion of each of the bodies after release depends on the instantaneous force on the body, torque, and the first and second integral of linear and angular accelerations.

Fortunately, the computer is not limited to the physical laws of the real world. A new universe can be defined wherein bodies acted on by forces follow laws that the designer is free to dictate. For example, a component may experience a repulsive force due to another component before the two actually make contact. Components can even be allowed to pass through one another should this prove advantageous.

Basically, the defined universe is as follows: the domain is an area in the x - y plane bounded by a closed curve whose points coincide with the edge of the board. Two-dimensional components within the domain are free to move if they are acted on by vector quantities, called forces. Any component acted on by a resultant force is moved in the same direction with a magnitude proportional to the force. Thus, a component acted on by a net force must move, but a component with a zero force will not.

Components to be connected to a common conductive path are acted on by forces that cause them to move toward one another. The further apart these components are, the greater the attraction. To prevent the components from moving to positions in which their individual boundaries overlap, a force of repulsion is imposed. This causes closely located components to move further apart. The repulsive force between two components increases as they get closer. To keep components from being moved out of the domain completely, a force of repulsion is defined from the borders of the domain. Since actual connection points on a component can be located at other than the center point, a torque is generated by forces on these actual points.

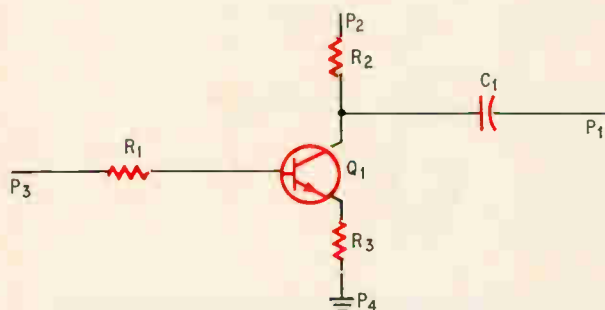

Force analogy. Contact points P_1 , P_2 , P_3 , and P_4 in this single-transistor circuit are fixed to components C_1 , R_1 , R_2 , and R_3 , shown in color, whose leads are assumed to be elastic. If the components are allowed to assume a position in which the net forces acting on each component are zero, the elements come to rest. The relative position of the components at this time becomes a possible board layout.

This torque then creates a force that rotates the component an amount proportional to the resultant torque. Thus, the four types of forces in this universe are attraction between components that connect to common conductive paths, repulsion between all components, repulsion between all components and the edges of the domain, and rotation from each connection point on a component to each common conductive point on others.

Force and moment on a particular component is the vector sum of the individual forces and moments contributed by each component and the borders. Force on a component, due to another component, is a function of both component size and the distance between components. The attractive forces and the repulsive forces reflect the shape of the components.

Forcing a move

At the start of the computation, the components are placed arbitrarily on the board. The forces acting on the first component are computed and summed vectorially. Then the component is moved in the direction of the force by an amount proportional to it, but not exceeding one-half the distance to any border. Next, the computation is performed for the second component, then the third, and so on. It is repeated until the last component has been moved. This completes one cycle. Successive iterative cycles are based on the positions of the preceding cycle.

For a converging set of force equations, the components move less on each successive cycle until a point is reached where the average movement is less than some predefined amount. A solution has been found to the set of force equations that determine when the components no longer move significantly—the resultant force on each is zero.

During N -iterative cycles, a component occupies N discrete positions in the domain. If the coordinates of the components are connected sequentially with straight lines, these components are considered as having followed this path in the x - y plane.

At the start of the placement process the attraction is undamped, while the repulsion is heavily damped. As the process progresses, the damping reverses—the repulsion increases and attraction decreases. This allows attracting components to quickly cluster, and the increased repulsion tends to eliminate overlap. When movement nears cutoff, each component is rotated to either a vertical or horizontal position on the board, depending on which orientation is the closer. Then the position of those components that overlap are readjusted to eliminate overlap. Next, the area that the components occupy is compared to the area of the board. If there is additional area available, the components are spread to give a more uniform placement.

The final set of coordinate points defines the component locations in the domain and on the face of the p - c board. Knowing the center points of the components and their lead coordinates with respect

Topographic simulation

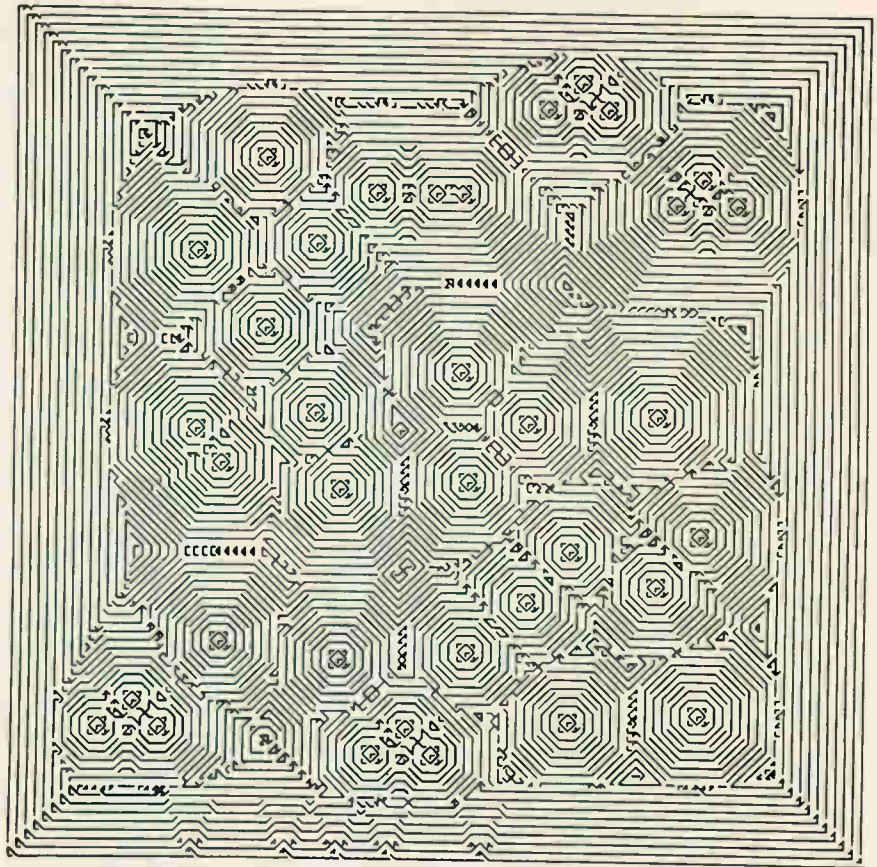

Contour map. Top view of initial layout of basin and peaks for a particular circuit at the start of the computer run. Peaks represent component conductor pins and the basins represent the possible conductor paths.

Pathfinder. To create a path from one peak to another, one is held fixed while the other is pulled down to form a target cone. With the cone formed, the computer scans the terrain for the nearest lowest altitude from the highest peak and a step is taken in that direction. At left, a circle in color is centered over peak about to be pulled down to form a target cone. At right, the peak is depressed and the surrounding area is scanned for a connecting path between the target and the peak pinpointed by square in color. Both views are from the side.

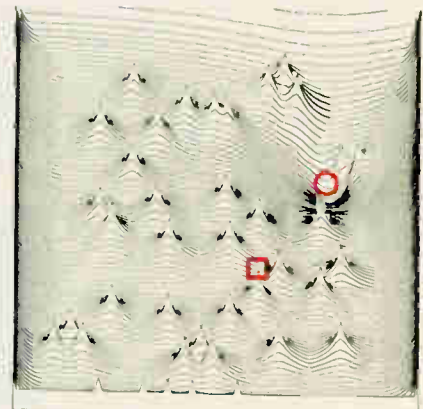
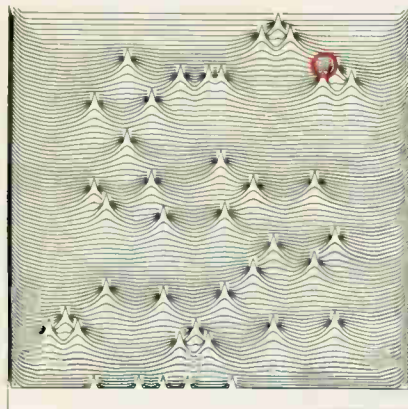

Sidestepping. Path shown in color indicates the connection between the two peaks. Sidestepping is caused by obstacles along the way. At right, target peak is again pulled down at a later stage of the process and the terrain examined for other connecting paths. Heavy black vertical lines and horizontal plateaus indicate several paths already completed.

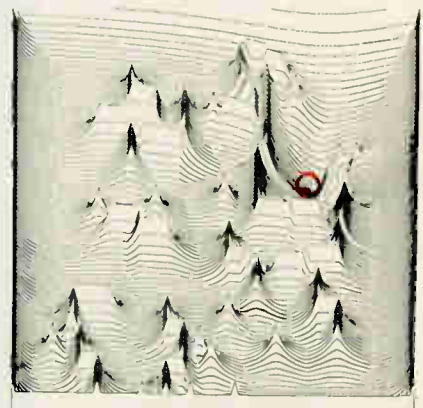
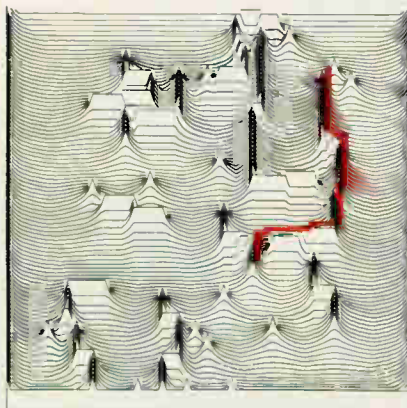

to their centers, the positions of the leads are computed. This completes the information needed for the conductor-routing program.

Conductor-path routing

Conductor routing requires that the circuit provide all needed conductors, and that the paths of different nodes will not cross. Also, the distribution of paths should fully utilize the available space. This is especially important from a reliability standpoint, because crowded paths are easily shorted by metallic specks or by slight etching imperfections.

To date, no technique has been found that satisfies all requirements on every board. The result is a compromise whereby jumper wires replace printed paths that tend to cross. If too many jumper wires are required, another compromise is to subdivide the circuit onto several blocks. Although these compromises are electrically adequate, they are undesirable from a manufacturing standpoint.

A technique that minimizes the effects of these compromises is incorporated in the Accel system as a combination of a topographic-simulation method and a modified version of Lee's algorithm.¹

In the earlier Accel attempts, an effort was made to improve the routing technique referred to as Lee's algorithm. This led to the introduction of still another compromise that attempts to make a connection with an L-shaped path, a path that can be made by only two perpendicular parts, and when this technique fails, resorting to an algorithm slightly modified from Lee's approach.

When the conducting path isn't completed by an L path, a number is affixed to each of the two connection points. One point is assigned the number 1, and the other, a large number like 100.

Starting from the point having the 1, the next

step is to move outward to all adjacent orthogonal matrix spaces. After establishing that these spaces are empty, they are filled with the number 2. Advancing from all spaces containing a 2, the outward movement continues to adjacent spaces. If these are empty, they are filled with the number 3, and so on. At the same time, the procedure is reversed from point 100 in steps 99, 98, 97 . . .

By scanning the entire board, the computer inserts 2's and 99's in the first scan, 3 and 98 in the second scan, and so on. The effect is to move numbers outward in count areas. When the two count areas intersect, a path is completed.

After the path is defined, it is filled with node numbers and the other spaces are cleared. The computer then proceeds to the next set of points to be connected. The routing matrix may contain coded elements that act as isolation to conductor paths. This allows for hole drilling areas, component heat sinks, irregular board perimeters, and all other objects that require conducting paths to bypass their locations.

Topographic approach

The method of topographic simulation was first developed and programed as an experiment separate from the Accel system. It is based on a scheme that represents the location of component-conductor pins by peaks and the areas between the peaks by combinations of slopes, plains, and valleys. By analyzing the terrain, the computer determines the trails that indicate conductor paths. It had been used to represent interrelated, steady-state forces,² such as the path of an electron in a vacuum tube. Applied to a computer, it becomes a scheme having self-modifying characteristics that produce a three-dimensional dynamic topography. In p-c board de-

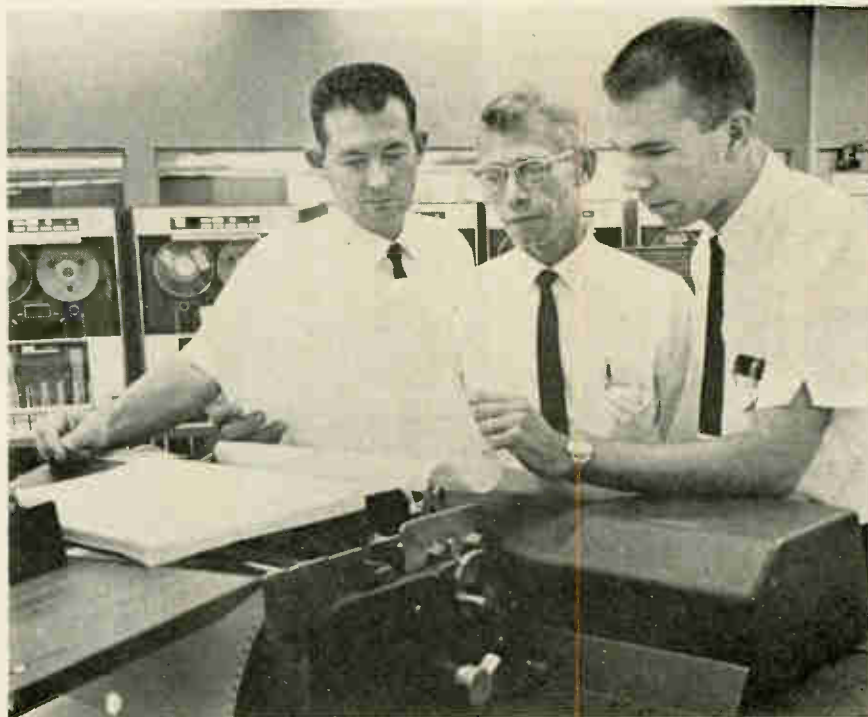

Checking results. Author West holds program printout while co-authors Fisk (left) and Caskey study the results.

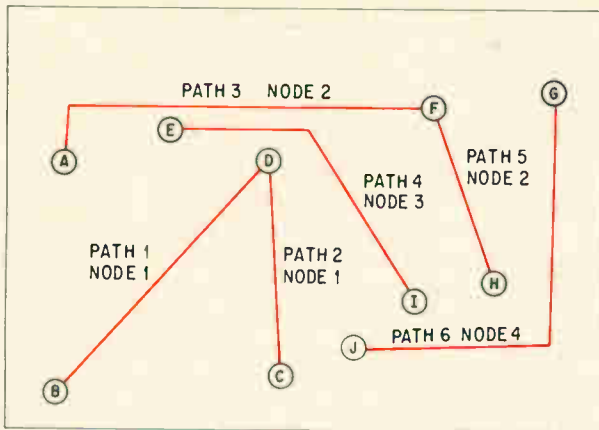

PATH NUMBER	PEAK TO PEAK		NODE NUMBER
1	B	D	1
2	D	C	1
3	A	F	2
4	E	I	3
5	F	H	2
6	G	J	4

Interconnection pattern. To indicate the possible path configuration, a drawing is prepared manually from the input data. Pin locations have been previously determined. Data representing these paths, nodes, and peaks are tabulated.

sign, this dynamic property is especially vital in representing the constantly changing conditions caused by the growth of circuit paths. Another feature of the simulation process is that any given point can be assumed as negative or downhill compared with other points at any given time.

In the computer, the topographic area is represented by a 100 by 100-element array (the grid size is limited only by the available core storage in the computer). The location of each element represents a corresponding location on the circuit board. Each element is a computer word and contains a number representing its altitude.

At first, only three features are on the contour map: shape or outline of the body, holes or other obstacles to conductor paths, and component and connector pin locations. Conductor paths, plated-through holes, and trouble spots that are established by the process are added to the topographic structure as they occur.

The process begins with all elements set at zero altitude. The data, representing locations of electrical contacts (component pins) and locations of physical obstacles, (such as holes in the board), are fed into the system. A peak is created in the grid at each location. By arbitrarily assigning a high altitude, say 1,000, surrounding elements are assigned lower altitudes, and the next ring of elements still a lower altitude. Then, to represent the edges of the circuit board, a ridge is created around the periphery of the grid. This ridge slopes inward from each of the four edges, forming a basin. The

actual form of the peaks and the basin is variable, governed by control data substituted in:

$$A = \frac{K}{C \times D + 1} \quad (1)$$

Although there are several ways in which the structure may be numerically developed, the one used most extensively is given by equation 1 where A is the altitude of any given element, C is a constant that controls the slope of the basin and peaks, D is the distance between the element and the nearest edge of the grid or between the element and the center location of the nearest peak, and K is the constant that determines the altitude.

Three variations of this form may be used. The first calculates the altitude that is caused by the basin and by each peak; whatever condition gives the greatest altitude is used as the value of that element. Another variation applies the cumulative effect of all peaks and the basin.

The third variation is the replacement of the constant, K, with a function. For example, if a peak represents a high-voltage contact on the board, K could represent voltage and thus cause low-voltage paths to avoid that area. Or, similarly, if a location in the circuit is particularly sensitive to the capacitance effects of conductive paths, the K (for peaks in that vicinity) could represent that sensitivity and thereby provide better dispersion of conductors.

After the basin and peaks have been formed, the process of establishing circuit paths begins. However, changes occur during the process.

Two conditions cause the topography to be modified. First, as the locations of circuit paths are

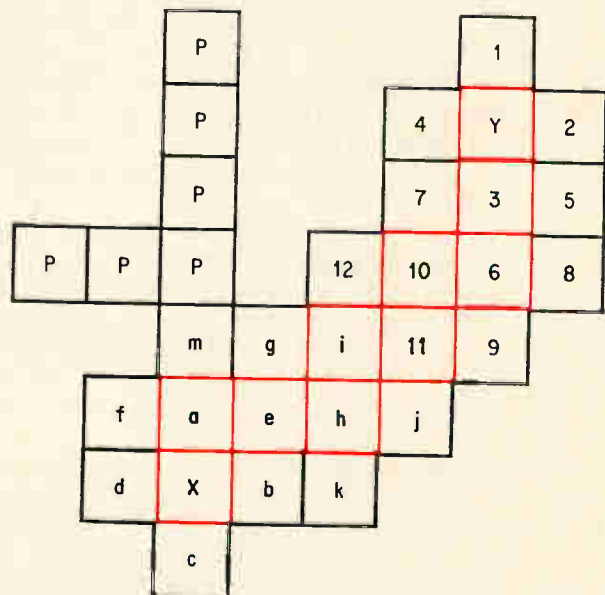

Step selection. With the X and Y squares representing the peaks between which a path is to be completed, the computer scans the area between them. Steps are chosen in the most downward direction from both X and Y. The squares surrounding the two peaks represent various lower altitudes. Steps can only be taken vertically or horizontally. They can neither be on or adjacent to steps of a different path nor retrace a previous step. The completed path is shown in color.

established, ridges are built along the paths. This, in effect, forms valleys between completed paths. The purpose is to help the computer route incomplete paths around or between completed ones. Second, when a path hits a trouble spot in the terrain, it is detoured in a zigzag. Such trouble spots may be caused by low areas surrounded by peaks, very narrow valleys caused by ridges of several completed paths, or V- or U-shaped bends in the completed path.

Up to this point, the topography is comparable to natural topography. The one remaining topographic characteristic has no natural counterpart.

To view this feature, imagine that the topography described thus far is built on a rubber sheet that is stretched on a frame. When a step is taken (a step representing an increment of a circuit path) from some location toward a target point, the latter is depressed, forming a cone with the ridges, peaks, and valleys on its inner surface. After the path is completed, the target location is released and the system is prepared to find the next path. Since an iterative step-sequencing system is used, all paths can be developed either simultaneously or individually.

Path-step selection

The system contains two basic features that work together to establish the location of circuit paths. One is the algorithm for step sequencing and evaluation; the other comprises the applications and variations of this algorithm in the several phases of the system.

A path step, as defined here, is an element in the 100×100 grid and represents a portion of a conductor path. If a path is to be developed between two peaks, it will be composed of at least as many steps as there are grid elements between them. Since paths are frequently routed, for example, around other peaks, the steps required to complete any path depends upon the obstacles between the two.

Input data is fed into the computer for preliminary analysis to determine between which pairs of peaks paths must be developed. When several peaks are interconnected, they are said to be on the same node. Specification data is then tabulated. In the sketch on page 77, the coordinate locations of the peaks, rather than the letter designations are used.

Since the process for developing steps is iterative, one step is taken from B toward D, then one from D toward B, then one from D to C, then C to D, A to F, F to A, and so forth down to G to J, and J to G. The next step cycle begins with the second step from B toward D, then D to B, and so forth. This process continues until the paths are completed, the uncompleted path ends are trapped, or a predetermined cycle limit is reached.

With this step-selection procedure, the computer examines the terrain's slope in the immediate vicinity of the element from which a step is to be taken, and chooses the direction that is most downhill.

However, a step must not be on or adjacent to steps of a different node and cannot intersect itself. As a result, the most direct route may be unacceptable. Therefore, it is necessary to provide alternate choices of step direction. Because a step must be one of the four orthogonal elements of the existing location, it cannot move diagonally.

Suppose it is necessary to develop a path between X and Y in the diagram on page 77, where P, P, P . . . are steps of a different path. The computer seeks the first step from X by examining the altitudes of elements a, b, c, and d. If the step to element a is the most downhill, there is no reason that this element cannot be occupied. Thus location a is the first step from X. Similarly, from Y, the altitude of elements 1, 2, 3, and 4 are examined, and element 3 is chosen as the first step from Y. Then for the second step from X (now at a) elements m, e, and f are examined. Since the element at X was a previously occupied step, it cannot be included. If the greatest downward slope is toward m, the elements around it are examined. Because m is adjacent to the path P, this choice is rejected. Then if the second best slope is toward e and it is unrestricted, e is chosen as the second step from X. If e had been restricted, the third choice, f, would have been considered.

After the second step from X has been taken, the next step from Y is examined and taken. This process continues until the two ends meet, which in this case occurs at element 11. The entire sequence of steps is as follows: X to a; Y to 3; a to e; 3 to 6; e to h; 6 to 10; h to i; and 10 to 11.

In this example, neither path end is trapped. But if one end of a path progresses to a point where it cannot step in any direction, it is considered to be trapped and not allowed to move any farther. However, the other end is still active and seeks to connect with the trapped end. In the event both ends are trapped, nothing more is done with this conductor until a subsequent phase.

This stepping is controlled by a data array that keeps track of the most recent step location of each path end, as well as the point of origin (peak) of each. For definition, the most recent step of a path end is called the target of the other end; the peak toward which a path is moving is called the target peak; and the path end that is in the process of taking a step is referred to as the active end.

During the step-evaluation process, three characteristics of altitude are measured for each of the orthogonal elements at the active end: the instantaneous altitude, the portion of this that is due to the target peak, and the effect on altitude caused by the target being pulled down to form a cone. The first two are computed values produced from the following equations:

$$\text{Altitude due to target peak} = \frac{1,000}{C \times D + 1} \quad (2)$$

$$\text{Cone altitude change} = K \times (100 - D') \quad (3)$$

where

Path-interconnection pattern

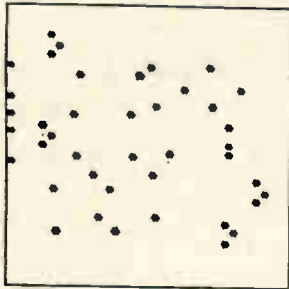

Frame 1

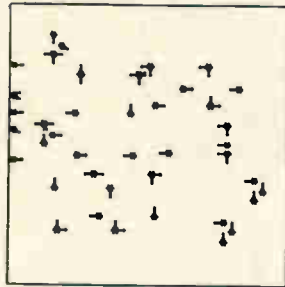

Frame 2

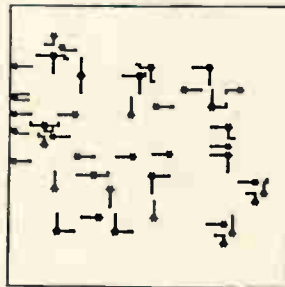

Frame 3

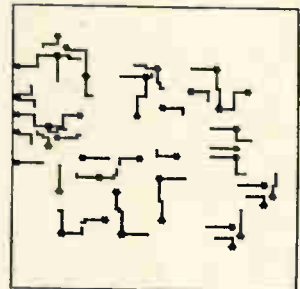

Frame 4

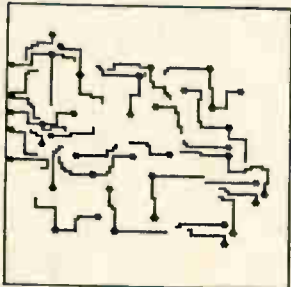

Frame 5

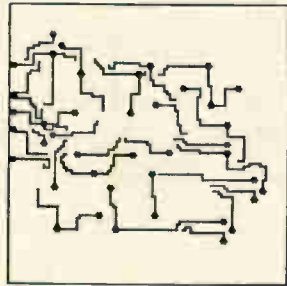

Frame 6

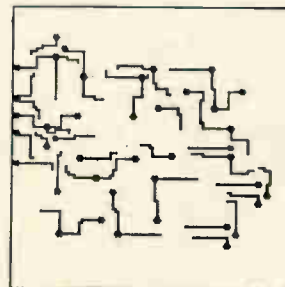

Frame 7

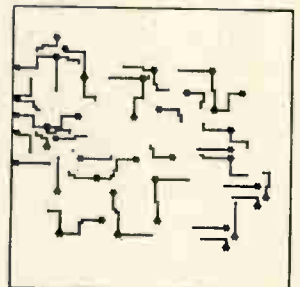

Frame 8

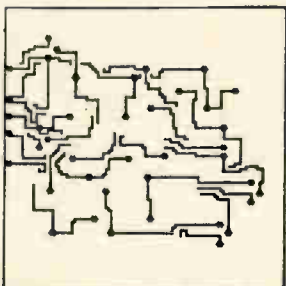

Frame 9

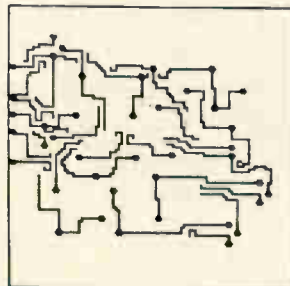

Frame 10

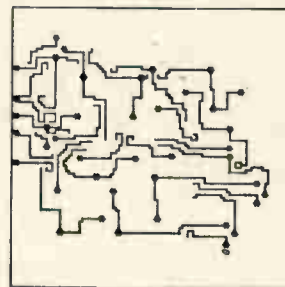

Frame 11

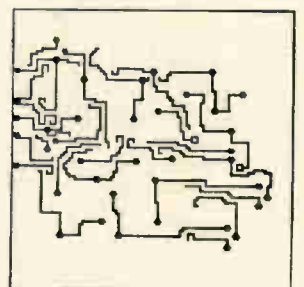

Frame 12

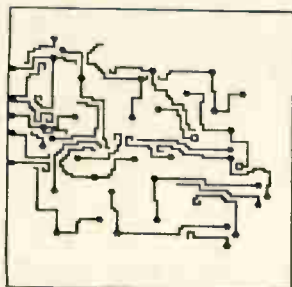

Frame 13

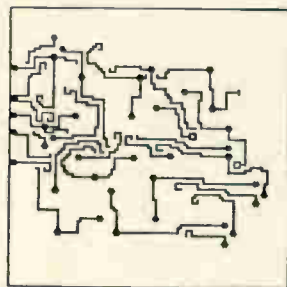

Frame 14

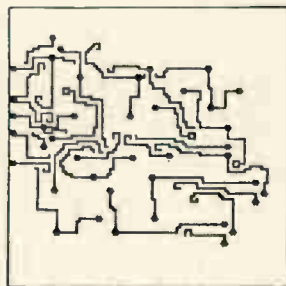

Frame 15

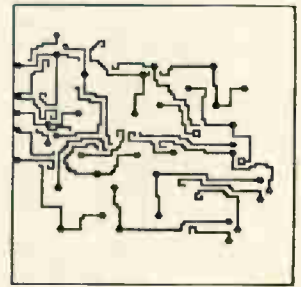

Frame 16

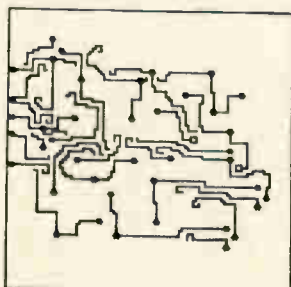

Frame 17

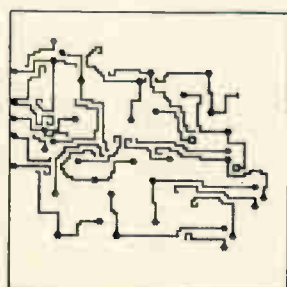

Frame 18

Stepping sequence. Pin locations, determined from the input data, are established in frame 1. As indicated in subsequent frames, paths between paired pins are allowed to step toward each other. While some paths are completed easily, others are not because paths cannot cross each other. At the end of the first computer run, the connected paths are stored in the memory and a second attempt is tried to complete the remaining unconnected paths. If this fails, a third attempt is made to connect incomplete paths on the back of the board. For those connections that are still incomplete, jumper wires are used.

An f-m stereo multiplex adapter without transformers

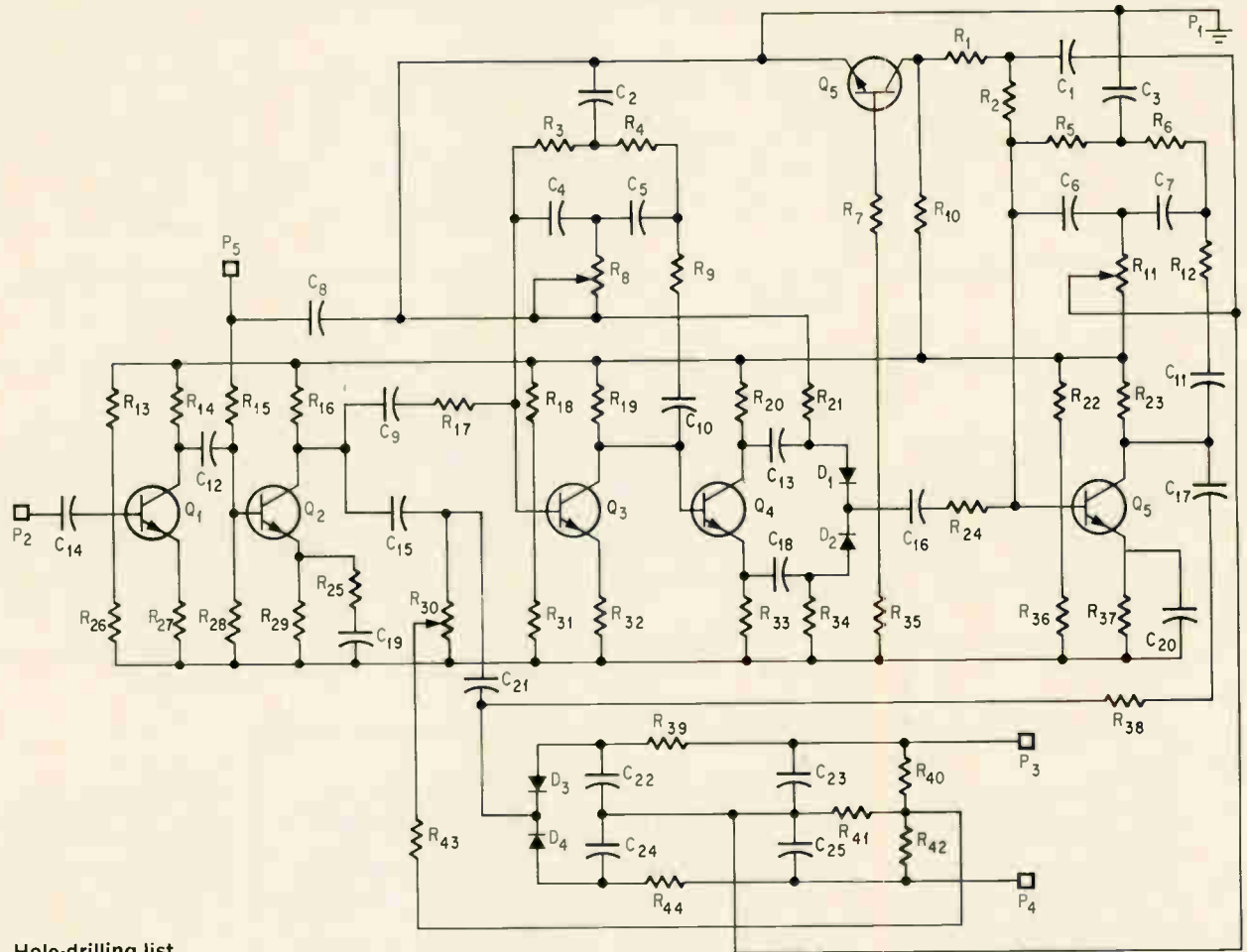

Hole-drilling list

SCHEMATIC NO CASKY4				HOLE DRILLING LIST				DATE 05/03/67				PAGE 1			
X	Y	DIAM	X	Y	DIAM	X	Y	DIAM	X	Y	DIAM	X	Y	DIAM	
1.000	9.680	0.065	2.000	9.680	0.065	3.000	9.680	0.065	4.000	9.680	0.065	5.000	9.680	0.065	
0.000	9.680	0.065	7.000	9.680	0.065	8.000	9.680	0.065	9.000	9.680	0.065	3.272	9.439	0.038	
3.272	0.338	0.038	2.051	9.076	0.038	2.051	8.502	0.038	5.611	3.368	0.038	5.611	2.794	0.038	
1.653	0.233	0.038	1.653	7.719	0.038	3.327	7.948	0.038	3.487	7.948	0.038	3.407	7.868	0.038	
3.372	1.447	0.038	4.798	1.447	0.038	3.683	6.924	0.038	3.683	6.024	0.038	2.252	6.335	0.038	
2.252	5.961	0.038	2.737	2.041	0.038	2.737	1.467	0.038	1.952	7.414	0.038	1.952	6.840	0.038	
1.016	5.549	0.038	1.016	5.389	0.038	1.096	5.469	0.038	4.956	3.025	0.038	4.956	2.451	0.038	
4.476	7.478	0.038	4.476	6.378	0.038	3.917	3.514	0.038	3.917	2.940	0.038	2.380	0.939	0.038	
3.480	0.939	0.038	2.240	3.565	0.038	2.240	3.331	0.038	3.113	2.567	0.038	4.239	2.567	0.038	
7.086	2.795	0.038	7.086	3.369	0.038	6.744	4.609	0.038	3.170	4.609	0.038	6.320	0.250	0.038	
6.320	0.950	0.052	6.320	1.242	0.052	7.833	1.762	0.038	7.833	1.996	0.038	4.759	3.742	0.038	
3.333	3.742	0.038	2.200	2.213	0.038	2.200	1.869	0.038	1.423	6.411	0.038	1.423	5.837	0.038	
1.141	3.017	0.038	1.715	3.017	0.038	9.086	4.757	0.038	9.086	5.433	0.038	8.456	5.005	0.038	
0.456	5.681	0.038	9.001	3.988	0.038	9.001	3.644	0.038	4.320	0.250	0.052	4.320	0.950	0.052	
4.320	1.242	0.052	2.943	6.714	0.038	2.943	6.140	0.038	1.544	4.247	0.038	1.704	4.247	0.038	
1.624	4.167	0.038	1.954	2.694	0.038	2.528	2.694	0.038	7.647	4.996	0.038	7.647	4.652	0.038	
6.786	5.853	0.038	6.786	6.197	0.038	6.915	2.120	0.038	6.915	1.546	0.038	3.901	1.333	0.038	
3.901	1.677	0.038	8.225	8.692	0.038	8.225	9.266	0.038	6.561	8.810	0.038	5.987	8.810	0.038	
2.851	2.948	0.038	2.851	3.522	0.038	3.028	5.064	0.038	3.754	5.064	0.038	3.827	8.338	0.038	
4.401	8.338	0.038	3.937	7.708	0.038	3.937	7.868	0.038	3.857	7.788	0.038	6.185	5.030	0.038	
6.185	4.456	0.038	7.650	6.512	0.038	7.306	6.512	0.038	6.307	6.586	0.038	5.963	6.586	0.038	
7.322	8.433	0.038	7.760	8.433	0.038	1.555	5.239	0.038	1.555	4.801	0.038	6.680	4.555	0.038	
6.680	5.129	0.038	8.008	4.336	0.038	8.582	4.336	0.038	4.541	2.238	0.038	4.541	1.664	0.038	
6.407	4.205	0.038	7.083	4.205	0.038	4.562	5.585	0.038	4.562	4.959	0.038	6.856	7.294	0.038	
6.856	6.720	0.038	6.096	7.646	0.038	6.096	8.220	0.038	7.296	5.426	0.038	7.136	5.426	0.038	
7.216	5.506	0.038	6.914	3.842	0.038	6.340	3.842	0.038	5.312	2.489	0.038	5.312	1.915	0.038	
2.964	8.257	0.038	2.390	8.257	0.038	5.852	5.418	0.038	5.852	5.762	0.038	5.549	7.436	0.038	
3.549	6.862	0.038	4.214	4.482	0.038	4.214	3.908	0.038	5.464	6.116	0.038	4.890	6.116	0.038	
8.708	1.964	0.038	8.708	2.964	0.038	4.906	4.649	0.038	5.480	4.649	0.038	2.751	4.275	0.038	
2.751	3.931	0.038	2.596	5.701	0.038	3.170	5.701	0.038	5.784	4.277	0.038	5.784	3.703	0.038	
7.507	4.046	0.038	7.507	3.702	0.038	5.320	0.250	0.052	5.320	0.950	0.052	5.320	1.242	0.052	
2.561	7.536	0.038	2.561	6.962	0.038	3.510	3.962	0.038	3.510	3.802	0.038	3.590	3.892	0.038	
7.774	1.216	0.038	7.200	1.216	0.038	8.255	3.224	0.038	7.681	3.224	0.038	6.083	3.402	0.038	
6.083	2.828	0.038	4.617	2.979	0.038	4.617	3.323	0.038	5.994	1.945	0.038	5.994	1.601	0.038	
6.390	2.152	0.038	6.390	2.726	0.038	4.114	5.344	0.038	4.114	6.070	0.038	5.069	8.611	0.038	
5.507	8.611	0.038													

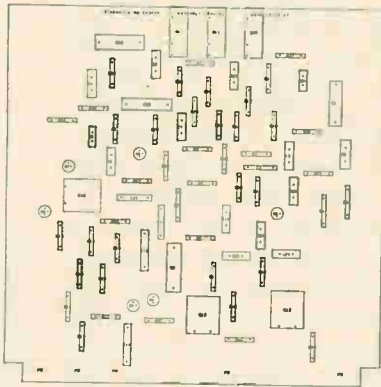

Component placement

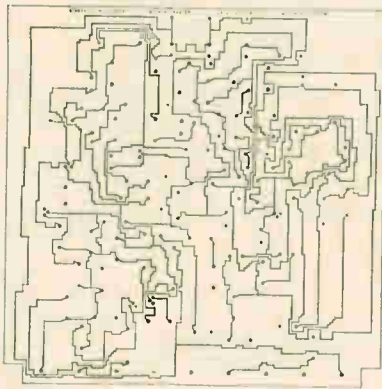

Front of board

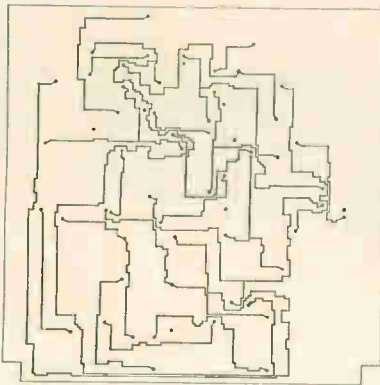

Back of board

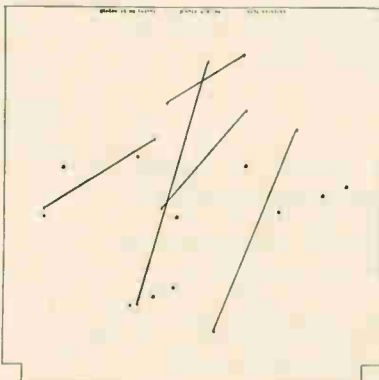

Jumper wires for unconnected paths

C = a constant that defines the peak's shape;
 D = the distance (grid elements) between the center of the peak and the element considered;
 K = a constant that defines the depth of the cone;

D' = the distance from the target to the element considered.

Then, for each of the orthogonal elements, an effective altitude is computed by subtracting the result of equation 2 from the instantaneous altitude, and the result of equation 3 from equation 2. The next step location is then the element that has the lowest effective altitude and does not violate any of the restrictions.

Multiphase operation

The over-all operation of the system is divided into four phases. Each phase, while employing the algorithm, follows a slightly different procedure for making connections. A control subroutine oversees the sequence of phases and is most subject to change. It is easily varied to try different procedures for making connections.

For the front of the board, phase 1 begins with a topography that includes only the border and the peaks at the land location. Here, steps are taken from both ends of a connection pair toward each other. A step from both ends constitutes one cycle of the stepping algorithm. The number of cycles in this phase, usually about 75, is specified by a data-control card. Although sloping ridges aren't present, there is an infinite barrier surrounding the progress of the paths. Consequently, no early warning of an impending obstruction is provided. Phase 1 terminates after the cycle limit is reached or when all the paths become trapped. Typically, about half the connections are made during this phase.

Phase 2 differs from phase 1 in one important aspect. The conductor paths completed in phase 1 are now provided with ridges, sloping downward and outward for 15 steps from each path end. Those connections not completed in the earlier phase are wiped out, and are attempted once again.

The final connections are now made on the front of the board. A special routine is used to determine whether the steps from the path ends are still progressing toward each other. If one end strays, its progress is halted and a land is placed at that point. Thus, when phase 2 terminates, after 100 cycles or less, a land is placed at the last position of each end of the incompleting path.

If a two-sided board is generated, the system attempts to complete the remaining paths between the new land locations on the second side. Completed path locations established for the front side are saved and the topography is set at zero before starting on the second side.

Back of board

To start on the back of the board, phase 1 is again employed to recalculate the topography, creating the peaks and border as before. However,

Lee's algorithm points the way

One of the major difficulties in laying out a printed-circuit board is determining whether a path exists between two points and if they can be connected. And, the larger the circuit, the more complex the problem. C.Y. Lee, of Bell Telephone Laboratories, Whippany, N.J., in a 1961 paper,¹ "An algorithm for path connections and its application," presented a technique that provides a solution.

Based on digital logic, the method enables a computer to solve efficiently the path-connection problem inherent in logic drawings and wiring diagrams. The algorithm is used to:

- Find a path between two points without using crossovers,
- Have the path avoid such obstacles as p-c board edges and circuit components,
- Determine the shortest path among several possible connections.

However, the algorithm has one drawback when used alone: it doesn't indicate the number of paths having a finite width that can be squeezed between two obstacles.

there are more lands or peaks than there were for the front of the board. The newly generated lands at the ends of incompleting paths, as well as the original lands, comprise the data for calculating peaks. These land positions must be avoided because the lands protrude through the circuit board.

After establishing the terrain for the back of the board, phase 1 is operated as before. Only those paths still not completed are attempted, and they step from new land locations.

Again, after phase 1 is completed, barriers are generated for newly completed paths, and incompleting paths are erased. Phase 2 is then tried, but only for 25 cycles. After phase 2, if there are still incompleting paths, phases 3 and 4 are tried.

Phase 3 and 4 differ from 1 and 2 in two ways: only one path is tried at a time, and steps are taken from only one end. Thus, these phases are executed once for each incompleting path. During phase 3, one end of the path stays at its land location while the other steps toward it. Up to 150 steps are taken to complete one path. If this doesn't succeed, phase 4 enters the picture.

This final phase is identical to the previous one except that the remaining incompleting paths are tried from the other end. Thus, if one end is trapped, the other end does the stepping. If there still are incompleting paths when phase 4 concludes, the program generates a tape for producing a picture of the board's paths before going on to the next circuit.

Topography and Lee's algorithm

The combination of topographic simulation and Lee's algorithm has been most successful. The main advantage of Lee's algorithm is that it finds a path if one exists. But, on the other hand, it

crowds paths so that some subsequent paths cannot be developed even when logically possible. The major advantage of the topographic method is that it disperses paths. Its disadvantage is that it doesn't know when paths are impossible to form.

In applying the two techniques, the process begins by first running Lee's algorithm to establish if there is a path available and its location. The topographic scheme is then employed to complete these paths, which takes a few minutes.

A topographic representation of the board is kept in one array, where land centers are represented by 0's and all paths found by -1's. The elements running outward from each side of a path are given decreasing altitudes; that is, the elements adjacent to the path have an altitude of -2, the next closest have an altitude of -3, and so forth to a maximum of -7. Then a topographic unblocking algorithm distorts the Lee path, pushing it toward the lower elevations. A final path is obtained when further movement is no longer possible. This path is added to the topographic array and the program is ready to begin the next path.

The sequence in which the connections are made is determined by the straight-line distance between each end of the path. The shortest connection is processed first.

References

1. C.Y. Lee, "An Algorithm for Path Connections and Its Application," Transactions I.R.E., PGEC-10, September 1961, p. 346.
2. V.K. Zworykin and G.A. Morton, "Television, the Electronics of Image Transmission in Color and Monochrome," 2nd ed., John Wiley and Sons, 1958, p. 108.

The authors



Clifford J. Fisk is a staff member in the advanced techniques section of the Sandia programming department and has been with the company since 1958. He was responsible for the routing and component placement portion of the Accel program.



David L. Caskey joined Sandia in 1964 after receiving his master's degree from MIT in electrical engineering. He is with the advanced techniques section of the programming department where he worked on the topographical-routing technique.



Leslie E. West who also worked on the topographical-routing technique has been with the advanced techniques section for the past seven years. Before that, he spent 11 years in the computer programming group. Prior to joining Sandia, he was employed by the Los Alamos Scientific Laboratory.

Drawing board for IC's

With the aid of a light pen, a computer and the Cadic program, an engineer can speedily design his IC layout on a crt display

By Arnold Spitalny and Martin Goldberg

Norden Division, United Aircraft Corp., Norwalk, Conn.

For the engineer who wants to design his own integrated circuit, a major drawback is that the designing process is often time consuming and costly. A computer can offset this by reducing both development time and cost substantially. The machine helps the engineer develop better ic designs faster, automatically checks them for conformance with all process tolerances, and generates a complete set of fabrication masks. Furthermore, since design changes can be made directly in the machine before an ic is actually built, the computer assures that a new circuit will work properly the first time.

Two factors make this design task more difficult than laying out a conventional printed-circuit board—the components vary more widely in size and shape, and more exact tolerances are required. The computer helps the designer determine size and shape of all elements, allows for isolation moats and clearance tolerances, arranges the elements into a rectangle of minimum total area that fits in a flat pack or header with satisfactory form factor, locates terminals, and routes interconnections without metalization crossover, if possible.

On-line computer program

Although computer programs can be designed to assist in developing ic's using conventional batch-processing computer techniques, they suffer serious limitations. For example, cards must first be punched that describe not only the input data but also the program operations. These cards are then scheduled and must wait their turn on the computer. Since the output from such a run is usually numerical, this data must be converted on additional cards or tape and fed into a plotter to obtain a visual display. If a change is desired, it cannot be performed until the computer run is completed; should there be an error in the change card, the run must be repeated from the beginning. Many changes and runs are usually needed before a satis-

factory design can be achieved.

A new graphical on-line system avoids these problems. Circuit-layout patterns are manipulated on a cathode-ray tube with a light pen and results in data that can be used to produce the mask artwork. Called Cadic, for computer-aided design of

continued on page 87



Light-pen operation. Martin Goldberg, author, points light pen at the left edge of a component while co-author Arnold Spitalny looks on.

Picturing an IC chip's layout

— a visual approach to design

Designing an integrated circuit is vastly simplified, thanks to the Cadic system. With a clear picture of his circuit on a cathode-ray tube, the designer merely uses a light pen to manipulate the component parts to obtain an efficient circuit layout. These illustrations, reproduced from a crt, show some of the capabilities of Cadic when applied to a simple demonstration circuit.

An initial display is automatically developed from the computer input and appears on the crt. This or any subsequent display can be recorded by the computer and recalled at any later time during the design. The first step shows the initial display being recorded. The designer selected the RECORD mode by pressing the record key on the function keyboard. On top of the screen appears the informa-

tion INITIAL DISPLAY, written in with the console typewriter to identify the data for reference.

The list of numbers at left of the screen indicates the storage areas in which a particular display can be recorded. After each operation, various messages appear in the conversational-message area of the crt. Here, for example, the placement mode is selected and the computer asks the designer to choose a command. A particular command is selected by pointing the light pen at it—in this case, the MOVE command. Once set in this command, many component moves can be done without repeatedly pointing to MOVE.

Immediately after this command is selected, the computer changes the message to SELECT MOVE PART OR GROUP. The part or group of parts to be moved is selected by pointing with the light pen, whereupon a new request for instruction is made to designate a constraint which indicates where the part or group should be moved.

Several variations of this command are available, depending on the part edges designated as move

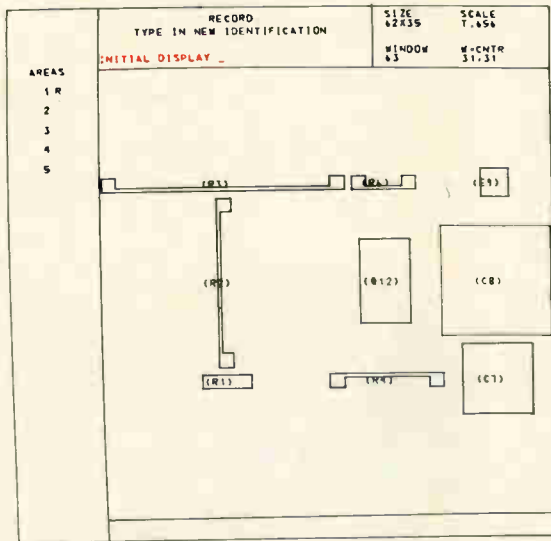

Step 1. Initial circuit layout.

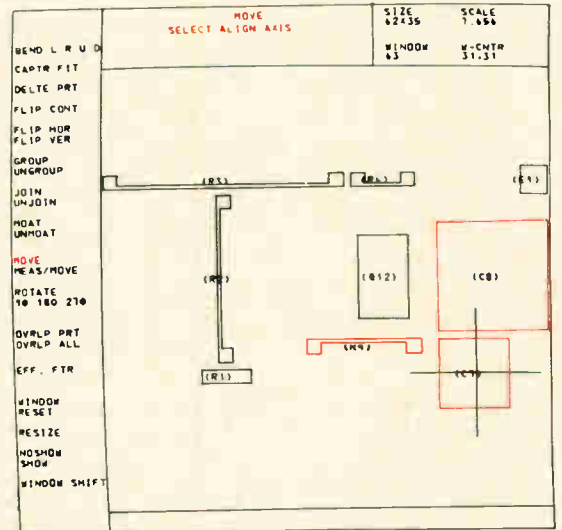

Step 2. Selecting alignment axis.

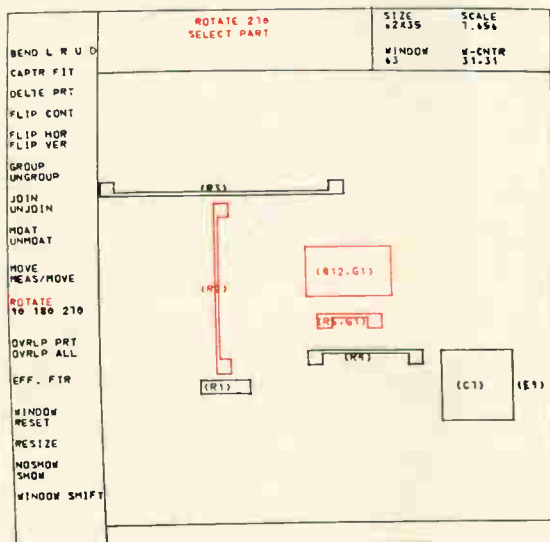

Step 5. Additional rotation.

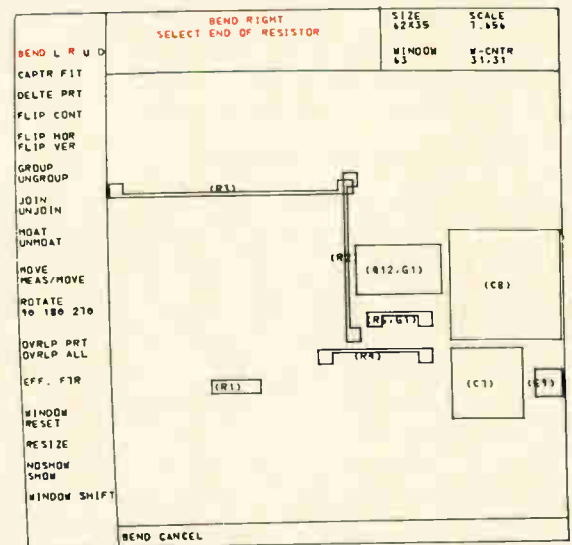

Step 6. Compressing parts.

and constraint edges. If the light pen is pointed at the left edge of two components, for example, the second is held fixed and the first moves to align its left edge with the left edge of the second component. Thus, R4, in the initial configuration, is moved slightly to the left, and the left edges of C7 and C8 are aligned. This alignment is accomplished simply by pointing with the light pen to the left edge of C7 (part to be moved) and then the left edge of C8 (constraint).

By pointing the light pen at the right edge of two components, a similar alignment takes place between them. Thus, the external pad, E9, is moved to the right to line up with the right edge of C8. Component E9 is then moved down and placed adjacent to the center of C7. To request a center-to-center move, labels are used instead of edges. An axis is then selected to indicate whether the center of the part moved should be shifted to the horizontal or vertical constraint axis.

To move one component next to another the light pen is pointed at different edges—here, the

left edge of Q12 and the right edge of R2. Element Q12 is then moved left to be adjacent to R2 with a preselected separation automatically applied.

By selecting ROTATE from the menu, components are automatically turned when designated by the light pen. Thus, R6 is rotated 270° and moved down to align its center with the center of C8. Also, Q12 is moved adjacent to R6. The message area now indicates that the command GROUP is selected, a command that enables a designer to choose and group several components and manipulate them like a single part.

A group is defined by successively pointing the light pen at the parts desired. As each part in the group is selected, a group label is placed next to it. Group G1 consists of Q12 and R6.

Additional moves are made to compress the parts into an even smaller area. For example, the message area indicates that the command BEND RIGHT is selected. This is achieved by pointing the light pen to the R next to the BEND menu item. As the result, R2 (end to be bent) is bent to the right

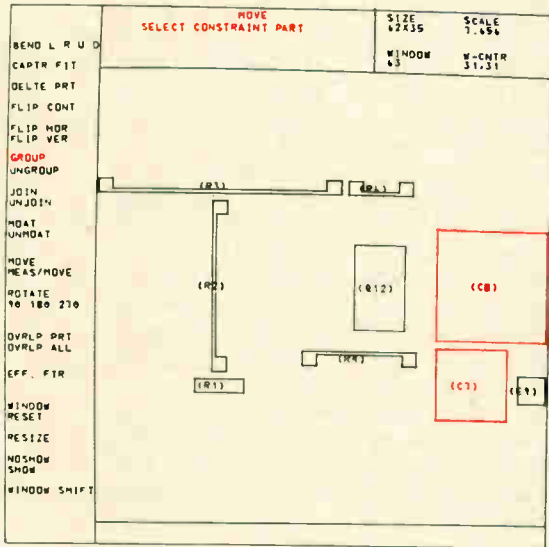

Step 3. Vertical alignment.

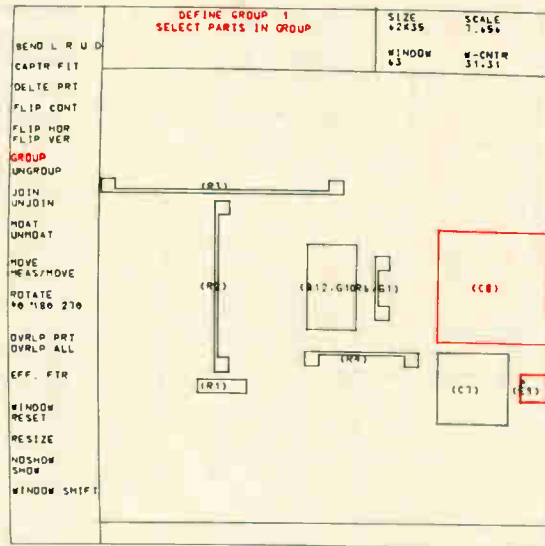

Step 4. Rotating and grouping.

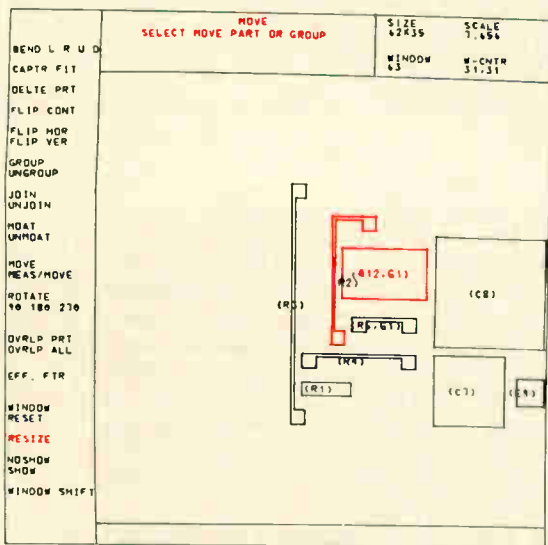

Step 7. Bending for compactness.

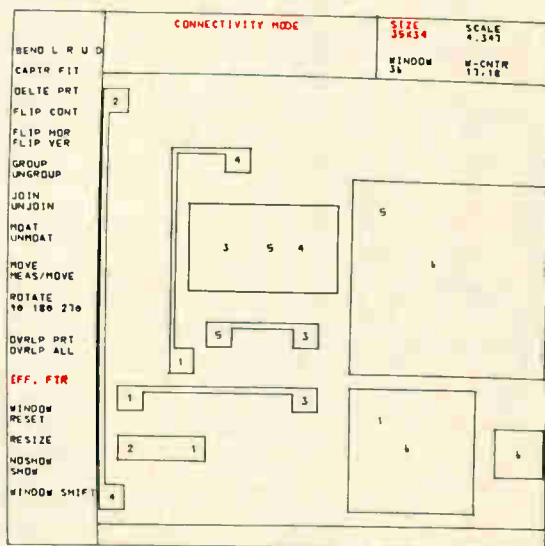

Step 8. Rescaling for smaller chip.

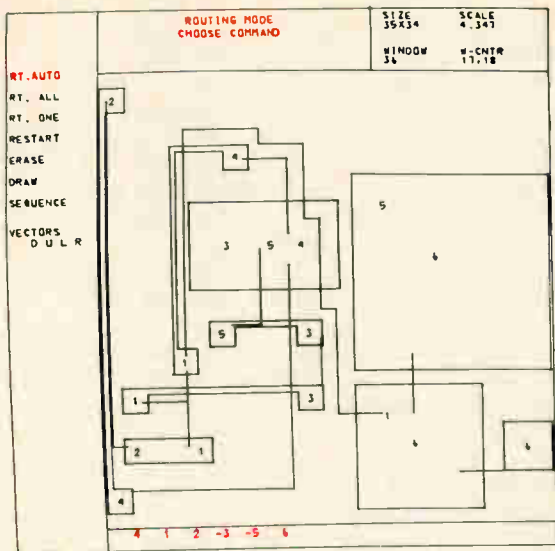

Step 9. Routing starts.

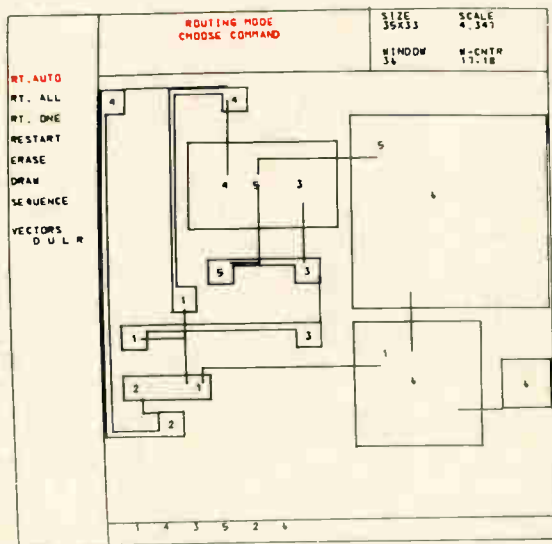

Step 10. Routing ends.

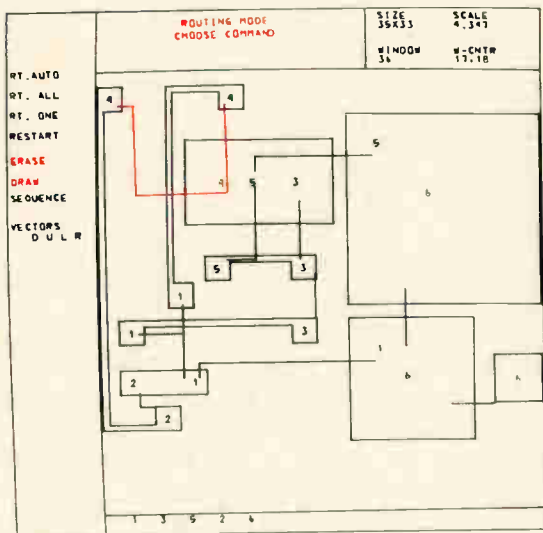

Step 11. Changing routing.

around Q12 (constraint). This is accomplished by pointing the pen at the top end of R2 and the top edge of Q12. Separation between the bent segment of R2 and the top edge of Q12 is automatically maintained. Another rotation and two moves complete the initial consolidation of chip area.

Since the parts as they now appear occupy considerably less area, it is desirable to readjust the boundaries (a rectangle enclosing all parts) to define a much smaller chip. The initial chip size is indicated as 62 by 35 mils, shown in the parameter area at the top right of the screen. Readjustment is achieved by pointing to the command **RESIZE**. This results in new boundaries. Rescaling is then made so the screen represents the full area of the chip now measuring 35 x 34 mils.

Chip-packing efficiency is measured at any time by selecting **EFF. FTR** in the menu. The ratio of total component area to total chip area is then computed and displayed in the message area.

To avoid unnecessary clutter on the screen, the designer eliminates the names of the components by pressing the names key on the panel. By pressing the nodes key, node numbers are displayed at the contact locations on each part. A node, or net, is a set of contacts that are to be electrically connected with interconnection metalization. Connectivity data is included on the input card, and can be displayed at any time during the layout to assist the designer in placing and orienting components.

Making connections. With node numbers on the screen, the route function key, calling for the routing mode, is pressed and a new list of commands appears in the menu area. The first command selected is **RT. AUTO**, which causes all the nets to be routed in descending order according to length. The computer determines length. The sequence of numbers, which appears at the bottom of the screen, indicates the order in which the nets were routed, reading from left to right. In this case, net 4 is routed first. Although contact geometry isn't shown, all the points on net 4 are indicated with a 4 on the layout display at the center of the corresponding contacts.

Blocked nets are indicated by a minus sign next to the net number in the sequence display. Here, nets 3 and 5 had blockages preventing the routing algorithm from connecting all their points. To move the blockages, the designer returns to the placement mode and applies the **FLIP HOR** and **FLIP VER** commands to reverse the contact position of R3 and Q12. R3 is also moved and bent to obtain a more compact chip. By reversing contact positions on R3 and Q12, the routing is simplified because nets 2, 3, and 4 are shortened.

Several other options are available to the designer to perform routing manipulations or eliminate blockages. Two of these are **ERASE** and **DRAW** commands. Here, the path for net 4 is erased and then drawn manually by the designer. In this case, there is no problem of blockages, but it is desired to change the path obtained by the algorithm. Instead of having the path proceed along the body of R2, it is preferred to have it cross at right angles to reduce capacitive pickup.

Erasing of net 4 is accomplished by selecting **ERASE** and then pointing anywhere on net 4.

Continued from page 83

integrated circuits, the system was developed for the Air Force by the United Aircraft Corp.'s Norden division.

Cadic is similar to the batch-processing techniques in one respect: both accept circuit definition from punched cards. But from there on, Cadic takes a different course. The input data is translated into size and shape of every component, recalled from the computer's memory and keyed by type designations. Additional component types may be added to the memory at any time. Resistor and capacitor dimensions are computerized from their values.

From this input, an initial layout is displayed on the crt. All components are presented in true outline size and shape, arranged for easy recognition in the same relative positions in which they appear on the schematic, and separated to avoid overlap.

While viewing the display, the designer can use a light pen to manipulate the components and make any desired changes instantly. The results are observed immediately on the screen. To assist the designer in making the layout more compact, the program provides messages on the screen that tell him what the computer is doing at all times and what information it needs.

Simple on-line commands are displayed for the design of interconnection routing. Included are many combinations of both automatic maze-solving programs and manual-routing techniques. The program has an automatic checking procedure to assure compliance with all design rules. It accommodates circuits of any size, and can adjust scale-screen size to enable the designer to look at the complete circuit or work on any desired portion.

The computer also stores and retrieves intermediate and final designs and generates display patterns for any or all desired mask designs.

Laying out an IC

The crt display is divided into five screen areas, shown above, as follows: the work area containing the layout display, the conversational message area, the command area called the menu, the parameter display area, and the request area for both display of data and input of operator requests.

Data on the input cards describe the circuit schematic, specify component values or types and connectivity, and indicate the designer's approximation of part centers estimated from a rough grid sketched on a schematic.

Based on this data, Cadic displays the initial layout. Overlapping of components is eliminated automatically by the computer, which also rotates the components to obtain preferred orientations for interconnection routing.

To avoid cluttering the display, the initial layout contains only element outlines and symbols. However, the designer can request the display of detailed mask geometries by pressing the keys.

A typical function keyboard, at the right, contains 32 keys, each of which calls for a discrete function to be performed. The first three rows of

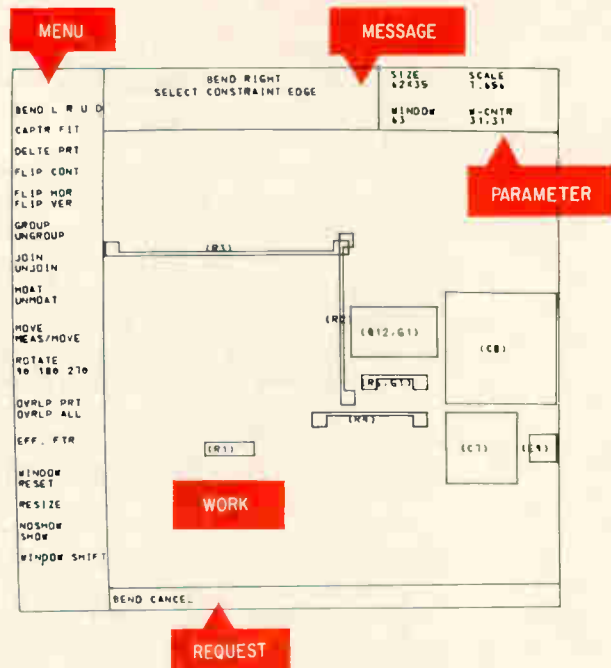

Screen areas. Five basic sections of the screen used by the designer to develop an IC layout.

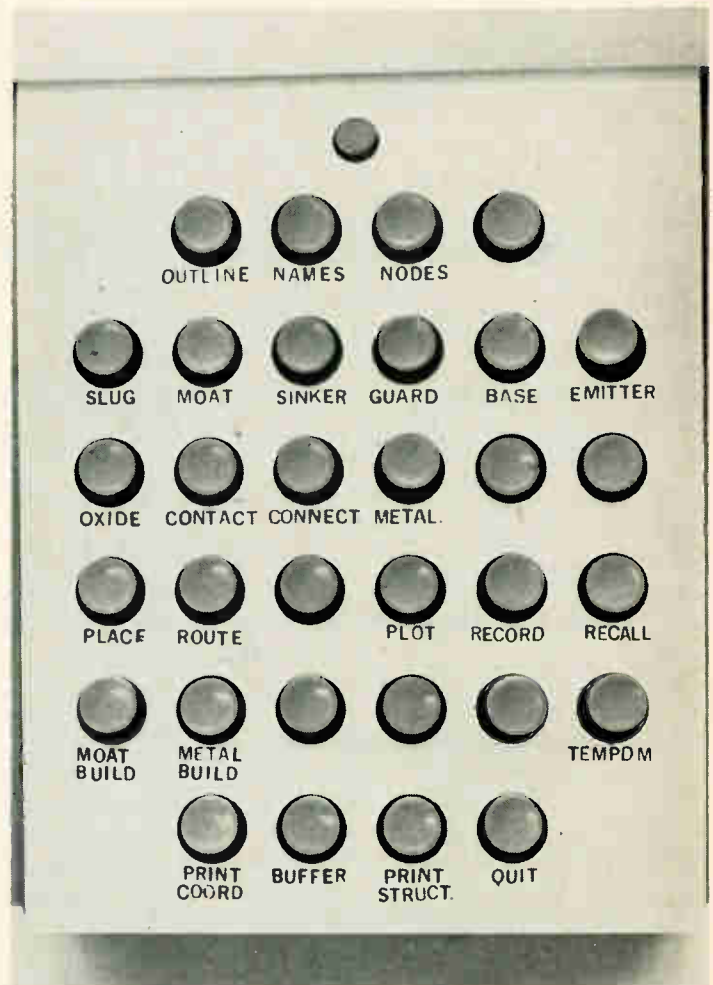

Function keyboard. Each of the 32 keys triggers a discrete function. Pressing the plot key, for example, causes a Calcomp plotter to draw the output.

keys, which are all press on-press off, are for display options. For example, pressing the emitter key causes the emitter diffusion mask to be displayed on the crt. Pushing the same key after the emitter mask is displayed removes the mask.

The fourth and fifth rows are mode-selection keys. For example, by pressing the place key, the designer selects the part-placement mode. By pressing the route key, he selects the interconnection-routing mode. The plot key calls for plots of the display on a Calcomp digital plotter. Record and recall keys are for recording a particular display on disk storage and recalling the display at a later time. Thus it isn't necessary for the designer to complete a design at one sitting at the console; he can always recall a partially completed layout and continue working where he left off.

Moat-build and metal-build keys tell the system to construct the isolation moats and metalization masks for the circuit, since these are not automatically determined at every stage of the layout design. The remaining keys request various system-check printouts, and the quit key ends a particular session at the console.

One of the methods of obtaining a hard-copy output from the Cadac system is with a Calcomp digital plotter, which provides a plot of several of the mask geometries superimposed. It is also possible to obtain separate plots of each mask geometry; however, the accuracy of these are not suitable for the photoreduction artwork required to make the circuit masks. These are used only to give the designer an indication of what the masks will look like. Suitable artwork can be obtained with equipment that uses light heads to expose film or sensitized glass plates. Presently, the Cadac system doesn't interface with direct mask-plotting equipment, but this will eventually be included.

The authors

Arnold Spitalny is chief of the engineering computer branch at United Aircraft Corp.'s Norden division. As a project engineer for the Cadac program, he developed the first experimental off-line system for generating IC layouts.

Martin Goldberg is a senior computer applications engineer at Norden. He investigates potential applications for graphic-computer techniques and is responsible for developing the on-line Cadac system.

Circuit design IV

Generating IC masks automatically

Now an engineer can describe a circuit to a computer and the machine provides the output to generate the artwork from which masks are produced

By Harlow Freitag

Thomas J. Watson Research Center, International Business Machines Corp., Yorktown, N. Y.

When it comes to fabricating integrated circuits, one of the most difficult—and expensive—steps is making the masks from which the IC's are manufactured. The more complex the circuit, the more complex the mask-making problem. It is now reaching the point where, in some cases, masks can't be produced without some aid from a computer.

With existing manual or batch-processing techniques, it can take as long as months to build an IC chip from the start of the design process. And the costs are often prohibitive, particularly when there are engineering changes or error corrections.

Generating conventional mask artwork can begin once the circuit and chip technology are determined. Then a layout of the chip is prepared, at which time problems of element placement and wiring must be solved. The layout enables the designer to prepare a detailed composite drawing for each mask, and the actual artwork is made by removing an opaque layer from selected areas of a double-layer plastic film. To achieve high quality, the original artwork is made on color overlays 200 to 500 times the final chip size. When the original artwork is found to be error free, it is reduced

photographically to 10 or 20 times the final chip size. In turn, these are used in step-and-repeat photographic operations to produce master masks.

This process works well with chips having a small number of circuits, but becomes cumbersome with the advent of large-scale integration.

Prior to LSI, integrated-circuit chips were relatively simple and had broad applications. Chip fabrication, lead bonding and packaging, and checkout were largely independent operations, with many chips manufactured and stockpiled by machine-design groups for off-the-shelf use. Changes in machine design were usually accomplished at the level of card or board wiring, rather than the chip level. For these chips, mask artwork was essentially an easy task.

A changing picture

But LSI changed this picture radically. The greater complexity of LSI chips tends to make them less universal. For example, an LSI chip containing 50 to 200 logic circuits will not have the general-purpose function of a chip that contains a single latch. It is expected that at the higher levels of integration a chip will be employed only in one machine type. Thus, while the number of chips may be reduced, the number of chip types—and, hence, the number of artwork sets—will increase.

In addition, the special-purpose nature of LSI chips makes stockpiling of completed chips unlikely. As a result, machine-design groups will not be able to use off-the-shelf chips for breadboarding and testing. Instead, these operations will have to wait for chip fabrication, which in turn must wait for mask fabrication.

Finally, the complexity of LSI chips makes the artwork generation a tedious and error-prone process, with perhaps several iterations necessary before artwork can be obtained that is 100% accurate.

Because chip fabrication and artwork generation have become a part of the machine design-checkout cycle, it is necessary that the artwork be prepared rapidly.

Several approaches may be taken to reduce the time it takes to design and build an LSI chip (turn-around time). These include:

- Applying computer to simulate hardware for the elimination of bad layouts and errors before mask design starts.
- Applying the master-slice technique in which only the final masks are changed to modify the function performed by a chip. Thus, wafers can be stockpiled at an advanced state of fabrication.
- Automating the mask designs completely with a computer, or with computer-aided techniques.
- Generating the artwork and masks by simple and rapid automatic techniques.

The approach taken by the researchers at the International Business Machines Corp.'s Thomas J. Watson Research Center applies all of these features in three parts: a language that enables the designer to describe the patterns and structures required in the individual mask, a computer pro-

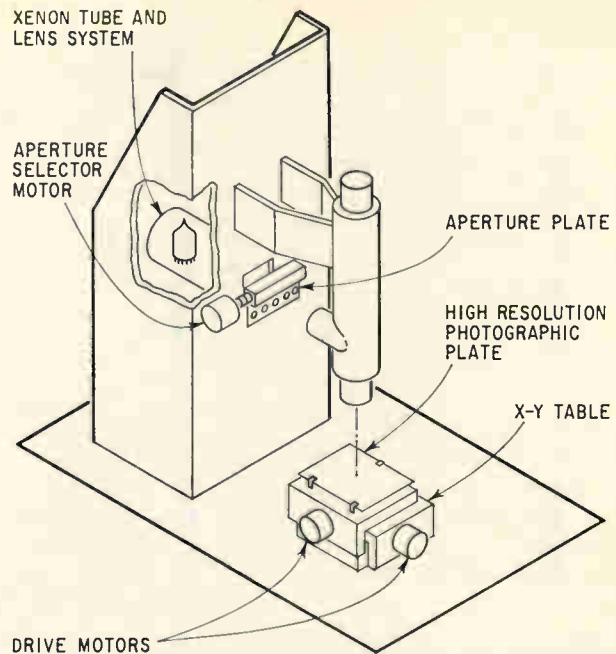

Light Table. Sensitized plate is exposed to light as the table moves in either x or y direction.

gram that translates the language into commands, and the automatic equipment that accepts the commands and generates the masks.

Understanding the language

The language is a convenient shorthand and symbolic way of describing the patterns a designer wishes to generate. Called Lager (for layout generating routine), it is analogous to Fortran. It accepts a higher-level description of mask geometries, automatically reduces this description to a list of line segments, and generates all the commands required to expose the segments.

The Lager language has a vocabulary of 12 words that defines five operations. The simplest operation accepts a series of point coordinates and connects them with a single line. If other commands are inserted in the series, they are executed in the order in which they occur. Additional operations select different apertures for exposure to accommodate different line widths and geometries, repeat patterns throughout a chip if desired, and provide macroinstruction (macro)—the most powerful command in the language. The macro capability defines and stores information under an arbitrary symbolic name. When that name is referred to later, it is regarded as equivalent to the stored information and becomes, in effect, a new command of the language. Included in the information that can be stored are single coordinates, parts of instructions, commands necessary to make a transistor, a logic circuit, or a group of logic circuits.

Macros may be nested, with one employed as part of a definition of another at a higher level. Unquestionably, it is the computer's macro-language capability that allows the designer to build specialized languages to suit his own needs. Simple macro

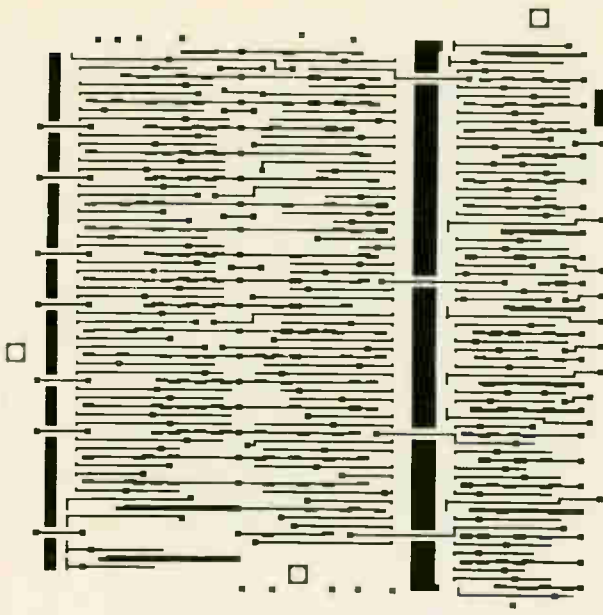

Generated artwork. Interconnection pattern for 122-element logic chip is generated 10 times oversize. Typical line width is 0.4 mil.

names replace whole series of commands.

Because computer language is complex, it is possible that errors may be buried within a set of input commands. To provide assistance, several error-checking routines have been built into the language. Here again the analogy with Fortran is appropriate. The routines detect errors in either incorrectly formed or incomplete instructions. However, the system does not determine whether a set of predefined instructions also represents the desired chip geometries. To aid in this latter check, the system plots for each mask all line segments that result from the input.

Another feature of the language permits any structure or group of structures to be represented three-dimensionally. Thus, when a designer requests a given pattern to be repeated at a particular part of a chip layout, the language automatically accounts for the multiplicity of masks required.

In addition, the language has a repeatability feature that permits a given pattern to be duplicated at a fixed interval around the layout. The pattern can be either along a row or column, or it can be a matrix.

Outlining the program

A rough sketch of the mask is first drawn from which the designer writes a set of statements needed to produce the layout. This may include previously prepared statements from other mask designs. The statements are punched on cards and fed into a computer.

A digital plot that represents the masks generated by the input statements is produced by the computer. The data is then plotted with a Calcomp plotter. If any errors are found in the output, the

statements are corrected and a new plot is obtained. This correction procedure is repeated until the design is error-free. At this time, the designer may call on the computer to produce a magnetic tape containing the commands necessary to generate the mask set. Each statement or set of statements may refer to several masks simultaneously. For example, a transistor is made from several processes, each requiring a different mask. One macroinstruction can be used to select all the masks needed to represent the transistor.

One task of the computer is to remember on which mask layer the pattern is to be found and then sort the entire set of patterns mask by mask. Individual masks are then produced with the appropriate patterns.

Producing the masks

Mask generation is performed with an automatic exposure device, called the Light Table. The unit contains three basic parts: a high-resolution photographic plate mounted on an x-y table, an aperture mechanism, and a light source.

The x-y table is made of two slides, mounted with one riding upon the other, but traveling on perpendicular axis, driven by a stepping-motor drive train. Each step of the motor results in a table motion of 0.5 mil. The field of table motion is 2.2 inches square, across which an absolute accuracy of ± 50 microinches and a short-term (measured in minutes or hours) repeatability of ± 20 microinches is achieved. Table speed is nominally 0.1 inch per second.

The aperture mechanism consists of a photographic plate, upon which the aperture images are formed, mounted on another slide assembly. By moving this slide, any one of several apertures may be selected.

System lighting is provided by a xenon flash tube, arranged to illuminate the selected aperture through a condenser-lens system. An image of the aperture, reduced in size by a factor of 10, is formed on the plate on the x-y table.

Associated with this equipment are two pieces of peripheral equipment: an incremental magnetic

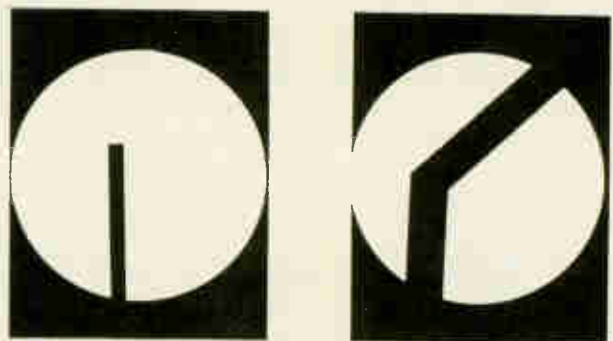

Sharp lines. Blown-up drawing of two typical line widths. Vertical line at left is generated by the y motion of the table. Diagonal line is achieved with successive x and y motions because the table can only move along one axis at a time.

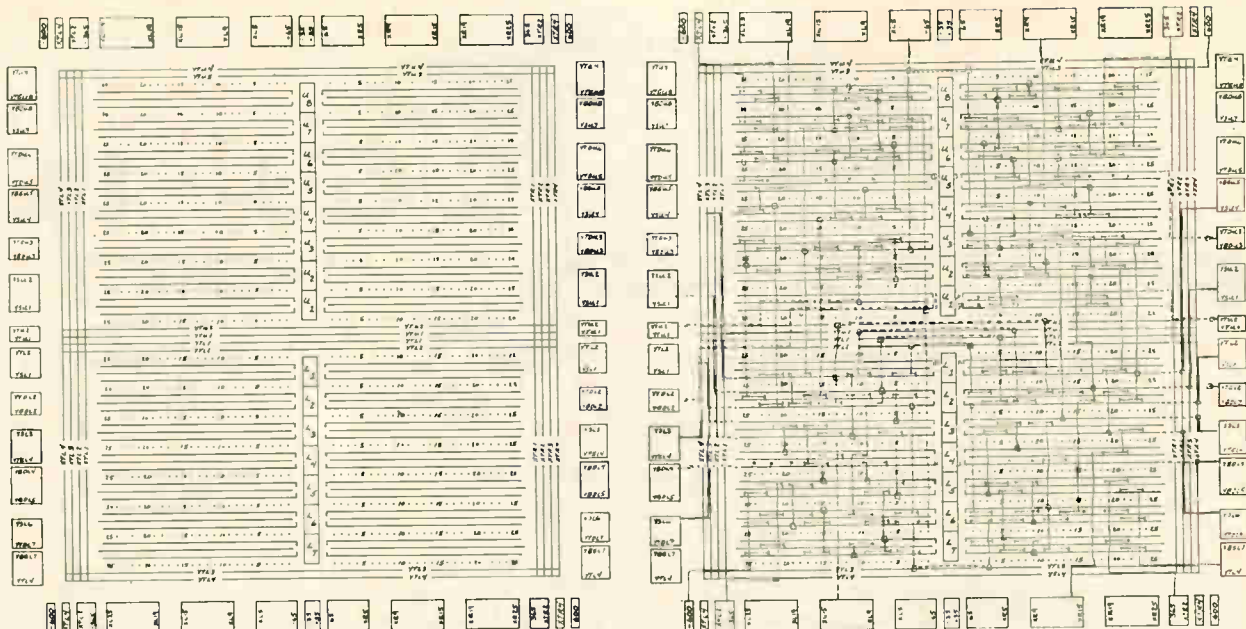

Mask layout. Both placement and wiring are laid out at left to indicate a final circuit scheme. Horizontal rows of dots indicate the vertical wiring positions; three solid lines between these rows indicate dual NOR circuits. By adding metal and diffused lines, the designer defines his final layout. Rectangles represent inputs to the circuit.

tape reader and appropriate control logic. The tape reader is the primary input to the system, with an incremental reading capability that minimizes the need for buffer memory. The control logic calls for the instructions read by the tape reader, interprets and executes them.

Stop and go

Operation of the light table is simple. A command—move or stop—is called for by the control logic. If the received command is to stop, no operation takes place and the logic waits for manual resetting. If the command is to move, it is de-

coded into axis selection, direction, distance, and flash instructions. Pulses are routed to the appropriate stepping motor to move the selected axis the desired distance. When motion is complete, the logic will, if the flash instruction is on, wait approximately 15 milliseconds, then fire the lamp and call for another instruction. If the flash is off, the logic calls for the next command without flashing the lamp.

Continuous lines are exposed by executing a series of move-flash instructions. Usually, in such cases, no overlap is provided between adjacent exposed areas; continuity of line is achieved by

Operation	Light Table-Lager			
	Conventional Regular ¹	Adhoc	Regular ¹	Full Design Automation
Encode and keypunch logic				1.5
Run program				0.5 ²
Manual layout	32	50 ³	32	
Prepare mask drawings	80			
Encode and keypunch mask data		30	12	
Cut film artwork	120			
Run Lager program ⁴		0.1	0.1	0.1
Light Table run		1	1	1
Prepare overlays	2	2	2	2
Reduce to single segment	2			
Step and repeat	4	4	4	4
Total	240	87.1	51.1	9.1
Artwork preparation time ⁵	204	33.1	15.1	3.1

1. Assumes use of regular array approach described in text.
2. Estimated 7094 time for good replacement and wiring program.
3. Includes preparation of skeleton drawing.
4. Optional plot generation may require several hours off line.
5. From completion of layout to start of step and repeat all times are in hours and do not include queuing time.

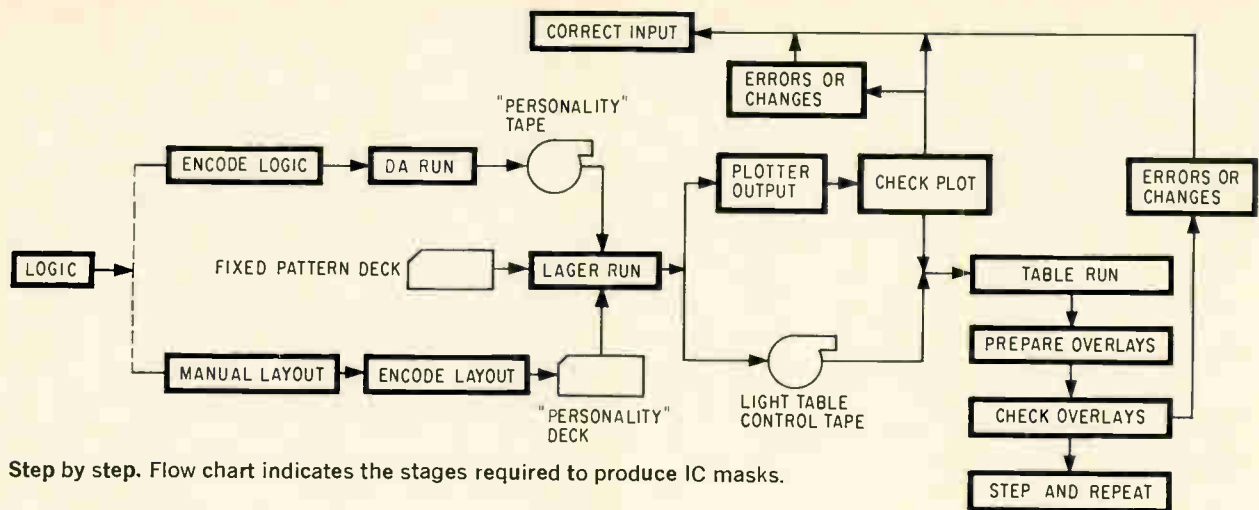

Step by step. Flow chart indicates the stages required to produce IC masks.

scattering of light in the material's emulsion.

When circuit density is at a premium, it is desirable to place the components in a way that will most efficiently use the available area. To accomplish this, the designer uses an adhoc layout in which the devices and their interconnections are arranged to make maximum use of the available silicon area. In this approach, manual solutions to placement and wiring problems are usually required since the layout is irregular. As in the conventional method, final layout is a composite drawing. But by using Lager language, the implementation of these layouts is simplified.

First, macros are defined for repetitive circuit features; for example, transistors, diodes, contact holes, pads, and resistors. These may be pinpointed on the composite drawing by a single reference point. Only the center lines of line segments need be shown. It is usually only necessary to show those mask layers that are used for interconnections; the others can be accommodated by the macros. Furthermore, it isn't necessary to prepare detailed drawings of all masks in a set, as coding into the Lager language may be done directly from the skeleton composite drawing.

Designing the arrays

When circuit density is not quite as important, it is possible to place all allowable circuit and track positions into a regular structure. This leads to the regular-array method of using a Light Table-Lager system. In this method, because of the symmetry of circuit and wiring-channel location, it is possible to assign a mnemonic code to every significant coordinate in the chip; circuit locations, entry and exit points, wiring locations, and pad locations may all have simple names assigned to them. The macro structure of Lager allows these names to replace the coordinates they represent. In effect, this allows a separation to be made between what may be termed mask topology (relative placement of features) and mask geometry, which is the exact location of all structures on the mask. Input expressed as mnemonics for the coordinates is es-

entially an expression of the mask topology; the Lager language translates this into geometry.

Because placement and wiring are largely topological problems, it is possible to prepare a sketch that expresses the allowed topology of a given layout scheme.

Such a sketch may be used as a preliminary design upon which lines can be added to represent the diffusions and metalization patterns. Coding into statements for the Lager program may be done directly from this diagram, applying the macro names associated with the array. This method brings to the mask-artwork generation many of the advantages of the master-slice technique. These advantages are rapid turnaround time and stockpiling of partially completed wafers at an advanced level of fabrication.

It is a simple matter to extrapolate to a third method of applying the Light Table-Lager system: the full design automation (DA) method. This technique would use macro instructions to fabricate the circuit structures. Topological problems of placement and wiring would be done by a design-automation program. The program is arranged to have its output recorded on a magnetic tape as Lager commands. This tape is then run as input to the Lager program together with a set of macro definitions.

The Light Table system, in addition to saving time is also more flexible. However, in the adhoc approach, this flexibility is limited by the need to conserve space on the chip.

When the regular-array method is used, the flexibility is even greater. Changes in array design may be easily accommodated, providing they do not alter the topological ground rules. Thus, wiring changes may be made at will and wiring may be added to any array design.

The author

Harlow Freitag manages design-automation research at the Thomas J. Watson Center. A mathematician, he is responsible for the development of advanced computer-aided design techniques.



AN OHM-PA-PA FROM PAPA OHM



TO MY LAW-ABIDING FRIENDS

Dear     and 

You five are the joy of my days these years! You have no idea how it makes me feel to know that you five - of all the ones who have tried - are following my law so faithfully.

With you, resistance is resistance, just as I saw it. No maybe's, excuses or big changes because of temperature, frequencies, time, etc.

I always felt someone would be able to make what you call "resistors" the way they should be.

So, to you  for developing Vishay Resistors, and to

 - Welwyn in Britain

 - Rosenthal in W. Germany

 - Sfernice in France

 - Kyowa in Japan

for becoming licensees of Vishay, for continuing to try to make even better precision resistors and networks, and for distributing them in your part of the world, my eternal thanks.

Papa Ohm
Papa Ohm

P.S. Could you send me some literature?
It will help me convince the doubters.



Standard Specs: $\pm 0.01\%$ Abs. R./ ± 1 ppm
TC(0 to 60°C.)/25ppm Shelf Stab. (1 year)
/1ns. Response Speed/No Ringing/
No Noise/ALL IN EVERY UNIT.



VISHAY RESISTOR PRODUCTS

A DIVISION OF VISHAY INTERTECHNOLOGY, INC.

63 Lincoln Highway
Malvern, Pa. 19355
(215) 644-1300

quiescent state— Q_1 is on, Q_2 is off.

Although \bar{A} 's positive transition at t_1 triggers the one-shot, the negative step at t_1 in waveform A has no effect on the circuit. If command pulse duration is shorter than the one-shot's transition time, however, the relay fires at t_2 by the trailing edge of pulse \bar{A} . The trailing edge of \bar{A} at t_2 does not affect the one-shot.

If the pulse duration is shorter than the one-shot's transition time, transistor Q_2 is conducting when the positive step in A occurs at t_2 ; the positive step turns off Q_3 through C_2 and D_2 . With Q_3 off, the base of transistor Q_5 moves to the negative supply, turns on and actuates the relay by closing its contact.

The positive step in A at t_2 also turns off Q_2 through C_4 and D_1 to reset the one-shot. The cut-off of Q_2 does not prevent the positive step of the

voltage that occurs at t_2 from turning off Q_3 .

If a command pulse longer than the one-shot's transition time is now applied, the leading edge of pulse A at t_2 reaches the flip-flop after Q_2 is off and has back biased diode D_2 . Hence, the positive step at t_2 is steered to the base of Q_4 and resets the flip-flop in the opposite direction by turning off Q_4 . With Q_4 off, Q_3 turns on and grounds the base of Q_5 to open the relay.

The circuit requires both a command pulse and its complement to operate. With modification, the circuit can function without the complement of the command pulse. To accomplish this, D_1 is shorted and input A operates the circuit. In this case, the one-shot is initially triggered by the negative step in pulse A at t_1 . However, the trailing edge of A at t_2 continues to operate the flip-flop and reset the one-shot.

Potentiometer turns flip-flop into an adjustable trigger

By David Schoon

Minneapolis

By placing a potentiometer at the input of a conventional flip-flop, a designer can construct a simple trigger circuit with adjustable hysteresis. The circuit is ideal for generating square pulses from sine waves or for providing a binary output from a transducer.

Potentiometer P_1 permits easy adjustment of the hysteresis; this feature is particularly useful where the desired hysteresis cannot be accurately ascertained until the trigger circuit has been installed in a piece of equipment. In one application, for example, a photocell produces a binary readout from punched paper tape; the cable between the photocell and the trigger circuit is unshielded so that a certain amount of 60-hertz hum is picked up. To prevent chatter in the trigger circuit as it changes state, a certain amount of hysteresis must be included. Since the amount of hysteresis varies with the background noise, the hysteresis setting differs for each application but may be quickly set by adjusting P_1 .

When the circuit is generating square pulses from sine waves, potentiometer P_1 facilitates shifting of the triggering level to any desired point on the leading edge of the positive half-cycle of the sine.

Only two transistors, Q_1 and Q_2 , are needed to

generate a rectangular output pulse that travels approximately between ground potential and the supply voltage—an amplitude of nearly 10 volts in the circuit shown. A Schmitt trigger circuit, comparably biased, would require three transistors to produce a similar output pulse. In addition, the Schmitt circuit has a considerably more difficult hysteresis adjustment than the modified flip-flop.

However the circuit is somewhat less flexible than a Schmitt trigger in that it requires zero-level triggering signals and negative reset voltages with amplitudes equal to the input triggering level; these two constraints are satisfied when the input sine wave is centered about ground. The sine wave shown at the input of the circuit, for example, triggers output pulses during positive half cycles and resets the trigger circuit during negative half cycles.

When the input voltage is near ground, the

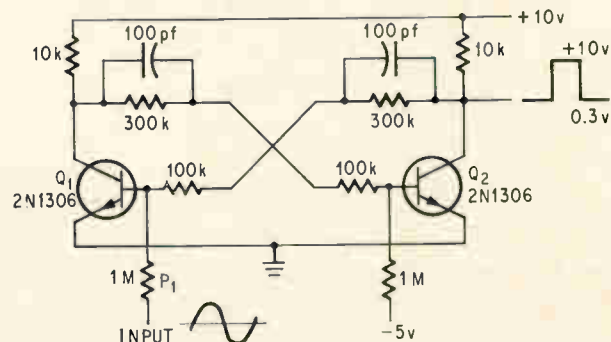

Adjustable hysteresis. Input signals, which exceed the threshold level set by potentiometer P_1 , turn Q_1 on and Q_2 off, generating an output step.

circuit is in a stable state with either Q_1 or Q_2 saturated. As the input voltage rises above the preset threshold level (1 volt when P_1 is 100 kilohms), Q_1 turns on, Q_2 turns off and the output voltage rises to 10 volts. The circuit remains

in this condition until the input voltage becomes sufficiently negative (-1 volt for P_1 at 100 kilohms) to pull Q_1 out of saturation. When Q_1 turns off, Q_2 turns on and drops the output voltage to 0.3 volt, completing the output pulse.

Transistor breakdown yields inexpensive thyristor trigger

By Robert B. Hood

Fairchild Semiconductor, Mountain View, Calif.

An inexpensive trigger circuit utilizes the reverse breakdown characteristic of a transistor's emitter-base junction to accurately set the triggering level. The design, a simple combination of two transistors and a resistor, is particularly valuable as a thyristor gate-drive trigger in phase controls. The circuit offers good temperature stability, low saturation voltage, efficient energy transfer, and rapid switching.

As voltage V_1 is increased, the collector-base junction of transistor Q_1 becomes forward biased. This causes V_1 , minus the collector-base forward drop, to appear across the reverse-biased base-emitter junction of Q_1 . As V_1 is increased, a point is reached where the reverse-biased junction breaks down, and a current, I_1 , flows (near 6 volts).

Transistor Q_2 's base-emitter junction is then forward biased by I_1 , and Q_2 begins to conduct. The collector current of Q_2 drives Q_1 into increased

Triggering. Current I_1 flows in the direction indicated after the reverse-biased base-emitter junction of Q_1 breaks down.

inverse conduction. The regenerative action thus initiated drives both transistors into saturation within less than 1 microsecond. The collector-emitter saturation voltage of Q_2 in series with the forward drop of Q_1 's collector-base junction determines the new value of V_1 .

In a typical thyristor gate drive, a capacitor charged to a predetermined level is discharged through a trigger element to the thyristor. If the trigger's energy transfer efficiency is high, lower-cost components can be used, and in some cases an amplifying state is not necessary. Also the efficiencies of most two-terminal triggers are limited by their high α voltages. The low saturation voltage of the trigger results in increased efficiency.

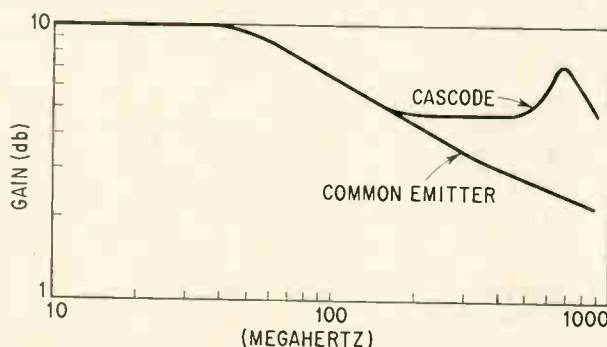
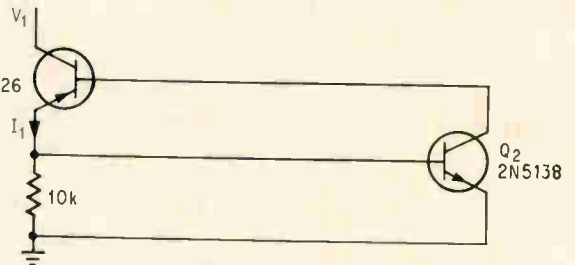

Resonant peak. Unlike the single common-emitter stage, whose frequency response is fairly flat, the cascode amplifier has a resonant peak. A variable capacitor, C_1 , controls peak position. When C_1 is increased, the resonance is shifted to a lower frequency and a higher amplitude. This circuit has an 18-db gain and a 550-Mhz bandwidth.

Emitter peaking pushes bandwidth to 500 Mhz

By H. T. McAleer

General Radio Co., Boston

Video amplifiers, operating at 500 megahertz, can be designed by adding variable capacitors to conventional cascode circuits.

A single common-emitter stage with 50-ohm input and output resistors has an initially flat response that falls off at the rate of about 6 decibels per octave at high frequencies. A cascode circuit,

Report from

**BELL
LABORATORIES**

Inside Solidifying Metals

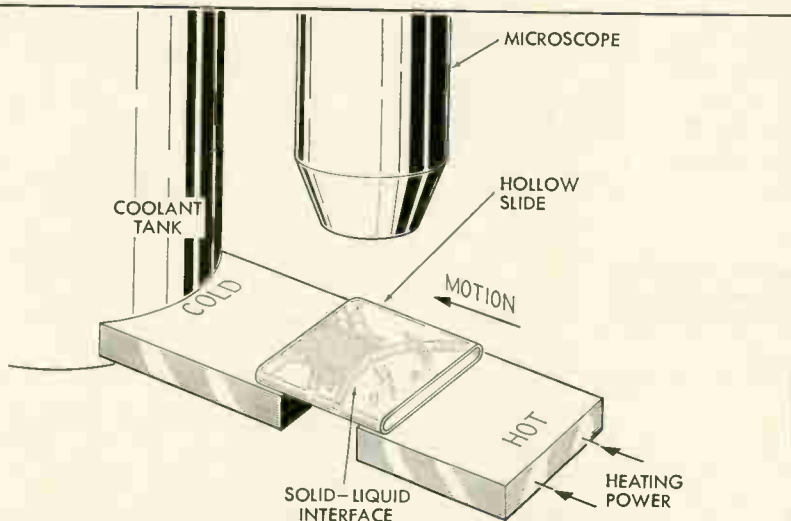

Experimental setup in which photographs such as that below were taken. The glass slide or cell—containing a liquid which freezes like a metal—is placed between hot and cold blocks of brass. This produces a temperature difference along the slide. A solid-liquid interface then forms between the two blocks. By moving the slide toward the cold block at a constant rate, one can observe the steady growth of the crystal under the microscope.

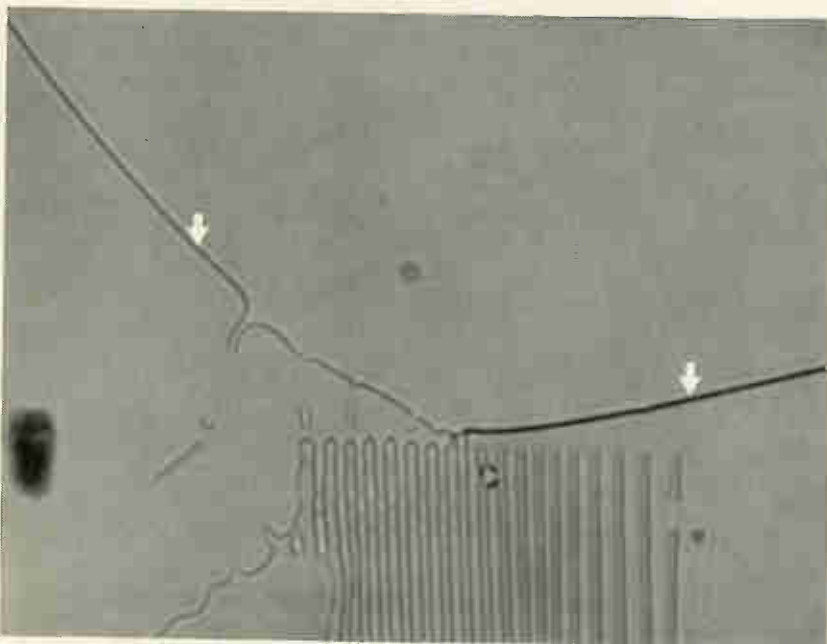

Bell Laboratories' model (200x) permits physical simulation of a eutectic phase diagram for an alloy such as lead-tin. Diagram relates liquid proportions (horizontal scale) to temperature (vertical).

Two different liquids were put into a single slide . . . hexachloroethane on the left and carbon tetrabromide on the right. After a brief period, the liquids formed a graded mixture, from 100% of one at the left to 100% of the other at the right. The mixture was partially frozen, then photographed with the slide stationary. The solid-liquid interface (arrows) then showed the freezing point for every possible composition.

The "grid" under the solid-liquid interface is made up of alternate solid layers of the two chemicals (the eutectic region).

At Bell Telephone Laboratories, metallurgist Kenneth A. Jackson has devised transparent models of solidifying molten metals. With these models, we can now study what happens inside a metal as it freezes. This gives us a tool which promises to improve existing alloys and will perhaps help us find new and better ones.

The models are hollow microscope slides (diagram) containing such organic liquids as camphor or carbon tetrabromide. These compounds are among the few transparent substances whose molecules freeze without having to rotate into a specific orientation. Metal atoms act the same way, hence the similarity in freezing behavior.

Various modes of metal-crystal growth—planar, dendritic (tree-like branching) and cellular—have been studied in detail with this technique. Also, the solidification of alloys has been simulated (photo). To do this, liquids with freezing characteristics corresponding to those of two metals are mixed and cooled. With this procedure, Jackson and J. D. Hunt (now at the University of Oxford) observed, for the first time, the process by which the "equiaxed" zone forms in alloy castings. This is a zone of relatively small crystals, usually found in the center of an alloy casting. The new technique shows that the equiaxed zone results from "branches" melted from dendritic crystals. As the alloy cools, freezing begins at the outer surface, producing dendrites which project inward toward the hotter, liquid center. Branches, melted from these growing dendrites, are carried to the center of the casting to form the crystals of the equiaxed zone.

Until now, the only methods for studying metal freezing were laborious . . . cutting, polishing and etching, for instance. The new technique is not only simpler but also reveals hitherto unknown details of crystal growth.



Bell Telephone Laboratories
Research and Development Unit of the Bell System

Paramatrix puts digital computer in analog picture, and vice versa

Prototype system uses digitally controlled analog circuits to handle preliminary transformation of graphic patterns cheaply and quickly

By W.J. Poppelbaum, Michael Faiman, and Edward Carr

Digital Computer Laboratory, University of Illinois, Urbana

A good interpreter can save a digital computer a lot of time in dealings with the analog world outside. With a foot in both worlds, digitally controlled analog circuits can do the job quickly and fluently. They can process and convert analog signals while the computer concentrates on its prime task—analyzing graphic patterns or making calculations. The hybrid circuits perform simple operations at great speed, and—with fewer components—they're cheaper than their digital equivalents.

Analog-digital gates and comparators are used in a prototype system designed to preprocess analog information—primarily graphs and pictures—while converting it into digital signals. The system, called the Paramatrix, can handle pictures of different sizes and orientations, reshaping them, displaying them on a grid, and transmitting them in digital form to the computer along a single wire. It does this under computer control but without using the time or memory the computer would need.

The Paramatrix can enlarge or shrink a picture, move it around, or rotate it. It can even make such corrections as filling in blurs or gaps. All this frees the computer to concentrate on analyzing what it sees in the picture. If the computer has to translate a line of handwritten letters or determine the content of a bubble-chamber photo, its job is eased if the picture is first juggled into a standard configuration.

Interface

The Paramatrix is essentially an interface between the picture and the digital computer. Its operations are basically nonmathematical, although they can be conveniently expressed in mathematical

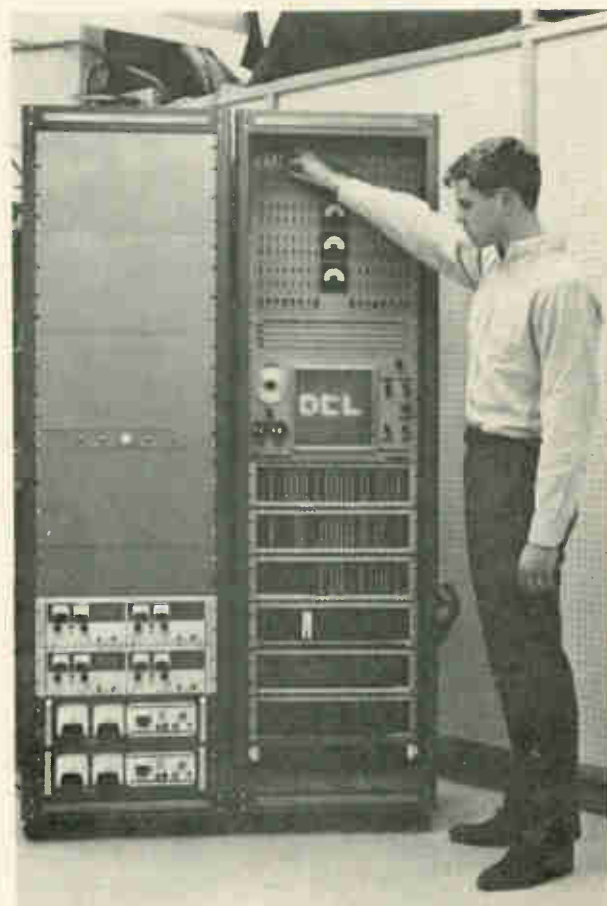

Prototype Paramatrix. Unit fits in half a rack, because it uses only about 50 printed circuit cards for its major functions, and another 68 cards for the display matrix flip-flops and drivers. The other half of the rack contains the input simulator. The second rack here contains power supplies shared by the Paramatrix with other projects in the laboratory.

Paramatrix juggles images

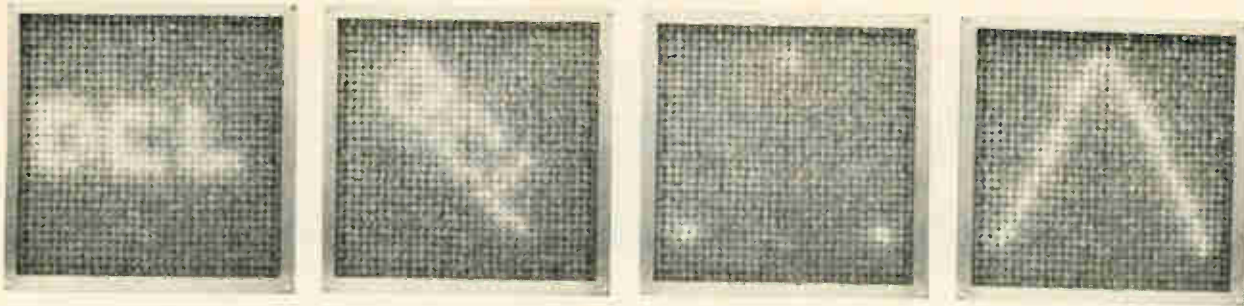

Alphanumeric display. Normal and rotated positions are at left. Other photos show how Paramatrix can fill in large gaps in an input picture.

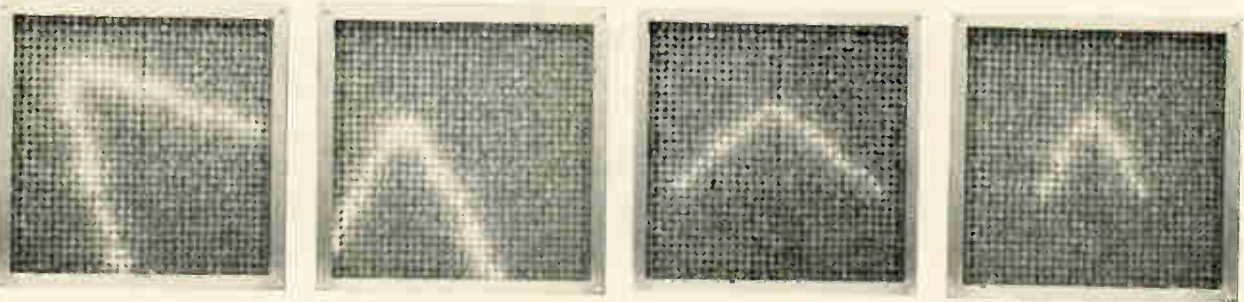

Translation, rotation, demagnification. These can be done in one or both coordinates.

form. Where a large digital computer would execute six multiplications and four additions—one at a time—and take 15, 20 or more microseconds to do it, the Paramatrix can perform the equivalent operation in 2 μ sec.

Furthermore, the computer needs great blocks of memory and much programming effort to produce an accuracy far greater than the simple preliminary operations demand. The accuracy of the Paramatrix is a few percent, about the same as that of most devices that receive and transmit pictorial information. Such devices—optical sensors, electronic display tubes, and the human eye, for example—can easily tolerate small departures from perfect straightness or roundness.

The prototype Paramatrix hasn't yet been connected on-line to a computer, nor does it scan real graphic inputs. But it does demonstrate that graphical data can be processed by hybrid digital-analog circuitry, and its principles have already been successfully applied in an automatic drafting project called Artrix.

Connections between the Paramatrix and a computer would be few and simple. The system's output, a processed picture in digital form, can go into a computer along a single wire. The computer can issue the five parameters of translation, magnification, and rotation through a digital-to-analog converter, and can easily supply commands for simple corrections.

These are the basic connections, but others could be made to attain a higher degree of sophistication. The computer, for example, could specify four numbers that define a smaller-than-normal area of the input picture for processing.

An input simulator is attached to the prototype

in place of a mechanism to scan real graphic inputs. This unit produces an arbitrarily modifiable set of signals resembling those a scanner would generate from a picture. A device to scan photographic slides is now being built to replace the simulator.

The Paramatrix is built from discrete components mounted on printed circuit boards, though it could easily have been built from integrated circuits. However, the University of Illinois has no ic facility of its own, and found it impractical to have custom-designed circuits built by an outside manufacturer at this development stage.

Fundamental scan

The fundamental scan in the system is the output scan; that is, the output picture is always scanned in the same way and the corresponding input scan is generated by means of the inverse coordinate transformation (translation, rotation, or enlargement). If the input scan were fundamental, some combination of transformations might create an output scan outside the permissible range. The inverse transformation is possible because the coordinate transformation between a pair of points in the input and the output scans is always on a one-to-one basis.

The decoded outputs of two digital counters are converted to analog voltages that increase step by step over a specified range. The variation in one of these voltages corresponds to a sweep from bottom to top of the output picture, and the other to a left-to-right sweep. Thus the Paramatrix scan covers its output display point by point and line by line in the same fashion as a raster scan on a cathode-ray tube, except that in the new system

the lines are vertical. For each point on the output scan, the system locates the corresponding point on the input picture, taking into account the specified translation, magnification, and rotation. If the input point is a point of interest in the picture, as opposed to part of the background, the output point lights up and a signal is transmitted to the computer. In this way, the input picture is reproduced with the specified transformations on the output display.

The analog raster in the Paramatrix is an array of 32 by 32 points. The two analog voltages sweep this array in steps of 0.5 volts over a total range of 16 volts. The operating range in the Paramatrix is 20 volts; the 2-volt margin at each end of the sweep permits out-of-range detection.

The circuits are accurate to within 0.3% over the analog range of -10 to $+10$ volts, and their frequency range is d-c to 1 megahertz square-wave. Raster size and resolution could be made greater with more refined circuits and wider ranges, but these values are adequate for the prototype.

The display—a 32-by-32 array of light bulbs driven by inexpensive flip-flops—serves as a visual monitor of the output and makes the Paramatrix a self-contained system. Other types of displays will probably be developed as the Paramatrix evolves; these might use cathode-ray tubes or electroluminescent panels, for example.

Analog process

Three operations are needed to transform a point on the input picture that has the rectangular coordinates (X, Y) . First the coordinate origin is translated a units left or right and b units up or down; the X and Y scales are then multiplied by factors m and n , respectively; finally the point is rotated counter-clockwise about the new origin by an angle, θ .

All this gives the point output coordinates (x, y) , which are related to the input coordinates (X, Y) by the equations:

$$x = m(X - a) \cos \theta + n(Y - b) \sin \theta$$

$$y = -m(X - a) \sin \theta + n(Y - b) \cos \theta$$

Parameters $a, b, m, n,$ and θ can be specified by the computer or dialed on five potentiometers.

The Paramatrix actually uses the inverse transformation. It scans its output field in successive steps whose digital coordinates are $(0,0), (0,1), (0,2), \dots (0,31), (1,0), (1,1), \dots (31,30), (31,31)$. Each pair of coordinates corresponds to a pair of analog voltages; coordinate 0 corresponds to -7.5 volts, 1 to -7 volts, 2 to -6.5 volts, and so on in half-volt steps up to $+8$ volts.

At each point in the output field, the system generates the inverse analog coordinates:

$$X = \frac{1}{m} (x \cos \theta - y \sin \theta) + a$$

$$Y = \frac{1}{n} (x \sin \theta + y \cos \theta) + b$$

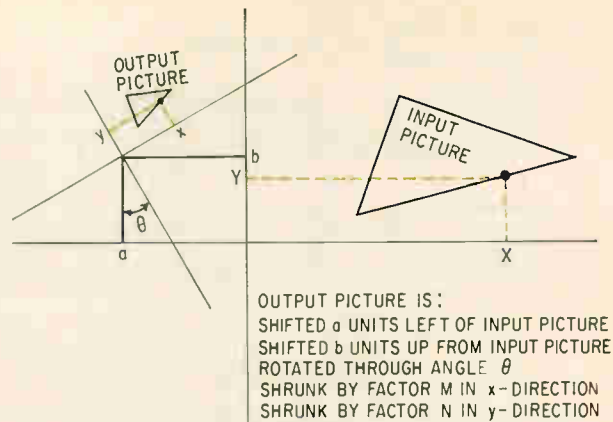

Shifting output picture. Limits on horizontal and vertical movement are those of the scan; angle of rotation is unlimited. The size can be increased or decreased. The transformation equations are derived from the quantities in this diagram.

The input picture simulator specifies up to 128 points—four on each of 32 uniformly spaced abscissae—also in the form of analog voltages in the range -7.5 to $+8$ volts. At each step in the scan, the Paramatrix compares the coordinates with the four specified points. If they agree, a digital signal is sent to the computer and another signal lights the bulb in the corresponding position in the display.

The major subsystems in the Paramatrix are a digital control, a hybrid processor, and an output/display unit as shown in the block diagram on the next page.

Coordinates are specified digitally at any given instant by the contents of the clock-driven y - and x -counters. The decoded outputs of these counters drive the coordinate transformer, which also has the parameters $a, b, m, n,$ and θ as inputs. The transformer in turn generates the new X and Y coordinates that specify the corresponding point in the input scan.

Splitting the difference

For each X -coordinate generated by the transformer, the corresponding Y -coordinates are generated from the input picture (the input simulator in the Paramatrix prototype) and compared with the successive Y -coordinates from the transformer. The interpolator—a set of comparator circuits and summing networks—selects “best” values for the Y -coordinates in those cases when the X -coordinate doesn’t exactly match one of the 32 reference levels. The technique followed is the simplest possible. If one of the transformed X -coordinates falls between two successive reference levels, a set of interpolated Y -coordinates is generated halfway between the specified Y -coordinates for comparison with the transformed Y -coordinates.

For example, the input simulator could specify $(8,3), (8,7), (8,17),$ and $(8,25)$ as the four input points for the coordinate $X = 8$, and $(9,5), (9,8), (9,15),$ and $(9,22)$ for $X = 9$. Suppose the transformed X -coordinate comes out to be $8\frac{1}{2}$. The four input points corresponding to this coordinate

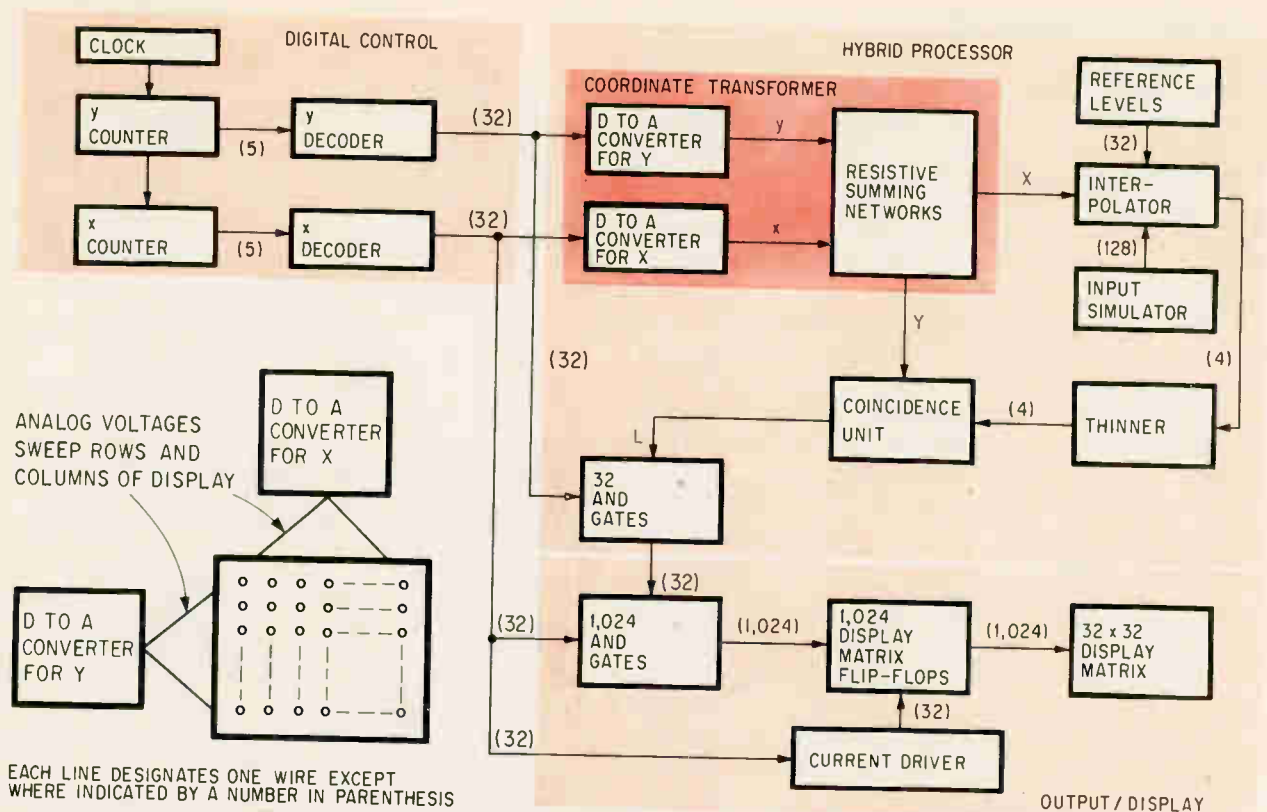

Three major parts. The Paramatrix sections are lightly tinted. The heavier tint indicates the coordinate transformer, which generates the input coordinates in response to an output scan by the digital control section.

are generated by the interpolator as $(8\frac{1}{2}, 4)$, $(8\frac{1}{2}, 7\frac{1}{2})$, $(8\frac{1}{2}, 16)$, and $(8\frac{1}{2}, 23\frac{1}{2})$; the new Y-coordinates are halfway between the specified values for $X = 8$ and $X = 9$.

The thinner compares the magnitudes of the four interpolated Y-coordinates. If two or more of these are essentially the same, the redundant voltages are suppressed and the thinner's outputs go to the coincidence units, where a comparison is made of the transformed Y-coordinate and the interpolated and thinned input Y-coordinate.

If the coincidence unit records an agreement between the transformed Y-coordinate and any one or more of the input Y-coordinates, it generates a signal (L in the block diagram) that gates the corresponding flip-flop in the display and, in an on-line system, notifies the computer.

The operation and speed of the Paramatrix are illustrated in the oscilloscope photographs on the opposite page. When these photos were made, the Paramatrix clock was running at 0.5 megahertz, processing one point every 2 μ sec and one complete picture about every 2 milliseconds.

In the first two photos, the staircase waveform is the X-coordinate produced by the transformer viewed over one complete picture scan. The Y-coordinate scans the entire picture top to bottom in each step. Beneath the X-coordinate waveform is one of the four outputs of the interpolator, steady at -10 volts except during one step near the center when it rises to -5 volts to indicate equality between the X-coordinate and one of the reference

levels. The first two photographs show the same thing except that the sensitivity of the comparator circuits in the interpolator has been decreased in the second photo so that the coincidence is registered over three adjacent steps.

The third and fourth photos show the Y-coordinate staircase waveform on an expanded time scale in the same situation. The lower trace in the third photo is the same as in the first photo. The fourth trace down is the output of the coincidence unit, and a signal that turns on the lamp is at the left.

Subsystem design

The clock has a frequency that is adjustable from 100 kilohertz to 1 Mhz and a mark-space ratio variable from 1 to 10. It has an additional output, inverted and delayed 0.6 μ sec, to provide a strobe for the counters and decoders.

The counters are conventional and made of NOR circuits. The y-counter continuously goes from 0 to 31, generating a pulse on return to 0 that steps the x-counter, an identical circuit that operates at $\frac{1}{32}$ the speed.

The decoders are also of conventional design, being built of OR circuits. They decode the five outputs from the counters into 32 lines, only one of which can carry a signal at a time.

The transformer generates the input coordinates corresponding to the coordinates of the output point under examination as defined by the inverse transformation equations.

The inverse transform is done in three steps.

First the analog voltages associated with the 64 digital outputs of the decoders are generated in the digital-to-analog converters, which gate voltages from a resistor chain, as at the top of the next page. The diamond-shaped symbol represents a digitally controlled analog gate, or diamond gate; its output is the same as its input when its digital control signal is a 1.

If the resistors labeled R are all equal, and the two supply voltages are +8 and -8, the voltages at the points V_0 through V_{31} assume the values -7.5 to +8 volts in 0.5-volt increments. These are the analog voltages corresponding to the x and y coordinates. Thus, when the x decoder output signal to any one diamond gate is a 1, the x output of the converter is the analog voltage corresponding to a specific abscissa on the matrix. Similarly, the y output corresponds to ordinates.

In the coordinate transformer, the outputs of a sine-cosine potentiometer replace +V and -V, and the output of the resistor chain becomes the desired rotational term for the inverse transformation. The sine-cosine potentiometer has four wipers 90° apart and capable of continuous rotation around a wire-wound resistance whose windings are proportional to the sine and cosine curves. The diamond gates that generate the two cosine terms are in the same order, but those that generate the two sine terms are reversed with respect to each other.

Thinning out equality

Comparator outputs			Thinner outputs			
F1=F2	F2=F3	F3=F4	F1	F2	F3	F4
NO	NO	NO	F1	F2	F3	F4
NO	NO	YES	F1	F2	F3	float
NO	YES	NO	F1	F2	float	F4
NO	YES	YES	F1	F2	float	float
YES	NO	NO	F1	float	F3	F4
YES	NO	YES	F1	float	F3	float
YES	YES	NO	F1	float	float	F4
YES	YES	YES	F1	float	float	float

The sine terms in the transformation equations have opposite signs, and the reversed order eliminates the need to subtract the analog signals.

The second step in transforming is to add the outputs of the resistor chains in pairs, in accordance with the parenthetical part of the inverse transformation equations, using the resistive summing network at the left in the diagram at the top of page 105. Because the current amplifiers on the inputs to the summing network act as buffers, the resistor network need provide only very small currents. These amplifiers can generate up to 10 milliamperes positive or negative current, and their output is within 50 millivolts of their input over the entire range of -10 to +10 volts. The

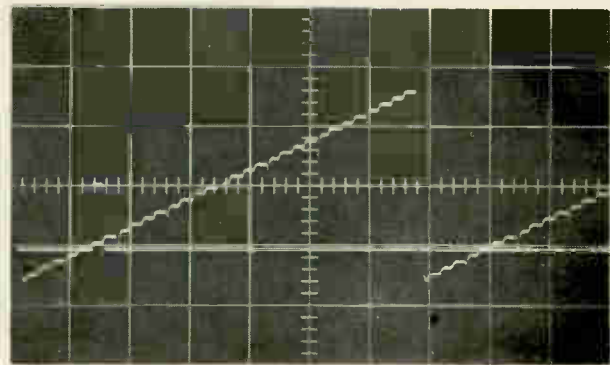
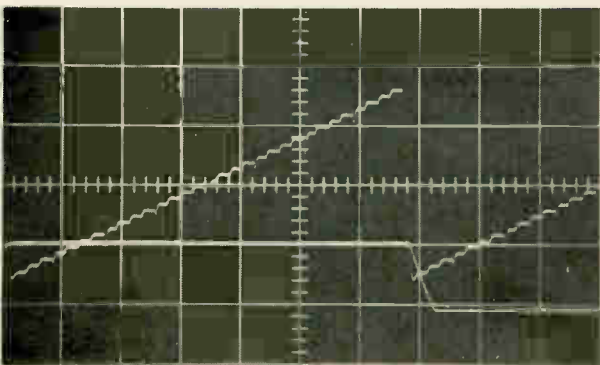
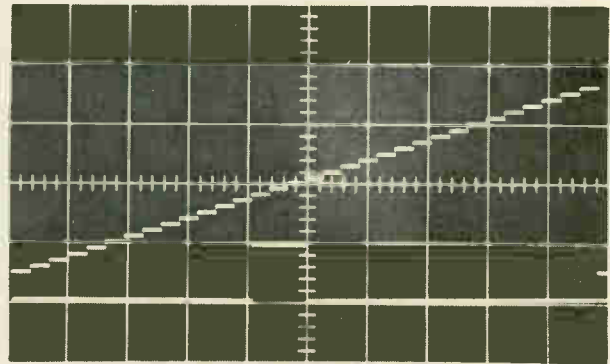
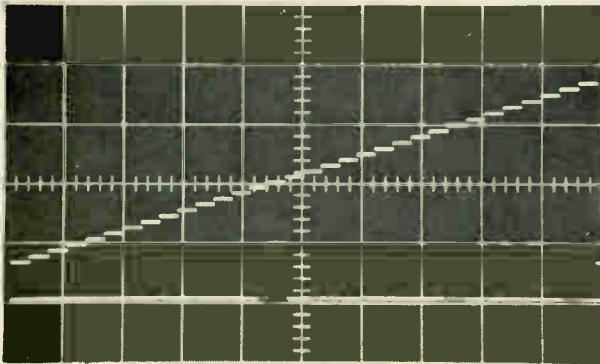

Speed of the Paramatrix. In the two upper oscilloscope traces, the staircase waveforms are of the X-coordinate output from the transformer, viewed over one complete picture scan of about 2 milliseconds. The lower traces in the upper photographs show one of the interpolator outputs, with a fine sensitivity setting in the photo at left and coarse sensitivity at right. The two lower photographs are of the Y-coordinate output on an expanded time scale; the entire staircase takes as much time as one step in the upper photos. The lower traces in the lower photographs show the interpolator output again (left) and the output of the coincidence unit. Note the pulse at left.

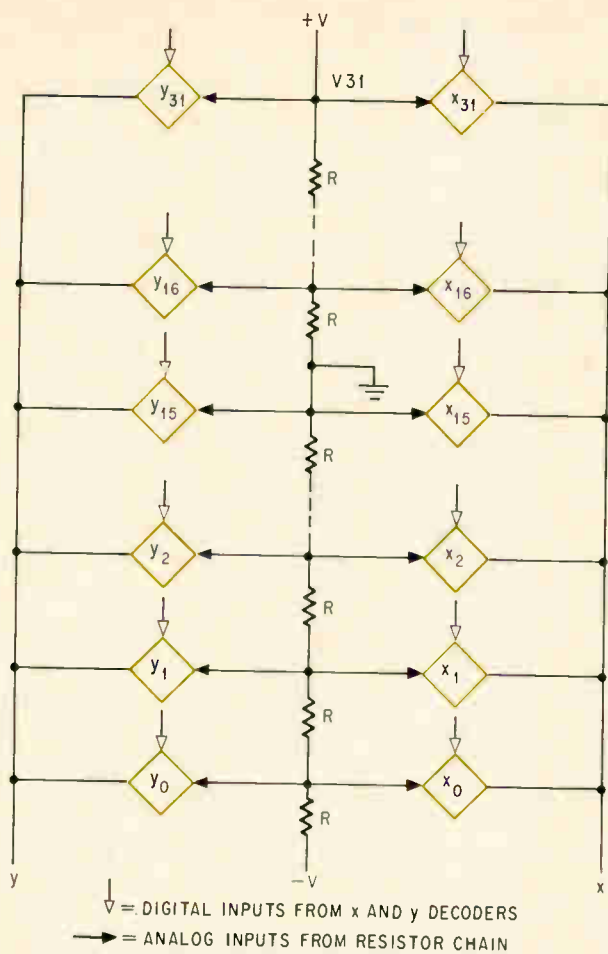

Digital-to-analog converter. Diamond gates (color) convert each of the x and y input coordinates from the digital decoder into an analog voltage.

variable summing resistors vary the coordinate voltage according to the terms $1/m$ and $1/n$, and compensate for gain in the voltage amplifiers and for attenuation in the summing networks.

In the third step, the terms a and b in the equations are added. The terms cover vertical or horizontal movement of the picture and voltage swings compatible with the system. The resistive summing networks, at the right in the diagram at the top of the opposite page, add these terms, which are generated by two potentiometers.

The voltage amplifier has a high input impedance and supplies 10 ma over the entire output range. Its gain is 20, and this remains constant over the frequency range.

Four potentiometers for each of the 32 columns of the matrix set the voltage levels in the range -7.5 to $+8$ volts to specify the 128 points in the input simulator.

Matchup

The input to the interpolator is the X -coordinate output of the coordinate transformer. It is compared with the 32 voltage reference levels, each corresponding to one column of the input picture. When the transformer signal equals a particular

reference level, the corresponding comparator (one of the hexagonal blocks on page 106) puts out a 1 that opens the four associated diamond gates, thus transferring the four simulated input signals for that abscissa to the resistive summing network, and generating the four input Y -coordinates.

If the transformer signal falls between two reference levels, the two nearest comparators produce a 1; two sets of diamond gates open, and the summing network does the interpolating.

The comparator circuit's sensitivity may be varied between 0.2 volt and 2 volts, so that the transformer signal can be compared with as many as nine reference levels or with none. The adjustment permits the smoothing of jagged sections in an input picture. The comparator outputs gate four times their number of potentiometer voltages into the resistive summing network, which produces the average of each group. All four ordinates are produced simultaneously for each abscissa.

Thinning can occur only if the four interpolated Y -coordinates, labeled $F_1, F_2, F_3,$ and F_4 , increase in magnitude in that order. With this restricted ordering, the thinner needs only three analog comparators, not six, and the comparator output gating is simpler. These outputs are 1 if the inputs are equal within some established tolerance. The thinner's outputs appear at the common point of a resistive summing network, as shown at the top of page 107. If no two outputs are equal, the thinned outputs are the same as the inputs; where equality occurs, the smaller-numbered output carries the signal and the other floats electrically.

The table on page 103 shows the thinner's outputs for all possible equality combinations from the interpolator. Each output is actually the average of the various equal inputs; this is usually about the same as one of the equal inputs, but the sensi-

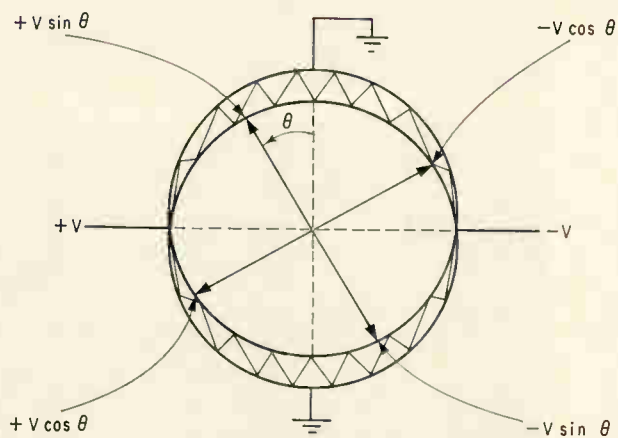

Rotation. A sine-cosine potentiometer connected to the power terminals of a network of diamond gates (color) enables the gates to generate analog signals that match the rotation angle of the potentiometer.

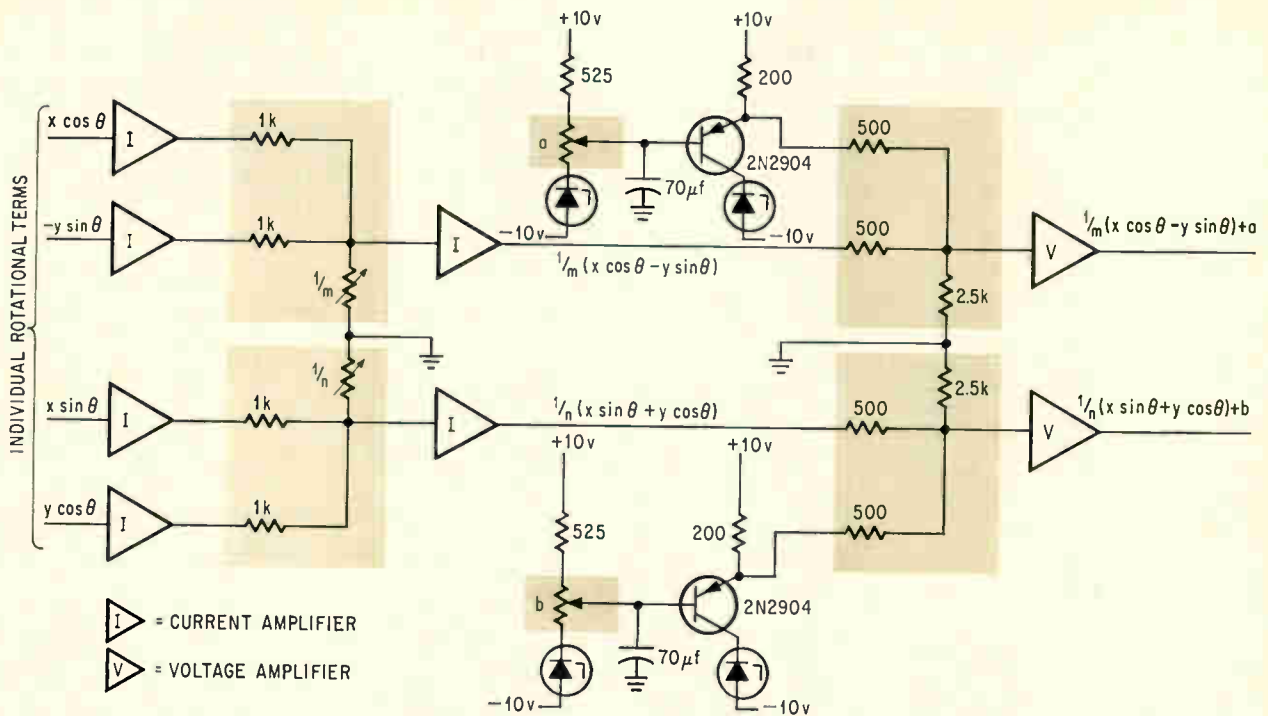

Adder. Resistive summing network (tinted at left) adds up the rotational terms and supplies the factors for magnifying or demagnifying the picture. Current amplifiers isolate the network from the preceding diamond-gate terminals. Translation terms are added by the second-stage summing network at right. Voltage amplifiers at the output boost the signal to sufficient strength for the interpolator and coincidence unit, and the potentiometer circuit provides the translation terms to the second-stage summing network.

tivity setting may cause a small variation.

The inputs to the coincidence unit are the four outputs from the thinner and the Y-coordinate output of the transformer; the Y-coordinate is common to all the comparator circuits. The coincidence unit's comparators determine if any of the thinner outputs are equal to the transformed Y-coordinate. If one or more are equal, and if the Y-coordinate

is within the limits of -7.5 to $+8$ volts as determined by the out-of-range indicator, the unit generates a signal to light a lamp.

Gates

Two types of diamond gates are used in the Paramatrix, both based on the principal of bypass gating. The type used everywhere in the system

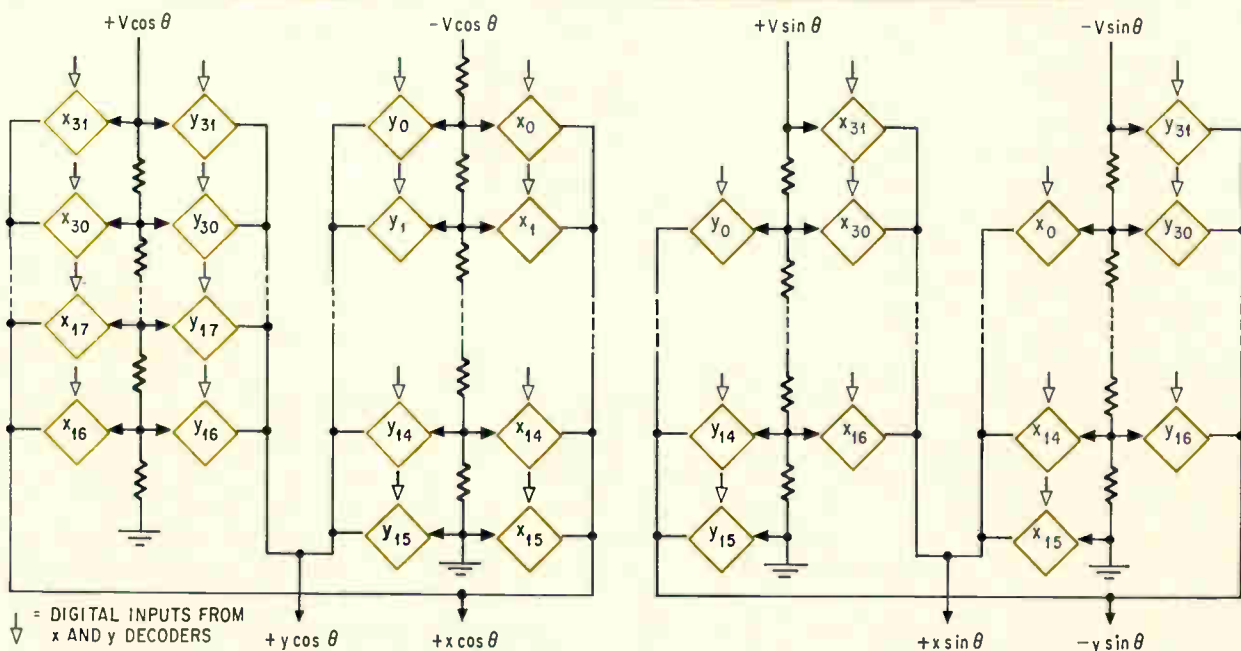

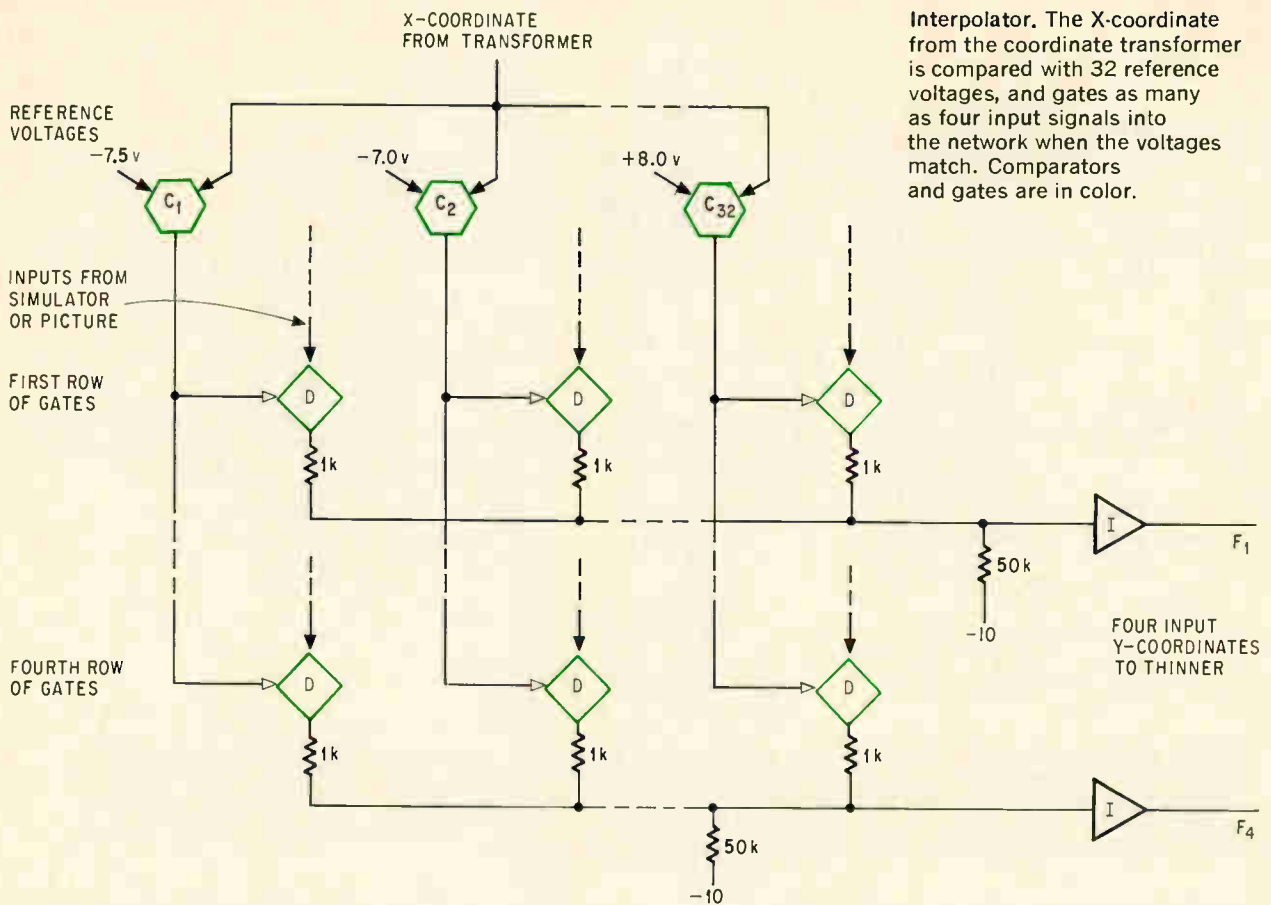

Interpolator. The X-coordinate from the coordinate transformer is compared with 32 reference voltages, and gates as many as four input signals into the network when the voltages match. Comparators and gates are in color.

except the interpolator has a single digital control input. An AND circuit controls the bypass action in the other type, which gates the potentiometer voltages in the interpolator to shut off an unused input.

When the signal at A is at ground potential in the first type of diamond gate, bottom of page 107 in black, the potential at point B is 13 volts and the emitter-base junction of Q_1 is reverse biased. Under these conditions, point C is about 10.7 volts and a current of about 15 milliamperes flows through the bridge diodes. If current is flowing in the bridge, point D is about 0.7 volt—the drop across the diode—above V_{in} . If the diode drops and the d-c gain of Q_2 and Q_3 are matched, point D is also 0.7 volt above V_{out} . Thus V_{out} follows V_{in} with an accuracy of 11 millivolts per milliampere up to 9 ma of input-output current.

The diamond gate is turned off when point A goes to -5 volts; this reduces the voltage at point B to 8 volts and turns on Q_1 . Now point C drops to about 8.7 volts, and this reverse biases the emitter-base junction of Q_2 and diverts the bridge current around the gate through Q_1 .

The second type of diamond gate is made from the first by adding the parts shown in color in the diagram. Both points A and A' must be at ground to turn on the gate. If, for instance, point A is at ground and A' is at -5 volts, point B will be at 13 volts and B' at 8 volts. Q_2 is then on, and point C is approximately at $+9$ volts, which, as

noted before, turns off the bridge circuit. The diodes in the emitters of Q_1 and Q_2 prevent damaging reverse currents.

The analog comparator is simply a difference amplifier. The sensitivity, varied from 0.2 to 2 volts, is controlled by the adjustment at S, which essentially is a variable voltage supply common to all comparators in a particular subsystem.

If both inputs are equal within the desired tolerance, transistors Q_1 and Q_2 are conducting equal amounts of currents, Q_3 is cut off, and Q_4 is conducting. The output is near ground—in this case, the binary 1 level. Now if the input to Q_1 rises substantially above that to Q_2 , Q_1 conducts more heavily and its collector voltage decreases. Because the total amount of current is held constant by transistor Q_5 , transistor Q_2 conducts less and its collector voltage increases. Point C follows the lower collector voltage; when it drops below 10 volts, Q_3 turns on, Q_4 turns off, and the output becomes negative, or a binary 0.

Driving circuits

The flip-flop that drives the indicating lamps is a single-loop regenerative circuit containing two transistors and a lamp that go on and off together. The circuit therefore draws very little power when it is off. The flip-flop is turned on when the x-decoder output, the y-decoder output, and the signal from the coincidence unit all go below -3.6 volts at the same time. The flip-flop turns off when a cur-

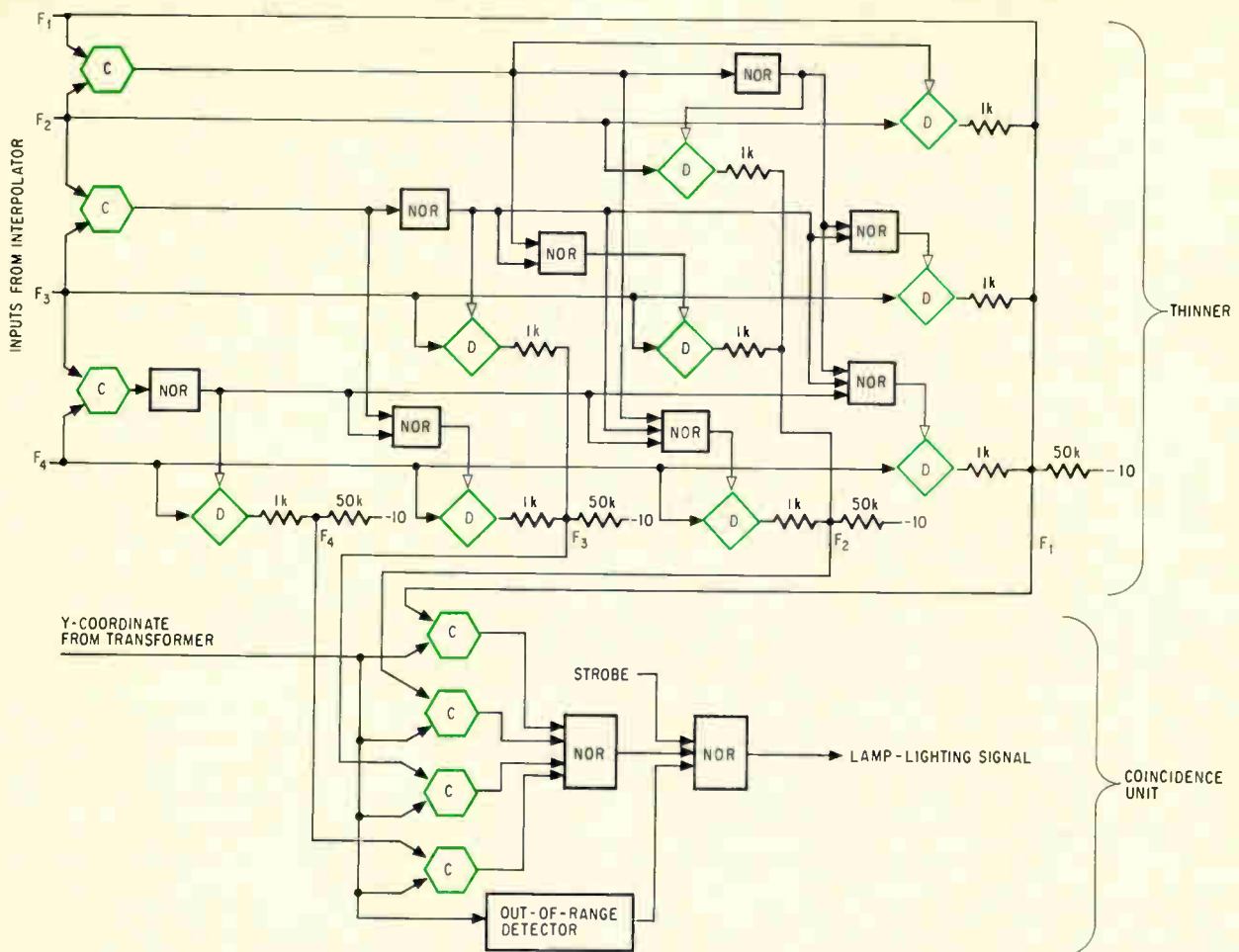

Thinner. The four outputs of the interpolator ($F_1 - F_4$) are compared. If two outputs are nearly equal, the thinner eliminates one of them by closing a diamond gate. The coincidence unit compares the four or fewer outputs of the thinner with the Y-coordinate from the transformer, and a lamp in the display is turned on when the comparators detect a matchup.

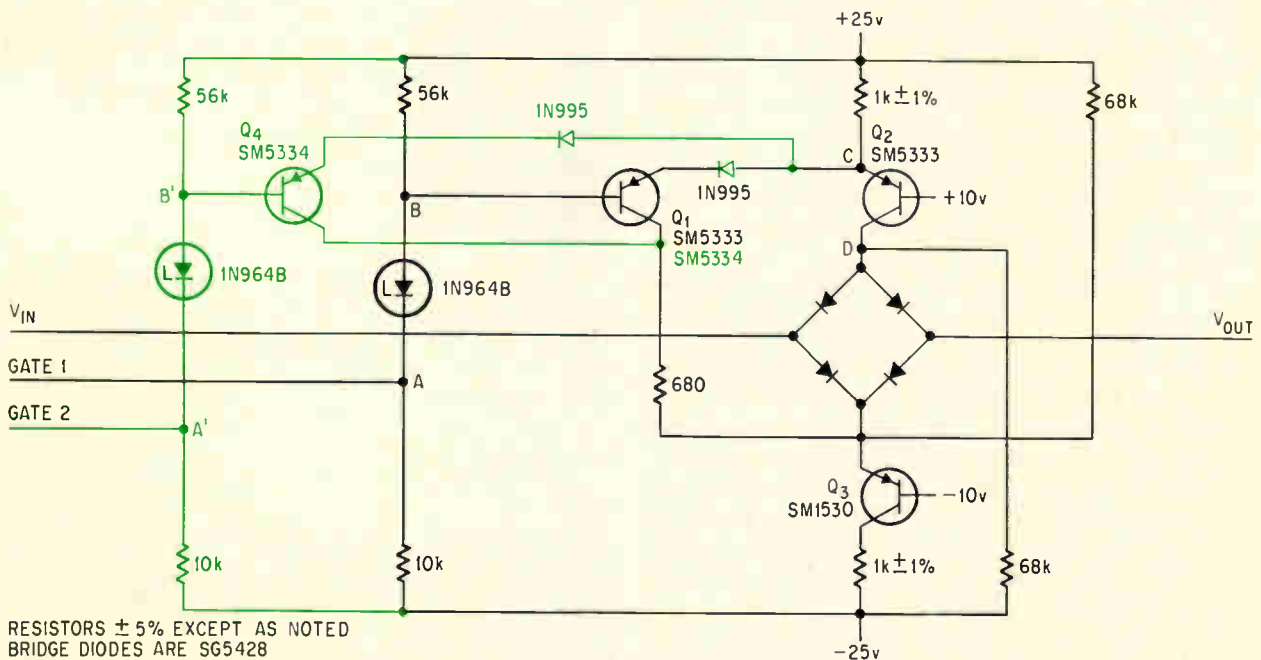

Diamond gate. A simple diode bridge transmits an analog voltage unchanged when an input gating signal is a binary 1. When the gating signal is 0, the output floats regardless of what the analog input is. The more complex diamond gate (with circuitry in color) used in the interpolator needs two digital gating signals to transmit the analog voltage.

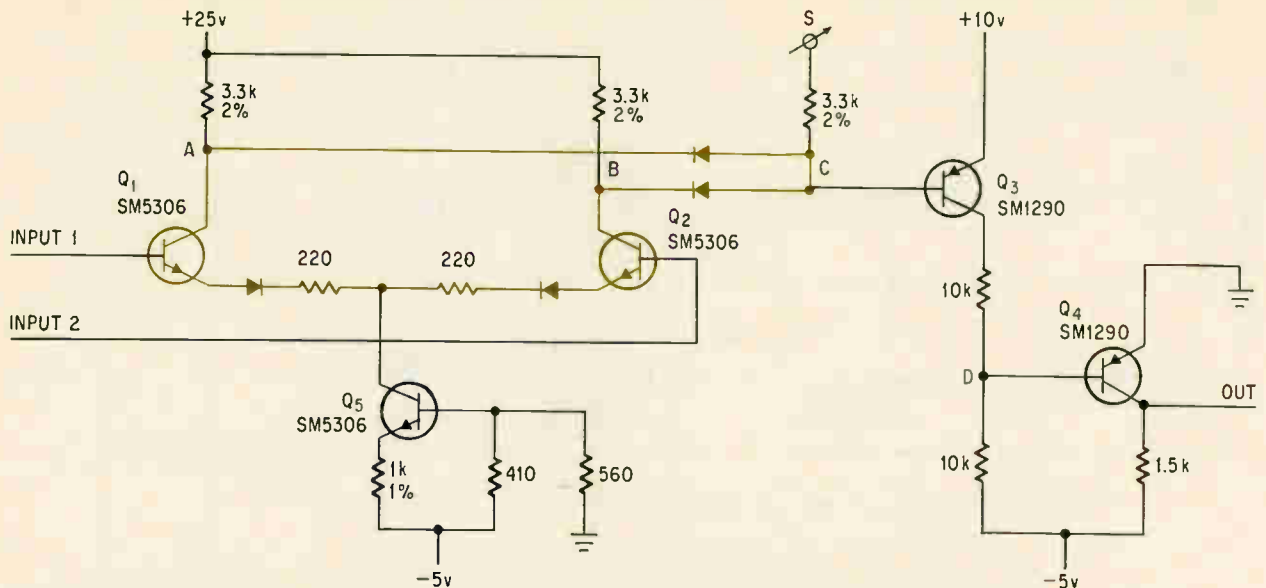

Comparator circuit. A binary 1 output appears when the two inputs are equal within a sensitivity margin determined by the setting at S. The circuit portion in color does the actual comparing. Point C follows the lower of the two collector voltages A and B, depending on which transistor is conducting more heavily.

rent driver circuit cuts off its emitter current.

One current driver circuit drives 32 flip-flops at once. An entire column of lamps is thus turned off just prior to being scanned, and then turned on one at a time if the coincidence unit so indicates.

Strobing and gap-filling

The 64 decoder output signals that drive the coordinate transformer also light the display bulbs. Obviously this lighting has to be inhibited until transients at the output of the coincidence unit have died away. The generation of analog voltages, transformation, blur thinning, and comparison with the input picture require about half a microsecond. To inhibit bulb-lighting during this interval, the Paramatrix timing circuitry is divided into two phases by another counting stage between the clock and the y-counter. During the first phase of a given clock period, the transformer, interpolator, and coincidence units are activated; in the second phase, the bulbs are lighted if the coincidence unit output so indicates.

The Paramatrix fills in gaps by the linear interpolation of the two voltages bordering the gap. The operator activates certain switches that indicate to the system where the gap exists. These switches connect a chain of 5K resistors between the two voltages bordering the gap—one resistor for each column of bulbs included in the gap—and also connect the junctions between resistors to the inputs of the diamond gates in the interpolator. The resistors produce a linearly related set of voltages that override the potentiometer voltages in the columns where the gap occurs.

Even if the output coordinates are in the specified voltage range, one or both of the input coordinates will be out of range for certain values of a , b , m , n , and θ . Since points of interest in the input aren't defined outside the specified range, a spuri-

ous signal could conceivably arise that could light a bulb in the output display corresponding to a non-existent or meaningless point in the input.

To prevent this, an out-of-range indicator checks the Y-coordinate on its way to the coincidence unit. The out-of-range indicator is a modified comparator whose digital output is a 0 if its analog input is less than -7.5 volts or more than $+8$ volts. A bulb-lighting signal can be produced only if the out-of-range output is 1.

The authors



W.J. Poppelbaum, a professor of electrical engineering at the University of Illinois, originated the Paramatrix idea and headed the design and construction work.



Michael Faiman is an assistant professor of electrical engineering. He did most of the design work on the Paramatrix.



Edward Carr, an engineering assistant in the Digital Computer Laboratory, assembled and debugged the Paramatrix prototype.

Leadership

We developed this new Operational Amplifier for its combination of high performance and low cost.



TYPICAL SPECIFICATIONS — Model 809CE

- Offset Voltage Drift: $10\mu\text{V}/^\circ\text{C}$
- Offset Voltage: 5 mV
- Offset Current Drift: $1.0\text{ nA}/^\circ\text{C}$
- Offset Current: 50 nA
- Power Supplies: $\pm 15\text{ V}$
- Power Dissipation: 90 mW
- Compensation:
40 db gain — none
0 db gain — two components
- Monolithic Integrated Circuit
in TO-78 or dual inline package
- Common Mode Range: $\pm 13\text{ V}$
- Common Mode Rejection Ratio: 90 db
- Power Supply Rejection Ratio: 90 db
- Gain: 40,000
- Input Impedance: 200K Ω
- Output Swing (5K load): 24 VP-P
- Output Short Circuit Protected
- Temperature Range:
Operating 0°C to $+100^\circ\text{C}$
Storage -65°C to $+150^\circ\text{C}$

Price:	1-99	100-99	1000	10,000
	6.50	5.85	5.00	4.50

Please compare the 809 with other Operational Amplifiers in the same price range, including the one you are now using, and buy the one you think is best.

AMELCO SEMICONDUCTOR

DIVISION OF TELEDYNE, INC. • 1300 TERRA BELLA AVENUE • MOUNTAIN VIEW, CALIFORNIA • Mail Address: P. O. Box 1030, Mountain View, California • Phone: (415) 968-9241 • REGIONAL OFFICES: East — Westwood, Mass., 805 High Street, (617) 326-6600; Melville, L. I., N. Y., (516) 692-4070; Syracuse, N. Y., (315) 437-8343; Paterson, N. J., (201) 696-4747; Glenside, Pa., (215) 887-0550; Towson, Md., (301) 825-3330; Orlando, Fla., (305) 423-5833 • Midwest — Des Plaines, Ill., 650 W. Algonquin Rd., (312) 439-3250; Cedar Rapids, Iowa, (319) 366-0635; St. Louis, Mo., (314) 427-7200; Farmington, Mich., (313) 474-0661; St. Paul, Minn., (612) 488-6634; Columbus, Ohio, (614) 299-4161; Dallas, Texas, (214) 631-6270 • Northwest — Home Office, Mountain View, Calif.; Los Altos, Calif., (415) 941-0336; Seattle, Washington, (206) 323-5100 • Southwest — Los Angeles, Calif., Suite 213, 8621 Bellanca Ave., (213) 678-3146; Los Angeles, Calif., (213) 870-9191; San Diego, Calif., (714) 298-4711; Phoenix, Ariz., (602) 277-9739; Albuquerque, N.M., (505) 268-0928; Littleton, Colo., (303) 798-8439 • Canada — Montreal, P.Q., (514) 384-1420.

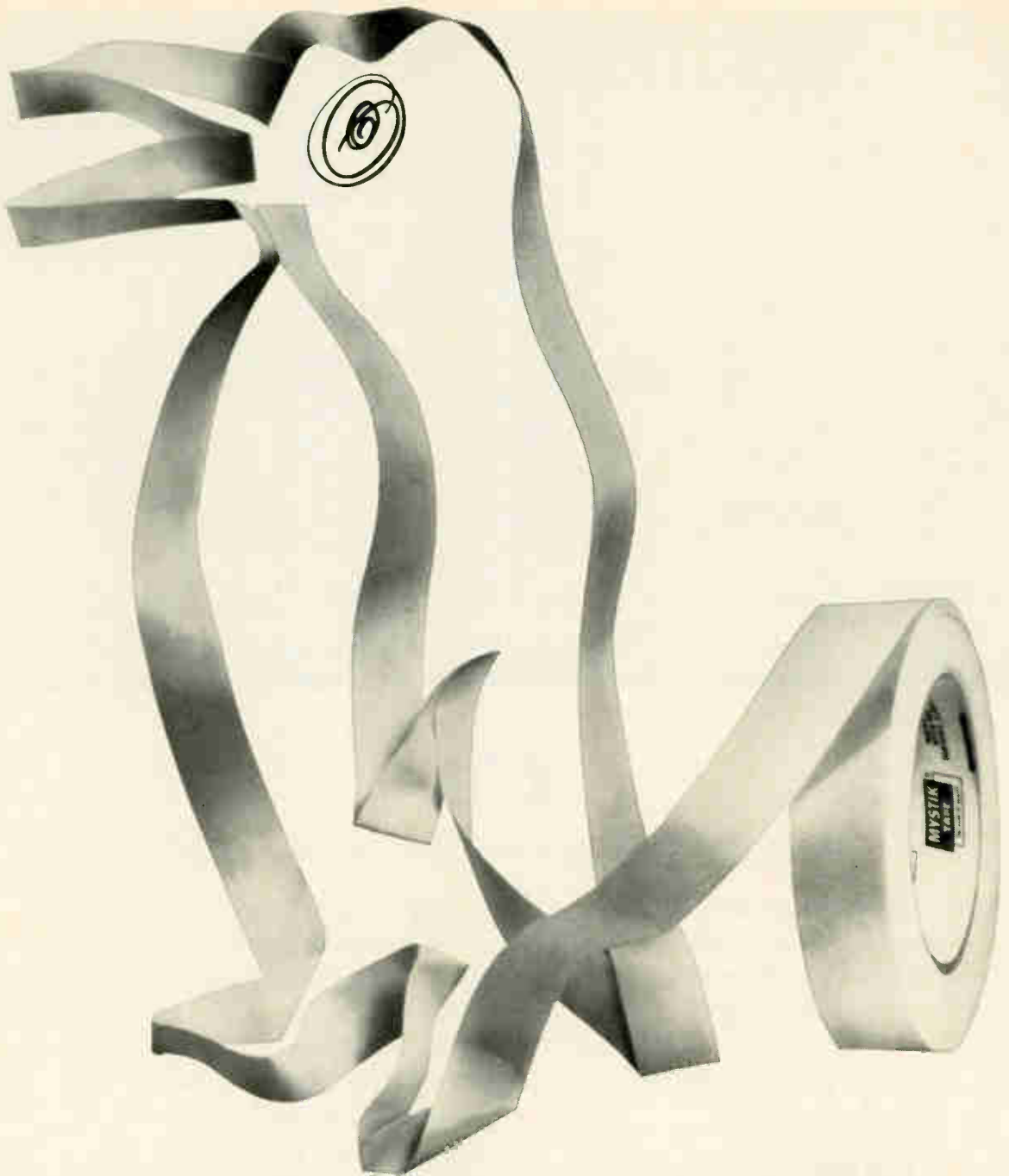

For hot and cold insulation...Mystik 7000!

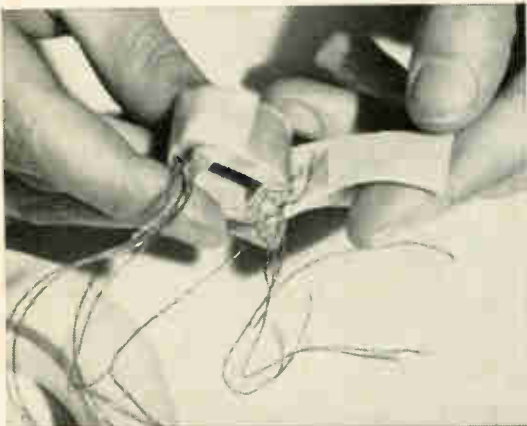

Superior thermal and electrical properties make Mystik 7000 suitable for an unusual range of cryogenic and elevated temperature applications. Uniquely inorganic, it has a tightly woven high tensile glass cloth backing with a pressure-sensitive silicone adhesive. Mystik 7000 has exceptionally high dielectric strength and offers high conformability and excellent shear resistance.

Here is a remarkable tape, perfect for insulating motors, generators or other components which must perform in critical operating environments.

This is only one of the Mystik family of tapes for the electrical industry. If you have an insulating problem or extreme temperature requirement, call your Mystik distributor. He's in the Yellow Pages under "Tape". Or write: The Borden Chemical Company, Mystik Tape Div., 1700 Winnetka Ave., Northfield, Illinois.



**BORDEN
CHEMICAL**



CERRO-FLEX* **Flat flexible cables** **give you less...**

- *Less space*... saves up to 75% as compared to round wire bundles... and eliminates nuts, bolts, clamps and brackets.
- *Less weight*... saves up to 60% by using thin, lightweight insulation and conductors.
- *Less risk*... eliminates errors because of simplicity and accuracy of connections... increases reliability and uniformity.
- *Less cost*... saves up to 50% on installed costs... minimizes handling, installation, and inspection time.

CERRO FLEX printed wiring and flexible cables are the logical solution to today's critical demands on electronic equipment. And Cerro is the logical source for reliable, high-quality materials.

We'll be glad to help you design circuits for... missiles, rockets and satellite systems; computers and data processing equipment; defense and weapons systems; instruments and control systems; and telemetering and communication equipment.

Cerro Wire & Cable Co., Division of Cerro Corp.
New Haven, Connecticut 06504.

Write now for our free,



authoritative 12-page design guide (CF-1/67-5M). It'll show you how to reduce weight, save space, simplify assembly, increase reliability and uniformity and... cut costs.

CERRO
WIRE & CABLE

ORDINARY 5 AND 10 AMP RELAYS MIGHT PERFORM LIKE THE NEW SIGMA SERIES 50.

If they had these features.

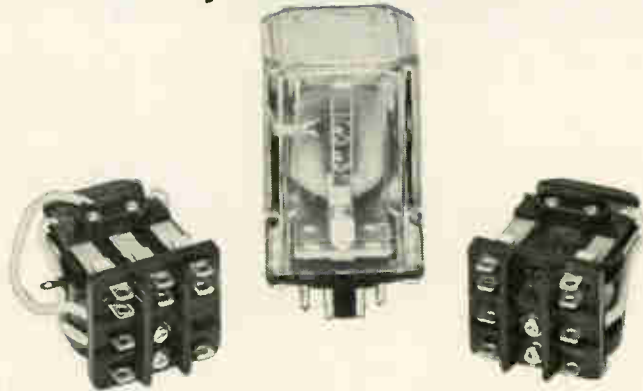

New 1, 2 and 3 pole Sigma Series 50 relays have five advantages over ordinary relays of this type.

All versions are recognized under the U.L. component program: AC-DC types; 1, 2 or 3 poles; open or plastic-dust-covered; the complete variety of coil and contact ratings.

Longer Contact Life: Slots in contact base between fixed contacts eliminate build-up of vaporized contact material and leakage paths. This prevents premature failure and is particularly effective at higher loads.

Coil Lead Breakage Eliminated: Molded phenolic bobbin assures positive mechanical interlock with frame preventing coil rotation and lead breakage.

Greater Motor Efficiency: Adjustable armature hinge permits optimum seating of armature on

pole face. Assures precise contact alignment as well as maximum use of drive circuit power.

Better Adjustment Stability: Contact base and armature support of diallyl phthalate. This does not deform under mechanical and thermal stresses.

We'd like to give you a new Sigma Series 50— or any of our other standard relays. Test and compare it against the brand you may now be using. It's the best way we know to prove what we say about Sigma relay performance. Just circle our reader service number. We'll send you the new Sigma relay catalog and a "free relay" request form. Return the form to us and your Sigma representative will see that you get the relay you need.

Need fast delivery? The new Series 50 is available off-the-shelf from your Sigma distributor.

SIGMA DIVISION  SIGMA INSTRUMENTS INC
Assured Reliability With Advanced Design / Braintree, Mass. 02185
Sigma Instruments (Canada) Ltd., P.O. Box 43, Toronto 18

Just 40¢ to ship a cubic foot of PELASPAN-PAC® loose-fill packing via 1st class (anywhere within the U.S.). \$3.20 for other kinds of packing materials. Gives you an idea of the savings in truck and rail costs when you use PELASPAN-PAC. A cubic foot of it weighs only 8 oz., 8 times lighter than other packing materials.

PELASPAN-PAC does a better job of cushioning delicate

electronic instruments on trips from here to there. The curled pieces of expanded polystyrene interlock. They actually hold the packed item in suspension. Never wad into a lump or collapse like makeshift packing materials do.

PELASPAN-PAC has other ad-

vantages. It's clean and dust free. So easy to work with, you'll realize major savings in labor time and cost.

Now that you've weighed the facts, isn't PELASPAN-PAC the best?

Your nearby distributor has it. Write us for his name.

The Dow Chemical Company, Plastics Sales, Department 71230, Midland, Michigan 48640.



Packing for shipment? Weigh the cost.

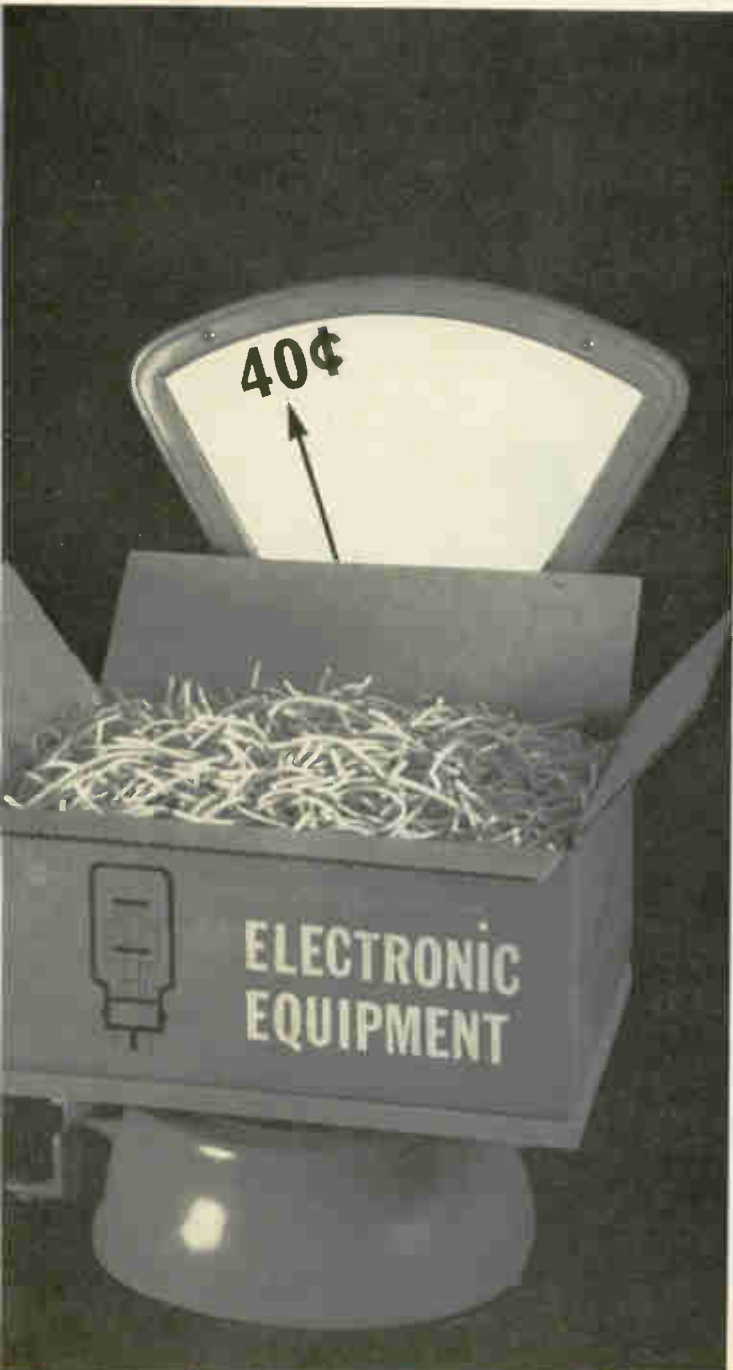

V for... Butterfly®

The unique Licon® Butterfly® double-break switch design is as simple as that—two blades that flex simultaneously, then actuate with a positive snap. That simple engineering concept has led to a full line of 2, 4 and 6-circuit miniature, sub-miniature and heavy-duty Butterfly® switches that fight hard to keep your products reliable and durable. It takes a book to tell the story. **This is what it looks like.**

We'd like to send you a copy. Ask.



**Be Victorious with LICON...
fastest growing
full-line switch supplier**

i t LICON
W

DIVISION ILLINOIS TOOL WORKS INC.
6615 WEST IRVING PARK ROAD — CHICAGO, ILLINOIS 60634

"Remember, you're never more than a few feet away from a product of ITW"®

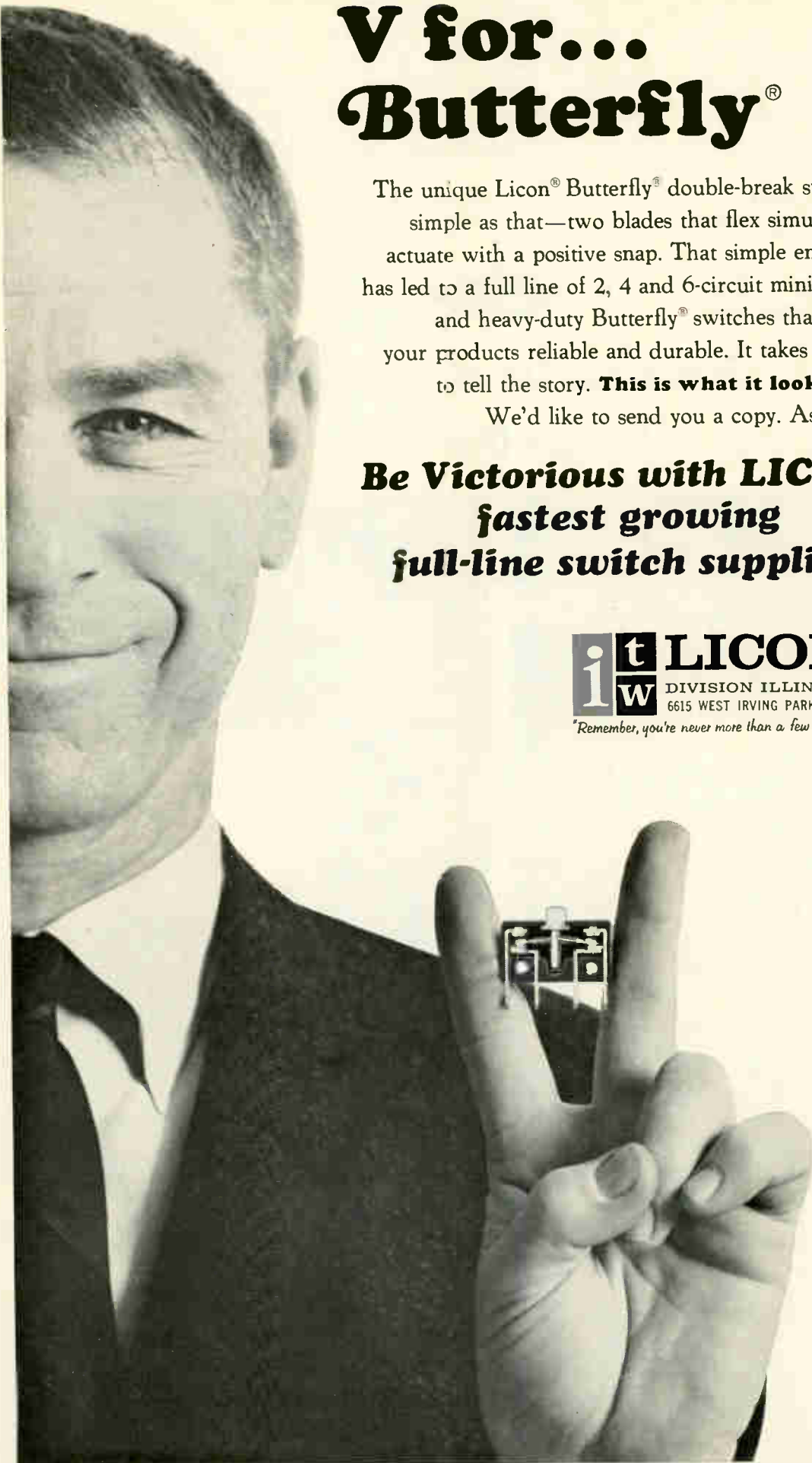

±0.05% regulation is only one of twelve outstanding specs in Helipot's exclusive new microcircuit dc voltage regulator series.



MODEL 803 DC Voltage Regulator, one of a complete family of six miniature, hybrid cermet thick film units with outputs from 3 to 32 volts.

The other eleven:

- short circuit proof models
- small size—0.5 sq. in.
- low profile—0.170"
- up to 5 amps load current
- output range—3 to 32 volts
- fixed and adjustable outputs
- fully sealed
- hybrid cermet construction
- operating temperature range: -55°C to +125°C
- 60 db ripple rejection
- mil spec tested

The price:

- \$30.00—fixed output models
- \$35.00—adjustable output models

(prices are 1-9 quantity, delivery from factory stock)

The applications:

Helipot Series 800 DC Voltage Regulators are physically compatible with dual in-line and flat pack integrated circuits. This permits system use of unregulated power with precise regulation at the point of use. In addition to the 1,000:1 ripple rejection capability, these units provide excellent circuit decoupling and protection from transients and sudden power surges.

	Application		
	Digital Circuits 3 to 9 Volts	Analog Circuits 9 to 21 Volts	Airborne and General Purpose Circuits 20 to 32 Volts
Fixed Output	Model 805 Reader Service No. 481	Model 801 Reader Service No. 482	Model 803 Reader Service No. 483
Adjustable Output	Model 806 Reader Service No. 484	Model 802 Reader Service No. 485	Model 804 Reader Service No. 486

Ask your local Helipot sales representative for information or circle the appropriate number on the reader service card.

Beckman®

INSTRUMENTS, INC.
HELIPOT DIVISION

FULLERTON, CALIFORNIA • 92634

INTERNATIONAL SUBSIDIARIES: GENEVA, MUNICH; GLENROTHES, SCOTLAND; TOKYO; PARIS; CAPE TOWN; LONDON; MEXICO CITY

Tips on cooling off hot transistors

See how circuit designers use IERC heat dissipators to protect semiconductors...improve circuit performance and life.

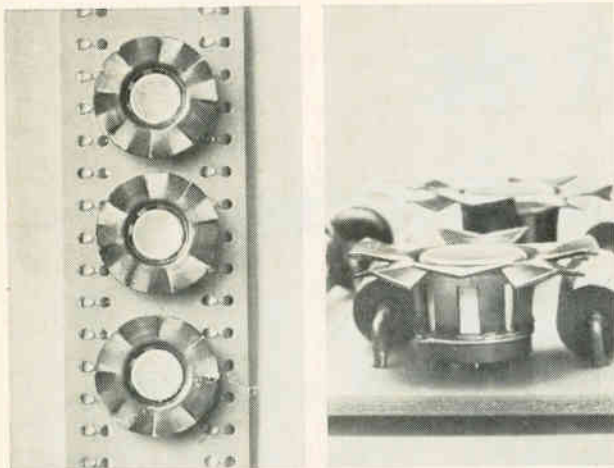

Fan-top dissipators for TO-5 and TO-18 cases drop temperatures dramatically; cost just pennies. T-shape adds almost nothing to board height; allows components to snuggle close to transistors. Spring fingers provide fast, press-on installation.



To cool off low-to-medium power transistors in TO-5 and TO-18 cases, use IERC's efficient LP's. Patented, staggered-finger design maximizes radiation and convection efficiency, radiates heat directly to ambient. Available in single or dual mounting for thermal mating of matched transistors.

IERC Thermo-Link Retainers provide efficient thermal links between transistors and chassis or heat sinks. (Also, excellent dissipation when used on p-c boards.) Integral BeO washers reduce capacitance up to 2/3. Fast, no-snap installation; transistors are firmly held.

New! Dissipators and retainers for plastic and epoxy transistors. 3 new series for RO-97A, RO-97 and X-20's. Permit a jump of 10% to 33% in operating power.

Free 8-page short form catalog discusses IERC's complete line of dissipators, retainers and tube shields. Gives specifications, prices, how to order. Send for your copy today.



Special insulating coating — Insulube 448, a special non-hygroscopic finish developed by IERC, combines excellent dielectric properties, 50 K megs insulation resistance, and high heat emissivity. Also protects against salt spray, fungus, etc.

Tough heat dissipating problem? IERC engineers welcome your letter-head inquiry for specific information or assistance in selecting heat dissipators.

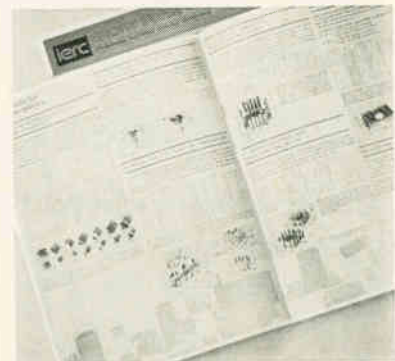
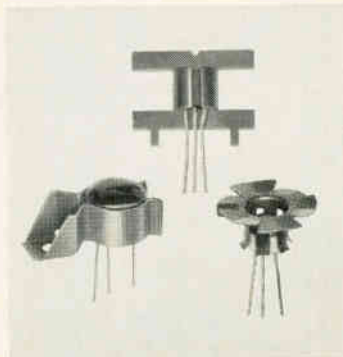

ierc
SEMICONDUCTOR
HEAT DISSIPATORS

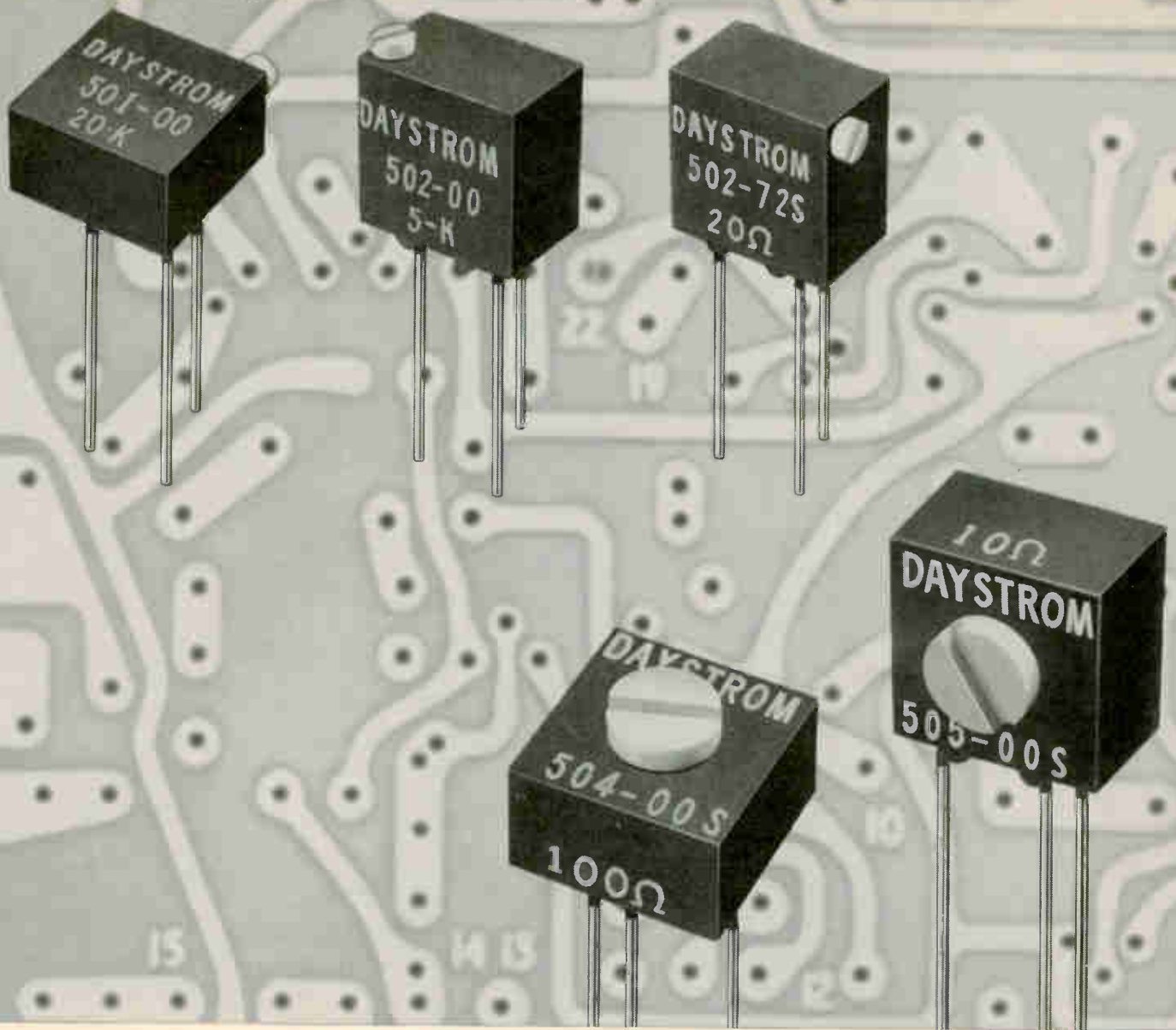

Savings across the board just took a new turn

DAYSTROM Commercial Squaretrim® potentiometers now include single-turn types. New models 504 and 505 are fully adjustable with just one turn. Models 501 and 502 are 15-turn types. They all clear up to 80% more PC board space—at no extra cost. But the trim .02 cubic inch size is only one reason why these commercial 500 Series pots are proving so popular. They also feature Weston's exclusive wire-in-the-groove design, and all these performance extras:

Convenience 5 different configurations with adjusting screw on top, side or end • Tolerance $\pm 5\%$ • Adjustability 15 turns or single turn • Slip Clutch eliminates wiper damage, cuts production delays • Suregard™ Terminations for better protection against vibration, shock and humidity—no pressure taps • Superior Resolution 0.125% or less • Wide Range 10Ω to $20K$ (higher values on request) • High Power 0.6 watt in still air at $70^\circ C$ • Wide Temperature Range $-55^\circ C$ to $150^\circ C$ • Low Temperature Coefficient 70 ppm max. • Low Noise 100Ω max. ENR • Small Size $\frac{3}{16}'' \times \frac{3}{16}'' \times \frac{3}{16}''$ • Low Cost \$2.10 each for 501/502 in 500 lot quantity, \$1.95 each for 504/505 in 500 lot quantity.

Daystrom potentiometers are another product of:

Weston Instruments, Inc. • Weston-Archbald Division • Archbald, Pa. 18403

WESTON® *prime source for precision . . . since 1888*

Throw away your old '67 Burr-Brown Catalog. It's 1967½!

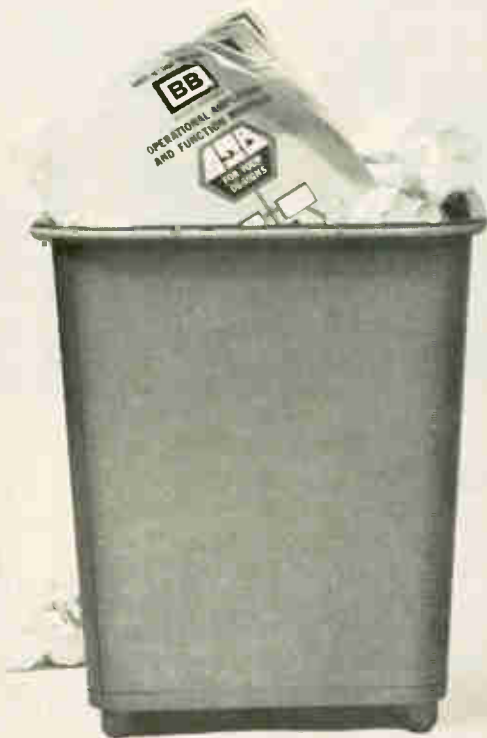

NEW OPERATIONAL AMPLIFIERS

Model 3049/15—SMALLEST CHOPPER STABILIZED UNIT. Only 1.80" x 1.20" x .60". Maximum voltage drift: 1 $\mu\text{V}/^\circ\text{C}$. Maximum current drift: .002 nA/ $^\circ\text{C}$. 500 kHz full power response. 160 dB gain. \$165.00

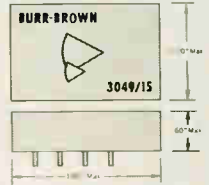

Model 3038/25 — HIGH COMMON MODE VOLTAGE, HIGH SUPPLY REJECTION LOW CURRENT OFFSET. Rated output: 100 V at 20 mA, minimum. 100 V common mode limit. Operates from any power supply voltage from $\pm 40\text{ V}$ to $\pm 135\text{ V}$ with output voltage 20 volts less than supply. Input impedance 10^{11} ohm. Input current offset: 0.1 nA. In a 2.40" x 1.80" x .60" package. \$175.00

Model 3071/25 — LOW FLICKER NOISE (6 μV peak to peak), FAST OVERLOAD RECOVERY (less than 1 μsec). Voltage drift less than 0.5 $\mu\text{V}/^\circ\text{C}$ max. Current drift 0.001 nA/ $^\circ\text{C}$ max. From -25°C to $+85^\circ\text{C}$. \$175.00

Model 3044/15 — HIGH SUPPLY REJECTION (2 μV per Volt and 0.5 nA per Volt) VARIABLE POWER SUPPLY (± 6 to $\pm 32\text{ V}$) Output Voltage = supply voltage minus 4 Volts. Output current: $\pm 10\text{ mA}$. \$75.00

Model 3063/40 — HIGH OUTPUT CURRENT ($\frac{1}{2}$ Amp) — HIGH SUPPLY REJECTION (2 μV per Volt and 0.2 nA per Volt). Ideal for servo applications. Completely encapsulated in 2" x 2" x 1" package. No external heat sinks required. Operating temperature range: -40°C to $+85^\circ\text{C}$. \$135.00

NEW QUARTER SQUARE MULTIPLIER

Model 4012/25 — Fully encapsulated in 2.40" x 1.80" x .60" package. Accuracy: $\pm 0.15\%$, 3 db response is 1 mHz. Rated output: 10 Volts at 10 mA. Will operate in multiply, divide, square, and square-root modes. Requires no external amplifiers. \$695.00

NEW SAMPLE AND HOLD MODULE

Model 4013/25 — Fully encapsulated in 2.40" x 1.80" x .60" package. Accuracy: $\pm 0.1\%$. Aperture time: 50 nsec. Acquisition time as low as 1 μsec . Frequency response: 500 kHz. \$225.00

NEW 20-PAGE FALL CATALOG

These and many other important new product developments are included in the new Burr-Brown 20-page fall 1967 catalog. It's available from your Burr-Brown Representative . . . or, use this publication's reader service card.

BURR-BROWN

RESEARCH CORPORATION

International Airport Industrial Park • Tucson, Arizona 85706
TELEPHONE: 602-294-1431 • TWX: 910-952-1111 • CABLE: BBRCORP



Operational Amplifiers
Instrumentation Amplifiers
Function Modules
Analog Simulators
Geophysical Instruments

ENGINEERING REPRESENTATIVES: ALABAMA, HUNTSVILLE (205) 534-1648 / ALASKA, ANCHORAGE (907) 272-5231 / ARIZONA, PHOENIX (602) 254-6085 / CALIF., LOS ANGELES (213) 665-5181, SAN FRANCISCO (408) 245-3321 / COLO., DENVER (303) 388-4391 / CONN., ENFIELD (203) 749-7888 / D.C., WASHINGTON (SEE MARYLAND) / FLORIDA, ORLANDO (305) 425-2764 / ILLINOIS, CHICAGO (312) 286-6824 / LA., NEW ORLEANS (504) 888-2266 / MD., SILVER SPRING (301) 588-8134 / MASS., BOSTON (617) 245-4870 / MICH., DETROIT (313) 353-3822 / MINN., MINNEAPOLIS (612) 781-1611 / MO., ST. LOUIS (314) 524-4800 / N.C., GREENSBORO (919) 273-1918 / N.J., CAMDEN (215) 925-8711 / N.M., ALBUQUERQUE (505) 255-1638 / N.Y.,

ALBANY (518) 436-9649, BINGHAMTON (607) 723-9661, MT. VERNON (914) 968-2200, NEW HARTFORD (315) 732-3775, ROCHESTER (716) 473-2115 / OHIO, CINCINNATI (513) 761-5432, CLEVELAND (216) 237-9145, DAYTON (513) 277-8911 / OKLA., TULSA (918) 835-2481 / OREGON, PORTLAND (503) 292-8762 / PENN., PHILADELPHIA (SEE CAMDEN, N.J.), PITTSBURGH (412) 243-6655 / TEXAS, DALLAS (214) 363-1671, HOUSTON (713) 928-5251 / UTAH, SALT LAKE CITY (801) 466-3709 / VIRGINIA, (SEE MARYLAND) / WASH., SEATTLE (206) 767-4260 / CANADA, TORONTO (416) 293-7011

Weatherford ships TI Series 54/74 TTL in quantity



Use Series 54/74 integrated circuits from Texas Instruments in your new digital systems. You'll realize higher performance and substantial cost savings.

This family of TI circuits is the most versatile and complete in the industry, offering designers the broadest choice of speed, power dis-

sipation, performance and cost-per-function available today.

One hundred eighty different integrated circuits make up this family, including standard and high speeds, military and industrial temperature ranges, dual in-line and flat-pack designs, and 39 circuit functions. This broad selection

enables you to tailor digital system designs to your exact requirements.

There's no problem of *availability* when you specify TI devices. Our complete stocks enable us to make delivery of the devices you need...in the quantities you require... at the time you specify.

Call us *today!*



R. V. WEATHERFORD CO.

DISTRIBUTORS OF ELECTRONIC COMPONENTS AND EQUIPMENT

ANAHEIM, CALIFORNIA

1651 State College Blvd.
714-532-6741
714-547-7521

GLENDALE, CALIFORNIA

6921 San Fernando Road
213-849-3451

PALO ALTO, CALIFORNIA

3240 Hillview Drive
Stanford Industrial Park
415-321-5373

SALES OFFICES

Albuquerque, N.M.
505-298-5593

Phoenix, Arizona
602-272-7144

Pomona, California

714-966-8461 714-623-1261

San Diego, California

714-278-7400

NOW WITH CUSTOMIZED COMPONENTS
**WEATHERFORD
SERVICE
PLUS** 

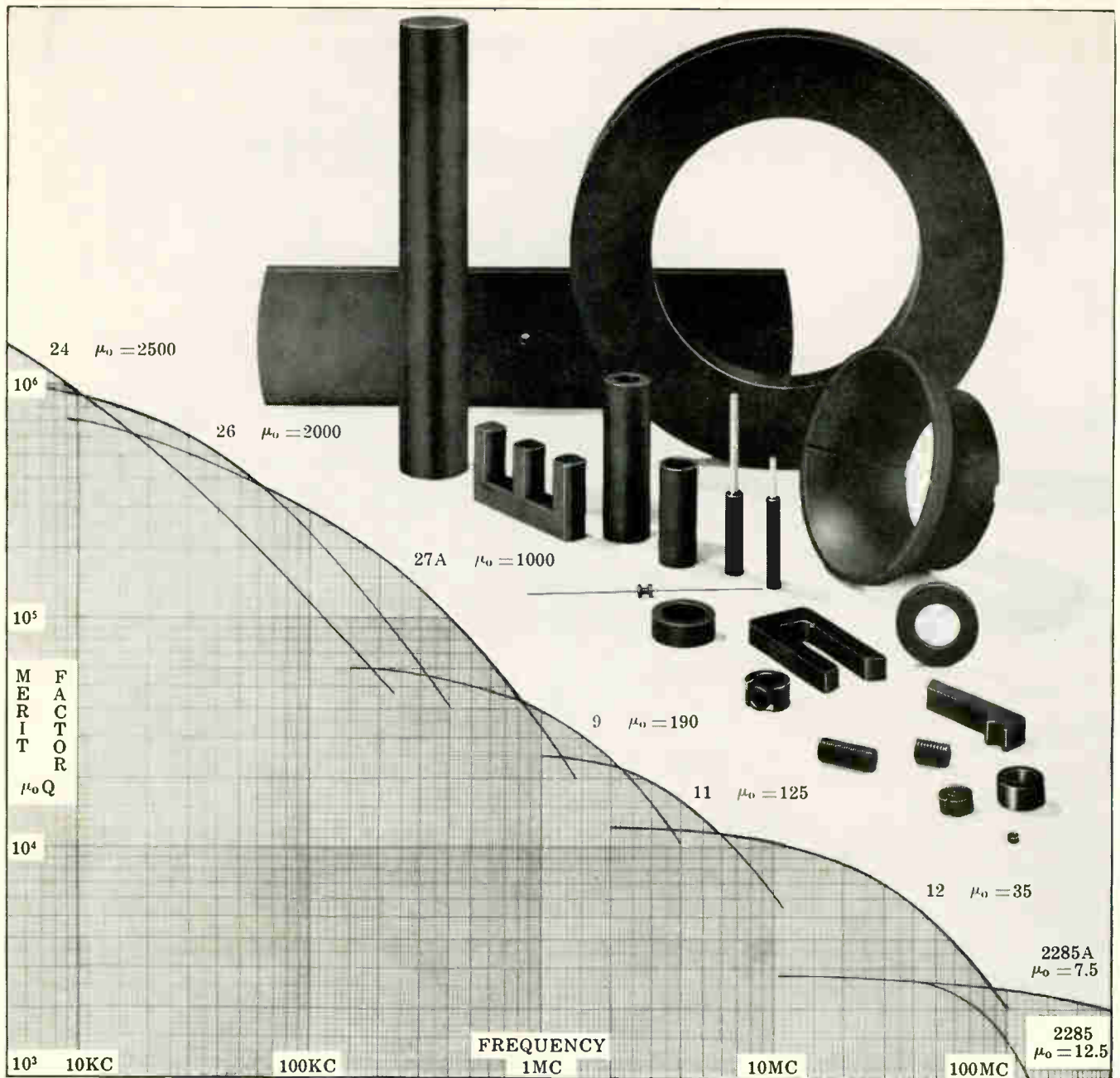

CERAMAG® FERRITE PARTS ARE CONSISTENT

Stackpole offers over 30 grades of Ceramag® material. More are being developed continually. Such up-to-the-minute technology permits you to specify Ceramag® on every new application. Discover the unique advantages of the versatile Ceramag® ferrites: complete moldability to virtually any shape, and the important savings over steel alloys for low frequency applications. When high permeability is an important factor, Ceramag® is the answer.

Hundreds of Ceramag® parts are already tooled as toroids, cup cores, insert cores, transformer cores, deflection yokes and rectangular solids. Special tooling is also available.

Stackpole is a name long associated with quality components in the electronic field. Only the closest attention to every production detail can result in the kind of product uniformity available with Ceramag® ferrites. As one of our customers

put it, "Your ferrite cores are more consistent from order to order than any of your competitors."

If you are about to select a ferromagnetic material for a new application, or if you are dissatisfied with the performance and service of your present ferrite supplier, why not investigate Stackpole's Ceramag®? To discover how you can save and still insure superior performance, write for our Bulletin 1-A, Stackpole Carbon Company, Electronic Components Division, St. Marys, Pennsylvania 15857. Phone: 814-781-8521 — TWX: 510-693-4511.



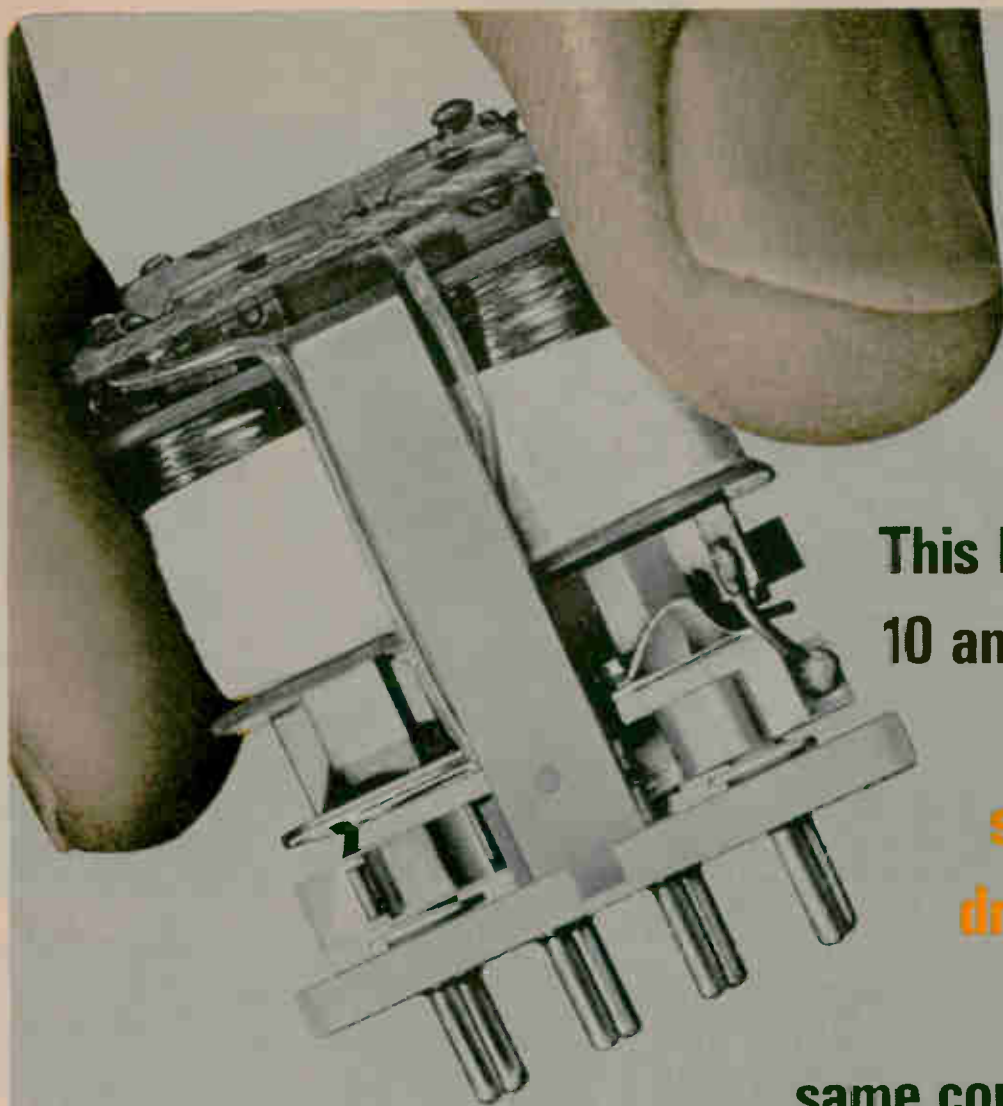

**This Babcock
10 amp. relay
also
switches
dry circuit
with the
same contact set**

Now, your Babcock 10 amp. full size crystal can relay will also switch dry circuit with the same set of contacts. These exclusive universal contacts have greatly simplified your relay stocking requirements. You can order one model to meet a given set of performance parameters without concern for load requirement — *at no cost premium*. Get complete information about this versatile relay, and the entire Babcock line, all with universal contacts.

Write Babcock Relays, Division of Babcock Electronics Corporation, 3501 Harbor Boulevard, Costa Mesa, California 92626; or telephone (714) 540-1234.



The Babcock Model BR7 relay will perform from dry circuit to 10 amps., with universal contacts, and is designed to meet critical aerospace applications.

SPECIFICATIONS

SIZE
1.200" h x 1.075" L x .315" w

WEIGHT
Approx. 1.0 oz.

CONTACT ARRANGEMENTS
SPDT and DPDT

FULL-ON POWER
Low to 80 mw.

LIFE
100,000 operations, min.

TEMP. RANGE
-65°C to +125°C

FROM THE BABCOCK FAMILY OF CRYSTAL CAN RELAYS



HALF SIZE
4PDT
dc to 10 Amps



FULL SIZE
DPDT
dc to 10 Amps



HALF SIZE
SPDT & DPDT
dc to 5 Amps



SIXTH SIZE
SPDT & DPDT
dc to 1 Amp

WATCH FOR BABCOCK RELAYS ON THE EDN MOBILE DISPLAY — SOON IN YOUR AREA.

TEKTRONIX

Type 547 sweep-switching oscilloscope

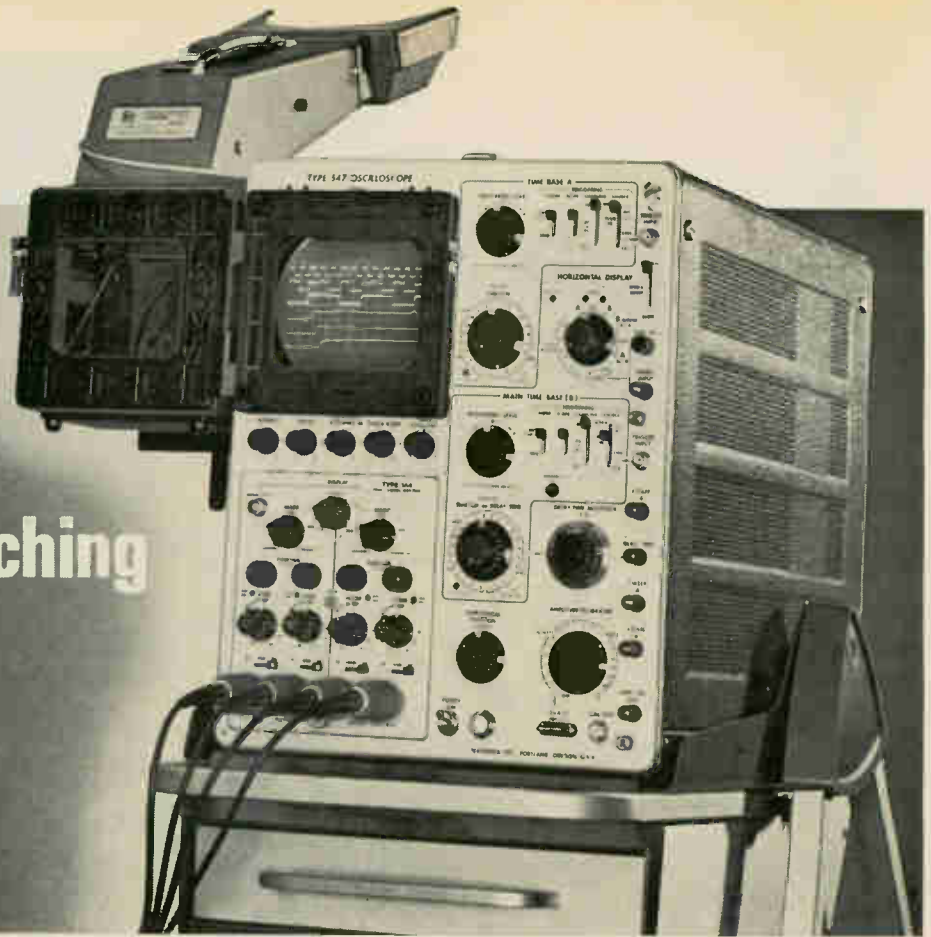

The Tektronix Type 547 is a 50-MHz, 7-ns sweep-switching oscilloscope that offers dual-beam measurement capabilities with most repetitive signals. A complete selection of plug-ins permits you to change your oscilloscope performance to meet your changing needs.

The sweep-switching feature of the Tektronix Type 547 Oscilloscope and the vertical switching of the new Type 1A4 Four-Channel plug-in provide two independent dual-trace oscilloscope systems that time-share the same CRT. The identical sweep systems provide 2% calibration from 5 s/cm to 100 ns/cm, extending to 10 ns/cm ($\pm 5\%$) with the horizontal magnifier. The calibrated sweep delay range is from 100 ns to 50 s and sweep-switching provides alternate displays of the delayed and delaying sweeps.

With the Type 1A4 Four-Channel Plug-in, the Type 547 has a 7-ns risetime and DC-to-50 MHz bandwidth over its 10 mV/cm to 20 V/cm calibrated range. You can also select from 50-MHz dual-trace plug-ins, differential plug-ins with bandwidths to 50 MHz, sub-nanosecond sampling and TDR plug-ins, and four spectrum analyzer plug-ins covering the spectrum from 50 Hz to 10.5 GHz.

Type 547 Sweep-Switching Oscilloscope	\$1875
Type 1A4 Four-Channel Plug-in	\$ 780
Type 1S1 Sampling Plug-in	\$1175
Type 202-2 Scope-Mobile® Cart	\$ 135
Type C-12 Camera	\$ 460
Type C-12 Camera Adapter (016-0226-00)	\$ 15

U. S. Sales Prices FOB Beaverton, Oregon

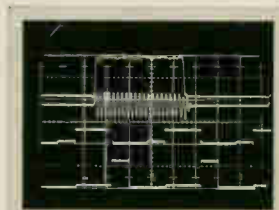

Four Signals—Two Sweeps

Using alternate vertical and horizontal display modes, Ch 1 and Ch 2 are locked to A Sweep (100 ns/cm) and Ch 3 and Ch 4 are locked to B Sweep (2 μ s/cm). This provides dual-beam measurement capabilities with most repetitive signals.

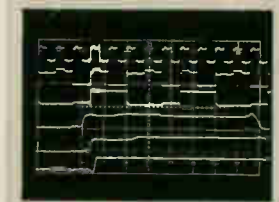

Three Signals—Delayed Sweep

Increased convenience is provided with sweep-switching in the delayed sweep mode. You alternately view both the delaying sweep (2 μ s/cm), intensified by the delayed sweep, and the delayed sweep (100 ns/cm). With the Type 1A4 Plug-in, eight traces can be displayed.

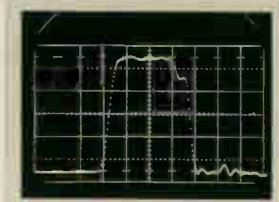

Sampling

More measurement functions are available with the Type 547's complete selection of plug-in units. The Type 1S1 Sampling Plug-in features 0.35-ns risetime, internal triggering and up to 100 ps/cm sweep speed.

For a demonstration, contact your nearby Tektronix field engineer or write: Tektronix, Inc., P. O. Box 500, Beaverton, Oregon 97005.



*Multi-trace, differential,
sampling and spectrum analysis*

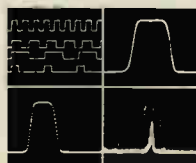

*... in all Tektronix 530-540-550-series
plug-in oscilloscopes*

Probing the News

Consumer electronics

Consumer electronics firms entertain the possibility of using more IC's

Aggressive development and sales tactics of semiconductor houses seem certain to make the home-entertainment field a volume market for devices, but set makers are typically closemouthed on their plans

By John D. Drummond

Consumer electronics editor

Manufacturers of television sets and other consumer electronics products are being forced to take a harder look at developments in the fast-moving field of linear integrated circuits. Zeroing in on potential volume markets, semiconductor houses have deliberately priced their latest generation devices low enough—in some cases, 50% less than previous offerings—to command attention from the price-conscious consumer market. What's more, the new breeds of assemblies are tailored to interface with tubes or discrete components. Some can be used as direct replacements for diodes, transistors, and

associated circuitry.

So far, ic's have been used sparingly in the sound sections of home-entertainment goods, and many firms view the devices as little more than promotional ploys. However, vendors are clearly aiming at saturation of the general-purpose radio-frequency and audio-amplification market with integrated assemblies providing multifunctions on a single chip. Special-purpose ic's for automatic fine tuning and remote control are also cropping up. Farther down the road, ic makers are staking a claim on such areas as waveshaping control, signal processing, and video amplification.

In keeping with the supersecretive customs of the industry, most manufacturers are playing it close to the vest on revealing plans to use more ic's in home-entertainment products. But it is safe to conclude that producers' public disinterest in volume applications obscures feverish behind-the-scenes investigation. Now that the price barrier has been decisively breached and availability presents no problems, big orders are clearly in store.

Integrated circuitry is not going to make immediately spectacular inroads in the home-entertainment field. Evaluation of the new devices

IC'S COMING ON STRONG IN CONSUMER ELECTRONICS

PERCENTAGE OF MANUFACTURERS USING ONE OR MORE IC'S PER SET IN 1967:

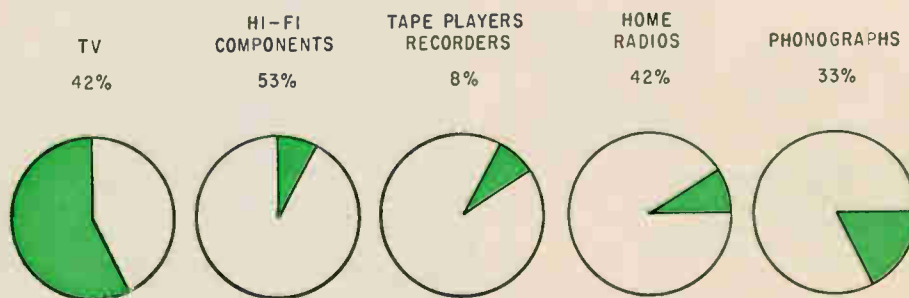

PERCENTAGE OF MANUFACTURERS THAT WILL BE USING ONE OR MORE IC'S PER SET IN 1972:



COLOR INDICATES APPROXIMATE MARKET SHARE OF EACH PRODUCT CATEGORY. DATA: ELECTRONICS ESTIMATE.

Introducing the D-ranged 0.01% DVM.



**the only crazy thing
about it is the price.**

Trymetrics' D-ranged DVM has true .01% accuracy with sensitivities to 10 microvolts and a choice of 9 plug-in heads starting as low as \$640.

\$640?
\$640! with 103 plug-in head!
Basic units start at \$595.

And that's not all. Check these Trymetrics features: Full 4 digit resolution plus overranging. Resolution to $10\mu\text{V}$. Accuracy ± 0.01 of reading ± 1 count. Automatic polarity and overscale indicator. High common mode rejection. Manual and Automatic Ranging plug-in heads. All silicon solid state circuitry. Operation up to 50°C . Sampling speeds up to (10) samples/second. BCD printer output (optional).

CHOOSE FROM 9 PLUG-IN HEADS

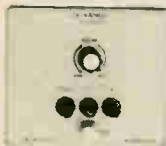

DELIVERY FROM STOCK
ON MOST MODELS
Models 103—104—105
Single range plug-in heads
 10V , 1V , 100MV

Models 300A—400A—500A
3, 4 and 5 automatic range
plug-ins; $10\mu\text{V}$ — 1000VDC



Models 300M—
400M—500M
3, 4 and 5 manual
range plug-ins;
 $10\mu\text{V}$ — 1000VDC

Prices Higher in Europe

If you'd like to be considered crazy (like a fox), write now for specifications or a demonstration.



TRYMETRICS
Corporation

204 Babylon Tpke., Roosevelt, L.I., N.Y.
Phone 516-378-2800 11575

... manufacturers say IC's must offer
flexibility and superior performance ...

will take time. Moreover, redesigning equipment and converting production lines to make it can consume 12 to 24 months. But ic makers have vastly improved their foot-in-the-door position of a year ago and crossed over the threshold. By 1971, the demand for ic's from consumers outlets is expected to rise from an annual rate of only a couple of million to 200 million units.

Roll call. Leading the pack so far in the race for consumer business are the Radio Corp. of America and the General Electric Co. These two firms are closely followed by Motorola Inc., the Semiconductor division of the Fairchild Camera & Instrument Corp., and Texas Instruments Incorporated. New arrivals include the Philco-Ford Corp. and the Westinghouse Electric Corp.

First off the mark with ic's in consumer goods was RCA which used home-made devices in the sound section of its 1966 black-and-white and color tv sets. Since then, other manufacturers have followed suit and incorporated ic's in a-m and f-m radios, phonographs, hi-fi components, stereo systems, and even kits. Ironically, however, ic's have achieved their greatest success in a comparatively minor

segment of the business—f-m receivers, particularly stereo models. It was not until recent months that semiconductor houses were able to shoot for volume applications in the vast television field.

I. Price is paramount

For all the ferment, a number of consumer goods companies still approach ic's with the enthusiasm of a bridegroom at a shotgun wedding. But the marketing pressures are almost irresistible: once any firm in this brutally competitive field tries something new, competitors are forced to follow—or take a long, hard look at—the development.

Manufacturers are vocal in their insistence that ic's must afford design flexibility and superior performance. However, their principal preoccupation still appears to be price. An official at GE's Semiconductor Products department puts it this way: "The switchover to ic's and the extent of their use will be determined by economic factors, not performance. Manufacturers of consumer goods have settled upon fixed levels of performance at each level of pricing."

Interim insert. Fred Hayden, director of engineering at the Packard-Bell Electronics Corp.'s Home

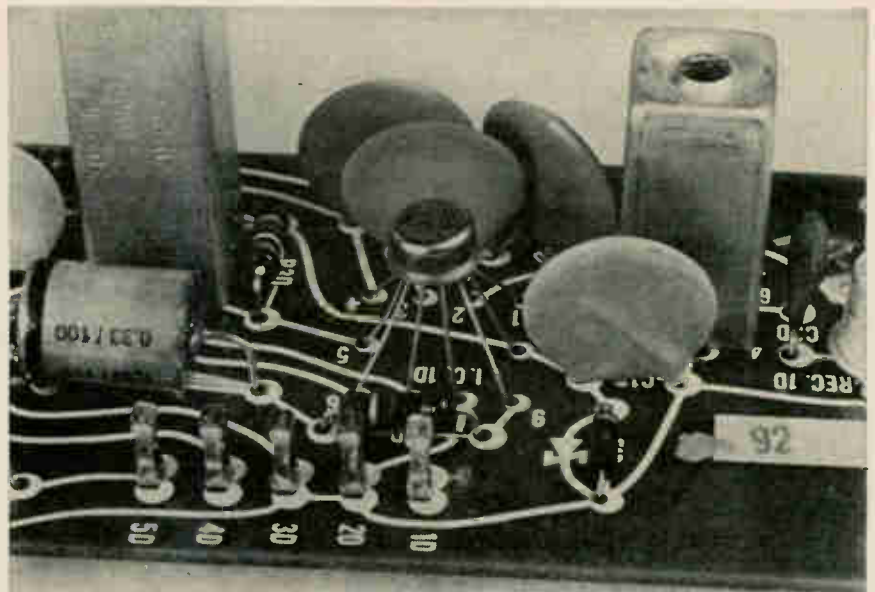

Replacement part. Audio IC in Motorola color-tv set replaced 15 discrete components; chip incorporates 15 resistors, 12 transistors, and 12 diodes.

Products division, says, "I don't think any IC's now being marketed compare with discretes on a price basis. As far as we are concerned, unless they help trim costs, there's no great argument for using them since we don't have a space problem in our products." The company is using an IC in the i-f sound amplifier and limiter circuit in one tv set in the current model run.

"From a performance and reliability standpoint," says Hayden, "the set was a success." But he estimates the cost of using the device was at least 25% higher than would have been the case with discrete components. Hayden concedes that Packard-Bell was looking for a merchandising edge when it decided to go the IC route; he says the device will be out of next year's models.

Satisfied customer. Motorola, which is using its own devices in the audio section of its 1968 color tv sets, is sold on IC's. The receivers, all solid state, cost about \$40 more to produce than those with tubes. But, says Motorola, the IC's are one of the least expensive aspects of the new models.

Gene Blanchett, manager of operations at Motorola's Semiconductor Products division, says the company uses IC's in critical audio applications. "We find we get a clearer f-m sound under adverse signal conditions when we use IC's," he notes. The chip going into Motorola's color sets replaces 15 resistors, 12 transistors, and 12 diodes.

Daniel von Recklinghausen, director of engineering at H. H. Scott Inc., says, "IC's are not necessarily more expensive than discrete components. On the whole, the use of IC's does not boost the total cost of the manufactured product significantly if labor savings and other factors are taken into account."

For all the concern over costs, a surprising disparity exists in pricing practices, apparently because IC makers are willing to negotiate. A recent check revealed that some set manufacturers are paying as much as 25% to 50% more than competitors for equivalent devices. For example, a sound i-f amplifier has been offered to a quality radio house for \$1 apiece, while others have gotten quotations of \$1.50.

As high-volume, general-purpose

Award-Winning

LINDBERG HEVI-DUTY DIE BONDERS

use **STEREOZOOM®**

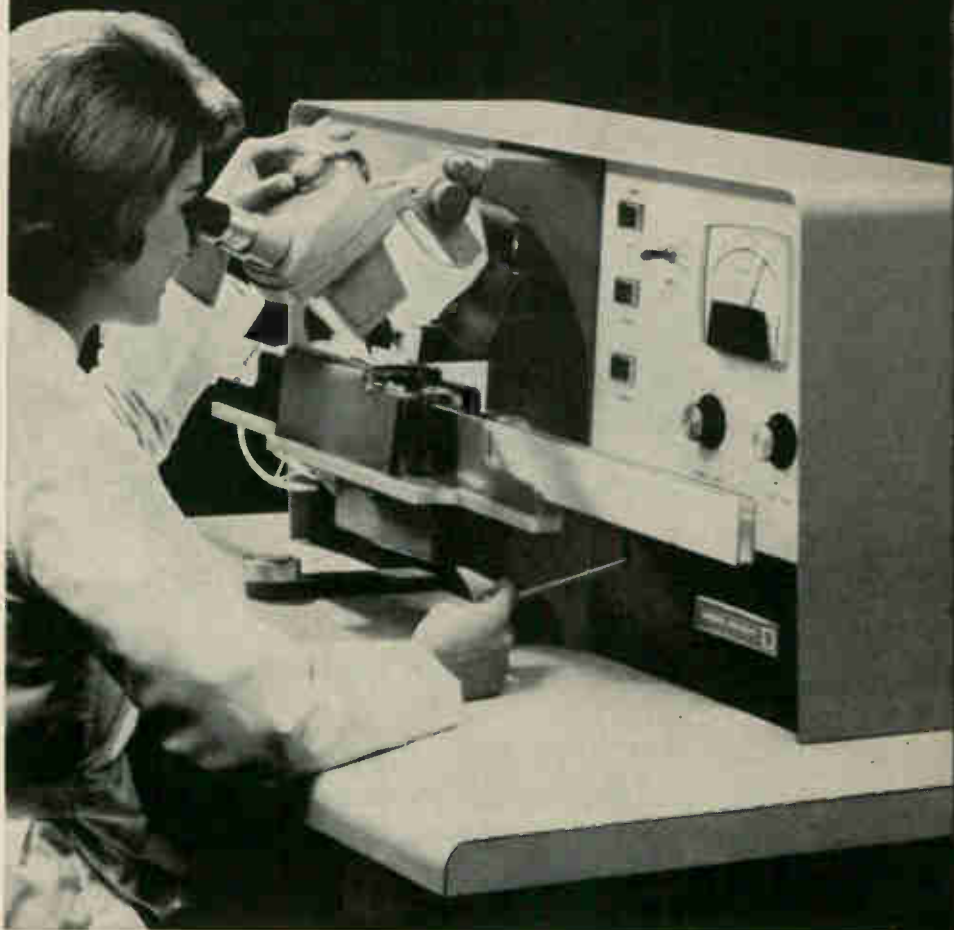

to see and check subminiature operations

you, too, should use a Bausch & Lomb StereoZoom microscope. Lindberg Hevi-Duty, a Division of Sola Basic Industries, does . . . on their automatic die and wire bonders. Designed to meet the most sophisticated demands of the semiconductor industry—for production and reliability, the bonders won a coveted 1966 Master Design Award from "Production Engineering" magazine.

StereoZoom, interlinked with a special mirror system, provides razor-sharp viewing during die pickup, positioning and bonding. StereoZoom gives a big, bright three-dimensional image—with full edge-to-edge, flat-field clarity. Continuously-variable magnification models let operator quickly zoom through a wide range to the precise setting desired. StereoZoom keeps work constantly in view, helps achieve high production rates and minimizes eye strain.



The extensive StereoZoom line lets you pick the right model for the job, or you may select individual components. Get the full story. Call your dealer, or send for Catalog 31-15. Write Bausch & Lomb, 61445 Bausch Street, Rochester, New York 14602.

BAUSCH & LOMB 

In Canada, Bausch & Lomb Optical Co., Ltd., 16 Grosvenor St., Toronto,

ADVANCING ELECTRONIC/OPTICAL
INSTRUMENTATION

Low Cost 4 DIGIT

400 SERIES

INTEGRATING DC

DIGITAL VOLTMETER



Extended Range Measurements: Fifth digit over-range.

Precise Measurements: With accuracies to 0.05%.

Input Flexibility: Four voltage ranges and a micro-current input for measuring in "Engineering Units" (psi, degrees, etc.)

System Compatibility: BCD Outputs and Remote Programming.

High Noise Rejection: Differential input and integration techniques provide common mode rejection greater than 120 db at 60 Hz.

Economical: 3 and 4 digit models range from \$349.50 to \$495.50.

These DVM's are not only **NEW**, they're **AVAILABLE** from Janus representatives from coast to coast!

CALL OR WRITE FOR A DEMONSTRATION.



296 NEWTON STREET • WALTHAM • MASSACHUSETTS 02154 • TEL: (617) 891-4700

... transistors are still
new to most engineers ...

circuits like audio amplifiers are integrated, increasing attention will be paid to trickier special-purpose circuits. Video circuits in tv sets are a prime target according to Motorola's Blanchett. "We've been working in this area for quite a while," he says. "We're in a design phase now, trying to find a way to increase yields to an economical point. We have to set up lines, sample customers, get feedback, and just plain learn how to use ic's more cheaply."

II. Different by design

Other sections of tv sets high on the list for integration include wave-shaping and sync circuits. At the moment, applications of ic's in tv receivers are limited largely to audio circuits. Among the exceptions, however, are Philco-Ford which uses a chip as a video driver and RCA which is using ic's for automatic fine tuning and as a remote control amplifier. Both companies report that these circuits are performing at least as well as the discrete transistors they dislodged and RCA says that, in the case of the automatic fine tuning application, frequency control is better because of the device's inherently stable operation. Finally, Warwick Electronics Inc. reports using an ic for automatic frequency control in one of the black-and-white tv sets it builds for Sears, Roebuck & Co.

However, before the ic millenium is reached in consumer electronics, equipment manufacturers and semiconductor houses will have to give a little. Set makers must be induced to eschew circuitry packages left over from the days of vacuum tubes and ic vendors must be willing to be increasingly responsive to specific design requirements. There are those who doubt that such a love-feast is scheduled to start any time soon. For example, Fred Mergner, director of engineering at the Fisher Radio Corp., says, "The engineer's mind has to be conditioned before he'll begin to think about ic's. After all, he's just crossed the bridge from tube to transistor, and he hasn't recovered."

Pro and Kahn. Some interested

... Zenith was one of the first to use IC's in consumer goods ...

parties profess to be worried that the use of off-the-shelf IC's will limit designers flexibility. "We are not using IC's at this time," says Morley Kahn, the director of marketing at the Marantz Co., a subsidiary of Superscope Inc. "Available devices cannot provide the high performance levels required in our sophisticated gear." Kahn's views are echoed by an audio engineer at an East Coast radio firm who complains that because of IC's encapsulated packages, circuit redesign is difficult. On the other hand, Fisher Radio's Mergner, Scott's von Recklinghausen, and E. C. Fiebich of the Heath Co. have been using IC's for a good while: they are unanimous in asserting that once the techniques are mastered, IC's afford the same design flexibility as discrete components.

III. Activity report

Publicly, a number of critics still contend that IC's performance characteristics are overrated. It is difficult to reconcile this mistrust with the consumer electronics industry's well-known price bent since the active elements which improve performance quality come cheap in IC's. Engineers designing entertainment products with discrete components still face limits on the number of diodes and transistors they can add to a circuit because of the costs involved. By way of example, however, a single RCA device that replaces 26 discrete components has 39 elements, 24 of which are active.

Morris Levy, vice president of engineering at the Emerson Radio & Phonograph Corp. says, "We've been experimenting with IC's for some time now and haven't detected any improvement in performance over discrete transistors." Levy cites this factor as the reason for the company's not having put devices in either its tv or radio lines. "Most people who are using IC's in a circuit here or there are doing so for marketing purposes," he concludes.

Traditionalist. The Zenith Radio Corp., one of the last, lonely outposts of hand-wired circuitry,

agrees with Levy's analysis—at least as far as television is concerned. A spokesman says, "Our philosophy is to use something only when it will make a contribution to the unit itself. We will increase our use of IC's only when they prove worthwhile."

However, Zenith was one of the first to use IC's in consumer goods, having incorporated monolithic devices in its hearing aids as long ago as 1963. In addition, the company is using IC's in its top-of-the line f-m stereo tuners. This is the one application in which there is a consensus that IC's improve performance. The Zenith chips, fabricated by TI, replace five resistors, one transistor, and three condensers in the intermediate-frequency amplifier section.

Despite its sparing use of IC's, Zenith conducts intensive research programs in thin- and thick-film technology as well as in hybrid and monolithic devices. "We have an elaborate laboratory arrangement where it is possible to fabricate IC's, says a spokesman. "We don't have the facilities to mass produce the chips but we can make enough for test applications."

Viewing the situation from the opposite side of the fence, Motorola's Blanchett takes a more optimistic tack, believing it is only a matter of time before IC's completely replace all conventional solid-state devices in home-entertainment goods. "Right now, IC's are more economical in the front ends and audio sections of many top-of-the line hi-fi sets and radios," he says. "In general, the limitation of IC's is that they do not offer high enough voltage or power. The power problem will be easy enough to solve, but voltage will be difficult."

IV. Beautiful music

Integrated circuits have enjoyed perhaps their greatest success in the hi-fi components sector of the home-entertainment industry. Engineers are virtually unanimous in their praise. Scott's von Recklinghausen says, "As a result of using IC's in our f-m i-f amplifier circuits,



Please send me the latest Acopian catalog that lists

62,000 DIFFERENT POWER SUPPLIES

available
for shipment
in 3 days.

Name _____

Title _____

Company _____

Address _____

City _____

State _____

ZIP _____

ACOPIAN CORP.
EASTON, PENNSYLVANIA
TEL: (215) 258-5441



SWITCHING PROBLEMS? Solve Them With These HSI Sealed Switches

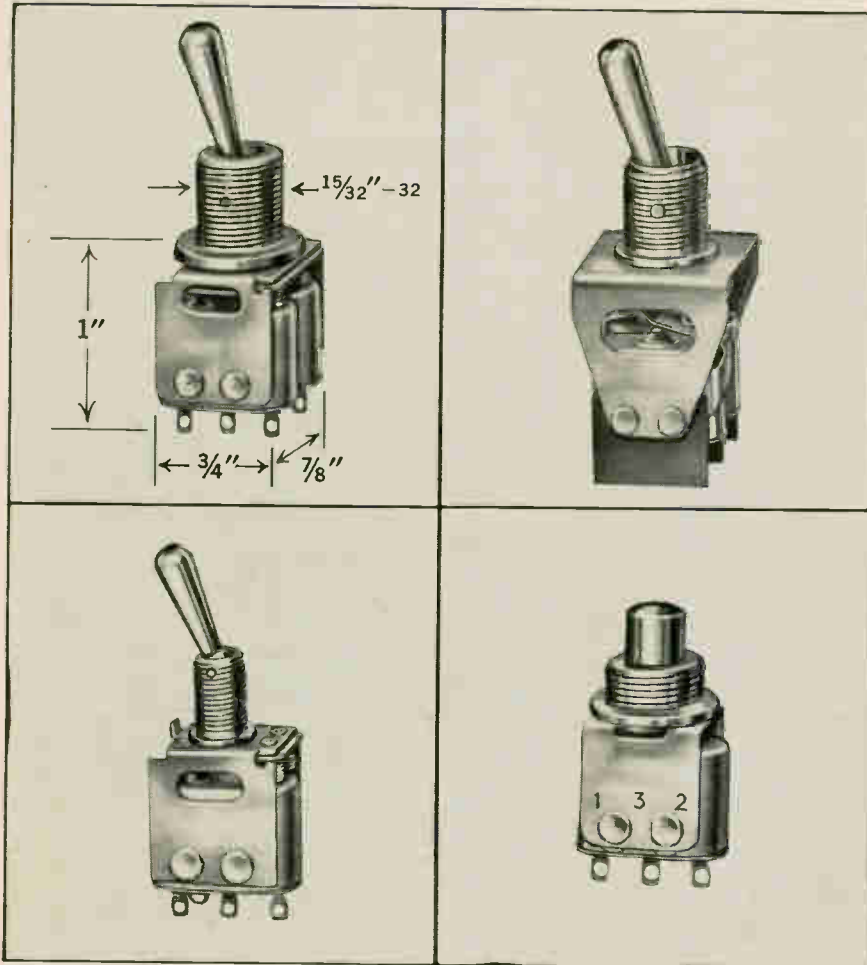

Premium Performance in Sub-miniature Switches

6100 series toggle and push-button switches are rugged compact assemblies designed for use wherever stringent environment conditions must be met — such as aircraft, space, industrial, shipboard and armored vehicles. The precision snap-action switches in these assemblies are hermetically sealed. They meet the requirements of MIL-S-8805 Enclosure 4 and perform reliably with consistently low contact resistance under the adverse conditions that cause unsealed switches to fail.

Wherever reliable switching is a problem, solve it by specifying "HSI". Basic hermetically sealed switches are single pole double throw rated 5 Amp. resistive, 3 Amp. inductive, 28V D.C. For single and multiple circuits. Extremely compact. Complete data in Bulletin 61T-1 . . . send for your copy, today.



HAYDON SWITCH & INSTRUMENT, INC.

Where Optimum Performance is Standard

1500 Meriden Road, Waterbury, Conn. 06720/Area Code (203) 756-7441

we have greatly increased the performance of our receivers. The devices provide better gain stability with circuit changes, vastly improve capture ratio, and i-f alignment is a lot easier."

A typical ic i-f amplifier like Fairchild's μ A 703E has three transistors and two diodes in an emitter-coupled bias arrangement. With high input signals, the circuit acts as a current limiter without saturation. Using an emitter-coupled pair also affords good isolation between input and output circuits so high gain can be achieved without resorting to neutralization.

At the moment, some top-of-the-line f-m stereo receivers are using as many as seven ic's. It appears certain that all manufacturers of hi-fi components will be incorporating ic's in their receivers by 1969 at the latest.

To each his own. The downward trend in the price of off-the-shelf ic's for consumer applications results from manufacturers' design and production ingenuity as well as from rising sales volume [Electronics, July 10, p. 125]. In their zeal to develop circuits with wide appeal, semiconductor houses are staying in close touch with consumer electronics engineers, supplying them with samples of new devices before getting into mass production. They are getting feedback and the interplay is proving increasingly fruitful.

Some set makers who concede they would like to integrate a number of their pet circuits are still scared by the prospect of high development costs. Custom designs of moderate complexity can run into the tens of thousands of dollars—a level beyond the reach of many manufacturers.

B. A. Jacoby, an RCA marketing official, estimates that custom-designed, special-purpose ic's, having annual production runs of 1,000 units, will sell for from \$10 to \$25 apiece in 1971. This contrasts sharply with the \$1.50 price tag expected for off-the-shelf devices produced at the rate of 100,000 units a year. Integrated circuits earmarked for general-purpose applications in consumer electronics markets, manufactured in volumes of 2 million or more units annually, will probably be priced as low as 50¢ each by 1971.

New **ALSiBASE[®]** COMPOSITE SUBSTRATES

PROGRESS REPORT

ALSiBase Composite Substrates bury metal patterns in a monolithic high-alumina ceramic and provide ready access from any level to any other level. Planes can be stacked one on top of the other with each plane hermetically sealed. This gives far greater concentration in the same surface area since conductors can be very short or can cross over and under each other without destroying electrical integrity.

Advantages include:

- Circuit space savings.
- Device areas can be closer together.
- Short electrical paths are faster and have less resistance.
- Conductors may cross over and under each other.
- External wiring minimized.
- Provisions for discrete devices can be incorporated in design.
- Interconnections wherever desired.
- Maximum reliability and stability.
- Excellent heat dissipation
- Any number of levels or planes of tungsten or molybdenum metallized patterns.
- Fine line precision metal patterns as narrow as 4 mils on 8 mil centers can converge about the chip area.
- Line resistance down to 10 milliohms per square or better is often possible.
- Each plane separated by HIGH alumina ceramic.
- Thickness of insulating planes can be from .002" to .030".
- Each plane hermetically sealed.
- Provision for hermetic sealing of device areas or entire unit with mechanically sealed pins or leads.
- Ability to plate exposed metallized areas to facilitate chip attachment, wire bonding and hermetic sealing.

Prototype production is available. Designers are invited to explore with our Engineers the possibilities of Composites for their requirements.

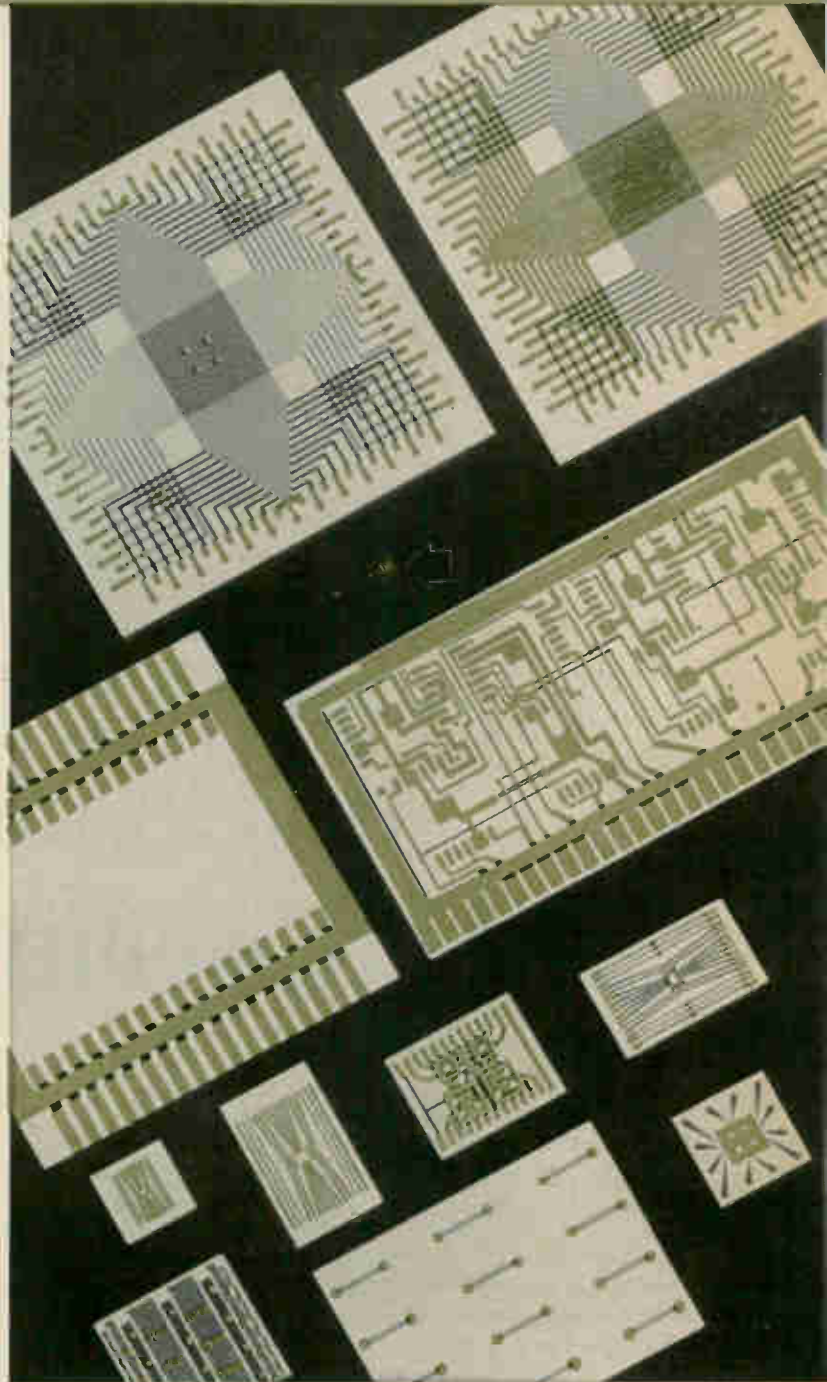

Illustrations about actual size.

CODE IDENT. NO. 70371

PHONE 615 265-3411, CHATTANOOGA, TENN. 37405

American Lava Corporation **3M**
A SUBSIDIARY OF COMPANY

For service, contact American Lava representatives in Offices of Minnesota Mining and Manufacturing Company in these cities (see your local telephone directory): Boston: Needham Heights, Massachusetts • Chicago: Glen Ellyn, Illinois • Cleveland, Ohio • Dallas, Texas • Laurens, S.C. • Los Angeles, Calif. • Metropolitan New York: Ridgefield, N.J. • Up-State New York and Canada: Baldwinsville, N.Y. • Orange, Conn. • Philadelphia, Penna. • Roanoke, Virginia • St. Louis: Lee's Summit, Missouri • So. San Francisco, Cal. • Troy, Mich. • 3M International, c/o American Lava Corp., Chattanooga, Tenn. 37405, U.S.A., 615/265-3411

66th
YEAR
OF
CERAMIC
LEADERSHIP

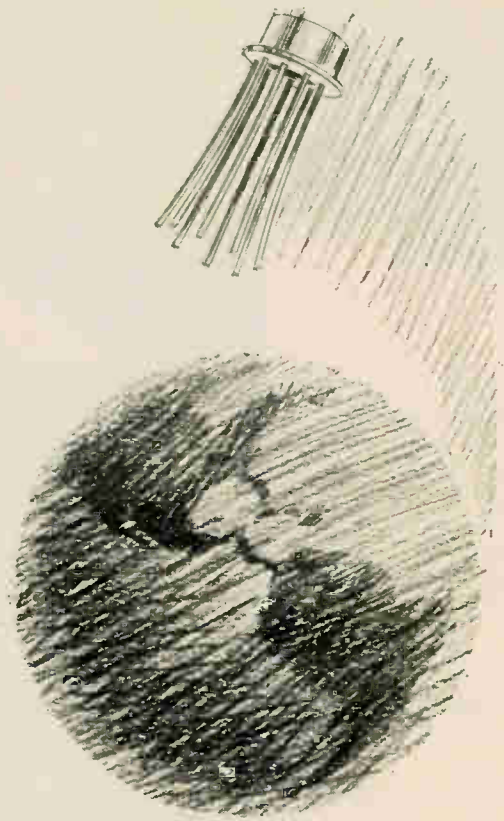

Why do AMI's MOS arrays travel with NASA?

High reliability is the reason.

When you send a system aloft, there are no repair men in space. You make it or break it on reliability. That's why NASA moved into the forefront of MOS applications. And, that's why NASA is using AMI's 3-Input NAND Gate and 3-Input NOR Gate for space flight. The case for reliability is plain: ask any AMI representative or distributor for a copy of our life test data on these NASA parts.

The case for reliability on down-to-earth systems is just as plain: the same type parts that NASA sends out of this world pay off in PFM telemetry, count-down chains, and analog commutators. Beyond that, AMI's complete line of MOS building blocks offers you the greatest low-cost versatility in integrated microelectronics today, including capacity to interface with bi-polar devices. Wait and see? Why? Application data, available on request, opens new opportunities in systems design.

HI REL MOS ARRAYS

Part Nos.

L103G	3-Input NAND Gate
L203G	3-Input NOR Gate
B002E	Binary Element
BG002	Gated 2-Stage Binary
B2002	2-Stage Binary
R0002	2-Stage Shift Register
R0008	8-Stage Shift Register
L4SSG	Stream Select Gate



American Micro-systems, Inc.

3800 Homestead Road, Santa Clara, California 95051 (408) 246-0330

Canada files claim on space sites

But its insistence on stationing a communications satellite system in synchronous equatorial orbit is producing friction with the U.S.

By William D. Hickman

Washington regional editor

A bitter test of national wills is shaping up between the U.S. and its northern neighbor as a result of Canada's top-priority effort to get a communications satellite of its own into operation by the early 1970's. The U.S. will do everything it can to discourage Canada from going it alone, according to a top Administration official.

While fully aware that it will need a technical boost from the U.S. to achieve its goals, the Canadian government has recently given additional evidence of its determination to play a lone hand. This summer, it set up a special

task force on satellites to plan and coordinate the development of an advanced system to distribute television signals and voice traffic. Estimated cost of the system: more than \$80 million.

Grow power. Canadians are confident they can furnish most of the needed research and industrial capacity. Moreover, the government plans to award local companies any contracts to tailor U.S. designs to Canadian needs, hoping to increase the firms' capabilities. But when it comes time to buy space hardware, practicality will transcend nationality; bids will be

thrown open to all. Canadian and U.S. companies are expected to share these dollars equally, with perhaps a small amount going to European concerns.

Canada will be totally dependent on the U.S. for launch services. Despite the penalty in foreign exchange, the Canadians feel that the planned frequency of their satellite launchings doesn't justify the construction of boosters locally.

I. Chapman reporting

In the wake of an offer by Canada's largest common carriers to underwrite a communications satel-

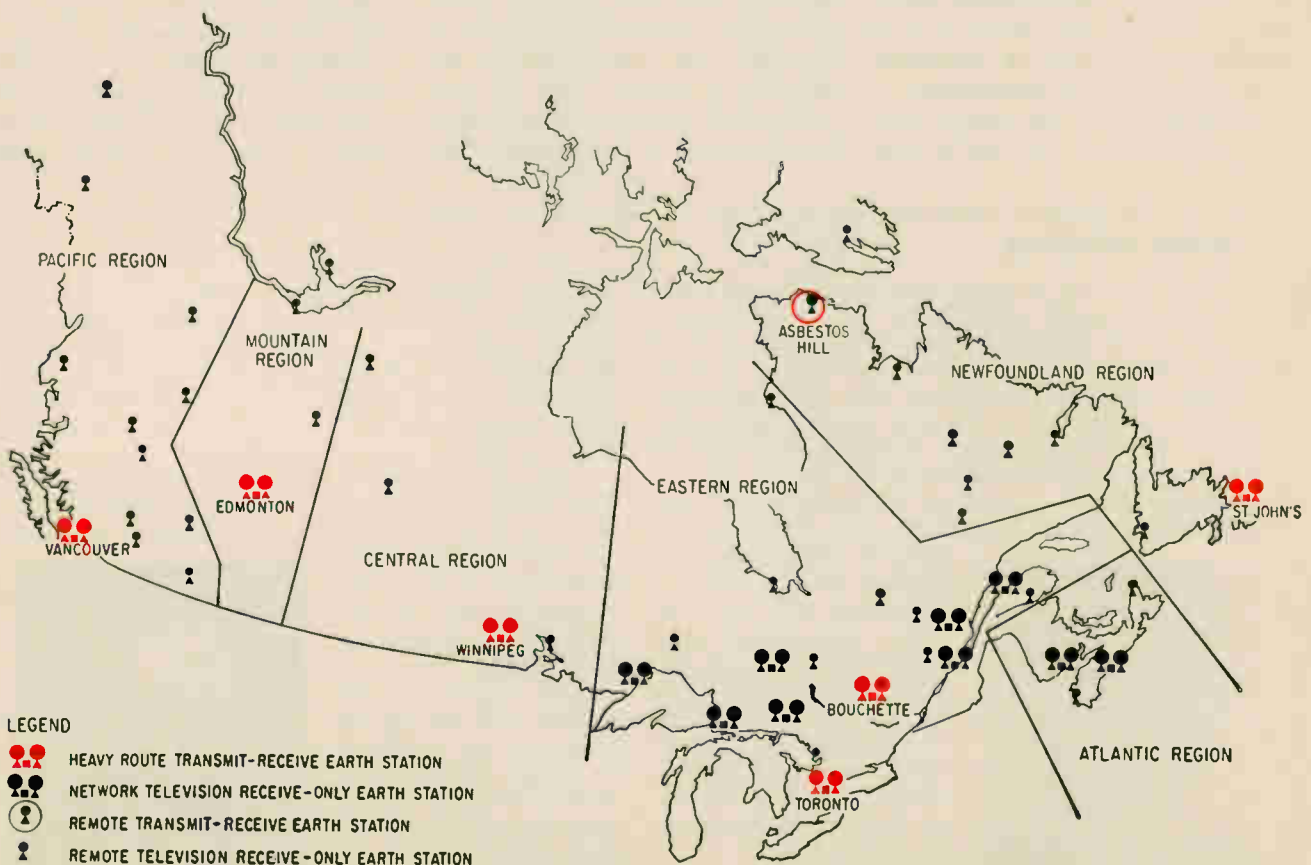

Checkerboard. Communications satellite system proposed by Canada's common carriers would have 54 ground stations.

... Canadians are in no mood to join forces with Intelsat or the U.S. . . .

lite program on their own [Electronics, June 26, p. 211], Ottawa named physicist John H. Chapman to head the special task force charged with overseeing system development. The author of last February's Chapman Report on Canada's space activities, he has since recruited a panel of top aides.

Chapman concedes that one of his biggest jobs will be to reconcile Canada's aims with those of the U.S. Along with other government people, he realizes that Canada can build the system only with U.S. assistance. And he insists that Canada should get this help because it has a greater need for communications satellites than any other country.

"It would be grossly unfair of the U.S. to deny Canada's attempt to establish a domestic system," says Chapman. But he's fearful this might happen. Further, Canadians are worried that the U.S. might usurp the equatorial orbit locations they are eyeing. Since the communications satellite frequency spread, set by international agreement, extends only from 4 to 6 gigahertz, spacecraft in proximity could interfere with one another.

Chapman holds that space territory where a satellite can be sta-

tioned is a natural resource "to be treated as prudently as the country's water." Thus, an important objective of his group is the gathering of data to arm Canada's diplomats when they sally forth to negotiate space rights.

II. South of the border

On Aug. 14, just 30 days after the Canadian government activated Chapman's task force, President Johnson formed a similar group in the U.S. [Electronics, Aug. 21, p. 26]. In doing so, he warned all 58 members of the International Telecommunications Satellite Consortium (Intelsat), including Canada, that failure to adhere to Intelsat's directives on the use of domestic or regional satellites would result in "communications anarchy."

An official at the White House's Office of Telecommunications Management reiterates that Canada and the entire world would be better served if all countries used the space facilities of Intelsat. He says the U.S. will not put any insurmountable stumbling blocks in Canada's way if it insists on developing a system. But, he indicates, there will be a good deal of foot-dragging in the process. The

U.S. might even propose—albeit reluctantly—a plan for a regional North American system if Canada cannot be dissuaded.

No sale. Canadians are in no mood for a joint venture with either Intelsat or the U.S. While agreeing that it's necessary to coordinate such matters as satellite positioning, effective radiated power, radiation patterns, polarization, and frequency stability, Canadians want assurances that any operational freedom they give up will be "on terms that are good for Canada," as the Chapman group puts it.

Conceding that Canada has a greater need for a satellite communications system than other countries, the U.S. telecommunications official says that he is sure an agreement can be made to provide sky space. He sees little immediate danger of overcrowding in the equatorial satellite belt, but a possibly critical problem in 20 or 30 years.

This spokesman is hopeful that the International Telecommunications Union will grant higher frequencies to communications satellites. He says there is a possibility of using the millimeter band—specifically, 16 to 18 Ghz for the down link and 35 Ghz for the up leg.

Above the battle. The Communications Satellite Corp. which holds a majority interest in Intelsat and plans a domestic satellite system

Coming and going

If Canada sets up a space agency—and it well might—the boss would probably be John H. Chapman. In July, Prime Minister Pearson appointed him to head the country's special task force on satellites, a group charged with putting Canada into the applications space race. Chapman's task force is operating at privy council level—the equivalent of the executive office of the President plus the Cabinet in the U.S.

Chapman is not a newcomer to Canadian space programs. He is project coordinator of the Canadian portion of the Alouette-Isis satellite project, and, until taking over the task force, was deputy chief superintendent of the Defense Research Board in charge of military telecommunications and radar programs. Chapman holds a doctorate in physics from McGill University in Montreal.



Alphonse Ouimet, sometimes called the father of Canadian television, will soon be retiring from his post as president of the Canadian Broadcasting Corp. He resigned last fall from the job he has held since 1953, but his actual departure will be deferred until legislation reorganizing the CBC is approved by Parliament—probably within a few months.

Ouimet began research in tv shortly after graduating from McGill University in 1932 as an electrical engineer. He joined the CBC in 1934 when it was still called the Canadian Radio Broadcasting Commission, and was the organization's chief engineer during the early years of tv's development. Ouimet is also credited with helping the Australians to develop a tv system of their own while working as a government consultant in that country in 1954.



for the U.S. has had little to say on Canada's plans beyond expressing support of President Johnson's statement. Anyway, Comsat says, the Canadians haven't notified it of their intentions in this area.

Comsat plans to begin domestic service by late 1969 [Electronics, July 24, p. 50]. Its program, subject to the approval of the Federal Communications Commission, includes two satellites, two terminals with two 85-foot dish antennas apiece, two terminals with 42-foot dishes, and 30 small receive-only facilities. The project is designed to serve the Western states, relaying eight tv channels and 6,200 voice or message circuits. Approval of the scheme is expected soon.

III. Spread thin

It's no good bewailing the passing of the pioneering spirit. Canada has to live with the fact that the exploitation of its rich mineral resources—a key to the nation's future prosperity—depends to a large extent on live television coverage of championship sports events. Mining companies report they are unable to recruit employees to work in areas that don't get live coverage of the Stanley Cup hockey and Gray Cup football classics. And establishing stable communities with families is all but impossible in areas without tv.

Providing nationwide tv is, however, but one of the reasons Canada is pushing hard for its own communications satellite system. With about 15% more land area than the continental U.S., Canada has only about 10% as many people. Although by no means undeveloped, the country's hinterlands lack the extensive microwave and land-line communications networks that blanket the U.S. In particular, because of prohibitive costs, the minerals-rich northern provinces lack direct lines to the well-served population centers along the St. Lawrence River and near the Great Lakes.

Prime Minister Pearson's administration has concluded that the only feasible and economic way to provide adequate telecommunications services to 20 million Canadians dispersed over nearly 4 million square miles of territory is to use satellite repeaters to relay telephone traffic and data trans-



Good news for digital head hunters

If you have a genuine desire to get a head—the kind that won't shrink from the most demanding digital task—then we respectfully suggest that you head for CEC.

And for these heady reasons:

Only CEC digital heads are designed to upgrade all present computer systems. CEC's years of leadership in producing digital heads for IBM compatible transports, airborne transports and incremental transports have provided the technological experience necessary to supply a *complete line* of digital heads at packing densities of 1600 BPI with no degradation in output. Furthermore, advanced manufacturing techniques and tight quality control assure that critical parameters such as self-erasure, crosstalk and skew far surpass the most demanding specifications.

Only CEC digital heads are guaranteed to 2500 hours, including 9-channel types. Result: replacement costs have

been dramatically reduced, and digital recorders can stay "on line" for far longer periods without time-consuming repairs or cleaning.

Only CEC has the advantage of Bell & Howell's advanced Research Center, which has assisted in the selection of superior materials that provide outstanding magnetic properties and an extremely low wear rate.

Is it any wonder that success has gone to our heads?

For all the facts about this advanced, complete line of digital magnetic heads, call your nearest CEC Field Office. Or write Consolidated Electrodynamics, Pasadena, California 91109. A subsidiary of Bell & Howell. Bulletin Kit 319-X4.

CEC
DATATAPE PRODUCTS



BELL & HOWELL



introducing the "PIXIEPOT"TM at an IMPossibly low price!

Duncan Electronics now offers for the first time in the history of the potentiometer industry a PRECISION TEN-TURN WIREWOUND pot for less than \$6 00. In fact, the new Model 3253 "PIXIEPOT" potentiometer is yours for as low as \$3.97 each in production quantities and only \$5.95 each for 1-24 units.

Outstanding "PIXIEPOT" potentiometer features:

- Length: ONLY $\frac{3}{4}$ "
- Diameter: $\frac{7}{8}$ "
- Linearity: $\pm 0.25\%$
- Resistance Range: 100 ohms to 100K ohms
- Power Rating: 2 watts @ 20°C
- Temperature Range: -25°C to +85°C
- Resolution: Better than any precision pot twice its size.

The Model 3253 "PIXIEPOT" potentiometer incorporates all of the fine engineering workmanship you've come to expect from other Duncan products. Only our new, unique production techniques enable us to bring this potentiometer to you at these unheard of prices.

And if you need your "PIXIEPOT" potentiometers in a hurry, we guarantee they'll be on an airplane out of Los Angeles within 24 hours after receipt of your order!

How can a "PIXIEPOT" potentiometer help you?

Call or write your Duncan representative (listed on the facing page). He will personally deliver to you, FREE, a 1K "PIXIEPOT" potentiometer for your evaluation in exchange for the filled out certificate.

This certificate redeemable for one 1K "PIXIEPOT"



(TYPE OR PRINT)

MY APPLICATION IS _____

NAME _____

COMPANY _____ TITLE _____

ADDRESS _____ DIVISION _____

CITY _____ STATE _____ ZIP _____

This offer expires December 1, 1967



DUNCAN ELECTRONICS, INC. • 2865 FAIRVIEW ROAD, COSTA MESA, CALIFORNIA 92626

ENGINEERING SALES REPRESENTATIVES

ALABAMA, Huntsville
Orbe, Inc.
Tel: (205) 881-8230

ARIZONA, Phoenix
Southwest Engineering Company
Tel: (602) 944-1521

CALIFORNIA, Costa Mesa
Duncan Electronics, Inc.
(Factory Sales Office)
Tel: (714) 545-8261

CALIFORNIA, San Francisco
Jack Pyle Company
Tel: (415) 349-1266

COLORADO, Denver
Hyde Electronics Co., Inc.
Tel: (303) 936-3456

CONNECTICUT, New Haven
Gerber Sales Co., Inc.
Tel: (203) 777-6279

FLORIDA, Orlando
Orbe, Inc.
Tel: (305) 424-0978

FLORIDA, St. Petersburg
Orbe, Inc.
Tel: (813) 894-0687

ILLINOIS, Chicago
Carlson Electronic Sales Co.
Tel: (312) 774-0277

MARYLAND, Baltimore
Biechler Associates, Inc.
Tel: (301) 825-8222

MARYLAND, Rockville
Biechler Associates, Inc.
Tel: (301) 762-6210

MASSACHUSETTS, East Longmeadow
Gerber Sales Co., Inc.
Tel: (413) LAurel 5-3059

MASSACHUSETTS, Waltham
Gerber Sales Co., Inc.
Tel: (617) 891-8040

MICHIGAN, Detroit
Grant Shaffer Company
Tel: (313) 273-5390

MINNESOTA, Minneapolis
Carlson Electronic Sales Co.
Tel: (612) 788-4111

MISSOURI, Kansas City
Harris Hanson Company
Tel: (816) 444-9494

MISSOURI, St. Louis
Harris-Hanson Company
Tel: (314) 647-4350

NEW JERSEY, Harrington Park
B. B. Taylor Corporation
Tel: (201) 768-0969

NEW MEXICO, Albuquerque
Hyde Electronics Co., Inc.
Tel: (505) 265-8895

NEW YORK, Baldwin, L.I.
B. B. Taylor Corporation
Tel: (516) 223-8000

NEW YORK, Rochester
Reed Electronics, Inc.
Tel: (716) 473-2767

OHIO, Cleveland
Rockford Controls Ohio, Inc.
Tel: (216) 531-4841

OHIO, Dayton
Rockford Controls Ohio, Inc.
Tel: (513) 274-1911

PENNSYLVANIA, Millersville
Biechler Associates, Inc.
Tel: (717) 872-2793

PENNSYLVANIA, Pittsburgh
Rockford Controls Ohio, Inc.
Tel: (412) 731-4600

TEXAS, Dallas
Robert R. Thomas Company
Tel: (214) 363-8591

TEXAS, Houston
Robert R. Thomas Company
Tel: (713) 644-2369

WASHINGTON, Seattle
Hamilton-Electro Corporation
of the Pacific Northwest
Tel: (206) 624-5930



DUNCAN electronics, inc.

... Canada wants to secure its claims to an equatorial orbit by occupancy ...

missions, as well as tv and radio signals, to local ground stations for rebroadcast.

Worlds apart. Canada's unique character imposes constraints—sociological as well as technical—on telecommunications that make a satellite system all the more attractive to common carriers and the government.

Alphonse Ouimet, president of the government-owned Canadian Broadcasting Corp., predicts that as many as 15 color-quality tv channels may eventually be needed to achieve coast-to-coast coverage. "We really have two networks at CBC," he says. The French-speaking minority of the population, about 6 million strong, has demanded and gotten completely separate programming and studio facilities.

To further complicate matters, Canada's vast breadth spans six time zones, and all programs except sports events have to be delayed and rebroadcast in each zone. And though French Canadians are concentrated in the eastern half of the country, every program must be rebroadcast in that language in four time zones.

Besides broadcasting in the two official languages, the CBC also beams programs to the Indians and Eskimos in the far north in their own tongues. Finally, the CBC, unlike U.S. networks, conducts regional operations serving specific areas of the country.

Natural enemies. Even the environment produces critical communications problems. Such phenomena as the northern lights, ionospheric storms, and a magnetic field that trails close to the moon's orbit from the sun are all factors in Canada's atmosphere that can affect terrestrial radio propagation.

Canada's policies are thus rooted more in necessity than in simple national pride. In space communications terms, Chapman says, the whole of the country is visible from only that part of the equatorial orbital plane lying between $\pm 20^\circ$ of 95° west longitude. Because there are so few nonconflicting positions commanding Central and North America in that belt, Canada reasons it must stake its claims and

secure them by physical occupancy as soon as possible.

IV. Technically speaking

So far as actual hardware, though, Chapman says: "Right now, what we want doesn't exist." However, the satellite system proposed this spring by the common carriers gives a good indication of the probable design that will be followed. The satellite would be a synchronous active repeater in a stationary orbit 22,300 miles above the equator. With 12 transponders, each capable of handling one color-quality tv channel or 1,200 one-way voice channels, the spacecraft would use uplink frequencies of 5.295 to 6.425 Ghz and transmit to ground stations at 3.7 to 4.2 Ghz. Effective radiated power would be 37 to 38 decibels above 1 watt. Solar cells for power would be backed by rechargeable storage batteries for use during periods of darkness or eclipse.

The common carriers recommend that Canada initially build three

Vast wasteland?

If an experimental scheme proves successful, the Canadian Broadcasting Corp. will provide television services to small, remote towns and mining camps in the far north. Yellowknife in the Northwest Territory, selected as the test site, has been getting four hours of programming a day since July via an Ampex Corp. 660 video tape recorder and a 5-watt transmitter. Programs are taped at the network outlet in Edmonton, Alberta, and flown to Yellowknife daily for rebroadcast. The local station, which cost about \$20,000, has an effective broadcasting range of five miles.

Pending favorable reaction to the pilot program, the CBC plans to provide as many as 40 more communities with what it calls its "frontier package." Such an arrangement would fill part of the broadcast gap until communications satellites go into operation. Meanwhile, the 6,000 inhabitants of Yellowknife have apparently taken to the idea: by the time service began, local merchants had sold all their tv sets.

WHAT CAN
YOU DO
WITH

RF
OUTPUT



4 WATTS of SWEEP RF?

(From 20 MHz to 1000 MHz)

If you're checking frequency response of a high power circuit you just can't get along without it! Now, with one of Telonic's four PD Sweep Signal Generators you can test response at power conditions that simulate actual operation of the circuit.

The PD instruments provide a full 4 watts of swept RF or 2 watts CW covering frequencies from 20 to 1000 MHz. Sweep width is continuously variable from 0.2% to 15% and a 1 db stepping attenuator provides a wide 59 db of attenuation range.

Call your local Telonic representative for a demonstration or write for Catalog 70 covering the entire line of Telonic Sweep Generators and "How To Use Them."



General Specifications

Models	Range (MHz)	Function
PD-2	20-100	Sweep—14 volts RMS
PD-3	100-250	into 50 (4 watts)
PD-7	200-375	CW—2 watts
PD-8	375-1000*	into 50 ohms

*Up to 2000 MHz (with 2 watts output) using Telonic Frequency Multiplier.

Telonic INSTRUMENTS

A Division of Telonic Industries, Inc.

60 North First Ave., Beech Grove, Indiana 46107
Tel.: (317) 787-3231 TWX: 810-341-3202

Represented throughout the U.S. and overseas. Factory offices in Maidenhead, England, and Frankfurt, Germany.

satellites. Two would be launched as soon as possible, one as a standby in case the other fails. The third would be ready for launching when needed. Useful life of the satellites is pegged at five years.

Nine transponders would be allocated for tv use. The CBC would get six of them, four for regional broadcasts and one each for English and French network transmissions. Canada's commercial tv would get a channel, and two would be used for educational purposes. The remaining three transponders would be devoted to message traffic, with one each allocated to the telephone system, the transportation companies, and remote telecommunications operations.

The carriers urge construction of 54 ground stations, 38 of them in Canada's far north country where telecommunications service is substandard or currently impossible. Operating costs, the carriers say, can be reduced by using 25-foot to 45-foot dish antennas with receivers equipped with parametric amplifiers that don't require cooling. Elimination of the need to perform tracking operations would also cut costs.

Openers. Canada's space ambitions are going to cost a lot, but the government appears more than willing to make the investment. Current annual spending on space projects comes to about \$17 million, but Chapman is calling for outlays of as much as \$70 million a year. Not all of this money would go for the communications satellite system, however.

Estimates of the system's cost run to \$38 million for the 54 earth stations, proposed by the carriers, \$17 million for three satellites, and \$25.5 million for launching services.

Chapman calculates that Canada's optimum investment in space activities will total 0.1% of its gross national product—about in line with U.S. outlays for applications projects. However, Canada's spending wouldn't accelerate overnight. Government officials reason that it's unrealistic to expect stable growth rates of better than 35% a year because of Canada's relatively limited technical manpower. The \$70 million rate of annual investment will probably be reached within four or five years.

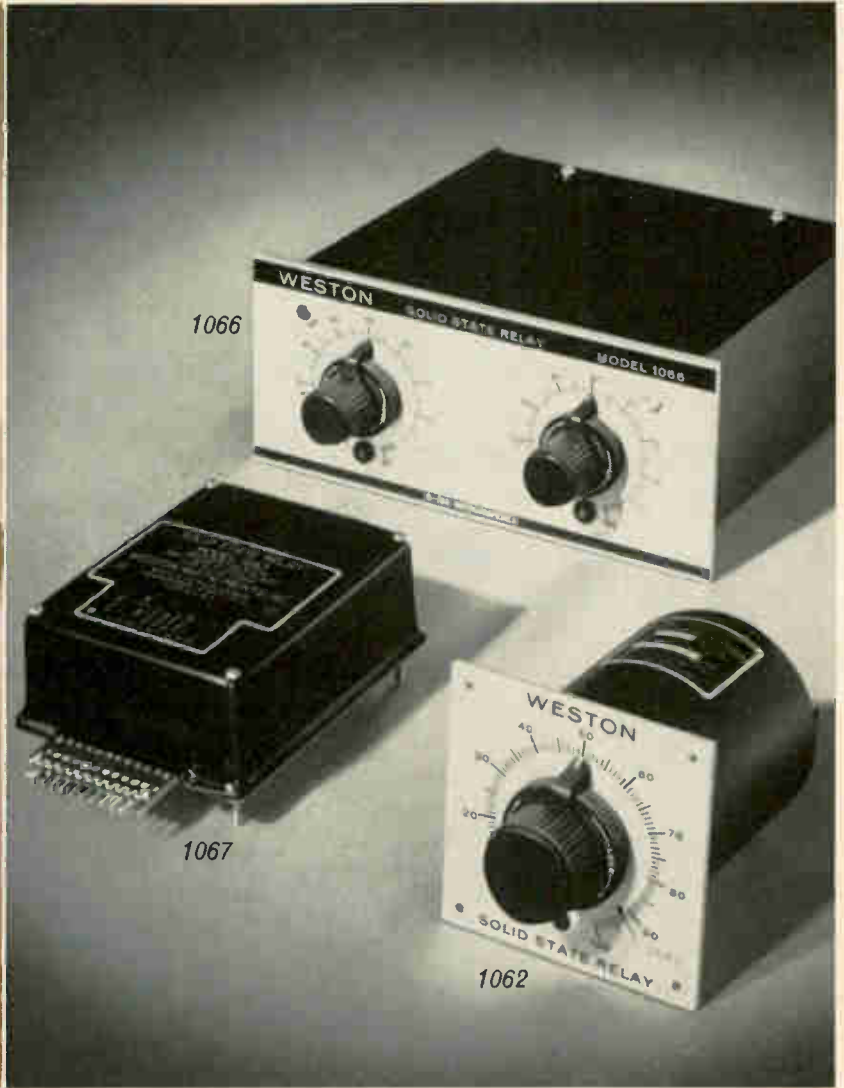

Weston solid state relays make electromagnetic relays look like antiques

Now the "mechanics" has been taken out of adjustable relays and replaced with rugged, reliable solid-state circuitry. As a result, these three new Weston relays not only look modern, they offer solid-state performance, too... the kind that eliminates rejects and puts more money in your pocket.

Model 1062 is fully adjustable over its entire 320° scale, includes a trip indicator and zero adjustment on the front panel, and features a self-contained differential amplifier, power supply and SCR switching circuit. Model 1066 is a Dual Set Point Relay with a synchronizing circuit for time-sharing between channels. Either

model can control a full amp at line voltage with ½% repeatability, 2% accuracy, and selectivity as low as 1 μa.

"Value engineered," low cost Model 1067 is designed for 28-volt dcooperation and has a load rating of 500 ma at 50 watts ac. All three relays are dust-free, vibration-proof, and operate from 0° to 50°C.

Find out what solid-state technology has done for the relay. Get complete details from your Weston distributor today, or write: Weston Instruments, Inc., Weston-Newark Division, 614 Frelinghuysen Avenue, Newark, N.J. 07114, a Schlumberger company.

WESTON® prime source for precision... since 1888

WESTON-ARCHBALD • WESTON-HATBORO • WESTON-NEWARK • WESTON-POUGHKEEPSIE • WESTON-LEXINGTON • WESTON-TRANSICOIL • WESTON-GARWIN CARRUTH • WESTON-CANADA

IBM[®] Circuit Design and Packaging Topics

- General Radio relies on IBM reed switches
- Suppression circuits extend reed switch life

□ General Radio relies on IBM reed switches

General Radio Company, West Concord, Mass., maker of test instruments, demands the best for their customers knowing that they can't tolerate equipment failure that will interrupt inspection or production routines.

That's why IBM reed switches go into General Radio's instruments.

General Radio uses reed switches in test instruments because they offer lower contact resistance than transistors, are smaller and more reliable than conventional relays.

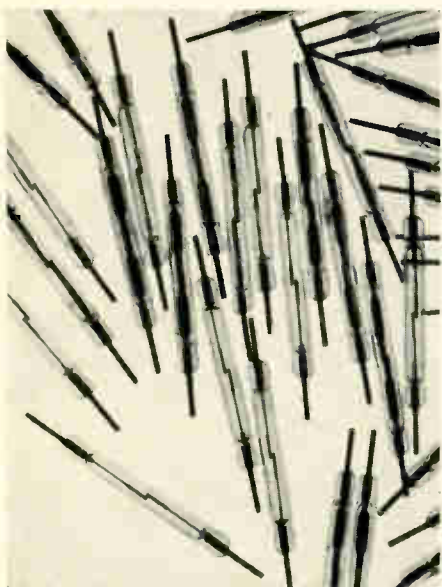

General Radio confirms through its own vendor-component evaluation program that IBM reed switches show zero failures after 25 million operations.

GR's Service Department claims they can't afford anything less since tests prove that the IBM switch "just keeps on going."

As a result, General Radio relies on IBM reeds in nine varieties of instruments, including the GR 1680-A Automatic Capacitance Measuring Assembly, the 1770 Scanner Systems and four different models of Coherent Decade Frequency Synthesizers.

□ Suppression circuits extend reed switch life

The miniature dry reed switch possesses characteristics which make it applicable to an extremely wide range of low power switching applications.

The reed offers rapid response, low actuate power, small size and a contaminant-free, adjustment-free contact arrangement. All of this provides the switching circuit designer with a highly adaptable device for modern, low-power, high density applications.

However, the construction of the miniature reed, with its small air gap and low-release spring force, makes it more susceptible to failure from contact degradation than any previous common contact switching device. Ac-

cordingly, special precautions must be taken when applying the miniature reed switch.

IBM conducts a continuing study to learn as much as possible about the reasons for contact degradation. Once we know why, we can take steps to prevent it—and, in some cases, prolong switch life by a factor of 10 or more.

What causes a reed switch to fail after 20-million cycles in one application yet continue to function after several hundred million cycles in another?

Failure in the reed switch can be caused by material transfer which occurs each time the contact makes or breaks current. This material transfer, plus any magnetic particles caused by wear, form a mound in the contact area. The mound eventually causes failure by increasing the contact resistance or bridging the air gap.

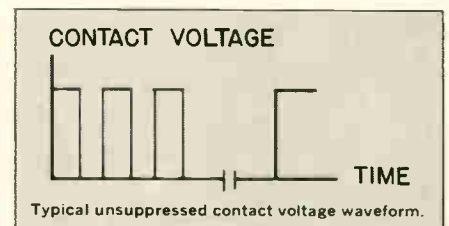

Bridge transfer occurs whenever two current-carrying conductors start to separate. The cross section of the contact point becomes increasingly smaller, giv-

ing rise to a constriction resistance that serves to heat the area. This heating effect first causes the metal to melt forming a bridge; then with further lever separation, to boil causing the bridge to rupture by vaporization.

fallacy to rely exclusively on volt-ampere ratings in estimating contact life. For any particular load condition, contact life can be considerably extended through the use of suppressive techniques.

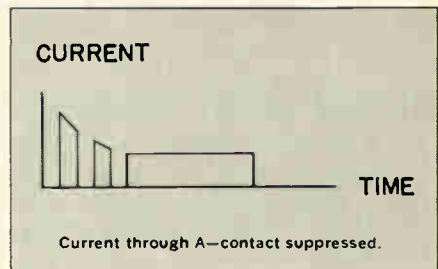
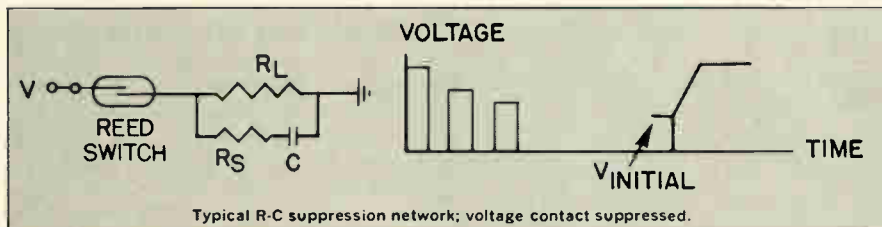

Another major process which causes material transfer in reed switches is arcing.

Arcing can occur both at the time the levers are first closing and at the time of the initial lever separation.

The arc on break is essentially the result of thermionic emission. It is caused by the heating of the levers, which in turn causes increasing constriction resistance at the time of lever separation.

The arc on make is caused solely by field emission and does not necessarily entail lever preheating. With open circuit voltages as low as 15 volts an arc can occur.

IBM studies to date indicate that major causes of contact degradation are a function of load conditions. It is a

On request, we will send you a detailed report on the design of typical R-C suppression circuits which can

maximize the life of your reed switches. Proper suppression techniques create new possibilities for circuit designers where speed, size and power are increasingly important.

Send in the coupon. IBM Industrial Products Marketing, 1000 Westchester Avenue, White Plains, New York 10604

**IBM Industrial Products Marketing Dept. T2
1000 Westchester Avenue
White Plains, New York 10604**

- IBM reed switch specifications
- Suppression circuits extend reed switch life

name _____

position _____

company _____

address _____

city _____ state _____ zip _____

...and another MTOS first

the only monolithic 16 channel random access multiplexers available...anywhere!

The MEM 5015 is the first multiplexer with address storage and decoding capability and the first with voltage and current mode operation.

MEM 5015 Random Access Multiplexers \$198⁰⁰ each*

OTHER FEATURES:

- Exclusive Differential Mode . . . permitting multiplexing of eight differential signal pairs
- Expandable . . . to permit larger multiplexing arrays
- Low Power Consumption . . . 80mW (total)
- Low Leakage . . . less than 2 nA per channel
- Zero Offset Voltage . . . not possible with bipolar switches

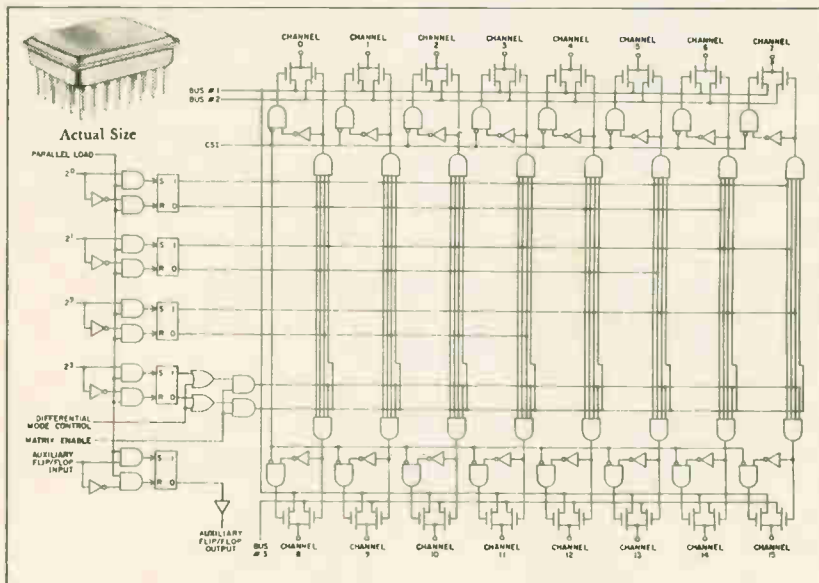

General Instrument's MEM 5015 is the newest complex integrated circuit available in the rapidly expanding line of MTOS firsts. It is a monolithic MTOS Large Scale Integrated Circuit containing 223 P-channel enhancement mode transistors on a chip 77 x 74 mils operating as a 16 channel randomly addressable multiplexer. The unit consists of four address holding flip-flops, a "four-in/sixteen-out" decoding matrix, 16 single-pole-double-throw switches, and some auxiliary logic for increased versatility. A Current Shunt Inhibit control line permits the selection of Current Mode or Voltage Mode multiplexing, while the Differential Control allows the switches to operate as eight ganged pairs. A Matrix Enable line allows multiple MEM 5015s to be connected to form larger multiplexing arrays.

The MEM 5015 is in a 40 lead hermetically sealed in-line package which can be soldered to a printed circuit board or used with a 40 pin socket. They're available off-the-shelf from your authorized General Instrument Distributor. In Europe, contact General Instrument Europe, Via Turati 28, Milano, Italy. Write for complete data.

*in quantities of 100



New Products

New systems

Data processing in 3-D

Holograms are made in crystal by a laser system that includes an air-suspended aluminum work table

Its most common manifestation seems to be three-dimensional pictures of toy trains and chess pieces, but the laser hologram can also help process side-looking radar data, predict the radiation pattern of phased-array radar antennas, analyze structural stress, and study seismic data.

A variation—Bragg-angle, or crystal, holography—is being investigated by the military [Electronics, Nov. 14, 1966, p. 52] and the National Aeronautics and Space Administration, and is now available to the public in a new data processing system from Car-

son Laboratories Inc.

Two systems compete with Carson's. One, from Jodon Engineering Associates, is called a holographic camera and has a full set of equipment for making high-quality holograms on film or glass plates. A line of optical correlators from the Conductron Corp., a subsidiary of the McDonnell Douglas Corp., performs optical data processing. Carson's system does both and adds a crystal holographic capability to boot.

1. Multiple images

The Government is studying the

use of Bragg-angle holography to store large amounts of data, such as engineering drawings or photos from planetary probes, in small volumes. But crystal holography's other features make it helpful in the research lab, and the Carson system makes the necessary equipment available in a single package.

Potassium bromide (KBr) stores data in the form of spots within its molecular lattice; the spots are bleached by laser light. A hologram consists of a thin layer of such spots. Since the angle of incidence of the light beams striking the KBr determines the depth at which the data is stored, multiple images can be stored by making slight changes in this angle between exposures.

Four advantages. Use of KBr rather than photographic plates has four advantages. First, no development is needed—one can even watch the hologram form within the crystal during exposure. Second, up to 50 holograms can be

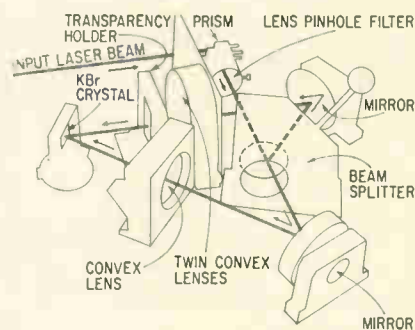
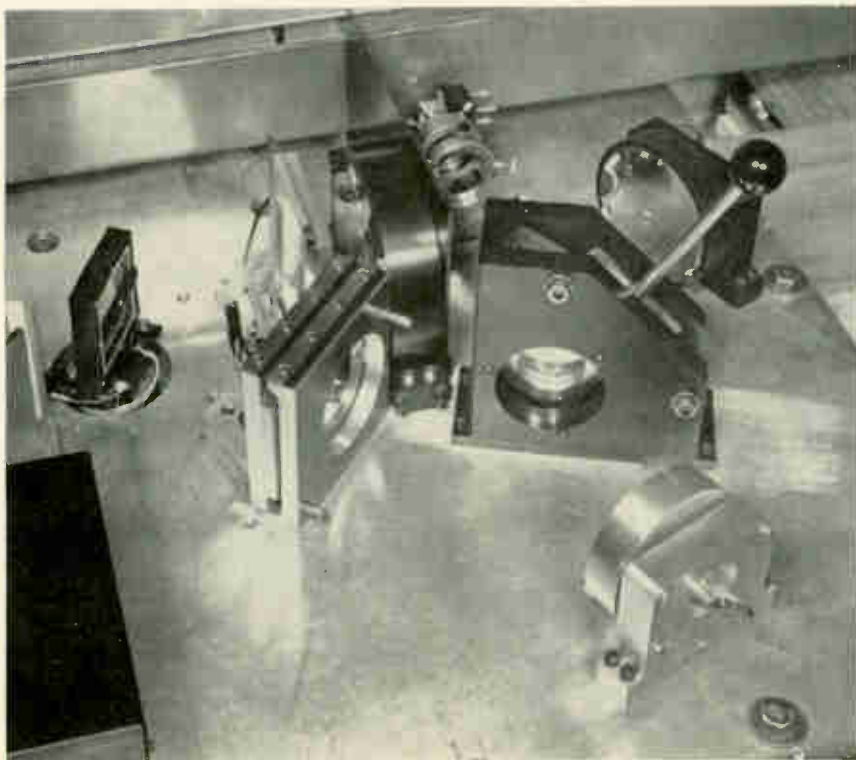

Crystal set. Diagram shows how light travels among prototype components set up in photo at left to record analog data such as photos or drawings. After exposure, a joy stick is used to lift the beam splitter out of optical path, and the crystal can be viewed from the rear. In this early model, the stepping motor for the KBr crystal holder is below the table.

**P&B DRY REED
CLIP FILE**

**Low cost
supervisory circuit
uses only one
double wound
P&B Reed Relay**

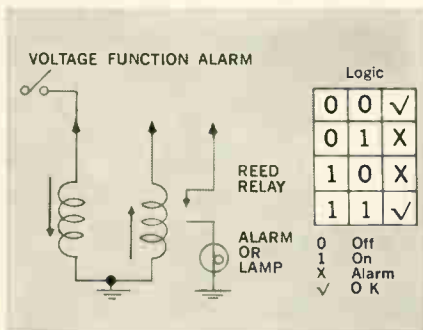

**Eliminates complex
solid state circuitry**

Monitor temperatures, vat levels, operating sequences or a host of other characteristics with just one double wound P&B dry reed relay. Performing the same functions with solid state elements could be more complex, more expensive. These relays, for example, may be operated by a wide range of DC voltages and are far more tolerant of excess voltage surges.

P&B dry reed relays give you speeds in the low milli-second range, long life (20 million operations), low contact resistance, short bounce times. Metal enclosures provide electrical shielding as well as physical protection for the coils and capsules.

**Full line—up to
5 reeds per module**

JR standard size and JRM miniature reed relays are available in assemblies of 1 to 5 switches. Both sizes come in a complete range of coil voltages and various combinations of Forms A, B and C contact arrangement.

**Capsule seals are
stress-protected**

Bobbin flange extensions support the terminal pins, providing stress protection of the capsule seals.

SEND FOR A CATALOG giving complete specifications. Contact your local P&B representative or the factory direct for complete information.

P&B Dry Reed Relays are now available from authorized electronic parts distributors.



POTTER & BRUMFIELD
Division of American Machine & Foundry Co.
Princeton, Indiana 47570

**... one can watch the hologram form
within the crystal during exposure ...**

stored within a single crystal by changing the angle at which the laser light strikes its face. Third, KBR has high optical resolution—at least 1,000 lines per millimeter. Finally, exposure to ultraviolet light erases stored data, leaving the crystal ready for reuse.

A good example of KBR holography would be the recording of bubble formation in viscous liquids. The crystal would be rotated through six minutes of arc as each new view is added. The hologram record wouldn't require development as would a photographic plate, and could be read out almost instantly by removing a beam splitter from the optical train by pulling on a joy stick, and rotating the crystal through the original angles. The result would be instant stop-action or moving photography in three dimensions, a valuable lab tool.

To simplify such recording, Carson supplies a KBR crystal mount with a stepping motor to move the crystal through its range of incidence angles, or to set it to a single one for stop-action viewing or single-shot holography.

Double exposure. KBR's high resolution makes it possible to find hot spots in components as tiny as integrated circuits. A hologram is taken with the IC inoperative and cool, and then with the IC working. This double exposure pinpoints hot areas by revealing their expansion; hot spots show up like measles.

In the event that the user's needs don't fit in with KBR, Carson supplies photographic-plate or film holders.

II. Optical correlation

The spatial filter is the key element in optical correlation and pattern recognition. To make a filter with the Carson system, the user first makes a transparency of the pattern to be identified, whether it's a waveform or a fingerprint, passes through it a collimated beam of laser light, and focuses it in the plane of a photographic plate. This gives a diffraction pattern of the original image—and a

contact print of the diffraction pattern is a spatial filter.

Spotting it. Optical correlation is performed by placing a transparency of raw data—a very noisy radar signal, for example—in a collimated laser beam. The beam then passes through a convex lens that focuses it in the plane of the spatial filter. Another convex lens beyond the filter forms the light into a "recognition" pattern in still another plane. Bright spots in this plane indicate a match—the waveform the user was looking for is contained in the raw data; blurs indicate a mismatch.

This sort of pattern recognition is one of the simplest forms of optical correlation possible with the new system, but enough optical accessories are included to accommodate most other arrangements.

III. Stable table

Carson's system includes an air-suspended stable table, necessary because holograms must be made in a vibration-free environment. This table is as unconventional in a commercial product as is the KBR. Usual engineering practice would call for a granite slab on a foundation possibly going down to bedrock. In Carson's design, a lightweight metal table rests on air sacks inflated to about 5 pounds per square inch. These damp all vibrations and completely block any above 2 hertz.

The combination work surface and optical bench is a reinforced aluminum plate. It was chosen over granite because it can be



Playing the angles. Crystal at right is rotated by stepping motor whose controller is at the rear. Six arc minutes of rotation change incidence angle of laser beam enough to separate holograms.



**WHAT'S AN ELECTRONIC
SPECIALIST DOING IN THE
SCREEN PRINTING BUSINESS?**

...PRINTED CIRCUITRY, OF COURSE!

Now, in addition to knowing about capacitors, diodes and resistors, you're supposed to know all about film, resolution, exposure and wash-out! . . . Cheer up!

Ulano doesn't know beans about microelectronics . . . but we know all there is to know about screen printing! We should. We've been at it for over 30 years. We're the world's leading manufacturer of screen stencil film . . . *any kind.*

. . . There's a right Ulano film for every project.



*In screen processing
of complex printed circuitry...
there's no margin for error!
That's why Ulano offers
a complete line of
Screen Process Stencil Films
especially designed for
the Electronics Industry.*

ulano

T.M.

610 DEAN STREET, BROOKLYN, N.Y. 11238

NEW YORK • CALIFORNIA • CHICAGO • ZURICH

In Europe: ULANO A. G., Untere Heselbachstrasse 22, Kusnacht 8700, Switzerland

Write on your letterhead for special electronic test kit (no charge) No. 5948.

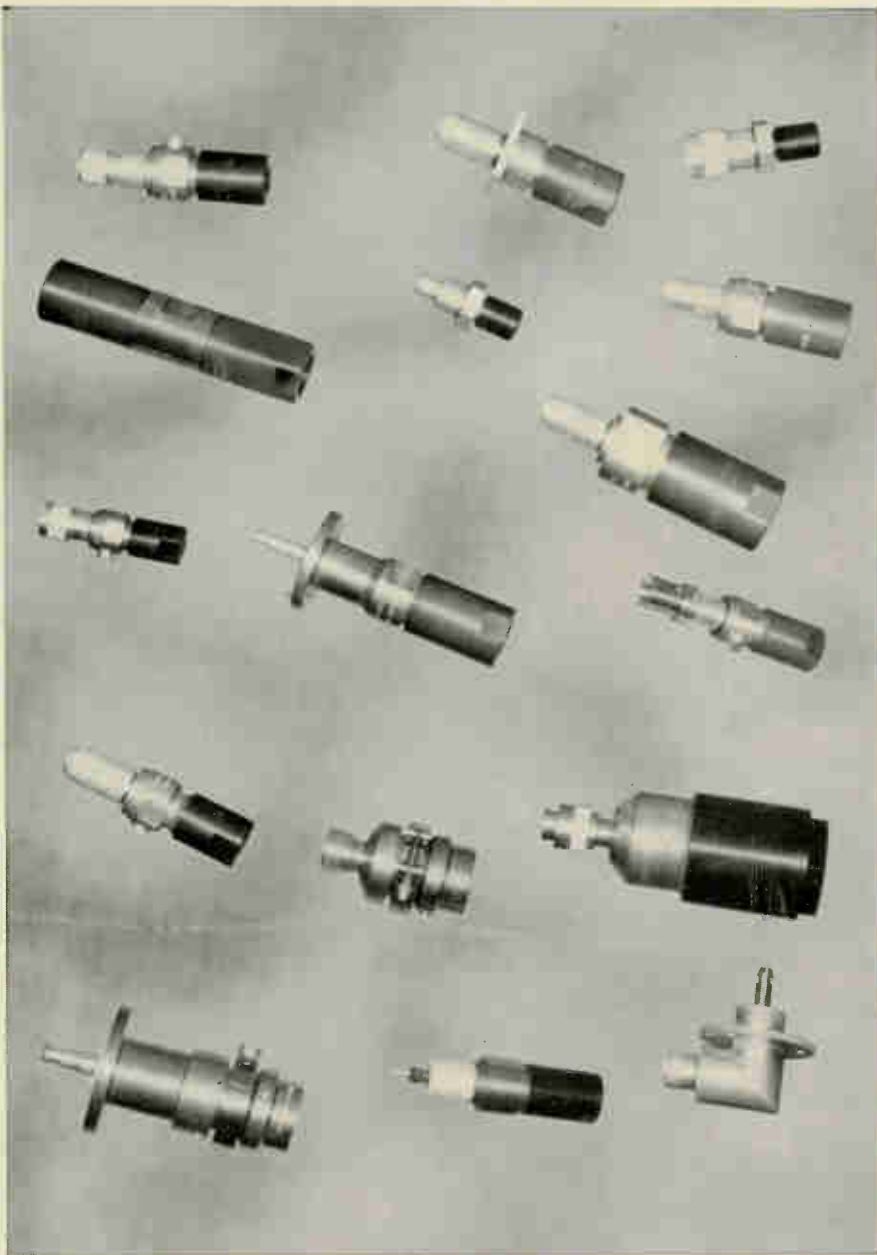

Connectors for semi rigid coax? Yes. All sizes, all interfaces!

Here is an all new series of connectors ideal for Phelps Dodge or any other make of semi-rigid coaxial cable ready for delivery from stock.

This new design incorporates a captivated collet holding mechanism providing positive holding capability with best possible electrical contact. VSWR is low, and the maintenance of cable pressures up to 30 psi are guaranteed when properly installed. And, best of all, these new connectors are immediately available off-the-shelf

in all sizes, all interfaces, from 1/4" to 7/8" in Type N, HN, UHF, C, BNC, TNC, GR and Splice. Other interfaces and sizes are available on request.

Other important features include a 1/8" NPT threaded gas port which is provided for the attachment of pressure lines or gages and a conventional "O" ring gasket gas and moisture seal. A special epoxy barrier around the base prevents electrolysis.

Can we tell you more? Write for Bulletin WH, Issue 4.

PHELPS DODGE ELECTRONIC PRODUCTS
NORTH HAVEN, CONNECTICUT



... for more light, there's
an argon-ion laser ...

drilled and tapped easily—optical components such as mirrors and beam splitters can be bolted down and will stay put—and because the metal's high thermal conductivity makes it a stable surface. Thermal shock is dissipated rapidly and produces only momentary warpage, and this reduces the need for temperature control in the holographic lab.

The system's \$11,500 price includes two KBR crystals as standard equipment, as well as the necessary rotating crystal mount and the stable table. Also covered are a red-emitting, 15-milliwatt helium-neon laser, two sets of fixed-angle and adjustable mirrors, a beam splitter, a selection of achromatic lenses with several focal lengths, a Polaroid film holder to record the results of optical correlation, holders for glass and film holographic plates, and holders for the transparencies needed in optical data processing.

Extras. For customers who want to make color holograms, or who need more light power, Carson offers a 100-mw argon-ion laser. Its emissions span the visual range, and for users who need power extending toward the ultraviolet, the same laser tube can be filled with krypton.

The argon-ion laser is one of a line of such systems just introduced by Carson. Not only is its plasma tube usable with various gases, but it's also warranted for 1,000 hours. Built of a ceramic material, it will outlast quartz plasma tubes by a wide margin, according to Carson.

A motorized film transport is available for users who want fast sequential input of optical correlation transparencies. And for those who want to record the results in style, Carson offers a 35-millimeter camera frame to replace the Polaroid film holder. Finally, for users who require the utmost accuracy in rotation of the KBR crystal, a servo-like control panel is offered with three separate vernier adjustments.

Delivery is within 90 days.

Carson Laboratories Inc., 375 Lake Ave., Bristol, Conn. 06011 [338]

RESOLVER/SYNCHRO DIGITAL CONVERSION

A very short course for engineers who are concerned with converting resolver or synchro data to digits and vice versa.

Engineers working in digital computer input/output interface systems for tactical airborne equipment, aircraft and space vehicle simulation, antenna positioning or programming, and similar systems are increasingly involved in solving the digital/analog interface problem for resolver and synchro data. Accomplishing this task becomes quite simple by taking advantage of North Atlantic's family of high accuracy resolver/synchro converters. Through the use of solid-state switching and precision transformer techniques, these converters provide single-speed accuracy and resolution from 10 to 17 bits, along with solid-state reliability and calibration-free operation.

Resolver/Synchro-To-Digital Conversion At 2000°/sec.

One typical North Atlantic resolver/synchro interface is shown in Figure 1. It continuously converts 400Hz resolver and synchro angular data to digits at angular velocities up to 2000°/sec. This device



Figure 1. Model 545 Automatic Angle Position Indicator converts resolver and synchro angles to digital form.

utilizes micro-circuits and all solid-state plug-in cards in conjunction with precision trigonometric transformer elements (no motors, gears, or relays), and operates at all line-to-line voltages from 9 to 115 volts. It can be supplied in a wide range of configurations for specific system requirements. For example, signal frequency bands of 50Hz to 1600Hz or 50Hz to 4.8K Hz, BCD

digital outputs, .001° resolution with 10 arc second accuracy and multi-speed inputs. The unit illustrated has an accuracy of .01°, and offers added submodes of operation; they are Command (single update and hold), and Free-Run (repetitive update and hold) for observation of changing or noisy data. Prices start at \$5900.00.

Digital-To-Resolver/Synchro Conversion

North Atlantic's all solid-state digital-to-resolver/synchro converters (Figure 2) accept digital input data at computer speeds in either binary angle or binary sine/cosine form and convert to either resolver or synchro data. Their high accuracy and resolution (up to 17 bits) and freedom from switching transients meets an important requirement in space-mission simulation and antenna positioning systems for smooth servo performance at low rates of data change. All models are usually supplied with input storage registers.

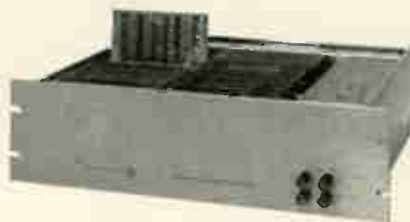

Figure 2. Series 536 Digital-To-Resolver Converters translate binary digital angle to four-wire resolver data.

Depending on the combination of features specified, prices are in the \$4500. to \$6000. range.

Modular D-R/S Converters For High-Density Systems

The plug-in converters pictured in Figure 3 were developed by North Atlantic specifically for airborne systems and for aircraft simulation systems requiring high-den-

sity multi-channel operation. The modules illustrated provide 11-bit digital-to-synchro conversion and are capable of driving up to four torque receivers. As with other North Atlantic resolver/synchro interfaces, conversion is achieved through solid-state switching and trigonometric transformers, so there are none of the stability or calibration problems associated with conventional resistor-chain/amplifier type converters. Prices, in production quantities, run about \$1100. per set. In prototype quantities about \$1500. a set.

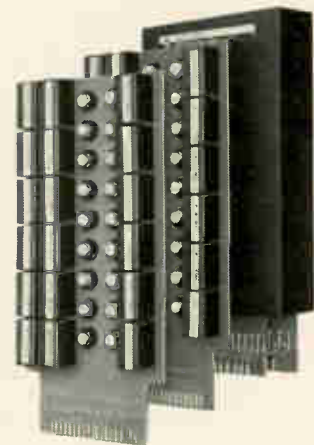
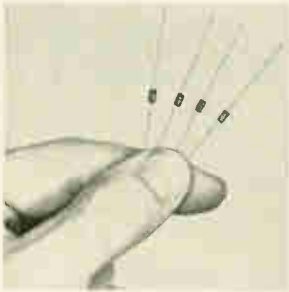

Figure 3. Series 537 D/S Converter Modules can drive multiple torque receivers from 11-bit digital data.

If you would like to take advantage of North Atlantic's state-of-art experience in resolver/synchro computer interface, we would be pleased to show you how these converters can meet your particular requirements. Or if you prefer, we will arrange a comprehensive technical seminar for your project group, without cost, in your own plant. Simply write: North Atlantic Industries, Inc., 200 Terminal Drive, Plainview, N.Y. 11803. TWX 510-221-1879. / Phone 516-681-8600.

New Components Review



Subminiature ceramic tubular capacitors series CT07 are rated at 50 v d-c over a temperature range of -55° to $+125^{\circ}$ C. Capacitance values are from 10 to 10,000 pf in tolerances of $\pm 10\%$ and $\pm 20\%$. The capacitors exceed the requirements of MIL-C-11015. They measure 0.165 x 0.095 in. Gulfon Industries Inc., 212 Durham Ave., Metuchen, N.J. [341]

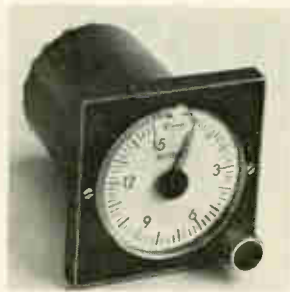

A plug-in industrial reset timer provides instant interchangeability for circuit testing and maintenance. Model 400 has time ranges from 6 sec to 96 hours, accuracy within 0.25%, and 2 load and 2 instantaneous switches. Applications include control of machine tools, induction heating equipment, and conveyor controls. Cramer Division, Conrac Corp., Old Saybrook, Conn. [342]



Rfi-shielded toggle switches attenuate conduction and radiation in the 0.14-to 200-Mhz range. They are suitable for radiation-free airborne electronic equipment conforming to MIL-I-26600. Series TR2100, 2150, and 3100 have an operating torque of 20 in.-oz max. Prices start at \$7.56. Control Switch Division, Controls Co. of America, 1420 Delmar Dr., Folcroft, Pa. [343]



Ultraminiature rear projection readout SR-90 has 12-message capability. It reads out symbols, characters, or up to 4-line messages 0.1 in. high. Front dimensions are 0.650 x 0.460 in. Lamp replacement is accomplished from the front panel, by removing the readout from the housing assembly. Shelly Associates Inc., 111 Eucalyptus Dr., El Segundo, Calif. 90246. [344]

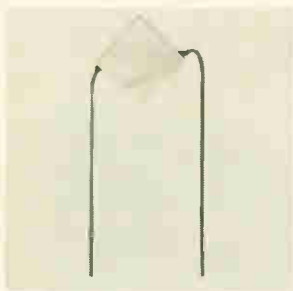

Thermoelectric module 3954-1 spot cools small components and controls temperatures of biological specimens. It is permanently mounted between 2 aluminum plates for mechanical strength and uniform cold junction temperatures. Units measure 4 sq cm with a heat-pumping capacity of 30.6 BTU/hr. Cambridge Thermionic Corp., 445 Concord Ave., Cambridge, Mass. [345]

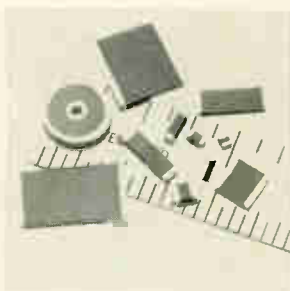

Ceramic chip capacitors are moisture resistant and contamination free in small rectangular, large rectangular, square, and monolithic disk feed-through configurations. Type K-1200 series, available in 51 models, ranges from 10 pf to 1.5 μ f. They operate from -55° to 125° C. D-c working voltages are 50, 100, and 200. Monolithic Dielectrics Inc., Box 647, Burbank, Calif. [346]

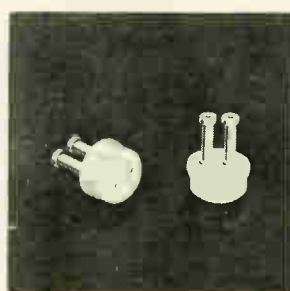

Two-pin, feed-through terminal FT-MC-300 features tubular lugs mounted in a single Teflon bushing suited for multiconnection applications in compact assemblies. Component leads come up from beneath the chassis, through holes in the lugs, and are then soldered in place. Circuit wiring can be attached to the outer lugs. Sealectro Corp., 225 Hoyt St., Mamaroneck, N.Y. 10543. [347]



Circular connectors type ESM are bayonet locking, subminiature, and have a high contact density (0.080 in. center-to-center). They come in a 37-contact version in a No. 12 shell, and a 92-contact type in a No. 18 shell. Contacts are rated at 5 amps. They accept 22-, 24- or 26-gauge wire and are accessible from the rear of the connector. Elco Corp., Willow Grove, Pa. 19090. [348]

New components

Diode chips for automatic tuning

Variable-capacitance units are available for use in hybrid integrated circuits

Totally electronic tuning systems are replacing everything from the fine-tuning controls in television sets to the ganged capacitors in a-m radios. The heart of these systems is a voltage-variable capacitor diode—a device whose ca-

pacitance is a function of applied voltage.

The availability of these diodes in chip form gives designers of hybrid integrated circuits the ability to design a complete ic to perform tuning tasks.

Fallout. The series VVCC diodes were originally developed for a large electronics firm by MSI Electronics Inc., but the order was cancelled and MSI is marketing the chips themselves.

The diodes are available in capacitance ranges from 3 to 18 picofarads, with a tuning ratio of 2:1. Each chip measures 0.020 by 0.020 by 0.008 inch, and the junction contact varies from 0.002 to 0.011 inch in diameter depending upon the capacitance value. The chips can dissipate up to 300 milliwatts; the operating junction temperature is rated at 150° C, although

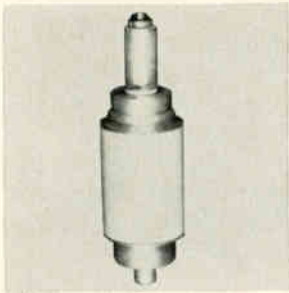

Variable capacitor CAQA-200 utilizes ceramic and copper materials with a vacuum dielectric. It handles 50 amps rms at 16 Mhz. Temperature rating is 120°C. Capacitance range is 10 to 200 pf. Over-all length is 3.75 in., diameter 1.31 in. The CAQA-200 makes possible the design of compact transmitter tank circuits. Jennings Division, ITT Corp., Box 1278, San Jose, Calif. [349]



A 40-pole, double-throw relay package has 2-amp, 28 v d-c resistive contacts. The SR package eases replacement of individual switching units, eliminating the need to replace the complete unit. The sealed relays operate in a -65° to +125°C range, withstand 50 g shock for 11 msec, 20 g vibration from 10 to 2,000 hz. Branson Corp., Vanderhoof Ave., Denville, N.J. [350]

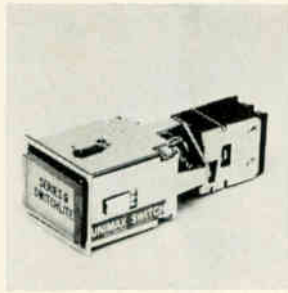

Illuminated pushbutton controls designated LPB series 9 consist of 4-lamp units that meet MIL-S-22885 requirements. Features include two-step (push-pull) re-lamping, and factory-installed internal lamp bussing. The LPB's are available with 2-, 3- or 4-pole momentary or alternate action switching. Unimax Switch Division, Maxson Electronics Corp., Wallingford, Conn. [351]

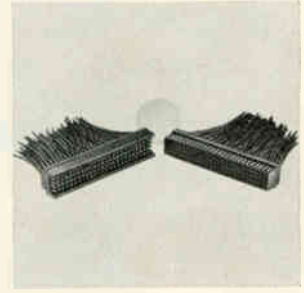

Miniature phenolic connectors offer from 4 to 104 circuits in multiples of 4. They have aligning ribs to assure positive polarity. The connectors are UL recognized to 250 v a-c at 5 amps average per contact. They can be used by manufacturers of computers, communications equipment, and consumer-type equipment. Molex Products Co., 5224 Katrine Ave., Downers Grove, Ill. 60515. [352]



Ten-turn wirewound pot model 3253 PixiePot is 7/8 x 3/4 in. and weighs 1/2 oz. Resistance tolerance is ±5% over 100 ohms to 100 kilohms. Linearity is ±0.25% and resolution is typically 0.222. Units are rated at 2w at 25°C. Price is \$5.95 in lots of 1 to 24; less than \$4 in production quantities. Duncan Electronics Inc., 2865 Fairview Rd., Costa Mesa, Calif. [353]

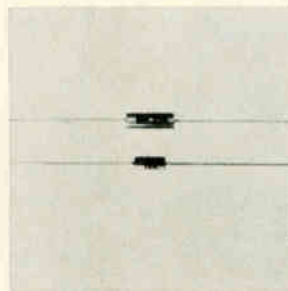

Molded metal film resistors conforming to MIL-R-10509E come in 2 types. The MR-31 and MR-39 have wattage ratings of 0.1 and 0.125 respectively. Units have a ceramic core on which a metal film is deposited. End caps make contact with the resistive film. Tinned copper leads are resistance welded to the end caps. Mepco Inc., Columbia Road, Morristown, N.J. [354]

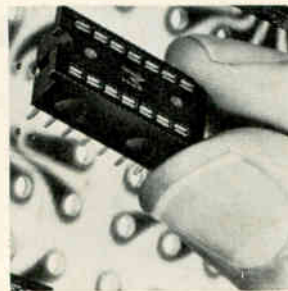

Dual in-line IC sockets series M-1000 have universal mounting capabilities. They can be p-c-board mounted with standard 0.100 x 0.300 pin spacing and have snap-in features for mounting into punched aluminum panels to 1/8 in. thick. Prices range from 15 cents each in large production quantities. Methode Manufacturing Corp., 1700 Hicks Rd., Rolling Meadows, Ill. [355]

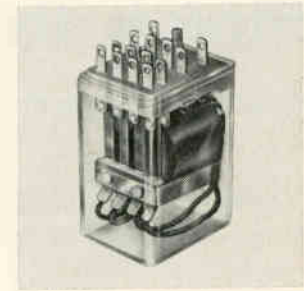

Magnetic latching relay type RR is offered in voltages ranging from 24 to 220 v a-c, and 12 to 110 v d-c. Standard design incorporates 4PDT contacts in fine silver, silver-cadmium oxide, gold nickel, silver palladium (60/40), and silver palladium (30/70). Mechanical life is 100 million operations. Schrack Electrical Sales Corp., 1140 Broadway, New York 10001. [356]

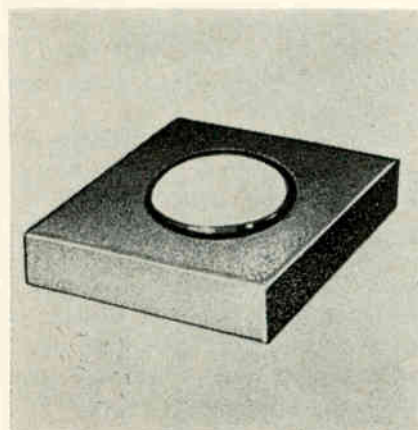

Contact. White dot on diode chip is junction contact.

the chip will withstand temperatures of up to 400°C for short periods.

Junctions are processed to resist adverse ambient conditions with an exclusive MSI silicon thermal oxide protection technique. The diodes have a 30-volt breakdown rating with a leakage current of 0.1 microamps measured at 20 volts reverse bias, and have a Q factor in excess of 200 at 50 megahertz.

Prices range from \$4.50 to \$16.50, depending upon capacitance, and delivery is from stock.

MSI Electronics Inc., 34-32 57th St., Woodside, N.Y. [357]

New materials

Dichlorethane's in — and dirt's out

Solvents for cleaning circuit boards remove dirt, leave part numbers

In a comment that might have been written for a Tide ad, the Union Carbide Corp. says that its

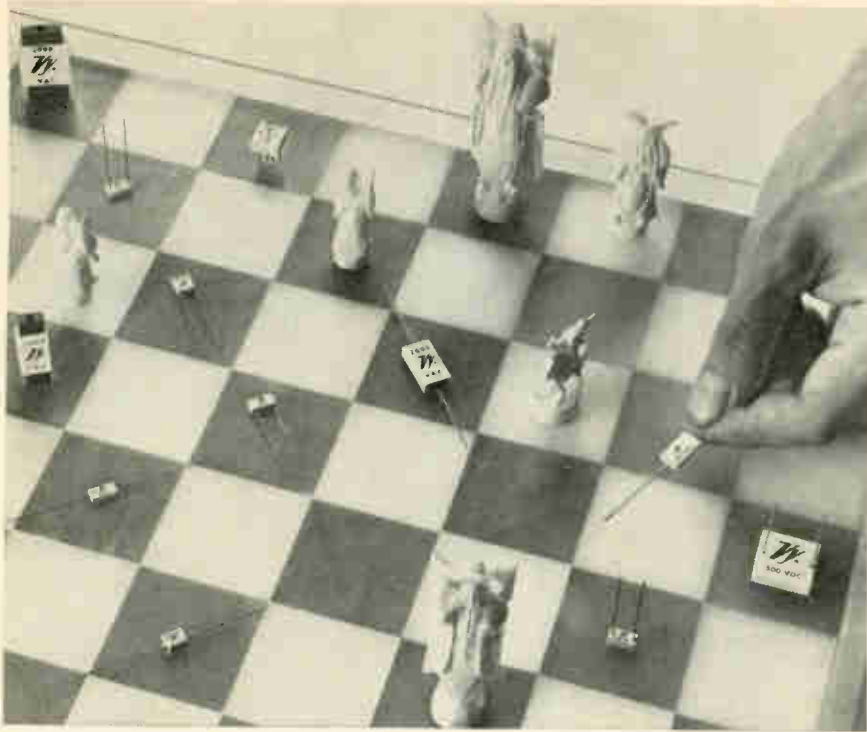

Make the right move!

Cover your board with "VY" Porcelain Capacitors

You're making the right move because you can **select** the exact features you need from over 20 styles of porcelain capacitors.

Most important, you obtain the high stability, low-loss characteristics for which the monolithic "VY" Porcelain Capacitor is famous.

In fact, you can **select** capacitors with either a positive, negative or zero temperature coefficient... voltage ratings to 2500 vdc... current ratings to 22 amps RF... capacitance values as low as 0.24 pf, as high as 10,000 pf — all with an extremely long MTBF. You can even obtain space-saving, **thin line** cases.

Want to be sure you're making the right move? Then let us make the first move by handing you our catalog. (It might clear up this complex chess game called 'capacitor selection.')

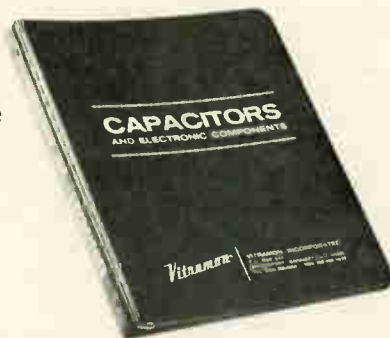

Vitramon

VITRAMON, INCORPORATED
BOX 544
BRIDGEPORT, CONN. 06601

In Greater Europe Contact:
VITRAMON EUROPE
Wooburn Green, Bucks, England

... for tough cleaning jobs, another mix ...

new solvent for cleaning printed-circuit boards provides gentle, controlled cleansing and a lifting, floating action that will get dirt out of even the smallest crevices in a p-c board assembly.

The solvent was concocted because customers had complained that straight trichlorotrifluoroethane—the standard 113-type solvent—didn't always do a good job. Sometimes it left contaminants on the board. Sometimes it dissolved printed identification numbers on components while leaving quality control markings, scribbled with grease pencil, on the boards.

Ink is safe. To the basic 113, the company added dichlorethane and called it 113 DCE. The additive allows the solvent to remove pencil markings, but not the standard component marking inks, and to do a more thorough job of removing soil. It also controls the cleaning action of the fluorocarbon base material, making it less harsh, the company adds.

Union Carbide also has another new type, 113 MCP, consisting of the basic 113 plus methylene chloride and cyclopentane. This is equivalent to Mr. Clean. Intended for tougher cleaning jobs, it will root out polymerized solder fluxes, greases, oils, and waxes—and those grease-pencil scrawls—but it still won't harm most component marking inks.

Samples ready. Type 113 DCE is exclusive with Union Carbide; 113 MCP is similar to a solvent made by the du Pont Co. Union Carbide is making samples available for test and evaluation. Sales in bulk—from 5 gallons to a tank car—will be made after Oct. 1. The company hasn't set prices for bulk quantities.

Both new solvents are azeotropes, which means they have constant boiling points and can be reclaimed, when full of dirt, by the usual distillation equipment. They don't require inhibitors or stabilizers and can be used in dip or ultrasonic baths, spray cleaners, vapor degreasers, and similar washing equipment.

Union Carbide Corp. Chemicals and Plastics, 270 Park Ave., New York 10017 [358]

any DIP'll do

One DIP Header
for all DIP's.
Mount it on your panel.
Wire posts automatically
—sharp corners bite wire.
One-piece posts
stand true, stand up.
Plug, unplug your
DIP's quickly, easily.
Low cost.

AMP



PUT YOUR IDEAS INTO ACTION WITH THE HELP OF AMP ENGINEERING . . . WORLDWIDE.

Circle 149 on reader service card

AMP INCORPORATED
Harrisburg, Pa. 17105

Show me what AMP's new Dual In-line Header'll do.

NAME _____
COMPANY _____
ADDRESS _____
CITY _____ STATE _____ ZIP _____

New materials

Ceramic magnet is 25% smaller

Improved resistance to demagnetization reduces size of focusing magnets

Traveling-wave tubes and motors can be made smaller if designers switch from the Indiana General Corp.'s Index 6-A ceramic magnet material to the new Indox 7. Focusing magnets in *trw*'s, or motor magnets, will give the same performance in 25% less volume.

Indox 7 was developed for applications requiring good flux output during or after exposure to severe demagnetizing influences. In motors, magnets must fight the armatures during stalls or starts, and in tubes must resist the like poles of neighboring magnets. Only high-priced cobalt-platinum does this better than Indox 7, says James R. Ireland, research and engineering vice president of Indiana General.

The specification that counts is $B_r H_x$ (residual induction times the intrinsic magnetization curve's H coordinate at 0.8 B_r). Index 6-A has a value of about 9.5 million, while Indox 7 has 12.7 million.

Production of ring-shaped magnets has started, and facilities to produce arc-shaped magnets will soon be ready.

Indiana General Corp., Magnet Division, Valparaiso, Ind. [359]

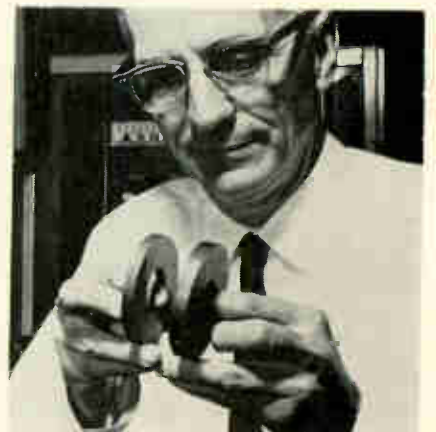

New ring. Slim magnet in the left hand is as strong as the fat ring.

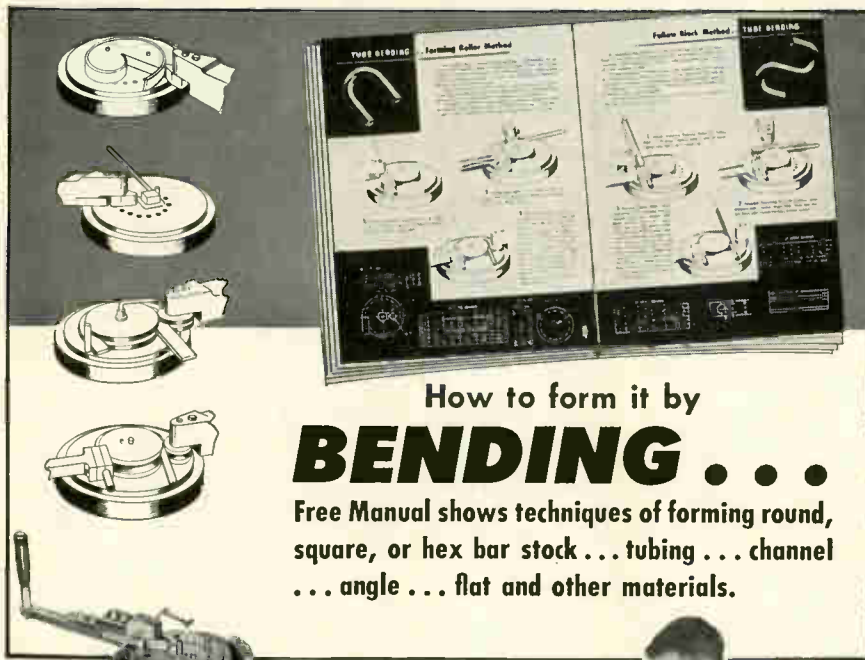

How to form it by
BENDING . . .
Free Manual shows techniques of forming round,
square, or hex bar stock . . . tubing . . . channel
. . . angle . . . flat and other materials.

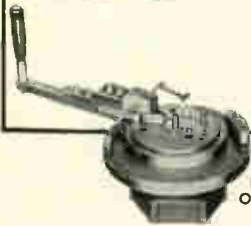

Di-Acro Hand Operated Bender



Di-Acro Hydra Power Bender

It's easy to bend a wide variety of material when you know how—profitable too because bending can simplify product design—make one curved piece do the job of two or more. Bending can improve product appearance and lower your production costs!

This 32-page illustrated manual shows how to make center eye and off center bends, circles, zero radius bends, scrolls, squares, springs and coils, loops and spirals—all with *one versatile machine*. Booklet also tells how to tool for tubular, channel, angels and other special bending needs.



439 EIGHTH AVENUE
LAKE CITY, MINNESOTA 55041

WHO PINNED A MEDAL ON THIS TINY TRW CAPACITOR?



...nearly everybody!

For your next design where there's too little room for components and *no room for compromise*...turn to "tiny but tough" TRW Type 608 Mylar* capacitors.

Excellent electrical characteristics and exceptionally small size make the Type 608 ultra-miniature a good capacitor for exacting military and instrument applications. Add the remarkable record of space-proven reliability and TRW Type 608 becomes a great capacitor!

Look at these outstanding features!

- 50% smaller than MIL-C-27287
- 4½ lb lead pull capability
- Mylar-foil, tape-wrapped construction
- Exceeds characteristics of many larger units
- MIL-C-27287 performance
- 50V and 100V, .001 to 2.0 mfd
- Temp. range -55 to +85°C; to 125°C with derating
- Tolerance to ±1% available

Product information is available from TRW Capacitor Division, TRW INC., Box 1000, Ogallala, Nebraska. Phone (308) 284-3611. TWX: 910-620-0321. *DuPont's trademark for polyester film.

TRW®

Now you can put long-term reliability into precision resistor applications.

Because Corning made a production of precision.

CORNING® NC Style Resistor
Design Tolerance
 ΔR in % over 10,000
hour load life

3-2-101123

RN55C, 1/8 watt @ 70°C, ±1%
" " " " " " 1%
RN55C, 1/4 watt @ 125°C, 1/2%
" " " " " " 1%
RN60C, 1/4 watt @ 70°C, 1/2%
" " " " " " 1%
RN60C, 1/8 watt @ 125°C, 1/2%
" " " " " " 1%
RN65C, 1/2 watt @ 70°C, 1/2%
" " " " " " 1%
RN65C, 1/4 watt @ 125°C, 1/2%
" " " " " " 1%

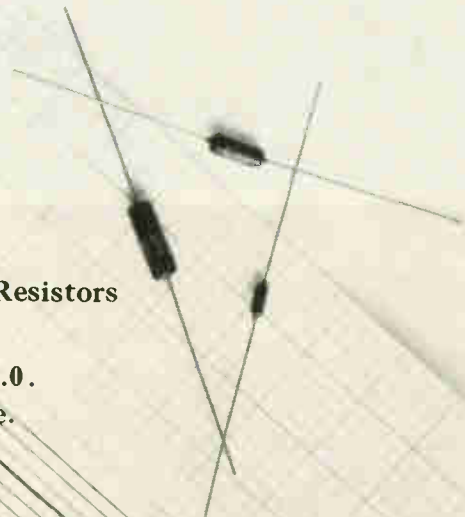

The continuous production process for CORNING® NC Style Resistors gives you total uniformity to these specs:

- Predictable end-of-life design tolerances from +1.8% to -1.0.
- Molecular bonding of metal oxide film and glass substrate.
- Matching TC's of film and glass.
- <math><1/2\%</math> load life ΔR .
- Overall TC of ± 50 ppm.
- Mil-R-10509E, Char. C conformance.

Get this precision again and again. Specify CORNING NC Style Resistors. In three sizes, with these ratings at 125°C.: 1/10 watt in 49.9 ohms to 150K, 1/8 watt in 49.9 ohms to 499K, and 1/4 watt in 49.9 ohms to 1 meg.

Precise data is yours for the asking from your Corning distributor, or by writing to: Corning Glass Works, 3913 Electronics Drive, Raleigh, N. C. 27602.

CORNING
ELECTRONICS

3-2-101123

New Semiconductor Review

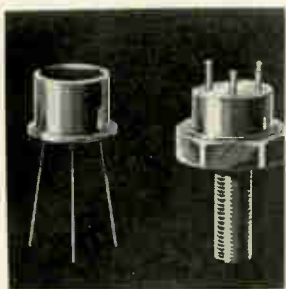

Silicon npn transistors A200/A201/A202 serve as class C r-f amplifiers. Power output is 1w, 7 w, and 12 w; gain is 10 db, 6 db, and 6 db, respectively. The inherently fail-safe units are intended for use in 12 v, battery-operated 175 Mhz mobile communication systems. Semiconductor and Receiving Tube Division, Amperex Electronic Corp., Slatersville, R.I. 02876. [436]



Axial-lead silicon rectifiers rated at 2 amps have a surge rating of 200 amps. Piv ratings range from 50 to 1,200. The devices are 0.2 in. in diameter and 0.38 in. long with a transfer molded, void-free body. They replace $\frac{3}{16}$ -in. stud units and eliminate heat sinks. Price of a typical unit—the MIBO (200v)—is 64 cents each. Electronic Devices Inc., 21 Gray Oaks Avenue, Yonkers, N.Y. [437]



Engineers experimenting with semiconductors can cut prototyping costs by 75% with a designers' kit of plastic-encapsulated components. Pnp and npn switching and amplifier transistors, FET's, unijunction transistors, scr's, silicon power transistors and an IC operational amplifier are included. Price is \$24.50. Texas Instruments Inc., 13500 N. Central Expressway, Dallas. [438]



Silicon planar npn Darlington transistors 2N2723-4-5 are 2 transistor chips mounted in either a 3- or 4-lead TO-18 package. Characteristics include h_{FE} within 10%, V_{BE} matched within 30 mv, and temperature tracking within $100 \mu v/^{\circ}C$. Applications are constant-current supplies and voltage comparators. Solitron Devices Inc., 1177 Blue Heron Blvd., Riviera Beach, Fla. [439]

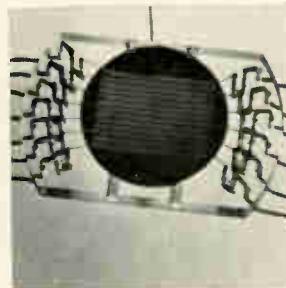

Gold-striped semiconductor detector 5441 on an n-type silicon disk is used for studying the structure of a beam of charged particles. It may be used in a beta spectrometer for the simultaneous measurement of electrons with slightly different energies. Resistivity is greater than 10,000 ohm-cm. Energy resolution is less than 35 kev. AB Atomenergi, Studsvik, Nyköping, Sweden. [440]



Mini-Mono, whiskerless glass diodes 1N5315 and 1N5316 are less than $\frac{1}{16}$ th of the standard subminiature DO-7 glass package. Minimum breakdown voltage at $10 \mu a$ is 100 v. Forward voltage drop at 10 ma is 0.650 and 0.690 v minimum for the 5315 and 5316. Reverse current at 50 v is 50 na. Continental Device Corp., 12515 Chadron Ave., Hawthorne, Calif. 90250. [441]

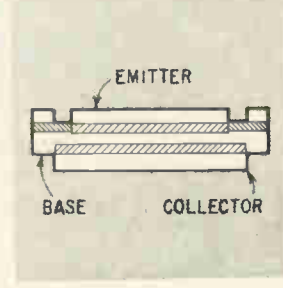

Utilizing the ADE (alloy diffused epitaxial) construction process, the MP2200A-2400A germanium transistors are suited for core driving, power conversion, and high-voltage switching where high power handling capability (80 to 120 v minimum at 8 amps) is needed. Prices range from \$2.25 to \$2.60. Motorola Semiconductor Products Inc., P.O. Box 995, Phoenix, Ariz. 85001. [442]

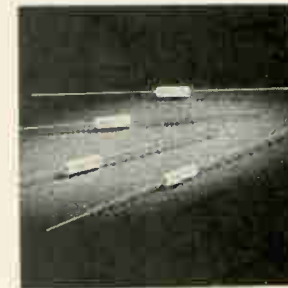

A radiation-hard squib firing switch withstands nondestructive testing. Called Squitches, the 2-terminal devices are made of Ovonic amorphous semiconductor materials encapsulated in standard DO-7 glass envelopes. Blocking resistance is over 1 megohm in the off-condition, switching speed, less than 1 nsec. Energy Conversion Devices Inc., 1675 W. Maple Rd. Troy, Mich. 48084. [443]

New semiconductors

IC line is based on feedback

Phonograph makers were sounded out before Westinghouse designed its first low-cost consumer IC, an audio amplifier

Latest to join the ranks of semiconductor suppliers introducing integrated circuits for consumer application is the Westinghouse Electric Corp.'s Molecular Electronics division. The company's deliberateness was caused in part by a market-research effort that sent a team

of engineers into consumer plants to ask manufacturers of entertainment equipment what they planned in the way of new products and how ic's could help.

The answers resulted in Westinghouse changing circuit designs considerably to satisfy performance

requirements. One product was the audio amplifier; the research team brought back the word that the makers of phonographs had specific demands: mainly, they wanted a circuit that required a low-voltage power supply and had a high-input impedance because the signal it would handle was likely to come from a ceramic pickup, which has a high impedance. At least 1 watt would be required to drive a typical speaker of 4 to 16 ohms impedance.

Westinghouse's amplifier WC334, built to specifications suggested by the inquiring engineers, is rated at $1\frac{3}{4}$ watts, requires 9 to 15 volts,

Eliminate Manual I.C. Testing

NOW! TEST FLAT-PACKS AND DUAL-IN-LINES FAST WITH BARNES HIGH-SPEED, AUTOMATIC TEST HANDLER



Are you still hand-feeding your expensive I.C. parameter test equipment? Now you can handle flat-packs ($\frac{1}{8}$ " x $\frac{1}{4}$ " to $\frac{3}{8}$ " x $\frac{3}{8}$ ") with up to 14 leads and standard 14 or 16 lead dual-in-lines in Barnes 029 Carriers at speeds up to 4000 test cycles per hour. For production test, QC and incoming inspection, the Barnes TH037-B02 Handler is fast, foolproof and flexible . . . featuring automatic magazine or manual input and go-no go sorting. Write for full data.



Lansdowne, Pa. 19050 • 215/MA2-1525

barnes / THE FIRST WORD IN CARRIERS, CONTACTORS & SOCKETS FOR I.C.'S

Circle 223 on reader service card

RSC micro-accuracy assures maximum ROTARY SWITCH

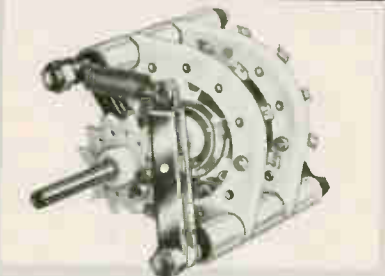
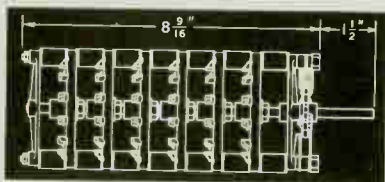

Operational Reliability!

Switch to the best!

Manufactured of materials especially suited for high performance in low level circuitry, RSC Rotary Switches provide reliable dry circuit switching under even adverse environmental conditions. The RSC quality line includes types from 10 to 100 ampere current carrying capacity, 2000 to 24000 volts flashover, 1 to 18 positions, 20° to 90° detents. Write for illustrated catalog.

MODEL 86 NON-SHORTING SWITCH FEATURES (Illustrated): 7000 volt peak flashover at 60 cps • 20 ampere current carrying capacity • Current carrying members heavily silver plated • Coin silver contact shoes • Low loss silicone impregnated seatite stator and shaft • Black anodized aluminum support brackets • Nylon detent wheel

RADIO SWITCH CORPORATION

MARLBORO, NEW JERSEY 07746

Telephone: (201) 462-6100

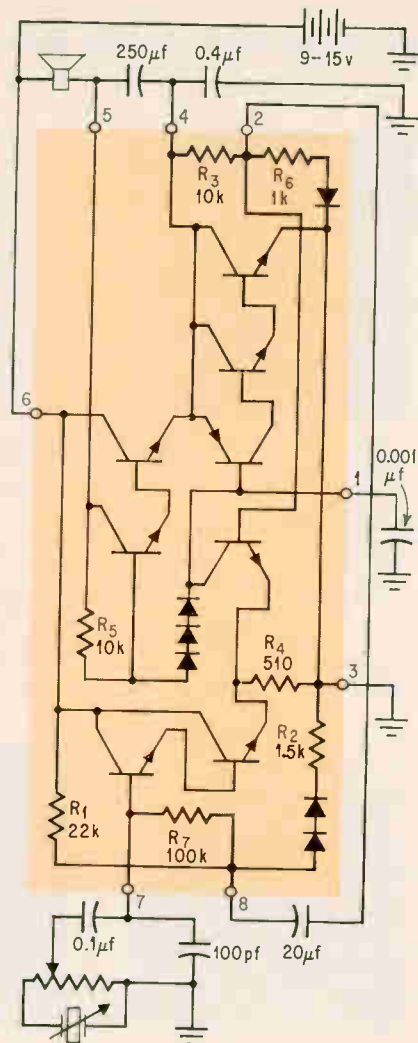

Push-pull. Output stage delivers more than a watt to speaker.

and has an input impedance of 400 kilohms. It is intended for phonographs, and its low-voltage rating makes it usable in battery sets.

Building resistance. Hardest part of fabricating the WC334 was building in the high impedance. To do it, Westinghouse designers chose a signal path whose configuration was a Darlington amplifier connected to the emitter follower. The gain of the Darlington multiplied the 510-ohm emitter-resistor to produce a signal whose input impedance was several-hundred kilohms.

Instead of using large-value resistors to increase the impedance of the bias networks, the company turned to positive feedback or bootstrapping. The feedback signal is obtained at the output from the resistive divider formed by R_3 and R_6 in the schematic, and applied to the 100-kilohm resistor, R_7 , feeding the bias to the input.

As the bootstrap signal raises and lowers the voltage on R₇ with fluctuations of the applied signal, the current drain through R₇ decreases, making that resistor appear larger. The effect is enough to multiply R₇ tenfold, so the bias impedance looks as if it were a megohm to the signal. This prevents shunting the signal to ground.

Output. The output circuitry is direct drive push-pull, which is capable of good performance without the use of an output transformer.

Because the push-pull stages are self-centering across a wide range of power-supply voltages—from less than 9 to more than 15 volts—the same circuits can be used in phonographs with different power-supply voltages. And it can continue to operate satisfactorily after the batteries have started to run down.

Westinghouse hopes to make its new amplifier competitive by pricing the circuit between \$1 and \$2 in large quantities.

Molecular Electronics division, Westinghouse Electric Corp., Elkridge, Md. [444]

New semiconductors

For stereo, two circuits in one

Isolation of 50 db separates channels in IC preamplifier

You don't get two for the price of one when you buy the new dual preamplifier for consumer stereo applications made by Motorola Semiconductor Products Inc., but you do get the first integrated circuit dual preamplifier on the market. It is priced competitively with single preamplifiers now available.

The two preamplifiers on a single monolithic chip are in a dual in-line plastic package designated MC1302P. In addition to saving space because the two preamps are in one package, the device provides isolation that is "quite good for stereo," says Clay Tatom, Motorola's linear-product planner for IC's. Channel separation is 50 decibels at 1 kilohertz, and 45 db at 10 khz. This is better than the 25-db sep-

FULL 1 CU. FT. CHAMBER— ONLY \$975⁰⁰!

New Associated chamber features:

- Cascade refrigeration to -120°F
- Solid-state $\pm 1/2^{\circ}$ controller
- All new design



Model SK-2101

The best price we know of for any one-cubic-foot refrigeration chamber on the market! Yet, this is not a stripped-down model. It operates over an expanded temperature range, from -120°F to $+350^{\circ}\text{F}$! It features a new all-solid-state controller with $\pm 1/2^{\circ}\text{F}$ stability! And, standard equipment includes an adjustable high-temperature fail-safe control, complete with indicating lamp.

What's more, everything's in a completely redesigned, handsome package with a combination hinged and removable door for added convenience. Write today for complete specifications!

**FREE CATALOG OF ALL-NEW LINE
OF ASSOCIATED CHAMBERS WITH
SOLID-STATE CONTROLLERS!
WRITE TODAY TO DEPT. E-6.**

**ASSOCIATED TESTING
LABORATORIES, INC.**

200 Route 46, Wayne, New Jersey
(201) 256-2800





workability

(pre-production training)



WESTern PENNSylvania has a proved-in-use plan by which adaptable, productive people with a variety of industrial aptitudes will be trained in advance for YOUR operation, usually at no cost to you. You can also save on labor-turnover costs in WESTern PENNSylvania where the "Voluntary Quit rate" is only one-

third the national average. This workability and training program . . . plus 100% financing at low, low interest rates . . . fair tax climate . . . four-season livability . . . give WESTern PENNSylvania a top combination of plant-location values.

West Penn Power

Part of the Allegheny Power System 

Area Development Department, Room 763
WEST PENN POWER—Greensburg, Pa. 15601

Phone: 412-837-3000

In strict confidence, I'd like to know more about WESTern PENNSylvania's:

- Pre-Production Training Financing Plans
 Fair Tax Climate Industrial Properties and Shell Buildings
 Please have your Plant Location Specialist call.

Name _____ Title _____

Company _____

Address _____

City _____ State _____ Zip Code _____ Phone _____

... frequency response goes back to flat ...

aration offered by stereo cartridges.

Clips crosstalk. Signal isolation is not necessarily obtained when two separate preamps are used. The signals can be coupled through the power supply, introducing crosstalk that can kill the stereo effect. Motorola not only eliminates the crosstalk problem, but does it on one chip, avoiding the need for isolation components in the outside circuitry.

The MC1302P is designed primarily for use in low-level audio signal processing, such as built-in responses for the Recording Industry Association of America's (RIAA), and the National Association of Broadcasters' (NAB) playback equalization curves for disk and tape recorders.

The output signal from a microphone in a recording studio is flat with frequency, but as the signal is recorded, the intensity of low frequencies is decreased, and that of high frequencies is amplified. To produce a flat response when the disk or tape is played back, the low frequencies must be amplified and the high frequencies must be attenuated.

Going flat. The dual preamp is employed in one type of circuit to give a flat response in RIAA applications, and in another type of circuit to produce a flat response in NAB applications. Typical gain using the MC1302P in the RIAA curve is 40 db, with 30 db for the NAB curve. Maximum distortion with an output of 1 volt rms is 0.8% for the RIAA characteristic, and 0.3% for the NAB characteristic.

Selling for \$4.20 in quantities of 100 or more, and \$3.50 in lots of 1,000, the cost of the MC1302P compares favorably with the \$2 price for single preamps. And these single devices are not designed specifically for stereo applications.

Specifications

Supply voltage	+8 vd-c and -8 vd-c
Differential input signal	+ or - 2.0 v
Output short circuit	
duration	continuous
Power dissipation	400 mw at 25°C
Operating temperature	0 to 75°C

Motorola Semiconductor Products Inc.,
Box 955, Phoenix, Ariz. 85001 [445]

SCIENCE/SCOPE

Survivability of materials in outer space is being studied at Hughes under a NASA contract. A special environmental chamber was designed to investigate the effects of high vacuum, extreme temperatures, and radiation on typical space-vehicle materials. Up to 25 specimens at a time can be mounted on its "Lazy Susan" turntable, and special experiments can be made to discover the "failure mechanism" when damage occurs.

An experimental tactical communications satellite for the U.S. Air Force is being built by Hughes under the direction of USAF's Space & Missile Systems Organization. Giant spacecraft -- biggest communications satellite ever built -- will have an array of five UHF antennas, each nearly eight feet long, extending from the top. It will be spin-stabilized, with the solar panels rotating while the antennas and inner structure remain in a fixed position.

Two new dielectric materials for encapsulating repairable high-voltage electronic components in spacecraft have been developed by Hughes. One is a lightweight polyurethane foam-in-place that has proved its long dielectric life aboard Hughes communications satellites. The other is a granular, ceramic-filled polymer with a very high filler-to-binder ratio. It is especially useful for high-voltage space and airborne networks that require dissipation of high thermal energy.

Career opportunities at Hughes include immediate openings for magnetic components and electro-optical engineers, circuit designers, and weapon systems analysts. Requirements: at least two years of applicable experience, accredited engineering or scientific degree, U.S. citizenship. Please send your resume to: Mr. J. C. Cox, Hughes Aircraft Company, Culver City, California. Hughes is an equal opportunity employer.

Large, ultra lightweight structures for space are getting special attention at Hughes. Structures would be compactly packaged for stowage in the launch vehicle. In space, they'd be unfurled and inflated, then chemically rigidized. Hughes chemists have developed vapor-catalyzed and ultraviolet- and infrared-activated systems. One particularly promising system uses the vacuum of space to cause automatic rigidization of fiber-reinforced structures that have been impregnated with gelatin -- such as precision antenna parts, gravity gradient booms, radomes, parabolas. System is reversible: structures can be erected on the ground (preferably in a dry climate), tested, and then softened and repackaged.

An improved infrared spectrometer for Nimbus D, scheduled for launch in 1969, is being built by Santa Barbara Research Center, a Hughes subsidiary. It will measure worldwide temperature and humidity distribution of the troposphere, providing useful data for weather forecasting. SBRC is also developing a two-channel, five-pound infrared radiometer to measure the surface temperature of Mars. It will be carried by the two Mariner flyby spacecraft to be launched in 1969.

Creating a new world with electronics



New Instruments Review



Magnetic stabilizer model MS-10 fully charges and stabilizes metallic alloy magnets up to ¼ lb with a stabilization accuracy within 2%. It is capable of up to 1,000 charging cycles per hour. It is available in 115-v or 230-v models with single pushbutton or foot pedal operation. Instrumentation Division, Thomas & Skinner Inc., 1120 E. 23d St., Indianapolis, 46207. [361]



Amateur and Citizens Band radio operators can measure noise, resonant frequency, and operating impedance of whip antennas, dipoles, beams, and quads using an antenna noise bridge and a receiver that tunes the range of interest. Operating range is 0.5 to 150 MHz, from 0 to 100 ohms. Price is \$24.95. Omega-t Systems Inc. 516 W. Belt Line Rd., Richardson, Texas. [362]



A single-channel analog recorder has 100-mm channel width. Single, dual, or multiple speeds in the range from 1 mm/sec to 100 mm/sec can be supplied. Amplifiers and power supplies are available for sensitivities from 1 mv/cm to 50 v/cm. Frequencies up to 125 hz can be recorded. Mechanics For Electronics Inc., 152 Sixth St., Cambridge, Mass. 02142. [363]

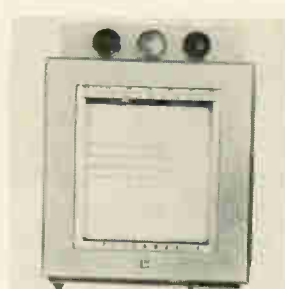

A dual-range Speedomax recorder measures molten-metal temperatures with the Temtip expandable immersion thermocouple, as well as carbon equivalent (or other analyses) with the Tectip thermal-analysis detector. This offers a savings for foundries and meltshops over the 2 recorders normally required. Leeds & Northrup Co., 4901 Stenton Ave., Philadelphia. [364]



ServiVar is a battery-operated instrument that measures a-c voltage from 25 to 600 v at frequencies from 25 to 500 hz; a-c current, from 0.2 to 100 amps at 60 hz; and resistance, from 50 to 100,000 ohms. A snap-around probe allows readings in hard-to-reach locations. It accommodates wire up to 0.5 in. Bacharach Instrument Co., 200 N. Braddock Ave., Pittsburgh, Pa. [365]



An injection-current probe can be clamped around d-c, 60 hz or 400 hz power lines carrying up to 300 amps, without altering their transfer characteristics. Designated GIP7418, it is also capable of injecting 1 amp from 100 hz to 100 khz into a circuit using an audio amplifier as the source. Genistron Division, Genisco Technology Corp., 18435 Susana Rd., Compton, Calif. [366]



The Micro/marker is a crystal controlled, time-mark generator. The battery-powered unit provides a harmonic output of approximately 1 v peak-to-peak with an output impedance of 50 ohms. Stability is better than $\pm 0.01\%$ from 0° to +60°C. The unit is packaged in a 1¼ x 1¼ x 4¾ in. aluminum case. Price is \$59.50. Accutronics Inc., 12 South Island, Batavia, Ill. [367]

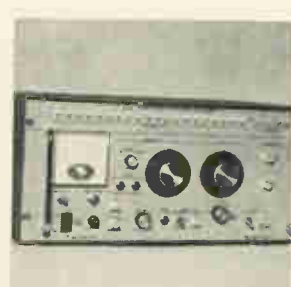

Fully automatic shock spectrum analyzer model N980 is designed for lab or field use. Accuracy is $\pm 3\%$ (any model), and frequency response is ± 0.5 db. The unit spans 1 to 10,000 hz. Frequency intervals are selected by pushbutton in ½-octave increments or by vernier control. Dynamic range is 60 db. MB Electronics Inc., 781 Whalley Ave., New Haven, Conn. 06508. [368]

New instruments

Plug-ins make voltmeter a triple threat

Developers see a \$20 million market for differential voltmeter that also measures ratios and frequencies

By year's end, Wavetek will be selling a differential voltmeter that can measure alternating- and direct-current voltages, d-c ratios, and frequencies from 5 hertz to 100 megahertz.

"This covers about 80% of all measurements made in the elec-

tronics industry," says a company spokesman. "We'll be offering all this capability in one small package for less than \$2,000. If a customer wanted to buy just a 100-Mhz counter, he couldn't get one for less than \$3,000."

Flexible. Wavetek entered the

differential voltmeter field a year ago with a unit that had two special features—a company-developed "transfermatic switch" that coupled the digit dials to cut down on knob twisting, and a nonsaturating null amplifier to speed the selection of null sensitivity. Now, the company has followed this up with a basic meter package incorporating similar features but designed to operate with a variety of plug-in units.

The model 210's meter has a five-hole, six-digit transfermatic switch (the last hole or disk has two digits for greater accuracy), an edge-reading taut band meter, Kelvin-

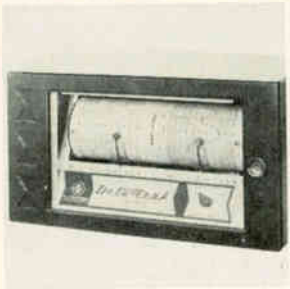

Data-Trak 5110-2P is an electrostatic curve follower with 2 curve-sensing probes which track the individual x and y coordinate data plotted on a Mylar chart. A precision pot is servocoupled to each probe to translate graphical data to equivalent electrical outputs. The unit is suited to any process requiring 2 synchronized and programmed signals. Research Inc., Box 6164, Minneapolis. [369]

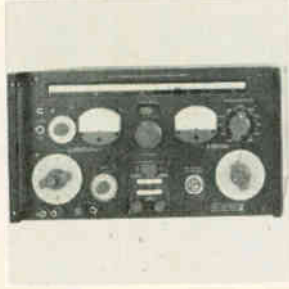

Standard-signal generator type 1003 covers 67 khz to 80 Mhz, with calibrated output of $0.1 \mu\text{v}$ to 6 v behind 50 ohms. Total warm-up drift is typically 150 ppm in 3 hours, and drift after the warm-up period is typically 1 ppm per 10 minutes. Price, including the automatic control package and crystal calibrator is \$2,995. General Radio Co., West Concord, Mass. 01781. [370]

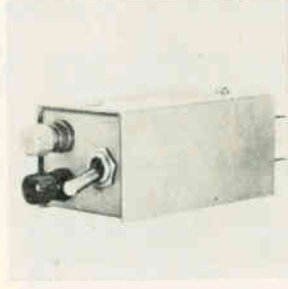

A plug-in thermocouple reference junction converts millivolt readings to thermocouple recorders. The JR393 measures any temperature with any thermocouple. Over the 55° to 90°F range, its accuracy is $\pm 1/2^\circ\text{F}$. Temperature range is -15° to $+200^\circ\text{F}$. Consolidated Ohmic Devices Division, Consolidated Airborne Systems Inc., 115 Old Country Rd., Carle Place, N.Y. [371]



Portable strain gauge and transducer indicator model 1-115SI is an input conditioning module with integral power supply, amplifier, and meter readout. It accepts inputs from 1, 2, and 4 active arm bridges using input wiring up to 8 wires, plus shield. Accuracy is $\pm 0.5\%$ full scale in 4 ranges to 20 mv. Price is \$475. B&F Instruments Inc., Cornwells Heights, Pa. 19020. [372]

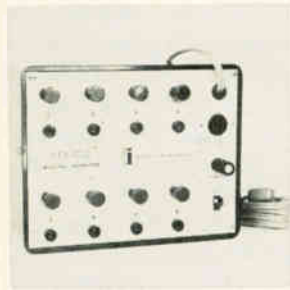

By providing a simultaneous visual indication of the logic states of up to 18 digital or binary circuits, the Logico digital monitor gives the engineer a picture of the operation of discrete or integrated systems. It can be left in the circuit while bread-boarding, and is useful for servicing. Price is \$59.50. Industrial Inventions Inc., RD2 463 US1, Monmouth Junction, N.J. [373]



Heat-Spy model HS-8 handles selective noncontact temperature measurement of small components. The exact target area is defined by a light beam which enables the operator to aim at objects 0.1 to 0.4 in. in diameter. The instrument is available in 4 models covering 60° to $1,000^\circ\text{F}$. Its accuracy is $\pm 2\%$. William Wahl Corp., 1001 Colorado Ave., Santa Monica, Calif. [374]



Analog peak sense and hold modules measure the amplitude of transients, obtain a peak noise voltage level, and measure the peak of a complex waveform. Operation up to 10 Mhz and accuracies as high as 0.01% full scale are provided by models 5138/5139 and 5146/5147. Prices are \$360 and \$400, respectively. Optical Electronics Inc., Box 11140, Tucson, Ariz. 85706. [375]



The Miniduser measures 0.5 x 1 in. and is available in pressure ranges from 0-500 to 0-10,000 psia and psig. Used primarily for airborne telemetry and control, it monitors air, fuel, and other media compatible with its NiSpanC sensing element. Over-all accuracy is $\pm 1.75\%$. Servonic Instruments, subsidiary of Gulton Industries Inc., 1644 Whittier Ave., Costa Mesa, Calif. [376]

Varley divider, null amplifier, power supply, and interface connections. The basic unit is a d-c differential voltmeter with ratio and infinite impedance to 1,000 volts. The plug-ins are:

- Model 2101, for d-c voltage and d-c ratio.
- 2102, d-c voltage, d-c ratio, and a-c voltage.
- 2103, d-c voltage, d-c ratio, and frequency measurement from 5 hz to 100 Mhz.

Shipments of these units will start within about 90 days.

The model 211, to be introduced later this year, will have an a-c converter built into the main frame,

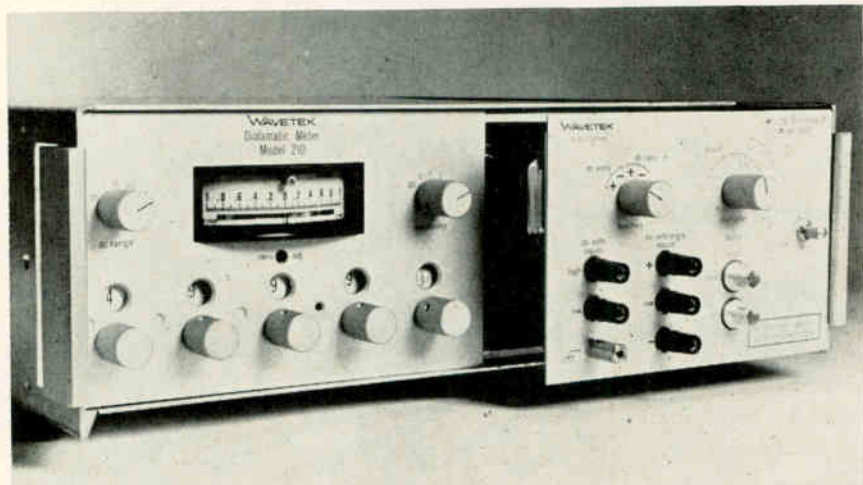

Gang switch. Coupled dials reduce time spent in knob twisting.

Direct Reading Precision Phase Measurements to 1MHz



The Aerometrics Model PM-720 Phase Meter covers from 0 to 180 degrees in four ranges. For measurements above 180 degrees, the PM-720 utilizes automatic lead-lag indicator lights to give direct reading capability to 360 degrees. The amplitude ratio of the two input signals can be as high as 5000 to 1 with sensitivity of 100 mv (p-p) to 500 v (option available to 1 mv). For direct meter readings the accuracy is $\pm 2\%$ but increase accuracy of $\pm .2\%$ can be obtained by utilizing the DC voltage output which reads directly in degrees on a DVM. The compact, all solid state construction offers true portability (total weight 7 pounds). Aerometrics also offers Model PM-730 which covers 0 to 360 degrees in four ranges. The frequency is extended to 1 MHz. The PM-730 also offers the unique advantage of measuring phase relationship between dissimilar wave forms.

Do you have Phase Measurement Problems to 750 MHz?

The PM-730 can be used with the Aerometrics Model SA-300 pulse sampler to give precision phase measurements to 750 MHz. For further information, write or visit us at the ISA show.

See us at ISA Exhibit Booth No. 544



AEROMETRICS

San Ramon, California 94583 • P.O. Box 216

... Integrated circuits
pay off at 100 Mhz ...

which measures 17 by 16 inches and is 5½ inches high. With the 2103 plug-in, it will measure a-c and d-c voltage, d-c ratio, and frequency.

Upcoming. Plug-ins slated for introduction next year will handle resistance, current, and phase measurement, and will make the unit a precision power supply. In the latter application, the user will simply dial the d-c voltage on the transformatic switch.

"We see a market potential of \$20 to \$30 million," says William Zongker, Wavetek's marketing manager. "We expect to pick up more of the differential voltmeter and frequency market, and will also be chipping away at the digital voltmeter and counter markets."

The transformatic switch, on which Wavetek has a patent pending, couples each meter switch or knob to the one on its left. Thus, by turning one knob, the user can advance all the decades—for instance, from 4.999 to 5.000.

Circuitry. The new 210 meter has an extra digit for greater accuracy, improved circuitry throughout to provide higher resolution and accuracy, and a 1,000-volt reference power supply. About 25% of the main frame circuitry is integrated, and ic's make up about 90% of the frequency-counting circuitry, which Wavetek calls a hertz meter.

The ic's are a major reason for the low cost. "Design is 50% of the trick, especially with the hertz meter," says Jerry Foster, chief engineer. "If it weren't for ic's, it wouldn't be economically feasible to build the 100-Mhz input circuit."

In the hertz meter, a specially developed frequency-to-voltage converter provides accuracy to 0.001% of range; the readout is said to limit this to $\pm 0.005\%$. "We have developed a one-shot multivibrator whose precision pulse width is not dependent on temperature-sensitive timing components, but is tied to the reference crystal," Foster says.

The hertz meters will take any input from 250 millivolts to 600 volts without adjustment. Special trigger circuitry automatically ad-

justs to the correct level for automatic triggering; there's no need for slope and level adjustments.

Specifications

Model 210 with 2101 plug-in

Input	0 to 1,000 v d-c in four ranges: 1, 10, 100, and 1,000 v full scale
D-c input impedance	Infinite at null in 1 v and 10 v ranges, 10 megohms at 100 and 1,000 v
Common-mode rejection	With 1 kilohm unbalance in either side of input: 130 db at 1 v d-c to 52 db at 400 hz and 1,000 v
Resolution	1 ppm of range
D-c accuracy	$\pm 0.005\%$ of reading + 0.005% of range + $5 \mu\text{v}$
Ratio linearity	$\pm 0.0025\%$ of reading, + 0.00025% of range
Null ranges	Full-scale sensitivity is $\pm .01\%$, $\pm .1\%$, $\pm 1\%$, $\pm 10\%$, and 100% of selected voltage range
Reference stability	$\pm 0.0005\%$ p/p per hour; $\pm 0.0025\%$ p/p per year
Recorder output	± 300 mv at full scale, 10-kilohm impedance
Environmental	As specified at $25^\circ\text{C} \pm 5^\circ\text{C}$; for 0°C to 50°C , derate by a factor of 3
Power	115 or 230 v, 50 to 400 hz, less than 25 w
Price	Model 210 main frame, \$845; 2101 blank plug-in, \$30; 2102, \$250; 2103, \$495

Wavetek, 8159 Engineer Road, San Diego, Calif. [377]

New instruments

Multimeter designer outdoes himself

With the help of IC's, the cost of a four-digit model is cut below \$1,000

When Phillip D. Wasserman joined Darcy Industries a year ago as director of instrument development, Darcy asked him to design a better digital voltmeter than Cubic Corp.'s model 271. The 271 was designed by Wasserman when he worked for Cubic. Although Cubic no longer makes the 271, thousands of them are still in use.

Darcy had bought out Cubic's industrial voltmeter line when Cubic decided to emphasize military products. The fruit of Wasserman's efforts, the DM-440 digital multimeter, was introduced at the Western Electronics Show and Convention. It is Darcy's first completely new instrument.

The instrument is a pushbutton,

750 MHz Sampling Oscilloscope for \$995



If your present oscilloscope has a minimum band width of 50 KHz, you can convert it into a high speed sampling oscilloscope using the Aerometrics dual channel pulse sampler. The Model SA-300 may also be used with an inexpensive X-Y recorder for permanent recording of fast computer wave forms, radar pulses, semiconductor characteristics, etc. The all solid state Aerometrics sampler offers rise time of typically one nanosecond and sweep speeds from 10 nanoseconds to 5 microseconds per full sweep. Like other Aerometrics instruments, the SA-300 features portability through compactness and light weight.

Multimeters, Pulse Generators & Electronic Counters

A full range of instruments which excel in precision, compactness, ruggedness, portability and flexibility—the most dependable instruments you'll ever use—and all in competitive price ranges. Be sure and check Aerometrics' specifications before investing in test equipment.



See us at ISA Exhibit Booth No. 544



AEROMETRICS

San Ramon, California 94583 • P.O. Box 216

Glass-Epoxy Copper-clad

through TAYLOR'S TOTAL RELIABILITY PLAN:

Raw materials, panels or punched blanks to your reliability requirements. You get what you order from a fully integrated source.

FAST DELIVERY from two fully equipped plants—one at Valley Forge, Pa., the other at La Verne, Calif. Or from warehouses in Chicago, Ill. and other key locations.

... **FULL SIZE SHEETS, CUT-TO-SIZE PANELS or PUNCHED BLANKS** to satisfy fabricating and processing requirements. Ease of fabrication is a plus value in printed circuit production.

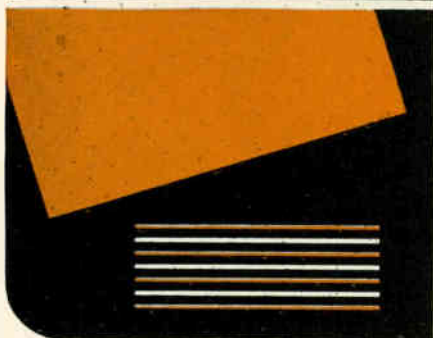
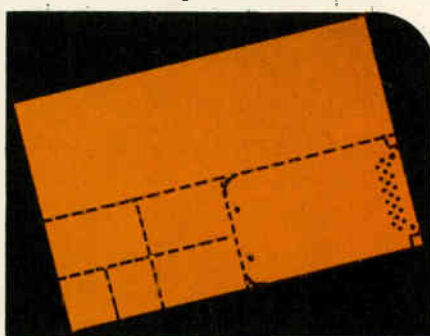

... **STANDARD AND ULTRA-THIN FORMS.** Standard sheets in all grades. Ultra-thin sheets and multilayer prepreps in GEC 500 (G-10) and Fireban 600 (G-10, FR-4).

... **WHITE GLOVE HANDLING** in atmosphere-controlled white rooms, careful processing, extremely tight quality control and special packaging assure top performance.

Taylor's copper-clad has proven total reliability demonstrated by an ever increasing number of major OEM's and commercial etchers. This acceptance substantiates our claim for unsurpassed quality, ease of fabrication and delivery to your scheduled requirements. Let us demonstrate this reliability to you. Ask for a sample (give grade designation and copper combination) and a copy of Bulletin GB-2.



... your assurance
of quality

Taylor copper-clad

TAYLOR CORPORATION • Valley Forge, Pa. 19481

Phone: 215-666-0300 TWX: 215-666-0659

West Coast Plant: La Verne, Calif.

Also manufacturer of Taylor laminated plastics, Taylorite® vulcanized fibre and Tayloron® prepreps

fully integrating device. It can measure d-c from 1 microvolt per digit—thanks to a built-in preamplifier—to 1,000 volts full scale. An accuracy of one digit is held for 90 days, without recalibration, at temperatures of 15 to 35°C. Liberal use of integrated circuits—about 75 of them—plus molded-plastic panels cut the cost to about \$975, and the size to a half rack, 5¼ by 8½ by 19 inches.

According to Wasserman, the DM-440's closest competitor is the Fairchild 7000 multimeter; it measures d-c to 100 microvolts per digit, but needs an external preamplifier to reach the DM-440's level and costs about \$1,150. Darcy's is not the lowest-priced multimeter, however. Non-linear Systems Inc. has a \$695, three-digit model.

Stores displays, too. Bipolar transistors drive the display tubes. The instrument can show 10 readings a second, with no intermediate figures between readings, and also store displays. The display has four full digits, plus an overrange digit, polarity, range, and units.

Wasserman claims the DM-440 is the only fully guarded half-rack multimeter. With a three-wire input, he got common-mode rejection of 120 decibels at 60 hz with a 1-kilohm imbalance at either input lead. Leakage capacitance past the guard is less than a picofarad.

"This instrument can measure voltages that are not isolated to earth ground," Wasserman asserts. "It behaves as though it were run by batteries instead of the a-c source."

Specifications

D-c range	±0.001 to ±1,000 v in ranges of ±10, ±100 and ±1,000 with 20% overrange
Ranging	Automatic, manual, and remote
Accuracy	±0.01% of reading, ±1 digit
Linearity	Within 1 digit at all readings
Input impedance	10,000 megohms
Common-mode rejection	Infinite at d-c
Normal-mode rejection	Infinite at 60 hz and integral harmonics
Input isolation from earth ground	1,000 v d-c or peak a-c
Operating temperature	0° to 55°C
Power	115 or 230 v rms, 47-63 hz (47-440 hz optional)

Darcy Industries, 1723 Cloverfield Blvd.,
Santa Monica, Calif. 90404 [378]

High Voltage Rectifiers

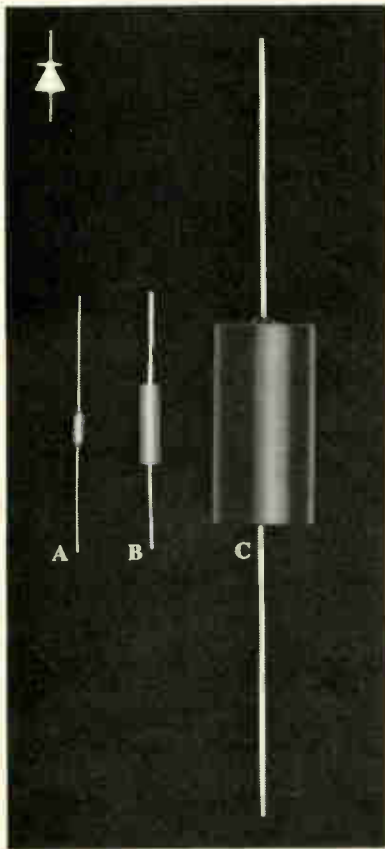

Diffused High Voltage silicon rectifiers available with 300 nanosecond recovery time (optional) and in custom designed assemblies. Epoxy encapsulation.

- A**
 .060 diameter.
 .150 long.
 1,000 to 3,500 volts PIV.
 25 to 50 ma average rectified current.
- B**
 .100 diameter.
 .400 long.
 1,000 to 6,000 volts PIV.
 50 to 100 ma average rectified current.
- C**
 .500 diameter.
 1 to 7 inches long.
 3,000 to 70,000 volts.
 15 to 75 ma average rectified current.

For use in diode-capacitor voltage multipliers, cathode ray tube power supplies, RF power supplies (up to 200 KC), precipitator power supplies, and photo multipliers. Also available in diode-capacitor multiplier assemblies.



SPECIAL PRODUCTS DIVISION
 2203 WALNUT STREET, GARLAND, TEXAS 75040
 (214) 272-3561

Circle 224 on reader service card

New instruments

Frequencies a la carte

Options convert 20-Mhz counter to a 200-Mhz unit, and to a meter-timer

The counter-timer that marks the entry of Beckman Instruments Inc. into the integrated circuit counter field is not an instrument but a whole series of them, each distinguished by a different set of input and function modules. Yet the series is still basically one piece of equipment; the user selects two modules according to his need, and should that need change he can buy a new module without junking the whole counter.

The flexibility of the 6300 series, built by Beckman's Electronic Instruments division, is more important than the achievement of a new industry high for direct counting—200 megahertz.

Neal W. Vinson, chief of the division's laboratory instruments group, isolated four components that, with a display, are common to counters: a power supply, a frequency standard, an accumulator, and some sort of gating control and recycling logic. The rest of the circuitry, he reasoned, was likely to change with the different requirements, which, in turn, would vary with what was being measured (input) and how it was to be measured (function).

Pick one A and one B. The user decides whether he wants six, seven, or eight digits of display; he can even take a ninth digit, for an extra decade of accumulation, at the sacrifice of the legend glow tube. Then he builds his own counter by selecting from four input modules and three function modules; as with a Chinese dinner, he chooses one from each list. Beckman says it will soon add seven more modules to the initial group.

The input modules, in order of increasing price, are: a single-channel unit counting to 20 Mhz; a double-channel unit, with the same frequency range; a single-channel

Need a custom fork oscillator



(in an 11-gram package)

fast?

For process control? Or for test or ground support equipment? Or for a signaling system?

call Varo.



This lead-mounted, 11-gram package is not only compact ($7/8" \times 7/8" \times 7/16"$), it's a lot more rugged than larger fork oscillators. Frequency range is 2KHz to 40KHz. Performance: .05% from -20 degrees C. to +70 degrees C. If we can't adapt this package to meet your specs, we'll build you one that does.

Varo answers fast.

Because our business is oscillators. Not oscillators and ovens and crystals and etc. But oscillators, period. Tell us what you need. We'll tell you how and when. Like we've done for General Precision, Westinghouse, Sandia, Litton, Raytheon, and others. Try us for speed.



TIME & FREQUENCY PRODUCTS
 402 GUTIERREZ STREET
 SANTA BARBARA, CALIF.
 TELEPHONE (805) 963-2055
 TWX 805-4497200

Circle 163 on reader service card

163

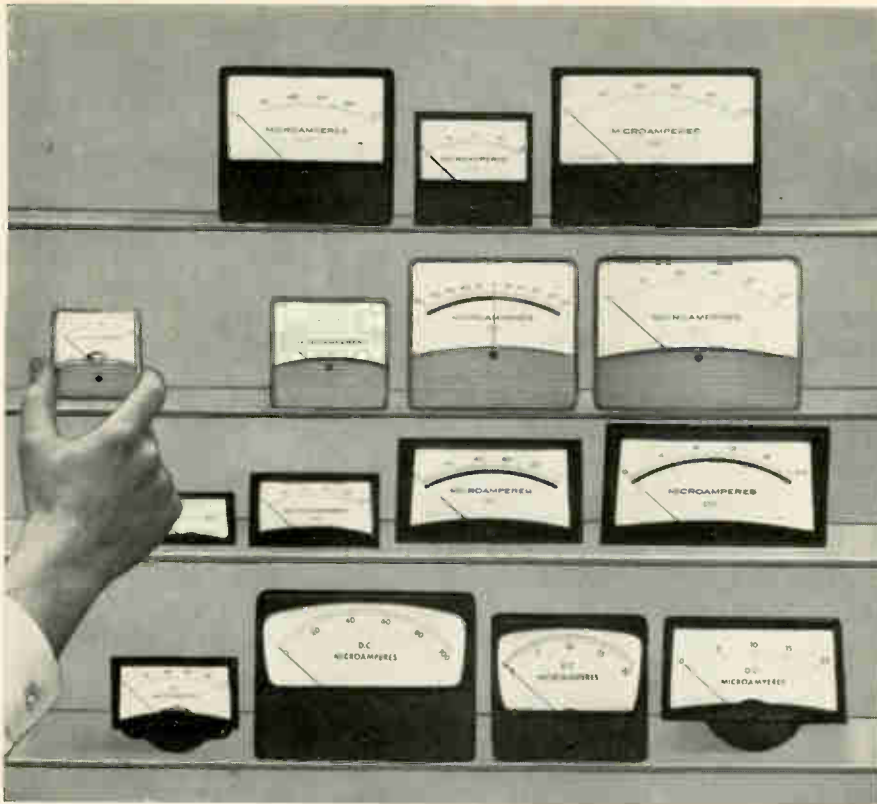

Off-the-Shelf Only from api

- 1% tracking
- taut-band
- no extra charge
- 20 to 100 μ a

There's extra value, but no extra cost, in API's line of DC panel meters in the 20 to 100 microampere ranges. Tracking of $\pm 1\%$ is standard. Frictionless taut-band construction produces meters that are the most accurate, sensitive to smaller signals, vibration-proof and durable.

No other manufacturer offers these bonus features at firm catalog prices.

15 Models in Stock

You'll get off-the-shelf delivery of the economically priced Panelist; Stylist and black phenolic meters shown above. Choose from these full-scale DC ranges:

Microamperes: 0-20, 0-50, 0-100

Millivolts: 0-5, 0-10

If ultra-precision tracking is the least you'll settle for, API offers 0.5% tracking at reasonable cost. This "super-calibration" is another API exclusive, again backed by published prices.

Ask for Bulletin 47.

Also stocked nationally by Allied Electronics and Newark Electronics.

See these instruments at the ISA Show, Booth No. 411.

api INSTRUMENTS CO.
CHESTERLAND, OHIO 44026 (CLEVELAND-216) 729-1611 • TWX: 810-427-9230

unit going to 200 Mhz; and a double-channel unit with one of the channels accepting 200 Mhz.

The function modules are a simple accumulator, a frequency meter, and a frequency meter and timer.

Direct drive. Even though two of the input modules count at 200 Mhz, the main-frame accumulator will accept only 20 Mhz. Higher frequencies are divided by 10 before entering this unit's binary-coded-decimal storage logic. Beckman displays the direct count by using four flip-flops in the input module's divided-by-10 logic to drive the last significant digit directly. Thus, for example, an input of 175.652 Mhz would be passed to the universal unit's accumulator as 17.568 Mhz. The four flip-flops (for the 1-2-4-8 BCD code) would then read out 0010 to drive the last 2 on the display.

Wave uneven. One common difficulty in using a counter is determining when the Schmitt trigger is firing. The Schmitt transforms the input sinusoid into an orderly train of pulses to the signal gate. But if the square waves are not symmetrical, the count will be in error. By trial and error, the operator must normally attenuate the input signal.

In the 6300, one IC package in the input module integrates the signal from the amplifier and pulses two tiny light bulbs on the front panel. If one bulb is getting more pulses because the wave is not symmetrical, that bulb appears to glow brighter. To assure symmetry the operator turns the attenuator until the bulbs are equally bright.

The main frame costs \$1,000 to \$1,275, depending on the choice of six, seven, eight, or nine digits. The prices of the plug-in modules range from \$150 for the accumulator input module to \$800 for the 200-Mhz, dual-channel unit.

Specifications

Display time	0.1 to 10 sec, variable or held indefinitely; 30 μ s recycle
Accuracy	± 1 count, \pm oscillator stability
Frequency standard	1 Mhz
Oscillator stability	3 parts in 10^7 per week
Output signals	6, 7, or 8 digits of 1-2-4-8 BCD; 1 = +4 v, 0 = 0.5 v
Power	115/230 v a-c $\pm 10\%$; 50 to 400 hz, 30 w

Beckman Instruments Inc., Instruments division, 2200 Wright Ave., Richmond, Calif. [379]

Our little black book has over 100,000 phone numbers.

You never had a black book like it. Over 1,500 pages. And those phone numbers! More than 100,000 telling you who to call/ where to go, for the over 4,000 different product categories listed and advertised in the yellow pages of the Electronic Buyers' Guide. There's never been a buyer's directory like it. The new '68 edition will be coming your way in October. Look for the book in the black box. EBG for '68... bigger, better and more useful than ever before.

Electronics Buyers' Guide
A McGraw-Hill Market Directed Publication,
330 West 42nd Street, New York, N.Y. 10036



new

from



Transmitters-Receivers-Filters
Highly Versatile VHF/UHF Receiver



Operating Frequency.....	200 to 580 mc (any single frequency)
Noise Figure.....	6db (nominal)
Frequency Stability.....	± 0.005%
Frequency Modulation Deviation.....	± 50 Kc typical operation (150 Kc max.)
S/N Ratio.....	15 db (5 microvolt input)
Time Delay Variation.....	±0.2 microsecond (max.)
Bandwidth (3 db).....	500 Kc
Image Rejection.....	50 db (minimum)
Squelch.....	Adjustable 1 to 4 microvolts
Vibration.....	30g (random)
Shock.....	100g
Size.....	3.5x2.2x1.2 inches

THIS IS ONE OF THE BEST VALUE RECEIVERS OF ANY TRF TELEMETRY FILTER TUNABLE RECEIVER AND TRANSMITTER PRODUCTS EVER IN 6-DIGIT

Dept.A
TRF INCORPORATED
Subsidiary of W.T.A.Inc.
6641 Backlick Road, Springfield, Virginia 22150
Phone (703) 451-5131



Circle 165 on reader service card

New HEAT-GRIP® Irradiated Polyolefin Tubing



SHRINKS TO HALF-SIZE AT 250°F







Here's the fast, sure way to protect or insulate. Heat-Grip forms a strong, tight-fitting, flexible shield when moderate heat is applied. Won't melt or flow upon heating. Has longer heat life and greater resistance to solvents. Conforms to spec. MIL-I 23053A.

Heat-Grip is available 1/8" to 1" I.D. in five colors and clear.

Excellent for mechanical protection, color identification, product encapsulation, insulation.

Send for Technical Data Sheet and FREE sample.

NATVAR CORPORATION
P. O. BOX 67 • RAHWAY, N. J. 07065

MON.	TUE.	WED.	THU.	FRI.
An RFI-shielded switch, maybe?			Subminiature toggle?	
 Then, a tiny indicator light?			And miniature pushbutton?	
	Impulse switch, maybe?			Or RFI-shielded indicator light?
				
		Compact switchlite?		Hermetically-sealed switch?
				

How many switches and indicator lights will you have to track down this month?

One card to Control Switch now will sure save you a lot of tracking!

If you send for all the Control Switch catalogs and bulletins offered below, you'll have the most complete file on switches and indicator lights you can get from any one source.

Every time you have to chase down a different switch or indicator light check your Control Switch data first! Odds are you'll find exactly what you want right away!

For Control Switch makes the largest line of switches and indicator lights of any manufacturer serving our fields. In addition, we specialize in high reliability components for applications

where dependable performance is an absolute must. Business machines, for example. And space vehicles, key electrical and industrial equipment.

You can order components from us, or better yet, through your Control Switch distributor. He handles electro-mechanical and electronic lines almost exclusively. He knows your problems. And he keeps his Control Switch stock at maximum levels for fast delivery!

SEND FOR THESE TODAY

Check numbers on the Reader Service Card corresponding to those at left below for any or all of these Control Switch references. While you're at it, get 'em all!

- #511 Condensed Switch Catalog 100
- #512 Basic Snap-Action Switch Catalog 110
- #513 Toggle Catalog 180
- #514 Indicator Light Catalog 120
- #515 Hermetic Switch Catalog 130
- #516 Switchlite Catalog 220
- #517 Pushbutton Catalog 190
- #518 RFI-Shielded Component Bulletin 62A

C
C
CONTROLS
COMPANY
OF AMERICA
CONTROL SWITCH DIVISION
1420 Delmar Drive, Folcroft, Pennsylvania 19032
A Subsidiary of
 General Precision Equipment Corp.

New Subassemblies Review



A universal dual-output power supply named Unitwin-164 meets MIL-E-5272 and related specs. It provides 2 voltage outputs adjustable between 0 and 25 v at 0.750-amp capacity for each section. Regulation is better than $\pm 0.005\%$ or 1 mv for line and load. Output impedance is 0.0032 ohm or less to 1 khz. Power/Mate Corp., 163 Clay St., Hackensack, N.J. 07601. [381]

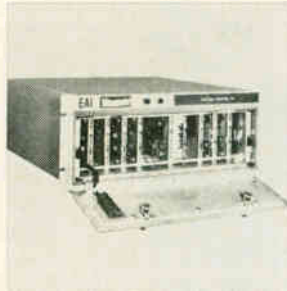

Series 10 analog data processor provides space for up to 10 plug-in operational modules. Module selection includes 3 dual voltage-to-current converters, 3 dual current-to-voltage converters, a low-level widebandwidth differential amplifier, and a dual amplifier resistor network. Prices are from \$3,000 to \$5,000. Electronic Associates Inc., West Long Branch, N.J. [382]

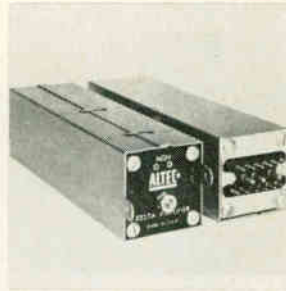

Amplifier model 2227A is a 15-pin device for voice frequency repeater systems. The low-frequency response may be adjusted for a flat characteristic or a roll-off at 200 hz. The unit has an input-output impedance of 600/1,200 ohms and operates on either 48 to 52 or 24 to 26 v d-c. Altec Lansing Division, LTV Ling Altec Inc., 1515 S. Manchester Ave., Anaheim, Calif. [383]

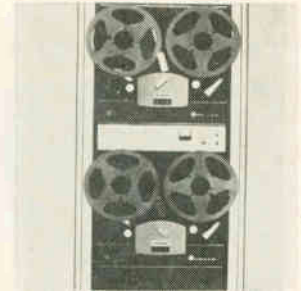

Multichannel recorder-reproducer model 248 is for communications in air traffic control, fire and police service, and other specialized uses in government and industry. It is expandable as logging needs increase and is equipped with 4,800 ft of tape on 10 1/2-in. diameter reels and allows 24 hours of recording time at 0.653 ips with each transport. Dictaphone Corp., Rye, N.Y. [384]



Tuning-fork oscillator LCG-2 is offered in discrete frequencies from 400 to 8,000 hz. Accuracy is 0.050% at 25°C. Output voltage at nominal d-c input is 6 v peak-to-peak 50% clipped sine-wave into 6,000 ohms through an external d-c blocking capacitor. D-c input voltage is 12 v at 3.33 ma. Price is under \$32. Philamon Laboratories Inc., 90 Hopper St., Westbury, N.Y. 11590. [385]



Operational amplifier OA-125 is stable at closed-loop gains of unity or greater, and provides a gain-bandwidth product of 125 Mhz. It is suited for linear applications as well as those involving nonlinear elements in the feedback loop, such as threshold circuits. Price is \$135. Computer Labs Division, Strandberg Engineering Laboratories Inc., 1109 Valley Park Dr., Greensboro, N.C. [386]

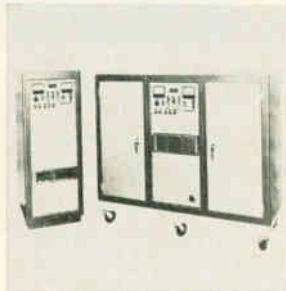

Laser power supplies for use with pulsed ruby and glass lasers range from 2.5 to 30 kw output. They are suited to high repetition operation in both the normal and Q-switched modes. All systems have solid state components including 20 amp, 7200 v piv single-phase, full-wave h-v rectifier. Prices from \$4,600. Spacerays Inc., Northwest Industrial Park, Burlington, Mass. [387]

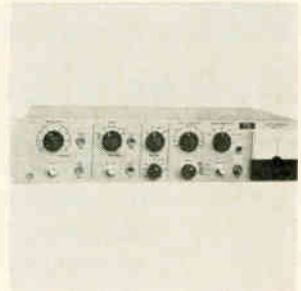

A phase-sensitive detection system recovers signals 51 db below ambient white noise in a 1-khz bandwidth. Model 120 lock-in amplifier operates as an amplifier-detector-filter combination with an equivalent over-all noise bandwidth of 0.0083 hz. Minimum full-scale sensitivity is 100 μ v. Price is \$765. Princeton Applied Research Corp., P.O. Box 565, Princeton, N.J. [388]

New systems

Computer analyzes memory performance

Digital testing system is programmed by a general-purpose computer that can be used by itself for design work

About \$100,000 will be the tab for Digital Equipment Corp.'s (DEC) programmed memory analyzer, the PMA-8. But the company is making the price palatable with attractive sweeteners that have whetted sales of process control computers.

Purchasers will get a software

package that permits a selection of memory test routines and parameter variations with plain language inputs. They will get hardware to interface a computer with the process controlled—in this case, the circuitry that stimulates the memory and checks its re-

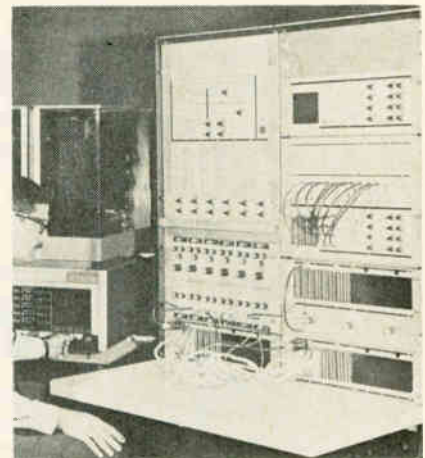

Lab assistant. Computer at left can exercise newly designed memories.

WANG Reports A Major Technological Advance . . .



Now an ELECTRONIC CALCULATOR

based on a unique Digital Log Generator which has been designed into electronic circuits. With the DLG at its heart, the calculator uniquely enables you to use logs and exponentials digitally, at electronic speeds. It provides order-of-magnitude gains in numerical analysis.

Now you can solve $(2.3)^{13.5^*}$ or $1603.08^{13.5^{**}}$ by just touching four operational keys. Results are shown instantly to ten significant digits with a floating decimal point.

Ans: *76440.89906 **1.727444442

Working the WANG electronic desktop instruments is a delightful experience. You sit at your desk and "communicate" with it for instant data analysis — from simple arithmetic to exponential functions.

WANG's modular DLG calculating instruments provide another technological advance. You can start with a simple calculator and build it to a highly versatile personal computer system. Over 4000 other business leaders are already using theirs. Prices range from \$1690 to \$10,000 purchased outright.

For complete information call:

(203) 666-9433
 (212) 682-5921
 (213) 278-3232
 (215) 839-3345
 (312) 456-1542
 (415) 454-4140
 (713) 668-0275
 (716) 381-5440

WANG

LABORATORIES, INC.

Dept. N-9, 836 North Street, Tewksbury, Mass. 01876
 Tel. (617) 851-7311

. . . tables are turned
 over to the computer . . .

sponses. And they will get a general-purpose computer, Digital Equipment's PDP-8.

When the production test department isn't using the analyzer, the engineering department can experiment with new memories or try an old one in a new digital system. In any remaining free time, the PDP-8 alone can perform other chores in the plant or lab.

Loaded memory. For analysis, the PDP-8's memory is loaded with test parameter reference tables and instructions for a variety of routines. The operator types into the computer the name of the test he wants, and any special instructions or parameter values not in the stored tables. However in most cases he can use punched tapes, supplied with the PMA-8, which program the standard tests for computer memories.

Analyses performed include go-no-go production testing, maximum-minimum parameter searches, distribution plot analysis, switching current measurements, core-peaking and difference testing, and schmoo plotting—a performance curve obtained from two variables [Electronics, July 25, 1966, p. 127]. Performance evaluations can be isolated down to a single core in the memory. For example, in go-no-go testing, the analyzer makes a test pass through the memory and decides if the cores are good or bad. Then results are tabulated in terms of error locations indicating both the address and reason for error.

Test circuitry, contained in a single cabinet, includes modular current drivers, switching systems, variable-width strobes, sense amplifiers, and discriminator subsystems. These are set up, timed and calibrated through the computer, which also tests the analyzer.

As the test is made, the results are printed out on a teletypewriter, or on a plotter that is an optional accessory. As he watches the results, the operator can vary the parameters, weigh the effect, and return to the original routine by entering instructions through the keyboard.

Adaptable, too. Digital Equipment says its software and hard-

Design engineer Bob Alden searched for nearly an hour to find he didn't have the information he needed.

iri could have told him that in less than 5 minutes.



But chances are 10-1 IRI has it... and it's up-to-date, too! IRI—Information Retrieval Incorporated—is a vendor catalog file on microfilm. Because we make no charge to vendors, and microfilm everything they have in print, IRI has more than 600,000 pages of vendor data including application notes, reliability tests, price lists and names of distributors and reps. What's

more, the IRI Vendor Catalog File on microfilm is updated every 60 days!

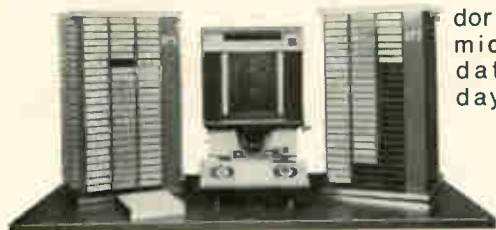

Small wonder.

In addition, the IRI system is tailored to your needs by adding the vendors you want – at no extra cost. We start with a basic file of the most wanted information. Up-date it regularly, and then—to top it off—"personalize" the file by adding the complete vendor information you request. Small wonder IRI enables you to eliminate your hard copy central catalog file. It also reduces storage area by 98%, cuts redundancies in design efforts and increases sources and use of standard items.

You can install an IRI vendor catalog file on an annual subscription for less than the cost of a file clerk. IRI vendor catalog files are in use in plants with as few as fifty employees. The "user-orientated" idea not only provides current knowledge of the component state-or-the-art, but also expedites the purchasing function. Because of its complete coverage, more than 60% of our recent installations have replaced other microfilmed vendor catalog systems.

It takes about 2 hours to demonstrate to your key people. But in much less time than that your design, standards, quality control, drafting, receiving, inspection and purchasing people will realize that an IRI system is the next best thing to a raise in pay! We have demonstration teams in most principal cities. To arrange a demonstration, send the coupon today.

Find it fast.
Make a print-out in 6 seconds.



iri INFORMATION RETRIEVAL INCORPORATED
801 Welch Road, Palo Alto, California 94304
Dept. #B-38R

- I'd like to see a demonstration of the IRI Vendor Catalog File. Have your representative call me for an appointment.
- I'm not ready for a demonstration at this time, but please send further information.

Name _____ Title _____

Company _____

City _____ State _____ Zip _____

Telephone _____ Ext. _____

Number of employees at this location _____

We have have not had experience with a vendor catalog file on microfilm.

In addition to the Vendor Catalog File on microfilm we're interested in Mil Specs Mil Standards.

iri INFORMATION RETRIEVAL INCORPORATED
801 Welch Road, Palo Alto, California 94304
Another information service of McGraw-Hill

**who meets
exacting specs
for stainless strip
and supplies it in
production quantities?**

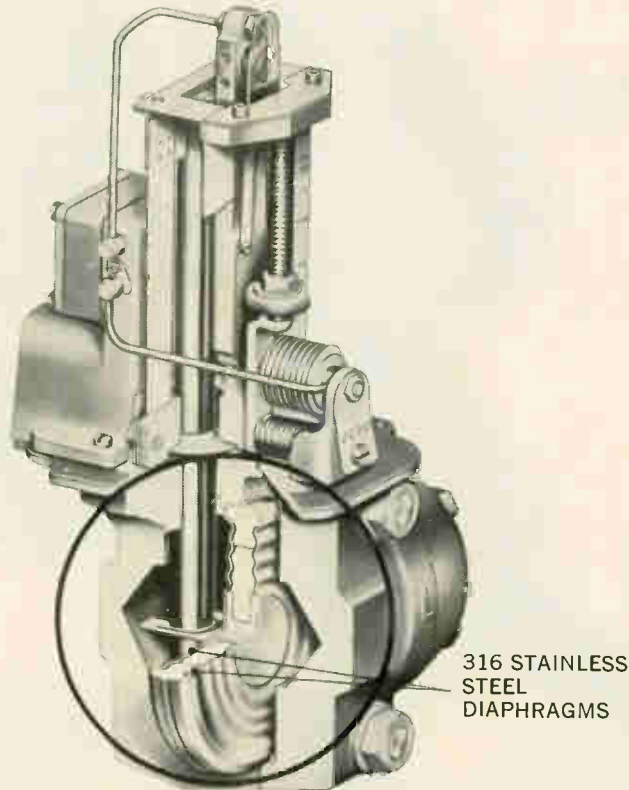

Foxboro differential pressure transmitter

An important component in this force-balance transmitter used for process control is a pair of stainless steel diaphragms. The material from which they are made must be strong enough to resist sudden surges of up to 6,000 psi on one side against no pressure on the other, yet thin enough to measure very slight pressure differences. For uniformity of operation, thinness tolerances must be held to ± 0.0001 ".

Hamilton Precision Metals, with their unmatched capability and productivity, easily met the critical specifications and satisfied the requirements for repetition of those properties from lot to lot.

Hamilton Precision Metals is your prime source for ultra-precision-rolled metals in mass production quantities. 7 proprietary metals, 12 pure metals and 112 commercial alloys are available from Precision Metals. Write today for new 48-page data book.

HAMILTON PRECISION METALS

division of Hamilton Watch Company, Lancaster, Pa. 17604

... replace the tapes,
not the test gear ...

ware is sufficient to test memories ranging from simple coincident-current models to those with multi-sense and multi-inhibit operation. However, if memories get more sophisticated, the system won't have to be replaced. Since it is based on a general-purpose computer, it can be updated by expanding the program instructions and by adding additional test-circuitry modules to the test frame. In fact, the company wouldn't be surprised if some users modified the system to test digital equipment other than memories.

DEC has been using the analyzer to test memories for its computer lines. A larger system, based on a PDP-7 computer, tests the company's logic circuitry.

The PMA-8 will be offered this fall, and the company expects to fill orders in 60 to 90 days. The decision to sell the memory analyzer has been in the works since last spring, when the market for computer-based instrumentation systems suddenly began opening up [Electronics, April 17, 1967, p. 161].

Digital Equipment Corp., 146 Main Street, Maynard, Mass. 01754 [389]

New subassemblies

**Everyman's
x-y recorder**

Extra features adapt
it to bench or rack,
lab or factory use

Like true Texans, the engineers at Texas Instruments Incorporated conducted a roundup before they sat down to design the company's first x-y recorder.

For the first time, says TI, the best features of other recorders have been corralled in a single instrument, the "function/riter." It can be employed in applications ranging from laboratory research to

160V

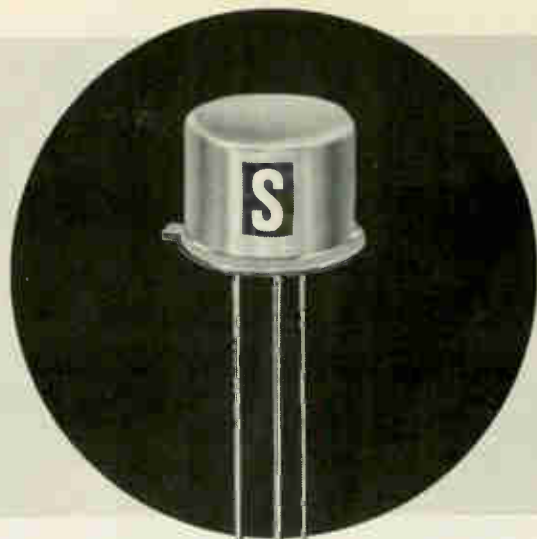

pnp silicon chopper transistors

from

Solitron

Solitron, now in full production of small signal transistors, has a complete line of PNP Silicon Choppers with voltage capabilities up to 160 Volts. Identified as the SSS 1001-4 Series, these devices are available in the TO-5 package. They offer high reliability, low saturation voltages and can be purchased as pairs with offset voltages matched to $100 \mu\text{V}@T_A=25^\circ\text{C}$. A few of their many circuit applications include modulators, servos, telemetry and multiplexing.

Type Number TO-5	Power Dissipation $T_A = 25^\circ\text{C}$ (mW)	Rated Breakdown Voltages			I_{ECX}			I_{EP}		$V_{CE(sat)}$		Cobo	
		$V_{BE(sbo)}$ (Volts)	$V_{BE(sco)}$ (Volts)	$V_{BE(sbo)}$ (Volts)	Max (na)	V_{EC} (Volts)	V_{EC} (Volts)	Max (na)	V_{EC} (Volts)	I_{Max} (mV)	I_B (μa)	Max (pF)	V_{CB} (Volts)
2N 1920	250	-40	-18	-40	-2.5	10	-15	-1.5	10	3.0	-500	14	-6
2N 1921	250	-50	-50	-50	-10	10	-30	-2.0	10	4.0	-750	14	-6
2N 3345	250	-50	-50	-50	—	—	—	—	—	3.0	-1000	25	-0
2N 3346	250	-50	-50	-50	—	—	—	—	—	1.5	-1000	25	0
2N 1922	250	-80	-80	-80	-10	10	-50	-2.0	10	4.0	-750	14	-6
SSS 1001	400	-100	-100	-100	-10	10	-60	-3.0	10	2.0	-750	30	-6
SSS 1002	400	-120	-120	-120	-10	10	-70	-3.0	10	2.0	-750	30	-6
SSS 1003	400	-140	-140	-140	-10	10	-80	-3.0	10	2.0	-750	30	-6
SSS 1004	400	-160	-160	-160	-10	10	-90	-3.0	10	2.0	-750	30	-6

*Emitter Offset Current **Emitter Offset Voltage

DIAL 1-800-327-3243 FOR A NO CHARGE TELEPHONE CALL AND FURTHER INFORMATION

Solitron DEVICES, INC.

1177 BLUE HERON BLVD. / RIVIERA BEACH, FLORIDA / (305) 848-4311 / TWX: (510) 952-6676

Leader in Germanium and Silicon Transistors, Cryogenic Thermometers, High Voltage Rectifiers, Hot Carrier Diodes, Temperature Compensated Zeners, Voltage Variable Capacitors, Random/White Noise Components, Microelectronic Circuits, and Power-Sink Interconnection Systems.

control/alarm time-cut



MAGSENSE

control/alarm for temperature, pressure, speed, flow

Here's how to cut the time it takes to solve your control/alarm problem. Hook up sensor, load and power source to a MAGSENSE® control/alarm module and adjust the setpoint. That's it. No time wasted designing and debugging a circuit. And while you're saving time you'll be saving money, getting *proven-in-service* reliability.

Capabilities? All MAGSENSE modules offer 100-billion power gain, accept inputs as low as 10 microvolts or 1 microamp *directly* without preamplification. Completely isolated inputs are unaffected by common mode voltages as high as 110vac, 60Hz, or overloads as large as 1000-times full scale input. Typical accuracy is $\pm 0.5\%$ full scale. And they all

operate from a *single* DC power source (either 28v or 12v).

Options? The list includes remote and dual setpoints, adjustable hysteresis, choice of output action, transducer excitation voltage, and cold junction and copper compensation on thermocouple models. There's a MAGSENSE model for your application.

Price? Get MAGSENSE control/alarm modules for as little as \$35 in quantity. Compare that with the cost of developing and building your own circuit.

More information? Write or call, or circle the reader service number and we'll send you complete specifications and prices.

ANALOG-DIGITAL SYSTEMS DIVISION

**CONTROL DATA
CORPORATION**

4455 Eastgate Mall, La Jolla, Calif.

MAGSENSE Sales, Dept. 204
Analog-Digital Systems Division
Control Data Corporation
4455 Eastgate Mall
La Jolla, Calif. 92037
Phone 714/453-2500

... even the inkwell
is a plug-in item ...

industrial process control.

Key features include high accuracy, guarded input, remote pen lift, and time-axis control. Plug-in modules handle single-range input signals, multirange signals, and time sweeps. Either the x or y axis can be geared to time.

Protection. To improve precision, infinite-resolution slide-wires are used instead of helical-wound resistance elements in the pen-positioning circuitry. Signal input leads are not grounded, but a guard shield insures accurate recording of signals with a-c and d-c common-mode interference. To increase transverse interference rejection, a low-pass input filter can be added.

The recorder can be used on a bench or mounted horizontally or vertically in a rack. When the instrument is on a bench, the chart can be tilted 45 or 90 degrees. The pen is fed ink from disposable cartridges, and the chart paper is held on the platen by vacuum.

Specifications

Accuracy	$\pm 0.2\%$ full scale or 5
Time base $\pm 2\%$	μv , whichever is greater
Linearity	
Time base $\pm 1\%$	$\pm 0.1\%$ full scale
Repeatability	0.1% full scale
Stewing speed	20 ips min. both axes at 60 hz
	16 ips min. both axes at 50 hz
Power requirements	120 or 240 v, $\pm 10\%$ at 50 or 60 hz
	90 w, 120 va max.
Price	\$1,600
Delivery	90 days

Texas Instruments Incorporated, 3609 Buffalo Speedway, Houston. [390]

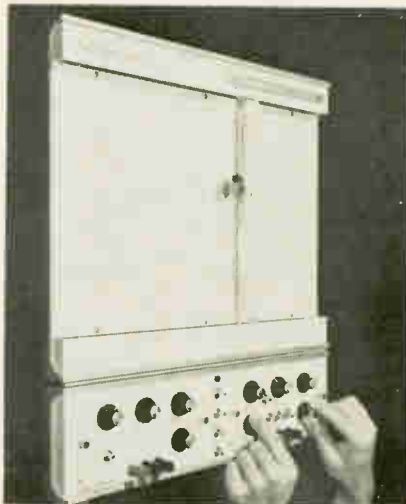

Facing up. Chart table can be tilted 90° for easier viewing.

No bubble, no trouble.

When you immerse your components in hot 3M Brand Inert Fluorochemical Liquids, bubbles of escaping air quickly detect gross leaks.

No bubble, no trouble.

That's one of the known test bath applications for 3M Inert Liquids. Thermal shock tests, transistor matching, temperature testing of integrated circuits at -55°C and $+150^{\circ}\text{C}$, are just a few other examples.

Our Inert Liquids quickly drain and leave no residue. So when the test is finished, additional cleaning steps are unnecessary. You save time and get greater accuracy.

Test 3M Inert Liquids...and save a lot of trouble.

3M Chemical Division
Dept. KAX-97, St. Paul, Minn. 55119
Send me all the details about 3M Brand Inert Liquids.

Name _____

Company _____ Title _____

Address _____

City _____ State _____ Zip _____

Chemical Division **3M**
COMPANY

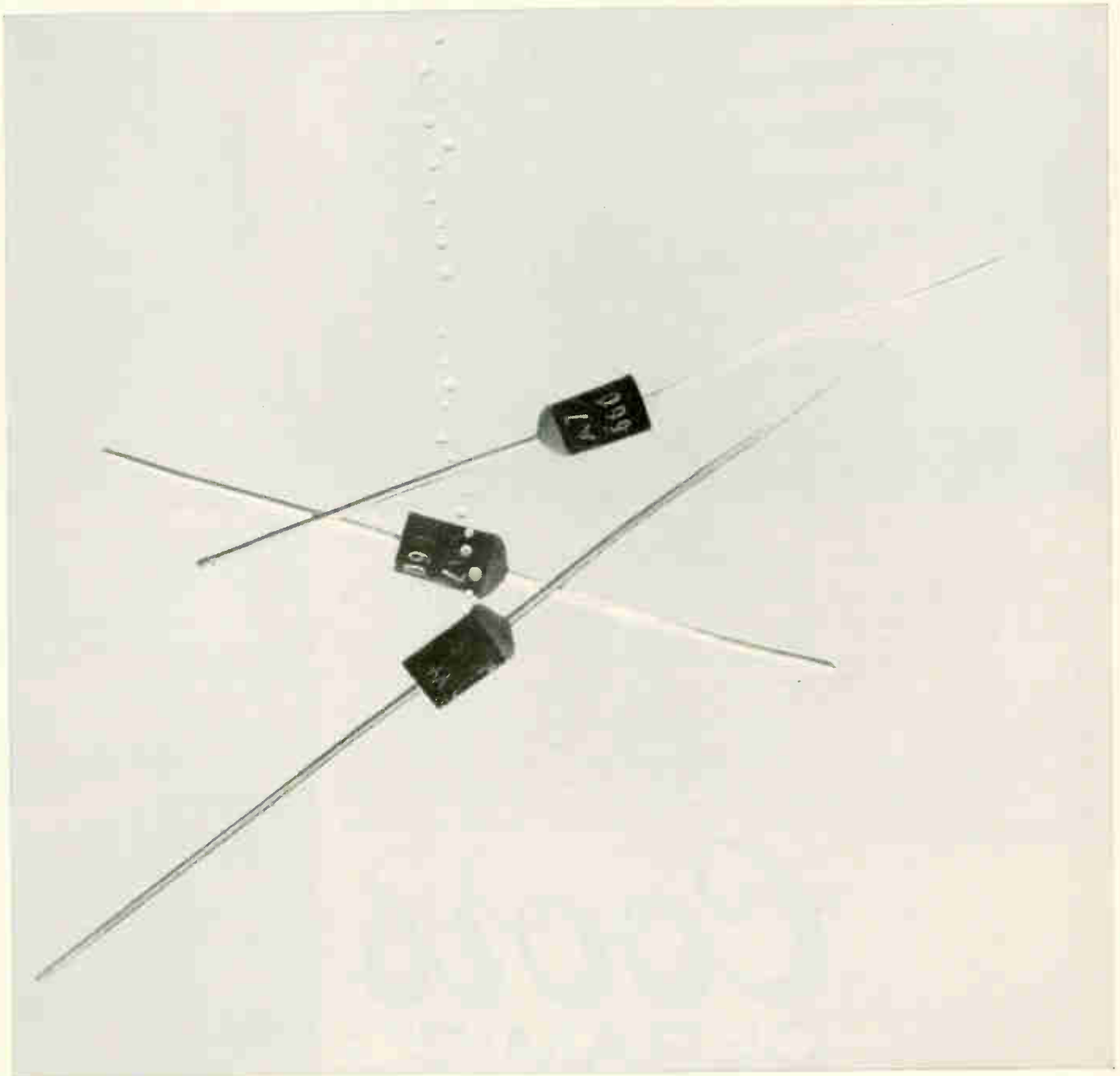

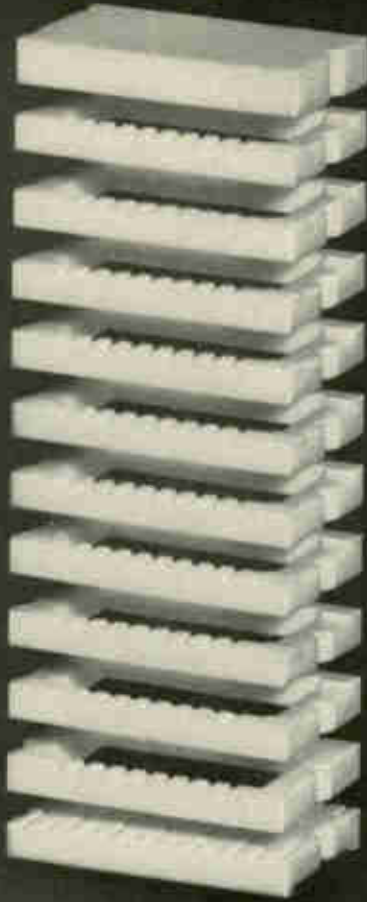

For reliable High Density Packaging

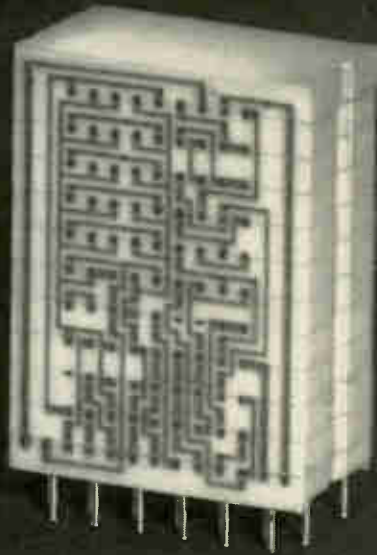

If you are working with a single chip or with complex circuit networks, Coors micro-ceramic modules offer you high reliability packaging. In the example above, the design engineer utilized base, frame, and lid modules to form a universal stacked package that can grow to fit any circuit density required. Each module is approximately 5/16" wide, 11/16" long and .050" high - indexed for high speed assembly. Because of the unique properties of Coors Ceramics, modules can be joined by epoxy, glass, low temperature solder, or high temperature brazes. Thin film or thick film technique can be used. The high mechanical strength, high surface resistivity and high thermal conductivity of Coors Ceramics combine to make the package reliable under widely varying operating conditions. Precision tolerances can be held even on complex designs. Whether your requirements call for thousands a week, or millions a week, Coors has complete facilities to offer you on-time delivery of alumina or beryllia packaging modules. Faced with a packaging decision? Get on-the-spot answers. Dial Coors - 303/279-6565, Ext. 361. For complete design criteria, write for Coors Alumina and Beryllia Properties Handbook No. 952.

*consider
Coors
ceramics*

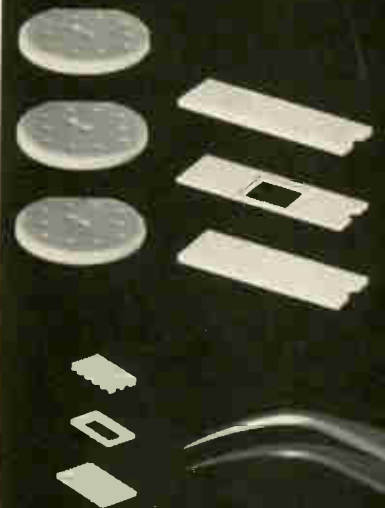

Coors

CERAMICS

ALUMINA • BERYLLIA • MAGNESIA • SPECIAL OXIDES

Coors Porcelain Co., Golden, Colo.

New Microwave Review



Designed to operate in X band in WR-12 waveguide, model 336505 is a 3-port junction circulator with a peak power of 300 kw and an average power of 300 w. Suitable as a circulator, isolator, or duplexer, it offers insertion loss of 0.3 db, isolation of 20 db, and vswr of 1.20. Price is about \$350. Airtron Division, Litton Industries, 200 E. Hanover Ave., Morris Plains, N.J. [401]



Class C pulse-cavity oscillator 11005 is a 2.5-kw unit that is tuned manually and covers 410 to 460 Mhz. Applications include drone control circuitry and a h-f test source. The unit is rated at 35% efficiency and has a duty cycle of 0.00015. Maximum input vswr is 2:1. Dimensions are 1 1/4 x 3 1/2 in. Microwave Cavity Laboratories Inc., 10 N. Beach Ave., LaGrange, Ill. [402]



Tunable coaxial magnetron SFD-325, for airborne and ground-based radar systems, has a frequency range of 16 to 17 Ghz, and peak output power of 75 kw. Compatibility of the tube with modulators delivering widely varied pulse shapes is assured by the low pushing factor (60 khz/amp). Duty factor is 0.001. S-F-D Laboratories Inc., 800 Rahway Ave., Union, N.J. [403]

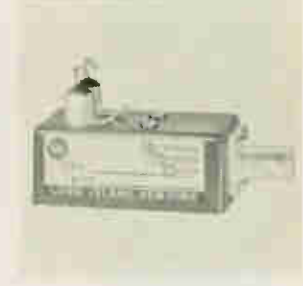

Fundamental voltage-tuned oscillator model ETS3152 has a tuning range of 1.2 to 1.8 Ghz. Linearity is within $\pm 1\%$ over 75% of the range. The devices, 1 x 1 x 2 1/4 in. provide a power output of 50 mw c-w. Noise is -70 db, and harmonics approximately -15 db, Microwave Products Division, Consolidated Airborne Systems Inc., 115 Old Country Rd., Carle Place, N.Y. [404]



Logarithmic amplifier ITL-5, for microwave receivers, provides a log video output with a 70-db input dynamic range. Video output is proportional, within ± 2 db, to the log of the input from -60 to $+10$ dbm. The unit is available at 30- or 60-Mhz center frequency, 4- or 8-Mhz bandwidth. It operates in a 50-ohm i-f system. Price is \$325. LEL Division, Varian Associates, Akron St., Copiague, N.Y. [405]



Coaxial bandpass filter model BK-51FN, covering 2.2 to 2.3 Ghz, is useful in telemetry receivers and down-converters. It offers high rejection-band characteristics—50 db at 2.04 and 2.46 Ghz—with 80 db image rejection. Insertion loss is 0.5 db, and vswr is 1.5 max. Price is \$275. The unit is available from stock. Microlab/FXR, 10 Microlab Rd., Livingston, N.J. 07039. [406]



Coaxial L-band circulator model CLL-83 operates at 1.2 to 1.4 Ghz. It has a maximum vswr of 1.20, maximum insertion loss of 0.3 db, and minimum isolation of 20 db. The unit has a Y package configuration. It can also be supplied with 1 port terminated for isolator uses. The circulator is 3 1/8 in. in diameter, 1 1/2 in. thick. Raytheon Co., 130 Second Ave., Waltham, Mass. [407]



R-f voltage detector model 8029 has a vswr rating specified as less than 1.2:1, with typical values of 1.05:1. It is designed for c-w and swept applications, as well as general purpose usage, covering 10 khz to 3 Ghz. Square-law sensitivity is typically 0.3 mv/ μ w; flatness, ± 0.5 db. Input impedance is 50 ohms. Price is \$95. Telonic Instruments Inc., 60 N. First Ave., Beech Grove, Ind. [408]

New microwave

Harmonic mixer trims receiver

With a single oscillator covering a 40-Ghz range, plug-ins aren't needed and weight drops to 18 pounds

Engineers going into the field to make electromagnetic compatibility tests can now carry their notebooks in one hand and a microwave receiver in the other. Less batteries, Scientific-Atlanta Inc.'s series 1710 receiver weighs only 18 pounds and is the size of a portable

typewriter. It is, the company says, the smallest wide-range receiver ever offered.

Despite its size, the 1710 can do the work of several narrowband receivers, or of a large one containing plug-in oscillators for different bands. Solid state design and a

crystal-harmonic mixer with a range of 40 gigahertz were used to trim down the circuitry.



Display. Oscilloscope is provided to facilitate tuning.

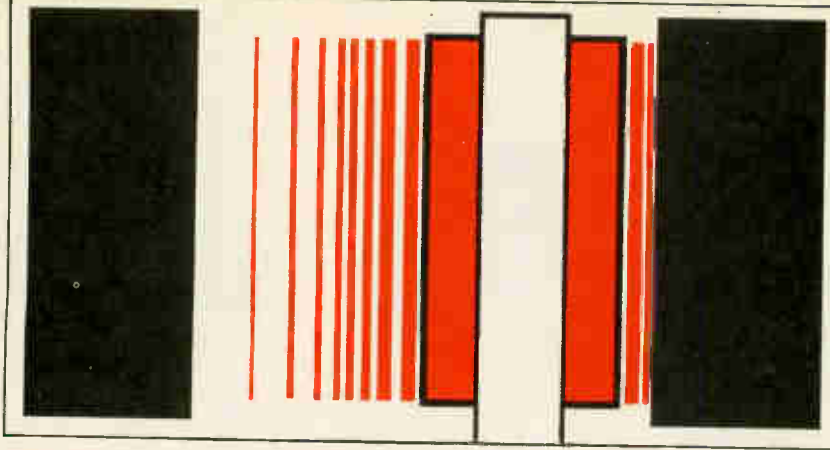

Why is a Jennings vacuum relay the only choice for high voltage switching?

There's nothing to it!

That's right. Only a vacuum dielectric can provide a solution to almost every high-voltage switching problem—and only a Jennings vacuum relay offers the numerous advantages unequalled by any other relay type. You pick a Jennings vacuum relay when you want the utmost in performance for switching sonar transducers, switching between antenna couplers, tap changing on rf coils, switching between transmitters, antennas, and receivers, and many similar applications in airborne, mobile, or marine communication systems. In fact, in any application where reliability is a must and space is minimal.

Why?

Check these features: High RF Current Ratings • Faster Operation • Highest Voltage Ratings • Long Contact Life • No Contact Maintenance • Impervious To Environment • Models To Interrupt High DC Power...*plus* the reliability and quality backed by more than 24 years experience in the design and manufacture of

vacuum electronic components.

If you have a high-voltage switching problem, Jennings probably already has a solution. If not, no one is better experienced to find one. For complete information write for our relay catalog No. 102. ITT Jennings, a division of International Telephone and Telegraph Corporation, 970 McLaughlin Avenue, San Jose, California 95108.



JENNINGS **ITT**

... I-o tuned above
or below ...

At frequencies between 940 Mhz and 2.5 Ghz, a local oscillator directly feeds the mixer, which is built around Schottky-barrier diodes. Crystal harmonics are used from 2.5 to 40 Ghz. The frequency range can be lowered to 20 Mhz with an optional low-frequency converter.

The output of the i-f amplifier is also detected by a crystal detector and the resulting audio signal is applied to the vertical amplifier of a monitor oscilloscope.

Automatic frequency control is used on both upper and lower sidebands, so if the receiver is tuned past the desired frequency, it can still be locked in with the upper sideband. An yttrium-iron garnet preselector is available for the 1-to-12.4-Ghz range. Since the preselector is electronically tuned and can be swept electronically, this option allows more rapid surveillance and detection of unknown signals in this portion of the spectrum.

The receiver is a natural for antenna pattern tests, as well as for electromagnetic compatibility tests, according to P.T. Spence, a project engineer at Scientific-Atlanta. It has ample sensitivity for field or lab measurement of radio-frequency power density.

Spence has measured the minimum detectable signal at -100 dbm at 10 Ghz, and at -118.5 dbm at 2 Ghz. The narrowband (0.1 Mhz) sensitivity of the 45-Mhz intermediate-frequency strip is even greater—only -124.5 dbm.

The dynamic range of 40 db can be extended to 60 db. Other options are signal-level compensation, a precision i-f attenuator, and a battery inverter for field use. A battery pack designed especially for the receiver will soon be available.

Specifications

Frequency range	940 Mhz to 40 Ghz
Dynamic range	40 db
Noise figure	4 db over-all
I-f sensitivity	-124.5 dbm
I-f bandwidth	0.1, 0.5, or 5 Mhz
Minimum detectable signal	-93 dbm at 11 Ghz -100 dbm at 8 Ghz -118.5 dbm at 2 Ghz
Size	6.6 x 8.3 x 11 in.
Weight	18 lbs.
Price	\$5,800 without options

Scientific-Atlanta, Inc., Box 13654, Atlanta, Ga. [409]

Do you think a bright young engineer should spend his most imaginative years on the same assignment?

Neither do we.

That's why many of our areas are organized by function—rather than by project.

At Hughes, you might work on spacecraft this year, communications satellites next year, tactical missiles the next year.

All you need is an EE, ME or Physics degree, 2-8 years experience, and talent. If you qualify, we'll arrange for you to work on several different assignments . . . and *you* can help pick them.



You may select specialized jobs, or broad systems-type jobs. Or you can choose *not* to change assignments if

you'd rather develop in-depth skills in one area.

Either way, we think you'll like the Hughes approach—the chance to be assigned by function, if desired. It means you'll become more versatile in a shorter time. (And your salary will show it.)

Then too it's nice to know that when a project is finished, you're not.



Some of the current openings at Hughes.

Electro-Optical Engineers
Microcircuit Engineers
Space Systems Engineers
Missile Systems Engineers
Guidance & Controls Engineers
Spacecraft Design Engineers
Weapon Systems Engineers
Components & Materials Engineers
Circuit Design, Development &
Product Engineers

Send resume to:
Mr. Robert A. Martin
Head of Employment, Dept. 80
Hughes Aerospace Divisions
11940 W. Jefferson Blvd.
Culver City, California 90230

U.S. Citizenship required
An equal opportunity employer

AE stocks over 200 types of relays and switches

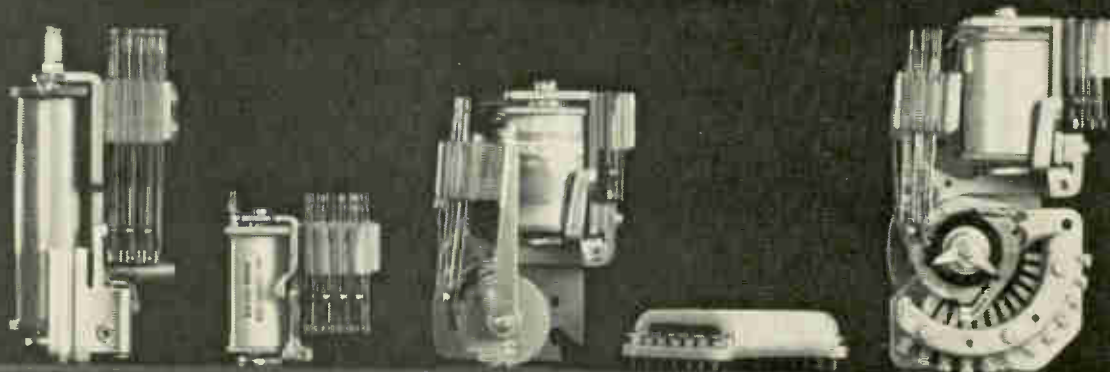

for off-the-shelf delivery within one week!



Get fast, direct delivery—at no extra charge. Thanks to the Automatic Electric Stock Program.

This program keeps growing. Now, we stock over 200 kinds of relays, switches, and accessories. In large enough quantities to fill your normal prototype requirements within 7 days.

That means fast delivery on many of the most popular types from AE's broad line. EIN (integral socket) relays with power contacts; mercury-wetted-contact relays; PC Correeds; rotary step-

ping switches with gold levels for dry- and low-level circuits; ERM (magnetic latching) relays; Class E relays with four different wire termination methods; and many more.

Send for a free copy of Circular 1053, our newest "Stock Letter." It's the latest listing of items you can get quickly. Just write to the Director, Relay Control Equipment Sales, Automatic Electric, Northlake, Illinois 60164.

AUTOMATIC ELECTRIC
SUBSIDIARY OF
GENERAL TELEPHONE & ELECTRONICS **GTE**

New Production Equipment Review



Thin-film sputtering modules for existing vacuum systems are designed for operation at vacuums of 10^{-6} to 10^{-8} torr. They provide film deposition rates of up to 1,100 angstroms/minute. Heart of the V4-8500 module is a d-c diode and r-f sputtering assembly that can be operated in d-c only, r-f only, or d-c r-f combined. Materials Research Corp., Orangeburg, N.Y. [421]



Ultrasonic die bonder DU-6 attaches dice to devices ranging from large stud packages to small headers or flatpaks. Ultrasonic energy is supplied by a 10-watt 40-khz generator. The dice are picked up by vacuum and a slide with the heater column holding the work is moved rapidly into place for bonding. Axion Corp., 6 Commerce Park, Danbury, Conn. [422]



Resistor trimming is performed by an automatic laser system suitable to production use. Safety to the operator or persons in close proximity is assured by light-tight seals and safety interlocks. The system has been tested for 100,000 discharges and operates continuously at rates up to 1 pps. Prices start at \$17,500. Space-rays Inc., Northwest Industrial Park, Burlington, Mass. [423]



Vacuum pumping module 3352 pumps about 900 liters per sec. This allows more rapid production operations in vacuum metalizing, IC deposition, high temperature furnaces, and space simulation equipment. The module measures $35\frac{1}{2} \times 21\frac{1}{2} \times 27$ in. It uses a 6-in. diffusion pump. Price is about \$2,000. National Research Corp., 160 Charlemont St., Newton, Mass. 02161. [424]

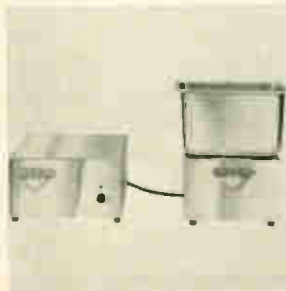

Ultrasonic cleaners for p-c boards and components come in tank capacities of $\frac{1}{2}$ and 1 gallon. Each cleaner consists of the tank (detachable for cleaning); the transducer assembly, which induces cavitation in the tank; and the generator, which powers the transducer. The tank is for use with water-base detergents. Blackstone Ultrasonics Inc., 25 Barrett St., Sheffield, Pa. [425]

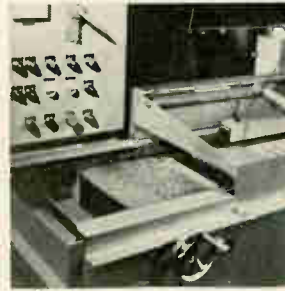

Integrated wavesolder system 364 has an adjustable conveyor, eliminating the need for board carrier or pallet. A p-c board from 2 to 15 in. is slipped into the conveyor and firmly held as it passes the fluxing, flux-drying, preheating, and soldering stations. The system is suited for white room use. Electro-Mechanical Division, Electrovert Inc., 86 Hartford Ave., Mt. Vernon, N.Y. [426]

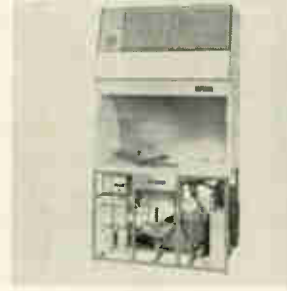

A cleaning station called Micro-Cleaner helps reduce rejects of ICs. It provides 5 hot, cascading rinses and a final rinse of hot, ultrapure water in a totally clean environment. The recirculating, re-purifying system includes a built-in still, demineralizer, organic removal bed, 0.1-micron particle filter, and storage sump. Barnstead Still & Sterilizer Co., 2 Lanesville Ter., Boston. [427]



Designated the Plasma Vac AST1 300, a reactive sputtering system features 2 parallel-mounted water-cooled disk electrodes. The target electrode and discharge suppressor are in the upper position and the substrate-table electrode in the lower. An r-f supported plasma discharge is used to ionize the gas. Consolidated Vacuum Corp., 1775 Mt. Read Blvd., Rochester, N.Y. [428]

New production equipment

Faster, safer packaging for semiconductors

Liquid molding process is reported to cut packaging cost in half while reducing damage from pressure and heat

Epoxy's popularity as a packaging material for semiconductor devices and other components will wane if a new encapsulating system lives up to test results compiled by Cryplex Industries Inc. The company says its resin can be molded around

components four times as fast as epoxy, and for half the cost. Molding temperatures and pressures are lower, so fewer components are damaged, Cryplex also claims.

The International Telephone & Telegraph Corp. is being licensed

to use the process, according to a company spokesman. The company wants its customers to pay royalties, in addition to paying \$8,000 to \$25,000 for the machines and 60 cents a pound for the resin. The resin was recently developed under the direction of John A. Lowry, Cryplex vice president, who was a research specialist at Rohm & Haas for 22 years.

No preheating. The formulation of the plastic has not been disclosed, but it is a thermosetting liquid that can be used at viscosities as low as 100 centipoise and molding temperatures as low

This announcement is neither an offer to sell, nor a solicitation of offers to buy any of these securities. The offering is made only by the Prospectus.

New Issue

August 11, 1967



130,000 Shares

OPTICS TECHNOLOGY, INC.

Common Stock

(\$1.00 Par Value)

Price \$12 Per Share

Copies of the Prospectus may be obtained from the undersigned.

New York Securities Co.

52 Wall Street, New York 10005

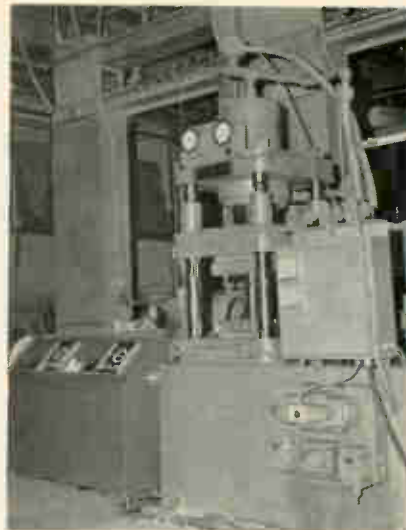

Press. Resin is cured in the mold.

as 170°F. The resin does not have to be preheated or preplasticized. Nor is a post-cure needed after molding, the company says. The storage life of the resin is reported to be six months and its work life, after catalysts are added, is four to 15 days—another economy.

Molding and curing time in the press ranges from about 15 seconds, when small components such as diodes are being encapsulated, up to two minutes for large components. In one test, Cryplex's complete molding cycle time was 30 to 40 seconds while transfer molding of epoxy took 168 seconds. However, the company said it needed 100 seconds to clean and lubricate the epoxy mold.

Safety in numbers. Significantly higher component yields are claimed. As evidence of how safe the process is, the company says, it successfully encapsulated hybrid circuits that could not be transfer-molded.

In another test, five batches of high-voltage rectifiers—200 in all—were given one-hour pressure-cooker tests after half were encapsulated in the new resin and half were transfer molded with epoxy powder. The reported yields per batch ranged from 15% to 47% for epoxy and 68% to 92% for Cryplex. One of the Cryplex-encapsulated components was said to show no damage after 1,200 hours storage at 150°C and thermal cycling from -55 to 125°C.

Cryplex Industries Inc., 2800 College Point Causeway, Flushing, N.Y. [429]

Circle 226 on reader service card

FOR Chemicals Think GC

Solve all electronic chemical needs quickly and economically... simply specify GC!

GC manufacturers and stocks cleaners, solvents, cements, lubricants, lacquers and varnishes for in-plant servicing and maintenance needs on all office and production equipment. Packaged, or in bulk, all are available for immediate shipment.



FREE!

Write today for the big GC Electronic Chemical Handbook — \$1.50 value — yours **FREE** when applied for on your Company letterhead. It's your solution to all chemical problems.

GC Electronics

400 South Wyman Street
Rockford, Ill. 61101

A Division of
GC-Hydrometals, Inc.

Shipping warehouses in:
Hicksville, L.I., N.Y.
Los Angeles, California



INSTRUMENT CASES

by
WAMCO



RUGGEDIZED FORMICA CASES are CUSTOM made to house Precision Instruments. All surfaces and edges of these cases, inside and out, are laminated with 1/16" FORMICA, which makes these cases tremendously strong, beautiful, light in weight and durable. These instrument cases are of the highest quality and workmanship.

RUGGEDIZED FORMICA CASES can be designed and made in any size, shape or quantity, with any desired cut-outs, partitions, panel seats or panel mounts, in your choice of patterns and colors, with any type of hardware.

W. A. Miller Company

Mingo Loop Road, Oquossoc, Maine 04964

Circle 240 on reader service card

180 Circle 180 on reader service card

Electronics | September 4, 1967



Heat this electrical tape to 621F and it becomes an encapsulant!

Use it between -400F and 500F, and it is . . .

- AN EXCELLENT DIELECTRIC
- EXTREMELY CONFORMABLE
- SELF-STICKING (WITHOUT ADHESIVE BACKING)
- MECHANICALLY STABLE
- IMPERVIOUS TO ALL ACIDS, GASES, SOLVENTS

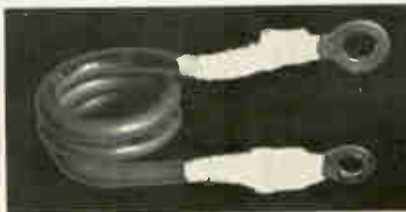

When heated above 621 F, Type E-125 TEFLON® tape sinters to form a rigid, tough, hermetic seal around coils, cables, or other forms. It won't burn either. Teflon just melts. Available in thicknesses from 0.002" to 0.010" and widths from 1/8" to 3", with tensile strengths from 1100 to 1800 PSI and dielectric strength from 700 to 800 VPM.

WRITE FOR COMPLETE DATA & SAMPLES to Dodge Industries, Fluorglas Division, Hoosick Falls, N. Y. 12090. You'll receive a prompt answer.

Dodge Industries

Now! Control 4 circuits up to 16 ways... at each of 12 steps... in minimum space... with ONE SWITCHING DEVICE!

The MSC Series 22 consists of 4 miniature SPDT switch modules in one package. Each 5 amp/250V switch is actuated by one of four cams positioned on a common shaft. At every 30° on each cam circumference provision is made to either close or open the switch contacts according to your required program. As many as 16 different combinations of switch modes can be made at each step to provide an ideal encoder for 4-bit binary coded output in any sequence. Units snap onto the back of many MSC lighted or unlighted push-buttons for versatile panel control functions. For detailed data, write on your letterhead or use the reader service card.



Custom Cams actuate switches in any specified program.

Series 22 PROGRAMMABLE SEQUENCING SWITCH

Provides Binary Coded Output!

TYPICAL PROGRAM

SWITCH STEP NO.	SWITCH IDENTIFICATION			
	A	B	C	D
1	ON	ON	ON	—
2	—	—	ON	ON
3	—	ON	—	ON
4	ON	ON	ON	ON
5	ON	—	—	—
6	—	—	ON	—
7	—	—	ON	ON
8	—	ON	ON	—
9	ON	—	ON	ON
10	ON	ON	—	—
11	—	—	ON	—
12	—	ON	—	ON



Master Specialties Company



25 YEARS IN INFORMATION DISPLAY AND CONTROL DEVICES

MSC Master Specialties Company, 1640 Monrovia, Costa Mesa, Calif. 92627 • Telephone (714) 642-2427 • TELEX 6-78433 Offices in Principal Cities.

FUSETRON

dual-element FUSES

Slow Blowing



"Slow blowing" fuses prevent needless outages by not opening on harmless overloads—yet provide safe, protection against short-circuits or dangerous overloads.

Write for BUSS Bulletin SFB

INSIST ON

BUSS QUALITY

BUSSMANN MFG. DIVISION, McGraw Edison Co., St. Louis, Mo. 63107

Circle 183 on reader service card

Blocks for fuses

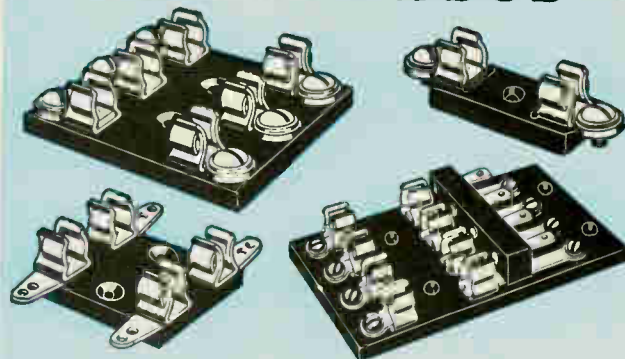

TYPES AVAILABLE FOR ALL APPLICATIONS

Single pole, multiple pole, small base, full base, molded base, laminated base, porcelain base for fuses from $\frac{1}{4} \times \frac{5}{8}$ inches up. Also signal type fuse blocks and special blocks of all types.

Tell us what you need or . . .

Write for BUSS Bulletin SFB

INSIST ON

BUSS QUALITY

BUSSMANN MFG. DIVISION, McGraw-Edison Co., ST. LOUIS, MO. 63107

Circle 183 on reader service card

BUSS: The Complete Line of Fuses and . . .



NEW lower-cost, epoxy flame-retardant copper-clad laminate

In response to the demand for a more economical epoxy grade of laminated plastic, Synthane now offers new grade FR-16.

FR-16 is reinforced with a random-oriented glass fiber mat which, because it can be produced on a modified paper machine, costs less than fabric reinforcements used in other flame-retardant grades.

FR-16 is excellent for printed circuits. It is mechanically strong, moisture-resistant, has a low dielectric loss and a high dielectric breakdown. Write Synthane Corporation, 36 River Road for the FR-16 Engineering Data Bulletin.

SYNTHANE

CORPORATION S OAKS, PA. 19456

Laminated Plastic Sheets, Rods, Tubes and Fabricated Parts

INCREASE SOLDERING PRODUCTION 10% TO 40%

with

LUMA Low Voltage Resistance Solder Tools

for perfect soft or hard, "pin-point" or medium heavy operations.

Carbon electrodes concentrate instantaneous heat at the solder point. No cold joints.

High capacity power unit, 5 to 2500 watt, (guaranteed for one year) draws current only when actually soldering. No warm-up needed. Permits simultaneous use by multiple operators, thus minimizing capital expenditure.

16 styles of small, light electrode holders balanced for easy, tireless handling. Generate negligible heat for safety from burns or fire hazards. Saving on solder alone can pay for the equipment in a year. The quick-changed carbons provide an average 30,000 contacts each.

Send for complete catalog



Luma

THE LUMA ELECTRIC EQUIPMENT CO.
1631 COINING DRIVE • TOLEDO, OHIO 43612

New Books

Hard core

Basic Theory of Waveguide Junctions and Introductory Microwave Network Analysis

D.M. Kerns and R.W. Beatty
Pergamon Press Ltd., 150 pages, \$5.50

Not intended for casual reading, this volume is essentially a textbook covering two areas—basic theory of waveguide junctions, written by D.M. Kerns, and introductory microwave network analyses by R.W. Beatty. And, as expected from authors connected with the National Bureau of Standards laboratory in Boulder, Colo., the book is heavily slanted toward measurements.

The network-analysis discussions, organized so they can be digested in small doses, center on the scattering matrix representation of microwave circuits and components. Scattering coefficients

are given for power terms, reflection coefficients, efficiency, attenuation, mismatch losses, and phase shifts. Two-port, three-port, and four-port networks are taken up in detail. Although practical components are discussed as waveguide elements, the basic matrixes are, of course, equally applicable to strip-transmission line and coaxial representations.

Beatty supplies a helpful touch by collecting the scattering matrixes in one comprehensive table for each type of network—phase shifters, isolators, and the like. This table is particularly useful in cascading two ports.

Three applications are touched upon in the entire book, but only lightly. It's unfortunate that Beatty didn't draw more on his experiences at NBS for unusual examples of the techniques he describes.

Majority rules

Threshold Logic
P.M. Lewis and C.L. Coates
John Wiley & Sons, 483 pp., \$15.00

Experiments have shown that threshold logic—also called majority, or voting, logic because the gate's output is determined by the state of the majority of its inputs—cuts by two thirds the number of gates in conventional logic schemes. However, threshold logic has not been used to any great extent in digital computers because of the lack of adequate design techniques and a need for tighter-tolerance circuits.

Two previously published books share the same title as this one—the first by M.L. Dertouzos, M.I.T. Press, 1965, and the other by S.T. Hu, University of California Press, 1965. While the latest is the most comprehensive and can be recommended for reference use, it still is not a complete treatise. And most designers would probably like a more compact treatment of the

.. Fuseholders of Unquestioned High Quality

BUSS

SPACE SAVER

Panel Mounted Fuseholders



Screw type slotted knob that is recessed in holder body and requires use of screwdriver to remove or insert it.



Screw type knob designed for easy gripping, even with gloves. Has a "break-away" test prod hole in knob.

Fuseholder only $1\frac{3}{8}$ inches long, extends just $\frac{2}{32}$ inch behind front of panel. Takes $1\frac{1}{4} \times 1\frac{1}{4}$ inch fuses. Holder rated at 15 ampere for any voltage up to 250.

Write for BUSS Bulletin SFH-10

INSIST ON

BUSS QUALITY

BUSSMANN MFG. DIVISION, McGraw-Edison Co., ST. LOUIS, MO. 63107

TRON SUB-MINIATURE

PIGTAIL FUSES

BODY SIZE ONLY .145 x .300 INCHES

For use on miniaturized devices, or on gigantic space tight multi-circuit electronic devices.

Glass tube construction permits visual inspection of element.

Smallest fuses available with wide ampere range. Twenty-three ampere sizes from 1/100 thru 15 amps.

Hermetically sealed for potting without danger of sealing material affecting operation. Extremely high resistance to shock or vibration. Operate without exterior venting.

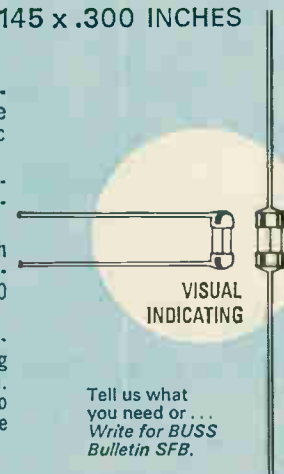

Tell us what you need or... Write for BUSS Bulletin SFB.

INSIST ON

BUSS QUALITY

BUSSMANN MFG. DIVISION, McGraw Edison Co., St. Louis, Mo. 63107

To provide you with a practical way of increasing your technical knowledge,

CREI now offers extension programs in Computers

Not simply courses, but complete programs in advanced electronics with Computers as a major elective. One program is for engineers who need updating, the other for high school graduates eager to move ahead in electronics.

CREI's industry-approved home study method permits you to study at your own pace, on your own schedule. Our free book gives full information and details on technical material covered. For your copy use coupon below, or write: CREI, Dept. 1809E-4, 3224 Sixteenth Street, N.W., Washington, D.C. 20010.

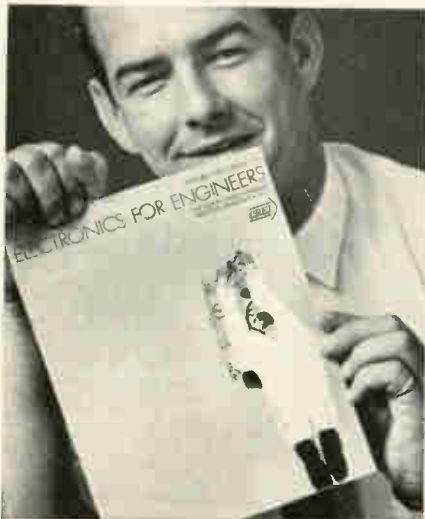

Founded 1927
CREI
 Accredited Member of the National Home Study Council

THE CAPITOL RADIO ENGINEERING INSTITUTE
 A DIVISION OF MCGRAW-HILL, INC.
 Dept. 1809E-4, 3224 16th St., N.W.
 Washington, D.C. 20010

Please send me FREE book describing CREI Programs in Electronics and Major Elective in Computers.

I am interested in Updating Program for Engineers
 Regular Program for men working in electronics

Name _____ Age _____

Address _____

City _____ State _____ Zip Code _____

Employed by _____

Position _____

New Books

major aspects of threshold logic.

The first three chapters cover in detail the properties of threshold functions and abstract models of the gates used in this technique. Because the authors have done well in selecting, presenting, and referencing their material, they do succeed in giving the reader a feel for the subject. But Karnaugh maps and switching cubes, which would help, are omitted; they deserve coverage.

Definitions are clearly proposed and the proofs are usually easy to follow. Many examples allow the reader to follow the text without studying the proofs in detail. The notation, however, is at times cumbersome and could easily have been streamlined.

Many well-chosen examples are included to illustrate the methods. Some pertinent references are given in the bibliography, which covers work through 1965, but much has been done recently on using integrated circuits as threshold gates. In IC form, threshold gates are compatible with conventional IC gate structures and even competitive with them.

The authors devote several chapters to the use of the "function tree" to synthesize single threshold gates and threshold-gate networks with prescribed tolerance bounds—a method that they originated several years ago. The major advantage of the procedure is that the designer controls tolerance requirements as he proceeds through the design.

Other synthesis techniques, also described, rely on three-input majority gates, easily built with a variety of components, and special networks for synthesizing symmetric functions, which are important in digital systems. One drawback in this procedure is that the networks of three-input majority gates usually contain many levels. Complementing these gates with others, such as AND's or OR's can simplify the problem. Synthesis methods based on duality, linear programming, and sequential techniques developed from pattern-recognition problems are also considered. Missing, however, are dis-

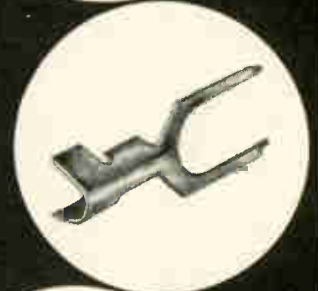

high quality Electrical Connectors

In the course of manufacturing its primary products, Wiring Assemblies, Jumper Leads and Harnesses, Beman Manufacturing has developed many Electrical Connectors for various applications.

Because of the success of these Connectors, Beman is now offering quality Terminals in strip form, to be applied with semi-automatic machines.

Primarily geared for high-volume production, Beman can offer economical, quality Terminals and aggressive design and production of new Applicators, as you may specify. Beman's machines are designed with simplicity for rugged use.



BEMAN MFG., INC.

P. O. Box 370 New Cumberland, Pa., 17070

Phone: (717) 774-0210

WHICH INSULATING TECHNIQUE WOULD YOU HAVE PICKED?

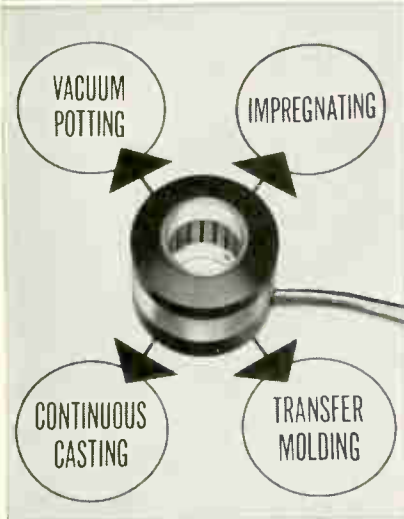

**HULL provides
equipment for all of them)**

Hull recommended vacuum potting. For this servo motor, cost, quantity and application requirements pointed to that choice.

Your unit may call for extremely high potentials. Or wide thermal shock resistance. It may encounter vibration, corrosive atmospheres, high ambient temperatures.

One of the four insulating techniques—or a combination will meet the end-use requirements. And keep your cost/quantity/quality ratios in line. Hull's application engineers will recommend and provide the ideal equipment.

You'll get guidance in resin selection. We'll furnish your work-holding fixtures and molds. Your complete production or pilot plant if you say go.

Hull's the only company we know of that can provide you all this. We'd like to work with you. Simply write or phone us: HULL CORPORATION, 7035 Davisville Road, Hatboro, Pa. 19040. Phone: (215) 672-7800



Circle 230 on reader service card

cussions of the applicability of each procedure and computational aids for both hand and computer calculations.

Donald R. Haring
MIT Electronic Systems
Laboratory
Cambridge, Mass.

Not cricket

Low Noise Electronics
W.P. Jolly
American Elsevier Publishing Corp.,
149 pp., \$5.00

Of late, many books have been published with the same idea—to make complex physical phenomena understandable to the engineer who completed his formal education long ago. To be successful with this sort of thing is not easy. It requires a detailed, intuitive-level explanation of a group of topics that are carefully selected. It cannot lean on mathematics or references for support; if it does, it defeats its own primary purpose. On these counts, this volume is, like most of the others, only moderately successful.

The portion devoted to maser systems is well done. Jolly describes pumping, refrigeration, and system noise. Unfortunately, in most of the other broad-brush descriptions, the references carry the weight of supplying details that are omitted in the text.

At that, the book is not particularly rich in references. The ones that are given were presumably carefully chosen, but they cannot be substituted for an actual description in the text. Some books like this turn out to be little more than annotated bibliographies; Jolly's book is not one of these, but in some cases it comes perilously close.

Even on the simplified level that is attempted, many parts of the book must be studied to be understood. This would hardly be fair criticism for a textbook, but if study is necessary, it would be better to find a book that offers a greater return for the time invested. The difficulty here may be related to the book's size and scope.

In 149 pages, the book covers the evolution of modern quantum theory, energy band structures, p-n junctions, Gunn effect, electron-

Circle 185 on reader service card →

FOR PRECIOUS METAL POWDERS BE SURE TO CHECK BISHOP



Here's Why

- Bishop offers variety in metals and their characteristics
- Bishop is willing to "tailor" to your specs and Bishop's prices are amazingly low

Look into Bishop's wide variety of powders which differ in particle size, surface area, bulk density, shape (powder or flake) to meet exacting requirements. No matter how you use powders—for fuel cells, metalizing preparations, resistors, printed circuits, circuit decals, capacitors, or in other ways, you will find Bishop has, or will make, precious metal powders to meet your particular specifications. By all means, contact us when you need a precious metal powder for making inks or pastes or for your own special application.

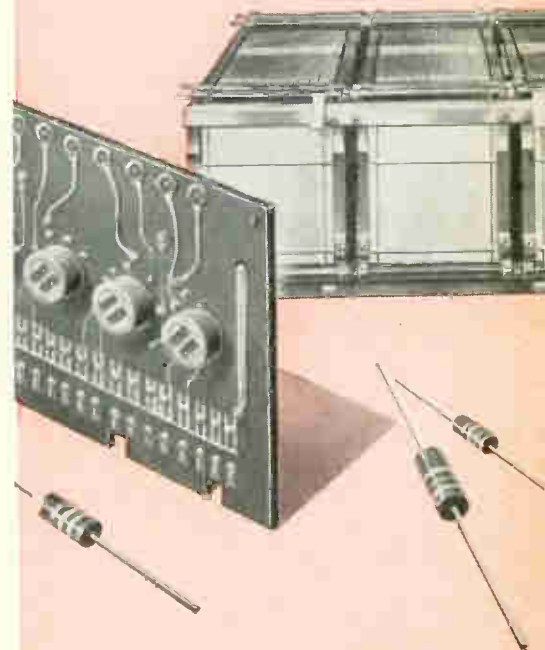

BISHOP



**J. BISHOP & CO.
PLATINUM WORKS**

CHEMICAL PRODUCTS DIVISION

Platinum Chemical Department

MALVERN, PENNSYLVANIA 19355

Phone: (215) 644-3100

A Johnson, Matthey Associate



EE'S

with military communications
equipment experience

call us collect

area code 317/459-2808

Rapid expansion of our ground based and airborne military communications capability has created urgent requirements for electrical engineers (B.S. or M.S.) at Delco Radio.

Opportunities at all levels—beginning, through supervisory, with 2-10 years experience—in the following areas:

Digital communications in the HF, VHF, and UHF bands

Single side band design, HF, and VHF

Frequency synthesizer techniques in all frequency ranges

Wide range electronic tuning

Retransmission techniques

Secure communications techniques

Man-portable and vehicular battle area communications equipment

Acoustic transducers, antennas, and micro-electronics applications.

Call us collect for an interview or more information. Area Code 317/459-2808. Ask for C. D. Longshore. Or send your resume to Mr. Longshore, Supervisor, Salaried Employment, Dept. 204, Delco Radio Division of General Motors, Kokomo, Indiana.



MARK OF EXCELLENCE

DELCO RADIO

DIVISION OF GENERAL MOTORS • KOKOMO, INDIANA

An equal opportunity employer

Easy to select
THE
BEST
DRIVE
for your
design
with
SYNCHRON
MOTORS



In addition to over 40 shafts and pinions, Hansen can supply you with more than 300 special drive and gear arrangements, for applications with SYNCHRON Motors. Almost surely, one fits your design exactly. 168 speeds; right, left or reversible rotations. 8, 20 and 30 oz.-in. torques; 220, 110 and 24 volts; 60, 50 and 25 cps., and DC models. Compact; easy to mount in any position. Accurate at -40° F. to 140° F. For SYNCHRON brochure and drive shaft and gear detail sheets, write or phone us, or your Hansen representative.

HANSEN
MANUFACTURING COMPANY, INC.
PRINCETON,
INDIANA

HANSEN REPRESENTATIVES: CAREY & ASSOCIATES, Houston and Dallas, Texas, R. S. HOPKINS CO., Sherman Oaks, Calif., MELCHIOR & MACPHERSON, INC., San Carlos, Calif., THE FROMM COMPANY, Elmwood Park, Ill., H. C. JOHNSON AGENCY, INC., Rochester, N.Y., JOHN ORR ASSOCIATES, Grand Rapids, Mich., WINSLOW ELECTRIC CO., Essex, Conn., Narberth, Pa., and New York, N.Y. EXPORT DEPARTMENT, 64-14 Woodside Ave., Woodside, N.Y.

New Books

phonon and electron-photon interactions, Compton and Mossbauer effects, stimulated emission, masers and lasers, parametric systems, electron-beam amplifiers, microwave ferrites, injection lasers, and atmospheric absorption of radiation. He also mentions low-temperature amplifier operation, ferroelectric amplifiers, laser applications, and radio telescopes, and provides an index to all these subjects.

In his preface, author Jolly, a professor at the Royal Naval College in Greenwich, England, compares his book to the lightweight cricket bat that a child might use to get the feel of the game before moving up to the real thing. But once he gets the feel of it, he'd better switch to a heavy bat or he'll never belt one very far.

Recently published

Integrated and Active Network Analysis and Synthesis, Paul M. Chirlian, Prentice-Hall Inc., 427 pp., \$10.50

Primarily a text, the book details the latest techniques for handling circuit problems in integrated and active circuits. Background information is provided on physical behavior of semiconductors and methods for fabricating IC's.

Electronic Counting Circuits, J.B. Dance, American Elsevier Publishing Co., 390 pp., \$16.75

Descriptions of all types of electronic counting circuits are given with many designs that include actual component values. No previous knowledge of pulse techniques is needed.

Quantum Electronics, Amnon Yariv, John Wiley and Sons Inc., 478 pp., \$14.95

Written at a first-year graduate level, the volume concentrates on the interaction of optical radiation and atomic structures and the devices that use such interactions. Laser amplifiers, oscillators, noise in masers, and other related topics are discussed.

Computer Programming and Computer Systems, Anthony Hassitt, Academic Press, 374 pp., \$10.95

An intermediate-level text for the programmer, the book offers an introduction to machine language programming, monitor systems, computer hardware, and advanced programming. A knowledge of Fortran or Algol is necessary to fully utilize the information presented.

Wave Phenomena, Dudley H. Towne, Addison-Wesley Publishing Co., 482 pp., \$12.50

The author presents a unified treatment of transverse waves on a string and acoustic and electromagnetic waves. Discussions of the wave equation, wave propagation, boundary value problems, and normal modes in various physical contexts are used to provide an introduction to the mathematical techniques of quantum mechanics.

COAX to 18 GHz!

New Hewlett-Packard coaxial instrumentation extends your measurement capabilities. You can enjoy the flexibility and convenience of using coax over wider frequency ranges, with greater accuracy.

Example No. 1



Precision coaxial attenuators with extremely flat frequency response and low swr at economical prices. Calibration data supplied on each unit, and all are **swept frequency tested** for attenuation and swr.

Standard attenuation values are 3, 6, 10 and 20 dB; full sets in storage case available.

Model 8491A Series, DC to 12.4 GHz, Type N, \$50 each.

Model 8491B Series, DC to 18 GHz, Type N, \$65 each.

Model 8492A Series, DC to 18 GHz, 7 mm APC-7 connectors, \$125 each.

Example No. 2



Compact step attenuator covers 0-60 dB range in 10 dB steps with low swr and flat response. From DC to 12.4 GHz. Model 354A, Type N, \$350.

TURN THE PAGE FOR MORE EXAMPLES!

HEWLETT  PACKARD

Tell your machine tools to:

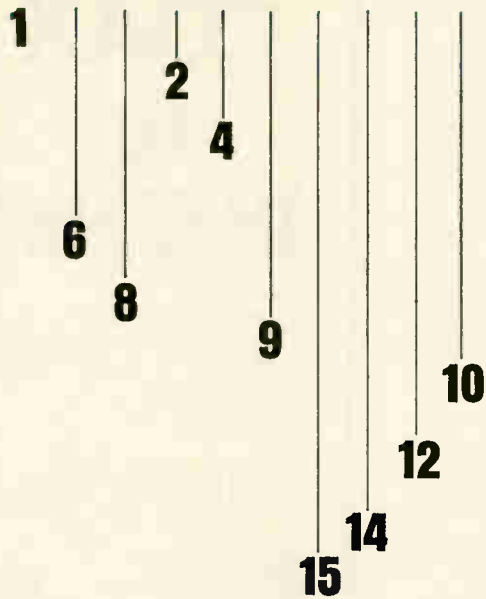

(they'll understand)

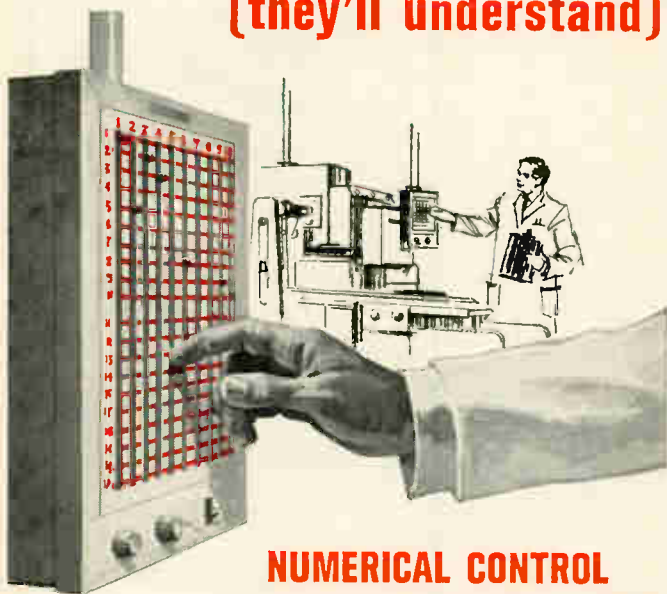

**NUMERICAL CONTROL
speeds up machine tool
function programming**

Select or re-program machine tool functions and phases in seconds with less chance for error. Rectangular coordinates make entire program visible at a glance, simplify selection by putting every selector at your fingertips. So compact, one hundred sequencing positions are accommodated in 10 sq. in. of panel area. Cross-grid printed circuit-board eliminates soldering—no jungle of wires to cause problems either. Choose from eleven standard models with from 100 to 2780 switching positions. Write now for full details on the C-10 unit.



CHERRY ELECTRICAL PRODUCTS CORP.
1656 Old Deerfield Road—Highland Park, Illinois 60035

This

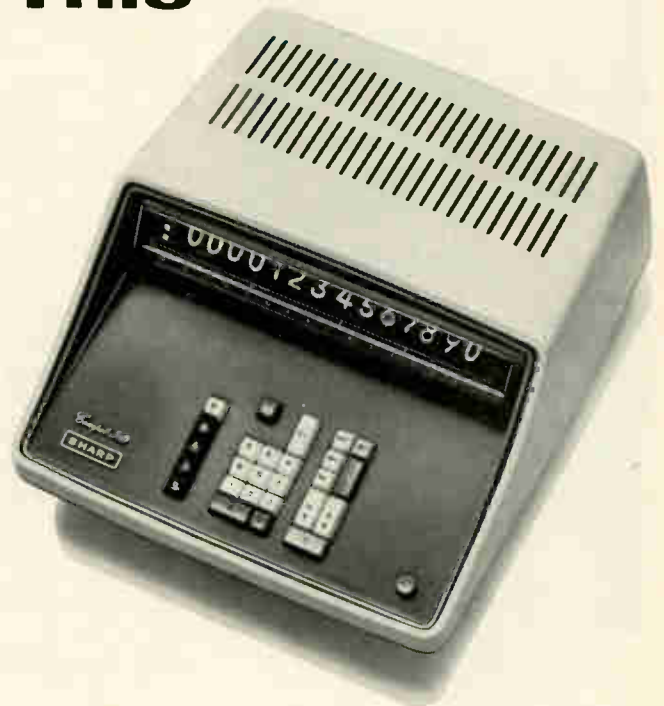

can save your time?

Yes, if faster calculation will help. Can you use saved time? Think a few minutes about your use of a Compet-30 --- it could save you hours --- which could be used other ways (i.e., playboy, work, family, etc.). And the CS-30B has two great new features on its face --- two little lights.

The **yellow** light is the "memory register" --- which stores intermediate answers for continuing calculation; saves much time! The **red** light prevents mistakes by overflow, an effort to get the human factor as accurate as the Compet-30 is --- no mistakes means saving even more time.

Check into the electronic desk calculator Compet-30 soon; save time. You deserve it.



HAYAKAWA ELECTRIC CO., LTD. Osaka, Japan

U. S. Subsidiary: SHARP ELECTRONICS CORP. 178 Commerce Road Carlstadt, New Jersey

Technical Abstracts

A blow at vidicons

A self-scanned solid state image sensor P.K. Weimer, G. Sadasiv, J.E. Meyer, L. Meray-Horvath, and W.S. Pike
RCA Laboratories
Princeton, N.J.

New scanning circuits for an array of thin-film photosensitive elements may soon make it possible to build a solid state television camera as a single integrated device.

RCA's self-scanned image sensor consists of a photosensitive array with 32,400 elements and two 180-stage shift register scan generators with associated video coupling transistors. Integration of all components was accomplished with thin-film techniques. Each element in the photo-sensitive array uses a photoconductor that is a mixture of cadmium sulfide and cadmium selenide for high gain. Center-to-center spacing is 2 mils. The scan generator uses 540 cadmium selenide thin-film transistors deposited on a glass substrate. The entire array is scanned at the conventional rate (63.5 microseconds) so that the picture can be displayed on a commercial tv receiver.

The sensor array is scanned with a method similar to that used in a vidicon. There, an electron beam acts like a commutator, contacting each picture element once during the scanning period. In the solid state device, the beam is replaced by switches attached to each photosensitive element. The switches are normally off, but when activated by pulses from a scan generator they connect the individual photoconductive elements across the video load. Although diode switches are used in this sensor, insulated gate transistors are also suitable. An appropriate scan generator might be a parallel-output shift register, as used in this camera, decoder switching circuits, or a tapped delay line.

The solid state camera's fast horizontal scan generator produces a positive pulse that travels across the array in 53.5 μ sec (line time for commercial tv). This pulse turns the diodes on sequentially, discharging

the photoconductors. Simultaneously, a slow vertical scan generator activates the video coupling transistor for the row being scanned.

Experimental image sensor arrays with more than 100,000 elements have been constructed, but they're still too expensive to compete even with the costly vidicon. Ultimately, integrated image sensors will need about 1 million individual components.

Although signal uniformity from element to element in the present array was good, most of the transmitted pictures were marked by vertical and horizontal streaks caused by disconnected lines and shorts in the sensor. This was due to imperfections in the fabrication of the monolithic array. Also, with the equipment used, image sensitivity was only about 1/10th that of the conventional camera's sensitivity.

The camera, however, was easy to use and reliable. The sensor array was operated for more than 6,000 hours with negligible changes in dark or light. The 180-stage scan generator was operated for 10,000 hours at 85°C without failures developing in any of the 100 stages under test.

Presented at Wescon, San Francisco,
Aug. 22-25.

... and another

100-by-128-element solid state imaging system
R.A. Anders, D.E. Callahan, W.F. List,
D.H. McCann, M.E. Wing
Westinghouse Defense & Space Center
Baltimore

Another scheme to replace the conventional television camera uses a 3-inch cube solid state imaging system in which silicon phototransistors are the sensors. Development units capable of 100-line resolution at 60 frames per second have been demonstrated, and resolutions of greater than 200 lines at the same scanning rate are predicted by 1970.

A monolithic silicon mosaic, consisting of 12,800 phototransistors

COAX to 18 GHz!

Example No. 3

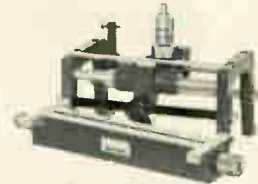

Coaxial slotted line for traditional swr measurements in coax 1.8 to 18 GHz. Very low residual swr (<1.04 at 18 GHz) results in highest accuracy. Model 816A, \$250. (Used with 809C Carriage, \$200, and 447B Detector, \$125.)



Coaxial swept slotted line system retains high accuracy resulting from 816A Slotted Section's low residual swr while you make swept frequency swr measurements from 1.8 to 18 GHz. This technique is described in HP Application Note 84, yours for the asking. Model 817A, \$925.

Example No. 4

Precision sliding load for more accurate impedance and swr measurements, 1 to 18 GHz. Supplied with interchangeable Type N male, female, 7 mm APC-7 connectors. Model 907A, \$275.

Fixed termination has extremely low reflection coefficient for terminating 50-ohm systems, DC to 18 GHz. Model 909A, APC-7, \$75; Type N, \$60.



KEEP GOING

HEWLETT  PACKARD

**There's a lot
to recommend the
Tung-Sol Digital
Readout for your
Application**

KNOWLEDGEABILITY—An ideal combination of readout characteristics is based on Tung-Sol's more than sixty years of low-current lamp making experience.

CAPABILITY—Tung-Sol is thoroughly experienced in the production of top quality electrical/electronic components to highest performance requirements.

RELIABILITY—Statistical quality control procedures enable Tung-Sol to maintain volume output to quality standards normally associated with laboratory production.

CREATE-ABILITY—Tung-Sol design engineers have exceptional freedom to explore the solution to a customer's problem. The result is reflected in economy as well as performance.

AVAILABILITY—Wide national representation provides engineering consultation on a local basis. National distribution assures dependable back-up of customers production schedules.

Now let us tell you about the product. Write for complete information about this exceptional digital readout. Tung-Sol Division, Wagner Electric Corporation, One Summer Avenue, Newark, N.J. 07104. TWX: 710-995-4607.



TUNG-SOL®

HI-OPTICS

DIGITAL READOUT

The most thoroughly engineered
readout on the market



*We
produce*

carbon film resistors

wirewound resistors

vitreous, cemented,

lacquered, non-lacquered

potentiometers up to 500 watts

Ceramic capacitors

Trimmer capacitors

Ceramic RF power capacitors

also water-cooled capacitors

up to 2000 kVAR

Precision ceramic parts

ROSENTHAL · ISOLATOREN · GMBH

P.O. Box 127
8672 SELB / West-Germany
Tel: 711 Telex: 0643533

Technical Abstracts

in a 100-by-128-element array, measures 0.5 by 0.5 inch. The phototransistors are sequentially scanned by rows and columns at rates up to 60 frames per second. Patterns can be easily recognized by this element-by-element scanning without external digital-to-analog conversion.

There are 100 horizontal common-collector strips, each containing 128 base-emitter junctions. The emitters are joined vertically by metalization. Thus, external connections in both the x and y directions provide access to any image element. The charge stored in each element's collector-base junction corresponds to the total light falling on the junction during one complete scan cycle.

To read the mosaic, a voltage is applied to each collector strip in turn, while the 128 emitters are sequentially connected to an output operational amplifier through field effect transistor switches. The output during the sampling time is proportional to the total light that has fallen on the sensor during the entire 1/60th-second frame time.

Presented at Wescon, San Francisco, Aug. 22-25.

Light sandwich

A solid-state image converter
R.D. Stewart and E.L. Littebrant
General Electric Co.
Syracuse, N.Y.

Light-emitting diodes, though easy to make and use, are limited to a single wavelength infrared output. To transform this output to a variety of visible wavelengths, researchers at the General Electric Co. have developed an electroluminescent image converter based on an old principle but having a high quantum gain.

The electroluminescent-photiconductor (EL-PC) light amplifier, a device first introduced in the late 1950's, is built in four layers. On top is a glass substrate through which infrared radiation passes. The radiation strikes a cadmium selenide photoconductive layer. A dielectric layer separates the cadmium selenide from the final layer

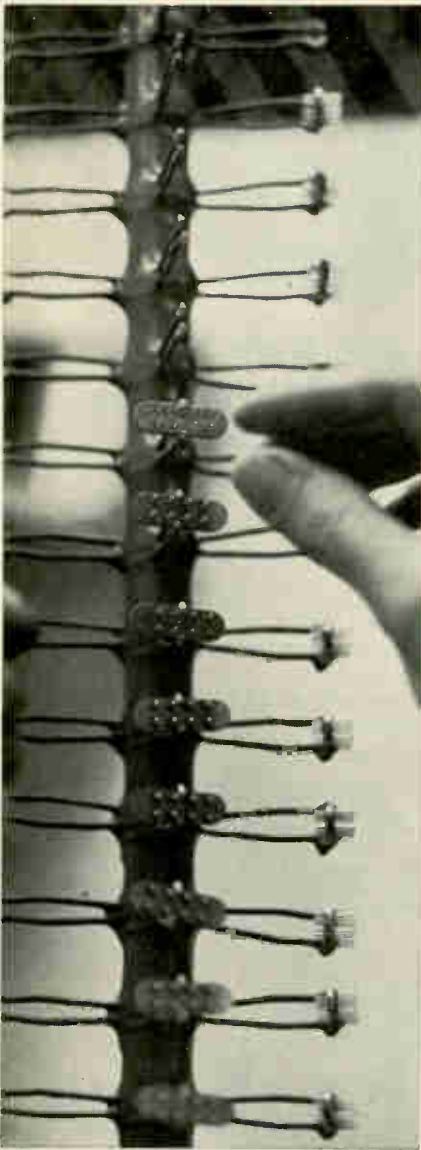

Pick a header... standard or custom

Then call Atlas—where reliability is a reality—whether you need custom headers to your drawings or any of more than 150 configurations of single-pin terminals for off-the-shelf delivery.

At Atlas a tape-programmed, six-head drilling machine reduces tooling time and total cost. An electron-beam welder bonds delicate parts with precision. And Helium Mass Spectrometers check for possible leakage.

In-house facilities such as these make it possible for us to manufacture and test to your specifications or MIL specs. For you that means unmatched quality and reliability. Challenge us today. Phone 215 666-0700. Or send for complete information.

ATLAS
CHEMICAL INDUSTRIES, INC.
Aerospace Components Division
Valley Forge, Pa. 19481

COAX to 18 GHz!

Example No. 5



Crystal detector provides wideband detection from 10 MHz to 18 GHz. Use for leveling and monitoring applications. Has low swr and very flat response (± 1 dB full range). Model 8470A, APC-7, \$175; Type N, \$160.

Example No. 6



Calibrated susceptance for time domain reflectometry. Direct reading in Shunt C, Series L; simplifies evaluation of discontinuities in transmission lines. Precision air line also serves as a 50-ohm Z_0 standard. Model 874A, GR874 connectors, \$250; Model 874B, APC-7 connectors, \$325.

Example No. 7



Waveguide-to-coax adapters for added convenience. Model X281B covers from 8.2 to 12.4 GHz, \$60; Model P281B covers from 12.4 to 18 GHz, \$75. With APC-7 connectors; also available with stainless steel Type N female, \$15 less.

KEEP GOING

HEWLETT  PACKARD

These two
heat-shrinkables
are hungry for
tough mil-spec
insulation problems.

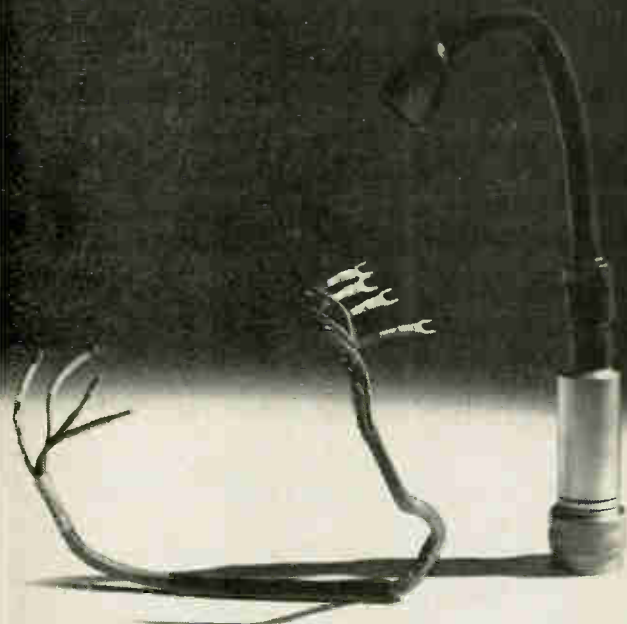

Feed them.

New Insultite® SR-350 eats up shock, strain and vibration like only a semi-rigid, irradiated polyolefin can. It combines superior dielectric characteristics with high structural strength. From 3/64" to 1" I.D.

Insultite FP-301, on the other hand, has a flexible polyolefin appetite that devours mil-spec applications. Quickly. Totally. From 3/64" to 4" I.D.

SR-350 meets classes 3 and 4 of MIL-I-23053A and NASA 276A. FP-301 meets classes 1 and 2.

Both are available in ten standard colors. Write today for free samples. (Specify diameters, please.)



**ELECTRONIZED CHEMICALS
CORPORATION**

A subsidiary of High Voltage Engineering Corporation
Burlington, Mass. 01803, Area Code 617-272-2850

E.C.C. heat shrinkables are recognized under UL component file E39100



Low cost, benchtop humidity test chamber 24" W x 26" D

Tenney Humidity Jr. is a compact, self-contained, full range benchtop chamber for low-cost humidity simulation. Plug into 115 V outlet for lab work, product development, Mil-spec testing, quality control testing, incubation, etc.—*maintenance-free.*

Humidity Range: 20-95%

Humidity Tolerance: $\pm 1\%$

Temperature Range: $+20^{\circ}$ F to $+200^{\circ}$ F

Control Tolerance: $\pm 1/2^{\circ}$ F

Interior Dimensions: 20" W x 12" D x 15" H (2 cu. ft.)

Off the shelf delivery.

Write or call today for complete details.



Tenney
ENGINEERING, INC.

1090 Springfield Rd., Union, N.J. 07083 • (201) 686-7870
Western Division: 15700 S. Garfield Ave., Paramount, Calif. 90723 446

Circle 235 on readers service card

Our little black book has over 100,000 phone numbers.

You never had a black book like it. Over 1,500 pages. And those phone numbers! More than 100,000 telling you who to call/where to go, for the over 4,000 different product categories listed and advertised in the yellow pages of the Electronics Buyers' Guide.

There's never been a buyer's directory like it. The new '68 edition will be coming your way in October. Look for the book in the black box. EBG for '68... bigger, better and more useful than ever before.

Electronics Buyers' Guide

A McGraw-Hill *Market Directed* Publication,
330 West 42nd Street, New York, N.Y. 10036

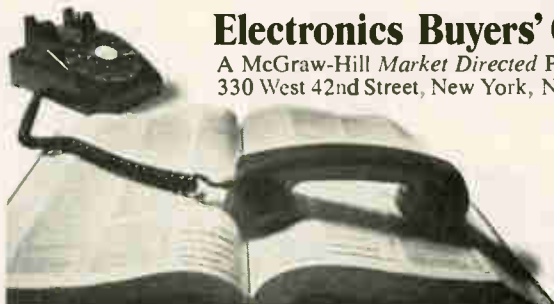

Technical Abstracts

—the EL zinc-sulphide phosphor. The electroluminescent and photoconductive layers are connected in series across the alternating-current supply and behave as a voltage divider. Thus, small changes in selenide conductivity with incident light cause variations in voltage across the EL layer, and, because the phosphor emission is highly sensitive to voltage, light amplification is achieved.

In addition to its resistance, however, the pc has a small fixed capacitive reactance that, if excessive, can mask changes in the pc cell's resistance and thus limit the EL cell's contrast.

For maximum sensitivity, therefore, a pc cell structure with a small capacitance must be used. In one structure having the necessary low capacitance, circular evaporated-gold terminals rest on a common electrode with windows to allow the light to strike the photoconductor. This scheme yields high optical efficiency, since none of the radiation is lost in absorption or reflection. The measured capacitance of the structure is less than 0.1 picofarad, about 0.1% that of the EL layer.

When the common electrode has been deposited on the glass substrate, cadmium selenide doped with copper and chlorine is sprayed over the surface to form the photoconductive layer. The plate is then fired in an inert atmosphere and the gold electrodes are deposited by evaporation through a metal mask.

An opaque dielectric film is applied to the photoconductor and indium pellets are placed directly over the gold terminals below, completing the series EL-PC circuit. The layers are then assembled with heat and pressure and encapsulated by covering the phosphor with a glass sheet and fusing it to the bottom substrate. The entire cell is about 10 or 12 mils thick. Electrical connections are made to the common electrode and to a transparent electrode deposited on the EL layer.

Presented at Wescon, San Francisco, Aug. 22-25.

COAX to 18 GHz!

Example No. 8



Coaxial thermistor mount for HP 431C Power Meter measures power in coax from 10 MHz to 18 GHz. Features low swr over entire range, zeroing holds for all measurement impedance, and units are temperature compensated for low drift. Mount efficiency data provided for highest measurement accuracy. Unit has Type N male connector (optionally available with 7 mm APC-7 connector). Model 8478B, \$275.

These are but a few examples of the precision coaxial instrumentation available from Hewlett-Packard.



Write for Application
Note #84

For more information, call your local HP field engineer or write Hewlett-Packard, Palo Alto, California 94304; 54 Route des Acacias, Geneva.

HEWLETT  PACKARD

SPUTTERING ELECTRODES

■ METALS

zone refined for the
ultimate in purity

■ ALLOYS

magnetic and custom
alloys — precisely
controlled compositions

■ NON-METALLICS

nitrides, oxides,
silicides

Any shape . . . any size!
Many available from stock
for immediate delivery.

MRC is the world's largest
supplier of hi-purity sputtering
and vapor deposition materials.
Equipment for sputtering is
also available.

Send for literature and prices
on MRC's Electronic Materials.

 **MATERIALS
RESEARCH
CORPORATION**

Orangeburg, New York 10962
(914)ELmwood 9-4200

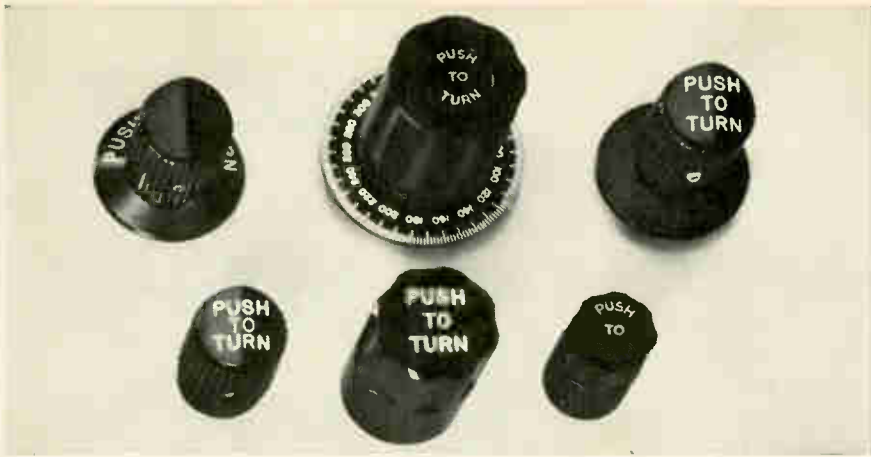

Now you can lock settings, eliminate complicated hardware with new self-locking push-to-turn knobs from Raytheon

When pushed, these new control knobs rotate instrument shafts in either direction—with infinite resolution and zero backlash.

When released, the knobs spring back and automatically lock the shaft against shock, vibration, accidentally turning.

These knobs feature: patented, all-mechanical locking device; stainless

steel parts; packaging which complies with MS91528C and MIL-K-3926B specifications.

Send reader service card for data on styles, sizes, colors, custom features. Or write Raytheon Company, Components Division, Quincy, Mass. 02169.



Circle 237 on reader service card

R-3000

SOLID STATE AC VOLTAGE REGULATORS

Write today for new Brochure



Designed Especially for OEM Application. Two Lines Available.

SPECIFICATIONS

	R-3100	R-3200
Type of Voltage Regulation	True RMS	Peak
Regulation Technique	Peak Clipping	Peak Clipping
Regulation Technique	RMS Sensor	Zener Diode
Type of Reference Input	100-130 VAC	100-130 VAC
Output	47-63 Hz	47-63 Hz
Line Regulation ($\pm 10\%$ line variation)	115 VAC	115 VAC (RMS)
Load Regulation (10% to Full Load)	$\pm 0.5\%$	$\pm 1.0\%$
Frequency Regulation (47-63 Hz)	$\pm 0.5\%$	$\pm 1.0\%$
Power Factor Regulation ($+0.7$ to -0.7)	$\pm 0.5\%$	$\pm 1.0\%$
Phase Shift	None	None
Response Time	10-50 μ sec.	10-50 μ sec.
Models Available	15-1000 va	15-1000 va

WANLASS ELECTRIC CO.



A Subsidiary of American Bosch Arma Corporation
2175 South Grand Avenue/Santa Ana, California 92705

194 Circle 194 on reader service card

WOW FLUTTER METER



Model MK-665B

A solid state sensitive and compact instrument for rapid and accurate determination of wow and flutter in sound recorders and reproducers.

SPECIFICATIONS:

Center Frequency 3kc and 1kc
 Input 30mV to 3V
 Wow Flutter Range 0.3, 1, 3% f.s.d.
 Weighting Characteristics
 as per JIS C5551 specs.
 Wow: 0.5 to 6c/s
 Flutter: 6 to 250c/s
 Calib. Osc. 3kc and 1kc



Circle 238 on reader service card

New Literature

I-f amplifiers. RHG Electronics Laboratory Inc., 94 Milbar Blvd., Farmingdale, N.Y. 11735, has available bulletin IFA-103 covering its line of solid state i-f amplifiers.
 Circle 446 on reader service card.

Memory core press. Computer Test Corp., Three Computer Dr., Cherry Hill, N.J. 08034, offers a brochure on the model 1104 multistation press that was designed for the production of memory cores. [447]

Digital computing system. Electronic Associates Inc., West Long Branch, N.J., has released a brochure discussing the technical specifications of 640 digital computing system. [448]

Production-line measurement. James G. Biddle Co., Plymouth Meeting, Pa. An eight-page brochure introduces the Mentor series of precision-measurement instrumentation for production-line use. [449]

Time-delay relays. Airborne Accessories Corp., 1414 Chestnut Ave., Hillside, N.J. 07205. Information on a line of solid state time-delay relays for industrial use is furnished in bulletin PS-15. [450]

Voltage reference standards. Instrulab Inc., 1205 Lamar St., Dayton, Ohio. Two data sheets are available describing the 600 series (a-c to d-c) and 700 series voltage reference standards. [451]

Reed relays. Wheelock Signals Inc., 273 Branchport Ave., Long Branch, N.J. 07740, has released a short-form catalog covering 160 of its complete family of reed relays. [452]

Glass delay lines. Corning Glass Works, Raleigh, N.C. 27602. Glass delay lines that store one horizontal sweep line of video information for 63 μ sec are described in a four-page bulletin. [453]

Digital magnetic tape. Memorex Corp., 1180 Shulman Ave., Santa Clara, Calif., has published a monograph entitled "Evaluating Performance of Digital Magnetic Tape." [454]

Solid state switches. American Electronic Laboratories Inc., P.O. Box 552, Lansdale, Pa. 19446. Bulletin 30-10 covers the physical dimensions, electrical characteristics, and capabilities of a line of solid state switches. [455]

Shielded programing system. AMP Inc., Harrisburg, Pa. 17105, has published catalog 612-7 illustrating and describing a low-capacitance shielded patchcord programing system. [456]

Portable recorder. Brush Instruments division, Clevite Corp., 37th and Per-

Electronics | September 4, 1967

PROFESSIONAL ENVIRONMENT

The Fort Worth Division of General Dynamics strongly urges and encourages all personnel to take advantage of the excellent educational facilities in and near Fort Worth to further their professional development through participation in graduate and undergraduate degree programs at five area universities and colleges. Full tuition refund is provided by General Dynamics for successfully completed, job-related courses.

A graduate study program of exceptional merit is offered by University of Texas at Arlington, located within 15 minutes' drive

of Fort Worth, with evening classes leading to the Master of Science degree in Electrical Engineering, Engineering Mechanics, and other fields.

Southern Methodist University and Texas Christian University, jointly, offer evening classes in Fort Worth leading to the Master of Science degree in five fields of engineering—electrical, mechanical, civil, and industrial engineering, and engineering mechanics. In addition, the Institute of Technology at Southern Methodist now offers "The Texas Twelve"—a new program of Cooperative Graduate Fellowships.

Short courses and seminars may be selectively attended at leading universities across the United States, and industry-

education liaison programs with Caltech, MIT, and the University of Texas facilitate a continuing exchange of ideas and knowledge.

Assistance and P. E. registration are provided for all qualified engineers, and membership is encouraged in professional societies.

Informal in-plant courses relating to current projects are conducted during working hours, with periodic after-hours courses with voluntary enrollment provided in response to employee interest. Membership is also available to all professional and technical staff members in the General Dynamics Management Association of Fort Worth, which provides a broad spectrum of knowledge-heightening programs.



Engineering and scientific action is required to solve the intriguing problems posed by aerospace projects in research, development, design, test and evaluation now in progress at the Fort Worth Division of General Dynamics. If your creative background and education qualify you for advanced assignments, you'll find room to satisfy your potential. You'll enjoy action living, too, in smog-free Fort Worth, where residential areas are easily reached via uncrowded freeways . . .

and where a broad range of cultural, recreational and upper level educational facilities is at hand.

A mild climate and low living costs make an added contribution to your career satisfaction. Call Collect—817-732-4811, Extension 3551; or send a résumé of your education and experience to Mr. J. B. Ellis, Industrial Relations Administrator-Engineering, General Dynamics, Fort Worth Division, P. O. Box 748E, Fort Worth, Texas 76101. An equal opportunity employer.

GENERAL DYNAMICS

Fort Worth Division

Of primary interest in the Fort Worth Division's current \$37 million facility expansion program is the new \$8 million Engineering and Office Building, encompassing 581,400 square feet and covering 12 acres.



The incomparably incomparable comparator

OK, so it's redundant, it got you to this point, didn't it? Small and quick, that's Redcor/Modules' 770-724 Comparator. 1.4 cu. in., and five times faster than any 1 mv comparator made. (Sure, you might find some guy who made one in his garage that's almost as fast. But will he sell it to you for 59 dollars American?) You also might as well know that our en-

tire line of modules has a great new pin layout that lets you easily interconnect with dual in-lines. Well, don't stand there gaping. Demand complete data and we'll arrange for a representative of the U.S. Government to deliver it to you.

REDCOR 7800 DEERING AVENUE
CANOGA PARK,
CALIFORNIA 91304
(213) 348-5892 • TWX 910-494-1228

Circle 239 on reader service card

Thermal Conductive DIELECTRICS



NEW FOLDER

Electrically insulating, thermally conductive . . . for bonding, encapsulating, coating or sealing-heat sinks, components or cryogenic devices where rapid heat transfer is desired. New four-page folder describes materials and applications.

Emerson & Cuming, Inc.



CANTON, MASS.
GARDENA, CALIF.
NORTHBROOK, ILL.
Sales Offices
in Principal Cities

EMERSON & CUMING EUROPE N.V., Oevel, Belgium

Cartoon by Whitney Darrow, Jr.



Be a buddy!

One gift works many wonders
THE UNITED WAY

New Literature

kins, Cleveland 44114. Bulletin 942-1 covers the Mark 220, a portable, two-channel recorder with four pushbutton chart speeds. [457]

General-purpose relay. Sigma Instruments Inc., 170 Pearl St., Braintree, Mass. 02185, offers a catalog bulletin on the series 11, a low-cost, 1-oz, general-purpose relay. [458]

Impulse counters. Landis & Gyr Inc., 45 W. 45th St., New York 10036. Bulletin 167 is an impulse counter selector chart that gives outline specifications for a wide range of models. [459]

H-f antenna systems. Delta Electronics Inc., 4026 Wheeler Ave., Alexandria, Va., 22304, has released an eight-page, short-form catalog describing h-f antenna systems. [460]

Solid state products. Philco-Ford Corp., Microelectronics division, 2920 San Ysidro Way, Santa Clara, Calif. 95051, has published a product reference guide listing its bipolar linear and digital IC's, MOS IC's, epoxy transistors, and MOS FET's. [461]

Low-noise preamplifier. Hamner Electronics Co., P.O. Box 531, Princeton, N.J. 08540, has issued a technical bulletin on the NB-20 low-noise preamplifier for high-resolution gamma spectrometry. [462]

Tone signaling equipment. Trepac Corp. of America, 30 W. Hamilton Ave., Englewood, N.J. A brochure is available on the Datatone model T/R-800 miniature, transistorized, a-m tone transmitters and receivers. [463]

Ceramic-to-metal seals. Eimac division of Varian Associates, 301 Industrial Way, San Carlos, Calif. 94070. A 14-page document outlines the company's research and manufacturing capability in a wide variety of ceramic-to-metal structures. [464]

Microwave products. Electro Magnetic Radiation Laboratory, P.O. Box 1054, West Acton, Mass. 01780. A two-page mailing piece discusses the company's facilities in the field of high-power microwave components and subsystems. [465]

Magnetic tape systems. Scientific Data Systems, 1649 17th St., Santa Monica, Calif. 90404. Three data sheets contain descriptions and specifications of magnetic tape units used with Sigma computers. [466]

Time-delay relays. G.C. Wilson & Co., Box 5437, Huntington, W. Va. An eight-page brochure provides a selection chart, wiring diagrams, outline drawings, and applications of time-delay relays. [467]

another
breakthrough
from
**FRANKLIN
ELECTRONICS**



the Model 120A
STRIP PRINTER

- Full alpha-numeric font of 64 characters and numerals.
- 1200 characters per minute.
- Serial entry.
- Impact printing with inked roller option.
- 8 $\frac{1}{8}$ " D x 3" W x 6 $\frac{1}{4}$ " H.
- Less than 5 lbs.
- Front paper exit.
- Less than \$300 w/o electronics, \$500 with.
- Franklin reliability!

SEND FOR
ENG. DATA 3010

FRANKLIN
electronics, inc.

East Fourth St. • Bridgeport, Pa. 19405
A Division of the Anelex Corporation

Military systems. Maxson Electronics Corp., Great River, N.Y. 11739. A 20-page brochure shows the facilities of the company's military systems and equipment research and engineering unit. [468]

Communications. Barker & Williamson Inc., Bristol, Pa., has announced an eight-page catalog detailing its instruments and components for communications. [469]

Photoelectric keyboard. Invac Corp., 26 Fox Road, Waltham, Mass. 02154. A two-page data sheet describes the series PK-200 photoelectric keyboard's format and function flexibility. [470]

Variable-speed drive. Reliance Electric Co., 24701 Euclid Ave., Cleveland 44117, offers bulletin D-2522-1 covering performance characteristics of the ComPak variable-speed drive. [471]

Display communications buffer. Sanders Associates Inc., 95 Canal St., Nashua, N.H., has available a six-page brochure describing elements of a total system that interfaces its 720 data display with IBM 360. [472]

Laboratory stop clocks. A.W. Haydon Co., 232 N. Elm St., Waterbury, Conn. 06720. Bulletin C1702 gives complete information on laboratory stop clocks suitable for bench use or panel-mounting. [473]

Videotape duplication. Ampex Corp., 2201 Lunt Ave., Elk Grove Village, Ill. 60120. Bulletin V66-280 describes the capabilities of the company's new videotape duplicating center. [474]

Crystal catalog. Texas Crystals division, Whitehall Electronics Corp., 1000 Crystal Dr., Fort Myers, Fla. A 12-page catalog details the frequency-control crystals being manufactured by the company. [475]

Spectrum analyzers. Federal Scientific Corp., 615 W. 131st St., New York 10027. A 12-page booklet describes the operating principles of the Ubiquitous spectrum analyzers, which produce high-resolution spectra for frequency bands as wide as 10,000 hz in real time. [476]

Shaft encoders. Librascope Group, General Precision Equipment Corp., 808 Western Ave., Glendale, Calif., offers a comprehensive brochure on shaft encoders, a line of devices for translating shaft rotation into digital form. [477]

Filter glossary. Electro-Mechanical Research Inc., P.O. Box 130, Van Nuys, Calif. 91408, has available a six-page glossary of terms most commonly used in describing filters and their characteristics. [478]

Digital interpolator. Boston Digital Corp., Ashland, Mass. A 16-page catalog describes the IM/10 digital interpolator. [479]

Bulova ovens are the smallest going



—but
they do
a
big job!

Simply stated, the Bulova BDX series is the smallest and most versatile in the miniature oven field!

Now, for the details. External dimensions are just 1.5" x 1.19" x .46" (or up to .9375", for larger models). Yet, the BDX can hold 1 to 6 tubular devices such as diodes, capacitors or resistors, up to .25" in diameter and length.

Controller is an RFI-filtered snap-action thermostat, meeting MIL-I-6181B. You get the BDX with your components installed and encapsulated in fluoro-carbon blown polyurethane foam insulation and hermetically-sealed. Result: a unit with minimal thermal leak that will withstand the most severe shock and vibration specifications.

The BDX is available with stud mounting, printed circuit board mounting, flange mounting or captive nut. Temperature settings from 50°C to 100°C are available, with a range of operating voltages from 6.3 to 117 VAC or DC. Temperature stabilities are as fine as .5°C over a -55°C to 90°C with a power drain as low as 5 watts.

This is just one of a complete line of Bulova ovens, including bi-metal thermostat, transistat, solid state switched mercury, and AC or DC proportional controls. For more information, write today to Dept. E-28.

Try Bulova First!

FREQUENCY CONTROL PRODUCTS

ELECTRONICS DIVISION
OF BULOVA WATCH COMPANY, INC.

61-20 WOODSIDE AVENUE
WOODSIDE, N.Y. 11377, (212) DE 5-6000

New Task Force for a Large Task:

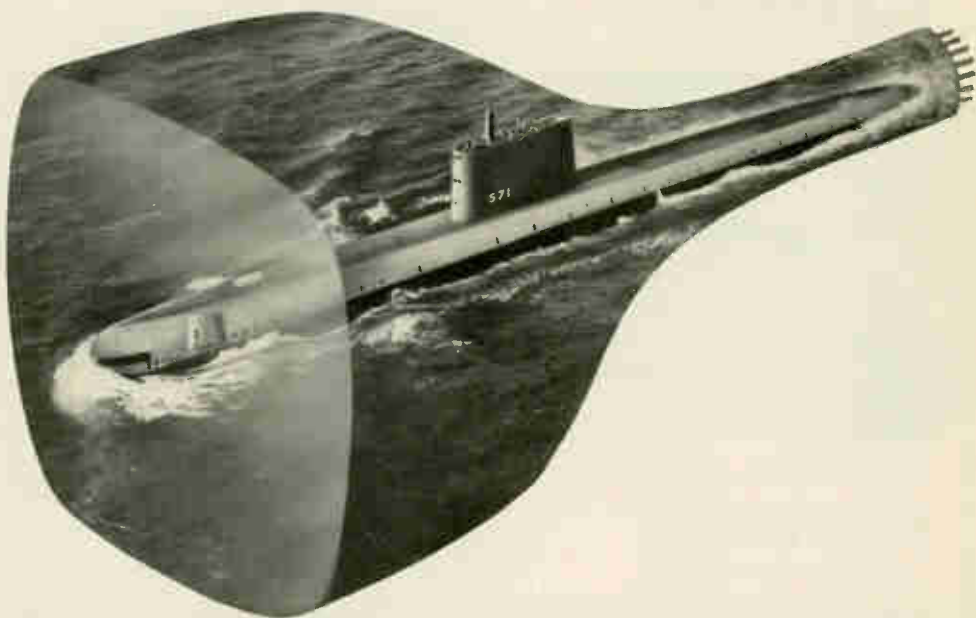

Determine a nuclear submarine's reactions to a constantly changing environment.

Here are problems so basic that answers cannot be sought until the questions themselves are formulated!

Electric Boat Division of General Dynamics has long been a leading investigator in all phases of undersea warfare—from determining the effects of ocean characteristics on sound transmission to development of new sonar signal processing techniques . . . the kinds of displays to be made available to the submarine commanding officer . . . mathematical modeling for computer simulation of the various phases of a submarine's operations . . . at-sea evaluation of general purpose computers for real time data processing and as the command and control mechanism for cathode ray tube displays—toward solution of the command/control problem.

Historically, work at Electric Boat Division has provided a cross-fertilization of engineering and scientific disci-

plines. An astronomer by education and experience, for instance, has also performed submarine tactical analyses and reliability modeling. New, close-knit, many-disciplined teams are now being formed to expand the capability in information processing and to prepare for future programs.

An 1107 is already in operation. A new computer built to MIL specs must be readied by fall, 1967, to perform large-scale experiments aboard a submarine in the area of command/control decision-making.

Positions are available for people with the following qualifications . . . who want to stay ahead of the state-of-the-art and who welcome challenge as a part of everyday work life.

■ Masters and PhDs in electrical engineering with experience in random signals and noise, signal processing, control

theory, sonar design.

■ Bachelors and Masters in electrical engineering with experience in digital logic, design and construction of analog-to-digital interface equipment, solid state circuit design, circuit and component reliability.

■ Bachelors and Masters in mathematics, physics or electrical engineering with experience in mathematical modeling, simulation studies, statistical data processing.

■ Programmers with Masters or Bachelors in engineering or mathematics, preferably with some experience in scientific programming, and ability to work closely with engineers and scientists, contributing toward analysis and solution of the problems mentioned above.

Further inquiries are invited. Send resumes in confidence to Mr. Robert Moore.

An Equal Opportunity Employer (M&F)
U.S. citizenship is required

GENERAL DYNAMICS
Electric Boat Division

128J Eastern Point Road, Groton, Connecticut

SEARCHLIGHT SECTION

- CLASSIFIED ADVERTISING
- BUSINESS OPPORTUNITIES
- USED OR SURPLUS EQUIPMENT

BIG CATALOG

World's "BEST BUYS" in GOV'T. SURPLUS Electronic Equipment

FULL OF TOP QUALITY ITEMS—Transmitters, Receivers, Power Supplies, Inverters, Microphones, Filters, Motors, Cable, Keyers, Phones, Antennas, Chokes, Dynamotors, Blowers, Switches, Test Equipment, Headsets, Amplifiers, etc., etc. SEND 25¢ (stamps or coin) for CATALOG and receive 50¢ CREDIT on your order. Address Dept. E-7.

FAIR RADIO SALES
P.O. Box 1105 • LIMA, OHIO • 45802

MINI-FLUID DISPENSER

AIR OPERATED
for miniature potting and encapsulating

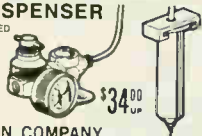

\$34.00

Available in 3 sizes
6cc - 12cc - 30cc

PHILIP FISHERMAN COMPANY
7 CAMERON ST., WELLESLEY, MASSACHUSETTS 02158

CIRCLE 968 ON READER SERVICE CARD

ELECTRON TUBES

KLYSTRONS • ATR & TR • MAGNETRONS
SUBMINIATURES • C.R.T. • T.W.T. • 5000-6000 SERIES

• SEND FOR NEW CATALOG A2 •
A & A ELECTRONICS CORP.
1063 PERRY ANNEX
WHITTIER, CALIF.
696-7544

CIRCLE 969 ON READER SERVICE CARD

X-band thermistor mount general microwave model X-101 JETDS MX-3667/U.

New \$25.00 each, also misc other waveguide and coaxial line components, high temperature tantalum capacitors, multirun pots, miniature pots, etc.

Write for List

E. U. BUTLER JR.

517 41st St. Sacramento, Calif. 95819

CIRCLE 970 ON READER SERVICE CARD

EMPLOYMENT OPPORTUNITIES

POSITION VACANT

Electronics Engineers—Japan-U.S. Naval Ship Repair Facility, Yokosuka, GS-7, GS-9, GS-11; \$7,516 to \$10,841 per year plus annual housing allowance of \$1700 to \$2700. 36-month tour of duty. Shipment of household effects, but not auto, at government expense. Dependents may accompany. Commissary and exchange privileges. One GS-7 and GS-11 with communications engineering division; one GS-9 and GS-11 with projects engineering branch. Professional education, experience required. Send resume or SF-57 to: Navy Overseas Employment Office (Pacific), Federal Office Building, Room 102, 50 Fulton St., San Francisco, California 94102. An Equal Opportunity Employer.

—PROFESSIONAL SERVICES—

Donald C. Harder, Inc.

Magnetic Component Engineers

Reactors—Transformers—Filters
Serving the Research Laboratory

2580 K Street, San Diego, Calif. 92102
Phone (714) 239-8021

AUTOTRACK ANTENNA MOUNT



360 degree azimuth, 210 degree elevation sweep with better than 1 mil. accuracy. Missile velocity acceleration and slewing rates. Ampidyne and servo control. Will handle up to 20 ft. dish. Supplied complete with control chassis. In stock—immediate delivery. Used world over by NASA, USAF, MP-61-B, Type SCR-584. Nike Ajax mounts also in stock.

PULSE MODULATORS

MIT MODEL 9 PULSER 1 MW—HARD TUBE

Output 25kr 40 amp. Duty cycle .002. pulse lengths .25 to 2 microsec. Also .5 to 5 microsec. and .1 to .5 microsec. Uses 6C21. Input 115v 60 cycle AC. Mfg. GE. Complete with driver and high voltage power supply. Ref: MIT Rad. Lab. Series, Vol. 5, p. 152.

2 MEGAWATT PULSER

Output 30 kv at 70 amp. Duty cycle .001. Rep rate: 1 microsec 600 pps. 1 or 2 msec 300 pps. Uses 5948 hydrogen thyratron. Input 120/208 VAC 60 cycle. Mfr. GE. Complete with high voltage power supply.

250 KW HARD TUBE PULSER

Output 18 kv 16 amp. Duty cycle .002. Pulses can be coded. Uses 5D21, 715C or 4PR60A. Input 115 v 60 cy. AC \$1200 ea.

18 MEGAWATT PULSER

Output 150KV at 120 amps. Rep rate: 50-500 PPS. Pulse length: 5 msec. 15KV 120 amp. Into pulse transformer. Also time 1.5 msec. Filament supply 5V 80 amp. Incl. 17.5KV 1.5 amp DC power supply. Input: 220V 60 cy AC.

VARIAN KLYSTRONS

V-45: 15W output CW 9 to 10 KMC
VA-800: 10 KW output CW 1.7 to 2.4 KMC
VA-800H: 1KW output CW 7.5 to 8.5 KMC

IBM 704 IBM 650

These computers in stock for immediate delivery

SCR 584 AUTOTRACK RADARS

Our 584s in like new condition, ready to go, and in stock for immediate delivery. Ideal for telemetry research and development, missile tracking, satellite tracking. Fully Desc. MIT Rad. Lab. Series, Vol. 1, pps. 207-210, 228, 284-286. Comp. Inst. Bk available \$25.00 each.

MICROWAVE SYSTEMS

L BAND RF PKG.

20 KW peak 990 to 1040 MC. Pulse width .7 to 1.2 micro sec. Rep. rate 180 to 420 pps. Input 115 vac incl. Receiver \$1200

200-225 mc RADAR SYSTEM

1 Megawatt output. 200 nautical mile range for long range detection of medium and high altitude jet aircraft as well as general search. AN/TPS-28.

10 KW CW S-BAND

Complete 1700-2400 MCS RF system using VA-800 klystron. New.

SURVEILLANCE DRONE RADAR SYSTEM

X-Band tracking system with plotting boards. Type AN/MPQ-29. Drone also in stock.

5 MEGAWATT C-BAND

Klystron RF package delivering nominal 5 megawatt pulse RF. Complete with pulser and power supply.

500 KW L BAND RADAR

500 kv 1220-1350 msec. 160 nautical mile search range P.I.L. and A scopes. MTT thyratron mod 5J26 magnetron. Complete system.

100 KW X BAND RADAR

Complete 100 kv output airborne system with AMTI. 5C22 thyr. mod. 4J52 magnetron. PPI. 360 deg sweep. 60 deg. elev. sweep, gyro stabilizer, hi-gain revr. Complete with all plus and cables.

AN/GPG-1 SKY-SWEEP TRACKER

3 cm. automatic tracking radar system. Complete package with indicator system. Full target acquisition and automatic tracking. Input 115 volts 60 cycle New. In stock for immediate delivery. Entire System 6' long, 3' wide, 10' high. Ideal for Infrared Tracker, Drone Tracker, Missile Tracker, R. & D.

500KW S BAND RADAR

250 miles search 115V 60 cy AC. Mfg. G.E.

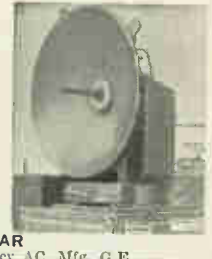

RADAR AUTO-TRACK & TELEMETRY ANTENNA PEDESTALS 3 & 10 CM. SCR 584 AUTOTRACK RADARS. M-33 RADAR TPS-1D SEARCH. APS-45 TPS-10D HT. FINDERS. WX RADARS. FPN-32GCA. APS-10 APS-15B APS-27 (AMTI) SEARCH. APN-102 DDPPLER. DOZENS MDRE. CARCINOTRONS. PFN'S. .25-5-1-23-6 MEGAWATT PULSE MODULATORS. CAVITIES. PULSE TRANSFORMERS. IF STRIPS. WAVEGUIDE. BENDS 200 MC. 1 KMC. 3 KMC. 6 KMC. 9 KMC. 24 KMC. RF PKGS.

RADIO RESEARCH INSTRUMENT CO.

550 5TH AVE., NEW YORK 36, N.Y. JU 6-4691

CIRCLE 966 ON READER SERVICE CARD

Available for sale:

a complete second-hand equipment for manufacture electronic tubes of following main types:

50B5 - PCL85 - ECH81 - ECC85 - 6AU6 - 6AL5 - 5X4G
6DQ6B - 6SN7GT - 6SK7 - 1G3 - 1X2B - EF183 - EF184
6AF4.

The machineries may be inspected at our plant in L'Aquila. Descriptions and price-lists available on request.

Apply to

SOCIETA ITALIANA TELECOMUNICAZIONI SIEMENS s.p.a.

Servizio Approvvigionamenti

P.le Zavattari, 12

20149, Milano - Italy

CIRCLE 967 ON READER SERVICE CARD

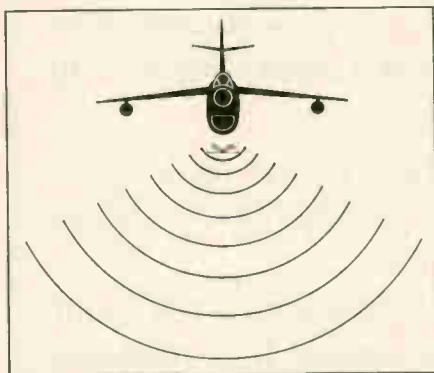
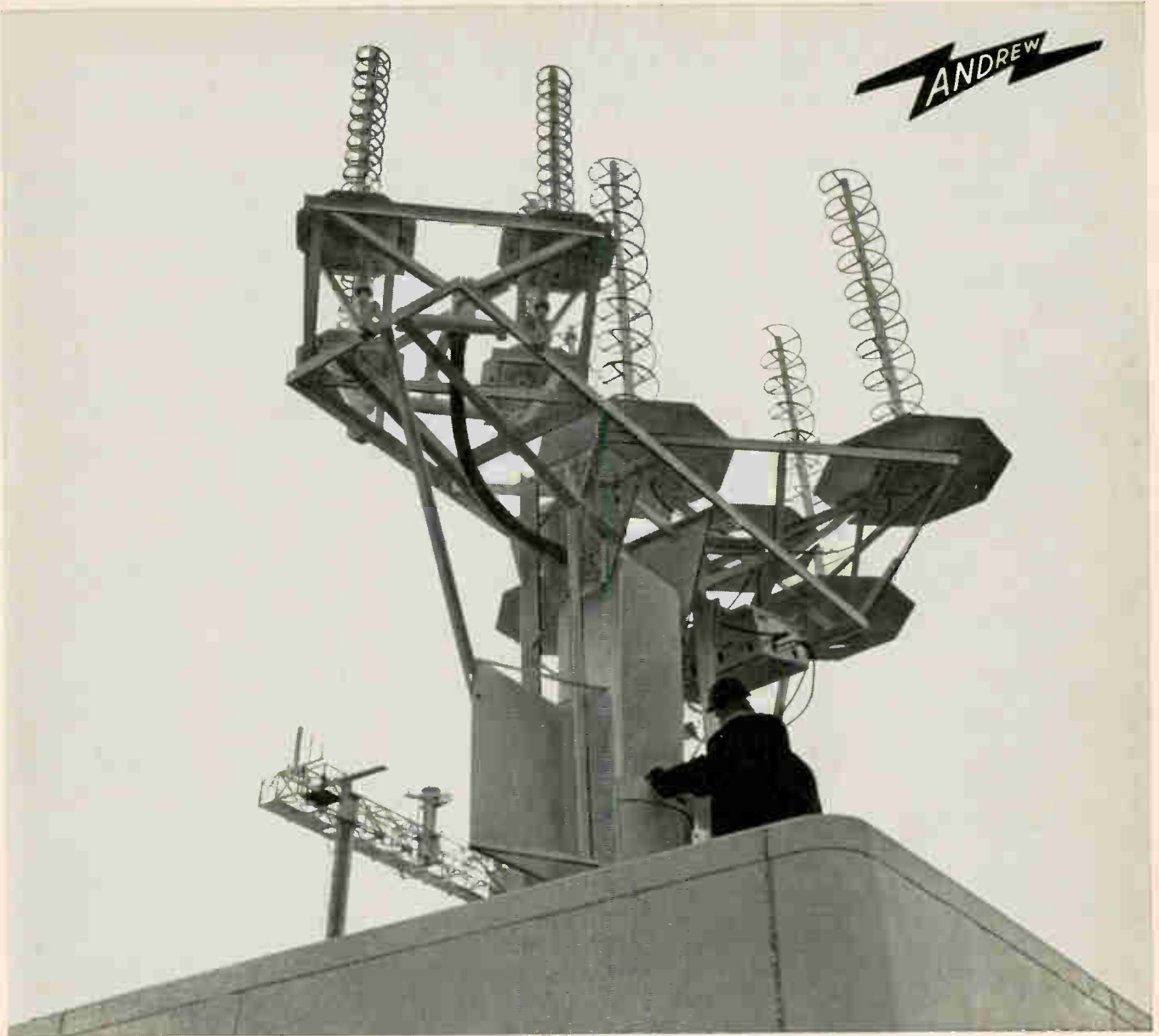

AIRBORNE ANTENNAS—Omnidirectional airborne antennas for UHF telemetry bands: 1.4-1.5 GHz (55070-4), 2.1-2.3 GHz (55070-21) and 4.4-5.0



GHz (55070-44). Typical characteristics are VSWR 1.3, Gain 5 dbi, average power 20 watts.

command control and telemetry antenna systems

DESIGNED...ENGINEERED...

AND MANUFACTURED AS A COMPLETE PACKAGE
Andrew antenna systems are designed as complete packages. Antenna and positioner engineering are integrated to guarantee system performance.

Andrew positioners are available with a wide choice of low, medium and high gain telemetry antennas to meet your requirements. HELIAX[®] coaxial cable provides the most reliable connection between transmitter or receiver and the antenna.

ONE SOURCE—ONE RESPONSIBILITY...Contact your Andrew sales engineer or write for complete system information and delivery.

5-65B

30 YEARS OF ENGINEERING INTEGRITY

Andrew
CORPORATION
P.O. BOX 807 • CHICAGO, ILLINOIS U.S.A. • 60642

IN EUROPE: ANDREW ANTENNA SYSTEMS, LOCHGELLY, FIFE, GREAT BRITAIN

Newsletter from Abroad

September 4, 1967

Hayakawa may test TI on IC patents

The long-standing hassle over integrated circuits between Texas Instruments and Japanese electronics interests may come to a head this fall. Although the TI-Japan patent snarl remains as entangled as ever, the Hayakawa Electric Co. is poised to export desk calculators with IC control circuits to the U.S.

The company will decide when to leap after it gets the results of a mid-September meeting between U.S. and Japanese trade officials. Japan's tiff with TI [Electronics, Nov. 28, 1966, p. 193] will be on the agenda, but there's little chance of a solution. Unless it looks like TI can get a court order to have the calculators seized, Hayakawa may take the gamble. Legal action by TI would also involve the Mitsubishi Electric Corp., which supplies the IC packages for the calculator.

Hayakawa's sortie into the U.S. market with an IC product apparently will have the blessing of the powerful Ministry of International Trade and Industry. MITI last spring warned Japanese producers not to export IC hardware until licenses had been arranged with Fairchild Camera & Instrument, which holds the basic U.S. patents on the planar process. With the exception of Matsushita Electronics and Sony, Japan's major IC producers have acquired rights to Fairchild's patents. But TI, which also owns basic IC patents, has been holding off on licenses because its bid to set up a wholly owned subsidiary has been turned down by MITI.

Hayakawa executives insist they're looking for a desk calculator market in the U.S. rather than a run-in with TI. The company is geared for mass production of its calculator and needs the large American market as an outlet. But TI can hardly let Hayakawa's move go unchallenged. Other Japanese firms are itching to export IC products and figure to follow Hayakawa once it establishes a beachhead.

Europe to kick off tv playback sales

CBS Laboratories' European partners in the development of Electronic Video Recording [see page 25] will probably be first to market the visual playback devices. CIBA of Switzerland and the Imperial Chemical Industries Ltd. of Britain plan to exploit the educational television market through "canned" programing.

CBS Labs' president, Peter Goldmark, expects CIBA to have the units on the market by 1968—perhaps several months before CBS starts sales in the U.S. CIBA, a chemicals and pharmaceuticals giant, will aim at the medical-school market. Imperial plans to sell or lease units directly to British schools.

The film used in the process, which stores video signals for playback to the antenna terminals of house sets, is made by a jointly owned subsidiary of CIBA and Imperial—Ilford Ltd. Another British firm, Thorn Electrical Industries Ltd. will manufacture the playback devices.

De la Rue pioneers time-sharing in U.K.

Britain's two native large-computer makers have been left at their marks by General Electric as far as time-shared data processing services go.

With multiaccess centers still very much in the planning stage at both English Electric Computers and International Computers & Tabulators, GE-controlled De la Rue Bull Machines last week launched Britain's first time-shared computer service open to all comers.

De la Rue will start with about 20 subscribers, linked by post-office

Newsletter from Abroad

lines to a GE 265 computer. The computer can handle up to 40 users simultaneously, but De la Rue expects it will need between 100 and 200 subscribers to keep the computer fully employed. Charges for the time-shared service won't be firmed until De la Rue picks up some experience; at the outset the rate will probably run around \$600 a month for between 10 and 30 hours of connection time to the computer.

If the scheme catches on, De la Rue will follow up with a second GE 265 system. The company apparently hopes to pin down a big share of the U.K. market for time-shared computer services before English Electric and ICT make their moves.

European trio eyes air traffic control software market

Makers of air-traffic control equipment now face formidable competition in software systems. Three of Western Europe's strongest electronics firms—Britain's Plessey Radar Ltd., Germany's AEG-Telefunken, and France's CSF-Compagnie Generale de Telegraphie sans Fil—have pooled their air control programming know-how in a Brussels-based subsidiary, called Eurosystem.

Eurosystem is sighting in on Eurocontrol's software business. Eurocontrol, the seven-nation organization that controls the upper air space over most of Western Europe, almost certainly will turn to the new company for software systems needed for its experimental facility in Bretigny, France. Eurosystem's parent companies supplied the air-control simulation equipment for the Bretigny center.

If Eurosystem pockets the software order, it would then have the inside track for the operational centers Eurocontrol will build. Eventually, the company hopes it can pick up about \$1 million yearly in software business from Eurocontrol and national air-control agencies.

Canadian pullout may still HARP

Canada's new emphasis on communications satellites in its space program [see story p. 131] may mean the end of a joint project with the U.S. aimed at drastically slashing the cost of getting small payloads into orbit.

As it reworked its space budget to match the accent on communications, the Canadian government last month earmarked nothing more for the high-altitude research program (HARP) that has been running for five years at McGill University in Montreal. Goal of the program was to cut launching costs to as low as \$100 a pound by shooting payloads out of big guns. Using a U.S. Scout booster, launching costs run upwards of \$2,500 per pound.

With Canada a dropout, HARP has been shifted to the University of Vermont. But unless the U.S. steps up its financial backing, the program appears doomed. Of the \$7.5 million spent thus far on the project, slightly more than half was funded by Canada.

Addenda

Hitachi Ltd. and the Tokyo Shibaura Electric Co. are switching to yttrium oxide-cadmium sulphide red phosphors for color-tv picture tubes. Matsushita Electronics touched off the scramble to get brighter tubes onto the Japanese market early this year [Electronics, Feb. 20, p. 295] . . . The Royal Air Force and the U.S. Air Force have teamed for a joint study of long-range propagation of radio signals. The two air arms expect to have a large transmitter and aerial array operating within two or three years on a low-lying peninsula near Orfordness on the east coast of England.

The Complex Few

If you compare a present day system to one designed several years ago, you will discover that the predominant difference is quantitative: the new system contains fewer components at every level. That means that a simple gating function, which used to require a dozen or so components, has been replaced by a single monolithic circuit. A circuit board containing a dozen integrated circuits replaces enough hardware to require a separate chassis in older systems. And a single chassis in a new system does the work of a whole rackful of older equipment. Assuming the basic overall function of the system hasn't changed, it follows that each of the new system elements is more complex than those of the old, since it must perform more of the total workload. And because it is more complex, it must perform to higher standards of reliability. These points are best illustrated by example.

THE SIMPLIFIED SYSTEM: In a recent redesign effort, the circuitry of an events-per-unit-time meter was updated by using the most recent FET's and integrated circuits available. The results were startling. Even though the instrument was only two years old and used integrated circuits, the updated circuitry reduced the total can count from 241 to 84, or by nearly two-thirds. This was achieved without altering any of the functions of the unit, and with some improvements in its performance specifications. The updated meter also required less power to operate: 2.48W as against 7.47W required by its predecessor. Clearly the change would have been more dramatic if the meter had been, say, five years old and made with discrete components only. It is also easy to see that these reductions in can count and savings in materials could be multiplied by extending the redesign to all elements instead of confining it to the frequency meter.

TOTAL INTEGRATION: There are two reasons for this dramatic reduction in componentry. The first is that integrated circuits are themselves becoming more complex. The counter portion of the meter, for example, previously used 30 J-K flip-flops. In the updated version 4 J-K flip-flops were used along with 5 integrated counter circuits (C μ L9958), for a total of 9 integrated circuits instead of thirty. A second reason is that linear integrated circuits and FET's offer an opportunity to integrate some functions which previously were of necessity discrete. For example, a saving of 14 components was effected in the input circuitry, by substituting 1 FET, 1 linear integrated circuit and 6 resistors for 5 transistors, 13 resistors, 2 capacitors and 2 diodes. This substitution also improved the performance characteristics of the circuit.

Thus, the designer of today's systems has at his disposal a wider selection of building blocks than ever before. He can choose to stick with discrete components, to integrate parts of the system, or to undertake the total system integration task. The trend is to total integration. This is not to say that the instrument designed two years ago is ready for the junk heap. Electrically, from a performance point of view, it could serve for some time to come. But in a competitive marketplace the customer will demand the equipment that does the best job at the lowest cost. The manufacturer who can reduce his component count by two-thirds while improving performance and reliability will surely have an advantage difficult to ignore.

TO SUM UP: Linear integrated circuits offer the designer an opportunity to integrate a larger percentage of the total system circuitry. New digital circuits offer the opportunity to substitute single elements for several older IC's of lesser complexity. If this trend continues unarrested, heaven forbid, it will soon be possible in theory to design a system with zero elements of infinite complexity.

Integrated Tape Transport

Modern computers are getting bigger and faster, requiring bigger and faster peripheral equipment. At the same time, however, another breed of computers has emerged over the past several years: small and medium sized desk computers, designed for engineers, accountants and small business or scientific organizations that cannot afford large scale equipment. Until recently such small computers used cards or paper tape for storage of data and programs. When data had to be transferred from the small computer to a larger one, inevitably it had to be translated to a faster medium such as magnetic tape. Recently magnetic tape units have appeared on the market, capable of recording data at the slow, asynchronous, single character mode of paper tape, then reproducing them at the fast, block mode suitable to large computers. And vice versa.

Dartex Division of Tally Corporation, Santa Ana, California, has introduced one of the smallest and most sophisticated tape units of this type. The Dartex 1020 digital

magnetic tape unit can asynchronously record and reproduce eight-bit parallel characters at any rate up to 120 characters per second. It can also record or reproduce characters at a continuous rate of 1600 characters per second. The unit is only 8" x 16" x 9 $\frac{3}{4}$ " and fits easily into a console or standard rack, and has such impressive standard features as automatic tape loading. It uses 3" reels of $\frac{1}{4}$ " tape for recording, with each reel capable of storing 140,000 characters.

The tape handling properties of this unit are characterized by precise tape motion control and gentle handling to reduce tape wear. The electronic circuitry consists of 12 two-sided printed circuit cards, and is implemented with silicon solid-state devices — primarily Fairchild RTL 900, 914 and 923 integrated circuits. This compact electronic package furnishes all the necessary control signals for the read and write circuits, for data format control, and for the electromechanical elements.

The Dartex 1020 is particularly useful in applications where data is received sporadically and recorded for later evaluation by a fast processing system. It can be used as a buffer between digital data collecting systems and a central processor, in process control systems, communication systems, or small accounting and business machines.

Since the unit was designed with integrated circuits from the start, direct comparisons with discrete models cannot be made. It is possible to estimate, however, that without integrated circuits the unit would have required three times the number of connector joints used, would clearly not have been as compact, and would have, in all probability, cost considerably more to manufacture.



NEW USES FOR INTEGRATED CIRCUITS

High Voltage Series Analog Regulator For Power Supplies. In a power supply regulator which uses an operational amplifier as the comparator, the unregulated input voltage must not exceed the maximum specified device supply voltage. The circuit shown in the diagram illustrates one way to get around this limitation. A Fairchild μ A709 linear integrated circuit is used as the comparator and is connected in a bootstrap circuit (numerals 1-8 show the actual lead connections). Normally the μ A709 is capable of 28V swings at its maximum bias of 30V. But in the bootstrap configuration it allows control swings of 70V, without losing any of its regulation properties. In this type of circuit, therefore, the μ A709 can be used for power supplies with an output voltage of 200V or more.

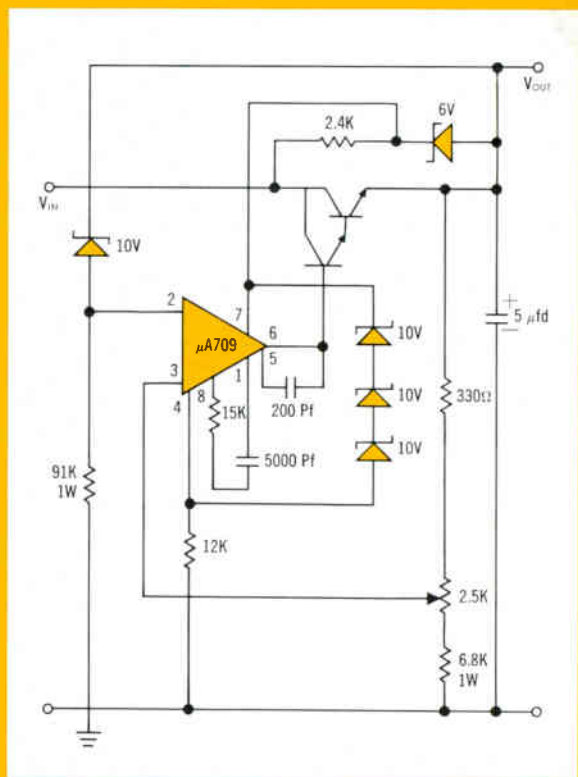

Circle Reader Service No. 480 for IC applications information.

FAIRCHILD
SEMICONDUCTOR

Electronics Abroad

Volume 40
Number 18

Israel

Peeking at prizes

After spreading the word that some of the Russian-made military hardware captured from the Arabs is "priceless" because details of its construction and operation are unknown in the West, the Israelis wrapped the equipment in a blanket of security and started looking for trade offers. A quick peek under that blanket by an Electronics editor shows that Soviet military electronics is built for ruggedness but not for sophistication. There are no integrated circuits in the field radio equipment, and only the newest models have transistors.

But perhaps the most important Soviet weapons taken by the Israelis are an advanced SA-2 ground-to-air missile being used against U.S. planes in Vietnam, a radar-controlled 57-millimeter anti-aircraft gun that has been particularly effective against our craft there, an electronically guided anti-tank rocket, and an infrared guidance system for tanks.

By the book. It looks as if the arsenal supplied by the Soviets was too sophisticated for the Arabs. The SA-2 missile launching sites captured intact by the Israelis had complete kits of spares, maintenance tools, and even handbooks. One Israeli official said that although Arab troops could cope with routine maintenance, they failed completely when up against anything not covered in the handbooks. "They lacked affinity with modern technology," he said.

Of all the Soviet weapons taken by the Israelis, the one drawing the most attention is the improved version of the SA-2 ground-to-air missile. Western intelligence people reportedly had some idea of what the original version would do and how it worked. But until a



Unveiled. Of all the Russian-made equipment captured by Israel, this new model of the SA-2 ground-to-air missile arouses most interest.

dozen or so were captured from the Egyptians, along with three launching sites, little was known in the West about improved models.

The radar-guided SA-2 has a solid-fuel first stage that drops off four seconds after launch, and a liquid-fuel second stage that accelerates to a speed of Mach 3.5 and can climb to 55,000 feet. The warhead carries 300 pounds of explosives.

Ack ack. The radar-controlled 57-mm anti-aircraft gun fires up to 60 rounds per minute. Its effective range is 2,200 yards and its maximum range is 5,500 yards. Each battery of four guns has a common fire-control system whose radar picks up potential targets at a range of 50 miles. At about 25 miles, the system locks onto one target and tracks it to within firing range. An analog computer and a five-man crew develop the aiming and pointing orders for the gun. To back up the radar for close-in targets, an optical tracking system is mounted atop the computer.

The desert war pitted antiquated Western-built Israeli tanks against some similar gear, but also against the latest tanks in the Soviet arsenal and a Russian antitank missile called the "Shmell." The Is-

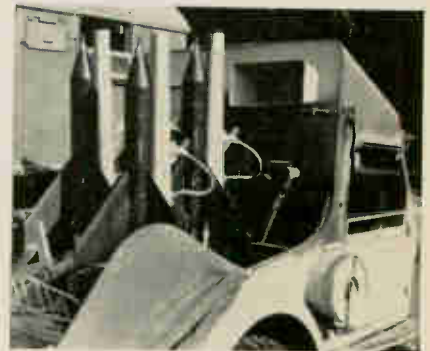

Tank buster. The "Shmell" antitank missile has 2,500-yard range.

raelis, though, hit so hard and so fast that their Arab adversaries hardly used their Shmells.

The Russian-made rocket can smack tanks up to 2,500 yards away. It is steered remotely under the visual control of an operator who guides it with a joystick. The launching gear can take up to four rockets, but is small enough to mount on a jeep.

Along with the rockets themselves, the Russians supplied Link-like trainers to sharpen the skills of Arab Shmell gunners. A dot representing a moving target moves across an oscilloscope screen, and the trainee tries to "hit" it with a second dot.

The Israelis also captured a Rus-

sian-made surface search radar, the Snar-2. The set is operated by nine men and can pick up targets as far away as 20 miles, depending on the target size.

West Germany

Pointing the way

The automation of rail traffic control, long touted as a way to optimum operating efficiency and a panacea for railroads' profit squeeze, has gotten a boost in recent German trials. The tests tend to confirm the promise of complete computer control and to indicate that implementation may not be too far off.

Officials of West Germany's federal railroad system say the trials showed that maximum train movement through stations can be accomplished by computer as a first step toward complete traffic control. Also, because nearly all the main rail routes in Germany are electrified, computers could control electrical energy distribution from power plants and transformers, which produce energy at different costs at different times.

At the heart of the tryout system was a Siemens 303 digital process-control machine installed at Siemens' Brunswick computer center. In an on-line operation, the computer furnished instructions for switching rolling stock at the Seelze yards, 45 miles away, which handle 4,500 cars a day. At the same time, the computer determined the routing for freight and passenger trains through the Uelzen station, 111 miles away on the busy Hanover-Hamburg stretch. Finally, it helped ease freight-handling at Kassel-Bettenhausen 138 miles away.

Braking point. At Seelze, information on freight cars—cargo, destination, identification number, weight, and braking capacity—was reported to the computer via teletypewriter. The computer then produced a tape instructing the switchman in the control tower on the routing of incoming trains, the



Orders. Computer 45 miles away tells switchman how to assemble trains.

reassignment of cars to other trains, the number of cars to put in each train, and the speeds and braking procedures to be followed. The computer further determined the status of each makeup track via signals from axle counters installed between the rails. The counters also told the computer if cars had been misdirected. In future systems, the computer would control track switches and car couplings.

The computer indicated to the switchman at Uelzen the tracks to switch for the best train movement through the station.

Complete automation won't come until the early or mid-1970's at the earliest, in the estimation of officials of the Federal Railroad Central Authority in Frankfurt.

Great Britain

A step closer

The designer's ideal computer would combine the speed of an analog machine with the reliability and ease of control of a digital. Size is the major hurdle; despite the advent of integrated circuits, it takes a massive amount of hardware to get a true analog

computer or its half-brother, the incremental computer, to carry out a complex series of computations.

In established types of incremental computer, such as the digital differential analyzer (DDA) and the operational-digital machine, each computation has to be set up individually by interconnection of the processing elements, generally through a patch board.

Phased. To get around this bottleneck, Brian Gaines and P.L. Joyce of Britain's Standard Telecommunication Laboratories, an ITT subsidiary, have designed and built an incremental phase computer with all interconnections controlled by auxiliary digital logic; the machine can be programed in the same way as a conventional digital machine. Gaines says it can be thought of as a conventional digital computer with the parallel binary arithmetic unit replaced by a complete DDA computer. Also, he notes, the advantage of programing makes for a considerably simplified DDA section.

The incremental digital processor uses unidirectional synchronous binary counters as storage registers. Each counter has 16 bits and a single input line through which it increments when the line is on. The arrangement permits the establishment of pseudo-analog computing loops, so that complex operations—division and square-rooting, for example—are performed with the same speed as simpler operations such as addition and data transfer. With the ease of programing, complex computations can be performed as a sequence of elementary operations.

Gaines and Joyce say they've tested their phase computer in aircraft-navigation, surveillance-radar, target-tracking, and biochemical-analysis applications, and report potential size and cost advantages.

The machine, designed and built in-house, is large and bulky because STL wanted to see what it could do. But it will be sold as a single-function computer rather than a large, comprehensive one. For example, STL is cooperating with SRT of Sweden in a project to apply the first production model to the job of azimuth-sweep genera-

tion in a digital plan-position-indicator radar for air traffic control. SRT will make the ppi, building in ic's on phase-computing principles.

Japan

What's cooking?

Two apparently unrelated elements—the search for new luxuries by well-heeled status seekers, and the expiration of Raytheon's Japanese patents on anode strapping in magnetrons—have convinced the Japanese electronics industry that the time has come to push electronic ovens as home appliances.

While last year's production came to only about 4,000 units, the figure this year might reach 10,000 and the total next year could be twice that. The market? Optimists say the same people who are buying color television sets (600,000 to 700,000 in Japan this year) and air conditioners (300,000 this spring and summer) will buy the ovens. In fact, the top producer, Matsushita Electric Industrial Co., plans to demonstrate its electronic ranges to customers who have already bought its other major appliances.

Price cuts. The patent expiration means the end of a license fee to Raytheon ranging from 2% to 5%. That fee wasn't an important cost factor in itself, but it did tend to dampen enthusiasm for all-out marketing campaigns. Now, the bullish production and sales outlook will bring a price cut by Matsushita and the number two producer, Hayakawa Electric Co., around the end of the year.

The price of the bottom-of-the-line unit, designed for home use and rated at an output of 500 to 600 watts, will be reduced from \$550 to \$415. Other electronic ovens range in price all the way up to \$3,000 for 2,000-watt units.

Besides Matsushita and Hayakawa, others champing at the bit are Toshiba (Tokyo Shibaura Electric Co.), Hitachi Ltd., Mitsubishi Electric Corp., Sanyo Electric Co., and Japan Radio Co.

Matsushita is pinning most of its

hopes on two small units. It rates the smaller at 500 watts output by working backwards from its power drain of 12 amps, which the company feels is the maximum possible in Japanese homes without installing special wiring. Using the same magnetron is a 700-watt unit.

Hayakawa's entry is a 600-watt model priced the same as Matsushita's 500-watter. The company is mounting a big home-use campaign to start after the price reduction.

Magnetron makers. About 80% of the magnetrons have been produced by New Japan Radio Co., a joint venture of Raytheon and Japan Radio. New Japan also exports some small magnetrons to the U.S. for Raytheon's use. Others in the business are Kobe Industries Corp., which exports some magnetrons for Litton, and Toshiba, which mainly supplies its own demand.

But this summer, Hitachi, with much fanfare, entered the cooker magnetron business with three models having ceramic seals rather than the usual glass seals. Two rated at 800 watts are air cooled; the third, at 1,400 watts, is water cooled. Matsushita, operating jointly with Philips of the Netherlands, has built a new plant and will go into the cooker magnetron business when it has developed a new product and completed life tests. Nippon Electric Co., a leading manufacturer of other types of microwave tubes, is also expected to start manufacturing cooker magnetrons.



Get ready, get set. . . . Production-line tempo picks up as Matsushita, Japan's biggest producer of electronic ovens, prepares for sales push.

International

Discordant Symphonie

France and West Germany a few months ago dubbed the communications satellite they plan to jointly develop "Symphonie." That was intended to convey a harmonious meshing of the two nations' independent projects. So far, though, Europe's first concert in space communications sounds a bit flat.

The governments agreed, when they signed their late April accord, to give each country's aerospace industry a precise half of the business [Electronics, May 15, p. 234]. They didn't quote a price, but estimates range from \$32 million to \$50 million for two operational payloads. They agreed, as well, to pick the prime contractor from industry. That was good news to the French, who, unlike West Germany, have already orbited satellites. Until Symphonie, however, prime contractor for the satellites has been the national space agency, Centre National d'Etudes Spatiales.

Satellite in a poke. Industry leaders are concerned, nevertheless, because they still don't know what they'll be asked to build—despite the hurry-up nature of the project. Originally scheduled for delivery in August, bid specifications now aren't expected to be ready until September or October. A CNES official blames summer vacations for the wait.

What worries industry still more

is what form a special government-level steering committee will want the bids to take. The question seriously jeopardizes the consortium formation because the committee may first order bids from all-French and all-German groups for the satellite's electronics. Then, industry insiders say, the steering group would select the two best groups, split each down the middle, and make one combining the two best of the four halves.

Because the number of candidates is fewer, the problem is less severe for the satellite structure makers. Only three are currently reported interested: Nord-Aviation and Engins Matra of France, and Boelkow of West Germany. However, consortium building is difficult there, too, because some hopeful participants expect the steering group to name two prime contractors, one for the electronics and one for the structure.

Nothing splashy. All the manufacturers want to start forming their consortiums quickly to assure launching in less than three years. Few are concerned about the technology the governments will require. Though most of the details are still unknown, one executive says: "There's nothing spectacular about it. It will just be a music and broadcast satellite with only a 50-megahertz bandwidth." The two nations agreed that the satellite will weigh 400 pounds and be capable of handling a thousand channels.

Despite the unknowns, one of two likely French consortiums is already lined up. Its members are Compagnie Générale de Télégraphie Sans Fil (CSF), Société Anonyme de Télécommunications (SAT), and Nord Aviation. If the steering group should accept binational bids, then those companies plan to join West Germany's Siemens AG, Telefunken, and Boelkow.

An assortment of additional companies, some well versed in communication satellites through Intelsat contracts, are talking of forming a second consortium, but want to see the steering committee's ground rules first. Among them are Compagnie Française Thomson Houston-Hotchkiss Brandt, ITT's

Laboratoire Central de Télécommunications, Electronique Marcel Dassault, Société d'Electronique et d'Automatisme (SEA), Engins Matra, and Entwicklungsring Nord (Erno), a joint venture of two North German aircraft makers.

France

Shrug—in living color

Despite the hoopla of a 10-day sales drive focused on the arrival of color television in France, early indications are that the French are as enthusiastic about buying color sets as they are about drinking milk. The start of the drive coincided with the opening last Saturday of the annual International Radio and Television Salon in Paris.

Why the apathy? Start with price. Color sets at the show cost around a thousand dollars each—four times the price of the cheapest black-and-white models. And there's little choice. Just about each manufacturer offers a single table model with a 24-inch screen. Then there's the dual standard in French tv. One of the two black-and-white channels uses an 819-line standard, the other uses 625 lines. Color will be available only on the second (625-line) channel beginning Oct. 1 for 12 hours weekly. Thus, to equip a set to pick up both channels plus color adds up to higher price.

Gaul is divided. That's not all. According to critics of the government, only about half the country will be able to pick up the second channel clearly if at all, because relay equipment hasn't yet been installed all over France.

And one final complaint: Frenchmen still using old tv sets, bought before the second channel existed, can't receive it. That wasn't so bad up to now because it was a secondary channel. But when color broadcasts start, the second channel will carry major shows because those are the ones that the Office de Radiodiffusion-Télévision Française, the broadcast network, will want to deliver in color.

Austria

Tv in waltz time

While 50 million Frenchmen ignore color tv, 7 million Austrians—921,000 of them set owners—are going to have to wait until 1970 for it. The delay from the original target date of this fall stems from politics, technology, and money.

The government-owned Austrian Broadcasting Company (ABC) until recently was run by political appointees more attuned to Viennese intrigue than to their fee-paying viewers. But that has been changed to more commercial-minded management that wants to make sure the 15-year conversion to color (costing \$600 million) will be financially feasible. Technically, the big problem is the transmission obstacle presented by the Alps.

The financial barrier comes in two sizes: the \$2-a-month subscription fee and the price of sets. ABC wants at least a million subscribers before starting color, but anticipation of the switch has caused sales this year to drop 25%. And color sets range in cost from \$921 for a Philips, \$999 for a Kuba (West German subsidiary of GE), to \$1,069 for a Bang & Olufsen from Denmark.

Soviet Union

Hard-to-get software

What's happened to Russia's fastest computer, the two-year-old BESM-6? So far only two machines are operating at civilian establishments: the Meteorology Center and the Computing Center of the Academy of Sciences, both in Moscow.

The delay, say informed Soviet specialists, is due to a lack of software that has delayed the machine's acceptance by the State Committee for Science and Technology, which has authority to order factory production.

Spread. Preparation of software is decentralized. Work is being done in Moscow at the Computing

Center, the Institute of Mathematics, and the Economics-Statistics Institute. Scientists are also working at the Institute of Cybernetics in Kiev and the Computer Center in Akademgorodok near Novosibirsk.

The Russians say the BESM-6 will be time-shared [Electronics, June 12, p. 244]; the software is expected to be developed early next year. But time-sharing will be further off because of a lack of adequate terminal facilities.

As far as the hardware is concerned, here's what goes into the BESM-6:

- A central processor with 16 registers and 300-nanosecond access time.

- Core storage consisting of eight blocks of 4,000 words each with each word containing 50 bits.

- Four magnetic drums, each with 120 tracks and three blocks of read-write heads. Each drum rotates at 3,000 rpm.

- Eight magnetic tape drives. Tape quality, according to a knowledgeable Russian, is "still not high enough."

- Two 700-cards-a-minute readers and two card punchers.

- One paper punch and a punch-paper reader.

- Two printers, each rated at 600 lines a minute. A set of 96 characters is on a cylinder opposite paper at each print position. Hammers behind the paper press it against the cylinder.

- A teletype input-output keyboard and printer.

The computer, which has no cathode-ray tubes, is considered a medium-scale machine by U.S. standards.

Around the world

Canada. The government has named a career diplomat as head of the Canadian Broadcasting Corporation. Jules Leger, currently ambassador to France, will succeed the retiring Alphonse Ouimet, who is credited with the technical development of the network [see story on p. 131].

Instant electronic heaven.

All you add is nothing.

Yummy yummy yum. Redcor/Modules' 770-401 buffer amplifier is a tasty little gem with scrumptious specs like 0.02% accuracy gains from 1 to 50, high cmr (80DB), and high cmv ($\pm 10v$) simultaneously. Its closed-loop design frees you from long hours over a hot slide rule designing feedback circuitry. Available in three flavors: operational, potentiometric, and differ-

ential. With a settling time of only 6 μ secs to 0.02%, and a price of \$95 (cheap) you're bound to love the 770-401 or our name's not Betty Crocker. Come to think of it, it's not, but what the hell it's a fine piece of gear so request complete data.

REDCOR

7800 DEERING AVENUE
CANOGA PARK,
CALIFORNIA 91304

(213) 348-5892 • TWX 910-494-1228

Circle 242 on reader service card

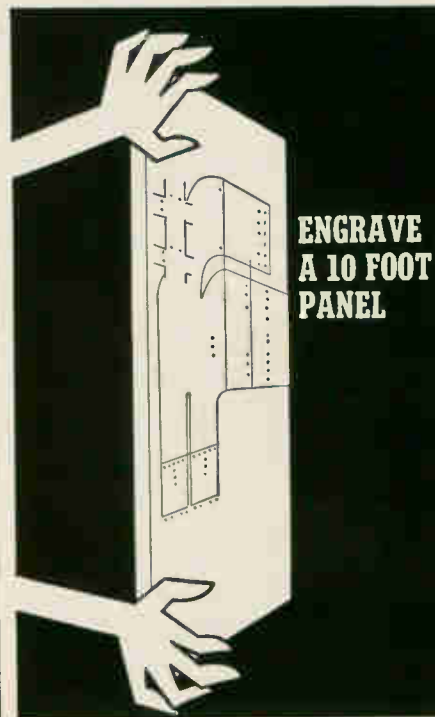

The New Hermes Engravograph is a highly versatile pantographic engraving machine. Anyone in your plant can operate it—with big savings. Write for 24 page catalog to Dept. 156.



new hermes engraving machine corp.

20 Cooper Square, New York, N. Y. 10003 • Chicago, Atlanta, Los Angeles, Dallas, Montreal, Toronto, Mexico City

Electronics advertisers

September 4, 1967

■ Acopian Corporation Mort Barish Assoc.	127	■ Delco Radio Div., General Motors Corp. Macbill/Ross, Inc.	186	ITT Semiconductors Div. Neals & Hickok, Inc.	212
Aemco-Division of Midtex, Inc. Mankato Graphic Arts	10	Di-Acro Corp., Div. of Houdaille Industries, Inc. Charles E. Brown Adv. Agcy.	150	Janus Control Corp. L. K. Frank Co., Inc.	126
Aeromet-General Corp. D'Arcy Adv. Co.	160, 161	Dodge Industries Winard Advertising	181	Jerrold Electronics Corp. Mohr & Co., Inc.	14
Airpax Electronics, Inc. Welch, Mirabile & Co., Inc.	55	Dow Chemical Co., The Mac Manus, John & Adams, Inc.	113	■ L E L, Div. of Varian Associates Snow & Depew Adv., Inc.	16
■ Amelco Semiconductor, Div. of Teledyne, Inc. Campbell-Ewald Co.	109	Dresser, SIE, Inc. Erwin Wasey, Inc.	211	Licon, Div. of Illinois Tool Works, Inc. Waldie & Briggs, Inc.	114
■ American Lava Corp. Sub. of Minnesota, Mining & Mfg. Co. Designers, Inc.	129	Duncan Electronics, Inc., Sub. of Systron Donner Corp. Bonfield Associates	134, 135	Litton Industries, Inc., Electron Tube Div. West, Weir & Bartel, Inc.	49
American Micro-Systems, Inc. Giulie, Smith & Beal, Inc.	130	Elco Corporation Fien & Schwerin, Inc.	32	Luma Electric Wendt Adv. Agcy.	182
■ AMP, Inc. Garceau, Hallahan & McCullough, Inc.	149	Electronized Chemicals Corp. Kenyon & Eckhardt, Inc.	192	■ Machlett Laboratories, Div. of Raytheon Co. Fuller & Smith & Ross, Inc.	9
■ Amphenol Corp., Connector Div. Marsteller, Inc.	56, 57	Emerson & Cuming, Inc. Edwin F. Hall	196	Master Specialties Co. William E. Wilson Co.	181
■ Andrew Corp. Fensholt Adv., Inc.	200	Fairchild Instrumentation Faust/Day, Inc.	30, 31	Materials Research Corp., MRC Corp. Sub. Keyes, Martin & Co.	193
A.P.I. Instruments George Z. Griswold Adv.	164	Fairchild Semiconductor, Inc. Faust/Day, Inc.	203, 204	Mequero Electronic Instrument General Adv. Agcy., Inc.	194
Associated Testing Laboratories, Inc. Frank Best & Co., Inc.	155	Field Emission Corp. Ken Webber Advertising	50	Microlab/FXR Frank Best & Co., Inc.	34
■ Atlas Chemical Industries, Inc. Aerospace Components Div. Harris D. McKinney, Inc.	191	Fluke Manufacturing Co., John Bonfield Associates	15	Miller Co., W. A. Minnesota Mining & Manufacturing Co., Chemical Div. Young & Rubicam, Inc.	180 173
Automatic Electric Co., Sub. of General Telephone & Electronics Corp. Doyle, Dane, Bernbach, Inc.	178	■ Franklin Electronics, Inc., Div. of Anelix Corp. James J. Cavella Adv.	197	Motorola Semiconductor Products, Inc. Lane & Bird Adv., Inc.	37, 51, 61
Babcock Relays, Div. of Babcock Electronics Corp. Leland Oliver Co.	121	G-C Electronics Co., Industrial Div. Sander Rodkin Adv. Agcy., Ltd.	180	National Semiconductor Corp. Jay Chiat & Assoc.	58, 59
Barnes Development Co. Industrial Public Relations, Inc.	154	General Dynamics, Fort Worth Div. Glenn Advertising, Inc.	195	Natvar Coro. Sanger-Funnell, Inc.	165
■ Bausch & Lomb, Inc. Wolff Assoc., Inc.	125	General Instrument Corp., Semiconductor Products Div. Norman Allen Assoc.	140	New Hermes Engraving Machine Corp. Lester Harrison Adv., Inc.	209
■ Beckman Instruments, Inc., Helipot Div. Hixson & Jorgensen, Inc.	115	General Radio Co. Horton, Church & Goff, Inc.	2nd Cover	New York Securities Co. Doremus & Company	180
Bell Telephone Laboratories N. W. Ayer & Son, Inc.	98	G-V Controls McCarthy, Scelba, De Biasi	12, 13	North Atlantic Industries, Inc. Murray Heyert Assoc.	145
Beman Manufacturing, Inc. Krone Art Service	184	Hamilton Watch Co. Beaumont, Heller & Sperling, Inc.	170	Oak Electro/Netics Corp. Buchen Adv., Inc.	27
Bendix Corp., Flight & Engine Instruments Div. MacManus, John & Adams, Inc.	38	Hansen Manufacturing Co. Keller-Crescent Co.	187	■ Pacific Measurements, Inc. Jack Herrick Adv., Inc.	7
Bishop & Company, J. Richardson, Thomas & Bushman, Inc.	185	■ Hayakawa Electronics Co., Ltd. Dai-Ichi International, Inc.	188	Phelps Dodge Electronics Products Corp. Smith, Dorian & Burman, Inc.	144
Borden Chemical Co., Mystik Tape Industrial Div. Conahay & Lyon, Inc.	110	■ Haydon Switch & Instruments, Inc. Reynolds & Foster, Inc.	128	Polaroid Corp. Doyle, Dane, Bernbach, Inc.	47
Bulova Watch Co., Electronics Div. Frank Best Co., Inc.	197	Heinemann Electric Co. Thomas R. Sundheim, Inc.	64	■ Potter & Brumfield, Div. of American Machine & Foundry Corp. Grant, Schwenck & Baker, Inc.	142
■ Burr-Brown Research Corp. N. A. Winter Adv. Agcy.	118	Hewlett Packard, Colorado Springs Div. Tallant/Yates Adv., Inc.	3rd Cover	Radio Corporation of America Al Paul Lefton Co.	4th Cover, 22
■ Bussmann Mfg., Div. of McGraw Edison Co. Henderson Adv. Co.	182, 183	■ Hewlett Packard, Dymec Div. Lennen & Newell, Inc.	1	Radio Switch Corp. George Homer Martin Assoc.	154
Capitol Radio Engineering Institute Henry J. Kaufman & Associates	28, 184	■ Hewlett Packard, Frequency & Time Div. Lennen & Newell, Inc.	46	Raytheon Co., Components Div. Fuller & Smith & Ross, Inc.	194
Cerro Wire & Cable, Div. of Cerro Corp. Marsteller, Inc.	111	Hewlett Packard, Loveland Div. Tallant/Yates Adv., Inc.	36	Redcor Corp. Smith-Kiitten, Inc.	196, 209
Cherry Electrical Products Corp. K & A, Inc.	188	■ Hewlett Packard, Microwave Div. Lennen & Newell, Inc.	2, 187, 189, 191, 193	Rosenthal-Isolatoren GMBH Werbeagentur Kurt Linnebach	190
Clare & Company, C.P. Reincke, Meyer & Finn Adv., Inc.	35	Hi.G, Inc. Marketing Assistance, Inc.	60	Sierra Electronics, Division Phico Ford Hal Lawrence, Inc.	67
■ Clifton Precision Products Co., Div. of Litton Industries Ivey Advertising, Inc.	24	Honeywell Computer Control Div. Franklin P. Folts, Inc.	43	Sigma Instruments, Inc. Marschalk Co., Inc.	112
Computer Test Corp. James Lees Adv.	63	Honeywell PMD Div. Batten, Barton, Durstine & Osborn, Inc.	29	Signetics Corp., Sub. Corning Glass Works Cunningham & Walsh, Inc.	20, 21
Consolidated Electrodynamics Corp., Sub. of Bell & Howell Hixson & Jorgensen, Inc.	133	Hughes Aircraft Co. Foote, Cone & Belding	157, 177	■ Silicon Transistor Corp. A. D. Adams Adv.	68
Control Data Corp., Analog-Digital Systems Div. Barnes-Champ Adv.	172	■ Hull Corporation Michener Co. Adv.	185	Solitron Devices, Inc. Transistor Div. Haselmire Pearson Adv., Inc.	171
■ Control Switch, Div. of Control Co. of America Harry P. Bridge Co.	166	IBM Corporation, Systems Development Div. Marsteller, Inc.	138, 139	Sorensen Operation, Raytheon Co. James Advertising, Inc.	11
Coors Porcelain Co. Tallant/Yates Adv., Inc.	174	Industrial Electronic Engineers Gumpertz, Bentley & Dolan, Inc.	48	Spectral Electronics Corp. Jones, Maher, Roberts, Inc.	66
Corning Glass Works, Electronic Products Div. Rumrill Hoyt, Inc.	152	Information Handling Services Martz & Associates	65		
■ Dale Electronics, Inc. Sub. of Lionel Corp. Swanson, Sinkey, Ellis, Inc.	52	Information Retrieval, Inc. Wank, Williams & Neylan, Inc.	169		
		International Electronic Research Corp. Van Der Boom, McCarron, Inc.	116		
		ITT Jennings Mfg. Co. West, Weir & Bartel, Inc.	176		



Advertising sales staff

■ Speer Carbon Co. Div., Air Reduction Co., Inc. Hazard Adv. Co., Inc.	45
■ S. P. Elettronica	66
Sprague Electric Co. The, Harry P. Bridge Co.	5, 8
■ Stackpole Carbon Co., Electronic Components Div. Meek & Thomas, Inc.	120
Sylvania Electric Products, Inc., Electronic Tube Div. Doyle, Dane, Bernbach, Inc.	33
Synthane Corp. Arndt, Preston, Chapin, Lamb & Keen, Inc.	182
Taylor Corp. Gray & Rogers, Inc.	162
■ Tektronix, Inc. Hugh Dwight Adv., Inc.	17, 122
Telonic Instruments Jansen Assoc., Inc.	136
Tenney Engineering, Inc. Keyes, Martin & Co.	192
Texas Instruments Incorporated Semiconductor/Components Division Don L. Baxter Incorporated	119
TRF, Inc. Arthur J. Lamb, Inc.	165
TRW Electronics, Capacitors Div. Fuller & Smith & Ross, Inc.	151
Trygon Electronics, Inc. Solow/Wexton Co., Inc.	62
Trymetrics Corp. Solow Wexton Co., Inc.	124
■ Tung Sol Div., Wagner Electric Corp. E. M. Freystadt Assoc.	190
Ulano & Co., J. Byrde, Richard & Pound, Inc.	143
Varian Associates, Recorder Div. Hoefer, Dieterich & Brown, Inc.	18, 19
■ Varo, Inc. Tracy-Locke Co., Inc.	163
Vishay Instruments, Inc. Alpern Communications	93
Vitramon, Inc. Ted Sommers, Inc.	148
Wang Laboratories Larcom Randall Adv., Inc.	168
Wanlass Electric Co. Leland Oliver Co., Inc.	194
Westinghouse/Metals Div. McCann/ITSM	6
■ Weston Instruments, Inc., Archbald Div. Arndt, Preston, Chapin, Lamb & Keen, Inc.	117
■ Weston Instruments, Inc., Newark Div. Arndt, Preston, Chapin, Lamb & Keen, Inc.	137
West Penn Power Co., Area Development Dept., Allegheny Power System Fuller & Smith & Ross, Inc.	156

Frank E. LeBeau [212] 971-6464
Advertising sales manager
Wallis Clarke [212] 971-2187
Assistant to sales manager
Donald J. Austermann [212] 971-3139
Promotion Manager
Atlanta, Ga. 30309: Michael H. Miller, 1375
Peachtree St., N.E.
[404] TR 5-0523
Boston, Mass. 02116: William S. Hodgkinson
McGraw-Hill Building, Copley Square
[617] CO 2-1160
Chicago, Ill. 60611: Robert M. Denmead,
J. Bradley MacKimm, Ralph Hanning,
645 North Michigan Avenue,
[312] MO 4-5800
Cleveland, Ohio 44113: William J. Boyle, 55
Public Square, [216] SU 1-7000
Dallas, Texas 75201: Richard P. Poole, 1800
Republic National Bank Tower,
[214] RI 7-9721
Denver, Colo. 80202: Joseph C. Page, David
M. Watson, Tower Bldg., 1700 Broadway,
[303] 255-5484
Detroit, Michigan 48226: Ralph Hanning
856 Penobscot Building
[313] 962-1793
Houston, Texas 77002: Kenneth George,
2270 Humble Bldg., [713] CA 4-8381
Los Angeles, Calif. 90017: Ian C. Hill,
John G. Zisch, 1125 W. 6th St.,
[213] HU 2-5450
Minneapolis, Minn. 55402: J. Bradley
MacKimm, 1104 Northstar Center
[612] 332-7425
New York, N.Y. 10036
500 Fifth Avenue
Donald R. Furth [212] 971-3615
James R. Pierce [212] 971-3616
Jeffrey M. Preston [212] 971-3617
Philadelphia, Pa. 19103:
Warren H. Gardner, Jeffrey M. Preston,
6 Penn Center Plaza,
[215] LO 8-6161
Pittsburgh, Pa. 15222: Warren H. Gardner,
4 Gateway Center, [412] 391-1314
Portland, Ore. 97204: James T. Hauptli,
218 Mohawk Building, 222 S.W. Morrison
Street, Phone [503] 223-5118
Rochester, N.Y. 14534: William J. Boyle,
9 Greylock Ridge, Pittsford, N.Y.
[716] 586-5040
St. Louis, Mo. 63105: Robert M. Denmead
The Clayton Tower, 7751 Carondelet Ave.
[314] PA 5-7285
San Francisco, Calif. 94111:
James T. Hauptli, 255 California Street,
[415] DO 2-4600
London W1: John W. Patten, Edwin S.
Murphy Jr., 34 Dover Street,
Hyde Park 1451
Milan: Pierre Braude,
1 via Baracchini Phone: 86-90-656
Frankfurt/Main: Pierre Braude,
Elsa-Brandstroem Str. 2
Phone: 72 01 81
Geneva: Pierre Braude,
1, rue du Temple Phone: 31 95 60
Paris VIII: Pierre Braude,
17 Avenue Matignon Phone: 359 6637
Tokyo: Nobuyuki Sato, 1, Kotohiracho
Shiba, Minato-Ku [502] 0656
Osaka: Ryoji Kobayashi 163, Umegae-cho
Kita-ku [362] 8771

Business department
Wallace C. Carmichael, Manager
[212] 971-3191
Stephen R. Weiss, Production Manager
[212] 971-2044
Thomas M. Egan,
Assistant Production Manager [212] 971-3140
Dorothy Carmesin, Contracts and Billings
[212] 971-2908
Circulation and research
Milton Drake, Manager [212] 971-3485
Isaac Siegel, Assistant Circulation Manager
[212] 971-6057
David Strassler, Assistant Research Manager
[212] 971-6058
Chloe D. Glover, Research Associate
[212] 971-6057
Electronics buyers' guide
George F. Werner, General Manager
[212] 971-2310
Ray Smyth, Eastern Regional Manager
[212] 971-6538
Regina Hera, Directory Manager
[212] 971-2544
Thomas M. Egan, Production Manager
[212] 971-3140

Classified Advertising

F.J. Eberle, Manager	
PROFESSIONAL SERVICES	199
EMPLOYMENT OPPORTUNITIES	198-199
EQUIPMENT (Used or Surplus New) For Sale	
ADVERTISERS INDEX	
A & A Electronics Corp.	199
E.U. Butler, Jr.	199
Fair Radio Sales	199
Phillip Fishman Co.	199
General Dynamics, Electric Boat Division	198
Radio Research Corp.	199
Societa Italiana Telecomunicazioni Siemens	199

■ For more information on complete product line see advertisement in the latest Electronics Buyers' Guide



Solve Your Special Purpose Filter, Transformer, Inductor and other Wire Wound Component Problems at SIE!



Built to Mil-Q-9858

Dresser SIE now offers a complete engineering and manufacturing service to fill all your needs for special purpose wire wound components for your ordnance, aircraft, aero space and seismic applications.

Send your specifications today to the address below for complete information.

Dresser Systems, Inc.

ONE OF THE DRESSER INDUSTRIES
P. O. BOX 2928
HOUSTON, TEXAS 77001



**ITT has eight instant solutions
to your VHF/UHF
power transistor procurement problems.**

Is there something missing from your procurement cycle for RF power transistors? Is it predictable delivery? Better-than-competitive pricing? Superior performance?

Let ITT "crack" your RF power vacuum. The eight popular part numbers listed above are in stock and

ready to go — at the ITT factory and at every one of ITT's distributors. Next time you send out an RFQ, send it to The Predictables, and fill your power vacuum.

ITT Semiconductors is a Division of International Telephone and Telegraph Corporation, 3301 Electronics Way, West Palm Beach, Florida.

*New state-of-the-art devices, exclusive from ITT, 1 to 50 W, 30 to 70 MHz.

semiconductors **ITT**

FACTORIES IN WEST PALM BEACH, FLORIDA • PALO ALTO, CALIFORNIA • LAWRENCE, MASSACHUSETTS • ENGLAND • GERMANY • PORTUGAL • AUSTRALIA

Electronics reader service

Warning: The Post Office now requires your ZIP CODE on all mail. Please include your ZIP CODE number when filling out your reply card.

Use these handy post cards for more detailed information on: products advertised, new products, new literature.

Circle the number on the Reader Service post card that corresponds to the number at the bottom of the advertisement, new product item, or new literature in which you are interested.

Please print clearly. All written information must be legible to be efficiently processed.

If someone has beaten you to the post cards, you may obtain the needed information by writing directly to the manufacturer, or by sending your name and address, plus the Reader Service number, to Electronics Reader Service department.

All inquiries from outside the U.S. that cannot reach Electronics before the expiration dates noted on the Reader Service post card, must be mailed directly to the manufacturer. The manufacturer assumes all responsibilities for responding to inquiries. Electronics merely provides and clears requests for information from inquirer to manufacturer.

Correct amount of postage must be affixed for all mailings from outside the U.S.

To subscribe to or to renew Electronics

Fill in the "For Subscriptions" area on the card if you desire to subscribe to or renew your present subscription to Electronics. Send no money. Electronics will bill you at the address indicated on the Reader Service post card.

Multi-product advertisements

For information on specific items in multi-product advertisements which do not have a specific Reader Service number indicated write directly to manufacturer for information on precise product in which you are interested.

18 Please Print Clearly September 4, 1967 Card Expires November 4, 1967 **14**

Name _____ title _____

Company _____

Address _____

City _____ state _____ zip code _____

1	20	39	58	77	96	115	134	153	172	191	210	229	248	267	286	305	324	343	362	381	400	419	438	457	476	495	514	962
2	21	40	59	78	97	116	135	154	173	192	211	230	249	268	287	306	325	344	363	382	401	420	439	458	477	496	515	963
3	22	41	60	79	98	117	136	155	174	193	212	231	250	269	288	307	326	345	364	383	402	421	440	459	478	497	516	964
4	23	42	61	80	99	118	137	156	175	194	213	232	251	270	289	308	327	346	365	384	403	422	441	460	479	498	517	965
5	24	43	62	81	100	119	138	157	176	195	214	233	252	271	290	309	328	347	366	385	404	423	442	461	480	499	518	966
6	25	44	63	82	101	120	139	158	177	196	215	234	253	272	291	310	329	348	367	386	405	424	443	462	481	500	900	967
7	26	45	64	83	102	121	140	159	178	197	216	235	254	273	292	311	330	349	368	387	406	425	444	463	482	501	901	968
8	27	46	65	84	103	122	141	160	179	198	217	236	255	274	293	312	331	350	369	388	407	426	445	464	483	502	902	969
9	28	47	66	85	104	123	142	161	180	199	218	237	256	275	294	313	332	351	370	389	408	427	446	465	484	503	951	970
10	29	48	67	86	105	124	143	162	181	200	219	238	257	276	295	314	333	352	371	390	409	428	447	466	485	504	952	971
11	30	49	68	87	106	125	144	163	182	201	220	239	258	277	296	315	334	353	372	391	410	429	448	467	486	505	953	972
12	31	50	69	88	107	126	145	164	183	202	221	240	259	278	297	316	335	354	373	392	411	430	449	468	487	506	954	973
13	32	51	70	89	108	127	146	165	184	203	222	241	260	279	298	317	336	355	374	393	412	431	450	469	488	507	955	974
14	33	52	71	90	109	128	147	166	185	204	223	242	261	280	299	318	337	356	375	394	413	432	451	470	489	508	956	975
15	34	53	72	91	110	129	148	167	186	205	224	243	262	281	300	319	338	357	376	395	414	433	452	471	490	509	957	976
16	35	54	73	92	111	130	149	168	187	206	225	244	263	282	301	320	339	358	377	396	415	434	453	472	491	510	958	977
17	36	55	74	93	112	131	150	169	188	207	226	245	264	283	302	321	340	359	378	397	416	435	454	473	492	511	959	978
18	37	56	75	94	113	132	151	170	189	208	227	246	265	284	303	322	341	360	379	398	417	436	455	474	493	512	960	979
19	38	57	76	95	114	133	152	171	190	209	228	247	266	285	304	323	342	361	380	399	418	437	456	475	494	513	961	980

For Subscriptions
 new renewal
 3 years \$16.00
 1 year \$8.00

2

First class
 Permit no. 42
 Hightstown, N. J.

Business reply mail
 No postage stamp necessary if mailed in the United States

Postage will be paid by

Electronics
Reader service department
Box 444
Hightstown, N.J. 08520



18 Please Print Clearly September 4, 1967 Card Expires November 4, 1967 **14**

Name _____ title _____

Company _____

Address _____

City _____ state _____ zip code _____

1	20	39	58	77	96	115	134	153	172	191	210	229	248	267	286	305	324	343	362	381	400	419	438	457	476	495	514	962
2	21	40	59	78	97	116	135	154	173	192	211	230	249	268	287	306	325	344	363	382	401	420	439	458	477	496	515	963
3	22	41	60	79	98	117	136	155	174	193	212	231	250	269	288	307	326	345	364	383	402	421	440	459	478	497	516	964
4	23	42	61	80	99	118	137	156	175	194	213	232	251	270	289	308	327	346	365	384	403	422	441	460	479	498	517	965
5	24	43	62	81	100	119	138	157	176	195	214	233	252	271	290	309	328	347	366	385	404	423	442	461	480	499	518	966
6	25	44	63	82	101	120	139	158	177	196	215	234	253	272	291	310	329	348	367	386	405	424	443	462	481	500	900	967
7	26	45	64	83	102	121	140	159	178	197	216	235	254	273	292	311	330	349	368	387	406	425	444	463	482	501	901	968
8	27	46	65	84	103	122	141	160	179	198	217	236	255	274	293	312	331	350	369	388	407	426	445	464	483	502	902	969
9	28	47	66	85	104	123	142	161	180	199	218	237	256	275	294	313	332	351	370	389	408	427	446	465	484	503	951	970
10	29	48	67	86	105	124	143	162	181	200	219	238	257	276	295	314	333	352	371	390	409	428	447	466	485	504	952	971
11	30	49	68	87	106	125	144	163	182	201	220	239	258	277	296	315	334	353	372	391	410	429	448	467	486	505	953	972
12	31	50	69	88	107	126	145	164	183	202	221	240	259	278	297	316	335	354	373	392	411	430	449	468	487	506	954	973
13	32	51	70	89	108	127	146	165	184	203	222	241	260	279	298	317	336	355	374	393	412	431	450	469	488	507	955	974
14	33	52	71	90	109	128	147	166	185	204	223	242	261	280	299	318	337	356	375	394	413	432	451	470	489	508	956	975
15	34	53	72	91	110	129	148	167	186	205	224	243	262	281	300	319	338	357	376	395	414	433	452	471	490	509	957	976
16	35	54	73	92	111	130	149	168	187	206	225	244	263	282	301	320	339	358	377	396	415	434	453	472	491	510	958	977
17	36	55	74	93	112	131	150	169	188	207	226	245	264	283	302	321	340	359	378	397	416	435	454	473	492	511	959	978
18	37	56	75	94	113	132	151	170	189	208	227	246	265	284	303	322	341	360	379	398	417	436	455	474	493	512	960	979
19	38	57	76	95	114	133	152	171	190	209	228	247	266	285	304	323	342	361	380	399	418	437	456	475	494	513	961	980

For Subscriptions
 new renewal
 3 years \$16.00
 1 year \$8.00

Reprint service

All Electronics editorial matter available in reprint form:

For reprints of special reports and feature articles see list on right side of this page. Send your order to Electronics Reprint Department at the address indicated. To expedite mailing of your order for single reprints please send cash, check or money order with your order. Allow 3-4 weeks for delivery.

Bulk reprints of editorial matter can be ordered from current or past issues. The minimum quantity is 100 copies. Prices quoted on request: call 212-971-3333, or write to address below.

Warning: The Post Office now requires your ZIP CODE on all mail. Please include your ZIP CODE number when filling out your reply card.

3

Business reply mail

No postage stamp necessary if mailed in the United States

Postage will be paid by

Electronics
Reader service department
Box 444
Hightstown, N. J. 08520

First class
 Permit no. 42
 Hightstown, N. J.



18 Please Print Clearly September 4, 1967 Card Expires November 4, 1967 14

Name _____ title _____

Company _____

Address _____

City _____ state _____ zip code _____

1	20	39	58	77	96	115	134	153	172	191	210	229	248	267	286	305	324	343	362	381	400	419	438	457	476	495	514	533
2	21	40	59	78	97	116	135	154	173	192	211	230	249	268	287	306	325	344	363	382	401	420	439	458	477	496	515	534
3	22	41	60	79	98	117	136	155	174	193	212	231	250	269	288	307	326	345	364	383	402	421	440	459	478	497	516	535
4	23	42	61	80	99	118	137	156	175	194	213	232	251	270	289	308	327	346	365	384	403	422	441	460	479	498	517	536
5	24	43	62	81	100	119	138	157	176	195	214	233	252	271	290	309	328	347	366	385	404	423	442	461	480	499	518	537
6	25	44	63	82	101	120	139	158	177	196	215	234	253	272	291	310	329	348	367	386	405	424	443	462	481	500	519	538
7	26	45	64	83	102	121	140	159	178	197	216	235	254	273	292	311	330	349	368	387	406	425	444	463	482	501	520	539
8	27	46	65	84	103	122	141	160	179	198	217	236	255	274	293	312	331	350	369	388	407	426	445	464	483	502	521	540
9	28	47	66	85	104	123	142	161	180	199	218	237	256	275	294	313	332	351	370	389	408	427	446	465	484	503	522	541
10	29	48	67	86	105	124	143	162	181	200	219	238	257	276	295	314	333	352	371	390	409	428	447	466	485	504	523	542
11	30	49	68	87	106	125	144	163	182	201	220	239	258	277	296	315	334	353	372	391	410	429	448	467	486	505	524	543
12	31	50	69	88	107	126	145	164	183	202	221	240	259	278	297	316	335	354	373	392	411	430	449	468	487	506	525	544
13	32	51	70	89	108	127	146	165	184	203	222	241	260	279	298	317	336	355	374	393	412	431	450	469	488	507	526	545
14	33	52	71	90	109	128	147	166	185	204	223	242	261	280	299	318	337	356	375	394	413	432	451	470	489	508	527	546
15	34	53	72	91	110	129	148	167	186	205	224	243	262	281	300	319	338	357	376	395	414	433	452	471	490	509	528	547
16	35	54	73	92	111	130	149	168	187	206	225	244	263	282	301	320	339	358	377	396	415	434	453	472	491	510	529	548
17	36	55	74	93	112	131	150	169	188	207	226	245	264	283	302	321	340	359	378	397	416	435	454	473	492	511	530	549
18	37	56	75	94	113	132	151	170	189	208	227	246	265	284	303	322	341	360	379	398	417	436	455	474	493	512	531	550
19	38	57	76	95	114	133	152	171	190	209	228	247	266	285	304	323	342	361	380	399	418	437	456	475	494	513	532	551

1

Business reply mail

No postage stamp necessary if mailed in the United States

Postage will be paid by

Electronics
Reader service department
Box 444
Hightstown, N.J. 08520

First class
 Permit no. 42
 Hightstown, N. J.

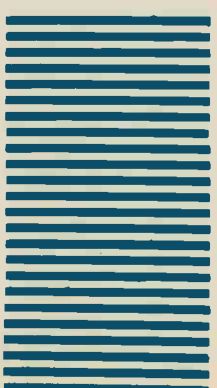

To order reprints or for further information, please write to: **Electronics Reprint Department, 330 West 42nd Street, New York, N.Y. 10036.**

You may order any of the below listed reprints by key number. Discounts on quantities over 10.

- Key no. R-01 **Computer-aided Design: Part I, The Man-machine Merger.** 16 pages. \$1.25.
- Key no. R-02 **Vietnam Communications Network Growing Into Southeast Asia's Best.** 3 pages. 25¢.
- Key no. R-03 **Sense Amplifier Fits Any Product.** 6 pages. 25¢.
- Key no. R-04 **Multilayer Circuit Boards: Sharpening An Imperfect Art.** 7 pages.
- Key no. R-05 **Topology Cuts Design Drudgery.** 12 pages. 50¢.
- Key no. R-06 **Report on Japanese Technology: Sony.** 20 pages. 50¢.
- Key no. R-07 **European Electronics Markets 1967.** 22 page forecast report with 4 page foldout chart. \$1.00.
- Key no. R-08 **U.S. Electronics Markets 1967.** 26 page forecast report with 6 page foldout. \$1.00.
- Key no. R-09 **1966 Electronics Index to Technical Articles and Authors Free.**
- Key no. R-010 **Special Report on Large Scale Integration.** 54 pages. \$1.50.
- Key no. R-011 **Medical Electronics (1967).** 8 part series, 44 pages. \$1.25.
- Key no. R-87a **The Packaging Revolution in Microelectronics, Parts I through VI.** 64 pages. \$2.00.
- Key no. R-86a **Computer Time Sharing. Parts I and II.** 32 pages. \$1.00.
- Key no. R-79 **MOS Integrated Circuits.** 12 pages.
- Key no. R-78 **The Overlay Transistor.** 15 pages.
- Key no. R-75 **Biotelemetry.** 2 part series, 16 pages.
- Key no. R-74 **Unijunction Transistors.** 24 pages.
- Key no. R-64 **Field Effect Transistors. Parts I, II, and III.** 64 pages. \$1.00.
- Key no. R-60 **Transistor Heat Dissipators.** 32 pages.
- Key no. R-31 **Electromagnetic Spectrum Chart. (22" x 30" foldout. chart).** \$1.00.

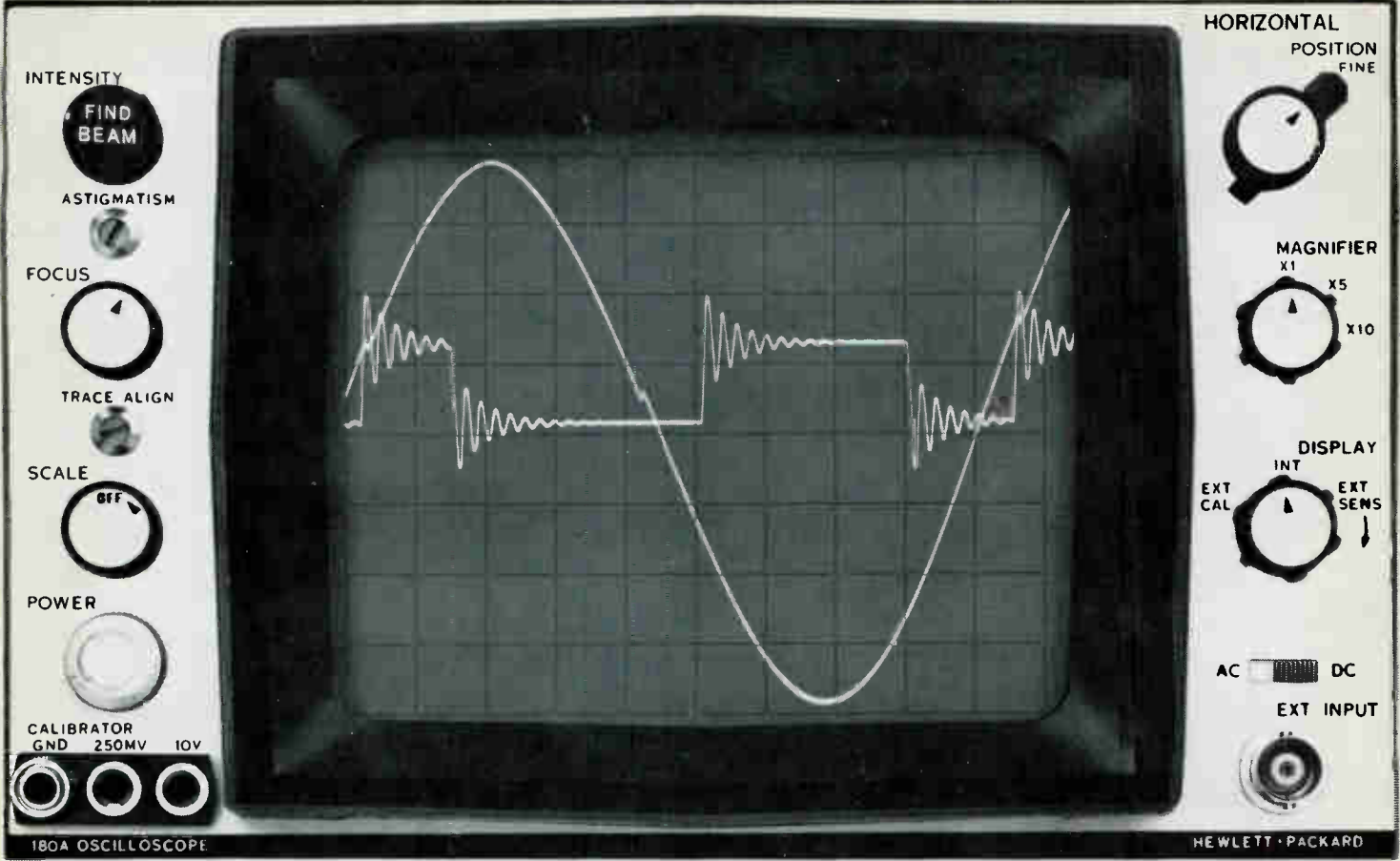

See More! Do More! With the hp 180A — the scope with room to grow!

The hp 180A—the new concept in overall scope design—is destined to be the industry standard. All solid-state circuitry gives you the big advantages of state-of-the-art technology, now! With plug-in capability, your 180A scope system has room to expand for tomorrow's demands!

All-solid-state design in the 180A gives sweep speeds and sensitivities that are easier to get and hold, easier to calibrate—better all-around reliability. All-solid-state design eliminates the need for fans, troublesome heat-producing vacuum tubes, excessively high current power supplies, and bulky, heavy cabinets. Get all the performance and versatility inherent in new solid-state technology . . . get the new hp 180A, the scope with room to grow!

Mainframe of the 180A lab/field scope has a big-picture 8 x 10 cm CRT for easier-to-see traces, readable to greater accuracies. Power supply and CRT have capability of handling existing and future solid-state plug-ins. Special internal phase bandwidth switch matches phase shift of horizontal to phase shift of vertical for accurate phase measurements.

Three plug-ins are currently available. The 1801A Dual Channel Amplifier plug-in allows you to plot A and B traces for accurate comparison. It gives you dc to 50 MHz bandwidth with 7 nsec rise time, on all ranges from 5 mV/cm to 20 V/cm. Use convenient internal Channel B trigger in ALT or CHOP modes for easy time correlation of traces.

The 1821A Time Base and Delay Generator provides slow/fast sweep displays. Exclusive hp mixed sweep features com-

bine display of first portion of trace at normal sweep speeds, and simultaneously expands trailing portion of trace at faster delayed sweep speed to allow magnified examination. The 1821A triggers to >90 MHz, sweeps from 1 sec/cm to 10 nsec/cm.

The 1820A Time Base has a variable holdoff to permit variation of time between sweeps to allow triggering on asymmetrical pulse trains. Triggers to beyond 90 MHz, sweeps from 2 sec/cm to 5 nsec/cm.

Specify the rugged hp 180A Oscilloscope to get the complete versatility you need for general laboratory and field work. Ask your hp field engineer for data sheet. Or, write to Hewlett-Packard, Palo Alto, California 94304. Europe: 54 Route des Acacias, Geneva. Price: hp 180A Oscilloscope, \$825; hp 180AR (rack) Oscilloscope, \$900; hp 1801A Dual Channel Vertical Amplifier, \$650; hp 1820A Time Base, \$475; hp 1821A Time Base and Delay Generator, \$800.

087/32

HEWLETT  PACKARD

OSCILLOSCOPE SYSTEMS

ACTUAL SIZE

How to eliminate a transformer, two SCR's and a triggering device...

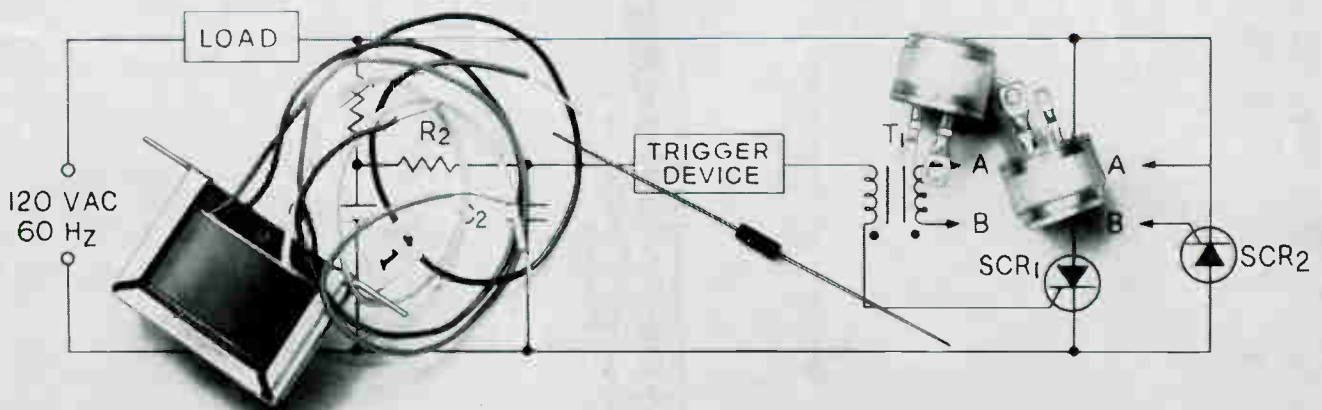

use one of RCA's new 6A Triacs with integral trigger!

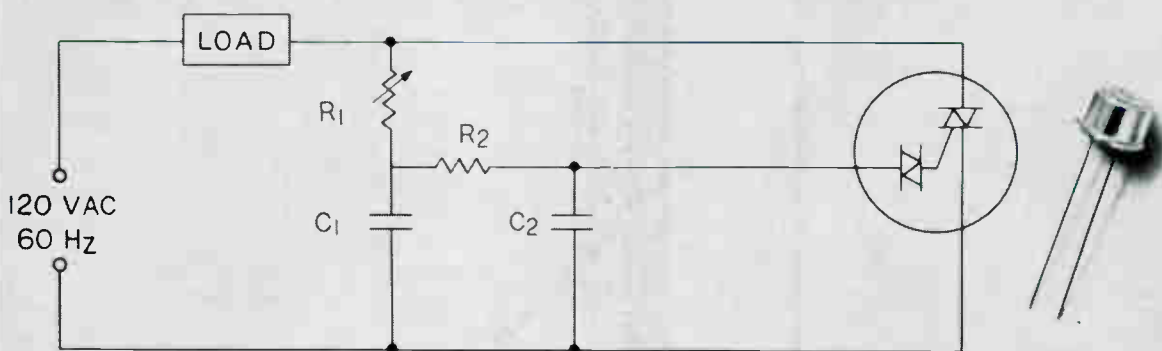

Why design in RCA's new 6A Triacs? Here are just a few of the more important reasons:

Because the triggering device and the firing characteristics of the 40431 and 40432 Triacs are integrated inside the compact TO-5 case by RCA before they sell you the device...you don't have to worry about designing in additional triggering components.

Because a Triac, by its very nature and construction, can replace two SCR's and a pulse transformer in ac circuits...you achieve significant savings in engineering and manufacturing costs, and you improve packing density.

And because RCA's 40431 and 40432 have excellent gate symmetry and surge current protection up to 100 amps...you get top circuit performance and reliability.

The 40431 controls 720 watts at 120 volts, 60 Hz. It costs only \$1.80*. The 40432 controls 1440 watts at 240 volts, 60 Hz. It costs only \$2.28*. So for modern, efficient phase control of ac loads in applications such as light dimming, universal and induction motor control, and heater control, specify RCA's new Triac with built-in trigger. Your RCA Field Representative can give you complete information, including price and delivery. Or for additional technical data, write RCA Commercial Engineering, Sec. RN9-1, Harrison, N.J. 07029. See your RCA Distributor for his price and delivery.

*Prices in quantities of 1,000 and up.

RCA Electronic Components and Devices



The Most Trusted Name in Electronics