

# Electronics<sup>®</sup>

**Applying glass semiconductors: page 74**

**Digital filters made with IC's: page 91**

**Computers in medicine: page 103**

July 24, 1967

\$1.00

A McGraw-Hill Publication

Below: Making glass semiconductors  
for a computer memory, page 77

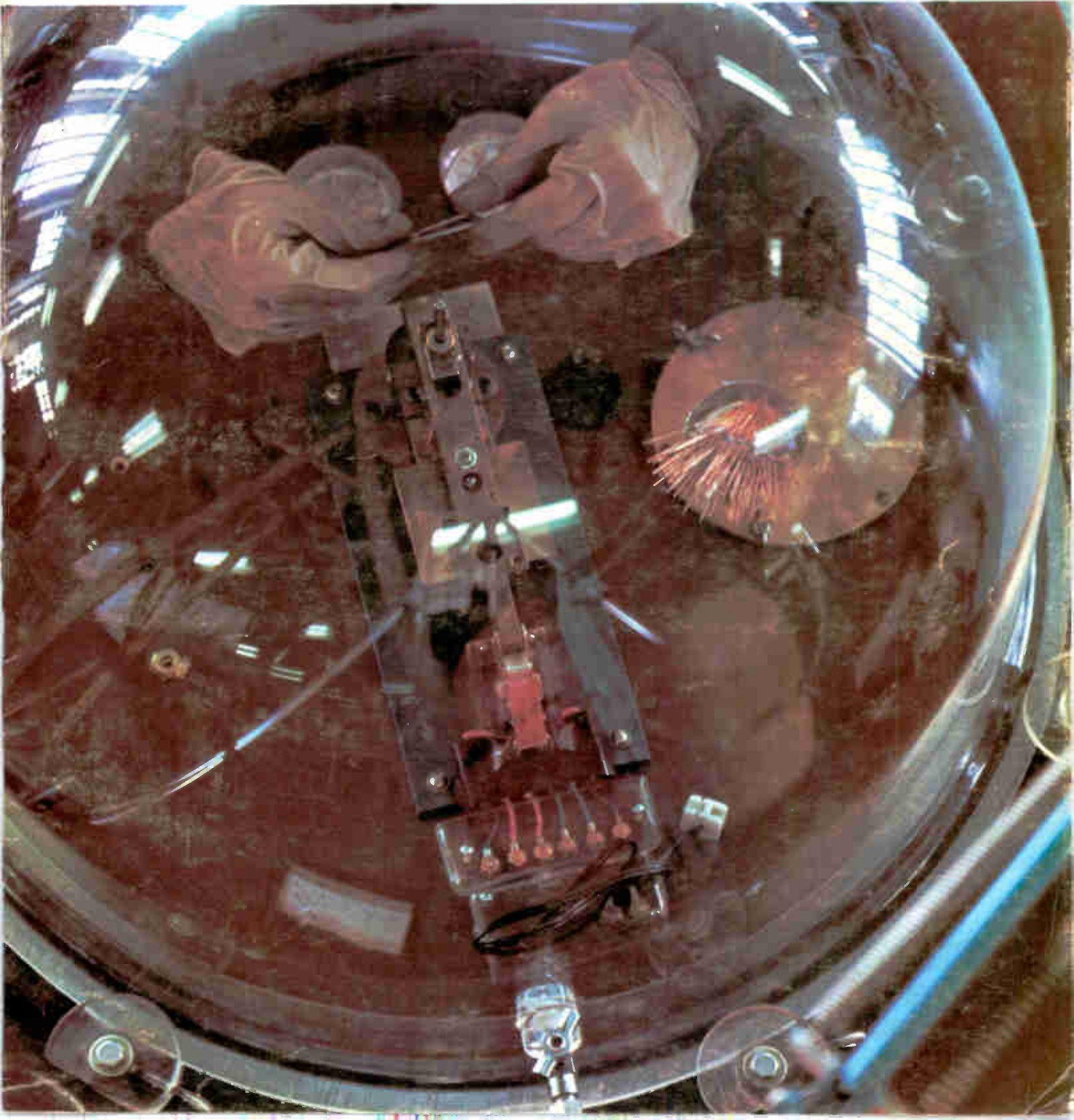



**PIONEERS IN  
MINIATURIZATION**

# "SPECIAL" CUSTOM BUILT FILTERS

## TO YOUR SPECIFICATIONS

**ILLUSTRATED ARE  
TYPICAL SPECIAL FILTERS**

RANGE OF FREQUENCIES ON SPECIAL UNITS  
IS FROM 0.1 CYCLE TO 400 MC.

Over thirty years of experience in the design and production of special filters have resulted in UTC being a first source for difficult units. Present designs both military and commercial incorporate a wide variety of core structures, winding methods, and capacitors to provide maximum performance, stability, and reliability. Fully experienced, top engineering talent backed by complete environmental testing and life testing facilities assure the highest standard in the industry. Full analysis and evaluation of materials are conducted in UTC's Material and Chemical Laboratories. Rigid quality control measures coordinated with exhaustive statistical findings and latest production procedures results in the industry's highest degree of reliability.

**MILITARY AND COMMERCIAL TYPES FOR  
EVERY PHASE OF THE ELECTRONICS ART**

**POWER TRANSFORMERS • AUDIO TRANSFORMERS • INDUCTORS • PULSE TRANSFORMERS • ELECTRIC WAVE FILTERS • LUMPED CONSTANT DELAY LINES • HIGH Q COILS • MAGNETIC AMPLIFIERS • SATURABLE REACTORS • REFERENCE UNITS**

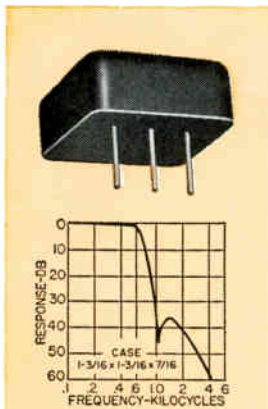

560 ~ Telemetering low pass filter. Available from 400 ~ to 70 KC.  $\pm$  7.5% bandwidth flat to 1 db. Attenuation greater than 35 db beyond the 2nd harmonic of  $\pm$  7.5% frequency. Impedance 47K ohms. MIL-F-18327B. Wt. 0.8 oz.

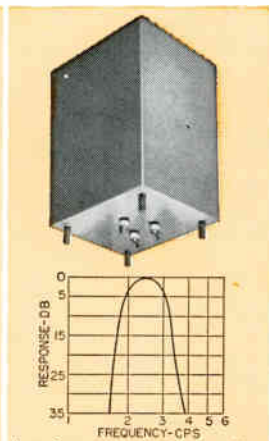

Low frequency band pass filter. Designed for 2.5 cps center frequency. At 2 to 3 cps within 3 db. At 1.5 cps and lower, and 4 cps and higher, greater than 30 db. Source and Load 10K ohms. Size: 4 x 4-11/16 x 6". MA MIL case, MIL-F-18327B.

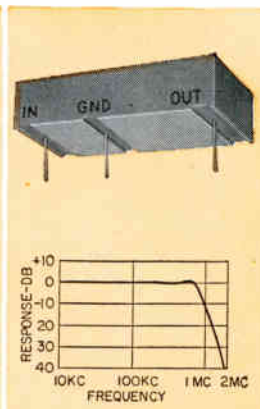

High frequency low pass filter. Zero to 700 KC within 1 db. 1.95 mc to 10 mc 40 db minimum. Source and Load 1000 ohms. Molded flat construction for printed circuit applications. Size: 1 x 2 x 1/2"; Wt: 1 oz. MIL-F-18327B.

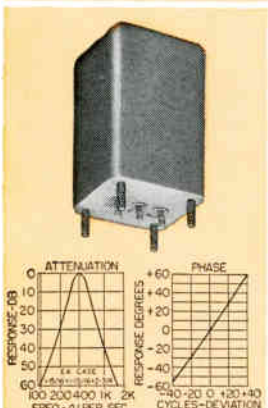

Band pass 400 cycle Gaussian filter. Linear phase response in pass band. Attenuation 380 cps to 420 cps within 0.5 db. 2nd harmonic down 25 db, 3rd harmonic down 45 db. Source and load 5K ohms. MIL-F-18327B Wt., 0.9 lbs.

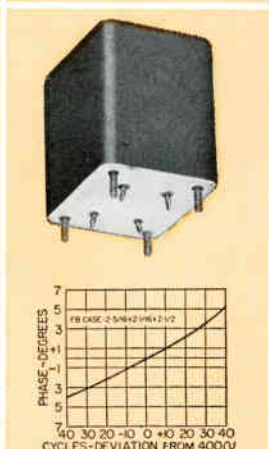

Minimum phase shift 400 cycle band pass filter. Within  $\pm$  1.5 db 370 to 430 cycles, greater than 45 db beyond 1100 cycles. 1K ohms to 100K ohms. MIL-F-18327B; 1 lb.

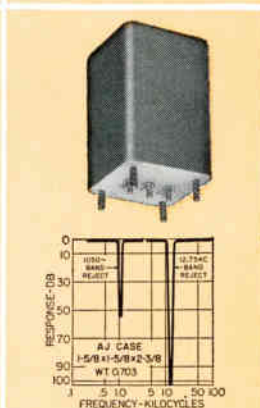

Band reject filters (two shown). The 1050 ~ filter has 50 db attenuation and is only 3 db at 950 and 1150 cycles. The 12.75 KC filter has more than 100 db attenuation and is only 3 db at 10.8 and 15 KC. Source and load 600 ohms, both are MIL-F-18327B.

Write for catalog of over  
1,300 UTC TOP QUALITY  
STOCK ITEMS  
IMMEDIATELY AVAILABLE  
from your local distributor.



**UNITED TRANSFORMER CO.**

DIVISION OF TRW INC. • 150 VARICK STREET, NEW YORK, N. Y. 10013

Circle 900 on reader service card

# HI GO LO



## NEW LOW-COST DECISION MAKER

Cut the time and the cost of repetitive tests in your production line, incoming inspection, quality assurance and laboratory—with the new hp 3434A Comparator! This limit tester enables nontechnical personnel to rapidly pass, reject or sort devices under test. The green GO light says that the test item is within the two preset limits. Red HIGH indicates test value exceeds the higher limit. Yellow LOW tells you the value is below the lower limit. Basic unit costs only \$1575.00 plus plug-in and programmer.

The new all solid state 3434A mainframe accepts any of the 3440A Series plug-ins to provide a wide range of ac and dc voltage, current and resistance measurements with a basic accuracy of  $\pm 0.03\%$  full scale. For production speed, an interchangeable pin board programmer enables you to preset 12 programs including limits, polarity, range and function using decimal notations.

### Interchangeable Pin Board Programmer

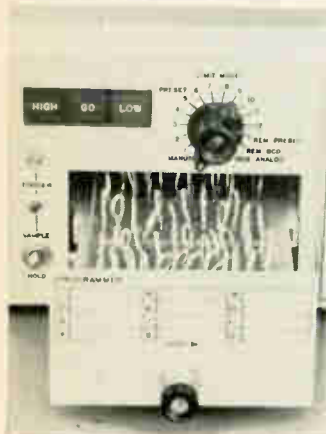

Five modes of limit selection (3-digit with 10% overrange) are possible with the 3434A Comparator. (1) Front panel thumbwheels provide rapid selection of limits for routine testing. (2) Preset programs on the interchangeable pin-board programmer can be selected manually, or

(3) by remote contact closure to ground. (4) BCD (1-2-4-8) inputs can be used when more than 12 programs are needed. (5) An infinite number of limits can be selected remotely by analog voltages ( $\pm 11$  V).

Talk with your hp field engineer about the possibilities of increasing speed and reliability of your routine test operations using the hp 3434A—hp's new LOW COST DECISION MAKER. Write or call Hewlett-Packard, Palo Alto, California, 94304. Telephone (415) 326-7000. Europe: 54 Route des Acacias, Geneva. Price: Basic unit hp Model 3434A, \$1575.00; interchangeable pin board programmer, \$225.00. Accepts all hp 3440A plug-ins listed below (\$40 to \$575).

Plug-in*	3441A	3442A	3443A	3444A	3445A	3446A
AC volts 10 V to 1000 V					•	•
DC volts 10 V to 1000 V	•	•	•	•	•	•
DC volts 100 mV to 1000 V			•	•		
DC amps 100 $\mu$ A to 1000 mA				•		
Ohms 1 k $\Omega$ to 10 M $\Omega$				•		
Manual ranging	•	•	•	•	•	•
Remote ranging		•	•		•	•
Remote function						•
Full scale Volt- age Accuracy	$\pm 0.03\%$	$\pm 0.03\%$	$\pm 0.03\%$	$\pm 0.03\%$	$\pm 0.06\%$ AC $\pm 0.03\%$ DC	$\pm 0.06\%$ AC $\pm 0.03\%$ DC

\* The 3434A Comparator requires a plug-in to operate.  
†  $\pm 0.04\%$  1;  $\pm 0.03\%$  R

097/3

**HEWLETT**  **PACKARD**  
An extra measure of quality



# new disciplines in DC



## take the models that MEMORIZE YOUR VOLTAGE SETTING

0.01% resettability featured in 7 precision-regulated all-silicon supplies

Set the five front panel dials to any desired voltage; output will be within 0.1% of setting. Change to another setting. Later, return to the first setting—output voltage will be within 0.01% + 200  $\mu$ V of original value, in spite of any changes (within rating) of line voltage and load current, ambient temperature changes up to 3°C, and elapsed time up to 8 hours.

All seven highly-stable STB Series instruments have performance at least an order of magnitude better than well-regulated laboratory supplies. Typical specs include: Regulation, Load or Line, 0.001%; Ripple and Noise 40  $\mu$ V RMS; **Controlled Environment Stability**, 0.0005% + 10  $\mu$ V for eight hours (constant load, line, and ambient temperature).

Can be used as a precision general purpose bench supply, as a portable DC reference or calibrator with high output current capability, as an adjustable reference or master supply for systems applications. Model 6110A also serves as an exceptionally stable photomultiplier supply.

All models except 6110A have Remote Programming, Remote Sensing, and four-position Multiple Range Meter Switch which sets full scale voltmeter and ammeter values at either 100% or 10% of nominal output rating.

Short-Circuit-Proof • Continuously Variable Current Limit Control  
No Overshoot on Turn-On, Turn-Off, or AC Power Removal • Floating Output, Ground Either Positive or Negative Terminal • Rack Mounting Hardware Available.

5-DIGIT FRONT PANEL DECADE CONTROL 5¼" H, Half Rack Width		
DC OUTPUT	MODEL	PRICE
0 - 20V, 0 - 1A	6111A	\$375.
0 - 40V, 0 - 500MA	6112A	375.
0 - 100V, 0 - 200MA	6116A	375.
0 - 3000V, 0 - 6MA	6110A	495.

10-TURN FRONT PANEL OUTPUT CONTROL 3½" H, Half Rack Width		
DC OUTPUT	MODEL	PRICE
0 - 20V, 0 - 1A	6101A	\$265.
0 - 40V, 0 - 500MA	6102A	265.
0 - 100V, 0 - 200MA	6106A	265.

HEWLETT  PACKARD  
POWER SUPPLIES

Contact your nearest Hewlett-Packard Sales Office for full specifications.

100 Locust Ave., Berkeley Heights, New Jersey 07922 AREA CODE (201) 464-1234 TWX 710-984-7972

#104c

## News Features

### Probing the News

- 141 FAA lies low as aerial jam worsens  
150 Bird in a gilded cage

### Electronics Review

- 35 **Advanced technology:** Little laser, big future  
36 **Manufacturing:** IC ribbons  
38 **Avionics:** Off course  
40 **Military electronics:** Two good  
40 **Components:** Out front  
42 **Instrumentation:** No moving parts  
44 **Companies:** Reshaping Fairchild  
46 **For the record**

### Electronics Abroad

- 227 **International:** Trial balloon  
227 **Japan:** Time to unwind; Routed by radar  
228 **Italy:** Colorful pair  
229 **France:** Small start; Window display  
230 **West Germany:** Belt tightening  
230 **Great Britain:** I'm all right, Jack  
231 **Around the world**

### Departments

- 4 Readers Comment  
8 People  
14 Meetings  
16 Meeting Preview  
23 Editorial  
25 Electronics Newsletter  
49 Washington Newsletter  
165 New Products  
166 New Products Index  
207 New Books  
210 Technical Abstracts  
218 New Literature  
223 Newsletter from Abroad

## Technical Articles

### I. Design

- Computers** 74 **On the threshold of success: glass semiconductor circuits (cover)**  
A controversial component, it can do the work of two conventional semiconductor components  
James A. Perschy, Applied Physics Laboratory, Johns Hopkins University
- 77 **Instead of circuits, a layer of glass**  
A portfolio of color photos shows the step-by-step manufacture of the controversial glass semiconductor switch
- Circuit design** 85 **Designer's casebook**
- Digital commands control differential amplifier gain
  - Low-cost digital IC performs linear functions
  - Negative impedance converter does double duty
  - MOS FET amplifier provides almost infinite impedance
- Design theory** 91 **Digital filters with IC's boost Q without inductors**  
RC network is more promising than the conventional LC filter  
William R. Harden, Chesapeake Systems Corp.

### II. Application

- Medical electronics** 103 **The widening impact of computers in medicine**  
Once it was just an accounting tool for hospitals, now the computer analyzes tests, monitors patients, and helps in diagnosis  
Evon C. Greanias, IBM
- 108 **Making informed decisions**  
A new system under development will store medical data so it can suggest examinations, diagnoses and treatments to its doctor users  
Frederick J. Moore, IBM
- 111 **A total systems approach**  
The Public Health Service has a system in which transducers are linked to a diagnostic computer by phone lines  
C.A. Caceres, U.S. Public Health Service

# Electronics

Editor-in-Chief: Lewis H. Young

## Associate managing editors

Design: Samuel Weber  
Application: George Sideris  
News: Robert Henkel  
Copy: Sally Powell

## Senior editor

Special projects: Donald Christiansen

## Senior associate editors

John F. Mason, Joseph Mittleman, Stephen E. Scrupski

## Department editors

Advanced technology: Stephen E. Scrupski  
Computers: Wallace B. Riley  
Design theory: Joseph Mittleman  
Industrial electronics: Alfred Rosenblatt  
Instrumentation: Carl Moskowitz  
Military electronics: John F. Mason  
New products: William P. O'Brien, John Drummond, Stephen Fields  
Solid State: Mark B. Leeds  
Staff writers: James Brinton, Kay Sloman, Howard Wolff

## Section editors

Electronics abroad: Arthur Erikson  
Electronics review: Stanley Zarowin  
Probing the news: Eric Aiken

## Regional bureaus

### Domestic

Boston: H. Thomas Maguire, manager; Robin Carlson  
Los Angeles: Lawrence Curran, manager; June Ranill  
San Francisco: Walter Barney, manager; Mary Jo Jadin  
Washington: Robert Skole, manager; William D. Hickman, Paul Dickson, Patricia C. Hoehling

### Foreign

Bonn: John Gosch  
London: Michael Payne  
Tokyo: Charles Cohen

## Copy editors

Albert Tannenbaum, James Chang, Frederick Corey

## Graphic design

Art director: Saul Sussman  
Assistant art directors: Ann Mella, Valerie Betz  
Production editor: Arthur C. Miller

Editorial secretaries: Claire Benell, Lynn Emery, Kay Fontana, Patricia Gardner, Lorraine Longo

## McGraw-Hill News Service

Director: John Wilhelm; Atlanta: Fran Ridgway; Chicago: James Rubenstein;  
Cleveland: Arthur Zimmerman; Dallas: Marvin Reid;  
Detroit: N. Hunter; Houston: Robert E. Lee; Los Angeles: Michael Murphy, Gerald Parkinson  
Pittsburgh: Louis Gomolak  
San Francisco: William F. Arnold  
Seattle: Ray Bloomberg; Washington: Arthur L. Moore, Charles Gardner,  
Herbert W. Cheshire, Seth Payne, Warren Burkett, James Canan, William Small  
McGraw-Hill World News Service  
Bonn: John Johnsrud; Hong Kong: Don Kirk; London: John Shinn;  
Mexico City: Bruce Cross; Milan: Ronald Taggiasco;  
Moscow: Howard Rausch; Paris: Peter Kilborn;  
Rio de Janeiro: Wes Perry; Tokyo: Marvin Petal

Reprints: Susan Nugent

Circulation: Milton Drake

Publisher: Gordon Jones

Electronics: July 24, 1967, Vol. 40, No. 15

Published every other Monday by McGraw-Hill, Inc. Founder: James H. McGraw 1860-1958.

Printed at 99 North Broadway, Albany, N.Y. 12207; second class postage paid at Albany, N.Y.

Executive, editorial, circulation and advertising addresses: McGraw-Hill Building, 330 W. 42nd Street, New York, N.Y. 10036. Telephone (212) 971-3333. Teletype TWX N.Y. 212-640-4646. Cable address: MCGRAWHILL N.Y.

Subscriptions are solicited only from those actively engaged in the field of the publication. Position and company connection must be indicated on orders. Subscription prices: United States and possessions and Canada, \$8.00 one year, \$12.00 two years, \$16.00 three years; all other countries, \$25.00 one year. Single copies: United States and possessions and Canada, \$1.00; all other countries, \$1.75.

Officers of McGraw-Hill Publications: Joseph H. Allen, President; Bayard E. Sawyer, Executive Vice President; Vice Presidents: J. Elton Tuchig, Operations; John R. Caljaham, Editorial; John M. Holden, Marketing; Huber M. Gemmill, Circulation; Angelo R. Venezian, Production; Robert M. Wilhelmy, Controller.

Officers of the Corporation: Donald C. McGraw, Chairman of the Board; Shelton Fisher, President; L. Keith Godrich, Donald C. McGraw, Jr. and Robert E. Slaughter, Executive Vice Presidents; John J. Cooke, Vice President and Secretary; John L. McGraw, Treasurer.

Title © registered in U.S. Patent Office; © Copyright 1967 by McGraw-Hill, Inc. All rights reserved. The contents of this publication may not be reproduced either in whole or in part without the consent of copyright owner.

Subscribers: The publisher, upon written request to our New York office from any subscriber, agrees to refund that part of the subscription price applying to copies not yet mailed. Please send change of address notices or complaints to Fulfillment Manager; subscription orders to Circulation Manager, Electronics at address below. Change of address notices should provide old as well as new address, including postal zip code number. If possible, attach address label from recent issue. Allow one month for change to become effective.

Postmaster: Please send form 3579 to Fulfillment Manager, Electronics, P.O. Box 430, Hightstown, New Jersey 08520

## Readers Comment

### Typical symptoms

To the Editor:

Your account of the difficulties with IC voltage regulators for automobiles [June 26, p. 23] could serve as an object lesson. Somebody didn't know that it gets hot in the engine compartment of an automobile, and that it vibrates.

Was the project engineer on the IC job so benighted that he never gave a thought to the environment that his design had to work in? Or did some engineer ask if he could take a trip to Detroit and visit the Ford Motor Co? Or did some engineer ask if he could stick a thermometer under the hood of a car, or make some vibration measurements? And did the boss reply that the project schedule wouldn't allow that sort of fancy digression? Did he say that funds were low, time was short, and stick to the job?

From your account of this particular little fiasco, somebody involved was, at best, behaving in an uninspired manner. I would assume that the engineer responsible was a dullard if I didn't recognize the typical symptoms of common, mediocre engineering management.

B. M. Steeger

Chief scientist  
Innes Instruments  
Costa Mesa, Calif.

### Patent treaty

To the Editor:

In the Washington Newsletter [June 12, p. 48], you indicate that it will be necessary for this country to change to a "first-to-file" criterion for granting patents, rather than the "first-to-invent" system now employed.

If we are to enter into the recently proposed patent cooperation treaty, that treaty would not provide for an international patent system in the sense of a single patent covering a number of countries. It would provide for an initial examination for patentability by a central authority, such as the International Patent Institute, with the possibility of a limited reexamination under local laws by the

**Now from Sprague!**

QUALITY  
STABILITY  
RELIABILITY  
SMALL SIZE

## All the advantages of tantalum in one **LOW COST** capacitor!

### **EPOXY-DIPPED TANTALEX® CAPACITORS...**

**For industrial, commercial, and entertainment electronic applications where tantalum capacitors were previously too expensive!**

—Type 196D Solid-electrolyte Tantalum Capacitors have special epoxy-dip coating which keeps costs down without sacrifice in dependability. Positively seals capacitor section while providing excellent electrical insulation. Protects against mechanical damage in handling.

—Radial lead design for plug-in mounting on printed wiring boards. The .250" lead spacing will fit standard .125" grids.

—High stability—very little capacitance change, even at outer limits of operating temperature range.

—Low dissipation factor of these capacitors permits higher ripple currents.

—Meet environmental test conditions of Military Specification MIL-C-26655B.

—Prime capacitance and voltage ratings. Based on rating popularity of other types of solid tantalum capacitors.

—Designed for continuous operation at temperatures from  $-55^{\circ}\text{C}$  to  $+85^{\circ}\text{C}$ .

*For complete technical data, write for Engineering Bulletin 3545 to Technical Literature Service, Sprague Electric Company, 35 Marshall Street, North Adams, Massachusetts 01247.*

**Now available for fast delivery from your Sprague Industrial Distributor**

### **SPRAGUE COMPONENTS**

CAPACITORS  
TRANSISTORS  
RESISTORS  
INTEGRATED CIRCUITS  
THIN-FILM MICROCIRCUITS  
45C-4138R1

PULSE TRANSFORMERS  
INTERFERENCE FILTERS  
PULSE-FORMING NETWORKS  
TOROIDAL INDUCTORS  
ELECTRIC WAVE FILTERS

CERAMIC-BASE PRINTED NETWORKS  
PACKAGED COMPONENT ASSEMBLIES  
BOBBIN and TAPE WOUND MAGNETIC CORES  
SILICON RECTIFIER GATE CONTROLS  
FUNCTIONAL DIGITAL CIRCUITS

**SPRAGUE®**  
**THE MARK OF RELIABILITY**

\*Sprague\* and ® are registered trademarks of the Sprague Electric Co.

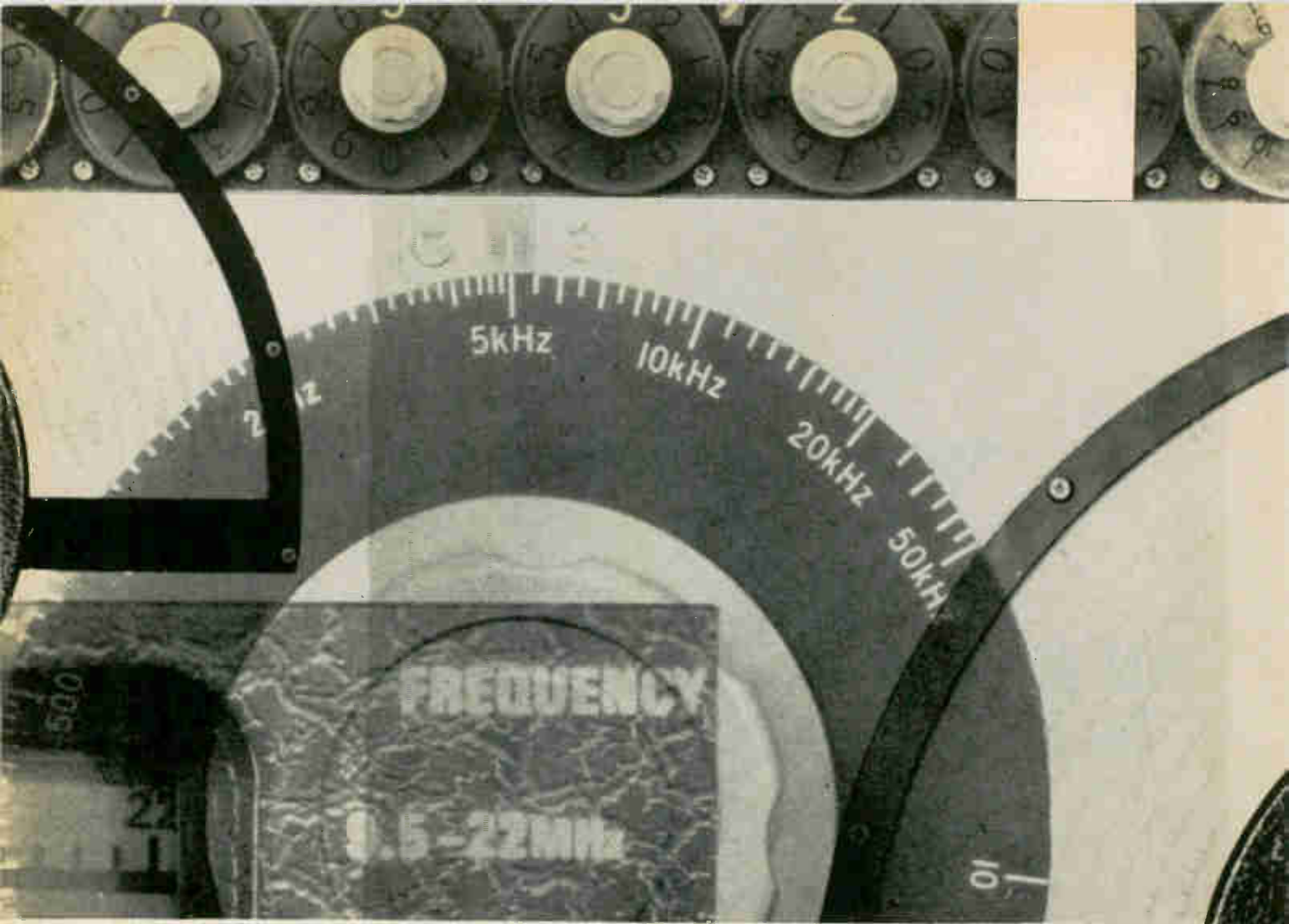

## Dial GR for Sine-Wave Signals

Over 100 different models of GR oscillators, signal generators, and synthesizers are listed in our catalog. These sine-wave signal sources provide a wide choice of frequencies, power outputs, and modulation and sweeping capabilities. For instance:

Included among the oscillators are our four new "sync-able" oscillators, each a small (8 x 6 x 8 in.), self-contained unit with a sync jack for phase-locking to an external signal. These oscillators offer a wide choice of performance: fixed frequencies (to 10 kHz) or continuous tuning (to 2 MHz), up to 1-watt output, as much as 0.001% short-term frequency stability, and distortion as low as 0.05% or less.

If you need a high-resolution signal source with a wide choice of operating features, you can satisfy your need with one of the 80 versions of our frequency synthesizers. Their modular construction makes it possible to order any of the four basic models with from three to seven manual step-decade modules, programmable modules, and with or without a continuously adjustable decade module that provides additional resolution and sweep capability. Upper frequency limits of the four basic models are 100 kHz, 1 MHz,

12 MHz, and 70 MHz with maximum possible resolutions of 0.0001, 0.001, 0.01, and 0.1 Hz, respectively.

The newest addition to our ensemble of sine-wave sources is the 1026 Standard-Signal Generator. This unique instrument puts out  $\frac{1}{2}$  watt into 50  $\Omega$  (10 V behind 50  $\Omega$ , 5 V when modulated), has excellent output leveling, and has true single-dial tuning over its entire 9.5- to 500-MHz frequency range. The ease of operation and outstanding performance of the 1026 in the most critical applications must be experienced to be appreciated. Request a demonstration and see for yourself.

Prices for GR sine-wave signal sources range from \$225 for a "sync-able" audio oscillator with 11 fixed frequencies to \$7515 for a full-complement, 70-MHz frequency synthesizer. For complete information, write General Radio Company, W. Concord, Massachusetts 01781; telephone (617) 369-4400; TWX (710) 347-1051. Sales Engineering Offices are located in major cities throughout the United States and Canada.



Type 1026 Standard-Signal Generator, \$6500 in U.S.A.

**GENERAL RADIO**



various countries which adopt the treaty. Accordingly, the broad principle does not require that this country change to the first-to-file system since our patent examination process could include the present priority-determination system, following the patentability investigation made by such as the International Patent Institute.

It is true that the draft treaty specifically forecloses application of the first-to-invent criterion, but this is merely an initial draft which will be the subject of consideration at an experts conference in October. At that time, or subsequently, the draft treaty could be amended very easily to permit the United States, Canada and the Philippines to adhere to their first-to-invent systems.

As you no doubt know, the American Bar Association is opposed to our switching to the first-to-file system, as well as elimination of the one year grace period, proposed in the so-called Patent Reform Bill because we believe that these drastic changes will adversely affect our patent system. While both changes are specifically contemplated by the draft patent cooperation treaty, neither is necessary to the objectives of that treaty.

Edward F. McKie Jr.  
Section of Patent,  
Trademark and Copyright Law  
American Bar Association  
Chicago, Ill.

### Standards for control

To the Editor:

Although the article, "Wider horizons for numerical control," [June 26, p. 127] provided an excellent summary of the current

status of the subject, as well as its potential for the future, we feel that the omission of mention of existing standards which have contributed significantly to the expansion of this field needs clarification.

The Electronic Industrial Association's Engineering Committee on Numerical Control Equipment and Systems has been active for the last decade and has issued a number of standards which are almost universally used in paper tape numerically controlled machines. These standards were developed with full representation from the three most concerned groups, that is, the manufacturers of numerical controls, the manufacturers of the machines to be controlled, and the users of numerically controlled machines.

These standards are available at nominal cost from EIA, 2001 Eye Street, N.W., Washington, D.C. 20006.

J.A. Caffiaux  
Manager  
Engineering Department  
Electronic Industries Association  
Washington, D.C.

### From far to near

To the Editor:

Shouldn't the report on solid state imaging arrays in Electronics Newsletter [June 26, p. 26] read, "... imaging arrays that operate in the near infrared" instead of "... imaging arrays that operate in the far infrared"?

John J. Voth  
U.S. Forest Service  
Northern Forest Fire Laboratory  
Missoula, Mont.

▪ Yes.

**in Mercury  
or Xenon**

**PEK**

**is the standard of  
reliability in  
High Intensity  
Light Sources**



Across a power range of 35 watts to 30KW in xenon, and 100 to 500 watts in mercury, PEK high intensity arc lamps are

noted for long life, maximum arc stability, dependable glass-to-metal seals. These are the qualities that have made PEK arc lamps the standard of reliability in applications ranging from photography to solar simulation, from microscope illumination to long-range projection.

PEK'S off-the-shelf line of arc lamps is the most comprehensive in the industry. Send for our new Product Reference Guide, or tell us what your special requirements are. There's a PEK lamp to fit your application.

**PEK**

PEK / 825 E. Evelyn Avenue  
Sunnyvale, California  
(408) 245-4111 / TWX 910-339-9214

### SUBSCRIPTION SERVICE

Please include an Electronics Magazine address label to insure prompt service whenever you write us about your subscription.

Mail to: Fulfillment Manager  
Electronics  
P.O. Box 430  
Hightstown, N.J. 08520

To subscribe mail this form with your payment and check  new subscription  renew my present subscription

Subscription rates: in the U.S.: 1 year \$8; two years, \$12; three years, \$16. Subscription rates for foreign countries available on request

### CHANGE OF ADDRESS

ATTACH  
LABEL  
HERE

If you are moving, please let us know five weeks before changing your address. Place magazine address label here, print your new address below.

name

address

city

state

zip code

# Save Space with MTP Tantalum Capacitors



We've proved by extensive testing that you don't need to de-rate our MTP miniature wet slug tantalum capacitors. And we'll jump at the chance to show you how you may save money and often use smaller case sizes by specifying *only the actual voltage* required by your circuitry. Want a copy of our engineering report? Write Mallory Capacitor Company, a division of P. R. Mallory & Co. Inc., Indianapolis, Indiana 46206.

## MALLORY

Circle 8 on reader service card

## People

"We're going to use computers," says **Dr. George H.C. Stobie**, the new research analyst at the Georgetown University Medical Center in Washington, "to make decisions on treatment and pharmaceutical orders much as doctors do. Not that computers are better than doctors and nurses, but they relieve personnel from tedious, routine work."



Dr. George Stobie

Dr. Stobie, who learned about computers through curiosity that led to investigation—"the only way a doctor can learn because medical schools don't offer computer courses"—will get Georgetown's Automated Concentrated Care Center functioning and serve as liaison between the hospital's doctors and administrative staff. He previously worked with computers at the University of Toronto's Hospital for Sick Children.

"At the start," he explains, "we'll have digital data-processing and work up to an analog monitoring system with an analog-to-digital converter." Dr. Stobie also hopes to experiment with automatic analyzers for laboratory work, a flying-spot scanner for taking X-rays, and image intensifiers to resolve minute X-ray details.

[See page 103 for more on how electronics, especially the computer, is helping the physician.]

Hoffman Electronics Corp., which has been in the red for four of the past five years, is beefing up its Military Products division in a move aimed at getting the company back into the black. To direct the division's expansion and diversification, the El Monte, Calif., company has named **Algert G. Grimaila** to the new post of director of engineering.



Algert G. Grimaila

Grimaila is no newcomer to mili-

Flat response from .001 to 500 MHz.

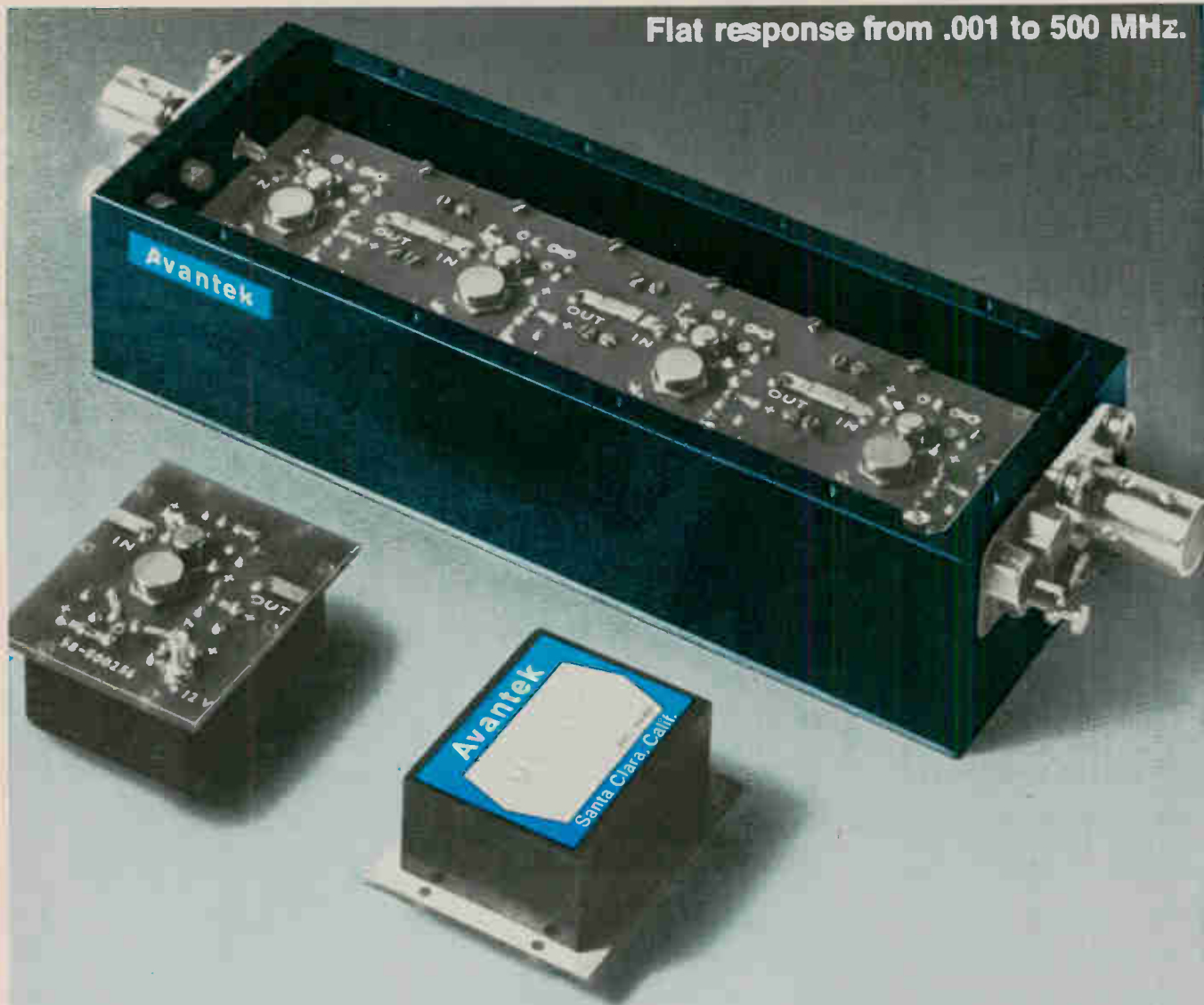

## The Unit Amplifier by Avantek... 5 decades of rf bandwidth in a single module.

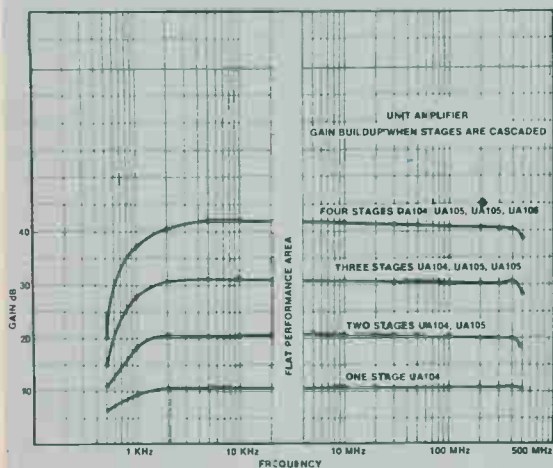

Avantek's **Unit Amplifiers** cover 1 KHz to 500 MHz with 1 db gain flatness, and a VSWR of less than 1.5:1, in the smallest, lightest, widest bandwidth module available. ■ A **Unit** of gain is 10 db. Individually packaged modules can be cascaded to obtain up to 70 db of gain and still preserve the characteristic gain flatness and 50 ohm impedance of each basic **Unit**. For rf, i.f., or video amplification and general broad band usage, **Unit Amplifiers** provide a new measure of flexibility and eliminate costly "in house" design efforts. **Unit Amplifiers** satisfy MIL or commercial environmental specs. Eleven different models are available with deliveries from stock to 30 days. ■ A companion series operating from 10 MHz to 1,000 MHz will also be available. Avantek guarantees all specifications on **Unit Amplifiers**. Write for our 6 page technical bulletin, or call our local representative. ■ The **Unit Amplifier** is a unique addition to our advanced solid-state product line which extends to 2,600 MHz. ■ Avantek, Inc., 2981 Copper Road, Santa Clara, California 95051. Phone: (408) 739-6170. Cable: AVANTEK

# Avantek

Advanced engineering opportunities are now available. Avantek is an equal opportunity employer.

# You Can Get All These Microcircuits from Sprague Electric

## \*SERIES SU300, LU300 UTILOGIC\*



K Package

For use in commercial, industrial, ground support applications. Available in two operating temperature ranges, -20 C to +85 C, and +10 C to +55 C. Propagation delay of 15 to 40 nanoseconds.

\*Trademark of Signetics Corp.

Circle 504 on readers service card

## \*SERIES SE100, NE100, US700 (Signetics CS700) DTL INTEGRATED CIRCUITS

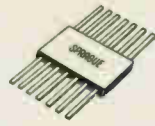

Two operating temperature ranges: -55 C to +125 C and 0 C to +70 C. NAND/NOR gates, clock and line drivers, gate expanders, RS/T and J-K binaries, one-shot multivibrator.

Circle 503 on readers service card

## \*SERIES 400 low-power TTL INTEGRATED CIRCUITS

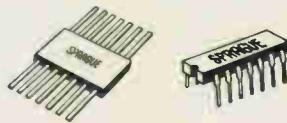

All dual or quad function devices . . . reduces can count and minimizes equipment size. Available in two package styles, three temperature ranges.

Circle 505 on readers service card

## \*SERIES SE500 LINEAR AMPLIFIERS



K Package

Operating temperature range: -55 C to +125 C. Two linear circuits available in 10-lead low silhouette TO-5 case. SE501K is a video amplifier, SE505K is a general purpose differential amplifier.

Circle 506 on readers service card

## \*SERIES SE800, NE800 TTL LOGIC

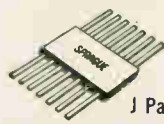

J Package

Designed for high-speed avionics systems. Eight high level circuits including four NAND Gates, Power Gate, Exclusive-OR Gate Input Expander, J-K Flip-Flop.

Circle 507 on readers service card

## D to A CONVERTER CIRCUITS



Expandable to 12 bits with  $< \frac{1}{2}$  bit error

	4-BIT SERIES	5-BIT SERIES
Ladder Network	UT-1000	UT-1001
Ladder Switch	UD-4001	UD-4036
Buffer Amplifier	UD-4024	UD-4037

Circle 508 on readers service card

\*Series SE100, NE100, CS700, SU300, LU300, SE400, NE400, SE500, SE800, NE800 are all available from Sprague Electric under technology interchange with Signetics Corp.

For data on the microcircuits in which you are interested, write Technical Literature Service, Sprague Electric Company, 35 Marshall St., North Adams, Massachusetts 01247

455-7100R1

# SPRAGUE®

THE MARK OF RELIABILITY

\*Sprague\* and ® are registered trademarks of the Sprague Electric Co.

## People

tary electronics. Before joining Hoffman he spent 17 years with Motorola Inc.; his most recent post being assistant general manager and director of engineering at the company's Government Electronics division. He spent most of his time specializing in communications and navigation equipment, radar displays, and space tracking.

Grimaila will coordinate the activities of three new laboratories: navigation, communications, and a third lab, yet unnamed, which will handle radar and special devices.

He described communications as the area offering Hoffman the greatest potential for expansion. "We plan to emphasize the high-frequency and very-high-frequency range in the airborne communications field. We also intend to break into the digital communications field. Tactical digital communications is an area that hasn't received much attention."

Within the past few weeks, Hoffman received its first major government contract in several years, an \$18.5 million incentive order to provide high-frequency communications equipment for Army aircraft. Under the five-year program, Hoffman will develop and produce an AN/ARC-98 single-sideband, high-frequency communications system. Four configurations of the completely solid state equipment will be developed.

The contract increases Hoffman Electronics' military backlog to \$38 million as compared with \$17 million just a year ago.

Gordon K. Teal, 60, a pioneer in the development of germanium and silicon transistors, has returned to Texas Instruments after 2½ years as director of the National Bureau of Standards' Institute of Material Research. His new assignment allows him free rein to size up scientific and technological developments that might affect TI. "We will be trying to take a look at things eight to 10 years off and decide what development work we should be doing now," he says.

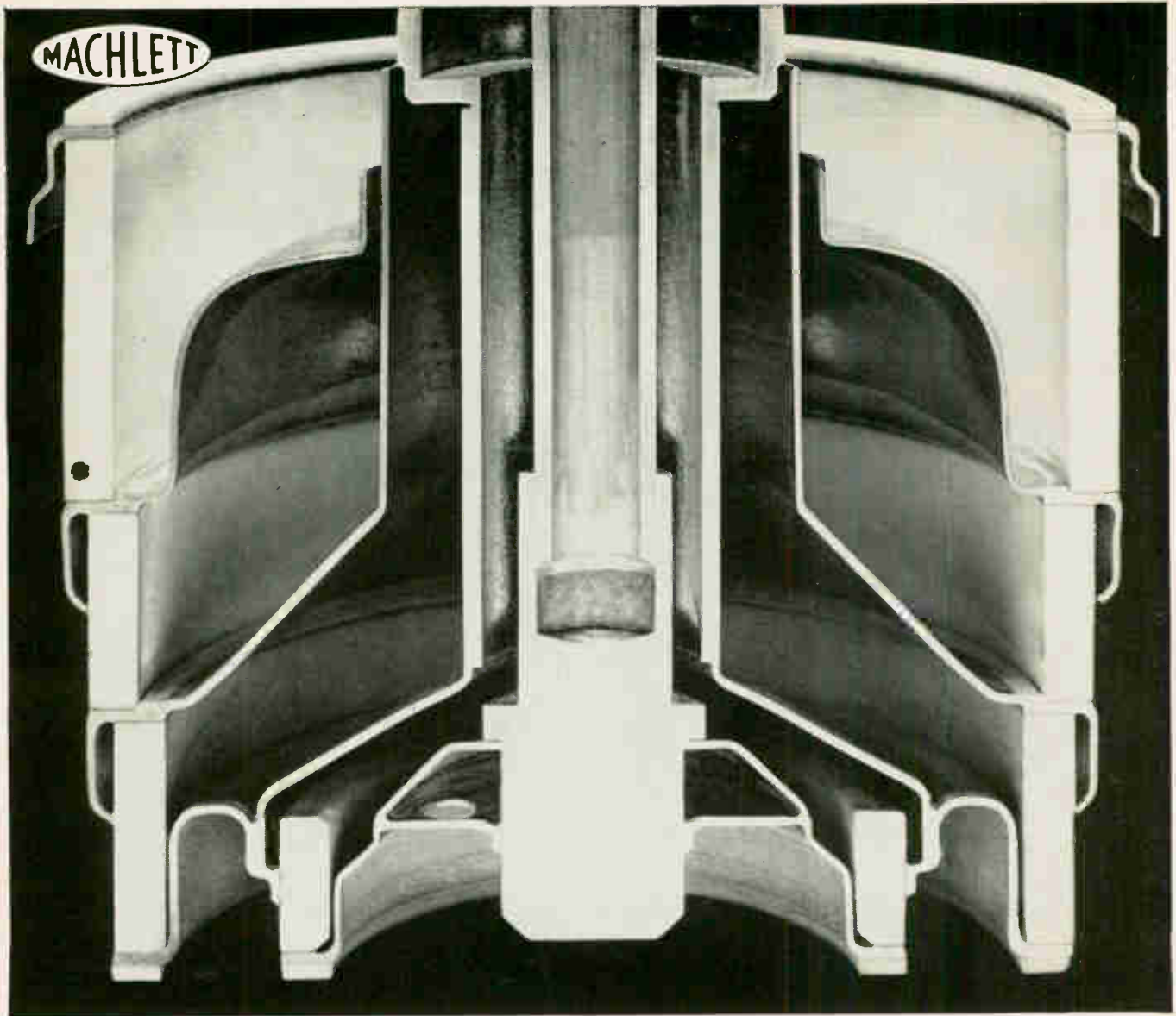

**Continuous cone electrode geometry: designed into all these tetrodes only by Machlett**



ML-8170/  
4CX5000A

ML-8171/  
4CX10000D

ML-8281/  
4CX15000A

The result: uniform internal r.f. energy distribution and high performance stability.  
Write for complete details:  
The Machlett Laboratories, Inc.,  
Springdale (Stamford), Conn. 06879.  
Engineers' resumes invited



**THE MACHLETT LABORATORIES, INC.**

A S U B S I D I A R Y O F R A Y T H E O N C O M P A N Y

# Total monolithic integration of analog subsystems:

## When?

# Now.

Big things are happening in Linear Integrated Circuits. And they're happening where they've always happened — at Fairchild (that's why we supply more LIC's off-the-shelf than all other manufacturers combined). We've got a pile of new data that belongs in your hands. Take a look:

## NEW, IMPROVED PERFORMANCE

We've done new things with old products. The original 702 and 710 circuits have powerful new specifications:

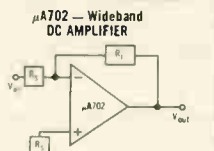
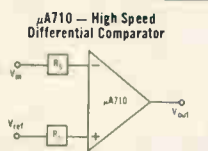
 <p><b>μA702 — Wideband DC Amplifier</b></p>			 <p><b>μA710 — High Speed Differential Comparator</b></p>		
<b>Typical Parameters</b>	<b>New</b>	<b>Former</b>	<b>Typical Parameters</b>	<b>New</b>	<b>Former</b>
V <sub>os</sub>	0.5mV	2.0mV	V <sub>os</sub>	0.6mV	2.0mV
I <sub>os</sub>	180nA	700nA	I <sub>os</sub>	750nA	1.0μA
A <sub>vo</sub>	3,600	2,600	t <sub>on</sub>	40nS	40nS
V <sub>os</sub> /ΔT	2.5μV/°C		A <sub>vo</sub>	1,700	1,500
			V <sub>os</sub> /ΔT	2.5μV/°C	

## NEW PRODUCTS

We've introduced three completely new circuits to allow you even greater design flexibility:

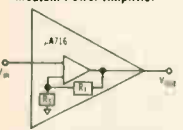
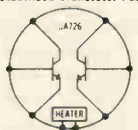
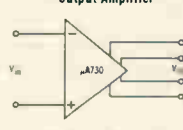
 <p><b>μA716 — Low Distortion Medium Power Amplifier</b></p>	 <p><b>μA726 — Temperature Stabilized Transistor Pair</b></p>	 <p><b>μA730 — Differential Output Amplifier</b></p>			
<b>Typical Characteristics</b>	<b>Typical Characteristics</b>	<b>Typical Characteristics</b>			
A <sub>vc</sub>	10, 20, 100, 200	ΔV <sub>be</sub> /T	0.2μV/°C	A <sub>vo</sub>	145
THD	0.05% @ 150mW	I <sub>b</sub> /T	10pA/°C	V <sub>os</sub>	1mV
I <sub>out</sub>	100mA pk	h <sub>FE</sub>	400 ± 5%	I <sub>os</sub>	0.5μA
V <sub>out</sub>	13V p-p	(-55 to +125°C) (I <sub>C</sub> = 100μA)	30V	V <sub>out</sub>	8 V p-p
		LV <sub>CEO</sub>		R <sub>out</sub>	70Ω

## TOTAL LINEAR CAPABILITY

Fairchild volume production gives you the quantity you need of the circuit you need, when you need it. Choose from the improved 702 and 710; the all-new 716, 726 and 730; or from these field-proven standards:

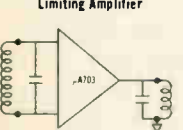
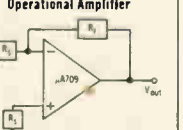
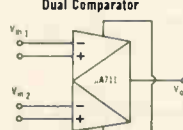
 <p><b>μA703 — RF-IF Limiting Amplifier</b></p>	 <p><b>μA709 — High Gain Operational Amplifier</b></p>	 <p><b>μA711 — High Speed Dual Comparator</b></p>			
<b>Typical Characteristics</b>	<b>Typical Parameters</b>	<b>Typical Parameters</b>			
G <sub>m</sub>	35 mmhos	V <sub>os</sub>	1mV	V <sub>os</sub>	1.0mV
Y <sub>12</sub>	.001 mmhos	I <sub>os</sub>	50nA	I <sub>os</sub>	0.5μA
I <sub>out</sub>	4mA p-p	A <sub>vo</sub>	45,000	t <sub>on</sub>	40nS
R <sub>in</sub>	3KΩ	V <sub>out</sub>	±14V	A <sub>vo</sub>	1,500

## NEW, LOWER PRICES

Fairchild sells more so Fairchild sells for less. Our high volume allows us to again reduce your costs, across the board. For instance, look at these new prices:

702C	\$ 5.50	711C	\$16.00
703E	1.50	716C	5.75
709C	5.95	726C	12.50
710C	4.95	730C	3.85

(all prices are 1000-quantity, industrial grades)

## FREE, NEW APPLICATIONS HANDBOOK

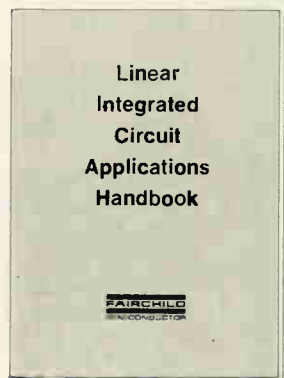

For a limited time, we'll send all inquirers our new 150-page Fairchild Linear Integrated Circuit Applications Handbook (just off the press). It's crammed with new design ideas, new applications, and new information on how to cut costs and improve performance utilizing Total Monolithic Integration (we'll also include complete specification data on the entire Fairchild LIC line). Along with this information, you receive complete rules and entry forms for our Special LIC Contest (see below).

## CONTEST



Win a new Pontiac Firebird for a year

We've even developed a personal incentive for you to update your knowledge of the Fairchild LIC line and the benefits of designing with Total Monolithic Integration. It's an Analog Subsystem Design Contest. If you're a winner, we'll put you behind the wheel of a brand new Pontiac Firebird. Complete contest rules and entry forms are included with your LIC Handbook Data Kit (all you need to do is write us or call your Fairchild Distributor or Sales Office). You can enter as often as you want. But hurry: The contest closes on September 30.

CIRCLE READER SERVICE NUMBER

**FAIRCHILD**  
SEMICONDUCTOR

# RCL

## miniature 1/2" rotary switches



(Actual Size)

### INDUSTRY'S MOST COMPLETE SELECTION

- Shorting AND non-shortng poles may be grouped on one deck in any combination.
- Up to 12 positions per deck with stops.
- As many as 6 poles per deck.
- All individual deck parts are self-contained, and are permanently molded into place.
- Life expectancy 200,000 mechanical operations.

### "Off-the-Shelf" Shipments

Write for complete engineering information

# RCL

General Sales Office  
RCL ELECTRONICS, INC.  
700 South 21st Street  
Irvington, New Jersey 07111

## Meetings

**Medac Symposium and Exhibition,** Association for the Advancement of Medical Instrumentation; Hilton Hotel, San Francisco, July 31-Aug. 4.

**Technical Symposium, Society of Photo-Optical Instrumentation Engineers;** International Hotel, Los Angeles, Aug. 7-11.

**Electromagnetic Measurement and Standards,** National Bureau of Standards; University of Colorado, Boulder, Colo., Aug. 7-18.

**Conference on Energy Conversion Engineering,** American Society of Mechanical Engineers; Miami Beach, Aug. 13-17.

**Guidance, Control, and Flight Dynamics Conference,** American Institute of Aeronautics and Astronautics; Sheraton Motor Inn, Huntsville, Ala., Aug. 14-16.

**Conference on Medical and Biological Engineering,** Royal Swedish Academy of Engineering Sciences; Stockholm, Aug. 14-19.\*

**Cryogenic Exposition,** Cryogenic Society of America; Cabana Motor Hotel, Palo Alto, Calif, Aug. 20-23.

**Cryogenic Engineering Conference,** Cryogenic Engineers; Stanford University, San Francisco, Aug. 21-23.

**International Conference on Phenomena in Ionized Gases,** International Atomic Energy Agency; Vienna, Austria, Aug. 27-Sept. 2.

**Association for Computing Machinery Conference,** Association for Computing Machinery; Sheraton Park Hotel, Washington, Aug. 29-31.

**Cornell Conference on Engineering Applications of Electronic Phenomena,** Cornell University and Office of Naval Research; Cornell University, Ithaca, N.Y., Aug. 29-31.

**Computer Conference,** IEEE; Chicago, Sept. 6-8.\*

**Technical Meeting on Space Simulation,** American Society for Testing and Materials, Sheraton Hotel, Philadelphia, Sept. 11-13.

**Symposium on Computer Control of Natural Resources and Public Utilities,** International Federation of Automatic Control, Haifa, Israel, Sept. 11-14.

**Instrument Society of America Conference and Exhibit,** Instrument Society of

America; International Amphitheater, Chicago, Sept. 11-14.

**International Symposium on Information Theory,** IEEE; Athens, Greece, Sept. 11-15.

**Seminar on Mathematical Systems Theory,** Pennsylvania State University; Pennsylvania State University's Residence Hall, Pa. Sept. 11-15.

**International Congress on Magnetism, International Union of Pure and Applied Physics and American Institute of Physics,** Boston, Sept. 11-16.

**Biennial Electric Heating Technical Conference,** IEEE; Statler Hilton Hotel, Detroit, Sept. 13-14.

**European Machine Tool Exhibition,** European Committee for the Cooperation of the Machine Tool Industries; Hanover, Germany, Sept. 17-26.

**Conference on Electrical Insulation and Dielectric Phenomena,** National Academy of Science; Pocono Manor, Pa., Sept. 18-20.

## Short Courses

**Laser propagation through the atmosphere;** Ohio State University's Department of Electrical Engineering, Columbus, Ohio; July 31-Aug. 11; \$360 fee.

**Research conference on instrumentation science;** Research Division of Instrument Society of America; Hobart and William Smith Colleges, Geneva, N.Y., July 31-Aug. 4; \$115 fee.

**Engineering vibrations;** University of Wisconsin's College of Engineering, Madison, Wis.; Aug. 7-11; \$150 fee.

## Calls for Papers

**Seminar on Components and Devices in System Applications;** Purdue University; Calumet Campus, April 19-May 27, 1968. Sept. 15 is deadline for submission of abstracts to Karl Steiner, seminar chairman, Purdue University, Hammond, Ind. 46323.

**Southwestern Conference & Exhibition,** IEEE; Houston Convention & Exhibit Center, Houston, Texas, April 17-19, 1968. Nov. 1 is deadline for submission of abstracts to J.V. Leeds, M.L. 106—Swieeeco, Rice University, Houston, 77001

\* Meeting previews on page 16.



**Design with  
confidence...**



**with  
Centralab's  
"Little Giant"  
Zeners  
up your sleeve**



- Microminiature • High Rel
- High Wattage • Competitively priced

With Centralab Little Giant 1 watt zeners up your sleeve, regulators will be the least of your problems in circuit design. Though microminiature in size (actual size in above illustration), Centralab's Little Giant replaces larger zeners\*, in entertainment, industrial and high reliability applications. Rugged tests the Little Giant is subjected to and passes include acceleration,

mechanical shock, vibration, lead and body strength, temperature, thermal shock, humidity, salt spray and altitude. If you need a tough zener regulator, drop us a line on your letterhead and we'll send you complete specifications and a sample *free*, which is better than on-the-cuff.

*Centralab's Little Giant is available from the factory and through our Semiconductor Products Distributors. Use the readers service card for location of your nearest distributor and additional technical data.*

\*The Centralab 1 watt zener regulator (HW6.8 through HW91.0) will replace any zener regulator that has a wattage rating of 1 watt or less within zener voltage breakdown of 6.8 to 91.0 volts, including aluminum can units, epoxies or other glass units. Here are the JEDEC types it will replace and outperform:

150mW	400mW	400mW	¼ watt	¼ watt	1 watt	1 watt
1N1313	1N754	1N957	1N710	1N764	1N1767	1N3016
through	through	through	through	through	through	through
1N1326	1N759	1N984	1N737	1N769	1N1794	1N3043

NOTE: Also available in 1.5 watt, in solderable and weldable lead styles.



**CENTRALAB**

Electronics Division  
GLOBE-UNION INC.

5757 NORTH GREEN BAY AVENUE  
MILWAUKEE, WISCONSIN 53201

M-6722

# If you are concerned with nuclear radiation hardness design Physics International has the high energy simulators and experienced personnel for radiation and EMP testing.

Physics International's pulsed power facilities in the 2 MeV to 6 MeV range are available for testing in our plant or may be purchased for your own installation. They produce exceptionally high dose rates of simulated gamma rays, electrons, neutrons. Electromagnetic pulse can also be generated separately or simultaneously. Contact Physics International today for complete information.

## **PHYSICS INTERNATIONAL COMPANY**

2700 Merced Street / San Leandro, California  
Telephone: 415/357-4610 TWX: 910/366-7033

---

## Meeting preview

---

### Hard line

The computer field has been more successful than most in keeping down the number of technical meetings. The American Federation of Information Processing Societies has concentrated its meetings into two major sessions a year—the Joint Computer Conferences.

However, there has been a rising chorus of complaints from engineers, such as logic and component designers, who feel the joint conferences are becoming more and more systems and software oriented. As a result, says William Davidow of Hewlett-Packard Co., the semiannual meetings are being attended by management people rather than working engineers.

Because of this trend, the IEEE Computer Group will sponsor the IEEE Computer Conference; the first meeting will be in Chicago from Sept. 6 to 8. Davidow is chairman of the conference and the meetings committee of the IEEE Computer Group, which will continue to cosponsor the joint conferences.

The Chicago conference will be devoted entirely to hardware-oriented subjects, design automation, new computer elements, reliable automata, pattern recognition, and on-line computer systems.

For example, R.R. Shively of Bell Telephone Laboratories will describe a processor designed to compute discrete Fourier transforms in real time, using the Cooley-Tukey "fast Fourier" algorithm.

Three approaches to the application of large-scale integration will be described by Motorola, Bunker-Ramo, and Intellux.

---

Medical data displays and hospital information systems will be covered this year for the first time at the International Conference on Medical and Biological Engineering in Stockholm, Aug. 14 to 19. Discussed will be multipurpose monitoring systems, programable audio-visual displays, and information-retrieval systems that give physicians only the relevant data on each patient.

# There's a Tektronix Field Engineer in your area

He can help you choose the proper  
oscilloscope for your needs

Because he is thoroughly familiar with the breadth and depth of the Tektronix product line, the Tektronix Field Engineer can quickly help you determine which oscilloscope will suit your measurement needs.

His working knowledge of all the combinations of oscilloscope characteristics results in a practical choice for the job.

He also can discuss the advantages of specialized oscilloscopes for specific applications, such as TV signal monitoring, semiconductor testing or sampling. And, if an oscilloscope is not the answer to a particular application, the field engineer usually can suggest another type of instrument.

Before you select your next oscilloscope, call your nearby Tektronix Field Engineer and take advantage of his experience in the technology of measurement.

***Tektronix, Inc.***

P.O. Box 500  
Beaverton, Oregon  
97005



*Robert M. Johnson of Detroit, Michigan  
(Lathrup Village, Mich.)  
One of the Tektronix Field Engineers  
serving you from 42 U.S. Field Offices  
and in more than 20 countries  
around the world.*





**ALFORD**



**HEWLETT-  
PACKARD**



**nard**

**ALFRED**  
ELECTRONICS

**PRD**  
ELECTRONICS, INC.

**We have connections  
with the leaders**



MAURY  
MICROWAVE



MICROLAB/FXR

EINSCHTEL  
ENGINEERING



When test equipment manufacturers select the Amphenol APC-7 precision connector for their equipment, there have to be good reasons.

There are.

With VSWR's less than 1.028 through X band, 1.037 at 17GHz and with the electrical length defined

within .002", their equipment can now perform coaxial microwave and short rise time pulse measurements with accuracies never achieved before.

When you have to make measurements you believe impossible, write to one of these leading manufacturers.

When you need APC-7 precision connectors for your test equipment, write to **Amphenol RF Division**, 33 E. Franklin St., Danbury, Conn. 06810.



**AMPHENOL**

Specify Amphenol . . . the leading name in cable, connectors, assemblies, RF switches, potentiometers, motors, microelectronics  
Circle 19 on reader service card

# Our first relay also the only one

That's because Bert Mitchell (his specialty is hybrids) found a crying need for a high voltage driver in a TO-5 package if only it were "fail-safe" and would cut out noise on the supply line.

Then, if it took standard DTL or TTL outputs so it could operate 28 VDC lamps or up to 300 mA relays, he felt you'd really have something.

You do. It's the NS-7673. And it

replaces the other.

It's a cermet hybrid IC. Designed so you hook one side to ground instead of to the supply voltage as you did in the past. That eliminates the problems of your relays latching up because of accidental grounding.

You get the "fail-safe" feature, while knocking out the noise problems at the supply voltage. Perfect.

*Inventive Bert Mitchell.  
What's he right in  
the middle of now?*



# lamp driver is of its kind.

You can buy these drivers from our distributors. They have them in quantity. 1-24 \$34.80, 25-99 \$27.85, 100-999 \$23.20. If you don't know who they are, call your local National sales engineer or National Semiconductor Corporation, (203) 744-0060. For the specs, write us at Commerce Park, Danbury, Connecticut 06813.

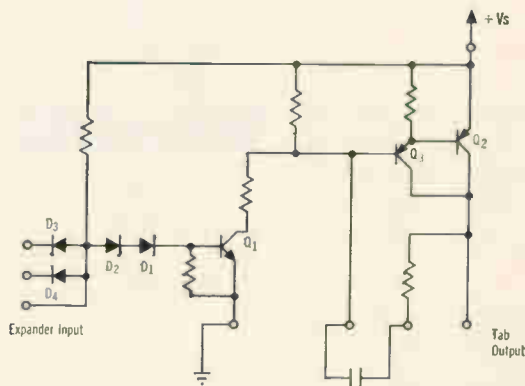

## National Semiconductor



# Inkless recording isn't a "record-breaking" technique.

## It's designed not to be.

The exclusive new inkless writing option for the Hewlett-Packard 10" 7100 series or the 5" 680 series strip-chart recorders won't "break" your records by tearing, smearing or running out of ink when you're not around to notice it.

Instead, it takes the uncertainty out of strip-chart use by offering reliable, long-term recording—without interruption or constant attention—with economical and maintenance-free operation. This new low-

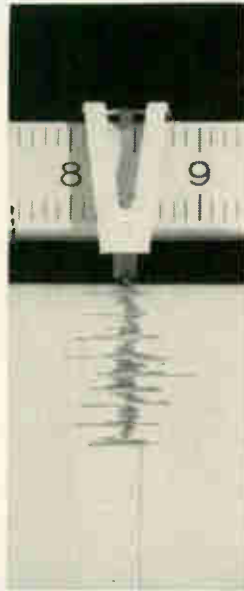

voltage electric writing method gives you sharp and clear printing on unique electro-sensitive paper—and with instant start-up.

Call your local HP field engineer or write Hewlett-Packard, Palo Alto, Calif. 94304. Europe: 54 Route des Acacias, Geneva.

HEWLETT  PACKARD

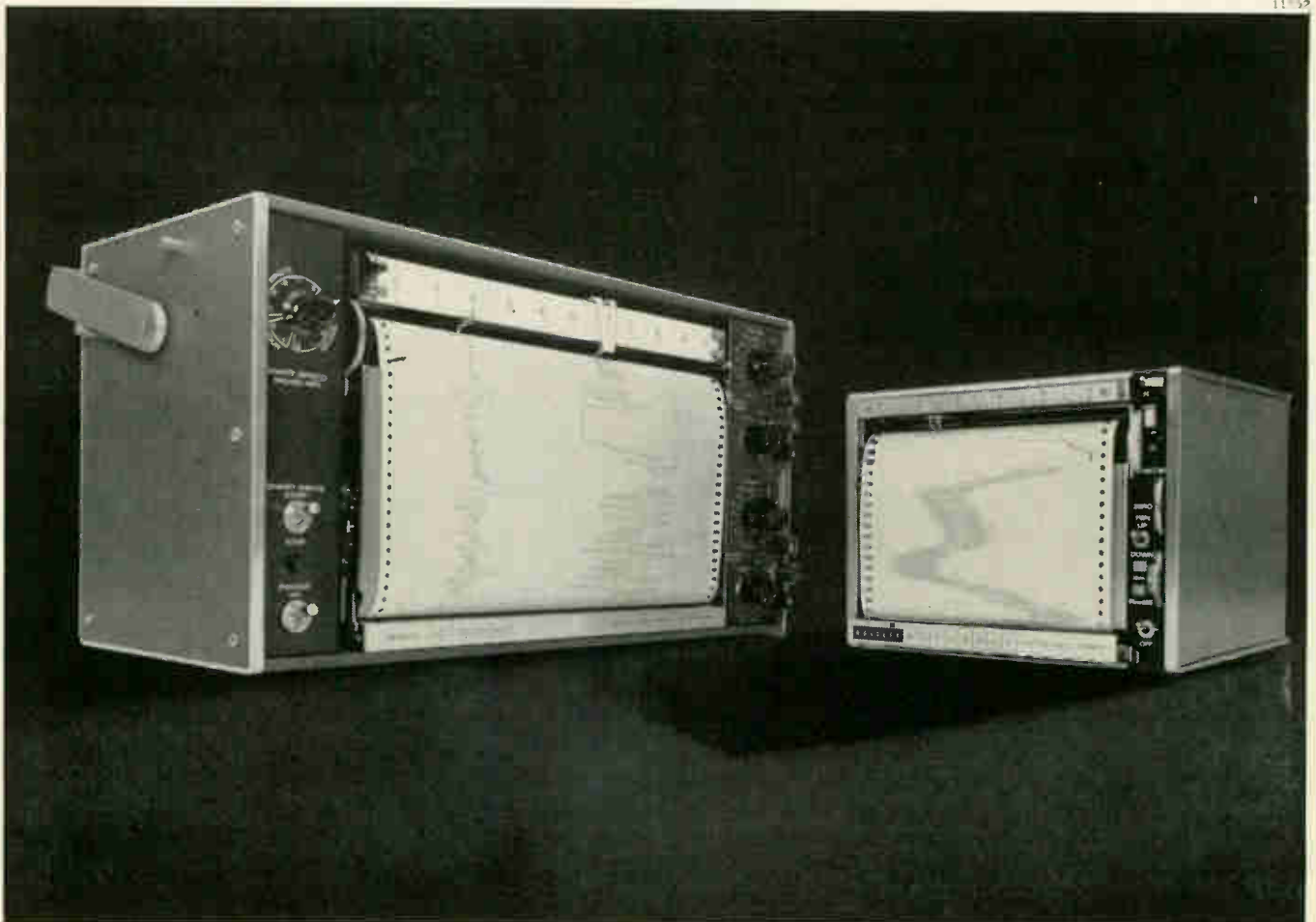



---

**Editorial**

---

## Victims of circumstance

**Phase one** of the investigation of the American Telephone & Telegraph Co. by the Federal Communications Commission ended earlier this month with the conclusions that the telephone utility ought to limit its profit rate to between 7% and 7½% (the company had pressed for a higher rate, 8%), that some long distance charges ought to be reduced, and that intrastate rates might be reduced by another 1%. To the disappointment of many, the probe didn't touch the crucial problem in communications today: technology is outpacing the regulation and management of communications systems.

With what engineers can already do, we could have a network of communication satellites instead of cables and microwave relays, pulse code modulation lines that can carry far more information than today's analog lines, and electronic switching—with its great flexibility—at every telephone center. Yet almost every move the FCC and AT&T take seems to stifle technological progress—even though staff members of the commission and executives of the utility want to speed it.

The reason for this frustrating paradox is that the commission and the utility are forced to operate under rules that were formulated 30 years ago. These rules are as out of date as the Street Singer or Amos and Andy.

For example, the FCC is terribly understaffed. Most of its senior personnel are hard-working; they've exhausted themselves trying to operate a space age agency on the budget of a commission whose structure was created in the days of crystal radio receivers. Just this year, piqued by the investigation of AT&T, some members of Congress forced a cut in the FCC's already too small budget. The FCC is in danger of wearing out the way the old Civil Aeronautics Administration did [see p. 149].

AT&T has a superb research and development operation at the Bell Telephone Laboratories. From it have come such important technical contributions as the roots of modern information theory, the transistor, the fundamentals of automatic control theory, and the design of electronic switching and pcm equipment.

Yet these technical accomplishments flow into the telephone system with the speed and directness of a glacier. Transistors, which celebrate their 20th birthday next year, are just being incorporated into commercial telephone equipment. Pcm lines are going in, but not as fast

as the users of data transmission would like. The number of electronic switching installations is growing at such a snail's pace that the job of retrofitting electromechanical centers will not be completed by the year 2000.

Still, AT&T is not completely to blame for this lethargy. Its investment in equipment runs to nearly \$33 billion, and the company can't throw it all out overnight. According to FCC rules, this equipment has to be amortized over a finite number of years. So the equipment has to last at least the same time for financial reasons.

But even if, by some magic, AT&T's management was able to afford a sudden change, one wouldn't be forthcoming because the equipment is not available. AT&T insists that its subsidiary, Western Electric Co., manufacture all its equipment. So installation of electronic switching centers must wait until Western Electric can build them, and the process has been painfully slow. One reason is that manufacturing people at Western Electric, used to working primarily with electromechanical parts, have found the switch to making electronic components and assemblies more troublesome than they expected.

Solving the critical communications problem will take some radical new approaches.

The problems are so gargantuan that a new organization is required, possibly a new Federal Department of Communications—not unlike the Department of Transportation established earlier this year. Certainly it is unfair to expect the FCC, with a total budget of only \$17.8 million, to do battle with problems like these: who is to run a domestic network of communications satellites? Should data transmission from computers be regulated by the Federal Government? Is the communication network keeping pace with new technology? What about direct telecasts by satellite? How can the limited frequencies be used for better efficiency?

Answers to such problems are likely to cause major dislocations in the economy and the electronics industry. One solution might involve the end of the near-monopoly AT&T has over telephone communications. Another might force a separation of AT&T and Western Electric. Or, the Government might require AT&T to buy its capital equipment at low bid from any supplier, with Western Electric competing with all other electronics companies. Or, the Government might give the utility some sort of equipment depletion allowance—much like the tax benefit oil companies are granted—to speed the installation of new equipment and new technology.

Clearly such answers require careful—and expensive—study and engineering.

For lack of manpower and facilities, the FCC has had to postpone making decisions on some of these critical questions. But postponements don't solve anything. Constructive steps ought to be taken now.

Engineers who have learned to live with the flutter problem in hysteresis synchronous motors will find that living comes easier now. Especially in voice/data recording applications.

Indiana General's unique inverted stator design provides up to six times the rotor inertia of conventional designs. Flutter characteristics are so low as to be practically negligible.

And the price is not so high that it

restricts the use of our inverted stator motor solely to recording devices. It is so economical to manufacture that it's priced competitively with induction type motors, making the Indiana General hysteresis motor economically practical for units like fans and blowers. And, the inverted stator design significantly reduces start-up input power-surge and combines very high operating efficiency with low slip characteristics.

Indiana General inverted stator motors are smaller and lighter than conventional synchronous motors and are available in a wide range of sizes, mountings, power ratings and torques. You can get full details by writing Mr. R. D. Wright, Manager of Sales, Indiana General Corporation, Electro-Mechanical Division, Oglesby, Illinois.

**INDIANA GENERAL** 

## **New inverted hysteresis motor design drives the flutter out of recording equipment.**



---

# Electronics Newsletter

---

July 24, 1967

## Computer fiasco makes one-stepping Air Force step back

With the embarrassed Air Force deciding, under pressure, to reopen negotiations on its controversial selection of IBM to supply \$115 million of housekeeping computers, **one big question remains unanswered: can the situation arise again?** An answer might have come from the threatened probe by Sen. McClellan's Investigations subcommittee, but that was called off when the Air Force backed down.

The unsuccessful bidders—Burroughs, Honeywell, and RCA—were publicly unruffled and privately gleeful after their complaints that IBM was the highest bidder brought about the reopening.

At stake, so far as the Air Force is concerned, is more than one of the biggest computer contracts in history. In going to IBM, **the Air Force had junked the usual two-step system of negotiating on technical aspects and then cost factors.** Instead, it negotiated the technical criteria and then asked for bids from companies meeting them. Officials of the service claim that two-step negotiations lead to "auctioning" and that only IBM really met the technical requirements.

**But one-step negotiating might not be entirely dead.** The House Military Operations subcommittee plans to look at how much negotiation is reasonable in one-step procurement. Meanwhile, the Air Force apparently will have to play it by ear.

## Even chance seen for h-f transistor parameter shift . . .

Manufacturers of high-frequency transistors figure their demands for revised semiconductor characterization parameters have a 50-50 chance of acceptance at the Aug. 3 and 4 meeting in Las Vegas of the Joint Semiconductor Device Committee on Industrial Signal Transistors (JS-9). But they are confident of eventual success.

Dissatisfaction with existing Electronics Industries Association parameters has been simmering for a long time [Electronics, April 17, p. 25]. What it boils down to is that designers are stymied by the scanty performance data that can be shoehorned into the traditional Y parameters, which are oriented to the end market (consumer, industrial, etc.) and are also used for low- and medium-frequency devices. Texas Instruments, KMC Semiconductor, and Raytheon are leading the fight for a switch to S parameters, which are geared to typical operating conditions, are easier to use and measure, and are compatible with Smith charts, the predominant high-frequency/microwave design aid. Both Motorola and Fairchild agree.

**However, there's no clear agreement on the minimum frequency value at which S is more advantageous.**

## . . . but less likely is new JS panel

Less likely to survive is a more radical change sought by the firms backing parameter revision: a new JS committee for high-frequency semiconductors, an idea that Motorola advanced unsuccessfully several years ago. One of three semiconductor committees is usually responsible for characterizing high-frequency transistors. Besides the panel overseeing industrial signal transistors (JS-9), there are ones for power transistors (JS-6) and entertainment signal transistors (JS-8). But all three are concerned primarily with power level or market, while the five makers, plus TRW Semiconductors, want frequency to be the major and only consideration.

---

# Electronics Newsletter

---

## TI will offer linear-IC tester

The instrumentation gap in linear integrated circuits is closing. Spurred by burgeoning sales of linear IC's [Electronics, July 10, p. 125], Texas Instruments' Apparatus division has developed a modular plug-in unit for dynamically testing the devices.

The module, which will be displayed at Wescon next month, mates directly with TI's model 553 IC tester. The 553 applies linear IC test waveforms between 10 hertz and 100 kilohertz, measures bandwidths to 50 megahertz, and provided true rms readout.

Linear IC testing heretofore has largely been done by modified digital IC test equipment, and has usually been restricted to d-c modes, giving users an incomplete picture of the chips' capabilities.

## Xerox gear to get integrated circuits

Xerox's new line of copying and printing equipment, to be marketed this fall, will be equipped with monolithic integrated circuits—the company's first major move to use IC's. According to a company spokesman, Xerox will also retrofit a number of current models with IC's.

Also this fall, the company will introduce a machine that can turn out one copy per second; the fastest copier Xerox now makes is the 2400, which prints 40 copies per minute.

## Philco, Motorola win advanced space-link pact

Ground hardware for the Air Force's 20-million-bit-per-second Advanced Space Ground Link Subsystem (ASGLS) will be built by Philco-Ford's WDL division and Motorola's Government Electronics division. Motorola was teamed with Philco-Ford, the only bidders that responded when the then Air Force Space Systems Division requested proposals [Electronics, April 13, p. 65]. The subsystem will use wideband, high-speed pulse-code-modulation equipment to combine telemetry, tracking, and command in one S-band channel for such applications as the MOL.

## Cryoelectric LSI: five years away

Cryoelectric large-scale integration (LSI) continues to be put forward as a candidate for associative computer memories, but cryotron processors are probably still five years away. J. Paul Pritchard, a researcher at Texas Instruments, cites two main obstacles to superconductor LSI associative memories—the inability of designers to see much beyond metal oxide semiconductor and bipolar arrays, and the cost of cooling gear.

TI, partially funded by the Air Force, has developed cryotron arrays with 20,000 equivalent gates of mixed logic and memory. Each 2-by-2 $\frac{1}{4}$ -inch array contains circuitry for 40 words of 50 associative bits each in a six-layer structure of glass, lead, tin, and insulation. Device density is 7,000 gates per square inch. The TI cryotron associative processor has done search-and-write operations in 2 microseconds, and has the same capability for search and read. Pritchard says the device has the same number of switching elements as one made by RCA, but notes that the RCA device doesn't have logic in memory, and has random access rather than an associative capability [Electronics, April 17, p. 111].

## Addendum

An electronically controlled probe for measuring the attitude of a plane to prevent a stall will go into Grumman's corporate jet aircraft, the Gulfstream II. Conventional probes align themselves with the wind, like a weather vane. The probe, which is part of an angle-of-attack system that includes a stall warning computer, was built by United Control.

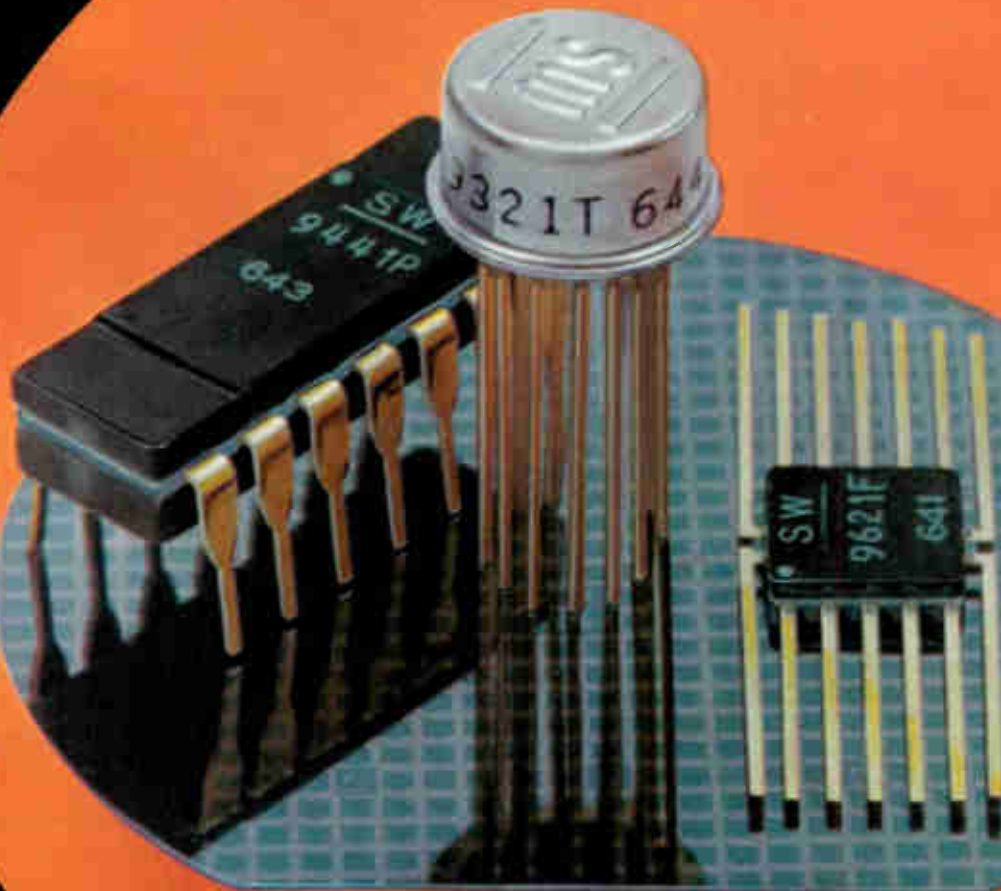

## The die is cast!

**We're committed to the manufacture of the industry's finest line of 930 DTL integrated circuits.**

Our customers know they could buy these monolithic integrated circuits elsewhere, but here's why they don't.

No one else has a better or more modern facility devoted exclusively to the manufacture of microcircuits.

No one else has demonstrated better yields.

No one else has provided better delivery.

No one else offers better prices on the same quality products.

And no one else has a more substantial name behind them than the "Stewart-Warner" name—for more than eighty-five years a leader in the manufacture of quality products.

Our customers are pleased with the superior quality of our products. If you

try them, we know you will be pleased, too.

Why not talk to one of our representatives? And, meanwhile, let us send you our 20-page "Composite Data Book" with the industry's most complete coverage of 930 series Flat Packs, Dual In-lines, and TO-5's.

**STEWART  WARNER**  
**MICROCIRCUITS, INC.**  
SUBSIDIARY OF STEWART WARNER CORPORATION

# Want a little more experience before you start a business of your own?

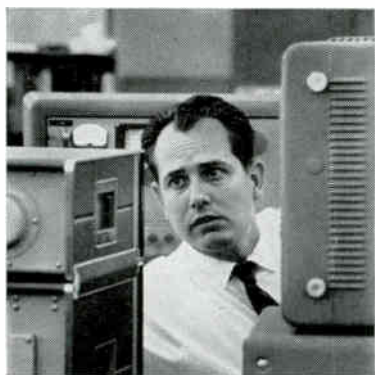

Hewlett-Packard may be the perfect proving grounds for you. One word of warning: You may never want to leave!

As an R&D engineer at Hewlett-Packard you'll be encouraged not only to develop ideas for marketable products, but given every opportunity to follow your concepts through research and development, pilot runs, manufacturing and finally even into marketing. You will be totally involved in every area of a business enterprise, gaining experience both as engineer and entrepreneur.

This year Hewlett-Packard will invest 19 million dollars in research and development. Our success is based on the concept that every instrument must be a contribution to the art of measurement, produced efficiently and delivered at a competitive price. Your work and training here will closely parallel this principle.

If your ideas are the kind successful businesses are founded on, we'd like to have you on our staff. If you decide to stay, you'll have unlimited opportunity to grow in any direction you choose. If you do go into business for yourself, you couldn't have a better background.

Write Ray Wilbur, Vice President, 1501 Page Mill Road, Palo Alto, California 94304. An equal opportunity employer.

HEWLETT  PACKARD

# EMI FILTER *BREAKTHROUGH*



ACTUAL  
SIZE

## ERIE *115 volt ac* LINE FILTERS

**SMALLER and LIGHTER THAN ANY OTHER  
LINE FILTER AVAILABLE!**

- **DESIGNED FOR OPERATION IN . . .**  
400 Hz lines @ 85°C  
60 Hz lines @ 125°C
- **INSERTION LOSS GUARANTEED FROM . . .**  
-55°C to +125°C @ rated current
- **TYPICAL INSERTION LOSS . . .**  
30 db @ 150 kHz  
80 db @ 1 MHz and up



These hermetically sealed ERIE EMI Power Line Filters represent a substantial reduction in size and weight without sacrifice in performance through the use of a sophisticated state of the art dielectric. Most measure less than 1 inch long and weigh less than 10 grams, making these tiny Filters perfect for power supply applications where reliability, size, and weight are design considerations.

The broad line of ERIE EMI Filters economically provides optimum performance for virtually any environment. For detailed specs see your local ERIE applications engineer or write for Catalog 9000.

ERIE

TECHNOLOGICAL

PRODUCTS, INC.



Erie, Pennsylvania

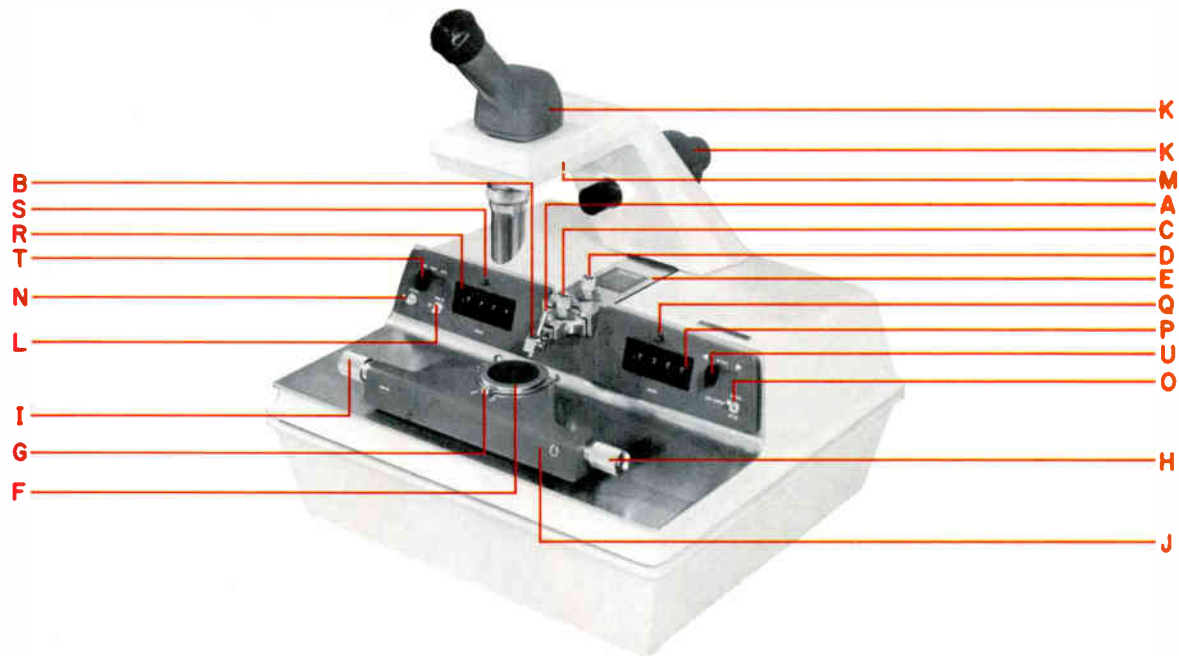

## NEW TEMPRESS AUTOMATIC SCRIBING MACHINE

### Scribe Any Rectangular or Triangular Pattern from 0 to .399 Inch

#### Operation:

1. Place semiconductor wafer on vacuum stage.
2. Make rotary and linear alignment of wafer with preset microscope reticle.
3. Dial desired index spacings in thousandths of an inch on two separate control channels.
4. Actuate first scribing cycle. (Indexing at first channel setting.)
5. Rotate vacuum stage 90° and recheck alignment. (Automatically switches channels.)
6. Actuate final scribing cycle. (Indexing at second channel setting.)

#### Salient Features:

- A. Diamond Scribing Tool.
- B. Scribing Tool Holder . . . holds 1/8" diameter diamond scribing tools rigidly, at various scribing angles; provides accurate orientation of tool shank reference flats.
- C. Pressure Adjusting Micrometer . . . provides scribing tool pressure adjustment from 10 to 100 grams; reads directly in grams with accuracy within ±1 gram at tool point.
- D. Depth Adjusting Micrometer . . . provides scribing tool depth adjustment of .100"; reads directly in thousandths of an inch with accuracy within ±.0005" at tool point.
- E. Scribing Ram . . . precision ball slide assembly with hardened ways is cam driven at 30 strokes per minute.
- F. Vacuum Stage . . . is retained in index carriage by vacuum. When vacuum is off, stage can be rotated for coarse alignment or can be instantly removed.
- G. Vacuum Stage Rotary Index Flange . . . allows extremely accurate 90 or 120 degree rotary indexing of vacuum stage, with positive no-play detent mechanism. (See Index Selector Switches and Indicator Lights.)
- H. Vacuum Stage Rotary Adjustment Knob . . . provides fine rotary adjustment of vacuum stage for rapid alignment of work.

- I. Vacuum Stage Linear Adjustment Knob . . . provides fine linear adjustment of vacuum stage for rapid alignment of work.
- J. Vacuum Stage Indexing Carriage . . . precision ball slide assembly with hardened ways is precisely controlled; provides guaranteed indexing accuracy within .0001" of selector setting continuously across range of vacuum stage.
- K. Optical Viewing and Illumination System . . . monocular erect image microscope provides 28x with vertical illumination and alignment reticle.
- L. Master Switch . . . energizes entire electrical system.
- M. Microscope Linear Adjustment Knob . . . provides fine linear slide adjustment of microscope, for alignment of reticle with scribing tool path.
- N. Vacuum Switch . . . controls vacuum to vacuum stage, from source which attaches at back of machine.
- O. Scribing Ram Control Switch . . . allows operation of scribing ram independent of index system; will stop and hold ram over vacuum stage for tool set-up.
- P. Right Side Index Selector Switch . . . allows selection of vacuum stage index increment from .000" to .1995" to nearest .0005" or from .000" to .399" to nearest .001" with digital readout directly in inches.
- Q. Right Side Index Selector Switch Indicator Light . . . lights when vacuum stage rotary index lever is in right hand position and right side index selector switch is active.
- R. Left Side Index Selector Switch . . . allows selection of vacuum stage index increment from .000" to .1995" to nearest .0005" or from .000" to .399" to nearest .001" with digital readout directly in inches.
- S. Left Side Index Selector Switch Indicator Light . . . lights when vacuum stage rotary index lever is in left hand position and left side index selector switch is active.
- T. Function Selector Switch . . . allows selection of three operational modes: traverse, single index without scribing, automatic index with scribing in sequence.
- U. Function Actuation Switch . . . actuates system operational modes to left or right, as selected.

**How to Order:** Price as described, with simple, low magnification monocular optical system, \$2875.00 F.O.B. Sunnyvale, California.

Model No.	Index Increments	Max Wafer Size
1713-5B	.001"—.399"	1½"
1713-10B	.0005"—.1995"	1½"
1713-102B	.0005"—.1995"	1¾"
1713-MB	.01mm—3.99mm	38.1mm

#### Physical Specifications:

Weight Packaged . . . . . 58 pounds  
 Dimensions . . . . . 14¾" W x 14" D x 8" H not including optical column. Machine height including optical column is 17¾".

#### Electrical Requirements:

115 volts, 60 cycles, 1 amp, single phase, 3 wire NEMA "U" ground power cord.



**TEMPRESS**  
 Tempress Research Co., 566 San Xavier Ave., Sunnyvale, California





## Proven... better, faster, more economical scribing

THE TEMPRESS AUTOMATIC SCRIBING MACHINE HAS FULFILLED THE PROMISE MADE WHEN INTRODUCED . . . NEW EFFICIENCY FOR SEMICONDUCTOR MANUFACTURE. To restate the advantages: one microscope . . . one group of positioned sequence controls . . . one streamlined package, as small as an office typewriter. A look inside discloses all electronic circuitry on easy-access circuit boards and life-lubricated mechanical components. The price has made it practical for an entire industry to adopt it as the standard scribing device. New refine-

ments include high reliability electronic components, high contrast illumination system, provision for triangular scribing, and a new system for clamping and adjusting scribing tools. The Automatic Scribing Machine is a product of the Tempress Standard of Excellence . . . a proud member of the growing family of Tempress miniature assembly tools and production machines.



**TEMPRESS**  
Tempress Research Co., 566 San Xavier Ave., Sunnyvale, California

Circle 31 on reader service card

# You didn't have to make it so soft on our account.



Our Kemet solid tantalum capacitors were among the least delicate components to soft-land on the moon. And, though the lunar night is  $-254^{\circ}\text{F}$ ... we survived.

Kemet capacitors have such sturdy reliability you can trust them on any project. They're also the only solid tantalums available graded as to failure rates.

This is why Kemet capacitors blast off with just about every American rocket — and why they're key components in so many earthbound products.

But capacitors are only one of the activities that keep Union Carbide up front, on the frontiers of electronics. Among other things, we're also leaders in research, development and production of single crystals and crystal products; laser systems; solid state devices; fuel cells.

They're reasons to keep Union Carbide in mind before your projects reach the breadboard stage.

**UNION CARBIDE** Electronics  
Union Carbide Corporation, Electronics Division,  
270 Park Avenue,  
New York 10017.

*An Equal Opportunity Employer*

# The hope of doing each other some good prompts these advertisements

## For the infrared file

Do you know Jack Stolp? You probably do if you have ever had to look seriously into the matter of a suitable, insoluble material for transmitting or refracting infrared radiation, particularly if you had thought you'd be better off without cold flow or cleavage planes. If you anticipate a concern with the subject, please clip or photocopy the following table and put it where you can find it so that when you do get in touch with Jack, you two can get down to cases right away without floundering around:

KODAK Infrared Optical Material						
	IRTRAN 1 Polycrystalline Magnesium Fluoride	IRTRAN 2 Polycrystalline Zinc Sulfide	IRTRAN 3 Polycrystalline Calcium Fluoride	IRTRAN 4 Polycrystalline Zinc Selenide	IRTRAN 5 Polycrystalline Magnesium Oxide	IRTRAN 6 Polycrystalline Cadmium Telluride
Transmittance > 50% at 2 mm thickness	1-8 $\mu$	1-13.5 $\mu$	0.4-10 $\mu$	1-19 $\mu$	0.7-7.5 $\mu$	2-28 $\mu$
Refractive index at 25 C	1.378 at 1 $\mu$ to 1.263 at 8 $\mu$	2.291 at 1 $\mu$ to 2.151 at 13 $\mu$	1.432 at 0.6 $\mu$ to 1.300 at 10 $\mu$	2.485 at 1.0 $\mu$ to 2.310 at 20 $\mu$	1.746 at 0.5 $\mu$ to 1.482 at 8 $\mu$	2.734 at 1.5 $\mu$ to 2.672 at 10.0 $\mu$
Hardness	575 Knoop	354 Knoop	200 Knoop	150 Knoop	640* Knoop	451 Knoop
Water solubility	Insoluble	Insoluble	Practically insoluble	Insoluble	Insoluble	Insoluble
Maximum diameter (circular flats)	8 inches	8 inches	6 inches	7 inches	6 inches	3 inches
Maximum thickness (circular flats)	1 inch	1 inch	½ inch	½ inch	¼ inch	⅙ inch
Dome or lens capability (diameter)	9-inch hemispherical dome	9-inch hemispherical dome	Maximum-size lens or dome that can be made from maximum-size flat disk.			
Relative prices	Low	Low	Moderate	Moderate	Moderate	High
IRTRAN 2 Lenses of 1, 2, and 3-inch focal length are stocked. *About as hard as a steel file †About as hard as hard coal						
Details from W. J. Stolp, Eastman Kodak Company, Apparatus and Optical Division, Rochester, N. Y. 14650, phone 716-325-2000, ext. 5166						

## This year's Q-switch

Hans Heynau phoned from United Aircraft Research Laboratories in East Hartford, Conn. for permission to mention the new EASTMAN 9860 Q-Switch Solution in a paper to the Institute of Electrical and Electronics Engineers. We said Kodak would feel honored, whereupon there went into the scientific record the fact that a certain experimental United Aircraft photodetector could develop 100 volts of output in 90 picoseconds, which amounts to a pretty good rate of rise.

The impulse was delivered to the detector by a mode-locked pulse from a neodymium glass laser. Our friend A. J. DeMaria of United Aircraft, who was first to report mode-locking with an earlier Q-switch solution called EASTMAN 9740, is convinced EASTMAN 9860 does a better job. When working with the earlier solution he calculated pulse widths down to  $2 \times 10^{-13}$  sec. Others elsewhere tried some measurements and were unable to report any pulses shorter than  $4 \times 10^{-12}$  sec. Investigations are in progress toward narrowing the gap with EASTMAN 9860.

For the benefit of those who have been too busy with their own affairs to read up on mode-locking but aren't too busy to be curious: Somewhat as 30,000 parallel scratches on a grating make for angular sharpness in the diffraction of light, so the 30,000 axial modes (or discrete resonant frequencies permitted by the broadening effect of the glass on the Nd<sup>3+</sup> transitions) come into phase at sharp points in time. To fight counter-effects, the dye should be as transparent as possible for high intensity and as opaque as possible for low. With EASTMAN 9860 there is more latitude in matching dye concentration to the other variables. DeMaria sees two reasons for this: 1) slightly better placement of the absorption spectrum in relation to the Nd<sup>3+</sup> glass emission spectrum; 2) better transparency to this radiation of the 1,2-dichloroethane solvent in EASTMAN 9860 during the brief period that transparency is wanted, before radiation completes a round trip between the

mirrors. For the latter reason, probably, DeMaria's trains of pulses are five times as long as with 9740—a whole microsecond.

For the benefit of those who care to go so far as to try EASTMAN 9860 Q-Switch Solution: Place order at \$100 with Distillation Products Industries, Rochester, N. Y. 14603 (Division of Eastman Kodak Company). You will receive 100 ml of solution with a (pre-lase) absorption coefficient at 1.06 $\mu$  between 25 and 30 marked on the bottle, and five 100-ml bottles of solvent with which to cut it back. Working life is longer than with 9740, and the dye stays in solution. Those who work with ruby lasers should order EASTMAN 10220 (\$50), a solution at  $\alpha_{6943A} = 25$  to 30 of Cryptocyanine in Acetonitrile, with which we furnish five 100-ml bottles of that solvent. In the usual solvent for cryptocyanine, methanol, we find that  $\alpha$  drops in the dark at 4% per month, as compared with 0.7% for EASTMAN 10220.

Prices subject to change without notice.

## A service for the bubble-chamber trade

For high-energy physics, Eastman Kodak Company, Instrumentation Products, Rochester, N. Y. 14650, is busy working out details with the designers and operators of bubble chambers.

Bubblechambers consume film by the ton. Millions of pictures of tracks of bubbles are screened at public expense by large numbers of ladies to find which ones are worth submitting to further scrutiny by computers in hopes that a few of the pictures will shake out as possible evidence for or against hypotheses tentatively put forth by a few theoreticians and tentatively questioned by a few others. The cost of the film and the wages of the ladies represent, of course, only a small fraction of the bill that the physicists have to explain, somehow. When ladies sit packing sardines into cans instead of looking at pictures of bubbles, no explanation is required.

This man likes sardine sandwiches. He also votes in congressional elections. We are not sure whether he drives a cab in Manhattan or tries to grow a little tobacco in Kentucky. In either case, life has not been easy. He hopes his son will do better. Bright kid, doing real well in college, where he has a scholarship and where in the physics department is displayed the bubble track picture from Brookhaven National Laboratory that established the existence of the omega-minus particle.

The what?

The kid wants to go on for a doctor's degree in physics. He probably has to know what things like that mean.

We are of two minds about that man's son. On the one hand, we'd like to see him use his time in physics lab toward an engineering career. We simply cannot understand why more kids aren't going into engineering. Maybe they don't know what an engineer does, how he determines the most efficient way to get things done, whether it's getting sardines into a can with less labor or manufacturing photographic film or hunting intermediate vector bosons or saying how much photographic quality is worth in the boson hunt. Engineers find money convenient, particularly for the measurement of efficiency, and we can understand that.

On the other hand, if the kid thinks he wants to understand more than that, maybe he ought to make himself into one of those hypothesizing theoreticians who keep the film-consuming bubble chambers busy.

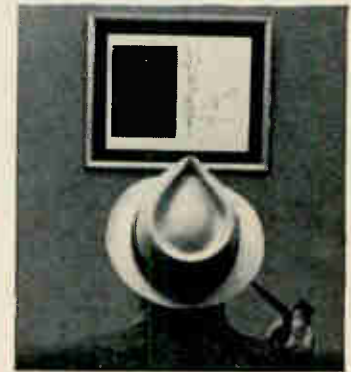

Bubble track picture from Brookhaven National Laboratory that established the existence of the omega-minus particle.

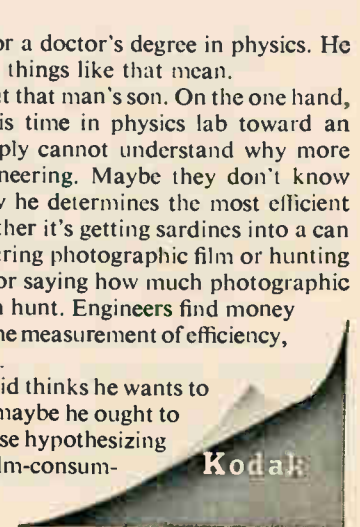

FROM PAR

Precision Instruments for Research & Development



## Tuned Amplifier/Oscillator is Six Instruments in One

- LOW-NOISE AMPLIFIER
- WAVE ANALYZER
- DISTORTION ANALYZER
- LOW-DISTORTION OSCILLATOR
- SENSITIVE AC VOLTMETER
- ALLPASS DELAY PHASE SHIFTER

The PAR Model 110 Tuned Amplifier/Oscillator is a versatile high-gain, low-noise, low-distortion frequency selective amplifier operating over the frequency range of 1 Hz to 110 kHz with Q variable from 1 to 100 with no gain change. It provides four outputs simultaneously: a second order (resonance) bandpass; a second order band-reject (notch) providing rejection of the center frequency in excess of 100 dB; a second order allpass characterized by an amplitude response which is flat with frequency and a phase lag which increases monotonically with frequency; and a flat output. Each of the 600 ohm outputs is capable of providing 5 volts rms into a 5K ohm load. A front panel AC voltmeter permits measurement of any one of the four outputs.

The instrument can function as a wave analyzer with bandwidth adjustable from 1% to 100%; as a flat

or selective AC voltmeter with sensitivity ranging from 10 microvolts to 5 volts rms full scale; as a distortion analyzer to measure distortion levels as low as 0.1% (as low as 0.001% when used in conjunction with a second Model 110); as a low-noise amplifier (typical noise figure of 1 dB) with voltage gain ranging from 1 to  $10^4$ ; as a stable general-purpose low-distortion oscillator providing up to 5 volts rms into 600 ohms, capable of being synchronized by an external signal; and as an AC-DC converter with ground-based output.

**Price:** \$1195. Export price approximately 5% higher (except Canada).

For additional information, write for Bulletin T-140 to Princeton Applied Research Corporation, Dept. D, P.O. Box 565, Princeton, New Jersey 08540. Telephone: (609) 924-6835.



**PRINCETON APPLIED RESEARCH CORP.**

# Electronics Review

Volume 40  
Number 15

## Advanced technology

### Little laser, big future

Something no bigger than a shoe box may put an end to the tired gag line that a laser is a solution in search of a problem. That alone would earn the International Business Machines Corp. the gratitude of countless engineers. But IBM's laser promises much more: it opens the door to the development of practical systems for television wall-size displays that tie directly to a computer, projector systems for high-speed photographic printing processes, computing and data-storage systems, and even a holographic movie projector.

The new laser is unusual in many respects. It can use almost any gas, producing a broad spectrum of light, from the infrared to the ultraviolet; it uses a low-cost, compact power supply—the same type that a computer works off; it produces a 3/8-inch-wide beam, and the entire laser measures six by four inches.

**Power aim.** Although early models have produced outputs of only

a quarter of a watt, quasi-continuous-wave, the researchers expect design improvements to boost output to 10 watts or higher.

Charles B. Zarowin, a physicist at IBM's Watson Research Center in Yorktown Heights, N.Y., designed the laser and built it with the aid of Clintis Williams, a technician.

The laser was designed primarily to be coupled with an earlier development, the Scanlaser, which came out of the same lab about a year ago. The Scanlaser, developed by Robert Pole, the lab's manager, marries a thick-beam laser with a cathode-ray tube. The thick beam is necessary to obtain a large number of resolvable light spots and the crt scans the spots.

What made the Scanlaser so attractive was the fact that it could be plugged directly into a computer—the way a crt is—producing a display that's bright enough for a large projection on a wall. Further, the Scanlaser could be used to feed data into the computer, simply by modifying its design.

But, good as the concept for the Scanlaser was, its development

was stymied until the Zarowin ion laser came along.

**Active leg.** The ion laser is built as a rectangular loop, with one leg acting as the active portion. Toroidal Permendur tape-wound cores surround the active leg and supply pump power to the plasma through transformer action. The plasma loop acts as a one-turn secondary, while three turns are placed on the primary, which is excited by a 150-volt, 100-ampere square wave. The changing flux through the loop induces 50 volts around the loop, causing a 300-ampere current to flow in the plasma.

Since the phase reversal of the 2.5 kilohertz square wave is immaterial as far as pump power is concerned, the pump power is almost a constant d-c level, except for the switching intervals. The rise and fall times of the high-current power supply limit the laser to a duty cycle of about 90% (the quasi-cw aspect).

**SCR's, too.** The 150-pound supply is all solid state, and uses silicon controlled rectifiers as the switching elements. It is far less expensive than equivalent high power r-f power supplies needed for other

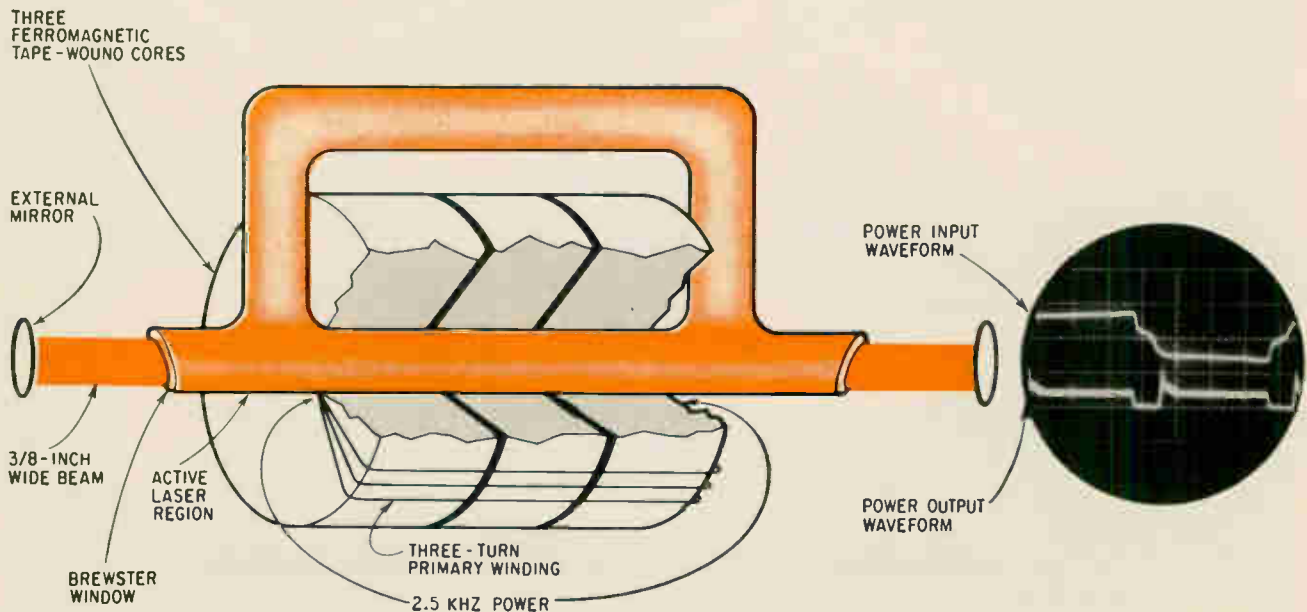

lasers. In the experiment, a production-model IBM 360 computer power supply was used.

The next-generation power supply will probably contain high-power transistors, which would boost the duty cycle of the laser above the 90% level.

The laser tube contains no electrodes, since it is pumped inductively. This means that even highly reactive gases such as chlorine can be used. Chlorine is a particularly promising material, since it produces 13 different colors of laser light.

In the initial experiments, a mixture of xenon and argon was used to provide an output at 4,880 angstroms, and optical gain was about 15% for each pass. The researchers expect to widen the beam and boost its power by adding an axial magnetic field.

The research was sponsored in part by the Air Force Avionics Laboratory at Wright-Patterson.

## Manufacturing

### IC ribbons

It sounds incredibly simple: laminate a strip of copper to a strip of Mylar. Etch the copper so as to form several thousand lead frames in a row. Bond integrated circuit dice face down on the strip. Run the strip through an injection molding machine for plastic encapsulation, and onto a reel. Run the reel through an automatic testing machine. Ship. Let the user put the reel through his testing machine, then through automatic insertion machinery which only at that point punches the Mylar from between the leads, cuts the circuits apart, and puts them on circuit boards.

A few steps have been omitted but in essence that's the packaging process developed by Frances Hugle of Hugle Industries. Within a month, the electrical products

division of the G.T. Schjeldahl Co., Northfield, Minn., will begin production of the Mylar-copper laminate rolls. It will etch the lead frames using masks provided by a semiconductor company. William B. Hugle, husband of the inventor and president of the Sunnyvale, Calif., company that bears their name, says that he has interested three major semiconductor manufacturers and "one large company that will soon enter the ic field" in the process.

Advantages of the system, the Hugles say, are these:

Because the Mylar, which is 3 to 4 mils thick, supports the lead frame, it permits flip-chipping, with its attendant cost advantages, in a plastic package. The thin lead frame is too flimsy to go through a face-down bonding process unsupported.

Because the Mylar is transparent, registering the chip on the frame is much simpler; the operator merely

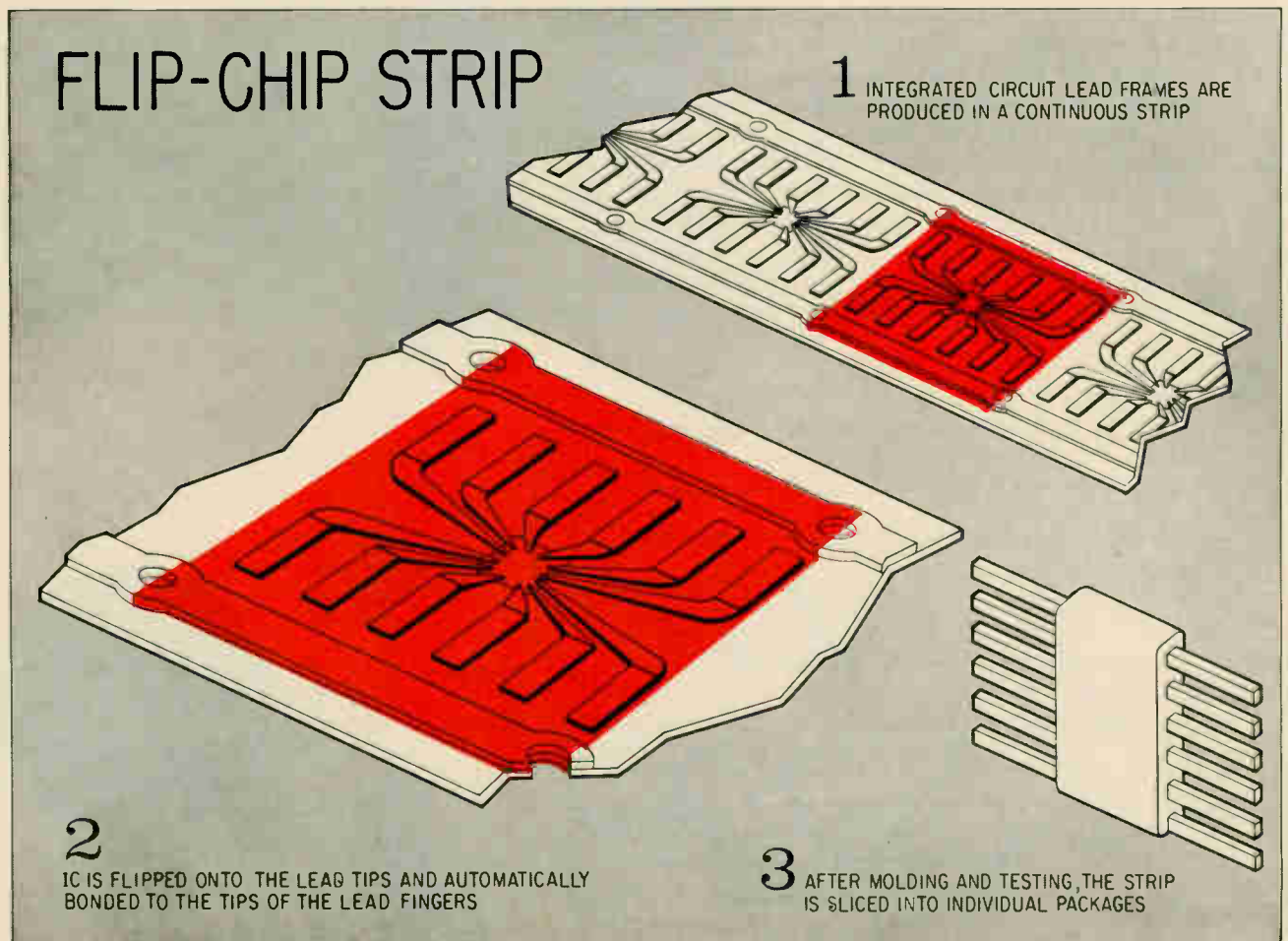

looks at a mirror underneath the strip and registers the chip optically, instead of referring both chip and frame to a third point, such as a microscope reticle.

Handling of the circuits is virtually eliminated. There is little chance for leads to be bent.

Since the circuits go into and come out of the testing process in the same order, which they retain at all times until final insertion, rejects can be tabulated by a computer, and test results by manufacturer and customer can be compared circuit by circuit.

The lead frame can be etched into what amounts to a miniature printed circuit board, so that several dice can be put into one package. Some circuit board costs can be avoided by laminating both sides of the Mylar and making intraconnections in the package.

**Easy does it.** The simplicity of the process can cut costs to a couple of cents per package and its flexibility permits a manufacturer to make a flip-chip package even though he does not have a process for making flip-chip dice.

The contact bumps would normally be put on the dice (as they are, for instance, in the ceramic Fairpak made by the Fairchild Camera & Instrument Corp.). However, an additional etching process by Schjeldahl can easily put the bumps on the lead frame, for about a cent per square inch of lead frame.

Further, the process is equally adaptable to the manufacture of flatpacks or dual in-line packages. As the IC's sit in the Mylar strip they are in flatpack configuration, but the leads can just as easily be crimped over into DIP form by the machine that cuts the circuits apart.

The almost complete automation of the packaging and insertion process offers still another benefit that might result in shrinking package size and thus cutting costs further. "Integrated circuit packages are only as big as they are because they have to be handled by human beings," says Mrs. Hogle. "The chip itself, of course, is tiny. The leads have to be a certain size and thickness—typically 10 mils thick and 30 mils wide, on 100-mil cen-

ters—so that they won't break in the handling; and the package has to be big enough so that it can be picked up and inserted into a board.

"But with the support of the Mylar strip, and the use of automatic insertion machines, there's no reason that you couldn't go to one-mil-thick leads on 50-mil centers; it would only require changing the circuit boards."

The Huges estimate that it might cost a semiconductor company a third of a million dollars to tool up to make the strips, whereas Schjeldahl, which already has continuous etching equipment, could do the job for half that amount. Schjeldahl will expose the laminated rolls in three-foot lengths, with conventional photoetching techniques, then etch and coat them continuously.

Running down both sides of each row of lead frames—but not connected to the frames—will be a strip of copper with regular holes, for indexing.

The etching process is in two steps: first the leads are etched 7 to 12 mils thick; then they are masked and the centers are etched 2 to 4 mils thick. Putting the bumps on the lead frames requires another etching step.

The process is only suited to plastic encapsulation, and any manufacturer who uses it would have to modify his bonder to accept the sprockets on the reel. He'd also need machinery to cut the circuits apart and insert them into printed circuit boards. In its use of Mylar to support a number of intra-connected IC's, the process bears some resemblance to an International Telephone & Telegraph Corp. system [Electronics, May 15, p. 39].

### Facing up to the chip

In conventional flip-chip integrated-circuit packages, the IC's are bonded face down on interconnecting layers to save space and money. But Friden Inc. says it can do the job better by flipping the package instead.

The company, a subsidiary of

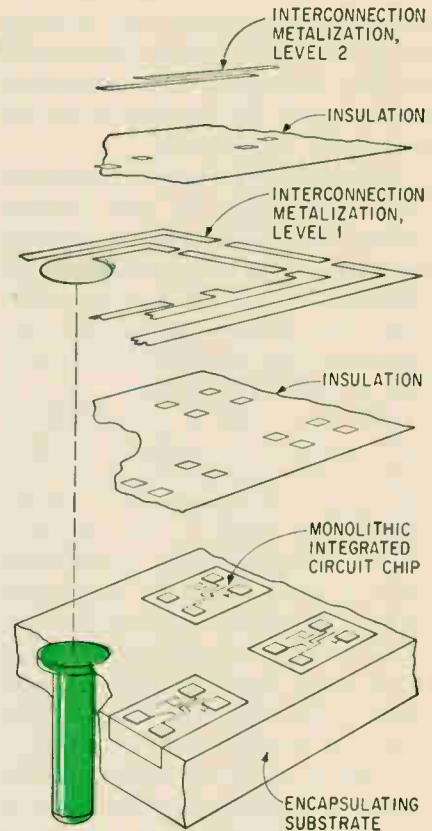

the Singer Co., says the process, called coplanar integration, casts chips in the ceramic substrate so that their faces are up and on the same level as the substrate surface. Friden inverts the package by placing the interconnecting grid of microscopic wires and two insulating silicon dioxide layers over the face-up chips.

Amelco, for example, bonds the IC's face down to the interconnecting layers and connects the layers with metal contacts through ceramic sandwiches in its flip-chip microelectronics modular assembly [Electronics, Feb. 20, p. 49].

Speaking of Amelco's unit: "I flip the interconnection and they flip the chip," says Jack Hinchey, Friden's microsystems research director. "We're both trying to do the same thing. We're trying to prevent jumping from little things [the chips] to big things [the connecting wires] back to little things [the chips] of conventional packages. Only where necessary do we want to go from microelectronics to macroelectronics."

**Up and out.** Friden makes outside connection with a pin that runs from the substrate surface,

through the substrate, and out the back, where it may be soldered or welded. Windows in the insulating layers allow for connection of the pin, grid, and ic pads.

Friden says the process will have two advantages: it will reduce labor costs by eliminating production-line steps and it will aid reliability by simplifying the package. Also, the company hopes less assembly-line handling will reduce the probability of error.

Hinchey, who is scheduled to give a paper on coplanar integration at Wescon next month, says the goal is "to interconnect in one process as many as 10 chips at once, which normally would take five to seven steps by individual labor." He points out that the process is still experimental at the company's research center in Oakland, Calif. "We can't do it with as many as 10 chips yet," he adds.

Friden hopes to automate the process. Hinchey says that isn't as simple as flip-chipping but Friden hopes to do it. Even so, Amelco's package now contains as many as 20 chips, whereas Friden is still shooting for 10.

Just when units might start showing up in Friden products, the company won't say. But Hinchey guesses it may be three years away. Significantly, the company says the new package would reduce the logic system in its model 130 desk top calculator to the size of a multiplication key.

**View from the top.** Hinchey describes the assembly this way: on the bottom there is a ceramic slab so cast that from a top view the ic chips' faces and the imbedded end of the connector pin—protruding through the assembly's back side—can be seen. Each chip's position is controlled to within .001 inch.

The next layer, on top of the ic's and the pin, is a silicon-dioxide coating, 10,000 angstroms thick, which has windows to make ohmic contact with the ic and pin pads. This layer is vacuum deposited.

On top of this is an etched gold-chrome interconnecting layer, 5,000 angstroms thick, for the pin and ic pads. The next to last layer is another crossover insulating layer with windows, if needed; a jumper

interconnect layer is on top.

The assembly is then encapsulated with a protective material. Hinchey says Friden is working with a variety of materials.

The pins are gold-plated Kovar, which has a coefficient of expansion close to that of the ceramic substrate and the silicon ic die.

**Versatility plus.** The plated Kovar pins are used in yet another way. By mounting a pin directly under an ic chip—but with no electrical connection between the chip and the pin—an excellent heat sink is provided. Further, the pin becomes a handy mount.

The company is still undecided on whether it will make its own chips or depend on packaged ic's. Development of the process won't affect Friden's use of Texas Instruments' transistor-transistor-logic devices for its volume office machinery.

"It's just like IBM," says Hinchey. "IBM's buying ic's but making them, too. It depends on what's profitable."

---

### Avionics

---

#### Off course

As late as the middle of June, a Pan American World Airways executive declared flatly that all Pan Am 707's would be equipped with Sperry Gyroscope scN-10 inertial navigation systems "by the end of the summer, 1968." Less than four weeks later Pan Am and Sperry announced that they'd agreed to give up on the scN-10.

Behind the bland announcement of failure is a \$25 million contract that Sperry underbid on as its entry fee into the field dominated by Litton Industries. Sperry wound up with an admitted \$6.5 million loss in the second quarter of this year alone. And Pan Am finds itself holding a bag containing eight scN-10's (cost: \$200,000 apiece); 45,000 hours and 20 million miles of tests; and a feeling that inertial navigation might be an idea whose time hasn't quite arrived commercially. That mixed bag is believed

to have cost Pan Am a total of \$10 million.

**Sperry mum.** Why the flop? Sperry is characteristically tight-lipped. "Repackaging problems," says one spokesman. "We couldn't meet that 1968 deadline," says another. But a word here and a hint there produce a picture of three years of size and weight problems, disagreements on which direction to take, and other wrinkles that resisted ironing. Take, for example, a paper delivered by William W. Moss of Pan Am's special projects division at an American Institute of Aeronautics and Astronautics meeting this year. The paper, entitled "The Status and Future of Inertial Systems in Airline Use," glowingly describes five systems. But only the scN-10, of all the systems tested, is described without a single word about system failure. Pan Am's prime requirements were accuracy and reliability. If that isn't enough, one Pan Am executive who insists on anonymity had this to say about the scN-10: "We don't like our people to get lost."

Where does Pan Am—and commercial inertial navigation—go from here? The airline says it's still discussing and negotiating with Sperry. Informed sources shrug that off as a face-saving statement and insist that Pan Am will go one of three other ways. First, it can stick with pilot-navigators, though it was an unwillingness to take the route that made Pan Am start thinking about inertial navigation in the first place. Second, the airline points out that its dc-8's are equipped with dual doppler systems that it just might install in all its craft. Even Pan Am officials consider that possibility pretty remote. Third, and most likely, is the possibility that Pan Am will shop elsewhere for an inertial navigation system.

**The line forms.** The logical place to shop is Litton, which at one time had in its LN-3 the only inertial navigator going. And Pan Am just finished 300 hours of tests on the LTN-50, a later generation version of LN-3. In fact, Litton officials were in New York talking to Pan Am just three days after the Sperry cancellation was announced, though





# Integrating Redeye

## ... A CASE HISTORY OF COST REDUCTION, COOPERATION AND BETTER PERFORMANCE!

In less than one year, General Dynamics, Pomona, completed the successful updating of the Redeye Guided Missile, from discrete to integrated circuitry. In the process, they lowered their systems costs, gained greater reliability, better performance; and, of course, a smaller, lighter package!

From start to finish, the conversion of Redeye is a success story grounded on the cooperative efforts of General Dynamics and Motorola Semiconductors. In all, it's a custom linear I/C program of unprecedented proportions — with a "crash program" time scale plus the additional problem of *directly translating* the discrete circuitry to custom integration.

Here are just a few of the *challenges* faced by Motorola I/C engineering and production experts:

- Design and build 24 different circuits — all but three Monolithic — for applications ranging from voltage regulation to notch filtering to feedback amplification to signal sensing.
- Innovate specifications for procurement control, with emphasis on process control, rather than costly, extensive life testing.
- Design and build test equipment to measure and electrically characterize the 24 circuits for parameters like:
  - 0.62  $\mu$ V of noise at  $-43^{\circ}\text{C}$
  - 0.05 dB gain change over a temperature range from  $-43^{\circ}$  to  $+70^{\circ}\text{C}$ .

The Result: TOTAL SUCCESS... The fact that this extensive system modification did not meet any major delays is an unusual tribute to the entire Redeye program. More importantly, it demonstrated the successful application of linear integrated circuitry to a complex electronic system, for the first time. The success of complete participation and cooperation between the manufacturer and the customer lays the groundwork for future successes in linear microelectronic system designs.

For complete details about this Success Story, write for, "Integrating Redeye" — a 6-page article-description of the entire process. Or, for more information about Motorola's broad line of "off-the-shelf" linear integrated circuits, contact your nearby franchised Motorola Semiconductor distributor.

— where the priceless ingredient is care!



**MOTOROLA Semiconductors**

Litton says that no decisions were reached and denies that Pan Am is negotiating for the LTN-51, a new version of the LTN-50, that will be ready next year. Also waiting in the wings is AC Electronics' Carousel IV, designed for the 747 and due in 1969.

### Military electronics

#### Two good

It's not often that the Air Force has to choose between two prototypes—from competing companies—that far exceed the required specifications. To be sure, the situation presents a problem, albeit a happy one. And now the service may work out some extra run-off tests before a selection can be made.

The gear, lightweight troposcatter communications units, was developed under a contract with the Rome Air Development Center. One, the AN/TRC-105, was designed and built by Motorola Inc.'s Government Electronics division; the other, the AN/TRC-104, by Textron Inc.'s Bell Aerosystems division.

The units were just shipped to Eglin Air Force Base in Florida for 60 days of tests. Later the Air Force will make cost comparisons.

**Deliver the goods.** When the bids went out, explains Frank Zawislak, the project engineer,

“we told them just what we wanted. But they decided they could deliver much more within the contract.”

For example, he points out, the bids called for a minimum range of 80 miles; both units have a range of about 120 miles. The mean-time-to-repair was supposed to be 30 minutes; both clock in at under 10 minutes. Power dissipation was set at 5 kilowatts; both run on about 2 kilowatts. More than four channels were sought; both provided 12—plus an extra channel for tests. Weight was set at 500 pounds; both came in under the wire by a few pounds.

And as a further plus, both firms provided built-in test equipment, although the order didn't call for it either.

One of the new units may replace either or both the 2,000-pound TRC-97 and the 6,000-pound TRC-66A.

The TRC-105 uses a single, 8-foot parabolic antenna, and the TRC-104, a parabolic cross, 10 feet high and 10 feet across. The TRC-66A requires two parabolic antennas 14 feet in diameter, and the TRC-97, two dishes, each measuring 10 feet across.

**No fading.** Motorola and Bell chose different ways to eliminate fading without having to rely on the redundancy provided by a two-antenna system. Motorola uses a frequency-scan diversity technique that constantly monitors the signals being transmitted (on 16 frequencies), switching to a better frequency when one begins to fade. A computer in the receiver examines the amplitude of each sampled signal, advising the sender when a particular frequency is beginning to get weak. Since the sampling rate is faster than the tropo fading rate, virtually no fading is experienced.

Bell accomplishes the same thing with an error-correcting coding technique having a 12-channel pulse-code modulation/multiplexer that uses frequency-modulation. The input intelligence is quantized into 32 discrete levels, which are then coded into eight r-f frequencies separated serially into nine time slots. The displacement

of frequencies into different time slots results in a possible  $8^9$  permutations, 32 of which are selected and have a maximum redundancy of one bit. In the event of fading, receipt of as few as two bits will reveal the whole word.

Other design features that helped reduce size and improve performance, include the use of digital modulation/multiplexing instead of conventional analog approaches; microminiaturized components, including integrated circuits; and the use of traveling-wave tubes instead of klystrons.

### Components

#### Out front

A relatively small components firm in Burlington, Mass., is challenging Texas Instruments for the lead in the infant microwave integrated circuit field. In the past few weeks, Microwave Associates has been selected to supply microwave IC's for three major development contracts. Examples of the recent flurry of microwave IC business:

▪ The Naval Air Command awarded two study contracts—one to Raytheon Co., the other to Westinghouse Electric Corp.—on a new program called Mair, for molecular airborne integrated radar. The six-month contract marks the



New tropo. Frequency diversity or . . .



. . . a coded technique to halt fading.

# New! 100 MHz in a ruggedized oscilloscope with 3.5-ns risetime at the probe tip

DC-to-100-MHz bandwidth at 10 mV/cm  
is NOW AVAILABLE  
in a plug-in oscilloscope  
with solid-state design . . .  
the Tektronix Type 647A and R647A.

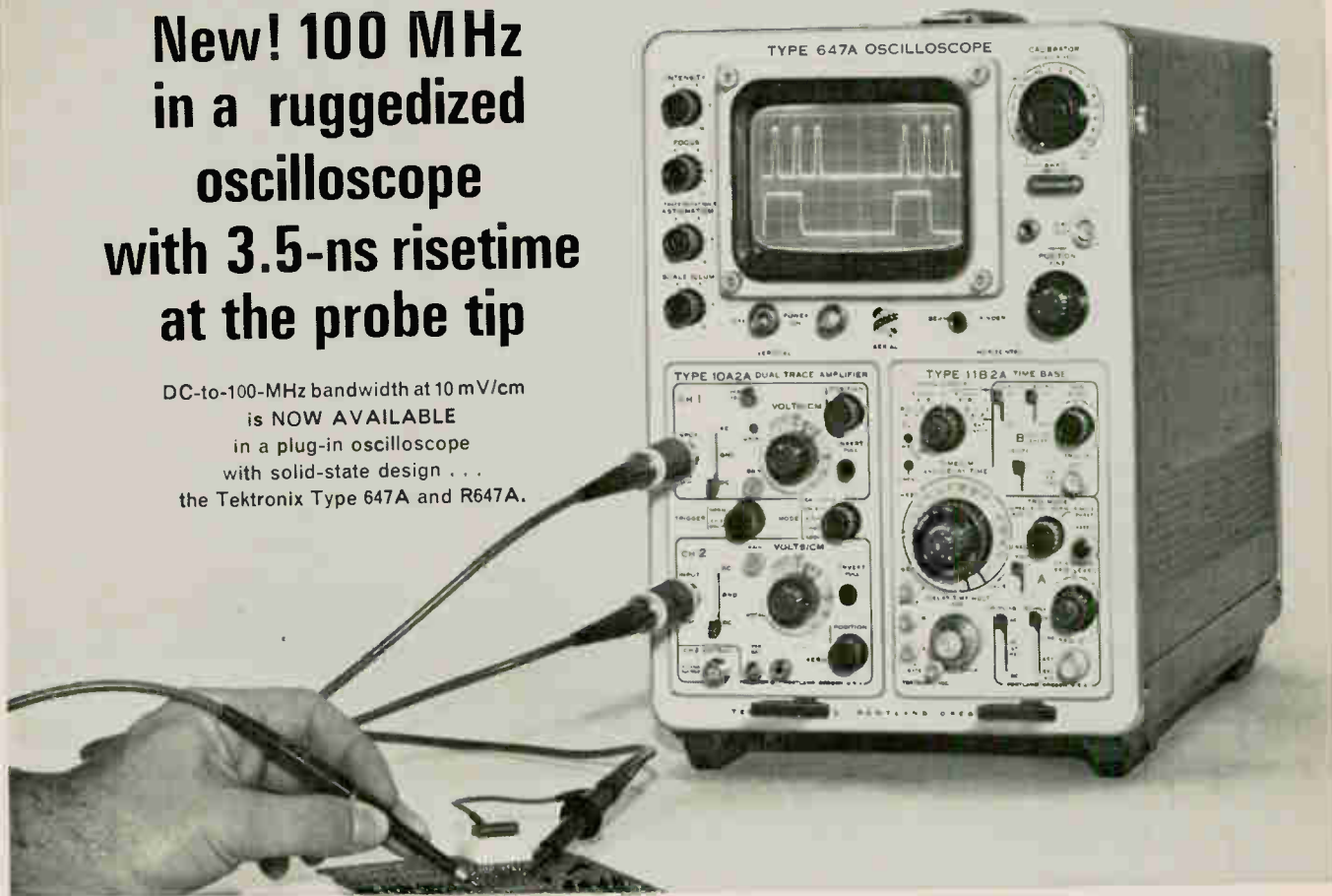

**New Type 10A2A Dual Trace Amplifier.** The risetime and bandwidth are specified where you use it — at the probe tip. The vertical system performance with or without the new miniature P6047 10X Attenuator Probe is DC-to-100 MHz bandwidth with 3.5-ns risetime at ambient temperatures of 0° C to +40° C (+32° F to +104° F). Bandwidth is DC-to-90 MHz with 4.1-ns risetime over its entire operating range, -30° C to +65° C. The calibrated vertical deflection range (without probe) is from 10 mV/cm to 20 V/cm.

**Bright Displays.** The Tektronix CRT provides bright displays with its advanced design and 14-kV accelerating potential. It has a 6-by-10 cm viewing area and a no-parallax, illuminated, internal graticule.

**New Type 11B2A Delayed Sweep Time Base.** The Type 11B2A triggers to above 100 MHz internally and provides a calibrated delayed sweep. Calibrated sweep range is from 100 ns/cm to 5 s/cm, extending to 10 ns/cm on both normal and delayed sweeps with X10 magnification. Calibrated sweep delay is from 1 μs to 50 s and the plug-in also provides single sweep operation.

**Rugged Environmental Capabilities.** These instruments are capable of accurate measurements in severe environments and offer an extra margin of dependability and even greater accuracy in normal environments. Temperature: Operating -30° C to +65° C. Non-Operating -55° C to +75° C. Shock: Non-Operating 20 G's max, 2 shocks, each direction, along each of the 3 major axes. Vibration: Operating or Non-Operating 0.025" p-to-p, 10-55-10 Hz, (4 G's) 1 min cycles, 15 min each major axis. Humidity: Non-Operating meets MIL-STD-202B, Method 106A, except freezing and vibration, through 5 cycles (120 hours). Altitude: Operating 15,000 ft. Non-Operating 50,000 ft.

**New Type R647A Rack Mount.** The same DC-to-100 MHz performance also is available in a 7-inch-high rack mount oscilloscope, the Type R647A. Additional plug-ins include the Type 10A1 Differential Amplifier and the Type 11B1 Time Base.

Type 647A Oscilloscope (includes 2-P6047 Probes) . . . . .	\$1500
Type R647A Oscilloscope (includes 2-P6047 Probes) . . . . .	\$1625
Type 11B2A Time Base . . . . .	\$ 850
Type 10A2A Dual Trace Amplifier . . . . .	\$ 775

© 1967 Tektronix, Inc. B-647A-100

For complete information, contact your nearby Tektronix Field Engineer or write: Tektronix, Inc., P. O. Box 500, Beaverton, Ore. 97005.



*Environmental testing*



*. . . part of the Tektronix commitment  
to technical excellence*

# HOW DID TRYGON IMPROVE THE MOST VERSATILE POWER SUPPLY \$249 CAN BUY?

## THE DUAL OUTPUT DL 40-1

It was already a winner: dual output, dual range—two power supplies in one—with two independently adjustable outputs, series-parallel combinations for 8 different outputs. We kept all that and—

- Increased power by 50%—to 1 amp. Now, each independent output provides 0-40 v at 500 ma, or 0-20 v at 1 amp.
- Added the calibrated adjustable current-limiting feature you wanted.

We kept the—

- Compact half-rack size
- The old price of \$249.



Those are the highlights of this new, improved power supply. Get all the facts.

MAIL THE COUPON TODAY.

**TRYGON**

POWER SUPPLIES  
PLEASANT AVE., ROOSEVELT, L.I., N.Y.

Please rush me your new 52-page Power Supply Handbook—FREE

Name \_\_\_\_\_

Title \_\_\_\_\_

Company \_\_\_\_\_

Address \_\_\_\_\_

City \_\_\_\_\_ State \_\_\_\_\_ Zip \_\_\_\_\_

## Electronics Review

first step in a program to build, for the Navy fighters of the 1970's, an X-band (5.2 to 10.9 gigahertz) multimode radar using ic's. Microwave Associates will provide the ic's for Raytheon, while TI will provide Westinghouse's ic's. But industry insiders say that Westinghouse may hedge its bet and place a parallel order for microwave ic's with Microwave Associates.

■ The Avionics Laboratory at Wright-Patterson Air Force Base awarded two \$300,000 development contracts for design of phased-array antennas using Ku-band (15.35 to 17.25 Ghz) digital diode phase-shift networks. One of the 18-month contracts to build a 144-element planar array went to a team consisting of Microwave Associates and Bendix Corp.; Microwave Associates is in the unusual position of being the prime contractor, while Bendix, a large systems firm, is the subcontractor. The other development order went to TI.

■ The third major order may come out of Texas Instruments' several-years-old, and highly successful, program to develop solid state radar circuits. Now, TI is seeking a follow-on to that program, called Mera, for molecular electronics radar application. But TI is facing competition from both Raytheon and General Electric Co. for this contract; and Microwave Associates has teamed up with both GE and Raytheon in the fight for the business.

**Buying time.** Despite the immediate success of the Microwave Associates trademark, all is not clear sailing for the firm. For one, the company's executives know only too well that the big systems companies are beating a path to its door only to get a foothold in an area beyond their competence.

Microwave Associates sales vice president, Richard T. DiBona, says frankly that the big systems firms are "just buying time."

But what's to keep Microwave Associates in the black once the systems firms learn to make their own microwave ic's?

DiBona says, "We tell the systems companies that we want a commitment on the microwave

hardware business farther down the road, not just the study business."

Microwave Associates introduced an integrated S-band switch driver assembly last fall, is preparing now to market an L-band integrated switch with built-in driver and multivibrator. Later this year, it plans to have ready a hybrid integrated mixer and local oscillator assembly using microstrip circuitry and designed for airborne and manpack radar receivers.

## Instrumentation

### No moving parts

Strip-chart recorders, with their attendant gadgetry of moving pens or deflecting galvanometers, are invaluable tools in hundreds of electronic, medical, and industrial applications; but they are limited in performance by their intricacy and the tendency of the moving parts to break down. Last fall, Honeywell Inc.'s Denver division removed the mechanical weak link from high-frequency oscillographs by using an electron beam to write at speeds of up to 1 megahertz [Electronics, Nov. 14, 1966, p. 217]. At Wescon, Varian Associates Recorder division will introduce two recorders that perform at frequencies of up to 3 kilohertz with an entirely different technique—electrostatic printing, or xerography.

The only moving part in the Varian process is the paper itself, which has a dielectric coating that is energized when the paper passes over a stationary recording head. The head is a glass plate with etched gold styluses. The styluses are pulsed serially by digital integrated circuitry, so that the traces are formed by a series of dots. The paper needs no chemical treatment.

The 3-khz frequency response refers to transient monitoring. With a top speed of 20 centimeters per second, continuous recording would reduce the space between peaks to less than 1/10 millimeter. Highest

# We've got something in the oven 18 hours a day... but we've never baked a cake.

With a string of ovens going day and night, there must be *some* good reason we don't make ourselves those goodies. And there is.

You see, our ovens are baking at 850°C, and 1150°C, and you don't need your wife to tell you that's a little bit hot for cakes. But those do happen to be just the right temperatures for doing some rather remarkable things to diodes.

The fact is, the Unitrode diode was designed from scratch with an entirely new construction. Basically, what we do is take a pair of terminal pins of exactly the same diameter as the silicon

die and metallurgically bond them at 1150°C.

That in itself gives you a virtually indestructible unit far smaller than conventional diodes, with many times their power capacity. And we could take that unit and cover it with plastic encapsulating material. But we don't. We like a belt with our suspenders.

We fuse a hard glass sleeve to the entire surface of the silicon at 850°C, so you have a voidless monolithic structure, sub-microscopically free of contamination.

What does all this mean?

Well, it means we can virtually guarantee a Unitrode diode will never fail. Ever.

If that seems extreme, consider this. Every Unitrode is controlled avalanche. The terminal pins are bonded over the full face of the silicon, so heat due to surge is carried away quickly into the pins.

You can apply full PIV to a Unitrode diode at high temperature for weeks at a time without making a dent in its characteristics.

As a matter of fact, the machine hasn't been built that can fail our diodes in acceleration, vibration, and shock tests.

We haven't heard of any other diodes like that. Have you?

So we're not too unhappy that our ovens aren't turning out cake. For the 500 of us here, it's bread and butter . . . and it tastes beautiful.

Can we show you what we make? We're at 580 Pleasant St., Watertown, Mass. 02172. Telephone: (617) 926-0404. TWX (710) 327-1296.

## UNITRODE®

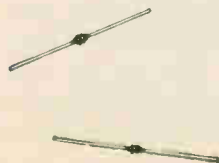

# NEW EG&G PHOTODIODE

HIGH SENSITIVITY  
FAST RESPONSE • LOW NOISE

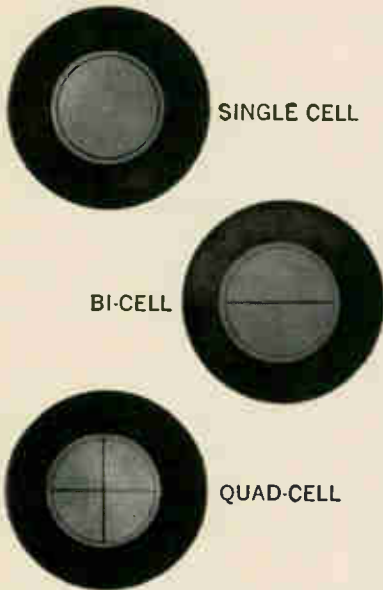

SGD-444 SERIES

The new SGD-444 Series complements versatile, new EG&G SGD-100 Photodiode. Improved diffused guard ring construction permits higher sensitivity, lower noise and faster response factors than ever before available in large (1 cm<sup>2</sup> active) area diodes.

Bi-cell and quadrature cell configurations with isolations of greater than 20 to 1 are standard. The photodiodes are oxide-passivated and hermetically sealed in a TO-36 package.

Sensitivity ..... 0.4 $\mu$ A/ $\mu$ W @ 0.9 $\mu$   
(55% Quantum Efficiency)  
Spectral Range ..... 0.35 to 1.13 $\mu$   
Leakage ..... 0.5 $\mu$ A @ 250 volts  
Rise Time ..... 10 nanoseconds  
NEP ..... 1.0 x 10<sup>-12</sup> watts  
Linearity of Response .... Over 7 decades

Applications include CW, pulsed light and laser detection and measurement, star tracking, optical navigation and guidance, and range-finding systems. The new SGD-444 series is in quantity production for fast delivery at low price.

For information, write EG&G Inc., 166 Brookline Avenue, Boston, Massachusetts 02215. Or phone 617-267-9700. TWX: 617-262-9317.



## Electronics Review

continuous frequency, Varian says, is about 300 hertz.

**Analog and digital.** Statos I, one model, is a strip-chart recorder that accepts two analog channels and one digital channel. With total deflection at 50 mm, the recorder operates at the 3-khz rate and has an accuracy of  $\pm 2\%$ . If deflection is extended to 100 mm, the rate drops to 1.5 khz, but accuracy doubles. Overshoot is less than 1%. Eight styluses are used to record events and five to indicate timing intervals of 10 minutes, 1 minute, 10 seconds, 1 second, and 0.1 second. A second recording head prints a time line across the entire 7-inch-wide chart, with accuracy depending on power line frequency. An interchangeable grid prints chart lines. The machine handles 250-foot rolls of paper.

The second model is the Statos II. Strictly an event recorder, it has 50 styluses to accept 50 channels. At \$4,700, it is priced competitively with other event recorders.

Statos I sells for \$7,100, considerably more than other three-channel strip-chart recorders. But Varian points out that the recorder's frequency response is 100 times that of competitive machines, and has greater accuracy to boot.

**Digitized signal.** Each analog channel has a plug-in differential amplifier, with a sensitivity of 100 microvolts and 12 ranges, from 1 millivolt per centimeter to 10 volts per centimeter of signal deflection. Changes in signal amplitude alter the voltage output of the preamp. The signal is then fed to what Varian calls a tracking converter—a comparator and a counter linked in a feedback network. The counter converts the analog signal to binary-coded decimal form; when the digital signal is returned to the comparator it is continuously compared with the incoming signal from the preamp to see if the voltage is increasing or decreasing, which determines whether the gating circuitry will switch the pulse to the next higher or the next lower strip on the recording head.

The IC's used in the instruments are off-the-shelf devices from Fair-

child Semiconductor and Texas Instruments.

Varian says that it had to make some advances in electrostatic printing—principally in chemical techniques to obtain high contrast writing—in order to make the recorder effective.

Because the signal is digitized, the recorder output can be fed directly to a computer for analysis; conversely, it can take computer output on its digital channel and produce a waveform. A user can feed data to a computer and use the recorder to get a quick set of curves indicating trends.

Varian expects the recorders to be used for physiological measurement, chemical analysis, quick-look telemetering, vibration analysis, and dozens of other jobs. Delivery of the machines is expected to start early next year.

The writing technique is similar to the method used in Leeds & Northrup Co.'s analog-to-decimal recorder, which, like Varian's machines, has no moving parts except for the paper [Electronics, June 26, p. 45]. The data is put on electro-sensitive paper by a stylus system. However, the data is a digital representation of the input signal and is broken up into decade segments.

## Companies

### Reshaping Fairchild

After five months as general manager of the Semiconductor division of Fairchild Camera & Instrument, Thomas H. Bay made his first big move last week: a wholesale recasting of the unit's marketing and manufacturing structure into something resembling that of Texas Instruments.

The key change is that Fairchild will divide its manufacturing operations into three main groupings—integrated circuits, discrete components, and special products—and that each of these groups will carry some marketing responsibility. The division's marketing manager, Donald T. Valentine, resigned in protest against the switch. Both Ben

# New Mercury Relay Applications From Adlake

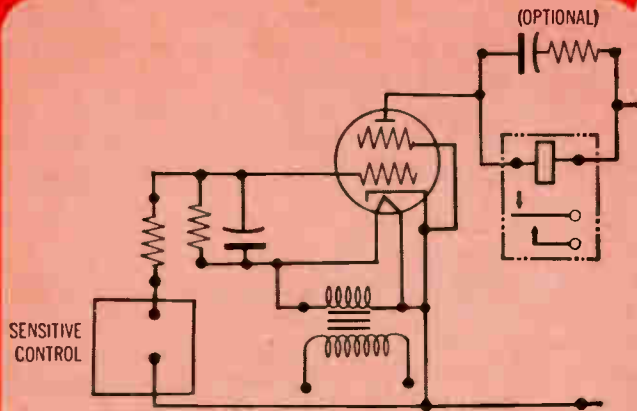

**MERCURY  
DISPLACEMENT  
RELAYS**

## *Small Currents Control "Heavy Duty" Load Relay*

In applications having extremely sensitive controls, this circuit illustrates how very small currents are capable of controlling an Adlake "Heavy Duty" load relay. Resistive loads of 35, 50 or 75 amperes at 120 volts, 60 cycles, are easily met up to 44 operations per minute. 100 ampere loads at the rate of 6 operations per minute.

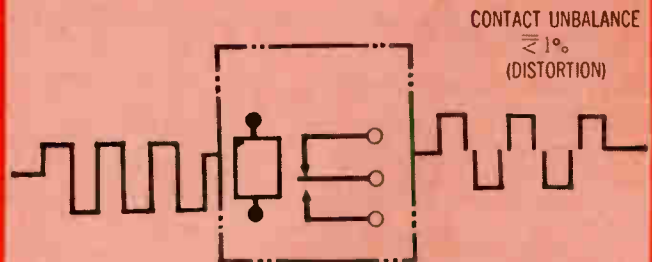

**MERCURY  
WETTED  
CONTACT  
RELAYS**

## *Ideal for Data Transmission, or Tele-Typing*

Adlake Polar Relays—Form C—are ideal for data transmission or tele-typewriting where a series of equal length impulses represent an alpha-numeric character or function. Baud rates up to 120 are available with Contact Unbalance—Distortion—of 1% or less including transition. Transition time is normally 200 microseconds or less.

Backed by sound research and disciplined engineering, Adlake applies the industry's broadest line of mercury displacement and mercury wetted relays to the creative solution of design circuit problems. However unique or special your application, Adlake can assist you in developing it. For prompt, personal and knowledgeable attention to your relay needs, contact the one source that is the complete source in the mercury relay field. Contact Adlake today for catalog and further information.



**THE ADAMS & WESTLAKE COMPANY**

A SUBSIDIARY OF ALLIED PRODUCTS CORPORATION

ELKHART, INDIANA 46514 • AC 219 • 264-1141

TRANSPORTATION EQUIPMENT • ARCHITECTURAL PRODUCTS • MERCURY RELAYS • DOORS AND ENTRANCES • CONTRACT MANUFACTURING

**SPERRY**  
 DIVISIONS OF  
 SPERRY RAND  
 CORPORATION

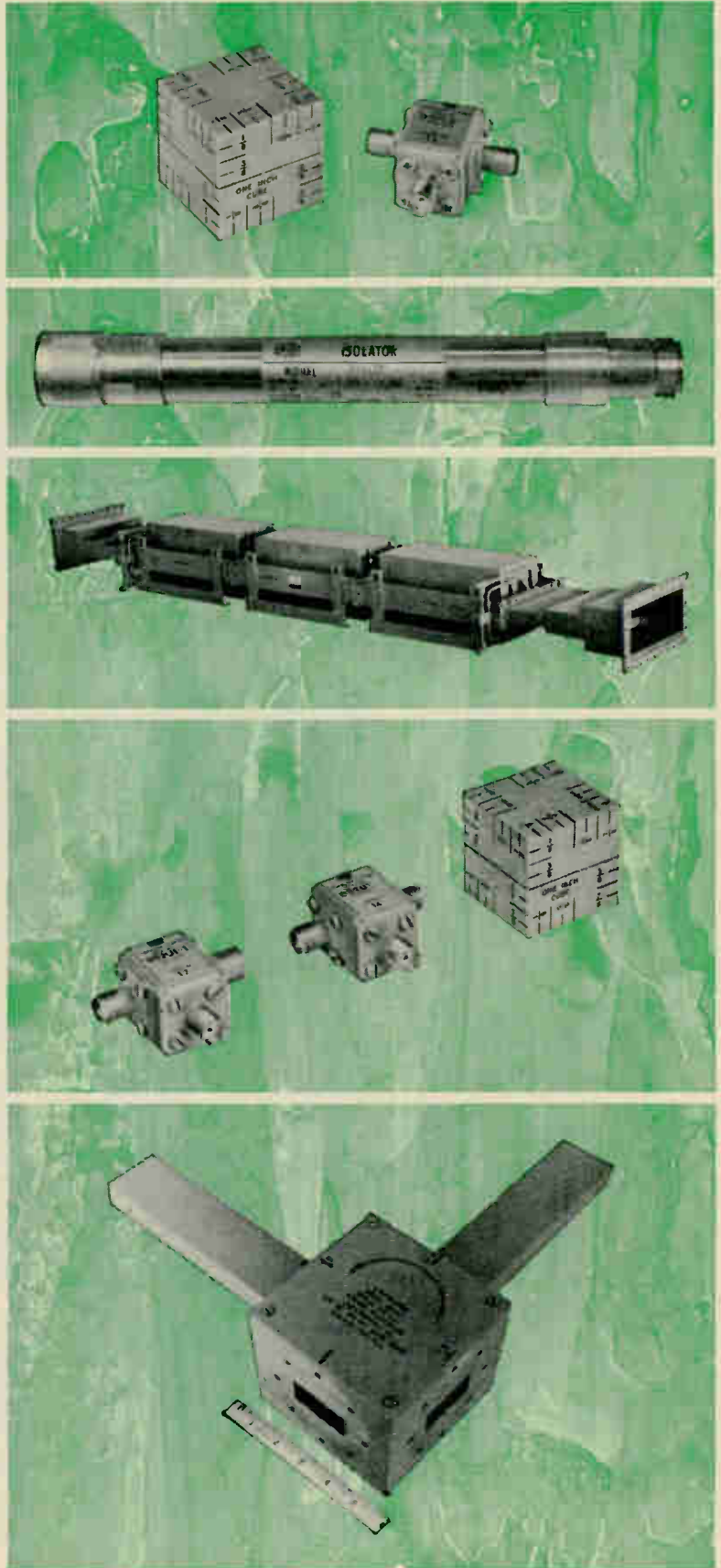

How much isolation does your microwave system need? How low must isolator insertion losses be?

Regardless of your answers, the right isolator or circulator is most likely to come from Sperry, no matter what frequency range you're working in.

After all, the coaxial isolator was invented at Sperry, and Sperry has set the pace in its development. Today the Sperry line is unquestionably the industry's most comprehensive.

You can get 217 models of standard Sperry isolators and circulators. Frequencies range from 0.1 to 40 GHz. Isolation can be as high as 40 db; insertion loss as low as 0.3 db. Remarkable custom development capability is also available.

Write for our new catalog and look over the line. Then, if you don't see exactly what you want, ask for it. Ask your Cain & Co. man or write Sperry Microwave Electronics Division, Sperry Rand Corporation, Box 4648, Clearwater, Florida 33518.

**SPERRY MICROWAVE ELECTRONICS AND  
 SPERRY ELECTRONIC TUBE DIVISIONS**  
 Sperry Rand Corporation  
 Clearwater and Gainesville, Florida

**The world's most comprehensive line of  
 microwave isolators/circulators is Sperry's.**



---

# Washington Newsletter

---

July 24, 1967

**Comsat eyes Hughes  
as antenna woes  
slow TRW craft . . .**

The first satellite in Comsat's global communications satellite system may not be launched until 1969. Technical problems with the big 1,200-channel Intelsat-3 satellite have delayed the project—perhaps as long as a year beyond its scheduled launch date next spring.

The major hangup is in the satellite's mechanically despun antenna being developed by Sylvania. A half-dozen breadboards of the antenna, which has never flown, have been built for TRW Systems, the prime contractor, but tradeoffs to solve mechanical problems may drop the gain to an unsatisfactory level.

Comsat is considering an option it holds to buy a beefed-up version of Hughes' Intelsat-2 satellite. Within a month, it will decide whether to buy the Hughes craft and launch it ahead of Intelsat-3, or gamble on TRW solving its problems. Hughes has said it could launch its satellite in about 13 months, retrofitting a reserve Intelsat-2 to boost channels from 240 to about 1,000. The upgraded satellite would probably use an electronically despun antenna of Hughes' design to increase effective radiated power from 15.5 dbw to 25 dbw.

**. . . while antenna  
TRW rejected  
makes hit in space**

Ironically, an electronically despun antenna from Sylvania is working well after being launched July 1 on an Air Force Despunte Antenna Test Satellite. It's very similar to one TRW Systems had originally planned for the Intelsat-3 satellite but dropped for the mechanically despun unit now in trouble. Both Sylvania antennas are used to counteract spin-stabilization to produce a pencil beam. Because the electronically despun model wasn't getting predicted gains in laboratory tests, TRW decided to drop it.

The Air Force version of the antenna is working so well, however, that when tests are completed, the Pentagon plans to add the satellite to the 18 in the Initial Defense Communications Satellite (IDCSP) network. Preliminary results indicate that the electronically despun antenna is providing the predicted order-of-magnitude improvement in gain over the operational IDCSP craft.

**Pentagon panel  
to coordinate  
navigation systems**

The Pentagon, worried about duplication of equipment and development efforts by the three services, is setting up a permanent tri-service navigation-programs committee in the Office of the Director of Defense Research and Engineering. The group will coordinate the development of all types of navigation systems now on service drawing boards and in prototype testing.

The Pentagon wants to get the services talking to each other on expensive navigation programs so that the widest possible number of military users can be included on each system. Donald Spencer, chief of DDR&E's avionics and guidance division, warns: "If we don't work together, navigation programs will advance at a much slower pace."

**Mississippi backs  
automated shipyard**

The Navy's hope that industry would build an automated shipyard seemed doomed when Congress killed a Pentagon proposal for the construction of 30 Fast Deployment Logistics ships. The picture has changed now that the Mississippi legislature has approved a \$130 million

---

# Washington Newsletter

---

bond issue to construct an automated yard at Pascagoula that Litton will manage. There may be a second yard at Erie if Litton works out a deal with the state of Pennsylvania; the yard would build Great Lakes ore carriers. Although it's academic now, General Dynamics is said to have won the competition for the FDL ships, over Lockheed and Litton.

## **ATS is good bet for Comsat's domestic system**

Comsat's pilot domestic satellite communications system, scheduled to be in operation over the U.S. by 1969 [Electronics, June 26, p. 59], is likely to use a modified version of the Applications Technology Satellite developed by Hughes for NASA. The stationary satellite will relay six commercial and two educational television channels, plus 6,200 message or voice circuits to an area stretching from western Kansas to California.

Major ground terminals will include two 85-foot antennas in Los Angeles and New York, and two 42-footers in the Midwest. Thirty receive-only stations—with either 32- or 25-foot-diameter antennas—will be spotted through the western U.S. Comsat will foot the construction and operating costs of the demonstration system until the FCC resolves the question of ownership.

## **Navy sees go-ahead soon on seaborne antimissile system**

Navy officials, confident they now have a technically and economically feasible system, expect a go-ahead this year to develop a sea-based anti-ballistic missile. Based on Nike-X technology and designed to operate from either surface ships or submarines, the antimissile system could be on station by the mid-1970's if work starts soon. The sea-based defensive system would be as cheap as or cheaper than the limited Nike-X ground deployment now being considered, the Navy claims. Ships could be taken out of mothballs and early models of the Polaris missile, now being retired, could be modified at relatively low cost.

Later this summer, the Navy will spend about \$1 million for more studies. Six contractors that have already done initial study work are in the running: Aerojet-General, Boeing, Hughes, Martin Marietta, McDonnell-Douglas, and Raytheon.

## **SST faces buffeting before Senate okay**

Expect to hear a great deal of opposition to the supersonic transport when the program comes up for debate in the Senate. Despite the furor, however, the Senate will probably approve prototype development without cutting into the Administration's request any more than the House did. The House Appropriations Committee trimmed the fiscal 1968 request of \$198 million to \$142 million. Since the cut was made primarily in a reserve fund, it won't affect the SST schedule; the plane is now in the final design phase at Boeing. Only \$1.4 million was pared from research funds—money to take care of any contract underestimates by contractors. The House figured this would spur firms to keep their costs down.

## **NIH proposes unit for bioengineering**

Engineers will play a bigger role in medical research if, as insiders predict, the President and Congress approve a National Institutes of Health plan to establish a division of bioengineering. The division would award contracts to industrial and research organizations to develop such medical equipment as diagnostic and monitoring systems, artificial organs, and automatic laboratory instruments.

# If Freon® is the "high-priced" cleaning agent

## ...how come it paid for itself in one year at Hazeltine?

Nearly all the printed circuits produced by Hazeltine at its plant in Riverhead, New York, go to customers in the space industry... who demand flawless components in spotlessly clean circuits.

Until two years ago, Hazeltine cleaned its printed circuits manually in other solvents. This system was effective, however, it was not very efficient... too expensive and time-consuming. In the spring of 1965, a new Branson printed-circuit-board cleaning system using FREON\* TMC was installed. This new system cleaned 50 pieces of equipment in the same time it took the old system to clean one. The total outlay for the new equipment was less than \$5,000. By the following spring it was completely amortized. Since then, FREON has been *making* money for Hazeltine.

The entire cleaning operation is done with the dissipation of only three gallons of FREON a day, compared with 28 gallons of the former solvent, which had to be discarded daily because of contaminant buildup. The reason for the better than nine-to-one advantage is that FREON itself can be cleaned. A small distilling and filtration tank reclaims FREON and returns it to the vapor degreaser crystal-clear.

How fast can FREON, the "high-priced" cleaning agent, pay for itself in *your* operation? Your first step in finding out is to write: Du Pont Company, Room 5264, Wilmington, Delaware 19898. (In Europe, write: Du Pont de Nemours International S.A., FREON Products Division, 81 route de l'Aire, CH 1211 Geneva 24, Switzerland.)

**FREON®**  
solvents



Better Things for Better Living... through Chemistry

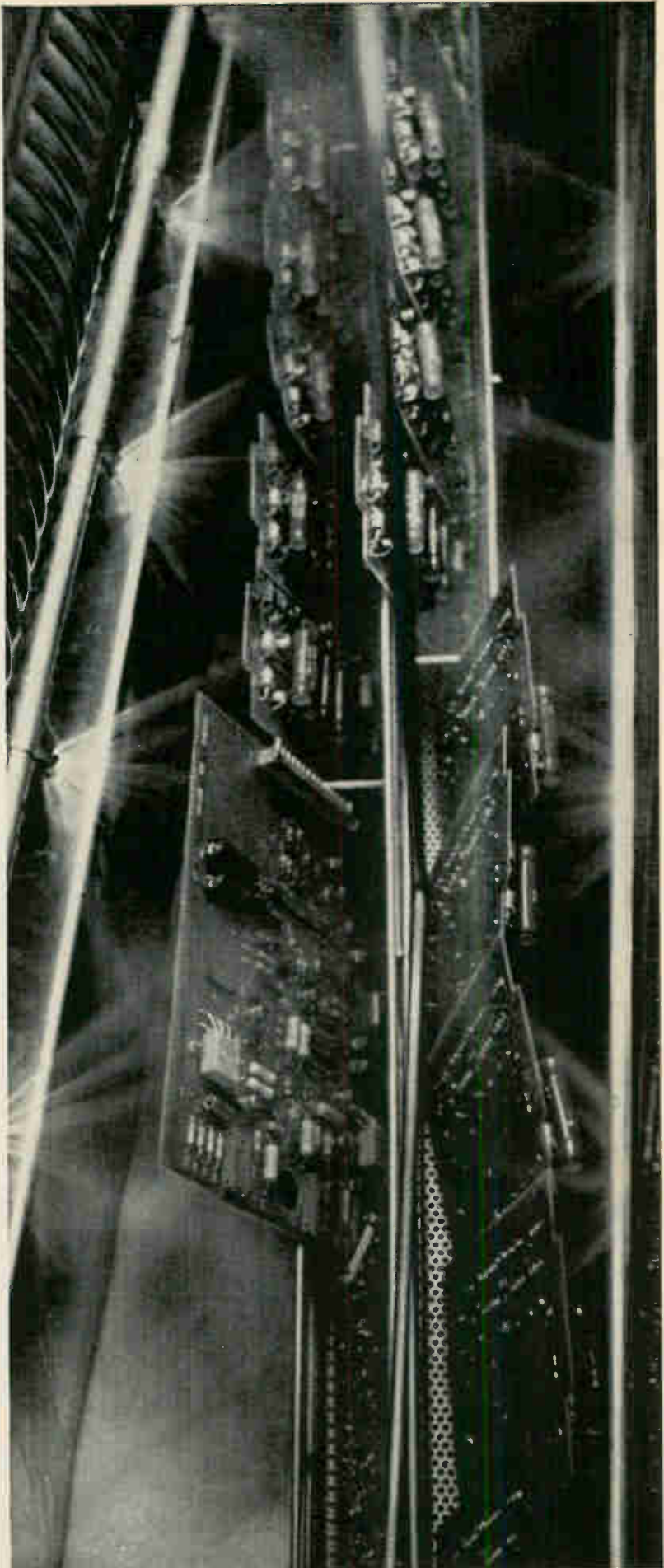

\*Du. Pont registered trademark of its fluorocarbon cleaning agent

**These counters  
will solve  
your present  
problems now...**



**Model 5245L Counter with new 5258A Sensitive Prescaler**



**Model 5246L Counter with new 5254B Frequency Converter**

## ...your future problems later.

HP counters will solve your present measurement problems first, and they'll be ready with the same versatility and high performance far into the future. They're always up to date, because their flexibility and performance are always widening. A large team of engineers is constantly working to keep the 5245L Counter, the 5246L Counter and their plug-ins the most advanced available. New accessories and plug-ins are continually being introduced to give you more versatility and protect your investment.

Latest examples of new plug-in versatility are shown in the photo: the 5254B Frequency Converter (0.2 to 3.0 GHz) and the 5258A Sensitive Prescaler (1 mV sensitivity from 1 to 200 MHz). Together, these two plug-ins will extend counter range from DC to 3 GHz. Or, if you like, you can cover DC to 12.4 GHz with just two plug-ins, the 5254B (0.2 to 3 GHz) and 5255A (1 to 200 MHz and 3 to 12.4 GHz).

The 5245L Counter accurately measures frequency, period, multiple period average, ratio and multiples of ratio and can be used to scale a signal by decades. Its time base aging rate is less than 3 parts in  $10^6$ /day, and a dual FET input amplifier provides 1 Meg/25 pF input impedance, independent of attenuator setting. Basic counting rate is DC to 50 MHz. BCD output is standard. It accepts the exclusive Model 5255A 3 to 12.4 GHz Converter—no need to use more than one module to measure in this range. Price: Hewlett-Packard 5245L Counter, \$2950.

The economical 5246L Counter offers many of the 5245L's advantages, and is a basic 50 MHz counter. It measures frequency and frequency ratio, has display storage and 6-digit readout, and a time base crystal aging rate of  $\pm 2 \times 10^{-7}$  per month. It accepts all accessories and plug-ins of the 5245L Counter. Price: Hewlett-Packard 5246L Counter, \$1850.

#### PLUG-INS TO USE WITH EITHER COUNTER:

- 5255A Heterodyne Converter, 3 GHz to 12.4 GHz (and 1 to 200 MHz). Price: \$1650.
- 5251A Plug-in Converter, 50 to 100 MHz. Price: \$300.
- 5252A Prescaler, DC to 350 MHz. Price: \$685.
- 5253B Plug-in Converter, 50 to 500 MHz. Price: \$500.
- 5254B Plug-in Converter, 0.2 to 3 GHz. Price: \$825.
- 5258A Prescaler, 1 to 200 MHz, 5 mV. Price: \$825.
- 5261A Video Amplifier, 1 mV RMS, 10 Hz to 50 MHz. Price: \$325.
- 5262A Time Interval Plug-in. Price: \$250.
- 5264A Preset Unit for normalized measurements. Price: \$650.
- 5265A Digital Voltmeter, 6-digit presentation of 10, 100 and 1000 V full-scale with 5% overrange capability. Price: \$575.

#### SOME OTHER ACCESSORIES:

- 5260A Automatic Frequency Divider for direct readout 0.3 to 12.4 MHz. Price: \$3450.
- 2590B Microwave Frequency Converter (phase-locked transfer oscillator), 0.5 to 15 GHz. Price: \$2150. (12-18 GHz optional).
- 5050A Printer, 20 lines/sec. Price: \$1750 + \$35/column.

For more information call your local HP field engineer or write Hewlett-Packard, Palo Alto, California 94304. Europe: 54 Route des Acacias, Geneva.



# OSCILLOGRAPHY

Since 1937, CEC has been the pioneer and recognized leader in data instrumentation. The oscillographs and support equipment described here are the newest and most advanced available today.



**Type 5-126**—the new "best buy" in oscillography. At a price hundreds of dollars less than any comparable instrument, the 5-126 offers the basic capabilities of a light beam oscillograph at a cost approaching that of a thermal writing recorder. With CEC's new 7-380 Galvanometer, this portable unit will record from dc to 1 KHz. Its tungsten light source assures optimum trace quality and lamp light, minimum cost and maintenance, instant operation with complete safety. Nine channels produce vivid data traces on 7-inch-wide paper. Records by direct print-out upon exposure to ambient light, thus eliminating the need for chemical processing. And, due to CEC's automatic front-loading system, no spooling or threading is required.

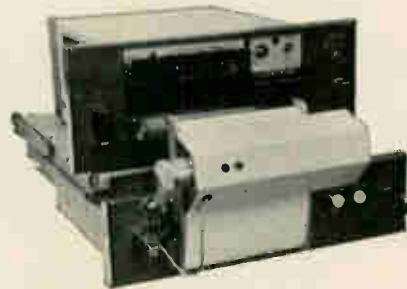

**Type 5-124**—Shown with the DataFlash Takeup Accessory which requires only 1 second to readout, the 5-124 has become a new "must" for industry. Portable, easy to operate, this instrument offers big recorder capability in a small-size, low-cost package. The 5-124 provides up to 18-channel print-out recording, 10 speed ranges, and record-drive systems with 16 options from 0.25 ipm to 128 ips.



**Type 5-119**—A truly universal oscillograph, the 5-119 has become a popular, proven performer for laboratory, mobile, airborne and marine use. Both dc and ac powered models are available. The 5-119 accepts all three types of record magazines, DATAFLASH, DATARITE, and conventional, making it possible to utilize every known photographic technique on either the 36- or 50-trace models.



**Type DG 5511**—CEC's unique, solid-state DG 5511—the first low-cost, three-in-one portable direct-writing recorder—provides capabilities formerly achieved only through multiple instruments. Plug-in signal conditioners are available to accommodate a wide range of voltage inputs. No preamp is needed for high-level signals. Converts from high-level to low-level inputs by a simple change of plug-in attenuator/amplifier units. The DG 5511 combines ease of operation with a high degree of resolution on heat-sensitive paper.

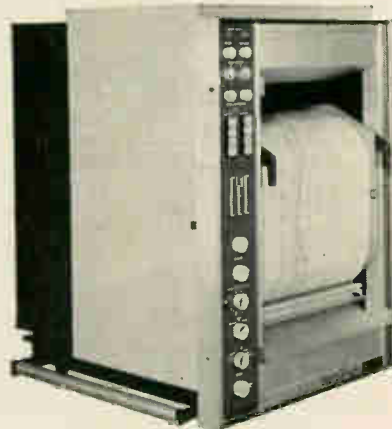

**Type 5-133**—This oscillograph is essentially two instruments in one. Reason: the 5-133 utilizes two galvanometer magnet assemblies. The galvo recording lamp intensity is individually controlled so as to permit recording from either magnet assembly, or both, as desired. Two data setups can be made at one time and recorded simultaneously, or be made alternately and recorded sequentially utilizing full chart width for each. The 5-133 is available in 12, 24, 36 and 52 channel configurations. There are 5 recording modes—3 direct writing and 2 develop-out. And being of modular design, the unit is readily adaptable to additional or future instrumentation.

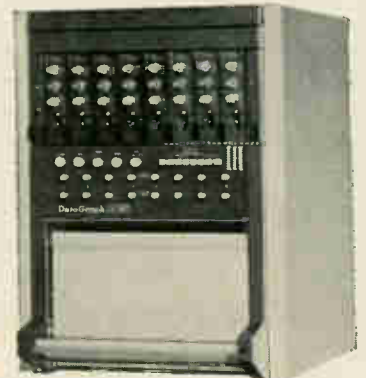

**Type DG 5510**—This 8-channel Thermal Writing Recorder brings a significant advance in performance and reliability to direct-writing oscillography. The basic 5-510 recorder is a self-contained instrument with driver amplifiers and power supply capable of accepting a wide range of high-level input signals. Interchangeable plug-in attenuator/preamplifiers are available to further extend the input range. It employs a heated writing stylus to deliver sharp contrast rectilinear traces on CEC's DataTrace® Thermal-Sensitive Paper.

Other outstanding features include: Solid-state electronics • Immediate readout • Superior frequency response • Calibrated zero suppression • Cabinet mounting, including dolly for complete mobility.

1967

## CEC Accessories, Signal Conditioning and Support Equipment

CEC has a *complete line* of dc and ac signal conditioning equipment specifically created to do the job at a realistic price. Furthermore, this wide range of instruments assures a compatible match with virtually any transducer device being used today.

**DataDigit™**—A unique *Datagraph®* Accessory. When used with any CEC oscillograph, this accessory generates the necessary waveforms to print decimal data on standard photographic papers. Up to 26 columns can be printed at speeds to 1600 lines-per-second. Decimal data can be portrayed simultaneously with analog data.

**8-108 Bridge Balance** provides coupling between as many as eight strain gages or resistive-bridge-type pickups and any suitable recording or indicating device.

**1-162A Galvanometer Driver Amplifier** is a solid state, low-gain, wideband power amplifier for driving high frequency light beam galvanometers.

**1-165 DC Amplifier** is a differential, high-gain, wideband instrument featuring four terminals to provide isolation between input and output and circuitry and ground.

**1-118 3 KHz Carrier Amplifier** is a self-contained four-channel carrier amplifier designed to amplify the output of strain gages and other transducers.

**1-163 DC Amplifier** can match and deflect all CEC galvanometers to full scale rated deflection, plus properly damp and drive any other available recording galvo.

**1-127 20 KHz Carrier Amplifier** raises the level of small signals produced by resistance-bridge or variable-reluctance-type transducers to a level suitable for operation of companion CEC galvanometers.

**3-140 Voltage Supply**—A solid-state, precision power source specifically designed for excitation of strain gage transducers. Can be housed in same assembly with 1-163 and 1-165 Amplifiers.

**CEC Technical Supplies**—CEC offers a complete selection of supplies needed to operate CEC DATAGRAPH oscillographs: print-out papers, recording papers and developing solutions.

## Building Block System



The **DG 5000**—new from CEC—is an assembly of standard product building blocks systemized into a complete configuration, thus providing overall capability from transducer to display. Since the DG 5000 will accept any CEC oscillograph, or any of the accessories, it may be tailor-made to virtually any configuration—or economically expanded to meet future configuration requirements. This fully flexible system will deliver up to 52 recording channels with light-beam galvanometers or 8 channels for thermal writing. Applications include industry, aerospace and medical science, or any operation calling for the acquisition and precise measurement of dynamic or static data.

For complete information about any of these products, call your nearest CEC Field Office, or write Consolidated Electrodynamics, Pasadena, California 91109. A subsidiary of Bell & Howell. Bulletin Kit 309-X3.

**CEC**  
DATAGRAPH PRODUCTS  
 **BELL & HOWELL**

# Nothing makes it work better.

Our customers tell us nothing makes their equipment work better than our vacuum components! That's because nothing else has all the advantages of the vacuum dielectric: high voltage ratings • high rf current ratings • long contact life • no contact maintenance • impervious to environment • faster operation • high capacity change ratios • compact design... and many others.

You just can't compare anything else with ITT Jennings vacuum

components for reliable solutions to high-voltage switching and control applications. Moreover, ITT Jennings offers industry the broadest range of vacuum products available: Our new diaphragm vacuum relays which ounce for ounce control more power for more applications than any other relays in the world • Complete coaxial switching matrices for communication control in satellite tracking stations • The widest selection of vacuum capacitors • Efficient, compact vacuum contactors.

The next time you need a reliable relaying or capacitive device for controlling high voltage or current let us show you how easily a vacuum component will solve your problem... even if you only have a crowded corner to put it in. Chances are our more than 24 years of experience with the vacuum dielectric has already provided an answer.

For information on any of the products shown, or for our complete catalog, write to ITT Jennings, a division of International Telephone and Telegraph Corporation, 970 McLaughlin Avenue, San Jose, California 95108.

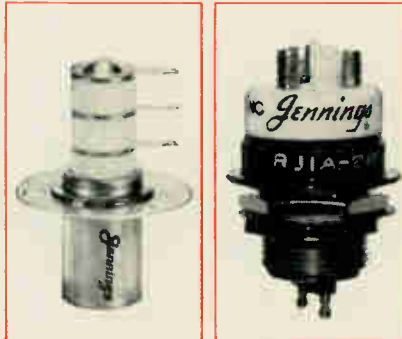

**Vacuum Relays** for high-voltage switching applications in airborne, mobile, or marine communication systems, and many industrial and commercial applications.

**Vacuum Capacitors** for the utmost in performance in rf generating devices such as high power transmitters and dielectric heating equipment.



**Vacuum Contactors** for the most reliable means available for the remote control of high voltages from 60 cycle through rf and in applications ranging from antenna switching to motor controls.

**High Voltage Measuring Equipment** for the measuring and testing of high voltage circuits from 60 cycle to rf frequencies.



**Vacuum Coaxial Relays** for automatic, remotely controlled coaxial switching in antenna and transmitter equipment for communication systems.

**JENNINGS** **ITT**



# EPICAP:10\*

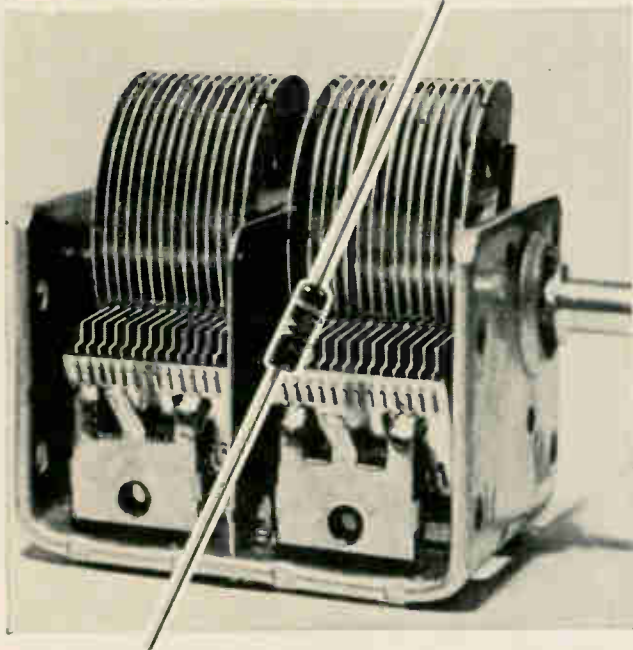

## A Solid-State Improvement For Electronic Tuning Of Broadcast Band Receivers

### New VVC Diodes Provide 10:1 Capacitance Tuning Ratio and High Q!

At long last, it's possible to say goodbye to the old "mechanical monster." Now, with Motorola's EPICAP : 10 — the first domestic VVC diode with a 10 to 1 capacitance ratio — you can design tuning circuits for broadcast band receivers where the tuning capacitor is small, very lightweight, easy to wire and inherently reliable.

Called the MV1403, Motorola's new VVC and versions thereof, offer the opportunity for remote tuning of car radios, TV sets; and, TV or FM preamps, located in the antenna but tuned from the receiver. Since capacitance is varied by a dc voltage, rather than a cumbersome linkage to a mechanical capacitor, the stylist and the designer are freed from layout limitations of the mechanical part.

In addition to an "ideal" tuning ratio, the MV1403 also offers a high Figure of Merit (Q) — 200 @ 1 MHz @ 2 Vdc, and a nominal capacitance of 175 pF. As a result, this revolutionary device also preserves the selectivity required by broadcast band receivers.

Motorola's Applications Engineering Department has prepared three comprehensive notes on the uses of tuning diodes. Subjects include: "EPICAP Tuning of Resonant Circuits"; "FM Modulation Capabilities of VVC's"; and, "Designing Around the Tuning Diode Inductance." We'll be happy to send them to you, with the data sheet for the MV1403.

\* Trademark of Motorola Inc.

*-where the priceless ingredient is care!*



**MOTOROLA**  
**Semiconductors**

MOTOROLA SEMICONDUCTOR PRODUCTS INC. / P. O. BOX 955 / PHOENIX, ARIZONA 85001

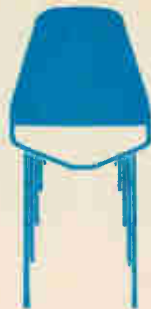

## You get all three in Philco's 9930 Series DTL.

*Philco's 9930 Series DTL: for military, commercial, and industrial applications. In E-line epoxy dual inline packages, ceramic flat packs, and ceramic dual inline packages. Broad range of circuit functions. Temperature ranges: military and limited for ceramic flat pack and ceramic dual inline; 0 to 75°C for E-line.*

Philco's 9930 meets the highest performance and reliability standards. Order now. Immediate delivery in volume quantities.

Call the sales offices and representatives of Philco-Ford: Philco Sales Office, El Segundo, California (213) 772-6226 / Santa Clara, California (408) 245-2966 / Philco Corp. of Canada, Ltd., Ontario, Canada (416) 44-2541 / Straube Associates, Boulder, Colorado (303) 443-8600 / J & J Associates, Hamden, Connecticut (203) 624-7800 / Philco Sales Office, Clearwater, Florida (813) 446-0124 / The John G. Twist Company, Chicago, Illinois (312) 777-2250 / R. O. Whitesell & Associates, Indianapolis, Indiana (317) 359-5374 / Fort Wayne, Indiana (219) 743-4411 / R. O. Whitesell & Associates, Louisville, Kentucky (502) 893-7303 / Philco Sales Office, Burlington, Massachusetts (617) 272-1600 / R. O. Whitesell & Associates, Detroit, Michigan (313) 862-2225 / Benton Harbor, Michigan (616) 927-2041 / Technical Associates, Inc., Minneapolis, Minnesota (612) 929-6721 / Technical Marketing Associates, St. Louis, Missouri (314) 427-3600 / Kansas City, Missouri (816) 523-7865 / Philco Sales Office, Ardsley, New York (914) 693-3700 / Graydon-Sherman Inc., Fayetteville, New York (315) 637-9611 / R. O. Whitesell & Associates, Cleveland, Ohio (216) 333-2585 / Dayton, Ohio (513) 298-9546 / Cincinnati, Ohio (513) 521-2290 / Philco Sales Office, Blue Bell, Pennsylvania (215) 643-2280 / Philadelphia line, Pennsylvania (215) 242-6420 / R. O. Whitesell & Associates, Pittsburgh, Pennsylvania (412) 242-0100 / Dunbar Associates, Inc., Dallas, Texas (214) 363-2536 / Philco Sales Office, Bellevue, Washington (206) 454-5061 / Philco Sales Office, Washington, D.C. (202) 298-7810.

**PHILCO**



PHILCO-FORD CORPORATION  
Microelectronics Division  
Santa Clara, California • 95051

# Now—the broadest line of convection-cooled, all silicon, .015% regulated power supplies

For test equipment and lab use 0-10,-20,-40,-60,-120 VDC, from 0-.5 amp to 0-66 amps

## Features and Data

- Rack or bench use
- Full five year guarantee on materials and labor
- Convection Cooled
- Remote Programming
- Regulation—.015% or 1 MV (Line or Load)
- Temp. Coef. .015%/°C
- Completely Protected—Short circuit proof—Continuously adjustable Automatic current limiting
- Remote Sensing
- Constant I./Constant V. by automatic crossover
- Series/Parallel Operation
- No Voltage Spikes or Overshoot on "turn on", "turn off" or power failure
- Ripple—LK models—500  $\mu$ V RMS  
LH models—250  $\mu$ V RMS, 1 MV P-P
- Meet MIL Environment Specs



Full Rack 7" LK Series



1/4 Rack LH Series

1/2 Rack LK Series-LH Series

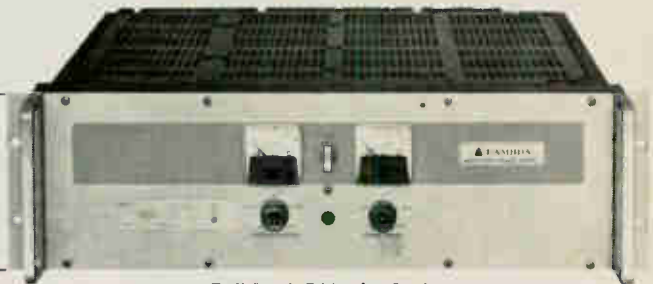

Full Rack 5 1/4" LK Series

### 3 Full-rack Models — Size 7" x 19" x 18 1/2"

Model <sup>2</sup>	Voltage Range	CURRENT RANGE AT AMBIENT OF: <sup>1</sup>				Price <sup>2</sup>
		40°C	50°C	60°C	71°C	
LK 360 FM	0-20VDC	0-66A	0-59A	0-50A	0-40A	\$995
LK 361 FM	0-36VDC	0-48A	0-43A	0-36A	0-30A	950
LK 362 FM	0-60VDC	0-25A	0-24A	0-22A	0-19A	995

### 3 Full-rack Models — Size 5 1/4" x 19" x 16 1/4"

Model <sup>2</sup>	Voltage Range	CURRENT RANGE AT AMBIENT OF: <sup>1</sup>				Price <sup>2</sup>
		40°C	50°C	60°C	71°C	
LK 350	0-20VDC	0-35A	0-31A	0-26A	0-20A	\$675
LK 351	0-36VDC	0-25A	0-23A	0-20A	0-15A	640
LK 352	0-60VDC	0-15A	0-14A	0-12.5A	0-10A	650

### 5 Quarter-rack Models — Size 5 3/16" x 4 3/16" x 15 1/2"

Model <sup>2</sup>	Voltage Range	CURRENT RANGE AT AMBIENT OF: <sup>1</sup>				Price <sup>2</sup>
		30°C	50°C	60°C	71°C	
LH 118	0-10VDC	0-4.0A	0-3.5A	0-2.9A	0-2.3A	\$175
LH 121	0-20VDC	0-2.4A	0-2.2A	0-1.8A	0-1.5A	159
LH 124	0-40VDC	0-1.3A	0-1.1A	0-0.9A	0-0.7A	154
LH 127	0-60VDC	0-0.9A	0-0.7A	0-0.6A	0-0.5A	184
LH 130	0-120VDC	0-0.50A	0-0.40A	0-0.35A	0-0.25A	225

### 11 Half-rack Models — Size 5 3/16" x 8 3/8" x 15 1/4"

Model <sup>2</sup>	Voltage Range	CURRENT RANGE AT AMBIENT OF: <sup>1</sup>				Price <sup>2</sup>
		40°C	50°C	60°C	71°C	
LK 340	0-20VDC	0- 8.0A	0- 7.0A	0- 6.1A	0-4.9A	\$330
LK 341	0-20VDC	0-13.5A	0-11.0A	0-10.0A	0-7.7A	385
LK 342	0-36VDC	0- 5.2A	0- 5.0A	0- 4.5A	0-3.7A	335
LK 343	0-36VDC	0- 9.0A	0- 8.5A	0- 7.6A	0-6.1A	395
LK 344	0-60VDC	0- 4.0A	0- 3.5A	0- 3.0A	0-2.5A	340
LK 345	0-60VDC	0- 6.0A	0- 5.2A	0- 4.5A	0-4.0A	395

Model <sup>2</sup>	Voltage Range	CURRENT RANGE AT AMBIENT OF: <sup>1</sup>				Price <sup>2</sup>
		30°C	50°C	60°C	71°C	
LH 119	0-10VDC	0- 9.0A	0- 8.0A	0- 6.9A	0-5.8A	\$289
LH 122	0-20VDC	0- 5.7A	0- 4.7A	0- 4.0A	0-3.3A	260
LH 125	0-40VDC	0- 3.0A	0- 2.7A	0- 2.3A	0-1.9A	269
LH 128	0-60VDC	0- 2.4A	0- 2.1A	0- 1.8A	0-1.5A	315
LH 131	0-120VDC	0- 1.2A	0- 0.9A	0- 0.8A	0-0.6A	320

<sup>1</sup> Current rating applies over entire voltage range.

<sup>2</sup> Prices are for non-metered models (except for models LK360FM thru LK362FM which are not available without meters). For metered models, add suffix (FM) and add \$25 to price of LH models; add \$30 to price of LK models.

<sup>3</sup> Overvoltage Protection: add suffix (OV) to model number and add \$60 to the price of LH models; add \$70 to price of half-rack LK models; add \$90 to price of 5 1/4" full-rack LK models; add \$120 to price of 7" full-rack LK models.

<sup>4</sup> Chassis Slides for full rack models: Add suffix (CS) to model number and add \$60 to the price.



**LAMBDA ELECTRONICS CORP.**

515 BROAD HOLLOW ROAD • MELVILLE, L.I., NEW YORK 11746 • (516) 694-4200 A  SUBSIDIARY

LA-182

Circle 61 on reader service card

Readout—bright, legible, IEE readout—makes the difference when the data must be accurately read at a glance, from any angle. That's the case with Lloyd Isaacs, Resident Manager of the Santa Monica office for Hornblower & Weeks—Hemphill, Noyes. On a busy trading day his clients start ringing for immediate quotations on New York prices. In 3/10 of a second, Isaacs gets and reads a crisp, brilliant figure from the IEE display on his electronic quoter. The client says *buy*. Done. He answers another line. Another client, and another quick-glance quotation goes out—accurately. IEE front-plane readouts assure that accuracy. Whether *your* product is business machines, test equipment, or space instrumentation, your customers demand the best readout available. Give it to them with IEE rear-projection, front-plane readouts—your choice of sizes with



an unlimited selection of characters and colors. Send now for your copy of the new IEE Readout Catalog. Illustrated: IEE Series 120 Readout—160° circular viewing angle; character boundaries  $\frac{5}{8}$ " wide horizontal band drawn through .800" D circle. Brightness to 100 F. L.

"I double-E," the world's largest manufacturer of rear projection readouts. **IEE**  
Industrial Electronic Engineers, Inc., 7720 Lemona Ave., Van Nuys, Calif. 91405.

**When big money rides on a stock quotation,  
"readout" makes the difference!**

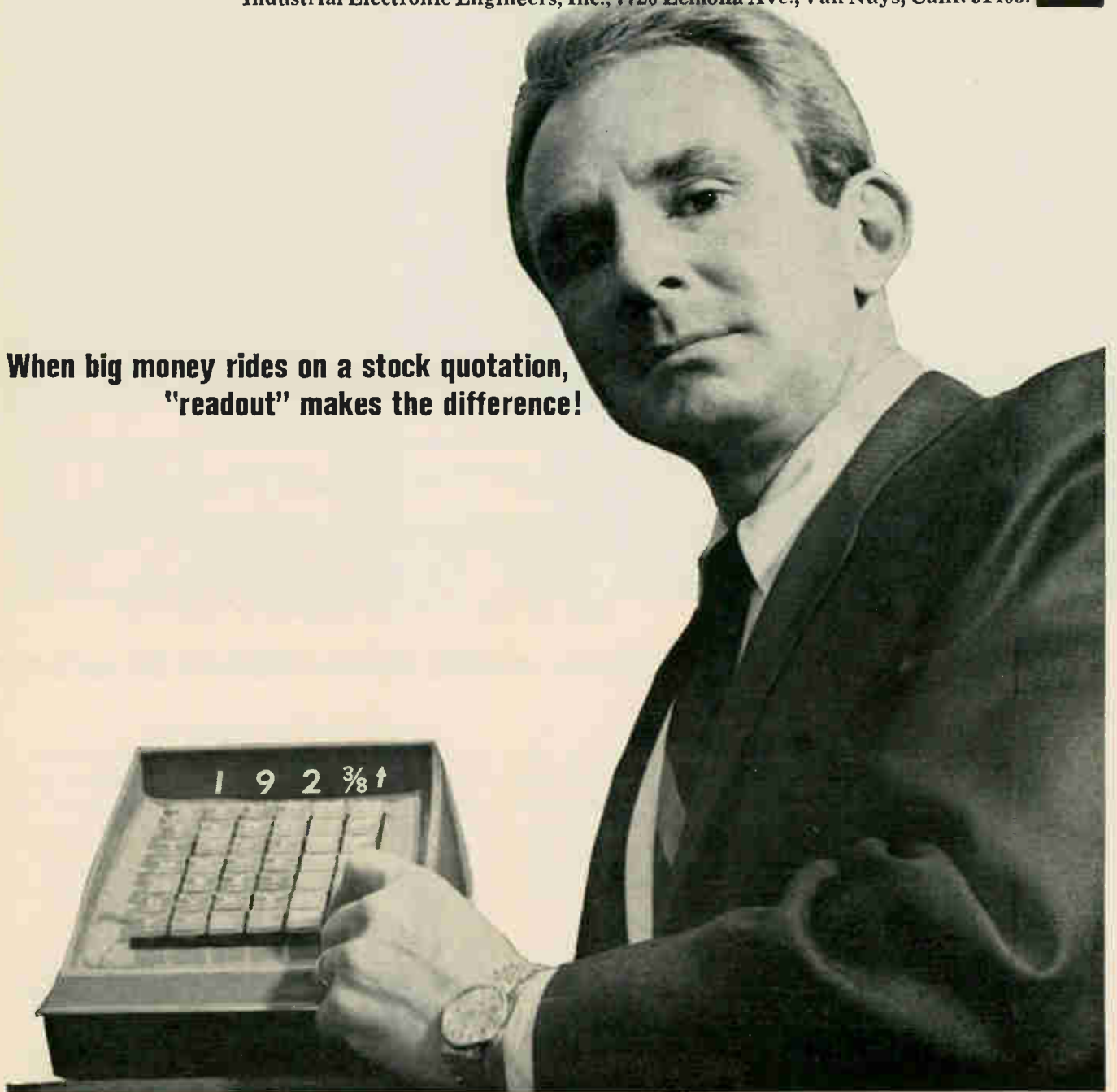

# CERAMIC MAGNETS

Remington takes advantage of the high energy of Allen-Bradley ceramic permanent magnets to achieve the small size required for the ideal performance of their 500 *Selektronic* shaver

This custom designed ceramic magnet is the result of cooperative efforts by Remington and Allen-Bradley engineers. Despite the complex geometry of the magnets, Allen-Bradley was able to achieve high volume production at reasonable cost.

Allen-Bradley MO5-C ceramic permanent magnets are radially oriented and can be furnished in segments for d.c. motors measuring no more than  $\frac{3}{4}$ " diameter up to a maximum rating of 10 hp. Coordinated and adequate manufacturing facilities at Allen-Bradley and tight quality control assure delivery in quantity—on time!

Allen-Bradley application engineers will be pleased to cooperate in the design of your motor magnets to obtain optimum performance. Allen-Bradley Company, 222 W. Greenfield Ave., Milwaukee, Wis. 53204. In Canada: Allen-Bradley Canada Limited. Export Office: 630 Third Ave., New York, N. Y., U.S.A. 10017.

**TYPE MO5-C CERAMIC PERMANENT MAGNETS** Typical Characteristics—stated values have been determined at 25° C.

Property	Unit	Nominal Value
Residual Induction ( $B_r$ )	Gauss	3300
Coercive Force ( $H_c$ )	Oersteds	2300
Intrinsic Coercive Force ( $H_{ci}$ )	Oersteds	2400
Peak Energy Product ( $B_d H_d$ max)	Gauss-Oersteds	$2.6 \times 10^6$
Reversible Permeability	—	1.09
Curie Temperature	+°C	450
Temperature Coefficient of Flux Density at $B_r$	%/°C	-0.20
Specific Gravity	—	4.85
Weight per Cu. In.	Lb.	0.175

**A-B ceramic magnets**  
used in the 500 *Selektronic* shaver  
shown actual size.



The 500 *Selektion* shaver features a unique dial which adjusts the shaving heads to four shaving positions for any combination of skin and beard, plus TRIM position for sideburn trimming and CLEAN position for instant cleaning. The shaver operates on its rechargeable energy cells or from an electric cord.



**ALLEN-BRADLEY**  
QUALITY MOTOR CONTROL  
QUALITY ELECTRONIC COMPONENTS

- 7** STANDARD single, dual, and triple units, including units with concentric shaft and vernier operation.

---

- 16** STANDARD resistance values from 50 ohms to 5 meg.

---

- 2** STANDARD tolerances 1% and 20%.

---

- 5** STANDARD resistance tapers.

---

- 18** STANDARD electrical tap options.

---

- 46** STANDARD shaft lengths from 3.8" to 6.0".

---

- 3** STANDARD shaft endings.

---

- 9** STANDARD variations of bushings.

---

- 4** STANDARD locating lug options.

---

- 4** STANDARD switch options with single and double pole.

# Allen-Bradley offers a 1,000,001 standard variations of Type J Potentiometers



Allen-Bradley Type J  
hot molded variable resistors  
rated 2.25 watts @ 70 C

These *standard* variations in the Allen-Bradley Type J hot molded potentiometer line eliminate the need for a "special" control. When you include the numerous special resistance values and tapers in which the Type J can be supplied, the variations become virtually infinite.

Yet, all of these Type J variable resistors have one thing in common—each and every one is made by the same A-B hot molding process—your guarantee of "tops" in quality. The solid hot molded resistance track assures extremely long life—exceeding well beyond 100,000 complete operations on accelerated tests with less than 10% resistance change. Control is always smooth and free from the sudden turn-to-turn resistance changes of wire-

wound units. And being essentially noninductive, Type J controls can be used at the higher frequencies—where wire-wound units are totally impractical.

Let Allen-Bradley Type J variable resistors be the answer to your special requirements—it's almost certain there's a "standard" unit in the Type J line. And you *know* you're obtaining the ultimate in reliability and performance. For more complete information on Allen-Bradley Type J potentiometers, please write for Technical Bulletin 5200: Allen-Bradley Co., 222 W. Greenfield Ave., Milwaukee, Wis. 53204. In Canada: Allen-Bradley Canada Limited. Export Office: 630 Third Ave., New York, N.Y., U.S.A. 10017.



**ALLEN - BRADLEY**  
QUALITY ELECTRONIC COMPONENTS

# When cable jacket must resist

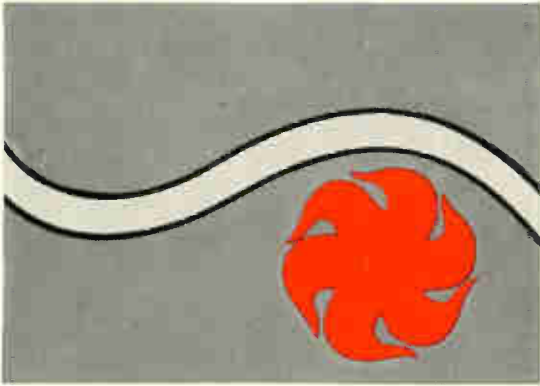

- 135°C temperature

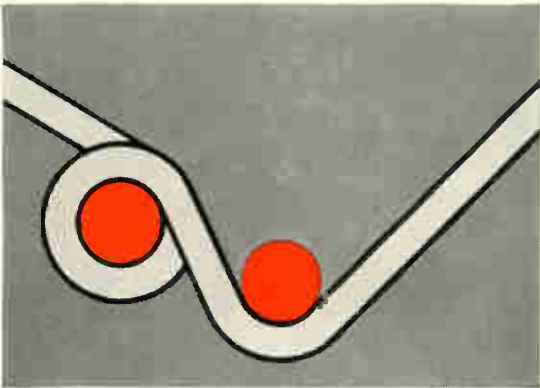

- mechanical stress

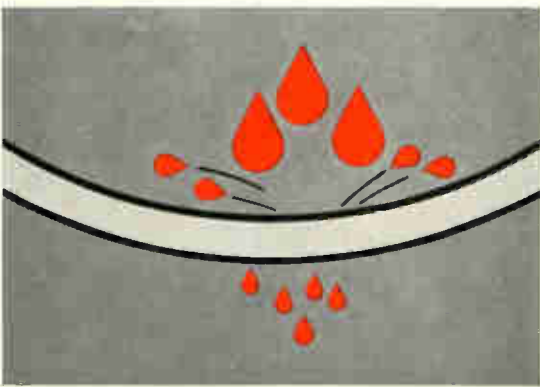

- corrosive fluids...

## It had better be Kynar\*!

Whether it's used in aircraft, down-well instruments, or computers, no other jacket material fills the bill like Kynar...Pennsalt's vinylidene fluoride resin! It stands up to temperatures from -80° to +300°F... has twice the mechanical strength of other fluoroplastics... withstands cut-through...resists acids, bases,

chlorinated cleaning solvents and jet fuels.

When only the best cable jacket material is good enough... when you need one that's tough... specify Kynar. For data, write or call: Plastics Department, Pennsalt Chemicals Corporation, 3 Penn Center, Phila., Pa. 19102.

***Kynar...the fluoroplastic that's tough!***

\*Kynar is a registered trademark of Pennsalt Chemicals Corporation for its vinylidene fluoride resin.



# TRIMMED

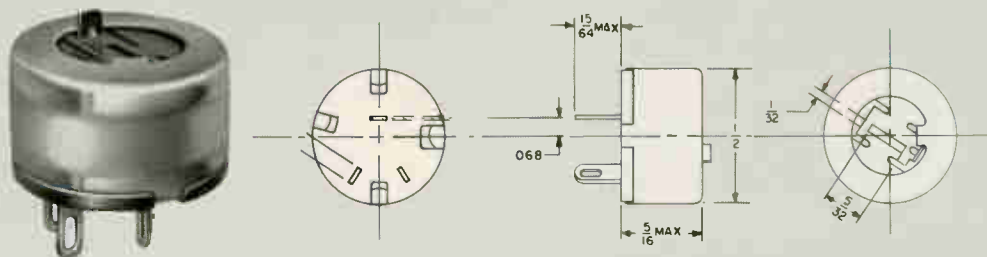

## CLOSER SPACING board-to-board SERIES 371 MOLDED CARBON POTENTIOMETER

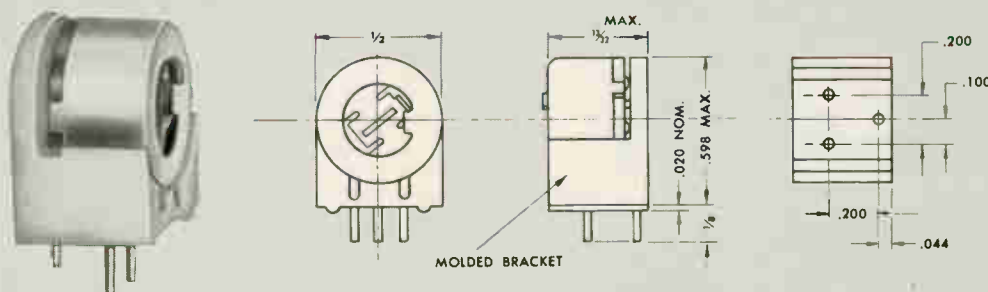

## EASIER ADJUSTMENTS at right angles... SERIES 371RA1 FOR PRINTED CIRCUIT BOARDS

When it comes to resolving big pot problems and confining them to a small space, Clarostat has the know-how. It brings them down to size.

In printed board applications where mounting is critical, the Clarostat 371 molded carbon trimming potentiometer provides maximum unit surface economy and permits closest board-to-board spacing. Elimination of the shaft and seal brings down costs as well as dimensions with the entire potentiometer limited to a minimum number of parts including a hot molded carbon element, carbon contact brush, pressure spring and cover.

Clarostat Series 371RA1 holder mounts are made of "Zytel 101" nylon with design rigidly encasing the leads at right angles to the pot even when mounted side-by-side on plug-in circuit cards. This permits easy adjustment of the trim pot body. Ends protrude from the mount on .1" grid centers. Since the Series 371RA1 is a bonded assembly, it should be specifically ordered.

### SPECIFICATIONS

#### Series 371 & 371RA1 Molded Carbon Potentiometers

Resistance Range: 100Ω to 1 Megohm.  
Resistance Tolerance: ±20% Standard, ±10% Special.  
Power Rating: .375 watt @ 70°C, derated to 0 watt @ 120°C.  
Taper: Linear.  
Dielectric Strength: Variable arm hot to case.

Working Voltage: 350 Vac maximum.  
Mechanical Rotation: 290° ±5°.  
Stop Torque: 20 oz.in.  
Operating Torque: 7.0 oz. in. maximum.

# CLAROSTAT

CLAROSTAT MFG. CO., INC. DOVER, NEW HAMPSHIRE



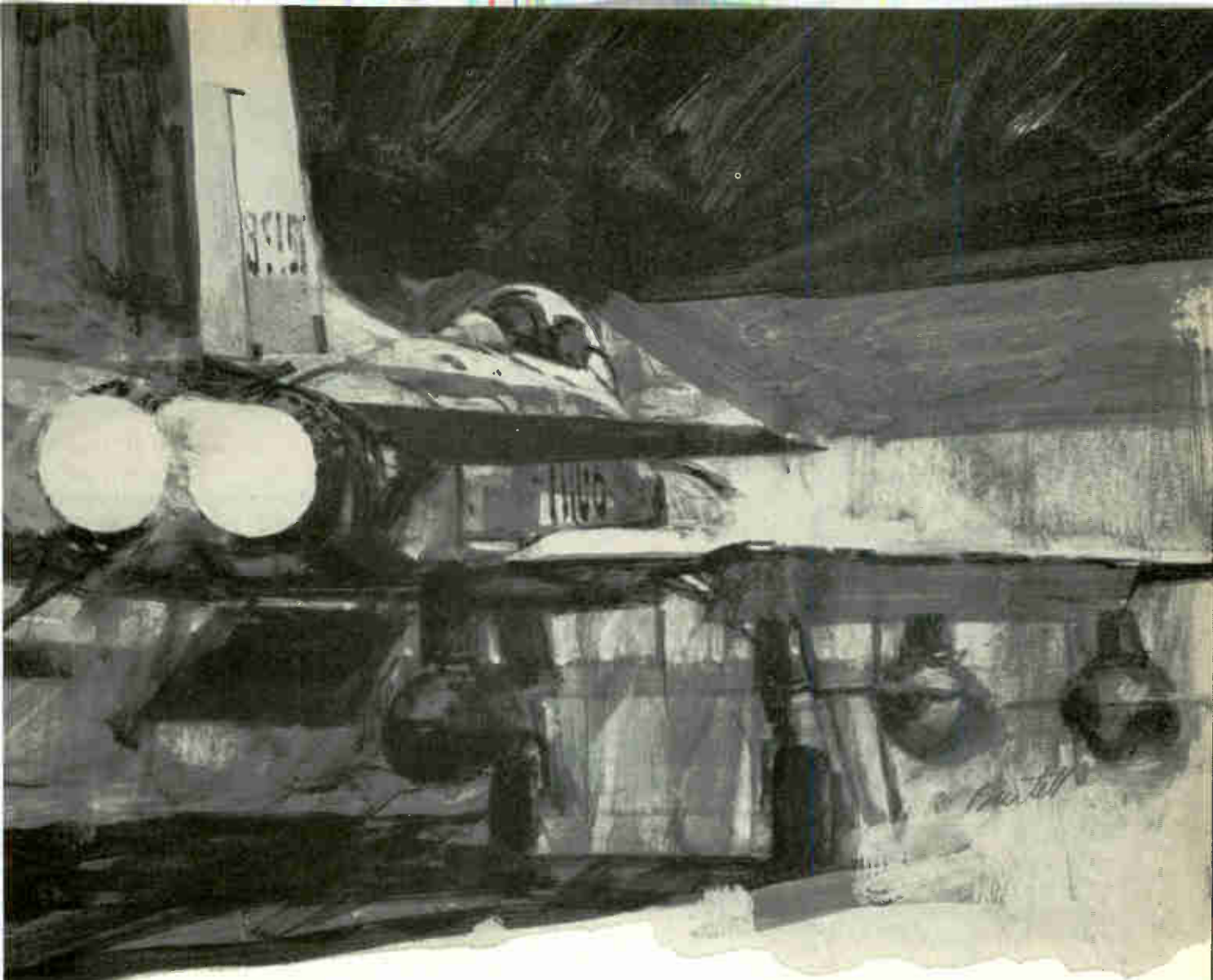

## When the heat's on... take the pressure off with Cannon® firewall plugs

Designed to increase maintainability and dispatch-reliability, ITT Cannon's new high performance FRF – firewall – connectors meet tomorrow's high temperature and fluid resistance requirements... in jet aircraft, missiles, and propeller aircraft.

These lightweight connectors exceed the requirements of MIL-C-5015, Class K, and feature front release, rear insertion, crimp snap-in MIL-C-39029 type contacts. They also operate

continuously in temperatures from  $-55^{\circ}\text{F}$  to  $+400^{\circ}\text{F}$



and up to  $2000^{\circ}\text{F}$  for short term. Besides saving weight by 25%, and assembly and servicing time by 200%, ITT Cannon's FRF plugs offer superior environmental sealing and feature high temperature elastomers which are compatible with aircraft fluids. Other features? One-piece steel shell and barrel hardware... optional self-locking coupling nut... rugged metal clip retention

system... intermateability with MIL-C-5015 connectors.

When the heat's on (for any connector application) let ITT Cannon take the pressure off. For our FRF catalog, write ITT Cannon Electric, 3208 Humboldt Street, Los Angeles, California 90031.

A division of International Telephone and Telegraph Corporation.



# CANNON ITT



**experience counts**  
**... and spells**  
**to produce**  
**information**  
**display**  
**systems**

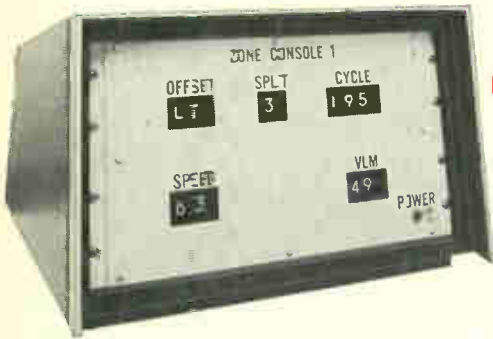

**B** **Burroughs Corporation**

Burroughs has produced many complete information display systems for a wide variety of industrial, commercial and military applications.

For application assistance or information write:  
Burroughs Corporation, Electronic Components Division  
P.O. Box 1226, Department A1  
Plainfield, New Jersey 07061  
Tel: (201) 757-5000

BURROUGHS CORPORATION  
ALPHANUMERIC AND NUMERIC REAL TIME DISPLAY  
SYSTEMS FOR COMPUTER READOUT - SCHEDULE BOARDS -  
TRAFFIC CONTROL MONITORING - STOCK MARKET  
DISPLAY BOARDS - NEWS AND INFORMATION DISPLAYS

# Technical Articles

---

**On the threshold of success:  
glass semiconductor circuits**  
page 74

## Electronics

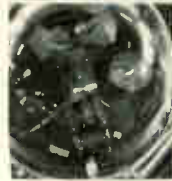

The glass semiconductor switch has already earned a controversial reputation even though it is very new. Few designers have put it into circuits, primarily because there have been doubts about its producibility and its reliability. Despite these reservations, the glass switch is attractive: one can do the work of two conventional semiconductor devices in some applications.

At the Applied Physics Laboratory of Johns Hopkins University, the glass switch has been designed into memory addressing circuits and the early results indicate it will prove valuable in memory systems for earth satellites. For the cover, J. Edward Bailey photographed one step in the production process: a technician assembling the switch so it can be sealed to its leads. The operation takes place inside a plastic bubble filled with an inert gas. He also photographed the other important steps in production for the color display on page 77, proof that the device can be mass produced.

**Digital filters  
boost Q without inductors**  
page 91

Until inductors can be made reliably with integrated circuits, another approach is required in building microelectronic band-pass amplifiers. Although most engineers have relied on inductance capacitance (LC) filters, a resistance-capacitance (RC) filter may be more promising. In such a network, the capacitors are connected sequentially into the circuit to produce a sharply tuned waveform. The RC filter eliminates the inductor and achieves high values of Q.

**Special report:  
Medical electronics,  
Part II,**  
page 103

**Computers in medicine.** The electronic computer can do many jobs for doctors, from administrative chores to real-time diagnoses.

3. **The widening impact of computers (p. 103).** The medical profession first applied the computer to administrative and accounting problems. Now the machine is becoming the center of a variety of systems that monitor patients' conditions, analyze laboratory tests, schedule operations, and allocate facilities.

4. **Making informed decisions (p. 108).** The doctor faces a complex multiple-choice test—with as many as 100,000 possible answers—every time he examines a patient. A computer-based system now under development will process stored data to suggest costs, diagnoses, and treatments.

5. **A total-systems approach (p. 111).** The U.S. Public Health Service has devised a system in which transducers are linked to a diagnostic computer by telephone lines. It is an integrated package that can handle routine jobs.

---

**Coming  
August 7**

- Linear integrated circuits—first of a series
- Laser interferometer
- Medical electronics: Part III

# On the threshold of success: glass semiconductor circuits

They're getting to look a lot better than conventional IC's as address decoders in satellite memory systems because they're much simpler and offer high radiation resistance

By James A. Perschy

Applied Physics Laboratory, Johns Hopkins University, Silver Springs, Md.

**Its alien structure** has made the glass semiconductor threshold switch a controversial class of component. It can do the work, in some applications, of two conventional semiconductor devices, yet it is merely an amorphous film between two electrodes. Few designers have tried the component in practical circuits, or even considered its use.

At the Applied Physics Laboratory (APL) of Johns Hopkins University, the use of glass semiconductor switches as decoders and current steerers in memory addressing circuits is being investigated. Preliminary results indicate that this type of switch may prove extremely valuable in memory systems for earth satellites. The experimental circuits are much simpler than transistor or integrated circuits and have high radiation resistance.

Because it appears feasible to batch-fabricate the circuits as monolithic structures, with fewer processing steps than ordinary semiconductor circuits, the glass semiconductors are potentially very reliable. This stems from the nature of the glass material, which is a bulk-effect semiconductor—the operation of the switches doesn't depend upon a junction between dissimilar materials, so junction diffusion steps are unnecessary. In addition, the

switches are bidirectional; only one switch is needed where two unidirectional devices with appropriate controls would otherwise be required.

The experimental circuits have been built with commercially available discrete glass devices. Tests show that at slow pulse rates, these circuits can switch 1-ampere currents billions of times without signs of wear. Moreover, they dissipate very little power. The characteristics appear to fit the applications being investigated—decoding and switching in sequential buffer storage circuits that temporarily store data at the satellite end of a ground-to-space communications link. These applications require slow data rates, low power consumption, and high reliability.

Experiments at APL indicate that the data storage portion of a satellite memory system can have half the weight and volume if the address circuits are built with two batch-fabricated threshold-switch matrixes instead of 136 standard, commercially available flatpacks containing integrated circuits, or circuits made of transistors, diodes, and resistors.

## The basic switch

The threshold switch is a thin film of amorphous material, essentially a semiconducting glass, that exhibits an avalanche effect when immersed in an electric field whose intensity exceeds a certain threshold.\* Above this threshold, the field causes electron multiplication, producing a high-conductance path between the electrodes. The electric field is established by applying a voltage across the glass film; field intensity depends on voltage magni-

## The author



James A. Perschy is the supervisor of the memory design project in the satellite digital systems group at Johns Hopkins University's Applied Physics Laboratory, where he has worked since receiving his bachelor's degree in 1958.

\*The composition of a typical semiconducting glass in percentages of atomic weight is: tellurium 47.7%, arsenic 29.90%, silicon 12.64%, germanium 9.76%.—W.B.R.

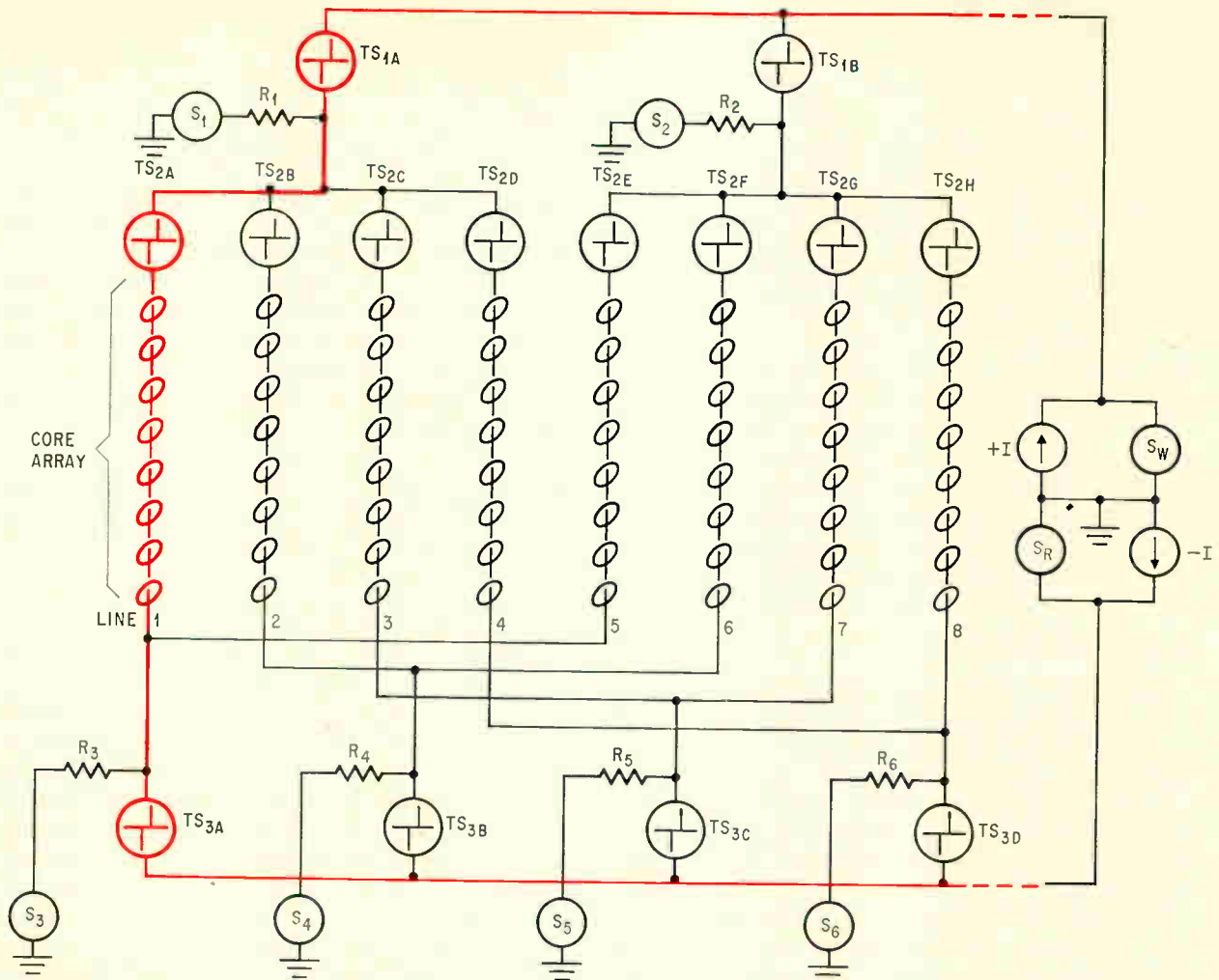

**Dual-polarity drivers.** Partial internal decoding is possible when threshold switches are applied as dual-polarity drivers. External decoding is still required for switches at bottom. One complete loop for a half-select current is shown in color.

tude and film thickness. Since the thickness in a particular device is fixed, the threshold is expressed in volts rather than in units of field intensity.

The below-threshold resistance of a typical switch may be as much as several hundred megohms. Capacitance is generally a few picofarads in parallel with the resistance. The threshold is about 12 volts in both directions. When the switch is conducting, it passes a current of 300 milliamperes with less than a 2-volt drop in voltage, corresponding to a resistance of about 6 ohms.

The switches are made by vacuum-depositing the semiconducting glass on individual electrodes, which are then fused to leads while the joint is encapsulated in an insulating glass package. Larger arrays could easily be made by depositing several dots of glass on a substrate and fusing electrodes on top of the dots. For more complex devices, alternate layers of metal and semiconducting glass could be deposited on a substrate. Switching would take place in the latter configuration wherever two layers of metal were separated by a thin layer of glass. To prevent switching, either a thick layer of semicon-

ducting glass or a layer of insulating material could be deposited between the two metal layers.

### Memory addressing

At APL the switches are being used experimentally in memory-addressing circuits to locate a single ferrite core in a rectangular plane array, which is threaded by wires—carrying half-select currents—passing both horizontally and vertically. Two intersecting half-select lines locate any one core, and can reverse the direction of magnetization around it. A single half-select current is in one direction for a read or clear cycle, and in the opposite direction for a restore or write cycle. In some memories a third set of wires detects the change in magnetization when reading data out of the array.

The diagrams accompanying this article show only one set of half-select lines for clarity. In an actual memory, another set of lines at right angles to the first, and a similar set of address circuits, would supply the remaining current.

The organization can be either one of a series of planes enabling parallel readout of several bits

(either two-and-a-half- or three-dimensional) or a single plane from which individual bits are read out in sequence. The latter may be considered either a one-bit-per-word  $2\frac{1}{2}$ -D or 3-D system. In addition to one or more such planes, a memory system also includes address and data registers, address decoders, current drivers, and sense amplifiers. The address register holds the address of the bit or word being accessed at any particular moment. The decoder translates the address, comprising only a few bits, producing a signal on the required half-select line. Since memories usually contain two sets of half-select lines at right angles to one another, they usually have two address decoders, each processing about half of the address word.

The current drivers generate a pulse that is routed by the decoder along the correct half-select line. Sense amplifiers pick up voltage pulses generated when selected cores in the memory change state; the pulses set bits into the data register, where they are made available to the computer or digital system that requires the data.

### Replacing the junctions

Threshold switches can replace a memory system's decoders and current drivers in several different ways of increasing complexity, representing increasing degrees of large-scale integration. They can replace the isolating diodes directly, one switch for two diodes; they can be used as dual-polarity drivers; or they can be connected in a binary-decoding matrix.

In conventional designs, a diode matrix isolates the wires carrying half-select currents.<sup>1</sup> A negative pulse on a voltage bus and a pulse that opens a positive current gate pass a half-select current through a diode and along a single half-select line threading an array of cores. Reversed diodes block parallel paths that exist for any given combination of one bus and one gate. A reversed half-select current is passed through the same wire with a positive pulse on the same voltage bus and a pulse that opens a different negative current gate.

This arrangement requires two diodes—two semiconductor junctions—for each half-select line; one passes positive current into the line and one passes negative current out of it.

Half as many threshold switches with no junctions can do the same job. One threshold switch is connected in series with each half-select line. Pulses on the voltage bus and the current gate cause the voltage across the switch to exceed the threshold, typically 12 volts. This turns on the switch, which then passes the necessary half-select current into the line through the cores—typically 300 milliamperes. As in the diode array parallel paths exist, but these paths all pass through three switches, and the voltage across each is well below the threshold, so that none turns on. The threshold switch turns on and conducts in either direction, depending on the polarity of the voltage and current.

The designs require one pair of current gates for

each group of half-select lines, where the number of lines equals the number of voltage buses. The addresses must be decoded by external circuits to pick out one gate in the array. When threshold switches are used as dual-polarity drivers, as in the diagram on the preceding page, fewer gates are necessary and the external address circuitry is simpler because the address is partially decoded in the array. In the diagram, the symbol for the threshold switch is that adopted by Energy Conversion Devices, Inc., manufacturer of the switches used at APL. It is a stylized representation of the switch's voltage-current characteristic as seen on an oscilloscope. Switches  $TS_{1A}$  and  $TS_{1B}$  are functionally equivalent to the voltage buses in the simpler design; switches  $TS_{3A}$  through  $TS_{3D}$  perform the task of the current gates. The product of these two quantities determines the number of lines that can be handled in combination. The current sources are basically unchanged except that each has an independent gate.

When a half-select current is to be driven through one of the eight wires, a connection to ground is established through two address gates. Gate  $S_1$  controls the four left-hand wires and gate  $S_2$  controls the four right-hand wires. The other four gates each control one wire from each group. Thus to select line 1, gates  $S_1$  and  $S_3$  are opened ( $R_1$  and  $R_3$  are shorted to ground); to select line 6, gates  $S_2$  and  $S_4$  are opened ( $R_2$  and  $R_4$  are shorted to ground). In the diagram, line 1 (color) has been selected.

One of the two current sources at the right side of the diagram is connected to the memory array, depending on whether a read or write cycle is being initiated. When a read cycle is initiated,  $S_R$  shorts to ground. The connection causes the voltage at  $TS_{1A}$  and  $TS_{1B}$  to rise above the threshold. But only  $TS_{1A}$  will turn on, because the other switch isn't grounded. Then current that passes through both the switch and resistor to the address gate,  $S_1$ , causes the voltage to rise beyond the threshold of the four switches immediately below. Of these, only  $TS_{2A}$  turns on because it is grounded through the address gate  $S_3$ . Voltage now rises past the threshold at  $TS_{3A}$ , and this switch turns on, completing the circuit to the current source.

Gates  $S_1$  and  $S_2$  can be controlled directly by one address bit, without additional decoding circuitry. Two more bits in the address must be decoded to establish a ground connection through one of the four address gates— $S_3$ ,  $S_4$ ,  $S_5$ , or  $S_6$ . These three bits are sufficient to address any one of the eight half-select lines shown, because  $2^3 = 8$ . In an 8-by-8 array, three more bits would locate any one of eight lines at right angles to those shown. Thus six bits can locate any one of the 64 cores. In most memories addresses are longer than six bits and arrays are considerably larger than 8-by-8. The address length equals the base-2 logarithm of the number of cores.

The three switches— $TS_{1A}$ ,  $TS_{2A}$ ,  $TS_{3A}$ —turned on one after the other in rapid sequence because they were connected in series to a common current source. This is possible because each switch is indi-

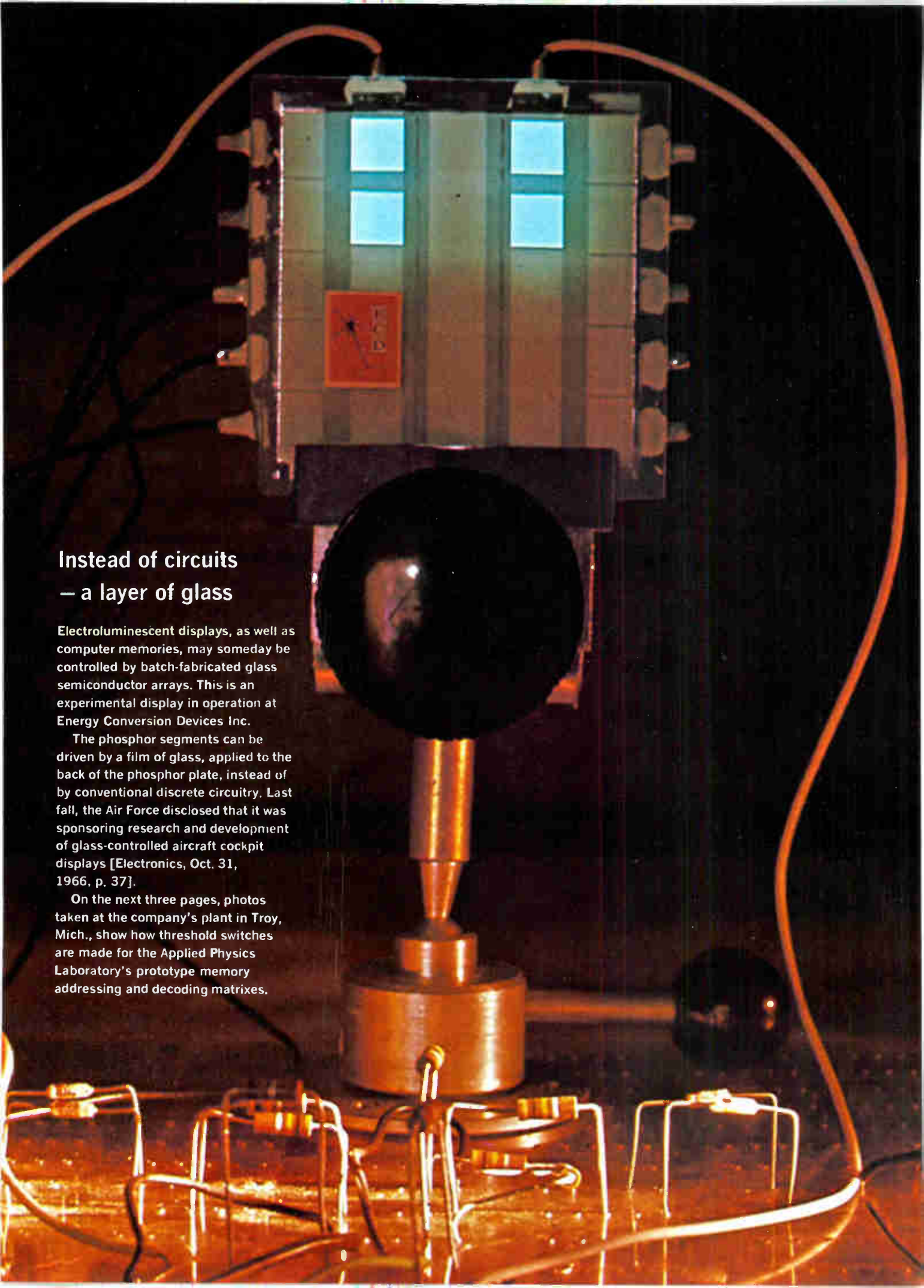

## Instead of circuits — a layer of glass

Electroluminescent displays, as well as computer memories, may someday be controlled by batch-fabricated glass semiconductor arrays. This is an experimental display in operation at Energy Conversion Devices Inc.

The phosphor segments can be driven by a film of glass, applied to the back of the phosphor plate, instead of by conventional discrete circuitry. Last fall, the Air Force disclosed that it was sponsoring research and development of glass-controlled aircraft cockpit displays [*Electronics*, Oct. 31, 1966, p. 37].

On the next three pages, photos taken at the company's plant in Troy, Mich., show how threshold switches are made for the Applied Physics Laboratory's prototype memory addressing and decoding matrixes.

## In one vacuum and out another

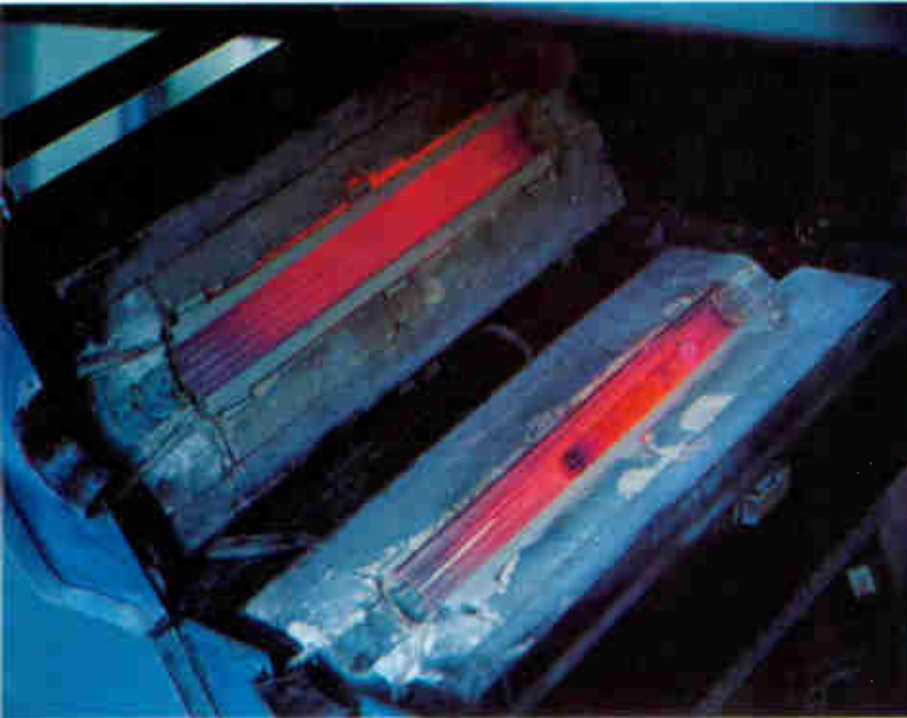

**Bomb fusing.** Technician prepares bomb by fusing the tube's open end, which is connected to a vacuum line to remove air.

**Glass furnace.** Semiconducting film's raw materials are compounded by melting them in evacuated glass tubes. Cooled, the glass looks like a lump of coal.

Photos by J. Edward Bailey

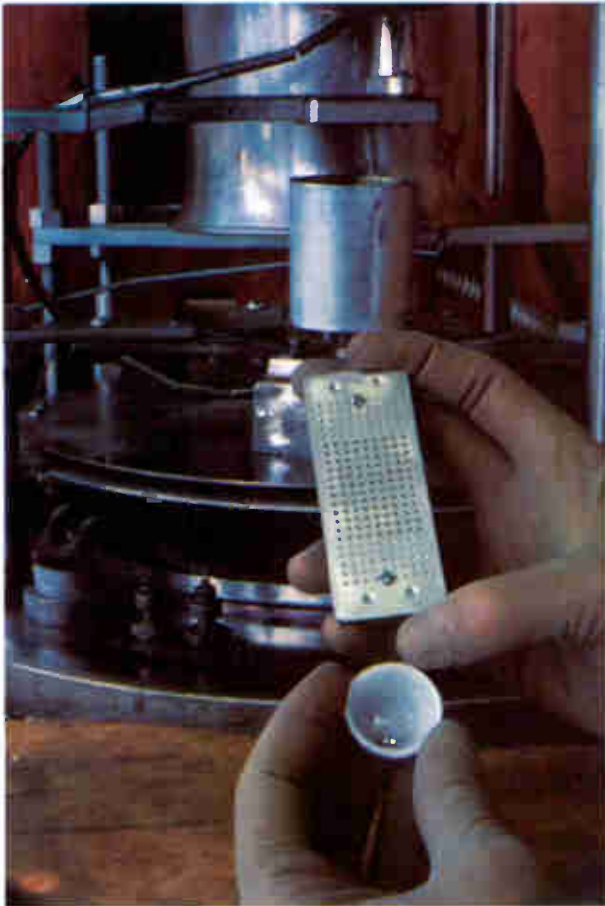

**Carbon electrodes.** Tiny carbon balls held in the fixture in front of a vacuum deposition chamber will become threshold switches when coated with glass film.



**Glass deposition.** Substrate heating lamp casts a red glow as the semiconducting glass films are deposited onto the electrodes.



## Glass package for a glass switch



**Package sealing.** Resistance-heating coil around the switch assembly fuses the glass film to the upper lead and seals the switch.

**Diode envelope.** Since the switches need only two leads, they are sealed in glass diode packages. First sealing step is dropping a coated carbon ball onto the lower diode lead.

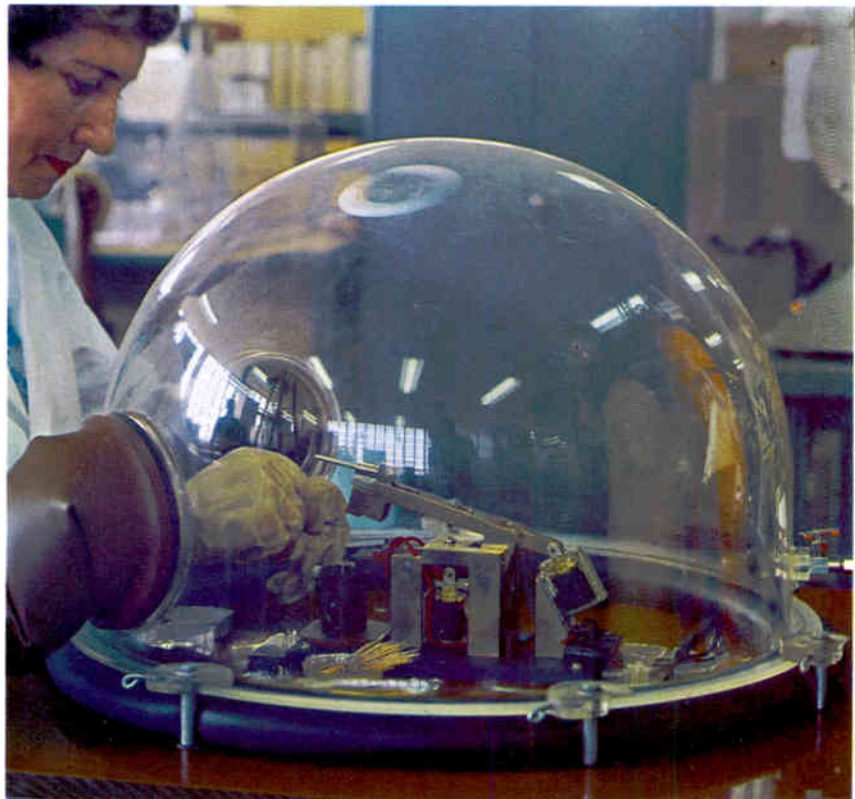

**Plastic bubble.** During sealing, plastic bubble (also shown on the cover) maintains an inert atmosphere around the switch. A diode envelope is in the sealing nest. When the operator lowers the sealer's arm, it will press the top lead into the envelope and turn on a resistance heating coil.

## Crooked cross marks a good switch

Burn-in test. Preliminary operation for 12 hours weeds out switches that don't work properly.



Two symbols. Oscilloscope pattern below is used as a schematic symbol of the switch. It is the current-voltage waveform produced by cycling a switch with 60-hertz line power. The switch generating the pattern is a symbol of design simplicity — a lead wire touching the glass coating on a second wire.

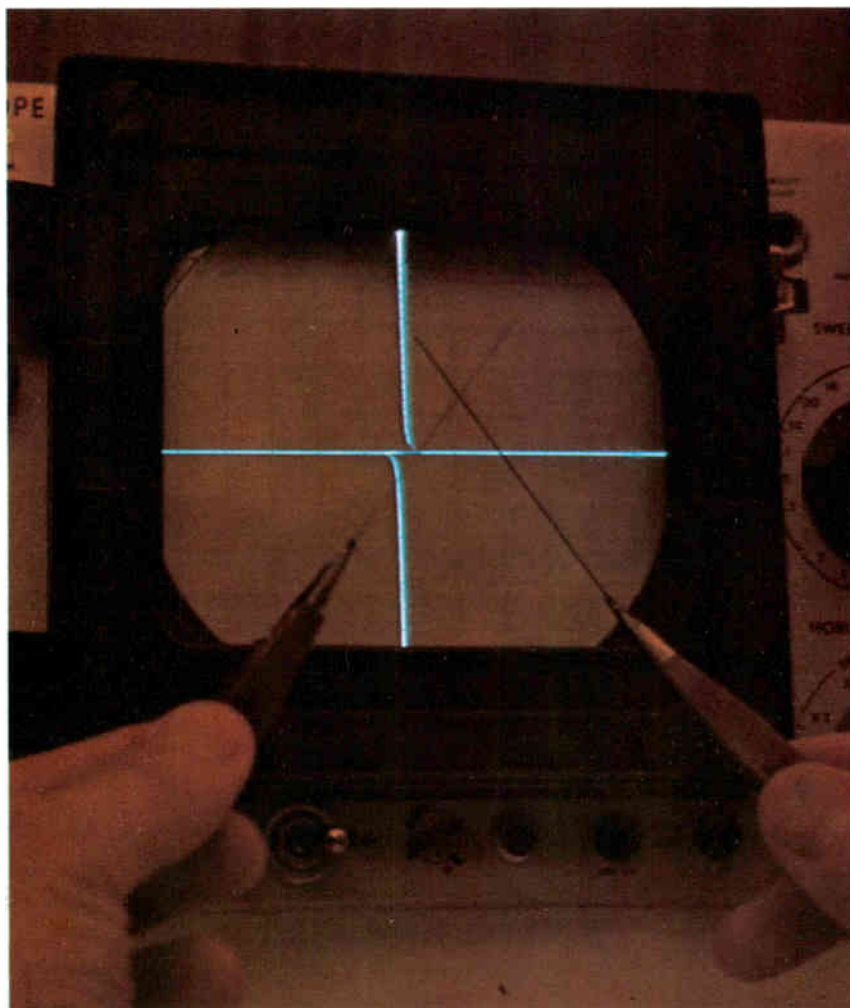

Final test. Symmetrical scope pattern tells the operator that there is a good switch in the test contacts on the table.

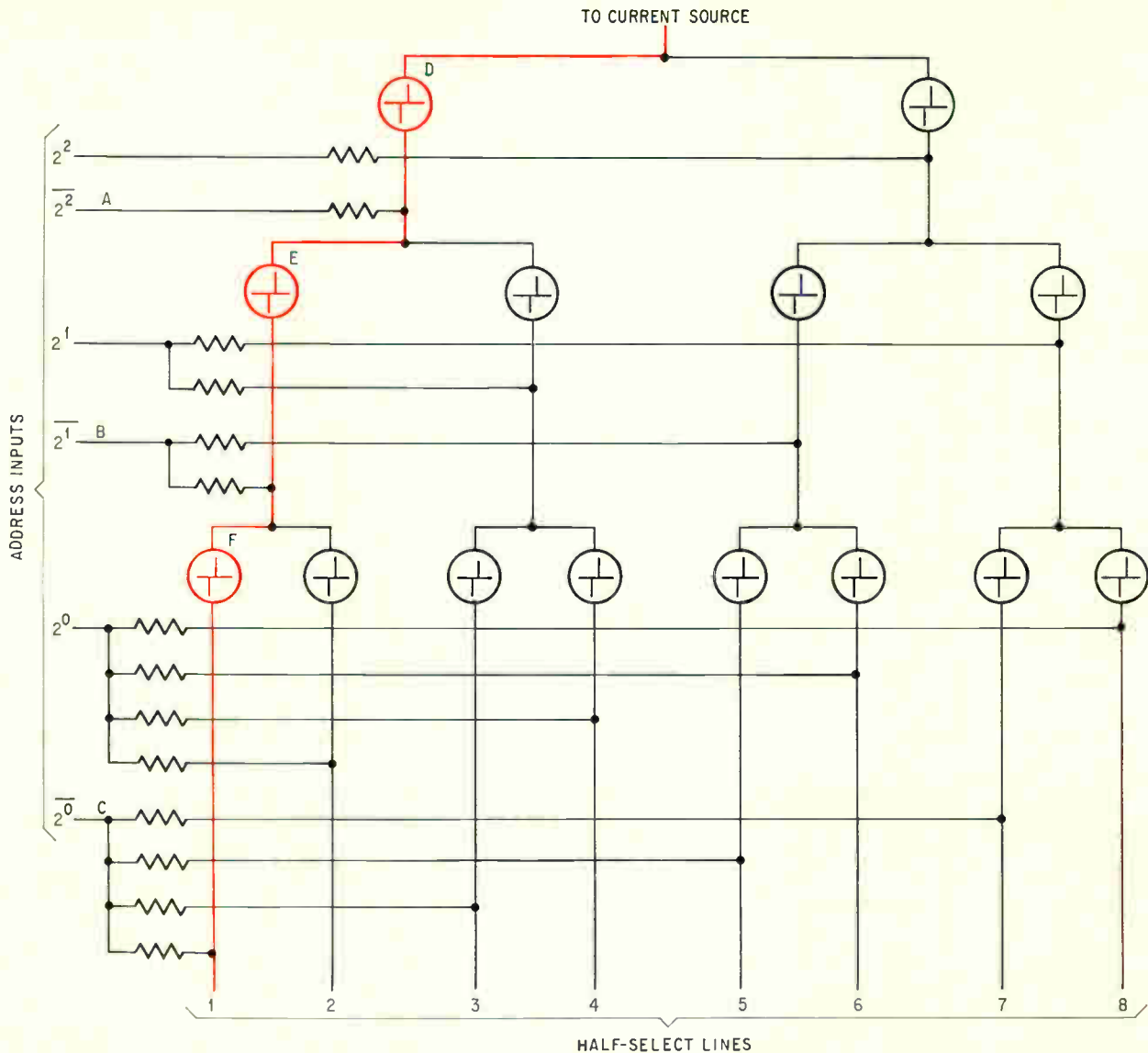

**Three-stage matrix.** Full internal decoding is possible with threshold switches arranged as binary decoder. As in simpler designs, lines are isolated from one another and all current is routed through the switches, as shown in color for one half-select line. Resistors are external; remainder may be a monolithic circuit.

vidually connected to ground through an address gate, enabling the total threshold voltage to be applied to each switch in sequence. This can't be done in the previous circuit, because the three blocking switches aren't grounded and don't receive the full applied voltage.

The dual-polarity drivers shown could be implemented in the form of arrays of threshold switches, but such small memory planes aren't used and the design calls for two different arrays, one with two switches and one with four switches. A more practical arrangement would use 10 eight-output arrays like the one shown at the top of the next page to select one of 64 lines. The lines would be divided into groups of eight lines. To each group would be connected one array corresponding in function to the switches  $TS_{2A}$  through  $TS_{2D}$ . A ninth array would drive these eight arrays, just as  $TS_{1A}$  and  $TS_{1B}$  drive the switches below them. The 10th array would correspond in function to  $TS_{3A}$  through

$TS_{3D}$ , returning the selected lines to the current source. A six-bit address would be required for this set of half-select lines; three bits would be decoded for the top array and three more for the array at the bottom. Two three-bit decoders are less complex than one six-bit decoder, so this arrangement is simpler than the one-switch-for-two-diodes replacement, which requires full decoding outside the memory array.

Such an eight-output array could be easily packaged on a chip about 30 mils square and mounted in a standard flatpack or transistor can.

#### With and without resistors

Another design, requiring more threshold switches, is capable of complete address decoding and is still more suitable for batch fabrication. The diagram shown above is of a three-stage binary decoding matrix capable of selecting one of eight lines.

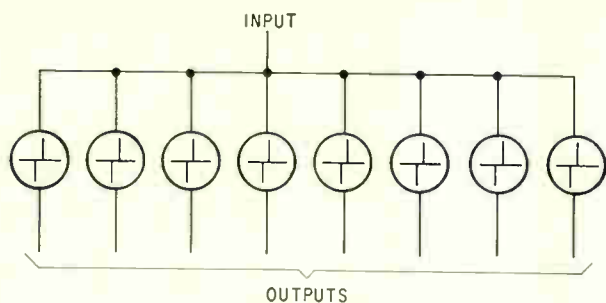

**Multiple array.** Proposed eight-output threshold switch array could be batch-fabricated on a single monolithic chip.

The first stage, the two switches at the top, selects four of the eight lines; the second stage, the next row of switches, selects two of these four; and the third stage selects one of the two. Complementary address inputs are required to establish a ground connection for one switch of each pair in the matrix. A current source is connected to the first stage, as in the circuit using dual-polarity drivers. When the voltage at this point exceeds the threshold, one switch in each stage turns on, three in rapid succession as described previously, establishing a connection to one of the eight half-select lines in the memory array.

The resistors in this design limit the current when the switch turns on. They must either be external to the batch-fabricated array, or deposited

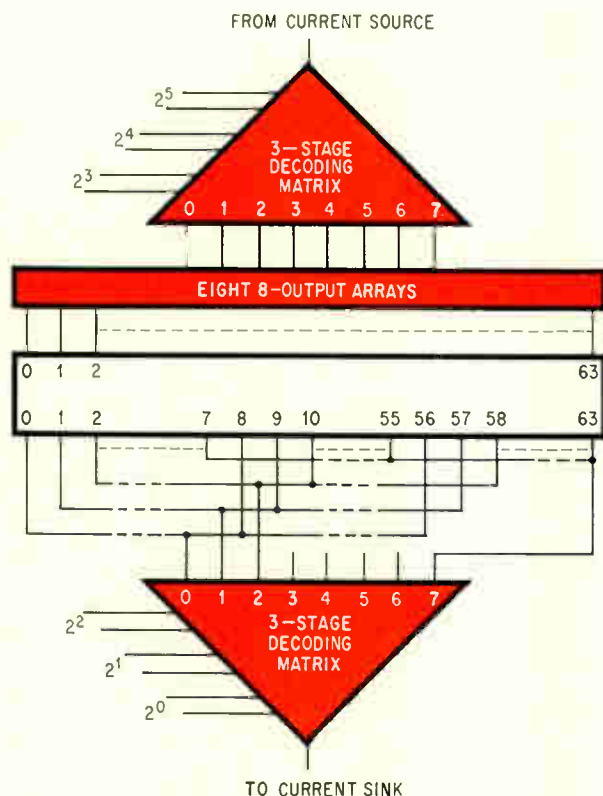

**Double-ended decoder.** Two 3-stage matrices and eight 8-output arrays can provide complete memory address decoding and driving cheaply. All the stages shown in color would be glass-switch arrays.

in some kind of hybrid process separate from the deposition of the metallic layers and the glass-semiconductor material.

In the binary matrix, the input is initially at ground. The address lines that will cause threshold switches to turn on—A, B, and C in the diagram on page 81—are set at a negative voltage one-fourth of the threshold voltage, or  $-V_t/4$ ; complementary address lines are set at  $+V_t/4$ . When current is admitted to the input, the voltage at D increases. When it reaches  $+3V_t/4$ , the threshold switch begins to conduct. Its current is routed through the resistor to the address gate at A, which is maintained at  $-V_t/4$ . The current through the resistor raises the voltage at the output of the threshold switch to a value slightly below the input, but the switch stays on. The input must continue to increase slightly after the threshold switch turns on so that the thresholds of the switches at E and F will be exceeded. Its final value is approximately  $3V_t/4 + V_t$ , where  $V_t$  is the voltage drop across all the conducting threshold switches.

An alternative design for the three-stage decoder requires twice as many threshold switches but no resistors in the address lines, as shown on the opposite page. Although the absence of resistors makes it suitable for complete batch fabrication in monolithic form, this design requires two switches in series to turn on in each stage of the decoder. These switches must have closely matched leakage currents near their threshold voltage in the high-resistance state and matched dynamic switching characteristics.

The leakage current is normally only a few microamperes. As the applied voltage increases, the leakage current increases slowly; and as the voltage approaches the threshold, the leakage current increases more rapidly. Different switches with nominally equal threshold voltages may have different threshold currents, and the way the leakage current increases near the threshold may also differ.

The time required for the threshold switch to become unstable and start changing from its high-resistance to its low-resistance state is inversely proportional to the difference between the pulsed voltage and the d-c threshold voltage; that is, the higher the pulse, the quicker the switching action.

If the threshold voltages and leakage currents of the two series switches in the all-glass decoder are not closely matched, one will start to turn on sooner than the other. But very little current will be drawn from the source and the following stages of the decoding matrix won't turn on until both switches have turned on.

In the matrix that has resistors, the switches needn't have closely matched leakage characteristics. The matrix also has more fanout—that is, it can drive a longer half-select line—because performance isn't degraded by unmatched switches.

In the binary matrix built from threshold switches only, the address lines must be set at levels equal to the threshold voltage; the lines for the switches at inputs P, Q and R are set to  $-V_t$ ,

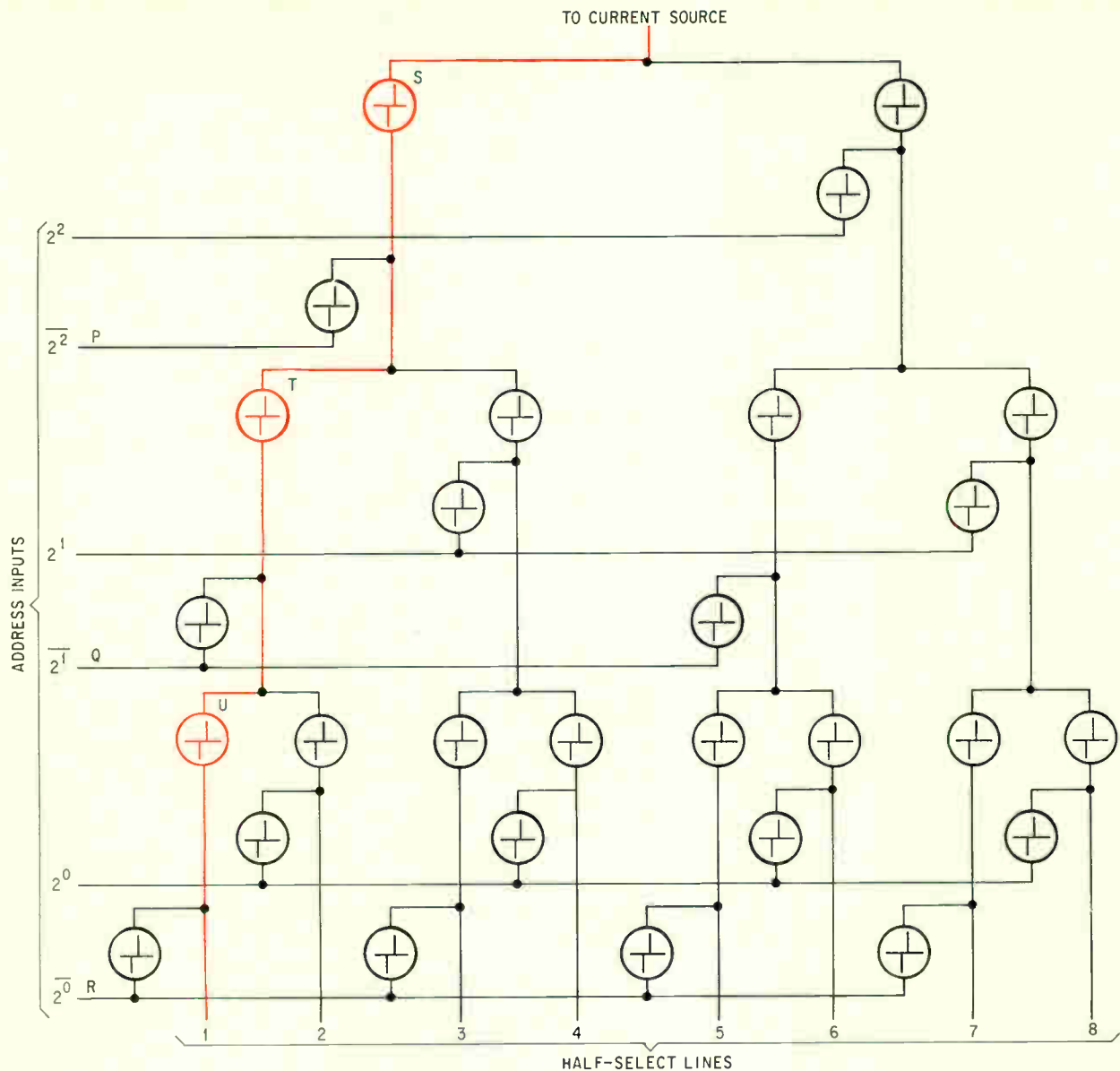

Alternative design. Binary decoder that doesn't require external resistors is made with doubled number of threshold switches, still in single monolithic array. Again, the first half-select line is picked by the switch routing shown in color.

and the others are set to  $+V_t$ . Then when the current is applied, the input voltage at S increases to  $+V_t$ . This makes the total voltage across the two threshold switches in series equal to  $2V_t$  and both of them turn on. This voltage increases still further to turn on switches T and U. The final level is approximately  $V_t + V_1$ . The current through this matrix is limited by the effective resistance of the address input circuit, which is external to the decoder itself.

### Eight by eight by eight by eight

Two of these three-stage matrixes—either design—in conjunction with eight of the proposed eight-output arrays can select one of 64 lines in a memory array of 4,096 cores—a useful size for some satellite applications. One matrix would decode three of six address bits and drive the eight arrays. These, in turn, would drive the lines through the memory, to

another three-stage matrix, which decodes the other three address bits. Because the configuration, shown at left, has decoding matrixes at each end, it is called a double-ended address decoder.

A larger version of this design could replace an addressing scheme requiring 136 standard flatpacks, used in a navigation satellite designed by APL for the Navy. That memory contains a data storage and addressing system that weighs 1.2 pounds, dissipates 6 milliwatts pulsed power and 150 milliwatts standby power, has a volume of 45 cubic inches, and a capacity of 25,280 bits. The pulsed power is dissipated by the integrated-circuit sense amplifiers, current drivers, and power switches. The IC's include 84 flatpacks of two types made by Texas Instruments Incorporated and 52 special flatpacks for the dual-polarity drivers, containing six transistors and four resistors each.

Two batch-fabricated binary decoding matrixes

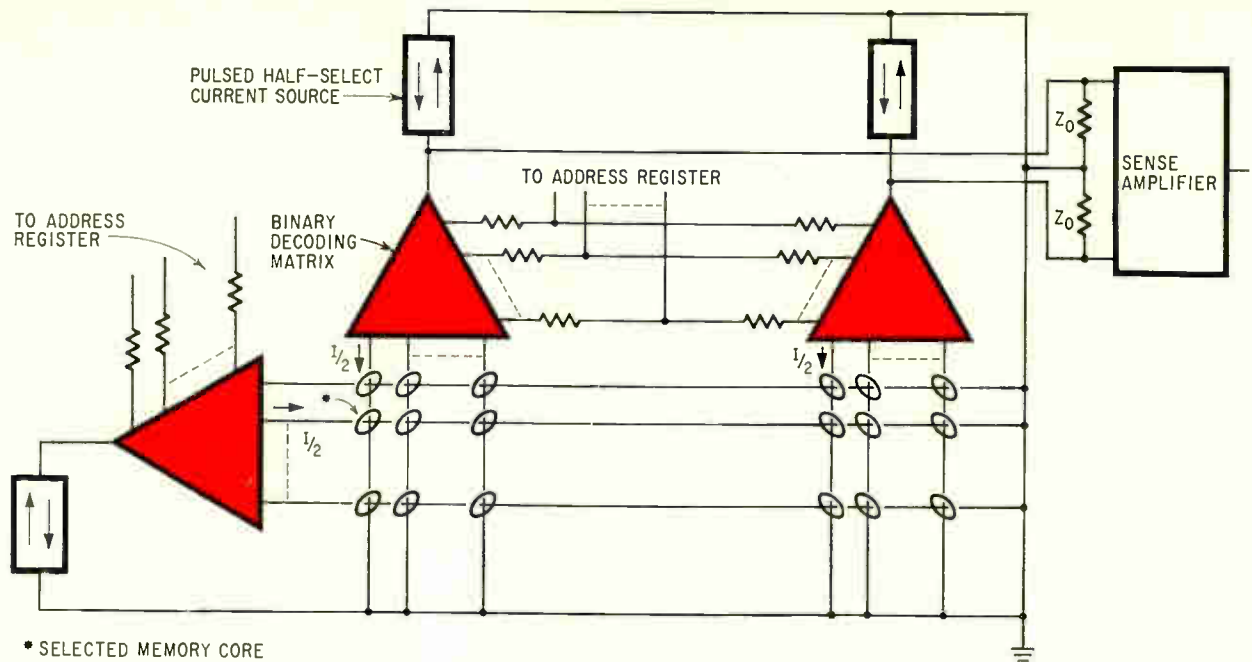

**Looped select lines.** Three decoding matrixes (color) in a  $2\frac{1}{2}$ -dimensional memory provide all addressing capability plus simple connections.

of eight stages each, capable of driving as many as 256 half-select lines (only 160 are needed in this application) could replace the 136 flatpacs, halving the weight and volume of the data storage portion of the memory system. It would require no standby power—only 6 milliwatts of pulsed power.

### $2\frac{1}{2}$ -D memory

A single-ended decoder is equally feasible with threshold switches. Single-ended addressing simplifies the core array by permitting all the half-select lines to have a common connection at one end, but the addressing circuit is more complex. A single-ended decoder capable of selecting one of 64 lines would be arranged just like the one-out-of-eight decoder with six stages instead of three.

A modified version of the single-ended decoder can be used in two-wire memory systems, in which one of the two half-select windings doubles as a sense winding. The double-duty winding loops around to pass through two rows of cores, in opposite directions, an arrangement called  $2\frac{1}{2}$ -dimensional organization. A half-select current in each of the two windings selects two cores; but the two currents pass through one core in the same direction and through the other in the opposite direction. One core or the other is therefore selected by the current direction in the looped half-select line.

In such an arrangement, one single-ended decoder addresses the straight-through half-select lines and two parallel single-ended decoders address the looped lines, which are grounded at their center point, as shown above. The sense amplifier is connected across the input of the two decoders. The sense signal is a back voltage generated on the looped line by the core that changes state. The back voltage appears also at the inputs to the two

parallel encoders, where the sense amplifier picks it up. If the core contains a binary 0 it neither changes state nor generates a back voltage.

### Driving test

A decoding matrix built only from threshold switches has already been tested. It has three levels of decoding and four outputs. The matrix steers 500-milliamper pulses 2 microseconds wide 1,000 times per second through an inductive load that generates a 40-volt back voltage in much the same way that a core matrix would. These pulses are more than adequate to drive a typical core memory.

In the test set-up, the conduction path is established with a 5-ma pulse before starting the 500-ma pulse. This prevents the sudden drop in impedance from affecting the leading edge of the big pulse, and permits the address input to be removed as soon as the conduction path is established.

Recovery time of the threshold switches is relatively long, permitting the matrix to be pulsed with a restoring signal of polarity opposite to that of the initial signal, without again selecting the addressed line. The conduction path is still established. The restoring or regenerating signal writes data back into the memory after it is read out.

### Reference

1. T.J. Gilligan, " $2\frac{1}{2}$ -D High Speed Memory Systems—Past, Present, and Future," IEEE Transactions on Electronic Computers, August, 1966, p. 475.

### Bibliography

S.R. Ovshinsky, "Symmetrical Current Controlling Device," U.S. Patent 3,271,591, Sept. 6, 1966.

J.D. Mackenzie, "Looking through glasses for new active components," Electronics, Sept. 19, 1966, p. 129.

George Sideris, "Transistors face an invisible foe," Electronics, Sept. 19, 1966, p. 191.

# Designer's casebook

Designer's casebook is a regular feature in Electronics. Readers are invited to submit novel circuit ideas, packaging schemes, or other unusual solutions to design problems. Descriptions should be short. We'll pay \$50 for each item published.

## Digital commands control differential amplifier gain

By I.W. Salmon  
Van Nuys, Calif.

Two gain levels selected by digital command are available in the preamplifier shown below. The unit is designed for use with the READ head of a digital magnetic tape transport. Selection of the high gain mode compensates for the reduced amplitude of the READ-head output pulse when the two-speed digital tape recorder is operated at its slower speed. Commands from the recorder's speed control logic automatically put the preamplifier in its high gain mode at low speed.

The differential amplifier formed by transistors Q<sub>1</sub> and Q<sub>2</sub> enables the preamplifier to handle READ-head signals with peak-to-peak difference amplitudes as low as millivolts and to reject common-

mode noise. Transistor Q<sub>3</sub> serves as a constant-current source for the differential amplifier. The state of digital gate Q<sub>4</sub> controls diodes D<sub>1</sub>, D<sub>2</sub>, D<sub>3</sub>, and D<sub>4</sub>, and these diodes control the gain of the differential amplifier by switching load resistors R<sub>1</sub>, R<sub>2</sub>, R<sub>3</sub>, and R<sub>4</sub> into and out of the collector networks of Q<sub>1</sub> and Q<sub>2</sub>. When the diodes conduct, the resistors are switched into the collector networks and reduce the gain.

When the two-speed recorder is operating at low speed, no command signals appear at diodes D<sub>5</sub> or D<sub>6</sub>, and switching transistor Q<sub>4</sub> remains off. With Q<sub>4</sub> off, the potential at point A is approximately equal to the positive supply voltage so that diodes D<sub>1</sub>, D<sub>2</sub>, D<sub>3</sub>, and D<sub>4</sub> are reverse biased; thus resistors R<sub>1</sub>, R<sub>2</sub>, R<sub>3</sub>, and R<sub>4</sub> aren't connected to amplifier Q<sub>1</sub>-Q<sub>2</sub>, and the preamplifier gain is

$$A_v = \frac{E_{OUT}}{E_{IN}} = \frac{R_A}{R_B} \left( \frac{1}{2 j\omega R_A C_1 + 1} \right)$$

$$= \frac{22}{1} \left( \frac{1}{2 (j\omega) (22) (120 \times 10^{-12}) + 1} \right)$$

$$= 22 \angle 0^\circ \quad (1)$$

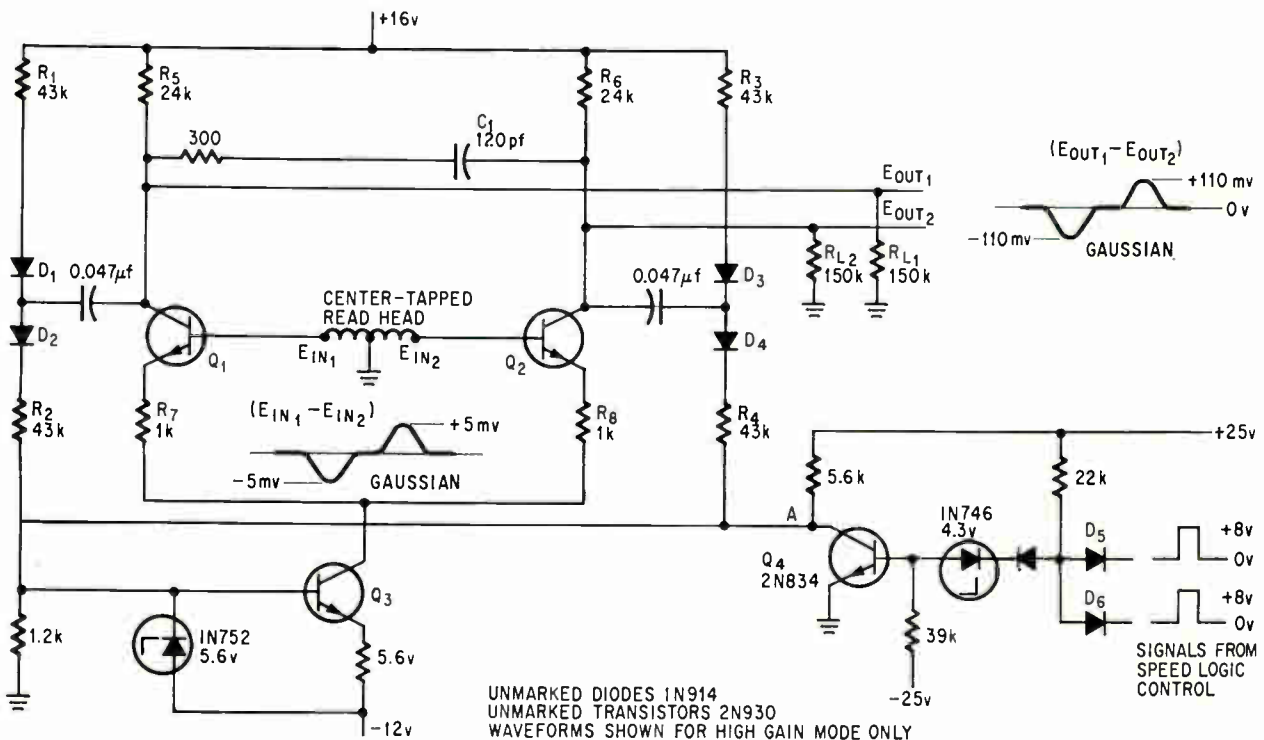

Digital gain control. Positive signals at D<sub>5</sub> and D<sub>6</sub> turn on Q<sub>4</sub>, and forward bias diodes D<sub>1</sub>, D<sub>2</sub>, D<sub>3</sub>, and D<sub>4</sub> so that resistors R<sub>1</sub>, R<sub>2</sub>, R<sub>3</sub>, and R<sub>4</sub> load the amplifier and reduce its gain.

where:

$$C_1 = 120 \text{ pf}$$

$$R_A \approx \frac{R_L R_5}{R_L + R_5} = 22 \text{ kilohms}$$

$$R_B = R_7 = R_8 = 1 \text{ kilohm}$$

$$R_1 = R_2 = R_3 = R_4 = 43 \text{ kilohms}$$

The peak-to-peak amplitude of  $E_{IN}$  is about 10 millivolts when the recorder is operating at its slower speed. The gain of 22 boosts the amplitude of the output pulse to the desired level of approximately 220 millivolts.

If the recorder's higher speed is selected, the speed selector switch logic sends to diodes  $D_5$  and  $D_6$  a +8-volt signal that turns on  $Q_4$ . The potential at point A drops to ground when  $Q_4$  is on, forward biasing diodes  $D_1$ ,  $D_2$ ,  $D_3$ , and  $D_4$ . With the diodes conducting, resistors  $R_1$ ,  $R_2$ ,  $R_3$ ,

and  $R_4$  load the output of amplifier  $Q_1$ - $Q_2$  and the gain drops to 11 as given by:

$$\begin{aligned} A_V &= \frac{E_{OUT}}{E_{IN}} = \frac{R_A}{2R_B} \left( \frac{1}{j\omega R_A C_1 + 1} \right) \\ &= \frac{22}{2} \left( \frac{1}{j\omega (22) (120 \times 10^{-12}) + 1} \right) \\ &= 11 \angle 0^\circ \end{aligned} \quad (2)$$

where all parameters are those defined for equation 1.

At the high gain setting, the amplifier's high-frequency break point is half that of the point at the low gain setting. The smaller passband in the high gain mode cuts down high-frequency amplifier and external noise, yet is wide enough to pass the signals generated at the slower tape speed.

## Low-cost digital IC performs linear functions

By Robert Ricks

Fairchild Semiconductor Division of the Fairchild Camera & Instrument Corp., Mountain View, Calif.

A digital integrated circuit, intended for switching applications, can be operated as a linear amplifier. The circuit consists of a Fairchild dual gate, the

$\mu L 914$ , coupled to an epoxy encapsulated transistor that serves as the amplifier's output stage.

Depending on the components selected for insertion at points A and B in the diagram, a number of applications are possible. For example, to operate the circuit as a linear amplifier, resistor  $R_5$  is removed and resistors are placed at A and B. The resulting configuration gives an output signal that is proportional to the input.

If resistor  $R_5$  is retained, the positive feedback introduced converts the amplifier into a versatile snap-action switch. For example, a thermostatic control switch can be obtained by placing a thermis-

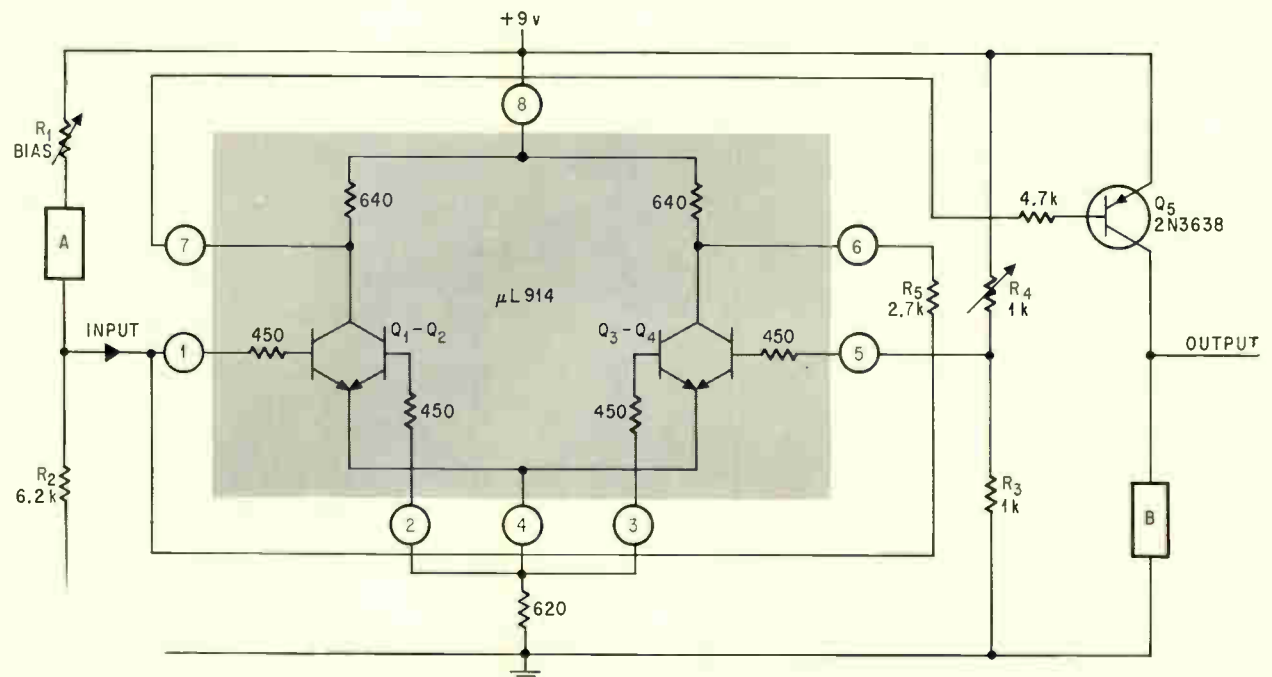

Versa... voltage at pin 1 turns on  $Q_1$ - $Q_2$ , turns off  $Q_3$ - $Q_4$ , and saturates output transistor  $Q_5$ .



tor at A and a relay at B. If, however, A is a phototransistor and B a load resistor, the circuit becomes a light-sensing preamplifier with a digital readout.

The basic circuit consists of the  $\mu\text{L} 914$  in a bridge circuit formed by  $R_1$ , a transducer at A, resistors  $R_2$ ,  $R_3$ , and potentiometer  $R_4$ . For operation as a thermostatic control switch, A is a 1-kilohm thermistor with negative temperature coefficient and B is a 6-volt, 100-milliampere relay.

When the temperature increases, the thermistor's resistance drops and the potential at pin 1 of the  $\mu\text{L} 914$  rises. As the voltage at pin 1 goes more positive, the potential rises at the emitters of  $Q_1$ - $Q_2$  and  $Q_3$ - $Q_4$ . Since the voltage at the base input to  $Q_3$ - $Q_4$  (pin 5) is held constant by  $R_3$  and  $R_4$ , the more positive potential at the  $Q_3$ - $Q_4$  emitters drives the pair into cutoff. The feedback supplied from pin 6 to pin 1 via resistor  $R_5$  assures a latching turn-off for  $Q_3$ - $Q_4$ .

With  $Q_1$ - $Q_2$  in saturation, the voltage at pin 7 drops to a potential near ground so that output

transistor  $Q_5$  turns on and actuates the relay at B.

A light-sensing preamplifier with digital readout is formed by placing an FPM 100 phototransistor at A and a 330-ohm load resistor at B. An increased light intensity on the phototransistor causes it to conduct more heavily; this enhances the potential at pin 1 of the  $\mu\text{L} 914$ . When the voltage at pin 1 becomes more positive, the circuit action described above causes  $Q_5$  to turn on. With  $Q_5$  on, the output voltage (at the top of the 330-ohm load resistor) increases, indicating greater light intensity.

The inherent matching of beta's, input thresholds, and resistors in the diffusion of a digital gate is exploited when the  $\mu\text{L} 914$  is used in the linear applications described. The matching of parameters is inherent because of the close proximity of the transistor pair on each integrated circuit chip, and the thermal tracking inherent in the closely-spaced transistor pair is considerably better than that attainable with devices in separate cans. The basic circuit, including IC and discrete components, can be built for about \$1.50.

## Negative impedance converter does double duty

By Gilbert Marosi

CMC Systems Inc., Sunnyvale, Calif.

A simple two-transistor amplifier with both positive and negative feedback functions as a Q multiplier or an infinite impedance amplifier. The circuit is basically a negative impedance converter.

When an inductor is used with the converter, the inductor's winding resistance is effectively cancelled by the converter's negative resistance so that a nearly lossless inductor results. This characteristic produces a high Q which may be exploited in tuned circuits.

Alternatively, the interstage feedback of the circuit can be adjusted to yield an infinite input impedance.

Operation of the circuit may be readily explained by substituting two operational amplifiers having the same total gain as the converter. Amplifier  $A_1$ , together with resistors  $R_1$  and  $R_2$ , is equivalent to transistors  $Q_1$ ,  $R_1$ , and  $R_2$  in the negative converter schematic. Similarly, amplifier  $A_2$  with  $R_3$  and  $R_4$  is equivalent to  $Q_2$ ,  $R_3$  and  $R_4$ . Resistor  $R_F$  corresponds to potentiometer  $R_5$  in the converter. The input impedance may be derived in terms of the gain of the equivalent operational amplifier circuit:

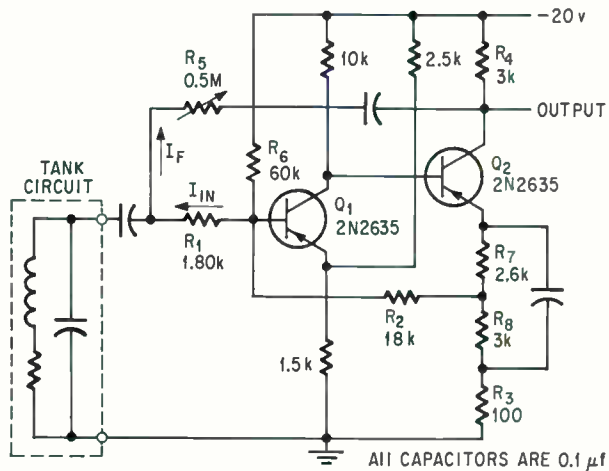

Impedance converter. Positive feedback through  $R_3$  and negative feedback through  $R_2$  combine to give amplifier  $Q_1$ - $Q_2$  a negative input impedance.

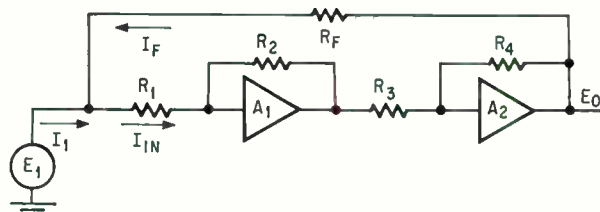

Equivalent circuit. Operational amplifier for negative impedance converter replaces transistors  $Q_1$  and  $Q_2$  in the original schematic with amplifiers  $A_1$  and  $A_2$ .

$$Z_{IN} = \frac{E_1}{I_1} \quad (1)$$

$$I_1 = I_{IN} - I_F \quad (2)$$

$$I_{IN} = \frac{E_1}{R_1} \quad (3)$$

$$I_F = \frac{K_V E_1 - E_1}{R_F} \quad (4)$$

where  $K_V$  is the total voltage gain of the circuit. Substituting equations 2, 3, and 4 into 1:

$$Z_{IN} = \frac{R_F}{1 + \frac{R_F}{R_1} - K_V}$$

If  $K_V$  is made equal to  $\left(1 + \frac{R_F}{R_1}\right)$ , the input impedance becomes infinite. If  $K_V$  is larger than  $\left(1 + \frac{R_F}{R_1}\right)$  the input impedance is negative.

The Q-multiplying capability of the circuit can

be represented by  $Q'$ , a new factor,

$$Q' = \frac{Q_0}{1 - Q_0^2 \frac{R_L}{R_N}}$$

where:

$Q_0$  is the Q of the uncompensated tank circuit.

$R_N$  is the equivalent negative impedance of the circuit.

$R_L$  is the winding resistance of the coil.

Potentiometer  $R_5$ , the equivalent of  $R_F$ , may be varied so that  $I_F = I_{IN}$  and  $I_1 = 0$  to achieve an infinite impedance. When  $R_5$  supplies more current than  $R_1$  can absorb, the direction of  $I_1$  is reversed, providing a negative impedance.

The d-c design of the circuit is conventional, and the operating point of  $Q_1$  is determined by

$$E_o = \frac{(V_{cc} - V_{E1} - V_{BE1})}{\alpha R_6} R_2 - \frac{(V_{E1} + V_{BE1})}{\alpha}$$

$$\text{where: } \alpha = \frac{R_3 + R_8}{(R_3 + R_7 + R_8)}$$

## MOS FET amplifier provides almost infinite impedance

By Thomas H. Lynch

SDS Data Systems, Pomona, Calif.

A simple buffer amplifier for isolating high impedance circuits is a direct-coupled source follower. It couples a junction field effect transistor,  $Q_1$ , to a bipolar transistor,  $Q_2$ . However, this circuit has one serious limitation—when source resistances greater than 1 megohm are encountered, d-c temperature drift may be unacceptable.

Temperature compensation is achieved by replacing the junction device with a dual stage mos fet MEM551, coupled to a complementary pair of transistors, MD6100. The complementary transistors hold the temperature drift to less than 1 millivolt over a range of  $0^\circ$  to  $40^\circ$  and the amplifier has an input resistance of greater than  $10^{15}$  ohms. The maximum input current for the mos fet is less than 0.1 picoampere—1/10,000th of that drawn by the uncompensated network.

Constant current is supplied to MEM551 by limiter diode,  $D_1$ . Because  $D_1$  requires only 1 to 1.5 volts of bias to produce a constant current, positive and negative voltage swings as large as 5 volts at the gates of  $Q_1$  do not affect it.

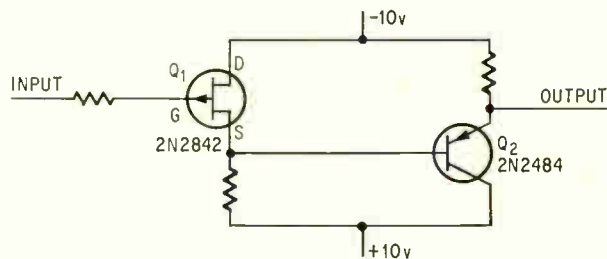

Drift-prone. Simple buffer amplifier is a source follower attached to a conventional emitter follower.

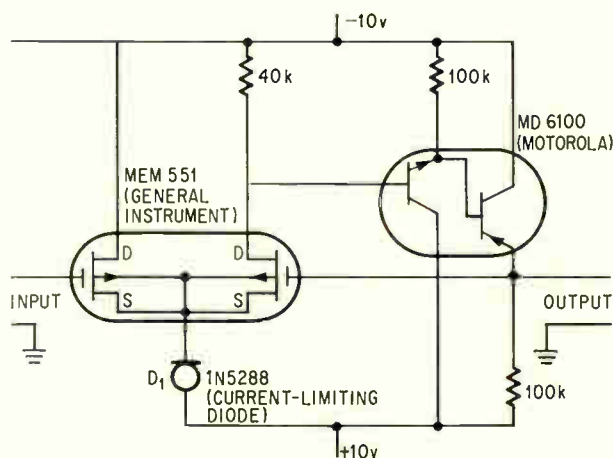

Improvement. Modified MOS FET buffer achieves excellent thermal stability with complementary output transistors.

# RESOLVER/SYNCHRO INSTRUMENTATION

*A very short course for engineers engaged in testing and evaluation of resolvers and synchros as components or as system transducers.*

Selecting a resolver/synchro test instrument for any engineering, production or system requirement is remarkably simple from North Atlantic's family of resolver and synchro instrumentation. Because this group has been developed to cover every area of need in both manual and automatic testing, obtaining the desired combination of performance and package configuration usually demands no more than 1) determining what you need and 2) asking for it.

## Remote Readout of Angular Position

For remote indication of resolver or synchro transmitters in system testing, North Atlantic's Angle Position Indicators (Figure 1) provide the advantages of low cost and continuous counter or pointer readout. These high-performance instrument servos are accurate to 4 minutes of arc, with 30 arc seconds repeatability and 25°/second slew speed. Dual-mode capability, multi-speed inputs, integral retransmit components and other optional features are available to match application needs. Priced from \$895.



Figure 1. Angle Position Indicators are available in half-rack, quarter-rack and 3-inch round servo packages.

## High-Accuracy Testing Of Receivers And Transmitters

Measuring receiver and transmitter performance to state-of-art accuracy is readily accomplished with North Atlantic's Resolver/Synchro Simulators and Bridges (Figure 2). Each of these dual-mode instruments tests both resolvers and synchros, and provides direct in-line readout of shaft angle, accurate to 2 arc seconds. Simulators supply switch-selected line-line voltages

from 11.8 to 115 volts from either 26 or 115 volts excitation, and so can be used to test any standard receivers. Bridges have constant null voltage gradients, making them ideally suited for rapid deviation measurements. Simulators and Bridges each occupy only 3½ inches of panel height and are available in a choice of resolutions. They are priced in the \$1500 to \$3000 range.



Figure 2. Resolver/Synchro Simulator provides ideal source for receiver testing.

## Automatic Measurement And Conversion

Where systems require continuous or on-command conversion of resolver or synchro angles to digits, North Atlantic's Automatic Angle Position Indicators (Figure 3) handle the job without motors, gears or relays. These solid-state automatic bridges accommodate all standard line-to-line voltages and provide both Nixie display and printer output, accurate to 0.01° and with less than 1 second update time. Many variations, including 10 arc second accuracy; binary, BCD or decimal outputs; multiplexed channels and multispeed operation, are available for specific requirements. Ballpark price: \$5900.



Figure 3. Model 5450 Automatic Angle Position Indicator. It measures shaft angles, converts them to digital data.

**Measuring Electrical Characteristics**  
Combine a Resolver/Synchro Bridge and a Simulator with a North Atlantic Ratio Box, a Phase Angle Voltmeter and a test selection panel and you have an integrated test facility for determining all electrical characteristics of resolvers and synchros in component production or Quality Control. An example is the North Atlantic Resolver/Synchro Test Console shown in Figure 4. It measures phasing, electrical zero, total and fundamental nulls, phase shift and input current, as well as angular accuracy. Standard North Atlantic instruments are used as modules, making it a simple matter to fill the exact need. The unit shown sells for about \$7500.

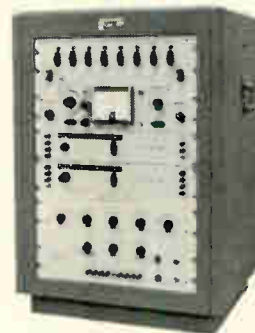

Figure 4. Model RTS-573 Test Console is a complete facility for the production line or in quality control.

If you require performance, reliability and convenience in resolver and synchro testing, we want to send you detailed technical information on these instruments (also on related instruments for computer system interface). Or, if you prefer, we will arrange a comprehensive technical seminar at your plant. Simply write to: North Atlantic Industries, Inc., 200 Terminal Drive, Plainview, N. Y. 11803 • TWX 516-433-9271 • Phone (516) 681-8600.



# Buy this ten dollar Philbrick Operational Amplifier

...and let everyone think  
you paid twenty.  
They'll believe it,  
when they see  
its performance.

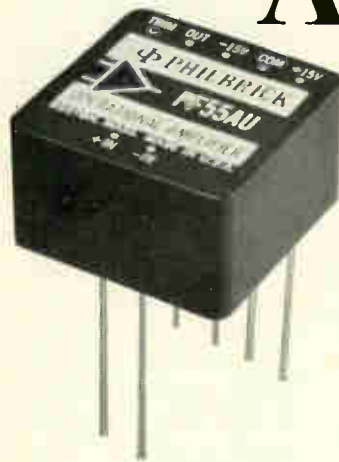

*Plain language*—our low prices come from volume-production savings and new packaging efficiencies. Others achieve them by cutting corners—thereby making your design job more expensive, more difficult, and more restricted.

*Here's what we mean*—Economy-Grade Philbricks give you *design resilience* the others don't have. Things like:

Safe, conservative operation at any supply voltage between  $\pm 7.5$  V and  $\pm 22$  V; a full  $\pm 11$  V output swing with a  $\pm 15$  V supply (even more at higher supply levels); gain to spare — enough to let you take full advantage of their low offset drifts; remarkably low quiescent power; exceptionally wide stability margins.

*We know*—that nine times out of ten, you would save money if you paid *twenty* dollars for a resilient Philbrick—but we don't ask you to; just pay what you would for a narrow-margin stiff one. Call us—we've

got what you want, at low prices you'll be surprised to find.

**EXAMPLE:** This new PF55AU preformed-case epoxy encapsulated miniature has open-loop gain of 40,000 driving  $10\text{k}\Omega$ , 1.5 MHz bandwidth, CMR of at least 1000:1, will slew at  $1.5\text{ V}/\mu\text{sec}$ ,  $20\ \mu\text{V}/^\circ\text{C}$  offset limit, and all the resilience described above. It outperforms the cut-spec cheapies, yet it's a genuine Philbrick, through and through. PF55AU price: In lots of 1,000 . . . \$10.00 (even less in larger quantities.)

Send for new Operational Amplifiers price list and 12 page brochure: Bulletin 6111. Philbrick Researches, Inc., 22-Y Allied Drive at Rte. 128, Dedham, Mass. 02026.

Phone: (617) 329-1600 TWX: (617) 326-5754.



**GOING THE MICROCIRCUIT ROUTE?** There's a resilient easy-to-stabilize Philbrick in a modified TO-5 package, too — at only \$6.95 (less in 100-lot quantities or more).

**ELECTRONIC ANALOG COMPUTING EQUIPMENT for MODELLING, MEASURING, MANIPULATING and MUCH ELSE**



**PHILBRICK**  
A TELEDYNE COMPANY

# Digital filters with IC's boost Q without inductors

RC-switched networks can be built with IC's to produce a bandpass response resembling that of a single-section LC filter, but with greater values of Q

By William R. Harden

Chesapeake Systems Corp., Cockeysville, Md.

**Until inductors** can be reliably made with integrated circuits, another approach must be used in building microcircuit bandpass amplifiers. Most engineers, confronted with the need for such an audio-tuned circuit, rely on the conventional LC filter. But LC networks have their limitations. The maximum obtainable Q is only about 100—and to produce it, a large inductor is required.

What may be more promising is an RC digital filter, in which capacitors are sequentially connected into the circuit to produce a sharply tuned bandpass response. It eliminates the inductor and achieves high values of Q.

Unlike LC filters in which the inductive reactance determines the value of Q, in the digital filter the values of R and C fix the bandwidth, and the frequency of the applied input signal determines the center frequency; thus, control of these parameters yields any desired value of Q. And with integrated circuits, the designer has a wide variety of reliable R and C values from which to choose. Thus a digital filter may be designed with a Q much greater than any possible from LC filters.

An additional advantage of a digital filter is that it behaves in the same manner as a tunable filter. Because the center frequency varies directly with

the clock frequency, the filter can follow changes in the input. A digital filter's center frequency is as stable as the input signal. In an LC filter, on the other hand, the center frequency is dependent upon the inductor's stability.

Shape of the bandpass response is also determined by R and C, and is identical to that of an LC filter. The response falls off from resonance at a rate of 6 decibels per octave and is centered about the clock frequency. An elaborate LC filter can be synthesized by combining multisection RC networks. If a multistage RC network is applied, the resulting bandpass response has an asymptotic slope of 6N decibels per octave from resonance, where N is the number of RC sections.

Maximum attainable attenuation is also fixed by the response of the low-pass RC filter section. To a lesser extent, attenuation is affected by the imperfections and saturation resistance of the transistors that switch the capacitors into the circuit. If a greater attainable attenuation is desired, a low-pass filter having a narrow bandwidth or a sharp asymptotic skirt response is needed. This can be achieved by increasing the number of RC sections in a digital filter. For higher frequency applications, the attainable attenuation becomes a function of the input pulse rise time.

Digital filters can also generate a comb-filter effect—a wave filter whose frequency spectrum contains many equispaced elements that resemble the teeth of a comb. This type of filter detects individual signals within a band of frequencies or locates all the harmonics of a signal.

## Understanding digital filter operation

There are two types of digital filters—shunt- and series-switched. Both produce a bandpass response

### The author



William R. Harden designs and develops electronic circuits for communication and radar systems. His education for his master's degree from Drexel University in 1966 heavily emphasized sophisticated signal processing theory. While at the Bendix Corp., Harden investigated the capabilities of digital filters.

# Digital filter configurations

## Mechanical equivalent

### Shunt-switched filter

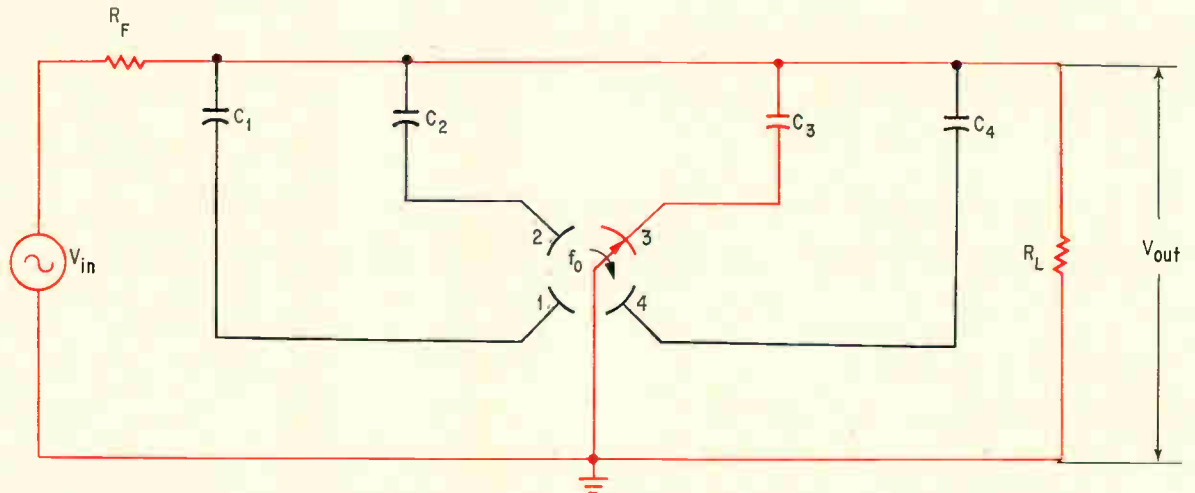

A simple shunt-switched digital filter is formed by connecting several capacitors in parallel to segments of a rotary switch. The circuit is returned to ground through a series resistor,  $R_F$ , and the switch. Output is the voltage developed across the grounded capacitor,  $C_3$ . Color indicates grounded capacitors in all diagrams.

### Series-switched filter

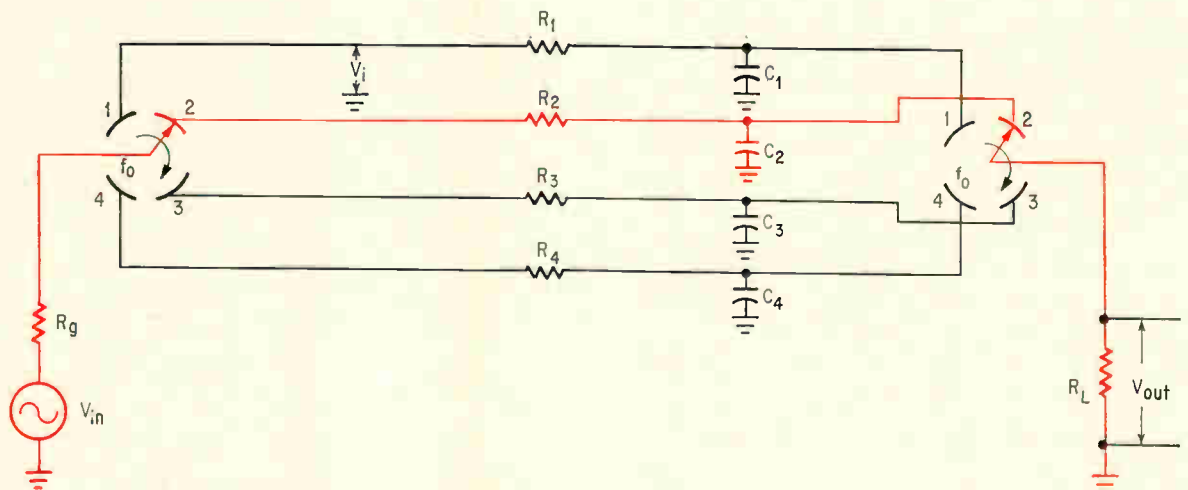

In the series-switched digital filter both the input and output signals are sampled by a pair of rotary switches revolving at a frequency  $f_0$ . Each time a pair of switches close, a quarter of a sine wave appears across the RC filter arm of the circuit. The output is the voltage developed across the grounded capacitor,  $C_3$ .

### Waveforms

Waveforms reveal the relationships between the input and output synchronous in-phase, out of phase, and nonsynchronous signals. The output is the average value of the input voltage that appears across each capacitor connected to ground.

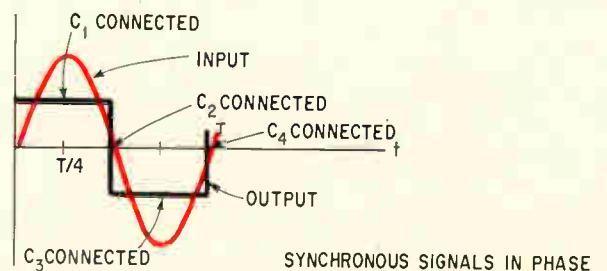

## Electrical equivalent

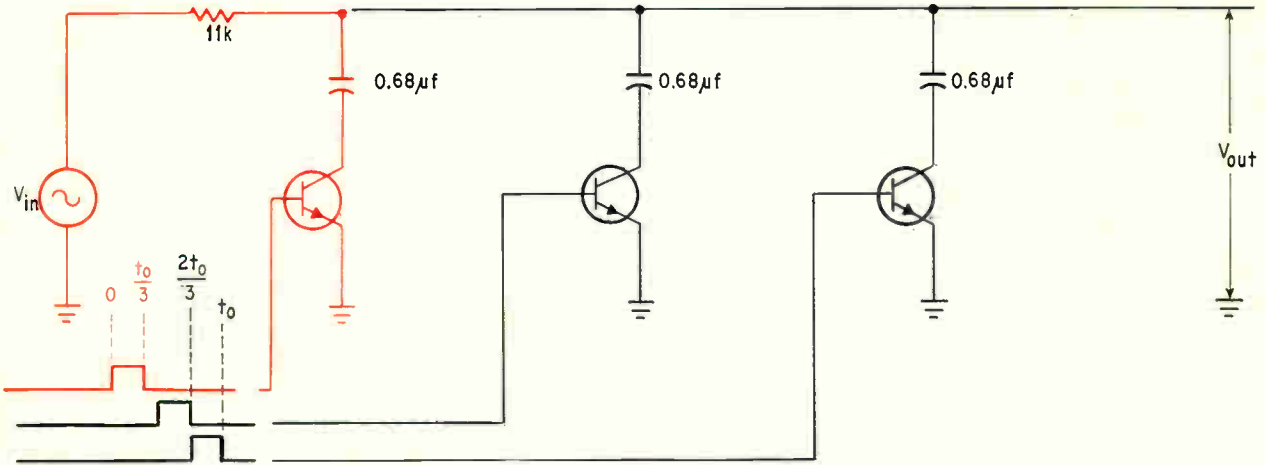

Transistors replace the rotary-switch segments used in the mechanical arrangement, and the switching is accomplished with a chain of delayed pulses. The output appears across the 0.68-microfarad capacitor. Circuits on this page are for three-section filters; opposite page contains four-section filters.

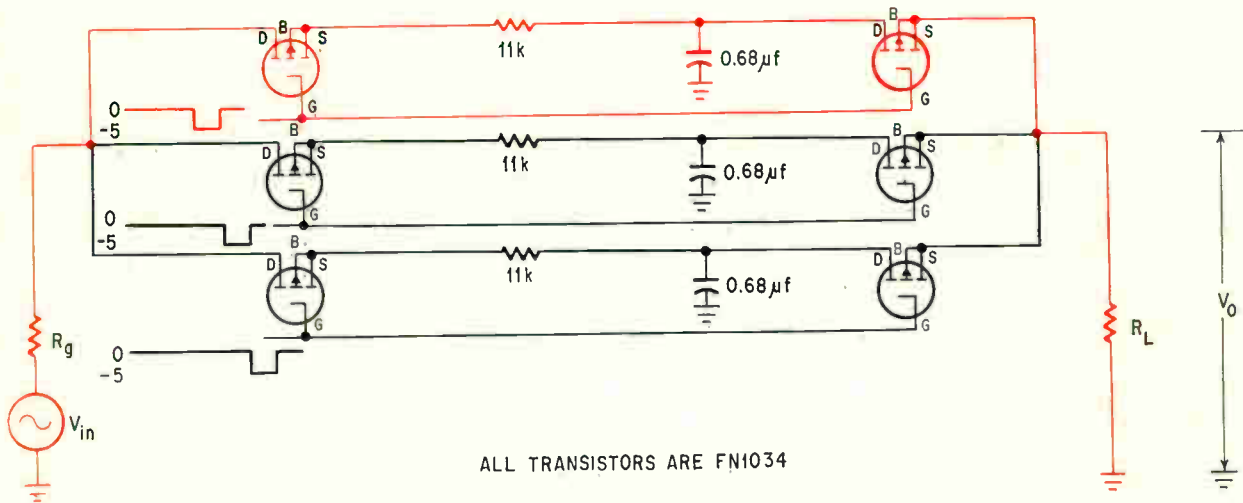

Two field effect transistors replace the pair of rotary switches used in the mechanical arrangement. Switching is controlled by a chain of delayed pulses applied to the coupled gates and the output is taken across the grounded capacitor.

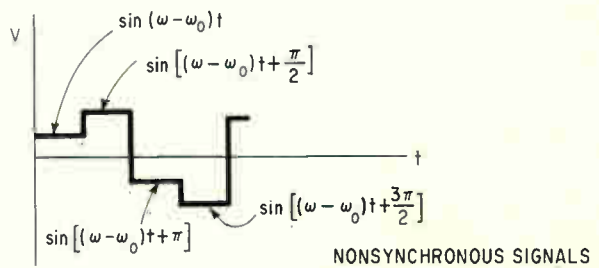
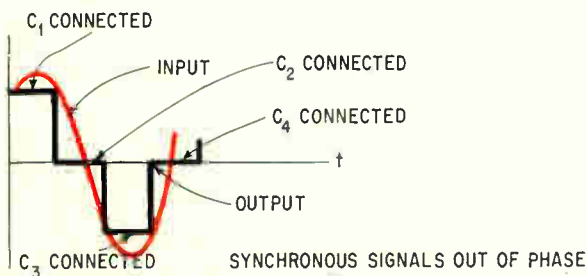

similar to that of a single-section LC filter. In its simplest form, the shunt-switched filter is represented by several parallel capacitors connected to segments of a rotary switch and returned to ground through the switch contact. The switch, which needn't be mechanical, rotates at a commutating frequency,  $f_0$ .

If an input sine wave,  $V_{in}$ , is applied with a frequency identical to  $f_0$ , each capacitor becomes exposed successively to a segment of the signal, and the voltage on each capacitor ultimately reaches the average value of the applied input waveshape. For example, if four capacitors are connected to four segments of a rotary switch, each element is grounded for one-fourth of the time and left floating for the remainder. The output at any given time is the voltage across the capacitor that is grounded at that time. Ideally, only when its switch is closed can a capacitor lose or gain charge or can the voltage on the capacitor change. At frequencies greater than  $f_0/2$ , the response of the RC section should be negligible. This enables the engineer to ignore the ripple voltages that are present.

In normal operation, the capacitors are switched at  $f_0$ . However, if the input frequency differs from  $f_0$ , the average value of the input voltage will differ for each successive time interval that the capacitor is connected. Because of the lack of synchronism between the input and switching frequencies, the voltage across the capacitor varies at a rate equal to the difference between the two. For large differences the capacitors do not accumulate appreciable charge and the output voltage remains near zero. Since the charging rate is limited by the RC time constant—which is large compared to the time that the switch is closed—the voltage across the capacitor becomes smaller and smaller, approaching zero as the difference between signal frequency and switching frequency becomes large. Thus the low-pass characteristic is translated into a bandpass characteristic centered about  $f_0$ .

A series-switched filter, consisting of several parallel branches with a series resistor and capac-

itor connected in each, operates in a similar manner as a shunt-switched filter. Each branch is connected to ganged segments of two rotary switches. Unlike the shunt filter in which the input grounds the capacitor, in the series filter both the input and output signals are sampled by a rotary switch at  $f_0$ . Each time a pair of switches is closed, one-fourth of a sine wave is impressed upon the RC filter. After several cycles, the voltage on the capacitor is at the average value of a quarter sine wave. Since this happens to all four RC networks, the output of the filter is similar to the input, but somewhat truncated. When the input frequency differs from  $f_0$ , the accumulated charge or voltage on the capacitor is less than for the synchronous case. Because the capacitor voltage is determined by the average value of the sampled sine wave, its magnitude is independent of the relative difference between the input signal frequency and  $f_0$ . Thus, the commutated filters have a symmetrical bandpass characteristic.

### Proving a concept

Both types of digital filters were investigated for their performance capabilities with all-electronic models. The mechanical switch contacts were replaced by transistors, and the rotation of the switch synthesized by delayed-switching pulses. Each type of digital filter is the equivalent of a single LC-tuned network section. For example, a single LC section having a Q of 71.5 at 1 kilohertz has the same frequency response as that of the shunt and series filters illustrated.

Frequency response of both types of filters were measured and plotted as shown below. The frequency-response curves for both are identical and have asymptotic slopes of 6 db per octave when measured from the center frequency, 1 kHz, about which they are symmetrical. An examination of the plot indicates that the 3-db point or cutoff frequency of the digital filter occurs at 7 hertz from the center frequency, and the Q of the digital filter is 71.5.

By reducing the number of sections of the low-pass RC filter, it is possible to alter the cutoff frequency. For example, in a three-section, shunt-switched configuration, the cutoff frequency is reduced from 21 to 7 hz. The reduction is directly related to the difference frequency and the time that the capacitor is connected to ground.

To understand the relationship, consider a single capacitor switched at a constant frequency. The switch connects the capacitor to ground during one-third of the period of  $f_0$ . If the frequency of the input signal differs from  $f_0$ , the voltage across the capacitor becomes a function of the difference frequency. When the difference frequency is 21 hz, the capacitor can only charge to one-third the amplitude of the input signal. Because the period of the difference frequency is short, the amplitude of the output signal is low. If the difference frequency is reduced from 21 to 7 hz, the period of the difference frequency increases by three. Since

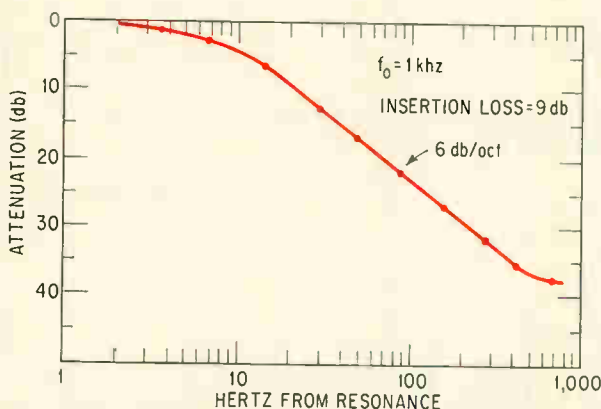

Frequency-response. Shunt- and series-switched digital filters with a single-section RC low-pass filter have identical frequency-response curves. Both types yield a response similar to that of an LC-tuned network.



the switching time remains constant, the capacitor now has three times as long to charge and, hence, the output voltage is three times larger. Therefore, the digital filter's half bandwidth is reduced by three over that of the low-pass filter.

The change in the bandwidth could be considered as an increase in the size of the capacitor. Since the bandwidth is now one-third the original, an equivalent circuit can be derived with a capacitor whose value is three times larger than in the original component. This increase in value is due to the commutating action of the switch.

The transistorized shunt circuit acts as a switch despite the fact that it has no d-c path between the collector of the transistor and ground. Proper operation requires current flowing in both directions to charge and discharge the capacitor. Test results based on the equivalent circuit of an a-c switch indicate that the current through the transistor is in the microampere range, but the saturation resistance varies from 30 to 50 ohms even with a small collector current.

To turn the transistor on, both the emitter-base and collector-base diodes are driven from their reversed-bias potentials to a forward bias. Because a negligible quantity of charge is required from the external collector circuit, most of the charge needed to forward bias the collector junction is supplied internally by transistor action. Positive regions of the current versus time plot represent the charge obtained from the external collector circuit.

During the on time of the transistor switch, the collector-to-emitter voltage assumes its saturated value,  $V_{CE sat}$ , and the collector current is given by

$$I_c = \frac{V_{CE sat} - V_{co}}{R_F} \quad (1)$$

By removing the charge stored in the base and reverse biasing both the collector and emitter, the transistor is turned off. The emitter-base diode is reverse biased first, and then the collector is turned off by applying current from an external collector circuit. This charge is represented by the area of the negative-collector current spike in the current versus time plot. The average charge removed from the capacitor by the transistor during each switching cycle is 10 picocoulombs.<sup>1</sup> For a switching time of 0.33 milliseconds, 10 picocoulombs represent an average current flow of  $10^{-2}$  picoamperes.

### Series-switched digital filter

An alternate method of achieving a bandpass response is to switch low-pass filter sections with a series-switch arrangement. If both the shunt-switched and series-switched digital filters incorporate identical low-pass sections, the frequency response is the same for each. This was verified with metal oxide semiconductors (MOS) replacing the mechanical switches in the circuit. Field effect transistors of the MOS type were selected because they are bilateral and have the low on

### Switching function

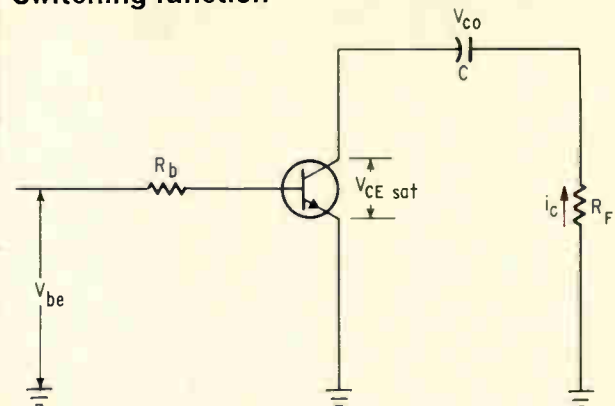

**Circuit operation.** An a-c switch requires current flow in both directions to charge and discharge the capacitor properly. When both the collector- and emitter-base diodes are switched from reverse-bias potentials to their forward-bias values the transistor is turned on. To turn the transistor off, the charged stored in the base is removed and both the collector and emitter are reverse biased.

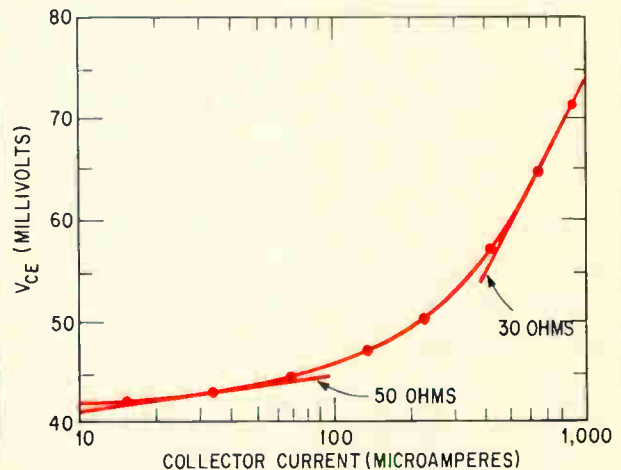

**Voltage-current plot.** Saturation resistance of the transistor varies from 30 to 50 ohms as the collector-to-emitter voltage is increased from 40 to 70 millivolts. The collector current through the transistor is in the microampere range.

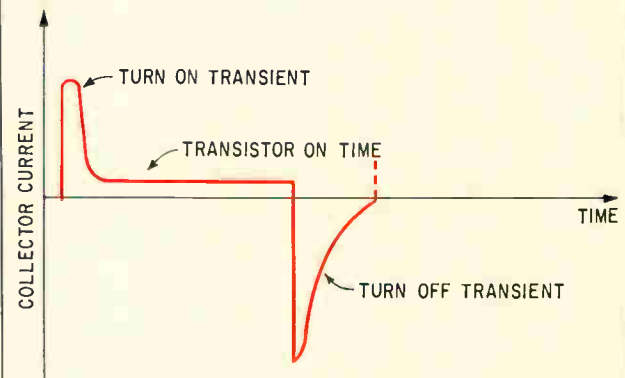

**On-off plot.** Positive regions of the current versus time plot represent the charge obtained from the external collector circuit of the switch. Charge stored in the base of the transistor is represented by the area of the negative-collector current spike. Transistor turn on is abrupt but the turn off occurs over a delayed period, needed to remove the charge.

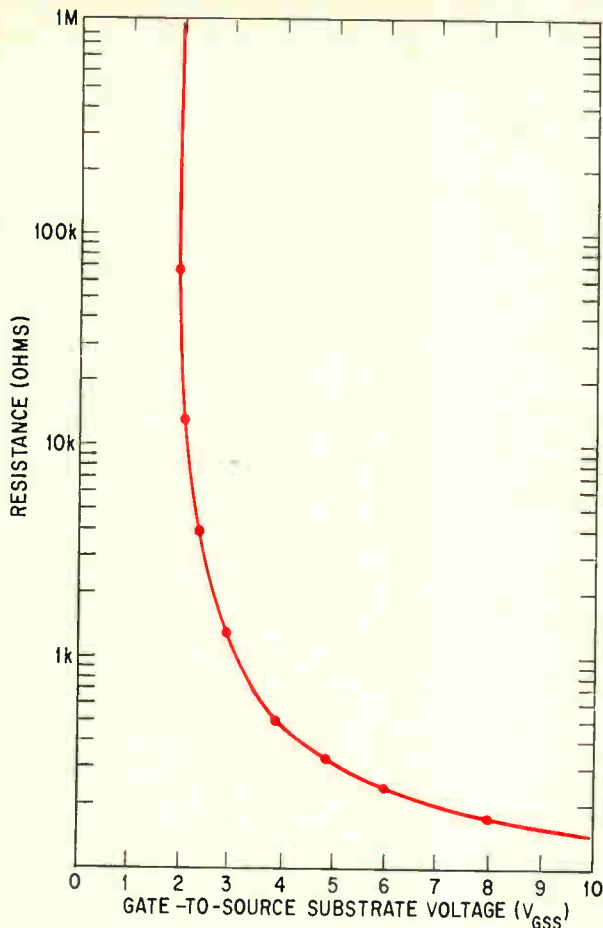

**Switching capabilities.** Plot of gate-to-source substrate voltage versus resistance for an MOS field effect transistor indicates a value of 200 ohms when  $V_{GSS}$  equals 5 volts. Resistance increases infinitely at  $V_{GSS}$  of 2 volts.

and high off resistance required for an ideal switch.

Switching capabilities of the FET were measured and the results plotted directly above. These results indicate that the high-resistance state occurs with a gate-to-source substrate voltage of 2 volts. Also, the on resistance is approximately 200 ohms with a  $V_{GSS}$  of 5 volts for a Raytheon Co. FN1034 transistor.

The frequency response of both types of digital filters has the multiple bandpass responses shown at the bottom left. Multiple responses are manifes-

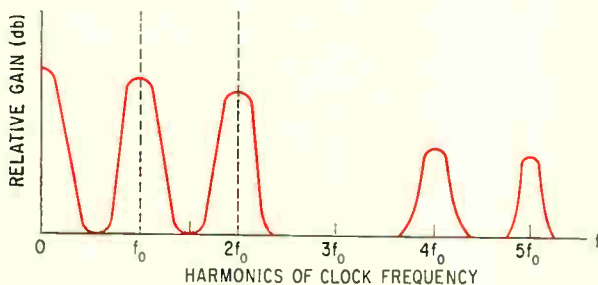

**Harmonic response.** Frequency spectrum of a three-section digital filter (above) indicates that the bandpass response at the third harmonic is zero. Plot (right) shows how harmonic responses are attenuated with respect to the fundamental frequency. Since the curves were obtained for a three-section filter the value of gain is zero for every harmonic multiple of three.

tations of the low-pass response of the low-pass networks, replicas of the low-pass response imaged about the clock frequency,  $f_0$ , and the harmonics of  $f_0$ . For a three-section digital filter the bandpass response centered at the third harmonic of the clock frequency is zero, because the average value of the input signal frequency over the sampling interval is zero.

Calculations were performed to determine how the peaks of the harmonic responses are attenuated with respect to the fundamental frequency. These are plotted at the bottom right. The relative amplitude of the harmonic peaks as a function of the harmonic number is obtained by evaluating the expression,

$$A = \left( \frac{\frac{\sin n\pi\gamma}{T}}{\frac{n\pi\gamma}{T}} \right)^2 \quad (2)$$

where  $\gamma$  = sampling interval  
 $T$  = sampling period  
 $n$  = harmonic of clock frequency  
 $A$  = amplitude of bandpass response

In a three-section digital filter, for example, neglecting the effect of the switch's rise and fall times, equation 2 becomes

$$A = \left( \frac{\frac{\sin n\pi}{3}}{\frac{n\pi}{3}} \right)^2 \quad (3)$$

if  $\gamma/T = 1/3$ ;  $A$  is 0 when  $\sin n\pi/3 = 0$  or when  $n = 3$ .

Therefore for all integral multiples of three, the bandpass response is zero as verified by the measured data.

### Series-switched two-section RC network

Unlike the shunt-switched filter whose bandpass response shape is always identical to that of a LC tuned network, the series-switched filter response may be changed by altering the low-pass filter section. To demonstrate this feature the two-section filter on the facing page replaced the single-section low-pass filter. It was designed with the same 3-db point as the one it replaced.

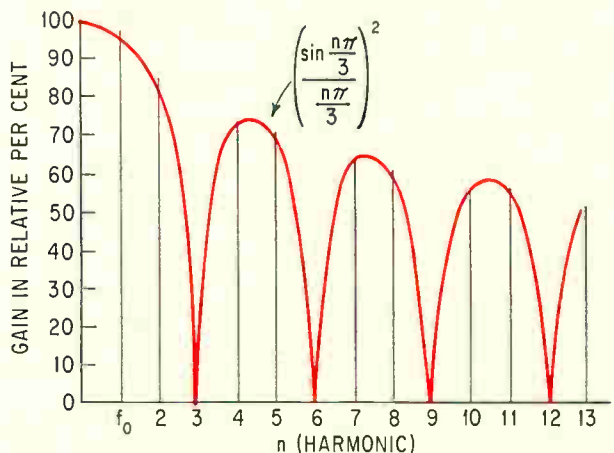

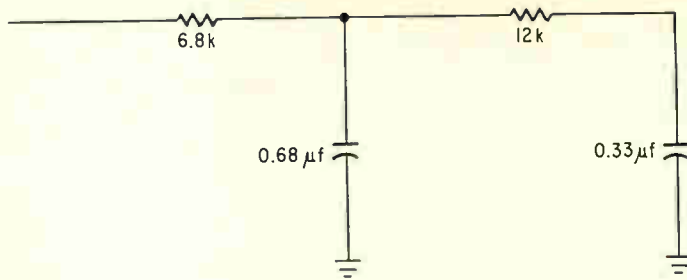
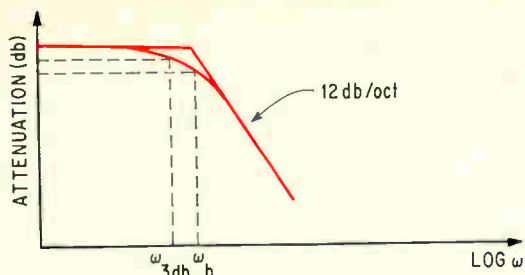

**Altering the response.** By changing the number of RC sections in a series-switched digital filter the engineer controls the shape of the frequency response. For a two-section filter the falloff is 12 decibels per octave.

Because a two-section RC filter (transfer function is second order) was used, it was necessary to establish the location of the 3-db point with respect to the break frequency  $\omega_b$ . The location is determined by considering the expression for attenuation versus frequency,

$$\text{Attenuation in db} = 20 \log |a - j\omega|^2 \quad (4)$$

where  $a$  = any frequency in the band;  $\omega$  = any frequency other than  $a$ ,  $\omega \neq a$ . Thus, this equation can be written as

$$\text{Attenuation} = 20 \log (a^2 + \omega^2) \quad (5)$$

Let  $\omega$  be some constant multiple of  $a$ ,  $\omega = ka$ , then equation 5 can be expressed as

$$\text{Attenuation} = 20 \log [a^2 (1 + k^2)] \quad (6)$$

or finally

$$\text{Attenuation} = 40 \log a + 20 \log (1 + k^2) \quad (7)$$

The term  $40 \log a$  is the high-frequency asymptote when  $a \gg \omega$ , and the term  $20 \log (1 + k^2)$  is the difference between the idealized and practical response.

For the two-section RC filter of the series-switched type, the second term on the right side of equation 7 becomes

$$3 = 20 \log (1 + k^2)$$

$$1.41 = 1 + k^2$$

$$k = 0.64$$

Therefore if  $a = \omega_{3db}$  and

$$\omega = \omega_{break} \text{ then}$$

$$\omega_{break} = 0.64 \omega_{3db} \quad (8)$$

A filter designed using this equation exhibits a 3-db point located at 7 hz as predicted and verified in the plot at the right. Note that the maximum attenuation is 50 db because the skirt rolloff is 12 db/octave with the two-section low-pass filter as compared with 6 db/octave for the single-section filter. However, when the network was placed in the series-switched filter, the asymptote slope becomes 10 db/octave. This reduction is explained by recalling that each low-pass filter is only switched into the circuit for one-third of the switching period. Since a residual charge is acquired by the capacitors when the filter is switched in, opening the switch tends to equalize the charge on the capacitor through the common resistance. This discharge tends to broaden the actual frequency response.

### Measuring maximum attenuation

The maximum out-of-the-band attenuation for the shunt-switched and series-switched filters can be increased by several methods. They are:

- Increase the clock frequency while holding the R and C values constant. Since this increases the Q, a greater attainable attenuation is possible.
- Decrease the low-pass cutoff frequency while holding the clock frequency constant. In a shunt-switched digital filter, this simply implies reducing the value of the series resistor or increasing the value of the capacitor. This method increases the Q by reducing the bandwidth of the filter.
- Change the low-pass frequency response so that the shape factor is reduced while holding the clock frequency constant. For example, the attainable attenuation of the series-switched digital filter made with a two-section RC network is 50 db with a center frequency of 1 khz. The attainable attenuation of the series-switched digital filter using a single-section RC network is 37 db with the same center frequency. Changing the shape of the frequency response of the low-pass filter section could also be accomplished by inserting an active low-pass filter having a Butterworth or Chebyshev response into the series-switched

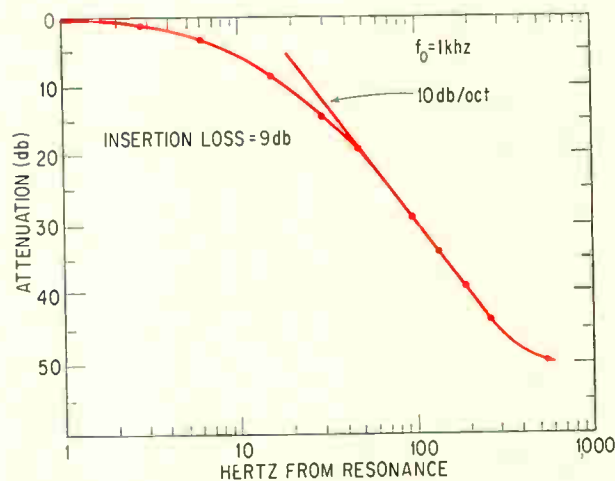

**Slope variation.** In the measured frequency response of a two-section series-switched filter the asymptotic slope is 10 decibels per octave instead of the theoretical value of 12 db per octave. This is due to a residual charge acquired by the network capacitors when the filter is switched into the circuit.

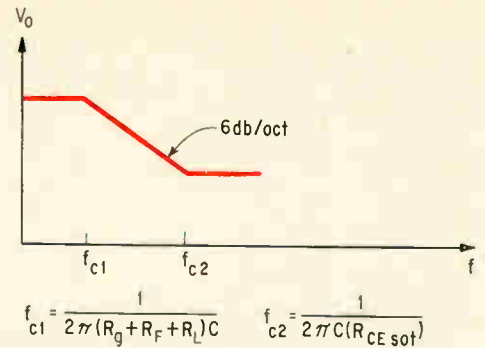
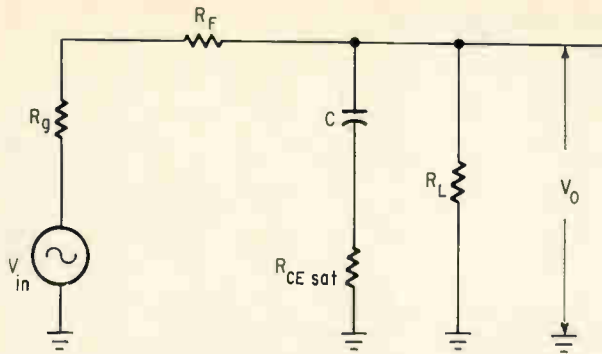

**Limiting the attenuation.** By including the transistor's saturation resistance into the equivalent circuit of the digital filter, the designer obtains an additional break point in the filter's response curve. Thus, he is able to limit the maximum attenuation.

digital filter. Although this makes the design more complex, it is easier than cascading shunt-switched filters.<sup>2</sup>

▪ Reduce the saturation resistance of the shunt switch. The equivalent circuit of the digital filter including the saturation resistance of the transistor switches is shown above. The effect of the saturation resistance is to add a break point to the frequency response of the filter, which limits the maximum attenuation of the filter section. The maximum attenuation of the low-pass section is given by the equation

$$\frac{V_o}{V_{IN}} = \frac{R_L'}{R_L' + (R_F + R_g)} \quad (9)$$

where

$$R_L' = \frac{R_{CE sat} R_L}{R_{CE sat} + R_L} \text{ and } X_c \text{ is negligible. Since}$$

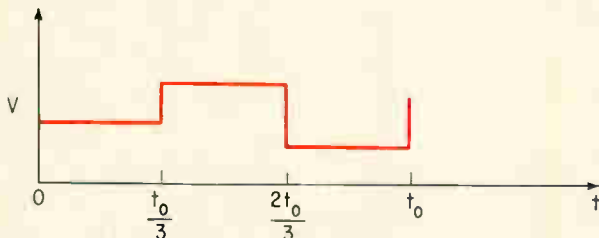

**Voltage waveshape.** Imperfection of transistor switches are obtained from the filter output's waveshape when the input is zero.

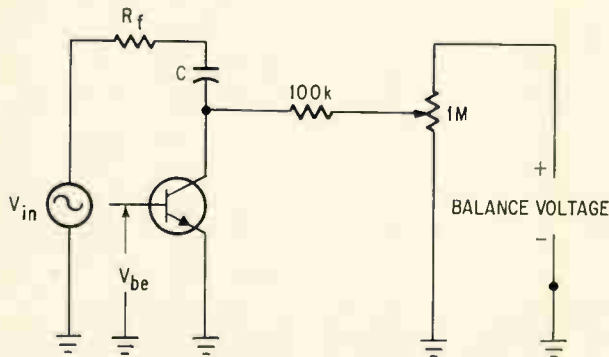

**Balance network.** To reduce zero-signal voltage of a shunt-switched filter, a nulling arrangement is applied.

the saturation resistance,  $R_{CE sat}$ , is much less than the load resistance then  $R_L' = R_{CE sat}$

$$\text{and } \frac{V_o}{V_{IN}} = \frac{R_{CE sat}}{R_{CE sat} + (R_F + R_g)} \quad (10)$$

If  $(R_F + R_g)$  is much greater than the saturation resistance  $R_{CE sat}$ , then equation 10 can be simplified to yield

$$\frac{V_o}{V_{IN}} = \frac{R_{CE sat}}{R_F} \quad (11)$$

Since the saturation resistance is typically between 30 and 50 ohms, a filter resistance,  $R_F$ , of 30 to 50 kilohms is required for a maximum attenuation of 60 db.

▪ Reduce the zero-signal noise. The zero-signal output noise, an indicator of the imperfection of transistor switches, is measured at the output of the filter when the input signal is zero. In a shunt-switched filter the noise output, which has the waveshape at the left, can be caused by the unequal saturation voltages of the transistor switches and unequal stored charge on the capacitors.

The actual attenuation in any digital filter is given by

$$\text{Attenuation} = 20 \log \frac{\text{input signal}}{\text{zero-signal voltages}} \quad (12)$$

Using the value of maximum attainable attenuation of 37 db, this equation shows the ratio of input signal to zero-signal voltage for the shunt- and series-switched filters should be approximately 100:1. The actual measured ratio was approximately 1,250:1.

The zero-signal voltage of a shunt-switched filter was measured with a wave analyzer and found to be approximately 170 microvolts at 1 khz. By balancing the voltages on the filter capacitors with the circuit at the left, the zero-signal noise was reduced from 170 to 100 microvolts. Charging the filter capacitors through a 1-megohm potentiometer during the off time adjusted the voltage

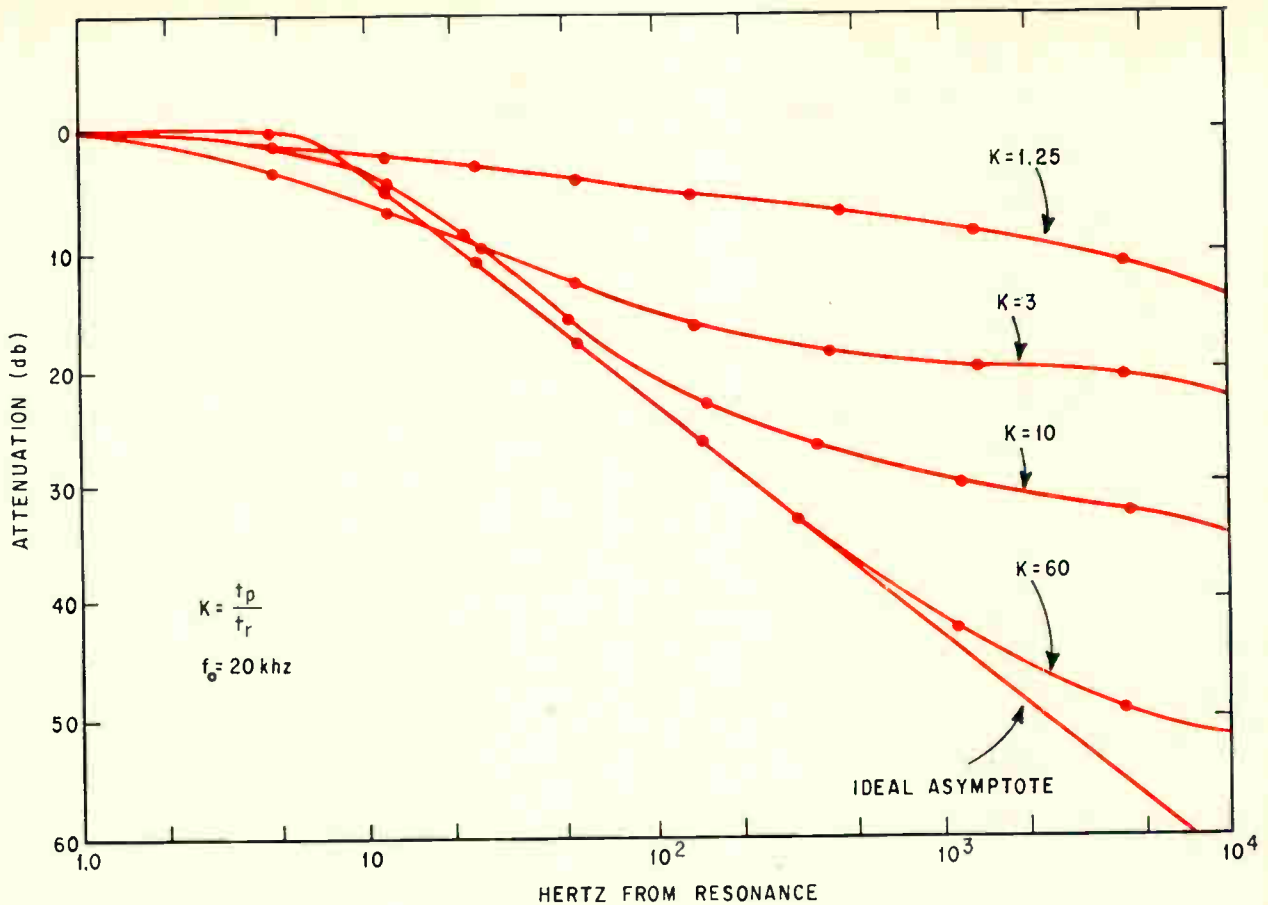

Varying  $k$ . As the ratio of pulse time to rise time increases, the shape of the frequency-response curve changes. Plots are obtained for a digital filter centered at 20 kilohertz.

on capacitor C. Since the charging resistor is much larger than the filter resistor, bandpass characteristics aren't affected. The requirement for external potentiometers, however, limits the usefulness of this technique for integrated circuit applications.

Zero-signal noise also exists in the series-switched filters. But here it's due to unequal channel resistance of the field effect transistors. The zero-signal output voltage for this type of filter is 170 microvolts. By balancing the voltages with the circuit at the right the zero-signal output noise is lowered to less than 50 microvolts. The potentiometers are needed to balance the difference in the channel resistance of the FET's. However, the maximum attenuation is limited by the zero-signal output noise when low-pass filters having a greater skirt rolloff than 6 db/octave are used.

At a center frequency of 1 khz, the zero-signal output noise has little effect upon the maximum attainable attenuation. However, as the center frequency is increased, the zero-signal output noise also increases as illustrated at the right. At high center frequencies, the noise increases rapidly, thereby directly influencing the attainable attenuation. Because of the input-signal limitations, maintaining large signal-to-noise ratio isn't possible. Thus the attainable attenuation is reduced.

The rapid increase in zero-signal noise with increasing center frequency is due to the imper-

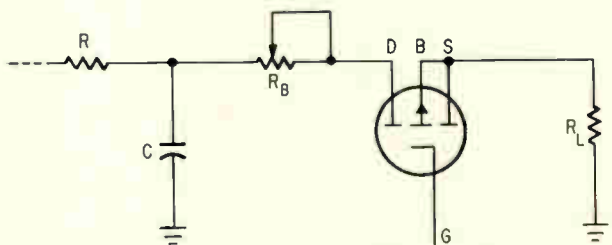

Reducing noise. For the FET, a balance network incorporating a potentiometer reduces the zero-signal voltage to below 50 microvolts.

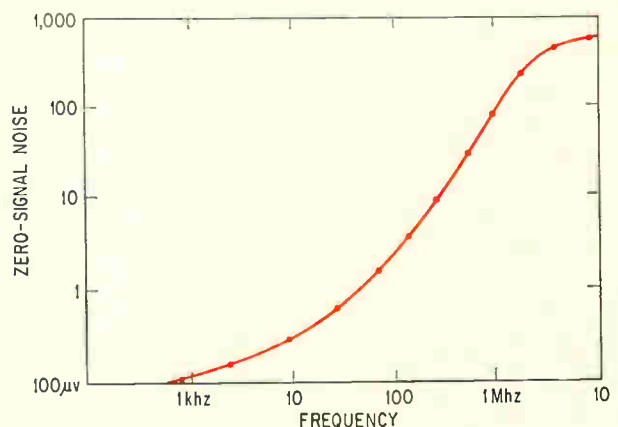

Shifting center frequency. As  $f_0$  increases, the zero-signal noise increases rapidly.

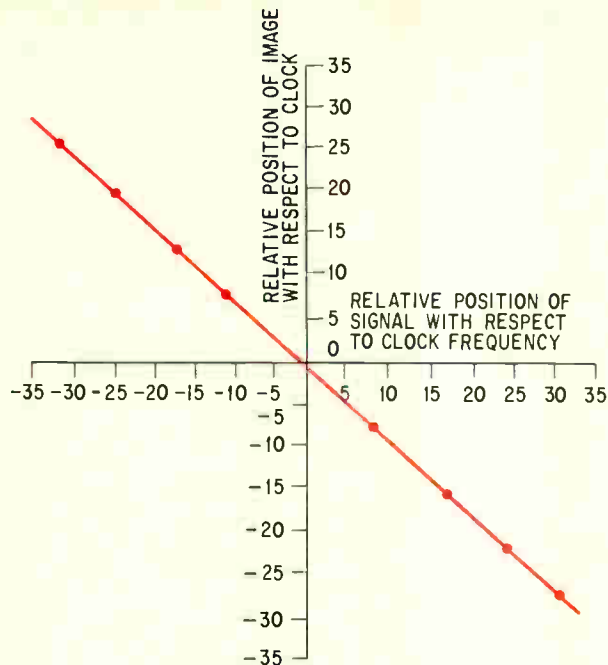
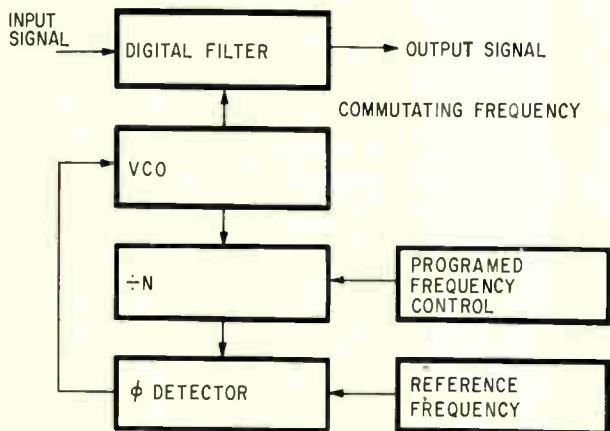

Image response. Relative location of the image frequency is plotted with respect to the clock frequency to enable the designer to locate a third-order image response.



Frequency hopping. Stages for a digitally controlled system indicate the operation sequence. By regulating the voltage-controlled oscillator from the phase detector, the commutating frequency changes, thereby retuning the digital filter.

fection of the transistor switches. Typical effects of a variable pulse rise time on the attainable attenuation are plotted on the previous page for a digital filter centered at 20 khz. As the ratio,  $k$ , of pulse on-time,  $t_p$ , to pulse rise time,  $t_r$ , is varied, the frequency response curve changes.<sup>3</sup> It is necessary to use a ratio of 50:1 or 60:1 to approach the ideal asymptote, but it is difficult to maintain large ratios in integrated digital circuits.

### Image response

Although, ideally, it is assumed that both the shunt- and series-switched filters have balanced low-pass sections—i.e., they all have identical frequency responses—this isn't the case. The effects of the unbalance can best be illustrated by measur-

ing the frequency spectrum of each filter's output signal with a wave analyzer. The most significant result is the appearance of a third-order image response. If the digital filter is centered at  $f_0$  and the input signal is at a frequency  $f_a$ , the difference frequency is  $f_0 - f_a$ . If the difference frequency is denoted as  $f_d$ , the input signal would be located at  $f_0 - f_d$  and the image frequency would be located at  $f_0 + f_d$ . This could be compared to an intermediate frequency system with the i-f at  $f_d$ , the carrier at  $f_0$ , and the local oscillator at  $f_a$ . To completely identify the image, the plot at the left was developed. This plot illustrates the relative location of the image with respect to the clock frequency.

The amplitude of the image frequency is a direct function of unbalance in the low-pass filter sections. If one channel's frequency response is 10% greater than the other two channels, the amplitude of the image will only be 20 db below that of the input signal. Balance to within 1% was achieved for the low-pass filters used. Hence, the amplitude of the image was approximately 40 db below that of the input signal frequency. Therefore, it is imperative to achieve an accurate balance between the low-pass filters. This is particularly true when higher-order RC low-pass filters are used (such as an active RC filter), because these present more critical tolerance problems.

The zero-signal noise level, which is actually a measure of the leakage of the clock signal through the digital filter, is quite low compared to the output signal. Although it can be reduced by the methods previously outlined, this isn't necessary because it is already low, due to the cancellation of the clock frequency.

### Analog signals introduce errors

Despite the many advantages of digital filters they do suffer from one limitation, when an analog signal is detected by a digital filter. Since an image signal is added to the analog signal by the digital filter, it can never be reduced. Hence, the filter's applications are limited to digital systems. One such application is a digitally controlled frequency-hopping system that can be used in jam-proof receivers.

The operation of the frequency hopping system is based on the fact that the digital filter provides a very narrow bandpass response centered about the commutating frequency. By controlling the voltage of the oscillator from the phase detector, the commutating frequency changes, thereby retuning the digital filter. The phase detector is controlled by a programmed frequency control.

### References

1. "Advanced functional electronic block development," Technical Documentary Report RTD-TDR-63-4203, AD 427141.
2. "Advanced fabrication processes for functional electronic blocks," Interim Report No. 03-64-18, AD 435131, pp. 22-24.
3. L.E. Franks and I.W. Sandberg, "An alternative approach to the realization of network transfer functions: the N-path filter," Bell System Technical Journal, Sept. 1960, pp. 1321-1350.

# 10 Amp *in*

# ISOLATED

# Collector Packages

from

# Soliton

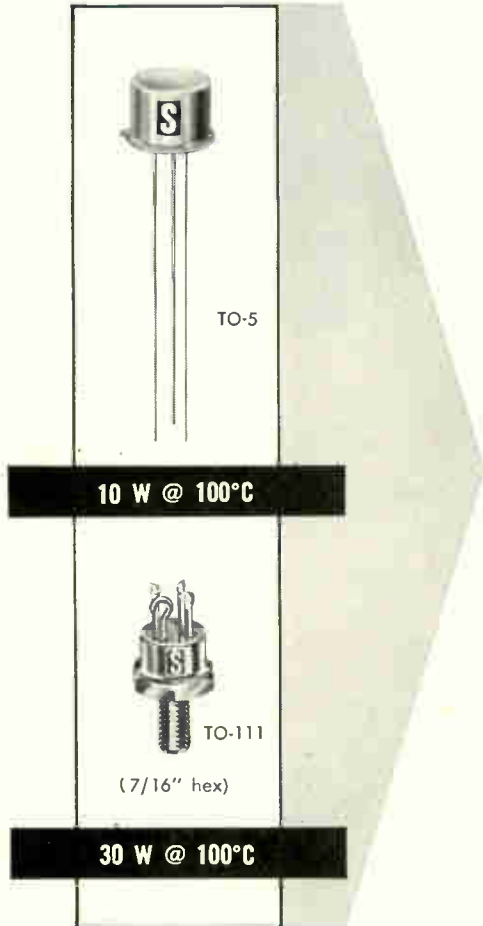

Soliton's popular 10-amp NPN silicon power transistors are now available in Isolated packages. Designated the SDT 7470 and SDT 7B00 families, these devices offer high performance and reliability, plus small size! The TO-111 is the smallest stud package produced with 10-amp capability. All of the units feature low leakage currents, a uniform gain over wide current ranges and low saturation voltages. Typical characteristic curves are similar to the widely accepted 2N2811-14 Series. These isolated packaged devices may be utilized in many areas where the MHT 7400 Series and MHT 7000 Series are in use.

Type Number TO-111	Type Number TO-5	DESIGN LIMITS			PERFORMANCE SPECIFICATIONS					
		$V_{(BR)CBO}$	$V_{CE0}$ (SUS)	$V_{(BR)EBO}$	$h_{FE}$		$V_{CE(sat)}$	$V_{BE(sat)}$	$I_{CBO}$	$f_T$
		Volts	Volts	Volts	$I_C = 5A$	$V_{CE} = 5V$	Volts	Volts	$\mu A$	MH <sub>z</sub>
		$I_C = 10 \mu A$	$I_C = 0.1A$	$I_E = 10 \mu A$			$I_C = 5A$	$I_B = 0.5A$	$V_{CB} = 60V$	
Min.	Min.	Min.	Min.	Max.	Max.	Max.	Max.	Max.	Typ.	
SDT 7B01	SDT 7471	80	60	5	40	120	0.6	1.5	1.0	50
SDT 7B02	SDT 7472	100	80	5	40	120	0.6	1.5	1.0	50
SDT 7B03	SDT 7473	120	100	5	40	120	0.6	1.5	1.0	50
SDT 7B04	SDT 7474	140	120	5	40	120	0.6	1.5	1.0	50
SDT 7B05	SDT 7475	80	60	5	20	—	0.6	1.5	1.0	50
SDT 7B06	SDT 7476	100	80	5	20	—	0.6	1.5	1.0	50
SDT 7B07	SDT 7477	120	100	5	20	—	0.6	1.5	1.0	50
SDT 7B08	SDT 7478	140	120	5	20	—	0.6	1.5	1.0	50

DIAL 1-800-327-3243 FOR A NO CHARGE TELEPHONE CALL AND FURTHER INFORMATION

## Soliton DEVICES, INC.

1177 BLUE HERON BLVD. / RIVIERA BEACH, FLORIDA / (305) 848-4311 / TWX: (510) 952-6676

Leader in Germanium and Silicon Transistors, Cryogenic Thermometers, High Voltage Rectifiers, Hot Carrier Diodes, Temperature Compensated Zeners, Voltage Variable Capacitors, Random/White Noise Components, Microelectronic Circuits, and Power-Sink Interconnection Systems.

# DCL<sup>®</sup>

## DESIGNER'S CHOICE LOGIC

Signetics puts IC systems design decisions back in the hands of the systems designer.

Some IC families put severe limits on the decisions the systems designer can make. He's often held back by the speed, power, and noise immunity trade-offs built into the family by the IC manufacturer. Now Signetics Designer's Choice Logic changes all that. Signetics DCL<sup>®</sup> Series 8000 includes high speed TTL circuits, slower low power TTL circuits that offer high AC noise immunity, and low power DTL circuits that provide high DC noise margins. The series also includes large functional arrays for counting and storage applications. All elements in the 8000-Series are specified compatibly. And we've got a 46-page data

handbook — the most complete one of its kind ever offered — to guide you in using these flexible circuits. In designing with DCL<sup>®</sup> you can optimize your system performance without drawn-out calculations, expensive and time-consuming ground-plane designs, or extensive use of outboard discrete components. The handbook provides special sections directed to systems, evaluation and design engineers. Find out fast what can be done with our DCL<sup>®</sup> series, and how to loosen constraints on your designs. Write Signetics for your DCL<sup>®</sup> handbook: 811 East Arques, Sunnyvale, California 94086.

® REGISTERED TRADEMARK 1967

**SIGNETICS  
INTEGRATED  
CIRCUITS**



A SUBSIDIARY OF CORNING GLASS WORKS

SIGNETICS SALES OFFICES: Metropolitan New York (201) 992-3980; Upper New York State (315) 469-1072; Southwestern (214) 231-6344; Western Regional (213) 272-9421; Eastern Regional (617) 245-8200; Mid-Atlantic (609) 858-2864; Southeastern (813) 726-3734; Midwestern Regional (312) 259-8300; Northwestern (408) 738-2710.

DISTRIBUTORS: Compar at all locations listed below. Semiconductor Specialists, Inc. (312) 622-8860; Terminal Hudson Electronics (212) 243-5200; Wesco Electronics (213) 684-0880; Wesco Electronics (405) 968-3475; Hammond Electronics (305) 241-6601.

DOMESTIC REPRESENTATIVES: Jack Pyle Company (415) 349-1266. Compar Corporation at the following locations: Alabama (205) 539-8476; Arizona (602) 947-4336; California (203) 245-1172; California (415) 697-6244; Colorado (303) 781-0912; Connecticut (203) 288-9276; Florida (305) 855-3964; Illinois (312) 775-5300; Maryland (301) 484-5400; Massachusetts (617) 969-7140; Michigan (313) 476-5758; Minnesota (612) 922-7011; Missouri (314) 428-5313; New Jersey (609) 429-1526; New Mexico (505) 265-1020; New York (518) 436-8536; New York (607) 723-8743; New York (716) 684-5731; New York (201) 471-6090; North Carolina (919) 724-0750; Ohio (216) 333-4120; Ohio (513) 878-2631; Texas (214) EM 3-1526; Texas (713) 649-5756; Washington (206) 725-7800.

INTERNATIONAL SALES: France, Germany, Italy, Belgium, Holland, Luxemburg, Spain — Sovcor Electronique, 11, Chemin de Ronde, Le Vesinet, (S.-&O.) France. United Kingdom, Ireland, Sweden, Denmark, Norway, Switzerland, Austria, Portugal — Electrosil Ltd., Lakeside Estate, Colnbrook-By-Pass Slough, Buckinghamshire, Great Britain. Australia — Corning, 1202 Plaza Building, Australia Square, Sydney, N.S.W. 27-4318. Canada — Corning Glass Works of Canada, Ltd., Leaside Plant, Ontario, Canada (416) 421-150. Israel — Optronix, P.O. Box 195, Ramat-Gan, Israel 724-437. Japan — ASahi Glass Co., Ltd., Corning Products Sales Dept. No. 2, 3-Chome Marunouchi, Chiyoda-ku, Tokyo, Japan.





# The widening impact of computers

Once simply an accounting tool at the hospital, the machine is becoming the center of systems that monitor patients' conditions, analyze laboratory tests, schedule operations, and allocate facilities

By Evon C. Greanias

International Business Machines Corp., Yorktown Heights, N.Y.

**The warning** "low cardiac output suspected" flashes across a television screen in a San Francisco hospital, alerting physicians to a change in the condition of a patient in an intensive-care unit. The tv set is connected to a remotely located computer that continuously monitors blood pressure, heart action, respiration, and body temperature. In this case, the computer has detected a decline in the patient's pressure and pulse, and the early-warning system has signaled the change before the appearance of any noticeable physical signs.

A Swedish surgeon enlists the aid of a computer to conquer Parkinson's disease. From X-ray plates of a patient's skull, the location of the diseased brain tissue is programed into a computer; the machine guides electrodes to the spot so that the tissue can be destroyed by audio-frequency energy.

In a less dramatic application, a computer system at a Texas hospital permits nurses to simultaneously order drugs from the hospital pharmacy and note the transaction on the patients' records. Before the system was installed, filling a routine medication order involved as many as 12 steps and up to seven written records.

These examples only hint at the potential of the computer in medicine. The machines are becoming indispensable in hospital administration and management. They have an important role in

the collection and storage of medical data and are being used increasingly to analyze the information. They also hold out great promise as aids to medical education.

## Labor savers

The field of health today ranks second only to defense as a Federal budget item. This ranking reflects an increasing demand for health services [Electronics, July 10, p. 98], a demand that is creating critical shortages of manpower and facilities.

Current medical applications of data processing demonstrate clearly that computers can help alleviate these shortages. Automated analytical instruments linked to computers can increase both the quantity and quality of laboratory data and can provide faster and more detailed diagnoses. And automated monitoring of hospital patients reduces the workload of doctors and nurses, and provides new and perhaps better ways of evaluating the condition of patients.

Not all medical data processing projects have saved labor and dollars, or improved patient care. But the instances of fruitless effort might have been avoided by a more realistic analysis of technical feasibility and potential values.

The biggest payoff to date has come in the area of hospital accounting and administration. Hospitals must continuously collect, record, store, retrieve, interpret, summarize, transmit, display, and follow up information about patients and about over-all hospital operation. How well these functions are performed can have a profound effect on patient care.

Hospitals began using punched-card data processing in the 1940's, initially to produce bills and accounts receivable. It soon became evident that hospital administrators could get more information

## The author



Since joining the International Business Machines Corp. in 1952, Evon C. Greanias has been closely associated with the development of pattern-recognition equipment. He currently manages the medical information systems program of the company's Advanced Systems Development division.

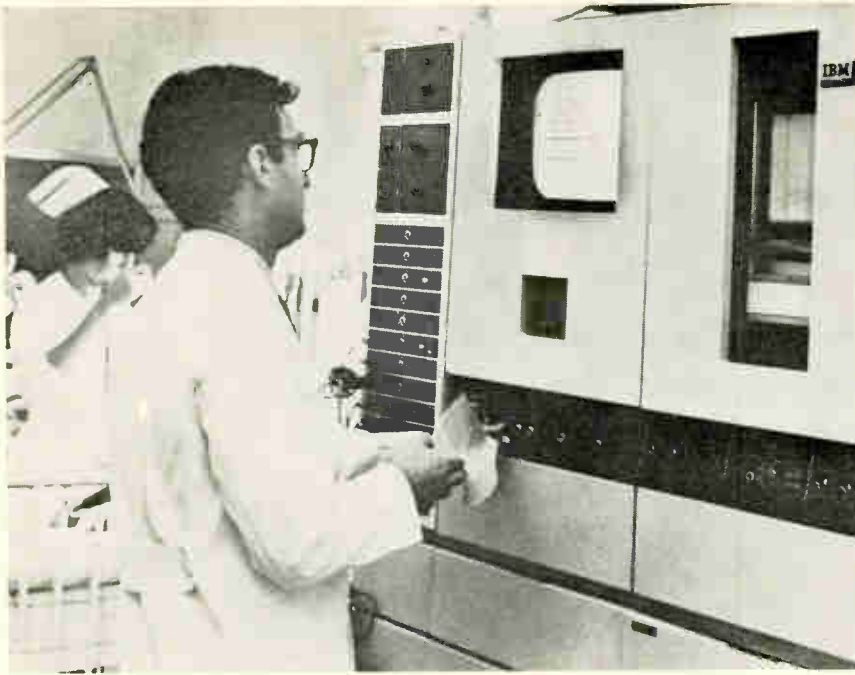

**Wary eye.** Doctor checks the condition of a cardiac patient by viewing data flashed on the tv screen of a computerized monitoring system. Inputs come from sensors attached to the patient. Factors relating to the patient's condition are calculated continually by the computer. Routine data displays are interrupted by alert messages when significant changes occur.



**Key-punch order.** Nurse requests medicine from a hospital pharmacy through a remote computer terminal. The request is simultaneously recorded on the patient's record.

from their punched-card files than just a record of accounts receivable. For example, from X-ray charges they could tell on a weekly, monthly, or annual basis how much revenue was coming in from this department, and which types of X-ray procedures accounted for what portion of the department's income. They could also sort data to determine such things as the makeup of the hospital's population, and the type and volume of illnesses treated.

The advent of hospital computer systems didn't radically alter this approach to data. Charges were fed into a computer instead of being entered onto punched cards, but the results were basically an invoice for the patient and a record on magnetic tape or disks for use in statistical summaries. The aim was better patient care through more efficient administration. With improved management, it was reasoned, the hospital could allocate more resources—both dollars and personnel—to the treatment of patients.

#### **Extended system**

The goal hasn't changed since, but the drive now is to extend computer control to other areas of hospital operation—to establish a total hospital information system. This network would tie in accounting, service, and medical activities to a central computer that would help control admissions, allocate beds, order drugs, schedule X rays and operations, report results of lab tests, plan special diets, and furnish doctors with updated records of patients' treatment and progress. Such a central information system is being installed in

Peoria, Ill., for use by 11 hospitals in three states.

The essentials for a central hospital information system are high-speed central processing; open-ended, direct-access storage; and fast communications—all features of third-generation computers. Another requirement is flexible, easy-to-use,

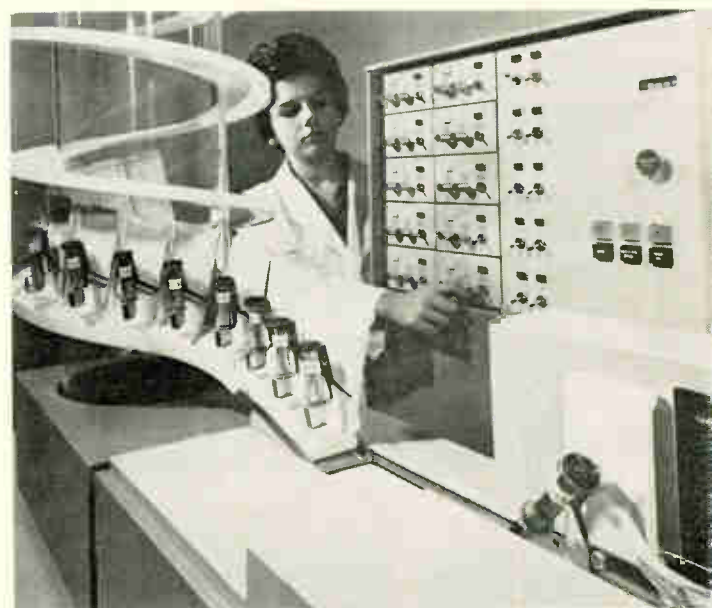

**Automated lab.** Experimental equipment demonstrates a possible scheme for rapid analysis of blood samples. Specimen is poured into a funnel and analyzed by conventional laboratory instruments. Signals from the instruments are converted by a control unit into computer-readable form, and the computer then calculates test results and prepares a report.

on-line data-transmission terminals to be located at nursing stations, service departments, clinical labs, operating rooms, and business offices.

### An eye on the patient

One of the main jobs of such a system is patient monitoring. As an example of this application, a digital computer at the Institute for Medical Sciences at the San Francisco Presbyterian Medical Center can monitor more than 20 physiological variables, including blood pressure, respiration rate, heart rate, and body temperature, and can compute from its measurements such things as the amount of blood pumped with each heart beat and the amount of lung movement with each breath.

Another promising application is computer analysis of electrocardiograms [see story on page 111]. In an experimental system developed at Mount Sinai Hospital in New York, a computer is used to compare digitized EKG signals to previously stored "normal-abnormal" patterns. This system is immobile, though, and a portable unit is needed to record EKG's in the field and send the recording to the computer.

Such a unit has been built. It contains a strip-chart recorder, an EKG preamplifier, EKG lead-selector switches, pulse-generating circuits, a frequency modulator, and an acoustical coupling device that permits the transmission of EKG's to a remote computer over a standard telephone handset. The frequency modulator converts the EKG from low-frequency analog signals to frequency-modulated signals at a portion of the spectrum suitable for magnetic tape recording and telephone transmission.

Still another computer application is a procedure for displaying data from radioisotope scanning. At the Mayo Clinic in Rochester, Minn., for example, pulses are collected from a radiation detector as it scans an area of a patient who has been fed or injected with a radioactive substance, and these pulses are recorded on multichannel digital magnetic tape. The tape is fed into a computer that then produces a contour map of the scan, pinpointing significant accumulations of radioactivity.

### Automating the lab

On-line data acquisition and analysis is also proving extremely useful in the clinical laboratory. The lab, where tests are performed on blood and other material taken from patients, is usually divided into such divisions as clinical chemistry, clinical microbiology, clinical microscopy, and a blood bank.

The clinical lab in a large medical center may perform more than 700,000 tests a year. To ease this workload, a system has been developed that collects electrical signals from chemical analysis instruments [Electronics, Oct. 31, 1966, p. 116] and converts them into reports on the chemical composition of the sample; this information is stored in a computer for retrieval by doctors. Critical time is thus saved in the actual analysis



**Bedside consultant.** Portable electrocardiograph sends EKG signals over a telephone line to a remote computer for analysis. The signals are also recorded in the conventional manner for immediate analysis by a doctor.



**Locating tumors.** Radioisotope scanner is positioned over a patient. Unlike ordinary scanners, which produce a paper chart or film image, this system records all data on magnetic tape for computer analysis. A new radiation pattern is recorded every tenth of a second. Computer-processed scans have better resolution than film records. Automatic gain control eliminates the need for extra scans and, perhaps, additional injections.

## Total hospital information system



**Data inputs.** Terminals like this will permit personnel at hospital stations to transmit data on patients' functions, such as pulse rate, blood pressure, and temperature, to the central computer.

**Nucleus.** Central processing unit for information system being installed in 11 hospitals in Illinois and two other states is an IBM System/360 model 50. Unit will include an auxiliary disk storage facility capable of holding more than 200 million characters of information.



**Logging Rx.** Terminals at such service areas as the pharmacy will transmit to the computer records of all drug dosages for entry into each patient's file.

**Recording tests.** Data acquisition sets similar to this IBM 1080 will automatically record for computer processing the results of clinical tests made in the hospitals' laboratories.



operation, in the recording of data, and in the reporting of results to physicians.

From these applications, it's only a small step to the automated physical examination. Automated checkups are routine now at the Kaiser Foundation Medical Centers in California. With computer analyses, doctors at the centers are able to detect a wider range and a greater number of unsuspected diseases among apparently healthy people.

The centers are operated for members of the Kaiser Foundation Health Plan. About 4,000 patients are examined monthly; each examination takes only two to three hours, roughly one-quarter of the usual time.

When a plan member comes to one of the centers for an examination, he is first given a medical questionnaire and a deck of prepunched computer cards used to enter test results into a computer. The patient then proceeds through 19 test stations in the center's automated laboratory.

The tests include bodily measurements of muscle tone, chest X rays, an EKG, an eye examination, a hearing test, and an analysis of blood and urine. The tests are organized in such a way that the results are entered in the computer before the examination is finished. For example, glucose is given the patient at station 4 so that a blood sample can be taken for analysis at station 16 an hour later.

At the end of the examination, the computer prints out preliminary advice based on previously established norms programmed into it by physicians. If certain test results are abnormal, more tests may be called for. Finally, a summary of all test reports is provided for review.

### No limits

These data storage, retrieval, and analysis jobs don't by any means exhaust the application possibilities. Mathematical modeling and computer simulation are being used to gain a better understanding of health problems. Models of biochemical systems, for example, can help medical students and researchers find out how various organs work. And a digital computer at the University of California at Los Angeles has been used to solve the basic equations for the chemical and thermodynamic equilibrium of blood.

These examples represent but a sampling of the ways the medical world can put computers to work. Here, as in other fields, the number and kinds of computer applications depend mostly on man's immediate needs and the dimensions of his imagination. As an increasing amount of clinical work is mechanized, the computer will become a familiar tool of medicine with an ever-expanding role.

## What do you think, doctor?

Doctors generally agree that the computer can help them handle routine jobs. Beyond that, they're a bit leery of the machine.

Many are especially wary about the use of the computer as a diagnostic tool. They feel that the kind of information an experienced physician can get out of a face-to-face meeting with a patient will be ignored.

"We need to observe things such as the patient's facial expression," says Dr. J.S. Denson of the University of Southern California's medical school. "Computers are all right for a canned program," declares Dr. Harold M. Silver, an associate professor of medicine at George Washington University, "but nearly impossible for anything original." Dr. John H. Knowles, general director of Massachusetts General Hospital in Boston, says he "would be very wary of substituting a machine for the direct confrontation between doctor and patient. Attempts to standardize history forms, stick them in a machine, and come up with a diagnosis can never replace a direct meeting."

Dr. Knowles, however, notes that "diagnostic computers will be helpful in teaching young doctors how to diagnose." He explains that "in programming a diagnostic computer, we have to study what allows us to make a diagnosis."

This question of data inputs is the key to doctors' reservations about diagnostic computers. "A diagnostic system is never going to be better than the information fed into it," says Dr. Ronald H. Selvester, a cardiologist at Rancho Los Amigos Hospital, Downey, Calif. "The range and variables must be spelled out carefully," he adds. "Categories must be clearly defined and screening must be adequate. The system can't be based on a probabilistic model."

Herbert Maisal, director of the computation center at George Washington University Hospital, agrees that a great deal of information must yet be processed before doctors fully trust computer diagnoses. "Patient histories have to be built up," he says. "New data may cause changes and reveal new associations."

Of course, many doctors are

sold on diagnostic computers. "Future physicians," says Dr. R. Eugene Tolls, president of the Bay-Area Pathologists Central Laboratory in San Francisco, "must be prepared to assume new roles when computers undertake some of their present tasks. Even so, somebody has to put the data into the computer, and it's going to be a doctor who makes the examination."

Still, the question remains whether an accurate patient history and a complete physical examination are sufficient for a diagnosis. How important are the intangibles a doctor can work with but a computer cannot? Behind this question lurks the fear that computers will usurp one of the doctor's main functions.

Regarding this fear, Dr. Charles P. Lebo, director of the San Francisco Medical Society, says: "Any physician who feels he's going to be replaced by the computer is probably ready to be replaced anyway. As long as the medical community makes intelligent applications of data processing techniques, medicine can only advance." However, Dr. Lebo warns against moving too fast. "We mustn't try to computerize things that shouldn't be computerized," he says.

But where is the line drawn?



## Making informed decisions

Computer system under development will store medical data and suggest examinations, diagnoses, and treatments to physicians

By Frederick J. Moore, M.D.

International Business Machines Corp., Yorktown Heights, N.Y.

**The patient** presenting himself for examination may have one, or several, of 10,000 identifiable diseases. These can manifest themselves in any combination of 100,000 symptoms. And the examining physician can prescribe one, or several, of some 100,000 treatments.

With this multiple-choice test facing him constantly, the doctor obviously could use an information system to support his decision-making. A computer-based system for hospitals is now being developed by the International Business Machines Corp. to assure that informed decisions will be made during examination, diagnosis, and treatment.

In its final form, the system is expected to release the physician from activities that can be delegated to aides and technicians, increasing his effectiveness by permitting him to concentrate on those tasks requiring his unique insight, skill, and understanding. In addition, the system will give a physician access to all current medical information related to the care of his patient and keep him abreast of medical developments. It should also make it possible for medical students to come to grips with real medical problems rather than relying entirely on textbooks during their early years of training, and may familiarize physicians with diseases not frequently encountered.

**Display station.** Input-output terminals for clinical decision support system will be similar to this IBM 2260. These units will link doctors, nurses, and medical technicians to the centrally located computer.



The medical knowledge stored in the computer will be available to hospital doctors through a keyboard-and-cathode-ray-tube arrangement or typewriter readout. After a patient's symptoms have been matched to this stored data, the system will display its diagnosis, any special tests required, and recommend treatment for the physician's consideration.

### Needed: information

Besides the computer-stored knowledge, the system will include:

- On-line, input-output terminals for bedside installation. They will have a keyboard for entering data and a crt display for the computer outputs.
- An off-line device to produce a printed record at nursing or floor stations.
- A direct-access file to store all information on each patient.
- Computer programs that will accept instructions in medical-oriented English.

Most, if not all, of this equipment and software is available now. The main hurdle is the accumulation of a body of medical knowledge.

The system's logic process imposes three constraints. First, the question to be decided must be unequivocally stated. This doesn't mean that the decision has to be based upon tested facts; it could be just a question of whether or not to order an upper gastrointestinal series depending on whether the patient complains of a bloated feeling after meals.

Second, the decision must be unequivocal—capable of being stated in binary (yes or no) terms.

Third, factors leading to the decision and their influence on the decision must be unequivocally defined.

The factors determining the decision can be either patient data or the results of prior decisions, or both. A chain of small, clearly defined, micro-decisions thus forms the decision process. Weights are assigned to the factors, and a decision is made when the sum of these weighted factors exceeds a threshold. It often happens that a single independent variable such as a symptom will throw its weight behind several different decisions.

### Question and answer

Only three kinds of decisions are made by the system: A eliminates B, A incriminates B, or A proves B. The input A may be a positive or negative response to a question from the machine. It can be a Boolean set of factors that activate the resultant B. And B can be almost anything—a succeeding question, a finding, a disease category, a diagnosis, or an action by the system, such as the printing of a drug requisition. Also, the resultant B of one microdecision may become the input of another, as the network of microdecisions converges on a diagnosis.

The main elements of this process are: the presentation of questions by the computer to ac-

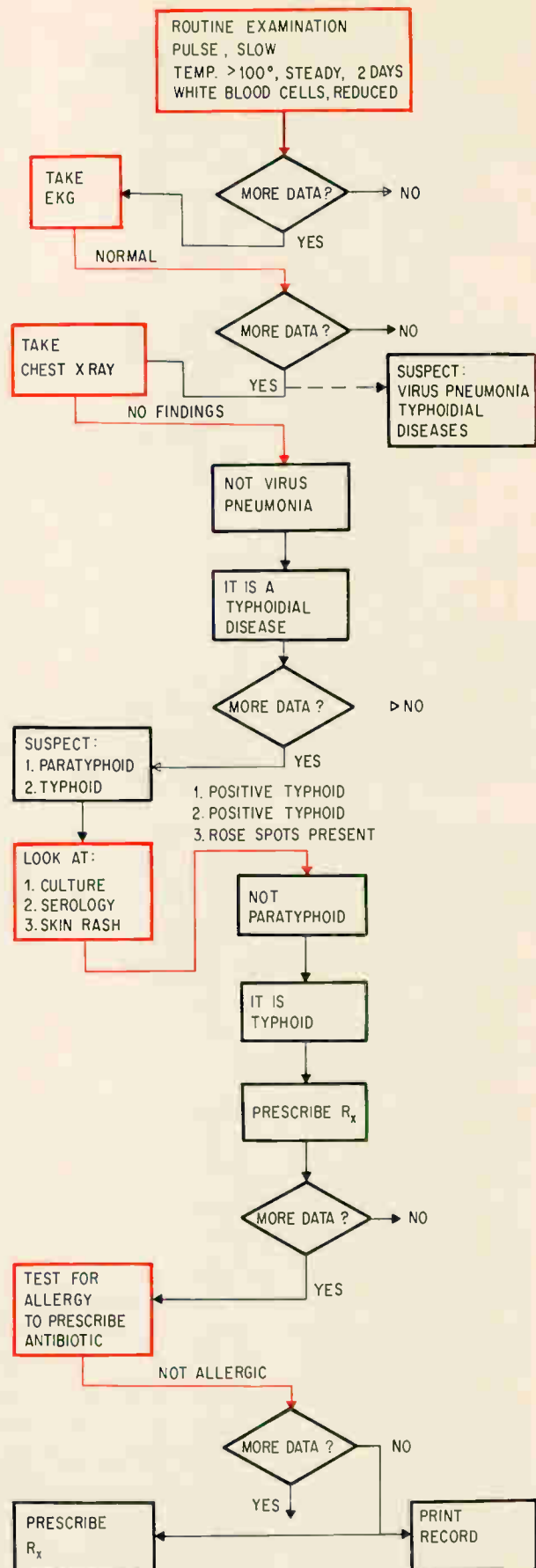

Zeroing in. Decision support system asks hierarchically arranged questions to converge on a diagnosis.

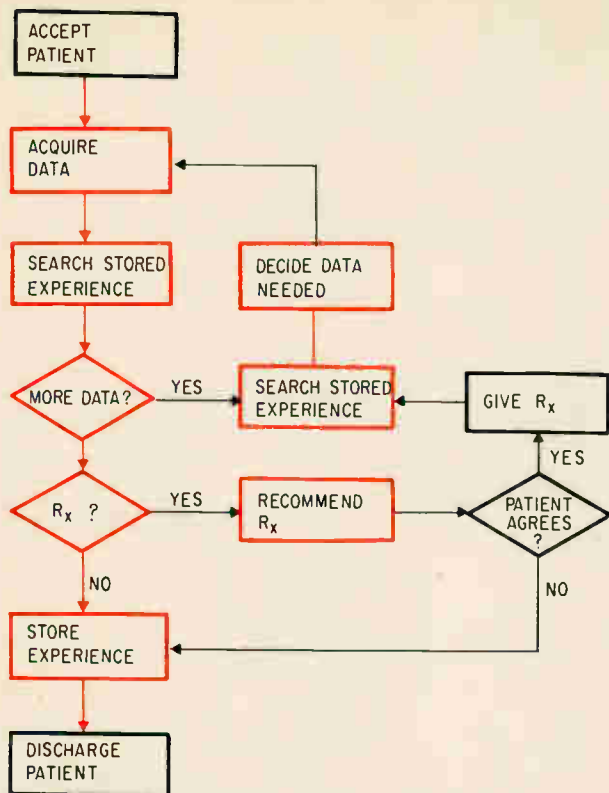

**New partnership.** The clinical physician's task is to decide the necessary steps in examining a patient, and diagnosing and treating illness. A decision support system can perform those functions shown in color.

quire inputs to decision modules (these questions are hierarchically arranged); the analysis of the decision modules; and the output of results of these analyses.

The questions put by the computer are either aggregates concerning a major disease or symptom,

or components concerning specifics. The doctor answers these questions by depressing the yes, no, unknown (result not yet available), or blank (not examined) response keys. A "no" response to an aggregate question eliminates the need to ask its components. Quantitative information—heart rate, for example—is entered by numerical key.

### An example

The system's decision process is demonstrated in the figure on page 109. The example is greatly over-simplified, but illustrates the approach.

When results of the patient's preliminary examination are fed in, the system responds to the indication of low pulse rate by recommending an electrocardiogram. At the same time, it searches its memory and links the examination results to two possible conditions—virus pneumonia and typhoidal diseases.

The system next suggests a series of tests—a bacteriological culture, serology tests, and visual skin check. Some results of these tests eliminate paratyphoid and diagnose typhoid. Virus pneumonia is eliminated as a possibility by such tests as a chest X ray.

The computer recommends a check to determine whether the patient is allergic to the preferred antibiotic. He isn't, and the drug is prescribed. At the same time, a record of the case is printed.

The IBM system under development has had built into it about 2,500 decision nodes in the area of diagnostic internal medicine. The clinical decision process will soon be extended to pediatrics, surgery, obstetrics, psychiatry, and other medical fields. Preliminary studies indicate that the same method covered here can be used to support prognoses, but that the amount of information required may be huge.

## Upgrading medical care

"Medical care depends on three factors," says the author, Dr. Frederick J. Moore. "Two—facilities and personnel—are easy to control. New facilities can be built and existing ones can be renovated. More paramedical personnel can be trained and kept in the field by raising their wage scales. But the third factor—the physician—is the central element and the most difficult to provide."

Expansions of medical-education facilities aren't enough to meet the rising demand for doctors in the next decade, he continues. "Equipment must be developed to improve the quality and increase the quantity of doctors' patient care."

Dr. Moore is familiar with attempts to use the computer for this purpose. Before joining IBM

in 1964, he was a professor of public health at the University of Southern California's medical school in Los Angeles and an associate in the university's computer sciences laboratory.

Most computerized diagnostic systems are based on a statistical approach. The computer calculates the probability of the presence of various diseases in patients with certain symptoms. However, probabilistic approaches require an extensive body of data on the frequency of the various findings, Dr. Moore notes. "And assumptions must be made that can hold only under very carefully selected situations. Consequently," he says, "these studies were confined to small groups of diseases and to small sets of findings."



On the other hand, at IBM, where Dr. Moore is manager of clinical decision support systems in the Advanced Systems Development division, the computerized system being developed is patterned on the traditional doctor-patient, question-answer relationship.





## A total-systems approach

Transducers are linked to a diagnostic computer by phone lines in a package developed and used by the Public Health Service

By C.A. Caceres, M.D.

U.S. Public Health Service, Washington, D.C.

An electrocardiogram was taken in a U.S. Senate hearing room last fall and transmitted over a telephone line to the Public Health Service's Instrumentation Field Station several miles away. Within seconds, the signal was analyzed by a computer and the result was returned by teletype to the chamber where a Senate subcommittee was considering health programs for the elderly. The operation incorporated transducers, telemetry, and a computer, and illustrated what can be done today and what will be routine tomorrow.

It also highlighted what doctors most need from engineers—an integrated package that can handle routine medical jobs and can be used by doctors without special engineering training.

The medical-systems concept dates from the early 1900's, when Willem Einthoven combined a galvanometer with a photographic display to analyze heart signals, and used telephone lines to

transmit EKG's. Since his time, though, surprisingly little has been done to link patients to remote analyzing machines.

The system at the Public Health Service in Washington, D.C., uses a small-scale digital computer to analyze heart rate and the amplitudes and durations of EKG waveforms. The resulting diagnoses are detailed and free of bias. Processed data is stored on magnetic tape and can be used later for comparison, follow-up, or statistical analysis.

It would take a researcher two hours to measure point by point the waves from a single EKG and calculate the parameters with the accuracy of the computer system. A clinical interpretation as detailed as the computer's analysis would take a cardiologist at least 10 to 15 minutes.

With its telephone-transmission feature, the computer can be made available to doctors anywhere. The MIS system is now being used by Hartford Hos-

### Congressional witness

Photo courtesy of Newsweek magazine.

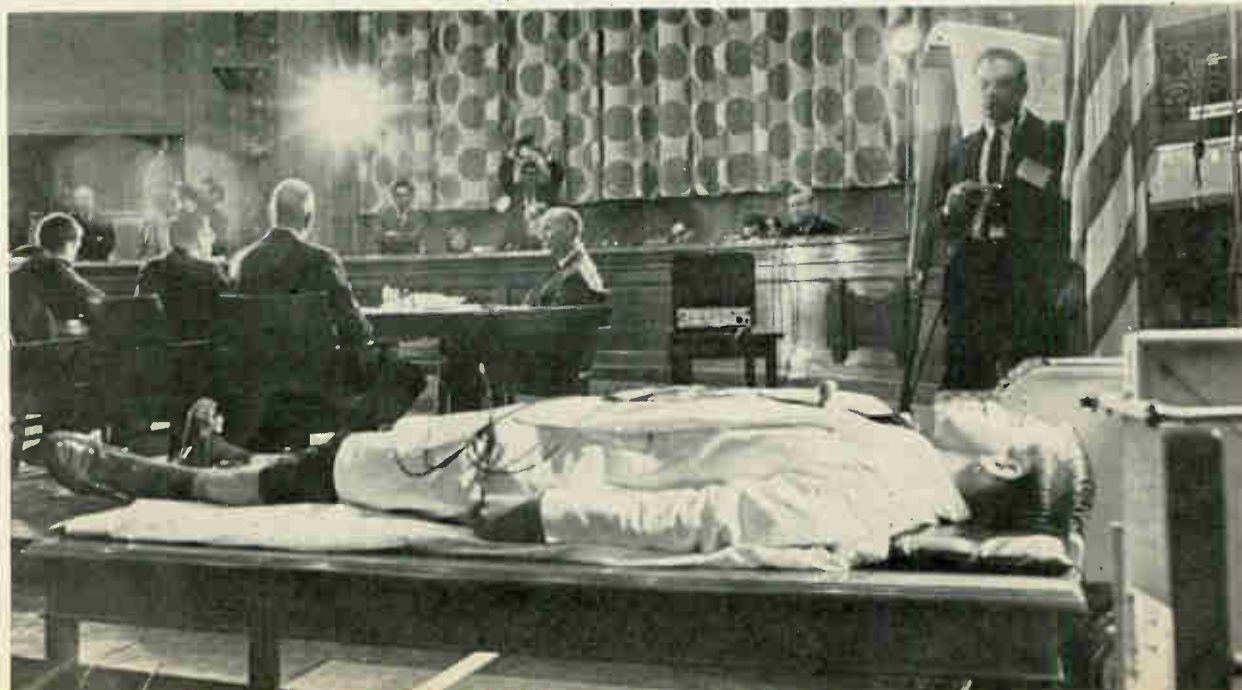

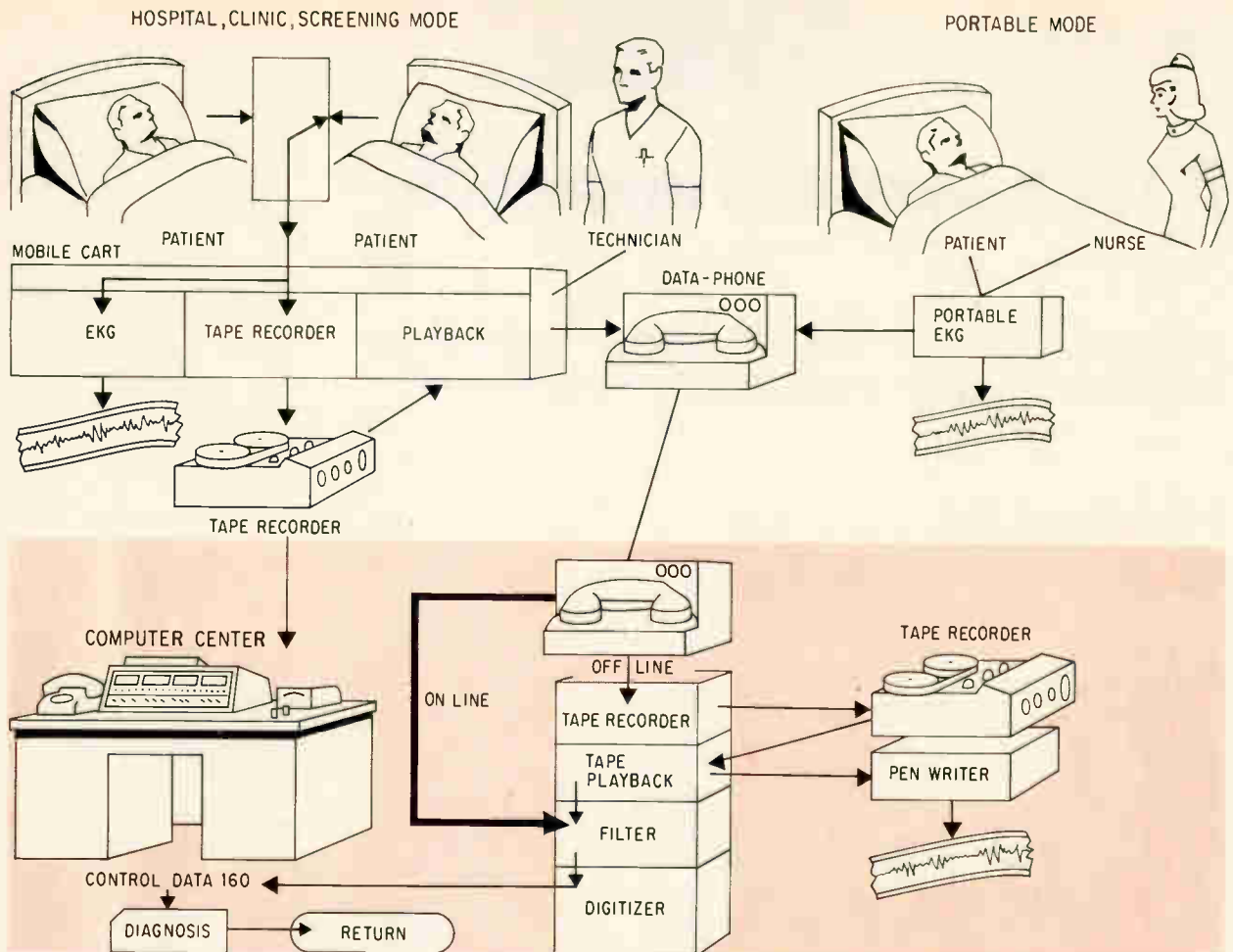

**Hookup.** Medical systems link hospital, clinic, or patient's home with a diagnostic computer. Tracings can be taken by a technician with a portable electrocardiograph. The computer's interpretation is then returned to the physician for his analysis. Both the analog EKG trace and the interpretation are permanently recorded on tape at the computer site.

pital in Hartford, Conn., and by several screening clinics; more than a hundred hospitals have expressed an interest in being hooked into such a setup.

The computer used by the PHS, a Control Data Corp. 160A, is a relatively fast data manipulator but isn't an arithmetic machine; multiplication and division can be accomplished only with external programing. The computer's word size is only 12 bits, but even this allows precision that greatly exceeds the level required by clinical practice.

Over the past two years, the system has been used to record and analyze 70,000 electrocardiograms from a number of hospitals and clinics. The experience garnered in this period shows that relatively elementary mathematical techniques can be used to evaluate electrophysiologic waves without human editing or selection. And if the PHS machine can do the job, so can a relatively slow, low-cost arithmetic computer.

### New breed

Linking the patient to the computer is a small, portable electrocardiograph machine. Several models of this new breed of machines have been built to PHS specifications. Used with a special transmitter,

the machine can send cardiographic signals over any conventional telephone. By simply dialing a special number, the technician transmits the signals to the computer center for recording and analysis. At the center, the telephone is answered automatically and the computer sends answers back to the originating station by telephone, teletype, or radio.

The new electrocardiographs, models for future medical data-acquisition sets, record EKG's on magnetic tape as well as on the familiar strip-chart. They also incorporate special switches for encoding the EKG's with identifying information—recording site, lead number, and patient's age, sex, and weight.

Analog electrocardiograms are frequency modulated for transmission over telephone lines. At the receiving end, a specially designed telephone set demodulates the tones.

The telephoned or taped playback is fed into an analog-to-digital converter that samples the continuous EKG waveforms 500 times a second. Each sample is tagged so the computer program can identify the peaks and valleys of the wave and measure the amplitudes and durations. The process is really a crude form of automatic pattern recognition.

Noisy tracings, with erratic baselines resulting

from movement of the patient or poor electrode contacts, are rejected by the program.

The logic required for the analysis is determined by the structure of the waveform itself. Locations of maximum and minimum points, baseline crossings, and constant slopes are scrutinized. Computer recognition programs at the Instrumentation Field Station aim at first defining the variants and then defining and measuring parameters.

### Starting point

Because electrocardiograms vary from person to person, the system must select a suitable reference point before the computer begins its analysis.

To find this point, the EKG is split into two signals before being fed to the analog-to-digital converter. One signal is passed through a differentiating circuit and converted into an approximation of the EKG's first derivative. The maximum negative derivative, which invariably appears during the most significant portion of the EKG complex on the descending slope between the R- and S-wave peaks [see diagram on page 114], is used to define the starting point of the heart cycle.

Sequential logic computes the necessary parameters by relating the maximums and minimums in the original EKG with the pattern of its first derivative. For example, if the interval between peaks varies by more than 25%, the disparity is recognized as a rhythm alteration.

There are some instances, however, when the first derivative alone isn't sufficient to indicate the start of a heart cycle. In these cases, when there is plateauing, notching, and extremely gradual slopes in the waveform, the maximum negative value of the derivative is combined with another measurement—a maximum or minimum value, or a baseline crossing of the EKG signal, for example—to determine the wave's onset.

The computer accepts 12 segments of electrocardiograms. Within 15 seconds after the computer has recognized the waveforms of all the accepted segments, it associates the values derived from the pattern-recognition logic and prints out the interpretation in three steps.

The computer first selects the measured data relating to the characteristics of the EKG wave. In the second step, multiple combinations of this condensed data are compared with prestored criteria corresponding to different diagnoses. Finally, a tentative diagnosis is made and the data is reviewed for redundant or secondary findings, which are discarded.

### Broad-based diagnosis

The computer's diagnosis is based on criteria abstracted from many and various physicians and medical groups. New criteria arising from physiological research, clinical discoveries, or revelations of regional differences can easily be programed into the machine.

Agreement between doctors' interpretations of EKG's and the computer's analyses have been close.

### Heart check-up results

Age	No.	Questionable EKG's	%
20-29	70	17	24.3
30-39	336	75	22.3
40-49	389	107	27.5
50-59	241	85	35.3
60-69	199	95	47.7
70-79	45	23	51.1
80-89	1	1	100.0
			(Average)
Total	1,281	403	31.4

The computer system has incorrectly interpreted less than 1% of the EKG's analyzed. Moreover, the computer has proven invaluable in giving physicians access to all significant data.

One of the major contributions a medical computer system can make is in the area of community health services. It can greatly enhance the capability of a health department, clinic, or hospital to handle mass screening for early detection and diagnosis of diseases. Easy recall and statistical analysis of the measurements are a further advantage in this area. The Instrumentation Field Station is currently working with local community health departments to demonstrate the feasibility of



House call. An electrocardiograph records a patient's heart signals in her home and simultaneously transmits them to a computer center for analysis.

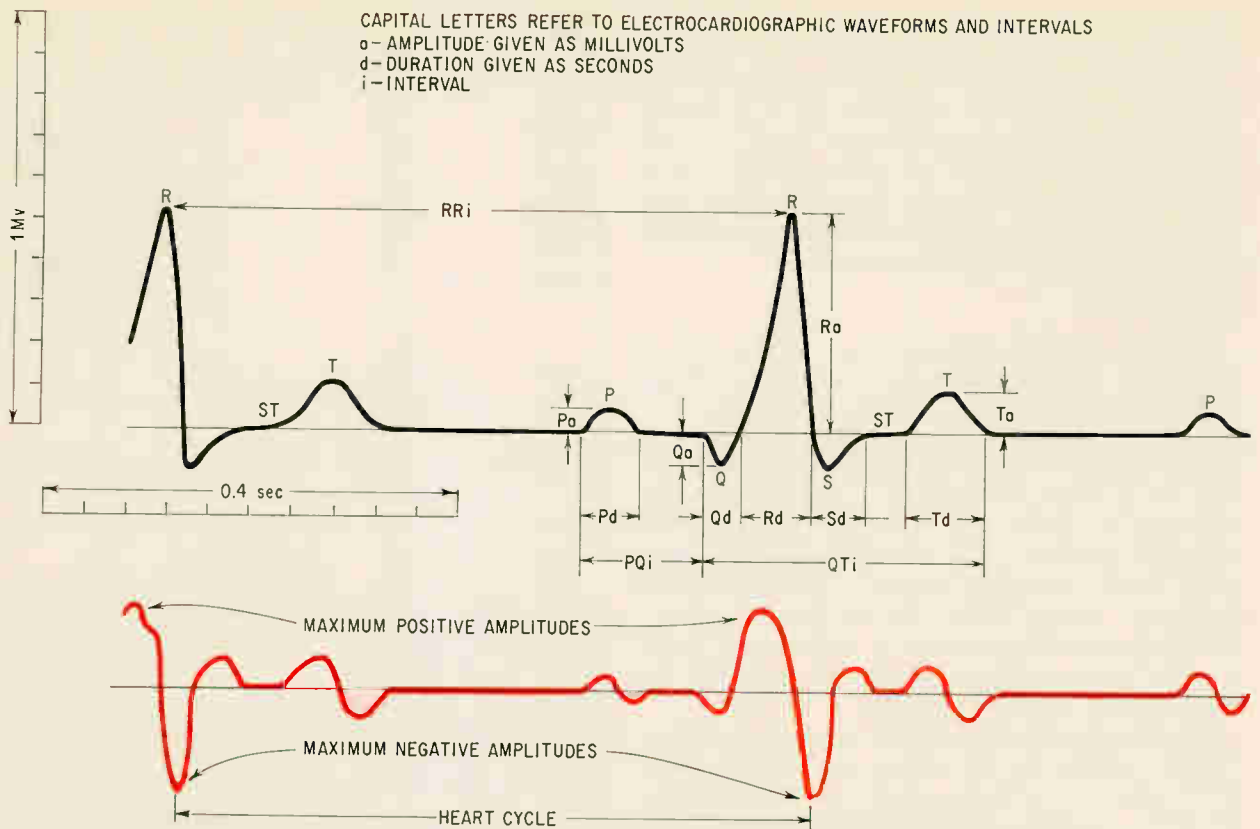

**Starting line.** Reference for the start of the heart cycle is the first derivative (lower curve) of the EKG waveform. The maximum negative value is the starting point. Once this is established for the computer's program logic, the machine can identify the significant components in the cycle (upper curve).

applying computers to mass screening programs.

The PHS computer interpreted more than 1,400 electrocardiograms recorded during the 106th annual meeting of the American Dental Association. As with the Senate demonstration, heart signals from the dentists were transmitted over phone lines to the Instrumentation Field Station and results were returned automatically. The computer grouped the EKG's into normal and questionable categories; 32% of the participants had questionable electrocardiograms. The average age of the participants was 46 years. As expected, the incidence of abnormalities rose with age [see table on page 113].

The computer at the field station is also programmed to measure and interpret spiograms [tracings of the behavior of the lungs], electroencephalograms [brain waves], and dye-dilution curves. In dilution studies, a dye is injected into the blood stream and is measured after passing through the heart. The computer can calculate within seconds the blood volume output during each phase of the heart cycle.

A pulmonary function curve such as a spiogram is useful in screening or diagnosing emphysema—inflammation of the airspaces in the lungs—and bronchitis.

To record the curve, the subject blows forcibly into a tube leading to a spirometer. This force is converted to an electrical signal by a potentiometer attached to a pulley on the spirometer, and the

signal is recorded on magnetic tape.

The first items entered on the tape are the patient's code number, the calibration curve for the pulmonary function being recorded, and a correction factor to compensate for possible signal non-linearity. The analog-to-digital converter provides numerical values of the spirometer voltage as the tape is played back for analysis.

Because the curve contains no frequencies greater than 30 hertz, a sampling rate of 200 points per second is adequate to obtain all the necessary information from the curve. However, a sampling rate of 500 points per second is used because it is more compatible with the field station's processing system. All the sampler points are stored in the computer's memory and all are inspected by the computer.

### Problems

In designing hardware for medical computer systems, a decision must be made as to what part should be analog and what part digital. As yet there are no compact, economical analog-to-digital converters suitable for magnetic tape recorders used in a hospital environment. But because the cost of developing a digital system is regarded as prohibitive, the PHS uses an analog system as a provisional solution.

The tape recorder, which operates on command from a standard EKG machine, has a sensitivity and

GEORGE WASHINGTON UNIVERSITY HOSPITAL HEART STATION  
COMPUTER ANALYSIS OF ELECTROCARDIOGRAM BY  
INSTRUMENTATION FIELD STATION HEART DISEASE CONTROL PROGRAM

NAME.....AGE.....SEX.....RECORDING DATE.....RECORDING TIME.....  
 ROOM.....HOSPITAL NO.....HEART STATION NO.....PHYSICIAN.....  
 DIGITALIS..QUINIDINE..OTHER DRUGS.....HT.....WT.....BP.....BED FLAT.....  
 CLINICAL DIAGNOSIS.....BED RAISED.....  
 A= AMPLITUDE IN MILLIVOLTS; D= DURATION IN SECONDS; O= ONSET; M= MIDPOINT; E= END

PROCESSING DATE 12-23-64 ECG 0066--0567

	I	II	III	aVR	aVL	aVF	V1	V2	V3	V4	V5	V6	
PA	.05	.13	.09	-.06	.04	.03	.04*	.05	.06	.04	.08	.06	PA
PD	.06	.10	.11	.05	.04	.10	.06	.05	.07	.04	.08	.07	PD
P'A	.00	.00	.00	.00	.00	.00	-.03	.00	.00	.00	.00	.00	P'A
P'D	.00	.00	.00	.00	.00	.00	.08	.00	.00	.00	.00	.00	P'D
QA	-.04	.00	.00	.00	-.06	.00	.00	.00	.00	.00	-.08	.00	QA
QD	.02	.00	.00	.00	.02	.00	.00	.00	.00	.00	.02	.00	QD
QA	.72	.60	.05	.05	.52	.00	.11	.06	.00	.00	.69	.95	QA
RD	.07	.05	.02	.02	.06*	.00	.03	.01	.00	.00	.04	.07	RD
SA	.00	-.04	-.20	-.64	.10	-.12	-1.34	-1.34	-1.10	-.79	-.06	.00	SA
SD	.00	.02	.07	.06	.00	.02	.07	.08	.10	.09	.02	.00	SD
ST	.12	.12	.09	.12	.12	.12	.12	.09	.11	.10	.12	.12	ST
STU	-.01	-.06	-.06	.01	.05	-.03	.06	.09	.08	-.03	.01	-.02	STU
STM	.05	-.08	-.07	.03	.07	-.06	.10	.17*	.15*	.08	-.01	-.05	STM
STE	.13	-.05	-.07	-.02	.09	-.03	.08	.20*	.23*	.13	.01	.02	STE
TA	.12	.10	-.05*	-.12	.13	.06*	.00*	.16	.09*	.09*	.07*	.06*	TA
TD			.13				.00	.15	.10	.10			TD
PR	.13	.15	.16	.12	.11*	.21*	.15	.13	.15	.12	.14	.12*	PR
QRS	.09	.07	.09	.08	.10	.02	.10	.09	.10	.09	.08	.07	QRS
QT	.30	.33	.31	.34	.33	.28	.00	.33	.31	.29	.36	.32	QT
RATE	78	79	75	76	74	78	69	76	72	80	75	77	RATE
CODE			L			L		C		C		C	

AXIS IN P QRS T U R S STU ST-T QRS-T ANGLE IN DEGREES 72 16 -05 20 -56 21 DEGREES

INTERPRETATION DATE 02-16-65

6631 MINOR ST DEPRESSION  
 5133 POSSIBLE OLD ANTERIOR MYOCARDIAL INFARCTION

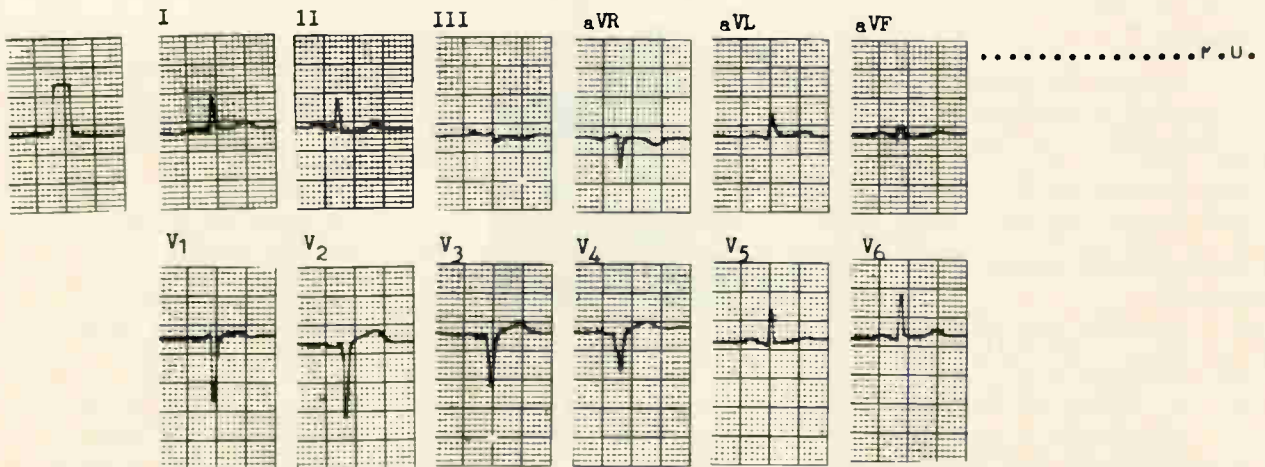

Printout. The amplitude (A) and duration (D) of the heart cycle's phases for each of 12 lead arrangements are calculated and tabulated by the computer. Asterisks (\*) mark suspicious values found by the computer as it compared the recording to a prestored table. The computer's diagnosis appears at the bottom of the printout.

LOCATION - U.S. NAVAL AVIATION MEDICAL CENTER, PENSACOLA, FLORIDA  
 PROCESSING DATE 10/08/65 CALIBRATION CONSTANT 1,083 ML  
 PATIENT NO. 0029-06 AGE: 24 YRS SEX: M HEIGHT: 74 IN  
 PREDICTED VITAL CAPACITY 4,689 ML

	TRIAL 1	NORMAL
FORCED VITAL CAPACITY (ML)	4,614	
PERCENTAGE OF PREDICTED VC	98	≥ 80
TIME OF FVC (SECONDS)	1.91	
TIME OF MAX. INST. FLOW RATE	0.12	
FORCED EXPIRATORY VOLUMES (ML)		
ONE-HALF SECOND	2,662	
PERCENTAGE OF FVC	57	
THREE-FOURTH SECOND	3,385	
PERCENTAGE OF FVC	73	
ONE SECOND	3,867	
PERCENTAGE OF FVC	83	≥ 75
TWO SECONDS	4,602	
PERCENTAGE OF FVC	99	≥ 94
THREE SECONDS	4,602	
PERCENTAGE OF FVC	99	≥ 97
AT MAX. INST. FLOW	638	
PERCENTAGE OF FVC	13	
FLOW RATES (ML/SEC)		
200-1200 ML	7,228	≥ 7,000
25%-75% FVC	3,967	≥ 3,400
25%-50% FVC	5,509	
50%-75% FVC	3,091	
.5 - 1 SEC	2,410	
1 - 2 SEC	735	
2 - 3 SEC	0	
MAX. INSTANTANEOUS	7,417	
MID-EXHALATION	4,431	

INTERPRETATION -  
 ABOVE DATA WITHIN NORMAL LIMITS

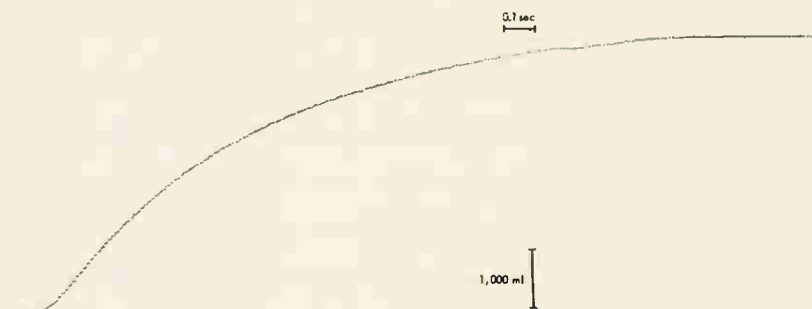

Spirogram. This processed sample was obtained within 10 seconds after a curve was presented to the computer.

frequency response comparable to the conventional electrocardiograph also incorporated in the unit. A binary pulse code identifies each electrocardiogram.

A serious hurdle to tape recording was presented by the frequency spectrum of EKG's, which can range from d-c to about 200 hz. Response of the circuits, electrodes, and transducers must be carefully tailored to the system. In a direct analog tape recorder, amplitudes may vary as much as 1% and frequency response doesn't extend to d-c. Frequency modulated carrier techniques are therefore required.

Frequency modulation gives good amplitude response, linearity, low dynamic distortion, and large bandwidth. However, flutter produced by non-linearities in the recording oscillator can be on the order of 0.5 to 1%, with dynamic distortions ranging from 1 to 2%.

This is intolerable in clinical electrocardiography, where 0.5-millivolt signal variations are medically

significant. Most good tape recorders have a signal-to-noise ratio of around 40 decibels—implying a noise level of about 0.105 millivolts. Thus, without flutter compensation, most standard tape recorders are inadequate for biological recordings.

This compensation is usually accomplished by recording an f-m reference signal on a separate track. On playback, gain and phase information from the reference track permit the canceling of the flutter component.

If a second channel is unavailable, the flutter-compensation signal can be superimposed on the data channel if the bandwidth is small; the EKG bandwidth is less than 200 hz.

The final part of this series, in the Aug. 7 issue, will look at the role of electronics in prosthetics, monitoring, and predictive medicine. Reprints of the entire series will be available next month.

### The author

Dr. C.A. Caceres has served since 1960 as chief of the Instrumentation Field Station of the Public Health Service's Heart Disease Control Branch. His group does original research and development work in addition to evaluating medical electronic equipment and techniques.

As a consultant specializing in the problems of electrophysiology and the automation of medical systems, Dr. Caceres works with health departments, academic groups, government agencies, hospitals, private practitioners, and industrial concerns. He directs the



formulation, validation, and demonstration of medical data- and signal-processing systems, and works with new system designers and with computer programmers.

Two commercially available medical data-acquisition systems

have resulted from the efforts of the field station, and a prototype preprocessing computer console has been built to put signals from the data-acquisition carts into a computer format.

Dr. Caceres is currently involved in projects aimed at developing special statistical studies, applying field testing, automating the analysis of phonocardiograms and respirograms, and designing equipment to screen heart sounds.

The doctor is an associate professor of medicine at George Washington University's medical school and a professorial lecturer in biomedical engineering at the university's engineering school.



One good tune  
deserves another,  
and another,  
and another,  
and another,  
and another,  
and another,  
and another.

Case styles in *Tuning Varactors* are not your only choice. Microwave Associates' silicon epitaxial voltage variable capacitance diodes range in capacitance from 1 to 100 pF, range in voltage from 15 to 150V, with figures of merit (Q) to 400 and higher.

But let's talk about your choice of case styles. We have channel mounted chips that go directly on substrates, all the standard glass and ceramic styles including pills and tab leads, and, on the other extreme, molded encapsulations.

Name your C, name your V, name your Q and name your case style.  
All told, the line is the broadest in the industry.  
More than 1,000 combinations available.  
Write.

**MICROWAVE ASSOCIATES**

Burlington, Massachusetts Offices: Burlington, Mass.; 9911 Inglewood Ave., Inglewood, Cal.  
Hyde House, Edgware Rd., London NW9, England.  
Subsidiary: Microwave Associates, Ltd., Luton, Beds, England.





## a TCXO that fits almost anywhere

and offers exceptional frequency stability between  $-55^{\circ}\text{C}$  and  $+85^{\circ}\text{C}$

Only about  $\frac{1}{2}$  of a cubic inch in size, this TCXO (temperature compensated crystal oscillator) offers excellent frequency stability; 5 ppm over a temperature range of  $-55^{\circ}\text{C}$  to  $+85^{\circ}\text{C}$ . It's one of four new miniature TCXO's from Motorola. The slightly larger models offer stabilities as low as  $\pm 1$  ppm. Zener diode regulated compensating circuits provide on-frequency operation the instant they're turned on. All-silicon solid-state construction provides exceptional reliability. Take a look at these facts.

See it at Booths 3116 & 7 at WESCON



**MOTOROLA**  
**PRECISION**  
**INSTRUMENT**  
**PRODUCTS**

**SMALL SIZE:** Sizes range from 0.58 cubic inch to 3.4 cubic inches.

**WIDE TEMPERATURE RANGE:** From  $-55^{\circ}\text{C}$  to  $+85^{\circ}\text{C}$ .

**HIGH FREQUENCY STABILITY:** Available as low as  $\pm 1$  ppm.

**WIDE FREQUENCY RANGE:** From 1 MHz to 30 MHz.

**LOW POWER CONSUMPTION:** As low as 100 milliwatts.

**NO WARM-UP TIME:** Adjusts instantly to temperature conditions.

FOR MORE INFORMATION contact your Motorola representative. Or write for bulletin TIC-3213.

**MOTOROLA COMMUNICATIONS AND ELECTRONICS INC.**  
 Dept. EO, 4900 West Flournoy Street  
 Chicago, Illinois 60644. A subsidiary of Motorola Inc.



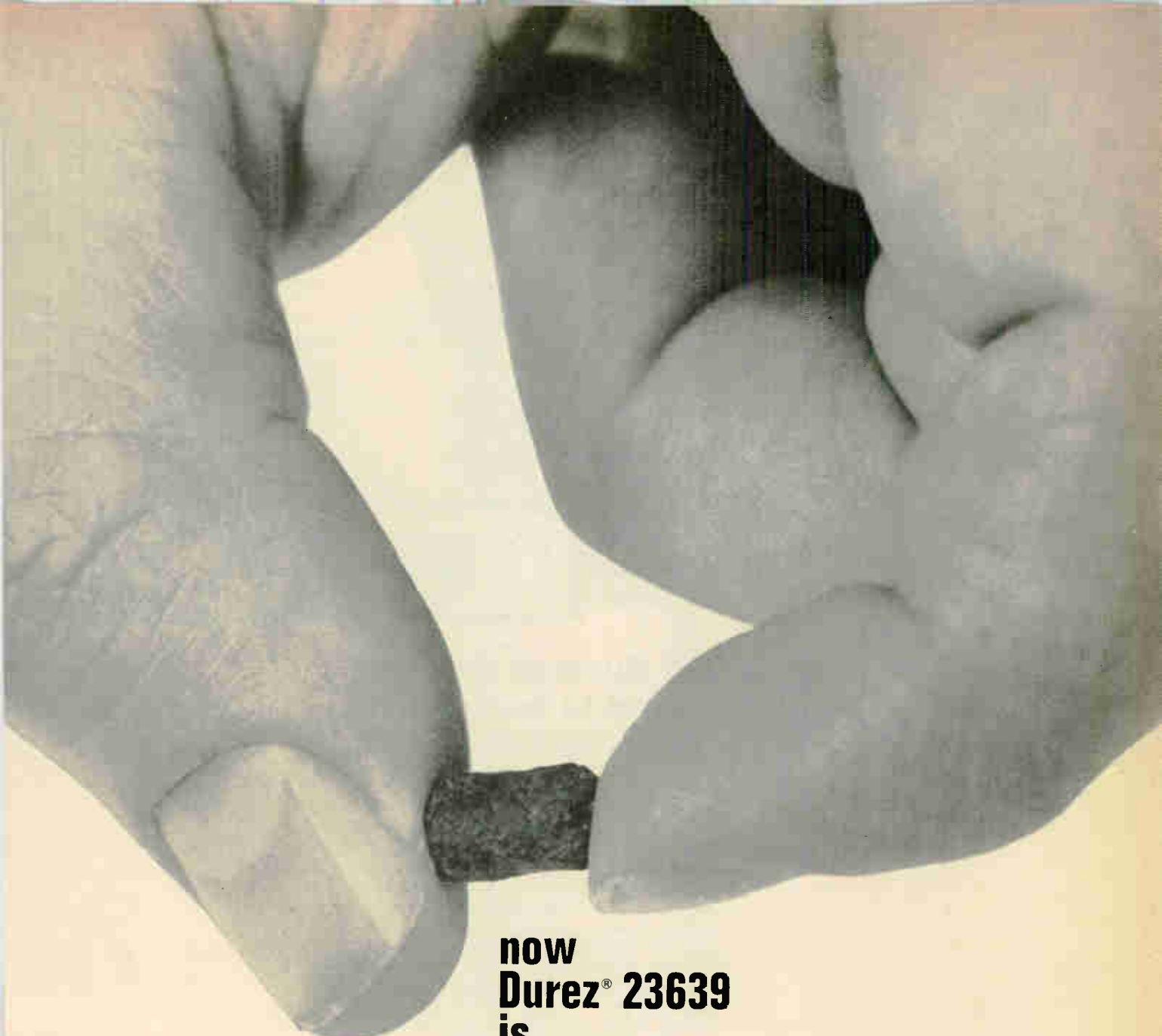

now  
**Durez® 23639**  
is  
**nodular**



**for high-speed molding  
of electrical parts.**

We have put all the high-impact resistance, heat resistance, and dimensional stability of Durez #23639 phenolic molding compound into a new, nodular form.

Durez #23639 nodular is particularly suited to the latest types of high-speed, screw-type molding equipment, and also greatly facilitates automatic preforming.

We particularly recommend it for such applications as automotive parts and heavy-duty industrial switches.

If your job calls for brown parts, rather than black, you can get the same high-quality performance by specifying Durez #23727 in nodular or flake form.

For complete data on these two members of the Durez family of high-grade molding compounds, please write Durez Division, Hooker Chemical Corporation, 9007 Walck Rd., No. Tonawanda, N.Y. 14120.



Circle 119 on reader service card



No one hates Bill as much as H-P and Beckman.  
And for that we love him.

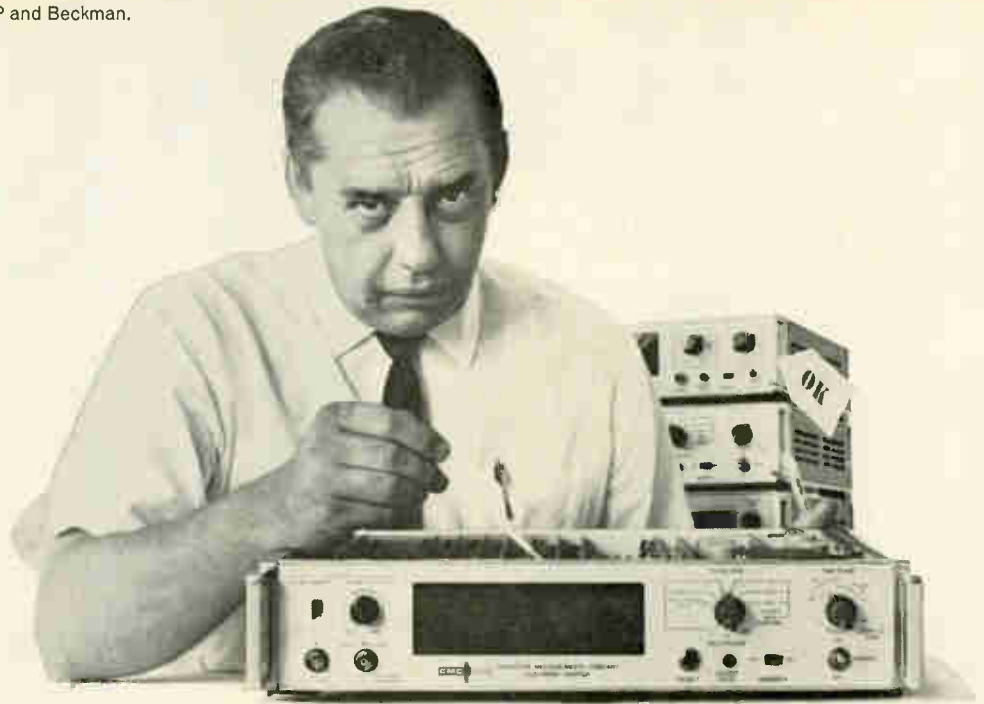

## Bill Busted doesn't expect to be loved.

He's not obsolete. We need him. And you need him. Bill's really a nice guy. Perhaps he is too persnickety and too great a perfectionist to be lovable. But you really can't expect a dedicated Quality Control Director to be a living doll. Bill knows his job.

We know ours, too. That's why we have people of Bill Busted's character and competence. And that's why CMC counters and other instruments are the finest that our human ingenuity and technology can deliver.

In this business everybody talks about quality and reliability. We, too, can talk about our 48-hour aging at 55°C, vibration testing, 100% electrical check-out (twice on every instrument), meticulous supervision, materials inspection, all our space-age instrumentation, and the only two Mil Spec counters on government's Qualified Products List. And we have a 52-man QC staff headed by finicky ol' Bill Busted.

But in the end, the best judge of quality and performance is you. So accept our challenge, and earn a free Crusading Engineer Medal in the process. Write for our Short Form Catalog, or for complete data on any CMC instrument that interests you. Then "Check the Specs," and make up your own mind. We're pretty sure of your decision.

One last favor... Bill Busted's birthday is the 20th of this month. If you have a moment, send him a little card. He needs to feel appreciated.

12981 Bradley / San Fernando, California  
Phone (213) 367-2161 / TWX 910-496-1487



**7.5 AMPS**

**10 WATTS**

TO-5

**40 WATTS**

TO-59

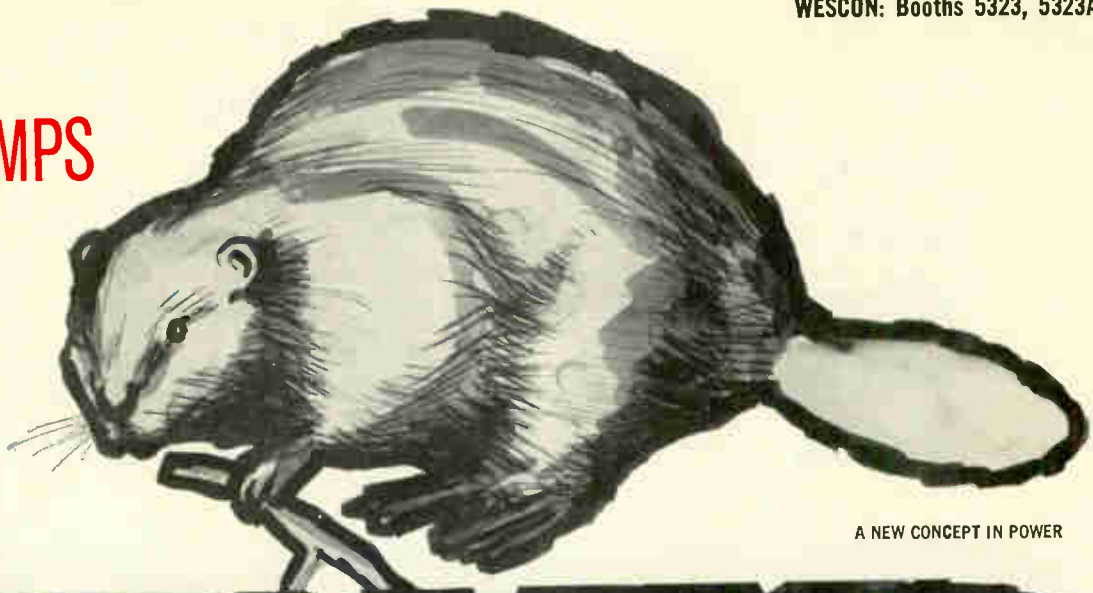

A NEW CONCEPT IN POWER

# POWER

High current triple diffused planar NPN silicon power transistors are now available from Silicon Transistor Corporation in a choice of small packages. The STT2400—STT2406 25 MHz series comes in a TO-5 case and is priced from \$6.60 to \$21.40 per unit on orders of 100. The STT2800—STT2806 25 MHz series is in the TO-59 package and prices range from \$8 to \$24 per unit on orders of 100. They have a voltage

range of 30V-150V, maximum  $T_j$  is 200°C,  $C_{ob}$  is 200 pf. Typical applications include: high power, high frequency inverters and converters; switching type regulated power supplies; power linear amplifiers; compact power circuitry; RF power amplification. For more information, call or write today. For immediate delivery, contact your representative or distributor.

**TRIPLE DIFFUSED PLANAR—NPN**

	Case	V <sub>CEO(sus)</sub> V <sub>EB0</sub>		I <sub>C</sub> max.	P max. (100°C)	hFE	hFE min.	
		Volts	Volts					Amps
STT 2400	TO-5	150	12	7.5	10	30-90	10 @ 6 Volts	
STT 2401	TO-5	120	12	7.5	10	30-90		
STT 2402	TO-5	120	12	7.5	10	50-150		
STT 2403	TO-5	100	12	7.5	10	30-90		
STT 2404	TO-5	80	12	7.5	10	30-90		
STT 2405	TO-5	60	10	7.5	10	30-90		
STT 2406	TO-5	30	10	7.5	10	25 min.	10 @ 5 Volts	
STT 2800	TO-59	150	12	7.5	40	30-90		
STT 2801	TO-59	120	12	7.5	40	30-90		
STT 2802	TO-59	120	12	7.5	40	50-150		
STT 2803	TO-59	100	12	7.5	40	30-90		
STT 2804	TO-59	80	12	7.5	40	30-90		
STT 2805	TO-59	60	10	7.5	40	30-90		
STT 2806	TO-59	30	10	7.5	40	25 min.		
TEST	CONDI- TIONS	I <sub>C</sub>	200mA			2A		5A
		I <sub>B</sub>	10mA			15V		
		V <sub>CE</sub>						

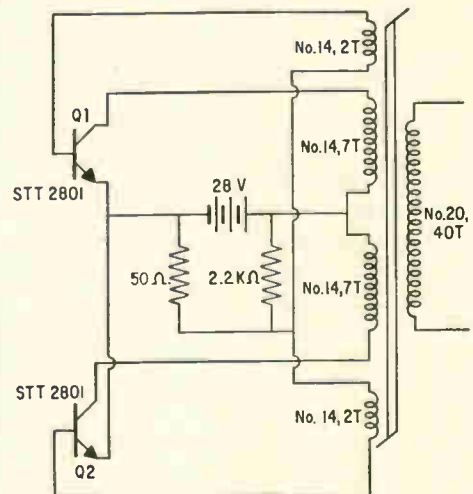

Silicon Transistor Corporation produces the broadest line of silicon power transistors in the industry.

**SILICON TRANSISTOR CORPORATION**



Executive Offices and main plant: EAST GATE BLVD., GARDEN CITY, N.Y. 11530 (516) Pioneer 2-4100, TWX 510-222-8258

**Problem:**

**Get  
faster,  
more  
efficient  
“read in”  
of data.**

**Solution from  
American Optical:**

**Fast,  
quiet,  
reliable  
fiber-optic  
“readers” for  
data processing.**

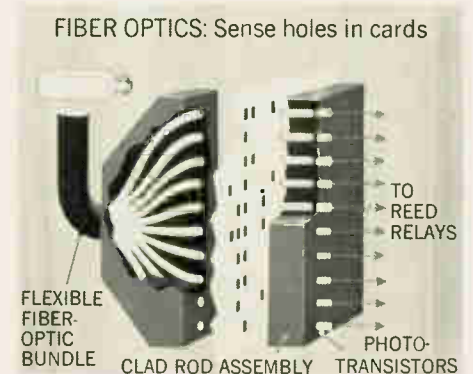
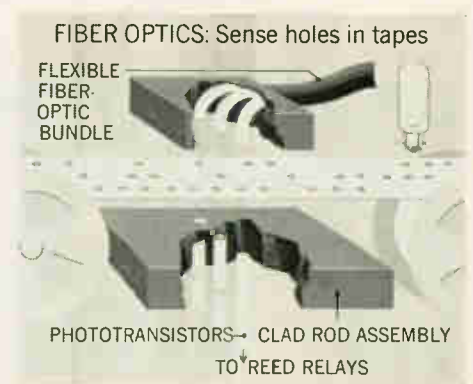
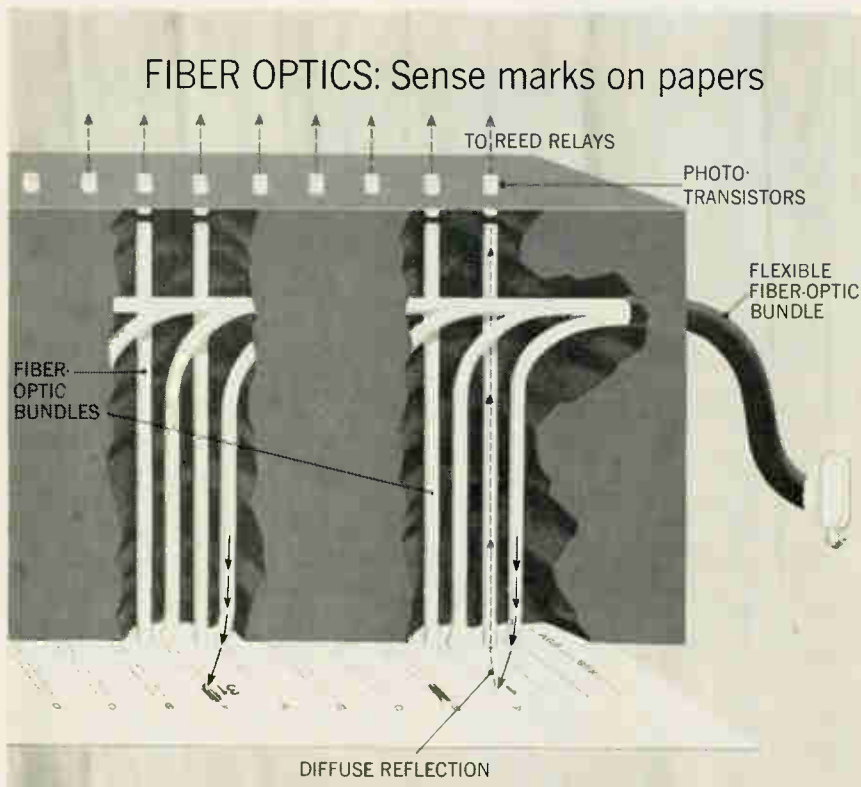

Electro-optical systems incorporating fiber optics are operating at up to four times the speed of electro-mechanical systems. When a combination of fiber optics, phototransistors, and reed relays is used, reading of basic data is not controlled by mechanical limitations. The use of fiber optics allows wide design freedom to increase system operating speed.

In addition, electro-optical devices provide inherently quieter operation. And the need for continual replacement of expensive electromechanical components is eliminated. The use of fiber-optic devices isolates heat and eliminates friction, the major causes of wear and failure. In most applications, both initial cost and use cost can be reduced by design simplicity.

American Optical know-how makes such design simplicity possible. AO pioneered fiber optics and today produces the most widely used sensing devices. This accumulated practical design and application experience, along with research and production capability, is readily available to you.

Contact AO now and lessen the time and expense of getting from exploration to application. Sorters and collators, verifiers and key-punch equipment, printers and readers, teletypes—most any data processing equipment—can benefit from these American Optical fiber-optic devices. Write American Optical Company, Fiber Optics Department, Southbridge, Massachusetts 01550. Or call 617-764-3211.

NEW FROM



**AMERICAN OPTICAL COMPANY**

SPACE-DEFENSE DIVISION—SOUTHBRIDGE, MASSACHUSETTS



# Operational amplifiers

Check the specifications of our compensated  $\mu$ A709's, FET-IC's and economy modules. Check our prices: they start at \$9.75. Check with us for complete information and applications assistance. Then check out one of our modules. Try it on a small signal. You'll make it big.



Typical Specifications	Economy Solid-State Modules		Compensated ICs $\mu$ A709C $\mu$ A709		FET-IC Modules		FET Input Modules	
	ADO-44	ADO-45	ADO-49C	ADO-49A	ADO-29	ADO-23	ADO-25	ADO-24
Open Loop Gain	10,000	100,000	40,000	40,000	140,000	140,000	50,000	50,000
Bandwidth	550KHz	1.5MHz	1MHz	1MHz	1.5MHz	1.5MHz	10MHz	10MHz
Slew Rate	0.2V/ $\mu$ s	1.4V/ $\mu$ s	0.2V/ $\mu$ s	0.2V/ $\mu$ s	2V/ $\mu$ s	2V/ $\mu$ s	15V/ $\mu$ s	15V/ $\mu$ s
Difference Current	10nA	10nA	100pA	100nA	10pA	10pA	10pA	10pA
Input Impedance	300Kohm	300Kohm	250Kohm	250Kohm	$10^{11}$ ohm	$10^{12}$ ohm	$10^{12}$ ohm	$10^{12}$ ohm
Drift	20 $\mu$ V/ $^{\circ}$ C	10 $\mu$ V/ $^{\circ}$ C	5 $\mu$ V/ $^{\circ}$ C	5 $\mu$ V/ $^{\circ}$ C	25 $\mu$ V/ $^{\circ}$ C	1 $\mu$ V/ $^{\circ}$ C	10 $\mu$ V/ $^{\circ}$ C	10 $\mu$ V/ $^{\circ}$ C
Output Voltage	10V	10V	10V	10V	10V	10V	10V	10V
Output Current	1mA	5mA	5mA	5mA	5mA	5mA	2.5mA	20mA
Price (1-9)	\$9.75	\$15.00	\$29.00	\$80.00	\$45.00	\$56.00	\$85.00	\$105.00
(100 pcs)	\$9.00	\$13.00	\$18.00	\$55.00	\$37.00	\$75.00	\$69.00	\$80.00

For the supplier nearest you, and/or for technical information and assistance, call Gayon Patterson at Fairchild (415) 962-2030 or 962-2086, or TWX 910-379-6944.

# Now in Paperback

An equally apt title for this 16 page opus would be "Selecting Memory Systems for Fun and Profit." Because when you get it, you will be able to select the most profitable memory system for your needs. And it ought to be fun compared to those "memory dream-books", full of options that never were, model

numbers that are sheer fantasy, and ghostly-vague "typical" specs.

Every system in this bulletin is real, is completely and accurately characterized, is priced, and is in production, available on reasonable, dependable delivery sched-

ules, ranging from in-stock to 90 days. And the prices are right.

Old-timer or tyro, end-user or OEM, Bulletin MS670 is *required reading*. Write for your free copy today.

**Ferrocube**   
Systems Division Englewood, Colorado

**Reveals all about 513 different standard memory systems!** "Unparalleled Diversity!"—Edwin L. Podsiadlo, Product Manager, Ferrocube Systems Division

**Thrill to tantalizing trade-offs...stirring savings...pulse-pounding performance!**  
"Couldn't put it down!"—Robert Derschang, Marketing Manager, Ferrocube Systems Division

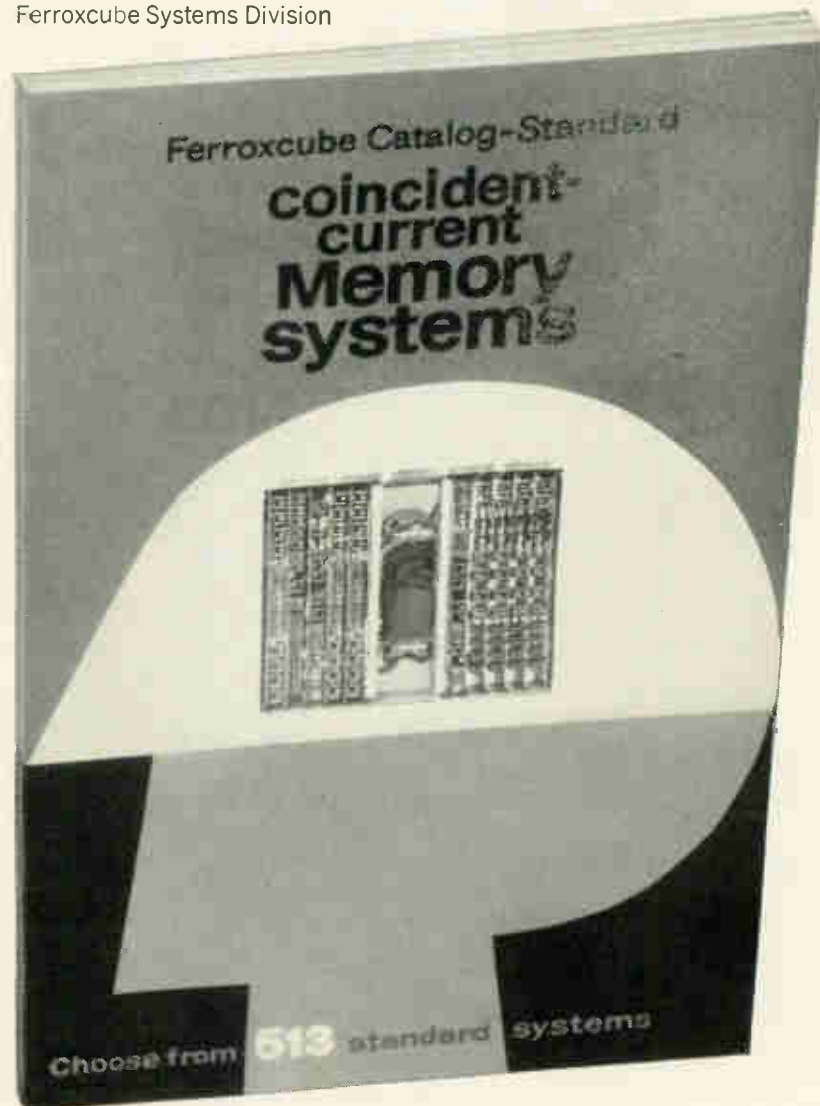

FERROXCUBE  
CORPORATION  
Systems Division  
5455 S. Valeria Way  
Englewood, Colorado  
303-771-2000

Boston  
617-899-3110

Chicago  
312-261-7880

Dallas  
214-255-0441

Los Angeles  
213-837-1484

Minneapolis  
612-888-4681

New York Area  
201-964-1844

Phoenix  
602-265-1792

Philadelphia  
215-927-6262

## Show us your designs for thin metal parts... chances are we can show you cost-saving ideas.

We're specialists in making precision electronic parts in volume. And doing it economically. Integrated circuit frames and anything else you need.

Let us evaluate your designs and make cost-saving suggestions on materials and production methods. The end result will be parts that meet your specifications, and at the right price.

We make our own dies and can form almost any intricate shape to extremely close tolerances. In a wide variety of dimensions, finishes and tempers

in many different kinds of materials.

And our range of fabrication is not limited to metal parts. We have plants for wire products, plastic parts, and complete component assemblies.

Contact your nearest Sylvania Parts Division sales office or write to us here at Warren. You may find your parts cost will be a good deal less than if you produced the parts yourself.

Sylvania Electric Products Inc., Parts Division,  
Warren, Pennsylvania 16365.

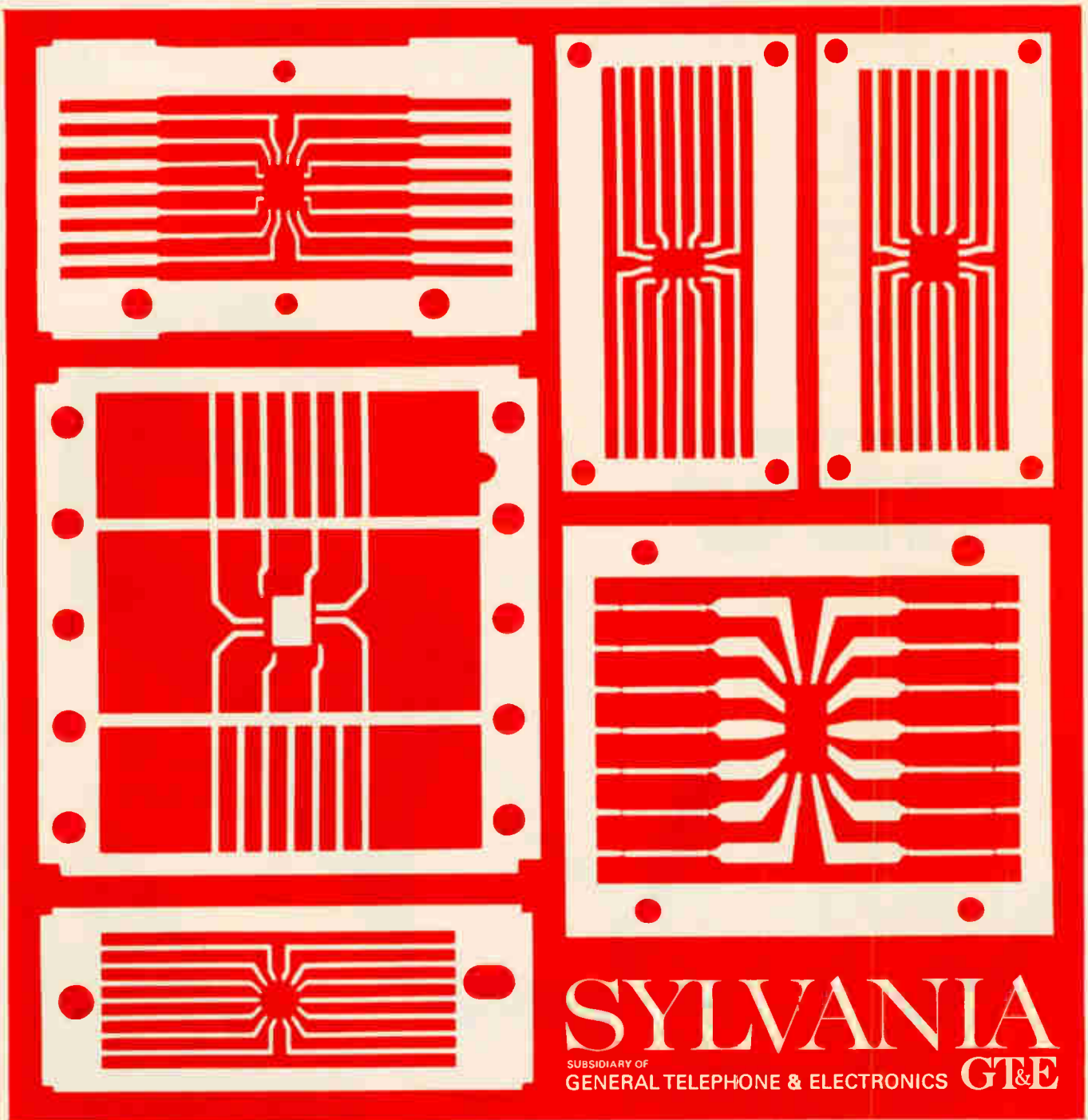

Did you ever reach the point where you'd like to stuff something down a salesman's throat? We were in that situation, once. We bought a highly touted heat-writing strip chart recorder. Although it worked well in the "spec" sheets, it failed miserably in our lab. We had to design our own heat-writing system to get the quality we demanded. It performed so well, we've put it on the market. We wouldn't have done so if it didn't come up to BLH Electronics standards.

The heart of the system is the BLH THERMOTIP™ STYLUS with its signal-regulated automatic heat control. You set the heat control and the system automatically adjusts to changes in signal without manual readjustments. Great for one-of-a-kind transients that must be caught. Great for multichannel applications where several different signals (with individual variation characteristics) must be handled.

Yes, BLH Electronics Recorders have a variety of signal-matching plug-in preamplifiers. They fit ALL BLH Systems . . . 2, 4, 6 and 8 channels . . . portable, console or low-boy configurations.

But the proof is in the "putting": putting traces of your signals on chart paper in your

laboratory. If a BLH High Speed Strip Chart Recorder doesn't surpass the others, instead of you stuffing Jack, let Jack stuff you . . . with a steak at your favorite restaurant. Could anything be fairer than that?

To arrange for a demonstration in your plant, or for information on this new THERMOTIP Stylus Recorder, call BLH Electronics or your nearest BLH Representative. BLH Electronics, Inc. a Subsidiary of Baldwin-Lima-Hamilton Corporation, Waltham, Mass. Plants in Waltham, Mass., Pasadena, Calif., and Darmstadt, West Germany.

**BLH ELECTRONICS, INC.**

A subsidiary of Baldwin • Lima • Hamilton Corporation



STRAIN GAGES • TEMPERATURE SENSORS • LOAD CELLS • PRESSURE CELLS • TORQUE PICKUPS • RECORDERS • INSTRUMENTATION • INTEGRATED SYSTEMS

**How would you like  
to stuff ten feet  
of Chart Paper  
down Jack Joyce's throat?**

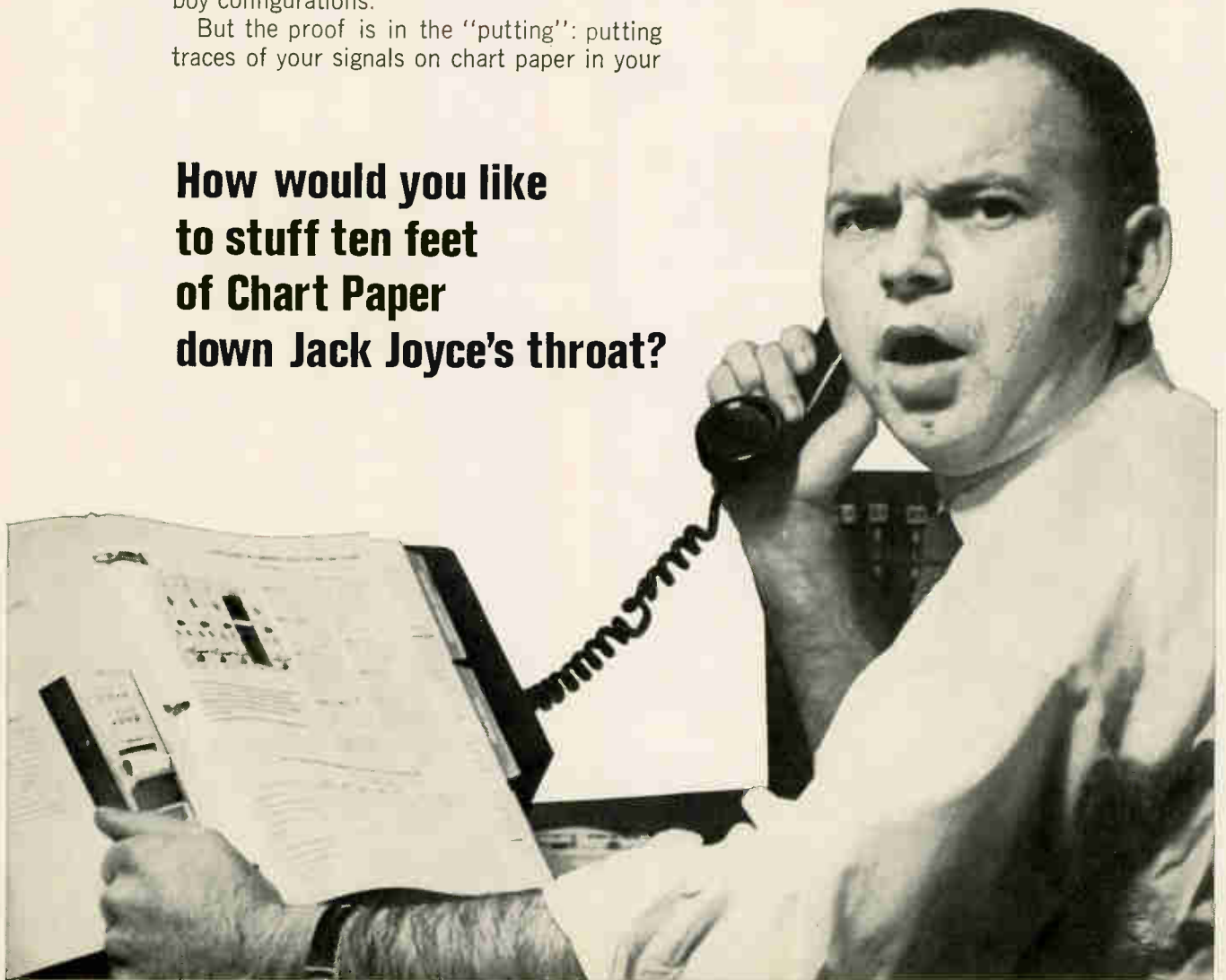



# "STACPAC", New, High Current High Voltage Rectifier Stacks

Semtech has developed "STACPAC", a new technique for high current, high voltage rectifier stack applications. "STACPAC", SCPH series, provides an average rectified current of 5.5 amps at 55°C and is available in discrete voltages from 1 kV to 25 kV.

SCPH series.

## cool power

"STACPAC" assemblies are extremely light weight. The aluminum discs provide cooling compensation and corona protection. Easy-to-install mounts are provided on all assemblies. Height 3.5", Width 3", Length 0.66" per kV per leg, plus 2.08" for 2 insulated mounts. Internally, "STACPAC" utilizes the Semtech double heat sink *Tungstalcid* pin rectifiers.

Other assemblies are: "STACPAC" *Single Phase Full Wave Bridges* (SCPB series), that provide an average rectified current of 11 amps @ 55°C and discrete voltages from 0.5 to 6 kV. "STACPAC" *Three Phase Half Wave and Full Wave Bridges* can be assembled by utilizing the individual legs in the SCPH series. "STACPAC" *Power Center Taps and Doublers*, (SCPP, SCPN, and SCPD series) provide an average rectified current of 11 amps in discrete voltages from 0.5 to 12.5 kV.

All assemblies are available for immediate delivery.

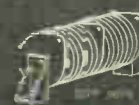

**SEMTECH**  **CORPORATION**

Western Offices: 652 Mitchell Rd., Menlo Park, California, 94025 (805) 498-2111/from L.A. (213) 638-5392 TWX: 910-336-1264

Central: 140 No. La Grange Rd., La Grange, Illinois, 60525 (312) 352-3227 TWX: 910-683-1696

Eastern: 116-55 Queens Blvd., Forest Hills, N.Y., N.Y. 11375 (212) 263-3115 TWX: 710-582-2559

European Sales: Ecomet AG, Alpenstrasse 1, Zug, Switzerland (042) 4 82 72 73

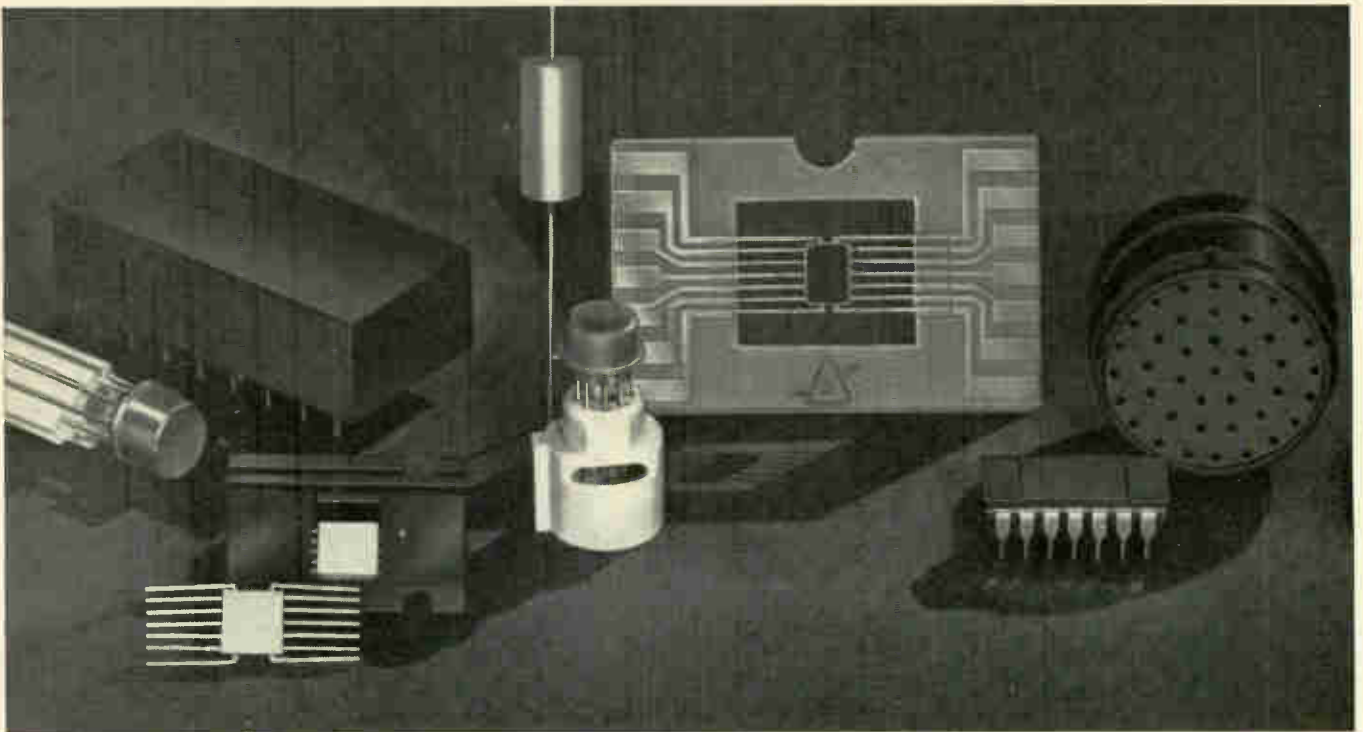

Good marking . . . makes the difference

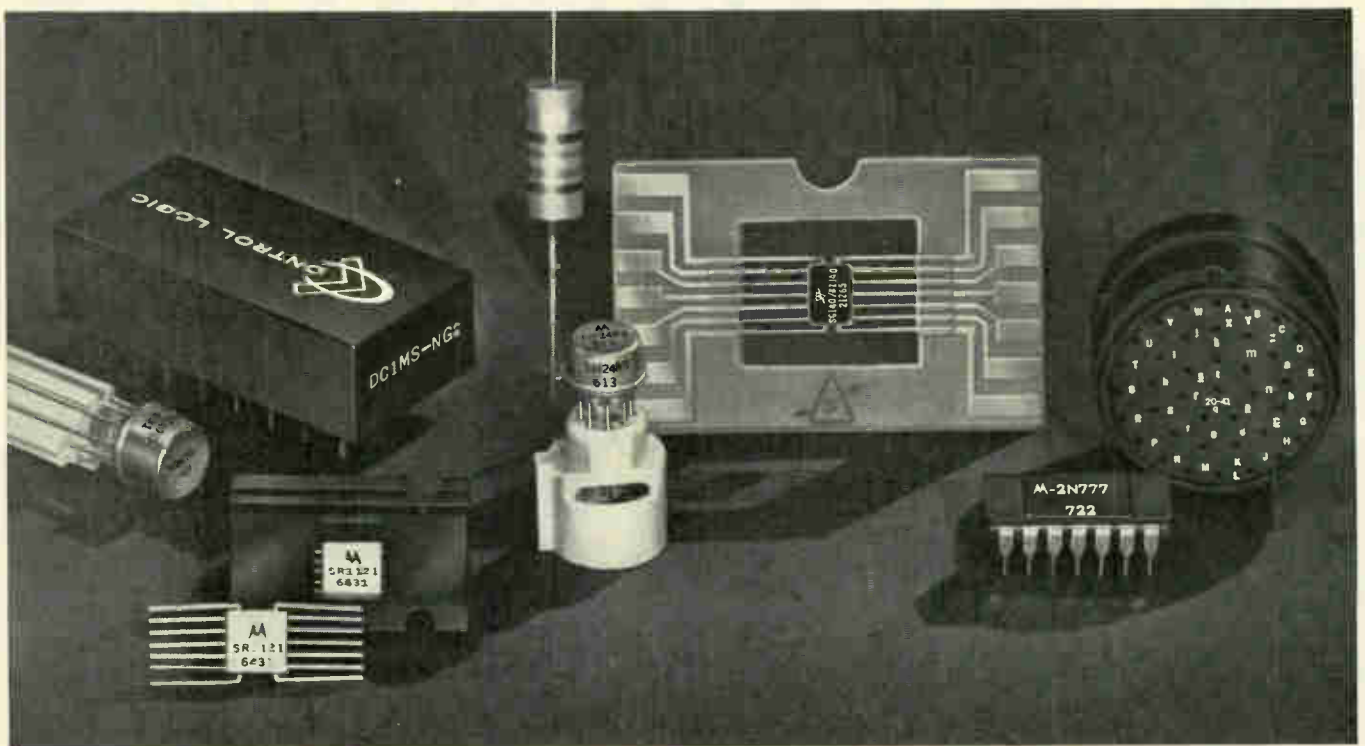

Don't waste time improvising and experimenting. Call in a Markem man and get acquainted with today's broadest line of marking equipment. Machines capable of putting several bands on a miniature diode; combining sequential numbering with identification; printing 14 characters plus trademark in an area 0.125" in diameter; printing integrated circuits in or out of carrier, registered to tab; and employing new techniques to meet severest durability specs. Whether your problem is size, speed or cost, we can help. Write Markem Machine Company, 305 Congress Street, Keene, New Hampshire.

*EQUIPMENT AND TECHNOLOGY TO HELP YOUR PRODUCT SPEAK FOR ITSELF*

**MARKEM**®

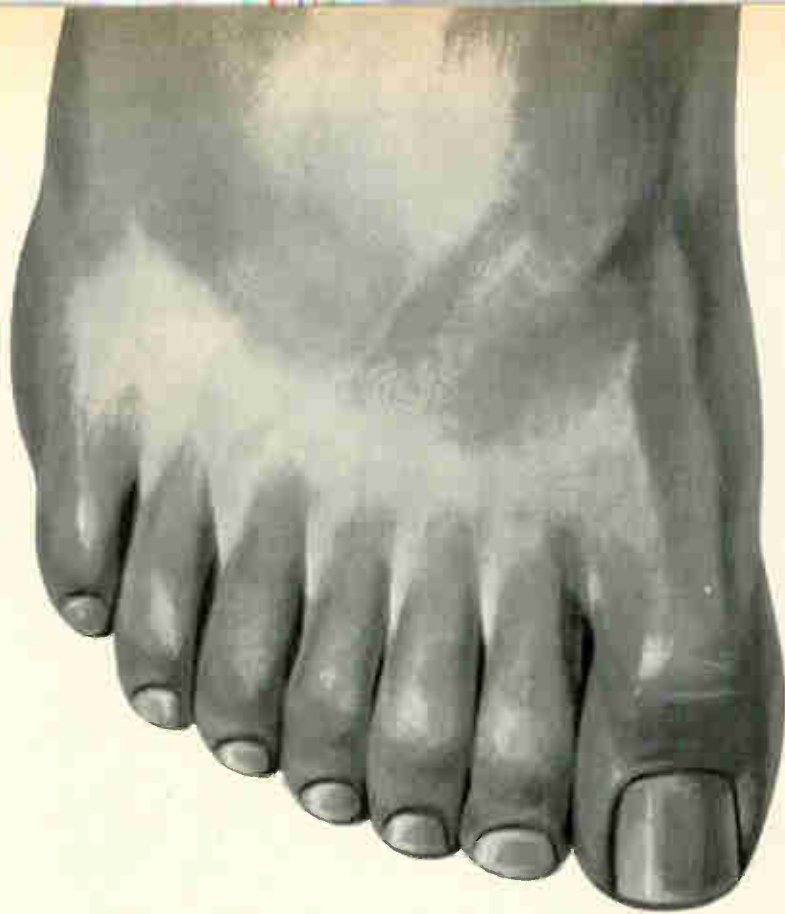

## Beckman EiD takes a firm foothold in industrial counting.

Our new 200 kHz integrated circuit counters put us a step ahead of competitive models.

Seven compact counter/timer models run the gamut of applications: preset process control...frequency and normalized rate measurements...down to basic accumulation. Reliability? They *more* than measure up due to design/style factors like: Simplified front controls. Easily readable in-line display. Low (25W normal) power need. Closed-box, drip-tight, dustproof design with no cooling fan needed. High input sensitivity. Built to take rough work environments. And *all-integrated* circuits.

All models are available with data output in 1-2-4-8 binary-coded decimal form. Feeds directly into tape punchers or digital printers. For a convincing demonstration, contact our nearest regional office, listed at right. You'll find EiD's up front with what counts.



EiD more than  
measures up.



**INSTRUMENTS, INC.**  
**ELECTRONIC INSTRUMENTS**  
**DIVISION**

2400 Harbor Blvd., Fullerton, Calif. 92634,  
(213) 691-0841

7360 N. Lincoln Ave., Lincolnwood, Ill.  
60646, (312) 583-1020

12051 Tech Rd., Montgomery Ind. Park,  
Silver Spring, Md. 20904, (301) 622-2500

International Subsidiaries: Geneva;  
Munich; Glenrothes, Scotland; Tokyo; Paris;  
Capetown; London; Mexico City

Circle 129 on reader service card



**If you want to see  
as well as these eyes,  
use the MTI Image Orth**

Nocturnal animals see well in the dark. MTI Image Orthicon television cameras see almost as well. We're specialists in low light level television equipment. In fact, the largest manufacturer in the world. And our equipment will pick up an

image in near total darkness. A pin hole of light is more than enough. Or more specifically, at  $1 \times 10^{-5}$  foot candles of ambient light (approaching total darkness).

This is but one research application. The possibilities in all fields

are endless, as research is discovering every day. If you have need — call us. We'll be there to help . . . quickly with quality.



**mti MARYLAND TELECOMMUNICATIONS, INC.**

York & Video Roads, Cockeysville, Md. 301-666-2727 World's largest manufacturer of low light level television cameras.

# Why do so many TV sets use so many **NORYL**<sup>®</sup> components? THERMOPLASTIC RESIN



**Self-Extinguishing, UL Group 1 Rating  
High Strength at Elevated Temperatures  
Economy, Easy Processing**

Because it withstands higher temperatures caused by miniaturization and color, Noryl is being specified more and more for TV parts like these tuner components, deflection yoke and convergence coil parts, tube sockets, high voltage cups and control shafts.

No more need to choose between premium priced plastics and lower cost materials with only marginal performance. Noryl combines excellent physical and electrical properties with easy processing and economy; a low resin cost with a specific gravity of only 1.06. Noryl's high heat deflection temperature (265°F at 264 psi), low creep and high modulus mean parts that remain dimensionally stable under load at TV receiver operating temperatures. Noryl also has

provisional UL rating for support of current carrying parts at 212°F (100°C).

Parts can be precision molded economically. Noryl offers low, predictable mold shrinkage, tight tolerances are held in thin sections and parts are ejected easily for fast cycles.

Look into Noryl for an economical answer to premium performance. It offers the extra properties without the extra cost.

For more information contact your GE Chemical Materials Sales Representative, or write Polymer Products Operation, General Electric Company, One Plastics Ave., Pittsfield, Mass. 01201. In Europe, N. V. Polychemie AKU-GE, 76 Velperweg—Arnhem (The Netherlands).

Aging test for Noryl shows excellent performance at elevated temperatures. SE1 Noryl maintains its impact and tensile strength after thermal aging at 115°C (240°F).

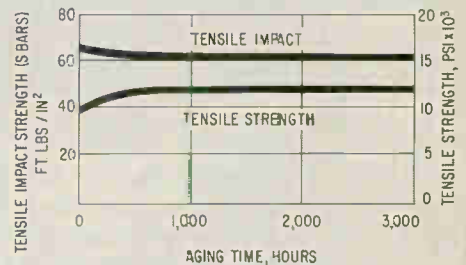

*Leader in Engineering Plastics*  
PPO<sup>®</sup> • LEXAN<sup>®</sup> • NORYL<sup>®</sup> • PHENOLICS

**GENERAL  ELECTRIC**

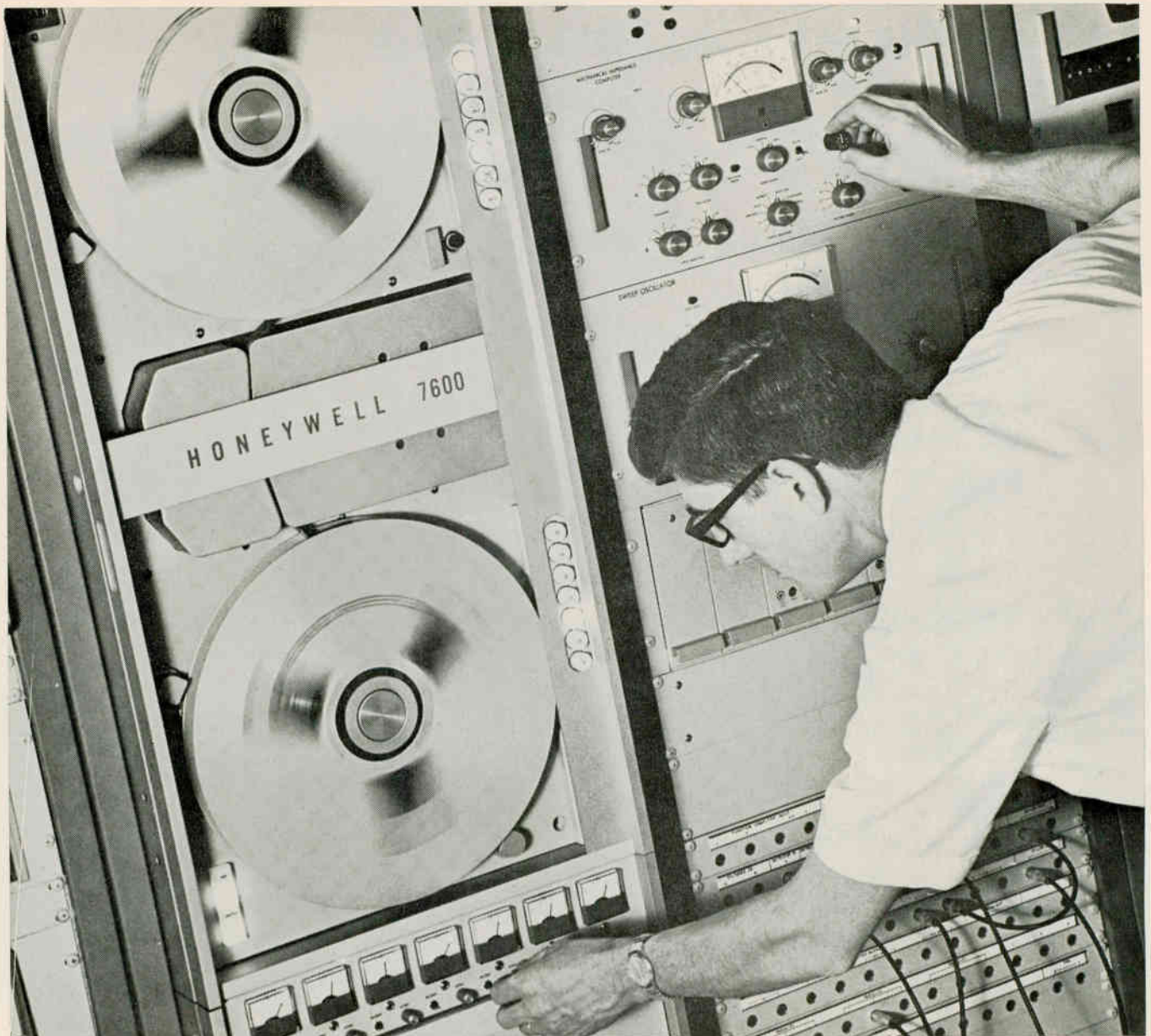

A 15-inch transport is one of many options that permit you to tailor the Honeywell 7600 to your exact requirements.

## We kept our promise. We've kept busy delivering 7600 Series Tape Systems ever since.

We promised you the best value in the magnetic tape industry, and that's just what the Honeywell 7600 Series is. Its modular concept allows you to specify the exact system you need — no more, no less — with your choice of 10½" or 15" transports, a wide selection of bandwidths and electronics, and many options for future expansion without costly modifications.

Users report performance that exceeds specs. The 7600 delivers greater signal fidelity than any comparably priced unit, thanks to high S/N ratios and extremely low flutter, skew, and time base error. Price? A lot less than you'd expect! And because it's mechanically simple (no belts, pulleys, gears or pinchrollers), highly reliable, and

easily maintained due to plug-in electronics throughout, 7600 operating costs are low, too.

In every way, the 7600 Series is another example of how Honeywell's broad line, backed by local sales and service, can provide the *precise* solution to your instrumentation problems. For an eye-opening demonstration, call your local Honeywell Representative. He'll be glad to put a 7600 through its paces for you. For technical literature, write: Honeywell, Test Instruments Division, 4800 East Dry Creek Road, Denver, Colorado 80217.

**Honeywell**  
Honeywell engineers sell solutions

# IRC

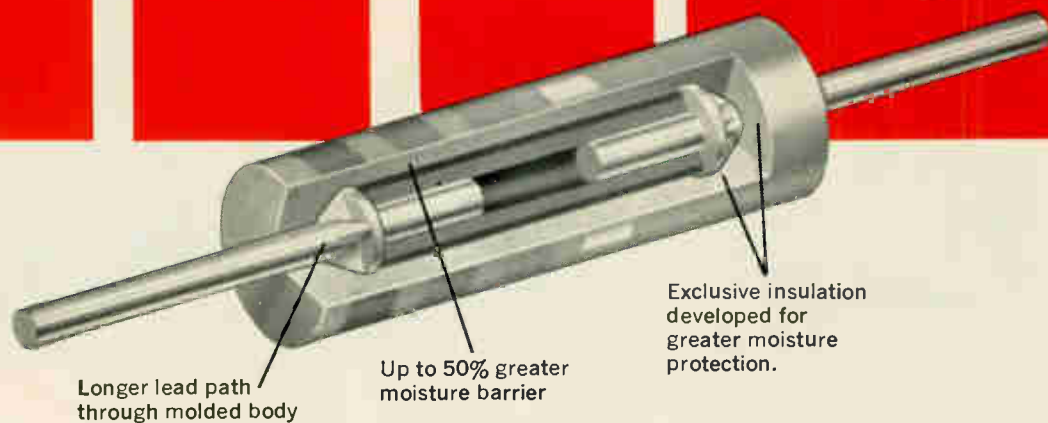

## Fixed composition resistors offer Greater moisture resistance

When tested to MIL-R-11 moisture resistance requirements, IRC's  $\frac{1}{2}$  and 1 watt fixed composition resistors exhibit resistance changes of less than 3%. Five times better than the 15% MIL allowance. Under more stringent conditions of 75°C, 100% RH for 120 hours, resistance changes are typically less than 5%. Even IRC's small  $\frac{1}{4}$  watt unit has moisture resistance changes well within MIL limits.

**Molding makes the difference.** IRC's resistance element is a carbon composition film that is thermally bonded to a glass body. This exclusive IRC design permits up to 50% more molded protection completely around the resistance element.

The molding material was developed by IRC specifically for superior moisture, electrical, and mechanical characteristics. This exclusive molding material, plus added insulation thickness, brings an extra measure of moisture protection to your circuit design. Write for catalog, prices and samples to: IRC, Inc., 401 North Broad Street, Philadelphia, Pa. 19108.



### IRC COMPOSITION RESISTORS ALSO OFFER

- Lower operating temperature
- Better resistance-temperature characteristics
- Superior high frequency characteristics
- Outstanding load life
- Stronger lead assembly
- Excellent solderability
- Values to 100,000 megohms





## SPECIAL (??) SHEET METAL ENCLOSURES

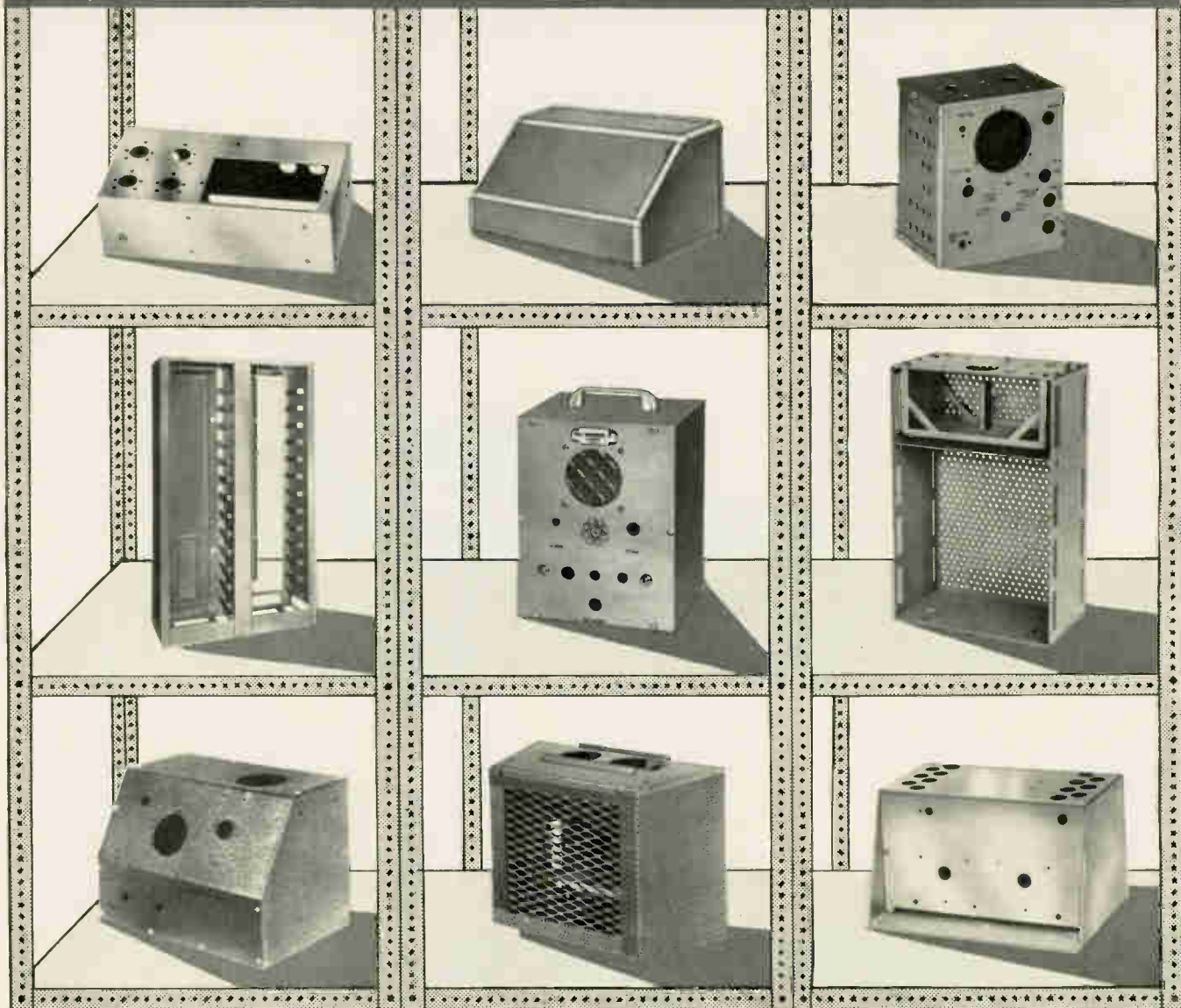

# Off the shelf?

This is not an irresponsible claim if your special requirement can be modified from one of the thousands of enclosures we regularly make.

Many producers of instrumentation have found that a very minor revision of a standard Bud product has suited their needs exactly and at the same time saved them considerable time and money.

If you have a housing problem that you think is special, talk to your Bud distributor about it first or submit your problem direct to us.



## BUD RADIO, INC.

WILLOUGHBY, OHIO



an invitation from 5,200 Manufacturers:

**"look into VSMF"**



5,200 manufacturers invite your judgment of their products in Visual Search Microfilm Files.

VSMF . . . 1,500,000 catalog pages, 5,200 manufacturers, millions of components and materials, indexed by product for side-by-side comparison. The VSMF Defense Design File, alone, contains over 250,000 pages from defense manufacturers. And, there's a file for OEM, too. In all, Information Handling Services produces 6 different VSMF files for industry and government.

We know that when you design a product you want to use the best components and materials. And, to do this, you need to compare all that is available. VSMF can help you in this comparison because VSMF supplies the data on all products. You supply the judgment.

Manufacturers who place their data in VSMF know this and invite comparison. The constantly changing "state of the art" is reflected in the pages of VSMF.

If you have VSMF in your company, look into it. If you don't, you might look into that, too. Write for "Looking into VSMF."

*William H. B. Combs, Manager, Engineering Services, Relay Division, Leach Corporation, Los Angeles, uses the VSMF Defense Design File.*

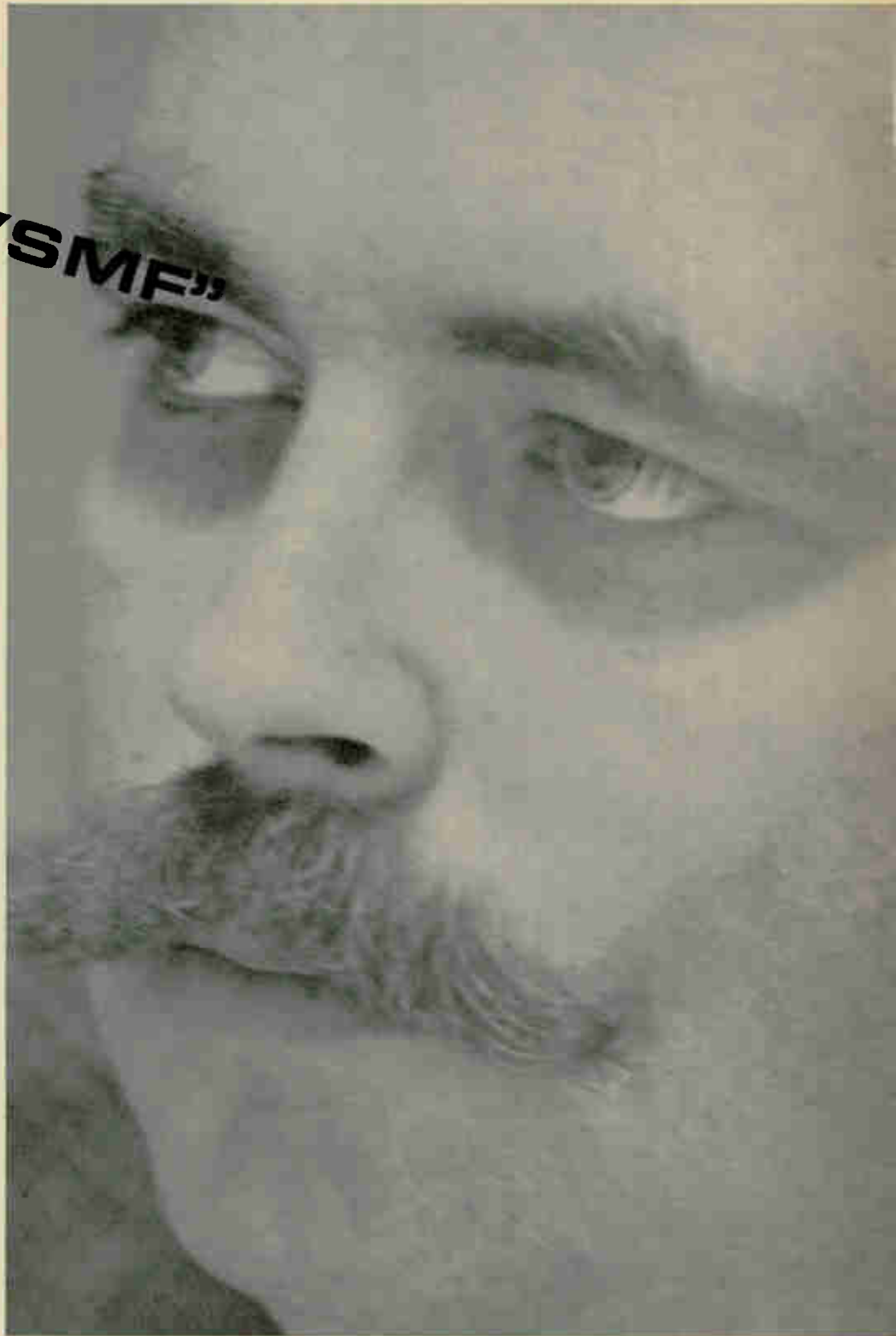

**Information**

HANDLING SERVICES, INC.  
Dept. E-724

Denver Technological Center  
Englewood, Colo. 80110

Circle 135 on reader service card



**Don't try to sell her  
on the challenging career  
Hughes has offered you.**

**Just mention . . .**

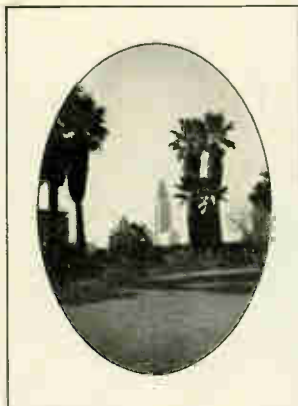

**The climate.** Often it's compared with the Riviera's. In truth, Southern California's is better. Drier in summer: no mosquitos, little mugginess. Balmy in winter: seven hours of sunshine a day. You'll save on galoshes!

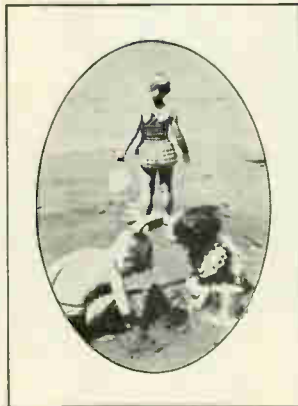

**Family fun.** You literally can ski and sunbathe the same day here. Swimming pools and ski runs are an hour apart. The kids will love mountain climbing, surfing, sailing, desert rockhounding. Every weekend's a vacation.

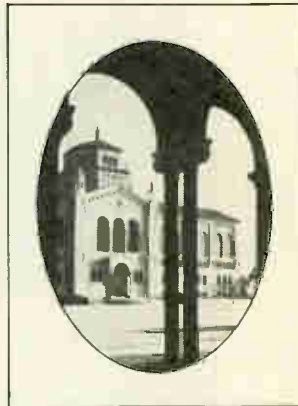

**Great schools.** Some of America's most respected school systems are in the Los Angeles area. Also, many fine city colleges; three branches of California State; U.C.L.A., U.S.C., Caltech, Occidental, Loyola, and *more*.

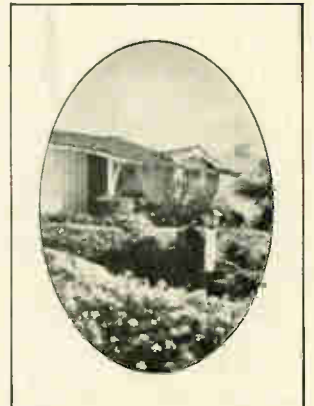

**The good life.** You can find it in communities like Westchester, Redondo, Playa del Rey. Or Sherman Oaks, Canoga Park or Pasadena. We have literally scores of beautiful residential areas within easy reach of Hughes plants.

**About that challenging career . . .** The Hughes Aerospace Divisions have over 200 openings now for graduate engineers. Opportunities exist on advanced projects and programs like ATS, VATE, TOW, PHOENIX, Communications Satellites, and many others. Please send resume to:

**Mr. Robert A. Martin**  
Head of Employment, Dept. 30  
Hughes Aerospace Divisions  
11940 W. Jefferson Blvd.  
Culver City, California 90230



Our  
roof  
is  
proof...

CHESTER,  
N.Y.

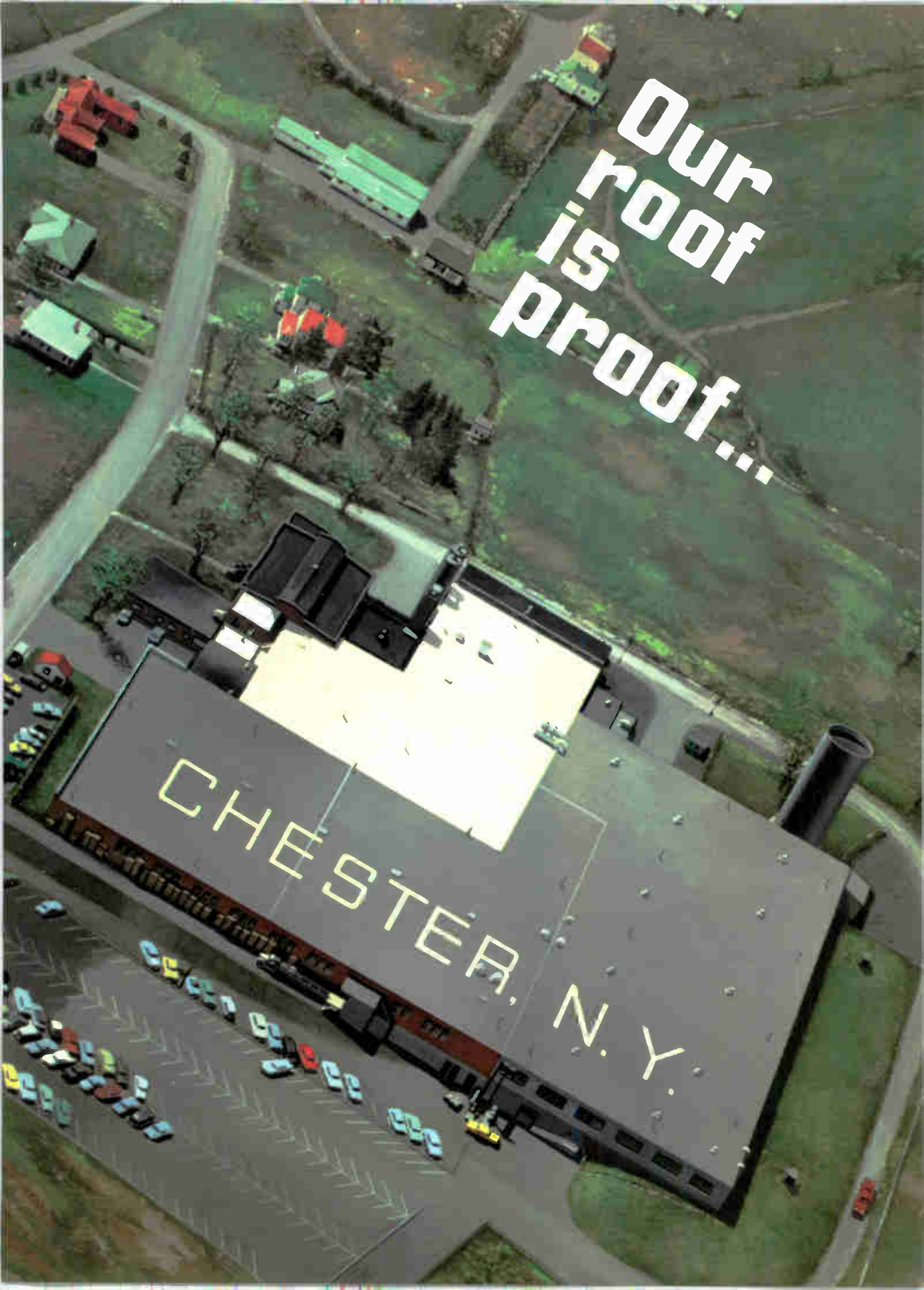

# Chester's growth through service

We can't think of a more graphic way to portray "Growth Through Service", than the illustration on the preceding page. The dark roof area represents Chester's plant expansion during the past ten years . . . expansion made necessary by the increasing requirements of our many valued customers in the electrical and electronic industries.

Actually, though, it's what's under the roof that counts: — The newest and most advanced production machinery . . . expanded research and test facilities . . . exacting quality control techniques . . . modern materials handling systems . . . and most important — experienced people, skilled in the manufacture of Plasticote® Wire and Cable.

Today . . . while we plan for the future . . . we still continue to meet industry's present requirements with unequalled service. The ultimate ingredient of this service is the most important facet of Chester's story of growth . . . the close, personal attention to each customer's requirement.

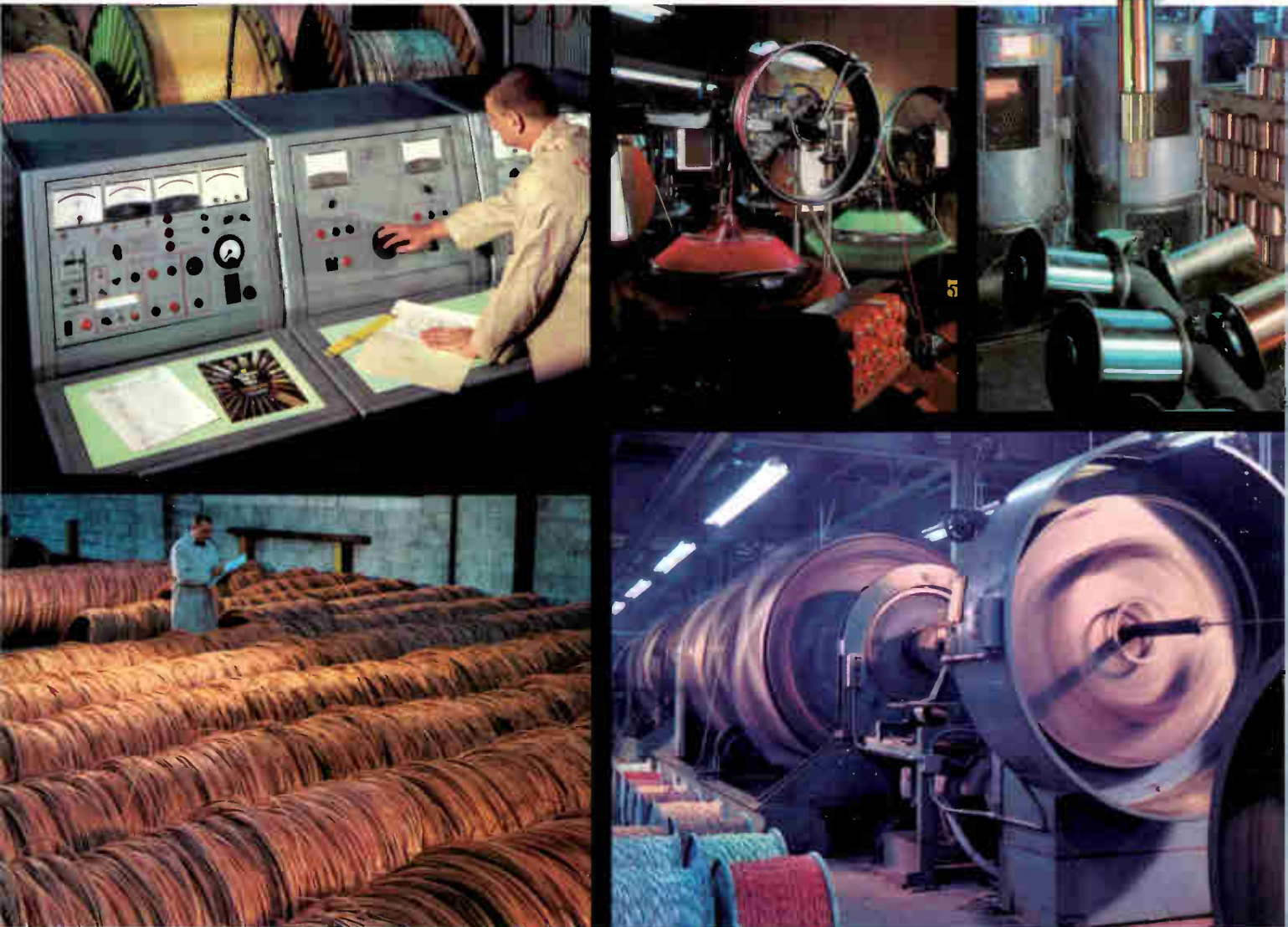

**CHESTER CABLE CO.**

DIVISION TENNESSEE CORPORATION, CHESTER, NEW YORK 10918

A SUBSIDIARY OF CITIES SERVICE COMPANY

PHONE: (914) 469-2141

TWX (914) 469-9801

Printed in U.S.A.

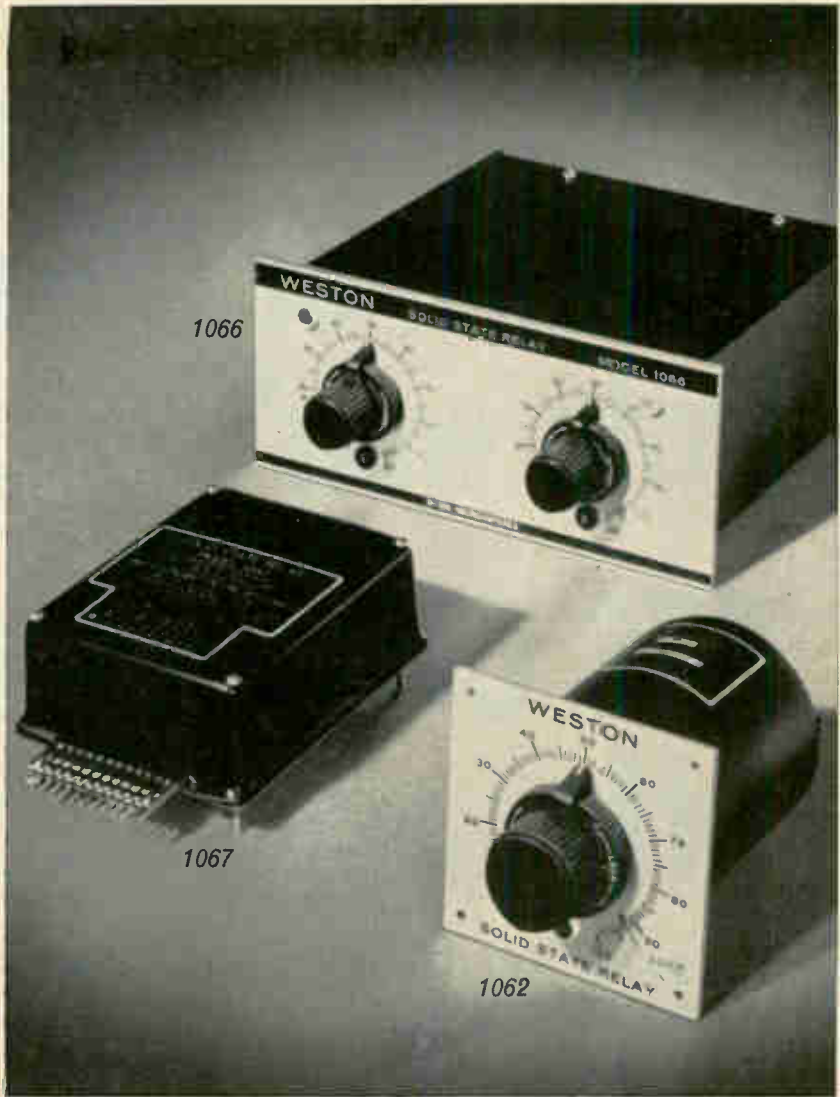
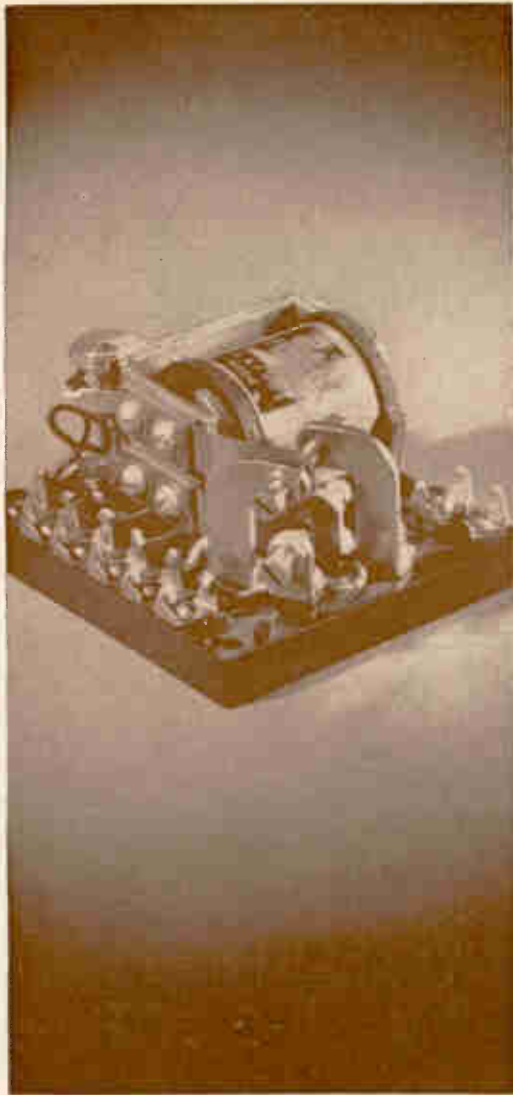

## Weston solid state relays make electromechanical relays look like antiques

Now the "mechanics" has been taken out of adjustable relays and replaced with rugged, reliable solid-state circuitry. As a result, these three new Weston relays not only look modern, they offer solid-state performance, too... the kind that eliminates rejects and puts more money in your pocket.

Model 1062 is fully adjustable over its entire 320° scale, includes a trip indicator and zero adjustment on the front panel, and features a self-contained differential amplifier, power supply and SCR switching circuit. Model 1066 is a Dual Set Point Relay with a synchronizing circuit for time-sharing between channels. Either

model can control a full amp at line voltage with ½% repeatability, 2% accuracy, and selectivity as low as 1 μa.

"Value engineered," low cost Model 1067 is designed for 28-volt dcooperation and has a load rating of 500 ma at 50 watts ac. All three relays are dust-free, vibration-proof, and operate from 0° to 50°C.

Find out what solid-state technology has done for the relay. Get complete details from your Weston distributor today, or write: Weston Instruments, Inc., Weston-Newark Division, 614 Frelinghuysen Avenue, Newark, N.J. 07114, a Schlumberger company.

**WESTON®** prime source for precision... since 1888

WESTON-ARCHBALD • WESTON-HATBORO • WESTON-NEWARK • WESTON-POUGHKEEPSIE • WESTON-LEXINGTON • WESTON-TRANSICOL • WESTON-GARWIN CARRUTH • WESTON-CANADA

# When even the Best Carbon or Wirewound Pots won't do...

## CTS Cermet Pots Offer a Solution

### 6 WEEKS DELIVERY...NEW LOWER PRICES...

due to CTS automated production techniques and the industry's biggest output.

Consider these CTS Cermet Pot characteristics:

1. 20  $\Omega$  to 5 megohms resistance range.
2. Greater power/size ratio. (See captions.)
3. The environmental stability & higher wattage rating of wirewound.
4. The wide resistance range & infinite resolution of carbon.
5. Extremely high temperature capabilities.
6. Stability under extreme humidity.
7. No catastrophic failures.
8. Low noise. Long life.
9. Exceed MIL-R-23285 (Navy) metal film; far exceed MIL-R-94B.

Specify from the broadest line of thick film controls available.

New low prices begin at \$1.35 each in large quantities.

**Series 500**  
3/4" dia.  
1-1/2 watts @85°C



**Series 400**  
1-3/64" dia.  
3 watts @85°C



**Series 600**  
1/2" dia.  
3/4 watt @85°C



**Series 550**  
3/4" dia.  
2 watts @70°C



**Series 2-500**  
3/4" dia.  
1-1/2 watts @85°C  
Tandem Series 500



**Series 385**  
1 1/32" dia.  
1/8 watt @125°C  
For P.C. applications



**Series 600PC**  
1/2" dia.  
3/4 watt @85°C  
For P.C. applications



**Series 660**  
3/8" dia.  
1/4 watt @125°C



**Series 630**  
1/2" dia.  
1/2 watt @85°C



Request Cermet Catalog.



Founded 1896

## CTS OF BERNE, INC.

BERNE, INDIANA

Subsidiary of CTS Corporation, Elkhart, Indiana

# Probing the News

Air traffic control

## FAA lies low as aerial jam worsens

Agency plods ahead with a semiautomatic system for enroute control, but largely ignores the increasingly dangerous snarls above airports

**Air traffic control** is apparently like the weather: everybody talks about it, but nobody can do much about it—least of all the Federal Aviation Administration, the Government agency charged with the responsibility.

Over the next five years, the FAA will sink an estimated \$500 million into hardware for air traffic control, but this vast outlay won't go very far toward relieving airplane congestion around airports. The agency is concentrating its resources on the semiautomatic National Airspace System of enroute centers where there are relatively few difficulties, and is neglecting the more critical problems of terminal control.

Some aviation experts go so far as to label the alphanumeric display, which is the heart of the National Airspace System, "a hoax" on technical grounds.

**Lost in the stars.** As any seasoned air traveler will attest, airspace around metropolitan airports is jammed intolerably close to capacity. "The most respected seers predict that air traffic delays in the New York area will approach in-

finity sometime between January 1969 and 1973," says Horace E. Wood, president of the National Business Aircraft Association.

There is some evidence that even FAA officials are catching on, if not up, to the implications of their predictions for a continuing boom in air traffic. "If we had the National Airspace System implemented today, it wouldn't seem too soon," says James H. Mollenaur, deputy associate administrator for development at the FAA.

But barring a public outcry over a series of disastrous crashes or unbearable jam-ups, it seems unlikely that the agency will move with anything more than its customarily deliberate speed in dealing with traffic control problems.

### I. Bill of particulars

Industry has long been sharply, if discreetly, critical of the FAA's meager efforts in this area. Many electronics concerns assert, with considerable justification, that an efficient, automatic, and safe terminal system could have been implemented years ago. But, a number of manufacturers that have de-

signed or developed systems claim it's virtually impossible to sell the FAA a new idea of any kind—much less one involving air traffic control. Among the more serious charges from the private sector:

- The FAA has developed an in-house capability it believes can solve all of its problems.

- Inadequate projects like the National Airspace System absorb an inordinate amount of research and development funds.

- The agency's rule against single-source procurement discriminates against those who have developed proprietary systems.

- Manufacturers cannot afford to do business with the agency because of the possibly exorbitant penalties involved.

**Rebuttal.** Answering these charges, Mollenaur says, "I don't know of any Government agency more receptive to ideas than the FAA. If industry can develop a system on its own, we'd rather have it do it. As a matter of policy, the FAA does applied research but no fabrication."

But a West Coast electronics executive says: "The FAA is the toughest Government agency to do business with. Their inspectors are nitpickers and just unreasonable in general. Other agencies don't hesitate to put the pressure on, but the FAA will go farther in forcing a firm to meet the letter of a contract. I have seen the FAA actually force several small companies out of business."

Another electronics official, whose company refused to deal with the FAA after suffering through some contract problems a few years back, notes that FAA agreements always include an unlimited

### First aid

Next month, the Federal Aviation Administration will hold its first conference with electronics firms to brief them on requirements for terminal air traffic control. No date has yet been set for the day-long conclave, which will take place in Washington under the aegis of the procurement division of the National Airspace System Program office.

In the past, the FAA has held a number of prebidding conferences. However, these meetings covered extremely broad areas and were attended by representatives of many industries. The August briefing will concentrate on the automation of air terminals and be directed specifically at the electronics field. The FAA's aim is to help companies plan their future bidding before requests for proposals are published.

## ... the NAS is essentially the same as systems that were used 30 years ago ...

"liquidated damage clause." By contrast, Pentagon damage provisions are limited to 25% of the contract's value.

Some companies stand up for the FAA, albeit obliquely. "Developing air traffic control systems and techniques is necessarily a slow process because the FAA has a very responsible and wide-reaching job," says Michael Nothman, senior technical specialist at ITT Gilfillan Inc., a subsidiary of the International Telephone & Telegraph Corp.

Wide reaching or not, the FAA has little to show for 16 years of effort in the field of air traffic control. Moreover, its record for availing itself of practical technology isn't inspiring.

**The sins of the fathers.** In 1951, the Civil Aeronautics Administration, the FAA's predecessor, began studying the possibility of automating air traffic control. By 1956, the CAA had installed a computer at its Indianapolis ATC center to provide printouts of flight data. Nothing much came of this project.

Government officials blame a "wrong approach" for "eating up" the 1957-61 period. Incredibly, however, approximately the same procedure—automation of only one part of the control system—has been adopted to implement the National Airspace System. Though the FAA is fond of lauding the "automation" of NAS, the system is actually semiautomatic. And with the exception of some data stored by computers and displayed automatically on radar scopes, it is essentially like the ATC systems used 30 years ago.

Explaining its decision to concentrate on enroute, rather than terminal, ATC problems, the FAA says that years ago it did more development work on the former. As a result, the agency felt the National Airspace System would be simpler to implement. This sort of rationalization makes at least as much sense as looking for a lost coin where the light is best.

**Screen test.** The FAA has thrown its resources behind a system that displays luminous blocks of data

on aircraft flying between U.S. cities. The data blocks, called alphanumeric tags and displayed on controllers' radar scopes, automatically follow the correct radar blips until the planes are through the area covered by the center. The system was designed to reduce controllers' workloads, but many observers feel that radar screens will be cluttered and that blips will merge when aircraft are stacked one above the other.

If, as some observers charge, alphanumerics are a hoax, they're going to be a costly one. The FAA recently awarded a \$22 million contract to the Burroughs Corp. for 177 digitizers to convert radar signals into computer data, and a \$44 million contract to the Raytheon Co. for computer display channel gear.

### II. Leadoff

The enroute ATC center in Jacksonville, Fla., is scheduled to become the first operational semiautomatic station in the U.S. some time next year, and the first of 20 continental centers, each costing between \$12 and \$18 million, in the National Airspace System. In the unlikely event that everything goes as planned, the network will be completed in 1972.

One hitch has already developed. Two of the first four common digitizers earmarked for Jacksonville were preempted by the military and shipped to Vietnam. The diversion

will limit the Florida facility's capacity until as late as December 1968 [Electronics, May 15, p. 51].

A duplicate of the Jacksonville center is being installed at the National Aviation Facilities Experimental Center (Nafec) in Atlantic City, N.J., for the purpose of testing systems, developing procedures, and training controllers.

**Overhaul.** Some of the system's components at Jacksonville are what the FAA describes as "interim" or "stopgap" hardware. A number of subsystems, including radar-bright display equipment, alphanumeric generators, computer entry and readout equipment, and the data filter apparatus, will eventually be replaced by a single computer display channel unit. The retrofit will not, however, occur before 1975 at the earliest.

While the FAA plugs away at its semiautomatic enroute centers, terminal problems are becoming critical. High on airports' shopping lists are: navigation systems, accurate to within 200 feet, that can guide aircraft through the crazy-quilt noise-abatement patterns near runways. But the agency has no continuing program to develop a ground-air terminal navigation system. The standard very-high-frequency omnirange tactical air navigation (vortac) systems at airports are simply not precise enough to assure either efficiency or safety. Incorporation of distance-measuring equipment at a vortac site adds little in the way of accuracy. Traffic controllers must still tell pilots by radio when to turn, hold position, and proceed; and, often, the pilots don't know just where in the

### False starts

During the period from April 19, 1965 through April 28, 1966, the Federal Aviation Administration set some sort of record for confusion by issuing three requests for quotes for an air traffic control system.

The first was canceled less than two months after issue because the specifications were too vague. Since nobody knew what was called for, the agency didn't get any bids.

On its second try, which attracted a flock of eager bidders, the FAA was only slightly more successful. Finally, the agency had to issue a revised request—the third in the cycle—because it discovered the equipment it sought on its second go-around was too expensive for its budget.

Raytheon eventually got a \$44 million contract for computer display channel equipment. But by the time the prize was finally won, at least four of the front runners in the second-stage bidding had withdrawn from competition for the third.



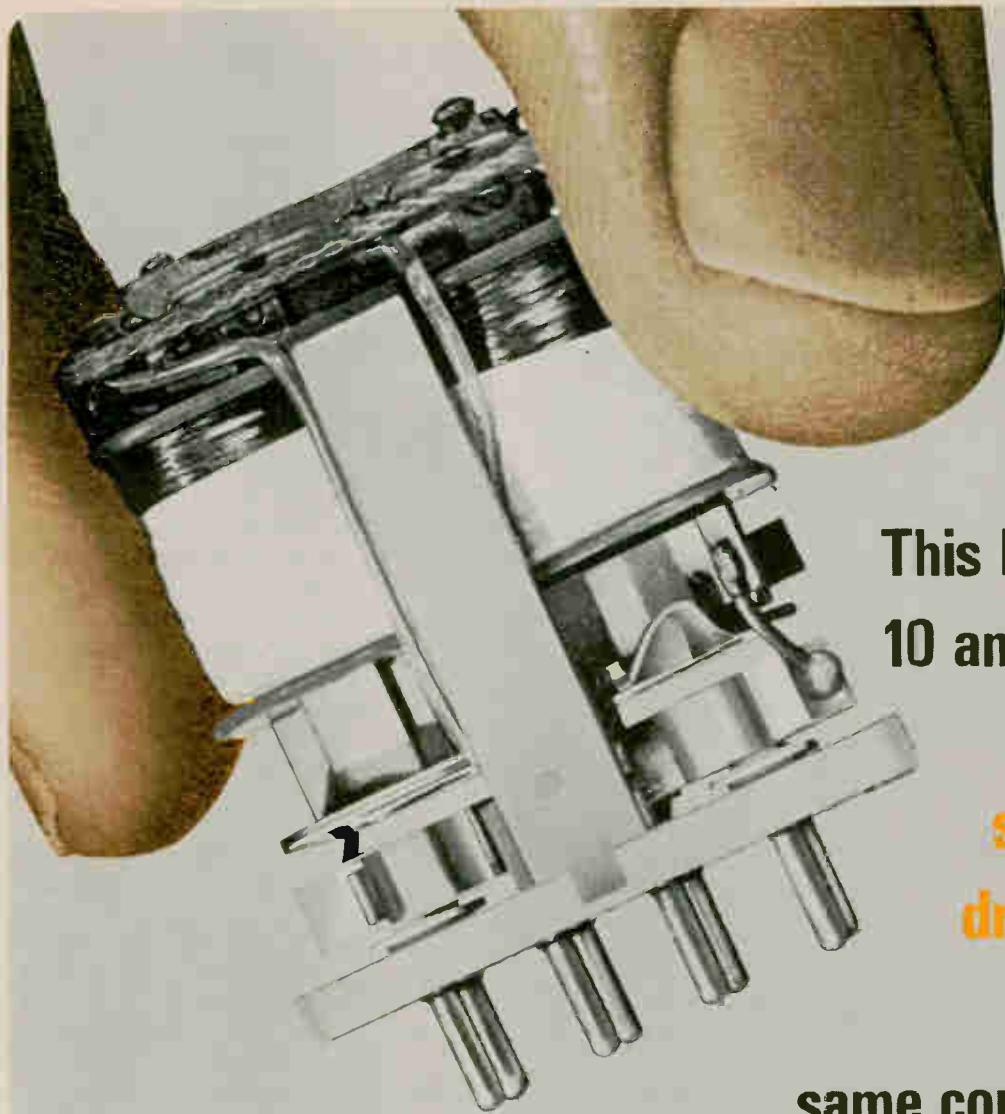

**This Babcock  
10 amp. relay  
also  
switches  
dry circuit  
with the  
same contact set**

Now, your Babcock 10 amp. full size crystal can relay will also switch dry circuit with the same set of contacts. These exclusive universal contacts have greatly simplified your relay stocking requirements. You can order one model to meet a given set of performance parameters without concern for load requirement — *at no cost premium*. Get complete information about this versatile relay, and the entire Babcock line, all with universal contacts.

Write Babcock Relays, Division of Babcock Electronics Corporation, 3501 Harbor Boulevard, Costa Mesa, California 92626; or telephone (714) 540-1234.



The Babcock Model BR7 relay will perform from dry circuit to 10 amps., with universal contacts, and is designed to meet critical aerospace applications.

#### SPECIFICATIONS

**SIZES:**  
1.300" h. x 1.075" l. x .515" w  
**WEIGHT:**  
Approx. 1.0 oz.  
**CONTACT ARRANGEMENTS:**  
SPDT and DPDT

**FULL-IN POWER:**  
Low as 80 mw.

**LIFE:**  
100,000 operations, min.  
**TEMP RANGE:**  
-65°C to +125°C

#### FROM THE BABCOCK FAMILY OF CRYSTAL CAN RELAYS



**TWICE SIZE  
4PDT**  
dc to 10 Amps.



**FULL SIZE  
DPDT**  
dc to 10 Amps.



**HALF SIZE  
SPDT & DPDT**  
dc to 2 Amps.



**SIXTH SIZE  
SPDT & DPDT**  
dc to 1 Amp.

**WATCH FOR BABCOCK RELAYS ON THE EDN MOBILE DISPLAY — SOON IN YOUR AREA.**

**when  
special  
cables**

**short-  
circuit  
your  
production**



**call  
Columbia  
Wire!**

When immediate delivery of special cables—any type up to 2" in diameter—will keep your production running smoothly and profitably, call Columbia Wire. Chances are we have the know-how and facilities for producing it for you . . . fast! Try us and see.



Write for our fully illustrated catalog

**Columbia**   
**WIRE PRODUCTS COMPANY**  
2850 Irving Park Rd. • Chicago, Ill. 60618

**. . . the FAA won't admit that 3-D radar could serve as a backup for beacons . . .**

air they are.

Federal safety regulations specify that aircraft be three miles apart when landing and 30 seconds apart when taking off. But this rule is often bent by the controller when traffic loads become heavy. A computerized system would permit the FAA to reduce minimums and enable air traffic controllers to get planes up and down faster.

The Airborne Instrumentation Laboratory, a division of the Cutler-Hammer Corp., developed one such system for the FAA. It had a general-purpose digital computer for mathematical calculations and data storage; input equipment to put the controller's requests into a computer format, as well as output equipment to convert the computerized data to a form suitable for display; and command and control displays for the controller's use in directing aircraft off runways.

Computerized systems that could automatically control the movement of aircraft on and off a runway were available in 1963. They were evaluated but discarded by FAA engineers.

Alphanumeric techniques have

been available since 1957. But it wasn't until 1961 and the Project Beacon report that such methods were taken seriously. The first units installed at Kennedy International Airport in New York aren't scheduled to be operational until late this year. Chicago, Los Angeles, and the Oakland-San Francisco airports won't have working systems until 1971.

**Gremlins.** An FAA-approved alphanumeric system is operating at the enroute traffic control center in Lake Ronkonkoma, N.Y. There are still a few bugs—aircraft responding to interrogation signals from the ground open electronically controlled garage doors and cause clutter on radar scopes.

Low- and medium-density airports may one day be equipped with the AN/TPX-42, a beacon interrogator being developed by the Whittaker Corp. Nine of the radar processing and display systems, called Direct Altitude and Identity Readout, or DAIR, have been funded under a joint Pentagon-FAA contract.

The DAIR system, though less elaborate than the beacon video processor at the FAA's enroute cen-

### Faint praise

Lack of an effective and articulate advocate on Capitol Hill has been a problem for the Federal Aviation Administration. Mike Monroney (D. Okla.), chairman of the Senate's aviation subcommittee, comes closest to filling the bill. But he often proves an embarrassingly equivocal champion.

Monroney believes the FAA is "moving as fast as it can" in getting an automated air traffic control system into operation. He feels, however, there has been a lag in putting older equipment into service while waiting for a new system to be perfected and produced. Nonetheless, says Monroney, the agency is getting as much money as it can use effectively.

That sum is no small amount. The FAA is down for \$894.7 million in the fiscal 1968 budget. But its research and development outlay is \$1 million below the fiscal 1967 level, which, in turn, was off \$10 million from the prior year.

On the other hand, the agency has no particularly virulent critics on the Hill. One reason for this is the FAA-administered aid-to-airports program. This lucrative pork-barrel is anathema to the Aircraft Owners and Pilots Association, which claims that most of the \$890 million expended under the plan during the past 20 years has benefited the commercial airlines rather than general aviation.

"The FAA's airport program has gone berserk during the last couple of years," says J.B. Hartranft Jr., association president. "Scandal is probably too strong a word to use, but disgraceful is too weak."

# POSITIVE LOW ENERGY SWITCHING

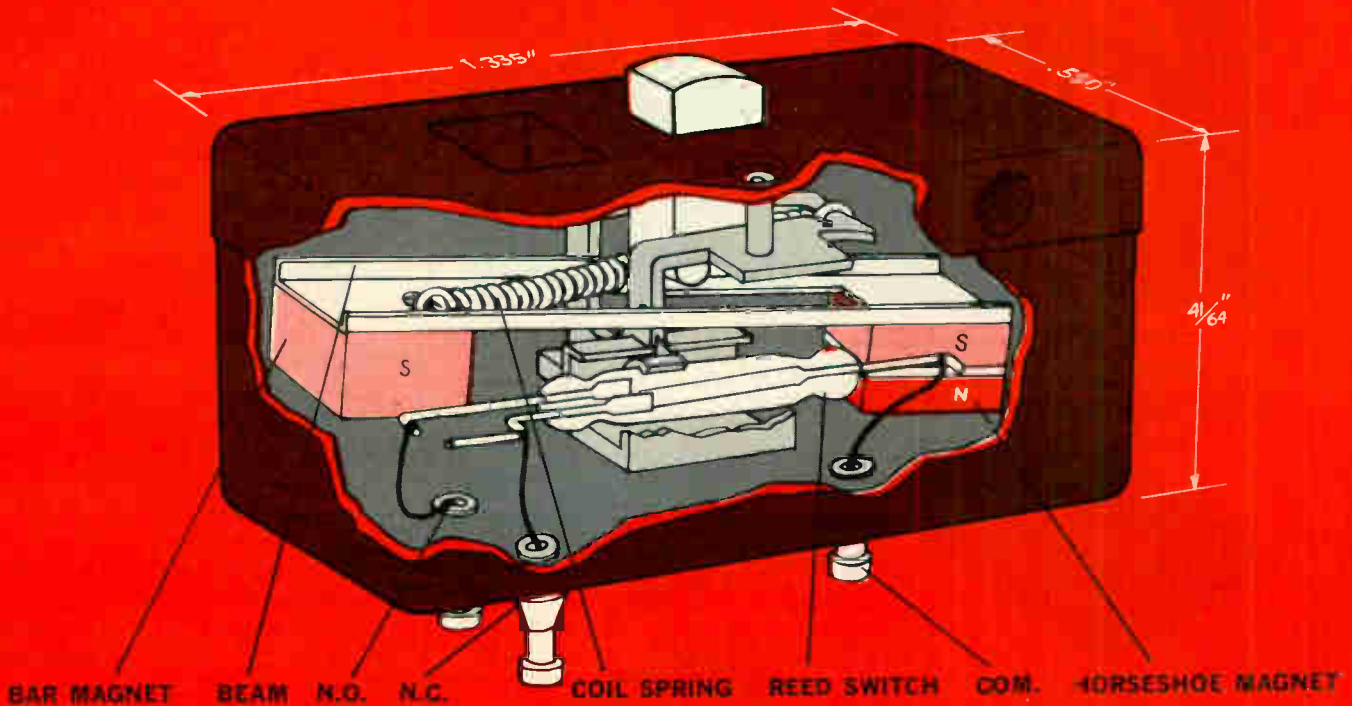

## “**snap/reed**” switch

**Mechanically actuated reed switch . . . combines reed reliability with snap switch utility**

All these features in one switch:

- long life\*
- high operation rate (60 per second)
- low bounce time (300 microsec., typical on single throw)
- precise operating points (.165 ± .015)
- low movement differential (.010 typical)

A completely new concept in switching low energy circuits, Cherry's "snap/reed" switch utilizes proven coil spring snap-action movement to position magnets, providing a positive push/pull drive of reed to open or closed position.

### SWITCH CHARACTERISTICS

Operating Point	.165 ± .015
Pretravel	.035 max.
Overtravel	.040 min.
Insertion Resistance	150 milliohms max.
Maximum D.C. Resistive Loads	3 Watts, 28 Volts, 110 M.A.
Maximum Sinusoidal Mechanical Operation Rate	60 per second

\*Expected electrical life at 25% of full load—20 million operations on single throw—10 million operations on double throw.

### BOUNCE TIME

	S.P.N.O.	S.P.N.C.	S.P.D.T.
Open Contact	1.0 msec. max. 0.3 msec. typ.		1.0 msec. max. 0.3 msec. typ.
Closed Contact		1.0 msec. max. 0.3 msec. typ.	3.0 msec. max. 1.0 msec. typ.

WRITE for detailed brochure on this new Cherry "snap/reed" Switch—today.

# CHERRY

CHERRY ELECTRICAL PRODUCTS CORP. • 1656 Old Deerfield Road • Highland Park, Illinois 60035

**TRANSISTORIZED**

# ANALOG MULTIPLIERS

*From Stock*

ALL MODELS: Full 4 Quadrant •  $\pm 10V$  In and Out •  $\pm 15$  VDC Supply • .5% FS Linearity (Max.) • Flatpack • No External Amplifiers



## DC MULTIPLICATION

MODEL **350**  
RP2

SIZE:  $\frac{3}{4}$ " X  $2\frac{1}{2}$ " X  $3\frac{3}{8}$ "  
BANDWIDTH: 3 DB AT 100 Hz  
STABILITY:  $\frac{1}{2}$ % FS  
TEMP RANGE:  $-25^{\circ}C$  TO  $+85^{\circ}C$   
IMPEDANCE: INPUT:  $100K\Omega$   
OUTPUT:  $500\Omega$

**\$219**  
(1-9)

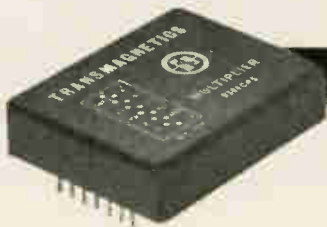

## WIDE BAND VERSION

MODEL **9380**  
CP5

GAIN: FLAT TO  $\frac{1}{2}$ % DC — 15 KHz  
PHASE:  $<1^{\circ}$  AT 15 KHz  
BANDWIDTH: 3 DB AT 30 KHz  
SIZE:  $\frac{3}{4}$ " X  $3\frac{1}{8}$ " X  $3\frac{3}{8}$ "  
STABILITY: ( $\pm 200$  PPM  $\pm 0.5$  MV)/ $^{\circ}C$   
TEMP RANGE:  $0^{\circ}C$  TO  $+70^{\circ}C$

**\$335**  
(1-9)

ULTRA-MINIATURE MULTIPLIERS  
2.6 CU. IN. MODELS  $-55^{\circ}C$  TO  $+85^{\circ}C$   
MODELS 350MP4, 9380MP4

### ALSO AVAILABLE

MODELS 9743CP5 $\sqrt{X^2 + Y^2}$	MODELS 9752CP2 SQUARER
9742CP5 ROOT MEAN SQUARER	9748CP2 SQUARE ROOTER
9480CP5 DIVIDER	9749CP5 $\sqrt{X^2 - Y^2}$

NEW CATALOG 675 NOW AVAILABLE SEE OUR PRODUCTS IN EEM

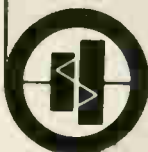

**TRANSMAGNETICS INC.**

134-25 Northern Blvd., Flushing, New York

Tel.: 212 539-2750

TWX 710 582-2472

ter in Lake Ronkonkoma, operates along the same lines. It processes beacon radar data and paints electronically generated alphanumeric tags next to the target blips on the radar scope. The tags have numerals to show which transponder code the plane is using, and can call out its altitude if the plane has an automatic altitude reporting capability.

In many ways the AN/TPX-42 interrogator will be similar to a beacon data display system Whitaker tried unsuccessfully to sell the FAA more than four years ago. The system was sold to West Germany and several other European countries, giving their ATC systems an altitude-determination capability that has yet to be achieved in the U.S.

**Safety valve.** A three-dimensional radar system could serve as a backup for the beacons, feeding radar-derived altitude and azimuth information to the ATC computer for storage and comparison with beacon data. In the event of garbled, overlapping, or unsynchronized returns, the computer would display the radar data to the traffic controller. It would automatically display azimuth and altitude information on all aircraft in the area, including private and business planes, which don't carry beacon transponders.

Three-dimensional radars suitable for airport traffic control have been built by the Maxson Electronics Corp., the Hughes Aircraft Co., Avco Corp., and ITT Gilfillan. Any of these companies could install a complete 3-D radar backup system at a major U.S. airport for less than \$2 million.

Perhaps the most neglected area of air traffic control is ground control. Systems to guide a plane quickly and safely from the landing strip to the terminal don't exist, and the FAA has no program to develop any. Meanwhile, the traffic jams around taxiways continue to cause maddening delays.

A system for the detection and control of aircraft on the runways was developed in 1960 by the Airborne Instrumentation Laboratory, and more recently, by the E.W. Bliss Co. [Electronics, May 30, 1966, p. 38]. Both systems eliminate the cacophony of radio transmission between ground controllers

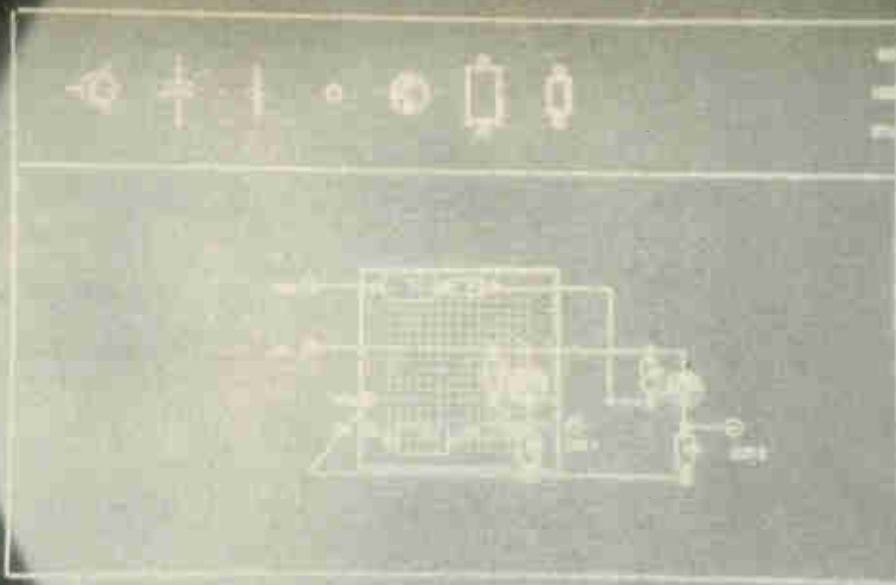

Readouts clear up problems.

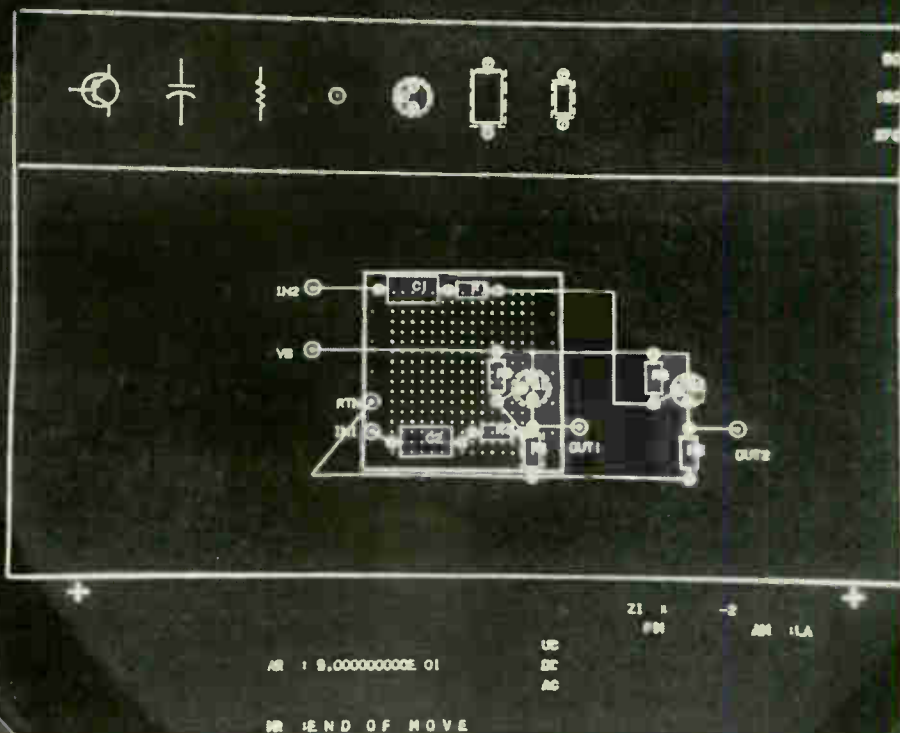

Polaroid circular polarizers clear up readouts.

It's never a problem to read readouts if they're equipped with Polaroid circular polarizers. Our polarizers improve readability from every angle by increasing contrast. In daylight. Or even in brightly lighted rooms.

But now you don't have to take our word for it. Send for our new brochure, and we'll include 3 samples of our circular polarizers (amber, neutral, and green). They'll help you see very clearly why many major display and

instrument manufacturers are now using Polaroid circular polarizers.

Write Polaroid Corporation, Polarizer Sales, Department 59, Cambridge, Massachusetts 02139.  
**Polaroid Circular Polarizers.**

This is the world's **SECOND** smallest power supply



Here's the **FIRST**

(Both are rugged, reliable and ready **NOW** for Advanced Aerospace Systems)

These new Bourns Power Supplies are not only the smallest available, they are the toughest! Both are specifically designed for advanced instrumentation systems where miniature size and exceptional environmental performance are mandatory. The 1/2 cubic inch Model 3960, with an output of 5VDC and 0-100mA, is ideal for multiple transducer excitation; while the even tinier Model 3965 (5VDC, 0-5mA) is suitable for single transducer use.

Both models feature a completely isolated and regulated DC output. Carefully designed circuits insure protection from reverse polarity, short circuits, and overvoltage. Bourns extensive experience in molding of plastics has resulted in sealed modules impervious to moisture and salt spray. Other outstanding environmental characteristics are wide temperature range of -55 to +100°C, 100 G shock and 20 G vibration. High quality microminiature components are used throughout the modules. Bourns Model 4210 Microtransformer is used in the converter circuits and a small TRIMPOT® potentiometer adjusts the output voltage.

Bourns famous Reliability Assurance Program guarantees performance by thorough inspection and test of each unit and by periodic requalification to all published specifications. All units receive a 100-hour burn-in prior to shipment for added reliability.

TRIMPOT® AND PRECISION POTENTIOMETERS—RELAYS—MICROCOMPONENTS: TRANSFORMERS, INDUCTORS, RESISTORS AND CAPACITORS  
Circle 148 on reader service card

As for delivery, these units are SHELF STOCKED. Convince yourself how good these power supplies are. Send for detailed technical data. Certified test data is available on request.

**SPECIFICATIONS**

	Model 3960	Model 3965
Input Voltage Range	24-32 VDC	24-32 VDC
Nominal Output Voltage	5.000 VDC	5.000 VDC
Adjustment Range	4.9 to 5.2 VDC	4.8 to 5.2 VDC
Load Current	100 mA	5 mA
Line Regulation, 24-32V	0.1%	0.3%
Load Regulation	1.0%	Not applicable
Temperature Shift, max. -55 to +100°C	0.01% /°C	0.01% /°C
Output Isolation at 100V	1000 megohms	1000 megohms
Size	1" x 1" x .50"	.73" x .5" x .52"
Weight	0.60 oz.	0.24 oz.



BOURNS, INC., TRIMPOT DIVISION · 1200 COLUMBIA AVE., RIVERSIDE, CALIF.  
PHONE (714) 684-1700 · TWX: 714-682 9582 · CABLE: BOURNSINC.

## ... powerful special-interest groups exert opposing pressures on the FAA ...

and pilots by displaying surface aircraft movements on a panel in the control tower. Pilots get directions from lights at runway intersection.

### III. Political pros and cons

The problem of air traffic control is closely linked with politics and the bureaucratic nature of the FAA. "This is the price we pay for democracy," says one critic of the agency.

Right now, it doesn't look as if this situation will change soon. Several months ago, the FAA was merged into the new Department of Transportation, and the union is off to a rocky start. Transportation Secretary Alan S. Boyd has clashed with FAA Administrator William F. McKee over minor administrative matters, and there is

minimum cooperation between the agencies' officials on the lower level.

**Sunny side.** Some optimists like Mollenauer feel that the FAA's new status will help aviation generally. "One basic effect of our being the Department of Transportation" Mollenauer says, "will be the requirement to interface our own research and development activities with other transportation activities, such as airport-to-city communication."

Air traffic woes are further exacerbated by the often opposing pressures exerted by powerful special-interest groups. For example, the Aircraft Owners and Pilots Association, with 138,000 members operating some 80,000 private aircraft, has a smoothly functioning lobby in Washington. This group, although in favor of modernizing

ATC techniques, is against what it terms "unwarranted" control. It opposes any moves that would require plane owners to install expensive equipment to fit in with sophisticated control systems.

On the other hand, the Air Transport Association of America, the airlines' trade association, is backing the "secondary radar" plan, which would involve the installation of costly transponders in all aircraft.

"All in all, the matter of crowded skyways is grossly exaggerated," says Victor J. Kayne, vice president for policy and technical planning of the Aircraft Owners and Pilots Association. "Yes, there is congestion at terminals, but a lot of it is the result of airlines' scheduling flight departures at the same time."

Kayne points out that the FAA's computerized system isn't fail-safe. He claims that at least 15% of the flight plans which are fed into traffic control computers are "lost somewhere."

### Editorial

## FAA: the worst agency

The Federal Aviation Agency was born on Jan. 1, 1959 amid great expectations, noisy fanfare, and an atmosphere of crisis. The crisis had arisen two years before when a TWA airliner crashed into a United Air Lines plane over the Grand Canyon, killing all aboard both planes. The accident brought home the fact that crowded air- lanes were becoming as hazardous as the highways.

The new agency replaced the Civil Aeronautics Administration, which had shepherded commercial aviation from the era of barnstorming over cow pastures to an age in which it ranked as the largest commercial carrier of travelers in the U.S. But in the process, the CAA had worn out. Its staff was exhausted from battling bureaucracy and lobbies, and was steeped in the attitudes of the Depression years. Its last administrator, James T. Pyle, an energetic executive frustrated by the staff's lethargy, ineptitude, and stolidity, complained bitterly in 1958 that he had tried unsuccessfully for two years to fire one incompetent employee as a first step toward overhauling his ineffectual agency.

The CAA was beyond rehabili-

tation. A new agency had to be created to tackle the critical problem of air traffic control with fresh people, bright ideas, new technology—and big money.

Its predecessor had been a poor-relation kind of agency. Most of its equipment was hand-me-downs from the military services, or outright rejects. CAA staff members had found that innovation meant trouble: every "new" piece of equipment the agency's air traffic controllers received usually meant that another piece of junk had been unloaded on them.

The new FAA would be different. It would be technically oriented, have its own strong development staff, and operate its own research facilities.

With the formation of the FAA came a giant blueprint to control air space automatically. But barely had the blueprint been drawn up than the critics took aim at it. Controllers thought it would undermine their traditional king-pin role; commercial airline pilots felt it didn't recognize that the real kingpin was the man flying the plane; private plane owners rallied to battle any proposal that might weaken freedom of the air

—their freedom to go anywhere, anytime.

Although the infant FAA made an effort to recruit some talented and dedicated staffers—and did in fact hire a few such people—it also took on large numbers of old CAA personnel. Outnumbered, the new people were unable to offset the torpor of the oldsters, and their spirit soon wilted.

The new people might have had a chance if the FAA had ever had aggressive management. But its top staff has always been more interested in politics, placating pressure groups, and not rocking boats than in air safety or technical accomplishment. The good people spin their wheels.

Of all the thousands of Government agencies, it would seem almost impossible to rate one as the worst. Yet technical men who have studied the air traffic control problem are willing to give that malodorous distinction to the FAA. The agency, born to perform great feats of technical innovation, has turned out to be weak, ineffectual, unimaginative, and apathetic.

The threat of mid-air collision hanging over the U.S. when the FAA was formed is still with us—only worse than ever. And the FAA is as far from coping with this threat as it was on the day it was founded.

# Bird in a gilded cage

Earthbound until its design accommodates sponsors' diverse objectives, multipurpose navigation satellite could open lush electronics markets

By Paul Dickson

Washington regional editor

Although the need for navigation/traffic control satellites has been clearly established and preliminary technical objectives appear within reach, the program may never get off the ground. A lot of give-and-take will be necessary to reconcile the widely variant aims of special-interest groups that will be using the system.

To a great extent, the fate of the system depends on the ability of

prospective users to agree on common goals. While there are no outspoken critics, there are those who offer earlier, single-purpose alternatives. It could well be that U.S. sponsors could wrangle so long that attractive substitutes will be developed. Already, the Communications Satellite Corp., for one, is pushing hard for a division of labor. It is studying the possibility of launching a satellite to provide

surveillance of aircraft for air-traffic control. In addition, although twice rebuffed, Comsat plans on renewing its pitch to the Federal Aviation Administration for a very-high-frequency communications satellite that would link aircraft, ground stations, and the spacecraft. "Should nothing be done with aircraft communications until positioning techniques are established?" asks E.J. Martin, manager

## UNEXCELLED QUALITY FOR LESS THAN 4¢

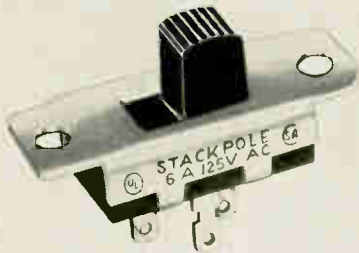

- Rated from 1 to 10 amps with full UL AND CSA approval.
- 7960 slide switch combinations — 23 basic types.
- New rugged solder lug terminal, designed for use with quick connectors.
- Uniform quality assured by automated assembly.
- Electro-silver plated terminals and contacts—shorting and non-shorting.
- Phenolic or nylon triggers in a variety of colors.
- Write for engineering bulletin.



**STACKPOLE**  
CARBON COMPANY  
Electro-Mechanical Products Division  
Johnsburg, Pa. 15845

## UNIQUE DESIGN ADDS VALUE AND APPEAL

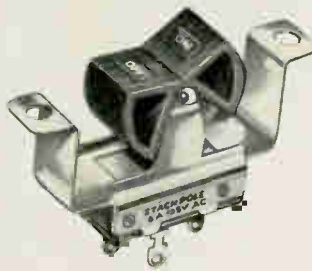

- 23 rocker switch configurations, including 2-3 positions, spring return and center-off.
- Variety of rocker designs available in a spectrum of colors and hot-stamped lettering.
- 1 to 10 amp UL AND CSA ratings at 125V and 250V.
- Solder lug, space saver, quick-connect or printed circuit terminals.
- Field-proven quality same as famous Stackpole slide switches.
- Prices start at less than 15¢.
- Write for engineering literature.



**STACKPOLE**  
CARBON COMPANY  
Electro-Mechanical Products Division  
Johnsburg, Pa. 15845

## ENVIRONMENT PROOF ROTARY SWITCHES



Series 600 1 3/8" Dia. — Series 100 1 1/8" Dia.

- Both index mechanism and electrical sections are completely enclosed.
- Corrosive atmospheres, dust, dirt and moisture are permanently sealed out, lubricants sealed in.
- Solder or quick-connect terminals molded permanently into position minimize production damage.
- Standard index angles include 15°, 30°, 36°, 60° and 90°, special angles available on request.
- Write for engineering bulletin.



**STACKPOLE**  
CARBON COMPANY  
Electro-Mechanical Products Division  
St. Marys, Pa. 15857



of advanced systems analysis at Comsat. "The answer is that we should get communications up there as soon as we can get the birds."

Nonetheless, within the next few weeks the National Aeronautics and Space Administration will let a mission-study contract that it hopes will lead to the launching of multi-purpose satellites by the mid-1970's. Such a system, which would be designed to meet the requirements of commercial concerns, Government agencies, and the military, could prove a bonanza for the electronics industry.

**Old hat.** Single-purpose navigation satellites—earth-orbiting spacecraft from which radio doppler shift measurements can be made under all weather conditions to pinpoint the position of a ship or aircraft—aren't new. The Transit system that the Navy implemented in 1959 can fix the positions of aircraft carriers, submarines, and oceanographic vessels within a few meters. Now, the Navy plans to

expand Transit applications: it will install satellite receivers aboard more warships. In addition, the system has been successfully tested for use in aircraft and is now being studied for use in civilian maritime installations. And the Army Corps of Engineers is evaluating a man-pack system that receives signals from Transit satellites with an eye

toward using the equipment to survey uncharted land areas.

However, a need still exists for a universal system to handle the staggering number of navigation and traffic control jobs that will have to be done during the next decade and beyond. A satellite system is the obvious choice. But unlike Transit, which performs only

### Getting the word from Sputnik

Ten years ago, when Sputnik 1 became the first orbiting satellite, two scientists at the Johns Hopkins University's Applied Physics Laboratory devised a makeshift monitoring station to track the Soviet spacecraft. During the three weeks Sputnik was on the air, the two-man team plotted the signals and realized that the curve they were getting from the doppler shift of the transmissions described the satellite's orbit. After further study, they concluded that by monitoring one pass of an active satellite, orbital parameters could be accurately determined.

The findings of the two scientists, G.C. Weiffenbach and W.H. Guier, were examined by a colleague, F.T. McClure, who suggested that the process could be reversed and that the location of an earth station could be fixed if the satellite's orbit was known. Less than two years after their jury-rigged tracking station had been set up, the Navy's Transit 1-B was orbited at an altitude of 500 miles, confirming the hypothesis that an accurate positioning system based on satellite signals was feasible.

### NEW SPECIAL PURPOSE RESISTOR PROTECTION



- Currently in use on lightning arrestors, circuit breakers, spark plugs.
- Available in rods, sleeves, rings, special shapes, up to 15" in length and 5" in diameter.
- Ceramic composition favors high voltage applications with high surges.
- Organic Special Purpose Resistors are inexpensive solution where heat dissipation is necessary.
- Both ceramic and organic available in wide range of resistivity values.
- Write for technical assistance.

 **STACKPOLE**  
CARBON COMPANY  
Electronic Components Division  
St. Marys, Pa. 15857

### SOLVE NOISE AND FILTERING PROBLEMS WITH CERAMAG® FERRITE BEADS



- Ceramag® ferrite beads are low cost, easy to install, and save space.
- Effective r.f. decoupling, shielding and parasitic suppression without sacrificing low-frequency power or signal level.
- Installed by simply sliding one or several over conductor leads.
- Beads can, but need not, be grounded.
- Sizes from .040" ID — .100" OD — 100" L.
- Sample quantities available.

 **STACKPOLE**  
CARBON COMPANY  
Electronic Components Division  
St. Marys, Pa. 15857

### GUARANTEED UNIFORMITY IN ELECTRICAL, PHYSICAL CHARACTERISTICS

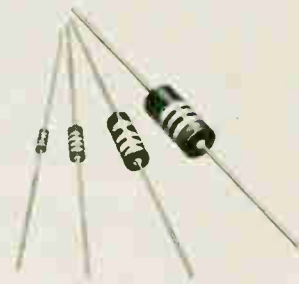

- Available in 2, 1, 1/2 and 1/4 watt sizes.
- Uniform from resistor to resistor, order to order.
- 100% tested for resistance value.
- Same day shipment on 9 orders out of 10.
- Solderability, load life and humidity-temperature characteristic checked.
- Impregnated to assure moisture resistance.
- Write for literature.

 **STACKPOLE**  
CARBON COMPANY  
Electronic Components Division  
Kane, Pa. 16735

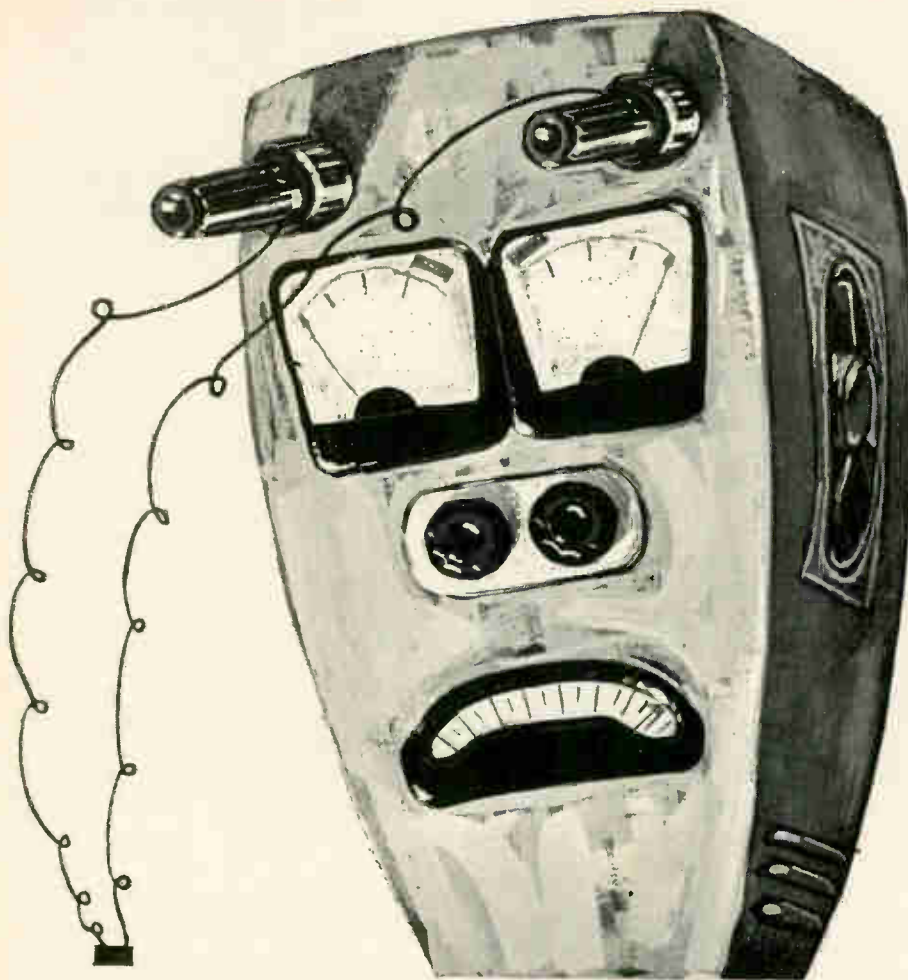

## IS A MONSTER FEEDING YOUR BABY?

If "baby" is a modern IC package, then it's all too likely that the associated power supply is a big, old-fashioned monster. This needn't be so — because now you can re-fashion baby's power source to Technipower's new family of state-of-the-art power modules! High frequency power transformation puts efficiency way up around 80% — in dwarf-size packages — priced to fit your budget!

### DESIGNED AND BUILT AS THE POWER SUPPLIES FOR MODERN MICRO MODULAR SYSTEMS

**HF-80 Series:** 30 Models, AC to DC, 4 to 60 VDC and up to 30 Amps. 0.1% line and 0.3% load regulation, 0.3% rms ripple, 2:1 adjustment range. Power to 360 Watts, Package densities in the order of 1.5 watts/in<sup>3</sup>, and prices start at just \$100.

**HFT-80 Series:** 4 Models, AC to DC, 2.5-10.5 VDC and up to 100 Amps. 0.1% line and 0.3% load regulation, less than 30 mv rms ripple, 2:1 adjustment range. Size for 100-Amp models is no larger than the average car battery.

**CF-80 Series:** 18 models, DC to DC, 4 to 60 VDC and up to 6 Amps. 0.1% line and 0.3% load regulation, 0.3% rms ripple, 2:1 adjustment range, full input to output isolation. Unique flat-pack cases for chassis or card bin mounting.

**CM-95 Series:** 14 models for DC to DC point of load regulation, up to 24 VDC and 1.5 Amps. These ice-cube size modules offer 0.5% regulation with 200:1 input ripple reduction, adjustable output voltage, short circuit protection, with either positive or negative output available. Best of all the price is just \$30 for any model, and much less in quantity.

Complete description, specifications, and prices are in the new 60 Page Technipower Catalog #671, available now. Ask your rep for a copy or write direct.

The catalog also gives you a complete fill-in on about 4000 power modules — none by any means out-of-date.

# TECHNIPOWER

A BENRUS SUBSIDIARY

RIDGEFIELD, CONNECTICUT 06877 PHONE 203-853-1201

... aviation services  
are most urgent ...

a single task for a single agency, it will have to be a jack-of-all-trades.

### I. Multifunctional

The space agency is overseeing the early stages of the navigation/traffic control satellite program. Eugene Ehrlich, program manager, says the system's general mission will be to provide useful services for ships and aircraft moving from one point to another. Although subject to additions and deletions, his list of specific system capabilities now includes:

- Position determination to an accuracy of one mile or better depending on users' needs.

- Communications between aircraft and ground stations and, possibly, open channels for passenger use.

- Traffic control; a combination of position fixing and communications services to enable ground-based controllers to space aircraft closer together.

- Collision-avoidance provisions for aircraft: a central station to monitor satellite data on positions and to caution planes using the same airspace via the satellite.

- Search and rescue; a central station to get an accurate fix on disasters and dispatch the ships or aircraft nearest the scene.

- Radiation warning for supersonic transports; solar cosmic ray detectors to transmit a signal from the satellite whenever the energy of incoming particles exceeds a certain level.

- Weather watch; sensors installed on aircraft to receive data and transmit it to ground controllers who would then use it as an aid in suggesting routes for both planes and ships.

**Crowded skies.** Generally acknowledged as the most urgent services, however, are those pertaining to aviation—specifically, air traffic control and communication. A 1964 FAA report on air traffic control over the North Atlantic warned that existing systems are inefficient, unwieldy, and would reach saturation within a few years. Rules calling for 120-mile and 2,000-foot separation between aircraft—necessary

because of inadequacies in the present system—cannot be eased until better means of navigation are developed. The advent of jumbo and supersonic transports and the over-all growth rate of aviation compound the problems.

The Philco-Ford Corp. is conducting an aeronautical systems-engineering study for Comsat. Among other things, the report—due in November—will include the results of a computer analysis of flight scheduling. Barry Mendoza, who is directing this work, says the number of flights daily across the Atlantic will double by 1975 as will those across the Pacific. In what Mendoza calls the vhf gap—the area outside the 300-mile effective range of vhf stations—traffic density is an increasingly acute problem. Planes operating in these dead areas are forced to rely on high-frequency radio—a notoriously unreliable communication medium.

## II. Preliminaries

In view of the critical nature of the problems involved, NASA is considering requesting funds for its fiscal 1969 budget to underwrite the satellite program. But the first step is the awarding of the eight-month mission-study contract. "The contractor, or contractors, will identify and evaluate various types of systems and determine which configuration has the best prospects," says Ernest Steele, project manager at NASA's Electronic Research Center. "They will point out deficiencies in existing technology and define what should be developed to implement the most promising approach."

**Roster.** There are 12 contenders for the contract, including the Adcom Corp., Communications Systems Inc., Cornell Aeronautical Laboratory, the Cubic Corp., the General Electric Corp., the Hughes Aircraft Co., the International Telephone & Telegraph Corp., the Lockheed Aircraft Co., the Martin Marietta Co., the Radio Corp. of America, TRW Inc., and the Westinghouse Electric Corp.

Ehrlich is hopeful there will be a national policy on the satellite program the following summer. Among those scrutinizing the study will be representatives from the Pentagon, the Department of



# μWATT 'TIME SINK' CIRCUIT GIVES SUBTOTALS AND TOTALS

Problem: measure the operating time of major components of a system, while also summing the operating time of the system. The old way: use two parallel meters, with their readout gears. The new way: use the Bissett-Berman E-CELL\* "time sink" circuit below for a total up to 1000 hours (which can be read out in 30 minutes), in a matchbox-size package that: uses only 1/100 watt-hour; has no moving parts; withstands mil spec shock and vibration; and is directly compatible with solid-state circuitry. Cost? a fraction of just one of the meters. Try it yourself!

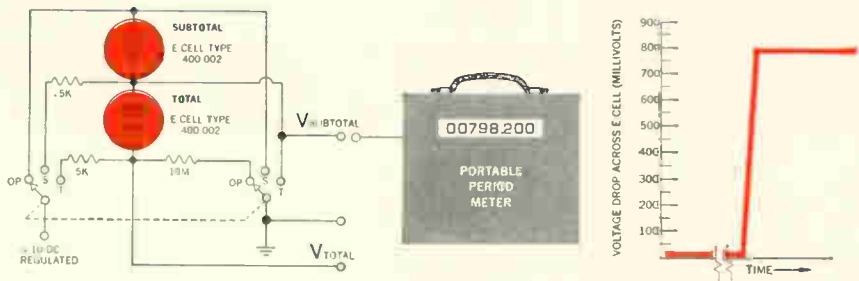

\* The Bissett-Berman E-CELL™ is a unique "liquid state" electrochemical timing and integrating component now being manufactured in high volume on fully automatic production lines. E-CELLs are designed for single use or re-cycling, can be set or re-set in the field, and are furnished in wire-lead or plug-in versions. A multiple-electrode E-CELL enables complex functions such as two-phase timing — or subtotalling and totaling — with



Actual size

signal outputs at each step E-CELLs can generate accurate time delays ranging from a fraction of one second to months; can integrate events from one to infinity; and can operate in the nanowatt range. Operating/storage temperature is  $-55^{\circ}\text{C}$  to  $75^{\circ}\text{C}$ . E-CELLs have been tested and approved by users for severe shock and vibration tolerance in accordance with military specifications. Patents applied for.

For technical information and application notes, contact: Components Division, The Bissett-Berman Corporation, 3860 Centinela Avenue, Los Angeles, California 90066; Telephone: Area Code 213, 390-3585.

**BISSETT  
BERMAN**

# mary alice just turned ten

...but she takes perfect 5-digit  
potentiometric readings in seven seconds!



**FIRST—SET POLARITY**  
If necessary . . . the arrow tells you!



**THEN—SET RANGE**  
If necessary . . . just follow the arrow.  
Decimal point lights automatically.



**THEN—BALANCE DIGITS**  
Arrows show you how, digit by digit,  
up or down.



**READ OUT RESULT**  
Only properly balanced digits will light.  
Typical balancing time, 6-7 seconds!



Child Prodigy? No, Mary Alice is a darling, but her mind's just average. However—she's using a Biddle MENTOR™ Logic-Assisted Potentiometer, the world's first and only decision-free, error-prohibiting differential voltmeter.

All she does is to follow the lighted arrows (see film strip). Until she balances a digit correctly, it won't light up. If she goofs, an arrow guides her back on the track. Which arrow? No problem—only one lights at a time!

What we did was to take one of our modern standards-lab potentiometers, peel off the sixth digit, and add a simple (but fairly clever) logic circuit for the arrows...so that

Mary Alice could read to 100PPM as easily as an engineer.

It took Mary Alice less than two minutes to become a zero-defects potentiometrist. We think the grown-up girls on your production test line might do even better. Following the arrow is really child's play.

Biddle MENTOR instruments will restore your faith in the human eye, hand, and brain . . . save you thousands of dollars per test position per year . . . and return "confidence," "speed" and "efficiency" to your production-test vocabulary. *Call or write for literature . . . or for a completely convincing demonstration.*

"MENTOR" is a trademark of the James G. Biddle Co. for certain of its electronic instruments, for which patent applications have been made.



**JAMES G. BIDDLE CO. / PLYMOUTH MEETING, PENNSYLVANIA 19462**

(Area Code 215) 646-9200

Circle 154 on reader service card



## ... each agency sees the project in a somewhat different light ...

Transportation, the Treasury, the Department of the Interior, and the Commerce Department.

The interagency group will also have at its disposal the results of a two-year study of navigation satellites now being conducted by the National Academy of Sciences. Heading the study is Peter Sandretto, director of engineering controls at IT&T. He says, "The navigation and traffic control needs of three eras will be studied and related to satellite programs." Periods to be reported on are the present through 1975, 1975 to 1982, and 1982 and beyond.

**Diversity.** Keeping a close watch on the program's progress is David Rose, technical director of display and navigation systems at Westinghouse's Baltimore, Md., opera-

tion. "Each agency sees this project in a different light," he says. "The FAA, for example, is looking for a traffic control setup that will tell it everything, while the military wants a system in which nobody knows the position of its ships and planes."

**Guidelines.** The agencies seeking to establish a national policy on navigation/traffic control satellite systems will—at least to an extent—have their own precepts as guidelines. In May 1966, after two years of deliberation, the Ad Hoc Joint Navigation Satellite Committee reported aviation needs were pressing and certain marine services desirable.

Rejecting the idea of a satellite solely for position determination as too costly, the committee did rec-



**Riding herd.** Eugene Ehrlich manages NASA's navigation satellite program.

ommend that a "system utilizing satellites combining communication, air traffic control, and navigation functions—either separately or in combination with nonsatellite techniques—should be investigated further." The group also recommended NASA as the focal point for future requirements in this area. According to Ehrlich, the needs of the various agencies have been considered in framing proposals for the program.

### III. Perfect attendance

After a national policy is determined, attention must be given to including private industry, foreign nations, and international organizations. Says Ehrlich: "We will have to have all or nearly all peoples cooperating in the project. For search and rescue we must have all or nearly all ships in the system and, of course, the same goes for air-traffic control. It would just about be impossible to have only some aircraft involved in such a program."

The political factors aren't lost on industry. Comsat's Martin is particularly concerned about participation: "If we are to introduce a system for air traffic control in which separation standards are changed we must have 100% participation. Even if the decision to go ahead were given tomorrow and the designs were complete, a system couldn't be operative until 1975." Ehrlich is optimistic, how-



**Looking up.** The Army is evaluating a manpack system that receives signals from the Navy's Transit satellites, hoping to develop surveying equipment.

# VICTOREEN HIGH VOLTAGE VACUUM TUBES SOLVE SWITCHING PROBLEMS



Victoreen high-voltage vacuum tubes make ideal components for switching circuits . . . as series or shunt regulators . . . as deflection amplifiers . . . or as inputs to pulse forming networks. Other uses which can capitalize on their superior performance, longer life, and compactness include — dunking, clamping, and crowbar circuits

Tube illustrated above, the Victoreen 6842 pentode with plate voltages to 4 kV, is shown in a typical shunt regulator circuit with two Victoreen Corotron corona type voltage regulators. Other tubes in the Victoreen line include —

- 7683** — Triode or pentode with plate voltages to 1 kV
- VX-80** — Triode with plate voltages to 4 kV
- VX-76** — Pentode with plate voltages to 5 kV
- 7235** — Triode with plate voltages to 10 kV
- 7234** — Pentode with plate voltages to 10 kV
- VX-107** — Beam pentode with plate voltages to 15 kV
- VX-68** — Vacuum high-voltage rectifier with 28,000 PIV; application as rectifier or clipper

**VICTOREEN INSTRUMENT DIVISION**  
10101 WOODLAND AVENUE • CLEVELAND, OHIO 44104  
IN EUROPE: GROVE HOUSE, LONDON RD., ISLEWORTH, MIDDLESEX, ENGLAND



ever, and sees no reason why the international part of the program could not be worked out by the United Nations, Comsat, or by treaty. He does concede that the difficulties involved in international cooperation are greater than the technical hurdles.

#### IV. Practically there

Ehrlich feels that with funding, practical techniques and technology could be demonstrated within three years. The feasibility of both communications and position finding by satellite have already been determined. Earlier studies for NASA by Westinghouse, Philco-Ford, and GE indicated that ship and aircraft positions could be fixed by satellite on a worldwide basis [Electronics, Feb. 8, 1965, p. 79].

With position-location concepts developed, the problem becomes one of choosing among available techniques. Synchronous clocks in the satellite could transmit a ranging pulse at known intervals to a craft, enabling it to fix its position. Alternatively, fan-shaped signals could be beamed from the spacecraft. Position could then be determined by measuring the time interval between signals. In addition, interferometric antennas and a range transponder installed aboard the satellite could be used to determine longitude and latitude. A transponder on the satellite could also relay a craft's signal to a computing ground station, then return a position fix provided by conventional radio navigation aids.

But Ehrlich believes a ranging scheme employing synchronous satellites in an equatorial, or inclined, orbit holds the most promise. He hopes to see tests of ranging techniques which will use Applications Technology Satellite-1 and the ATS-C, scheduled for launch in November. Transponders in the two spacecraft will transmit signals to a ship or plane. By clocking the time the signals need to travel from point to point, position can be determined.

**Numbers game.** Another problem will be deciding on the technique that provides the most service to the greatest number of users—economically. There is, for example, no consensus on just how many satellites should be employed. Initially, GE proposed 24 for world-

wide coverage; Westinghouse recommended eight. The Navy's Transit system operates with three.

The practicality of communication satellites and aircraft has been demonstrated in experiments with Syncom-3 and ARS-1. Ehrlich says the navigation traffic control project will use the ultra-high-frequency L band—1,540-1,660 megahertz—because it is an available area of the spectrum, will not interfere with existing vhf operations, and utilizes high-gain satellite antennas. Electronics in general and the aircraft antenna in particular are hurdles that must be overcome in developing an L-band system.

"Gain estimates for an L-band antenna fall in the 12- to 25-decibel range," says Raymond Spence, the FAA's chief of voice communications systems. "This necessitates a steerable, directional array on the aircraft. There is simply no such animal today and while we have no doubt that one can be produced, there will be some fairly ticklish technical considerations in getting one that will ride on an aircraft." Once developed, the equipment must be retrofitted on existing aircraft. Philco-Ford's Mendoza says: "Even if design problems were attacked immediately and there were an acceptable design by 1971, it would take from four to five years for retrofit." According to Mendoza, aircraft manufacturers want to know now what kind of harnesses to design for the communications equipment in future aircraft.

**Within reach.** The FAA will ask for funds in its fiscal 1969 budget for an L-band system, and according to Spence, NASA may help in the development of a communications system. The FAA is now encouraging several electronics firms—including Texas Instruments Incorporated, Westinghouse, and Sylvania Electric Products Inc., a subsidiary of the General Telephone & Electronics Corp.—to work on L-band projects on an in-house basis.

Satellites for the program are envisioned by Ehrlich as ones which will either be stabilized by a three-axis gravity subsystem, to be tested on the ARS-D that is scheduled for launch in 1968, or by an active control system of the kind used on the Nimbus 2. Solar cells will provide the power required for the electrical system.

# We've got good connections in high places



Surveyor, Mariner, F-111, OGO, X-15, Apollo, LEM, and most other high flying programs rely on Cinch-Graphik printed circuitry for dependable electronic interconnections. The lunar surface, or 6000 miles above Mars, isn't the place to find out that circuitry doesn't perform to specs. That's why Cinch-Graphik maintains complete in-house facilities for NASA and MIL Spec testing. Cinch-Graphik's unequalled competence in producing single and multilayer printed circuits to these stringent requirements uniquely qualifies them to produce circuits for applications where "it has to be right."

## CINCH-GRAFIK

D I V I S I O N   O F   U N I T E D - C A R R



200 South Turnbull Canyon Road, City of Industry (Los Angeles), Calif. 91744 • Phone (213) ED 3-1201. Sales offices in 33 principal cities throughout the United States, Great Britain, Canada, Australia and West Germany.

CONSISTING OF CINCH MANUFACTURING COMPANY, CINCH-GRAFIK, CINCH-MONADNOCK, CINCH-NULINE, UCINITE (ELECTRONICS) AND PLAXIAL CABLE DEPT.

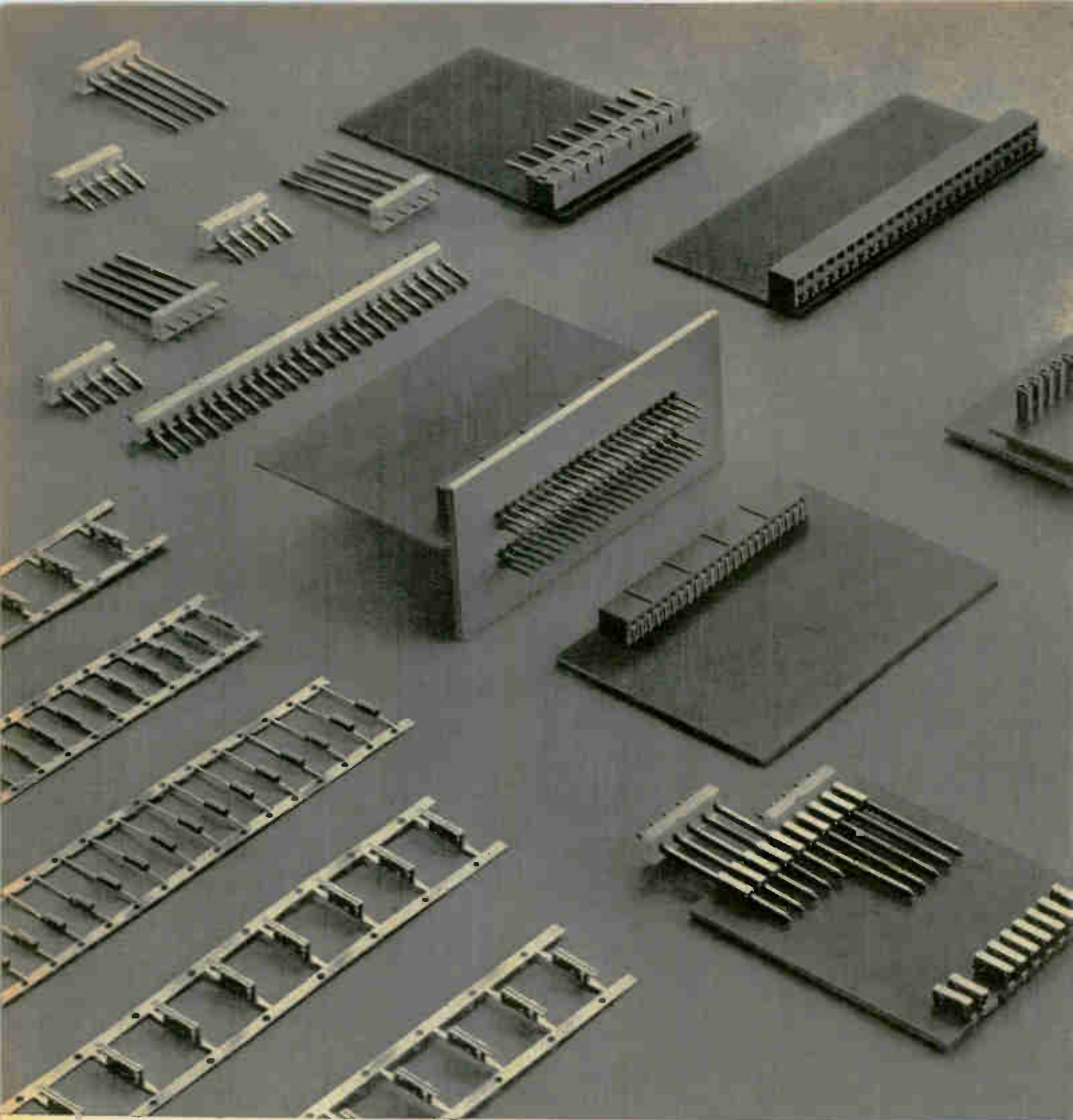

## Go modular the easy way

This entirely new approach to modularization is the AMPMODU\* Interconnection System. It permits almost unlimited design flexibility, high production speed, and economies resulting from automation and low per line cost.

Specifically designed for modular applications using printed circuit boards, it enables mounting module cards at 90° to a mother board, stacking them, or putting them end to end. The female contacts may be staked directly to a printed circuit board or enclosed in molded housings. Male contacts may be staked directly to a printed circuit board, used in nylon incremental connectors, or mounted with nylon bushings in aluminum grid plates. Two sizes of contacts are available: the standard size, which uses .031 x .062" posts for mounting on .156" centers, and the miniature size, which uses .025 x .025" posts for mounting as dense as .100". Electrical and mechanical efficiency are enhanced by the simplicity of the female contact design, which includes dual cantilever-beam springs for redundant contact action and anti-overstress devices to ensure reliability. The long life of the phosphor bronze contacts is a result of AMP's special gold plating.

New modular ideas don't have to dead-end at the design stage. For information on how you might use the AMPMODU Interconnection System to modularize your product and lower your costs, write us today.



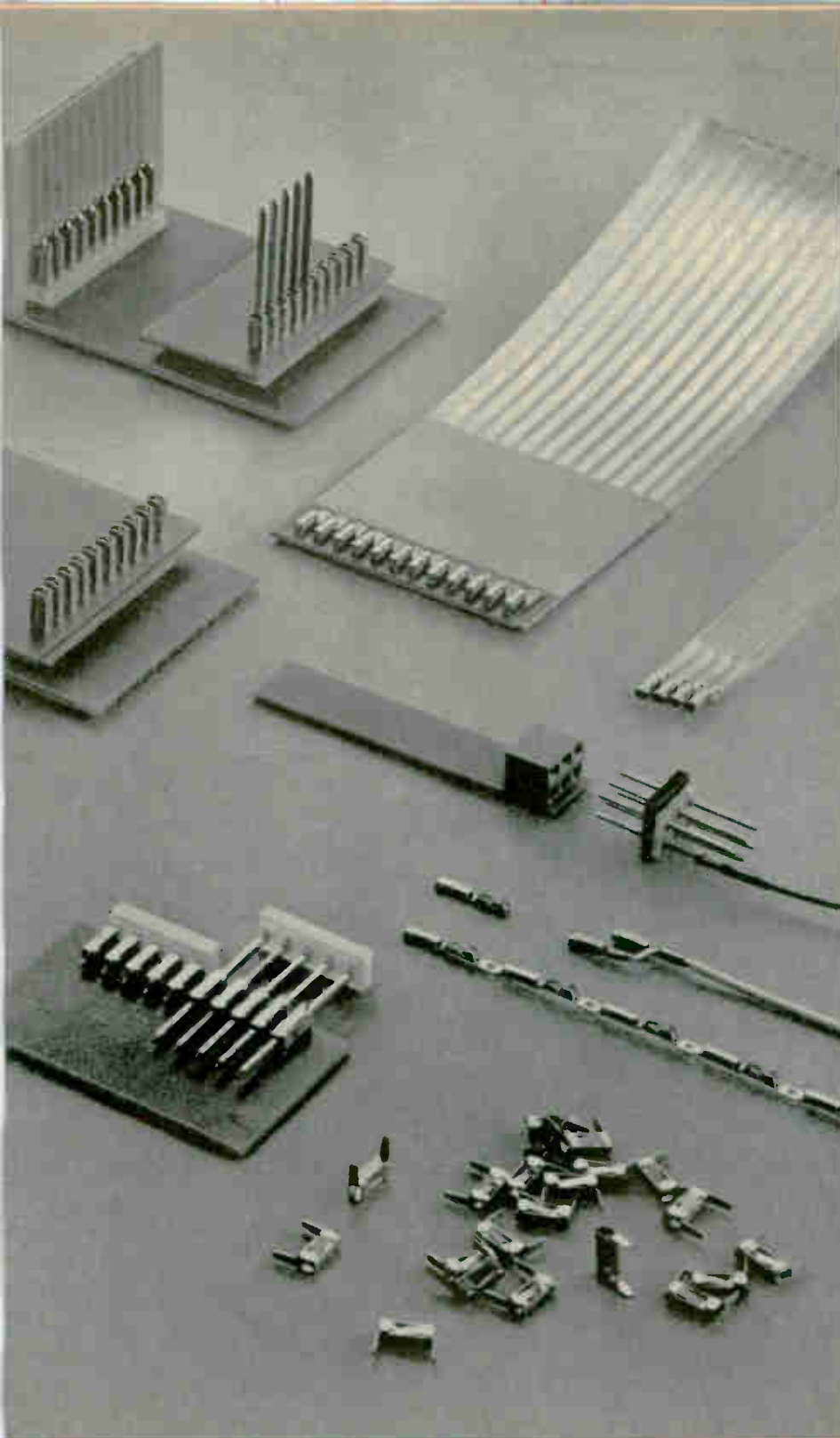

Automatic machines can stake contacts to printed circuit boards at rates of up to 1800 an hour

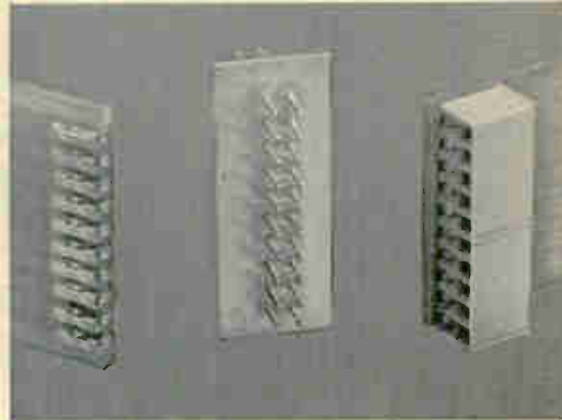

Miniature AMPMODU contacts may be mounted ten to the inch

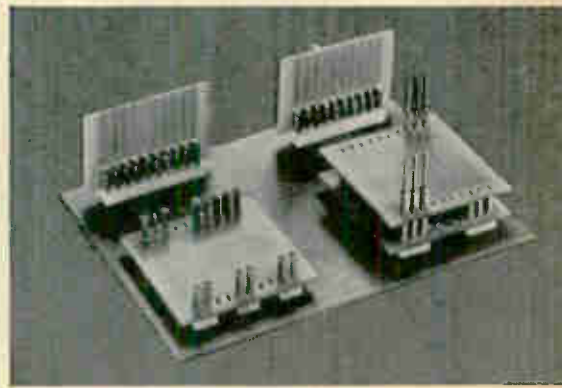

The AMPMODU female contacts may be mounted in one of three ways for modular connection versatility

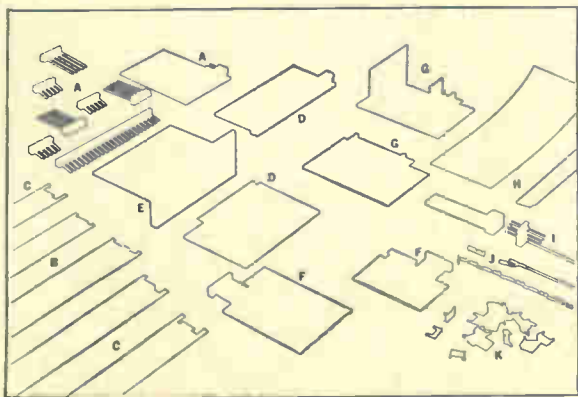

- A. AMPMODU Male Incremental Connectors
- B. Miniature AMPMODU Female Contacts in strip form
- C. Standard AMPMODU Female Contacts in strip form
- D. Miniature contacts in two-row housings
- E. Grid Plate Header
- F. Horizontally staked AMPMODU Contacts with incremental connectors
- G. Vertically staked AMPMODU Contacts
- H. Flexible tape cable AMPMODU Connectors
- I. Molded-in AMPMODU Pin Header and printed circuit board connector
- J. Miniature Crimp-Barrel AMPMODU Female Contacts
- K. Individual Standard AMPMODU Female Contacts

**AMP**  
**INCORPORATED**  
 Harrisburg, Pennsylvania

Here's the new printed circuit  
manufacturing process\*  
that eliminates costly  
through-hole electroplating  
...and opens the way to  
denser

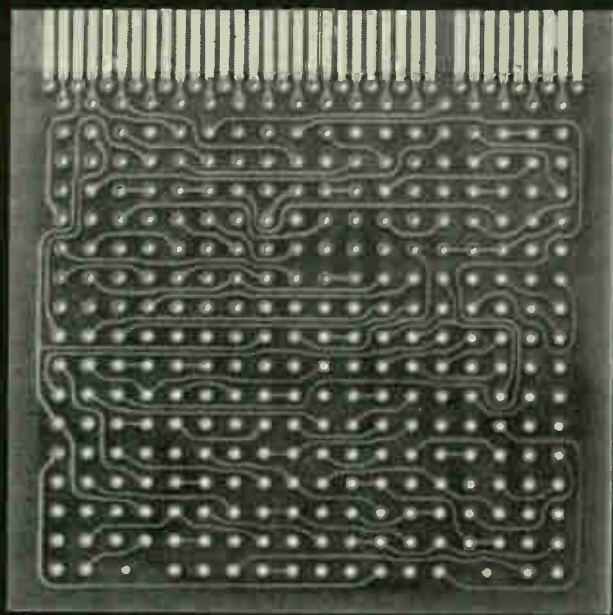

denser

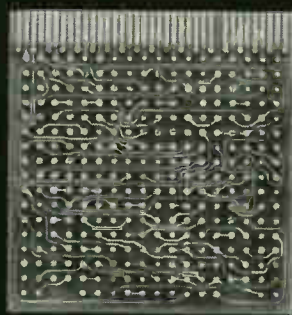

denser

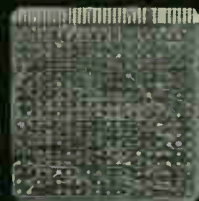

patterns for your  
circuit boards...and  
reliable IC packaging.

# \*We call it NT-1.

And the process is as simple as:

- a. A catalytic copper-clad laminate.
- b. Electroless deposited copper.
- c. A permanent non-registered solder mask.

These are the three unique Photocircuits' developments which, when combined with conventional manufacturing techniques, provide circuit boards that satisfy the denser packaging requirements of integrated circuits. Now you can have highly reliable plated-through circuit boards without the need—and expense—of electroplating.

For example: fine line patterns and small diameter plated-through holes (down to 20 mils on 50-mil centers) can now be produced at much lower cost.

That's not all. Problems which might occur in conventional plated-through boards, such as solder bridging, undercut, and slivers from

plating overhang, are completely eliminated by NT-1.

Find out more about the new process that satisfies present IC packaging requirements, and anticipated future needs as well. Mail the attached coupon today for complete information on NT-1.

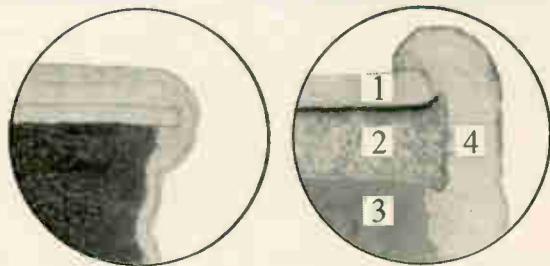

(a) Typical section of an electroplated hole, showing heavy build-up of metal plating at the orifice.

(b) Typical section of an NT-1 plated hole with uniform electroless deposition of copper.

1. Transparent solder mask.
2. Foil clad copper.
3. Catalytic laminate.
4. Electroless deposited copper.

 **Photocircuits**<sup>®</sup>  
CORPORATION

Glen Cove, New York 11542  
Phone: (516) 676-8000

\* NT-1  
Patent and Patents Pending

**Photocircuits Corporation**  
31 Sea Cliff Avenue  
Glen Cove, N. Y. 11542  
Attn: Dept. 107

Please send me literature on your NT-1 process.

Name \_\_\_\_\_

Company \_\_\_\_\_

Address \_\_\_\_\_

City \_\_\_\_\_ State \_\_\_\_\_ Zip Code \_\_\_\_\_

# 23 new TTL circuits from TI

Series 54/74 features three levels of speed and power dissipation

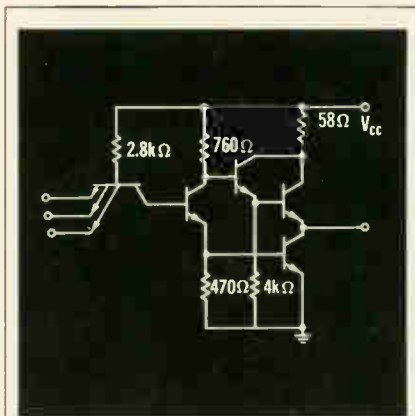

Typical Characteristics	Gate	Flip Flop
Propagation delay	6 nsec	17 nsec
Power dissipation	22 mW	80 mW
Noise immunity	1 V	1 V
Fan-out		
Standard loads	12	12
High-speed loads	10	10

**16 Series 54H/74H high speed circuits feature 6 nsec propagation delay**

This line offers the highest speed available in saturated logic... six nanoseconds per gate. Applications include critical portions of digital systems such as high speed computation and data processing sections.

Series 54H/74H circuits may also be combined with standard and low-power TTL circuits in a single system... giving you the advantage of speed where it is required while keeping system power consumption low.

Sixteen circuit functions include AND gates as well as NAND so you can design simpler less costly systems.

Circle 210 for data sheets.

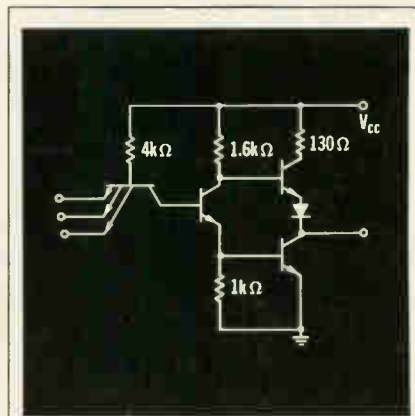

Typical Characteristics	Gate	Flip Flop
Propagation delay	13 nsec	40 nsec
Power dissipation	10 mW	60 mW
Noise immunity	1 V	1 V
Fan-out	10	10

**27 standard Series 54/74 circuits include 3 new devices for added versatility**

Standard Series 54/74 integrated circuits offer a combination of speed and power dissipation best suited for most applications. When used with the new high-speed and low-power circuits, they provide today's system designer with unprecedented flexibility... in selecting speed and power requirements.

Twenty-seven circuits are offered in the standard line, including many complex-function devices that perform up to forty gate functions. These complex-function circuits enable you to cut costs while simplifying system design and improving reliability.

Circle 211 for data sheets.

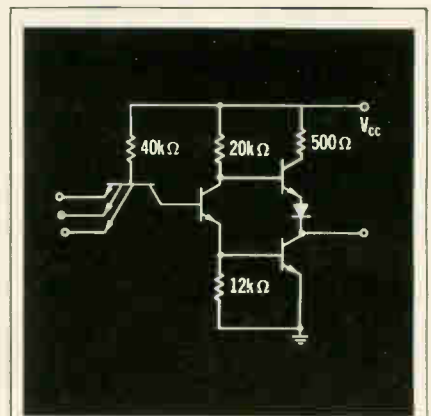

Typical Characteristics	Gate	Flip Flop
Propagation delay	33 nsec	47 nsec
Power dissipation	1 mW	3.8 mW
Noise immunity	1 V	1 V
Fan-out		
Standard loads	1	1
Lower-power loads	10	10

**New series 54L low-power circuits feature 1 mW per gate power drain**

This line of four circuits features power requirements less than one-tenth that of standard circuits... yet speeds are approximately twice as fast as other circuits with similar power dissipation.

TI's Series 54L/74L circuits are specifically designed for space systems, avionic systems and other applications where power consumption and heat dissipation are critical. They may be combined with standard and high-speed Series 54/74 circuits to provide almost any desired speed/power dissipation combination the system designer requires.

Circle 212 for data sheets.

**New standard-line additions reduce cost, improve performance of systems using Series 54/74 TTL**

With three speed ranges, three power dissipation levels, two lead arrangements, two packages, and two temperature ranges, TI's Series 54/74 family of 47 TTL integrated circuits is industry's most versatile and complete logic line. All circuits use the same 5 Volt supply voltage and all use the same familiar TTL design rules.

Here are three new additions to the standard line that open the way to further cost reductions and improvements in performance.

**SN7475 quadruple bistable latch replaces four flip flops**

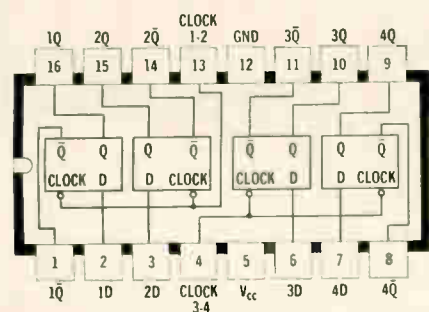

This specialized circuit was designed for readout tube applications. When used with the SN7490 decade counter and the SN7441 decoder/driver, the SN7475 will enable you to realize substantial savings in overall system costs.

This latest addition to TI's growing group of complex-function circuits features a propagation delay of 30 nanoseconds. Power dissipation is 40 milliwatts per latch.

Circle 213 for data sheet.

**SN5401 NAND gate features open collector output for "Wire-OR" logic**

This circuit enables designers to employ the economical "Wire-OR" logic function to simplify system designs. With the open collector output, the "collector-OR" function is built-in, permitting outputs to be connected directly.

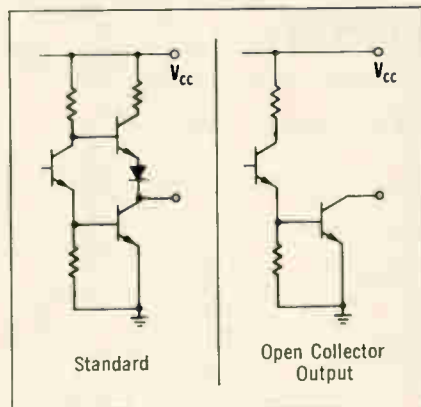

Before this circuit was developed, "Wire-OR" logic could only be used with DTL and RTL circuits. Now system designers can take advantage of this simplification and still benefit from the speed, economy and noise immunity of TTL.

Circle 214 for data sheet.

**SN5402 NOR gate reduces package count and propagation delays**

Here is a quadruple 2 input NOR gate that performs the "Not-OR" logic function directly. It eliminates the need for three or four NAND gates, making possible a 100 percent speed improvement as well as a 67 percent reduction in gate count.

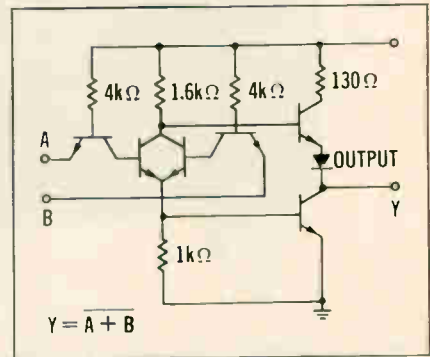

Designers may use the SN5402 with other Series 54/74 circuits ... including complex-function types ... to reduce overall system costs significantly below that possible with any other logic types.

Circle 215 for data sheet.

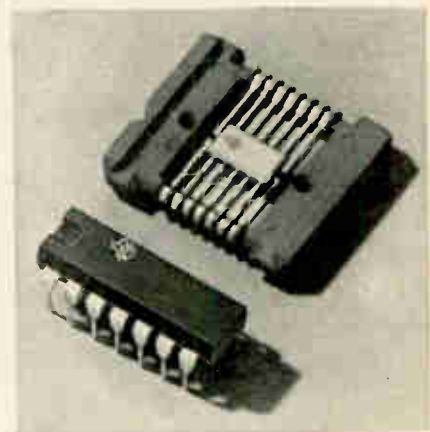

No other high-performance IC family is as complete, versatile and economical as Series 54/74 TTL from Texas Instruments. For more information, contact your nearest TI field sales engineer or authorized distributor, or write P. O. Box 5012, Dallas, Texas 75222.



**TEXAS INSTRUMENTS**  
INCORPORATED

# MATCH PROTECTOR TO HARDWARE



## An APL Circuit Protector—

will rupture a fault of 5,000 amperes at 240 volts!



provides a time delay for every demand!



is entirely magnetic — no heater elements!



Tripping coils can be completely isolated!

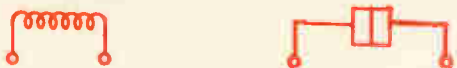

Gang every circuit together!

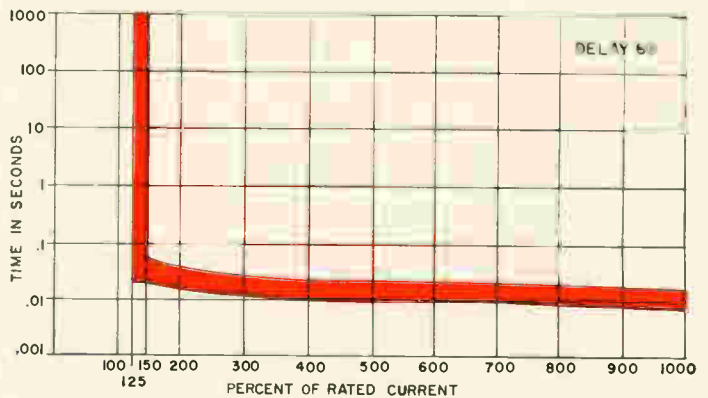
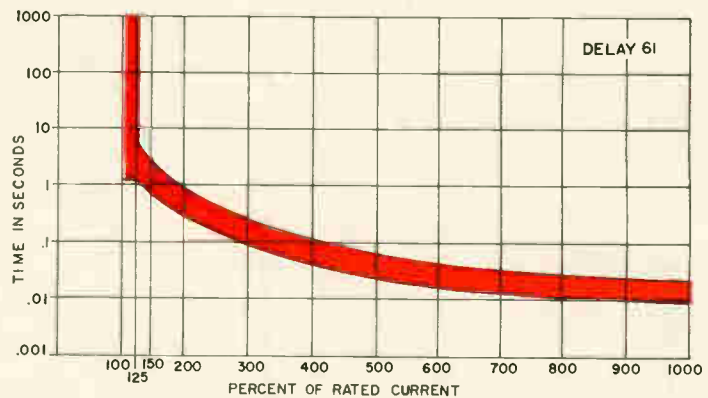
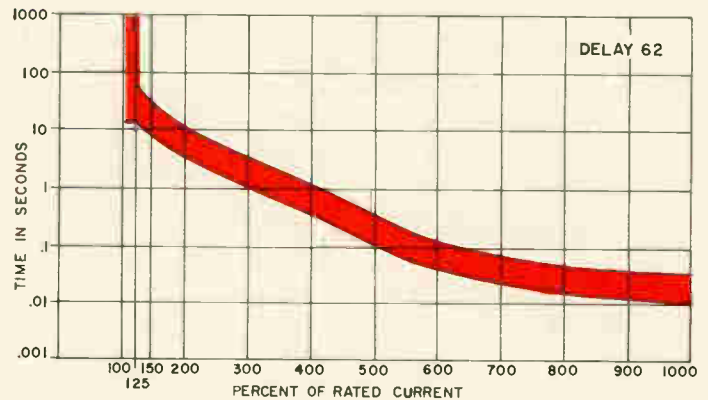
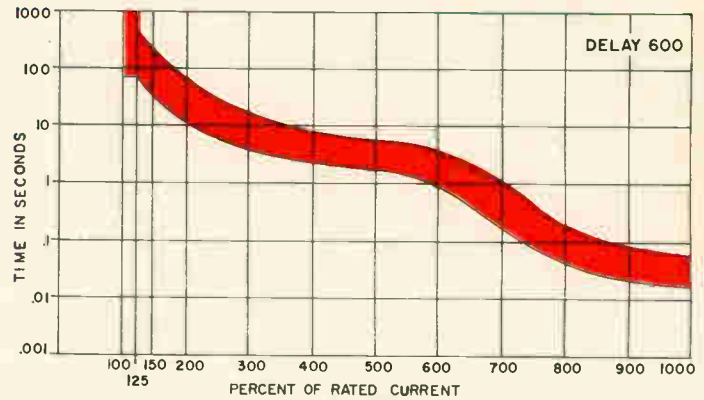
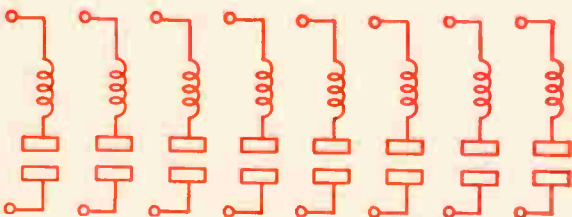

TYPICAL 60 CYCLE DELAYS

**AIRPAX ELECTRONICS**  
CAMBRIDGE, MARYLAND • 301-228-4600

# New Products

New instruments

## Digitizing synchro data faster, more accurately

Inductive dividers are used by solid state converter to maintain stability and reliability over long periods

When selecting a synchro-to-digital converter, an engineer has had to make a compromise: if he wanted great accuracy he sacrificed speed; if he wanted speed, he sacrificed accuracy.

Such a compromise is no longer required with a new synchro-to-digital converter whose speed is 100 times faster than any other on the market. By making the converter electronic, with unusual solid state circuitry instead of synchro motors, North Atlantic Industries Inc. has built an instrument that, if it were mechanical, would have the same inertia as a pinhead.

That means the device can run at very high speeds and still maintain great accuracy: 0.01° at a tracking rate of 2,000° per second in model 545. Other models have even greater accuracies and higher speeds: up to 0.001° resolution and tracking rates of 5,000° per second.

The new unit will be used in a variety of military and industrial applications where accurate information has to be fed speedily into a computer for real time or near real-time processing. It will translate analog position information from machine tools, radar antennas, telescopes, gyroscopes, and air-

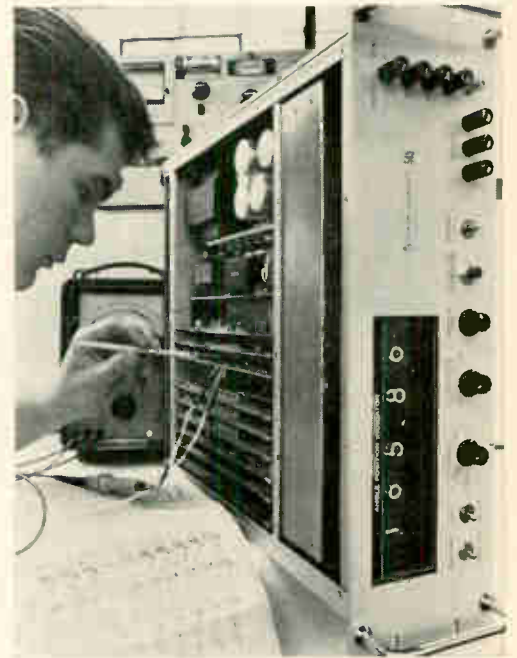

**Solid state.** Synchro-to-digital converter undergoing evaluation. Use of IC's minimizes size and weight.

craft and satellite simulators into digital format. Or it can be used on a test bench to read shaft angles accurately just as a digital voltmeter reads voltages.

**Inductive networks.** In addition to the solid state circuitry, North Atlantic's new design incorporates inductive voltage dividers instead of traditional resistive networks. Any synchro-to-digital converter that is to have high accuracy operates on a null-balancing principle; data from the resolver is fed through a Scott-Tee transformer to a bridge circuit. Accuracy depends on the stability of the dividers and the null-sensing circuit that follows.

Since the accuracy of inductive dividers depends solely on turns ratio, it isn't affected by age or temperature—a common failing of resistive networks. In addition, the high input and output impedances of inductive dividers help reduce loading errors. Over-all, compared to resistive dividers, the inductive dividers can improve accuracy and

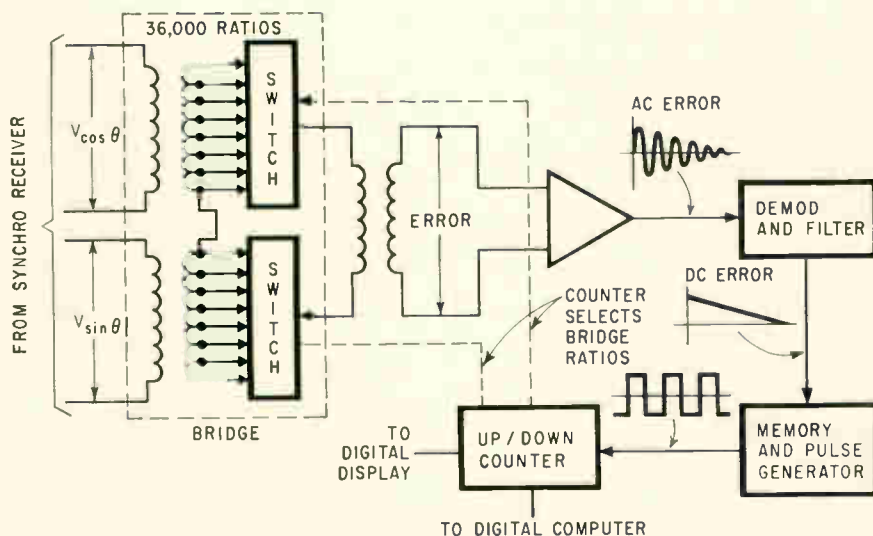

**Imbalance at work.** Error voltage caused by bridge imbalance drives pulse generator. Output pulses feed an up-down counter to advance digital display.

# Introducing the D-ranged 0.01% DVM.



**the only crazy thing  
about it is the price.**

Trymetrics' D-ranged DVM has true .01% accuracy with sensitivities to 10 microvolts and a choice of 9 plug-in heads starting as low as \$640.

\$640?  
\$640! with 103 plug-in head!  
Basic units start at \$595.

And that's not all. Check these Trymetrics features: Full 4 digit resolution plus overranging. Resolution to 10 $\mu$ V. Accuracy  $\pm 0.01$  of reading  $\pm 1$  count. Automatic polarity and overscale indicator. High common mode rejection. Manual and Automatic Ranging plug-in heads. All silicon solid state circuitry. Operation up to 50°C. Sampling speeds up to (10) samples/second. BCD printer output (optional).

## CHOOSE FROM 9 PLUG-IN HEADS



DELIVERY FROM STOCK  
ON MOST MODELS  
Models 103—104—105  
Single range plug-in heads  
10V, 1V, 100MV

Models 300A—400A—500A  
3, 4 and 5 automatic range  
plug-ins; 10 $\mu$ V—1000VDC

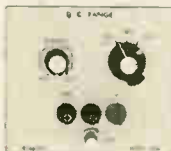

Models 300M—  
400M—500M  
3, 4 and 5 manual  
range plug-ins;  
10  $\mu$ V—1000VDC

*Prices Higher in Europe*

If you'd like to be considered crazy (like a fox), write now for specifications or a demonstration.



**TRYMETRICS**  
Corporation

204 Babylon Tpke., Roosevelt, L.I., N.Y.  
Phone 516-378-2800 11575

... capacitive memory operates counter, assuming next error won't differ from the previous one ...

stability 10 times—and at the same cost.

### I. Dissecting the circuit

When the bridge of North Atlantic's instrument is unbalanced by an input signal, the error voltage is demodulated so that a control pulse is generated. To bring the bridge back to balance, the pulses are stored in an up-down counter that issues switching commands to the divider advancing the bridge ratios one step for each count.

When the error voltage drops to zero—and the bridge is balanced—the counter reads out the digital value of the synchro angle. Since the bridge arms have sine and cosine ratios instead of linear output taps, the synchro output undergoes a trigonometric conversion from voltage ratios to angles.

**Capacitive memory.** The counter has a capacitive memory which operates with the counter on the assumption that the next error will not differ from the previous one—so it anticipates the next error voltage value, sending a signal to step towards null as if it were already received. Compensating networks prevent overshooting the null point.

Thus, North Atlantic does not use the cycle-then-step procedure that slows down other converters. In fact, the memory-counter combi-

nation can step hundreds of times per cycle.

Other converters are limited to one or, at most, two steps per supply voltage cycle because they have to go through a cycle before the bridge takes one step toward null. The rate of change of readout is strictly limited. For example, in a device whose resolution is 0.01° and which operates on a 400 hertz power supply, the maximum angular rate of change is 8° per second (2 x 400 x 0.01). That means the converter can handle data only from shafts moving slower than 1 2/3 revolutions per minute, making it unusable in many radars, satellite trackers, and machine tools.

In contrast, North Atlantic's new converter can digitize information from shafts rotating at speeds up to 300 rpm.

### Specifications (Model 545)

Signal input	11.8 to 90 v, 400 hz (standard) 60 hz to 5 khz (optional)
Input impedance	300,000 ohms (min.)
Angular accuracy	0.01° or 0.001° $\pm 1$ digit
Repeatability	0.01° or 0.001°
Range	000.00° through 359.99° or 359.999°
Track speed	2,000°/second
Digital readout	5 decimal digits for 0.01°
Resolution	0.01° or 0.001°
Power	115 volts $\pm 10\%$ or 230 v $\pm 10\%$ $\pm 10\%$ or 250 v $\pm 10\%$ all from 45 hz to 440 hz
Price:	From \$6,000

North Atlantic Industries Inc., Plainview, N.Y. [338]

## New products in this issue

165 Digitizing synchro data faster, more accurately

180 Tv makers offered a tuner package

182 Data retrieval in sharp focus

### Components

168 New components review

168 A power transistor to compete with scr's

### Microwaves

186 New microwave review

186 Military mixer invades civilian market

188 Cutting costs of tv relay

### Instruments

172 New instruments review

172 High-speed converter costs \$750

### Semiconductors

193 New semiconductor review

193 DTL that fits TTL pins

196 IC's call the tune in electric organ

200 Linear IC's take consumer spotlight

### Subassemblies

180 New subassemblies review



# You can tell Celanese Nylon from other nylons by the label.

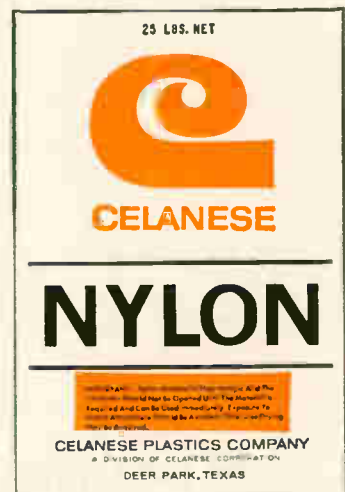

Not at all. Celanese Nylon is fully competitive. In quality. In physical properties. In molding characteristics. In meeting established specifications. Customers who have been using Celanese Nylon resin since the first of the year agree.

And isn't it nice to have another completely dependable source of type 6/6 nylon!

Celanese Plastics Company—and the entire Celanese Corporation—is committed to volume production of the best possible nylon resins. We offer them in quantity right now. Including glass-reinforced Celanese Nylon grades. And a general-purpose black resin. There will be even more in the

near future. More resins. More advanced nylon technology. More molding and marketing assistance.

But you'd expect that from Celanese, a leader in the development of engineering resins. Remember Celcon. And, of course, we do have some twenty-five years of nylon technology behind us.

Let us give you all the facts about Celanese Nylon. Write to: Celanese Plastics Company, Dept. 133-G, P.O. Box 629, Linden, New Jersey 07036.

Celanese® Celcon®



Celanese Plastics Company is a division of Celanese Corporation. Canadian Affiliate: Canadian Chemical Company, a division of Chemcell (1963), Limited. Export Sales: Amcel Co., Inc., and Pan Amcel Co., Inc., 522 Fifth Ave., New York 10036.

## New Components Review



Precision connectors assure rated voltage standoff in mated or unmated condition. Recessed center contacts and precontact grounding are for safe handling. Maximum leakage across the interface is less than  $1 \mu\text{a}$  at 20 kv d-c and sea level pressures. The rated voltage is for limited pulse use. Reynolds Industries Inc., 2105 Colorado Ave., Santa Monica, Calif. [341]

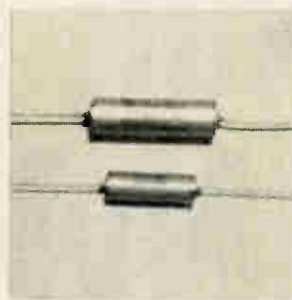

Miniature, metalized polycarbonate capacitors are for use in transistorized circuits requiring low-loss components. The 50-v devices need no voltage derating from  $-55^\circ$  to  $+125^\circ$  C. They exhibit a dissipation factor of less than 0.3% and an insulation resistance of 100,000 megohms at room temperature. Marshall Industries, 1960 Walker Ave., Monrovia, Calif. [342]

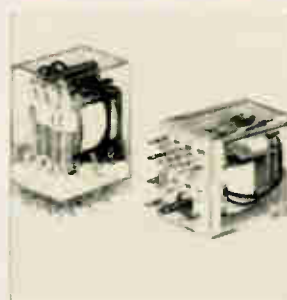

Enclosed in a clear, plastic dust cover, a 1.281 x 1.109 x 0.859-in., 4-pole relay is available in a-c and d-c versions. Model KHU has gold-plated silver contacts rated 3 amps 120 v a-c, 3 amps 28 v d-c, and  $\frac{1}{4}$  hp 120 v a-c. Coil ratings are to 120 v 60 hz, and to 120 v d-c. The relays have computer and switching applications. American Machine & Foundry Co. Princeton, Ind. [343]

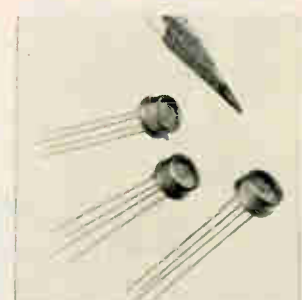

Each unit of the type 4610 photocells has 2 independent, isolated photoconductors. Use of 1 enclosure assures equal illumination for the 2 elements. Both elements are processed at the same time on a single substrate to yield equal response characteristics. Lighted resistance changes less than 1.5 from  $25^\circ$  to  $65^\circ$  C. Hewlett-Packard Co., 1501 Page Mill Rd., Palo Alto, Calif. [344]



Resistors with 0.1-in. diameter, range in values from 10 to 5,000 megohms in the  $\frac{1}{4}$ -watt size, type HACW, and 10 to 10,000 megohms in the  $\frac{1}{2}$ -watt size, type HADW. They are rated at 1,000 v and 5,000 v maximum, respectively. Both are terminated with  $1\frac{1}{2}$ -in., No. 20 tinned-copper leads. Prices start at \$2.50. Resistance Products Co., Harrisburg, Pa. [345]

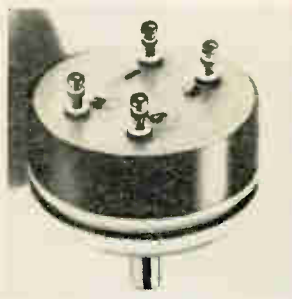

Custom-engineered pots made of conductive plastic, have 0.5% absolute linearity in the centers of their operational range, tapering to 0.15% in their end regions. Model 14C-1 offers a resistance of 100 to 20,000 ohms  $\pm 10\%$ ; power capability, 1.3 w at  $25^\circ$  C; torque, 0.2 oz maximum; minimum life, 5 million cycles. Gamewell division, E. W. Bliss Co., 1238 Chestnut St., Newton, Mass. [346]

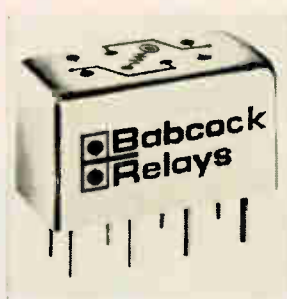

Half-size crystal can relays incorporate a magnetic circuit that locates the armature inside the coil, reducing leakage and coil power requirements for switching. Units, designated BR17 and BR16 for latching and nonlatching versions, require only 175 mw pull-in power to switch any load from dry circuit to 2 amps. Babcock Electronics Corp., 3501 Harbor Blvd., Costa Mesa, Calif. [347]

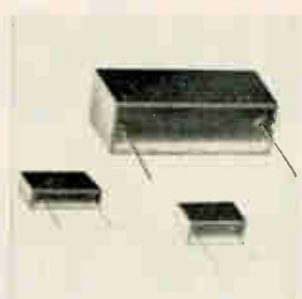

Epoxy-encased metalized mylar capacitors in a molded thin-rectangular configuration with radial leads are designed for high-density circuits. Series 17N is available in 100-, 200-, 400-, and 600-v sizes in capacitance values from 0.001 to 5  $\mu\text{f}$  with 20% to 1% tolerances. Operating temperature is from  $-55^\circ$  to  $+125^\circ$  C. SEI Mfg. Co., 18800 Parthenia St., Northridge, Calif. 91324. [348]

### New components

## A power transistor to compete with scr's

Device that handles 250 amps, 625 watts ends paralleling smaller transistors or silicon controlled rectifiers

In the race to build electronic controls for big industrial machinery, the biggest stumbling block is still the component: fabricating semiconductors powerful enough to handle the giant currents and powers that course through such equipment. The problem moved closer

to solution last month when the Westinghouse Electric Corp.'s semiconductor division introduced a new power transistor that can handle 250 amps continuously and can dissipate 625 watts.

Designated type 1401 the new transistor is for switching control

amplifiers, series regulators, inverters or converters. And it may replace some silicon controlled rectifiers that the company also makes for power switching applications.

**Using scr techniques.** In breaching the limits on power transistors, Westinghouse borrowed a lot of manufacturing know-how from its scr operation. For example, a method of encapsulation, developed in 1961 for power scr's, solved the major cause of power transistor failure that can be attributed to manufacturing (the other two sources of failure are excessive voltage and excessive current applied to the device). The new manufacturing process is called com-



Trans-O-Netic time-delay relay has an interval repeatability of  $\pm 2\%$  at 70° F and 115-v a-c that isn't affected by line variations from 100- to 135-v a-c. Standard time for the delay-on-make model is 1 to 60 sec; for the delay-on-break unit, 1 to 30 sec. Prices range from \$20 to \$26 for sample units. Heinemann Electric Co., 252 Magnetic Dr., Trenton, N.J. 08602. [349]

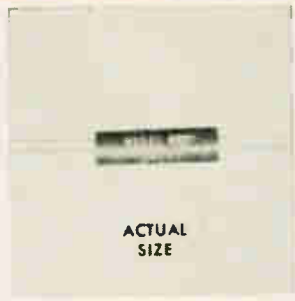

ACTUAL SIZE

Fast-switching, Microreed relay, model 8021, with a coil drive rated 9 to 12 v, 60 ma, is designed to be driven by transistors. Encapsulation provides high environmental protection. The single-pole, single-throw unit has a 10-million-cycle life. Contact resistance is 0.15 ohm d-c max. Price is \$48 each. Solid State Electronics Corp., 15321 Rayen St., Sepulveda, Calif. [350]



Side-viewing numerical indicator tube CK8650 has conventionally shaped  $\frac{3}{4}$ -in. numerals from 0 to 9 that can be read from distances up to 30 ft and at angles up to 60° from horizontal. Tube diameter is  $\frac{7}{8}$  of an inch. Seated height is 1.8 inches maximum. The indicator tubes are available from stock. Raytheon Co., Industrial Components Operation, 465 Centre St., Quincy, Mass. [351]

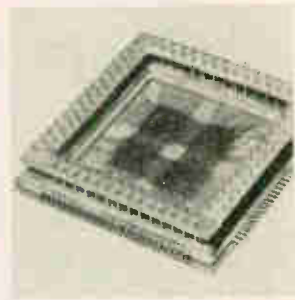

Core memory storage planes called Platrics can be used in memory systems for digital instrumentation and control equipment. A stack of Platrics is mounted on a p-c board through connection pins at the bottom of the stack. Units are available in 8 standard configurations with bit capacities ranging from 256 to 1,024. Ferroxcube Corp., Saugerties, N.Y. 12477. [352]

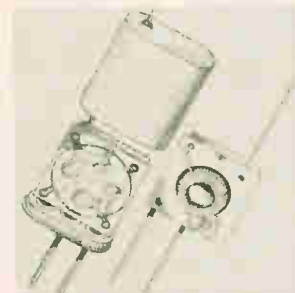

A six-pole quartz filter for use at or above 8 Mhz is contained in an HC 6/U package. The filter network is prepared using vacuum deposition with all resonators on a single quartz wafer. Foil leads are attached to the wafer and these leads, in turn, to the terminals of a p-c board. This allows 2 half-lattice sections on the wafer. Clevite Corp., 232 Forbes Rd., Bedford, Ohio. [353]

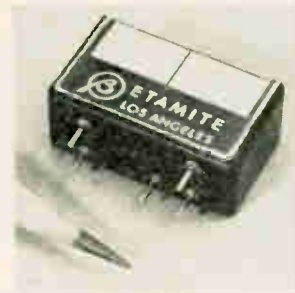

A solid state voltage switch, model RT-128-3, closes when a-c input voltage reaches 30 v rms  $\pm 10\%$ , 400 hz or more. With max input voltage of 45 v rms for 5 msec, it can be used in 28-v d-c gyro systems. It has 5 or 7 pins, 2- and 4-pole contacts, rated for 2 and 10 amps resistive. Betamite Electronic Devices, 6321 W. Slauson Ave., Culver City, Calif. 90230. [354]



An electromagnetic switch provides a sharply rising electrical output voltage at a specified core position. It may be used to energize an indicator light at the switching point directly, to actuate a relay, or to trigger an electronic switch. Input is 26 v, 400 hz; output 6 v, 400 hz. Kavlico Electronics Inc., 20869 Plummer St., Chatsworth, Calif. 91311. [355]

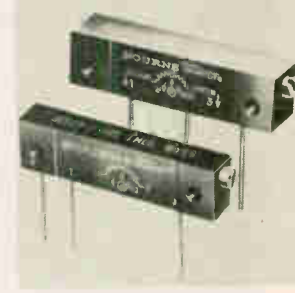

Standard resistance range of the models 3012 and 3052 Palirium cermet adjustment pots has been expanded from 10 ohms to 1 megohm. Operating temperature range is  $-65^{\circ}$  to  $+175^{\circ}$  C; contact resistance variation, 2.5%; and power rating, 1 w at 70° C. The Palirium cermet provides infinite resolution. Bourns Inc., 1200 Columbia Ave., Riverside, Calif. 92507. [356]



Borrowing. New transistor uses scr-type package.

pression bond encapsulation.

Mechanical pressure instead of soft solder (used prior to 1958) or hard solder (used after 1959) makes connections, holding the semiconductor chip against the case and the lead. Thus, the semiconductor chip isn't subjected to repeated heating and cooling during the bonding process that used to be done by welding equipment. Instead, four belleville washers, which are usually slightly warped, and a circlip press the junction to the base of the case and against the lead. Westinghouse uses this method in the manufacture of 70% of its scr's rated over 35 amperes.

**Bigger junctions.** Since the semi-

conductor chip isn't exposed to thermal stresses, Westinghouse has been able to make junctions of larger diameters. And the power capability of a transistor depends directly on wafer diameter. In the 1401, the silicon wafer is 0.9 inches in diameter.

The wafer, in what Westinghouse calls a sunburst design, is fabricated by a single diffusion process that is proprietary. But the company is likely to produce an alloy junction since it has stayed with this technology longer than other semiconductor companies.

#### I. Fewer components

At the start, the 1401 will cost

# To turn off rejects of 3rd generation circuits:

## Turn on Barnstead's New Micro-Cleaner

There's no better way to make micro-circuits come clean!

Barnstead's new microelectronic cleaning station provides an ultra-pure final rinse — in a totally clean environment — at minimum cost.

Write for Bulletin 211, describing this 3rd generation cleaning station.

### **Barnstead**

Subsidiary of Ritter Pfaudler Corp.  
461 Lanesville Terrace  
Boston, Massachusetts 02131.

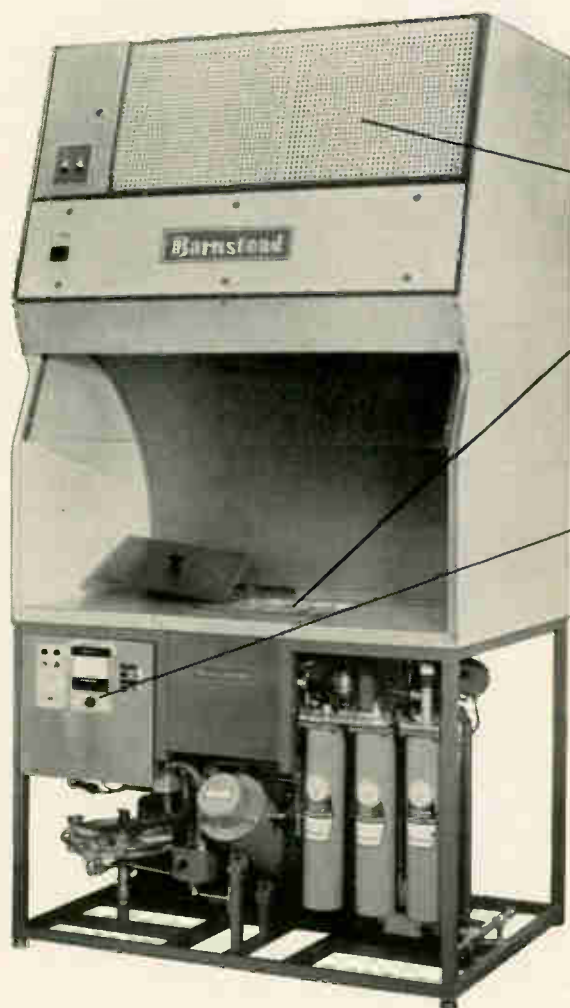

*Positive-pressure hood keeps work area free of airborne contaminants, with absolute air filter; quiet, spark-free blower. Meets or exceeds applicable MIL SPECS.*

*Five hot, cascading pure water rinses in tinlined monel tanks do a thorough cleaning job. Final rinse, measuring 18 megohms/cm @ 25°C and free of organics, gases, biologicals — is much purer than demineralized water.*

*Purity meter checks quality of rinse water, both "upstream" and "downstream" from final rinse.*

*To make a few gallons do the work of thousands, water is continuously recirculated, repurified. System includes . . .*

*Demineralizer. Automatic still. Organic removal bed. 0.1 micron particle filter. Sump, protected by ultraviolet unit, Ventgard® air filter. Regenerative heat exchanger. Cuts electrical load by more than 50%*

**. . . need only one-tenth as many components . . .**

\$500, only \$400 in quantities more than 100. But for engineers who are committed to electronic control of high powers, the new transistor makes possible a large reduction in the number of components. For example, compared to a circuit that uses scr's or 30-amp transistors in parallel to handle the large power, a circuit with the 1401 would need only one-fifth as many heat sinks, one-tenth as many components, simpler wiring, and can squeeze into a volume one-eighth as large. Normally, paralleling is the only way large powers can be handled.

**Instrument dilemma.** As Westinghouse started production of the new power transistor it ran into a number of obstacles. One was a traditional difficulty in semiconductor production: getting yields to an economic point. The large diameter junction complicates this problem.

But even harder to solve has been the testing of finished transistors. No commercially available instrument can handle the 250-amp rating. Westinghouse found a Tektronix laboratory-type curve tracer would work up to 200 amps, but it had to design and build its own device to go beyond that—to 300 amps.

**Possibility for autos.** Although the company is predicting the biggest use of the new devices will be in industrial circuits, one intriguing application is the control of drive motors for the electric automobile. At a division in Redlands, Calif., Westinghouse is readying a small electric car for production. Initial plans call for using a rheostat control—not unlike that used in electric street cars. But engineers at Redlands are now evaluating the 1401 transistor as an electronic control. The decision will be made on the basis of economics; the old-fashioned street-car control is relatively inexpensive.

The 1401 is the first in what is to be a family of power transistors. Soon to be announced will be additional units, some with lower ratings and some with higher.

Westinghouse Electric Corp., Semiconductor Division, Youngwood, Pa. [357]

MEC's new C band 7 kilowatt, cw, traveling wave tube powers the world's most advanced, high quality, commercial satellite communications system. It handles hundreds of voice and several TV channels simultaneously over the 5,925 to 6,425 GHz frequency range. Major design features include:

- 7 kW (min.) at 37 db gain
- Gain stability  $\pm 0.25$  db after warmup (max.)
- 0.05 db/MHz gain slope (max.)
- 6° Phase change/db change in drive level @ 7 kW (max.)
- 0.2°/volt phase modulation factor (max.)

Development of this tube is a natural extension of MEC's capability. After all, MEC was the first to deliver 12 kW cw traveling wave tubes for X band satellite ground stations; first to develop a complete family of 20, 50, 100, and 200 watt cw tubes for military ECM and data systems; and the first, and only, independent supplier to deliver C band high power TWTs for commercial satellite ground stations.

So, when you're considering high average power TWTs for telemetry, communications, data links or ECM... *think first of MEC.* Complete specifications and performance data are available on all MEC high average power TWTs. For detailed information, write us at 3165 Porter Drive, Palo Alto, California 94304



**MICROWAVE ELECTRONICS**  
A TELEDYNE COMPANY



The two foot tube  with the 20,000 mile reach

## New Instrument Review



Suited for the chemical and aerospace fields where high pressures are to be monitored, series 250 transducers are available in 6 ranges from 0 to 5,000 to 0 to 20,000 psig. Housing and pressure cavity are of stainless steel and electrical components are sealed from the pressure media by stainless steel diaphragms. Taber Instruments, 455 Bryant St., North Tonawanda, N.Y. [361]



Transistor curve tracer CTA-2 displays a family of curves for both bipolar and field effect devices when used with any general purpose d-c scope. Base current steps of 20, 100, and 200  $\mu$ a are provided with 4 ranges of sweep voltage to 240 v. Voltage steps for FET testing are continuously adjustable. Price is \$435. Rameco Corp., Box 580, Deerfield Beach, Fla. [362]

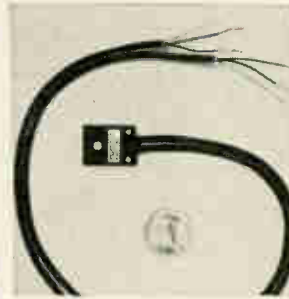

Hall-effect transducers measure steady-state, pulse, or transient currents without connection to the conductor under test. The CT-7W offers a rise time less than 1  $\mu$ sec, dynamic range of less than 1 ma to 30 amps peak, and frequency response flat to over 1 Mhz. It measures  $1\frac{3}{4} \times \frac{3}{8}$  in. with a  $\frac{3}{16}$ -in.-diameter opening. Ohio Semitronics Inc., 1205 Chesapeake Ave., Columbus, Ohio. [363]

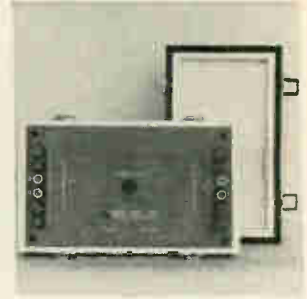

Transportable resistance standard SR104 establishes a reference level at 10 kilohms instead of the traditional 1 ohm. Virtually immune to thermal and mechanical shock, its accuracy is 5 ppm with a stability of 1 ppm, achieved without a temperature-regulated oil bath. Price is \$550. Electro Scientific Industries Inc., 13900 N.W. Science Park Drive, Portland, Ore. [364]

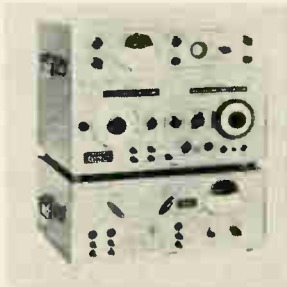

Twenty-seven controls and a crt provide versatility and ease of balance on the 2702 inductance bridge. The unit has a range from 0.3  $\mu$ h to 21,000 henrys, with internal frequencies of 10 khz, 1 khz, and 60 hz. The crt display indicates direction of inductor balance and reports at test frequency. Marconi Instruments, 111 Cedar Lane, Englewood, N.J. [365]

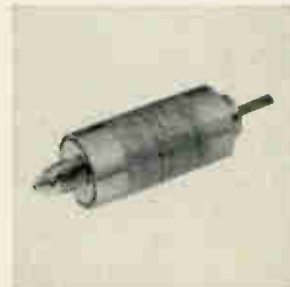

Potentiometric transducer 2101 operates in the ranges of 0 to 350 through 0 to 20,000 psi. It has an over-all accuracy of  $\pm 1\%$  at vibrations of 50 g. Normally used for control and telemetry, the unit will measure and monitor air, fuel, lubricants, and hydraulic fluids. It weighs 2 oz. and measures 0.75 x 1.5 in. Servonic Instruments Inc., 1644 Whittier Ave., Costa Mesa, Calif. [366]

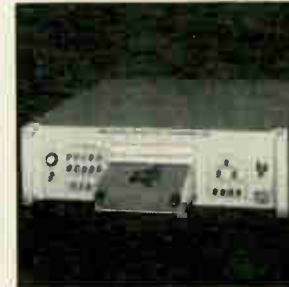

Analog measurements are made of digital IC's automatically by instrument 133. It can do up to 10,000 parameter measurements in 1,000 steps in  $\frac{1}{100}$  sec. Up to 15 readings can be made at a 10- $\mu$ sec logical step. Programming is by two 5 x 6 in. circuit cards; one covering all devices in a family, the other the type to be tested. Teradyne Inc., 183 Essex St., Boston. [367]



A spectrum analyzer designed for the community-antenna tv industry covers a range of 1 to 300 Mhz. A sensitivity of -90 dbm, flat responses, high stability, and spurious-free displays characterize its design. The Mark I analyzer has a 60-db display dynamic range and a 46-db distortion dynamic range. Price is \$1,500. Nelson-Ross Electronics Inc., 5-05 Burns Ave., Hicksville, N.Y. [368]

### New instruments

## High-speed converter costs \$750

Integrated circuits and machine assembly help reduce cost of unit that has medium accuracy

In the course of its regular business of building general-purpose computers for the engineering and scientific community, Digital Equipment Corp. has designed a lot of analog-to-digital converters that are incorporated into the com-

pany's machines. Scrutinizing the converter field, company engineers were struck with the need by others besides computer makers for a small, high-speed instrument that would be capable of medium accuracy and cost under \$1,000. With

such specifications as a goal—a speed of 100,000 samples per second, an accuracy of 0.1%, and a size of 5 by 5 by  $\frac{1}{2}$  inch—the company launched a product development program last year.

This month the resultant product goes on sale. It meets or better the goal, selling for \$750. With this kind of cost and performance, the company sees its model A-801 converter winning a wide market of users needing an uncomplicated link between measuring equipment and computing machines. It should encourage the use of computerized systems in experiments where time is now lost correlating information and predicting results manually.

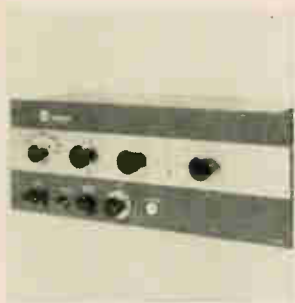

Panel-mounted potentiometers feature central readout window and an 11-position switch for selecting inputs. Two models are 3-dial instruments with a limit-of-error of  $\pm 0.03\%$  of reading. Others have one decade switch plus a 27.5-in. calibrated slide-wire scale with a limit-of-error of either  $\pm 0.1\%$  or  $\pm 0.2\%$ . Leeds & Northrup Co., 4901 Stenton Ave., Philadelphia. [369]



Ceramic-encapsulated platinum temperature transducer 5001-19 is designed for surface measurement over a range of  $-260^\circ$  to  $+400^\circ\text{C}$ . Resistance at  $32^\circ\text{C}$  is 500 ohms  $\pm 1\%$ , and resistance-vs.-temperature relationship is linear over the entire temperature range. Time constant is 250 msec; repeatability,  $\pm 0.1^\circ\text{C}$ . Thermal Systems Inc., 13920 S. Broadway, Gardena, Calif. [370]



The Helmer gauge measures pressures obtained by vacuum equipment accurately down to  $1 \times 10^{-13}$  torr because the ion collector is optically shielded from the main source of X-ray current with no sacrifice in gauge sensitivity. Pressure is displayed on a single meter with a one-cycle logarithmic scale. Vacuum division, Varian Associates, 611 Hansen Way, Palo Alto Calif. [371]



Infrared detector QKN1304 is for airborne and lab use. It uses an N-type indium-antimonide detector element that is sensitive in the 300-micron to 8-mm-long wavelength region, with 250-nsec response time. Standard aperture area is 4-mm diameter. Price is \$5,590; delivery time, from 30 to 60 days. Raytheon Co., 130 Second Ave., Waltham, Mass. 02154. [372]



Charge detector CM467 measures electrostatic fields. Two interchangeable sensor probes are available. One measures charges in the  $10^{12}$  coulomb range by direct contact. The other measures charges as low as  $10^{-12}$  coulombs, and is used for remote monitoring. Price of the Coulometer, with either probe is \$195. Metronics Associates Inc., 3201 Porter Drive, Palo Alto, Calif. [373]

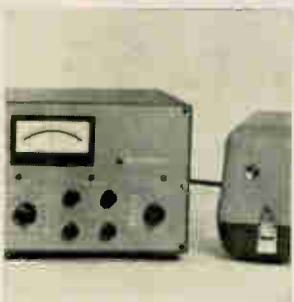

Operation from any source resistance without changes in response or damping, is featured in model 900 nanovolt galvanometer. The multirange unit has 120-db a-c rejection and infinite common-mode rejection. It measures from 10 nv (10 picoamps) to 3 mv (3  $\mu\text{a}$ ). Noise is less than 2 nv. Electro Scientific Industries Inc., 13900 N.W. Science Park Dr., Portland, Ore. [374]



Model 15-400 aircraft transducer is a quick-reacting sensor that determines rate of altitude change and provides a linear d-c output voltage proportional to the rate of climb or dive at rates up to 6,000 ft minute over an altitude range from sea level to 70,000 ft. Accuracy is  $\pm 5\%$  to 50,000 ft and  $\pm 10\%$  to 70,000 ft. Ed-cliff Instruments, 1711 Mountain Blvd., Monrovia, Calif. [375]



Ohmmeters for production lines have easy-to-read linear meters. Operational amplifier circuitry allows full-scale accuracy of 0.5%. Current through the item under test is 3 ma max on the 0-to-1-ohm scale. Model 40 has resistance scales of 0 to 1, 0 to 10, 0 to 100, 0 to 1,000, 0 to 10,000, and 0 to 100,000 ohms. Price is \$245. Faradan Corp., 4130 Menes Ave., Riverside, Calif. [376]

**Shrinking.** Integrated circuits and machine assembly are the main reasons for the low cost. The ic's also helped shrink the size of the device. Off-the-shelf ic's, already purchased in large volume for other purposes, are used in the control logic, the digital register, and the comparator.

### I. Successive approximation

Looking for the optimum trade-off between speed, circuit simplicity, and number of components, the designers chose successive approximation as the method of analog-to-digital conversion most likely to allow them to meet the required objectives. In this ap-

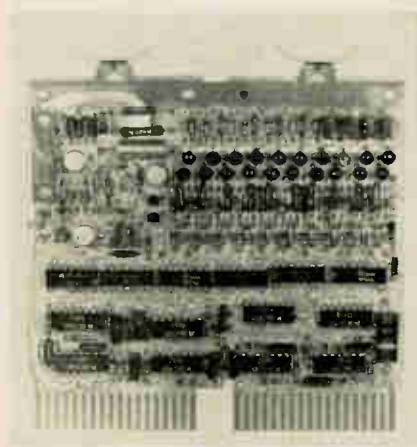

Machine built. Entire A/D converter is built on a double-sided board, using plated-through holes. Most components are inserted by machine.

proach, the digital output is obtained one bit at a time in a number of successive steps.

First, the unknown analog voltage is compared with a half-scale value. If the analog value is greater, the most significant bit is set to a binary 1; if not, the bit becomes 0. Next, a quarter or three-quarter scale is applied, depending on whether the first estimate was too big or too small.

**Step per digit.** As each significant bit is introduced, the digital approximation moves closer to the real value of the analog input. The method requires only one step per bit to convert any number, so that after three approximations, for ex-

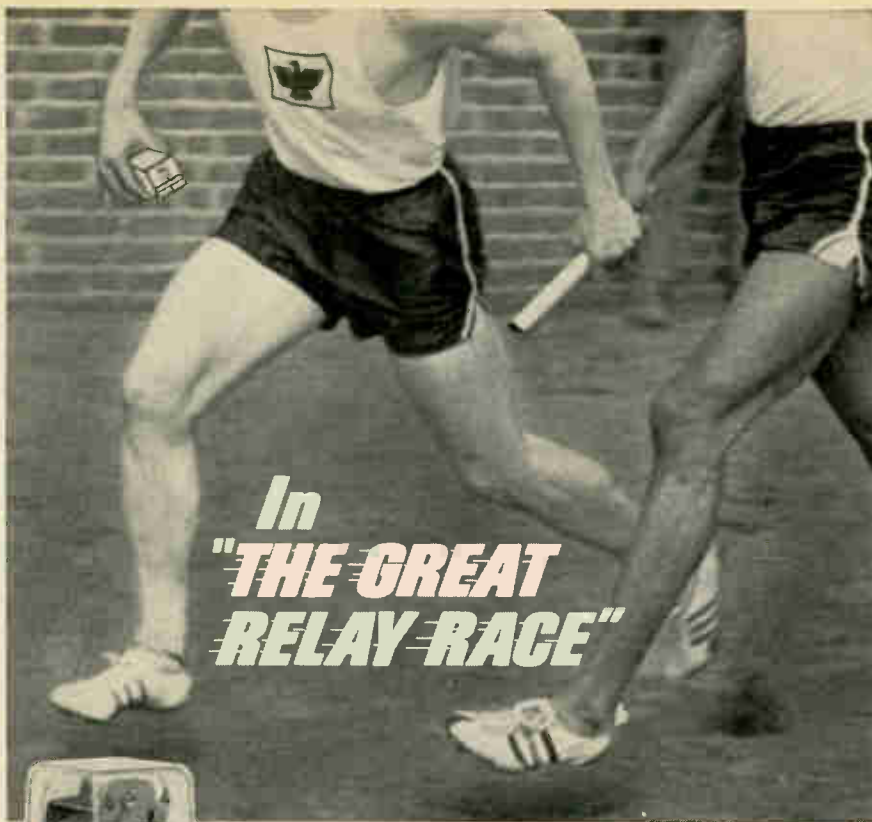

*In*  
**"THE GREAT  
RELAY RACE"**



**A FREE RELAY IS YOURS . . .** to run your own relay race (evaluation test) in your own plant . . . under your own conditions.

**YOU BE THE OFFICIAL JUDGE!** You'll find out what we already know (see our race results below). Eagle Relays run longer . . . and better. There's no premium in cost . . . and they're readily available.

**YOU'LL BE A WINNER EVERY TIME!** Send for your Official Judge's Entry Blank now by contacting: R. W. Emelander, Eagle Signal Division, E. W. Bliss Company, 736 Federal Street, Davenport, Iowa, 52808 or circle reader service number below.

CONTACTS	COMPETITIVE BRANDS						EAGLE RELAYS
	"A"	"B"	"C"	"D"	"E"	"F"	
Arrangement Rating	3 PDT 5 Amp.	3 PDT 5 Amp.	3 PDT 5 Amp.	3 PDT 5 Amp.	3 PDT 5 Amp.	3 PDT 5 Amp.	3 PDT 5 Amp.
LIFE Mechanical	15,061,261 Operations	14,077,866 Operations	28,808,000 Operations	21,625,333 Operations	16,923,133 Operations	29,433,600 Operations	34,492,950 Operations
ELECTRICAL	295,466 Operations	490,433 Operations	129,600 Operations	235,700 Operations	778,200 Operations	921,400 Operations	948,675 Operations
	5 Amp. Resistive	488,666 Operations	1,071,666 Operations	496,000 Operations	284,333 Operations	3,529,466 Operations	1,842,000 Operations
1.6 Amp Inductive							

**FOR A FAST START** in Eagle's "Great Relay Race" see us at the Wescon Show, San Francisco Cow Palace, Aug. 22-25. Booth No. 3401.



A DIVISION OF THE E. W. BLISS COMPANY

At Wescon, stop at Eagle's booth No. 3401 for the latest "race results."

. . . each bit is changed into a binary-weighted current . . .

ample, a three-bit digit results.

An initial input pulse into the converter causes the control logic to set the most significant bit of the digital register to the 1 state and the other registers to the 0 state. Each bit is then transformed to a binary-weighted current: the first bit to a half-scale value, the second to a quarter, and so on.

**Comparison.** The D/A signal, which is the sum of all these currents, is compared against the analog input current in the comparator. If the output is too large, the control logic resets the corresponding bit in the register to 0 and sets the next bit. If it's too small, the associated bit is kept, and the next bit is set. When the D/A output equals the input, the corresponding bit may or may not be retained. If kept, all successive lower-order bits are rejected because they will unbalance the comparator input. If the bit is discarded, then all lower-order bits will be retained because their sum is less than the rejected bit by the resolution of the converter. For an accuracy of 0.1%, a minimum of 10 bits is required.

**II. Current vs. voltage summing**

Two different circuit approaches were considered—current summing and voltage summing—during the design of the converter. Current summing was chosen because it requires half as many parts, can be driven from a simpler drive circuit, and is faster—the result of operat-

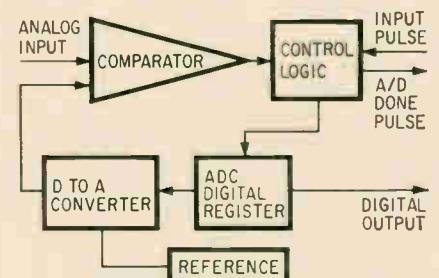

Comparison made. An input pulse triggers the control logic to set the most significant bit of the digital register. The bit is changed to a binary-weighted current in the digital-to-analog converter. The D/A current is then compared to the analog input, and the bit is either kept or rejected, depending on its size relative to the input current.



# Will the capacitor you take for granted take out your entire system?

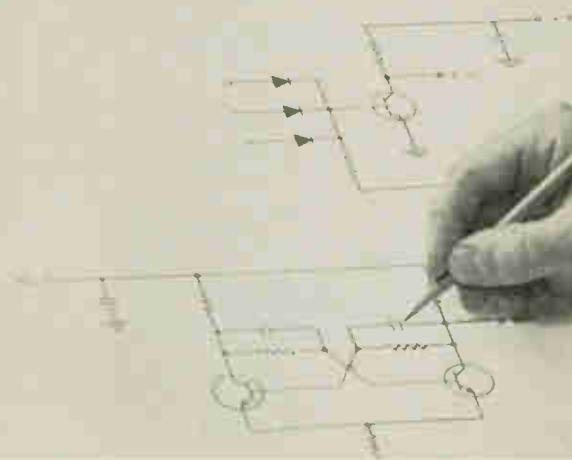

## Specify CORNING® Capacitors for confidence.

Considering the finality of capacitor failure, anything less than the reliability of glass is false economy.

Protect all the critical design work you put into your active circuits.

Back them up with the documented reliability of glass dielectric capacitance in the vital roles of coupling, bypass, filtering. Corning offers this confidence in a full range of types, sizes, values and costs.

---



CORNING® CYFR Capacitors, from .5 to 10,000 *pf*, substantially exceed the requirements of Mil-C-11272, including environmental performance and Quality/Reliability Assurance, and are backed by a heritage that includes use in Surveyor, Minuteman, Gemini, among others.

---



CORNING® CYFM Capacitors offer low cost, high reliability, from .5 to 10,000 *pf*. Give you CYFR-type environment-proof performance at substantial savings.



CGW  
TYO7  
751E

CORNING® TYO Capacitors from 1 to 2700 *pf*, radial leads, precision case for snug, upright mounting. Dense circuitry without doubts. Meet or exceed all performance requirements of Mil-C-11272.

---



CORNING® Glass-K Capacitors cram from 1000 to 100,000 *pf* in a quarter-inch case size with a new dielectric material for guaranteed reliability.

In all types, standard items are shipped in two weeks or less. Tell us what you want in capacitance; we'll tell you which CORNING® Capacitor will give you the confidence you need.

For complete specs, write to:  
Corning Glass Works,  
Electronic Products Division,  
3913 Electronics Drive, Raleigh, N. C.

**CORNING**  
ELECTRONICS

# Taylor's total reliability plan: Glass-Epoxy Copper-Clad

in sheets, panels or punched blanks to your specifications and reliability requirements

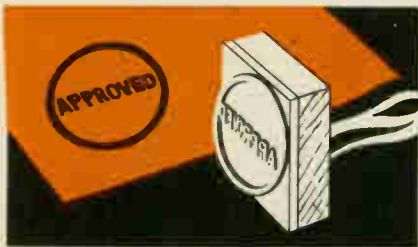

Accepted by an increasing number of major OEMs and commercial etchers who give their stamp of approval, because . . .



. . . they get highest quality level assurance from two fully-equipped copper-clad plants using white-glove techniques . . .



. . . in atmosphere-controlled white rooms, under extremely tight quality control procedures, to produce copper-clad . . .



. . . to specifications and established reliability requirements in standard sheets, ultra-thin sheets and multi-layer prepresses . . .



. . . then deliver when promised, or in an emergency, from plant or warehouse stocks in special packages.

Let us prove the advantages of Taylor's TOTAL RELIABILITY PLAN to you! Ask for a demonstration today. Write for a sample (give grade designation and copper combination) and Bulletin GB-2,

**Taylor copper-clad**

... your assurance of quality

TAYLOR CORPORATION • Valley Forge, Pa. 19481

Phone: 215-666-0300 TWX: 215-666-0659  
West Coast Plant: La Verne, Calif.

Also manufacturer of Taylor laminated plastics, Taylorite® vulcanized fibre and Tayloron® prepresses

. . . single current-summing needs fewer components . . .

ing with less charge transfer.

In the single current-summing state, one transistor,  $Q_1$ , amplifies the output of the digital register to operate a second transistor,  $Q_2$ , serving as a switch. Precision resistor  $R_1$  ensures a precise current flow to the summing junction when  $Q_2$  is closed. Resistor  $R_2$  has two main functions—it provides a low-impedance path for the discharge of stray capacitance, and it shunts much of the leakage current to ground, minimizing leakage-current errors.

More complicated. The voltage summing network is much more complicated. It requires a two-transistor switch and two precision

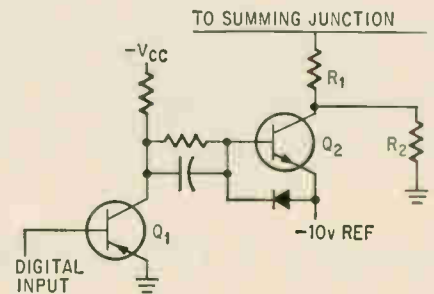

Sums current. A single current-summing stage consists of amplifying transistor  $Q_1$  driving switch  $Q_2$ . Resistor  $R_1$  shunts  $Q_2$ 's leakage current and is a low-impedance path for the discharge of stray capacitance.  $R_1$  is a precision resistor.

resistors. Capacitance must be discharged at all nodes in the circuit before a comparison can be made. This is most critical at the output, which must be able to move over the whole signal range.

To provide a low-cost switch for the current summer, a number of transistors used in high volume at Digital Equipment were evaluated. The collector-to-emitter voltages of transistors of the type chosen can be matched to within one millivolt with a yield of 15%. More than 10 times the number of devices needed for one year are therefore available.

Checking results. In addition to the usual engineering tests performed on A/D converters, Digital Equipment has added two for implementation by computer, to sup-



# Servo is a safe landing

Air safety recently took a giant step forward. A light plane was lost in the fog over rugged Alaskan terrain miles from Kenai airport. Fuel was running low. The pilot came in for a 3-point landing. How? With ADF. And laurels go to a Servo Corporation VHF-UHF direction finder system. These Doppler-effect units will soon be installed throughout the U.S.

The Servoflight® Model 5000 VHF/UHF Doppler Direction Finder is pictured above. Frequency coverage is 118 to 160 MHz and 225 to 400 MHz. It has

10 preset channels on VHF and 10 on UHF. Servoflight offers a bearing accuracy of  $\pm 1^\circ$ , and a sensitivity of  $10 \mu\text{V}/\text{Meter}$  on VHF and  $20 \mu\text{V}/\text{Meter}$  on UHF.

This is one of the many sophisticated systems produced by Servo's Communications & Navigation Division. Other Servo divisions produce unique products which daily serve safety through science: the Servodynamics Division, the Infrared & Electro-Optics Division, and the Railroad Products Division.

servo corporation of america

# Servo

111 new south road  
hicksville, l.i., new york 11802  
516 938-9700

Circle 177 on reader service card

# RF Attenuators

TELONIC RF Attenuators are supplied in 29 models with a wide range of dB values in various increments. Constructed of individually shielded, precision resistor packages, they exhibit high accuracy, low VSWR and low, constant insertion loss.

Ideal as a lab instrument or as a component in a manufactured system, their quick, positive action, precise operation and superior construction save the user's time by providing the right answer the first time and every time, and save the user money by virtue of a long, useful operating life.

**ROTARY**— Telonic Rotary Attenuators may be specified with 50 or 75 ohm impedances, come in single or ganged versions, and feature direct digital readout in many models.

**TOGGLE**— Toggle Switch Attenuators incorporate heavy duty switches for long life with double knife edges, and self wiping action for the best repeatability. Available in 50 and 75 ohm models.

**DC TO 1250 MHz**— Most Rotary Attenuators are useable to 1250 MHz Toggle Switch types to 300 MHz.

**.1 TO 110 dB**— The overall dB range of Telonic Attenuators covers 0.1 dB to 0-110 dB with increments of .1, 1, and 10 dB.

**CATALOG**— Full line catalog covers all Attenuators, and other Telonic instrumentation in detail; also includes Application Section. Send for your copy.

*Telonic*  
INSTRUMENTS

A Division of Telonic Industries, Inc.  
60 No. First Ave.  
Beech Grove, Indiana 46107  
TEL.: (317) 787-3231  
TWX-810-341-3202



... over half a million measurements to test ...

ply a clearer picture of the unit's performance.

### III. Computer tests

The first is a measure of the converter's differential linearity. A special 15-bit digital-to-analog converter is used in the evaluation.

The computer sends static voltage signals to the equipment under test through the D/A converter. For each voltage selected, 64 conversions are made and stored in its memory and checked. As a decision zone is reached and passed, the value of the conversions increases by one, and when more than half the conversions result in the next higher number, the switching point is assumed to be located.

**Keeping track.** By keeping track of the number of incremented voltages required to get from one switching point to the next, the computer is able to measure the variations in step size of the different states of the converter. The results are retained in the memory and finally printed out as a histogram, summarizing the measurements made. The histogram presents a clearer picture of the unit's performance than listing 1,024 separate measurements.

In a second test, the computer prints out a summary of the tests made to spotlight potential trouble areas. This evaluation again increments the voltage input to the converter under test. Sixty-four trials and checks are also made to see they are all within one count. If not, a summary of the tests taken and the results is printed. Narrow states are also checked for and revealed. In the 1½ minutes required to examine each converter, more than 500,000 measurements are made.

### Specifications

<b>Input</b>	Uni-polar Voltage 0 to +10v Impedance 1 Kohm
<b>Output format</b>	Parallel binary uni-polar
<b>Digital output</b>	Logical "0" +0.4v max. Logical "1" +2.4 min. Output "0" 16.0 ma max. Output "1" -0.4 ma min.
<b>Resolution</b>	10 bits
<b>Accuracy</b>	0.1% of full scale
<b>Conversion rate</b>	100 khz max.
<b>Power</b>	+15v ±1%, 20 ma -15v ±1%, 160 ma +10v ±1%, 300 ma

Digital Equipment Corp., 146 Main St.,  
Maynard, Mass. [377]

The Hewlett-Packard 4204A Digital Oscillator in one instrument gives you an accurate frequency source of measured amplitude. It provides 0.2% frequency accuracy in highly stable test signals for both lab and production applications. Low distortion, 0.01% frequency repeatability and a flat frequency response of 0.3% variation add to your dollar value.

The 4204A allows you to select any frequency between 10.0 Hz and 999.9 kHz to four significant figures... 36,900 discrete frequencies are available. One vernier

control provides infinite resolution and extends the upper frequency limit of the 4204A Oscillator to 1 MHz.

This oscillator also has a built-in impedance voltmeter to measure output. It is calibrated to read volts or dBm into a matched 600 ohm load. The output attenuator has an 80 dB range and is adjustable in 10 dB steps with a 20 dB vernier. Price is \$695.

Call your local HP field engineer for more information, or write Hewlett-Packard, Palo Alto, California 94304. Europe: 54 Route des Acacias, Geneva.

## Stable and repeatable signal accuracy

HEWLETT  PACKARD  
S I G N A L   S O U R C E S

18701



## New Subassemblies Review

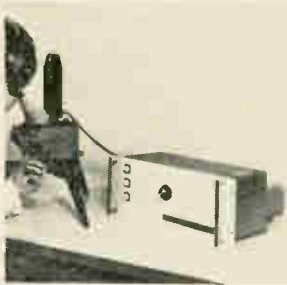

Laser system K-MV will vaporize minute portions of any material for spectrographic analysis without damaging the remaining material. It consists of laser head, power supply, and optical stage. The laser head, mounted on the optical stage, contains a neodymium-doped glass rod with emission at 1.06 microns. Korad Corp., 2520 Colorado Ave., Santa Monica, Calif. [381]

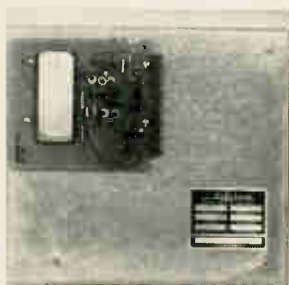

Fully compatible with IC's, the RZ-90 recirculating memory module accepts a variety of delay lines to provide storage capabilities between 20 and 10,000 bits and delays between 20 and 15,000  $\mu$ sec. Applications include sequential information storage for crt displays and programming for numerically-controlled machines. Sealectro Corp., 225 Hoyt St., Mamaroneck, N.Y. 10543. [382]

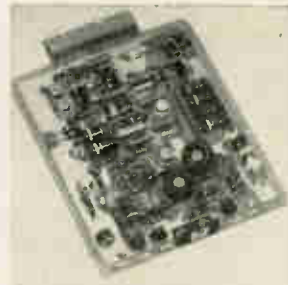

Video amplifier VA1367 is a d-c coupled, 10 Mhz, solid state plug-in unit featuring a gamma-corrected transfer function to produce a linear relationship between crt light output and input-video drive. It employs feedback and temperature compensation to provide optimum gain stability and temperature independence. Beta Instrument Corp., 377 Elliot St., Newton Upper Falls, Mass. [383]



Portable a-c field demagnetizers are designed and built to user's specifications. The laminated core structure permits continuous-duty operation without heating. Peak field strengths are from 0 to 10,000 oersteds, infinitely adjustable. Units are available for 115-v or 230-v operation. Instrumentation division, Thomas & Skinner Inc., 1120 E. 23rd St., Indianapolis 46207. [384]



Regulated supply model 630 is suited for applications involving digital or linear IC's. It provides a continuously adjustable output voltage from 0 to 6 v at a maximum current of 3 amps. Dual concentric coarse and fine voltage controls enable voltage adjustment resolution of better than 1 mv. Power Designs Inc., 1700 Shames Dr., Westbury, N.Y. [385]

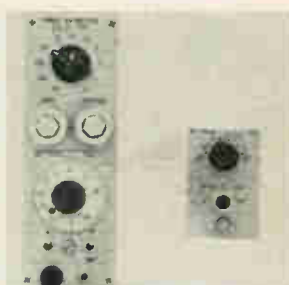

Model 8806B is a phase-sensitive demodulator. It is a solid state plug-in preamp for acquiring accurate amplitude and phase information. It has a carrier frequency range of 50 hz to 40 khz, gain stability of better than 0.25%/10° from 0° to 40° C, and response 3 db down at 1/5th of reference frequency. Hewlett-Packard Co., 175 Wyman St., Waltham, Mass. [386]

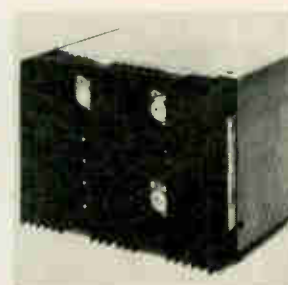

High-voltage d-c power supply modules include units to 410 v. Voltage regulation of 0.01% is provided in the BX series and 0.5% in the BC series. Both have plug-in p-c board construction, automatic overload and short-circuit protection, remote sensing, and remote voltage adjustment or programming. ACDC Electronics, 2979 N. Ontario St., Burbank, Calif. [387]

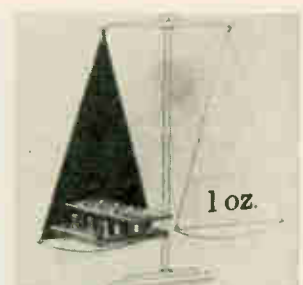

Protection of electronic systems against damage from power surges up to 12 kw is achieved with solid state transient suppressors. The devices use matched silicon-zener diodes to achieve the required power ratings. They maintain zener breakdown voltage levels constant from -65° to +175° C. Motorola Semiconductor Products Inc., Box 955, Phoenix, Ariz. [388]

### New subassembly

## Tv makers offered a tuner package

Cramming additional functions into an assembly, at a cost less than tuners alone, Oak hopes to steal a march on other makers

Normally, a television-set maker buys a tuner and then worries about matching it to an intermediate-frequency strip he designs himself. Now, for the first time, a set maker can buy a tuner package that includes an already matched i-f strip—and pay less for the package

than he would for a tuner alone.

That's a neat trick and the Oak Electro/Netics Corp. has done it by cramming more functions into a subassembly and then building it in Hong Kong. The package contains separate vhf and uhf tuners—both solid state—and the comple-

mentary strip, which is a three-stage video i-f amplifier. It is intended primarily for the portable tv market. Priced at \$10 f.o.b. Hong Kong, it is \$2 less than the cost of a tuner set alone.

**Sharp competition.** With this ploy, Oak expects to gain an edge on other tuner makers and increase its share of the market. Because sales of both color and black and white tv sets have been slumping, the tuner business has become increasingly competitive. Many set makers have excess capacity because they geared up for the big production year expected in 1967 and all the suppliers are anxious to boost their sagging volume.



Precision resistor networks designed for plug-in to p-c boards cover a range from 10 ohms to 1 megohm. The line is available in accuracies from 0.0005% to 0.1% absolute and  $\pm 0.0002\%$  to  $\pm 0.1\%$  ratio. Stability is  $\pm 0.0015\%$  per year absolute and  $\pm 0.0002\%$  ratio. Price varies from \$20 to \$200. Julie Research Laboratories Inc., 211 W. 61st St., New York. [389]

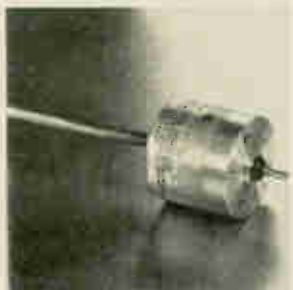

Model 15 shaft-angle encoder uses low-voltage light sources and wide-aperture optics. Standard units can be supplied with resolutions up to 6,000 counts per shaft revolution. Starting torque is 0.02 oz-in. Voltage levels are 200 mv peak-to-peak minimum into a 2,000-ohm load. Options include an internal amplifier shaper. Dynamics Research Corp., 38 Montvale Ave., Stoneham, Mass. [390]



Portable active delay lines, called Delay Long, have applications in low-frequency signal-processing fields. Model APD 120 provides a delay of 120 msec. Delay to rise time ratio is 5:1. Input impedance is 1 megohm; output impedance, 4,000 ohms maximum signal level,  $\pm 4$  v. Size is  $4\frac{1}{2}$  x  $5\frac{1}{4}$  x  $6\frac{5}{8}$  in.; price, \$650. A.P. Circuit Corp., 865 West End Ave., New York. [391]



Compatible with most data recording systems, model SC1100 solid state bridge amplifier features a voltage output of 10 v full scale. Its 5-ma output current can drive most galvanometers directly without additional amplification. Continuously adjustable linear gain is  $\pm 0.5\%$  from 0 to 10 v. Price is \$95. Statham Instruments Inc., 12401 W. Olympic Blvd., Los Angeles. [392]



A digital-to-synchro converter accepts a parallel 10-bit binary angle and delivers a synchro signal equal to the digital input. Inputs of the DS800 are compatible with IC logic levels at updating speeds to 10,000 words/sec. Accuracy, no load to full load, is better than 0.5%. The unit's front panel is  $5\frac{1}{2}$  x  $3\frac{1}{2}$  x 8 in. Astrosystems Inc., 6 Nevada Dr., New Hyde Park, N.Y. [393]



A solid state pulser provides up to 250 amps for driving laser diodes at room temperature. It uses avalanche-transistor techniques to produce 70-nsec pulses with 7- to 10-nsec rise times. Pulse repetition is adjustable from 300 hz to 10 khz. Volume of a 150-amp unit with a 10-khz driving oscillator is 1 cu. in. Austron Inc., 10214 N. Interregional Highway, Austin, Texas. [394]

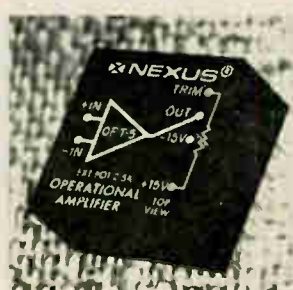

FET input operational amplifier QFT-5 provides  $10^{10}$  ohms differential and common mode impedances, less than 1 nanoamp of input offset current, 6 db octave roll-off and high tolerance to capacitive loads. Output voltage is  $\pm 11$  v at  $\pm 5.5$  ma. Frequency (full output) is 50 khz. Price (1 to 9) is \$29 each. Nexus Research Laboratory Inc., 480 Neponset St., Canton, Mass. [395]



Compact closed-circuit tv cameras, called the S 40 series, offer solid state reliability 800-line resolution, temperature tolerance from  $-22^{\circ}$  to  $+140^{\circ}$ F, high signal-to-noise ratio and easy maintenance. Design enables placement of the camera in formerly inaccessible areas. Net weight reduction from earlier models is 7 lbs. Motorola Inc., 4501 W. Augusta Blvd Chicago 60651. [396]

Although Oak integrated several functions into one package, performance of the individual parts of the package isn't exceptional.

The transistorized vhf tuner has a standard 300-ohm balanced antenna input, and operates on 12 volts at 17 milliamperes. Torque required to turn the channel selector is 68 in. per ounce; torque to

Matched set. Package is supplied prealigned and matched to perform as a unit, so customer invests no engineering time designing and testing the i-f amplifier or tracking and aligning time on the assembly line.

The i-f strip is normally mounted on the vhf tuner (far right), but can be supplied with matching connecting cables for mounting anywhere in the receiver.

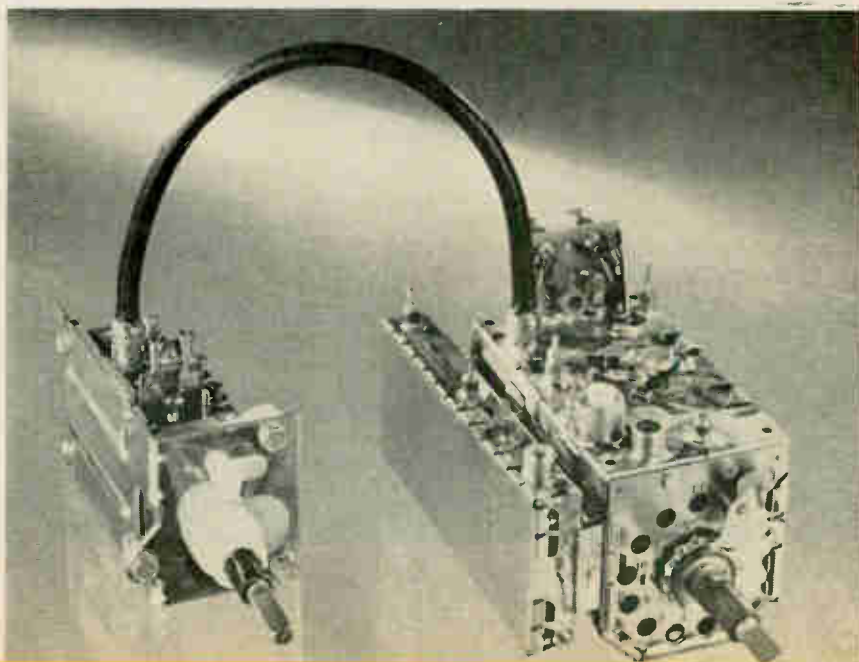

NEMS • CLARKE

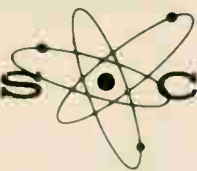

## 2-CHANNEL MONOPULSE TRACKING RECEIVER SYSTEM

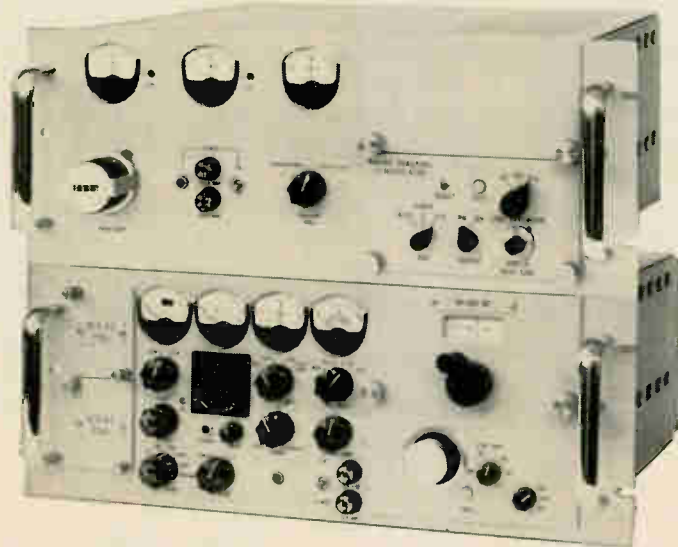

- FOR TWO-CHANNEL (SUM AND COMPOSITE DIFFERENCE CHANNELS) MONOPULSE SYSTEMS
- CORRELATION AND PHASE-LOCK TRACKING MODES
- FM, PM, AND AM DATA DEMODULATION WITH A WIDE RANGE OF BANDWIDTHS
- PLUG-IN FILTER/DEMODULATOR UNITS
- PLUG-IN RF TUNERS FROM 55 MHz TO 2300 MHz
- PLUG-IN SPECTRUM DISPLAY UNIT
- SOLID STATE DESIGN

The Nems-Clarke Two-Channel Monopulse Tracking Receiver system uses azimuth and elevation (X and Y) RF error voltages which are added in phase quadrature to form a composite RF error voltage. The system consists of a modified Nems-Clarke type 2074 Dual-Channel Telemetry Receiver, and a type MDM-1000 Monopulse Demodulator Unit. The X and Y error voltages are separated at the error detectors by a compensating quadrature network, and applied to the antenna servo system. Couplers for combining the azimuth and elevation RF error voltages can be supplied if required. An alternate two-channel system, in which the difference channel is time-shared between azimuth and elevation error voltages, may also be employed.

V-51

**Vitro ELECTRONICS**

PRODUCERS OF NEMS-CLARKE EQUIPMENT

VITRO CORPORATION OF AMERICA

919 Jesup-Blair Drive • Silver Spring, Maryland (301) 585-1000  
2301 Pontius Avenue • Los Angeles 64, California (213) 477-6717

... a computer can  
run the system ...

is a film that is sensitive only to ultraviolet light; it is developed by the application of heat.

A typical roll of Kalvar in the system is about 500-feet long and 17-inches wide. On this are 11 rows of images, each 35 mm in size; from 2,500 to 5,500 images per row.

Because exposure is by ultraviolet and development is by heat, new documents can be added to unused portions of the scroll at any time. The entire film is not sensitized at one time.

**Coded papers.** Each document is coded by an x and y coordinate. To retrieve a specific document, the operator punches in its digital code using a keyboard. A computer could supply a digital output to run the information retrieval system automatically.

Longitudinal locations are printed on the top of the Kalvar scroll. Vertical position information is attached to the carriage of the machine.

As the machine searches, the scroll moves both horizontally and vertically until it places the desired document image in position for viewing, reproduction, or conversion to a tv signal.

**Protecting secrets.** One interesting application of the system may be to safeguard classified documents because papers can be viewed without removing them from the files. Because the system is capable of high resolution it can be used to view documents such as aerial photographs or X-ray pictures.

Litton Industries, Beverly Hills, Calif. [398]

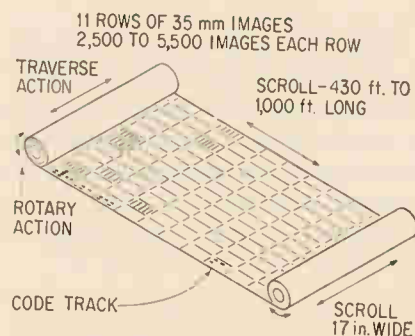

**Kalvar scroll.** Data can be retrieved from storage in about 20 seconds. Putting an image on the scroll costs about one cent.



R-Series  
2 sizes: 3-1/2", 4-1/2"

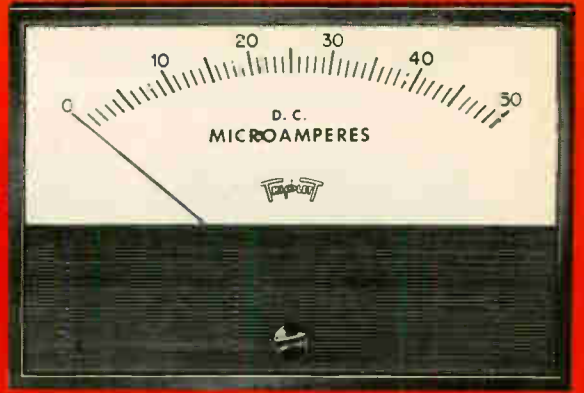

# TRIPLET

## "CLEAN SWEEP" PANEL INSTRUMENTS

A fresh approach to ultra-modern instrument design provides a "clean sweep" of the pointer over the full scale.

- 1** You get instant readability easier and at greater distances—plus more attractive designs to integrate into your equipment.
- 2** Self-shielded, accurate, reliable D.C. instruments have the exclusive Triplet BAR-RING movements.
- 3** Whatever your panel instrument requirement, look to Triplet for the right size and style, the right capability at the right price.

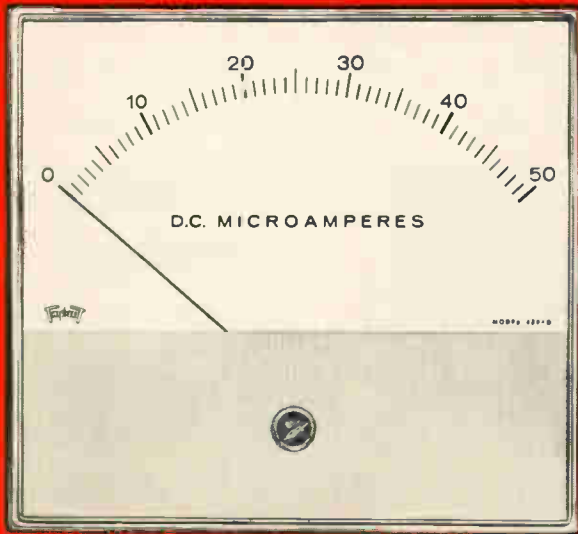

G-Series  
5 sizes: 1 1/2", 2 1/2", 3 1/2", 4 1/2", 5 1/2"



MODEL 120 Edgewise Panel Meters

### SHIELDED BAR-RING MOVEMENTS

ALNICO MAGNET IS MOUNTED INSIDE SOFT IRON RING; FULLY SELF-SHIELDED

Not affected by magnetic panels or substantially by stray magnetic fields for D.C.

More Torque  
Lower Terminal Resistance  
Faster Response  
Exceedingly Rugged and Accurate

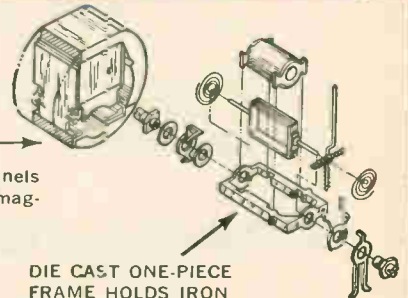

DIE CAST ONE-PIECE FRAME HOLDS IRON CORE IN EXACT ALIGNMENT

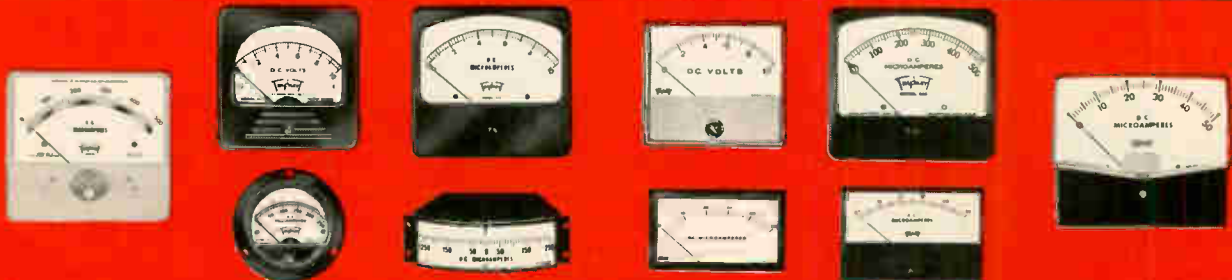

TRIPLET ELECTRICAL INSTRUMENT COMPANY, BLUFFTON, OHIO

Circle 133 on reader service card

## New Microwave Review

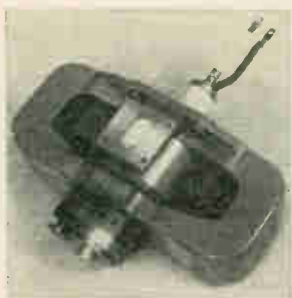

Mechanically tuned, coaxial magnetron model 304 is for use in airborne and ground-based radar systems. It develops 250 kw peak power across the 8.5- to 9.6-Ghz range. The 19-lb, air-cooled tube can be used in existing systems using the 6249 family of tubes. Dimensions are  $9\frac{3}{4} \times 10\frac{3}{4} \times 4\frac{1}{2}$  in. SFD Laboratories Inc., 800 Rahway Ave., Union, N.J. [401]



Two 50-ohm feed units provide a means of separating the d-c bias circuit from the r-f measuring circuit. Maximum bias current is 2.5 amps with voltage across the capacitor limited to 150 v d-c. The BN35616/6N/50 spans 30 to 100 Mhz, with vswr of 1.04:1; the 7N, 300 to 3,000 Mhz, with vswr of 1.06:1 at 3 Ghz. Rohde & Schwarz Sales Co., 111 Lexington Ave., Passaic, N.J. [402]



Power tetrodes 4CW800B and 4CW800F, designed for distributed amplifier applications, feature 4 individual circuit connectors to the active part of the grid. Filament voltage ratings are 6 v and 26.5 v, respectively. Units are capable of 1,000-w output. Minimum self-resonant frequency is over 900 Mhz. Eimac division, Varian Associates, 301 Industrial Way, San Carlos, Calif. [403]



Voltage-tunable over half an octave, the ETS3152 is a 1.2- to 1.8-Ghz fundamental oscillator that offers greater than 50 mw of output power. Control voltage is 0 to 20 v. The unit measures  $1 \times 1\frac{1}{4} \times 2\frac{1}{4}$  in. It will meet its specifications in  $-50^\circ$  to  $+70^\circ\text{C}$  environments. Delivery takes about 45 days. Consolidated Airborne Systems Inc., 115 Old Country Rd., Carle Place, N.Y. [404]



Eight compact, direct-reading attenuators span 7.05 to 90 Ghz. Attenuation range of each unit is 0 to 50 db. Vswr of 1.15, accuracies to  $\pm 0.5$  db, and maximum insertion losses of 0.5 db are attained. The units, all panel-mountable, range in price from \$350 to \$700. DeMornay-Bonardi division, Datapulse Inc., 1313 N. Lincoln Ave., Pasadena, Calif. 91103. [405]

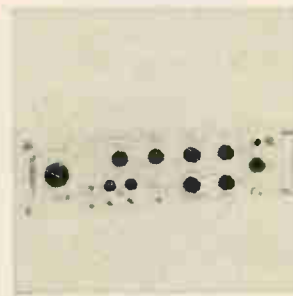

Phase measurements and impedance plots can be made with pulsed r-f signals using the model 306 pulse adapter. Among the applications is testing phase shift through microwave tubes with pulses as short as  $0.2 \mu\text{sec}$  and having a phase resolution of better than  $1^\circ$  from 2 Mhz to 40 Ghz. Wiltron Co., 930 East Meadow Dr., Palo Alto, Calif. [406]



A thin, flexible microwave absorber based on silicone rubber, Eccosorb FGM has an average reflectivity of 12 db down from 2 to 12 Ghz over a wide range of incidence angles. It is usable up to  $425^\circ\text{F}$  continuously, and up to  $500^\circ\text{F}$  for short times. It weighs less than 2 lbs per sq ft. Price is in the \$50 per sq ft range. Emerson & Cuming Inc., Canton, Mass. [407]



Double-balanced mixer 10514B, measuring  $1.63 \times 0.70 \times 0.43$  in., mounts on p-c boards. Range is 0.2 to 500 Mhz at l-o and signal ports; third port is d-c coupled. Conversion loss is less than 9 db over full range. Uses include pulse modulators, and current-controlled attenuators. Price is \$150. Delivery is from stock. Hewlett-Packard Co., 1501 Page Mill Rd., Palo Alto, Calif. [408]

New microwave

## Military mixer invades civilian market

Designed for a missile project, a mixer fits neatly into commercial communications

Rarely does a product developed for a military project ever find its way into civilian equipment. One exception may be a double-balanced mixer that was designed for the radar system of the Short Range Attack Missile (SRAM). Now Relcom, a small manufacturer in

Mountain View, Calif., says the same mixer can be used in a variety of commercial applications—as an r-f modulator, a pulse-code modulator, or a phase detector in a-m and f-m communications, and in telemetry equipment operating between d-c and 500 megahertz. The

company also has introduced a low-frequency version for 50-kilohertz to 200-Mhz operation.

Both models are priced at \$50, well under the \$150 to \$200 range of other double-balanced mixers.

**Crammed full.** For some time the company had been making a type M5B vhf/uhf mixer, but the device was bulky and relatively expensive. Then the military came along and wanted the M5B mixer crammed into a tiny package because of the SRAM receiver's space limitations. Relcom redesigned the mixer to fit into a hermetically-sealed can having a volume of only 0.064 cu. in. Now called the M6E, the mixer has eight leads, each 30



An L-band transistor amplifier is stable in an airborne rocket environment under all conditions of vswr and phase at the input and output. It has a gain of 17 db, 3-db bandwidth of 40 Mhz, and dynamic range of 60 db. With a center frequency of 1 Ghz, it includes a 10-db image reject filter at 1,120 Mhz. Micro State Electronics Corp., 152 Floral Ave., Murray Hill, N.J. [409]



Frequency converter CX-7 has 8 to 12 Ghz (r-f) and 2 to 6 Ghz (i-f) bandwidths. Noise figure is 8 db; conversion loss, 7 db average. Harmonically related spurs are 30 db, other spurs 70 db below desired output for an input level of 3 mw or less. An l-o delivering 3 mw for low level and 20 mw for high level use at 14 Ghz is required. Spacekom Inc., Box 235, Goleta, Calif. [410]



Monopulse tracking receivers handle standard frequency bands including 225 to 260, 1,700 to 1,800, and 2,200 to 2,300 Mhz, and will track all IRIG frequencies. They use synchronous cross-correlation and phase-lock-loop error detection techniques to derive d-c error voltage for controlling servosystems. Canoga Electronics Corp., 8966 Comanche Ave., Chatsworth, Calif. [411]

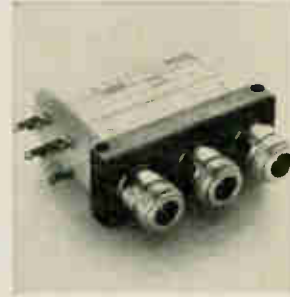

Coaxial latching switches of the MA-7524 series are for channel selection in military and commercial communications and radar equipment where space is limited. They feature 60-db interposition isolation from d-c to 12.4 Ghz and vswr of 1.5. Maximum insertion loss at 11 Ghz is 0.5 db. Maximum switching time is 0.015 sec. Microwave Associates Inc., Burlington, Mass. [412]

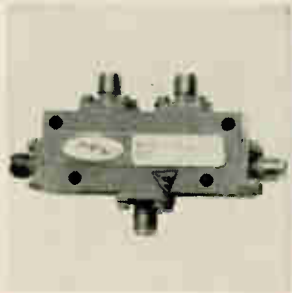

Solid state switch S001350, single pole, double throw, has a switching speed of 100 nsec. Its guaranteed high isolation value is 50 db to 2 Ghz, 46 db to 4 Ghz and low insertion loss of a maximum of 2 db to 2 Ghz, 2.8 db to 4 Ghz. R-f handling capacity is 2 w c-w. The switch weighs under 2 oz. Price is \$375 each. American Electronic Laboratories Inc., Colmar, Pa. [413]

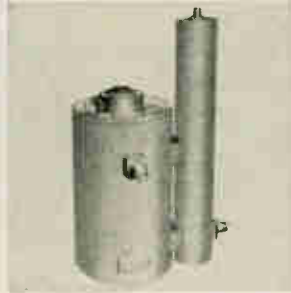

Pulse-amplifier cavity model 11026 can be used in phased-array and broadband-radar systems. It is rated at 10-kw output and operates in L band. Basic frequency is 425 Mhz and it is tuned manually. Bandwidth is 50 Mhz at 1.0-db points. Power input is 2.5 kw peak; maximum input vswr, 1.5:1. Microwave Cavity Laboratories Inc., 10 North Beach Ave., LaGrange, Ill. [414]



Precision 7-mm coaxial slotted line type 2852-05 is equipped with an APC-7 connector. It uses compensated dielectric pins instead of a conventional bead to support the inner conductor. Rated residual swr is under 1.025 up to 18 Ghz. Over-all dimensions are 2.7 x 3.6 x 10.6 in. Weight is 2.7 lbs. Price is \$1,140. Alford Manufacturing Co., 120 Cross St., Winchester, Mass. [415]



Model 410-A09 automatic frequency control and monitor cavity has a stability of  $\pm 1$  Mhz from  $-30^\circ$  to  $75^\circ$  C. It can be used to stabilize klystrons in discriminator circuits. The cavity offers a tuning resolution of  $\pm 0.5$  Mhz from 5.9 to 7.4 Ghz. A locking device protects the frequency setting against accidental change. Microlab/FXR, 10 Microlab Rd., Livingston, N.J. [416]

mils in diameter, positioned on 0.2 in. centers for plug-in mounting on printed-circuit boards.

Input and output coils of the

mixer are precisely wound and tapped. The coils are coupled by a balanced bridge that uses hot diode carriers to obtain turn-off

and turn-on times in the nanosecond range.

Unlike conventional transistor mixers, the diode bridge is a passive device, which doesn't require a power source. But the greatest advantages are in performance. The device has excellent cross-modulation characteristics, wide dynamic range, and good image rejection and carrier suppression. Of equal importance is its extremely low noise level, so low that a preamplifier isn't needed at times.

### I. Applications

Although the new device is designed primarily to extract the

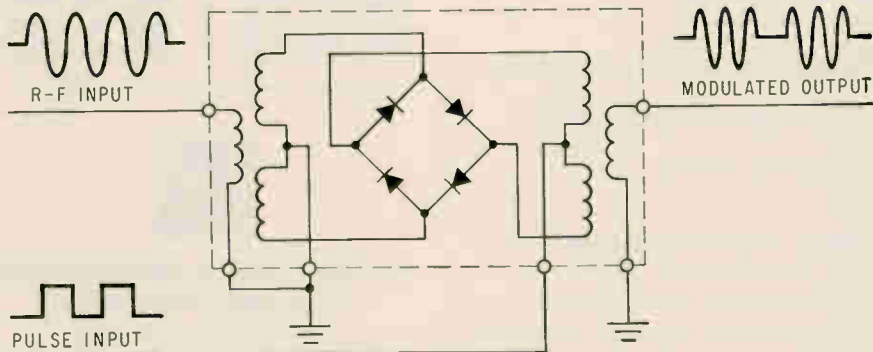

Power saver. Bridge of hot carrier diodes needs no power supply.



Model 71A  
Capacitance-Inductance Meter

**Instant readings of capacitance and inductance at 1 Mc/s... with an accurate DC analog of the measured value**

- Measures 3-terminal capacitance from 0 to 1000 pF; basic accuracy, 1%; resolution, 0.01 pF
- Measures 2-terminal inductance from 0 to 1000  $\mu$ H; basic accuracy, 1%; resolution, 0.01  $\mu$ H
- Ideal for semiconductors
  - DC bias to  $\pm 200$ V
  - 1 Mc/s crystal controlled test frequency
  - 15 mV test level
- Accommodates both high and low Q devices
- DC analog output; linearity, 0.1%

The Model 71A provides Continuous Measurement of C and L with the speed and convenience of a VTVM. DC analog output is capable of at least 4-digit resolution with appropriate DVM; permits rapid plots of such functions as capacitance vs. voltage of varactor diodes or linearity of variable capacitors on X-Y plotter. Also useful for automatic go/no-go testing, sorting, batching, or matching.

Price: \$795.00

Full technical details on request.

12

**BOONTON ELECTRONICS CORPORATION**  
 ROUTE 287 AT SMITH RD. PARLISIPANY, N. J.  
 TELEPHONE: 201-887-5310 TWX: 510-235-6747

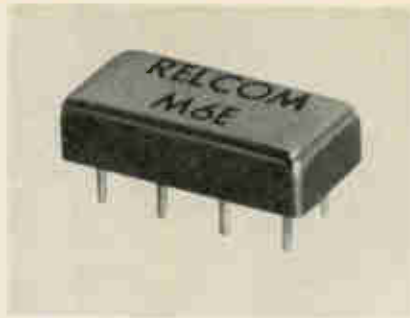

Tiny package. Mixer is squeezed into volume only 0.064 cu. in.

sum or difference of two input frequencies in superhot receivers, it is also used as a pulse modulator in radar systems.

In such a circuit, an r-f signal applied to the local oscillator terminal is amplitude- or pulse-modulated by the signal applied to the r-f terminal. The output is a double-sideband suppressed carrier signal. In this process, the pulse can be of any duration and either positive or negative to shift phases 180°.

**Attenuator or detector.** If the modulating pulse is replaced by a variable d-c source, the mixer becomes a signal attenuator with a range of -3 to -50 decibels. In another application, the mixer can work as a phase detector because its characteristics are so well-balanced, it needs no null-balance adjustments. As a result, interactions between signal sources are minimized.

Relcom, 2164 E. Middlefield Rd., Mountain View, Calif. [417]

New microwave

## Cutting costs of tv relay

Operating at FCC minimums new system fills needs of industrial users

Does a microwave system that relays closed-circuit television require the same resolution as a system needed by network broadcasters? No, say engineers at Varian Micro-Link Systems in Copiague,

# Buying Power?

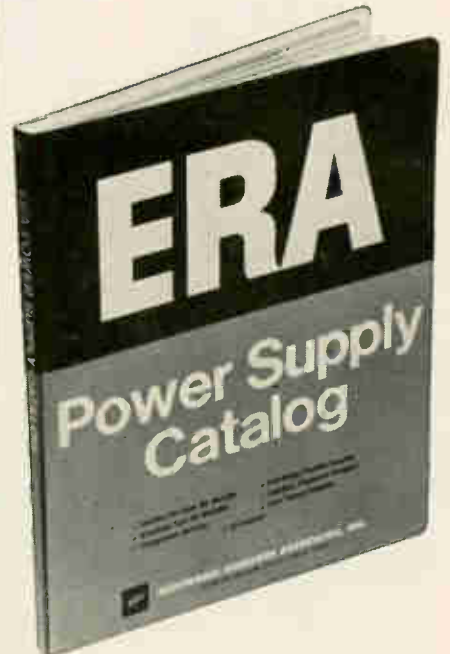

**Here's the new, single source for all your power needs.**

- Certified Mil Spec Transpac® DC Modules
- New Low-Cost Silicon Transpac DC Modules
- Full-Range Variable Supplies
- Inverters, Frequency Changers
- High-Voltage Supplies

**AC to DC • DC to AC  
 AC to AC • DC to DC**

Send for Your Free Copy TODAY!



**ELECTRONIC RESEARCH ASSOCIATES, INC.**

Dept. E-7 67 Sand Park Road  
 Cedar Grove, N. J. 07009 • (201) 239-3000  
 Subsidiaries: ERA Electric Co. • ERA Acoustics Corp.  
 ERA Dynamics Corp. • ERA Pacific, Inc.

# Just a few of the hundreds of answers Aerovox has to your RFI problems



## MINIATURE CERAMIC LOW PASS RFI FILTERS



Present military specifications require that electronic equipment be kept free of interference from 150 KHz to 10 GHz. Aerovox type FC low pass, miniature ceramic RFI suppression filters will meet or exceed the applicable requirements of MIL-F-15733. These new units have been life tested for 250 hours at 1½ times the working voltage. After test, insulation resistance of units is greater than 50 megohms.

All FC units are hermetically-sealed in silver plated cases and have been tested for moisture resistance, temperature cycling and immersion and vibration under MIL-STD-202. Six standard ratings are available depending on minimum insertion loss, maximum DC resistance and maximum DC current or low frequency AC. Operating temperature is -55°C to +125°C. Our filter application engineering department will work with you to design and manufacture the exact filter for your specific application requirement.

## RFI FEED-THROUGH SUPPRESSION CAPACITORS



Designed for applications in aircraft, industrial and vehicular equipment these new Aerovox feed-through suppression capacitors will hold effective series inductance to an absolute minimum and effectively filter broadband interference. Series P340 and P341 units have been specifically engineered for through chassis or through panel mounting. Three terminal design — case serves as actual ground termination and the through input-output line for DC or low frequency AC appears at the remaining two terminals.

These capacitors are available in 5 DC voltage ratings from 100 to 600 VDC and 10 capacitance ranges from .001 to 2.0 uf. They are hermetically sealed with glass-to-metal end seals for maximum performance in all environments. Aerovox types P340 and P341 meet or exceed the requirements of MIL-C-11693. Write today for complete descriptive literature.



**AEROVOX**  
CORPORATION  
OLEAN, NEW YORK  
NEW BEDFORD, MASS.

Selected commercial and military products are available off-the-shelf from Authorized Aerovox Distributors.

Cinch  
Creative  
Problem  
Solving

# for the most accurately plated contacts

## develop new QC techniques

Consistently high levels of quality control for precious metal plating requires measurement of plating thickness—in microinches—with reproducible results!

To be sure that Cinch equipment would produce contacts meeting even the most rigid plating specifications, an elaborate, continuing program of quality control was developed. Based on beta ray backscatter measurements, it involved—

1. Devising a new BetaScope calibration system traceable to the Bureau of Standards.
2. Designing new methods for consistent contact alignment in the BetaScope.
3. Establishing new procedures for the statistical analysis of data obtained from plating thickness measurements.

**RESULT:** Cinch can provide the exact plating thickness required at any point, or at all points, on a contact. Plating processes can be controlled to guarantee minimum plating depth because variations can be detected immediately.

At Cinch, the Quality Control Director reports directly to the President. Cinch is the *only* connector manufacturer whose products are accepted without incoming inspection by one of the nation's leading communications equipment manufacturers.

This sophisticated approach to quality control is another example of the extra dimension in Cinch's capabilities. Beyond the ability to develop fine products, we also offer in-depth production engineering, and tool, die, mold and equipment design and fabrication.

MEMBER

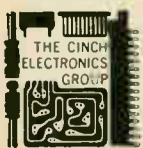

**CINCH**

DIVISION OF UNITED-CARR

CONSISTING OF CINCH MANUFACTURING COMPANY, CINCH-GRAPHIK, CINCH-MONADNOCK, CINCH-NULINE, UCINITE (ELECTRONICS) AND PLAXIAL CABLE DEPT.



Four-foot dish. Mounted behind antenna is transmitter sending to . . .



. . . Receiver dish. Receiver converter is also mounted right behind dish.

N.Y. They believe an industrial user can get by with a relay system that operates at the minimum standards set by the Federal Communications Commission.

Varian has come up with a relay system selling for \$4,060—about half the price of others on the market. Transmitting over a 4-mile distance in the 2.5-gigahertz band, the new system has a carrier-to-noise ratio of 37 decibels. Although this performance is borderline for commercial color transmission, Varian's engineers say it is more than adequate for most industrial or education applications. An improvement of about 7 db is possible if the system's standard 4-

foot antennas are replaced by 6-foot dishes.

The system includes an exciter, transmitter, transmitting antenna, receiving antenna, and receiving converter. Electronic portions are solid state. All a user needs to go on the air is a tv camera and monitor.

**Channel choice.** The exciter accepts a composite video signal and associated audio, then generates a vhf signal on channel 7, 9, 11, or 13 and sends it to the transmitter, which is mounted directly behind the transmitting antenna. One transmitter can accept the output of one or more exciters, converting it—or them—to the 2.5-Ghz carrier frequencies.

Mounted behind the receiving antenna is a receiver converter, which changes the 2.5-Ghz signal back to channel 7, 9, 11, or 13.

Up to four tv signals can be transmitted simultaneously and color can be transmitted by adding exciter units.

#### Specifications

##### Transmitter Model CU-1A

Power input 117 v a-c, 12 w  
 Frequency range 2,500 to 2,686 Mhz  
 Power output 2 mw peak visual  
 Type of emission visual A5, aural F3  
 Temperature range -40 to +140°F

##### Exciter Model EE-2

Power input 117 v a-c, 100 w  
 Frequency range 168 to 222 Mhz  
 Bandwidth 4.2 Mhz  
 Input 0.75 v pp video, -10 db audio

##### Receiver converter Model CE-5C

Power input 20 v d-c, 4 w  
 Power gain 16 db minimum  
 Noise figure 8.5 db nominal  
 Output frequency 168 to 222 Mhz  
 Temperature range -40 to +140°F

Varian Micro-Link Systems, Copiague, N.Y. 11726 [418]

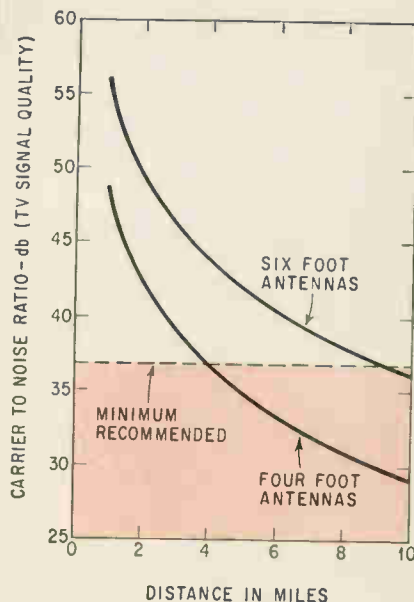

Minimums. Relay can operate at distances above the red area.

Our skills and services are available to you. For Cinch creative problem solving assistance contact Cinch Manufacturing Company, 1501 Morse Avenue, Elk Grove Village, Illinois, 60007

## RECORD DATA IN INK ON Z-FOLD PAPER AND READ IT LIKE A BOOK

The new Hewlett-Packard 7850 Series Rectilinear Fluid-Process Recorder produces ultra-clear traces on Z-fold paper or rolls. The numbered Z-fold pages offer more convenient access to recorded data. Contactless pen tip sensing and a low-pressure ink system produce traces of constant width throughout the recorder's

variable speed ranges of .025 to 200 mm. per second. Designed with modular, solid-state electronics, the 7850 Series Recorder provides high-resolution, permanent, rectilinear recording of up to eight variables from dc to 160 Hz.

A wide selection of 8800 Series Preamplifiers provides signal conditioning to the driver-amplifiers which drive the recording pens of the recorder.

The 7850 Series system includes a preamplifier power supply, a driver amplifier power supply and a cabinet to house the complete unit. The frequency response of the recorder is 160 Hz for 10 div p-p deflection and 60 Hertz maximum for full scale deflection. Maximum ac or dc non-linearity is 0.5% full scale. Additional features include: 14 electrically-con-

trolled chart speeds; built-in paper take-up; low ink supply warning light; plug-in ink supply cartridge that may be replaced while the recorder is in operation and complete modular construction of all components for easy maintenance:



For complete information on the 7850 system, optional and related equipment, contact your local HP Field Office or write Hewlett-Packard Company, 175 Wyman St., Waltham, Mass. 02154.

HEWLETT  PACKARD

17701

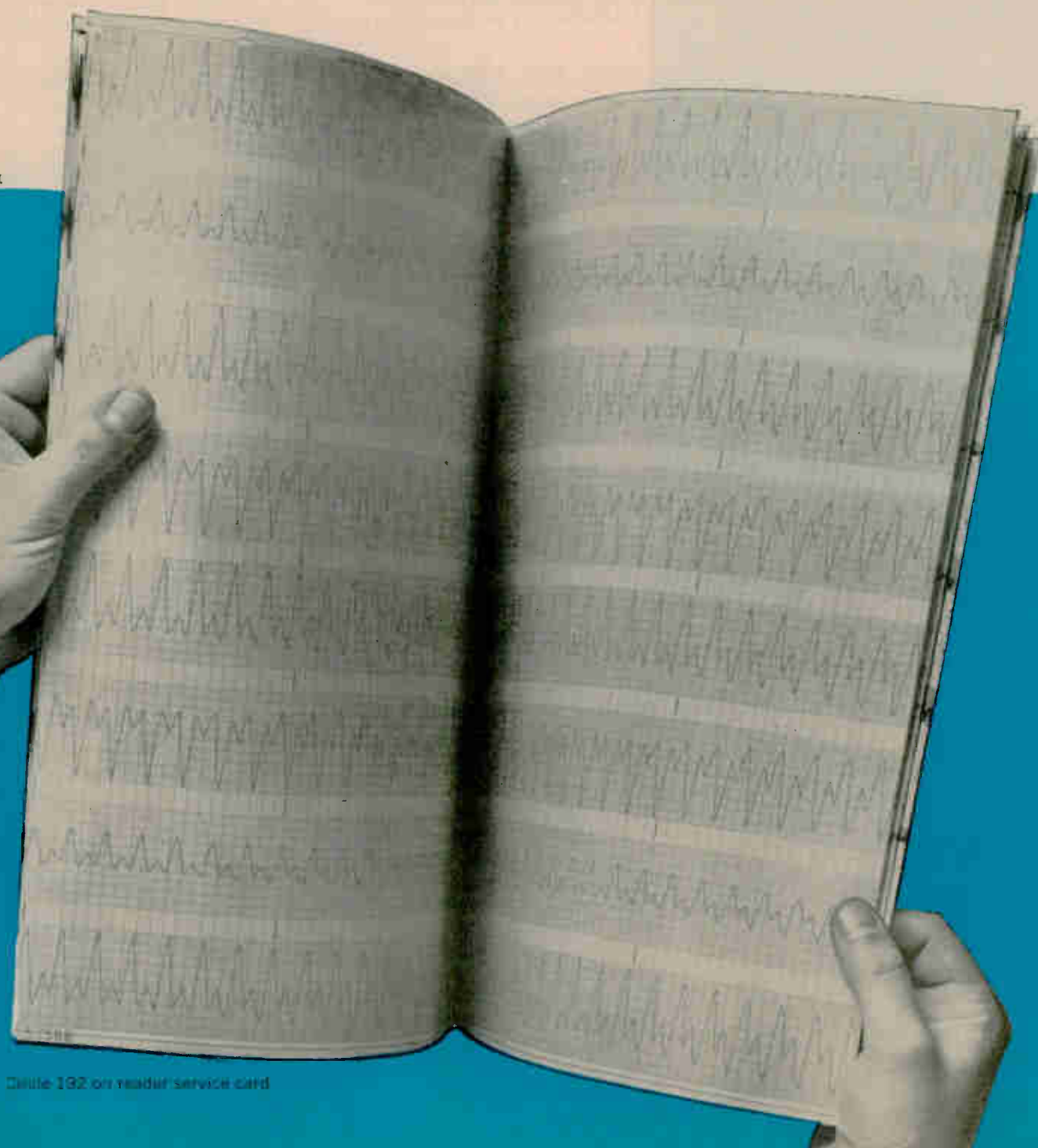

Circle 192 on reader service card



## New Semiconductor Review

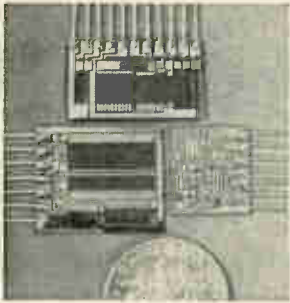

Designed for a-d converters, threshold logic gates, and voltage comparators, an operational amplifier uses a circuit with inherent 6 db/octave rolloff and a through delay of less than 6 nsec to achieve unconditional stability. Input offset voltage is under 3 mv; offset temperature coefficient, under  $10 \mu\text{v}/^\circ\text{C}$ . Bunker-Ramo Corp., 8433 Fallbrook Ave., Canoga Park, Calif. [436]



Six npn silicon transistors are available at 200, 300, and 400 VCER, with either 1- or 2-amp beta ratings. The 200-v units have a 200 VCEO(sus), the 300-v units have a 325VCEO(sus), and the 400-v units have a 400VCEO(sus). The entire line of triple-diffused devices has a power rating of 75 watts. Industro Transistor Corp., 35-10 36th Ave., Long Island City, N.Y. [437]



High-frequency, hybrid IC operational amplifiers are designated types ATF406 and ATF408. The thin-film circuits are fully frequency compensated at 25 khz for 6 db/octave rolloff. Open-loop gain is 100,000. Gain bandwidth product is 5 Mhz. Noise voltage is  $10 \mu\text{v}$  maximum. Micro-electronics division, Amperex Electronic Corp., Slatersville, R.I. [438]

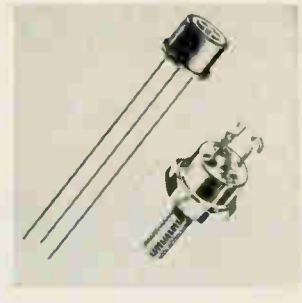

Triple-diffused, planar npn silicon transistors, designated 2400-6 (TO-5 case) and 2800-6 (TO-59 case), are rated 7.5 amps. They range from 30 to 150 v with a typical frequency of 25 Mhz. The TO-5 units, at 10 w, cost from \$6.60 to \$21.40 each on orders of 100. Prices of the TO-59's range from \$8 to \$24. Silicon Transistor Corp., East Gate Blvd., Garden City, N.Y. [439]



Hot-carrier diodes are packaged to permit use in circuits operating at frequencies up to 12.4 Ghz. Model 2701 has a single sideband noise figure of less than 6 db with a carrier frequency of 9.375 Ghz (local oscillator power, 1 mw). Model 2702 has a noise figure of 6.5 db; and model 2703, 7 db. Hewlett-Packard Co., 1501 Page Mill Rd., Palo Alto, Calif. [440]

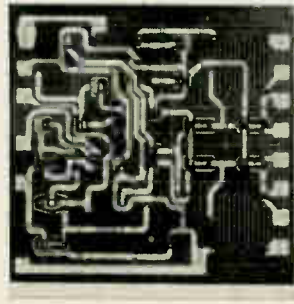

Silicon planar IC operational amplifier UC4000 has an offset voltage adjustable to 0 with external pot. Common mode voltage is  $\pm 10$  v; differential input offset current, 15 nanoamps; differential input offset current drift, 175 picoamps/ $^\circ\text{C}$ ; and input offset voltage drift,  $10 \mu\text{v}/^\circ\text{C}$ . Prices start at \$17. Union Carbide Electronics, 365 Middlefield Rd., Mountain View, Calif. [441]



Fast-recovery rectifiers IN4942, -4, -6, -7, and -8 are suited for use in high-reliability airborne- and missile-power supplies. Typical reverse recovery is 100 nsec up to 600 v, and 250 nsec up to 1,000 v piv. Units handle 1-amp average rectified current at  $55^\circ\text{C}$ , with low leakage current of 0.1  $\mu\text{a}$  at rated piv,  $25^\circ\text{C}$ . Semtech Corp., 652 Mitchell Rd., Newbury Park, Calif. [442]

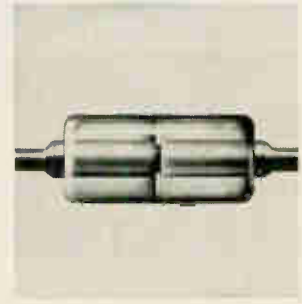

Whiskerless, voltage-variable capacitance diodes cover 3 to 18 pf. The Q's exceed 500 at 50 Mhz. Inductance is less than 0.5 nh; package capacitance, 0.2 pf. The diffused planar silicon units offer leakage under 100 na at 20-v reverse voltage. Double-plug construction gives reliability; the DO-35 package, high density. MSI Electronics Inc., 34-32 57th St., Woodside, N.Y. [443]

### New semiconductors

## DTL that fits TTL pins

Two new dual J-K flip-flops are part of a holding action fought against the onrush of TTL

With the proliferation of integrated circuits has come what marketing men call the pin game—the tendency, either accidental or deliberate, of a semiconductor manufacturer to design a unique pin configuration for its line of digital logic. Although the individuality

makes a manufacturer's line unique, it wreaks havoc on a user who may end up married to a certain line of ic's solely because of the location of the connector pins. To make a change could mean re-designing everything else.

Four new flip-flops, introduced

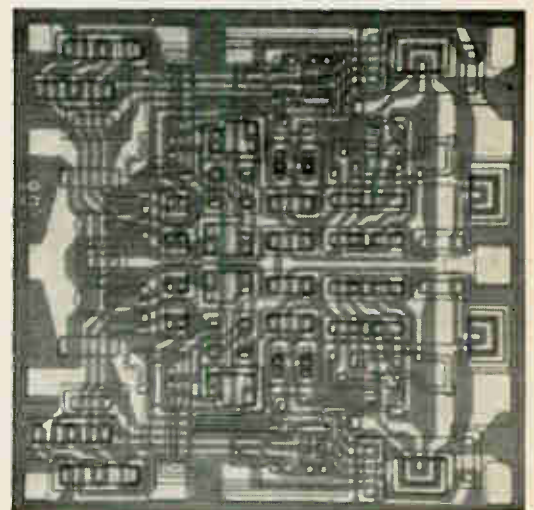

Compatible. DTL flip-flop fits TTL pins.

# NEW! Push-Button Bridge

## Measures Impedance to 0.1% Accuracy

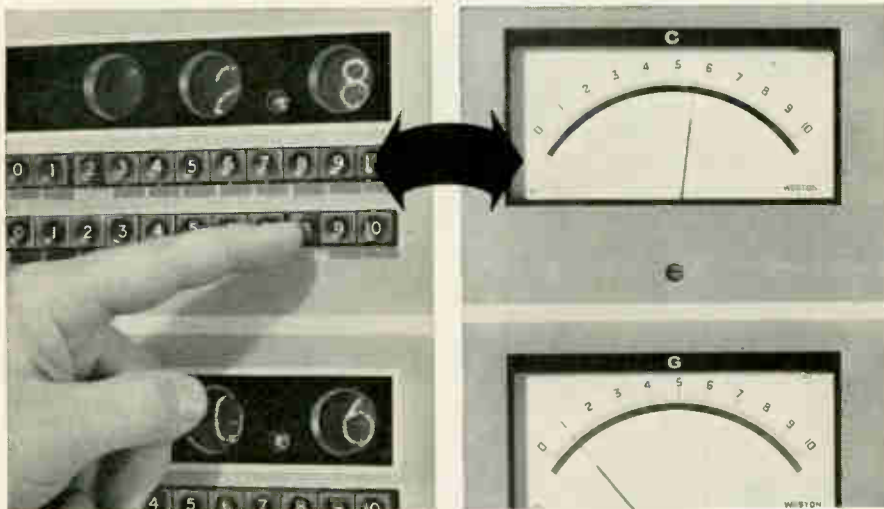

Once the Bridge is trimmed, a series of front-panel range push-buttons are suppressed in sequence until a reading is obtained on the meter. Setting up the first one or two digits of this reading on push-button decade controls gives the final reading.

## No Manual Balancing with New Wayne Kerr B641 Universal Impedance Bridge

Now, batch testing of components or the observation of changing values under laboratory conditions are made simpler and faster by the new Wayne Kerr B641 Universal Impedance Bridge.

Designed for the continuous measurement of any type of impedance or admittance, at audio frequencies, as low as 1 picofarad — to an accuracy of 0.1% — the B641 eliminates manual balancing, makes readout virtually automatic.

Operation is simple: once the Bridge is trimmed, it is necessary only to depress a series of front-panel range push-buttons in sequence until a reading is obtained on the electronically-balanced meters. Setting up the first one or two digits of this reading on push-button decade controls makes the balancing automatic; the meters can read the first, second, third or fourth digits.



The Bridge produces analog voltage proportional to the meter readings and BCD (in a 1248 code), for the nixie readout.

The B641 is based on the transformer-ratio-arm principle, giving stable performance even when components under test form part of a sub-assembly (such as a printed board or an encapsulated unit) or when long measurement leads must be used.

### SPECIFICATIONS

Overall Ranges: 0.002pF — 50,000 $\mu$ F	Accuracy: 0.1% from 1pF to 10 $\mu$ F
20p $\bar{c}$ — 500 $\bar{c}$	10n $\bar{c}$ to 100m $\bar{c}$
200nH — 5MH	1mH to 10kH
2n $\bar{c}$ — 50,000M $\bar{c}$	10 $\bar{c}$ to 100M $\bar{c}$
Discrimination: 0.01% of max. on all ranges	Price: \$1,700 FOB Montclair, New Jersey

For literature and detailed specifications, write:



## Wayne Kerr CORPORATION

18B Frink Street, Montclair, N.J. 07042 • Phone 201 746-2438

INNOVATIONS IN INSTRUMENTATION

... the speed of TTL has  
blinded some engineers ...

by Stewart-Warner Microcircuits Inc., gives that company a small gain in the pin game. The devices, which are dual J-K clocked flip-flops, fill out Stewart-Warner's DTL line, which is the same logic Fairchild Semiconductor calls the 930 line. But if a different final mask is used for metalization, the pin configuration will be identical to that of the SUHL 2 TTL dual flip-flops made by Sylvania Electric Products Inc., a subsidiary of the General Telephone & Electronics Corp.

**Fighting back.** The move also reflects the great inroads that transistor-transistor logic has made into the sales of diode transistor logic. Edward Farrell, marketing manager of Stewart-Warner Microcircuits, believes that TTL has been oversold for some applications. He thinks that some engineers have been blinded by its speed superiority over DTL and have designed TTL into systems where such speed isn't needed. The move creates other problems, such as power and noise.

If TTL proves unsatisfactory, or suppliers can't meet demands, says Farrell, the engineer can replace it with a Stewart-Warner DTL circuit that is compatible. No physical design changes are required because the pin connectors are in the same place in both families.

Initially, Stewart-Warner had hoped to make the new circuits also compatible with the TTL line offered by Texas Instruments Incorporated, but the layout problems were so complex the objective had to be dropped. Farrell explains, "We would have to bring the same set of output and inputs to three different kinds of pin configurations. It could be done, but not on a chip 56 mils square."

**Pairs of circuits.** The new circuits come in pairs: the SW 705 and SW 706 are of the Fairchild 945 type; the SW 708 and SW 709 correspond to Fairchild's 948. In each set, the first is a circuit with separate clock inputs and the second has a common clock and reset. By interchanging connections—the Q with the Not Q and the J with the K—the designer can use asynchronous inputs for clearing in-

# New CVC AutoMate™...The Decision Maker

## Just Touch The Control...

## AutoMate Does The Rest

An AutoMate™ control system will handle your vacuum cycle for production—and do it automatically. AutoMate is engineered to make human decisions without human errors. Think what this means:

*Finger-tip control on the AutoMate Decision Control Center . . . relieves operators from further machine attendance.*

*Automatic sequence operation . . . the cycling decision is made and carried out in response to actual pressure in the system.*

*Repeatable performance . . . get exactly the same results every time.*

So let AutoMate make the vacuum decisions to free your operator for more important tasks in your production process. Use AutoMate in electronics, optics, ceramics, metallurgy.

AutoMate gives you a complete system with automatic control center, chamber, pumping system, and gauge. These elements have been human-engineered into a new design that makes AutoMate stand for the latest technological advances in high-vacuum automation. Write for details. Consolidated Vacuum Corporation, Rochester, N.Y. 14603. Subsidiary of Bell & Howell.



**AutoMate Automatic Control Center** as installed on CVC's new systems. Just touch the control—AutoMate does the rest. This Control Center introduces a whole new era of automated high-vacuum systems. Watch for more . . . from CVC.

Circle 195 on reader service card

# Sample and hold. Sample and hold. Do dah. Do dah.

The closed-loop performance of Redcor/Modules' new Sample-and-Hold will put a smile on your face and a spring in your step. The 770-715 has an accuracy of 0.01%. If that don't get you, try a settling time of 5 microseconds for 20V step input. Or how about an input impedance of 10 megohms at 1 kc? Maybe a frequency response of DC to over 50 kHz? This performance, friends, is yours for a mere \$250 in quantities of 50. Redcor makes equally appealing comparators,

dynamic bridge and buffer amplifiers, 8-channel multiplexers, plus 0.1% Sample-and-Holds. They all have a great new pin layout that for the first time lets you easily interconnect modules with dual in-lines. So quit clapping your hands long enough to request complete data.

**REDCOR CORPORATION**  
7800 DEERING AVENUE  
CANOGA PARK, CALIFORNIA 91304  
(213) 348-5892 • TWX 213-348-2573

Circle 241 on reader service card

Capacitors and Resistors



Relays



## Our parts go into everything electronic



Connectors

Producers of *all types* of electronic components have their reasons for relying on Volkert Stampings. It comes out in the extra things Volkert does. Like converting a multi-piece design to a single stamping. Or consistently using high-speed equipment to reduce per-part costs.

Write or call Volkert Stampings, Inc., 222-35 96th Avenue, Queens Village, L. I., New York 11429. Telephone 212-464-8400.

**Volkert STAMPINGS, INC.**

Subsidiary of The Stanley Works

stead of setting, reversing functions.

The new circuits are available in flatpack or dual in-line ceramic packages. Prices in lots of 100: \$10.10 per circuit with a military rating ( $-55^{\circ}$  to  $+125^{\circ}\text{C}$ ).

### Specifications

Model 945	
Internal power dissipation at 25°C ambient	500 mw
Typical power dissipation at $V_{cc}=5$ v	82 mw
Operating temperature range	$-55^{\circ}$ to $+125^{\circ}\text{C}$
Fan-out	10
Propagation delay time	75 ns max turn-on 75 ns max turn-off 55 ns typ turn-on 40 ns typ turn-off

Model 948	
Internal power dissipation at 25°C ambient	500 mw
Typical power dissipation at $V_{cc}=5$ v	100 mw
Operating temperature range	$-55^{\circ}$ to $+125^{\circ}\text{C}$
Fan-out	9
Propagation delay time	75 ns max turn-on 65 ns max turn-off 55 ns typ turn-on 40 ns typ turn-off

Stewart-Warner Microcircuits, Inc., 730 Evelyn Ave., Sunnyvale, Calif. 94086 [444]

### New semiconductors

## IC's call the tune in electronic organ

Two new MOS circuits are created for the consumer electronics industry

A rock 'n' roll band would be the first to appreciate two complex integrated circuits introduced by the Semiconductor Products division of Motorola Inc. The units, fabricated with metal-oxide-semiconductor (MOS) technology to reduce their costs, are for inclusion in small portable electronic organs that can be moved about by such musical groups. The circuits—a frequency divider designated MC-1124P and a dual-keyer gate designated MC1120P—are the first IC's made especially for the consumer electronics industry with MOS technology. They cost \$2 each in large volume purchases.

Although Motorola is aiming

# ARNOLD IS



## ***ELECTRICAL ALLOY TRANSFORMER LAMINATIONS***

Our transformer laminations are used in every conceivable application from toys to sophisticated military space equipment.

We stock standard sizes in DU, E, EE, EI, F, LE, L, UI. We also have facilities for custom designs to your specifications. Chemically milled ultra-thin laminations and parts are also available. Silicon laminations only available west of the Rocky Mountains. Write for Catalog PD-122A.

Arnold is also ■ Permanent Magnets ■ Tape Wound Cores ■ MPP Cores  
■ Magnetic Shielding ■ Transformer Cans and Hardware ■ Bobbin Cores  
■ Silectron Cores ■ Special Magnetic Materials.

 **ARNOLD**  
SPECIALISTS in MAGNETIC MATERIALS

THE ARNOLD ENGINEERING COMPANY, Main Office MARENGO, ILL.  
BRANCH OFFICES and REPRESENTATIVES in PRINCIPAL CITIES

# it costs you nothing to call on experience:

Reeves-Hoffman design and manufacture  
is 100% custom . . . . .  
let us quote your needs!

★ quartz crystals

★ crystal filters

★ oscillators

★ discriminators

★ standards

★ ovens



400 WEST NORTH STREET, CARLISLE, PENNSYLVANIA 17013  
Telephone 717-243-5929

- Md., Del., D.C., Va., W.Va., N.C.  
Valley Electronics, Inc.  
Baltimore, Maryland  
(301)668-4900; (202)659-1760
- New England  
Howard Jappe Company  
Wakefield, Mass.  
(617)245-9359
- Pa. (except Pittsburgh), So.N.J.  
Eastern Components, Inc.  
Philadelphia, Pa.  
(215)927-6262
- New York (except N.Y.C.)  
Midstate Research Sales Co.  
Syracuse, New York  
(315)478-8314; (315)478-0715
- New York City, No.N.J.  
G. M Moch Company  
Ridgefield, New Jersey  
(201)945-0080, (212)279-6758
- So. California  
Ash M Wood Company  
Arcadia, California  
(213)283-1201, (213)287-0449
- No. California  
L & M Engineering  
Santa Clara, Cal  
(408)243-6661
- Ill., Ind., Wisc., Minn.  
PGM Sales, Inc  
Chicago, Illinois  
(312)622-8183
- Ohio, W.Pa., Mich., Ky.  
Tri-State Marketing, Inc.  
Cincinnati, Ohio  
(513)631-5060
- Texas, Okla., Ark.  
Carter Associates, Inc.  
Garland, Texas  
(214)276-7151
- Ariz., N.M., Las Vegas  
Carter Associates, Inc  
Scottsdale, Arizona  
(602)947-4355

Circle 242 on reader service card

... IC's eliminate 80%  
of the assembly work ...



On the inside. Motorola engineers built this organ with a 5-octave, 61-note keyboard, and 18 function and voicing stops, to demonstrate what its new MOS IC's could do.

these new devices at a specific market. the company feels the functions have use in other applications, particularly home appliances, automotive, and industrial control.

Both circuits are monolithic devices. The frequency divider has four flip-flops, so it's really four dividers in one; the keyer has two gates. In the new IC's, each transistor is a field-effect device with an insulated gate.

Using the IC's, an electronic-organ manufacturer eliminates 80% of the assembly work required with discrete bipolar transistors and diodes.

### 1. Making Music

The keys of the organ operate switches that turn electronic oscillators on or off. When a key is depressed, a keyer gate is closed selecting the proper frequency dividers to produce the desired tone. Motorola's new circuits do this switching. Since a square wave is required, a digital flip-flop makes a good frequency divider.

**Bright note.** Motorola's applications engineers see the organ as an ideal application for integrated circuits because it uses large numbers of the same kinds of circuits. The divider chain of a typical organ has 44 frequency dividers, but can vary from 25 in small in-



## No Engineer or Draftsman should be without the BY-BUK handy CROSS REFERENCE GUIDE to better printed circuit drafting

which include standard sizes  
as specified in MS 16912,  
(NORD) conforming to MIL-P-  
55110A... & its **FREE**



The booklet features over 3000 sizes of tapes, pads and shapes for **FASTER MORE ACCURATE DISTORTION-FREE PRINTED CIRCUIT MASTER DRAWINGS.**

Write today for **FREE** handy cross-reference guide, price list and **FREE** samples from the most complete supplier of Printed Circuit Drafting and Masking Aids.

### BY-BUK COMPANY

4326 West Pico Blvd., Los Angeles, Calif. 90019 • Phone (213) 937-3511

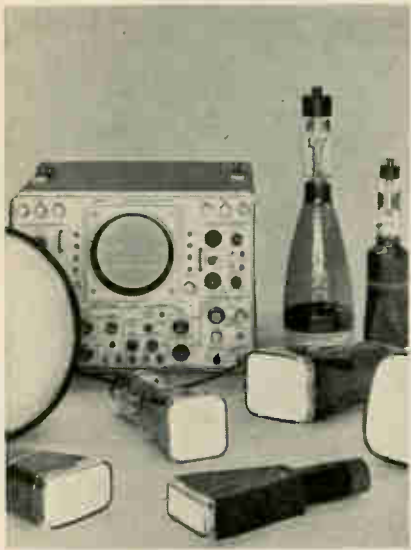

Tubes, ETC.

ETC. means many things. In cathode ray tubes, *ETC.* means everything from design leadership to volume manufacturing.

Write for more information.



**GENERAL ATRONICS**

ELECTRONIC TUBE DIVISION

PHILADELPHIA • PENNSYLVANIA 19118

Circle 243 on reader service card

**MINIATURE  
PUSH BUTTON SWITCHES.  
WIPING, SNAP ACTION  
and BUTT CONTACTS.  
SPST. SPDT. DPST. DPDT.  
PUSH-PULL. LIGHTED.  
25,000 to 1,000,000  
OPERATIONS.**

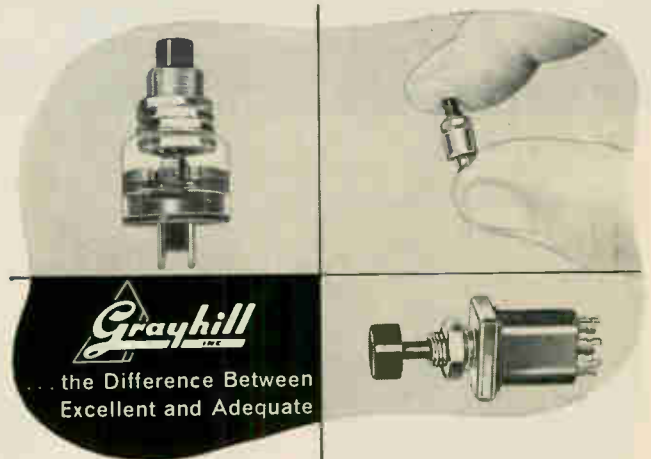

**Select Materials**

- Contacts—Fine Silver
- Springs — Tinned Music Wire
- Housing — Molded Phenolic per MIL-M-14
- Shorting Bar & Terminals — Fine Silver or Silver Plated Copper Alloy

**Typical Specifications**

- ¼ Amp. to 10 Amps., 115 VAC Resistive
- Contact Resistance 10 Milliohms
- Insulation Resistance — 25,000 to 900,000 Megohms

All fully described in Engineering Catalog G304

Write



523 Hillgrove Avenue

LaGrange, Illinois 60525

Area Code 312, Phone 354-1040

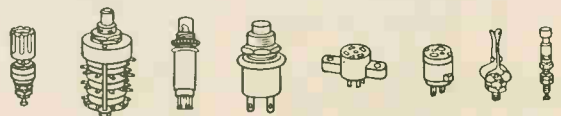

"PIONEERS IN MINIATURIZATION"

Circle 199 on reader service card

199

# Need Fast Decay in Photocells?

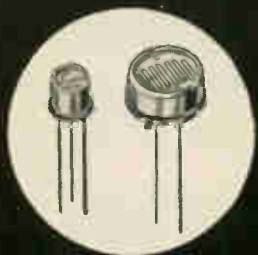

Clairex Type 7H cells offer .0006 sec. at 100 ft-c

In addition to fast decay time, Clairex Type 7H photocells also provide 240 ohms @ 100 ft-c and CdS stability. They are available in TO-18 and TO-5 cases and in 6 resistance ranges.



CLAIRES ELECTRONICS, INC. ■ 1239 BROADWAY, NEW YORK, N.Y. 10001

Circle 244 on reader service card



1 1/2 in. AM-1 (actual size)

## Distinctively Styled high torque, self-shielded panel meters

Smart, sophisticated styling . . . easy reading scale . . . sizes 1 1/2 to 4 1/2". Rugged, high torque mechanism offers 1% linearity, 2% accuracy and sensitivity to 20 ua. Completely shielded to eliminate error from magnetic panels. Mounts bezel-to-bezel on any material without interaction or effect on calibration. Choice of colors or finishes, custom dials — ASA/MIL 4-stud mounting.

### AMMON

AMMON INSTRUMENTS, INC.  
345 Kelley St., Manchester, N.H. 03105

200 Circle 200 on reader service card

we have experience with



SIMMS

MIL-M-24100A

and can help you with  
**COMPOSITION-ARTWORK-PRINTING**

A ZERO DEFECTS PLANT

**BRACELAND BROTHERS, INC.**

141 EAST HUNTING PARK AVENUE,  
PHILA., PA. 19124 - 215 - GL5 4400

Circle 245 on reader service card

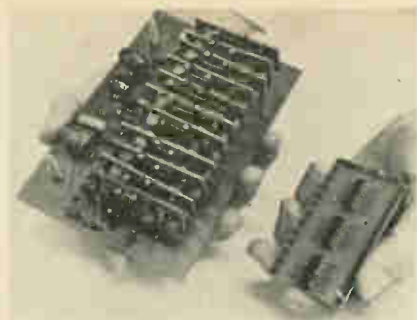

Simplicity in IC's. Subsystem (right) built with MOS IC's, which are packaged in plastic, takes only one-tenth the space of an equivalent unit (left) built with discrete devices.

struments to 60 in large ones.

Since each part of a divider chain can be formed by using flip-flops from one or several packages of MC1124P circuits, an organ with a good range can be built with as few as 12 of the frequency divider MOS circuits. And all 12 packages can be mounted on a single printed-circuit board.

The keyer section is also repetitive. The MC1120P circuit channels several notes at each keying position, supplying better than 70 decibels isolation.

Semiconductor Products Division, Motorola Inc., Phoenix, Ariz. [445]

New semiconductors

## Linear IC's take consumer spotlight

Three circuits for audio applications aimed at entertainment market

To the makers of integrated circuits these days, no buyer looks as attractive as the one who works for a consumer electronics company. As engineers from entertainment electronic firms gathered at annual meetings in Chicago and New York last month, representatives of semiconductor companies were bustling about showing off new IC products designed especially for consumer equipment.

Texas Instrument Incorporated is making its big play with hybrid

Electronics | July 24, 1967



# This

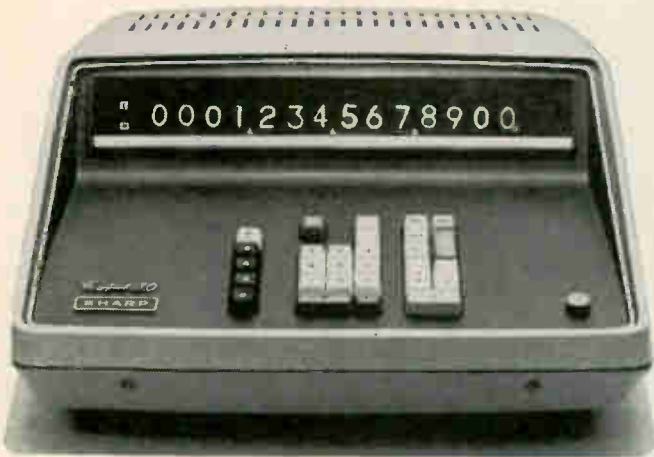

**chains you  
to your desk a much  
shorter time.**

Some things must be done at the desk. But as quickly and accurately as possible. Sharp's electronic desk calculator, Compet-30, is the answer to cutting calculation time.

Two new features on the face of Model CS-30B really save time. The yellow one is the "memory register"—which stores intermediate answers for continuing calculation. The red one attempts to prevent human error by warning of overflow. Together they free you from the desk much faster.

And quietly. The boss can't hear if you are working or not! The CS-30B has no moving parts. Leave the desk and check the Compet-30 now.



COMPET Model CS-30B

- Easy to operate and maintain
- Impossible to double set keys
- Fraction round-off key
- Decimal, plus, minus automatically displayed
- 14 digit display

# SHARP

HAYAKAWA ELECTRIC CO., LTD. Osaka Japan

U. S. Subsidiary: SHARP ELECTRONICS CORP. 178 Commerce Road Carlstadt, New Jersey

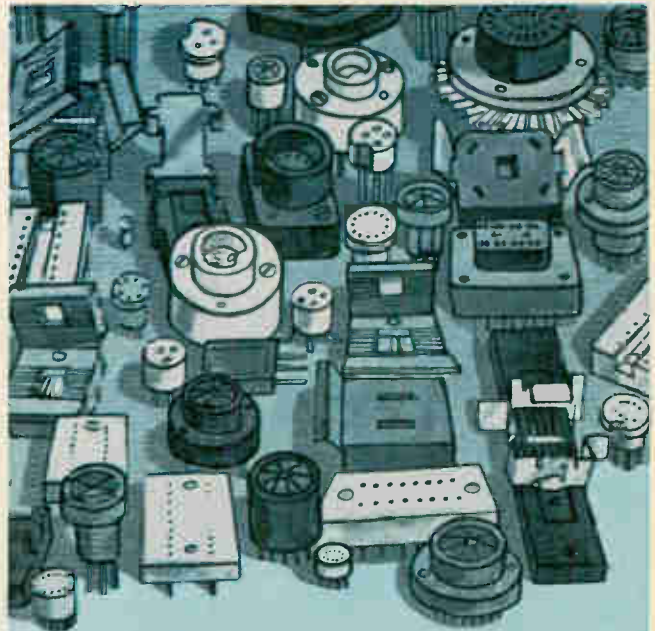

*...and everything  
in between*

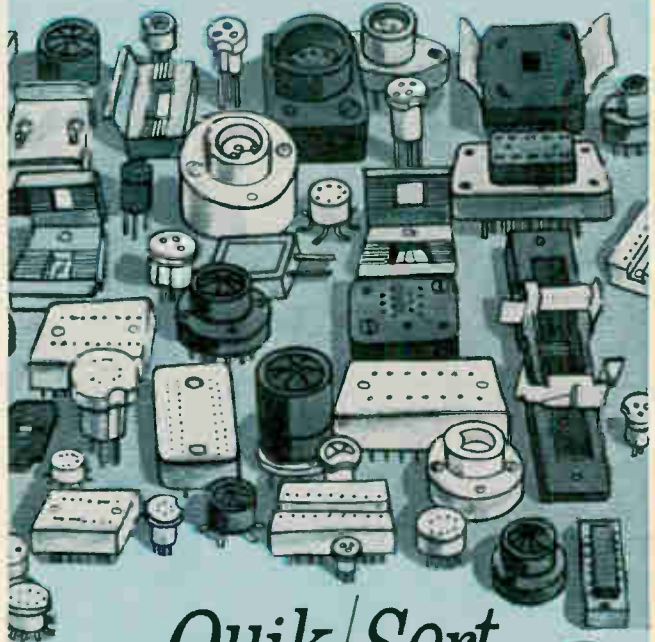

**Quik/Sert**  
**SOCKETS**  
**CARRIERS and CONTACTORS**

**barnes**  
DEVELOPMENT COMPANY

LANSDOWNE, PA. 19050 ■ (215) MA 2-1525

# Meet The Dividers!

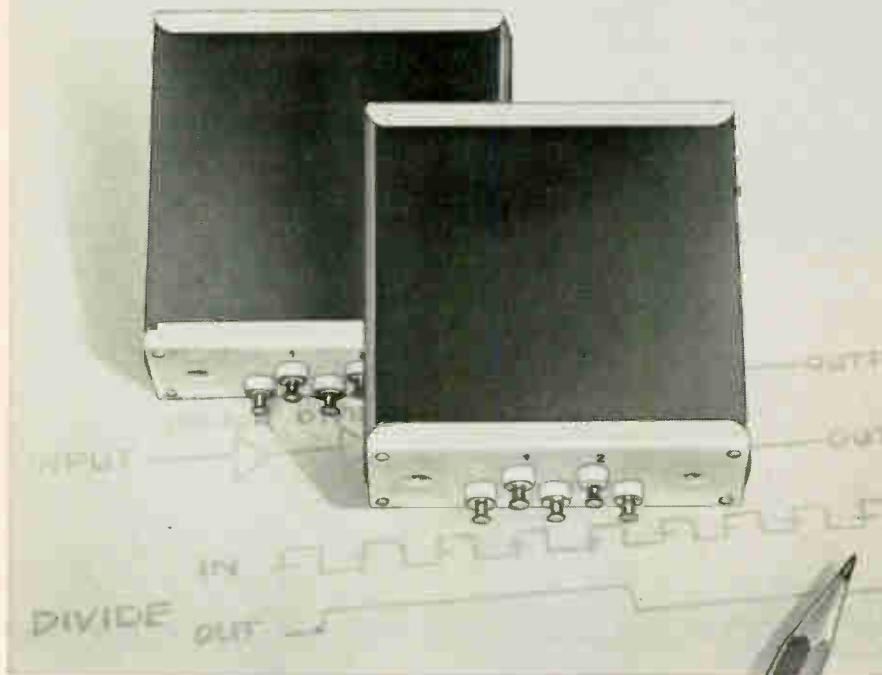

## ICD SERIES INTEGRATED CIRCUIT DIVIDERS

They are new from International. Use them for crystal controlled time bases, scope calibrators, and clock sources.

International ICD units are totally integrated circuit frequency dividers. They are smaller than a pack of cigarettes (1" x 2¼" x 2⅜"). All have two separate outputs. They are packaged in nine types providing divide ratios 2 thru 10. No tuning or adjustment is required. The output pulse has the same stability as the driving pulse. Voltage required, 3.6 vdc ± 10%.

### FREQUENCY RANGE

ICD-10 to 10 MHz	\$19.95 ea.
ICD-2 thru ICD-9 to 2 MHz	\$19.95 ea.
ICD Buffer (for feeding more than one circuit)	\$ 9.95 ea.

WRITE FOR COMPLETE CATALOG.



**CRYSTAL MFG. CO., INC.**  
10 NO. LEE • OKLA. CITY, OKLA. 73102

... packaged in plastic  
to reduce costs ...

ic's [Electronics, June 26, p. 163]; Motorola has the first consumer-oriented ic's built with metal oxide semiconductor technology [see p. 198]; and General Electric is expanding its bridgehead into the consumer marketplace with three additional linear integrated circuits.

**Three more.** At the top of GE's new line is a 2-watt audio amplifier for phonographs, tape-cartridge playbacks, sound projectors, television sets, f-m receivers, or any high-quality reproduction. It has the equivalent of seven transistors, five diodes, and four resistors. Two of the units can be used to obtain stereophonic reproduction. Called the PA237, the new circuit complements GE's first ic product, which was introduced several months ago: the 1-watt audio amplifier PA222. The company's new amplifier will cost \$2.38, compared to \$2.20 for the smaller device.

For a variety of functions in tv and f-m receivers, a combination amplifier-discriminator circuit has been packaged as the PA189. One of its most useful characteristics is high voltage gain, 70 decibels. Price is \$2.16.

The third product is a small signal amplifier for general-purpose service, the PA230. Its output is protected against short circuit.

**In-line package.** All of GE's ic's are—like Motorola's—packaged in dual in-line units made of plastic to reduce cost and facilitate handling on the customer's assembly line. A metal tab built into the plastic package transfers heat from the ic to the circuit board.

Before GE developed its new ic's, it sent a team of engineers around the country to question circuit engineers at consumer companies about their needs. The three new products were those most often mentioned. Still, there hasn't been any rush to buy the ic's as yet. Most consumer companies are still figuring how big—if any—the savings might be if they switched to integrated circuits. GE's own radio and television division is not yet committed to using them.

General Electric Semiconductor,  
Syracuse, N.Y. [475]



## *Cimron's Fast-Track DVM gives you the whole ball of wax—speed and accuracy!*

Some DVM's are fast. Some are more accurate than others. Cimron's Fast-Track is something else—the perfect balance between the increased speed and accuracy you need for systems work. The 5-digit Fast-Track achieves its speed with a new solid state logic that can “change its mind” as the unknown voltage changes. You get this per-

fect balance, plus all of Cimron's customer concern extras—like the calibration procedure printed on the guard shield. 5-digits plus overrange; 100 millisecond maximum balance time; accuracy of .001% F.S. + .005% of reading. Model 4600 Series, from \$4390. For details, write Cimron, Dept. A-104, 1152 Morena, San Diego, California 92110.

**CIMRON**  
A Division of  
Lear Siegler, Inc.



# PUT YOUR FINGER ON REAL MINIATURIZATION



It's one thing to build small connectors. It's something else again to make them tiny *and reliable*. Like BRM, designed and developed by BENDIX/DAGE. BRM is one-fourth the size and weight of standard BNC and TNC, yet is loaded with quality features such as hermetic sealing, captive contacts, gold-over-silver plating . . . and low, *low* VSWR. That's *real* miniaturization. BENDIX/DAGE engineering contributes to the state of the art by helping *you* move forward to greater capabilities in *your* field.

Write for BRM/BRMM brochure and Engineering Qualification Test Reports. If you have a special problem, call. Call today!



**DAGE** ELECTRIC COMPANY

a subsidiary of the Bendix Corporation

Hurricane Road • Franklin, Ind. • Phone 317/736-6136

FIRST WITH IDEAS • FIRST WITH QUALITY • FIRST WITH SERVICE

Good, old-fashioned, Scottish thrift.

We've become so thrifty at Honeywell that we've pared the prices of taut-band meters down even lower than the prices of pivot-and-jewel meters. (About 10% lower, on the average.)

Now, if your shrewd business sense tells you we've left something out, you're right.

We've left out half



the parts. (All the unnecessary ones.) Which doesn't make the meter less sophisticated. Just less complicated.

This taut-band meter is so ingeniously simple, there's hardly anything to go wrong.

There's no friction in the moving system, so the pointer doesn't stick. (Better readout accuracy and repeatability.) And the meter's self-shielded.



The low-cost taut-band meter from Honeywell. It comes in just about any style you'd like. Write Honeywell Precision Meter Division in Manchester, N.H. 03105 and we'll send you a brochure with all the sizes, styles and prices.



## What's the secret of Honeywell's taut-band meter success?



among other things...

# This P&B relay can save you up to \$2.40\* per relay installed

\*Compared with ordinary 3-pole dust-covered relays using an octal socket.

## The KU series is available in many variations to fit your requirements



1 Open relays can be mounted with stud and locating tab, tapped core or bracket as shown.  
Five or ten ampere contact ratings. AC or DC.

.187" quick connect/solder terminals standard (.205" available).

2 Stud and locating tab on top of cover may be ordered.

3 Built-in push-to-test button is available.

4 High impact polycarbonate dust cover.

5 Optional neon lamp shows if power is reaching coil.

6 Flanged dust covers for direct chassis mounting are available.

7 True 10 ampere nylon socket.

The KUP can save you up to \$2.40 (including socket costs) over similar relays with factory wired octal plugs. A true 10 ampere nylon socket can be supplied to receive the quick-connect terminals. Standard KU/KUP relays are covered by Underwriters' Laboratories' Component Recognition Program.

Quick-connect terminals mean faster installation on your production line . . . easier replacement in the field. Standard models have .187" terminals, but .205" may be ordered. All terminals are punched for those who prefer solder connections.

Long life, improved reliability, exceptional versatility and, in the case of covered relays, substantially lower costs are all part of the KU Series. Call your P&B sales representative today, or get in touch with us direct.

### KU SERIES SPECIFICATIONS

#### GENERAL:

Description: 5 or 10 amp. General Purpose Relay.  
Expected Life: 10,000,000 cycles, Mech.  
Breakdown Voltage: 1,500V rms 60 Hz  
between all elements;  
500V rms 60 Hz between open contacts.

#### CONTACTS:

Arrangements: Up to 3 Form C.  
Rating: 5 or 10 amps @ 28V DC or 120V AC.

#### COILS:

Voltage: DC to 110V; AC to 240V 60 Hz.  
Power: DC 1.2 W; AC 1 and 2 poles 2.0 VA;  
AC 3 poles 2.7 VA.  
Resistance: 16,500 ohms max.

#### MOUNTING:

(open relay) 5-32 mtg. stud,  $\frac{7}{32}$ " locating tab  
on  $\frac{7}{16}$ " centers. Socket available.

STANDARD P&B RELAYS ARE AVAILABLE AT  
LEADING ELECTRONIC PARTS DISTRIBUTORS



**POTTER & BRUMFIELD**

Division of American Machine & Foundry Company Princeton, Indiana  
Export: AMF International, 261 Madison Avenue, New York, New York

## New Books

### Unfinished story

Theory of Semiconductor Devices  
J.H. Leck  
Pergamon Press, 164 pp., \$4.75

This conventional treatment of the subject is not much different than many works published on semiconductor device theory over the past 10 years. In a book of this modest size, perhaps not too much should be expected. But there are some oddities that must be mentioned.

First, the author quotes carrier concentrations in terms of carriers per cubic meter, instead of the conventional units—carriers per cubic centimeter. Thus for the reader who is accustomed to the usual practice, all the numbers given for this parameter in the book must be scaled down by  $10^{-6}$ . Similarly, electric fields within the semiconductor are given in volts per meter rather than volts per centimeter.

Another oddity is the statement on the opening page: "At the present time the most important semiconductors commercially are elements from group IV of the periodic table—carbon (diamond), silicon, germanium, and, grey tin." The III-V and II-VI compounds are said to be "obviously interesting and important but quite outside the scope of this text." With all the interest, energy, and money being expended on light detectors and emitters and bulk effect devices made from these compounds, it would have been worth while to widen the scope a little to include these other important materials. The full chapter devoted to the pnpn controlled rectifier could have been replaced with such a discussion.

Field effect transistors are allotted only seven pages. The metal oxide semiconductor version gets only one and a half pages, while integrated circuits get nothing. The book also is not particularly strong on processing techniques, which are now being pushed to the limits, and make the difference between success and failure with many of today's devices.

The book is intended as a text for senior undergraduates and certainly any undergraduate who ab-

sorbs all the material would be doing well. But regardless of the low price, a practicing engineer would be better advised to invest his money in a book with a wider scope. In such a volume, the contents of Mr. Leck's book would only take up the first few chapters while the remaining material could be devoted to the details of such topics as radiation damage, surface effects, processing techniques, and photoelectronics and bulk effects.

### Chosen few

Basic Switching Circuit Theory  
Moshe Krieger  
The MacMillan Co., 256 pp., \$9.95

This work does not deal with the basic concepts of reliability of switching circuits, iterative circuits, speed independence, nor, to any extent, threshold circuits. Instead, the author has zeroed in on certain restricted areas of circuit theory, treating the material carefully and thoroughly. The book is therefore most suitable for a short introductory course on switching circuits. It is also valuable for those who wish to find out what a central segment of switching circuit theory is about without having to struggle with many unfamiliar notations and definitions.

Of the four chapters, the first two act as an elementary introduction to such basic concepts as n-cubes and Boolean algebra. They can be understood by almost any interested reader. The last two chapters, however, deal with the advanced topics and also some of the more interesting aspects of the design of asynchronous and synchronous sequential circuits.

Chester Lee

Bell Telephone Laboratories  
Holmdel, N.J.

### Lasers for learners

Gas Lasers  
C.G.B. Garrett  
McGraw-Hill Book Co.  
144 pp., \$10.95

Trying to cover the topic of gas lasers in a 144-page text aimed at

**P&B DRY REED  
CLIP FILE**

**A dry reed  
relay makes this  
memory circuit  
do double duty...**

**faster,  
cheaper, longer**

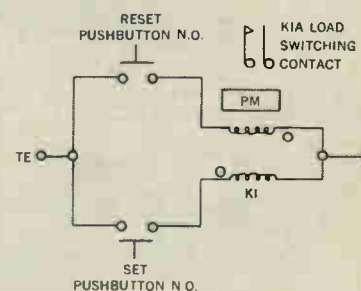

This double-duty circuit provides (1) memory and (2) switching from low level to 50 watts. Specify an inexpensive P&B dry reed relay and get high speed (in the low millisecond range), extremely long life (20 million operations) and compact size. Metal enclosures provide electrical shielding as well as physical protection for the coils and capsules.

### Full line—up to 5 reeds per module

JR standard size and JRM miniature reed relays are available in assemblies of 1 to 5 switches. Both sizes come in a complete range of coil voltages and various combinations of Forms A, B and C contact arrangement.

### Capsule seals are stress-protected

Bobbin flange extensions support the terminal pins, providing stress protection of the capsule seals.

Send for a catalog giving complete specifications. Contact your local P&B representative or the factory direct for complete information.

P&B Dry Reed Relays are now available from authorized electronic parts distributors.



**POTTER & BRUMFIELD**  
Division of American Machine & Foundry Co.  
Princeton, Indiana 47570



**Couch**  
ROTOR  
RELAYS

## Cramped for space?

### Use Couch 1/7-size Relays

Space/weight problem? The new Couch 2X 1/7-size crystal can relay gives you tremendous savings in space and weight. 0.1" grid — plus many outstanding specs — *all in micro-miniature*. Thoroughly field-proven in electronics and space applications.



	2X (DPDT)	1X (SPDT)
Size	0.2" x 0.4" x 0.5"	same
Contacts	0.5 amp @ 30 VDC	same
Coil Operating Power	100 mw 150 mw	70 mw 100 mw
Coil Resistance	60 to 4000 ohms	125 to 4000 ohms
Temperature	-65°C to 125°C	same
Vibration	20 G	same
Shock	75 G	same

Meets Mil-R-5757D

Broad choice of terminals, coil resistances, mounting styles. Write for detailed data sheets.

RUGGED ROTARY RELAYS  Dynamically and Statically Balanced

## COUCH ORDNANCE INC.

3 Arlington St., North Quincy, Mass. 02171, Area Code 617, CYPress 8-4147 • A subsidiary of S. H. DUCH CDMFANY, INC.

## New Books

research people working on or with the devices is like writing the great American novel on an index card; you can't cover the material in depth. The author's hopes that the book will prove useful to researchers and also to students interested in the borderline between physics and technology are in vain. Neither of these groups would greatly benefit from studying this text. Rather it is an appropriate introductory text for those who are not in the field of laser physics but who have had sufficient exposure to modern physics and have the interest to learn what is involved.

By limiting himself to gas lasers the author has simplified the description of such topics as energy levels, lifetimes, spectroscopy, optical properties, and cavity modes. The reader is further helped by a table of symbols and an adequate bibliography to lead him to more detailed information. Topics such as stabilization, modulation, and Q switching are mentioned with references made to the most recent results.

The book, which is not up to the technical level of others in McGraw-Hill's Advanced Physics Monograph Series, has a minimum number of equations and can easily be read in one evening.

David R. Whitehouse  
Raytheon Co.  
Waltham, Mass.

### Recently published

Residue Arithmetic and its Applications to Computer Technology, Nicholas S. Szabo and Richard I. Tanaka, McGraw-Hill Book Co., 236 pp., \$12.50

All of the known work in the field has been reduced and unified by the authors in this summary. Basic principles, fundamental theorems, and specific examples are offered in a tutorial description of the residue number system. Several methods of implementing residue arithmetic techniques with computers are described.

Radioisotope Measurement Applications in Engineering, Robin P. Gardner and Ralph L. Ely Jr., Reinhold Publishing Corp., 483 pp., \$16

A text-reference in radio-isotope methods, covering the basic physics of nuclear radiation, instrumentation, radiation safety techniques, radiotracing and radiography. An appendix describes 15 laboratory experiments that illustrate the principles presented and can be performed with simple, inexpensive equipment.



## TIGHT DEADLINES? SYNCHRON MOTORS CAN HELP YOU MEET THEM

You can schedule hot action display deliveries confidently, knowing that Hansen will back you up with SYNCHRON Motors. Consistently finer performance in displays, and excellent delivery service, have built the biggest demand in our history.

To meet this demand and to help you meet your fast deadlines, production capacity has been nearly doubled and our precision-trained work force increased. Any reasonable schedule can be met with the finest synchronous hysteresis motor made. 8, 20 and 30 oz.-in. torques; 220, 110 and 24 volts; 60, 50 and 25 cps. 168 speeds, over 300 drives. Write or call us, or your nearest Hansen Mfg. Co. representative.



HANSEN REPRESENTATIVES: CAREY & ASSOCIATES, Houston and Dallas, Texas; R. S. HOPKINS CO., Sherman Oaks, Calif.; MELCHIOR & MacPHERSON, INC., San Carlos, Calif.; THE FROMM CO., Elmwood Park, Ill.; H. C. JOHNSON AGENCY, INC., Rochester, N.Y.; WINSLOW ELECTRIC CO., Essex, Conn.; Narberth Pa., and New York, N.Y.  
EXPORT DEPARTMENT: 64-14 Woodside Ave., Woodside, N.Y.



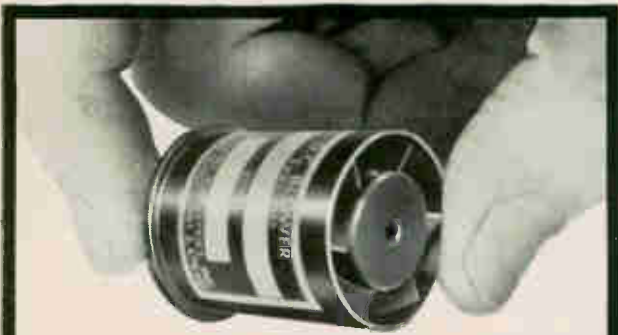

## AC OR DC SMALLEST VANEAXIAL BLOWERS

Only 1 1/8" in diameter, these smallest blowers deliver 4 times as much air as other comparable size blowers, 15,000 times their own volume per hour. Use these rugged sub-miniature blowers for spot cooling of critical components where space is cramped and weight is important. A.C. units exceed 1000 hour life. Designed to meet MIL-E-5272. Globe makes larger blowers, too. Some units available for 24-hour delivery. Request Bulletin XAV. Globe Industries, Inc., 2275 Stanley Ave., Dayton, Ohio 45404.

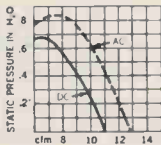

VAX-1-AC 26 v.a.c. (115 v.a.c. w/1.2 MFD capacitor in series), 400 cps, 320 MA, 2.0 MFD phasing capacitor 1 1/8" dia. x 1 1/2" long. 1.5 oz.  
 VAX-1-DC 26 v.d.c., 250 MA, 1 1/8" dia. x 1 1/8" long. 1.4 oz.

Circle 248 on reader service card

# CURTIS TERMINAL BLOCKS



FREE

## NEW, INFORMATIVE SELECTION GUIDE

A new, 24-page, completely illustrated catalog contains photos, descriptions, ratings, engineering drawings, and prices of the complete line of Curtis terminal blocks. Included are printed circuit, insulated feed-thru, quick disconnect, track type, and high current terminal blocks.

Send today for your free copy.

**CURTIS DEVELOPMENT & MFG. CO.**  
 3203 N. 33rd Street • Milwaukee, Wisconsin 53216



SEE US AT WESCON, BOOTH 1013

Circle 249 on reader service card

## PINS

as short as this



## LEAD WIRES

as long as this



## BASES MOLDED

to any specs



The Tung-Sol method of molding subminiature lamp bases permits meeting almost limitless mounting specifications—long lead wires—short pins—and base configurations in a great variety of forms. Molded bases achieve mounting simplicity that sharply reduces production costs. There is no mounting receptacle to install. Elimination of the cemented-on metal bases insures improved reliability. Harnessing can be to your specs. Let one of our idea men suggest how Tung-Sol molded base lamps can help you produce a better product at a saving. Write, without obligation, Tung-Sol Division, Wagner Electric Corporation, One Summer Avenue, Newark, N.J. 07104.

# TUNG-SOL®

## WHERE BIG THINGS ARE DONE WITH SMALL LAMPS

\*REGISTERED TRADEMARK WAGNER ELECTRIC CORPORATION

Circle 209 on reader service card

209

# Got a 30 MHz counter headache?



## Count on Janus for speedy relief!

If your counter instrument or system designs have been a bit sluggish and out of spec, lately, you may have a 30 MHz Counter Headache! Reach for a Janus UC-300 Series 30 MHz BCD Counter-Display, WITH TTL, and get speedy relief! This Series accepts periodic and aperiodic signals to 30 MHz. Important features: BCD outputs, preset to non-zero numbers, external count control and bright in-line display. Input and output levels are compatible with DTL and TTL integrated circuit logic levels. Also available with latch storage for "blur-free" display and BCD data storage. For slower-speed headaches use Janus 5 MHz Counter-Display Modules.

See your local Janus Representative or write for clinical data.

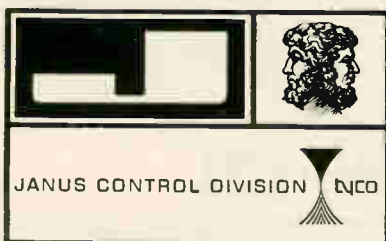

296 Newton St., Waltham, Mass. 02154  
Phone (617) 891-4700

## Technical Abstracts

### On and off sputtering

Pulse plasma sputtering  
J.G. Froemel and M. Sapoff,  
Victory Engineering Co.,  
Springfield, N.J.

Sputtered microcircuits, from the lab to production  
John Hall,  
Union Carbide Corp.,  
Mountain View, Calif.

An efficient electrode for forward and reverse sputtering  
R.R. Rodite and R.E. Dreikorn,  
International Business Machine Corp.,  
Endicott, N.Y.

Vacuum evaporation is still the workhorse thin-film deposition technique, but sputtering is winning the hurdle-jumping honors these days. Specialists have been mixing the three basic sputtering methods — direct-current, radio-frequency, and reactive—in a score of ways that make practical the deposition of such exotic materials as compound semiconductors, as well as dielectrics, metal alloys, and mixtures of metals and dielectrics.

Now, the number of possible combinations has been raised by a fourth sputtering technique, reported by J.G. Froemel. Called pulsed sputtering, the technique allowed Victory Engineering Co. to develop a new line of thermistors made with multiple-oxide thin films [Electronics, March 6, p. 125].

As in triode sputtering systems, a glow discharge is set up in a gas between two electrodes. Ions from the plasma bombard a target of the material to be deposited, dislodging atoms that settle onto the thermistor substrate near the target.

In the new system, the plasma is generated by applying pulses at negative potential to a field-emission cathode and positive pulses to an anode. The target is pulsed negative or is supplied r-f energy, depending on the material being sputtered. Pulse rates range from 10 hertz to 1.2 Mhz and potentials range up to 23 kilovolts.

Pulse generation of the plasma gives very close control over sputtering action, essential to prevent changes in properties of complex compounds. In addition, the targets are cooled to prevent their degradation—and in some cases,

thermal disintegration. The pulses also made ion action livelier, boosting deposition rates. A speed record of 800 angstroms a second was set during the deposition of copper, with the target cooled below 90°C.

John Hall told how a combination of several tricks of the trade enable Union Carbide Corp. to sputter thin-film resistors onto monolithic ic's at a rate of 25,000 circuits an hour. This, he pointed out, represents a reduction in processing cost allowing, at long last, film resistors to be made as cheaply as diffused resistors. The bonus is higher precision and fewer performance limitations, such as the substrate parasitics of diffused resistors. The film resistors equal the diffused ones in power dissipation—up to 5 watts per resistor, or 100 watts a square inch, at which point the contact materials diffuse into the ic.

The basic machine is a conventional bell-jar sputterer. R-f coils and ring magnets whose polarities are periodically reversed were added to help make the sputtering action more even. Fringes of the atomic flow are masked off by a glass shield around the plasma and target. The substrates are on a revolving drum behind a window in the shield and are heated to promote sticking of the sputtered atoms.

Net effect of the modifications is that films are deposited more uniformly over an unusually large area of substrates, more than 25 square inches, allowing many silicon slices to be processed in batches.

Another cost cutter is elimination of the film-etching step normally used to pattern the resistor. The pattern is developed in photoresist, before the substrates go into the vacuum chamber. The deposited film sticks only to the substrate areas bared by the resist pattern.

R.R. Rodite has been experimenting with reverse sputtering in hopes of making printed circuits by a cleaner, simpler process than chemical etching. The ions will remove copper from a substrate if

# NOW

## illuminated panel switch

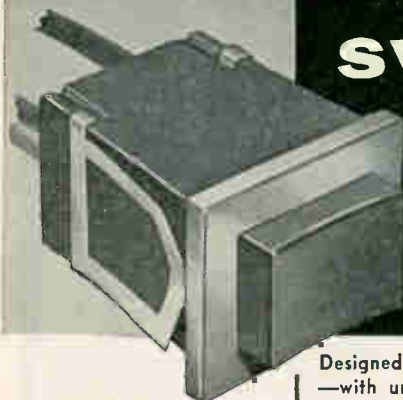

- UL LISTED  
2 amps 115 V a-c
- Combination Light and Switch
- Low Cost per unit

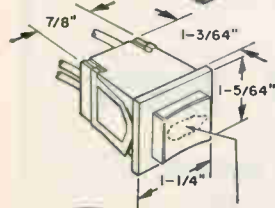

Designed for functional beauty —with unlimited button and trim ring color combinations. Unique snap-in mounting available for panel installations from 1/32" to 7/16" thickness. Diffused lens. Legend identification on button available. Switch is available in push-on-push-off and momentary contact units. 115 V a-c (neon) 6 thru 28 V (incandescent). Specials up to 8.5 amp. rating.

For complete details . . . write to



**MOLEX® PRODUCTS CO.**

5741 Katrine Ave., (312) 969-4550  
Downers Grove, Ill. 60515 TWX 910 695-3533

Circle 250 on reader service card

# ELIMINATE WASTEFUL DRAWING-BOARD- TEDIOUS!

Engineers and draftsmen should use their time creatively. Let STANPAT prepare any symbol, diagram, spec, detail, title block, or any other drawing that appears in your tracings repeti-

tively. Simply apply the STANPAT in seconds directly to your drawing. It will be accurate . . . permanent . . . perfectly reproducible . . . and you will gain more creative time!

Drawing-board time should be used for creative problem-solving . . . not for repeated and re-repeated rendering of often-used elements. STANPAT changes draftsmen from drawing-machines to creative assets. But it has to be STANPAT if you want STANPAT's advantages: pre-printing on finest tri-acetate; crisp, clean reproduction even with microfilm, matte surface that thrives on erasures; flat-lying, easy-storing sheets; complete freedom from "ghosting".

Send for literature and samples today.

faithfully serving the engineer for a quarter century



**STANPAT PRODUCTS INC.**

Covert and Main Street, Dept. J-7  
Port Washington, N.Y. 11050  
Telephone: 516 883-8400

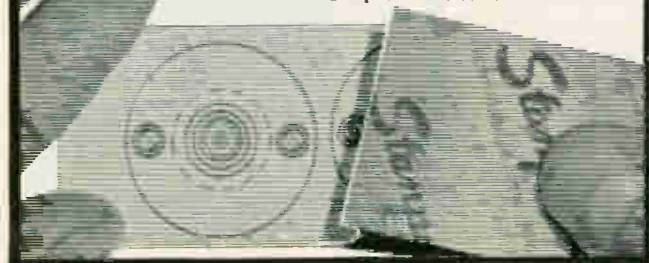

Circle 251 on reader service card

# What price performance in a quality filter?



less than \$15  
with Clevite's compact  
ceramic ladder filter.\*

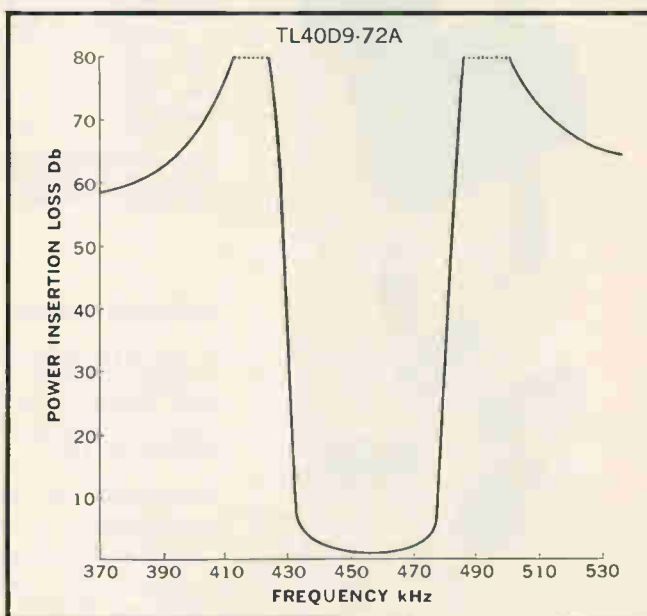

Here's the smallest (less than 0.07 cu. in.), most rugged fixed-tuned filter on the market today!

Clevite's 9-disc miniature filter is packaged in a hermetically-sealed cylinder, exceeds all military environmental specifications, is ideal for transistorized i-f amplifier circuitry in AM and FM sets plus many other applications that call for a fixed-tuned filter. Stop band rejection: 50 db. Center frequency tolerance:  $\pm$  3kHz. Stability: within + 0.2% for 5 years; within 0.2% from  $-40^{\circ}\text{C}$  to  $+85^{\circ}\text{C}$ . Impedance (in and out) 2000 ohms for B/W less than 12 kHz; 1000 ohms for broader bandwidths.

Following models standard at 455 kHz (A) or 500 kHz (C) (custom models on special order):

Model Number	min. @ 6db	B/W	max. @ 60 db
TL10D9-20 (A or C)	10 kHz		20 kHz
TL16D9-32 (A or C)	16 kHz		32 kHz
TL20D9-38 (A or C)	20 kHz		38 kHz
TL30D9-57 (A or C)	30 kHz		57 kHz
TL40D9-72 (A or C)	40 kHz		72 kHz

\*PRICES: 1—\$25 ea; 25—\$20 ea; 100—\$17.50 ea; 500—\$15 ea; 1000—\$13.75 ea; 2500—\$12 ea.

(Prices subject to change without notice)

Send order or request for Bulletin 94021 to: Clevite Corporation Piezoelectric Div., 232 Forbes Rd., Bedford, Ohio 44014, U.S.A. Or: Brush Clevite Company, Limited, Southampton, England.

# CLEVITE

Circle 253 on Reader Service Card

211

Specify  
**PERMACOR®**  
 where iron cores  
 is our one and  
 only business



*Illustrated: flexible shielding and threaded iron cores*

In this age of specialists, PERMACOR stands above all others in the production and design of powdered iron cores. This is our sole business and our core specialists can solve any problem. We have a full line of stock cores and unexcelled facilities for manufacturing any custom cores.

IRON CORES... Plain, Hollow, Threaded, Insert, Tuning, Cup, and Toroidal Iron Cores, Iron Coil Forms, Sleeves, Flexible Magnetic Shielding, Bobbins and special shapes...our only business and we're the world's largest. We invite your inquiry.

**PERMACOR®**

A Division of Radio Cores, Inc.

9540 Tulley Ave., Oak Lawn, Ill. 60454  
 Phone: 312-422-3353

## Technical Abstracts

the circuit board is used as the target in an r-f type of system. He has not yet determined the etching resolution, but says the process is reliable.

Copper was removed at a rate of 700 angstroms a minute from 5-inch disks masked by photoresist so that lines on a half-inch grid were etched. Switched-polarity magnetic fields and an ion shield around the target solved two problems that cropped up, the tendency of the system to etch one side of the target faster than the other and to etch through the copper into the substrate along the edge of the conductor pattern.

No special fixturing is needed. The disks are simply placed on the horizontal anode surface and held there by gravity.

Papers presented at the Symposium on the Deposition of Thin Films by Sputtering. University of Rochester, N.Y., June 6-7.

## Cool component

A low loss S-band circulator for operation at 77°K  
 W.C. Heithaus, J.W. McManus  
 Sperry Microwave Electronics Co.  
 Clearwater, Fla.

Properties of microwave ferrites vary widely as temperature is reduced to the cryogenic level. If not magnetically compensated, the changing ferrite parameters can severely degrade the performance of a microwave component used at low temperatures. In a cooled parametric amplifier for the 2.2 to 2.3 Ghz telemetry band, a combination of permanent magnets and special alloys was found to stabilize a stripline four-port circulator's properties and thus produce the same performance at low temperatures as at room temperature.

The ferrite, polycrystalline yttrium iron garnet, exhibits higher saturation magnetization at 77 K than at 300°K. Without compensation, the higher saturation level would produce 20 decibels less isolation and about 0.7 db more insertion loss at low temperature. However, with a combination of oriented barium-ferrite magnets, Alnico VIII magnets and Carpenter temperature-compensating alloy in

Now Available...  
**Power Supply Manual**  
 From  
**Transformer Electronics Company**



Imaginative engineering, a proven record of reliability and dependability, plus a dedication to customer service have given T.E.C. an international reputation in the design and manufacture of miniature regulated DC to DC converters and associated solid state products for aerospace, military and commercial systems. Now, for the first time in one easy-to-use catalog... the details, the specifications, the technical data and the prices, all packaged for your convenience. For your copy, write or call...



**TRANSFORMER  
 ELECTRONICS  
 COMPANY**

BOULDER INDUSTRIAL PARK  
 BOULDER, COLORADO

TWX 910-940-3246 PHONE (303) 442-3837

POWER SUPPLIES • INVERTERS  
 CONVERTERS • TRANSFORMERS

design the most intricate **thin metal** part you can design.....

.....for immediate need!

Tech-Etch photoetching technology turns out thin, intricate metal parts impossible to produce using mechanical methods.

Without costly dies or high tooling charges. Parts with close tolerances. Perfect flatness. Free of burrs, distortion and stresses. Thin parts of hardened or dead soft metals.

Design changes? Fast, easy and inexpensive. Fast delivery from prototype to production in large or small quantities, too! That's what we mean when we say, for immediate need.....

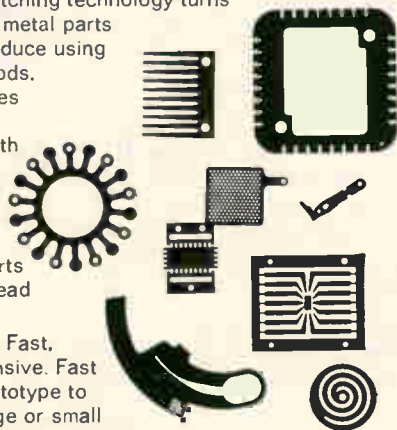

turn to  
**TECH-ETCH, inc.**  
 quality custom-producers of chemically etched parts  
 10 INDUSTRIAL PARK ROAD, HINGHAM, MASS. 02043/(617) 749-0993

Circle 257 on reader service card

# TTL DTL

**Monitor lets you choose**

No restrictions when you choose MONILOGIC™ IC circuit cards. Select from TTL or DTL types in dual in-line configuration. All are electrically, logically, and physically compatible with each other.

Take your pick from more than 140 different cards, the widest selection in the field. You get important systems-oriented extras with every card. Features like high fan-in and fan-out capacity, built-in auxiliary functions, top-mounted test points and Elco Varicon connectors.

Full specs are in our latest bulletin, which is yours for the asking.

**MONITOR**  
 SYSTEMS INC  
 Fort Washington, Pa. 19034 A Subsidiary of Epsco, Inc.

3713

Circle 258 on reader service card



## SAGE Resistors Travel 22,300 Miles to Start a New Job

The "job" of course, was to work in unison with thousands of other components which make up the Early Bird Satellite. Perched high in a hovering orbit over the Atlantic since April 6, 1965, this marvel of the electronic age provides a direct link for both visual and audio communication between Europe and North America.

Sage was selected to produce the special high reliability resistors used in this complex assembly which was built by the Hughes Aircraft Company for the Communications Satellite Corporation (COMSAT).

Needless to say, we are proud of our significant contribution to the success of this undertaking which has opened a new and exciting chapter in world-wide communications.

*Your resistor requirements may not be as "far out" as this particular application. However, it could be to your advantage to consult us—whatever they may be. You'll find us most cooperative.*



Catalog R-66 gives detailed information about the complete Sage Resistor line. A request on your company letterhead will bring you a copy.

SEE OUR SPECIFICATIONS IN  
**VSMF**  
 THE MICROFILM CATALOG FILE

# SAGE

**SAGE ELECTRONICS CORP.**  
 BOX 3926 • ROCHESTER, N. Y. 14610

Circle 256 on reader service card 213



## this is an antenna!

That's right! Concealed within this rugged rear view mirror is an omnidirectional V.H.F. antenna for the 148-174 Mc band. The Sinclair Mobile Mirror Antenna defies detection ... prevents vandalism ... eliminates special antenna mounting. Independent tests prove efficiency equal to — or better than a ¼ wave whip. V.S.W.R. is less than 1.5 to 1 at design frequency. Clip the coupon for FREE literature, including test data and prices.

## so's this

It looks — and mounts — like a standard car radio antenna. Yet it conceals a rugged V.H.F. two-way radio antenna for the 148-174 Mc band. Each Sinclair Disguised Whip Antenna is perfectly "matched" to your specific frequency. This exact matching, combined with a 2.5 db gain, insures greater efficiency than any other disguised antenna now on the market. Clip the coupon for FREE literature, test data and prices.

## SINCLAIR RADIO LABORATORIES

### FREE LITERATURE

TO: SINCLAIR RADIO LABORATORIES, INC.  
Dept. 101K 523 Fillmore Avenue  
Tonawanda, New York 14152

Name: \_\_\_\_\_

Title: \_\_\_\_\_

Company: \_\_\_\_\_

Address: \_\_\_\_\_

City: \_\_\_\_\_

State: \_\_\_\_\_ Zip: \_\_\_\_\_

## Technical Abstracts

series with the magnetic circuit, isolation can be held within 3 db of the room temperature value and additional insertion loss can be held to less than 0.2 db.

Magnetic compensation automatically increases the bias from 2,000 oersteds at room temperature to 2,600 oersteds at 77°K to accommodate changes in ferrite properties. At first, the parameters were adjustable so that the small impedance drift which remains despite magnetic field compensation could be matched by a variable shunt capacitance placed at a convenient point in the line. This proved unnecessary in the final version, however, because magnetic field compensation alone holds the change in reflection coefficient to less than 0.05. Although designed for 77°K, the device performs equally well at 20°K.

Presented at the IEEE International Conference on Communication, Minneapolis, June 12-14.

### Avoiding traps

High performance CdSe thin-film transistor  
Richard C. Smith  
National Cash Register Co.  
Dayton, Ohio

In the operation of a cadmium-selenide thin-film transistor, two types of short-term switching instabilities have been observed: a slow increase and a slow decrease in drain current in response to a step d-c voltage applied to the gate. In each type of instability, the response of the drain current to a stepped d-c voltage on the gate consists of an initial fast component followed by one of the two types of slow components. These slow responses, which are related to the traps in the insulator-semiconductor system, can be eliminated by removing absorbed oxygen from the surface.

A model is proposed in which the two types of instability for CdSe thin-film transistors are related to two distinct trapping levels, one empty and the other occupied, in the insulator. The slow response is believed to be the result of slow filling and emptying of these trapping levels across a

# Reed Relay Problems?

A special hi-reliability relay for the Hawk Missile.

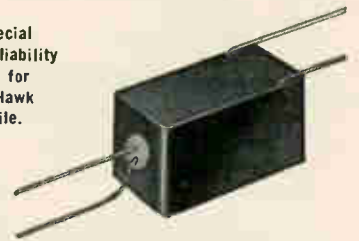

## Can We Solve Your Problem?

Operating Inputs: low as 1mA. and 15mW.  
Standard Coil Voltages: 6, 12, 24, 32, 48V in stock for immediate delivery.

Special Voltage or Resistance, multiple windings for flip flop, memory and crosspoint selection applications — to customer specifications.

Relay Contacts in Form A, B, C and latching. Also high vacuum type 5000V Form A.

Write for catalog and prices of our standard line of magnetic reed relays. For special requirements, give complete details for quotation.

**Coto-Coil** COMPANY INC.  
61 Pavilion Ave.  
Providence, R. I. 02905  
Phone: (401) 941-3355

Circle 260 on reader service card

## WOW FLUTTER METER



A solid state sensitive and compact instrument for rapid and accurate determination of wow and flutter in sound recorders and reproducers.

### SPECIFICATIONS:

Center Frequency ..... 3kc and 1kc  
Input ..... 30mV to 3V  
Wow Flutter Range ..... 0.3, 1, 3% f.s.d.  
Weighting Characteristics .....  
as per JIS C5551 specs.  
Wow: 0.5 to 6c/s  
Flutter: 6 to 250c/s  
Calib. Osc. .... 3kc and 1kc

• Calibrate zero on request



**MEGURO DENPA SOKKI K.K.**

(Meisiro Electronic Instrument Co., Ltd.)  
No. 5, 1-2-chome, Chio-cho, Meguro-ku, Tokyo, Japan  
TEL. 71-7191-7 Telex: MEGURDENPA TOKYO

**DIGITEC** digital LINE VOLTAGE MONITOR

**NEW!**  
**Series 350**  
**\$195**



MODEL 351 shown



Model 351 with panel mounting adapter flange

The series 350 Digital Line Voltage Monitors are used to accurately measure AC line voltages. Model 351 (shown) is designed to monitor the range of voltages from 85 to 135 volts. Model 352 will monitor voltages within the range of 170 to 270 volts. Panel adaptors furnished with instruments at no additional cost.

**Accuracy:**  $\pm 0.1\%$  of Mid-scale reading with Sinewave input

**Reading Ease:** Illuminated Digital display provides resolution better than 100 MV.

**Reading Speed:** Instrument tracks line fluctuations smoothly and accurately to rates of 20 volts/sec.

**Size:** 6.75"L x 4.94"W x 2.59"H

**Weight:** Less than 4 pounds

**Optional Retransmitting Potentiometer:** 1000 OHM retransmitting potentiometer (1/4% linearity) is an available option—\$65.00.

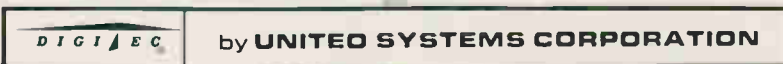

Stocking Representatives  
 Throughout the World

918 Woodley Road Dayton, Ohio 45403

Circle 263 on reader service card

*yes,*

**CCTV Cameras work best**



with **COSMICAR** LENSES

Superior cameras deserve superior lenses. COSMICAR's proven precision performance is the combined result of advanced optical engineering and exquisite workmanship.

Now widely used, COSMICAR LENSES come in 23 models for focal lengths ranging from 12.5 mm to 500 mm, and in 3 zoom models including a remote control zoom.

Your CCTV camera and COSMICAR LENSES will make an unbeatable team. For technical data and other particulars, please write.



568, Shimoochiai, 2-chome, Shinjuku-ku, Tkoyo  
 CABLE ADDRESS: "MOVIEKINO TOKYO"

# Expanded versatility in reversible counters



Now two new options for the Hewlett-Packard 5280A Reversible Counter add to its measurement capabilities:

1. An internal time base permits precise setting of gating period in discrete increments as small as 1 msec, with front-panel setting. This means that besides straight totalizing, you can now measure frequency or normalize your readings.

2. A special "Readout on the Fly" feature allows you to record measurements at any instant without interrupting the count. This is achieved by transferring your count to an internal storage register. Time between recording commands can be as short as 1 msec, making the 5280A useful in information or control system work without retarding system speed.

#### These new options PLUS:

- six operating modes, including modes for interferometer fringe counting;
- 2 MHz counting rate, up or down;
- reversal in 0.25  $\mu$ sec;
- adds or subtracts (1 MHz rate for each channel);
- stable, wide-range trigger input level controls.

The standard 5280A with the 5285A Universal Plug-in costs \$1900. Options are extra.

A 40-page Application Note (AN #85) is now available without charge—"Using A Reversible Counter." Call your local HP field engineer or write Hewlett-Packard, Palo Alto, Calif. 94304. Europe: 54 Route des Acacias, Geneva.



## Technical Abstracts

potential barrier established by an oxygen layer on the surface of the CdSe film. In one portion of the insulator, the Fermi level is held fixed and in the other portion the Fermi level shifts, establishing the potential barrier related to the difference in Fermi levels.

The occupied trapping levels act as donor levels and are associated with the weakly bound oxygen molecules which are farthest removed from the oxygen layer. A large concentration of occupied trapping levels in the insulator clamps the Fermi level to this trapping level. The bands cannot bend with an applied field until electrons are exchanged between the traps and the conduction band.

The empty trapping levels act as acceptor levels and are associated with the absorbed oxygen which is closest to the oxygen layer. Since these levels are for the most part empty, the Fermi level is not clamped. Bands can bend instantaneously with an applied electric field and exchange of electrons between the traps and the conduction band will follow. Because it is further from the semiconductor surface, the donor trapping level takes longer to empty and fill than the acceptor level. When the absorbed oxygen species are removed from CdSe surface, the slow response is eliminated and a high performance device can be fabricated.

Eliminating the traps and their associated slow responses minimizes the capacitance and reduces the rise and fall times for a square wave input to the gate. Reducing the capacitance also increases the gain-bandwidth product.

A high-performance transistor was fabricated and had the following properties: transconductance, 5 millimhos; capacitance 3.5 picofarads; calculated gain-bandwidth product 280 Mhz. Rise and fall times to a square-wave input voltage were 20 nanoseconds and 15 nsec, respectively. Thus the output voltage will not be time dependent and the device may be used in digital applications.

Presented at the Microelectronics Symposium, St. Louis, June 19-21.

## Continuous Refrigeration

at **ultra-low** Temperatures



Model "L-4.5."

### STORAGE FREEZER

For storing frozen sealants, adhesives, encapsulating compounds, medical and research specimens, pharmaceuticals, hospital supplies and other substances requiring continuous refrigeration at low temperatures.

Down to  $-45^{\circ}\text{F}$  ( $-43^{\circ}\text{C}$ ),  $-100^{\circ}\text{F}$  ( $-74^{\circ}\text{C}$ ) or  $-120^{\circ}\text{F}$  ( $-85^{\circ}\text{C}$ ) available on order. Full 4.5 cu. ft. storage space. Plug into 115 VAC. No CO<sub>2</sub> required.

**MISSIMERS**  
Incorporated

3737 San Fernando Rd., Glendale, Calif. 91204  
(213) 245-8471 TWX 213-240-2187

Circle 265 on reader service card

New! From MESON! New!

# ELECTRONIC TIME DELAY RELAY



- High Accuracy,  $\pm 10\%$
- Repeatability,  $\pm 3\%$
- Fast recycling time — .05 sec. max.
- Input — 115 VAC
- Up to 180 sec. delay, fixed or variable with external variable resistor.

Only **\$6<sup>91</sup>** in 100 lots  
**IMMEDIATE DELIVERY!**

Order one for test at \$8.80. Your MONEY BACK if not satisfied!

**MESON**  
**ELECTRONICS CO. INC.**  
380 Cottage St., Rochester, N.Y. 14611  
Phone (716) 235-7070



8 of a series

TRANSCOIL SOLVES SERVO PROBLEMS

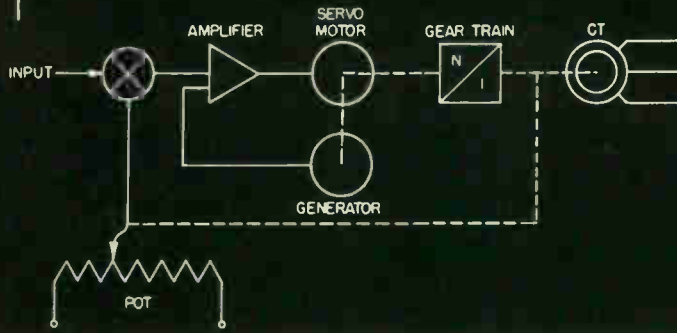

shown without cover

**New Transcoil position servo assembly**

Weston-Transcoil built this position servo assembly for an Increased Maneuverability Kit used on the BMQ-34A Firebee target drone. Designed with provision for hermetic sealing, it provides accurate and constant error voltages per degree of bank angle, guaranteeing precision control of the Firebee during high *g* maneuvers. Synchro output closely follows analog voltage input with the 10-turn potentiometer connected by precision gearing to a size 10 motor generator driven by a standard size 11 amplifier. Typical of Transcoil engineered servo packages, all components in the position servo are supplied by Weston and the entire assembly is designed for plug-in installation.

**PERFORMANCE:** Feedback Potentiometer: 1K 10-turn size 5 • Output: Size 8 control transformer • Slew Speed: 1 Rad/sec • Accuracy: 1° (over range of -90° to +90° at synchro) • Power Required: 26V, 400 CPS; 28V DC • Size: 2½" dia. x 3¼" length.

Weston Instruments, Inc., Weston-Transcoil Division, Worcester, Pa. 19490, a Schlumberger company

**WESTON®** prime source for precision... since 1888

Circle 267 on reader service card

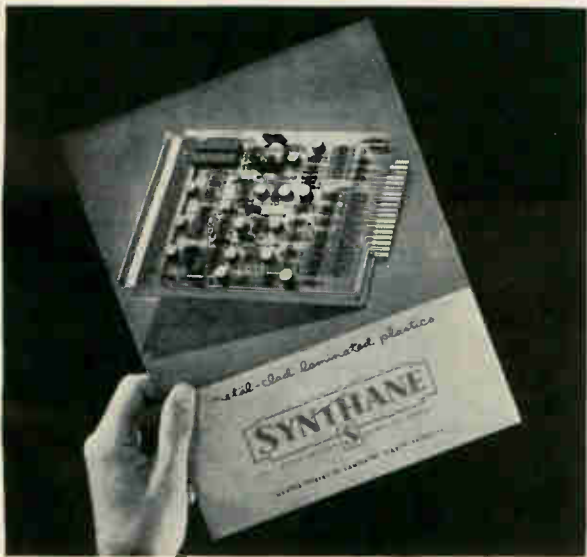

**IT'S NEW!**

New folder on Synthane metal-clad laminates contains latest information on Synthane copper-clad grades, sizes, foils, trademark identification, typical and guaranteed property values, thin laminates and pre-preg materials. Write for your copy to Synthane Corporation, 36 River Road, Oaks, Pa. 19456.



Laminated Plastic Sheets, Rods, Tubes and Fabricated Parts

*New from Helipot*

**First \$1<sup>10</sup> cermet trimmer sealed for board washing**

**New Helitrim® Model 77:**

only trimmer in its price class made fail-safe for solvent washing on the board... and offering essentially infinite resolution, 10 ohm — 2 megohm resistance range and 105°C. max. operating temp. No general purpose adjustment potentiometer has wider performance parameters. Directly interchangeable with competitive models 3067, 3068. \$1.10 in quantity — ask your Helipot rep for a free sample.



**Beckman®**

INSTRUMENTS, INC.  
HELIPOT DIVISION  
FULLERTON, CALIFORNIA • 92634

INTERNATIONAL SUBSIDIARIES: GENEVA; MUNICH; GLENROTHES, SCOTLAND; TOKYO; PARIS; CAPE TOWN; LONDON; MEXICO CITY

# HIGH RESOLUTION SERVO / DIFFERENTIAL RELAY

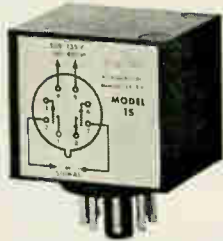

**REQUIRES NO  
EXTERNAL  
AMPLIFICATION**

Can be used over a dynamic operating range of up to 2000/1. Here are a few of the many applications:

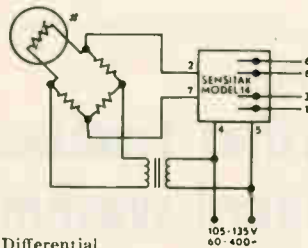
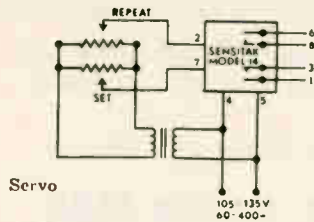

Differential Thermistor (temperature controller)  
Photo resistor  
Strain gauge

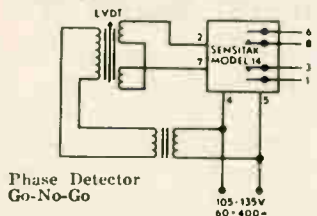

## CONDENSED SPECIFICATIONS

Model Number	#14	#15
Input Z	50K	20K
Signal Sensitivity	500 mv. r.m.s.	5 mv. r.m.s.
Resolution	1/100 = 1%	1/2000 = .05%
Capability	150 r.m.s.	10 r.m.s.
Signal Overvoltage	\$21.75*	\$31.75*
Unit Price		

\*Quantity Prices Available

Consult us for relay technology to meet individual requirements.

For additional information, contact



**INSTRUMENT CORP.**

531 Front Street  
Manchester, New Hampshire 03102  
Phone (603) 627-1432

## New Literature

**Reed relays.** General Reed Co., P.O. Box 858, Clark, N.J., 07066. Technical bulletin GR-8 gives complete information on the series 200 plastic-cased, miniature reed relays.

Circle 446 on reader service card

**Capacitor conversion chart.** Union Carbide Corp., 30-20 Thomson Ave., Long Island City, N.Y. 11101. An eight-page brochure compares the electrical characteristics, acceptance inspection tests, and marking requirements of Mil-C-26655B and Mil-C-39003A solid tantalum capacitor established reliability specifications. [447]

**Multiuse computer.** Scientific Data Systems, 1649 Seventeenth St., Santa Monica, Calif. 90404. A multiuse computer with nanosecond hardware is described in 20-page brochure 64-06-01B. [448]

**Trimming potentiometers.** Amphenol Controls Division, Amphenol Corp., 120 S. Main St., Janesville, Wisc. 53545, offers the company's entire line of wirewound and metal-film trimmers in slide-rule form for easy selection. [449]

**Motor reference chart.** Globe Industries Inc., 2275 Stanley Ave., Dayton, Ohio 45404. Bulletin R-1 gives speed-torque curves for units from 0.001 h-p to 0.25 h-p at speeds from 100 to 20,000 rpm. [450]

**N/C zig-zag systems.** Farrand Controls Inc., 99 Wall St., Valhalla, N.Y. 10595. A six-page brochure describes the Olivetti-Farrand numerical control zig-zag system. [451]

**Precision potentiometers.** Beckman Instruments Inc., 2500 Harbor Blvd., Fullerton, Calif. 92634, has released data sheet 67724 on 3- and 5-turn precision pots designated series 7360 and 7460. [452]

**Optical mark readers.** National Computer Systems, 1015 S. 6th St., Minneapolis, Minn. 55415. Advantages of optical mark reading equipment—a new approach to the computer input of source data—are shown in a four-page brochure. [453]

**Matrix program boards.** Co-Ord Switch, Division of LVC Industries Inc., 102-48 43rd Ave., Corona, N.Y. 11368. A brochure provides a compilation of actual matrix program board uses to aid systems and design engineers. [454]

**Machinable ceramics.** Aremco Products Inc., P.O. 145, Briarcliff Manor, N.Y. 10510. Product bulletin 502 describes a variety of high-temperature machinable ceramics. [455]

**Storage drum subsystems.** Bryant Computer Products, 850 Ladd Road, Walled Lake, Mich. 48088, offers a data sheet that discusses servo-mechanism-controlled, data storage drum subsystems. [456]

**Solid state choppers.** Solid State Electronics Corp., 15321 Rayen St., Sepulveda, Calif. A comparative data profile covers 20 models of microminiature, solid state electronic choppers. [457]

**Modular core memories.** Ampex Corp., 401 Broadway, Redwood City, Calif. 94063. Brochure C030 describes performance, operation, and interface of a family of modular core memories for computers. [458]

**Capacitors.** Transitron Electronic Corp., 168 Albion St., Wakefield, Mass., has available a selection guide and data hand book on its line of Lemco capacitors. [459]

**Silicon transistor oscillator.** Solid State Electronics Corp., 15321 Rayen St., Sepulveda, Calif., 91343. A data sheet covers model C-110 crystal and heater controlled silicon transistor oscillator. [460]

**Power supplies.** NJE Corp., 20 Boright Ave., Kenilworth, N.J., 07033, offers a 22-page illustrated catalog entitled "Power Supplies Unlimited." [461]

**Ceramic capacitors.** Vitramon Inc., P.O. Box 544, Bridgeport, Conn. 06601. The CKR05 ceramic capacitors, which demonstrate low failure rates of 1% or less, are described in data sheet C19. [462]

**Instrumentation.** Dranetz Engineering Labs Inc., 1233 North Ave., Plainfield, N.J. 07062. An eight-page brochure gives details on a family of integrated instruments for complex impedance, admittance, and transfer function. [463]

**Portable oscilloscope.** Measurement Control Devices, Inc., 2445 Emerald St., Philadelphia, Pa. 19125, has published a two-page bulletin on the model 300 featherweight Transi-Scope that offers a sensitivity of better than 10 mv

# Not much of a plot, but a great cast of characters.

The characters are 6,000 manufacturers and more than 4,000 product listings. Even if you're not the literary type, you'll be interested in the unprecedented opportunity the Electronics Buyers' Guide affords you to reach *readers*. Over 445,000 engineer users go to EBG year round as a one-stop shopping center for all their electronic needs.

## Electronics Buyers' Guide

A McGraw-Hill *Market Directed* Publication,  
330 West 42nd Street, New York, N.Y. 10036

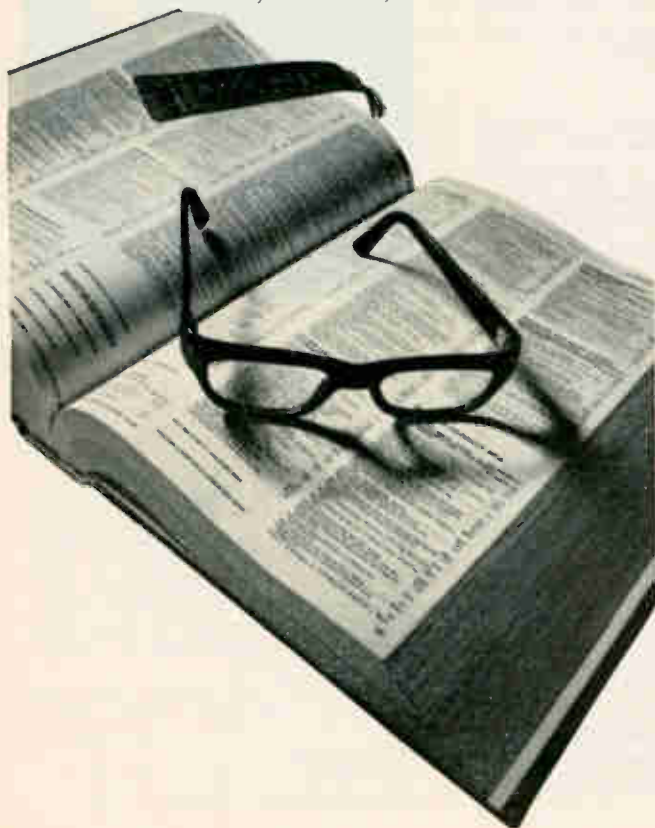

## Big performance in small space

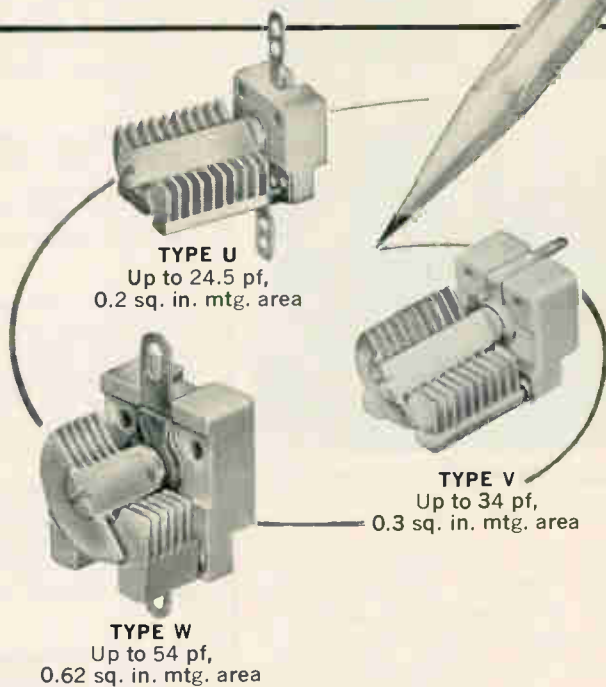

### Johnson increases U capacitor plate area, keeps same overall dimensions

Sub-miniature Type U capacitors now provide 28% more capacitance in the same compact package that takes less than 0.2 square inches of mounting area. Type V miniature and Type W capacitors, available in higher capacities, are also unusually compact.

Unique Johnson milling technique permits machining each rotor and stator from a single piece of solid brass. This provides exceptional uniformity and stability, both mechanically and electrically. "Q" is greater than 1500 at 1 MHz. Temperature coefficients are typically plus 45 ± 15 PPM/°C. Breakdown ratings 650 volts DC.

Johnson Type U, V, and W capacitors are available from stock in a wide range of sizes. Type U single section in PC, panel, or two-hole mounting. Type U butterfly and differential in PC mounting. U-LC tuners in PC or panel. Type V and Type W single section in PC or panel mounting.

**FREE CATALOG** includes complete information on these and other Johnson quality electronic components. See your Johnson representative or write for your copy today.



**E. F. JOHNSON COMPANY**

3017 Tenth Ave. S.W., Waseca, Minn. 56093

Providing nearly a half-century of communications leadership

## COMPUTER TALK

by W. Henry du Pont, President  
**SCI-TEK  
COMPUTER CENTER, INC.**



### ENGINEERING OR ACCOUNTING WHICH COMES FIRST?

Does your computer still wear a green eyeshade and paper cuffs? Does it belong to the accounting department? Do your important engineers have to wait for free time after the payroll is run? Maybe you've thought of getting a computer of your own for the exclusive use of the engineering department, or research and development group. If we've hit home with these thoughts, let us at SCI-TEK help you solve your problem inexpensively.

Give the engineers and scientists of your company one of the largest computers in the country to use as and when they need it. This computer may be remote controlled from a desk in your engineering department.

This problem solving capability of the SCI-TEK COMPUTER SYSTEM is the reason why more and more of the leading chemical, electronic and aerospace companies are turning to SCI-TEK for the low cost fast solution to technical work. How SCI-TEK can aid your engineering and technical people is best explained in our brochure "SATEL-LITE SERVICE". To obtain a copy, contact:

**SCI-TEK  
COMPUTER CENTER, INC.**  
1707 GILPIN AVENUE  
WILMINGTON, DELAWARE 19806  
Phone: (302) 652-3967

## New Literature

peak-to-peak on both the horizontal and vertical axes. [464]

Incremental shaft encoders. Disc Instruments Inc., 2701 S. Halladay St., Santa Ana, Calif. 92705, offers bulletin 400 describing its line of Rotaswitch incremental shaft encoders. [465]

Indicating devices. A. W. Haydon Co., 232 N. Elm St., Waterbury, Conn. 06720. Four-page bulletin MR102 illustrates and describes 16 models of indicating devices. [466]

Microwave components. Sperry Microwave Electronics Co., Box 4648, Clearwater, Fla. A 24-page illustrated catalog contains specifications and performance data on a full line of microwave components. [467]

General purpose relays. General Electric Co., Schenectady, N.Y., 12305. Technical data sheet GEA-7906 describes the CR2790 type E, long-life, general purpose relays. [468]

Process instrumentation. Barber-Colman Co., Rockford, Ill. 61101. Brochure 1700 ML1, a functional guide for process instrumentation, illustrates all major system components. [469]

Microwave products. Weinschel Engineering, Gaithersburg, Md. Short form catalog No. 4 describes a line of precision microwave components, instruments, and systems. [470]

Reed-relay circuit. Win-Elco, 799 Main St., Half Moon Bay, San Mateo, Calif. 94019, has available a specification sheet for the Ampl-Switch, model 28-2-C, sensitive reed-relay circuit. [471]

Disk storage unit. Systems Engineering Laboratories Inc., 6901 W. Sunrise Blvd., Fort Lauderdale, Fla. 33310, has issued an illustrated specification sheet on the model 81-654-A fixed-head disk storage unit. [472]

Weldable laminates. The Mica Corp., 4031 Elenda St., Culver City, Calif., 90230, has available a data sheet of high-reliability Micaply weldable glass-epoxy laminates for printed circuits. [473]

Operational amplifier. Solid State Electronics Corp., 15321 Rayen St., Sepulveda, Calif. 91343, has released a four-page bulletin describing the model 3001 differential operational d-c amplifier. [474]

## ECCOMOLD® EPOXY MOLDING COMPOUNDS



### FREE CHART

NEW

NEW

Comparative physical, electrical and processing properties of Eccomold transfer molding compounds are in colorful chart. Typical applications are indicated.

This Valuable Chart is Yours  
Write or Use Reader Service Card

**Emerson & Cuming, Inc.**



CANTON, MASS.  
GARDENA, CALIF.  
NORTHBROOK, ILL.  
Sales Offices  
In Principal Cities

EMERSON & CUMING EUROPE N.V., Oevel, Belgium

Circle 268 on reader service card

THIS SPACE CONTRIBUTED BY THE PUBLISHER



*The Voice. Anybody's voice. Your voice. It has a special quality and timbre all its own. But.*

*If it should become hoarse or if a cough should persist, find out what the reason is. Promptly. It could be a warning signal of cancer. And cancer is easier to cure when it's detected early.*

*Frank Sinatra knows the seven warning signals of cancer. Do you? 1. Unusual bleeding or discharge. 2. A lump or thickening in the breast or elsewhere. 3. A sore that does not heal. 4. Change in bowel or bladder habits. 5. Hoarseness or cough. 6. Indigestion or difficulty in swallowing. 7. Change in a wart or mole.*

*If a signal lasts longer than two weeks, see your doctor without delay. It makes sense to know the seven warning signals of cancer.*

*It makes sense to give to the American Cancer Society.*

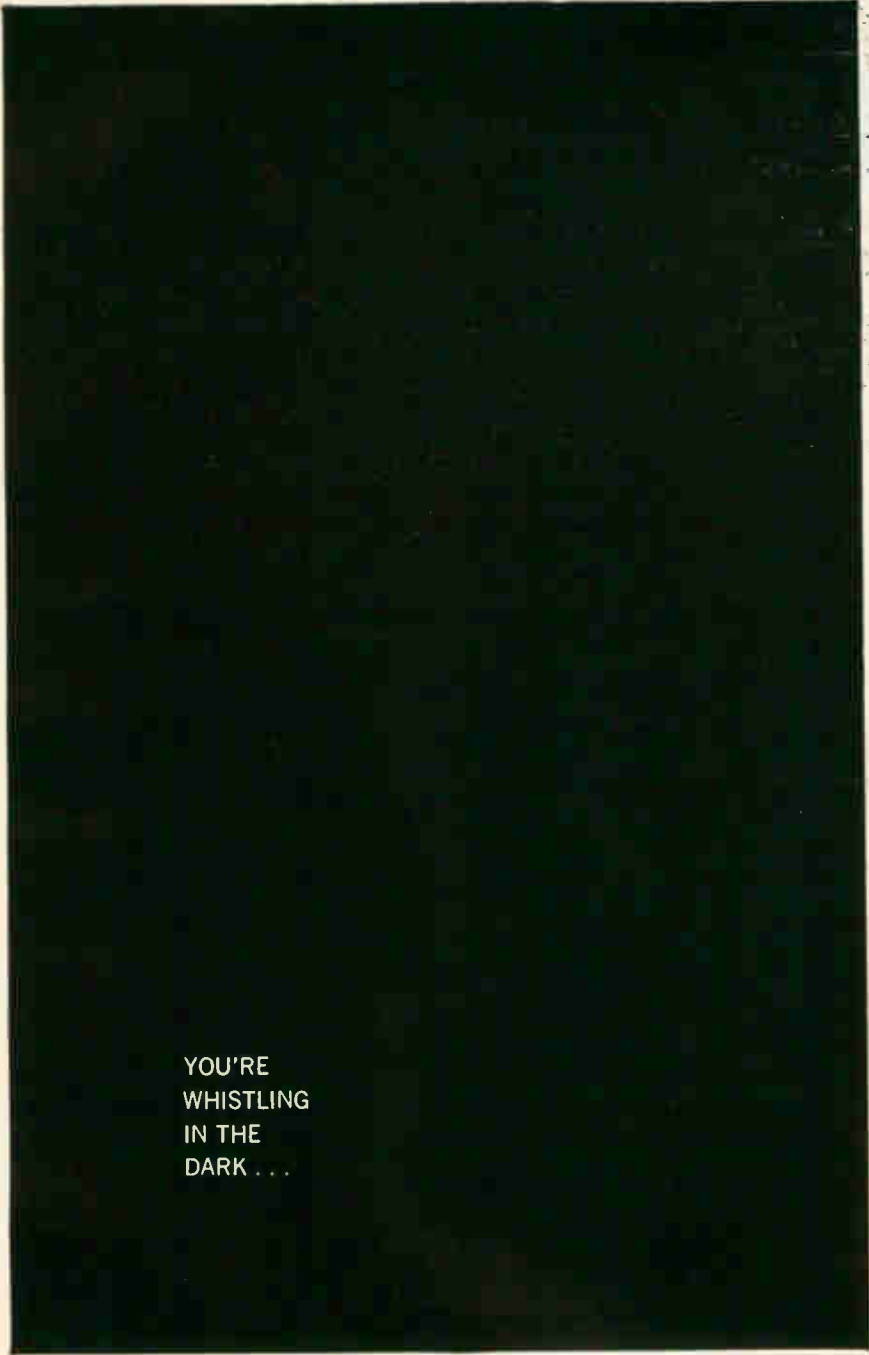

YOU'RE  
WHISTLING  
IN THE  
DARK . . .

. . . if you think that heart disease and stroke hit only the other fellow's family. No one is immune. Protect the hearts you love. For authoritative information, ask your Heart Association. For medical advice see your doctor. To safeguard your family . . .

**GIVE...**  
so more will live  
**HEART  
FUND**



Contributed by the Publisher

Electronics | July 24, 1967

## PROFESSIONAL SERVICES

**Donald C. Harder, Inc.**

Magnetic Component Engineers

Reactors—Transformers—Filters

Serving the Research Laboratory

2580 K Street, San Diego, Calif. 92102

Phone (714) 239-8021

### SEARCHLIGHT SECTION

RADAR AUTO TRACK & TELEMETRY ANTENNA PEDESTALS  
3 & 10 CM. SCR 584 AUTOTRACK RADARS. M-33 RADAR  
TPS-1D SEARCH. APS-45 TPS-10D HY. FINDERS. WA RADARS.  
FPN-32GCA. APS-10 APS-15B APS-27 (AMTI) SEARCH. ■ ■  
APN-102 DOPPLER. DOZENS MORE GYROTRONS. PEN'S  
.25-5.1236 MEGAWATT PULSE MODULATORS. CAVITIES.  
PULSE TRANSFORMERS. IF STRIPS. WAVEGUIDE. BENDS  
200 MC. 1 KMC. 3 KMC. 6 KMC. 9 KMC. 24 KMC. RF PKGS.

**RADIO RESEARCH INSTRUMENT CO.**

550 5TH AVE., NEW YORK 36, N. Y.

JU 6-4691

CIRCLE 967 ON READER SERVICE CARD



## EMPLOYMENT OPPORTUNITIES

ADDRESS BOX NO. REPLIES TO: Box No.  
Classified Adv. Div. of this publication.  
Send to office nearest you.  
NEW YORK, N. Y. 10036: P. O. Box 12  
CHICAGO, Ill. 60611: 645 N. Michigan Ave.  
SAN FRANCISCO, Cal. 94111: 255 California St.

### POSITION VACANT

**U.S. Government Career Opportunities** in commodity standardization for electrical engineers and quality control electronics specialists. Beginning salary range \$9,221 to \$10,927 for engineers depending upon experience; \$12,873 for Q.C. specialists. Annual increases, liberal Civil Service benefits. Jobs in Washington, D. C., fast-growing scientific and technical center, with GSA, nation's largest purchaser. Send resume or Gov't Form 57 (avail. at Post Offices) to Richard Cullen, Rm. 1105, General Services Administration, Wash., D.C. 20405.

### ELECTRONICS ENGINEER INSTRUMENTATION

Transistor circuit design experience.

Firm manufactures electro-optical instruments for medical and chemical analysis. Initial assignment will include service of installations in major laboratories to gain insight into applications.

Our goal — To develop a Project Engineer for new instrumentation who can also serve as a specialist in circuit design.

No military contracts. An equal opportunity employer. Excellent fringe benefits. Salary open. Send resume to:

**G. K. TURNER ASSOCIATES**

Subsidiary of American Sterilizer

2524 Pulgas Ave.  
Palo Alto, Calif. 94303



**E.E.'s**

For **FEE PAID** positions  
throughout U.S.

**SEND RESUME TODAY**

(if none, send coupon for  
confidential application.)

**ATOMIC PERSONNEL, INC.**  
Suite L, 1518 Walnut St., Phila., Pa.  
Experienced Engineers  
Working Full Time for You!

Name \_\_\_\_\_

Address \_\_\_\_\_

City \_\_\_\_\_

State \_\_\_\_\_

AN EMPLOYMENT AGENCY FOR ALL TECHNICAL FIELDS



## Winchester: the word for pc connectors.

Winchester Electronics offers printed circuit connectors for every application: card edge, right angle, board center, two-piece, NAS, wire wrap, flexible cable, crimp-removable contact, test points, Mil Spec (including MIL C 21097), microminiature and many more. All assure you quality, reliability and economy. Get the word on printed circuit connectors today: Write: Winchester Electronics, Main Street & Hillside Ave., Oakville, Conn.



**WINCHESTER ELECTRONICS**

DIVISION OF LITTON INDUSTRIES

---

# Newsletter from Abroad

---

July 24, 1967

## Hong Kong plants keep output high despite Red riots

Continuing Communist-led riots, curfews and a serious water shortage have had surprisingly little effect so far on production at the plants of U.S. electronics companies in Hong Kong. Most now think they can weather several months more of unrest if the rioting doesn't get completely out of hand. But the riots, coupled with rising labor rates, have ended the rush of electronics firms to the Crown Colony [Electronics, May 29, p. 209].

Transport strikes have not hit U.S. companies hard. Their plants are located mainly in Kowloon, the mainland sector of the colony, and most workers live nearby. Plant managers have coped with curfews by calling in second-shift workers early. Water is supplied four to five hours a day and has been adequate, although plants with extensive plating operations are beginning to feel the pinch.

Despite the riots, plant managers say, production has been on the rise during the troubled summer. Arvin Industries added 500 workers to its staff after the demonstrations started in May and since has kept its output 30% or more above the April level. Wireless Products Ltd., a subsidiary of the General Telephone & Electronics Corp., also has boosted its staff and its production since the troubles began. Ampex Ferrotec Ltd., after a slight dip in May, started to climb again in June and this month expects output will run between 10% and 15% above April.

Although still queasy about their Hong Kong investments, U.S. firms expect to hang on. And skilled Hong Kong electronics workers apparently intend to stick it out, too. Only a couple of dozen responded to a recent Philco-Ford Corp. recruiting drive to lure people to its Taiwan plant.

## Brazil opts for PAL —but with a twist

Brazilian telecommunications officials have tentatively decided to adopt—in their own fashion—AEG-Telefunken's phase-alternation-line (PAL) color-tv system. Color broadcasts won't start in Brazil for five years or more, but the decision now could put all of South America into the PAL camp. The Latin American countries have agreed to consult one another before making firm decisions on color-tv, and henceforth Brazil will plump for a modified PAL system as the regional standard.

The system Brazilian officials have in mind would keep Telefunken's phase-alternation scheme for chrominance-carrier transmission but have a 4-megahertz video bandwidth instead of the 5-Mhz bandwidth used by European PAL broadcasters. With the narrower bandwidth, the modified PAL system would be compatible with black-and-white transmission equipment and receivers now in service in Brazil.

## France and Germany find junior partners for satellite project

French space officials now are convinced that Belgium and Italy will sign on for minor roles in the Franco-German "Symphonie" communications satellite project [Electronics, June 12, p. 242]. Negotiations among the four countries, they say, have cleared up everything but the extent of the new partners' participation. The target date for putting Symphonie—a 400-pound satellite—into stationary orbit is early 1970.

The junior partners were lined up this month in Rome at the annual meeting of European science ministers, where France's Maurice Schumann tried to turn Symphonie into a multinational project with broad European participation. France and West Germany see the project as a means of challenging U.S. domination of the International Tele-

---

# Newsletter from Abroad

---

communications Satellite Consortium when the current provisional Intelsat program expires at the end of 1969.

Although there's general dissatisfaction among European Intelsat members over U.S. predominance in the consortium, Schumann found only two interested parties. And the Rome conference also failed to produce the expected agreement to stress communications satellites in future European space programs [Electronics, June 26, p. 203]. Largely because Great Britain doesn't want to relegate research satellites to a secondary role, the ministers settled for an across-the-board review of their joint space efforts.

## Philips makes pitch to get TI patents for Japan affiliate

Philips Gloeilampenfabrieken will make a strong bid to have its Japanese affiliate included in the renewed cross-licensing agreement it is now negotiating with Texas Instruments.

TI has steadfastly refused to grant licenses for its basic integrated-circuit patents to Japanese companies until it gets the right to set up a wholly owned subsidiary in Japan [Electronics, April 3, p. 257]. But Philips, armed with an arsenal of key electronics patents, may wangle an exception for Matsushita Electronics Corp., in which it holds a 30% interest. The current cross-licensing contract between TI and the Dutch concern expires on Sept. 1.

Philips committed itself to put pressure on TI when it negotiated a 10-year extension of its joint venture with Matsushita Electrical Industrial Co., which owns 70% of Matsushita Electronics. Under the new contract, the two parent companies will each get royalties of 2.5% on Matsushita Electronics' production starting next year. Since Philips had a higher rate previously, it has the right to boost its holding to 35%. The new contract also allows Matsushita Electronics to sell worldwide instead of only in Asia.

## Tank deal bolsters Belgian electronics

A mild lift—some \$14 million in orders from the West German government—is in the offing for Belgium's recession-hit electronics industry. The orders are part of the full offset the Belgian government will get for a \$90 million purchase of 300 West German Leopard tanks.

The tanks will be delivered fully equipped, but Belgian electronics firms hope the Germans will fit them with some Belgian hardware—possibly communications gear. No matter what the Belgian content of the tanks, though, electronics has been put down for a 15% share of the offset orders.

## Computer center in Britain to aid design engineers

Britain's Ministry of Technology has earmarked \$7 million to set up the country's first computing center for design engineers.

The center will be ready in about a year at Cambridge University and initially be limited to engineering departments of universities and colleges. Later, the ministry will open the Cambridge facility to industry and even help firms finance the remote peripherals they'll need to tie into the center's computer.

For its Cambridge computer facility, the ministry has picked an International Computers & Tabulators Atlas 2 machine. Cambridge scientists worked with ICT on the Atlas and will convert the university's prototype version for multiaccess by about 40 users.





*In days of old, when steams were bold,  
 Before the electronic computer:  
 The "electric kiss" was a test of love  
 To match a lass and suitor.*

One of a series of...

**Vignettes in Electronic History**

The "electric kiss" was a romantic 18th Century fad, but it produced no practical results even for that early period. Today, ardor and zeal alone are even less likely to produce significant technological innovation. Now, only the companies with the most modern facilities and the best people and machines can maintain technical leadership. That's why a visit to Spectrol's new facility in the City of Industry has turned many a skeptic into a fervent customer. Quote from a large user of potentiometers: "What impressed me most wasn't just the large, modern, R&D, fabrication, and assembly areas; but also the orderly

layout and the efficient way people went about their jobs. It looked to me like good management as well as a fine facility — and that's what makes for reliable products." But why not? Spectrol designed and built this plant from the ground up for the sole purpose of producing the quality components you need, at competitive prices. Of course, we're not perfect yet but we're working at it! (Perhaps you'd like to be working with us.)

**Spectrol Electronics Corporation**  
 A subsidiary of the Carrier Corporation  
 17070 E. Gale Ave., City of Industry, Calif. 91745  
 Copyright © 1993

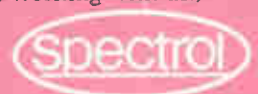

**Better Components for Better Systems:** precision potentiometers • trimming potentiometers • turns-counting dials • miniature switches

*A limited number of full-color reproductions of the "electric kiss" painting, along with the story of the vignette, are available upon request.*

Think  
vertically.

Get your  
functional  
circuit  
designs  
stacked  
in a  
MicroCircuit  
Pack™...  
ready to  
mount.

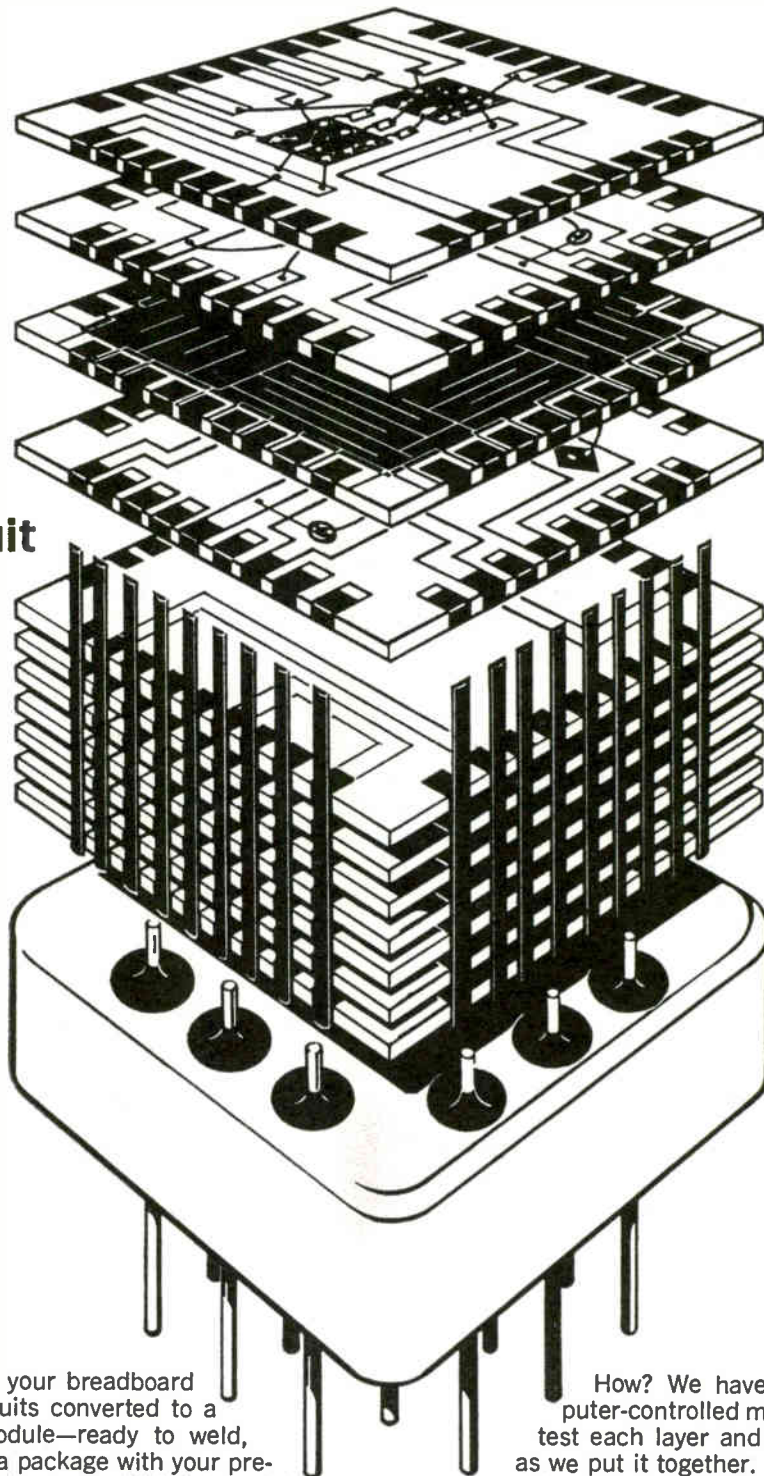

SEE US  
AT  
WESCON

Wouldn't you like to see your breadboard model of functional circuits converted to a fully microelectronic module—ready to weld, solder, or plug in? Want a package with your preferred mix of semi-conductors, monolithic integrated circuits, thin-film and discrete devices ready to perform a number of system functions, either analog or digital—one that combines all the advantages of vertical, multilayer stacking, welded interconnections, hermetically-sealed enclosure, and uniform modular assembly?

That's no pipe dream with Hamilton Standard's MicroCircuit Pack technology. We can deliver a custom-built module of up to 15 ceramic wafers, pretested to meet your design, in either evaluation or production quantities. And it will cost far less than you would think.



Actual size

How? We have developed flexible, computer-controlled methods of manufacture. We test each layer and each module step-by-step as we put it together. And we use electron-beam scribing, welding and sealing under ultraclean vacuum conditions. Results? Your packaged module is strong and reliable, will resist moisture and radiation, and will operate over a wide temperature range.

Whatever your system requirements might be, investigate going to MicroCircuit Packs direct. Consider all the in-between expenses you can save. For more information, price quotations, or assistance in component selection and system layout, contact the Marketing Manager, Electronics Department, Hamilton Standard, Windsor Locks, Conn., 06096. Phone (203) 623-1621, ext. 2012. TWX 710-420-0586.

**Hamilton Standard** DIVISION OF UNITED AIRCRAFT CORPORATION  
WINDSOR LOCKS, CONNECTICUT

U  
A

## International

### Trial balloon

The U.S. Commerce Department has singled out the electronics production-equipment industry for a pilot program that could lead to radical changes in the way the Government backs up American exporters.

So far, Commerce has taken a hard-sell, scatter-gun approach in its efforts to promote U.S. goods abroad. Now the department's Bureau of International Commerce is considering a shift to long-range concentrated marketing and will try out the technique in Europe's Common Market with electronics production equipment.

**Recruiting drive.** Bernhard Haffner, who heads the pilot program, says it will start this year and could last from two to four years. As a first step, Commerce will try to sign up American producers of electronics plant equipment for a joint effort to promote the industry as a whole in Europe. After that, both Haffner and Grove Smith, Commerce's marketing director, expect a gradual evolution. The few people in Commerce who know about the embryonic pilot program call it "EM<sup>2</sup>"—for electronics manufacturing equipment marketing.

Haffner and Smith see several approaches that could emerge as the project takes shape. Working seminars are one possibility. Instead of covering exports in general, as Commerce brainstorming sessions now do, EM<sup>2</sup> seminars would deal with a specific effort—selling printed circuit board production gear in Italy, for example. Then, too, the trade shows Commerce sponsors overseas presumably would become part of long-range promotion efforts rather than one-shot affairs.

**Data centers.** And there's a chance that the pilot program will

lead to clearing houses for marketing information on electronics production equipment. Because the range of equipment is so wide—from circuit-board inks to automated integrated-circuit lines—market figures are hard to come by. "Right now," says Haffner, "we don't know if exports of electronics production equipment total \$1 million, \$2 million, or \$50 million to a country."

If the pilot plan takes hold, Smith sees groups of U.S. companies offering complete plants to European electronics producers on a "turnkey" basis. Once EM<sup>2</sup> is running smoothly, Commerce plans to bow out and let the industry take over.

## Japan

### Time to unwind

Electronics hardware designers nowadays have most of their components taken care of when the integrated-circuit chips are down. But to wind up the job, designers must add outboard coils to their

ic's whenever they need inductances.

One means of eliminating the bulky outboard coils is in the works at the Japanese government's Electrotechnical Laboratory in Tokyo. A research team headed by Shoei Kataoka has a solid-state inductor in an early stage of development. Kataoka's group already has built experimental devices with inductances of about 0.5 millihenry at 1 kilohertz. Now the group is concentrating on finding optimum designs for the solid-state inductors, whose Q or reactance/resistance ratio—about 0.35 at present—needs considerable improvement.

**Two-step.** Basically, the inductance is a Hall-effect device, a slab of high-mobility semiconductor material (indium antimonide) fitted with four terminals. If an external capacitor is connected to the two "Hall" terminals, an inductive impedance develops across the two "current" terminals when a magnetic field is applied to the slab.

The inductive impedance comes from a two-step Hall effect. Current flow through the slab produces a small voltage drop across the current terminals. A strong magnetic field perpendicular to this main current flow causes a larger voltage

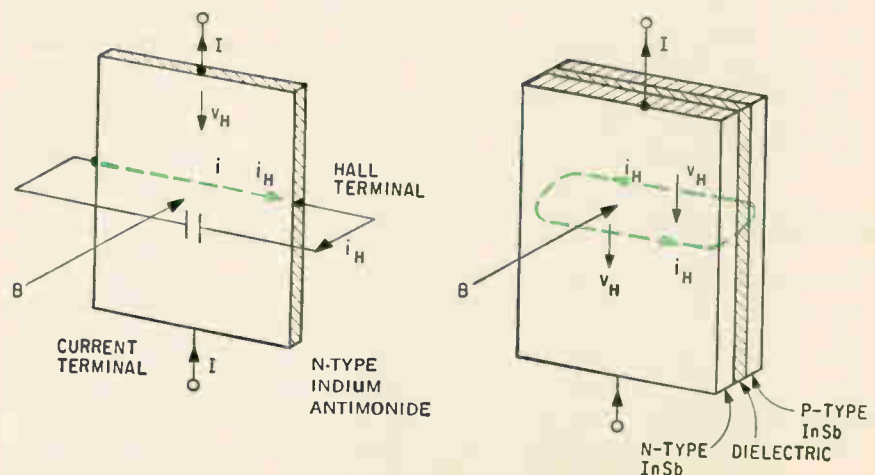

**Inductive slab.** Basic solid-state inductor (left) consists of InSb slab with external capacitor connected to two of its four terminals. Dielectric sandwiched between two slabs gives device internal capacitor.

to appear at the Hall terminals. This first Hall voltage is in phase with the alternating current applied to the device.

Because of the external capacitor connected to the Hall terminals, current flow through them leads the first Hall voltage by 90 degrees. And this current flow provokes a second Hall voltage, across the current terminals but leading the alternating current applied to them by nearly 90 degrees—the phase relationships in an inductor.

**Inside job.** Although Kataoka's group established the principle of the solid-state inductance using indium-antimonide slabs with external capacitors, its latest devices have integral capacitances. They are obtained by sandwiching a thin layer of dielectric between slabs of n-type and p-type semiconductors. In the sandwich devices, the first Hall voltages in the n and p slabs have opposite polarity and thus add in the capacitance loop, whose current flow produces the second Hall voltage that appears at the current terminals.

The p-type material, however, has lower mobility than n-type material and therefore lowers the Q of the device. The group is now attempting to develop devices having only n-type semiconductor material. Theoretically, Q's in the range of 5 to 10 should be possible with InSb.

**Piggy back.** The first experimental devices typically measured about 9 by 7 by  $\frac{3}{4}$  millimeter. Latest units, however, are about one-fifth that size. For fixed inductors, thin ferrite permanent magnets are fixed to the devices. The solid-state inductances can be made variable by using them with small pot-core magnets.

### Routed by radar

Most cities with extensive computer-controlled traffic systems have tried all sorts of sensors to pick up the car counts the computer needs to establish the optimum traffic flow. And in most cases, loop inductances—buried in the pavement—have worked best.

Now the inductance loop—and digging up streets to install them

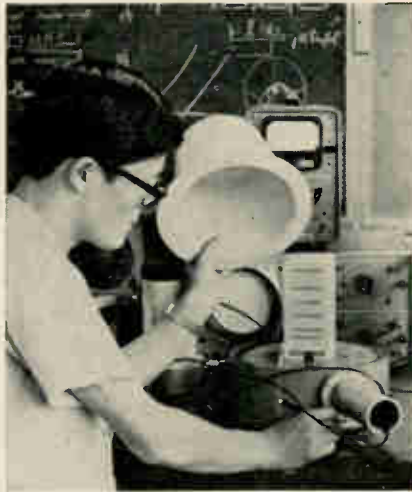

On the block. Yagi antenna for doppler-radar traffic sensor is made of foil strips cemented to polystyrene foam block. The "hat" is antenna's radome.

—seems on the way out. Matsushita Communication Industrial Co., has developed a traffic sensor that it claims can beat inductance loops both in performance and operating cost. Matsushita Communication, a wholly owned subsidiary of the Matsushita Electrical Industrial Co., set up the system that controls the lights in Tokyo's Ginza district.

**Simplified.** For the Ginza system, Matsushita experimented with pole-mounted ultrasonic sensors, doppler radar sensors, and buried loops before deciding on development of a simple low-power doppler radar unit. All circuits in the new sensor are solid state and the antenna is novel—foil strips cemented onto a block of polystyrene foam.

The switch to solid state eliminates a major drawback of the earlier units—a power-hungry lighthouse tube that had to be replaced after operating from six months to one year. In the new unit, the only components that operate at microwave frequency are long-life devices—a transistor oscillator and a varactor diode. Matsushita estimates mean time between failure for the solid state sensor at better than 50,000 hours.

**Zero i-f.** For simplicity, Matsushita assigned a dual role to the single varactor diode. It serves both as a frequency tripler and a

homodyne detector. The output of the transistor oscillator is tripled by the diode, which feeds 10 milliwatts of output power at 2,455 megahertz into the antenna. The incoming signal beats against the 2,455-Mhz frequency, and thus the doppler shift signal is extracted at zero intermediate frequency and passed directly to a bandpass amplifier that operates over a range of 10 to 30 hertz.

After amplification and wave-shaping, the doppler signal is processed to compensate for potential errors like a single long output signal from a group of cars traveling close together past the detector unit. A timing circuit divides long signals into a number of outputs that statistically correlate with the actual number of cars passing.

**Yagi block.** For the doppler radar antenna, Matsushita came up with an unusual design. Two stacked Yagi antennas are built up by cementing foil strips onto opposite sides of a foam block. Because the block has a dielectric constant of 1.05, the elements act almost as if they were suspended in air.

The driven element is a copper-foil folded dipole. The directors are aluminum-foil strips. Unlike a classic Yagi antenna, which uses rods similar to the directors as reflectors, the Yagi-on-a-block's reflector is the circular aluminum plate on which the plastic block is mounted.

---

## Italy

---

### Colorful pair

For all its drawbacks, the shadow-mask color television tube figures to predominate for a long time to come. Other tubes may be more elegant in conception, but so far none has been put into volume production. Meanwhile, shadow-mask tubes keep coming off the production lines by the millions.

Still, the quest for something better—and suitable for mass production—continues. The latest candidate for successor to the shadow mask is a two-gun tube developed

by Jato Srl., a small company in Florence. Walter Jaeger, who heads the firm, claims his tube could be mass-produced more easily than shadow-mask tubes.

Within the next few weeks, Jaeger expects to send a first batch of experimental tubes to the Institute for Radio and Television Technique, a test center in Munich run by the West German broadcasting networks. Jaeger already has held exploratory talks with AEG-Telefunken about putting the tube into production.

**Green fields.** The Jatron, as Jaeger calls the tube, is based on a simple premise: put only as many color-producing elements on the screen as the eye needs for image detail. Instead of a million-plus red, green, and blue color dots, the Jatron has 1,200 color stripes. What's more, half of the stripes in the Italian tube are green, the color that dominates in the luminance

guides the two electron beams onto the right stripes.

**Lift.** In each frame—two interlaced fields—the green gun writes a complete green picture. The second gun, however, alternates between blue and red from line to line. Although this effectively halves the amount of red and blue information, a viewer sees no difference in the color image on the screen.

The alternation of red and blue lines, though, would set up a crawling-line pattern unless there is a correction. In the Jatron, the crawl is eliminated by using a vertically lengthened red-blue beam and a pair of special electrodes. They alternately lift and lower the beam the width of half a line at each change of field.

**On the line.** Jaeger can trot out a number of reasons why the Jatron will be easy to produce. The color selector grid, for example, is glass-soldered into the bulb before the screen phosphors are applied. This simplifies alignment of the grid and the color stripes, which Jaeger says can be laid down on the screen by electronic masking techniques. And with only a twin-gun assembly, instead of three single guns, gun alignment and convergence correction are vastly simplified.

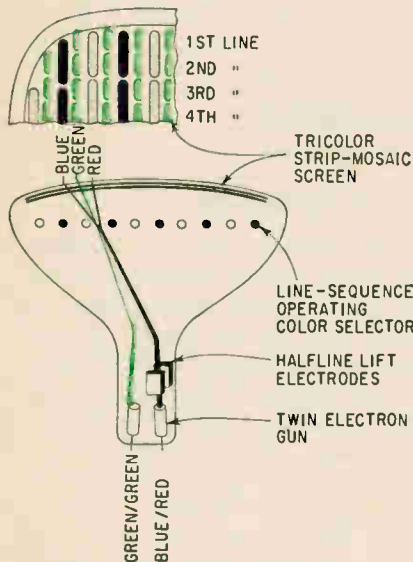

**Double-barreled.** Jatron color-tv tube has only two guns instead of the usual three, and strips instead of phosphor dots.

signal. The stripes are arranged in a red, green, blue, green vertical sequence.

To get twice as much green horizontally as well as vertically, the tube has one "green" gun and a "red-blue" gun. A vertical grid of stainless-steel wires near the screen is common for both guns. It provides post-deflection acceleration and focusing, and at the same time

## France

### Small start

A year ago, President Charles de Gaulle hatched his Plan-Calcul, a scheme designed to give France an independent computer industry. This month, the merged company set up under the plan to build central processors started marketing its first hardware—a small, third-generation, general-purpose computer.

With the small machine, Compagnie Internationale pour l'Informatique got the Plan-Calcul off to a deceptively fast start. Actually, the new computer was in the works at the Compagnie Européenne d'Automatisme Electronique before it became part of *ciu* [Electronics, Oct. 17, p. 223]. The small ma-

chine's design in no way resembles that planned for the medium computer *ciu* is developing with Plan-Calcul funds.

What's more, the transistor-transistor-logic integrated-circuit packages in the small machine are coming for the moment from U.S. companies, hardly the sort of independence de Gaulle is aiming at. It will be next spring, at the earliest, before French producers can supply the *ic*'s.

**Sanguine.** With its first machine, *ciu* doesn't stand to benefit much from the preference the de Gaulle government will give Plan-Calcul companies in its computer buying, which represents some 70% of the French market. The 10-010, as *ciu* calls its new machine, is essentially a process-control computer and the government's big need is for business machines.

Still, *ciu* figures the 10-010 will be a strong seller. Robert Remillon, *ciu*'s vice-president and general manager, says the goal is 300 machines next year and close to 1,000 yearly by 1970. In addition to France, where the market for process-control computers is growing fast, Remillon has high hopes for export sales in Europe and particularly West Germany. Remillon expects to sell, rather than lease, the machines, since they'll cost between \$18,000 and \$20,000, not enough to warrant rentals.

**Cousin.** In performance, the 10-010 falls into about the same class as the *pdp* 8 computer introduced in the U.S. more than two years ago by the Digital Equipment Corp. The French machine adds in 5.5 microseconds, multiplies in 9 microseconds and divides in 10. Its ferrite core memory has a cycle time of 1 microsecond. The basic memory store is 4,000 bytes of 8 bits, but can be expanded to 64,000 bytes.

### Window display

No matter how skilled he may be at spotting key displays on a cluttered instrument panel, it takes a pilot about eight-tenths of a second to switch his view from the sky out front onto the instruments in the cockpit. Brief though it is,

the time to refocus could be too long in clutch situations when the airlines start flying supersonic transports.

An obvious solution is a "heads-up" display that projects instrument readings into the pilot's field of view through the windshield. Most developed so far have been based on cathode-ray tubes and thus limited to a single-color projection of three or four key displays. Now CSF-Compagnie Générale de Télégraphie sans Fil has readied a system that shows pilots 10 or more parameters in five colors.

The display, which appears to be superimposed on the sky ahead, is so bright it can be seen against any background but the sun itself. Along with the plane reference line, the pilot has grouped before his eyes a gyroscope-derived horizon, a flight-director marker, an instrument-landing-system marker, a roll and pitch indicator and scales that show altitude, speed, and course.

**Prospects.** CSF has yet to sell its heads-up display system, but sees a promising market ahead in supersonic transports. The company is negotiating with Sud-Aviation and the British Aircraft Corp. to install the system on two preproduction versions of the Concorde, the Anglo-French supersonic transport. CSF plans to price the equipment at about \$40,000 for preproduction versions and later to drop the price to \$25,000 or less if the equipment catches on with airlines.

For the North American market, CSF has licensed the heads-up display to the Librascope group of the General Precision Equipment Corp.

**Infinity.** Instead of a cathode-ray tube, the CSF system is based on a combination of reticles and a beehive assembly of colored lamps—red, orange, green, blue, and white. The reticle images are projected through a mixing prism and a collimating lens 120 millimeters in diameter onto a semitransparent plate in the pilot's field of view. Since the plate absorbs only about 15% of the incoming light from outside the cockpit, and about 15% of the reticle light, the plate appears as transparent as the wind-

shield to the pilot.

Signals to drive the reticles and switch on the battery of colored lamps are developed in a control unit that is linked to all the aircraft's major navigation and flight-control equipment. Most of the circuitry in the control unit is built around IC packages.

---

### West Germany

---

#### Belt tightening

Military-hardware salesmen who ply their trade in Bonn have become increasingly disenchanted in recent months watching a once-lush market dry up. Early this month, the disenchantment turned to dismay as the Kiesinger government announced plans to lop off some \$2.33 billion from its defense appropriations over the next four years.

The cuts are a result of a thorough overhaul of the government's finances projected through 1971. In a move to wipe out a \$2 billion deficit and get the country's stagnant economy moving again, Kiesinger's coalition cabinet decided on an increase in taxes, a short-term investment program, and an over-all reduction of government spending.

**Up and down.** Hardest hit by the cutbacks will be the defense ministry. Long-range defense spending plans drawn up last year called for an increase in annual military outlays from the present level of \$4.85 billion to \$5.68 billion in 1971. These now will be trimmed an average of \$580 million a year.

So far, military officials in Bonn aren't sure which projects will get short shrift because of the cutbacks. But it seems likely that the government will now drop any plans it may have had to phase out its accident-prone Starfighters soon. Until the government pared its budget, there'd been talk about buying McDonnell Phantom 2 fighters or switching to the Italian version of the Starfighter.

**Ground and air.** Another project endangered by the cuts is joint

U.S.-German development of a heavy tank. Although it seems certain that the prototype will be ready—as scheduled—by early 1968, Bonn may pull out of the project after that.

And there's no doubt that West Germany will pare its participation in the Transall C-160 project, a joint venture with France to build a military transport plane. Even before the budget cuts Bonn was thinking about slashing its share from the originally planned 110 planes to 60.

One project that looks like it may still get off the ground is an advanced vertical takeoff and short-landing fighter (AVS). West Germany and the U.S. have joined in a feasibility study and now the Germans want to bring Britain in as a third partner to make sure the project would survive a pullout by the U.S. The AVS is one of several advanced-fighter projects under consideration at the Pentagon and could be dropped by the U.S.

---

### Great Britain

---

#### I'm all right, Jack

British avionics equipment makers had little trouble keeping stiff upper lips when the news broke this month that the de Gaulle government was pulling out of the Franco-British project to develop a swingwing supersonic fighter-bomber.

Despite the public clamor touched off in Britain by the announcement — Defense Minister Denis Healey over the past year had repeatedly said the Wilson government considered the plane its long-term mainstay—the decision was no surprise to British avionics officials. They had long been skeptical about the French commitment to the program since it called for a plane much heavier and more sophisticated than the French feel they need. What's more, France has developed alone a smaller swingwing fighter—the Dassault Mirage 3G—slated to fly this summer.

**British swinger.** The Wilson government now says it plans to con-

tinue the preliminary study for the project, but to aim for a version of the variable-geometry plane tailored to British needs. The feasibility study was complete and cost estimates drawn up when the French pulled out, but no actual work on the aircraft had been started.

By and large, the feeling in the British avionics industry is that this swingwing plane never will get off the ground even though the government has started to look for potential new partners.

One prospect is West Germany. Although the Kiesinger government just this month cut its defense spending plans, one project the Germans apparently will push on with is an advanced vertical take-off and short-landing fighter [see story above]. The British Aircraft Corp., which had been working with Dassault on the Anglo-French swinging project, already has held exploratory talks with the companies involved in the U.S.-German avs program. Thus the British may end up as a partner in the avs, but there's no chance the Germans will replace the French in the swingwing project.

**Unfazed.** But avionics equipment makers in Britain figure they'll end up with about the same amount of business no matter what happens. If the Wilson government does see its way clear to going it alone on a swingwing plane, they'll have twice as much to do on half the number of planes that would have been built under a joint program. If (and more likely) the upshot of the French pullout is a joint project, U.K. avionics firms would be as well off as they were before.

## Around the world

**Great Britain.** Mullard Ltd. has developed a radar "no more complicated than a television receiver" to guide ground vehicles operating at fog-bound airports. The radar's range is from 3 to 100 yards and its resolution is 2 yards. The company plans to try out an experimental version under field conditions within a few months.

# VACTEC

announces a new line of

## VACTROL Lamp-Cell Controls

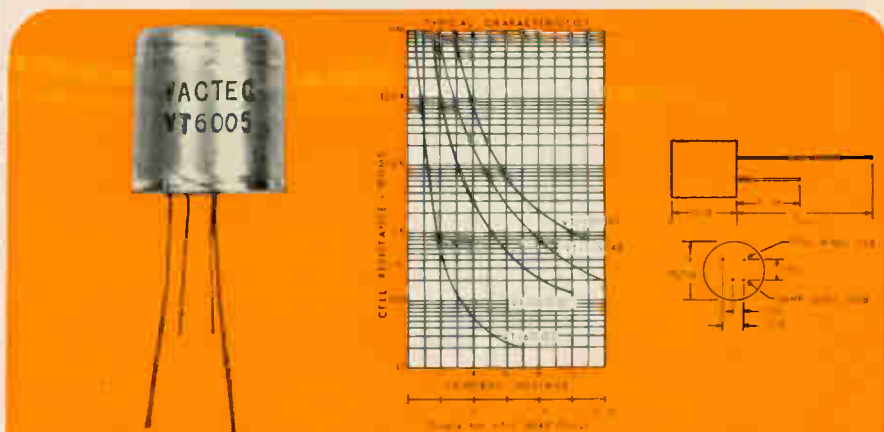

Now 1.5v, 6v, and two 10-volt Vactrols are available for electronic amplifier applications. Combines a dependable Vactec photocell with the proper long-life incandescent lamp in a complete low-cost module.

Provides noiseless, trouble-free volume and

tone control for TV, radio, guitars, organs, and other musical instruments.

Unit is protected by an epoxy sealed metal enclosure. Leads are spaced on .100" centers for circuit board mounting. Special characteristic designs available for unique applications. Write for Vactrol Bulletin PDC-4C 1.



**VACTEC, INC.**

2423 Northline Ind. Blvd. • Maryland Hts., Mo. 63042 • AC 314. 432-4200

See Vactec's listing in EBG under "Semi-Conductors," and in EEM, Sec. 3700.

Circle 269 on reader service card

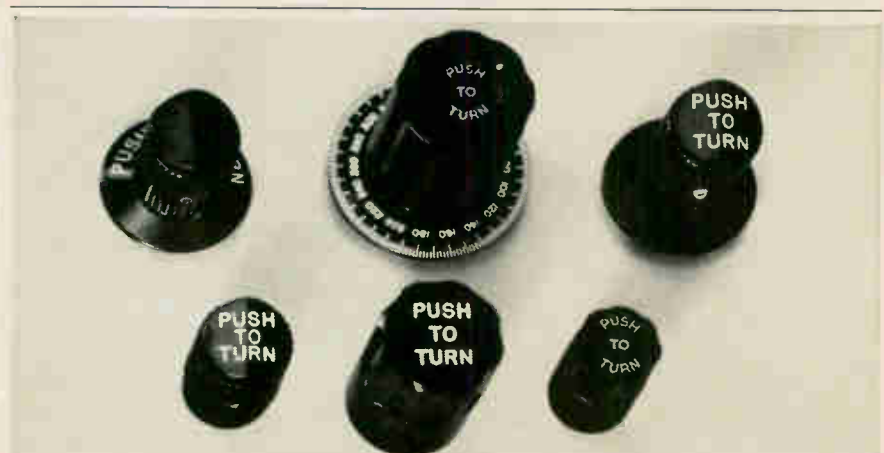

## Now you can lock settings, eliminate complicated hardware with new self-locking push-to-turn knobs from Raytheon

When pushed, these new control knobs rotate instrument shafts in either direction—with infinite resolution and zero backlash.

When released, the knobs spring back and automatically lock the shaft against shock, vibration, accidentally turning.

These knobs feature: patented, all-mechanical locking device; stainless

steel parts; packaging which complies with MS91528C and MIL-K-3926B specifications.

Send reader service card for data on styles, sizes, colors, custom features. Or write Raytheon Company, Components Division, Quincy, Mass. 02169.



# Electronics advertisers

July 24, 1967

Adams & Westlake Co. Kasper & Assoc., Inc.	45	Corning Glass Works, Capacitor Div. Rumrill Hoyt Co., Inc.	175	■ Hewlett Packard, F. L. Moseley Co. Div. Lennen & Newell, Inc.	22
□ Aerocom Grant Adv., Inc.	OAS 6	Coto Coil Co., Inc. Williams Co., The	214	Hewlett Packard, Rockaway Div. Culver Adv., Inc.	65
Aerovox Corp., Hi-Q Div. Lescarbourea Adv., Inc.	189	■ Couch Ordnance, Inc., Couch Co. Div. Culver Adv., Inc.	208	Hewlett Packard, Sanborn Div. Culver Adv., Inc.	192
Airpax Electronics, Inc. Welch, Mirabile & Co., Inc.	164	□ C. S. F. SPI Agency	OAS 3, 9	Honeywell PMD Div. Batten, Barton, Durstine & Osborn, Inc.	205
Allen-Bradley Co. Fensholt Adv. Agcy.	67, 68	■ CTS Corporation Burton Browne Adv.	140	Honeywell, Test Instruments Div. Campbell Mithum, Inc.	132
American Optical Co. Fuller & Smith & Ross, Inc.	122	Curtis Development & Mfg. Co. Keck Adv. Agcy.	209	Hooker Chemical Corp., Durez Div. Rumrill-Hoyt, Inc.	119
■ Ammon Instruments, Inc. Culver Adv. Agcy., Inc.	200	■ Dage Electric Co., Inc. Garrison, Jasper, Rose & Co.	204	Hughes Aircraft Co. Foote, Cone & Belding, Inc.	136, 183
■ AMP, Inc.	158, 159, 182	■ DuPont de Nemours & Co., Freon Div. Batten, Barton, Durstine & Osborn, Inc.	51	■ Ichizuka Optical Co., Ltd. Matsushita, Inc.	215
■ Amphenol Corp., RF Div. Marsteller, Inc.	18, 19	■ DuPont de Nemours & Co., Mylar Div. Batten, Barton, Durstine & Osborn, Inc.	62	Indiana General Corp., Electro Mechanical Div. Griswold & Eshleman Co.	24
Arnold Engineering Co. Burton Browne Adv.	197	■ Eagle Signal Div. of Gamewell Sub. of E. W. Bliss Co. Feeley Adv. Agcy.	174	Industrial Electronic Engineers Gumpertz, Bentley & Dolan, Inc.	66
Avantek Bonfield Assoc., Inc.	9	Eastman Kodak Co., Technical Corporate Adv. Rumrill Hoyt, Inc.	33	Information Handling Services Martz & Associates	135
Babcock Relays, Div. of Babcock Electronics Corp. Leland Oliver Co.	143	E G & G, Inc. Culver Adv., Inc.	44	International Crystal Mfg. Co. Robert V. Freeland & Assoc.	202
Barnes Development Co. Industrial Public Relations, Inc.	201	Electronic Research Associates, Inc. Josephson, Cuffari & Co.	188	I R C, Incorporated Gray & Rogers, Inc.	133
■ Barnstead, Sub. of Ritter Pfaudler Corp. Creamer Trowbridge & Case, Inc.	170	Emerson & Cuming, Inc. Edwin F. Hall	220	■ ITT Cannon Electric, Inc. West, Weir & Bartel, Inc.	71
Beckman Instruments, Inc. Electronic Instrument Div. Hixson & Jorgensen, Inc.	129	□ English Electric Valve Co., Ltd. Allardyce Palmer, Ltd.	OAS 10	■ ITT Jennings Mfg. Co. West, Weir & Bartel, Inc.	58
■ Beckman Instruments, Inc., Helipot Div. Hixson & Jorgensen, Inc.	217	Erie Technological Products Co., Inc. Altman-Hall Associates	29	ITT Semiconductors Div. Neals & Hickok, Inc.	234
■ Belden Mfg. Co. Fensholt Adv., Inc.	56, 57	Fairchild Instrumentation Faust/Day, Inc.	123	Janus Control Corp. L. K. Frank Co., Inc.	210
Biddle Co., James G. The Michener Co.	154	Fairchild Semiconductor, Inc. Faust/Day, Inc.	12, 13	Johnson Co., E.F. Midland Associates	219
Bissett-Berman Corp. S.F. Associates	153	Ferroxcube Corporation of America Solow Wexton, Inc.	124	■ Lambda Electronics Corp. Michel Cather, Inc.	61
BLH Electronics Gray & Rogers, Inc.	126	General Atronics Corp. Garceau, Hargrave & McCullough, Inc.	199	Litton Industries, Inc., Winchester Electronics Div. West, Weir & Bartel, Inc.	222
Boonton Electronics Corp. The Creative Group	188	■ General Electric Co., Component Capsules Div. Robert S. Cragin, Inc.	39	■ Machlett Laboratories, Div. of Raytheon Co. Fuller, Smith & Ross, Inc.	11
Bourns, Inc., Trimpot Div. Lester Co., The	148	■ General Electric Co., Polymer Products Operation Div. Ross Roy, Inc.	131	■ Mallory & Co., P.R., Mfg. Div. Aitkin-Kynett Co.	8
Braceland Brothers, Inc.	200	General Radio Co. Horton, Church & Goff, Inc.	6	□ Maconi Company, Ltd. Hampshire House, Ltd.	OAS 2
Bud Radio, Inc. Allied Adv. Agcy., Inc.	134	Globe Industries, Inc. Odiorme Industrial Adv., Inc.	209	Markem Machine Co. Culver Adv., Inc.	128
Burroughs Corp., Electronic Components Div. Conti Adv. Agcy., Inc.	72	■ Grayhill, Inc. Merchandising Adv., Inc.	199	Maryland Telecommunications, Inc. Ray E. Finn Adv.	130
By-Buk Company Albert Frank-Guenther Law Adv., Inc.	198	■ Gudebrod Brothers Silk Co., Electronics Div. Ramsdell-Buckley & Co.	64	Meguro Electronic Instrument General Adv. Agcy., Inc.	214
Celanese Corporation of America, Celanese Plastics Div. West, Weir & Bartel, Inc.	167	Hamilton Standard Co., Div. of United Aircraft Corp. Cunningham & Walsh	226	Meson Electronics Co., Inc. Wolff Associates, Inc.	216
Centralab, Div. of Globe-Union, Inc. The Brady Co.	15	Hansen Mfg. Co. Keller-Crescent Co.	208	Microwave Associates, Inc. Kalb & Schneider, Inc.	117
Cherry Electrical Products Corp. K & A, Inc.	145	Hayakawa Electronics Co., Ltd. Dai-Ichi International, Inc.	201	Microwave Electronics Corp., Sub. of Teledyne Bonfield Associates	171
■ Chester Cable Corp. Lewis Adv. Agcy.	137, 138	Hewlett Packard Lennen & Newell, Inc.	28	□ Milo International, Div. of Milo Electronics Corp. Industrial Marketing Assoc.	OAS 8
Cimron, Div. of Lear Siegler, Inc. Phillips-Ramsey, Inc.	203	□ Hewlett Packard, S. A. Walter Zurcher Agcy. S.A.	OAS 5	Missimers, Inc. J.R. Underwood Adv.	216
Cinch Graphik, Div. of United Carr Fastener Co. Reach, McClinton & Co.	157	■ Hewlett Packard F & T Div. Lennen & Newell, Inc.	52, 53, 216	Molex Products Co. J.D. Culea Adv., Inc.	211
Cinch Manufacturing Co. Stral Adv. Co.	190, 191	Hewlett Packard, Harrison Div. Healy Adv. Agcy.	2	■ Monitor Systems, Inc. Thomas R. Sundheim, Inc.	213
■ Clairex Corp. Michel-Cather, Inc.	200	Hewlett Packard, International Div. Lennen & Newell, Inc.	179	Monsanto Company Foote, Cone & Belding	3rd Cover
Clarostat Manufacturing Co. Lescarbourea Adv., Inc.	70	Hewlett Packard, Loveland Div. Tallant/Yates Adv., Inc.	1	Motorola Communications & Electronics, Inc. K & A, Inc.	118
■ Clevite Corp., Piezoelectric Div. Carr Liggett Adv., Inc.	211			Motorola Semiconductor Products, Inc. Lane & Bird Adv., Inc.	47, 59
Columbia Wire Products Co. Sander Rodkin Adv. Agcy., Ltd.	144				
Computer Measurements Co. The Bowes Co.	120				
Consolidated Electrodynamics Corp., Sub. of Bell & Howell Hixson & Jorgensen, Inc.	54, 55				
Consolidated Vacuum Corp., Sub. of Bell & Howell Wolff Assoc., Inc.	195				





## Advertising sales staff

<b>National Semiconductor Corp.</b> Jay Chiat & Assoc.	20, 21	<b>Taylor Corp.</b> Gray & Rogers, Inc.	176
<b>North Atlantic Industries, Inc.</b> Murray Heyert Assoc.	89	<b>Tech-etch, Inc.</b> Van Christo Assoc., Inc.	213
		■ <b>Technipower, Inc.</b> S & S Creative Services	152
<b>Pek Laboratories</b> Sturges Advertising	7	■ <b>Tektronix, Inc.</b> Hugh Dwight Adv., Inc.	17, 41
<b>Pennsalt Chemicals Corp.</b> Aitkin-Kynett Co., Inc.	69	<b>Telonic Instruments</b> Jansen Assoc., Inc.	63, 178
<b>Philbrick Researches, Inc.</b> Culver Adv., Inc.	90	<b>Tempress Research Co., Inc.</b> Hal Lawrence, Inc.	30, 31
<b>Philco/Ford Co., Microelectronics Div.</b> Hoefler, Dieterich & Brown, Inc.	60	<b>Texas Instruments Incorporated</b> Semiconductor/Components Division	162, 163
□ <b>Philips Eindhoven, N.V.</b> T.A.G. De La Mar	OAS 1	■ <b>Torotel, Inc.</b> Spangler Adv., Inc.	46
■ <b>Photocircuits Corp.</b> Duncan-Brooks, Inc.	160, 161	<b>Transformer Electronics Co.</b> Dacey, Wolff & Weir	212
<b>Physics International</b> Conley, Baker & Steward	16	■ <b>Transmagnetics, Inc.</b> Adrian Clarke Jr., Inc.	146
<b>Polaroid Corp.</b> Doyle Dane Bernbach, Inc.	147	<b>Triplett Electrical Instrument Co.</b> Burton Browne Adv.	185
■ <b>Potter &amp; Brumfield, Inc. of</b> <b>Amer. Machine &amp; Foundry Corp.</b> Grant, Schwenck & Baker, Inc.	206, 207	<b>Trygon Electronics, Inc.</b> Solow/Wexton Co., Inc.	42
<b>Princeton Applied Research Corp.</b> Mort Barish Assoc., Inc.	34	<b>Trymetrics Corp.</b> Solow/Wexton Co., Inc.	166
		■ <b>Tung Sol, Div. Wagner Electric Corp.</b> E.M. Freystadt Assoc.	209
		<b>Union Carbide Corp. Electronics Div.</b> J.M. Mathes, Inc.	32
■ <b>Radio Cores, Inc.</b> Sander Rodkin Adv. Agcy., Ltd.	212	■ <b>Unitrode Corp.</b> Silton Brothers, Inc.	43
<b>Radio Corporation of America</b> Al Paul Lefton Co.	4th Cover	<b>United Systems Corp.</b> Adv. & Merchandising, Inc.	215
<b>Raytheon Co., Components Div.</b> Fuller & Smith & Ross, Inc.	231	■ <b>United Transformer Co.</b> Philip Stogel Co.	2nd Cover
<b>RCL Electronics, Inc.</b> Morvay Adv. Agcy.	14		
<b>Redcor Corp.</b> Smith-Klitten, Inc.	196		
■ <b>Reeves Hoffman, Div. of</b> <b>Dynamics Corp. of America</b> Adams Assoc., Inc.	198	■ <b>Vactec, Inc.</b> Coleman & Assoc. Adv.	231
		<b>Victoreen Instrument Co., The</b> Palm & Peterson, Inc.	156
		■ <b>Vitro Corp. of Amer. Vitro Electronics</b> Buchen Adv., Inc.	184
<b>Sage Electronics Corp.</b> Mathison Adv., Inc.	213	<b>Volkert Stampings, Inc.</b> Fred Wittner Co., Inc.	196
<b>Sci-Tek Computing Center, Inc.</b> Stanley, Richard & Fredrick, Inc.	220		
<b>Semtech Corp.</b> Burruss Advertising	127	<b>Wayne Kerr Corp.</b> Josephson, Cuffari Co.	194
<b>Sensitak Instrument Corp.</b> Allied Adv. Agcy., Inc.	218	■ <b>Weston Instruments, Inc.</b> Newark Div.	139
■ <b>Servo Corporation of America</b> Basford, Inc.	177	Arndt, Preston, Chapin, Lamb & Keen, Inc.	
□ <b>Sesco</b> Maurice Ridant Editions Techniques & Publicite de Firmes	OAS 7	■ <b>Weston Instruments, Inc.</b> Transicoil Div.	217
<b>Signetics Corp. Sub.</b> Corning Glass Works Cunningham & Walsh, Inc.	102	Arndt, Preston, Chapin, Lamb & Keen, Inc.	
■ <b>Silicon Transistor Corp.</b> A.D. Adams Adv.	121		
<b>Sinclair Radio Labs., Inc.</b> John E. Hayes Co., Inc.	214	<b>Classified Advertising</b>	
<b>Soliton Devices, Inc., Transistor Div.</b> Haselmire Pearson Adv., Inc.	101	F.J. Eberle, Manager	
<b>Spectrol Electronics Corp.</b> Jones, Maher Roberts, Inc.	225	<b>PROFESSIONAL SERVICES</b>	221
□ <b>S.P. Elettronica</b>	OAS 4	<b>EMPLOYMENT OPPORTUNITIES</b>	221
<b>Sperry Rand Corp.,</b> Microwave Components Neals & Hickok, Inc.	48	<b>EQUIPMENT</b> (Used or Surplus New) For Sale	221
<b>Sprague Electric Co., The</b> Harry P. Bridge Co.	5, 10	<b>ADVERTISERS INDEX</b>	
■ <b>Stackpole Carbon Co.,</b> Electronic Components Div. Meek & Thomas, Inc.	150, 151	<b>Atomic Personnel Inc.</b>	221
<b>Stanpat Products, Inc.</b> Morton Advertising, Inc.	211	<b>Radio Research Instrument Co.</b>	221
<b>Stewart Warner Microcircuits, Inc.</b> Jones, Maher, Roberts, Inc.	27	<b>Tallon Co. Inc.</b>	221
<b>Sylvania Electric Products, Inc.,</b> Parts Div.	125	<b>Turner Assoc. G.K.</b>	221
<b>Synthane Corp.</b> Arndt, Preston, Chapin, Lamb & Keen, Inc.	217		

### Frank E. LeBeau [212] 971-6464

Advertising sales manager

Wallis Clarke [212] 971-2187

Assistant to sales manager

Donald J. Austerermann [212] 971-3139

Promotion Manager

Atlanta, Ga. 30309: Michael H. Miller, 1375 Peachtree St., N.E.  
[404] TR 5-0523

Boston, Mass. 02116: William S. Hodgkinson  
McGraw-Hill Building, Copley Square  
[617] CO 2-1160

Chicago, Ill. 60611: Robert M. Denmead  
J. Bradley MacKimm, Ralph Hanning,  
645 North Michigan Avenue,  
[312] MO 4-5800

Cleveland, Ohio 44113: William J. Boyle, 55  
Public Square, [216] SU 1-7000

Dallas, Texas 75201: Richard P. Poole, 1800  
Republic National Bank Tower,  
[214] RI 7-9721

Denver, Colo. 80202: Joseph C. Page, David  
M. Watson, Tower Bldg., 1700 Broadway,  
[303] 255-5484

Detroit, Michigan 48226: Ralph Hanning  
856 Penobscot Building  
[313] 962-1793

Houston, Texas 77002: Kenneth George,  
2270 Humble Bldg., [713] CA 4-8381

Los Angeles, Calif. 90017: Ian C. Hill,  
John G. Zisch, 1125 W. 6th St.,  
[213] HU 2-5450

Minneapolis, Minn. 55402: J. Bradley  
MacKimm, 1104 Northstar Center  
[612] 332-7425

New York, N.Y. 10036

500 Fifth Avenue

Donald R. Furth [212] 971-3615

James R. Pierce [212] 971-3616

Jeffrey M. Preston [212] 971-3617

Philadelphia, Pa. 19103:

Warren H. Gardner, Jeffrey M. Preston,  
6 Penn Center Plaza,  
[215] LO 8-6161

Pittsburgh, Pa. 15222: Warren H. Gardner,  
4 Gateway Center, [412] 391-1314

Portland, Ore. 97204: James T. Hauptli,  
218 Mohawk Building, 222 S.W. Morrison  
Street, Phone [503] 223-5118

Rochester, N.Y. 14534: William J. Boyle,  
9 Greylock Ridge, Pittsford, N.Y.  
[716] 586-5040

St. Louis, Mo. 63105: Robert M. Denmead  
The Clayton Tower, 7751 Carondelet Ave.  
[314] PA 5-7285

San Francisco, Calif. 94111:  
James T. Hauptli, 255 California Street,  
[415] DO 2-4600

London W1: John W. Patten, Edwin S.  
Murphy Jr., 34 Dover Street,  
Hyde Park 1451

Milan: Robert M. Saidel  
1 via Baracchini Phone: 86-90-656

Frankfurt, Main: Gerd Hinske, Dieter  
Rothenbach, Elsa-Brandstroem Str. 2  
Phone: 72 01 81

Geneva: Michael R. Zeynel,  
1, rue du Temple Phone: 31 95 60

Paris VIII: Kenneth Davey,  
17 Avenue Matignon Phone: 359 6637

Tokyo: Nobuyuki Sato, 1, Kotohiracho  
Shiba, Minato-Ku [502] 0656

Osaka: Ryoji Kobayashi 163, Umegae-cho  
Kita-ku [362] 8771

### Business department

Wallace C. Carmichael, Manager

[212] 971-3191

Stephen R. Weiss, Production Manager

[212] 971-2044

Thomas M. Egan,

Assistant Production Manager [212] 971-3140

Dorothy Carmesin, Contracts and Billings

[212] 971-2908

### Circulation and research

Milton Drake, Manager [212] 971-3485

Isaac Siegel, Assistant Circulation Manager

[212] 971-6057

David Strassler, Assistant Research Manager

[212] 971-6058

Chloe D. Glover, Research Associate

[212] 971-6057

### Electronics buyers' guide

George F. Werner, General Manager

[212] 971-2310

Ray Smyth, Eastern Regional Manager

[212] 971-6538

Regina Hera, Directory Manager

[212] 971-2544

Thomas M. Egan, Production Manager

[212] 971-3140

# The Predictables.

**Some computer  
manufacturers  
inspect every  
incoming diode.**

**The others order  
from ITT.**

We do it for them. ITT inspects every diode 100% three different times before it's shipped. Any part number, silicon or germanium, double plug or DO-7. Make us prove it. RFQ: The Predictables.

diodes **ITT**

ITT SEMICONDUCTORS IS A DIVISION OF INTERNATIONAL TELEPHONE AND TELEGRAPH CORPORATION

FACTORIES IN WEST PALM BEACH, FLORIDA; PALO ALTO, CALIFORNIA; LAWRENCE, MASSACHUSETTS; HARLOW AND FOOTSCRAY, ENGLAND; FREIBURG AND NURENBERG, GERMANY

# Latest in the line of Monsanto IC counter/timers.

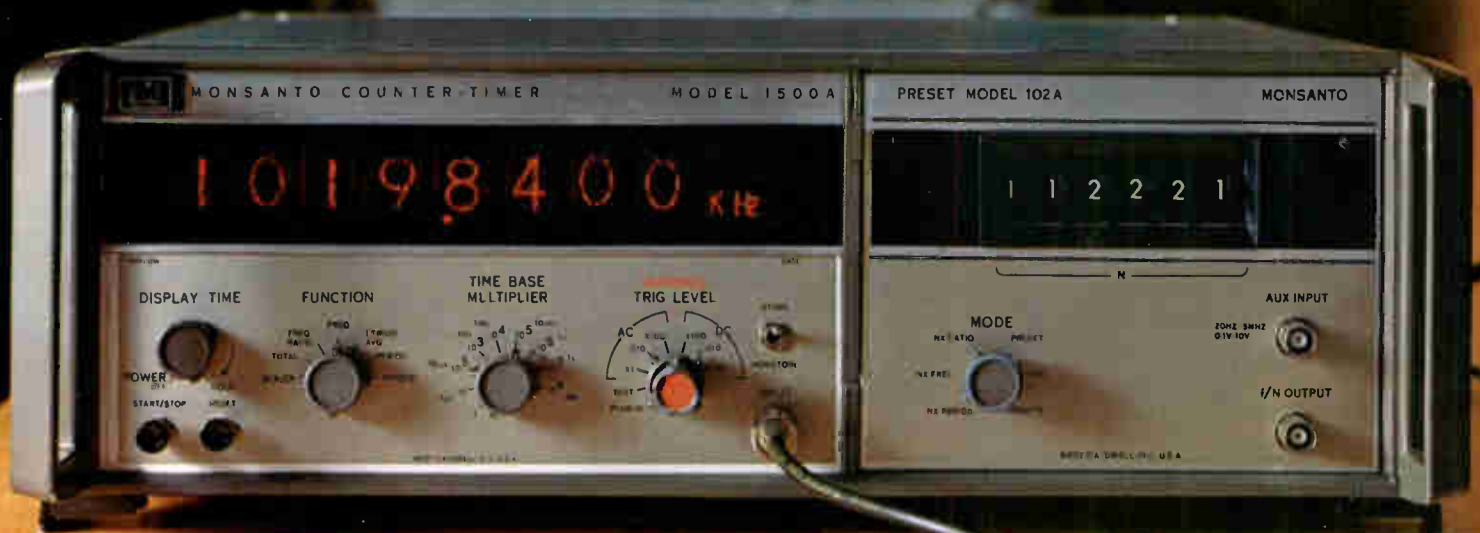

AVAILABLE PLUG-INS: TWO FREQUENCY CONVERTERS (50 MHz TO 500 MHz, 100 MHz TO 3 GHz); PRESCALER (dc TO 1 GHz); PRESET UNIT (20 Hz TO BEYOND 10 MHz); VIDEO AMPLIFIER (1 mV SENSITIVITY, 10 Hz TO 200 MHz); TIME INTERVAL UNIT (100 ns RESOLUTION); NON-COMMITTED PLUG-IN.

**With 90% integrated circuit construction this new "4th generation" instrument is the most advanced plug-in counter/timer yet.**

Our new model 1500A takes full advantage of IC capabilities to bring you: main-frame counting range from dc to over 125 MHz; to 3 GHz with a single plug-in. Remote programability by either contact closure or voltage level. Provision for external time base up to 10 MHz. And

naturally, the inherent stability and reliability of integrated circuit construction, as indicated by our two-year warranty. All this for only \$2,850 (U.S. dollars, FOB West Caldwell, N.J. exclusive of plug-ins). Circle the inquiry number for full technical details, or contact us directly at: Monsanto Electronics Technical Center, 620 Passaic Avenue, West Caldwell, N.J. 07006. Phone: (201) 228-3800; TWX 710-734-4334.



ELECTRONICS

Circle 901 on reader service card

# The "non-plastic" plastic transistors



So reliable you'd think they were hermetic

We're big enough to realize that with any plastic transistor, you're bound to have questions concerning reliability.

So...long before RCA announced this family of "Hometaxial-Base" silicon power plastic devices (10 transistors with ratings of 36W or 83W), our reliability engineers devised a most rigorous new-product testing program. RCA

TA 7155  
36W type for TO-66 sockets

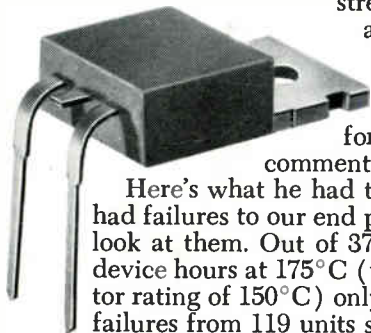

subjected hundreds of units to stresses beyond device ratings and the results are so impressive that, frankly, you'd think the transistors were hermetic.

We thought it would be appropriate for you to see our reliability manager's comment on the tests to date.

Here's what he had to say: "...sure we've had failures to our end points. But take a close look at them. Out of 376 units totalling 410,000 device hours at 175°C (versus an actual transistor rating of 150°C) only 3 failed. There were 2 failures from 119 units subjected to 25 temperature cycles of -65°C to 175°C (device rating is 5 cycles of -65°C to 150°C). In all, our actual unit hours on all life tests, including storage, operating, and reverse bias, total over 1,600,000 with a failure rate of 1.7% per 1,000 hours. And if you adjust for the fact that all these tests were essentially at over-stress conditions, the result is an estimated failure rate of less than 0.1% per 1,000 hours."

Why not evaluate the facts behind RCA's "non-plastic" plastic transistors yourself? We documented all of the details in a no-nonsense brochure (HBT-600A) which we'll be glad to send you. Just write RCA Commercial Engineering, Section IN 74, Harrison, N. J. 07029, or see your local RCA representative.

RCA Electronic Components and Devices



TA 2911  
36W type for printed-circuit boards

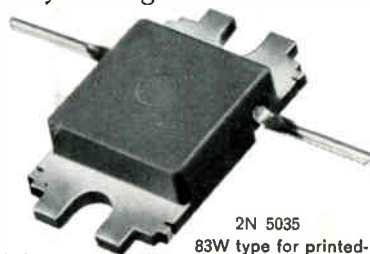

2N 5035  
83W type for printed-circuit boards



2N 5034  
83W type for TO-3 sockets



The Most Trusted Name in Electronics

Circle 902 on reader service card