

Electronics®

Integrating a military calculator: page 76

Spying on the enemy: page 89

An all-purpose circuit: page 109

May 29, 1967

\$1.00

A McGraw-Hill Publication

Below: Integrated circuits calculate interceptor's flight path: page 76



**"SPECIAL"
CUSTOM BUILT**



POWER TRANSFORMERS & INDUCTORS

TO YOUR SPECIFICATIONS

Exceptional quality and reliability is provided in all UTC designs. Over 30 years of engineering knowledge and experience backed by complete environmental testing and life testing facilities assure the highest standard in the industry. Full analysis and evaluation of materials are conducted in UTC's Material and Chemical Laboratories. Rigid quality control measures coordinated with exhaustive statistical findings and latest production procedures results in the industry's highest degree of reliability. Range covered in Power Transformers is from milliwatts to 100 KVA. Some typical applications include: Current Limiting, Filament, Isolation, Plate, Transistor Inverter, Transistor Supply.

MILITARY AND COMMERCIAL TYPES FOR EVERY PHASE OF THE ELECTRONICS ART

POWER TRANSFORMERS • AUDIO TRANSFORMERS • INDUCTORS • PULSE TRANSFORMERS • ELECTRIC WAVE FILTERS • LUMPED CONSTANT DELAY LINES • HIGH Q COILS • MAGNETIC AMPLIFIERS • SATURABLE REACTORS • REFERENCE UNITS

<p>Low capacity current limiting filament transformer. Primary 118 V. 60 cycles to 6.3 V. at 3 A., 8 A. at short circuit. 25 MMFD capacity. 30 KV hipot and 200:1 capacity divider; 5 x 3 3/4 x 4 1/2", 9 lbs.</p>	<p>MIL-T-27B ultraminiature Scott connected power transformer, 5/16 Dia. x 13/32" H., 1/10 Oz. Primary 28 V. 400 — with taps @ 50% & 86.6%. Two units provide 28 V two phase from three phase source.</p>	<p>Molded Power Transformer 3 Phase. Input 200V, 380-420 cps. Electrostatic Shield, 8 output windings, 26 terminals. MIL-T-27B, Grade 2 Class S. Max. Alt. 50K Ft. Size 6 x 2 1/2 x 5", 8 lbs.</p>
<p>Commercial type molded power transformer. Primary 115/230 V., 50/420 cycles to 680 VCT.-.015 A., 6.3 VCT.- 1.2 A., 6.3 V.-.6A. Size: 2 1/2 x 3 x 2 7/8", weight: 1.6 lbs.</p>	<p>Three phase high voltage power transformer. Primary jumper hardware for easy conversion from delta to wye inputs. Made to MIL-T-27B specifications. Primary: 440 V 60 cycles delta or wye 3 phase input. Secondary: 2100 V line to line or 1215 V line to line @ 242 ma.</p>	<p>High current filament transformer. Primary 140/156 V., 47/63 cycles to 1.8 V.-1070 A. Current limiting through separate primary reactor, MIL-T-27B; 10 x 10 x 1 1/2", 150 lbs.</p>

Write for catalog of over 1,300 UTC TOP QUALITY STOCK ITEMS IMMEDIATELY AVAILABLE from your local distributor.



UNITED TRANSFORMER CO.
DIVISION OF TRW INC. • 150 VARICK STREET, NEW YORK, N. Y. 10013

NEW DVM

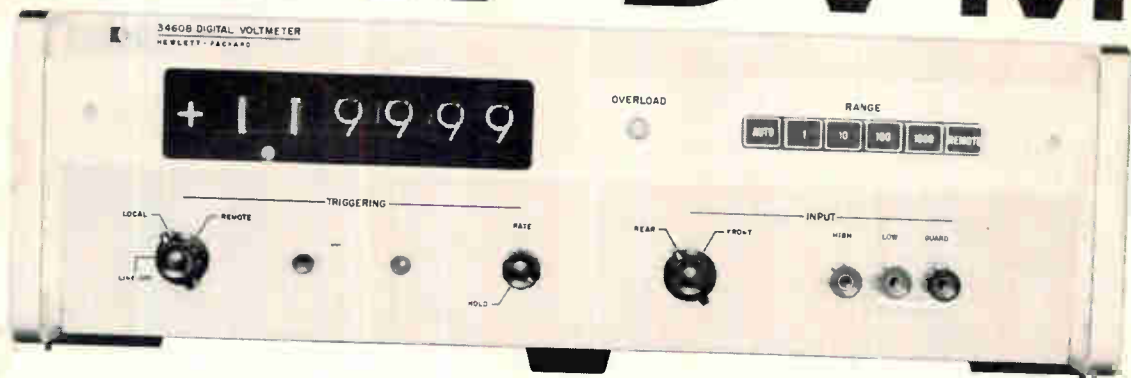

Dual Technique for 0.004% Accuracy

hp 3460B Integrating/Potentiometric Voltmeter Has High Accuracy... $>10^{10}\Omega$ Input Resistance... Systems Compatibility

The new hp 3460B Digital Voltmeter is a dual-technique instrument that combines the best features of an integrating voltmeter with those of a potentiometric voltmeter—to give an accuracy of 0.004% of reading, superimposed noise immunity of integrating DVM's and a high common mode rejection of 160 dB at dc.

You get up to 15 readings per second with five full digits and 20% overranging indicated by a sixth digit. Polarity selection is automatic. The 3460B has 10 μV sensitivity. Four ranges are selectable by pushbuttons on the front panel, or, range selection can be automatic or remote.

Floating and guarded input connectors are on both the front and back of the instrument. Input resistance is $>10^{10}\Omega$ at balance on 1 V and 10 V ranges (minimum 10 M Ω), and a constant 10 M Ω on 100 V and 1000 V ranges.

Programmability.—hp 3460B is designed for

fully automatic operation in a digital data acquisition system. A four-line BCD output (1-2-4-8) on the back of the instrument contains 6 digits of data, polarity, decimal location and overload information. Voltage range and two integration periods can be selected by external circuit closure to ground.

Get the full story on the new dual-technique hp 3460B Digital Voltmeter from your nearest hp field engineer. Or, write to Hewlett-Packard, Palo Alto, California 94304, Tel. (415) 326-7000. Europe: 54 Route des Acacias, Geneva. Price: hp Model 3460B, \$3600.00.

097/13

HEWLETT  **PACKARD**
An extra measure of quality

Bring on your complex, small, noisy, difficult signals.

We'll give you traces that show them for what they really are.

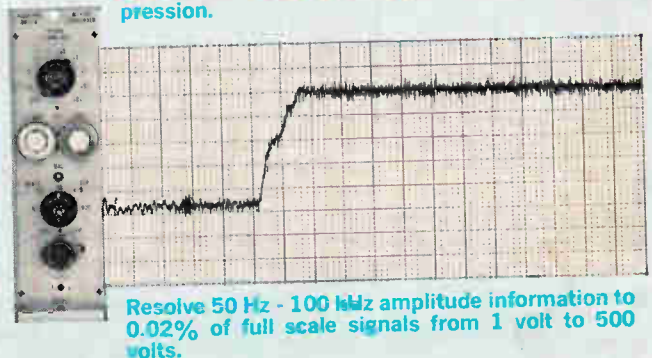
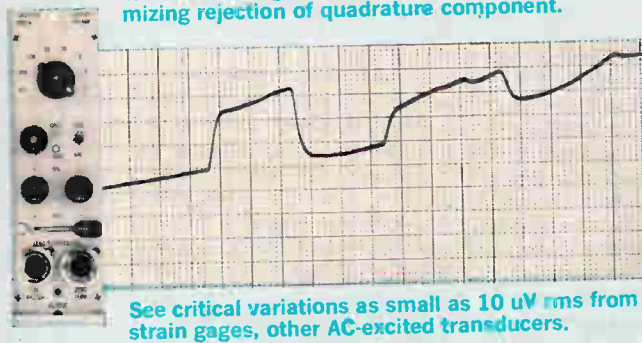
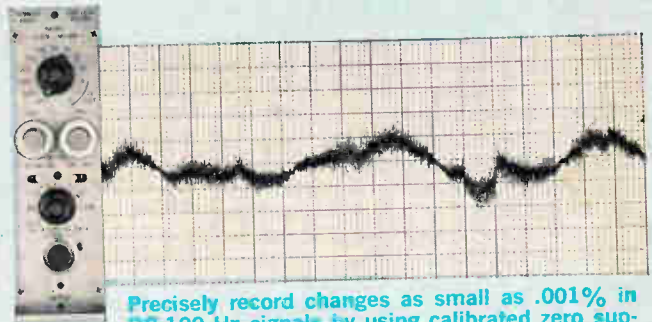
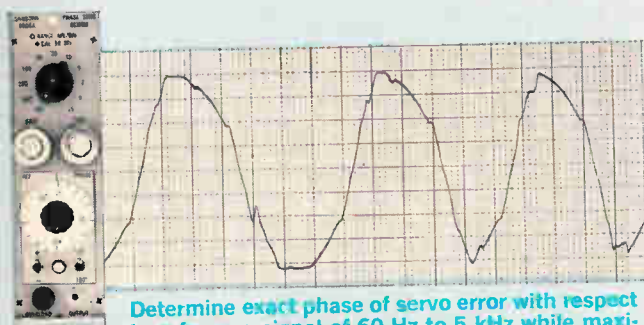

When you need the greatest possible degree of signal-conditioning precision and operational control, Sanborn 7700 Series oscillographs with solid-state "8800" plug-ins will give you chart recordings of maximum resolution and intelligibility.

Seven highly versatile signal conditioners offer unique performance capabilities: three DC types with a 1 uV - 250 V dynamic range, floating differential input and calibrated zero suppression . . . an AC-DC Converter with calibrated zero suppression and scale expansion permitting resolution better than 0.1%, 10 ms response and isolated, 1 meg. input . . . a phase-sensitive demodulator with calibrated reference phase shift, 90° calibrated dial with four quadrant selections, and a frequency range of 60 Hz to 5 kHz . . . a carrier preamp with 2400 Hz internal transducer excitation supply, calibrated zero suppression, cal. factor control and conversion gain of 10,000 . . . and a general-purpose DC preamp particularly useful for 100 mm wide chart recording.

Use any of these "8800" plug-ins in the 7700 thermal writing oscillograph matched to your packaging and channel requirements — 4-, 6- and 8-channel 7704A, 7706A and 7708A console types . . . 2-channel 7702A system in rack-mount or mobile cart versions . . . single-channel 7701A wide chart (100 mm) portable system. Every one of these thermal writers will give you permanent, rectangular-coordinate recordings whose resolution and accuracy make all your measurements more useful.

For a new brochure describing the advantages and wide choice of Sanborn thermal writing oscillographs, write Hewlett-Packard Company, Sanborn Division, 175 Wyman Street, Waltham, Mass. 02154.

Circle 2 on reader service card



**HEWLETT
PACKARD**  **SANBORN
DIVISION**

News Features

Probing the News

- 137 Latest word in printing spells new electronics market
- 145 Quick-change technique converts monopulse radar into phase array

Electronics Review

- 45 Integrated electronics: Wide, pure wafers; Model kit for masks
- 47 Companies: Varian variegates
- 47 Instrumentation: MOS scrutinizes MOS
- 48 Computers: Faster yet
- 48 Military electronics: Passive sentry
- 48 Space electronics: One path to success; The light track; Fail safe
- 52 Advanced technology: Impatt's impact
- 52 Consumer electronics: Off color; On the track
- 54 Avionics: Matchmaker
- 56 Circuit design: Worth the trip
- 56 For the record

Electronics Abroad

- 211 Sweden: Stress signals; Updating an old trade
- 212 Japan: What's up front counts; Calculated entry
- 213 Great Britain: Against the tide
- 214 International: A common code

Departments

- 4 Readers Comment
- 8 People
- 14 Meetings
- 16 Meeting Preview
- 23 Editorial
- 25 Electronics Newsletter
- 59 Washington Newsletter
- 157 New Products
- 157 New Products Index
- 196 New Books
- 200 Technical Abstracts
- 204 New Literature
- 209 Newsletter from Abroad

Title R registered U.S. Patent Office; © copyright 1967 by McGraw-Hill Inc. All rights reserved, including the right to reproduce the contents of this publication, in whole or in part.

Technical Articles

- Integrated electronics 76 **Integrated circuits in action: part 6**
Shrinking a military calculator (cover)
The equivalent of 12,000 discrete components are squeezed into a package only $\frac{3}{4}$ cubic foot in volume
R.W. Ward, Motorola Inc.

- Circuit design 84 **Designer's casebook**
 - An easy guide for selecting the right transformer core
 - Permanent magnet motor measures its own speed
 - Amplifier erases swing of 19-db in input signals
 - Audio amplifier adjusts gain to input levels
 - Two added transistors reduce ignition-system current drain

- Avionics 89 **In reconnaissance, the eyes have it**
Changing requirements of intelligence keep makers of airborne sensors at work
John Mason, military electronics editor

- 94 **Flying the Phantom**
An eyewitness report of the Air Force's most advanced reconnaissance plane in action

- 100 **Watching the invisible enemy**
To see through rain and foliage, the Air Force is improving infrared and radar techniques

- 103 **Automation opens the way**
Inflight tester has been developed to check out the multisensor Phantom automatically

- Design theory 109 **A good turn for old components**
A new device, which is essentially an all-purpose circuit, alters the output response of conventional components
Leon O. Chua, Purdue University

Electronics

Editor-in-Chief: Lewis H. Young

Associate managing editors

Design: Samuel Weber
Application: George Sideris
News: Robert Henkel
Copy: Sally Powell

Senior editor

Special projects: Donald Christiansen

Senior associate editors

John F. Mason, Joseph Mittleman, Stephen E. Scrupski

Department editors

Advanced technology: Stephen E. Scrupski
Avionics: W.J. Evarzia
Communications: Leonard Weller
Computers: Wallace B. Riley
Design theory: Joseph Mittleman
Industrial electronics: Alfred Rosenblatt
Instrumentation: Carl Moskowitz
Military electronics: John F. Mason
New products: William P. O'Brien
Staff writers: Paul Dickson, James Brinton, Kay Sloman

Section editors

Electronics abroad: Arthur Erikson
Electronics review: Stanley Zarowin
Probing the news: Eric Aiken

Regional bureaus

Domestic

Boston: H. Thomas Maguire, manager; Robin Carlson
Los Angeles: Lawrence Curran, manager; June Ranill
San Francisco: Walter Barney, manager; Mary Jo Jadin
Washington: William D. Hickman, Patricia C. Hoehling

Foreign

Bonn: John Gosch
London: Michael Payne
Tokyo: Charles Cohen

Copy editors

Albert Tannenbaum, James Chang, Frederick Corey

Graphic design

Art director: Saul Sussman
Assistant art directors: Ann Mella, Valerie Betz
Production editor: Arthur C. Miller

Editorial secretaries: Claire Benell, Lynn Emery, Lorraine Fabry,
Kay Fontana, Patricia Gardner, Lorraine Longo

McGraw-Hill News Service

Director: John Wilhelm; Atlanta: Fran Ridgway; Chicago: James Rubenstein;
Cleveland: Arthur Zimmerman; Dallas: Marvin Reid;
Detroit: N. Hunter; Houston: Robert E. Lee; Los Angeles: Michael Murphy, Gerald Parkinson
Pittsburgh: Louis Gomolak
San Francisco: William F. Arnold
Seattle: Ray Bloomberg; Washington: Arthur L. Moore, Charles Gardner,
Herbert W. Cheshire, Seth Payne, Warren Burkett, James Canan, William Small

McGraw-Hill World News Service

Bonn: John Johnsrud; London: John Shinn;
Mexico City: Bruce Cross; Milan: Ronald Taggiasco;
Moscow: Howard Rausch; Paris: Peter Kilborn;
Rio de Janeiro: Wes Perry; Tokyo: Marvin Petal
Reprints: Susan Nugent

Publisher: Gordon Jones

Electronics: May 29, 1967, Vol. 40, No. 11

Published every other Monday by McGraw-Hill, Inc. Founder: James H. McGraw 1860-1958.

Printed at 99 North Broadway, Albany, N.Y. 12207; second class postage paid at Albany, N.Y.

Executive, editorial, circulation and advertising addresses: McGraw-Hill Building, 330 W. 42nd Street,
New York, N.Y. 10036. Telephone (212) 971-3333. Teletype TWX N.Y. 212-640-4646. Cable address:
MCGRAWHILL N.Y.

Subscriptions are solicited only from those actively engaged in the field of the publication. Position and
company connection must be indicated on orders. Subscription prices: United States and possessions and
Canada, \$8.00 one year, \$12.00 two years, \$16.00 three years; all other countries, \$25.00 one year.
Single copies: United States and possessions and Canada, \$1.00; all other countries, \$1.75.

Officers of McGraw-Hill Publications: Joseph H. Allen, President; Bayard E. Sawyer, Executive Vice President;
Vice Presidents: J. Elton Tuohig, Operations; John R. Callahan, Editorial; John M. Holden, Marketing;
Huber M. Gemmill, Circulation; Angelo R. Venezian, Production; Robert M. Wilhelmy, Controller.

Officers of the Corporation: Donald C. McGraw, Chairman of the Board; Shelton Fisher, President;
L. Keith Goodrich, Donald C. McGraw, Jr. and Robert E. Slaughter, Executive Vice Presidents; John J. Cooke,
Vice President and Secretary; John L. McGraw, Treasurer.

Title © registered in U.S. Patent Office; © Copyright 1967 by McGraw-Hill, Inc. All rights reserved. The contents
of this publication may not be reproduced either in whole or in part without the consent of copyright owner.

Subscribers: The publisher, upon written request to our New York office from any subscriber,
agrees to refund that part of the subscription price applying to copies not yet mailed.

Please send change of address notices or complaints to Fulfillment Manager; subscription
orders to Circulation Manager, Electronics at address below. Change of address notices
should provide old as well as new address, including postal zip code number. If possible,
attach address label from recent issue. Allow one month for change to become effective.

Postmaster: Please send form 3579 to Fulfillment Manager, Electronics,
P.O. Box 430, Hightstown, New Jersey 08520

Readers Comment

Fear of technology

To the Editor:

In your editorial, "In search of a scapegoat," [May 15, p. 23] you castigate the "breastbeaters and finger pointers" that have been lambasting the space agency and its contractors. Yet on the same page; "Where blame should go," you do a little breastbeating of your own.

We are extremely fortunate that the FAA has not been taken in by the technology salesman. The FAA is trying to uphold the standards of professionalism required in the industry. As an airline pilot I am well aware of the deficiencies of the present system. I am also well acquainted with the failures of electronic hardware in the system. I have yet to meet a manufacturer who will guarantee 100% reliability.

The LaGuardia incident was not a failure of the system, but a failure of a user to follow instructions issued by the controller. In effect, you are advocating single lane one-way streets throughout the nation as a solution to our traffic problems.

It is impossible to eliminate human judgment from our society because the machine is limited by the knowledge of the man that conceived it.

I am surrounded by black boxes that control myriads of functions in today's jet liners. The FAA makes it requisite that a crew member be able to function in their place when they fail.

Leave it to technology and the population explosion will pose no threat.

Robert C. Hummel

Captain

Pan American World Airways
Amityville, N.Y.

■ Reader Hummel reflects the psychology and school of thought that permeates the Federal Aviation Agency. Technology, and the prospects of a breakdown, are so feared that reliance is placed heavily on people who, as he points out, also fail. The editorial's main

Sprague low-power TTL

STOP using so many ICs

All Sprague low-power Series 400 TTL circuits are dual or quad functions. Cut your can count and minimize equipment size. And the Series 400 has dual-source availability through the Sprague/Signetics full technology interchange.

Circuit Function	TO-88 Hermetic Flatpack		Plastic DIP Package		
	-55 to +125 C	0 to +70 C	0 to +70 C		+15 to +55 C Commercial
			Military GSE	Industrial	
DUAL 4-input NAND gate	SE416J	NE416J	NE416A	ST416A	SP416A
DUAL 3-input NAND gate	SE417J	NE417J	NE417A	ST417A	SP417A
DUAL A-C binary	SE424J	NE424J	NE424A	ST424A	SP424A
DUAL 4-input Exclusive OR gate	SE440J	NE440J	NE440A	ST440A	SP440A
DUAL 4-input buffer/driver	SE455J	NE455J	NE455A	ST455A	SP455A
QUAD 2-input NAND gate	SE480J	NE480J	NE480A	ST480A	SP480A

For complete technical data on Series 400 integrated circuits, write to Technical Literature Service, Sprague Electric Company, 35 Marshall Street, North Adams, Mass. 01247

SPRAGUE COMPONENTS

INTEGRATED CIRCUITS
THIN-FILM MICROCIRCUITS
TRANSISTORS
CAPACITORS
RESISTORS
4511-7120

PULSE TRANSFORMERS
INTERFERENCE FILTERS
PULSE-FORMING NETWORKS
TOROIDAL INDUCTORS
ELECTRIC WAVE FILTERS

CERAMIC-BASE PRINTED NETWORKS
PACKAGED COMPONENT ASSEMBLIES
BOBBIN and TAPE WOUND MAGNETIC CORES
SILICON RECTIFIER GATE CONTROLS
FUNCTIONAL DIGITAL CIRCUITS



Sprague and *®* are registered trademarks of the Sprague Electric Co.

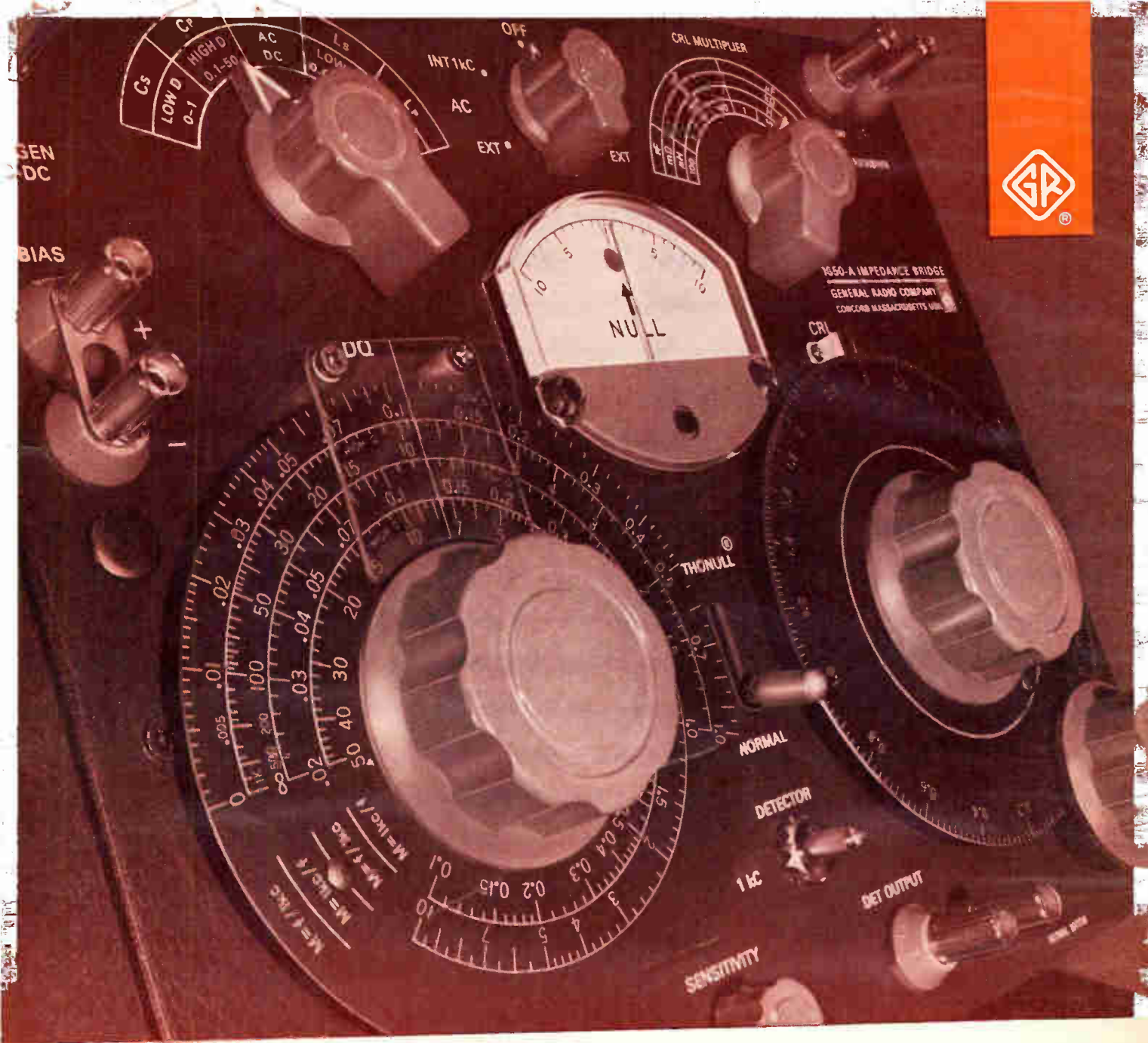

Close-up on quality

There are more impedance measurements made with a 1650-A than with any other bridge. Why? Here are a few reasons:

- It is versatile, essentially five bridges in one package. It measures ac or dc resistance from 1 m Ω to 11 M Ω , capacitance from 1 pF to 1100 μ F, and inductance from 1 μ H to 1100 H. It also measures D or Q over a wide range.
- It is completely self-contained and portable. It contains its own 1 kHz generator, detector, and power supply (four D-size batteries). The patented Flip-Tilt case doubles as an adjustable stand and as a storage case.
- It is accurate to 1% for R, L, and C measurements. Accuracy is maintained over a frequency range of 20 Hz to 20 kHz, ex-

ternally supplied, for L and C (to 5 kHz for R). Usable to 100 kHz with reduced accuracy.

- It has an Orthonull[®] balance finder, which eliminates sliding nulls in low-Q balancing.
- It is low-cost. Price is only \$475 in U.S.A.
- It was designed and is manufactured by a company with over 50 years of impedance-measurement know-how.

For complete information, write General Radio Company, 22 Baker Avenue, W. Concord, Massachusetts 01781; telephone (617) 369-4400; TWX 710 347-1051.



Type 1650-A Impedance Bridge

Circle 6 on reader service card

GENERAL RADIO

points were 1) technology can reduce the chances of equipment or people failure, and 2) that the application of technology has to be directed by the Federal Aviation Agency, which is supposed to be the expert in the problems of air traffic control, not by technology salesmen.

Recount?

To the Editor:

The circuits described by Irwin Math in "A simple way to count with integrated circuits" [April 3, p. 99] will not operate as expected in most cases.

The modulo-28 counter or any other counter of this type will be subject to two problems:

1. Counting rate in this "ripple counter" must be slow enough so that a new pulse has not arrived at the first flip-flop before the last pulse has had a chance to ripple down to the end of the flip-flop chain. If the counting rate is too fast, all the inputs to the AND gate will not be synchronized and the equality—in this case at 28—will not be found at the proper time.

2. More importantly, if counting is slow, when all inputs to the AND gate are 1, the gate will cause all the flip-flops to reset. This will clear the inputs to the AND gate and the reset level will be removed. The actual timing of each gate and flip-flop determines whether all the flip-flops have been reset when the reset level is removed. The flip-flop string can clear to a number other than zero. The problem can be avoided if the reset level is held after output of the AND gate goes to zero. A monostable one-shot multivibrator inserted between the output of the AND gate and the connec-

tions to the various reset lines will eliminate this problem.

Jerrold Grochow

MIT
Cambridge, Mass.

The author replies:

I have constructed a divide-by-31 ripple counter along the lines of the article for use in a commercial application and have had no miscounts or failures in 75 such units when counting at a 6-Mhz rate. Furthermore, the temperature range at such a counter is well in excess of -35°C to $+125^{\circ}\text{C}$. This counter used Fairchild DTuL ic's.

Also, a divide-by-25 ripple counter was constructed with Signetics type SE integrated circuits and a counting rate of 1 Mhz with no apparent problems at a 2-Mhz counting rate.

Although it is true that extremely fast counting rates can cause resetting errors in this type of counter, good design practice usually does not allow operation of flip-flop circuits at speeds close to their maximum rating except in simple counters. I believe that reliable counting can be obtained up to 75% of the maximum rating for the integrated flip-flop with this technique.

The addition of a one-shot to keep the reset voltage for a short time after the reset gate has gone to zero is another matter. Most of the integrated circuit flip-flops on the market today have companion gates that are strictly designed to avoid just this problem. The action of the override reset input is such that the flip-flop resets on the leading edge of the signal before the signal is even removed.

I. Math

Frequency Electronics Inc.
New Hyde Park, N.Y.

**NEED
HIGH VOLTAGE
CAPACITORS
FAST?**

... Prompt Delivery -

NO!

... Immediate Delivery

YES!



GLASS CONTAINERS



METAL CAN CONTAINERS



Our list of satisfied "blue chip" customers is growing and growing which necessitated a large expansion of our manufacturing and engineering facilities. Now, we can supply a complete range of voltages from 2,000 to 50,000 volt capacitors from our expanded "stock on hand". Don't take excuses, we'll supply you faster than at any time in our many years in the field—**BETTER PRODUCTION FROM US—BETTER DELIVERY FOR YOU!**

Write for complete list of Standard High Voltage Capacitors in stock—or, send specifications for custom quotations.



Plastic Capacitors, INC.

2620 N. Clybourn • Chicago 14, Ill.
DI 8-3735

SUBSCRIPTION SERVICE

Please include an Electronics Magazine address label to insure prompt service whenever you write us about your subscription.

Mail to: Fulfillment Manager
Electronics
P.O. Box 430
Hightstown, N.J. 08520

To subscribe mail this form with your payment and check new subscription renew my present subscription

Subscription rates: in the U.S.: 1 year \$8; two years, \$12; three years, \$16. Subscription rates for foreign countries available on request

CHANGE OF ADDRESS

ATTACH LABEL HERE If you are moving, please let us know five weeks before changing your address. Place magazine address label here, print your new address below.

name _____
address _____
city _____ state _____ zip code _____

New bargain in performance!

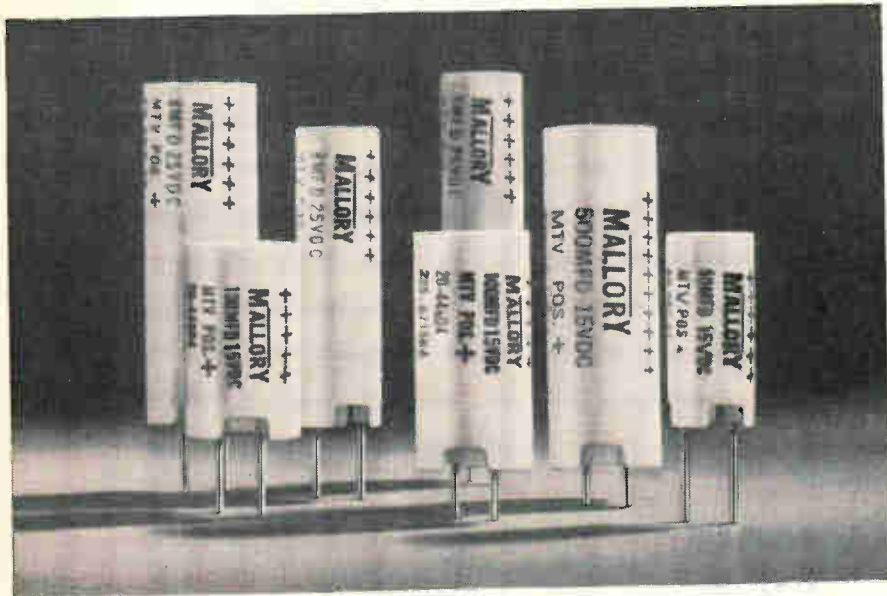

Molded case electrolytics for vertical mounting.

Meet the MTV... newest member of the unique Mallory family of molded case aluminum electrolytic capacitors. It's designed for vertical mounting, with built-in standoffs that facilitate soldering and ease in cleaning printed circuit boards.

Temperature performance? Good stability down to -30°C , excellent life at rated 65°C ... or intermittent 85°C operation.

Reliability? Just ask for our data—the most and best you ever saw for an economy-priced capacitor.

Price? Lower than metal case types and most epoxy-sealed plastic tubulars.

Ratings? Up to 1000 mfd at 3 WVDC and 115 mfd at 50 WVDC. Nine case sizes: diameters of .375" and .500"; lengths .812" to 1.50".

For bulletin and prices, write or call Mallory Capacitor Company, a division of P. R. Mallory & Co. Inc., Indianapolis, Indiana 46206.

MALLORY

People

The new director of urban technology ranks urban problems "second only to defense" in national importance. And he should know.

Thomas F. Rogers, left a Defense Department post as deputy director of the Electronics and Information Systems division to take the newly created job in the Department of Housing and Urban Development (HUD).



Rogers will mastermind HUD's attempts to apply technology and the system analysis approach to solving urban problems.

Rogers took over the post May 1 and is preparing a broad research and development program; the department is asking Congress for \$20 million for fiscal 1968. Rogers points out that for 1967 the department spent only 1/40 of 1% of its \$2 billion budget in R&D, whereas the Defense Department put from 10% to 15% of its \$70 billion budget toward R&D.

Call to colleagues. A prominent scientist and engineer, Rogers urges his colleagues to think of the city as a system. "Of course, the social scientist will have to translate the city's needs into terms the engineer can understand. The engineer can then come up with proposals and test to see if they will work," he declared.

The electronics industry can look forward to increasing business, Rogers anticipates. "City planners will need computers and a vast amount of other equipment to carry out jobs of traffic control and law enforcement, for communications in hospitals, police and fire department, and for handling city records."

With the appointment of **Charles H. (Bud) Blankenship** as vice president it appears certain that Siliconix Inc. will expand its role in the integrated circuit market, as it did in the field-effect transistor market, by aiming for custom jobs. Blankenship, a 35-year-old engi-



put
a little
salt
on this
bird's
tail

(less than 5 grams will actuate it!)

To operate Cherry's new "Feather-Touch" switch, forget about piling on the pressure. On this extended lever version, for example, a mere 5 grams is the maximum operating force. You won't find another 5 amp. miniature snap-action switch with an operating force that low—anywhere.

Only 45 grams maximum at the actuator button, and the basic version of this switch springs into action. At the same time, the "Feather-Touch" offers the same large over-travel, high reliability, and long life that make our other miniature switches so popular.

If you prefer, specify the "Feather-Touch" in 10 or 15 amp. models (maximum operating forces are, respectively, 75 and 100 grams at the button).

For a sample of this unusual switch development and complete specifications, write to us today.















CHERRY ELECTRICAL PRODUCTS CORP.

1656 Old Deerfield Rd., Highland Park, Ill. 60035

Circle 9 on reader service card

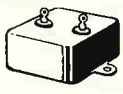
All from Sprague!

TWELVE OF OUR MOST POPULAR METALLIZED CAPACITOR TYPES

SPRAGUE TYPE	Case And Configuration	Dielectric	Temperature Range	Military Equivalent	Eng. Bulletin
 680P	hermetically-sealed metal-clad tubular	metallized Metfilm* 'A'	-55 C, +85 C	no specification	2650
 431P	film-wrapped axial-lead tubular	metallized Metfilm* 'E' (polyester film)	-55 C, +85 C	no specification	2445
 155P, 156P	molded phenolic axial-lead tubular	metallized paper	-40 C, +85 C	no specification	2030
 218P	hermetically-sealed metal-clad tubular	metallized Metfilm* 'E' (polyester film)	-55 C, +105 C	CH08, CH09 Characteristic R	2450A
 260P	hermetically-sealed metal-clad tubular	metallized Metfilm* 'K' (polycarbonate film)	-55 C, +105 C	no specification	2705
 121P	hermetically-sealed metal-clad tubular	metallized paper	-55 C, +125 C	no specification	2210C
 118P	hermetically-sealed metal-clad tubular	metallized Difilm® (polyester film and paper)	-55 C, +125 C	CH08, CH09 Characteristic N	2211D
 143P	hermetically-sealed metal-clad "bathtub" case	metallized paper	-55 C, +125 C	no specification	2220A
 144P	hermetically-sealed metal-clad "bathtub" case	metallized Difilm® (polyester film and paper)	-55 C, +125 C	CH53, CH54, CH55 Characteristic N	2221A
 284P	hermetically-sealed metal-clad rectangular case	metallized paper	-55 C, +105 C	no specification	2222
 283P	hermetically-sealed metal-clad rectangular case	metallized Difilm® (polyester film and paper)	-55 C, +125 C	CH72 Characteristic N	2223
 282P (energy storage)	drawn metal case, ceramic pillar terminals	metallized paper	0 C, +40 C	no specification	2148A

*Trademark

For additional information, write Technical Literature Service, Sprague Electric Company, 35 Marshall St., North Adams, Mass. 01247, indicating the engineering bulletins in which you are interested.

SPRAGUE COMPONENTS

CAPACITORS
TRANSISTORS
RESISTORS
THIN-FILM MICROCIRCUITS
INTEGRATED CIRCUITS
INTERFERENCE FILTERS

PACKAGED COMPONENT ASSEMBLIES
FUNCTIONAL DIGITAL CIRCUITS
MAGNETIC COMPONENTS
PULSE TRANSFORMERS
CERAMIC-BASE PRINTED NETWORKS
PULSE-FORMING NETWORKS



*Sprague and ® are registered trademarks of the Sprague Electric Co.

People

neer, will be responsible for coordinating the company's engineering, manufacturing, and marketing for both IC's and FER's. He comes well-qualified for the job.

One of the 15 engineers who founded the company in 1962, Blankenship started as a design engineer in its IC group. In quick succession, he became marketing manager, took over the IC group as applications manager, and then became project manager. In the process he has worked in almost every area, including product testing and development.



C.H. Blankenship

The way to the top. "I guess you would call it a promotion," he says of his new post. "I had the responsibilities without the title before. But now I'll be more concerned with operations in the plant."

Plant operations alone will keep him busy. Siliconix, which has worked double shifts from the outset, makes two basic product lines: FET devices and custom IC's for the military. The 320-employee company handles both by tightly interweaving production and development.

Time-saver. Blankenship estimates that the company saves about six months product-development time by eliminating the engineering pilot line. Since all new products move down the standard production line, the manufacturing and development personnel work together to quickly smooth out kinks.

Siliconix also freely shifts men to areas where it believes their talents can best be used at the moment.

"We're pretty unstructured," Blankenship says. "We mold the company to individual capabilities. Few companies would have a vice president in charge of both manufacturing and integrated circuit development.

By carefully extending the two established product lines, Blankenship counts on a controllable growth rate.

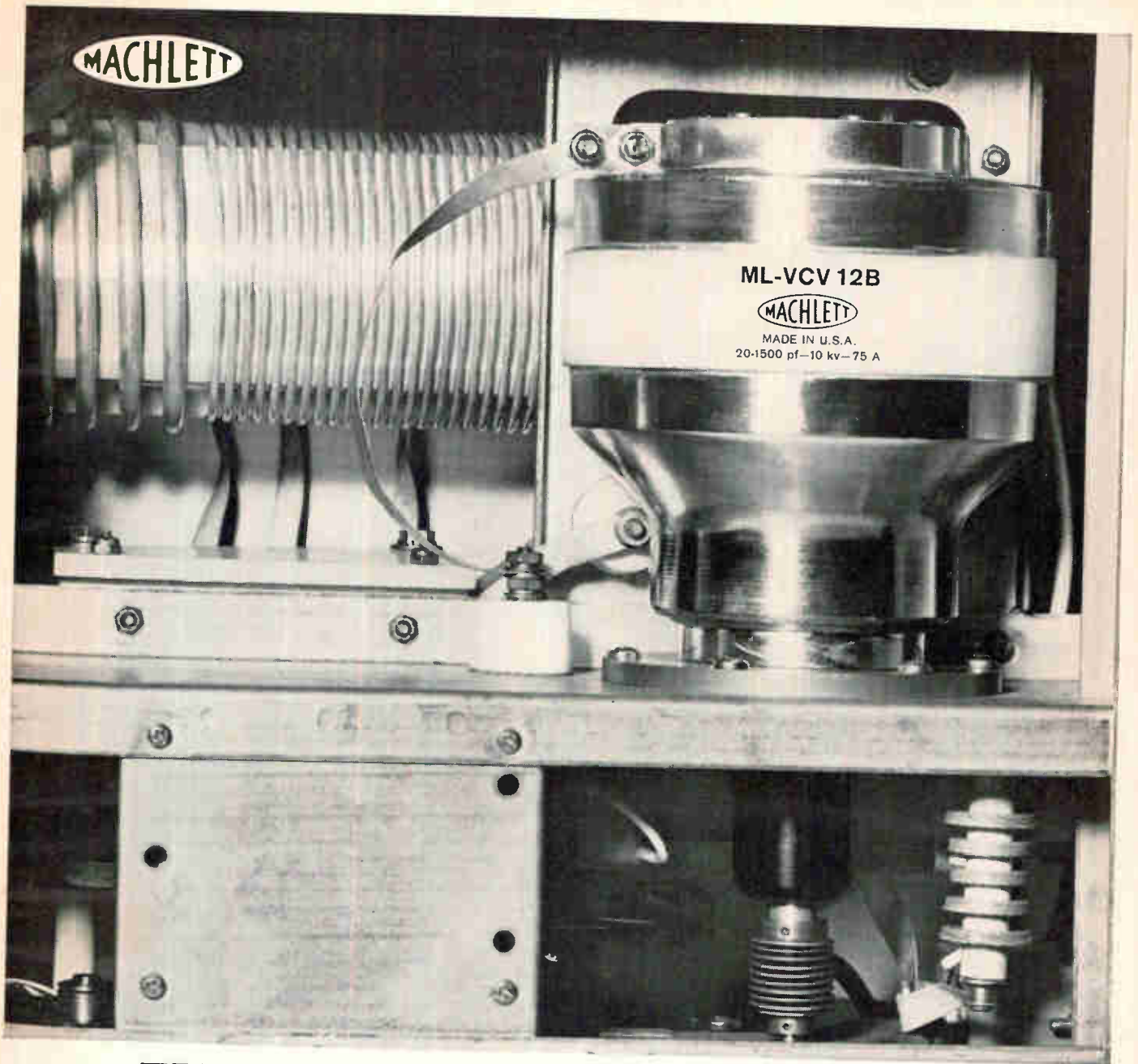

TRW's T-368/URT transmitters* use Machlett variable vacuum capacitors

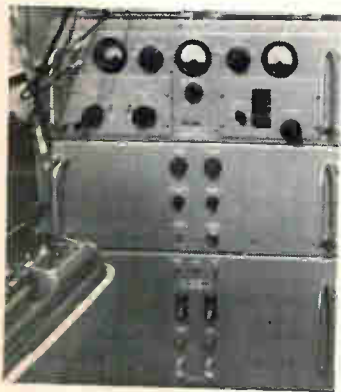

For peak performance under adverse temperature and humidity conditions, TRW's rugged field transmitters for military teletypewriter communications use ML-VCV 12B ceramic variable vacuum capacitors.

The ML-VCV 12 series: 20-1500 pF; 7.5; 10, 15 kV and 75A RMS.

Direct replacements for previously used glass capacitors, these ceramic units provide great structural rigidity and low capacitance change with temperature variation.

Send for "Vacuum Variable Capacitors—An Introduction to their Design, Ratings and Installation," printed in the Machlett *Cathode Press*:
The Machlett Laboratories, Inc., 1063 Hope St., Stamford, Conn. 06907.

*Used in Radio Set AN/GRC-26D, Frequency Range: 1.5-20 mc
 Power levels: AM voice or FSK/AM 400 watts, CW or FSK 450 watts.

The Machlett Laboratories, Inc., welcomes resumes from engineers and scientists.

RAYTHEON

THE MACHLETT LABORATORIES, INC.

A S U B S I D I A R Y O F R A Y T H E O N C O M P A N Y

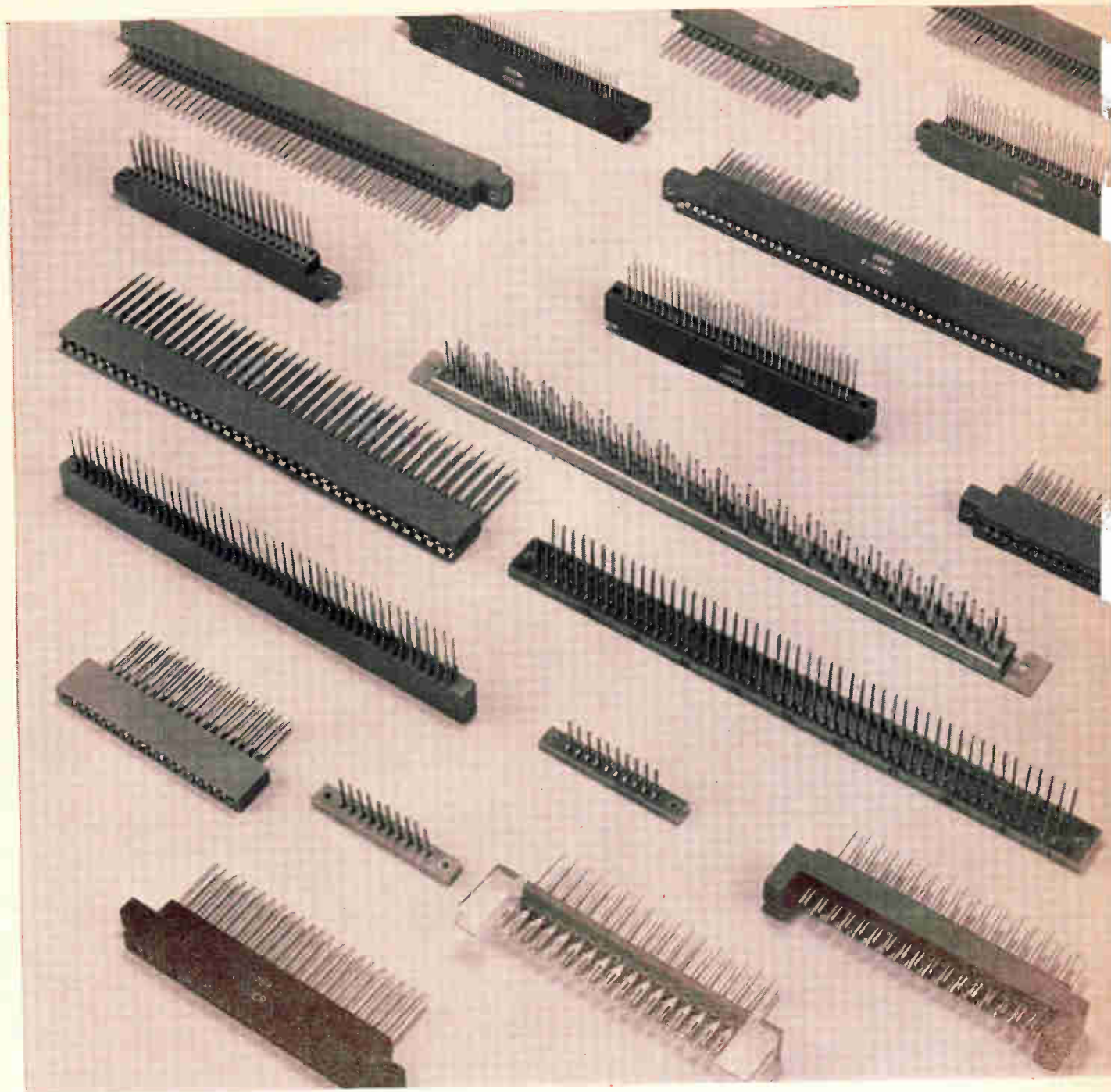

**Associated
TERMI-POINT*
products
keep you
posted...
25 different
ways!**

Here are 25 of our latest associated TERMI-POINT products for your high-density wiring applications. They all feature AMP's unique post, designed especially for TERMI-POINT clips and tooling, yet they're compatible with other point-to-point connection methods.

Here's the easy solution to those finicky wiring jobs on miniature connectors and tedious interconnections on densely packed equipment. With these products you can forget about burnt insulation, burnt fingers, bulky tools, and special training of wiring personnel. From lightweight hand tools to fully automatic machines, TERMI-POINT tooling is matched to these products for foolproof operation and utmost reliability.

This new technique is the culmination of AMP's continuing research into advanced wiring technology, yet it is based on the solderless pressure connection principle which the company began developing a



Lightweight hand tool applies bulk wire and strip terminals for limited volume production.



Tape-programmed TERMI-POINT Automatic Wiring Machine routes and fully terminates a 10" lead in less than four seconds.

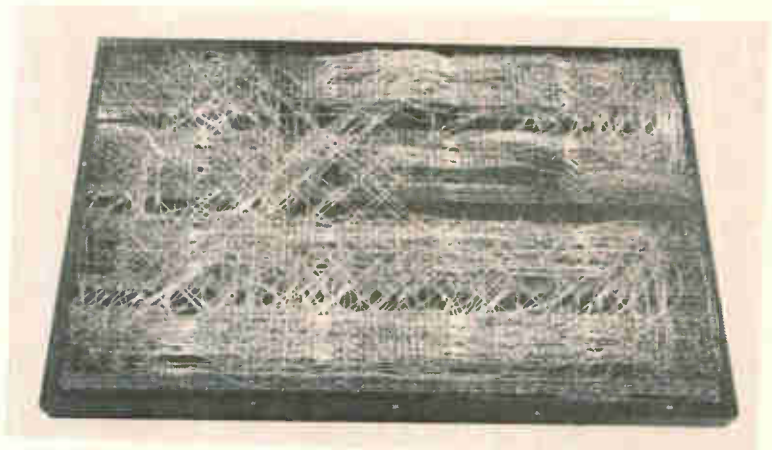

Panels pre-wired at AMP's Harrisburg facilities give you the benefits of automated production without requiring capital investment.

quarter century ago. Today, in communications, data processing, military electronics and related fields, TERMI-POINT products provide flexibility, speed, and applied cost savings that are unequalled in the industry. And this will be true in generations of new products under development for the future.

Now's a good time to find out about this modern technique, and its matched tooling and product line. Write today. We'll see that you get the whole story, posthaste.

★Trademark of AMP INCORPORATED

AMP
INCORPORATED
 Harrisburg, Pennsylvania

A-MP* products and engineering assistance are available through subsidiary companies in: Australia • Canada • England • France • Holland • Italy • Japan • Mexico • Spain • West Germany

Etch your own PC boards automatically!

(in less than 5 minutes)

from this →
to 11" x 14"



Shown
actual
size!

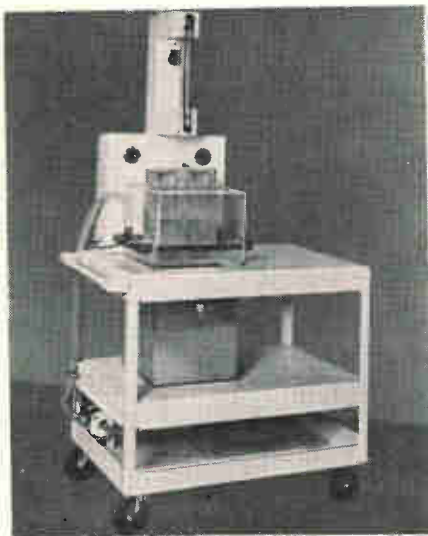

"fine line" etcher

for prototypes—limited runs

No cooling or venting required!
Etches as fine as .001"!
Cuts costs in half—saves time!
Complete photo processing instructions!
Work is illuminated while etching!
No patterning . . . minimum undercutting!
Model No. 201 (illus.), etches two
11" x 14" one-sided **\$695**
boards or one 11" x 14"
two-sided board: Pat. applied for

NOW IN USE BY:

AMP, Inc.
Atomic Energy Com.
Bendix
Charles Brunning
Esso Research
General Dynamics
IBM
ITT
Jordan Elect.
Lear Siegler
Magnavox
Micro Switch
Owens-Illinois
Sonotone

Sprague Electric
Union Carbide
U.S. Air Force
Varo, Inc.
Whirlpool
Univ. of Calif.
Univ. of Chicago
Univ. of Colorado
Univ. of Georgia
Univ. of Hawaii
Univ. of Penn.
M.I.T.
Oklahoma State U.
Washington Univ.

Representatives: Some Territories Still Available.

CYCLO-TRONICS, INC.

3858 N. CICERO—CHICAGO, ILL. 60641
TELEPHONE: (312) 282-6141

Meetings

Seminar on Underwater Acoustics, Pennsylvania State University; Nittany Lion Inn, Penn State University Park Campus, Penn., June 4-9.

Conference on Application of Digital Computers for Process Control, International Federation of Automatic Control; Nice, France, June 5-9.

Symposium on Manufacture of Integrated Circuits, Industrial Electronics Control Instrumentation; United Engineering Center, New York, June 5.

Workshop on Nuclear Magnetic Resonance Spectroscopy, Catholic University of America; Catholic University, Washington, June 5-7.

Conference & Exhibit, Marine Technology Society; San Diego, Calif., June 5-7.

Symposium on the Deposition of Thin Films by Sputtering, Consolidated Vacuum Corp.; University of Rochester, Rochester, N.Y., June 6-7.

First Conference on Laser Applications and Engineering, IEEE; Hilton Hotel, Washington, D.C. June 6-8.

Applications of Lasers to Photography & Information Handling, Boston Chapter of Society of Photographic Scientists & Engineers; Holiday Inn, Newton, Mass., June 7.

Microwave Exposition '67, Microwave Expositions, Inc.; New York Coliseum, June 7-9.

Science Seminar, Air Force Office of Scientific Research; Albuquerque, June 7-14.

International Real Time Control Systems, Czechoslovakia Institute of Technological & Economic Research of the Machine Building Industry; Prague, June 7-16.

International Communications Conference, IEEE; Leamington Hotel, Minneapolis, Minn., June 12-14.*

Commercial Aircraft Meeting, American Institute of Aeronautics and Astronautics; Los Angeles, June 12-14.

Computer Models & Simulation Techniques for Power Systems Engineering, Engineering Institutes, University of Wisconsin, Madison, June 12-23.

Meeting of the Institute in Technical & Industrial Communications, Institute in Technical & Industrial Communications; Colorado State University, Fort Collins, Colo., June 12-16.

Short courses

Applications of Lasers to Photography and Information Handling, Boston Chapter, Society of Photographic Scientists and Engineers; Holiday Inn, Newton, Mass., June 7.

Quality control engineering; University of Wisconsin's College of Engineering, Madison, Wis.; June 12-16; \$189 fee.

Digital process control systems; Purdue University's Schools of Engineering, Lafayette, Ind.; June 12-21; \$250 fee.

Call for papers

Automotive Conference, IEEE; Howard Johnson's Motor Lodge, Detroit, Sept. 21-22. June 1 is deadline for submission of abstracts to William N. Lawrence, Department of Electrical Engineering, University of Michigan, Ann Arbor. 48104

Reliability Physics Symposium, Reliability and Electron Devices Groups of IEEE; Los Angeles, Nov. 6-8. June 15 is deadline for submission of abstracts to George Jacobi, symposium program chairman, IIT Research Institute, 10 West 35th St., Chicago 60616

Conference on Effects of Diffuse Electrical Currents on Physiological Mechanisms with Application to Electroanesthesia and Electrosleep; Marquette University School of Medicine and College of Engineering; Milwaukee, Wis., Oct. 25-28. July 15 is deadline for submission of abstracts to Anthony Sances, conference chairman, 8700 W. Wisconsin Ave., 10 East, Milwaukee. 53226.

* Meeting preview on page 16.

THE CONNECTOR THING

A periodical periodical, designed quite frankly to further the sale of Microdot Inc. connectors and cables. Published entirely in the interest of profit.



2. Our special atmosphere controlled furnaces for high reliability parts make it a cinch to produce the highest quality line of hermetic seal connectors. To meet MIL-C-26482 (Rev. B) we offer high pressure units with both push-pull and bayonet connections. Hi temp and High pressure units are also available to meet MIL-C-26500, threaded or bayonet and with feed-thru adapters. For those concerned with MIL-C-5015, there are also special cryogenic, hi temp and high pressure models.

3. Ultraminiature is the word for this connector line. How ultra? Like 5/32" outside diameter and 3/8" to 7/16" long, depending on your selection from seven configurations. Lepra/Con gets that small because it uses the Twist/Con (see above) closed-entry, tubular-type, gold contacts and helically wound phosphor-bronze pins. Screw-on and slide-on versions in entire line.

4. Microdot's standard line of coax connectors comes in so many configurations that you'll find selection is a ball. You can, for instance, get Neoprene or silicone bend relief caps—in colors—and knurled or hex nuts, gold plating, slide or screw type, hermetically sealed bulkhead type, etc., etc., and so forth. But get the catalog and see for yourself the hundreds of variations. Oh yes. For the contest, this paragraph describes "standard coaxial connectors".

5. This line is the greatest in high density, cylindrical, multi-pin connectors. It combines exclusive Posilock ruggedness in push-pull lock coupling with unique Posiseal multiple-silicon rings for sealing. Fingertip operation. No mismatching even in "blind" conditions. Meets MIL-C-38300A (USAF) for altitude—that's the MARC 53. The brand-new rear insertable version, MARC 53 RMD, is revolutionary—field assembly without special insertion or extraction tools. The subminiature lightweight version, the MARC 43, conforms to MIL-C-26482 and it's economical as can be. Neither of the MARC's requires heat to terminate conductors to contacts.

6. Look, Ma, both hands. All you need for any of these coax connectors besides your hands are standard Microdot crimping tools, a bargain. With Microcrimp, you can forget soldering, burning, and miscrimping. Also, Microdot's "snap-lock" feature lets you quickly snap the connector into a bulkhead or mounting block afterwards.

HAPPY 1/2 NEW YEAR

Last December 31 our crass commercialism made us forget to wish you a happy gala in this journal. But now we'll make it up to you, with the celebration you didn't expect...

WELCOME TO LATTER '67 FROM MICRODOT! Grab a gal or a half-gallon, give half a toot on your pizzazz maker, and join us at least half-heartedly in making whoopee. We're sure your 1967 calendar is pretty grubby by now, with all sorts of notations you'd rather forget... so to help you get off to a clean start in 1967 1/2.

GET YOUR 1967.5 CONNECTOR GIRL CALENDAR! Actually, we wanted to make a calendar showing our six beautiful major connector lines; however, some D.O.M. in the Sales Dept. insisted you'd rather have girls. So we've set up this contest where you get both the girls and the connector information. Sneaky.

MATCH OUR MATCHLESS CONNECTORS July through December are represented by Mary through Patricia, otherwise known as the Connector Girls. That's on the calendar. In this ad they're shown representing the six major Microdot connector lines. To get your superb 1967.5 calendar, merely match the letters under the girls with the paragraph number describing the connector each girl illustrates. Read carefully. Careless readers may be punished by being sent a calendar that shows the products.

1. When you want economical, microminiature pin and socket connections, this one is the ticket. The contact spring member has been eliminated through a breathing helical spring principle. The name is Twist/Con, and its construction permits high-density packaging of contacts on 0.050" centers—up to 420 contacts per square inch. Can you imagine 420 contacts on a postage stamp square? That's dense!



Attention: Coupon for Connector Girl Calendar



MICRODOT INC.
220 Pasadena Avenue, South Pasadena, California 91030

Dear Sirs:

- Send your 1967 1/2 Connector Catalog.
- Send me a Microdot Rep.
- Send me anything, if it's free.

Here's my matchup below. Send me my groovy 1967.5 Connector Girl Calendar. Hurry! It's almost the 1/2 New Year.

A	1
B	2
C	3
D	4
E	5
F	6

(Connect letters and numbers with a pencil line.)

Name _____ Title _____

Firm _____



Address _____

City _____ State _____ Zip _____

Telephone _____

Offer void where taxed or restricted, and expires June 30, 1967.

RCA supersedes the 2N681-690 SCR family with better performing devices at "mind-changing" prices!

			
2N690 2N689	2N3899 \$6.50	2N3873 \$6.35	Voltage
2N688 2N687 2N686	2N3898 \$4.50	2N3872 \$4.35	600 V
2N685 2N684	2N3897 \$3.25	2N3871 \$3.10	400 V
2N683 2N682 2N681	2N3896 \$3.00	2N3870 \$2.85	200 V
25 A	35 A	35 A	100 V
			RMS current

Prices in quantities of 1,000 and up

If you're using conventional SCR's in the mid-current range... RCA's 35-amp types offer greater protection from voltage transients, better performance... and just check the prices!

RCA's 2N3870-2N3873, 2N3896-2N3899 35-amp power-rated SCR's offer you a choice of press-fit or stud-mounted packages... and your circuits will not only be more reliable, they'll be a good deal less expensive! Just check the performance advantages of RCA's "mind-changing" SCR's over those of the 2N681-690 family:

	<u>2N681-690</u>	<u>RCA 2N3870-2N3873 2N3896-2N3899</u>
Forward Current	25 A	35 A
Peak Surge Current	150 A	350 A
Gate Power	5 W	40 W (for 10- μ s duration)
Gate Current	2 A	Any value giving maximum gate power is permissible.
Gate Voltage	10 V	
Thermal Resistance	2°C/W	0.9°C/W

Of course, if your design requirements call for the famous 2N690 family, RCA can still deliver more performance for less cost. Your RCA Field Representative can give you complete details. For additional technical data, write RCA Commercial Engineering, Section RN5-2, Harrison, N. J. 07029. See your RCA Distributor for his price and delivery.

RCA ELECTRONIC COMPONENTS AND DEVICES



The Most Trusted Name in Electronics

THE CONNecTOR THING

A periodical periodical, designed quite frankly to further the sale of Microdot Inc. connectors and cables. Published entirely in the interest of profit.



HAPPY 1/2 NEW YEAR

Last December 31 our crass commercialism made us forget to wish you a happy gala in this journal. But now we'll make it up to you, with the celebration you didn't expect...

WELCOME TO LATTER '67 FROM MICRODOT! Grab a gal or a half-gallon, give half a toot on your pizzazz maker, and join us at least half-heartedly in making whoopee. We're sure your 1967 calendar is pretty grubby by now, with all sorts of notations you'd rather forget... so to help you get off to a clean start in 1967 1/2.

GET YOUR 1967.5 CONNecTOR GIRL CALENDAR! Actually, we wanted to make a calendar showing our six beautiful major connector lines; however, some D.O.M. in the Sales Dept. insisted you'd rather have girls. So we've set up this contest where you get both the girls and the connector information. Sneaky.

MATCH OUR MATCHLESS CONNECTORS July through December are represented by Mary through Patricia, otherwise known as the Connector Girls. That's on the calendar. In this ad they're shown representing the six major Microdot connector lines. To get your superb 1967.5 calendar, merely match the letters under the girls with the paragraph number describing the connector each girl illustrates. Read carefully. Careless readers may be punished by being sent a calendar that shows the products.

1. When you want economical, microminiature pin and socket connections, this one is the ticket. The contact spring member has been eliminated through a breathing helical spring principle. The name is Twist/Con, and its construction permits high-density packaging of contacts on 0.050" centers—up to 420 contacts per square inch. Can you imagine 420 contacts on a postage stamp square? That's dense!

2. Our special atmosphere controlled furnaces for high reliability parts make it a cinch to produce the highest quality line of hermetic seal connectors. To meet MIL-C-26482 (Rev. B) we offer high pressure units with both push-pull and bayonet connections. Hi temp and High pressure units are also available to meet MIL-C-26500, threaded or bayonet and with feed-thru adapters. For those concerned with MIL-C-5015, there are also special cryogenic, hi temp and high pressure models.

3. Ultraminiature is the word for this connector line. How ultra? Like 5/32" outside diameter and 3/8" to 7/16" long, depending on your selection from seven configurations. Lepra/Con gets that small because it uses the Twist/Con (see above) closed-entry, tubular-type, gold contacts and helically wound phosphor-bronze pins. Screw-on and slide-on versions in entire line.

4. Microdot's standard line of coax connectors comes in so many configurations that you'll find selection is a ball. You can, for instance, get Neoprene or silicone bend relief caps—in colors—and knurled or hex nuts, gold plating, slide or screw type, hermetically sealed bulkhead type, etc., etc., and so forth. But get the catalog and see for yourself the hundreds of variations. Oh yes. For the contest, this paragraph describes "standard coaxial connectors".

5. This line is the greatest in high density, cylindrical, multi-pin connectors. It combines exclusive Posilock ruggedness in push-pull lock coupling with unique Posiseal multiple-silicon rings for sealing. Fingertip operation. No mismatching even in "blind" conditions. Meets MIL-C-38300A (USAF) for altitude—that's the MARC 53. The brand-new rear insertable version, MARC 53 RMD, is revolutionary—field assembly without special insertion or extraction tools. The subminiature lightweight version, the MARC 43, conforms to MIL-C-26482 and it's economical as can be. Neither of the MARC's requires heat to terminate conductors to contacts.

6. Look, Ma, both hands. All you need for any of these coax connectors besides your hands are standard Microdot crimping tools, a bargain. With Microcrimp, you can forget soldering, burning, and miscrimping. Also, Microdot's "snap-lock" feature lets you quickly snap the connector into a bulkhead or mounting block afterwards.



MICRODOT INC.



Attention: Coupon for Connector Girl Calendar

MICRODOT INC.
220 Pasadena Avenue, South Pasadena, California 91030

Dear Sirs:

- Send your 1967 1/2 Connector Catalog.
- Send me a Microdot Rep.
- Send me anything, if it's free.

Here's my matchup below. Send me my groovy 1967.5 Connector Girl Calendar. Hurry! It's almost the 1/2 New Year.

A	1
B	2
C	3
D	4
E	5
F	6

(Connect letters and numbers with a pencil line.)

Name _____ Title _____

Firm _____

Address _____

City _____ State _____ Zip _____

Telephone _____

Offer void where taxed or restricted, and expires June 30, 1967.

Weapon systems survivability



Radiation hardness



WHATEVER IT'S CALLED
IT'S GOING TO HAVE TO BE THERE FOR
COMPONENTS, SUB-SYSTEMS AND SYSTEMS

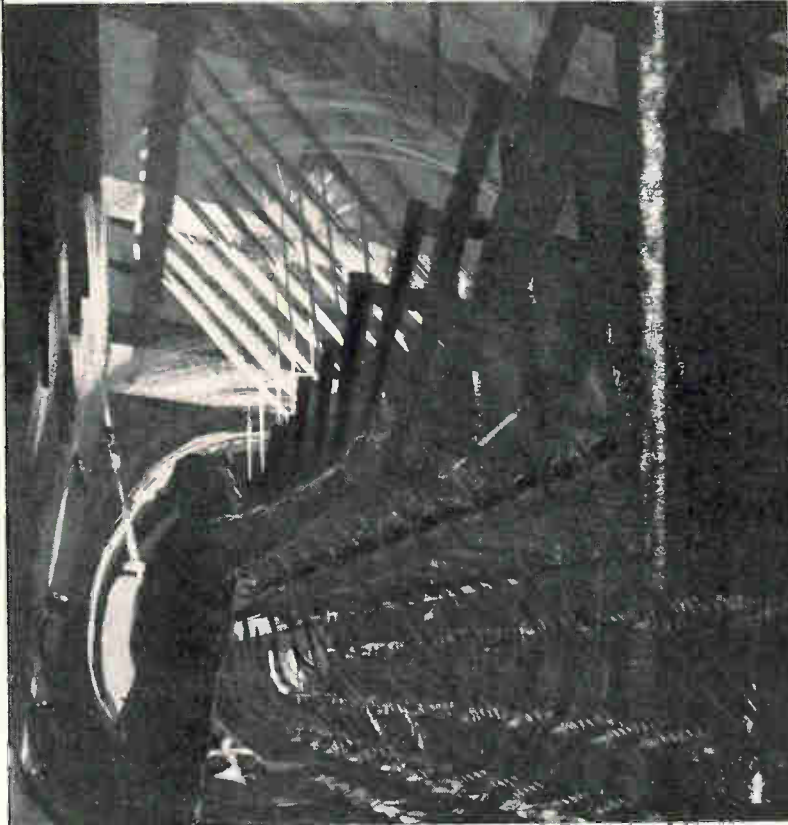

Survivability design, capable of withstanding high energy radiation, demands studies under nuclear weapons' effects simulation. Pulsed simulators capable of simulating X-rays, electrons, neutrons or electromagnetic pulses at fantastically high levels of energy (2 to 6 megavolts) are required to produce this.

Physics International has them.

You can buy one to use in your own plant or time is available on ours in our plant. Either way, we have the skilled personnel and diagnostic equipment to help you solve your "hardness" or "survivability" design problems, whatever it's called.

Contact Physics International today for complete information.

PHYSICS INTERNATIONAL COMPANY

2700 Merced Street / San Leandro, California 94577
Telephone: 415/357-4610 TWX: 910/366-7033

Meeting preview

Computers, communications

Computers and communications systems will share top billing at the IEEE's International Conference on Communication scheduled June 12 to 14 in Minneapolis, Minn. The conference's new emphasis on computers reflects the trend to marry the two technologies.

The planners of the conference consider the marriage so important that they have scheduled, among other things, a special session on the applications of computers to communications systems; no other sessions are planned at that time so all conferees can attend.

The papers during the special session review the current state of the art of systems in which a central computer links communications terminals. Also to be discussed are methods of providing multiple access both for data processing and conversational interaction, and an extension of these techniques to networks in which computers interact within the system.

Other computer-related sessions will detail new work involving error analysis, data transmission, coding, and the application of computers in designing systems.

New techniques. Other areas of interest to the communications engineer haven't been neglected. Of the 43 sessions that are planned, many are devoted to telephone, radio, vehicular, and satellite communications. New techniques in theory, equipment and components will be highlighted in individual sessions. For example, the Technical Communications Corp. of Lexington, Mass., will describe a swept-frequency modulation system which utilizes techniques used in chirp radars. Designed for very-high-frequency communications, the system is intended to reduce interference problems caused by multipath transmission.

Also scheduled is a panel session on simulating communications such as high frequency links. Three different approaches to simulation will be weighed and the discussion will be centered on whether the techniques available are advanced enough to duplicate actual operating conditions.

There are two kinds of spectrum analyzers



This kind has a swept first LO and high frequency first IF to permit viewing of wide (2 GHz) spectra, free from images, spurious and residual responses; calibrated 60 dB display range for accurate comparison of signals widely different in amplitude; RF attenuator for detecting overdriven input and for setting level; just one wideband (0.01-12 GHz), sensitive (-100 to -85 dBm) mixer with extremely flat response (± 1 dB on fundamental mixing, $< \pm 3$ dB for harmonics) over full 2 GHz sweeps. These and other unique features come to almost \$10,000.

The other kind of spectrum analyzer does not offer any of these performance features. That's why it costs half as much.

HEWLETT  PACKARD

To find out more about 1967-style spectrum analysis, call your Hewlett-Packard field engineer for complete data on the 8551B/851B, or write Hewlett-Packard, Palo Alto, California 94304; Europe: 54 Route des Acacias, Geneva.

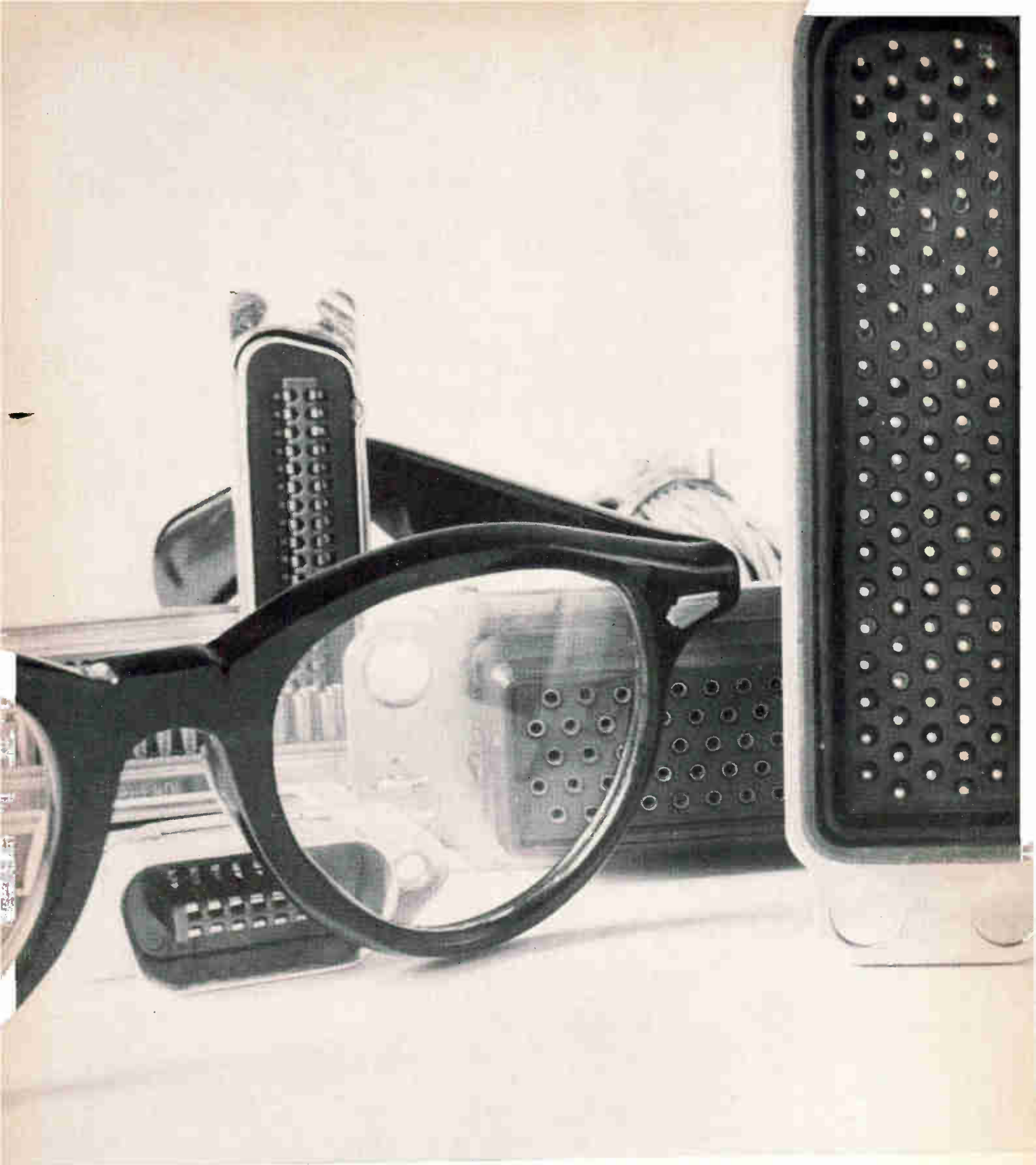

**What to look for
in a good miniature
rack and panel connector.**

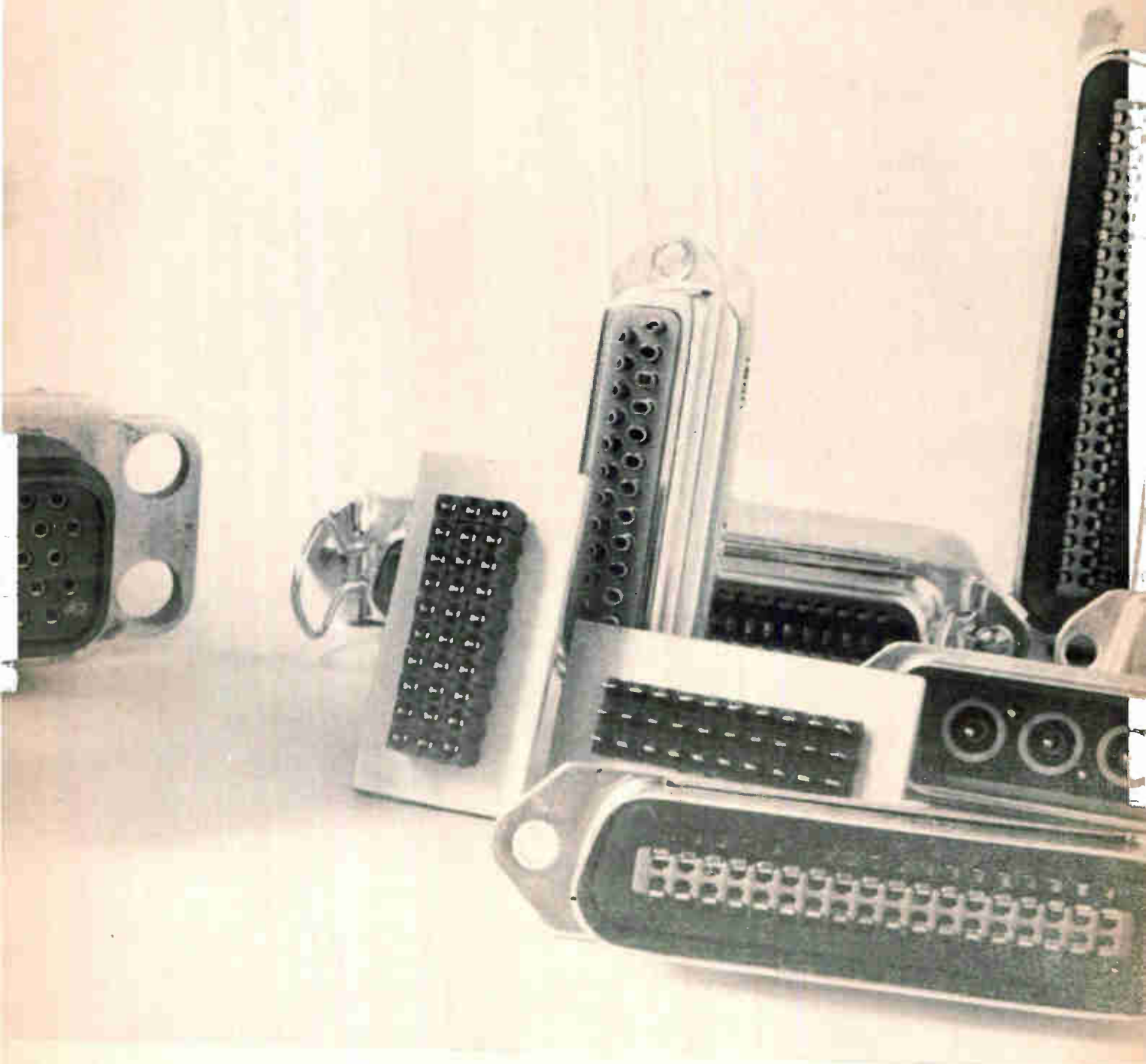

Miniaturization. Amphenol can give you rack and panel connectors with envelope dimensions of less than $2\frac{1}{2}$ " by $\frac{1}{2}$ ". With positive locking devices, too.

More Contact Density. .100" contact centers to .050" in standard lines for 24-, 26- or 28-gauge wire—with

no loss of dielectric strength. Environmental or non-environmental.

Greater Shielding Use. To provide protection through the connector, Amphenol gives you shielded contacts in key product lines.

Wide Selection—Fast Delivery. Chances are most distributors have

what you need in stock. If not, call your Amphenol Sales Engineer or write **Amphenol Connector Division**, 1830 S. 54th Ave., Chicago, Ill. 60650.



AMPHENOL

Specify Amphenol . . . the leading name in cable, connectors, assemblies, RF switches, potentiometers, motors, microelectronics
Circle 19 on reader service card

Now that you're going to buy a multi-function meter, get hp's extra measure of

Performance

Step-ahead design, extra attention to construction, use of premium components throughout – these are the features that give you an extra measure of performance in hp Multi-Function Meters!

Step-Ahead Design. – Here are four of hp's most popular multi-function meters. Each of them has contributed to the state-of-the-art of multi-function meter design. One of the first meters in this line, the *hp Model 410B* was the first to offer high accuracy, sensitivity and stability over a wide frequency range. The *hp Model 410B* still warrants high preference because the circuit performs better than its predecessors or any of its later copiers. The *hp Model 412A* was the first multi-meter to use a photo-chopper to make a dc amplifier stable enough to eliminate the necessity for a front panel zero control. The *hp Model 410C* was the first multi-meter design to adapt solid-state circuitry for better performance, increased reliability and compactness of size. The 410C also utilized the first hp taut-band meter – now used in all hp multi-function meters. The *hp Model 427A* is the first multi-function meter to combine use of the inherent advantages of all-solid-state, ultra-low current circuitry with battery operation.

Extra Attention to Construction. – Reliable, glass-epoxy circuit boards with extra-heavy copper etch are used throughout hp multi-function meters. These instruments will withstand rugged use and tolerate wide fluctuations in temperature and humidity. Exclusive hp-made taut-band suspension meters give excellent repeatability with friction completely eliminated. Each meter scale is individually calibrated for accurate readings over the entire range.

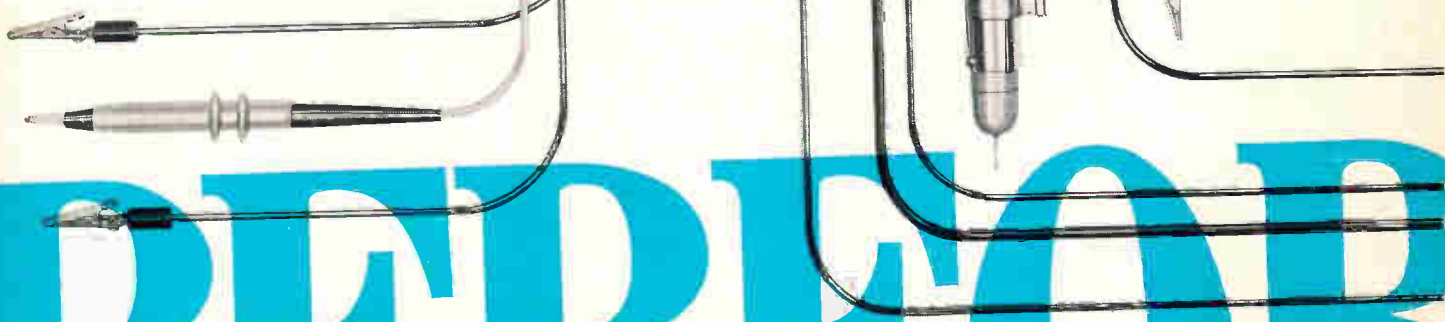
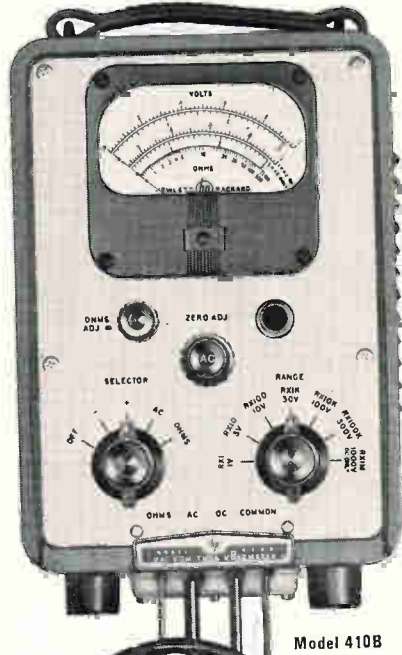
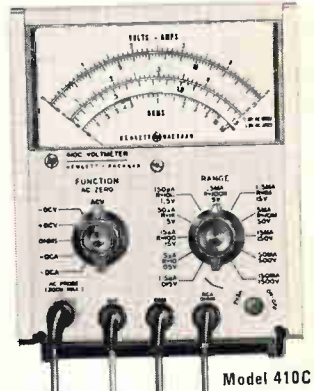
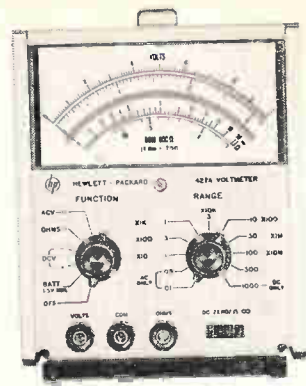
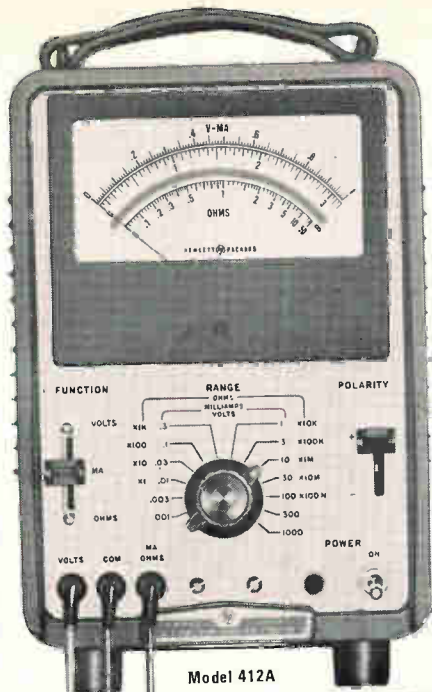

PREFERRED

Premium Components Used Throughout. — Only premium high reliability components are used throughout hp multi-function meters. When hp can't get components necessary to meet the high hp quality standards, they are manufactured "in-plant." Resistors, taut-band meters, and even the exclusive hp photo-chopper are manufactured "in-plant."

Now that you're going to buy a multi-function meter, get step-ahead design, extra attention to construction, premium components — get the hp extra measure of performance!

hp Model 410B
for Wide Frequency Range

Performance

Since the 410B Vacuum Tube Voltmeter was first introduced, it has proved to be an outstanding instrument because of the large number of tasks it will perform, and its frequency range of 20 Hz to 700 MHz. Use the 410B in laboratory, broadcast stations or production testing department—wherever you need a broad frequency range instrument.

The wide frequency range is made possible by the exclusive Hewlett-Packard high-frequency diode used in the probe. The probe gives low inductance, low input capacitance (1.5 pF) so it won't affect the circuit under test. Total input impedance at low frequencies for ac measurements is 10 mΩ shunted by the 1.5 pF.

When you need a reliable, broad frequency range voltmeter with ohms capability, the hp Model 410B Vacuum Tube Voltmeter is your No. 1 choice! See the table for specifications.

hp Model 412A
for DC and Ohm Sensitivity

Performance

Model 412A DC Vacuum Tube Voltmeter was the first multi-function meter to incorporate the exclusive hp photo-chopper design. The photo-chopper gives you an acoustically and electrically noise-free design for low drift dc amplification.

The 412A has a four-terminal ohmmeter for highly accurate resistance/current measurements. The four-terminal system greatly minimizes resistance lead loss.

Because of its high sensitivity, you can use the Model 412A as a high gain dc amplifier—a sensitive bridging amplifier, or output for a dc recorder.

Check the 412A dc and ohm sensitivities in the table. Note the 1 mV FS dcV sensitivity, and 1Ω midscale ohms sensitivity. Pick the 412A for laboratory accuracy and a simplicity of operation that makes the instrument ideal for production line testing!

hp Model 427A
for High AC Sensitivity

Performance

High ac sensitivity in a general-purpose, fully portable multi-function meter—that's what you get in the all-solid-state battery-powered hp Model 427A. Option 01, (price \$25.00) gives you both battery and line operation.

This small, light-weight, multiple function instrument has field effect transistors in the input circuit to give a 10 MΩ input impedance. Specifically designed temperature compensating circuitry minimizes zero drift. You can make ac and dc volts and ohms measurements and expect an extremely stable reading.

The versatile hp Model 427A Voltmeter is your choice when you need 10 mV FS, with 100 μV resolution in a general purpose fully-portable instrument—best for field use!

Condensed specifications are given in the table.

hp Model 410C
for All-Purpose Meter

Performance

If you have to limit your choice to only one instrument, hp Model 410C Multi-Function Voltmeter is your No. 1 preference! This one compact, easily portable instrument measures just about everything... nanoamps, millivolts and ohms with laboratory precision!

The exclusive hp high-sensitivity photoconductor chopper amplifier makes the 410C suitable as a pre-amplifier for data recording on analog recorders. The photo-chopper eliminates need for zero adjustment.

The hp taut-band meter gives you reliability and repeatability possible only with a friction-free hp meter!

For a high-sensitivity, broad band, easily portable all-purpose meter, you'll get best performance from the 410C! Check the specifications in the table.

	410B	410C	412A	427A
DCV	1—1000 V	15 mV—1500 V	1 mV—1000 V	100 mV—1000 V
Accuracy	± 3%	± 3%	± 1%	± 2%
ACV	1—300 V	.5 V—300 V	—	10 mV—300 V
Accuracy	± 3%	± 3%	—	± 2%
DCI	—	1.5 μA—150 mA	1 μA—1 A	—
Accuracy	—	± 3%	± 2%	—
Ohms	10 Ω—10 MΩ	10 Ω—10 MΩ	1 Ω—100 MΩ	10 Ω—10 MΩ
Accuracy	± 5%	± 5%	± 5%	± 5%
Zdc	122 M	10—100 M	10—200 M	10 M
Zac	10 M/1.5pF 20 Hz—700 MHz	10 M/1.5pF 20 Hz—700 MHz	—	10 M/40pF 10 Hz—1 MHz
BW	—	—	—	—
Price	\$275	\$425	\$450	\$225
Amplifier	—	Yes	Yes	—
AC Response	Peak	Peak	—	Avg
Power	50—1000 Hz	50—1000 Hz	50—60 Hz	Battery (Line Optional)

Get full specifications on these four hp Multi-Function Meters from your nearest hp field engineer. Or, write to Hewlett-Packard, Palo Alto, California, 94304, Tel. (415) 326-7000; Europe: 54 Route des Acacias, Geneva.

097/3R



HEWLETT *hp* **PACKARD**
An extra measure of performance



MANAGE

Circle 21 on reader service card

RCA supersedes the 2N681-690 SCR family with better performing devices at "mind-changing" prices!

				Voltage
2N690 2N689	2N3899 \$6.50	2N3873 \$6.35		600 V
2N688 2N687 2N686	2N3898 \$4.50	2N3872 \$4.35		400 V
2N685 2N684	2N3897 \$3.25	2N3871 \$3.10		200 V
2N683 2N682 2N681	2N3896 \$3.00	2N3870 \$2.85		100 V
25 A	35 A	35 A		RMS current

Prices in quantities of 1,000 and up

If you're using conventional SCR's in the mid-current range... RCA's 35-amp types offer greater protection from voltage transients, better performance... and just check the prices!

RCA's 2N3870-2N3873, 2N3896-2N3899 35-amp power-rated SCR's offer you a choice of press-fit or stud-mounted packages... and your circuits will not only be more reliable, they'll be a good deal less expensive! Just check the performance advantages of RCA's "mind-changing" SCR's over those of the 2N681-690 family:

	<u>2N681-690</u>	<u>RCA 2N3870-2N3873 2N3896-2N3899</u>
Forward Current	25 A	35 A
Peak Surge Current	150 A	350 A
Gate Power	5 W	40 W (for 10- μ s duration)
Gate Current	2 A	Any value giving maximum gate power is permissible.
Gate Voltage	10 V	
Thermal Resistance	2°C/W	0.9°C/W

Of course, if your design requirements call for the famous 2N690 family, RCA can still deliver more performance for less cost. Your RCA Field Representative can give you complete details. For additional technical data, write RCA Commercial Engineering, Section RN5-2, Harrison, N.J. 07029. See your RCA Distributor for his price and delivery.

RCA ELECTRONIC COMPONENTS AND DEVICES



The Most Trusted Name in Electronics

Editorial

A dim picture

European and American electronics firms expecting a bonanza when color television broadcasts start in Europe this summer may be due for a letdown. Any really big market there is likely to be three to five years off, or longer.

Most forecasters look for the same kind of sales boom the U.S. has enjoyed since 1965, though the boom has slowed down this year. What they are ignoring are the 10 painful years before 1965 when sales of color television receivers limped along at a disappointingly low level. And some of the main factors in the poor U.S. turnover during that period are present in Europe today.

Probably the most serious deterrent to color tv sales in Europe now is the slim schedule of color telecasts to be presented. In July, the British Broadcasting Corp. will start broadcasting in color—but only for 15 hours a week. When they start color telecasts in August, West German broadcasters will be even stingier, offering only eight hours a week. And French plans for a September start are no more generous.

The broadcasters in these three countries—all government operated—grumble so much about the high cost of telecasting in color that there's little chance that the schedules will be bolstered sharply in the next year or so.

Sales prospects throughout the rest of Europe are dim. Italy has put off the start of color broadcasts a year or longer—according to one view, because economic planners fear that sales of color sets, priced unexpectedly high at nearly \$900, would cut deeply into auto sales and damage the whole economy. In Spain, the government is still straddling the fence on which system to adopt—the West German PAL or the French Secam—while the French send in free Secam receivers and transmitting equipment to influence the choice. Scandinavian countries are also holding off on the start of color telecasting.

Looking back over the American example of success, the experts now see that it was only when all three major U.S. networks started telecasting almost all their shows in color that set sales took off on a dizzying upward curve.

History also shows that another obstacle in the

U.S. up to 1965 was the high price of color receivers. Prices will be even higher in Europe at the start: in Britain, \$800 per set; in France, \$750 to \$1,000; and in West Germany, over \$600. Low manufacturing volume isn't the only reason for the high prices; PAL and Secam receivers need more components than do the NTSC sets in use in the U.S.

Solving the big problems of high prices and slender programing will take time. For example, efforts to reduce the cost of color receivers can open the door to still more troubles. Some U.S. set makers tried to cut costs by skimping on components—using fewer than they'd like for good picture quality or using components that were run perilously close to their maximum specifications. The result was a buildup of service problems that discouraged some potential buyers when they heard about them from friends with sets laid up in the shop.

On top of this, U.S. set designers minimized the number of control circuits to the point that tuning and focusing were difficult for the average viewer. Now, finally, the makers are moving to simplify color tuning by adding aids to focusing and fine-tuning circuits.

The consumer often blames the tuner and focuser for poor-quality pictures that really start at the studio transmitter. Good colorcasting requires careful control of lighting on the sound stage and stringent control of broadcast parameters. Minor deviations in either can ruin the color as the viewer sees it on his set.

How bad this can be is best illustrated by an anecdote an executive at RCA tells. A few years ago, before Europe split on which system to use and RCA was still preaching the benefits of NTSC around the world, the company was careful not to schedule any demonstrations of commercial color broadcasting for foreign visitors during July and August. It had learned that studio engineers were notoriously careless during this period about controlling color hues because they assumed nobody looked at commercial television during the summer.

The consumer gets caught in this crossfire between set manufacturer and broadcaster. The repairman called in to solve a viewer's color problem may blame the broadcasting. Meanwhile, back at the studio the broadcast engineers are blaming real and fancied shortcomings in the receivers. The end result is a dissatisfied viewer—a bad salesman for color receivers.

Europe has all this to look forward to when color broadcasts start in a few weeks.

Sometimes the problem is size and weight. Like the customer making a special automatic pilot for airplanes. Size and weight were critical. We designed a specially shaped Alnico 5-7 magnet that was 1/3 smaller and lighter.

Or the high frequency speaker manufacturer who used a 10.65-lb., 2" long Alnico 5 magnet. Our design with an Indox® 5 ceramic magnet reduced weight to 2.76-lbs., and cut height of the entire assembly from 3" to 1.5".

Other times cost is the problem. We

replaced the Alnico magnet in a washing machine hysteresis drive coupling with an Indox magnet. Cost of the assembly was cut from \$7.00 to \$3.00 and size reduced from 4" to 1.5".

We solve environmental problems, too. We've just come up with an aircraft alternator magnet that operates in the -25° to -60°C range, withstands shock and vibration at 30,000 to 40,000 rpm, and has an AQL of zero.

We're not low-rating your engineers. They can't be expected to know about

the special advantages of all the ceramic, metallic, and other magnetic materials available. But our engineers do. They work for the world's largest manufacturer of magnetic materials.

So, if you've got a tough magnet problem, old or new, let your engineers get a good night's sleep and send it to Mr. C. H. Repenn, Manager of Sales, Indiana General Corporation, Magnet Division, Valparaiso, Indiana.

INDIANA GENERAL 

Our engineers have a way of eliminating magnet problems that bug our customers.



Electronics Newsletter

May 29, 1967

**Westinghouse,
a newcomer, gets
Taclan study**

Unhappy with industry attempts to build a tactical landing system (Taclan), the Air Force has chosen Westinghouse, a firm with no experience in the field, to take an eight-month, \$60,000 look at new approaches to Taclan. Westinghouse beat seven competitors for the study contract, several of which had designed systems for the Air Force's Interim Remote Area Terminal Equipment (Irate). Irate, still being evaluated, isn't living up to expectations and its failures may have triggered the Air Force's desire for a contractor with a fresh point of view on such a system.

Irate was to have been built with off-the-shelf components to speed deployment, but contractors claimed they couldn't do the job with the components on hand. Nor could designers agree whether to put Irate's primary controls in a plane or on the ground. Also, Irate had weight problems; it took five men to move systems that the Air Force had hoped two could carry.

The Army, as well as the Air Force, will be watching Westinghouse. The Army would like to adapt any resulting system for combat use with helicopters.

**RCA readies tetrode
for tv tube market**

A four-element field effect transistor that could replace a host of higher-priced tubes in home television receivers is expected to go into mass production by RCA by year's end. The transistor, now offered in sample quantities for \$8 each, will probably sell for less than 50 cents, a company source discloses.

Designated the TA-2644, the new tetrode is composed of a series arrangement of two separate channels and two independent gates. The device has better cross-modulation performance than bipolar and single-gate units, and the performance improves near cutoff. The tetrode features high transconductance, low feedthrough capacitance resulting from a-c grounding of the second gate, and low feedback capacitance—0.03 picofarad maximum and a noise figure of 3.5 decibels are typical at 200 megahertz.

**Loran steadies
inertial navigator**

Litton Industries' Litcom division will begin airborne tests of an inertial-loran navigational system this month. If it proves accurate enough, the system could supplement or replace some target-location schemes and such navigation gear as Tacan in tactical or strategic applications. It may even be possible to send small navigational units into the field with ground troops.

The proposed navigator would be the first lightweight unit to combine loran and inertial techniques. Airborne inertial navigators suited to tactical operations can retain high accuracy for only a few hours; loran is accurate over long periods of time, but is confused by the quick maneuvers of tactical aircraft. In the Litcom system, the loran would update the inertial subsystem during short level-flight periods and keep the platform reference accurate during long missions.

The equipment was developed in-house, but an unsolicited Litcom proposal has won an Air Force study contract. An award has also gone to Sperry Gyroscope for a study of similar equipment. Sperry's gear is due for bench tests in June.

Electronics Newsletter

Army seeks ways to 'see' through Vietnam foliage

The Vietnam war is spurring Army research into a number of techniques to enable pilots to "see" through heavy foliage.

Low-frequency radar is being tested to see if the long waves can get past the leaves, reach the ground, and bounce back. The low-frequency radar waves are bigger than an individual leaf, so they spill past the edges of the leaves, and onto the ground and back. Also being tested is higher-frequency radar, using filters and timers to reject the strong returns from foliage and isolate returns from a target.

In another approach being explored, a composite of aerial photographs is electronically processed on the ground in such a way that the "holes" in the leafy canopy are featured rather than the foliage itself.

Also, the Army is investigating the use of radiometers, which detect the natural electromagnetic emissions from any black body, to detect enemy tunnels from the air.

Kearfott wins missile order

Staging a comeback from its ill-fated 1963 venture as a prime contractor for the defunct mobile, medium-range ballistic missile, General Precision's Kearfott Products division has just been awarded an Army contract to design and develop a liquid-propellant missile with inertial control.

The missile would be launched from a 105-mm howitzer; the Army hopes the missile will double the range of this artillery workhorse. The inertial system will have a single gyro with two degrees of freedom.

'Active' mirror in space telescope adjusted by laser

A laser-controlled "active" mirror may help solve the delicate problem of keeping a telescope mirror close to a true parabola despite thermal effects, gravity perturbations, solar wind, and an astronaut's pattering around aboard astronomical satellites.

The Goddard Space Flight Center is planning development of a 10-foot-wide mirror that would be composed of seven smaller, adjustable hexagonal mirrors. If the mirror is perfect, a laser beam directed at it will be reflected back in phase from all portions. Sensors will monitor the interference fringes. The mirror sections will be adjusted by an electronic feedback system until the correct interference pattern is formed, indicating the mirror is perfect. An 18-inch, three-segment model, made by the Perkin-Elmer Corp., has worked in the laboratory.

Radar order delayed by X-band ruling

The Air Force has been forced to go to X band for its planned TPN-19, the lightweight ground-controlled radar approach system being developed for tactical aircraft. Three companies were selected to compete in contract definition—ITT, Raytheon, and Westinghouse—[Electronics, Nov. 28, 1966, p. 25] but the program has been held up for amendments to the specifications because at least one proposal included an S-band subsystem which the Defense Department's frequency allocation board wouldn't approve.

Japanese makers are sought for U.S. calculators

American manufacturers of electronic desk calculators are looking for Japanese companies to produce their wares, in a move to take advantage of lower Japanese labor costs. Negotiations are now in progress between Friden and Hitachi, and a Burroughs vice president has just completed a round of visits to Japanese manufacturers. Sources in Japan say Litton's Monroe International division is also shopping for a manufacturer there.

Integrated Circuit

SYLVANIA
Electronic Components Group

IDEAS

Sylvania's ceramic-pack ICs, for unexceeded reliability

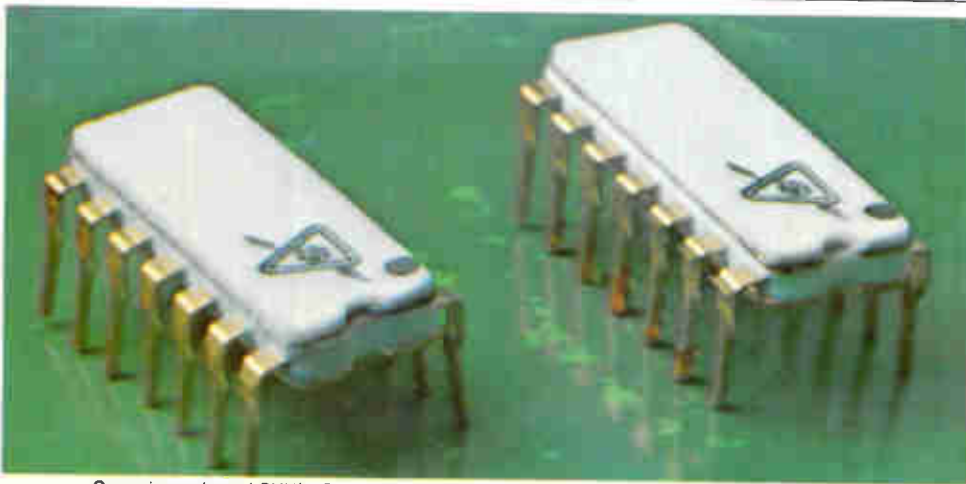

Ceramic-packaged SUHL ICs use fastest TTL logic available.

Sylvania's ceramic-packaged TTL integrated circuits provide greater reliability and higher performance levels.

Ceramic packaging offers the finest environmental protection for integrated circuits. Therefore, the ICs operate at peak design efficiency since the package insures that the circuits are never exposed to moisture or other performance degrading environments. Also, consistent reliable operation under varying temperatures is assured because all parts of Sylvania's package, including the IC chip, have matched temperature coefficients of expansion.

But reliable operation depends on more than an excellent package; a good logic approach, a properly designed semiconductor chip, precisely controlled manufacturing, proper testing, quality auditing and a continuous reliability improvement program assure high reliability.

All Sylvania integrated circuits
(Continued)

This issue in capsule

Power supply

You can customize performance by tailoring the supply voltage.

Flip-flops

How designers can implement just about any function calling for flip-flops.

SUHL I & SUHL II; Arrays

A guide to the industry's largest high-level TTL line: 48 functions, 380 types.

Who's MR. ATOMIC?

How Sylvania can assure the IC performance you want.

Interfacing problems

A simple way to overcome them.

I-Hz generator

You can build an accurate, but inexpensive one whose input is the power line frequency.

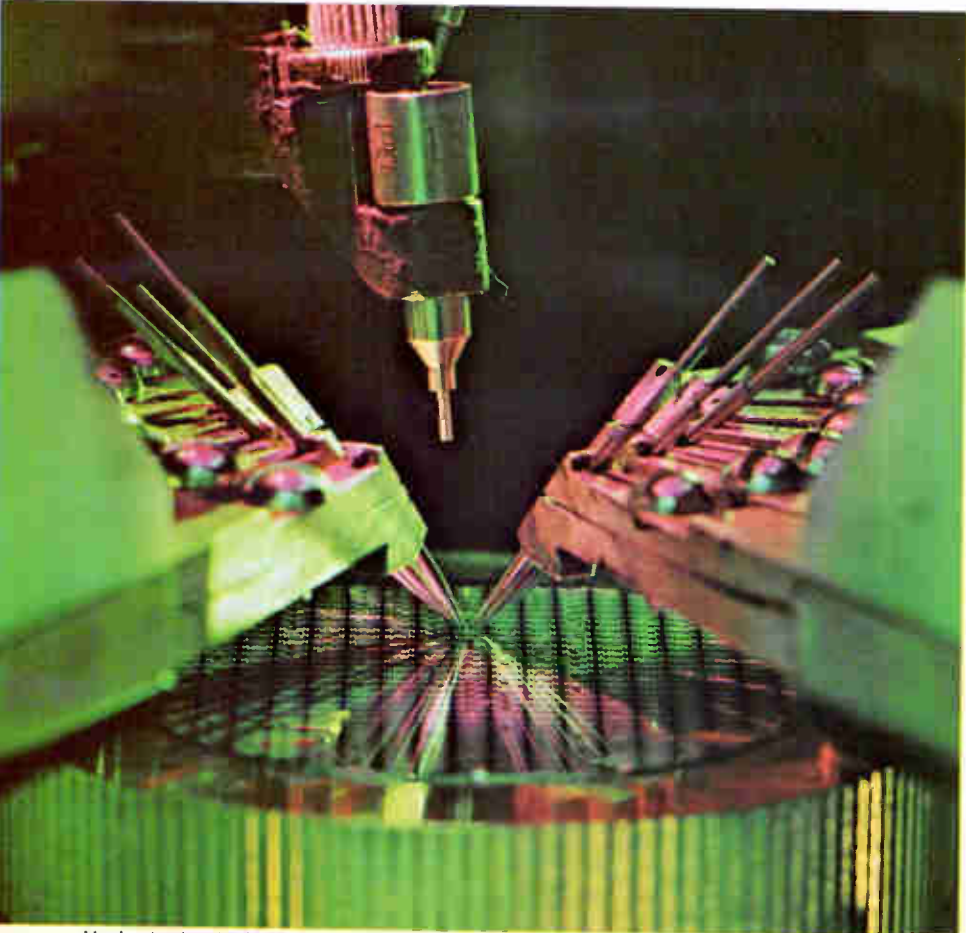

Mechanized water-level testing with this 14-point probe.

(Continued)

go through extensive testing during and after manufacturing. Once packaged, they are thermally and mechanically stressed, then tested for hermeticity. After a high-temperature stabilization period, they are ready to be tested for static and dynamic characteristics by "MR. ATOMIC", Sylvania's automatic IC tester.

Additional quality checks on each IC lot supplement the 100 percent testing program.

Typical of the continuing effort devoted to reliability improvement is an extensive wire bonding program just completed. The result was an improved ultrasonic bonding process. In the first tests of this new technique, over 1200 ICs were subjected to accelerated temperature cycling from -65°C to 200°C for 400 cycles. The result: out of 16,800 connections, only one bond on one circuit failed. That's high reliability!

CIRCLE NUMBER 300

You can customize SUHL performance by tailoring the supply voltage

Designers can't always use ICs at their rated supply voltage. Here's what you gain (and lose) when SUHL™ circuits are not operated at their nominal value.

SUHL integrated circuits by Sylvania provide maximum speed, highest noise immunity, greatest fan-out with a minimum of power. To accomplish this, a 5.0 volt nominal power supply is needed for proper drive to the outputs in the "0" state and for a high logic "1" for negative noise immunity.

SUHL devices are designed for power supply variations of $\pm 10\%$ retaining good circuit performance over the range of 4.5 to 5.5 volts.

Below 4.5 V the performance, speed and noise immunity are degraded, particularly at low temperatures. Supplies larger than 5.5 volts may be used with a resultant increase in speed and an increase in negative noise immunity, but this causes a disproportionate increase in power consumption. Supply voltages greater than 6.0 V are not recommended for normal operation. The increased power causes an internal temperature rise of about $0.3^{\circ}\text{C}/\text{mW}$ in free air. This temperature rise degrades the positive noise immunity about $4\text{mV}/^{\circ}\text{C}$, or $1.2\text{mV}/\text{mW}$. A higher power supply of 6.0 would normally have a tolerance of $\pm 10\%$ which would cause even greater degradation.

The degradation is not in the junctions or in reliability, but in a heating effect which restricts logical performance. This is the reason for the maximum

supply voltage rating of 8.0 V and a maximum operating supply voltage of 4.5 to 6.0 V. At 8.0 V, the circuits are not destroyed but probably won't operate logically.

The best results are obtained by keeping within the optimum design value for the power supply, 5.0 to 5.25 volts.

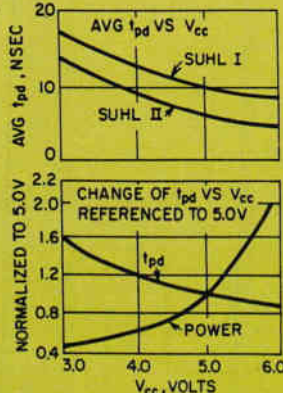

CIRCLE NUMBER 301

If the problem can be solved with flip-flops, Sylvania has the solution

What can designers do with Sylvania's line of TTL flip-flops? They can implement just about any circuit function calling for flip-flops.

Because Sylvania has the most flexible line of TTL flip-flops, designers are finding it easier to solve a host of circuit problems. They can choose from many flip-flop types—SR, two-phase SR, single-phase SRT, J-Ks with AND inputs, J-Ks with OR inputs, dual J-Ks with common or separate clocks. Frequency ratings for these units are as high as 50 MHz. All these flip-flops are available in military or industrial versions, packaged in the TO-85 flat pack or in Sylvania's dual-in-line plug-in pack.

Here are a few typical applications for SUHL™ flip-flops.

The lowest power approach to flip-flop register applications is offered by Sylvania's set-reset SF-10 series (Figure 1). The SF-10 units are useful for a variety of register applications where high speed word transfer is required. In the method illustrated in Figure 1, the reset line clears the central register and permits the clock line to transfer word information from the buffer register.

The SF-20 series of SR clocked flip-flops are particularly useful for application in dual rank or 2-phase systems or as half shift registers. Figure 2 gives the interconnections for a dual rank shift register.

How a synchronous binary counter can be implemented with the SF-30 series of single-phase SRT flip-flops is shown in Figure 3. The SF-30 devices are particularly useful in applications requiring a simple ac coupled flip-flop.

The advantages of multiple J and K inputs are seen in the synchronous binary counter of Figure 4 which uses only four SF-50 series J-K flip-flops. Because gating is internal, this circuit has no external gate delays and counts at 14 MHz. The counting rate can be upped to 38 MHz by using SF-200 flip-flops which otherwise display the same functional characteristics.

Figure 5 shows how OR input J-Ks can be used for parallel to serial conversion. The flip-flops are Sylvania's SF-60 series (14 MHz) or SF-210 (38MHz).

Dual J-Ks with separate clock input terminals for each flip-flop are used in the *high-speed* ripple-type binary counter of Figure 6. This configuration offers both minimum wiring and minimum package count.

You can choose 35 MHz (SF-100 series) or 50 MHz (SF-120 series) devices for this application. These same dual J-K devices are also excellent for systems where multiple J-K flip-flops are needed for separate, unrelated processing activities.

The way that the SF-110 (35 MHz) and SF-130 (50 MHz) dual J-Ks with a common clock can be used in a semi-ripple counter is seen in Figure 7. Decoding rate of this circuit is 25 MHz.

These are just a few of the circuit problems which can be solved effectively and efficiently with the wide range of flip-flops in completely compatible SUHL I and SUHL II.

CIRCLE NUMBER 302

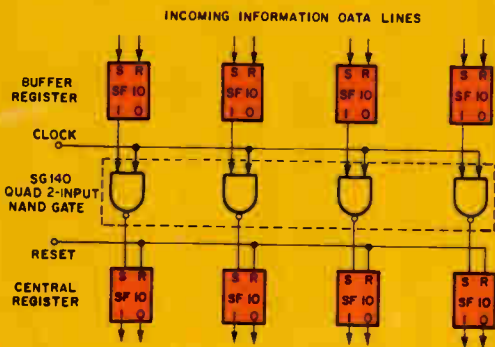

Fig. 1—Flip-flop register application.

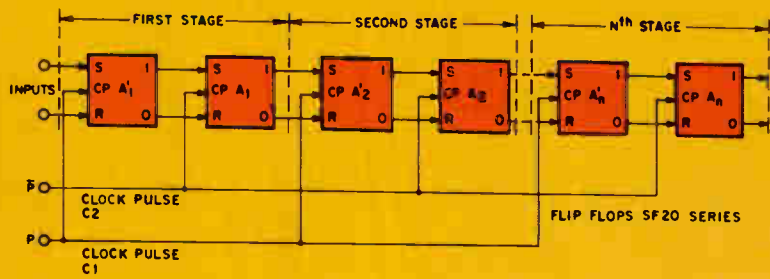

Fig. 2—Shift register—dual rank.

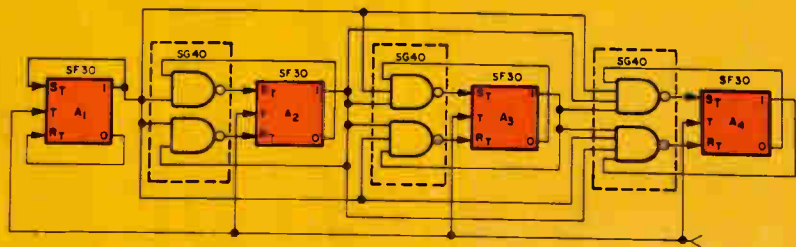

Fig. 3—Synchronous binary counter with SRT flip-flops.

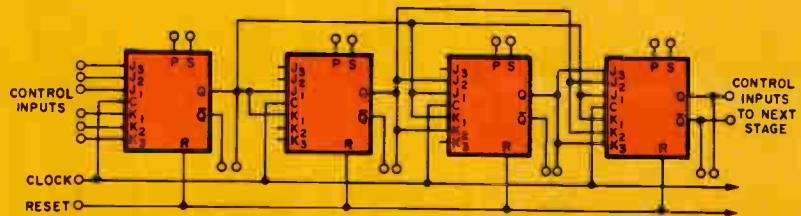

Fig. 4—Synchronous binary counter takes advantage of multiple J and K Inputs.

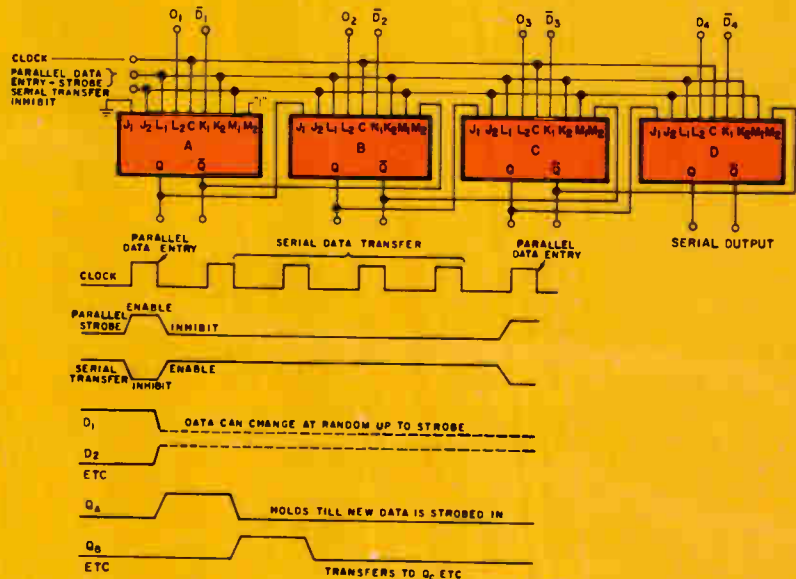

Fig. 5—In parallel to serial converter data is inserted through one set of DRed Inputs on each flip-flop.

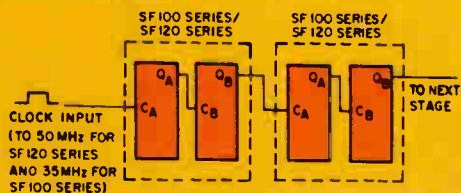

Fig. 6—High-speed ripple counter can be clocked at up to 50 MHz.

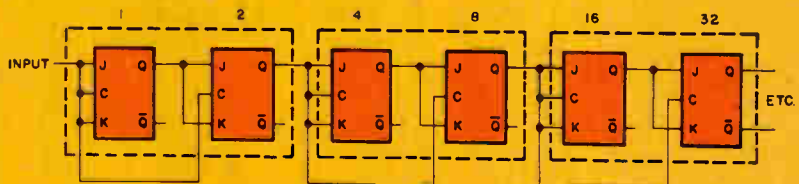

Fig. 7—Semi-ripple counter employs dual J-Ks with common clock.

380 circuit types in Industry's largest TTL line

SUHL I TYPICAL CHARACTERISTICS (+25°C, +5.0 Volts)										
Function	Type Nos.	t_{pd} (nsec)	Avg. Power (mw)	Noise Immunity +(volts)-		**Military (-55°C to +125°C) Prime FO Std. FO		**Industrial (0°C to +75°C) Prime FO Std. FO		
NAND/NOR Gates										
Dual 4-Input NAND/NOR Gate	SG-40, SG-41, SG-42, SG-43	10	15	1.1	1.5	15	7	12	6	
Single 8-Input NAND/NOR Gate	SG-60, SG-61, SG-62, SG-63	12	15	1.1	1.5	15	7	12	6	
Expandable Single 8-Input NAND/NOR Gate	SG-120, SG-121, SG-122, SG-123	18	15	1.1	1.5	15	7	12	6	
Dual 4-Input Line Driver	SG-130, SG-131, SG-132, SG-133	25	30	1.1	1.5	30	15	24	12	
Quad 2-Input NAND/NOR Gate	SG-140, SG-141, SG-142, SG-143	10	15	1.1	1.5	15	7	12	6	
Triple 2-Input Bus Driver	SG-160, SG-161, SG-162, SG-163	15	15	1.1	1.5	15	7	12	6	
Triple 3-Input NAND/NOR Gate	SG-190, SG-191, SG-192, SG-193	10	15	1.1	1.5	15	7	12	6	
AND-NOR Gates										
Expandable Quad 2-Input OR Gate	SG-50, SG-51, SG-52, SG-53	12	30	1.1	1.5	15	7	12	6	
Expandable Dual Output, Dual 2-Input OR Gate	SG-70, SG-71, SG-72, SG-73	12	20/gate	1.1	1.5	15	7	12	6	
Exclusive-OR with Complement	SG-90, SG-91, SG-92, SG-93	11	35	1.1	1.5	15	7	12	6	
Expandable Triple 3-Input OR Gate	SG-100, SG-101, SG-102, SG-103	12	25	1.1	1.5	15	7	12	6	
Expandable Dual 4-Input OR Gate	SG-110, SG-111, SG-112, SG-113	12	20	1.1	1.5	15	7	12	6	
Non-Inverting Gates										
Dual Pulse Shaper/Delay-AND Gate	SG-80, SG-81, SG-82, SG-83	11	30/gate	1.1	1.5	15	7	12	6	
Dual 4-Input AND/OR Gate	SG-280, SG-281, SG-282, SG-283	11	38/gate	1.0	1.5	10	5	8	4	
AND Expanders										
Dual 4-Input AND Expander	SG-180, SG-181, SG-182, SG-183	< 1	0.9/gate	1.1	1.5					
Dual 2 + 3 Input AND/OR Expander	SG-290, SG-291, SG-292, SG-293	7	15/gate	1.0	1.5					
OR Expanders										
Quad 2-Input OR Expander	SG-150, SG-151, SG-152, SG-153	4	20	1.1	1.5					
Dual 4-Input OR Expander	SG-170, SG-171, SG-172, SG-173	3	5	1.1	1.5					
Flip-Flops										
Set-Reset Flip-Flop	SF-10, SF-11, SF-12, SF-13	20MHz*	30	1.1	1.5	15	7	12	6	
Two Phase SR Clocked Flip-Flop	SF-20, SF-21, SF-22, SF-23	20MHz*	30	1.1	1.5	15	7	12	6	
Single Phase SRT Flip-Flop	SF-30, SF-31, SF-32, SF-33	15MHz*	30	1.1	1.5	15	7	12	6	
J-K Flip-Flop (AND Inputs)	SF-50, SF-51, SF-52, SF-53	20MHz*	50	1.1	1.5	15	7	12	6	
J-K Flip-Flop (OR Inputs)	SF-60, SF-61, SF-62, SF-63	20MHz*	55	1.1	1.5	15	7	12	6	
Dual 35MHz J-K Flip-Flop (Separate Clock)	SF-100, SF-101, SF-102, SF-103	35MHz*	55/FF	1.0	1.5	11	6	9	5	
Dual 35MHz J-K Flip-Flop (Common Clock)	SF-110, SF-111, SF-112, SF-113	35MHz*	55/FF	1.0	1.5	11	6	9	5	
SUHL II TYPICAL CHARACTERISTICS (+25°C, +5.0 Volts)										
NAND/NOR Gates										
Expandable Single 8-Input NAND/NOR Gate	SG-200, SG-201, SG-202, SG-203	8	22	1.0	1.5	11	6	9	5	
Quad 2-Input NAND/NOR Gate	SG-220, SG-221, SG-222, SG-223	6	22	1.0	1.5	11	6	9	5	
Dual 4-Input NAND/NOR Gate	SG-240, SG-241, SG-242, SG-243	6	22	1.0	1.5	11	6	9	5	
Single 8-Input NAND/NOR Gate	SG-260, SG-261, SG-262, SG-263	8	22	1.0	1.5	11	6	9	5	
AND-NOR Gates										
Expandable Dual 4-Input OR Gate	SG-210, SG-211, SG-212, SG-213	7	30	1.0	1.5	11	6	9	5	
Expandable Quad 2-Input OR Gate	SG-250, SG-251, SG-252, SG-253	7.5	43	1.0	1.5	11	6	9	5	
Expandable Triple 3-Input OR Gate	SG-300, SG-301, SG-302, SG-303	7	36	1.0	1.5	11	6	9	5	
Expandable Dual Output Dual 2-Input OR Gate	SG-310, SG-311, SG-312, SG-313	7	30/gate	1.0	1.5	11	6	9	5	
AND Expanders										
Dual 4-Input AND Expander	SG-180, SG-181, SG-182, SG-183	< 1	0.9/gate	1.1	1.5					
OR Expanders										
Quad 2-Input OR Expander	SG-230, SG-231, SG-232, SG-233	2	28	1.0	1.5					
Dual 4-Input OR Expander	SG-270, SG-271, SG-272, SG-273	2	6.7	1.0	1.5					
Flip-Flops										
Dual 50 MHz J-K Flip-Flop (Separate Clock)	SF-120, SF-121, SF-122, SF-123	50MHz*	55/FF	1.0	1.5	11	6	9	5	
Dual 50MHz J-K Flip-Flop (Common Clock)	SF-130, SF-131, SF-132, SF-133	50MHz*	55/FF	1.0	1.5	11	6	9	5	
50MHz J-K Flip-Flop (AND Inputs)	SF-200, SF-201, SF-202, SF-203	50MHz*	55	1.0	1.5	11	6	9	5	
50MHz J-K Flip-Flop (OR Inputs)	SF-210, SF-211, SF-212, SF-213	50MHz*	55	1.0	1.5	11	6	9	5	

FUNCTIONAL ARRAYS, TYPICAL CHARACTERISTICS (+25°C, +5.0 Volts)										
Function	Type Nos.	t_{pd} (nsec)	Avg. Power (mw)	Noise Immunity +(volts)-		**Military (-55°C to +125°C) Prime FO Std. FO		**Industrial (0°C to +75°C) Prime FO Std. FO		
Full Adder	SM-10, SM-11, SM-12, SM-13	sum 22	carry 10	90	1.0	1.0	20	10	20	10
Dependent Carry Fast Adder	SM-20, SM-21, SM-22, SM-23	sum 22	carry 10	125	1.0	1.0	20	10	20	10
Independent Carry Fast Adder	SM-30, SM-31, SM-32, SM-33	sum 22	carry 10	125	1.0	1.0	20	10	20	10
Carry Decoder	SM-40, SM-41, SM-42, SM-43	2	25	1.0	1.0					
Decade Frequency Divider	SM-50, SM-52	30 MHz	120	1.0	1.0	15		15		
Four Bit Storage Register Bus Transfer Output	SM-60, SM-61, SM-62, SM-63	20	30/bit	1.0	1.0	20	10	20	10	
Four Bit Storage Register Cascade Pullup Output	SM-70, SM-71, SM-72, SM-73	20	30/bit	1.0	1.0	20	10	20	10	
16-Bit Scratch Pad Memory	SM-80, SM-81, SM-82, SM-83	25	250	1.0	1.0	40	20	40	10	

The performance you ask for, assured by MR. ATOMIC

IC users expect to get the performance they specify. This means every IC made by Sylvania undergoes extensive dynamic testing before delivery.

At Sylvania, a unique IC tester called MR. ATOMIC permits comprehensive and accurate testing of every integrated circuit produced, and it does this with complete assurance that each individual test has been precisely performed. Hence, all possibility of human error has been eliminated.

MR. ATOMIC (Multiple Rapid Automatic Test Of Monolithic Integrated Circuits) includes four temperature controlled dc test chambers, one each for +75°C, 0°C, +125°C, and -55°C, as well as a 25°C switching station. This tester features automatic mechanical feed and precise control by a digital process computer and magnetic drum memory.

Prior to testing, individual circuits in special plastic pallets are stack-loaded into MR. ATOMIC'S dispensing rack, which automatically dispenses a new circuit to the tester every two seconds. As each IC enters the first control chamber (75°C ambient temperature), it is automatically inserted into a large rotary holding device which moves the circuit to the test position. Holder and chamber are designed to insure that the time required for the IC to travel the 180 degrees to the test position is such that the entire device (chip, case and junction) has stabilized at the test temperature.

The test probe block for the IC package is arranged so that two probes make contact with each lead on the package. One probe performs the actual testing; the other is a sensing probe which allows MR. ATOMIC to determine that electrical contact has indeed been established with each lead. Any IC failing the contact sensing test at any test station is automatically sorted into a special bin for retesting.

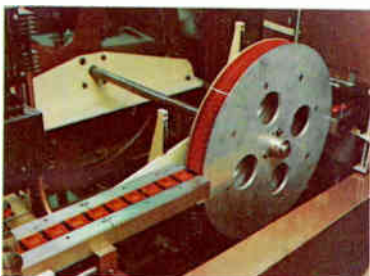

Fifth testing station tests 30 switching parameters at 25°C.

Once electrical contact has been verified for all 14 leads, up to 100 parameters are checked at the rate of 17 milliseconds

per test. The result of each test is stored in the computer memory for use in final circuit sorting.

After the first chamber tests are completed, each IC is fed automatically to the second, third and fourth chambers where it is tested at 0°C, +125°C, and -55°C respectively. Again, the result of each test at each temperature is stored in the computer memory.

After completion of the dc tests, the IC moves to the fifth test station where dynamic switching tests are performed at 25°C. Here, as in dc testing, the integrated circuit is "worst case" tested for switching performance. Rise time (t_r), fall time (t_f), turn on delay (t_{on}), and turn off delay (t_{off}) are verified to the specification for each IC.

In this test, each input is individually checked through its appropriate gate structure for all parameters. Each input is verified; i.e., it is more than testing just one input of a multiple input gate and then assuming that all other inputs will function identically.

After each integrated circuit emerges from the switching test station, the complete history of that integrated circuit's electrical performance, stored in the computer memory, is reviewed and a decision made on sorting it. The package then is automatically placed into one of 20 sort bins where it is stored for packaging for shipment.

CIRCLE NUMBER 304

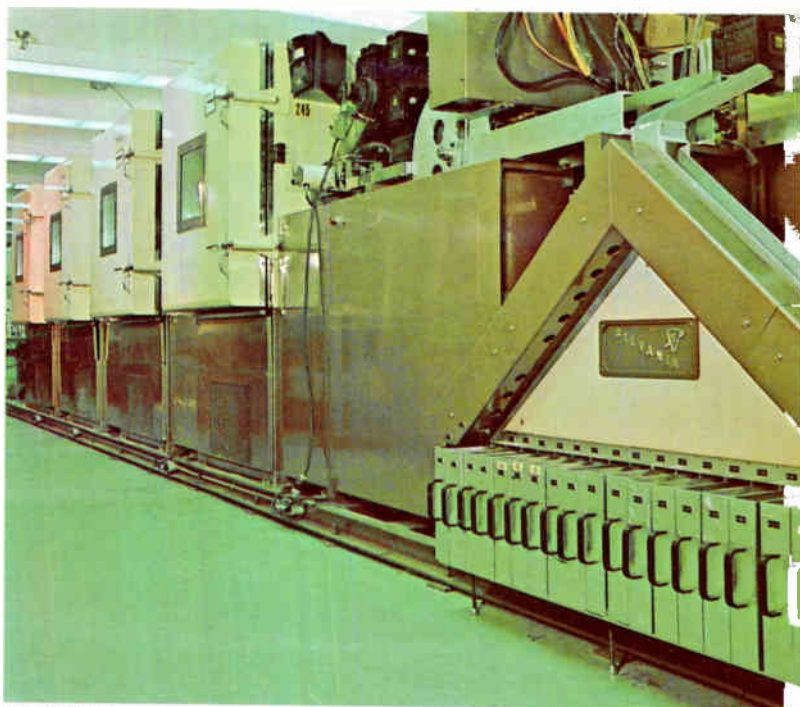

MR. ATOMIC tests each Sylvania IC in four temperature-controlled chambers.

You can overcome IC interface problems this simple way

There's no need to give up the superior performance of SUHL™ circuits due to logic interface problems. Simple circuits overcome most of these problems.

Often, system requirements make it necessary to interface SUHL devices with other types of logic or other types of circuit functions. This is easily done.

One technique for interfacing SUHL circuits with RTL or other logics with similar restrictions is shown

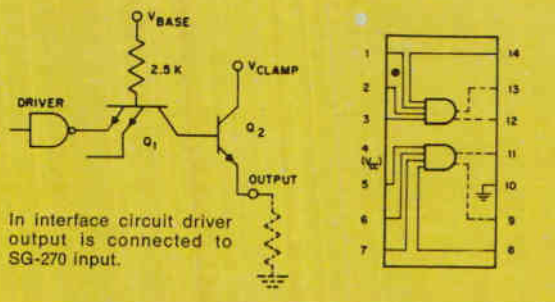

in the Figure. Here, the driving gate (or gates) is connected to the input of an SG-270 dual 4-input OR expander.

When the driver output is at logic "0", Q₂ is OFF and the output is at logic "0" (or ground). As the

(Continued)

driver gate output goes to logic "1" (3.2V), the emitter of Q_2 follows. When the input of Q_1 gets to $V_{clamp} + V_{BE}$ of Q_2 , the collector-base and base-emitter of Q_2 become forward biased and the output is essentially V_{clamp} . Further increases in the input have no effect on the output emitter of Q_2 .

Impedance of the load determines the current in Q_2 . This current should be no greater than 10 mA, as the transistor is designed to operate at a nominal value of about 5 mA.

To get sufficient drive at the base of Q_2 , the current through the base resistor of Q_1 should be calculated

for a beta of 5 for the temperature range of -55°C to $+125^\circ\text{C}$, or a beta of 8 for 0°C to $+75^\circ\text{C}$.

Base drive can be adjusted by the V_{base} supply. For 1 mA drive to the base of Q_2 :

$$V_{base} = V_{clamp} + 2 V_{BE} + (2.5 \text{ K}\Omega \times 1 \text{ mA})$$

$$\text{or, } V_{base} = V_{clamp} + 2 V_{BE} + 2.5 \text{ V}$$

Since the voltage on the load will be V_{clamp} and the input must rise to $V_{clamp} + V_{BE}$, the maximum clamp voltage using a 5-V supply would be 2.5 volts. When higher clamp voltages are desired, a resistor is tied from the driver gate output to the B^+ supply.

CIRCLE NUMBER 305

An accurate 1-Hz generator doesn't need to be expensive

Here's how to build an inexpensive 1-Hz generator with an accuracy of better than 0.1% and which uses the power line frequency as its input.

A 1-Hz generator can be made with four Sylvania ICs: one SM-50 decade frequency divider and three SF-50 J-K flip-flops. The circuit uses the 60-Hertz line frequency as a P.R.R. control. Since power companies hold the power line frequency between 59.95 and 60.02 Hertz, this results in an accuracy of better than 0.1%.

In the circuit (Figure 1) the 60-Hertz line frequency is fed into the SM-50 and divided by ten. The resulting 6-Hz signal is put into three SF-50s connected in a synchronous divide-by-six configuration, giving an output of 1 pulse per second.

Because there is an emitter-follower on the SM-50 chip, the 60-Hertz sine wave can be fed directly into the SM-50. Output of the emitter-follower, which is essentially a rectified half-sine wave, serves as the

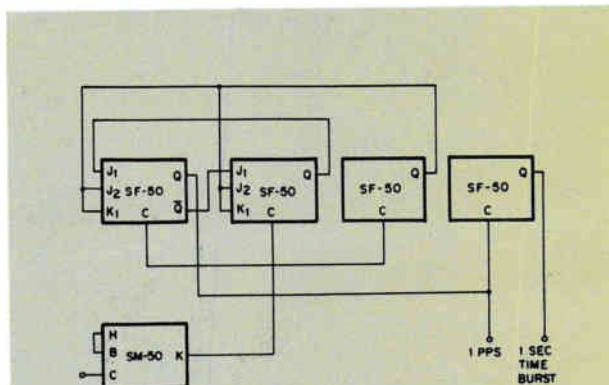

Fig. 1—Simple, accurate 1-Hertz generator using SUHL ICs.

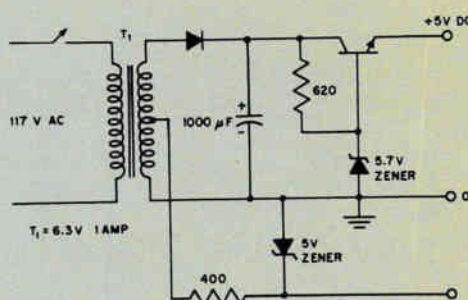
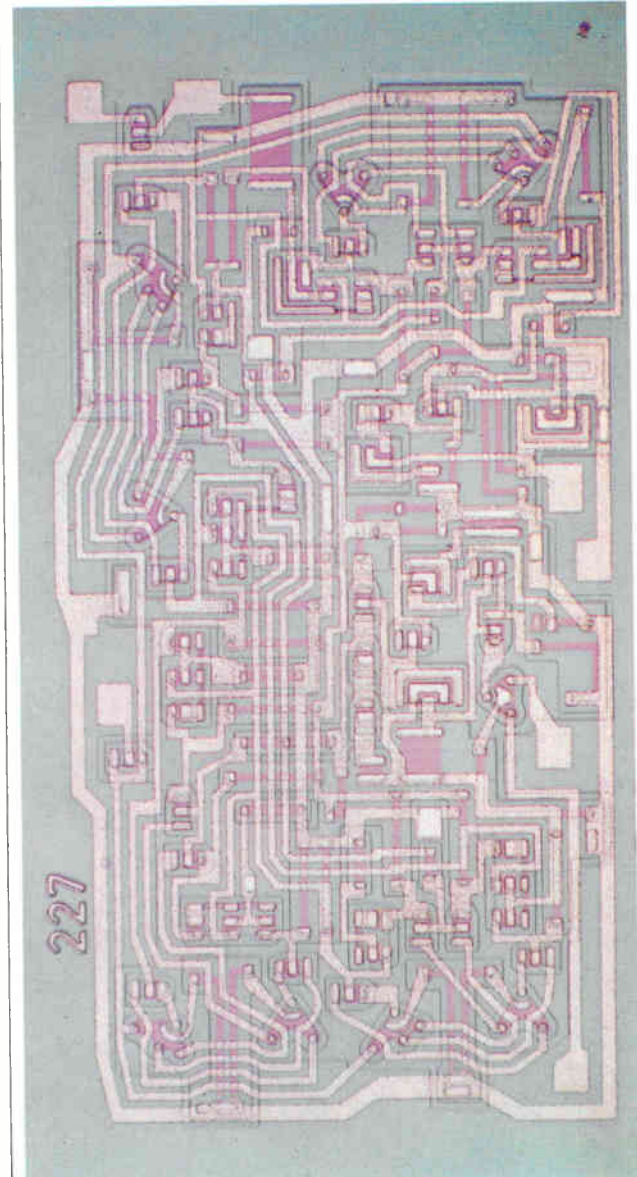

Fig. 2—Power source for low-frequency generator.



SM-50, Decade Frequency Divider

input to the divide-by-ten circuit. The output of the SM-50 is compatible with the circuits in the SF-50 and with the other devices in the SUHL family.

When a one second time burst is desired, output of the divide-by-sixty goes into another SF-50. This produces an output voltage which will be ON for one second and OFF for one second.

With proper gating, the basic circuit can be used to make an accurate timer. The time-burst configuration can be used to open and close a gate to a counter so that accurate counts per second can be made, such as is used in frequency counting.

Figure 2 gives the details of a simple power supply to power this 1-Hz generator circuit.

CIRCLE NUMBER 306

How to error-check with SUHL NAND/NOR gates

When processing binary data, it's important that errors be immediately detected. The practical way to detect such errors is to use IC gates for parity checking.

Parity checking can insure that errors do not creep into information being processed in a computer or being transferred from a computer to other equipment. Essentially an error detection method, parity checking is based on checking the total number of 1s present in a computer word at various stages within the computer or after data is transferred. This is done by including an extra binary digit (parity bit) in the word so that the total number of 1s in the computer word (including the parity bit) is always odd or always even.

If a system uses ODD parity checking, then an error is indicated any time there is a single error or an odd number of errors in a computer word. In Figure 1, Row 1 shows an 8-bit word having ODD parity, there are five 1s. In Row 2, there is a change of one bit (the 8th bit went from "1" to "0"). Now there is an even number of 1s and an error signal would be produced by the ODD parity checker. Row 3 has an odd number of errors (bit positions 8, 6, & 5) are different from the original word). In this case, an error signal would be produced by the ODD parity checker because, again, there is an even number of 1s.

	8	7	6	5	4	3	2	1
1. Original word	1	1	0	0	1	0	1	1
2. Single error	0	1	0	0	1	0	1	1
3. ODD # of errors	0	1	1	1	1	0	1	1

Fig. 1—Eight-bit data word showing parity checks.

In a similar manner, in an EVEN parity checker the total number of 1s in a computer word (including the parity bit) is always EVEN. Thus, EVEN parity is the complement of ODD parity.

How parity checking is implemented with SUHL devices is shown in Figures 2 & 3. Figure 2 shows the ease of implementing ODD/EVEN parity checking with only 1 1/4 SG-140 packages for 2 bits. Each SG-140 has four 2-input NAND/NOR gates. With the units shown, the typical propagation delay for EVEN parity is 36 nsec; for ODD parity, 48 nsec.

An 8-bit binary ODD/EVEN parity checker consisting of 7 1/4 SG-140 packages is outlined in Figure 3. An advantage of this method is that only the uncomplemented inputs are necessary, and wiring interconnects are straight forward and repetitive.

CIRCLE NUMBER 307

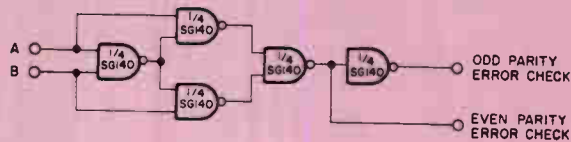

Fig. 2—ODD/EVEN parity checking for two bits.

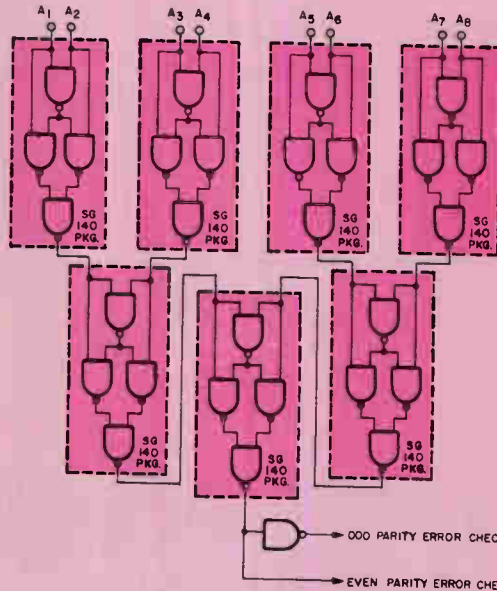
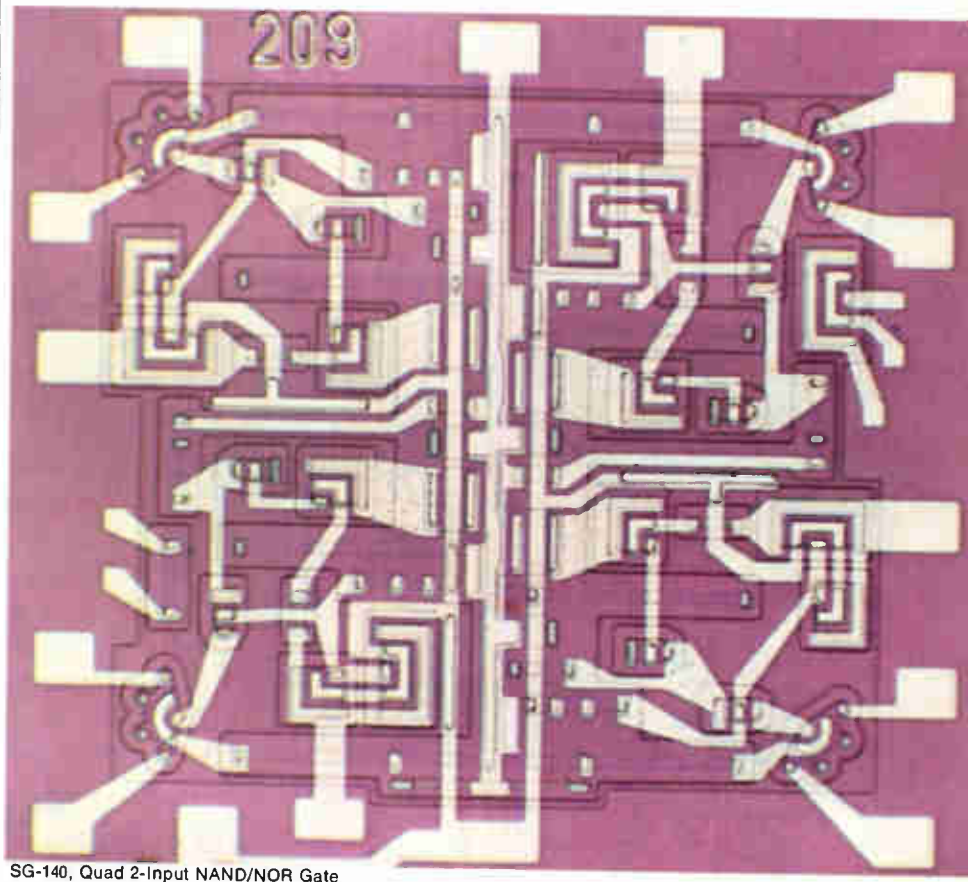

Fig. 3—Parity checking for 8-bit binary word which includes the parity bit.



SG-140, Quad 2-Input NAND/NOR Gate

Good specification sheets can both simplify and maximize IC utilization

You're cheating yourself if you're using inadequately specified integrated circuits.

Let's take a closer look at the problem. First of all, say that an IC spec sheet's purpose in life is to transmit technical information about a particular circuit to all parties who will be involved in its usage and application.

Next, add to this basic description certain other essentials:

- It must be readable, i.e., well organized and written in the simplest appropriate style.
- It must be easy to understand, i.e., all technical data presented in an orderly manner, with all information in logical groups.
- It should provide the greatest number of guarantees over the broadest range of practical considerations, i.e., give realistic results of product tests. By keeping within practical limits, the user may be assured of the results as stated on the sheet.

While the specification sheet should be descriptive, the description is of the greatest practical benefit to the user when it relates to and assists in the actual use of the circuit in a system. A specification can be quite elaborate, yet be unrelated to the end application.

The specification sheet will provide the packaging engineer with package dimensions, thermal characteristics, conductivity, orientation. It provides the logic designer a description of the logical operation and rules for applying that particular logic element. Application notes also give ideas on optimizing logic capability.

The specification provides all details on the circuit and pertinent standards. For component engineers the sheet offers a description of the circuit, its opera-

tion and parameters—as well as information on how these parameters are effected by pertinent conditions (capacitance, frequency and temperature).

The actual "specification of electrical characteristics" portion of the spec sheet is generally the most difficult portion for the manufacturer to provide. Often it gets the greatest amount of his consideration, and also the user's. It's here that parameter limits and conditions of measurement are specified.

Parameters, limits, and conditions must be derived from:

- Circuit analysis and calculations
- Product distribution
- Application or system requirements

A good specification is a combination of these criteria. All are valid and necessary and effect the acceptability of the product, either by limiting its usefulness or its cost. The electrical specification should be developed under conditions that duplicate those of the circuit's eventual application.

Sylvania integrated circuits specifications combine all these criteria to provide well defined circuit input, output, and transfer characteristics which are directly translatable into system parameters and design rules. Parameters are not only specified over the temperature range, but are verified by actual testing at specified temperatures before shipment.

To make it easier to use the product and maximize the utility of the circuits, all Sylvania specifications provide circuit and logic diagrams plus a description of the circuit function and its operation. In addition, to assist you in using the circuits under conditions other than those specified, (data such as typical characteristics vs. temperature, power supply, loading, etc.) are specified. Our specification sheet also assists in system design by giving applications ideas which we feel highlight the circuit's special capabilities.

SUHL circuits make system design easy, and SUHL specification sheets make it easy to use SUHL.

JOHN RIENZO

SYLVANIA
SUBSIDIARY OF
GENERAL TELEPHONE & ELECTRONICS **GTE**

This information in Sylvania Ideas is furnished without assuming any obligations.

NEW CAPABILITIES IN: ELECTRONIC TUBES • SEMICONDUCTORS • MICROWAVE DEVICES • SPECIAL COMPONENTS • DISPLAY DEVICES

Need IC information in a hurry?

You can get full information on any integrated circuit or application shown in this special issue of Sylvania IDEAS.

The quickest way is to drop us a line at the address shown here. Be sure to give us your name, title, company, address, and tell us the names of the products on which you'd like

to receive more information. And if you have a particular design problem, just let us know. We'll rush you full particulars. Please write to:

Dept. No. B 5 5
Sylvania Electronic Components Group
1100 Main Street
Buffalo, New York 14209

You can also get information using the publication's card elsewhere in this issue.

Indicate the items you're most interested in and circle the appropriate reader service numbers.

Code and Program Your Attenuation As You Go Along ...in Milliseconds

You can switch attenuation while operating . . . as you need it . . . for fast signal sampling and measurement. Switch in less than 100 milliseconds over a frequency range of DC to 1 GHz in 1 db steps from 0 to 139 db.

DC TO 1 GHz PROGRAMMABLE ATTENUATOR MODEL 2163/1M2

AUTOMATICALLY SETS attenuation levels in response to 9-line binary coded decimal input signals . . . 1-2-4-8 . . . 10-20-40-80 . . . 100. Make before break logic ensures that at no time while switching is the attenuation less than the starting or final programmed value.

DYNAMIC RANGE covers from 0 to 139 db in 1 db increments. At 1 KHz, the programmer is accurate to $\pm 0.5\%$ ± 0.1 db up to 120 db (± 1 db up to 130 db) . . . at 1 GHz, it's accurate to $\pm 1\%$ and ± 0.2 db up to 100 db (with additional 0.5% at 130 db).

VSWR does not exceed 1.10 below 100 MHz . . . 1.25 below 500 MHz . . . or 1.50 below 1 GHz. Insertion loss 0.35 db per 100 MHz.

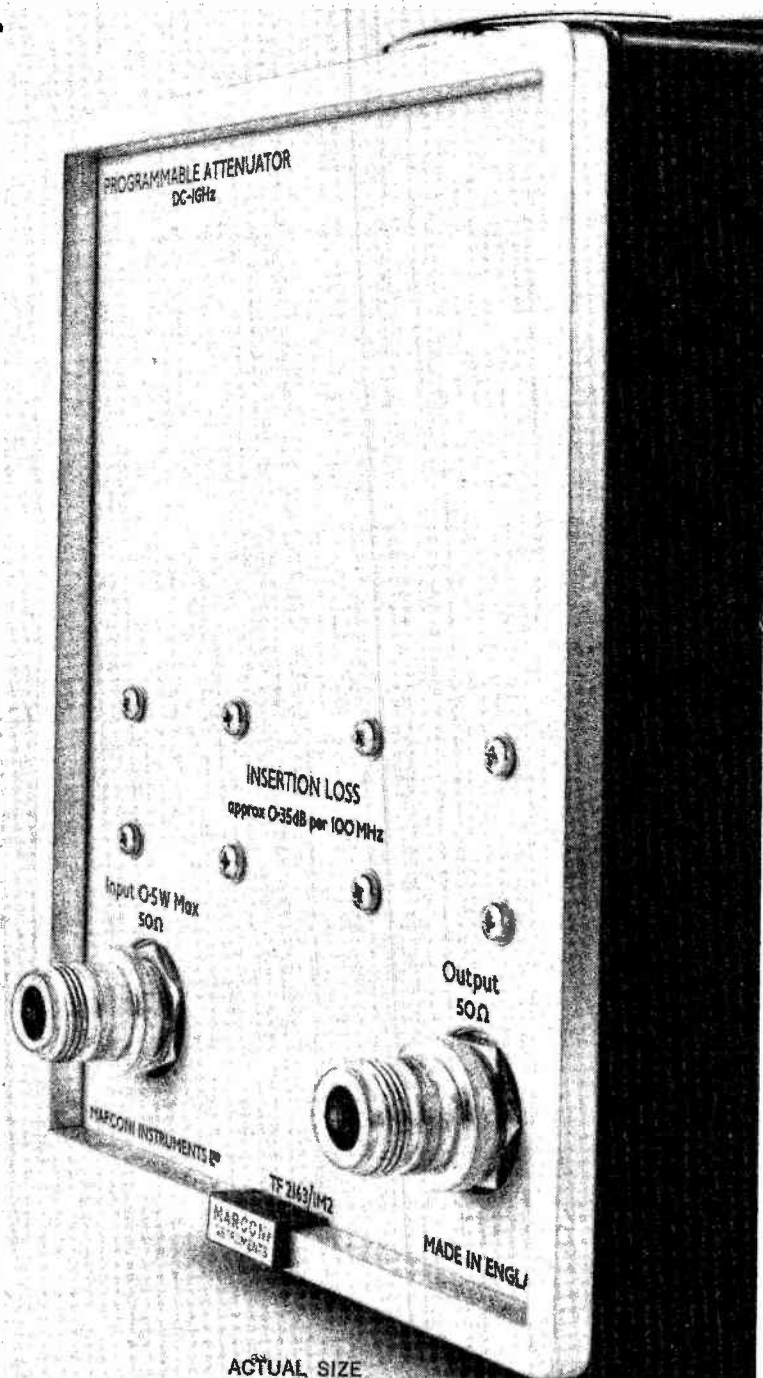

MARCONI INSTRUMENTS
Division of English Electric Corporation

111 CEDAR LANE • ENGLEWOOD • NEW JERSEY 07631 • TELEPHONE: 201-567-0607

Now there's a "4th generation"



of plug-in digital counters



The use of IC's in a prize-winning package design gives you more of what you want in a counter, from DC to microwave.



THE 125 MHz MAIN-FRAME ACCEPTS ANY OF THESE PLUG-INS: Model 1104A 0.3-3 GHz Converter; Model 1102A Six-digit Preset; Model 1101A 1GHz Pre-scaler; or the Model 1103A 50-500 MHz Converter. Available soon: compatible video preamplifier, DVM plug-in and microwave frequency converters.

Look what you get in Monsanto's new Model 1500A plug-in digital counter-timer: Cool, solid reliability of its IC circuits; 125 MHz main-frame range; built-in remote programmability compatible with either passive contact closures or active circuits; increased flexibility, by trigger level control, by overflow and gate indicators, by the ability to accept *any* external time base up through 10 MHz; new package detail which includes a unique lever latch that frees a plug-in with the flip of a finger. With the Model 1500A you get a lot of counter for just \$2,850! (U.S.A. dollars, f.o.b. New Jersey; plug-ins extra)

Monsanto Electronics Technical Center,
620 Passaic Avenue, West Caldwell, N. J.
07006. Phone: (201) 228-3800.

Monsanto
ELECTRONIC
INSTRUMENTS

Circle 37 on reader service card



Multibeam Cassegrain, 94GHz,
10½" dia., 4 overlapping
beams and reference beam

Azimuth Scanning Reflector-
Lens Antenna with Radome,
26 to 40GHz, CSC² θ Pattern.
Polarization manually selectable.

Conical Scanning Plano-
Convex Lens, 36GHz, 9½" dia.

Prime source for custom-designed antennas

For unique antennas from 300MHz to 300GHz, TRG has the experience and capability necessary to meet your requirements. Contact: TRG, 400 Border St., East Boston, Mass. 02128. Telephone (617) 569-2110.



A Division of Control Data Corporation

You don't have to be Scottish to go for this.

We're so thrifty-minded at Honeywell that we've been able to put the taut-band meter's price down even lower than the price of a pivot-and-jewel meter. (About 10% lower, on the average.)

Maybe that sounds to you like we've left something out.



We have.

We've left out half the parts, in fact. (All the unnecessary ones.) This doesn't make the meter less sophisticated. Just less complicated.

It's a very different kind of meter. It costs less, for one thing — for us to make and for you to buy. It's simpler and more reliable.

There's no friction in the moving system, so you get better readout ac-

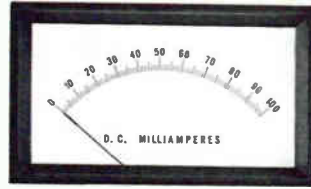

curacy and repeatability. And it's self-shielded.

Honeywell's new taut-band meter. It comes in just about any style you like.

Write Honeywell Precision Meter Division in Manchester, N. H. 03105 and we'll send you a brochure.

Honeywell

We've put the taut-band meter's price where you want it.

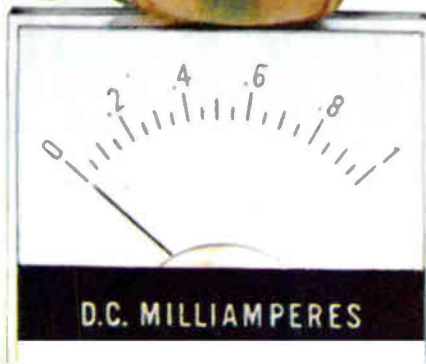

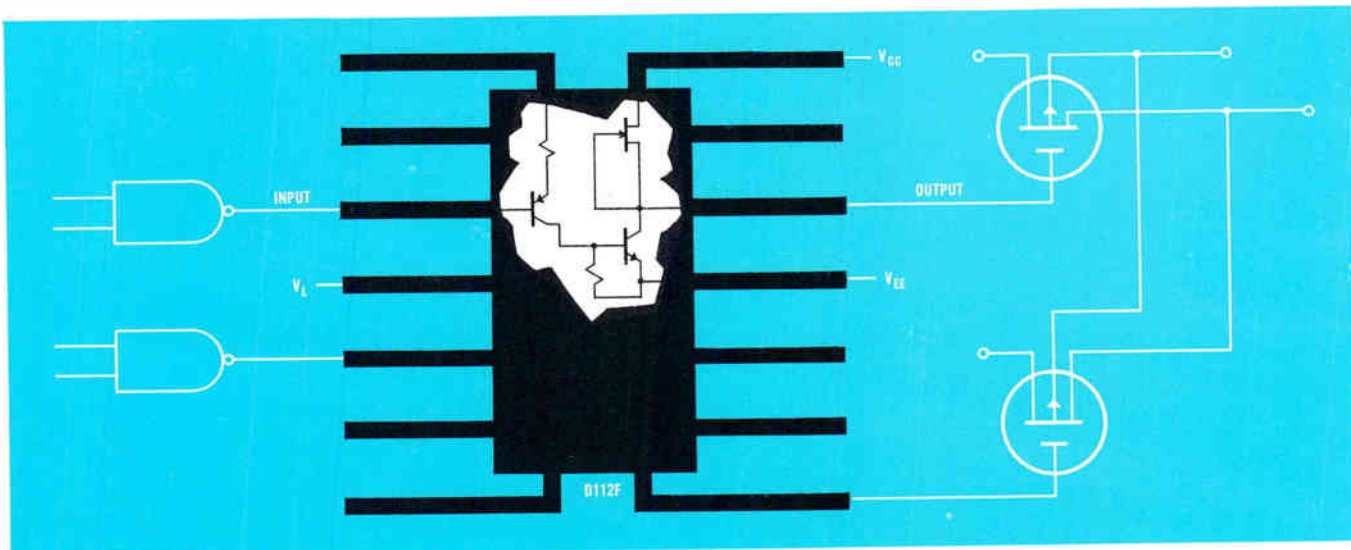

Siliconix FET-Switch DRIVERS...amplify low-level logic to 30-volt signals for controlling FET Switches.

This family of six IC Buffer/Drivers provides flexible interfacing between logic circuits and MOS or junction FET Switches. Each Driver flatpack contains two independent circuits that deliver 30-volt output swings from input signals as low as 0.5 volt. Output levels may be preset to obtain

PERFORMANCE SUMMARY

Type No.	Typ. Input Switching Threshold Voltage	Max. Input Drive Current Required	Max. Output Current	Inverting Function
D111F	0.8 Volt	0.1 mA	1.8 mA	YES
D112F	3.0	1.5	1.8	NO
D113F	0.8	1.0	1.8	YES
D119F	0.8	0.1	5.7	YES
D120F	3.0	1.5	5.7	NO
D121F	0.8	1.0	5.7	YES

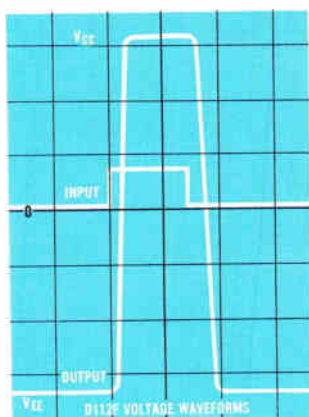

dc level shifting. Both inverting and non-inverting Drivers are available, which allows either N- or P-channel FET switches to be used & Siliconix also makes six-channel FET-Switch Drivers, a line of discrete and integrated (MOS or junction) FET-Switches, and Driver/FET-Switch combinations. Mark the inquiry card or write for complete data.

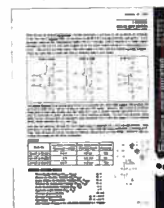

EASTERN
 ALABAMA Perrott Associates, Inc. (205) 837-2290
 Huntsville
 CONNECTICUT Cramer Electronics, Inc. (203) 288-7771
 Hamden
 FLORIDA Perrott Associates, Inc. (305) 275-1132
 Clearwater (305) 585-2535
 Orlando (305) 585-7761
 West Palm Beach
 MARYLAND Milgray Electronics, Inc. (410) 864-6330
 Hyattsville (202) 864-6330
 MASSACHUSETTS Cramer Electronics, Inc. (617) 969-7700
 Newton
 NEW JERSEY Technical Electronic Dist. (201) 384-3643
 Bergenfield
 NEW YORK Summit Distributors, Inc. (716) 884-3450
 Buffalo
 Milgray Electronics, Inc. (212) 989-1600
 New York City
 East Semiconductor Sales (315) 455-6641
 Syracuse
 PENNSYLVANIA Simco Electronics, Inc. (215) 229-1880
 Philadelphia

CENTRAL
 ILLINOIS Semiconductor Spec. (312) 279-1000
 Chicago
 MINNESOTA Semiconductor Spec. (612) 866-3434
 Minneapolis
 MISSOURI Semiconductor Spec. (314) 521-8866
 St. Louis
 OHIO Alpine Industries, Inc. (513) 278-5861
 Dayton

OKLAHOMA Oil Capitol Elec. Corp. (918) 836-2541
 Tulsa
TEXAS Sterling Electronics (512) 452-0271
 Austin (214) 357-9131
 Dallas (713) 225-1321
 Houston
 Lenert Company (713) 225-1465
 Houston

WESTERN
 ARIZONA Barnhill Associates (602) 959-2115
 Phoenix Sterling Electronics, Inc. (602) 258-4531
 CALIFORNIA Hollywood Radio & Elec. (213) 466-3181
 Hollywood (415) 322-3431
 Menlo Park Kierulff Electronics, Inc. (213) 685-5511
 Los Angeles (714) 278-2112
 San Diego Elmar Electronics, Inc. (415) 961-3611
 Mountain View (415) 834-3311
 Oakland Electronic Supply, Inc. (714) 683-8110
 Riverside Barnhill Associates (303) 934-5505
 COLORADO Denver Barnhill Associates (505) 265-7766
 DENVER Albuquerque Sterling Electronics, Inc. (505) 247-2486
 NEW MEXICO Washington Electronics (206) 682-8981
 WASHINGTON Seattle



Siliconix incorporated

1140 West Evelyn Avenue, Sunnyvale, California 94086
 Telephone (408) 245-1000 TWX 408-737-9948

CANADA & INTERNATIONAL
 MONTREAL Prelco Electronics, Ltd. (514) 389-8051
 Quebec
 OTTAWA Wackid Radio, Ltd. (613) 232-3563
 Ontario

TORONTO Electro Sonic Supply Co. (416) 924-9251
 Ontario
INTERNATIONAL Siliconix Inc. (408) 245-1000
 Sunnyvale, California



Ball .002" dia., Iteration $\pm 5\%$

TEMPRESS HYDROGEN FLAME-OFF TORCHES FOR LEAD-BONDING MACHINES ARE STAINLESS STEEL, WITH SAPPHIRE ORIFICE INSERTS that maintain size and shape accuracy of the 2166°C hydrogen flame. The highly polished inner surface of the sapphire insert assures this by eliminating gas turbulence and a resultant distortion of the flame. The end result is essentially identical gold balls on every lead, from start to finish of a production run. 14X magnification of operation shows flame-off torch at left, with orifice partially visible. Gold wire, with perfectly formed ball, protrudes from Tempress tungsten

carbide capillary tube, ready for next bonding cycle. This extreme precision symbolizes the Tempress approach to every project... explains why it requires 11 months to train an operator for many Tempress production operations. Other Tempress products include automatic scribing machines, diamond scribes, diamond lapping points, and tungsten carbide probe contact needles.

Lead-bonding, Model DTN-1, at Union Carbide Electronics.



TEMPRESS

Tempress Research Co., 566 San Xavier Ave., Sunnyvale, Calif.

Some of your experiments are all wet.



It's still experimental, but one of the best ways to communicate under water is to modulate a green laser beam.

Because, to it, water is just about invisible.

So, among other things, we make a frequency-doubling lithium niobate crystal. Its remarkable ability is to take a perfectly simple infra-red laser beam...

And turn it green with nearly 100% efficiency.

But crystals and related products are only one of the up-front activities that keep Union Carbide on the frontiers of electronics. We are also leaders in the research, development and production of laser systems, solid state devices, fuel cells, and solid tantalum and foil-film capacitors.

They're among the many reasons to consult Union Carbide before your advanced projects reach the breadboard stage.

 Union Carbide Corporation, Electronics Division, 270 Park Avenue, New York 10017.

ELECTRONICS

**TURN
TO
DELEVAN**



as the industry leader
for inductive components.

Delevan's engineers provide a flow of newly developed products which continually push the state-of-the-art on inductive devices. Combine this know-how with large volume production experience and a world-wide distribution organization and you have a company that you can depend on for quality and service. Shouldn't you be buying from Delevan?



**Delevan Electronics
Corporation / Division**

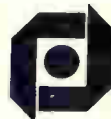

AMERICAN
PRECISION
INDUSTRIES INC.

270 QUAKER ROAD / EAST AURORA, NEW YORK 14052 / 716 652-3600

OTHER DIVISIONS OF AMERICAN PRECISION INDUSTRIES, INC.: BASCO, INC. • ELECTRO-MECHANICAL PRODUCTS DIVISION



Tuned Amplifier/Oscillator is Six Instruments in One

- LOW-NOISE AMPLIFIER
- WAVE ANALYZER
- DISTORTION ANALYZER
- LOW-DISTORTION OSCILLATOR
- SENSITIVE AC VOLTMETER
- ALLPASS DELAY PHASE SHIFTER

The PAR Model 110 Tuned Amplifier/Oscillator is a versatile high-gain, low-noise, low-distortion frequency selective amplifier operating over the frequency range of 1 Hz to 110 kHz with Q variable from 1 to 100 with no gain change. It provides four outputs simultaneously: a second order (resonance) bandpass; a second order band-reject (notch) providing rejection of the center frequency in excess of 100 dB; a second order allpass characterized by an amplitude response which is flat with frequency and a phase lag which increases monotonically with frequency; and a flat output. Each of the 600 ohm outputs is capable of providing 5 volts rms into a 5K ohm load. A front panel AC voltmeter permits measurement of any one of the four outputs.

The instrument can function as a wave analyzer with bandwidth adjustable from 1% to 100%; as a flat

or selective AC voltmeter with sensitivity ranging from 10 microvolts to 5 volts rms full scale; as a distortion analyzer to measure distortion levels as low as 0.1% (as low as 0.001% when used in conjunction with a second Model 110); as a low-noise amplifier (typical noise figure of 1 dB) with voltage gain ranging from 1 to 10^4 ; as a stable general-purpose low-distortion oscillator providing up to 5 volts rms into 600 ohms, capable of being synchronized by an external signal; and as an AC-DC converter with ground-based output.

Price: \$1195. Export price approximately 5% higher (except Canada).

For additional information, write for Bulletin T-140 to Princeton Applied Research Corporation, Dept. D, P.O. Box 565, Princeton, New Jersey 08540. Telephone: (609) 924-6835.



PRINCETON APPLIED RESEARCH CORP.

Electronics Review

Volume 40
Number 11

Integrated electronics

Wide, pure wafers

At least one integrated-circuit manufacturer is experimenting with a method of growing silicon crystals that not only produces slices up to 3 inches in diameter—having twice the area of the largest slices now in use—but also provides greater control over the purity of the finished product. Developed by the Temescal Corp. of Berkeley, Calif., the process uses electron beam heating.

The common method of producing single-crystal silicon is to melt polycrystalline silicon, dip a "seed" crystal, and pull out the thick monocrystalline rod that forms around it. Silicon melts at 1,420°C, and the crystal-pulling process is carried out at about 1,450°C, so hot that conventional inductive- or radiant-heating methods tend to oxidize the quartz crucible, thus contaminating the silicon. The impurities show up as changes in the resistivity of the finished slice.

Electron beam techniques, ex-

plains Temescal's vice president, Hugh R. Smith Jr., concentrate heat on the surface of the silicon. The crucible itself can be made of copper, with a water-cooling tube system on the bottom. Thus silicon on the bottom solidifies into a "skull" that protects the molten silicon from the copper. In effect, the crucible is lined with silicon.

Gentle grade. Equally important, says Smith, is that the distribution of energy can be precisely controlled by using electron beams. In the Temescal process, the outer rim of the surface is kept a few degrees hotter than the 3-inch center "hole" so that a meniscus forms where the hotter and cooler areas meet, facilitating the pulling of the crystals. Both the seed crystals and the crucible are rotated in opposite directions to insure uniformity.

There is nothing startling about the theory of preventing contamination by melting silicon in silicon, but performing the trick is something else again. Temescal, a 15-year-old company that has just been acquired by the Air Reduction Corp., has developed systems in which multiple electron beams are

deflected through 270 degrees by an electromagnetic field, so that ions from the material being heated do not erode the emitting cathodes. Temperature is controlled by feedback. Required power is from 30 to 40 kilowatts.

"The process is beautifully controllable," says Smith. "And operational costs are low—even though the equipment itself is expensive." An electron-beam system would cost from \$40,000 to \$120,000, depending on how much automation a customer wanted, he added. Conventional quartz-crucible systems cost about \$18,000 to \$30,000.

How big? In the past year, IC manufacturers have increased wafer size from 1 inch to 1½ inches to 2 inches. The aim is to improve yield; the more dice per slice, the smaller percentage of dice that will be spoiled by impurities.

But 2-inch wafers tax the capacity of present oxidation and diffusion furnaces. To accept a larger slice, the furnaces would have to be modified. Step-and-repeat masking techniques might not be adaptable to the larger area. And even slicing the big crystal poses prob-

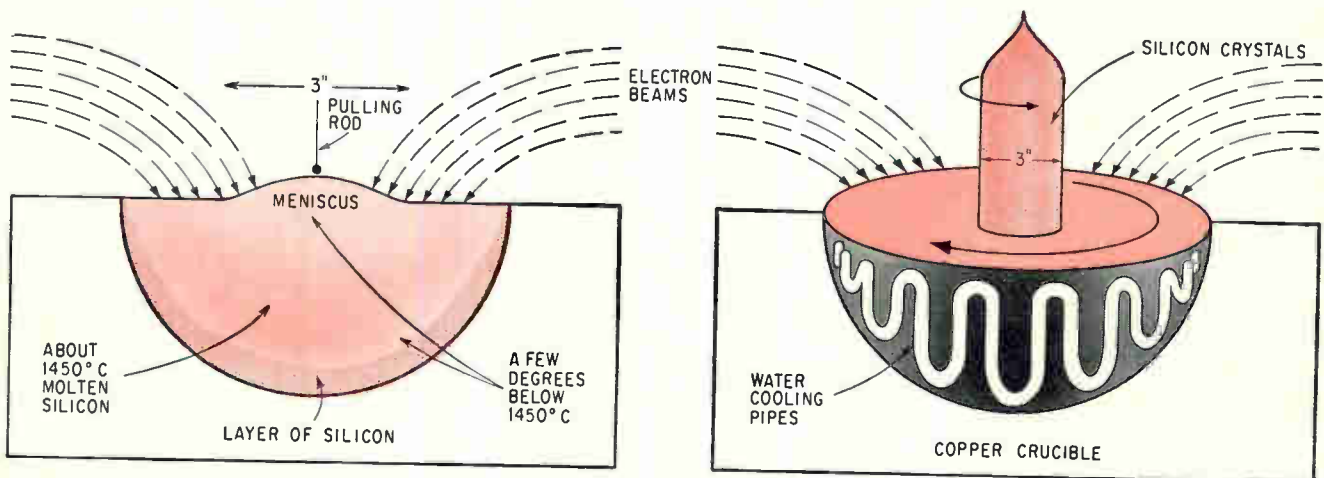

Crystal-pulling. High-purity silicon crystal rods, up to three inches in diameter, are produced by process developed by Temescal Corp. of Berkeley, Calif. The advantage of the technique lies in its repeatability. Large, high-purity crystals are needed in increasing numbers as more companies turn to large-scale integrated circuits.

lems; the biggest hollow diamond saws now in use have a 3-inch blade, barely large enough for a 3-inch crystal.

It is in the production of very-pure, high-resistivity silicon crystals of conventional size that the electron beam technique may find its first widespread use. Very-pure single crystals can be made now by passing a circular coil around a polycrystalline rod. Using this technique, a "float zone" of molten silicon is held in place by surface tension, and the rod size is limited to 1¼ or 1½ inches in diameter.

Smith says the length of the crystal that can be pulled from the copper crucible isn't limited; because additional silicon can be simply poured in over the side. Some conventional crucibles have a silicon weight limit which would mean that increasing the diameter of the crystal would decrease the length.

Model kit for masks

After nearly a year of using building blocks in the design of large-scale integrated circuits, the Microelectronics division of the Philco-Ford Corp. will now invite others to join in the fun. It will send customers a set of decalcomanias

and an invitation to design their own circuits. The purpose is to restore to the user some of the design control he had with discrete components.

The company claims a very fast turnaround time; it says it built a 200-bit metal oxide semiconductor shift register for a customer in three days.

Philco's building blocks are standard logic functions, such as flip-flops and gates, which can be combined in various ways to produce complex metal oxide semiconductor ic's. Philco designers work from composite masks; the customer gets a set of decals that correspond to these masks in area and in inputs and outputs.

Tradeoffs. Using a guidebook of design rules provided by Philco, the customer can shuffle the decals around until he has a circuit that minimizes the number of chips, or the amount of power, or total cost, or whatever his chief design aim may be.

When he is satisfied with the design, the customer pastes down the decals and returns the sheet to Philco, which selects the appropriate masks and builds the circuit.

The decal itself is actually derived from the composite mask, which is a transparency made from

stacking the individual masks used in the MOS diffusion process. The interior of the decal, however, is blank; all the customer sees are the inputs and outputs, and all he knows is that the decal represents a particular logic function. Philco could provide him with the composite mask itself, but masks are considered proprietary, and they change internally from time to time anyway.

"The major problem in LSI is in partitioning a system," says David C. Condon, Philco's engineering manager. "It's strictly a topological question—the same problem you have in putting TO-5 cans on a printed circuit board."

Four approaches. Condon notes that there are four basic approaches to the design of LSI devices: the discretionary wiring technique championed by Texas Instruments Incorporated; the Micromatrix favored by the Semiconductor division of the Fairchild Camera & Instrument Corp.; the building-block method; and the "hand-hewn" technique of completely customizing the array [Electronics, Feb. 20, p. 123]. Condon lists these approaches in increasing order of development cost and decreasing order of production cost; Philco has tried to strike a balance.

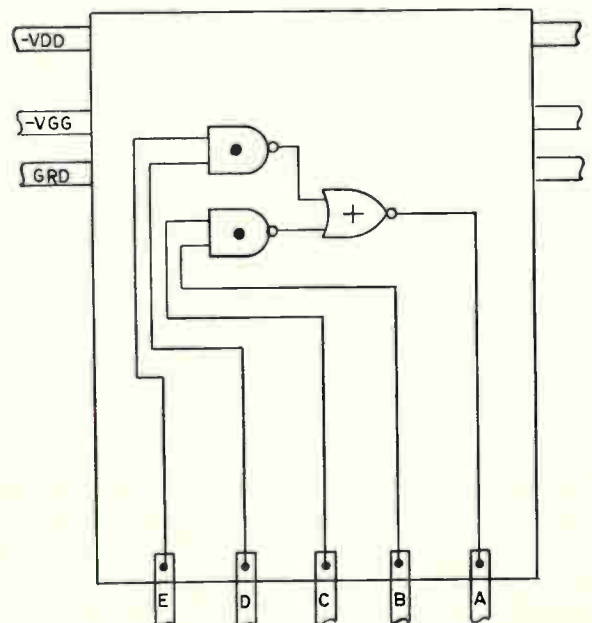
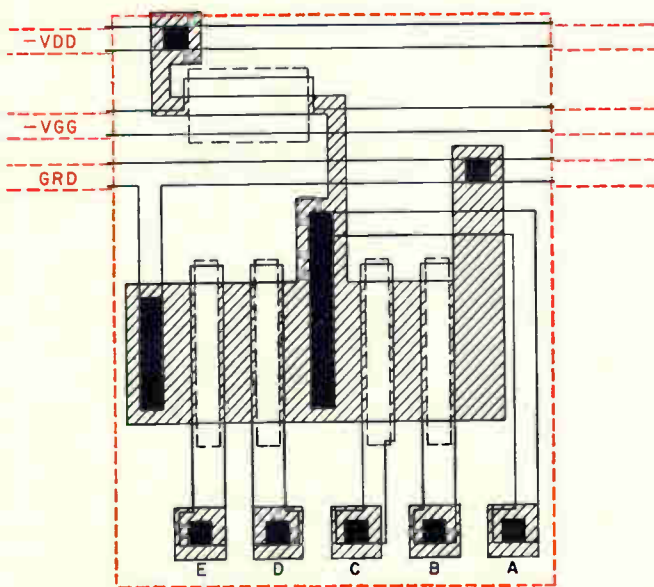

Do-it-yourself. Integrated circuit users can design their own complex circuits with a set of decals supplied by the Microelectronics division of the Philco-Ford Corp. Decal outline, at left in color, corresponds in area and in input-output connections to the composite mask for Philco's building blocks. Decal for an AND/NOR logic function is at right.

The company concedes that a prime difficulty is telling the customer how to use the decals. The book of rules gives lists of do's and don'ts, such as "Don't allow too many crossovers," but it cannot cover all cases. Condon says that one good way for the customer to start is to draw his own logic diagram so as to minimize crossing lines; he then can look for logic patterns that match the functions provided by the building blocks.

Companies

Varian variegates

Within a few years, predicts Emmett G. Cameron, Varian Associates' vice president for corporate development, 30% to 40% of the cost of instrumentation systems will go for digital equipment. Certainly its purchase this month of a small computer manufacturer, Decision Control Inc. of Newport Beach, Calif., puts Varian in that expanding group of instrument makers in the systems field [Electronics, April 17, p. 161].

But, says Cameron, "we're already in that field. Digital computation elements are becoming more and more important in our gas chromatography instruments and our nuclear magnetic resonance spectrometers. The prime reason for the acquisition is our interest in the computer field itself—in specialty computers for process control, medical and other instrumentation, and straight computation."

Nice fit. Decision Control is an 11-year-old company with sales currently running at about \$5 million a year. Its fastest-growing product area is small- to medium-sized general-purpose computers that can be used in just the applications cited by Cameron.

Though Varian has been purchasing the digital hardware for its instrument systems, it has been developing a software capability and last year formed a Data Systems division in its instrument group. "For two years," Cameron



Tilt. Autonetics could build large-scale MOS IC's, but couldn't find a system to test them. So they built their own. Circuits to be tested are mounted at upper left. Test results appear on neon lamp array just below. No news is good news—a lighted lamp means a faulty IC.

says, "we've been planning to incorporate hardware capability." Decision Control, which will operate in Varian's equipment group, should provide that capability and give Varian a foothold in the computer field at the same time.

Varian's move emphasizes the trend toward digital computers in biomedical instruments. Industry sources predict that these computers will account for half the dollars spent on such instruments over the next 10 years. It's the potential of markets such as this one, Cameron stressed, that prompted the acquisition, but the enhanced systems capability won't hurt either.

Instrumentation

MOS scrutinizes MOS

When North American Aviation Inc.'s Autonetics division began building metal oxide semiconductor logic circuits with 800 or more transistors on a chip, it found the IC's impossible to test with any available equipment. So Autonetics built its own, using MOS circuits in the tester.

No bigger than a suitcase, Autonetics' XM1300 measures circuit

speed, output waveform, rise and fall times, voltage in "true" and "false" logic states, and saturation resistance. It has test fixtures for both packaged and unpackaged IC's. Unpackaged IC's are laid face down on a prealigned 40-point test probe; with packaged IC's, a holder makes contact with each ribbon lead. Dynamic testing of unpackaged IC's is an important capability since packaging can account for a big part of a device's total cost.

Matchup. Input bit patterns and specified output-current response patterns are stored in MOS shift registers in the tester. Logic circuitry with MOS drivers compares these patterns with the performance of the circuit being tested, and turns on various lights to indicate nonconformities.

The unit isn't just a simple go, no-go tester. By checking at each input-output point in an IC and noting how the pattern of lights varies from test to test, process control engineers can discover the nature of the fault and perhaps correct it in the next batch of circuits.

To make tests, a technician uses selector switches to pick the appropriate contact pads on the IC, programs the input shift registers with a switch panel, sets clock rate, presses a start button, and observes the array of lights. With each test point selected manually, a test run

can take several minutes.

Update. Future tests will be faster. Autonetics has on its drawing boards an automated tester that will program itself with punched cards, will step its 40-point probe from IC to IC automatically, and will be able to test circuits on a wafer a row at a time prior to dicing.

The new system will have all the capabilities of the present unit, plus the ability to make direct current, or static, tests. It also will test all outputs simultaneously rather than individually.

Autonetics doesn't plan to sell the testers, though a company spokesman conceded that a market for them probably does exist. The spokesman wouldn't comment on possible licensing agreements with other firms to build the equipment.

Computers

Faster yet

An experimental computer memory with a cycle time of 110 nanoseconds, yet built with ferrite cores similar to those used in conventional memories, has been developed at the International Business Machines Corp. The cores are only 7.5 mils in inside diameter. The fastest commercially available memories for general-purpose machines have 750-nsec cycle times and are built with 13-mil cores.

The memory was built by G.E. Werner and R.M. Whalen, the same engineers who previously built a 375-nsec memory [Electronics, Dec. 27, 1965, p. 36]. That speed was attained by using the small cores, packing them close together to keep the wires short, and organizing the memory for maximum speed.

They predicted at that time that they could build a 110-nsec memory. Now they have done it, by using faster drive circuits and two cores per bit to improve noise rejection.

Speed limit. The designers predict now that additional improve-

ments in speed can be attained with smaller cores that have a shorter switching time. In the present design, switching time is over 60% of the cycle time, which is attained only by starting a cycle during the last 15 or 20 nsec of the previous cycle.

"We think we can get the switching time down to maybe 40 nsec, which would give us a cycle time of about 70 nsec," says Whalen.

"Among other things, we are considering using ultratiny cores—4.5 mils inside diameter—made by a dipping process." [Electronics, Nov. 28, 1966, p. 26]

Military electronics

Passive sentry

The Army is testing a passive infrared intrusion detector that ignores hot or cold objects in its field of view if they're stationary, but sets off audible and visible alarms if a heat-emitting object moves, no matter how slowly.

Built by Barnes Engineering Co. of Stamford, Conn., the small, portable system can detect a man walking or even crawling at 1,000 feet and a moving vehicle at 2,000—and can determine the direction in which the target is moving. The detector head weighs three pounds and the remote alarm, four. It operates for more than 400 hours on self-contained batteries.

The device is now being tested at the Army's Aberdeen Proving Grounds in Maryland and Fort Monmouth Signal Laboratories in New Jersey.

The system's operation is fairly simple. A pair of highly sensitive, adjacent thermistors in the detector head receive radiation through a common refractive optical system. Each thermistor has its own field of view, two feet wide by six feet high at a range of 250 yards. Separation between the fields at this range is two feet.

Trigger alarm. The detector's thermistors are connected in a compensated bridge circuit, and

direct-current bias voltage is applied. This arrangement balances out the changes in ambient temperature and in light and shadow that are produced by variations in sun elevation and cloud motion. When a moving target appears, transient changes in either field do not cancel out; the bridge becomes unbalanced, a current flows, and the alarm is triggered.

Target discrimination is aided by a simple, passive bandpass filter with a range of from 0.2 to 2.0 cycles per second. Very slow variations in the background are filtered out; the alarm sounds when there is movement through the field of view at any speed.

Barnes says that the instrument can even detect partially concealed intruders. A man with only his head and neck exposed has been detected in tests at a distance of 750 feet. The difference in temperature between his face and the background was only 1°C. With more of the intruder showing and with greater temperature difference, the range would increase. Detection is accomplished whether the target is warmer or colder than the background.

Commercial versions for industry are available for less than \$6,000 each.

Space electronics

One path to success

A satellite's ultrahigh frequency radio signal reaching an aircraft's small antenna is good if it is received only once. If it is reflected off water or the ground and is picked up again by the antenna, the signal is distorted, faded, or even canceled. Air Force researchers want to be sure that the receiver will accept the signal only once. Developing technology to that end is the major reason for next month's launching of the fifth in a series of Lincoln Experimental Satellites (LES-5).

The uhf bands which LES-5 will test are going to be used in the

Sometimes a big idea comes in a little, tiny package.

We wouldn't want you to think for one minute we believe our diodes are anywhere near as important as marriage.

But the picture does make a point, though.

The characteristics of a Unitrode would be remarkable even if they *weren't* packed into a miniature package. But when you stop to think that those little, tiny Unitrodes are virtually indestructible, it makes you wonder.

After all, how many diodes of *any* size can be virtually guaranteed to never fail? Ever.

Unitrodes can. They are.

But when you consider how a Unitrode is made, it's not hard to understand. First, the silicon die is metallurgically bonded between two terminal pins of the same diameter.

That bond is stronger than the silicon itself, so the silicon will break before the bond does. Then the entire unit is fused in hard glass at over 800°C. It's voidless, so all contaminants are excluded.

Now that's not easy. But it's worth it.

Because that's why a Unitrode can stand virtually an infinite number of days of temperature cycling from minus 65°C to plus 200°C. That's why, after 2000 hours of life testing, at full load, our parts still meet initial specified limits.

Because the terminal pins are bonded over the full face of the silicon die, heat due to surge is carried away quickly from the silicon into the pins.

You can apply PIV at high temperature for weeks at a time without even budging a Unitrode. And *every* Unitrode is controlled avalanche.

All of which makes us believe the Unitrode diode is a pretty big little idea. Can you blame us?

So if what you're working on involves the problem of fitting a big idea into a little package, maybe we can help. We'll be glad to send you complete information and samples. We're at 580 Pleasant St., Watertown, Mass. 02172. Telephone (617) 926-0404. TWX (710) 327-1296.

UNITRODE®



Tactical Communications Satellites Program. These frequencies suffer from the multipath problem more than signals beamed at higher frequencies, X band for example. But X-band signals require a dish antenna and a projecting rotodome on the aircraft.

One way the Air Force hopes to solve the multipath problem is by redesigning aircraft antennas for better control of the side lobes. Or it might put an antenna on the top of the fuselage where the reflected signal could reach it. For the LES-5 tests, modified blade antennas will be installed on jet aircraft.

While the Air Force is conducting its LES-5 experiments to improve airborne antennas, the Army and Navy will be working on the ground and shipboard terminals, but that work is secondary to the multipath research.

Simple satellite. The LES-5, built by the Massachusetts Institute of Technology's Lincoln Laboratory, is simple as communications satellites go. It will transmit at low data rates by teletypewriter. Multiple-access experiments using a number of ground stations simultaneously will not be conducted.

The 225-pound LES-5 will ride a Titan 3C from Cape Kennedy sometime in mid-June. It will be injected into a near-synchronous orbit of about 19,000 miles and will be spin-stabilized.

Air Force officials are close mouthed about specific frequencies, effective radiated power, or the amount of power LES-5's solar cells will generate.

Two more LES satellites are on Air Force drawing boards. One will be used for research on electronically despun antennas and the other, considerably larger, will investigate ways to increase effective radiated power output.

All together. The same Titan 3C which will loft the LES-5 will also put into orbit five satellites for experiments in communications techniques.

Four of them will be added to the Initial Defense Communications Satellite Program (IDCSF), making a total of 19 in orbit and operating. Although this program originated as a development proj-

ect, the military is now using it operationally. One of the four IDCSF satellites will test an electronically despun antenna [Electronics, Feb. 6, p. 48].

The fifth space vehicle is called Dodge, for Department of Defense Gravity Experiment [Electronics, Aug. 22, p. 44]. It will test three-axis gravity gradient stabilization in near-synchronous altitudes.

The light track

To track reflector-equipped satellites by laser, NASA operates a complex system steered by a tape-fed computer to obtain range accuracies as high as ± 1.5 meters.

Though this system is working well, the space agency now is hedging its bet by spending \$100,000 with the Smithsonian Astrophysical Observatory to find out if a simpler system can do the job just as well or better than its relatively expensive computer-steered system.

The Smithsonian's laser system will be manually steered, using computer-generated elevation and azimuth look-up tables as reference. Carlton Lehr, director of the observatory's ranging project, expects the simpler equipment to make measurements to within 1 meter.

The prototype laser system should be working by August at the Smithsonian's new Mount Hopkins observatory in Arizona. During a six-month checkout the new system will track the reflector-equipped Beacon Explorer and the Geophysical satellites to duplicate some NASA experiments. If the results are good the Smithsonian will ask NASA for money to buy five more of the laser systems to upgrade its tracking network.

Better accuracy. Smithsonian presently has a worldwide network of passive camera systems to determine orbital parameters by triangulation. Accuracy here has been limited to about 10 meters.

Eventually, the laser systems could be added to each of the Smithsonian's 12 satellite observatories, giving the United States its first laser tracking network. Only the French have such a network

now, with stations located in the French Alps, Greece, and Algeria.

Spacerays Inc. of Burlington, Mass., is building the laser system, which consists of two lasers in series. The instrument will use one seven-inch-long ruby rod to pump another in an oscillator-amplifier arrangement.

A Q-switch will boost output power to 500 megawatts per pulse. The 10-nanosecond pulses will be repeated at a rate of four per minute. Output beam divergence is about 6 milliradians, but the output optics can narrow this to 0.5 milliradian.

The light reflected from a satellite will be detected by an instrument built by Tinsley Laboratories Inc. of Berkeley, Calif. The detector will use a Cassegrain telescope equipped with a photomultiplier tube. The tube's output will feed a counter that will time the light pulses' round trip to within 10 nanoseconds. These signals will then be converted to a range readout.

Fail safe

Lessons learned by NASA a year ago when its Orbiting Astronomical Observatory failed aren't being wasted on the designers of the space agency's first Radio Astronomy Explorer. Engineers at the Goddard Space Flight Center are building increased internal subsystem redundancy into the craft, scheduled for launching this fall.

To ensure that the satellite, carrying the longest antennas ever used in space, will operate efficiently during its slated nine months in orbit, every circuit aboard will have a counterpart. Also, more than 200 silicon controlled rectifiers will prevent power drain from any circuit failures. Further, 115 performance parameters will be monitored during the craft's flight; an analog readout of these parameters will warn program officials of any faulty circuits.

Noise map. The satellite's mission is to study low-frequency cosmic noises—signals that are usually screened from the earth by ionospheric reflection, refraction, or absorption. It will make a galactic

150 MHz, 2.4 ns

New performance from probe tip to CRT!

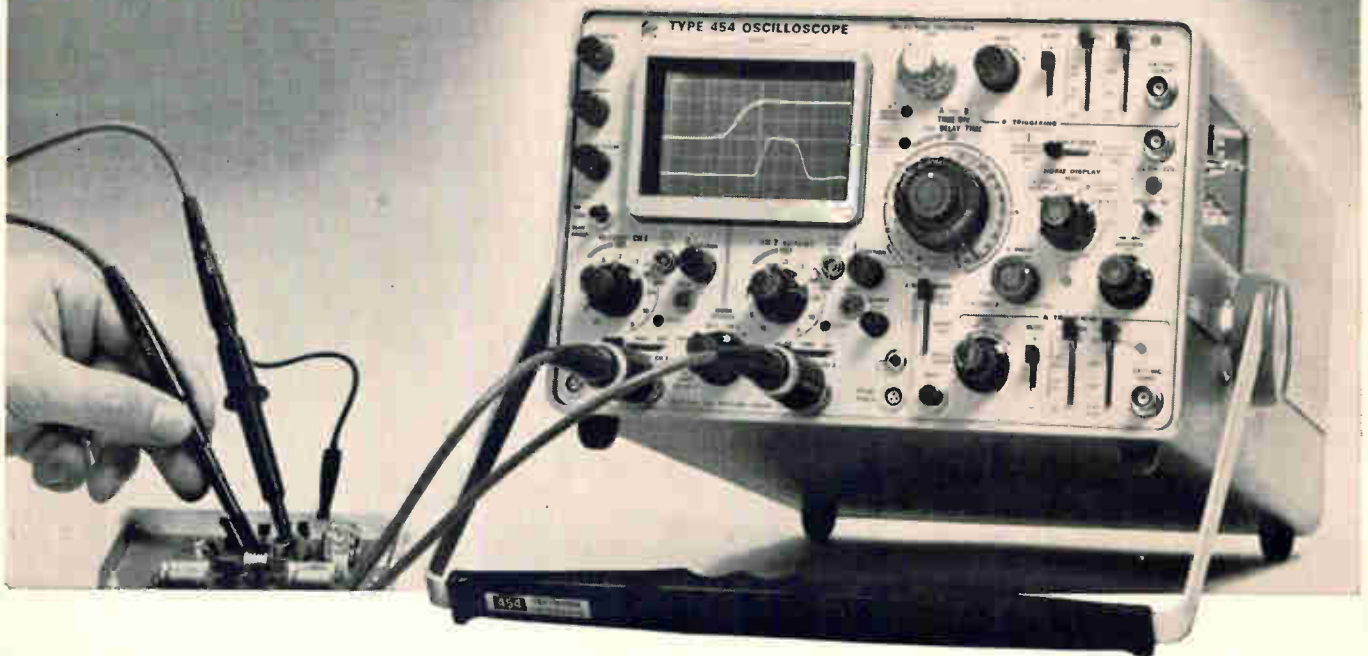

The Tektronix Type 454 is an advanced new portable oscilloscope with DC-to-150 MHz bandwidth and 2.4-ns risetime performance specified at the probe tip. The new P6047 10X Attenuator Probes and the optional FET and current probes are designed to solve your measurement problems.

The Type 454 has a dual-trace vertical, high-performance triggering, 5-ns/div delayed sweep and solid state design. You also can make 1 mV/div single-trace measurements and 5 mV/div X-Y measurements.

The dual-trace amplifiers provide the following capabilities with or without the P6047 probes:

Deflection Factor*	Risetime	Bandwidth
20 mV to 10 V/div	2.4 ns	DC to 150 MHz
10 mV/div	3.5 ns	DC to 100 MHz
5 mV/div	5.9 ns	DC to 60 MHz

*Front panel reading. With P6047 deflection factor is 10X panel reading.

The Type 454 can trigger to above 150 MHz internally, and provides 5 ns/div sweep speed in either normal or delayed sweep operation. The calibrated sweep range is from 50 ns/div to 5 s/div, extending to 5 ns/div with the X10 magnifier. Calibrated delay range is from 1 μ s to 50 seconds.

For further information, contact your nearby Tektronix field engineer, or write: Tektronix, Inc., P. O. Box 500, Beaverton, Oregon 97005.

Two P6047 Miniature 10X Attenuator Probes are included with the Type 454. They have a 10 M Ω input resistance and 10.3 pF input capacitance and provide DC-to-150 MHz bandwidth with 2.4-ns risetime performance when used with the Type 454.

The Optional P6045 FET Probe features unity gain with 10-M Ω input resistance and 4-pF input capacitance. With the Type 454 it provides a system risetime of 2.7 ns and a bandwidth of DC to 130 MHz from 20 mV/div to 10 V/div without signal attenuation. Probe power is obtained from a jack on the front panel of the Type 454.

The Optional P6020 Current Probe is easy to use with its clip-on feature and it provides up to 2.4-ns risetime and 150-MHz bandwidth when used with the Type 454.

Type 454/P6020 Characteristics (454 at 20 mV/div)

P6020	Deflection Factor	Risetime	Bandwidth
1 mA/mV	20 mA/div	3 ns	8.5 kHz to 120 MHz
10 mA/mV	200 mA/div	2.4 ns	935 Hz to 150 MHz

Type 454 (complete with 2-P6047 and accessories) \$2550
 Rackmount Type R454 (complete with 2-P6047 and accessories) . . . \$2635
 Type P6045 FET Probe (010-0204-00) \$ 275
 Type P6020 with Passive Termination (015-0066-00) \$ 135
 U.S. Sales Prices FOB Beaverton, Oregon



Research and development



... part of the Tektronix commitment
 to progress in the measurement sciences

map of cosmic noises received by its 750-foot incrementally extended antennas at frequencies between .3 megahertz and 10 Mhz. The direction of noises received at 1 Mhz and above will be accurately determined, and some directive gain will be possible at levels as low as .5 Mhz.

The crude noise map resulting from this flight will be progressively refined; plans call for three other satellites in the series to be launched at one-year intervals.

Pin cushion. The initial 420-pound craft will carry eight protruding antennas and booms: two 630-foot gravity gradient libration dampers, two 120-foot short dipole antennas, and four of the giant 750-foot antennas. The dipole antennas, made of silverplated beryllium copper alloy tape, will be used to measure intense bursts of short duration from the sun and Jupiter when the large antennas aren't properly directed to receive them.

More accurate measurements will come from the big antennas, which will form "V's" at each end of the spacecraft, because their length roughly corresponds to one wavelength at 1 Mhz. Twin vidicon cameras will be trained on the tips of the long antennas to check their behavior.

The first satellite in the series will be launched by a thrust-augmented Delta booster from the Western Test Range into a 3,700-mile circular orbit at a 58°-to-60° inclination. Cost of the first two craft being built at Goddard is put at \$15 million.

Advanced technology

Impatt's impact

"Within a year we should see prototype systems with avalanche diode power sources, and the most likely initial application will be in a portable doppler radar system," says Frank Brand, director of microwave research at the Army's Electronics Command, Fort Monmouth, N.J.

Brand's prediction, made this

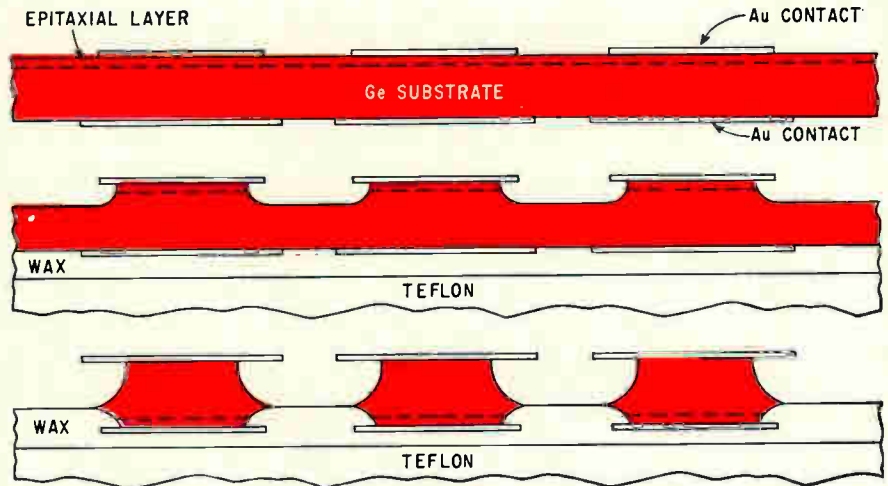

How to make an Impatt. Gold contacts are first deposited on both sides of a germanium slice. With a Teflon and wax support on the opposite side, the junction side is then etched. Finally, the slice is inverted and the diode pellets are etched out. This time the junction side is supported by Teflon and wax.

month at the International Microwave Symposium, came after Bell Telephone Laboratories' report that its silicon Impatt (impact-avalanche and transit-time) diode had achieved continuous-wave output power of 4.7 watts at 14 gigahertz with 9% efficiency. This is the highest c-w power level yet achieved from a solid state microwave oscillator.

Barney C. De Loach Jr., who heads the semiconductor device physics department at Bell Labs, indicates that much attention is also being given to germanium diodes. Although output powers are lower than those achieved with the silicon devices, efficiencies are somewhat higher, and the noise performance is improved by an order of magnitude. Frequency-modulation noise characteristics close in to the carrier are better than those obtained with currently available klystrons, suggesting the use of germanium diodes as local oscillators in communications systems.

Consumer electronics

Off color

Auto manufacturers, it turns out, aren't the only firms forced to rec-

tify potentially dangerous design defects in products already sold. The General Electric Co. conceded this month that some of its large-screen color television sets are emitting "soft X-radiation in excess of desirable levels," and announced plans to modify 90,000 sets in homes all over the country.

GE spokesmen hastened to note that the X rays are "directed toward the floor, not the viewer" and that "nationally recognized radiology experts confirm that the emissions aren't sufficient to cause harm." In the interest of "improving performance and reliability," however, the company said it is launching a nationwide effort to remedy the problem by July 31.

Troublespots. The defect, which first showed up in GE quality-control tests, involves only sets produced between June 1966 and last February. The problem isn't in the picture tube, company sources indicate, but is in the regulator tube and high-voltage power supply. Dealers are contacting buyers of the 90,000 sets and will send servicemen to replace the regulator tube and adjust the power supply at "no cost to the owner."

Legislation to create a national commission on product safety is on its way through Congress right now. Electrical appliances are covered in the bill.

The industry was stunned by GE's

ANNOUNCING...

The *WORLD'S* most compact *QUALITY*

CERAMIC TRIMMER CAPACITOR



AMAZING 5 to 25 pF. CAPACITANCE RANGE IN LESS THAN .007 CUBIC INCH

A precious jewel? Not at all... This is a new subminiature Ceramic Trimmer Capacitor. It represents the most significant development in variable capacitors in more than a decade... and again Erie leads the State of the Art. The tiny 518 occupies only .007 cubic in... and has an incredible capacitance range of 5 to 25 pF. Operating temperature range: -55°C to 125°C. — Working voltage 100 WVdc to 85°C; 50WVdc to 125°C. The unit exhibits remarkable ruggedness, being a development from Erie's exclusive Monobloc Process®. The Monobloc rotor with its sealed electrode provides stability under extreme environmental conditions. The 518 permits rigid mounting in both printed circuit and point to point wiring applications. Tuning linearity is assured by precision lapped bearing surfaces.

This compact little trimmer is the ultimate in volumetric efficiency... after all, it's only .218" in diameter — almost the size of a precious jewel.

ERIE OFFERS THE MOST COMPLETE SUBMINIATURE TRIMMER CAPACITOR LINE IN THE INDUSTRY...



CERAMIC



AIR



GLASS AND QUARTZ



PLASTIC

Another Series of Components in Erie's Project "ACTIVE"
Advanced Components Through Increased Volumetric Efficiency



Erie, Pennsylvania

announcement. At the Electronic Industries Association a spokesman who could hardly believe what he heard said, "It's unthinkable; GE tests all its sets before they leave the factory."

On the right track?

By taking advantage of the conventional approach used in audio tape recorders—recording the signal down the tape longitudinally—Newell Associates Inc. expects to have a \$1,250 color video tape recorder on the market within the year. Moreover, C.W. Newell, head of the small Sunnyvale, Calif., research concern, predicts that in three years the price will be down to \$500. By contrast, the Ampex Corp.'s most inexpensive black-and-white video recorder sells for \$1,100.

If Newell is right, leading video tape recorder producers, such as Ampex and the Sony Corp. will have missed the boat in abandoning longitudinal recording in favor of helical and transverse techniques, which utilize a moving head.

Experts who saw the new tape transport for the first time this month at the National Telemetry Conference in San Francisco agreed that it was novel and simple and promised a good cost-to-performance ratio, but some doubted that the unit could retain its high-performance characteristics if it were mass produced.

The design of the Newell transport is surprisingly simple: two flangeless reels are butted against a large, powered capstan, whose own rotary motion moves the tape from one reel to another. There is no point at which the tape runs free, and there is almost no tension on the tape. The single recording head is also pressed against the capstan.

Show off. With show-business fanfare that would have served for the opening of a Liz Taylor film, Newell showed a preview audience flawless color in a recording of the Lawrence Welk Show made on 1/4-inch tape with 16 tracks, each 10 mils wide. A color tv recording takes two tracks, and the tape takes

about four minutes to make one pass through the recorder; Newell got 32 minutes of color tv on a reel. There was a picture flicker every four minutes as the tape changed direction and the head indexed to the next track.

Newell also displayed a conventional audio system, and an instrumentation recorder that operates in a 12-megahertz bandwidth and is rated at 1,000 inches per second. The company claims a potential speed of 4,000 ips in a 50-Mhz bandwidth. Turnaround time at the end of the tape can be as low as 100 milliseconds—still too slow for some instrumentation applications, but only a mild annoyance with tv and audio recordings.

The Borg-Warner Corp. will produce and market the instrumentation recorder under a license. Newell wouldn't say who would turn out the home television unit, but industry insiders say the company has a link with Arvin Industries, which has been dropping hints lately about making a tv recorder.

Open and shut. Newell was free with performance figures on the transport, but close mouthed about its mechanical and electronic details. The tv recorder apparently uses band-splitting techniques to record on two tracks, and consequently must alter the NTSC signal as it records it, and return to NTSC so that the receiving tube can display it.

The tv set used must be modified because longitudinal recording has poor time-base stability that can put the horizontal scan out of synchronization. Newell estimates the typical cost of such a modification at \$30 to \$40; some recorder experts question this figure, however.

Moreover, there are serious doubts about the repeatability of the high-performance characteristics. To maintain performance levels, one industry source says, tolerances would have to be so tight that costs would skyrocket. Compatibility between different manufacturers' tapes as well as the effect of temperature cycling during tape storage were also cited by observers as potential problems.

When asked about another possible problem—the effect of a me-

chanical splice on the tape—a Borg-Warner spokesman said that if the splice made the tape overlap, the resulting small bump could break the tape. This would cause it to fly off the recorder. But Borg-Warner and Newell asserted that normal, careful handling would make this possibility remote. Because air is squeezed out as the tape runs onto the takeup reel, the reel itself is extraordinarily stable. Newell bounced one reel on the floor during the demonstration to prove its stability.

Avionics

Matchmaker

Area correlators, room-size analog computers used for ground-based photo interpretation, may be given a new job now that Autonetics—using digital circuitry and large-scale integration to make it small enough to fit into an airplane or missile—has slimmed one down to 14 pounds.

The design, developed in-house by the North American Aviation Inc. division, could form the basis of real-time systems for guiding a plane or missile to its target. The airborne correlator would compare previously taken aerial photos or radar displays with scenes viewed by the craft as it flew over the area. Autonetics' next step may be an unsolicited proposal to the Air Force to design a correlator for use in a missile guidance system or airborne navigator.

Light and dark. The new correlator uses 64 large-scale integrated metal oxide semiconductor circuits to reduce chassis size to 7 by 8 by 11 inches, and power drain to less than 10 watts. Reference photo or radar data is run through an analog-to-digital converter and stored in a memory consisting of 32 100-bit mos shift registers. Each shift register contains 630 transistors. The memory can hold a 2,304-bit rectangular master map in a 48-by-48-bit matrix.

The memory also stores smaller

don't confuse it with a tube...



Actual Size

RCA's new 40468 (MOS)FET performs like a tube with its exceptionally low cross modulation, high unneutralized gain and wide dynamic range, but it's a solid state device.

Now for the first time you can design solid-state front-ends for hi-fi FM radios, receivers, and tuners without compromising performance or sacrificing gain...at economy prices!

Because of its excellent square law characteristics and wide dynamic range, the new RCA 40468 (MOS)FET can greatly reduce spurious responses and interference from undesired signals. Very low cross modulation distortion makes it an exceptionally fine RF amplifier or mixer, offering noticeably better performance than is possible with bipolar transistors.

Extremely low feedback capacitance (0.2 pF max.) provides as much gain *without* neutralization as junction

FET types do with neutralization, so you can reduce production costs. If neutralization is added, even more stable gain can be achieved.

In addition, the RCA 40468 (MOS)FET's insulated gate permits large signal swings to be handled at the maximum gain point without input circuit detuning or loading.

Investigate the advantages of designing RCA's 40468 (MOS)FET into FM receivers, tuners, and auto radios. Your RCA Field Representative will be glad to give you complete information, including price and delivery. For a technical data sheet, write RCA Commercial Engineering, Section EN5-2, Harrison, New Jersey 07029.

ALSO AVAILABLE THROUGH YOUR RCA DISTRIBUTOR.



RCA Electronic Components and Devices

The Most Trusted Name in Electronics

digitized maps as large as 24 by 23 bits. Displayed on an oscilloscope, the stored maps look like rectangles of light and dark squares; their pattern varies with the terrain in the original display.

Correlation is performed in a parallel arithmetic mode. Rather than correlating line by line as in analog systems, Autonetics' correlator sequentially matches the entire smaller map to all possible locations on the master map. Depending on map size, correlation can be achieved in less than 1/2 second.

As the small map is compared with various areas on the master, counters keep a running total of the number of matches between light and dark squares. The section of the larger map having the highest number of matches indicates the location of the smaller map. A numerical readout shows the number of matches and gives the coordinates of the smaller map's location.

Through the clouds. Although the number of bits per map is relatively low with Autonetics, system, good correlations have resulted even with fuzzy displays. The device works well even with low-resolution photographs taken through heavy cloud cover.

The Aeronutronic division of the Philco-Ford Corp. and the Cornell Aeronautical Research Laboratory have classified correlator development contracts. The Aeronutronics correlator is reported to be almost as bulky as an analog system.

Design theory

Worth the trip

Engineering seminars in small university towns rarely attract much attendance because the papers are usually so bad. But this month a large contingent of notable circuit theorists traveled to West Lafayette, Ind., to attend the 10th Midwest Symposium on Circuit theory at Purdue University.

Behind the unusual pilgrimage of over 150 engineers was a program full of high-quality presenta-

tions. Most reflected a changed emphasis in Government-sponsored research and development: Government agencies are now willing to pay for research by design theorists. Previously, the Government would foot the bills only for hardware-oriented research.

Government agencies have so stepped up their financing of this new type of study that they are paying universities three times more for pure theoretical research than they were five years ago. NASA, for example, has been a prime stimulus in computer-aided design, financing seminars, the writing of new programs, and the design of computer models.

Among the contributions made at Purdue's seminar:

- Jacob Shekel of Spencer-Kennedy Laboratories Inc. described a new programming language for linear network analysis at a remote terminal.

- S.D. Bedrosian of the University of Pennsylvania offered topological guides to integrated RC circuit design.

- E.A. Davila of the University of Notre Dame discussed the synthesis of multiflow networks.

- J.F. O'Neill of New York University reported on how to design frequency-selective admittances using resonators.

For the record

Obstruction site. With New York City's major television stations planning to move their transmitters from the Empire State Building downtown to the Port of New York Authority's planned World Trade Center, metropolitan-area viewers are in for some scrambled pictures over the next few years. Before the transfer, the rise of the Trade Center will affect some transmissions; afterward, reflections from the Empire State Building will be a problem.

Two-tone tube. Red and green are displayed on a one-gun tube now commercially available from Sylvania Electric Products Inc. The device is designed to replace monochrome tubes in displays of infor-

mation ranging from air-traffic patterns to stock prices.

Getting it on the road. New York City, which had hoped to have automatic traffic control in midtown Manhattan by the end of this year, must now wait until September 1968 for delivery of the first set of workable equipment from the Sperry Gyroscope Co. Sperry, which faced cancellation of its \$5.4-million contract for traffic sensors and controllers, [Electronics, April 17, p. 54], has beefed up its development group and assigned a new project director to salvage the program. Also, instead of supplying individual components, Sperry will assemble, pretest, and deliver systems capable of directing traffic within relatively large areas. Says a Sperry spokesman: "We wish we'd done this in the first place."

Power plus. The Eimac division of Varian Associates has developed a 500-kilowatt continuous-wave klystron. The output is said to be the highest available for this tube type. Designated the X3070, the tube has been delivered to the Jet Propulsion Laboratory for use with one of the lab's tracking antennas at Goldstone. The 1,200-pound five-cavity tube has 56% efficiency, 56-decibel gain, and is tunable over a 2.35-to-2.445-gigahertz band. The tube's frequency range makes it suitable for microwave heating applications. It could also power linear accelerators.

Freight fiasco. A force composed of KLM Royal Dutch Airline employees and university students has been busy sorting parcels at Amsterdam's Schipol Airport because a new all-electronic, \$1.4-million freight-handling system is not working. The system, supplied by Dorteck Inc. of Stamford, Conn., failed in its first week of operation because the IBM 360 computer used to code freight for stacking did not function. Computer ills were laid to inexperienced operators who did not have time to practice on the system, which was delivered late, and high temperatures in the computer room. Now the solid state 360 will get its own air conditioner and Dorteck specialists are in Amsterdam training the operators.

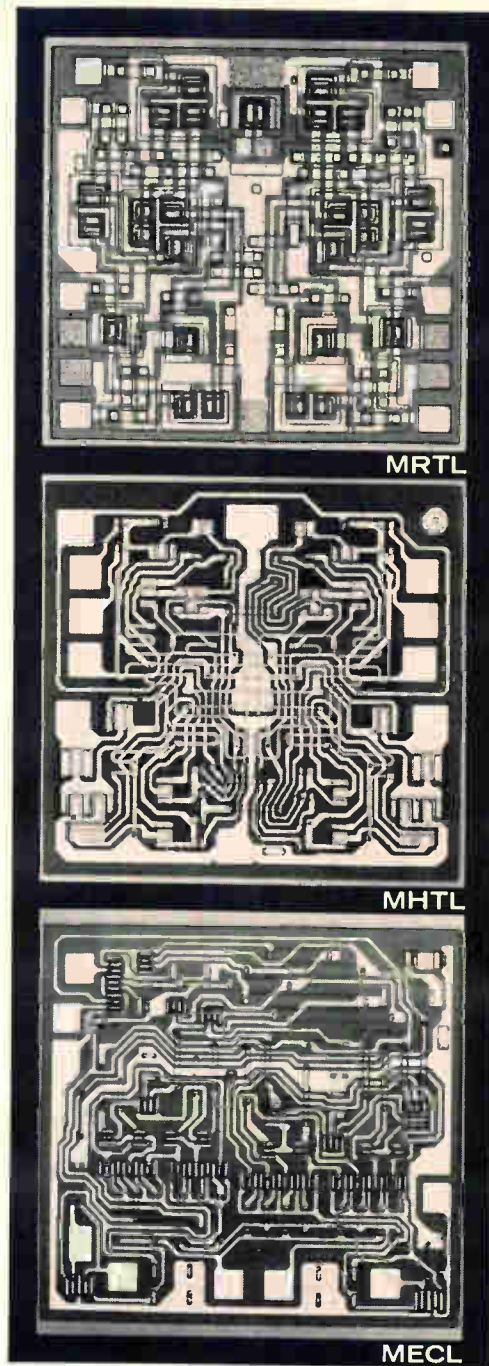
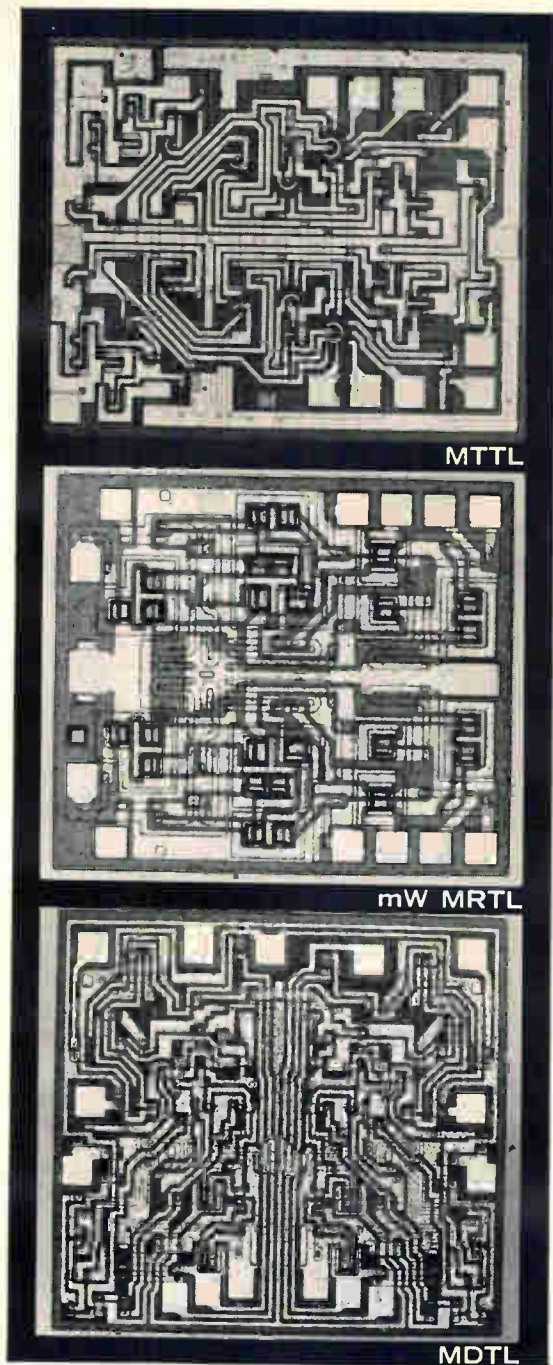

... digital integrated circuits

Only Motorola Makes them All!

(And More Linear Circuits, Too).

Send for a free copy of our new
integrated circuits full-line brochure.



CAIN & CO. OFFICES

★ LOS ANGELES, 213 / 783-4700

★ BOSTON, 617 / 665-8600

★ CHICAGO, 312 / 253-3578

★ DALLAS, 214 / 369-2897

★ DAYTON, 614 / 861-2119

★ NEW YORK, 914 / 337-3445

★ PHILADELPHIA, 215 / 664-3797

★ SAN FRANCISCO, 415 / 948-6533

★ SYRACUSE, 315 / 437-2933

★ WASHINGTON, 202 / 296-8265

★ SOUTH AMBOY, 201 / 727-1900

★ HUNTSVILLE, 205 / 859-3410

★ ORLANDO, 305 / 422-3460

★ SAN DIEGO, 714 / 278-1031

★ MONTREAL, 514 / 844-0089

(See the full Sperry line at Booth 200 in the Microwave Exposition.)

If you would like a simpler way to select and specify microwave components, Sperry has the answer, and the answer is your Cain & Co. representative. He now serves as your single source for such outstanding Sperry products as:

ISOLATORS • CIRCULATORS

MICROWAVE SOURCES • BWO — klystron — solid-state

AMPLIFIERS • Klystron — traveling wave — parametric

MICROWAVE ACOUSTIC DELAY LINES
PHASE SHIFTERS

Why not speed up your job by talking to the Cain man? He has the products, the technical knowledge and the close factory liaison it takes to help you build a better system faster.

Write for your free catalog. It shows the whole family of microwave components designed, developed and manufactured by:

SPERRY MICROWAVE ELECTRONICS CO.
Clearwater, Florida

SPERRY ELECTRONIC TUBE DIVISION
Gainesville, Florida

Now it's easier to buy any Sperry microwave component because you can buy them all from one man.

Your Cain & Co. man.

Washington Newsletter

May 29, 1967

NASA drafted for war work

The civilian space agency is working on military projects. Much of the research in support of the Vietnam war is going on at the Jet Propulsion Laboratory, but other NASA centers are contributing.

NASA and Pentagon officials decline to discuss the nature of this work, the number of NASA employees involved, or the number of military projects under way. However, it's known that JPL, for example, is developing an acoustic mortar detector.

Space officials will say only that NASA is responding to Defense Secretary McNamara's call to all Government agencies to lend a hand in the war effort—particularly in the limited-war field. NASA scientists have been ordered to keep on the lookout for technology that could aid the military. And NASA researchers with experience in a critical area could be assigned to a military project while remaining on the NASA payroll.

NASA's authorization in this area is hazy. Officials point to a section in the National Aeronautics and Space Act of 1958 that directs the agency to make available to defense organizations "discoveries that have military value or significance." Another part of the act, however, bars NASA from engaging in activities "peculiar to, or primarily associated with, the development of weapons systems, military operations, or the defense of the U.S."

Vance seen quitting Pentagon; Brown tabbed as successor

A physicist may be replacing a lawyer in the number two job at the Pentagon. Cyrus Vance, Deputy Secretary of Defense, is expected to resign soon because of a long-time back ailment. He will probably be succeeded by Harold Brown, current Air Force Secretary and former director of defense research and engineering. Brown's replacement is also expected to be a present top-level Pentagon official.

Brown, a former nuclear scientist was one of the first of the "whiz kids" brought by McNamara to the Pentagon. While he has generally followed McNamara's lead, he is supporting the development of an advanced manned bomber and an antiballistic-missile system, both opposed by McNamara.

Vance, known to be a favorite of President Johnson's, had been considered the logical successor to McNamara. But McNamara, who has already established a longevity record in his post, is reluctant to leave it before a turning point is reached in the Vietnam war. Vance's anticipated resignation appears to make McNamara's immediate departure even more remote.

IBM will market a teaching system based on study job

IBM plans to market a computer-assisted instruction system based on the design it will explore for the U.S. Office of Education under a contract awarded this month. In IBM's approach, the central processor would not only handle time-shared instruction of students, but would perform batch processing of such school administrative functions as record-keeping and class scheduling. The portion of the processor working on each job would depend on the workload. Using the computer in this manner would go a long way towards overcoming a major hurdle for CAI: high cost.

IBM received \$85,000 to study the feasibility of designing a central

Washington Newsletter

computer facility to serve 50 high schools and junior colleges in a 100-mile radius. IBM will concentrate on the hardware, while the General Learning Corp. will work on software under a parallel \$129,050 contract. Some 38 firms bid for these orders.

If the studies work out, the two firms will design a model system to instruct students in programing computers as well as other subjects. The Office of Education hasn't decided whether it will finance the production of hardware if the feasibility studies are successful, but that could be the next step.

Defense spending swamps forecasts

The flow of military contracts in the closing months of fiscal 1967 has grown into a wave that will spill over into fiscal 1968. The quickened pace of spending has boosted predictions of total orders in the current year to \$42 billion from the \$37 billion anticipated just five months ago. Estimates of the resulting deficit in the proposed \$73 billion fiscal 1968 budget now range from \$700 million up to \$5 billion.

Pentagon, industry on the defensive

Industry trade groups and the Pentagon are mounting a quiet campaign to convince a Senate antitrust subcommittee that relatively few firms have the know-how or desire to build complex military systems. They are arguing that fewer, but costlier, systems are being built and that competition for these contracts is usually quite sharp.

The reason: both the Pentagon and industry are fearful of getting black eyes in the nation's press when the committee's upcoming probe digs into why half the dollar volume of military prime contracts goes to 25 firms. The committee wants to know whether Pentagon procurement policies tend to inhibit competition, and why so many defense companies are merging.

It's hi-ho silver, better buy pronto

Higher prices for silver are almost certainly ahead for electronics companies. Within a year, the Treasury is expected to get out of the silver business altogether—and when it does, the \$1.29-per-ounce ceiling the Government has maintained will go with it. Indications are that the price could soar as high as \$1.50.

Closer at hand, the Treasury's decision this month to halt the sale of silver to everyone but industrial users won't affect the electronics industry—a big user of the metal, which is the best conductor. The move was aimed at stopping private hoarding that threatened to exhaust the Government's supply. Once the price climbs high enough—past \$1.40—it may pay to melt silver coins still in circulation. As much as 1.2 billion ounces of silver could be reclaimed by melting—enough to meet the nation's needs for years.

Outlook is dim for patent reform

Administration sources are conceding it's unlikely that the patent reform bill will get through Congress this session. One of the roadblocks is the mounting opposition on Capitol Hill to the section that would change the criterion for granting patents from "first to invent" to "first to file." Opponents charge that the "first to file" test would reward the speculative inventor and encourage industrial espionage.

How did Aerodyne meet the Space Program's most rigid cleaning requirements? By switching to Freon[®]

Two years ago, Aerodyne Controls Corporation of Farmingdale, New York, developed a new-type gas-bearing regulator for use on instrument panels of space vehicles. However, to sell the unit for use in the nation's Space Program, Aerodyne would have to *clean* it to meet inspection standards of the utmost stringency. For a speck of dust on the bearing could abort an entire mission.

Aerodyne developed a white room and tested several cleaning agents, but failed to pass inspection. The problem wasn't solved until a Du Pont salesman arrived one day and left a gallon of FREON* for testing. *It worked!* Since then, Aerodyne has cleaned over 20,000 regulators and other parts for the space industry *without a single rejection.*

One reason FREON is uniquely effective is its low surface tension that allows it to penetrate small orifices, a critical and most difficult area to clean. FREON leaves practically no residue and its drying time is extremely rapid. Also, its toxicity is extremely low.

During the cleaning operation, FREON is used in three forms: as a liquid in the ultrasonic bath (right), as vapor in the degreaser, and, finally, as a spray rinse. In each case, FREON is constantly filtered, distilled and re-circulated.

Do you have a tough cleaning problem that FREON can solve? Your first step in finding out is to write: Du Pont, Room 145B, Wilmington, Del. 19898. (In Europe, write Du Pont de Nemours International S.A., FREON Products Division, 81 route de l'Aire, CH 1211 Geneva 24, Switzerland.)

FREON[®]
solvents



Better Things for Better Living... through Chemistry

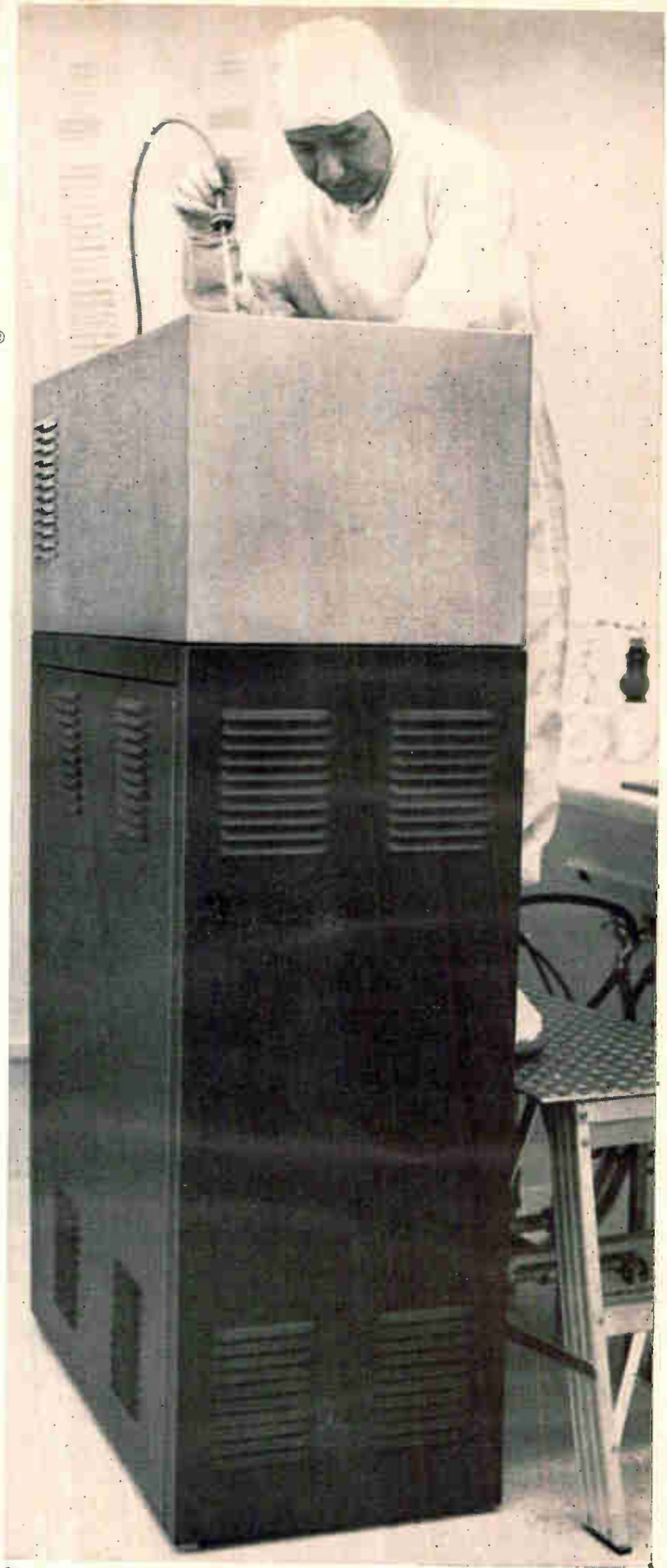

*Du Pont registered trademark for its fluorocarbon cleaning agent.

Winchester Electronics
just changed the shape
of the high density
connector market.

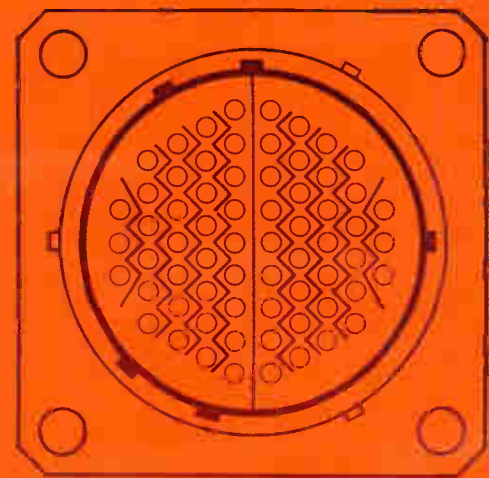
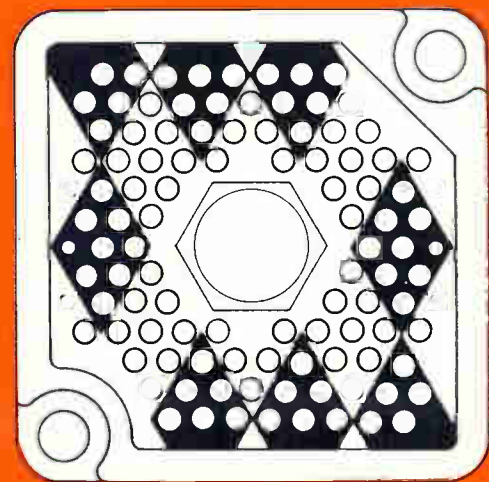
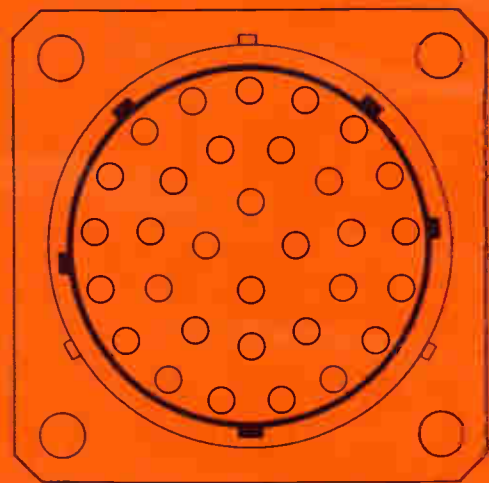
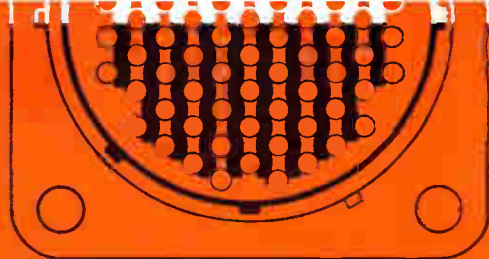

We put more contacts into the connector, more connectors into the mounting space, and more ease into the installation.

We call it the SQC Square High Density connector. It gives you 100 contacts and provision for six polarizing pins in an MS size 18 shell area. And lets you mate them with a single center jackscrew. The result: a true high density connector that can do the job of up to three size 18 shell connectors.

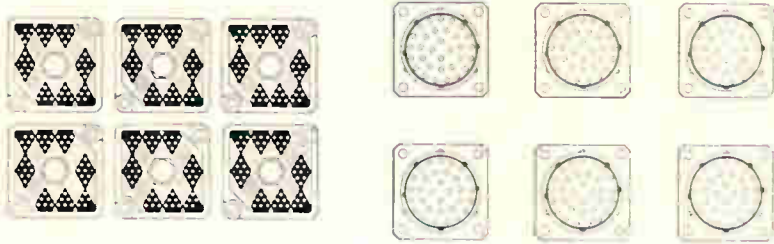

Exclusive square SQC design eliminates need for service area required between cylindrical connectors. Area for multiple mounting is reduced almost 50%.

Specifications are equally impressive: Cost per mated contact is about \$.25. Contacts are removable crimp, .030 diameter, rated at 5 amps, accommodating #20 through #32 wire. Shell is integral, polarized and made of tough thermoplastic for rugged duty and minimum weight.

Winchester Electronics' new SQC Series is designed for controlled environmental applications such as computers, office equipment, commercial, industrial and military-type installations. SQC Connectors are now on the shelves of your Winchester Electronics distributor. You'll be surprised at the exciting design possibilities that will start taking shape when you use them. For more information, contact Winchester Electronics, Main Street & Hillside Ave., Oakville, Conn.



WINCHESTER ELECTRONICS

DIVISION OF LITTON INDUSTRIES

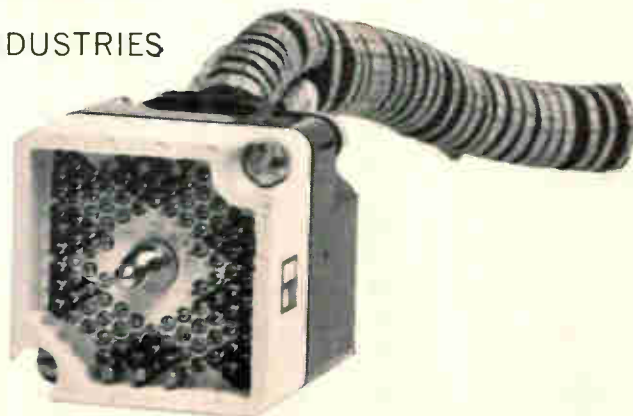
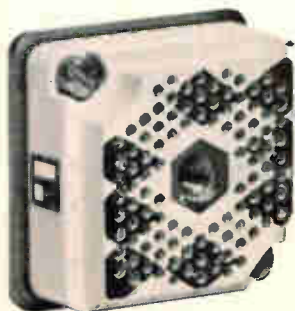

Circle 63 on reader service card



ECI's microelectronic switching systems have automatic solid-state pathfinding, handle voice or data and are compatible with existing system terminals.



Microelectronic multiplexer achieves dramatic reduction in size and weight. Each bank handles 12 channels of audio, data or teletype. Overall systems can be configured in any multiple of 12 channels.



Delegate your communication system size and weight problem to us.

If we haven't
already solved it,
we will. That
goes for your
compatibility,
message integrity
and dependability
problems too.



ELECTRONIC COMMUNICATIONS, INC.
ST. PETERSBURG DIVISION

To investigate career opportunities in
communications, call or write Mr. Chuck Kelly,
Professional Placement Office, Electronic
Communications Inc., P.O. Box 12248,
St. Petersburg, Florida 33733.
Telephone (813) 347-1121. (Equal opportunity
employer, M & F.)

(Saturn V
photo by NASA.)

Circle 65 on reader service card



Ultra-reliable microelectronic transceiver for airborne
systems has all-electronic instant tuning with an
order of magnitude improvement in MTBF.

Now in development — a microminiaturized flight
control computer for advanced space programs.

The Unbeatable IC System:

Your logic design and Raytheon Computer modules and hardware.

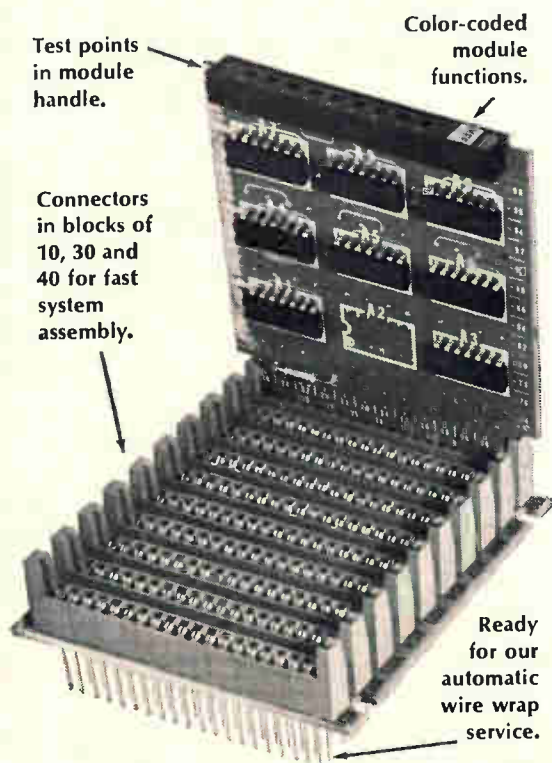

Laminated power bus bars installed and wired in each module case. Reduces noise, eliminates power inter-connections, cuts hours from assembly and test time.



Indicator lights display system operation.

This case holds 120 modules. There's also one for 40; another for 400.

Raytheon Computer's M-Series — more than 30 modules—connectors, cases, power supplies and power distribution are so thoroughly engineered you can concentrate on logic and electronic design, not mechanical details. Every step—design, assembly, test, check-out, troubleshooting—is easier than you thought it could be.

We'll even help you design your logic. Call or write today for a visit from a helpful applications engineer or for the whole story in print. Ask for Data File M-136. Raytheon Computer, 2700 S. Fairview St., Santa Ana, Calif., 92705, Phone: (714) 546-7160.



First from Westinghouse: 1.5 to 40 amp plastic rectifiers with more hermeticity than you need.

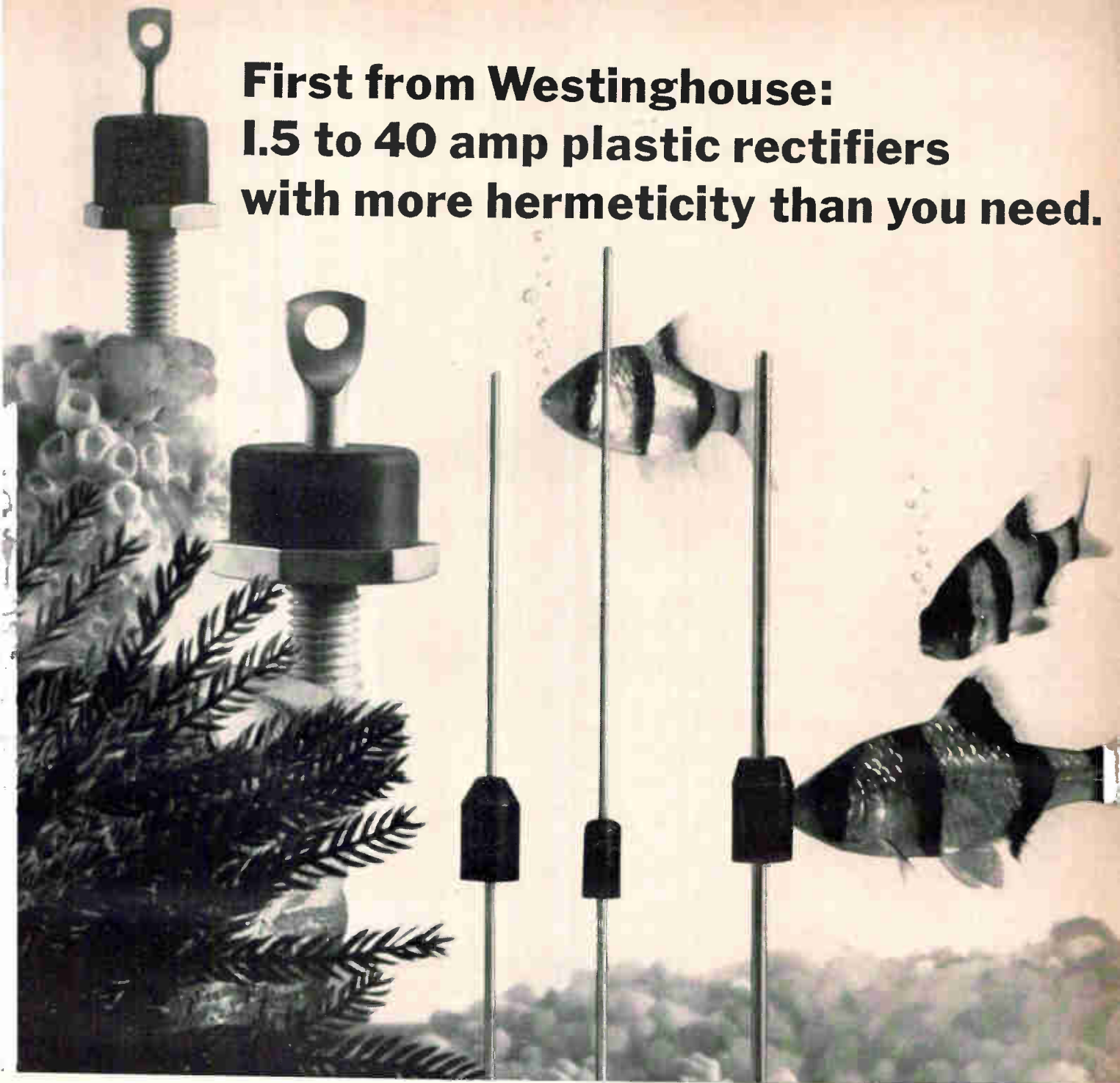

WESTINGHOUSE PLASTIC RECTIFIERS CHARACTERISTICS

Type	Suggested Retail Price*	Fwd. Current @ Temp °C	Surge Amps	Max. T _j	I ² t	Voltage
384	.30	1.5 40°T _A	50	175°C	10	50-1000
359	.30	1.5 40°T _A	50	175°C	10	50-1000
(1N4816)						
398	.42	3.0 50°T _A	200	175°C	167	50-1000
407	.57	5.0 150°T _C	125	175°C	65	50-600
408	.60	10.0 150°T _C	175	175°C	127	50-600
409	.64	15.0 125°T _C	250	175°C	260	50-600
417	1.57	20 150°T _C	350	175°C	490	50-600
418	1.61	25 145°T _C	400	175°C	640	50-600
419	2.01	40 120°T _C	500	175°C	1000	50-600

Price in 100 piece quantities for 200 PRV device

Our 1.5 to 3 amp plastic lead-mount diodes are becoming the industry standard. And now, only from Westinghouse, you can get plastic stud-mount rectifiers from 5 to 40 amps.

We give you plastic economy with metal case performance for all your rectifier needs. Voltages range from 50 to 1000 V, forward or reverse polarity. No matter what your application, Westinghouse is the first place to go for the broadest line of plastic rectifiers.

Hermeticity? These rectifiers could easily work in a fishbowl. They're tested in live steam at 15 psig for 2 hours. In other performance parameters, they measure

up equally well. Look over the characteristics table here.

Why pay a premium for a metal case? In virtually all applications, there is no need. Westinghouse plastic rectifiers are a totally practical equivalent. Advanced

manufacturing techniques and a proprietary junction coating combine to produce a completely stable device at lower cost.

Send for our brochure SA-9892 on the Westinghouse plastic rectifier line. These, plus other rectifiers, thyristors, and power transistors can help keep your products competitive into the 1970's. Call your Westinghouse Semiconductor Distributor. Or write Westinghouse Electric Corporation, Semiconductor Division, Youngwood, Pa. 15697.

You can be sure
if it's Westinghouse



SC 2090

Circle 67 on reader service card



Since 1 in 10 integrated circuits in use are our own UTILOGIC units, we thought the line deserved its own handbook. It's yours. Free.

It's the first applications handbook of its kind. Make it your very own. It will give you 32 pages of everything you need to know about using UTILOGIC. Signetics introduced UTILOGIC in 1964; it was the first line designed specifically for the commercial and industrial market. Customers bought them by the millions. No wonder. The UTILOGIC series offers 800 mv minimum noise margins, fan-outs of up to 17 from Gates and J-K Binary and high capacitive drive capability. SU-element operation is guaranteed from -20° to $+85^{\circ}$ C, and LU-elements from $+10^{\circ}$ to $+55^{\circ}$ C. Send for your own UTILOGIC Handbook. Write: Signetics, 811 E. Arques Avenue, Sunnyvale, California 94086.

**SIGNETICS
INTEGRATED
CIRCUITS**

A SUBSIDIARY OF CORNING GLASS WORKS

SIGNETICS SALES OFFICES: Metropolitan New York (201) 992-3980; Upper New York State (315) 469-1072; Southwestern (214) 231-6344; Western Regional (213) 272-9421; Eastern Regional (617) 245-8200; Mid-Atlantic (609) 858-2864; Southeastern (813) 726-3734; Midwestern Regional (312) 259-8300; Northwestern (408) 738-2710.

DISTRIBUTORS: Compar at all locations listed below. Semiconductor Specialists, Inc. (312) 622-8860; Terminal Hudson Electronics (212) 243-5200; Wesco Electronics (213) 684-0880; Wesco Electronics (405) 968-3475; Colorado (303) 781-0912; Connecticut (203) 288-9276; Florida (305) 855-3964; Illinois (312) 775-5300; Maryland (301) 484-5400; Massachusetts (617) 969-7140; Michigan (313) 476-5758; Minnesota (612) 922-7011; Missouri (314) 428-5313; New Jersey (609) 429-1526; New Mexico (505) 265-1020; New York (518) 436-8536; New York (607) 723-8743; New York (201) 471-6090; North Carolina (919) 724-0750; Ohio (216) 333-4120; Ohio (513) 878-2631; Texas (214) EM 3-1526; Texas (713) 649-5756; Washington (206) 725-7800.

INTERNATIONAL SALES: France, Germany, Italy, Belgium, Holland, Luxemburg, Spain - Sovcor Electronique, 11, Chemin de Ronde, Le Vesinet, (S.-&O.) France. United Kingdom, Ireland, Sweden, Denmark, Norway, Switzerland, Austria, Portugal - Electrofil Ltd., Lakeside Estate, Colnbrook-Bypass Slough, Buckinghamshire, Great Britain. Australia - Corning, 1202 Plaza Building, Australia Square, Sydney, N.S.W. 27-4318. Canada - Corning Glass Works of Canada, Ltd., Leaside Plant, Ontario, Canada (416) 421-150. Israel - Optronix, P.O. Box 195, Ramat-Gan, Israel 724-437. Japan - ASAHI Glass Co., Ltd. Corning Products Sales Dept. No. 2, 3-Chome Marunouchi, Chiyoda-ku, Tokyo, Japan.

**if you could
find a more
stable
polyester film
you'd use
it.**

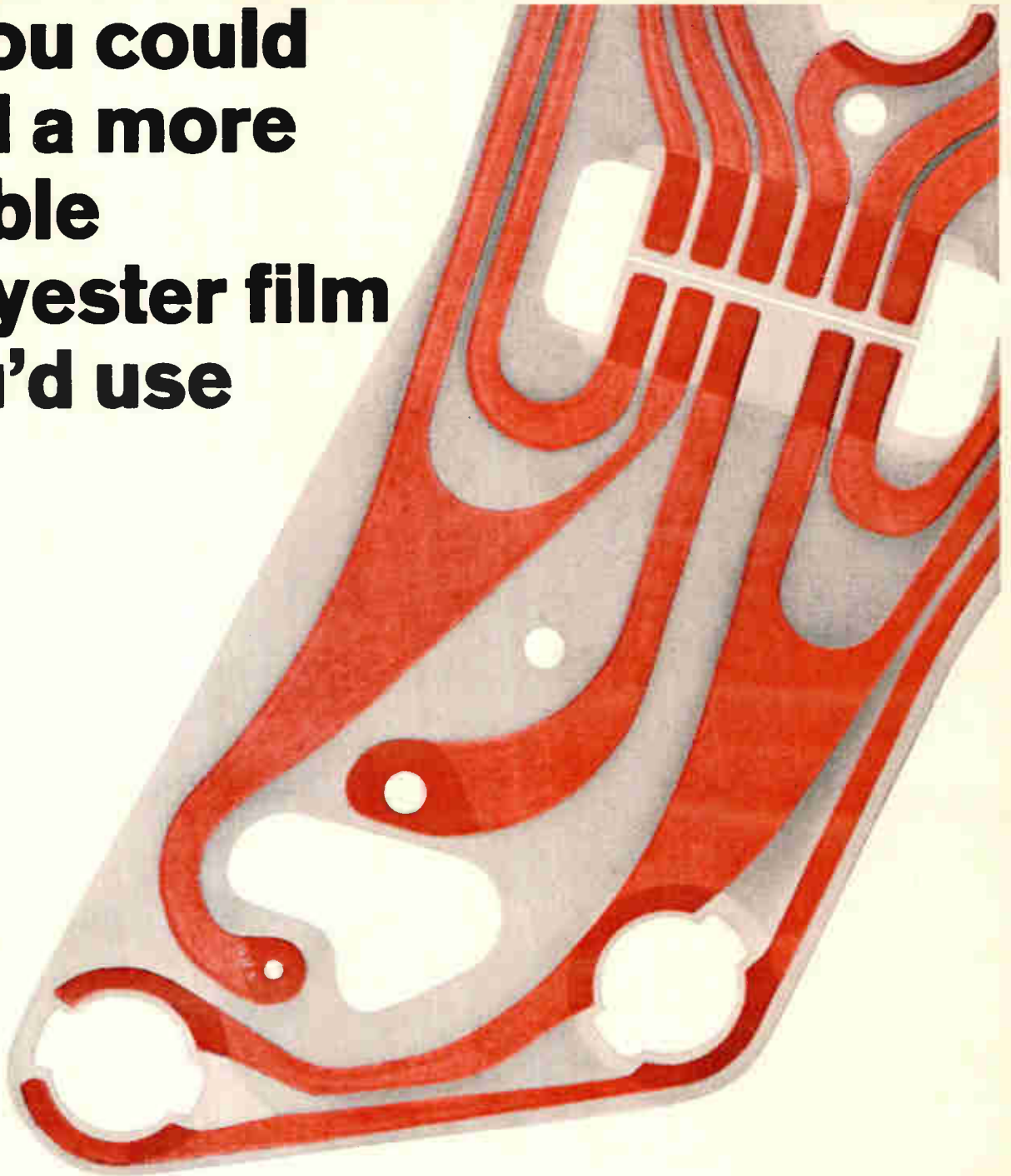

right?

Users report a measurable stability advantage with Celanar polyester film. In printed circuits Celanese polyester film means less shrinkage—hence a more reliable circuit.

Celanar has other substantial advantages, too. Its tensile (pull) strength is 30% stronger than other films. And Celanar film is the cleanest, freest from contamination, in the industry. We produce Celanar in a "White Room" where air filtration systems effectively trap dirt specks as tiny as 0.3 microns—infinitesimal as the point of a needle.

What's more, we lean over backwards to supply

Celanar film in the roll lengths, widths and gauges most convenient for you. Ship it with temperature recording flags, even impact recorders where necessary, to assure your receiving quality as high as we produce.

Those are reasons why major automotive manufacturers use Celanar film for under-the-dash printed circuitry. And why you should know the full facts about Celanar film. All it takes is a letter to: Celanese Plastics Company, Dept. 133-E, P. O. Box 629, Linden, New Jersey 07036. Celanese® Celanar®



Celanese Plastics Company is a division of Celanese Corporation.

read a little



Pay a Little. The price is as small as the product. It's a miniature rear projection readout, and it costs as little as \$14.00. The new IEE Series 345 Readout requires very little space, but it offers the readability and versatility available only with rear projection readouts. And the price is comparable to other types of readouts with limited messages and cluttered displays.

The Series 345 operates on the rear projection principle. A lamp in the rear of the unit illuminates one of the 11 film messages, and projects it to the front viewing screen. A single plane display on the non-glare screen, so you get no distortion or confusion. It is very versatile, since anything that can be put on film can be displayed on the screen. You can display a variety of messages or colors.

The Series 345 has a front plug-in feature. It can be quickly inserted into the housing. It can be just as easily removed to insert a new readout with a different display, or to replace a lamp.



Series 345 Readout: 1/2" wide x 3/4" high. Six digits will fit in a 3" wide panel space. Depth, 2 1/2". Character height, 3/8". Weight, 3/4 oz. Six available colors, including white, amber, yellow, blue, red or green.

Straight decimal input. Vertical and horizontal viewing angle 175° with V-1 viewing screen, or 160° with standard screen.



"I double-E," the world's largest manufacturer of rear projection readouts.
Industrial Electronic Engineers, Inc., 7720 Lemona Ave., Van Nuys, California



High Strength Dielectric

Coors Alumina Ceramics were originally developed to provide high mechanical strength insulators used in extremely high voltage applications. With Coors Ceramics you have high dielectric strength, plus a material with physical properties far superior to porcelain, glass or plastic. They are good structural materials, compressive strengths extend to 380,000 psi. They are inert, have long endurance at high voltages, are impervious to moisture or fungus, and are stable under intense radiation. Use Coors Ceramics, in sizes from micro wafers to large 24" x 60" cylinders. They can be glazed for easy-to-maintain cleanliness, or metalized for brazed ceramic-metal assembly. Faced with a high potential design decision? Get on-the-spot answers, dial Coors—303/279-6565, Ext. 361. For complete design criteria, write for new Coors Alumina and Beryllia Properties Handbook 952.

*consider
Coors
ceramics*

Coors

CERAMICS

ALUMINA • BERYLLIA • MAGNESIA • SPECIAL OXIDES
Coors Porcelain Co., Golden, Colo.





A 15-inch transport is one of many options that permit you to tailor the Honeywell 7600 to your exact requirements.

We kept our promise. We've kept busy delivering 7600 Series Tape Systems ever since.

We promised you the best value in the magnetic tape industry, and that's just what the Honeywell 7600 Series is. Its modular concept allows you to specify the exact system you need — no more, no less — with your choice of 10½" or 15" transports, a wide selection of bandwidths and electronics, and many options for future expansion without costly modifications.

Users report performance that exceeds specs. The 7600 delivers greater signal fidelity than any comparably priced unit, thanks to high S/N ratios and extremely low flutter, skew, and time base error. Price? A lot less than you'd expect! And because it's mechanically simple (no belts, pulleys, gears or pinchrollers), highly reliable, and

easily maintained due to plug-in electronics throughout, 7600 operating costs are low, too.

In every way, the 7600 Series is another example of how Honeywell's broad line, backed by local sales and service, can provide the *precise* solution to your instrumentation problems. For an eye-opening demonstration, call your local Honeywell Representative. He'll be glad to put a 7600 through its paces for you. For technical literature, write: Honeywell, Test Instruments Division, 4800 East Dry Creek Road, Denver, Colorado 80217.

Honeywell
Honeywell engineers sell solutions



Servo is a safe landing

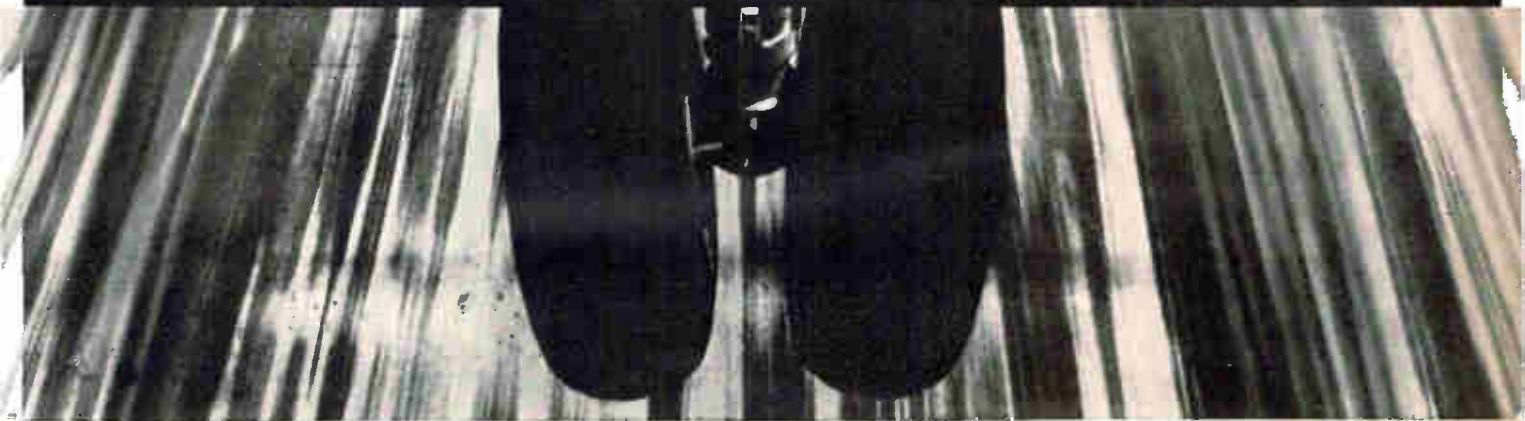

Air safety recently took a giant step forward. A light plane was lost in the fog over rugged Alaskan terrain miles from Kenai airport. Fuel was running low. The pilot came in for a 3-point landing. How? With ADF. And laurels go to a Servo Corporation VHF-UHF direction finder system. These Doppler-effect units will soon be installed throughout the U.S.

The Servolight® Model 5000 VHF/UHF Doppler Direction Finder is pictured above. Frequency coverage is 118 to 160 MHz and 225 to 400 MHz. It has

10 preset channels on VHF and 10 on UHF. Servo-flight offers a bearing accuracy of $\pm 1^\circ$, and a sensitivity of $10 \mu\text{V}/\text{Meter}$ on VHF and $20 \mu\text{V}/\text{Meter}$ on UHF.

This is one of the many sophisticated systems produced by Servo's Communications & Navigation Division. Other Servo divisions produce unique products which daily serve safety through science: the Servodynamics Division, the Infrared & Electro-Optics Division, and the Railroad Products Division.

servo corporation of america

Servo

111 new south road
hicksville, l.i., new york 11802
516 938-9700

Circle 73 on reader service card

How fast can you get the fastest core memory system?

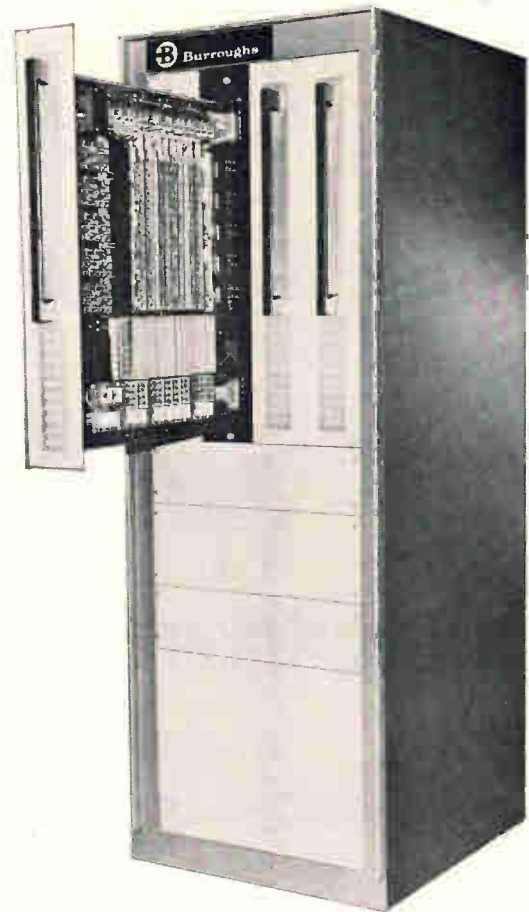

500 nanoseconds in 5 months!

Burroughs gives you a choice of 0.5 μ sec. to 1.0 μ sec. full cycle times with 4096 or 8192 words by 20 bit modules. All modules contain the same high quality components, circuits and workmanship that you've come to expect from Burroughs, including these features:

- 2½ D organization
- Pluggable core stacks
- Low cost per bit
- Building block construction

- Module size: 26¾" high x 20½" deep, 4¼" wide
- Temperature range of +15°C to +40°C
- Access time — Less than half the cycle time
- Separate control module containing the timing circuits, address register and decode logic

For further information, contact Burroughs Corporation, Electronic Components Division, P.O. Box 1226, Department M2, Plainfield, New Jersey 07061, (201) 757-5000.

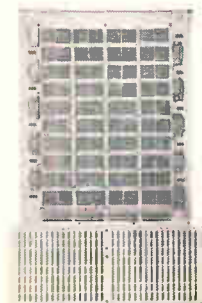

2½ D
Ferrite Core
Memory Stack

 **Burroughs Corporation**

Technical Articles

Integrated circuits in action: part 6, Shrinking a military calculator
page 76

Electronics



Even in military equipment intended for ground duty, size can be a critical problem. For example, a calculator that was to help a controller dispatch interceptor fighters against as many as five enemy air formations required 12,000 discrete components, enough to fill three standard 6-foot equipment racks. To shrink its size and reduce its power consumption, engineers turned to integrated circuits. On the cover is the completed machine calculating an intercept problem. Built with ic's, the calculator occupies only three-quarters of a cubic foot and sits atop a plan position indicator that displays the intercept pattern.

Electronic reconnaissance:
page 89

Because reconnaissance experts need more than ordinary daylight sight as recorded by conventional cameras, they are turning more and more to electronic devices that use other parts of the electromagnetic spectrum, such as infrared and radar. In this special report:

I. In reconnaissance, the eyes have it. An examination of optically controlled cameras, with the emphasis on new equipment (p. 89).

II. Flying the Phantom. An eye-witness report of the most sophisticated tactical reconnaissance aircraft as it flies a mission (p. 94).

III. Watching the invisible enemy. Techniques for seeing at night and through rain and foliage (p. 100).

IV. Automation opens the way. An inflight tester is being developed for the multisensor Phantom aircraft (p. 103).

A good turn for old components
page 109

A new device called the rotator turns out to be an all-purpose circuit. It rotates the output curve of a component about an origin, thus changing the characteristics of diodes, transistors, resistors, or any other two- or three-terminal components. By changing the characteristics of components, the engineer can create new elements and perform functions unattainable with conventional devices.

**Coming
June 12**

- New jobs for gallium arsenide
- A maser for use in radar
- Read-only memories for computers
- Using r-f breakdown

Integrated circuits in action: part 6

Shrinking a military calculator

Small size, low power, and high performance were the prime attributes designers were seeking in outfitting an experimental calculator to process radar information for an air intercept system

By R.W. Ward

Government Electronics Division, Motorola Inc., Chicago

The case history of an experimental calculator built under the sponsorship of the Air Force provides insight into the use of integrated circuits—both bipolar and metal oxide semiconductor—in a military application. The calculator was designed to help a ground controller direct interceptor planes against as many as five separate enemy aircraft formations. Along with an air-search radar, a ground-to-air communications link, and a plan position indicator (PPI), it forms a semiautomatic intercept system.

First among the factors determining Motorola Inc.'s choice of IC's for the calculator was size. The unit contains 2,800 flatpack diode-transistor-logic circuits and 150 MOS shift registers—the equivalent of 12,000 discrete-component functions. Built with transistors, the calculator would fill at least three standard 6-foot equipment racks; built with IC's, it measures $\frac{3}{4}$ cubic foot, weighs 38 pounds, and sits conveniently atop the PPI console.

A second requirement imposed by the military character of the machine was low power consumption. The power source in a tactical environment is typically a gasoline engine generator that requires periodic fueling—often under difficult conditions.

Finally, the use of IC's simplifies operation by making possible rapid, accurate computation. Just 10 of the front-panel controls are normally used in handling an intercept problem, and a radar operator or air controller can be taught to use the calculator in less than an hour.

Scramble!

In the intercept system, the air-search radar provides data on target and friendly aircraft during each revolution of its antenna. This information

is displayed on the PPI, and the air controller uses it to direct the intercept [see "Hitting the target," p. 80]. The calculator has the job of computing the course and speed of the planes to predict the point and time of the interception. This prediction is sent to the interceptors by the ground-to-air link.

The calculator's memory can retain five problems at a time. As soon as one intercept problem is set up and running, it can be put in storage and another problem set up. Stored information can be retrieved and displayed at will; strobe positions marking the estimated positions of the planes are continuously updated while in the memory so that a real-time display is presented upon retrieval.

The machine was designed to interface with existing radars such as the AN/FPS-20 air-search unit and the AN/FPS-6 height finder, and with any general-purpose PPI with offset capability. The inputs to and outputs from the calculator are shown on the block diagram, page 78. The calculator takes the system trigger pulse that initiates range sweep, raw video, and bearing data—in the form of azimuth change pulses (ACP's)—from the search radar and height data from the height-finding radar. From these inputs, it automatically pinpoints targets and determines their position in x and y coordinates.

Sweep signals for the PPI are supplied by digital sweep generation circuits in the calculator. ACP bearings from the antenna are converted to sine and cosine data and multiplied digitally with a range clock to generate real-time radar information in x and y coordinates. Conversion of the digital coordinates to an analog signal gives the x and y components of a sweep signal for PPI display. From target positions determined on successive radar

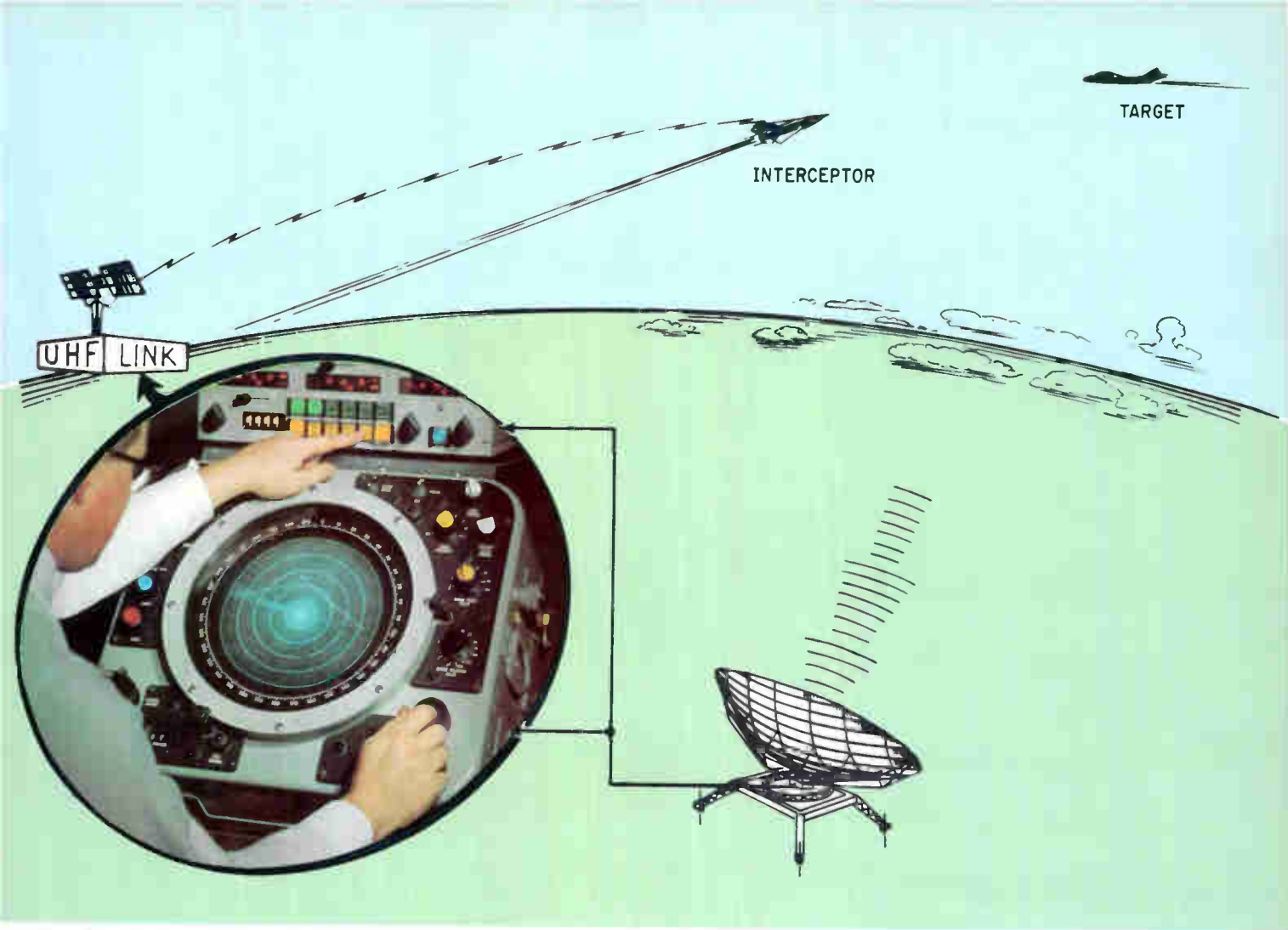

Ground-based radar operator zeroes in on the target, controls data input to the intercept calculator, and selects appropriate intercept tactics. The calculator confirms the target's location and computes distance, velocity, and time to intercept.

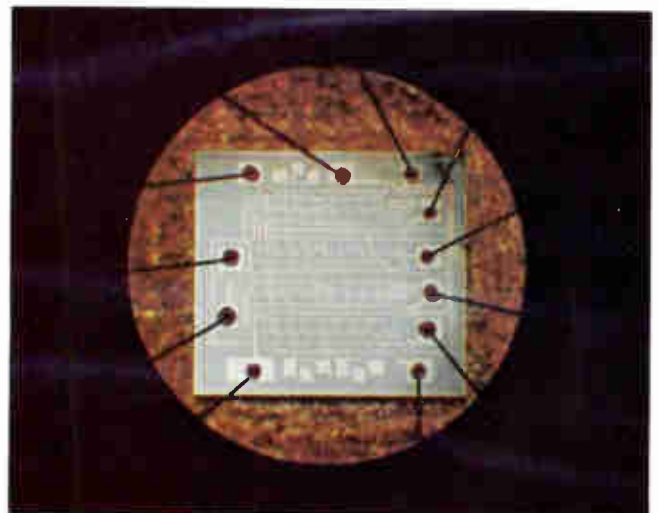
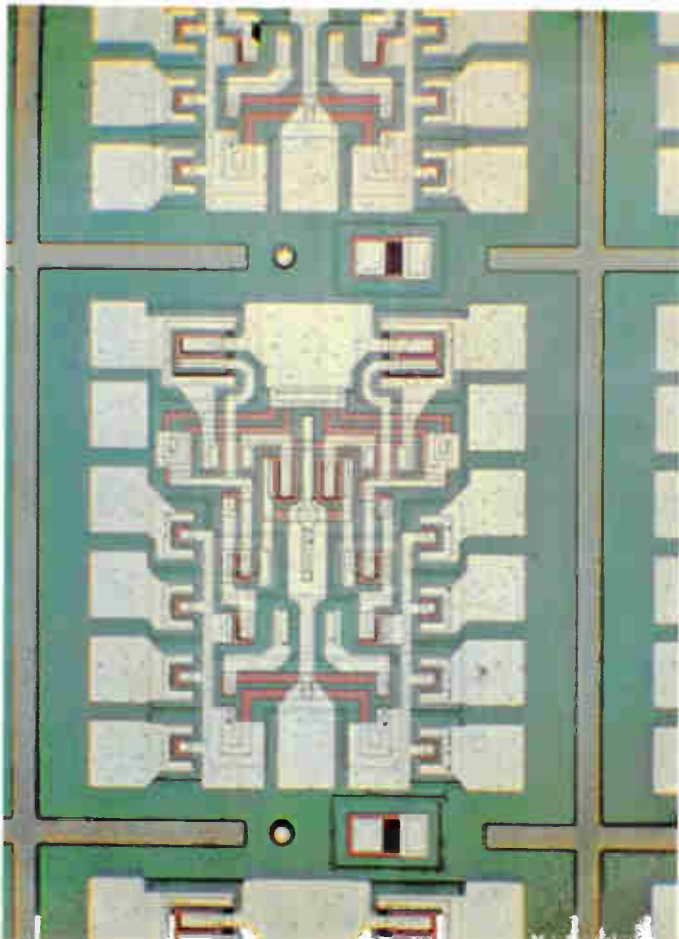

MOS shift register by Philco-Ford Microelectronics division is typical of those in calculator. It can be connected as a dual 8-, dual 16-, single 24-, or single 32-bit delay.

Dual buffer, Signetics' NE156, is used in clock and capacitive line-driving applications and is typical of the calculator's monolithic DTL circuits. Each of the two symmetrical sections contains four input diodes, four transistors, and seven diffused resistors.

Functions are packed in less than a cubic foot

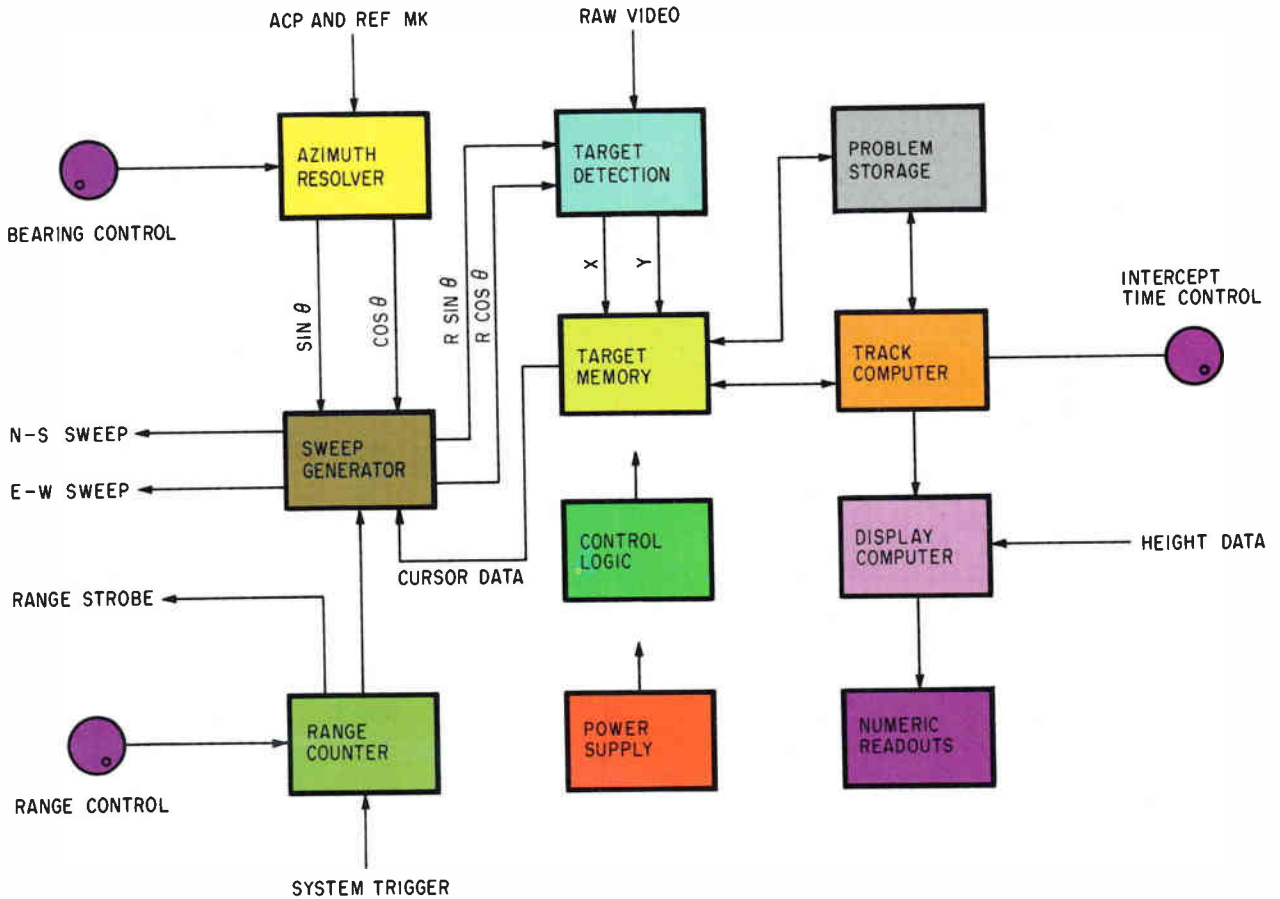

Basic functions performed by the radar intercept calculator. Azimuth resolver, sweep generator, and range counter generate the sweep and cursor signals for the PPI display. Target detector confirms the location of the target, and the target memory stores data representing the problem being displayed. The track computer calculates velocity, distance, and time to intercept, and the problem storage can hold five separate problems.

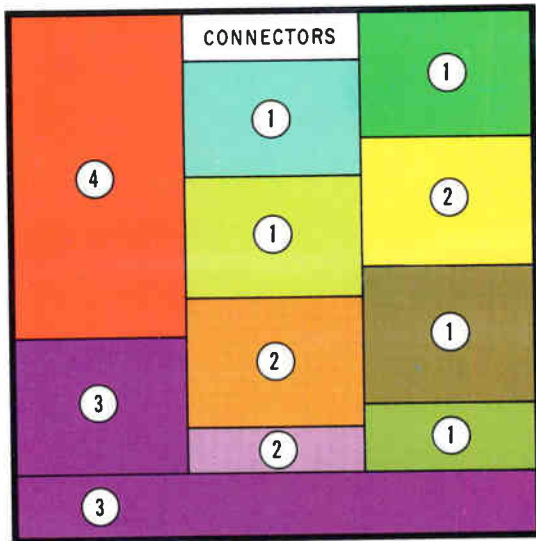

Space occupied by each function is color coded to match block diagram of calculator. DTL's are used in substantial portions of blocks labeled 1. MOS IC's are used in the problem storage block, not visible from the top of the calculator. Blocks labeled 2 contain MOS and DTL circuits, while those labeled 3 contain some DTL's. The power supply uses discrete components, 4.



Digital supersedes analog

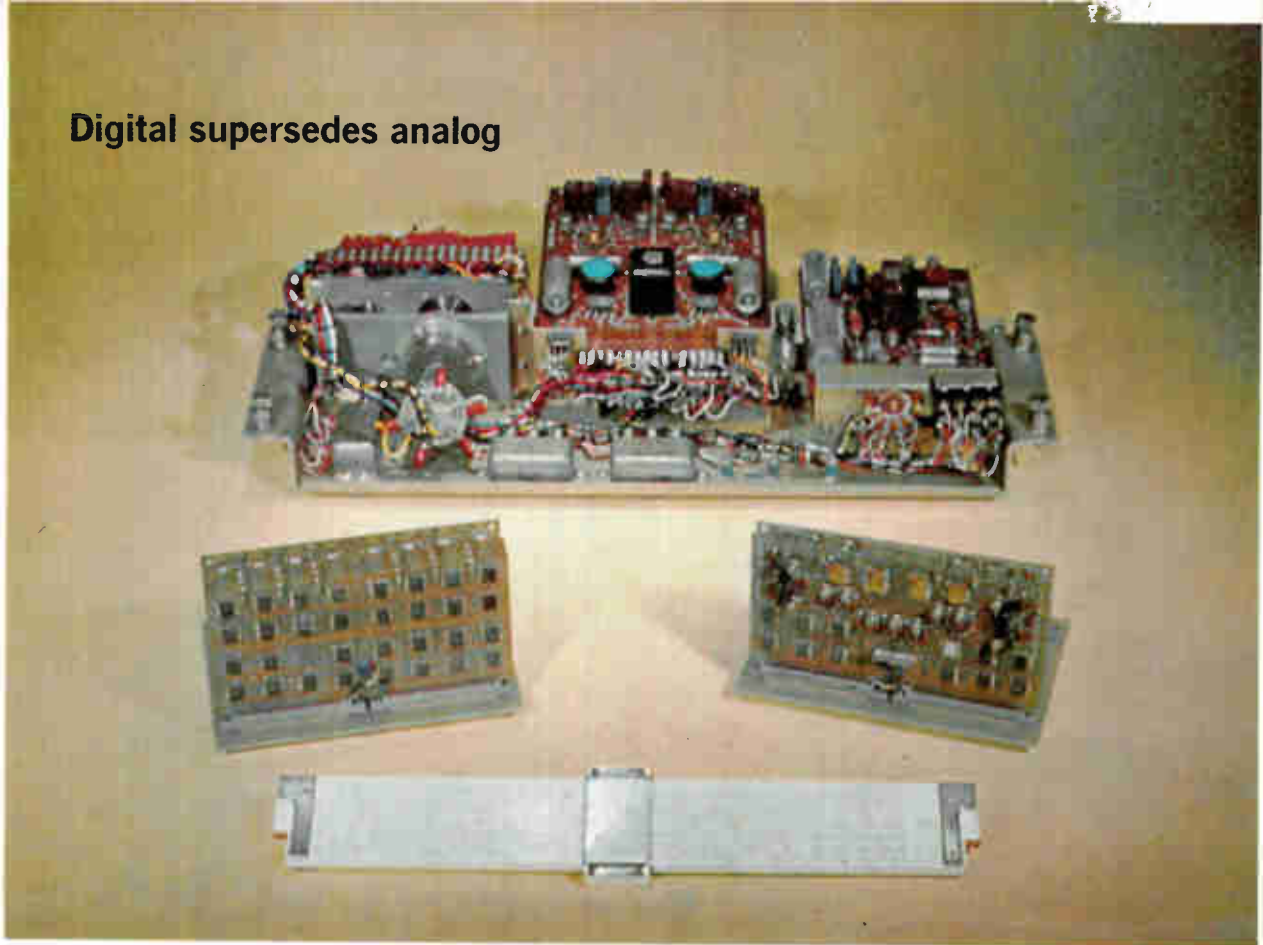

Analog resolver in the background dwarfs IC equivalents. Four-board IC version, left, uses MOS shift registers, and bipolar arithmetic, logic, and timing. A later two-board version at the right has MOS shift registers and digital differential adders, plus bipolar timing.

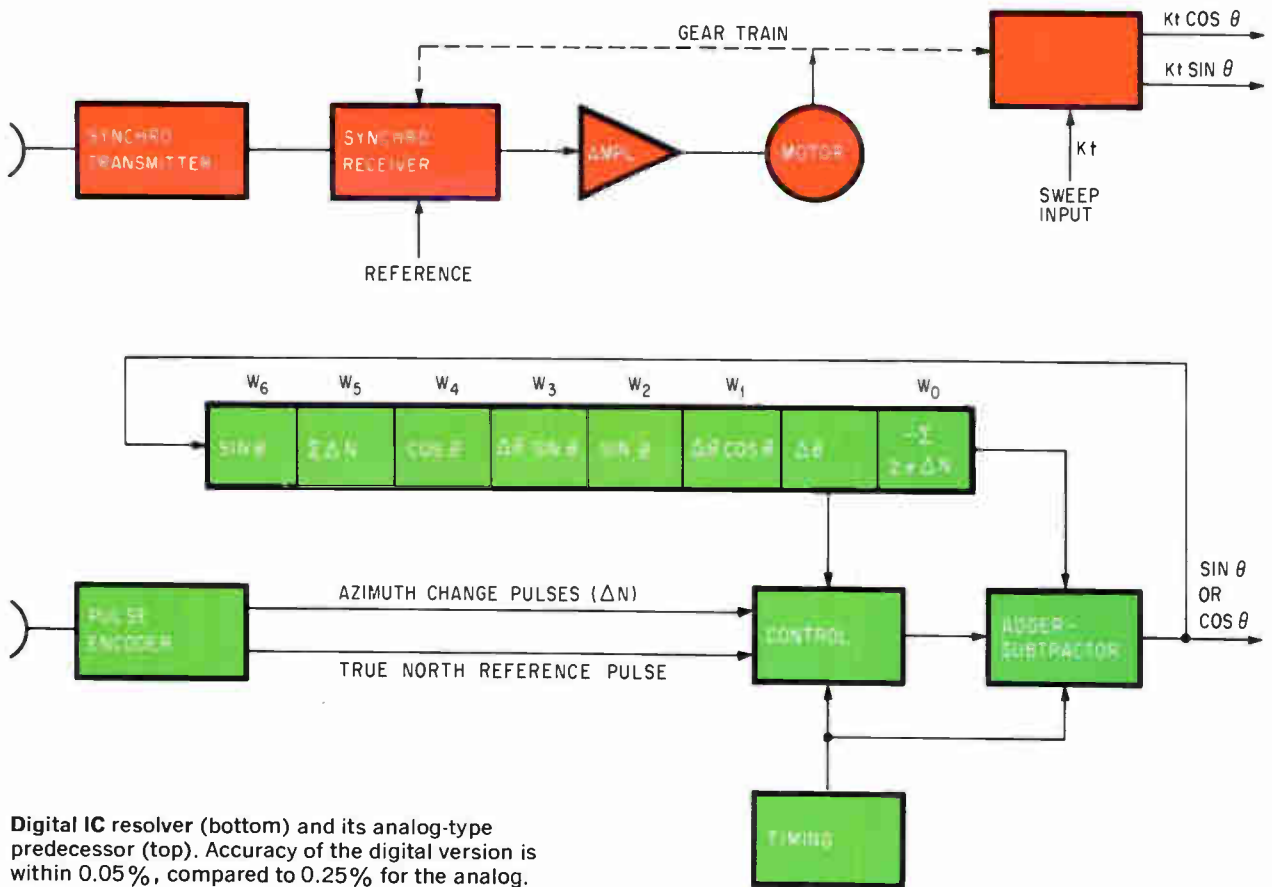

Digital IC resolver (bottom) and its analog-type predecessor (top). Accuracy of the digital version is within 0.05%, compared to 0.25% for the analog.

Hitting the target

Slide rules and grease pencils may be on the way out as the weaponry of air-interception control. With this experimental radar intercept system, the air controller picks his target by scanning a plan position indicator. To designate the position of the target, the operator of the system's calculator uses a bearing cursor originating at the center of the PPI display, plus a range strobe. A video window is then automatically generated that covers an area about five miles around the selected target's center point.

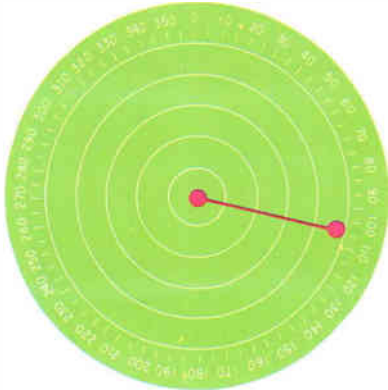

When the target is designated, the calculator automatically estimates its position. If the radar input from the target exceeds a predetermined signal-to-noise threshold, a binary 1 is generated. The range is divided into $\frac{1}{4}$ mile intervals, or cells. When three consecutive 1's (one per sweep) are received in adjacent range cells, the target is confirmed. Three 0's in a row mark the end of the target. The azimuth position of a target is calculated from the start and end signals.

The cursor origin then moves automatically to the initial target position. After a short period of time, the operator, by adjusting the bearing cursor and range strobe controls, designates the latest position of the target. After the calculator confirms this position, it establishes the target track cursor between the two points.

The calculator records both time and distance traveled between the two target positions to determine heading and speed. A range strobe marking the estimated position of the target at any given time is continuously updated on the basis of the computed velocity. If the actual target bearing or velocity

changes, the operator must reestablish the problem.

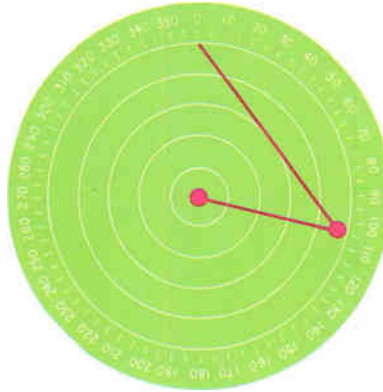

The track cursor continues to be generated automatically. A second bearing cursor for the interceptor is established by the operator in the same way that the original target bearing cursor was set.

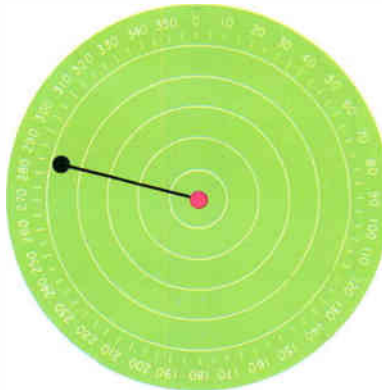

When the calculator confirms the interceptor position, the intercept cursor origin moves to that position automatically. The operator then enters the speed the interceptor has been directed to fly. He adjusts the interceptor bearing and the intercept time controls so that both cursors terminate at the same point.

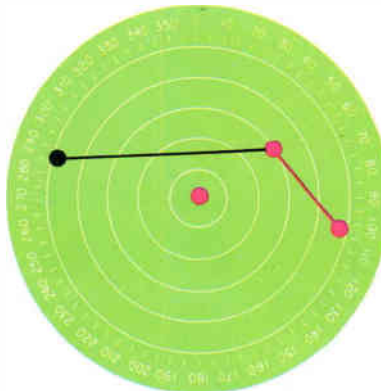

This position represents the intercept point if both the target and the interceptor maintain constant bearing and velocity. The bearing that the interceptor must fly and the time to intercept are read out on the front panel of the calculator.

To confirm the speed of the interceptor, the operator tracks it to obtain a second fix in the same way that he did for the target. The computations are thereafter based on the actual velocity and bearing of the interceptor.

A second mode of intercept can be used for offset or right-angle attack. The operator sets the offset distance and selects a right or left hand turn. In this mode, the operator must tell the interceptor pilot the time remaining to the offset point, the angle of turn for the attack, and the time from offset to intercept.

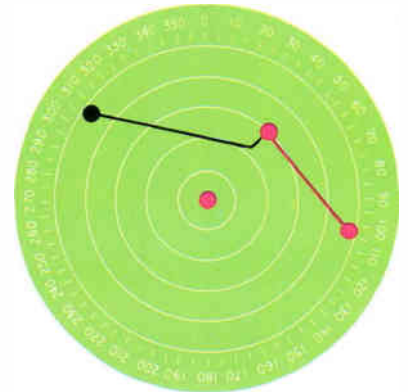

The problem illustrated above corresponds to a left-hand turn option and the one below represents a right-hand option turn.

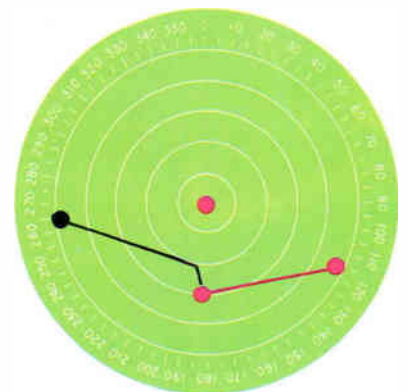

A problem can be returned to storage at will, and any one of four additional problems retrieved and displayed within one second.

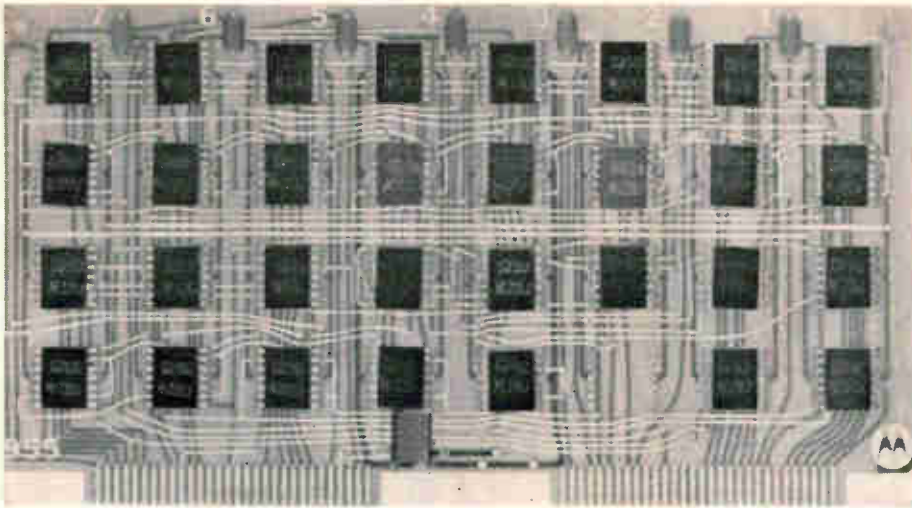

Diode-transistor-logic IC's are in TO-88 flatpacks. The multifunction devices include triple three-input NAND gates, RST binaries, and dual four-input line drivers. The N prefix denotes an operating range of 0° to 70°C—a limited range suitable for ground support equipment.

scans, the calculator figures the trajectory and velocity of the targets, and computes bearing, time to go, and height data to be used in directing the intercept.

Major decisions

Two key decisions were involved in the choice of integrated circuits—one to use digital rather than analog techniques, and the other to use special-purpose rather than general-purpose computation.

The chief benefits of digital implementation are increased precision and circuit stability, greater flexibility in handling data, and improved stability of memory functions. Since several circuits can be put on one IC chip, these advantages are achieved without sacrifices in size, weight, or power consumption. Special-purpose computation contributes to the small size by minimizing the logic functions required.

The resolver function is a good example of how binary IC's perform the equivalent task of analog circuitry. Here, antenna bearing information must be resolved to $\sin \theta$ and $\cos \theta$ elements. Typically, a radar transmits synchro information from the antenna to a synchro receiver and servo follower at the PPI, driving the shaft of a resolver [block diagram, page 79]. In addition to exacting a weight penalty, this approach results in errors on the order of about 0.5° for a single synchro system; this can

lead to significant target azimuth errors, particularly for search radars with beamwidths of 1° to 2° . Dual-speed synchros reduce the error to about $\pm 0.25^\circ$.

On the other hand, the integrated circuits and shaft encoders, page 79, perform resolver functions with much greater precision and less chance of drift or misalignment, and at a saving in size and weight. Most future radars will be equipped with a shaft encoder on the antenna pedestal instead of synchros.

Typical shaft encoders generate 4,906 and 8,192 pulses per antenna revolution. The incremental nature of the variables and the need for high computation speed suggest the use of digital differential analyzer techniques. Using binary integrated circuits in a serial digital differential analyzer to generate $\sin \theta$ and $\cos \theta$, the radar intercept calculator achieves a level of computation error—including pulse increment error—of $\pm 0.05^\circ$. Additional advantages of the IC version are freedom from the sort of component aging that necessitates realignment of servos, and elimination of the need for servo adjustments.

The calculator's electronics can be considered in three basic sections: PPI and cursor sweep generation, target detection, and computation and memory. The digital sweep is generated by high-speed binary rate multipliers and digital-to-analog

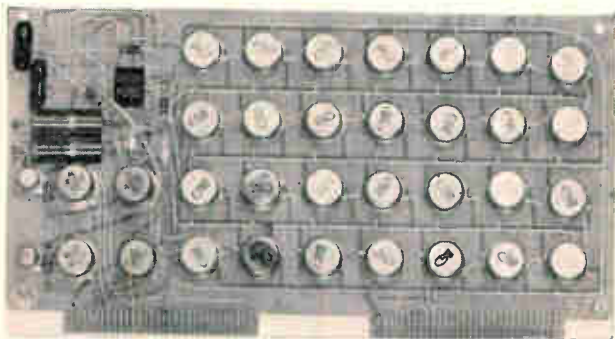

MOS shift registers in TO-5 cans operate at a 1-megahertz bit rate. These 16-, 20-, and 32-bit devices are used to store problems in the calculator's active memory. The p-c boards measure $6\frac{1}{2} \times 4\frac{5}{8}$ inches.

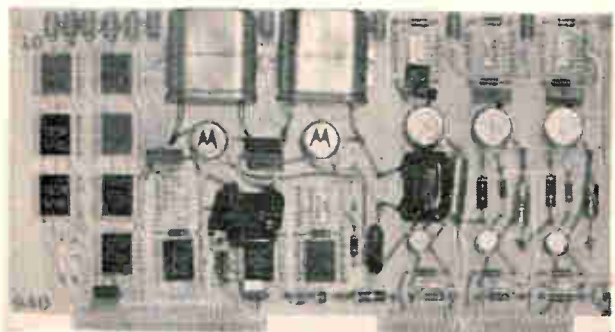

Clock circuit using these transistors and conventional discrete components is typical of those circuits in the calculator that don't lend themselves to all-IC construction.

Designer's casebook

Designer's casebook is a regular feature in Electronics. Readers are invited to submit novel circuit ideas, packaging schemes, or other unusual solutions to design problems. Descriptions should be short. We'll pay \$50 for each item published.

An easy guide for selecting the right transformer core

By Jacob Overduin

Glentronics Inc., Gendora, Calif.

Transformer core selection can be a problem for an engineer with limited exposure to transformer design. However, a quick guide for estimating core size is available from the transformer's volt-ampere rating, regulation, and operating frequency.

In good transformer design, core and copper losses are approximately equal. Therefore, core weight can be determined from curves of watt-per-pound losses versus induction level. This data is supplied by core manufacturers.

As an example, assume the engineer is seeking the correct core weight for a transformer having a 115-volt ($\pm 10\%$), 60-hertz a-c source, an output power of 200 watts, and a permissible loss of 5%.

At the specified output power, a 5% transformer loss is 10 watts, of which 5 watts is the core loss. The core material recommended for 60-hz operation is 12-mil silectron. From the curves given for this material (in this case, Arnold Engineering Co.

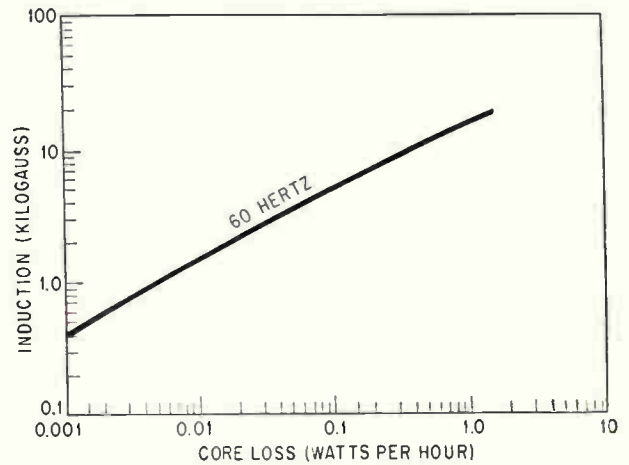

Manufacturer's data for 12-mil silectron transformer cores at 60 hertz indicates a loss of 1 watt per pound at 15 kilogauss.

data is used), a loss of 1 watt per pound at 15 kilogauss (the recommended operating level for 60 hz) is indicated. This establishes a desired core weight of 5 pounds.

Manufacturer's data tables will list a number of cores weighing approximately 5 pounds. Final selection depends on the window area required for the winding.

Permanent-magnet motor measures its own speed

By James B. Tiedemann*

University of Kansas, Lawrence, Kan.

Measuring the speed of a permanent-magnet motor simply and directly is possible because the electromotive force is directly proportional to the motor's speed. Furthermore, it is accomplished without additional lead wires or slip rings.

The motor's no-load counter-emf charges a capacitor during the interval between half-wave pulses from the power supply; the capacitor voltage is then filtered for display on a voltmeter.

* Now with University of Alaska, College, Alaska

Ordinarily, the average voltage at the output terminals of a permanent-magnet motor is the sum of the no-load counter-emf and the drop caused by the winding resistance. The counter-emf is pro-

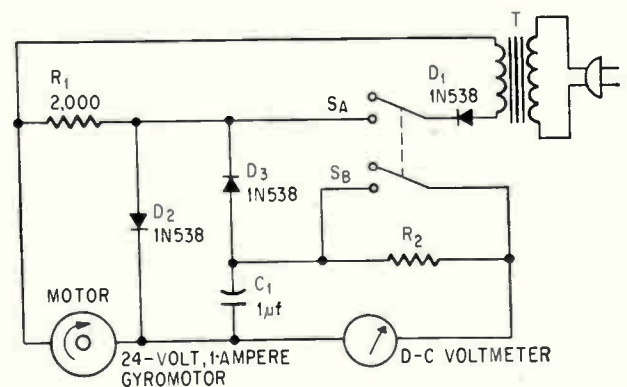

Counter-emf from the motor charges capacitor C_1 between power pulses to indicate motor speed.

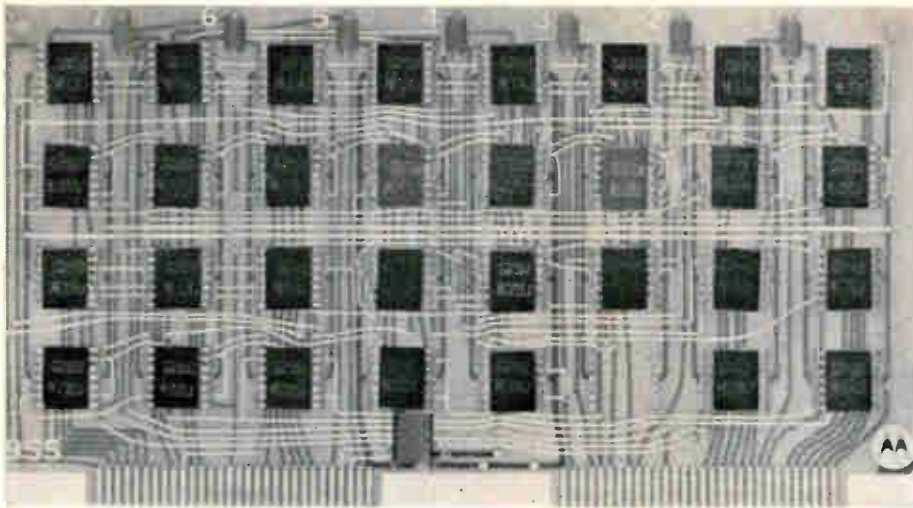

Diode-transistor-logic IC's are in TO-88 flatpacks. The multifunction devices include triple three-input NAND gates, RST binaries, and dual four-input line drivers. The N prefix denotes an operating range of 0° to 70°C—a limited range suitable for ground support equipment.

scans, the calculator figures the trajectory and velocity of the targets, and computes bearing, time to go, and height data to be used in directing the intercept.

Major decisions

Two key decisions were involved in the choice of integrated circuits—one to use digital rather than analog techniques, and the other to use special-purpose rather than general-purpose computation.

The chief benefits of digital implementation are increased precision and circuit stability, greater flexibility in handling data, and improved stability of memory functions. Since several circuits can be put on one IC chip, these advantages are achieved without sacrifices in size, weight, or power consumption. Special-purpose computation contributes to the small size by minimizing the logic functions required.

The resolver function is a good example of how binary IC's perform the equivalent task of analog circuitry. Here, antenna bearing information must be resolved to $\sin \theta$ and $\cos \theta$ elements. Typically, a radar transmits synchro information from the antenna to a synchro receiver and servo follower at the PPI, driving the shaft of a resolver [block diagram, page 79]. In addition to exacting a weight penalty, this approach results in errors on the order of about 0.5° for a single synchro system; this can

lead to significant target azimuth errors, particularly for search radars with beamwidths of 1° to 2°. Dual-speed synchros reduce the error to about $\pm 0.25^\circ$.

On the other hand, the integrated circuits and shaft encoders, page 79, perform resolver functions with much greater precision and less chance of drift or misalignment, and at a saving in size and weight. Most future radars will be equipped with a shaft encoder on the antenna pedestal instead of synchros.

Typical shaft encoders generate 4,906 and 8,192 pulses per antenna revolution. The incremental nature of the variables and the need for high computation speed suggest the use of digital differential analyzer techniques. Using binary integrated circuits in a serial digital differential analyzer to generate $\sin \theta$ and $\cos \theta$, the radar intercept calculator achieves a level of computation error—including pulse increment error—of $\pm 0.05^\circ$. Additional advantages of the IC version are freedom from the sort of component aging that necessitates realignment of servos, and elimination of the need for servo adjustments.

The calculator's electronics can be considered in three basic sections: PPI and cursor sweep generation, target detection, and computation and memory. The digital sweep is generated by high-speed binary rate multipliers and digital-to-analog

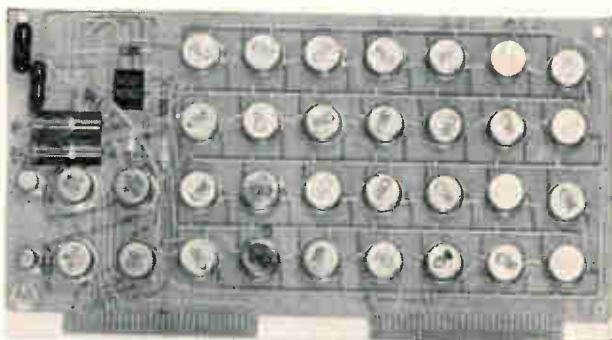

MOS shift registers in TO-5 cans operate at a 1-megahertz bit rate. These 16-, 20-, and 32-bit devices are used to store problems in the calculator's active memory. The p-c boards measure $6\frac{1}{2} \times 4\frac{5}{8}$ inches.

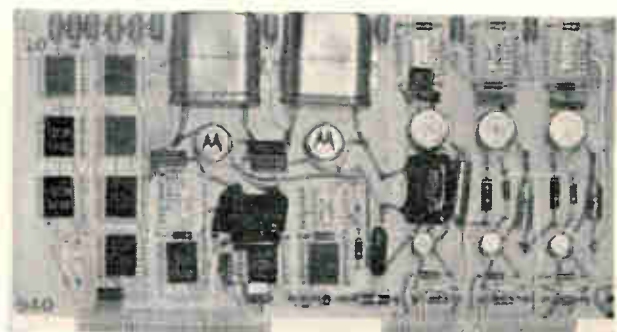

Clock circuit using these transistors and conventional discrete components is typical of those circuits in the calculator that don't lend themselves to all-IC construction.

Three generations of intercept calculators

	1957 Vacuum tubes	1961* Transistors	1967 Integrated circuits
Volume (cu. ft.)	104	25	0.75
Weight (lb.)	4,700	1,250	38
Power (watts)	4,700	1,000	210
MTBF (hours)	22	200	1,300

* data for this version based on estimates

converters for direct drive of PPI deflection circuits. The target-detection section uses parallel processing, while the computation is done with special-purpose serial data processing and the memory is integrated with the computation as serial storage loops.

Specialization

Regarding the key question of whether the computation and memory should be implemented as a general-purpose, stored-program computer or as a special-purpose serial machine, analysis of calculator functions established a storage requirement of 3,000 to 5,000 bits. This requirement, along with provision for program storage, made a general-purpose approach economically unfeasible as regards input-output hardware, power, size, and weight.

Because data from the computation section has to be provided on a real-time basis to several points in the calculator, it must be continuously updated. Here it was found that the use of serial processing loops saves hardware and cuts power consumption. One set of timing circuits can service all the loops, and the arrangement permits the use of economical and easily manufactured circuits with a bit rate of 1 megahertz.

The computation section provides data on real-time variables related to track equations, the real-time clock, and the azimuth resolver. Computation techniques used in the azimuth resolver are typical.

When the increment of the bearing angle θ is small, the $\sin \theta$ and $\cos \theta$ values can be generated

by the following difference equations:

$$\begin{aligned}
 N &= \Sigma \Delta N \\
 \Delta \theta &= -2\pi \Delta N \\
 \Delta \sin \theta &= \cos \theta \Delta \theta \\
 \Delta \cos \theta &= -\sin \theta \Delta \theta \\
 \sin \theta &= \Sigma \Delta \sin \theta \\
 \cos \theta &= -\Sigma \Delta \cos \theta
 \end{aligned}$$

where N is the number of azimuth change pulses; initial conditions are $N = 0$, $\sin \theta = 0$, and $\cos \theta = 1$.

The computation format is arranged in seven words of 18 bits each. The words are circulated serially through a delay-line storage element and an arithmetic section, as in the diagram on page 79. Each word is shifted through the delay at a 1-MHz bit rate and is presented to the added-subtractor with the least significant bit first. The word available at the delay line tap and presented at A can be added to the word available at the end of the delay line, B. Four cycles through the delay line accomplish the multiplication of $\sin \theta$ and $\cos \theta$ by the four-bit increment of $\Delta \theta$. The eleven most significant bits of $\Delta \sin \theta$ and $\Delta \cos \theta$ are used to update $\sin \theta$ and $\cos \theta$, respectively. Each cycle takes 126 microseconds; a full computation takes 504 μsec . A double-length calculation to update sine and cosine maintains the desired accuracy throughout the full 360° and prevents discontinuities in the presentation as the reference mark resets to the initial conditions.

MOS memory

Serial processing and storage require some form of serial dynamic memory, and magnetostrictive delay lines and metal oxide semiconductor shift registers were considered for the job. The delay lines available were fundamentally of either 300 bits or 1,500 bits in length and presented a stability problem over the temperature range demanded by the calculator's tactical role. Also, the MOS devices provided readily apparent size and weight advantages.

Further, magnetostrictive delay lines are limited to use over a temperature range of 0° to 50°C by the wire's temperature coefficient of expansion, which can result in a shift in delay or in the number of bits in storage. But MOS shift registers don't have temperature coefficient problems because they are binary devices and are clocked with the system.

The shift registers chosen represent the first practical application of large-scale integration techniques. Much has yet to be learned in this area, but considering the infancy of the technology, the experience with the MOS devices in this equipment has been reasonably good. A fairly high percentage of units was lost at incoming inspection and during early burn-in and equipment debugging. Some failures could be blamed on the devices themselves, while others were obviously caused by handling. The person working with MOS devices, and his soldering equipment, must be grounded.

The shift registers used are standard 16-, 20-,

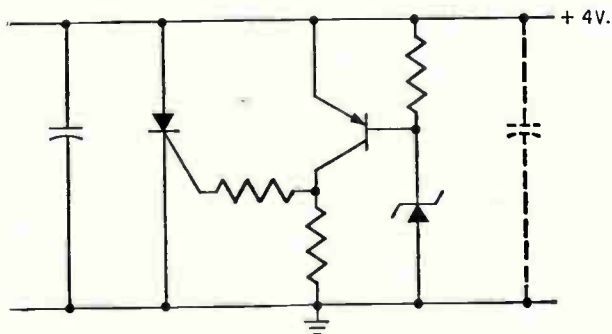

Thyristor sensing circuit protects integrated circuits from overvoltage. It detects voltages above 6 v and shunts the power source. Capacitor at right represents bypass capacitors on logic boards.

Looking ahead

Encouraged by the performance of the integrated-circuit calculator, author Ray Ward envisions greater gains in next-generation radar gear. Ward, whose experience encompasses electronics in radar and display systems, is a project leader at the radar laboratory of Motorola's Government Electronics division.



Among his predictions: ic's will greatly enhance the processing of radar data, and will be used in advanced radar displays to increase stability and reliability, and to make these displays compatible with integrated computers. Motorola is already at work on a tactical modular display—a ppi that will interface with a general-purpose computer and present alphanumeric target data.

Ward looks forward to large-scale integration in radar systems. More complex shift registers, digital differential analyzers, and binary and decade counters, for example, will be used off the shelf, he says.

With the gains, Ward cautions, will come prob-

lems. In military gear, heat removal will continue to challenge thermal experts. Further, the trend is toward greater complexity of equipment and less skilled maintenance personnel. As a result, he says, the military will put more emphasis on built-in fault detection.

Among those changes that may be considered for the next-generation intercept calculator are an all-flatpack construction, more complex shift registers, and alternate methods of heat dissipation. And perhaps a logic scheme other than DTL might be considered; when the design of the calculator was frozen, transistor-transistor-logic devices with the required power and speed weren't available.

Air Force Systems Command engineers suggest that some improvement is possible in the calculator's module commonality. Currently there are 120 ic boards in the system and 80 different types; it's believed that the total number of boards can be increased to 150, and the number of different types cut to 20. This would mean that the number of on-board spares could be held to a small fraction of the total number of modules. This benefit would be accompanied by an increase in equipment complexity of about 20%.

and 32-bit devices [see photograph, p. 77].

Since the calculator was designed for possible field deployment in forward areas, easy maintenance and economical assembly were musts. The package design chosen was a compromise between the number of submodular levels and accessibility for repair. Printed circuit boards that will hold 32 flatpacs, page 81, were selected as the basic submodule. Multilayer boards were considered but rejected; they would have permitted a flatpack density of something less than twice that achieved with the two-sided boards, but at a prohibitive increase in cost.

The boards chosen are wave soldered and repairable at the flatpack level. Partitioning was carried out at the functional level, an approach that helps minimize the number of interconnections between modules. The interconnections within a module are made with printed wiring motherboards.

All bipolar diode-transistor-logic ic's in the calculator are contained in TO-8S flatpacs. The MOS devices were available only in TO-5 cans when the development began, but they now come in flatpacs as well.

With integrated circuits, total power is reduced, but power density climbs. This presents a problem common to tactical gear: how to remove the heat dissipated in the electronics without paying a premium in weight and prime power. From the table on the opposite page it can be calculated that comparable tube equipment dissipates 45 watts per cubic foot, while the ic unit dissipates about 300 watts per cubic foot.

The calculator uses forced-air cooling to hold temperature rises to about 10°C above air ambient. There were no particular spot cooling problems; the unit runs rather hot over-all, and the solution was simply to maintain sufficient air flow. In suc-

ceeding generations, cold plates or liquid cooling will be considered, with their attendant tradeoffs in size, weight, and power.

To exploit the size and weight advantages of integrated circuits, front-panel controls and readouts had to be carefully planned. All the control functions required to solve intercept problems are provided in a panel that measures only 5 by 16 inches.

Power supply

The calculator needs a well-regulated power supply to provide low voltage (4 volts) at high currents (20 to 30 amperes). Designers built a 12-pound thyristor-regulated unit that operates from 400 cps at 60% conversion efficiency.

Voltage transients on the power supply bus can result from excessive fluctuations in prime power-source voltage or the loss of internal voltage regulation. To prevent such surges from burning out ic's, a sensing circuit and a thyristor "crowbar," opposite page, were installed.

The integrated circuits run at 4 volts and are rated for 8 volts maximum. If the sense circuit detects a voltage above 6 volts, it fires the thyristor and shunts the power supply. The thyristor not only stops the voltage from reaching 8 volts, but it draws enough current from the prime power source to blow the equipment fuse. The circuit is fast enough so that step voltage transients at the regular output are absorbed by the individual p-c-board bypass capacitors until the thyristor fires.

Acknowledgment

The experimental model of the radar intercept calculator was developed by Motorola Inc. under the sponsorship of the Air Force Systems Command's Research and Technology Division, Rome Air Development Center, Griffiss Air Force Base, Rome, N.Y.

Circuit design

Designer's casebook

An easy guide for selecting the right transformer core

By Jacob Overduin

Glentronics Inc., Gendora, Calif.

Transformer core selection can be a problem for an engineer with limited exposure to transformer design. However, a quick guide for estimating core size is available from the transformer's volt-ampere rating, regulation, and operating frequency.

In good transformer design, core and copper losses are approximately equal. Therefore, core weight can be determined from curves of watt-per-pound losses versus induction level. This data is supplied by core manufacturers.

As an example, assume the engineer is seeking the correct core weight for a transformer having a 115-volt ($\pm 10\%$), 60-hertz a-c source, an output power of 200 watts, and a permissible loss of 5%.

At the specified output power, a 5% transformer loss is 10 watts, of which 5 watts is the core loss. The core material recommended for 60-hz operation is 12-mil silicetron. From the curves given for this material (in this case, Arnold Engineering Co.

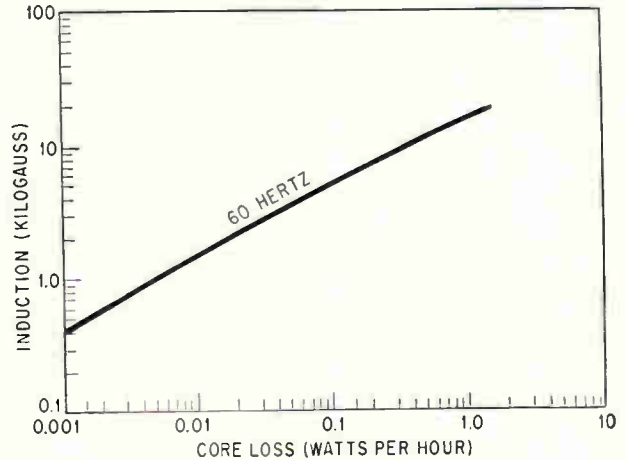

Manufacturer's data for 12-mil silicetron transformer cores at 60 hertz indicates a loss of 1 watt per pound at 15 kilogauss.

data is used), a loss of 1 watt per pound at 15 kilogauss (the recommended operating level for 60 hz) is indicated. This establishes a desired core weight of 5 pounds.

Manufacturer's data tables will list a number of cores weighing approximately 5 pounds. Final selection depends on the window area required for the winding.

Permanent-magnet motor measures its own speed

By James B. Tiedemann*

University of Kansas, Lawrence, Kan.

Measuring the speed of a permanent-magnet motor simply and directly is possible because the electromotive force is directly proportional to the motor's speed. Furthermore, it is accomplished without additional lead wires or slip rings.

The motor's no-load counter-emf charges a capacitor during the interval between half-wave pulses from the power supply; the capacitor voltage is then filtered for display on a voltmeter.

* Now with University of Alaska, College, Alaska

Ordinarily, the average voltage at the output terminals of a permanent-magnet motor is the sum of the no-load counter-emf and the drop caused by the winding resistance. The counter-emf is pro-

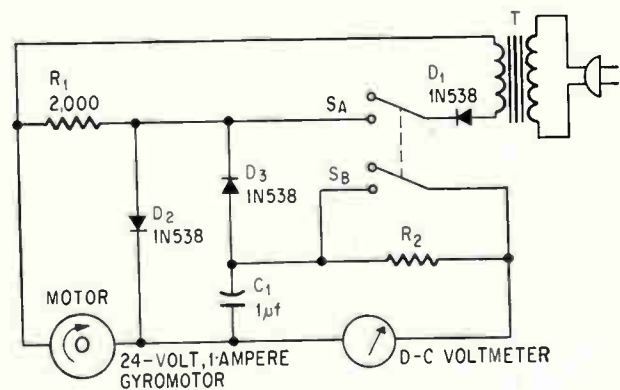

Counter-emf from the motor charges capacitor C_1 between power pulses to indicate motor speed.

portional to the speed of the motor and the resistance drop depends on the motor's load. This circuit ignores the resistance drop and displays only the open-circuit counter-emf. Thus, the voltmeter reads zero when the motor is stalled by a mechanical overload, even though the power supply produces a large voltage drop by applying several volts across the windings.

Half-wave rectified pulses from transformer T are supplied to the motor via diode D_1 . During the coasting half-cycles between pulses, capacitor C_1 is charged to the motor counter-emf through diode D_3 and resistor R_1 . Once C_1 is charged, pulses exceeding the voltage on C_1 drive the motor through diode D_2 ; in the process, reverse bias is applied to D_3 so that C_1 is not discharged. The voltage on C_1

remains equal to the open-circuit counter emf and may be read out on the d-c voltmeter.

While the motor is driven by pulses from T with power switch S_A closed, capacitor C_1 may be partially discharged by current drawn through the voltmeter. With S_A open, however, no pulses interrupt the charging process and the charge on C_1 is maintained. Thus, a slight calibration change occurs if power switch S_A is alternately opened and closed while the motor is running. The change is minimized by adding ballast resistor R_2 ; the resistor is placed in series with the voltmeter when the ganged switch, S_A-S_B , is opened. Resistor R_2 should be approximately 1/10th of the meter resistance; the optimum value may be found by adjusting R_2 for minimum meter displacement.

Amplifier erases swing of 19-db in input signals

By C.A.J. van der Geer

FOM-Instituut voor Plasma-Fysica,
Rijnhuizen, Jutphaas, Netherlands

An output amplitude that is nearly constant, despite a 19-decibel range in the alternating-current input signal, is provided by an amplifier that helps measure phase changes, such as in a microwave signal. The a-c gain is automatically controlled by an error signal that alters the dynamic resistance of

a diode in the a-c feedback loop.

The circuit is part of a system that determines plasma density. The shift in the resonant frequency of a plasma-filled microwave cavity indicates density when compared with the resonant frequency of an unfilled reference cavity. The amplifier overcomes the plasma's damping effect when it is connected to the test cavity's crystal detector.

Transistors Q_1 , Q_2 , and Q_3 form the basic amplifier. Bias stability is maintained by d-c feedback from the collector of Q_3 to the base of Q_1 through resistors R_1 and R_2 . The a-c feedback loop, consisting of R_3 , C_1 , C_2 , and R_4 , reduces the amplifier output. The amount of a-c feedback depends on the dynamic resistance of diode D_1 , which is con-

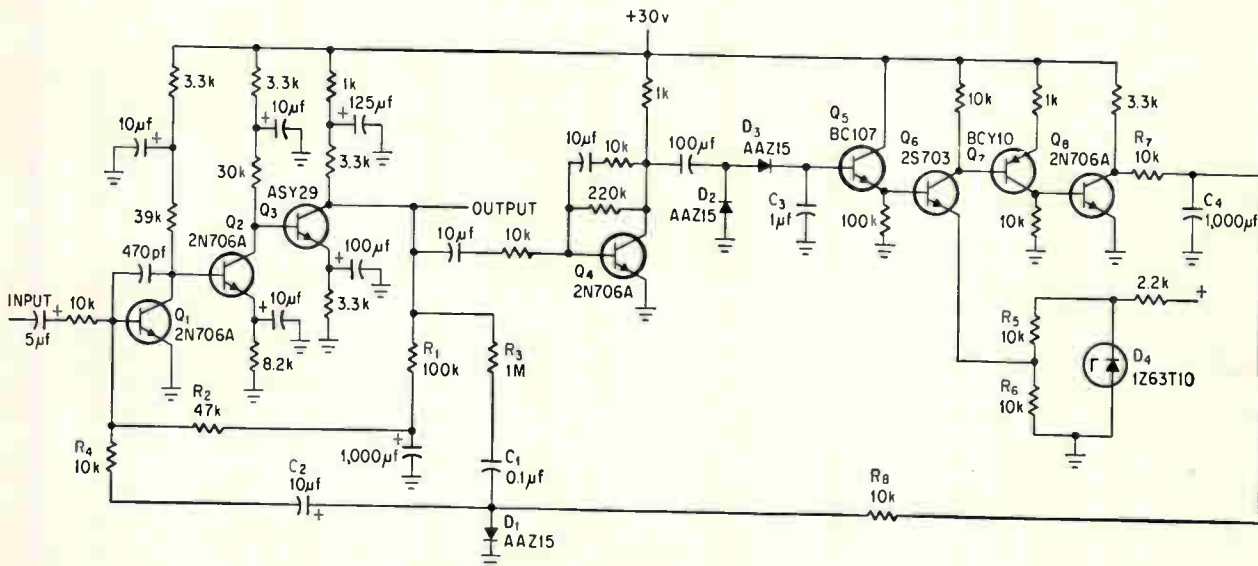

Transistors Q_1 , Q_2 , and Q_3 constitute a basic amplifier in which the gain is controlled by a correction signal generated by the remainder of the circuit.

trolled by the amount of current flowing through the diode.

The error signal controlling the current through D_1 is developed by the portion of the circuit containing transistors Q_4 through Q_8 . Transistor Q_4 , in unity gain configuration, isolates the detector (D_2 , D_3 , and C_3) from the output at the collector of Q_3 . Transistors Q_5 , Q_6 , and Q_7 form a differential circuit that compares the output of the detector with a reference voltage generated by zener diode D_4 and voltage divider R_5 and R_6 . Transistor Q_8 supplies the current to diode D_1 , controlling the gain of the basic amplifier.

When the output at the collector of Q_3 is greater than the desired amplitude, the output of the detector exceeds the voltage set by the zener reference, causing Q_5 , Q_6 , Q_7 , and Q_8 to conduct more heavily; Q_8 then reduces the current through diode D_1 , increasing its resistance. Thus the a-c feedback to

ground through the diode is reduced, and more negative feedback reaches the base of Q_1 .

Resistors R_7 and R_8 and capacitor C_4 form a low-pass filter that separates the a-c portion of the error signal and prevents distortion. The choice of a low-pass filter is determined by the desired response time, t . The low frequency response of the amplifier should be small compared to $1/t$ to prevent oscillation. Response time is about 1.7 seconds.

The circuit has a 3-db frequency range of 10 hertz to 50 kilohertz, a maximum gain of 10,000 and a noise level of 20 microvolts. The quality of the circuit's regulation is:

Input amplitude	Output amplitude	Distortion
0.25 mv	2.66 v	0.7%
0.80 mv	2.67 v	0.4%
2.25 mv	2.66 v	1.0%

Audio amplifier adjusts gain to input levels

By George S. Lehsten

Alpine Geophysical Associates Inc., Norwood, N.J.

Audio amplifiers for seismic studies of the earth's structure require extremely high gain and wide dynamic range. They must be capable of amplifying faint echoes of an explosive charge from long distances, and also handle the direct sound level of the explosion without saturating. Since materials are identified by the frequency of the reflected signals, there must be no frequency response limitation due to signal level or phase.

These requirements are satisfied by an audio

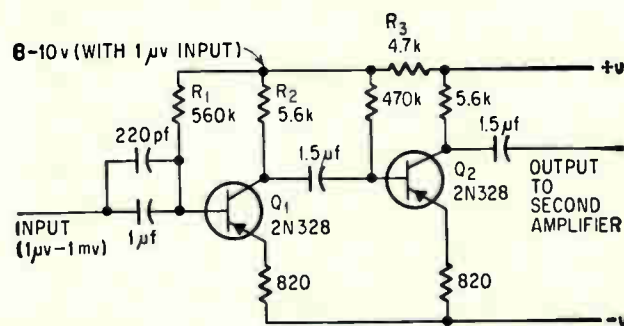

As the conduction current in Q_1 increases, the voltage at the junction of R_2 and R_3 decreases, due to the drop across R_3 . Thus, a rising input level results in a reduction in gain.

amplifier that features five interconnected amplification stages—each providing gain compensation with input level changes. A schematic of a typical stage (in this case, the first amplifier) is shown. With small input signals (microvolts), the gain is approximately 25. Under large-signal conditions (millivolts), the stage acts as an automatic gain-control network in which a linear change in gain is obtained with input level variations.

A large positive input swing causes transistor Q_1 to conduct heavily. The higher current from the supply increases the voltage drop across resistor R_3 , which reduces Q_1 's collector potential and output swing capacity. The presence of R_3 in the supply line causes Q_1 's output to be returned to its base through R_2 and R_1 , further reducing its gain. With the increased drop across R_3 , the bias on Q_2 is reduced—increasing its gain slightly. As Q_1 approaches saturation, the over-all stage gain approaches 5, with a considerable portion of the waveform retained for succeeding stages.

Resistor R_3 and its counterparts in the other stages are connected in series with the power supply. This produces an interaction between stages that is similar to the interaction between Q_1 and Q_2 . Thus, gain compensation is provided along the entire chain, yielding a virtually undistorted output over the wide dynamic range that is desired.

The five amplifying stages have a maximum over-all gain of 10^6 with an input dynamic range of 60 db from a 1 microvolt minimum. Five stages represent the best compromise for minimum noise in relation to the desired gain and dynamic range. Noise contributions are further reduced in an in-

put stage that includes an impedance matching circuit. The circuit permits adjustment of the amplifier input impedance without causing changes in signal level. Included in the circuit is a balance adjustment that provides correction for inductive radiation in the input cable and ensures a high

common-mode rejection ratio.

A level control incorporated in the third amplifier provides gain adjustment without affecting the dynamic range or frequency response. The output stage is a modified emitter follower that matches the amplifier's output impedance to the load.

Two added transistors reduce ignition-system current drain

By Konrad W. Scheel

Jackson, Miss.

Two transistors added to a capacitor-discharge ignition system enhance its performance at high speeds and cut current drain at idling speeds. The modification prevents the silicon controlled rectifier used in these systems from shorting the supply voltage when discharging the capacitor—a common problem at the upper speed limit. Consequently, the stringent requirements usually placed on the inverter transformer and diodes are eased, and the system doesn't have to employ specially designed transformers. The added transistors, Q_3 and Q_4 , are shown within the dotted box on the circuit diagram.

Transistors Q_1 and Q_2 , together with transformer T_1 , form an inverter circuit that chops the 6-volt

d-c battery voltage and steps it up to 150 volts a-c at the secondary of T_1 . The voltage is then rectified by diodes D_1 and D_2 and smoothed by capacitor C_1 to give about 170 volts d-c. This voltage is within the insulation limits of the primaries.

When the ignition points open, a pulse is sent to the gate of SCR_1 and the base of transistor Q_3 . The pulse turns on SCR_1 , grounding the positive terminal of capacitor C_1 , which then discharges through the primary of the ignition coil, supplying a high-voltage pulse to the spark plug.

The initial triggering pulse also grounds the base of transistor Q_3 , turning it on and cutting Q_4 off. With Q_4 off, the power supply is isolated from the short-circuit created by SCR_1 when conducting.

The network consisting of D_3 , R_1 , and C_2 protects SCR_1 from high-voltage transients. The possibility of false triggering due to contact bounce is corrected by low-pass filter D_4 , R_2 , C_3 , C_4 , R_3 , and R_4 .

A system test indicated that the current drain from the power supply is about 0.7 ampere at standstill, 1 ampere while idling, and 3 amperes at 12,000 pulses per minute. The unit has been checked to an upper limit of 30,000 ppm.

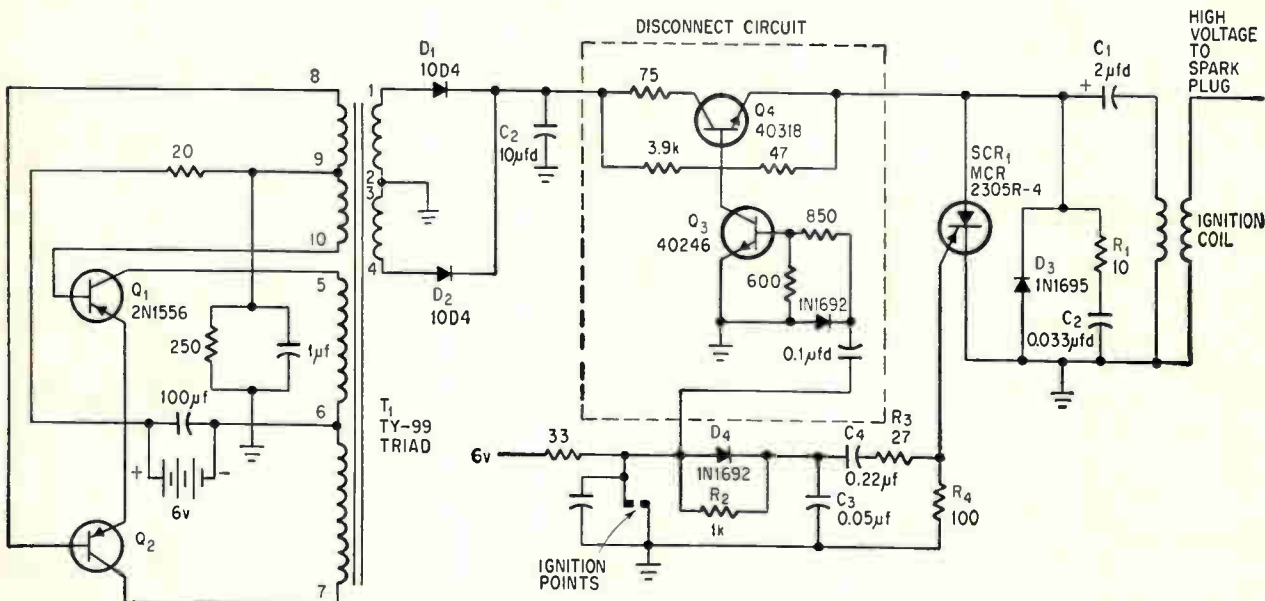

Transistors Q_3 and Q_4 in the disconnect circuit isolate the power supply while capacitor C_1 discharges through SCR_1 .

TEMPERATURE SCANNER SYSTEMS

50 POINTS/SECOND

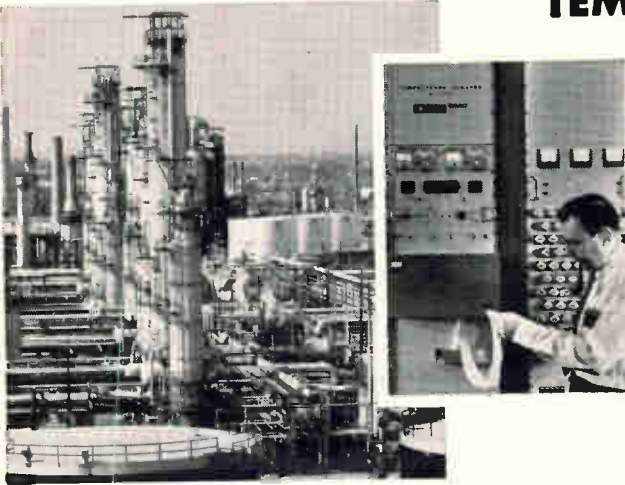

Proven EMC temperature scanner systems are now available for countless applications in a variety of industries. Monitoring temperatures at a rate of up to 50 points a second from 0°C to 500°C with a demonstrated accuracy of 0.1% of full scale, these systems have already saved thousands of man-hours for users in the chemical industry. These modularly-constructed systems are simple to install, operate and maintain. Pushbutton controls provide monitoring ease and flexibility. Modular units are interchangeable. The highly reliable systems are constructed from circuit modules with proven reliability of 4.5 million hours MTBF. This gives the typical system an MTBF in excess of 8,000 hours. (Other scanning requirements can be accomplished with the same basic techniques and systems components.)

DIGITAL REMOTE CONTROL DATA SYSTEM

The EMCON Digital Remote Control Data System, designed for railroad, utility, pipeline and other remote applications and proven by over 10,000 system hours of actual field operational testing, provides supervisory control and/or alarm capability using existing communications media without disturbing voice communications, if the latter also uses the same link. It provides for remote control of relays, signals and other devices with positive answer-back. EMCON uses digital computer techniques and solid state circuit modules throughout to ensure positive performance and adjustment-free service. EMCON generally consists of a control receiver at each of the remote stations and a dispatcher's control console and control transmitter at the dispatcher's or controller's office.

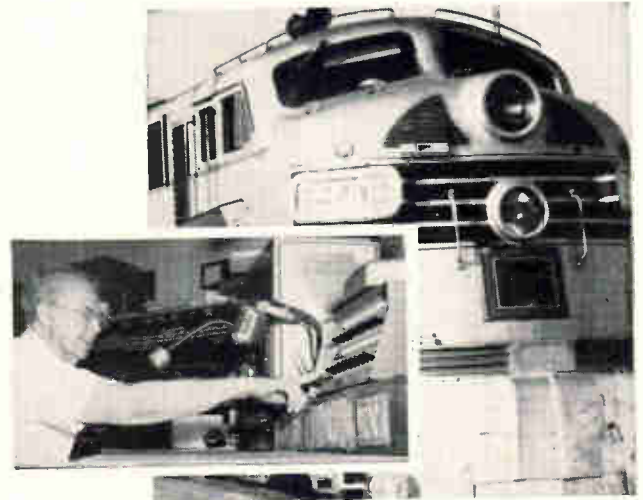

SOLID STATE TEMPERATURE CONTROLLERS

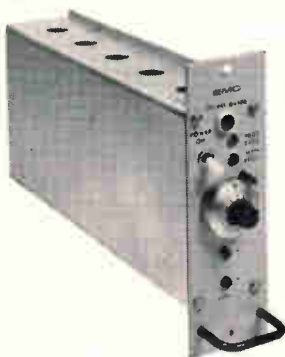

Precision temperature control of remotely located processes is provided by the EMC Temperature Control System which is composed of a Model D6100 Controller, a Model D5085 Load Driver, and a sensor. The Model D6100 narrow band proportional Temperature Controller contains an A.C. bridge (sensor and calibrated ten-turn set-point potentiometer are in one leg of the bridge), error signal amplifiers, bias adjust circuitry and SCR firing circuitry. Temperature response of the controller is extremely rapid with temperature lags less than 0.05°C. Proper design and location of the heater with respect to the load and the sensor are also necessary for optimum performance.

Our representative will be glad to provide additional information on how these and other EMC systems can meet your requirements for monitoring and control.

**ELECTRONIC
MODULES
CORPORATION**

Electronic Modules Corporation • SYSTEMS DIVISION
P.O. BOX 141 TIMONIUM, MARYLAND 21093 TWX-301-0723 301-666-3300

In reconnaissance, the eyes have it

Aircraft carrying electronically controlled cameras seek out the enemy, but because recon men need more than daylight sight, the Air Force is developing sensors that span the electromagnetic spectrum

By John F. Mason

Military electronics editor

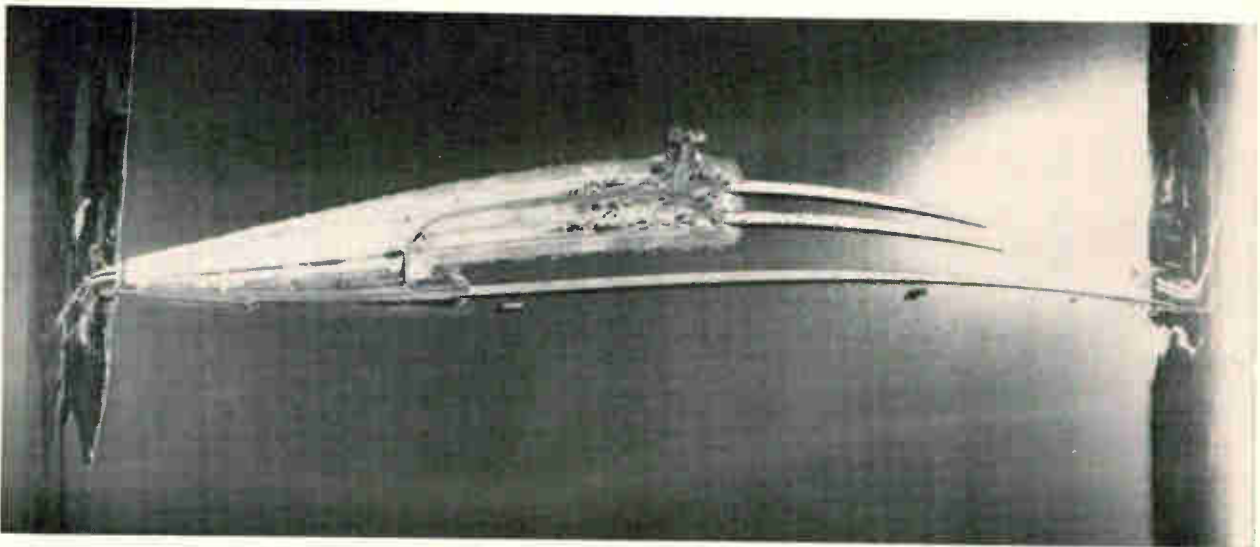

Horizon-to-horizon pictures are taken at low altitude by rotating a prism in front of the camera's lens, painting the scene, line by line, across moving film. This picture of a road bridge across South Carolina's Lake Marion was taken from an RF-4C Phantom jet with a KA-56 camera, built by the Fairchild Camera & Instrument Corp.

Makers of airborne reconnaissance sensors are having a rough time keeping up with the ever-changing requirements of the recon men. Charged with recording every significant move the enemy makes, the reconnaissance crews are only as good as their sensors.

Before the fall of 1962, reconnaissance flights were usually made at high altitudes and employed relatively slow-speed, narrow-angle photographic cameras that produced high-resolution pictures. But after the American U-2 plane was shot down over Cuba on Oct. 27, 1962, the RF-101 Voodoos began flying in beneath the radar coverage, about 250 feet above the sea at speeds of 600 knots. These runs called for fast-cycling cameras that were electronically controlled—there was no longer time to do much more than pilot the plane.

Then in Vietnam, recon men learned that cameras were no longer enough. They needed new kinds of sensors and techniques.

Their daylight, fair-weather flights were so successful that the enemy all but abandoned daylight operations. He moves at night, or under the protection of low-hanging clouds or a blanket of rain. If there is a ceiling of jungle foliage over the trail he uses it, or if he can create his own camouflage, he does. Penetrating these obstacles is the new battlefield for Air Force scientists and engineers, and for industry.

Already being used in Vietnam are night flash cartridges for photographic film cameras, infrared sensors and side-looking radar. But heavy clouds are obstacles to infrared and more sensitivity is needed. Radar provides good maps at night and

through clouds, but the scale is small and detail is hard to read.

These systems are being improved. Almost no portion of the electromagnetic spectrum is being ignored in the search for new sensors.

A laser is under test that paints a creditable picture with its own light beam. Infrared and ultraviolet lasers are also being considered.

Other projects include data links from sensors to home base, a more precise navigation, or self-positioning, system to pinpoint targets for the strike planes, and multisensor integration so one sensor can search for a target and another sensor zero in to identify it.

The evolution of new equipment begins officially at Wright-Patterson Air Force Base, Dayton, Ohio, where work is done in-house and by industry under contract. There, the Air Force Systems Command's avionics laboratory, tests breadboard models of new sensors. Promising ones are turned over to the Aeronautical Systems Division, which has an advanced version built and tested. Later, the Tactical Air Command's Tactical Air Reconnaissance Center at Shaw Air Force Base, Sumter, S.C., tests several models for operational feasibility and for the best applications. Sometimes, items off the shelf are sent directly to Shaw instead of Wright-Patterson.

Sensor control

To operate a variety of sensors, an electronic control unit is needed. The one in the RF-4C Phantom aircraft works well and with modifications will undoubtedly be the basis for future systems.

The unit, often called the photocontrol set, but officially known as the aircraft camera parameter control, is built by the Electronic Specialty Co. Information fed to the set by the aircraft's subsystems and the pilot is converted into instructions to all the sensors in the plane.

The inertial guidance system provides the set with the plane's ground speed (V) and the ground speed-to-altitude ratio (V/H). A sensor control panel provides such information as lens focal length and the depression angles at which the cameras are mounted—the number of degrees below horizontal. The pilot uses the panel to set the mode when flying at night and the desired film frame overlap—film frames overlap either 12% or 56% so there will be no skips in photographic coverage of the ground.

Armed with all this information, the control system tells each camera how many pictures to take per second; this depends on a combination of lens focal length, film format, depression angle and V/H—if the plane is flying low at high speed, pictures must be taken more frequently.

The unit emits pulses to trip the camera shutters and d-c voltages for image motion compensation. To get clear pictures image motion is neutralized by moving the film or the camera lens at a rate computed from V/H, focal length and depression angle.

The unit also generates distance markers every

five nautical miles—information derived from the inertial guidance system. These marker pulses are used by the side-looking radar, the data display system, and the infrared set to record the location of each picture.

For night photography, the pulses control the flash cartridge ejector system. The flash cartridge, once ejected, lasts 20 to 30 milliseconds. A special detector senses the increase in light during the first half millisecond and actuates a servo that opens the camera shutter in time for the peak intensity of light.

A number of companies are working on ways to get more accurate V/H data. The radar altimeter and doppler radar velocity indicators are not precise enough and their response time is too slow over uneven terrain. Besides efforts to improve the radars, sensors are being designed to measure the V/H ratio without radar. These include altitude determination by X-ray, active infrared, and optical techniques.

Bolsey Associates Inc. at Glenbrook, Conn., has offered the V/H sensor it provided for the Lunar Orbiter. This optical device uses a photomultiplier in the daytime and infrared at night. Instead of separately determining altitude and ground speed, it obtains V/H by measuring the angular rate of change of a fixed object on the ground as it passes from forward to rear of the plane.

Bolsey's general manager, Norman Altman, says the sensor is accurate to 0.1% and it responds in milliseconds to rapid altitude changes. The present system is accurate to approximately 1½% over more or less flat terrain, and less over rugged stretches. Bolsey is developing a much faster sensor for planes or unmanned craft that move at high speed at low altitudes.

Other companies working on sensors, according to Wright-Patterson, include the Perkin-Elmer Corp., Chicago Aerial Industries Inc., the Goodyear Aerospace Corp., a subsidiary of the Goodyear Tire & Rubber Co., North American Aviation Inc., the Hycon Manufacturing Co., and Baird-Atomic Inc.

The new breed

Before the Cuban missile scare, cameras were slow and didn't require much electronics. The K-38 high altitude camera, for example, had a maximum shutter speed of 1/150 second and took one picture every 1½ seconds.

This was adequate for high altitude work, but not for low altitudes at faster flying speeds, both of which increase relative speed over the terrain. Exposure rates on new cameras are up to 1/10,000 of a second. New cameras don't have conventional shutters; they have slits in the focal plane that widen or narrow to change the amount of light that reaches the film. Operational cameras now take six pictures a second, and newer ones take up to 12 per second.

Older cameras had an 80° field of view, panoramic cameras now look 180°—from horizon to horizon

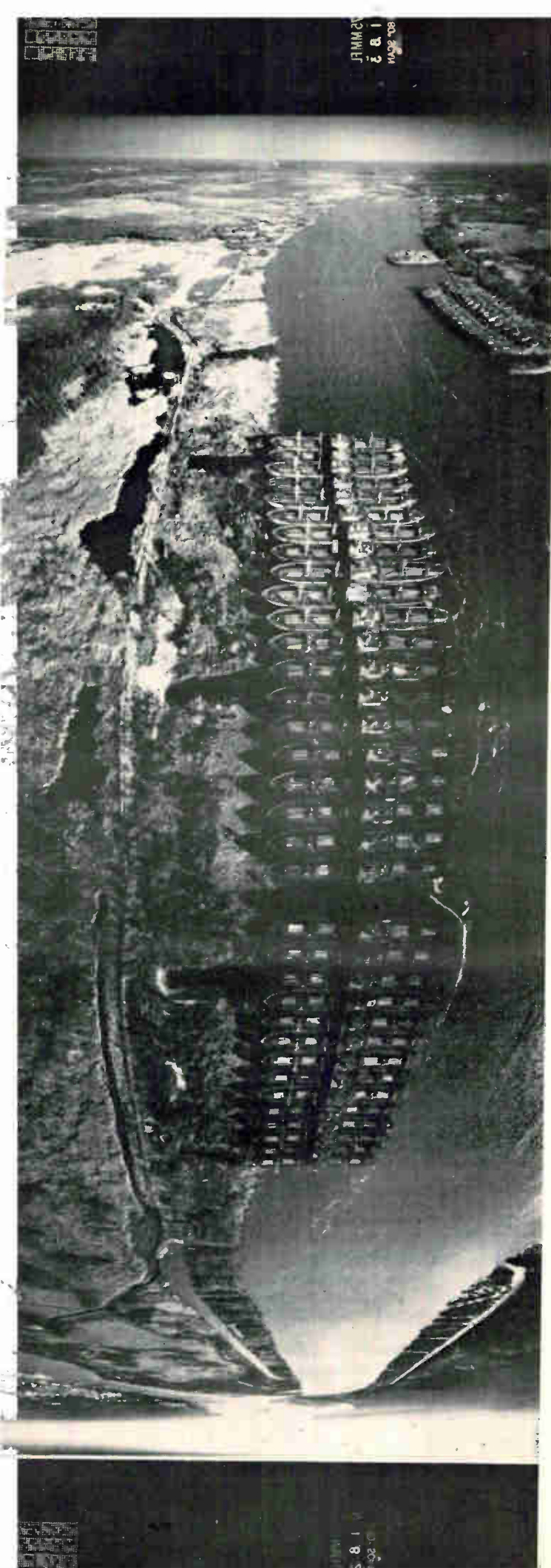

on either side of the plane.

A panoramic camera allows the pilot to fly to one side of the target and still get his picture. He might miss the target inadvertently, or deliberately, if it is hostile.

Moving and exposing so much film so quickly created many problems. To take 12 5-by-18 inch pictures a second, for example, the film has to move at a rate of 250 inches a second while the picture is being taken. A prism is used that rotates in synchronization with the moving film. It rotates about an axis parallel to the flight line, directing its narrow light beam through the lens to "paint" a 180° picture on the moving film.

To avoid quick starts and stops, the film moves about 125 inches per second, accelerating to 250 inches per second while the picture is being taken. In one second, more than nine feet of film moves through the camera, accelerating and decelerating six times. The film transport creates a lot of heat and required redesign of the cameras. Very precise servos were installed and components vulnerable to heat, such as the lens, film, transistors, and miniaturized circuits, were moved away from the transport.

Chicago Aerial partially solved the problem in the new KS-87A camera it is building for the Navy, and the KS-87B version for the Air Force, by using mechanical timing and switching devices rather than heat-producing electronic components. All electronic components are solid state. The new camera's performance is comparable to the KS-72's, described on page 95.

Electronic control for cameras

A control unit in each camera receives instructions from the aircraft parameter control system.

After the operator sets up the sensor control panel and turns on the set, three things typically happen in the new breed of camera:

- A scan servoamplifier accepts the V/H command signal and causes the magnetic amplifier to provide a proportional voltage control to the scan motor. The scan motor drives the camera prism rotation speed, film scan speed and the magazine metering speed. As the prism rotates, the terrain image is transmitted by it through the lens and the image is progressively "painted" on the moving film.

- The image motion control servoamplifier responds to the V/H command to set the image mechanism to the proper position. In the KA-56A panoramic camera, built by the Fairchild Camera & Instrument Corp.'s Space and Defense systems, the image motion is controlled by moving the lens at an equal velocity, but directionally opposed, to image velocity. The lens, therefore, moves parallel to the direction of flight during the scan,

Mothball fleet near historic Ft. Sumter, S.C. photographed at low altitude with the KA-56A panoramic camera. The aircraft was flying from right to left.

'Today's aerial recon cameras are electronic monsters . . .'



Camera compartment in this RF-101 holds three high- and low-altitude cameras. Black boxes at top contain the electronic switches for camera control.

This KS-72 high- and low-altitude camera may be replaced by the less electronic and more mechanical KS-87 camera. The newer KS-87 has been designed to keep electronic components away from heat-producing film transport mechanism.

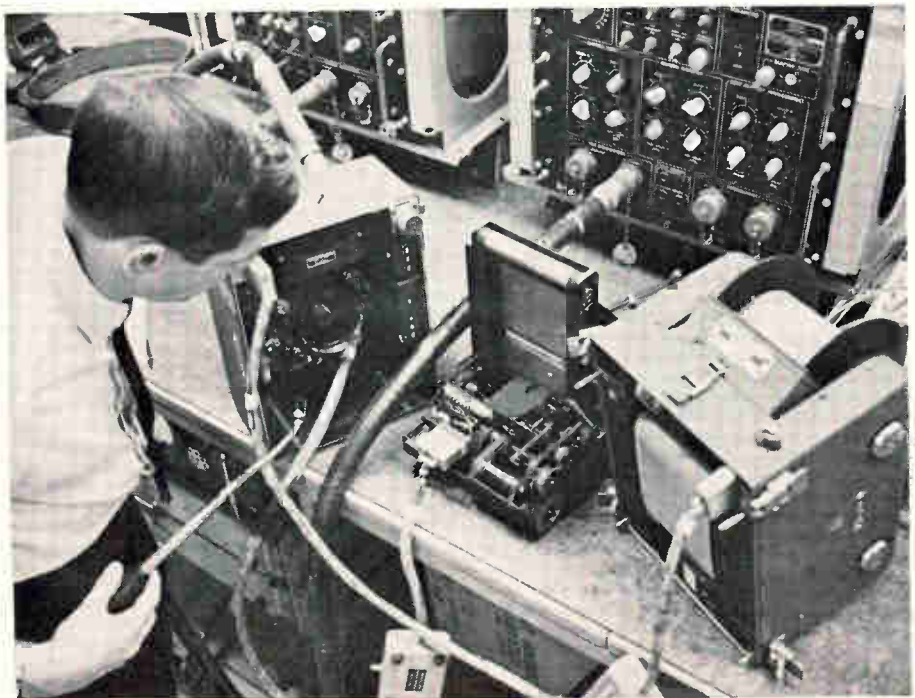

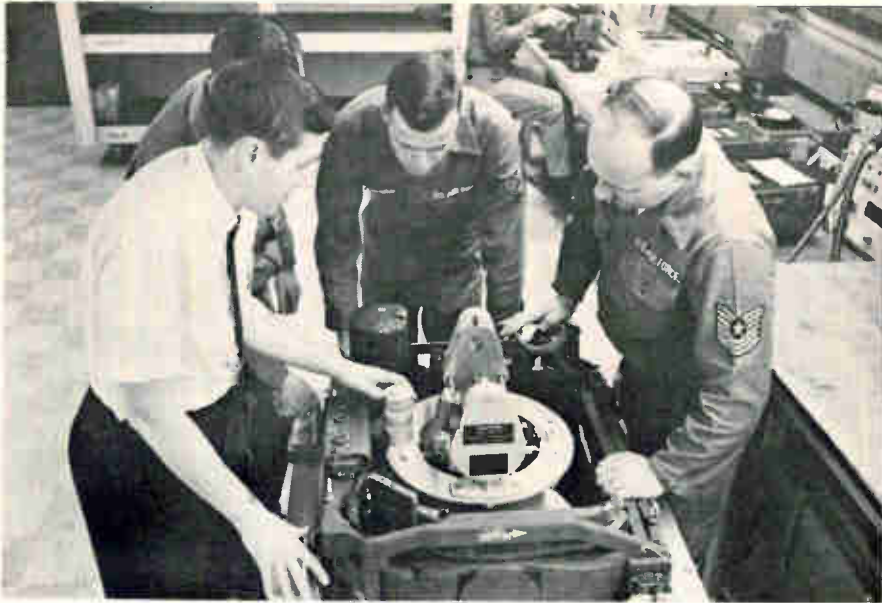

Stabilized mount in the RF-4C keeps photographic cameras perpendicular to the ground, corrects for roll, yaw, and pitch. The mount is electronically controlled, built by Fairchild Camera.

KA-56A camera is shop tested for a suspected malfunction.

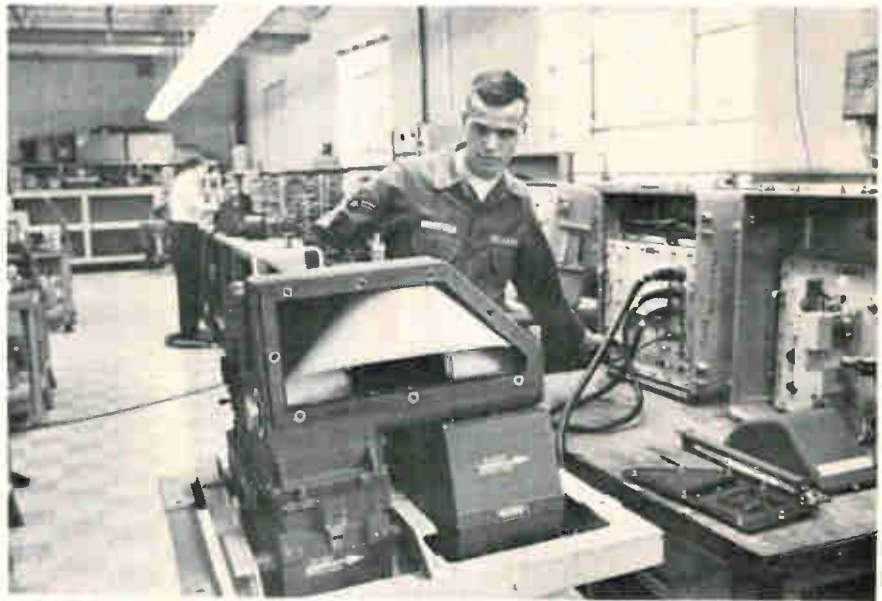

Auxiliary data annotation system prints in binary form information on the sensor being used, altitude, longitude, and time. Data is presented on the 4-inch cathode-ray tube on top of the unit. The goal is to add data in easy-to-read alphanumeric symbols.

and returns during the between-scan period. It oscillates at the same frequency as the picture-taking frequency. The rate is controlled by a wobble-plate cam which a d-c servoamplifier positions in accordance with the V/H command signal.

▪ The automatic exposure control positions the slit in the focal plane. The control voltage of this servosystem is obtained from a photoelectric cell in the camera. The cell voltage and a voltage representing the starting slit position are compared and the error signal is used to drive the slit to the proper position.

An inhibiting and scaling control module converts the V/H signal input of the camera to certain scaled voltages proportional to V/H for portions of the V/H input. The modified d-c signal is then coupled to the automatic exposure control servoamplifier, image motion compensation servoamplifier, and scan-drive amplifier modules. Another module demodulates the pulsating d-c signal from the photocell amplifier. It performs exposure control and timing by delaying the operate command long enough to allow the scan-drive motor to come to speed. In addition, it also contains the firing circuits for the capping shutter and data annotation.

Data recorded on each film frame identifies the picture for the photo interpreter. The inertial navigation system provides latitude and longitude, drift angles, true heading, and aircraft pitch and roll angles. Other information recorded includes the radar and barometric altitudes, the sensor used, the time and date the picture was taken, the mission number, and the squadron.

This data is printed in binary form as a result of signals from the timing and control circuit and the V/H inhibiting circuit. The information is ex-

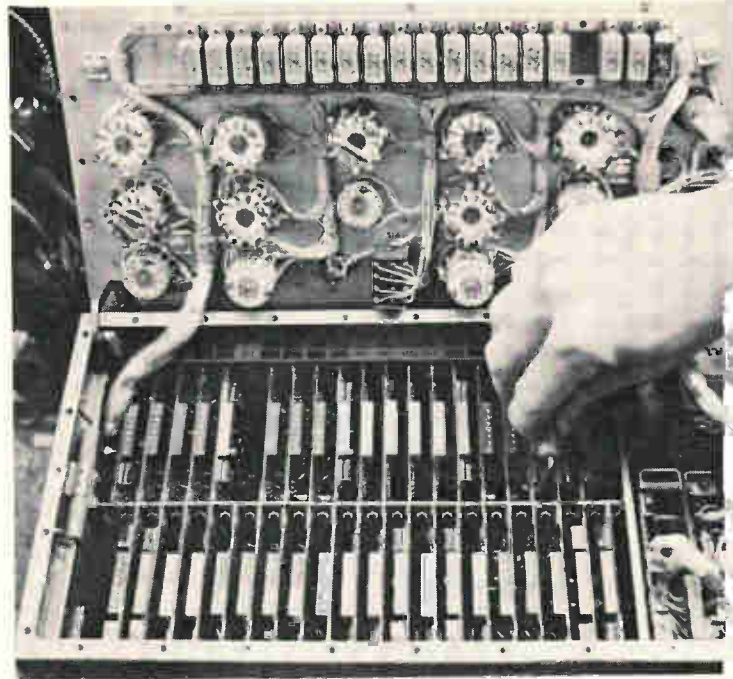

Electronic control systems, like this one used in the RF-4C, feed each sensor the information it needs and give it commands. Work is under way to provide this system with a new sensor that will determine the velocity-over-height ratio faster and at night.

posed on film by using a high-voltage, cathode-ray tube. The system, built by the Fairchild Hiller Corp., is called the auxiliary data annotation system. The company is developing a version that will print out some of the information in alphanumeric form as well as in binary dots.

Fairchild Camera (the two companies are not connected) has built a solid state system that con-

Flying the Phantom . . .

The whine of the powerful jets builds to a shrill squeal as the pilot tests the engines of our RF-4C Phantom—often called a “horizontal missile.” We are going through check-out procedure and waiting for our turn to take off. Several RF-101 Voodoos are lined up at the active runway, waiting. Behind them there’s an RB-66 Destroyer and another Phantom.

We are at the Tactical Air Command’s Shaw Air Force Base, at Sumter, S.C., where the most advanced airborne reconnaissance gear and concepts are tested by the Tactical Air Reconnaissance Center, and where the Ninth Air Force trains pilots and reconnaissance officers for TAC bases around the world.

An RF-101 screams down the runway and lifts into the air. It is

carrying electronically operated photographic cameras—some Voodoos are equipped with as many as seven. The RB-66 Destroyer electronic warfare plane is still waiting, its small after cabin crammed with radio receivers and transmitters and a crew of four.

Our Phantom, like the one just ahead of us, is the most sophisticated tactical reconnaissance aircraft in the Air Force today. It flies equally well at 200 knots or more than twice the speed of sound. Day or night, in good weather and bad, at tree-top level and above 57,000 feet, it is able to sense almost anything, anytime, anywhere.

The Phantom’s sensors include high-resolution, side-looking radar for mapping large areas; an infra-red detecting set; high- and low-altitude panoramic cameras; for-



Author (left) with Phantom pilot Lt. Col. Vassilias “Bill” Tsufis.

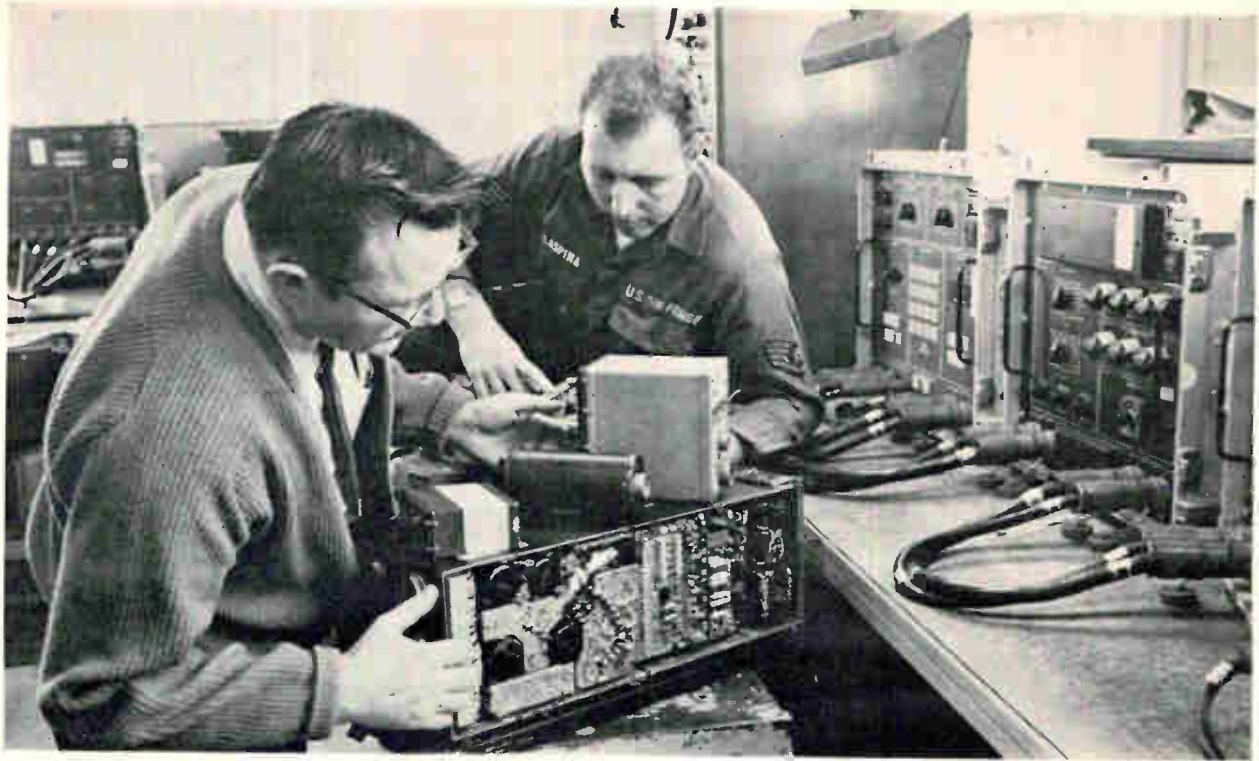

Navigational computer in the RF-4C's inertial navigation system solves hundreds of problems human navigators used to handle; it continually provides the pilot with his position, plus heading and distance to home base.

sists of a semiconductor chip with a matrix of 576 silicon light pulsers which emit light in response to a current pulse input. The points of light expose the film, thereby recording the data. The device is small— $\frac{1}{2}$ cubic inch as opposed to the cathode-ray tube's 4 cubic inches. Fairchild Camera has flown its device successfully.

The RF-4C Phantom is usually equipped with

three reconnaissance cameras.

Mounted in the nose in either a vertical or forward oblique position is the KS-72A framing camera, a high-resolution instrument with interchangeable lens cones. The camera can be used during the day at any altitude the aircraft can fly. At night, illumination is provided by photoflash cartridges. It can automatically take six $4\frac{1}{2}$ -inch-

ward-oblique and vertical cameras; and a low-altitude night photographic system.

To aid the pilot and reconnaissance officer make use of this elaborate complex of sensors there is a forward-looking radar with a direct-scope camera for mapping. The radar is also used for spotting a target soon enough to decide whether to fly over it, or past it, and at what altitude for a particular sensor. The radar is also used extensively in Vietnam for terrain avoidance when the pilot is streaking toward his target as close to the ground as he can fly.

Flight preparations. An hour in the RF-4C trainer yesterday helped familiarize me with the sensors and navigation gear in the recon officer's cockpit. The pilot, Lt. Col. Vassilias "Bill" Tsufis, in the front seat of the tandem plane, will tell me over the intercom when to turn the equipment on as the mission

proceeds.

The coordinates of Shaw AFB have already been set into the inertial navigation system, the LN-12B made by Litton Industries Inc. Its panel is at the left of my seat. I flip the switches needed to warm up the system and align the gyros, then put it into the automatic navigation mode.

We check the flight controls and other items on a "challenge and response" list and begin moving toward the runway.

Camera warmup. Now, the cameras must be tested. The master operating switch on the high-altitude camera indicates that there's 495 feet of film.

On Bill's command, I turn the camera on and we use five feet of film. The procedure is repeated for the low-altitude panoramic camera. We start with 500 feet of film and test down to 495 feet.

Bill turns the radar altimeter

and then the side-looking radar to "Standby." This starts the electrical circuits that warm the radar to the correct operating temperature.

The forward-looking radar gets a more thorough test. It stays on "Standby" for two minutes, then to "Test." An E² presentation appears on the scope. Bill says the pitch pointer is in "full up deflection." This means the radar is presenting reliable information for the terrain-following mode. Switched to the "Mapping" mode, the tower appears on the scope and behind it a gas station across the road from the runway. Bill says the set is in good condition.

Both cockpits have scopes that show the terrain ahead. Because of the life-or-death importance of the system's reliability during the automatic terrain clearance mode, built-in test circuitry monitors the system's components continually

square pictures a second. The camera is built by the Hycon Manufacturing Co., carries 500 feet of film, half of which can be developed in flight.

Located behind the KS-72 is Fairchild's KA-56A low-altitude panoramic camera, providing horizon-to-horizon coverage with 56% overlap at a minimum altitude of 250 feet at a ground speed of 500 knots. It takes six 4.5-by-10.8-inch pictures a second and can also process film in flight.

To the rear of the KA-56A is Hycon's high-altitude panoramic KA-55A, for use in daylight at altitudes as low as 10,000 and as high as the aircraft can fly. Cycling rate is 1.8 seconds, film size is 4.5 inches by 18.8 inches.

Under development

Fairchild Camera is working on a new camera for post-strike damage assessment under an \$8.6-million Air Force contract. It is a 70-millimeter, panoramic type that fighter-bombers will carry to photograph their approach to the target, weapons delivery and the post-strike damage. Designated KB-18, the camera evolved from the KA-60, a 12-cycle-per-second camera. It uses some integrated circuits. Resolution is 45 lines per millimeter, but as with all cameras this specified resolution is degraded by vibration caused by the camera mechanism and by the aircraft. "You turn the switch on and you've already lost 15 lines per millimeter of resolution," an official at Wright-Patterson says.

Fairchild also is developing three new cameras:

- The F-638 is a medium-altitude camera for use between 4,000 feet and 30,000 feet. Although almost horizon-to-horizon—120°—the F-638 doesn't use a prism, but a rotating lens. The new camera

will provide greatly improved resolution—more than twice that of previous cameras, Fairchild says.

- The KA-77 is a low- and high-altitude (300 feet and 50,000 feet) prism panoramic that is one step beyond the KA-56A. It takes a picture 5.5 by 18.8 inches and its circuitry is more sophisticated. Mechanical switches are replaced by solid state switches, and infrared light sources with infrared detectors are used. This permits the use of optical rather than mechanical controls, since the infrared does not affect the exposed film.

- Fairchild's KA-78 will be a prism panoramic for low altitude at supersonic rates. It will operate at 12 cycles per second.

The KA-77 uses digital integrated circuits in many control functions. "This will improve reliability and decrease weight and space," says Billy Gaddy, Fairchild's project engineer. "We'll be able to package our electronics more efficiently within the camera itself."

Another improvement the Air Force would like, according to an official at Wright-Patterson, is the elimination of static electricity in the cameras caused by circuits and the film transport mechanism. "We're a little tired of St. Elmo's fire in the cameras, exposing the film," he complains.

Cameras can provide just about any resolution needed today with the lenses and film available. The only problems are static and vibration from starting and stopping film.

Present cameras are good. To improve them a little requires tremendous effort. Other sensors, however, are not so advanced. A little effort on them may result in a big step forward.

Continued on page 100

... over the target with cameras running ...

for malfunctions. The system, designated AN/APQ-99, is built by Texas Instruments Incorporated.

Milk run. The pilot gets clearance from the tower to move to the active runway. He rolls into position and runs the engines up to 85% of their capacity. The pilot receives clearance to take off. He releases the brakes and pushes the throttles forward to 100% military thrust.

At 60 knots, Bill turns on the afterburners. Thirty-two thousand pounds of thrust kicks us in the rear. In 10 seconds the air speed is up to 160 knots. The pull against the back of the seat is noticeable but not much more than you feel in a DC-8. A few moments later, the plane leaps into the air. We have used up only 2,000 feet of runway.

Bill tells me to switch the radar

altimeter to "On" and the infrared to "Cool." We are now 1,500 feet high passing over the end of the 10,000-foot runway making a true air speed of 360 knots. We've accelerated 200 knots since we left the ground 8,000 feet back.

We begin following a railroad track to our first target run. A few moments later we make a hard 3½-G left turn to a heading of 136°. We are at 1,500. True air speed is 480 knots, but the ground speed indicator registers 473 knots. We have a slight head wind.

Our first target comes into view on the forward-looking radar scope. It is a road bridge across South Carolina's Lake Marion.

Over the water we drop to 550 feet, check the target on radar again and correct course. Five miles from the target Bill says to

turn on the infrared.

A half mile out, the low-altitude panoramic camera and the vertical camera are turned on. We pass over the target and the pilot banks sharply with the cameras still running. The crazy picture of the horizon and sky will indicate clearly to the photo interpreter later that this is the end of the first target.

The next target is a power plant, four minutes away, requiring only a slight change in course. Bill gets the target on his forward-looking radar scope and heads the plane to pass slightly on the left of the plant so we can get a good side-looking radar picture. We also turn on the oblique low-altitude panoramic camera and the infrared set. We fly past the power plant 500 feet above the ground at a speed of 485 knots.

Route reconnaissance. The third target is Walterboro, S.C., airfield. We turn off all the cameras, bank



After U-2 was shot down new cameras were developed to come in low, under enemy radar beams. This KA-56A folds up into the sleek RF-4C Phantom and photographs the terrain horizon-to-horizon from as low as 250 feet moving at 600 knots. The camera can process its pictures in flight and has automatic exposure control.

right to a heading of 245°, level out and turn on the infrared to perform route reconnaissance. There's a road that parallels our course to the airfield and we'll record all the traffic along the way. The infrared provides considerably greater lateral coverage than the vertical photographic camera does; and because the film moves slowly, its linear coverage is also greater.

I feed the coordinates of Wal-terboro airfield into the inertial navigator. It's 30 miles away at a bearing of 243°. We are making a ground speed of 480 knots. Three minutes later Bill tells me to turn on the low-altitude panoramic camera and the side-looking radar.

After passing over the target and a very hard 5-G turn, he wants the cameras turned off. We drop down to 300 feet and head for the coast. The shadow of our plane out to the left is streaking over a desolate swamp. The flight is as

smooth as a commercial jet.

Our flight plan calls for a left turn at the coast to proceed to Ft. Sumter but Pilot Tsufis spots a ship a few miles out. Checking the barometric altimeter against the radar altimeter—it's hard to judge altitude accurately over the ocean—we pull up to 1,000 feet and fly over the ship. We use both the low-altitude panoramic and the vertical cameras. The film indicator shows 380 feet of film left for the low-altitude panoramic camera, 420 feet for the vertical panoramic, and 490 feet of infrared film.

We turn back in the general direction of Ft. Sumter but the shore line is hazy due to a temperature inversion. There is heavy air traffic in the area so we climb to 1,500 feet and slow down to 360 knots. The inertial navigator indicates Ft. Sumter is 60 miles away at a bearing of 355°. The ground track checks perfectly with

the tactical air navigation system.

After Ft. Sumter we photograph a mothball fleet near Charleston at 500 feet and then head back to the base. Bill goes into a steep climb. Seconds later we are at 18,000 feet.

"There's a swamp down below," Bill says. "We can move through Mach 1 into supersonic speed without disturbing anything but a few muskrats." The Mach meter goes from Mach 0.88 to 1.0—here the barometric altimeter jumps 1,000 feet due to the difference in airflow over the static ports—to 1.2. The true air speed indicator shows 724 knots—about 830 statute miles an hour. The only sensation is speed.

Ten minutes later we land at Shaw. Two technicians rush out and take the film from our cameras. Fifteen minutes later we are in the debriefing room examining the negatives.

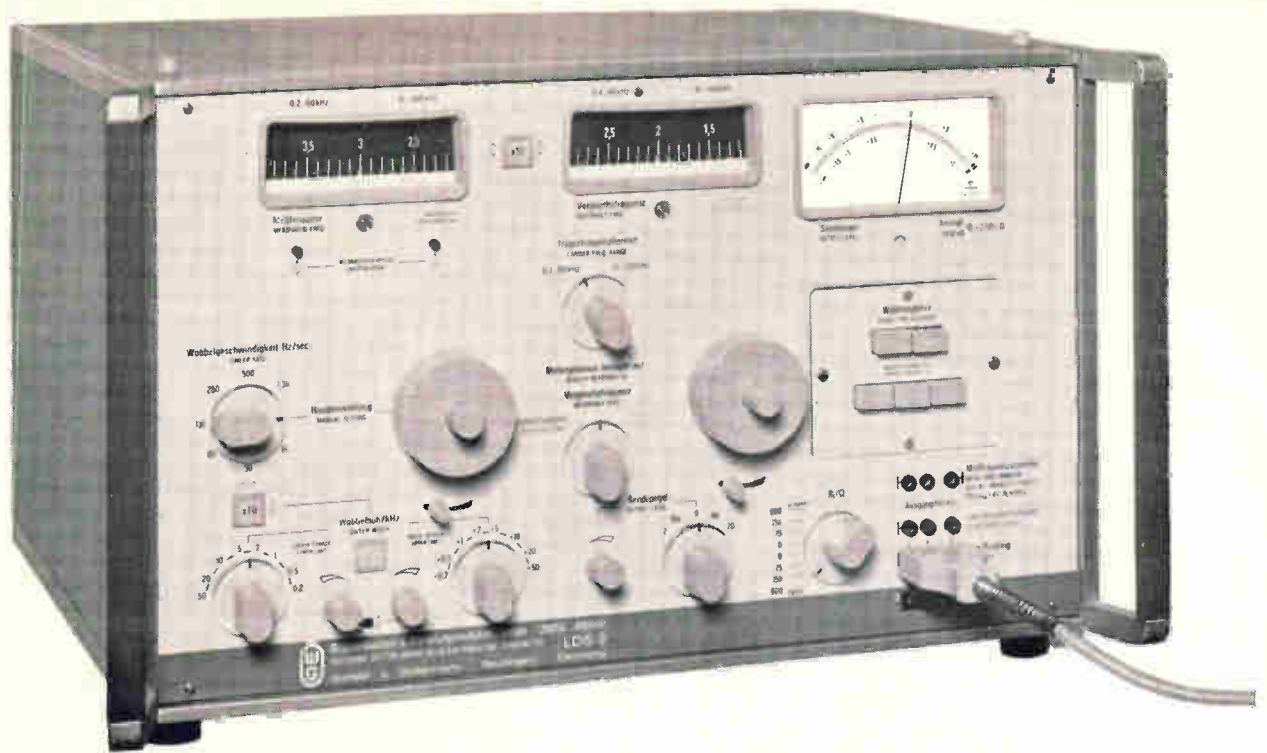

Automatic Phase Control

the Solution for End-to-End Measurements of Envelope Delay on Data Transmission Circuits.

Group Delay plays an important role in high speed data transmission where maximum system capacity is to be utilized.

Measurement of Group Delay (as a function of measuring frequency) in the laboratory poses no problem as transmission of the reference phase is easily accomplished.

But how do you solve the problem if the circuit under test is hundreds of miles long and cannot be looped?

Even the best crystal oscillator has a drift which superimposes itself on the measurement if transmitting and receiving ends are not synchronized. Can you afford a two hour wait while the crystal temperature reaches its as-

signed value? Will you tolerate constant phase readjustments to compensate for instability in your measuring instrumentation or for the changing value of the absolute delay of the measured circuit (as in the case of a satellite transmission)?

You have more important things to do. You can insist that your group delay measuring instrumentation be operable immediately upon turn-on and that it yield reproducible, stable results. You can because W & G has now developed a measurement technique which eliminates the drawbacks of all former methods of measurement.

Based on the measuring set to 14 MHz (Model LD-1) which has proven itself as the only instrument available for

measurements on video tape recorders, a group delay measuring instrument was developed for the frequency range from 200 Hz to 600 kHz. Only one, fixed, modulation frequency of 40 Hz is used for the entire frequency range — in spite of this the instrument attains the remarkable sensitivity of 1 μ s at all measuring frequencies.

You can sweep or measure point by point; the result is always exactly reproducible.

The results are displayed on three meters simultaneously: Frequency; Attenuation; and Group Delay. You can connect an X-Y-Recorder and immediately have a permanent record of the test results. Obviously solid state — Naturally 19" Rack Mountable.



The New Wandel & Goltermann Envelope Delay Measuring Set LD-2

Features:

Principle:

Nyquist principle, modulation frequency 40 Hz, therefore, no beat with the line frequency.

Readout:

Simultaneous, separate, meter displays of frequency and group delay and attenuation distortion; or frequency and absolute group delay and attenuation—for either point by point or sweep measurement. Output for X-Y-Recorder available.

Dial Tone Elimination:

Provisions are incorporated in the generator to avoid unwanted actuation of dial tone receivers within a system under test.

Typical diagram of a telephone connection recorded by an X-Y Recorder connected to the output.

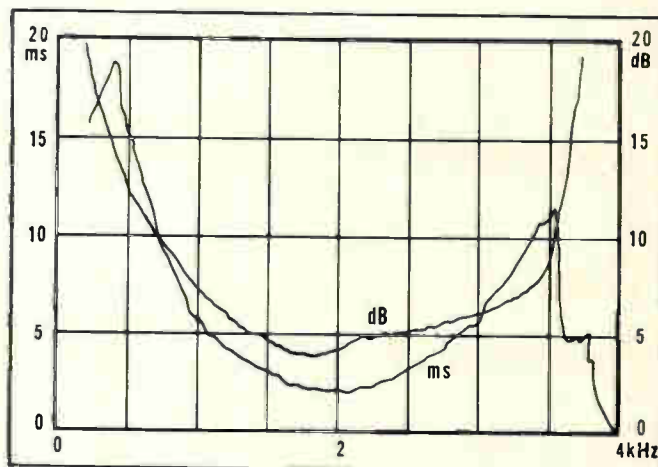

Frequency Range:

200 Hz to 600 kHz. Accurate frequency adjustment assured by an 8 foot long projection scale with sub-ranges 200 Hz to 60 kHz and 10 kHz to 600 kHz.

Phase Control:

The receiver is automatically phase synchronized to the generator via a phase reference transmitted through the circuit under test, thus assuring repeatable measurements without warmup or preliminary phase adjustments.

Resolution:

1 μ s for group delay measurements; 0.05 dB for attenuation.

Sensitivity:

Transmitter output level +10 to -35 dB. Receiver sensitivity +10 to -50 dB. Dynamic range of the receiver 40 dB.

Impedances:

75, 150, 600 ohms; plus 0 Ω (generator) and 10 k Ω (receiver).

Sweep:

Sweep width from 400 Hz to 600 kHz continuously adjustable. Sweep time from 0.3 second to 1 hour.

Power Supply:

Operation from AC line or a 24 volt battery.

TEL-COM
INSTRUMENTS, INC.

U.S. Agents for

Wandel & Goltermann

Representatives in CANADA: R-O-R Associates Ltd., Don Mills, Ontario; ENGLAND: Wandel & Goltermann (UK) Ltd., London, W3; AUSTRALIA: Jacoby, Mitchell & Co., Sydney, and in 30 more countries.

17715 Chatsworth Street • Granada Hills,
California 91344 • Phone (213) 360-2278

741 Reutlingen • Germany • Postbox 259



Watching the invisible enemy

To see at night, through rain and foliage, the Air Force is updating infrared and radar and working on other techniques

Sensors that can rip the cover off the enemy, no matter how he tries to conceal himself, are now the big challenge in the development of airborne reconnaissance systems.

The Phantom's side-looking radar and infrared detection system need improvements. A simplified radar would reduce maintenance problems while a larger display scale would show more target detail. The trend in infrared is toward more sensitive systems and to detector arrays that can gather a greater amount of target data.

These efforts are being backed up by work on data transmission systems to send sensor information back to the base for analysis before the plane returns.

So the pilot can also see what his sensors are picking up, in-flight processors for the infrared and side-looking radar are being developed with near-real-time readout displays in the cockpit.

Integrated displays are also a prospect for the future. A pilot might see a target on his forward-looking infrared system and, then, to get a better look, focus his high-resolution radar on the same spot.

Every other known technique is being examined to determine new ways to see in the dark, through bad weather, and under camouflage. The use of passive microwave receivers to pick up the normal electromagnetic radiation emitted by any object is being considered. Magnetic anomaly devices also might be useful; they have already been employed in mine detection by aerial prospectors for locating ore, and by antisubmarine warfare planes for spotting enemy subs. And even X-ray detectors are being studied.

Infrared detector arrays

The infrared system used in the RF-4C Phantom is the AN/AAS-18, built by Texas Instruments Incorporated. A single detector must scan the terrain quickly, without taking a second look at any given spot. Nor does the pilot see what the infrared system detects. Readout from the AAS-18 is photographed on standard strip film, not displayed in the cockpit. The film is developed on the ground after the flight.

However, in a report to its stockholders, dated

April 19, TI said "we now have a new forward-looking (infrared) system which produces instantaneous views of the terrain under the aircraft."

The scanning speed of the present system limits system resolution, while the one-look-only limitation makes it impossible to see whether a heat source is moving or not. A system that used an array of detectors—10 rows of 10 elements, for example—and had a real-time cockpit display would overcome the limitations of the present system. With an array, the scanning speed could

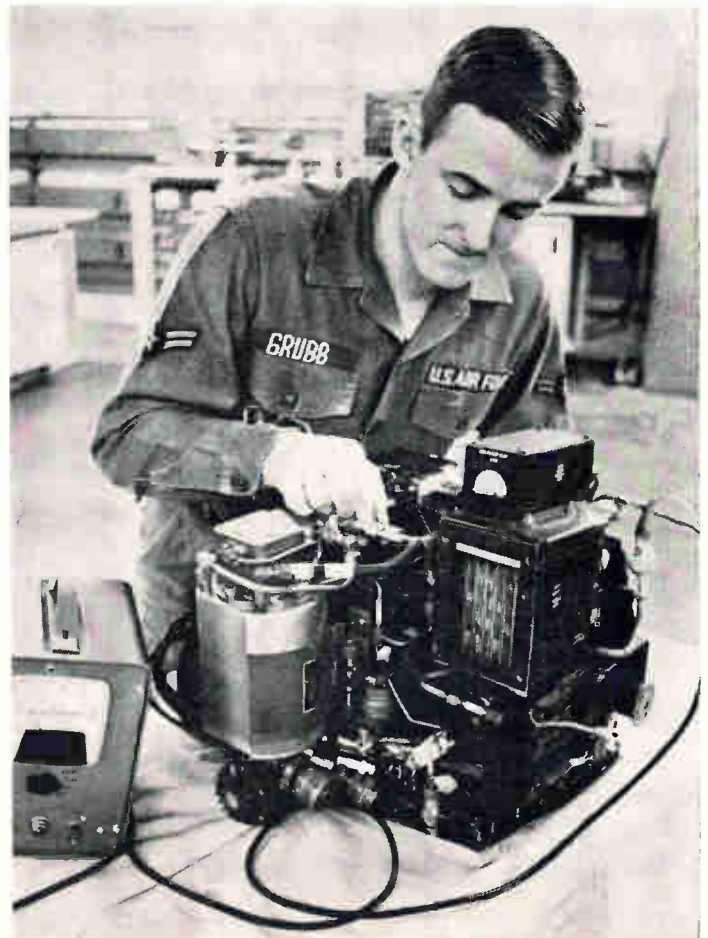

Infrared sensor, AN/AAS-18, built by Texas Instruments, is doing effective work in the RF-4C.

be lowered and the system could look at each spot 10 times, allowing the cockpit display to be designed as a high-resolution, moving target indicator.

Wright-Patterson is working toward arrays of up to 100 infrared detectors.

One company developing detector arrays is the Avco Corp.'s Electronics division. The company is now making infrared arrays composed of long strings of mesa-type detectors with diffused junctions made in single chips of indium-antimonide semiconductor.

The detectors look through a slot in an optical mask of deposited gold, as an auxiliary optical system scans the scene ahead of the plane. The detectors respond to relatively small variations in target temperatures because they are cooled by liquid nitrogen to 77° K.

Improved detector arrays are now under development at Avco. These will be two-dimensional, point-by-point imaging arrays rather than linear arrays. Avco proposed two array sizes: 5×5 , or 25 detectors, and 10×10 , or 100 detectors. To provide the detector sampling circuitry that will be needed, the company plans to put metal-oxide semiconductor (MOS) integrated circuits into the cryogenic cooling system along with the detector-array chips [Electronics, April 3, p. 42].

The best way to improve the sensitivity of each detector is still to be determined, but the need is well defined.

If, for example, an infrared sensor with 5° temperature resolution flies over a truck that is only 4° hotter than the road it's on, the truck won't be seen.

At present the way to improve sensitivity is to make the detecting element cooler; the lower the temperature, the more sensitive the element is to variations in heat. Unfortunately the more effective the cooling system is, the bulkier, heavier, and more prone to failure it is. Improvements would be welcome at either end: a material that is extremely sensitive to temperatures without having to be so cold; or a cooling system that isn't so elaborate.

Other companies working on infrared elements for Wright-Patterson are HRB-Singer Inc., a subsidiary of the Singer Co., the Aerojet-General Corp., the Santa Barbara Research Corp., and Honeywell Inc.

Operational system

The operational AAS-18 infrared set in the RF-4C consists of four units: the power supply, receiver, recorder, and film magazine.

The receiver has two helium-cooled detectors that point straight down. One detector is used at high altitude and the other at low. The terrain below is scanned through a four-sided rotating mirror scanner, a folded-mirror transmission system, and a parabolic focusing mirror. The detector output is amplified and passed through a video selector and video gates.

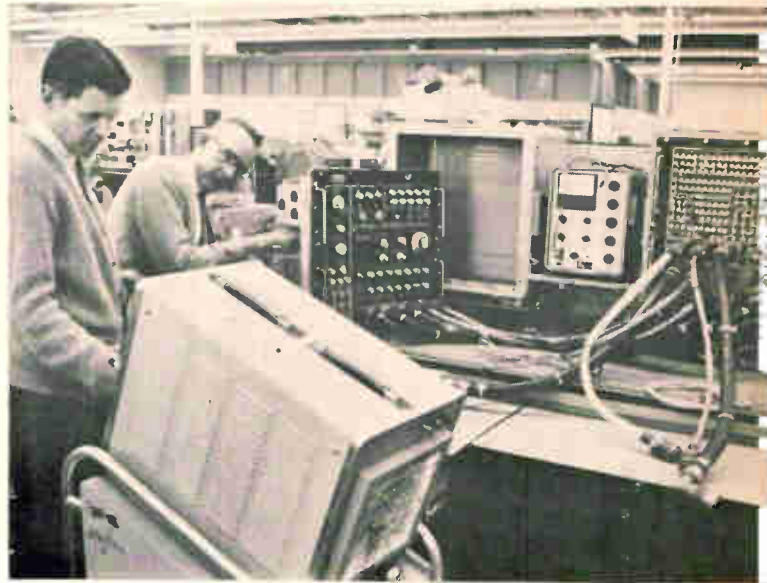

Forward-looking radar, AN/APQ-99, built by TI must be checked out carefully because of its important terrain-avoidance mode during low-level flight.

In the recorder, a video correction circuit enhances signal contrast. After further amplification the signals are displayed on a 5-inch cathode-ray tube.

The display is photographed on standard strip film which is developed and studied on the ground. A nonlinear sweep generator compensates for tangent distortion and produces a rectilinear recording. Drift and pitch servosystems adjust the cathode-ray tube deflection yoke to compensate for aircraft instability.

Certain vital information is fed to the set from the inertial navigation set. The aircraft's drift angle is needed to determine true bearing. Pitch and roll angles are needed to stabilize the infrared set perpendicular to the ground track. Velocity, velocity-to-altitude ratio, and velocity fault signals



A side-looking radar antenna is built into each side of the RF-4C fuselage.

are used to control recording speeds and to indicate errors in velocity, height or V/H ratio.

Laser scanners

Infrared detectors are generally passive. Active optical detection systems, based on lasers, are also under development.

Good results have been obtained with an airborne line-scan laser system that illuminates the terrain with a sharp pinpoint of light. The light reflected from the terrain builds a photograph on standard film by a video sequential-type scanning process. The camera uses a continuous wave that is coherent, monochromatic and unidirectional. The system operates well at high speeds.

The first laser tested was a long continuous-wave, plasma tube. It was too long and the next system used four shorter tubes. Now, they're trying to replace the four tubes with one powerful one.

A laser system built by the Hughes Aircraft Co. has been tested at Wright-Patterson, and one is being developed by the Goodyear Aerospace Corp. Others working on airborne lasers include Aerojet-General and TRW Systems.

Ultraviolet and infrared lasers have been tested, but without significant success so far. Officials point out that infrared sets are heavy and bulky and that ultraviolet is more affected by the atmosphere—ozone blocks it—than visible light. The range of an ultraviolet system is limited and the power requirement is high.

Radar

For looking through clouds, day and night, the Phantom is equipped with the AN/APQ-102A side-looking radar mapping set, built by the Arizona division of Goodyear Aerospace. The system is a dual-channel, high-resolution, coherent, side-looking radar operating at a very high frequency. It can map on one or both sides of the aircraft at high and low altitudes and it records moving targets.

When in the high resolution mode, the radar illuminates the terrain in very small increments. In the moving target indication modes, the terrain is illuminated in even smaller increments. Pulse compression provides high resolution in range. The doppler principle is used to achieve high resolution in azimuth.

The set uses two antennas, one built into the right side of the aircraft fuselage and the other in the left. Each antenna is actuated and stabilized by its own control system. Attitude control loops stabilize the antenna to the aircraft's inertial reference platform regardless of the actual attitude of the plane. Any excess attitude error is corrected in the radar mapping recorder.

Presentation of side-looking radar is complicated. Signals are first recorded on film as a doppler history of the returns. To present a picture an interpreter can understand, these recordings are then fed into a processor correlator which in turn prints on another film the actual radar image.

Another problem is repeating good performance. Two pictures taken at different times under almost identical circumstances often are different. This is caused by the big difference in the reflectivity of an object when hitting it with signals from another angle. Wright-Patterson hopes to solve this problem by taking pictures from several points and integrating the results with circuitry that will smooth out the variations. "We also need a larger scale for the display," one official says. "Now, the pictures cover far too much territory to permit us to read detail."

Shop support for the side-looking radar requires a test bench for each of five portions of the system: the recorder, the antenna, the intermediate-frequency/radio-frequency portions, the amplifier modulator, and the reference computer and recorder control.

Test gear on the flight line itself is also complicated. It consists of seven test sets and 52 cables connected to the aircraft. To connect the analyzer alone requires almost an hour, and to check out the whole system may take up to six hours.

A number of companies are working on side-looking radar, trying to simplify it and thereby reduce malfunctions and the need for so much test gear. Integrated circuits are being used whenever possible. Developers include the Westinghouse Electric Corp., Goodyear Aerospace, the Raytheon Co., and Motorola Inc.

Radars in frequency bands higher and lower than that used by the operational side-looking radar are also being investigated.

Data presentation

How and where should the data be displayed? In the cockpit on individual sensor displays, all in real time? In the cockpit on one integrated display? Or at home base, sent back by data link?

Real-time cockpit readout seems to be the most desirable solution, but there are complications. Cockpits like those in the RF-4C are too limited in size to accommodate a series of displays; they would be too small to be easily read. Also, some sensors are only revealing when their presentation can be compared with a previous picture of the same place. The only displays, therefore, that would be helpful in the cockpit are those that readily disclose a target without the need for comparison or study.

An integrated display in the cockpit, or at home base, would be the ideal way to present a target. The best from radar for example, such as roads, rivers, and coastlines would be presented; superimposed on this would be the hot returns from infrared. Then a detailed picture with high resolution would be included from extremely high frequency radar. In lieu of this, the pilot could look at individual displays and integrate them mentally. Both Wright-Patterson and the Rome Development Center, N.Y., are working on high fidelity displays.

Data link would be handy for those sensors that depend on change detection, such as infrared, side-

looking radar, and a low-frequency radar. As new data comes in, home base could compare it with previously prepared maps.

Data link was tested at Shaw Air Force Base and the concept proved to be good. For the test, side-looking radar, infrared, and film cameras were all installed in two RB-66's, and their presentations were linked by means of video transmission to a ground station. A third RB-66 was used in some of the tests as a relay plane to extend the range be-

tween the sensor planes and the ground receiver.

The airborne portions of the data link and the ground station were built by the Cubic Corp. The airborne data link provided three video data channels. Frequency-modulated transmitters accept the video signals from side-looking radar, visible, and infrared photoscanners. The ground station consisted of a parabolic tracking antenna 12 feet in diameter, f-m receivers and data processing equipment matching each airborne sensor.

Avionics III

Automation opens the way

To prevent malfunctions in the multisensor Phantom an in-flight tester is under development and an ingenious computer is being tried out to predict sensor resolution

"The RF-4C, with its variety of sensors, is a very successful reconnaissance plane but we've still got a lot to learn about installing and testing the equipment," Col. Oscar G. Johnson, director of the Tactical Air Reconnaissance Center's test and requirements section, says.



Ground resolution analog computer predicts resolution for a given sensor under expected conditions.

Much of this problem, Johnson hopes, will soon be solved with a system that, in flight, will print out on tape what went wrong, where, when, why, and the line replaceable item needed to repair it. The system, called CAPA, for central airborne performance analyzer, is being developed under an Air Force contract by the Aeronautical division of Honeywell Inc., in Minneapolis. CAPA evolved from a van-housed, self-check system for the Bomarc surface-to-air missile. Before launch it runs through a series of punched cards to check components.

CAPA is designed to keep tabs mainly on the side-looking radar, the infrared set, and portions of the navigation system and the KS-72A camera. Its present test capability, over 200 points, is expandable. Three remote units will select test points and condition signals. A central processor will measure the data, compute performance, compare against allowed limits, and set malfunction indicators when a fault is detected; a malfunction display will provide the operator and ground crews with a visual indication. A magnetic tape transport will record system data and correlate time and flight conditions against malfunction occurrence.

The system has a random-access memory which contains test limits, test routines and the main sequence program for controlling the entire analyzer system.

Ground resolution computer

One new computer allows a reconnaissance operator to predict the ground resolution he can

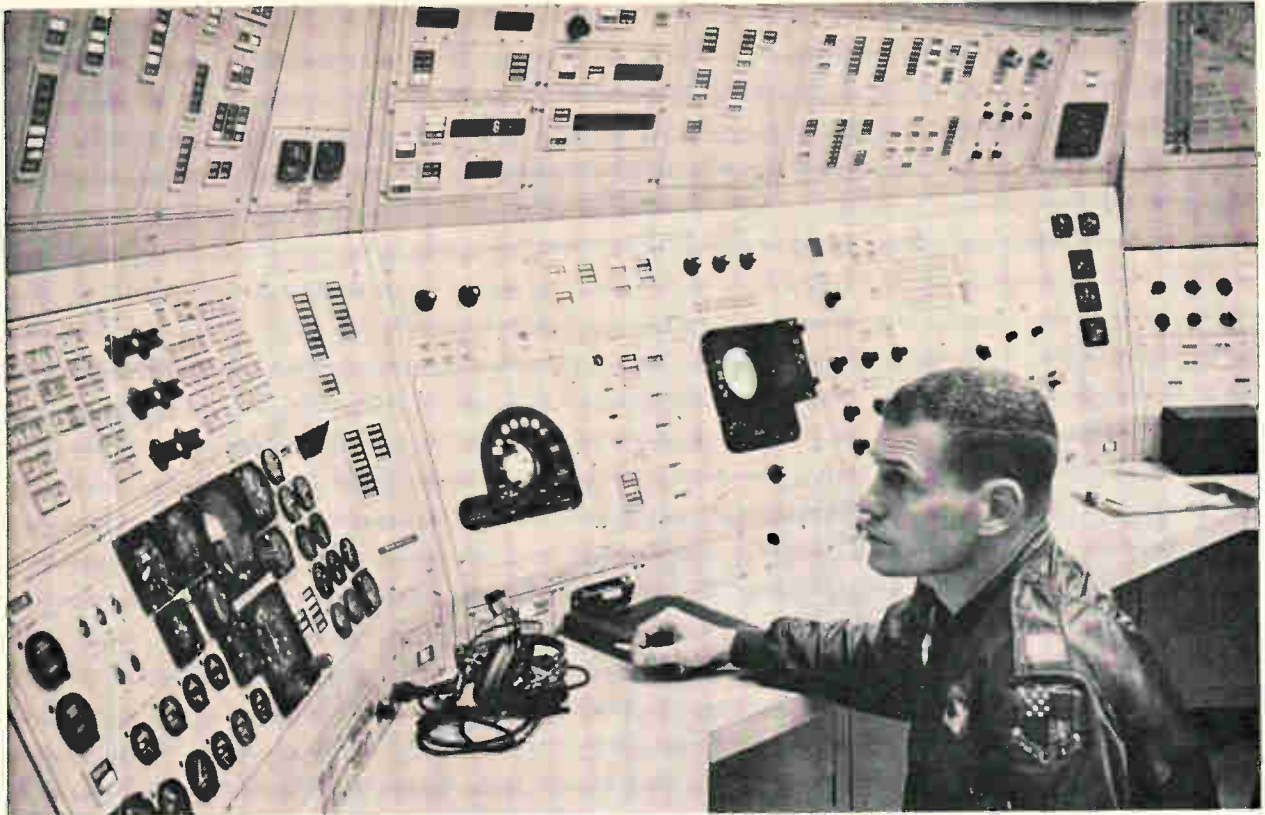

Operator of the RF-4C simulator can throw a variety of malfunctions at the pilot and reconnaissance officer who are "flying" a mission nearby. Simulator is built by General Precision's Link group.

expect before he takes off. If, for example, he needs to distinguish objects two feet in diameter he can feed the computer information about the camera, his proposed flight plan and the camera platform, and in seconds be told whether he'll see what he's after. If the answer is negative, he can change certain parameters until he does achieve the resolution he needs.

Designed by the engineers at the Tactical Air Reconnaissance Center and built by Aeroflex Laboratories Inc., the analog computer is given the following camera information: focal length, shutter speed, camera resolution, film type, and film size; flight information consists of ground speed, altitude, expected drift angle, expected target area contrasts (dull, hazy, brilliant), and expected turbulence; camera platform information consists of whether the stabilization is on or off, the image motion compensation error, and whether the drift correction is on or off.

Simulator

Before flying the RF-4C, pilots and reconnaissance observers "fly" long missions in an elaborate simulator that reproduces the sounds, and to some extent, the sensation of motion of the plane. The simulator, and six like it, were built by the General Precision Equipment Corp.'s Link group.

As in the plane, both cockpit positions provide a forward-looking radar display and controls for the side-looking radar, infrared set, photographic systems, four radio direction finders and a ground

controlled approach for landing in bad weather.

The pilot learns to turn on all this equipment, check it out, and correct for malfunctions, whenever possible, that the instructor at the large console outside chooses to feed into the system. If an instructor feels particularly devilish, he can jam a camera at a crucial moment, foul up the terrain-following radar just as the pilot spots a tall obstruction ahead, and blow a fuze in the system for ejecting flash cartridges at night.

While the RF-4C simulator is very satisfactory, it does use an analog approach. Future simulators, Link says, will be digital. Otto Ling, manager of Link's military systems engineering, points out some of the advantages of digital over analog. "In an analog system, the inertial navigation system is simulated by using operational amplifiers and servomechanisms. These drift and cause errors. In a digital system there is no drift. Not only are the functions computed to a high degree of accuracy as to the number of bits, but the bits cannot change unless something in the program tells them to."

Another advantage is the relative simplicity of a digital system. In an analog system every input, such as a radio station, requires servos or some kind of hardware. With a digital system, these things are programmed into the computer. In an analog simulator every target requires three servos. A flight situation with 20 targets must have 60 servos. With a digital system, a single target generator takes information from the digital computer providing any number of targets.

If You Want To Reduce Costs and Get Faster Delivery On Hi-Rel Silicon Transistors Take A Closer Look At MEG-A-LIFE II!



- where the priceless ingredient is care!

Investigate Motorola's tri-level assurance program, Meg-A-Life II[†], as the practical approach to today's customized high-reliability transistor requirements:

Meg-A-Life II combines standardized processing with customized procedures . . . offering 28 types of silicon annular* transistors, certified to any one of three reliability levels (Level 1, 2, & 3) — with the added flexibility of a full range of options to meet every special reliability requirement. (Meg-A-Life II is one of the most stringent standard hi-rel programs offered by any semiconductor manufacturer.)

Delivery time is faster because preliminary 100% processing tests, including life testing, are standardized and performed ahead of time. You select the suitable reliability level. Then, if you need additional tests and screens, they are performed after receipt of your order. Costs are cut because the time and expense of writing and negotiating custom specifications is eliminated . . . plus the cost of acceptance testing is prorated over the entire lot of Meg-A-Life II devices.

TAKE YOUR CHOICE . . . THREE LEVELS OF MEG-A-LIFE II TRANSISTOR RELIABILITY ASSURANCE

LEVEL 1 100% reliability processing; Group A Electrical Inspection to military acceptance tests or equivalent; certified reliability data from latest lot of continuous production having completed Group B inspection (military tests or equivalent).

LEVEL 2 Same as Level 1, plus 100% 96-hour burn-in and screening.

LEVEL 3 Same as Level 2, except Group B inspection data for actual lot from which devices are shipped.

. . . plus Meg-A-Life options, including radiographic inspection, hermetic seal, temperature cycling, thermal shock, and shock.

ORDER BROCHURE

Learn more about the modern reliability assurance program — Meg-A-Life II — ideal for both the smaller reliability order — or as the starting point for custom-tailored, more complex, reliability programs. Request the 6-page folder by writing Motorola Semiconductor Products Inc., Box 955, Phoenix, Arizona 85001.

[†]Trademark of Motorola Inc.

*Annular semiconductors are patented by Motorola Inc.



MOTOROLA
Semiconductors

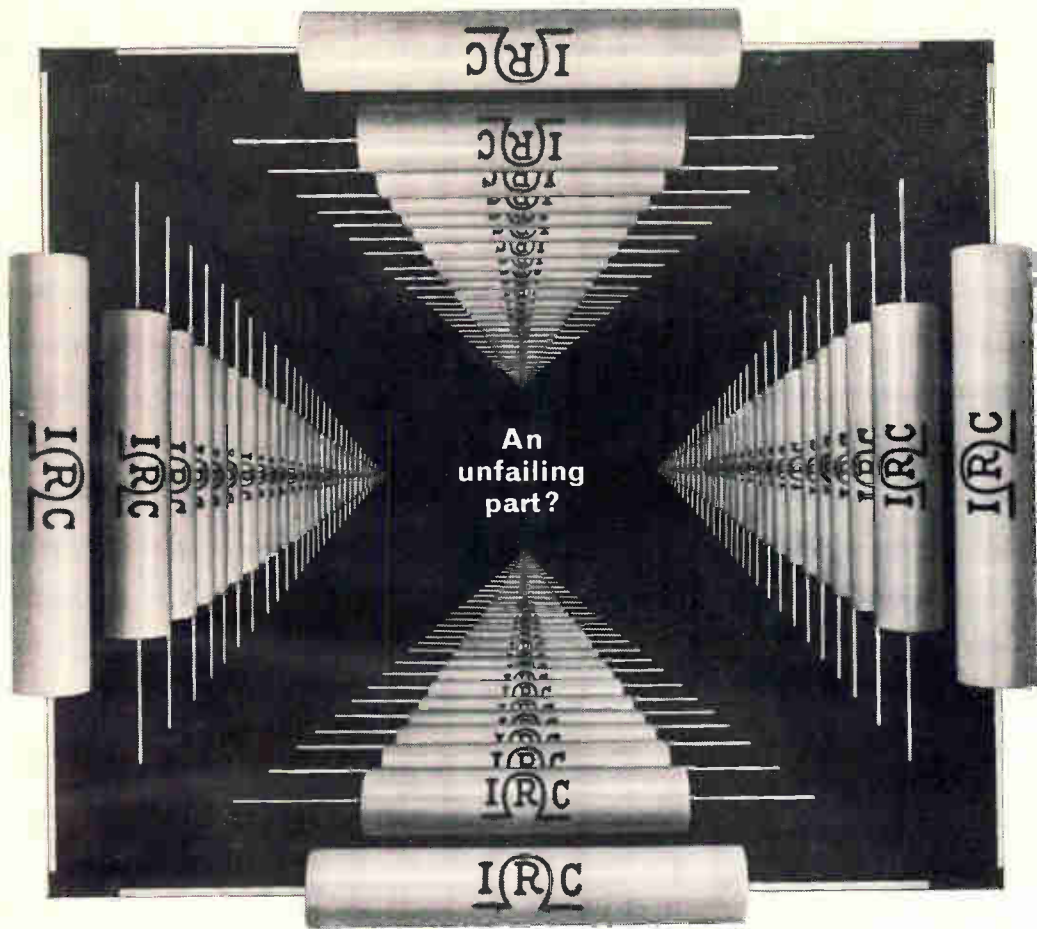

Nobody makes parts that absolutely won't fail. Not yet, anyhow. In a sense, reliability only provides a measure of how close you are to perfection.

But we're working toward it. And we have been since 1956 when we established the discipline structure that led to the production of our first Minuteman resistor.

We are tough on ourselves, too. Our Director of Reliability carries his concern into everything from basic design through final inspection. The result of discipline and concern is product homogeneity and predictable performance—time after time... in resistors, in potentiometers and in semiconductors.

We don't have infinite reliability yet. What we do have is the widest choice of reliability levels to match your present cost and performance needs. At IRC reliability begins with front door management, not back door management. Questions on reliability get top management attention by writing to our Director of Reliability.

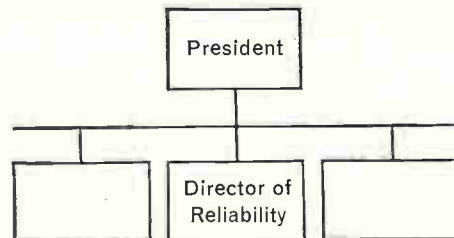

IRC, Inc., 401 N. Broad St., Philadelphia, Pa. 19108



If You Want To Reduce Costs and Get Faster Delivery On Hi-Rel Silicon Transistors Take A Closer Look At MEG-A-LIFE II!



- where the priceless ingredient is care!

Investigate Motorola's tri-level assurance program, Meg-A-Life II[†], as the practical approach to today's customized high-reliability transistor requirements:

Meg-A-Life II combines standardized processing with customized procedures . . . offering 28 types of silicon annular* transistors, certified to any one of three reliability levels (Level 1, 2, & 3) — with the added flexibility of a full range of options to meet every special reliability requirement. (Meg-A-Life II is one of the most stringent standard hi-rel programs offered by any semiconductor manufacturer.)

Delivery time is faster because preliminary 100% processing tests, including life testing, are standardized and performed ahead of time. You select the suitable reliability level. Then, if you need additional tests and screens, they are performed after receipt of your order. Costs are cut because the time and expense of writing and negotiating custom specifications is eliminated . . . plus the cost of acceptance testing is prorated over the entire lot of Meg-A-Life II devices.

TAKE YOUR CHOICE . . . THREE LEVELS OF MEG-A-LIFE II TRANSISTOR RELIABILITY ASSURANCE

LEVEL 1 100% reliability processing; Group A Electrical Inspection to military acceptance tests or equivalent; certified reliability data from latest lot of continuous production having completed Group B inspection (military tests or equivalent).

LEVEL 2 Same as Level 1, plus 100% 96-hour burn-in and screening.

LEVEL 3 Same as Level 2, except Group B inspection data for actual lot from which devices are shipped.

. . . plus Meg-A-Life options, including radiographic inspection, hermetic seal, temperature cycling, thermal shock, and shock.

ORDER BROCHURE

Learn more about the modern reliability assurance program — Meg-A-Life II — ideal for both the smaller reliability order — or as the starting point for custom-tailored, more complex, reliability programs. Request the 6-page folder by writing Motorola Semiconductor Products Inc., Box 955, Phoenix, Arizona 85001.

[†]Trademark of Motorola Inc.

*Annular semiconductors are patented by Motorola Inc.



MOTOROLA
Semiconductors

used to be
nagging pain
figuring out
how much
resistor precision
to buy.

Then Corning changed the rules.

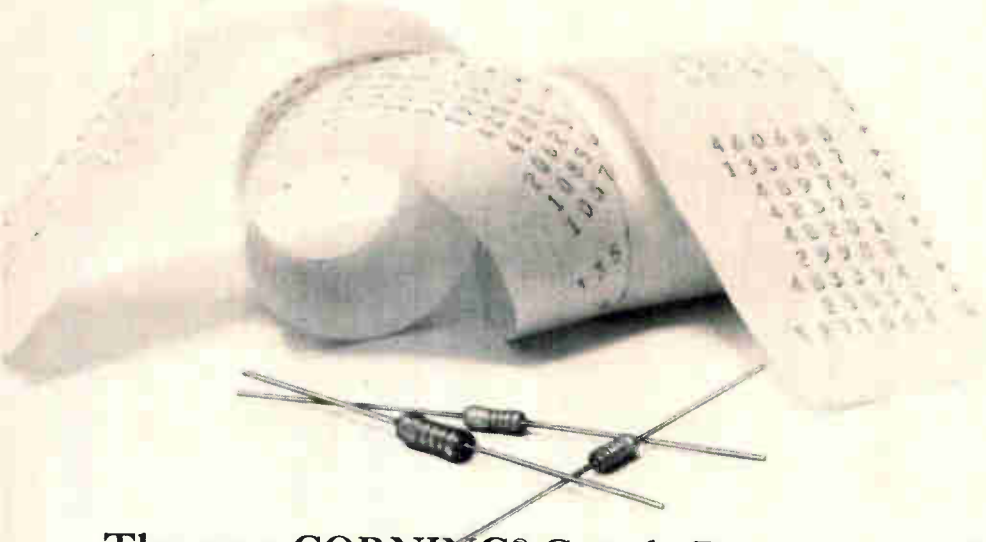

The new CORNING® C-style Resistors handle precision, semi-precision and general purpose applications. What could be easier? They offer precision stability and reliability at far less than precision prices.

100 ppm TC. 1, 2 and 5% tolerances. Performance requirements of both MIL-R-22684B and MIL-R-10509F, Char. D.

New C-Style Resistors come with 1/10, 1/8, 1/4, 1/2 watt ratings, in the 10 ohm to 499K range. Samples and complete data for the asking. Meanwhile, we're looking for more changes that will improve resistors. That's how we've earned our qualifications for exceptional stability and for reliability. That's how our line of glass tin oxide film resistors has grown to be one of the most extensive. Including precision, high reliability, low power, high power and water cooled types. Corning Glass Works, 3901 Electronics Drive, Raleigh, North Carolina.

CORNING
ELECTRONICS

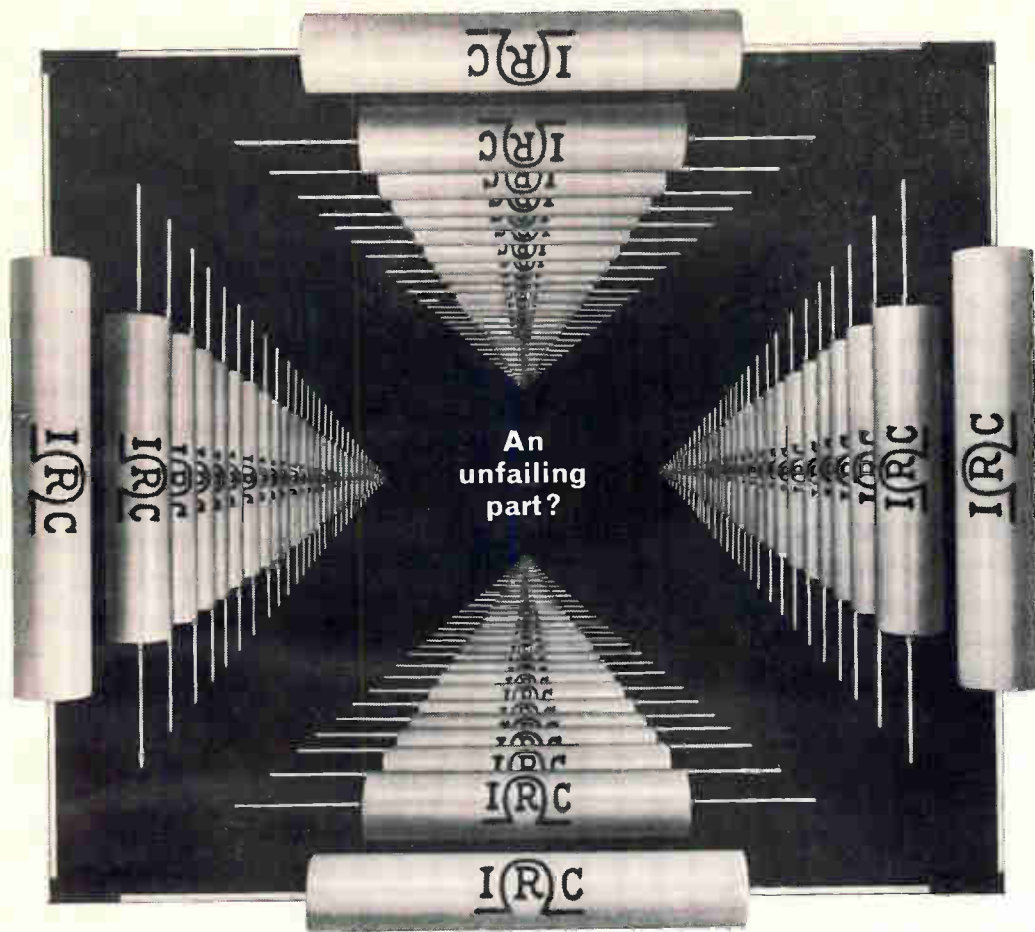

An
unfailing
part?

Nobody makes parts that absolutely won't fail. Not yet, anyhow. In a sense, reliability only provides a measure of how close you are to perfection.

But we're working toward it. And we have been since 1956 when we established the discipline structure that led to the production of our first Minuteman resistor.

We are tough on ourselves, too. Our Director of Reliability carries his concern into everything from basic design through final inspection. The result of discipline and concern is product homogeneity and predictable performance—time after time . . . in resistors, in potentiometers and in semiconductors.

We don't have infinite reliability yet. What we do have is the widest choice of reliability levels to match your present cost and performance needs. At IRC reliability begins with front door management, not back door selection. Questions on reliability get top management attention by writing to our Director of Reliability.

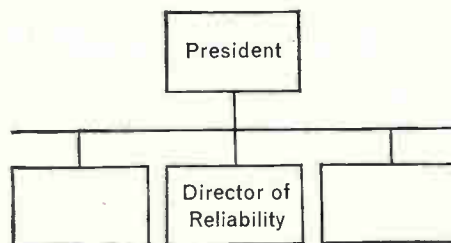

IRC, Inc., 401 N. Broad St., Philadelphia, Pa. 19108



A good turn for old components

A new device, essentially an all-purpose circuit, alters the output response curve of conventional components and offers designers new circuit possibilities

By Leon O. Chua

Purdue University, West Lafayette, Ind.

Characteristics of diodes, transistors, resistors, or any other two- or three-terminal component are altered with a new device called the rotator. The name rotator was chosen because the circuit, an inexpensive two-port, varies the characteristic curve of a component by revolving it about an origin.

For example, a conventional diode provides current and voltage relationships that can be shown as an i-v curve with positive slopes. When the same diode is connected to a rotator the i-v curve can be rotated anywhere from 0° to 360° about the origin. If it is revolved 90° counterclockwise, a portion of the i-v curve is shifted to the negative-voltage positive-current region, and the diode exhibits a negative resistance. When the curve is rotated approximately 180° counterclockwise, both current and voltage are negative; a 270° shift produces negative current and positive voltage.

Curve rotation is made possible with a pi- or tee-circuit available in three types: resistive, inductive, and capacitive—called R-, L-, and C-rotators, respectively. Only resistors are combined in the R-rotator; the L-rotator has only inductors; the C-rotator is composed only of capacitors. Each type alters the characteristics of corresponding

external components without physically changing the component. For example, an R-rotator varies the curves of resistors, an L-rotator that of inductors, and C-rotators that of capacitors.

Each pi- or tee-rotator requires one negative impedance element, which is provided by a six-transistor negative impedance converter.¹ All the engineer need do is connect the component whose characteristic he desires to alter to the output port of the pi- or tee-network. The angle of rotation is fixed by the values of the network components and is calculated from the trigonometric relationships given in table 1. An oscilloscope at the input port of the rotator network displays the rotated curve.

By changing the characteristics of conventional components the engineer creates new elements. With these, the designer can build new circuits that perform specific functions unattainable with conventional components.

Characterizing the rotator

Rotator action is described by two parameters—an angle of rotation, θ , and a scale factor, k . The term k specifies the scale associated with a given curve. For example, a rotator designed to revolve an i-v curve calibrated in ampere-volts is clearly different from one devised to rotate an i-v curve calibrated in milliampere-volts. Introducing the appropriate scale factor into the associated equations automatically adjusts for the difference in the scales.

The parameters θ and k for the three different rotators are denoted by (θ, R) for an R-rotator, (θ, L) for an L-rotator, and (θ, C) for a C-rotator as shown on page 110. All three rotators can be repre-

The author



Leon O. Chua teaches nonlinear analysis at Purdue University. He earned his Ph. D. at the University of Illinois. In creating some analysis problems for a textbook he is writing Chua developed the theory for the rotator. Robert Adams, a Purdue student, built the circuit.

FOR TWO-TERMINAL CONNECTIONS

FOR THREE-TERMINAL CONNECTIONS

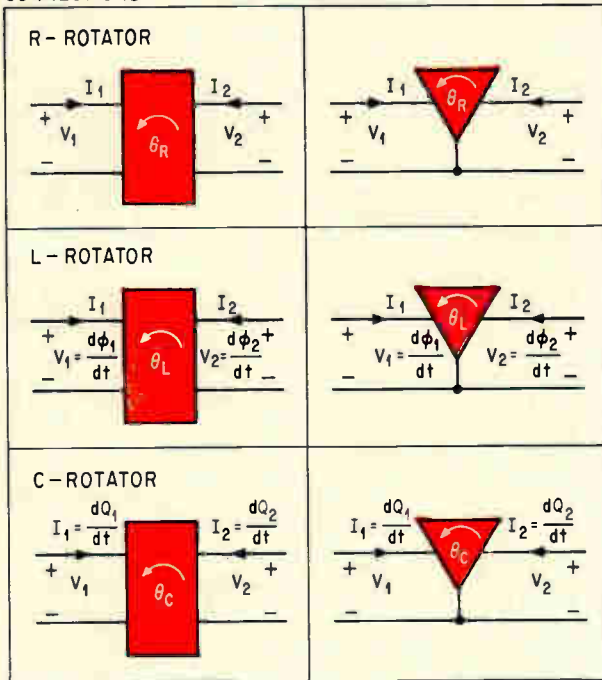

Rectangular and triangular shapes represent the symbolic models for the R-, L-, and C-rotators when connected to a two- or three-terminal component, respectively. Parameters V , I , ϕ and Q are the terminal voltage, current, magnetic flux-linkage, and electric charge needed to relate the rotators to the external circuits.

sented in terms of input voltage and current, V_1 and I_1 :

R-rotator:

$$V_1 = (\cos \theta) V_2 + R (\sin \theta) I_2 \quad (1)$$

$$I_1 = (1/R) (\sin \theta) V_2 - (\cos \theta) I_2 \quad (2)$$

L-rotator:

$$\phi_1 = (\cos \theta) \phi_2 + L (\sin \theta) I_2 \quad (3)$$

$$I_1 = (1/L) (\sin \theta) \phi_2 - (\cos \theta) I_2 \quad (4)$$

C-rotator:

$$Q_1 = -(\cos \theta) Q_2 - C (\sin \theta) V_2 \quad (5)$$

$$V_1 = -(1/C) (\sin \theta) Q_2 + (\cos \theta) V_2 \quad (6)$$

where V is voltage, I is current, ϕ is magnetic flux, and Q is electric charge. Since equations 1 through

6 are linear functions of V_2 , I_2 , ϕ_2 and Q_2 , the rotator is a linear two-port network. Therefore it can be represented by any of several conventional matrix notations—the z-impedance, y-admittance or s-scattering parameter matrix. Matrix relationships in table 1 are given as a function of the frequency variable p , and are therefore expressed in the frequency domain. The properties listed in the panel on page 122 are derived from these relationships.

Networks for realizing rotators

All three rotators are realized with either a pi- or tee-network of linear resistors, inductors, or capacitors, as illustrated in table 1. Each circuit has a common ground and only one negative element is needed. However, the symmetrical lattice network at the top of page 111 can be used if a common ground is not desired, but this requires two negative elements.

The simplest method of obtaining a negative impedance is with a two-port network called a negative impedance converter (NIC). A simple form of NIC is shown at the bottom of page 111 along with the relationships between the terminal variables. By definition, $i_1 = -i_2$; $v_1 = -v_2$

where

- i_1 = current entering at the input terminal
- i_2 = current entering at the output terminal
- v_1 = voltage developed across the input port
- v_2 = voltage developed across the output port.

The consequence of these relationships is that the input impedance of an NIC terminated in either a resistor, R , inductor, L , or capacitor, C , is the negative value of the element's impedance. Conversely, an impedance applied to the input port appears as its negative when observed from the output port.

Negative elements can also be produced by techniques other than NIC's. In fact, any device or interconnection of devices that exhibits a negative resistance characteristic across some terminal resistance for low-power rotators is realized by connecting two tunnel diodes as shown below.

Stability criteria for a rotator

Since the rotator is an active circuit that contains a negative element, it is potentially unstable. There-

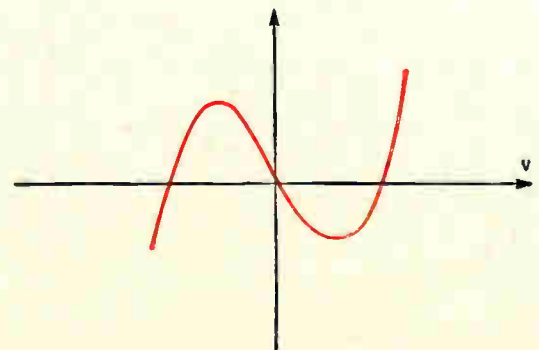
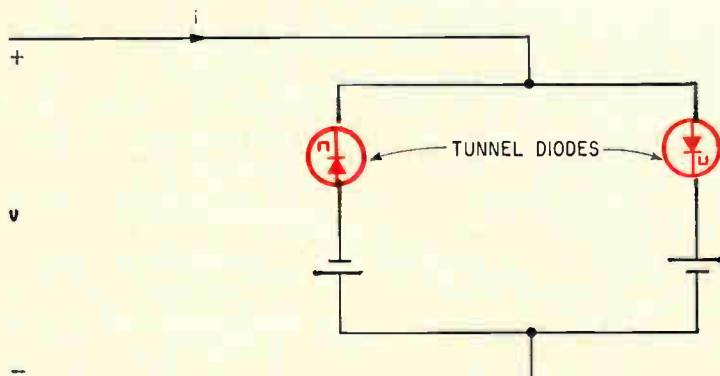

Negative resistance can be produced by two biased tunnel diodes connected in parallel as indicated by slope of the i - v curve through the origin.

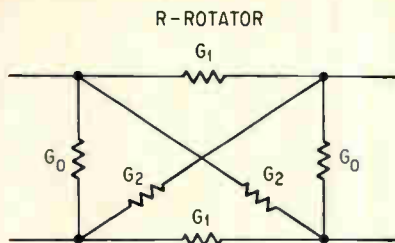

$$G_0 = \cot \theta - [\csc \theta] \text{ mho}$$

$$G_1 = [\csc \theta] - \csc \theta \text{ mho}$$

$$G_2 = [\csc \theta] + \csc \theta \text{ mho}$$

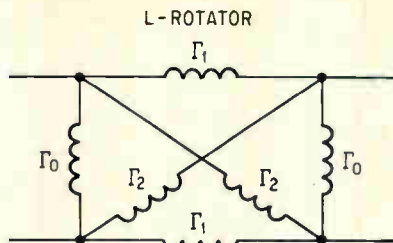

$$\Gamma_0 = \cot \theta - [\csc \theta] (\text{HENRY})^{-1}$$

$$\Gamma_1 = [\csc \theta] - \csc \theta (\text{HENRY})^{-1}$$

$$\Gamma_2 = [\csc \theta] + \csc \theta (\text{HENRY})^{-1}$$

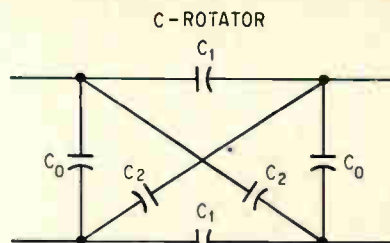

$$C_0 = \cot \theta - \csc \theta (\text{FARAD})$$

$$C_1 = [\csc \theta] + \csc \theta (\text{FARAD})$$

$$C_2 = [\csc \theta] - \csc \theta (\text{FARAD})$$

Balanced rotator can be produced with a symmetrical lattice network. In each of the three cases two negative elements are required.

fore, a shunt or series type negative impedance converter must be used to assure stability. The shunt type is short-circuit stable and the series type is open-circuit stable. To establish when each type is required, assume the following lemma:

Let R_n be the magnitude of a negative resistance obtained by connecting a positive resistance R_n across an NIC. Let R_{eq} be the Thevenin equivalent resistance of the external network connected to the negative resistance. If

$$R_{eq} > |R_n| \quad (7)$$

then the negative resistance is stable, but only if the NIC is of the open-circuit stable type.

Conversely, if

$$R_{eq} < |R_n| \quad (8)$$

then the negative resistance is stable, but only if the NIC is of the short-circuit stable type.

To determine the R-rotator's stability the designer finds the Thevenin equivalent resistance R_{eq} across the terminals of the negative resistance and substitutes R_{eq} into equation 7 or 8 to make an evaluation.

The following results apply to both the pi- and tee-network configurations: for a given load resistance R_L and source resistance R_s , as represented in the center diagram on page 116, the R-rotator networks are stable, but only if an open-circuit stable NIC is used and

$$R_s > \frac{R [R - R_L \cot \theta]}{[R_L + R \cot \theta]} \quad (9)$$

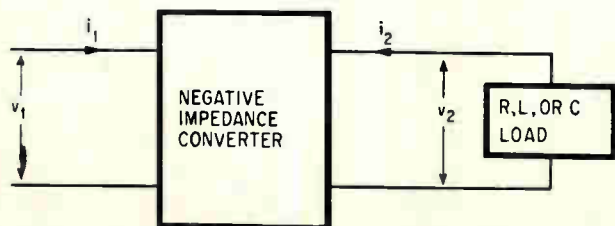

Negative impedance converter is defined as a two-port network whose input impedance is the negative-value of the load at the output port.

where R is the scale factor. Conversely, a short-circuit stable NIC must be used whenever

$$R_s < \frac{R [R - R_L \cot \theta]}{[R_L + R \cot \theta]} \quad (10)$$

In practice, it is convenient to express these criteria by several stability curves, obtained by plotting the equation

$$(R_s/R) = \frac{[1 - (R_L/R) \cot \theta]}{[(R_L/R) + \cot \theta]} \quad (11)$$

in terms of the normalized variable R_s/R and R_L/R . The resulting curves, plotted on pages 115 and 116, are symmetrical with respect to a line drawn through the origin bisecting the x-y plane. For a given R_L/R , R_s/R and θ , an open-circuit stable NIC must be used whenever the point $(R_L/R, R_s/R)$ lies above the stability curve corresponding to the specified θ . When these points lie below the curves, a short-circuit stable converter must be used to assure stability.

In practice, the load is usually a nonlinear device; therefore, its d-c resistance, R_L , at any value v/i along the i-v curve will be different at each point. If R_L^- and R_L^+ represent, respectively, the smallest and largest value assumed by R_L along a given i-v curve, then

$$R_L^- < R_L < R_L^+ \quad (12)$$

In this case, the stability curves are still used to determine the type of NIC needed. However, all load resistance values within the range given by equation 12 must be checked for stability. In some cases both converter types are needed to cover the entire specified range. To assure stability in such cases, it is necessary either to change the value of R_s or restrict the dynamic range of the nonlinear resistor, or both.

Although the stability criteria are only derived here for the R-rotator, similar criteria can be derived for the L- and C-rotators.

Rotator circuits and curves

Since various types of negative impedance elements are available for forming a rotator, the

Counterclockwise rotation

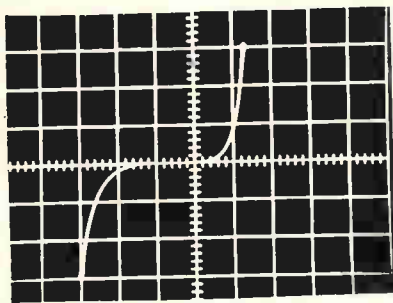

$\theta = 0^\circ$

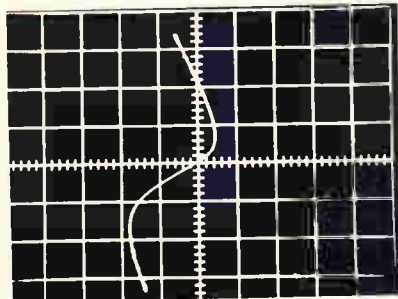

$\theta = 30^\circ$

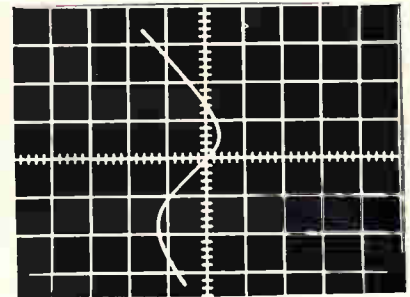

$\theta = 45^\circ$

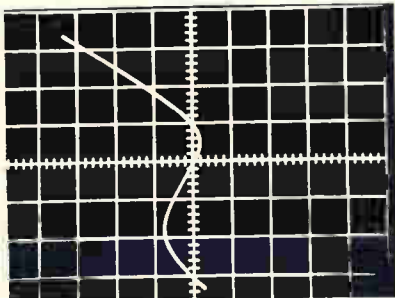

$\theta = 60^\circ$

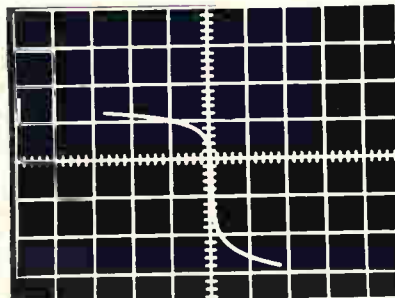

$\theta = 90^\circ$

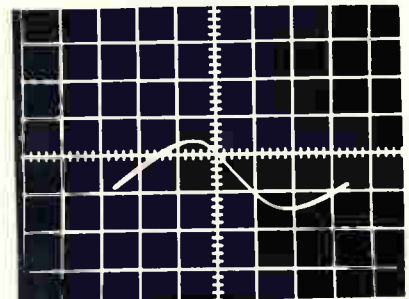

$\theta = 135^\circ$

Clockwise rotation

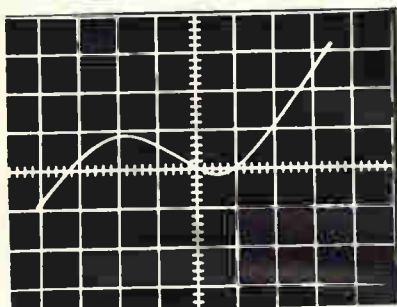

$\theta = -30^\circ$

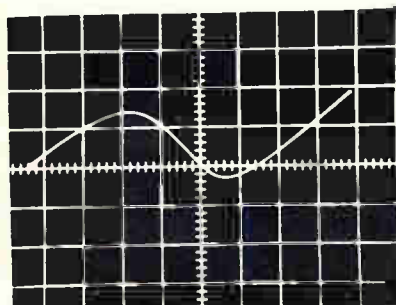

$\theta = -45^\circ$

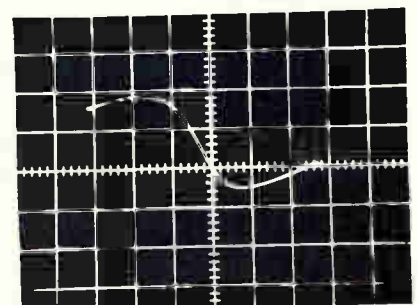

$\theta = -60^\circ$

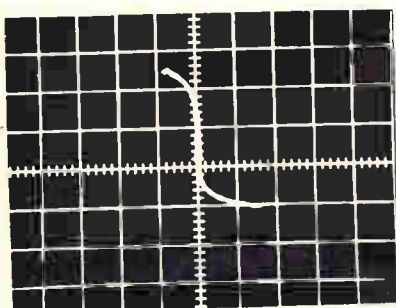

$\theta = -90^\circ$

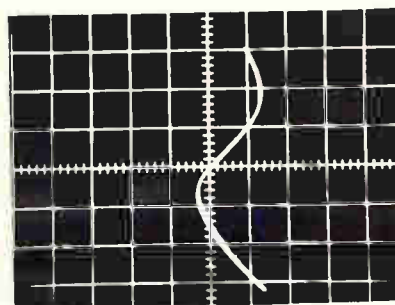

$\theta = -135^\circ$

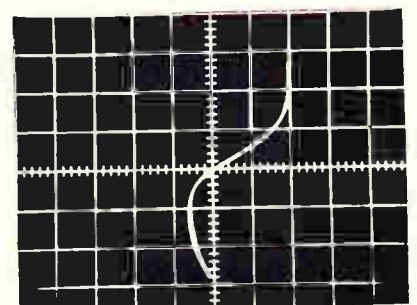

$\theta = -150^\circ$

Curve of a typical nonlinear resistor is rotated counterclockwise about the origin by a pi-network R-rotator. Clockwise rotation is achieved with a tee-network R-rotator. In all the clockwise and counterclockwise rotation curves the vertical scale is calibrated in milliamperes, and the horizontal scale is calibrated in volts.

most useful rotator circuit is achieved with an π ic. Three practical considerations in the design of an π ic are: first, direct coupling so the rotator operates down to d-c. This requirement eliminates many existing π ic circuits. Second, biasing, so that the voltage across port 1 is zero when port 2 is short-circuited. This establishes the origin as the reference point for both rotated and unrotated curves.

Making fine adjustments compensate for unequal voltage offsets of the transistors in the negative impedance converter. Third, adding small trimming capacitances to critical parts of the circuit to improve the frequency response.

The π ic circuit designed for the rotators is the current inversion type shown on page 116.^{2,3} The circuit reduces range of collector voltage swings of

Table 1: Two-port parameters of the rotator

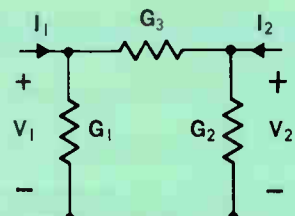
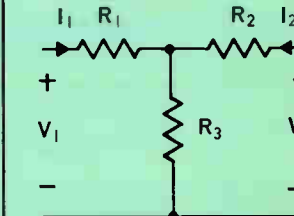
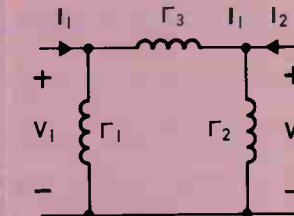
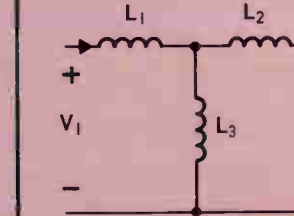
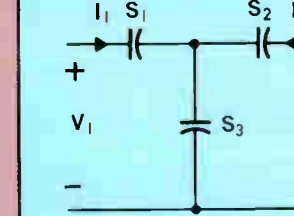
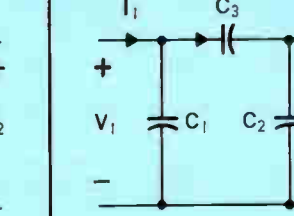
Network matrixes	R-rotator (Resistor)		L-rotator (Inductor)		C-rotator (Capacitor)		
	Π - Configuration	T - Configuration	Π - Configuration	T - Configuration	T - Configuration	Π - Configuration	
							
	$G_1 = G_2 = \left(\tan \frac{\theta}{2}\right) \frac{1}{R}$ $G_3 = -(\csc \theta) \frac{1}{R}$ <p>$G_1, G_2,$ and G_3 in mhos</p>	$R_1 = R_2 = \left(\tan \frac{\theta}{2}\right) R$ $R_3 = (\csc \theta) R$ <p>$R_1, R_2,$ and R_3 in ohms</p>	$\Gamma_1 = \Gamma_2 = \left(\tan \frac{\theta}{2}\right) \frac{1}{L}$ $\Gamma_3 = -(\csc \theta) \frac{1}{L}$ <p>$\Gamma_1, \Gamma_2,$ and Γ_3 in henrys⁻¹</p>	$L_1 = L_2 = -\left(\tan \frac{\theta}{2}\right) L$ $L_3 = (\csc \theta) L$ <p>$L_1, L_2,$ and L_3 in henrys</p>	$S_1 = S_2 = \left(\tan \frac{\theta}{2}\right) \frac{1}{C}$ $S_3 = -(\csc \theta) \frac{1}{C}$ <p>$S_1, S_2,$ and S_3 in farads⁻¹</p>	$C_1 = C_2 = -\left(\tan \frac{\theta}{2}\right) C$ $C_3 = (\csc \theta) C$ <p>$C_1, C_2,$ and C_3 in farads</p>	
	Range of θ requiring only one negative element	$0 < \theta < 180^\circ$ (counterclockwise)	$-180^\circ < \theta < 0$ (clockwise)	$0 < \theta < 180^\circ$ (clockwise)	$-180^\circ < \theta < 0$ (counterclockwise)	$0 < \theta < 180^\circ$ (clockwise)	$-180^\circ < \theta < 0$ (counterclockwise)
Open circuit impedance matrix $Z(p)$	$\begin{bmatrix} V_1 \\ V_2 \end{bmatrix} = Z(p) \begin{bmatrix} I_1 \\ I_2 \end{bmatrix}$	$Z(p) = \begin{bmatrix} (\cot \theta)R & (\csc \theta)R \\ (\csc \theta)R & (\cot \theta)R \end{bmatrix}$	$Z(p) = \begin{bmatrix} p(\cot \theta)L & p(\csc \theta)L \\ p(\csc \theta)L & p(\cot \theta)L \end{bmatrix}$	$Z(p) = \begin{bmatrix} -\frac{\cot \theta}{pc} & -\frac{(\csc \theta)}{pc} \\ -\frac{(\csc \theta)}{pc} & -\frac{\cot \theta}{pc} \end{bmatrix}$			
Short circuit admittance matrix $Y(p)$	$\begin{bmatrix} I_1 \\ I_2 \end{bmatrix} = Y(p) \begin{bmatrix} V_1 \\ V_2 \end{bmatrix}$	$Y(p) = \begin{bmatrix} -\frac{(\cot \theta)}{R} & \frac{(\csc \theta)}{R} \\ \frac{(\csc \theta)}{R} & -\frac{(\cot \theta)}{R} \end{bmatrix}$	$Y(p) = \begin{bmatrix} \frac{-(\cot \theta)}{pL} & \frac{(\csc \theta)}{pL} \\ \frac{(\csc \theta)}{pL} & \frac{-(\cot \theta)}{pL} \end{bmatrix}$	$Y(p) = \begin{bmatrix} p(\cot \theta)C & -p(\csc \theta)C \\ -p(\csc \theta)C & p(\cot \theta)C \end{bmatrix}$			
Transmission (chain) matrix $T(p)$	$\begin{bmatrix} V_1 \\ I_1 \end{bmatrix} = T(p) \begin{bmatrix} V_2 \\ -I_2 \end{bmatrix}$	$T(p) = \begin{bmatrix} \cos \theta & -(\sin \theta)R \\ \frac{\sin \theta}{R} & \cos \theta \end{bmatrix}$	$T(p) = \begin{bmatrix} \cos \theta & -p(\sin \theta)L \\ \frac{\sin \theta}{pL} & \cos \theta \end{bmatrix}$	$T(p) = \begin{bmatrix} \cos \theta & \frac{(\sin \theta)}{pc} \\ -p(\sin \theta)C & \cos \theta \end{bmatrix}$			
Scattering matrix $S(p)$ (Normalized to unit port numbers and unit scale factors)	$\begin{bmatrix} b_1 \\ b_2 \end{bmatrix} = S(p) \begin{bmatrix} a_1 \\ a_2 \end{bmatrix}$	$S(p) = \begin{bmatrix} -\tan \theta & \sec \theta \\ \sec \theta & -\tan \theta \end{bmatrix}$	$S(p) = \begin{bmatrix} \frac{(p^2 + 1)}{(p^2 - 2p \cot \theta - 1)} & \frac{-2p \csc \theta}{(p^2 - 2p \cot \theta - 1)} \\ \frac{-2p \csc \theta}{(p^2 - 2p \cot \theta - 1)} & \frac{(p^2 + 1)}{(p^2 - 2p \cot \theta - 1)} \end{bmatrix}$	$S(p) = \begin{bmatrix} \frac{-(p^2 + 1)}{(p^2 - 2p \cot \theta - 1)} & \frac{-2p \csc \theta}{(p^2 - 2p \cot \theta - 1)} \\ \frac{-2p \csc \theta}{(p^2 - 2p \cot \theta - 1)} & \frac{-(p^2 + 1)}{(p^2 - 2p \cot \theta - 1)} \end{bmatrix}$			

Electronics' guide to rotator design

New circuit called the rotator makes it possible to turn an old component into a new building device

With each pair of pi and tee networks in table 1, an engineer is able to alter the characteristic output curve of any linear or nonlinear component. By simply connecting the conventional component across the output terminals of the pi or tee, he can rotate the curve about the origin anywhere from 0° to 360°. Thus, for each position of the component's curve, the designer simulates a new component from which he can obtain new curves and build unique circuits that were previously unobtainable.

To design a rotator, the user follows this procedure:

- Decide on the type of curve desired.
- Determine whether the load must be resistive, inductive, or capacitive.
- Apply the corresponding R-, L-, or C-rotator with the respective resistive, inductive, or capacitive load.
- Predetermine the desired angle of rotation and whether the curve is to be turned clockwise or counterclockwise.
- Substitute the desired angle of rotation into the component relationships given directly below each circuit configuration in table 1 to determine the component values needed.
- Note which component is to be negative for the angle chosen. Each angle requires one negative component for each pi and tee network. This is apparent from the component values determined after substitution.
- Use the negative impedance

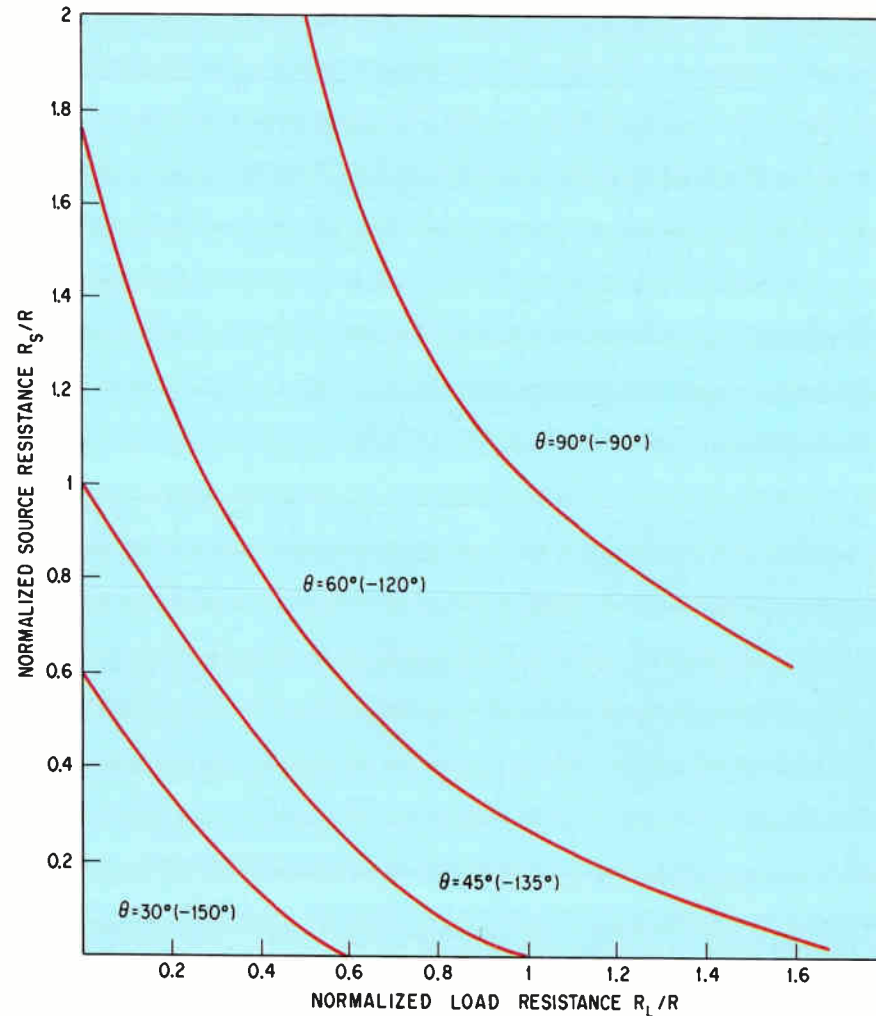

converter (NIC) on the foldout chart to produce the negative impedance effect.

Use the curves on the foldout chart to determine whether the NIC is to be connected for open-circuit or short-circuit stability.

Use the z-, y-, T-, or s-parameters to express the terminal relationships of the rotator network.

Example. It is desired to rotate the i-v curve of a diode 60° counterclockwise with a rotator. In this example the scale factor, R, is equal to one ohm since it is assumed that the scales are in amperes and volts. It is also assumed that the source impedance is also one ohm.

Solution. Since the i-v curve of a diode is resistive, an R-rotator is required. The angle of rotation lies between 0° and 180°; therefore, a pi network is used. The component values are $G_1 = G_2 = \tan 60/2 = 0.577$ mhos, and $G_3 = -\csc 60° = -1.15$ mhos.

A negative value of G_3 is obtained by connecting a positive-valued resistor of 1.15 mhos to the negative impedance converter. To determine

whether it should be connected to the open-circuit or short-circuit stability terminals of the NIC the value of the resistor must be checked with the stability curves. Enter the horizontal axis with $R_L = 1/1.15 = 0.08$ ohms, and the vertical axis with $R_s = 1$. For $\theta = 60°$ the point formed by the intersection of R_L and R_s lies above the curve; therefore connect G_3 to the open-circuit stability port. The diode is then placed across G_2 , all elements in the pi network are connected and the rotator is ready.

By attaching an oscilloscope to the input port of the pi network, the user views the original i-v curve of the diode rotated 60° counterclockwise about the origin. In this position, the rotated curve falls in the positive-current, negative-voltage portion of the i-v plane. Hence, the diode appears as a negative impedance, i/v, as seen from the input port of the pi network. With a different choice of component values the i-v curve of the diode can be rotated into any of the four quadrants of the plane.

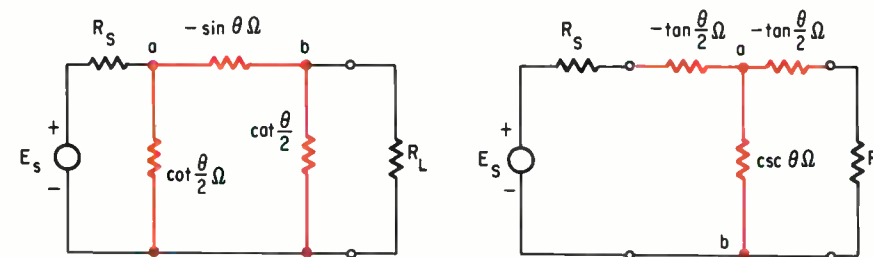
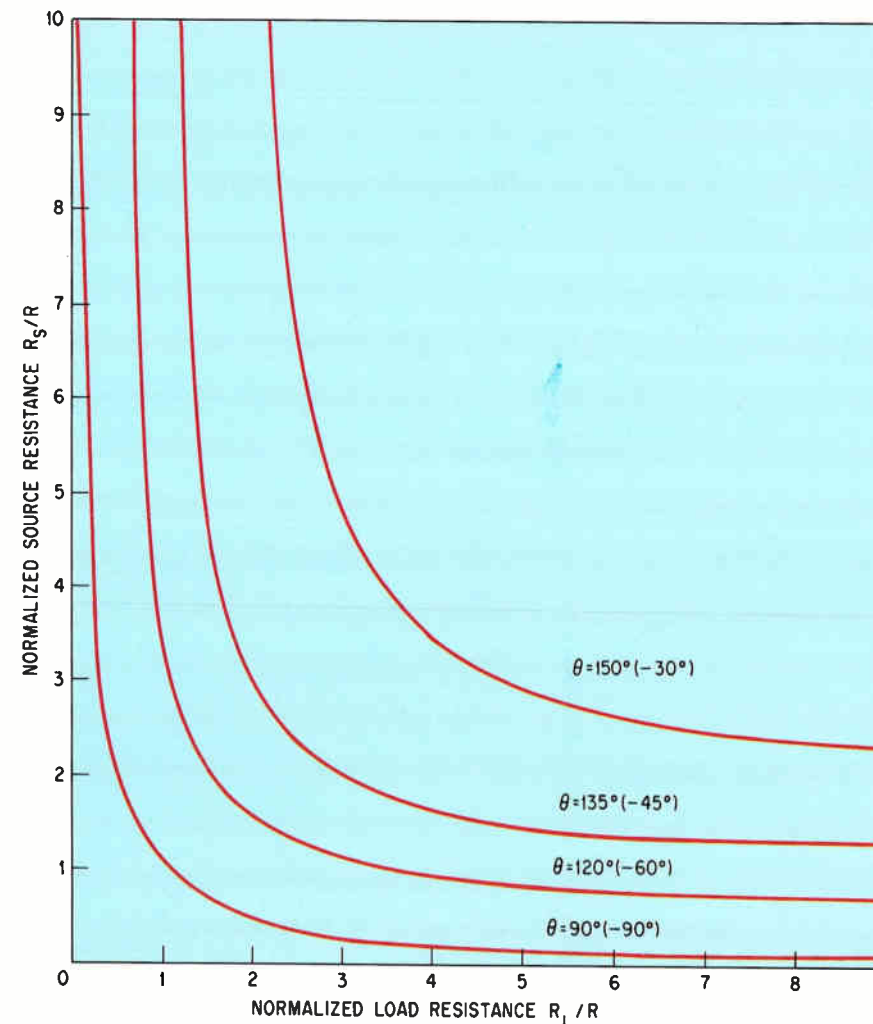

Stability plots for rotation angles 30°, 45°, 60°, and 90° are obtained from equation 11. If points for R_L/R or R_s/R fall above the curve for a corresponding rotation angle, θ , an open-circuit stable NIC is required to produce the negative impedance. Conversely, if the points fall below the corresponding curves a short-circuit stable NIC is needed.

Rotators are formed with either the pi- or tee-networks shown in color. Both the load resistance, R_L , and the source resistance R_s , are assumed to be linear.

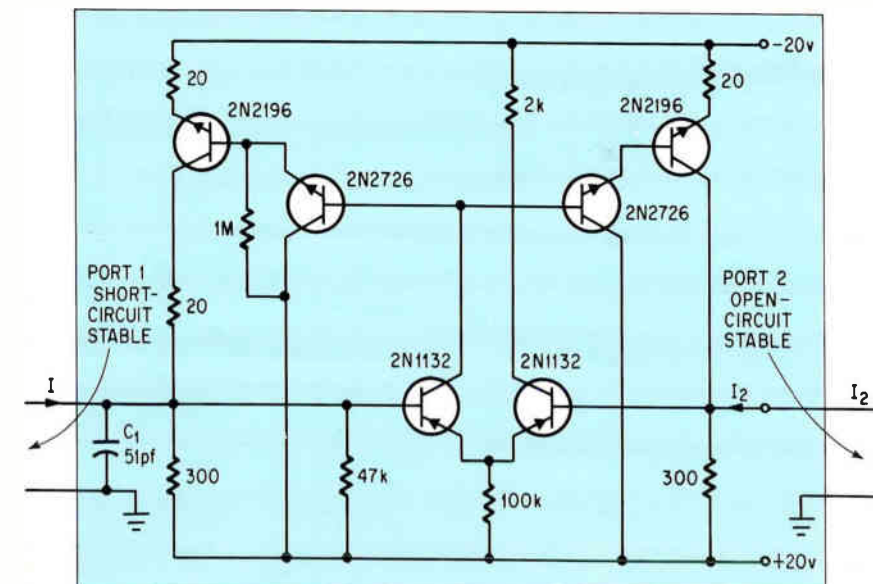

Six-transistor negative-impedance converter of the current inversion type produces the negative impedance for the rotator. With the values shown, frequency response is good and sensitivity to parameter variations is no problem.

Counterclockwise rotation

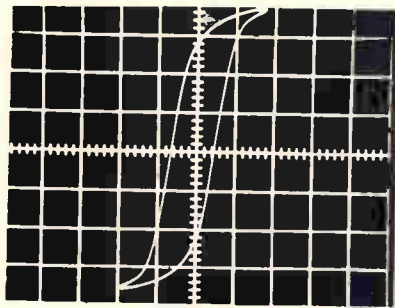

$\theta = 0^\circ$

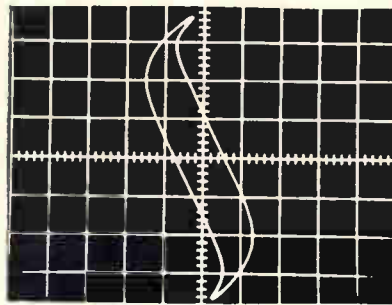

$\theta = 30^\circ$

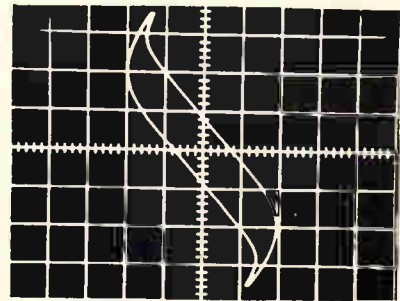

$\theta = 45^\circ$

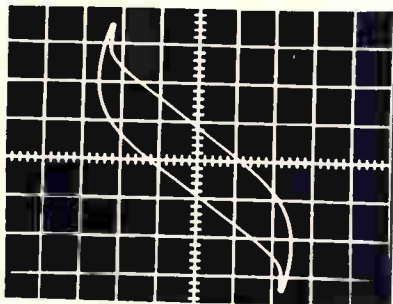

$\theta = 60^\circ$

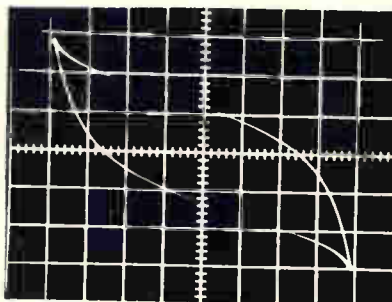

$\theta = 90^\circ$

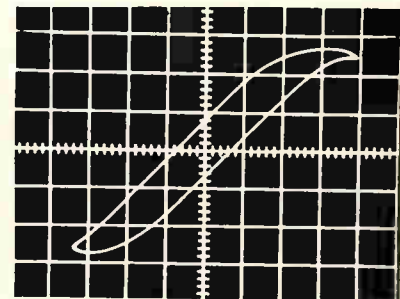

$\theta = 135^\circ$

Clockwise rotation

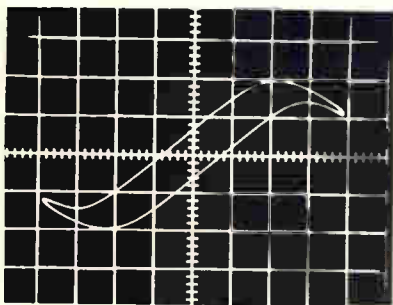

$\theta = -45^\circ$

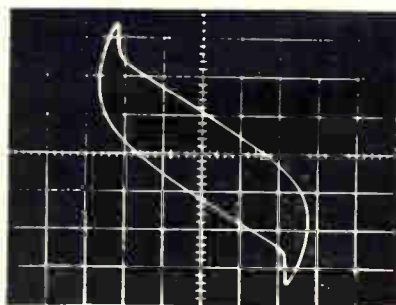

$\theta = -120^\circ$

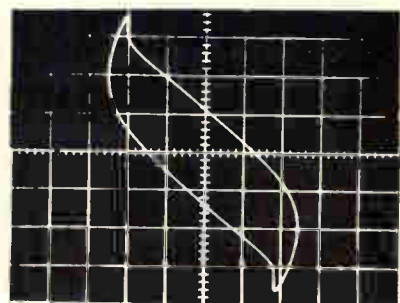

$\theta = -127^\circ$

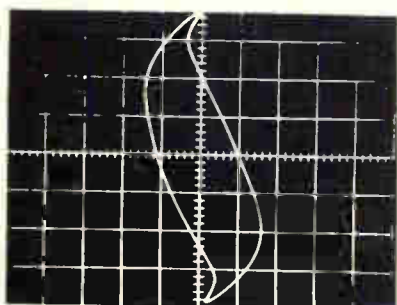

$\theta = -150^\circ$

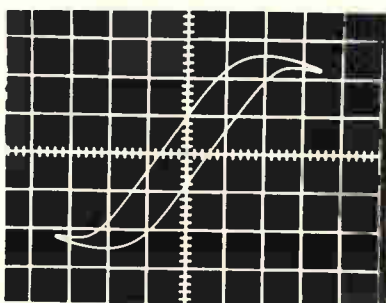

$\theta = -290^\circ$

Counterclockwise rotation (positive θ) of the ϕ - i curve of a typical nonlinear inductor is accomplished with a tee type L-rotator. Clockwise rotation (negative θ) is achieved with a pi-network L-rotator. Vertical scale for flux-linkage, ϕ is in milliwbebers; horizontal axis for current, i , is in milliamperes.

the transistors and provides good frequency characteristics.

To demonstrate that rotation is possible, a typical nonlinear resistor and inductor were chosen as loads. The i - v curve of each element and the corresponding i - v curves after counterclockwise and clockwise rotation are shown on pages 112 and 117.

The rotator also revolves the input or output characteristic curves of a three-terminal nonlinear device. The examples, displayed on page 118, were obtained by connecting the collector and emitter terminals of a pnp transistor across one port of

an R-rotator, and the resulting collector-to-emitter characteristic curves are observed across the other port for several angles of rotation.

To verify the device's stability, data curves on pages 120 and 121, were obtained for a given rotation angle by first adjusting the source resistance, R_s , to a fixed value, and then slowly increasing the load resistance R_L (with the nlc in the short-circuit stable mode) until the rotator becomes unstable. The value of R_L that results in instability is plotted as a function of R_s . The experiment is repeated with the nlc in the open-circuit stable mode, and

Stackpole commercial resistors helped Wurlitzer engineers discover a new harmony in four parts quality, price, delivery and service.



Only strict attention to detail produces a fine musical instrument. That's why Wurlitzer engineers so carefully select each component that goes into Wurlitzer Organs. Stackpole commercial resistors help make these magnificent instruments electronic, as well as musical, marvels. Performance in tune with your most demanding needs is the Stackpole guarantee. Write: Stackpole Carbon Company, Electronic Components Division, Kane, Pa. 16735.



Counterclockwise rotation

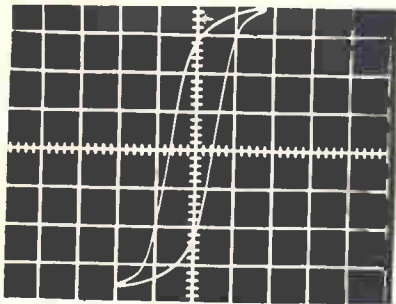

$\theta = 0^\circ$

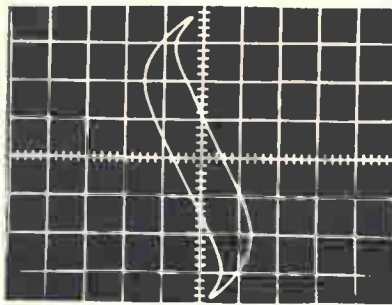

$\theta = 30^\circ$

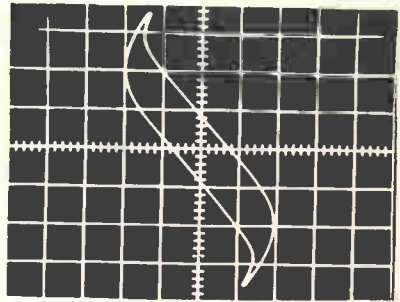

$\theta = 45^\circ$

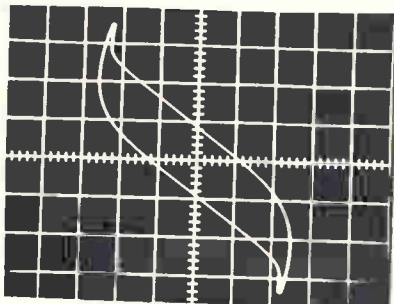

$\theta = 60^\circ$

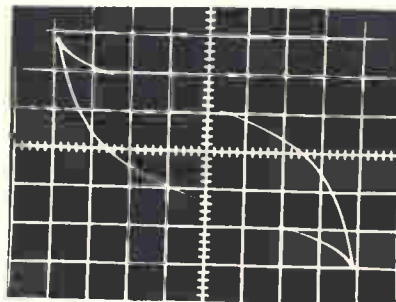

$\theta = 90^\circ$

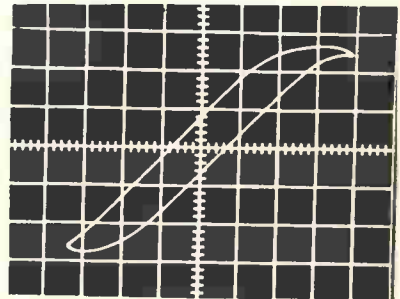

$\theta = 135^\circ$

Clockwise rotation

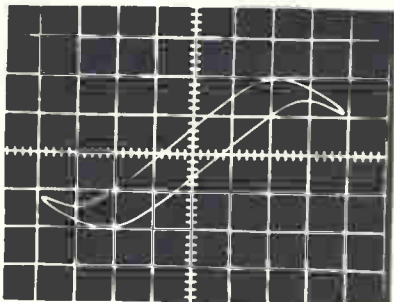

$\theta = -45^\circ$

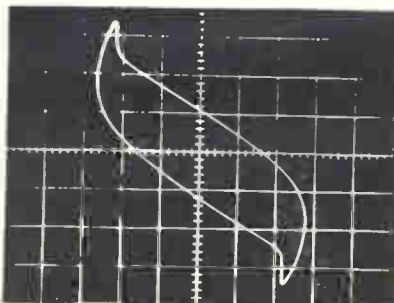

$\theta = -120^\circ$

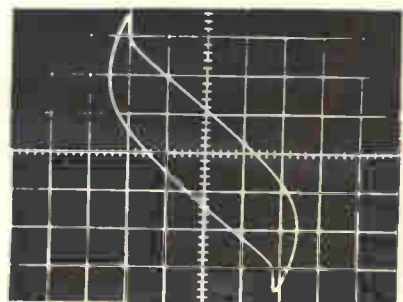

$\theta = -127^\circ$

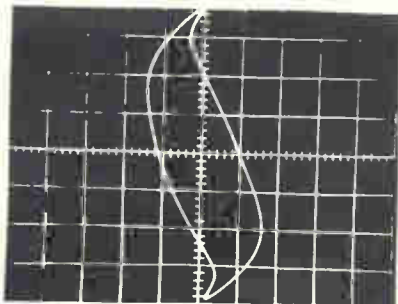

$\theta = -150^\circ$

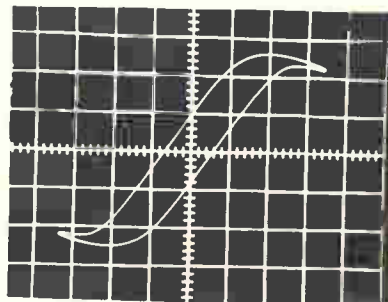

$\theta = -290^\circ$

Counterclockwise rotation (positive θ) of the ϕ - i curve of a typical nonlinear inductor is accomplished with a tee type L-rotator. Clockwise rotation (negative θ) is achieved with a pi-network L-rotator. Vertical scale for flux-linkage, ϕ is in milliwbebers; horizontal axis for current, i , is in milliamperes.

the transistors and provides good frequency characteristics.

To demonstrate that rotation is possible, a typical nonlinear resistor and inductor were chosen as loads. The i - v curve of each element and the corresponding i - v curves after counterclockwise and clockwise rotation are shown on pages 112 and 117.

The rotator also revolves the input or output characteristic curves of a three-terminal nonlinear device. The examples, displayed on page 118, were obtained by connecting the collector and emitter terminals of a pnp transistor across one port of

an R-rotator, and the resulting collector-to-emitter characteristic curves are observed across the other port for several angles of rotation.

To verify the device's stability, data curves on pages 120 and 121, were obtained for a given rotation angle by first adjusting the source resistance R_s to a fixed value, and then adjusting the load resistance R_L (with stable mode) until the device becomes unstable. The value of R_L that results is plotted as a function of R_s . This curve is repeated with the ΔI_C in the operating mode, and

Counterclockwise rotation

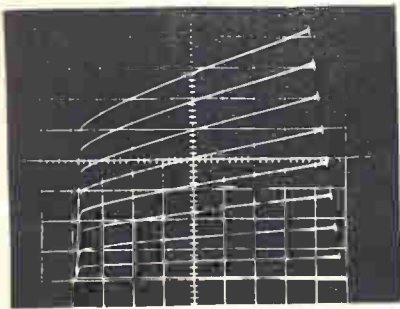

$\theta = 0^\circ$

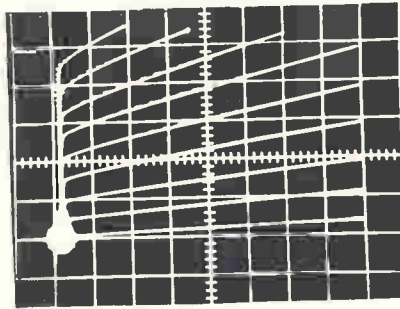

$\theta = 2^\circ$

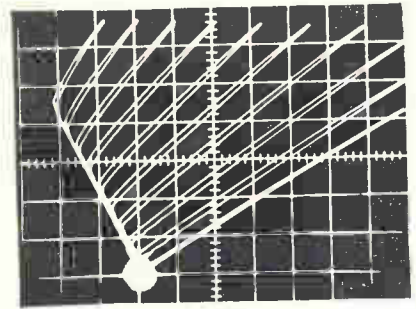

$\theta = 30^\circ$

Clockwise rotation

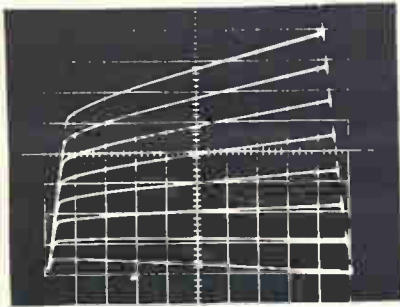

$\theta = -5^\circ$

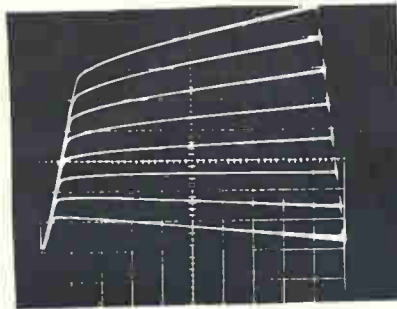

$\theta = -10^\circ$

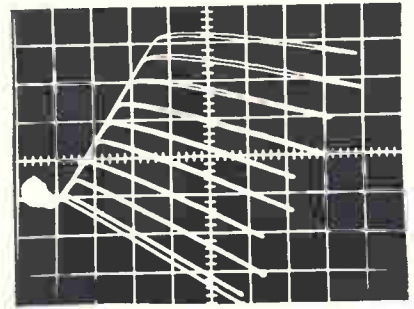

$\theta = -30^\circ$

Collector-to-emitter characteristic of a 2N404A transistor is rotated counterclockwise (positive θ) and clockwise (negative θ) by an R-rotator. In all the transistor curves the vertical scale for collector current is calibrated in milliamperes, and the horizontal scale for collector-to-emitter voltage is calibrated in volts.

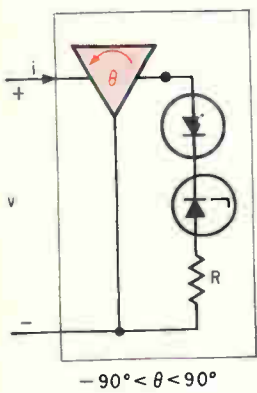

$-90^\circ < \theta < 90^\circ$

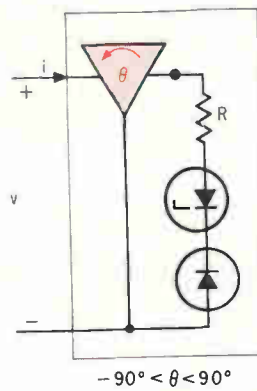
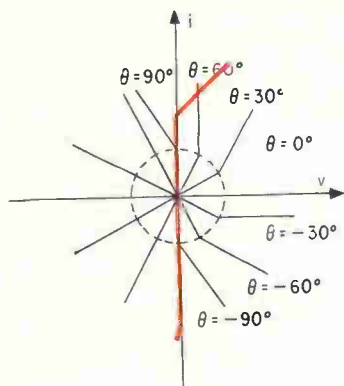

$-90^\circ < \theta < 90^\circ$

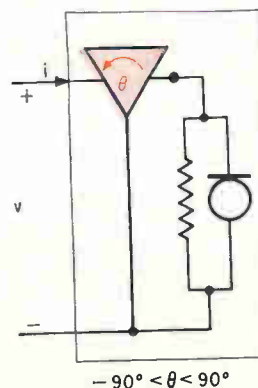
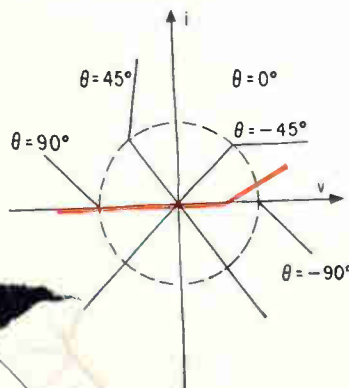
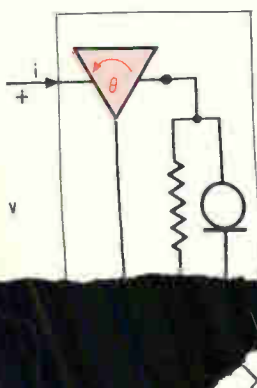
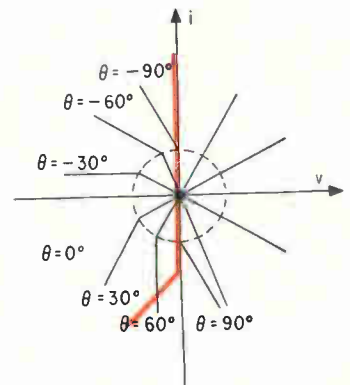

$-90^\circ < \theta < 90^\circ$

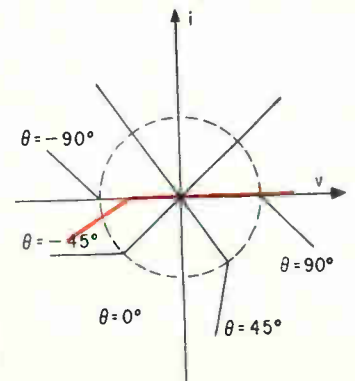

Rotation of a concave (top) a set of wave shapes that (bottom) resistor is formed with an R-rotator and can be used to create d to produce unique circuits or curves.

R_L is gradually decreased until the rotator becomes unstable. This accounts for the two circles and two crosses that appear for each value of R_s . (Wherever the same value of R_L was observed, only one circle or one cross is plotted.) In some cases, the procedure was reversed by first fixing R_L , and adjusting R_s until instability occurred. This accounts for the vertically adjacent data points on the curve.

Excellent agreement exists between the predicted stability curves and the experimental data.

Applying the rotator

The rotator was conceived as a tool for synthesizing nonlinear elements that are characterized by multivalued curves. As an example, several practical problems for realizing multivalued $i-v$ curves follow. The same concepts are applicable to the synthesis of multivalued $\phi-i$ and $Q-v$ curves.

▪ **Positive-sloped $i-v$ curve.** Two curves that are useful for forming a variety of nonlinear wave-shapes are the concave and convex patterns at the right. Note that in the concave waveform $i = 0$ for $v \leq E$. Thus a concave resistor is defined by the two parameters E and R (reciprocal of the slope). It can be obtained with a zener diode whose breakdown voltage is equal to any value E in series with a junction diode and a resistor of value R . Conversely, for the convex waveform, $v = 0$ for $i \leq I$ and is described by the two parameters I and R . A convex resistor is obtained with a parallel combination of a field effect diode having a constant current equal to any value I and a resistor with any value R . Field effect diodes are commercially available semiconductor devices in which the charge carriers are of only one polarity. By connecting a concave or convex resistor across the output port of a rotator the basic curves can be altered, as shown on the opposite page.

Both the concave and convex resistors can be used to produce multivalued $i-v$ curves. Previously no standard procedure was known for realizing multivalued $i-v$ curves without voltage- or current-controlled sources. By definition, an $i-v$ curve is current-controlled if any horizontal line ($i = \text{a constant}$) intersects the curve at only one point, and a vertical line intersects it at several points. Conversely, a curve is voltage-controlled if any vertical line ($v = \text{a constant}$) intersects it at only one point and a horizontal line intersects it at several. One technique for synthesizing both current- and voltage-controlled curves is shown on page 122.

If a horizontal or a vertical line intersects a multivalued $i-v$ curve at more than one point the curve is considered neither voltage- or current-controlled. An example of such a curve is at the bottom left of page 120, where a line through $i_2 = 10$ will intersect the curve at three points. With the help of rotators any multivalued curve of this type can be rotated about the origin, as shown at the bottom right of page 120, to produce a current- or voltage-controlled curve. Note that after rotating the curve to its new position a vertical line through $i_2 = 10$ intersects the curve at only one point. This type of

Basic curves

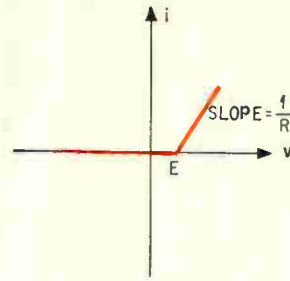

$i-v$ CURVE OF A CONCAVE RESISTOR

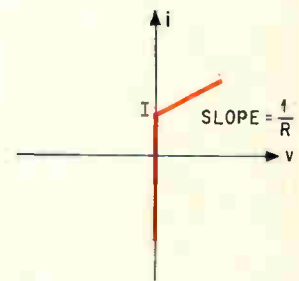

$i-v$ CURVE OF A CONVEX RESISTOR

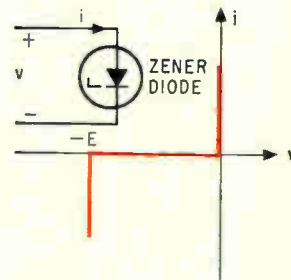

$i-v$ CURVE OF A ZENER DIODE

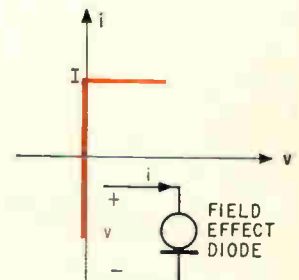

$i-v$ CURVE OF A FIELD EFFECT DIODE

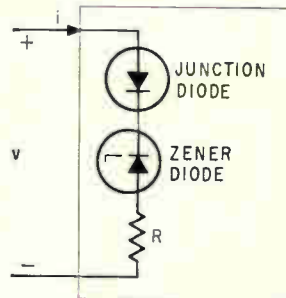

A PRACTICAL REALIZATION OF A CONCAVE RESISTOR

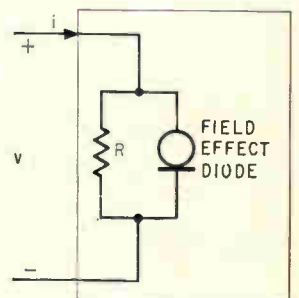

A PRACTICAL REALIZATION OF A CONVEX RESISTOR

Zener diode's versatility is extended when used with an R-rotator for producing concave or convex resistor curves. Junction and zener diode series combination or a resistor and field effect diode parallel combination achieve the same result.

curve could not have been achieved without a rotator.

▪ **Large-valued slopes.** By connecting a linear component to the output of a rotator, the engineer is able to control the slope of the characteristic curve for the component and hence the value of the component. For example, an inductor's slope is defined $d\phi_1/dt_1$ for a straight line in the $\phi-i$ plane. With the rotator the line can be turned to a new position with a slope of $d\phi_2/dt_2$ when observed from the input port of the rotator.

▪ **Astable multivibrators.** The piecewise linear $i-v$ curve on page 121 can be approximately realized by a diode-battery network, or by connecting two identical zener diodes back-to-back in series. If the $i-v$ curve is rotated about the origin until a negative slope is obtained, the resulting $i-v$ curve can synthesize many valuable pulse circuits. For ex-

Stability curve plots

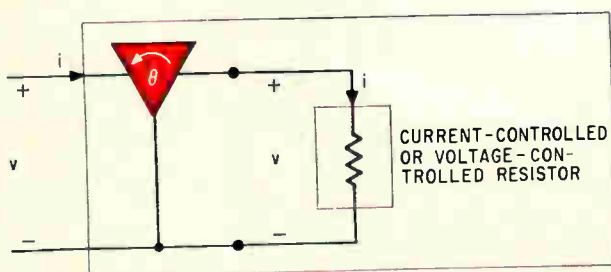
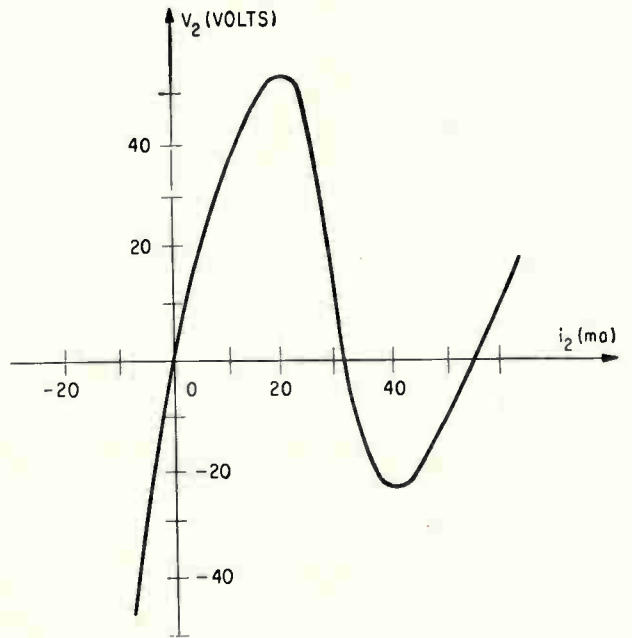
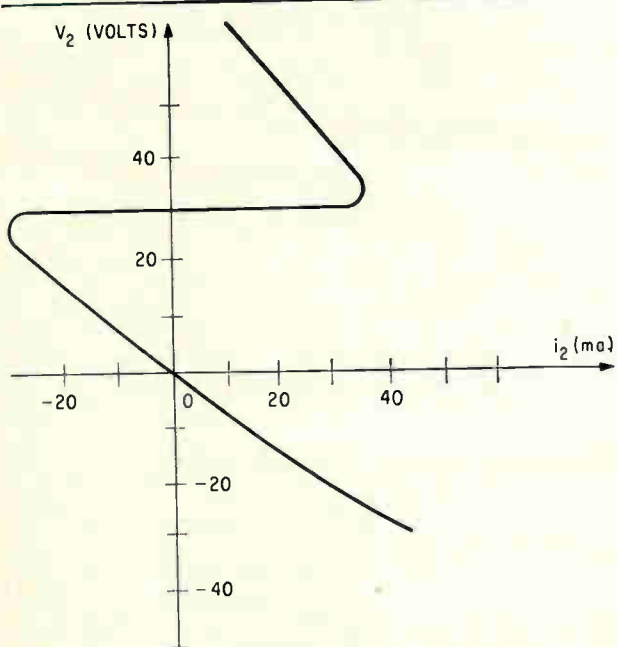
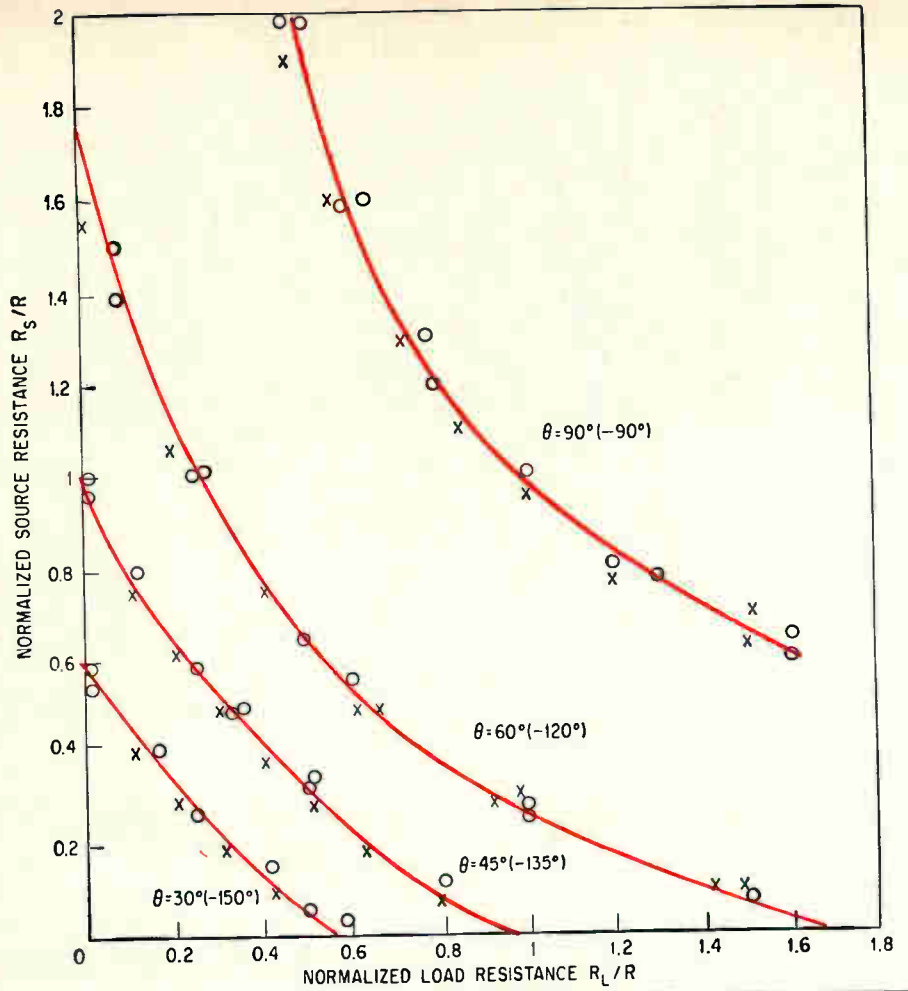

By connecting the current- or voltage-controlled resistor (left) that produces the multivalued curve at the above left, a plot is obtained whose points at each $i-v$ position are of single value. A vertical line through 10 volts in the original curve intersects the curve at several values.

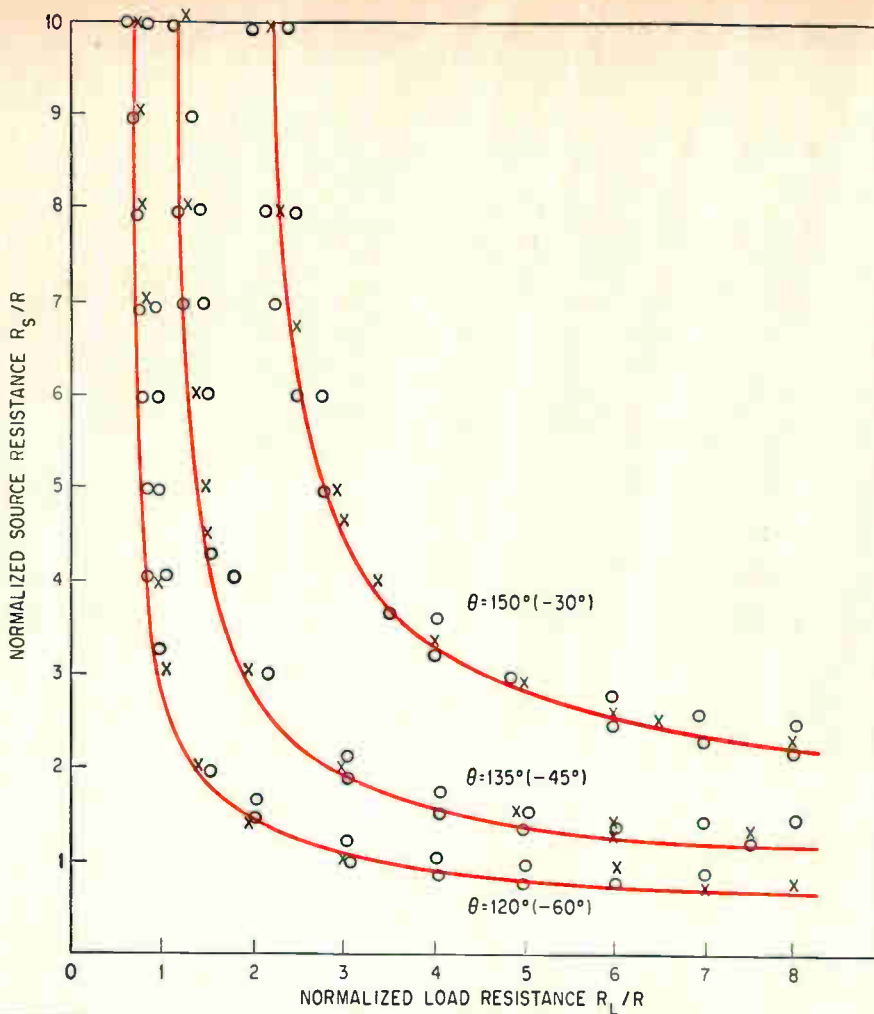

Stability characteristics are plotted for an R-rotator for various angles of rotation. If a point for R_L/R , or R_s/R lies above the stability curve for a desired θ , an open-circuit NIC must be used to assure stable operation. Conversely, when a point falls below the desired θ -curve a short-circuit NIC must be used.

Stability plots for angles in the second quadrant.

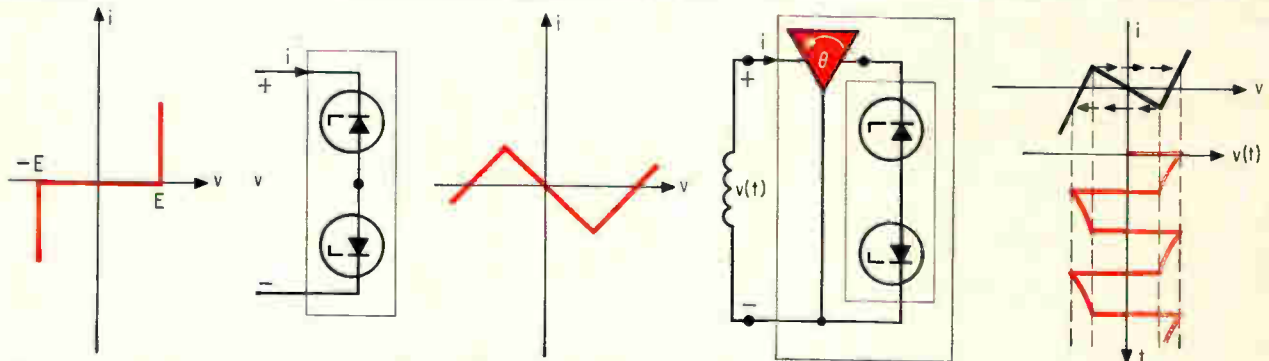

Square-wave pulse train is generated by rotating the $i-v$ curve for series connected zener diodes and placing an inductor across the input port of an R-rotator.

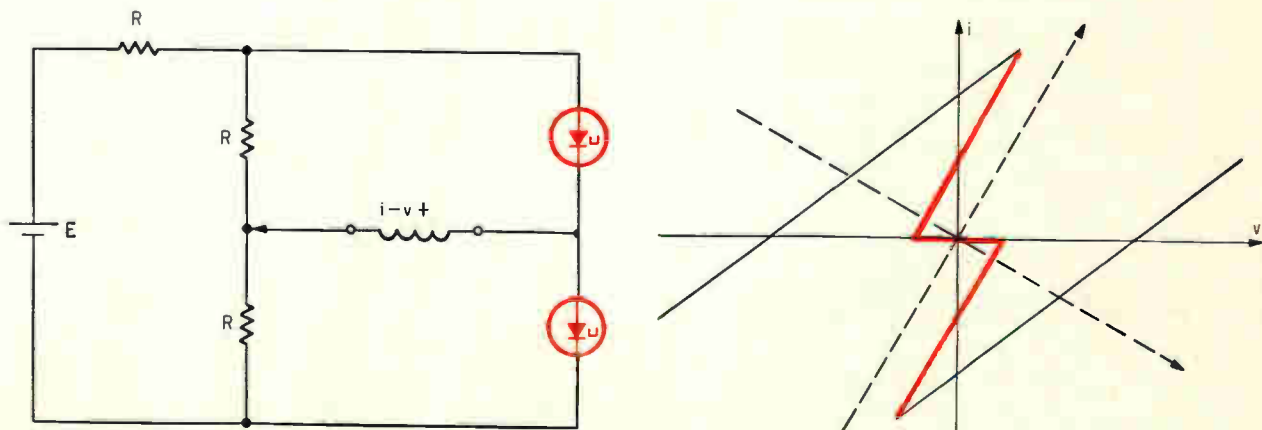

Rotator network obtains the colored portion of the trace, usually unobtainable with conventional curve tracers.

Properties of a rotator

▪ Property 1. If a two-terminal resistor, inductor, or capacitor is connected across port 2 of an R-, L-, or C-rotator, the resulting two-terminal network across port 1 is equivalent to a new resistor, inductor or capacitor, respectively. The i - v curve of the new resistor is obtained by rotating the i - v curve of the given resistor about the origin by θ° in the counter-clockwise direction for all $\theta > 0$. The ϕ - i curve of the new inductor is obtained by rotating the ϕ - i curve of the given inductor by θ° in the clockwise direction for all $\theta > 0$. Similarly, the q - v curve of the new capacitor is obtained by rotating the q - v curve of the given capacitor by θ° in the clockwise direction for all $\theta > 0$.

▪ Property 2. The rotator is a

symmetrical two-port network element; port 1 and port 2 of the rotator can be interchanged without affecting the external circuitry.

▪ Property 3. The rotator is a linear, reciprocal, active two-port network element. Therefore, it is necessary to supply external power.

▪ Property 4. The determinant of the two-port matrixes of an R-rotator (see table 1 on page 113), is either +1 or -1.

▪ Property 5. If n rotators are connected in cascade, a new rotator is obtained whose angle of rotation is given by

$$\theta = \sum_{i=1}^n \theta_i$$

where θ_i is the angle of rotation of the i th rotator.

▪ Property 6. A θ° rotator can be transformed into a $(\theta^\circ \pm 180^\circ)$ rotator by interchanging the two terminals of port 1 and port 2.

▪ Property 7. One-to-one correspondence, physically and mathematically, exists between each point of the rotated curve and the point of the original curve.

▪ Property 8. If port 2 of an R-rotator is terminated by a linear load impedance Z_L or admittance Y_L , then the input impedance Z_i or admittance Y_i across port 1 of the rotator is related to Z_L or Y_L by the bilinear transformation.

$$Z_i(p) = \frac{R[(\cot \theta) Z_L(p) - R]}{Z_L(p) + R(\cot \theta)}$$

$$Y_i(p) = \frac{1 + R Y_L(p) \cot \theta}{R[\cot \theta - R Y_L(p)]}$$

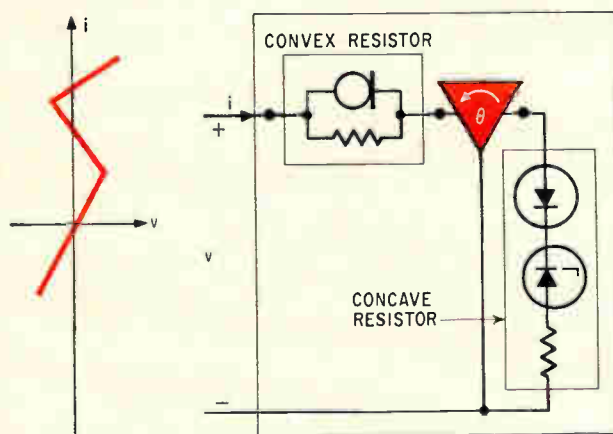

Current-controlled i - v curve (top) is obtained with a convex resistor connected to an R-rotator and a concave resistor. Two concave resistors connected to an R-rotator (right) produce voltage-controlled i - v curve.

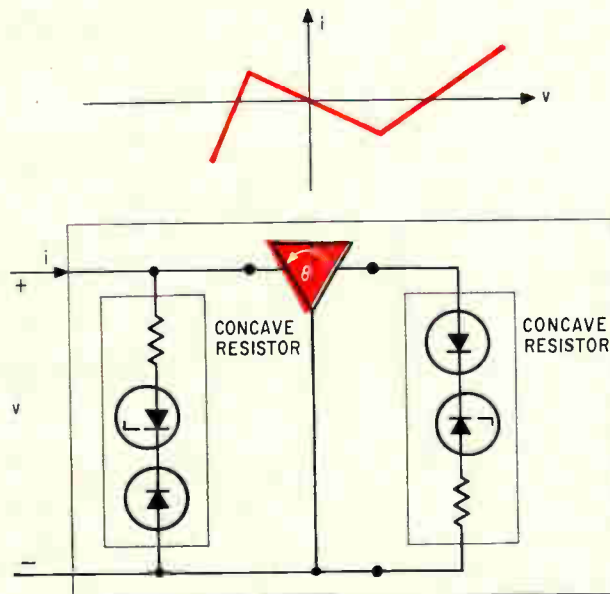

ample, an astable multivibrator is easily built by connecting an inductance, L , across the rotated element. The resulting output voltage waveform $v(t)$ across the inductor can be clipped to obtain a square wave. The peak value of $v(t)$ is controlled by the breakdown voltage E of the zener diodes and the circuit produces a square wave with any prescribed amplitude by merely choosing the appropriate zener diodes.

▪ Curve tracer. Special-purpose instruments, like curve tracers, can be designed with rotators, for displaying multivalued i - v curves. If a conventional curve tracer is used, the i - v curve at the bottom of page 119 is obtained. Comparing the waveform that appears on the curve tracer to the i - v curve derived analytically, reveals that only parts of the curve are

displayed, namely the two black lines. In fact, the portion of the i - v curve, shown in color, is most useful for optimizing the circuit's performance and is usually absent. The reason for this is simple: existing curve tracers are capable of displaying only single-valued voltage and current curves. The rotator furnishes this type of valued curve.

References

1. C. Jones, W. Caywood, and E. Williams "Using negative reactance for independent phase and attenuation," *Electronics*, Dec. 14, 1964, p. 44.
2. Kendall L. Su, "Active Network Synthesis," McGraw-Hill Inc., 1965, p. 42.
3. L. P. Huelsman, "Circuits, Matrices, and Linear Vector Spaces," McGraw-Hill Inc., 1963, p. 119.

*FMC's new CAPER process
(continuous ammonium persulfate etching & recovery).*

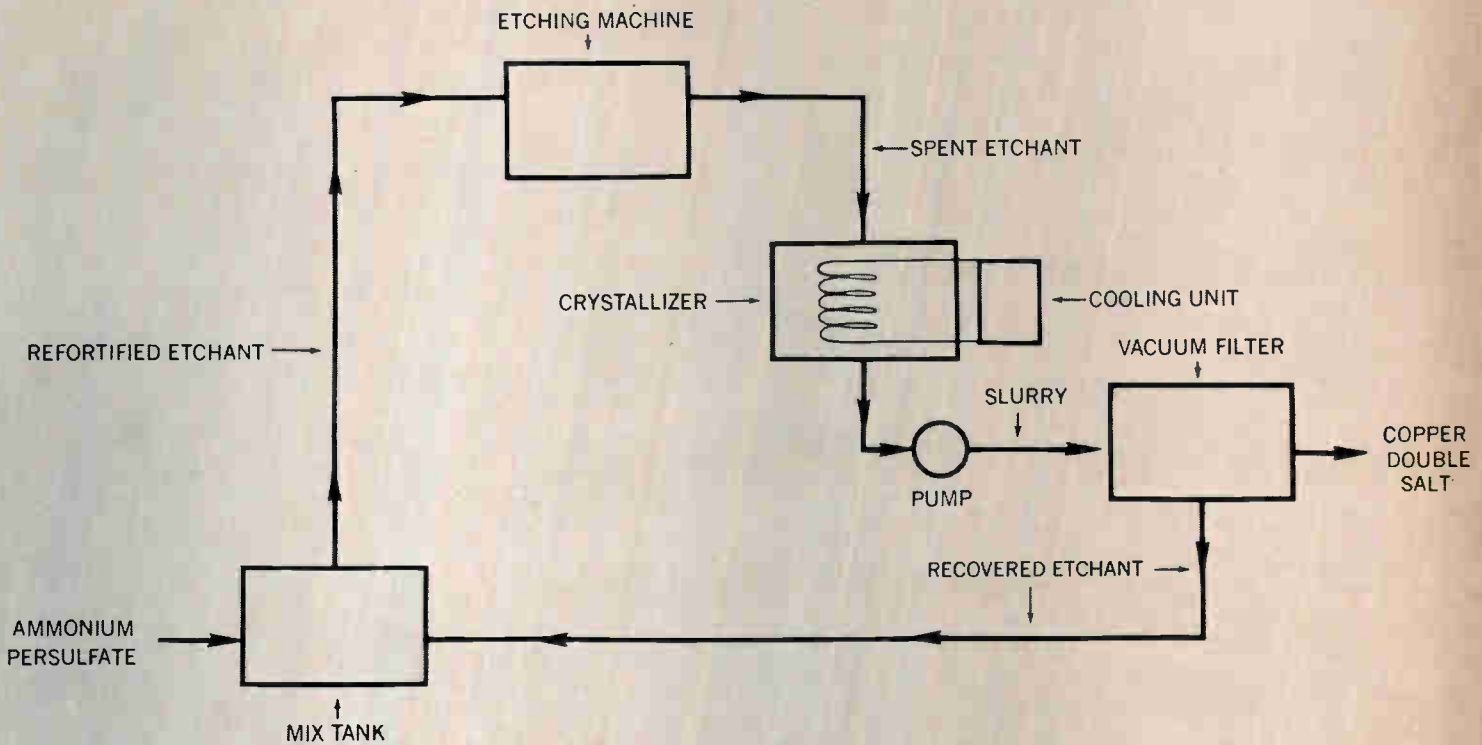

What continuously etches circuit boards
at a constant rate without waste disposal problems?

(It also cuts your ammonium persulfate etchant costs in half.)

 For further information about this new process, contact our Product Promotion Department,
FMC CORPORATION, INORGANIC CHEMICALS DIVISION, 633 Third Ave., New York, N.Y. 10017.

Circle 123 on reader service card

SEE IT AT NEP/CON '67 EAST FMC BOOTH 615.

Philbrick...

the source for things Analog

Philbrick is the top-value supplier of analog instrumentation components, software, and related accessories for modeling, measuring, manipulating . . . and much else. We offer the widest variety of advanced-technology analog products available . . . and the best in total value — which includes price, plus applications assistance, plus field service, plus stock delivery . . . and Philbrick's 2-year warranty. *Only at Philbrick* can you obtain all six of the analog product types described below.



DISCRETE-COMPONENT OPERATIONAL AMPLIFIERS

Philbrick Operational Amplifiers are, in the simplest terms, high-gain, low-drift amplifiers designed for use in stable feedback loops to provide precise, predictable operations on one or more input signals. In addition to linear applications, a wide variety of nonlinear functions and operations can be performed using them with passive nonlinear elements or with Philbrick Transconductors.

IC OPERATIONAL AMPLIFIERS

Philbrick MICRO-HYBRID Operational Amplifiers combine the best of two technologies — linear monolithic chip and discrete microminiature components — and offer immunity to overloads, shorts and supply-voltage stresses. They provide superior electrical performance and mounting and assembly advantages. There are no equivalents, particularly in high-reliability applications. Philbrick ISOLITHIC* Operational Amplifiers are state-of-the-art monolithic amplifiers, superior electrically and mechanically to present monolithic chip amplifiers. *Trademark.

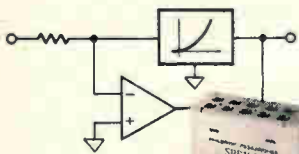
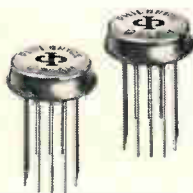

TRANSCONDUCTORS

Philbrick Transconductors are plug-in analog system components for linearizing or embodying nonlinear functions. These analog network devices include natural continuous function and straight-line approximation (piecewise-linear) types. Philbrick transconductors include networks that accurately exhibit logarithmic, trigonometric, and quadratic behavior.

REGULATED DC POWER SUPPLIES

Philbrick power supplies are precisely regulated and are essentially noise-free. Typical regulation (including drift) is of the order of 100 PPM, noise and hum less than 1 PPM; and recovery (to within .001%) from a step-change in load is accomplished in microseconds. Philbrick power supplies are available in rack, cabinet, modular, plug-in or built-in models.

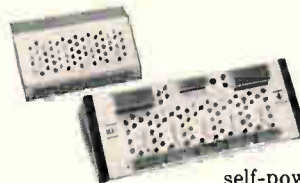

OPERATIONAL MANIFOLDS

Philbrick operational manifolds offer a new "breadboarding" technique. These all-in-one self-powered analog instruments virtually eliminate wiring problems; components and jumper leads plug into prewired panel jacks. Model MP (with 4 amplifiers) and Model RP (with 5 amplifiers) simplify experimentation, simulation, and instruction in the practical application of feedback techniques, and employ all-silicon solid-state operational amplifiers. Their many uses and habitats include industrial process control, physics and electronic laboratories, educational institutions, as well as in-line analog data processing.

MODULAR ANALOG COMPUTING INSTRUMENTATION

Philbrick equipment for the implementation of both analog and hybrid computers, simulators and analyzers includes: arbitrary function fitters, universal linear operators, multiplier-dividers and manifolds. Components may be formed into systems by mounting them on Philbrick unique Q3-series modular front panels, chassis, adaptors and accessories. Completely-wired modules for amplification, multiplication, and other analog operations are available individually as self-powered instruments or for integral systems use.



TECHNICAL SUPPORT SERVICES

For prompt, competent applications engineering advice, call Philbrick in Dedham or one of Philbrick's worldwide Engineering Representatives. Our engineers welcome opportunities to help you apply analog techniques and products in such areas as industrial and scientific instrumentation, process and quality control systems, in-line analog data processing. You are welcome to write to us for technical literature on the product categories of interest. Philbrick Researches, 22-J Allied Drive at Route 128, Dedham, Massachusetts 02026

ELECTRONIC ANALOG COMPUTING EQUIPMENT for MODELLING, MEASURING, MANIPULATING and MUCH ELSE



PHILBRICK

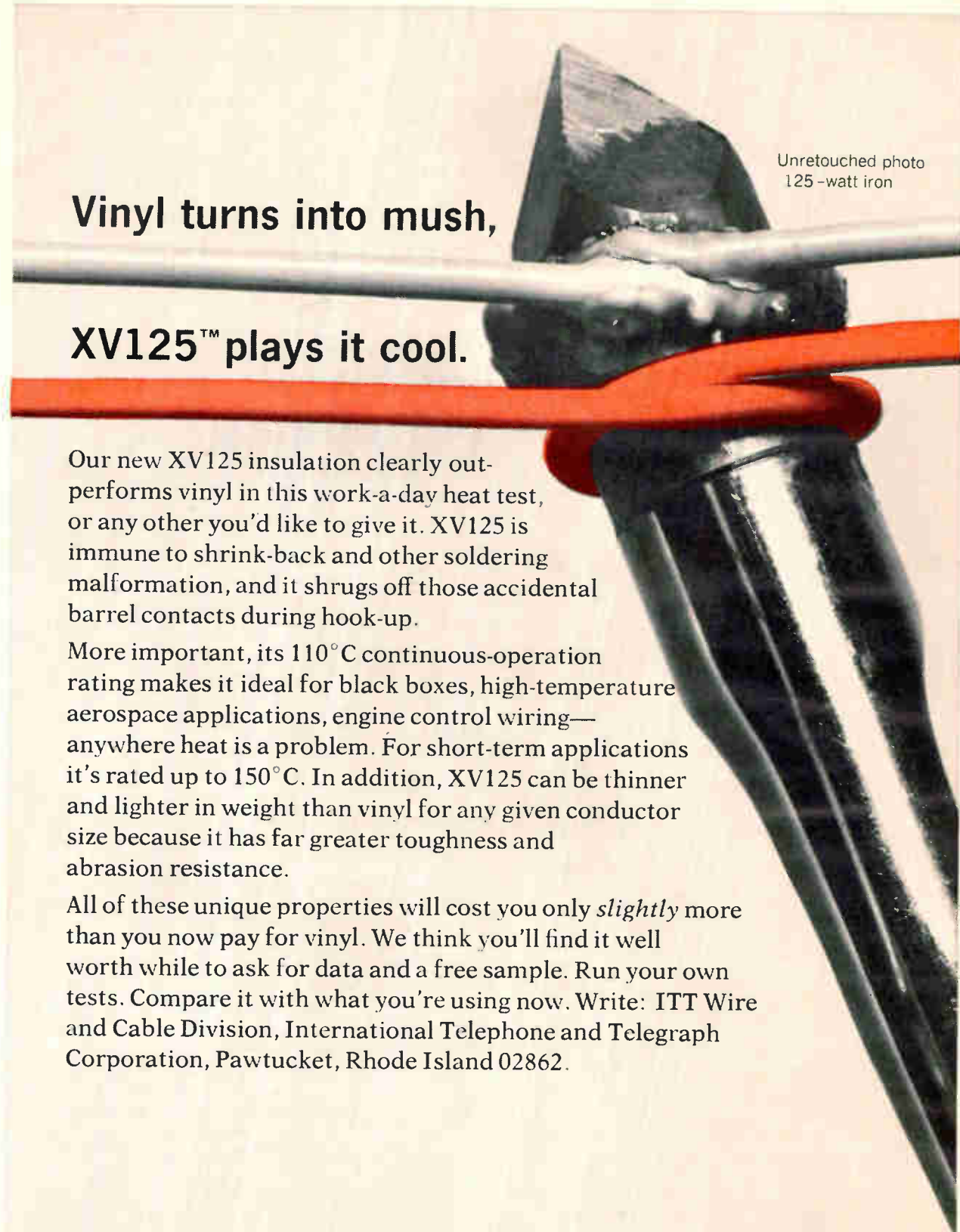

Unretouched photo
125-watt iron

Vinyl turns into mush,

XV125™ plays it cool.

Our new XV125 insulation clearly outperforms vinyl in this work-a-day heat test, or any other you'd like to give it. XV125 is immune to shrink-back and other soldering malformation, and it shrugs off those accidental barrel contacts during hook-up.

More important, its 110°C continuous-operation rating makes it ideal for black boxes, high-temperature aerospace applications, engine control wiring—anywhere heat is a problem. For short-term applications it's rated up to 150°C. In addition, XV125 can be thinner and lighter in weight than vinyl for any given conductor size because it has far greater toughness and abrasion resistance.

All of these unique properties will cost you only *slightly* more than you now pay for vinyl. We think you'll find it well worth while to ask for data and a free sample. Run your own tests. Compare it with what you're using now. Write: ITT Wire and Cable Division, International Telephone and Telegraph Corporation, Pawtucket, Rhode Island 02862.

wire and cable division

ITT

How to save money and avoid headaches in transformer and inductor design.

STEP 1. Mental attitude is important. Don't think you have to use laminated metal cores just because Steinmetz did. He didn't know about ferrite cores. **STEP 2.** Reflect on the advantages of ferrite cores: self-shielding for complete packaging freedom... easy to wind and assemble, miserly of space... wide range of standard sizes, shapes and magnetic characteristics... two-way economy —lower direct costs of manufacturing your product and indirect savings in tight tolerance control, which often "unburdens" associated circuitry. **STEP 3.** Update your knowledge of ferrite cores and their advantages. Read our Design Manuals 220 and 330. They cover the application of Ferroxcube ferrite cores to the design of optimum inductors and transformers. **STEP 4.** With a slide rule, go ahead and design all pad and HF and power transformers, filters and tuned circuits.

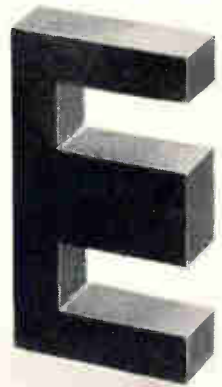
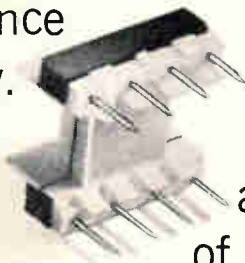

FERROXCUBE CORPORATION

Saugerties, New York
914-246-2811

Boston
617-899-3110

Chicago
312-261-7880

Dallas
214-363-0107

Los Angeles
213-837-1484

Minneapolis
612-888-4681

New York Area
201-964-1844

Phoenix
602-265-1792

Philadelphia
215-927-6262

San Francisco
415-863-3300

600 ounce-inches torque

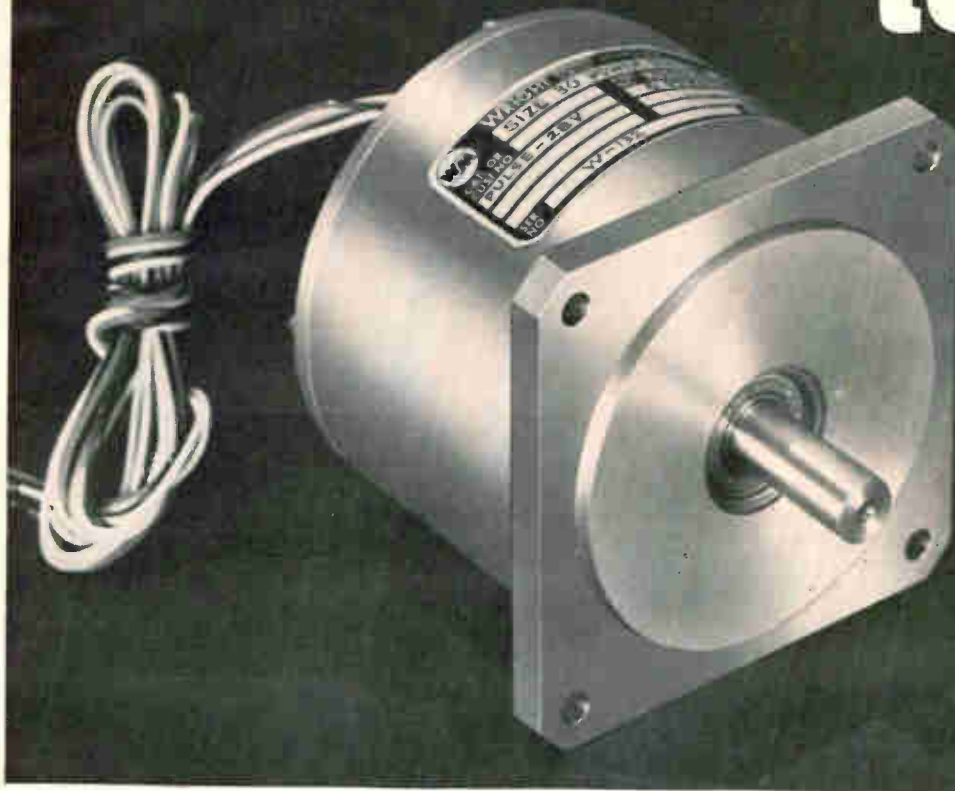

now
available
in 15°
step
angles

Powerful, permanent magnet stepper motors by Wright Division of Sperry Rand open whole new fields of application for steppers. For the first time, designers are offered a line of stepper motors for the direct drive of all types of mechanical systems. With the high torque (up to 600 ounce-inches) and wide step angle (15°) of these motors, you can replace clutches, ratchets, gearheads, belts and cams with high speed electrical drives.

15° Step Angle Power Steppers

SIZE	20 S	20 L	25 S	25 L	34 S	34 L	40
Outside Diameter, inches	2.000	2.000	2.500	2.500	3.390	3.390	4.000
Length, inches	1¾	2¾	1¾	2¼	2½	4¾	4¾
Rotor Moment of Inertia, oz.-in. ²	.18	.36	.73	1.50	4.10	8.2	12.8
Volts Per Phase	28	28	28	28	28	28	28
Current Per Phase, amps	.40	.65	1.14	1.85	3.2	5.2	4.8
Input Power Per Phase, watts	11.5	18	32	52	90	145	135
Stall Torque, oz.-in.	15	30	60	120	220	450	600
Max. Controlled Stepping Rate, steps/sec.	250	250	250	250	200	200	150

Applications

Tape drive, carriage, valve, belt, paper, azimuth, hydraulic, position, printer, screw, elevation, worm, digital, meter, instrument, set point, and similar drives.

Speed

150 - 250 steps per second controlled.

Low Power

Requires half the power of other devices. Benefits: simplicity, smaller size, lighter weight, lower cost, longer life.

Design engineers are invited to write or telephone for details. Comparison will show you that on applications where digital rotation is needed, this new Wright concept in steppers offers substantial advantages.

WRIGHT 
Division of Sperry Rand Corporation

Durham, North Carolina ■ Telephone 919-682-8161 ■ TWX 919-682-8931

The ultimate in Q JFD Uniceram capacitors

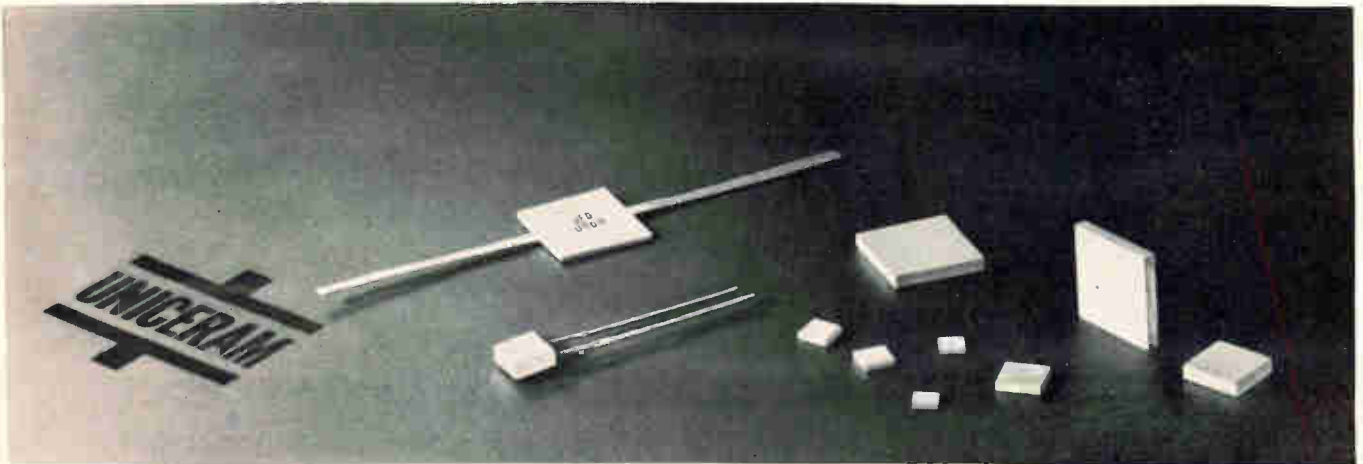

Capacitors shown enlarged 25%

Glass encapsulated or unencapsulated wafer Uniceram monolithic High Q ceramic fixed capacitors — offer a high ratio of capacitance per unit volume. They combine exceptional stability and a guaranteed High Q in a smaller size package than competitive units. Q at 1 MHz for values of 1000 pf or less is 5000 min.

Over 1,000 glass encapsulated models, with capacitance values from 0.5 to 3000 pf, provide the ultimate

in High Q—proven reliability and stability. All models meet applicable requirements of MIL-C-11272B.

Uniceram High Q capacitors are also available as wafers with metalized edges. These lower-cost units in the same capacitance values offer the same outstanding electrical properties. These wafers, or chips, ideally suited for hybrid integrated circuits, can be soldered directly to printed circuit boards or used as discrete components.

ACTUAL CASE SIZES (Encapsulated leaded units)

- No. 1: 7/64" Sq. X 1/16" Thick
Cap. — 0.5 to 62. pf
- No. 2: 9/64" Sq. X 1/16" Thick
Cap. — 27. to 130. pf
- No. 3: 3/16" Sq. X 5/64" Thick
Cap. — 150. to 470. pf
- No. 4: 1/4" Sq. X 5/64" Thick
Cap. — 510. to 1000. pf
- No. 5: 13/32" Sq. X 5/64" Thick
Cap. — 1100. to 3000. pf

Write for catalog UNM-H/Q-67.

"TODAY'S COMPONENTS BUILT FOR TOMORROW'S CHALLENGES"

JFD

JFD ELECTRONICS CO. / COMPONENTS DIVISION • 15th Avenue at 62nd Street • Brooklyn, New York 11219 / Phone 212-331-1000
Sales Offices — Arcadia, California / Chicago, Illinois / Baltimore, Maryland / Saxonville, Massachusetts / Brooklyn, New York
New Hartford, New York / Cincinnati, Ohio / Philadelphia, Pennsylvania / Pittsburgh, Pennsylvania / Paris, France / Azor, Israel

When cable jacket must resist

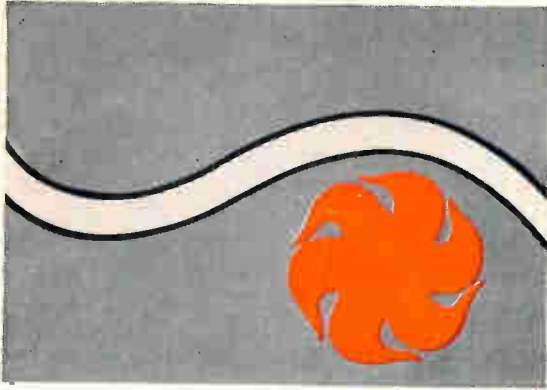

- 135°C temperature

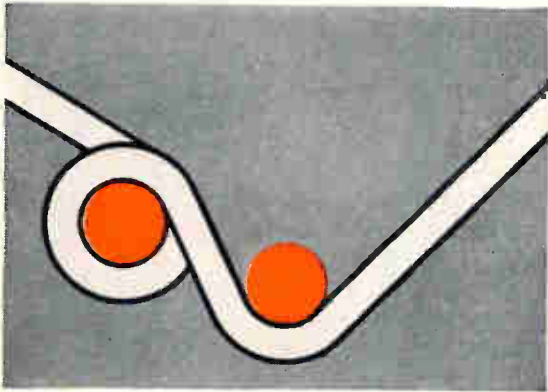

- mechanical stress

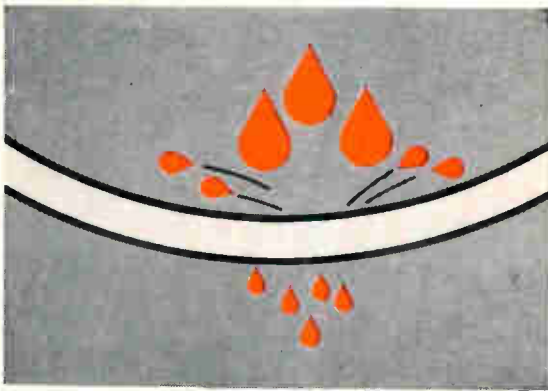

- corrosive fluids...

It had better be Kynar*!

Whether it's used in aircraft, down-well instruments, or computers, no other jacket material fills the bill like Kynar...Pennsalt's vinylidene fluoride resin! It stands up to temperatures from -80° to +300°F... has twice the mechanical strength of other fluoroplastics... withstands cut-through...resists acids, bases,

chlorinated cleaning solvents and jet fuels.

When only the best cable jacket material is good enough... when you need one that's tough... specify Kynar. For data, write or call: Plastics Department, Pennsalt Chemicals Corporation, 3 Penn Center, Phila., Pa. 19102.

Kynar...the fluoroplastic that's tough!

*Kynar is a registered trademark of Pennsalt Chemicals Corporation for its vinylidene fluoride resin.



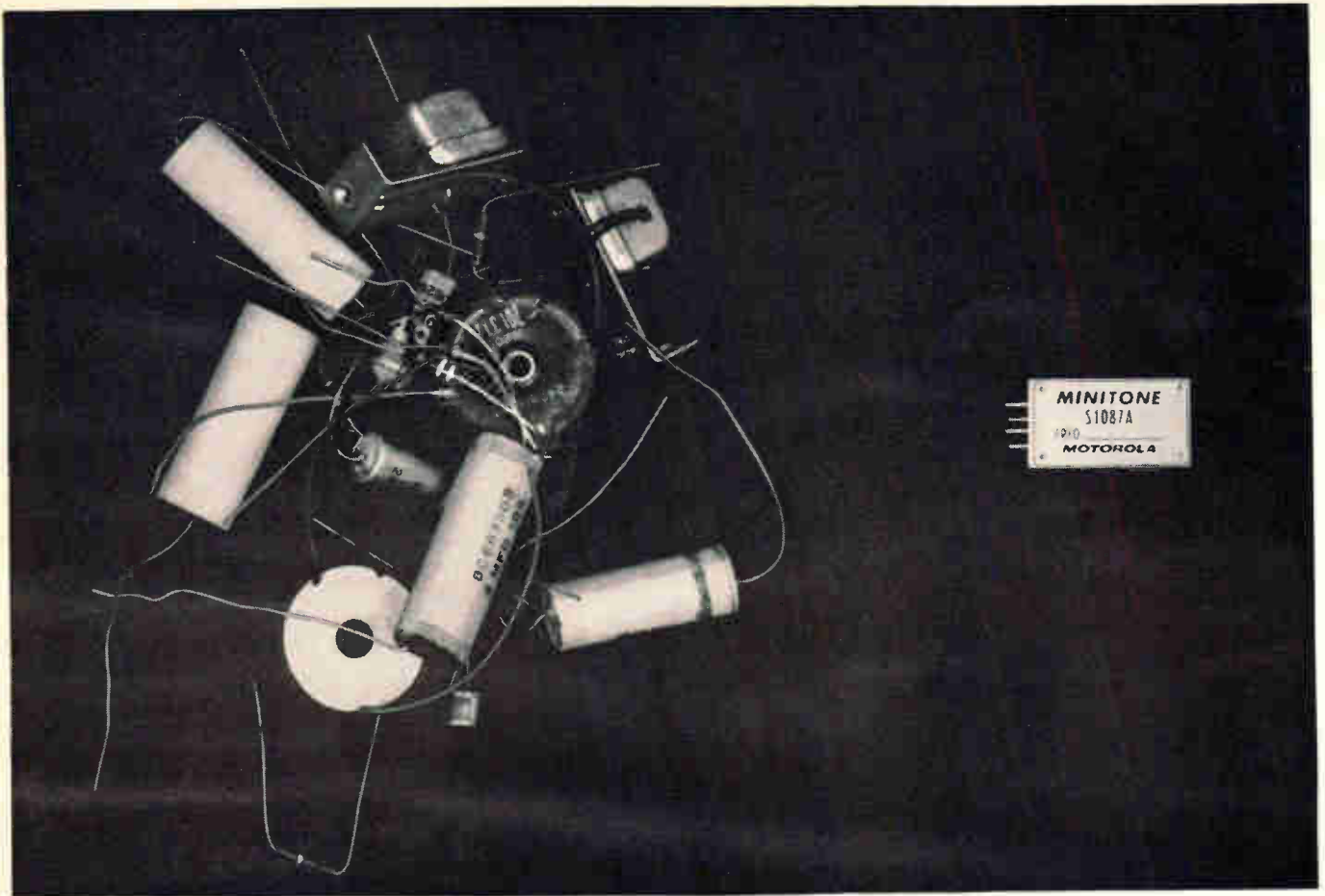

Two ways to achieve selective signaling

The MINITONE reed on the right does it better

Motorola's new miniaturized resonant reed either generates a highly stable audio tone, or provides very selective decoding. It does the job better because it's small, has excellent stability, and contains no contacts to wear out. And the MINITONE resonant reed is more economical; it eliminates the expense of extra components and design time needed to build highly selective tone oscillators and associated compensating circuits. Take a look at these facts:

SMALL SIZE: About 1/4 of a cubic inch in volume. Measures only 1.11" x 0.619" x 0.393".

LONG LIFE: No contacts to wear out or cause malfunctions; life comparable to solid-state devices. Plus 3-year warranty.

HIGH STABILITY: Frequency tolerance $\pm 0.1\%$. Temperature stability better than $\pm 0.001\%$ per $^{\circ}\text{C}$ between -30°C and $+100^{\circ}\text{C}$ (25°C reference).

WIDE FREQUENCY RANGE: From 67 Hz up to 3150 Hz.

QUICK DELIVERY: Over 200 standard frequencies available from stock.

RUGGED CONSTRUCTION: Exceeds E.I.A. standards for shock and vibration.

PROVEN PERFORMANCE: Reeds have been proven in thousands of demanding situations, such as in aviation, control systems and radio communications applications.

FOR MORE INFORMATION contact your Motorola representative. Or write for bulletin TIC-3214.

MOTOROLA COMMUNICATIONS AND ELECTRONICS INC.
4900 West Flournoy Street
Chicago, Illinois 60644. A subsidiary of Motorola Inc.



MOTOROLA
PRECISION
INSTRUMENT
PRODUCTS

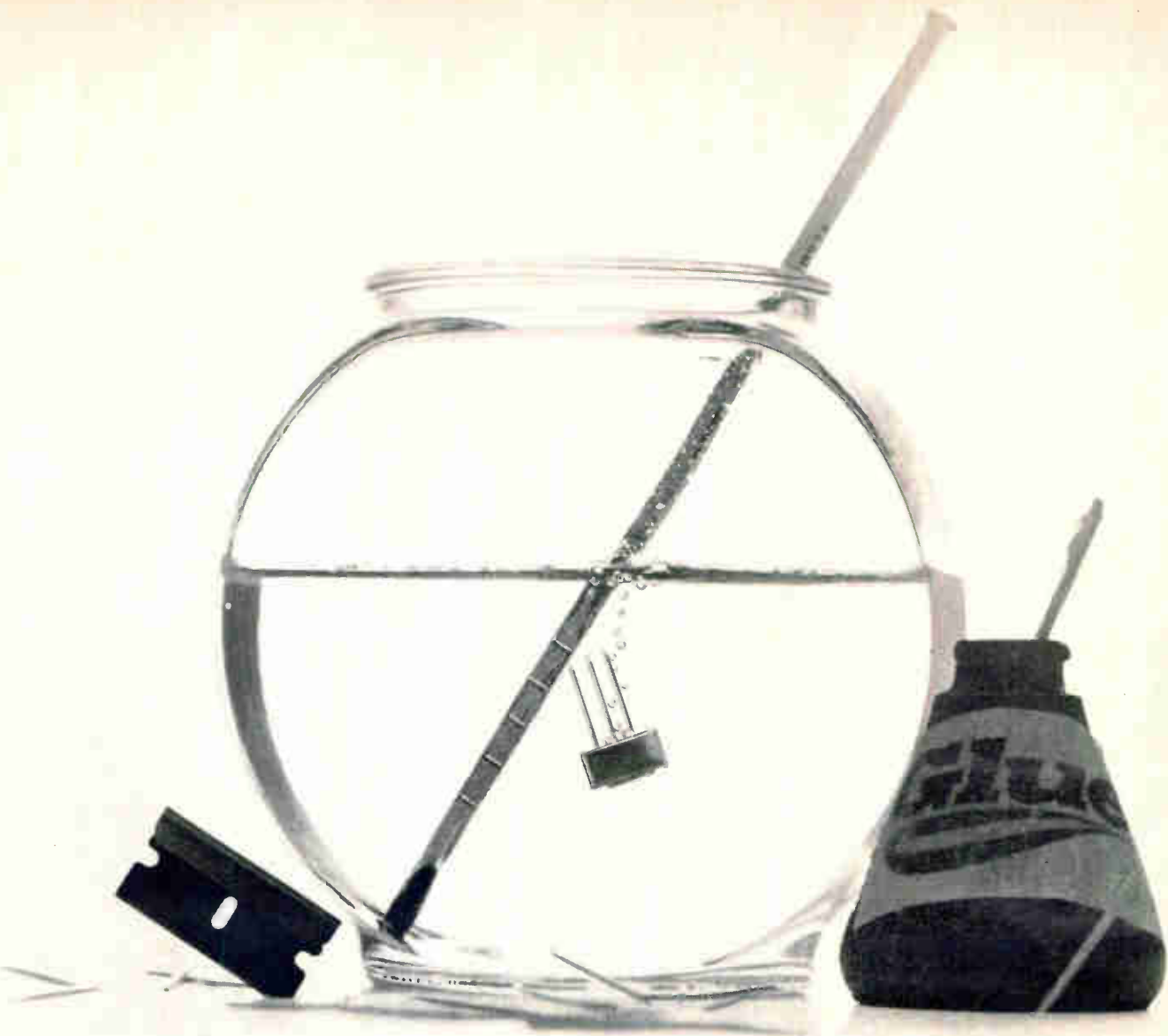

Having trimmer leakage problems?



Not with the Spectrol Model 53!

Here's the end of "toothpick-and-glue" trimmer designs. At last, here's a trimmer with an exclusive seamless construction that virtually eliminates leakage problems through a molding process that provides integral bonding without the use of adhesives or potting. Want to know how we do it? Don't ask. Does Macy's tell Gimbel's? But for technical specs, circle the reader service card.

Spectrol Electronics Corporation
17070 E. Gale Ave. / City of Industry, Calif. 91745



Better Components for Better Systems

Stackpole commercial resistors helped Wurlitzer engineers discover a new harmony in four parts quality, price, delivery and service.



Only strict attention to detail produces a fine musical instrument. That's why Wurlitzer engineers so carefully select each component that goes into Wurlitzer Organs. Stackpole commercial resistors help make these magnificent instruments electronic, as well as musical, marvels. Performance in tune with your most demanding needs is the Stackpole guarantee. Write: Stackpole Carbon Company, Electronic Components Division, Kane, Pa. 16735.





COMPONENT CAPSULES

SCR's in GE's new
PRESS PAK . . . another
packaging innovation



Also available soon:
PRESS PAK rectifier diodes
rated up to 1200 V.

Forget internal soldered joints. GE PRESS PAK SCR's are mounted by externally applied pressure. Double sided cooling increases their average current rating up to 60%. Reversibility eliminates the need for special reverse polarity units. Rated up to 1300 volts at either 115 amps average or 235 amps average, PRESS PAK SCR's cost 10% less than equivalent stud mounted units. Motor drive control, phase control and electromechanical applications are excellent typical uses. Circle **Number 90** on the magazine inquiry card for more information.

Volt-Pac® variable
transformers:
maximum life with
minimum maintenance

Every GE Volt-Pac transformer features corrosive resistant parts throughout: **1** Spring-loaded, grain oriented solid carbon brush assures even contact . . . reduces wear. **2** Self-lubricating nylon bearing causes low friction in voltage selector. **3** Polyesterimide insulation for coil windings provides extra dependability. **4** Aluminum radiator and base dissipate heat evenly . . . extend life. **5** Low-resistant gold plated track lessens heat build-up at brush contact.

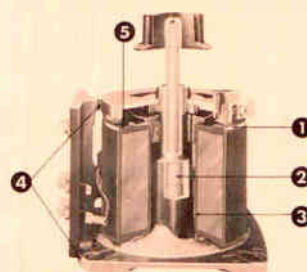

Specify precision-built Volt-Pac transformers for continuously adjustable output voltage. A complete line of manually operated and motor-driven models, including plug-in cord units, is now available. Circle **Number 91** for more facts.

New Horizon Line®
panel meter
relay



Features solid-state,
light-sensitive switching

New Type 196 Meter Relay takes advantage of totally new contactless control action . . . gives you exceptional control simplicity and reliability. Install it quickly and easily by just plugging in the unique "piggyback" control module. The module can be readily removed without interrupting measurement circuit, as its indicator mechanism connections are on the rear of the meter. Horizon Line Meter Relays, available in 3½" and 4½" sizes with single or double setpoints, can be front-mounted or back-of-panel mounted. Circle **Number 92**.

What's new
for peripheral
computer equipment?

Instant response—inertial time constants as low as 1 millisecond—is what you get with the new GE Hyper-Servo* motor. And it accelerates faster than any other motor ever developed by General Electric. Hyper-Servo motors greatly increase the overall capacity of peripheral data processing equipment. They're available in 3.4-, 4.6-, and 4.8-inch diameters. Performances include torque-to-inertia ratios in excess of 350,000 rad/sec² and continuous torque ratings from 32 oz-in at 2700 rpm to 326 oz-in at 2800 rpm. A wide variety of models can provide the high performance drive motor for nearly every computer peripheral application. Circle magazine inquiry card **Number 93**.

*Trademark of the General Electric Company.



Hyper-Servo* Motors
Typical 32-Frame Models

Here's Blue Jay*—
GE's newest
film foil capacitor



Superior Blue Jay polycarbonate capacitors feature:

- **EXCELLENT CAPACITANCE STABILITY** over their entire operation range (−55 C to 125 C). Maximum capacitance change at 25 C will not exceed −2.0% to +0.3% over the entire operating range. Capacitance change is negligible over the 25 C to 65 C range, and nearly linear with a negative coefficient in the +65 C to 125 C range.
 - **HIGH INSULATION RESISTANCE**. Typical resistance, measured on units rated 0.1 μf 200 volts, is 2x10⁶ megohms.
 - **LOW DISSIPATION FACTOR**—does not exceed 0.3% over the temperature range of 25 C to 125 C at 1000 Hz, making Blue Jays ideal for many AC applications.
- Circle **Number 94**.

*Trademark of the General Electric Company.

MORE 



Speeds as low as one revolution per day with GE D-C torque motors

GE d-c Torque Motors, with low speed capability, eliminate gearing with inherent backlash and windups . . . permit direct connection to the driven load. This combined with low inductance and low-reflected motor inertia means you can design your system to accelerate, decelerate, or position high-inertia loads with excellent precision and accuracy. Rapid-response GE d-c Torque Motors, with permanent-magnet or wound field excitation, are available with or without endshields and/or bearings to meet your mechanical requirements. Circle magazine inquiry card **Number 95**.

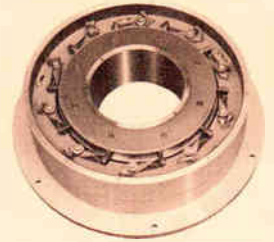

Available with from 30 to 200,000 lb-ft torque

Versatile ignitrons . . . still going strong

GE Ignitrons provide application versatility—year after year in circuit after circuit. They're unmatched for economy and ruggedness in high power applications. Here are four typical circuit applications:

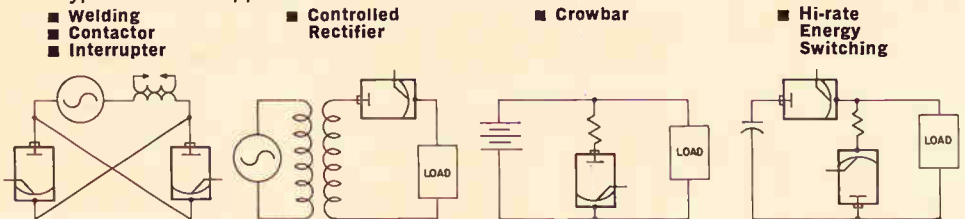

Circle **Number 96** for more Ignitron facts.

COMING YOUR WAY—GE'S MICROWAVE TUBE VAN. CIRCLE NUMBER 97.

Insert PTC thermistors automatically

GE Positive Temperature Coefficient Thermistors (PTC's) are small, rugged, hermetically sealed units with weldable/solderable gold-plated Dumet leads. A temperature coefficient of resistance of approximately +0.875% per degree Centigrade operable to 150 degrees Centigrade makes them ideal for temperature compensation in silicon transistor circuits. They can also be used as sensors in temperature indicators and temperature controls. Their small size and uniform dimensions permit automatic insertion into printed circuit boards. Circle **Number 98**.

PTC—actual size

Reel drive motors for computer tape transports



Fractional HP DC Motor

GE's full line of fhp direct-current motors includes four frame sizes widely used for reel drives: 3 $\frac{3}{8}$ " , 3 $\frac{1}{2}$ " , 4 $\frac{5}{8}$ " and 6 $\frac{1}{8}$ " diameters. Special end mountings and shaft extensions meet exacting application requirements. Series, split-series, compound, shunt, and compensated-shunt winding designs offer a broad design choice. Stall torque ratings from 3 to 120 ounce-feet and higher span various application needs, and motor voltage requirements are normally matched to your system design. Circle **Number 99** on the magazine inquiry card for more information.

New thumbwheel switches require less panel space; simplify data input

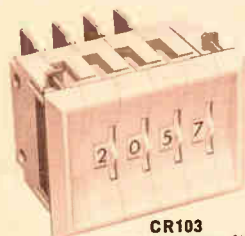

CR103 Thumbwheel Switch

GE space saving CR103 Type F Thumbwheel Switches—rated 150 volts a-c/d-c—are ideal for welding control, computer systems and numerical control. Manual data insertion is made easy by simply dialing in the information. Both standard-duty and oiltight forms are constructed of unbreakable Lexan*. Large easy-to-read colored numerals (or symbols) are neat in appearance. Assemble your own non-oiltight standard-duty switches, if you prefer, by purchasing individual switch modules, end blocks, spacers and shafts. Circle **Number 100**.

*Registered trademark of General Electric Company.

WE MAY NOT OFFER EVERYTHING YOU WANT FROM ONE COMPONENTS SUPPLIER. BUT WE DO COME A LITTLE CLOSER THAN ANYONE ELSE.

Can we help it if other lightbeam oscillographs need a different galvo for every frequency/sensitivity combination that comes along?

Yes.

We start by selling you a Brush Series 2300 lightbeam oscillograph with just one type of galvo—a "1-kc". Then, for another \$250/channel, we add our new four-channel galvo amplifier. And just like that you have a lightbeam recording system that's in a class by itself!

Without ever touching any galvo, you get a range of frequency response flat from d-c to 1 kc full scale (to 2.5 kc at smaller amplitudes) . . . and sensitivities from 200 millivolts per inch to 100 volts per inch. What's more, the amplifier protects against electrical overloads . . . *there is no way you can overdrive the*

system and damage the galvo! The attenuator is marked in easy-to-read volts-per-inch, and there's a "CAL" control for calibrating each channel. The amplifier also takes care of damping, so there's no fussing with ham-fat damping-resistor circuits.

So why buy a recorder that needs half a dozen different galvos and a handful of resistors to give you complete recording flexibility? The Brush 2300, with *one* galvo and *one* easy-to-use amplifier, will do the job far better for less money. Ask your Brush Sales Engineer for a "Show Me" demonstration.

Clevite Corporation, Brush Instruments Division, 37th and Perkins, Cleveland, Ohio 44114.

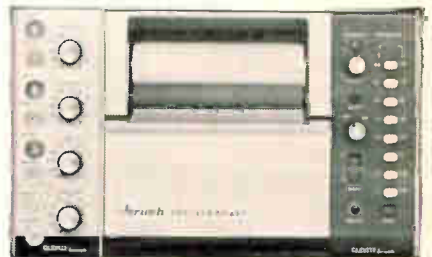

THE BRUSH SERIES 2300: FIRST LIGHT-BEAM OSCILLOGRAPH THAT'S AS EASY TO USE AS AN INK-WRITER!

brush **CLEVITE**
INSTRUMENTS DIVISION

With the L and S bands covered, the overall frequency of the Polarad generator line is now extended from 21.0 to 0.95 GHz. Model 1105 covers 0.95 to 2.4 GHz. Model 1106 ranges from 2.0 to 4.6 GHz.

Both generators provide single-band continuous UNIDIAL® tuning with digital frequency indication accurate to $\pm 0.5\%$. Frequency stability is 0.0008% per line volt change, 0.005% per $^{\circ}\text{C}$ change in ambient temperature. Output is calibrated from 0 to -127 dbm for

Model 1105, $+3$ to -127 dbm for Model 1106, accurate to $\pm 2\text{ db}$. A rear tuning shaft extension permits motor-driven programming.

Use these generators alone, or rack or stack them with other Polarad modules to meet specific testing needs. Add a Model 3815 Frequency Stabilizer, for example, to obtain phase lock with crystal stability at any generator frequency. Add a Model 1001 Modulator for full FM, squarewave and pulse modulation. Signal sources, covering the

same frequency ranges, are available too. Prices:

Model 1105 (0.95 — 2.4 GHz)... \$1900

Model 1106 (2.0 — 4.6 GHz)... \$1900

For information or a demonstration, contact your local Polarad field engineer or write Polarad Electronic Instruments, 34-02 Queens Boulevard, Long Island City, N. Y. 11101. Telephone: (212) 392-4500.

POLARAD

two new microwave signal generators extend Polarad's modular line down to 0.95 GHz.

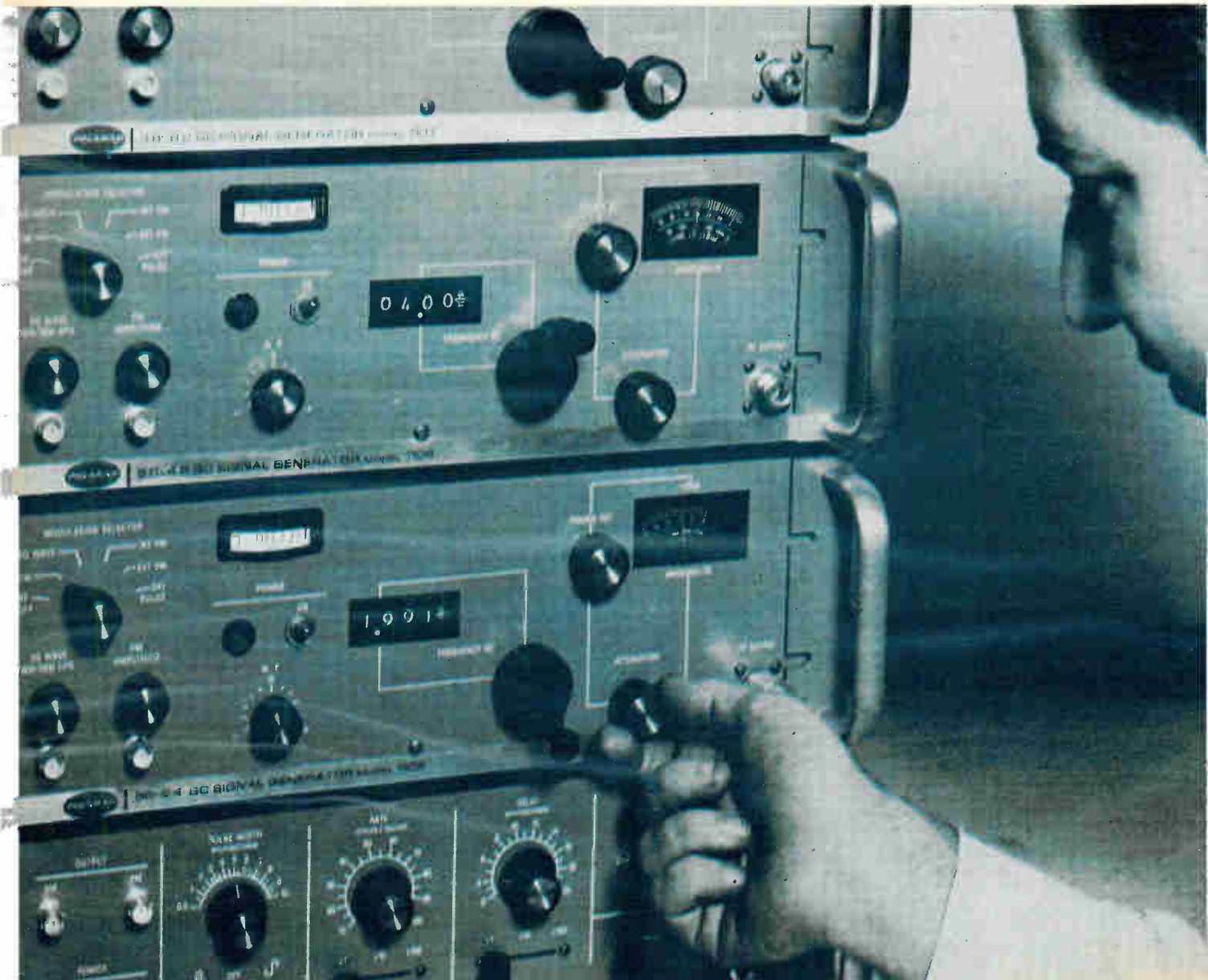

Probing the News

Industrial electronics

Latest word in printing spells new electronics market

Automatic phototypesetters are invading the printing industry in growing numbers, and few observers doubt that these machines will eventually dominate the field

By Paul Dickson

Staff writer

Printing technology is undergoing its first fundamental change since Johannes Gutenberg introduced a practical method of using metal type more than five centuries ago. And a major electronics market is shaping up.

Radically new machines—automatic phototypesetters—are flooding the marketplace. Last month alone, five optical-mechanical systems drive by special-purpose computers were introduced. Such units are already at work in printing houses throughout the U.S., and all-electronic cathode-ray-tube systems are being readied for full-fledged industry jobs.

The market potential here hasn't been lost on the major computer makers. Last month, the International Business Machines Corp. announced that it will buy phototypesetting machines from a small Long Island firm, Alphanumeric Inc. IBM plans to eventually sell and service printing systems built around its 360 line of computers.

Only about 10% of the typesetting machines currently operating in the U.S. are of the new automatic variety, but observers believe it's only a matter of time before such electronics-laden equipment dominates the printing business. Kurtz M. Hanson, chairman of Photon Inc., a major supplier of phototypesetters, predicts that within five years no hot-metal

equipment will be sold for typesetting.

1. Image making

Phototypesetting involves the optical positioning of type characters on photosensitive film or paper, which is used to form a metal mold in photoengraving, or a lithographic plate in offset printing. Speed and

versatility are the benefits of generating characters optically as images rather than physically as slugs of metal.

Schemes for phototypesetting date from the late 19th century, but the first commercial machine didn't arrive until 1949 when the Harris-Intertype Corp. introduced the Fotosetter, a converted line-

New cast of characters

RCA's Videocomp -- an electronic phototypesetter employing a computer driven cathode-ray tube -- set this type for Electronics in 2.0 seconds. Such devices are currently being installed in several printing operations in the United States. Characters are composed of lines -- the enlarged capital E to the right is made up of 70 lines. The digital coordinates of characters are stored in the typesetter's core memory. As a character is needed, it is brought from the memory, displayed on the picture tube, and directed through a lens on to film or sensitized paper.



One type-style was used here but various effects can be produced by varying the size or shape of the electronic grid in which a letter appears. Words can be expanded, condensed and obliqued to produce italics. By moving the grid in two directions type sizes can be made smaller or larger. The memory can store a variety of type styles and a range of characters from Japanese ideographs to any image.

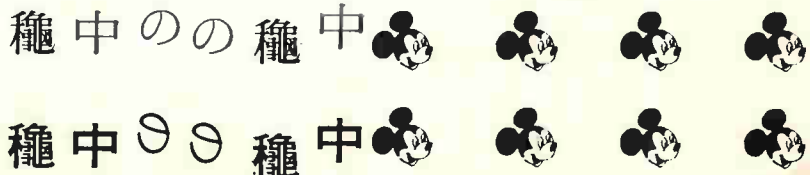

Mickey Mouse © Walt Disney Productions

. . . markets are shaping up for units tailored to smaller work volumes . . .

casting unit in which image-carrying matrices were substituted for metal-type matrices. Since then, a dozen firms have offered a diverse array of phototypesetters, mostly during the past two years. Price tags on this new equipment range from less than \$20,000 to more than \$250,000. Speeds run from three newspaper lines a minute to an anticipated rate of 60,000. By contrast, the fastest operational hot-metal linecasting machine sets 15 lines a minute.

Workhorse. The ranges of price and performance in the phototypesetting field are attributable in about equal parts to technical developments and market exigencies. Along with other low-cost first-generation systems, Harris-Inter-type's Fotosetter is still gainfully employed in hundreds of locations around the U.S. Sales of this unit remain brisk, and the Lanston Monotype Co. introduced a "first-generation" machine as recently as 1964.

Since then, however, units with

spinning glass discs and rectangular character-imprinted arrays have been developed and marketed. Offering significant advantages in speed, these optical-mechanical systems have caught on quickly. Photon, of Wilmington, Mass., offers probably the most complete product line in this particular field.

Finally, high-speed all-electronic phototypesetting systems are just now being offered commercially. These expensive machines incorporate a computer to drive tape characters across the face of a high-resolution cathode-ray tube.

II. Scattered returns

The fragmented nature of the printing industry, practically forces suppliers to vend variety. With more than 45,000 domestic printers, there are no single large marketing targets as would be found, say, in the automobile industry. This year, for example, McGraw-Hill Inc., which publishes *Electronics*, will use more than 125 printers, ranging from large contract houses to

produce its magazines to small job shops to crank out dust jackets for new novels. Closer to home, this issue of *Electronics* is the product of a half-dozen printing operations in several states.

The proprietor of a small weekly newspaper, acting as his own printer, obviously has requirements that are quite different from those of the Government Printing Office. The product lines of phototypesetter makers necessarily reflect the range between these extremes. Thus, along with demand for expensive, high-speed systems, markets are shaping up for units tailored to particular applications and smaller work volumes.

With an eye on this latter portion of the market, Photon is offering 14 different customer-oriented units; the Photon 513, for example, is designed to set newspapers' display advertising. This approach apparently pays off: Hanson claims that about half of the automatic phototypesetters now operating in this country are Photon products.

The most recent entrant in the field, the Graphic Equipment division of the Fairchild Camera & Instrument Corp., is following Photon's lead. Among the wares it introduced last month was the PhotoTextSetter 2000, a machine aimed at the daily newspaper field.

Backlash. There are, however, several factors that will keep sales of phototypesetters out of the "hotcakes" category for a while. The daily newspaper field furnishes handy examples of these factors. For one thing, reliability is an absolute must in this business; advantages of speed and versatility notwithstanding, publishers are reluctant to risk the perils of downtime until the machines are fully proven. For another, the International Typographical Union is strong and well entrenched here. While union leaders are learning to live with automation—there is a Photon machine at the ITC's training center in Colorado Springs, Colo.—they militantly refuse to accept the dislocation of union members.

The ITC's ability to care for its own and keep the cost of automation high is evident in its 1963 contract with the New York City newspapers. The pact required the papers to indemnify the union's Local No. 6 for the use of prepared Tele-

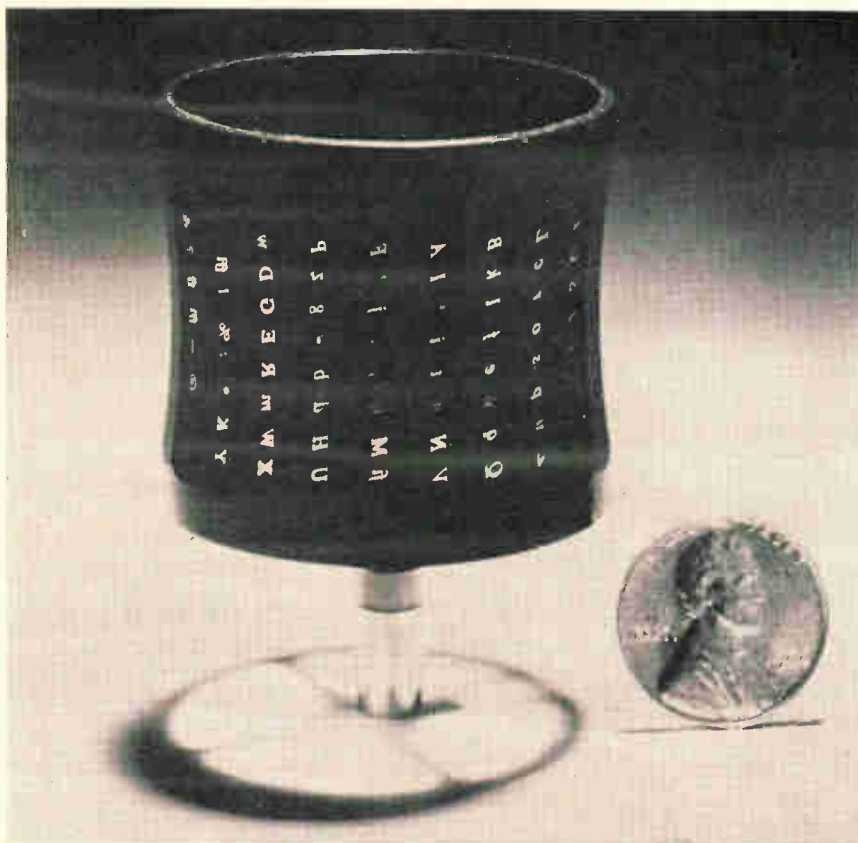

Shot glass. In Fairchild's recently introduced PhotoTextSetter 2000, small "font" can project as many as 264 different type characters.

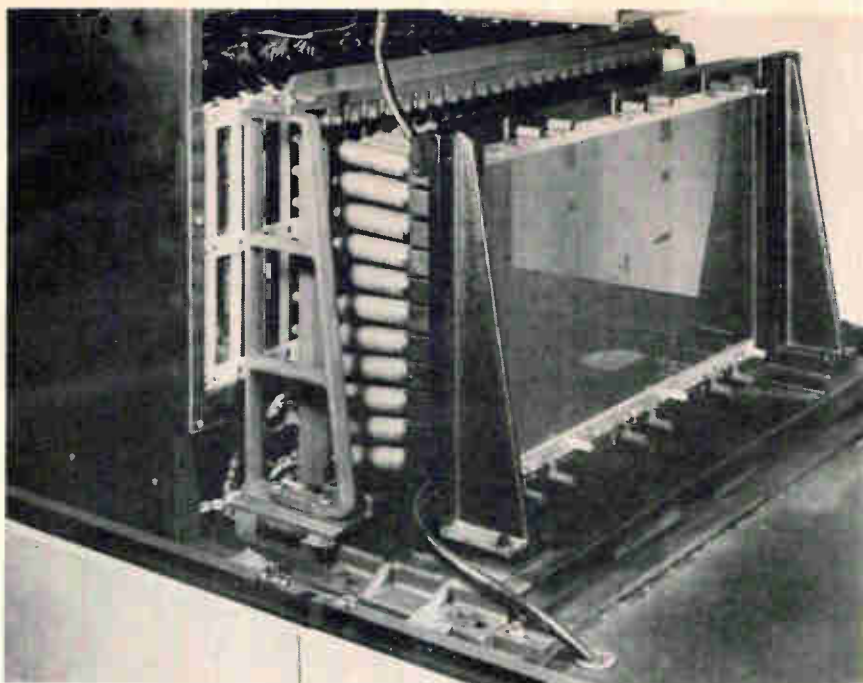

Quick as a flash. Three glass matrix plates, backed by xenon flash units, are the source of type characters in Photon's Zip 901 phototypesetter.

typesetter tape for stock market tables; the local's first bounty from the New York Post, covering a period of 20 months, amounted to \$205,000.

Despite such hurdles, second-generation optical-mechanical systems are getting a chance to prove the effectiveness of phototypesetting. Photon rules this roost, with the Mergenthaler Linotype Co., a division of the Eltra Corp.; American Type Founders Inc., a subsidiary of White Consolidated Industries Inc.; and Harris-Intertype as strong contenders.

Most models offered by these firms use special-purpose computers to provide a format for the page being set. Among these processors are the Radio Corp. of America's 30 Newscom and Harris-Intertype's Cognitronics Editape.

III. Success stories

Second-generation phototypesetters have found work at a number of well-known addresses. Photon's Series 700 and 200 machines, for example, are employed, among other places, at the Wall Street Journal's Highland, Ill., plant. The New York Telephone Co. sets its Staten Island directory with Photon's Zip 901 at the rate of a page a minute, and another directory is now being readied for this process.

The National Library of Medicine at Bethesda, Md., is using a

Zip 900 to compose its massive monthly and annual Index Medicus; the machine can set a 3,000-page annual index in two weeks. Time Inc.'s Time-Life Book division is also using Photon equipment, and the New York Times is currently taking delivery of the company's phototypesetters. This fall, subscribers to Electronics will receive a 1968 Electronics' Buyers Guide that will have been set on the Zip 901.

The most advanced commercially available second-generation unit is the Zip 901, which Hanson calls "a second-and-a-half-generation device." It costs more than \$200,000 and can print 500 characters a second. Ten have been sold since the system was introduced in 1964 as the Zip 900.

Flashing words. The Zip 900 series generates characters from a

stationary glass matrix of 264 characters, each of which has its own flash illumination unit. Words fall into place on photosensitive film or paper as a moving reciprocating lens picks up the flashes of characters. A memory storage system and control circuitry time the illuminations.

Hanson sees the Zip as a product line for a limited market. He says Photon is more interested in the potentially huge market for smaller units than in the smaller market for big high-speed systems. He numbers the shops that can use the smaller units in the thousands.

Photon's product roster lists four basic series of phototypesetters. Closest to the high-speed Zip 900's in performance are the five Series 713 models, which can set from 20 to 70 newspaper lines a minute. These machines, priced from \$23,950 to \$63,500, are designed for newspaper, print-shop, and book-production operations, and can handle paper-tape, computer, and manual-keyboard inputs. The 713's are the company's newest line, with three of the five models having been introduced this spring. The 713-5—"everyman's machine," according to Hanson—is designed to compete with Fairchild's Photo-TextSetter 2000. The machines in the original Photon series, the 200's, were designed for such complicated chores as setting display advertisements and are usually manually operated. The Series 500 units are similar to the 200's except they can be operated with paper tape.

IV. Younger generation

If the medium-priced second-generation phototypesetters must run an obstacle-ridden course, they are at least service-tested and operational in a number of lucrative

Typesetting milestones: few and far between

- 1440:** Johannes Gutenberg demonstrates the practical use of movable metal type.
- 1886:** A keyboard-operated machine that casts metal type in lines of hot lead goes into operation.
- 1946:** The Mergenthaler Linotype Co. experiments with crt devices to put type characters on film.
- 1949:** The Harris-Intertype Corp. introduces its Fotosetter, the first commercial phototypesetter.
- 1957:** Photon Inc. markets the first spinning-disc phototypesetter.
- 1967:** Crt phototypesetters made by RCA, Harris-Intertype, and Mergenthaler-CBS are installed.

Multiplier actual size
3" x 2" x 5/8"



3.75 Cubic Inch Analog Multiplier Requires No External Amplifiers

Advanced design makes possible this solid state DC voltage multiplier that performs multiplication, squaring, division, and square rooting. The multiplying function is accomplished without the use of special non-linear or magnetic devices.

Major features include DC differential inputs with common mode capability, mode selection by shorting pins, no critical supply regulation requirements, and no zero adjustments. The new four quadrant Intronics M 101 costs less than \$500, requires no external amplifiers and gives systems designers a compact, rugged answer to multiplier problems.

Features

Input Voltage	± 10 volts differential maximum	Operating Temperature	$- 25^{\circ}\text{C}$ to $+ 85^{\circ}\text{C}$
Input Impedance	75,000 ohms minimum	Frequency Response ($- 3\text{db}$)	DC to 1 KHz
Output Voltage	± 10 volts at 5 ma maximum	Supply Voltage	$+ 15$ to $+ 16$ volts DC $- 15$ to $- 16$ volts DC at 50 ma maximum
Output Impedance	less than 1.0 ohm	Package	3" x 2" x 5/8" Solid Epoxy Encapsulated Module with 0.25" Long, .040" Diam. Gold Plated Pins
Linearity	0.25% full scale	Mil Specs:	Meets MIL Standards.
Output Offset (both inputs zero)	0 ± 10 mv DC max.		
Temperature Stability of Output Offset	$0.5 \text{ mv}/^{\circ}\text{C} - 25^{\circ}\text{C}$ to $+ 85^{\circ}\text{C}$		

Write or call Intronics 617-332-7350 for more information and a quotation.



intronics

I N C O R P O R A T E D

57 CHAPEL ST., NEWTON, MASSACHUSETTS 02158

of these units run to about 1,000 a second, the only element that can feed and retrieve information fast enough is a general-purpose digital computer. The processor's primary job is to prepare the paper or magnetic tape in accordance with instructions on type size, character fonts, hyphenation, justification, and spacing.

Package deal. In effect, high-speed crt units sell computers, and would-be vendors realize this. Along with IBM's prospective entry, RCA has introduced the logic from its Spectra 70 line of computers into Videocomp and has "suggested" the use of the Spectra 70 with the phototypesetter. The Raytheon Co., which has been supplying computers for Photon's second-generation equipment, has brought photographic elements from Photon and should shortly announce its entry into the phototypesetting field. A prototype is now being installed at the Los Angeles Times-Mirror Press, where it will be used initially to turn out catalogs and directories. On the basis of this experience, Raytheon hopes to develop and sell a standard line of phototypesetting systems.

Though definite reservations exist about the potential size of the market for costly crt equipment, other firms are contemplating entry into the field. "How many plants can use them?" asks Photon's Hanson. But he concedes that "we'd be foolish if we weren't paying close attention to the crt." He declines, however, to say whether his firm is working on a crt unit. At American Type Founders, Richard Cantalupi, assistant sales manager, simply says, "We are working on faster and better equipment." Stromberg-Carlson, a General Dynamics Corp. subsidiary that produces crt devices for putting symbols, graphs, and diagrams on film, is also a good bet to invade the field of high-speed phototypesetters.

Delayed payoff. "There is no money being made on the crt devices now, nor will there be for several years," declares an official at Harris-Intertype. This executive feels that the first real market for the units will be in applications where printed material has to be updated and keyboard operation time can be substantially reduced. Mergenthaler's domestic sales man-

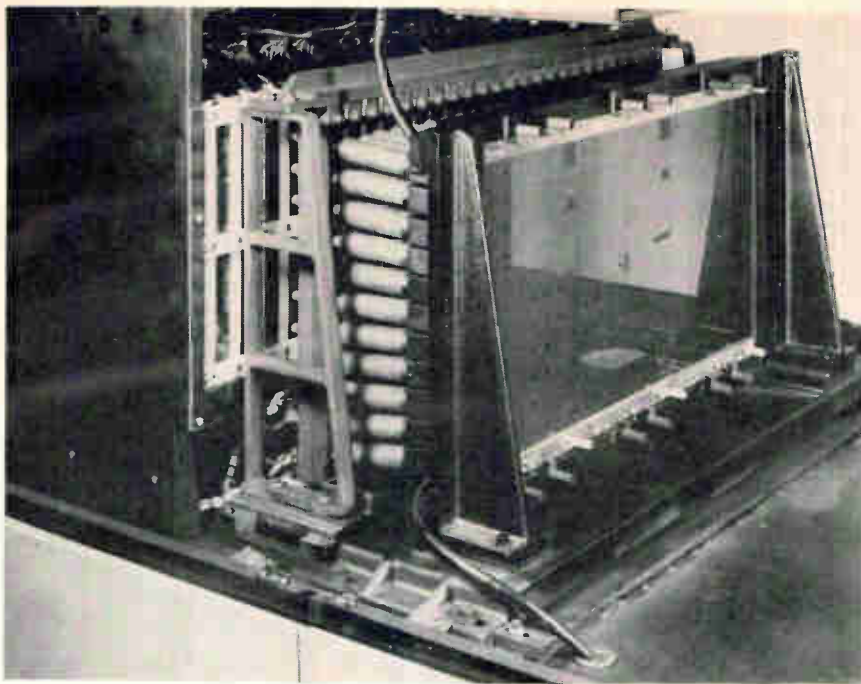

Quick as a flash. Three glass matrix plates, backed by xenon flash units, are the source of type characters in Photon's Zip 901 phototypesetter.

typesetter tape for stock market tables: the local's first bounty from the New York Post, covering a period of 20 months, amounted to \$205,000.

Despite such hurdles, second-generation optical-mechanical systems are getting a chance to prove the effectiveness of phototypesetting. Photon rules this roost, with the Mergenthaler Linotype Co., a division of the Eltra Corp.; American Type Founders Inc., a subsidiary of White Consolidated Industries Inc.; and Harris-Intertype as strong contenders.

Most models offered by these firms use special-purpose computers to provide a format for the page being set. Among these processors are the Radio Corp. of America's 30 Newscom and Harris-Intertype's Cognitronics Editape.

III. Success stories

Second-generation phototypesetters have found work at a number of well-known addresses. Photon's Series 700 and 200 machines, for example, are employed, among other places, at the Wall Street Journal's Highland, Ill., plant. The New York Telephone Co. sets its Staten Island directory with Photon's Zip 901 at the rate of a page a minute, and another directory is now being readied for this process.

The National Library of Medicine at Bethesda, Md., is using a

Zip 900 to compose its massive monthly and annual Index Medicus; the machine can set a 3,000-page annual index in two weeks. Time Inc.'s Time-Life Book division is also using Photon equipment, and the New York Times is currently taking delivery of the company's phototypesetters. This fall, subscribers to Electronics' Buyers Guide that will have been set on the Zip 901.

The most advanced commercially available second-generation unit is the Zip 901, which Hanson calls "a second-and-a-half-generation device." It costs more than \$200,000 and can print 500 characters a second. Ten have been sold since the system was introduced in 1964 as the Zip 900.

Flashing words. The Zip 900 series generates characters from a

stationary glass matrix of 264 characters, each of which has its own flash illumination unit. Words fall into place on photosensitive film or paper as a moving reciprocating lens picks up the flashes of characters. A memory storage system and control circuitry time the illuminations.

Hanson sees the Zip as a product line for a limited market. He says Photon is more interested in the potentially huge market for smaller units than in the smaller market for big high-speed systems. He numbers the shops that can use the smaller units in the thousands.

Photon's product roster lists four basic series of phototypesetters. Closest to the high-speed Zip 900's in performance are the five Series 713 models, which can set from 20 to 70 newspaper lines a minute. These machines, priced from \$23,950 to \$63,500, are designed for newspaper, print-shop, and book-production operations, and can handle paper-tape, computer, and manual-keyboard inputs. The 713's are the company's newest line, with three of the five models having been introduced this spring. The 713-5—"everyman's machine," according to Hanson—is designed to compete with Fairchild's Photo-TextSetter 2000. The machines in the original Photon series, the 200's, were designed for such complicated chores as setting display advertisements and are usually manually operated. The Series 500 units are similar to the 200's except they can be operated with paper tape.

IV. Younger generation

If the medium-priced second-generation phototypesetters must run an obstacle-ridden course, they are at least service-tested and operational in a number of lucrative

Typesetting milestones: few and far between

- 1440:** Johannes Gutenberg demonstrates the practical use of movable metal type.
- 1886:** A keyboard-operated machine that casts metal type in lines of hot lead goes into operation.
- 1946:** The Mergenthaler Linotype Co. experiments with crt devices to put type characters on film.
- 1949:** The Harris-Intertype Corp. introduces its Fotosetter, the first commercial phototypesetter.
- 1957:** Photon Inc. markets the first spinning-disc phototypesetter.
- 1967:** Crt phototypesetters made by RCA, Harris-Intertype, and Mergenthaler-CBS are installed.

the only
all-metal fan
that gives you
reliable operation
in a compact
3½"
package!

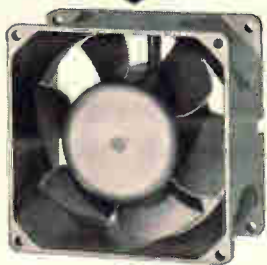

**PAMOTOR
Model 3000
Miniature
Axial Fans**

- Over 20,000 operational hours at 45°C
- Extremely low-noise level
- Delivers 65 cfm
- Efficient inside-out induction type motor
- Low-cost design
- 50-60 Hz operation at 117 or 230 vac

**IMMEDIATE DELIVERY THROUGH
LEADING ELECTRONIC DISTRIBUTORS
OR DIRECTLY FROM FACTORY STOCK**

Write for technical data to:
**PAMOTOR, INC., 312 Seventh Street
San Francisco, California 94103**

PAMOTOR, INC.

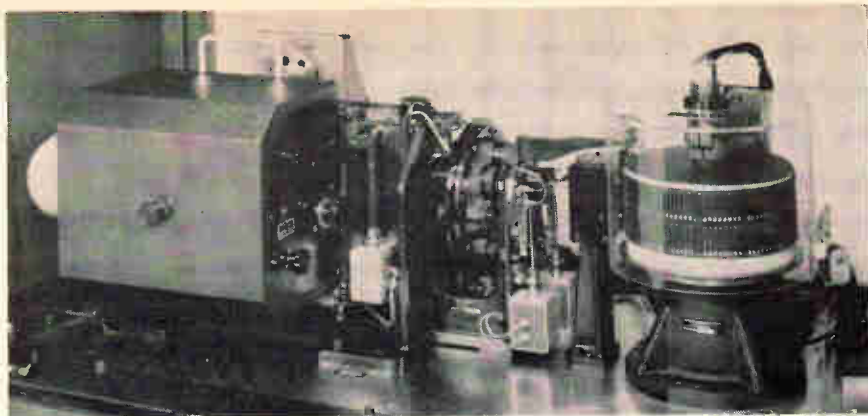

Spinner. In the Photon 713-40, a rotating character drum (right) is set and characters are projected as a stationary internal flash unit is fired.

markets. The same can't be said of the long-awaited and expensive crt systems now making their debuts.

During the late 1940's, engineers at Mergenthaler began experimenting with the use of a cathode-ray tube to produce type on film. The project was abandoned because the crt's of the time couldn't deliver the resolution needed. Now, with the availability of tubes capable of resolving at 500 lines to the inch, some crt systems are being offered commercially and others are being readied for introduction. None, however, has yet been proven in full-fledged printing operations.

Perhaps the first such unit to achieve widespread acceptance will be the Videocomp 70/S20, built by a German firm. Dr. Ing. Rudolf Hell, and sold and serviced in this country by RCA's Graphic Systems division. Videocomps have already been installed in two large printing houses—Poole Brothers Inc., Chicago, and Video Graphics Systems Inc., Patchogue, N.Y.—and RCA says 13 others have been sold, including one to a major Eastern newspaper.

Another leading company, Harris-Intertype will deliver a crt system this summer to the Baird-Ward Co., a large Nashville, Tenn., printer [Electronics, Feb. 6, p. 34]. A Linotron machine, the product of a joint effort by Mergenthaler and the Columbia Broadcasting System, will be installed this year at the Government Printing Office, and another unit is slated for the Air Force [Electronics, April 3, p. 113]. No date has yet been set for introduction of the first Alphanumeric-IBM system, but it could come later this year.

With these third-generation de-

vices, characters flash across the face of a crt, are focused, and are exposed to the photosensitive material used for making printing plates. Character-generating techniques differ. The Linotron employs a glass plate containing 256 characters. The plate is constantly illuminated and all images are carried to the cathode of an image-dissecting tube; character beams selected by a computer are allowed to pass through an electron multiplier for display on the crt. Videocomp stores the coded digital coordinates of characters in a magnetic-core memory. After the coordinates are pulsed out of the memory and deflected, the characters are painted on the crt with a rapid succession of linear strokes.

An Alphanumeric official refuses to discuss the techniques employed by his firm, explaining that "IBM is now digging into the system for improvements and changes." Reportedly, however, Alphanumeric's system works on a digitized coding scheme similar to that used in the Videocomp.

Price of progress. Crt devices are expensive. Harris-Intertype's unit will fall in the \$200,000-to-\$400,000 range; the Videocomp is being offered at about \$170,000, and the Linatron, when commercially available, will sell for \$300,000 to \$350,000. A spokesman for Alphanumeric says that concern's crt system will be priced to compete "head on against the Videocomp."

The total cost of a crt phototype-setting system will run much higher than the basic price because it will cover such peripheral equipment as tape readers, tape-storage units, and keyboards. Also, because the rated character-generating speeds

DON'T BUY A MICROWAVE SPECTRUM ANALYZER

UNTIL YOU
COMPARE ALL **3**



SPA-100

Here are the facts

Significant Specifications	BRAND "T"	Panoramic SPA-100	BRAND "H"	COMMENTS
RF Sensitivities 10 MHz-40 GHz max. to min.	-110 to -70 dbm (1 kHz bandwidth)	-110 to -75 dbm (1 kHz bandwidth)	-95 to -65 dbm (10 kHz bandwidth)	Highly efficient individual mixers and leveled L. O. of SPA-100 result in greater RF sensitivity and gain stability.
"On Screen" Dynamic Range (maximum bandwidth)	≥40 db CW and pulse, uncalibrated (51 sq. cm CRT)	60 db CW and pulse, calibrated (73 sq. cm CRT)	60 db CW only, calibrated; pulse, uncalibrated (68 sq. cm CRT)	Successive detection Log IF with 1 MHz pulse bandwidth exclusive with SPA-100.
Maximum Dispersion (with no spurious)	±25 MHz at dial frequencies below 275 MHz (100 MHz at dial frequencies above 275 MHz)	100 MHz at all dial frequencies (optional 2000 MHz* at all dial frequencies with no inband images, or multiple responses)	2000 MHz (with 400 MHz inband images on 1.8 to 4.2 GHz Band and multiple inband responses above 4 GHz)	Up-converter, unique to SPA-100, translates 0.01 to 1 GHz up to 1 to 3.5 GHz band for full 100 MHz dispersion with no spurious. Conventional L.O. technique requires limiting dispersion to prevent spurious.
Bandwidth Range (resolution)	1 kHz to 100 kHz stepped only	1 kHz to 1 MHz stepped and variable	1 kHz to 1 MHz stepped only	Combination of 1 MHz bandwidth and fast sweep rates allow <i>only</i> the SPA-100 to be used as synchroscope for time domain measurements.
Sweep Time	0.5 sec/div to 10 μsec/div stepped and variable	1 sec/div to 10 μsec/div stepped and variable	1 sec/div to 3 millisecc/div stepped and variable	
Markers	1 MHz	IF Center Frequency with 1 and 10 MHz sidebands	None	For self calibration and alignment of SPA-100.
Price	From \$4,200	From \$4,620	From \$9,500	

*Buy it *only* when you need it (available soon).



Write for complete technical data; better yet, call for a demonstration.

EMPIRE • EMC • GERTSCH • SENSITIVE RESEARCH

SINGER
INSTRUMENTATION

Multiplier actual size
3" x 2" x 5/8"



3.75 Cubic Inch Analog Multiplier Requires No External Amplifiers

Advanced design makes possible this solid state DC voltage multiplier that performs multiplication, squaring, division, and square rooting. The multiplying function is accomplished without the use of special non-linear or magnetic devices.

Major features include DC differential inputs with common mode capability, mode selection by shorting pins, no critical supply regulation requirements, and no zero adjustments. The new four quadrant Intronics M 101 costs less than \$500, requires no external amplifiers and gives systems designers a compact, rugged answer to multiplier problems.

Features

Input Voltage	± 10 volts differential maximum	Operating Temperature	-25°C to $+85^{\circ}\text{C}$
Input Impedance	75,000 ohms minimum	Frequency Response (-3db)	DC to 1 KHz
Output Voltage	± 10 volts at 5 ma maximum	Supply Voltage	$+15$ to $+16$ volts DC -15 to -16 volts DC at 50 ma maximum
Output Impedance	less than 1.0 ohm	Package	3" x 2" x 5/8" Solid Epoxy Encapsulated Module with 0.25" Long, .040" Diam. Gold Plated Pins
Linearity	0.25% full scale	Mil Specs:	Meets MIL Standards.
Output Offset (both inputs zero)	0 ± 10 mv DC max.		
Temperature Stability of Output Offset	0.5 mv/ $^{\circ}\text{C}$ -25°C to $+85^{\circ}\text{C}$		

Write or call Intronics 617-332-7350 for more information and a quotation.



intronics
I N C O R P O R A T E D

57 CHAPEL ST., NEWTON, MASSACHUSETTS 02158

of these units run to about 1,000 a second, the only element that can feed and retrieve information fast enough is a general-purpose digital computer. The processor's primary job is to prepare the paper or magnetic tape in accordance with instructions on type size, character fonts, hyphenation, justification, and spacing.

Package deal. In effect, high-speed crt units sell computers, and would-be vendors realize this. Along with IBM's prospective entry, RCA has introduced the logic from its Spectra 70 line of computers into Videocomp and has "suggested" the use of the Spectra 70 with the phototypesetter. The Raytheon Co., which has been supplying computers for Photon's second-generation equipment, has brought photographic elements from Photon and should shortly announce its entry into the phototypesetting field. A prototype is now being installed at the Los Angeles Times-Mirror Press, where it will be used initially to turn out catalogs and directories. On the basis of this experience, Raytheon hopes to develop and sell a standard line of phototypesetting systems.

Though definite reservations exist about the potential size of the market for costly crt equipment, other firms are contemplating entry into the field. "How many plants can use them?" asks Photon's Hanson. But he concedes that "we'd be foolish if we weren't paying close attention to the crt." He declines, however, to say whether his firm is working on a crt unit. At American Type Founders, Richard Cantalupi, assistant sales manager, simply says, "We are working on faster and better equipment." Stromberg-Carlson, a General Dynamics Corp. subsidiary that produces crt devices for putting symbols, graphs, and diagrams on film, is also a good bet to invade the field of high-speed phototypesetters.

Delayed payoff. "There is no money being made on the crt devices now, nor will there be for several years," declares an official at Harris-Intertype. This executive feels that the first real market for the units will be in applications where printed material has to be updated and keyboard operation time can be substantially reduced. Mergenthaler's domestic sales man-

ager, Brian Patterson, agrees and points to potential Linotron applications in the printing of catalogs, manuals, classified advertisement pages, and directories. Patterson says Government agencies and large aerospace companies that regularly produce large volumes of revised technical data are also possible customers.

An RCA spokesman cites the annual revision of encyclopedias as a natural job for crt devices. Videocomp, he says, could set the average encyclopedia in three days; static entries—Darwin and Descartes, for example—could be reprinted from stored magnetic tape and updated entries on subjects like Vietnam could be entered on the tape.

V. But is it art?

Phototypesetting has both ardent advocates and severe critics. Frank Weiss, who supervises production of telephone directories for the New York City area, is proud of the job done by the Zip 901 with the Staten Island book.

But Norman Hoss, managing editor of the American Heritage Dictionary, is less than satisfied with the phototypesetting work being done for the American Heritage Publishing Co. on the book. "I'm quite sure that phototypesetting is here to stay, but at this point many editors feel that traditional means are still the most trustworthy," he says. "The other day I received proofs run off on a fast phototypesetter and they were a mess—the kind of thing that a composing room supervisor never would have let out of his shop. These companies just don't have the men who insist on quality or know what it is."

A practical path to quality may lie in bringing the artist into the lab. At RCA's Graphic Systems division, for example, Alan Taylor, an art director with impressive credentials in design, printing, and advertising, rides herd over that part of the Videocomp software operation concerned with the design and quality of type characters. In Taylor's shop, Videocomp printouts are enlarged and checked against the artists' original drawings of the characters. Taylor, who now works on character fonts designated by customers, hopes to be designing original RCA fonts by summer.



Time integrator consumes μ watts; fires 100-w load

Try it yourself! Using a Bissett-Berman E-CELL* in the power-switching circuit shown below, a signal current of 200 microamps or less will fire the SCR and light the 100-watt lamp exactly 72 hours after you throw the switch. You get a complete time integration function performed virtually power-free. (Actually, 600 microwatts are consumed by the timing circuit shown.) To get the equivalent time delay using conventional microcircuitry would increase both the power drain and the cost by several orders of magnitude.

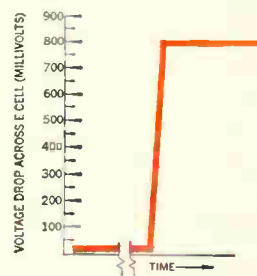
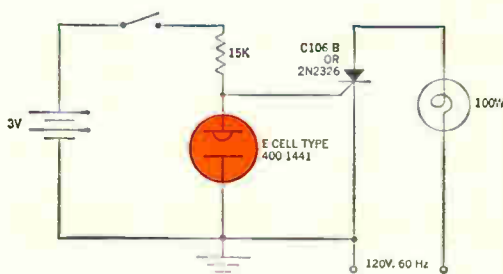

* The Bissett-Berman E-CELL™ is a unique "liquid state" electrochemical timing and integrating component now being manufactured in high volume on fully automatic production lines. E-CELLs are designed for single use or re-cycling, can be set or re-set in the field, and are furnished in wire-lead or plug-in versions. A multiple-electrode E-CELL enables complex functions such as two-phase timing — or subtotaling and totaling — with



Actual size

signal outputs at each step. E-CELLs can generate accurate time delays ranging from a fraction of one second to months; can integrate events from one to infinity; and can operate in the nanowatt range. Operating/storage temperature is -55°C to 75°C . E-CELLs have been tested and approved by users for severe shock and vibration tolerance in accordance with military specifications. Patents applied for.

For technical information and application notes, contact: Components Division. The Bissett-Berman Corporation, 3860 Centinela Avenue, Los Angeles, California 90066; Telephone: Area Code 213, 394-3270.

**BISSETT
BERMAN**

Now—the broadest line of convection-cooled, all silicon, .015% regulated power supplies

For test equipment and lab use—rack or bench

0-10, 0-20, 0-40, 0-60, 0-120 VDC, from 0-.5 amp to 0-66 amps—

Features and Data

- Full five year guarantee on materials and labor
- Convection Cooled
- Remote Programming
- Regulation—.015% or 1 MV (Line or Load)
- Temp. Coef. .015%/°C
- Completely Protected—Short circuit proof—Continuously adjustable Automatic current limiting
- Remote Sensing
- Constant I./Constant V. by automatic crossover
- Series/Parallel Operation
- No Voltage Spikes or Overshoot on "turn on", "turn off" or power failure
- Ripple—LK models—500 μ V RMS
LH models—250 μ V RMS, 1 MV P-P
- Meet MIL Environment Specs

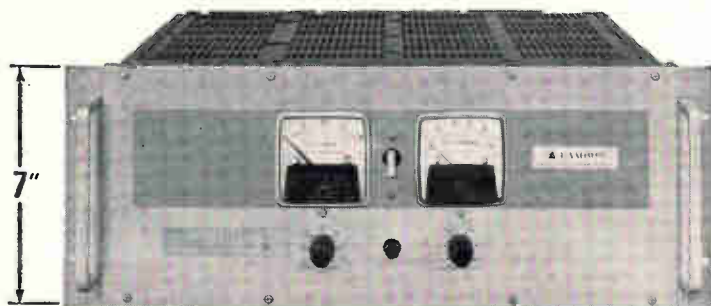

Full Rack 7" LK Series

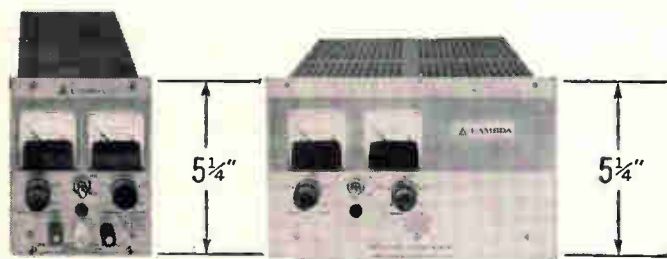

1/4 Rack LH Series

1/2 Rack LK Series-LH Series

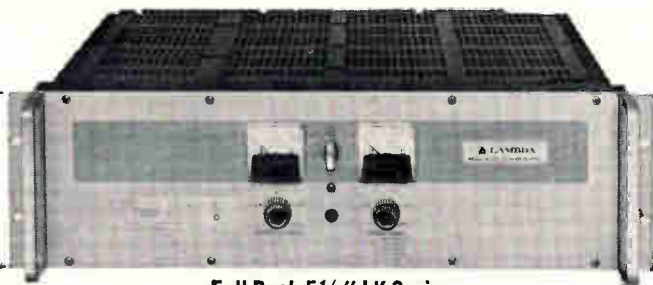

Full Rack 5 1/4" LK Series

3 Full-rack Models — Size 7" x 19" x 18 1/2"

Model ²	Voltage Range	CURRENT RANGE AT AMBIENT OF: ¹				Price ²
		40°C	50°C	60°C	71°C	
LK 360 FM	0-20VDC	0-66A	0-59A	0-50A	0-40A	\$995
LK 361 FM	0-36VDC	0-48A	0-43A	0-36A	0-30A	950
LK 362 FM	0-60VDC	0-25A	0-24A	0-22A	0-19A	995

3 Full-rack Models — Size 5 1/4" x 19" x 16 1/2"

Model ²	Voltage Range	CURRENT RANGE AT AMBIENT OF: ¹				Price ²
		40°C	50°C	60°C	71°C	
LK 350	0-20VDC	0-35A	0-31A	0-26A	0-20A	\$675
LK 351	0-36VDC	0-25A	0-23A	0-20A	0-15A	640
LK 352	0-60VDC	0-15A	0-14A	0-12.5A	0-10A	650

5 Quarter-rack Models — Size 5 3/16" x 4 3/16" x 15 1/2"

Model ²	Voltage Range	CURRENT RANGE AT AMBIENT OF: ¹				Price ²
		30°C	50°C	60°C	71°C	
LH 118	0-10VDC	0-4.0A	0-3.5A	0-2.9A	0-2.3A	\$175
LH 121	0-20VDC	0-2.4A	0-2.2A	0-1.8A	0-1.5A	159
LH 124	0-40VDC	0-1.3A	0-1.1A	0-0.9A	0-0.7A	154
LH 127	0-60VDC	0-0.9A	0-0.7A	0-0.6A	0-0.5A	184
LH 130	0-120VDC	0-0.50A	0-0.40A	0-0.35A	0-0.25A	225

11 Half-rack Models — Size 5 3/16" x 8 3/8" x 15 1/2"

Model ²	Voltage Range	CURRENT RANGE AT AMBIENT OF: ¹				Price ²
		40°C	50°C	60°C	71°C	
LK 340	0-20VDC	0- 8.0A	0- 7.0A	0- 6.1A	0-4.9A	\$330
LK 341	0-20VDC	0-13.5A	0-11.0A	0-10.0A	0-7.7A	385
LK 342	0-36VDC	0- 5.2A	0- 5.0A	0- 4.5A	0-3.7A	335
LK 343	0-36VDC	0- 9.0A	0- 8.5A	0- 7.6A	0-6.1A	395
LK 344	0-60VDC	0- 4.0A	0- 3.5A	0- 3.0A	0-2.5A	340
LK 345	0-60VDC	0- 6.0A	0- 5.2A	0- 4.5A	0-4.0A	395

Model ²	Voltage Range	CURRENT RANGE AT AMBIENT OF: ¹				Price ²
		30°C	50°C	60°C	71°C	
LH 119	0-10VDC	0- 9.0A	0- 8.0A	0- 6.9A	0-5.8A	\$289
LH 122	0-20VDC	0- 5.7A	0- 4.7A	0- 4.0A	0-3.3A	260
LH 125	0-40VDC	0- 3.0A	0- 2.7A	0- 2.3A	0-1.9A	269
LH 128	0-60VDC	0- 2.4A	0- 2.1A	0- 1.8A	0-1.5A	315
LH 131	0-120VDC	0- 1.2A	0- 0.9A	0- 0.8A	0-0.6A	320

¹ Current rating applies over entire voltage range.

² Prices are for non-metered models (except for models LK360FM thru LK362FM which are not available without meters). For metered models, add suffix (FM) and add \$25 to price of LH models; add \$30 to price of LK models.

³ Overvoltage Protection: add suffix (OV) to model number and add \$60 to the price of LH models; add \$70 to price of half-rack LK models; add \$90 to price of 5 1/4" full-rack LK models; add \$120 to price of 7" full-rack LK models.

⁴ Chassis Slides for full rack models: Add suffix (CS) to model number and add \$60 to the price.



LAMBDA ELECTRONICS CORP.

515 BROAD HOLLOW ROAD • MELVILLE, L.I., NEW YORK 11746 • (516) 694-4200 A Veeco SUBSIDIARY

Quick-change technique converts monopulse radar into phased array

Developed for the Air Force, conversion method enables multitarget tracking at low cost by changing the antenna and adding 2 computers

By W.J. Evanzia

Avionics editor

Change the antenna, add two computers and a conventional monopulse radar system becomes a phased array. What's more, the conversion costs only a fraction of what a new phased array radar would. The big advantage of the changeover is that it adds electronic beam steering to the original radar's mechanical slewing, thereby enabling simultaneous tracking of as many as 20 targets.

Called REST, for Radar Electronic Scan Technique, the conversion method was worked out by engineers at the Radio Corp. of America's Missile and Surface Radar division in Morristown, N.J., for the Air Force's Electronic Systems Division. So promising is this development that a number of classified Air Force projects which were to have used billboard-type phased arrays are being redesigned to take advantage of the conversion kit.

Missile tracking. For openers, the Pentagon would like to convert

most of its missile-tracking radars—particularly those aboard the Atlantic Range Instrument Ships (ARIS)—to electronically scanned arrays. These vessels carry a C-band tracking radar and combination L/X-band units. However, the first experimental REST antenna system will probably be installed at Patrick Air Force Base in Florida where it will be used to track missiles and satellites launched from Cape Kennedy.

The new system will enable the Air Force's midrange radars to track multiple targets in real time—an important new capability, particularly for future space missions like Apollo. For example, the Trax radar presently used on Kwajalein atoll to evaluate Atlas missile flights down the Pacific range is capable of tracking only one target at a time. The output of the intermediate-frequency amplifier is digitized and recorded on a wide-band 20-channel tape recorder,

which contains about five miles of tape and records at about 1,080 inches per second. During a mission, the tracking and recording procedures must be repeated until every target—like the missile itself, the booster, the nose cone, or decoys—is put on tape. This cumbersome procedure is fine for post-flight analysis of missile trajectories and the like but the Air Force says it must have a real-time system for analysis of complex missions and it is turning to REST.

I. Cost plus

If an array radar had to be installed at a station where a missile attack was likely from more than one direction, a phased array with four faces, or billboards, would be necessary to provide simultaneous antenna scanning in all directions. Such a system, however, is too complex and costly for tactical installations like surface-to-air missile sites since there can

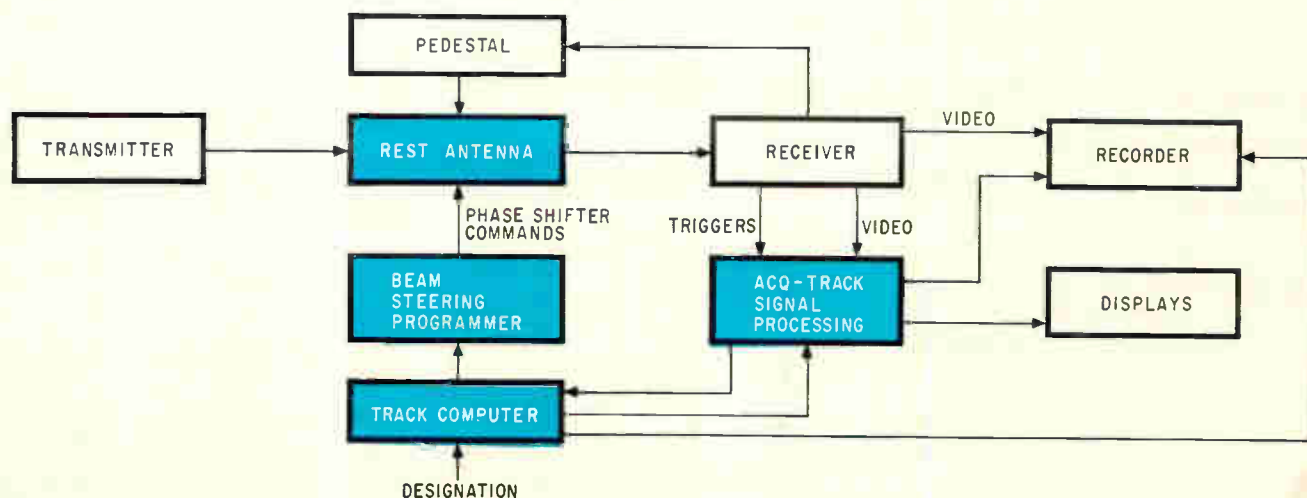

On a new track. Adding the components, in color, converts conventional monopulse radar systems into phased arrays that can follow up to 20 targets simultaneously; the technique, developed by RCA, can be used on any dish-type antenna.

Discover the widest range of gold-plated specialty wire available.

From thick to thin. So thin, in fact, it has to be weighed to be measured.

We start with the highest-quality base stock, draw and then plate it with a bright, ductile, temperature-resistant 24K gold. The deposit is 99.5% pure. Its porosity is minimal. Its solderability is excellent. And it's resistant to discoloration. If that's not enough, our specially designed electroplating equipment and rigid quality control give a completely uniform plating

around the wire—and from spool to spool.

We have a total capability to produce practically anything you want. Deposits from 5 to 200 millionths of an inch in thickness can be plated on almost any temper or diameter specialty wire or ribbon to your specification.

If you'd like to see what we can do with wire or ribbon, send for a sample today. Write: Sylvania Electric Products Inc., Parts Division, Warren, Pennsylvania 16365.

SYLVANIA
SUBSIDIARY OF
GENERAL TELEPHONE & ELECTRONICS **GTE**



be as many as 2,000 expensive traveling-wave tubes per antenna face. And, the system would be too large for shipboard applications. In these cases, the RCA antenna could provide a practicable compromise. Once the direction of attack has been determined by surveillance radars, a converted array antenna can be positioned within seconds.

Another advantage of REST, says Frank Klawnsnik, manager of advanced microwave techniques at RCA, is the short time that the radar need be out of operation during changeover. If, for example, the 30-foot C-band ARIS paraboloid antenna was being converted into a phased array, the radar would be out for less than a week—the time it takes to switch antennas.

Quick change. Conversion is relatively simple: the dish is unbolted and removed, leaving intact the support structure, the microwave comparator, and feed horn. The phased-array antenna is swung into place and bolted to the supports. The radar can then be operated as a conventional monopulse system while a special-purpose computer for beam programming, a conventional general-purpose computer for data processing, and two cabinets containing acquisition and track-signal processing circuits are installed. If necessary, the receiver is modified to accept both vertically and horizontally polarized beams. Total time to complete the changeover and provide electronic-beam steering: four to six weeks.

On a pedestal. The REST antenna is more stable than dish types. Its face is flat, thus preventing local hot spots that cause antenna distortion. It is also shallower: the distance from the mounting flange to the face of a 30-foot antenna is about 50 inches, approximately 24 inches narrower than that of a dish, so the pedestal doesn't have to be redesigned.

II. Collection agencies

Klawnsnik says the method of reradiating the radar energy from REST's antenna feed horn is unique. The antenna radiates in every direction the exact form—regardless of polarization—of the energy received from the feed horn. The antenna itself is made up of two arrays: a primary for energy collec-

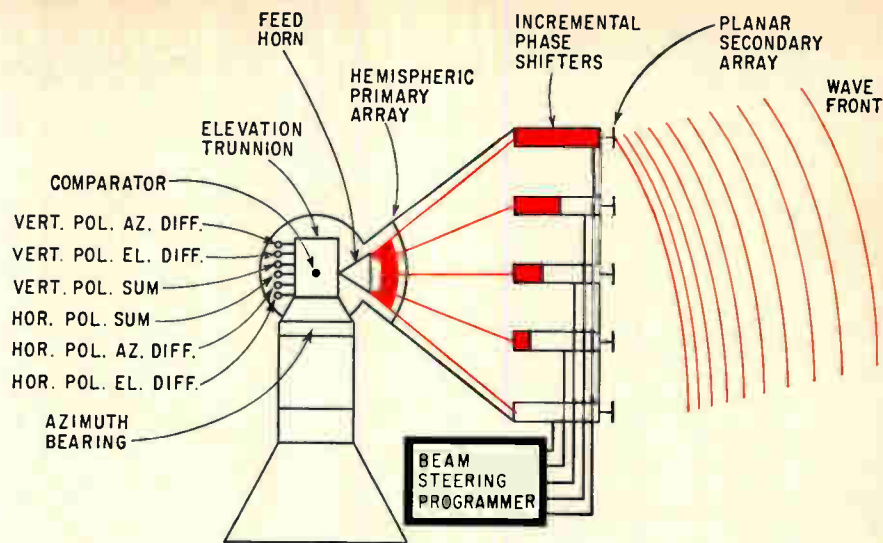

New phase. In an electronically scanned antenna mounted on conventional monopulse pedestal, beam-steering programmer excites ferrite phase shifters to phase-delay signals that are picked up by the primary array's dipoles; the beam can be steered $\pm 5^\circ$ around antenna's axis to form a 10° cone.

tion and a secondary for reradiation of the energy.

Energy from the feed horn is aimed at the curved primary array where it is collected by a number of dipoles each equidistant from a point centered on the face of the feed horn. The energy is then passed through the face of the array and coupled by coaxial cables to ferrite phase shifters on the back of the secondary planar array. The ferrites pass the radar energy to the secondary array's face where dipoles radiate the energy into space.

Fewer elements. Each antenna module on the secondary array of the experimental 10-foot antenna [see page 150] contains a matrix of 64 dipoles in two groups, 32 in one direction and 32 at right angles. The ferrites connect each group to a single similarly oriented dipole on the primary array.

The antenna has only 1,000 elements instead of the usual 25,000 since it needs to electronically scan only 10° rather than 60° . This reduction is a result of the antenna's limited scan requirements. The antenna modules are arranged in patterns of concentric rings with the modules in adjacent rings offset from each other. This irregular spacing enables RCA to utilize large radiating elements and eliminate grating or unwanted side lobes. If the elements were spaced regularly more than half a wavelength apart, the attendant grating lobes would

reduce the accuracy of the tracking radar.

The arrangement of the planar array's dipoles maintains the beam's original polarization and enables the system to transmit both horizontally and vertically polarized signals simultaneously. The antenna is also phase coherent across the aperture since the electrical path length from the feed horn to any element in the secondary array is identical.

Solid state. The ferrite phase shifters are the key to the antenna's beam-steering capability, says Willard Patton, engineering group leader on the REST project. These units are solid-state devices that are inserted into the microwave waveguides; when energized by control voltages from the beam-steering programmer, they shift the phase of the signals passing through. The ferrite phase shifters are gadolinium-doped yttrium-garnet (aluminum substitute). These units have a latching quality: they remain in the energized state even after the control voltage has been removed. By digital techniques the ferrites are used to scan the radar beam in increments as small as 3 milliradians.

Four digital bits are used for the phase shifting: one bit shifts the signal 22.5° ; two bits shift it 45° ; three bits, 90° ; and four bits, 180° . Any combination of these phase shifts can be obtained by the beam-steering programmer. Thus, the pat-



TIGHT DEADLINES? SYNCHRON. MOTORS CAN HELP YOU MEET THEM

You can schedule hot action display deliveries confidently, knowing that Hansen will back you up with SYNCHRON Motors. Consistently finer performance in displays, and excellent delivery service, have built the biggest demand in our history.

To meet this demand and to help you meet your fast deadlines, production capacity has been nearly doubled and our precision-trained work force increased. Any reasonable schedule can be met with the finest synchronous hysteresis motor made. 8, 20 and 30 oz.-in. torques; 220, 110 and 24 volts; 60, 50 and 25 cps. 168 speeds, over 300 drives. Write or call us, or your nearest Hansen Mfg. Co. representative.



HANSEN REPRESENTATIVES: CAREY & ASSOCIATES, Houston and Dallas, Texas; R. S. HOPKINS CO., Sherman Oaks, Calif.; MELCHIOR & MacPHERSON, INC., San Carlos, Calif.; THE FROMM CO., Elmwood Park, Ill.; H. C. JOHNSON AGENCY, INC., Rochester, N.Y.; WINSLOW ELECTRIC CO., Essex, Conn.; Narberth Pa., and New York, N.Y.
EXPORT DEPARTMENT: 64-14 Woodside Ave., Woodside, N.Y.

tern of the phase delays can steer the radar beam 5° in any direction from the array axis to provide a 10° cone of coverage.

Return signals are routed back along the same path to the feed horn and processed by amplitude-comparison techniques in the monopulse radar's error channels. The antenna pedestal's servosystem drives the array in bearing and elevation to give the system hemispherical coverage.

III. Other efforts

When RCA won a contract to develop a radar conversion kit, a second parallel award went to Sedco Systems Inc., Farmingdale, N.Y. In general, the RCA and Sedco approaches to the antenna problem were similar. However, Sedco used a variation of a corporate feed and transmission lines to excite the array. In addition, its antenna elements were made in various sizes and spaced in a pseudorandom manner but mounted parallel to each other instead of radially. According to Sedco engineers, their construction technique enabled them to reduce the number of radiating elements to 840. A 6-foot breadboard array was built last year to prove feasibility. But no further work is in progress.

Controversy. The Blass Antenna Corp. in Leonia, N.J., an affiliate of Engelhardt Industries Inc., has built reflector phased arrays at L, S, and C bands. In the Blass system, the feed horn is mounted in front of the array and the radar energy is beamed inward at the phase shifters, then reflected into space. The company claims this technique is more economical than RCA's optically fed system. But RCA engineers counter that the Blass system can't match the performance of the REST antenna and claim that it requires almost 25 times more radiating elements, making it less reliable. Moreover, a reflector-fed antenna has higher side lobe levels.

The Raytheon Co., a leading manufacturer of tactical phased-array radars [Electronics, Jan. 9, p. 172], makes both optically fed and reflector-fed phased arrays. A spokesman says that most of their reflector systems are built at X band or higher. Raytheon has built a feasibility model of an X-band reflector-fed phased array for shipboard use. It's now being evaluated at the Naval Ordnance Test Station at China Lake, Calif. In an in-house project, Raytheon's Wayland Laboratories is developing a C-band reflector-fed array that can

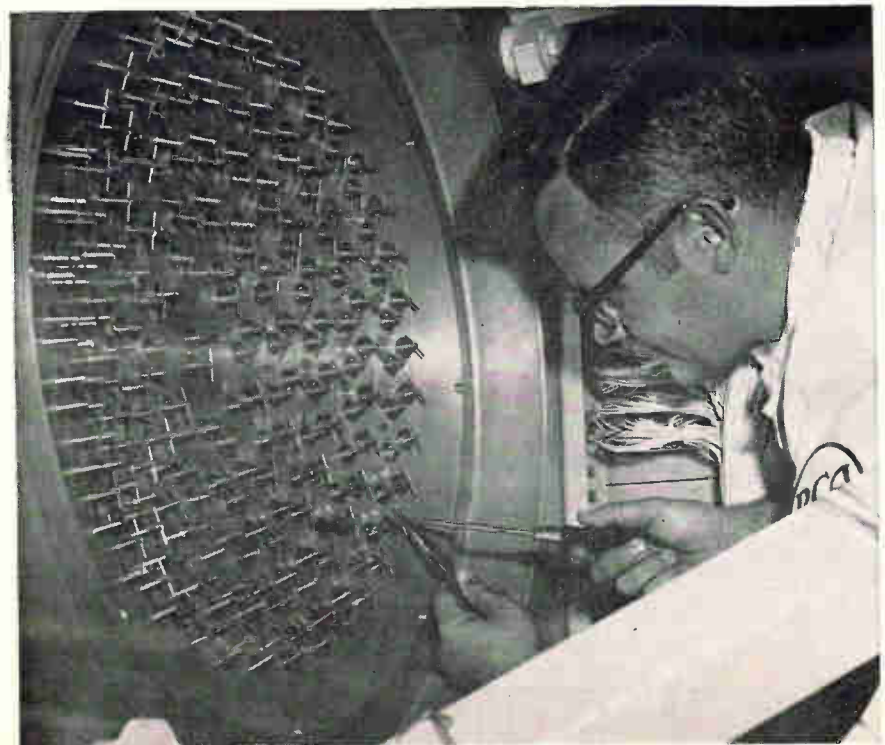

Each dipole on the primary array is oriented to the geometric center; array's configuration enables it to transmit cross-polarized beams.

Something new in a thin film ion-pumped system

... Sputtering!

Here's the only system specially designed to deposit thin films by sputtering in an ion-pumped chamber. The new CVI-18 combines with CVC's PlasmaVac® sputtering unit to give you the first and finest ion-pumped sputtering system capable of electronic and optical thin-film deposition.

With the CVI-18 you get faster, more efficient coating cycles for pilot plant or production line operation: An automatic pre-bake saves up to two hours every working day. The high efficiency Quick-Start ion pump and gettering system give you

faster pumpdown, high throughput that allows starting in the 50 micron range, and ultimates to the 10^{-10} range.

You get more consistent performance, too—with a new titanium sublimation unit. System pressure may be automatically held below a preset process pressure over a wide range of gas loads.

Typical CVI-18 applications include electronic, optical, and optoelectronic coating as well as environmental studies. The CVI-18 is something new, something better in an ion-pumped coater. Just write for full details. Consolidated Vacuum Corporation, Rochester, N.Y. 14603. A subsidiary of Bell & Howell.



SAVE TIME AND MONEY

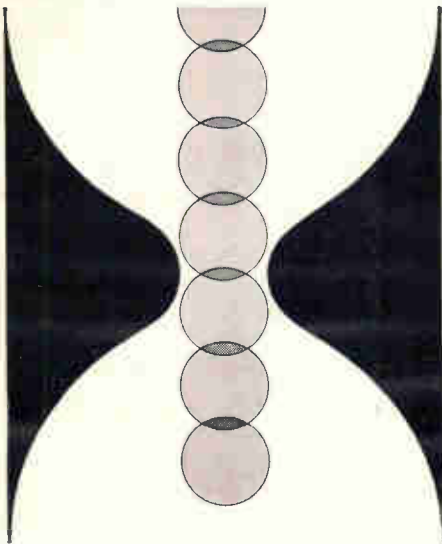

Reduce your masking costs
Increase your production
with

BY-BUK KWIKY-DOTS® OVERLAPPING MASKING DISCS

Connected strings of several discs can be used for faster application, no adhesive transfer. High heat resistance, size from 1/8" dia. up.

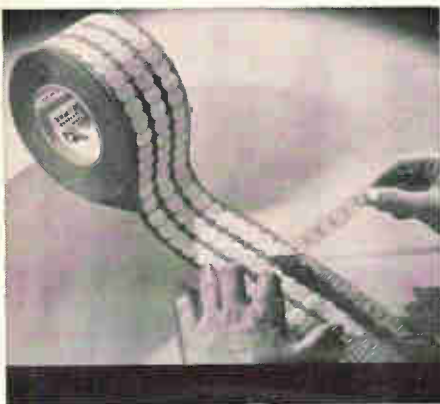

Also, masking tape cut to special widths 1/2" to 6". Pre-cut spray masks, die-cut masks, caps, plugs and other masking aids.

Write for FREE catalog and samples

BY-BUK COMPANY

4326 W. Pico Blvd.
Los Angeles, Calif. 90019
Area Code (213), 937-3511

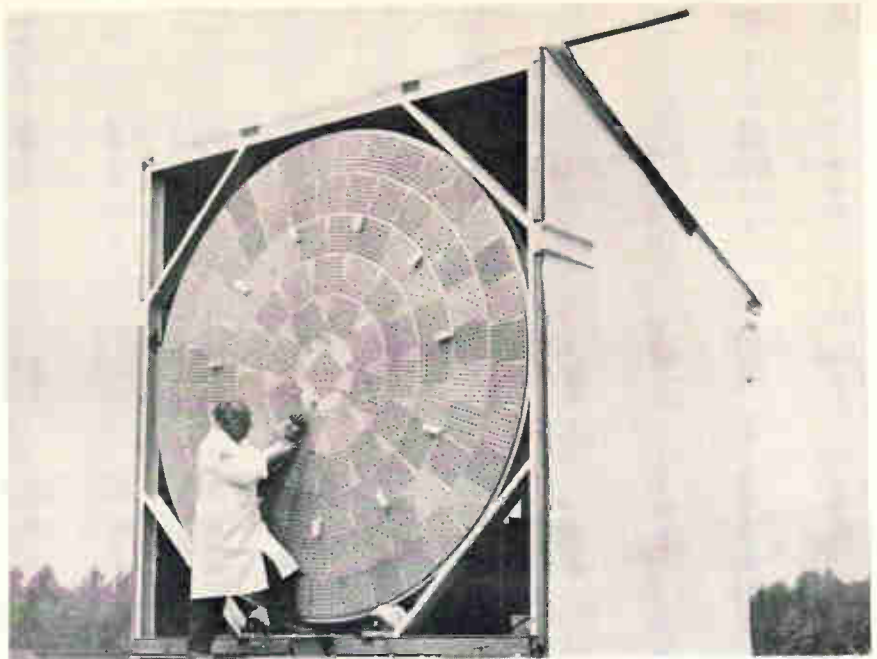

In the round. Technician installs new dipoles on secondary array of RCA's experimental electronically scanned phased-array radar.

be pedestal-mounted and used aboard ships.

IV. Power handling

The gain of RCA's experimental electronically scanned antenna is about 51.0 decibels, almost equal to the 51.5 db gain of the operational ARIS C-band dish antenna. The Air Force specified the experimental RESR antenna have a 50.5 db gain.

Because of improved beam collimation and power management of the phased array, the power transmitted into space by the electronically scanned antenna is almost equal to that of the dish antenna—despite increased power losses in the antenna itself. The total one-way loss through the phased-array antenna is about 1.35 db. About 0.7 db of the power is lost in the ferrite phase shifters; the balance is lost in the waveguide, dipoles, and couplers. Losses in dish antennas are typically about 0.3 db.

Radar output is limited by the amount of power that can be handled by the ferrite phase shifters. These devices were chosen over diode phase shifters because they can easily dissipate 10 kilowatts—many times the power-handling capability of diodes. The ferrites in the center of the antenna dissipate 10 times as much power as those at the outer edge.

There is another limiting factor

to the power-handling capacity of the array radar—the size of the waveguide. In tracking a missile from a very great distance, a certain amount of power must be put in the vicinity of the missile. An unpressurized C-band waveguide, 2 inches by 1 inch, will handle about 5.5 megawatts of peak power, but this might not be enough to do the job. Many new high-powered, long-range radars operate at L band or lower frequencies because the waveguide is bigger and therefore capable of transmitting greater power. Multiple feed horns and pressurization with sulfur hexafluoride are also used to boost the power-handling capability of waveguide.

V. What's ahead

Some time during June RCA will probably announce the development of a technique that uses integrated-circuit microwave modules in a RESR-like antenna system [Electronics, March 20, p. 112]. Such components could be used to make low-cost systems with power outputs varying from a few watts to kilowatts. According to a spokesman at the David Sarnoff Research Center, Princeton, N.J., the design will put new phased-array radars within the reach of all users. It is expected the commercial system will have both a surface and airborne capability.



We've got a chip on our shoulder!

Not enough of you know that we are one of the industry's leading manufacturers of high-quality 930 DTL digital integrated circuits. Well, we are.

Who has a larger more modern facility devoted exclusively to the manufacture of these kinds of microcircuits? (We don't dilute our efforts with the manufacture of a thousand other semiconductor components.)

Who has better yields in this DTL line? (Our manufacturing capability is unsur-

passed, and we invite you to inspect it for yourself.)

Who can give you better delivery on these products? (It's pretty hard to beat our *immediate* delivery!)

Who can offer you better prices? (Try us on a quantity bid.)

Who has a more substantial name behind them than the "Stewart-Warner" name—a name associated with the manufacture of quality products for more than 85 years? (We'll be around to keep you supplied with

microcircuits for years to come.)

Why have we got a chip on our shoulder? Not enough of you have tried our 930 DTL monolithic circuits, and that's too bad. We know you'd like our product, available in all the standard packages. So why not help us take the "chip" off our shoulder and put it in your equipment. Send for our 20-page "Composite Data Book" for the industry's best coverage of the 930 DTL series.

STEWART  WARNER
MICROCIRCUITS, INC.
SUBSIDIARY OF STEWART-WARNER CORPORATION



SILICONIX CURRENT-LIMITER DIODES ELECTRICAL CHARACTERISTICS (25°C)

Type	Drain Current Nominal $I_D \pm 20\%$ at $V_{DS} = 25\text{ V}$	Small-Signal Drain Impedance $z_{d(\min)}$ at $V_{DS} = 25\text{ V}$	Knee Impedance $z_{k(\min)}$ at $V_{DS} = 5\text{ V}$	Limiting Voltage $V_{L(\max)}$
CL2210	220 μA	6.0 meg	1.0 meg	1.0 V
CL3310	330	4.0	0.6	1.1
CL4710	470	2.5	0.4	1.3
CL6810	680	1.4	0.25	1.5
CL1020	1000	1.0	0.12	1.8
CL1520	1500	0.65	0.08	2.1
CL2220	2200	0.5	0.05	2.5
CL3320	3300	0.35	0.025	3.0
CL4720	4700	0.25	0.015	3.5

If you don't
see what
you're
looking for,
don't feel
obliged to
change your
circuit.

Siliconix makes a pretty impressive array of current-limiter diodes (the electrical dual of Zener diodes). They're also handy as constant current sources for differential transistors. That's why Milgray stocks them all. Plenty of each. More than enough to fit 80-90 percent of our customers' needs. Except yours? Don't give up.

If the requirements for your own pet circuits are nowhere in the line, drop us a line with the specs you need. Or better still, call. There's a good chance somebody else's "special" is a Siliconix "standard." Even if it isn't, Siliconix makes so many standards that a special isn't so special.

And neither is its price.



MILGRAY / NEW YORK / 160 VARICK ST. / N. Y., N. Y. 10013 / 212-YU 9-1600 / NEW JERSEY 201-HE 2-4300 / TWX 710-581-5808 / TELEFAX-FQF
MILGRAY / DELAWARE VALLEY / 2532 N. BROAD ST. / PHILA., PA 19132 / 215-BA 8-2000 / CAMDEN, N. J. 609-WO 6-7750 / TWX 710-670-3400
MILGRAY / WASHINGTON / 5133 LAWRENCE PLACE / HYATTSVILLE, MARYLAND 20781 / 202-864-6330 / BALT. 301-727-1870 / TWX 710-826-1127
MILGRAY / CLEVELAND / 1821 EAST FORTIETH STREET / CLEVELAND, OHIO 44103 / AREA CODE 216 881-8800 / TWX 810-421-8573
MILGRAY / INTERNATIONAL / 160 VARICK ST. / NEW YORK, N. Y. 10013 / TWX 710-581-5808 / TELEFAX-FQF / CABLE-MILGRAYEL-NEW YORK
ENTERPRISE AND ZENITH NUMBERS IN LEADING INDUSTRIAL AREAS

Mylar[®] helped Maxwell Labs save 75% on size and weight in its new 5KV capacitor.

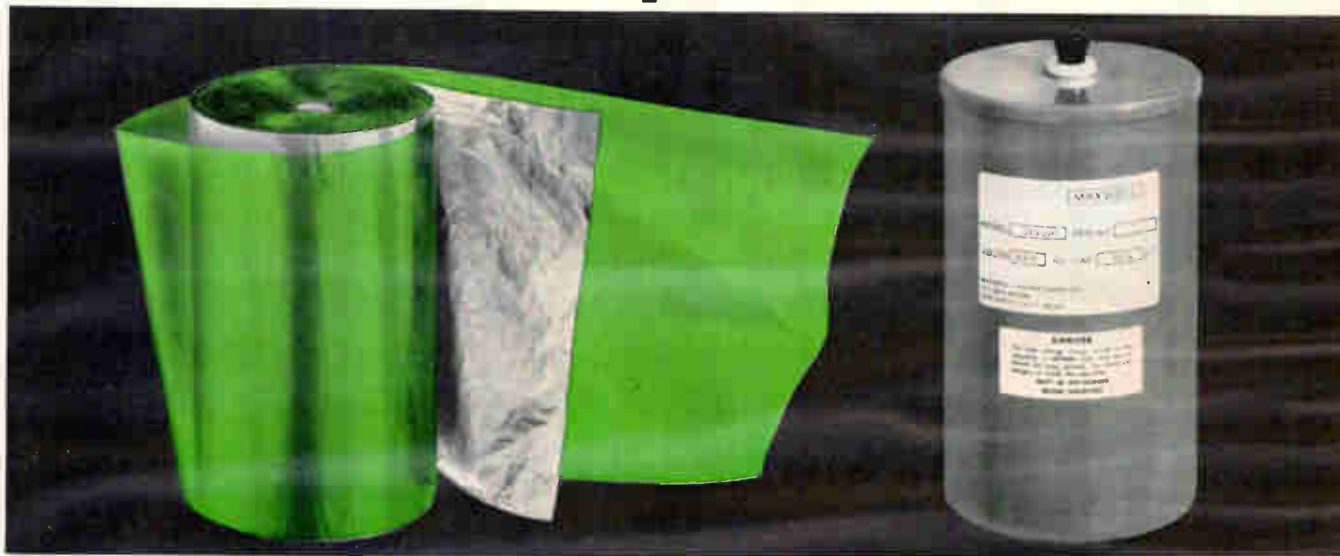

What would you like Mylar to do for you?

This new high-voltage capacitor of MYLAR* polyester film is about the size of a can of beans. Yet it stores enough energy to illuminate all the lights in the city of Washington, D. C., for a millionth of a second.

"We believe these new capacitors represent the first significant breakthrough this industry has seen in the last ten years", said Dr. Terence J. Gooding, President of Maxwell Laboratories, Inc., San Diego, California, developers of the capacitor.

Capacitor manufacturers in the past have frequently relied on paper impregnated with chemicals as a capacitor dielectric material. These units were often up to four times as large and bulky.

Where can you use the size and weight savings available with MYLAR? In aerospace? Other airborne uses? You name it. MYLAR can do it. Why? Higher dielectric strength in thinner

gauges than other materials. MYLAR also offers excellent resistance to most chemicals and moisture plus thermal stability from -60°C . to $+150^{\circ}\text{C}$.

MYLAR is manufactured by the Du Pont Company — leader in plastic-film technology. Du Pont offers more types and gauges of polyester films than any other film supplier.

Better find out more about MYLAR. Send the coupon for a free Fact File today. Or write: Du Pont Company, Room 4991C, Wilmington, Del. 19898.

*Du Pont registered trademark.

DU PONT MYLAR[®]

Du Pont Company
Room 4991C
Wilmington, Delaware 19898

I'd like to find out what MYLAR can do for me.
Please send me a Fact File.

Name _____

Company _____

City _____ State _____ Zip _____

ANY OF FIVE PROTECTIVE CIRCUITS IN ONE EASILY OPERATED SWITCH

Series Trip

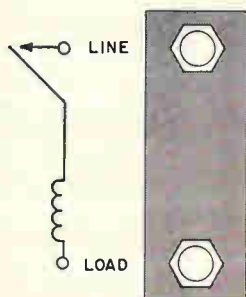

Airpax APL circuit protectors are manufactured in five circuit configurations. Each is available in any of 10 time delays, in any of 16 standard trip levels, and rated for a maximum of either 50 vdc, 250 vrms at 60 Hz, or 250 vrms at 400 Hz. This choice gives you great flexibility in protective design.

Shunt Trip

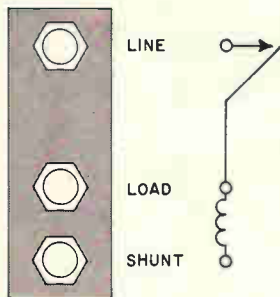

Shunt trip provides you with several possibilities. For example, you can program an external shunt across the coil to change trip level for different operating modes of your equipment.



To the operator it's an ON-OFF switch. To you it's a design simplifier.

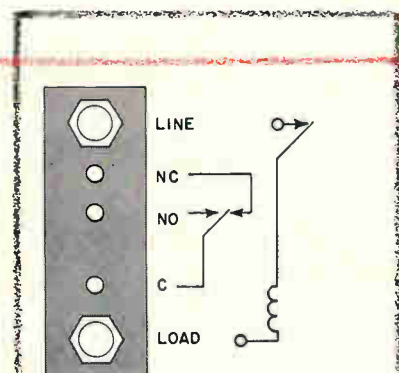

Remote Indication

A switch built into Type APL-RE protector transfers up to 5 amperes in a separate signalling circuit.

Relay Trip

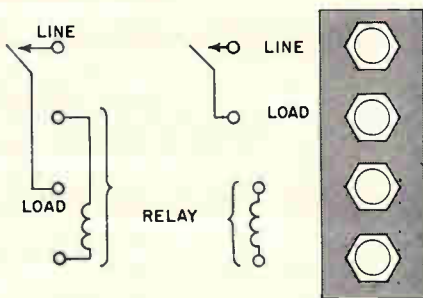

In protector Types APL-4 and -5, coil and contacts terminate at separate pairs of terminals. With this configuration, you can control current in one circuit (up to 50 amperes) by a different current in a separate circuit (50 ma to 50 amps).

FOR LOADS FROM 50 MA TO 50 AMPS

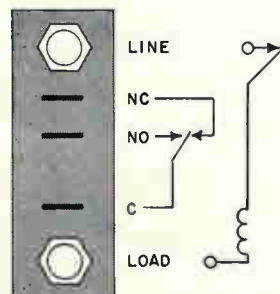

Remote Operate

Auxiliary contacts built into Types RO and -RO1 handle up to 10 amperes. This spdt switch operates simultaneously with the main contacts. Used to switch a remote load, this feature provides you with means for interlocking and protecting related loads.

AIRPAX ELECTRONICS
CAMBRIDGE, MARYLAND 301-228-4600

Mylar[®] helped Maxwell Labs save 75% on size and weight in its new 5KV capacitor.



What would you like Mylar to do for you?

This new high-voltage capacitor of MYLAR* polyester film is about the size of a can of beans. Yet it stores enough energy to illuminate all the lights in the city of Washington, D. C., for a millionth of a second.

"We believe these new capacitors represent the first significant breakthrough this industry has seen in the last ten years", said Dr. Terence J. Gooding, President of Maxwell Laboratories, Inc., San Diego, California, developers of the capacitor.

Capacitor manufacturers in the past have frequently relied on paper impregnated with chemicals as a capacitor dielectric material. These units were often up to four times as large and bulky.

Where can you use the size and weight savings available with MYLAR? In aerospace? Other airborne uses? You name it. MYLAR can do it. Why? Higher dielectric strength in thinner

gauges than other materials. MYLAR also offers excellent resistance to most chemicals and moisture plus thermal stability from -60°C . to $+150^{\circ}\text{C}$.

MYLAR is manufactured by the Du Pont Company — leader in plastic-film technology. Du Pont offers more types and gauges of polyester films than any other film supplier.

Better find out more about MYLAR. Send the coupon for a free Fact File today. Or write: Du Pont Company, Room 4991C, Wilmington, Del. 19898.

*Du Pont registered trademark.

DU PONT MYLAR[®]

Du Pont Company
Room 4991C
Wilmington, Delaware 19898

I'd like to find out what MYLAR can do for me.
Please send me a Fact File.

Name

Company

City State Zip

keeping new ideas
for electrical energy moving

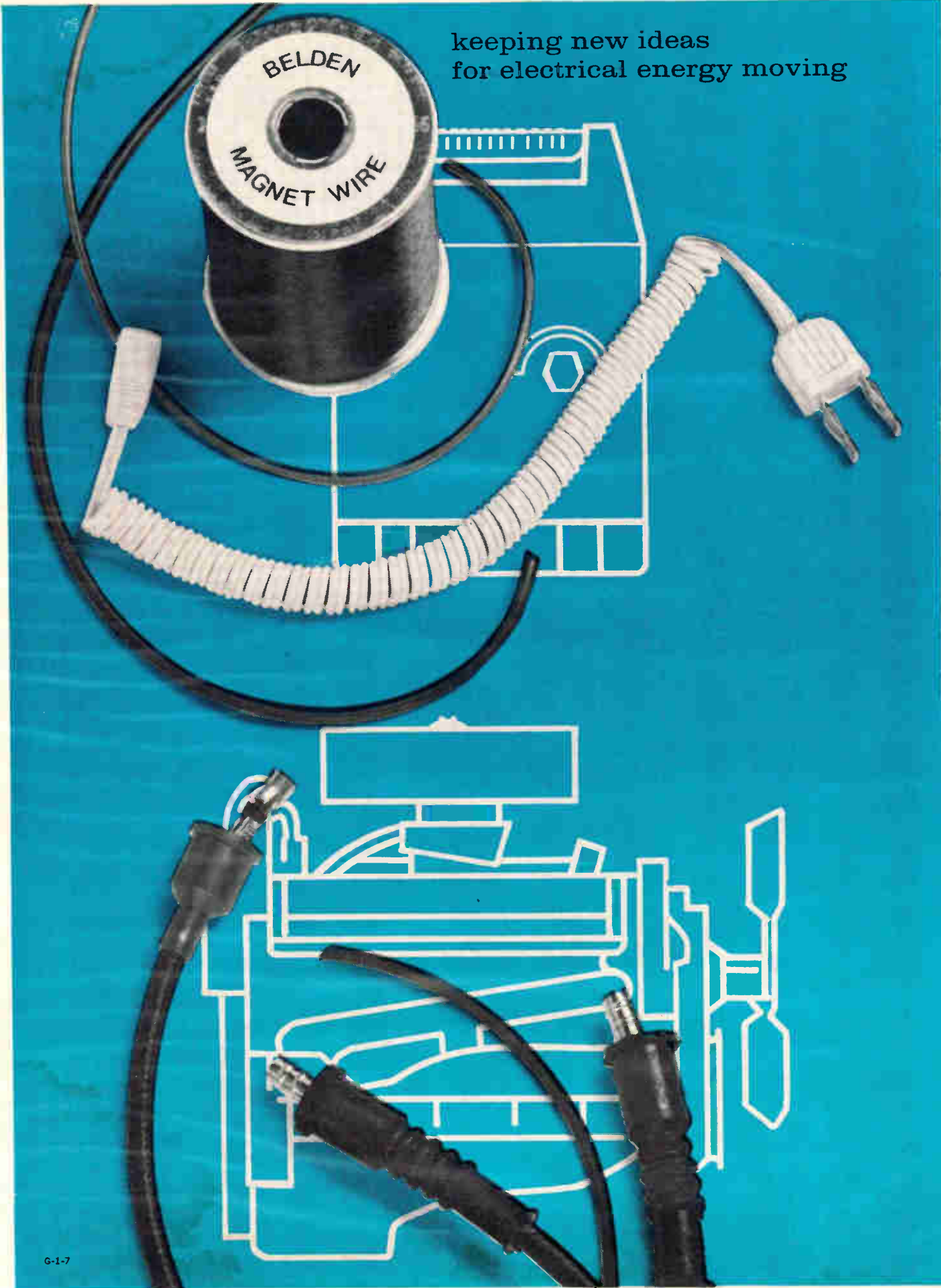

G-1-7

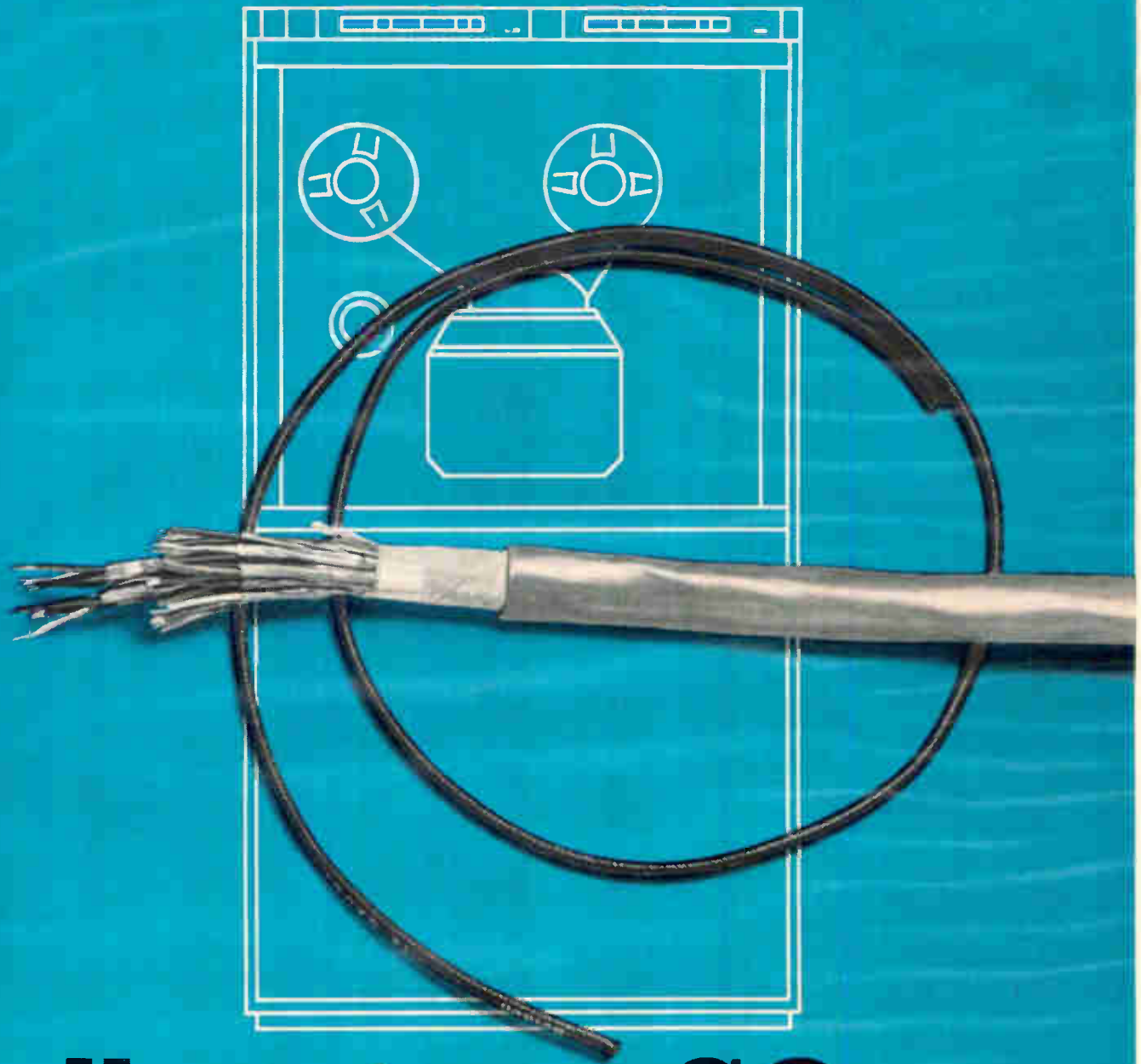

all systems GO

...when a Belden team of wire specialists shows you their dozen or so ways to wring out hidden values and costs. For example you can delve into design..maneuver with materials..analyze assembly..pry into processing..pick different packaging..or a host of others. But success takes a supplier who is really perceptive — one who makes all kinds of wire for all kinds of systems. Want to join us in wringing out values and costs? Just call us in...Belden Manufacturing Company, P.O. Box 5070-A, Chicago, Illinois 60680.

Belden

ANY OF FIVE PROTECTIVE CIRCUITS IN ONE EASILY OPERATED SWITCH

Series Trip

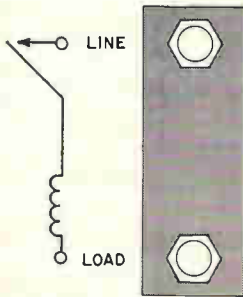

Airpax APL circuit protectors are manufactured in five circuit configurations. Each is available in any of 10 time delays, in any of 16 standard trip levels, and rated for a maximum of either 50 vdc, 250 vrms at 60 Hz, or 250 vrms at 400 Hz. This choice gives you great flexibility in protective design.

Shunt Trip

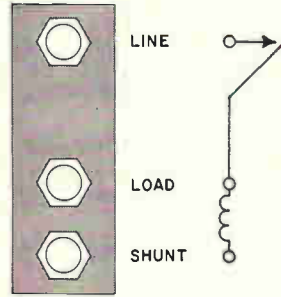

Shunt trip provides you with several possibilities. For example, you can program an external shunt across the coil to change trip level for different operating modes of your equipment.



To the operator it's an ON-OFF switch. To you it's a design simplifier.

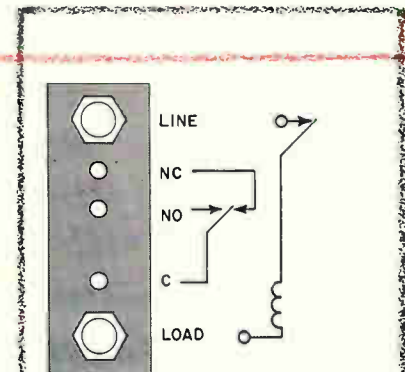

Remote Indication

A switch built into Type APL-RE protector transfers up to 5 amperes in a separate signalling circuit.

Relay Trip

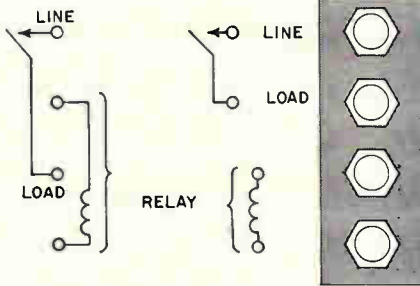

In protector Types APL-4 and -5, coil and contacts terminate at separate pairs of terminals. With this configuration, you can control current in one circuit (up to 50 amperes) by a different current in a separate circuit (50 ma to 50 amps).

FOR LOADS FROM 50 MA TO 50 AMPS

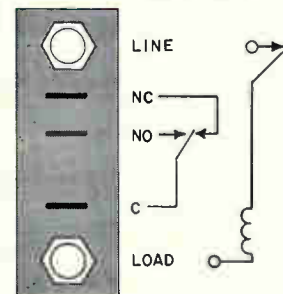

Remote Operate

Auxiliary contacts built into Types RO and -RO handle up to 10 amperes. This spdt switch operates simultaneously with the main contacts. Used to switch a remote load, this feature provides you with means for interlocking and protecting related loads.

AIRPAX ELECTRONICS
CAMBRIDGE, MARYLAND 301-228-4600

Subtracting errors adds up to accuracy

FET operational amplifier improves common-mode rejection 60-fold

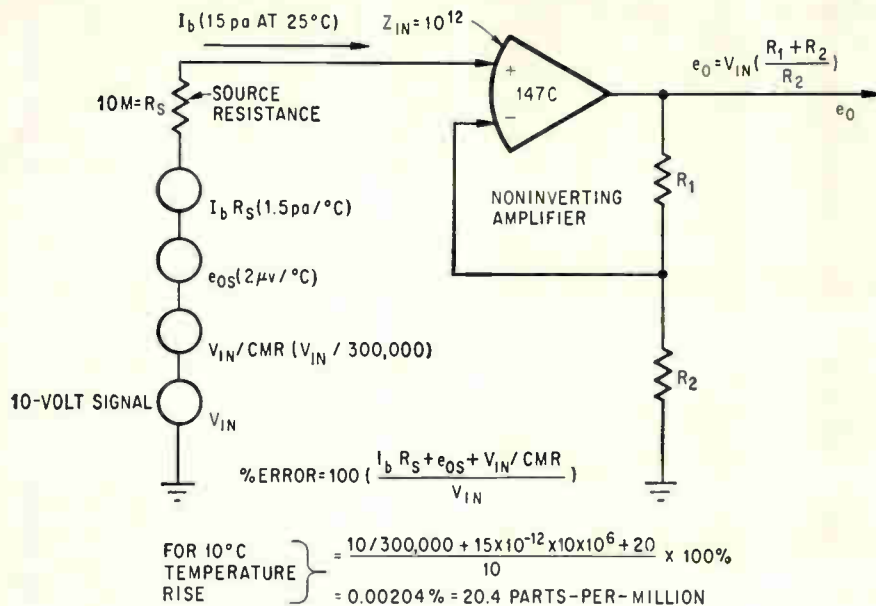

more, the CMR is raised from a typical value of 5,000:1 to a minimum of 300,000:1. Consequently, common-mode errors, V_{in}/CMR , are reduced to less than 0.0005%, and circuits are possible that can handle signals from 10-megohm sources with less than 50 parts-per-million over-all error.

In comparison, a conventional FET voltage-follower circuit having only 1,000:1 CMR, develops a minimum error of 0.1%, which can severely reduce the accuracy. The common-mode problem also occurs in differential amplifiers, sample-and-hold amplifiers, and other circuits in which input signals are applied to both inverting and non-inverting input terminals; it occurs because voltage gain is never identical for the two input terminals—one input is amplified more than the other.

The new amplifiers also reduce two other major error sources—variations due to bias current, $I_b R_S$, and offset voltage e_{OS} . Although an external zero-setting potentiometer usually compensates for both ef-

High input impedance of field effect transistor amplifiers helps engineers minimize loading errors caused by multimegohm sources. The FET amplifiers are almost as good as the highly rated varactor bridge and certainly less expensive, but the high impedance advantage

is offset by the poor common-mode rejection ratio (CMR).

By adding a separate circuit to the FET amplifier, the CMR problem is circumvented in Analog Devices Inc.'s Series 147 because the gain of the FET is independent of the common-mode voltage. Further-

New products in this issue

- 157 Subtracting errors gives accuracy
- 158 A more effective Hall effect

Components

- 160 Passive filters are flat to d-c
- 160 Glass delay lines
- 160 Shielded cables
- 162 Miniature film potentiometer
- 164 Direct-drive piston trimmer
- 164 Fast multiturn pot
- 166 Tiny square trimmer
- 168 Air dielectric coaxial cable

Semiconductors

- 170 Operational amplifier in plastic
- 172 Photosensing focuses on a 4-in-1 assembly

Instruments

- 175 A new measure of calibration—speed

- 177 Six-in-one amplifier/oscillator
- 177 Economically priced sweep generator
- 178 Fast-response temperature sensor
- 179 A-c/d-c voltmeter

Subassemblies

- 181 Contour control shapes up at low cost
- 182 Accessory provides automatic log plot

Microwave

- 184 Transistor oscillator can replace klystrons
- 184 Magnetrons are dither-tuned

Production equipment

- 186 Tapes and lamps guide wiring
- 187 Automatic dispenser of two-part resins
- 187 Ultrasonic, one-step bonding of flip chips
- 188 Optical glass scales aid coordinated measure
- 189 Air tool bends p-c board leads
- 189 High-vacuum evaporator
- 190 Diffusion pump for ultrahigh vacuums

Materials

- 192 Conductive cement has a silver lining
- 192 Superconductors vary in size and shape
- 194 Sealing glass reduces heat damage

New Products

fects at any given temperature, changes in temperature alter both the bias current and voltage offset values. For maximum accuracy, bias current and voltage offset in the amplifier should be designed for minimum variation with temperature.

Each noninverting circuit has three basic sources of error—that due to common-mode rejection, voltage offset, and current offset. For best accuracy, errors due to each source must be of similar magnitude. For example, there is no benefit in having exceedingly low errors due to offset, if the common-mode rejection errors are very high.

With the Series 147 all three major parameters have been improved in a single unit. One unit provides $2 \mu\text{V}/^\circ\text{C}$ maximum voltage drift from 10° to 60°C , and bias current is 15 picoamperes at 25°C , yielding a current drift of only $1.5 \text{ pa}/^\circ\text{C}$ for the first 10° temperature rise. The unit's 10-megahertz bandwidth and 150-kilohertz full power response preserve accuracy at high

operating frequencies, and make the amplifier particularly useful as a fast analog-to-digital converter or fast sample-and-hold circuit.

Specifications

Common-mode rejection ratio	300,000
Maximum voltage drift	$15 \mu\text{V}/^\circ\text{C}$ (Model 147A) $5 \mu\text{V}/^\circ\text{C}$ (Model 147B) $2 \mu\text{V}/^\circ\text{C}$ (Model 147C)
Bias current at 25°C	30 pa (Model 147A) 15 pa (Model 147B) 15 pa (Model 147C)
Current noise d-c to 1 hz	0.1 pa
Voltage noise d-c to 1 hz	$3 \mu\text{V}$
Input impedance:	
between inputs	10^{11} ohms
common mode	10^{12} ohms
Output rating	$\pm 10 \text{ v}$, 10 ma
Bandwidth	10 Mhz
Full power response	150 khz
Slewing rate	$10 \text{ v}/\mu\text{sec}$
D-c gain	1,000,000
Input capacitance:	
between inputs	3 pf
common mode	3 pf
Unit price	\$110-\$135
Availability	From stock

Analog Devices Inc., 221 Fifth St., Cambridge, Mass. 02142
Circle 349 on reader service card

tens of amperes.

However, the loop formed by the wires and the Hall transducer in the probe develops an induced voltage which increases with the frequency. At low frequencies, the induced voltage can be made small enough so that the Hall-effect voltage is much larger and the device's calibration holds. When the frequency is raised, the induced voltage grows and can swamp out the Hall voltage. Thus, to get a response that's flat with frequency, the loop must be small or the induced voltage must be canceled out. Ohio Semitronics Inc., the developer, says it shapes the parts in the transducer and designs the probe so that the effects of the induced voltage are inhibited over a much wider frequency range than previously possible.

The new current transducer, Model CT-7W, has a response flat within ± 1 db from d-c to 10 megahertz. Above 10 Mhz, the response curve rises due to the induced voltage. Output sensitivity is 2 millivolts per ampere of test current. Dynamic range is 100 microamps to 20 amps. The wide dynamic range results, in part, from the low 10-ohm source impedance with the corresponding low noise generation and from the reduction of induced voltage effects.

Typical control current is 200 ma dc, from a 2-volt battery. The transducer then provides an output wave which is an exact replica of the current passing through the test wire. In a pulsed-control current mode, the output sensitivity can be increased to 20 mv per ampere of test current without overheating the transducer.

Flat frequency response permits reproduction of microsecond or shorter current pulses, making easy spectral analysis of complicated waveforms. Other applications include transient waveform monitoring, pulse power measurements, transient level sensing and electromagnetic interference measurements.

The indium-arsenide Hall-effect transducer is in a package measuring $1 \times \frac{3}{4} \times \frac{3}{8}$ inch. The test wire is placed through a $\frac{3}{16}$ -inch diameter opening. Price is \$325.

Ohio Semitronics Inc., 1205 Chesapeake Ave., Columbus, Ohio 43212 [350]

A more effective Hall effect

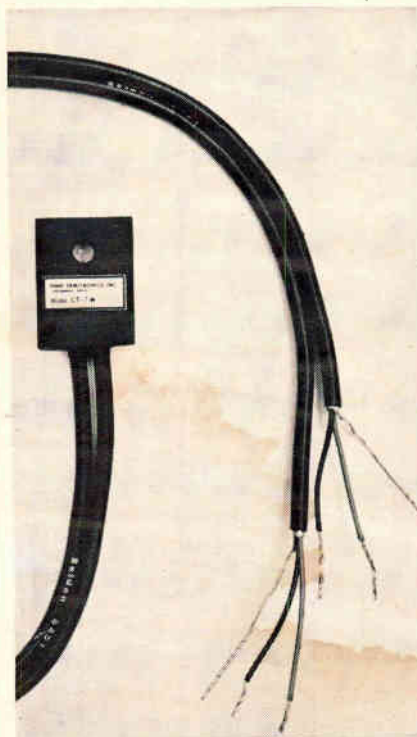

Until now, inductive pick-up in the probe has limited Hall-effect transducers to operation well below 1 megahertz. A new device has broken the 1-Mhz barrier and operates with a flat response up to 10 Mhz. Other devices with 100, 500, and even 1,000 megahertz responses may be made by simple redesign, the company says.

The Hall effect, in which a magnetic field acts on a semiconductor's charge carriers to develop a voltage proportional to the magnetic field, has long been attractive as a current-measuring tool. By sensing the magnetic field produced by the unknown current, the device measures the current without a direct connection into the circuit. Little circuit loading is produced while the inherent characteristic of the Hall effect yields a wide dynamic range, measuring currents from microamperes up to

In Making Masks for
Electronic Components...
...there's no
Margin for Error!

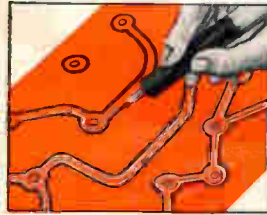

With sharp blade, outline the areas to be masked. Do not cut through the backing sheet. The Ulano Swivel Knife does the job quickly, easily.

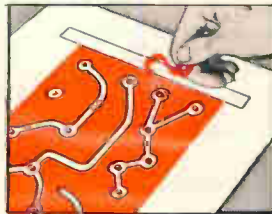

Now carefully peel off the film as outlined leaving a completed photo mask, positive or negative, that corresponds exactly to the desired pattern.

**THAT'S WHY EXPERIENCED DESIGNERS
AND ENGINEERS ALWAYS INSIST ON...**

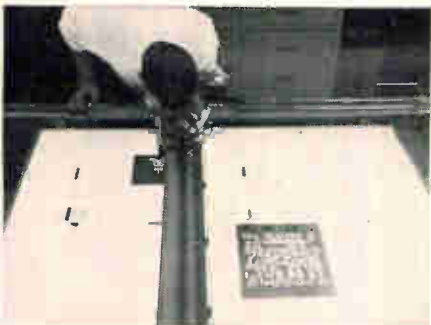

RUBYLITHTM

HAND-CUT MASKING FILM FOR THE GRAPHIC ARTS

**THE KNIFE-CUT, LIGHT-SAFE MASKING FILM
LAMINATED TO A STABLE POLYESTER BASE**

The most versatile line of hand-cut masking films, including

**.0075—RUBYLITH 75 DR* .005 RUBYLITH 5 DR
.005 AMBERLITH 5 DA**

These new, thick Ulano films provide the positive answers where exact register assumes a critical importance.

**Available in sheets only, cut to your specifications.*

by

UlanoTM

ulanoTM

610 DEAN STREET, BROOKLYN, N. Y. 11238

NEW YORK • CALIFORNIA • CHICAGO • ZURICH

In Europe: ULANO A. G., Untere Heselbachstrasse 22, Kusnacht 8700, Switzerland

Write on your letterhead for special electronic test kit (no charge) No. 4148

NEW! VACTEC Photocell-Lamp Control Module

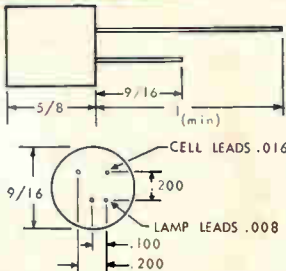
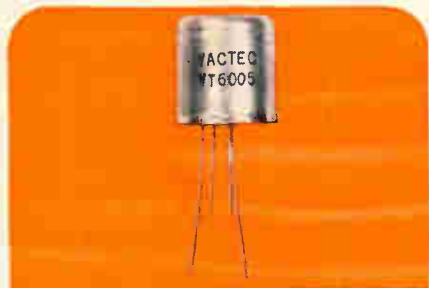

The first of a complete line designed for improved, noiseless volume and tone controls in transistorized amplifiers. Perfect for guitars, organs, musical instruments, radio, TV and the like.

Combines a proven dependable Vactec photocell with an extremely long-life incandescent lamp. Complete low-cost module in a unique epoxy sealed metal enclosure. Leads are spaced on standard .100" centers to simplify circuit board mounting.

Six and 10-volt units now available. Special characteristic designs on request.

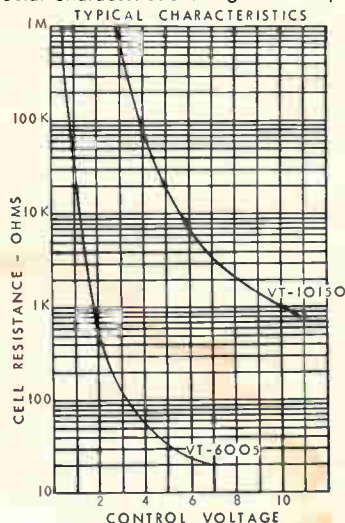

For details, write requesting Bulletin OC-1.

VACTEC, INC.
2423 Northline Ind. Blvd.
Maryland Hts., Mo. 63042 AC 314, 432-4200
See Vactec's listing in EBG under "Semiconductors," and in EEM, Sec. 3700.

New Components and Hardware

Passive filters are flat to d-c

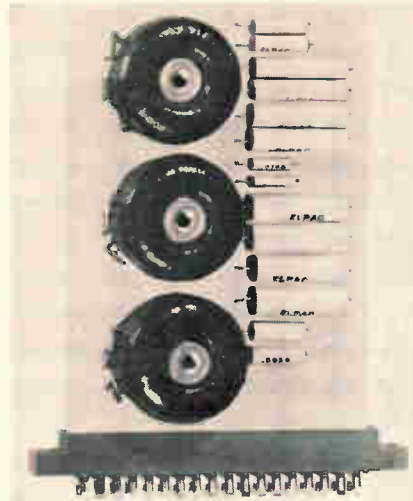

Low-pass filters limit the spectrum of analog signals to prevent the generation of unwanted frequencies when signals are sampled by a multiplexer. These unwanted frequencies are duplications of the sampled waveform centered at harmonics of the sampling frequency.

Employing extremely sharp cut-off characteristics and linear phase shift in the pass band, Series AF filters provide maximum attenuation of frequencies above half the sampling rate, along with minimum attenuation or distortion of the useful data. All these filters are passive, requiring no power. They are flat to d-c and employ toroidal inductors to provide low distortion and low pickup.

Having an attenuation rate of 80 db per octave, standard AF filters are available for 250-hz, 500-hz, and 1,000-hz sampling frequencies. Characteristic impedance is 10,000 ohms. Other cutoff frequencies are available upon request.

Metrix Instrument Co., P.O. Box 36501, Houston 77036. [351]

Glass delay lines for video processing

Storage of one horizontal sweep line of video information for 63.5 μ sec is now possible with a new

glass delay line. Delay information is then presented on crt's in tv cameras and receivers, video tape recorders, and in computer displays.

Applications include:

- Vertical aperture correction in color-tv cameras. To sharpen edge response between adjacent horizontal scan lines, the lines above and below the main signal are stored in a delay line.

- Dropout compensation in video tape recorders. Particles of dust, faulty tape and other imperfections can cause white light to appear on a tv screen. If such an error is detected, the previous scan line of information is substituted for the missing information, eliminating the streak.

- Digital displays for high-speed computers. The units act as buffers and store up to 1,890 bits on one horizontal scan line.

The 63- μ sec delay lines show high repetition rate of operating frequency ranging from 2.5 to 40 Mhz. Three-decibel bandwidths are available at 1.2, 2.0, 4.5 or 20 Mhz. The 25-Mhz unit exhibits a high signal-to-noise ratio of 40 db.

Dimensions of the 25-Mhz unit are $4\frac{1}{8} \times 1\frac{1}{4} \times 6\frac{5}{8}$ in. Price for the broadcast-camera quality line in sample lots is \$250; in high quantity about \$125.

Corning Glass Works, Raleigh, N.C. 27602. [352]

Shielded cables are tiny and tough

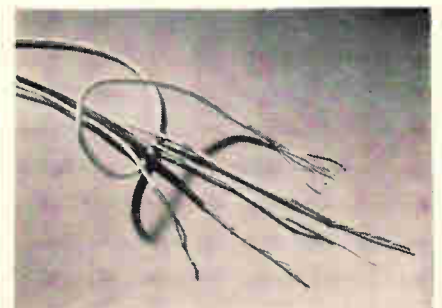

A family of shielded cables features small size and ruggedness. Jacketed with silicone rubber and shielded with a light tinned copper,

VSMF is a product supermarket

John Manning, Missiles Systems Division, Raytheon Company, Bedford, Mass., has installed 4 VSMF Files: Defense Design, Documentation, Mil Specs and Mil Standards.



look into it!

Design engineers have been telling us for years that VSMF is much like a product supermarket. That's because Visual Search Microfilm Files contain more than 1,000,000 products from over 15,000 manufacturers—all arranged with design engineers in mind.

Of course, VSMF isn't exactly a supermarket. At Information Handling Services, we've collected 1¼ million pages of product data, indexed them, microfilmed them, put them in compact consoles, and combined them with the most modern microfilm retrieval equipment. VSMF has all the advantages of a product supermarket... complete, easy-to-use and up-to-date.

We know that when you design a product you want to use the best components and materials. And, to do this, you need to compare all that is available. VSMF can help you in this comparison because VSMF supplies the data on *all* products. You supply the judgment.

Manufacturers who place their data in VSMF know this and invite comparison. The constantly changing "state of the art" is reflected in the pages of VSMF.

More than 125,000 engineers in 500 great corporations now shop in the VSMF supermarket. If you have VSMF in your company, look into it. If you don't, you might look into that, too. Write for "Looking into VSMF."



Information

HANDLING SERVICES, INC.
Dept. E-529
Denver Technological Center
Englewood, Colo. 80110

Circle 161 on reader service card

Short course

on how to choose a demineralizer...

1. It's not easy.

Every plant has different pure-water needs. Your company's raw water, processes and equipment usually differ sharply from the next company's.

2. Look for a demineralizer manufacturer who can advise you with total objectivity.

Barnstead is a good choice, because we make over 100 types of demineralizers, from midgets to monsters. And if a still is called for, you'll find we make a huge line of these, too — plus a broad range of accessory equipment.

Check the chart below, to see where your demineralizer requirements might fit. Then contact Barnstead for a no-obligation recommendation.

THE PROBLEM	THE SOLUTION
Take 10 common minerals out of "average" water.	Barnstead 2-Bed Demineralizers, 50 to 2500 gph and larger.
Get extra removal power for silica, CO ₂ ; ultra-high electrical resistance; constant pH.	Barnstead Mixed-Bed Demineralizers, 30 to 3,000 gph.
Purify water with unusually heavy mineral concentrations; lengthen operating cycles; minimize per-gallon operating costs.	Barnstead 4-Bed Demineralizers, 30 to 3,000 gph.
Eliminate full shutdowns for regeneration.	Two Barnstead 2-Bed Demineralizers, in parallel.
Eliminate manual labor involved in regeneration.	Barnstead demineralizers that automatically regenerate themselves.
Reduce maintenance and equipment investment to absolute minimum.	Barnstead throw-away or regenerable Cartridge Type Demineralizers, 5 to 3,000 gph.
Pretreat water loaded with sediment, organics, coloring, odors.	Barnstead sand, carbon, organic removal filters; coagulant feeders; water softeners; stills.



Barnstead

A subsidiary of Ritter Pfaudler Corporation
442 Lanesville Terrace, Boston, Mass. 02131

New Components

the five cables of the Flexicable series 200 have from one to five conductors and outside diameters ranging from 0.095 in. to 0.140 in. The conductors are No. 30 PVC insulated wire and are color coded. The cables are rated at 105°C.

The cables are suitable for use with biological probes and sensors in equipment with moving parts, such as x-y recorders; with microphones and headsets; with vibrating machinery; and with all types of miniature transducers in instrumentation and control equipment.

Prices range from 74 cents to 14.9 cents per foot depending on type and quantity. Delivery is stock to four weeks.

Caltron Industries, 1214 Fourth St., Berkeley, Calif. [353]

Film potentiometer in miniature package

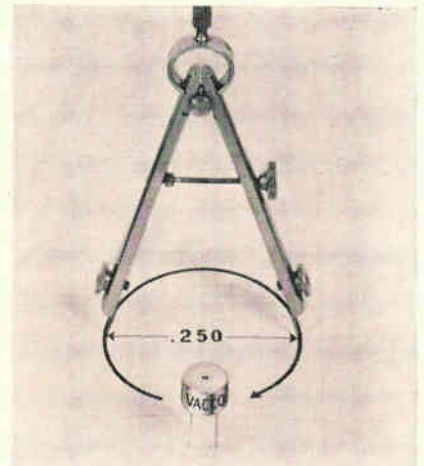

A potentiometer measuring 0.250 in. x 0.150 in. with a metal film resistance element deposited on a ceramic substrate provides virtually infinite resolution. By rotating a recessed hex screw in the top of the metal can-type housing, a multitang wiper assembly is rotated 288° in a single turn. The center shaft is completely sealed by "O" rings and stops are provided to limit wiper travel.

The unit meets or exceeds all environmental characteristics covered in MIL-R-22097B. Nominal resistance ranges are available from 0.5 ohm to 1 megohm, with adjustabil-

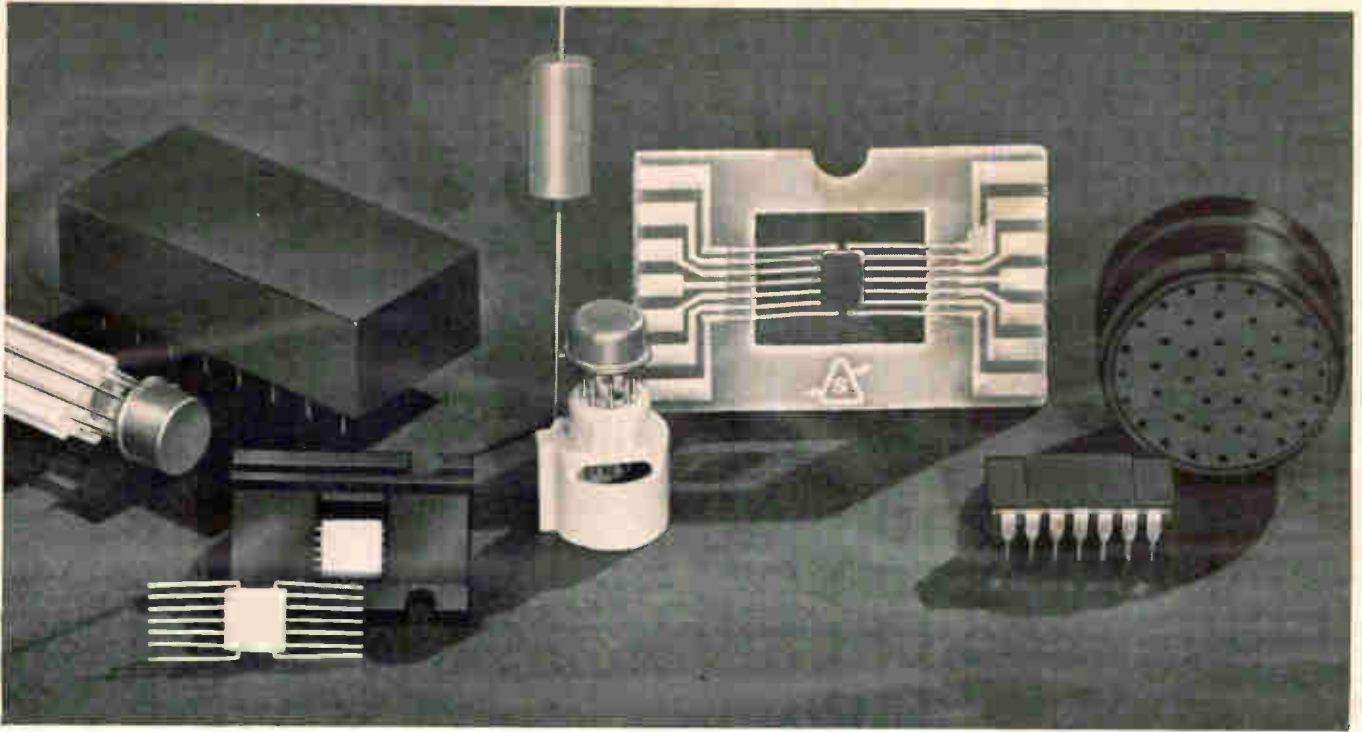

Good marking . . . makes the difference

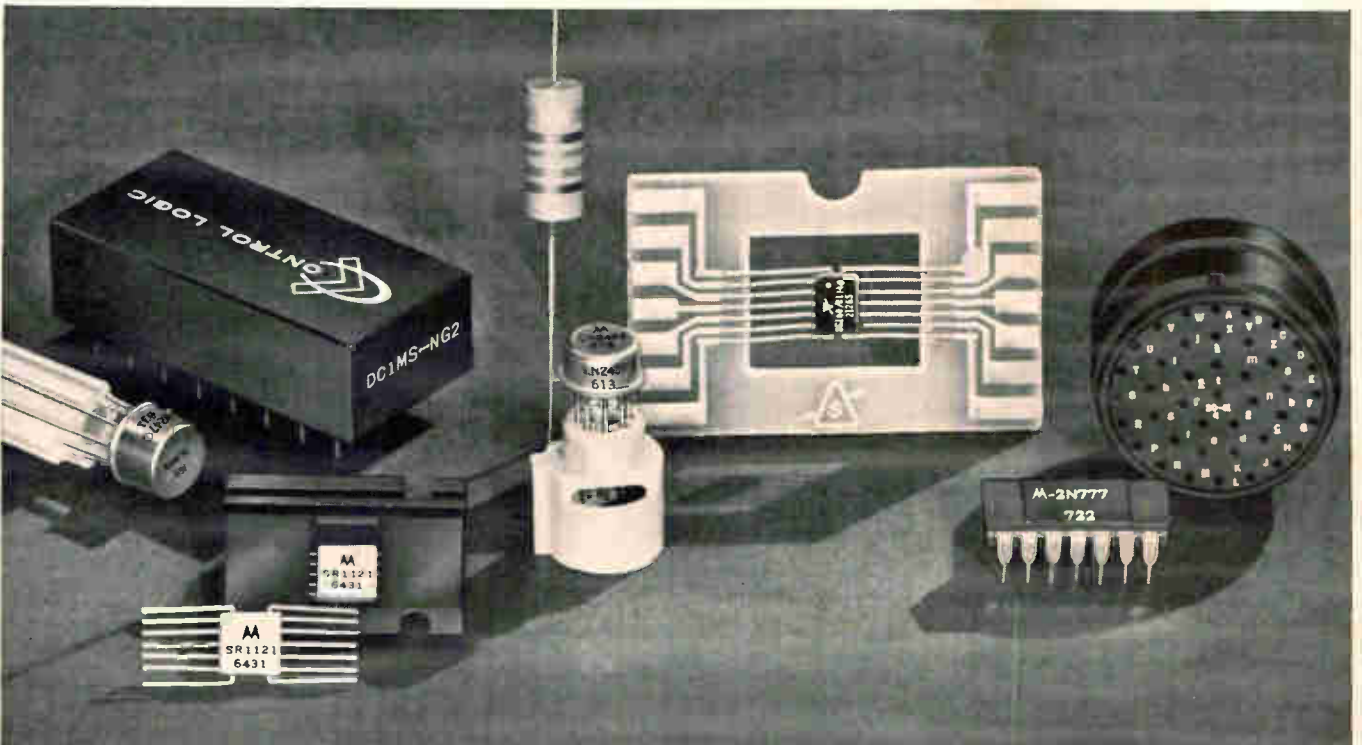

Don't waste time improvising and experimenting. Call in a Markem man and get acquainted with today's broadest line of marking equipment. Machines capable of putting several bands on a miniature diode; combining sequential numbering with identification; printing 14 characters plus trademark in an area 0.125" in diameter; printing integrated circuits in or out of carrier, registered to tab; and employing new techniques to meet severest durability specs. Whether your problem is size, speed or cost, we can help. Write Markem Machine Company, 305 Congress Street, Keene, New Hampshire.

EQUIPMENT AND TECHNOLOGY TO HELP YOUR PRODUCT SPEAK FOR ITSELF

MARKEM®

republic makes aluminum strip conductor

the electrogage® way

Republic Foil has been one of the leaders in developing aluminum strip for coil applications and led the industry in guaranteeing tight gauge control. Experience gained from producing Electrogage precision slit strip conductor for a number of years has led to the development of superior quality edge contoured strip. Electrogage edge contoured strip offers a uniformly curved edge from surface to surface free of any protrusions which could affect insulation values.

Both Electrogage contoured strip and precision slit strip conductor are carefully monitored for gauge and conductivity throughout fabrication.

Each master coil of end product is measured and certified for conductivity. *Write for a copy of our new 8-page Bulletin SC.*

THE LEADING MANUFACTURER OF A COMPLETE LINE OF PLAIN & ETCHED CAPACITOR FOIL



REPUBLIC® FOIL INC.

General Offices, Danbury, Conn. 06813: Tel. 203-743-2731

BRANCH SALES OFFICES

Chicago, Ill. 312-545-2142 • Salisbury, N. C. 704-633-6020 • Cleveland, Ohio 216-871-6268
WEST COAST — Electrical Specialty Co., 213 E. Harris Ave., So. San Francisco, California
2820 E. 12th Street, Los Angeles, California 90023

PLANTS • Danbury, Conn. • Salisbury, N. Carolina • Somerville, Mass.

New Components

ity from -20% of nominal to nominal. Power dissipation is 0.25 w at 70°C derated to 0 at 200°C. Insulation resistance is 1,000 megohms minimum at 500 v d-c. Operating temperature range is -65° to 200°C. Terminals are gold-plated and may be soldered or welded.

Vacco Electronics, P.O. Box 3096, South El Monte, Calif. [354]

Piston trimmer with high-Q dielectric



A direct-drive piston trimmer operates over the full military temperature range of -55° to +85° C. It incorporates a dielectric of polyphenylene oxide, a material that has a typical Q of 1,000 at 3 Ghz. Rated at 250 wdc, the part has a tuning resolution of 0.97 pf/full 360° turn and a capacitance range of 0.8 to 4.5 pf.

Used in circuit applications where precise adjustments, high Q, and stability are required, this trimmer will perform the same function as units costing twice as much, according to the manufacturer, Erie Technological Products Inc., Erie, Pa. [355]

Speed is featured in multiturn pot

Capable of operating at speeds 30 times faster than conventional types, a multiturn potentiometer features infinite resolution with unlimited ganging of linear or non-linear outputs.

Known as the Model 10200, this

small



smaller



smallest



G.E.'s new wet slug tantalum capacitor gives you the performance of the CL64 in only 1/2 the case size

Get the highest volt-microfarad product per unit weight and volume of any capacitor you can buy with General Electric's new 69F900 wet slug tantalum capacitor. How? General Electric reduced the case size of the military type (CL64) wet slugs by 1/2 (it's even smaller when compared to solids). Electrical characteristics and performance remain essentially the same. G.E.'s new 69F900 answers the need for a commercial wet slug capacitor with the high volumetric efficiency demanded by modern high density applications.

G.E.'s new addition to its complete line of tantalum wet slug capacitors has excellent high capacitance retention at low temperatures and can be

RATING	CASE SIZE	VOLUME
50V, 30μf		
solid (CS12)	.341 x .750	100%
wet slug (CL64)	.281 x .681	58%
69F900	.145 x .600	15%
15V, 80μf		
solid (CS12)	.341 x .750	100%
wet slug (CL64)	.281 x .681	58%
69F900	.145 x .600	15%
6V, 180μf		
solid (CS12)	.279 x .650	100%
wet slug (CL64)	.281 x .641	100%
69F900	.145 x .600	25%

stored to -65°C . Its wide operating range is -55°C to $+85^{\circ}\text{C}$. And it meets the parameters of larger military wet slugs: vibration to 2000 Hz, 15g acceleration!

The new sub-miniature 69F900 capacitor is fully insulated and has a low, stable leakage current. Voltage ratings are available from 6-60 volts; capacitance ranges from 3.3-450 microfarads.

Choose from a complete line of G-E wet slug tantalum capacitors to fill your slim, trim circuit needs. Write for GEA-8369 for details about the 69F900 and the other capacitors in General Electric's complete wet slug tantalum line, or ask your G-E sales engineer. Capacitor Department, Irmo, South Carolina.

ELECTRONIC COMPONENTS DIVISION

GENERAL ELECTRIC

430-28A

HOW

to solve your electronic component packaging problems...

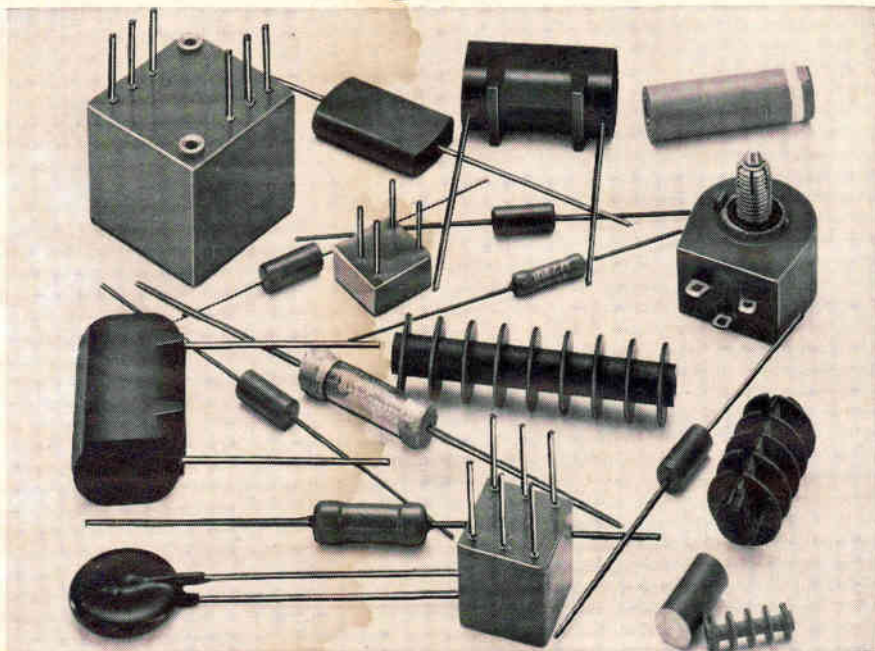

HYSOL has more answers than anyone in the business

HYSOL HYFLO® epoxy molding powders are being used, successfully and economically, for transfer molding encapsulation of just about every type of component, from tiniest capacitors and precision resistors to large transformers and complex modules.

HYSOL liquid epoxy systems, in several hundred varieties, are being used for casting or potting the most delicate components. Most compatibility problems can be solved, too.

HYSOL DRI-KOTE® POWDERS, for spray or aerated bed application offer a particularly fast, economical way to encapsulate components that can withstand elevated temperatures during manufacture.

Our experience in the entire spectrum of epoxy and urethane encapsulating techniques, and our background in depth in all types of epoxy powder and liquid systems, are yours for the asking. Let us work to develop the best answer to your problems, as we have already done for scores of leading manufacturers.

Call, write or wire HYSOL today for technical data and application engineering assistance. Ask for Bulletins E3-100, E7-100 and E8-900.1.

PROGRESSIVE PRODUCTS
HYSOL HYSOL CORPORATION • OLEAN, NEW YORK
THRU CHEMICAL RESEARCH LOS ANGELES, CALIFORNIA/HYSOL (CANADA) LTD., ONTARIO/LONDON, ENGLAND

New Components

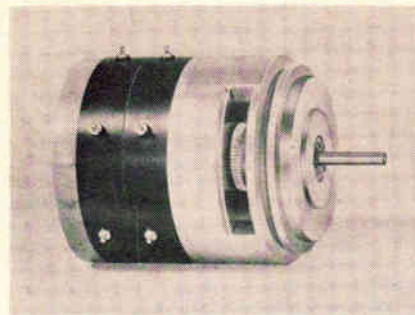

servomount pot incorporates a precision zero backlash gear train and a single-turn, infinite resolution potentiometer in a diameter of 2 in. and a length of 1½ in. Each additional cup adds less than ½ inch to the length with no loss of resolution, accuracy, or speed capability.

Long life with no catastrophic failure, insignificant quadrature error above 100,000 hz, low operational noise, and infinite resolution make the unit suitable for a-c or d-c applications where unreliable wirewound and more expensive a-c potentiometers are currently in use.

The assembly is capable of meeting all applicable military environmental requirements. Resistance range is 0.5 kilohm to 250 kilohms, with linearities to 0.035% and sine/cosine conformities to 0.075%.

Computer Instruments Corp., 92 Madison Ave., Hempstead, N.Y. [356]

Tiny square trimmer resists heat, humidity

Square design of a ⅜-in. trimmer permits a longer mandrel than is used in a rectangular device and provides up to 131% better resolution than is obtained from the best ¼-in. rectangular trimmer, according to the manufacturer. The new trimmer provides up to 85% better resolution than called for in MIL-R 27208B, RT24.

Designated the Model 3610, the trimmer is immersion-tested for leakage. A silicon O-ring seal locks out dust and humidity. The lid and case are weld-fastened.

Resistance values are available from 100 to 20,000 ohms. Power rating is 0.5 w at 40°C. Operating



1967...another vintage year for Midwestern Oscillographs



Model 1210
50 channels;
12-inch chart;
0.1 to 160 ips

For 16 years Midwestern Instruments has made the finest direct-recording oscillographs obtainable, and this year is no exception, because — like fine wine — we're improving with age.

Through continuous product refinement, we have brought the Midwestern family of oscillographs to the "peak of perfection." Each of the six is a state-of-the-art leader — a vintage product — the finest issue of the year.

But we don't expect you to accept an oscillograph on faith, any more than you'd allow the wine steward to serve your guests without first tasting it yourself.

If you'd like to sample the champagne of data recording instruments, please call your nearest Midwestern Instruments representative. He has the key to our cellar.



Model 801 B
Oscillograph
36 channels;
8-inch chart;
.125 to 128 ips.

MIDWESTERN INSTRUMENTS / **TELEX**

DATA SYSTEMS DIVISION
A SUBSIDIARY OF THE TELEX CORPORATION
6422 E. 41ST STREET TULSA, OKLAHOMA 74135
PHONE 918-627-1111 TWX 918-627-6030 TELEX 049-589

control / alarm shortcut

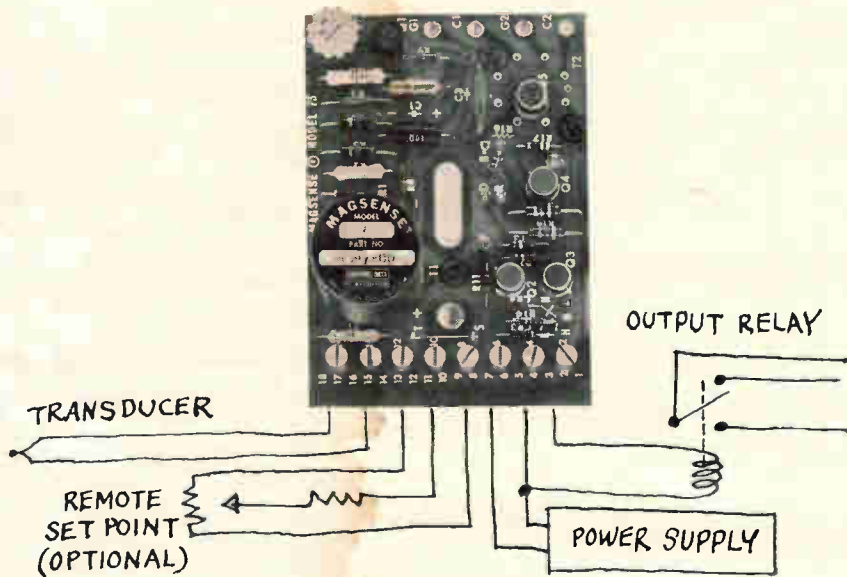

MAGSENSE®

control/alarm for temperature, pressure, speed, flow

Here's a fast, easy way to design a solid-state control/alarm circuit you can depend on. Just connect sensor, load and power source to the standard MAGSENSE model that meets your specific requirements. That's it. Your circuit is complete. You'll save time and money by using MAGSENSE, and you'll be taking advantage of accuracy and reliability proven in hundreds of temperature, pressure, speed, position, liquid level and flow applications.

All 11 Magsense models offer 100-billion power gain and accept inputs as low as 1 microamp or 10 microvolts *directly* without preamplification. Continuous overload capability is 1,000 times nominal full-scale input without damage. Trip point is unaffected by common mode voltages as high as 110 VAC, 60 Hz because input is full floating with respect to the

output circuit.

Single or dual setpoints and hysteresis are easily adjusted internally or remotely. You can specify latching, non-latching or pulse control/alarm action. Non-latching and pulse units have adjustable differential gap and proportional band capabilities.

Transducer excitation voltage is available from all MAGSENSE units, and cold junction and copper compensation are standard in models for thermocouple applications.

Priced from \$35 in quantity, all MAGSENSE modules are available from stock.

For data sheets or a quote, contact MAGSENSE Sales, Dept. 126, La Jolla Division, Control Data Corporation, 4455 Eastgate Mall, La Jolla, California 92037. For immediate action, phone (714) 453-2500.

LA JOLLA DIVISION
CONTROL DATA
CORPORATION
4455 Eastgate Mall, La Jolla, Calif

New Components



in a temperature range from -65° to $+125^{\circ}\text{C}$, the trimmer has silver-brazed terminations, gold-plated terminals, and a clutch.

The 3610P version, which mounts flat on the p-c board, requires only 0.200-in. card space vertically. Amphenol Controls Division, Amphenol Corp., 120 S. Main St., Janesville, Wis. 53545. [357]

Air dielectric coaxial cable



A solid polyethylene helix completely covers the copper conductor in an air dielectric coaxial cable. The cable, called Spirafil II, is easily installed and maintained, according to the maker, and is available at prices competitive with the costs of conventional foam cables.

Basically, Spirafil II consists of a seamless aluminum outer conductor, a continuous polyethylene dielectric, and a solid copper inner conductor. It's available plain or jacketed in $\frac{3}{8}$ -, $\frac{1}{2}$ -, and $\frac{7}{8}$ -in. diameters. The $\frac{1}{2}$ -in. Spirafil II produces a loss at 100 Mhz of 0.79 db/100 ft.

Phelps Dodge Electronic Products Corp., 60 Dodge Ave., North Haven, Conn. 06473. [358]



Greater channel capacity by existing Pacific cables

A new carrier telegraph system . . . "RECTIPLEX"

A brilliant development in multiplex telegraphy, called RECTIPLEX, will be put into Trans-Pacific telegraph service between Japan and U.S.A. in early 1968. It was developed by FUJITSU under a joint research plan with Kokusai Denshin Denwa Co., Ltd. (Japan Overseas Radio and Cable System).

The big problem was how to economically increase the speed and capacity of communication especially where cable installation or "for hire" cable is too costly . . . the trans-continental

or transoceanic, for example. The RECTIPLEX, in which unique eight-phase modulation enables carrying of three binary channels on one carrier, can transmit 108 binary channels of 50 bauds each over a single voice channel. RECTIPLEX line capacity is increased fivefold over that of the conventional 50-baud frequency modulation multiplex.

In addition, the bandpass filter is replaced by an integrator to achieve effective band utilization. An outstand-

ing demodulator eliminates noise, error and line interruption. And the RECTIPLEX handles higher speed transmission as well as standard 50-baud telegraph signals. These fine qualities promise a brilliant future in efficient data transmission as high-performance terminal equipment.

This is yet another example of innovation by FUJITSU, where brilliant initiative and mature experience are constantly focused on every problem of communications and electronics.



FUJITSU LIMITED

Communications and Electronics

Marunouchi, Tokyo, Japan

24 HOUR DELIVERY

PLEASE CONTACT OUR NEAREST REPRESENTATIVE

MICRO-MINIATURE ENCAPSULATED TOROIDS



CASE SIZE
7/16 DIA. X 1/4 HIGH
INDUCTANCE RANGE
30 MICRO-HENRIES—
200 MILLIHENRIES

NEW

MOLDED TOROIDS



P 48
33 Inductances
2.0 MH—600. MH
P 89
35 Inductances
1.5 MH—600. MH
P 06
53 Inductances
5.0 MH—7.2 HY
P 30
61 Inductances
5.0 MH—17.5 HY
P 90
56 Inductances
3.0 MH—6.0 HY
P 54
57 Inductances
20. MH—40. MH



P 45
43 Inductances
.05 MH—15. MH
P 50
52 Inductances
1.0 MH—4.0 HY
P 51
36 Inductances
1.0 MH—500. MH

QUALITY STOCK

MAY WE QUOTE ON YOUR:
FILTERS
DELAY LINES
PULSE TRANSFORMERS

WRITE FOR OUR COMPLETE CATALOGUE.

TOROTEL
INC.

13402 SOUTH 71 HIWAY
GRANDVIEW, MO. 64030
PHONE: SO 1-6314

New Semiconductors

Operational amplifier in plastic

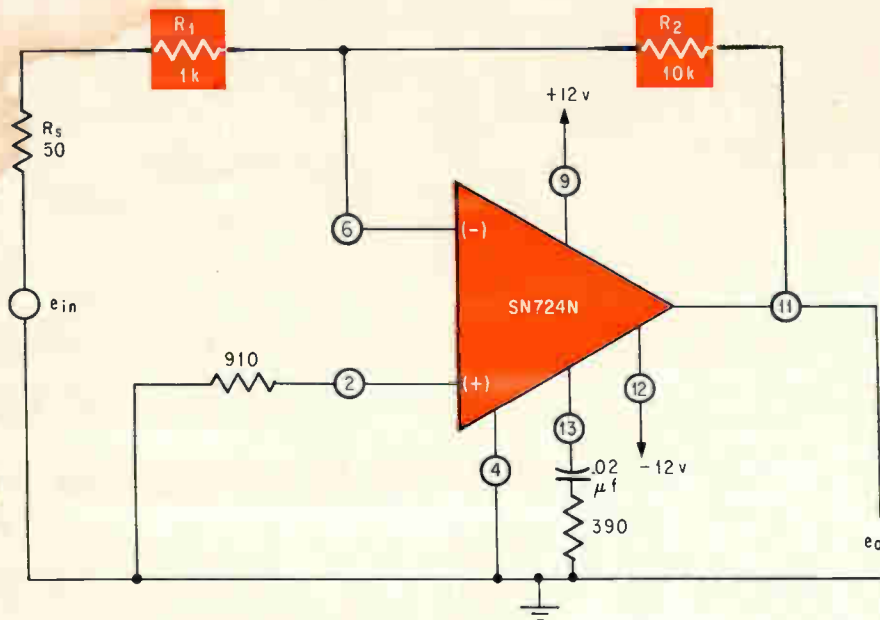

The latest evidence of a trend toward low-cost plastic encapsulation of linear integrated circuits is the introduction by Texas Instruments Incorporated of a general-purpose operational amplifier priced 40% below comparable metal-can units.

Described by TI as "the first premium-characteristic operational amplifier to be made available in a dual in-line package," the IC has guaranteed specifications between 0° and 70°C. The plastic-packaged SN724N is suitable for buffer amplification, summing, and gain-stable amplifier applications, and can also be used in comparators, oscillators, integrators, and differentiator circuits. Robert Grimes,

TI's product marketing engineer for linear IC's, says the monolithic circuit has low bias-current needs, high input impedance, and high common-mode rejection, and asserts that with a price tag of \$5.60 in lots of 100, "it is the least expensive operational amplifier with those characteristics."

In a gain-stable amplifier application, the guaranteed performance of the unit results in constant gain independent of device-to-device variations in the open-loop gain parameter. In the circuit, the gain figure is determined by the ratio of R_2 to R_1 . If, for example, R_1 is 1,000 and R_2 is 10 k, the gain is 10.

The chip shown at left contains two npn Darlington pairs and three pnp transistors. High input

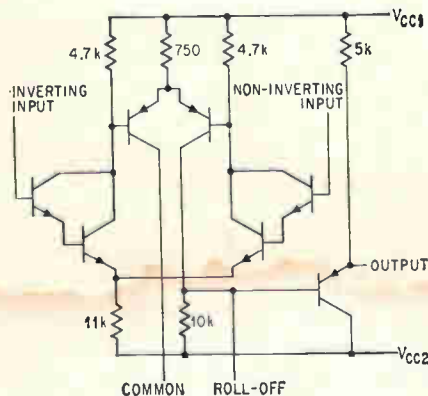

Typical characteristics at 25°C

Parameter	Value
Differential-input offset voltage	15mv
Temperature coefficient, offset voltage	30 μ v/°C
Input current	110na
Differential-input offset current	44na
Maximum output voltage	12v-pp
Maximum common-mode input voltage	\pm 5v
Voltage gain	1,200
Common-mode rejection ratio	55db
Bandwidth	140khz
Input impedance	800k
Output impedance	0.3k
Total power dissipation	120mw

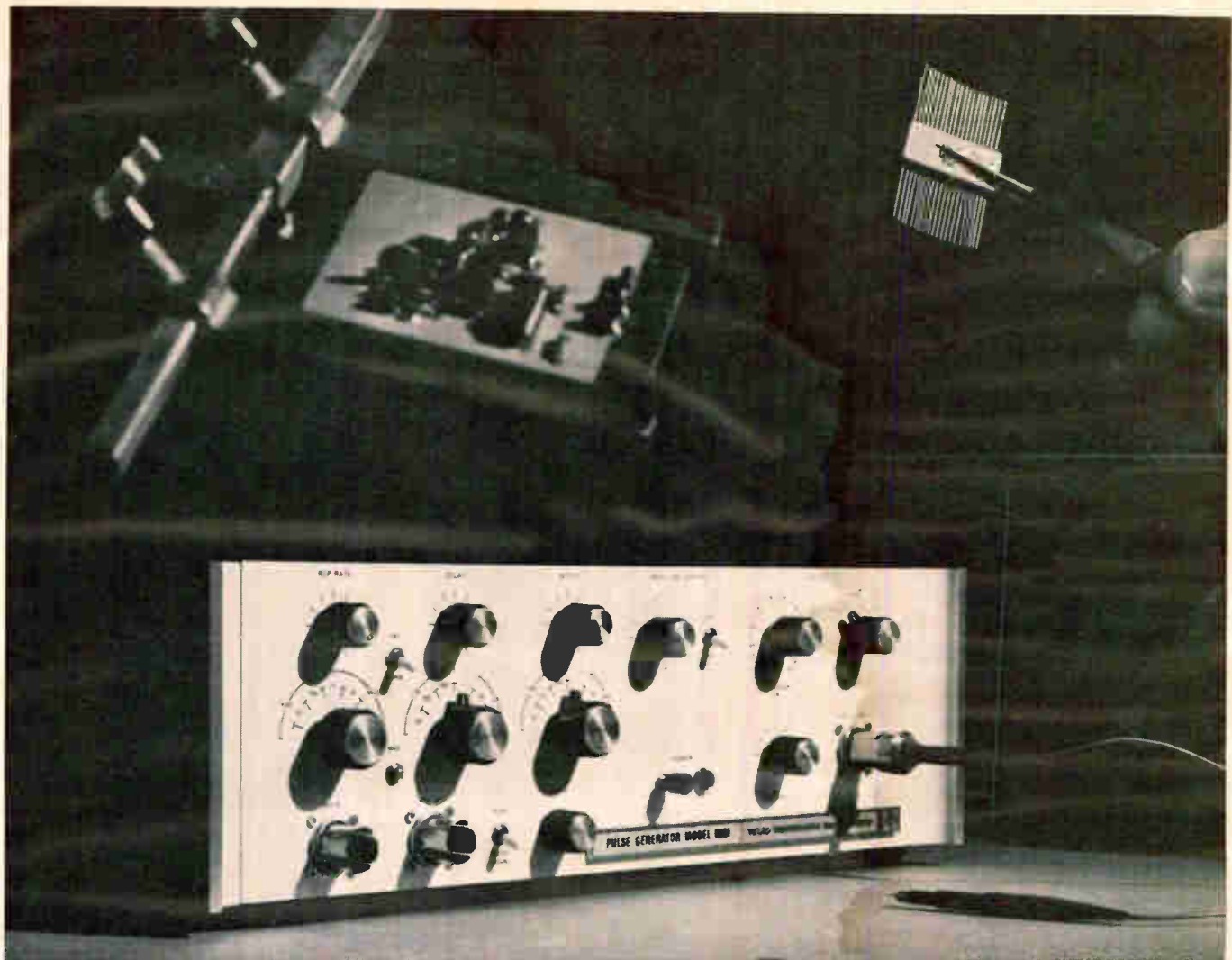

Why You Need a Special Pulse Generator for State of the Art Circuit Design



With high speeds and critical design parameters, you need the best test instruments to be sure your designs will be optimum. The TI Model 6901 Pulse Generator gives outputs from 1 KHz to 0.1 GHz; independent amplitude and baseline controls; jitter less than 0.1% of period + 50 psec; and countdown synchronization output.

The 6901 makes your designing simpler, too. Because the pulse amplitude of the generator can be changed without affecting DC offset, you can use the offset instead of an external bias supply for your circuit.

All this, and a price of only \$1950. For more information, contact your TI Field Office, or the Industrial Products Group, Texas Instruments Incorporated, 3609 Buffalo Speedway, Houston, Texas 77006.

TEXAS INSTRUMENTS
INCORPORATED

827

SPECTRUM ANALYZER OR SWEEP GENERATOR?



YES!

Here's performance versatility where it counts. Just take a look at the frequency patterns below and see how a Telonic Sweep Generator can double as a spectrum analyzer* in hundreds of applications.

If you're about to purchase either type of instrument, examine the possibilities of the SM-2000 that covers DC to 3000 MHz, provides CW as well as swept signals, at less than half the cost of a spectrum analyzer alone.



Response of a faulty CW oscillator, causing it to squibulate, or produce side bands around the fundamental signal.



Insertion loss of a modulated buffer amplifier with B+ reduced to 0. Using each 2 cm division of scope as 60 db, amplifier's attenuation is approximately 70 db.

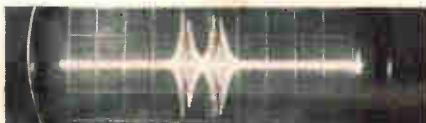

Direct comparison of known with unknown signal, the former attenuated to equal the unknown to determine its strength.



Frequency markers at 80, 90, and 100 MHz identify unknown frequency as approximately 77.5 MHz.



Response of an unstable test signal shown as blurred wave form when compared to a crystal controlled reference.



Display shows DC mark, fundament test signal, 1st harmonic, and 1/3, 1/2, and 2/3 of fundamental.

Telonic INSTRUMENTS
Division of Telonic Industries Inc.
50 NO. FIRST AVE., BEECH GROVE, INDIANA 46107, TEL (317) 787-3231

Representatives in all major cities in the U.S. and foreign countries.
Factory offices located at Maidenhead, England and Frankfurt, Germany

*CATALOG 70 COVERS THIS APPLICATION IN DETAIL PLUS A DOZEN MORE, AND CONTAINS COMPLETE SPECIFICATIONS ON OVER 30 INSTRUMENTS.



New Semiconductors

impedance is provided by the Darlington devices forming the differential stages.

Grimes stated that the addition of the SN724N brings TI's line of IC operational amplifiers to 10 and indicated that the company plans to soon offer plastic-encapsulated versions of some of its other linear integrated circuits.

Texas Instruments, Inc., P.O. Box 5012, Dallas, Texas 75222 [361]

Photosensing focuses on a 4-in-1 assembly

A four-quadrant position photosensor has been developed for use with homing devices, machine-control devices, servosystems, light-pickoff devices, and optical inspection equipment. Called the PIN-Spot/4, it is a sensitive silicon Schottky-barrier photodevice with four cells closely spaced on a single chip. The x and y positions of a defocused incident light spot are determined by comparing currents from each of the four quadrant cells.

There is uniform 5-mil spacing between the quadrants and capacitance is less than 5 pf per quadrant. Spectral response of the photosensor ranges from ultraviolet to near infrared. The unit is said to cover three times as many angstroms as a photomultiplier and to possess a short wavelength response unobtainable in ordinary silicon p-n detectors.

Response time of the PIN-Spot/4 is in nanoseconds, faster than most other solid-state type photodetectors, and as fast as a photomultiplier.

Minimum detectable light power is less than 10^{-12} watts. The dark current is less than half a microampere; light current is greater than $10 \mu\text{a}$ for a few footcandles illumination.

The device comes in a hermetically sealed TO-5 size package.

Price is \$37 each in quantities of one to 10; \$32 each, 11 to 50. Delivery takes two weeks.

United Detector Technology, P.O. Box 2251, Santa Monica, Calif. 90405. [362]

1 Take a tone generator... incorporating L-C oscillator and emitter follower, and available at 31 frequencies 120 c/s apart

2 two band-pass filters... available for 31 centre frequencies with an insertion loss less than 5db

3 a tone detector... with built-in amplifier, rectifier and d.c. switching circuit

4 and an electronic switch... (optional) incorporating two separate switches independently controlled by current or voltage sources—

and you've got a one-way channel of a low-cost, remote control or signalling system!

COMPLETE SYSTEM

Could it be simpler?

Four miniature transistorised units which enable you to build up your own remote control or telegraph system.

Up to 31 channels in the 540 to 4,000 c/s range.

Suitable for wire or radio link.

Plug into B.P.O. type-3000 relay bases or our universal chassis.

Low pass filter (2.7 or 2.3 kc/s) just added to the range.

Hybrid and line transformers available. Off-the-shelf delivery for common types.

Want to know more? Just write or telephone to:

Plessey Incorporated

170 Finn Court

Farmingdale, Long Island

New York 11735

Tel: 516 MY 4-7377 Telex: 126519

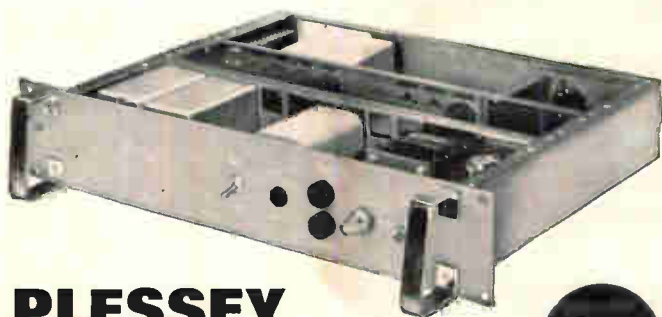
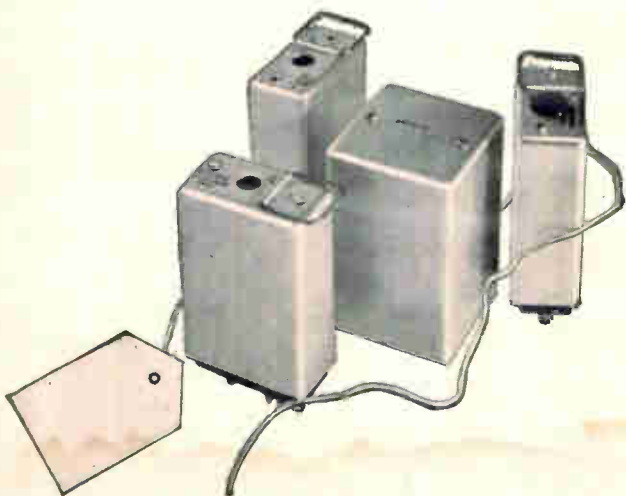

PLESSEY Electronics



PE(RT)6 US

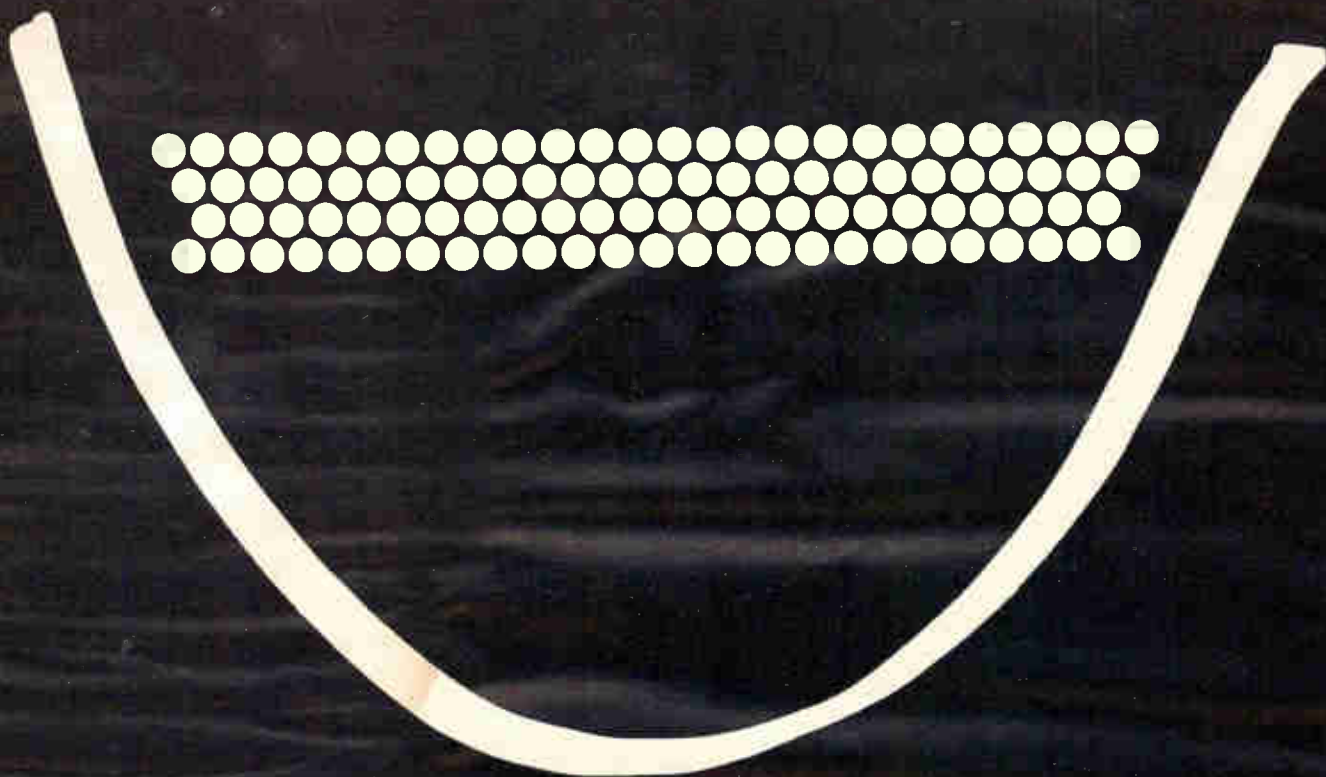

Now you can smile at weight and space problems...
 We doubled the density of our D Subminiature connectors.

You can get out of a tight spot fast by specifying crimp, removable snap-in contacts in ITT Cannon's popular D Subminiature shell configurations with double the contact density!
 You get two for the space of one in five different shell sizes. For instance, 100 contacts instead of 50. Also available in 19, 31, 52



and 79 contact arrangement sizes — all on .075" centers. The Double Density D is intermountable with our D Subminiature series, and uses the same wide range of accessories. The new series incorporates highly reliable CENTI-PIN® contacts which assure positive contact alignment and reduce contact bending, as well as providing a low noise level and electrical continuity even under severe vibration and shock.

These new Double Density D connectors are available in quantity now from your nearby ITT Cannon factory authorized distributor. For complete information write for Catalog 2D-1. ITT Cannon Electric, 3208 Humboldt Street, Los Angeles, California 90031. A division of International Telephone and Telegraph Corporation.



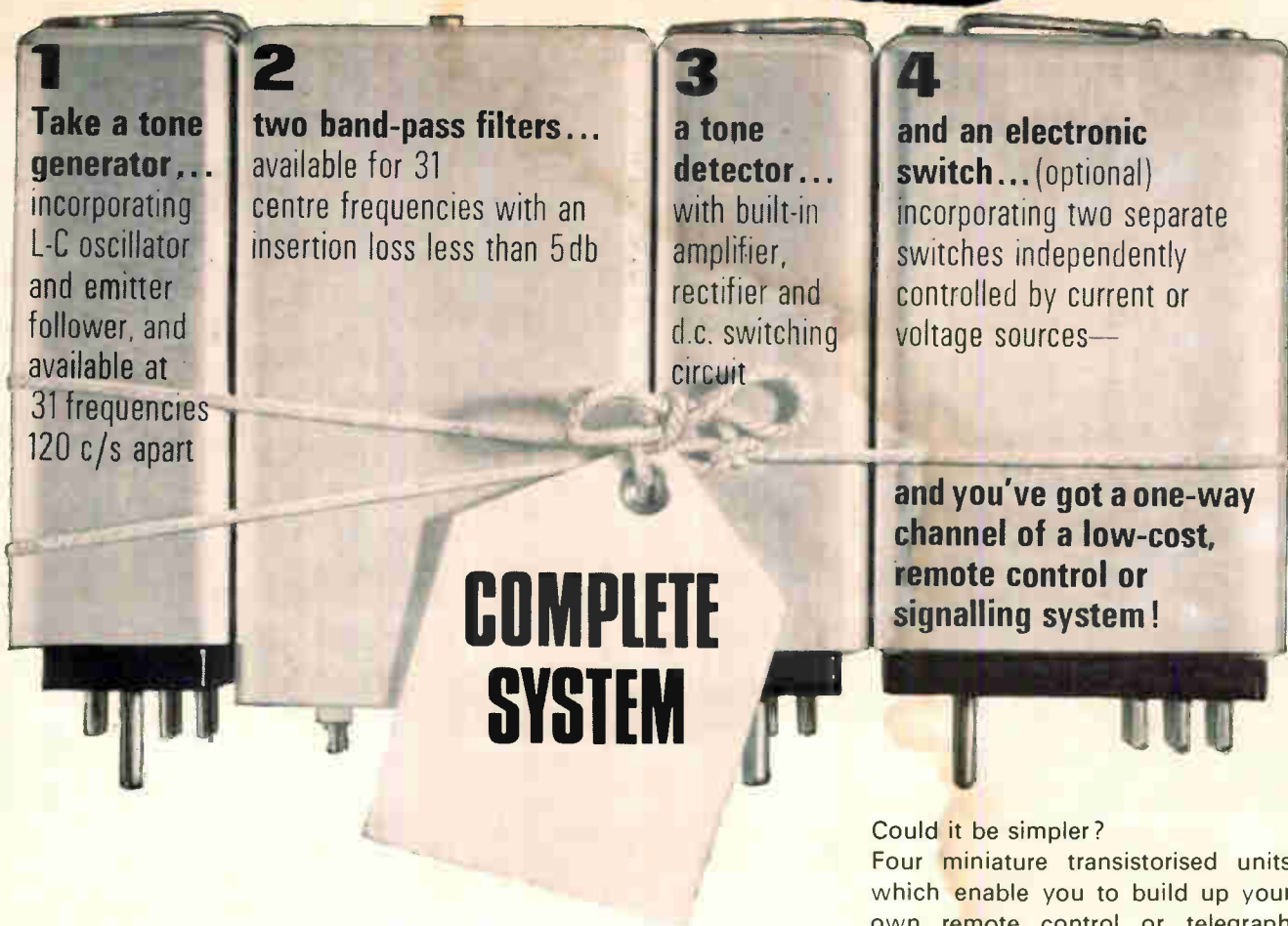

1 Take a tone generator... incorporating L-C oscillator and emitter follower, and available at 31 frequencies 120 c/s apart

2 two band-pass filters... available for 31 centre frequencies with an insertion loss less than 5db

3 a tone detector... with built-in amplifier, rectifier and d.c. switching circuit

4 and an electronic switch... (optional) incorporating two separate switches independently controlled by current or voltage sources—

COMPLETE SYSTEM

and you've got a one-way channel of a low-cost, remote control or signalling system!

Could it be simpler?

Four miniature transistorised units which enable you to build up your own remote control or telegraph system.

Up to 31 channels in the 540 to 4,000 c/s range.

Suitable for wire or radio link.

Plug into B.P.O. type-3000 relay bases or our universal chassis.

Low pass filter (2.7 or 2.3 kc/s) just added to the range.

Hybrid and line transformers available. Off-the-shelf delivery for common types.

Want to know more? Just write or telephone to:

Plessey Incorporated

170 Finn Court

Farmingdale, Long Island

New York 11735

Tel: 516 MY 4-7377 Telex: 126519

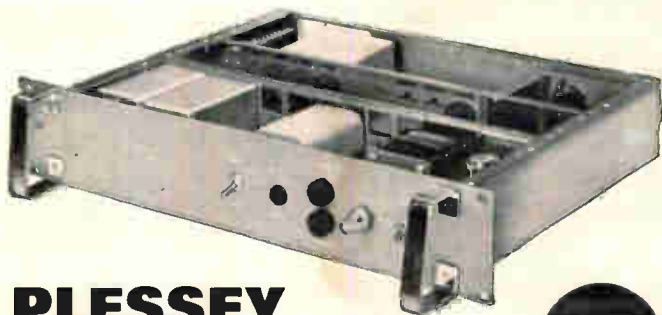
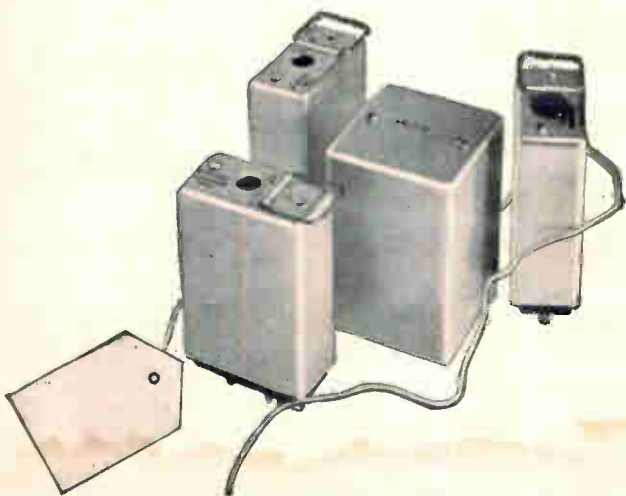

**PLESSEY
Electronics**



PE(RT)6 US

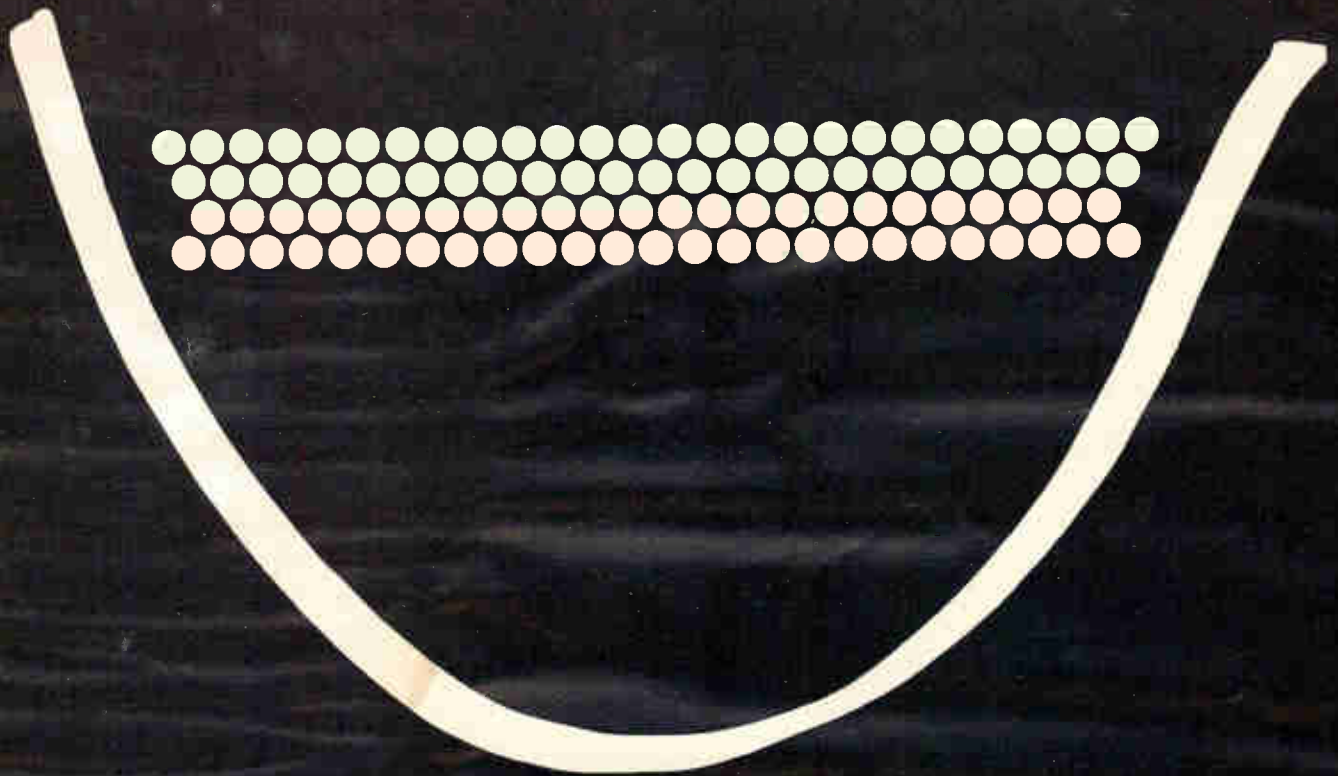

Now you can smile at weight and space problems...
 We doubled the density of our D Subminiature connectors.

You can get out of a tight spot fast by specifying crimp, removable snap-in contacts in ITT Cannon's popular D Subminiature shell configurations with double the contact density!

You get two for the space of one in five different shell sizes. For instance, 100 contacts instead of 50. Also available in 19, 31, 52



and 79 contact arrangement sizes — all on .075" centers.

The Double Density D is intermountable with our D Subminiature series, and uses the same wide range of accessories. The new series incorporates highly reliable CENTI-PIN® contacts which assure positive contact alignment and reduce contact bending, as well as providing a low noise level and electrical continuity even under severe vibration and shock.

These new Double Density D connectors are available in quantity now from your nearby ITT Cannon factory authorized distributor. For complete information write for Catalog 2D-1. ITT Cannon Electric, 3208 Humboldt Street, Los Angeles, California 90031. A division of International Telephone and Telegraph Corporation.



New Instruments

A new measure of calibration—speed

Almost every engineer has at one time or another had a test setup torn down because the calibration certification for the measuring instruments had lapsed. As bad as this is, the problem is compounded because the instruments can't be recalibrated quickly enough to avoid wasted time. In large companies, the backlog of instruments in need of calibration can become staggering. But now Electro Scientific Industries Inc. has developed a meter calibrating system that can do in five minutes what normally takes one to two hours manually.

Called the Model 70, the system is capable of calibrating multimeters, ohmmeters, d-c and a-c voltmeters and ammeters, as well as other similar instruments. Alternating and d-c voltages and currents accurate to within 0.05% and resistances accurate to within 0.01% are generated by the system in accordance with programs punched onto paper tape or cards. The calibration procedure for almost any instrument—covering all ranges and functions along with the accuracy limits for each measurement—can be punched, in a binary-coded decimal format, on a standard 80-column data card. This enables the cards to be prepared centrally and the procedures to be standardized.

Calibration results are printed out digitally, including the percentage deviation from full scale. If the instrument's measurement exceeds the programmed limits, the typewriter prints a pair of X's alongside the data, shown below. When no out-of-specification points are found, the system automatically produces a sticker that includes the instrument's serial number and date of calibration.

ESI claims that measurements can be done at a rate of one every five seconds. A punched card cor-



responding to a particular instrument type is selected from a file. The operator simply inserts the card into the system's card reader. A proceed button is then pressed and a lighted display instructs the operator at which function—voltage, current, or resistance—and range to set the instrument being calibrated. The button is pressed again and the function is applied. The function's value—up to 15 on any range—is shown as a fraction of full scale in a second lighted display. A dial on the system's front panel is adjusted to enable the instrument being calibrated to read the applied function properly. A shaft encoder senses the dial's setting, from which the system computes the deviation percentage.

The calibrating system is basically a set of programmable generators. The basic signal for all active functions is d-c, derived from a standard cell. A constant-current generator that is connected to a current divider is driven by the cell. The divider output is brought to a summing junction at the input of an error amplifier, the output of which feeds into an electronic chopper. Frequency of the chopper's reference signal determines the system output frequency, which ranges from 50 hertz to 20 kilohertz. The frequency is derived from a set of four crystals followed by a chain of nine binary scalars to produce any one of 36 possible output frequencies.

If the system output is an a-c

25.0	VOLTS AC 09			
02/02	3.3 PCT XX	01/02	3.1 PCT XX	
50.0	VOLTS AC 09			
02/02	2.5 PCT	01/02	2.5 PCT	

HERE ARE YOUR AUTHORIZED CANNON DISTRIBUTORS

ALABAMA

Nelson Radio & Supply Company, Inc.
Mobile
Phone: (205) 479-1471

ALASKA

Alaskan Aircraft Equipment Supply, Inc.
Anchorage
Phone: 907 322-3202

ARIZONA

Kimball Electronics, Inc.
Phoenix
Phone: 602 264-4438

CALIFORNIA

ABC Connectors, Inc.
North Hollywood
Phone: 213 875-0665,
765-8881, 983-1738

K-Tronics

Los Angeles
Phone: 213 695-5888
Kierulff Electronics, Inc.
Pain Alto
Phone: 415 968-6292

Liberi Electronics

Inglewood
Phone: 213 678-8111
Rafferty Electronics, Inc.
North Hollywood
Phone: 213 761-6133,
877-2651

San Debor, Inc.

San Diego
Phone: 714 274-3131,
276-2653

COLORADO

Waco Electronics
Denver
Phone: 303 322-7708

CONNECTICUT

Connector Corporation of America
New Haven
Phone: (203) 624-0127

FLORIDA

Electro Air of Florida, Inc.
Orlando
Phone: 305 241-5461
Industrial Electronics Associates, Inc.
Palm Beach Gardens
Phone: 305 848-8686

GEORGIA

Electro Air Corp.
Atlanta
Phone: 404 351 3545

HAWAII

Pacific Electronics
Honolulu
Phone: 808 810-1111
Radio-Television Corp., Ltd.
Honolulu
Phone: 808 564-416,
52-901

ILLINOIS

Merquip Electronics, Inc.
Chicago
Phone: 312 282-5400
Radio Distributing Company, Inc.
Chicago
Phone: 312 379-2121

INDIANA

Radio Distributing Company
Indianapolis
Phone: 317 637-5571
Radio Distributing Co., Inc.
South Bend
Phone: (219) 287-2911

KANSAS

Hall-Mark Electronics
Kansas City
Phone: (913) 236-4343

LOUISIANA

Southern Radio Supply Company, Inc.
New Orleans
Phone: (504) 524-2345

MARYLAND

Radio Distributing Co.
Baltimore
Phone: (301) 377-6402,
377-4616

MASSACHUSETTS

Lafayette Industrial Electronics
Natick
Phone: Boston (617) 969-6100
Natick (617) 875-1358

MARYLAND

Radio Distributing Co.
Baltimore
Phone: (301) 377-6402,
377-4616

MASSACHUSETTS

Lafayette Industrial Electronics
Natick
Phone: Boston (617) 969-6100
Natick (617) 875-1358

Schwabe Electronics

Waltham
Phone: (617) 891-8484

MICHIGAN

Newark-Detroit Electronics, Inc.
Detroit
Phone: (313) 548-0250

MINNESOTA

Lew Bonn Co.
Minneapolis
Phone: (612) 339-9461

MISSISSIPPI

Elliington Electronic Supply, Inc.
Jackson
Phone: (601) 355-0561

MISSOURI

Electronic Components for Industry Co.
St. Louis
Phone: (314) 647-5505

MONTANA

Electronic Supply Company
Billings
Phone: (406) 252-2197

NEW MEXICO

Waco Electronics, Inc.
Albuquerque
Phone: (505) 268-2409

NEW YORK

Progress Electronics Co., Inc.
Plainview, L. I.
Phone: (516) 433-1700
Schwabe Electronics
Westbury
Phone: (516) 334-7474

Stack Industrial Electronics, Inc.

Binghamton
Phone: (607) 723-6326
Summit Distributors, Inc.
Buffalo
Phone: (716) 884-3450

Time Electronic Sales
Great Neck, L. I.
Phone: (516) 487-0100

NORTH CAROLINA

Kirkman Electronics, Inc.
Winston-Salem
Phone: (919) 724-0541

OHIO

Hughes Peters, Inc.
Cincinnati
Phone: (513) 381-7625
Hughes Peters, Inc.
Columbus
Phone: 614 294-5351

Radio Distributing Company, Inc.

Willoughby
Phone: (216) 946-0900

OKLAHOMA

Hall-Mark Electronics
Tulsa
Phone: (918) 835-8458

PENNSYLVANIA

Aercon, Inc.
Clifton Heights
Phone: 215 622-2500
Philadelphia Electronics, Inc.
Philadelphia
Phone: (215) 568-7444

Radio Parts Co., Inc.
Pittsburgh
Phone: (412) 361-4600

TENNESSEE

Lavender Radio & TV Supply, Inc.
Memphis
Phone: (901) 276-2756

Texas

Hall-Mark Electronics Corp.
Dallas
Phone: (214) 231-2531
Harrison Equipment Co., Inc.
Houston
Phone: (713) 224-9131

McNicol, Inc.
El Paso
Phone: (915) 566-2936
Sterling Electronics, Inc.
Dallas
Phone: (214) 357-9131

Wholesale Electronic Supply, Inc.
Dallas
Phone: (214) 824-3001

UTAH

Kimball Electronics, Inc.
Salt Lake City
Phone: (801) 328-2075

WASHINGTON

Kierulff Electronics, Inc.
Seattle
Phone: (206) 725-1550

MELPAR

Where Performance Comes

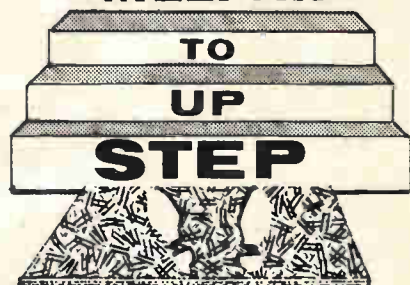

FIRST

With 22 years of achievement in space and defense programs, MELPAR continually expands horizons of R & D into broad new capabilities. Intimately associated with Mercury, Gemini and Apollo, we are now pioneering creative efforts on Voyager, Nimbus, Delta, and advanced Technical and Orbital Satellites.

Exciting opportunities exist in the following areas:

ASTRO SYSTEMS CENTER

Located at NASA Goddard Space Flight Center

The ASTRO Systems Center operates laboratories engaged in **Astrochemistry, Astrophysics, Systems Integration, Monocrystalline Integrated Circuitry, Heat and Thermodynamics.** Additionally, the Center has very attractive positions for Mechanical, Electrical and Chemical Engineers, as well as for Information Processing Specialists and Design personnel in its diversified operations at the Goddard Space Flight Center, Marshall Space Flight Center, Manned Space Flight Center, Wallops Station and Electronics Research Center of the National Aeronautics and Space Administration.

APPLIED ELECTRONICS DEPARTMENT

- RF circuit design for automatic and remotely controlled HF receivers, HF, VHF and UHF Frequency Synthesizers—Video Signal Processing
- Design of small special purpose digital computers and programming for real time and control applications, mathematical modelling.
- Theoretical and experimental design of missile and ground-based microwave antennas and microwave receivers and Microwave Components
- Advanced circuitry development and computer application related to information handling and processing.

SIMULATION & TRAINING DEPARTMENT

Computer systems design, programming, analysis and Human Factors for advanced weapon systems and tactics trainers.

THE AVIONICS DEPARTMENT

Radar, countermeasures and microminiature packaging techniques for aircraft avionics systems—video, HF transistor circuitry design

ELECTRONICS RESEARCH CENTER

- Data Compression Systems
- Redundancy Removal Coding Techniques
- Phonetic Pattern Recognition.
- Signal Enhancement Techniques.
- Wave Propagation-Acoustic-Electromagnetic.
- Underwater Systems Research.
- Thin Film Microelectronic Circuits
- Seismics

FIELD SERVICE ENGINEERS

- Flight Simulators
- Airborne Radar Countermeasures

CHEMISTRY & LIFE SCIENCES CENTER

Develop methodology for detecting low levels of microbial contamination in and on spacecraft and space hardware to include Apollo and other major space programs.

INSTRUMENTATION LABORATORY

Instrumentation and technology of physical and chemical properties to include gas chromatograph, aerosols, measurements and particle size determinations.

Write, in confidence, to: **Manager, Professional Placement**

WABCO MELPAR, INC.

A SUBSIDIARY OF WESTINGHOUSE AIR BRAKE COMPANY

7764 ARLINGTON BOULEVARD, FALLS CHURCH, VA. 22046

(Suburb of Washington, D. C.)

An Equal Opportunity Employer M/F

New Instruments

voltage, the chopper output is passed through a five-pole Butterworth filter to extract the sinusoidal fundamental of the chopper's square-wave output. But if the required output is d-c, the chopper output bypasses the filter. In either case, the signal is applied to a power amplifier and on to an output transformer. Taps on the transformer accommodate the desired range of output voltages and currents. For a-c outputs, the transformer is connected directly to the load; for d-c, it is rectified and filtered.

To control the amplitude of the test signal, the output is sampled, fed back to a programmable resistor decade, passed through an a-c to d-c converter, and referenced to the standard cell.

Model 70's basic price is about \$25,000, including the typewriter, but will vary depending on the options desired.

Electro Scientific Industries Inc., 13900 N.W. Science Park Dr., Portland, Ore. 97229 [371]

Kelvin-Varley prices drop

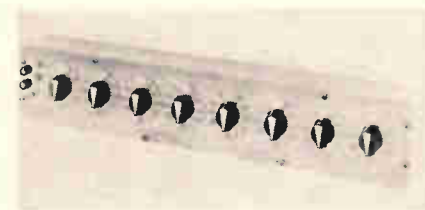

A price breakthrough is claimed for a Kelvin-Varley divider with 1-ppm (0.0001%) accuracy. The company says one of the factors contributing to the low cost—\$339, about two-thirds lower than comparable units—is the use of a Wheatstone bridge during production to select groups of components matched to a few parts in 10 million (0.00002%) at a rate of hundreds per hour.

Model DV5008 has eight dials and provides 0.01 ppm resolution. All dials are discrete position decades; the unit contains no potentiometers.

Features include accuracy (ter-

minal linearity) for settings from 0.1 to full scale of ± 1 ppm (for settings below 0.1 accuracy improves to 0.004 ppm); rugged construction; wear-proof numerals and lettering; and in-line numeric display.

General Resistance, Inc., 430 Southern Blvd., Bronx, N.Y. 10455 [372]

Six-in-one amplifier/oscillator



Called a virtual "lab in a box," a tuned amplifier/oscillator is actually six instruments in one. It can function as a wave analyzer, a distortion analyzer, a selective a-c voltmeter (maximum full-scale sensitivity of $10 \mu\text{v}$), a low-noise amplifier (maximum gain of 10,000), a low-distortion oscillator (providing up to 5 v rms into 600 ohms and capable of being synchronized by external signals), and an all-pass delay phase shifter.

The Model 110 is basically a selective amplifier with a Q variable from 1 to 100 operating in the frequency range of 1 hz to 110 khz and providing four outputs simultaneously: a resonance bandpass; a band-reject or notch; a flat output; and a second order all-pass.

The unit measures 19 x 5 $\frac{1}{4}$ x 12 in. and costs \$1,195. Delivery takes 60 days.

Princeton Applied Research Corp., P.O. Box 565, Princeton, N.J. 08540. [373]

Economically priced sweep generator

Developed for production-line testing of uhf tv tuners, a solid state sweep generator is priced at under \$350. Designated Model 1005, the unit features continuously variable tuning from 450 to 910 Mhz, an output level of 0.5 v rms, a sweep width that can be varied from 5 to 50 Mhz, and a number of options to adapt the instrument to specific

Glass-Epoxy

Copper-Clad

through TAYLOR'S TOTAL RELIABILITY PLAN:

Raw materials, panels or punched blanks to your reliability requirements. You get what you order from a fully integrated source.

FAST DELIVERY from two fully equipped plants — one at Valley Forge, Pa., the other at La Verne, Calif. Or from warehouses in Chicago, Ill. and other key locations.

... **FULL SIZE SHEETS, CUT-TO-SIZE PANELS** or **PUNCHED BLANKS** to satisfy fabricating and processing requirements. Ease of fabrication is a plus value in printed circuit production.

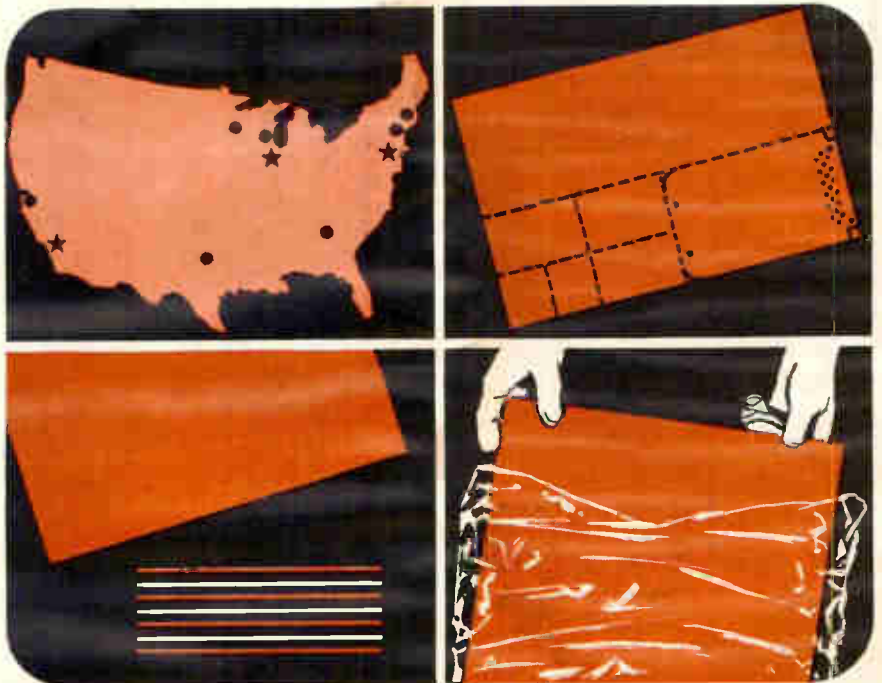

... **STANDARD AND ULTRA-THIN FORMS.** Standard sheets in all grades. Ultra-thin sheets and multilayer prepreps in GEC 500 (G-10) and Fireban 600 (G-10, FR-4).

... **WHITE GLOVE HANDLING** in atmosphere-controlled white rooms, careful processing, extremely tight quality control and special packaging assure top performance.

Taylor's copper-clad has proven total reliability demonstrated by an ever increasing number of major OEM's and commercial etchers. This acceptance substantiates our claim for unsurpassed quality, ease of fabrication and delivery to your scheduled requirements. Let us demonstrate this reliability to you. Ask for a sample (give grade designation and copper combination) and a copy of Bulletin GB-2.



Taylor copper-clad

TAYLOR CORPORATION • Valley Forge, Pa. 19481

Phone: 215-666-0300 TWX: 215-666-0659

West Coast Plant: La Verne, Calif.

Also manufacturer of Taylor laminated plastics, Taylorite® vulcanized fibre and Tayloron® prepreps



NEW from McGRAW-HILL

1. DIGITAL COMPUTER USER'S HANDBOOK. By MELVIN KLERER and GRANINO A. KORN. **New.**

Written to be used, this book presents an invaluable collection of essential material on computer applications, programming and numerical analysis.

In it a group of experts have pooled their talents and experience to provide reliable guidance on such subjects as list processing, sorting and merging, interpolation and curve fitting, symbolic logic, linear and nonlinear programming, commercial data processing, information retrieval, and scheduling and inventory control. They have produced a manual of great utility and extraordinary clarity. **750 pp., \$27.50.**

2. HANDBOOK OF TELEMETRY AND REMOTE CONTROL. ELLIOT L. GRUENBERG, Editor-in-Chief. **New.**

This comprehensive handbook has been prepared by a group of experts to present, for the first time and all in one place, the fundamental principles of information, communication, and control system theory — as well as all of the practical data required for both industrial and space applications. Remote handling and manipulation are discussed, the design of transistor circuits is covered for the first time in a telemetry book, and many recent advances, such as PCM telemetry and phase-locked loops, are exhaustively treated. **1200 pp., \$35.00.**

3. MODERN COMMUNICATION PRINCIPLES. With Application to Digital Signaling. By SEYMOUR STEIN and J. JAY JONES. **New.**

For engineers who are active in the field as well as those involved in peripheral activities, this is an uncommonly convenient, complete source of ready information on modern communications. Applications to system design are emphasized throughout. The style is clear and to the point. **416 pp., \$15.00.**

4. MOSFET IN CIRCUIT DESIGN: Metal-Oxide Semiconductor Field-Effect Transistors for Discrete and Integrated-Circuit Technology. By ROBERT H. CRAWFORD. **New.**

This sixth book in the Texas Instruments Electronics Series gives circuit designers the basic principles necessary in MOSFET device and circuit engineering, and includes a description of an actual MOSFET complex integrated circuit. **144 pp., \$10.00.**

At your bookstore or direct from publisher

10 DAYS FREE EXAMINATION

McGraw-Hill Book Co., Dept. 23-L-529
330 West 42nd Street, New York, N. Y. 10036



Send me the book(s) circled below for 10 days on approval. In 10 days I will remit for book(s) I keep, plus a few cents for delivery costs, and return others postpaid. Include local sales tax if applicable.

1 035043-9 3 061003-0

2 025075-3 4 013475-9

NAME (print) _____

ADDRESS _____

CITY _____

STATE _____ ZIP CODE _____

For prices and terms outside U.S. write McGraw-Hill Int'l, NYC

23-L-529

New Instruments



production-line assignments.

Options available with the 1005 include: a selection of attenuators, 10-db and 3-db steps, or 50 db continuously variable at 50- and 75-ohm impedances; remote control of sweep width and/or attenuation; either binary or pulse-marker systems providing single frequency and color, and video markers.

As an additional convenience, the pulse-marker system allows a selection of scope vertical signal addition, intensity modulation, and r-f output level modulation displays.

The range of the 1005 and its frequency-marking capabilities suit it for use in aligning uhf tv receivers and tuners, and for testing filters, attenuators, and similar devices.

The instrument measures 8½ in. wide, 6¼ in. high, and 12 in. deep. Telonic Instruments, 60 No. First Ave., Beech Grove, Ind. [374]

Temperature sensor responds in 100 msec

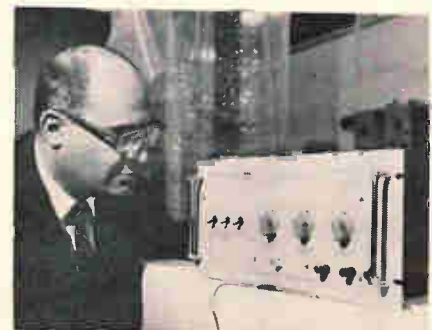

Oceanographic researchers should be helped by an in-ocean temperature sensor system with high sensitivity and fast response time. The SV-201 system measures small in-

crements of temperature over a wide range by scale expansion techniques. Output is provided in either analog or digital form depending upon requirements.

By electronically expanding the scale of standard analog measuring devices, such as voltmeters and strip-chart recorders that normally measure to within accuracies of 2% to 3%, an over-all accuracy of $\pm 0.02^\circ$ can be achieved over a temperature range of 30° or more. Response time with the appropriate sensor is in the order of 100 msec.

The system may be used with standard or special resistance-type wire sensors designed for in-ocean environment, including those made of platinum. Any number of sensors can be accommodated by the system design.

Solid state circuitry is used throughout the SV-201 series. The power supply is a plug-in unit. The basic amplifier is encapsulated and miniaturized.

GCA Corp., Burlington Road, Bedford, Mass. 01730. [375]

A-c/d-c voltmeter yields high accuracy

Laboratory, production, and field applications are seen for a solid state a-c/d-c voltmeter. The instrument offers d-c accuracy of 0.2% of reading, a-c accuracy of 0.2% of reading, 100- μ v null sensitivity, and a 6-digit in-line readout with automatic decimal. It incorporates an ultrastable, temperature-compensated zener reference that is not adversely affected by shock, vibration, wide temperature excursions, or short-circuiting. The voltmeter achieves very high sensitivity and resolution through use of a stable and sensitive 100- μ v, full-scale null detector.

Compact and portable, the model 345A is available with a self-contained rechargeable battery that provides up to 60 hours of operation. Precision wirewound resistors, aged and tested, ensure long-term stability and low temperature coefficient.

Ranges are 1,000 v, 110 v, and 1,100 mv a-c and d-c, and 110 mv d-c.

Precision Standards Corp., 911 Westminster Ave., Alhambra, Calif. [376]

IF THERE IS

MORE THAN ONE VOLTAGE LEVEL

YOU
NEED

VOLTROL® STABILIZERS WITH EI LAMINATIONS

Where multiple output voltage levels are required the importance of lamination design in stabilizing the voltage outputs in constant voltage transformers should be a critical factor in specifying a voltage stabilizing system.

With thin gauge EI laminations the magnetic core of a voltage stabilizer can be adjusted during construction to compensate for variation in electrical parameters. The addition or removal of one or more EI laminations to or from the core stack, while the unit is under construction, can correct minor voltage differences. This then permits that the output voltage can be set precisely to a specified nominal value.

When the proper functioning of electronic equipment is dependent upon the stabilization AND VALUE of the voltage supply, then Voltrol Stabilizers built with EI laminations and precisely adjusted to specified voltages are the solution to this problem.

Voltrol® is a trademark of Acme Electric



Write for a copy of Bulletin 09 and an "Electro-Technology" reprint covering "Transformer Lamination Design for Constant Voltage Stabilizers".

Acme Electric

315 WATER STREET
CUBA, NEW YORK 14727



Cinch
Creative
Problem
Solving

for the most precise connectors...

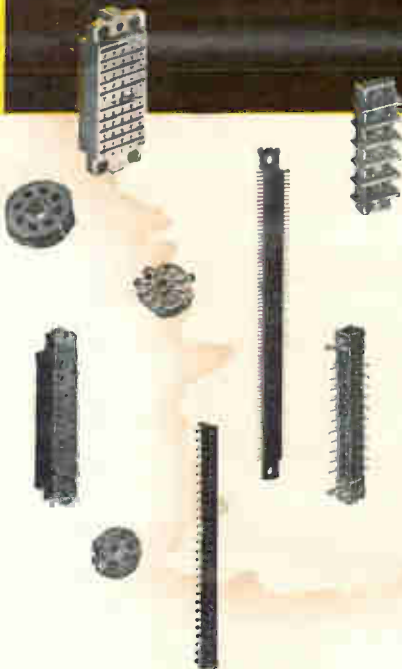

When a radical new precision transfer molding press was developed by Hull Corporation, Cinch installed the first prototype . . . and now has nine of them.

RESULT: Insulators for Cinch connectors are structurally better, with higher density and higher dielectric strength and insulation resistance than insulators *of the same material* molded by others! This is achieved through a special rapid cure stage utilizing a 7½ KW, 100 MHz dielectric heater.

Cinch knowledge and experience in precision plastic molding is known and respected throughout the industry. That's why Hull came to Cinch with the first unit. Cinch production engineers supervised the field testing, recommended and assisted in the engineering of necessary design changes—and then ordered eight more units!

Here is another demonstration of the extra dimension in Cinch's design and engineering skills. Beyond the ability to develop fine products, we offer in-depth production engineering capabilities, including tool, die, mold and equipment design and fabrication.

MEMBER

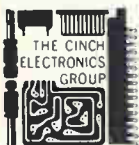

CINCH

DIVISION OF UNITED-CARR

CONSISTING OF CINCH MANUFACTURING COMPANY, CINCH-GRAPHIK, CINCH-MONADNOCK, CINCH-NULINE, UCINITE (ELECTRONICS) AND PLAXIAL CABLE DEPT.



pioneer
the
newest
molding
equipment

Our skills and services are available to you. For Cinch creative problem solving assistance, contact Cinch Manufacturing Company, 1026 South Homan Avenue, Chicago, Illinois 60624.

New Subassemblies and Systems

Contour control shapes up at low cost

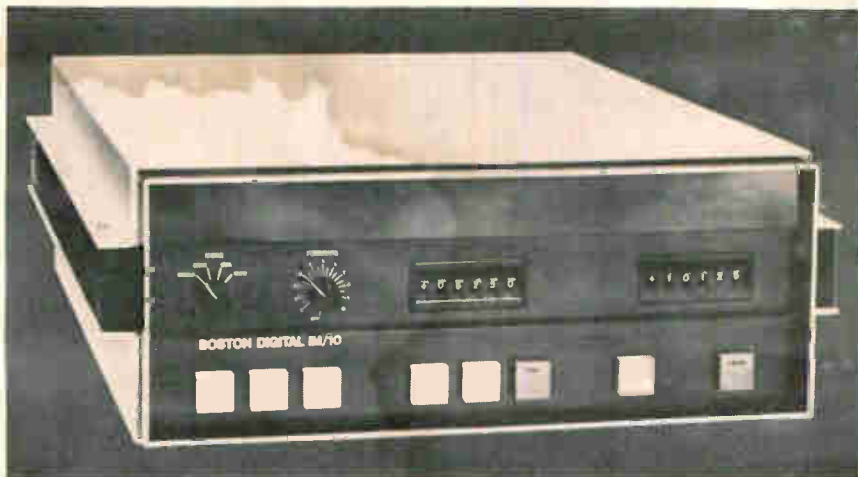

While the giant manufacturers of control systems for machine tools have concentrated on the metal-working industry, a diminutive newcomer to the field—the two year-old Boston Digital Corp.—has turned to areas in which the competition hasn't tread. A low-cost numerical control device has been developed by the firm for machines to which numerical techniques haven't previously been applied.

Although the first systems sold by the company are being used on milling machines, major intended applications include sewing and pattern-cutting machines, glass- and wood-working machines, seam welders, and flame cutters—machines requiring a tool or working head to be moved precisely across a predetermined path.

Boston Digital's positioner, called the IM/10 digital interpolator, is a two-axis contour control device. Its low price—the basic model, which accepts a four-digit manual input, costs less than \$6,500—is what the company feels will make it most attractive to equipment builders. Built almost entirely of Philco-Ford DTL integrated circuits, the device automatically generates two separate pulse trains that, when applied to step motors or analog servos, interpolate a straight line between two input points. A circular interpolation feature can be added to the IM/10 at a cost of \$700.

Coupled with a \$2,000 tape reader at its input, the interpolator costs just about as much as low-cost point-to-point control systems. But it is roughly half the price of other contour control devices, which cost \$15,000 and up. A circular interpolation feature on the more expensive devices can add thousands of dollars to the price.

Boston Digital's interpolator was designed to be used by itself or as a building block in a larger, computer-controlled system. Options were designed to enable each user to customize the device to meet his needs and pocketbook.

The IM/10 is available with manual, punched or magnetic tape inputs. It can also be driven directly by a digital computer, time-shared in a multiaccess system, or driven remotely over a Dataphone set.

The interpolator will interface with any stepper motor. Velocities of 240 inches per minute can be achieved with 0.001-inch resolution because of the filtered output pulse train, says the company. The device can drive synchros, resolvers, or potentiometers to obtain digital-to-analog conversion. Standard rate control is 0 to 3 kilohertz, variable through a front-panel potentiometer. Unfiltered output for analog servocontrol is available up to 50 khz.

Most options can be accommodated within a 7-inch-high standard design rack. Other features include

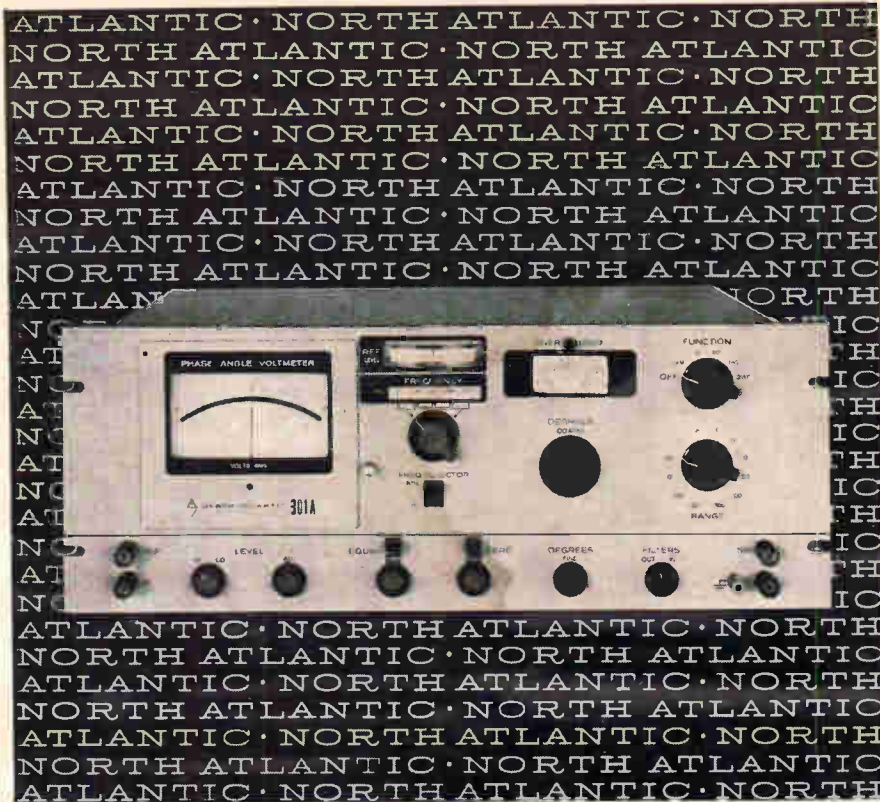

how to measure phase angle down to $.25^\circ$ from 10Hz to 100KHz (plus in-phase and quadrature!)

North Atlantic's Model 301A Broadband Phase Angle Voltmeter* adds a new dimension to AC by enabling you to measure phase angle, in-phase and quadrature while frequency is varying over half-decades... without recalibration. It provides complete coverage from 10Hz to 100KHz and incorporates plug-in filters to reduce the effects of harmonics in the range from 27Hz to 28KHz with only 11 sets of filters. Vibration analysis and servo analysis are only two of the many applications for this unit. Selected specifications are listed below:

Voltage Range.....	1 mv to 300 volts full scale
Voltage Accuracy.....	2% full scale
Phase Dial Range.....	0° to 90° with 0.1° resolution (plus 4 quadrants)
Phase Accuracy.....	0.25°, 31.6Hz to 31.6KHz (derating to .6° at 10Hz, 1° at 100KHz)
Input Impedance.....	10 megohms, 30 μ f for all ranges (signal and reference inputs)
Reference Level Range.....	0.15 to 130 volts
Harmonic Rejection.....	50 db
Nulling Sensitivity.....	less than 2 microvolts
Size.....	19" x 7" x 13½" deep
Price.....	\$2290.00 plus \$160.00 per set of filters

North Atlantic's sales representative in your area can tell you all about this unit as well as other Phase Angle Voltmeters* for both production test and ground support applications. Send for our data sheet today.

*Trademark



NORTH ATLANTIC industries, inc.
TERMINAL DRIVE, PLAINVIEW, NEW YORK 11803 • 516-681-8600

New Subassemblies

five- and six-digit ranges, a one-block input buffer, relay contact closures, z-axis control and absolute command positioning.

Boston Digital Corp., Ashland, Mass. [381]

Accessory provides automatic log plot

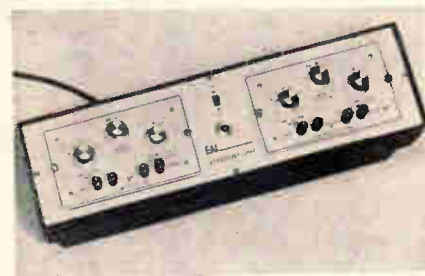

Logarithmic or a-c plotting versatility can be added to any x-y recorder with a new accessory unit. Designated the Model 5.46.0001, the self-contained unit accepts two plug-in modules and provides power for their operation in an x-y plotter.

Fast, accurate logarithmic plots of linear a-c or d-c functions are provided when the Model 12.1384 log module is included, and automatic presentations of high-frequency a-c sine-wave signals are provided when the Model 12.1134 a-c module is used. The modules can be interchanged at will.

The 12.1384 log module generates logarithmic plots of an input rms a-c or \pm d-c voltage function in either the arm or pen axis. When used in the accessory unit, it permits measurement with any x-y recorder to offer d-c/log, a-c/log, or log/log recording.

The 12.1134 a-c module enables the user to record sine-wave signals generated by a-c amplifiers, transducers, audio measuring devices, and analog computers generating sine-wave signals. It can also be used in either the arm or pen axis.

Both rack and bench facilities are provided Panel height is 5¼ in. Electronic Associates Inc., West Long Branch, N.J. [382]

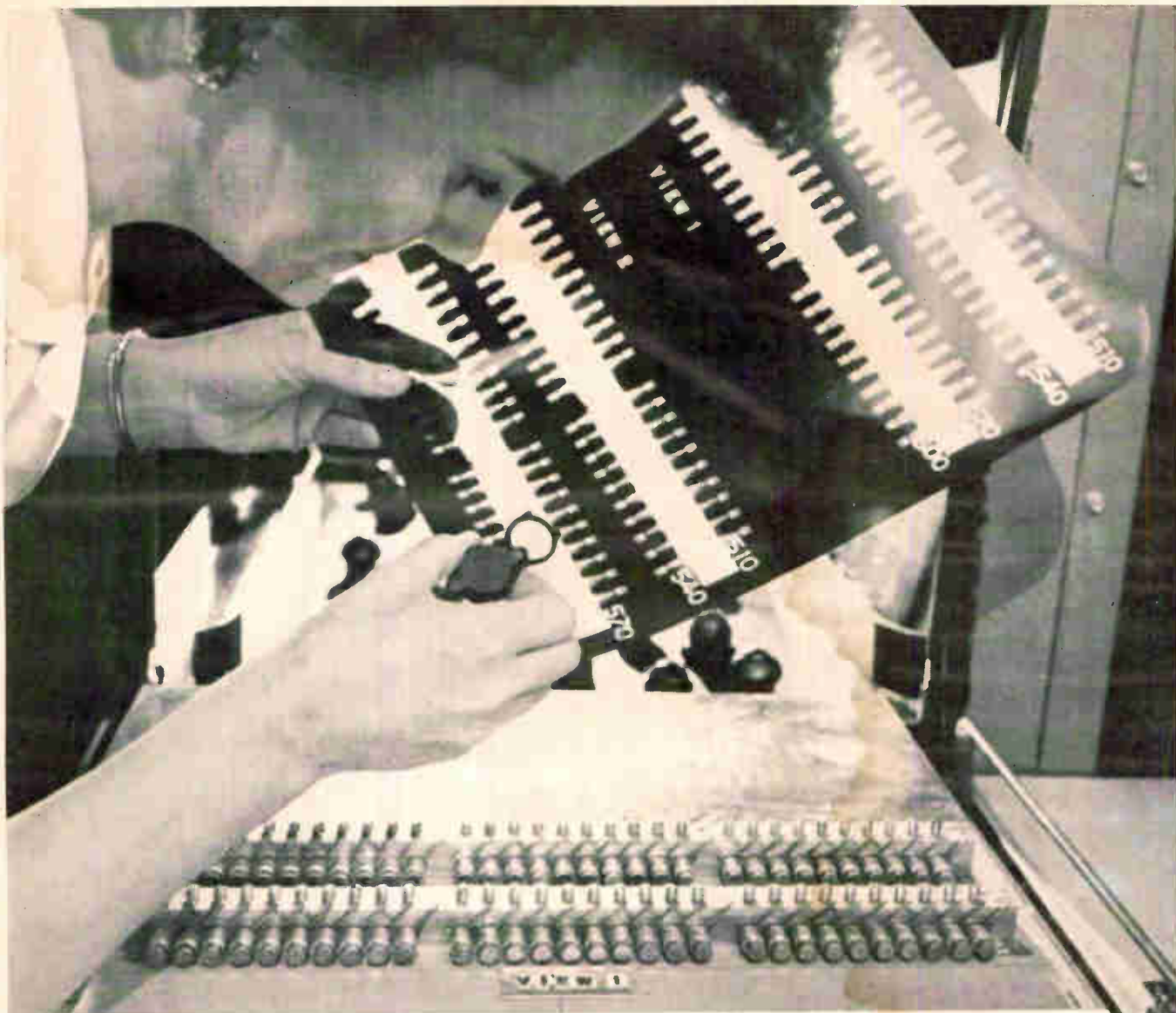

Texas Instruments chooses GAF x-ray film to prove there's not the tiniest mistake



Texas Instruments Incorporated, a prime manufacturer of miniaturized electronic equipment for both industry and government, uses GAF industrial x-ray film to prove zero defects in critical components, assemblies and sub-systems.

Diodes, rectifiers, capacitors, resistors and germanium and silicon transistors, used in everything from hearing aids to missile guidance control systems, are subjected to exhaustive radiographic examination to assure faultless performance and long life.

In the photograph above, Texas Instruments Quality Control Inspector, Mrs. Dorothy Gross, is studying a GAF Industrial 'H-D' radiograph. Industrial 'H-D' is an ultra-fine grain, very high contrast film designed to yield high image definition—even when radiographing minute subjects and very thin materials. Industrial 'H-D' is available in a wide

variety of package types and sizes.

Contact your nearest distributor of GAF x-ray products, and he'll introduce you to the GAF X-ray Representative assigned to your area. Or write directly.

gaf

GENERAL ANILINE & FILM CORPORATION

140 WEST 51 STREET, NEW YORK, NEW YORK 10020

Att: Customer Service Dept. E-529

Please send me more information on GAF Industrial 'H-D' x-ray film.

Name _____

Title _____

Company _____

Address _____

City _____ State _____ Zip _____

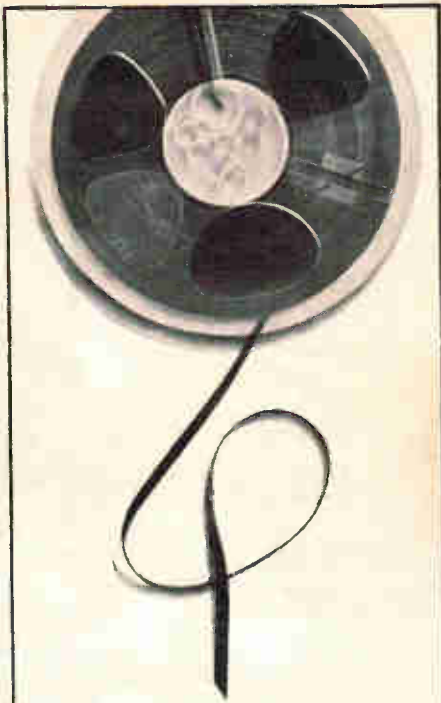

GREATER TAPE SENSITIVITY

with Pfizer
magnetic iron oxides

Whenever there's a need for a more sensitive magnetic tape of any kind, chances are Pfizer has the magnetic oxide for you to produce it. Significant advances in magnetic tape technology have coincided with Pfizer's continuing development of high quality oxides. Available are IRN® magnetic oxides of high density which facilitate more magnetic action in a given volume, providing greater sensitivity in a wide variety of uses:

- Audio, video, computer and instrumentation tapes;
- Memory drums and discs;
- Cinema film stripings;
- Magnetic inks;
- Transfer tapes;
- Ribbons.

Pfizer's continuing research & technical service programs are ready to help you on any specific problem you may have in this growing field. Complete technical data on request.

Pioneering in Physical Chemicals

MINERALS PIGMENTS & METALS DIVISION

Dept., 75, 235 East 42nd Street
New York, New York 10017

New Microwave

Transistor oscillator can replace klystrons

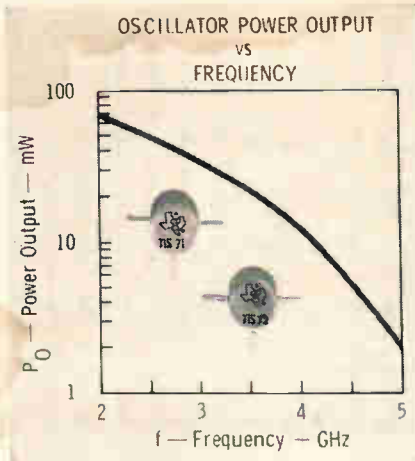

A silicon transistor oscillator can produce as much as 10 mW at frequencies as high as 4 Ghz. Primarily suited for replacing klystrons in S- and C-band microwave applications, the TIS71-72 is a low-power device that can operate as a local oscillator. Its guaranteed power-frequency characteristic permits service between 2 and 4 Ghz, with

outputs of 65 mw and 10 mw at these respective frequencies.

In addition to the inherent benefits of solid state (size, reliability, no filament power), the device offers other advantages over klystrons. Only 15 volts of bias is required; klystrons typically need 500 to 3,000 volts. An optional package composed of nonmagnetic parts allows direct service in yig-tuned oscillators.

Among the areas of application for the TIS71-72 are radar systems, communication equipment, and microwave instrumentation. It may also substitute for some traveling-wave tubes and tunnel diodes.

Maximum collector current is 10 ma and maximum collector-to-base, collector-to-emitter, and emitter-to-base voltages are 25, 15 and 1 v, respectively. Collector-to-base capacitance is typically 0.7 pf, minimum d-c gain (h_{fe}) is 20, and leakage (I_{CES}) is 1 μ a maximum.

In quantities of 25, the TIS71-72 costs under \$85 and is available from stock.

Texas Instruments Incorporated, 13500 North Central Expressway, Dallas, Texas [391]

Magnetrons with a dither



Two dither-tuned, high-power magnetrons provide frequency-agile radars with a pulse-repetition frequency capability of up to 4,000 hz, and signal improvement of 90% over an operating range of 16 to 17 Ghz. The BLM-181 delivers 70 kilowatts and the BLM-180 gives 45 kv.

The magnetron's frequency agility greatly reduces sea and ground

clutter, enhancing resolution in target areas that would otherwise be hard to penetrate. The technique is also valuable in reducing interference between friendly radar sources. The manufacturer reports that these tubes have reduced the bearing error in search radar and have improved the aiming accuracy of fire-control units.

By dithering the output frequency at rates up to 200 hz, the frequency of each successive pulse is different, requiring some method of automatically tracking the receiver local oscillator. Dither control connections to the local oscillator are simplified by the use of a solid state unit connected directly to the magnetron.

An electromechanical device built into the magnetron permits the tube to be tuned slowly while the output is being dithered. Varian Bomac Division, 8 Salem Road, Beverly, Mass. 01915. [392]



Cold camera



on the air in 30 seconds at WBAL-TV.

The MTI Image Orth is a problem solver at WBAL-TV in Baltimore. Crash news programs can be on camera in seconds with a flick of the switch. No need to interrupt camera crews who might be in the middle of a taping session. Operational set-up is minimal too. Here's how WBAL-TV makes use of the MTI Image Orth.

Camera is aligned and locked in fixed position in a small announce booth studio. Few lights are used due to the excellent

low-light capabilities of the camera. And as a result, no additional air conditioning facilities are required. While desk and chair are fixed furnishings, backdrop can be quickly changed to fit any presentation situation.

WBAL-TV engineers claim camera needs little maintenance, has good depth of focus and needs trimming only once per week. Low light levels do not affect picture quality.

You might have other uses for a camera of this size and quality. If so, give us a call. We'll have a sales engineer to see you quickly—but not as quickly as the MTI Image Orth warm-up period.



mti MARYLAND TELECOMMUNICATIONS, INC.

York & Video Roads, Cockeysville, Md. / 301-666-2727 / World's largest manufacturer of low light level television cameras.

**Seelskrews® Seelrivits®
Seelbolts®** For positive seal
against air, gas, fluids



Seals Pressures—internal or external—exceeding 10,000 psi, thanks to unique design. Precision-tooled groove with captive O-ring gives metal-to-metal seal. Vibration-resistant and reusable, too. Assures longer wear and better performance.

Precision molded miniature O-rings

Precise miniature O-rings also available at very competitive prices. Materials include Silicone rubber, Viton A, Buna N and others, with quality manufacture to extremely close tolerance.

For samples and data write:
APM-Hexseal Corp.
41 Honeck St., Englewood, N. J.

Circle 516 on reader service card

**Sealing Boots for
all types of switches**

Keep out moisture, dust and RFI



Hexseals. RubRglas-Seals. Snap-Seals. One piece, flexible high pressure sealing boots fit all standard push-button, toggle and rotary switches and circuit breakers. Flexible, do not impede action of switch in any way. Available with knitted monel wire for RFI shielding.

For samples and data write:
APM-Hexseal Corp.
41 Honeck St., Englewood, N. J.

Circle 517 on reader service card

**SiliKrome®
Colored Filters**



Slip over clear incandescent lamps to change their color. Can withstand in excess of 500°F for over 1,000 hours. Unbreakable, interchangeable. Reusable. No mounting hardware needed.

For samples and data write:
APM-Hexseal Corp.
41 Honeck St., Englewood, N. J.

Circle 518 on reader service card

New Production Equipment

Tapes and lamps guide wiring



"It makes sure the wiring is right the first time," says company president Saul Liss describing a system that automatically guides the routing and terminations of wires in a back panel or harness, and tests the connections as they are made. "The system is designed to eliminate inspection, debugging and reworking of what should be a finished product," he asserts.

The Micro Metrics Inc. development, called the Rapid Zero Defect Wiring System, is controlled by punched tape. It has an unusual lamp display, actuated by the data on the tape, which provides a visual equivalent of a point-to-point wiring list. Up to 50 remotely located wiring stations can be multiplexed to a single master control.

The display consists of a servo-controlled bar, as wide as a standard 19-inch rack panel, holding tiny lamps spaced 0.4 inch apart, a standard terminal spacing. The light bar moves in front of the panel terminals, stopping just beneath the row containing the terminal to be wired. The lamp below the terminal lights, and the operator connects the wire with a hand-held wrapping, soldering, crimping, or other wiring tool.

The operator then threads the wire through the rows and columns of terminals, guided by the light bar as it moves to the next row in which a termination is to be made.

Finally, a single bulb glows again to indicate the end terminal of the wire.

If the terminals are 0.2 inch apart rather than 0.4, the bulb blinks to tell the operator that he must use the terminal above and to the right of the bulb, not the one above it.

Each connection made to a terminal is checked by using dummy plug-in boards to connect all of the terminals in the panel to the system's selection logic. The system automatically checks for shorts, opens and misplaced terminations as the wiring is applied. If the operator even touches the wrong terminal, the system halts until the error is corrected.

After the panel is completely wired, the system double-checks it completely by cycling through the punched tape in an automatic test mode. "Test time of a typical back panel dropped from 25 hours to 35 minutes," claims chief engineer George Hansen.

Optional test capabilities include measuring contact resistance as small as 100 milliohms, leakage resistance to 500 megohms, and dielectric breakdown at 1 kilovolt for up to 100 seconds.

Several configurations are offered. The basic wiring system costs about \$10,000 and has 3-digit logic to accommodate 100 terminal points. This can be expanded in 100-point increments to 1,000 points. With 4 and 5 digit logic, the system will handle up to 10,000 and 100,000 terminals respectively.

The light-bar indicating system, called the Wirematic indicator, is about \$12,000 more. If this indicator is not used, the Rapid system relies on alphanumeric readouts to present the wiring information to the operator. In multiplexed operation, the local station contains only a tape reader and indication logic for driving the light bar or alphanumeric displays. The master station contains the logic for selecting the termination points and the automatic testing circuitry. The master

is connected to the remote stations through a special multiplexing traffic director.

Micro Metrics Inc., 165 Pennsylvania Ave., Paterson, N.J. 07503. [399]

Automatic dispenser of two-part resins

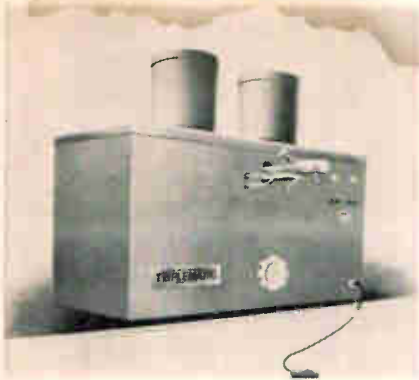

A bench-top resin dispenser automatically proportions, mixes, and dispenses a wide range of two-part materials, including epoxies, urethanes, polysulfides, and depolymerized rubbers.

The electromechanically actuated Series 1200 Triplematic machine plugs into a 120-v a-c outlet. Resin-to-hardener ratios from 1:1 to 10:1 are preset at the factory, but ratio changes can be made readily.

The unit handles any flowable viscosity down to 800 centipoise but isn't recommended for water-thin liquids. A wide range of models provide dispensing outputs of from 0-1 lb to 0-5 lbs a minute.

Price is \$1,950 plus optional accessories.

H.V. Hardman Co., 600 Cortlandt St., Belleville, N.J. 07109. [400]

Ultrasonic, one-step bonding of flip chips

An ultrasonic bonder connects flip-chip devices in semiconductor and hybrid circuits in one step. The unit, model 2906, bonds the chips with their single-plane bump connections, directly to metalized thin or thick film pads. The bonding process does not require either heating of the circuits or protective atmospheres.

The bonder is movable over a

RCL 1/2" ROTARY SWITCHES

ESTABLISHING A NEW SET OF PERFORMANCE STANDARDS!

- Up to 12 positions per deck with stops.
- As many as 6 poles per deck.
- Shorting and non-shorting poles may be grouped on one deck in any combination.
- All individual deck parts are self-contained, and are permanently molded into place.



"OFF-THE-SHELF" SHIPMENTS
FOR INDUSTRY'S BEST DELIVERY!

RCL

Write for complete engineering information

ELECTRONICS, INC.

General Sales Office: 700 South 21st Street
Irvington, New Jersey 07111

Circle 231 on reader service card

New high efficiency, high frequency Photochopper Modules

- High stability from -25 to $+75^{\circ}\text{C}$, efficiency varies less than 5% over temperature range
- 50% efficiency at 1000 Hz
- Internal electrostatic shielding
- CdS cells for fast warm up

Write for new Bulletin 201/ITD3-67

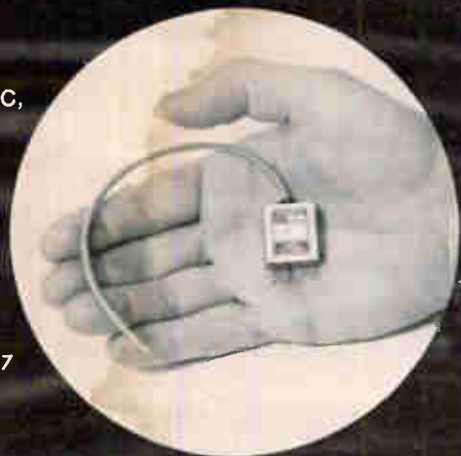

**CLAIREX
ELECTRONICS**

INC. ■ 1239 BROADWAY, NEW YORK, N.Y. 10001

This automatic transfer molder CURES THERMOSETS in 9 SECONDS!



Installation-proved, the 99C can *double* production of your thermosets! Curing itself takes only 9 seconds—in a six-cavity connector mold. What's more, the 99C molds all thermosetting compounds, including glass-filled materials . . . without modifications.

Why not get full details, today? Write or phone: HULL CORPORATION, 7033 Davisville Road, Hatboro, Pa. 19040. Phone (215) 675-5000.

Hull's rapid cycling Model 99C has an integral electronic pre-heater.

Visit us at NEP/CON EAST, Booth 1110



Circle 232 on reader service card

Production Equipment



work area of 1.1 in. x 1.1 in. using a manipulator with a 5 to 1 reduction rate. A built-in vacuum system picks the flip-chip up and holds it in position.

The unit bonds devices to alumina or glass substrates that are metalized with standard interconnect depositions. A simple shear test, for testing bond strength, insures continued process control and reliability. Substrates as large as 2 x 4 in. can be handled.

Basic price of the model 2906 is \$4,850 with delivery in two weeks. Hughes Aircraft Co., Microelectronics Division, 500 Superior Ave., Newport Beach, Calif. 92663 [401]

Optical glass scales aid coordinate measure

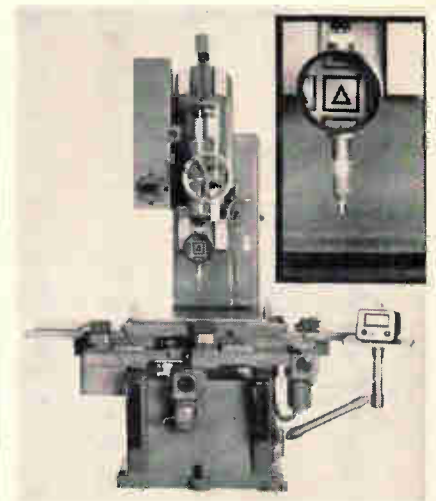

A coordinate measuring machine uses Leitz precision optical glass scales with readout in 50 micro-inches in each of the three axes. It has a measuring range of 15 $\frac{3}{4}$ x 25 $\frac{3}{4}$ inches in the x-y plane and

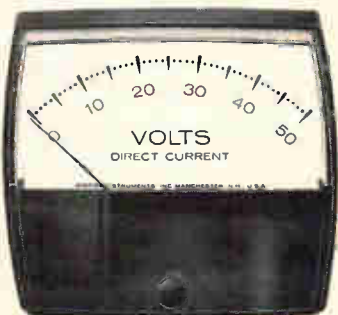

2 $\frac{1}{2}$ in. AP-2

Snap-in Dial 2% full scale accuracy, self-shielded panel meters

New! Panel meters with plastic bezels give you tailor-made meters at no increase in price. Covers snap off . . . interchangeable dials snap in. High torque mechanism offers 1% linearity, 2% accuracy and sensitivity to 20 μ a. Magnetic system is unaffected by external field influences, mounts on any material without interaction. Size: 2 $\frac{1}{2}$ ". Choice of colors and finishes. ASA/MIL 3 or 4-stud mount.

AMMON

AMMON INSTRUMENTS, INC.
345 Kelley St., Manchester, N.H. 03105

New! From MESON! New!

ELECTRONIC TIME DELAY RELAY



- High Accuracy, $\pm 10\%$
- Repeatability, $\pm 3\%$
- Fast recycling time — .05 sec. max.
- Input — 115 VAC
- Up to 180 sec. delay, fixed or variable with external variable resistor.

Only **\$6⁹¹** in 100 lots
IMMEDIATE DELIVERY!

Order one for test at \$8.80. Your
MONEY BACK if not satisfied!

MESON
ELECTRONICS CO. INC.
380 Cottage St., Rochester, N.Y. 14611
Phone (716) 235-7070

15 in. in the z axis. The machine is equipped with a Leitz projector with magnifications of up to 1,000 times.

The instrument is designed for use in the inspection laboratory, the prototype shop, and the tool-room. It can also be used to measure large photo masks. The Leitz precision scales have an over-all accuracy of ± 0.0001 in. The machine weighs over 5,500 lbs. Opto-Metric Tools Inc., 308 Hudson St., New York 10013. [402]

Air tool bends p-c board leads

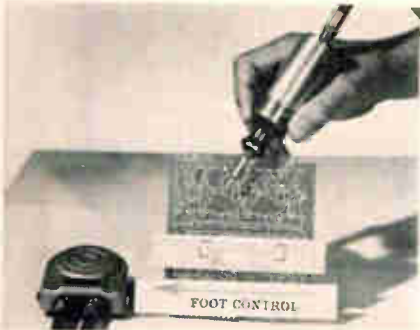

Engineered for miniature and sub-miniature printed circuits, an air-powered tool known as Bend-Eze cuts and bends leads of up to 0.035-in. diameter quickly and easily. Operating with 60 to 100 lbs of air pressure, the lightweight tool performs to all existing military and NASA specifications. It can be operated manually or with a foot switch and is available with 20°, 30° or 45° working angle. The Bend-Eze cutter is made from high-speed steel drill blanks and the holder from tool steel. The cutter and holder are easily replaceable. Simonds Machine Co., 246 Worcester St., Southbridge, Mass. 01550. [403]

High-vacuum evaporator is readily adaptable

Being able to change work modules easily eliminates the need for lengthy tooling development in a high-vacuum system designed to manufacture integrated circuits, thin-film components, and optical devices. It accommodates a variety of evaporation sources and allows

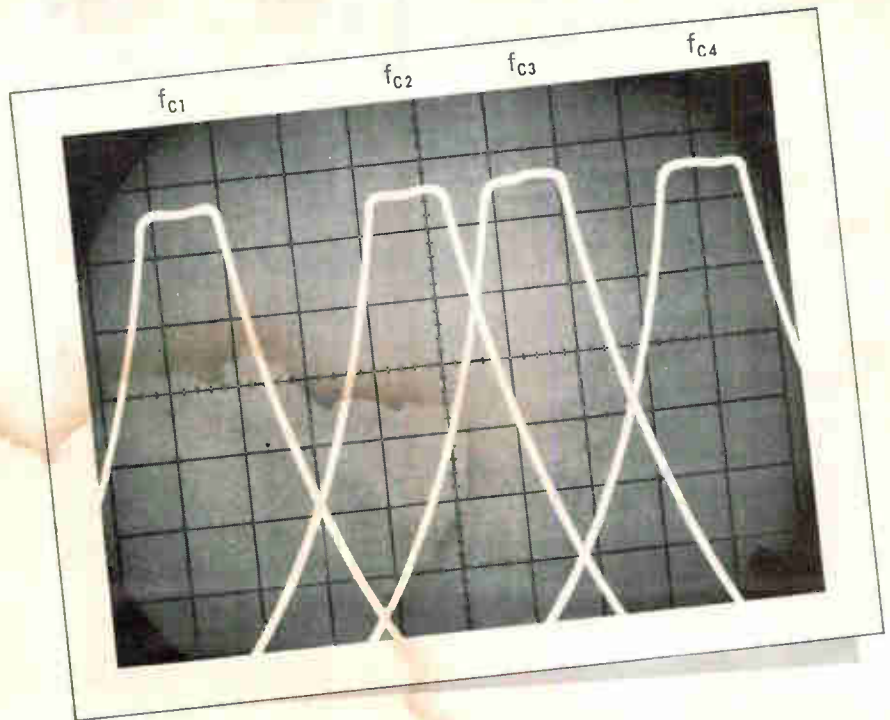

ONE FILTER?

Yes, in fact a Telonic Tunable Filter will give you an *unlimited* number of passbands within its octave frequency range—it's as simple as turning the dial. If you are working with varying frequency sources or several different sources that require filtering, consider the time and material savings tunable filters provide.



Telonic TTA Tunable Filter

48 MHz to 4 GHz RANGE

Telonic Tunable Filters come in two series, over 50 stock models. Each has a full octave coverage with ranges from 48 to 4000 MHz.

INDIVIDUALLY CALIBRATED

The Filter tuning dial is direct-reading, and pre-calibrated. Just set the center frequency to select passband—no interpolation. Repeatability is 1% of set frequency.

LOW INSERTION LOSS and VSWR

Filters are iris-coupled, .05 db Chebyshev designed cavities in 3 and 5 section versions. Inherent high Q keeps insertion loss to a minimum.

SPECIALS AVAILABLE

All Tunable types are available in special frequency ranges, with band widths from 1% to 10%, special mounting provisions and connector types. Submit your requirements.

Telonic

ENGINEERING CO.

Division of Telonic Industries, Inc.

BOX 277, LAGUNA BEACH, CALIFORNIA 92652 • TEL. (714) 494-9401 TWX (910) 596-1320
REPRESENTATIVES THROUGHOUT THE U.S., CANADA AND OVERSEAS BRANCH OFFICES IN MAIDENHEAD ENGLAND, FRANKFURT, GERMANY, AND MILAN, ITALY



NEW CATALOG, APPLICATION DATA, and FILTER SELECTION SLIDE RULE.

NAME _____

FIRM _____

ADDRESS _____

CITY _____

STATE _____ ZIP _____

Yours on request.

DESIGN PROBLEMS?

solve them with

PIONEER PHOTOCELLS



CDS-9

A 1" photodiode, especially designed for numerous applications in outside or inside lighting, flame control, and relay applications where the light source is incandescent. Proven by

hundreds of thousands of photocell years of service.



CDS-7

Has the same general characteristics as the CDS-9 but a smaller size (1/2") for use where space is at a minimum.



CDS-5

A very compact unit with a T.O. 5 housing, produced to your specifications.

Our engineering department will work with you on any special application of photosensitive layers.

STANDARD MODELS

Curves for load line design available for each model.

CDS Type No.	1 FC Simulated Daylight 50 V AC Mean* Output	Nominal Resistance 50 FC 2800° K Incand.	Max. Dark Current** or Min. Dark Resistance	Max. Volt Dark
701	1.5 ma		25 ua	500 V
702	3 ma		25 ua	500 V
703	6 ma		40 ua	350 V
710		1330 ohms	4 meg.	500 V
711		670 ohms	4 meg.	500 V
712		330 ohms	2.5 meg.	350 V
901	1.5 ma		25 ua	1000 V
902	3 ma		25 ua	1000 V
903	6 ma		40 ua	700 V
904	12 ma		200 ua	500 V
910		1330 ohms	4 meg.	1000 V
911		670 ohms	4 meg.	1000 V
912		330 ohms	2.5 meg.	700 V
913		165 ohms	0.5 meg.	500 V

*Range of values in any category equal to ±33% of mean.
**Measured at 100 V, 5 seconds after 50 FC light extinguished.

THE **PIONEER**
ELECTRIC & RESEARCH CORPORATION
Subsidiary of **EG&G** Controls, Inc.
743 Circle Ave., Forest Park, Ill. 60130
Telephone: (312) 771-8242

Production Equipment

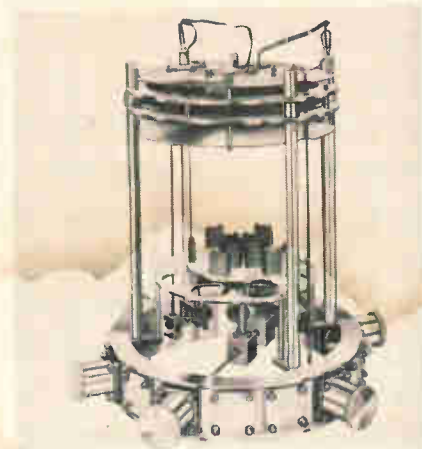

for vapor stream control and modulation, and substrate and mask handling.

For fabricating ic's, the mask-changer module handles six substrates up to 2 1/4 in. square with registration accuracy of 0.0005 in.

Other modular accessories include induction-heated source modules, e-gun source modules, feed-throughs, and collars.

Allen-Jones/Vacuum Technology, a subsidiary of WEMS Inc., 17171 South Western Ave., Gardena, Calif. 90247 [404]

Diffusion pump for ultrahigh vacuums

Oil diffusion pumps, the mainstay of high-vacuum technology for decades, are subject to pressure fluctuations caused by eruptive boiling of oil. A diffusion pump developed by the Tokyo Shibaura Electric Co. of Japan uses an external ring heater around the boiler to eliminate this problem. As the oil is stirred automatically inside the boiler, the temperature gradient in the oil is narrowed and oil and vapor is obtained at relatively low temperatures. Control of the rate of heat transfer gives control of pressure fluctuations. In this design, fluctuation is less than 5×10^{-11} torr at 10^{-9} torr.

The pump also has a 30% higher pumping capacity than similar-sized conventional units and higher feed-pressure tolerance.

Toshiba America Inc., 530 Fifth Ave., New York, N.Y. [405]



11 experts at work on every printed board

High Quality Printed Circuit Boards!

(UL Approved: E-38255)

Through the strictest quality control system, Tokyo Print have won the fullest confidence, as top printed circuit board manufacturers in the field. Indeed, all the manufacturing processes are so systematically installed and organized that all engineers can keep watch on every part and every process.

For computer use

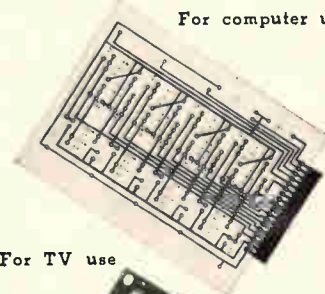

For TV use

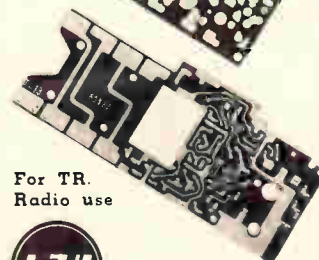
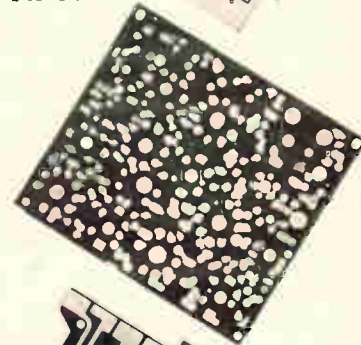

For TR Radio use



* For further please write to

Tokyo Print Industrial Co., Ltd.
No. 782, Shimoishihara, Chofu-shi, Tokyo, Japan
Tel. 0424 (83) 5711

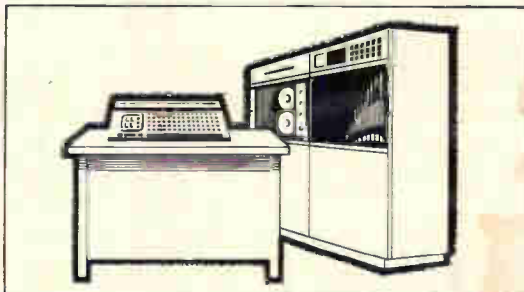

Broaden your talents with the most varied and advanced systems organization in the industry.

Electronics Professionals . . .

Our demonstrated capability has resulted in a constant flow of new contracts and requests to explore new fields, new directions in such broad areas of advanced systems engineering as: Guidance & Control, Computer Engineering, Tactical Weapons, Intelligence, Avionics, Library, Weather, Marine, and Rail Transportation.

At United Aircraft Corporate Systems Center you can be sure of continuing challenge, professional growth and personal progress. A wide range of truly exciting programs has created a multitude of unusual opportunities for top-flight, systems-oriented engineers and scientists. Here in Farmington, Connecticut, you will find the accent on creative, original thinking . . . the emphasis on individuality in a highly professional environment.

If you should feel qualified for one of the following prime openings, please contact us immediately. If not, we have further need for people with systems

experience at all levels. Why not send your resume today?

COMPUTER DEVELOPMENT CHIEF

Requires MSEE degree and 10-12 years experience in digital computer design and development. The successful candidate will head up our Computer Development Group, and will be the key individual between software and hardware groups. Familiarity with digital computer components and systems development absolutely essential.

SENIOR ELECTRONICS PACKAGING ENGINEER

BSME or BSEE (7-8 years experience). Requires experience in micro-miniaturized electronic packaging for space applications — capable of assessing thermal and structural integrity of packaging. Prefer preliminary design and proposal experience — an individual who can assume responsibility for design of electronic packaging for space programs.

SENIOR ELECTRONICS ENGINEER

BS degree in Electrical or Electronics Engineering. MS preferred. Four to eight years experience: should include Logic Design and/or Digital Circuit Design. Computer Systems experience required, as well as a working knowledge of computer languages.

PROJECT ENGINEER

Requires BS degree and 10 years experience. An experienced leader with mechanical, naval or transportation engineering background to direct the development of new transportation systems. Duties will include work package layout, scheduling, manufacturing liaison, system design and layout supervision, equipment selection, cost control, and project coordination. Resumes and salary requirements should be sent to Mr. John B. Henley, United Aircraft Corporate Systems Center, 1690 New Britain Avenue, Farmington, Conn. 06032. We are an equal opportunity employer.

United Aircraft Corporate Systems Center





Apollo Wiring Assemblies



SPACE to UNDERSEA Instrumentation

TSC

THE SIPPICAN CORPORATION

*Concepts • Engineering
Manufacturing*

Contact: W. J. Lavery, Programs Manager,
Marion, Massachusetts 02738
Tel. 617 748-1160.



Expendable BT System (AN/SSQ-56)

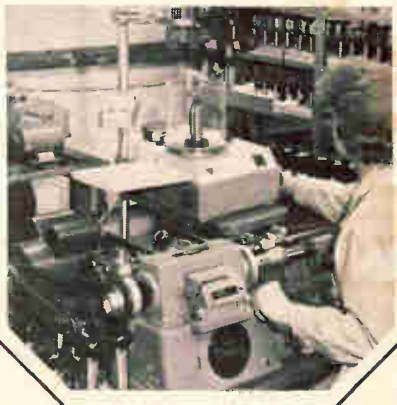

New Books

Communicating theory

Advances in Communications Systems; Theory and Application Volume 2
Edited by A. V. Balakrishnan
Academic Press, 328 pp., \$13.50

In this second of a planned series of annual volumes, seven specialists discuss selected aspects of communications theory and applications. Because there isn't a unifying theme, each section stands by itself. Of the seven sections, two deal with optical communications, one is on adaptive data compression, another is on stochastic approximation, and three are concerned with satellite communications and systems.

Except for the sections on satellite systems, which give panoramic views with little theory, the book is difficult reading. Its primary value is as a reference work providing comprehensive discussions on the particular areas. As such, it would serve admirably in a company's library. However, unless an individual is particularly interested in the specific subjects, the book will not have enough value for him to add it to his private collection.

Although the book is intended for engineers familiar with communications theory, many sections require a thorough knowledge of probability theory. However, even in the more theoretical areas, background information is provided to give the reader at least some degree of understanding. In this sense, the book bridges the gap between the terse presentations in professional journals and the detailed discussions in textbooks.

Leonard Weller
Communications editor

Random sampling

Approximate Analysis of Randomly Excited Nonlinear Controls
Harold W. Smith
M.I.T. Press, 138 pp., \$7.50

Existing methods of analyzing nonlinear feedback systems having random inputs fall into three categories: quasi-linear, functional, and direct. Of these, only the quasi-linear method is generally useful. Although Smith develops no entirely new methods in this mono-

graph based on his research, he makes a significant contribution by defining the validity of the quasi-linear technique. He establishes three criteria (two numerical, one verbal) for the applicability of these methods by combining the results of his approximate nonlinear function technique and experiments.

After discussing methods of analysis, the author reviews mathematical representations of simple (zero memory) nonlinear systems. He presents a series of approximations and derives an integral equation that can be solved in closed form. This approximate nonlinear solution is compared with the quasi-linear solution for feedback systems having different types of nonlinearities. The approximate solution will always be less accurate than the quasi-linear solution; however, when the two differ significantly, the quasi-linear solution is also inaccurate. Thus, the nonlinear approximate solution is a good check on the validity of a quasi-linear solution.

Smith then compares the two mathematical results with those obtained through experimentation. Results of experiments show that the quasi-linear solution is sufficiently accurate for engineering analyses when the approximate nonlinear and the quasi-linear solutions are within 5% of each other.

The monograph is well written, but the reader needs to have some knowledge of the correlation and power spectrum techniques used in linear systems analysis as well as familiarity with quasi-linear methods.

Gunther R. Geiss
Grumman Aircraft Engineering Corp.
Bethpage, N.Y.

New look at old hat

High-Power Electronics Volume 2
Edited by P.L. Kapitza and L.A. Wainstein
Pergamon Press, 117 pp., \$8.00

Primarily of interest to the specialist in high-power microwave engineering, this collection of translated articles is the second in a series of

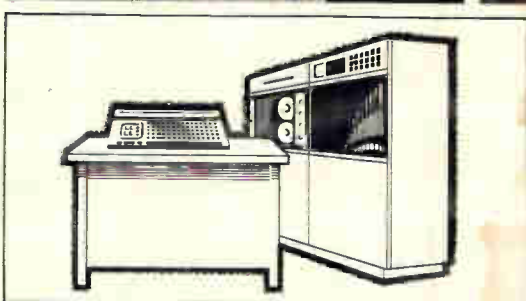
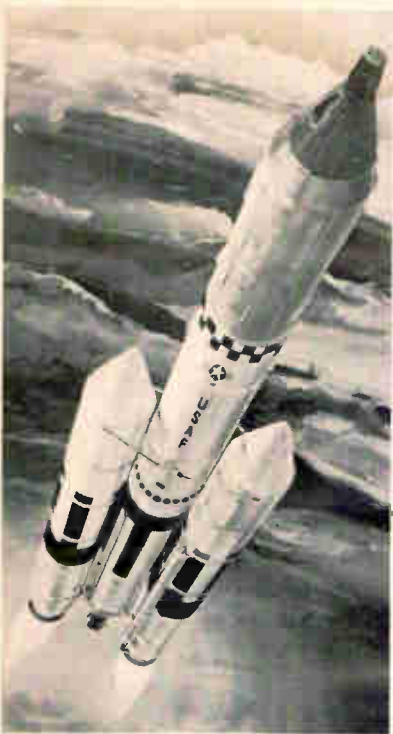

Broaden your talents with the most varied and advanced systems organization in the industry.

Electronics Professionals . . .

Our demonstrated capability has resulted in a constant flow of new contracts and requests to explore new fields, new directions in such broad areas of advanced systems engineering as: Guidance & Control, Computer Engineering, Tactical Weapons, Intelligence, Avionics, Library, Weather, Marine, and Rail Transportation.

At United Aircraft Corporate Systems Center you can be sure of continuing challenge, professional growth and personal progress. A wide range of truly exciting programs has created a multitude of unusual opportunities for top-flight, systems-oriented engineers and scientists. Here in Farmington, Connecticut, you will find the accent on creative, original thinking . . . the emphasis on individuality in a highly professional environment.

If you should feel qualified for one of the following prime openings, please contact us immediately. If not, we have further need for people with systems

experience at all levels. Why not send your resume today?

COMPUTER DEVELOPMENT CHIEF

Requires MSEE degree and 10-12 years experience in digital computer design and development. The successful candidate will head up our Computer Development Group, and will be the key individual between software and hardware groups. Familiarity with digital computer components and systems development absolutely essential.

SENIOR ELECTRONICS PACKAGING ENGINEER

BSME or BSEE (7-8 years experience). Requires experience in micro-miniaturized electronic packaging for space applications — capable of assessing thermal and structural integrity of packaging. Prefer preliminary design and proposal experience — an individual who can assume responsibility for design of electronic packaging for space programs.

SENIOR ELECTRONICS ENGINEER

BS degree in Electrical or Electronics Engineering. MS preferred. Four to eight years experience: should include Logic Design and/or Digital Circuit Design. Computer Systems experience required, as well as a working knowledge of computer languages.

PROJECT ENGINEER

Requires BS degree and 10 years experience. An experienced leader with mechanical, naval or transportation engineering background to direct the development of new transportation systems. Duties will include work package layout, scheduling, manufacturing liaison, system design and layout supervision, equipment selection, cost control, and project coordination. Resumes and salary requirements should be sent to Mr. John B. Henley, United Aircraft Corporate Systems Center, 1690 New Britain Avenue, Farmington, Conn. 06032. We are an equal opportunity employer.

United Aircraft Corporate Systems Center



CONVERT RADAR, SONAR, AND IR DATA TO TV DISPLAY WITH THE ELECTROSTORE®

This TV display is a composite of a compass reference superimposed on a stored

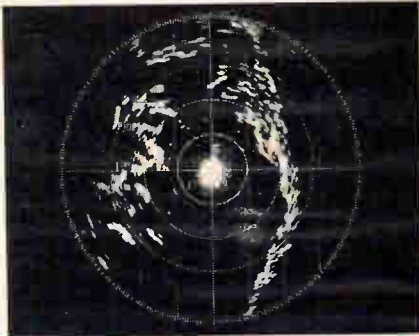

ppi display. It is an example of how the Electrostore Model 221 can convert radar data to a high resolution TV picture.



Model 221 Electrostore
single-gun storage tube
Input/Output Response
10 MHz or 20 MHz
Input Amplitude
Required 0.7 volts to
2.0 volts p-p
Deflection Amplitude
5 volts p-p
Deflection Response
DC to 800 KHz
Programmer Optional

The Model 221 scan-converter utilizes a cathode-ray recording storage tube. Input video signals and deflection information are applied to the tube through various amplifiers and control circuitry. Data is stored within the tube in the form of a raster, circular, or spiral scan. This information can be read off periodically through appropriate amplifiers without destroying the stored data. The input can be up-dated periodically and the stored information erased partially or in its entirety. By introducing the proper signals, the Electrostore can convert a variety of formats to TV display, i.e. computer-to-TV, radar-to-TV, IR-to-TV, or sonar-to-TV.

Write for technical memos and application notes covering the Electrostore.



223 Crescent Street
Waltham, Mass. 02154
Tel. (617) 894-8200

A DIVISION OF
DASA CORPORATION

New Materials

Conductive cement has a silver lining



A cement containing silver in a thermosetting resin has good conductivity under a variety of environmental conditions. It can be

used continuously at temperatures to 400° F. and intermittently at higher temperatures.

Designated DAG-413, the conductive silver cement adheres to a variety of rigid porous and non-porous materials, including glass, porcelain, ceramics, metal, and most plastic surfaces. Applications include the cementing of conductors and terminals on electronic and electrical components. It may also be used as a conductive bonding medium between panels and components.

The material may be applied with a spatula, or, for repetitive applications, by silk screen. The cement is cured at elevated temperatures. Higher cure temperatures require shorter bake periods. For example, the cement can be cured at 500° F for 10 minutes or 400° F for 30 minutes.

Volume resistivity of DAG-413 is 0.001 ohm-cm.

Acheson Industries, Inc., Acheson Colloids Division, Port Huron, Mich. [406]

Superconductors vary in size and shape

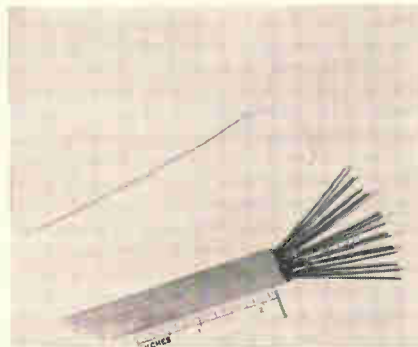

Flexibility in designing superconducting coils is possible with a family of composite superconductors. Called Supergenic Multicore, the superconductors consist of fine, high-current-density niobium-titanium (Nb-Ti) wires encased in high purity copper. They are available in round, square, and strip configurations and with one or as many as 20 niobium-titanium wires.

The multicore conductors were

developed to provide specially shaped conductors with varying current densities and stability requirements. They are especially useful at fields up to 100 kilogauss. Current densities of more than 20,000 amperes per sq cm at 45 kilogauss have been achieved.

The Multicore technique has several advantages over cabling or single-strand design. A number of fine superconducting wires evenly distributed through a solid copper substrate provides increased contact area between the superconductor and the substrate, decreasing contact resistance. Temperature is also more evenly distributed within the superconductor.

In addition to improved superconductor performance, the Multicore approach offers several mechanical advantages, points out its manufacturer. The conductor's strength improves performance under high magnetic stresses. Its smooth outer surface improves handling characteristics and provides a better surface for insula-

Save space, time and money with RIB-LOC™ insulated terminals

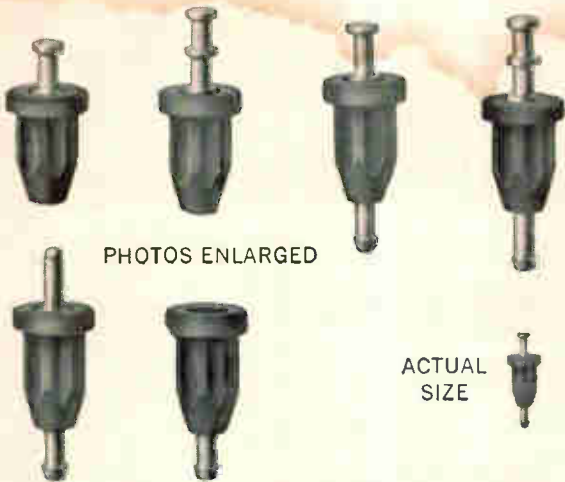

New stand-offs, feed-thrus, tip jacks and plugs press in, provide secure mounting

Johnson RIB-LOC polyamide insulated components make it possible for your commercial equipment designs to reflect size reductions formerly limited to military equipment because of cost. The RIB-LOC line offers advantages over TFE insulated types at a substantially lower price. Though lower in cost, RIB-LOCs provide considerably better retention than most widely used TFE insulated types.

RIB-LOC components include single turret stand-off, double turret stand-off, single turret feed-thru, double turret feed-thru, .040" tip plug, and tip jack for .040" plug. All press into .136" dia. panel holes.

Terminals are brass, silver-plated and Iridited for good solderability. Available in six colors to Federal Standard 595: white, red, black, green, yellow and blue. Pullout force 21 lbs.; turning torque 18 oz. in.; capacitance (.050" panel at 1 MHz) 1.00 pf.; flash-over voltage 5300 DC; max. temp. 250° F.; leakage current (at 3500 VDC) only .01 ua.

FREE CATALOG includes detailed specs and prices on these and other high quality E. F. Johnson components. See your E. F. Johnson representative or write for your copy today.



E. F. JOHNSON COMPANY

3029 Tenth Ave. S.W., Waseca, Minn. 56093

Providing nearly a half-century of communications leadership

AVAILABLE FOR PROMPT DELIVERY GRAYHILL 15 AMP., 125 VAC RESISTIVE, POWER TAP SWITCH. 50,000 OPERATIONS



Select Materials

- Contacts: Silver Alloy
- Shaft: 303 Stainless Steel
- Mounting Bushing: Brass, Cadmium Plated
- Terminals: Silver Plated Brass
- Base and Rotor: Arc Resistant, Mineral Filled Phenolic per MIL-M-14E

Typical Specifications

- Contact Resistance: 10 Milliohms
- Voltage Breakdown: 2500 VAC
- Rotational Torque: Approx. 22 in.-oz.
- Contact Force: Approx. 12 oz.
- Contacts: Non-shorting
- Built-in Stops: Provided on all switches

This compact Grayhill Series 19 Power Tap Switch is also available with special shafts, bushings and other modifications on special order.

Ask for Engineering
Data Book G304
for full information—
Write



523 Hillgrove Avenue
LaGrange, Illinois 60525
Area Code 312, Phone 354-1040

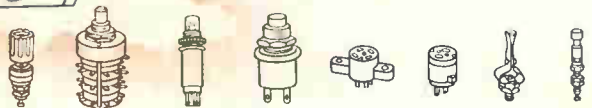

"PIONEERS IN MINIATURIZATION"

Microsonics

State of the Art Design in Filters Oscillators and Delay Lines



Continuously
Variable Delay
Systems

Bulletins 4301 and 4302



Broad Bandwidth
Highly Selective
Crystal Filters
Bulletin 6350

Comb. Filter Sets
Bulletin 6350



Broad Bandwidth
Delay Lines

Bulletin 4300

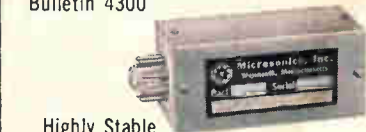

Highly Stable
Oscillators — Bulletin 6350



Voltage Controlled
Crystal Oscillators
Bulletin 6350



High Density
Digital Storage
Systems

Bulletin
5350

Send for literature.



MICROSONICS, INC.
60 Winter Street
Weymouth, Mass. 02188
Tel: 617 337-4200

A subsidiary of the Sangamo Electric Company

New Materials

tion. This type of conductor also makes possible improved splicing and windings which are more easily supported and more uniform in cross section.

At 50,000 gauss, current levels in Supergenic Multicore may be varied from 50 to over 1,500 amps. Dimensions vary from 0.040 in. to 0.150 in. diameter in rounds and squares. Strips have been produced in widths up to 0.750 in. Supergenic Multicore is available in continuous lengths of 1,000 to over 5,000 ft, depending upon the conductor cross section.

Avco Everett Research Laboratory, Division of the Avco Corp., 2385 Revere Beach Parkway, Everett, Mass. 02149. [407]

Sealing glass reduces damage from heat



Heat damage and electrical degradation of semiconductor devices due to alkali poisoning can be minimized with a new sealing glass. The glass is a lead-alumino-borosilicate composition with an alkali content of less than 0.1%. It can be sealed at approximately 740°C.

The glass, designated type 7063, is suited for encapsulating resistors, rectifiers, double-stud zener regulators, varactors, and high-speed switching diodes, the company claims.

Maximum alkali content of the new glass is Li_2O , 0.010%; Na_2O , 0.050%; and K_2O , 0.050%.

Expansion coefficient and viscosity of the glass provide good hermetic seals to molybdenum, Kovar, and tungsten, according to the manufacturer.

Corning Glass Works, Corning, N.Y. 14830. [408]

Microcircuit Engineers

(Southern California)

Hughes Research and Development Division is opening a new Microcircuit Facility in Culver City. This Facility will provide experimental and prototype microcircuits of all kinds to System Design Engineers. The following assignments offer a unique opportunity for advancement in the field of microelectronics:

SENIOR APPLICATION ENGINEERS. Primary responsibility is to interface between Design Engineers and the Microcircuit Facility. Must be capable of converting input-output requirements to schematic diagrams and converting schematic diagrams to substrate layouts. Disciplines of primary interest are: thin/thick films and integrated circuits.

ASSEMBLY & PACKAGING ENGINEERS. Primary responsibility is to determine assembly and packaging techniques for thin/thick film and integrated circuits used in aerospace systems. Experience required includes: interconnection techniques (such as microsoldering, parallel gap joining, thermocompression bonding and ultra-sonic joining) and a thorough understanding of hermetic and non-hermetic packaging design and techniques.

These assignments require: an accredited applicable degree, a minimum of two years of professional experience and U.S. citizenship.

For immediate consideration, please airmail your resume to:

Mr. Robert A. Martin
Head of Employment
HUGHES Aerospace Divisions
Dept. 36
11940 W. Jefferson Blvd.
Culver City, Calif. 90230

HUGHES

HUGHES AIRCRAFT COMPANY
AEROSPACE DIVISIONS

An equal opportunity employer

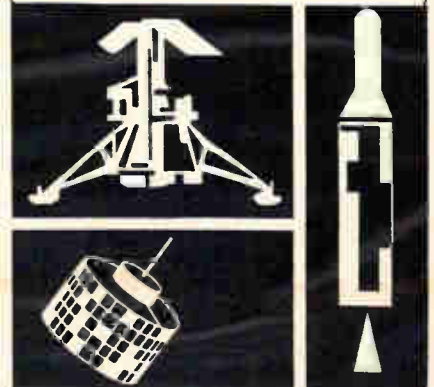

Common denominator

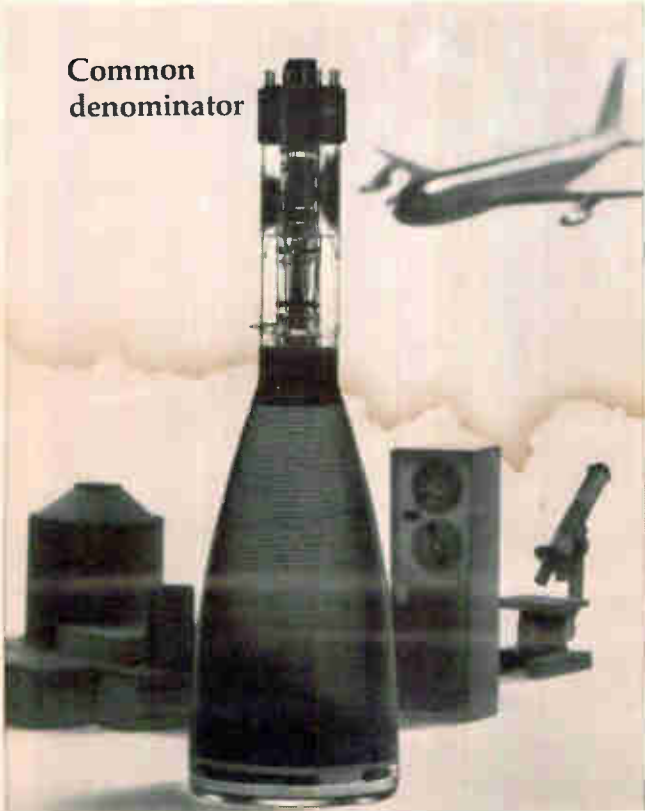

What's a CRT got to do with Planes, Power Plants, Punch Tape and Physiology...? Plenty!

Planes need a CRT with resistance to extreme shock, severe vibration and high altitudes.

For Power Plants—the Atomic kind—a 5-inch tube with helical resistance winding to insure a smooth voltage gradient is needed.

Punch Tape Computer Systems call for a 19-inch model with an aluminized screen for increased light output.

Physiological studies demand a CRT able to display four phenomena simultaneously.

ETU builds them all. Tomorrow our ever-growing list of industrial applications may include CRT's to help make peanuts, parachutes, petticoats—or your product. Write today for the complete **ETU** capability story.



**GENERAL
ATRONICS**
ELECTRONIC TUBE DIVISION
PHILADELPHIA • PENNSYLVANIA 19118
Cable: ATRONIC

(Sales representative areas available in U.S. and abroad.)

Circle 237 on reader service card

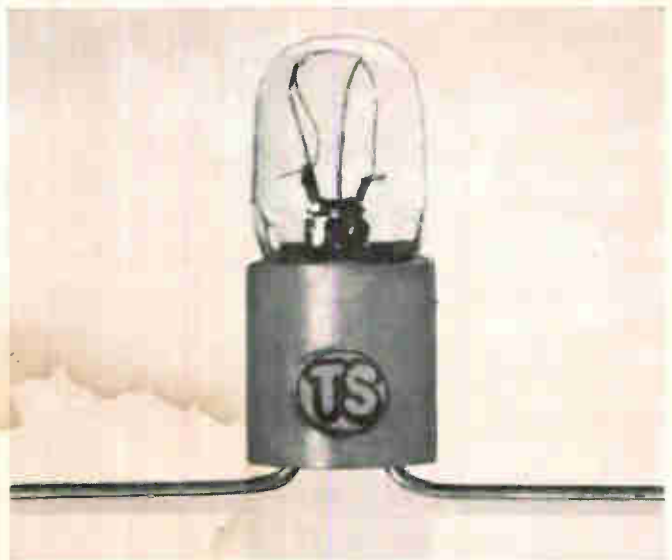

Mounting Flexibility

Tung-Sol Molded Base Subminiature Lamps provide mounting flexibility not possible with the usual cemented-on base and socket installation. Lead wires can be bent sharply at the base without harm to the assembly. Because they are self-mounting, any computer type circuit board provides a fully adequate mount. No more installation is required than with transistors. And like transistors, Tung-Sol Molded Base Lamps may be installed with automated equipment.

The popular Tu-Pin lamp has wide application for instrumentation lighting. For special requirements, the molded nylon base can be formed in a wide variety of configurations. Also, special harnessing can be supplied to customers' specifications. Write for more information about how the flexibility of Tung-Sol Molded Base Lamps can effect economies in the assembly of your equipment. Tung-Sol Division, Wagner Electric Corporation, One Summer Ave., Newark, N.J. 07104.

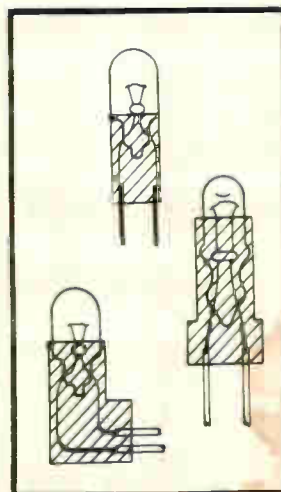

Molded bases can be designed to meet customers' specifications.



Computer circuit board assembly demonstrates mounting flexibility of Tung-Sol Tu-Pin lamps.

TUNG-SOL®

MOLDED BASE SUBMINIATURE LAMPS

Circle 195 on reader service card

195



Apollo Wiring Assemblies



SPACE to UNDERSEA Instrumentation

TSC

THE SHIPPICAN CORPORATION

Concepts • Engineering
Manufacturing

Contact: W. J. Laverty, Programs Manager,
Marion, Massachusetts 02738
Tel. 617 748-1160.



Expendable BT System (AN/SSQ-56)



New Books

Communicating theory

Advances in Communications Systems;
Theory and Application Volume 2
Edited by A. V. Balakrishnan
Academic Press, 328 pp., \$13.50

In this second of a planned series of annual volumes, seven specialists discuss selected aspects of communications theory and applications. Because there isn't a unifying theme, each section stands by itself. Of the seven sections, two deal with optical communications, one is on adaptive data compression, another is on stochastic approximation, and three are concerned with satellite communications and systems.

Except for the sections on satellite systems, which give panoramic views with little theory, the book is difficult reading. Its primary value is as a reference work—providing comprehensive discussions on the particular areas. As such, it would serve admirably in a company's library. However, unless an individual is particularly interested in the specific subjects, the book will not have enough value for him to add it to his private collection.

Although the book is intended for engineers familiar with communications theory, many sections require a thorough knowledge of probability theory. However, even in the more theoretical areas, background information is provided to give the reader at least some degree of understanding. In this sense, the book bridges the gap between the terse presentations in professional journals and the detailed discussions in textbooks.

Leonard Weller
Communications editor

Random sampling

Approximate Analysis of Randomly
Excited Nonlinear Controls
Harold W. Smith
M.I.T. Press, 138 pp., \$7.50

Existing methods of analyzing nonlinear feedback systems having random inputs fall into three categories: quasi-linear, functional, and direct. Of these, only the quasi-linear method is generally useful. Although Smith develops no entirely new methods in this mono-

graph based on his research, he makes a significant contribution by defining the validity of the quasi-linear technique. He establishes three criteria (two numerical, one verbal) for the applicability of these methods by combining the results of his approximate nonlinear function technique and experiments.

After discussing methods of analysis, the author reviews mathematical representations of simple (zero memory) nonlinear systems. He presents a series of approximations and derives an integral equation that can be solved in closed form. This approximate nonlinear solution is compared with the quasi-linear solution for feedback systems having different types of nonlinearities. The approximate solution will always be less accurate than the quasi-linear solution; however, when the two differ significantly, the quasi-linear solution is also inaccurate. Thus, the nonlinear approximate solution is a good check on the validity of a quasi-linear solution.

Smith then compares the two mathematical results with those obtained through experimentation. Results of experiments show that the quasi-linear solution is sufficiently accurate for engineering analyses when the approximate nonlinear and the quasi-linear solutions are within 5% of each other.

The monograph is well written, but the reader needs to have some knowledge of the correlation and power spectrum techniques used in linear systems analysis as well as familiarity with quasi-linear methods.

Gunther R. Geiss
Grumman Aircraft Engineering
Corp.
Bethpage, N.Y.

New look at old hat

High-Power Electronics Volume 2
Edited by P.L. Kapitza and
L.A. Wainstein
Pergamon Press, 117 pp., \$8.00

Primarily of interest to the specialist in high-power microwave engineering, this collection of translated articles is the second in a series of

Power Supply Slide Guide from NJE

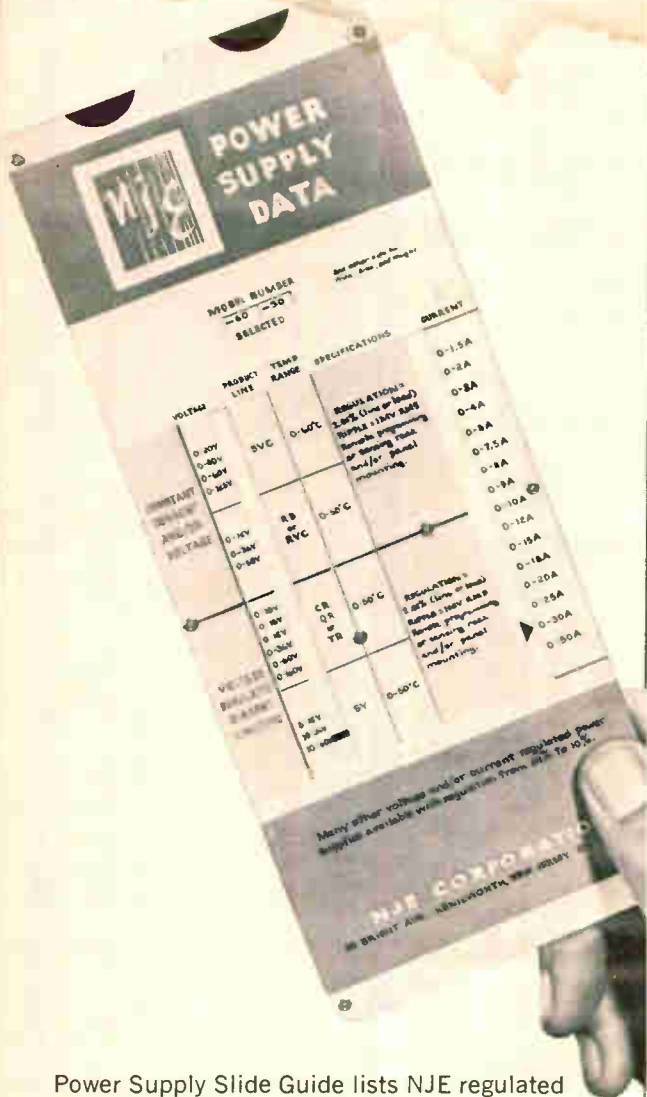

Power Supply Slide Guide lists NJE regulated power supplies for systems, laboratories and general purposes . . . makes specifying power supplies a snap. Just slide the guide to the voltage, amps and regulation you need. The guide slides to the right model and price. Write today on your company letterhead for your own smooth-working NJE Slide Guide. Ask for the new, 1967 NJE catalog. It's free!



N.J.E. Corporation
 Kenilworth, N. J. 07033/(201) 272-6000
 Telefax: FFP • TWX: (201) 276-7630
 Electronic Development and Manufacture

307

Leadership is no accident!

in sports
 or in
 industry



QUALITY PRODUCTS are one of the reasons for ALPHA'S LEADERSHIP

The extensiveness of Alpha's quality product line is unmatched anywhere. Alpha offers a complete system of solders, fluxes, soldering chemicals, special alloys, lead and tin products, solder preforms and ultra high purity metal fabrications for semi-conductor devices. There is an Alpha product for every soldering requirement in industry . . . electronic, electrical, automotive, aerospace. Additional reasons for Alpha Leadership include authoritative Soldering Technology Seminars; an outstanding Research and Development Department geared to problem solving; prompt, reliable service; and unequalled know-how and experience.

BULLETIN A103 TELLS THE ALPHA STORY.
 WRITE FOR YOUR FREE COPY TODAY.



alpha metals, inc.

56 WATER STREET, JERSEY CITY, N. J. 07304 201-434-6778

Los Angeles, Calif. • Alphasoy Corp. (Div.), Chicago, Ill.
 Alpha Metals, Inc. (U.K.) Ltd., Hounslow, Middlesex, Eng.

SEE US AT NEP/CON EAST-BOOTH 627

J-6826

COMPUTER TALK

by W. Henry du Pont, President
SCI-TEK
COMPUTER CENTER, INC.



TO THE MAN WHO THINKS HE NEEDS A COMPUTER and feels that the investment is more than he can afford now.

SCI-TEK has the answer for you with our SATELLITE SYSTEM. We supply you with the hardware you require and a direct data line to our large scale 1107 computer in Wilmington.

The cost is low because you share the 1107 with other clients of SCI-TEK and yet you have the convenience of a complete computer center right in your office.

Does the SCI-TEK SATELLITE SYSTEM require highly skilled technical people at my installation? The answer is no. The SCI-TEK SATELLITE SYSTEM'S extremely simple to operate. It does not require any programming, and only minimal additional programming of the SCI-TEK COMPUTER is needed. By merely referring to a brief instruction book, your personnel will be able to properly operate it in a few hours.

Will the SCI-TEK SATELLITE SYSTEM work with engineering and scientific problems? The SCI-TEK SATELLITE SYSTEM was developed to fill a need for this service. Programs in COBOL, FORTRAN, ALGOL or other source language can be written locally and quickly transmitted to SCI-TEK for compilation. Almost immediately the results are returned to your facility, saving you valuable time between your need and the response.

For detailed information on the SCI-TEK SATELLITE SYSTEM, contact us today. No obligation, of course.

SCI-TEK
COMPUTER CENTER, INC.
1707 GILPIN AVENUE
WILMINGTON, DELAWARE 19806
Phone: (302) 652-3967

New Books

studies performed several years ago at the Soviet Union's Academy of Sciences. Although a number of the experimental and analytical techniques and devices discussed are covered in existing literature, the treatment given them in this book is, in many cases, more complete.

For example, a presentation of reactive piston theory (quarter-wave chokes and impedance transformers in coaxial transmission lines) includes methods of correcting for end effects rarely treated in most texts. A unique approach is given for calculating the transmission and reflection properties of small irises in waveguide short-circuiting walls—applying coupled resonator theory. The particular case chosen is a circular waveguide operating in the H_{01} mode, a low-loss, high-power mode popular in high-power microwave devices.

Unfortunately, the delay in publishing these articles inevitably means that some of the techniques and devices lag behind the state of the art. A technique presented for measuring gap parameters of klystron-type cavities with a field perturbation beam was covered in E.L. Ginzton's "Microwave Measurements," published in 1957. The panoramic wavemeter described in this volume is considerably inferior in performance to presently available wideband-spectrum analyzers.

On the other hand, two highly specialized topics get analytical treatments not available in other literature. The first is the electromagnetic theory of grids, a magnetic analysis of transmission and reflection properties of a parallel array of straight conductors; the second is cathode losses in magnetrons. Because of the difficult nature of the latter analysis, the results presented must be considered qualitative rather than quantitative and serve as a good guide in estimating the magnitude of the cathode bombardment effect in magnetrons. The additional heating contributed by this effect is an important factor at the higher frequencies and power levels.

Joseph F. Hull
Litton Industries Inc.,
Electron Tube Division
San Carlos, Calif.

MELPAR

to
Step up

Where Performance
Comes
FIRST

A LEADER IN COMPUTER AND DATA HANDLING SYSTEMS

MELPAR, now celebrating more than 22 years in Space and Defense brings new life to creative pioneering by continually expanding in new areas of R & D and further developing our broad capabilities.

Melpar's Engineering Division has immediate openings for qualified personnel in the following areas:

- **Project Engineers**
Video Signal Processing
- **Senior EE's and EE's**
Computer Programming and Analysis
HF, VHF, and Microwave Receivers and Antennas
Communications—Microwave Components Design
Digital Circuit and Systems Design
Flight Simulation — Human Factors
- **Senior Programmers and Analysts**
Real Time and Control Applications
Math Modeling
Business Applications — Teleprocessing
- **Senior ME's and ME's**
Electronic Packaging
Heat Transfer and Stress Analysis
- **Field Service Engineers**
Flight Simulators
Airborne Radar Countermeasures

Write in confidence, to:

Professional Placement

WABCO
MELPAR INC

A Subsidiary of Westinghouse Air Brake
Company

7760 ARLINGTON BOULEVARD
FALLS CHURCH, VA. 22046
(Suburb of Washington, D. C.)

An equal opportunity employer M/F

yes,

CCTV Cameras work best



with **COSMICAR**[®] LENSES

Superior cameras deserve superior lenses. COSMICAR's proven precision performance is the combined result of advanced optical engineering and exquisite workmanship.

Now widely used, COSMICAR LENSES come in 23 models for focal lengths ranging from 12.5 mm to 500 mm, and in 3 zoom models including a remote control zoom.

Your CCTV camera and COSMICAR LENSES will make an unbeatable team. For technical data and other particulars, please write.

 **ICHIZUKA**
OPTICAL CO., LTD.

568, Shimaochiai, 2-chome, Shinjuku-ku, Tokyo
CABLE ADDRESS: "MOVIEKINO TOKYO"

Circle 199 on reader service card



Great editorial is something he takes on a business trip
(What a climate for selling!)

Electronics

A McGraw-Hill Market-Directed Publication
120 West 42nd Street, New York, N.Y. 10036

INTRODUCING

A New Member of

The
Transformer Electronics Co.

Family of
Miniature Regulated

POWER SUPPLIES

THE 6 WATT
9589 SERIES
(23 Models)

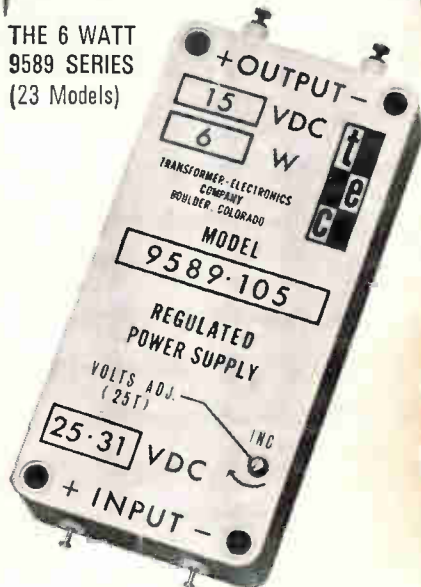

Output Power Capability:	6 watts
Operating Temperature:	-55°C to +100°C
Input Voltage:	25-31vdc
Line Regulation:	0.1%
Load Regulation:	<3% (½ to full load)
Output Ripple:	<0.6% p-p
Efficiency:	>46%
No Load Current:	<75 ma
Voltage Adjustability:	±10%
Volume:	4.3 cu. in. (1.75" x 3.5" x .7")
Weight:	7 oz.
Voltage Range:	5 to 5000vdc; ±15, ±25, ±50, ±100

Other T. E. C. Power Supplies—1 WATT, 9583 Series; 3 WATT, 9567 Series; 10 WATT, 9584 Series—Write or Call for complete details.



**TRANSFORMER
ELECTRONICS
COMPANY**

BOULDER INDUSTRIAL PARK
BOULDER, COLORADO
TWX 303 443-2581 PHONE (303) 442-3837

POWER SUPPLIES • INVERTERS
CONVERTERS • TRANSFORMERS

Technical Abstracts

Bugs resurface

Increased crystal unit resistance at oscillator noise levels
Marvin Bernstein
Electronics Components Laboratory,
U.S. Army Electronics Command,
Ft. Monmouth, N.J.

Crystal oscillator problems that seemed to have been solved last year have cropped up again. Some military communications equipment has failed during production-line testing because contaminating microscopic particles and films of oil on the surfaces of quartz crystals have increased the crystals' resistance, inhibiting oscillation.

Part of the problem had been traced earlier to failure to etch the crystal after the final lapping of the surface. Thus, last September an etching specification was added to MIL-C-3098D.

The etch removes contaminants and corrects some of the surface defects that occur during lapping. But the quartz crystals still have to be handled after the etching process to put on leads and package the unit. Though this is usually done in a "white room," contaminating films from body oils or impurities on test fixtures can still form on the crystal surface.

With a packaged unit, one simple method of determining whether the crystal surface is clean is to measure the crystal's d-c resistance at very low power levels in the microwatt range. Resistance should be below the specified maximum for the crystal under test. A suitable tester is a modified version of impedance meter TS-683/TSM.

Earlier tests used a high drive level that obscured the presence of surface contaminants. Strong oscillations of the crystal create an ultrasonic cleaning effect that can temporarily remove particles and possibly oil from the surface.

Inspection of a number of AT-cut crystal units of various frequencies shows the high resistance effect to be common. It has been found in crystals operating in fundamental modes—up to about 30 megahertz — and overtone modes. However, it isn't a serious problem except when the os-

cillator's circuit gain has been optimized for the maximum resistance specified for the crystal type. This usually occurs only with overtone crystals.

Presented at the Frequency Control Symposium, Atlantic City, N.J., April 24-26.

Two-way trimmer

Bidirectional electrochemical trimming of thick film resistors
J.A. O'Connell, E.A. Zaratkiewicz, and H.J. Curnan
ITT Federal Laboratories, Nutley, N.J.

Failure analysts have turned a source of trouble into an electro-mechanical method of increasing or reducing the resistivity of screen-printed resistors in hybrid integrated circuits. With the new technique, the person doing the trimming can run the value up or down at will by flicking switches.

Several months ago, circuit failures were traced to drifts in resistor values caused by the release of hydrogen during the curing of a silicone potting compound. The hydrogen reduced the oxide in the resistor film and lowered its resistivity. The problem was solved by changing the type of silicone.

Discovery of this interaction led to attempts to deliberately reduce resistor values with hot hydrogen gas, and to increase the value by oxidizing the film with hot hydrogen. The method worked, but the reactions were sluggish and hard to control.

Water electrolysis was found to be an answer to this. A felt pen filled with pure water was applied to the resistor, and the pen and resistor were connected to a battery. When the resistor was at negative potential, hydrogen formed on the resistor and oxygen at the top of the water droplet, and the resistor value fell. Reverse current flow reversed the reaction.

A later version of this setup has a direct current supply, a bridge to monitor resistance, and feedback circuitry to alternate polarity. This could be the basis for an automated trimming system, but the technique requires further refinement before it can be used in production. Some types of re-

NEW Ultrasonic Soldering Systems

I/C PACKS
COMPONENTS
SUBASSEMBLIES

- Fluxless
- Increase throughput
- Reduce rejects

Redford has a broad range of fully automated, semi-automated, and manual systems. With ultrasonic soldering there is no worry about corrosion caused by residual flux because no flux is used. Pre-cleaning and post-cleaning eliminated. Send our application engineers a sample of your 'problem'—or call and tell them about it... even between noon and 1 pm.

1092 Catalyn Street
Schenectady, NY 12303
Phone 518/377-2204

REDFORD
CORPORATION

Circle 239 on reader service card

ANOTHER WORLD'S SMALLEST Soshin's Dipped Mica Capacitors/DM05

Developed by SOSHIN ELECTRIC, the only mica capacitor maker in Japan with MIL-C-5C qualifications. This newest and its bigger brothers will meet all your requirements. Volume orders accepted.

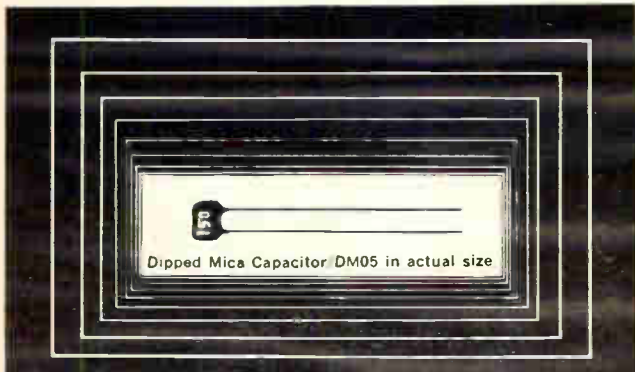

Dipped Mica Capacitor DM05 in actual size

Types	Max Allowable Capacitance (pF)		Dimension (mm)											
	100 WV	50 WV	100 WV			50 WV			50 WV			50 WV		
			L Max	W Max	T Max	L Max	W Max	T Max	L Max	W Max	T Max	L Max	W Max	T Max
CM 5	10	10	7.0	0.35	7.0	5.0	3.5	-	-	-	-	-	-	-
CM 10	10	10	11.0	0.35	11.0	8.0	5.0	3.5	8.0	5.0	3.5	8.0	5.0	3.5
CM 15	10	10	11.0	0.35	11.0	8.0	5.0	3.5	8.0	5.0	3.5	8.0	5.0	3.5
CM 20	10	10	11.0	0.35	11.0	8.0	5.0	3.5	8.0	5.0	3.5	8.0	5.0	3.5
CM 30	10	10	11.0	0.35	11.0	8.0	5.0	3.5	8.0	5.0	3.5	8.0	5.0	3.5
CM 40	10	10	11.0	0.35	11.0	8.0	5.0	3.5	8.0	5.0	3.5	8.0	5.0	3.5
CM 50	10	10	11.0	0.35	11.0	8.0	5.0	3.5	8.0	5.0	3.5	8.0	5.0	3.5
CM 60	10	10	11.0	0.35	11.0	8.0	5.0	3.5	8.0	5.0	3.5	8.0	5.0	3.5
CM 70	10	10	11.0	0.35	11.0	8.0	5.0	3.5	8.0	5.0	3.5	8.0	5.0	3.5
CM 80	10	10	11.0	0.35	11.0	8.0	5.0	3.5	8.0	5.0	3.5	8.0	5.0	3.5
CM 90	10	10	11.0	0.35	11.0	8.0	5.0	3.5	8.0	5.0	3.5	8.0	5.0	3.5
CM 100	10	10	11.0	0.35	11.0	8.0	5.0	3.5	8.0	5.0	3.5	8.0	5.0	3.5

For further information, write to
SOSHIN ELECTRIC CO., LTD.
18-18, Nakamagome 1-chome, Ohta-ku, Tokyo, Japan
Cables: SOSHINCAPACITOR TOKYO

Circle 240 on reader service card

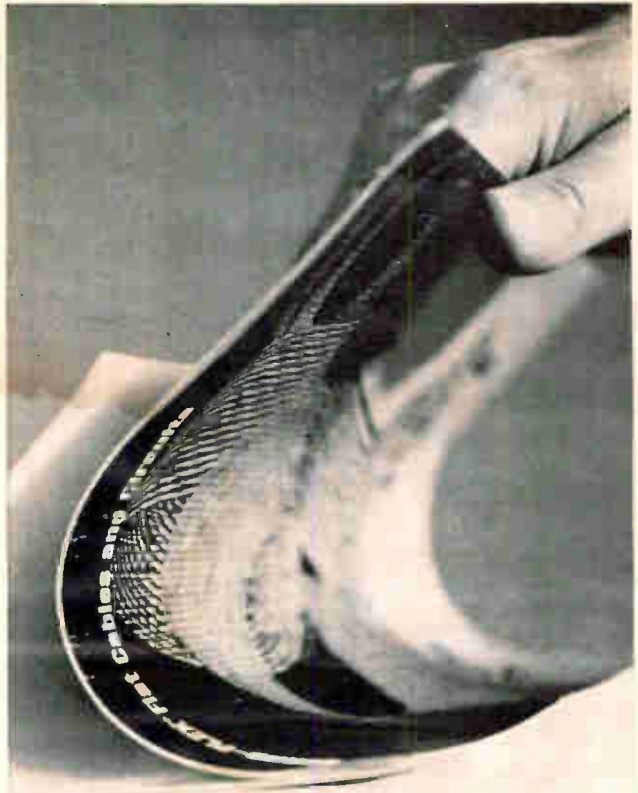

You've heard a lot of talk about flexible cables.

Read these facts.

This new, authoritative, 12-page design guide will help you: 1) decide when and where to use flexible cables and printed wiring; 2) exploit their specific advantages; 3) design the proper form for your application; and 4) choose the right insulation and conductor size.

The booklet is free. Write today. It'll show you how to reduce weight, save space, simplify assembly, increase reliability and uniformity and... cut costs.

Cerro Wire & Cable Co., Division of Cerro Corp.
New Haven, Connecticut 06504.

Please send me "CERRO-FLEX"
Flat Flexible Cables"

NAME _____

TITLE _____

COMPANY _____

ADDRESS _____

CERRO
WIRE & CABLE

®Trademark

Circle 201 on reader service card

201

**WHY SETTLE FOR LESS?
GET TOP
PERFORMANCE
WITH
DELTA'S FABULOUS
MARK® TEN**

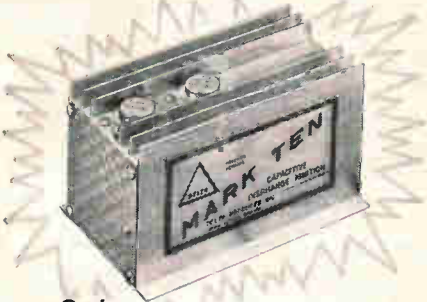

Only
\$44.95 CAPACITIVE
ppd. DISCHARGE
Deltakit - Only
\$29.95 ppd. IGNITION SYSTEM

You read about the Mark Ten in the April issue of Popular Mechanics!

Now discover why even Detroit has finally come around. In 4 years of proven performance and reliability, the Mark Ten has set new records of ignition benefits. No wiring. And works on literally any type of gasoline engine. Buy the original, the genuine, the real McCoy — Mark Ten. From Delta. The true electronic solution to a major problem of engine operation.

READY FOR THESE BENEFITS?

- ▲ Dramatic Increase in Performance and in Fast Acceleration
- ▲ Promotes more Complete Combustion
- ▲ Points and Plugs last 3 to 10 Times Longer
- ▲ Up to 20% Mileage Increase (saves gas)

LITERATURE SENT BY RETURN MAIL
BETTER YET — ORDER TOOAY!

DP 7-8

DELTA PRODUCTS, INC.

P.O. Box 1147 E • Grand Junction, Colo. 81501

Enclosed is \$_____. Ship prepaid.
Please send: Ship C.O.D.

Mark Tens (Assembled) @ \$44.95
 Mark Tens (Delta Kit) @ \$29.95
(12 Volt POSITIVE OR NEGATIVE GROUND ONLY.)

6 Volt: Negative Ground only.
 12 Volt: Specify Positive Ground
 Negative Ground

Car Year _____ Make _____
Name _____
Address _____
City/State _____ Zip _____

Technical Abstracts

sistor films cannot be trimmed in both directions, but can only be returned to the original value after being trimmed in one direction.

If the resistors are coated after trimming, as is often done after mechanical trimming, they show little drift—0.6% after 5,000 hours of test.

Presented at the Electronic Components Conference, Washington, D.C. May 3-5.

Copper blotter

Laminated ceramics
Bernard Schwartz and D.L. Wilcox
International Business Machines Corp.,
Hopewell Junction, N.Y.

Porous metals can resolve one of the dilemmas in the fabrication of multilayer ceramic structures—the need for a low-resistivity conductor that will bond strongly to the ceramic and withstand the stresses of sintering at high temperature.

The metals that meet the physical requirements have much higher resistivities than copper. But resistivity almost as low as that of copper can be achieved if the conductor is formed by filling capillary paths in a refractory metal with molten copper. The conductivity is more than doubled.

The technique is being developed to fabricate multilayer ceramic circuit boards. Experimental boards a few inches square contain five internal wiring layers and could interconnect more than 50 integrated-circuit chips. Similar techniques might be used to make ferrite memories and capacitors.

Thin sheets of alumina, screen-printed with wiring paths of metallic ink, are laminated and then fired at a temperature above 1,500° C. The ink is made of molybdenum trioxide and a greater amount of binder than normally used.

When the laminate is fired in hydrogen, the oxide is reduced to molybdenum. The binder evaporates, leaving molybdenum capillaries between the layers. When molten copper is drawn into the capillaries, each path becomes a microminiature equivalent of stranded wire.

Presented at the Electronic Components Conference, Washington, D.C. May 3-5

MATSUO

High Reliable Capacitors

POLYESTER FILM CAPACITORS.

Type MXT: In plastic tube. Capacitance Range: .001 MFD to .22 MFD. Voltages: 100v, 200v, 400v, 600v DC.

Type MFK: Dipped flat shape, non-inductive construction. capacitance Range: .01 MFD to .47 MFD. Voltages: 100v, 200v, 400v, 600v DC.

Type MFL: Dipped flat shape. Capacitance Range: .001 MFD to .22 MFD. Voltages: 50v, 100v, 200v DC.

METALLIZED POLYESTER FILM CAPACITORS.

Type FNX-H: Mylar wrapped semi oval with epoxy end seal. Capacitance Range: 1 MFD to 10 MFD. Voltages: 100v, 200v, 400v, 600v DC.

SOLID TANTALUM CAPACITORS.

Type TAX: MIL-C-26555A hermetically sealed.

Type TSX-TSL: Sealed with epoxy resin. Capacitance Range: .22MFD to 330 MFD. Voltages: 3v, 6v, 10v, 15v, 20v, 25v, 35v, 50v DC.

for full details, contact :

MATSUO ELECTRIC CO., LTD.

3-chame, Sennari-cho, Toyonaka-shi, Osaka, Japan
Cable Address "NCC MATSUO" OSAKA

LOW OHM SPACE TRAVELER

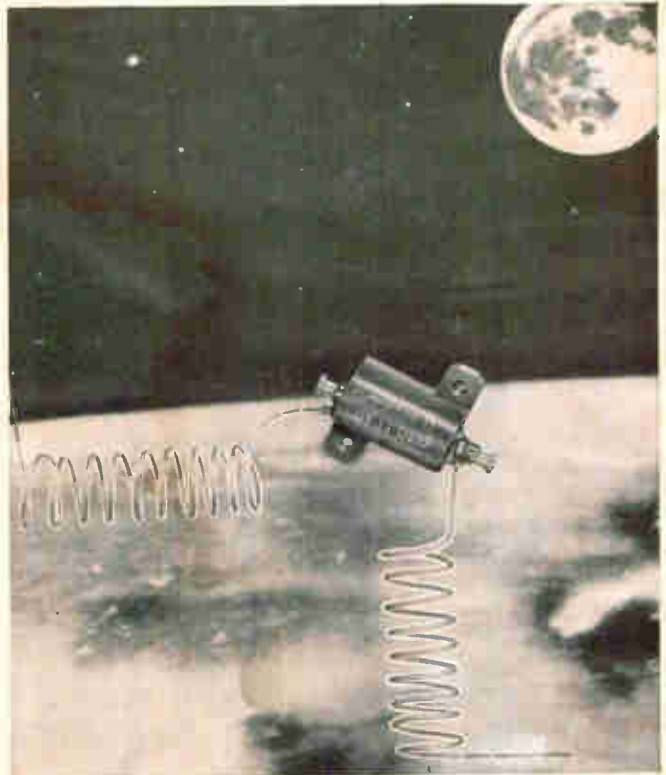

Resistor shown actual size

THIS SAGE RESISTOR

will travel 238,840 miles to play a leading role in one of the most dramatic events in world history.

The role is one vital to the successful operation of the EMU Portable Life Support System that will be carried by the first U.S. Astronauts to be landed on the moon.

The Hamilton Standard Division of United Aircraft Corporation has awarded SAGE a development contract for designing and producing current-sensing resistors based on the ultimate requirements in respect to:

RELIABILITY: Four terminal design... Multiple elements for redundancy... 3 watt dissipation in hard vacuum... Precious metal current terminals.

STABILITY: .03 ohms \pm 1% over complete temperature range of 0° F. to 160° F. and 0 through 10 ampere load.

This is another example of the role that SAGE is playing in custom-designing for highly sophisticated space electronics.

P.S. We design for down-to-earth applications also. Why not consult us regarding your resistor requirements?



SAGE

SAGE ELECTRONICS CORP.
BOX 3926 • ROCHESTER, N. Y. 14610

GENALEX
2way

PRECISION STEPPING SWITCH

for circuits which require a switch that steps positively, in either direction, around a bank of 25 contacts. **FEATURING:**

- self-cycle or remote control operation
- 65 steps per second on self-interruption
- bridging or non-bridging wipers
- 20 steps per second from external impulses

Over 10,000,000 steps in each direction without replacement.

for complete data on this and other unique GENALEX switches, write:

IMTRA

11 UNIVERSITY ROAD, CAMBRIDGE 38, MASS.
U. S. AGENTS FOR THE GENERAL ELECTRIC COMPANY, LTD. OF ENGLAND

Circle 242 on reader service card

A466

AMPERES OUT
VS
SIGNAL VOLTS IN

A466 WITH COVER REMOVED

2 KW RFI FILTERED SERVO AMPLIFIER

Westamp servo amplifier model A466 is designed to drive DC motors from an AC line supply with either DC or AC signal inputs. These high power DC motor-drive SCR amplifiers, are bi-directional and full wave. The A466 has high gain and high input impedance, provides for parallel summing of 3 signal inputs, and has adjustable current limiting. Furthermore servo amplifier A466 is designed to comply with requirements of MIL-I-16910A for RFI.

For more complete information just send for our catalog.

WESTAMP

HIGH POWER SERVO AMPLIFIERS
1542 15TH STREET, SANTA MONICA,
CALIF. 90404, PHONE: (213) 393-0401

Circle 243 on reader service card

Circle 203 on reader service card 203

* ANOTHER
COMPLETE

HATHAWAY

RELAY SERIES
Form A's, B's or C's

*



SERIES
MINIATURE RELAYS

GENERAL PURPOSE Series—Automated Production for both small and large volume applications. Nylon cover—bobbin construction, film sealed coil. Choice of low level or power carrying contacts. A mechanically secure instrumentation relay. Available in all standard coil voltage & contact configurations.

Write for new condensed catalog.

HATHAWAY INSTRUMENTS, INC.
5250 EAST EVANS AVENUE
DENVER, COLORADO 80222
(303) 758-8301 • TWX 292-2935
Distributed Nationally by
COMPAR CORPORATION

New Literature

Mercury-wetted relay. James Electronics Inc., 4050 North Rockwell St., Chicago 60618. A four-page catalog discusses the Merc-O-Scan mercury-wetted relay designed for high-speed signal switching and multiplexing.
Circle 420 on reader service card.

Ceramic capacitors. Vitramon Inc., P.O. Box 544, Bridgeport, Conn. 06601. Data sheet C17 describes VK ceramic capacitors that feature CK06 capacitance values (1,200 to 10,000 pf) in a CK05 case (0.2x0.2x0.1 in.). [421]

Trimming potentiometers. Techno-Components Corp., 7803 Lemona Ave., Van Nuys, Calif. 91405, offers bulletin No. 24 on its RT 24 style 3/8-in.-square trimming potentiometers. [422]

Beam centering unit. Syntronic Instruments Inc., 100 Industrial Rd., Addison, Ill. 60101, has issued bulletin 67-2 describing the Type C4268 compact, low-cost, easily adjusted, permanent magnet beam-centering device that requires no auxiliary power supply [423]

Argon-ion laser. Korad Corp., 2520 Colorado Ave., Santa Monica, Calif. 90406, has published a data sheet on its model K-GA, a completely self-contained argon-ion laser. [424]

Conical scanners. Canoga Electronics Corp., 8966 Comanche Ave., Chatsworth, Calif. 91311. A four-page illustrated brochure discusses a line of conical scanners for use with paraboloidal antenna reflectors. [425]

Broadband ferrite circulators. Huggins Laboratories Inc., 999 East Arques Ave., Sunnyvale, Calif. 94086, has available bulletins on a full line of broadband, three-port, single-junction waveguide circulators. [426]

Shaft encoders. Theta Instrument Corp., 22 Spielman Rd., Fairfield, N.J. 07006, has released a four-page bulletin giving full details on its line of five-digit, decimal shaft encoders. [427]

Magnetically shielded room. Magnetic Shield Division, Perfection Mica Co., 1322 N. Elston Ave., Chicago 60622. Time-saving manual MSR-1 gives detailed data for engineers' use in specifying a magnetically shielded room. [428]

Computer tape tester. General Kinetics Inc., 2611 Shirlington Road, Arlington, Va. 22206, announces a technical brochure on its Model 3200 computer tape tester. [429]

Urethane seal coat. CRC Chemicals, Dresher, Pa., has released a data sheet on urethane seal coat, a flexible insulating film for electrical and electronic parts and equipment. [430]

Process control computer. Bailey Meter Co., 29801 Euclid Ave., Wickliffe, Ohio 44092. Bulletin No. 855-1 covers the high-speed 855 computer that utilizes silicon IC's throughout, is equipped with magnetic core working memory, and is designed to implement the most advanced time-sharing, multiprogram, and satellite-processor techniques. [431]

High-purity chemicals. Semi-Elements Inc., Saxonburg Boulevard, Saxonburg, Pa. 16056, has published a brochure that gives complete information on the SEVAC line of high-purity chemicals. [432]

Sealed rechargeable batteries. Gulton Industries Inc., 212 Durham Ave., Metuchen, N.J. Sealed, rechargeable, nickel-cadmium spiral cell batteries for industrial, commercial, and consumer products are described in Bulletin V0116f. [433]

Microwave tubes. Varian Associates, 611 Hansen Way, Palo Alto, Calif. 94303, has available a four-page catalog, "Advanced Microwave Tubes for Advanced Systems." [434]

Laminated tapes. Lamart Corp., 16 Richmond St., Clifton, N.J., has a circular describing a line of laminated tapes designed for the wire and cable industry. [435]

Voltage regulators. Trio Laboratories Inc., 80 Dupont St., Plainview, N.Y. A technical bulletin describes flatpack, solid state voltage regulators designed for economical, simplified construction of series-regulated d-c power supplies. [436]

Line-driven chopper. Solid State Electronics Corp., 15321 Rayen St., Sepulveda, Calif. 91343. Model 64 plug-in, line-driven chopper is illustrated and described in a single-sheet bulletin. [437]

IC applications for photocells. Sensor Technology Inc., 7118 Gerald Ave., Van Nuys, Calif. 91406, has an illustrated brochure on IC applications for silicon photocells. [438]

Operational manifolds. Philbrick Researches Inc., Allied Drive at Route 128, Dedham, Mass. 02026. Operational manifolds—analogue instruments for breadboarding, computing, modeling, measuring, and on-line controlling—are described and illustrated in a six-page brochure. [439]

Temperature test chamber. Scionics Corp., 8900 Winnetka Ave., Northridge, Calif. 91324. Bulletin No. 710 details the function and applications of a precision temperature chamber that controls environmental temperatures

TERMINAL BLOCKS

CURTIS



SEP



SEIF

SEP - for connections to printed circuits

SEIF - for miniature insulated feed-thru

SEF - for miniature feed-thru

SES - for miniature surface contacts

All types of "SE" blocks include:

- Only 1/4" center-to-center terminal spacing
- Bright tin plated screw machine inserts
- #2-56 terminal screws for up to 16 #AWG wire
 - Molded black phenolic base
 - Choice of 1-18 poles
 - 300 volts — 5 amps



Send Today for Further Information
CURTIS DEVELOPMENT & MFG. CO.
 3203 N. 33rd St. • Milwaukee, Wis. 53216

See us at Booth 3743 Design Engineering Show, New York City
 Circle 244 on reader service card



**Great editorial is
 something he takes to work**
 (What a climate for selling!)

Electronics

A McGraw-Hill Market-Directed Publication
 120 West 48th Street, New York, N.Y. 10036

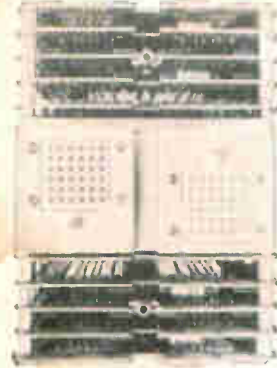

**all under
 one roof:**

Token memory systems are totally Token from start to finish. At Token we handle everything concerned with the memory systems we make. That's why we guarantee top quality: the Token quality you expect. We not only save time by doing it all ourselves, we save you money by cutting costs.

Token is the largest manufacturer of memory cores, planes and stacks in Japan. (We make more 20-mil-and-under cores than anyone else here.) Token uses its famous ferrite cores for the very latest in 2 1/2 D memory systems: you get improved performance, lower cost potential in larger memory sizes.

Write:



Tohoku Metal Industries, Ltd.

4, 7-chome, Ginza-Higashi, Chuo-ku Tokyo, Japan

Telephone: Tokyo 542-6171 Cable Address: TOHOKUMETAL TOKYO

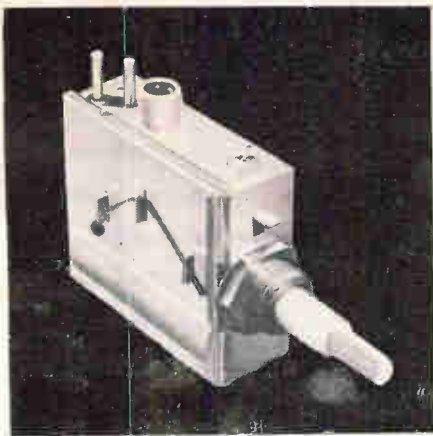

MITSUMI UHF TV TUNER

outrating international tuner standards!

Far outrating the FCC and VDE specifications, which are widely prevailing in the World as telecommunication standards, the MITSUMI UHF tuner only radiates spurious signals less than 33.5 dB below the reference field strength. Material, plating, soldering, as well as the proprietary circuit design are the technical achievements by MITSUMI based on a long-term fundamental research.

By virtue of high compactness, light-weight, outstanding durability and overall use of silicon transistors, the MITSUMI TV-tuner has made possible of minimum frequency drift due to temperature variation. And also, the MITSUMI TV-tuner is made available to tube-type TV sets.

Model	UHF TV tuner
Specifications	UK-A32 for American channel
Gain (dB)	10 min.
Noise figure (dB)	14 max.
Image ratio (dB)	30 min.
IF rejection (dB)	60 min.
Frequency stability	Temperature stability :
	300 kc at 25 ~ 65° C
	Voltage stability :
	100kc at 11V ± 1V
Outer dimensions (mm)	51 · 62.5 · 24.5

Model	UHF TV tuner
Specifications	U-ES12B for European channel
Gain (dB)	10 min.
Noise figure (dB)	16 max.
Image ratio (dB)	35 min.
IF rejection (dB)	55 min.
Frequency stability	Temperature stability :
	800kc at 20 ~ 30° C
	Voltage stability :
	400kc at 11V ± 1.1V
Outer dimensions (mm)	46.5 · 50 · 19

MAIN PRODUCTS

- Polyethylene variable capacitors ● IF Transformers
- Micromotors ● Synchronous motors ● Front-end FM tuners ● UHF & VHF TV tuners ● CdS photoconductive cells ● Trimming potentiometers ● Various types of coils
- Various types of sockets ● Trimmer capacitors
- Various types of terminals ● Fuse holders



MITSUMI

MITSUMI ELECTRIC COMPANY, LIMITED
 1056 Kojimachi Komae-machi Tokyo 415-6211
 302, Cheong Hing Bldg., 72 Nathan Road,
 Kowloon, Hong Kong 666 925
 Marienstrasse 17, Dusseldorf, W. Germany,
 MITSUMI ELECTRONICS CORPORATION
 11 Broadway, New York 4, N.Y. 10004. HA5-3085
 333 N. Michigan Avenue, Chicago, Ill. 60601
 263-6007

New Literature

±0.25°F over a range of -100° to 500°F. [440]

Balanced transformers. B&K Instruments Inc., 5111 W. 164th St., Cleveland 44142, has a brochure on balanced input and output transformers. [441]

Numerical tape controls. Superior Electric Co., Bristol, Conn. 06010. Bulletin NTC167 covers three-axis numerical controls that feature mirror-image capability. [442]

Digital voltmeter. Electrolab Inc., 18271 Parthenia St., Northridge, Calif. 91324, has a four-page catalog on its Model 100 digital voltmeter with autorange. [443]

Permanent magnet materials. General Electric Co., P.O. Box 72, Edmore, Mich. A family of Alnico 8 permanent magnet materials is covered in a two-page bulletin, GEA-8248. [444]

Miniature relays. Sigma Instruments Inc., 170 Pearl St., Braintree, Mass. 02185, offers a six-page catalog bulletin providing detailed engineering and ordering information on the Series 22 high-performance d-c spdt and dpdt relays. [445]

Mixer-preamplifiers. RHG Electronics Laboratory Inc., 94 Milbar Blvd., Farmingdale, N.Y. 11735. A four-page product bulletin, MP-102, lists a line of fully integrated balanced mixers and low-noise preamplifiers providing MIL-grade, solid state units for systems applications. [446]

Reversible counters. Hewlett-Packard Co., 1501 Page Mill Rd., Palo Alto, Calif. 94304. Application Note No. 85 is a 44-page booklet surveying some of the varied applications for reversible counters that have two inputs. [447]

Line protector. Quindar Electronics Inc., 60 Fadem Rd., Springfield, N.J. 07081, has prepared a bulletin providing a block diagram, description, and specifications of the QLP-7 line protector. [448]

Electromechanical switch. Microwave Associates Inc., Burlington, Mass., has released a technical bulletin on a broadband, spdt, coaxial electromechanical switch that combines high r-f performance and mechanical reliability in a subminiature package. [449]

Automation products. Boonton Electronics Corp., Route 287 at Smith Road, Parsippany, N.J. 07054, has available a 32-page catalog outlining instruments and systems for testing and manufacturing-process control in electronic-component and integrated-circuit production. Copies may be obtained by request on company letterhead.

High Reliability Instruments

meguro



MAK-658

Dist. meter

— for AUDIO LABS and PRODUCTION —

FEATURES:

- Efficiency is achieved in measurements by elimination input level and balancing adjustments for each change in the frequency; errors due to personal factors are reduced.
- The null network for the fundamental frequency suppression (patent applied for) has such a characteristic that makes possible the determination of the distortion due to frequency modulation in tape recorders.

● Catalog sheet on request:



MEGURO DENPA SOKKI K.K.

Meguro Electronic Instrument Co. Ltd.
 No. 5, 1-2-chome, Chuo-ku, Meguro-ku, Tokyo Japan
 TEL: 711-7191-27 Cables: MEGURODENPA TOKYO

Circle 245 on reader service card

THIS SPACE CONTRIBUTED BY THE PUBLISHER



The Voice. Anybody's voice. Your voice. It has a special quality and timbre all its own. But.

If it should become hoarse or if a cough should persist, find out what the reason is. Promptly. It could be a warning signal of cancer. And cancer is easier to cure when it's detected early.

Frank Sinatra knows the seven warning signals of cancer. Do you? 1. Unusual bleeding or discharge. 2. A lump or thickening in the breast or elsewhere. 3. A sore that does not heal. 4. Change in bowel or bladder habits. 5. Hoarseness or cough. 6. Indigestion or difficulty in swallowing. 7. Change in a wart or mole.

If a signal lasts longer than two weeks, see your doctor without delay.

It makes sense to know the seven warning signals of cancer.

It makes sense to give to the American Cancer Society.



E.E.'s

For FEE PAID positions throughout U.S.

SEND RESUME TODAY
(if none, send coupon for confidential application.)

ATOMIC PERSONNEL, INC.
Suite L, 1518 Walnut St., Phila., Pa.
Experienced Engineers
Working Full Time for You!

Name _____

Address _____

City _____ State _____

AN EMPLOYMENT AGENCY FOR ALL TECHNICAL FIELDS

engineers

Here is your opportunity to associate with a high calibre staff in its formative state. At our research center in Ithaca we are engaged in exploratory activities in aircraft and ocean instrumentation. Our job is to come up with new ideas and new designs for transducers, modules and sub-systems using the latest techniques and components. We seek the help of talented and resourceful engineers (E.E. & M.E.) having up to ten years applicable experience.

Technical domain of this work will range through... Solid-state applications • Servo-mechanisms • Transducer design • Circuit design • Electromechanical design • Subsystems design & testing • Analog and digital techniques.

This is a real ground floor opportunity. Your opportunity also to live and work in the stimulating atmosphere of Ithaca, the educational, recreational and scenic center of the Finger Lakes region.

Inquiries will be treated in confidence. Send resume to: Mr. R. G. Thrasher, Dept. E

THE BENDIX CORPORATION
FLIGHT & ENGINE INSTRUMENTS DIVISION
RESEARCH CENTER, CORNELL RESEARCH PARK, ITHACA, N.Y. 14850



An Equal Opportunity Employer

CLASSIFIED ADVERTISING

SEARCHLIGHT SECTION

BUSINESS OPPORTUNITIES
USED OR SURPLUS EQUIPMENT

RELAYS-RELAYS-RELAYS

- ALL TYPES IN STOCK
- OFF-THE-SHELF DELIVERY
- PRODUCTION QUANTITIES

MS, AN, power, HV, telephone, crystal can, general purpose, sens. meter . . . and MANY OTHERS TO SELECT FROM OUR INVENTORIED LISTINGS, by mfr. part no. and Fed. stock No. 5945 series. **SAVE TIME SAVE \$\$\$**

PHONE • WRITE • WIRE • TOOAY!



STANDARD RELAY CORPORATION
77 STAGG STREET - BROOKLYN, NEW YORK 11208

SEND FOR OUR LATEST CATALOG

CIRCLE 966 ON READER SERVICE CARD

free catalog

POTTING APPLICATORS
MANUAL AND DISPOSABLE

6cc 12cc 30cc

FOR POTTING, ENCAPSULATING, AND SEALING OF MINIATURE COMPONENTS

PHILIP FISHMAN COMPANY

7 CAMERON ST., WELLESLEY 81, MASSACHUSETTS

CIRCLE 968 ON READER SERVICE CARD

For Sale

VACUUM METALIZER or COATING SYSTEM

N.R.C. Type 3143B-42301. Chamber size 36" dia. X 6' long complete with diffusion pumps, mechanical pumps, gauges and power supplies. Overall dimensions 19' long, 8' 6" high. Used 3 months.

Also 2 G.E. 5 KW dielectric heaters, 45 megacycles.

INSTRUMENTS & MACHINES, INC.

1200 Grove St. Irvington, N.J. 07111
Telephone: (201) 371-7900

CIRCLE 967 ON READER SERVICE CARD

RADAR AUTO-TRACK & TELEMETRY ANTENNA PEDESTALS 3 & 10 CM. SCR 584 AUTOTRACK RADARS. M-33 RADAR TPS-1D SEARCH. APS-45 TPS-100 HT. FINDERS. WX RADARS. FPN-32GCA. APS-10 APS-15B APS-27 (AMT) SEARCH. APN-102 DOPPLER. DOZENS MORE. CARCINOTRONS. PENS. 25-5-1-23.6 MEGAWATT PULSE MODULATORS. CAVITIES. PULSE TRANSFORMERS. IF STRIPS. WAVEGUIDE. BENDS 200 MC. 1 KMC. 3 KMC. 6 KMC. 9 KMC. 24 KMC. RF PKGS.

RADIO RESEARCH INSTRUMENT CO.
550 5TH AVE., NEW YORK 36, N.Y. JU 6-4691

CIRCLE 969 ON READER SERVICE CARD

**NEED ELECTRONIC EQUIPMENT? LOOK IN
ELECTRONICS SEARCHLIGHT SECTION!**

ELEKTRONIK IN BUCHUNGSMASCHINEN

Eines der führenden westdeutschen Unternehmen der Sparte Organisations- und Buchungsmaschinen (Einzelplatztypen) sucht einen überdurchschnittlich begabten, deutschsprachigen

ELEKTRONIK-INGENIEUR (DIPL.-ING.)

zur

LEITUNG

VON ENTWICKLUNG UND
KONSTRUKTION

Es kommen nur Persönlichkeiten mit ausgereiftem Fachwissen, möglichst auf dem Gebiet der Kombination Elektronik/Mechanik, in Frage, die in ähnlicher leitender Stellung tätig sind oder die Qualifikation besitzen, vorzüglich arbeitende Teams (ca. 200 Personen) in modernsten Techniken sachkundig zu leiten und schöpferische Ideen zur Entfaltung zu bringen.

Der grossen Verantwortung stehen ein entsprechendes Einkommen, eine ausreichende Altersversorgung und gute Wohnmöglichkeiten (gegebenenfalls Mitfinanzierung eines Einfamilienhauses) gegenüber.

Nach Gruenlicher Einarbeitung Ist Die Aufnahme In Das
Fuehrungsgremium Vorgesehen.

Interessierte Herren bitten wir um Zustellung von vollständigen Unterlagen samt Foto, Handschriftprobe und Gehaltsvorstellung.

AG für Personalberatung, Talstrasse 20, 8001 Zuerich (Switzerland)

PROFESSIONAL SERVICES

Donald C. Harder., Inc.

Magnetic Component Engineers

Reactors—Transformers—Filters
Serving the Research Laboratory

2580 K Street, San Diego, Calif. 92102
Phone (714) 239-8021

ELECTRICAL & ELECTRONIC ENG.

10-20,000 all fees paid

Staffing new plants, need eng. EE's various location. 4A natl firm offering real growth & challenge.

BAKER & ASSOCIATES

414 Walnut St. Cincinnati, Ohio 45202
421-1530

Elementary!
For solid-state
power sources
from L to X band...
RCA

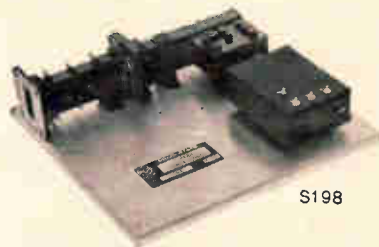

S198

Looking for microwave power? Try RCA solid-state power devices which provide a wide range of power outputs—from 750 mW at 1225 MHz to 100 mW at 9.9 GHz.

More specifically, these RCA units are frequency-multiplier-oscillator power sources. Available now, they can solve your design problems in those areas of communications requiring a dc input and RF power output—with the added plus of low cost!

You can choose from a line of RCA Solid-State Microwave Packaged Devices. Their technological advances can make your present systems obsolete. Check these examples:

RCA TYPE	S195	S198	S199	S200
Power Output	10-40 mW	100 mW	750 mW	200 mW
Frequency	4.2-5.2 GHz	9.2-9.9 GHz	1225 MHz	1680 MHz

Compact and rugged, these RCA solid-state power sources meet the requirements of equipment designers for low-power radar transmitters, pumps for parametric amplifiers, solid-state "klystrons," low-power relay transmitters,

local oscillators, and FM signal and laboratory applications.

Whatever your requirements, investigate these solid-state devices from RCA—whose design and production resources are unmatched in the industry; whose L-, S-, C-, and X-Band microwave capabilities can thereby help improve your systems designs. For technical data, write: RCA Commercial Engineering, Section E19Q, Harrison, N. J. 07029.

RCA Electronic Components and Devices



**The Most Trusted Name
in Electronics**

Newsletter from Abroad

May 29, 1967

Hong Kong rioting threatens to sour U.S. firms on colony

Communist-led riots in Hong Kong could cost the Crown Colony its position as a site for electronics industry expansion. Managers and directors of Hong Kong's 15 U.S.-owned manufacturers of electronic components and transistorized radios have been terrorized and some production schedules have been upset. All the plants are located in Kowloon, the segment of the colony attached to the Chinese mainland and the focal point of the initial rioting, and curfews imposed in this area have kept night shifts from work. The Fairchild Semiconductor division's factory—the biggest in Hong Kong—lost its third shift for four straight nights. The Fairchild plant currently has between 3,500 and 4,000 employees—down from its peak of 5,000 because of reduced demand for components for consumer electronics.

Electronics executives fear the rioting may be directed at their facilities next. Even before the trouble broke out at plastic flower plants, the Communist press had been criticizing Hong Kong's electronics industry, which last year exported \$170 million of goods. In an article entitled "War prosperity of American-owned electronic firms," the Economic Reporter, a Communist publication, named U.S. firms operating in the colony and accused them of producing equipment exclusively for the U.S. Air Force and Defense Department. Denials from all the U.S. companies have been ignored.

Expressing the general attitude of fear, the manager of one plant said nervously, "I saw them rioting outside my window. It wouldn't take much for some of them to tear this place apart."

And it wouldn't take much for some of the electronics firms to pull out of Hong Kong, though most are anxious to make the most of their investments there. All expansion plans have been delayed or shelved.

The upheaval comes at a bad time for Hong Kong. Cheaper labor rates have lately been luring electronics concerns to Taiwan and South Korea. After surveying conditions in Hong Kong, Philco-Ford, General Instrument, Signetics, and Motorola have chosen other Asian sites. Fairchild has opened a factory in South Korea, and Oak Electro-Netics, which also has a plant in Hong Kong, will break ground for one this summer in Korea.

Sony comes up with low cost video tape file

Sony Corp. has developed a video document-retrieval system that it will market next year in Japan for about \$20,000. No decision has been reached yet on whether the system will be exported.

Designed around Sony's industrial video tape recorder, the system stores up to 100,000 documents on a 2-inch-wide, 600-foot-long reel of magnetic tape. Documents are recorded by the system's video camera and are retrieved by writing in the address on a keyboard. Maximum access time is less than 2 minutes.

Scanning frequency of the developmental system is 268 lines per frame, but Sony says this may have to be increased—possibly to the 525-line scan of television—to accommodate a wider range of documents.

An incremental counting method is used for reading out tape address; 100,000 lateral lines are pre-recorded, one for each document to be stored. A magnetic modulation head reads the absolute value of recorded flux—rather than the rate of change—so that it can read out even when the tape is stationary.

Newsletter from Abroad

Microwaves speed material tests

British developers of a microwave nondestructive technique for testing materials claim it is as much as 10 times faster than ultrasonic methods because no coupling between test equipment and material is needed. A typical industrial installation would cost about \$3,000, slightly higher than an equivalent ultrasonic setup, according to engineers at the government's Rocket Propulsion Research Laboratory.

In testing bulk materials such as rubber or plastics, 8-millimeter waves are beamed at the material. Measuring the amount of signal attenuation will give information on the degree of emulsification or curing, while detecting the deflection of normal scatter patterns will show up any faults, such as tiny cracks. Energy from a 100-milliwatt output will penetrate two feet of rubber; this level could be increased several times before any radiation hazard would develop, according to the British group.

French Plan-Calcul picks up steam

France's Plan-Calcul, the government-industry venture to build a national computer capability, begins to look even more ambitious than originally described. A third manufacturing operation will be built at Toulouse, the southwestern city that is rapidly becoming France's second electronics center after Paris.

The Compagnie Internationale Pour L'Informatique (CII), created with \$20 million worth of government subsidies and loans, so far has only one plant, outside Paris. CII will build a second one nearby.

CII says its decision to build in Toulouse has nothing to do with the presence of two U.S. semiconductor makers, ITT's Cannon Electric and Motorola Semiconductor, also building there. CII will have a "tendency" to buy French, says a CII official. He concedes, however, that French semiconductor makers won't be able to supply all the integrated circuits CII will need for its first computers, and that the company will try to buy IC's from U.S. producers in France before importing them.

Patent ruling spells British tv bonanza for U.S. company

Now that a British judge has granted three-and-a-half-year extensions on two color tv patents that were to have expired this spring, the question is how much money will this mean for the owner of the patents, the Hazeltine Corp. of Little Neck, N.Y. Philips Electrical and EMI Electronics, two firms that opposed the extension, see British set manufacturers paying a rich royalty, possibly as much as \$14 a set. Hazeltine will say only that "those are their figures, not ours."

In any event, the price will be high. The patents cover "shunted monochrome" and "constant luminance"—processes that permit reception of black-and-white and color pictures by the same set.

Aerospace firms to merge with Bonn's blessings

Prodded by the Bonn government, Messerschmitt and Boelkow have agreed to a merger—a move seen as a giant step toward concentration of West Germany's aerospace industry. Both firms are active in electronics and satellite work; a Messerschmitt subsidiary is building the Highly Eccentric Orbit Satellite (HEOS-A) and Boelkow developed the attitude control and monitoring systems for the European Space Research Organization's Europa rocket.

Boelkow is also weighing a merger with another aerospace firm, Vereinigte Flugtechnische Werke, making a three-way linkup likely.

Sweden

Stress signals

"If an executive knows his blood pressure is going to rise dangerously before a board meeting, he can take a pill. Or, maybe he should change jobs."

So says Dr. Lennart Levi of Stockholm, one of Sweden's leading specialists in clinical stress research. But this choice is possible only if it is known how a person's blood pressure changes under the varying conditions of daily life. Dr. Levi points out that blood pressure readings taken in the doctor's office are at best a guide, not an accurate measurement of the patient's condition.

At the request of Dr. Levi, a portable electronic blood-pressure meter has been developed in Sweden that records a subject's pressure directly on a chart at periodic intervals—at work, at home, watching television, or while sleeping.

Pressure point. The device operates much like the hand-pump-type meter found in every doctor's office, but it is automatic. A pump forces air through a small rubber tube into the sensor, called the cuff. This is a bulb which is wrapped around the thumb. A manometer balances the blood pressure in the thumb against that in the cuff bulb. When they are the same, this pressure is registered. The instrument, called the Tonograf, was built by Bejert Svensson, head of the medical equipment department of Svenska AB Tradlos Telegraf in Stockholm. It has electronic controls with a conventional chart recorder, driven by a spring-power clock mechanism.

The recorder weighs three pounds and is housed in a container the size of a cigar box. It is carried on a shoulder strap.



Control digit. Changes in blood pressure are picked up by thumb sensor and recorded on a chart in a container slung on a shoulder strap.

"After the first hour, the patient forgets about it," says Dr. Levi. The Tonograf, powered by button-sized batteries, can give continuous readings on a disc chart for 24 hours. Since this is not usually necessary, a control switch permits measurements for one minute in every 15 minutes. The recording includes the time of the reading.

Dr. Levi expects the device will have important uses in aviation medicine. On long-distance flights, blood pressure drops as the pilot's "biological clock" tells him it's night, even though he is landing at midday local time. The relationship between blood pressure and fatigue can also be studied.

The meter will be valuable in studies of hypertension. In early stages, blood pressure fluctuates greatly and it is sometimes difficult to spot the ailment.

Some surprises. Dr. Levi, who is encouraged by the results of a six-month trial, says the tests show there are people who seem to have

high blood pressure but actually have lower pressure, and vice versa. He has found patients whose pressure rises considerably during a working day, and feels this might be one reason that cerebral hemorrhages often occur when people are on the job.

The present device cannot be used by persons doing manual work. If the sensor moves too much, erroneous recordings are produced.

The Tonograf, which measures systolic pressure only, consists of a pressure follower and a pressure recorder. The pressure exerted by the cuff bulb is maintained by a servosystem that allows only a fraction of the thumb-pressure pulse to reach the far side of the cuff, where a pulse sensor is located.

Dotted graphs. When the measurements are being recorded, a series of dots is produced on the graph, each dot representing a momentary pressure value. Short-

Tabulator Ltd.'s computers are bucking trends set by their American counterparts.

One approach being tried in the U.S. is large-scale integration, with monolithic arrays of IC's connected by thin-film wiring. Another involves assembling large numbers of IC chips on miniature multilayer circuit boards, usually made of thick films of wiring separated by layers of ceramic or glass.

ICR plans to use chip-and-board assemblies, but to vacuum-deposit the wiring as thin films of gold and plastic. This will simultaneously solve several processing and reliability problems, according to K.C. Bingham, manager of ICR's interconnection development group. Bingham observes that the process can also be used for monolithic-array connections when LSI becomes practical.

With this technique, the plastic is polymerized to make it strong, free of pinholes that could short the wiring, and flexible enough to withstand unequal expansions of board materials during fluctuations in processing and operating temperatures. Bingham says that inorganic dielectrics were discarded in favor of the organic film because

inorganics cannot be deposited over a large area without pinholes.

To supplement this deposition technique, ICR has worked out a method of etching a layer of gold and a layer of polymer at the same time.

Traditional target. Bingham indicates that the goal of this development effort is a new generation of computers to win sales away from the International Business Machines Corp. IBM holds the major share of the European market.

However, a spokesman at ICR headquarters denies that a new series of computers is in the wings. He says the company intends first to replace discrete-component circuitry with IC's in the central processors of its 1900 series computers. The upgraded processors will be faster than the current versions, but will still be able to use the 1900 series software.

The changeover may not occur for many months, the spokesman noted, adding that a final decision on whether to use the new technique, regular logic IC's, or both, hasn't been made.

Base plate. The base of the multilayer board used with the new process is a ceramic plate. As a

preliminary step, a power plane and ground plane are deposited on the ceramic. Then 12 substrates, each 1 by 2 inches, are put in a rotating holder in a vacuum-deposition chamber. A first layer of polymer is deposited on each, followed by a first layer of gold.

Bingham and a co-worker, W.R. Cuttell, described the polymerization and patterning techniques at the Electronic Components Conference in Washington earlier this month. The dielectric, dimethyl polysiloxane, is fed into the chamber as a monomer gas. An electron beam aimed at the substrate creates a glow discharge that causes the monomer to polymerize as it condenses on the substrate. Residual bonds on the polymer fasten it strongly to the gold when that layer is deposited.

The gold is etched to form the first-layer wiring pattern, and a film of positive photoresist is developed to leave strips of resist wherever openings are needed in the second layers of polymer and gold. After these layers are deposited, the board is dipped into an ultrasonic bath of resist solvent; the solvent attacks the resist through tiny openings in the polymer. The unwanted strips of polymer and gold are loosened and peeled off the substrate.

To complete the wiring pattern, bridging links of aluminum are deposited to join selected spots on the first and second layers. Some of the signal wiring is terminated as lead fingers with electroplated pillars for face-bonding of integrated-circuit chips.

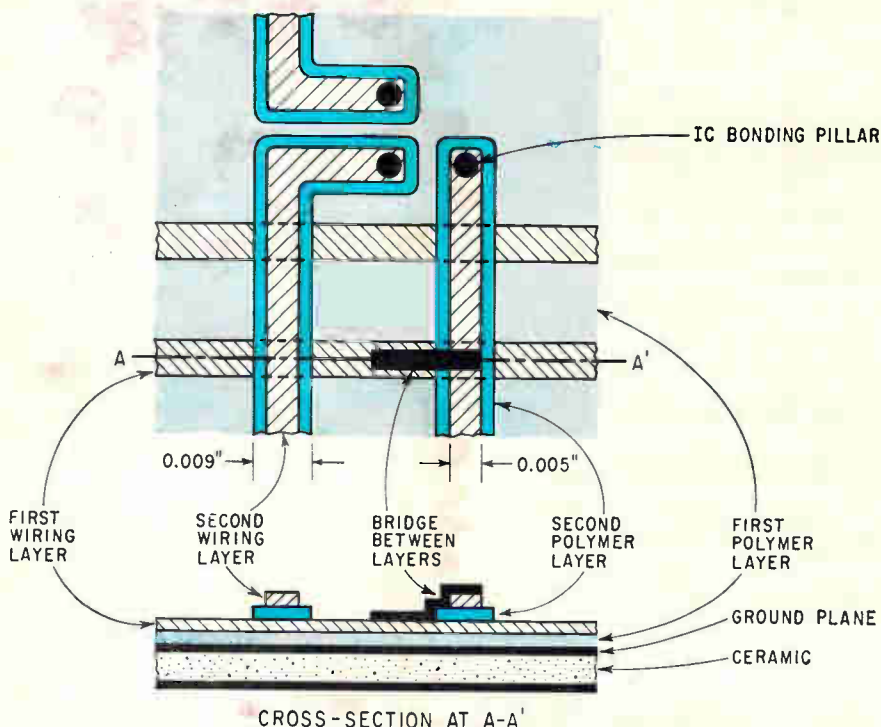

Chip connections. Layers of plastic will insulate layers of thin-film wiring in British firm's new method of interconnecting IC's for computers.

International

A common code

After several years of hesitation and slow progress, a standardized, European-wide system for registering and identifying semiconductor devices and electronic tubes appears to be catching on.

Spearheading the drive is Pro Electron, a nonprofit industry as-

Sweden

Stress signals

"If an executive knows his blood pressure is going to rise dangerously before a board meeting, he can take a pill. Or, maybe he should change jobs."

So says Dr. Lennart Levi of Stockholm, one of Sweden's leading specialists in clinical stress research. But this choice is possible only if it is known how a person's blood pressure changes under the varying conditions of daily life. Dr. Levi points out that blood pressure readings taken in the doctor's office are at best a guide, not an accurate measurement of the patient's condition.

At the request of Dr. Levi, a portable electronic blood-pressure meter has been developed in Sweden that records a subject's pressure directly on a chart at periodic intervals—at work, at home, watching television, or while sleeping.

Pressure point. The device operates much like the hand-pump-type meter found in every doctor's office, but it is automatic. A pump forces air through a small rubber tube into the sensor, called the cuff. This is a bulb which is wrapped around the thumb. A manometer balances the blood pressure in the thumb against that in the cuff bulb. When they are the same, this pressure is registered. The instrument, called the Tonograf, was built by Bejert Svensson, head of the medical equipment department of Svenska AB Tradlos Telegraf in Stockholm. It has electronic controls with a conventional chart recorder, driven by a spring-power clock mechanism.

The recorder weighs three pounds and is housed in a container the size of a cigar box. It is carried on a shoulder strap.



Control digit. Changes in blood pressure are picked up by thumb sensor and recorded on a chart in a container slung on a shoulder strap.

"After the first hour, the patient forgets about it," says Dr. Levi. The Tonograf, powered by button-sized batteries, can give continuous readings on a disc chart for 24 hours. Since this is not usually necessary, a control switch permits measurements for one minute in every 15 minutes. The recording includes the time of the reading.

Dr. Levi expects the device will have important uses in aviation medicine. On long-distance flights, blood pressure drops as the pilot's "biological clock" tells him it's night, even though he is landing at midday local time. The relationship between blood pressure and fatigue can also be studied.

The meter will be valuable in studies of hypertension. In early stages, blood pressure fluctuates greatly and it is sometimes difficult to spot the ailment.

Some surprises. Dr. Levi, who is encouraged by the results of a six-month trial, says the tests show there are people who seem to have

high blood pressure but actually have lower pressure, and vice versa. He has found patients whose pressure rises considerably during a working day, and feels this might be one reason that cerebral hemorrhages often occur when people are on the job.

The present device cannot be used by persons doing manual work. If the sensor moves too much, erroneous recordings are produced.

The Tonograf, which measures systolic pressure only, consists of a pressure follower and a pressure recorder. The pressure exerted by the cuff bulb is maintained by a servosystem that allows only a fraction of the thumb-pressure pulse to reach the far side of the cuff, where a pulse sensor is located.

Dotted graphs. When the measurements are being recorded, a series of dots is produced on the graph, each dot representing a momentary pressure value. Short-

term variations due to respiration are averaged out when reading the chart.

The sensor on the thumb sends an impulse to the preamplifier, filter, rectifier, and power amplifier, which make up the servosystem control for the motor. The motor activates a pump which sends impulses back to the bulb around the finger as well as to the manometer.

The first units contain silicon transistors. Svensson says second-generation devices will have hybrid integrated circuits. This will improve reliability rather than reduce size, since the graph holder and clock cannot be made much smaller and still produce a readable chart.

Updating an old trade

Armaments have been an important export item for Sweden since the Thirty Years' War more than 300 years ago. The business is now taking a new direction: the exporting of complete and highly sophisticated defense systems.

The Paris Air Show, May 26 to June 4, marked the first marketing effort abroad by Swedegroup, a consortium quietly formed about a year ago by six Swedish companies in the defense electronics, aviation, and munitions industries.

Establishment of this venture doesn't mean the companies will drop their individual operations, but Swedegroup will handle the promotion of large joint projects. "The offer by major Swedish companies of a complete defense system will be more attractive than bids from each firm for a piece of the business," says Frank Cervell, managing director of Swedegroup.

The most obvious potential customers are neighboring Scandinavian nations and neutral countries elsewhere. A big selling point will be the claim that the independence and stability of nations will be served if they build up their defense systems with equipment supplied by neutrals like Sweden rather than by one of the major powers. "I'm thinking of nations in Africa and Asia, for example," says Per Odelberg, managing director

of AB Bofors, one of the members of the consortium. "If they buy defense materials from Sweden, they get them with no strings attached."

Swedish policy prohibits the export of arms to nations at war or those at swords' point. This restriction would rule out many potential customers.

At Paris, Swedegroup showed a high-speed radar display unit that uses integrated circuits. The maker, Standard Telefon & Radio AB, says the system displays alphanumerics, symbols and graphics, and will be available in digital and analog versions.

Also shown at Paris was an automatic technique for testing the avionics in the new Viggen aircraft, radar for the latest version of the supersonic Draken fighter, and a miniaturized airborne digital computer.

Japan

What's up front counts

Many variations of the cathode-ray tube have been developed through the years but the latest change may well be the most radical. Now there's an inside-out crt designed as a digital readout tube for elec-

tronic desk calculators. Conventional tubes have the cathode in the rear, but the new crt—called the Digitron—has the cathode up front.

Invented by Japan's Tadashi Nakamura, president of the Ise Electronics Corp., the Digitron is a joint Ise-Hayakawa Electric Co. development effort. Hayakawa is incorporating the crt into a line of calculators scheduled for a fall debut.

Not only is the new tube small, but its cost is low and it requires little power, says Nakamura, who invented the one-gun Colornetron picture tube [Electronics, May 31, 1965, p. 81].

Vanishing cathode. Digitron has phosphor-coated number segments toward the rear. The 30-micron-wide, forward-mounted filamentary cathode is kept at a low-enough temperature so that its faint glow isn't discernible, says Ise. A space-charge grid, consisting of 15-micron wire woven into a 100-mesh-per-inch screen, is located directly behind the cathode. Segments of numerals are outlined by a photo-etched screen electrode that serves as a mask to define the individual segments. This simplifies production by eliminating the need for precisely shaping the segments.

The phosphor segments are attached to a ceramic support, which has lead wires extending through

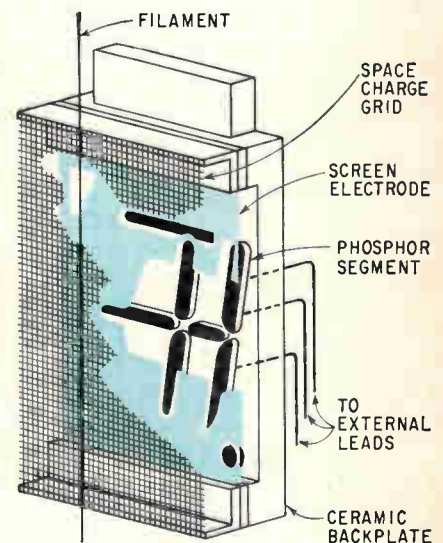
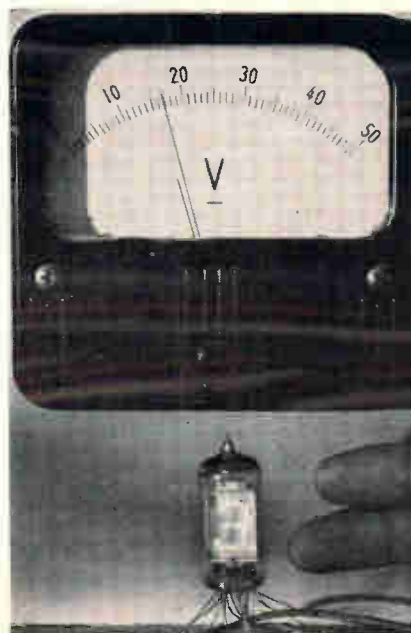

Planar display. New digital readout tube draws as little as 15 volts. Cathode mounted up front in envelope is invisible when number-segments glow.

it. The segments consist of a resistive layer—which makes contact to the segment leads—and a zinc oxide phosphor layer.

The cathode location is not just a matter of departing from a conventional theme. Electrons are emitted from the oxide-coated filament in all directions. Those starting toward the envelope are repelled toward the space-charge grid by the negative charge that collects on the envelope's inside surface. Ise says careful design of the tube geometry assures that an electron shower with constant density at all points passes through the grid which is operated at +25 volts. The screen electrode has the same 25-volt potential, and electrons continue on toward it.

Lighting up. Phosphor numeral segments can be turned on at 25 volts, or as low as 15 volts. The electrons strike only those segments needed to make a selected numeral glow. The remaining segments are held at zero potential.

Heater input is 0.8 volts at a current of 90 milliamperes. At an accelerating potential of 25 volts, the total cathode current is 7.7 milliamperes. Regardless of the number of phosphor segments switched on, cathode current remains constant because of the shielding effect of the space-charge grid. Current within the tube changes, however, depending on the number of segments that are turned on. For a typical numeral, the total phosphor segment current is 0.7 milliampere. The remainder of the current goes to the space-charge grid and screen electrodes, which are internally connected.

Ise says Digitron has a two-digit-per-inch density. The numerals measure 0.46 inch high by 0.35 inch wide, in a cylindrical glass one-half inch in diameter and 1.7 inches high. The display includes a decimal point and a prime mark.

Shines brightly. Since the bright green numerical display is formed by segments that lie in the same plane, numbers do not "dance" as they do in multiple-cathode gas-discharge tubes. Ise says display brightness is at least 80 foot-lamberts. Digitron can provide a dis-

play at 15 volts and can be switched directly by integrated circuits. The device can operate from 15- to 25-volt, d-c power supplies.

The company says operational life isn't known yet but reports tubes have been running upwards of several thousand hours.

Calculated entry

The latest entry in Japan's calculator sweepstakes is the Sony Corp., which will be off and running on June 1 with an electronic desk model that uses hybrid integrated circuits and has two memories.

Called the Sobax, for solid state abacus, the unit will be priced at \$722. Plans call for a 500-unit monthly production quota initially, with sales limited to Japan.

A first. Although its price is slightly higher than the lowest-priced Japanese calculators now available, Sony's entry seems to be competitive. It is a 14-digit calculator where most of the others have 12 digits and lack a memory feature. The new unit operates from low-voltage d-c power supplies and is the first made in Japan that blanks out all zeros before the first significant digit.

Sobax uses a single ultrasonic delay line—invented by the University of Osaka's Zenichi Kitamura—for five registers, and is believed to be the first to incorporate this feature. Three of the registers are used for arithmetic and the other two operate as memories.

The delay line performs the functions of five registers on a time-division basis. In the multiplexing scheme, the registers are numbered one through five. The first bit for each register is inserted into the delay line in sequence; then the second bit of each, and so on. Coiled in a metal box and housed at the base of the calculator, the 3-meter-long delay line has a capacity of 360 bits and a delay time of 1.5 milliseconds.

Time sharing. The clock frequency is about 40 kilohertz and the time interval of each clock pulse is divided into six phases—

one for each of the five registers and one more for synchronizing the delay line.

Although they are now using hybrid ic's, Sony engineers indicate that they may eventually switch to monolithic circuits. Use of hybrid circuits fits in with Sony policy, since one reason for marketing this calculator is to make use of the production at Sony's semiconductor plant. Company officials say that purchase of outside units even at low cost would negate an important reason for building the device.

There are 500 ic's mounted on the calculator's five printed-circuit boards. These circuits have a total of about 8,000 individual components, including 200 transistors and 1,700 diodes. The hybrid circuits are built on alumina substrates and are dip-coated for moisture protection.

Transistors are the only components within the hybrid circuits that are prepackaged in epoxy. The transistors are the same type used in most of Sony's tape recorders, radios, and television sets. Diodes and capacitors are attached to the substrate without prior encapsulation.

There's a difference. Logic circuits consist mainly of diode gates and transistor flip-flops, with a sprinkling of inverters. Among differences between logic circuits developed by Sony and those that are used by most other firms are the connections between gates and flip-flops, and between clock input and flip-flops. Sony uses capacitor coupling between gates and flip-flops, and d-c coupling of clock to flip-flops. Other manufacturers use d-c coupling between gates and flip-flops, and capacitor coupling of clock to flip-flops.

Great Britain

Against the tide

Engineers developing methods of interconnecting integrated circuits for International Computers &

Tabulator Ltd.'s computers are bucking trends set by their American counterparts.

One approach being tried in the U.S. is large-scale integration, with monolithic arrays of IC's connected by thin-film wiring. Another involves assembling large numbers of IC chips on miniature multilayer circuit boards, usually made of thick films of wiring separated by layers of ceramic or glass.

ICR plans to use chip-and-board assemblies, but to vacuum-deposit the wiring as thin films of gold and plastic. This will simultaneously solve several processing and reliability problems, according to K.C. Bingham, manager of ICR's interconnection development group. Bingham observes that the process can also be used for monolithic-array connections when LSI becomes practical.

With this technique, the plastic is polymerized to make it strong, free of pinholes that could short the wiring, and flexible enough to withstand unequal expansions of board materials during fluctuations in processing and operating temperatures. Bingham says that inorganic dielectrics were discarded in favor of the organic film because

inorganics cannot be deposited over a large area without pinholes.

To supplement this deposition technique, ICR has worked out a method of etching a layer of gold and a layer of polymer at the same time.

Traditional target. Bingham indicates that the goal of this development effort is a new generation of computers to win sales away from the International Business Machines Corp. IBM holds the major share of the European market.

However, a spokesman at ICR headquarters denies that a new series of computers is in the wings. He says the company intends first to replace discrete-component circuitry with IC's in the central processors of its 1900 series computers. The upgraded processors will be faster than the current versions, but will still be able to use the 1900 series software.

The changeover may not occur for many months, the spokesman noted, adding that a final decision on whether to use the new technique, regular logic IC's, or both, hasn't been made.

Base plate. The base of the multilayer board used with the new process is a ceramic plate. As a

preliminary step, a power plane and ground plane are deposited on the ceramic. Then 12 substrates, each 1 by 2 inches, are put in a rotating holder in a vacuum-deposition chamber. A first layer of polymer is deposited on each, followed by a first layer of gold.

Bingham and a co-worker, W.R. Cuttell, described the polymerization and patterning techniques at the Electronic Components Conference in Washington earlier this month. The dielectric, dimethyl polysiloxane, is fed into the chamber as a monomer gas. An electron beam aimed at the substrate creates a glow discharge that causes the monomer to polymerize as it condenses on the substrate. Residual bonds on the polymer fasten it strongly to the gold when that layer is deposited.

The gold is etched to form the first-layer wiring pattern, and a film of positive photoresist is developed to leave strips of resist wherever openings are needed in the second layers of polymer and gold. After these layers are deposited, the board is dipped into an ultrasonic bath of resist solvent; the solvent attacks the resist through tiny openings in the polymer. The unwanted strips of polymer and gold are loosened and peeled off the substrate.

To complete the wiring pattern, bridging links of aluminum are deposited to join selected spots on the first and second layers. Some of the signal wiring is terminated as lead fingers with electroplated pillars for face-bonding of integrated-circuit chips.

International

A common code

After several years of hesitation and slow progress, a standardized, European-wide system for registering and identifying semiconductor devices and electronic tubes appears to be catching on.

Spearheading the drive is Pro Electron, a nonprofit industry as-

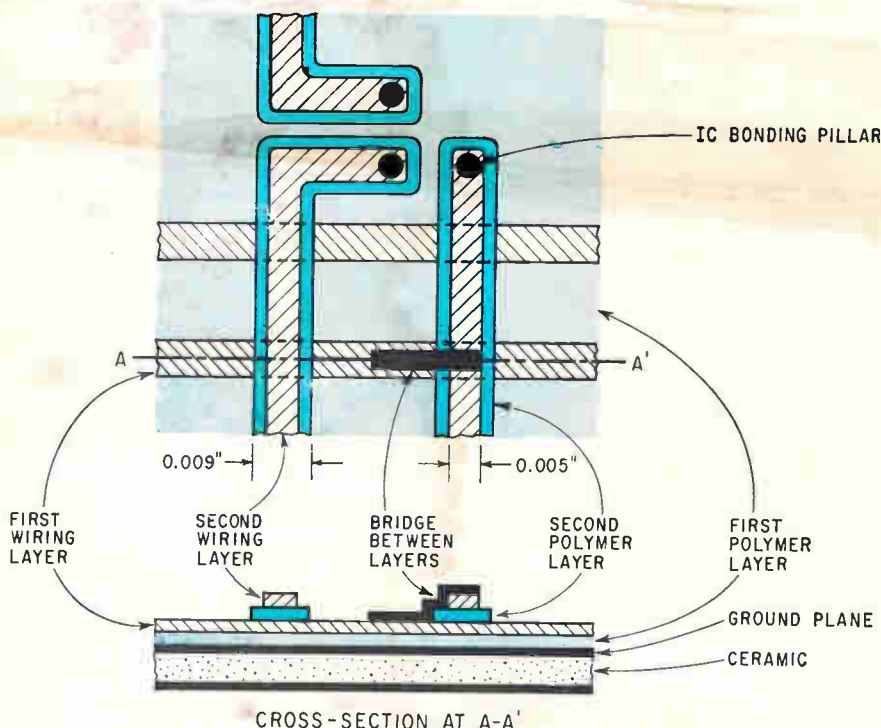

Chip connections. Layers of plastic will insulate layers of thin-film wiring in British firm's new method of interconnecting IC's for computers.

sociation headquartered in Brussels. The association is offering a coding system similar to the one used by America's Electronic Industries Association.

Taking hold. It wasn't until earlier this year, when the association published a new constitution spelling out its aims and coding system, that Pro Electron aroused favorable reaction from the industry. In one swoop, 30 manufacturers signed up for membership and more followed their lead. Although some British firms haven't joined the fold, M.J. Haantjes, the association's director, claims: "Our subscribers now account for 80% of the market."

Pro Electron's coding system avoids using the same type designation for different products, and prevents any product from having more than one designation. Unlike the U.S. system, Pro Electron's codes enable the device and its function to be identified instantly. A combination of letters and numbers defines the device's category and its application or function.

The first letter of the semiconductor code—the first two letters for integrated circuits—indicates the "family" of the device, and the following letter indicates the function. The second part of the code is the same for different categories of devices having similar functions. The letter C, for example, is used for audio-frequency transistors, high-vacuum triodes, and trigger tubes.

By the numbers. For cathode-ray tubes, the first letter tells the category, the first number or group of numbers indicates the diagonal size of the screen in centimeters, the second number or grouping of numbers refers to the serial number, and the final letters identify the color and other properties of the screen.

A code number is issued immediately for a new product when a company sends in a data form. After six months, with fuller specifications available, the registration is published.

The major problem, says Pro Electron, is with companies whose in-house codes clash with the organization's.

SOLID CARBIDE CIRCUIT BOARD DRILLS

*... for every circuit board
drilling need*

Precision to maintain location and hole size tolerances to close limits.
Permits ultra high speed drilling at feeds up to 15 feet per minute.
Design features include four facet point configuration and very fine flute finish. Drill point concentric to drill diameter within .0005".

STANDARD CIRCUIT BOARD DRILLS... Standard design with flute and shank same diameter. For use on any type production drilling from single board to high volume, stacked drilling tape controlled set-ups.

SERIES 125—1/8" SHANK DRILLS . . . Eliminate need for drill bushings when used with precision spindles and collets. Drill diameter to shank concentricity is within .0003". Common 1/8" shank for all drill sizes ends need for collet inventory for each size.

For complete information write for Bulletin CB66.



THE METAL REMOVAL COMPANY

1859 West Columbia Avenue • Chicago, Illinois 60626
Manufacturing Plants Located in CHICAGO/LOS ANGELES/SAN JUAN

**MASTER TOOL AND WHEEL MAKERS FOR THE WORLD
END MILLS / DRILLS / REAMERS / BURS / SPECIAL TOOLING**

Circle 246 on reader service card

INTERESTED IN GOING PUBLIC? OR IN ADDITIONAL FINANCING?

We are a dynamic established member of the New York Stock Exchange eager to explore this important financing step with you and assist you in implementing a comprehensive constructive financing program. Write or call J. Morton Davis, Partner.

D. H. BLAIR & COMPANY

Serving investors since 1904

Members: New York Stock Exchange • American Stock Exchange
66 BEAVER STREET, NEW YORK, N. Y. 10004 • WH 3-5800
10889 WILSHIRE BLVD., LOS ANGELES, CAL. 90024



Advertising sales staff

Pioneer Electric & Research Corp. K & A Incorporated	190	Texas Instruments Incorporated, Industrial Products Group Robinson-Gerrard	171
Plastic Capacitors, Inc. Sander Rodkin Adv. Agcy., Ltd.	7	□ Thermionic Products Ltd. Southern Adv. Ltd.	OAS 6, 7
□ Plessey Electronics Co., Components Div.	OAS 4, 5	Tohoku Metal Industries Ltd. Hakuhodo, Inc.	205
Roles & Parker Ltd.		Tokyo Print Industrial Co., Ltd. General Advertising Agcy.	190
Plessey Electronics Co., Ltd., Transistorized Signalling Units Roles & Parker Ltd.	173	■ Torotel, Inc. Spangler Adv., Inc.	170
■ Polarad Electronics Corp. Mort Barish Assoc., Inc.	136	Transformer Electronics Co. Dacey, Wolff & Weir	200
Princeton Applied Research Corp. Mort Barish Assoc., Inc.	44	TRG, Inc., Div. of Control Data Corp. Culver Adv., Inc.	38
		■ Tung Sol, Div. of Wagner Electric Corp. E.M. Freystadt Assoc.	195
Radio Corporation of America	4th Cover, 22, 55, 208		
Al Paul Lefton Co.		Ulano & Co., J. Byrde, Richard & Pound, Inc.	159
Raytheon Computer Co. Martin Wolfson Adv.	66	Union Carbide Corp., Electronics Div. J.M. Mathes, Inc.	42
RCL Electronics, Inc. Morvay Adv. Agcy.	187	United Aircraft Corporate Systems Center B.E. Bussell & Assoc.	191
Redford Corp. Communications Assoc.	201	■ United Transformer Co. Philip Stogel Co.	2nd Cover
■ Republic Foil, Inc. The Graphic Group	164	■ Unitrode Corp. Silton Brothers, Inc.	49
Sage Electronics Corp. Mathison Adv., Inc.	203		
Sci-Tek Computing Center, Inc. Stanley, Richard, Fredrick, Inc.	198	■ Vartec Inc. Coleman & Associates Adv.	160
■ Servo Corporation of America Basford Incorporated	73	Westamp, Inc. Siegmeister-Grant	203
Signetics Corp., Sub. Corning Glass Works Cunningham & Walsh, Inc.	68	Westinghouse, Semiconductor Div. McCann/ITSM	67
■ Siliconix, Inc. Miller/Stoll Adv.	40	■ Wright Machinery Co., Div. of Sperry Rand Corp. C. Knox Massey & Assoc., Inc.	127
Singer Co., Metrics Div. Hepler & Gibney, Inc.	141		
Sippican Company Marketing Assistance, Inc.	196		
□ Solartron Electronic Group Ltd. Southern Advertising, Ltd.	OAS 2, 3		
Soshin Electric Co. Shinwa Adv. Co. Ltd.	201		
□ Sovcor Electronique Dorland & Grey	OAS 8		
Spectrol Electronics Corp. Jones, Maher Roberts Adv.	131		
Sperry Electronic Tube, Div. Sperry Rand Corp. Neals & Hickok, Inc.	58		
Sprague Electric Co., The Harry P. Bridge Co.	5, 10		
■ Stackpole Carbon Co., Electronic Components Div. Meek & Thomas, Inc.	132		
Stewart Warner Micro Circuits, Inc. Jones, Mahar, Roberts Adv.	151		
Sylvania Electric Products, Inc., General Telephone & Electronics Div.	27 to 34		
Tatham-Laird & Kudner, Inc.			
Sylvania Electric Products, Inc., Parts Div.	146		
Tatham-Laird & Kudner, Inc. Adv.			
Taylor Corporation Gray & Rogers, Inc.	177		
■ Tektronix, Incorporated Hugh Dwight Adv., Inc.	51		
Tel-Com Instruments, Inc. Gross Advertising Service	98, 99		
Telonic Engineering Co. Jansen Assoc., Inc.	189		
Telonic Instruments Jansen Assoc., Inc.	172		
Tempress Research Co., Inc. Hal Lawrence, Inc.	41		

Classified Advertising

F.J. Eberle, Business Mgr.	
PROFESSIONAL SERVICES	207
EMPLOYMENT OPPORTUNITIES	207

EQUIPMENT (Used or Surplus New) For Sale	207
------------------------------------------------	-----

ADVERTISERS INDEX

AG fur Personalberatung	207
Atomic Personnel, Inc.	207
Baker Personnel Service	207
The Bendix Corp., Flight & Engine Instr. Div.	207
Instruments & Machines, Inc.	207
Philip Fishman Co.	207
Radio Research Instrument Co.	207
Standard Relay Corp.	207

■ For more information on complete product line see advertisement in the latest Electronics Buyers' Guide

□ Advertising in Overseas Advertising Section following Newsletter from Abroad

Frank E. LeBeau [212] 971-6464

Advertising sales manager
Wallis Clarke [212] 971-2187
Assistant to sales manager
Donald J. Austermann [212] 971-3139
Promotion Manager
Atlanta, Ga. 30309: Michael H. Miller, 1375
Peachtree St., N.E.
[404] TR 5-0523
Boston, Mass. 02116: William S. Hodgkinson
McGraw-Hill Building, Copley Square
[617] CO 2-1160
Chicago, Ill. 60611: Robert M. Denmead,
J. Bradley MacKimm, Ralph Hanning,
645 North Michigan Avenue.
[312] MO 4-5800
Cleveland, Ohio 44113: William J. Boyle, 55
Public Square, [216] SU 1-7000
Dallas, Texas 75201: Richard P. Poole, 1800
Republic National Bank Tower,
[214] RI 7-9721
Denver, Colo. 80202: Joseph C. Page, David
M. Watson, Tower Bldg., 1700 Broadway,
[303] 255-5484
Detroit, Michigan 48226: Ralph Hanning
856 Penobscot Building
[313] 962-1793
Houston, Texas 77002: Kenneth George,
2276 Humble Bldg., [713] CA 4-8381
Los Angeles, Calif. 90017: Ian C. Hill,
John G. Zisch, 1125 W. 6th St.,
[213] HU 2-5450
Minneapolis, Minn. 55402: J. Bradley
MacKimm, 1104 Northstar Center
[612] 332-7425
New York, N.Y. 10036
500 Fifth Avenue
Donald R. Furth [212] 971-3615
James R. Pierce [212] 971-3616
Stanley J. Kail, Jr. [212] 971-3617
Philadelphia, Pa. 19103:
Warren H. Gardner, Jeffrey M. Presto,
6 Penn Center Plaza,
[215] LO 8-6161
Pittsburgh, Pa. 15222: Warren H. Gardner,
4 Gateway Center, [412] 391-1314
Portland, Ore. 97204: James T. Hauptli,
218 Mohawk Building, 222 S.W. Morrison
Street, Phone [503] 223-5118
Rochester, N.Y. 14534: William J. Boyle,
9 Greylock Ridge, Pittsford, N.Y.
[716] 586-5040
St. Louis, Mo. 63105: Robert M. Denmead
The Clayton Tower, 7751 Carondelet Ave.
[314] PA 5-7285
San Francisco, Calif. 94111:
James T. Hauptli, 255 California Street,
[415] DO 2-4600
London W1: John W. Patten, Edwin S.
Murphy Jr., 34 Dover Street,
Hyde Park 1451
Milan: Robert M. Saidel
1 via Baracchini Phone: 86-90-656
Frankfurt, Main: Gerd Hinske, Dieter
Rothenbach, Elsa-Brandstroem Str. 2
Phone: 72 01 81
Geneva: Michael R. Zeynel,
1, rue du Temple Phone: 31 95 60
Paris VIII: Kenneth Davey,
17 Avenue Matignon Phone: 359 6637
Tokyo: Nobuyuki Sato, 1, Kotohiracho
Shiba, Minato-Ku [502] 0656
Osaka: Ryoji Kobayashi 163, Umegae-cho
Kita-ku [362] 8771

Business department

Wallace C. Carmichael, Manager
[212] 971-3191
Stephen R. Weiss, Production Manager
[212] 971-2044
Thomas M. Egan,
Assistant Production Manager [212] 971-3140
Dorothy Carnesini, Contracts and Billings
[212] 971-2908

Circulation and research

Milton Drake, Manager [212] 971-3485
Isaaca Siegel, Assistant Circulation Manager
[212] 971-6057
David Strassler, Assistant Research Manager
[212] 971-6058
Chloe D. Glover, Research Associate
[212] 971-6057

Electronics buyers' guide

George F. Werner, General Manager
[212] 971-2310
Ray Smyth, Eastern Regional Manager
[212] 971-6538
Regina Hera, Directory Manager
[212] 971-2544
Thomas M. Egan, Production Manager
[212] 971-3140

The Predictables.

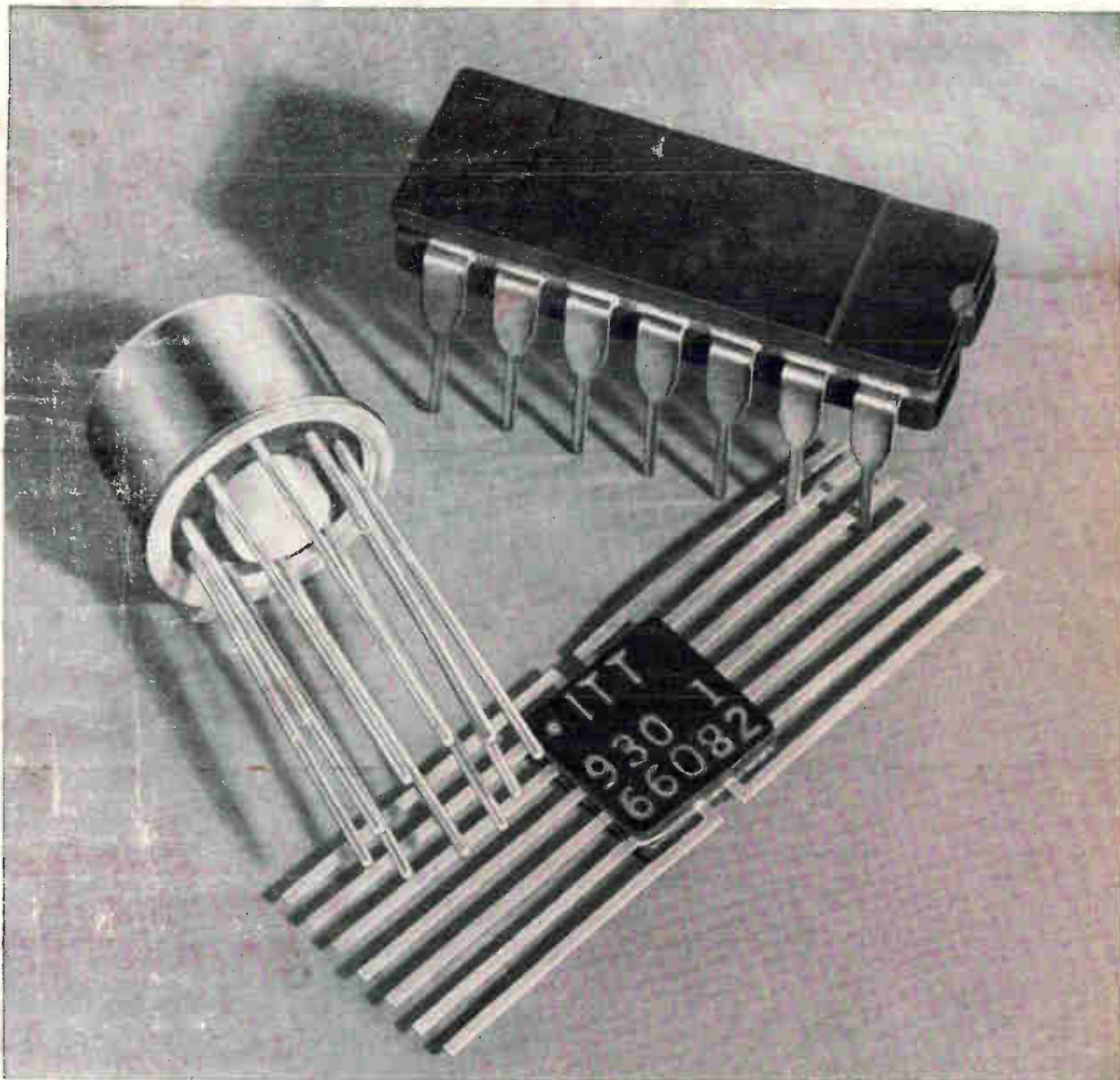

100% DC and dynamic testing verifies the performance of every circuit in ITT's full line of Series 930 DTL

When your order of ITT Series 930 DTL arrives, you can have absolute confidence in its performance. First of all, every circuit gets full DC and dynamic testing at 25°C, plus temperature cycling, centrifuge, and fine leak tests. Then there's 1% AQL testing at -55°C, +25°C and +125°C for 15 DC parameters and at +25°C for 2 dynamic parameters. If circuits flunk, we just don't ship them.

ITT's Series 930 "predictables" come in 15 circuit functions and three package styles. If you're tired of rejecting and returning DTL, try ordering it from ITT. It's available off-the-shelf from your distributor or direct from the factory through your ITT representative. ITT Semiconductors is a Division of International Telephone & Telegraph Corporation.

integrated circuits **ITT**

FACTORIES IN WEST PALM BEACH, FLORIDA; PALO ALTO, CALIFORNIA; LAWRENCE, MASSACHUSETTS; HARLOW AND FOOTSCRAY, ENGLAND; FREIBURG AND NURENBERG, GERMANY

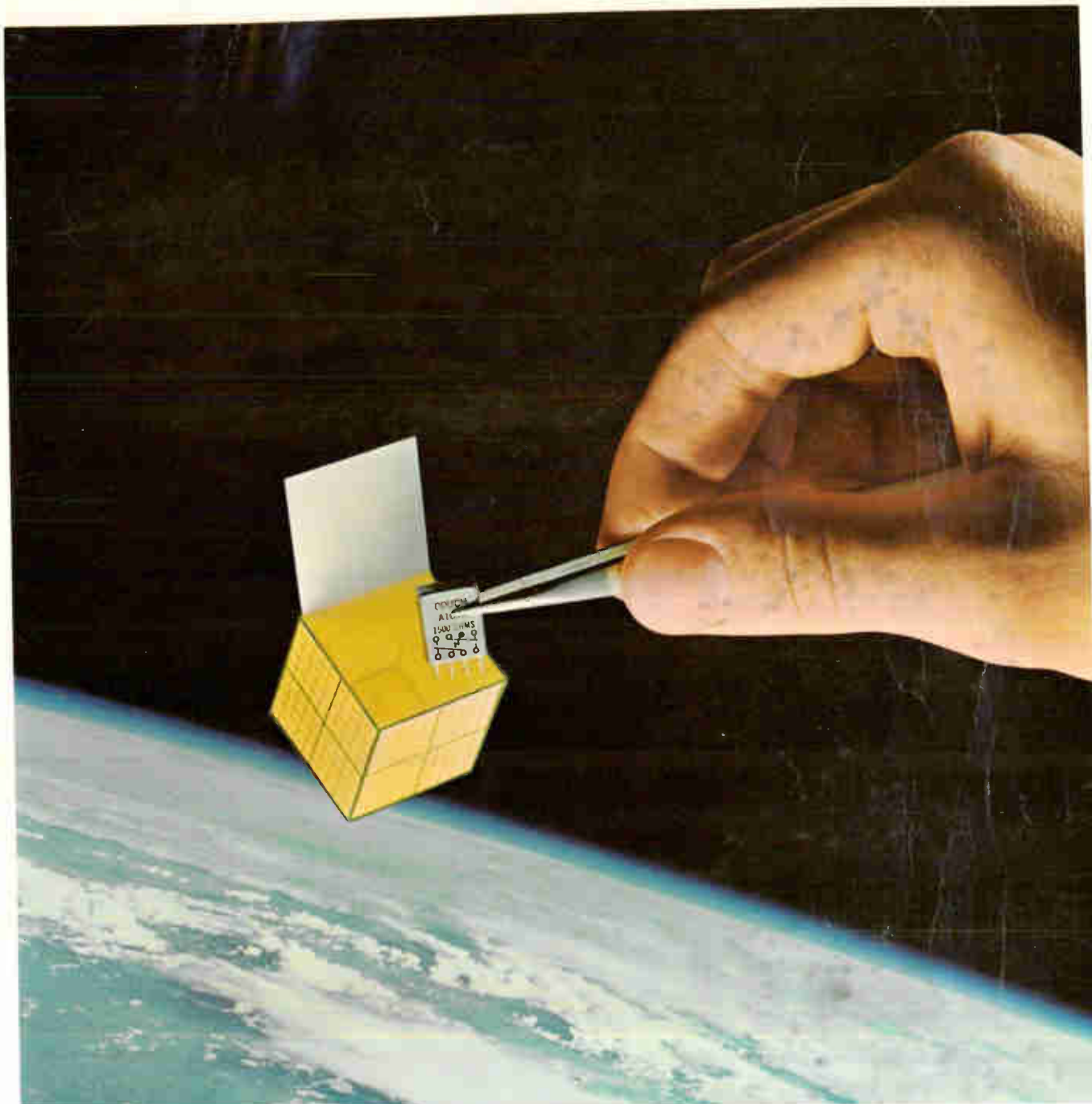

NASA

Couch 2X relays in new 1/7 size meet MIL-R-5757D/19 in 1/25th of a cubic inch

The new Couch 2X 1/7 size rotary relay helps solve switching problems where space and weight are critical factors. Predecessors of the Couch third generation relays delivered unflinching performance in the missile, aircraft and space fields — and they still do. Today the new Couch 2X offers the same high degree of reliability in microminiature. Use them with complete confidence for signal switching with other circuit board components. Each relay delivered is fully tested. Additional screening tests are available at your option. Couch 2X relays are made in a variety of coil resistances, three terminal styles and in a wide choice of mounting styles. Other products available include: 10 amp rotary relays, ultra-sensitive crystal can relays and full-size rotary switches.



	2X (DPDT) 2-pole	1X (SPDT) 1-pole
Size	0.2" x 0.4" x 0.5"	same
Weight	0.1 oz. max.	same
Contacts	Low Level to 0.5 amp @ 30 VDC	same
Sensitivity	100 mw	70 mw
Coil Resistance	60 to 4000 ohms	125 to 4000 ohms
Temperature	-65°C to 125°C	same
Vibration	20 G to 2000 Hz	same
Shock	75 G, 11 Ms	same

Write for Data Sheets No. 9 and 10.

RUGGED ROTARY RELAYS  Dynamically and Statically Balanced

Couch
1897

COUCH ORDNANCE, INC.

3 Arlington Street
North Quincy, Mass. 02171
(617) 298-4147

A subsidiary of S. H. COUCH COMPANY, INC.

Circle 901 on reader service card

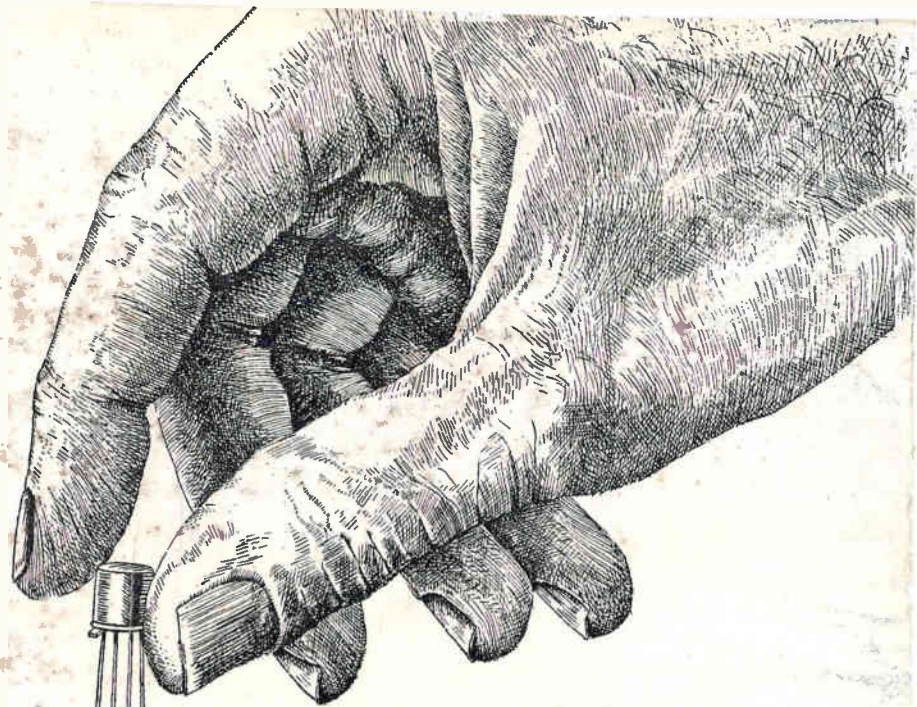

The new RCA **2N3839** for critical low-noise UHF applications in Military and Aerospace equipment is...

directly interchangeable with the low-noise RCA 2N2857... **and has a 1.1 dB lower NF**

That's right! The famous, field-proved transistor family that brought you the low-noise RCA 2N2857, with types which meet requirements of MIL-S-19500/343 USAF, now gives you even lower noise capability in amplifier, oscillator and converter applications with the new RCA 2N3839.

Formerly known as developmental type TA2363, the new RCA 2N3839 silicon r-p-n epitaxial transistor offers the superior performance and reliability features of the 2N2857, with a substantially lower noise figure... *only 3.4 dB max. at 450 MHz!* And power gain is 12.5 dB min. at 450 MHz. Furthermore, RCA can supply these new, high reliability UHF transistors in production quantities.

For complete pricing and delivery information on the new, low-noise 2N3839, call your RCA Field Representative. Ask him, too, about RCA developmental types which can meet even lower NF requirements, as well as information on ultra-reliable versions of the RCA 2N2857. For technical data sheets, write RCA Commercial Engineering, Sec. CN5-3, Harrison, N.J. 07029. Also available through your RCA distributor.

RCA Electronic Components & Devices



The Most Trusted Name in Electronics

Circle 902 on reader service card