

# Electronics<sup>®</sup>

Shifting phases digitally: page 104

Norad's fabulous computer system: page 113

Special report on large-scale integration: page 123

February 20, 1967

\$1.00

A McGraw-Hill Publication

Below: Many masks make up large-scale integration, p. 123

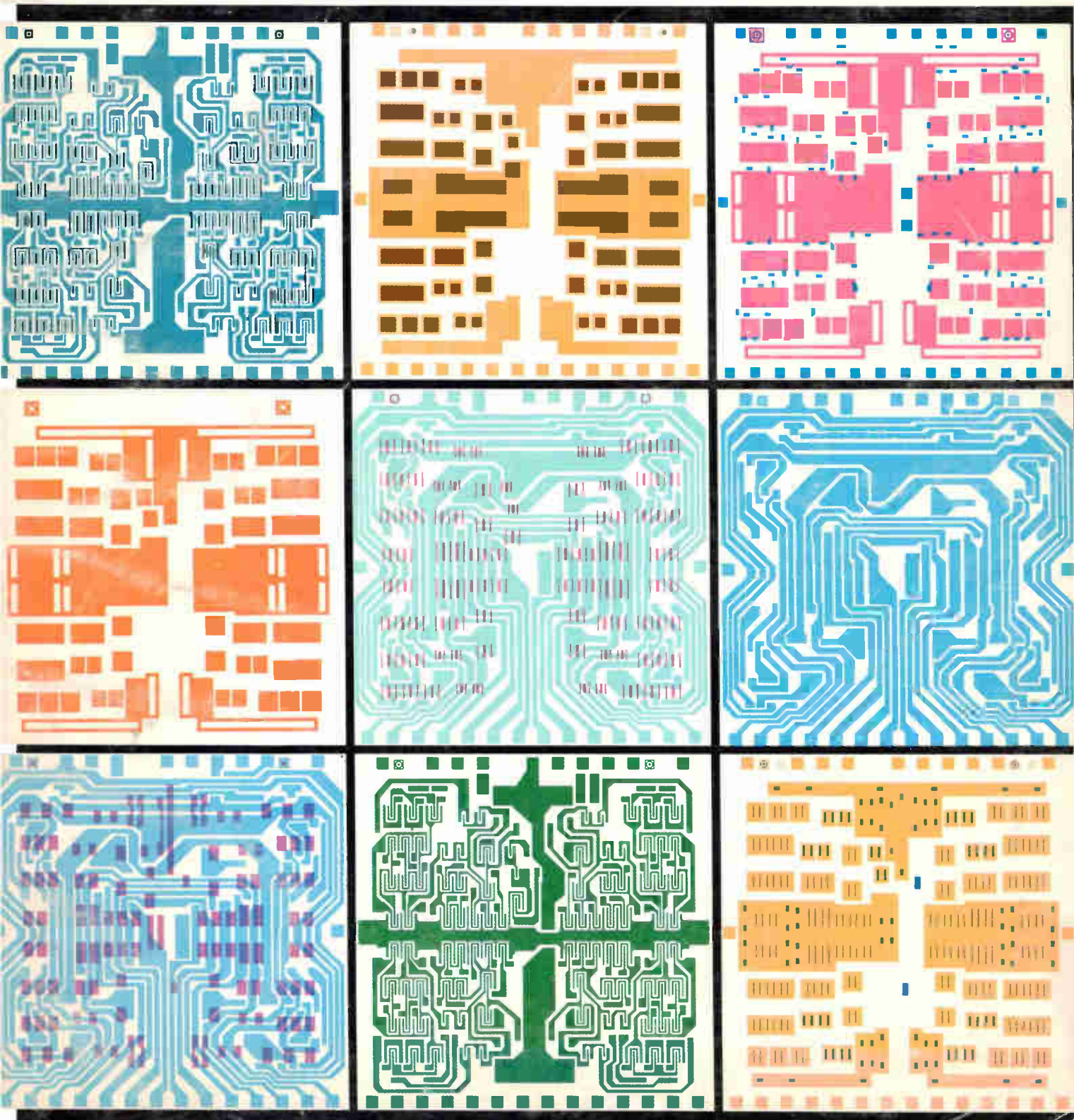

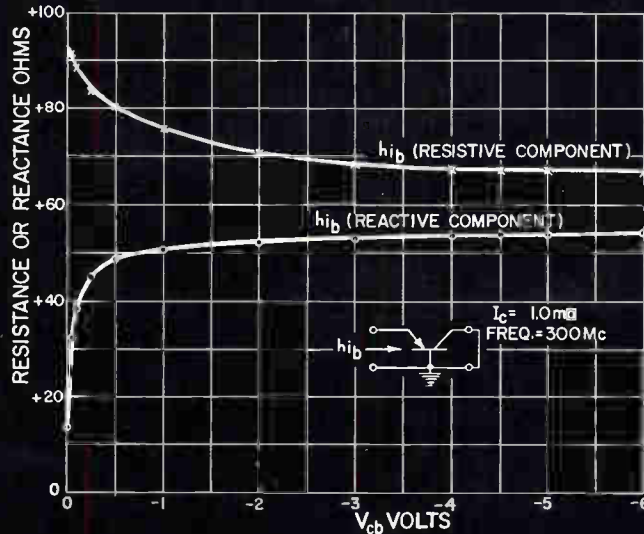

## Measure transistor $h$ and $y$ parameters directly without resorting to the "New Math."

If you use  $h$  and  $y$  parameters in your design work, you can measure them directly with the 1607-A Transfer-Function and Imittance Bridge. You can measure  $h_{ob}$ ,  $h_{oe}$ ,  $h_{ib}$ ,  $h_{fe}$ ,  $h_{ib}$ ,  $h_{ie}$ ,  $h_{rb}$ ,  $h_{re}$ ,  $y_{ob}$ ,  $y_{oe}$ ,  $y_{ib}$ ,  $y_{fe}$ ,  $y_{ib}$ ,  $y_{ie}$ ,  $y_{rb}$ ,  $y_{re}$ , as well as all open-circuit impedance parameters directly, without using mathematical transformations that could degrade data accuracy. These measurements can be made over a broad 25-MHz to 1.5-GHz range.

Since the 1607-A uses adjustable lines settable to half and quarter wavelengths, both open- and short-circuit conditions can be easily established. Eight specially designed, electrically invisible mounts for almost all popular transistor configurations provide a readily defined reference plane for measurements. No measurement corrections need be made for the mounts. Even transistors with

2-inch leads can be measured without correction (the mount "swallows" the leads). The transistor can even be mounted with some of its lead length exposed to simulate its eventual connection in the circuit. In this way, the parasitic effects of the leads can also be considered.

Price of the 1607-A is \$1995; transistor-mount prices range from \$65 to \$115. For a complete description of the 1607-A, request our Engineering Reprints E107 and E109. Write General Radio Company, 22 Baker Avenue, W. Concord, Massachusetts 01781; telephone (617) 369-4400; TWX 710 347-1051.

## GENERAL RADIO

# multiple choice

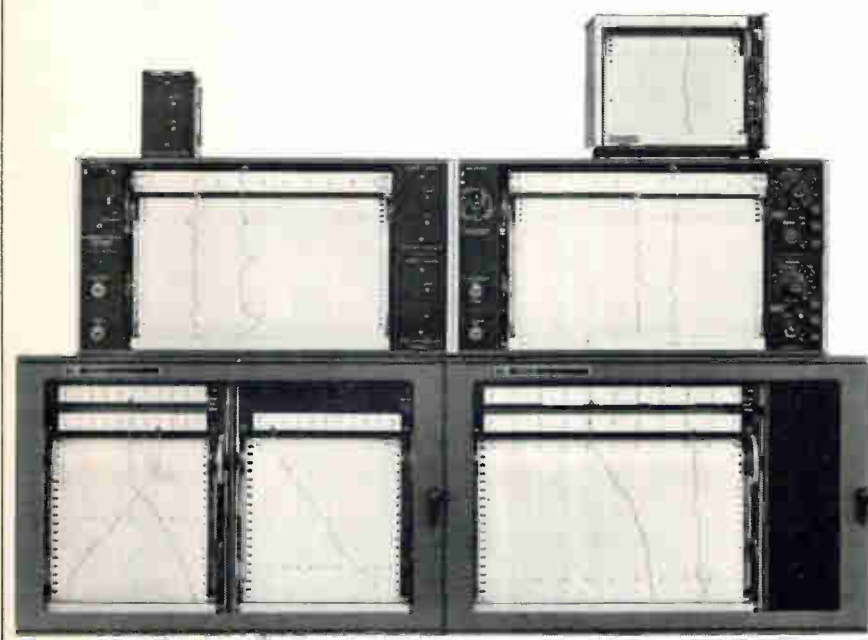

which of  
these  
strip-chart  
recorders  
is best for  
your needs?

With three highly flexible groups of recorders, Hewlett-Packard offers you a range of reliable models for the widest laboratory and industrial application. They feature modular solid-state construction, improved ink or inkless electric writing systems, and a choice of mechanical or optical slidewires.

The 680 is a general-purpose laboratory-type model that provides high accuracy and swift response in a 5" writing width. Important features are a 3-position tilting chart magazine, plus multi-range inputs and chart speeds. The Model 680 is priced at \$750.

In the 7100 Series, four recorders with plug-in modules provide customer-selected input level spans for versa-

tile, general-purpose 10" recording capability. Lower-cost models (7127 and 7128) are designed primarily for use with gas chromatographs. Recorders are priced from \$850 to \$1300, and plug-in modules are priced from \$200 to \$350.

The new 5700 Industrial Series of strip-chart recorders offers modular design for rapid interchange of modules on line and minimum down-time. Choose sensitivity and speed from a wide selection of low-cost recorders and match the recorder to your particular need; convert later if requirements change. One- and two-pen models, 6" and 11" recording. A choice of four models priced from \$825.

**HEWLETT  
PACKARD**  **MOSELEY  
DIVISION**

2393

# SPECTRALLY PURE FREQUENCIES up to 500 MHz

(Yes, 500)

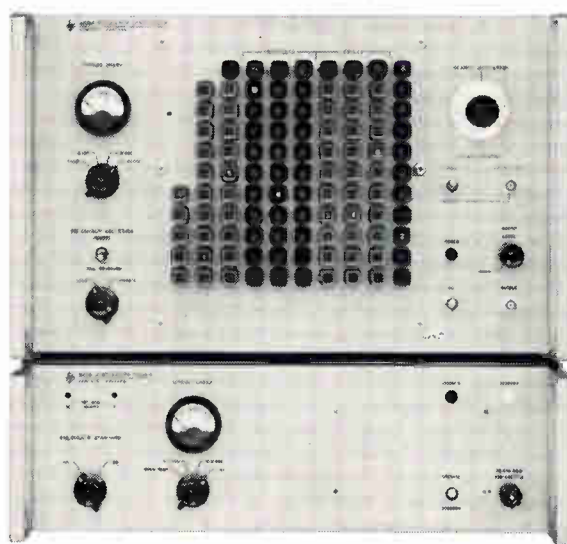

The new Hewlett-Packard 5105A Frequency Synthesizer generates spectrally pure frequencies from 0.1 MHz to 500 MHz in 0.1 Hz steps—a frequency range 10 times higher than previously available by direct synthesis.

Now you can get rapidly switched UHF signals without multiplication and without the accompanying noise increase. Spurious signals are at least 70 dB below the selected output. The 5105A affords extremely rapid digital frequency selection either remotely (typical switching time, 20 microseconds) or from the front-panel pushbuttons. An internal search oscillator provides continuous tuning. Output of the 5105A is  $0 \text{ dBm} \pm 1 \text{ dB}$ ; phase modulating capability, dc to 1 MHz rate; frequency stability is at least 3 parts in  $10^9$  per day.

The 5105A uses direct frequency synthesis, with the output frequencies derived from a quartz crystal by arithmetic operations instead of by phase-locked oscillators. This provides faster frequency selection and fail-safe operation.

Model 5105A—\$9150.

Model 5110B driver, required for the synthesizer (will drive up to four 5105A's)—\$4350.

Need a lower frequency model? 1, 10 and 50 MHz models are also available.

Call your local field engineer or write for complete information to Hewlett-Packard, 1501 Page Mill Road, Palo Alto, California; Europe: 54 Route des Acacias, Geneva.

HEWLETT  PACKARD

## News Features

### Probing the News

- 203 Airborne computers set to take off
- 211 Sea dogs' seeing eye
- 217 Numbers game comes to naught

### Electronics Review

- 49 Solid state: Flip-chips emerge; IC price slash
- 50 Instrumentation: All in the family
- 51 Space electronics: Fewer dishes . . . ; . . . and better discrimination
- 52 Medical electronics: Sound eye; Scanning sleuth
- 54 Military electronics: SAM-D surfacing; Space-link probe
- 56 Communications: Tactical transceiver; Solid power
- 58 Manufacturing: Super clean
- 61 Computers: Good housekeeping
- 62 Consumer electronics: Holographic static
- 64 For the record

### Electronics Abroad

- 301 France: Countdown; Changing the guard
- 302 Japan: Color it rosy
- 302 Italy: Color it later
- 303 Great Britain: Caught by a wave
- 303 Poland: The collector
- 303 West Germany: Electronic St. Bernard; Faster forecasts
- 305 Sweden: Talk-box takeover
- 306 International: Well spaced
- 307 Around the world

### Departments

- 4 Readers Comment
- 8 People
- 14 Meetings
- 16 Meetings Preview
- 23 Editorial
- 25 Electronics Newsletter
- 71 Washington Newsletter
- 221 New Products
- 221 New Products Index
- 276 New Books
- 282 Technical Abstracts
- 287 New Literature
- 295 Newsletter from Abroad

## Technical Articles

### I. Design

- Avionics 104** Digital phase shifter  
A signal generator shifts two sets of low frequency sine waves digitally  
Edwin M. Drogin, Airborne Instruments Laboratory
- Circuit design 109** Designer's casebook
  - Instant commands trigger monostable tunnel diode
  - Unijunction switches tones without transients
  - Negative inverter simplifies symmetrical level detection
  - Zener diodes convert signals from digital to analog

### II. Application

- Military electronics 113** Norad's computers get all the facts  
Unique interface equipment and endless programming guarantee no messages are lost  
Roger T. Stevens, Mitre Corp.

### III. Large-scale integration

- Integrated electronics 123** LSI: The technology converges (cover)  
Economic and technical pressures force makers of devices and systems into an unwilling partnership  
Samuel Weber, associate managing editor
- 130** The effect on systems design  
Although LSI promises great benefits it imposes some restrictions  
W.A. Notz, E. Schischa, J.L. Smith and M.G. Smith, IBM
- 143** Active memory calls for discretion  
With discretionary wiring, the designer uses only the good elements on a slice  
M. Canning, R.S. Dunn and G. Jeansonne, Texas Instruments Incorporated
- 157** Customizing by interconnection  
Start with a standard wafer and customize by interconnections  
C.E. Marvin and R.M. Walker, Fairchild Semiconductor Division
- 166** Computer accelerates design  
Using logic entities, the computer does the detailing while man supplies the creativity  
Lester Hazlett, Motorola Inc.
- 171** Silicon-on-sapphire for freedom and flexibility  
Different devices can be mixed on a single microcircuit substrate  
Arnold Miller, Autonetics
- 179** Slow, but small, may win the race  
Better processes and faster designs give metallic oxide semiconductors an edge  
E. Thomas and J.D. Callan, General Instrument Corp.

# Electronics

Editor-in-Chief: Lewis H. Young

Associate managing editors

Design: Samuel Weber

Application: George Sideris

News: Kemp Anderson

Copy: Sally Powell

Senior editor

Special projects: Donald Christiansen

Senior associate editors

John F. Mason, Robert Henkel, Joseph Mittleman

Department editors

Advanced technology: Stephen Scrupski

Avionics: W.J. Evanzia

Communications: Leonard Weller

Computers: Wallace B. Riley

Design theory: Joseph Mittleman

Industrial electronics: Alfred Rosenblatt

Instrumentation: Carl Moskowitz

Military electronics: John Mason

New products: William P. O'Brien

Staff writers: William Olcott, Paul Dickson,

Jan Rahm

Section editors

Electronics abroad: Arthur Erikson

Electronics review: Stanley Zarowin

Probing the news: Eric Aiken

Regional bureaus

Domestic

Boston: Thomas Maguire, manager; Robin Carlson

Los Angeles: June Ranill

San Francisco: Walter Barney, manager; Mary Jo Jadin

Washington: Robert W. Henkel, manager; William D. Hickman,

Patricia C. Hoehling, correspondents

Foreign

Bonn: John Gosch

London: Michael Payne

Tokyo: Charles Cohen

Copy editors

Albert Tannenbaum, James Chang

Graphic design

Art director: Saul Sussman

Assistant art directors: Ann Mella, Valerie Betz

Production editor: Arthur C. Miller

Editorial secretaries: Marlene Angrist, Claire Benell, Lynn Emery, Lorraine Fabry,

Kay Fontana, Patricia Gardner, Lorraine Longo

McGraw-Hill News Service

Director: John Wilhelm; Atlanta: Fran Ridgway; Chicago: James Rubenstein;

Cleveland: Arthur Zimmerman; Dallas: Marvin Reid;

Detroit: N. Hunter; Houston: Robert E. Lee; Los Angeles: Michael Murphy, Gerald Parkinson

Pittsburgh: Louis Gomolac

San Francisco: Margaret Drossel

Seattle: Ray Bloomberg; Washington: Arthur L. Moore, Charles Gardner,

Herbert W. Cheshire, Seth Payne, Warren Burkett

McGraw-Hill World News Service

Bonn: John Johnsrud; London: John Shinn;

Mexico City: Bruce Cross; Milan: Ronald Taggiasco;

Moscow: Howard Rausch; Paris: Peter Kilborn;

Rio de Janeiro: Wes Perry; Tokyo: Marvin Petal

Reprints: Susan Nugent

Publisher: Gordon Jones

Electronics: February 20, 1967, Vol. 40, No. 4

Published every other Monday by McGraw-Hill, Inc. Founder: James H. McGraw 1860-1958.

Printed at 99 North Broadway, Albany, N.Y. 12207; second class postage paid at Albany, N.Y.

Executive, editorial, circulation and advertising addresses: McGraw-Hill Building, 330 W. 42nd Street, New York, N.Y. 10036. Telephone (212) 971-3333. Teletype TWX N.Y. 212-640-4646. Cable address: MCGRAWHILL N.Y.

Subscriptions are solicited only from those actively engaged in the field of the publication. Position and company connection must be indicated on orders. Subscription prices: United States and possessions and Canada, \$8.00 one year, \$12.00 two years, \$16.00 three years; all other countries, \$25.00 one year. Single copies: United States and possessions and Canada, \$1.00; all other countries, \$1.75.

Officers of McGraw-Hill Publications: Joseph H. Allen, President; Bayard E. Sawyer, Executive Vice President; Vice Presidents: J. Elton Tuohig, Operations; John R. Callahan, Editorial; Donald C. McGraw, Jr., Marketing; John M. Holden, Marketing Services; Huber M. Gemmill, Circulation; Angelo R. Venezian, Production; Robert M. Wilhelm, Controller.

Officers of the Corporation: Donald C. McGraw, Chairman of the Board; Shelton Fisher, President; L. Keith Goodrich, Hugh J. Kelly and Robert E. Slaughter, Executive Vice Presidents; John J. Cooke, Vice President and Secretary; John L. McGraw, Treasurer.

Title registered in U.S. Patent Office: © Copyright 1967 by McGraw-Hill, Inc. All rights reserved. The contents of this publication may not be reproduced either in whole or in part without the consent of copyright owner.

Subscribers: The publisher, upon written request to our New York office from any subscriber, agrees to refund that part of the subscription price applying to copies not yet mailed. Please send change of address notices or complaints to Fulfillment Manager; subscription orders to Circulation Manager, Electronics at address below. Change of address notices should provide old as well as new address, including postal zip code number. If possible, attach address label from recent issue. Allow one month for change to become effective.

Postmaster: Please send form 3579 to Fulfillment Manager, Electronics, P.O. Box 430, Hightstown, New Jersey 08520

## Readers Comment

### Misplaced division

To the Editor:

In the article "Jungle fighters on Chesapeake Bay" [Jan. 23, p. 153] the developer of the AN/GRC-64 radio is listed erroneously as the Delco Products Division of the Ford Motor Co. Delco Radio, of course, is a division of the General Motors Corp.

Hamlin Welling

Delco Radio Division

Kokomo, Ind.

### Ode to a node

To the Editor:

The article, "Topology cuts design drudgery," [Nov. 14, 1966, p. 112] contains a most useful survey of network analysis by topological methods. I believe that these methods would find more application if the rules could be more easily remembered.

What is needed is an aid, maybe doggerel, which will stick in the memory.

Something like this:

Node to a network

Listen all if ye would fain,  
Solve a network without slaving the  
brain,

Get input admittance from a sub-graph,  
And dismiss determinants with a laugh.

Take the trees of network N,  
Form the admittance products then,  
Add admittance product set,  
Delta is the sum you get.

Now short vertex one to one prime,  
Make the two-trees, two edges each  
time,

Form the admittance products then,  
Get delta one-one by summing again.

Delta over delta one-one is sought,  
To find admittance at the input port.

Try it once and you'll soon see  
Much more can be done with topology.

Peter Robinson

Needham Heights, Mass.

### Aircraft separation

To the Editor:

In the article "Put to the test" [Jan. 23, p. 44], you identify the International Civil Aviation Organization as "the airlines industry group." ICAO is a specialized agency in relationship with the United Nations, with a membership of 111

# You Can Get All These Microcircuits from Sprague Electric:

## \*SERIES SU300, LU300 UTILOGIC\*



K Package

For use in commercial, industrial, ground support applications. Available in two operating temperature ranges, -20 C to +85 C, and +10 C to +55 C. Propagation delay of 15 to 40 nanoseconds.

\*Trademark of Signetics Corp.

Circle 482 on readers service card

## \*SERIES SE400, NE400 LOW POWER LOGIC

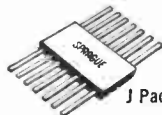

J Package

Operating temperature ranges: -55 C to +125 C, and 0 C to +70 C. For use in Aerospace and other applications where low power drain is required. Optimized speed, noise margin.

Circle 483 on readers service card

## \*SERIES SE100, NE100, US700 DTL LOGIC

(Signetics CS700)

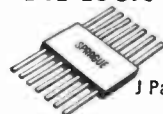

J Package

Eighteen functions in two operating temperature ranges: -55 C to +125 C and 0 C to +70 C. Circuits include NAND/NOR gates, clock and line drivers, gate expanders, RST and JK binary elements, one-shot multivibrator.

Circle 481 on readers service card

## \*SERIES SE500 LINEAR AMPLIFIERS



K Package

Operating temperature range: -55 C to +125 C. Two linear circuits available in 10-lead low silhouette TO-5 case. SE501K is a video amplifier, SE505K is a general purpose differential amplifier.

Circle 484 on readers service card

## \*SERIES SE800, NE800 TTL LOGIC



J Package

Designed for high-speed avionics systems. Eight high level circuits including four NAND Gates, Power Gate, Exclusive-OR Gate Input Expander, J-K Flip-Flop.

Circle 485 on readers service card

## UNICIRCUIT® RTL LOGIC



(8x actual size)

Sprague Series US-0100 . . . a complete line of silicon monolithic digital building blocks featuring low power consumption (2 mW typ.)

Circle 486 on readers service card

## UNICIRCUIT® mW RTL LOGIC



TO-5 Case

Types US-0908 through US-0921 . . . Fully interchangeable mW digital building blocks featuring power consumption of 2 mW/node and propagation delay of 40 nsec.

Circle 487 on readers service card

## UNICIRCUIT® CUSTOM HYBRID CIRCUITS

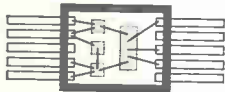

Combine monolithic silicon circuits with tantalum or Ni-Cr alloy resistors. Close resistance tolerances, low temperature coefficient. Resistor matching,  $\pm 1/2\%$ .

Circle 488 on readers service card

## DIGITAL-TO-ANALOG CONVERSION CIRCUITS



UT-1000—Four-bit ladder network  
UD-4001—Ladder switch for driving resistor ladder networks  
UD-4024—Buffer amplifier

Circle 489 on readers service card

\*Series SE100, NE100, CS700, SU300, LU300, SE400, NE400, SE500, SE800, NE800 are all available from Sprague Electric under technology interchange with Signetics Corp.

For data sheets on the microcircuits in which you are interested, write to: Technical Literature Service, Sprague Electric Company, 35 Marshall St., North Adams, Massachusetts 01247

### SPRAGUE COMPONENTS

INTEGRATED CIRCUITS  
THIN-FILM MICROCIRCUITS  
TRANSISTORS  
CAPACITORS  
RESISTORS

PULSE TRANSFORMERS  
INTERFERENCE FILTERS  
PULSE-FORMING NETWORKS  
TOROIDAL INDUCTORS  
ELECTRIC WAVE FILTERS

CERAMIC-BASE PRINTED NETWORKS  
PACKAGED COMPONENT ASSEMBLIES  
BOBBIN and TAPE WOUND MAGNETIC CORES  
SILICON RECTIFIER GATE CONTROLS  
FUNCTIONAL DIGITAL CIRCUITS

**SPRAGUE®**  
THE MARK OF RELIABILITY

\*Sprague® and ® are registered trademarks of the Sprague Electric Co.

## Discover the widest range of gold-plated specialty wire available.

From thick to thin. So thin, in fact, it has to be weighed to be measured.

We start with the highest-quality base stock, draw and then plate it with a bright, ductile, temperature-resistant 24K gold. The deposit is 99.5% pure. Its porosity is minimal. Its solderability is excellent. And it's resistant to discoloration. If that's not enough, our specially designed electroplating equipment and rigid quality control give a completely uniform plating

around the wire—and from spool to spool.

We have a total capability to produce practically anything you want. Deposits from 5 to 200 millionths of an inch in thickness can be plated on almost any temper or diameter specialty wire or ribbon to your specification.

If you'd like to see what we can do with wire or ribbon, send for a sample today. Write: Sylvania Electric Products Inc., Parts Division, Warren, Pennsylvania 16365.

**SYLVANIA**  
SUBSIDIARY OF  
GENERAL TELEPHONE & ELECTRONICS **GTE**





sovereign governments; the airlines industry group is IATA, the International Air Transport Association.

The decision to reduce separations from 120 to 90 nautical miles was taken in December 1963 by ICAO on proposals from its member governments, not from the airlines. The 90 nautical-mile separation is still on ICAO's books as the minimum, although the implementing states are using a separation higher than that minimum.

The article also states that the navigational problems come from the accuracy—or the lack of accuracy—of existing navigational equipment. Actually, this is not so; existing equipment is quite accurate enough to keep aircraft with a 90-nautical-mile-wide path. The problem actually is dependability: how often do gross navigational errors occur because of equipment or human failure, errors large enough to put aircraft outside the path.

The tests are being run by ICAO member states, rather than by ICAO itself, and the ground radar equipment is being installed by governments.

Joachim Schypek  
International Civil Aviation  
Organization, Montreal

#### Filter debate

To the Editor:

I would like to comment on the article "FET's call the tune in active filter design" [Oct. 3, 1966, p. 98] which I read with considerable interest.

On page 99 the statement  $R = R_1 + R_2$  should have been written as  $R = R_1 = R_2$ , a restricted case. Then equation,

$$\omega_n = \frac{1}{RMC_2} = \text{resonant frequency}$$

is correct.

But equation 3 is incorrect and should be

$$\rho = \frac{1}{M} + \frac{M}{2}(1 - K_2),$$

On page 100 the statement

$$C_1 = C_2$$

is a mistake. Equation 6 is the generalized case of the high-pass filter.

For the low-pass filter, the generalized equations should be as follows:

$$\omega_n^2 = \frac{1}{R_1 R_2 C_1 C_2};$$

$$\rho = \frac{1 + \lambda^2}{2M\lambda} + \frac{M}{2\lambda}(1 - K_2);$$

where:

$$M^2 = \frac{C_1}{C_2} \quad \text{and} \quad \lambda^2 = \frac{R_2}{R_1}.$$

Edward Poncracz-Bartha  
Member, Technical Staff  
ITT Federal Laboratories  
San Fernando, Calif.

#### The author replies:

The statement  $R = R_1 + R_2$  should read  $R = R_1 = R_2$ , a necessarily restrictive case.

The generalized equations have no usefulness in the voltage tunable filters described in the article because  $R_1$  must be equal to  $R_2$  to be at all practical.

Pongracz-Bartha's remaining statements are true and they are well known to filter designers. It was not my intent that the article be tutorial. It was intended to outline a new active filter technique in sufficient detail to be useful to design engineers.

James M. Loe

Project engineer  
Philco-Ford Corp.  
Blue Bell, Pa.

### SUBSCRIPTION SERVICE

Please include an Electronics Magazine address label to insure prompt service whenever you write us about your subscription.

Mail to: Fulfillment Manager  
Electronics  
P.O. Box 430  
Hightstown, N.J. 08520

To subscribe mail this form with your payment and check  new subscription  renew my present subscription

Subscription rates: in the U.S.: 1 year \$8; two years, \$12; three years, \$16. Subscription rates for foreign countries available on request

### CHANGE OF ADDRESS

ATTACH LABEL HERE If you are moving, please let us know five weeks before changing your address. Place magazine address label here, print your new address below.

name \_\_\_\_\_

address \_\_\_\_\_

city \_\_\_\_\_

state \_\_\_\_\_

zip code \_\_\_\_\_

## Make your oscilloscope display linear in db

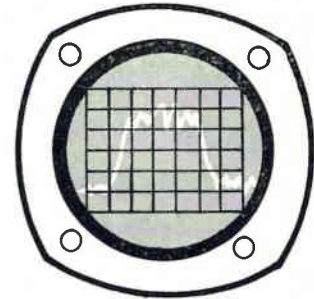

## with the new 120 db ultra-fast LOGARITHMIC CONVERTER

This new logarithmic converter provides two unique features: The 120 db dynamic range (one-million-to-one) allows full coverage of virtually any phenomena in a single range. The microsecond response of the PM 1002 makes it the first logarithmic converter fast enough to work with oscilloscopes, integrating digital voltmeters or high speed graphic recorders.

Small, solid state, rugged, and drift free, the PM 1002 is invaluable for all types of ratio measurements and for applications where dynamic range is unknown.



Let us prove it  
—write or call













\$660.00

**PM** PACIFIC  
MEASUREMENTS  
INCORPORATED

940 INDUSTRIAL AVENUE,  
PALO ALTO, CALIFORNIA  
(415) 328-0300

# All from Sprague!

## TWELVE OF OUR MOST POPULAR METALLIZED CAPACITOR TYPES

SPRAGUE TYPE	Case And Configuration	Dielectric	Temperature Range	Military Equivalent	Eng. Bulletin
 <b>680P</b>	hermetically-sealed metal-clad tubular	metallized Metfilm* 'A'	-55 C, +85 C	no specification	2650
 <b>431P</b>	film-wrapped axial-lead tubular	metallized Metfilm* 'E' (polyester film)	-55 C, +85 C	no specification	2445
 <b>155P, 156P</b>	molded phenolic axial-lead tubular	metallized paper	-40 C, +85 C	no specification	2030
 <b>218P</b>	hermetically-sealed metal-clad tubular	metallized Metfilm* 'E' (polyester film)	-55 C, +105 C	CH08, CH09 Characteristic R	2450A
 <b>260P</b>	hermetically-sealed metal-clad tubular	metallized Metfilm* 'K' (polycarbonate film)	-55 C, +105 C	no specification	2705
 <b>121P</b>	hermetically-sealed metal-clad tubular	metallized paper	-55 C, +125 C	no specification	2210C
 <b>118P</b>	hermetically-sealed metal-clad tubular	metallized Difilm® (polyester film and paper)	-55 C, +125 C	CH08, CH09 Characteristic N	2211D
 <b>143P</b>	hermetically-sealed metal-clad "bathtub" case	metallized paper	-55 C, +125 C	no specification	2220A
 <b>144P</b>	hermetically-sealed metal-clad "bathtub" case	metallized Difilm® (polyester film and paper)	-55 C, +125 C	CH53, CH54, CH55 Characteristic N	2221A
 <b>284P</b>	hermetically-sealed metal-clad rectangular case	metallized paper	-55 C, +105 C	no specification	2222
 <b>283P</b>	hermetically-sealed metal-clad rectangular case	metallized Difilm® (polyester film and paper)	-55 C, +125 C	CH72 Characteristic N	2223
 <b>282P (energy storage)</b>	drawn metal case, ceramic pillar terminals	metallized paper	0 C, +40 C	no specification	2148A

\*Trademark

For additional information, write Technical Literature Service, Sprague Electric Company, 35 Marshall St., North Adams, Mass. 01247, indicating the engineering bulletins in which you are interested.

### SPRAGUE COMPONENTS

CAPACITORS	PACKAGED COMPONENT ASSEMBLIES
TRANSISTORS	FUNCTIONAL DIGITAL CIRCUITS
RESISTORS	MAGNETIC COMPONENTS
THIN-FILM MICROCIRCUITS	PULSE TRANSFORMERS
INTEGRATED CIRCUITS	CERAMIC-BASE PRINTED NETWORKS
INTERFERENCE FILTERS	PULSE-FORMING NETWORKS

42C-6135



\*Sprague and ® are registered trademarks of the Sprague Electric Co.

## People

The increasing demand for electronic equipment for the Vietnam conflict and the high risk involved in bidding on government contracts are two of the problems facing **David Shore**, new chief defense engineer for the Radio Corp. of America's defense electronics products group.



David Shore

Shore, formerly chief engineer in the Communications Systems division, says the Southeast Asian war "has created a demand for short-term-payoff equipment. Fewer Government dollars are available for longer-range research and development programs."

**Risky business.** The Pentagon's cost-effectiveness program has also

put pressure on electronics companies. Shore says that with the number of fixed-price contracts growing, a company's proposal must be carefully prepared. "We practically have to have a 'talking dog' when we make a proposal—that is, we must be able to demonstrate how the equipment works and how much it will cost."

The 47-year-old Shore will be responsible for the technical and engineering performance of the five divisions in his group—Communications Systems, Missile and Surface Radar, Astro-Electronics, Aerospace Systems and West Coast. He will also be in charge of RCA's systems engineering, evaluation and research, defense microelectronics, applied research and central engineering.

**Program development.** Succeeding Shore as chief engineer for the Communications Systems division will be **C. K. Law**, 43. As manager of the division's engineering operations, Law was called upon last year to reorient operations as the early Minuteman ICBM contracts neared completion. His job was to



C. K. Law



# MACHLETT ML-8618 magnetically beamed triode requires 10 to 100 times lower drive

	IN PULSE SERVICE		IN RF TELEGRAPHY AMPLIFIER/OSCILLATOR SERVICE	
	ML-8618	Conventional Triode	ML-8618	Conventional Triode
Power Output	6 megawatts	6 megawatts	200 kilowatts	200 kilowatts
Driving Power	2.5 kilowatts	400 kilowatts	0.7 kilowatts	7.2 kilowatts
Filament Power	2.5 kilowatts	4.0 kilowatts	2.5 kilowatts	4.0 kilowatts

**RESULT: ML-8618 reduces pulse driving power by a factor of 100 or better.**

**RESULT: ML-8618 reduces rf driving power by a factor of 10 or better.**



Machlett's exclusive development, magnetically beamed tubes like the ML-8618 give you these advantages:

- By magnetically controlling the trajectory, electrons from the cathode bypass the grid structure so that nearly all emitted electrons reach the anode.
- Grid current is very low because of the great reduction in grid interception—about 3% as compared to 25% in conventional triodes.
- Low grid current means that grid dissipation no longer limits tube power.
- Parallel plane electrode structure eliminates "shielded" portion of filaments, permits 360° of the cathode surface to face anode surface and complete use is made of the filaments emission surface—result is higher cathode current per watt of heating power.

For details, write The Machlett Laboratories, Inc., Springdale, Conn. 06879.



THE MACHLETT LABORATORIES, INC.

A SUBSIDIARY OF RAYTHEON COMPANY

# SURVEILLANCE ... a very special ART

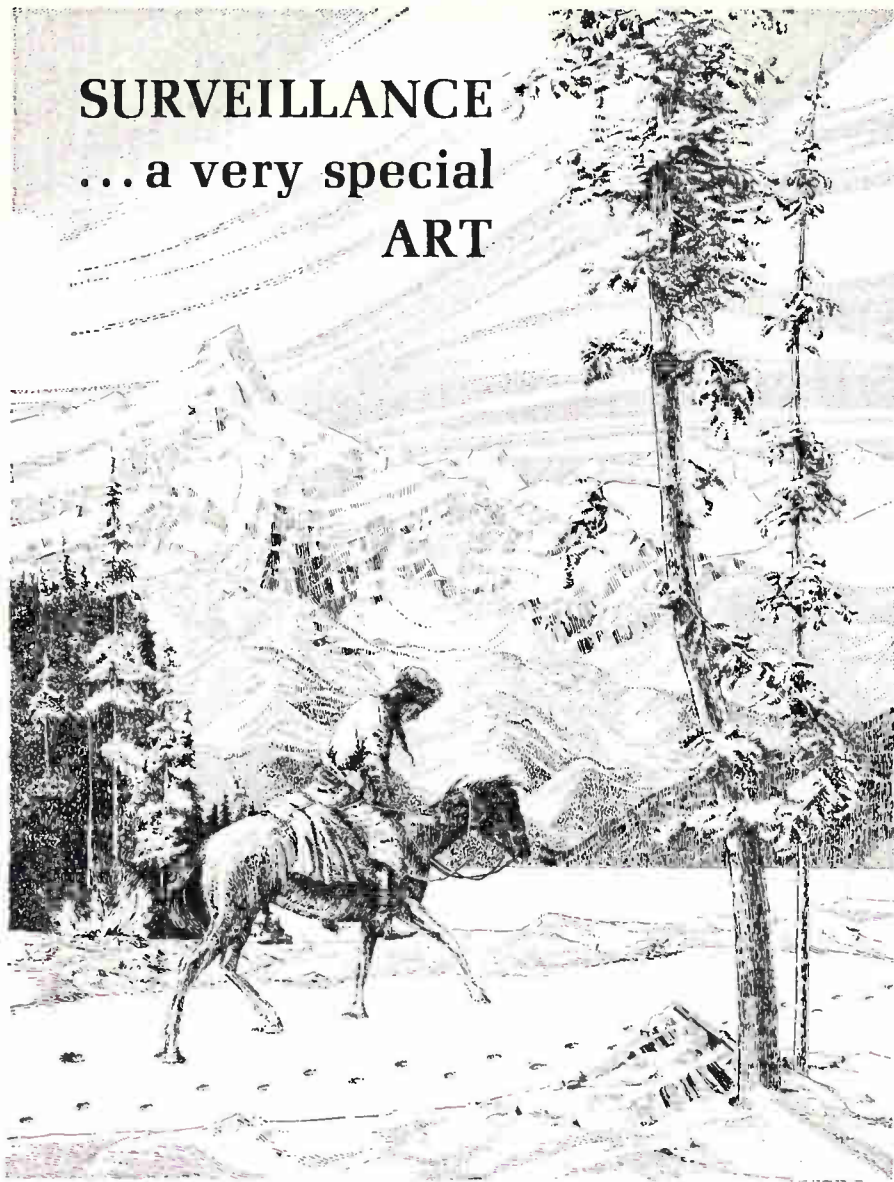

Tracks in the snow leave a message easily read by the skilled scout. In warfare enemy moves and buildups may be less discernible. Accurate knowledge requires the best in surveillance devices.

Applied Technology Incorporated is an innovator and manufacturer of advanced electronic systems and equipments. One important unit is ATI's all-new PR-500 PAN/MAN airborne receiver, adaptable to many surveillance requirements.

The receiver consists of a main frame B-1-D containing power supplies and control circuits. Any one of four RF heads may be installed in the main frame to cover the bands 1-2, 2-4, 4-8, and 8-12 GHz. The system design offers minimum noise figure, wide spurious-free dynamic range, and excellent local oscillator stability and linearity.

- Engineers
- Designers
- Technicians

Join the Growing One.  
ATI has positions open  
in many disciplines and  
on all levels.

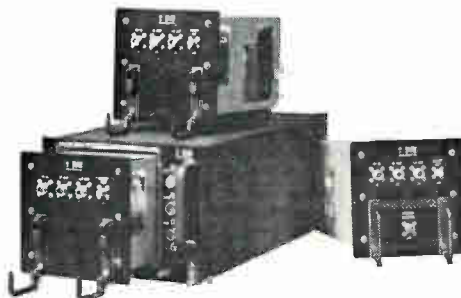

## APPLIED TECHNOLOGY INCORPORATED

3410 HILLVIEW AVENUE • STANFORD INDUSTRIAL PARK • PALO ALTO, CALIFORNIA 94303  
TELEPHONE (415) 321-5135 • TWX: 492-9370 • CABLE: APTEC

ATI is an equal opportunity employer

RECONNAISSANCE & SURVEILLANCE • ACTIVE COUNTERMEASURES • SPECIAL COMMUNICATIONS TECHNIQUES

## People

replace the larger program with several smaller ones and coordinate efforts in engineering, marketing and management.

To assure that RCA takes full advantage of new technology, Law has set up a program development group to handle applications engineering, plan projects and consider proposals for new programs.

When **S.F. (Fred) Eyestone** took over as president of North American Aviation Inc.'s Autonetics division [Electronics, Feb. 6, p. 8] he reinstated the "troika" administrative system, dropped last year, by appointing two executive aides.



S. F. Eyestone

The three-man executive office is to provide greater depth in managing Autonetics, the most diversified of North American's operations. Eyestone points out that while work on the Minuteman ICBM guidance system and the Mark II avionics system will continue to dominate Autonetics' operations, "we would like very much to increase the portion of our business in smaller programs."

**Moving up.** To further this aim, George W. Leisz and William F. Sauers were named division executive vice presidents. Leisz, who now has executive responsibility for products, was formerly vice president of Autonetics' navigation systems operation. Sauers, who is in charge of programs, was vice president of Autonetics' electro sensor systems unit.

The smaller programs to which Eyestone refers include Autonetics' work in astrionics, information systems, and ocean systems.

Autonetics also plans to put increasing emphasis on its microelectronics capability and will be producing more specialized integrated-circuit devices for its own products. Eyestone said the division is "studying the kind of production line we would like to set up" for production of MOS arrays.

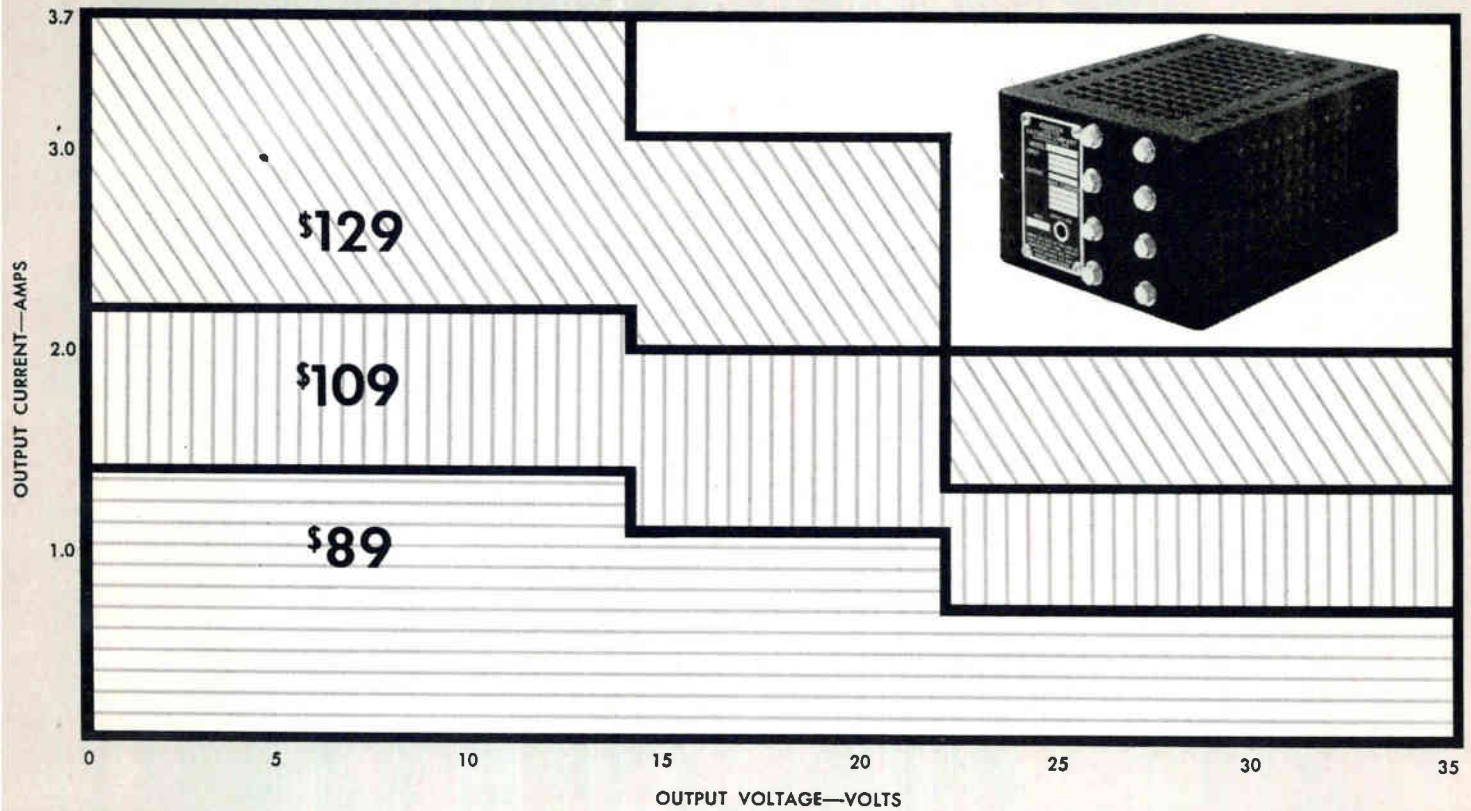

All-silicon QSA Series: 12 models; regulation  $\pm .005\%$ ; response time 20  $\mu\text{s}$ .

# New Sorensen Modular Power Supplies

The new Sorensen QSA Series offers the only modular power supply line in the 0 to 35 volt range that combines  $\pm .005\%$  regulation line and load, 20  $\mu\text{s}$ . response time, 71°C operating temperatures, 300  $\mu\text{V}$  ripple—all at prices below other lines having lesser performance specifications. Sorensen's QSA Series modules are ideal for OEM, lab or system applications. They can be used as bench models (mounted in any position) or mounted in combinations of 3 or 4 in an optional 19" (3½" high) rack adapter. Other design features include: Load current vs. temperature, 110% @ 40°C—100% @ 50°C—85% @ 60°C—66% @ 71°C • Temperature coefficient 0.01%/°C • Stability

0.025%/8 hrs. • Models QSA10-1.4, QSA10-2.2 and QSA10-3.7 permit operation of up to 20 units in series; other units permit operation of 2 units in series; All models permit operation of 4 units in parallel • No turn-on/turn-off overshoots • Remote sensing • Remote programming • Ripple voltage peak to peak 3mV. All Sorensen power sources conform to proposed NEMA standards. For additional QSA Series details or for data on other standard/custom DC power supplies, AC line regulators or frequency changers, call your local Sorensen representative, or write: Raytheon Company, Sorensen Operation, Richards Avenue, Norwalk, Conn. Tel: 203-838-6571, TWX: 710-468-2940.

SPECIFICATIONS	
<b>MODELS (RANGES)</b>	QSA10-1.4 (0-10V, 1.4A) QSA12-1.4 (8-14V, 1.4A) QSA18-1.1 (14-22V, 1.1A) QSA28-.7 (22-35V, .7A)
<b>SIZES (IN.)</b>	7 x 3-5/16 x 3-7/8
<b>PRICES (U.S. List)</b>	\$89
	QSA10-2.2 (0-10V, 2.2A) QSA12-2.2 (8-14V, 2.2A) QSA18-2.0 (14-22V, 2.0A) QSA28-1.3 (22-35V, 1.3A)
	7 x 3-5/16 x 5-1/8
	\$109
	QSA10-3.7 (0-10V, 3.7A) QSA12-3.7 (8-14V, 3.7A) QSA18-3.0 (14-22V, 3.0A) QSA28-2.0 (22-35V, 2.0A)
	10 x 3-5/16 x 5-1/8
	\$129



Circle 11 on reader service card

PATENT NOS. 3025589, 3064167 & 3108359:  
THE PLANAR PROCESS

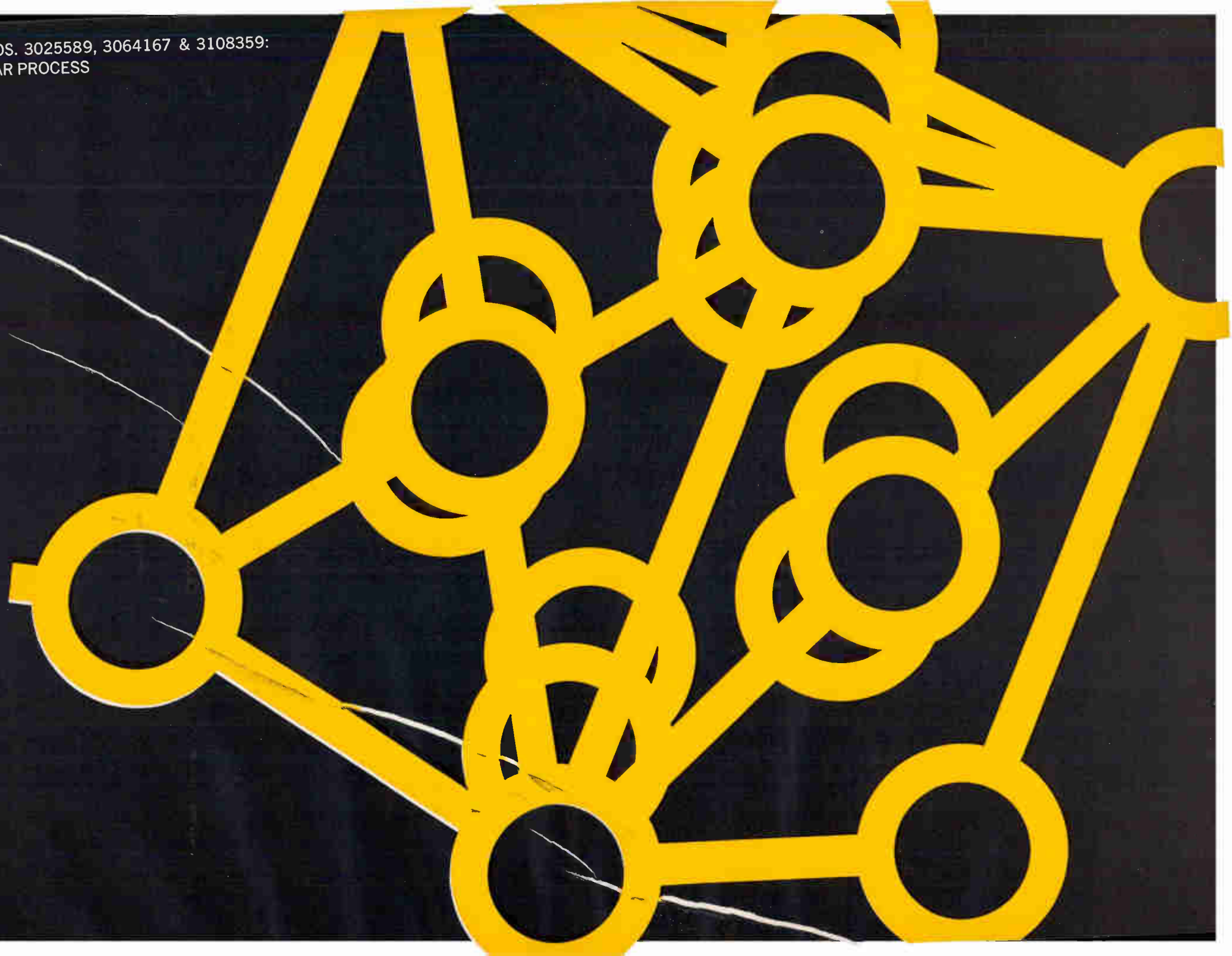

**Planar. Pure PN  
junctions from a pile  
of sand. Silicon  
integrated circuits.  
Invented here.**

**FAIRCHILD**  
SEMICONDUCTORS

# ERRORS make us angry!

that's why we  
manufacture  
variable  
attenuators  
with error of less  
than 0.05 db\*

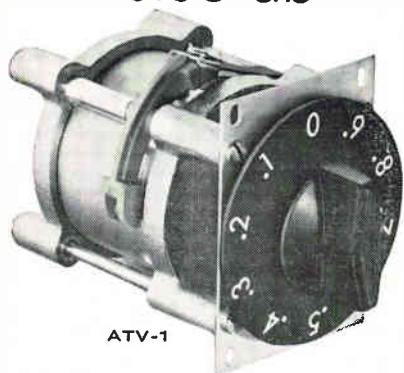

ATV-1

Think attenuators... say the words "Precision Performance"... and you must conclude Jerrold ATV-Series Turret Attenuators. Small, compact, they cost far less than you might expect.

Jerrold attenuators set the pace with intrinsic quality like coin-silver contacts for maximum conductivity, finest-quality deposited carbon disc and rod pad resistors for extreme accuracy, and positive spring-loaded detent mechanism for faultless resolution—in fact all the electrical features of "pull-and-turn" attenuators at one third the cost!

Model ATV-1,\* 0-0.9 db in 0.1 db steps (Fixed Attenuation 3 db), Accuracy  $\pm 0.05$  db at max. attenuation. \$275.00

Model ATV-9, 0-9 db in 1 db steps, Accuracy  $\pm 0.1$  db at max. attenuation. \$250.00

Model ATV-50, 0-50 db in 10 db steps, Accuracy  $\pm 0.5$  db at max. attenuation. \$195.00

Group this with 50 ohm impedance, VSWR of 1.06:1 at 1000 MHz (1.1:1 at 1200 MHz), low insertion loss .1 db maximum, and you come up with THE BEST BUY IN THE INDUSTRY! If you're operating DC to 1200 MHz... send for complete specs today.



MEASUREMENT AND  
TEST INSTRUMENTATION

JERROLD ELECTRONICS CORPORATION  
Government and Industrial Division  
Philadelphia, Pa. 19105

## Meetings

**National Air Meeting on Collision Avoidance**, Institute of Navigation; Dayton, Ohio, Feb. 23-24.

**National Electric Automobile Symposium**, Santa Clara Valley Engineers' Council; San Jose State College, San Jose, Calif., Feb. 24-25.

**Electronic Industries Association Systems Effectiveness Conference**, Electronic Industries Association; Statler-Hilton, Los Angeles, Feb. 28-March 1.

**Numerical Control Society Conference**, Statler Hilton Hotel, Detroit, March 1-3.

**Particle Accelerator Conference—Accelerator Engineering and Technology**, IEEE; Shoreham Hotel, Washington, March 1-3.

**U.S. National Particle Conference**, IEEE; Shoreham Hotel, Washington, March 1-3.

**Symposium on the Effects of Radiation in Semiconductor Components**, Faculte de Sciences of the University of Toulouse; Toulouse, France, March 7-10.

**International Symposium on Residual Gases in Electron Tubes and Sorption-Desorption Phenomena in High Vacuum**, Italian Society of Physics; Rome, March 14-17.

**National Convention**, Air Force Association; Hilton and St. Francis Hotels, San Francisco, March 14-17.

**Temperature Measurements Society Conference and Exhibit**, Temperature Measurements Society; Hawthorne Memorial Center, Los Angeles, March 14-15.

**International Convention**, IEEE; New York Hilton Hotel and Coliseum, March 20-24.

**Symposium on Modern Optics**, Polytechnic Institute of Brooklyn; Waldorf-Astoria Hotel, New York, March 22-24.

**Lectures on Glass in Electronics**, New York State Science of Technology Foundation; Polytechnic Institute, Troy, New York, March 28-29.

**Photovoltaic Specialists Conference**, IEEE; Sheraton Cape Colony Inn, Cocoa Beach, Fla., March 28-30.

**Advancing Technology & Purchasing Management Workshop**, Institute of Science & Technology; University of Michigan, Ann Arbor, Mich. March 29-30.

**Structures, Structural Dynamics & Materials Meetings**, American Institute of Aeronautics and Astronautics; Palm Springs, Calif., March 29-31.

**Symposium on Microwave Power**, International Microwave Power Institute; Stanford University, Stanford, Calif., March 29-31.

**Conference on the Transport Properties of Semiconductors**, Solid State Physics Committee of Institute of Physics; Canterbury, Kent, England, March 30-31.

**International Electronic Components Show**, FNIE; Porte de Versailles, Paris, April 5-10.\*

## Call for papers

**Instrument Society of America Conference & Exhibit**, Instrument Society of America; McCormick Place, Chicago, Sept. 11-14. **March 1** is deadline for submission of abstracts to 1967 Conference Program Coordinator, Instrument Society of America, 530 William Penn Place, Pittsburgh, Pa. 15219

**International Electronic Circuit Packaging Symposium**, Wescon; San Francisco, Aug. 21-22. **March 15** is deadline for submission of abstracts to Papers Selection Committee, c/o Wescon, 701 Welch Rd., Palo Alto, Calif. 94304

**Temperature Measurements Society Conference and Exhibit**, Temperature Measurements Society; Hawthorne Memorial Center, Los Angeles, March 14-15. For further information write R.A. Finch, conference and exhibit chairman, Atomics International, P.O. Box 309, Canoga Park Calif.

**Southeastern Instrument Conference**, Instrument Society of America; Cocoa Beach, Fla., April 18-20. For further information write Arlie Keith, 1127 South Patrick Drive, Satellite Beach, Fla.

\* Meeting preview on page 16



Is there really a choice in differential voltmeters? You bet! You can buy Fluke solid state dc, ac/dc, or true rms differential voltmeters or you can buy our vacuum tube versions. After you take a look at the brief specs of each model, it's a sure thing you won't care about anyone else's differential voltmeter (if there are any).

DC DIFFERENTIAL VOLTMETERS							
MODEL	INPUT VOLTAGE	ACCURACY % OF INPUT	INPUT IMPEDANCE	MAX. METER RESOLUTION	PRICE	NOTES	
801B	0-500 VDC	±0.05%	Infinite at null	50 uV	\$ 485.00	} +\$20 for rack models	
825A	0-500 VDC	±0.02%		5 uV	\$ 590.00		
821A	0-500 VDC.	±0.01%	Infinite at null to ±11V 10 Meg above ± 14V Infinite at null to ±1100V	5 uV	\$ 795.00		
871A*	0-1100 VDC	±0.02%		10 uV	\$ 565.00	} +\$130.00 for rechargeable battery pack	
881A*	0-1100 VDC	±0.005%		1 uV	\$ 825.00		
885A*	0-1100 VDC	±0.0025%		1 uV	\$ 965.00		
895A*	0-1100 VDC	±0.0025%	1 uV	\$1,195.00			
AC/DC DIFFERENTIAL VOLTMETERS							
803B	0-500V AC or DC	±0.05% DC, ±0.2% AC	Infinite at null DC	50 uV	\$ 875.00	} +\$20 for rack models	
803D	0-500V AC or DC	±0.02% DC, ±0.1% AC		5 uV	\$1,055.00		
823A	0-500V AC or DC	±0.01% DC, ±0.1% AC	1 Meg, 35-50 pf AC	5 uV	\$1,215.00		
873A*	0-1100V AC or DC	±0.02% DC, ±0.2% AC	Infinite at null to 10 Meg above 11 VDC	10 uV	\$ 875.00	} +\$160.00 for rechargeable battery pack	
883A*	0-1100V AC or DC	±0.005% DC, ±0.1% AC		1 uV	\$1,215.00		
887A*	0-1100V AC or DC	±0.0025% DC, ±0.05% AC		1 Meg, 40 pf AC	1 uV		\$1,375.00
TRUE RMS DIFFERENTIAL VOLTMETER							
931A*	0-1100V AC	±0.05% AC	1 Meg, 8 pf with BNC Input	20 ppm of dial setting	\$ 895.00	+\$ 50.00 for permanent probe +\$100.00 for recharge- able battery pack	

\*Solid State



FLUKE • Box 7428, Seattle, Washington 98133 • Phone: (206) 774-2211 • TWX: (910) 449-2850

All Fluke differential voltmeters from the least costly on up offer standard lab performance in portable instrumentation. They are "human engineered" for easy use. They give you direct digital readout, with automatic decimal point indicator. Fluke differential voltmeters feature highest possible off-null resistance. Solid state units are available as bench-top models adaptable for half-rack or full-rack mounting. All vacuum tube versions are available in cabinet or full-rack configurations. More accessories are available for greater flexibility. All but one of the solid state models are offered in both line and rechargeable battery operated versions. For full information, please call your Fluke sales engineer or write us.

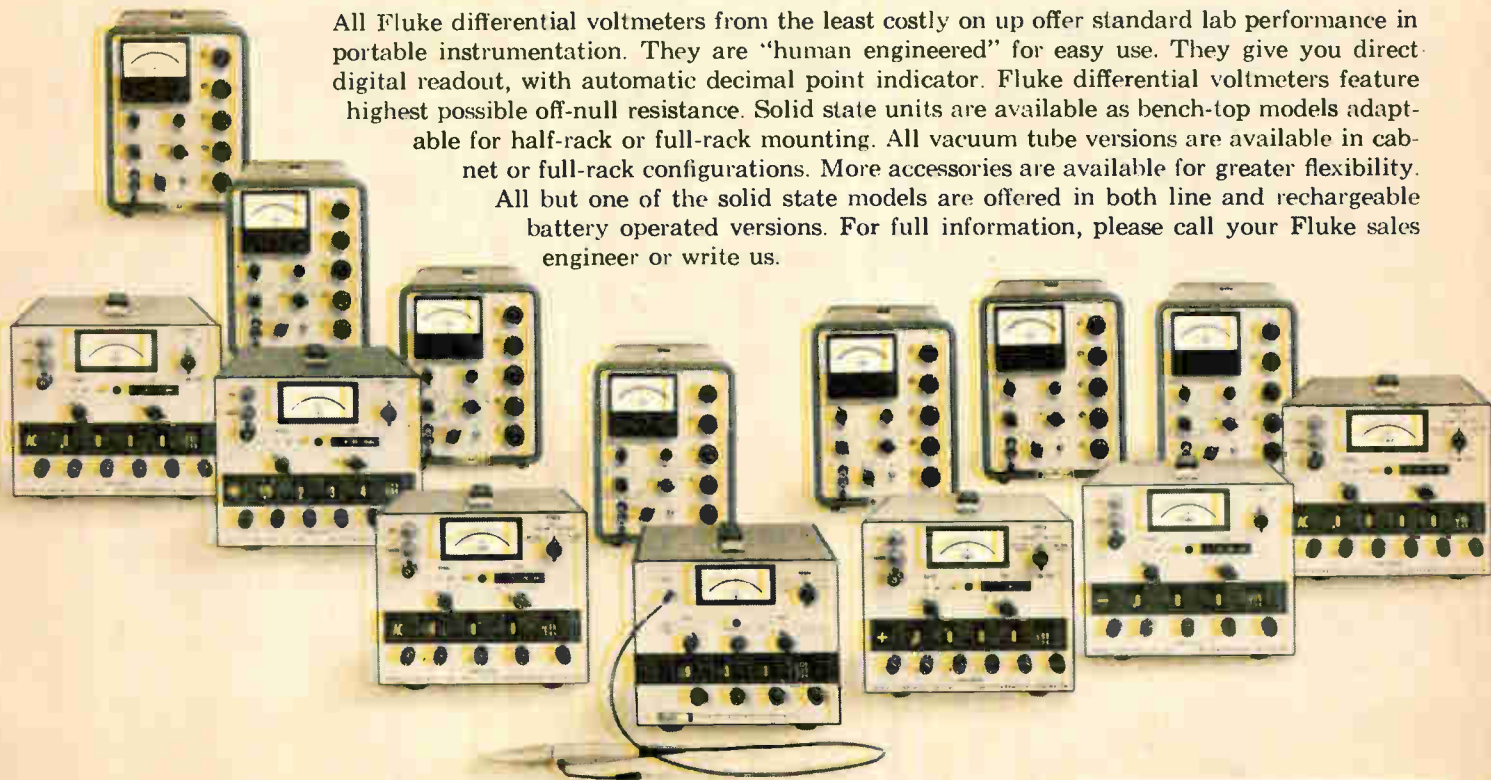

See us at IEEE, Booths 2C02, 2C04

# New from Sprague!

**5 Times the Resistance of  
a Conventional Metal-Film Resistor  
of Equal Size!**

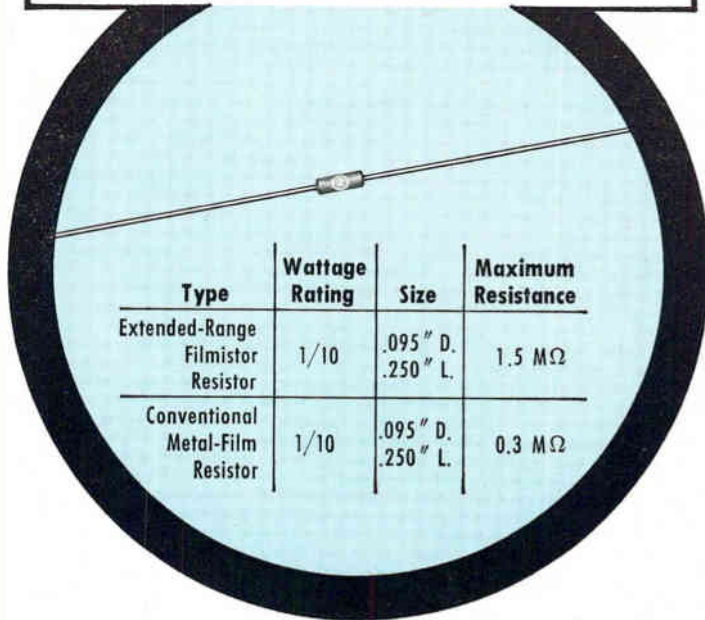

## EXTENDED-RANGE FILMISTOR<sup>®</sup> METAL-FILM RESISTORS

**Substantial saving of space in all wattage ratings —  
1/20, 1/10, 1/8, 1/4 1/2, and 1 watt—with  
absolutely NO SACRIFICE IN STABILITY!**

Extended-Range Filmistor Resistors now offer, in addition to accuracy . . . stability . . . reliability . . . resistance values in size reductions which were previously unobtainable. Size and weight advantages of Filmistor Resistors now make them ideal for applications in high-impedance circuits, field-effect transistor circuits, etc. Many designs which previously had to settle for the higher temperature coefficients of carbon-film resistors in order to obtain required resistance values can now utilize the low and controlled temperature coefficients of Filmistor Metal-Film Resistors.

Other key features are  $\pm 1\%$  standard resistance tolerance, low inherent noise level, negligible voltage coefficient of resistance, and tough molded case for protection against mechanical damage and humidity.

*For complete technical data, write for Engineering Bulletin 7025C to Technical Literature Service, Sprague Electric Co., 35 Marshall Street, North Adams, Massachusetts 01247.*

### SPRAGUE COMPONENTS

RESISTORS  
CAPACITORS  
TRANSISTORS  
INTEGRATED CIRCUITS  
THIN-FILM MICROCIRCUITS  
INTERFERENCE FILTERS

PACKAGED COMPONENT ASSEMBLIES  
FUNCTIONAL DIGITAL CIRCUITS  
MAGNETIC COMPONENTS  
PULSE TRANSFORMERS  
CERAMIC-BASE PRINTED NETWORKS  
PULSE-FORMING NETWORKS



'Sprague' and '®' are registered trademarks of the Sprague Electric Co.

## Meeting preview

### Semiconductors in Paris

The International Components Show in Paris, April 5-10, the continent's traditional meeting place for component companies and their customers, will demonstrate the strides European electronics companies have taken in the production of semiconductor devices.

Among the market developments spurring this advance are the scheduled start of color television broadcasts in several countries next fall, the race to develop third-generation computers, and governmental demands for more sophisticated devices for space, aviation and defense.

**Competition.** Société Européenne des Semiconducteurs (Sesco), a joint venture of Thomson-Houston and the General Electric Co., says it will introduce a new line of power transistors for tv sets. La Radiotechnique, a Philips Gloeilampenfabrieken nv subsidiary and Thomson's top competitor in the French tv market, is also expected to unveil television components along with its rapidly evolving line of semiconductor radiation detectors.

Both Sesco and the semiconductor-producing subsidiary of CSF-Compagnie Générale de Télégraphie Sans Fil may take the wraps off the integrated circuits they are developing for an all-French third-generation computer that will be ready for delivery late next year or in early 1969.

**Lineup.** From elsewhere in Europe, only Elliott-Automation Ltd. of Britain has disclosed some of the items in its exhibit. Among the Elliott devices will be a range of diode-transistor-logic ic's in two-package form for commercial and military use. The company will also show a line of transistor-transistor-logic devices with propagation delays of 10 to 12 nanoseconds.

Show officials predict a strong showing by European firms struggling to close the production lead held by U.S. companies. Of the 709 exhibitors, 359 will be French electronics concerns. The U.S. will be represented by 121 companies. East Germany will be the only Eastern European exhibitor.



## HOT CARRIER DIODES...

Negligible charge storage

Low leakage, high forward conductance

Available in matched pairs and quads

Low cost

### ...from HPA

The performance specifications and prices in the table below show why the HPA 2900 is ideally suited for commercial applications requiring ultra-fast switching, RF/UHF mixing, detecting and limiting. Call your local HP field engineer or write direct for your data sheet. HP Associates, 620 Page Mill Road, Palo Alto, California 94304.

Typical specifications		
Forward Current $I_F$	Breakdown Voltage $V_{BR}$	
20 mA min. @ $V_F=1.0$ V 1.0 mA min. @ $V_F=0.4$ V	10 V @ $I_R=10$ $\mu$ A	
Leakage Current $I_R$	Lifetime $\tau$	Price
100 nA @ $V_R=-5.0$ V	120 ps	1 to 99, \$3.00 100 to 999, \$2.25

HEWLETT  
PACKARD  HP  
ASSOCIATES

2585

**We wanted programmable logic cards  
for our circuit packaging system.  
We had to design our own.**

**Here's what they give you.**

#### **Modular circuit packaging**

Our family of digital logic circuit cards gives you new solutions to your circuit packaging problems. With a selection of relays—wire contact, permissive-make and reed relays—and our modular circuit packaging system, you have the tools to easily breadboard new circuit designs. IBM's logic circuit packaging system handles a variety of packaging options and gives you the solution to numerous applications including data processing, digital logic testing, timing control, telemetering, and process and numerical control. We designed our packaging system to provide the kind of flexibility we needed in IBM data processing systems and to create total system economy.

Then we decided to make our flexible, low-cost packaging system even more versatile.

This programmable card performs the functions of many different circuit configurations. A program cap is shown being inserted to convert the card to one of those configurations.

#### **Programmable circuit cards**

To be truly versatile, a digital logic circuit card has to perform more than one function. So, when we developed our family of printed circuit cards we made five of them programmable. You can program each of these five cards to perform the functions of many different circuit configurations. You can program each of the five cards for high-speed or low-speed operation. And you can program the collector resistors for individual load requirements. That's versatility. The kind that simplifies cir-

cuit modification. Versatility that saves you the costs of in-process inventories. The kind that lets you design flexibility into your prototype designs.

#### **SDTDL circuits**

The remaining cards of the family are discrete cards acting as flip-flops, complementary emitter followers, NAND gates, AND gates, oscillators, power drivers, and single shot inverters. We developed these cards using saturating drift transistor diode logic (SDTDL). This technique uses diodes to perform the logic function. Transistors are used

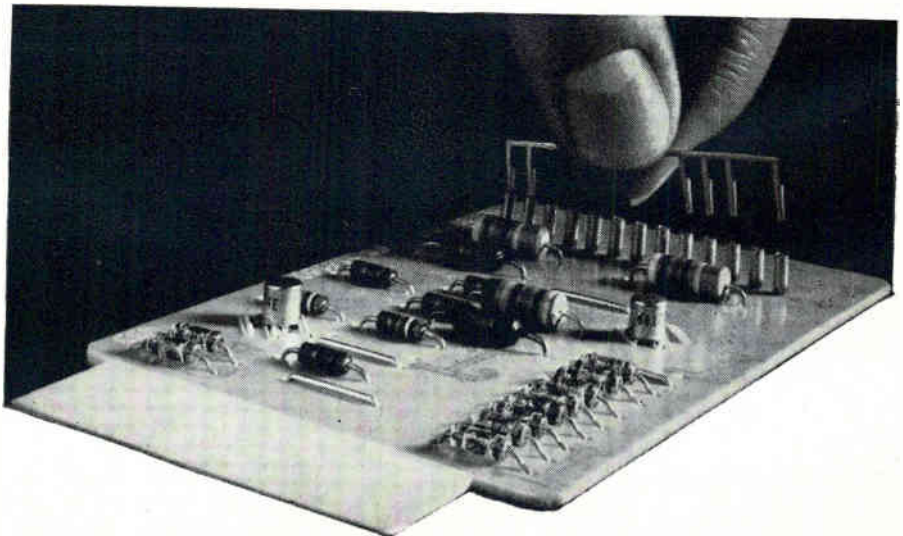

only to invert and amplify the logic output.

#### **Performance data**

Full and complete circuit data, in the most realistic terms, are supplied for each circuit and logic card. IBM Engineering Specification Sheets for all circuit configurations are available, as well as Data Sheets for each card. The engineering specifications list important data such as worst case parameters under various loading conditions, equivalent circuits, noise sensitivity, available output currents, loading equations, transient response, rise and fall curves, turn-on and turn-off delays, voltage levels and application notes.

#### **Total packaging capability**

The development of this group of digital logic circuit cards extends your overall packaging capability. With a selection of relays, programmable circuit cards, and low-cost flexibility in



packaging systems, IBM gives you the tools to simplify the problems of breadboarding your circuit designs. For the full story of simplified circuit packaging write IBM Industrial Products, 1000 Westchester Avenue, White Plains, New York 10604.

# announcing...

An exclusive thick-oxide process that now makes possible major progress in Large Scale Integration.

With the introduction of MTOS, Metal-Oxide-Silicon technology has now moved into the second generation of its development. This breakthrough is significant because it makes realizable major progress in Large Scale Integration through reliability and cost parameters that

can now be achieved for the first time. The exclusive General Instrument MTOS (Metal-Thick-Oxide-Silicon) manufacturing process produces circuits of a substantially higher order of reliability, performance, circuit complexity and yields.

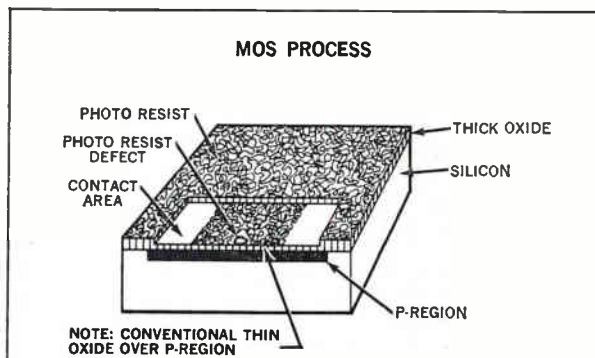

1-A. Conventional MOS crossover point prior to etching of thin oxide from contact areas. Note photo resist defect which will allow etchant to attack the oxide.

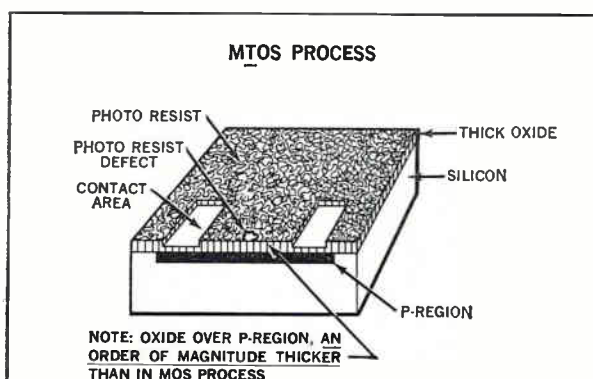

1-B. MTOS crossover point prior to etching of thin oxide from contact areas. Note photo resist defect which will allow etchant to attack the oxide.

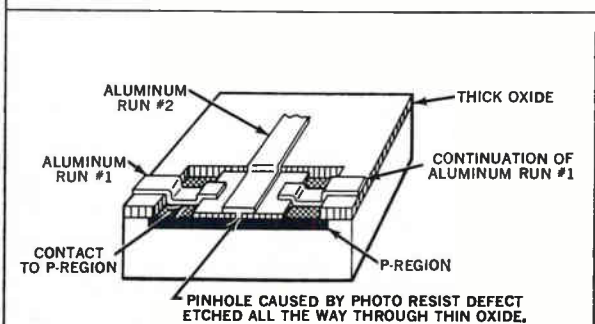

2-A. Completed conventional MOS crossover point. The pinhole in the thin oxide has caused a short-circuit between aluminum run #1 and run #2.

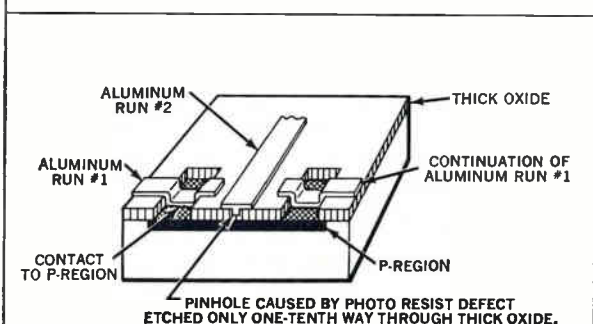

2-B. Completed MTOS crossover point. Aluminum run #1 makes electrical contact to the conducting P-region which crosses underneath aluminum run #2. Contact is then made to the continuation of run #1. The two runs are separated by the thick oxide insulation layer.

# MTOS

## Second Generation MOS Technology

MTOS is a process for the manufacture of integrated circuits in which thick oxide is grown over the entire chip, except for the gate regions. The MTOS process produces an oxide layer ten times as thick over the P-regions as any other known process employed in the

manufacture of MOS devices. This strengthened thick-oxide layer over the P-regions, and the sequence of steps used in the MTOS process, eliminate pinholes that could occur at crossover points, a major cause of failure in integrated circuits. Further, the thick oxide over the P-regions also minimizes the possibility of electrical short-circuits caused by the breakdown of the oxide resulting from a flaw in the oxide layer.

Parametric enhancement is an additional benefit accruing to the user due to the MTOS process. Crossovers occurring over the thick oxide reduce stray capacitance, thereby offering higher frequency performance and faster switching speeds.

The inherently higher yields resulting from the thick-oxide process will reduce the cost per function to the user as well as offer greater complexity per chip area.

This advance in the art of MOS processing creates not only new standards of reliability, performance, circuit complexity and product availability, but is also of prime importance to the position of leadership held by General Instrument in the technology of Large Scale Integration.

MTOS devices are in stock and immediately available from your authorized General Instrument Distributor.

Write for full information.



GENERAL INSTRUMENT CORPORATION  
600 WEST JOHN STREET, HICKSVILLE, L. I., NEW YORK

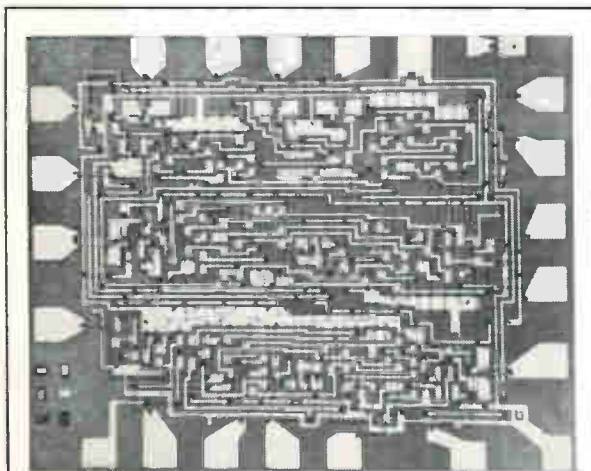

Photo above is of the MTOS Digital Differential Analyzer (MEM 5021), one example of General Instrument's LSI accomplishments (a single chip 86x70 mils contains 244 MOSFETS), and one of a complete line of MTOS ICs and single devices available from General Instrument in production quantities. Below is a listing of some of the more popular MTOS devices also available.

MEM 3050 . . . . .	Dual 25-Bit Shift Register	MEM 2008 . . . . .	Series Shunt Chopper
MEM 3021/3021B . . . . .	21-Bit Shift Register	MEM 1008 . . . . .	Dual Exclusive OR/NOT Gate
MEM 3020 . . . . .	20-Bit Shift Register	MEM 1005 . . . . .	R-S-T Flip-Flop
MEM 3016-2 . . . . .	Dual 16-Bit Shift Register	MEM 1002 . . . . .	Dual 3-Input NOR-Gate
MEM 3012 SP. . . . .	12-Bit Serial In/Parallel Out Shift Register	MEM 1000 . . . . .	Dual Full Adders
MEM 3008 PS. . . . .	8-Bit Parallel In/Serial Out Shift Register	MEM 551 . . . . .	Dual P-Channel MOSFETS
MEM 2009 . . . . .	6-Channel Multiplexer	MEM 550 . . . . .	
		MEM 520 . . . . .	P-Channel MOSFETS
		MEM 517/517A. . . . .	
		MEM 511 . . . . .	
		2N4353 . . . . .	



## The \$10,000 Question: Can a small computer find happiness as part of your instrument?

Time was, general purpose computers were expensive to buy, expensive to use — unapproachable. No more.

If you build instruments or systems that analyze, or measure, or compute, or adjust, or control processes, consider this:

For less than \$10,000 (much less, if you order several at once) the PDP-8/S — a full, real-time, on-line, 12 bit, 4096 word, FORTRAN speaking, general purpose digital computer can be part of your system. To analyze, measure, compute, adjust, or control processes.

If you make more than one kind of system, you still may need only one kind of computer. It's general purpose, you see. And if your requirements are big, we have big

fast machines too, upwards compatible. And a complete line of modules for interfacing.

One advantage for your product is clear: if your customer needs more or different capability after he buys, he adapts by plugging in options, or writing new programs, or changing them, or expanding them. And your product just might be easier to sell if there's a computer inside.

The PDP-8/S offers security. Security in change. It is priced lower than many special purpose machines. More than 300 have been sold in the past three months. And chances are still good that your competition hasn't even looked into it. Why don't you.



540 page Small  
Computer Handbook  
Free for the asking.

**digital**  
COMPUTERS · MODULES



---

**Editorial**

---

## A 'No' vote on Nike X

**One of the controversial** issues Congress will be tackling soon is whether the U.S. should start production of Nike X, the antimissile defense system. Although the weight of emotional arguments and public opinion tends to sway one toward believing this defense system should be built—after all, the Russians are building one—the cold, hard facts say no. Electronics magazine has rarely agreed with Defense Secretary Robert S. McNamara and seldom approved of his conduct, but it does support his stand on Nike X wholeheartedly. He, of course, has ruled “No production.”

It is tempting to sit back and realize that even a sparsely deployed Nike X system would pump anywhere from \$3 billion to \$8 billion into the economy, while full deployment might inject as much as \$40-billion. And the electronics industry would be one of the chief beneficiaries. But if the electronics industry cannot prosper without that kind of Government handout, it would be better off out of business. In fact, such expenditures could seriously cripple the economy by overheating it, thus hurting electronics companies as much as helping them.

There are good diplomatic reasons for not building Nike X installations now. The current attempt to persuade the Russians to hold off building such a system is only one. Then too, it seems clear that a Nike X system will not halt the spread of nuclear weapons or lessen the chances of nuclear war.

There is a good and fundamental tactical reason for not building Nike X, too: it won't be effective against the newest warheads and missiles. In atomic war, unhappily, half-measures in defense are as good as none.

But probably the most rational reason for delaying production of Nike X is technical. The system currently proposed is obsolete, having been designed five years ago. Technological advances made since could vastly improve it. Great strides have been made in understanding and designing phased-array radars since the pioneering work was done on the one for Nike X. Integrated electronics for microwaves will be in production within 18 months. And large-scale integration could lead to smaller, faster and cheaper computers for the system within the same time. With these improvements, the antimissile system could be more effective, faster reacting and cheaper. With them, it might even be possible to install a saturation system, if

diplomacy breaks down, without bankrupting the economy.

Managers will tell you that engineers are never satisfied with a design and are never ready to release it to production. The complaint frequently has merit, but it shouldn't be applied to the improvement of Nike X. Today's antimissile system is comparable to the Army's old Jupiter, the first long-range (1,200 miles) missile. The Jupiter's liquid fuel made it unwieldy to fire and inaccurate compared to the solid-fueled Minuteman missile that followed it. With its computers and hard launching sites, Minuteman has revolutioned the strategy of atomic warfare. A truly modern antimissile system would represent an even greater improvement over Nike X.

Nike X is the kind of system that can't be improved by adding bits of new hardware piecemeal. Rationality pleads that its deployment be held off until an up-to-date system is designed. Thus, rather than starting production of Nike X now, the Defense Department should accelerate development in those technical areas that will lead to a more efficient, more effective and cheaper system.

## Typical day at an airline

**Airlines continue to ignore** modern electronics technology, Electronics has said pointedly before on this page [Sept. 19, 1966 and Nov. 14, 1966]. Airline executives, happily oblivious to what's happening in this field, are content to buy electronic systems so they can advertise them rather than use them seriously.

American Airlines, which has had more than its share of disappointments with its computer reservation system, exhibited this type of myopia when it ran a seven-column—nearly a full page—advertisement in New York newspapers on Wednesday and Thursday, Feb. 8 and 9.

“Yesterday was a typical day,” the ad proclaimed, “and we filled 35,000 seats with 35,000 people. To do that without making one little mistake, we'd have had to use a computer. We did. Its name is Sabre . . .”

Typical day? An air passenger would hope not. This “yesterday” was the day a blizzard paralyzed the northeastern portion of the United States, canceling a large portion of American's and other lines' flights and all of American's service into Boston, New York and Washington. New York's three airports, for example, were closed for over 25 hours. The result: most flights cancelled; others rerouted to unwanted destinations; still others days late; reservations chaotic; check-in-lines winding serpentine back and forth in front of counters. Maybe that is a typical day at American Airlines.

# Bourns Introduces INFINITRON™-Element 10-Turn Precision Potentiometers\*

Here at last are multi-turn precision potentiometers that offer long life and essentially infinite resolution without asking you to compromise on your specifications. Noise in Bourns INFINITRON-element units is so low you can test them as if they were wirewounds. You don't have to hook up special filter circuits or contrive "output smoothness" tests. No need, either, to limit these potentiometers to voltage-divider applications or to guess where the resistance element starts and ends. Precise end-points make our linearity specification a reality in your circuits.

Convince yourself of the higher performance that Bourns INFINITRON-element 10-turn potentiometers can bring to your designs. Write today for product information and actual test data.

## STANDARD SPECIFICATIONS

1/2" Diameter, 10-Turn, Bushing-Mount Model 3501  
3/8" Diameter, 10-Turn, Servo Mount Model 3551

Noise Performance:	100 ohms or 1% of total resistance, whichever is greater
Humidity Performance:	MIL-STD 202, Method 103
Independent Linearity:	±0.5%
Temperature Coefficient, All Resistances:	±300 PPM/°C
Total Resistance Tolerance:	±5%
Rotational Life:	Model 3501: 4,000,000 shaft revolutions Model 3551: 10,000,000 shaft revolutions
End Resistance:	1 ohm or .1% max., whichever is greater
Electrical Rotation:	3600° (+10°/-2°)
Power Rating:	2 watts at 70°C
Operating Temperature Range:	-65°C to +125°C
Environmental Stability:	Resistance shift < 5%
Approximate Weight:	1 oz.
Resistance Range:	1K to 500K
Price, 1-9 pieces:	Model 3501 (Bushing Mount): \$14.00 Model 3551 (Servo Mount): \$30.00

Long-life, ball-bearing shaft supports, standard in the servo-mount model, are also available in the bushing-mount unit.

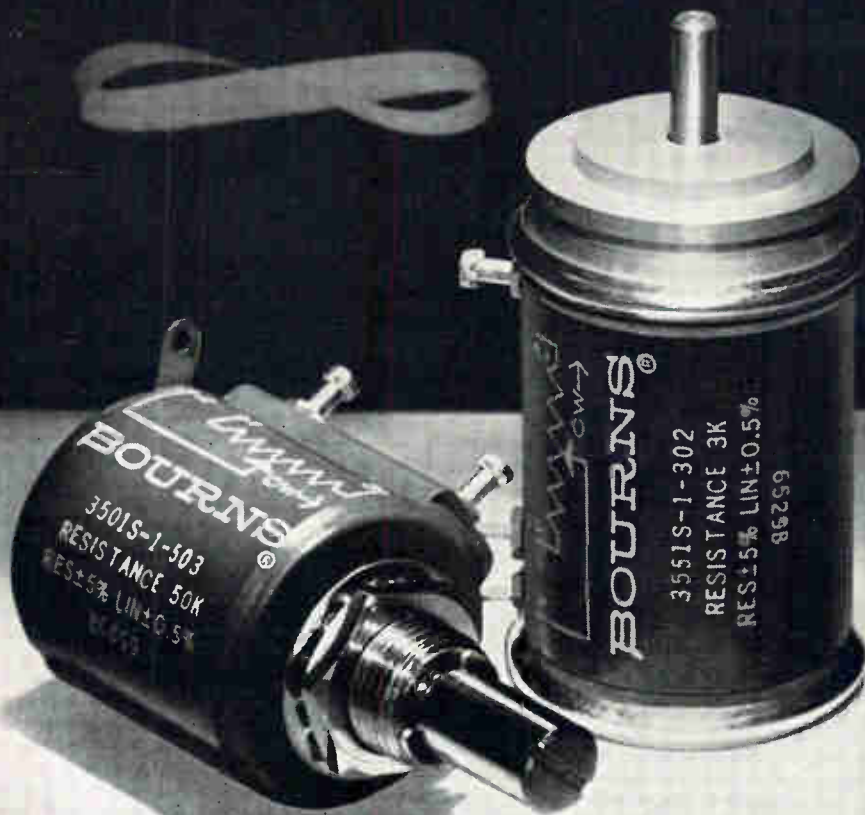

BOURNS, INC., TRIMPOT DIVISION  
1200 COLUMBIA AVE., RIVERSIDE, CALIF.  
PHONE 684-1700 · TWX: 714-682 9582  
CABLE: BOURNSINC.

\*Patent pending

TRIMPOT® AND PRECISION POTENTIOMETERS—RELAYS—MICROCOMPONENTS: TRANSFORMERS, INDUCTORS, RESISTORS AND CAPACITORS—MICROCIRCUITS

---

# Electronics Newsletter

---

February 20, 1967

## King-size pack for IC arrays

Fairchild Semiconductor plans to continue its "think big" approach to integrated-circuit packages when it starts selling large-scale arrays of up to 200 circuits in a jumbo version of the popular dual in-line package.

The standard dual-in-line package lead spacing of 0.1 inch (100 mils) will be retained, but each package will have 50 leads—25 on each side—instead of the usual 14. The package will be about 2½ inches long, instead of ¾ inch, and about 1 inch wide instead of 0.3 inch. The 1-inch spacing between lead rows will allow up to 50 printed circuit interconnections to run between the lead rows when the packages are plugged into circuit boards.

Rex Rice, the man responsible for keeping Fairchild IC packaging in tune with upcoming digital systems designs, says the package will permit building large digital systems without using multilayer circuit boards. He estimates system designers will be able to interconnect an average of 150 circuits per array with the 50-lead packages and double-sided circuit boards. Rice calculates that up to 21,000 circuits can be interconnected in a volume of 702 cubic inches. He recommends system packaging ground rules similar to those he worked out for the original dual in-line packages [Electronics, Feb. 7, 1966, p. 109].

## Air Force seeks control towers

The Air Force has defined its needs for helicopter-transportable air traffic control towers and will request bids this week on 22 of them to be used by the Tactical Air Command. This will be the first production procurement of the towers. The request for proposals will come from the Electronic Systems division, with initial procurement—expected to reach \$5 million—by the 407L program office at Hanscom Field, Mass.

The towers, designated TSW-7, will be the outgrowth of the TSW-6 tower developed for the Air Force by the Radio Corp. of America, which has been undergoing tactical field tests. Chu Associates, Harvard, Mass., is modifying the RCA version, incorporating a single mast for the various antennas.

## AT&T to test compact radio telephones

Compact radio telephones will be field tested later this year in the Houston and Phoenix areas by the American Telephone and Telegraph Co. The "lineless" phones look like oversize Trimline handsets with an antenna. Bell Telephone Laboratories, AT&T's research arm, is at work to further reduce the size of the portable units by designing integrated circuitry for them.

## Real-time tv from outer space?

Real-time television picture transmission from other planets is the goal of tests on a laser space-to-earth communications system at NASA's Goddard Space Flight Center.

The 20-watt carbon dioxide laser, built under a \$100,000 contract by Sylvania Electric Products Inc., a subsidiary of the General Telephone & Electronics Corp., transmits data at 10<sup>6</sup> bits per second. At the present 8 bits-per-second transmission speed, on a narrow bandwidth, it took eight days to send pictures from Mars to earth.

Use of the CO<sub>2</sub> laser, which has a wavelength of 10 microns, overcomes one problem of a laser system, attenuation, by providing a window in

---

# Electronics Newsletter

---

the atmosphere. Another problem, that of cloud cover, hasn't been tackled but NASA says several solutions are available. Signals could be relayed by earth-orbiting satellites, sent to stations in cloud-free areas, or the data could be stored and sent when the clouds disappear.

In the tests at Goddard, coherent light is bounced off passive satellites, such as Echo 2, and received at Goddard.

## Administration readies patent reform bill

The Johnson Administration's forthcoming bill aimed at modernizing the 129-year-old patent system is generally backed by the electronics industry but is already under attack from powerful lobbies.

The American Society of Inventors and the Patent Law Association oppose some of the 35 recommendations offered by a Presidential commission appointed to study the system.

Electronics companies support nearly all the proposals—especially those that would speed patent processing. Some companies, however, criticize the first-to-file proposal, which would grant ownership to the first company applying. They claim this would start a race to the patent office before an invention is developed and would penalize a company that invested heavily in time and money to develop a workable device. Other companies favor it, saying it would eliminate litigation over patent rights.

Another commission recommendation would drop all computer programs from patent consideration. Currently, programs can be copyrighted.

## Broken-up memory slated for Illiac 4

Individual small memories instead of the single large capacity memory that was originally planned, will be built for each of the 256 processors in the University of Illinois' Illiac 4 computer. The Burroughs Corp. will design and fabricate a thin-film memory containing more than 2,000 64-bit words and operating at a cycle time of 250 nanoseconds for each processor. Originally one memory containing many 512-bit words was to serve all the processors simultaneously [Electronics, April 4, 1966, p. 36].

Contract negotiations are under way between Burroughs and the University's digital computer laboratory for the entire system; the contract is to be signed in four to six weeks. For logic circuitry in the giant system, Texas Instruments Incorporated will make large-scale integrated circuits to Burroughs' specifications. As high a level of integration as possible will be used in the completed system, according to Daniel L. Slotnick, project director at Illinois. The project is sponsored by the Advanced Research Projects Agency of the Department of Defense.

## FAA evaluating superbright radar display

A radar display with a brightness of 1,200 foot-lamberts is being tested at airports in Atlanta and Washington where control tower personnel have difficulty seeing conventional displays rated at 50 to 100 foot-lamberts. The system, consisting of a monitor with a 5-inch cathode-ray tube and a television camera, was developed by the Federal Aviation Agency's experimental center in Atlantic City, N. J. Brightness is achieved by using a P-31 phosphor made from zinc, sulfur and copper on the tube, and by higher voltage—22,000 volts compared with 15,000—than is used with present radar display crt's.

# Integrated Circuit IDEAS

SYLVANIA  
Electronic Components Group

## Build binary counters with fast (to 50 MHz) J-Ks

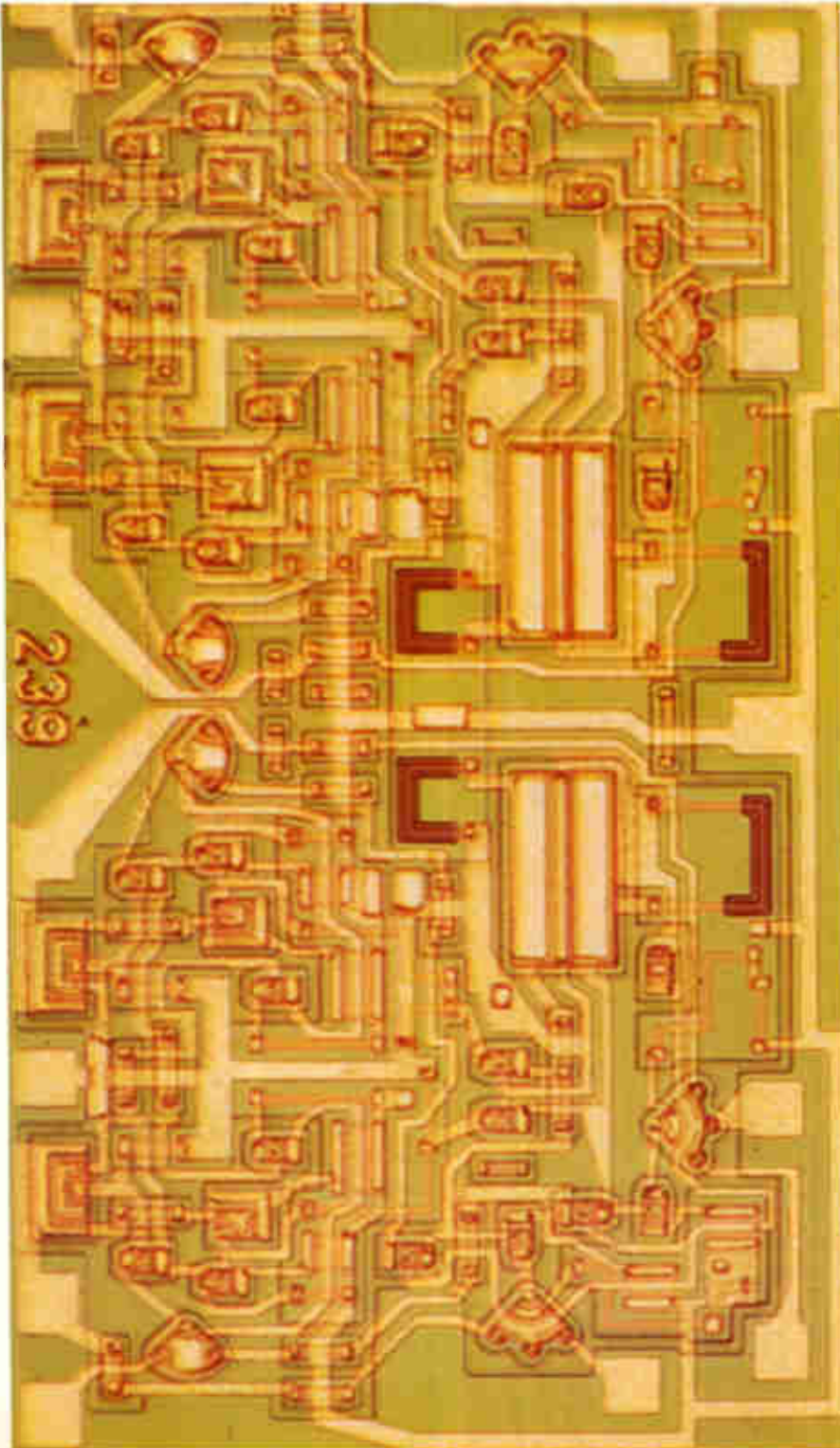

Whether it's ripple or synchronous binary counting, Sylvania has the right J-K flip-flop. Ten types (single and dual) go to 50 MHz.

Flexibility provides the optimum design! That's the best description of how the wide range of J-K flip-flops available from Sylvania can solve your binary counting problems. Here's how two techniques, ripple and synchronous counting, can be implemented with Sylvania's J-Ks to get rates of 5.5, 7.5, 14, 15, 18, 25, 38 MHz in a binary counter.

Ripple type binary counters are sequential in nature: the designated clock pulse drives the first stage flip-flop with each subsequent stage being driven in turn by the preceding flip-flop. As seen in Figure 1, at the 8th clock pulse, the 4th flip-flop settles at a time  $t_1 + t_2 + t_3 + t_4$  after the initial clock pulse. Also note, it is possible that the 4th stage flip-flop might not be settled before clock pulse #9 occurs.

The speed of a ripple counter, however, is limited because decoding can't begin until the last flip-flop in the counter has settled down. As a result, the maximum frequency is:

$$f_{\max} = \frac{1}{\text{clock width} + t_1 + t_2 + t_3 + t_4}$$

For Figure 1, SUHL J-K flip-flops would be capable of the following typical decoding rates:

$$\text{SF-50 (20MHz)} = \frac{1}{35\text{ns} + (4\text{bits} \times 37\text{ns})} = 5.5\text{MHz}$$

$$\text{SF-250 (30MHz)} = \frac{1}{30\text{ns} + (4\text{bits} \times 25\text{ns})} = 7.5\text{MHz}$$

$$\text{SF-200 (50MHz)} = \frac{1}{12\text{ns} + (4\text{bits} \times 14\text{ns})} = 15\text{MHz}$$

*(Continued on next page)*

## This issue in capsule

### SUHL I & II

The largest high-level TTL line on the market: 41 functions, 164 types.

### Full adders

With 8 adders and 9 SUHL units you can build an 8-stage parallel add/subtract subsystem using ripple carry.

### Wideband amplifiers

100 MHz linear devices for video and pulse applications.

### IC reliability

How Sylvania makes certain that product quality levels are maintained.

### Functional arrays

Monolithic digital devices that reduce power, delays, and connections.

The semi-ripple counter in Figure 2 shows how SUHL SF-110 and 130 series dual J-K flip-flops can be used to obtain even higher decoding rates:

$$SF-110, 130 = \frac{1}{[12ns + (4bits \times 14ns/2)]} = 25MHz$$

High-speed applications invariably call for synchronous binary counters. In a synchronous counter each flip-flop is triggered simultaneously and is driven separately by the clock. Therefore, all the counter's outputs occur simultaneously. This type counter must be designed so that each flip-flop is properly set ahead of clock time in order that the proper output appears when triggered by the clock. Therefore, each flip-flop must have a gate stage at its input end to set the flip-flop for triggering.

Figure 3 shows a four-bit synchronous binary counter using SUHL flip-flops which have input gate structures. Each flip-flop has the output of all previous flip-flops fed into its J and K terminals. The maximum time at any clock pulse is  $t_1$ . All outputs appear simultaneously and reading or decoding can be performed in  $t_1$  nanoseconds after the clock trigger. Maximum frequency is:

$$f_{max} = \frac{1}{(Clock\ width + t_1)}$$

Typical SUHL J-K flip-flops would be capable of:

$$SF-50 (20MHz) = \frac{1}{(35ns + 37ns)} = 14MHz$$

$$*SF-250 (30MHz) = \frac{1}{(30ns + 25ns)} = 18MHz$$

$$SF-200 (50MHz) = \frac{1}{(12ns + 14ns)} = 38MHz$$

With synchronous counters, the number of inputs increases as the number of bits increases. For example, a 5-bit synchronous counter requires 4 inputs at the last flip-flop stage and a 10-bit counter requires 9 inputs at the last flip-flop stage.

Figure 4 shows a synchronous counter greater than 4-bits in length. It is completely synchronous. Using SUHL J-K flip-flops, this counter can operate at:

- SF-50 with SUHL I gates = 11.0 MHz
- SF-250 with SUHL II gates = 13.5 MHz
- SF-200 with SUHL II gates = 22.0 MHz

\*For new designs, the SF-200, SF-210 series are recommended replacements for the SF-250, SF-260 series.

CIRCLE NUMBER 300

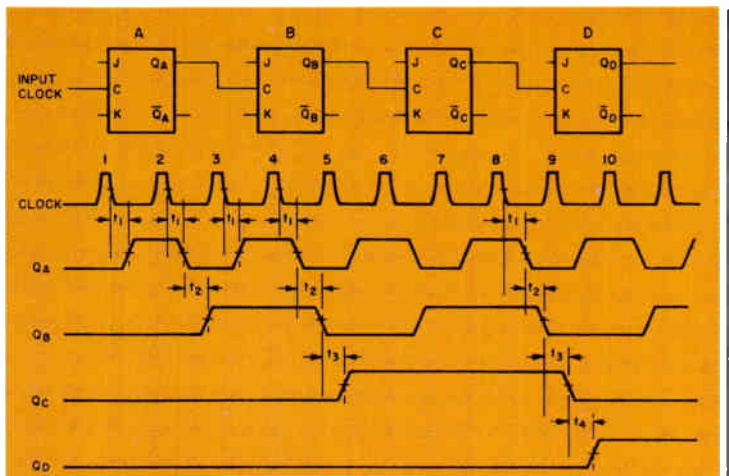

Fig. 1. Ripple Counter

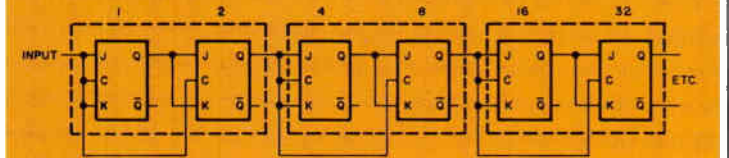

Fig. 2. Semi-Ripple Counter Using SF-110 or SF-130 Dual J-K F-F with Common Clock

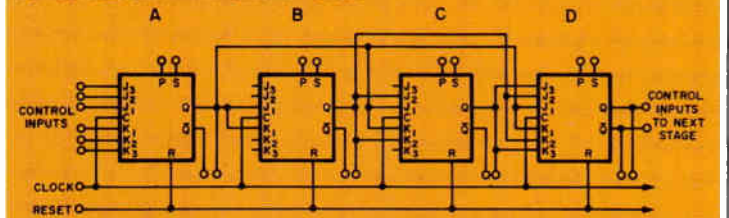

Fig. 3. Synchronous Binary Counter

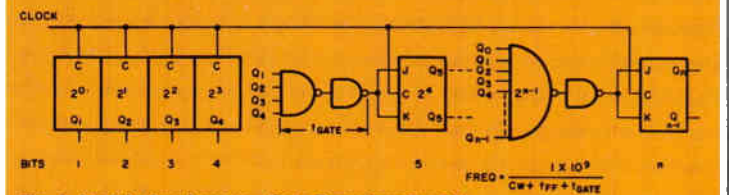

Fig. 4. Straight Synchronous—Gate Expanders Per Bit

## 100 MHz wideband amplifiers for video and pulse applications

Sylvania's high-performance, three-stage, direct-coupled linear amplifiers have low output, high signal voltage outputs, and excellent linearity.

While configurations of Sylvania's SA-20 and SA-21 wideband amplifiers are the same, the SA-20 is for applications requiring higher signal swing and tighter performance tolerances. Here's how you can use them.

Figure 1 shows the circuit diagram for the SA-20 series amplifier. Negative feedback is applied from output stage to first stage emitter through the divider consisting of  $R_4$  and  $R_6$ . Typical voltage gain of the device is 21 db. An external capacitor connected from the collector to base of  $Q_2$  provides local high-frequency feedback. This feedback shapes the roll-off of gain at high frequencies. Values ranging from 2.5 to 5.0 pF normally give the most uniform high-frequency response.

Tests with resistive loads show that a feedback capacitance ( $C_f$ ) of 3.6 pF gives a voltage gain essentially constant to 50 MHz. Gain is down 3 db at frequencies approaching 100 MHz. Increasing  $C_f$  to 6.5 pF reduces the -3 db frequency by 30 to 50 MHz.

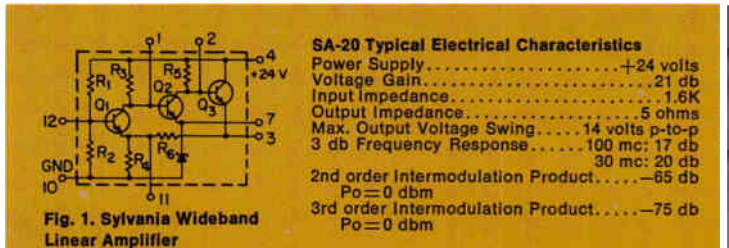

Fig. 1. Sylvania Wideband Linear Amplifier

### SA-20 Typical Electrical Characteristics

- Power Supply . . . . . +24 volts
- Voltage Gain . . . . . 21 db
- Input Impedance . . . . . 1.6K
- Output Impedance . . . . . 5 ohms
- Max. Output Voltage Swing . . . . . 14 volts p-to-p
- 3 db Frequency Response . . . . . 100 mc; 17 db
- 30 mc; 20 db
- 2nd order Intermodulation Product . . . . . -65 db
- $P_o = 0$  dbm
- 3rd order Intermodulation Product . . . . . -75 db
- $P_o = 0$  dbm

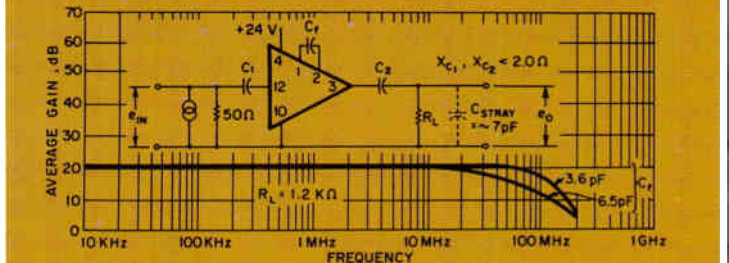

Fig. 2. SA-20 Typical Gain vs. Frequency

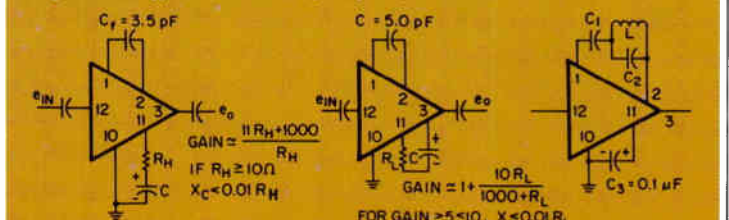

Fig. 3. High Gain Configuration

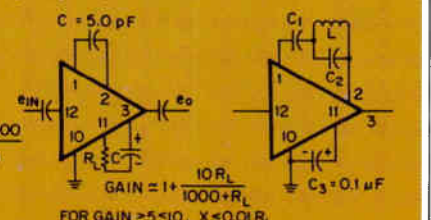

Fig. 4. Low Gain Configuration

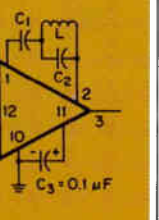

Fig. 5. Selective Amplifier

Figure 2 shows how the voltage gain varies with frequency.

Amplifier gain can be changed by resistive shunting of feedback resistors (Figures 3 and 4). It is necessary to connect a dc blocking capacitor in series with the external resistor to prevent shifting of the normal quiescent voltages.

Maximum amplifier gain is realized when all forms of feedback are removed. This is done by not connecting a feedback capacitor between base and collector of  $Q_2$  and by bypassing the emitter resistor of  $Q_1$ . In this configuration, the amplifier has a typical voltage

gain of 60 db and a  $-3$  db gain frequency of about 4.5 MHz with an  $R_I$  of 1.2K.

Connecting the circuit as shown in Figure 5 gives bandpass characteristics. Voltage gain at the resonant frequency of L and  $C_2$  approaches the gain realized in the maximum gain configuration. Capacitor  $C_1$  blocks dc and should be large enough to prevent series resonance with inductor L. A notch characteristic is obtained when  $C_2$  is removed and L and  $C_1$  are series resonant. Selectivity of bandpass and notch circuits can be improved by replacing the tuned circuits with piezoelectric crystals. CIRCLE NUMBER 301

## Reliability: engineering superior circuits with superior packages

In short, the reliability of integrated circuits depends on how well the circuit chip is made and how well it is packaged.

Sylvania's integrated circuit Quality Assurance and Reliability Department recently completed evaluation of data compiled on 400 four-input NAND gates after 10,000 hours of life test (a total of 4 million component hours). Failure rate was a low 0.009% per 1,000 hours at 25° C.

The circuits tested were basic SUHL four-input NAND gates produced throughout 1964 and early 1965. Thus, they do not represent the improved products made since either the completion of Sylvania's new facilities, or the introduction of newer integrated circuit processing improvements. The improved devices are now undergoing life tests.

The NAND gates were life tested in the ring counter configuration. Life test sockets were placed in an oven where ambient temperature was maintained at 125° C. The graph relates failure rates and confidence limits to temperature.

Sylvania's in-house life and performance tests are supplemented by users' testing programs. A leading manufacturer of aerospace equipment recently completed an extensive testing of Sylvania's TO-85 packaged ICs. The manufacturer performed these key tests per MIL-STD 750 and 202 on SUHL devices and their packages: (1) 10-day JAN moisture resistance, (2) Radflo leak test, (3) Shock, (4) Centrifuge, (5) Vibration fatigue, (6) Vibration-variable frequency (7) Lead fatigue, (8) Lead bending, (9) Salt atmosphere, (10) Storage life at 150° C, and (11) Operating life at 125° C. The package passed these qualification tests which led to the selection of Sylvania ICs for use in the firm's equipment.

To insure continued improvement in reliability and maintain product quality levels, Sylvania has an extensive quality assurance test program. In addition to in-process testing of wafers, all Sylvania integrated circuits also go through a sequence of reliability tests after being sealed in packages. These tests insure that

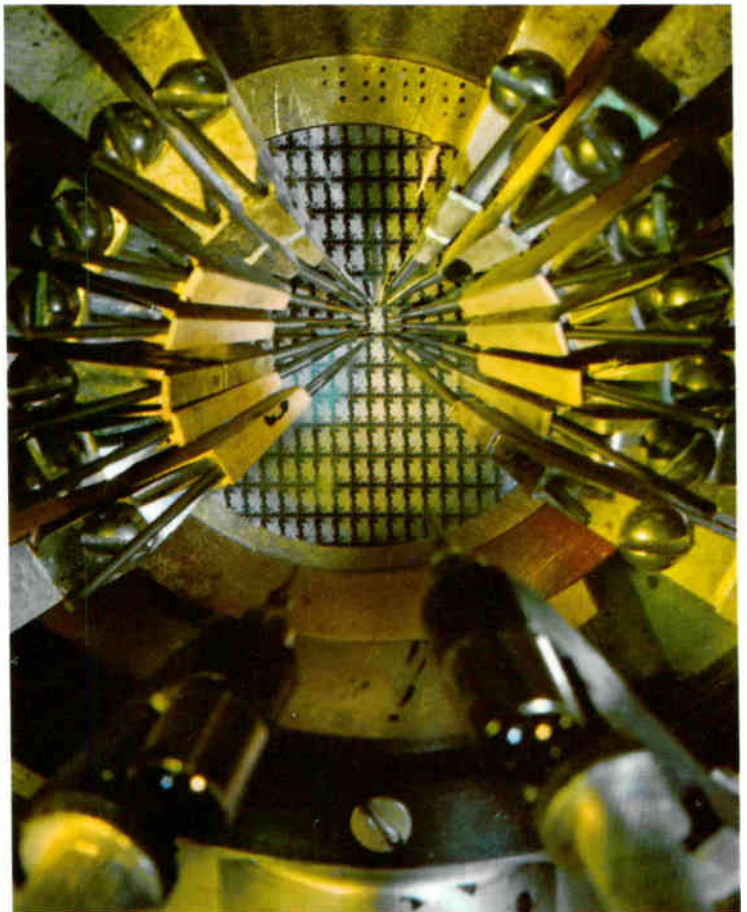
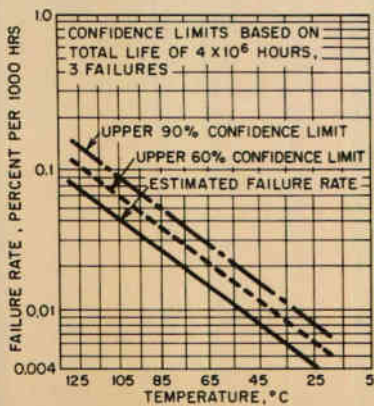

Mechanized wafer-level dc testing

both the actual circuit and the package maintain their integrity.

Each IC first goes through five cycles of  $-65^{\circ}$  C to  $+200^{\circ}$  C cycling with a fifteen-minute soak time at each temperature extreme. A 20,000 G centrifuge test, while units are in the  $Y_1$  plane, insures that the wire bonds are properly connected. Bubble-testing in  $150^{\circ}$  C glycerine points out leaks which may have resulted from the first two tests or from previous processing.

Next, units are baked at  $300^{\circ}$  C for 48 to 60 hours to stabilize them. Then all circuits must meet worst-case tests at the temperature extremes guaranteed in addition to all parameters called for on the Sylvania data sheet or in the customer's qualifications. Electrical capability of each IC is tested at  $75^{\circ}$  C,  $125^{\circ}$  C,  $-55^{\circ}$  C and  $0^{\circ}$  C for dc parameters.

Finally, each unit is tested for all switching characteristics at  $25^{\circ}$  C. This is done by Sylvania's fully automatic test equipment at the rate of one circuit every two seconds. Only at this point is differentiation made between military and industrial capability.

This 100% testing program is in addition to extensive tests of random samples from each lot of circuits. These samples are subjected to electrical, environmental and life testing. CIRCLE NUMBER 302

# SUHL I & II, the most efficient, most complete TTL lines

SUHL ICs are high-level TTL units and more. Designers get flexibility from a wide variety of functions without sacrificing performance.

Sylvania's IC pioneering has led to the highest quality and most complete lines of high-level TTL ICs in the industry. With each of 41 separate functions now available in four different versions (for a total of 164

types), SUHL I and II represent the largest high-level TTL lines on the market.

SUHL units combine propagation delay times as low as 6 nanoseconds with high noise margin, high logic swing, high fan-out, low power and high capacitance drive capability (see Table).

Advantages of SUHL integrated circuits are not limited to electrical performance characteristics. Because Sylvania provides more logic per package, you can build a computer, or other digital equipment, with 25% less packages. The savings in system cost which result from lower package count are not eaten up in higher initial costs because SUHL units are competitively priced.

Sylvania's head start in TTL integrated circuit de-

SUHL I TYPICAL CHARACTERISTICS (+25°C, +5.0 Volts)										
Function	Type Nos.	$t_{pd}$ (nsec)	Avg. Power (mw)	Noise Immunity +(volts)-	**Military (-55°C to +125°C)		**Industrial (0°C to +75°C)			
					Prime FO	Std. FO	Prime FO	Std. FO	Prime FO	Std. FO
<b>NAND/NOR Gates</b>										
Dual 4-Input NAND/NOR Gate	SG-40, SG-41, SG-42, SG-43	10	15	1.1	1.5	15	7	12	6	
Single 8-Input NAND/NOR Gate	SG-60, SG-61, SG-62, SG-63	12	15	1.1	1.5	15	7	12	6	
Expandable Single 8-Input NAND/NOR Gate	SG-120, SG-121, SG-122, SG-123	18	15	1.1	1.5	15	7	12	6	
Dual 4-Input Line Driver	SG-130, SG-131, SG-132, SG-133	25	30	1.1	1.5	30	15	24	12	
Quad 2-Input NAND/NOR Gate	SG-140, SG-141, SG-142, SG-143	10	15	1.1	1.5	15	7	12	6	
Triple 2-Input Bus Driver	SG-160, SG-161, SG-162, SG-163	15	15	1.1	1.5	15	7	12	6	
Triple 3-Input NAND/NOR Gate	SG-190, SG-191, SG-192, SG-193	10	15	1.1	1.5	15	7	12	6	
<b>AND-NOR Gates</b>										
Expandable Quad 2-Input OR Gate	SG-50, SG-51, SG-52, SG-53	12	30	1.1	1.5	15	7	12	6	
Expandable Dual Output, Dual 2-Input OR Gate	SG-70, SG-71, SG-72, SG-73	12	20/gate	1.1	1.5	15	7	12	6	
Exclusive-OR with Complement	SG-90, SG-91, SG-92, SG-93	11	35	1.1	1.5	15	7	12	6	
Expandable Triple 3-Input OR Gate	SG-100, SG-101, SG-102, SG-103	12	25	1.1	1.5	15	7	12	6	
Expandable Dual 4-Input OR Gate	SG-110, SG-111, SG-112, SG-113	12	20	1.1	1.5	15	7	12	6	
<b>Non-Inverting Gates</b>										
Duc Pulse Shaper/Delay-AND Gate	SG-80, SG-81, SG-82, SG-83	11	30/gate	1.1	1.5	15	7	12	6	
Dual 4-Input AND/OR Gate	SG-280, SG-281, SG-282, SG-283	11	38/gate	1.0	1.5	10	5	8	4	
<b>AND Expanders</b>										
Dual 4-Input AND Expander	SG-180, SG-181, SG-182, SG-183	< 1	0.9/gate	1.1	1.5					
Dual 2 + 3 Input AND/OR Expander	SG-290, SG-291, SG-292, SG-293	7	15/gate	1.0	1.5					
<b>OR Expanders</b>										
Quad 2-Input OR Expander	SG-150, SG-151, SG-152, SG-153	4	20	1.1	1.5					
Dual 4-Input OR Expander	SG-170, SG-171, SG-172, SG-173	3	5	1.1	1.5					
<b>Flip-Flops</b>										
Set-Reset Flip-Flop	SF-10, SF-11, SF-12, SF-13	20MHz*	30	1.1	1.5	15	7	12	6	
Two Phase SR Clocked Flip-Flop	SF-20, SF-21, SF-22, SF-23	20MHz*	30	1.1	1.5	15	7	12	6	
Single Phase SRT Flip-Flop	SF-30, SF-31, SF-32, SF-33	15MHz*	30	1.1	1.5	15	7	12	6	
J-K Flip-Flop (AND Inputs)	SF-50, SF-51, SF-52, SF-53	20MHz*	50	1.1	1.5	15	7	12	6	
J-K Flip-Flop (OR Inputs)	SF-60, SF-61, SF-62, SF-63	20MHz*	55	1.1	1.5	15	7	12	6	
Dual 35MHz J-K Flip-Flop (Separate Clock)	SF-100, SF-101, SF-102, SF-103	35MHz*	55/FF	1.0	1.5	11	6	9	5	
Dual 35MHz J-K Flip-Flop (Common Clock)	SF-110, SF-111, SF-112, SF-113	35MHz*	55/FF	1.0	1.5	11	6	9	5	
<b>SUHL II TYPICAL CHARACTERISTICS (+25°C, +5.0 Volts)</b>										
<b>NAND/NOR Gates</b>										
Expandable Single 8-Input NAND/NOR Gate	SG-200, SG-201, SG-202, SG-203	8	22	1.0	1.5	11	6	9	5	
Quad 2-Input NAND/NOR Gate	SG-220, SG-221, SG-222, SG-223	6	22	1.0	1.5	11	6	9	5	
Dual 4-Input NAND/NOR Gate	SG-240, SG-241, SG-242, SG-243	6	22	1.0	1.5	11	6	9	5	
Single 8-Input NAND/NOR Gate	SG-260, SG-261, SG-262, SG-263	8	22	1.0	1.5	11	6	9	5	
<b>AND-NOR Gates</b>										
Expandable Dual 4-Input OR Gate	SG-210, SG-211, SG-212, SG-213	7	30	1.0	1.5	11	6	9	5	
Expandable Quad 2-Input OR Gate	SG-250, SG-251, SG-252, SG-253	7.5	43	1.0	1.5	11	6	9	5	
Expandable Triple 3-Input OR Gate	SG-300, SG-301, SG-302, SG-303	7	36	1.0	1.5	11	6	9	5	
Expandable Dual Output Dual 2-Input OR Gate	SG-310, SG-311, SG-312, SG-313	7	30/gate	1.0	1.5	11	6	9	5	
<b>AND Expanders</b>										
Dual 4-Input AND Expander	SG-180, SG-181, SG-182, SG-183	< 1	0.9/gate	1.1	1.5					
<b>OR Expanders</b>										
Quad 2-Input OR Expander	SG-230, SG-231, SG-232, SG-233	2	28	1.0						
Dual 4-Input OR Expander	SG-270, SG-271, SG-272, SG-273	2	6.7	1.0	1.5					
<b>Flip-Flops</b>										
Dual 50 MHz J-K Flip-Flop (Separate Clock)	SF-120, SF-121, SF-122, SF-123	50MHz*	55/FF	1.0	1.5	11	6	9	5	
Dual 50MHz J-K Flip-Flop (Common Clock)	SF-130, SF-131, SF-132, SF-133	50MHz*	55/FF	1.0	1.5	11	6	9	5	
50MHz J-K Flip-Flop (AND Inputs)	SF-200, SF-201, SF-202, SF-203	50MHz*	55	1.0	1.5	11	6	9	5	
50MHz J-K Flip-Flop (OR Inputs)	SF-210, SF-211, SF-212, SF-213	50MHz*	55	1.0	1.5	11	6	9	5	

\*Minimum toggle frequency \*\*Minimum fan-out



sign, manufacturing and testing is reflected in the superior quality of the SUHL lines. Patented active pull-up networks allow high output logic levels. Use of smaller device geometries not only gives better electrical characteristics, but also cuts device cost. Aluminum to aluminum ultrasonic bonding improves reliability two ways, better bonds and less heat applied to the silicon chip. Automatic testing by Sylvania's specially designed Multiple Rapid Automatic Test Of Monolithic Integrated Circuit (MR. ATOMIC) equipment insures that the units you get meet the specification to which they're bought. Tested here are all dc parameters at temperature and all switching parameters at 25° C.

The continuing leadership in TTL innovation and manufacturing exemplified by the SUHL lines makes Sylvania the prime source for high-level TTL devices.

CIRCLE NUMBER 303

## This is Sylvania's DTL line

The 930 series of DTL ICs now available from your Sylvania distributor comes in flat and dual in-line plug-in versions.

Sylvania's DTL circuits are a low-power logic family with high noise immunity and moderate speed capabilities. Operating over a temperature range of -55° C to +125° C, these units are ideal replacements for similar units designed into digital systems already in production. They are electrically interchangeable and have pin for pin compatibility with other 930 series devices. Prices are competitive with those of other manufacturers.

Type*	Description
S9301/S9303	Dual 4-Input Expandable NAND Gate
S9321/S9323	Dual 4-Input Expandable Buffer
S9331/S9333	Dual 4-Input Expandable
S9441/S9443	Dual 4-Input Expandable Power Gate
S9461/S9463	Quadruple 2-Input NAND Gate
S9621/S9623	Triple 3-Input NAND Gate
S9311/S9313	J-K/R-S Flip-Flop
S9451/S9453	High Performance J-K/R-S Flip-Flop
S9481/S9483	Fast Rise Time J-K/R-S Flip-Flop

\*A number ending in "1" indicates the MIL version (-55°C to +125°C temperature range); those ending in "3" are industrial types (0°C to 75°C).

TYPICAL CHARACTERISTICS		
Parameter	Basic Gate	FLIP-FLOP
Supply Voltage	4.5 to 5.5V	4.5 to 5.5V
Temperature Range	Series 9301 -55° to +125°C Series 9303 0° to +75°C	-55° to +125°C 0° to +75°C
Propagation Delay	25 nsec	50 nsec
Power Dissipation at 4.5V Supply	5 mw	20 mw
Noise Margin	750 mv	750 mv
Input Unit Load	"0" 1.1* mA 0.5µA	"1" 1.1* mA 0.5µA
Fan-out	8	8
Output Logic Levels	"0" 0.3V 4.65V	"1" 0.3V 4.65V

\*V<sub>IN</sub> = 0V; 0.9 mA V<sub>IN</sub> = 0.75V

The added plus in this DTL line is the availability of devices housed in Sylvania's dual in-line plug-in package. With this package, designers get an extremely effective hermetic seal, circular leads with tapered shoulders, leads which can be flexed close to the package body, and a package of very small total volume.

CIRCLE NUMBER 304

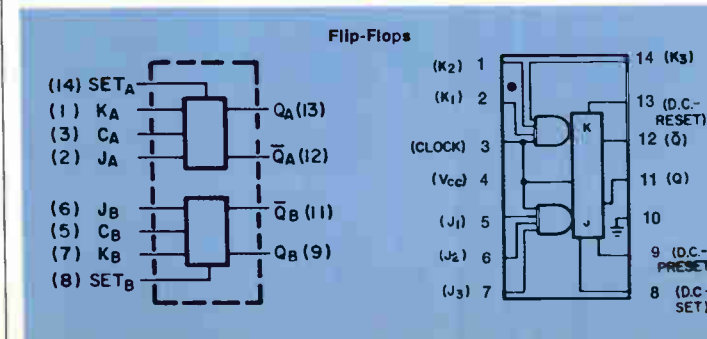
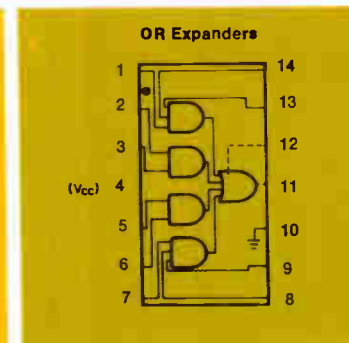
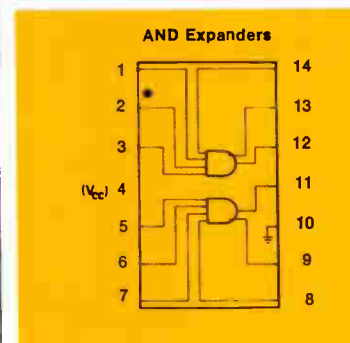
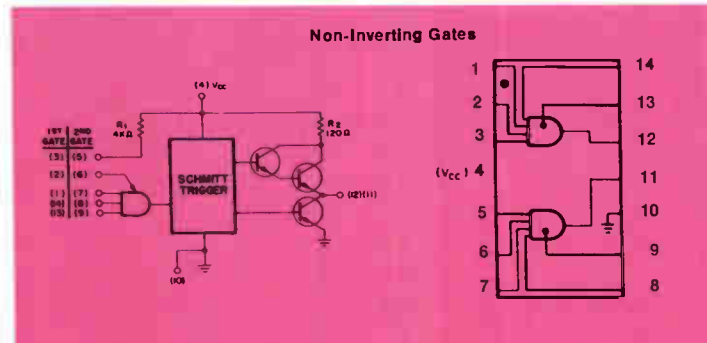
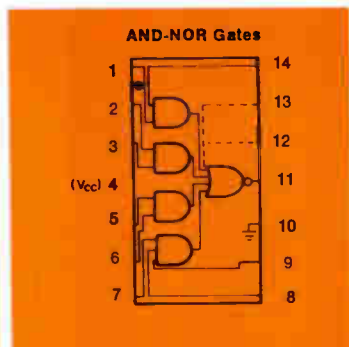
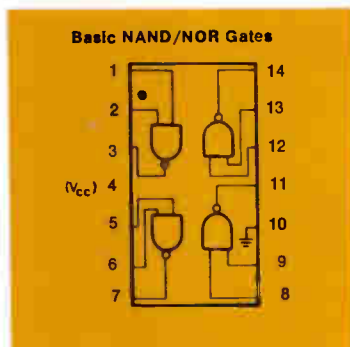
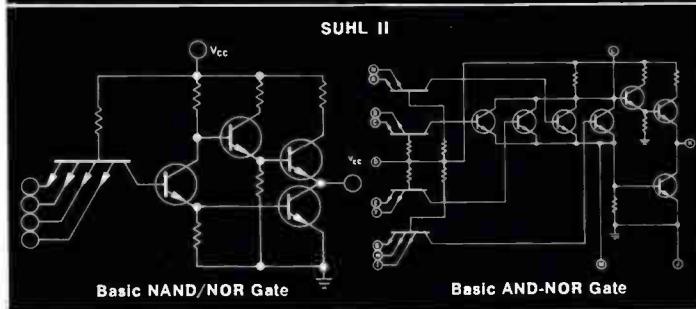
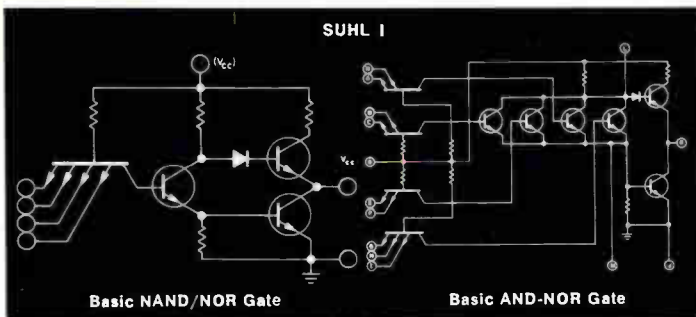

# 8-stage parallel add/subtract system uses only 17 ICs

Here's an example of compatible devices—a system using units from three Sylvania IC families: functional arrays, SUHL I and SUHL II.

An eight-stage parallel add/subtract subsystem using ripple carry techniques can be made with 17 packages—eight SM-10 series full adders, eight SG-110 series expandable dual 4-input OR gates, and one SG-280 series dual 4-input AND/OR gate. The full adder is one of Sylvania's family of monolithic digital functional arrays. The SG-110 and SG-280 are SUHL family high-level TTL gates.

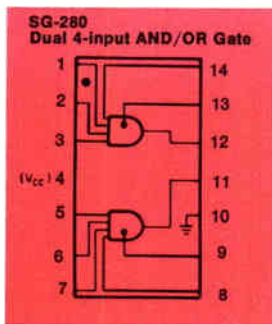
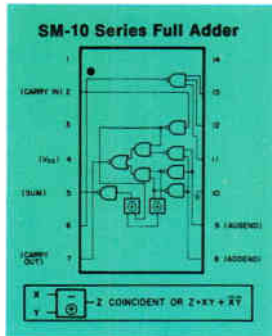
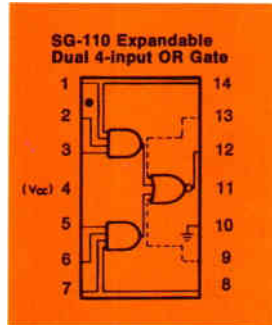

In the ripple adder configuration shown, control for the subsystem is represented by a mechanical switch. When the switch is in the SUBTRACT position, complement binary addition is performed. With the switch in the ADD position, straight binary addition is performed. It is assumed that only positive numbers will be added or subtracted, and that the most significant digit is the sign (0 = Positive, 1 = Negative).

The independent three-input NAND gate included in each SM-10 full adder package provides the complement of the SUM for subsequent operations. This includes such operations as complementing the answer in subtraction (depending on the sign bit in the answer). Enabling of the SG-280 AND gate during the subtraction process provides end around carry.

Typical propagation delay times are found by assuming that the number to be added or subtracted (the B inputs) is present in both true and complemented form, and that all A and B inputs are presented simultaneously. Then propagation delay times can be calculated with these equations:

### Addition

$$\begin{aligned} \text{Final Sum} &= (N-1)t_{pd\text{carry}} + t_{sum} + t_{pd\text{gate}} \\ \text{where } N &= \text{Number of adder stages} \\ t_{pd\text{carry}} &= \text{one carry delay or 15 ns (typ.)} \\ t_{sum\text{carry}} &= \text{one sum delay or 25 ns (typ.)} \\ t_{pd\text{gate}} &= \text{propagation delay of SG-110 or 15 ns (typ.)} \end{aligned}$$

### Subtraction

$$\text{Final Difference} = (N-1)t_{pd\text{carry}} + t_{sum} + 2t_{pd\text{gate}} \text{ where } t_{pd\text{gate}} \text{ includes the propagation delay through the SG-280 (15 ns, typ.)}$$

Thus, for an 8-stage add/subtract unit:

$$\begin{aligned} \text{Final Sum} &= [(8-1) \times (15)] + 25 + 15 = 145 \text{ nsec} \\ \text{Final Difference} &= [(8-1) \times (15)] + 25 + (2 \times 15) = 160 \text{ nsec} \end{aligned}$$

Average Power Dissipation for a complete 8-stage unit is 880 milliwatts.

If a faster subsystem is needed, an eight-stage anticipated carry adder using SM-20, SM-30 and SM-40 digital functional array adders can be employed to replace the SM-10 devices.

CIRCLE NUMBER 305

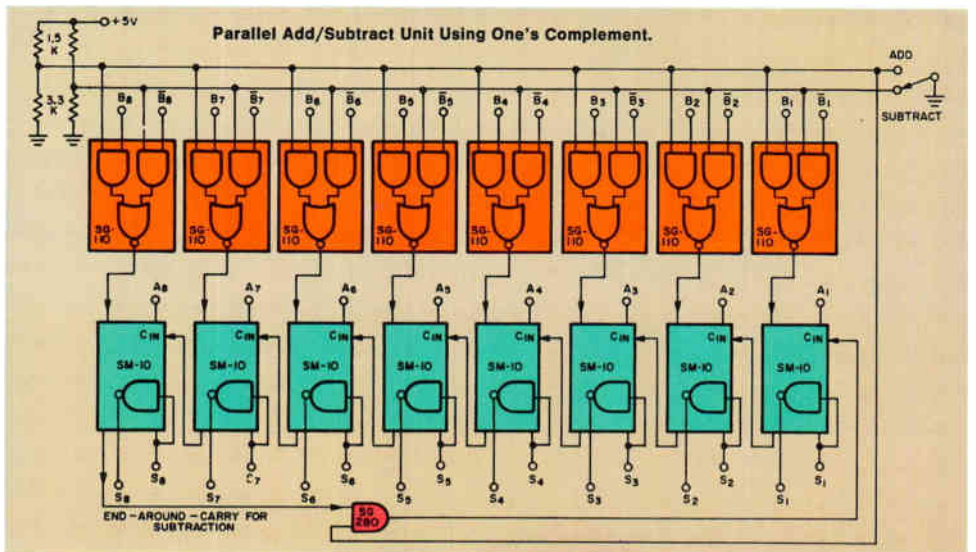

# These functional arrays reduce power, delay, and connections

This line of monolithic digital functional arrays provides computer and communications system designers with a powerful design tool.

Sylvania's line of monolithic digital functional arrays represents a significant advance over conventional integrated circuits. You can get typical computer subsystems such as adders, frequency dividers, registers, and memories which work at faster speeds, use less power and need fewer external connections.

For example, in a decade frequency divider with a frequency range of dc to 30 MHz, power can be reduced to one-fourth of that required by conventional

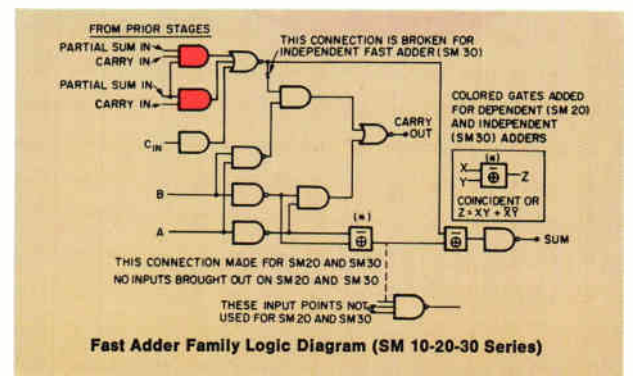

MONOLITHIC DIGITAL FUNCTIONAL ARRAYS VS. CONVENTIONAL ICs								
Typical Computer Subsystems	Sylvania Monolithic Digital Functional Arrays				Conventional Integrated Circuits			
	Number of Packages	Number of Equivalent Discrete Components	Speed (nsec)	Power (Milliwatts)	Number of External Connect'ns	Equivalent Number of IC Gates	Power (A) (Milliwatts)	No. of External Connect'ns (B)
Basic Single Stage Fast Adder With Anticipated Carry	1	73	14	120	14	18	180	64
Four Bit Anticipated Carry Adder	4	292	35	480	56	72	720	252
Four Bit Ripple Carry Adder	4	264	60	400	32	36	540	132
Eight Bit Anticipated Carry Adder	12	704	45	1040	168	172	1460	602
Eight Bit Ripple Carry Adder	8	528	120	800	112	72	1080	252
Decade Frequency Divider	1	116	DC to 30 MHz	150	6	40 <sup>(C)</sup>	600 <sup>(C)</sup>	140 <sup>(C)</sup>
Four Bit Register (Bus Transfer Output)	1	87	15	120	12	25	350	89
Four Bit Register (Cascode Pullup Output)	1	94	15	120	11	25	350	89

(A) Based on Average of 15mw per NAND/NOR and Average of 5mw per AND-NOR Expansion.

(B) Based on Average of 4 Gates per 14-Lead Package.

(C) Using 4 Sylvania JKs and a Pulse Shaping Gate, the Package Count would be 5 and Interconnections 37. Average Power Drain would be 190mw.

ICs while cutting external connections from 140 to 6. The table shows other examples — four-bit and eight-bit fast adders, and four-bit registers.

The functional arrays used in such circuits combine as many as 40 conventional integrated circuit functions in a single package while providing greater reliability and less costly system assembly.

The fast adder family of arrays contains the equivalent of 70 discrete components. Its basic integrated circuit is interconnected by three standard metal patterns to form the SM-30 single-stage independent fast adder, the SM-20 single-stage dependent fast adder, and the SM-10 single-stage full adder. The independent and dependent fast adders, in conjunction with the SM-40 carry decoder, can form parallel anticipated-carry fast-adder subsystems of any size.

Sylvania's SM-50 series decade frequency divider accepts both analog and digital inputs and produces a symmetrical square wave output. Digital signals from dc to 30 MHz and analog signals from 5 Hz to 30 MHz can be processed. This frequency divider is a six-stage circuit with the first a buffer which shapes the input. The following three stages perform a synchronous division by five. The next divides by two to complete the decade division. An output buffer in the final stage provides high ac and dc fan-out.

Four-bit storage registers, Series SM-60 and SM-70, are used as high-speed storage elements in con-

(Continued on next page)

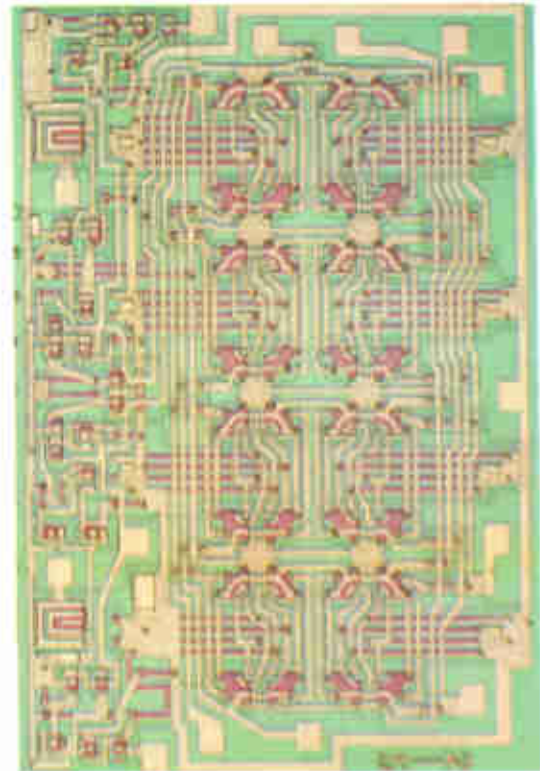

SM-80 16-bit scratch pad memory



Use Sylvania's "Hot Line" inquiry service, especially if you require full particulars on any item in a hurry. It's easy and it's free. Circle the reader service number(s) you're most interested in; then fill in your name, title, company and address. We'll do the rest and see you get further information almost by return mail.

FIRST CLASS  
Permit No. 2833  
Buffalo, N. Y.

BUSINESS REPLY MAIL  
No Postage Stamp Necessary if Mailed in the United States

POSTAGE WILL BE PAID BY

**SYLVANIA ELECTRONIC COMPONENTS GROUP**

Sylvania Electric Products Inc.  
1100 Main Street  
Buffalo, New York 14200

Dept. No. B 2 2



trol and arithmetic sections of computers. The SM-60 series has clock input as well as clock output. Further, SM-60 output has wired-OR capability which means outputs can be tied together to perform the logic OR function. The SM-70 series is similar to the SM-60 but has a SUHL type output network and is not clocked with an enable signal. This means information set in the device is available at the output after a delay of 20 nanoseconds.

The SM-80 series 16-bit memory is for high-speed scratch pad memory systems with cycle times in the 100 nanosecond range. This single chip memory consists of 16 solid-state set/reset flip-flops arranged to form an addressable four-by-four memory matrix. This structure permits nondestructive readout of all 16 bits. Reading and writing is through four X and four Y lines which are brought out to eight external terminals, one for each line. Read and write control is by four internal amplifiers. Each flip-flop in the four-by-four matrix is logically connected to its own  $X_M$ ,  $Y_N$  address combination and to the sense and write amplifiers.

All these monolithic digital functional arrays are compatible with SUHL ICs. The arrays are rated for operation in the temperature ranges up to  $-55^\circ\text{C}$  to  $+125^\circ\text{C}$  and are available in the standard Sylvania 14-lead dual in-line plug-in package and the TO-85 flat pack.

CIRCLE NUMBER 306

of a line of high-level transistor-transistor logic which we called SUHL, for Sylvania Universal High-level Logic.

These high-level TTL circuits were originally available in a limited number of logic configurations. However, customers required a wider variety of circuits to implement their logic designs. Our various solutions to their requests resulted in our present SUHL lines; one operating at 20 megahertz, the other at 40 megahertz with some 40 different logic configurations available to designers.

The next step was to develop functional arrays such as storage registers, counters, and adder circuits which satisfied customer requirements for more logic per package and for complete interfacing capability with SUHL circuits.

Our production philosophy was equally customer-oriented. We met the requirements for a dual in-line plug-in package with a ceramic/Kovar 14-pin enclosure using the same construction as was proven out in the TO-85 flat pack. The dual in-line package was developed and met customer needs including stringent military requirements. In conjunction with such development, Sylvania decided the best way to produce highly reliable integrated circuits was to concentrate on a single process. This included a series of 100% production tests and final 100% testing of all dc parameters at temperature extremes and ac parameters at room temperature.

We did this and now we're able to state that all our circuits, regardless of grade, are identical in construction. Any improvements are always immediately incorporated in the total line. Further, such upgrading is an intrinsic part of our manufacturing process. For example, when we added a Kovar base plate to the flat pack to improve its heat dissipation capabilities, we made a similar change in our dual in-line plug-in package.

We intend to continue pursuing this philosophy which permits us to assure all our customers that our circuits, regardless of grade, represent the best in performance and construction available.

*Harry Luhrs*

H. M. LUHRS

#### MARKETING MANAGER'S CORNER

## Sylvania's commitment to IC upgrading

Fifty years of manufacturing electronic components has taught us that it pays to give our customers what they want.

Five years ago, when we started our integrated circuit facility, we polled our customers and, based on their reaction, initiated design on transistor-transistor logic to meet their need for faster integrated circuits. When this new line was introduced, some of our customers asked for buffered outputs to handle higher capacitive loads. The result was a development

# SYLVANIA

SUBSIDIARY OF  
GENERAL TELEPHONE & ELECTRONICS GTE

NEW CAPABILITIES IN: ELECTRONIC TUBES • SEMICONDUCTORS • MICROWAVE DEVICES • SPECIAL COMPONENTS • DISPLAY DEVICES

This information in Sylvania Ideas is furnished without assuming any obligations.

I am especially interested in ICs for the following application(s) \_\_\_\_\_

NAME \_\_\_\_\_

TITLE \_\_\_\_\_

COMPANY \_\_\_\_\_

ADDRESS \_\_\_\_\_

CITY \_\_\_\_\_ STATE \_\_\_\_\_

Circle Numbers Corresponding to Product Item

300      301      302      303      304      305      306

Please have a Sales Engineer call



### HOT LINE INQUIRY SERVICE

Need information in a hurry? Clip the card and mail it. Be sure to fill in all information requested. We'll rush you full particulars on any item indicated.

You can also get information using the publication's card elsewhere in this issue. Use of the card shown here will simplify handling and save time.

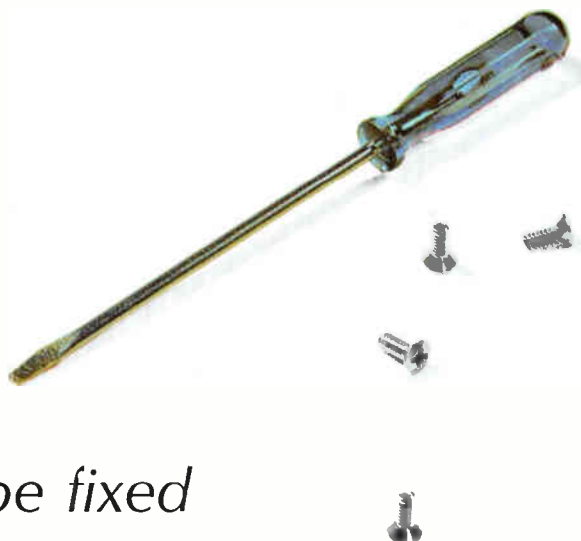

## Sure, DVM's have to be fixed

Cimron just makes it easy! We all know digital voltmeters are influenced by environment and the work demanded of them—and they do have to be calibrated at times. So Cimron makes it easy by etching this procedure on the guard shield. Lift 4 screws and you can do it in 15 minutes. That's Cimron's customer concern in action, a philosophy you'll see at work in everything from the way

the instruments operate to after-sales interest. Premium Line P9000B Series Instruments offer a 3-year warranty; 5 digits, automatic, programmable or manual ranging; 1 year stability of 0.001% F.S. +0.01% of reading; ratio, AC, low-level DC, resistance, true RMS available as options. Price: the P9200B DVM, \$3190. Write Cimron, Dept. A-101, 1152 Morena, San Diego, California 92110.

**CIMRON**

A Division of  
Lear Siegler, Inc.







# **MICRO SWITCH treats you to a little extra design freedom**

It's easy to satisfy your hunger for the right flavor in switches when you reach into the MICRO SWITCH line. For three reasons:

1. The world's largest selection, and local availability—meaning we can provide the practical answer to your design requirements right off-the-shelf.
2. The world's largest research and development facilities devoted exclusively to switch design—meaning the answer you need may be on file waiting for a problem like yours to come along.
3. The world's largest group of trained field engineers specializing in precision switching—meaning we can add a switch specialist to your design team for the asking.

These benefits can be helpful to you in finding the right combination of switch design, quality and cost.

Call a Branch Office or Authorized Distributor (see Yellow Pages, "Switches, Electric"). Or, write for the most complete switch selection guide ever published, Catalog 50.

## **MICRO SWITCH**

FREEPORT, ILLINOIS 61032

**A DIVISION OF HONEYWELL**

**HONEYWELL INTERNATIONAL** • Sales and service offices in all principal cities of the world. Manufacturing in United States, United Kingdom, Canada, Netherlands, Germany, France, Japan.



## Go 1, Go 2, Go 3 . . . with Series "G"!

As you can see, something new has been added to our connector line. They've gone modular. Now you can stylize your electronic equipment from front to back, get all three kinds of service—signal, power, coaxial—from one basic housing style. You no longer need a different connector for each type of circuit in your product. AMP's Series "G" Connectors are designed so you can "go" with one, two, or three modular inserts for the exact combination of contact types you want. Inserts are available in either diallyl phthalate or general purpose phenolic with numbered cavities for one or more of these types:

Type I—#12 screw machine pin and socket power contact

Type II, III and III(+)—regular signal circuit pin and socket contacts

Type IV—miniature coaxial contact

Type XII—new 35-amp stamped and formed power contact

New subminiature COAXICON\* contact

Designed for rugged, dependable performance as well as flexibility, Series "G" Connector shells are two-piece cast aluminum. They consist of a polarized two-piece shell and retainer plate for easy, drop-in assembly of the modules. And, they're available with floating bushings or locking springs, so you can use them equally well for rack-and-panel mounting, service drops, and in-line hook-up applications.

Try this new connector concept in your engineering designs. You'll get all kinds of service . . . with style! It's the practical way to cut inventory costs, too. Write today for complete details.

\*Trademark of AMP INCORPORATED

**AMP**  
**INCORPORATED**  
 Harrisburg, Pennsylvania

A-MP\* products and engineering assistance are available through subsidiary companies in: Australia • Canada • England • France • Holland • Italy • Japan • Mexico • Spain • West Germany



among other things...

# This P&B relay can save you up to \$2.40\* per relay installed

\*Compared with ordinary 3-pole dust-covered relays using an octal socket.



## The KU series is available in many variations to fit your requirements

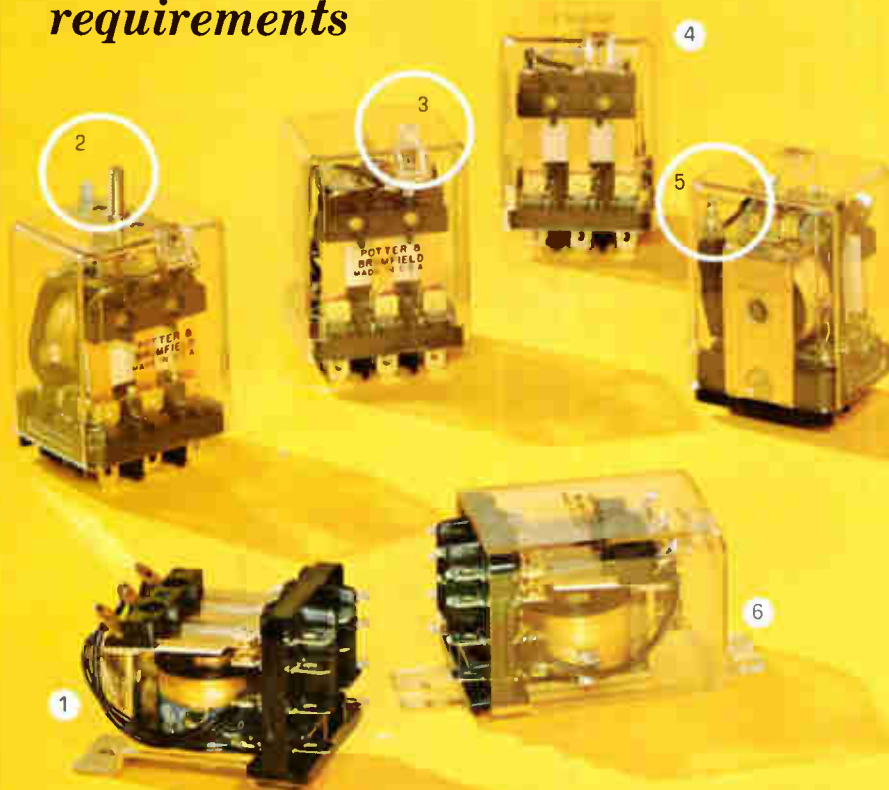

The KUP can save you up to \$2.40 (including socket costs) over similar relays with factory wired octal plugs. A true 10 ampere nylon socket can be supplied to receive the quick-connect terminals. Standard KU/KUP relays are covered by Underwriters' Laboratories Component Recognition Program.

Quick-connect terminals mean faster installation on your production line . . . easier replacement in the field. Standard models have .187" terminals, but .205" may be ordered. All terminals are punched for those who prefer solder connections.

Long life, improved reliability, exceptional versatility and, in the case of covered relays, substantially lower costs are all part of the KU Series. Call your P&B sales representative today, or get in touch with us direct.

### KU SERIES SPECIFICATIONS

#### GENERAL:

Description: 5 or 10 amp. General Purpose Relay.  
Expected Life: 10,000,000 cycles, Mech.  
Breakdown Voltage: 1,500V rms 60 Hz  
between all elements;  
500V rms 60 Hz between open contacts.

#### CONTACTS:

Arrangements: Up to 3 Form C.  
Rating: 5 or 10 amps @ 28V DC or 120V AC.

#### COILS:

Voltage: DC to 110V; AC to 240V 60 Hz.  
Power: DC 1.2 W; AC 1 and 2 poles 2.0 VA;  
AC 3 poles 2.7 VA.  
Resistance: 16,500 ohms max.

#### MOUNTING:

(open relay) 6-32 mtg. stud,  $\frac{7}{32}$ " locating tab  
on  $\frac{7}{16}$ " centers. Socket available.

1 Open relays can be mounted with stud and locating tab, tapped core or bracket as shown.

Five or ten ampere contact ratings. AC or DC.

.187" quick connect/solder terminals standard (.205" available).

2 Stud and locating tab on top of cover may be ordered.

3 Built-in push-to-test button is available.

4 High impact polycarbonate dust cover.

5 Optional neon lamp shows if power is reaching coil.

6 Flanged dust covers for direct chassis mounting are available.

7 True 10 ampere nylon socket.

STANDARD P&B RELAYS ARE AVAILABLE AT  
LEADING ELECTRONIC PARTS DISTRIBUTORS



**POTTER & BRUMFIELD**

Division of American Machine & Foundry Company, Princeton, Indiana  
Export: AMF International, 261 Madison Avenue, New York, New York

# New 18 MHz wave analyzer system

Ideal for lab and production use  
Ideal for communications systems

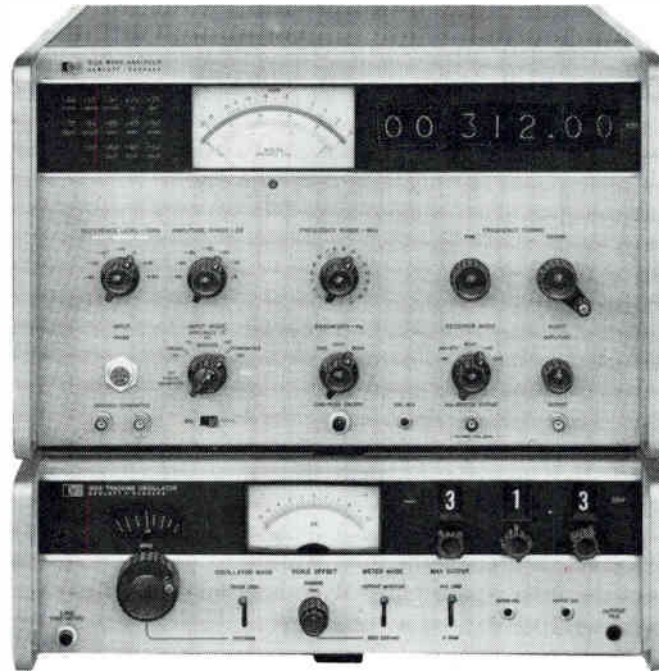

**It's precise . . .** Digital frequency readout with 10 Hz resolution and 2 ppm/week stability.

Amplitude measurements to  $< -110$  dBm with  $\pm 0.2$  dB flatness to 10 MHz,  $\pm 0.5$  dB to 18 MHz.

AFC locks analyzer to signal; frequency indicator displays any signal drift.

**It's versatile . . .** Flexible input selection—wide range of impedances, balanced or unbalanced, bridged or terminated; or use 0 dB-loss probe.

Three selectable bandwidths—200 Hz, 1000 Hz, 3000 Hz—for all measurement needs; and with high selectivity ( $> 60$  dB down when only 2.2 times 3 dB bandwidth).

## High Accuracy Wave Analyzer

Measure all frequency components from 10 kHz to 18 MHz with the HP 312A Wave Analyzer. High selectivity lets you separate the input components, and high sensitivity, plus wide dynamic range, lets you measure the fundamental, harmonics and intermodulation products. The digital frequency indicator pinpoints signal frequencies exactly, with no errors from tuning backlash, dial nonlinearities and the like.

The 312A's wide frequency coverage, its high stability, sensitivity, selectivity, and its wide selection of all common input impedances make it outstanding for maintaining multiplex communications systems. Such measurements as distortion, attenuation, crosstalk and frequency response are made quickly, easily and accurately.

Price: HP Model 312A Wave Analyzer, \$3900

## Full Test System with HP 313A Tracking Oscillator

When you combine the 313A Tracking Oscillator with the 312A Wave Analyzer, you have a complete "closed-loop" measurement system operating at the frequency setting of the 312A. The 313A Tracking Oscillator delivers up to +10 dBm output with  $\pm 0.1$  dB full range frequency response, and has a precision 100 dB attenuator calibrated in 0.1 dB steps. The 312A/313A combination can measure frequency response of circuits having 100 dB gain, with amplitude resolution approaching 0.02 dB.

The 313A can also be operated separately as a wideband (10 kHz-22 MHz), flat ( $\pm 0.1$  dB) signal generator with its precision 100 dB output attenuator.

Price: HP Model 313A Tracking Oscillator, \$1250

For complete data, call your HP field engineer or write Hewlett-Packard, Palo Alto, California 94304; Europe: 54 Route des Acacias, Geneva.

HEWLETT  PACKARD



## Precise people make precision products

The red carpet is symbolic of our regard for those who make Tempress the sort of organization it is today . . . technically sound, service oriented, and one hundred percent dedicated to the development and production of high precision products. It requires very special people to deliver, day in and day out, in quantities sufficient to satisfy the burgeoning semiconductor industry, using materials such as tungsten carbide, diamonds, and sapphires at ten thousandths tolerances: capillary tubes, probe contact needles, flame-off torches, diamond scribes, diamond lapping points, and the new automatic scribing machine. They receive the red carpet

treatment, because we realize that the Tempress product can be had from only the finest people, working under ideal conditions . . . and they, in turn, reserve a large portion of that carpet for our customers, whose requirements and whose loyalty are the ultimate reasons for the Company's existence. We have already put in our order for a larger carpet, as this one was outgrown while the picture was being taken.



# TEMPRESS

Tempress Research Co., 566 San Xavier Ave., Sunnyvale, Calif.

Circle 41 on reader service card

# A brilliant way to spread pure gold around.

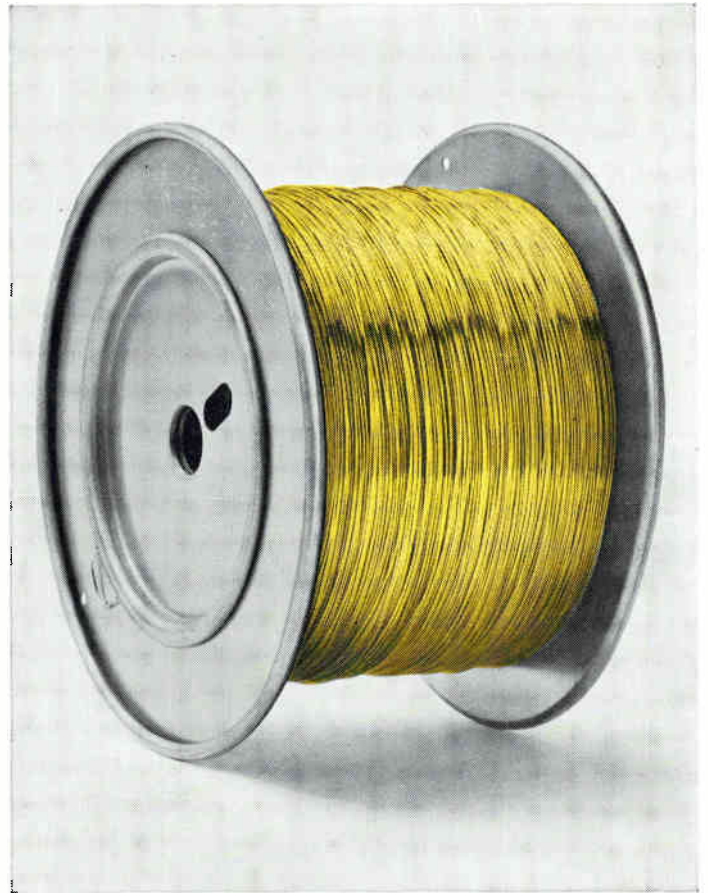

Take the Sel-Rex BDT™ 200 process, for example. Deposits from this patented system are not just pure —they're brilliant! They are also unusually uniform and have an extraordinary levelling effect—unique qualities which enabled one manufacturer to establish new standards for gold plated wire.

A half-dozen of the more than 20 patented Sel-Rex gold processes produce 24 karat deposits—ductile, solderable, weldable, impervious to discoloration. One of them has that *extra* quality just right for *your* application. We'll be happy to demonstrate it to you. Write Sel-Rex Corporation, Dept. X-2, Nutley, New Jersey 07110.



# Compatible Current Sinking Logic.

We have prepared a special product sampler to help you discover the advantages of designing with Fairchild's compatible logic. You can get it for less than you'd normally pay for the samples alone.



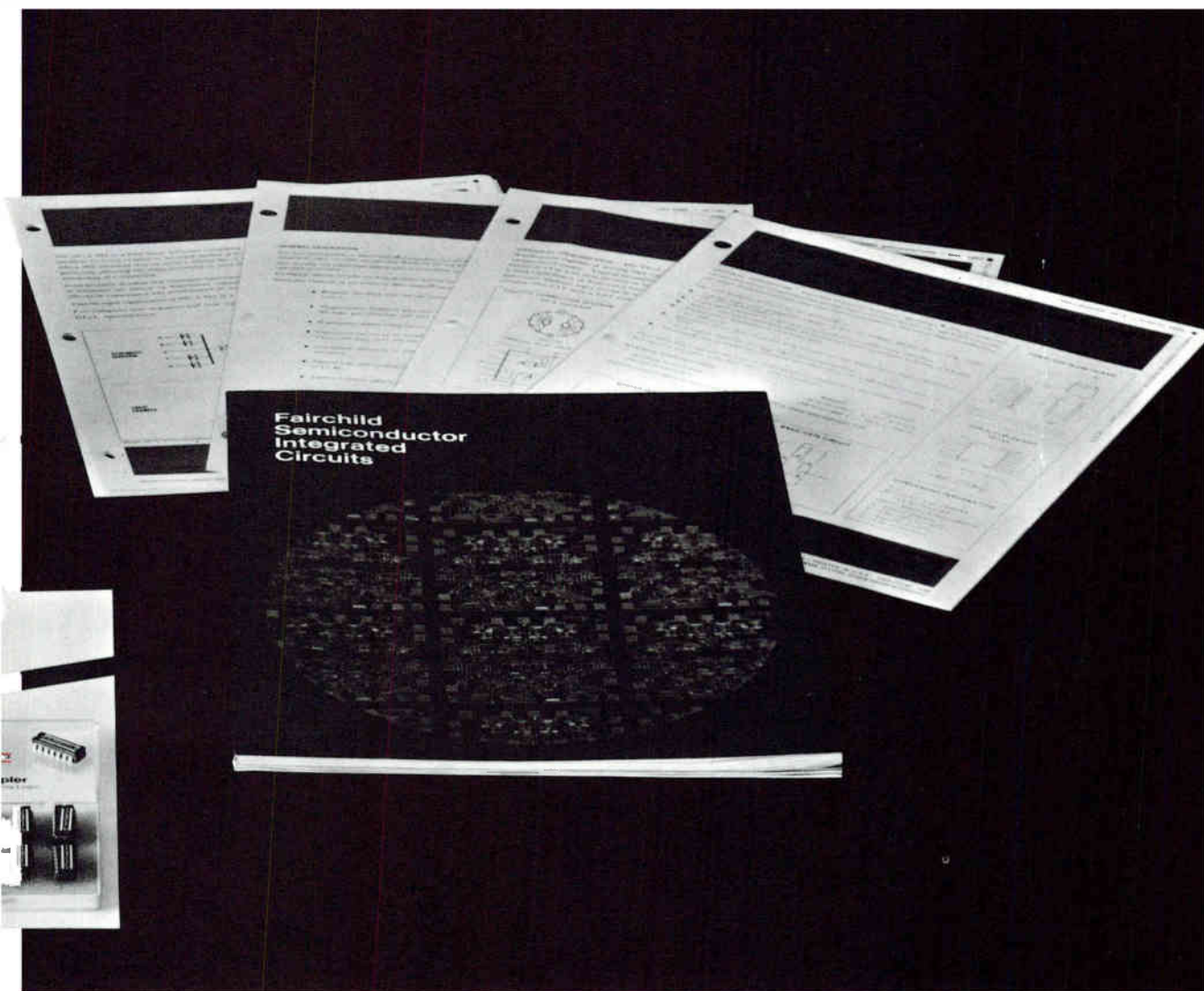

Fairchild  
Semiconductor  
Integrated  
Circuits

and LPDT $\mu$ L (Low-power diode-transistor Micrologic) integrated circuits. By crossing family boundaries within the compatible logic group, you can optimize your system design. Here's how:

**How compatible logic helps you:** TT $\mu$ L is the fastest of the three families and also the one that dissipates the most power. LPDT $\mu$ L dissipates the least power, but is slower than the others. DT $\mu$ L is right in between, both in speed and in power dissipation. There are clearly some functions in your system that require all the speed you can get. There are other functions where the speed of TT $\mu$ L, for example, is wasted, because it is waiting for slower system elements. So you can use a slower logic family and optimize your power dissipation without sacrificing overall system speed. When you design with Fairchild's current sinking logic group, you are assured that all the families within the group are fully compatible.

**What we mean by compatibility:** All three families use NAND logic, and all basic NAND logic functions are available in any of the three forms. All three families use a single 5V

power supply, and all three are guaranteed to perform compatibly when the specified fan-out and fan-in rules for inter-connecting between logic forms are observed. Pin configurations for the same functions are the same, and all three families come in the same two package configurations (maximum-density  $\frac{1}{4}$ " x  $\frac{1}{4}$ " Flatpak, and easy-to-handle Dual in-line). Finally, all three families are manufactured using the same technology, so that within the same working environment they will maintain a uniform stability over a period of time.

**Get our product sampler:** We want you to get acquainted with Fairchild's compatible current-sinking logic group at first hand, so we have prepared a special product sampler you can get. The sampler contains a 90-page book describing Fairchild integrated circuits; a guide to current sinking logic; data sheets on individual products and families; and actual product samples (see listing on back). Our complete product sampler kit sells for \$51.00, which is the over 100 price of the samples alone. But quantities are limited, so act now.

**How to get it:** Simply return the attached postcard, or call.



**Compatible Logic can optimize your system.  
Send for proof.**

Please send me the Compatible Current Sinking Logic Product Sampler.

Name \_\_\_\_\_

Title \_\_\_\_\_

Company \_\_\_\_\_

Address \_\_\_\_\_

City \_\_\_\_\_

State \_\_\_\_\_ Zip \_\_\_\_\_

Check enclosed  Bill me  Bill my company. P.O. No. \_\_\_\_\_

Check here for data pack only

Integrated circuits are conventionally classified by family, and within each family by function. This method of classification restricts you to a single family within a system. Now Fairchild allows you to cross family boundaries and to design by function, selecting circuits from compatible logic families. This permits you to choose the best circuit for each function, and to optimize the system as a whole.

**What is compatible logic?** Fairchild classifies all digital integrated circuits into compatible logic groups: current sinking logic, current sourcing logic, and current mode logic. A current sinking logic gate (for example, a DTL gate) draws current into its output ("sinks" current) when in the low state, and draws virtually no current when in the high state. A current sourcing gate (for example, an RTL gate) drives current out of its output in the high state and, except for minor leakage, drives no current in the low state. Current mode logic can draw or drive current.

**Compatible current sinking logic:** There are three families within the Fairchild current sinking group: TT $\mu$ L (Transistor-transistor Micrologic), DT $\mu$ L (Diode-transistor Micrologic<sup>®</sup>)

# Compatible Current Sinking NAND Logic Summary

Number and function	Typical Specifications at 25°C Free Air Temperature			
	Noise Immunity	Propagation Delay	Power Dissipation	Fan-out
<b>TT<math>\mu</math>L</b>				
9000 Clock-gated J-K flip-flop	1 volt	25nsec.	45mW	10
9001 Clock-gated J-K flip-flop	1 volt	25nsec.	45mW	10
9002 Quad 2-input gate	1 volt	10nsec.	12mW	12
9003 Triple 3-input gate	1 volt	10nsec.	12mW	12
9004 Dual 4-input gate	1 volt	10nsec.	12mW	12
9005 Dual AND/OR/NOT gate	1 volt	12nsec.	12mW	12
9006 Dual 4-input extender		4nsec.		
9007 8-input gate	1 volt	10nsec.	12mW	12
9008 Quad 2-input AND/NOR gate	1 volt	12nsec.	12mW	12
9009 Dual 4-input buffer	1 volt	15nsec.	22mW	30
<b>DT<math>\mu</math>L</b>				
9111 Parallel-gated clocked flip-flop	1 volt	40nsec.	48mW	8
9930 Dual 4-input gate	1 volt	25nsec.	8mW	8
9931 Clock-gated flip-flop	1 volt	50nsec.	20mW	7
9932 Dual 4-input buffer	1 volt	35nsec.	35mW	25
9933 Dual 4-input extender				
9936 Hex inverter	1 volt	25nsec.	48mW	8
9937 Hex inverter	1 volt	20nsec.	72mW	6
9941 Monostable multivibrator	1 volt	25nsec.	35mW	10
9944 Dual 4-input power gate	1 volt	40nsec.	20mW	27
9945 Clock-gated flip-flop	1 volt	50nsec.	42mW	9
9946 Quad 2-input gate	1 volt	25nsec.	32mW	9
9948 Clock-gated flip-flop	1 volt	40nsec.	48mW	8
9949 Quad 2-input gate	1 volt	20nsec.	48mW	5
9950 High speed gated flip-flop	1 volt	20nsec.	50mW	10
9951 2-input monostable multivibrator	1 volt	25nsec.	35mW	10
9961 Dual 4-input gate w/extender	1 volt	20nsec.	24mW	6
9962 Triple 3-input gate	1 volt	25nsec.	24mW	8
9963 Triple 3-input gate	1 volt	20nsec.	36mW	6
<b>LPDT<math>\mu</math>L</b>				
9040 Clocked flip-flop	1 volt	180nsec. (Output going positive) 90nsec. (Output going negative)	4mW	10
9041 Dual 3-input gate	1 volt	65nsec.	2mW	10
9042 Dual 3-input gate	1 volt	65nsec.	2mW	10
9043 Three and 4-input gate w/extender	1 volt	65nsec.	2mW	10
9044 Dual 4-input gate w/extender	1 volt	65nsec.	2mW	10
9046 Quad 2-input gate	1 volt	65nsec.	2mW	10
9047 Triple 3-input gate	1 volt	65nsec.	2mW	10

### Contents of Sampler Kit

Qty.	PART No.	Description	PRICE 1-99 each
4	9000	J-K flip-flop	\$ 5.10
2	9002	Quad 2-input gate	\$ 3.65
2	9946	Quad 2-input gate	\$ 3.65
2	9046	Quad 2-input gate	\$20.00

These products are in the industrial temperature range.

FIRST CLASS  
Permit No. 111  
Mountain View,  
California

BUSINESS REPLY MAIL  
No postage stamp necessary if mailed in the United States

Postage will be paid by \_\_\_\_\_

**FAIRCHILD**  
SEMICONDUCTOR

A Division of Fairchild Camera  
and Instrument Corporation  
313 Fairchild Drive  
Mountain View, California 94040

**FAIRCHILD SEMICONDUCTOR**  
P. O. Box 1058  
Mountain View, California 94040



# RESOLVER/SYNCHRO INSTRUMENTATION

*A very short course for engineers engaged in testing and evaluation of resolvers and synchros as components or as system transducers.*

Selecting a resolver/synchro test instrument for any engineering, production or system requirement is remarkably simple from North Atlantic's family of resolver and synchro instrumentation. Because this group has been developed to cover every area of need in both manual and automatic testing, obtaining the desired combination of performance and package configuration usually demands no more than 1) determining what you need and 2) asking for it.

## Remote Readout of Angular Position

For remote indication of resolver or synchro transmitters in system testing, North Atlantic's Angle Position Indicators (Figure 1) provide the advantages of low cost and continuous counter or pointer readout. These high-performance instrument servos are accurate to 4 minutes of arc, with 30 arc seconds repeatability and 25°/second slew speed. Dual-mode capability, multi-speed inputs, integral retransmit components and other optional features are available to match application needs. Priced from \$895.



Figure 1. Angle Position Indicators are available in half-rack, quarter-rack and 3-inch round servo packages.

## High-Accuracy Testing Of Receivers And Transmitters

Measuring receiver and transmitter performance to state-of-art accuracy is readily accomplished with North Atlantic's Resolver/Synchro Simulators and Bridges (Figure 2). Each of these dual-mode instruments tests both resolvers and synchros, and provides direct in-line readout of shaft angle, accurate to 2 arc seconds. Simulators supply switch-selected line-line voltages

from 11.8 to 115 volts from either 26 or 115 volts excitation, and so can be used to test any standard receivers. Bridges have constant null voltage gradients, making them ideally suited for rapid deviation measurements. Simulators and Bridges each occupy only 3½ inches of panel height and are available in a choice of resolutions. They are priced in the \$1500 to \$3000 range.



Figure 2. Resolver/Synchro Simulator provides ideal source for receiver testing.

## Automatic Measurement And Conversion

Where systems require continuous or on-command conversion of resolver or synchro angles to digits, North Atlantic's Automatic Angle Position Indicators (Figure 3) handle the job without motors, gears or relays. These solid-state automatic bridges accommodate all standard line-to-line voltages and provide both Nixie display and printer output, accurate to 0.01° and with less than 1 second update time. Many variations, including 10 arc second accuracy; binary, BCD or decimal outputs; multiplexed channels and multispeed operation, are available for specific requirements. Ballpark price: \$5900.



Figure 3. Model 5450 Automatic Angle Position Indicator. It measures shaft angles, converts them to digital data.

Measuring Electrical Characteristics Combine a Resolver/Synchro Bridge and a Simulator with a North Atlantic Ratio Box, a Phase Angle Voltmeter and a test selection panel and you have an integrated test facility for determining all electrical characteristics of resolvers and synchros in component production or Quality Control. An example is the North Atlantic Resolver/Synchro Test Console shown in Figure 4. It measures phasing, electrical zero, total and fundamental nulls, phase shift and input current, as well as angular accuracy. Standard North Atlantic instruments are used as modules, making it a simple matter to fill the exact need. The unit shown sells for about \$7500.

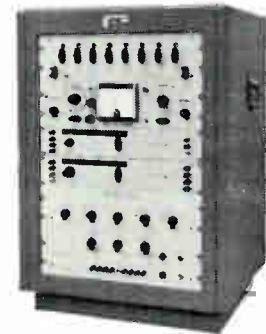
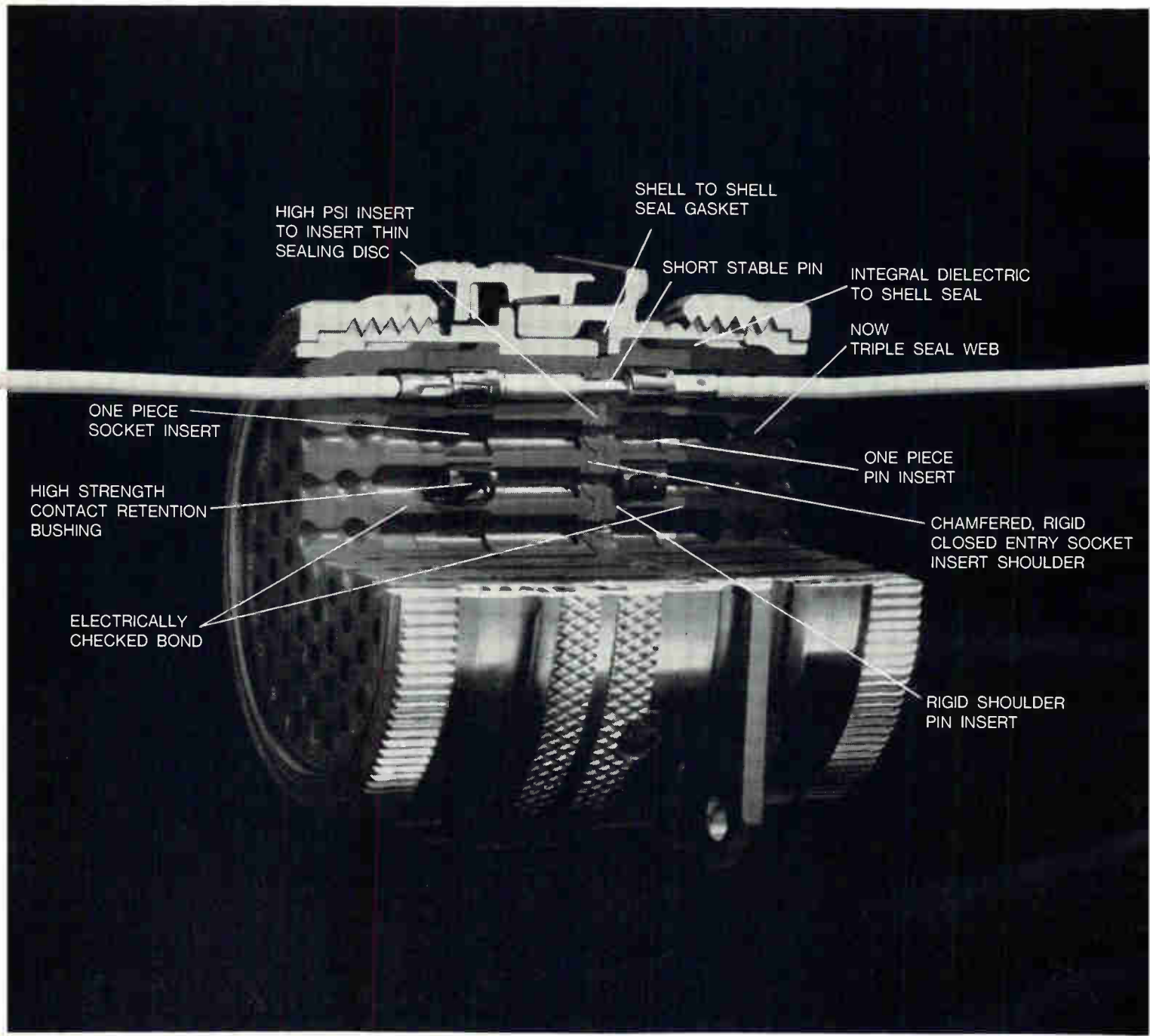

Figure 4. Model RTS-573 Test Console is a complete facility for the production line or in quality control.

If you require performance, reliability and convenience in resolver and synchro testing, we want to send you detailed technical information on these instruments (also on related instruments for computer system interface). Or, if you prefer, we will arrange a comprehensive technical seminar at your plant. Simply write to: North Atlantic Industries, Inc., 200 Terminal Drive, Plainview, N.Y. 11803 • TWX 516-433-9271 • Phone (516) 681-8600.

# The simpler the better.



Design simplicity. That's what makes Bendix® JT Pancake™ connectors so reliable. As you can see, Bendix JT connectors have plenty to show: One-piece socket inserts. One-piece pin inserts. Single-piece interfaces. Shell-to-shell sealing with-

out extra components. Plus other features, shown above, that speak for themselves, purely and simply.

What about versatility? Choose from a host of options. Crimp, solder, standard temperatures, high temperatures, grommetted and potted

versions. Hermetic seals in 8 shell types, 9 shell sizes. Choose, too, from 35 insert patterns, 16-, 20-, 22- and 22M-contact sizes that will accept a wire range of 16 through 28 gage. Contact Electrical Components Division in Sidney, New York.

**Bendix** **Electronics**

## Solid state

### Flip-chips emerge

The integrated-circuit package that goes by the sprightly name of the flip-chip has long been considered one of the best ways to match the low cost of the plastic package without sacrificing the hermetic seal. At least two companies have now solved some of the knottier problems of flip-chip technology and have put the devices on the market.

The Fairchild Semiconductor division of the Fairchild Camera & Instrument Corp. will announce at the Institute of Electrical and Electronics Engineers convention in New York next month that it is offering off the shelf four types of diode-transistor-logic circuits in ceramic dual in-line packages. And the Amelco semiconductor division of Teledyne Inc., is building and shipping 16- and 20-bit shift registers in a ceramic IC array package called the microelectronics modular assembly.

The Amelco assembly consists of up to 20 individual IC's that normally would be connected by bonding wires from their pads to a metalized interconnect pattern on the ceramic base of the package. With flip-chip techniques, in which the IC's are bonded face down on aluminum bumps, Amelco lost the interconnect flexibility provided by wires. It has therefore developed a multilayer ceramic sandwich with metalized holes connecting two layers of interconnects, a design it considers as significant as the flip-chip itself.

**Bumping along.** Flip-chip techniques save money by eliminating the tedious process of individually bonding each of the 14 IC pads to a lead running outside. Instead, a gold interconnect pattern is laid out on the ceramic substrate and

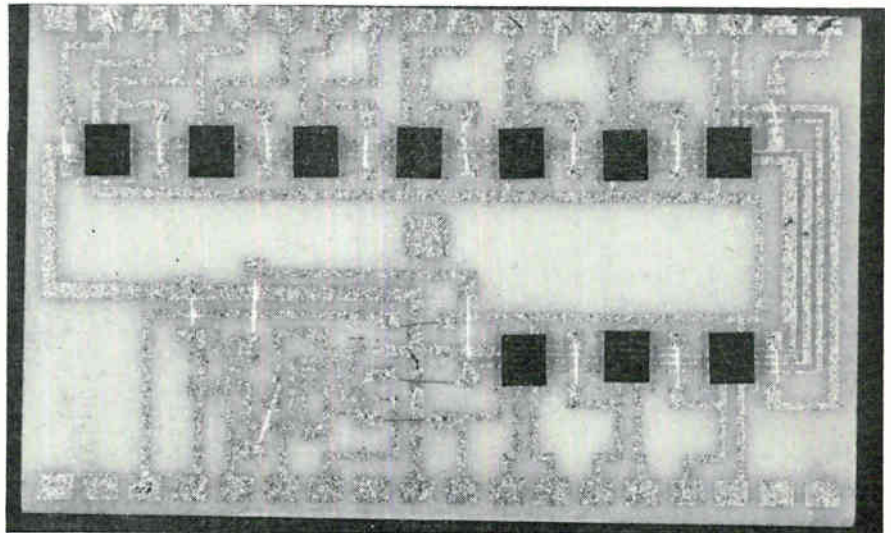

One of Amelco's two microelectronics modular assembly packages has 18 leads on each side or 24 on one side.

aluminum bumps are formed in alignment pads.

Like most semiconductor processes, this one isn't as simple as it sounds. If the bumps aren't exactly the same height, the IC will tilt like a table with a short leg, and some of the connections won't be made. If pressure is exerted to bond the chip, it may break. This problem doesn't exist with flip-chip transistors, because their three leads always lie in the same plane, like the feet of a three-legged stool.

"A large part of our success lay in making the bumps high enough," says Joseph Welty, who heads Amelco's integrated helicopter avionics system program under which the arrays were developed. "There has to be enough room for a 'cold flow' of the metals so that the bump can be squeezed out a little and the aluminum oxide on the surface broken up." Amelco found that five microns was too short and had to build 15-micron pyramids to get the desired cold flow.

Making the aluminum bumps is also difficult. Electroplating is a touchy process, and etching away unwanted aluminum as is done in laying interconnect patterns a half-

micron thick, would be uneconomical for a high bump. Amelco turned to evaporation, depositing the bumps through a metal mask.

The problem here is to peel away the mask, which would naturally tend to bond itself to the bumps the way an angel food cake bonds itself to the funnel in the middle of the pan. A baker can grease his pan to prevent the bonding; Welty will say only that Amelco changed the metal composition of the mask to prevent sticking.

**Hot sandwich.** Amelco likens the multilayer ceramic to a micro-miniature, hermetically sealed, multilayer etched circuit board, and thinks that it will be a direct competitor to discretionary wiring for complex integrated circuits. "Nobody had ever been able to bury a conductor in a ceramic before, because the metal was oxidized when the ceramic sandwich was fired," Welty says. As with the masks, Amelco experimented with new materials, and finally settled on a refractory metal (one which has a melting point higher than 4,000° Fahrenheit) for the conductor to be buried in the aluminum oxide ceramic. The company won't

say which metal or combination of metals it chose, but common refractory metals are molybdenum, tantalum tungsten and columbium.

Crossovers in the microelectronics modular assembly package are thus made in the ceramic itself. An interconnect pattern one mil thick is printed on the lower layer, the two layers are fired together fusing them, and a second interconnect pattern is printed on the top. The whole sandwich is 24 mils thick.

James F. Battey, general manager of Amelco, says the company will extend the flip-chip techniques to any product with healthy volume. "I would expect a substantial flip-chip production in the second half of 1967," he says. Besides the microelectronics modular assembly, Amelco is working on a dual in-line package and a flatpack. It began offering the two shift registers when procedural improvements brought costs down to the level of conventional methods.

Fairchild Semiconductor says its flip-chip dual in-line package, called "Fairpak," pairs industrial and consumer ic prices with military-level reliability.

### IC price slash

Costs and speeds of ferrite-core and integrated-circuit main memories for computers appear to be converging, although cores are still less expensive per bit stored and ic memories are still much faster.

The Memory Products division of Fairchild Semiconductor, the first company to produce all-ic main memories as a standard line, plans to cut prices on a new line of ic memories to about one-tenth the present levels.

Fairchild's current ic memories contain 256 32-bit words per module, have a cycle time of 100 nanoseconds and cost \$1 to \$2 per bit. The larger but far slower core memories generally used in computers rarely cost that much, and the biggest and slowest types are priced at only pennies per bit.

**Compromise.** Each module in the upcoming Fairchild ic line will contain at least 1,000 words and

will cost 10 to 20 cents per bit. As a trade off, speed will be reduced to a 200-to-300-nsec cycle time.

This will still make them at least twice as fast as the high-speed core memories that Fairchild is also producing. The latter have a cycle time as fast as 550 to 650 nsec, according to the company. This speed, two to three times that of conventional core memories, is the result of 2½-D organization [Electronics, Oct. 31, 1966, p. 83] and small, low-inductance packaging. Five or six other companies have also been making 2½-D memories with submicrosecond cycle times. Modular design allows the manufacture of memories with as many as 2,350,000 bits.

Fairchild has just started designing a line of faster core memories, with speeds of less than 500 nanoseconds the goal. It hopes to achieve this by cutting core size from 22 mils to 16 or 18 mils and by further reducing package induction. However, it hasn't been decided whether to retain the 2½-D structure or go to a different organization, according to Jack Schmidt, engineering manager of the Memory Products unit.

Schmidt declines to estimate per-bit prices on the planned memories, except to say that they will be competitive.

**Ahead of demand.** Schmidt indicates that computer designers have been slow in accepting high-speed, all-ic main memories. There is no ready made market for them, he explains, because existing computers weren't designed to employ main memories with such speed. Very fast ic scratchpad or register-type memories are being used in computers now, but the capacities of the scratchpads are tiny compared with the storage of the Fairchild memories.

---

### Instrumentation

---

#### All in the family

On the lower level of the sprawling Palo Alto, Calif., headquarters of

the Hewlett-Packard Co. is an integrated-circuit facility whose capabilities have kept both semiconductor and instrument manufacturers guessing for more than a year. At the Institute of Electrical and Electronic Engineers international convention next month in New York, Hewlett-Packard will lift the veil a little when it introduces three electronic counters—its first products built with homemade ic's. The scope of the company's ic operation is indicated by its intention to continue making the circuits for the production line while maintaining its ic research and development.

"We expect to take care of our market predictions," declares Ed Hilton, manager of the ic facility. That means the company will be producing dual in-line packaged circuits for:

- The 12.4-megahertz model 5216A, a seven-digit multipurpose counter that measures frequency, period, period average, multiple period average, and time interval, draws only 6 or 7 watts of power so that it may be offered with self-contained batteries, fits in half a rack panel, and is priced below \$1,300.

- The 12.4-Mhz model 5221A, a frequency counter 6¼ by 5¼ by 8 inches, available with four, five or six digits, priced at "well under \$600."

- The 12.4-Gigahertz 5240A, an eight-digit hybrid unit that combines a counter and a divider and gives an unambiguous readout, with no further calculation necessary. It will sell for less than \$5,500.

Each of the instruments has all of the counter circuitry, plus new miniature Nixie tubes on one printed circuit board.

**Self-sufficiency.** Hewlett-Packard reportedly has a fourth instrument in the wings. The design philosophy behind all of them bears out a statement made by company president David Packard almost a year ago [Electronics, April 4, 1966, p. 23] that to maintain its market position, Hewlett-Packard would make its own custom circuits. "If we go into a store and buy a lot of parts which we then assemble, someone else can go into the store, buy the same

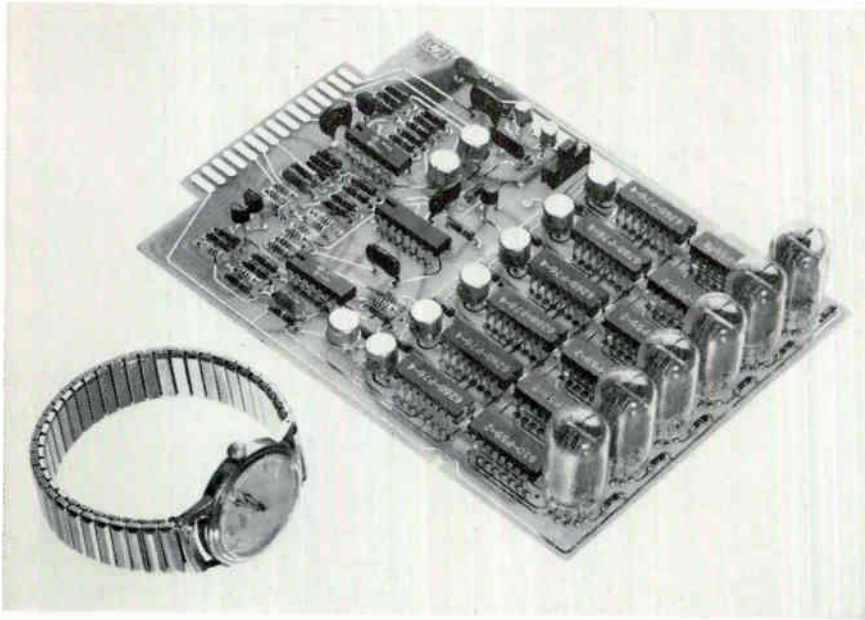

Integrated-circuit counter from Hewlett-Packard puts counter circuitry and new miniature Nixie tubes on one circuit board. It costs under \$600.

parts, and produce the same thing. If we do our own design and engineering, then we can make products that other people cannot make."

The 5216A, for example, will have 34 ic packages, 29 of which were developed at Hewlett-Packard. (The other five are Texas Instruments Incorporated logic functions.) "We optimized those 29 circuits for use in the kind of instrument we make," says Dexter Hartke of the company's frequency and time division. "In the case of the time base, a chain of decades, we have added extra circuitry, in the form of gating, that reduces the number of ic packages. Without that circuitry, we would have had to use three more packages; the \$9 we saved pays for the crystal oscillator."

**Proximity is bliss.** "We could tailor those decades to our needs," Hilton explains, "because we didn't have to worry about different end-use; we didn't have to be concerned with a large fan-out capability, for instance." Hilton's domain is just across a corridor from Hartke's, which makes for close cooperation between instrument designers and ic designers. "We have freedom of design, with more control over design, and shorter turnaround time for design changes," Hilton says.

The hybrid 12.4-Ghz counter is

only a cousin to the other two. Project manager Robert Allen says the division wanted to make an X-band frequency meter to combine the functions of two other Hewlett-Packard instruments—a counter and a divider. "We found that the ic people had developed a decade counter that we could use, so we took it," Allen says. "I would have gone to TI or Fairchild if ours hadn't been available, because it was obvious that we had to go to ic's. We did use Texas Instrument's TTL in the logic to get the speed we needed, but put our own RTL circuits in the drivers."

**The competition.** Hewlett-Packard is not alone in the ic counter field. Aerometrics, a subsidiary of the Aerojet-General Corp. introduced a 10-Mhz counter last year and now has plans to push it as high as 28 Mhz with Micrologic circuitry developed by the Semiconductor division of the Fairchild Camera & Instrument Corp. Aerometric's unit measures only 3¼ by 9¼ by 11 inches, and weighs 8 pounds. Its 114 ic's replace 1,768 discrete components. At \$1,250 to \$1,925, (with from four to eight digits), it is competitive with the 5216A.

The Systron-Donner Corp. will introduce at the IEEE meeting a series of seven counters that range from 5 Mhz to 12.4 Ghz, with di-

rect counting up to 100 Mhz. The counters are designed exclusively with ic's.

Fairchild's own electronic instrumentation division is reportedly ready to market an instrument that uses an automatic transfer oscillator to count up to 15 Ghz. It will have an aging rate of one part in 10<sup>9</sup> a day. Fairchild promises some surprises in the scope and price of the new instrument.

But Hewlett-Packard's own series has quite a span. The 5221A has the capabilities of five counters now in the company line, and the 5216A can do as much as two of its discrete ancestors. Hewlett-Packard is really counting on its own ic's.

## Space electronics

### Fewer dishes . . .

High angular resolution at millimeter-wavelengths is the goal of an experimental antenna being built for the Air Force's Cambridge Research Laboratories, Bedford, Mass. This move into relatively unexplored antenna frequencies is aimed at increasing capabilities for ground identification of satellites, secure communications, and satellite-to-satellite measurements and observations.

Also, in using four paraboloid dishes to do the work of seven, the antenna will represent an experiment in "thinned array" design. "If you have to pay a lot for dishes, you don't buy as many," explains Allan C. Schell, a physicist at the Air Force labs and the designer of the antenna.

**Aim for January.** Operating as a multiple-element interferometer at a wavelength of 2 millimeters, the antenna will explore the 140-giga-hertz frequency band. It is slated to begin operations next January.

The array consists of four 4-foot paraboloid reflectors coupled by a low-loss wideband feed and mounted side by side on a 28-foot-long structure slotted for seven reflectors. Various combinations of outputs from the four dishes will

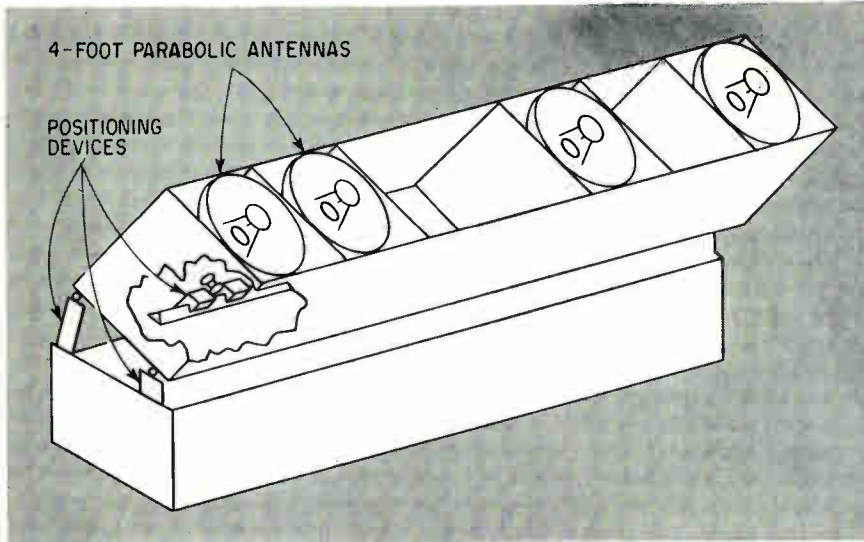

Four dishes do the work of seven in thinned array being built for the Air Force's Cambridge Research Laboratories.

provide measurements of all spacings up to six, and the spatial frequency responses will thus be equivalent to those obtainable with seven dishes. The technique is similar to the one employed by Stanford University in building an array of five dishes to do the work of 10 [Electronics, Sept. 19, 1966, p. 48]. Schell concedes that basically "the method is a way to skimp on an antenna and still get your data."

**Down the waveguide.** The four-dish interferometer will be mounted on a tiltable frame and will be steerable along that axis only. The reflectors will be fed by a beam-waveguide structure that will combine optical and microwave techniques to provide power division among the dishes and individual phasing. The signal will move down the waveguide structure like a light beam, being refocused by lenses in the structure. It will, however, be varied in amplitude and will phase like a microwave signal.

The TRC division of the Control Data Corp. is building the \$150,000 antenna system, including a temperature-controlled structure to house it, on Katahdin Hill overlooking the Air Force Labs. After the interferometer is used to explore millimeter-wave antenna techniques, it will probably be turned over to radio astronomers to be used as an atmospheric re-

search tool. The design may be useful at microwave frequencies, Schell notes, "but first we have to prove it can be implemented at 2 mm."

### ... and better discrimination

A few miles away, on 90 acres in Maynard and Sudbury, Mass., Schell's group has built an interferometer that operates near the other end of the radio spectrum. This high-frequency array may also prove to be a prototype for a new class of antennas yielding high-angular-resolution data on satellites, and may be particularly useful in handling the problem of discrimination among simultaneous multiple targets.

The \$80,000 antenna consists of 103 elements—wire dipoles strung on utility posts—arranged in a circular pattern whose diameter is 2,040 ft. It will have a 3-degree beam, which will be used only as a receiving antenna.

**Almost ready.** First tests will be conducted in early spring, with the antenna operating initially at 6.5 megahertz but tunable between 5 and 7.5 Mhz. The Air Force Labs assert that it will be the first high-resolution radio telescope operating at such low frequencies.

In a van parked near the perimeter of the array, a control console with 103 knobs can be used

to vary the antenna pattern as desired. "The targets will do the moving. Our patterns will be set," says Schell. If this design concept works out, future antennas could have real-time display and beam-switching capabilities, but for the experimental system, output data will be sent back to a computer at the Cambridge labs for processing, while the scan angle can be changed only by individual adjustments at each of the 103 dipoles, an operation requiring about one hour. The adjustments have to be previously calculated by computers.

**Filling in points.** In the experimental program, data will be taken from celestial radio sources, although aircraft may occasionally be flown over for some measurements. "We hope to see the spectral output of radio sources at lower frequencies than now available," says Schell, pointing out that scientists have voluminous data on emissions from celestial bodies at microwave and optical frequencies, but hardly any at h-f.

Information derived will also be of interest to communications researchers since the ionospheric cutoff point, or maximum usable frequency, is often in the 5- to 10-Mhz band. The program's principal problem will be the signal-to-noise ratio.

According to Schell, the dipole pattern plus computer processing of output data will give the antenna a resolution equivalent to that of a 2,000-ft. aperture dotted with 1,000 separate dipoles. The phase and amplitude of signals reaching pairs of dipoles will be compared, and these in turn will be correlated with the phase and amplitude of signals reaching other pairs, resulting in a high resolution—or separation—of targets.

---

## Medical electronics

---

### Sound eye

A team of scientists in Cleveland has developed a surgical technique, using high-frequency sound waves,

to push a detached retina back into place and to "weld" it securely against the eyeball. The group, at the University Medical Center, has performed the operation on animals only.

Test results encourage the developers, Adnan Sokollu, associate professor of biophysics, and Dr. Edward S. Purnell, assistant professor of ophthalmology, to believe that ultrasonic retina welding can be used on humans soon. The center is part of Western Reserve University's School of Medicine.

Retina detachment—caused by disease, accident or shock—results in serious impairment of vision or in blindness, unless it is successfully treated.

**Lean on gravity.** Eye surgeons long have depended primarily on gravity to get the retina back in place because the eye is too delicate for more direct surgical methods. A patient might be confined to bed for weeks until the retina eventually settles back into place. Or the patient might be whirled around on a turntable to let centrifugal force push the retina back.

Recently, retinas have been welded with a laser beam. However, the light can only pass through transparent media to reach the retina. The laser can't be used with a clouded cornea, a cataracted lens or a bloody vitreous humor.

Electric sparks have been used for retina welding, with the sparks applied from behind the eyeball

to form a blister that will adhere to the eyeball. But small incisions are required to place an electrical probe behind the eye. All the techniques used heat to effect the weld but the spark method produces a slow-healing burn.

The ultrasonic method, on the other hand, is directly and immediately effective and does not produce any tissue trauma. Ultrasound is focused on the patient's eye through a cone-shaped nozzle. A few drops of liquid lubricator placed in the eye serve as a conducting medium. Ultrasound will not pass through an air gap but travels easily through liquids or solids.

**A little push.** The short, high-frequency sound pulses enter the eye, pass through, but do not affect the intervening tissue and exert a gentle pressure on the detached retina. The sound beam can be focused on a spot as small as  $\frac{1}{16}$  inch in diameter.

To produce focused ultrasound a quartz-crystal energy converter is used to develop low-power sound waves at about 7 megahertz. Interchangeable lenses and cones vary the beam's convergence.

Coupled by a 50-ohm coaxial cable to a radio-frequency power generator, the transducer can be excited with up to 40 watts of radio-frequency power to deliver 6 watts of sonic power. Efficiency in transduction is low because the sonic wave has to travel through

a polystyrene lens in the transducer and the liquid media in the eye.

The focal intensity averages up to 250 watts per square centimeter for retinal welding. For pushing the retina back into place, a lower-power convergent beam is used, with an average intensity of 0.1 to 2 watts per sq. cm. All cases were treated with pulsed ultrasound at 3 to 7 Mhz.

The whole operation, performed experimentally several hundred times, takes only a fraction of a second.

Some five years have been spent in establishing proper levels for the process. Too much power would cause cavitation of the eye fluids, damaging the eye; too little would not produce a lesion, and the retina would not be welded.

### Scanning sleuth

An electronic scanner display system developed in a Massachusetts Institute of Technology study of cognitive processes is now being turned to research on blood cells and the elusive chromosome.

Chromosomes, the rod- or loop-shaped bodies that the protoplasm of a cell nucleus divides into before cell multiplication, have proven difficult to classify, because they exist in many combinations. Also, their pairings and structural changes during cell growth are extremely complex. Since they carry genes, the units of heredity, chromosomes are believed to hold some of the keys to inherited tendencies toward certain diseases.

**Identification.** MIT's new scanner display system, called Scad, links pictures and a computer. As a fallout from the data processing study, it's hoped that the system can help researchers categorize and pair chromosomes and identify various kinds and stages of development. The alternative for a researcher would be to manually examine millions of electron micrographs, keep a file and try to remember the correlations himself.

While the immediate goal calls for computer scanning of chromosomes and blood cells for the pur-

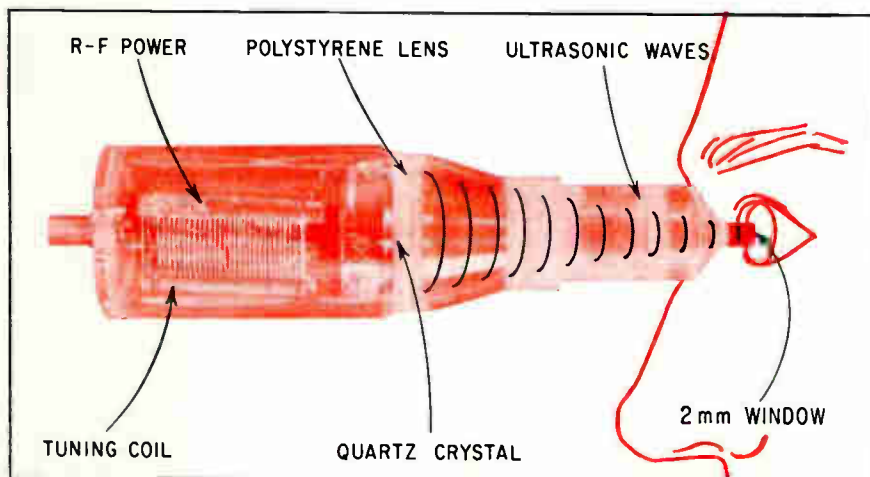

Results of tests to relocate and "weld" detached retinas of animals hold promise that the process may be used on humans.

pose of classification and correlation, the head of the program, Oleh J. Tretiak, says his personal goal is to get a "fingerprint" of a chromosome during a cell's splitting process. The longer-range objective of the project is automatic scanning of X rays of cell sections.

Says Tretiak: "Medical people can ask us for certain kinds of information they want to know about chromosomes or about blood cells and we will try to get this with the scanner. We will also try to ferret out certain correlations in the pictures—information, for example, about the center of gravity in a chromosome spread or about moments of inertia—and ask the medical people if these offer any useful clues."

**How it works.** The scanning system can accept transparencies, measure transmission of light at various points and convert this data into digital numbers for storage and retrieval. It can also accept digital data and produce pictures from it. Tretiak says Scad can delineate in a micrograph a part of one chromosome lying under another chromosome.

Scad measures display data and brightness over a raster of discrete points. When a transparency is placed in the scanner, the picture may be viewed on a monitor or photographed with a display unit. In the scanner, a spot of light from a cathode-ray tube is imaged on a transparency. The light passing through the transparency is collected by a condenser and sent through a sequence of dichroic mirrors that split the light spectrum into three bands. Each band is sent to a different photomultiplier; signals from the photomultipliers control the crt drive.

**Color.** Scad can measure color as well as brightness—an important feature in both chromosome research and in studies of red and white blood corpuscles. To scan color pictures, light passed through the transparency is split into three spectral bands and the amount of light in each band is measured by photomultiplier tubes. Color pictures are obtained from the display by photographing three separate pictures through three color filters.

---

## Military electronics

---

### SAM-D surfacing

An advanced development contract for the Army's SAM-D system, which incorporates the first tactical phased-array radars for the battlefield, is slated for award sometime this spring. Work on the project should be under way by the summer.

More than \$2 billion will be spent on SAM-D (Surface-to-Air Missile — Developmental) during the next six years and most of the money is ticketed for electronics. The price tag includes the \$300 million needed to get the system through engineering development, a process that should be finished by the early 1970's. Planners hope to have units ready for operation in 1972.

**Triple threat.** Originally designed to protect troops in the field against aircraft and short-range missiles, SAM-D — which also incorporates sturdy battlefield computers and solid-fuel missiles—has two other prospective applications. Besides replacing the Hawk as a mobile air-defense system, it may be used for continental defense, replacing the Nike-Hercules and complementing Nike X if that system is deployed around cities and fixed installations. And SAM-D subsystems may also be adapted for shipboard use to replace all or parts of the Navy's Talos and Standard missile systems.

In the three-way competition for the contract, the Radio Corp. of America, which is teamed with the Beech Aircraft Corp., is reported to have a slight edge. Also in the running are the Hughes Aircraft Co., working with the FMC Corp., and the Raytheon Co., which heads a group that includes the Martin-Marietta Corp. Raytheon, once eliminated from the SAM-D bidding, was reinstated when requests for proposals were reissued.

Evaluation of the proposals submitted to the Army last month will be complete by mid-Spring. These studies, along with recommendations will be forwarded to the Pentagon for action.

**Three units.** The system's final design won't be determined until a contractor is chosen because each group takes a slightly different approach. However, plans call for SAM-D to be divided into three separate units—radar, launcher and computer command. The continental defense system will be installed in fixed vans and the battlefield version in trucks. No specifications have yet been issued for the shipboard system.

Phased-array radar will be a key element of SAM-D [Electronics, Jan. 9, p. 172]. Continental defense units may be able to sweep 360°, while mobile defense systems will be equipped with more-limited arrays that can be angled to cover likely attack approaches. Calibration, normally a problem with phased-array apparatus, will present no special difficulties in the field since the system requires data only on the relationship between the bearing of the target and itself.

Compact digital computers able to handle a number of targets simultaneously will direct the fire of the missile batteries. A terminal-guidance system will assume control when the missile reaches mid-course.

The missile, said to be about the size of the 1,275-pound Hawk, will carry either a conventional or a nuclear warhead. Its range is classified but it's estimated to be about 60 miles. No decision has been made on how many SAM-D batteries will be deployed, but the projected number is said to range from 75 to 150.

### Space-link probe

An Air Force investigation into alleged improprieties associated with the upcoming award of a multimillion-dollar set of contracts for a secret communications link between satellites and ground stations is essentially complete [Electronics, Dec. 26, 1966, p. 49], and a source close to the probe says the results will definitely not affect the selection of contractors.

A prototype of the communications link, called the space-ground link subsystem, was developed for



**Only  
Honeywell Offers  
A Family of  
Compatible  
High Speed\*  
I/C Core Memories**

$\mu$ -STORE ICM core memories are fast, reliable, and able to store more words in less space than any other core memories on the market. They are field-proven and in high volume production . . . yet offer a flexible design which meets a wide range of system requirements.

ICM-47 — 750 nanoseconds full cycle time; capacities from 4K to 32K words in a single 5 1/4" high module (like the one shown below). ICM-40 — 1 microsecond full cycle time; capacities from 4K to 32K words. In addition, multiple module capability allows ICM's to be expanded to larger capacities. Both models feature high noise protection, data retention in case of power failure and maximum use of integrated circuits to achieve high reliability. In brief, you'll find the ICM-40 and ICM-47 designed to perform

comfortably in a wide variety of operating environments and to fit easily into almost any system requirement.

Because ICM's come from Honeywell, Computer Control Division, you know they're backed by more than eight years' experience in the design and production of standard core memories . . . and by some pretty intensive special purpose memory systems experience as well. Add to this our I/C capabilities, logic module capabilities, and digital computer capabilities, and you can be sure of dependable support in solving your core memory applications and systems design problems.

Write today! Ask for our  $\mu$ -STORE summary brochure. Honeywell, Computer Control Division, Old Connecticut Path, Framingham, Massachusetts 01701.

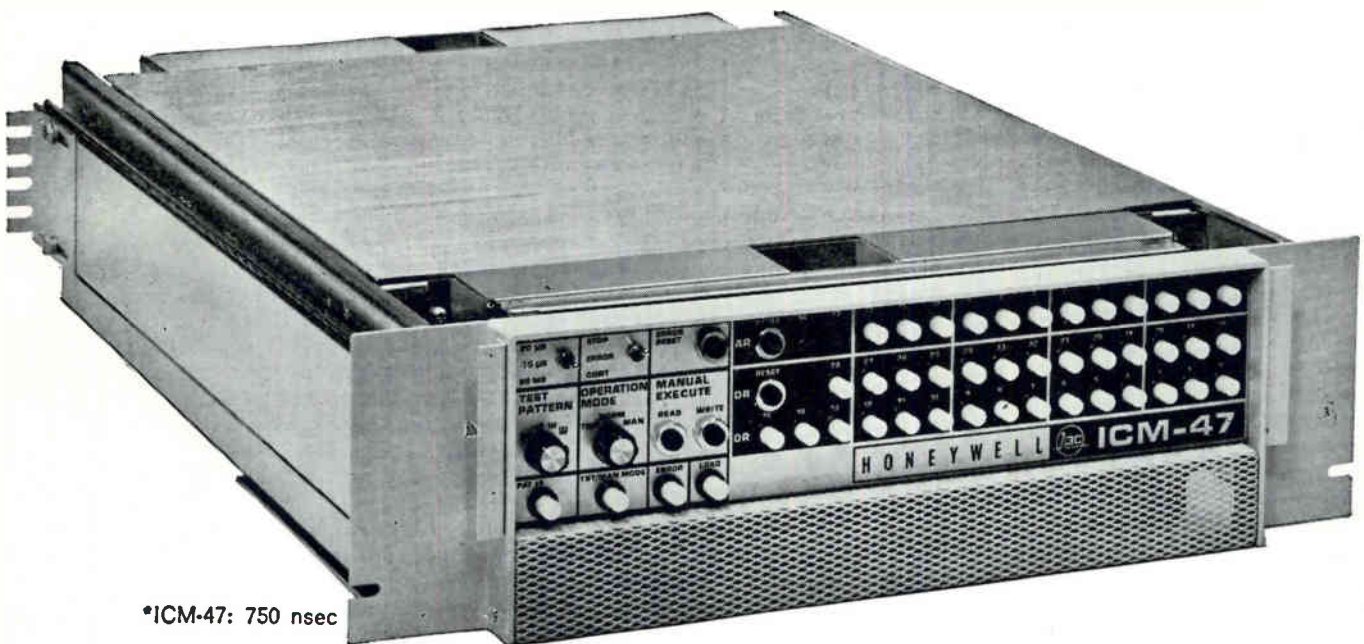

\*ICM-47: 750 nsec

**Honeywell**

**COMPUTER CONTROL  
DIVISION**

the Air Force's Space Systems Division by the systems group of TRW Inc. The link was tested in orbit recently, TRW has just disclosed; the results were described by the concern as highly successful.

The investigation, it was reported, confirmed that gratuities were accepted by an individual connected with the program from a company interested in a development contract. But the source says there's no doubt that the gratuities did not represent an effort by the company to influence the Air Force's decision.

**Awards pending.** The Space Systems Division is currently studying bids for work on the project, and the award of the contracts is a few months away. A report on the investigation will be made before the orders are let.

The contracts are broken down into three parts: integration, installation and check-out; ground stations; and telemetry. The major bidders are the Philco-Ford Corp., TRW, the General Dynamics Corp. and Radiation Inc.

The aim of the program is to standardize and consolidate all the various tracking, telemetry and command functions of Air Force satellites. By using ultrawide bandwidth and high-speed pulse code modulation techniques, at least three separate communications links—very high frequency for telemetry, ultrahigh frequency for command and S band for tracking—are to be integrated into a single multiplexed S band channel.

**Compatibility.** The system is understood to be able to handle 1 million bits per second. The digital techniques that were designed for it are compatible with the Air Force's real-time computer data processing and with NASA's S band tracking system. The system could also handle voice communications between satellites and ground stations.

The plan calls for 10 space-ground link stations to be in operation next year; eventually, stations would be peppered all over the world.

A typical space-ground link spacecraft unit, the Air Force says,

weighs about 25 pounds and consumes about 50 watts.

## Communications

### Tactical transceiver

A solid state transceiver that combines a high antijam capability with security and multiple-access and discrete address features has been developed for tactical military use by the Autonetics division of North American Aviation Inc.

Called Rascal (random access secure communication antijam link), it has an anti-jam margin of 22-25 decibels. This means an enemy would have to put into the band 200 to 300 times the power Rascal uses in order to jam it.

The line-of-sight transceiver operates with a 10-megahertz transmission band over the ultrahigh-frequency range from 225-400 Mhz. It is a frequency-hopping system operating in a pseudo-random manner. Both voice and digital data are transmitted in digital form.

**Unique breed.** The principle is not limited to uhf, says Dr. Robert W. Parkinson, engineering manager for Autonetics' electro sensor systems operation. "We could go to S band or X band, but above uhf we would probably have to use tubes," he notes. The significance of the system, according to Parkinson, is that it is the only one that combines the antijam property with such features as:

- Multiple access with discrete address. Each unit has its own address and can call another unit without getting the wrong party.

- Tight security. Since the signal is wideband, it would be difficult for an enemy to demodulate it.

- Reliable synchronization of transmitter and receiver. Synchronization time is one to two seconds.

- Efficient use of the spectrum. About 800 addresses could be assigned to the 10-Mhz band and about 200 could be on the air at the same time without appreciable degradation of the antijam capability and without crosstalk.

Each unit has a bell to signal incoming calls, an acknowledgment signal to advise the caller that the bell on the other end is ringing, and a busy signal. Further, there is provision for an override capability in case a third party wants to break in. To contact another station, the operator selects the code of the day, then punches in the numerical four-digit address of the other station on the push-buttons of the address panel.

**Demonstration.** Autonetics recently demonstrated four units under simulated tactical conditions before representatives of all the services at the Coronado, Calif., base of the Navy's Pacific Fleet amphibious force. Rascal units were set up to link a trailer at the base, a bunker at an electronics laboratory in Point Loma, five miles away, and a ship 220 miles out to sea.

### Solid power

Until recently, the highest very-high-frequency output generated by solid state amplifiers has been about 100 watts. Now the Collins Radio Co. of Dallas has built a unit that achieves 500 watts continuous-wave power by linking high-power transistors in parallel and summing their outputs. Collins says the 500-watt output for frequency modulated signals is the highest yet delivered without the use of vacuum tubes.

Linking the transistors in hybrid-type summation networks provides isolation and assures that the failure of one transistor will not short out the others. In a tube amplifier, a tube failure would put the entire unit out of service.

In the unlikely event that three modules failed, the amplifier would still operate on about half power, says Tom Dennis, head of the Collins department that developed the device.

Collins developed the amplifier for its standard 618 series radio transmitter, which the firm supplies to commercial airlines. The solid state unit was made expressly for use in last December's tests of vhf voice communications between

# SPEER COMPONENT COMMENTS

9 out of 10 of our SC commercial resistors will deliver military quality. We're just not sure which 9

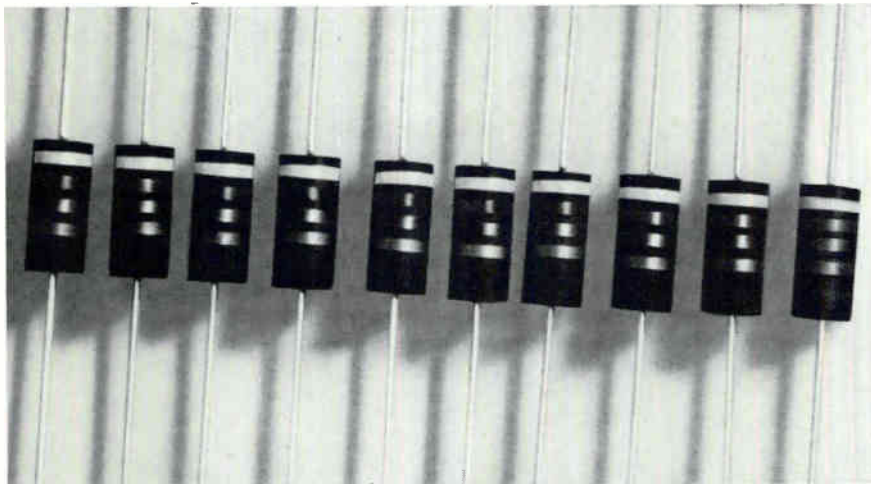

Nevertheless, you'll have to admit that those are pretty good odds.

The secret of our superior commercial carbon composition resistors is that they aren't, strictly speaking, "commercial" resistors at all.

They're made from the same materials—on the same equipment—and with the same in-process quality controls—as our MIL-R-11 and MIL-R-39008 "military" resistors. In fact, the only thing that sets our SCs apart (aside from having to meet merely commercial AQLs) is that they don't undergo the costly testing required

for military documentation.

But if they did, there'd be a better than 90% chance that they'd meet even the stringent MIL-R-39008 specifications!

Are you paying for more commercial reliability than you actually need? Why not get more reliability than you actually pay for? Come to Speer—where the odds are definitely in your favor.

For complete information about our generous SC commercial resistors, mail the coupon.

Here's a capacitor that can give your assembly line a run for its money

High-speed production assembly operations happen to be rather rough on some kinds of capacitors. If you've been stymied by this particular problem, it's time we put in a good word for the Type JM fixed composition capacitors made by our Jeffers Electronics Division.

With their dimensional uniformity, rugged construction, small size and axial lead wires, these inexpensive general-purpose units can survive even the speediest assembly operation. They're unusually well-suited for special applications, too.

At the moment, JMs are being used most widely in TV sets, FM car radios and other commercial products. However, they also possess the degree of reliability required for military applications.

So get a real run for your money, with these extra-durable capacitors. Available capacitances range from 0.1 to 10.0 ps. To learn more, just send us the coupon.

## Oops! Watch out for Typical Error #7 in inductor testing

As we indicated in an earlier issue, there are eight errors that are easy to make when you're using the test procedures for measuring inductance and Q (see MIL-C-15305).

Error #7? Specifying a non-standard test frequency.

Where this is unavoidable, induct-

ance values between 0.10 and 10 Microhenries can be determined by using the following formula:

$$L = \frac{25,330}{F^2 C}$$

with L in  $\mu$ h, F in Mc/s and C in pf.

For values above 10 Microhenries, use a 260 Q meter. And we recommend that you stay below 1/10th of the Self Resonant Frequency of the inductor at all times.

For additional errors — and their remedies — stay tuned to this frequency.



St. Marys, Pennsylvania 15857

Speer Carbon Co. is a Division of  
Air Reduction Company, Inc.

Rush complete information on  SC resistors and  JM capacitors.

Name \_\_\_\_\_

Title \_\_\_\_\_

Company \_\_\_\_\_

Street \_\_\_\_\_

City \_\_\_\_\_ State \_\_\_\_\_ Zip \_\_\_\_\_



# "ALPAC" A NEW CONCEPT!



## high current integrated rectifier circuits

"ALPAC" bridge rectifier circuits offer:

**ALUMINUM CASE** — A new power bridge rectifier circuit designed in a functional aluminum case.

**HIGH CURRENT** — Up to 25 amps average rectified current available from PIV ratings of 50 to 600 volts.

**SMALL SIZE** — Case size is 1.125"x1.125" x.406" max.

**TERMINALS INSULATED FROM CASE** — Unique 3-way-universal-terminals allow maximum installation flexibility.

"ALPAC" is specifically designed to simplify packaging and minimizing production costs. Economically priced to replace multiple stud rectifier usage, "ALPAC" reduces space requirements by one third with improved reliability.

Internally, "ALPAC" utilizes the Semtech high performance rectifiers, welded together for mechanical strength. The device is rated at a maximum thermal resistance of 1.5°C/Watt.

Technical bulletins describing the "ALPAC" high current Bridge Rectifiers, Doublers, and Center Taps are available.

**SEMTECH**  
**CORPORATION**

WESTERN OFFICE: 652 Mitchell Road, Newbury Park, California  
(805) 498-2111 (213) 628-5392/TWX 805-499-7137  
Central: 140 No. La Grange Road, La Grange, Ill. (312) 352-3227  
Eastern: 71 West 23rd St. N.Y., (212) 989-7550/TWX 212-640-5060  
European Sales: Bourns AG, Alpenstrasse 1,  
6301 Zug, Switzerland (042) 4 82 72/73

airliners and ground terminals via the Applications Technology Satellite (ATS-1) of the National Aeronautics and Space Administration [Electronics, Nov. 28, 1966, p. 121; Jan. 9, p. 52]. Collins provided the radio for American Airlines Inc., which used it on a Boeing 707 jet airliner.

**Fledgling market.** The firm is building additional models for use in later tests with satellites in the ATS series, and is also producing another version for satellite control applications in NASA ground stations. But Collins expects its biggest customers to be the airlines after the carriers begin regular use of communications satellites.

The amplifier can also put out 125 watts when transmitting amplitude modulated signals for troposcatter. The input signal is the 25-watt output of a standard 546 transceiver.

Bandwidth of the two-stage amplifier is 20 megahertz. Collins has operated it with this bandwidth at frequencies from 116 to 152 Mhz. The low impedance level of the transistors permits this broad bandwidth operation.

The first stage is the driver amplifier, which uses two transistors. The second stage, the final amplifier, has 16 transistors in parallel. These transistors (ITT type 3TE225) are set up in eight modules. Each pair produces 100 watts. However, Collins has been operating the unit so that the modules actually run at about 70 watts, bringing the total output to around 560 watts. Some 60 watts are lost in the amplifier's low-pass filter, hybrid coaxial networks, and antenna

switching relays.

**Efficiency and cost.** Dennis claims the amplifier is as efficient as a tube amplifier (around 59% in f-m mode). Gain is 9 decibels per stage.

Thin-film resistors are used in the attenuators and the hybrid coaxial connections.

Collins could make a smaller package, Dennis says, but so far the firm is putting the unit in a standard air transport rack.

No price has been established for the amplifier, but Dennis expects it will be close to that of a tube unit. He contends that while the transistor cost is about triple the tube cost, a savings is effected by the elimination of tuning and servomechanism elements.

## Manufacturing

### Super clean

Semiconductor firms are playing the numbers game again. This time it's not unit sales figures they're matching, but the particulates per cubic foot of air in their clean rooms. Firms from coast to coast —among them the General Instruments Corp., Texas Instruments Incorporated, American Microsystems Inc., Westinghouse Electric Corp. and the Radio Corp of America—are claiming cleanliness levels of from one to 100 particulates per cubic foot of air for existing or planned facilities.

All this stems largely from the

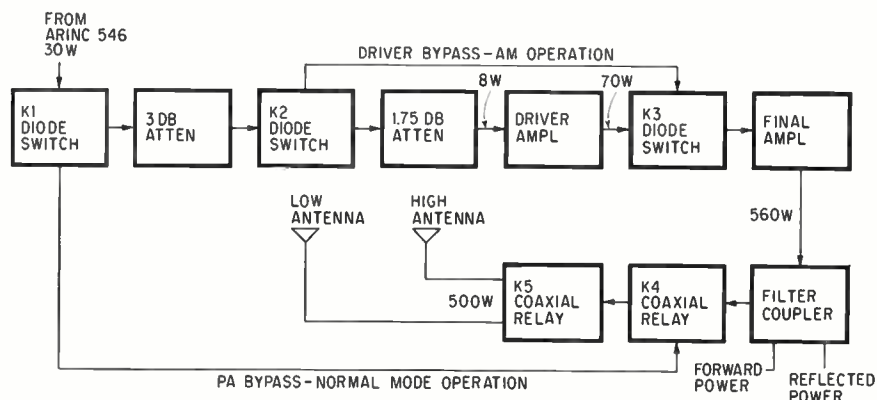

Solid state amplifier used in aircraft-to-satellite-to ground voice link.

This is a triode?

This is a triode?

This is a triode?

This is a triode?

This is a triode?



**RCA's new 40461 N-channel, depletion-type, insulated full-gate (MOS) transistor may not be a triode...**

**but it works like one in critical audio and wideband amplifier applications from DC to 100 MHz...with solid state reliability!**

RCA's new Metal-Oxide-Semiconductor transistor makes it easy to design solid state devices into your high impedance control and instrumentation circuits. Unlike bipolar transistors, the 40461 has an extremely high input resistance ( $10^{15}$  ohms typical) which is relatively insensitive to temperature, at any gate polarity.

Further, this RCA MOS transistor features high transconductance and low input capacitance. Long-term stability is assured by a metallized gate which covers the *entire* source-to-drain channel. The 40461 is hermetically sealed in a TO-72 4-lead metal case.

With these features, the 40461 can do the job done by conventional triode devices and you gain the extra advantages of transistors! And this new MOS transistor can be used where conventional bipolar semiconductor devices were not previously applicable. You can also use two of these MOS transistors in cascode for greater versatility in your circuit design.

*FOR YOUR CRITICAL CHOPPER APPLICATIONS use the new RCA 40460 solid state chopper. It eliminates problems associated with mechanical choppers. The full-gate construction permits symmetrical operation and assures long-term stability. Offset voltage is virtually zero. And you can use the new RCA 40461 triode in the chopper amplifier's high impedance second stage.*

Design these devices into your existing circuits. Check your RCA Field Representative for complete information on both the 40460 and 40461 MOS transistors. Write RCA Electronic Components and Devices, Commercial Engineering, Section CN2-2, Harrison, N.J. 07029, for data sheets.

**ALSO AVAILABLE THROUGH YOUR RCA DISTRIBUTOR**

RCA Electronic Components and Devices



**The Most Trusted Name in Electronics**

# Complete Shaft Encoder Systems



**DECITRAK®** is the only complete system, encoder plus all electronics, for transforming shaft rotation as well as synchro/resolver outputs into digital readout. Low-cost DECITRAK systems are available in 3-digit to 6-digit versions with 523 solid-state accessories. They interface precisely with most digital computers . . . also offer digital outputs for sequencing, motor control and set-point programming. All have extraordinarily long life. Fast delivery, too!

Write for **Free Engineering Catalog**, which gives details on hundreds of encoder systems.

*Theta*  
**INSTRUMENT  
CORPORATION**

22 SPIELMAN ROAD  
FAIRFIELD, NEW JERSEY 07006  
(201) 227-1700 • TWX: 710-734-4331

## Electronics Review

trend to large-scale integration. The technique requires multilayer interconnections, and the associated crossovers can be short-circuited during fabrication by particles in the atmosphere. TI has found that work in a normal clean room—one containing about 100,000 particulates per cubic foot of air—results in a rate of around 100 defects per 100,000 crossovers; the company figures that large scale integration isn't feasible if the level is above 10 defective crossovers per 100,000.

TI has already achieved a rate of only one defect per 100,000 crossovers by cutting the air contamination level over the work-bench area to one particulate per cubic foot in a clean room rated over-all at 100 particulates. And it is now building a plant in which the clean rooms themselves will contain only one particulate per cubic foot of air.

This new TI facility is an example of the general trend in semiconductor production. The entire operation will be built around two ultraclean clean rooms, each of 10,000 square feet. A new vertical laminar system will keep air flowing from the ceilings of these rooms down to gratings in the floors to maintain the slated one-particulate-per-cubic-foot level.

Others in the industry aren't far behind in this business of counting particles.

"We're providing a really benign atmosphere for the chip," says Val Valandingham, operational vice president of American Microsystems, a company formed only last summer by a group formerly associated with the old General Micro-Electronics Inc. The goal of this benignity is increased yield, and the concern feels its investment in cleanliness is paying off.

More than 20% of the \$1.5 million that American Microsystems Inc. spent on its new 24,000-square-foot production facility for the manufacture of metal oxide semiconductor integrated circuits went toward making the plant one of the cleanest in the business. Every process except final assembly is carried out in class-10,000 clean rooms and every bench inside

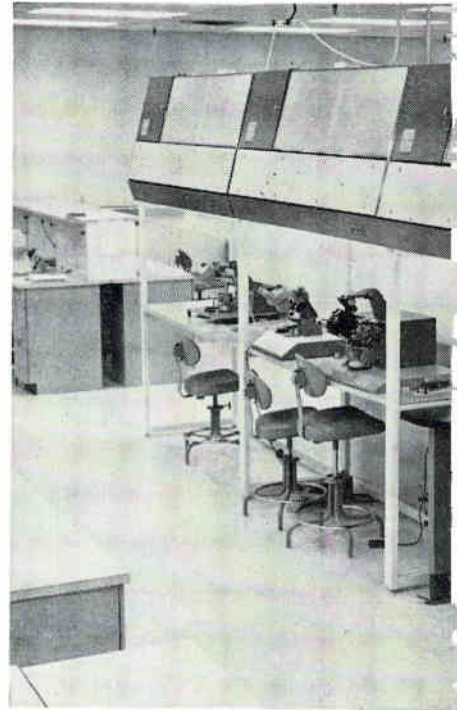

Work stations at American Microsystems are rated class 100.

these rooms is under a laminar-flow hood that gives the actual work area the environment of a class-100 clean room.

**Designer's dream.** The plant, in Sunnyvale, Calif., is a semiconductor designer's dream. The air in each room is passed through absolute filters and is changed every 45 seconds. Absolute filters theoretically pass no impurities. Epoxy paint, which won't flake or oxidize, is used throughout. Exhaust ducts are polypropylene rather than aluminum, which might flake. Humidity is controlled within  $\pm 5\%$  and temperature is  $\pm 2\%$ .

Stewart-Warner Microcircuits, a subsidiary of the Stewart-Warner Corp., has been operating for more than two years in a clean plant specifically designed for the advent of large-scale integration.

The failures associated with contamination are random—that is, they may occur anywhere on the silicon wafer. As the size of individual chips increases to accommodate the complex circuitry of large-scale integration, the percentage of failures attributable to contamination is bound to rise.

Frances B. Hugel, who designed the Stewart-Warner plant when she and her husband William ran it,

explains that the necessity for clean facilities was impressed on her when the couple was at Siliconix Inc. "We were making a series of four field-effect transistors that were exactly the same except for the area; they increased in size as they went up in power. We found that we got good yields for the smallest two, almost as good for the next largest, and no yield at all for the biggest. If you plotted random failure against device size, the curve was exponential."

## Computers

### Good housekeeping

The General Services Administration — the Government's house-keeper—is discovering that it's just as difficult to get Federal agencies to share their computers as it would be with a group of competing private companies.

For this reason, it has earmarked \$10 million of fiscal 1968 funding to get into the computer service center business. It would rent computer time to agencies that periodically have either too much work for their own electronic data processing systems or don't have enough to warrant buying their own.

The agency is concerned over the growing number of digital computers used by Government and is seeking better use of existing equipment. It wants to set up regional centers to handle excess loads that can't be parceled out to other agencies. Los Angeles and New Orleans are being considered as sites.

**Profits.** Operating like a private data processing center in renting time and billing user agencies, General Services would maintain a \$10-million internal revolving fund for the purchase and leasing of equipment, and would plow profits — income over that sum — back into the Treasury's coffers. Plans also call for the service centers to handle their own electronic data processing maintenance. Officials regard equipment maintenance as a high profit area for computer manufacturers and believe the Govern-

basic measuring tools from

**HEWLETT  
PACKARD**



## hp 203A

### Variable-Phase Function Generator

provides reference and variable-phase sine, square waves  
range 0.00005 Hz to 60 kHz  
distortion less than 0.06%  
continuously variable phase shift 0-360°  
four simultaneous adjustable outputs 0-30 v peak-to-peak

#### Use it for:

- phase shift measurements
- low-distortion signal generation
- vibration studies
- frequency response measurements
- servo applications
- medical research
- geophysical problems
- subsonic, audio testing

Here is a solid-state function generator offering simultaneous sine and square-wave signals 0.005 Hz to 60 kHz in 7 overlapping bands (two optional bands available, down to 0.00005 Hz). Total harmonic distortion hum and noise (0.06%) is less than 64 db below fundamental.

Accurate 1% frequency dial calibration with 180 dial division, vernier drive for precise adjustment. All four floating output circuits have individual 40 db continuously adjustable attenuators. One each of the sine and square-wave outputs

contain the 0-360° phase shifter. A front-panel calibration provision permits easy line-frequency calibration of the oscillator to the environment in which it's being used. Price, \$1200.

For a demonstration of the unique 203A call your Hewlett-Packard field engineer. Or write for complete specifications to Hewlett-Packard, Palo Alto, California 94304, Tel. (415) 326-7000; Europe: 54 Route des Acacias, Geneva.

*Data subject to change without notice.  
Price f.o.b. factory.*

**HEWLETT**  **PACKARD**  
An extra measure of quality

1186



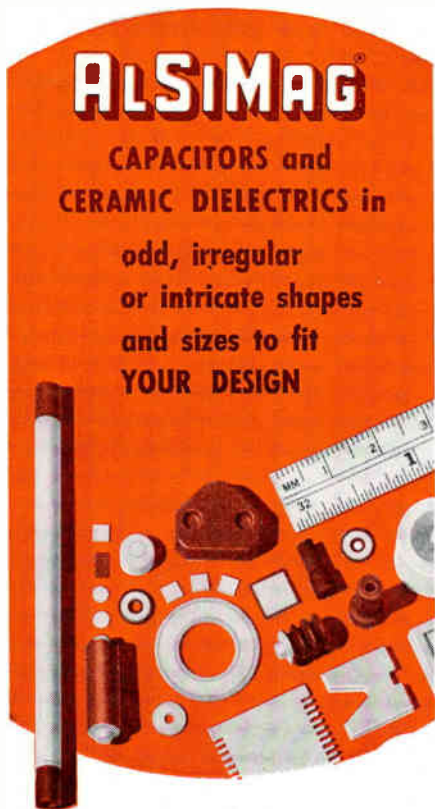

Custom made ALSiMag special purpose capacitors are available in almost any shape, contour or size. Wide choice of ceramic compositions with dielectric constant from 6 to 10,000 offer flexibility in design for rugged, dependable, low cost performance.

Electrical characteristics are controlled to required specifications. Capacitance drift, voltage, coefficient of capacitance and aging rate are also considered. These may offer plus values for your design.

DISC DIELECTRICS are available in a closely controlled range of materials that can be silvered to a  $\pm 5\%$  tolerance.

Give us your operating and capacitance requirements and your space, shape and size limits and let us submit a proposal for a custom made capacitor or ceramic dielectric especially suited to your use.

American Lava Corporation **3M**  
A SUBSIDIARY OF  
 Titania Division  
 Chattanooga, Tennessee 37405  
 Sixty-Fifth Year of Ceramic Leadership

## Electronics Review

ment could cut its data processing costs by training its own maintenance men.

The agency, as the Government's central purchasing agent, is also asking Congress for an additional \$1.1 million to study centralized buying, leasing and use of all Government computers. Federal agencies operate about 3,000 computers—half of them are leased. The head of General Service's supply operation, H.A. Abersfeller, says the agency wants to determine how it can get rid of unnecessary equipment and add to existing systems while still saving money. In calling for computer pools as well as service centers, General Services officials believe many small Federal agencies now clamoring for their own computers could be fitted into the scheduling of equipment owned by larger agencies.

**Program proliferation.** Also to be included in the \$1.1 million study will be methods to increase computer programing efficiency. Abersfeller says "there is vast duplication that we might pull together—such things as payroll programing, for instance."

The agency wants to identify the equipment that can be kept up to date and that can pay for itself fairly quickly if purchased rather than leased. In its funding request, General Services said that in many cases a piece of equipment being leased might pay for itself in three or four years if its usefulness could be extended. But first, Abersfeller notes, it must be determined how adaptable existing gear is to new features and whether there are agencies with less complex problems that can use older equipment being phased out by another agency.

## Consumer electronics

### Holographic static

H.M. Siegel, one of the strongest proponents of holographic television for both consumer and military applications, resigned as president of Conductron Corp., Ann Arbor,

Mich., in a policy dispute over the commercial potential of the three-dimensional photographic technique in tv. [Electronics, Nov. 28, 1966, p. 25]. Siegel had wanted to buy a consumer electronics company that produces television and stereo sets so that he could lead Conductron into the holographic tv business before the end of the decade. But the company that controls 83% of Conductron, the McDonnell Co. of St. Louis, objected to the plan.

"The powers that be said 'no'—that's all; so I quit," said Siegel. "There were no arguments, just an honest difference of opinion."

McDonnell, currently negotiating to acquire the financially troubled Douglas Aircraft Co., was too heavily committed to the Douglas transaction to consider his proposal, Siegel explained.

**Pioneering.** Siegel, one of the founders of Conductron, had been pushing the company's research divisions to develop techniques for shrinking the bandwidth needed for 3-D television. "The techniques are within reach," he says. In fact, only a few months ago he claimed that a prototype system would be in operation this year.

As much a promoter as a researcher and teacher (he holds a professorship at the University of Michigan in Ann Arbor), Siegel had an "academic spat" with such holography experts as Emmett N. Leith, also a professor at the University of Michigan, and Dennis Gabor, the man who invented holography but could not demonstrate it at the time because the laser hadn't been invented. Both felt then that holographic tv was beyond the state of the art.

The company that Siegel wanted to buy was the old Trav-ler Industries Inc., which Hoffman Electronics Corp. and Montgomery Ward & Co. jointly acquired in 1964. Under the now-defunct plan, Conductron was to purchase a 51% interest in Trav-ler.

The move would have given Conductron some diversification. The firm produces fine-resolution radars and is doing operations research on missile penetration aids for the military.



# NEW

## semi-automatic integrated circuit analyzer

# MICA 150

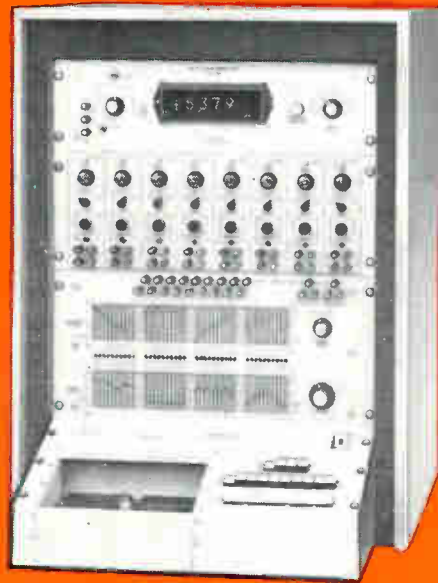

COMPUTER TEST  
CORPORATION

Now the integrated circuit user can get all the flexibility and performance of an expensive, large scale IC test system in an accurate and reliable DC bench top analyzer.

**The new MICA-150 Modular Integrated Circuit Analyzer tests all IC configurations of up to 40 pins with unique programming, fast pushbutton sequencing and built-in DVM readout.**

**Fast, Versatile Programming** Two independent 10x40 crossbar switches and rapid pushbutton sequencing provide up to 40 tests on a single device without re-programming. For example, it's now quick and easy to check a 10 pin device using four completely different test programs without resetting any switches to advance the test from pin-to-pin or program to program. Additional flexibility allows the built-in DVM to measure current on one pin of the device and voltage on another—all pre-programmed.

**Universal Test Adapters** Through use of universal test adapters, the MICA-150 is designed to check ICs according to the number of pins of a particular package, not device or circuit type. Adapters are available for diode, transistor, TO-5, flat-pack, dual in-line and other package configurations, and can also be provided for Kelvin connections.

**Accurate Digital Readout** Specifically designed for the MICA-150 analyzer, the built-in Digital Volt/Ammeter has a conservatively rated readout accuracy of 0.1% with a four digit display. Other features include automatic ranging and polarity selection, self-calibration, automatic voltage or current readout selection. Measures currents as low as 1 nanoamp, voltages to 1 mv.

**Modular Design** Modular construction allows users to select an economical, customized tester without obsolescence problems. Maximum capacity of eight function generators permits later expansion, including modules for AC and pulse testing, without additional modifications.

**Variable Soak Time** Marginal device operation can be easily detected through use of an adjustable test time control which provides a period for thermal stabilization prior to measurement. A continuous position on the control allows parameters to be varied while observing results.

**Precision, Wide Range Power Supplies** Highly precise supplies utilize multi-turn calibrated potentiometer controls with high resolution and repeatability. Constant current supplies are continuously variable from 0-100 ma with voltage compliance adjustable to 100v. Constant voltage supplies are variable from 0-100v with automatic current limiting to 100 ma to provide device protection.

### QUICK ACTION REPLY

Detailed technical literature on the MICA-150 will be mailed immediately upon receipt of this request.

Attn.: A. Norman Into, Marketing Manager  
Computer Test Corporation, Three Computer Drive  
Cherry Hill, N.J. 08034 • Phone: (609) 424-2400

Name \_\_\_\_\_

Company \_\_\_\_\_

Address \_\_\_\_\_

City \_\_\_\_\_ State \_\_\_\_\_ Zip \_\_\_\_\_

**“Just building a lipstick size relay that worked would have been easy.**



**Building one around our great high-rel idea was another story.”**

Wedge-action\*, our great high-rel idea, is 9 years old. Our 2PDT lipstick-case size relay has been around for less than 2 years. But it's already a standard replacement for the competition in lots of MIL-R-5757/8 applications.



Why? Because it outperforms every spec requirement for both high and low-level loads. Like all our wedge-action relays, it combines long contact wipe with high contact force to give you continually clean precious-metal mating surfaces throughout life. Competitively priced with fast delivery.

The lipstick is just one of our family of wedge-action relays, which cover almost every dry-circuit to 2 amp application. When you need a high-rel relay that really works, test one of ours and try your darndest to prove we're wrong. You won't be able to.

\* U.S. Patent No. 2,866,046 and others pending.



**Electro-Tec Corp.**

SLIP RINGS • RELAYS • SWITCHES • OPTICS

P.O. Box 667 • Ormond Beach, Florida  
(904) 677-1771 • TWX 810-857-0305

Manufacturing Facilities:  
Ormond Beach, Fla. • Blacksburg, Va.

## Electronics Review

### For the record

**Delayed action.** The launch date for the third Intelsat 2 communications satellite has been set back one month—to March 15—because of problems with the Delta booster. The satellite—built by the Hughes Aircraft Co.—is to be placed in stationary orbit over the Atlantic Ocean to supplement the Communications Satellite Corp.'s Early Bird satellite. It is also slated to become part of NASA's Apollo communications network.

**Destination Mars.** An engineer at Hughes, Thomas P. Van Horne, has outlined plans to redesign the Surveyor spacecraft to enable it to make a soft landing on Mars and survey the planet with its tv cameras. Another Hughes engineer, Harold S. Brahan, suggested that a synchronous satellite be orbited around Mars to relay signals from a Surveyor spacecraft. The proposals were made at the IEEE's winter convention on aerospace and electronic systems in Los Angeles.

**Trial run.** The first population census by mail—a dress rehearsal for the 1970 census—is scheduled to take place in New Haven, Conn., in April. Robert F. Drury, assistant director of operations for the Bureau of Census, says the study will evaluate new data collection procedures. Every household will receive a short-form questionnaire coded to be read by high-speed optical scanning devices. A long-form questionnaire will go to every fourth household.

**Education.** Cornell University's College of Engineering in Ithaca, N.Y., is using a "blackboard-by-wire" system to teach a course in physical metallurgy to a group of Sylvania research and development specialists in Towanda, Pa., 55 miles away. The lecturer's voice and any graphics he uses are transmitted from a console in the Ithaca classroom to a television monitor and speaker system at Towanda.

**Merger.** The proposed merger between the International Telephone and Telegraph Corp. and the American Broadcasting Co.

may be stalled for several months. The Justice Department threatens court action against the Federal Communications Commission if the agency refuses to reopen hearings on the merger.

**Marketing.** The General Electric Co. is marketing a frequency-modulated two-way radio using integrated circuits. The integrated circuit oscillator module is a thumb-sized device containing components smaller than a pinhead.

**Programing.** General Electric also has added a new software capability to its GE-400 computer series. Called the direct access programing system, it provides multi-programing and communications capabilities.

**New system.** The Federal Aviation Administration has awarded a \$44.8 million contract to the Raytheon Co. for a compact display system that will replace four subsystems currently needed to keep tabs on aircraft: alphanumeric generator, data filters, radar bright displays and computer entry and read-out equipment. Using ic's almost exclusively, the new system will increase the control air traffic personnel have over data inputs to a central computer.

**Longevity.** A new argon laser providing 1,000 hours of operation—more than three times the life of previous units—has been developed by the Radio Corp. of America. The laser will be used in data processing, space communications, satellite tracking, earthquake detection and surgery.

**Firing up.** The Zirconium Corp. of America is making furnace furniture with an inert refractory material that reduces impurities in the production of ceramic capacitors. The material, zirconium oxide, is effective at temperatures up to 4,600°F. Melting point is 4,800°F. Capacitors are usually fired at temperatures from 2,000°F to 2,600°F.

**Education.** The Philco-Ford Corp. is building an education development center in Ft. Washington, Pa. The computerized facility, which is expected to be completed in April, will give the company a high-level base for entering the field of academic education.

# First come first served.

You can have all the SDS T Series integrated-circuit modules you want now. We're in full production.

All T Series active elements are integrated circuits and guarantee reliable operation at clock rates to 10 mc. Each circuit output drives 14 unit loads, even after generous allowances for wiring capacitance.

Outputs switch 60 ma (4 times more than standard IC's). Noise rejection is at least 1.5 volts at the 0 and 4-volt logic levels.

SDS Natural Logic gives you AND and OR as well as NAND and NOR —

Each card uniquely keyed for proper installation.

Test points.

Ground plane laminated through middle of entire glass-epoxy board.

Load resistors separate from IC's for heat isolation.

Discrete diode-resistor inputs for gating flexibility, high noise rejection.

Four pins reserved for ground lines.

Four integrated-circuit buffer amplifiers in each hermetically sealed TO-5 can.

52 ribbon connectors (26 each side) for easy access to all circuits.

All components clearly identified.

Individual power line filters.

Actual size 4¼ x 4¾.

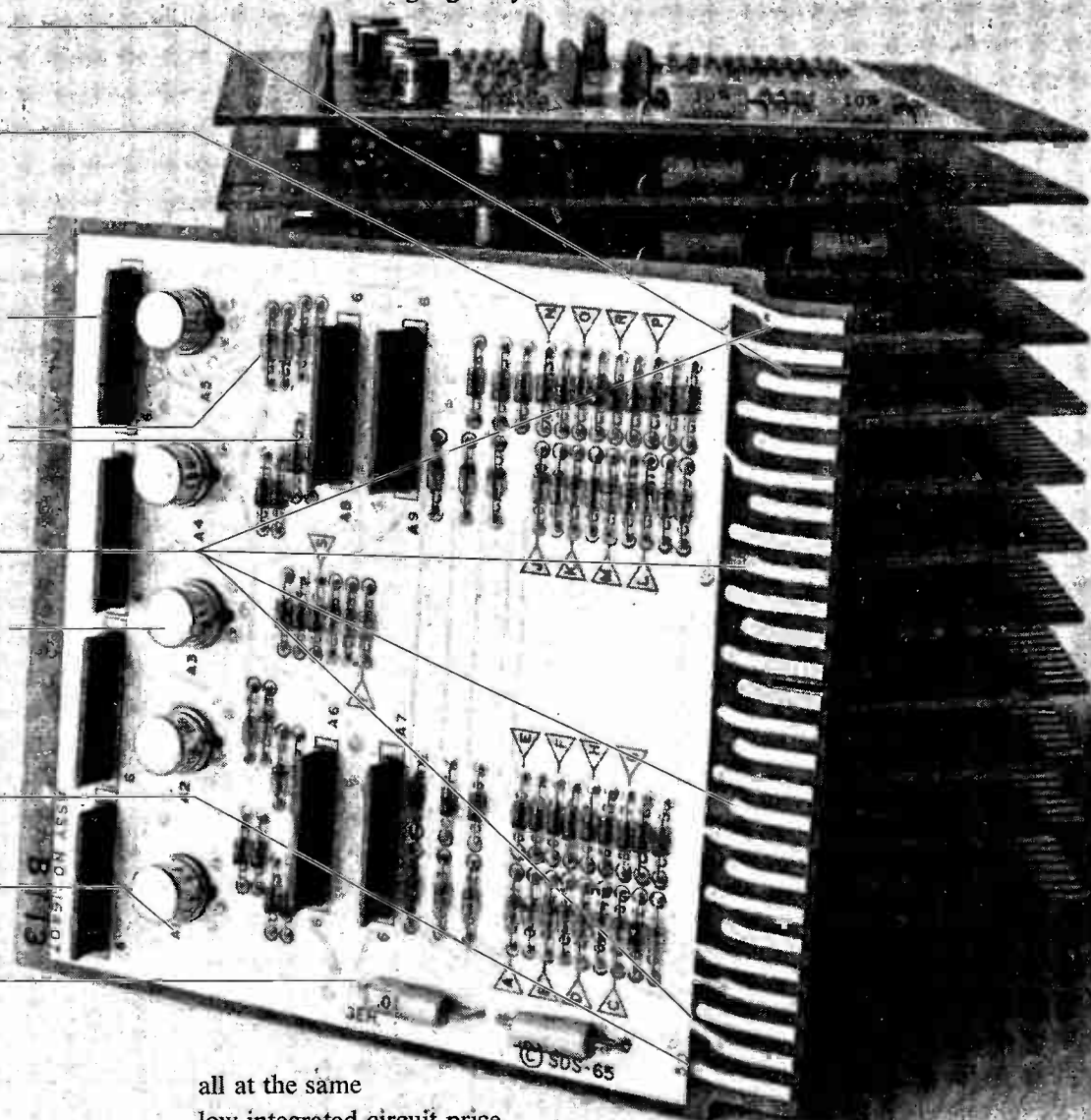

all at the same low integrated-circuit price.

We designed these modules for our new Sigma computers, but we also intend to become the largest manufacturer of logic modules for system designers.

We don't want to give away any of our Sigma secrets.

But we'll sell them pretty cheap.

**SDS**  
Scientific Data Systems,  
Santa Monica, California

# NEW

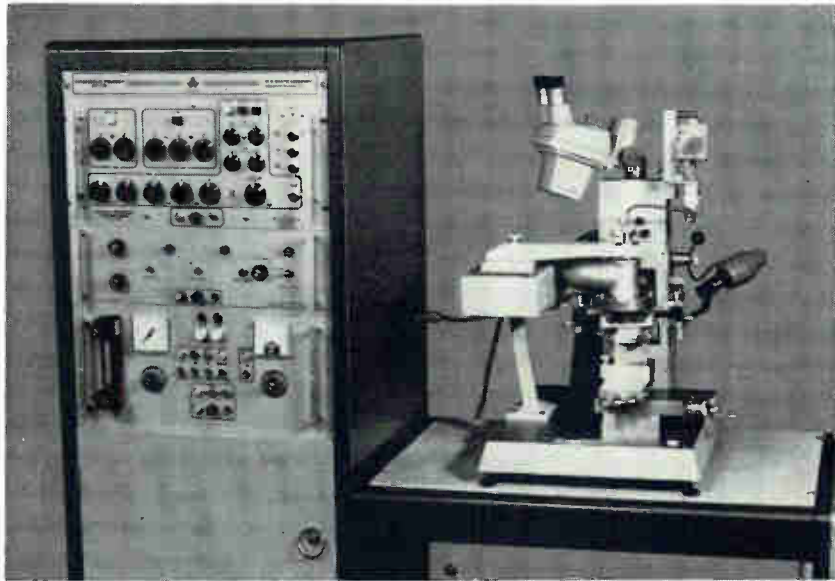

## Airbrasive<sup>®</sup> Resistor Trimming System:

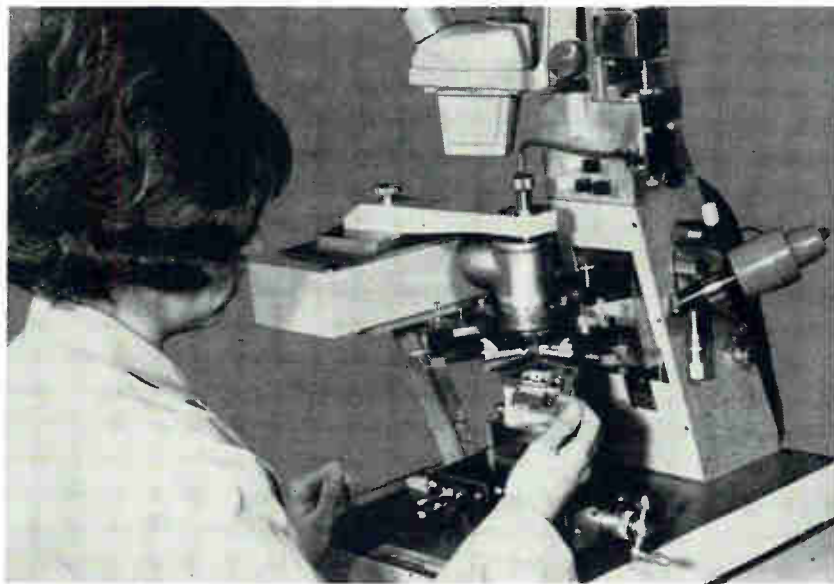

**a complete system that adjusts  
IC resistors to 0.5% accuracy**



Production rates of 600 trims per hour are attainable with this new, complete system which automatically trims and tests resistors to any specified value within 0.5%. Once operator has placed module in position, checking, trimming, and inspection are automatic. Complete cycle requires from one to three seconds, depending on programmed tolerance and the amount of material to be removed.

Final value tolerance limits may be programmed from 0% to 11% in increments of 0.1%. The machine increases production yield by holding programmed tolerance with great accuracy. Modules which cannot be trimmed to required value are rejected before further processing is done.

Trimming is accomplished by the proven Airbrasive method—a miniature abrasive jet of 27- $\mu$  aluminum oxide

provides precise, cool, shockless abrading which does not affect substrates or electrical properties of resistance material. Machine may be programmed for a wide range of values, will trim resistors in any position, on any size module, with thick or thin film substrate.

WRITE FOR BULLETIN 6610-A for detailed information

**FOR A LIVE DEMONSTRATION, SEE  
US IN BOOTH 1D30, IEEE**

S. S. WHITE COMPANY, INDUSTRIAL DIVISION  
Dept. R<sub>2</sub>, 201 E. 42nd St., New York, N.Y. 10017 Tel. 212 661-3320



**S.S. WHITE**<sup>®</sup>

**NEW!**

20kHz - 20MHz

IMMEDIATE DELIVERY  
FROM STOCK  
\$6,605.

XTAL  
MARKER GENERATOR

LARGE READOUT  
TUBE (8 x 14 cm)

SELECTIVE  
TRACKING RECEIVER

SWEEP SIGNAL  
GENERATOR

OPTIONAL SIDE BAND  
ADAPTER (30 - 1000MHz)

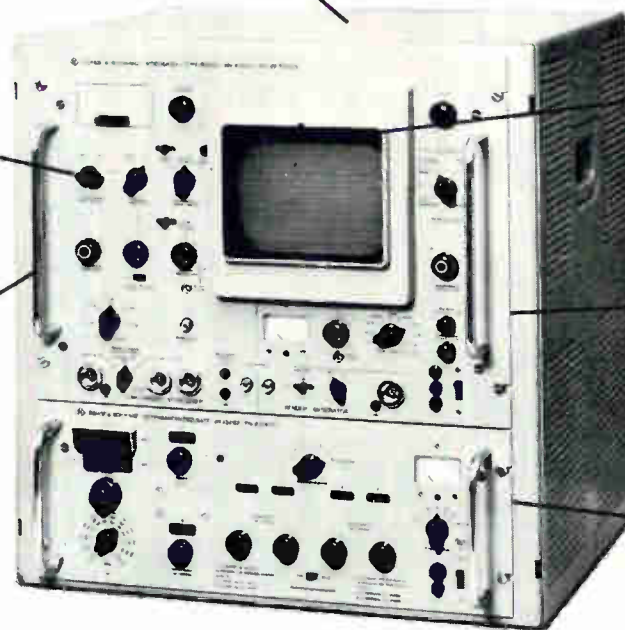

## VIDEOSKOP TYPE SWOF SWEPT FREQUENCY SYSTEM

### FEATURES:

- Complete test system: Sweep Signal Gen., Selective Tracking Receiver, Large Display Unit
- Frequency range: 20kHz — 20MHz
- Sweep width: 1-16MHz
- Sweep rate: .2 to 20 sweeps/sec.
- Selective tracking receiver: 3kHz bandwidth
  - Permits measurements in presence of sync. and blanking pulses
  - Use as spectrum analyzer
- Separate audio and video inputs
- Use as Sweep Source and Plotting Detector with R/S Type LFM Group Delay Test Set

### MEASURE:

- Absolute and relative amplitude-frequency response
- Return loss
- Transmission characteristics of TV units
- Amplitude characteristic of TV Test Demodulator

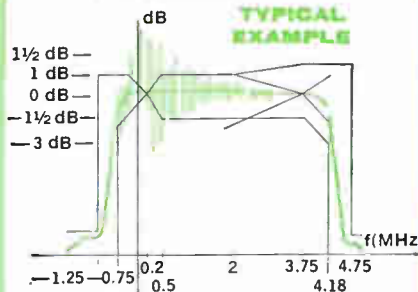

Vestigial sideband characteristic of a TV channel signal generator (SBTF). Test condition: Sweep component in composite picture signal 10% of picture, set-up at picture white. Combination of analyzing and sweeping methods permits the sideband characteristic to be studied between the pulse spectrum lines.

Videoskop is a complete visual display sweep frequency system covering the range of 20kHz to 20MHz. An optional sideband adapter (\$5,605) extends the range to 1,000MHz and permits measurement of sideband characteristics to within 50kHz of TV picture carrier. Type SWOF Videoscope provides an automatic display of the amplitude response of a test item instantaneously, thereby eliminating point-by-point measurements. Level meter, calibrated input and output attenuators, and crystal marker generator (0.5, 1.0, 5.0MHz, EXT.) permit absolute measurements. Selective tracking receiver makes possible plotting of characteristics of TV systems in the presence of sync. and blanking pulses. It further eliminates errors due to harmonics and can be used as a spectrum analyzer. Measuring range is 40dB dynamic and 100dB overall. By substitution attenuation or gain as small as 0.1dB can be easily measured. Accessories available: single sideband adapter, camera adapter, graticules in accordance with FCC TV-transmission standards and custom graticules to your specifications.

Get The Extra Capability,  
Greater Reliability, and  
Longer Useful Life Of...



**ROHDE & SCHWARZ**

111 LEXINGTON AVENUE, PASSAIC, N. J. 07055 • (201) 773-8010

Inquiries outside the U.S.A. should be directed to Rohde & Schwarz, Muehlendorfstrasse 15, Munchen 8, West Germany

**We  
have  
the  
only  
fully compatible  
family of  
high speed  
and  
low power  
TTL  
circuits.**

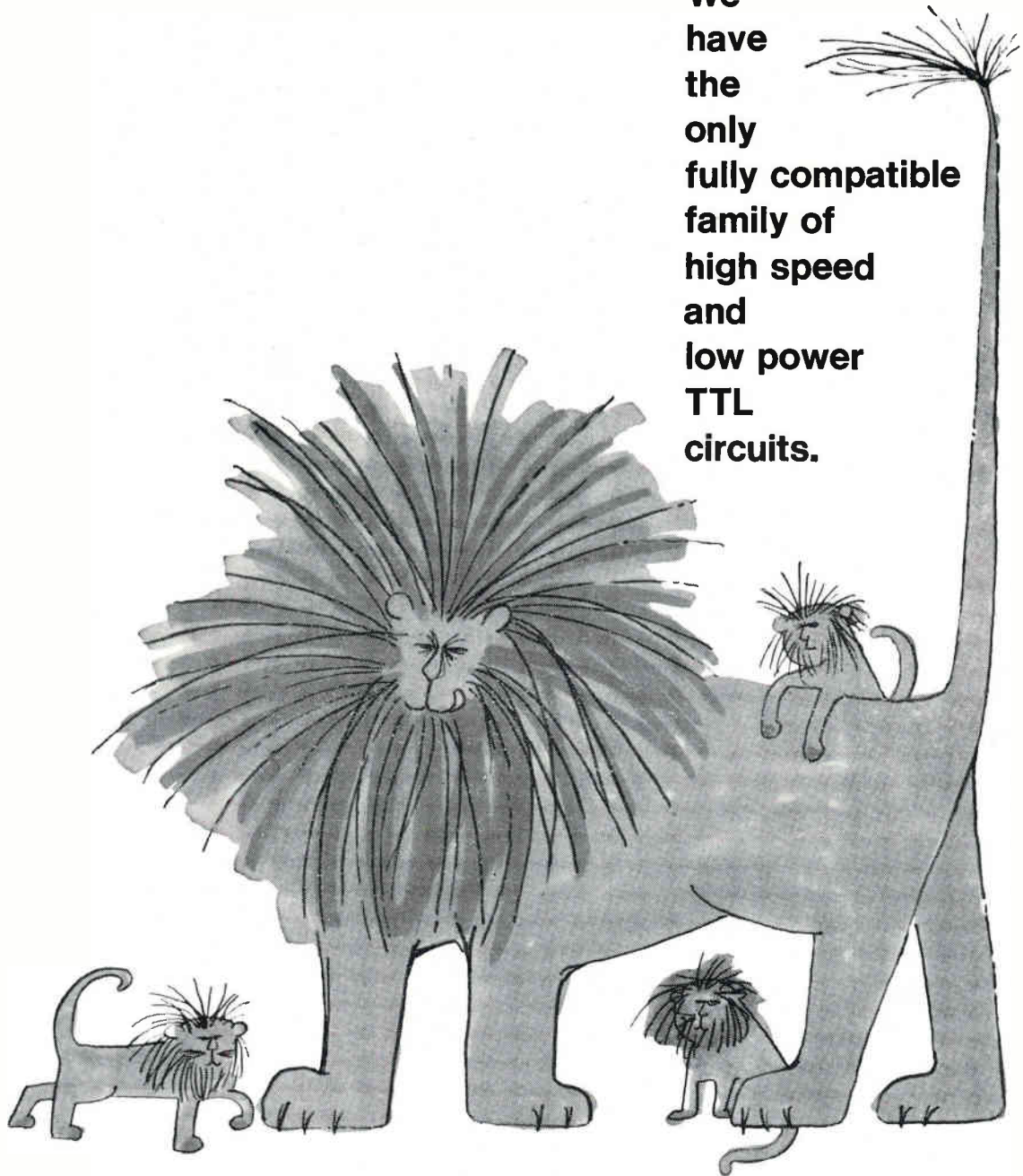

You can go wild with Signetics new Designer's Choice 8000 Series: it gives you the widest selection of design trade-offs in speed, power, noise immunity and price ever offered in a TTL family. The family consists of a very high speed set (the 8800's) and a fully compatible but slower low power set which offers very high AC noise immunity. Now TTL system designs can be optimized without laborious calculations, unusually expensive and time-consuming special ground-plane designs, or extensive use of outboard discrete components in areas where the highest possible speed is not required. All you do is follow the published S8000-series usage rules. All circuits are compatible over the full MIL temperature range of  $-55^{\circ}\text{C}$  to  $+125^{\circ}\text{C}$  and are available off-the-shelf in Signetics 14-lead glass-Kovar flat pack. Hunt up your local Signetics distributor. For further information on the Designer's Choice 8000 Series, write Signetics, at 811 E. Arques Avenue, Sunnyvale, California 94086. ■ At the IEEE Show, be sure to check into Rooms 3000A & B at the New York Coliseum, for latest Signetics news.

TYPE	DESCRIPTION		
S8416	Dual 4-Input Nand Gate	S8816	Dual 4-Input Nand Gate
S8417	Dual 3-Input Nand Gate	S8825	DC Clocked J-K Binary Element
S8424	Dual AC Binary Element	S8826	Dual J-K Binary Element
S8440	Dual Exclusive-Or Gate	S8840	Dual 4-Input Exclusive-Or Gate
S8455	Dual 4-Input Buffer/Drive	S8855	Dual 4-Input Power Gate
S8480	Quadruple 4-Input Expander	S8870	Triple 3-Input Nand Gate
S8806	Dual 4-Input Expander	S8880	Quadruple 2-Input Nand Gate
S8808	8-Input Nand Gate		

**SIGNETICS  
INTEGRATED  
CIRCUITS**



A SUBSIDIARY OF CORNING GLASS WORKS

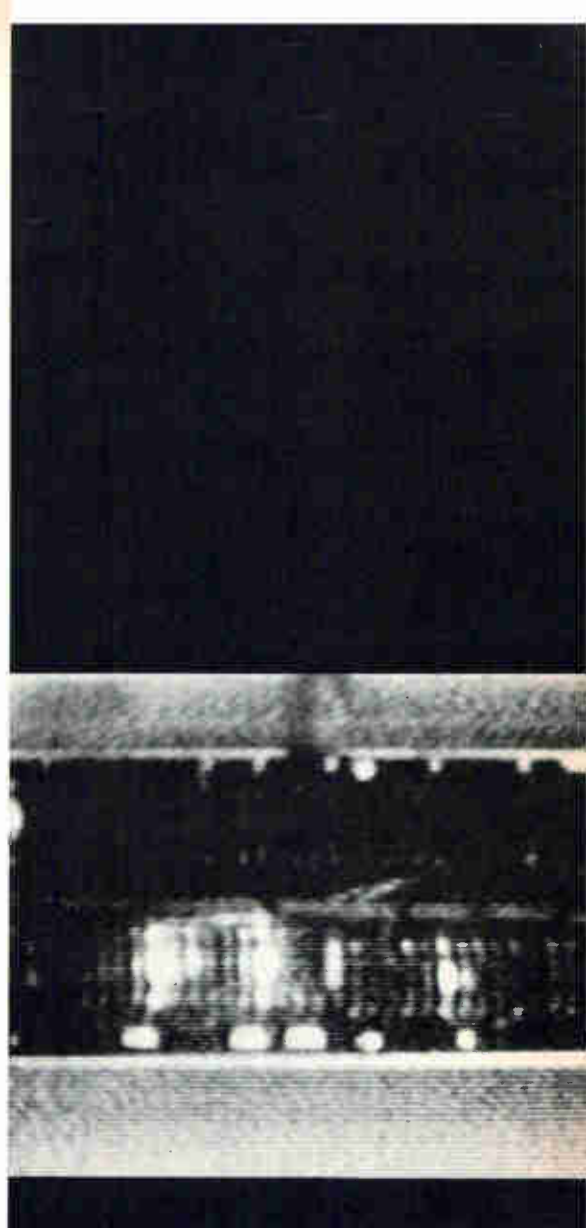
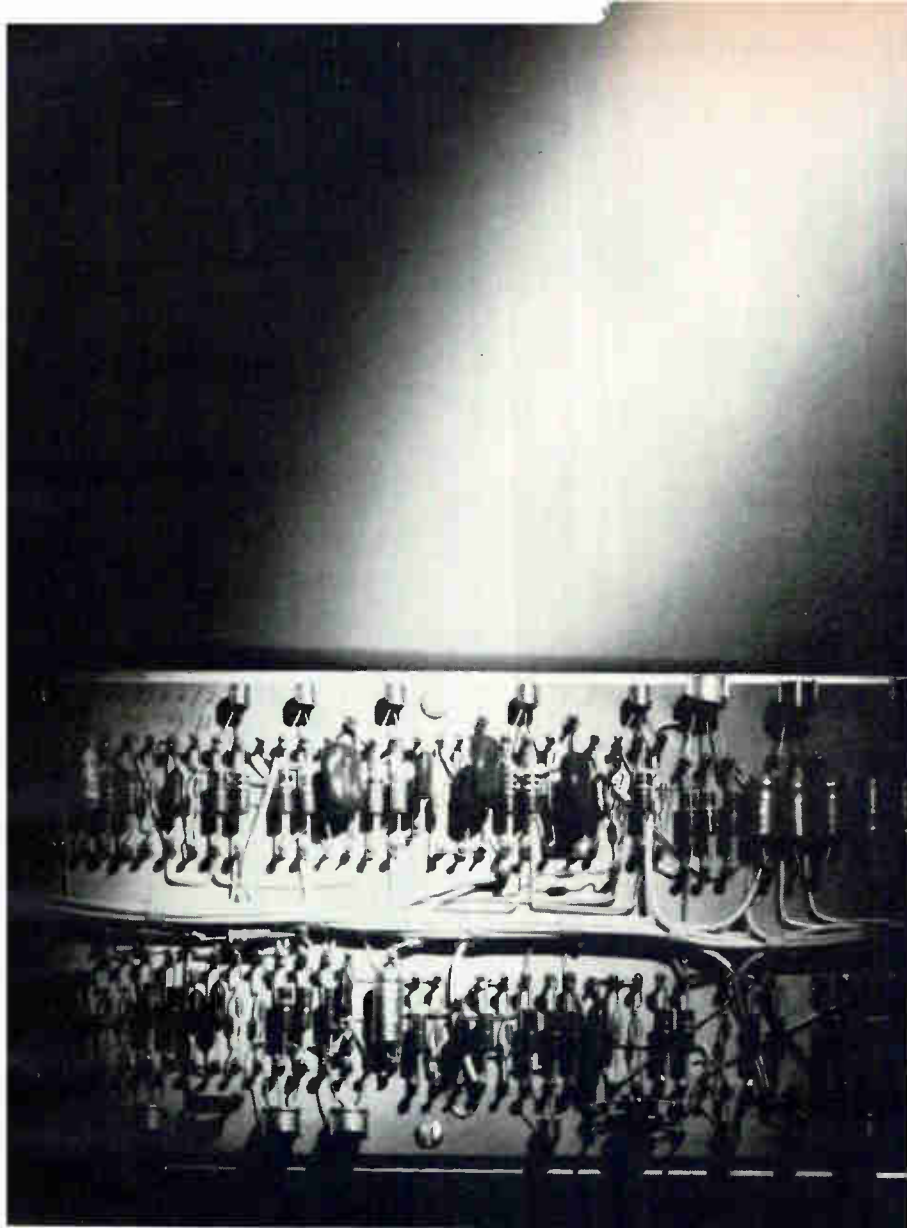

## What defect lurks in the shadows of this PC board?

Faulty diodes, overheating resistors, cold solder joints give themselves dead away under the searching eye of Sierra's Model 710B Infrared Scanner. And fast! The scanner puts the heat on hidden problem makers in as little as five seconds.

Model 710B functions as a closed-circuit television system that sees heat instead of light — an ideal setup for nondestructive testing. Point the scanner at an object, such as our PC board above, and seconds later a detailed thermal map appears on the scope (photo above right). Cool components remain relatively dark. Flaws show up as hot spots. By running a scan line you can measure absolute temperatures across the board. Model 710B lets you stop the scan at any point to study individual segments.

The scanner resolves thermal detail down to 0.03 inch at 3½ inches, discriminates gradients of 0.6°C. You can vary optical attenuation from 2°C to 1200°C black-to-white. The instrument scans a complete raster in five seconds, forming an image containing approximately 15,000 picture elements.

Model 710B consists of a precision scanner, tripod, power supply, dual-scope console, and Polaroid camera with special scope mount. For further data and detailed applications information, write Sierra, 3885 Bohannon Drive, Menlo Park, California 94025.

...The Scanner knows!

**PHILCO**

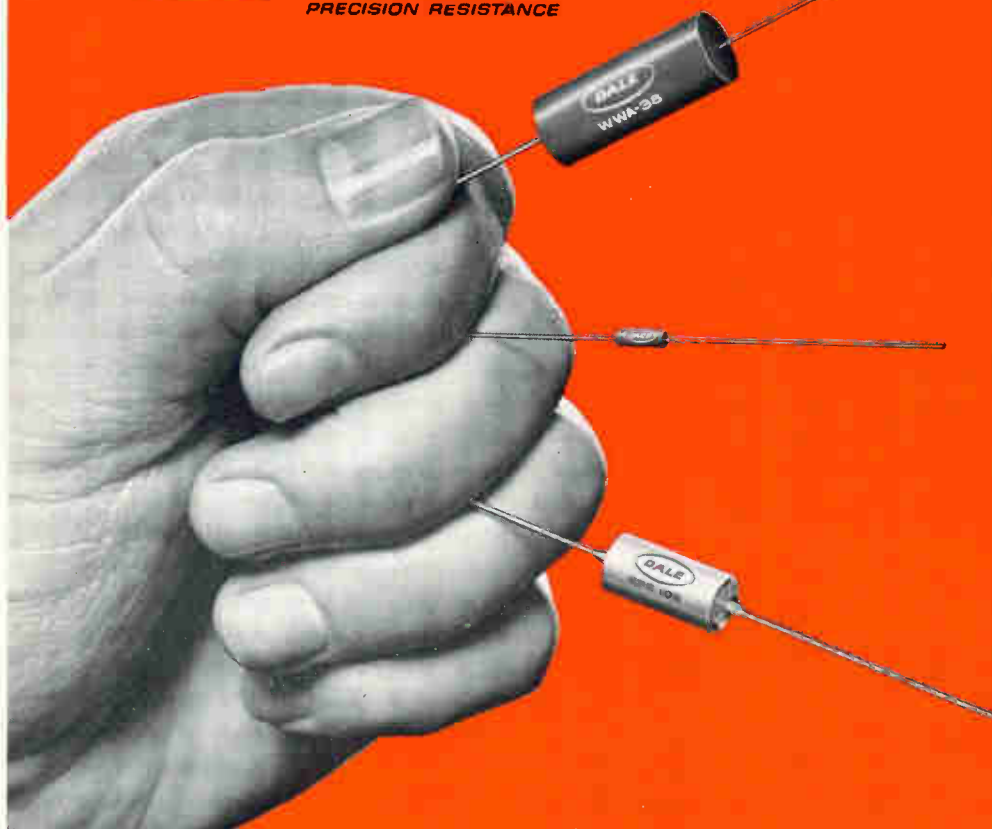

PHILCO-FORD CORPORATION  
Sierra Electronic Operation  
Menlo Park, California • 94025

**DALE****RELIABILITY**TOTAL CAPABILITY IN  
PRECISION RESISTANCE

## DALE can do a better job of making the BOBBIN you need

Specify Dale when you need the stability of a wirewound bobbin resistor. Here's why:

### 1. BETTER BASIC CONSTRUCTION

New molded bobbin spool has thermal expansion coefficient matched to resistance wire. Simplified element uses integral end cap to provide reliable stress-free termination area. All models meet applicable requirements of MIL-R-39005 and MIL-R-93.

### 2. BETTER WIRE QUALITY

Procured under same standards used in Dale's famous Minuteman High Reliability Development Program.

### 3. BETTER ALL-MOLDED PROTECTION

Special Dale-developed molding compounds provide solid, high-density package; pass salt water immersion test.

### 4. BETTER "SPECIAL" CAPABILITY

High-rel. models with special screening and acceptance testing. Multiple bobbin networks. Pairs matched for stability and T.C.

FOR MORE INFORMATION, CALL DALE — 402-564-3131  
OR WRITE FOR NEW RESISTOR CATALOG A

MWA & WWA SERIES BOBBIN SPECIFICATIONS

DALE TYPE	MIL-R-93 TYPE	POWER RATING (WATTS)	RESISTANCE RANGE (1% TOLERANCE)	DIMENSIONS (L. x D.)
MWA-8	—	.1	1 ohm - 100K ohms	.250 x .078
MWA-10	—	.125	1 ohm - 160K ohms	.312 x .078
WWA-13	—	.125	1 ohm - 311K ohms	.375 x .125
WWA-22	—	.15	.1 ohm - 600K ohms	.250 x .250
WWA-23	RB-56	.15	.1 ohm - 650K ohms	.375 x .250
WWA-24	RB-55	.20	.1 ohm - 900K ohms	.500 x .250
WWA-26	RB-54	.25	.1 ohm - 1.72 Meg.	.750 x .250
WWA-36	RB-53	.33	.1 ohm - 4 Meg.	.750 x .375
WWA-38	RB-52	.50	.1 ohm - 5.4 Meg.	1.000 x .375

**Standard Tolerances:** 1%, .5%, .25%, .10%, .05%

**Load Life:** .5% Max. ΔR in 1500 hours at MIL-R-93 conditions. Power ratings may be doubled for commercial applications.

**Operating Temperature:** -55° C to +145° C

**Special Modifications Available:** Tolerances to .005%; Matched Resistor Tolerances to .001%; Special TC's to ± 2 PPM/°C; Special Matched TC's to an accuracy of 1 PPM/°C.



**DALE ELECTRONICS, INC.**

1300 28th Ave., Columbus, Nebr. 68601  
In Canada: Dale Electronics Canada, Ltd.





---

# Washington Newsletter

---

February 20, 1967

## Systems approach seen coming on like gangbusters

The role of the electronics industry in the Johnson Administration's assault on crime will involve a total systems approach and the implementation of military-style command and control techniques rather than the production of two-way wrist radios and other Dick-Tracy-style devices that some in the industry had expected [Electronics, Aug. 8, 1966, p. 52]. S.I. Gass of IBM, a consultant to the staff of the science and technology task force on crime, says one proposed study would determine if emergency calls and the dispatching of police cars could be best handled by real-time computer response. Envisioned by the task force is a system in which a switchboard operator would feed the location of an emergency call directly into a computer. A dispatcher would immediately read out on a cathode-ray-tube display such data as the location and number of the police car and hospital nearest the scene of the call.

## Weigh new uses to save Ilaas

Two new jobs may save the integrated light attack avionics system. The Navy is considering using Ilaas displays in its F-111B aircraft and the Air Force may use technical inputs from the system in the F-X advanced tactical fighter. Being developed by the Sperry Gyroscope Co., the system was originally earmarked for the A-7 attack aircraft, but was dropped because it would have added \$230,000 to the plane's cost [Electronics, Oct. 3, 1966, p. 75]. The Air Force is also considering using technology from the Mark II avionics system for the F-X.

## Walkie-talkie firms unruffled by FCC band-change plan

Neither Japanese nor U.S. manufacturers are fretting much over the Federal Communications Commission's proposal to ban unlicensed walkie-talkies from the 27-megahertz Citizens Band. Most feel sure that no action will be taken for several years, perhaps as many as five.

The proposed changes in regulations covering unlicensed walkie-talkies—operated mainly by children—were prompted by growing complaints by licensed Citizens Band users about interference from the toys. The FCC proposal would shift the walkie-talkie allocation to a channel in the 40-kilohertz region and at the same time lower the permissible power limit for the radios from 100 milliwatts to 60 mw.

New designs to accommodate the shift to the higher frequency would force toy walkie-talkie producers—there are more than 80 in Japan alone—to raise their retail prices by about \$2 to \$3 a unit. Thousands of the walkie-talkies, some priced as low as \$10, are sold each year.

## Apollo changes may undercut other programs

The division of NASA funds is up in the air pending a report by a board of inquiry on the Jan. 27 disaster that killed three astronauts.

There is some worry among officials of the space agency's unmanned programs that fiscal 1968 budget funds earmarked for such projects as Apollo Applications and Voyager may be diverted to the manned Apollo program in the wake of the space capsule fire.

Pressure in Congress to pare NASA's \$5.1 billion budget request appears to be easing, but if costly Apollo changes are required, the unmanned programs may be undercut. However, NASA officials hint that the investigators will call for procedural revisions rather than more

---

# Washington Newsletter

---

expensive hardware modifications; such findings could also enable the agency to hold to its schedule of landing a man on the moon by 1970. Meanwhile, NASA will proceed with the launching of three unmanned Apollo flights this year.

## **FAA tests system reporting weather every two minutes**

A system to provide aircraft preparing to land with continuous reports on weather conditions above the runway is being tested by the Federal Aviation Agency at Atlantic City, N.J. In the trial program 13 observation points around the airfield, each equipped with rain, temperature and pressure gauges, rotating-beam ceilometers to measure cloud height, and transmissometers to measure visibility, are queried every 24 seconds. Analog outputs from the equipment are converted into digital signals and fed into a computer that checks the data and puts the information in forecast form.

Incoming pilots will receive updated weather reports every two minutes. The FAA hopes to eventually install the system at 25 major U.S. airports.

## **Comsat requests bids on terminals**

The Communications Satellite Corp. has asked for bids on three more satellite ground terminals. To be jointly owned by Comsat and international-communications common carriers, the stations will have fully steerable 85-foot antennas. Estimated cost: about \$5 million to \$6 million each.

One station will be built near King City, Calif., the second at one of four sites now being considered in West Virginia and the third in Puerto Rico where two sites are under study. The proposals, for architectural and engineering services, were sent to 35 firms. Comsat also has plans to add another antenna at its Hawaiian terminal.

## **U.S. copter system is studied by Bonn**

West Germany may be a customer for the Navy's integrated helicopter avionics system, which is nearing the production stage at Teledyne Inc. in Hawthorne, Calif. Some of the project's subsystems, such as stationkeeping radar, are being suggested for use in German military helicopters; Pentagon and Teledyne representatives are briefing Bonn officials in Germany this month.

## **Addenda**

The Internal Revenue Service is seeking \$1 million next year for optical scanner research and \$2 million for electronic direct data entry equipment . . . The Food and Drug Administration will set up an automatic laboratory in St. Louis to increase testing of drug samples from 40,000 annually to 1 million. A computer will tie together a modular complex of sorting, testing and evaluation equipment . . . Electronics companies spent \$122 million of their own money in 1965 on basic research, up \$10 million from 1964, and \$304 million on applied research, up from \$280 million. Company-funded development hit \$1.487 billion, up from \$1.445 billion in 1964, according to figures released by the National Science Foundation . . . Industry meetings may have to scratch policy briefings by Federal Communications Commission officials from their programs unless they can pick up the travel and per diem tab. The FCC has already spent all of its fiscal 1967 funds for these items.

# MATCH PROTECTOR TO HARDWARE



## An APL Circuit Protector—

will rupture a fault of 5,000 amperes at 240 volts!



provides a time delay for every demand!



is entirely magnetic — no heater elements!



Tripping coils can be completely isolated!



Gang every circuit together!

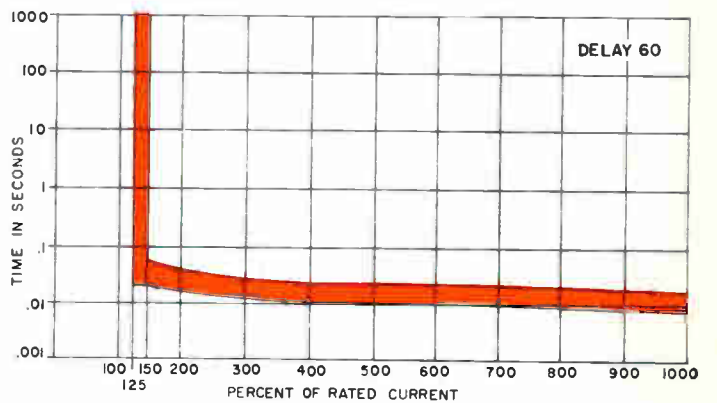
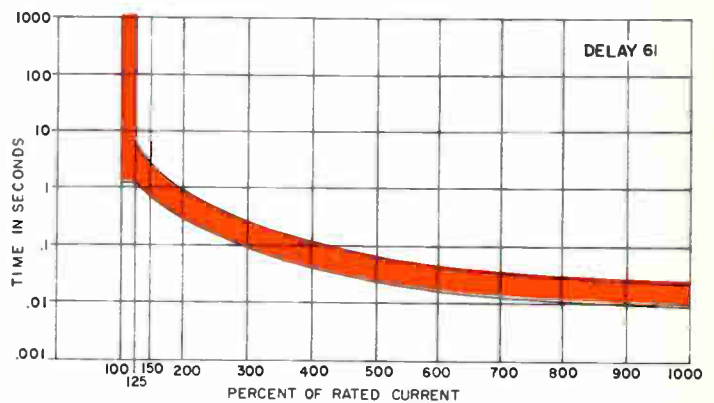
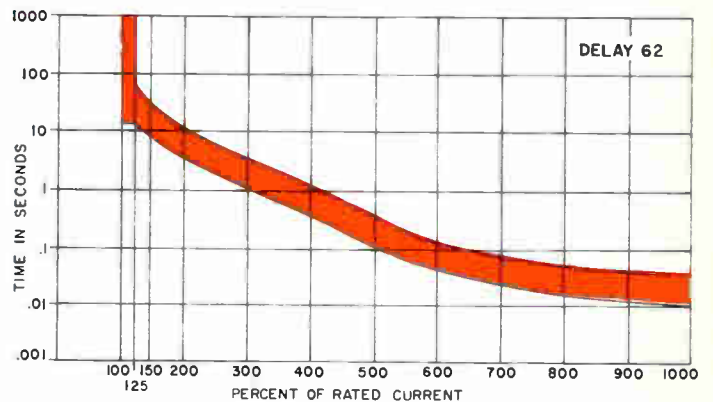
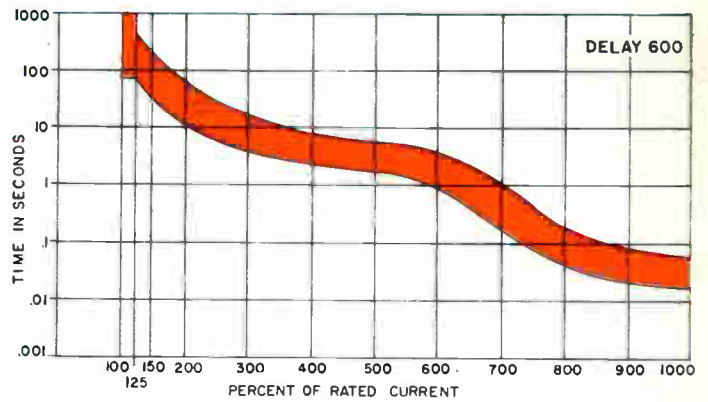
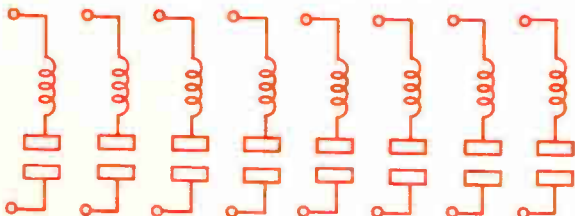

TYPICAL 60 CYCLE DELAYS

**AIRPAX ELECTRONICS**  
CAMBRIDGE, MARYLAND 301-228-4600

## **Total Systems Responsibility**

Look to COMCOR . . . to accept total responsibility in designing and building the world's largest hybrid computer systems — similar to the one shown below, now under construction for Lockheed Missiles & Space Company, Sunnyvale, California.

Look to COMCOR . . . mathematicians, applications engineers, logic designers, analog and digital specialists, programmers, and software people; experts with the knowledge to assume complete systems responsibility from logic design, through critical interfacing, to final assembly.

Look to COMCOR . . . backed by the corporate facilities of Astrodata, renowned for its leadership in large complex computer systems.

Look to COMCOR . . . whose precise combination of talents and facilities has made it responsible for the majority of large hybrid computer systems in existence today.



A Subsidiary of Astrodata, Inc.  
1335 South Claudina Street | Anaheim, Calif. 92803

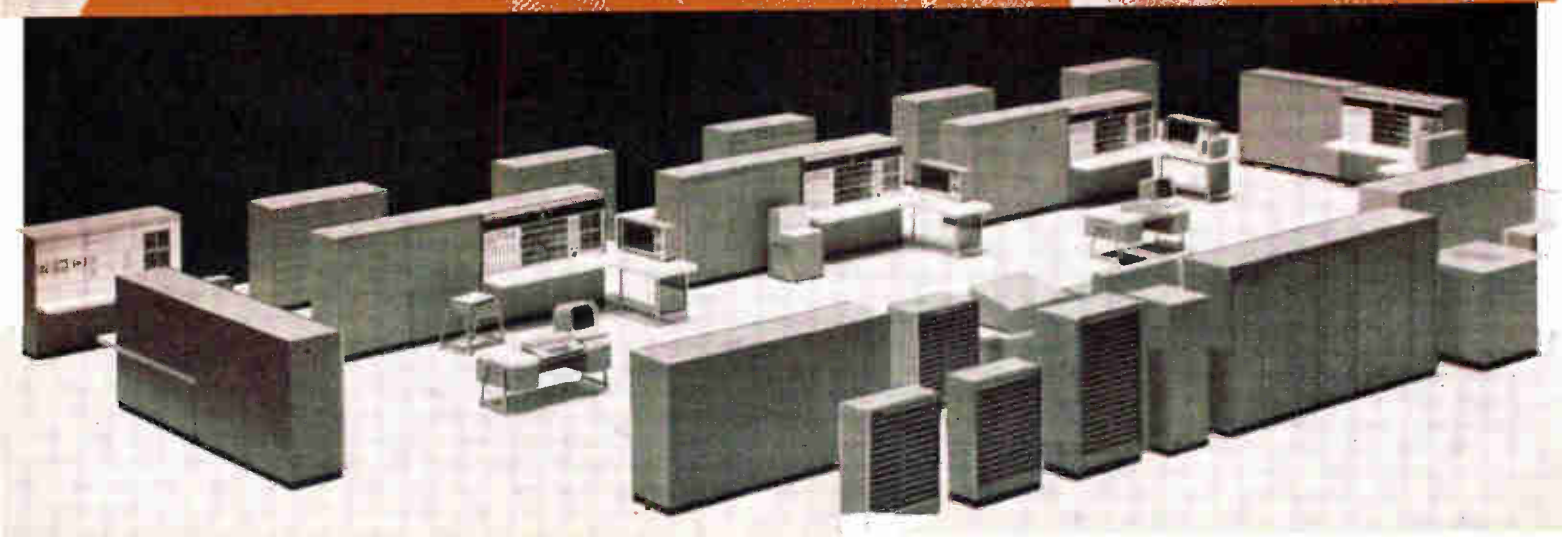

# can't decide to make or buy your power supplies?

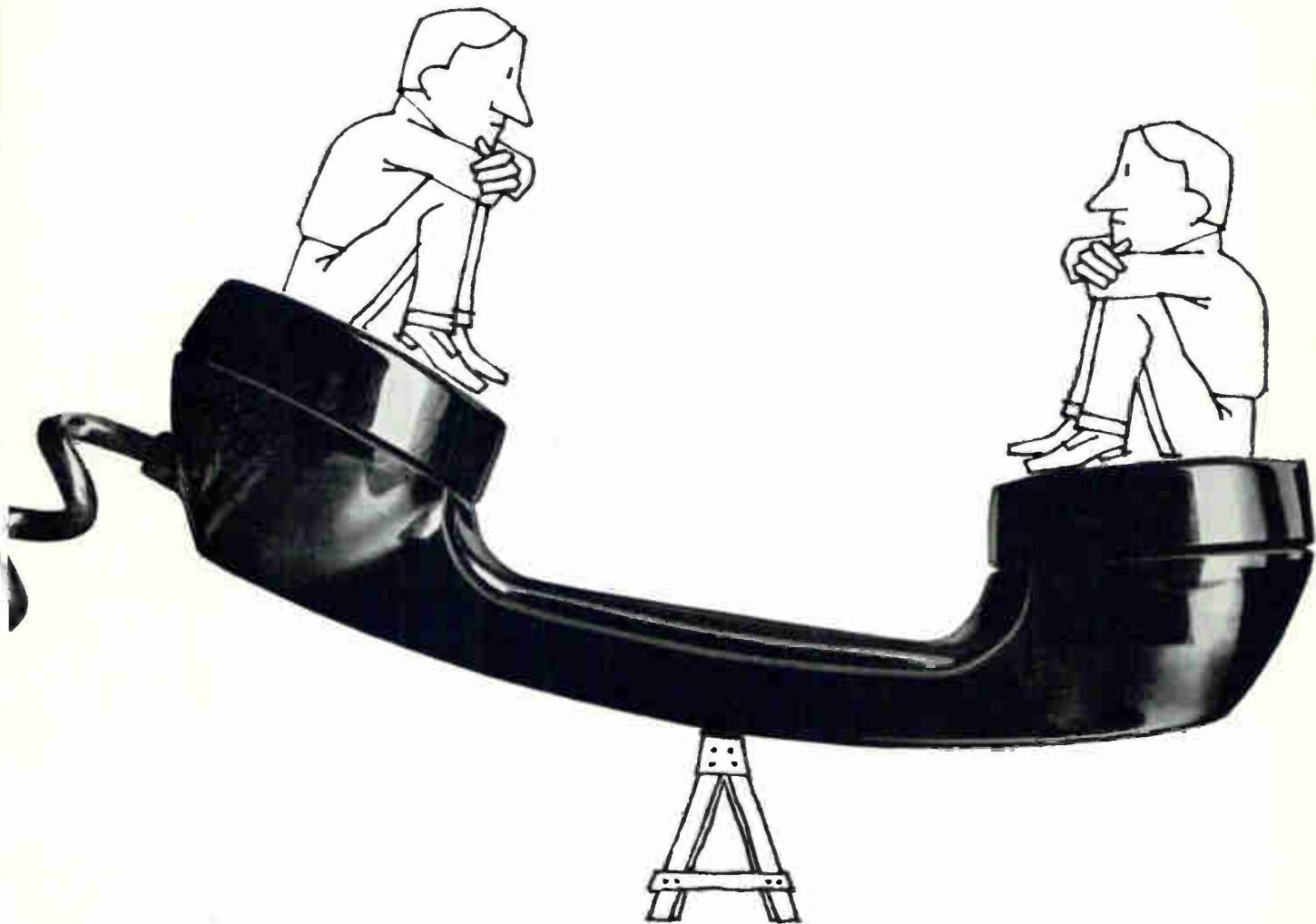

**call 312 439-2800**

Sola quotes both ways.

First, we'll quote an entire custom-built Sola power supply—designed to your specs by power supply specialists. Second, we'll tell you the cost of a custom Sola CV<sup>®</sup> transformer. And give you the ratings of other components, too,



so you can build your own power supply. Then you decide with the facts.

Want to know more? Call Marv Boyer at 312/439-2800. Or write him for catalogs CV-200 and PS-100: Sola Electric, 1717 Busse Road, Elk Grove Village, Illinois 60007.

**SOLA ELECTRIC** **SB**  
DIVISION OF SOLA BASIC INDUSTRIES

OTHER DIVISIONS: ANCHOR ELECTRIC • ENGINEERED CERAMICS • HEVI-DUTY ELECTRIC • LINDBERG HEVI-DUTY • NELSON ELECTRIC

# Send us a cable.



Send us a small sample, at least one foot, of the coaxial cable you're using and tell us what you're using it for. Then we'll install the Burndy crimp removable coax contact that'll do the job best. Guaranteed.

A tough job? Not really.

Remember, crimp removable contacts began at Burndy. As a result Burndy offers the most complete line of coaxial connectors for standard, miniature and sub-miniature coaxial cables. And

they're available for all rectangular, rack and panel and terminal block configurations.

Send your sample along to Mr. M. Elkind, Product Manager, Burndy, Norwalk, Conn. He'll see that the job is done and returned quickly. You'll receive our latest coax connector catalog, too.



INTERNATIONAL SALES HEADQUARTERS AND MANUFACTURING FACILITIES:  
CANADA: Scarborough, Ontario / ENGLAND: St. Helens, Lancs. / BELGIUM: Mechelen / MEXICO: Naucalpan de Juarez / BRAZIL: Sao Paulo / JAPAN: Tokyo / Sales Offices in Other Major Cities

# TRW CAPACITORS ARE SMUG



...especially our new metallized polycarbonates!

TRW has now extended its leadership in film capacitors to include metallized polycarbonate types. Two features of the X463UW are outstanding. Precise processing assures low TC through temperature ranges to 125° C. Metallized construction reduces size to less than one half that of film-foil designs. Other features of the line include:

- Capacity range from .01 to 10.0 mfd
- Low dielectric absorption
- Available in tolerances to  $\pm 1\%$
- Humidity resistance per MIL-C-27287

For full information contact: TRW Capacitors, Box 1000, Ogallala, Nebraska. Phone: 308-284-3611 • TWX: 910-620-0321.

## **TRW** CAPACITORS

The top half of the advertisement features a black and white photograph of a young child smiling and looking down at a turtle. The child is holding the turtle, which is resting on a dark, textured rock. The child is wearing a light-colored shirt. In the upper left corner of the photograph, the Siemens logo (a stylized 'S' symbol) is positioned above the word 'SIEMENS' in a bold, sans-serif font.

**SIEMENS**

## durability

Performance tests of up to 64,000 hours (approx. 8 years) show that Siemens electrolytic capacitors can operate as long as all other types of capacitors. This is achieved through an optimum balance of dissipation and corrosion. Siemens electrolytic capacitors feature minimum size along with maximum performance, and are available out of stocks in White Plains, N.Y. Tell us your application, we'll be glad to show you how adaptable they are. It's child's play.

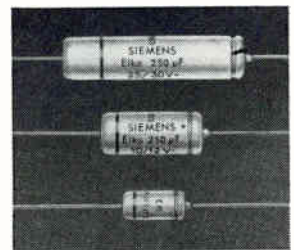

### SIEMENS ELECTROLYTIC CAPACITORS

99.99% pure aluminum for the anode makes it possible for Siemens to project performance capability accurately for usage up to 100,000 hours (approx. 12 years). Special sealing technique and choice of materials assure longest possible operational span of electrolyte. Siemens components include ferrite materials, metallized polyester and polystyrene capacitors, all electronic and microwave tubes, rectifiers and a complete line of semi-conductors.

**SIEMENS AMERICA INCORPORATED**

VISIT BOOTH 4J 20-22 I.E.E.E. SHOW

Components Division • 230 Ferris Avenue, White Plains, N.Y. 10603





Many parts can be plated better, faster,  
and more economically with  
**BURTON'S NEW CONTINUOUS  
PRECIOUS METAL PLATING PROCESS**

Burton's new CONTINUOUS precious metal plating process normally reduces cost of precious metal substantially by putting the plating only where you want it. In addition, some parts can be plated and manufactured ready for your use (see inset)!

If you use precious metal plated parts of any kind this outstanding advancement in plating techniques may save you time

and money while greatly improving quality. Why not find out about it? We'd be glad to send you complete information.

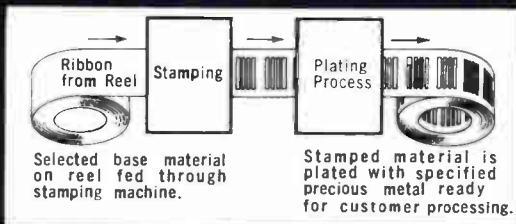

**BURTON RESEARCH LABORATORIES, INC.**  
11240 PLAYA / CULVER CITY, CALIFORNIA / (213) 391-6325  
*A Division of Burton Silver Plating Company*

# NEW

## Lambda high current LK Series power supplies 0-20, 0-36, 0-60 VDC • up to 35 amps • 5¼" height • starting at \$330.

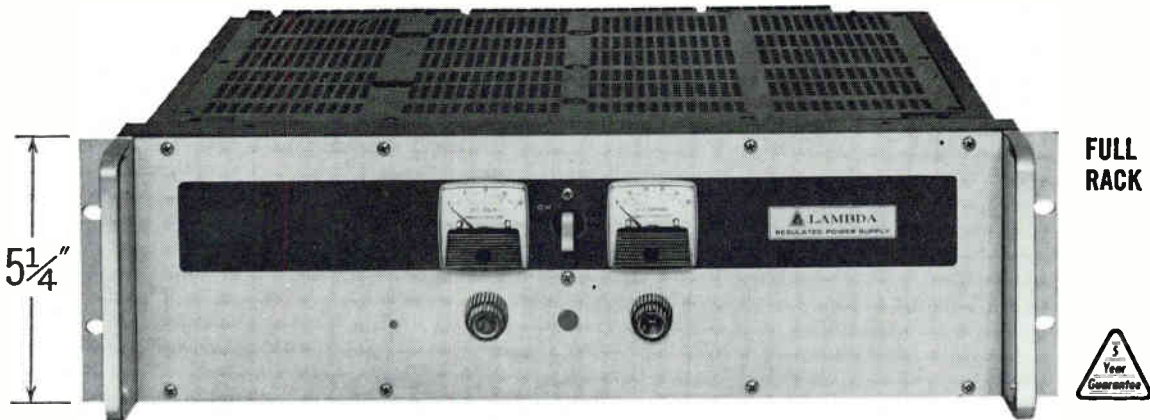
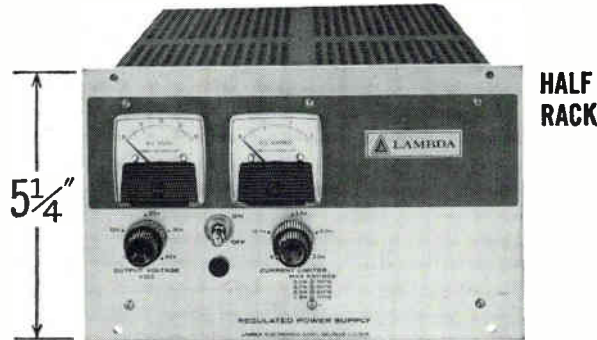

### Features

- All Silicon
- Convection cooled
- Remotely programmable
- Meet Mil-Environment specs

Vibration, MIL-T-4807A

Shock: MIL-E-4970A

- Proc. 1 & 2

Humidity: MIL-STD-810

- Meth. 507

Temp. Shock: MIL-E-5272C

- (ASG) Proc. 1

Altitude: MIL-E-4970A

- (ASG) Proc. 1

Marking: MIL-STD-130

Quality: MIL-Q-9858

- Remote Sensing

- Series/Parallel Operation
- Regulation—.015% or 1 MV (Line or Load)
- Ripple—500  $\mu$ V RMS.
- Temp. Coef. .015%/°C
- Transformer—designed to MIL-T-27 Grade 6
- Completely Protected—Short Circuit Proof—Continuously Adjustable Automatic Current Limiting
- Constant I./Constant V. by automatic crossover
- No Voltage Spikes or Overshoot on "turn on, turn off" or power failure
- Wide Input Voltage and Frequency Range—105-132 VAC, 47-63 cps

Rack or Bench use—rubber feet included for bench use.

### 3 full-rack models — Size 5¼" x 19" x 16½"

Model <sup>2</sup>	Voltage Range	CURRENT RANGE AT AMBIENT OF: <sup>1</sup>				Price <sup>2</sup>
		40°C	50°C	60°C	71°C	
LK 350	0-20VDC	0-35A	0-31A	0-26A	0-20A	\$675
LK 351	0-36VDC	0-25A	0-23A	0-20A	0-15A	640
LK 352	0-60VDC	0-15A	0-14A	0-12.5A	0-10A	650

### 6 half-rack models — Size 5¼" x 8¾" x 16½"

Model <sup>2</sup>	Voltage Range	CURRENT RANGE AT AMBIENT OF: <sup>1</sup>				Price <sup>2</sup>
		40°C	50°C	60°C	71°C	
LK 340	0-20VDC	0- 8.0A	0- 7.0A	0- 6.1A	0-4.9A	\$330
LK 341	0-20VDC	0-13.5A	0-11.0A	0-10.0A	0-7.7A	385
LK 342	0-36VDC	0- 5.2A	0- 5.0A	0- 4.5A	0-3.7A	335
LK 343	0-36VDC	0- 9.0A	0- 8.5A	0- 7.6A	0-6.1A	395
LK 344	0-60VDC	0- 4.0A	0- 3.5A	0- 3.0A	0-2.5A	340
LK 345	0-60VDC	0- 6.0A	0- 5.2A	0- 4.5A	0-4.0A	395

<sup>1</sup> Current rating applies over entire voltage range.

<sup>2</sup> Prices are for non-metered models. For metered models add suffix (FM) to model number and add \$30.00 to price.

<sup>3</sup> Overvoltage Protection: Add suffix (OV) to model number and add \$70.00 to the price for half-rack models; \$90.00 for full-rack models.



LAMBDA ELECTRONICS CORP.

515 BROAD HOLLOW ROAD • MELVILLE, L. I., NEW YORK • 516 MYRTLE 4-4200

A Veeco SUBSIDIARY

LA-173

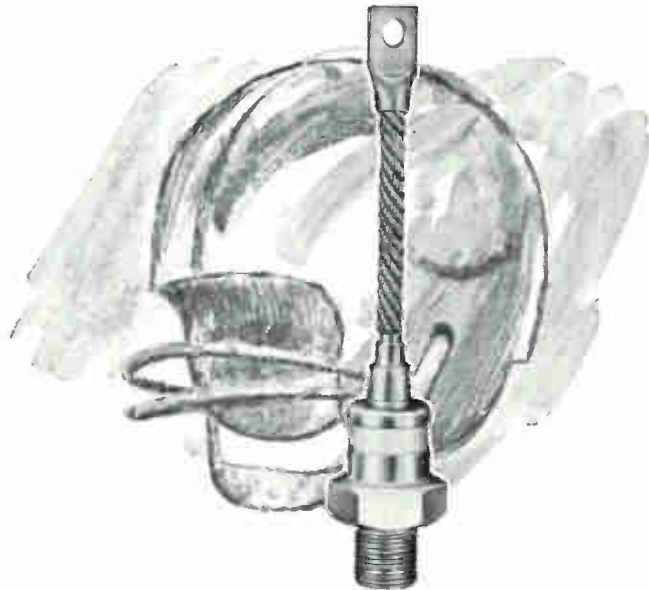

## ***Put in the first team***

### **Syntron's Full Line of Avalanche Silicon Rectifiers Score High**

When you need reliable conversion of electric power, call on the performance-proven line with built-in protection against voltage transients. Diodes with complete Jedec listings from 1 to 250 amperes. Efficient Avalanche Silicon Controlled Rectifiers in 3 sizes—16, 70 and 150 amperes. Mail coupon.

Please send details about Syntron's Complete Line of Rectifiers

Name & Title \_\_\_\_\_

Company \_\_\_\_\_

Street \_\_\_\_\_

City & State \_\_\_\_\_ Zip \_\_\_\_\_



**SYNTRON COMPANY**

241 LEXINGTON AVE. • HOMER CITY, PA. 15748

TELEPHONE 412-479-8011

Sales Representatives Coast-to-Coast

67R5



# Name your failure rate

this  
G-E  
sealed  
relay  
will give  
it to you

But you have to let us establish:

- level of confidence
- operating conditions
- what constitutes a failure

By varying these conditions, we can give you any failure rate you want.

Doesn't make sense, does it? You're supposed to set the conditions. Not us.

That's why we don't establish failure rates till you give us application information.

If we did, we'd hurt you. And us.

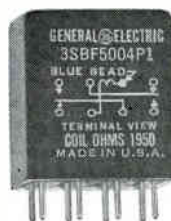

You, because you might buy the wrong relay.

Us, because we might hurt our reputation and lose you—a valued customer.

Want realistic failure rate data and the best relay for your next project? Contact your G-E Electronic Components Sales Engineer. Or for latest catalog information, write General Electric Company, Section 792-40, Schenectady, New York 12305.

**GENERAL**  **ELECTRIC**

**Now available in  
16 different configurations  
– all with 0.01% accuracy –**

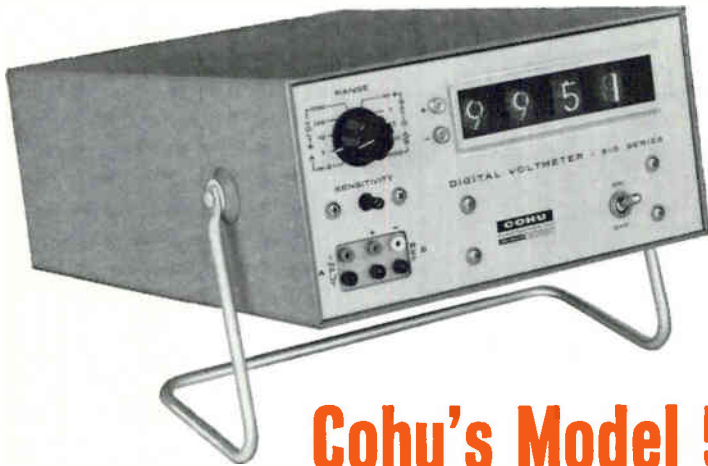

## **Cohu's Model 510 Series Digital Voltmeter-Ratiometer!**

This highly reliable and stable instrument is now being delivered in models to meet virtually every application—laboratory, bench and assembly line. The basic cabinet model weighs only 12 lbs. and sells for \$995, while the basic rackmount model is \$1050. Both prices are FOB San Diego. Additional export charge.

The 510 series is available either with manual ranging only or optionally with both manual and automatic ranging of the four voltage ranges. Electrical output options are biquinary, 1248 BCD, or 1224 logic level outputs, enabling this DVM to drive most types of digital recording devices. An optional accessory probe is also available.



### **These features are common to all models in the 510 Series:**

- 0.01%  $\pm$  1 digit accuracy
- automatic polarity indication
- 4-place reading on all ranges
- 4 manual ranges, 2 functions  
(1V to 1000V, 1:1 to 1000:1 ratios)
- single control, range and function
- front panel sensitivity control
- high input resistance
- solid-state reference and circuitry
- bidirectional tracking logic

For full details, contact Cohu engineering representatives in major cities throughout the world.



Box 623  
San Diego, California 92112  
Phone 714-277-6700

# AE stocks over 200 types of relays and switches

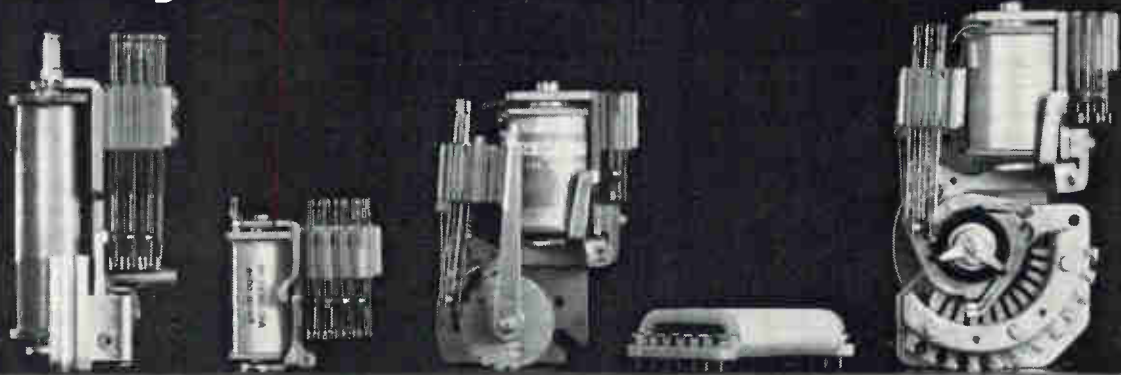

## for off-the-shelf delivery within one week!



Get fast, direct delivery—at no extra charge. Thanks to the Automatic Electric Stock Program.

This program keeps growing. Now, we stock over 200 kinds of relays, switches, and accessories. In large enough quantities to fill your normal prototype requirements within 7 days.

That means fast delivery on many of the most popular types from AE's broad line. EIN (integral socket) relays with power contacts; mercury-wetted-contact relays; PC Correeds; rotary step-

ping switches with gold levels for dry- and low-level circuits; ERM (magnetic latching) relays; Class E relays with four different wire termination methods; and many more.

Send for a free copy of Circular 1053, our newest "Stock Letter." It's the latest listing of items you can get quickly. Just write to the Director, Relay Control Equipment Sales, Automatic Electric, Northlake, Illinois 60164.

***AUTOMATIC ELECTRIC***  
SUBSIDIARY OF  
GENERAL TELEPHONE & ELECTRONICS **GTE**

# NEW DVM



This special version of the popular, field-proven Hewlett-Packard 3460A Digital Voltmeter provides an accuracy and stability that makes 1 ppm resolution realistic.

**ACCURACY**—The H04-3460A can measure up to 1200 v and maintain an absolute accuracy of  $\pm 0.002\%$  of reading or  $\pm 0.0004\%$  of full scale for 24 hours after calibration. Long-term absolute accuracy is  $\pm 0.005\%$  of reading or 0.0005% of full scale, guaranteed for 90 days (over 20°-30°C).

**STABILITY**—Typical stability of the internal reference is 0.001% per month. Readings are typically repeatable to better than 2 ppm.

**USES**—Low-level (strain gauge, thermocouple, transducer) measurements with an absolute accuracy not obtainable before (0.005% of reading at 100 mv). Semiconductor temperature coefficient and long-term stability monitoring. Standard cell intercomparison with 1  $\mu\text{v}$  resolution (ten times more than previously available). Null detection applications with typical 2  $\mu\text{v}$  error.

Besides programmability and BCD output, the H04-3460A has front and rear isolated inputs so that measurements can be compared against a rear-connected standard cell by using the convenient front-panel switch.

With the low price of \$4250, you may want to call your Hewlett-Packard field engineer or write for more information to Hewlett-Packard, Palo Alto, California 94304, Tel. (415) 326-7000; Europe: 54 Route des Acacias, Geneva.

**1  $\mu\text{v}$  in 1 v,  
1 mv in 1000 v—  
six full digits,  
plus a seventh  
for 20%  
overranging!**



**HEWLETT**  **PACKARD**  
*An extra measure of quality*

*Data subject to change without notice. Price f.o.b. factory.*

*“Why do more and more executives say MICHIGAN has more of everything?”*



*“... because superb educational and research facilities place Michigan among the nation’s leaders.”*

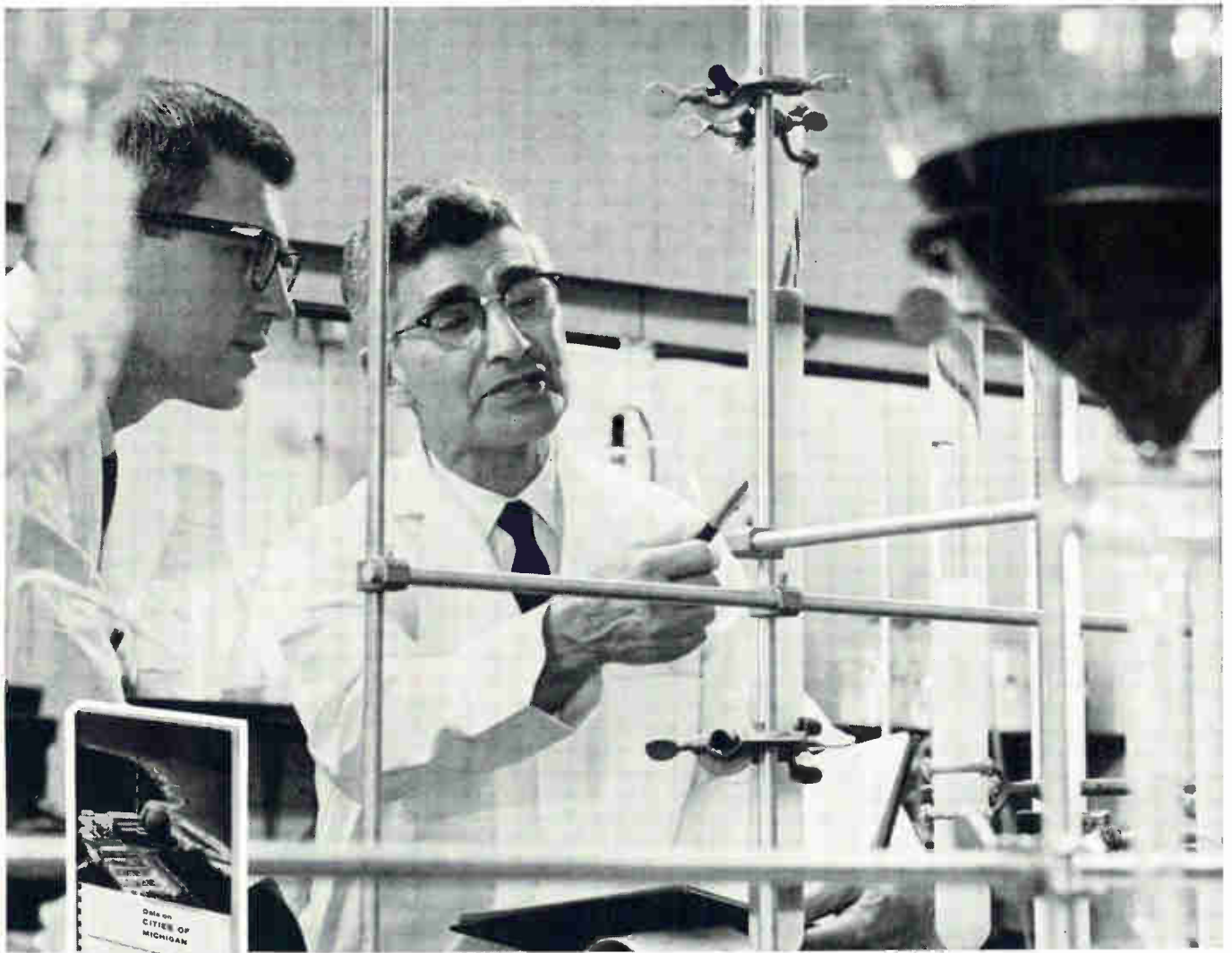

For the research-minded or technically oriented company, Michigan is a must. Its universities produce 25% more Ph.D.s than the state uses — 10% of all engineering and science Ph.D.s in the nation. And Michigan industrial research facilities are keeping pace with this tremendous output of scientific manpower. Research activity has soared at a rate far in excess of the national average.

If you are interested in utilizing Michigan’s vast education and research capabilities in your own profit-growth plan, write in confidence:



**Consumers  
Power  
Company**

Director of Area Development • 216 West Michigan Ave., Jackson, Michigan 49201 • Area Code 517-788-0500





## Here's an engineer's magazine even your wife will love

It's the *portable* chart paper magazine from our new Mark 250 Strip Chart Recorder. Now you can take the record home with you, or any place for that matter! Manual turning knobs let you roll the chart forward and back. Later, you can re-record on the same chart for side-by-side comparison. Chart take-up is automatic. And you can reload the magazine in seconds. (Many users get an extra magazine . . . study one while the other is in the recorder.)

But the world's slickest chart magazine is just one of the Mark 250's great new features. Step response over the full 4½-inch span (10% to 90%) is 40 milliseconds . . . records up to 100 cps . . . flat to 10 cps full scale! Choice of 21 interchangeable preamps. Pushbutton selection of 12 chart speeds. Crisp, clear, rectilinear presentation. Patented,

pressurized inking system. Owners say there's no other strip chart recorder in the same league.

Words just don't do it. You have to see a Mark 250 to understand why it's called "the first strip chart recorder for the perfectionists of the world." A call to your local Brush Sales Engineer brings a Mark 250 right to your office or lab. Go ahead. Even *our wives* will love you for *that*. Clevite Corporation, Brush Instruments Division, 37th & Perkins, Cleveland, Ohio 44114.



**CLEVITE**  
—brush INSTRUMENTS DIVISION

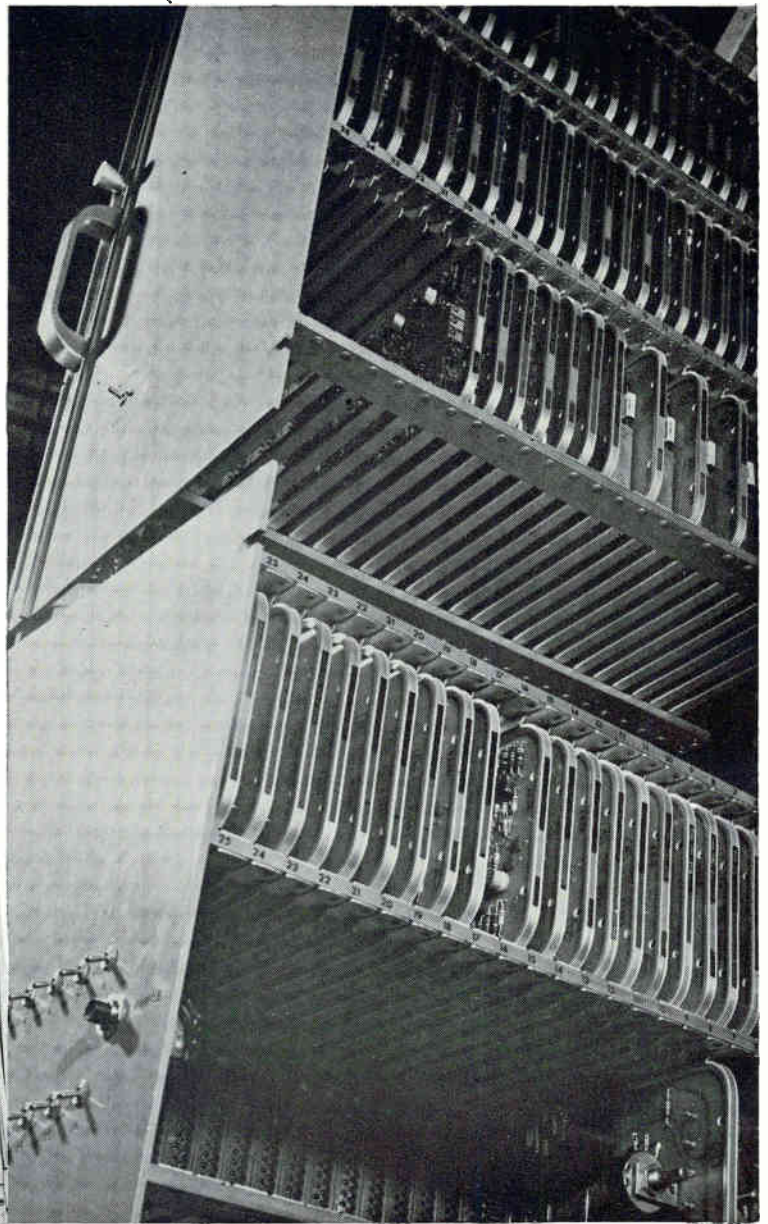
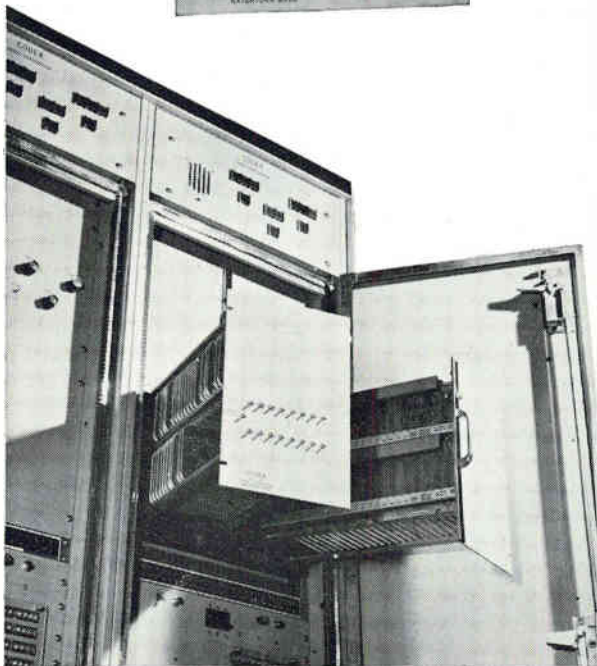
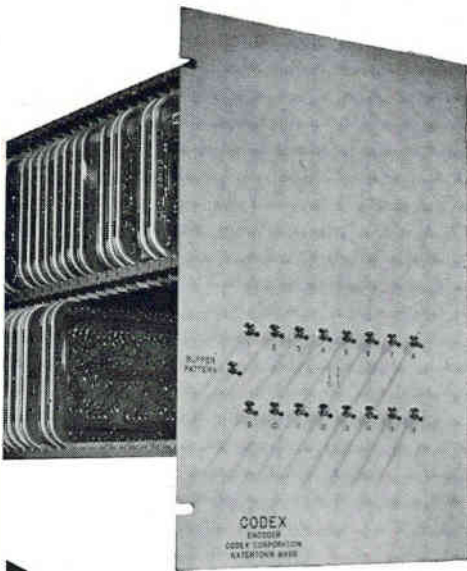

## DATA HEADACHE REMEDY!

The Codex CT-1A Digital Communications Terminal is not coding theory. Quite some time ago we made forward-acting error correcting equipment a fact. Daily on-line service in operational systems proves that Codex equipment does transmit high-quality data through low-quality, substandard voice channels.

The CT-1A Terminal is a complete dc in-audio out digital communications terminal. It transmits 1200 bps data with low error rates over any nominal 4 KC circuit except HF radio. The CT-1A Terminal was designed to work over long haul circuits which include one or more tropo scatter hops, but if HF radio is your problem, we have equipment which will handle that too. Three of the terminal's six transmission modes are compatible with the maximum allowable delay of the Autodin system.

For additional information, and our new CT-1A brochure, write, phone, or Telex Codex — the company with the headache remedy for data transmission.

**CODEX**  
**CORPORATION**

• 222 ARSENAL STREET, WATERTOWN, MASSACHUSETTS •  
ZIP CODE 02172 • (617) 926-3000 • TELEX 094-6332 •

# American Bosch

## uses Allen-Bradley Oriented Ceramic Permanent Magnets...

because of their uniformity in staying within specifications, and delivery schedules—though tight—are kept!

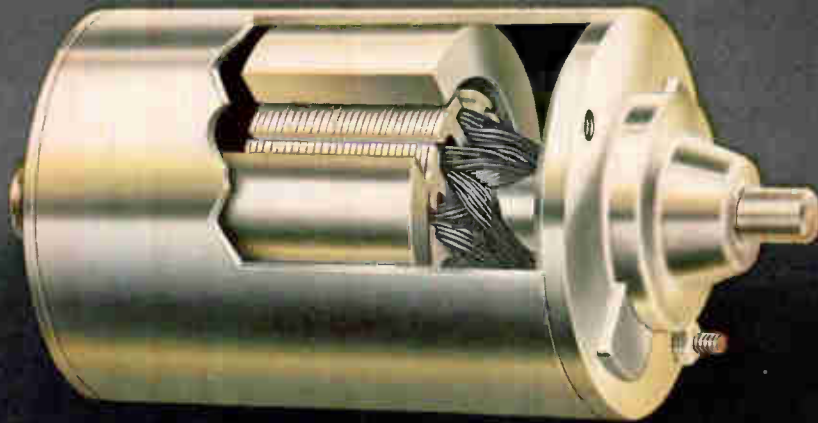

American Bosch permanent magnet motors are used for...

power windows

electric windshield wipers

power seats

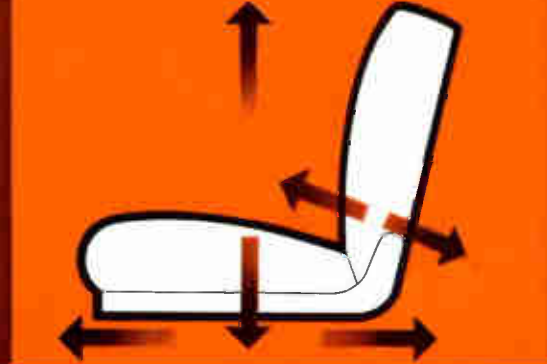
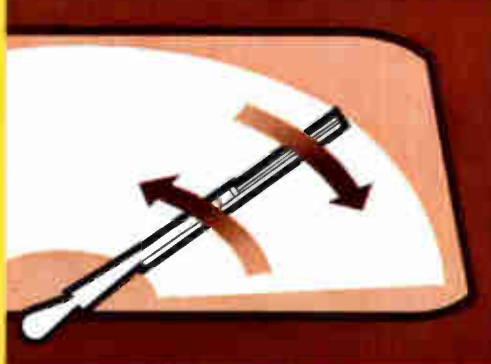
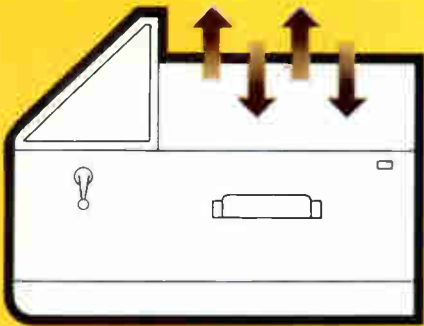

Allen-Bradley's quality control procedures assure the continuously uniform properties—both electrical and physical—that are essential to profitable large volume motor production. The most modern manufacturing facilities in the hands of technically experienced craftsmen produce the highest quality, radially oriented ceramic permanent magnet segments that are presently available.

Allen-Bradley ceramic permanent magnets can be furnished for a wide range of motor sizes—from  $\frac{3}{4}$ " diameter up to a 10 hp motor rating. They are available in a variety of types—having different properties—to satisfy your specific requirements. A-B application engineers will be happy to consult with you in developing your dc motors for maximum motor performance. Allen-Bradley Co., 1316 S. Second St., Milwaukee, Wis. 53204. In Canada: Allen-Bradley Canada Limited. Export Office: 630 Third Ave., N. Y., N. Y., U.S.A. 10017.

Properties of typical Allen-Bradley ceramic permanent magnets

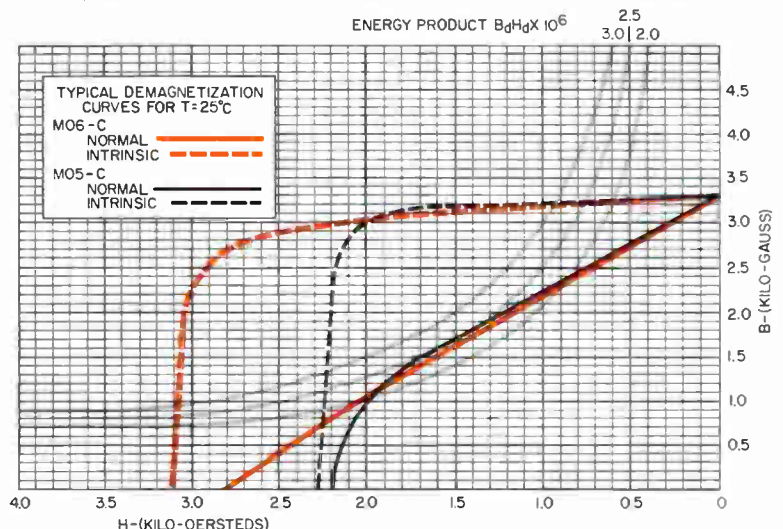

# ALLEN-BRADLEY

QUALITY MOTOR CONTROL  
QUALITY ELECTRONIC COMPONENTS

Yes—Allen-Bradley hot molded potentiometers cost more, but—

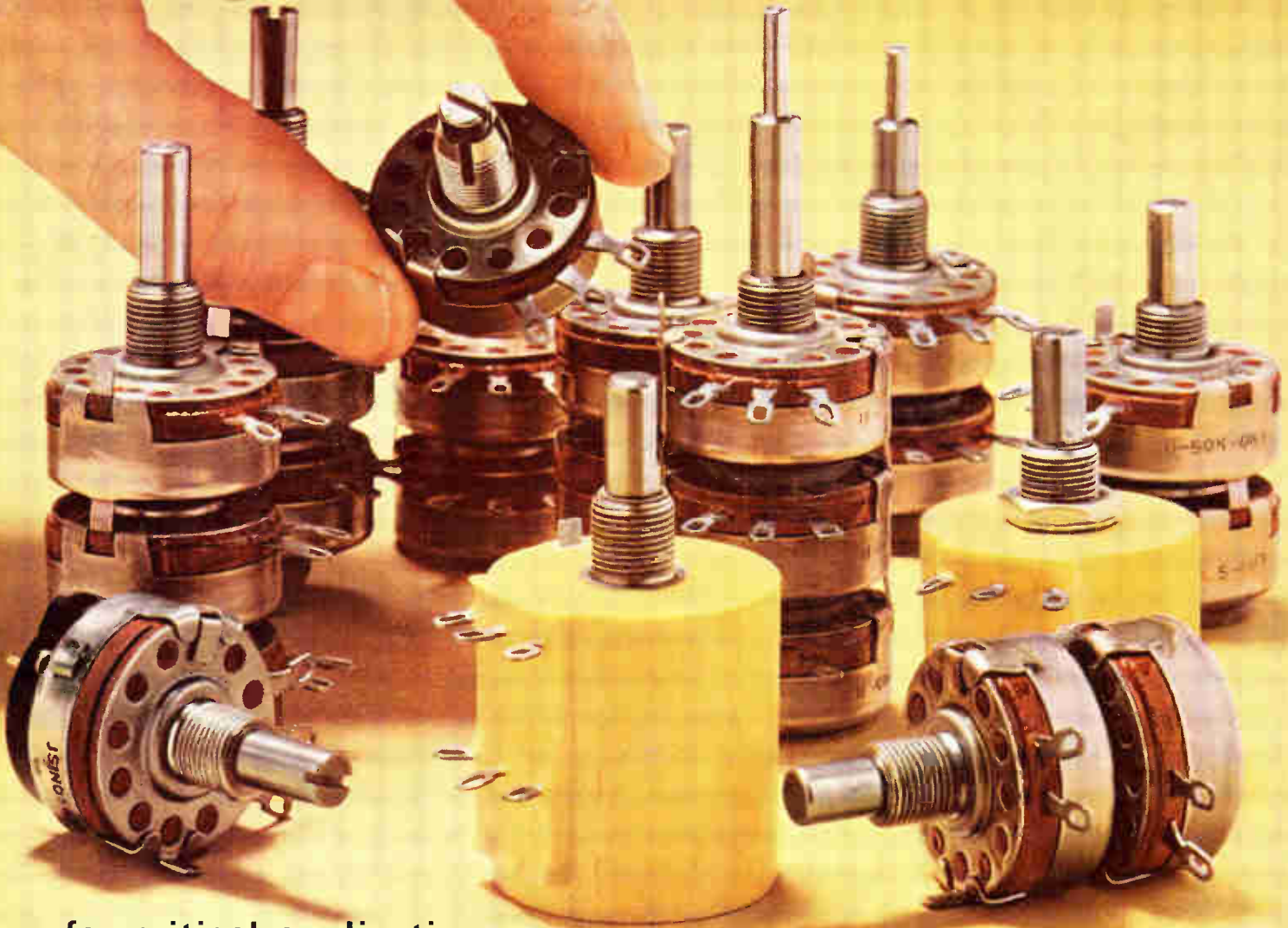

for critical applications  
they prove themselves far superior—and well worth the price

■ When a potentiometer in your equipment does not provide the kind of service expected of it—or fails completely—it is only natural for the user to blame you, the manufacturer of the respective instrument. After all, you selected the lower cost component, and your engineer or your purchasing agent decided that “it was good enough.” Correcting the mistake usually runs into real money—it does not necessarily eliminate your customer’s dissatisfaction. However, you can protect yourself and your customers against such potentiometer failures by joining the ever growing list of the nationally recognized equipment manufacturers who are standardizing on Allen-Bradley potentiometers.

The resistance track of all Allen-Bradley potentiometers is hot molded—a process developed and used only by Allen-Bradley. Resistance adjustment is always smooth—never an abrupt change. Though the initial noise level is very low, it is still further improved with use. The long life of all A-B potentiometers is a fact, established by

performance during the many years that these controls have been on the market. For instance, on “speeded up” tests this “life” will exceed 100,000 complete operations, with less than 10% resistance change. And during the 30-year history of this control there has never been recorded a single catastrophic failure.

Protect your reputation as a quality equipment manufacturer by having your purchasing specification call for Allen-Bradley hot molded potentiometers. They are available in single, dual, and triple units. Can be equipped with a 2 ampere 125 volt line switch. Dual units can be supplied with vernier control that provides 20 times finer setability than obtainable with a single control. Units for T, L, and Bridged T and H attenuators are also available. Yes—Allen-Bradley controls *cost slightly more*, but they are *worth much more*. For more details please write: Allen-Bradley Co., 222 W. Greenfield Ave., Milwaukee, Wisconsin 53204. In Canada: Allen-Bradley Canada Ltd. Export Office: 630 Third Ave., N.Y., N.Y., U.S.A. 10017.



**ALLEN-BRADLEY**  
QUALITY ELECTRONIC COMPONENTS

# Enter The Hudson Bulb Sweepstakes:

## 500 Tensor Lamps given away Free!

Here's your chance to win one of those mighty mite high intensity lamps—you've been meaning to get—and at the same time learn about the mighty mite bulbs that Hudson makes for almost any miniature bulb application you can think of: electronics, automotive, aircraft, indicator, instrumentation and others, including high intensity lamps. Hudson specializes in miniature bulbs so bright and reliable that purchasing agents specify our products again and again. Bulbs so tiny that Design Engineers get the space they need. Bulbs so long-lived (some exceeding 100,000 hours) that you can install them—and forget them. Send in your entry to the Hudson Bulb Sweepstakes today. It could brighten up your life in more ways than one.

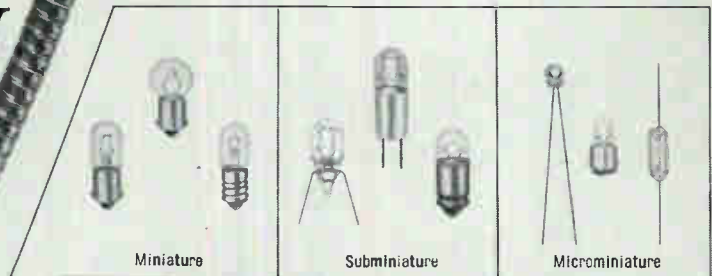

(TYPICAL BULBS IN THE HUDSON BULB LINE)

#### RULES

1. As a specifier or purchasing agent, write in any one miniature bulb application your company may have, on the coupon line below.
2. Complete the coupon with your name, company and address and mail it to the Hudson Lamp Company.
3. Entries must be postmarked before midnight, April 30, 1967. Winners will be notified before May 31, 1967.
4. This Sweepstakes is void where prohibited, and closed to employees of Hudson Lamp Company, its affiliates and agencies.

Hudson Lamp Company  
550 Elm Street  
Kearny, New Jersey 07032

LAMP COMPANY  
**Hudson**

YES, enter me in your Sweepstakes. My company's miniature bulb application is:

Name \_\_\_\_\_ Title \_\_\_\_\_

Company \_\_\_\_\_

Address \_\_\_\_\_

City \_\_\_\_\_ State \_\_\_\_\_ Zip \_\_\_\_\_

# small



## smaller



## smallest



# G.E.'s new wet slug tantalum capacitor gives you the performance of the CL64 in only 1/2 the case size

Get the highest volt-microfarad product per unit weight and volume of any capacitor you can buy with General Electric's new 69F900 wet slug tantalum capacitor. How? General Electric reduced the case size of the military type (CL64) wet slugs by 1/2 (it's even smaller when compared to solids). Electrical characteristics and performance remain essentially the same. G.E.'s new 69F900 answers the need for a commercial wet slug capacitor with the high volumetric efficiency demanded by modern high density applications.

G.E.'s new addition to its complete line of tantalum wet slug capacitors has excellent high capacitance retention at low temperatures and can be

RATING	CASE SIZE	VOLUME
<b>50V, 30<math>\mu</math>f</b>		
solid (CS12)	.341 x .750	100%
wet slug (CL64)	.281 x .681	58%
<b>69F900</b>	<b>.145 x .600</b>	<b>15%</b>
<b>15V, 80<math>\mu</math>f</b>		
solid (CS12)	.341 x .750	100%
wet slug (CL64)	.281 x .681	58%
<b>69F900</b>	<b>.145 x .600</b>	<b>15%</b>
<b>6V, 180<math>\mu</math>f</b>		
solid (CS12)	.279 x .650	100%
wet slug (CL64)	.281 x .641	100%
<b>69F900</b>	<b>.145 x .600</b>	<b>25%</b>

stored to  $-65^{\circ}\text{C}$ . Its wide operating range is  $-55^{\circ}\text{C}$  to  $+85^{\circ}\text{C}$ . And it meets the parameters of larger military wet slugs: vibration to 2000 Hz, 15g acceleration!

The new sub-miniature 69F900 capacitor is fully insulated and has a low, stable leakage current. Voltage ratings are available from 6-60 volts; capacitance ranges from 3.3-450 microfarads.

Choose from a complete line of G-E wet slug tantalum capacitors to fill your slim, trim circuit needs. Write for GEA-8369 for details about the 69F900 and the other capacitors in General Electric's complete wet slug tantalum line, or ask your G-E sales engineer. Capacitor Department, Irmo, South Carolina.

ELECTRONIC COMPONENTS DIVISION

**GENERAL**  **ELECTRIC**

430-28A



**WHAT'S AN ELECTRONIC  
SPECIALIST DOING IN THE  
SCREEN PRINTING BUSINESS?**

*...PRINTED CIRCUITRY, OF COURSE!*

Now, in addition to knowing about capacitors, diodes and resistors, you're supposed to know all about film, resolution, exposure and wash-out! . . . Cheer up!

Ulano doesn't know beans about microelectronics . . . but we know all there is to know about screen printing! We should. We've been at it for over 30 years. We're the world's leading manufacturer of screen stencil film . . . *any kind.*

. . . There's a right Ulano film for every project.

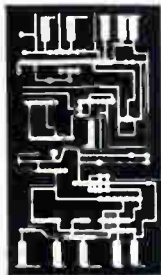

*In screen processing  
of complex printed circuitry...  
there's no margin for error!  
That's why Ulano offers  
a complete line of  
Screen Process Stencil Films  
especially designed for  
the Electronics Industry.*

**ulano**<sup>T.M.</sup>

610 DEAN STREET, BROOKLYN, N. Y. 11238

NEW YORK • CALIFORNIA • CHICAGO • ZURICH  
In Europe: ULANO A. G., Untere Heslibachstrasse 22, Kusnacht 8700, Switzerland

*Write on your letterhead for special electronic test kit (no charge) No. 5948.*

Circle 93 on reader service card

# A LOW-COST 1 AMP SPDT RELAY MIGHT DO THE JOB BETTER THAN AN EXPENSIVE ONE.

If it's the new 75-cent Sigma Series 65.



New Sigma Series 65 miniature relays are specifically designed for low-level DC switching applications where economy is of major importance. Available in quantity for 75 cents, these general purpose relays include extra design benefits:

**Superior Switching Performance:** The precision knife-edge hinge design of the armature provides better magnetic coupling for full utilization of coil power. This results in heavier contact forces, lower contact resistance and better electrical stability.

**Greater Mechanical Strength:** Glass-filled nylon, not ordinary phenolic, is used to support contact members assuring long-term mechanical life and stability.

**Better Thermal Stability:** Use of high-grade, low-

temperature-coefficient materials assures excellent thermal stability over a wide temperature range up to 70°C.

**We'd like to give you a new Sigma Series 65—** or any of our other standard relays. Test and compare it against the brand you may now be using. It's the best way we know to prove what we say about Sigma relay performance. Just circle our reader service number on the reader service card. We'll send you the new Sigma relay catalog and a "free relay" request form. Return the form to us and your Sigma representative will see that you get the relay you need.

**Need fast delivery? The Series 65 is available off-the-shelf from your Sigma distributor.**

SIGMA DIVISION  SIGMA INSTRUMENTS INC  
Assured Reliability With Advanced Design / Braintree, Mass. 02185



if you're developing  
prototype hybrid circuits  
you need this...

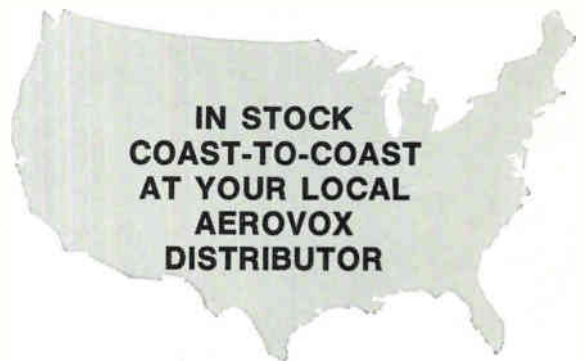

# CHIP CAPACITOR ENGINEERING KIT



AEROVOX—the industry's leading supplier of ceramic chip capacitors offers this Engineering Kit to facilitate your prototype development of hybrid circuits. The kit contains 125 chip capacitors in values from 1 pf to 100,000 pf in three basic temperature characteristics (stable, semi-stable and Hi-K) to permit the user to select the smallest chip for any given temperature and capacitance requirement.

The CERALAM capacitor featured in this kit is a rugged, monolithic block of ceramic dielectric and noble metal plate laminated into an extremely dense unit. Because of their unique structure, these units are impervious to

moisture and organic solvents. They can be soldered or welded directly into the circuitry. The high ratio of capacity-to-volume inherent with Ceralam capacitors permits significantly smaller sizes suited to hybrid circuitry.

The Chip Capacitor Engineering Kit is available from your local AeroVox Distributor at \$59.95. For the name of your nearest distributor or further information write or call...



**AEROVOX**  
CORPORATION  
OLEAN, NEW YORK

do we  
have to change  
our name  
from  
WEMS to  
HYBRID MICROCIRCUITS, INC.?

For years, WEMS has been the word for Welded Electronic Modules and Systems. The name fit . . . beautifully. But what do we do now that we're in the hybrid microcircuit business? **W** Guess we really should have planned ahead knowing we'd eventually turn to this market. After all, what could be more logical.

We have **E** over 10 years of experience in circuit design, microwelding techniques and packaging, so today, in response to your growing demands, we're producing hybrid micro-**W** circuits as well. Custom tailored to your specifications, these hybrid microcircuits are the result of the same research and development talent that made us number one in the module business. The same skilled microwelding and fabrication techniques are used, and the same precise quality control assures you that our hybrid microcircuits will give you the **M** same high reliability as our electronic modules.

Do we have to change our name? We hope not. We'd prefer to make the name WEMS synonymous with hybrid **S** microcircuits as well as with Welded Electronic Modules and Systems.

Like to learn more about this new capability? Just give us a call.

4650 West Rosecrans Avenue  
Hawthorne, California 90252  
(213) 679-9181



**W E M S**

# Worlds of Clifton Quality

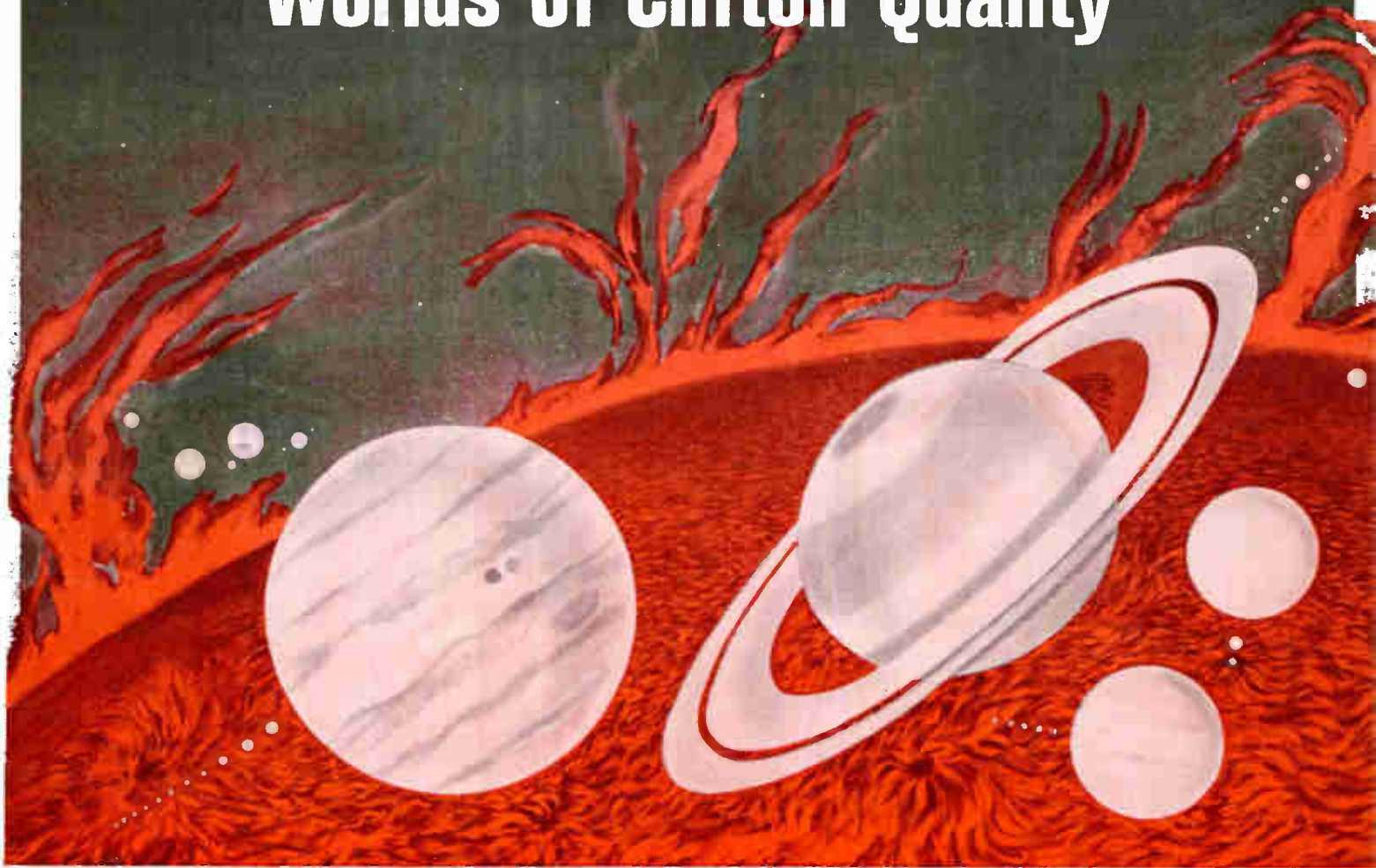

## in our **NEW**, Competitively Priced DC Motors



The illustration of our Solar System shows the nine planets and their 31 satellites in scale with each other and the enormous sun. The procession starts with Mercury at the left and ends with Pluto on the far right.

Built to exacting Clifton and MIL-E-5272 standards, these DC motors are a completely new design. They offer many advantages such as: stainless steel, corrosion resistant housings and ball bearings, and brush springs which maintain constant pressure over brush life. Brush life itself is up to 1000 hours depending upon environmental conditions and application.

These motors feature a five bar commutator. Due to the inherent design, the rotor produces a magnetic detent under zero excitation which minimizes gear train drift. Units available in both 14 and 28 volt excitation. Special voltages, shafts and housings available upon request.

Clifton Precision Products, Division of Litton Industries, Clifton Heights, Pa., Colorado Springs, Colo.

**cppe**

**CLIFTON**  
PRECISION PRODUCTS  
DIVISION OF LITTON INDUSTRIES



**3-Decade, automatic, continuous sweeps.  
Output constant  $\pm 0.25\text{dB}$  from 0.005 to 50,000 Hz.  
Self-contained log converter . . .  
and it costs only \$1965, f.o.b. San Diego**

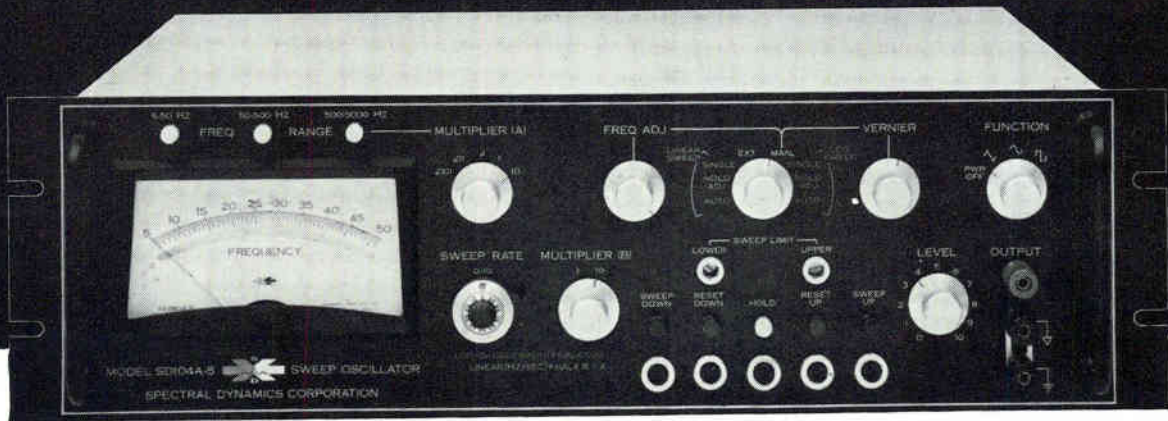

**It's our SD104A Sweep Oscillator/Function Generator**

**HERE ARE THE WAYS IT OPERATES . . .**

- As an internally swept signal source
- As an externally controlled sweep generator
- As a manually tuned function generator
- As an externally tuned function generator

**HERE ARE SOME OF ITS FEATURES . . .**

- 3-decade automatic sweeps . . . linear and log . . . continuously variable rates
- Extremely constant output level over entire sweep
- Self-contained log converter
- 8 simultaneous outputs, including constant amplitude sine, square and triangle wave; variable amplitude sine, square or triangle wave; extremely accurate DC outputs ( $\text{DC} \propto \text{linear frequency}$  and  $\text{DC} \propto \text{log frequency}$ ) for direct plotting on X-Y recorders; and a sweep sync for triggering external equipment
- Highly accurate frequency indication and resolution through automatic range switching of panel meter

**AND HERE'S HOW YOU CAN USE IT . . .**

- Automatically and directly plot response vs frequency and linearity vs frequency
- DC amplifier design
- Telemetry checkout
- Audio amplifier design
- DC hysteresis testing
- Fatigue testing
- Power spectral density analysis
- Vibration testing
- Fourier analysis



*WRITE US. There's a new Applications Manual which tells you in detail how the SD104A combines oscillator-generator-log converter capabilities into one of the most versatile instruments on today's market*

**SPECTRAL DYNAMICS CORPORATION  
OF SAN DIEGO**

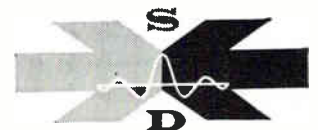

P.O. BOX 671 • SAN DIEGO, CALIFORNIA 92112 • (714)-278-2501 • TWX 910-335-2022

For space and weight savings  
in Saturn V countdown system...  
it's flexible circuitry.\*

For utmost reliability...  
it's flexible circuitry  
insulated with TEFLON® FEP FILM.

Flexible circuitry is an important improvement for the National Aeronautics and Space Administration's Saturn V countdown system. It weighs less. Takes up less space. Is easier to assemble and maintain.

To obtain these advantages—and at the same time to meet the stringent reliability requirements in the countdown system—Electro-Mechanisms chose TEFLON FEP film for the insulation.

This film offers unsurpassed dielectric properties, reliability over a wide temperature range, non-flammability and high tear resistance. Du Pont TEFLON resins have long been known as the most reliable of all insulating materials. Du Pont's TEFLON FEP film permits total encapsulation of flexible printed circuitry by heat sealing, bonding or cementing. It is transparent for quality control. It can be soldered. For your next high-reliability design, consider the advantages of TEFLON FEP film. Send for full information on properties and applications. Write: Du Pont Company, Room 4912, Wilmington, Delaware 19898.

TEFLON® FEP FILM  
...A new dimension in TEFLON



Better Things for Better Living  
... through Chemistry

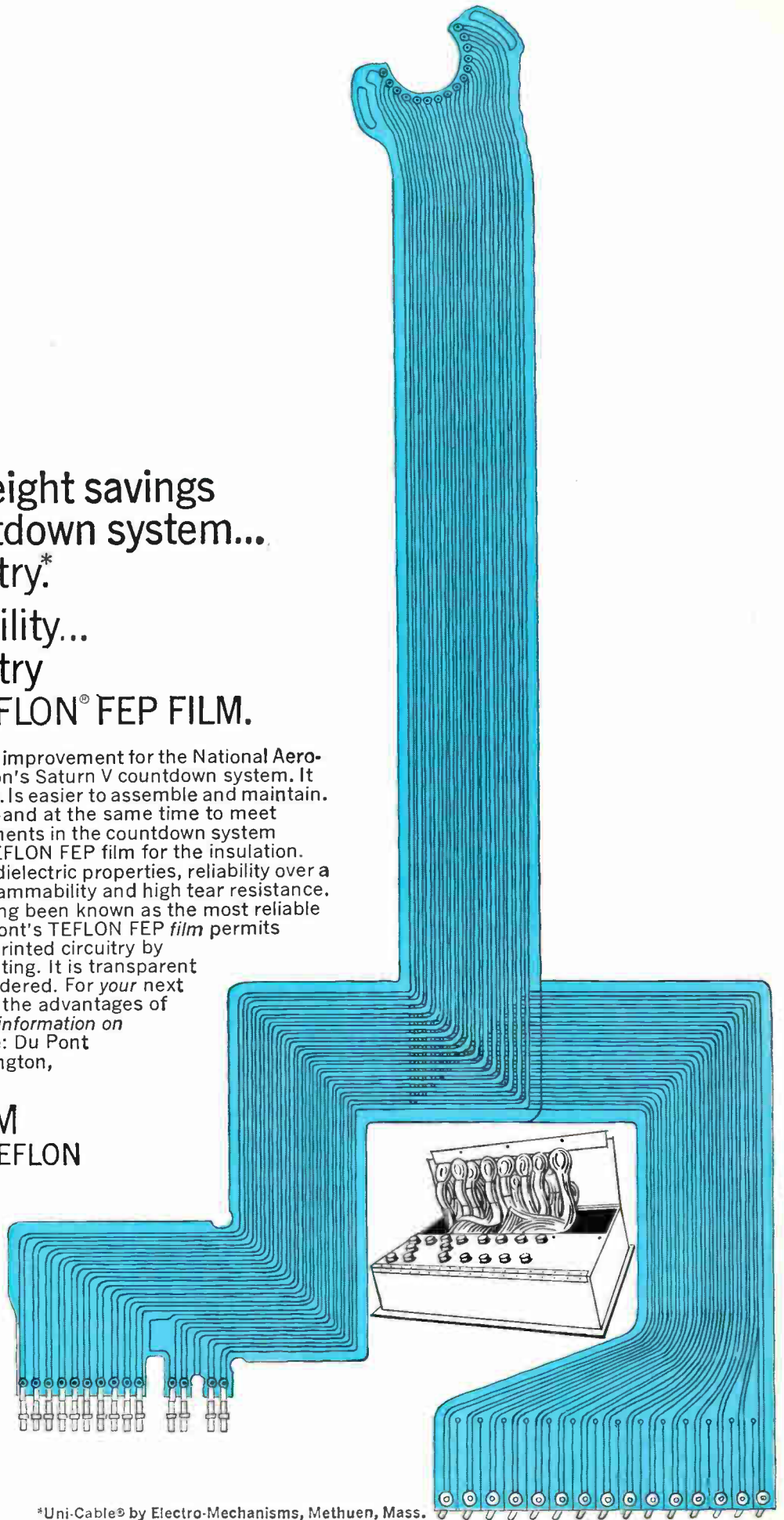

\*Uni-Cable® by Electro-Mechanisms, Methuen, Mass.

# Philbrick's NEW BREED Micro-Hybrid Operational Amplifiers Obsolete Monolithics

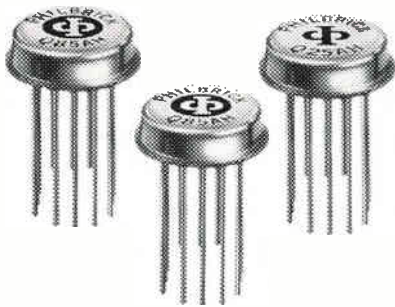

If you are still using monolithic-chip operational amplifiers, your system may be on its way to obsolescence — perhaps even before it gets off the board. A full year of industry-wide evaluation has proved it.

Philbrick's NEW BREED of "micro-hybrid" operational amplifiers combines the best of the linear-monolithic and discrete-component technologies. The result: a line of "micro-hybrid" operational amplifiers unequalled in reliability and performance. You'd expect premium amplifiers like these to cost more. They do — but your total system cost, including design, development, materials, and production, is usually substantially lower when you use NEW BREED Operational Amplifiers.

You can bid, win, and build highly superior "third-generation" systems with the NEW BREED — systems with an order of magnitude better performance, and absolute immunity to overloads, shorts, and supply-voltage stresses. Without the NEW BREED, your analog Aerospace/Weaponry designs are no longer competitive — technologically or economically.

More than 200 systems organizations have evaluated (and many have already approved) the NEW BREED. The facts are all assembled in our report entitled "THE NEW

BREED MICRO-HYBRID — A STATUS REPORT." Write, wire, or phone for your copy. Philbrick Researches, Inc., 000 Allied Drive at Route 128, Dedham, Massachusetts 02026. TWX (617) 326-5754. Telephone (617) 329-1600.



## GENETIC EVOLUTION OF THE NEW BREED HYBRID

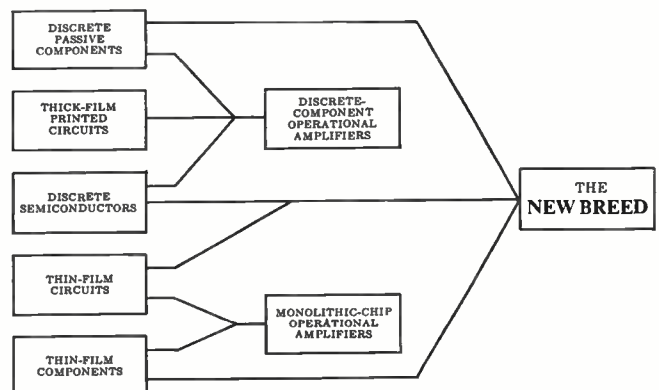

ELECTRONIC ANALOG COMPUTING EQUIPMENT for MODELLING, MEASURING, MANIPULATING and MUCH ELSE



## PHILBRICK

## Specification Summary

Model 2936

Universal SSB Test System

10 Hz–30 KHz/1-40 MHz

### Model 2736 LF Analyzer and Display Module:

Low Frequency Input Range (Center frequency, digitally read out)	10 Hz to 30 KHz (with calibrated dispersions from 150 Hz to 30 KHz)
IF <sub>1</sub> IF <sub>2</sub>	500 KHz } Other IF's on special order request 1750 KHz }
RF Input Range	1 to 40 MHz (Useable to below 100 KHz and to over 100 MHz)
Low Frequency Sensitivity	100 $\mu$ V RMS } For full scale logarithmic display. Tangential sensitivities are respectively 1 and 10 $\mu$ V
IF, RF Sensitivity	1 Mv RMS
Manual Sweep	Over full dispersion range
Dynamic Range	All intermodulation products more than 80 db down
Vertical Display:	
Linear	10 to 1 voltage (20 db)—accuracy $\pm$ 3%
Log	40 db plus 20 db step for 60 db dynamic range accuracy $\pm$ 2 db
Power	Square law (10 db)— $\pm$ 0.25 db
Display	5½ by 4½ inch rectangular CRT with scale illumination
Outputs	Standard X-Y recorder
Dispersion	Six fixed, calibrated dispersion ranges with automatic optimum resolution as listed below

Dispersion Ranges	150 Hz	300 Hz	1 KHz	3 KHz	10 KHz	30 KHz
Resolution Rate	7	7	18	32	100	173
Second/Scan	10	10	3	3	1	1

Calibrated Rate Override	X3 and X10, for all dispersions
Low Frequency or Intermediate Frequency Attenuators (100 kc $\Omega$ input impedance)	80 db in 20 db steps (100 volts maximum input) plus 20 db in one step
Intermediate Frequency or RF Input Attenuators (at 50 $\Omega$ input impedance)	63 db in 1 db steps, accuracy 0.1 db/db 20 db in one step

### Model 1102 Two-Tone RF Signal Synthesizer:

Frequency Range:	1 to 39.999 MHz with digital tuning in 1 KHz steps. Useable from below 100 KHz to 1 MHz
Frequency Modes	Tone A, Tone B, Tones A+B, L.O. output
Two-Tone Difference	0 to 20 KHz continuously tuned
Frequency Accuracy	0.08% at 10 MHz 0.02% at 39.999 MHz
Output Impedance	50 ohms
Output Level	0 to -127 dbm, calibrated, independent metered vernier output control for each tone
Local Oscillator Output for Analyzer	1.0 Volt, 300 KHz frequency offset
Harmonic Distortion	More than 30 db down
Non-Harmonically-Related Spurious signals	More than 70 db down
Intermodulation Distortion	More than 60 db down

### Model 1101 Two-Tone Audio Generator:

Frequency Range	100 Hz to 9.9 KHz with digital tuning in 100 Hz steps
Frequency Accuracy	+2%
Frequency Modes	Tone A, Tone B, Tones A+B
Power Output	+10 dbm per tone into 600 ohms
Output Impedance	600 ohms (balanced and unbalanced)
Attenuation Range: Each Tone	0 or 20 db in one step independent metered vernier output control for each tone
Combined tones	9 to 95 db in 1 db steps
Harmonic Distortion	Less than 0.1%
Hum	60 db below output voltage
Intermodulation Distortion	More than 60 db down

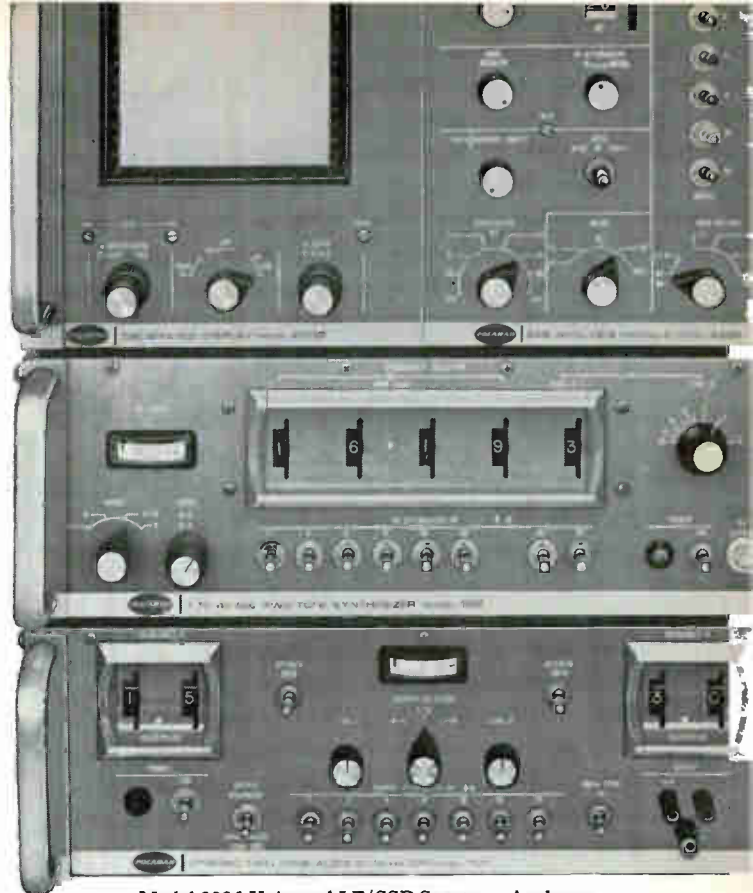

Model 2936 Universal LF/SSB Spectrum Analyzer,

*It Stands  
Alone ...  
at the top*  
the Only *truly* Universal  
SSB Spectrum Analyzer

The Model 2936 is unique. It is the only spectrum analyzer providing pure, two-tone RF and two-tone AF, for accurate, anomaly-free frequency-domain display and measurement of low-frequency and single-sideband signals.

Because it contains independently useful AF and RF signal generators, in addition to the LF analysis module, it is a Universal/AF/RF/SSB Test Set. It will check a complete communications system, from transmitter microphone to receiver loudspeaker, at every point of interest; yet it costs no more than a conventional, limited, pseudo-two-tone spectrum analyzer.

Check the range and versatility shown here. Then send for full data—or call PEI Sales at (212) EX 2-4500, and we'll arrange for a trial demonstration... *from stock*.

**POLARAD**

**POLARAD ELECTRONIC INSTRUMENTS**

A Division of Polarad Electronics Corporation  
34-02 Queens Boulevard/Long Island City, New York 11101

World Leader in Microwave Instrumentation



## Need to find out if beer is clear?

Take a turbidity meter, add an Esterline Angus DC Milliammeter and you can record the clarity of beer. Or you can check almost anything else that can be transduced to an electrical signal. ■ So versatile is our basic milliammeter measuring element that milliampere, ampere and voltage ranges can be combined in a single multi-purpose recorder. You can also choose: ▷ rectilinear or curvilinear recording ▷ left-hand, center, offset or right-hand zero ▷ virtually any milliampere calibration ▷ 10 microampere or 10 millivolt calibration through use of our magnetic amplifier ▷ recording of AC watts or vars, power factor or frequency by adding Esterline Angus Transducers ▷ a variety of spring driven or electric chart drives ▷ complete portability . . . power sources not required on spring driven recorders ▷ alarms ▷ event pens ▷ portable, flush, desk top, wall mounted or twin case styles ▷ single or two-channel. ■ You get ½ second full scale (4½") response and accuracy 1%

*You can do it* of full scale. What's more, you get ten day delivery\* and recorders priced as low as \$410. ■ Want complete information about these recorders? Write for DC Milliammeter data or call your Esterline Angus sales engineer. ■ \*Quick delivery is possible on certain DC Milliammeter models which have become so popular we have them in production at all times.

*with an*

*Esterline Angus*

*DC Milliammeter*

ESTERLINE ANGUS INSTRUMENT COMPANY, INC.  
BOX 24000 • INDIANAPOLIS, INDIANA 46224

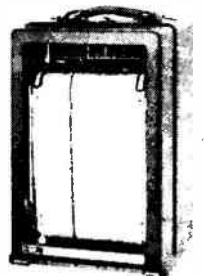



# Technical Articles

---

**Digital phase shifter  
tests navigation system**  
page 104

Like a watchdog watching a watchdog, a new kind of signal generator checks out the monitors that are constantly checking a new VOR aircraft navigation system. An interesting feature of the generator is the way the phases of the output signal are shifted—digitally. The low-frequency phase shifting technique could be used in other applications such as servo-analyzers.

**Norad's computers get  
all the facts**  
page 113

Although the computers installed in Cheyenne Mountain are not new—in fact their design is at least five years old—unique interface equipment has been developed, along with endless programming, to guarantee that no message is lost. The computer complex is the forerunner of the giant information systems that soon will screen data in other government operations and help run industrial organizations.

**Special report:  
Large scale integration**  
pages 123 to 182

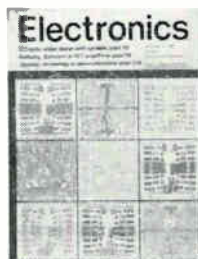

Large scale integration—putting hundreds and thousands of components on a single slice of silicon—is the next step in integrated electronics. Technically, it brings together important new developments like monolithic technology and computer-aided design. Although some people are saying LSI is a long way off, the evidence in this special report shows it is much closer.

Prototype equipment is already being built; commercial production of pioneering items will start within 18 months. For the cover, art director Saul Sussman arranged some of the masks required to make a large integrated array.

- LSI: The technologies converge, p. 124
- Benefitting the system designer, p. 130
- Changing the system design process, p. 133
- Layout and logic: two roads to part repeatability, p. 136
- Organizing for processing power, p. 139
- Active memory calls for discretion, p. 143
- Customizing by interconnection, p. 159
- Computer accelerates design and production of large arrays, p. 166
- Silicon-on-sapphire approach affords freedom and flexibility, p. 171
- Slow, but small, may win the race (MOS), p. 179

---

**Coming  
March 6**

- New product development at IEEE
- Computer-aided design: nonlinear analysis
- Selecting digital IC's
- Airborne computers
- Lunar television

# Digital phase shifter tests navigation system

Logic system in a signal generator simulates operation of new very-high-frequency omnirange system by creating two sets of sine waves whose phases are shifted in hundredths of degrees

By Edwin M. Drogin

Airborne Instruments Laboratory, Cutler-Hammer Inc., Deer Park, N.Y.

**Like a watchdog** watching a watchdog, a new kind of signal generator is checking out the monitors that are checking out a new vor aircraft navigation transmission system. The generator digitally generates two sets of low-frequency sine waves and then digitally shifts the phases of the output signals with a resolution of  $0.01^\circ$ .

The prototype of the generator is calibrating new high-precision digital receivers that, in turn, are being used to test an experimental navigation transmitter, called the precision multilobe vor. The transmitter, a version of a conventional very-high-frequency omnirange navigation system, is being tested by the Federal Aviation Agency at Lake Ronkonkoma, N.Y.

Two versions of the generator have been developed, both built mostly of off-the-shelf monolithic integrated circuits. The first generates signals at 30 and 53 hertz; the phase shift at the higher frequency is 13 times greater than the shift at 30 hz, as a digital "gear changer" in the signal generator multiplies the phase shifts. The second type of generator puts out only 30 hz signals.

Beyond the immediate application of calibrating vor receivers, there is a good chance the signal generator will be built into automatic checkout equipment. In the near future, large facilities

for repairing and testing aircraft navigation systems—such as those operated by major airlines and the FAA—are expected to turn from manual to automatic digital checkout systems.

The basic low-frequency phase-shifting technique of the signal generators could also be adapted to such applications as servoanalyzers. The technique, however, is restricted to low frequencies because high resolution can only be achieved at a clock frequency hundreds of times that of the basic phase-shifted sine wave. If the sine wave frequency were increased significantly, the clocks would require a greater stability and accuracy than is currently possible to maintain the same degree of resolution, probably ruling out such applications as phasor generation in radar systems.

## Standard signal generator

Standard 30-hz vor receivers measure phase changes between two 30-hz sine waves transmitted by a ground station. The phase difference indicates an aircraft's position in relation to the vor ground station, with each variation in phase of  $1^\circ$  corresponding to  $1^\circ$  of azimuth. In a standard vor system, both the ground station and aircraft depend on analog equipment.

In the digital signal generator that simulates the standard transmitter, J-K flip-flops generate two 30-hz square waves—one of fixed reference and the other variable—that are converted to sine waves and used to modulate a standard vor carrier wave. The phase relationship between the reference and variable-phase waves is controlled in the signal generator by a set of five thumbwheel switches that the operator sets between  $000.00^\circ$  and  $359.99^\circ$ . The thumbwheel switches are 10-position rotary mechanical switches whose output is a binary-coded decimal code. The BCD signal controls the operation

## The author



Edwin M. Drogin is a consultant in the radar systems department at the Airborne Instruments Laboratory of Cutler-Hammer Inc. He has assisted in the development of systems to evaluate ground navigation equipment for the Federal Aviation Agency.

of comparators that set up the phase differences.

After the phase relationship between the two 30-hz square waves has been established, the waves are converted to sine waves by two narrow-band filters at the counter's output. These filters are very stable and do not reduce the  $0.01^\circ$  accuracy of the thumbwheel settings. When the phase-shifts through the reference and variable-phase filters are identical no relative bearing errors occur, and the system accuracy of  $0.01^\circ$  is maintained by a built-in calibration circuit. The calibrator measures the phase shift through the filters by picking off a portion of the sine wave output and converting it back to a square wave, allowing the sine wave's zero crossing time to be accurately measured.

The precision multilobe vor ground station radiates two sets of waves instead of one. The first set contains the standard vor signals, while the second set theoretically will allow the special receivers to be 13 times more accurate in determining a plane's bearing. The standard 9,960-hz subcarrier in the second set is frequency modulated at a 53-hz rate, and radio frequency carrier is amplitude-modulated by a 53 hz sine wave which changes in phase by  $13^\circ$  for each degree of azimuth; the larger phase change is expected to provide the greater bearing resolution, while the standard phase change prevents ambiguity in the bearings measured.

Aircraft equipped with the older receivers could still obtain bearing measurements from the first set of signals even if the FAA decides to replace its standard vor transmitters with the new precision system. Receivers equipped with 53-hz adapters are set up on the ground around the experimental system at Lake Ronkonkoma to monitor the operation of the experimental vor.

In both versions of the signal generator, the 30-hz signals are derived from a BCD counter driven by a crystal-controlled oscillator. The counter counts repeatedly from 0 to 35,999. Since each count cycle represents  $360^\circ$ , each clock period represents  $0.01^\circ$  of phase; the clock frequency is

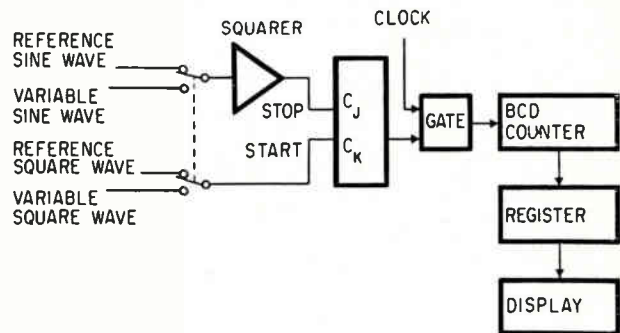

Squarer converts sine waves into square waves so that the zero crossings of the variable-phase and reference signals can be measured accurately by the digital counter.

1.08 megahertz so the counter cycles at 30 hz.

There are 18 flip-flops in the counter chain, with the first four forming the hundredths decade (below). When this decade reaches a count of nine, flip-flop  $2^2_1$  is enabled by the technique known as standing on nines. This flip-flop is the first stage in the second decade, which counts tenths. When it reaches nine tenths, a similar third decade counting units is enabled.

The tens decade, flip-flops A through D in the drawing on page 106, is of special design because it must be changed from a decade counter to a modulo-6 counter when the two flip-flops in the hundreds counter have counted to three. Hundreds are counted by flip-flops E and F; this counter has only two flip-flops because it must only count up to three, which is 11 in binary notation.

The change in modulus is accomplished as follows: At the count of three in the highest decade, NAND gate 1's output equals  $\overline{EF}$  and gate 2's output is  $EF$ . NAND gate 7 is therefore enabled and NAND gate 8 disabled. At the count of 5 (represented by the Boolean expression  $D'CB'A$ , or in binary code as 0101) the outputs of gates 7 and 8 go to logic 0. When the outputs of these digital transistor logic NAND gates are tied together, they perform

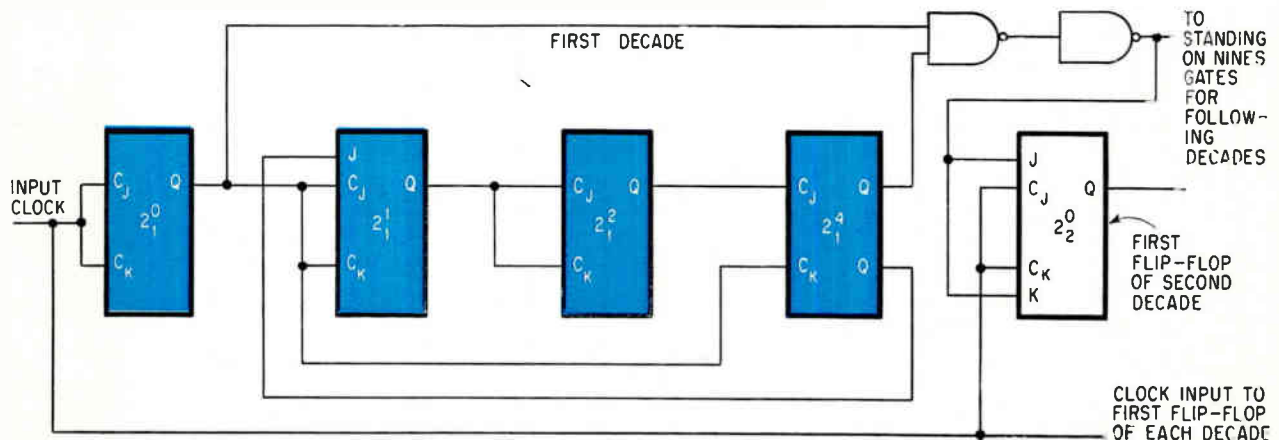

$C_J$  AND  $C_K$  CLOCK INPUTS  
J AND K SET AND RESET LOGIC INPUTS  
 $2^0_1$  ET AL. SUPERSCRIPIT IS BINARY WEIGHT, SUBSCRIPT IS DECADE NUMBER

Four flip-flops in color make up the first (hundredths) decade in the BCD counter. The flip-flop  $2^2_1$  at the far right is the first in the second (tenths) counter, and is enabled when the count in the hundredths decade reaches nine.

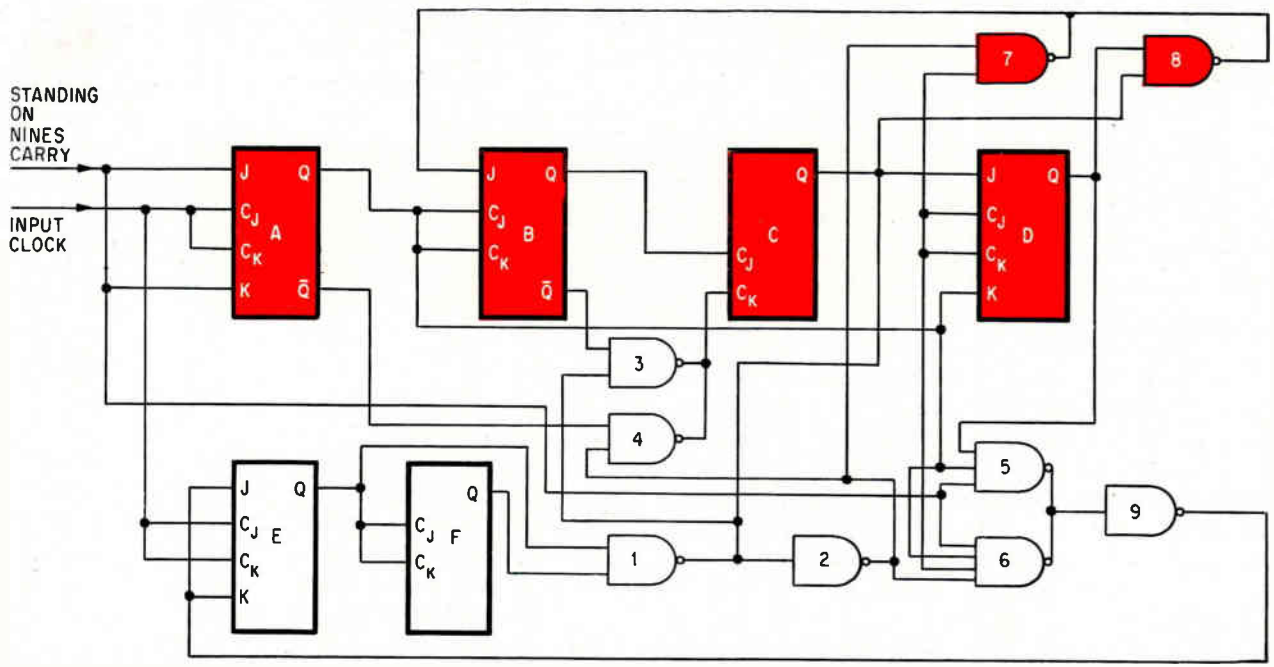

Tens counter operation is changed from modulo-10 to modulo-6 by the gates in color when flip-flops E and F of the hundreds decade are both at logic 1 (BCD 3). This prevents phase shifts greater than 359.99° in the output signal (an impossible VOR output). Otherwise, the tens decade can count to nine.

an AND function, preventing flip-flop B from going to logic 1 at the next switching of flip-flop A because the J input of flip-flop B is held at 0.

At the same time, NAND gate 4 is enabled so that the change of flip-flop A from logic 1 to logic 0 will pulse flip-flop C. Thus the tens decade resets from 0101 to 0000, never going over 5 when the hundreds counter is at 3. Note that the D flip-flop is prevented from going to logic 1 when C is reset because the clock inputs are 0.

For other states of flip-flops E and F—hundreds count of 0, 1 and 2—the logic is in the standard decade configuration. NAND gates 5, 6 and 9 ensure that flip-flop E will be pulsed to start a new hundreds count when the tens decade is reset from a count of five to zero and when E and F are both at logic 1. When E or F are not at logic 1 and the decade changes from 9 to 0, gates 5, 6 and 9 enable the clock. The 30-hz reference square wave is provided by an additional flip-flop. This flip-flop is triggered when the counter output passes through a count representing 0° and 180°.

### Generating the trigger

When the counter output agrees with the thumbwheel settings, a trigger is generated to drive the variable phase flip-flop. Most computers use exclusive OR logic circuits to generate triggers at the correct time. A typical comparator circuit is shown at the top on page 107. This method, however, is unsatisfactory in the VOR generator because it needs three gates per bit and requires that both the true code and its inverse be provided by the thumbwheels. For example, if the outputs of the counter chain are labeled 1, 2, 3... n, and the outputs of the thumbwheel switches are labeled A, B... n, coincidence between the counter output

and thumbwheel input pulses occurs at (A1 + A'1') (B2 + B'2') and so on. When the counts in the BCD counter chain agree with the switch settings, one term in each of the above logic groups will be "true," or at logic 1. Therefore, the over-all expression goes to logic 1. This method thus requires two coded BCD wafers per digit on the thumbwheel or an extra inverting gate per bit in the counter because both A and A', B and B' and so forth are needed.

The coincidence circuitry of digital VOR generator's BCD counter only looks for an agreement between the logic 1's in the counter chain and the binary code 1's from the thumbwheels. The logic 0's can be treated as "don't cares" and the following expression used:

$$\text{coincidence} = (A1 + A')(B2 + B')$$

which can be simplified to

$$\text{coincidence} = (1 + A')(2 + B')$$

This is illustrated in the lower part of the drawing, which shows the NAND outputs tied together to implement an AND function.

If one of the NAND gate inputs is at ground, the transistor in that DTL circuit is cut off and at logic 1; that is, if flip-flop 1 is ON or A' is ON, A is at ground and the first logic gate will have its output transistor cut off. This implements the first term in the coincidence expression (1 + A'). Similarly if all the transistors in the chain are cut off, the common line stays at logic 1. If it weren't possible to tie these outputs together, the NAND gate outputs would have to be fed into a separate multiple-input NAND logic circuit that would drive a second NAND gate to invert the signal and give the correct output.

With this logic circuitry, coincidences will occur as soon as the logic 1's in the counter chain are in the same positions as the logic 1's on the thumb-

wheels. However, there will be additional coincidences at counts higher than the count set on the thumbwheel. For example, if thumbwheel input A is at logic 1, and B through R are at logic 0 (thumbwheel bearing setting is  $0.01^\circ$ ), the first term  $1 + A'$  will equal logic 0 when the counter chain is at zero. All the remaining terms are always at logic 1 regardless of the state of the counter.

As soon as the counter goes up one count, flip-flop 1 will go to logic 1 and coincidence occurs. However, at every odd count after this—three, five, seven and so forth—the first flip-flop will be at logic 1 and additional undesired coincidences would occur. This is easily prevented, however, by a flip-flop latching circuit set at the first coincidence and not cleared until the next cycle. The extra latching circuitry is worth its cost because the comparison process requires only one gate and one input wire per bit.

### Adding angles

To generate the 30-hz variable square wave, triggers must be provided at some phase angle,  $\theta$ , and  $\theta + 180^\circ$ , the zero crossing points. It's impossible to provide these triggers by running the BCD counter at a 60-hz rate because the thumbwheel's phase steps would be twice the amount needed. For example, if a  $20^\circ$  phase step were indicated on the thumbwheel and the counter were running at 60 hz, the actual phase step would be  $10^\circ$ . This would cause the triggers to fall at the wrong point and would result in an incorrect bearing output.

Fortunately, providing the  $\theta + 180^\circ$  trigger is not too difficult, as indicated by the table that shows the BCD codes for  $\theta$  and  $\theta + 180^\circ$  trigger positions. Only the first five bits of the bearing code are shown because the low-order bits, to the right of

#### Conversion of $\theta$ to $\theta + 180^\circ$

$\theta$	RQ	PON	$\theta + 180^\circ$	rq	pon
$0^\circ$	00	000	$180^\circ$	01	100
$20^\circ$	00	001	$200^\circ$	10	000
$40^\circ$	00	010	$220^\circ$	10	001
$60^\circ$	00	011	$240^\circ$	10	010
$80^\circ$	00	100	$260^\circ$	10	011
$100^\circ$	01	000	$280^\circ$	10	100
$120^\circ$	01	001	$300^\circ$	11	000
$140^\circ$	01	010	$320^\circ$	11	001
$160^\circ$	01	011	$340^\circ$	11	010
$180^\circ$	01	100	$0^\circ$	00	000
$200^\circ$	10	000	$20^\circ$	00	001
$220^\circ$	10	001	$40^\circ$	00	010
$240^\circ$	10	010	$60^\circ$	00	011
$260^\circ$	10	011	$80^\circ$	00	100
$280^\circ$	10	100	$100^\circ$	01	000
$300^\circ$	11	000	$120^\circ$	01	001
$320^\circ$	11	001	$140^\circ$	01	010
$340^\circ$	11	010	$160^\circ$	01	011

Given  $\theta$ , the Boolean expression for  $\theta + 180^\circ$  is:

$$\begin{aligned}
 r' &= R + QP + Q'P'O'N' \\
 q' &= R'Q'(P+O+N) + R'QO'N' + RQ'P' \\
 p' &= R'(P+O+N) + R(O'+N') \\
 o' &= R'P'(O'+N') + R'Q(O'+N') + RO'N' + RQ'O'N \\
 n' &= RQ'P + RN + R'P'(O'+N') + R'Q(O'+N)
 \end{aligned}$$

COUNTER FLIP-FLOPS

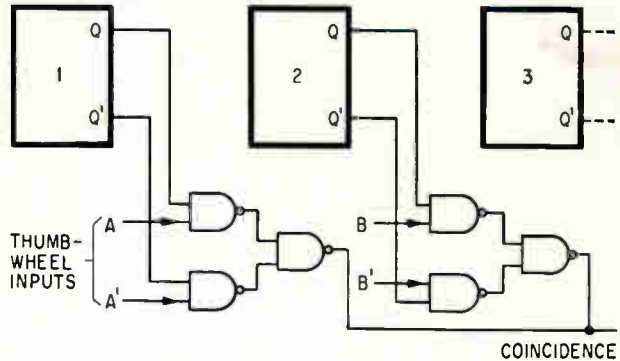

COUNTER FLIP-FLOPS

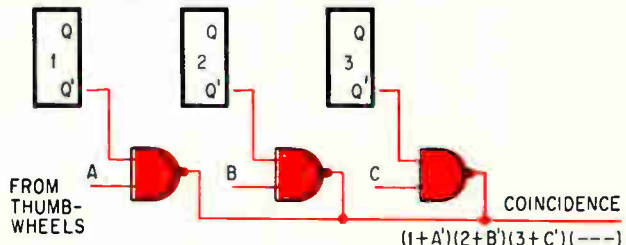

The output signal is triggered by coincidence between thumbwheel settings and internal count. Conventionally, coincidence is detected by exclusive OR logic (top) requiring three NAND gates per flip-flop. In the signal generator, the coincidence is detected by a comparator (bottom) with only one gate per flip-flop (color) and one input from the thumbwheel.

the fifth bit, are unchanged when  $180^\circ$  are added to the bearing. There are therefore only 18 codes (0 to  $340^\circ$  in  $20^\circ$  steps) that must be listed. In the  $\theta$  group, the Boolean expression  $rQ$  represents the two lower bits of the hundreds digit and  $pon$  represents the three highest bits of the tens digit. Likewise, the hundreds and tens digit in the  $\theta + 180^\circ$  group are represented by the Boolean terms  $rq$  and  $pon$ .

The reason for dropping the excess codes is the commonality between the two columns. Suppose, for example, that  $\theta$  is an angle  $325^\circ$ . The hundreds digit 3 in BCD code is 11, and numeral 2—the tens digit—in BCD code is 0010. The units digit 5 is 0101 in BCD code, but the last five bits are not shown because they do not change if 180 is added to a bearing. At  $\theta + 180^\circ$ , the angle of interest is  $145^\circ$  degrees ( $325^\circ + 180^\circ - 360^\circ$ ). Here the numeral 1 is represented by 01, the numeral 4 by 0100, and the numeral 5 by 0101, the duplicate of the previous number. The Boolean equations  $r'$  through  $n'$  show how the angle  $\theta + 180^\circ$  is derived from angle  $\theta$ .

### Comparator output

The NAND-gate circuitry on page 108, which compares thumbwheel outputs with the outputs of the BCD counter stages, is an extension of the basic comparator circuitry. The comparison results in a set of triggers at  $\theta$  and  $\theta + 180^\circ$  that are fed in turn to the upper flip-flop in the diagram. The flip-flop generates a square wave at the instant required for it to represent the variable-phase square wave.

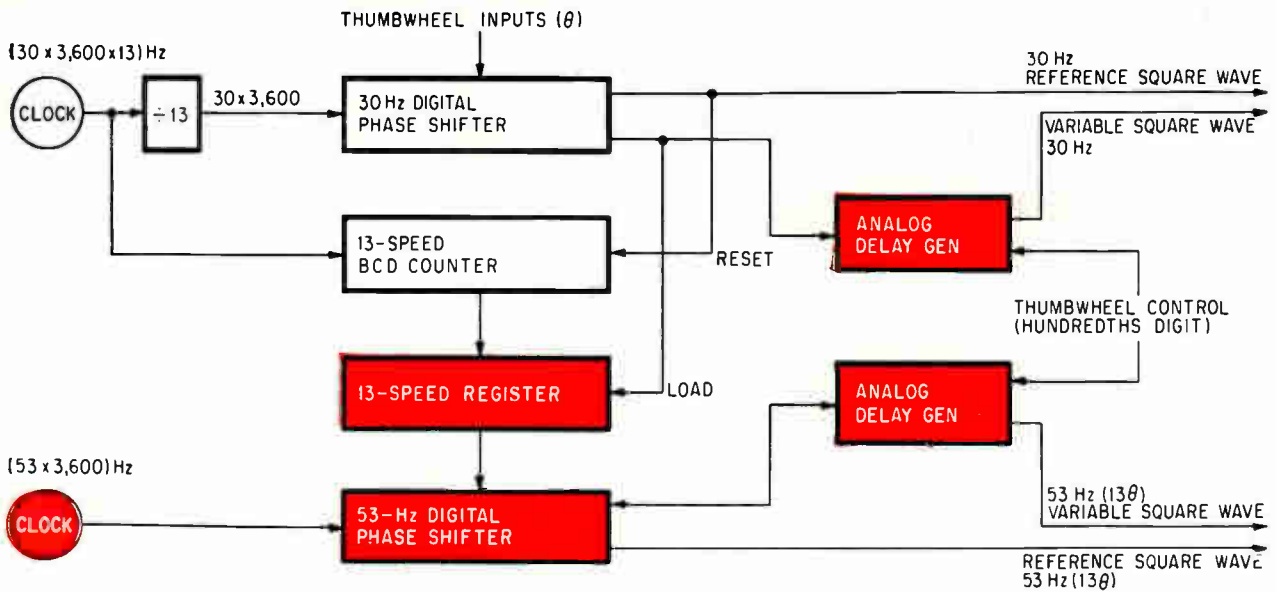

Digital "gear changer" provides the second set of signals in the signal generator that simulates the precision multilobe VOR system. Each degree of phase shift in the standard 30-hertz output becomes  $13^\circ$  of phase shift in the 53-hz output. The multiplication is accomplished with the 13-speed counter.

This will be the selected point in the clock cycle from 0 to 35,999.

Complementary and uncomplemented code disks on the tens and hundreds thumbwheels provide the Boolean terms—R and R', Q and Q', and so on—that are needed. Also, only two bits are required on the hundreds thumbwheel to coincide with the two bits, from flip-flops E and F on page 106. This thumbwheel is an octal wheel with the numbers 0 to 3 repeated twice.

The highest bearing that can be set on the thumbwheels is  $399.99^\circ$ . However, if a bearing larger

than  $359.99^\circ$  is set, the output of the variable square wave flip-flop drops to zero since no coincidences can occur. It would therefore be helpful to the operator if a simple mechanical arrangement could be devised to prevent the thumbwheels from being set at useless bearings.

### Precision VOR generator

In the version of the generator that tests the precision multilobe VOR receivers, a set of 53-hz square waves must be provided in addition to the 30-hz signals. At 53 hz, the relative phase shifts are 13 times that of the 30-hz square waves because a 13-speed counter and other circuits are added to the 30-hz signal generator.

The clock in the standard VOR generator runs at 1.08 Mhz, but the precision generator's clock oscillates at 1.404 Mhz. This signal is divided by 13 before it enters of the 30-hz counter section so that the 30-hz counter output represents  $0.1^\circ$  instead of  $0.01^\circ$  as in the standard unit. To obtain the required 13-to-1 phase shift ratio in the 53-hz section, the 13-speed counter runs 13 times faster than the 30-hz counter as reset line keeps the two counters synchronized. At the time the 30 hz variable square wave passes through zero, the contents of the 13-speed counter (which is 13 times the number of counts in the 30-hz section) are loaded into the 13-speed register. The register then controls the 53-hz phase shifter in the same manner as the thumbwheels did in the standard 30-hz unit.

Bearing resolution is restored to  $0.01^\circ$  by analog delay generators in the variable square wave output circuits. The generators are controlled by the hundredths thumbwheel, which is built as a decade switch and delays the clocks in  $0.01^\circ$  steps (1/10 clock periods). This technique saves flip-flops and gates and has little effect on accuracy. A delay generator that is linear to within 5% will have a maximum error of  $.005^\circ$  at a  $0.9^\circ$  setting.

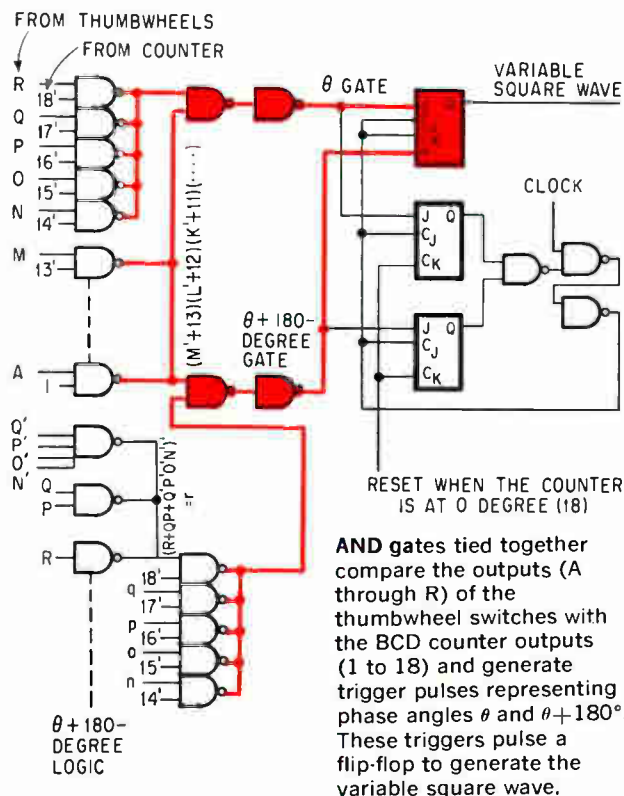

# Designer's casebook

## Instant commands trigger monostable tunnel diode

By R.C. Garavalia and E.B. Daly\*

Automatic Electric Co., Northlake, Ill.

**Output pulses** are obtained instantly from the monostable multivibrator at the right because the input pulses automatically discharge the timing capacitor and reset it to zero. Access to a monostable is usually delayed until the circuit executes the previous command and has had time to recover.

The no-waiting feature enables successive commands to generate an output pulse of indefinite duration by continually discharging the timing capacitor. A missing pulse is also detected in an incoming pulse train since the capacitor has time to charge, thus terminating the output pulse.

An emitter follower isolates the timing circuit from the output so that long time constants (and long output pulse durations) are possible; output switching by a tunnel diode circuit assures compatibility with high-speed logic without a separate pulse shaping circuit. Since millisecond pulse durations with nanosecond transition times can be achieved, flexible pulses can be generated.

When the circuit is quiescent, the input voltage is at ground potential, holding  $Q_1$  off. Transistor  $Q_2$  is held on by base current  $I_{R_2}$ . Emitter follower  $Q_2$  generates an emitter current,  $(h_{fe2} + 1) I_{R_2}$ , large enough to operate tunnel diode  $D_1$  in its high voltage state at point S and saturate  $Q_3$  at point S' as illustrated in the graph. With  $Q_2$  and  $Q_3$  on,  $C_1$  charges to the sum of the voltages across  $R_3$  and the base-emitter diodes of  $Q_2$  and  $Q_3$ .

An incoming positive pulse triggers the circuit by driving  $Q_1$  into saturation thus providing a discharge path for  $C_1$ . As  $C_1$  discharges, the base voltage at  $Q_2$  approaches ground so that  $Q_2$  gradually cuts off and  $I_{R_3}$  decreases to a very small value.

With its current source removed,  $Q_3$  starts to turn off and discharges its stored charge through  $D_1$  and  $R_4$ . The discharging continues until  $Q_3$ 's base-emitter voltage reaches valley point V on the composite characteristic. At point V,  $D_1$  snaps to point L where the resistance of  $D_1$  is much lower.

\* Authors now with Bell Telephone Laboratories, Naperville, Ill.

Designer's casebook is a regular feature in Electronics. Readers are invited to submit novel circuit ideas, packaging schemes, or other unusual solutions to design problems. Descriptions should be short. We'll pay \$50 for each item published.

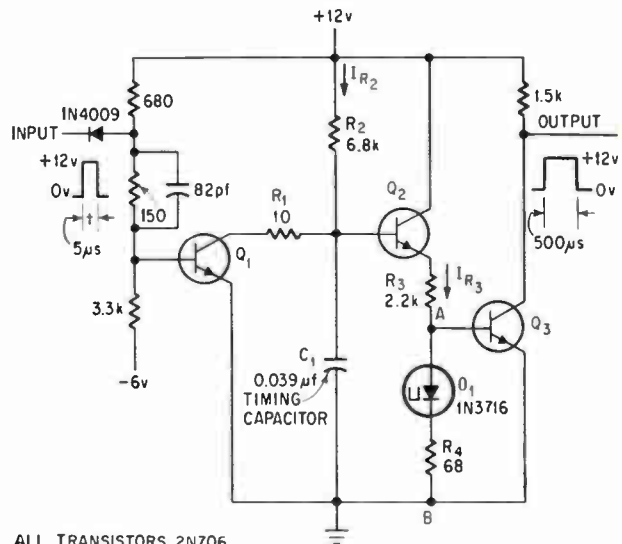

ALL TRANSISTORS 2N706

Input pulses turn on  $Q_1$  to provide a discharge path for timing capacitor  $C_1$ .

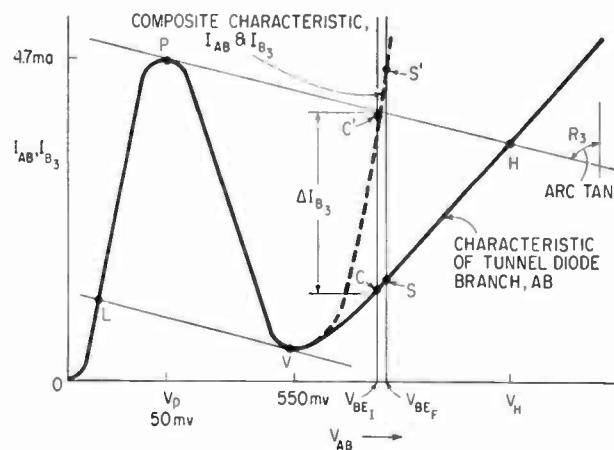

Composite characteristic shows the additional current,  $\Delta I_{B_3}$ , switched into the base of transistor  $Q_3$ .

Thus, the stored charge of  $Q_3$  is quickly drained to ground. As  $Q_3$  turns off, its collector voltage jumps to 12 volts, initiating the output pulse.

The input pulse must stay positive long enough to discharge  $C_1$  through  $Q_1$ . When the input voltage drops to ground,  $Q_1$  turns off and the timing capacitor,  $C_1$ , begins to charge. Because the input impedance to the base of emitter-follower  $Q_2$  is at least 10 times larger than  $R_2$ 's impedance,  $C_1$  charges essentially through  $R_2$ . The charge of  $C_1$

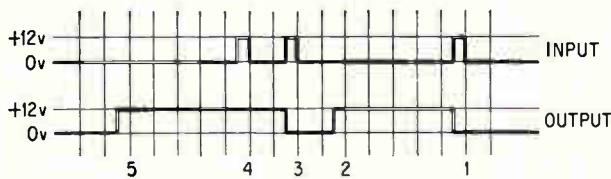

Third input pulse initiates a new 5-unit output pulse.

approaches the positive supply voltage with a time constant  $R_2C_1$ .

As the voltage across  $C_1$  increases,  $Q_2$ 's emitter current  $I_{E3}$  increases. Since  $Q_3$  is in cutoff, the entire current  $I_{E3}$  flows through  $D_1$ . Current  $I_{E3}$  increases until the peak tunnel diode current is reached at point P, and  $D_1$  attempts to switch to point H in its high voltage state.

As  $D_1$  is switching, the voltage  $V_{AB}$  across the tunnel diode branch is in transition from  $V_P$  to  $V_H$ . When the  $V_{AB}$  voltage reaches the turn-on level for  $Q_3$ , it turns on and clamps the voltage at  $V_{BE1}$ , the initial base-to-emitter voltage.

In turning on,  $Q_3$  diverts a large amount of current,  $\Delta I_{B3}$  away from  $D_1$  and into  $Q_3$ 's base very quickly. When  $C_1$  becomes fully charged, quiescent conditions are again established with the tunnel

diode current at S,  $Q_3$  saturated at S', and  $Q_3$  base-emitter voltage clamped at its final value,  $V_{BE1}$ .

The waveforms demonstrate the operation of the no-waiting feature. The first input pulse triggers the circuit and the operation takes place as previously described.

The duration of the output pulse (shown as 5-time units) is a function of the time constant  $R_2C_1$ .

A second input pulse at point 3 triggers the circuit in a similar manner. Two time units later, a third input pulse at point 4 triggers the circuit and starts a new 5-unit output pulse by turning on  $Q_1$  and discharging all of the charge placed on  $C_1$  after the end of the second input pulse. The resulting output waveform is a 7-unit pulse terminating near point 5; the third triggering pulse causes no interruption of the output pulse because  $D_1$  stays in its low voltage state.

Millisecond output-pulse durations are possible because time constant  $R_2C_1$  can be made very large. The size of  $C_1$  is limited only by the duration of the input pulse which must hold  $Q_1$  on until  $C_1$  has been discharged. A large value can be chosen for resistor  $R_2$  since  $Q_1$ 's base current will be multiplied by the current gain,  $(h_{FE2} + 1)$ .

## Unijunction switches tones without transients

By Michael G. Mladejovsky

Ajax Presses Division, McGraw-Edison Co., Salt Lake City

**Switching audio tones** instantly without large transients can be accomplished simply with a unijunction relaxation oscillator.

The circuit converts d-c pulses to audio tones that modulate the amplitude of a carrier for transmission of radioteletypewriter signals on the very high frequency amateur bands. Every character on the teleprinter keyboard is represented by a corresponding seven-bit code transmitted as a train of seven, 22-millisecond pulses. When the pulse train is applied to the keying relay's driving coil each pulse opens the normally closed relay contacts. As the contacts open, resistor  $R_3$  is removed from the tuned circuit. Therefore, the presence of a pulse is signaled by a 2,125-hertz audio tone

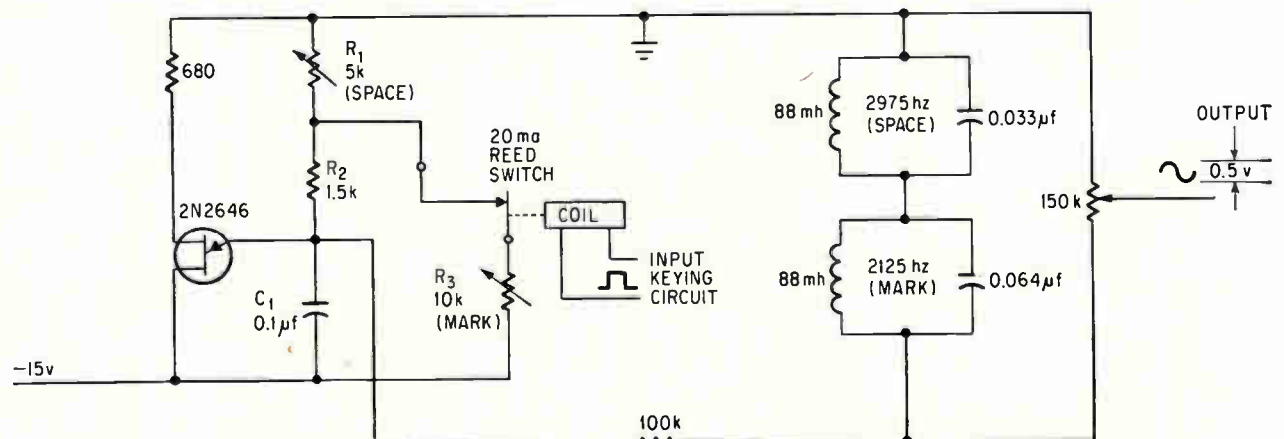

Input pulses from the keying circuit of the teleprinter switch  $R_3$  into the network, making the frequency 2,125 hz.



called a mark and the absence of a pulse is signaled by a 2,975-hertz audio tone that is called a space.

The relaxation oscillator is well suited for this application since it shifts instantly from one tone to the other, generates an equal output at both frequencies and has good long-term stability. However, the sawtooth output of the relaxation oscillator must be filtered to produce a desired sinusoid. Two parallel-resonant LC tank circuits with high-Q toroidal inductances perform the filtering and insure a good output waveform that represents a perfect sinusoid.

With the reed switch open, the frequency of the

relaxation oscillator is dependent on the value of  $C_1 (R_1 + R_2)$ , so  $R_1$  is adjusted for an output of 2,975 hz, the space tone. When the reed contacts are closed, resistor  $R_3$  is shunted across  $R_2$  and  $C_1$ ; the additional current path slows the rate at which  $C_1$  is charged, lowering the frequency. Therefore,  $R_3$  is adjusted for an output of 2,125 hz with the contacts closed. With the contacts closed the circuit generates a mark tone.

The LC filters should be adjusted for resonance at 2,125 hz and 2,975 hz. If the output at one frequency is greater than the other, the outputs can be equalized by detuning the appropriate filter or padding it with resistance.

## Negative inverter simplifies symmetrical level detection

By Phil Salomon

Hycon Manufacturing Co., Monrovia, Calif.

By inverting the negative portion of input waveforms, a Schmitt trigger can detect both positive and negative amplitude peaks. The circuit simplifies symmetrical level detection because it attains the accuracy of circuits with separate level detectors, but without their tracking problems.

When only single-polarity bias voltage is available, as in the space vehicle for which the circuit was designed, the circuit achieves symmetrical level detection without cumbersome, sign-inverting power supplies.

The circuit is essentially a full-wave rectifier. A transistor provides the isolation and the 180° phase separation usually provided by a center-tapped transformer. Elimination of the transformer substantially improves the circuit's frequency response while reducing its cost.

A-c input signals appear intact at the emitter of  $Q_1$ . The negative portion of the a-c input is inverted and appears at the collector of  $Q_1$ . Both waveforms are then applied to a full-wave rectifier, diodes  $D_1$

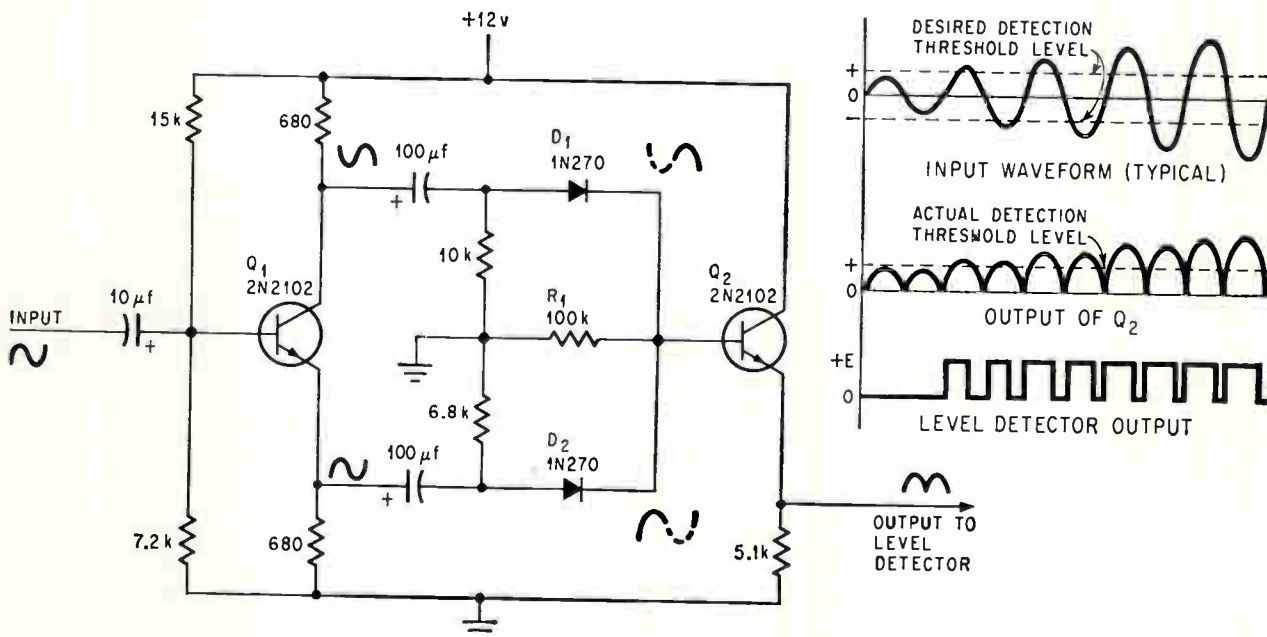

A-c input signals at the emitter of  $Q_1$  and their inverted images are inputs to the full-wave rectifier formed by  $D_1$  and  $D_2$ . The fully rectified signals appear at the output of emitter follower  $Q_2$ .

and  $D_2$ , working into load resistor  $R_1$ . The diodes clip negative portions of the signals, and yield full-wave rectification of the a-c input. The rectified signal appears at the output of emitter follower  $Q_2$ .

By employing a conventional level detector at the output of transistor  $Q_2$ , symmetrical detection of both positive and negative peaks of the input waveform is obtained.

## Zener diodes convert signals from digital to analog

By P.P. Tong\*

Systems Development Division, International Business Machines Corp., Rochester, Minn.

Where high accuracy and high resolution are not required, digital commands can be converted into equivalent analog signals by summing the voltages of back-biased zener diodes. The zener conversion circuit produces a high output voltage at low output impedance and is much simpler than similar circuits using operational amplifiers.

\* Now with the University of Wisconsin, Madison

The analog output taken from the emitter of  $Q_5$  (2N1310), equals the base voltage of  $Q_5$  except for the negligible base-to-emitter-diode drop. The base voltage at  $Q_5$  is determined from combinations of zener voltages. The combinations are formed when the shunting transistors short certain zeners from the base voltage chain in response to digital commands.

Zener diodes  $D_1$ ,  $D_2$ ,  $D_3$  and  $D_4$  are shunted by transistors  $Q_1$ ,  $Q_2$ ,  $Q_3$  and  $Q_4$  (2N1305), these transistors are, in turn, controlled by switching transistors  $Q_6$ ,  $Q_7$ ,  $Q_8$  and  $Q_9$  (2N1306) which are normally off, but can be turned on by positive 6-volt pulses on base lines A, B, C, and D. For example, a positive pulse on input line A turns on  $Q_6$  which then turns on  $Q_1$ , shorting  $D_1$  out of  $Q_5$ 's base voltage chain and reducing the analog output signal by 40 volts.

Zener voltages are shorted out of  $Q_5$ 's base voltage chain by shunting transistors which, in turn, are controlled by their respective switching transistors. The switching transistors are turned on by applying positive 6-volt pulses to their bases.

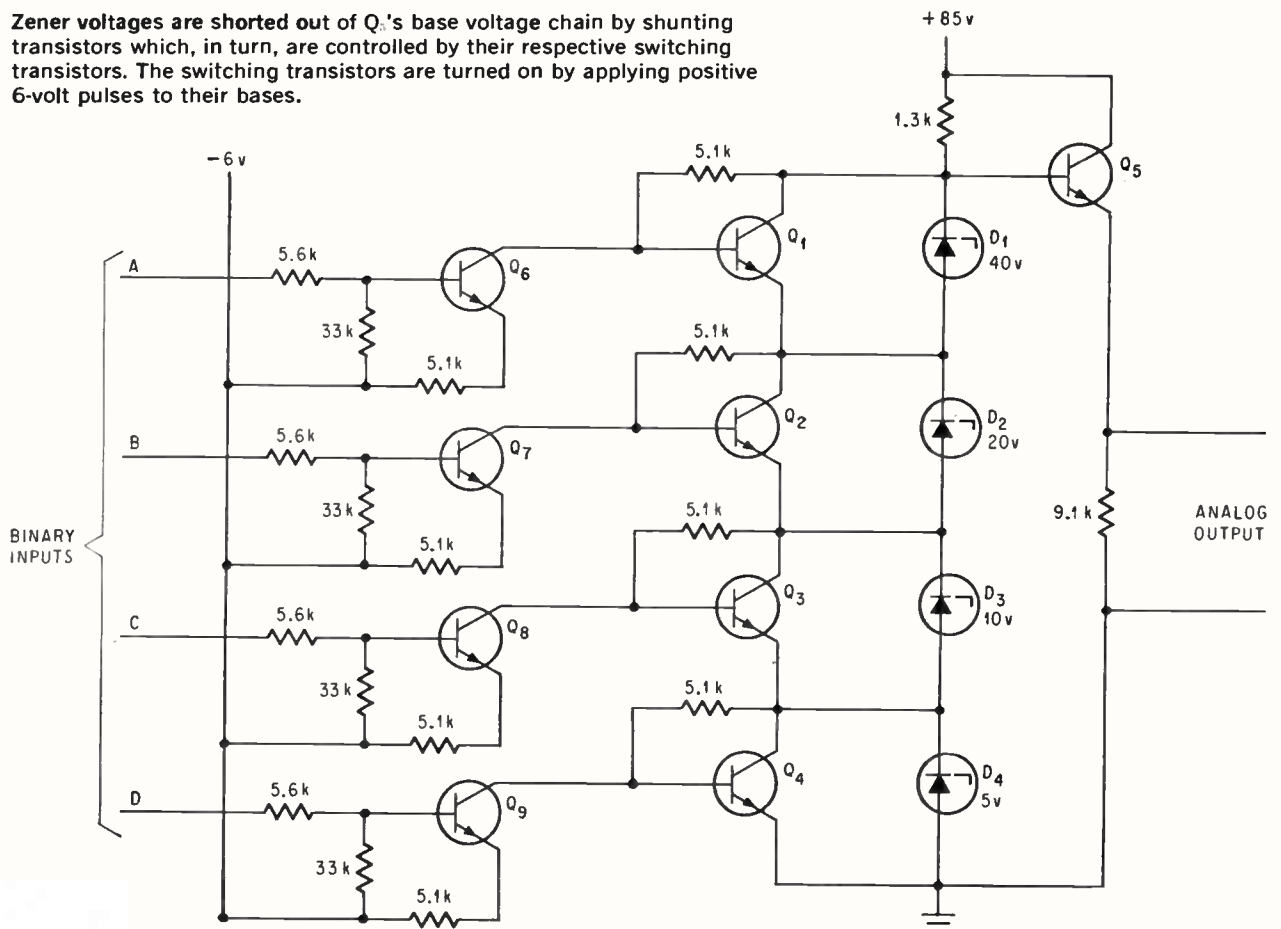



The large group display dominates the command post of Norad's combat operations center. Battle-staff personnel also monitor real-time displays on the screens of small display consoles.

## Military electronics

# Norad's computers get all the facts

Unique interface equipment and endless programming guarantee that no vital message is lost by the commercial computers of the command and control system that guards against nuclear attack

By Rogert T. Stevens

Mitre Corp., Bailey's Crossroads, Va.

If North America were attacked, the alarm would be flashed to the nerve center of the North American Air Defense Command buried deep inside the solid granite of Cheyenne Mountain, near Colorado Springs, Colo. Half-a-second or less after the first warning was received, the information would be displayed for the Norad commander and his battle staff in the Combat Operations Center.

Aircraft activity over the continent, predicted missile impacts, actual nuclear detonations and the

status of all defense facilities would be reported by teletype, high-speed data links and other specialized communications lines and radio. Counterattack commands and alerts to all important military and Government centers would go out through the communications channels.

At the heart of the center's complex command and control system—probably the Western world's most important military data processing installation—are three standard commercial digital com-

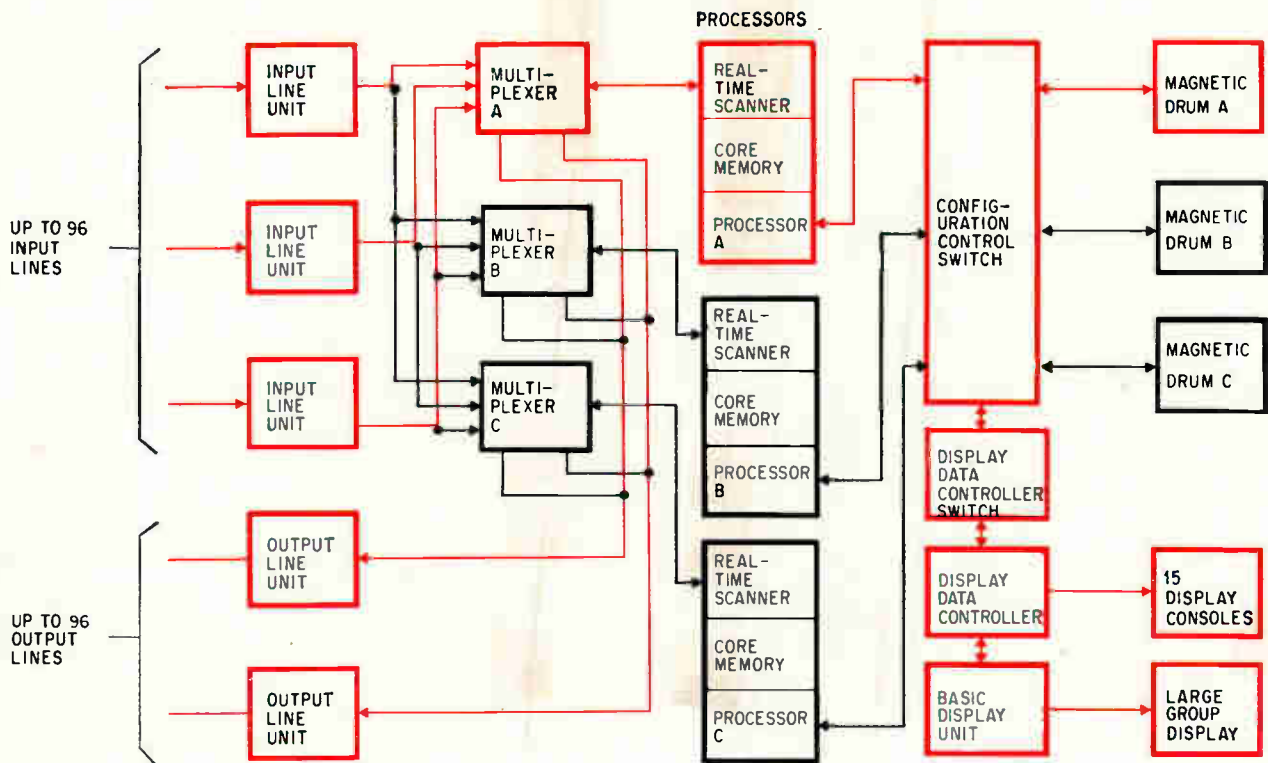

Command and control system is triply redundant. Normally, the configuration shown in color would process and display incoming messages and transmit messages to remote commands. If processor A should fail, the B or C subsystems are put into operation through the configuration control switch. The line units and their controllers (not shown) and multiplexers form the input-output data control set.

puters, more than five years old in design. Two computers were originally installed. Recently, a third computer was added to provide the increased reliability of triple redundancy.

The basic computers have been left unchanged in their functioning. They were adapted to their vital role by special peripheral equipment and the programming, designed to make it impossible for a computer to lose a single bit of message data. Even when thousands of messages are arriving every minute at different transmission rates over many separate communications links, the computer cannot be overloaded.

The general-purpose computers selected for Norad were the only suitable high-speed, large-scale digital computers available at the time the system design was frozen in 1963.

### Messages, messages, messages

Even in peacetime, a constant stream of information is processed and displayed in the operations center. Messages flow to and from eight Norad regions, Ballistic Missile Early Warning System (BmeWS), Distant Early Warning (DEW) and coastal radar networks, picket planes and ships and other information sources and field commands. In addition, there is two-way communication with Washington and Ottawa—Norad is jointly operated with Canada—and such agencies as the Federal Aviation Administration.

Each message normally relates to a single event. The Norad system must process the messages to update stored information on names, locations and status of aircraft, airbases, command centers and major cities and, in case of war, predicted missile impacts and tracks of hostile aircraft. In peacetime, tracks of unknown aircraft and Strategic Air Command flights are displayed.

### Triple redundancy

Incoming data is combined with the stored information in the computers, called the data base, to calculate the importance of attack threats, match duplicating reports and tally tracks and predicted impacts. Displays requested by the battle staff are taken from memory files and updated by the fresh inputs. The system must display information in immediately usable form, either in English or in easily understood symbols on maps and in tables.

Any of the three digital computers can be switched into the attack-alert on-line system, while another is used for Norad's second responsibility, space surveillance. Norad keeps track of every detectable object in orbit, including dead satellites and other "space garbage." The third computer is ready as a standby, undergoing maintenance, or processing off-line data. The three main computers are Philco 2000/212's. A fourth computer, a Philco 1000, performs routine off-line data processing for the center.

Originally, the Norad system called for only two computers, with automatic switching of the second to replace the on-line computer if it failed. Automatic switching has been abandoned in favor of manual switching, because any system failure requires a command decision.

A highly significant message, such as a missile attack warning, may never be repeated. Automatic switching could conceal the failure of the on-line computer, and the message would unknowingly be lost. The commander must know of the failure and evaluate the possibility of data being missing and its importance. His decisions will depend on the whole North American defense posture and the world political situation. They are too important to be left to a machine.

If the commander switches to an alternate computer, the data in the first computer's drum memory is transferred to the second computer's drum memory. All significant information in the data base is stored on the drum of the computer in use every 60 seconds. For example, the data base would include special combinations of displays that had been "assembled" with the display control consoles. These displays would not be stored as safe data on the drum, but they could be reassembled after startover. To guard against drum failure, essential data is also stored in the tape memory every 15 minutes and can be transferred to the second drum. Less data is stored on tape than on the drums.

A commercial real-time system, such as an airline reservation computer, can make do with a single computer since an occasional failure would cause only inconvenience. A system whose task is more critical, such as the one that will control airliner spacing in the airplanes, requires higher reliability. The Mitre Corp., which designed the Norad system, is also systems engineer for the FAA's National Air Space Enroute system.

Each computer module has a spare that will go into operation automatically if an on-line module fails. It doesn't matter if some of the radar data indicating aircraft position is lost during such reconfiguration, since the data is frequently updated, but it is essential that the air traffic controller have uninterrupted use of the system.

#### Always room at the input

Since a vital message might also be lost if the computer became overloaded and could not accept it, the Norad system program makes it virtually impossible for the computer to lose a single piece of incoming data. The only exception is if the equipment were saturated and then failed, but this would be known immediately. As messages are fed into and cleared from the computer memory there is always a specific assigned station available for any arriving message.

In conjunction with the system program, the special interface equipment called the input-output data control set allows the unmodified commercial computers of the Norad command and control sys-

tem to handle this highly demanding mission. A control set, designed by the Philco-Ford Corp. for the Norad system, can address the computer core memory without computer program intervention. It transfers incoming data directly into the computer's memory.

Most large-scale digital computers are designed to accept input data in large batches that can be processed almost instantly. However, inputs to the Norad system usually arrive in serial form at widely differing data rates. If the on-line computer attempted to accept the serial messages directly, each bit of each message would require a distinct program action. It would take as long to process a single bit as it would to handle a complete message. At peak loads, there wouldn't be enough time to handle the data on a bit-by-bit basis, even if the computer stopped all other processing. The data control set allows the computer to process peak loads of data, perform all its other processing jobs and still have time available for contingencies.

The data in outgoing messages is transferred from the computer's core memory to the output line units without program intervention. The line unit then controls the serial transmission at the correct rate and in the correct form for the communications link selected. This, again, avoids tying up the computer program in bit-by-bit processing of each message.

#### Program without end

The Norad program is probably the most extensive and complex command and control system program in use. A command and control system program, unlike other large digital computer data processing programs, does not have a definite end. Once it starts, it continues to operate—in theory—forever. Incoming data arrives continually throughout the life of the system and results must be displayed at once. In contrast, a typical computer program, consisting of addresses and instructions for processing data, begins with the raw data and ends when the results are obtained.

The command and control program may be indefinite, but it isn't formless. It can be broken up into discrete segments. Each segment consists of all the instructions for processing one particular

#### Computer capacities

Model	Philco 2000/212
Word size	48 bits
Memory capacity	
core	32,768 words
drum	512,000 words
Memory access time	
core	1 microsecond
drum	17.5 milliseconds
Fixed-point add time	0.6 microseconds
Floating-point times	
add or subtract	1.5 microseconds
multiply	5 microseconds
divide	12.5 microseconds

type of message or to create one specific display. The complete program, in the usual computer sense of the term, contains an endless sequence of such tutorial segments. Their real-time order is determined by incoming messages and display requests.

The complete set of segments making up the command and control program is stored on magnetic tape. It is initially read into the on-line computer, then stored in its assigned drum memory. The complete program can be read into either of the alternate computers almost instantaneously. An executive-control subprogram held in a reserved section of the computer core memory examines the interrupt signals from the data control set and display consoles. It selects the specific program segment needed for processing each message or request.

The program also allows the system to be used for training exercises, with simulated inputs. While the exercises are carried out, a portion of the sys-

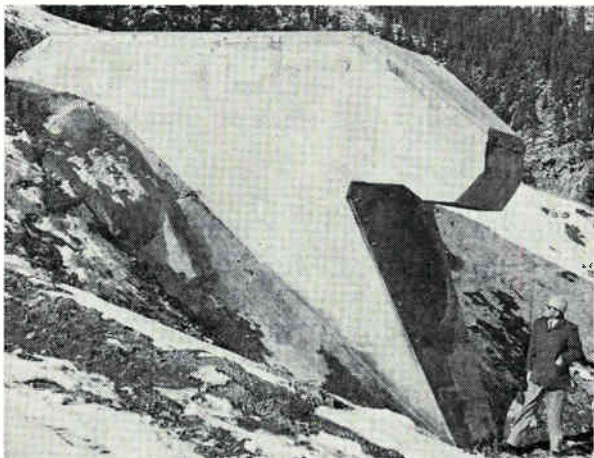

**Blast-resistant microwave antenna provides one of many communications links to the combat operations center.**

tem continues to record and display live inputs in an isolated portion of the data base. If a significant real-time event occurs, the live display console issues alarms that permit the entire system to return to live operation.

### **Message traffic commissioner**

Message flow into and out of the on-line computer is governed by an input-output data control set, diagramed on page 114. In the set are a multiplexer attached to the on-line computer, the input and output line units and their input or output controllers. All the line units are connected to each of the three multiplexers, but the line units handling tactical messages address and are addressed by the on-line multiplexer only. Messages referring to space surveillance automatically go to the second computer's multiplexer. An input or output controller controls data flow and computer addressing for up to three input and output line units. There are now a total of 42 such units, but the system can handle as many as 96 input and 96 output line units.

Each line unit terminates a single incoming or outgoing line and provides temporary storage for its data. A line unit's circuitry is tailored to match the input of each line. Messages from Norad regions and DEW sites arrive on standard teletype lines at data rates of 40 to 100 words a minute in several standardized formats. Each character is defined by a start and a stop pulse. The teletype line units strip these pulses from each character as they appear and store the characters in their own shift registers for later transfer to the computer memory.

Data from the Ballistic Missile Early Warning System comes in on digitally modulated 1,500-hertz sine wave carriers, accompanied by an unmodulated reference sine wave. The data is demodulated in the line units and stored serially in the registers. Bomb alarm data arrives in parallel, needing only to be stored in a line unit register until time to pass it to the memory. Other data, called "fielddata," in codes at 600, 1,200 or 2,400 bits a second, require a locally generated synchronizing signal for processing. The control bits are stripped from the signal by the fielddata units that also check character parity and generate the synchronizing signal to gate the characters into the shift register.

Line units handling serial data store the incoming bits of each character in six-bit character shift registers. As each character is assembled, it is shifted to a 48-bit word register. When the word register is filled, the contents must be transferred to the computer core memory before the character register fills again. Otherwise, when the new character is transferred to the word register, one character already in the word register would be lost.

### **Slots of memory**

Messages received by the line units run up to 32 words long. Each unit is assigned a unique location in the computer core memory known as a "slot," which is exactly twice the length of the maximum message that can be received by that unit. The slots are divided into halves whose functions are similar to those of the shift registers in a line unit. When one half-slot is filled, it must be cleared before the other half is filled to avoid loss of data. The computer supplies the initial slot address to the line unit, which adds the address to each completed word. The line unit increments the address after a word is transferred to the memory, so the next word takes the adjacent address.

When a line unit has assembled a word, it notifies the multiplexer. The multiplexer scans all its line units according to a priority system based on rate of data transmission, not data importance.

Line units are guaranteed processing within 1.66 milliseconds under A priority, in 3.33 msec under B priority, 9.9 msec under C priority and within 60 msec under D priority. The priorities insure processing of an assembled word before the line unit character register refills. Even if all line units are receiving messages at their maximum rates, no data will be lost, because of the priority transfer



### Norad's hideaway

Visitors to the combat operations center enter through a tunnel, one-third of a mile long. At the end of the tunnel are two steel doors, 50 feet apart. Each door weighs 30 tons. Beyond the doors is a complex of two- and three-story welded-steel buildings mounted on massive steel springs. The buildings are in a cavern hewed from the granite of Cheyenne Mountain.

The buildings house the Norad staff and the command post of Air Force Gen. Raymond J. Reeves. The center was designed to be impervious to the blast effects of nuclear warfare and to be self-sufficient for several weeks. Electromagnetic pulses from a nuclear explosion would be attenuated to safe levels before reaching the electronic equipment in the center.

system and the dual half-slot memory locations.

The input controller that services a particular line unit keeps track of the number of words transferred to a slot. It changes the address by one count for each successive word so that the message enters the half-slot in proper sequence. When a message is completed or a half-slot is full, an interrupt signal is sent to the computer which notifies it that a message is ready for processing. Up to this point, the message has been handled without any computer program action.

### From drum to core

The computer, under the executive-control subprogram, now selects the program segment needed for processing this message and moves the segment from the magnetic drum into its internal core memory. A storage area, twice the size of the largest program segment, is reserved for the active program segments. Meanwhile the computer schedules processing action for the message. There is one restriction on computer action: while a word transfer into a memory half-slot is taking place, the computer is denied access to the memory section containing that slot. However, the transfer only takes 1.5 microseconds per millisecond of operation, so there is ample time between transfer cycles for computer access. Under simulated battle conditions, when message traffic is at its peak, the time between completion of a message and display of the data is less than 400  $\mu$ sec. In peacetime operations, delays are much less.

While one message is being processed, other actions are taking place concurrently. The executive control subprogram is selecting the program segment for processing the next message and reading it into the other half of the core memory segment storage area. The line units are forming words from incoming data and the control set is transferring them into the empty half-slots in the memory. Messages are being completed and scheduled for processing by the computer.

As processing of a message is finished, its half-slot in the core memory becomes free to accept message words again, and the stored program segment goes to work on the next scheduled message. This parallel-series functioning of the command and control system will continue as long as data continues to feed into it.

### Let's see it now

The role of the command and control system in the over-all functioning of the Norad combat operations center is to supply the commander and his battle staff with up-to-the-minute displays of the tactical situation. The center is manned 24 hours a day by personnel in the command post and at the center's four divisions. The divisions are:

- Missile warning, which is responsible for the integrity of Bmews communications and for alerting the command post to missile attack threats.
- Operations, which maintains Air Force resources records and is responsible for detection and

tracking of unknown, hostile or special aircraft.

- Logistics and damage analysis, which assesses damage and reassigns the defense forces according to the situation.

- Communications, which takes care of all the data links and the operation of the command and control system itself.

The Norad commander watches a large group display, measuring 12 by 16 feet. His staff operates 15 cathode-ray-tube console displays measuring 10.8 by 14.4 inches. Each display operator can select the combination of data he looks at and modify the data base.

Display consoles and the unit that drives the large display are supplied with data from the display data controller. Each block of data words is transferred through the controller as a single computer program action.

Combinations of the data and maps shown on the smaller displays are combined in the large group display and projected in three colors. The large display is first assembled on a console display, then switched over to the large group display. Data to be displayed in each color is generated in turn on a small, intense crt and photographed as three adjacent frames on a roll of 35-millimeter film. The pictures are projected through color filters and a lens system so that they are superimposed on the screen.

Film processing takes 14 seconds. Under battle conditions, the group display can be updated in 14 seconds, but it would usually be updated every minute or 30 seconds. Normally, the updating cycle is 5 minutes. Although the commander's display is not in real time, the crt displays are, so the staff can instantly alert the commander to any significant event.

### Display consoles

Map backgrounds of Norad regions and North America, category displays that are superimposed on the maps, tabular information and inputs and outputs through an electric typewriter are stored in each display console in a 2,048-word core memory.

The category display section of the memory contains 120 nine-word slots. Each slot contains one word representing a symbol, such as an aircraft track, an airbase, or a nuclear detonation, plus four pairs of feature words. Each pair describes some characteristic of the symbol, such as altitude or speed of a track. The capacity is normally ample, since 120 symbols with four features each are more than an operator can normally discern. If more than four features per symbol are required, each must be assigned a second slot, reducing the total to 60 symbols.

If the operator requests more data from the data base than the slots can hold, data arriving after the slots are filled will not be displayed. An alarm will ring and the word "Saturation" will be printed on the display. The console also checks parity of incoming data and gives an alarm if it is not correct.

Each display word contains coordinate data

which are converted to the analog voltages that control deflection of the crt's electron beam. This establishes the location of the symbol or vector on the crt screen. Each word also contains character-indication and vector-generation bits. These activate character and vector generators that cause the beam to draw symbols, alphanumeric characters and tracks on the crt screen.

### Planning ahead

Five years ago, when the system design was just beginning, it required advances in the state of the art in hardware and software. The hardened site is, in itself, a significant advance in mechanical engineering. The system is sometimes criticized as being obsolete because recent advances have not been adopted. The critics overlook the fact that by the time more advanced electronic equipment could have been integrated into the system, that equipment would also have become out of date. Meanwhile, the Norad system has become fully operational.

For the future, more sophisticated systems are envisioned. The volume and speed of input data may in time exceed the extra capacity of the data control sets. Being considered is the use of medium-speed mass-storage devices such as input-output buffers, with perhaps a small computer exclusively for message processing.

A second look is being taken at command and control programming. For example, the central data processor operates at only 10% of its capacity during routine peacetime operation. A more efficient, second-generation program might allow time-sharing of many routine computations without degrading performance of the command and control system.

Real-time operation of a large group display is still beyond the state of the art, but several promising methods are being studied. The Eidophor system and thermoplastic recording are two possibilities [Electronics, May 30, 1966, pp. 80-89, and July 25, pp. 143-146]. In its present form, the Eidophor system is not suitable for display of random data.

### Acknowledgment

The research described was sponsored under contract AF-19(628)5165, by the Electronic Systems Division, Air Force Systems Command, Hanscom Field, Bedford, Mass. The Mitre Corp. had full engineering and design responsibility for the Norad combat operations center.

### The author



Roger T. Stevens earned his master's degree in mathematics at Boston University. Before joining the Mitre Corp. in 1965, he worked with computer-driven displays, among other things, at Sanders Associates Inc.



What's different about OFHC® brand copper?

## Its immunity to hydrogen embrittlement

Susceptibility of conventional high-conductivity copper to embrittlement when brazed or welded in a hydrogen atmosphere results from oxygen in the copper. *Unconventional* OFHC® brand copper is immune. OFHC is oxygen-free, 99.99+% pure copper. There's no oxygen to unite with hot hydrogen to form pockets of water vapor. Thus, its structure is not disrupted. The metal can't become brittle and lose its strength. □ Freedom from hydrogen embrittlement plus high conductivity (averaging 101.6% IACS) is only one of the combinations of unconventional properties OFHC develops from its exceptional purity. Other practical advantages over

conventional coppers include OFHC's ductility and impact strength. □ The full story of OFHC's immunity to hydrogen embrittlement is given in OFHC Technical Bulletin H. Request your free copy today. It may open up fabricating possibilities you thought closed—until now.

# AMAX

AMERICAN METAL CLIMAX, INC.

Oxygen-Free Copper Products Group  
1270 Avenue of the Americas, New York, N. Y. 10020

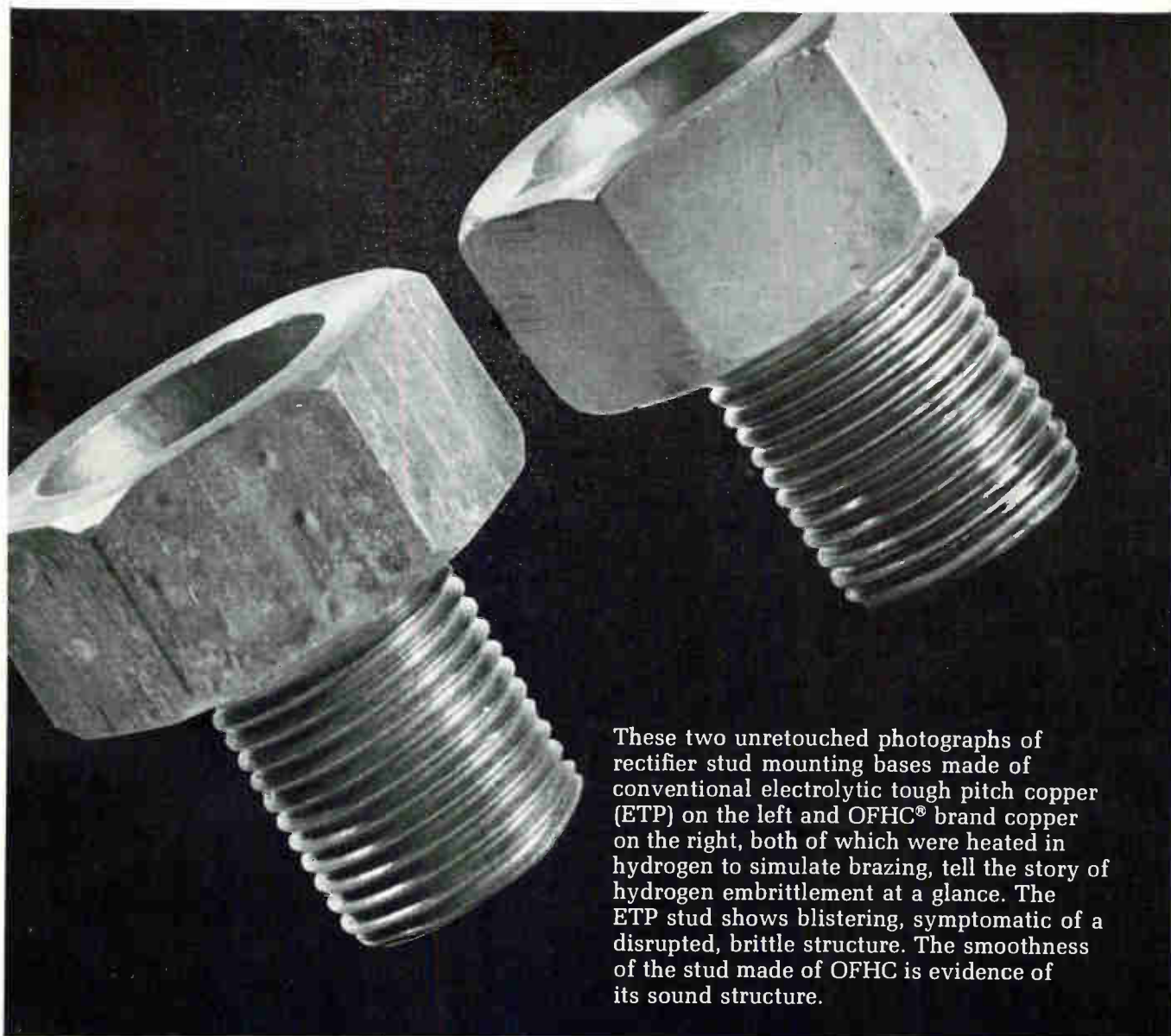

These two unretouched photographs of rectifier stud mounting bases made of conventional electrolytic tough pitch copper (ETP) on the left and OFHC® brand copper on the right, both of which were heated in hydrogen to simulate brazing, tell the story of hydrogen embrittlement at a glance. The ETP stud shows blistering, symptomatic of a disrupted, brittle structure. The smoothness of the stud made of OFHC is evidence of its sound structure.

## OFHC® brand copper... the different copper

It used to be  
a nagging pain  
figuring out  
how much  
resistor precision  
to buy.

# Then Corning changed the rules.

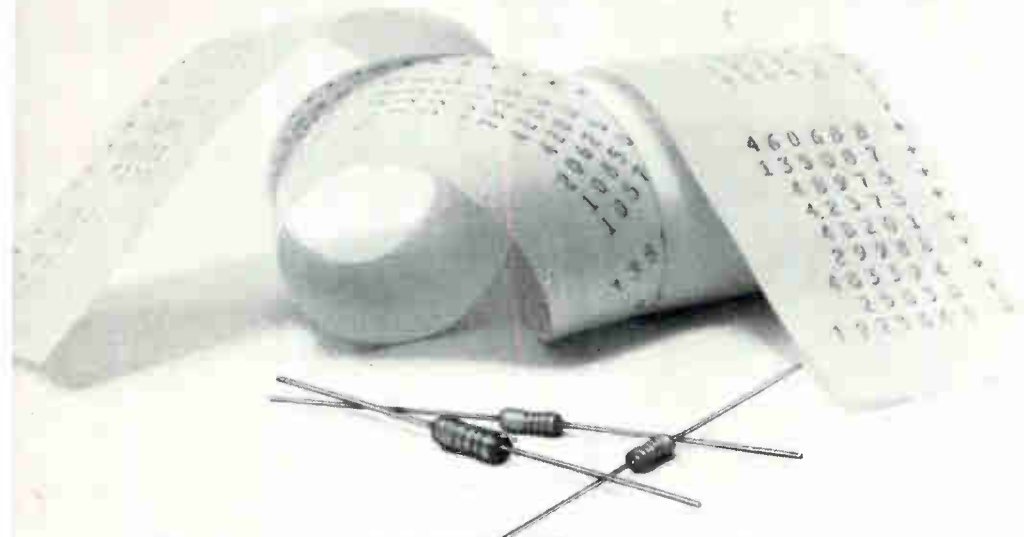

The new CORNING® C-style Resistors handle precision, semi-precision and general purpose applications. What could be easier? They offer precision stability and reliability at far less than precision prices.

---

100 ppm TC. 1, 2 and 5% tolerances. Performance requirements of both MIL-R-22684B and MIL-R-10509F, Char. D.

---

New C-Style Resistors come with 1/10, 1/8, 1/4, 1/2 watt ratings, in the 10 ohm to 499K range. Samples and complete data for the asking. Meanwhile, we're looking for more changes that will improve resistors. That's how we've earned our qualifications for exceptional stability and for reliability. That's how our line of glass tin oxide film resistors has grown to be one of the most extensive. Including precision, high reliability, low power, high power and water cooled types. Corning Glass Works, 3901 Electronics Drive, Raleigh, North Carolina.

**CORNING**  
ELECTRONICS

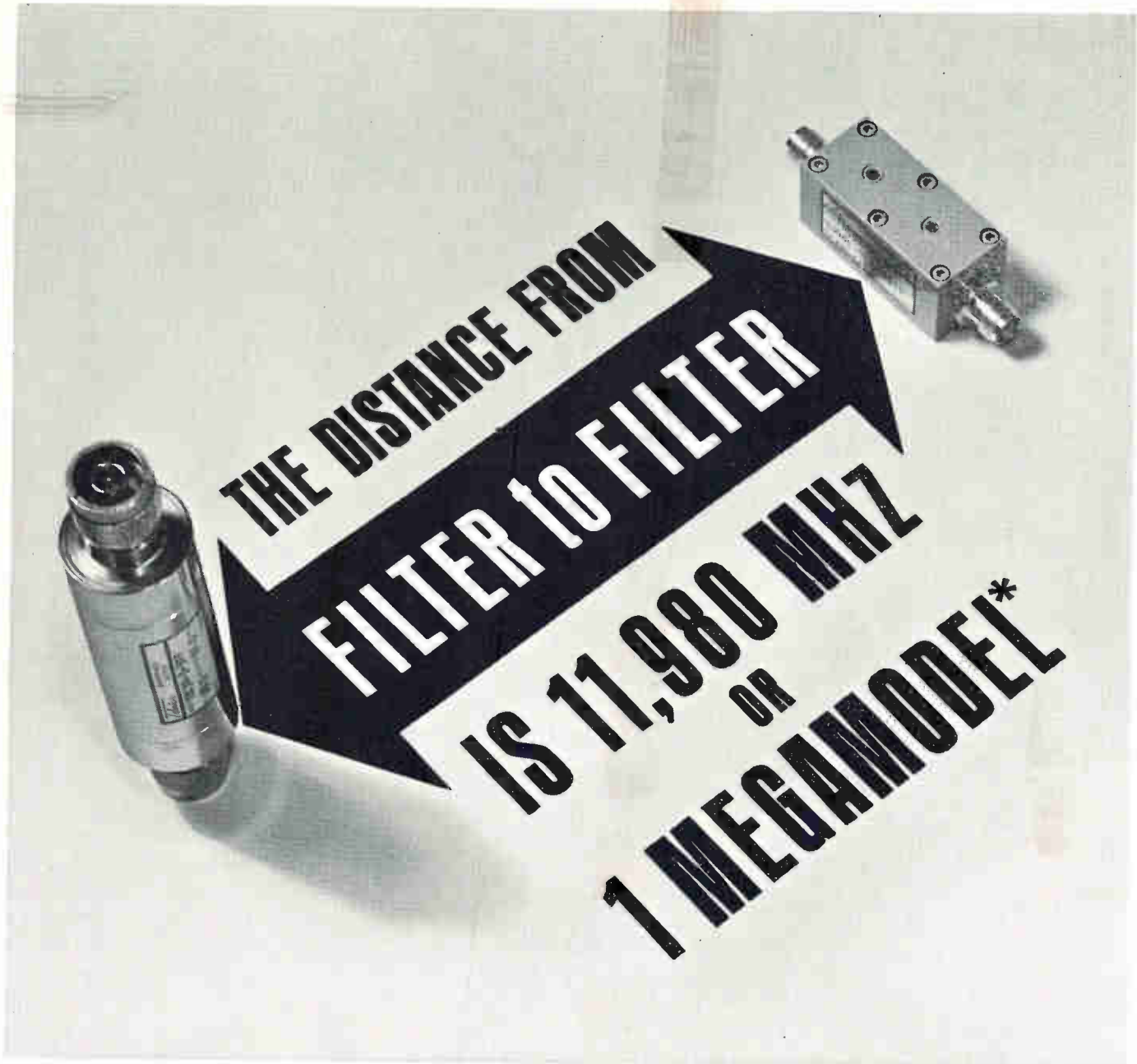

Telonic RF and Microwave Filters cover a long distance in terms of frequency (20 MHz to 12 GHz) and in terms of product line (tubular, cavity, and interdigital). \*In fact, between a simple two-section tubular type and a resonant cavity model there are an infinite number of variations that can be ordered, virtually, off-the-shelf.

Then, consider that your specifications are computer-engineered into the

**Telonic** **ENGINEERING CO.**  
 A DIVISION OF TELONIC INDUSTRIES, INC.  
 P.O. Box 277, Laguna Beach, California 92651 • Tel. 714-494-9401 • TWX 910-596-1320  
 REPRESENTATIVES THROUGHOUT THE U.S. AND OVERSEAS. FACTORY OFFICES IN MAIDENHEAD, ENGLAND AND FRANKFURT, GERMANY.

filter's design to expedite delivery, and performance of every unit is guaranteed without reservation.

Now you hardly need a second source.

**TYPICAL SPECIFICATIONS**

SERIES	FREQUENCY RANGE	BANDWIDTH
Low Pass Tubular TLP, TLA, TLC, TLR, TLS	30 MHz to 2750 MHz (Cut Off)	—
Band Pass Tubular TBP, TBA, TBC	30 MHz to 2400 MHz (Center)	1.5% to 60%
Band Pass Cavity TSF, TCF, TCC, TCA, TCG, TCH, TCB	30 MHz to 12000 MHz (Center)	0.1% to 3.5%
Band Pass Interdigital—TIF	1000 MHz to 6000 MHz	3% to 50%

Complete Guaranteed Specifications in Catalog C-101. Available on request.

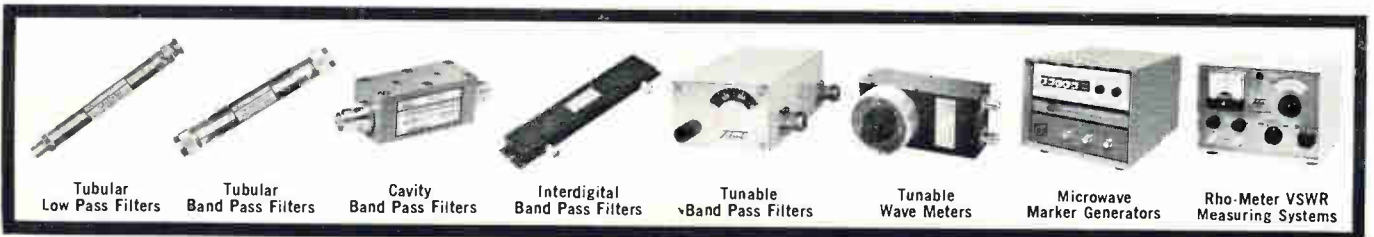

Special report

# Large scale integration

# LSI: the technologies converge

Economic and technological pressures are forcing device and systems manufacturers toward an intimate, though unwilling, partnership

By Samuel Weber

Associate managing editor

**Discussions of large-scale integration** these days are marked by a kind of majestic sweep that stirs and disturbs the mind. Descriptions of the potential rewards afforded by LSI, and the drastic penalties for failure to exploit it, as depicted by its proponents, are characterized by a brand of rhetoric unmatched since the discovery of the laser. Typical discussions of LSI bring emotional responses ranging from awe ("... more impact on circuit design engineers than the discovery of the transistor") to panic ("LSI means LSD for circuit designers").

LSI is being hailed on the one hand as making possible, at last, the achievement of that Holy Grail of the more mystical designers—the computer on a chip—and on the other is decried as heralding the end of the electronics industry as we know it.

## Not all talk

The cynical observer of the electronic scene might point out that the only products being turned out on a large scale are words, not arrays. It's easy, in this kind of climate, to dismiss all the ballyhoo as another case of overreaction to a new development, another publicity ploy by the innovation-loving technical press.

But LSI cannot be dismissed so easily.

While it is true that few products legitimately classified as large-scale arrays have left the laboratory, the magnitude of the efforts by digital systems and semiconductor manufacturers alike to get into LSI, the amount of manpower being devoted to it and the piles of hard cash being laid out for the required sophisticated equipment testify to the fact that LSI is indeed here, and will soon be a way of life for semiconductor manufacturers, system producers, circuit designers and process engineers. In point of fact, with the newly developed capability of putting 100 gates on a chip, semiconductor manufacturers are now assuming responsibility for the design and fabrication of subsystems instead of

merely circuit functions. And as always, new, unaccustomed responsibilities bring uncomfortable and disturbing problems.

## Converging forces

LSI is the result of a convergence of a number of technological and economic forces that have been gathering since Texas Instruments Incorporated's Jack Kilby produced his first crude, lumpy integrated circuit. Foremost is the improvement of integrated circuits under the impetus of the drive for higher reliability, higher speed and low cost in digital systems. In the last five years, the realization of these goals has been amply demonstrated and exploited, and in fact progress has been more rapid than anyone had anticipated. The era has been marked by improvements in fabrication methods, reduction in the size of components and circuits and the trimming of manufacturing costs. With these substantial gains, it wasn't difficult for both device and systems designers to extrapolate their results and envisage further improvements in performance and cost reduction as a result of higher component densities.

But merely increasing the number of components on a chip does not produce lower cost in itself. The total cost per function of a monolithic IC depends on a complicated relationship of several parameters that include engineering cost, processing cost, assembly cost and testing cost. Thus while it is true that to a point, the manufacturing cost per component decreases as the number of components rises, beyond a certain number the component cost increases again due to circuit complexity which tends to reduce the yield. According to Helmut Wolf and Kenneth Greenough of the research and development laboratories of Signetics Corp., a division of Corning Glass Works, there is, in any given point of time, an optimum number of components per IC, which will produce minimum cost



Computer facility at Motorola's semiconductor products division is called on to produce artwork in a hurry for large scale arrays.

per component.<sup>1</sup> At the present time, they say, the optimum number is about 70 from a fabrication cost standpoint. The cost per component has been reduced by a factor of 30 from the level of 1962 where 10 components per circuit represented the optimum.

Wolf and Greenough predict that the optimum number will increase from 70 in 1966 to 1,000 in 1970, and to about 5,000 in 1972. This increase in optimum number of components will be accompanied by a commensurate reduction in the price level. R.A. Henle and L.O. Hill of the International Business Machines Corp. predict that in the early 1970's, interconnected arrays of circuits (presumably gates) will be available at a cost of less than five cents per circuit, for moderate performance.<sup>2</sup>

Incentive for LSI is also coming from the system manufacturers who are seeking not only lower cost but more performance per dollar. The higher densities of LSI will reduce the time delays introduced by wired interconnections in today's machines, and thus speed up operation. Furthermore, transferring much more of the circuit interconnection wiring to the chip will increase system reliability.

As the economic benefits of LSI accrue, the technical benefits will probably multiply. As the cost and density of logic keeps going down, it will be possible to try new ideas in designing computer systems or ideas that weren't economically feasible when first proposed. For example, there will probably be more software functions built into the hardware, in an effort to mitigate mounting software costs. There may be a trend toward more parallel processing systems as a way to get more speed. There will surely be a growth of memory capacity, and the use of more memory and logic in peripheral equipment.

#### Computer aid essential

All of these developments would be impossible without some form of computer-aided design—the

influence of which is another of the converging forces referred to earlier. Without the computer as an engineering tool LSI would be science fiction. In actuality, all the major semiconductor manufacturers are committing large capital investments to computer-aided design in anticipation of LSI. There are a number of reasons for this—most of them relate to the complex relationship that exists between the semiconductor manufacturer and his customers. With the advent of LSI, this relationship must become more intimate than ever.

To be practical, a semiconductor supplier must be able to furnish LSI arrays quickly, and at reasonable cost. According to Robert Noyce, vice president and general manager of the semiconductor division of the Fairchild Camera & Instrument Corp., the start-up costs associated with making a custom circuit are about 30% of the total outlay. Unless some way of reducing this critical cost is found, Noyce says, LSI is doomed to oblivion, even if manufacturing expenses are reduced to zero. At Fairchild, it has been estimated, on the basis of the demands imposed by some 100 design programs initiated in a year, that approximately 320 different arrays would have to be designed per week.<sup>3</sup> The design work, bookkeeping and testing associated with that rate of array engineering just aren't feasible without a computer.

Another reason the computer is essential to LSI is that, to be efficient from a system point of view, arrays must be designed with a high gate-to-pin ratio. Designers will shun packages bristling with a hundred or so pins to be connected to the outside world. This means that the computer logic must be partitioned in such a way that most of the interconnections can be committed internally on the chip to provide a given subsystem function. (The partitioning problem is discussed in greater detail in an article starting on page 130.) For this reason, most of the initial efforts in LSI are directed

toward memories, which is apparent from the programs described in the following pages. Memory design is an area where it is relatively easy to interconnect an array of repeatable cells with a high gate-to-pin ratio.

### Resistance to standardization

But as partitioning efficiency gets higher, the designer's flexibility in other parts of the system will be severely limited, and as a result, many different kinds of arrays will be needed to satisfy the requirements of all the equipment manufacturers. In other words, the need for off-the-shelf standard arrays will be small, if present conditions prevail, and the trend will be away from industry-wide array standardization—something dear to the hearts of the semiconductor firms, but inimical to the interests of the system makers. Nonstandardization means more start-up problems, larger catalog inventories and difficulty in making engineering changes. From the fabricator's point of view it would be much more advantageous to encourage all his customers to build systems from a limited selection of standard off-the-shelf arrays. Unfortunately, the facts of commercial life being what they are, it is not likely to happen.

On the other side of the coin, the system manufacturer must find ways to standardize the arrays inside his own new computers. (See the article beginning on page 130). For economic reasons, he will want to use the same LSI chip over and over again, either in one system, or over a whole line. This will help to increase the volume of any one LSI chip design, but whether the user will permit semiconductor firms to market proprietary designs as off-the-shelf units is questionable. Systems people are notoriously jealous of their proprietary prerogatives and are not wont to turn them over to the device makers.

To offset this, semiconductor firms will aim to expand the market for LSI into a broad range of equipment products, and will probably turn their own unique designs, or obsolescent proprietary designs, into off-the-shelf units, to be used outside the realm of digital computer systems. Richard L. Petritz, director of TI's semiconductor research and development laboratories, considers this a major challenge in the era of LSI: to find new ways to use integrated equipment components, as he calls LSI arrays, and to persuade a variety of equipment makers to use them.

### Computer aid a must

In the meantime, to satisfy the requirements of this decade, semiconductor people are turning to computer assistance to achieve the fast engineering turnaround and flexibility that will be required.

How the computer will be used specifically is a subject of some controversy. One way is the so-called discretionary wiring approach advocated—but by no means to the exclusion of other approaches—by TI. Its application of discretionary wiring to the design of a memory is described in

the article starting on page 143. In this approach, many unit cells consisting of gates or flip-flops are constructed on individual wafers. Each cell is tested, and only those which are good are interconnected by alternating metal and insulating layers to form the desired function. The interconnection masks are designed by computer, based on the test data fed into it. The advantages of this system include increased yield because only the good cells are used, while providing the necessary artwork in fairly short order. One disadvantage is that the necessity for probing each cell imposes a requirement for providing contact pads for the probe, which substantially reduces the available real estate on the chip that can be used for circuit cells.

An alternative, favored by Fairchild and Motorola Inc. is the so-called "100% yield" approach to LSI. Here, the fabricator assumes that all the cells on the wafer are good, and testing is left until one of the final steps, after metalization. Because probing is not required, more devices can be put on the chip, with additional gains in array complexity and speed.

### The computer's role

C. Hugh Mays<sup>3</sup> of Fairchild and W. Raisanen of Motorola<sup>4</sup> have both described concepts of a computer-aided facility for LSI production that are remarkably similar. In both cases, the design begins with the customer's logic diagram and test specifications. The array designer will have available to him a terminal consisting of a cathode-ray tube display, a light pen and a keyboard. On file in the computer memory will be a library of gate designs, cell designs and test sequences. The designer will be able to call up, by means of the keyboard, any combination of gates and cells that he requires to fulfill the customer's logic diagram. With the light pen he will be able to change interconnections at will, rearrange cell designs and check out the design's conformity with specifications without ever actually building the circuit. When he's satisfied with the array design, the computer will determine wire routing and test routines, and on command will generate the artwork necessary for producing the array pattern.

Raisanen estimates that with such a system, a vendor will be able to produce prototype arrays to customer specifications within two weeks to a month, at a cost not above a few thousand dollars.

It should be apparent that LSI will call for an unprecedented degree of sophistication on the part of designers—those who work for fabricators as well as users. One of the major problems will be communication between those involved in systems design, and those engaged in semiconductor technology. With LSI, device designers will be working at the subsystem level, and will necessarily be working much more intimately with systems designers. Because many more people are involved in systems design and systems definition than in semiconductor technology, says R.D. Lohman of



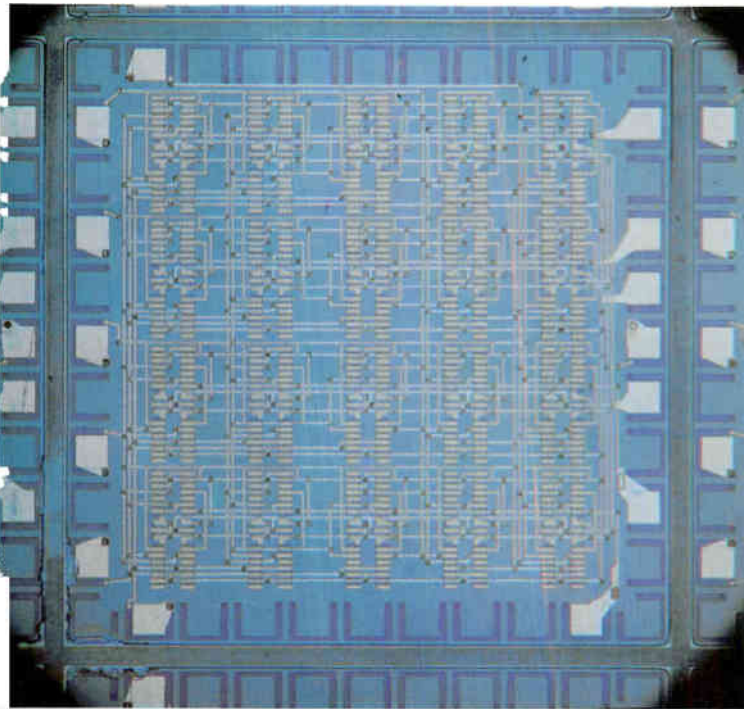

**Bipolar array by Fairchild Semiconductor is composed of eight cells in a 4 by 2 pattern. Each cell is a four input diode-transistor NAND gate. Cells are interconnected to produce function desired by customer.**

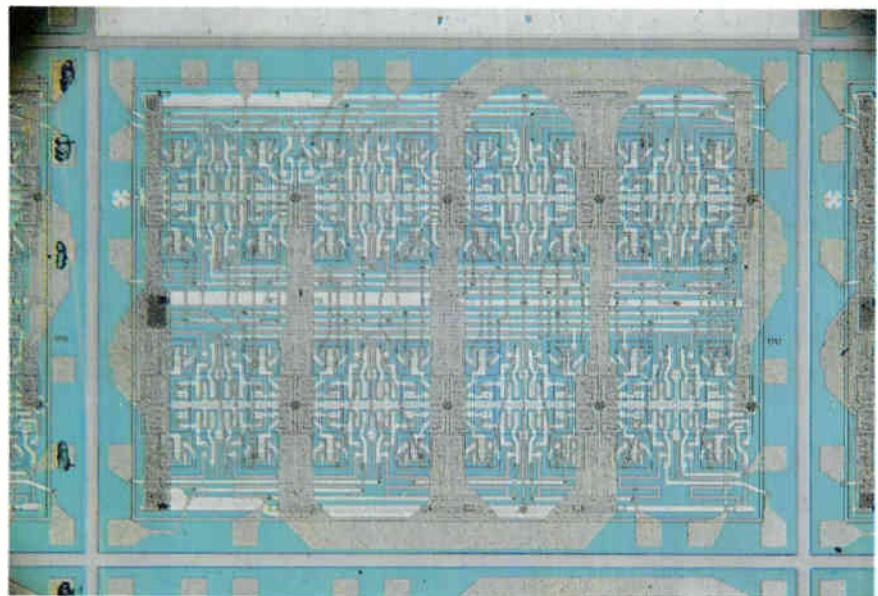

**Higher density of MOS arrays is demonstrated by this Fairchild 20-cell chip, which provides the equivalent of 80 three-input gates. For examples of versatility of these arrays, see page 163**

the Radio Corp. of America, there is a tremendous need for a common language that can enable these two groups to translate system needs into viable products. Here again, the computer will be required to bridge the gap.

### The many roads to LSI

Already, before the first large-scale arrays reach the marketplace in any volume, some choices available to the designer are beginning to take shape. These are explored in some depth in this special report. In addition to the choice between discretionary wiring and 100% yield, there is the choice of metal-oxide-semiconductor or bipolar technologies, a matter of how much you want to pay for how much performance. There is the choice of materials technology—which make available the bene-

fits of heteroepitaxy with its inherently high but more costly isolation characteristics, as described on page 171. The articles in this special report do not provide all the answers to the problems imposed by LSI, but they do reveal that there are many roads that can be taken, and that all of them are busy thoroughfares at the moment.

### References

1. H. Wolf and K. Greenough, "The trend toward monolithic subsystems," Second International Symposium on Microelectronics, Munich, Oct. 24, 1966.
2. R.A. Henle and L.O. Hill, "Integrated computer circuits—past, present and future," Proceedings of the IEEE, Dec. 1966, p. 1849.
3. C. Hugh Mays, "Computer-aided design for large-scale integration," International Solid State Circuits Conference, Philadelphia, Feb. 16, 1967.
4. W.R. Raisanen, "Current mode logic and its application to large scale integration," NEREM Record, p. 208, Nov. 1966.

## Five approaches to large scale integration



Early version of an experimental array developed by the International Business Machines Corp. Eighty standard circuits in fixed locations on a silicon slice have been interconnected by discretionary wiring to give the array an individual "personality."

Versatility of silicon-on-sapphire technology is demonstrated by this nondestructive readout memory array from the Autonetics division of North American Aviation Inc. Memory is made up of complementary p- and n-channel MOS transistors arranged in cells, single p- and n-channel field effect transistors and resistivity-checking structures.

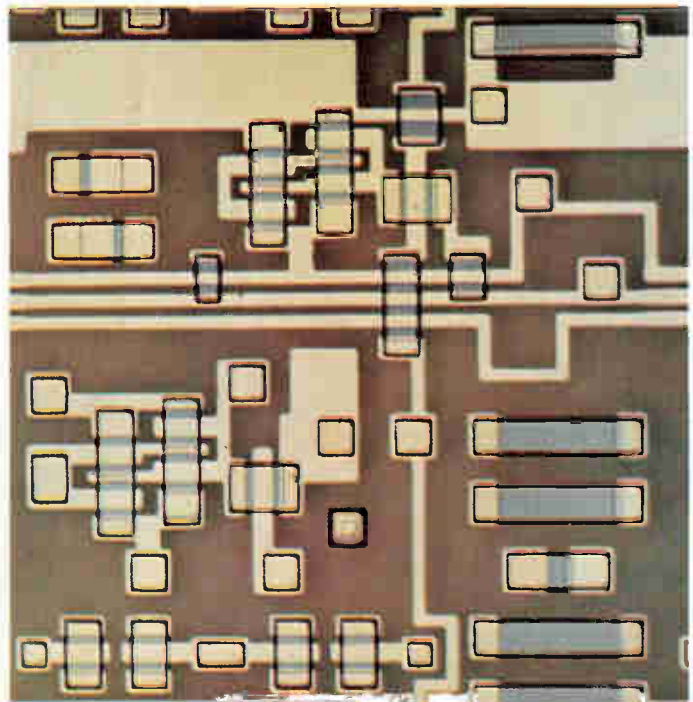

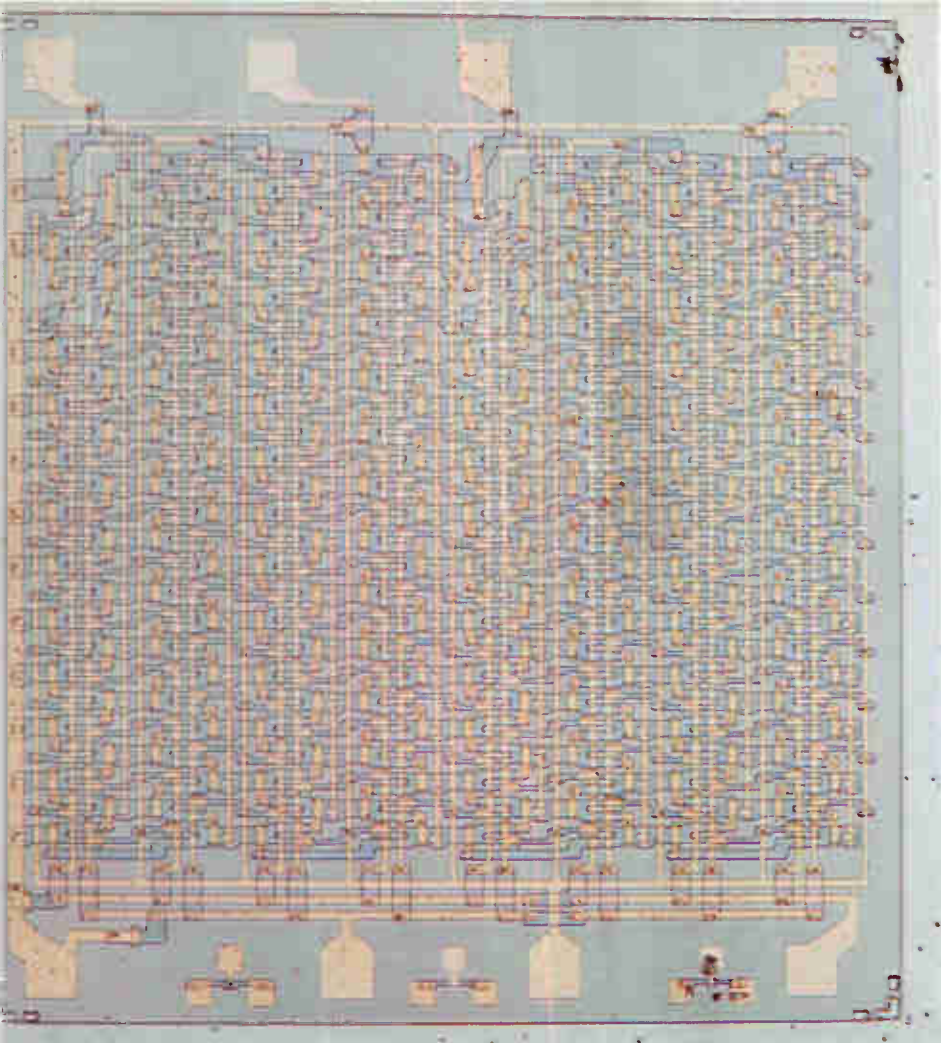

Isolation afforded by SOS permits design of high-density arrays such as this 100-bit, two-phase shift register from Autonetics' advanced electronics technology laboratory.

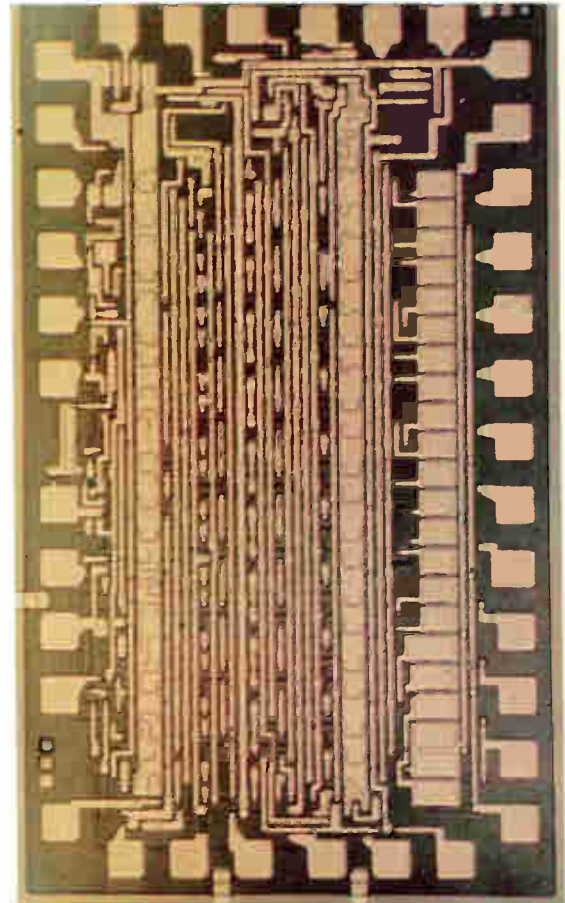

Approximately 300 MOS transistors are interconnected on this General Instrument Corp. array to provide three modes of operation: a 10-bit analog to digital converter, a 10-bit digital to analog converter, or a 10-channel analog multiplexer.

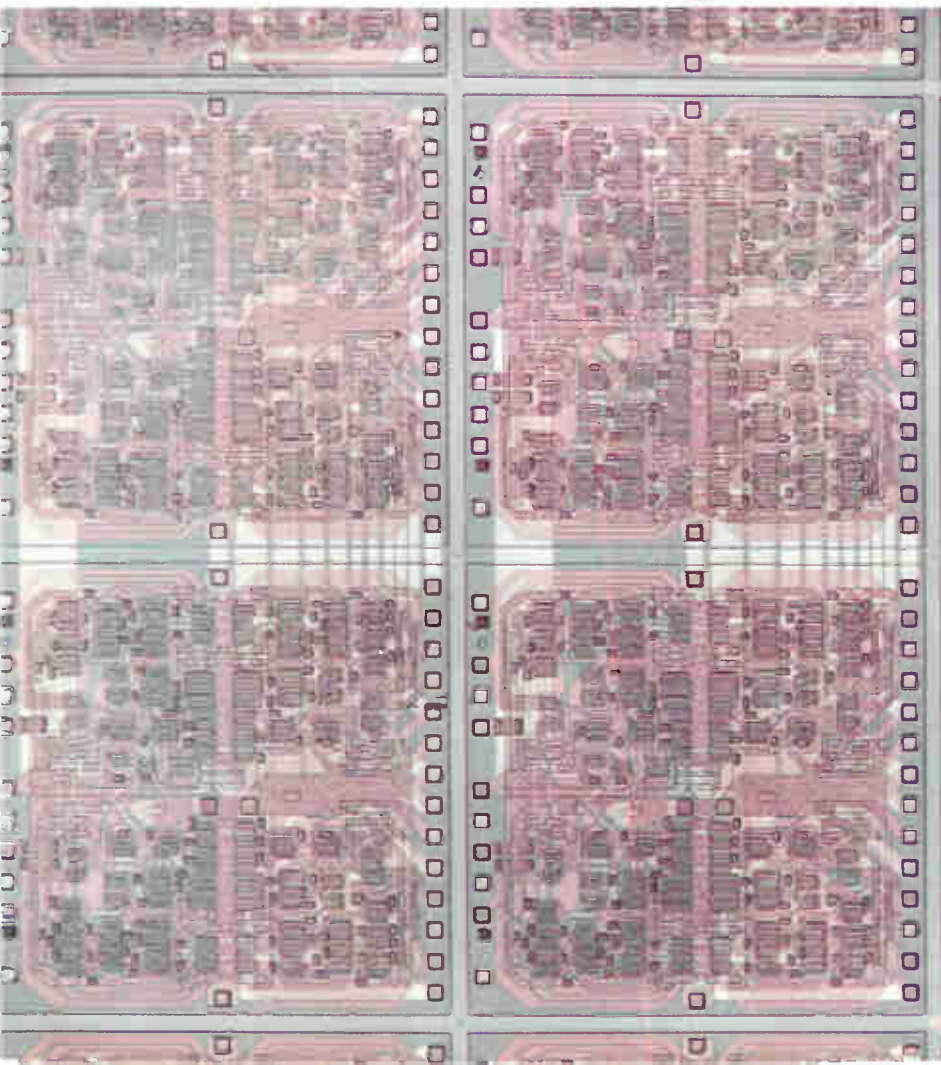

Each cell on this chip is a four-bit content-addressable memory array connected internally by two metalization layers. Motorola Inc., which developed this approach to LSI, calls them Polycells. Cells shown here are interconnected in groups of two by a third layer of metal to form a 16-bit memory. A final metal layer will complete the memory, which includes 524 diffused components.

# Benefitting the system designer

Although LSI promises substantial improvements in performance and reliability at lower cost, the system designers must first examine the complex trade offs that are required

By William A. Notz, Erwin Schischa, J.L. Smith and Merlin G. Smith

Thomas J. Watson Research Center, International Business Machines Corp., Yorktown Heights, N.Y.

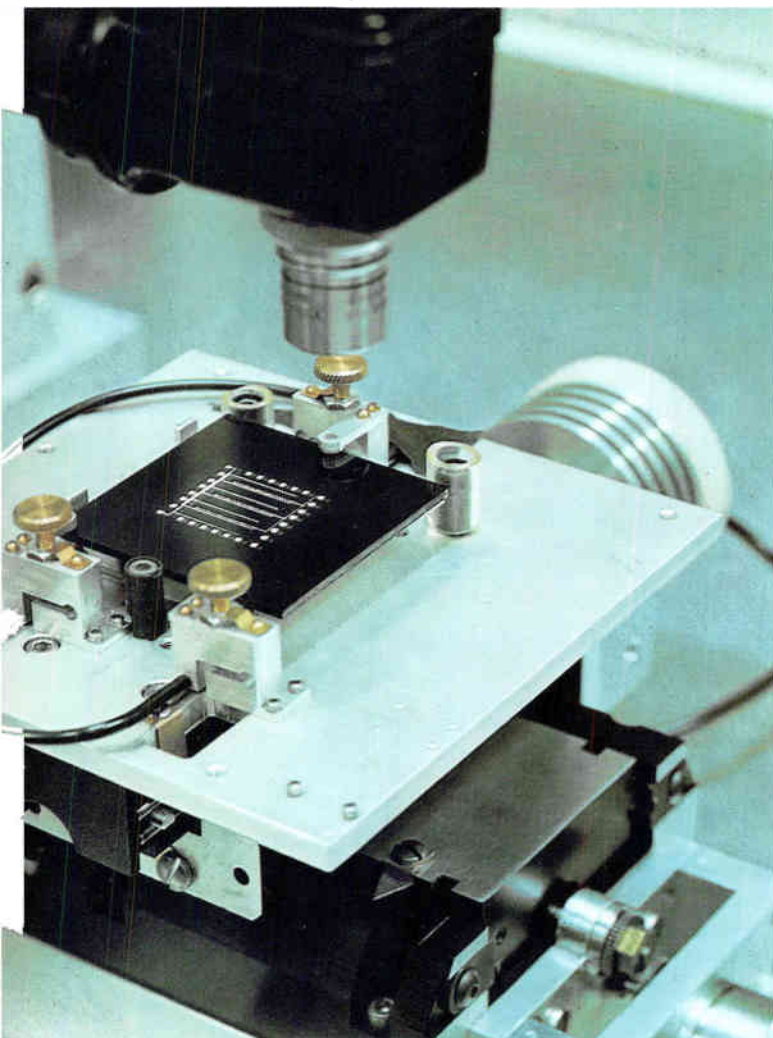

Interconnection mask for large scale array is generated on computer-controlled optical table.

**The advent of large-scale integration** will have a major impact on the design of data processing machines, and significant changes in the system design process will occur. But radically new systems will not appear until more is known about the economic and technological trade offs inherent in LSI.

System designers will have to approach LSI cautiously, applying it first in areas offering the fewest constraints and the greatest economic advantages. System organization won't change drastically until over-all LSI circuit costs are reduced substantially below those of other means of implementation. Although LSI promises to offer cost reductions, improved reliability, better performance and use less power, the technology does impose some restrictions on the system designer. Mainly it forces him into a design before he may be able to test it thoroughly.

## What is LSI?

There is no fixed definition of LSI when practical machine designs are considered because the level of integration offered to the machine designer varies as a function of circuit performance. Higher performance circuits are fabricated to closer tolerances so that the number of circuits that can be integrated at the chip level with reasonable yield will be lower than those designed for more modest performance. This is one of many trade offs to be considered in planning machine organization.

LSI also depends on the choice of device technology and hardware implementation. Since it isn't convenient to deal with all the alternatives each time numbers are used in the discussions that follow, a handy rule of thumb is that integration levels are typically two to four times higher for storage over logic, insulated-gate field effect tran-

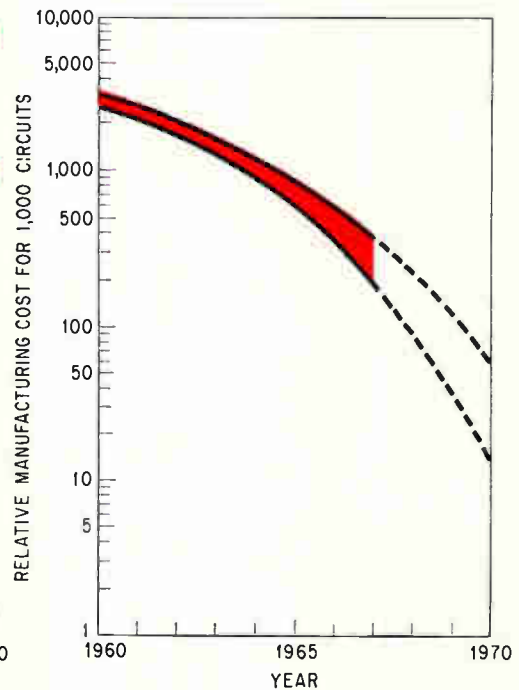
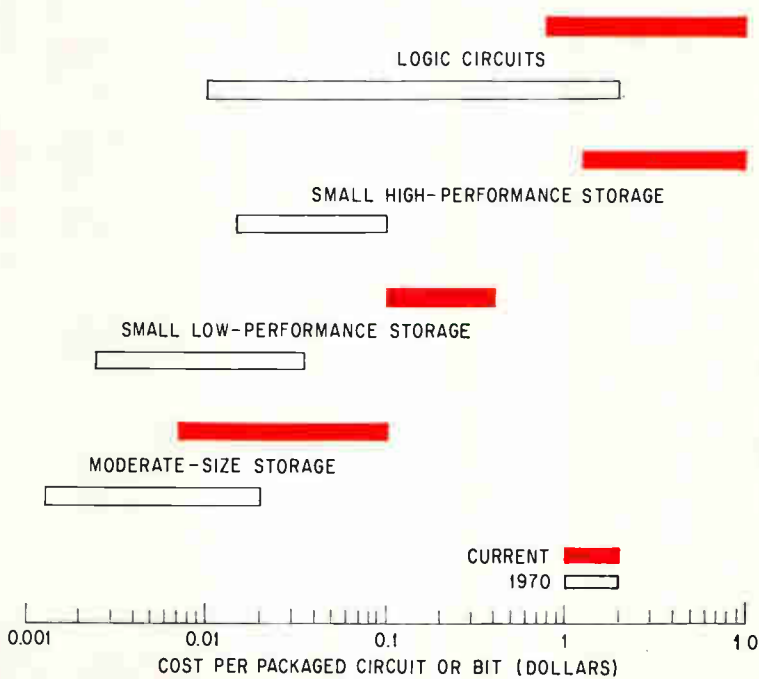
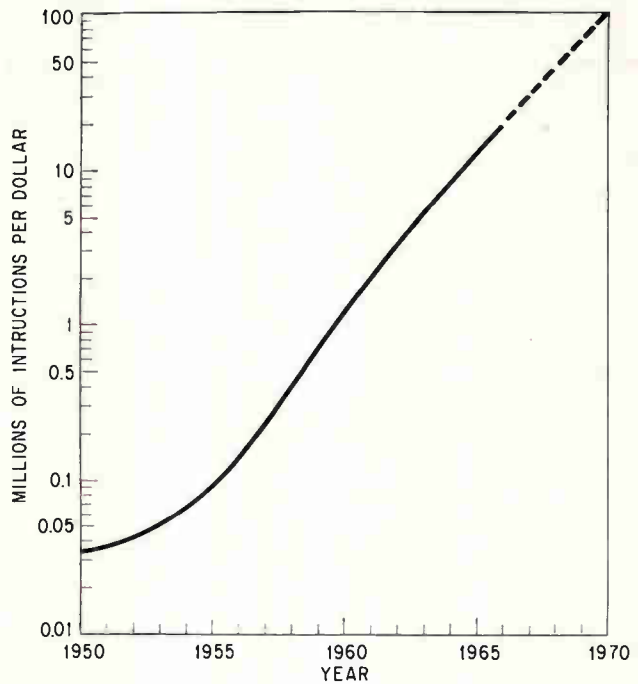
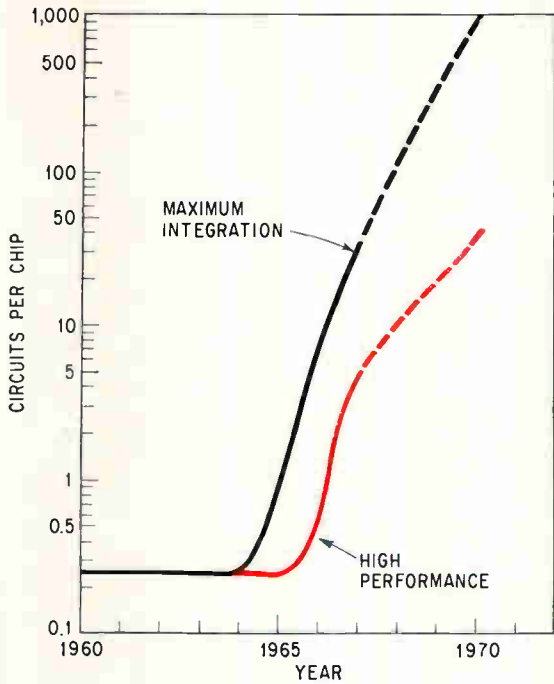

Improvements in integrated-circuit technology are generating a steep uptrend in performance, while costs are going down dramatically, as these curves indicate. At upper left, the number of circuits on an individual chip is increasing from one in 1965 to about 1,000 by 1970. At the same time, computer versatility is also expanding (top, right). This curve shows the gain in the ability of computers to handle instructions for problem-solving (not in real time) in relation to cost. Logic and storage costs will be reduced by large-scale integration (lower curves) as chips begin to carry more and more circuits. The range indicated by color in the curve at lower right reflects variations between the products of different manufacturers.

sistors (IGFET's) over bipolar transistors, and for custom-made over master-slice approaches. [See the article starting on page 157.

One of the major benefits to be gained from LSI is lower cost. LSI will permit many systems and system functions to be introduced which otherwise would be economically marginal or prohibitive,

and this is vital; however, it will not necessarily mean dramatic reductions in the total system cost of existing designs.

For example, in some typical systems where logic costs are only a small fraction of the total price, an order-of-magnitude reduction in logic-circuit costs would appear inconsequential. Fur-

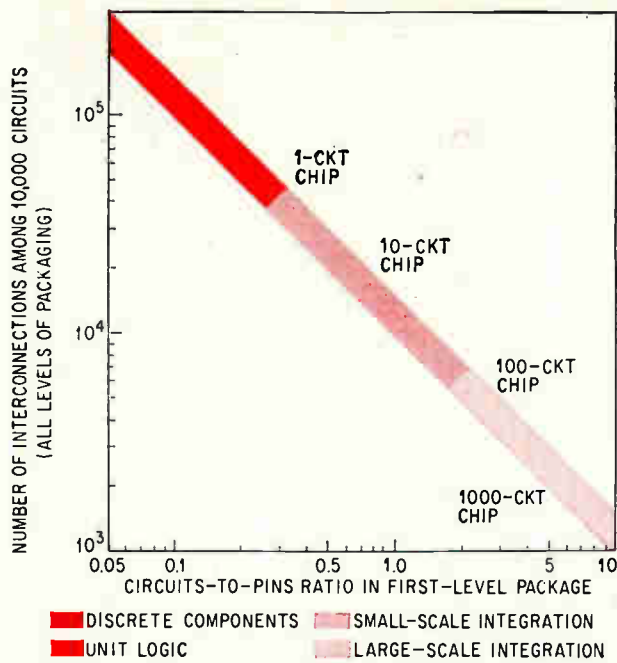

As circuit density at the first level increases, the number of interconnections at all levels of packaging decreases, resulting in better reliability.

ther, the impact of this reduction may continue to be blunted by other costs which cannot be similarly reduced. On the other hand, significantly more logic circuitry can be provided at little or no additional cost. Thus, logic capability can be added to achieve greater computing power, higher reliability, improved system interfaces and reduced software requirements. This will be one major

impact of LSI on the evolution of computers.

From the customer's point of view, the best over-all measure of these benefits is expressed by system performance per unit cost. A curve of the trend that relates system cost and performance, projects that the net performance-to-cost ratio will continue to increase dramatically with LSI. A machine designer can either produce a higher performance system without increasing system cost, if he chooses high-performance circuits, or a low-cost system without degrading performance, if he chooses a high level of circuit integration. The trend towards system performance and cost improvement can be expected to accelerate as integrated circuit technology is refined. Within the hardware of a computer the trade off in cost will also change.

At present the cost per logic circuit in computers is about 100 times as large as the cost per bit of main storage. As the level of integration increases, the cost per circuit will approach the cost per bit of storage and be within a factor of only 5 or 10 as large. Other logic-to-storage relationships change as well. At present, 1,000 circuits require two or three levels of packaging while in the future this will be one semiconductor chip. The cost for a 1,000-circuit unit, with improving technology, including the cards and boards that may be used to package this number of circuits will decline markedly, as shown on page 131.

#### Reliability gains, too

A second important benefit to be expected from LSI is greater reliability. The number of circuit

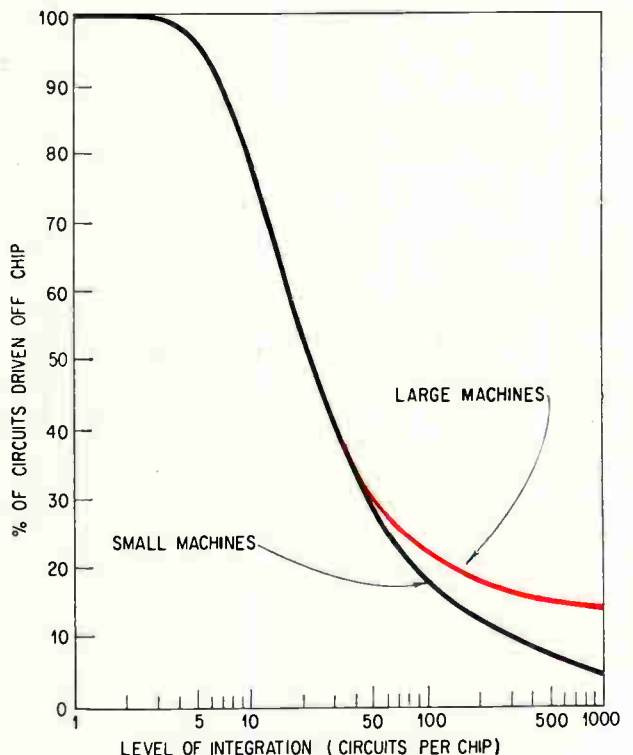
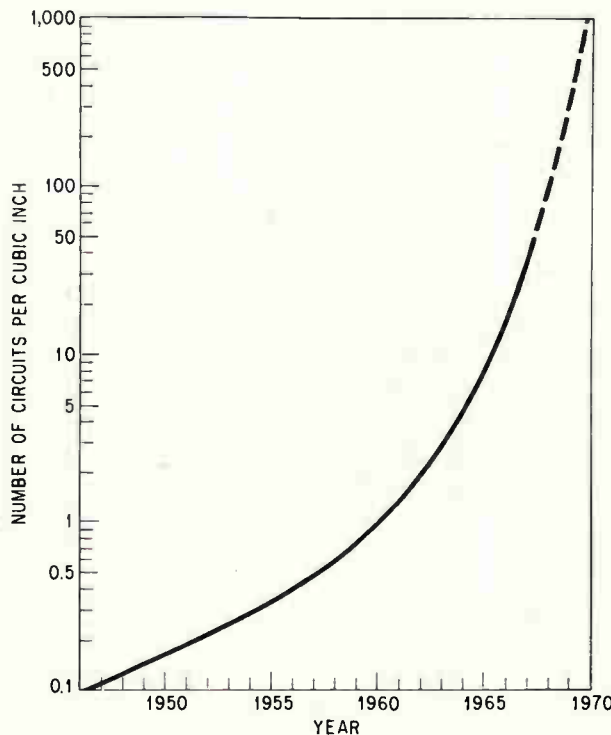

Benefits expected from LSI include increased circuit density (left), which reduces power and results in higher speeds due to lower circuit loading (right).

failures per 1,000 hours has been decreasing by a factor of 10 every five years since about 1950. LSI may be the principal means for continuing this decrease. Although marked improvements in both system reliability and maintainability are expected, an exact quantitative measure of these advantages is as yet not available.

The impact of LSI on reliability may be mainly in the reduction of interconnections. It is an accepted fact that the more interconnections integrated on the chip, the more reliable the system. If no new failure mechanisms intrinsic to LSI arise, then a considerable increase in system reliability will occur. This increase can be traded off in several ways. A given system will run longer, or if the system failure rate is adequate the system can be made larger. In some cases error checking and correcting circuits can be removed or extra circuits can be added to take over the functions of less reliable electromechanical equipment.

Other important and related benefits to be gained from LSI are lower power per circuit and higher speed. Much of the improvement will come from the decrease in the load imposed upon circuits by their environment as a function of the increase in circuit density.

As the number of circuits on a chip is increased,

more of them will have the load they are driving on the same chip. In these cases, the transmission delays or reactive loads will be decreased significantly, often more than an order of magnitude. This cut in circuit loading can be cashed in for either higher performance or lower power or some trade off between these factors. This is especially significant in the IGFET technology.

LSI introduces very few truly new constraints to the system designer but the limits can be much more severe and impose a strong influence on design. Important among these are the potentially high costs and longer turnaround times associated with producing a new part or making changes. These costs are sensitive to both quantity and performance. Without careful partitioning, intermediate levels of integration can also produce enormous numbers of unique parts. In addition, the proliferation of larger systems and more complex parts will increase the susceptibility to these factors.

Trade off relationships will reflect more significant interdependences among more diverse factors. For example, the yield (and cost) of a specific level of integration may not be known until chips have been produced in a manufacturing environment, yet by this time the system hardware design may be frozen to prevent product obsolescence.

## Changing the system design process

The aim with LSI is to minimize the number of chips in a system, while increasing their versatility and reducing interconnections

**Limitations inherent in LSI** have to be circumvented throughout the computer system's design process before the technique can be applied extensively. Because large-scale integration affects all the traditional steps in the design process and the interaction among them, its application demands a more unified approach to systems design than is currently taken. In other words, a new set of ground rules is needed.

The systems design process has always involved the following steps:

1. The drawing up of over-all specifications. These include functions to be executed by the system, performance objectives and cost projections.

2. Definition of system architecture. Functions are allocated to hardware and software, and the organization of the system is determined. At this point, machine instructions and formats for data and instruction are established, performance levels are set, circuits and equipment are selected and packaging is specified.

3. Design of the logic for the machine. Detailed algorithms are developed for machine functions, synchronization techniques are defined and micro-

programs to describe the execution of instructions are developed. Detailed logic for the machine is expressed in terms of the selected logic circuits.

4. Partitioning of machine logic and storage into packages. Logic signals are allocated to package pins.

5. Assignment of packaged logic and storage to locations within the machine framework.

6. Specification of wire routes interconnecting the packages for logic, storage, input-output equipment and console.

In modifying his approach to this process to accommodate LSI, the designer must bear in mind that large-scale integration will increase the capability of logic and storage per unit cost in those parts of the system that can use it.

### New approach to logic design

Current techniques of logic design aren't adequate for LSI. The logical structure of a machine has traditionally been expressed as a set of Boolean equations that has then been transformed to achieve minimum circuit count through such techniques as Karnaugh maps, Veitch charts or Quine-

McCluskey tables. Sometimes computer programs have been used to carry out the design process. These techniques were developed in the days of discrete-component technology and are still being used to advantage with unit-logic monolithic circuits.

With LSI, however, the development of a minimum-circuit system may not result in minimum product cost. Extra circuits may be justified by the need to reduce pin requirements, to allow package testing and to create part repeatability. Where previously one attempted to design an optimum set of elementary logical building blocks and then proceeded to implement the logic in a straightforward manner, one is now faced with the much larger task of designing the optimum hardware implementation of a complex logic structure (100 or more gates) while at the same time optimizing many other design criteria. Well-defined systematic design techniques aren't currently available to cope with this problem.

The basic effect of LSI is to increase the amount of logic and/or storage in the most elementary building blocks of a system to the point where a single chip carries a significant fraction of the total logic in a small system or represents a major functional unit of a large system.

In machine organization, the application of LSI will force the designer to consider hardware constraints to an unprecedented degree. Cost objectives, intended applications and production volume will, of course, affect these considerations. For example, if a machine is being designed for high-volume and low-cost output, the organizational objective may be to minimize the total number of parts even though all the parts are different. On the other hand, if the machine's projected sales volume isn't high but low machine cost is still important, a considerable effort may be made to achieve part repeatability.

Heretofore, standardization has generally stopped at an integration level of two or three logic decisions in first-level packaging (modules) and at levels of 5, 10 and 20 interconnected modules, corresponding roughly to 15, 30 and 60 circuits in second-level packaging (cards). Extrapolation from statistics on part repeatability at the level of 100 circuits per part, representative of a large collection of machines that have been designed for unit-logic modules, would indicate that on the average, a 100-circuit part would only be used twice. This need to standardize larger and larger sections of a system presents the greatest current challenge in LSI machine organization and LSI chip design.

### The partitioning problem

The selecting of portions of a system (carried through the logic-design stage) capable of being implemented on LSI chips without violating hardware constraints is called partitioning.

The criteria one attempts to satisfy in partitioning are numerous, and the relative weight of each depends on the final application of the system. In

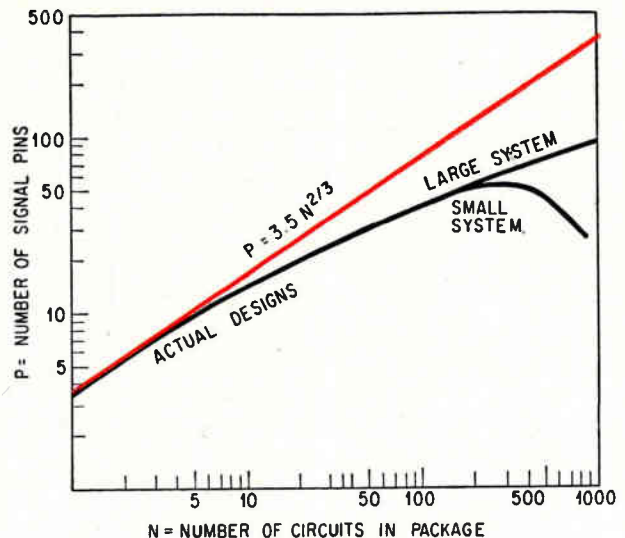

As package complexity increases, the number of pins required departs radically from figures derived from empirical data (color) and valid for low-density integrated circuits.

partitioning to the chip level, a designer is usually given a ceiling on the number of circuits and on the possible values for the number of input-output pins. The criteria that must be optimized to achieve a minimum system cost with LSI include: the number of first-level packages required (chips or parts); wiring on the second-level package; part repeatability; testing; ease of maintenance; reliability; performance; engineering-change capability; and requirements for special applications.

A close examination of these factors indicates that efforts to optimize some of them will conflict and that compromises must therefore be made. Furthermore, the techniques of achieving some of these criteria aren't well developed, although designers have gained some experience in satisfying the first three criteria and have come up with some preliminary measuring tools.

There are two principal objectives in organizing a system for LSI:

- Minimize the total number of chips and the interconnections between chips.
- Minimize the number of different chips to achieve a high degree of standardization.

### Actual partitions compared with Equation 1

No. of circuits in partitions	No. of pins according to Eq. 1	No. of pins according to actual designs
1	3.5	
8	14.0	
27	31.0	12-24
64	55.0	24-41
125	87.0	39-52
216	125.0	
343	170.0	
512	220.0	45-96
729	285.0	45-92
1,000	350.0	62-120



The first objective must be met no matter what the production volume of the system is to be. If the second objective is met satisfactorily, means must be found to successfully interconnect the various chips.

### Pin-package trade offs

If one can pare the number of chips without increasing the total number of input-output pins, then the wiring on the second-level package will be reduced. The trade off here presents a choice between either increasing the unit package cost at the first level or cutting the cost of the second-level package. In the past, when first-level packaging had a small degree of functionality, an empirical relationship could be stated to indicate the number of input-output pins needed for a given number of circuits. The equation representing this early circuit-to-pin relationship is

$$P = kN^{2/3} \quad (1)$$

where  $P$  = Number of input-output pins required

$N$  = Number of circuits in package

$k$  = Average fan-in of circuits plus 1

The table and chart on page 134 show typical calculations based on equation 1 and compare them with actual designs in which high circuit-to-pin ratios were primary objectives.

It's quite clear that the empirical relationship drawn by equation 1 is not valid for optimized circuit partitions with more than about 40 circuits. It should also be recognized from this data that wide variations can be obtained in circuit-to-pin ratios, depending primarily on the degree of effort, the techniques employed and the basic objectives of machine partitioning.

To achieve a minimum first-level package count while at the same time reducing the second-level package wiring, a new set of rules has been developed to augment those in general practice, which are applied at low levels of integration to partition logic into small units with few interconnections.

The usual objective in partitioning (except where the functionality of parts is of overriding importance) is to cut as few signal lines as possible so as to have the least number of interconnecting pins on the first-level packages. Rule 1 of the new set is rather general and aims at achieving minimum package count. Rule 2 touches upon the benefits to be gained through the addition of supernumerary circuits. Rule 3 has as its basis the fact that, at the outputs of bit storage cells (latches, flip-flops, etc.), one usually finds nonindependent information compressed to the fullest extent, usually for the sake of minimizing the number of stored bits. This compressing of logical information, whether it be for actual data or for the stable states of a collection of sequential control circuits, is usually called "encoding."

Rule 1. In general, to reduce the number of first-level packages and at the same time achieve high circuit-to-pin ratios, simply begin looking at larger collections of logic circuits as candidates for the partitions, or organize the logic into units with

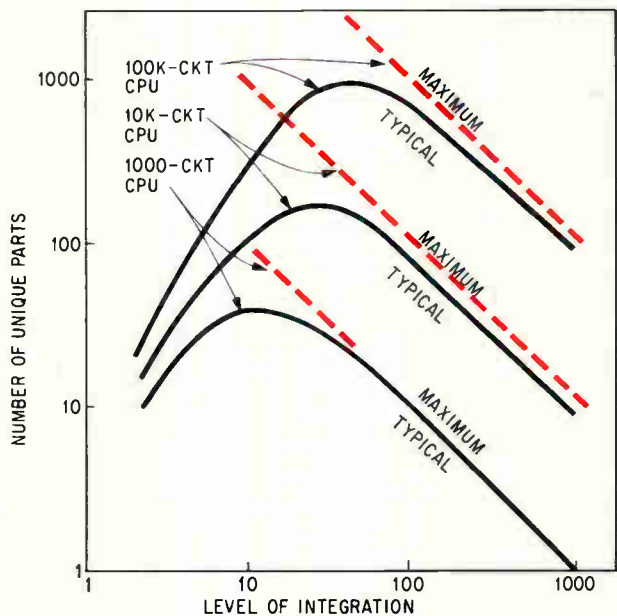
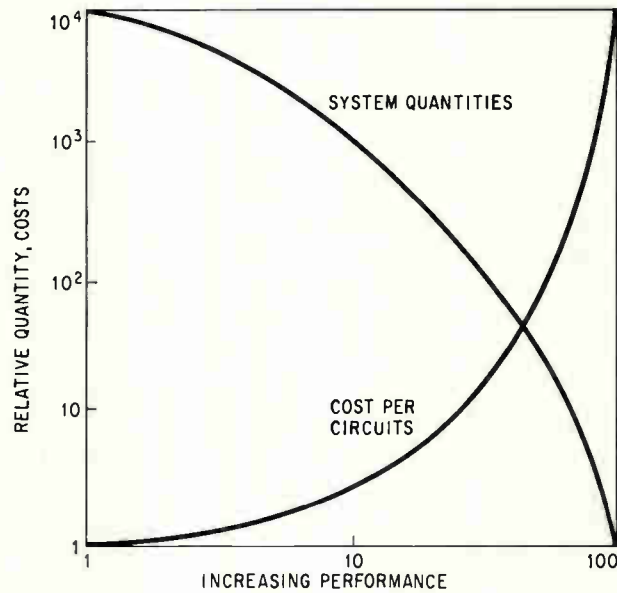
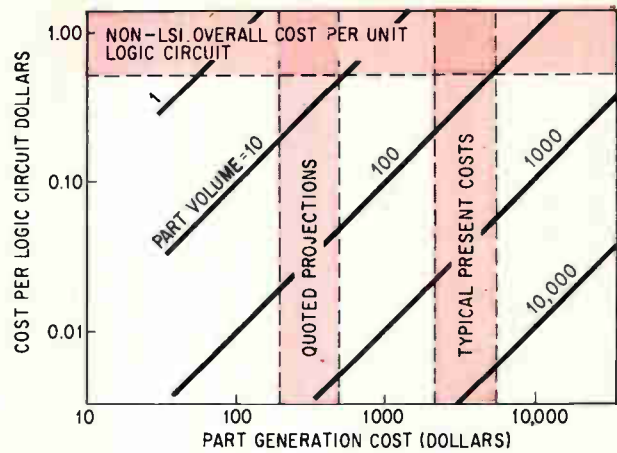

Constraints imposed by large-scale integration must be weighed against benefits. To produce a new part or make a change in an old one may be very costly with LSI, as these curves show. Moderately dense chips will result in large numbers of unique parts (lower curve) in central processor.

### Partitioning study for small system

	Partition I	Partition II
Chips	8	7
Circuits	656	740
Average circuit/chip	82	106
Total pins	309	255
Average pins/chip	39	36
Average circuit/pin ratio	2.1	2.9

high circuit-to-pin ratios in mind.

Rule 2. Where possible, add supernumerary circuits to encode all nonindependent signals leaving the chip and to decode those signals at the destination chips.

Rule 3. Partition at the outputs of bit storage cells both in data-flow sections and sequential-circuit control sections, because here the information is usually completely encoded. Try to avoid cutting within the sections of signal-combining circuitry that lie between sets of storage cells; the intercircuit connection density here is often quite high.

Rule 4. Choose as outputs from a chip those signals having large fan-out, and keep all the destination points together—on one chip if possible. The signals with large fan-out can be replicated

on the destination chip as required.

A study of a small system was conducted to demonstrate the efficacy of these partitioning rules. The system studied was complete, encompassing storage, arithmetic processing, control functions and input-output interface. The table summarizes the results of a partitioning study of the logic of this system.

The over-all study showed that with a 29% increase in circuit density and a 12.5% increase in total circuits, one could achieve an 8% decrease in the average number of pins used per chip, a 17% decrease in the total number of pins used and a 12.5% decrease in the number of chips. These results are believed to be sufficiently general to validate the following projections: an extra 10% of circuitry can free enough pins so that an additional 10% of logically useful circuits can be placed on each chip, while maintaining the same pin count. Furthermore, a 10% reduction in the number of chips per system can be expected. Also, if IGFET technology is utilized, this boost in circuitry doesn't result in a proportional increase in chip area or power dissipation. If the number of pins is reduced, so is the number of drivers, which, in IGFET technology, are relatively large and dissipate considerable power.

## Layout and logic: two roads to part repeatability

LSI calls for a reduction in the number of special parts in a system to hold down costs

**Part repeatability** is a prime factor in any consideration of system design and partitioning. The larger the number of unique parts, the higher the costs of producing, servicing, field stocking and documenting them. The cost of conventional designs is generally linked to production volume, and the application of LSI proves no exception.

In cases where cost is a prime design objective, the optimum part volume lies in the flat portion of a cost-volume curve. If the system being designed isn't going to be produced in large volume, the number of different parts to be turned out must be pared during chip layout, logic implemen-

tation or system organization in order to hold down costs.

Three different layout schemes are being proposed for LSI, each taking a different route to part repeatability. The fixed interconnection pattern approach (ad hoc FIP) utilizes a special set of masks to define each logical structure. As the layout maximizes the utilization of chip area to implement a specific logic function, the masks resulting from this approach are useful only in producing that part. The volume of the part must therefore be large enough to sustain the cost of mask-making as well as the other costs that are

### Comparison of layout efficiencies

Integration level	Circuit alone (Circuits/in. <sup>2</sup> )		Circuits+pad+scribe loss (Circuits/in. <sup>2</sup> )	
	Ad hoc	Master slice	Ad hoc	Master slice
50-100 circuits.....	27,000	9,800	16,300	8,900
100-150 circuits.....	23,000	7,700	17,000	6,800

related to generating that part.

### Sharing the masks

If the part volume is small, some way must be found to spread the mask-generating cost among different parts and reduce the inefficiency that a large quantity of low-volume parts creates in a production facility. In one approach to this, called the master-slice technique, parts share all the masks except those involved in metalization—the last step in the fabrication process. The production facility thus handles only one high-volume part until the metalization step. The sketch shows a way of implementing the master-slice approach by fabricating circuits in a standard array with horizontal and vertical wiring tracks left between circuits, and then mass-producing this configuration. The designer has only to specify the wiring (metalization) to produce the logic required. [For a more detailed description, see page 157].

A comparison of the relative layout efficiencies of the ad hoc and master-slice FIP approaches leads to the conclusion that the ad hoc technique achieves more than twice the area utilization of the master-slice approach, and that this advantage becomes more pronounced as the integration level increases. The question of master-slice versus ad hoc, therefore, comes down to a choice between lower mask-making costs and greater utilization of silicon areas.

The master-slice concept can be applied efficiently, for example, to a read-only store (ROS). For such functions, monolithic versions become impractical for addresses (source code) greater than about six or seven bits, because the number of circuits increases exponentially with the number of source code bits. For this reason, the design would combine a number of elementary sections looking superficially alike and differing only in the decoded functions to be furnished—in other words, in "personality." Increased versatility would be afforded by the extender input connected externally to other similar elementary sections.

### Applying the master slice

A particular application of this principle is the code translator shown on page 138. This chip, containing 78 circuits (558 ICFET devices), would provide up to four bits of the output, and could flexibly extend its logical capabilities. Quantities of such chips, differing only in the personalities of their AND-gate blocks, can be interconnected to provide any kind of code translation with a source code having no more than eight bits.

A third method of chip layout and fabrication is the programed interconnection pattern (PIP) or discretionary wiring approach [see page 143]. This technique is similar to the master-slice except that each chip produced has a different interconnection pattern, though the same logic is implemented. Since this method also permits the use of identical masks and processes up to the final fabrication stage, the unique-part cost is concentrated in one step. This technique may be economically feasible

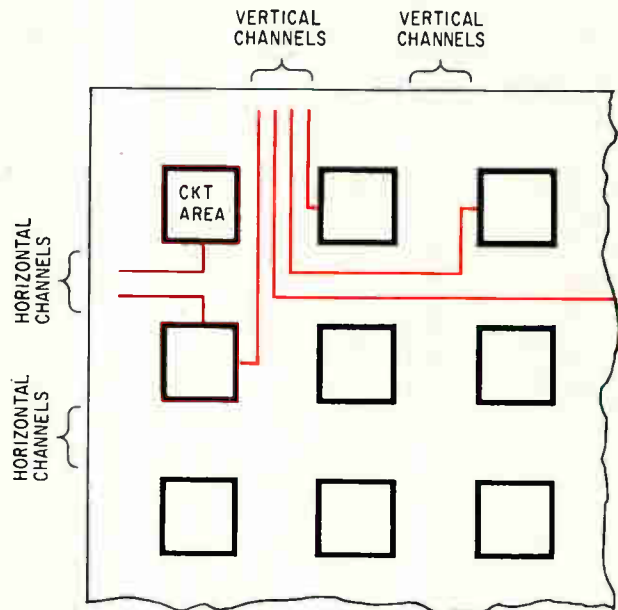

Master-slice technique permits addition of metalization to mass-produced wafer to implement logic.

at certain levels of integration, device and interconnection yield, and density, but as circuit yield exceeds a certain level the fixed interconnection pattern becomes less expensive.

### Attacking cost through logic

Another means of increasing the volume of standard parts is through logic implementation. One technique involves the deliberate introduction of redundancy or superfluity on one chip to make it useful for several applications. The table shows the estimated increase required in the circuit density of various functions to standardize them for use in a typical medium-performance application.

The amount of extra logic one can afford to add in order to reduce the number of different parts can be evaluated in terms of the advantages of part repeatability within one particular system. The cost of an LSI part of a given type can be expressed as

$$C_P = C_M + C_T = \frac{C_G}{V} = C_{MF} \quad (2)$$

where

$C_M$  = manufacturing cost per part (processing plus first-level packaging)

$C_T$  = test cost per part

$C_G$  = generating cost per part number (masks,

### Effects of standardizing functions

Functional part	% increase in circuit count	Relative weight in medium size system
Adders	Up to 50%	0.10
Buses	Up to 100%	0.25
Registers	100 to 400%	0.25
Control (ROS)	500 to 1,000%	0.40

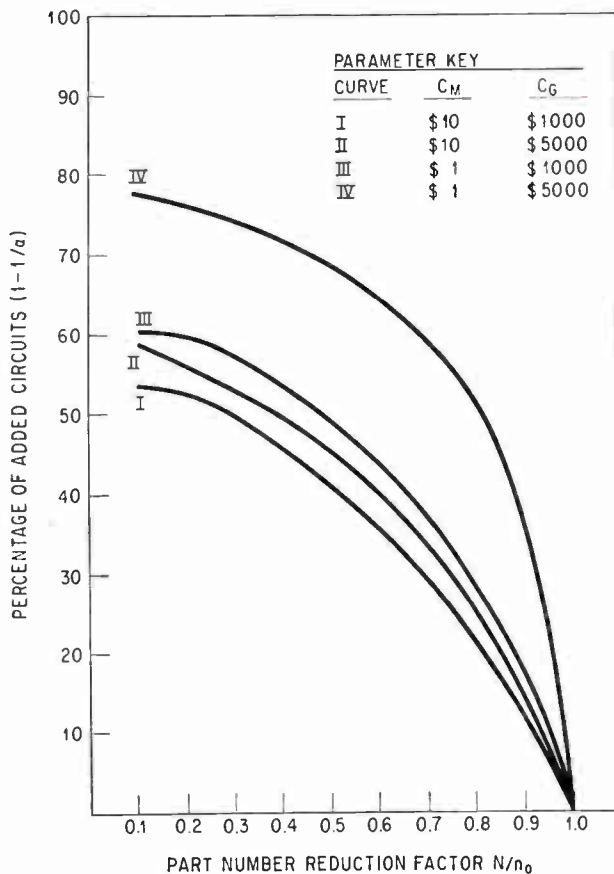
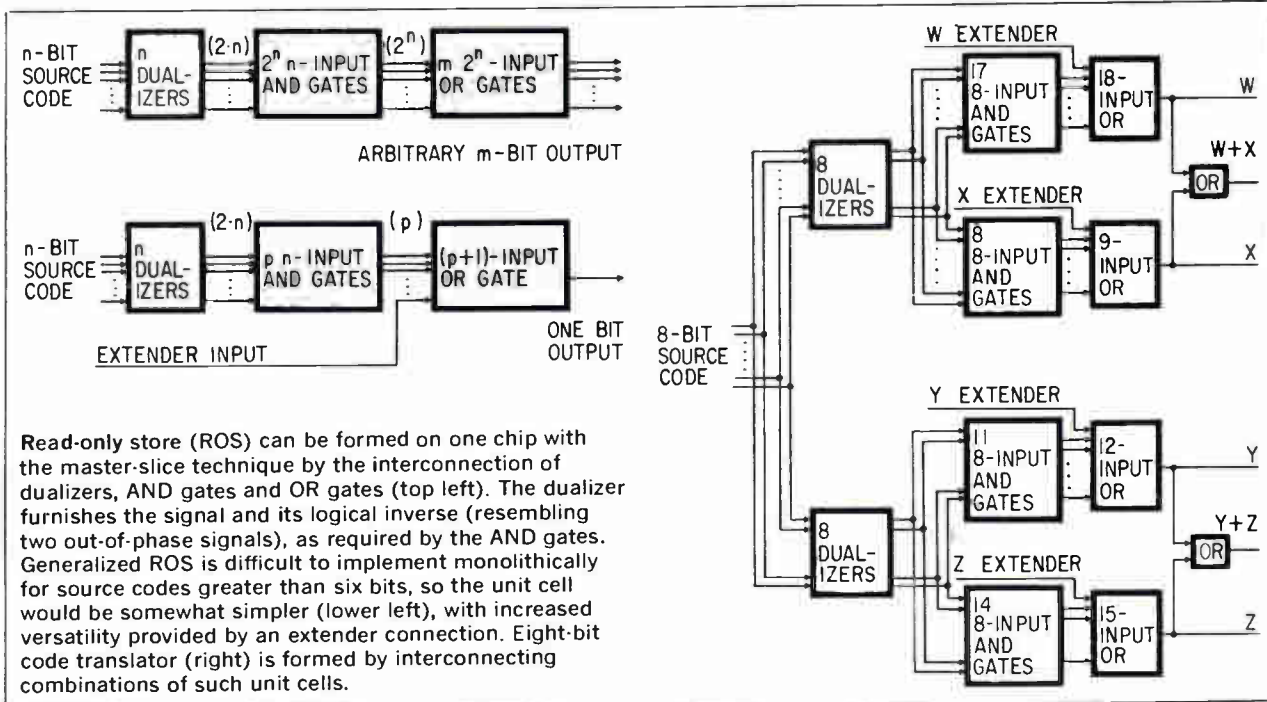

The number of different part types can be reduced by adding extra circuits. These curves show results of analysis of four different combinations of fabrication and packaging costs ( $C_M$ ) and costs of design, test and documentation ( $C_G$ ).

test patterns, documentation)  
 $V$  = parts per part number (volume = useful volume + stock volume)  
 $C_{MF}$  = field maintenance cost per part  
 The cost of a system is the summation of all the parts' costs, expressed as

$$C_S = \sum_{i=1}^{n_0} (C_{M_i} + C_{T_i} + \frac{C_{G_i}}{V_i}) + BC_{MF} + C_{PK} \quad (3)$$

where

- $C_{PK}$  = cost of the higher levels of packaging plus cooling plus power supply, etc.
- $B$  = the manner in which the maintenance cost varies as a function of the number of different part numbers, the number of systems in a given user location, stocking philosophy, etc.
- $N$  = the number of different part numbers in a system
- $n_0$  = the number of unique parts needed in the system (the ratio of total circuits in a system to the integration level).

$\alpha = \frac{1}{\text{utilization factor}} \geq 1 = \text{increase in system parts to allow for a decrease in system part numbers.}$

$1 - \frac{1}{\alpha} = \text{fraction of circuits on a chip that are extra, or supernumerary.}$

Equation 3 can now be solved with  $C_S$  kept constant to find the relationship of  $\alpha$  to  $N$ . The results shown above were determined under the following

assumptions:

$$C_M = C_T = C_{PK}$$

$C_{PK}$  varies directly with  $\alpha$

$$\left( \begin{array}{l} C_{PK} = C_{PK0} \text{ for } \alpha = 1 \\ C_{PK2} = 2C_{PK0} \text{ for } \alpha = 2 \end{array} \right)$$

On-site stocking

One machine per location

$$C_{MF} = 2 \left( C_M + C_T + \frac{C_G}{V} \right)$$

Increase of  $V$  due to  $N \neq n_0$  has a second order effect on  $C_M$  and  $C_T$ .

Results applicable to any size machine as long as the same distribution of system parts in a part number is used.

In general, the analysis shows that:

- The higher the values of  $C_M$ ,  $C_{PK}$  and  $C_T$ , the

fewer the supernumerary circuits that can be added to achieve a given part-number reduction.

- The larger the ratio of  $C_G/C_M$ , the larger the number of supernumerary circuits that can be added to achieve a given part-number reduction.

- More supernumerary circuits could be added if  $C_M$  and  $C_T$  are reduced significantly with volume.

- Fewer supernumerary circuits could be added if a more optimistic stocking and system distribution philosophy were used.

Even for the wide range of parameters considered, the maximum number of supernumerary circuits indicated by the analysis doesn't appear to allow a practical one-part-type system—all chips in a system alike—at least in terms of conventional thinking. However, further significant reduction is possible.

# Organizing for processing power

With LSI, low-cost logic and storage hardware can be used to tackle software problems

**Most general-purpose** commercial computing machines are organized on the basis of the von Neumann concept: a single central processor that executes sequentially a single stream of instructions, a main memory, and input and output facilities. The current trend toward more complex machine organization is principally spurred by a need for greater system capability.

Parallel data processing has been increased within the von Neumann concept by: boosting the parallel computation capability of such arithmetic processing functions as adders and multipliers; expanding the number of bits in the primary instructions of the machine to include several microinstructions, each to be executed in parallel by semiautonomous functional units of the system; and increasing the types of processing units that execute microinstructions ranging from arithmetic functions to logical, shift, editing and machine monitoring and control functions.

These efforts have put more hardware to work to improve total system capability, and they point to further steps that can be taken to exploit the cost reductions expected from LSI. The increased parallelism in machine structure provides the opportunity for a high order of part repeatability, so necessary for LSI.

## Entire system affected

The standardization of chip types affects all facets of system organization—the arrangement of storage units, the manner of system control, the degree of sophistication in the central proc-

essing units (CPU), the variety and degree of autonomy of peripheral equipment (input-output), and the trade off between hardware and software for the over-all system.

One way to achieve part repeatability in small machines is to find some area of commonality among several different machines, such as some shift-register storage, an adder, some counters, etc. A common part might then be built using only three or four chip types in an efficient manner. The remaining parts would be peculiar to each different system and could be implemented through the master-slice technique or other more conventional technologies.

In the large-machine category, the use of parallelism in the organization could doubtless achieve considerable commonality of parts, though the picture here is less clear.

## Main and functional storage

From the standpoint of system organization, a distinction can be made between the main storage units used in the classical manner (serial as well as random access) and so-called functional storage units such as read-only stores (ROS) and content-addressed associative stores. In an associative storage system, data is addressed and retrieved from the main store by name rather than by reference to its physical location in the memory. An associative store is characteristically prodigal in the use of logic circuitry, and serves as a good example of how hardware can replace software.

The significance of LSI to storage-unit design

is immediately apparent in the small number of different chips required for memories. If they are properly designed, many replicas of two or three chip types can be fitted together to create quite large stores. Associative stores could be constructed out of standard chips to translate the names of data into physical-location addresses.

### Central processors

The greatest logical complexity in most systems is found in the area of system control and arithmetic processing. Included in the CPU are temporary storage registers (for instructions and addresses as well as alphanumeric data), adders, counters, decoders, all the accompanying "traffic control" switching circuitry, sizable collections of heterogeneous combinational switching-circuit networks of varying width and depth, and sequential circuits consisting of latches, triggers, and flip-flops interconnected in various complicated ways.

Some of these, particularly the registers, which often comprise 30% to 50% of the CPU circuits, can be designed as modules and made exactly alike except for word length. The same is true for adders, with binary counters included as special cases. Much can be done in the systematizing of so-called "control logic" by deliberately adding redundancies and superfluities to the chips for the purpose of standardization. Doubtless the ROS master slice can gain a wider role in microprogramed control devices and in the construction of combinational circuitry. For sequential circuits, the use of a general-purpose-logic master slice is attractive.

The interfaces between the main store and peripheral equipment (input-output channels) execute multiplexing, buffering, format control and synchronization functions. They bear certain resemblances to the CPU insofar as their organization is concerned, differing mainly in the reduction of arithmetic functions, and they possibly can utilize the same standard chips in their design.

### Peripheral equipment

With regard to peripheral equipment, the modern trend seems to be to include as much or more digital circuitry in all the input-output units of a complete system as is built into the CPU. This trend will probably be accelerated in the future, and it's expected that LSI will have extensive applications in peripheral equipment by virtue of the degree of standardization it allows and of the specialized data-processing functions that can be incorporated.

For example, remote terminals now in use in time-shared systems could be expanded in computing power, flexibility and autonomy to any desired degree. Certainly LSI will find a place in the interfacing circuits of existing devices—magnetic tapes and disks, card readers and punches and the like—requiring code translations, code checking and buffering. The technique can also lead to the development for the mass market of highly sophisticated but compact devices for improved communications between man and ma-

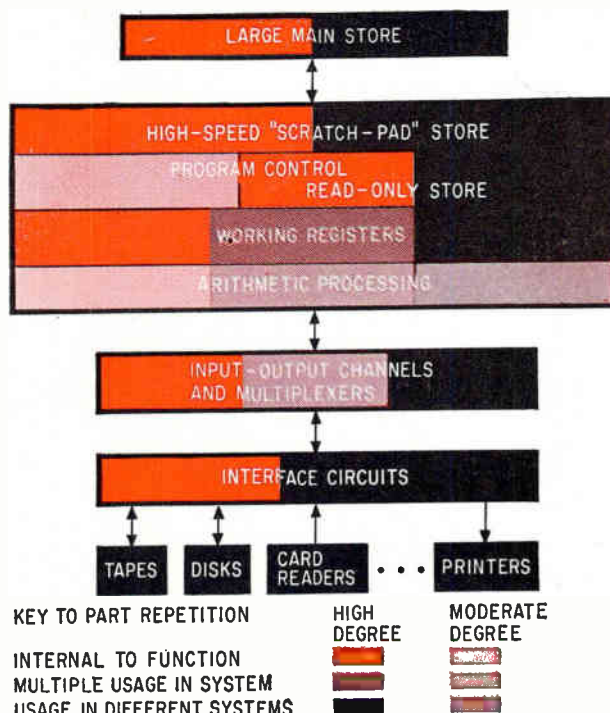

**Degree of part repeatability in a modern computer system.** Degrees of shading indicate proportion of circuitry that can be duplicated in the various system functions.

chine. These devices include document readers, voice-recognition and vocal-response gear, graphic displays and graphic input units.

### At home with the computer

Small but flexible remote terminals in the private homes of the future will be connected to computing centers by telephone lines. The programming languages used in this linkup will have to be extremely simple; experimental software systems have already been developed to enable untrained persons to use a limited-vocabulary programming language to solve simple problems.

At this stage, it seems that improvement in the man-machine interface is primarily a software problem; the main role of LSI here will doubtless be in data acquisition and display devices. More pre-processing of data by low-cost logic at the source will reduce the amount of information transmitted over communication facilities and aid in data multiplexing.

There is considerable concern today about the cost of computer software—both on the part of those who use machines to solve their problems (applications programmers) and those who create the program to match the machine to the user (system programmers). While the programmer shortage worsens, expenditures on software today almost equal the outlay for hardware and are growing at a faster rate.

How can LSI help to alleviate this situation? Well, in the broadest sense it can lead to hardware that will simplify the programmer's job. LSI can benefit applications programmers, for example, by

improving input-output equipment, increasing the information capacity of systems and reducing their response time.

### Where hardware ousted software

System functions that have been converted from software to hardware in large machines include:

- Special instructions (multiply, divide, shift, logical, editing).
- Interrupt (branch to another instruction when specific internal or external conditions exist).
- Channel capability (for example, concurrent operation of input, output and computation).
- Look-ahead (permits parallel processing of instructions that don't depend on one another).
- Dynamic storage relocation (procedure for making a hierarchy of storage look like one large main random access storage to the programmer).
- Storage protection (restricts unauthorized access to specified areas of storage).

With the advent of LSI, these functions can be included in the hardware of small systems, and greatly extended in the hardware of large machines.

The increase in reliability expected with LSI will lead to a reevaluation of error detection hardware and may result in the remodification of systems organization to include some new concepts. Intermittent failures in present computers may interrupt programs and necessitate a search for the point of failure and a rerun from that point. Despite an anticipated reduction in intermittent failures with LSI, it may be advantageous to incorporate in the system an automatic "instruction retry" feature.

### Where we are headed

This has been an attempt to predict the future of an evolving LSI technology under a number of system and hardware design constraints. The forecast has generally been cost-oriented, but "ultimate" LSI costs weren't considered and it was assumed that other cost-competitive means of logic implementation were available. It was further assumed that part-number costs were very sig-

nificant in small-quantity systems. In this environment, LSI would be applied first to:

- Special small storage applications where the constraints are minimal and where magnetic arrays (including peripheral circuits) aren't now economically attractive or don't meet performance requirements.
- Selected logic systems such as small computers, terminals and input-output equipment, or subsystems to be produced in large quantities.
- Selected portions of systems that can be widely used within and between systems.

Over-all, the increased logic and higher-performance storage per dollar offered by LSI will be used to ease hardware constraints and, more importantly, to expand the capability of systems to handle a growing number of computing, man-machine and software functions.

### Bibliography

- J.C.R. Licklider and W.E. Clark, "On-line Man-Computer Communication," 1962 Proc. SJCC, pp. 113-128.
- T. Kilburn et al, "One-Level Storage System," Trans. IRE on Electronic Computers, Vol. EC-11, pp. 223-235, April 1962.
- C.Y. Lee, "Intercommunicating Cells-Basis for a Distributed Logic Computer," Proc. Fall Joint Computer Conf., Phila., 1962.
- A.W. Burks, A.H. Goldstine and J. Von Neumann, "Preliminary Discussion of the Logical Design of an Electronic Computing Instrument," June 28, 1946, summarized in Datamation, Pt.1, pp. 36-41, September 1962.
- J. Gregory and R. McReynolds, "The SOLOMON computer," IEEE Trans. on Electronic Computers, Vol. EC-12, pp. 774-781, December 1963.
- B.A. Crane and J.A. Githens, "Bulk Processing in Distributed Logic Memory," IEEE Trans. on Electronic Computers, Vol. 14, pp. 186-195, April 1965.
- D.E. Farina and D. Trogger, "MOS Integrated Circuits Save Space and Money," Electronics, Vol. 38, pp. 84-95, Oct. 4, 1965.
- F.P. Brooks, Jr., "The Future of Computer Architecture," 1965 Proc. IFIPS, Washington, D.C., Spartan Books, 1965, pp. 93-97.
- J.A. Rajchman, "Memories in Present and Future Generations of Computers," IEEE Spectrum, Vol. 2, pp. 90-95, November 1965.
- J.C. Logue, "System Utilization," ISSCC, Univ. of Pennsylvania, Feb. 9, 1966.
- S. Triebwasser, "Programmable Interconnection Techniques," ISSCC, Univ. of Pennsylvania, Feb. 11, 1966.
- L.C. Hobbs, "The Impact of Hardware in the 1970's," Datamation, Vol. 12, pp. 36-44, March 1966.
- H. Freitag, "Design Automation for Large-Scale Integration," WESCON, Los Angeles, Aug. 25, 1966.
- M.G. Smith, "Systems considerations for Large-Scale Integration," WESCON, Los Angeles, Aug. 25, 1966.

### The authors



William A. Notz manages a group concerned with large-scale integration in systems. He came to IBM from the National Bureau of Standards, where he worked on advanced computing machines.



Erwin Schischa is investigating the impact of large-scale integration on the organization and design of data processing systems. He previously did research on high-performance computer systems at IBM.



J. Lynn Smith, another alumnus of the National Bureau of Standards is engaged in research on machine organization with large-scale IC technologies.



Merlin G. Smith is currently responsible for research into the engineering aspects of an LSI program.

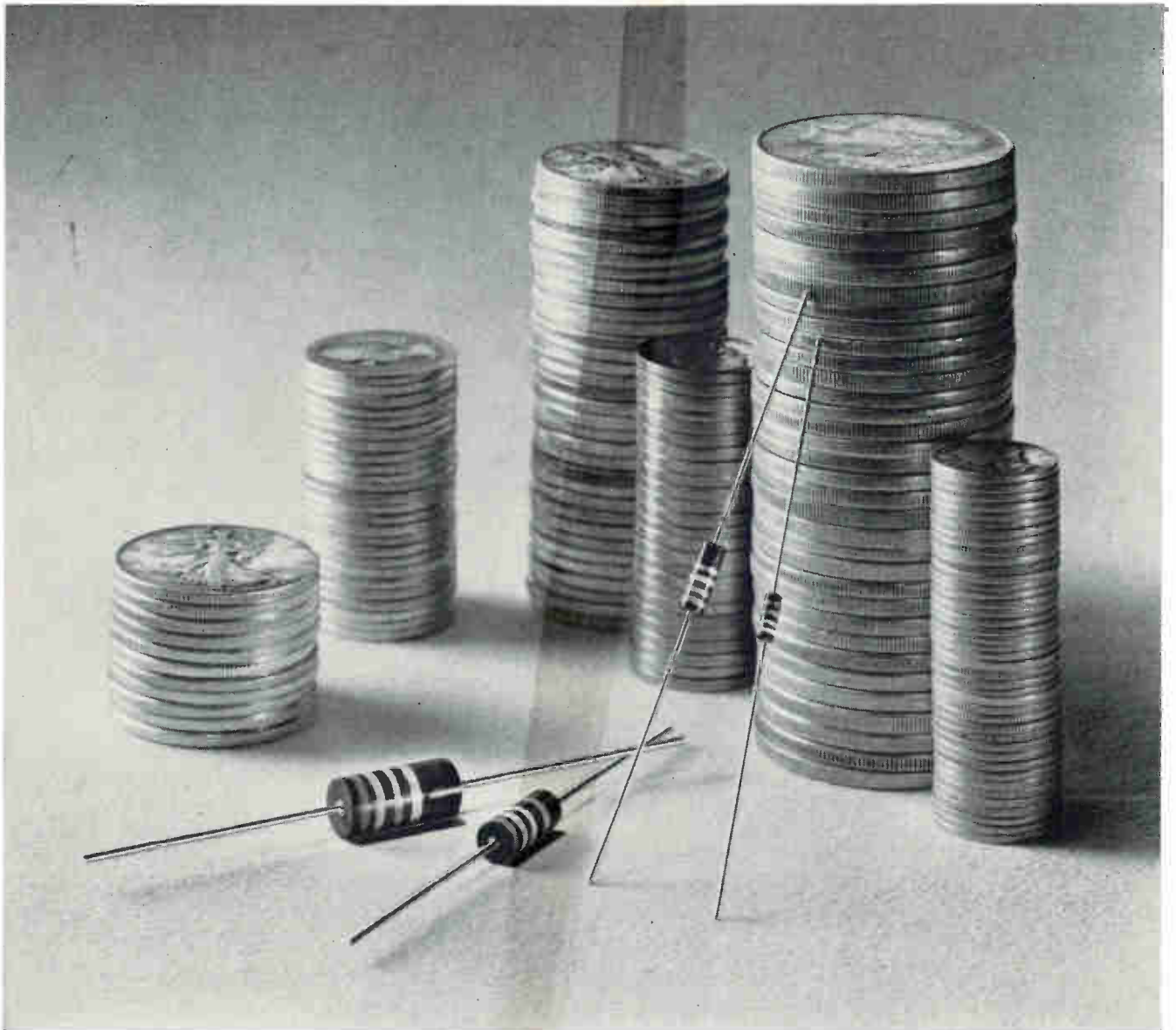

## Quality Need Not Be Expensive

Some people would have you believe that to buy the best, you must pay the most. This is not necessarily true. Price is only a measure of value—never a substitute for it.

At Stackpole, the real value of any resistor is determined by a combination of its performance record and its price. Perhaps this is why so many of our customers continue to specify Stackpole resistors year after year to maintain top performance for established products and for their new ones, too. Such confidence and loyalty cannot be based on price alone.

Uniformity has become the accepted characteristic of Stackpole resistors. Unique production methods, coupled with in-depth experience in manufacturing and testing are your assurance that Stackpole resistors will give you absolute performance. The resistors you order today will be identical in every way to your last order.

Most leading manufacturers of electronic equipment have long recognized Stackpole resistors for reliability.

Whether it be the rugged demands of portable television or the critical tolerances of space age communication and tracking equipment, Stackpole resistors deliver the performance you expect—the kind of dependability that builds a reputation for your products.

Why continue to pay a premium for quality? Let us prove that you get value from Stackpole. Quality resistors, economically priced, are delivered promptly and backed up by our complete corporate facility. Next time, specify Stackpole. There's a family of fine resistors available in sizes of 2, 1, ½ and ¼ watts. For samples and additional information, write: Stackpole Carbon Company, Electronic Components Division, Kane, Pa. Phone: 814-837-7000 — TWX: 510-695-8404.



**STACKPOLE**  
ELECTRONIC COMPONENTS DIVISION  
"OUR 60th YEAR"



# Active memory calls for discretion

High yield of 1600-bit memory slices is assured by a computer that converts test data into an interconnection pattern that bypasses defective cells. The approach is called discretionary wiring

By Michael Canning, Roger S. Dunn and Gerald Jeansonne

Semiconductor-Components Division, Texas Instruments Incorporated, Dallas

**A high-speed general-purpose** computer now being developed for the Air Force's MERA program<sup>1</sup> will be constructed of high-density bipolar arrays interconnected by discretionary wiring. This is an ambitious and sophisticated approach to large-scale integration.

Like the master slice, or 100%-yield approach, discretionary wiring interconnects groups of circuits or cells with multilevel metalization to form complex functions on a single silicon slice. But with discretionary wiring, each cell is tested prior to interconnection, and only the "good" circuits are used in the final array. This greatly increases the yield of usable slices, especially at high-component densities where defective cells are bound to occur.

The MERA (molecular electronics for radar applications) computer is designed around transistor-transistor logic (TTL), and the logic portions as well as the memory are being fabricated in LSI arrays. For the logic, 881 five-input NAND gates having an average propagation time of 12 nanoseconds are fabricated on a slice of silicon. The gates are tested after the first level of metalization, and good gates interconnected with two discretionary metal layers to form the desired function.

The memory for this machine is in two parts. One is a nonvolatile (it retains the stored data after power is removed) read-only memory for storing the program, various constants and "look-up" tables, and the other is a read-write memory for storing the processed data. The complete memory system is designed to be compatible with the logic portions in terms of circuitry and packaging.

## Ideal for LSI

For a number of reasons, the active memory described in this article is a particularly useful vehicle for proving out the concept of large-scale

integration in general, and the technique of discretionary wiring in particular. First, a basic product in the form of an array of X words containing Y bits can be applied to many functions ranging from scratchpad memories to shift register applications. As in nondiscretionary approaches, this offers the customer the advantage of availability, and offers the producer standardized testing and low development costs.

A second important feature of active memory arrays is the regularity of interconnection of the memory cells. This permits the use of a simple two-level lead pattern requiring very little silicon area for interconnection. Thus, the circuits per unit area may be maximized while the yield loss associated with more than two levels of processing is avoided.

The interconnection regularity does require the formation of a rectangular matrix of memory cells on a circular slice; a simple matrix is inefficient in the use of material. However, by including the word drivers and address decoders on the same slice, the total active area is increased, and a drastic reduction in pin connections achieved. Hence, over 1,000 cells on a chip may be controlled with about 100 pin connections.

## Memory circuits

A memory cell designed for large-scale integration must meet several requirements. First, it must be small so that the slice can be used efficiently and the cost per bit minimized. Second, it must be of simple design and tolerant of large parameter variations to increase circuit yield. Third, the power dissipation of the cell should be low to reduce the cost of packaging and cooling. Fourth, its output signal must be large enough that sensing it does not limit the performance of the memory. Fifth, the cell should be fast enough to be useful in a large

number of applications. Finally, the drivers and sense amplifiers must be compatible with the system logic, and the cell should allow the slice to be adaptable to a variety of organizations.

The cell designed for use in this system is a basic flip-flop storage element with provisions, by means of two emitter transistors, for writing into and reading out of the cell.

To understand the READ operation of the cell, assume that  $Q_1$  is conducting and the cell state is defined as 0. The collector of  $Q_1$  and the base of  $Q_2$  is at  $V_{CE(SAT)}$  volts above the unselected word line potential, or about 0.3 volt with respect to ground. The base of  $Q_1$  and collector of  $Q_2$  is at  $V_{BE}$  above the word line voltage or about 0.9 volt. The emitter of  $Q_1$  connected to the word line is conducting the sum of the base and collector currents. If, while the  $V_{REF}$  line and bit line are held at 1.2 volts, the word line is raised to 2.5 volts, current flowing in the emitter connected to the word line will be switched to the  $V_{REF}$  emitter. If the cell stores a logical 1, this current is switched to the bit line where it is detected by a sense amplifier.

To write information into the cell, the word line is selected, and during selection the bit line is driven to either 0.2 volt or 2.5 volts, depending on whether a 0 or 1 is to be stored. If the bit line is driven to 0.2 volt,  $Q_2$  is switched into conduction, and remains in that state when the word line returns to the non-select state storing a logical 1. Similarly, a 0 will be written if the bit line is driven to 2.5 volts during word select.

The circuit occupies a very small area on the slice. The present design requires an area of about 8 x 15 mils, allowing space for the bit-line contact pad and lead routing. This permits more than 3,800 cells to be fabricated on a 1¼-in. slice along with the required word drivers. Many such cells may be connected to the same word line, the number limited primarily by the word driver capacity.

### Switched power

The memory requirements for low power dissipation, high signal current and short propagation delay are basically contradictory. However, a circuit has been developed which solves this problem

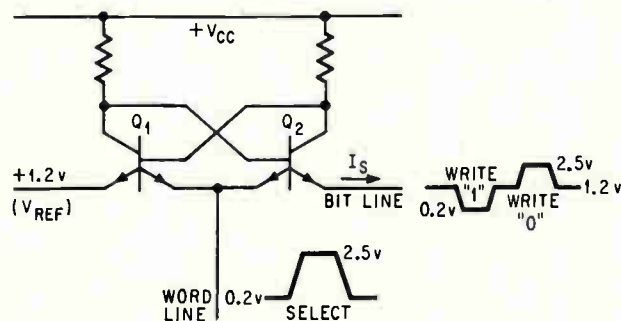

Basic memory cell is a flip flop with multi-emitter transistors arranged to permit writing and reading the state of the cell. More than 3,800 of these cells can be placed on a slice with required word drivers.

in a unique way. Since only one word line in the memory is selected at any time, unselected words require merely enough power to maintain noise immunity. Any excess power consumed by unselected words is inefficient. The word-driver circuit therefore, is designed to raise the power level of the cells on a word line during selection, and to reduce the power dissipation of unselected cells.

The word-driver circuit is shown at right. Before selection,  $Q_2$  is saturated and grounds all word line current.  $D_3$  is forward biased through  $R_1$  and  $R_2$ . This forms a low voltage supply for cells connected between lines  $W_2$  and  $W_1$ , where  $W_2$  is the cell supply line and  $W_1$  is the word line. During selection,  $Q_2$  is turned off and  $Q_1$  on. The voltage on lines  $W_2$  and  $W_1$  is raised, increasing the supply voltage to the cells and selecting the word line.

In the low power, non-select mode, the cell dissipates about 0.3 milliwatt. During selection, cell power is raised to 3.5 milliwatts where read delay time of the cell is approximately 15 nsec.

Without this provision, power dissipation in the array would be more than 6 watts for a typical slice containing 32 words. With provisions for switched power the memory cells are arranged in columns separated by an interconnection area. It should be noted that since the whole unscrubbed slice is packaged, no extra area need be left between circuits for scribing.

Cell parameters of particular importance are signal current, and bit-line leakage current when the cell is storing a 1 in the non-select mode. The minimum cell 1 current is specified at 500 microamperes and this parameter is tested in each cell. When the unselected cell is storing a 1, a small leakage current will flow into the emitter connected to the bit line due to the inverse current gain of the transistor. This 1 leakage current must be kept small, since it diverts signal current from the bit line when another cell on that line is selected. Switching the supply voltage to the cell reduces this leakage current by reducing the cell's operating current and its degree of saturation. Inverse current gain is minimized by doping the transistors with gold, to reduce the carrier lifetime. Also, the resistance of the base tends to reduce the saturation, and hence the leakage current.

The maximum leakage allowed on an unselected cell in the 1 state is 2 microamperes. This means that if 128 cells are connected to a bit line, up to 256 microamperes could be subtracted from the signal current of 500 microamperes, leaving only 244 microamperes of effective signal current to be detected by the sense amplifier.

### Compatibility makes sense

The sense amplifier must provide an output compatible with TTL system logic. It must maintain the bit line voltage within very narrow limits during sensing and therefore must exhibit low input impedance. It must recover from very large overdrive within a relatively short time and must have a

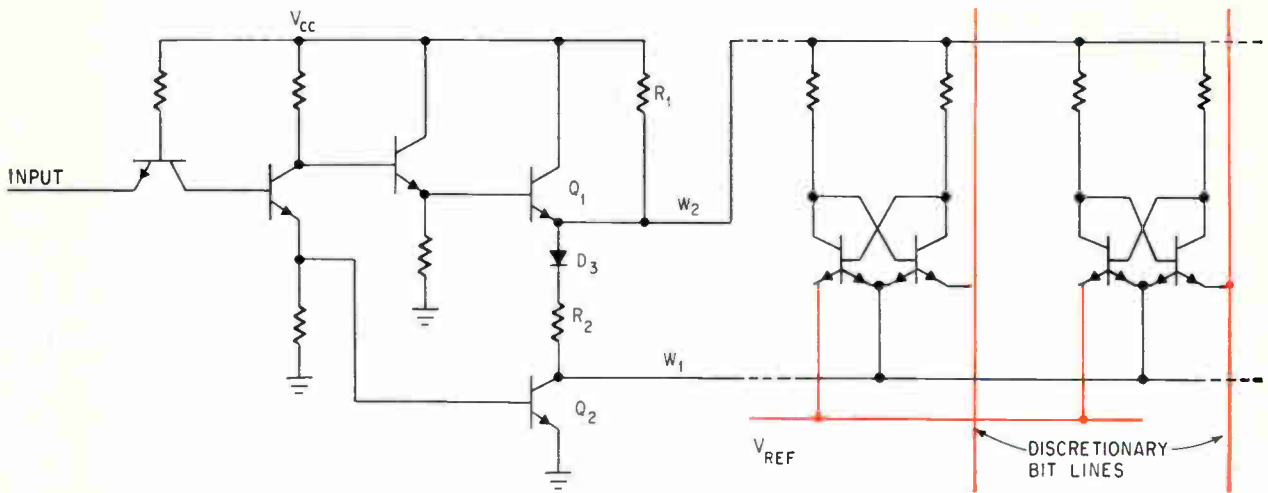

**Word-driver circuit** keeps power requirements low by reducing the power to unselected words and activating only selected cells. Transistor  $Q_1$  acts as the power switch and  $Q_2$  grounds unselected word line current.

reasonably short propagation delay.

The sense amplifier circuit designed to meet these requirements is shown below. It has a propagation delay of 30 to 50 nsec and recovers from write pulses on the bit line in 50 nsec. The output stage is an emitter follower so that up to eight such circuits may be connected together into a positive wired-OR function. A SENSE INHIBIT line is provided so that sense amplifier outputs may be inhibited by a control signal. The WRITE circuit is simply a TTL gate with an added inhibit feature, so that when the WRITE INHIBIT line is lowered to a logical 0 the voltage on the bit line is determined by the sense amplifier and  $V_{REF}$ . Fifty sense amplifiers and 50 write drivers are discretarily connected on a separate array to accommodate each 256-word by 25-bit memory module.

A memory module then, contains five circuit types: logic gates for decoding, memory cells, word

drivers, sense amplifiers, and bit drivers. The word drivers are each capable of driving 50 bits, and the bit drivers and sense amplifiers will handle 128 bits.

### Slice partitioning

In an LSI memory, the cells on the slice must be arranged to produce a maximum number of good circuits per slice and a minimum number of output pin connections. For this reason the circuit design was constrained to use a single bit line per cell for both reading and writing. While separate read and write lines would permit higher operational speed, more pin connections would be needed and more importantly—fewer cells would be available since the interconnection area required would be greater than the cell area.

Two word lines per cell are permitted because the word drivers on the same slice fix the number

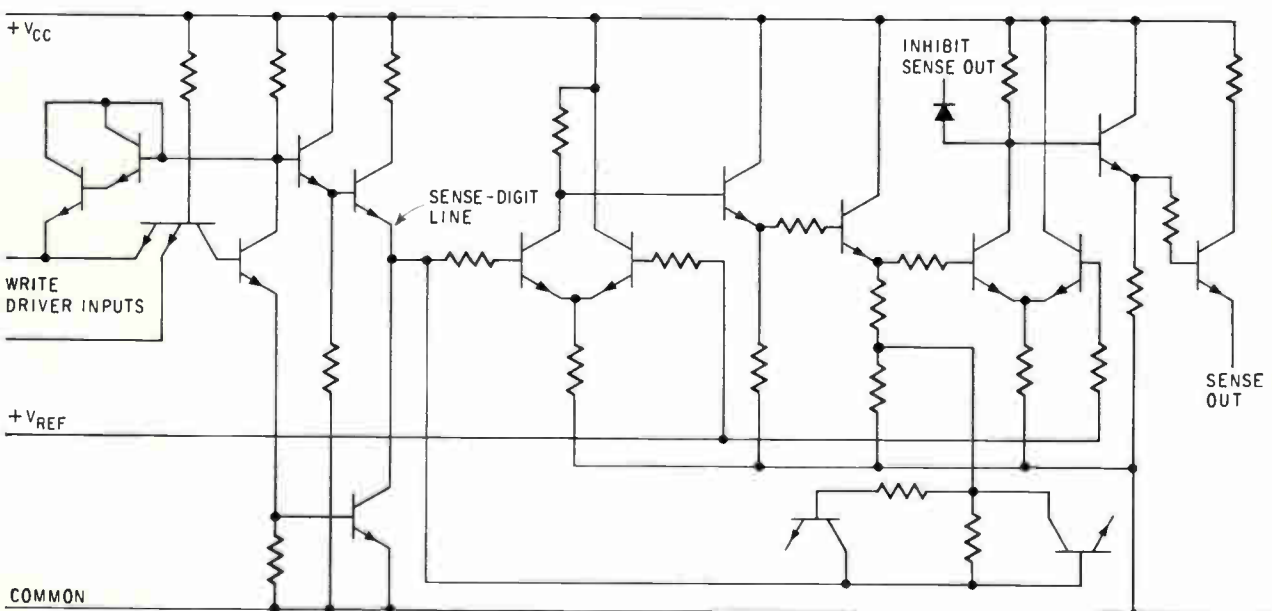

Sense amplifier must be able to detect minimum current of 244 microamperes and maintain low output impedance. Fifty of these sense amplifier-bit drivers are required for each 256-word module.

of address input pin connections to the array.

With these design considerations established, the maximum freedom for discretionary wiring is achieved by interconnecting the power supply and word lines at the first metalization level, and the bit lines at second level.

### Memories help partitioning

Unique characteristics of memory arrays can also be exploited to get efficient partitioning of the slice. In memory arrays, the basic cell in the array can itself be a small array of several circuits. The yield on such a group of cells is naturally smaller than a single cell, but the area required for a single cell with its own discretionary supply and word line connections is so much greater than the cell area alone, that it is more efficient to form large arrays by discretionarily wiring groups of cells that have been preconnected by fixed wiring.

The preferred arrangement is to group the cells as parts of a single word. Each group then requires only one supply line and two word line connections for all its cells. This approach combines the benefits of fixed interconnections with the higher

yields afforded by discretionary interconnections.

By positioning the cells in columns, as shown on page 147, the bit lines may run horizontally across the columns and no silicon "real estate" is required for their interconnection. At the top and bottom of the columns, word and supply lines are linked to other good columns and to the word drivers by means of a discretionary connection. With present tolerance limits, the interconnections at the end of a column of cells occupy an area nearly equal to three cells.

Redundancy in the form of extra cells incorporated in each column reduces the area needed for interconnections and improves group yield. The extra cells provide more space for the discretionary bit lines that cross the columns. They also provide some design flexibility because the internal connections may be changed while holding the external pin connections constant.

With preconnected redundant cell groups, two failure modes are possible. Such defects as transistors with high inverse leakage will affect only one cell, but a short circuit from supply line to substrate would eliminate a complete column. Data on the expected cell yield and the relative predominance of these two types of failures permits a calculation of the probability that a preconnected group of cells will be good.

If each column contains  $m$  preconnected cells of which  $(m - n)$  are redundant, the probability of obtaining at least  $n$  good cells from the  $m$  cells available must be established. For the case where  $m = n$  there is a certain probability of obtaining a good group, which increases sharply under the influence of redundancy and reaches a peak at a particular value of  $m$ . Then, as the influence of catastrophic defects becomes more pronounced, the probability of obtaining a good group falls and no advantage results from further redundancy. Therefore the best group length is that which gives the highest probability of obtaining the required number of good cells.

The considerations that combined to fix the optimum slice layout were:

- Requirements of fewest possible pin connections with highest possible packing density defined the cell design, leaving its layout flexible.

- Slice dimensions ( $1\frac{1}{4}$  in. diameter) and memory specifications for 25-bit words indicated that the length of the array should correspond to 25 or 50 bits. The need for discretionary interconnections that consumed little silicon area narrowed the choice to a pair of 25-bit words for each word driver.

- Available processing data showed that cell yields in excess of 80% could be expected and that fewer than 4% of the cells would have catastrophic defects.

With this information, the final choice of group length was fixed at half of one memory word. By applying redundancy, the layout could best be achieved by designing the array in preconnected groups of 16 bits each, in which at least 13 good

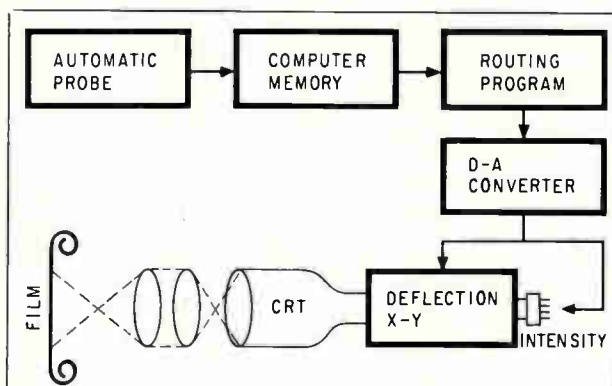

### How discretionary wiring works

The heart of Texas Instruments' discretionary wiring facility is the multilevel interconnection generator (MIG) which produces the final interconnection pattern mask. The MIG system is shown in block diagram form above.

Good and bad cells on the slice are determined by an automatically stepped multipoint probe controlled by a computer. This test information is stored on tape for later processing by a high-speed central computer facility in direct contact with the test facility.

From the automatic probe test data, a unique discretionary interconnection pattern is determined by the computer that bypasses defective cells on the slice and achieves the desired over-all function. This becomes the input to the MIG, in which a computer-controlled cathode-ray tube beam generates the required pattern on film. The mask image is generated by incrementally exposing small spots on the film based on the data from the interconnection program. Masks generated in this way have line widths as small as 1 mil, with 1-mil spacing between lines. The procedure only takes a few seconds.

For details, see the picture story on page 148.

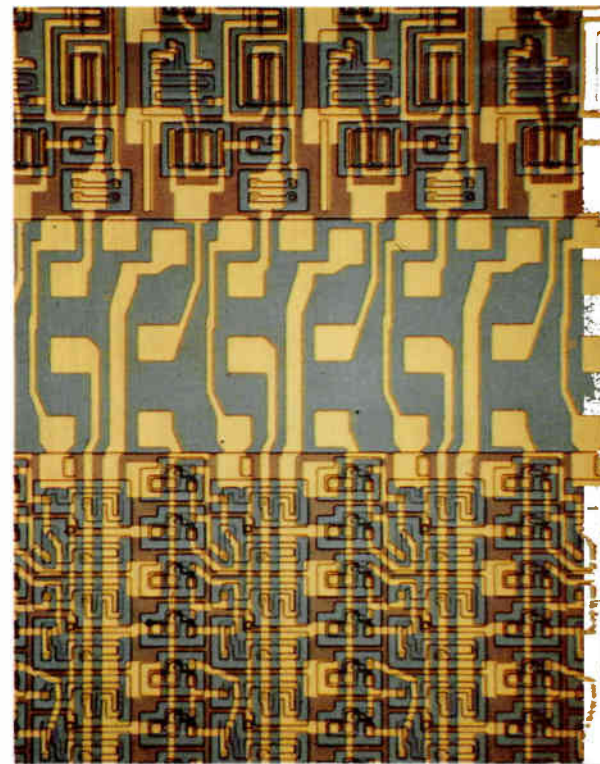
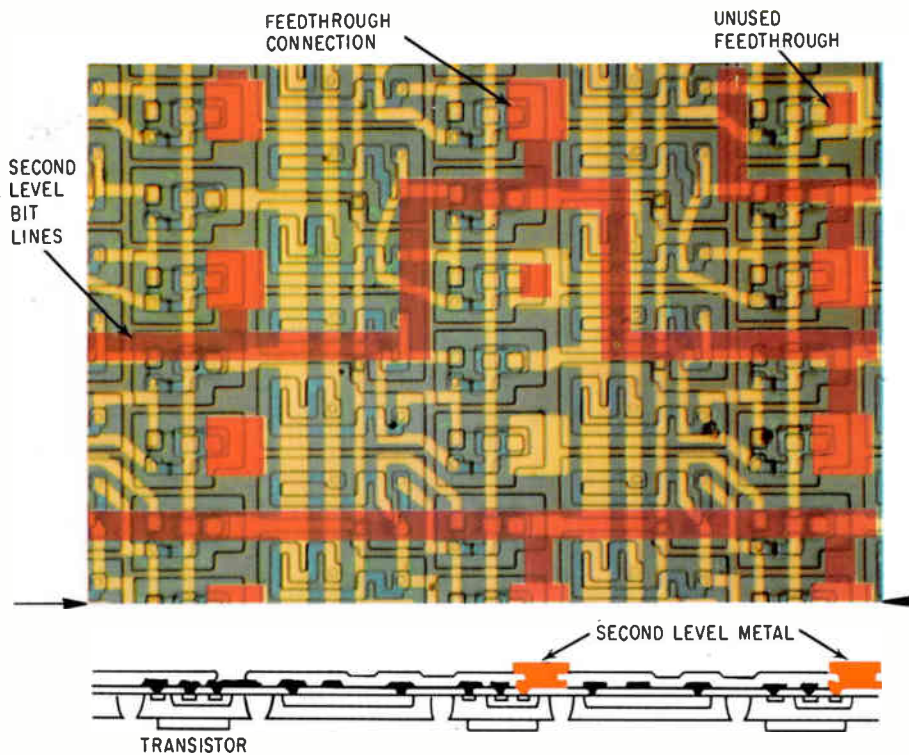

Second-level discretionary wiring, shown in closeup at left, interconnects columns of memory cells. In unconnected slice at right, word drivers are at top, separated from memory cells by interconnection area.

cells were needed for a good group.

The actual slice layout was defined in terms of a 60 by 64 cell matrix. Under these circumstances, the probability of obtaining a good word was estimated to be greater than 0.5. With a maximum of 60 words available on each slice, this meant that at least 32 good words should result. Consequently, only one row of word drivers across the top of the array was required.

### Memory organization

The memory is organized around a basic block of 1,024 words and 25 bits per word (figure on page 151). Up to 32 such blocks may be assembled to make a memory system with a capacity of 32,768 words.

Each word block is divided into four 256-word modules, each module being handled by a set of 50 sense amplifiers. The modules are further divided into four groups of 64 words each. Each memory slice in the module, then, contains 32 word drivers (one per word pair) and 1,600 bits of memory.

Eight sense amplifier outputs are wire-OR'd together for each output data channel and a buffer gate is connected between the wired OR and the interface. Address decoding is divided into two levels. At the first level, five address bits are decoded to select one of 32 word-pair lines; and four additional bits select one of the 16 groups. At the second decoding level the word drivers are selected by a single "even-odd" address bit which gates the sense amplifiers for selection of the top or bottom half of the selected word-pair. The organization

of two words per driver halves the required number of word drivers and decode circuits.

In the present design, second level decoding is performed on two slices separate from the array slices. Though inefficient, this organization was chosen to simplify the slice design and the development of the slice circuits. The second-level decoder slice holds 64 decode gates, sufficient for two array slices.

The write drivers and sense amplifiers required for a 256-word module are on another separate slice. An additional slice contains the first-level decoding circuits, on another the required fan-out generation and the write-even and write-odd gates for a 1024 word block.

Therefore, a complete 256 word module comprises four memory array slices, two second-level decode slices and one bit-channel slice. A 1,024 word block consists of four such modules plus one first level decode slice for a total of 29 arrays.

A new more efficient design is in progress where the word line driver is a three-input circuit, capable of performing second-level decoding. This will reduce the 256-word module to an assembly of five slices rather than seven, and will result in a 1,024-word block containing 21 arrays instead of 29. The new design will not only reduce the number of slices but the number of interconnections between packages as well.

### First-level testing

The success of discretionary wiring stands or falls on testing of the circuits at the first level

## Push a button and a mask is born



**This technician** is taking the first step in Texas Instruments' discretionary wiring process, initiating a test sequence on an LSI slice. After optical alignment of probes on a unit cell, the slice is automatically indexed until all cells are tested. Data from test equipment is stored on magnetic tape.

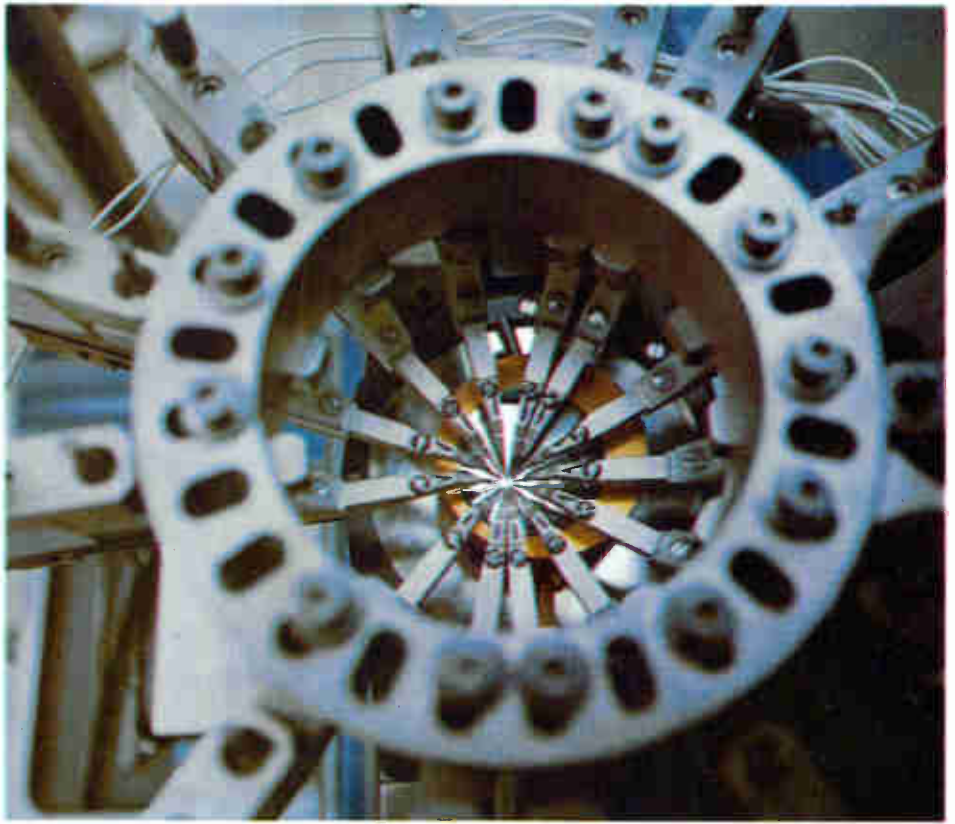

**Each LSI unit cell** is subjected to 32 electrical tests on this automatic multiprobe equipment.



**Test data** is converted into a slice map showing location of good and bad gates (see p. 153). The map is transmitted in the form of magnetic tape to TI's computer center, where metalizing and insulator feedthrough routing patterns are determined for each slice.



**Magnetic tape** bearing the routing program from the computer center is used to control a TI 860 computer in generating an interconnection pattern. Here the program data is being checked out on a high-speed printout.



**Computer-controlled pattern generator** consists of a digital-to-analog converter, control electronics, a high-resolution cathode-ray tube and optical reduction film printing apparatus. Depending on the number of metal and insulating layers required, several masks are made for each slice.



**Vertical optical bench** supports lens and camera system that records the patterns generated on face of crt. Photo shows roll-film camera in position to print crt image, but sheet film or glass plates may also be used.



**Film bearing the discretionary patterns** is automatically developed in the same area. With this processor, film comes out in a few minutes completely dry and ready to be transported, with the slices, to the metal and insulation processing area.

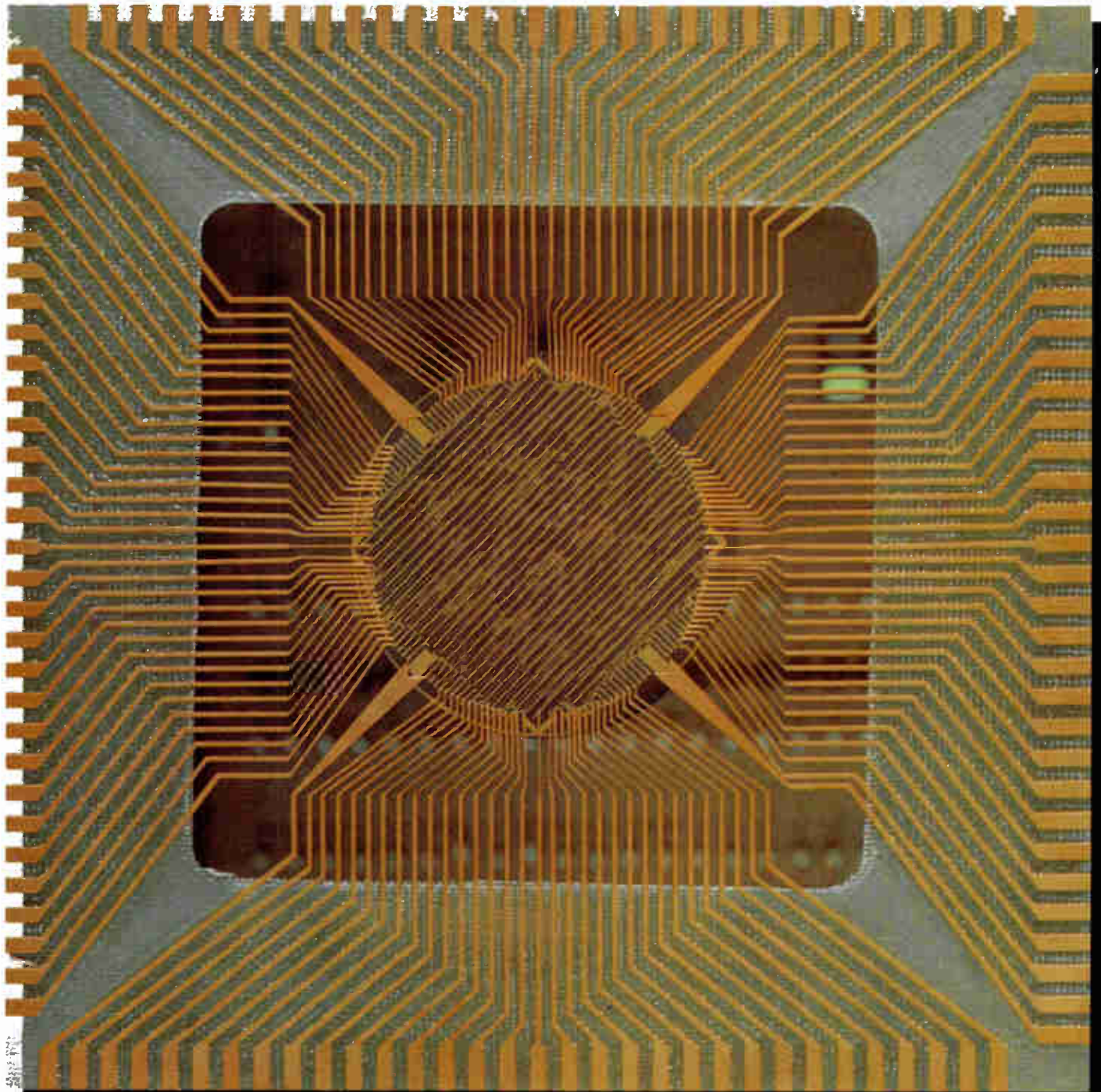

Packaged LSI slice is 2½ inches square and has 32 leads on each side. After final metalization and insulation processes have been completed, the slice is sealed with a potting compound and mounted on a printed-circuit board frame. Leads are ultrasonically bonded to reduce package costs. TI refers to complex finished product as an integrated equipment component (IEC), as distinguished from a conventional IC.



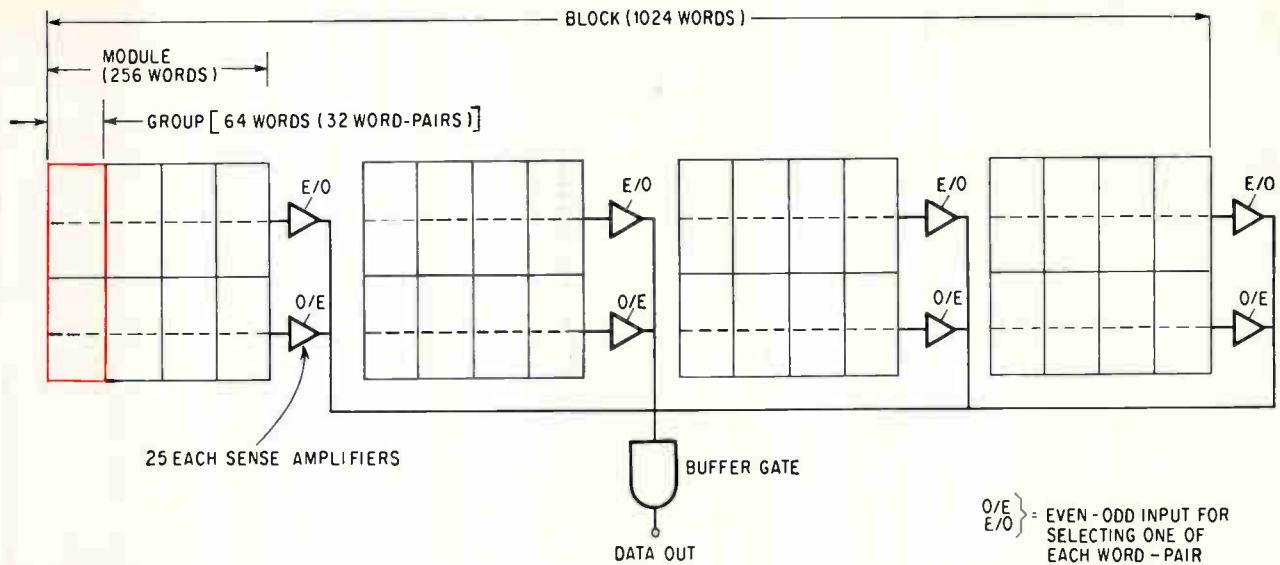

Basic block of memory is 1,024-words by 25-bits. Each block consists of four 256-word modules and 200 sense amplifiers in groups of 50. Area outlined in color represents 64-word group which subdivides the modules.

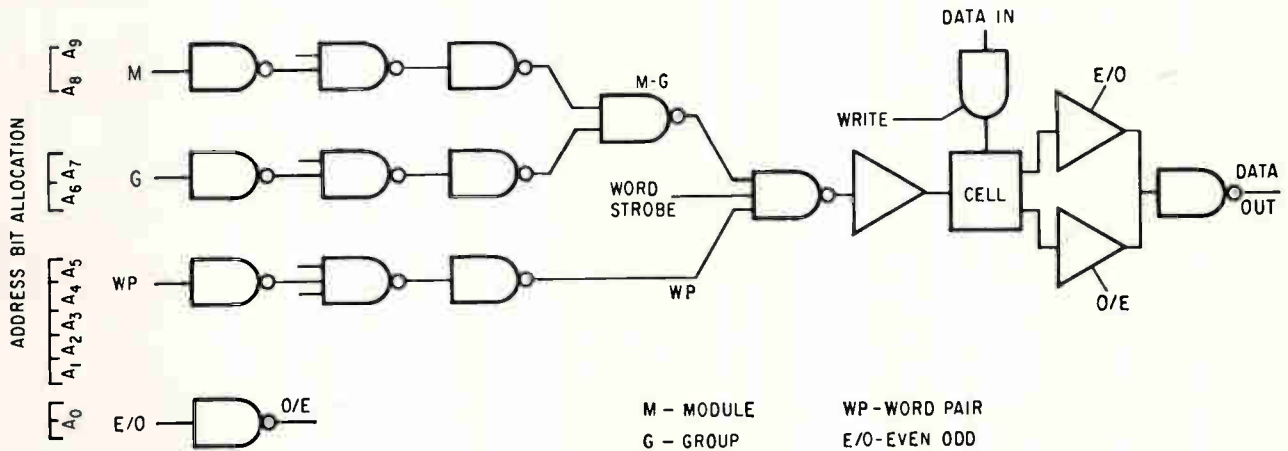

Decoding is performed at two levels from a 10-bit address code, illustrated by logic diagram.

of metalization as indicated by the block diagram on page 152. At this stage, the location of usable cells or circuits on a slice must be determined very accurately. It doesn't matter too much if a few usable circuits are declared defective, but problems result if the test declares defective cells good.

First-level testing is accomplished by using multi-point automatic probe equipment coupled to a TI-662 sequential integrated circuit tester. The results of the tests are recorded either on punched cards or on magnetic tape. Either individual parameters may be recorded, or simple go-no-go results indicated. Testing of most circuits is relatively straightforward—an input is applied and an output is measured. However, memory-cell testing poses a more difficult problem because the cell must be tested while in a known state, either storing a 0 or

Cells are tested in groups of four in the same interconnected group. There are eight probe points for the four cells—four of them (ground, cell supply, word line and VREF) are common to all cells. The remaining four points are bit-line connections

A, B, C and D. The test is designed so that worst-case conditions may be tested. Each cell is tested for its ability to store both a 1 and 0; other tests determine 1 current and 1 leakage current. An additional test detects the presence of a condition on the word line which would cause excessive loading on the word driver.

The test results are recorded on a slice "map" showing the location of each cell group. The test results form input data to the computer which generates the discretionary interconnection pattern for the second-level metalization photomask.

In the map on page 153, a dot represents a defective cell, and X represents catastrophic defects that eliminate the group. Note that relatively few failures are catastrophic. The over-all yield of groups containing 13 good cells is 84.4%. The word yield is limited by the minimum number of good groups in any one of the four sections. From this slice, a maximum of 11 words could be obtained, which is well in excess of the 32 words per slice specified for the memory.

The computer-generated discretionary wiring pat-

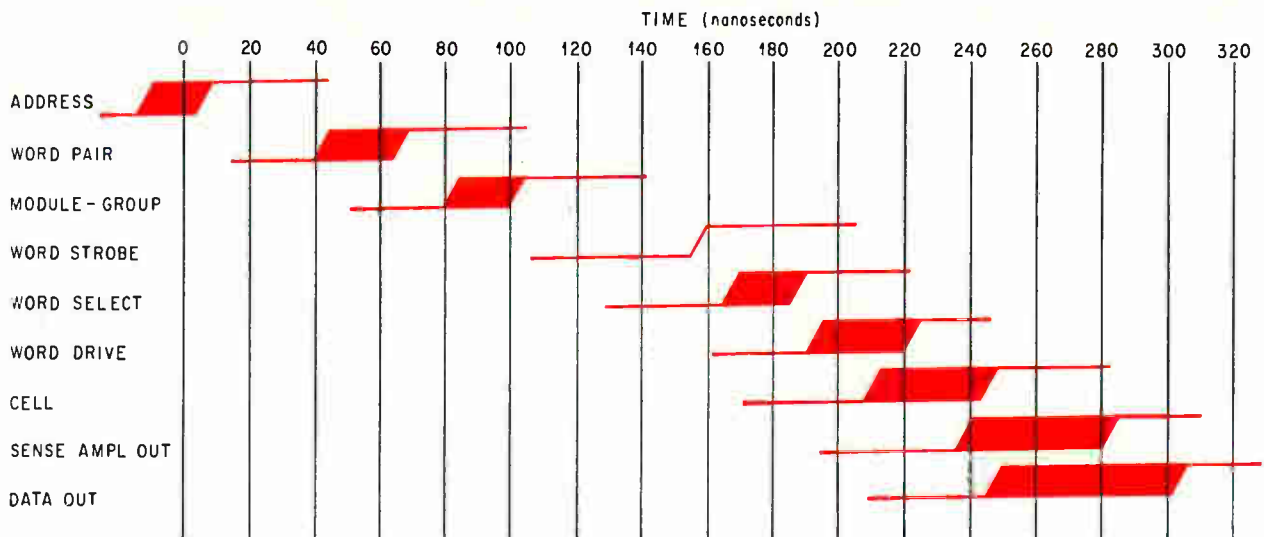

Timing diagram of the memory-read cycle shows an over-all access time of about 300 nanoseconds.

tern illustrated on page 153 corresponds to the slice map. Interconnections on this pattern fall broadly into three categories:

- Discretionary bit line connections.
- Connections between preconnected groups of memory cells and between word drivers and cell columns.
- Connections between the array and the bond-

ing pads along the slice periphery.

Thirteen discretionary bit lines connect to each quarter section, picking up thirteen memory bits in each usable column. If the automatic tester has indicated that any column contains a catastrophic defect or less than thirteen good cells, no connections are made to that column.

#### Fixed pattern insulation

The connections to good memory cells are made by small pads which cover holes in the insulation layer and make contact with the first level of metalization. The insulation is a fixed pattern, so that oxide windows are provided for contact to every memory cell on the slice. When contact is not made to any memory cell, these windows are avoided by the discretionary interconnections. Circuit layout is arranged so that there is sufficient room to run two interconnections between windows in adjacent rows and four interconnections between windows in adjacent columns. This provision of two horizontal and four vertical routing channels, and the use of a staircase interconnection pattern between columns where necessary, ensures that connections can always be made if a column contains at least thirteen good cells out of the sixteen available.

At the interconnection areas between quarter sections of the array and between the array and word drivers, three discretionary connections are made to each usable 13-cell column. One connection is made to the reference voltage line which runs across the slice at the bottom of each column and at the bottom of the row of word drivers. The other two connections, a word line and a cell supply voltage line, run through the interconnection area and link good columns in upper and lower quarter sections of the array.

Each good column in a section of the array may be connected to any one of the five columns immediately below it, provided that the column chosen is also good. This results in discretionary links, which are either vertical or move a maximum

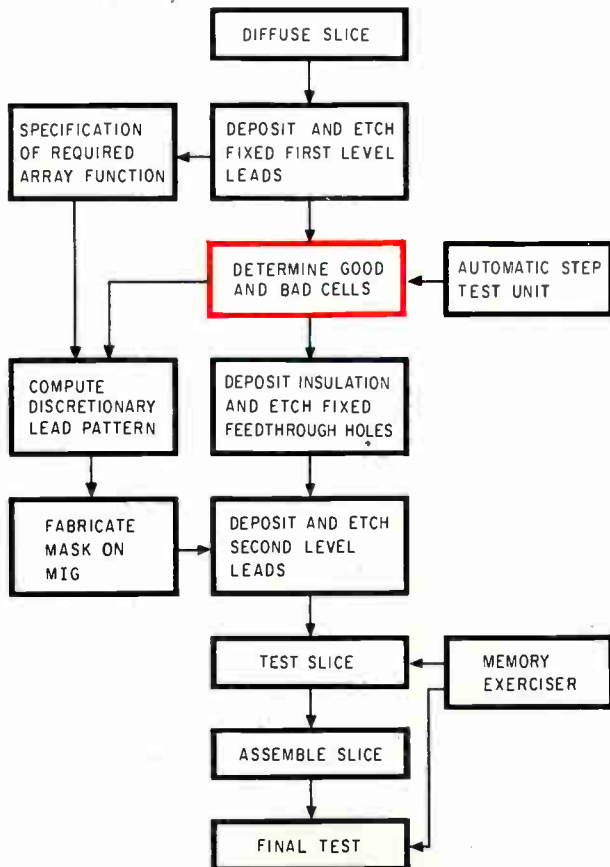

Testing is the heart of the discretionary wiring concept, as this diagram of the active memory fabrication process shows. Short turnaround time and design flexibility are provided by the multilevel interconnection generator, which can turn out the final mask in a few seconds.

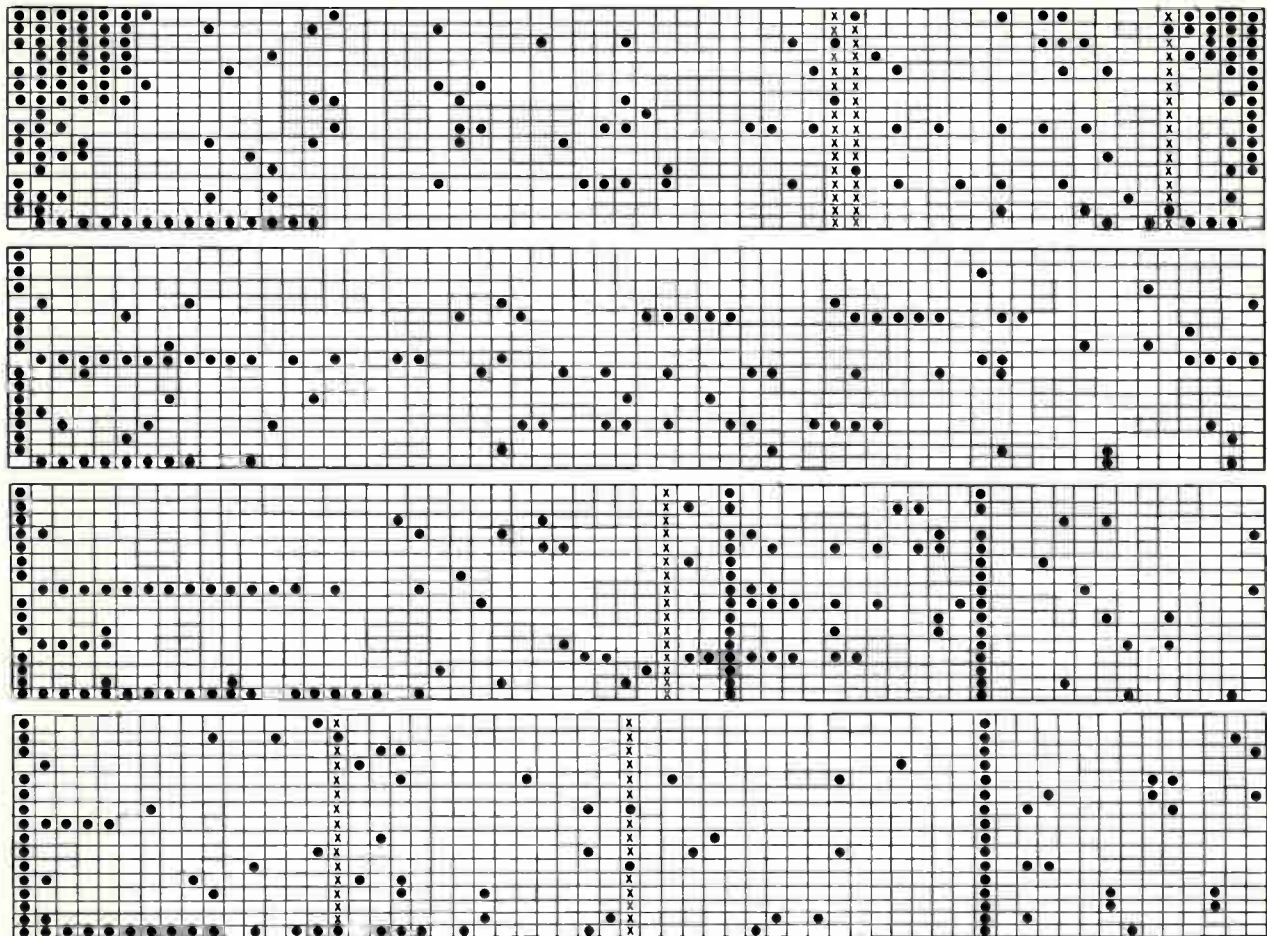

SLICE NO. 0212, TEST LIMITS,  $I_0$ -60 $\mu$ a MAX,  $I_1$ -0.6 MIN., 1.5 ma MAX.,  $I_L$ -4 $\mu$ a MAX

Active memory slice map, produced by probe test of slice shows location of good and bad cells. Cells below specifications are shown as dots and catastrophic failures are indicated by "X." There are enough good 13-cell groups to qualify this slice for discretionary interconnection. Below is the interconnection diagram generated by the computer from the test data on the slice map.

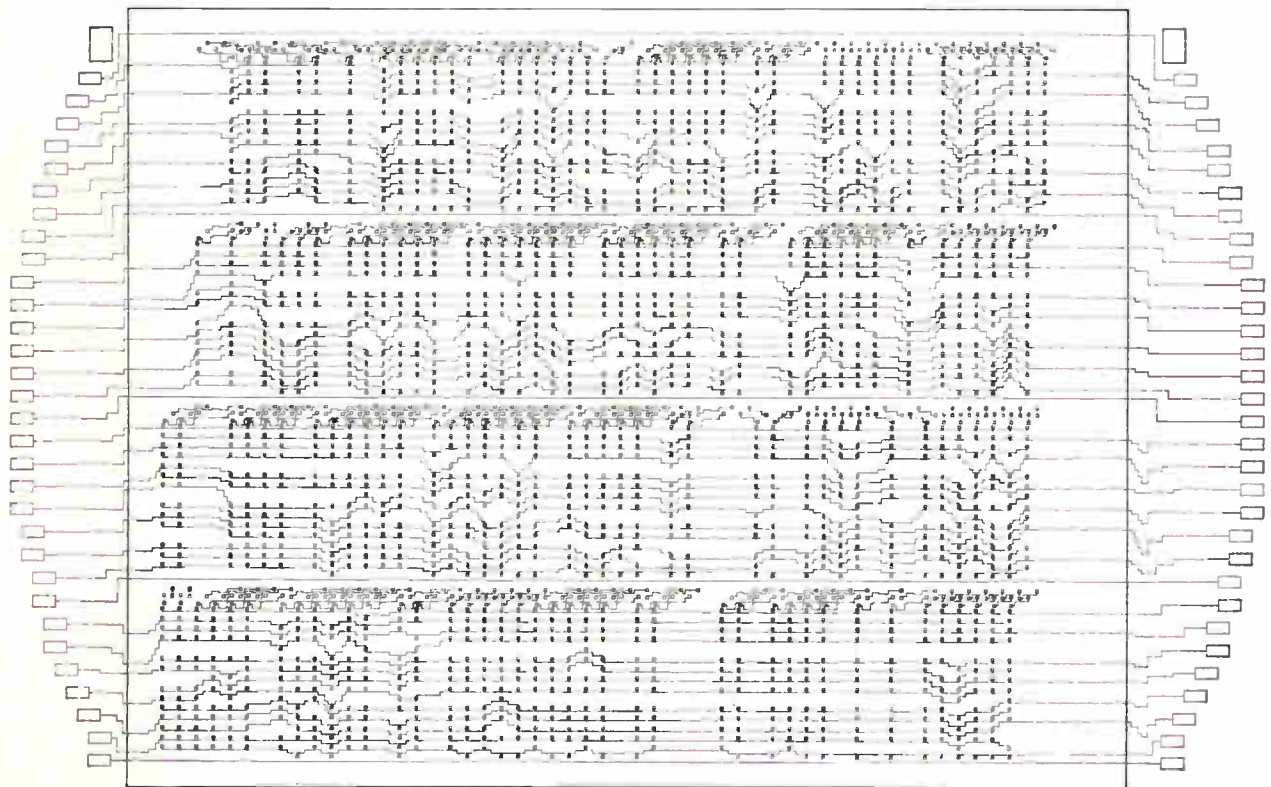

of two column widths to either side. If this sideways movement is more than two columns, access to good columns in the upper section may be blocked, but if the upper section columns are bad the lateral movement may be more than two column widths, provided that no more than two good columns are bypassed. This flexibility in connecting good 13-bit columns ensures that nearly all good columns may be interconnected.

All the information required to define the discretionary interconnection pattern is computed from the automatic probe test data. This data becomes the input to the MIC which generates the final metalization mask. [See "How discretionary wiring works," p. 146 and picture story on p. 148].

Two depositions of radio-frequency sputtered quartz form the insulation between metal layers. The second level metalization, a molybdenum-gold system, is deposited and etched using the computer-generated discretionary mask.

Points to be connected externally are brought to bonding pads around the periphery of the slice. Fixed connections to the bonding pads are designed to ensure that a particular pad always carries the same signal or supply voltage on every memory slice. This facilitates the design of printed circuit array interconnection boards.

### Packaging

The slice is packaged in a lead frame as shown on page 150. Leads are ultrasonically bonded to reduce package costs. The package is designed so that after the slice is sealed by potting, connectors may be plugged into the four edges for testing. After acceptance of the completed slice, the lead frame is sheared around the interior portion. This leaves weldable tabs protruding from the encapsulated slice package on appropriate centers for conventional multilayer printed circuit board design.

Final test equipment consists of a slice probe, memory exerciser and interface electronics. The TI memory exerciser (TIME) is capable of operating a 16,384-word by 50-bit memory, at up to a 700 nsec cycle time. It is programed by 120 rotary switches to write selected patterns into each word, to read each word and compare the output data to the proper bit pattern. Four preset bit patterns and their complements may be selected.

Interface electronics for coupling the slice probe to the exerciser include level shift circuits, address decoding, and bit-channel circuitry, all built on conventional printed circuit boards. The interface is designed for testing not only individual slices before and after packaging, but also 256-word memory modules with their sense amplifiers and bit drivers and complete blocks of 1,024 words containing address decoders.

### Other applications

The 1,600-bit memory array is adaptable to a variety of applications. For example, a memory array may be addressed sequentially to function as a

1,600-bit shift register or as a digital delay line. This operation requires the addition of an input data accumulator and a sequential address counter, but with a 1,600-stage packing density the extra logic is insignificant. The feasibility of another technique which uses the discretionary wiring approach to produce up to 800 shift-register stages on one active memory slice is being evaluated.

Another possibility is to change the first-level metal pattern on the basic memory slice to form a fixed read-only array of several thousand bits.

The present day capability of 1,600 bits per array is determined primarily by cell yields and mask tolerances. As these factors are improved by techniques already demonstrated, the distribution of signal and supply current to circuits will ultimately limit cell sizes and the number of bits per array. Nevertheless 10,000 bipolar cells per array will be achieved in the foreseeable future and even more in MOS arrays. Thus it is probable that active memories will be used not only for special memory functions and applications, but also for the main-frame memory of commercial computers.

### Acknowledgment

The work described in this article was supported in part by USAF Contract AF33 (615) 3546

### References

1. J. Eimbinder, "Microwave IC's: hybrid or monolithic?," *Electronics*, Feb. 21, 1966, p. 135.
2. J.S. Kilby, "Device fabrication," keynote address, 1966 International Solid State Circuits Conference, Feb. 9, 1966.

### The authors



Michael Canning, a project engineer in the computer components branch at Texas Instruments Incorporated, received a Ph. D. from the University of Newcastle in England for research on active filters.



Roger S. Dunn, program manager of the active element memory group in the computer components branch, joined TI's British subsidiary in 1962. He was in charge of the development section of the unit's integrated circuits department.



Gerald Jeansonne joined TI in 1963 and transferred to the computer components branch in 1964. He was responsible for the development of logic and driver circuitry for a thin-film memory system, and helped design a scratch-pad memory.

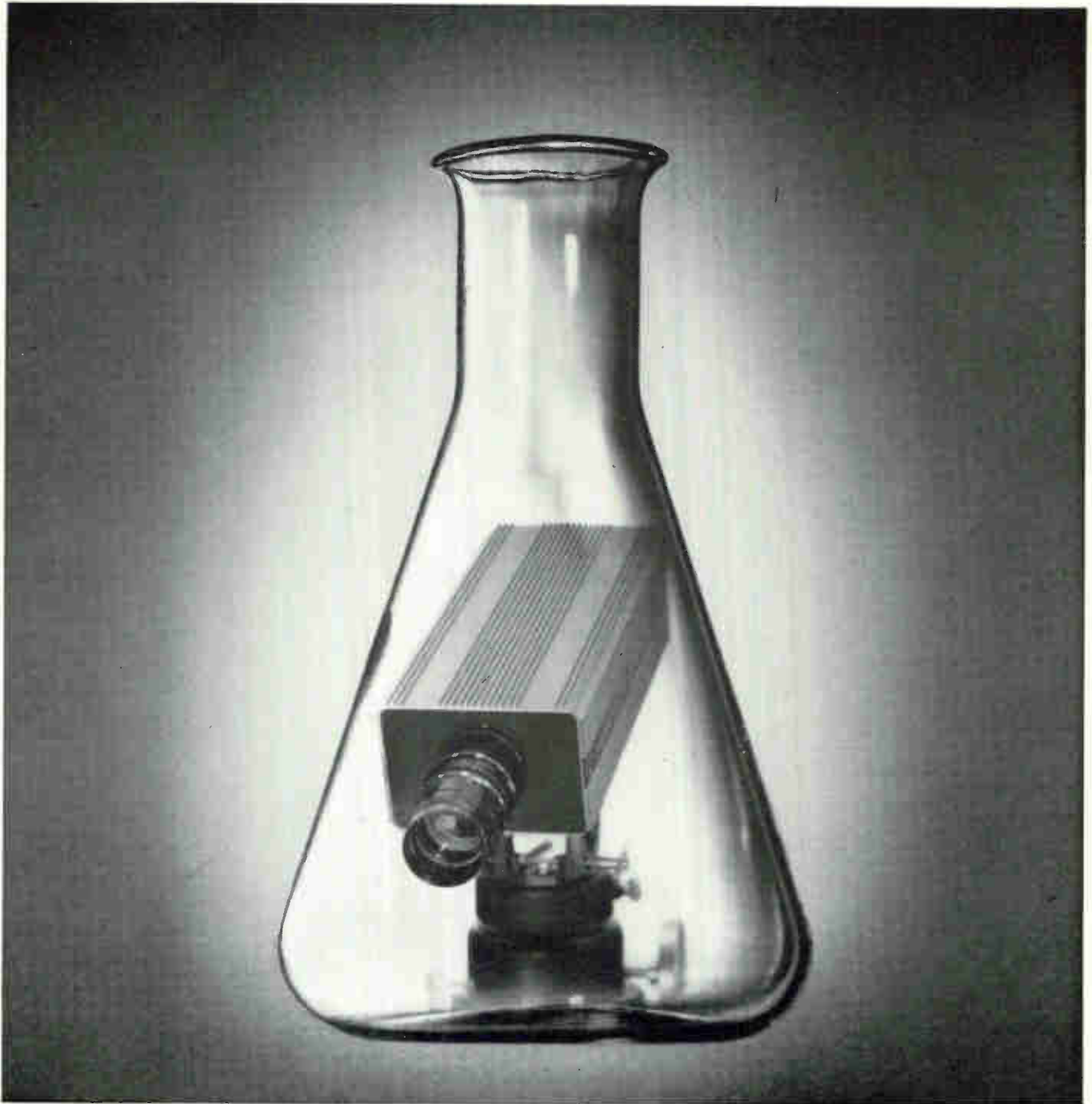

## RESEARCH HAS A NEW TOOL

To date there are over 1000 known applications of closed circuit TV. The unknown are in the millions, but scientists are discovering new uses every day — as are we.

MTI camera equipment has become the accepted standard in the medical field. And the reasons are as simple as the equipment is to operate. A flip of the switch gives you 7 day - 24 hour continuous operation with no adjustment. Compact, lightweight, completely

reliable — you have perfect viewing instantaneously. MTI equipment needs no special "studio lighting" — no special staff.

It's a new tool—a valuable new tool in research. So may we suggest that if you have an application — known or unknown — call or write:

**mti** MARYLAND TELECOMMUNICATIONS, INC.  
York & Video Roads, Cockeysville, Md. 301 - 666-2727  
World's largest manufacturer of low light level television cameras.



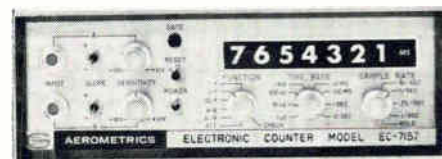
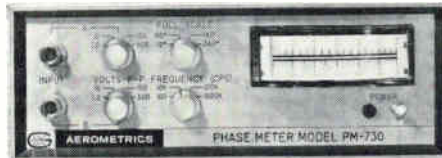
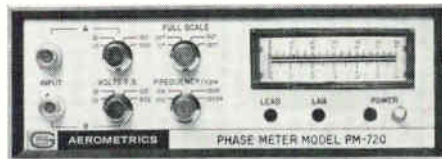
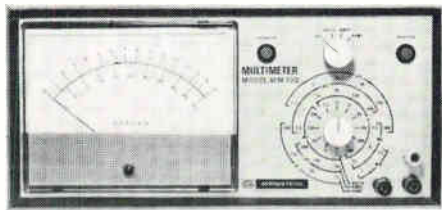

# new instruments from Aerometrics

## portable-solid state-rugged-light weight

Smaller than your briefcase...Standardized in size and configuration for minimum cost...Combining high performance with easy portability, these precision instruments are designed and developed the AEROMETRICS way for long trouble-free use in the field or laboratory. Ready now for your most challenging applications.

All units available without cases for standard rack mounting.

**PULSE SAMPLER** Displays fast computer waveforms, Radar pulses, Semiconductor rise times on oscilloscope or X-Y Recorder • Permits accurate peak voltage measurements of nanosecond pulses • Rise time—1 nanosecond maximum. Sweep speed—10 nanoseconds to 5 microseconds. Price: Model SA-300 \$995.

**VOLTAGE CONTROLLED PULSE GENERATOR** Features voltage or manual controlled frequency, pulse delay, pulse width and pulse amplitude • Frequency range—10Hz to 20 MHz • Rise and fall times less than 5 nanoseconds • Single or dual pulse output • Stability .1% • 0-20 Volts dual polarity output from 50 ohm source • External triggering—push button single pulse operation. Price: Model PG-200 \$950.

**MULTIMETER** Solid state multimeter with exclusive automatic polarity indication • Features optional rechargeable battery operation • Current ranges:  $\pm 50$  nA to 15 mA full scale • Voltage ranges:  $\pm 5$  mV to 1500 V full scale • Resistance ranges: 15 ohms to 5 Megohms full scale • Input impedance: 1000 Megohms to 1.5 volts. Price: Model MM-100, \$400.

**PHASE METERS** All silicon • Integrated circuit construction • 10 millivolts per degree DVM output • Low level strip chart output • 0.2% Full scale accuracy • Selectable phase response time • 100 millivolts to 500 volts peak-to-peak input.

Model PM-720: Automatic lead-lag indication. 5 Hz to 500 KHz. Ranges 0-12°, 0-36°, 0-90°, 0-180°. Price \$950.

Model PM-730: 10 Hz to 1 MHz. Ranges 0-12°, 0-90°, 0-180°, 0-360°. Price \$1490.

Options: (A) 180° phase shifter for increased resolution about 0°, \$170. (B) Pulse output at zero crossover on channels A and B, \$270. (C) D.C. output for lead-lag indication, Model PM-720 only, \$90.

**UNIVERSAL ELECTRONIC COUNTERS** All silicon • Integrated circuit construction • Frequency 10 MHz • Single & multiple period • Ratio • Time interval • Dual channel slope & sensitivity controls • Weight 7 lbs. Prices: 4 digit Model 7154—\$1250, 5 digit Model 7155—\$1400, 6 digit Model 7156—\$1550, 7 digit Model 7157—\$1700, 8 digit Model 7158—\$1925. Option: 1-2-4-8 BCD out and single point remote programming of all modes, \$75.

Aerometrics, Aerojet-General Corporation, P.O. Box 216, San Ramon, California.



# AEROMETRICS

# Customizing by interconnection

One way to supply design flexibility and fast design turnaround is to start with a standard wafer and customize by metallic interconnection to produce a specific design

By Cloyd E. Marvin and Robert M. Walker

Fairchild Camera & Instrument Corp., Semiconductor Division, Mountain View, Calif.

**The question of custom** versus standard integrated circuits is being revived with the advent of large-scale arrays.

With LSI, the economics of custom versus standard arrays is greatly complicated by the interrelationships of yield, circuit density and the quick turnaround required to meet the customer's deadlines. There still will be a considerable demand for standard arrays composed of such repetitively used functions as shift registers, counters and simple arithmetic units like digital differential analyzers and analog and digital converters. Undoubtedly, custom arrays—subsystems equivalent to 300 to 400 gates—will also be available when large production runs justify the high design costs.

In the early days of IC's, the controversy centered around whether systems manufacturers would use off-the-shelf IC's and sacrifice a portion of contributed value to the device manufacturers in re-

turn for reduced costs.

The debate was resolved quickly when the semiconductor industry provided two alternatives for their customers. Standard circuits were made available in volume to meet the majority of needs, while facilities were also provided to produce custom devices for customers with special needs who were willing to pay the necessary development costs.

But what is needed now is an approach that satisfies the requirements of custom-built subsystems designed for moderate-volume sales, while permitting the customer a degree of design flexibility at low cost.

To meet this need, the Fairchild Camera & Instrument Corp.'s Semiconductor division has developed the Micromatrix, its version of the master-slice technique, which is described earlier in this issue [page 136].

## Specialized cells

With Micromatrix, design families of cellular arrays, complete except for metalization interconnections, are provided. Each array consists of a predetermined matrix of component-pattern cells that can be interconnected to form the required custom circuit. In addition, each cell may be individually specialized by cell intracconnections to form one of a variety of fundamental building blocks, such as gates or flip-flops.

One of the fundamental rules of this concept is that customization is permitted only for the metalization connections, not for the devices. Basic wafers, completely fabricated up to metalization, will be stocked and drawn for custom arrays. This enables the wafers to be manufactured in high volume with correspondingly low costs. In addition to eliminating the costs normally involved in wafer processing and evaluation, this approach permits reduced in-process inventories of many different

## The authors



Cloyd E. Marvin has been at Fairchild Semiconductor since 1961. He holds the title of marketing manager for large-scale arrays and digital products. He received his engineering degree in 1958 at the University of Colorado.



Robert M. Walker joined Fairchild last year. He is a senior engineer in Fairchild's systems engineering group where he specializes in applications of large-scale integrated arrays.

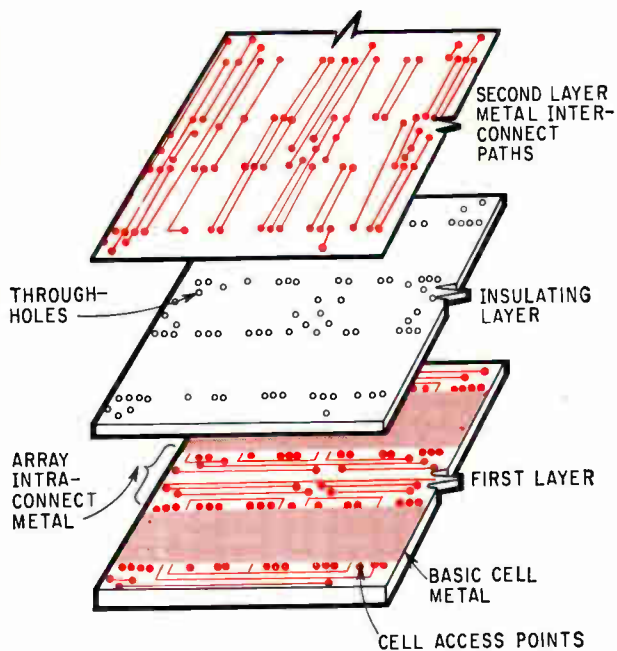

Multilayer metalization is the key to the Micromatrix approach to arrays. To provide a customized design from a standard chip, only three masks are required to complete the interconnection of the array cells.

wafer types, as well as greater process uniformity. Additionally, it provides for more thoroughly characterized devices and a large volume of data upon which reliability and failure-mode predictions can be made.

For obvious reasons, interconnection masks alone can be designed more quickly than a complete set of diffusion and interconnection masks, thus assuring a faster turnaround time than a completely custom approach.

The designer enjoys an almost infinite variety of alternatives in LSI array selection, including the number of cells, cell topology, speed, power, and MOS or bipolar. Even within a specific category, there may be requirements for special designs. For example, an array designed for general-purpose logic will not be particularly efficient for certain repetitive functions such as memory or decoding. Here again, the standardization inherent in Micromatrix allows many array types to achieve sufficient fabrication volume to be economically feasible.

### Two-layer metal a must

The key to the feasibility of Micromatrix is the two-layer metal interconnection technique. Until recently, only area-consuming diffusion crossovers were available.

In the expanded view of a general-purpose cellular organized structure, the first-layer metalization pattern consists of the basic cell metal (identical for all arrays) and the first-layer array interconnections peculiar to that design. The first layer intra-connect can also contain bars of metal over the cell metal areas at predetermined points, allowing a degree of cell specialization.

An inorganic insulating layer is next applied and through-holes are etched where interconnection is required between the two metalization layers. The second-layer metalization is then applied, completing the chip. Only three masking operations, first-layer metal, insulating layer through-hole, and second-layer metal, are required to custom-connect each array.

In Micromatrix, testing is carried out after fabrication is complete; thus, if one cell is bad, the entire array is useless. This design philosophy is based on data that indicates yield is a much stronger function of chip area than of component density. Elimination of area-consuming test pads permits an array to be fabricated on a relatively small chip, while insuring reasonable yield. This approach is distinguished from the test-and-connect or discretionary wiring approach [see the article starting on page 143] in that no testing is performed at the cell level. What is often overlooked in evaluating the discretionary wiring approach is that four additional process steps are required after 100% testing of cells, followed by a complete array test. In addition, each final product will have its own unique interconnection and dynamic characteristics.

### How designs proceed

The Micromatrix interconnection pattern is designed on the basis of logic specifications, provided by the customer. A step-by-step procedure is used for layout and interconnection artwork generation.

The specifications are analyzed and the appropriate array type selected. A design that will perform the desired function may already exist in a library of custom designs. Basic decisions concerning the use of MOS or bipolar technologies, and how many cells are required are made at this point. After the array is selected, cell and input-output pads are allocated. Design layout sheets are used to assign logic functions to specific devices; cell assignments are based on ease of cell interconnection, while bonding pads are chosen for ease of bonding to desired package pins.

The designer then lays out the two-layer interconnection pattern, using special layout sheets; device metal follows a precision X-Y grid. The process is similar to the layout of a conventional double-sided printed circuit board.

After layout, a set of precision artwork is taped, using the layout sheet as a guide. This corresponds to the first-layer metal, dielectric cut-pattern and second-layer metal. Using the artwork, a set of photolithographic masking plates is generated. These interconnecting patterns are then applied to the inventorized wafers containing the standard arrays of devices, and the custom design is complete. The systematic approach using the regularized grid of potential interconnection paths holds artwork to a minimum. For example, the BCD [binary coded decimal] decoder diagramed on page 163 was laid out and masks taped in eight man-hours.



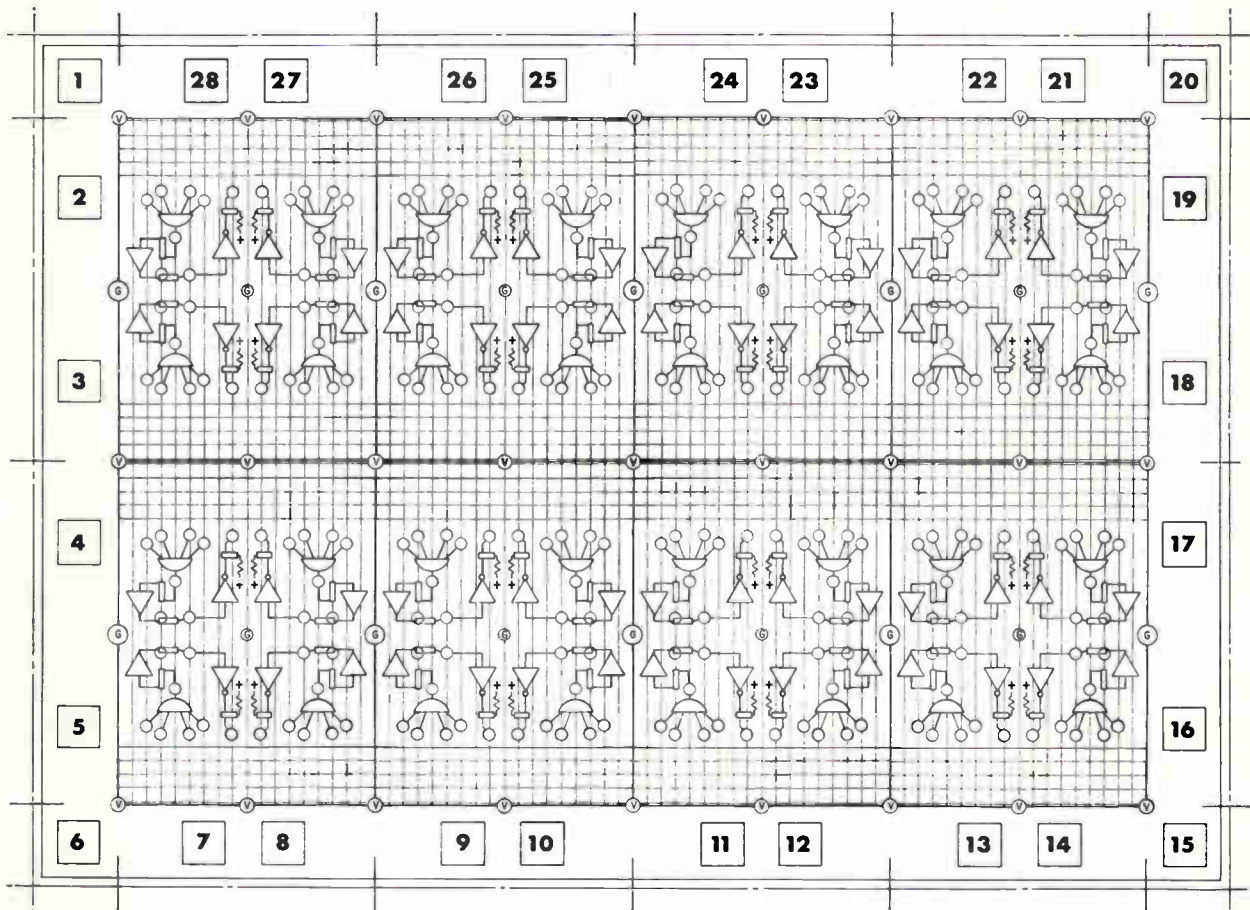

Eight cells form Fairchild's 4500 bipolar array. Each cell contains four NAND gates designed with diode-transistor logic, each gate with four inputs. Extra versatility is provided by permitting each gate to be treated as a group of four independent elements.

Testing complex arrays is a formidable problem because of the inherent difficulties in testing large networks without access to intermediate cells and because the cost represents a large percentage of the price of the finished unit. The problem is so complex that fast, computer-controlled testers with rather sophisticated software will be required to test large arrays in production. While more powerful testers are being designed Fairchild is using a Fairchild model 8000A computer-controlled tester. A PDP-8 digital computer controls the functional testing of packages with up to 50 pins.

### MOS versus bipolar

The controversy over whether MOS or bipolar technology is superior for LSI is not new. Some semiconductor firms have staked their existence on one technology to the exclusion of the other. Fairchild feels both techniques are useful, and the choice of implementation should be determined by the customer's system requirements. For example, a single-polarity MOS inverter, using an MOS load resistor exhibits at least twice the potential packing density when compared with the same circuit using bipolar transistors and a load resistor. This assumes similar process resolution capabilities. In addition, the MOS transistor's very high input re-

sistance results in virtually unlimited d-c fan-out, and the low power requirements of MOS also enhance packing density by easing power distribution and ground requirements.

### Bipolar IC's compatible

The bipolar transistor, on the other hand, shows a clear superiority on a speed-power basis. This results from the bipolar transistor's excellent transconductance per unit area, which in turn is a measure of the device's ability to charge and discharge capacitance. In addition, bipolar arrays are compatible with today's existing integrated circuit signal levels, power and logical organization. Bipolar arrays may be mixed with discrete integrated circuits and complex standard product integrated circuits for maximum cost effectiveness.

From the comparisons cited, it is clear that arrays using both technologies are required. Where the speed-power product and system compatibility permit, MOS is superior from a packing density standpoint. Where speed or power capability or both are at a premium, or compatibility with discrete integrated circuits or existing systems is required, bipolar is the choice. It should be noted that a favorite argument of the MOS advocates, namely fewer wafer processing steps, holds little

**From one bipolar chip . . .  
 . . . a bagful of digital functions**

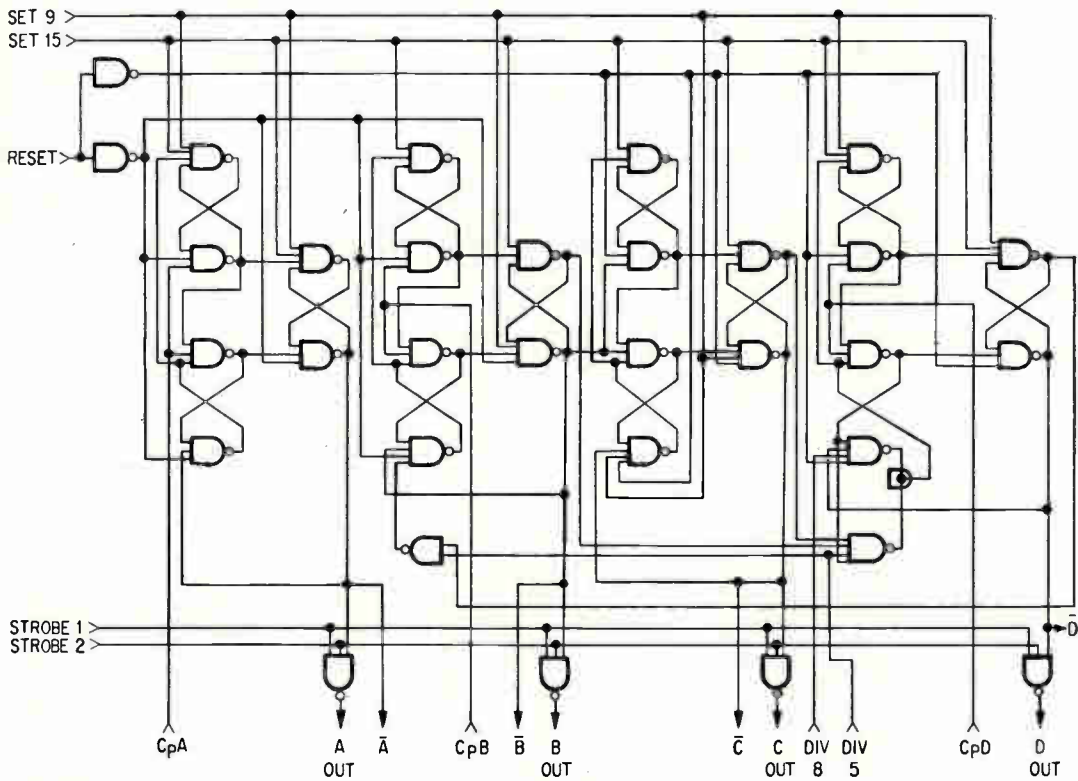

**Four-bit ripple carry counter.** External connections allow division by factors of 2, 4, 8, 16, 5 or 10. Strobed outputs are provided.

**Word-organized eight-bit buffer storage.** Data is transferred in and out of each flip-flop over a single input-output line.

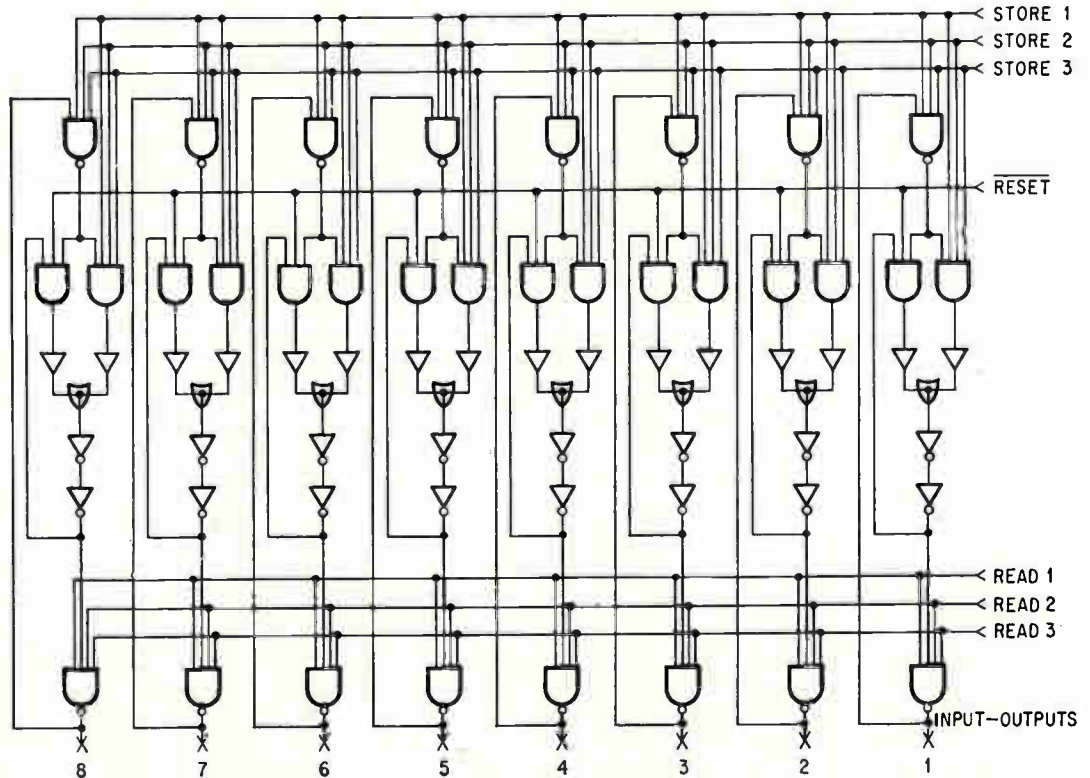

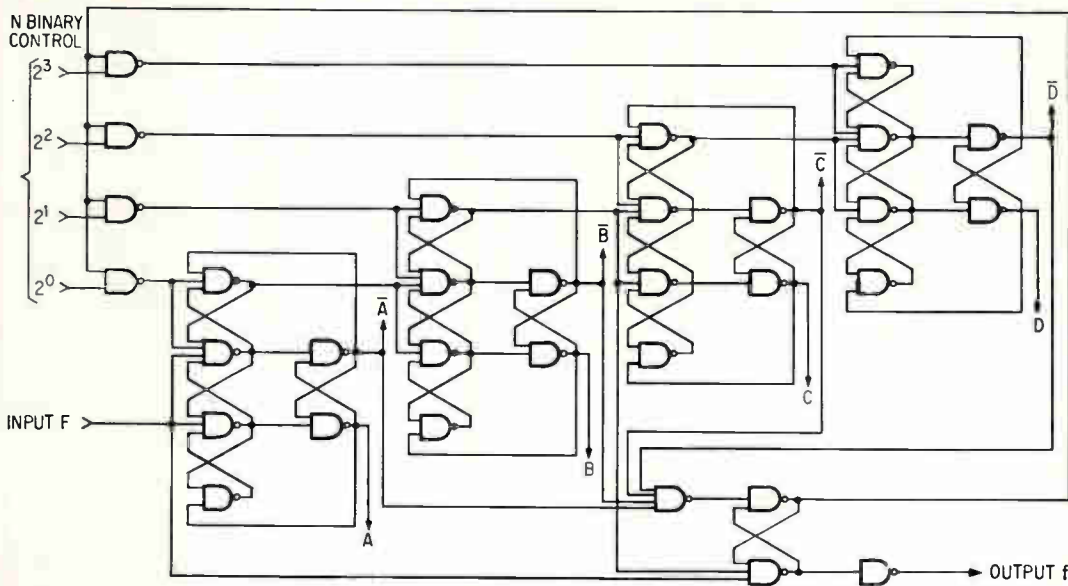

Four-bit, divide-by-N counter. Output frequency  $f = F/i$ , where  $F$  is input frequency and  $i$  any integer from 2 to 16. Output frequency is set by a four-bit binary input.

Decoder converts 1-2-4-8 binary coded decimal input to a seven-bit code suitable for driving a seven-segment numeric display. Discrete lamp drive-transistors may be driven directly from the logical 1 outputs of the circuit.

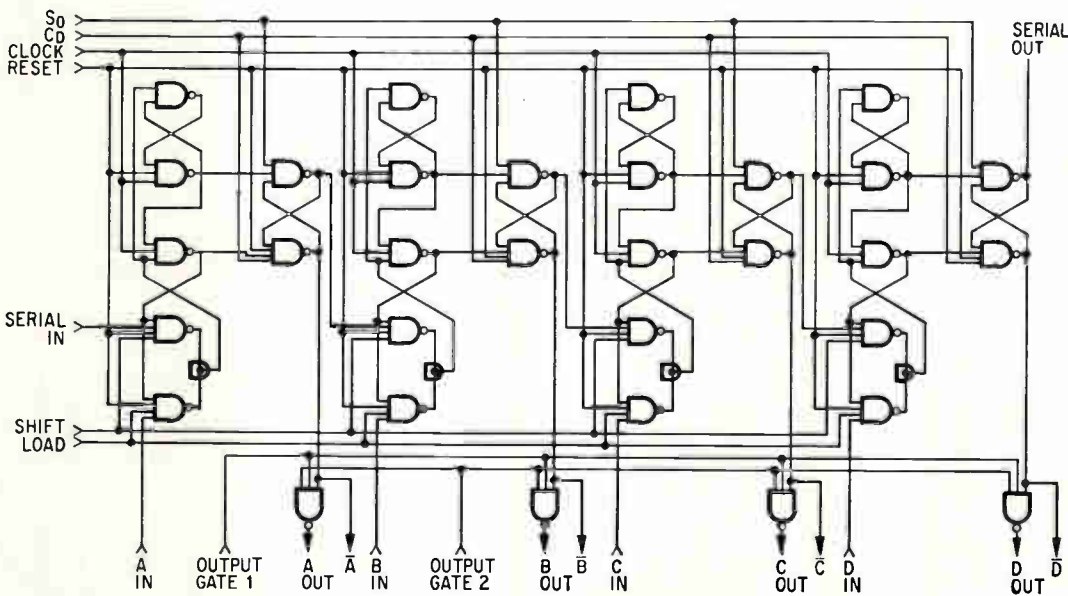
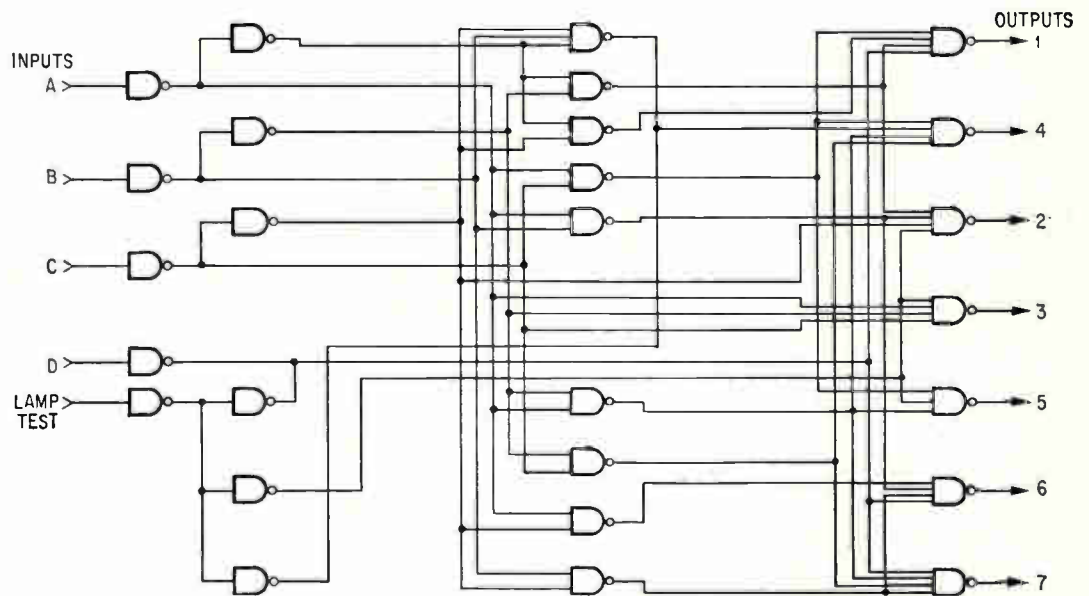

General-purpose, four-bit register adaptable for any combination of parallel or serial input or output. Control lines select either LOAD (parallel input) or SHIFT modes.

## An extra measure of versatility

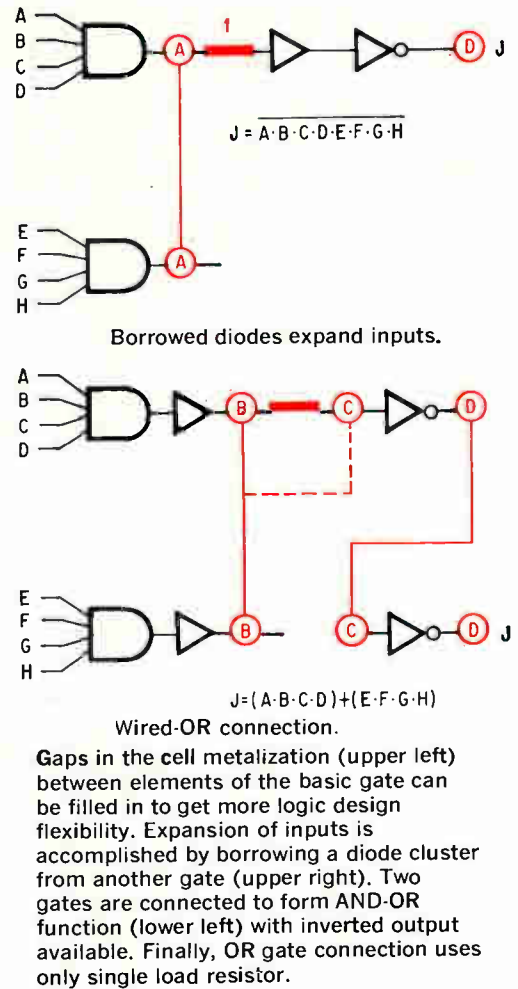
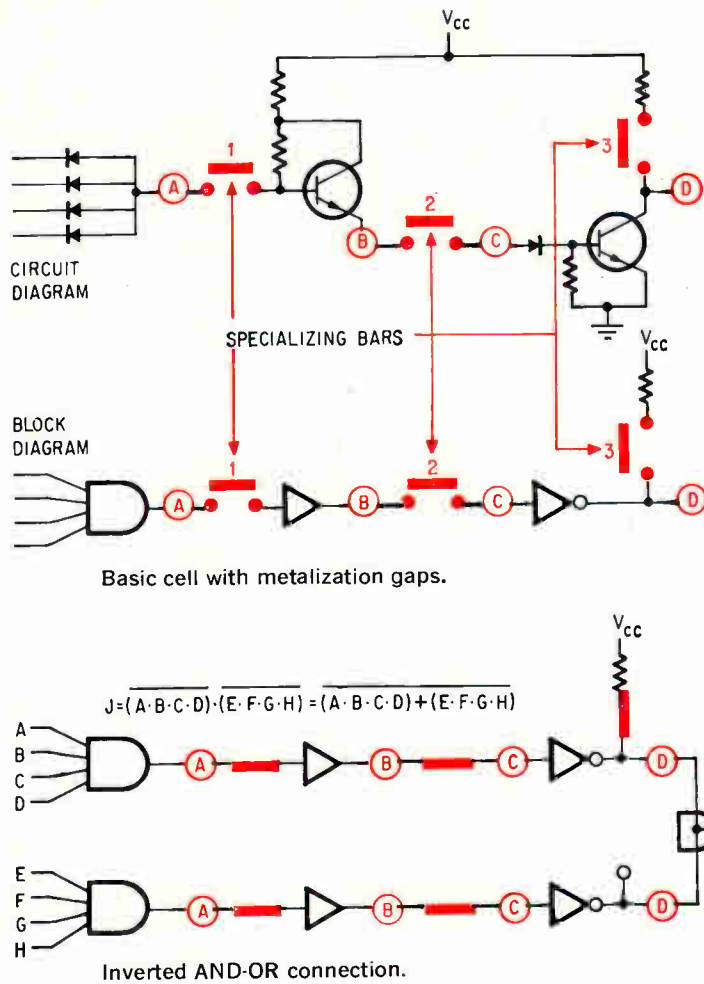

applicability to Micromatrix. Unconnected array wafers will be produced in enough volume so that their processing cost will be negligible when compared to the other costs of custom interconnection, testing, and packaging.

Thus, the Micromatrix concept is independent of device implementation, and is being applied to both MOS and bipolar arrays under development.

### An example of bipolar technology

One such array built using bipolar technology is Fairchild's 4500, composed of eight cells, arranged in a 4 by 2 pattern. The chip size is 80 by 110 mils with an active area of 6,000 square mils. Provision is made for up to 28 bonding pads for input-output signals and power.

The basic building block of the 4500 is the four-input, diode-transistor NAND gate; this logic configuration has well-known advantages of low power dissipation, a single power supply, high worst-case noise immunity and specified operation over a wide temperature range. In addition, the array is compatible with most forms of discrete integrated circuit logic such as DTL or TTL and Fairchild's new CCSL (compatible current sinking logic).

One unique aspect of the DTL NAND gate circuit

of the 4500 array in the use of gaps in the cell metalization to allow connections not possible with discrete integrated circuits (illustrated above). The gate may be thought of as four independent elements: a diode cluster shown logically as an AND gate, a pull-up resistor and transistor shown logically as a non-inverting amplifier, a common emitter transistor shown logically as an inverting amplifier, and a load resistor. These elements may be connected by the use of "specializing" bars (first-layer metalization) to increase the logical power of the element. Expansion of the gate inputs is accomplished by using a diode cluster from another gate.

In another example, two gates are connected to form an AND-OR function. Note use of the left-over inverter to provide the additional inversion stage. The output gate "wired-OR" connection may also be used without loss of d-c fan-out margin, since only a single load resistor need be connected.

The 32-gate capability which is demonstrated on pages 160 and 161, makes the 4500 appropriate for a variety of useful designs.

### MOS is versatile, too

An example of MOS technology is Fairchild's

# MOS cells offer quick-change logic

**Three-input NAND gate (four per cell).**

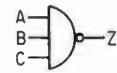

$$Z = \overline{ABC}$$

LOGIC BLOCK REPRESENTATION

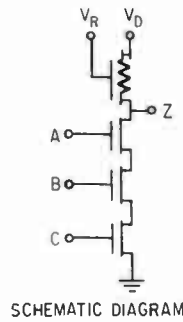

SCHEMATIC DIAGRAM

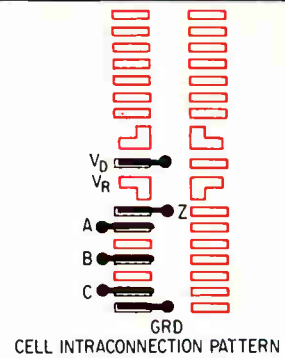

CELL INTRACONNECTION PATTERN

**Three-input NOR gate (four per cell)**

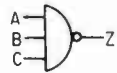

$$Z = \overline{A+B+C}$$

LOGIC BLOCK REPRESENTATION

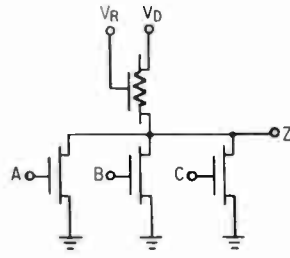

SCHEMATIC DIAGRAM

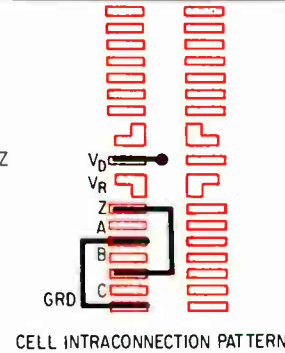

CELL INTRACONNECTION PATTERN

**Exclusive OR gate (two per cell).**

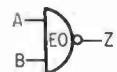

$$Z = A\bar{B} + B\bar{A}$$

LOGIC BLOCK REPRESENTATION

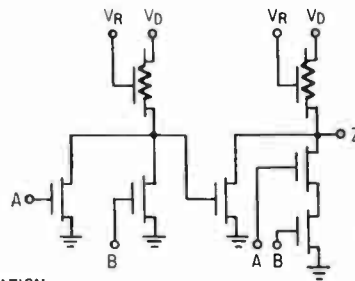

SCHEMATIC DIAGRAM

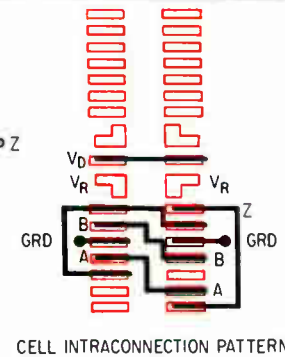

CELL INTRACONNECTION PATTERN

**Dual clocked RS (reset-set) flip-flop.**

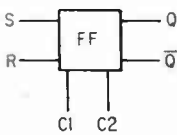

LOGIC BLOCK REPRESENTATION

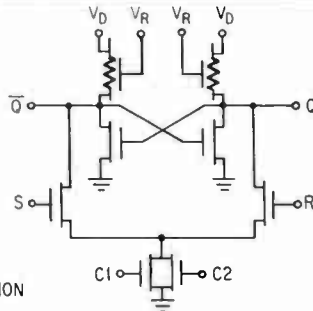

SCHEMATIC DIAGRAM

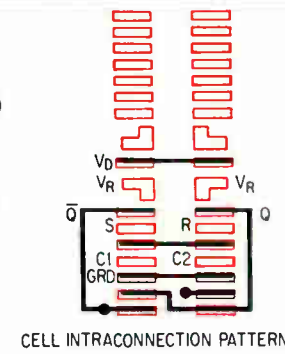

CELL INTRACONNECTION PATTERN

**Binary full adder requires an entire cell.**

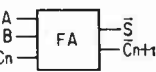

$$\begin{aligned} C_{n+1} &= AB + C_n(A+B) \\ S &= \overline{C_{n+1}}(A+B+C_n) + ABC \end{aligned}$$

LOGIC BLOCK REPRESENTATION

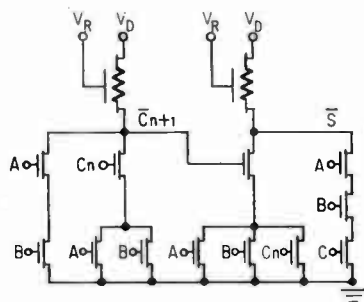

SCHEMATIC DIAGRAM

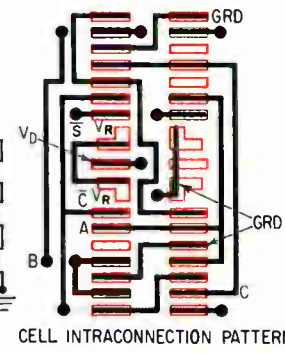

CELL INTRACONNECTION PATTERN

- KEY:
- DEVICE METAL
  - CELL INTRACONNECTIONS:
  - FIRST LAYER
  - DIELECTRIC CUTS
  - SECOND LAYER

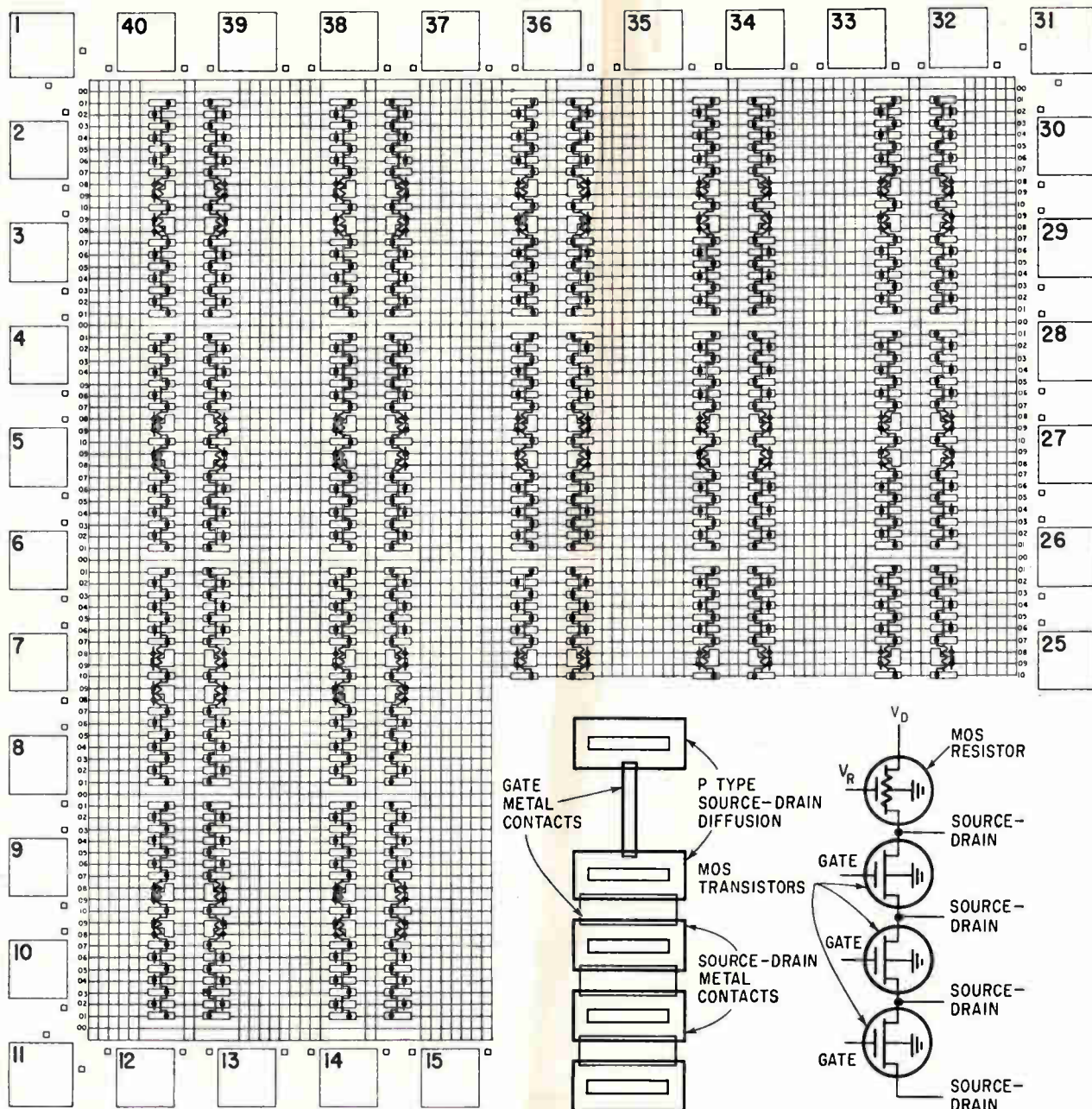

High density of MOS arrays, illustrated with this arrangement of 20 cells, is designed for an 80-mil square chip. There are four NAND gates to a cell, each with three inputs. Each gate (inset) consists of three MOS transistors in series with an MOS resistor.

4001 array, composed of 20 cells arranged in a 5 by 4 pattern. Each cell contains four three-input NAND gates consisting of three series MOS transistors and a MOS resistor. The array provides the equivalent of 80 three-input gates. The chip size is 80 mils square, with an active area of 60 by 62.5 mils. Provision is made for 40 bonding pads for input-output signals and power. The margin between the active area and the bonding pads contains 40 diffused resistors which may be used as over-voltage protection on input-output signals.

The basic building block of the 4001 is the three-input MOS gate. The top element is an MOS resistor followed by three MOS transistors, with common source-drain regions connecting adjacent com-

ponents.  $V_R$  (in the figure shown above) is the resistor control gate bias and  $V_D$  is the supply which controls the logic swing. The p-channel, enhancement mode MOS transistors exhibit an ON resistance between 2 and 4 kilohms and source-to-drain leakage currents of typically 1 nanoampere, in the OFF state. The turn-on voltage is in the -3v to -6v range.

The MOS resistors have a nominal value of 50 kilohms under normal biasing conditions. Typical propagation delay on the chip is 10 nanoseconds with  $V_D = -10$  volts and  $V_R = -28$  volts.

Wide design versatility with the 4001 can be achieved by proper cell intraconnection (page 163). Extensions of the concept to other applications are limited only by the designer's imagination.

# Be a genius —dream up an application for our MIL-R-12934E single-turn pots—



(and win your very own certificate of genius).

Submit *any* design, simple or complex. Use one, two or any number of functions—including trigonometric, logarithmic, and non-linear empirical. And because all Litton single-turn pots are designed to meet or exceed MIL-R-12934E requirements—*especially* resolution—you can list your most stringent performance specs.

Producing single-turn pots *in production quantities* with .0004" wire is a speciality with us. So designs requiring a high degree of accuracy and superior resolution can also be submitted. These features alone make it easy for you to become a certified genius. But here are other points to enhance your design idea.

Litton pots are lined with dialyl phthalate to insure moisture resistance, dimensional and temperature stability—a unique plus that produces far greater reliability. What's more, we can easily reduce size and weight so make your design as compact as you like. And don't worry about shunts or slope changes. Our special butt welding results in a clean, even tap that prevents distortion in the functions.

Now let's see what you can come up with. Just jot down your application and we'll send your certificate by return mail. And if yours is one of the 50 best ideas we'll publish it in our next IDEA BOOK.

**LITTON INDUSTRIES**   
POTENTIOMETER DIVISION

*If your present supplier can't solve your potentiometer problems, try us. For single-turn and multiturn, linear and functional, wirewound and conductive film, ganged or unitized with servo modules—Litton begins where others leave off.*

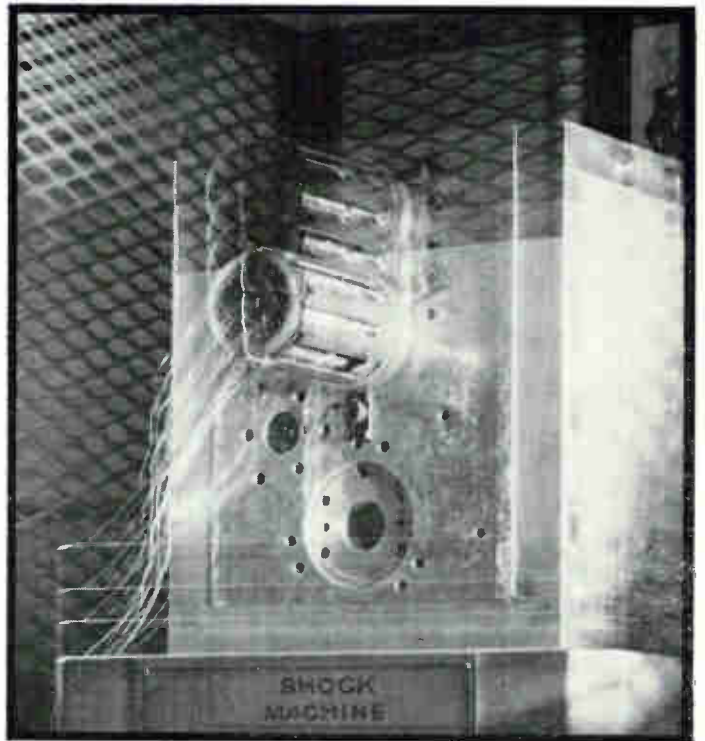

Certified testing equipment allows *simultaneous* measurement of Litton potentiometers under the extremes of environmental exposure.

Litton Industries, Potentiometer Division  
226 East Third Street, Mt. Vernon, New York 10550  
Tel.: (914) 667-6607 • TWX: 914/699-4687

My idea for an application is attached. Send my certificate of genius.

I have an idea, but need more data first. Send specs.

Name \_\_\_\_\_ Title \_\_\_\_\_

Company \_\_\_\_\_

Address \_\_\_\_\_

City \_\_\_\_\_ State \_\_\_\_\_ Zip \_\_\_\_\_

# Computer accelerates design and production of large arrays

Using logic entities called Polycells as building blocks, computers do design detailing while men do the creative work. The result: batch-fabricated integrated systems

By Lester Hazlett,

Semiconductor Products Division  
Motorola Inc., Phoenix, Ariz.

The complexity of arrangement and the density of components in a large-scale integration dictate that the designer have considerable help from a computer. In fact, it is doubtful if large-scale arrays of integrated electronics can be designed economically and efficiently without such help. One computer-aided design system, created especially to handle large-scale integration, uses logic entities automatically fetched from a computer memory and transformed into mask masters for circuit fabrication. Though the machine performs design detailing, the real creative work still is done by the engineer.

This technique is being developed at Motorola Inc., where it is emphasized because it promises earlier implementation and greater flexibility. Industrywide feeling that large-scale integration (LSI) should become a commercial reality within five years is shared by Motorola, based upon demonstrable results already achieved with the logic-entity idea.

The logic entity that is the basis of this approach may be a gate, a flip-flop, or a more complex func-

tion. Motorola's trademarked name for the logic entity is the Polycell. The principal advantage of the Polycell approach is that it allows cost reduction through design optimization combined with minimum response time to a new or revised design.

## The Polycell approach

Data structures representing Polycells are stored in a computer library. For a particular array, the designer specifies to the computer the desired configuration of Polycells. The computer translates the configuration into instructions for an automatic drafting machine which prepares a complete set of mask masters for the required array.

This phase alone represents a considerable improvement over the methods in general use at this time. The machine, taking the place of the draftsmen in the tedious job of mask preparation, can perform this more rapidly and far more efficiently, with less chance for error. Moreover, the machine is able to produce more accurate artwork than the conventional coordinatograph, which can locate points to an accuracy of 0.001 inch. As a result, Polycell and array geometries can be smaller.

Final cost depends on both setup and production costs. Setup costs include product specification, design and engineering. Production costs include all the phases of material processing and testing. The Polycell approach uses simplified CAD procedures to achieve reasonably low setup costs and minimum production costs. Production cost is minimized if the design is optimized for batch fabrication. This is as essential for LSI as it has been for conventional IC's.

## The author



Lester Hazlett is manager of design automation at Motorola's semiconductor products division. His responsibilities include development of computer-aided design systems for IC's.



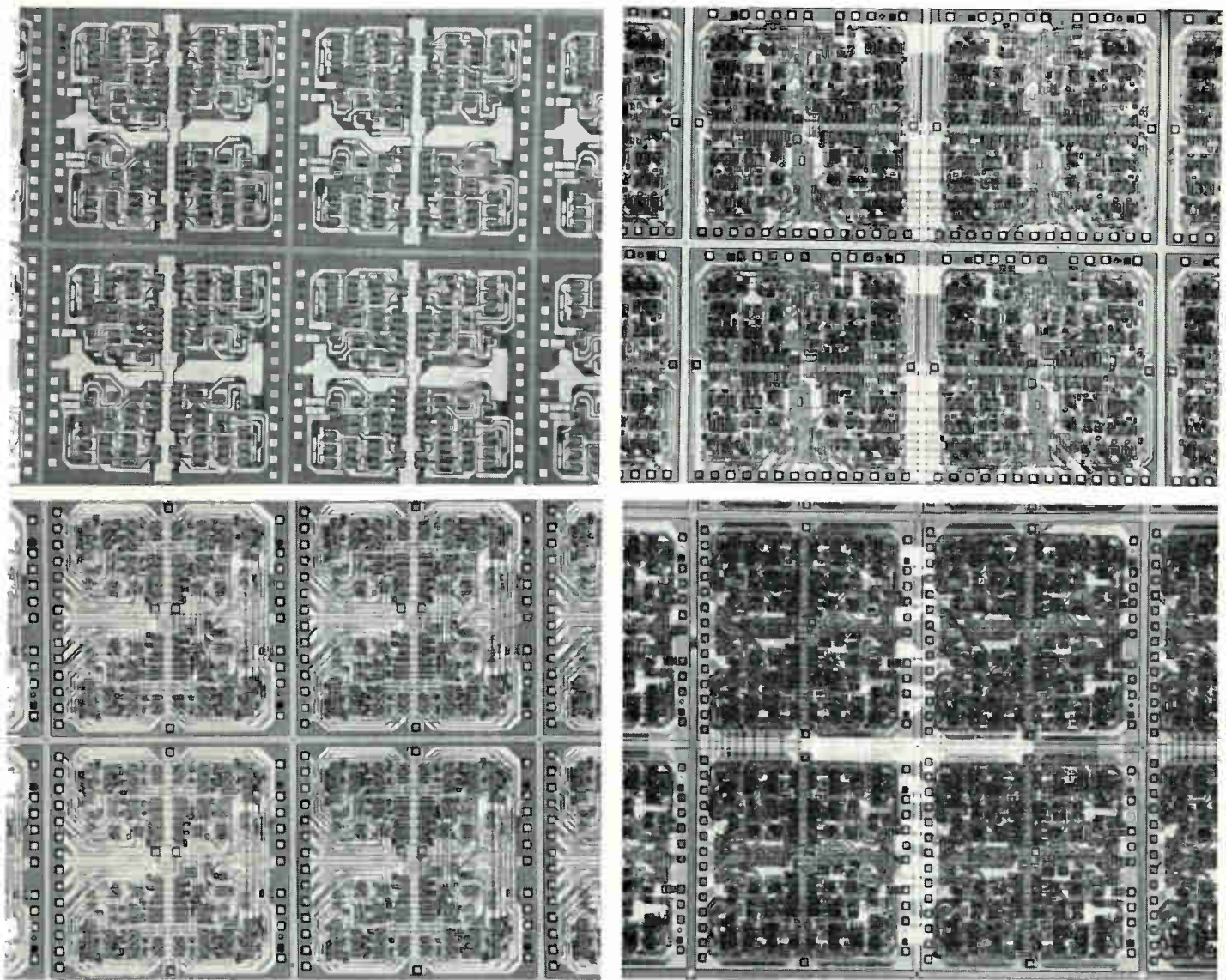

Steps in the fabrication of a 16-bit content-addressable memory array using Polycells. Each individual chip is a high-order Polycell made of smaller Polycells grouped together. At the upper left is part of the wafer showing four 4-bit arrays with the first layer of metalization. Below it, another layer of metal completes the highest-order Polycell. At the upper right the four arrays are connected in pairs by a third layer of metal. Finally a fourth layer of metal completes the 16-bit memory. The chip is 0.120 inch square and includes 524 diffused components.

### Quick turnaround

Initial production parts and early samples of modified designs must be available quickly if LSI arrays are to be designed into large systems. The increasing complexity requires that some LSI arrays be altered when the total system is modified. What today is considered an excellent response time will be intolerable when individual chips make up complex subsystems or even entire systems.

Vendor response time depends primarily on four factors:

- Communication of the product specification.
- Design, or design modification.
- Material processing.
- Product testing.

To standardize, simplify and expedite product specification requires a mutually well-defined selec-

tion of Polycells. The definitions can be in the form of standard specification sheets, like integrated circuits, or in the form of logic diagrams for more complex functions. From these definitions, any LSI array can be simply and clearly specified as a logically interconnected set of Polycells.

The CAD system on page 168 mechanizes all non-creative and repetitive design functions, while the designer controls the design procedure creatively. Such a system can be implemented in stages, allowing for early achievement of significant utility and ultimate accomplishment of full objectives.

A useful CAD system includes a computer, peripheral devices and automatic drafting equipment properly programed to allow man-machine interaction in the design of integrated semiconductor systems.

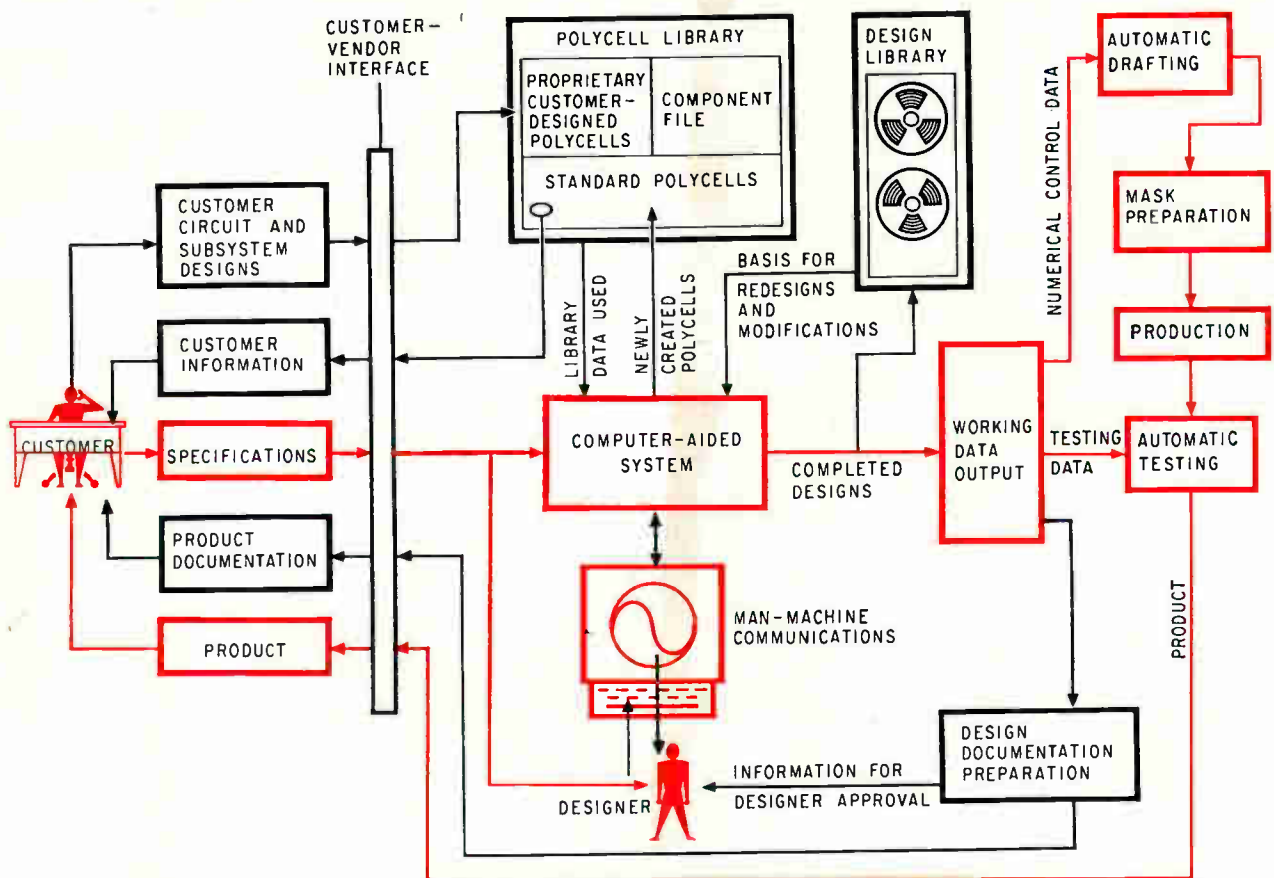

The customer is the beginning and the end of the design cycle. The designer, aided by a library of Polycells and prior designs stored in a computer memory, tries to meet the customer's specifications. The customer approves the final design before it goes into production.

The starting point of the Polycell approach to computer-aided LSI design, as in any other custom design project, is the customer. His prime inputs are the specifications for the final array. In many cases the customer will add his proprietary or preferred designs for some circuits and subsystems.

The designer works with the customer's specifications for the final system, using the CAD system. Once he analyzes the requirements and the special tools available, including the customer's proprietary Polycells, the CAD phase begins. Seated at the display console, the designer requests the desired Polycells and positions their images on the display. With a light pen and the keyboard the designer shifts or rotates Polycells. When he is satisfied with the arrangement, he switches his attention to the design of the metal interconnections between Polycells. The computer applies various algorithms to establish most of the routing. The designer can interrupt the machine if its solution becomes cumbersome and complete the routing manually.

Next the designer orders the computer to prepare design documentation and to store the design in the design library. He then carefully analyzes the documentation to guarantee that all requirements have been met and that the design is optimum.

If he is not fully satisfied, he returns to the console and calls up the complete design. He makes the required changes just as in the original design.

He can insert new Polycells, remove old ones, shift the Polycells around, and revise interconnections. The computer prepares new documentation and the revised design is filed.

The optimization proceeds until the designer is content. Then the final documentation is submitted. The customer may then request further revisions until agreement is reached.

#### Now it can be built

When the design has been approved, the final version is once again called from the library. This time, the system generates numerical control data for the automatic drafting machine. These instructions specify the exact size, shape and location of each component element and for all the metalization. The drafting machine draws mask masters, from which a set of masks is prepared for the actual manufacture of the integrated system.

Though the Polycell approach to large-scale integration has not yet been proven in its entirety, it is close to implementation. Computer programs have been developed at Motorola and various phases of the operating sequences have been checked out successfully.

The progression from current technology to LSI will not be instantaneous, but a logical progression of circuits of ever-increasing complexity can be expected with correspondingly decreasing costs.

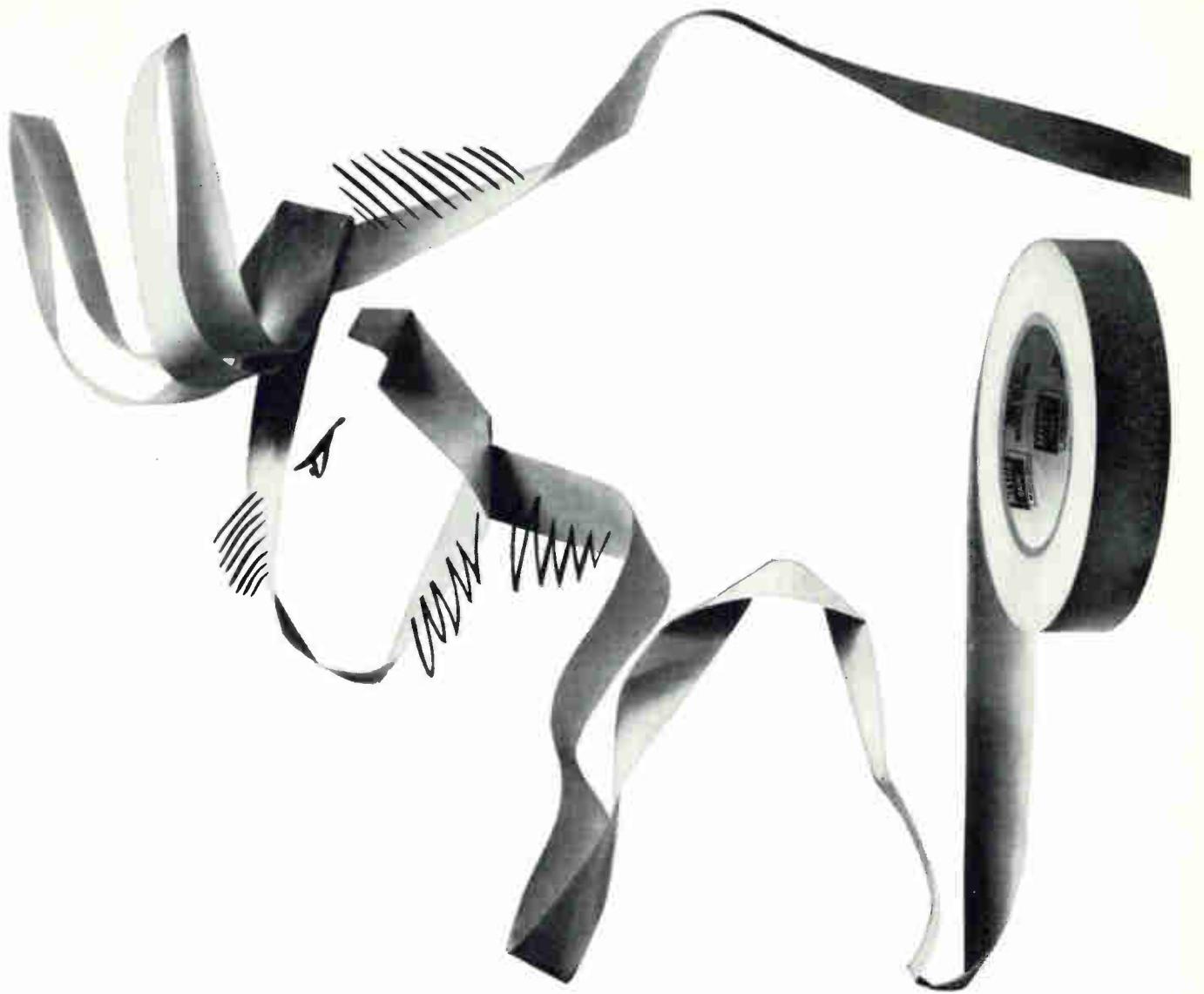

## What's gnu? Mystik NOMEX<sup>®</sup>, KAPTON<sup>®</sup> and TEDLAR<sup>®</sup>, that's what!

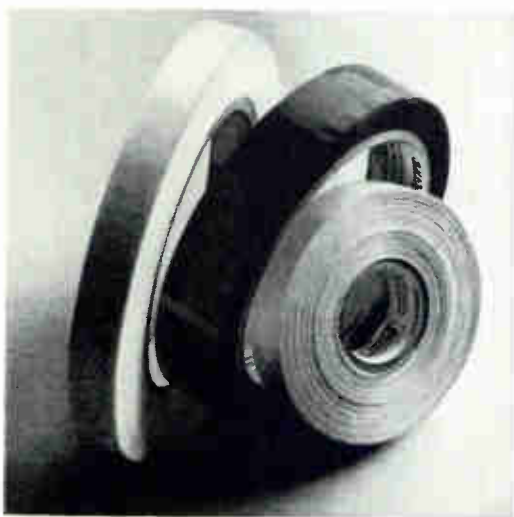

Mystik scores again by being the first to utilize three new materials ... Nomex, Kapton and Tedlar ... and add them to their already extensive line of pressure-sensitive tapes.

**NOMEX** —a highly conformable tape that offers excellent holding power and dielectric strength characteristics.

**KAPTON**—the featherweight of wire insulations... excellent high temperature applications which require low weight structures.

**TEDLAR**—ideal for electrical applications because of high dielectric strength combined with excellent weather and hydrolytic resistance.

If you would like more information on these or any other Mystik special-purpose tapes, contact your local Mystik distributor. He is listed in the yellow pages under "Tapes—Adhesive". Or, write Mystik Tape Division, The Borden Chemical Company, 1700 Winnetka Avenue, Northfield, Illinois 60093.



**BORDEN  
CHEMICAL**

**for  
sophisticated crystal filters  
in  
miniaturization**

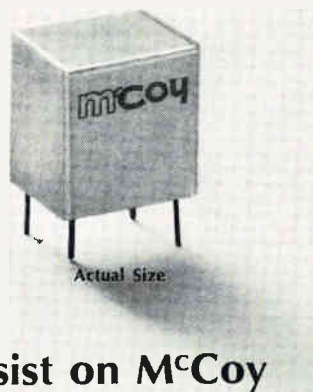

**insist on M<sup>c</sup>Coy**

Sophisticated filters demand sophisticated design—  
Miniaturization requires manufacturing know-how—  
M<sup>c</sup>Coy has both.

In ten years of manufacturing crystal filters—from 5 kc to 125 mc—M<sup>c</sup>Coy has accumulated a wealth of filter manufacturing knowledge. Coupled with complete crystal manufacturing facilities, this background of filter know-how has established M<sup>c</sup>Coy as a leader in the industry.

When sophisticated designs and miniaturization are required, practically everyone insists on M<sup>c</sup>Coy, where sophisticated filters are routine.

Why not put your filter requirements in capable hands?

Contact M<sup>c</sup>Coy for quotations on your specific requirements.



**M<sup>c</sup>COY ELECTRONICS COMPANY**

A SUBSIDIARY OF OAK ELECTRO/NETICS CORP.

MT. HOLLY SPRINGS, PA. 17065

TELEPHONE: 717-488-3411 • TWX 717-488-3400

# Silicon-on-sapphire approach affords freedom and flexibility

Isolation provided by etched islands allows the mixing of different devices on a single microcircuit substrate

By Arnold Miller

Autonetics Division, North American Aviation Inc., Anaheim, Calif.

The growing complexity of conventional integrated-circuit arrays is magnifying the importance of three familiar restrictions: the parasitic capacitances of the back-biased p-n isolation junctions, the limits on mixing semiconductor devices and the difficulties of using resistive films on a silicon wafer. The silicon-on-sapphire (sos) approach, however, frees the designer from constraints and offers him the flexibility he once enjoyed with discrete-device systems.

This method, in which silicon film is deposited on the insulating sapphire substrate by heteroepitaxial techniques, affords complete isolation of semiconductor devices, allows the designer to use the devices best suited for each function, and permits the combination of precision resistive films or capacitive elements with monolithic devices on the same substrate.

After a single-crystal silicon film is grown on a single-crystal sapphire substrate, active-element locations are isolated by etching away the intervening silicon to form an array of silicon islands. The isolation thus achieved is limited only by the conductivity of the insulating substrate. The devices are then fabricated by the usual masking, oxidation and diffusion techniques and the interconnections, crossovers and precision passive com-

ponents are added by vacuum deposition. The active elements formed in this way are in intimate contact with the insulating substrate and thus have thermal characteristics that allow them to operate at higher power levels than ordinarily possible with conventional integrated circuits.

Diode matrixes, metal-oxide-semiconductor complementary arrays, hybrid networks and bipolar structures all can be fabricated on a single sapphire substrate. A conservative estimate of the capabilities of present-day photolithographic methods is about 10,000 interconnected thin-film devices per square inch. It can be shown that, on a 10-mil-thick substrate, an sos 30-bit, 8,000-word memory (about 250,000 bits) with accompanying electronics would occupy less than two cubic inches of volume.

## Diode structures

The sos film structure allows us to achieve small junction areas in the semiconductor devices. In the vertical-junction geometry produced by successive, side-by-side diffusions of p and n impurities, the junction area is simply the product of film thickness and silicon-island width. A 2-mil-wide structure in a 0.5-micron film, for example, produces a junction area of about 25 square microns that can give a junction capacitance of less than 0.005 picofarad. Without benefit of gold doping, vertical-junction diodes exhibit storage times of less than 1 nanosecond when switching from 3 milliamperes forward to 2 volts reverse, a property that suggests their use as step-recovery diodes in microwave harmonic generators.

On a single wafer, diode yield is about 99%, rectification ratios are greater than  $10^5$ , and the variation in electrical characteristics can be held to less than  $\pm 15\%$  across the wafer.

A diode read-only memory array can be used to

## The author



Arnold Miller, director of Autonetics' central microelectronics laboratory, has spent 14 years in industrial research on surface chemistry, the physics of solids and photochemical reactions. He is a member of IEEE's Professional Committee on Integrated Circuits.

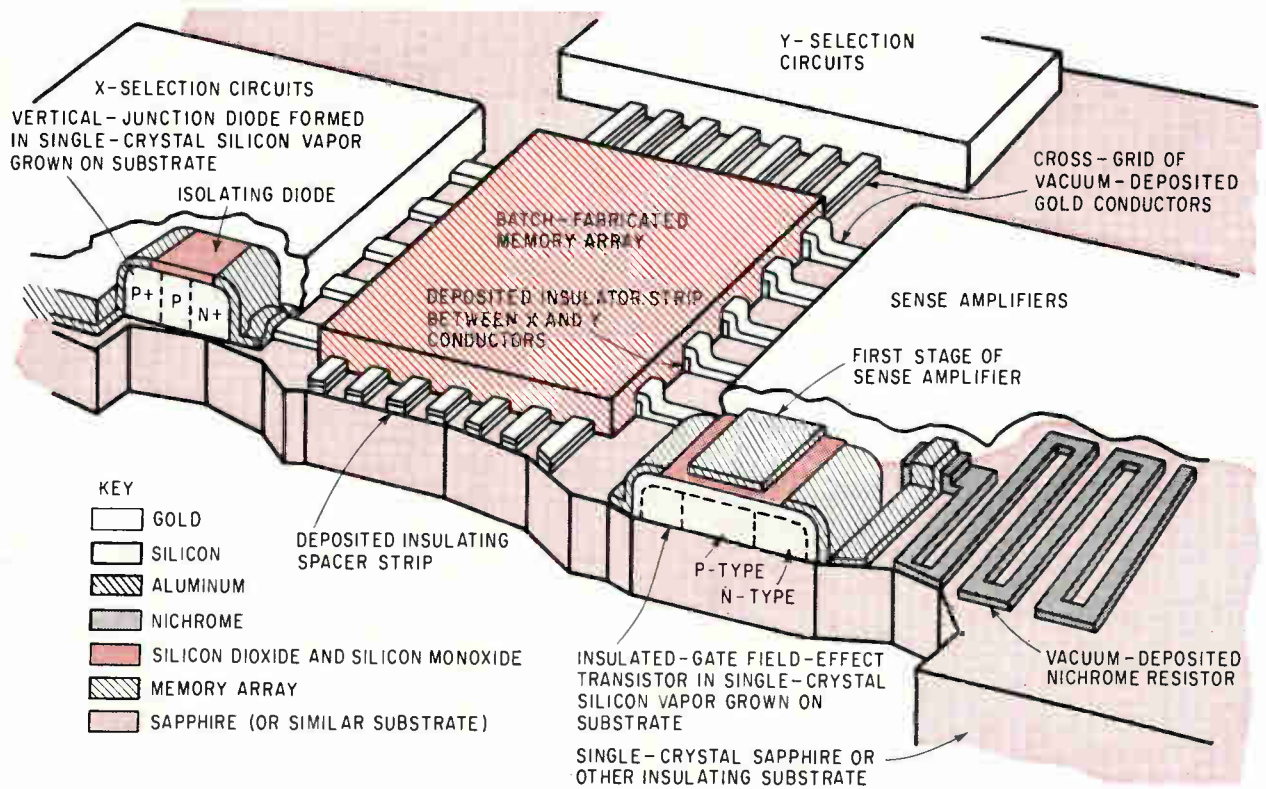

Isolation afforded by the silicon-on-sapphire approach allows the mixing of a variety of devices on the same substrate. The vertical-junction devices have small junction areas with low junction capacitances, which add to their capability at high frequencies.

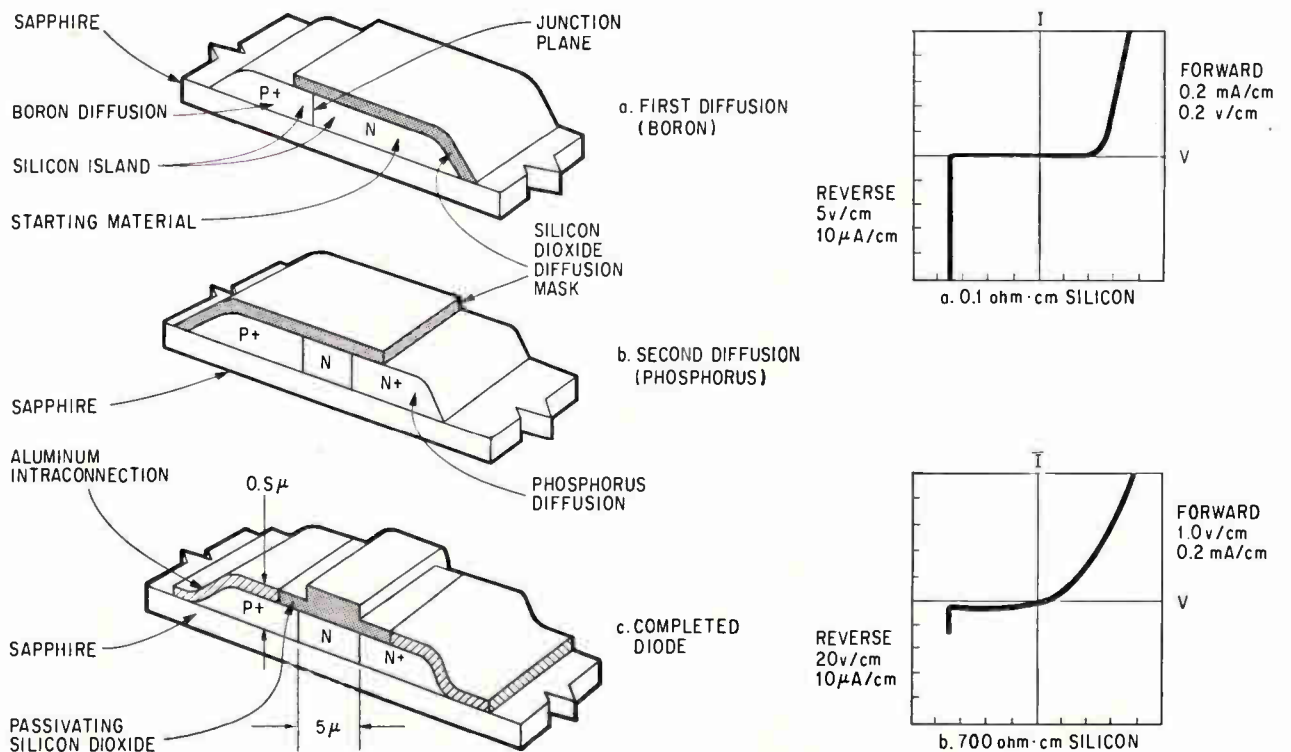

In forming a vertical-junction SOS diode from the basic n-type silicon film, a first diffusion forms the junction and a second reduces the diode forward impedance and provides a low-resistance silicon region for contact. In the final step, the passivation film and contact pads are added to the diode. The V-I characteristics show the operation of two different diodes, one made from low-resistivity, 0.1 ohm-cm silicon film and the other from high-resistivity 700 ohm-cm silicon.

show the advantages of the sos approach. The memory not only demonstrates the capabilities of sos, but shows the two interconnection schemes that can be used.

A fixed-memory diode array uses prewired diodes to store information and provide address selection. Though hardly new, such diode stores haven't been used often because of the cost of discrete diodes, the limitations imposed by leakage paths, capacitance restrictions and the advances made in other types of memories. The availability of sos, however, refocuses attention on diode stores.

A 26-by-26 diode matrix structure on a 0.75-inch sapphire wafer was made as a prototype.<sup>1</sup> The 676 thin-film silicon islands located in the center  $\frac{1}{4}$ - x  $\frac{1}{4}$ -in.-square of the substrate were fabricated into the appropriate 2-mil by 5-mil diodes, arranged on 10-mil centers. Gold lines, 2 mils wide, were deposited in a parallel array; contacting the end of each diode, they formed the column lines of the matrix. Wide silicon monoxide layers overlaid the column lines for insulation and orthogonal sets of gold conductors were deposited to form the row lines. The final step was the appropriate connec-

tion of individual diodes to the column lines with a gold link.

Early prototype structures exhibited rectification ratios in excess of  $3 \times 10^5$  and read-in and read-out capacitances from the interconnection matrix of less than 1.5 pf. Yields were in the 99% range for an appropriately interconnected system<sup>2</sup> at a density of  $10^4$  bits per square in.

After the initial demonstration of the feasibility of the 676-diode matrix unit, a more complex high-density matrix was considered.<sup>2</sup> The second unit was built on a 1-in.-diameter, 20-mil-thick sapphire wafer, and consisted of a 96-column by 70-row array with a double redundant diode pair at each intersection. The matrix itself occupies 0.25 in.<sup>2</sup>, with final interconnection to the drive and sense circuits handled by a fan-out pattern. The components are interconnected through low-resistance, n-degenerate silicon islands at the crossover point. In building this unit, a thick silicon dioxide insulating layer was formed over the exposed silicon islands, and contact points were exposed by etching. An orthogonal array of conductors was then deposited so that the column lines contacted the

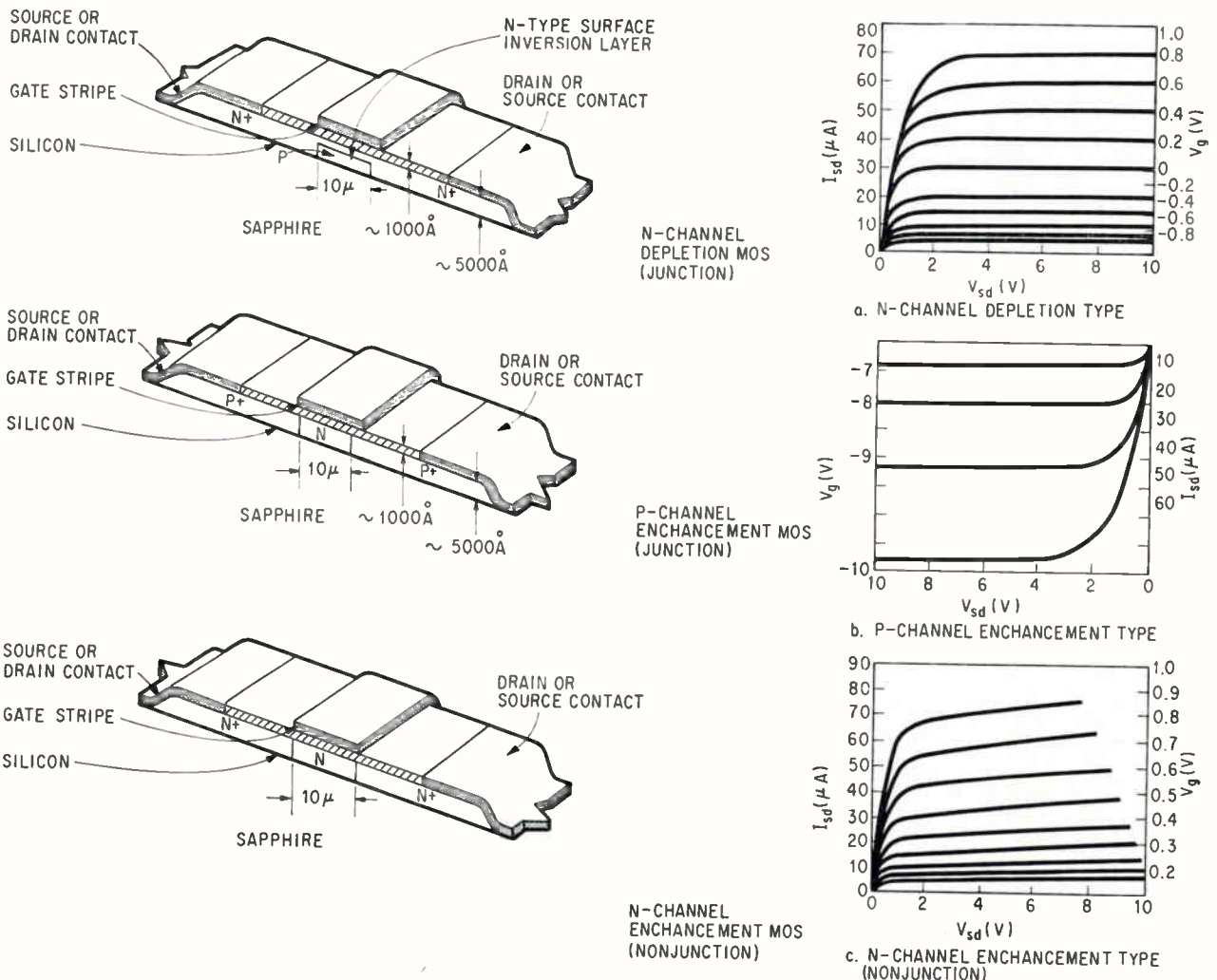

Three types of MOS field effect transistors have been made in the SOS structure. The amplification factors for the devices are typically in the 50-to-300 range. The fourth possible device, the p-channel depletion model FET, hasn't been successfully made because of instabilities related to charges in the oxide layer, a problem common to conventional MOS structures.

## Heteroepitaxy

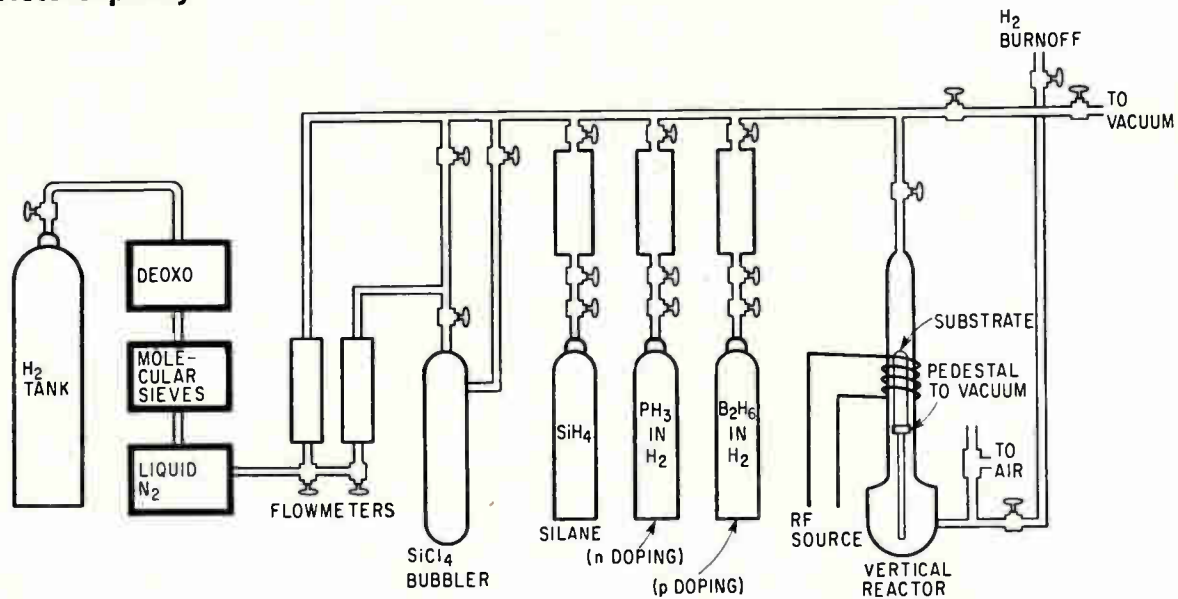

The successful growth of a single-crystal film of one substance upon another largely depends on the crystallographic relationships at the interface and on the physical condition of the substrate surface. The substrate itself must first of all be a single-crystal material free of surface grain boundaries, scratches and impurities. Its surface must be prepared carefully by multiple lapping, polishing and ultrasonic cleaning before the substrate is inserted into the reactor, and it must get a final gas-phase polishing inside the reactor.

The film quality is also related to the source of silicon. Films deposited with silicon tetrachloride are usually of medium- to high-resistivity p-type. With silane, some variations occur from batch to batch, with both p and n types being obtained. Silane has been found to yield films with fewer dislocations, dislocation density usually being on the order of  $10^8/\text{cm}^2$ . The dislocations probably are related both to the dislocation density of the substrate and to the differences in expansion coefficients between the film and the substrate.

During processing, the film quality is affected by the substrate temperature, the gas composition and the flow rate, although satisfactory silicon films have been obtained over a fairly wide range of these variables.

Steps in growing a silicon film on a sapphire substrate

1. Place the sapphire wafer in the reactor on an alumina spacer resting on either a silicon or carbon rf-heating susceptor.
2. Polish the sapphire surface at  $1,450^\circ\text{C}$  with HCl or  $\text{SF}_6$ .
3. Pretreat the surface with  $\text{H}_2$  at  $1,250^\circ\text{C}$ .
4. Lower the temperature to  $1,150^\circ\text{C}$  and deposit silicon with either silicon tetrachloride ( $\text{SiCl}_4$ ) or silane ( $\text{SiH}_4$ ) at a concentration of 0.3 mole percent in  $\text{H}_2$ :  
Using  $\text{SiCl}_4$ : pass the  $\text{H}_2$  through the  $\text{SiCl}_4$  bubbler. The hydrogen reduction of  $\text{SiCl}_4$  deposits the silicon on the sapphire.  
Using  $\text{SiH}_4$ : feed the silane into flowing  $\text{H}_2$  to deposit silicon by thermal decomposition of  $\text{SiH}_4$ .
5. Bypass the bubbler, purge the reactor with  $\text{H}_2$ , turn off the r-f heating supply and cool the pedestal with flowing  $\text{H}_2$ .
6. Passivate the silicon surface with a 1,000-angstrom oxide layer and give thermal homogenization treatment in an inert atmosphere ( $\text{H}_2$  or He) at high temperature. This maintains uniform film properties across the wafer and prevents aluminum transfer from sapphire to silicon (an autodoping process).  
The mobility in the resulting film, because of imperfections, will be about 20% to 30% less than the mobility of comparable bulk silicon.

beveled edges of the islands under the oxide, while the row lines crossed over the insulated regions.

### MOS structures

Mos field-effect transistors of various types and geometries can be fabricated in sos form through techniques developed for vertical-junction diode structures.<sup>3</sup> After the device islands are formed, a series of vertical-junction diffusions are made. The silicon-dioxide gate insulation is formed by masked vacuum evaporation, and the structure is completed by vacuum-deposited aluminum source, drain, gate and interconnection stripes.

Useful p-channel depletion devices haven't yet

been successfully made because charges in the oxide layer have introduced instabilities. However, with the unique structure of thin-film sos we can build a nonjunction enhancement-type device that

#### High-density diode matrix array

Forward current	0.1 to 0.5 ma at 2 v
Leakage current	< 100 na at 5 v
Voltage breakdown	> 15 v
Storage time	1 nsec
Junction capacitance	0.005 pf/diode
Row-line capacitance	3.4 pf
Reverse-to-forward resistance ratio	$10^7 - 10^8$
Wafer electrical variation	$\pm 15\%$



A 676-diode memory array is spot checked for forward current, voltage and leakage current before the attachment of leads and encapsulation. The inset shows one method of connecting devices to the gold interconnection stripes.

A gold link is added from the conductor to the device pad. A silicon monoxide film insulates the row lines from the column lines.

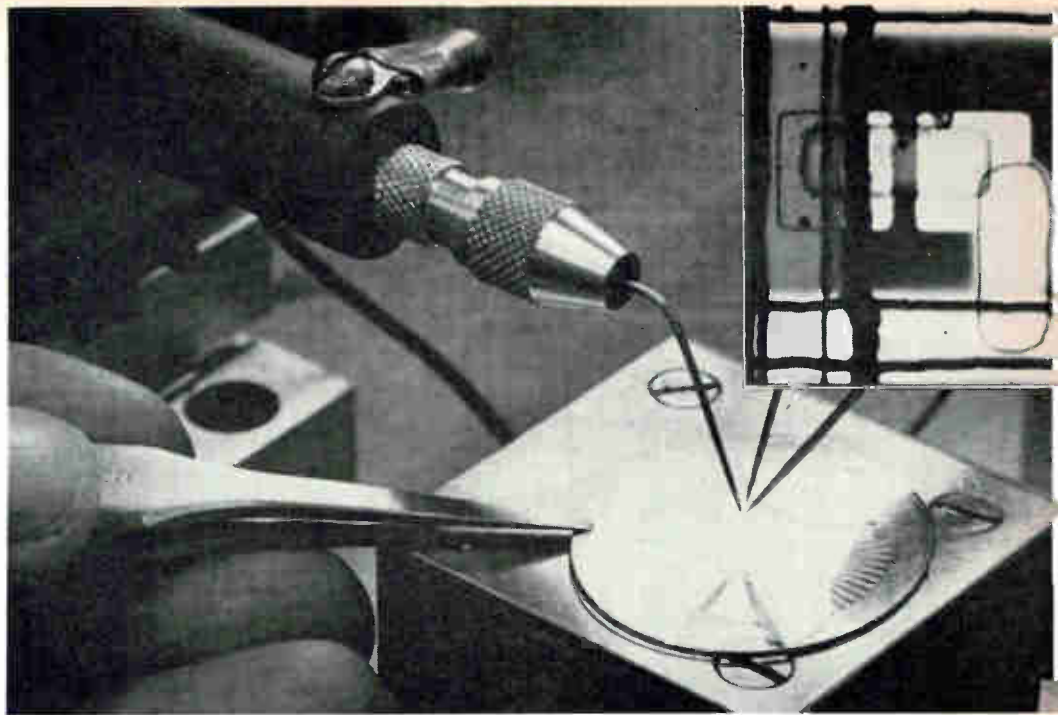

can't be made in bulk silicon. This structure is comparable to the polycrystalline, vacuum-deposited MOS field effect transistor, but with its single-crystal nature, it has enhanced characteristics and better stability.

The channel width of the device affects its transconductance and drain-resistance values. In the structures illustrated, the gate length is held at 2 mils. The amplification factor, which is relatively insensitive to the gate length, is typically in the 50-to-300 range.

Leakage measurements show values in the 10-to-100-picoampere range, depending on the device geometry. At 10 microamps, the threshold voltage is usually 1.5 to 2 v when oxide thicknesses are maintained at 1,000 angstroms. For a 10-mil channel width, gate capacitance is approximately 1.5 pf, with source-to-drain breakdown voltages of about 25 v. For a 20-mil channel width, switching-time measurements indicate typical rise and fall times of 10 nsec.

The thin-film rendering of MOS field-effect transistors in an SOS system provides a number of additional advantages in complex circuit designs requiring large numbers of devices. For maximum speed, stray capacitance must be reduced to a minimum, and this is a severe problem where large numbers of devices must be interconnected. With sapphire as an insulating substrate, however, the only capacitance contributions are at the crossover points and in the devices themselves; there is no capacitance to the substrate. Thus, MOS drain-to-source capacitance can be neglected, although the gate-to-source and gate-to-drain capacitance contributions are still significant.

The SOS approach permits the ready fabrication of both p- and n-channel MOS field effect devices on the same substrate. This ability to design with MOS devices of both types results in circuit simplification and a reduced power requirement.

Resistors and capacitors also may be added on the same sapphire substrate. The silicon films themselves may be used as resistors; at film thicknesses

of 0.5 micron, with 10 ohm-cm resistivity silicon, sheet resistors of 200 kilohms per square are attainable. Precision nichrome thin-film resistors can be deposited with conventional masked evaporation techniques. The MOS structures may be used as capacitors where required.

Low-power flip-flops using complementary p- and n-channel, enhancement-mode, junction-type MOS field effect transistors have been fabricated in SOS form in an experimental memory-array configuration. A circuit structure of this type would yield significantly reduced power consumption and improved frequency characteristics without requiring the use of multiphase clocking.

A simple memory cell, for example, consists of two inverter circuits connected back-to-back to form a flip-flop, plus a fifth MOS field effect transistor for cell readout. The basic flip-flop occupies an area of 225 sq. mils. Low-level leakage measurements give values in the nanoampere range on the complementary array. The p-channel devices exhibit thresholds of 4 v at 10  $\mu$ a, while the n-channel

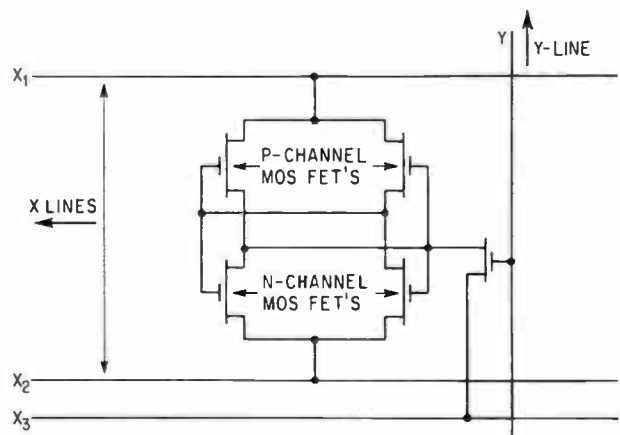

Simple MOS memory cell for an alterable NDRO array consists of two inverter circuits connected back-to-back to form a flip-flop, with a fifth MOS transistor added for cell readout. The basic flip-flop occupies 225 square mils.

devices have thresholds of less than 2 v.

Another example of sos design is provided by a nondestructive readout (NDRO) scratch-pad memory plane consisting of 24 columns and 22 rows, plus peripheral circuits. Each individual cell in the array is a circuit composed of six p-channel and six n-channel MOS transistors and five diodes; the heart of each circuit is a four-transistor, complementary bistable flip-flop. At the top of each column, a column-selection circuit is integrated into the array; at the bottom of each column, a complementary inverter permits the "folding" of columns without an increase in capacitance loading. Along the sides of the array, an extensive crossover matrix and read/write contact pads are integrated into the storage plane.

### Bipolar structures

To date, sos bipolar structures showing current gain have been successfully built in conventional planar npn form, as well as in vertical-junction npn and pnp forms, but much more work is necessary.<sup>4,5</sup>

Using sos films of thicknesses on the order of 5 microns, a series of conventional planar npn devices has been fabricated. Since the silicon films currently under investigation have dislocation densities of approximately  $1 \times 10^8/\text{cm}^2$ , the work centered on structures of small device areas. No device structure of a larger size showed transistor action, and the failure in all cases was traced to collector-emitter shorting.

In a planar npn transistor fabricated from 2 ohm-cm material, an  $h_{FE}$  of only 2 was observed, but current gain was achieved. Going from a 2 ohm-cm film to a 0.1 ohm-cm film (on Czochralski sapphire) leads to a deeper base penetration with a correspondingly wider base region and results in  $h_{FE}$  values of 20.

Interesting results of perhaps greater ultimate promise have been achieved with small-area, vertical-junction bipolar transistors. In an experimental homogeneous-base pnp bipolar device made in silicon films on the order of 0.5 microns in thickness, the emitter-base area is 92 square microns and collector-base area is 135 square microns. The  $h_{FE}$  is low, with a sharp decrease occurring when only a few microamps collector current is attained. At 40 na, the  $h_{FE}$  observed is 19.

The homogeneous-base transistor has a limited frequency response due to the absence of drift fields in the base region. However, the low device capacitance, in combination with thin-film, high-value silicon resistors, could well result in integrated amplifiers capable of operating at frequencies of at least 10 megahertz. The diffusion process control would be considerably less critical for the homogeneous-base bipolar transistor than for the corresponding diffused-base device.

A vertical-junction, diffused-base npn bipolar transistor that was built differs from the corresponding homogeneous-base structure in processing sequence and geometry. The collector-base junction area of this device is 30 square microns and

the emitter-base junction area is 6 square microns. This structure is similar to the homogeneous-base device in that it shows an  $h_{FE}$  peak at low current. A current gain of about 2 is obtained at the 10-na collector current level.

This device has the low capacitance of the vertical-junction, graded-base bipolar transistor, and can be integrated into microstrip or stripline circuits with sapphire as the dielectric material and a ground plane on the back side. This kind of device could thus be used to advantage in microwave IC's operating in X band. Its possible application in low-power subnanosecond digital IC's and integrated-circuit arrays is also apparent.

The small-area vertical-junction devices with collector-base and emitter-base junction areas of 10 and 5 square microns respectively give rise to associated capacitances in the 0.001-pf regions, an order of magnitude smaller than can currently be achieved in bulk with conventional techniques.

### References

1. T.J. LaChapelle and F.L. Morritz, "Thin Film Silicon-on-Sapphire Diode Matrix Memory," IEEE Wescon, Technical Paper 16 A-5, August 1965.
2. A.C. Lowell, T. Mitsutomi, R.T. Matsumoto, G.J. Burnett, "Silicon-on-Sapphire Batch Fabrication of Comouter Logic and Memories," 1966 Aeronautical Electronics National Conference Proceedings, May 1966.
3. R.W. Downing and P.J. Hagon, "Silicon-on-Sapphire Device and Integrated-Circuit Processing Technology," IEEE Wescon, Technical Papers 16 A-3, A-4, August, 1965.
4. R.W. Downing and P.J. Hagon, "Silicon-on-Sapphire Thin-Film Integrated Circuits," presented to the Second International Symposium on Microelectronics, Munich, Germany, October 1966.
5. Arnold Miller, "Semiconductor Films on Insulators—Devices and Circuits," IEEE Fifth Annual Microelectronics Symposium, St. Louis, July 1966.

### Bibliography

- H.M. Manasevit and W.I. Simpson, "Single Crystal Silicon on a Sapphire Substrate," American Physical Society Meeting, August 1963, Edmonton, Alberta; Journal of Applied Physics, April 1964, pp. 1,348-9.
- C.W. Mueller and P.H. Robinson, "Grown-Film Silicon Transistors on Sapphire," Proceedings of the IEEE, December 1964, p. 1,487.
- B.A. Joyce and R.J. Bennett, "The Epitaxial Deposition of Silicon on Quartz and Alumina," Transactions of the Met. Society, AIME, March 1965, p. 556.
- H.M. Manasevit, Arnold Miller, F.L. Morritz and R.L. Nolder, "Heteroepitaxial Silicon-Aluminum Oxide Interface, I. Observations on the Growth Mechanism," Transactions of the Met. Society, AIME, March 1965, p. 540.
- R.L. Nolder and I.B. Cadoff, "Orientation Relationships of Single Crystal Silicon on Alpha Aluminum Oxide," Transactions of the Met. Society, AIME, March 1965, p. 549.
- P.J. Hagon, "Thin Film Devices Fabricated in Single Crystal Silicon Films on Sapphire," IEEE Conference on Thin Film Active Devices, Johns Hopkins University, Baltimore, April 1965.
- C.Y. Ang and H.M. Manasevit, "Residual Stress in Epitaxial Silicon Films on Sapphire," Solid-State Electronics, August 1965, p. 994.
- D.J. Dumin, "Deformation of and Stress in Epitaxial Silicon Films on Single Crystal Sapphire," Journal of Applied Physics, September 1965, p. 2,700.
- J.L. Porter and R.G. Wolfson, "Silicon/Corundum Epitaxy," Journal of Applied Physics, September 1965, p. 2,746.
- P.J. Hagon, "Silicon on Sapphire Integrated Circuits Technology," Electrochemical Society Meeting, San Francisco, May 1965, Journal of Electrochem. Society, May 1965, 70C, Abstract 117.
- R.L. Nolder, D.J. Klein and D.H. Forbes, "Twinning in Silicon Epitaxially Deposited on Sapphire," Journal of Applied Physics, 36, 1965, p. 3,444.
- P.H. Robinson and C.W. Mueller, "The Deposition of Silicon Upon Sapphire Substrates," Transactions of the Met. Society AIME, March 1966, p. 268.
- Arnold Miller and H.M. Manasevit, "Single Crystal Silicon Epitaxy on Foreign Substrates," Journal of Vac. Sci. and Tech., March/April 1966, p. 68.
- T.J. LaChapelle, Arnold Miller and F. L. Morritz, "Progress in Solid-State Chemistry," Pergamon Press, Vol. III, Chapter 1, 1966.

# “How can we scan temperatures at a rate of ~~10~~ 50 points/second?”

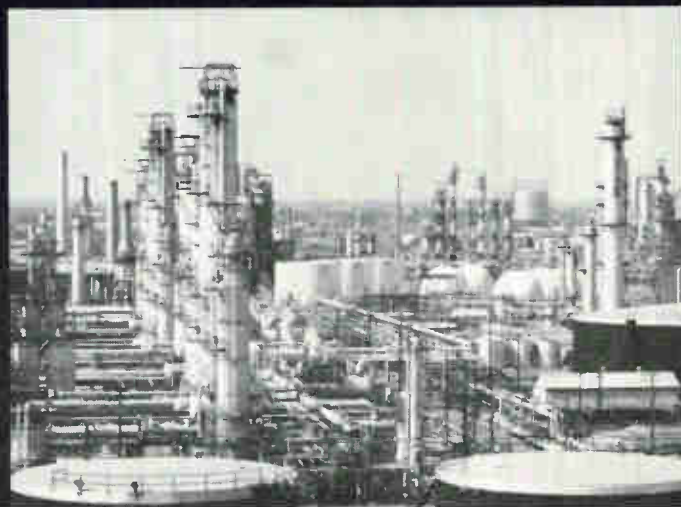

## With an EMC Scanner System!

Proven EMC temperature scanner systems are now available for countless applications in a variety of industries.

Monitoring temperatures at a rate of up to 50 points a second from 0 °C to 500 °C with a demonstrated accuracy of 0.1% of full scale, these systems have already saved thousands of man-hours for users in the chemical industry.

These modularly-constructed systems are simple to install, operate and maintain. Pushbutton controls provide monitoring ease and flexibility. Modular units are interchangeable.

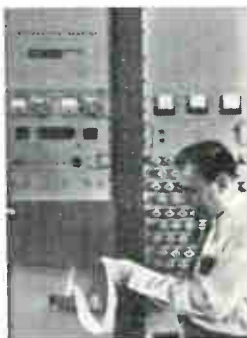

The highly reliable systems are constructed from modules with proven reliability of 4.5 million hours MTBF. This gives the typical system an MTBF in excess of 8,000 hours.

An EMC representative will be glad to provide you additional information on how EMC systems can meet your requirements for process monitoring and control.

**ELECTRONIC  
MODULES  
CORPORATION**

**Electronic Modules Corporation • SYSTEMS DIVISION**

P.O. BOX 141 TIMONIUM, MARYLAND 21093 TWX-301-0723 301-666-3300

# Adage makes the fastest A-to-D converter on the market

8 bits at 1 Mc, 1  $\mu$ s conversion time (Model VT7-AB)  
14 bits at 200 Kc, 4  $\mu$ s conversion time (Model VT13-AB)

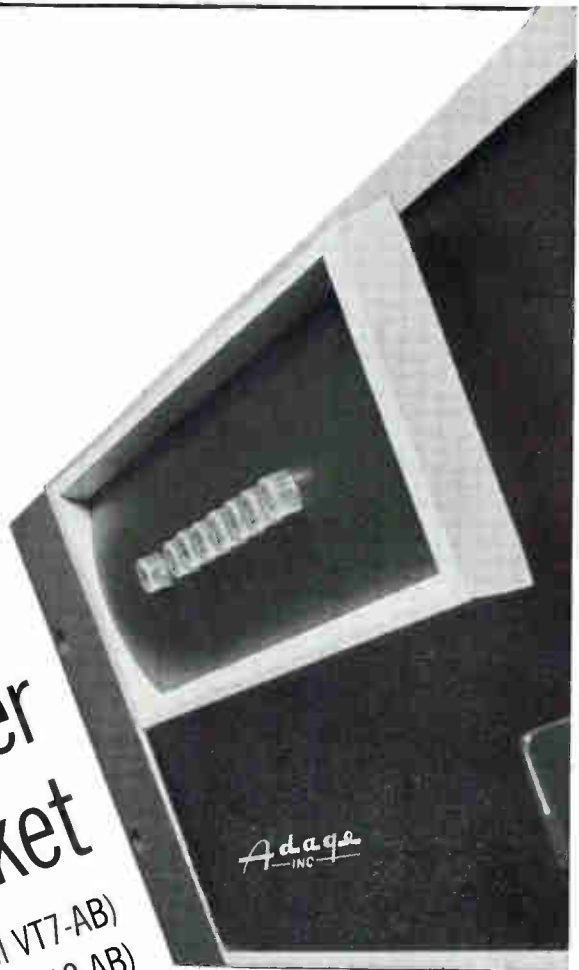

Adage has been making solid-state analog-to-digital converters, and compatible sample-and-hold amplifiers, multiplexers, and D-to-A converters, since 1957 — longer than anyone else. We like to think our record of performance is also unmatched.

May we send you literature describing our products — or an applications engineer to help you with your problem? Write Leon Dall, Product Manager, Adage, Inc., 1079 Commonwealth Ave., Boston, Mass. 02215, (617) 783-1100.



**Adage**  
INC

# Slow, but small, may win the race

MOS integrated circuits, with hundreds of transistors on a chip, got a head start in the LSI sweepstakes, but lag behind bipolar IC's in speed; better processes and faster designs help close the gap

By Earl Thomas and J. David Callan

General Instrument Corp., Newark, N.J.

**Large-scale integration** and metal-oxide-semiconductors circuits are old friends. Mos integrated circuits with nearly 1,000 devices were being produced before bipolar LSI arrays had emerged from the laboratory.<sup>1</sup> Their potential of providing complete digital subsystems on a single chip was recognized even before the term LSI was coined.

In view of MOS's head start and clear superiority in small size, why is there a controversy between MOS and bipolar LSI approaches? The main drawback of MOS circuits hasn't been cost, because they cost less to make than bipolar IC's. The problems have been the relatively slow speed of MOS circuits, compared with bipolar circuits, and the need to design systems that could quickly process data despite low internal clock speeds.

A year ago, the maximum clock frequency was normally about 2 megahertz. That has just recently

been more than doubled and there is no doubt that it will be doubled again soon. Clock rates can be expected to continue to climb, to about 15 Mhz in the future.

This progress in MOS design and processing is typified by a 64-bit shift register that the Microelectronics division of General Instrument Corp. is now producing and delivering as a custom-made IC. It has an operating frequency of 5 megahertz. The shift register is a dynamic one, with all the logic circuitry needed for loading and recirculating data on the chip. Each internal bit occupies only 11 square mils of chip area and the whole circuit, including bonding pads has an area of 3,364 mils.

The increase in speed and the smaller size of the elements of the IC is largely due to an improved MOS process, which General Instrument calls *m*MOS, for metal-thick oxide-semiconductor. The oxide at metalization crossover points is made thick to reduce shorting through pinholes, while the oxide in gate areas is made thin to enable the device to work properly [Electronics, Jan. 23, 1966, p. 38]. This process has also significantly improved the yield of good IC's from each starting wafer of silicon.

The shift register is also a good example of how far MOS design has progressed in terms of controlling power dissipation and heat generation. At a frequency of 5 Mhz, the register dissipates 100 microwatts at each internal node. The data outputs are both true and inverted. Each output stage dissipates 14 milliwatts into a 7-picofarad load. Total dissipation of the register is about 80 milliwatts when each output has a load of 7 pf. Each register can drive another directly without the addition of external components. If the operating frequency is reduced, the power dissipation drops proportionately since power is dissipated only during the switching transient.

The major advantages of MOS over bipolar IC's

## The authors



J. Earl Thomas joined the General Instrument Corp. in 1964 as a corporate new products manager and technical adviser to the president. Before that, he was director of research and engineering for Sylvania Electric Products Inc.



Since 1966, as manager of the digital computation section of General Instrument's Micro-electronic division at Tarzana, Calif., J. David Callan has been responsible for the development of LSI circuit chips. He has a master's degree in engineering from the University of Southern California.

have been cited before, but are worth discussing again since the numbers continually change. In general, the advantages of MOS are:

- Higher yield because the process is simpler.
- Inherently high device impedances.
- More circuits can be put into a chip.
- Arrays are in production while bipolar large-scale IC's are still experimental.

In comparison with bipolar devices, MOS devices also have a number of circuit advantages. The bias voltage levels are simpler to supply and MOS devices can be used in place of high-value load resistances. The "tree building" and stacking of devices that made old-fashioned relay logic systems so easy to design can be accomplished in MOS. Four-phase MOS circuits allow stacks of 32 switches at frequencies of 5 Mhz. Two examples of tree-type MOS circuits are shift registers and differential digital amplifiers, which will be described later. To duplicate these functions with bipolar IC's would require more circuit elements and twice as many processing steps for each element.

### Two sets of building blocks

On the system level, the trade offs between the two types of IC's are more complicated, because the advantages of each are intertwined.

For example, LSI requires that a computer be divided, or partitioned, into blocks of circuits that can be made together as a single chip. Designers of large general-purpose computers almost invariably turn to tailor-made IC's to optimize manufacturing cost and to allow the computer to perform a variety of computational problems in the shortest possible time. These designers strive to take advantage of the maximum speed capabilities of bipolar logic, when they use such IC's. This design fact has several consequences:

First, it will obviously be impossible to use standard LSI building blocks—at least until an entirely new philosophy of system design evolves that is based upon the use of functional blocks instead of unit logic circuits. In any case, simple partitioning of large computers inevitably leads to a greater number of input-output leads on each IC than the IC designer can easily provide.

Second, when LSI chips are tailored to a specific computer, the processing plant is locked into a short-run manufacturing situation. This makes design and setup costs difficult to amortize and militates against the yield advantages of long-run, repetitive processing.

The number of leads per unit length of chip edge, which governs the maximum number of leads per chip, can be reduced if the chip contains so many unit circuits that it represents a significant fraction of the computer. With planning, the bigger the function, the fewer the number of input and output signals needed. That kind of super-LSI is not yet practical and even if it were, the short-run cost and yield problems would be even more acute. An orderly transition from medium-scale integration to large-scale integration is needed.

On the other hand, if special-purpose computers can be made less costly, the economic advantage of the general-purpose machine will be reduced. When the computer designer thinks about using several special-purpose systems instead of one all-purpose system, he finds that he can make repetitive use of such building blocks as digital differential amplifiers and shift registers. Such classes of functional blocks are ideal for LSI applications because they are complete functions requiring only power input, information input and information output.

Now that he has solved his pin problem, the designer can consider the long-run production advantages. Shift registers, digital differential analyzers (DDA), analog to digital converters and similar functional blocks are useful in many types of data-processing systems, from airborne navigation receivers to process control computers. This makes possible wide use of the blocks by many customers, providing each customer's engineer is willing to change his design concepts to achieve low system costs.

### Digital differential analyzer

An example of a building block is the General Instrument MEM 5021 DDA integrator. It consists of two chips. One is a 32- or 50-bit serial memory and the other contains all the logic that operates the memory. On the logic chip, which measures 86 by 72 mils, are 230 MOS transistors interconnected as about 65 gate functions.

A DDA integrator employs the following algorithm

$$Y_{n+1} = Y_n + \Delta Y$$

where  $\Delta Y = \left( \frac{dy}{dx} \right) \Delta X$

The  $\Delta Y$  and  $\Delta X$  functions are discrete increments that take on values of  $+2^{-n}$ , zero and  $-2^{-n}$ . Therefore, the integration is a finite summation process

$$\int \left( \frac{dy}{dx} \right) dx \cong \sum \left( \frac{dy}{dx} \right) \Delta X$$

The integration requires two registers, one for the remainder (R) and one for the integral (Y), as in the upper part of the diagram on page 181. As the R register overflows or underflows into the Y register, the integral is rounded off and only the most significant part in the Y register is used. To conveniently use more than one integrator, the MOS registers and logic circuits can be paired as shown in the lower part of the diagram. Aside from improving the functional organization, this keeps the number of inputs and outputs to each block at a minimum.

Seven such integrators, arranged as on page 182 solve the differential equation for Bessel's functions. The over-all clock speed of such a computer would be rather low, about 500 khz; for a 10-bit number this represents a 50-khz integration rate so the equation is solved every 20 microseconds when the data flow is continuous. This is a very high over-all computing speed, probably 10 times faster than

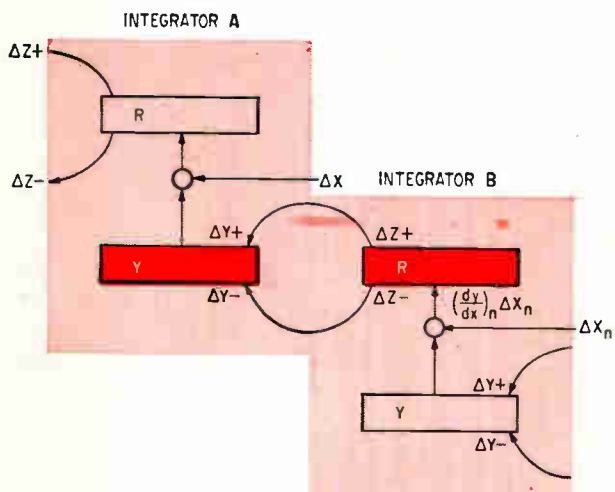
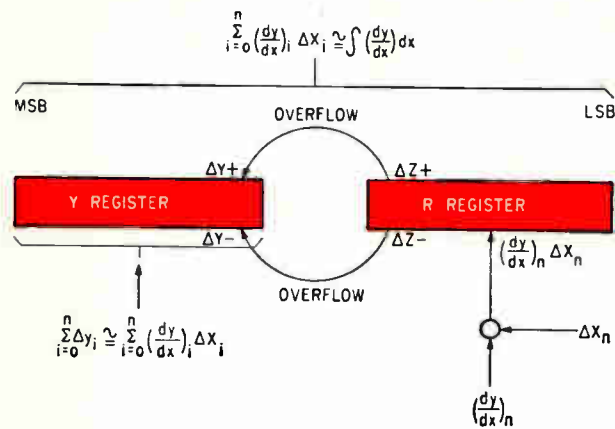

Two registers perform the integration operation in a digital differential analyzer by the summation process given in the formula of the upper diagram. Rearrangement of the registers (lower diagram) in the MOS circuits allows stacking of the integrators to perform more complex functions. The registers in color are the same in both diagrams.

a general-purpose machine. A general-purpose computer would have to do many simpler operations to complete one integration.

Other integrator arrangements will solve trigonometric equations, control feedback, compute aircraft positions, or perform any function that can be expressed as a differential equation or a set of them.

### High impedance

The inherently high impedance of MOS devices means that signal voltages in MOS circuits will be four to five times as high as in bipolar IC's. Therefore, the MOS circuit has greater immunity to noise and other unplanned transients in the voltage supply. The reduced likelihood of false operation is a boon to the engineer who might otherwise spend months debugging a computer designed with IC's sensitive to noise.

A second advantage of high impedance is that multilayer wiring can be avoided through the use of cross-under conduction paths diffused into the

silicon substrate. The technique is used in bipolar circuits, too, but sparingly because the diffused connection introduces considerably higher series resistance than the metalized wiring. The resistive unbalances are difficult to compensate for in bipolar designs, but are of little consequence in MOS design, since the resistances are extremely high.

### Speed versus clock rate

As the price paid for high impedance, the speed of MOS devices is lower than that of bipolar IC's. But systems can be built with MOS circuits that have a higher data processing rate than systems built with bipolar IC's, which is the important point.

Since a one-sided answer to the speed question can be misleading, a few statistics are in order first. General Instrument is marketing a 50-bit MOS shift register with a specified clock frequency of 1 Mhz. Some customers are running it at 2 Mhz. In contrast, an 8-bit bipolar shift register is available elsewhere (Texas Instruments Incorporated) that operates at 15 Mhz.

The CI chip size is 40 by 60 mils and the TI chip size is 130 by 60 mils. In development at General Instrument is a 256-bit shift register that would have a chip size of 70 by 80 mils and operate at a clock frequency of 8 Mhz. On a bits-per-second-per-unit-area of silicon basis, this indicates MOS is eight times as fast as bipolar. This is, of course, a numbers game that is strongly influenced by the fact that bipolar IC yield is presently too low to permit the commercial sale of shift registers longer than 8 bits.

There is no denying that bipolar clock rates are much higher. The clock rates appear to be converging, but the ultimate clock rate available with the two technologies is hard to forecast. One reason is that LSI is probably going to make it attractive to use more circuits to process a given amount of data, rather than push the data through a lesser number of circuits operating at the ultimate clock rate of the type of LSI used.

The clock rates of MOS circuits may never surpass those of bipolar IC's, but who cares? As soon as the designer familiarizes himself with special-purpose "wired-logic" systems like the integrator, he finds MOS logic is not limited by clock speed. A machine designed to solve a specific class of problem can solve it an order of magnitude faster than a general-purpose machine. Simply put, its operation isn't cluttered up by hardware it can't use on a particular task.

For example, it is believed that missile guidance calculations can be done with digital differential analyzers 100 times as rapidly as with the best existing general-purpose computers.

Another way of boosting speed is to provide each memory circuit with an arithmetic circuit—an associative computer—so arithmetic operations can be performed concurrently.

### High yield, low cost

In production costs, bipolar cannot compete with

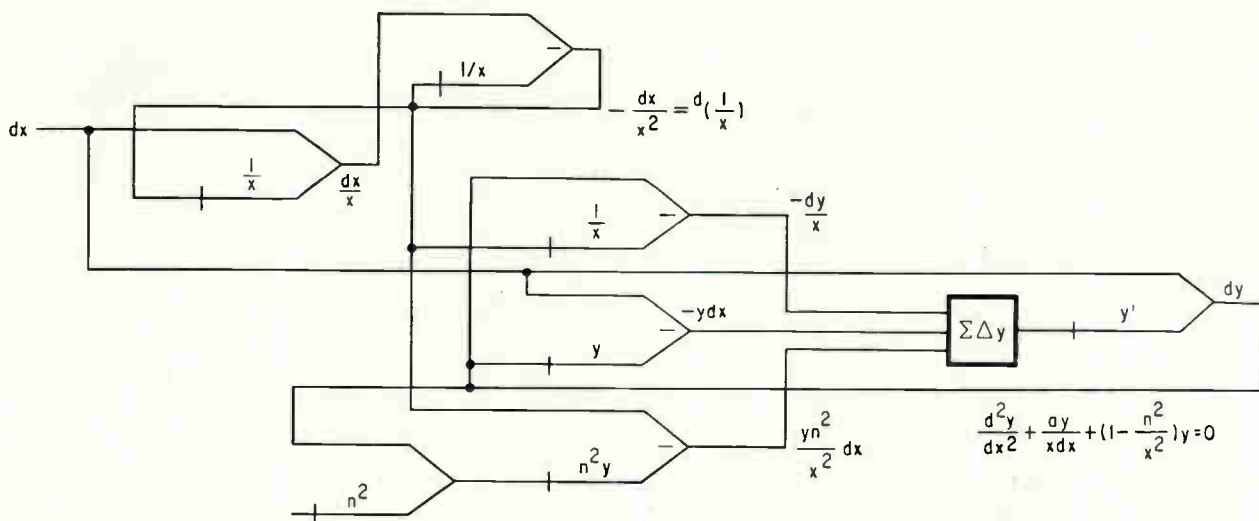

**Bessel's equation**, often used in circuit design, is solved by a combination of seven integrators. Other combinations of integrators solve navigation and control problems that can be expressed as differential equations.

MOS. The basic MOS process requires only one diffusion and four masking steps, while the bipolar process can require up to four diffusions and as many as 10 masking steps if multilayer wiring is used. Most bipolar LSI approaches involve multilayer wiring.

In addition, an MOS circuit's silicon substrate is homogeneous. Bipolar requires the growth of an epitaxial layer, probably preceded by a diffusion step. Because it is more complicated, the yield of the bipolar process is less.

An example of a specific processing disadvantage is that the epitaxial layer always has small defects. This further limits yield and makes it impossible to use chrome masks for oxide photoetching. These masks are economical because they last a long time, if not damaged, and they improve yield by improving consistency from one batch of circuits to another. The defects in the epitaxial layer puncture the thin film of chrome, allowing light to expose a spot of resist the next time the mask is used.

A pinhole in the oxide at that spot can cause a short from the metalization layer to the silicon substrate. The loss of a circuit is not too serious when the IC's are to be used individually, but several such shorts can play havoc with LSI approaches that depend upon fairly high yield of complex cells of circuits.

Even a fraction of a percent better yield is an important advantage in LSI production. The final yield of an LSI circuit consists of the product of many numbers—the number of processing steps and the number of devices. Since no process is perfect, each number is less than 1. For example, if device yield is improved from 0.99 to 0.995 (99% to 99.5%), the yield of LSI circuits with 500 devices will go from 0.7% to 8%, an improvement factor of 12.

### Packing density

The number of circuits a user can afford is dependent on how many circuits can be put on a chip.

This, too, is hard to forecast, since it depends upon processing and factors that have nothing to do with processing—for example, how much of the chip must be reserved for input and output leads?

In round numbers, the functional equivalent of 10 to 20 conventional bipolar transistors and diffused resistors can be made in MOS form today on 20 square mils of silicon substrate. The ultimate packing density depends upon how cleverly the wiring can be arranged and how small the wiring pattern can be.

Considering system design again, the true packing density of MOS can be even more dramatic. A transistor DDA, for example, is customarily used with an acoustic delay line, rather than a shift register, for the memory function. An MOS DDA requires only two chips.

Much of the apparent competition between bipolar and MOS approaches to LSI doesn't exist. MOS is in production and is winning a place in system design. When both are available, the system designer who weighs their pros and cons will find that they compete like beef and carrots. Each will win different fractions of the market as their relative prices change.

The system designer will have to make his choice at the outset because bipolar and MOS arrays are not interchangeable and will never be completely interchangeable. He'll have to choose one system design concept or another and follow it through. If bipolar arrays were successfully being produced now, the average engineer might give MOS short shrift. Actually, the shoe seems to be on the other foot for the present.

### Reference

1. Donald E. Farina and Donald Trotter, "MOS integrated circuits save space and money," and Jerome Eimbinder, "The expanding market," *Electronics*, Oct. 4, 1965, pp 84-98.

Reprints of this report are available at \$1.50 each.  
© copyright 1967, Electronics® A McGraw-Hill Publication



# How to make a better integrator smaller.

Put a KEMET Flat-Kap capacitor in the circuit. Minimize integrating errors by combining Flat-Kap's high IR with extremely low input current (100 picoamperes in our H7000A

Operational Amplifier, for instance). And you add real miniaturization to this high accuracy because Flat-Kaps are smaller than ordinary polystyrene, glass or mica capacitors.

The reason is Flat-Kap's remarkable new dielectric, a Union Carbide development called Parylene. It is vacuum-vapor-deposited in micron-range thickness on the aluminum foil conductor. Yet, even in such a thin layer, it holds Flat-Kap's IR at rated voltage and 25°C to 10<sup>6</sup> megohms, minimum.

Typical retrace stability for Flat-Kaps is 0.1% from cycling, use or storage, over the full operating range from -55° to +125°C, with nominal

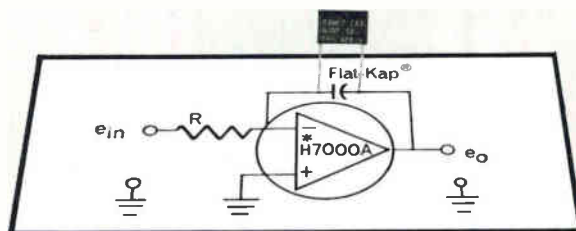

TC -200 ppm/°C. They are available in any value from 0.001 to 0.100μF, 50 VDC, with tolerances as tight as ± 1%.

Where you want maximum volumetric efficiency

in a stable capacitor for such applications as integrators, filters and timing circuits—think of KEMET Flat-Kaps. For details, mail the coupon, or see your nearby sales representative.

Clip, fill in name and title, attach to letterhead.

Union Carbide Corporation  
Electronics Division, Dept. E-23  
270 Park Avenue, New York 10017

Please send Engineering Bulletin #22, on  
KEMET Flat-Kap film-foil capacitors

Name \_\_\_\_\_

Title \_\_\_\_\_



**ELECTRONICS**

KEMET is a registered trade mark of Union Carbide Corporation.

**REGIONAL SALES OFFICES.** New England: T. J. Roper, 300 First Ave., Needham Heights, Mass. Phone: 617-444-5400. Mid-Atlantic: R. H. Robecki, 1341 Hamburg Turnpike, Wayne, New Jersey 07472. Phone: 201-696-2710. Mid-West and South: K. S. Collart, P. O. Box 6087, Cleveland, Ohio 44101. Phone: 216-221-0600. West Coast: D. Purcell, 701 East Whittier Boulevard, Whittier, California 90605. Phone: 213-698-8077.

# Why Struggle?



## OPTIONAL SYSTEMS EQUIPMENT

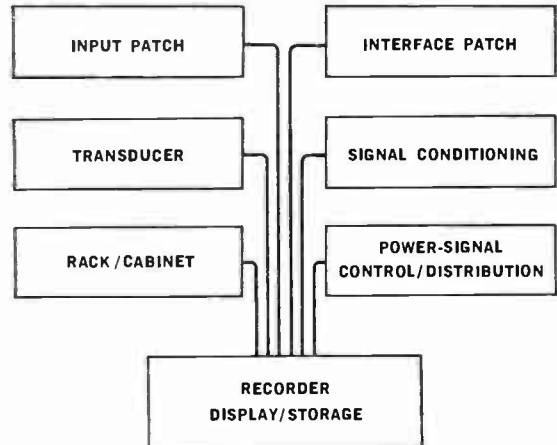

## Let Midwestern Instruments Data Systems Division tailor your system!

Our engineers guarantee a perfect fit — a completely calibrated system — tailored to your specific data recording requirements. Give us your measurements and we'll outfit you, from sensors to readout, with a system custom-tailored to assure you of faster and more accurate data acquisition.

See your nearest Midwestern sales office for a fitting.



Model 800 B  
Oscillograph  
36 channels  
8-inch charts;  
0.1 to 150 ips

**MIDWESTERN INSTRUMENTS** / **TELEX**

A SUBSIDIARY OF THE TELEX CORPORATION  
41st AND SHERIDAN ROAD, P. O. BOX 1526  
TULSA, OKLAHOMA 74101  
PHONE 918-627-1111 • TWX 918-627-6030 • TELEX 049-589

**this AMELCO FET  
combines low  $R_{ON}$ ,  
low  $I_D$  (OFF) and low  $C_{DG}$   
better than ever before...  
2N4091**

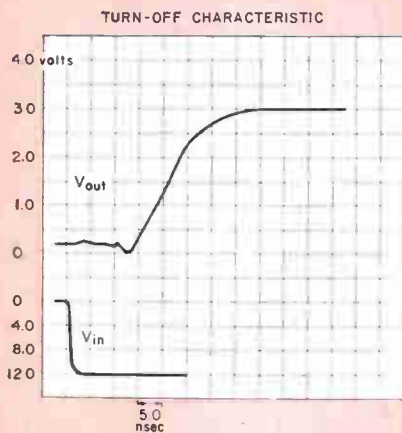

**SPECIFICATIONS:**

$R_{ON}$	30 ohms MAX	$t_{OFF}$	40 nsec MAX
$I_{D(OFF)}$	200 pA MAX	$V_F$	10 V MAX
$C_{DG}$	5 pf MAX	$I_{DSS}$	30 mA MIN
$t_{ON}$	25 nsec MAX	$BV_{DSD}$	40 V MIN

Now being mass produced, this FET switch is available from Amelco Distributor stock for only \$6.35 in quantities of 100 or more.

Amelco's new 2N4091 FET switch offers extra high speed with the highest switching ratio ever available in a standard device. If you are working with multiplexing, commutating, analog switching or DC chopping, consider these facts...  $R_{ON}$  is 30 ohms max., the lowest of any FET on the market with  $C_{DG}$  of less than 5 pf;  $I_D$  (on)/ $I_D$  (off) ratio is better than  $10^8$ . Designers may now consider FET devices where previously the requirement for very low on resistance demanded use of bipolar transistors. In addition, applications presently using FET's can benefit from this improved performance.

**AMELCO SEMICONDUCTOR**

DIVISION OF TELEDYNE, INC. • 1300 TERRA BELLA AVENUE • MOUNTAIN VIEW, CALIFORNIA • Mail Address: P.O. Box 1030, Mountain View, California • Phone: (415) 968-9241 / TWX: (415) 969-9112 / Telex: 34-8416 • REGIONAL OFFICES: Southwest—Suite 213, 8621 Bellanca Ave., Los Angeles, California 90045, (213) 678-3146 • Northwest—1300 Terra Bella Ave., Mountain View, California, (415) 968-9241 East—27 Traphagen Road, Wayne, New Jersey, (201) 696-4747 • Southeast—711 Magnolia Avenue, Orlando, Florida 32803, (305) 423-5833 • Northeast—805 High Street, Westwood, Massachusetts 02090, (617) 326-6600 • Midwest—650 West Algonquin Road, Des Plaines, Illinois, (312) 439-3250 Canada—Deskin Sales, Montreal, Quebec, (514) 384-1420.

# When you measure operational amplifier value



## use the whole ruler!

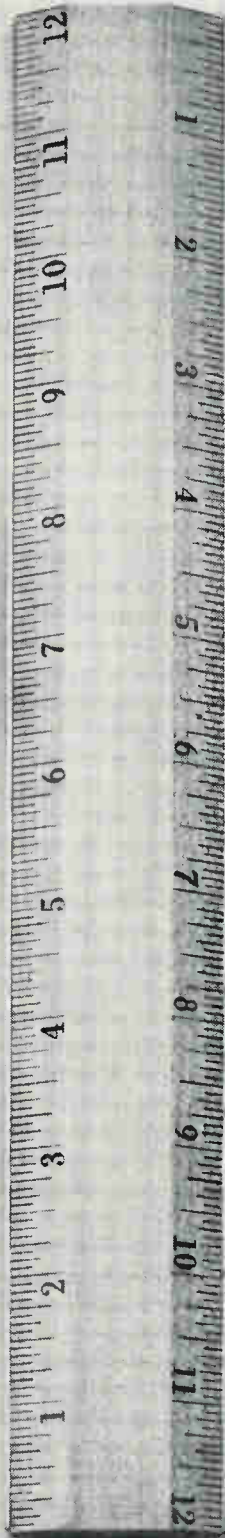

**The Right Amplifier** — You get the amplifier that's just right for your application from Burr-Brown's broad line. General purpose, FET, chopper stabilized, high voltage, low voltage, military, miniature and custom units are available in a wide range of configurations.

**The Right Circuit** — Burr-Brown wrote the book on operational amplifier applications. In addition to two popular handbooks, a large Applications Engineering staff is always at your service.

**The Right Accessories** — Burr-Brown has a complete line of support accessories including: power supplies, connectors, circuit simulators, adapters, and regulators.

**Immediate Delivery** — After all, "Dash" is our middle name. Exclusive Jet-Stock service puts most units in your hands within 24-hours. We have even designed, built and shipped custom demonstrator units in less than one day.

**Guaranteed Performance** — Every Burr-Brown unit is tested under a Quality Assurance program designed to meet the requirements of MIL-Q-9858A, MIL-I-45208A, MIL-C-45662A, and NASA NPC-200-3.

**Reliability** — Conservative component stress design, conservative ratings, and stringent process control procedures result in predicted MTTF ratings in excess of 700,000 hours for most units.

**Satisfaction** — In ten years, we've built a reputation for customer satisfaction we don't intend to jeopardize.

**Guaranteed Source** — Burr-Brown is still supplying units introduced in 1956 despite averaging 200 new models a year.

**No-Cost Evaluation** — We currently have over 1,600 demonstrator units available at Field Offices. Which one would you like to evaluate?

**Local Service** — Over 80 domestic Burr-Brown Engineering Representatives are ready, willing and able to assist you.

### FOR CURRENT CATALOG

on Burr-Brown "maximum value" Operational Amplifiers and Accessories, contact your nearest Engineering Representative, write Burr-Brown, or use this publication's reader-service card.

# BURR-BROWN

## RESEARCH CORPORATION

International Airport Industrial Park • Tucson, Arizona 85706  
TELEPHONE: 602-294-1431 • TWX: 910-952-1111 • CABLE: BBRCORP



Operational Amplifiers  
Instrumentation Amplifiers  
Function Modules  
Analog Simulators  
Geophysical Instruments

ENGINEERING REPRESENTATIVES: ALABAMA, HUNTSVILLE (205) 534-1648 / ALASKA, ANCHORAGE (907) 272-5231 / ARIZONA, PHOENIX (602) 254-6085 / CALIF., LOS ANGELES (213) 665-5181, SAN FRANCISCO (408) 245-3321 / COLO., DENVER (303) 388-4391 / CONN., MILFORD (203) 874-9222 / FLORIDA, ORLANDO (305) 425-2764 / ILLINOIS, CHICAGO (312) 286-6824 MD., SILVER SPRING (301) 588-8134 / MASS., BOSTON (617) 245-4870 / MICH., DETROIT (313) 353-3822 / MINN., MINNEAPOLIS (612) 781-1611 / MO., ST. LOUIS (314) 524-4800 / N.C., GREENSBORO (919) 273-1918 / N.J., CAMDEN (609) 365-2450 / N.M., ALBUQUERQUE (505)

255-1638 / N.Y., ALBANY (518) 436-9649, BINGHAMTON (607) 723-9661, BUFFALO (716) 632-2727, MT. VERNON (914) 968-2200, NEW HARTFORD (315) 732-3775 / OHIO, CINCINNATI (513) 761-5432, CLEVELAND (216) 884-2001, DAYTON (513) 277-8911 / OKLA., TULSA (918) 835-2481 / OREGON, PORTLAND (503) 292-8762 / PENN., PITTSBURGH (412) 243-6655 / TEXAS, DALLAS (214) 363-1671, HOUSTON (713) 928-5251 / UTAH, SALT LAKE CITY (801) 466-8709 WASH., SEATTLE (206) 622-0177 / CANADA, TORONTO (416) 293-7011, VANCOUVER (604) 736-6377

# ARNOLD IS



## **ORIENTED FERRITE PERMANENT MAGNETS**

Arnox 5 & 6 oriented ferrite permanent magnets are used in giant iron ore separating devices, industrial separators, loudspeakers, DC motor arcs, holding devices and exotic traveling wave tubes.

We have the largest inventory of dies for rectangular ferrite magnets and a large inventory of dies for standard loudspeaker magnets. Our modern hard ferrite facility is well equipped to handle large production runs.

Arnold is also ■ Alnico Permanent Magnets ■ Tape Wound Cores ■ MPP Cores ■ Magnetic Shielding ■ Electrical Alloy Transformer Laminations ■ Transformer Cans and Hardware ■ Silectron Cores ■ Special Magnetic Materials.

 **ARNOLD**  
SPECIALISTS in MAGNETIC MATERIALS

THE ARNOLD ENGINEERING COMPANY, Main Office MARENGO, ILL.  
BRANCH OFFICES and REPRESENTATIVES in PRINCIPAL CITIES

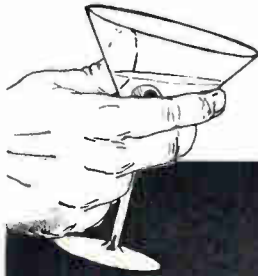

**IF YOU WANT YOUR MARTINIS DRY  
AND YOUR FREQUENCIES MODULATED...**

# **MARCONI SIGNAL GENERATORS**

**WILL SOLVE ONE OF YOUR PROBLEMS...**

## **10MHz-470MHz**

From fundamentals clean FM, high stability, low FM noise, electronic fine tune, for communications, telemetry, FM broadcast.

Model 1066B/Series.

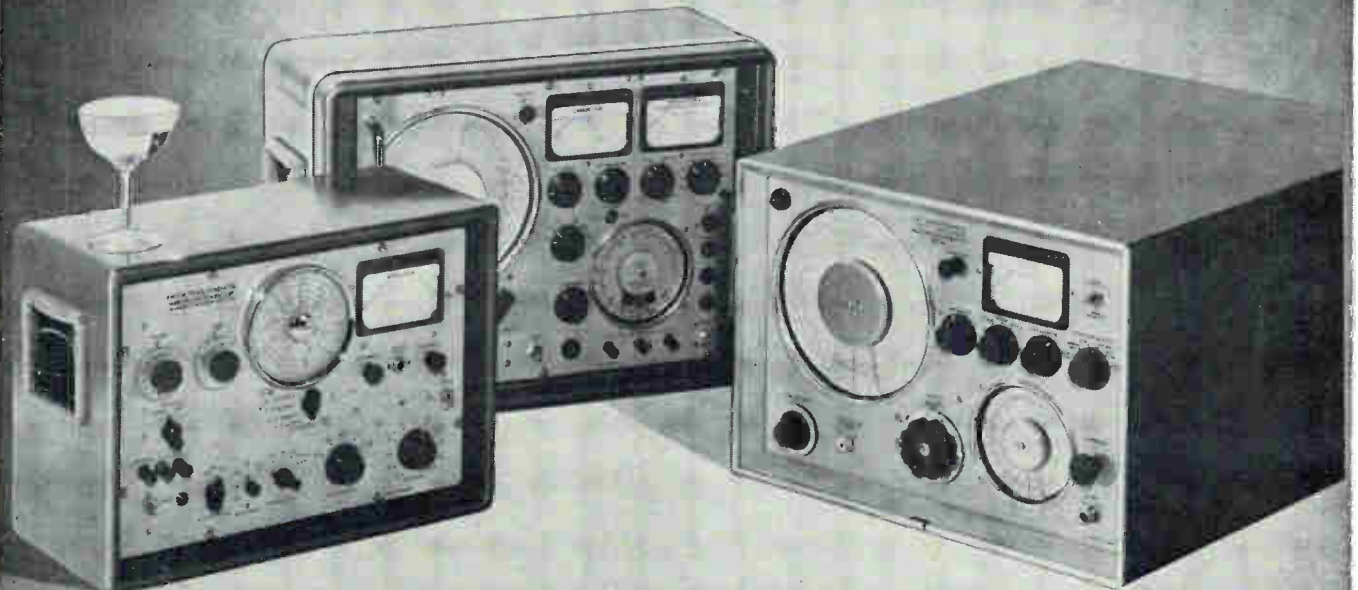

## **1.5MHz-220MHz**

A multiplier generator used in FM/AM broadcast, stereo and FM/AM communications, wide range, good AM and FM.

Model 995A/Series.

## **470MHz-960MHz**

A tuned line covers channels 14 thru 83 for FM sound, also telemetry, with FM deviation to  $\pm 300\text{KHz}$ , mod. rates to 100KHz.

Model 1060/3.

A taste for dry martinis makes friends... so do these Marconi Signal Generators make friends. Some of the reasons are listed in these specs.; most of the reasons are listed in the literature. Write for it today.

# **MARCONI INSTRUMENTS**

111 Cedar Lane • Englewood, N. J.

*Division of English Electric Corporation*

Telephone: 201-567-0607

188 Circle 188 on reader service card

Electronics | February 20, 1967

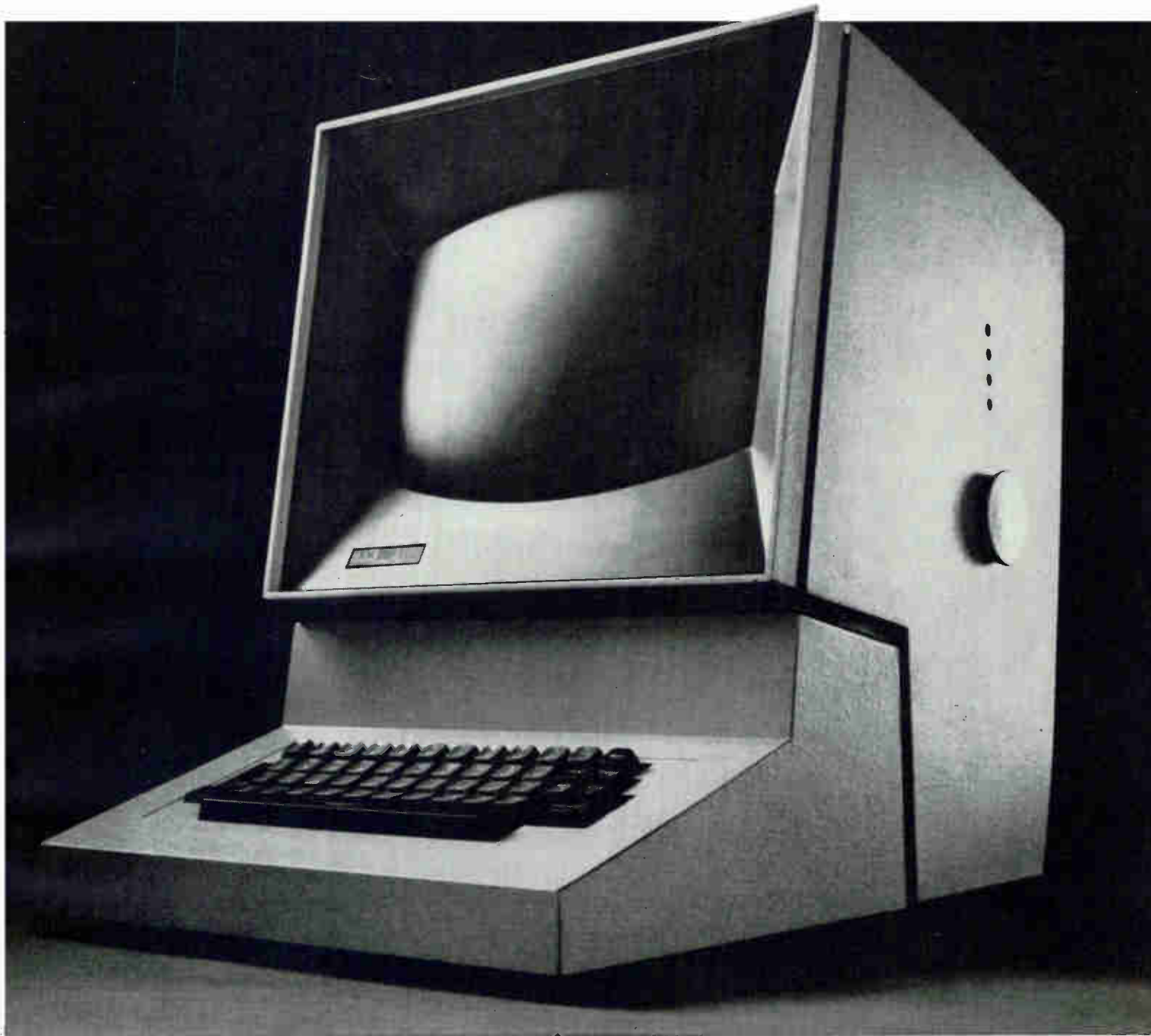

(PART MOLDED BY CIMASTRA DIVISION OF CINCINNATI MILLING MACHINE CO.)

## A big case for G-E NORYL<sup>®</sup>

THERMOPLASTIC RESIN

Once you learn about Noryl resin, it's easy to build a big case for using this new General Electric engineering thermoplastic. IBM did with its computer display station. The finished unit measures 17" x 17" x 13" and uses 12 pounds of molded Noryl.

Take high heat resistance. The unit operates at temperatures up to 200°F. No problem for Noryl with its heat deflection temperature of 265°F at 264 psi. In fact, Noryl was one of the few materials that could withstand bake cycles up to 250°F after the case is painted.

This unit required the best self-extinguishing material. Noryl came through again. New grade SE-1 is self-extinguishing,

non-dripping UL Group I, even in 1/16" thin sections.

Moldability and appearance were also important considerations. Flow requirements of 25 inches into .060" walls, 12 right angle changes of direction and 128 ventilation slots measuring 4½" x 3/32".

And economy? Noryl met these specifications more economically than other materials tested. One reason is its low specific gravity which means more-parts-per-pound than most materials.

Noryl is also tough, dimensionally stable, has low, predictable mold shrinkage and offers outstanding hydrolytic stability.

Looking for a material that offers good

properties, economy and easy processing? IBM found a good case for Noryl. So can you. For more information contact your Chemical Materials Sales Representative. Or write Section 6B6, Polymer Products Operation, General Electric Company, One Plastics Avenue, Pittsfield, Massachusetts 01201. In Europe contact, N. V. Polychemie AKU-GE, 76 Velperweg—Arnhem (The Netherlands).

*Leader in Engineering Plastics*

**PPO<sup>®</sup> • LEXAN<sup>®</sup> • NORYL<sup>®</sup> • PHENOLICS**

**GENERAL  ELECTRIC**

Circle 189 on reader service card

Say "good bye" to hand loading of charts

# 3 new X-Y recorders

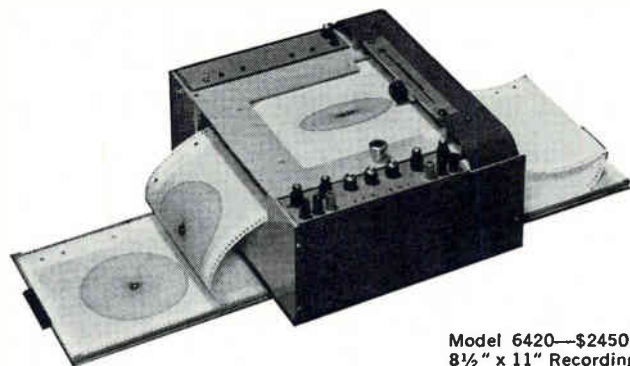

Model 6420—\$2450  
8½" x 11" Recording  
Surface

All the advantages of conventional X-Y's yet based on a radically new but proven recording principle

**Chart Paper** Z-fold. Perforated for ease in tearing out to notebook size. Automatic chart advance eliminates the need to manually load and unload each chart.

**Recording Mechanism** Two independent servo drives for X and Y. Automatic index or reversal of chart on command—local or remote.

**Slewing Speed** 15 in./sec., of course.

**English/Metric Scale** Front panel control quickly selects either scale.

**Input Impedance** 1 megohm all ranges—fixed or variable.

**Accuracy**  $\pm .2\%$  of full scale.

**Repeatability**  $\pm .1\%$  of full scale.

**Standardization** Dual regulated temperature compensated zener reference.

**Pen Control** Local or remote.

**Voltage Ranges** 18 calibrated ranges for each axis, continuously variable in between.

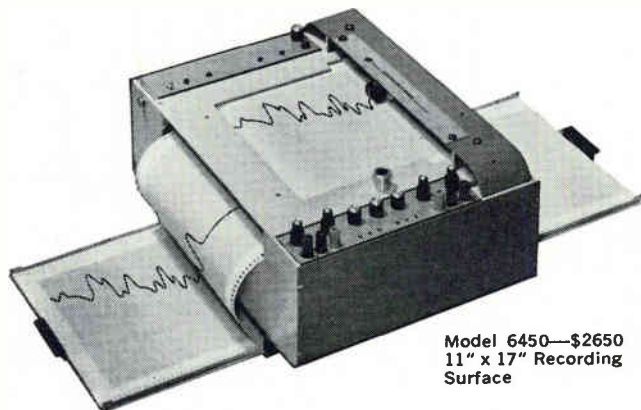

Model 6450—\$2650  
11" x 17" Recording  
Surface

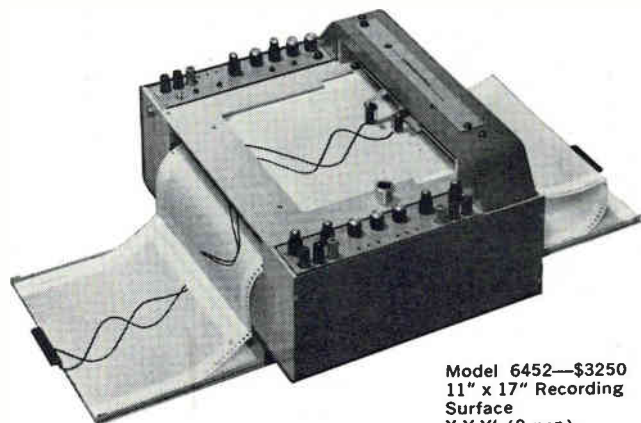

Model 6452—\$3250  
11" x 17" Recording  
Surface  
X-Y-Y' (2 pen)



**houston OMNIGRAPHIC corporation**

a subsidiary of houston instrument corporation  
4950 Terminal Ave. / Bellaire, Texas 77401  
(713) 667 7403 / cable HOINCO / TWX (713) 571 2063



# NOW...a full-sized **VOM** in a palm sized "package"

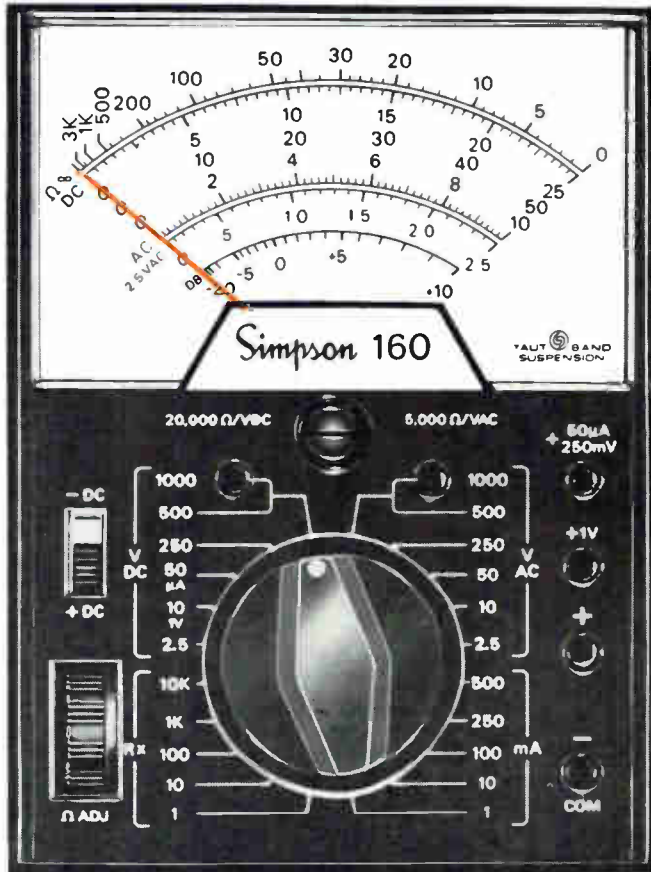
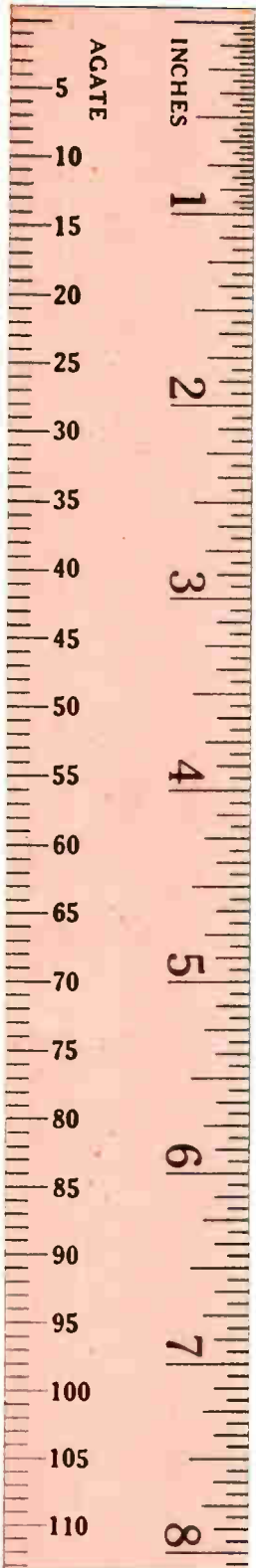

160 Volt-Ohm-Milliammeter  
Complete with alligator clip  
leads and operator's manual.

..... \$50.00



Carrying Case—  
Cat. No. 2225..... \$ 9.50

Accessory Leads—  
Probe Tip Lead—  
Cat. No. 2055..... \$ 2.75

## Simpson 160 Handi-VOM<sup>®</sup>

Simpson Handi-VOM gives you the ranges, the time-saving conveniences and the sensitivity of a full-sized volt-ohm-milliammeter—yet it's only 3-5/16" wide, weighs a mere 12 ounces. Recessed range-selector switch never gets in the way . . . polarity-reversing switch saves fuss and fumble. Self-shielded taut band movement assures high repeatability and freedom from external magnetic fields. Diode overload protection prevents burn-out—permits safe operation by inexperienced employees and students. The demand is BIG, so get your order in to your electronic distributor, TODAY!

### RANGES

ACCURACY:  $\pm 3\%$  FS DC  $\pm 4\%$  FS AC

DC VOLTS: 0-0.25, 1.0, 2.5, 10, 50, 250,  
500, 1000 (w/ 20,000  $\Omega/V$ )

AC VOLTS: 0-2.5, 10, 50, 250, 500, 1000  
(w/ 5000  $\Omega/V$ )

DC MICROAMPERES: 0-50

DC MILLIAMPERES: 0-1, 10, 100, 500

DB: -20 to +10, -8 to +22, +6 to  
+36, +20 to +50

"0" REFERENCE: 1 MW into 600 $\Omega$

RESISTANCE: Rx1, Rx10, Rx100, Rx100,  
Rx10K

(30  $\Omega$  center)



DIVISION



**SIMPSON ELECTRIC COMPANY**

5200 W. Kinzie Street, Chicago, Illinois 60644

Phone: (312) 379-1121

Export Dept: 400 W. Madison Street, Chicago, Illinois 60606, Cable, Simelco

IN CANADA: Bach-Simpson Ltd., London, Ontario

IN INDIA: Ruttonsha-Simpson Private Ltd., International House, Bombay-Agra Road, Vikhroli, Bombay

Representatives in Principal Cities  
... See Telephone Yellow Pages

WORLD'S LARGEST MANUFACTURER OF ELECTRONIC TEST EQUIPMENT



by courtesy of H.M. Postmaster General

## 20 MHz AND NO MAINS LEAD

A portable fully solid state oscilloscope having a D.C. to 20 MHz bandwidth, which can be operated from its own internal batteries or from any A.C. supply from 110-250 volts, 50-400 Hz.

Its batteries give 4 hours operation per charge, and it has its own integral charging unit. Yet it weighs only 22 lbs. complete.

Y sensitivity is 5 mV per division and the sweep ranges cover 40 nanoseconds to 0.5 second per division. Other features are a 3" high intensity P.D.A. tube and an internal square wave calibrator.

This high performance general purpose oscilloscope is the Bradley Type 150.

*We shall be pleased to send you full details on request.  
See your Electronic Engineering Index Library for full technical data.*



**G. & E. BRADLEY LIMITED**

Electral House, Neasden Lane, London, N.W.10

Telephone: Dollis Hill 7811    Telegrams: Bradelec London N.W.10    Telex: 25583

# Think twice about your switch requirements.



## Think Unimax.

Break the Brand M habit—think twice about your switch supplier. The Unimax line is complete from miniature sub-miniature to big, rugged, explosion-proof metal-cased switches. And we bow to no one in the quality, price or delivery of our products.

If your switch requirement decisions have become automatic Brand M selections, you may not have considered Unimax's 20 years of experience in snap-acting switch design and manufacture. Or the thousands of specials we have developed for individual applications.

Why not—this time—think twice before you act? The coupon at right offers you, free, your personal "Think Twice" button and any or all of our detailed, full specification catalogues.

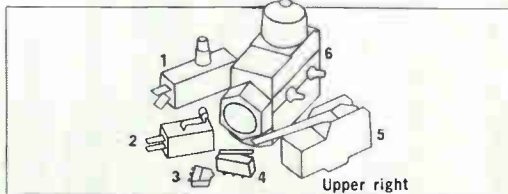

Typical switches from each category of the complete Unimax line.

1. General Purpose: Complete line of actuator styles, single and double pole. Ratings up to 25 amps at 250 V. AC.
2. Miniature. Extra long life. Complete range of forces and motions in all actuator styles. Rated to 15 amps and 1/2 H.P., 125/250 V. AC.
3. Miniature Subminiature. Differential motion as low as .0005" max. Leaf and leaf-roller integral actuators available.
4. Subminiature. Designed to meet the requirements of applicable Military specifications. Close control and high repeatability on sealed and unsealed units.
5. Basic Precision. Standard line rated at 20 amps 125/250/480V. AC. Other ratings to 25 amps; 1 H.P. 125 V. AC; 2 H.P. 250 V. AC.
6. Metal-Cased. Compact, Heavy-duty, Splash-proof and Explosion-proof models, with all types of actuators.



Unimax Switch Dept. E-70  
Division Maxson Electronics Corporation  
Wallingford, Connecticut 06492

Yes, I've thought twice about it and I would like to receive, in addition to my free, personal "Think Twice" button, the following catalogues.

- General Purpose. Cat. 40-2.
- Miniature, Subminiature. Cat. 20-2.
- Basic Precision. Cat. 10-2.
- Metal-Cased. Cat. 30-2.
- I can't wait for the mail. Please have your local representative contact me immediately to discuss a particular need.

Name \_\_\_\_\_

Company \_\_\_\_\_

Address \_\_\_\_\_

City \_\_\_\_\_ State \_\_\_\_\_ Zip \_\_\_\_\_



### Unimax Switch

DIVISION MAXSON ELECTRONICS CORPORATION / WALLINGFORD, CONNECTICUT 06492

# Tektronix Type 453 oscilloscope has

- 50 MHz Performance
- Dual Trace ● Delayed Sweep
- Easy-to-Use Triggering



## and-----it's designed to be carried!

Pick it up and be convinced. The Type 453 weighs 28½ pounds and is built to go when and where you go.

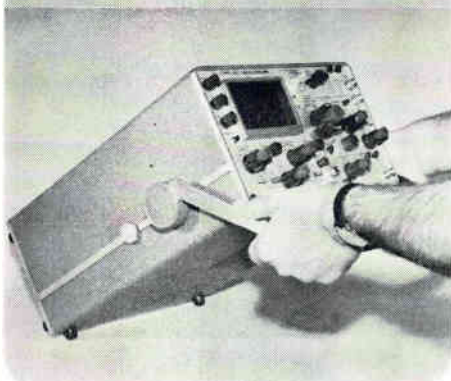

Don't worry about damaging the front panel and knobs—they're protected by a cover that also carries the accessories.



Take the Type 453 through tight places easily . . . the vertical carrying position increases portability.



Take it anywhere. The rain/dust cover is a standard accessory and carries the complete manual and optional viewing hood.



The Type 453 is a portable instrument with rugged environmental capabilities plus the built-in high performance normally found only in multiple plug-in instruments.

The vertical amplifier provides dual trace, DC to 50 MHz bandwidth with 7 ns risetime from 20 mV/div to 10 V/div. (DC to 40 MHz, 8.75 ns  $T_r$  at 5 mV/div.) The two included Type P6010 miniature 10X probes maintain system bandwidth and risetime performance at the probe tip—DC-50 MHz, 7 ns—with an increase in deflection factors of 10X. You can also make 5 mV/div X-Y and 1 mV/div single trace measurements.

The Type 453 trigger system takes the guesswork out of triggering. Pushing all the lever switches up provides a sweep and the most often used trigger logic. The sweep triggered light gives the operator a positive indication of a triggered sweep and the automatic triggering provides greater usability.

You can operate the delayed sweep with ease. Lever con-

trol to the right and HORIZ DISPLAY switch to A INTEN DURING B gives delayed sweep operation. Setting the B TIME/DIV and the DELAY-TIME MULTIPLIER to meet your requirements and switching to DELAYED SWEEP allows  $\pm 1.5\%$  delay measurements to be made.

The Type 453 is a continuation of the Tektronix commitment to quality workmanship. Its design and layout make it easy to maintain and calibrate. Transistors plug in and are easily removed for out-of-circuit testing. An accurate time ( $\pm 0.5\%$ ) and amplitude ( $\pm 1\%$ ) calibrator permits quick field calibration.

The front panel protection cover carries all the accessories with the complete manual carried in the rain and dust cover. The Type C-30 Camera and a viewing hood that fits in the rain cover also are available.

Type 453 (complete with probes and accessories)	. . . \$1950.00
Type C-30 Camera	. . . \$ 390.00
Collapsible Viewing Hood	. . . \$ 7.50

U.S. Sales Prices, FOB Beaverton, Oregon

## Tektronix, Inc.



For complete information, contact your nearby Tektronix field engineer or write:  
Tektronix, Inc., P.O. Box 500, Beaverton, Oregon 97005

**Almost every engineer who uses our IC bandpass amplifier says it's better than a discrete amplifier.**

**(Charlie Wisgard says it's just as good.)**

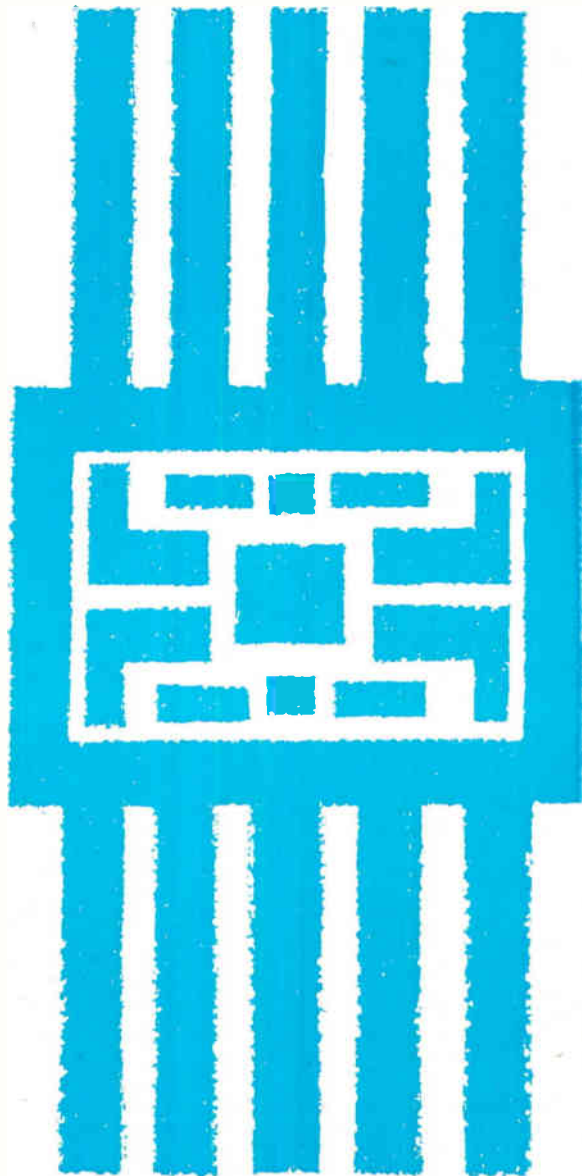

But, at the price, we know that you won't be able to get a discrete or IC bandpass amplifier that can out-perform the PA 7601.

Look at the performance. It has a gain control circuit which provides 12 db of gain reduction with typically less than 10% variation in output terminal impedance. In broadband applications, gain control from 0 to 12 db produces negligible effect on bandwidth over a frequency range of 30 to 150 MHz.

Our PA 7601 is your best solution to high-frequency phase and amplitude distortion problems. For nar-

rowband applications, you can use a bandpass filter or selective feedback components.

Don't take our word for it. Try the PA 7601 for yourself. It's available in 10-lead flat pack or TO-5 can. Temperature range:  $-55^{\circ}\text{C}$  to  $100^{\circ}\text{C}$ .

Call or write: **Philco-Ford Corporation Microelectronics Division**  
Sales Offices: 2920 San Ysidro Way, Santa Clara, California (408-245-2966) / 999 North Sepulveda, El Segundo, California (213-772-6226) / Northwest Industrial Park, Second Ave., Burlington, Mass. (617-272-1600) / Benson Manor, Suite 114B, Washington Lane, Jenkintown, Pa. (215-885-0430) / 1215 Drew Street, Clearwater, Florida (813-446-0124) / 815 Connecticut Avenue, N. W., Washington, D. C. (202-298-7810) / Suite 208, 700-108th St., N. E., Bellevue, Wash. (206-454-5061) / New York, N. Y. (212-244-1373).



PHILCO-FORD CORPORATION  
Microelectronics Division  
Santa Clara, California • 95051

*The best electronic packages  
are more than a collection  
of individual components*

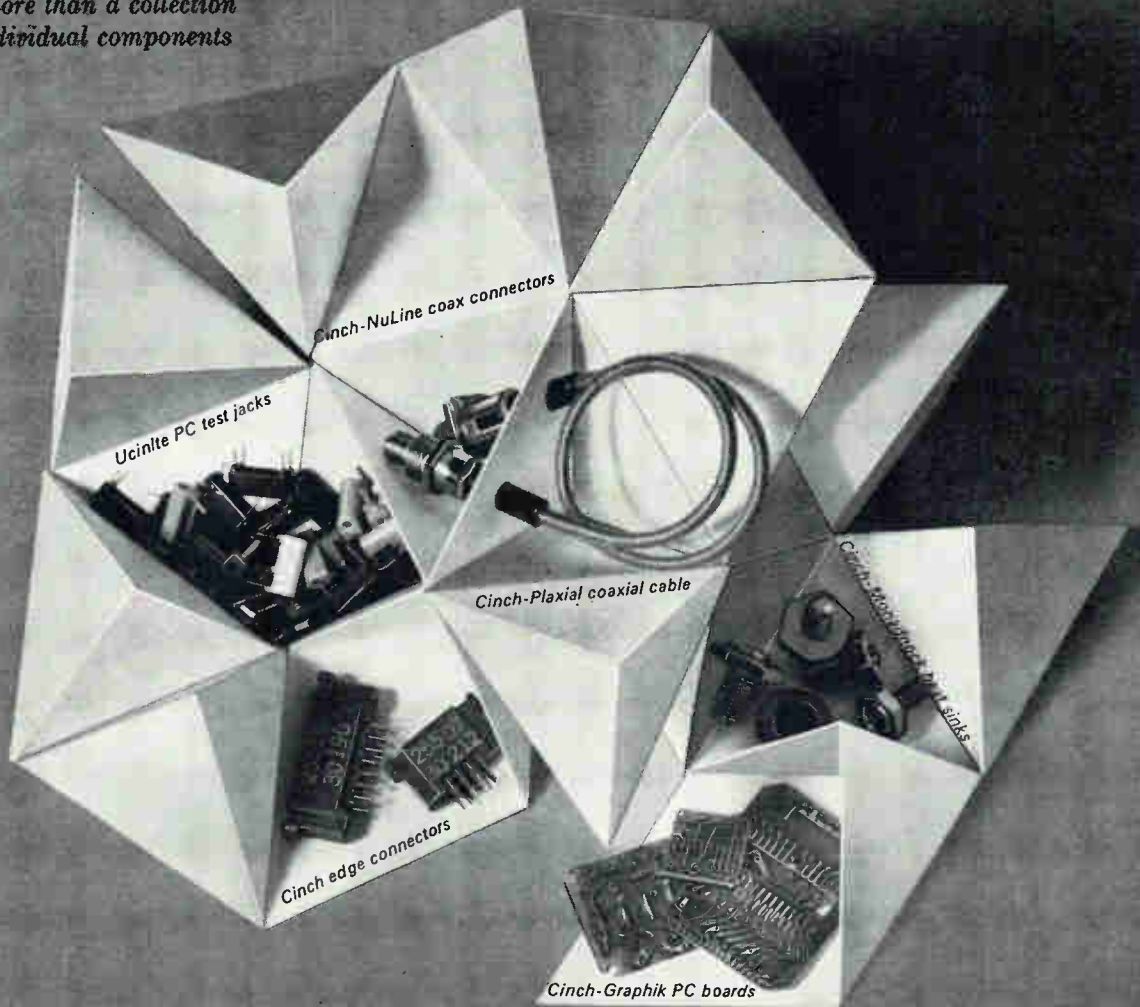

## THE CINCH ELECTRONICS GROUP PRESENTS THE COORDINATED "PACKAGE-PACKAGE"

The members of  
the Cinch Electronics Group  
and their principal products  
are:



**CINCH MANUFACTURING CO.**  
connectors, sockets, contacts, terminal strips  
**CINCH-GRAPHIK**  
multi-layer and printed circuit boards  
**CINCH-MONADNOCK**  
heat sinks, grommets, other electronic hardware  
**CINCH-NULINE**  
coaxial connectors and cable termination  
**CINCH-PLAXIAL**  
miniature low loss coaxial cable  
**UCINITE (ELECTRONICS)**  
switches, indicators, test jacks,  
communication, plugs and jacks

CM 6620

*You get better products and better service through  
coordinated package design and engineering with one  
central ordering point for all components.*

A new approach to component packaging? We think so. The Cinch Electronics Group coordinates design, application engineering and production for six related divisions of United-Carr Incorporated and provides one central ordering point for all parts. (We call the result the "Package-Package"—you'll call it an efficient way to achieve a superior product!)

For more details on this coordinated approach to electronic packaging or for further information on any of these specific product areas, write to The Cinch Electronics Group, 1026 S. Homan Avenue, Chicago, Illinois, 60624.

**UNITED-CARR**

INCORPORATED

Large helpings? *precisely!*



Smaller and smaller and smaller parts . . . tighter and tighter tolerances . . . in larger and larger quantities . . . this is the story of microceramics. Regular production includes substrates so tiny that a teaspoon holds more than 8,000 parts! Coors offers a complete facility for creating small, consistent, ceramic substrates—in several Coors Alumina and Beryllia ceramics, metallized or unmetallized. To assure economy, “as-fired” parts are produced in quantity, to extremely close tolerances (as shown at right). Let Coors provide the special help you need. Write for “Ceramic Substrate Design,” Data Sheet No. 7002, or call your nearest Coors Regional Sales Manager: SOUTHERN CALIFORNIA: R. E. Ousley, (213) 347-3060, Los Angeles, Calif. BAY AREA AND NORTHWEST: W. Everitt, (408) 245-2595, Sunnyvale, Calif. MIDWEST: Tom Daly, (312) 529-2510, Chicago, Ill. CENTRAL: Don Lewis, (216) 228-1000, Cleveland, Ohio; EAST COAST: Robert F. Doran, (516) 427-9506, Huntington, N.Y.; Herbert W. Larisch, (215) 563-4487, Philadelphia, Pa.; NEW ENGLAND: Warren G. McDonald, (617) 222-9520, Attleboro, Mass.; SOUTHWEST: William H. Ramsey, (713) 864-6369, Houston, Tex.; John West, (214) AD 1-4661, Richardson, Tex.

EXAMPLES OF AS-FIRED TOLERANCES HELD BY COORS IN REGULAR PRODUCTION

HOLE PATTERN DIA. .200 ± .0005		.205 x .257 x .030 LOCATION OF .016 DIA. HOLES HELD WITHIN .001
.060 DIA. .030 I.D. .001 CON- CENTRICITY		.097 x .222 .007 THICK- NESS ± .0005 .001 CAMBER
.143 DIA. .013 THICK- NESS ± .0005 .001 CAMBER		.186 DIA. .013 THICK- NESS ± .0005 .001 CAMBER
.268 DIA. .002 FLAT- NESS		.008 SLOT WIDTH
.010 THICK- NESS ± .001 .001 MAX. CAMBER		.015 THICK- NESS ± .001 .001 MAX. CAMBER .230 I.D.

# Coors

## CERAMICS

ALUMINAS • BERYLLIAS • MAGNESIAS • SPECIAL OXIDES  
Coors Porcelain Co., Golden, Colo.

Circle 197 on reader service card

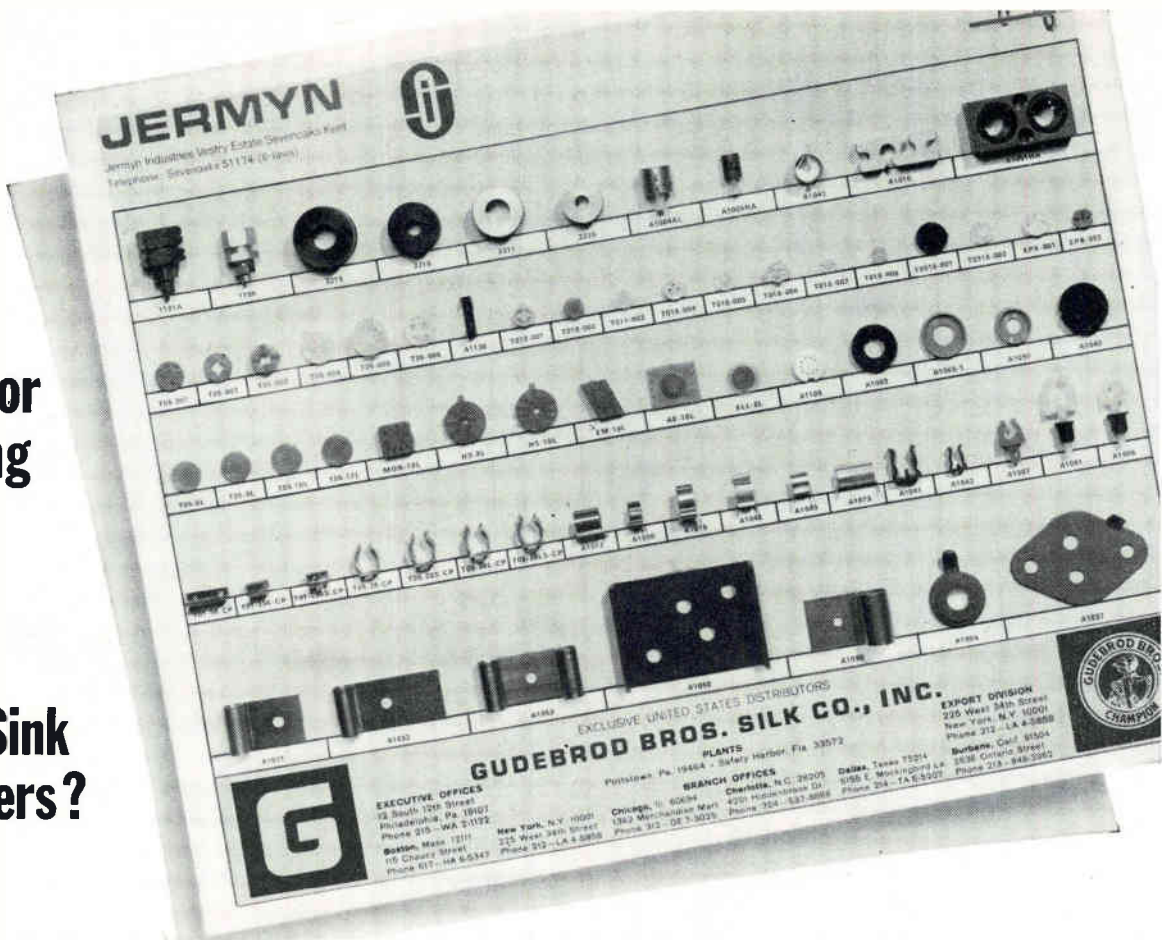

**Transistor  
Mounting  
Pads?**

**Clips?**

**Heat Sink  
Adapters?**

**GUDEBROD is your new, reliable source  
for this important circuit hardware.**

**Precision made with traditional English  
craftsmanship—by JERMYN Industries.**

**Stocked and sold exclusively in the  
United States by GUDEBROD.**

**You ought to know more  
about these products!**

**Send for catalog now!**

Gudebrod is now exclusive U.S. distributor for the electronic products manufactured by Jermyn Industries of Kent, England. Gudebrod feels it will be providing the industry with electronic hardware consistent with the high quality products manufactured by Gudebrod for nearly 100 years. Gudebrod will extend the same quality and depth of service it has become known for in lacing tapes. Write for the Catalog GJ100.



**GUDEBROD BROS. SILK CO., INC.**

FOUNDED IN 1870

*Electronics Division*

12 SOUTH 12th STREET, PHILADELPHIA, PENNSYLVANIA 19107

Area Code 215, WA 2-1122



**Broad  
selection**

**Superior  
construction**

**Competitive  
prices**

**and  
fast  
delivery**

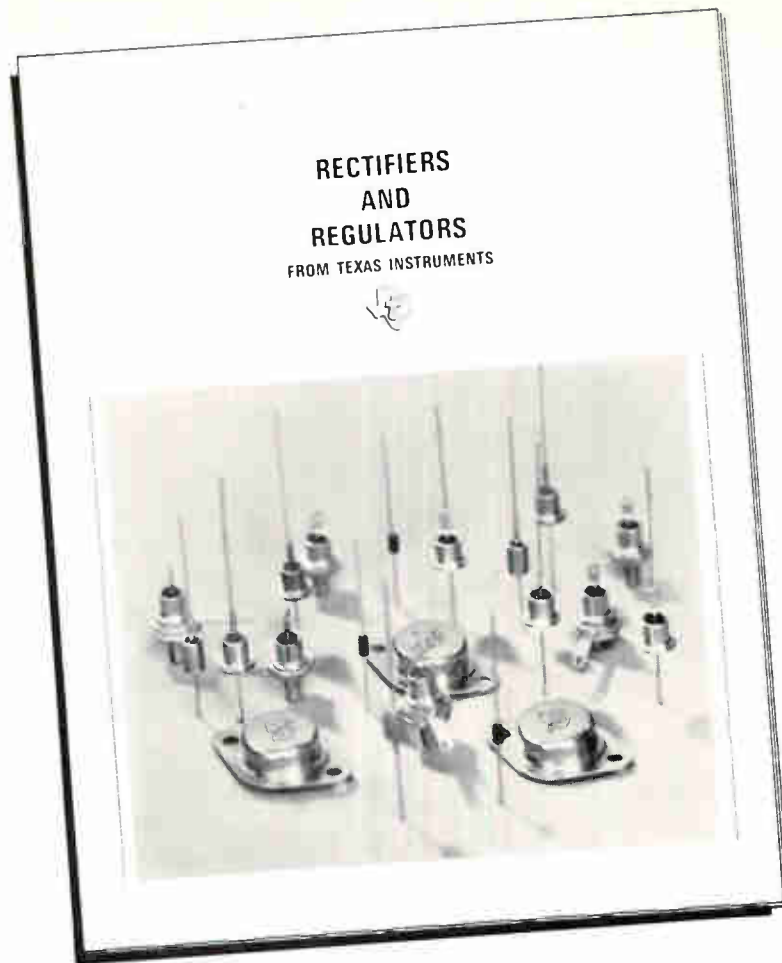

## **... four good reasons to call WEATHERFORD for TI rectifiers and regulators**

You'll benefit in many ways when you order TI rectifiers and regulators from us. Our large stocks and personalized service mean fast delivery. Our prices — of course — are competitive.

In addition, you can get the exact performance you require from TI's broad selection. The TI line is shown in a new product bulletin.

This new bulletin (shown above) also describes the superior construction features that make TI rectifiers and regulators exceptionally reliable.

In addition, other new bulletins on TI power semi-conductors are available for the asking. Circle the appropriate numbers on the Reader Service card for the bulletins you want.

- **Number 201 for TI Rectifiers and Regulators (shown above)**
- **Number 202 for Epitaxial Planar Power Transistors**
- **Number 203 for Regulator Interchangeability**
- **Number 204 for Transistor Interchangeability**



# **R. V. WEATHERFORD CO.**

**DISTRIBUTORS OF ELECTRONIC COMPONENTS AND EQUIPMENT**

**ANAHEIM, CALIFORNIA**  
1651 State College Blvd.  
714-532-6741  
714-547-7521

**GLENDAL, CALIFORNIA**  
6921 San Fernando Road  
213-849-3451

**PALO ALTO, CALIFORNIA**  
3240 Hillview Drive  
Stanford Industrial Park  
415-321-5373

**SALES OFFICES**  
**Albuquerque, N.M.**  
505-298-5593  
**Phoenix, Arizona**  
602-272-7144

**Pomona, California**  
714-966-8461 714-623-1261  
**San Diego, California**  
714-278-7400

NEW WITH CUSTOMIZED COMPONENTS  
**WEATHERFORD  
SERVICE  
PLUS** 

To: The wizards at Hoffman,  
the quiet, reliable semiconductor house.

We just might spend about a nickel more for your splendid commercial 1 watt microglass zeners than we do for those comparatively clumsy cans we've been using. Send us one to abuse cruelly.

**Hoffman** SEMICONDUCTOR  
HOFFMAN ELECTRONIC PARK  
EL MONTE, CALIFORNIA 91734

NAME \_\_\_\_\_

COMPANY \_\_\_\_\_

ADDRESS \_\_\_\_\_

\_\_\_\_\_ ZIP \_\_\_\_\_

(If you will be so kind as to attach the coupon to your letterhead, it will aid us in discouraging impostors, rascals, free-loaders and hobbyists who make artistic earrings.)

# WOULD YOU BELIEVE THIS IS A LAB INSTRUMENT?

This 6½-ton coating machine is used in our R&D labs to perfect new reproduction papers and films. Bristling with sensitive reading devices, it measures vaporizations to 1/100 of a percentage point . . . light absorption through coatings to .5 per cent. Rollers are machined to a fine .0001 in. tolerance. The material being tested zips through the big 12-zone oven at speeds up to 10,000 yards an hour . . . or crawls so slowly you can't see it move.

With the test coater, we are able to achieve true simulation of actual manufacturing conditions . . . in order to test new chemical formulae and base stocks . . . improve present ones . . . and design (and re-design) the equipment used in producing coatings and emulsions for reproduction materials.

It is one of the many reasons why, when important coating advances happen, they often are likely to happen first at K&E. Because K&E has some of the most sophisticated R&D coating capabilities in the world.

Because K&E has more experience with more different varieties of reproduction materials than anybody else. And because K&E aims to keep it that way. (For a look at one of our most popular papers, please turn the page.)



1867

1967

**KEUFFEL & ESSER CO.**

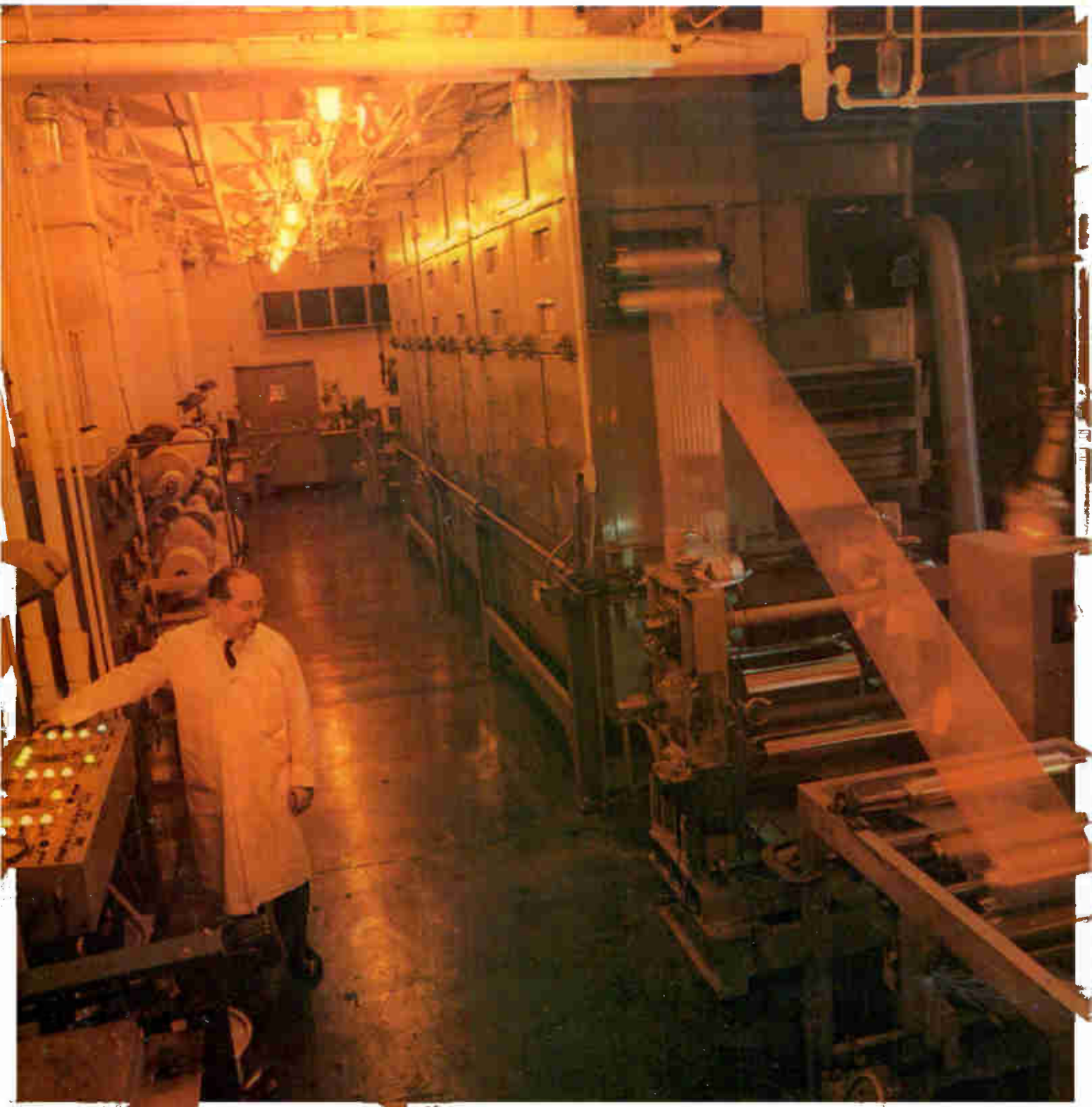

**R&D:  
PLEASE  
DON'T  
IMPROVE  
THIS  
ONE.**

Don't change it: That's what K&E salesmen say about 21 2145 Helios® Sepia Paper. It's perfect just the way it is, they maintain, and they point to this as proof: 21 2145 is our most widely used sepia diazo intermediate . . . *even though it costs more.*

Why are customers willing to pay an extra penny or two for 21 2145? In most duplicating processes, there is a perceptible and significant falling-off in quality with each additional step in reproduction. With 21 2145, quality actually improves. That's why it's used so often in "problem" regeneration of old, faded, worn masters.

21 2145 has excellent transparency because it's been "Albanized," much the same as Albanene® tracing paper. This means a considerably faster reprint speed.

21 2145 makes a superior drafting medium. One big reason: while other papers require eradication, you can erase easily on 21 2145. And after erasing, pencil and ink take much better, too.

21 2145 is hardy, durable paper. Takes a lot of wear and tear. Because it's made of 100 per cent rag bond.

But the best way to find out about 21 2145 is to try it once. You'll see the difference. Of course, you may not need

the extra quality of 21 2145. In that case, we've got other intermediates for you. Because K&E makes such a wide variety of diazo materials. Papers, cloths and films—73 different kinds in all, in every weight and size, dry and semi-moist. That's K&E policy. Everything for the engineer. Over 10,000 products now. More as you need them. And constant improvements in present products. (Even when our salesmen don't want them "improved.")



CREATIVE PRODUCTS  
FOR THE CREATIVE ENGINEER

**KEUFFEL & ESSER CO.**



**21 2145**

TRANSPARENT

**SEPIA**

21 2145 OLD NAME

**SEPIA**

SPEED

8 1/2 X 11  
IN.

250  
SHEETS

7684  
LOT NO.



## DIAL DANA...before you buy your next DVM

No need to regret a decision based on catalog claims—not when you can dial Dana and see for yourself why the Dana Model 5400 is the fastest selling digital voltmeter in its class.....you'll see 0.01% accuracy, 2-millisecond digitizing speed, 5th-digit overrange, a starting price of \$1,695.00.....so pick the number for your area code and dial Dana for a Model 5400 demonstration.....do it today.

201 201: 687-8737	305 305: 723-6924	413 617: 648-2922	518 315: 454-9377	716 716: 271-7430	<b>Austria</b> Wien: 82 46 732
201 201: 542-1441	309 312: 539-4838	414 414: 547-5131	602 602: 959-2115	717 717: 761-0577	<b>Denmark</b> Jyllinge: (03388) 150
202 301: 946-0300	312 312: 539-4838	415 415: 968-7116	603 617: 648-2922	802 617: 648-2922	<b>England</b> Studham: Whipsnad 466
203 203: 246-5686	313 313: 892-2500	417 913: 648-4173	606 513: 298-7203	805 213: 684-2840	<b>France</b> Paris: 722 70 40
205 205: 881-3721	314 314: 837-0597	419 216: 885-5616	607 315: 454-9377	812 317: 253-1681	<b>Germany</b> Munich: 0811 48 65 58
206 206: 763-2755	315 315: 454-9377	501 214: 231-6541	609 215: 265-3250	814 412: 892-2953	<b>Greece</b> Athens: 98 09 34
213 213: 684-2840	316 913: 648-4173	502 317: 253-1681	612 612: 537-4501	815 312: 539-4838	<b>Israel</b> Tel Aviv: 244 311-2
214 214: 231-2573	317 317: 253-1681	503 206: 725-2700	614 216: 885-5616	816 913: 648-4173	<b>Italy</b> Milano: 54 20 51
215 215: 265-3250	318 713: 528-6904	504 205: 881-3721	616 313: 892-2500	817 214: 231-6541	<b>Japan</b> Tokyo: 279-0771
216 216: 885-5616	319 319: 365-6635	505 505: 265-7766	617 617: 648-2922	904 305: 783-9407	<b>Netherlands</b> Genep: 08851 1956
217 312: 539-4838	401 203: 246-5686	507 612: 537-4501	618 314: 837-0597	912 215: 881-3721	<b>Norway</b> Oslo: 28 26 24
218 612: 537-4501	402 913: 648-4173	512 713: 528-6904	703 301: 946-0300	913 913: 648-4173	<b>Sweden</b> Vallingby: 08/87 03 30
219 312: 539-4838	404 404: 261-5459	513 513: 298-7203	712 319: 365-6635	914 914: 769-1811	
301 301: 946-0300	405 214: 231-6541	515 319: 365-6635	713 713: 621-0040	916 415: 968-7116	
302 301: 946-0300	408 415: 968-7116	516 516: 433-1421	714 714: 297-4619		
303 303: 934-5505	412 412: 892-2953	517 313: 892-2500	714 213: 684-2840		

**DANA**

Dana Laboratories, Incorporated Telephone (714) 833-1234  
2401 Campus Drive, Irvine, California 92664 Teletype 910-595-1136

# RCA OP AMPS GO PLASTIC ...LOW COST

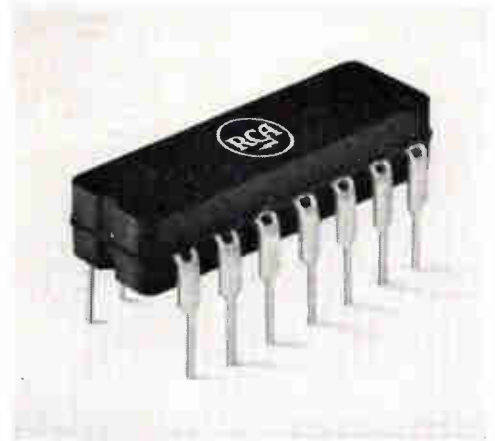

**Today's biggest Op Amp values  
in dual in-line plastic packages**

**CA3029...\$5.00 (1000+)  
CA3030...\$5.75 (1000+)**

RCA CA3029 and CA3030 offer you today's outstanding performance/dollar values PLUS the big advantages of the tough, versatile 14-lead dual in-line plastic package—easier handling, high packing density, and faster printed circuit board insertion.

Check RCA's new plastic packaged operational amplifiers today for your application.

## New RCA CA3029

in plastic dual in-line package for new economy, high performance

- 60 dB Open-Loop Voltage Gain (typ)
- 94 dB Common-Mode Rejection Ratio (typ)
- 6.75 Volts peak-to-peak Max Output Voltage Swing (typ)
- 300 KHz Bandwidth @ -3 dB (typ)
- 14 Kilohms  $Z_{in}$  (typ)
- 200 Ohms  $Z_{out}$  (typ)
- $V_{CC}$  to +6 Volts,  $V_{EE}$  to -6 Volts

## New RCA CA3030

in plastic dual in-line package for output swing to 14 volts

- 70 dB Open-Loop Voltage Gain (typ)
- 103 dB Common-Mode Rejection Ratio (typ)
- 14 Volts peak-to-peak Max Output Voltage Swing (typ)
- 320 KHz Bandwidth @ -3 dB (typ)
- 7.8 Kilohms  $Z_{in}$  (typ)
- 92 Ohms  $Z_{out}$  (typ)
- $V_{CC}$  to +12 Volts,  $V_{EE}$  to -12 Volts

## NEW! Two Popular Op Amps now in RCA's Economy Line

### CA3031/702A

for stable operation over the full -55°C to +125°C operating range

- 70 dB Open-Loop Differential Voltage Gain (typ)
- 85 dB Common Mode Rejection Ratio (typ)
- 10 Volts peak-to-peak Max Output Voltage Swing (min.)
- 8 lead TO-5 package

### CA3032/702C

for high-gain performance at big savings over 0 to 70°C range

- 70 dB Open Loop Voltage Gain (typ)
- 80 dB Common-Mode Rejection Ratio (typ)
- 10 Volts peak-to-peak Max Output Voltage Swing (min.)
- 8 lead TO-5 package

## Check RCA's Growing Economy OP Amp Line

MAX OUTPUT VOLTAGE SWING	DUAL IN-LINE PLASTIC	TO-5 STYLE	FLAT PACK
6.75V (typ)	CA3029	CA3010	CA3008
10V (typ)		CA3031/702A CA3032/702C	
14V (typ)	CA3030	CA3015	CA3016

For information check your RCA Representative or your RCA Distributor. For literature, write Commercial Engineering, Section ICN2-4, RCA Electronic Components & Devices, Harrison, N.J. 07029.

SEE YOUR RCA DISTRIBUTOR FOR HIS PRICE AND DELIVERY



RCA Electronic Components and Devices

The Most Trusted Name in Electronics

# Probing the News

While military and civilian markets for compact digital computers promise to be vast, they pose difficult questions for manufacturers.

1. Should systems be custom designed or off the shelf?
2. How big a threat is European competition in domestic markets?
3. Will demand be greater for multiprocessors or special-purpose units?

## Computers

# Airborne computers set to take off

Bandwagon demand for small digital machines spurs an industrywide scramble to climb aboard

By Paul Dickson

Staff writer

The sky's not the limit for the compact digital computer. In addition to a certain future in military and commercial avionics systems, lightweight, speedy little machines, in both multifunction and special-purpose versions, are set for a variety of shipboard and land-based jobs. So good are the prospects—the total market is being measured in billions of dollars—that a score of companies are scrambling for a piece of the action.

A recent Government survey illustrates what the scramble is all about; it estimated that during the next five to seven years the Department of Defense will purchase between 10,000 and 20,000 airborne digital computers. Included are units to be employed in such areas as the Tacfire artillery management system, the SAM-D missile, the

407L tactical air-control system and aboard Navy vessels. With many general-purpose computers selling for better than \$100,000 apiece, the Pentagon's prospective demand alone represents a tidy sum. When the requirements of the National Aeronautics and Space Administration, other Government agencies and commercial aviation are added, the dollar market is staggering.

### I. High hurdles

The compact computer field is now the preserve of a dozen or so companies. None enjoys an overwhelming technical edge and most share common problems.

Interservice commonality is but one of many difficulties that must be faced by manufacturers anticipating the needs of the future. John W. Koltz, assistant director for

Tactical Control and Surveillance Systems at the Director of Defense Research and Engineering Office, says: "We tell the services that they had better be able to live with the decisions they make. The Navy would look pretty foolish if one whole deck of an aircraft carrier had to be used for maintaining different types of computers."

One aspect of the commonality problem is being studied at Holloman Air Force Base, Alamogordo, N.M. A low-cost inertial navigation system with a digital computer to provide continuously updated flight coordinates is being developed there. Called the AN/ASN-66, the system would be made initially for the Air Force. But officials are hopeful that it can eventually be used to navigate all aircraft. They intend to make their findings avail-

# digital systems

## opportunities at NCR electronics division in los angeles

### SYSTEMS FORMULATION & ANALYSIS ENGINEERS

For assignments in commercial on-line computer applications with emphasis on communications interface. Extensive experience required in hardware specifications and advanced systems, including multiprogramming and list processing. Requires B.S. in engineering, business or related field.

### SOFTWARE PROGRAMMER

### DIAGNOSTIC PROGRAMMER

### PROJECT ENGINEERS

Computing Systems  
Peripheral Equipment  
Discs & Controllers  
Packaging

### CIRCUIT DESIGN ENGINEERS

### ELECTRICAL & MECHANICAL LIAISON ENGINEERS

### PACKAGING ENGINEERS (ALL LEVELS)

### MECHANICAL DEVELOPMENT ENGINEER

### RELIABILITY ENGINEERS

### QUALITY CONTROL ENGINEERS

### PROCESS ENGINEER —ELECTRONIC

### TEST EQUIPMENT DESIGN ENGINEERS

### MEMORY DESIGN—RESEARCH

### MECHANISMS SPECIALIST—Ph.D.

### MECHANICAL/OPTICS DESIGN ENGINEER

### ARRANGE NOW FOR INTERVIEW AT IEEE CONVENTION OR IN YOUR AREA

To arrange for a confidential interview at the March IEEE convention in New York, or in your area, please send your resume, including training, experience and salary history, to Bill Holloway, Technical Placement.

The National Cash Register Company



ELECTRONICS DIVISION  
2816 W. El Segundo Blvd., Hawthorne, Calif.  
Telephone: Area Code (213) 757-5111  
*An equal-opportunity employer*

## ... the problem is to get the computer to interface with the real world ...

able to the other services as well as to commercial airlines. The contract for the computer is expected to go to either the Northrup Co.'s Nortronics division or Lear Siegler Inc.'s Instrument division when the system goes into production.

But even if the commonality problem could be overcome, another still exists: multipurpose versus special-purpose units. In the AN/ASN-66 the computer does one job, leaving fault-finding, fire-control and related tasks to other systems. On the other hand, the Air Force's Research and Technology division at Wright-Patterson Air Force Base recently awarded a contract to the Teledyne Systems Co. of Hawthorne, Calif., to study the possibility of a doppler-inertial-loran system using a single multipurpose computer.

### II. Schools of thought

Entrants in the compact digital computer field are at odds over what kind of production is best. On one side are firms like the Kearfott division of General Precision Inc. which favor the customer-oriented approach, producing a specific system for a specific application. An opposite tack has been adopted by the International Business Machines Corp. which prefers to have a family of versatile off-the-shelf computers that can be adapted to the needs of many customers.

Availability of three digital computers, called the 4 Pi series [Electronics, Oct. 31, 1966, p. 42], has

something to do with IBM's marketing stance. J.B. Jackson, vice president and general manager of the company's Electronics Systems Center says, "There has been an excellent acceptance of 4 Pi and we now have firm contracts for a number of applications." Jackson points to the machines' "read-only-store" capability as having been critical to the acceptance of the series but also points to reliability, maintainability and cost advantages.

**Marketing.** The outlook for the 4 Pi computers is bright, according to Jackson. "Anyplace there is a hardened military environment, I see an application for 4 Pi," he says. Thus far, IBM has four contracts. The most significant is the order for the Mark II avionics system for the Air Force's F-111 fighter-bomber. About 1,000 computers will be produced for this system: two units for each aircraft, one for weapons delivery and a second for navigation. Other 4 Pi contracts include applications in the Manned Orbiting Laboratory, the EA6B Navy attack aircraft; and the target identification acquisition system for the antiradiation missile. Moreover, IBM and Litton Industries Inc. are currently the only two manufacturers still in the running for the computer contract in the E2A early warning aircraft.

The 4 Pi may become a factor in commercial aviation as well. Eastern Air Lines is flying IBM equipment to determine whether failure patterns can be recognized

### Some entries in the airborne digital computer race

#### Companies

AC Electronics  
Autonetics  
General Precision  
Honeywell  
IBM  
Lear-Siegler  
Litton  
Nortronics  
Raytheon  
RCA  
Sagem (French)  
Sperry Gyroscope  
Teledyne  
Univac

#### Computers

Magic series  
D26 line  
Dydan, L-90-1 and Micro Minac  
Alert, SIGN-3  
4 Pi series  
Divic  
300 and 3000 series  
1051 and 1051A  
R-11, R-25 and R-31  
VIC  
AE51c  
Mark 12 and Mark 14  
DIL  
1830A and 1824



before a breakdown occurs. Joseph E. Jenette, marketing manager at IBM's Electronic Systems Center, sees commercial aviation "as a definite marketplace for 4 Pi."

GPI's customer approach has also been successful with one digital computer system alone generating \$20 million worth of annual volume. Its AN/ASN-24(v) is in production for the central navigation system in the Air Force's C-141 transport and a system designated GPK-10 is being readied as a solid-state follow-on for the same program. In addition, the company's GPK-33 is being turned out for the Centaur B space launch vehicle while the GPK-20 is in production for the Navy's P3C patrol aircraft. Awaiting applications are Dydan, an incremental computer for low-cost navigation systems; the L-90-1, a high-capacity general-purpose unit for navigation and central processing tasks; and Micro Minac, a special-purpose solid-state digital computer for low-cost airborne navigation applications.

"Any three graduates of a good engineering school with a course in digital design can produce a compact digital computer," says Alfred F. Schmitt, director of the aerospace digital computer department at Kearfott. According to Schmitt, the problem is to fit the computer into the system, or as he puts it, "interface with the real world." High-speed aircraft pose difficulties not present in a ground-based system, he says, citing power sources, progressive error, scaling (the placement of decimal point to record a real value) and achievement of real time in milliseconds.

**Bundles from Britain.** Still another problem for American firms trying to establish a position in the airborne digital computer field is British competition. A Pentagon agreement to buy \$300 million worth of British hardware to offset the cost of the 50 F-111's to be ordered by Britain puts a very large foot in the door. Elliott Automation Ltd., Ferranti Ltd., the Marconi Co., the Decca Navigator Co. and G.E.C. Computers and Automation Ltd. all have bantam airborne digital computers for sale. Elliott has been awarded a contract to supply analog units for the giant C-5A transport and is developing the digital computer interface and



How to design simple antenna systems which furnish desired radiation pattern coverage for missiles, rockets and spacecraft?



How to develop the most versatile line of off-the-shelf, S-Band telemetry antennas for airborne range instrumentation.



How to build telemetry antennas that are rugged enough to be used on artillery shells, perform in flight, impact 12' into the earth, and still be functional after recovery.



How to solve precision, RF, check-out problems on entire Airborne Range Instrumentation Systems for large spacecraft in the crowded launch-pad environment.

Aerospace project people know that, when it comes to precise high performance and rugged reliability in antennas and related equipment, they can say, **...D&M KNOWS!** with assurance ...

Have you had antenna engineering experience at a high level? Would you like to apply it to problems of immediate practical value, like improving flight safety? Call or write the Chief Engineer at either our new Long Island plant or at Chatsworth (San Fernando Valley), California

# dorne and margolin

INCORPORATED

**WEST COAST**  
9730 Cozycroft Avenue  
Chatsworth, California 91311

**EAST COAST**  
2950 Veterans Memorial Hwy.  
Bohemia, New York 11716



20 Years of Leadership in Aircraft and Missile Antennas



Raytheon's multipurpose R-11 computer is designed for weapons systems use.

power supply for the Navy's integrated light attack avionics system.

### III. Economy sizes

With the complex and crowded conditions prevailing in the airborne digital computer field, many manufacturers are concentrating on specialized segments of the market in their efforts to establish a niche.

Nortronics is betting on low cost with its 1051 computer which is price tagged in the \$25,000 to \$30,000 bracket each in production quantities of 100 or more. E.A. Klein, chief of Nortronics' computer development group, says, "Our ratio between labor charges and material costs used to be 70:30, but we have nearly reversed that."

In addition to the 1051 system, Nortronics has a 1050A being tested at Holloman for the low-cost inertial navigation program. This computer is installed in the doppler-inertial navigation system and the malfunction-and-analysis detection and recording system to be used in the C-5A. Nortronics considers Loran-D, weapons delivery and navigation systems, airborne data processing and space missions as outlets.

**Throwaways.** Low cost has undeniable appeal and the Raytheon Co. is currently investing large amounts of its own money in an effort to produce a low-cost digital computer using large-scale integration (LSI) techniques. Wendell Smith, marketing manager at the company's Bedford Laboratories, explains, "By low-cost computers, I mean those in the \$5,000-to-

\$10,000 range. This will put them in the throwaway category. Military managers are encouraging electronics systems that will not need maintenance but which will simply be used up to failure and then discarded."

**New offerings.** For the immediate future, Raytheon's computer roster includes three new airborne machines that resulted in part from systems work on the Army's Hawk and the Navy's Sparrow missiles. The first in the new series of Raytheon computers is the R-11, a high-speed, large-memory multipurpose computer. Designed for installation in complex weapons systems, it has a cycle time of 1-microsecond. Raytheon shortly will introduce a cut-down version designated R-25, which will give up speed in return for advantages in size, weight and power consumption. The R-11 weighs 100 pounds and the R-25 only 38. Raytheon would like to find R-25 applications in airborne fire control, airborne guidance and navigation, simulation and training, and shipboard navigation. A third member of the family to be ready this month is the R-31, which has been designed specifically for the Hawk, for which Raytheon is prime contractor.

Donald R. Kirsch, the company's military marketing manager emphasizes that the R-31 is a multipurpose machine. The company plans to market the R-31 for a wide variety of airborne and military applications. A salient feature of the R-31 is that input-output has direct access to memory. "This allows very high speed data transfer," Kirsch says. "Any competent electronics house can build a central processor and buy or build a memory. But the important distinction among machines is in input-output, including the ability of the computer to handle peripherals at high data rates."

One of the earliest applications of the Raytheon computer will be in tactical phased-array radar systems for airborne, ground and shipboard use [Electronics, Jan. 9, p. 172].

Lear Siegler is also aiming at the economy computer market with its 25-pound Divic (digital variable increment computer) [Electronics, Sept. 5, 1966, p. 105]. Divic features a core-rope memory which

has an extremely low cost per bit—about two cents. The read-write memory is a conventional ferrite core. The company is getting sales price down to \$20,000 per unit in large production quantities.

**The mating game.** Compatibility is the word being used at the Radio Corp. of America's Aerospace Systems division. "With our approach in vic (variable instruction computer) we've found a way to be compatible with a wide range of ground computers," says Edward H. Miller, manager of aerospace computer applications. Next month, the vic system—demonstrated last December for the Air Force—will undergo an airborne test of its compatibility with an IBM 7090 in a command and control environment [Electronics, Dec. 12, 1966, p. 45].

Preliminary design work is under way on variations of the vic and RCA is looking to the data processing needs of the Awacs (airborne warning and control system) and airborne antisubmarine defense programs for additional outlets. Miller sees commonality of the airborne system with ground-based computers as a major trend in command and control. An advocate of customer-oriented policies, Miller says program managers are finding that attempts to use a universal off-the-shelf computer impose penalties in weight and price.

### IV. Commercial inertial

Inertial navigation systems have the greatest sales potential for digital computers in commercial aviation. E. Leslie Keates, senior marketing representative at the Sperry Gyroscope Co., a division of the Sperry Rand Corp., believes "every new aircraft built for overseas transport from here on out will contain two systems and possibly more. The supersonic transport (sst) may contain as many as four redundant inertial systems." Sales estimates of inertial systems in the commercial sector during the next five years have run as high as 3,000 units. System price tags are in the \$100,000 class.

Two companies with an edge in this field are Sperry Gyroscope and the AC Electronics division of the General Motors Corp.

Sperry is already producing an inertial navigation system, the scx-

10, which it is delivering to Pan American World Airways for use on the Boeing 707's. There are now 28 systems on 14 Pan Am aircraft. According to Keates, the system's Mark 12 digital computer "is performing well within specification and improving with quantity production." Sperry expects the Federal Aviation Agency to certify the SCX-10 sometime this spring and anticipates additional orders to result from it. The Mark 12 is also being used as part of the radar system on the Canadian weather ship, Vancouver, and in the control system aboard the Navy's deep submergence vessel Trieste II.

Another Sperry computer in production is the Mark 14, being delivered to the Army for the Loran-D tactical navigation system.

Company-supported research and development at AC Electronics has paid off in the award of production and development contracts for the company's Magic series of airborne computers. One order covers the inertial navigation system for the Boeing 747 Jumbo Transport [Electronics, Feb. 6, p. 38]. Another machine in AC's Magic line of computers is in pilot production on the SRAM (short range attack missile). The company also has a contract for development work on the computer for the Navy's ship's self-contained navigation system.

**Foreign commercial.** The influence of the French-British Concorde SST on commercial aviation extends into the digital computer field and success in the area could prove a strong selling point. A pair of computers aboard the Concorde will perform self-checking and fault diagnosis, provide steering signals, navigate inertially and provide such housekeeping data as fuel consumption. A unique feature of the system will be computation in concert with a pictorial-situation display which will project a map of the area over which the plane is flying on a cockpit console. The combination will enable Concorde pilots to carry all navigation information in a film cassette. Supplied by the French Societe d'Applications Generales d'Electricite et de Mecanique, the computer is designated the AE51c; the display portion will be made by Ferranti.

**Upkeep.** In some computer mar-

kets, maintainability is a powerful sales weapon. Teledyne and the Univac Defense Systems divisions of Sperry Rand each has recently received contracts for airborne digital computers which feature simplified maintenance.

Teledyne's latest was a \$24 million production contract for avionics systems in the CH-53A and CH-46A helicopters. The company is also a subcontractor of the Lockheed Aircraft Corp. for a triply redundant computer complex for the Army's advanced aerial fire-support system.

Univac offers two small digital computers: the 1830A, a general purpose command-and-control unit which will go into production for the Navy's A-New antisubmarine warfare system [Electronics, Dec. 12, 1966, p. 184], and the 1824, for the inertial navigation system in the Titan III booster.

#### V. Off the shelf

"We looked ahead to what our potential users will need and then went ahead and developed the series to meet these requirements," says Leon Bloom, special assistant to the vice president for special programs at Litton's Data Systems division. "Litton thinks like IBM in this area," says Bloom.

Litton is working on two lines which each have three small stored-program machines with different computation speeds. The 304 from the company's 300 series is in production and being evaluated for the E2A aircraft. A prototype 3050 for the 3000 line is also being built.

Litton's Guidance and Control division has turned out more than 5,000 analog and digital computers for navigation systems in military aircraft. It is now working on a design contract for a "wafer" computer which will have extreme accuracy, reliability and a sufficiently low price to permit convenient replacement.

Alert, a computer being produced by the aeronautical division of the Military Products Group at Honeywell Inc., is, according to M.J. Leonard, divisional marketing manager, "the most powerful off-the-shelf computer in production today." Honeywell, an off-the-shelf advocate, also has a prototype general-purpose airborne digital computer which is designated SICX-3

# Etch your own PC boards automatically!

(in less than 5 minutes)

from this →  
to 11" x 14"



Shown actual size!

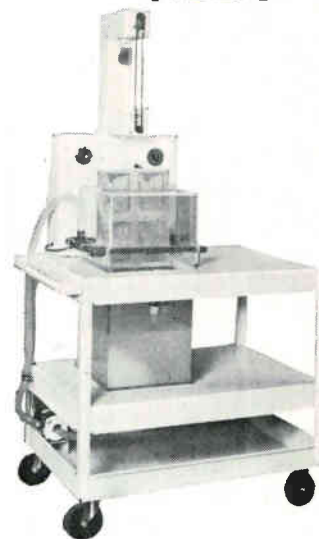

## "fine line" etcher

for prototypes—limited runs

No cooling or venting required!

Etches as fine as .001"!

Cuts costs in half—saves time!

Complete photo processing instructions!

Work is illuminated while etching!

No patterning . . . minimum undercutting!

Model No. 201 (illus.), etches two 11"x14"

one-sided boards or one 11"x14" two sided board:

**\$695**

Pat. applied for

NOW IN USE BY:

AMP, Inc.  
Atomic Energy Com.  
Bendix  
Beta Corp.  
Charles Brunning  
C.G. Conn  
Esso Research  
General Dynamics  
IBM  
ITT Gilfillan  
Jordan Elect.  
Lear Siegler  
Micro Switch  
Microwave Elect.

Sonotone  
Sprague Electric  
Union Carbide  
U.S. Air Force  
Varo, Inc  
Whirlpool  
Woodward Gov.  
Univ. of Chicago  
Univ. of Colorado  
Univ. of Georgia  
Univ. of Hawaii  
Univ. of Penn.  
Oklahoma State U.  
Washington Univ.

Representatives: Some Territories Still Available.

## CYCLO-TRONICS, INC.

3858 N. CICERO—CHICAGO, ILL. 60641  
TELEPHONE: (312) 282-6141



Electron Beam Gun.

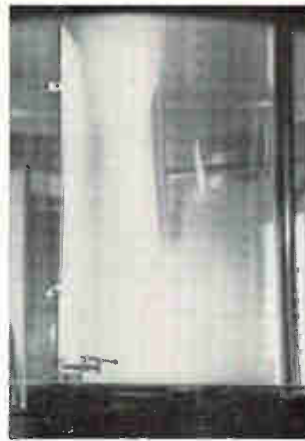

Plasma-Vac® low-energy sputtering with RF capability.



CV-type coaters.

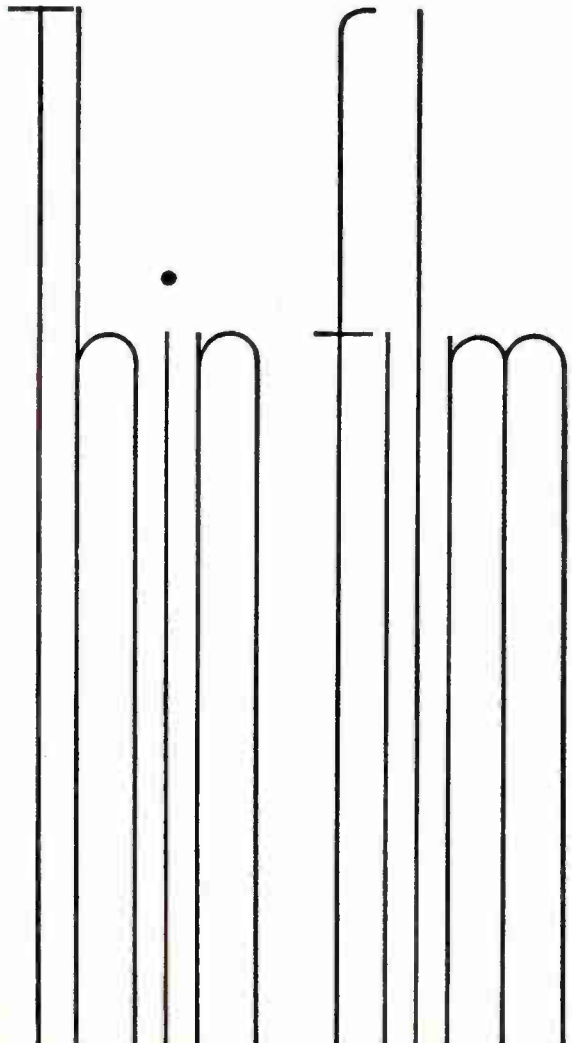

Here's all the equipment you need to put thin-film techniques to work on a research or production basis . . .

CVC's PlasmaVac® low-energy sputtering system gives you controlled deposition of metals, alloys, semi-conductors and insulators. Quality and yields are of a degree that make production-line operations a commercial reality.

Or, if your research or production application calls for resistance heating or electron beam gun evaporation, CVC has the equipment you need.

More important to you, we have the technological background and the applications laboratory to analyze your requirements and help you decide which thin-film deposition method will best handle your application.

Let us know how you would like to use thin-film deposition. We'll be glad to make recommendations. Consolidated Vacuum Corporation, 1775 Mt. Read Blvd., Rochester, N.Y. 14603. A subsidiary of Bell & Howell.



10, which it is delivering to Pan American World Airways for use on the Boeing 707's. There are now 28 systems on 14 Pan Am aircraft. According to Keates, the system's Mark 12 digital computer "is performing well within specification and improving with quantity production." Sperry expects the Federal Aviation Agency to certify the SCN-10 sometime this spring and anticipates additional orders to result from it. The Mark 12 is also being used as part of the radar system on the Canadian weather ship, Vancouver, and in the control system aboard the Navy's deep submergence vessel Trieste II.

Another Sperry computer in production is the Mark 14, being delivered to the Army for the Loran-D tactical navigation system.

Company-supported research and development at AC Electronics has paid off in the award of production and development contracts for the company's Magic series of airborne computers. One order covers the inertial navigation system for the Boeing 747 Jumbo Transport [Electronics, Feb. 6, p. 38]. Another machine in AC's Magic line of computers is in pilot production for the inertial guidance on the SRAM (short range attack missile). The company also has a contract for development work on the computer for the Navy's ship's self-contained navigation system.

**Foreign commercial.** The influence of the French-British Concorde SST on commercial aviation extends into the digital computer field and success in the area could prove a strong selling point. A pair of computers aboard the Concorde will perform self-checking and fault diagnosis, provide steering signals, navigate inertially and provide such housekeeping data as fuel consumption. A unique feature of the system will be computation in concert with a pictorial-situation display which will project a map of the area over which the plane is flying on a cockpit console. The combination will enable Concorde pilots to carry all navigation information in a film cassette. Supplied by the French Societe d'Applications Generales d'Electricite et de Mecanique, the computer is designated the AE51c; the display portion will be made by Ferranti.

**Upkeep.** In some computer mar-

kets, maintainability is a powerful sales weapon. Teledyne and the Univac Defense Systems divisions of Sperry Rand each has recently received contracts for airborne digital computers which feature simplified maintenance.

Teledyne's latest was a \$24 million production contract for avionics systems in the CH-53A and CH-46A helicopters. The company is also a subcontractor of the Lockheed Aircraft Corp. for a triply redundant computer complex for the Army's advanced aerial fire-support system.

Univac offers two small digital computers: the 1830A, a general purpose command-and-control unit which will go into production for the Navy's A-New antisubmarine warfare system [Electronics, Dec. 12, 1966, p. 184], and the 1824, for the inertial navigation system in the Titan III booster.

#### V. Off the shelf

"We looked ahead to what our potential users will need and then went ahead and developed the series to meet these requirements," says Leon Bloom, special assistant to the vice president for special programs at Litton's Data Systems division. "Litton thinks like IBM in this area," says Bloom.

Litton is working on two lines which each have three small stored-program machines with different computation speeds. The 304 from the company's 300 series is in production and being evaluated for the E2A aircraft. A prototype 3050 for the 3000 line is also being built.

Litton's Guidance and Control division has turned out more than 5,000 analog and digital computers for navigation systems in military aircraft. It is now working on a design contract for a "wafer" computer which will have extreme accuracy, reliability and a sufficiently low price to permit convenient replacement.

Alert, a computer being produced by the aeronautical division of the Military Products Group at Honeywell Inc., is, according to M.J. Leonard, divisional marketing manager, "the most powerful off-the-shelf computer in production today." Honeywell, an off-the-shelf advocate, also has a prototype general-purpose airborne digital computer which is designated SIGN-3

# Etch your own PC boards automatically!

(in less than 5 minutes)

from this →  
to 11" x 14"



Shown actual size!



## "fine line" etcher

for prototypes—limited runs

No cooling or venting required!

Etches as fine as .001"!

Cuts costs in half—saves time!

Complete photo processing instructions!

Work is illuminated while etching!

No patterning . . . minimum undercutting!

Model No. 201 (illus.), etches two 11"x14" one-sided boards or one 11"x14" two sided board:

**\$695**

Pat. applied for

— NOW IN USE BY: —

AMP, Inc.  
Atomic Energy Com.  
Bendix  
Beta Corp.  
Charles Brunning  
C.G. Conn  
Esso Research  
General Dynamics  
IBM  
ITT Gilfillan  
Jordan Elect.  
Lear Siegler  
Micro Switch  
Microwave Elect.

Sonotone  
Sprogue Electric  
Union Carbide  
U.S. Air Force  
Voro, Inc  
Whirlpool  
Woodward Gov.  
Univ. of Chicago  
Univ. of Colorado  
Univ. of Georgia  
Univ. of Hawaii  
Univ. of Penn.  
Oklahoma State U.  
Washington Univ.

Representatives: Some Territories Still Available.

**CYCLO-TRONICS, INC.**

3858 N. CINCERO—CHICAGO, ILL. 60641

TELEPHONE: (312)-282-6141



# AD-YU

## ELECTRONICS, INC.

249-259 TERHUNE AVENUE, PASSAIC, N. J.  
Phone (201) 472-5622 • CABLE: ADYU PASSAIC

### PRECISION PHASE METER TYPE 406 Most Popular Direct Reading Phase Meter



#### SPECIFICATIONS:

FREQUENCY RANGE — Type 406, 8 cps to 100 kc; Type 406H, 8 cps to 500 kc; Type 406L, 1 cps to 100 kc.

FULL SCALE RANGE: 0-12, 0-36, 0-90, and 0-180 up to 360 degrees.

ACCURACY:  $\pm 0.25^\circ$  relative,  $\pm 0.3^\circ$  or 2% absolute.

INPUT VOLTAGE: 0.05 volt to 90 volts without adjustment.

#### FEATURES:

Direct reading in degrees.

No amplitude adjustment of either signal voltage.

No frequency adjustment from 1 cps to 500 kc.

No ambiguity at zero reading.

Meter reading independent of the ratio of input signal amplitudes.

#### USES:

Phase checking in production lines.

Plot phase curve for networks, amplifiers, systems.

Measure fractional degree in the vicinity of zero.

### DIGITAL PHASE METER TYPE 524A3

$\pm 0.03$  Degree Accuracy, 20 CPS to 500 KC



Type 524A3 with indicator. Computer alone (bottom panel) can produce analog output to drive recorder and d.c. digital voltmeter. Price \$999.

#### FEATURES:

Phase reading directly in degrees in 5 digits (or 4 digits).

No amplitude adjustment from 0.3v to 50v.

No frequency adjustment up to 500 kc.

Analog output available for recorder or programmable system.

#### USES:

Plot phase vs. frequency curve of unknown network.

Plot envelope delay curve with RF sweep oscillator.

A standard phase meter with 5-digit readout.

WORLD FAMOUS FOR PHASE AND TIME MEASUREMENT 0.001 CPS TO 18 GC

WIDEBAND PRIMARY PHASE STANDARD, TYPE 209  
50 CPS TO 10 KC



VIDEO AND RF PHASE METER, TYPE 422A  
50 CPS TO 10 MC



MICROWAVE PHASE AND TIME DETECTOR, TYPE 206A  
1 GC TO 8.2 GC



DUAL-CHANNEL SYNCHRONOUS FILTER, TYPE 1034  
2 CPS TO 20 KC



See our Booths 2J43-2J45 at the IEEE Show.

for inertial navigation applications.

**Contract awards.** Alert figures in a number of development contracts including two automatic reconnaissance projects. The system is also being considered for the X-15 rocket plane's energy management system and the AN/USQ-28 photo mapping system. Leonard says Alert has been selected for additional programs by several prime contractors.

North American Aviation Inc.'s Autonetics division supplied the systems in the Minuteman I and II missiles, and an improved version is being developed for the Minuteman III. Autonetics' D-26 line is designed for avionics use. The latest model, D-26J, a small single-purpose unit underwritten by the company, will be the inertial navigation computer in the F-111. Autonetics is also developing a D-26J-type machine for the control system in the RF-111.

**Debuts.** Newcomers also are flocking into the compact field. Last month the Control Data Corp. formed a new aero systems department to vend special-purpose airborne computer systems. Also among the more recent entrants is the guidance and control division of the Aerospace Group at the Hughes Aircraft Co. It has a fire-control computer, the HCM-205, and a full-scale data handling system, the HCM-206, which can be adapted for command-and-control applications. The 206 uses multiple arithmetic units and multiple memory modules to make it suitable for rugged military environment. Hughes officials say the firm is negotiating its first contract for the 206 in a classified program. Charles F. Saunders, marketing manager for the division, says, "The 206 will be in full-scale production by the end of the year."

Saunders, who believes this family of computers has a lifetime of five years, echoes the sentiments of his counterparts around the industry. "The next level of technology—breakthroughs in cost and productivity—will probably occur within five years and will make extensive use of LSI techniques," he says. Saunders may be off in his estimate. Texas Instruments Incorporated is scheduled to deliver a prototype digital computer featuring LSI to the Air Force in 1968.

# 30-gage wire can't have much insulation

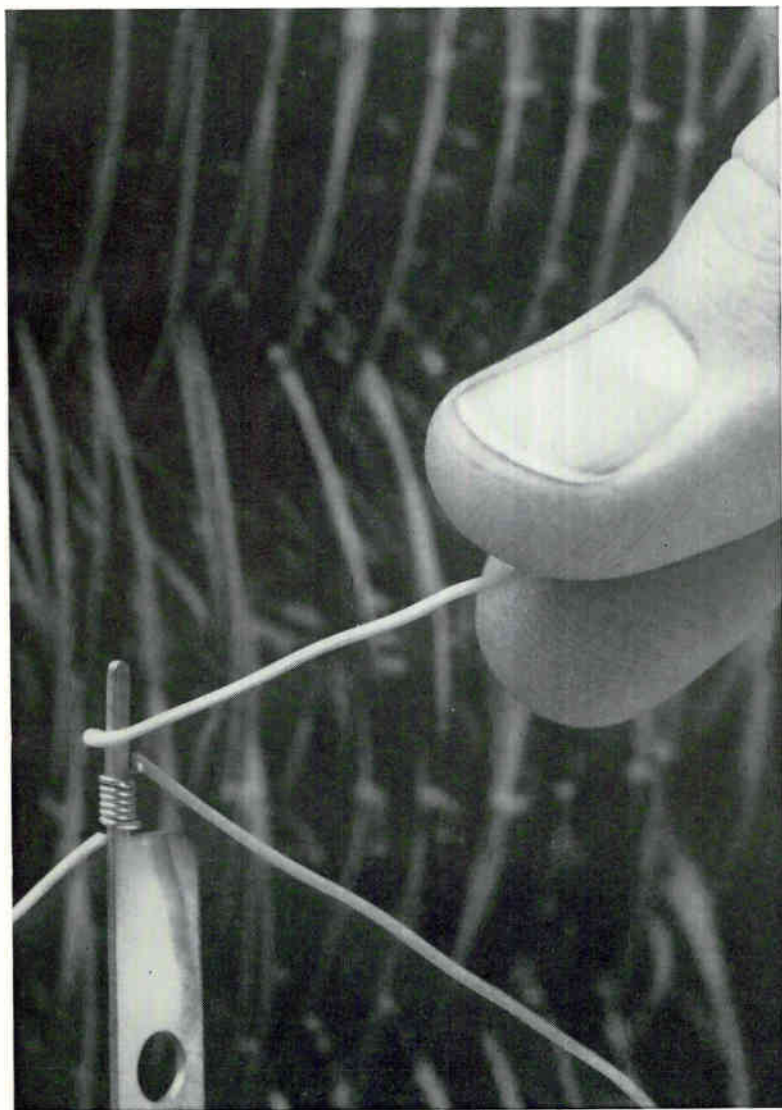

**It's got  
to be tough**

**That's why  
it's Kynar<sup>®</sup>**

Kynar has superior cut-through and abrasion resistance . . . double the mechanical strength of other fluoroplastic insulations. It withstands bending . . . vibration . . . resists cleaning solvents . . . operates from  $-80^{\circ}$  to  $300^{\circ}\text{F}$  . . . feeds, cuts and strips smoothly in hand and automatic wiring machines.

Wire insulated with Kynar is available from leading manufacturers. For data, write or call Plastics Department, Pennsalt Chemicals Corporation, 3 Penn Center, Philadelphia, Pa. 19102.

***Kynar...the fluoroplastic that's tough!***

**PENNSALT**



Electron Beam Gun.



Plasma-Vac® low-energy sputtering with RF capability.



CV-type coaters.

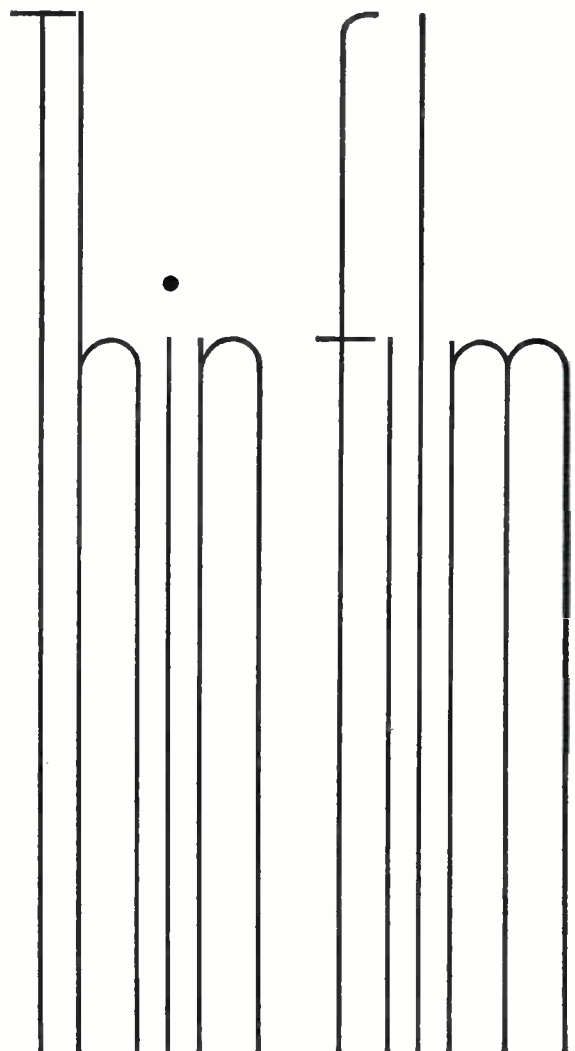

Here's all the equipment you need to put thin-film techniques to work on a research or production basis . . .

CVC's PlasmaVac® low-energy sputtering system gives you controlled deposition of metals, alloys, semi-conductors and insulators. Quality and yields are of a degree that make production-line operations a commercial reality.

Or, if your research or production application calls for resistance heating or electron beam gun evaporation, CVC has the equipment you need.

More important to you, we have the technological background and the applications laboratory to analyze your requirements and help you decide which thin-film deposition method will best handle your application.

Let us know how you would like to use thin-film deposition. We'll be glad to make recommendations. Consolidated Vacuum Corporation, 1775 Mt. Read Blvd., Rochester, N.Y. 14603. A subsidiary of Bell & Howell.





# Sea dogs' seeing eye

The Naval Tactical Data System coordinates fleet's battle operations and provides commanders with instant intelligence

By Gerald Parkinson

Los Angeles Bureau

**Though battle-proven** and efficient, the Naval Tactical Data System is set for a facelifting. Provision for sonar inputs, a navigation capacity, incorporation of integrated circuits and standardization of display consoles are among the refinements planned for the system, now in its third generation.

The NTDS, which has been operational in Vietnam waters, provides battle commanders aboard warships with a comprehensive, real-time picture of friendly and hostile ships and aircraft from conventional electronic sensors. It is installed on 30 to 40 vessels, including aircraft carriers, destroyer leaders and cruisers.

The Hughes Aircraft Co. has a

three-year, \$18.9-million contract to supply 343 display consoles and related equipment for 15 more ships.

At the heart of the NTDS are computers supplied by the Univac division of the Sperry Rand Corp. Configurations depend on the class of ship that is involved, but there can be as many as four computers in a system. The AN/USQ-20 is a general-purpose, stored-program digital computer processor with a 4-microsecond cycle time and 32,000-word memory. It occupies about 54 cubic feet of space, weighs 2,100 pounds and operates in real time. Among other things, the computer stores information on the fleet's aircraft and weapons status. It also serves as a way station for data

supplied from surveillance gear.

Track information from such sources as long-range, height-finding and navigation radars and sonar is presented on the 12-inch radarscopes of data input (DI) consoles. An aircraft carrier's NTDS might have as many as 10 DI consoles.

## I. Seascope

To track, the console operator simply places a marker over the target on his scope. He pushes a button to feed the target's coordinates into the computer. Operators can also send iff (identification, friend or foe) and ecm (electronic counter measures) data and information as to whether a track is

**Data utilization consoles**, important elements of the NTDS, installed aboard the carrier Enterprise, enable battle commanders to evaluate threats and decide on effective countermeasures.

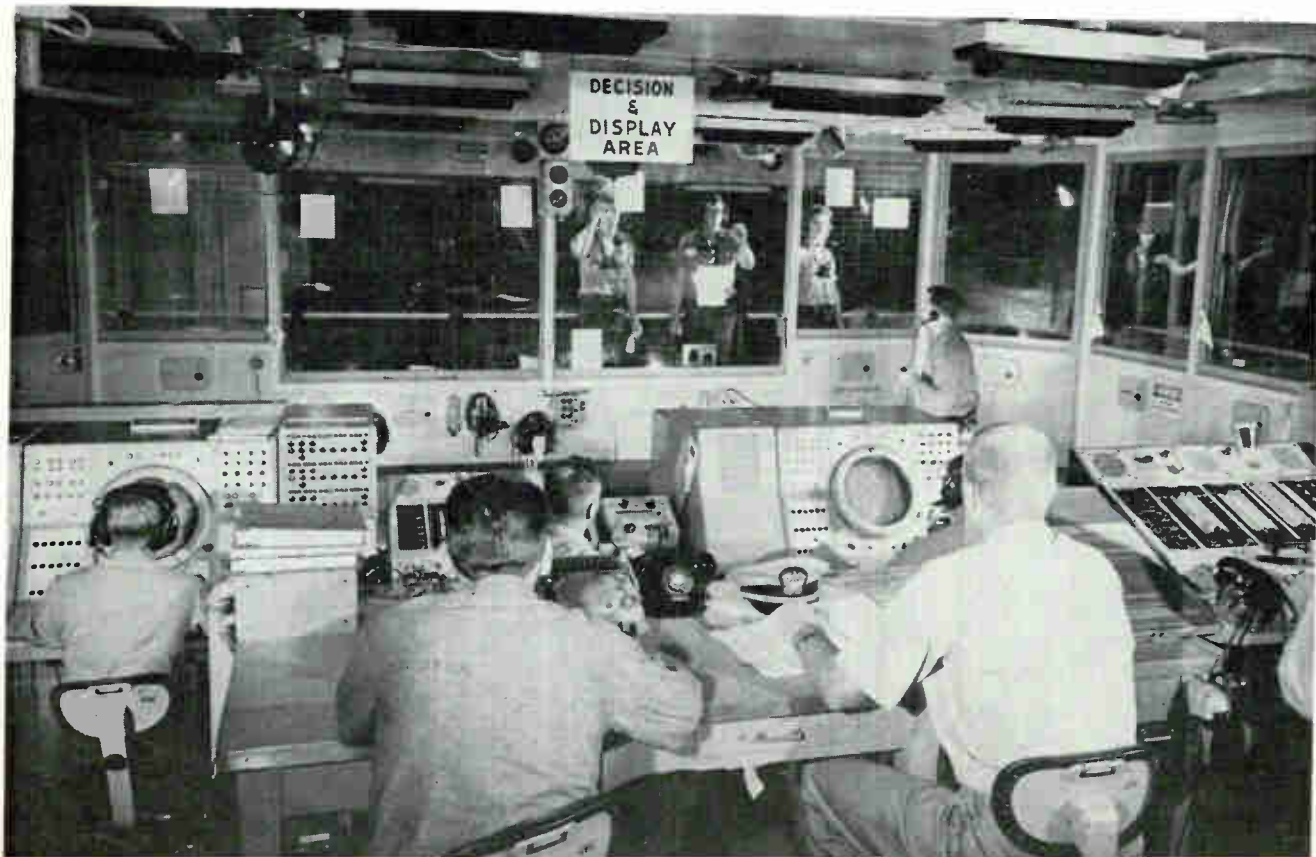

---

**CUSTOM  
DESIGNED  
POWER  
SUPPLIES  
TO**

**Mil-E-16400**

**Mil-E-5400**

**Mil-E-4158**

**Mil-T-21200**

**Mil-P-11268**

**NASA-200-2**

**Mil-I-983**

**Mil-F-18870**

*Detailed data on facilities,  
capabilities and contract  
accomplishments on request.*

**SBD**  
**Systems, Inc.**

90 ROME STREET  
FARMINGDALE, NEW YORK 11735  
Phone (516) 694-5484  
TWX 510-224-6420

surface or air. Meanwhile, the computer automatically plots the course and speed of the target in real time.

When a DI console operator is following more than one target, he pushes a sequence button to record coordinates. This enables the computer to indicate which track the operator should update next. If a target moves out of range, the computer actuates a warning light. The repeating accuracy of the Hughes scopes is 0.1%, regardless of the symbol's position.

Although all DI console operators have access to the same data, they are responsible only for discrete geographical sectors or situations. A supervisor, who can switch consoles to an area where the load is heavy, monitors the input operation. An NTDS generally includes several consoles in the DI area to display data from height-finding radar or enlargements of other sensor information. According to David Heebner, division manager for Navy programs at Hughes, the system can handle hundreds of tracks simultaneously. He declines, however, to give specific figures.

**Display details.** An NTDS installation has another display section which may include as many as 15 data utilization (DU) consoles. These units reproduce for battle commanders information supplied by the DI equipment through the computers and symbol generators. There are several dozen symbols, including alphanumeric, to provide detail on tracked objects. Operators can determine whether a target is surface, subsurface or air and whether it is friendly or unfriendly. If the craft in question is not hostile, symbols indicate whether it is engaged or ready for

engagement. When an operator requests information for display, logic circuits within the console extract it from the computer's data flow by closing all but the appropriate gate.

Air controllers and the weapons officer have their own consoles to follow aircraft during battle. A plane in combat can be continuously monitored by DI consoles. Since the computer has been programmed with data on each aircraft's fuel and ordnance supply before the engagement, it can furnish immediate information on reserves. The controllers can thus calculate quickly how much longer any given plane can stay in the air as well as its remaining ammunition by identifying the aircraft from its coordinates or by dialing its code number into a computer.

The display capability of the NTDS enables the weapons officer to analyze threats rapidly and decide on the best way to meet them. When the pertinent data has been presented, he can select shipboard missiles, aircraft or both.

## II. All at sea

In an NTDS-equipped task force, an aircraft carrier flagship and perhaps four destroyer leaders coordinate operations. Each system ship transmits digital track data in a net-controlled, roll-call sequence to other vessels. The receiving warships correlate force track data with their own ship's data to make tactical decisions. The system automatically controls track reporting so that no two ships report on the same target. In the event that two systems are tracking the same target, computers screen the available inputs to assign a priority. The ves-

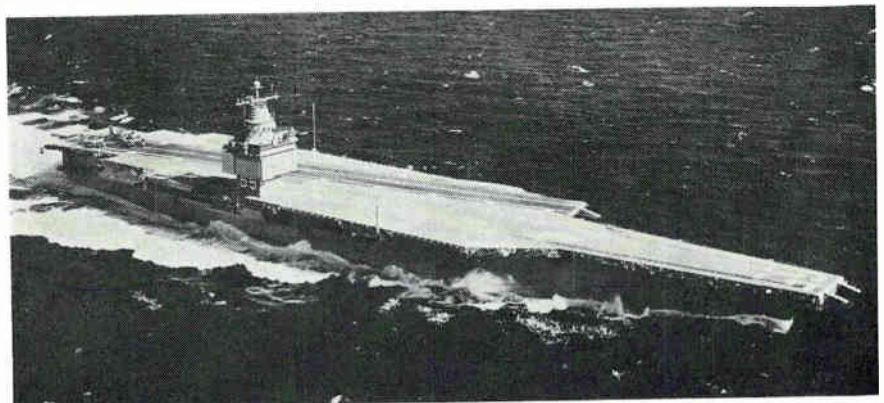

Enterprise is equipped with an NTDS that presents a comprehensive picture of ships, aircraft and submarines within range of the fleet's electronic sensors.

sel closest to the target receives top billing and its inputs are displayed on the DI consoles throughout the NTDS.

**Consolidating gains.** In the third-generation NTDS, the DI and DU consoles have been standardized into a single general-purpose unit which can handle both input and utilization functions. The new assembly will also incorporate an auxiliary display for amplifying alphanumeric data that cannot conveniently be presented by symbol encoding.

In the standardized version of the consoles, IC flatpacks will replace discrete solid state components. These modifications will not only simplify the system's configuration but also save the Navy money and space. The use of IC's will cut labor outlays, and since only one kind of production line is now required for the key display units, manufacturing economies have been obtained. The Navy has also reduced its cost by purchasing the system in volume over a three-year period. It had previously bought the NTDS on an annual basis. Hughes will not comment on the aggregate amount of dollar savings.

Another improvement in the upcoming NTDS is the provision for sonar inputs. Previous systems are presumed to have had an anti-submarine warfare capability but they could not plug directly into sonar sensors. The new configuration remedies the deficiency.

A summary console, with a 22-inch, flat-face, multiple-viewing display, which provides battle commanders with better-quality navigation data, is a completely new feature in the third-generation NTDS. It presents immediate information which is far more accurate than that obtainable from a manual, dead-reckoning tracer.

Finally, two standard cabinets will house the symbol generators, pulse amplifiers and sensor data converters that were installed separately in earlier versions of the NTDS. The sensor switchboards that enable console operators to change from one sensor to another are still discrete.

### III. Behind the scenes

The most significant technical feature of the new NTDS, in Heebner's opinion, is its capacity to present sensor data interlaced with

## **100's of times more stable** **100's of times more sensitive** **than conventional microwave power meters**

**new RF  
Microwattmeter  
with  
70 dB range**



**Model 41A**

**High frequency full wave diode detector overcomes stability, sensitivity, and overload limitations of thermal types**

- Frequency range: 100 KHz to 7 GHz
- Power range: 0.01  $\mu$ W (-50 dBm) fs to 10 mW (+10 dBm) fs with a single detector
- Power sensitivity: 0.001  $\mu$ W (-60 dBm)
- Drift less than 0.001  $\mu$ W per hour
- No zero balancing except for fractional-microwatt measurements
- Withstands overloads up to 300 mW
- Can be calibrated from low frequency rf source
- Stable dc output
- Price: \$695.00, fob Parsippany, N. J.

**SEE IT AT THE NY IEEE SHOW — BOOTHS 2J30 - 2J34**

**Full technical details available on request**

**BOONTON  
ELECTRONICS** ||||  
CORPORATION

ROUTE 287 AT SMITH RD.  
PARSIPPANY, N. J. 07054  
TELEPHONE: 201-887-5110  
TWX: 710-986-8241



TC/VCXO

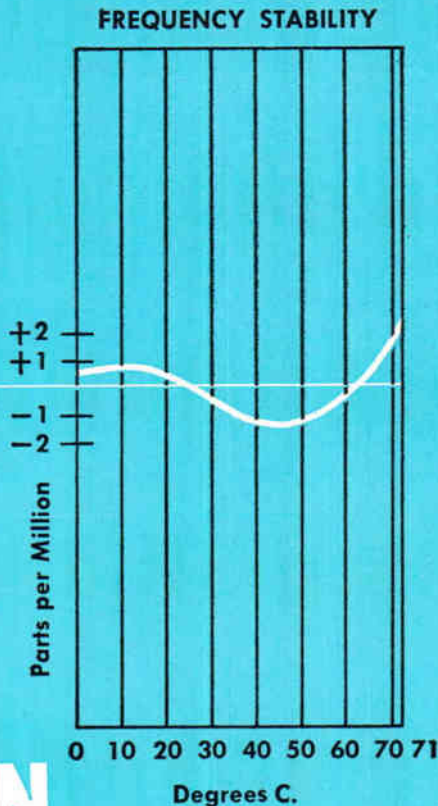

# NO OVEN

# TC/VCXO

Frequency Stability  
within  $\pm 2 \times 10^{-6}$   
over 0 to 71°C range



Typical TC/VCXO Model 5968WA  
Center Frequency: 6.8 MHz  
Size: approx. 2½" L x 1¼" W x ¾" H

If space and power are limited in your telecommunication system, consider the advantages of the Damon Temperature Compensated Voltage Controlled Crystal Oscillator (TC/VCXO). This rugged, miniaturized unit provides a frequency deviation of  $\pm 100$  Hz about center frequency and maintains a stability comparable to that of an "ovenized" unit without the need for added circuitry and power.

The illustration, above, shows a frequency stability curve for a simple Damon TC/VCXO. To achieve comparable frequency stability an "ovenized" unit would require more space and more power.

Tight temperature compensation is only one example of Damon VCXO capability. Low noise, small size and increased reliability are other Damon VCXO accomplishments. Perhaps your telecommunication system suggests new VCXO problems? Consultations between circuit designers and Damon engineers are the best route to proper VCXO selection. As a starter, may we invite you to write for the Damon VCXO Brochure. Damon Engineering, Inc., 240 Highland Avenue, Needham Heights, Mass. 02194 (617) 449-0800.

# DAMON

computer-generated data without degrading the accuracy of either.

Another major feature, according to John Molloy, Navy marketing manager at Hughes' Data Processing Products division, is that the system is entirely digital. "We make the digital conversion at the sensor end, and by switching all data into a common digital format, get a general-purpose display. This makes for greater accuracy and cuts out noise," Molloy reports.

While analog sweep signals may vary from one sensor to another, they are all converted so the displays will have only to handle a variety of digital pulse trains. If the conversions were not made at the sensors, each console in the system would have to incorporate electromechanical assemblies. This would tend to aggravate maintenance problems. The same techniques that have been successfully applied to radar and television inputs are now being used on integrating sonar.

**IC's for logic.** "The consoles have as much digital equipment in them as the average small-scale computer," Heebner says. The display, a one-gun cathode-ray tube, is actually digital because the beam's analog deflection amplifiers are driven by a series of digital pulses. In addition, digital data services both the computer and the display. Digital logic in each console converts operator actions into 30-bit words for processing by the computers. In the third-generation system, IC's are being used in the logic assemblies. The new NTDS is reportedly twice as reliable as its predecessors.

The NTDS represents something of an embarrassment of riches for the Navy. Basic hardware modifications would throw a huge investment in software overboard, so a gradual policy has been adopted on design changes. The Navy is now doing its own programming, and one reason for this, a Hughes man surmises, is that the service believes it is easier to teach a crewman programming than it is to teach a civilian programmer military doctrine.

**Multimission.** Although originally a mobile air-defense system, the NTDS has been assigned a role in a flock of additional missions, including amphibious, electronic and anti-submarine warfare.

**It's a fact! ITT Jennings has more experience in using the vacuum dielectric than anyone else in the world . . . and when it comes to high-voltage switching and control — any kind, any description — nothing else comes close to the compact size, speed and reliability of vacuum components.**

Any time you have a switching or capacitor application where voltage is high, reliability is a must, and space is minimal — you will find an ITT Jennings vacuum device just right for your requirement. Check the features possible with the vacuum dielectric: High voltage ratings • High rf current ratings • Long contact life • No contact maintenance • Impervious to environment • Faster operation • High capacity change ratios • Compact design . . . and many others, **plus ITT Jennings'**

more than 24 years experience in the design, manufacture, and testing of vacuum electronic components.

If you want unequalled circuit design freedom, find out how Jennings can help with such components as: **Vacuum Relays** for high-voltage switching applications in airborne, mobile, or marine communication systems —



**WE'VE  
GOT  
PLENTY  
OF  
NOTHING**

with new models available for almost any industrial or commercial relay application.

**Vacuum Capacitors** for the utmost in performance in rf generating devices such as high power transmitters and dielectric heating equipment. **Vacuum Contactors** for the most reliable means available for the remote control of high voltages from 60 cycle through rf and in applications ranging from antenna switching to motor controls. **Vacuum Interrupters** for many applications in the utilities field including sectionalizing, underground distribution control, paralleling, capacitor bank switching, and others. **Vacuum Coaxial Relays** for automatic, remotely

controlled coaxial switching in antenna and transmitter equipment for communications systems.

ITT Jennings probably already has a vacuum device to meet your reliability and size requirements; if not, no one is more experienced or qualified to find one. For information on any of the above vacuum components, or our complete catalog, write to ITT Jennings, a division of International Telephone and Telegraph Corporation, 970 McLaughlin Avenue, San Jose, California 95108.



**JENNINGS ITT**

DOW CORNING

## Silastic® 1603 silicone rubber insulation is

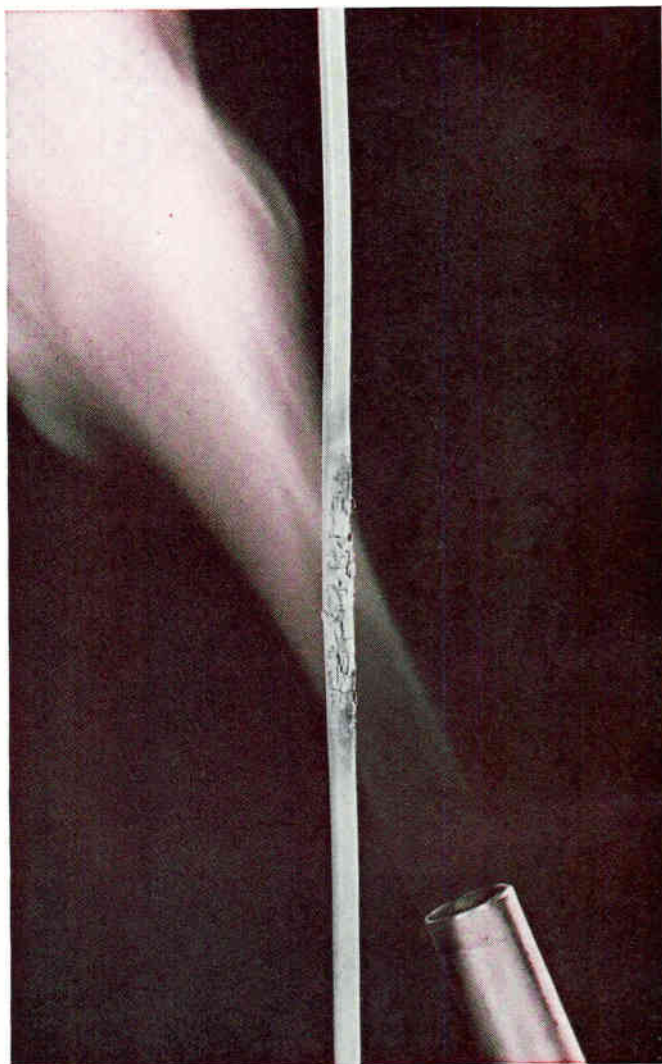
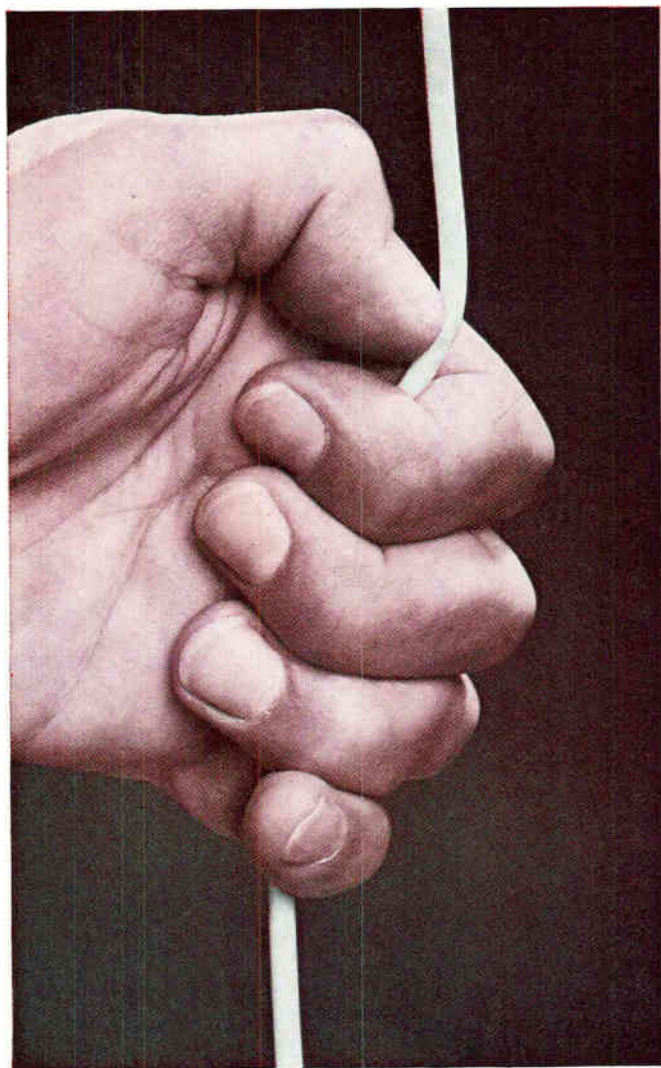

**... tougher than nails ... and flame retardant!**

This **NEW** Silastic brand silicone rubber insulation takes torture tests without cutting, crawling, oozing or burning. You can now specify braidless silicone rubber insulation for those tough applications... and the hot ones, too.

Typical properties of Silastic 1603 rubber are: 65 durometer hardness; 1300 psi tensile strength; 125 ppi

tear strength; 350% elongation; only four inch flame travel and zero seconds burn time in the U.L. vertical flame test. Combine these physical properties with 500 volts per mil and 17 kv insulation breakdown ratings —both after immersion for 24 hours in water—and you have an excellent wire insulating material. Add silicone rubber's resistance to ozone,

moisture, chemicals and corrosives, heat, cold, heat-aging, and you have an ideal insulation for appliances, motor lead wire and high voltage hook up wire.

For further information, write to: Dept. 3714, Engineering Products Division, Dow Corning Corporation, Midland, Michigan 48640.

# Numbers game comes to naught

Industry apathy has stymied the lengthy efforts of the Electronic Industries Association to register IC's

Robert Henkel

Washington regional editor

**Attempts** by the Electronic Industries Association to register integrated circuits have so far failed to get results. Although EIA officials talked of issuing type numbers for "several hundred" IC's when the registration program was announced in December 1965, not one circuit number with the 6N prefix for IC's has ever been put out. In fact, there is still no IC with a data sheet written to the EIA format. The latest word is that the first numbers "may" be issued sometime this year.

Registration is supposed to be the first step toward greater standardization of IC's. Nonstandardization, the reasoning goes, generally results in higher unit costs and a fragmented market, factors that make it difficult for IC customers to develop more than one supply source.

There has been some debate—but no real outcry—about the delay in the registration program. One reason for this is the absence of the kind of pressure exerted by the Pentagon to obtain registration of discrete semiconductor devices during the 1950's.

Edmund E. Farrell, marketing manager for Stewart-Warner Microcircuits Inc., a subsidiary of the Stewart-Warner Corp., thinks that the new policies of the Defense Department, together with the advent of large-scale integration, will work against the adoption of standardized circuits. One big argument for standardization, Farrell notes, is that with it, spare parts could be plugged into existing systems. But the Pentagon is no longer stockpiling components; it is banking on redundancy within systems and on throwaway modules. "The drive for standardization is a hangover from transistor days," says Farrell, add-

ing that he hasn't been aware of any real pressure for it except from relatively unsophisticated buyers of IC's.

## I. Industry: pro and con

The Lockheed Missiles & Space division of the Lockheed Aircraft Corp. buys large quantities of IC's but sees no real need for registration. The unit feels that technology is advancing so rapidly and new devices are being introduced so quickly that the EIA and suppliers are hard put to process data before it is outdated. Lockheed gets current specifications by going directly to the vendor. A staff engineer at the division suggests that the EIA shorten the registration period because better devices might become available in the interim.

"You certainly can't be opposed to standards," says Robert C. Baron, director of modular products at Honeywell Inc. But he sees problems in the question of which IC's and which specifications should be accepted. Obviously, he points out, there would be complaints from manufacturers who had to change their IC's to conform to standards that perhaps competitors had already met.

"If they try to specify the same level as for transistors," Baron says, "they'll have to overspecify or underspecify and hope that IC makers will fill in the gaps." Baron feels that the Government is the only agency able to force something like registration. He does, however, give the EIA full credit for motivation: "If by instituting standards, we're trying to guarantee that only a few types of IC's are in use, we'll fail. But if we're trying to guarantee that when a manufacturer and user sit down to talk, they talk on the same terms, then I believe

that's a very good idea."

**A funny thing.** "A system—standardized in families by name or number—would be ideal because we could buy the entire slice to offer greater savings to our customers," says Edward Martin, product manager at the Microelectronics division of the Bunker-Ramo Corp., a custom packager of IC's. On the whole, however, the company hasn't found the lack of standardization a serious obstacle, he says, since its customers have usually chosen the type of chip best suited to their needs before coming to Bunker-Ramo. Nevertheless, Martin would still like to see metalization patterns and bonding diagrams of the chips in all IC literature. "It's a funny thing that manufacturers don't provide it," he says. "We need to know the size of the chip, what it looks like and how big the lands are before we try to use it."

On behalf of the manufacturers, Murray Siegel, industrial applications manager at the Fairchild Semiconductor division of the Fairchild Camera & Instrument Corp., puts matters this way: "Devices are moving forward at such a dynamic pace that by the time you have the information you would like to register, the device itself is a part of the passing parade. We come up with a new family about every six months and we just don't like to register obsolete data." Siegel says to those who urge standardization: "Baby, we can't even stand still; we're moving like a frog."

Fairchild takes the position that the knowledgeable user treats data sheets as a guide, and, after deciding on his requirements, goes to the vendor to negotiate individual specifications.

Seeing the situation in a some-

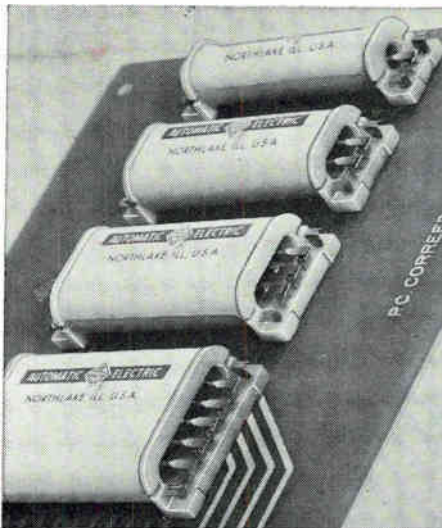

PC Correed switches with Nylafil bobbin by Automatic Electric, Northlake, Illinois. Molded by Mayfair Molded Products, Schiller Park, Illinois.

## Automatic Electric Switch has Nylafil® Bobbin

Low moisture absorption, strength  
stability and heat resistance

Automatic Electric's unique dry reed switch is housed in a bobbin injection molded from Fiberfil Nylafil (fiberglass reinforced nylon). The FRTP material has high mechanical strength and heat resistance, as well as low moisture absorption and dimensional stability... all important properties for switches used in electronics industries.

Nylafil is just one of the many fiberglass reinforced thermoplastics, pioneered and developed by Fiberfil. There is a full line of familiar structural plastics such as ABS, polystyrene, styrene-acrylonitrile and others, all incorporating glass fibers in the molding compound to give the molded part greatly improved physical properties.

Compare Physical Properties

Property	Unit	Unreinforced Nylon Type 6-10	Nylafil G-2/30 (type 6-10)
Tensile Strength @ 73°F	PSI x 1000	8.5	19.0
Izod Impact Strength @ 73°F (1/2" x 1/2" bors)	Ft. Lb./In.	1.2	2.5
Water Absorption 24 hrs.	%	0.4	0.2
Coef. Linear Thermal Expansion	In./In./°F	5.5 x 10 <sup>-5</sup>	1.33 x 10 <sup>-5</sup>
Heat Distortion Temp. @ 66 PSI	°F	300°	437°

FRTP's were pioneered and patented by Fiberfil, so only Fiberfil can give you complete technical data, practical experience and a full line of reinforced materials. Send for your free copy of the Fiberfil Engineering Manual. Fiberfil Co., Div. Rexall Chemical Co., Evansville, Indiana 47717.



Fiberglass Reinforced Thermoplastics

## ... it may be too late to implement registration of integrated circuits ...

what different light, R. Edward Shaut, product sales manager at the Transitron Electronic Corp., another manufacturer, comments: "We're all for standardization, but it may be too late to implement registration of IC's." He notes that some users have raised the question but that there has been no determined pressure for standardization.

"Obviously we are in favor of registration if it can be practically implemented," asserts Steve Levy, Motorola Inc.'s integrated-circuit department manager. "In fact we are pushing toward it, as evidenced by the number of our people serving on the EIA committees." However, Levy says the company's representatives can't recommend registration because so far there isn't a practical format of detailed recommendations.

### II. Miscalculation

The fact is that the EIA and the industry—both circuit users and suppliers—greatly underestimated the complexity of the problems involved in registering IC's. New packages and higher-speed devices have arrived at a far faster rate than was anticipated by the association and its various committees.

After many months of debate, the first IC format was released in September 1965 by a committee of the Joint Electron Device Council. The EIA assumed control of this committee in January 1966 and the problem of IC registration was assigned to an engineering committee of the association's microelectronics subdivision.

Covering semiconductor integrated logic gating circuits, the first format provided an 11-page registration outline plus two standard test methods for measuring direct current and dynamic characteristics. "We attempted to provide a really clean format, a standardized method of presenting data, tests and parameters," says C. Everett Coon, the engineer running the registration program for the EIA. Expectations of rapid progress were at least partially based on the erroneous premise that IC's could be treated like discrete semiconductor

devices, which required only a two-page format.

Aside from being lengthy, the format is also proving troublesome because it covers characteristics or descriptions for which IC suppliers often don't have information. Moreover, each firm presents its data differently.

The upshot is that additional material, which some manufacturers feel is irrelevant, must be collected for registration. The EIA's procedure, developed by IC engineers with the cooperation of customers, is divided into two parts: the reservation of numbers, a four-month process; and registration, requiring one more month. Several manufacturers have reached the point where they need only complete the registration statement, Coon says. But no one has yet taken the final step. The two dozen or so letters received by the EIA asking for type-number reservations for IC's are, in Coon's opinion, trial balloons.

**Second format.** Another difficulty has been that the format for gating circuits covers only about 70% of all digital IC's. However, the association will soon issue a format covering bistable devices, which account for another 15% or so of the total number of digital IC's.

Also delaying progress is that fact that the registration system doesn't take into account company families of logic circuits. For the past nine months, the EIA has been studying a designation system that would be more appropriate for such groupings. But because many IC's are on the borderline between digital and nondigital categories, the association has shelved a tentative plan to use the 7N prefix for nondigital units.

Last October, the EIA released its first format for nondigital IC's—direct-coupled, open-loop amplifiers and operational amplifier circuits. Two more nondigital formats are close to being issued, Coon says, but "a multitude of them will be needed to cover the entire area."

Despite the delays, Coon is still willing to bet that type registrations for IC's will be released sometime during 1967.



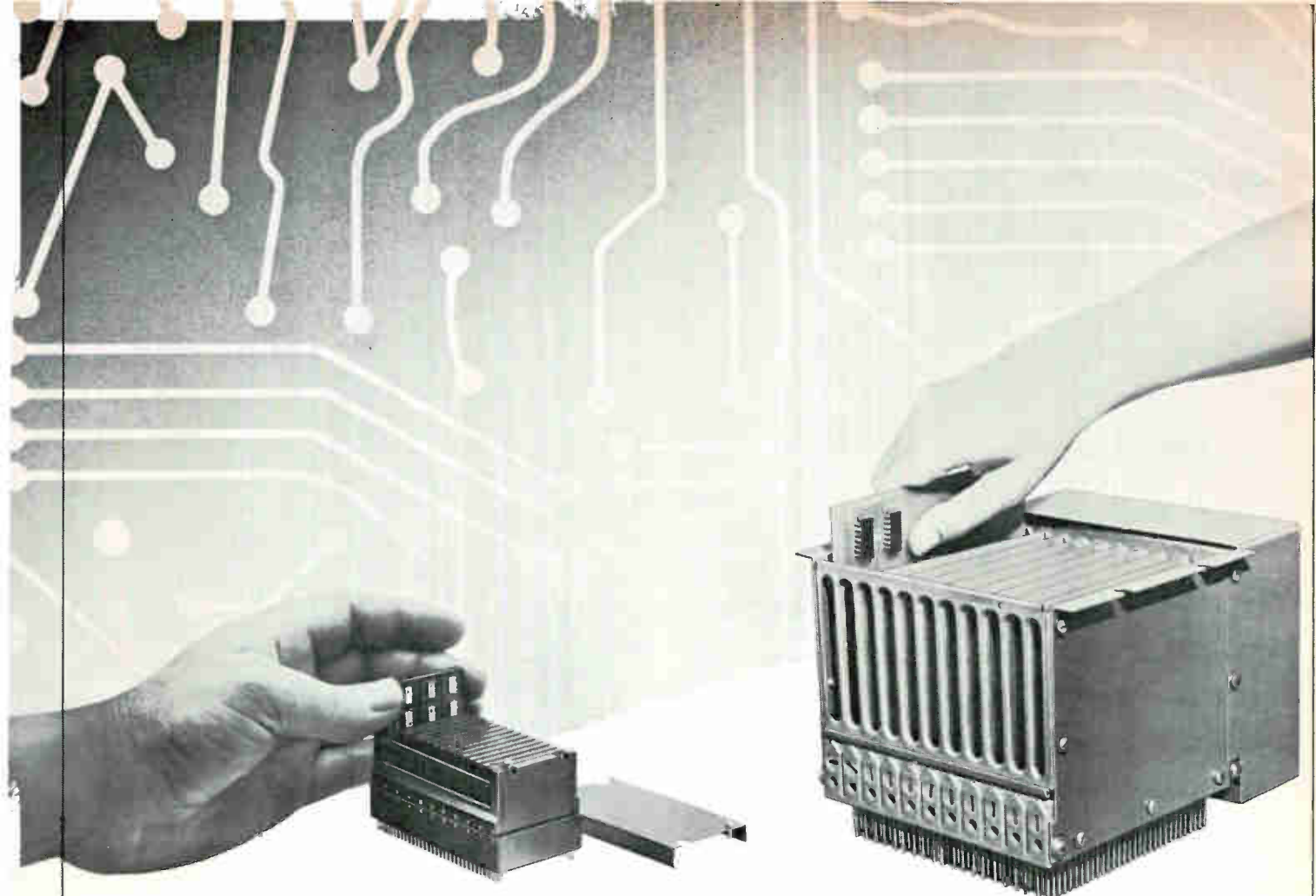

Meet the challenge of change...

Wrap up your integrated circuits with a helping hand from ITT Cannon

**Lightweight aircraft and space applications?  
Specify the CHICO Pac!**

The new CHICO Pac meets industry's need for a high density standardized system which enables designers to effectively package integrated circuits as well as discrete components. CHICO Pac eliminates the major bottlenecks which have

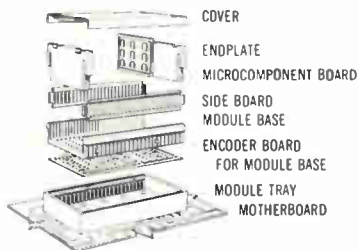

blocked full utilization of today's integrated circuit packages... meets the four key requirements demanded by every packaging and systems designer: reliability, versatility, maintainability and size/weight reduction.

**Versatile low cost for 2-sided PC boards?  
Specify CAM-RAC™ Modules!**

The lightweight aluminum CAM-RAC integrated circuit packages offer the same benefits of the CHICO Pac but in larger, economical modules. Cam actuation of the contacts in the CAM-RAC modules assures zero mating and unmating forces. Contacts do not engage the printed circuit pads until they are actuated by the cam system. Discrete components, as well as ICP's, can be accommodated in CAM-RAC modules which contain up to 10 two-sided printed circuit boards from 4" x 5" to 12" x 15" card size. The fully shielded module and circuit boards minimize crosstalk and RFI. For the complete package, write ITT Cannon Electric, 3208 Humboldt St., Los Angeles, California 90031.

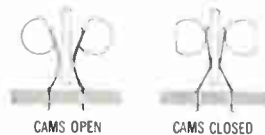

A division of International Telephone and Telegraph Corp.



**CANNON ITT**

# IRAW

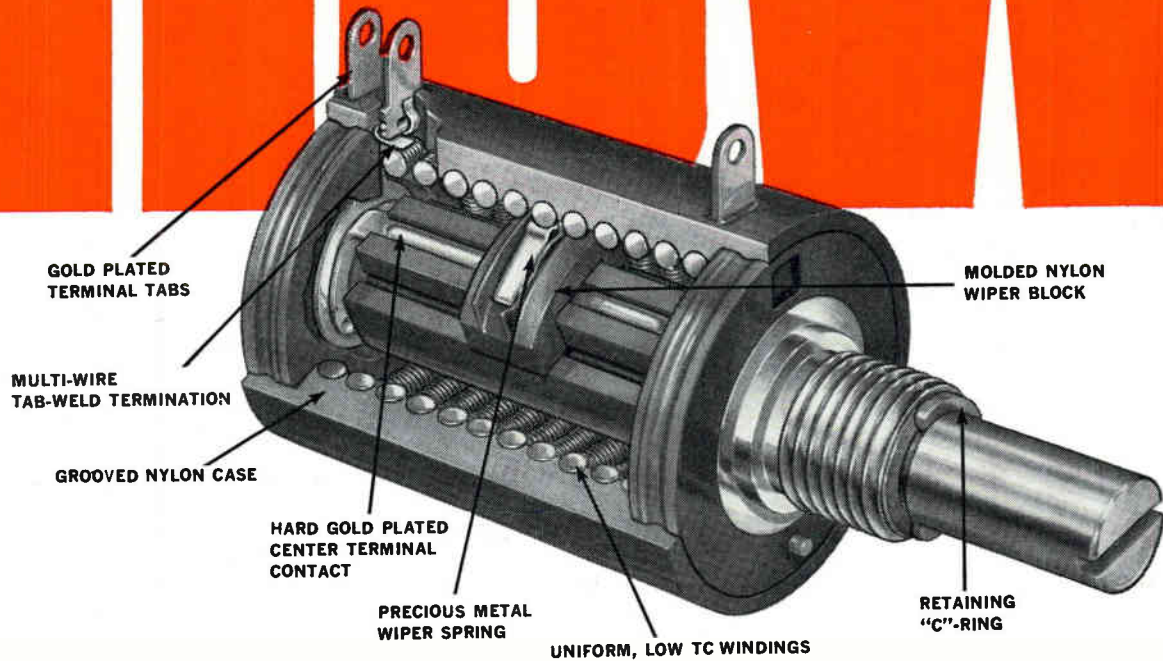

## LOW-COST 10-TURN POTENTIOMETER

*7/8" diameter, 0.25% linearity, plus long life*

Here's a rugged high-performance potentiometer that means space and cost savings for your industrial and commercial applications. With only 1 1/8" projection behind the panel, this 7/8" diameter unit has stability and reliability features normally found only in MIL-type units.

- Rugged nylon housing and end plate—withstands rough handling and mechanical abuse.
- Grooved case—maintains uniformity of wire windings and provides for  $\pm 0.25\%$  independent linearity.
- Tab-weld termination—means low end resistance and easier external connections.
- Longer winding—20"-long, low TC wire provides better stability and resolution over the entire resistance range.
- Precious metal wiper spring—assures better contact and long rotational life.
- Retaining "C"-ring—prevents possible snap-out of rear plate.

Immediately available, this new IRC precision potentiometer has popular side terminals and a 1/4" diameter shaft that permits knob or screwdriver adjustment. Write for data and prices. IRC, Inc., 401 N. Broad St., Philadelphia, Pa. 19108.

### CAPSULE SPECIFICATIONS IRC TYPE 8400

SIZE	7/8" diameter
TURNS	10
POWER	2 watts @ 25° C
INDEPENDENT LINEARITY	$\pm 0.25\%$
TOLERANCE	$\pm 5\%$
RESISTANCE	100 to 100K $\Omega$
END RESISTANCE	0.1% or 2 $\Omega$ (whichever is greater)



# Synthesize your own active filter

External resistor and capacitor connected to miniature active resonator produce a wide variety of active filters

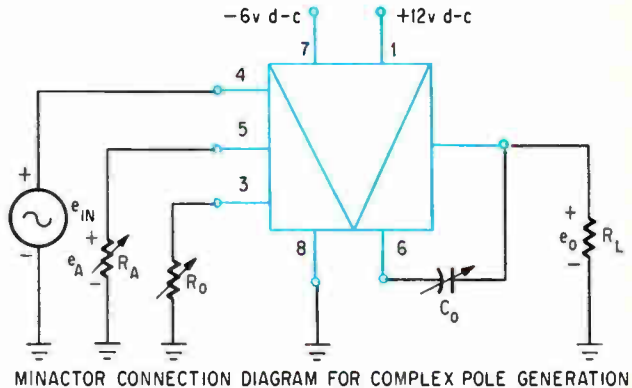
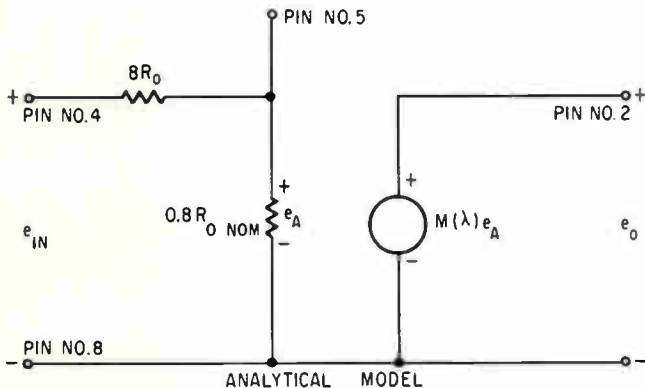

**Design from scratch** was once the rule for active filters. This was not only costly, but it was always a tedious time-consuming job that often produced unsatisfactory results. Now all an engineer has to do is decide on a filter configuration, reach for a new miniature eight-pin component, the Minactor, add a few external resistors and capacitors and he has a completely tunable low-pass, bandpass or high-pass active filter. Seventy-five percent of the synthesis, supplied in the form of a characteristic curve shipped with each unit, is already performed by the manu-

facturer, EG&G Inc., Boston.

The Minactor (for miniature active resonator) is a completely encapsulated unit that contains a thick-film resistor substrate, discrete capacitors for fixed frequency operation, and an integrated-circuit amplifier with eight transistors. Each device provides an independent pair of complex conjugate poles and a tunable Q in its voltage transfer function. The resonant frequency can be tuned externally with optimum results from 0.7 to 1.4 of the nominal resonant frequency. The Q of the device can be tuned from less than one to

infinity (the condition for oscillation) at each frequency over the range of 0.25 to 4.0 times the nominal frequency of the unit. [Electronics, Jan. 23, 1967, p. 40.]

Each Minactor measures 0.8 by 0.6 by 0.2 inch and has a 0.1-inch spacing between pins. With 10 nominal units spanning the range of 100 hertz to 18 kilohertz, temperature-stabilized filters can be designed for operation at any frequency in the 70-hz to 25-hz interval.

The combination of resonator and passive components can provide low-pass, bandpass and

## New products in this issue

221 Synthesize your own active filter

### Components

- 224 Contacts dropped from resonant-reed relay
- 226 Trimmer capacitor
- 226 Transistor sockets
- 228 P-c reed relays
- 230 Proximity switch
- 232 Deflection assembly
- 232 Plastic cable ties
- 234 Coaxial attenuator pads

### Semiconductors

- 237 Built-in sensors stabilize IC
- 237 Silicon diodes rated to 5 kv
- 238 Half-amp npn transistors
- 238 Small zener diode
- 239 N-channel FET's

### Instruments

- 241 Programmer with simple touch
- 242 Current sensors
- 243 Phase-tracking receiver
- 243 Transistorized millivoltmeter
- 244 Transducer bridge signal conditioners
- 245 Digital picoammeter

### Subassemblies

- 246 Circuit for brighter crt display
- 246 Frequency standard
- 247 Plotting system
- 248 IC memory modules
- 249 Pulse generator
- 249 Voltage memory card
- 250 Low-pass filters
- 251 Preamp with remote gain switching
- 252 Strip printer with spooler

255 Numerical control

256 Hybrid multiplier

257 Power supply for crt displays

### Microwave

- 258 Radar klystron
- 258 Waveguide terminations
- 258 Fixed-tuned bolometer
- 260 Frequency translator
- 260 Air-strip package
- 262 Pulsed traveling-wave tube

### Production equipment

- 265 Component inserter
- 266 Ultrasonic degreasers
- 268 Component lead welder
- 270 Ultrasonic lead bonder

### Materials

- 274 Long glass pipes light the way
- 274 Epoxy molding powders
- 274 Water-soluble fluxes
- 274 Ruby laser rod

# New Products

high-pass filters; notch filters; low-frequency f-m modulators, low-frequency sine-wave oscillators, low-frequency automatic gain control for specific frequencies, low-frequency f-m demodulators or discriminators and complex pole-zero generators for elliptic filter synthesis.

In the equivalent circuit for the Minactor the output is equal to a function of frequency and a voltage  $e_A$ . The voltage  $e_A$  is a fraction of the input voltage and is

not frequency dependent. When a frequency dependent voltage is desired it can be applied to pin 5. In one typical application, complex pole generation, an external resistor  $R_A$  is connected to pin 5 to attenuate voltage  $e_A$ . Resistor  $R_0$ , connected to pin 3, shifts the pair of poles from left to right in the s-plane and capacitor  $C_0$ , shifts the poles up and down along the  $\omega j$  axis. Pin 8 is a common ground.

Other typical applications, together with appropriate component

values and corresponding wave-shapes, are tabulated.

## Specifications

<b>Bias supply</b>	+12 volts d-c at 5 milliamperes -6 volts d-c at 5 milliamperes
<b>Output maximum</b>	2.5 volts rms to a 10 kilohm load
<b>Short-circuit output noise</b>	1 millivolt rms
<b>Short-circuit d-c offset</b>	±100 millivolts
<b>Minimum peak gain</b>	60 decibels
<b>Price</b>	\$95 in quantities from 1 to 24
<b>Availability</b>	Off the shelf
EG & G Inc., Boston, Mass.	
Circle 350 on reader service card.	

## Minactor applications and output waveforms

Application	Circuit	Waveshapes
1000-hz oscillator	<p>May be turned on and off by a switch placed in series with <math>R_0</math>.</p>	<p>Waveshape is controlled by <math>R_0</math> and the frequency by <math>C_0</math>.</p>
Bessel, 3-pole low-pass filter	<p>Provides minimum delay and rise time in its step response function while maintaining zero overshoot for a given cutoff frequency. Cutoff was chosen at 500 hz. <math>R_0 = 120</math> k, Bessel <math>t_0 = 550</math> <math>\mu</math>sec or 200 k for <math>t_0 = 500</math> <math>\mu</math>sec (shown)</p>	<p>Optimum transient response is achieved by adjusting the Q of the unit.</p>
Bandpass filter	<p>Circuit could be used in telemetry, spectrum analysis or whenever tone filtering is required. Cascading of circuits provides sharper selectivity. <math>Q = 50</math> at 1000 hz.</p>	<p>The bandpass behavior is demonstrated in the time-domain by passing only the 3rd-harmonic component of a squarewave input signal.</p>
1000-hz notch filter (complex pole generator)	<p>Circuit may be used to design elliptic filters (low-pass or bandpass), notch filters or unbalanced all-pass networks. Both the pole and zero are identically adjustable.</p>	<p>The notch filtering is shown in the time-domain by the rejection of the fundamental signal in a triangular waveform, leaving the total harmonic content of the input signal.</p>

# The Predictables.

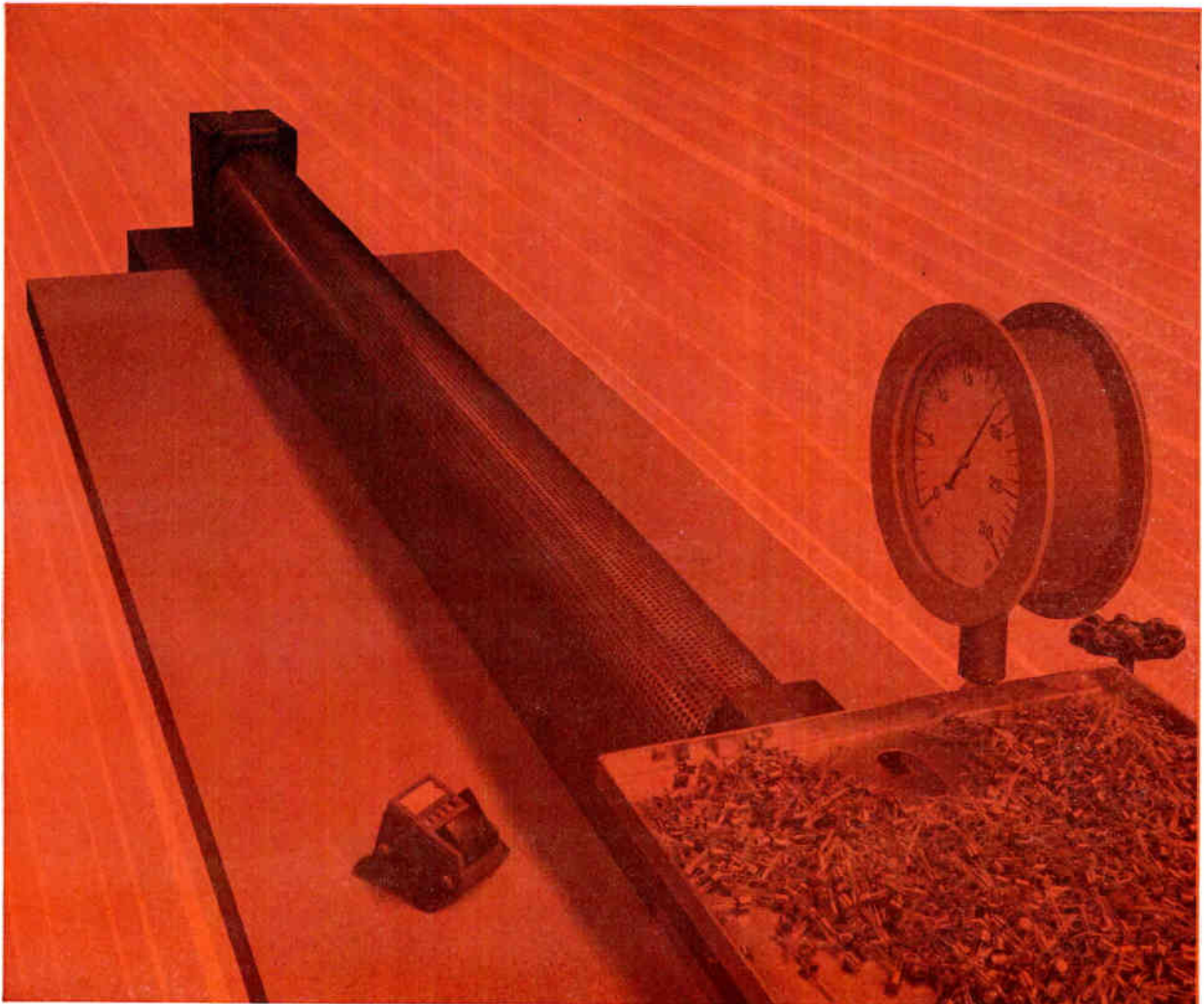

## **NPN planars from ITT are "shot from guns" to prove they can take more abuse than they'll ever get**

Before any ITT small signal transistor goes to final test, our "air rifle" slams it against a plate with 30,000 G's of shock. Then every ITT "predictable" is automatically tested for up to 256 DC & dynamic parameters.

That means you can buy popular transistors like the 2N2222, 2N2369A, 2N3725 and 2N3014 families

with complete confidence. If there's one out of spec, we find it . . . you don't. The ones you get from your ITT distributor or factory representative will be 100% reliable. Why not order some today? ITT Semiconductors is a Division of International Telephone and Telegraph Corporation.

**transistors** **ITT**

FACTORIES IN WEST PALM BEACH, FLORIDA; PALO ALTO, CALIFORNIA; LAWRENCE, MASSACHUSETTS; HARLOW AND FOOTSCRAY, ENGLAND; FREIBURG AND NURENBERG, GERMANY

# Now! TCXO's from Bulova!

Stability:  
±0.5 PPM!



Now you can get Temperature Compensated Crystal Oscillators from Bulova, with all the quality and dependability that have made Bulova the leader in frequency control products. Our new Model TCXO-5 is just four-cubic-inches, consumes only 50 mW, and employs a computer-selected-and-optimized compensation network designed to maintain frequency stability over wide temperature ranges without the need for an oven (±0.5 PPM from -40°C to +70°C). Perfect for aerospace and military applications where power, space and weight restrictions are severe.

## SPECIFICATIONS

Frequency Range: 2MHz to 5MHz  
 Frequency Stability: ±0.5 PPM from -40°C to +70°C  
 Output: Sine Wave, 1VP-P into a 1000 OHM Resistive Load  
 Input: 50 mW  
 Size: Just 4 cu. in.  
 Weight: Only .5 oz.

Other frequencies, output wave shapes, output levels and load impedances can also be supplied.

Write today for more information about Bulova's new TCXO-5, or assistance with any Crystal Oscillator problem. Address: Dept. E-27.

# Try Bulova First!

## FREQUENCY CONTROL PRODUCTS

ELECTRONICS DIVISION  
OF BULOVA WATCH COMPANY, INC.

61-20 WOODSIDE AVENUE  
WOODSIDE, N.Y. 11377, (212) DE 5-6000

## New Components and Hardware

### Contacts dropped from resonant-reed relay

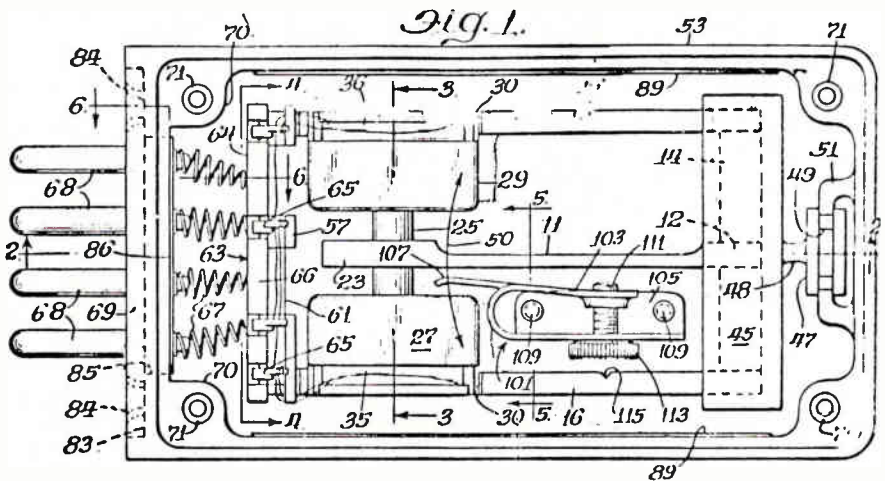

In a contactless resonant-reed relay, reed 11 has a magnet 25 mounted on its end which vibrates at the resonant frequency through the two coils 35 and 36 (input and output). The Q of the device may be adjusted by inserting conducting sleeves of varying thicknesses inside coil bobbins.

The resonant-reed relay is the backbone of selective tone-signaling systems used in telemetry, industrial controls and remote alarms. But the chore of continually replacing corroded contacts on most resonant reeds has been a constant irritation to users. Although at least one other company has already announced a contactless reed relay, this new unit from Motorola Inc. appears to have a major edge. The unit is covered by Motorola's patent No. 3,221,120, granted on Nov. 30, 1965.

Motorola Communications division, the manufacturer, has been using the unit in its own systems since 1965. The company has now decided to go commercial with the "Minitone," model 51087A, available from stock at a price of \$20.

The Minitone, with 207 different units, covers the frequency range

## Specifications

Frequency range	67—3,150 hz
Frequency tolerance	±0.1% (67-230 hz) ±0.05% (230-3,150 hz)
Temperature stability	±0.05% (230-3,150 hz) —30°C to 100°C (25°C ref.) ±0.00075%/°C (230-3,150 hz)
3-db bandwidth	1 hz at 67 hz 3 hz at 3,000 hz
Coil resistance	400 ohms
Nominal input	0.4 v rms below 230 hz 0.75 v rms above 230 hz
Nominal input power	0.2 mw below 230 hz 0.7 mw above 230 hz
Size	1.114 x 0.619 x 0.343 in.

of 67 to 3,150 hertz. The all-important frequency tolerance is ±0.1%, for units between 67 and 230 hz and is ±0.05% for units between 230 and 3,150 hz, which is somewhat better than the ±0.15% tolerance announced for the competing unit.

The relay operates on a simple principle: a permanent magnet attached to the end of the resonant reed vibrates through the center of two coils, input and output. When the input coil is energized at the proper frequency, the coil drives the reed and magnet, which in turn sets up a voltage in the output coil at the resonant frequency of the reed. A well-shaped sinusoid is thus delivered to the output circuit for any control purpose. The unit



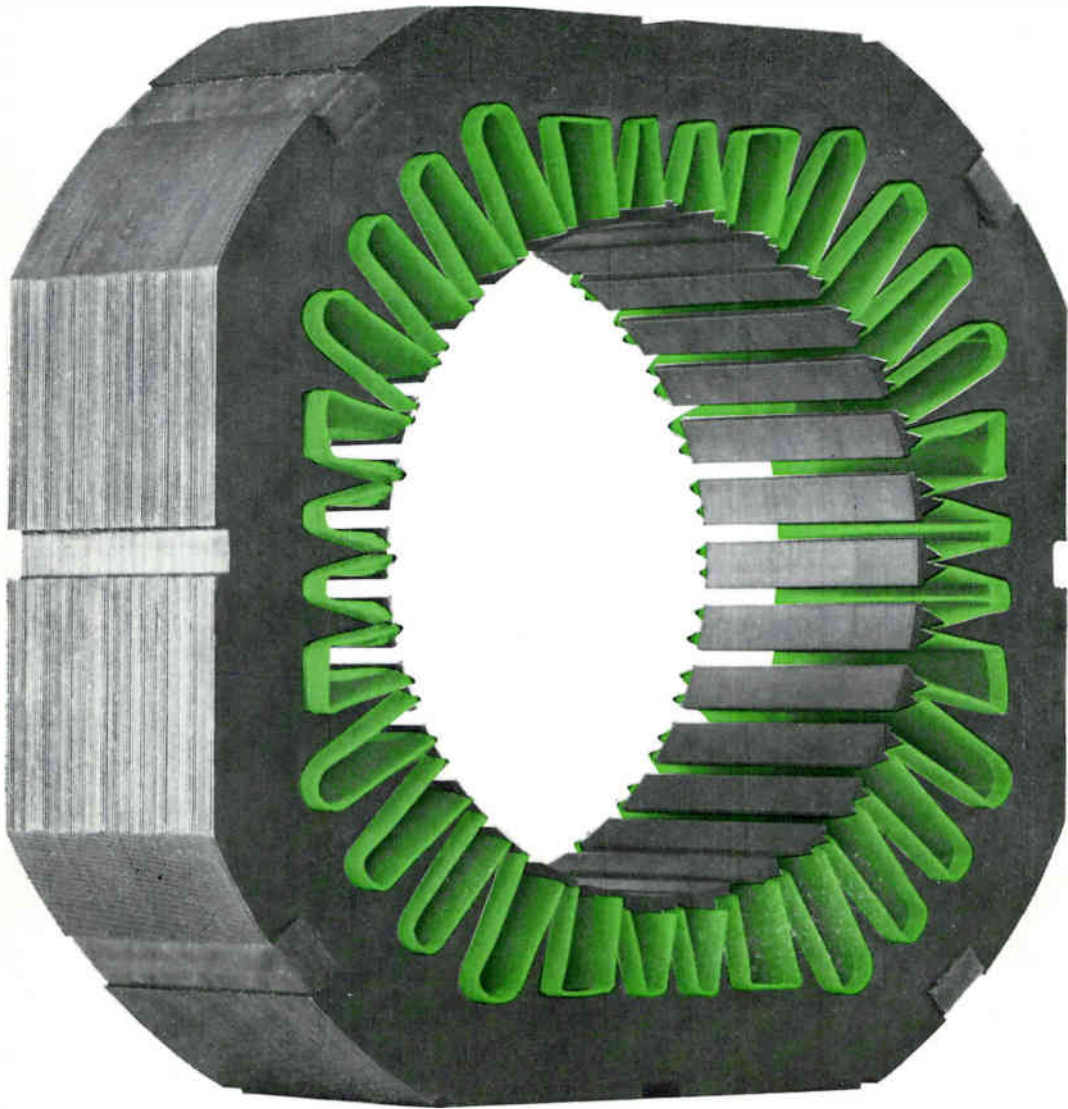

## This stator costs less thanks to a more expensive insulation... **MYLAR®**

Pound for pound, MYLAR\* polyester film costs just a little more than most other materials. But stator for stator, it costs less.

	Cost Per Pound		but	Cost Per Stator	
	MYLAR	Powdered Resin		MYLAR	Powdered Resin
Motor Stators insulated with 7½-mil. MYLAR compared with powdered-resin coating					
Two-Speed Washing Machine 1/3 HP	(\$1.40)	(\$1.25)		\$0.07	\$0.21
General-Purpose, 1/4 HP	(\$1.40)	(\$1.20)		\$0.04	\$0.09
Two-Speed, General-Purpose 1/3 HP	(\$1.40)	(\$1.20)		\$0.08	\$0.13

With thinner, flexible MYLAR you can replace heavier, bulkier insulation materials such as rubber, paper and resins. You can save on the weight, size and cost of your components.

MYLAR has excellent resistance to most chemicals and moisture, and can withstand temperatures from -60°C. to +150°C. In addition, many systems using MYLAR as electrical insulation have received full Underwriters' Laboratory approval for Class A and Class B applications.

Find out how you can save costs and improve reliability. Mail the coupon today for a complete Fact File on MYLAR.

\*Du Pont's registered trademark for its polyester film.



Du Pont Company, Room 3886C  
Wilmington, Delaware 19898  
I'd like to know more about MYLAR. Please send me a Fact File.

NAME \_\_\_\_\_  
COMPANY \_\_\_\_\_  
ADDRESS \_\_\_\_\_  
CITY \_\_\_\_\_ STATE \_\_\_\_\_ ZIP \_\_\_\_\_

The same is true for relays, bus-bars, ballast transformers, step-switches, and many other electrical/electronic applications.

It is possible for you, too, to lower your insulation costs because less MYLAR is required for a given insulation value. The high cut-through resistance and lasting durability of MYLAR enables you to use thinner gauges.

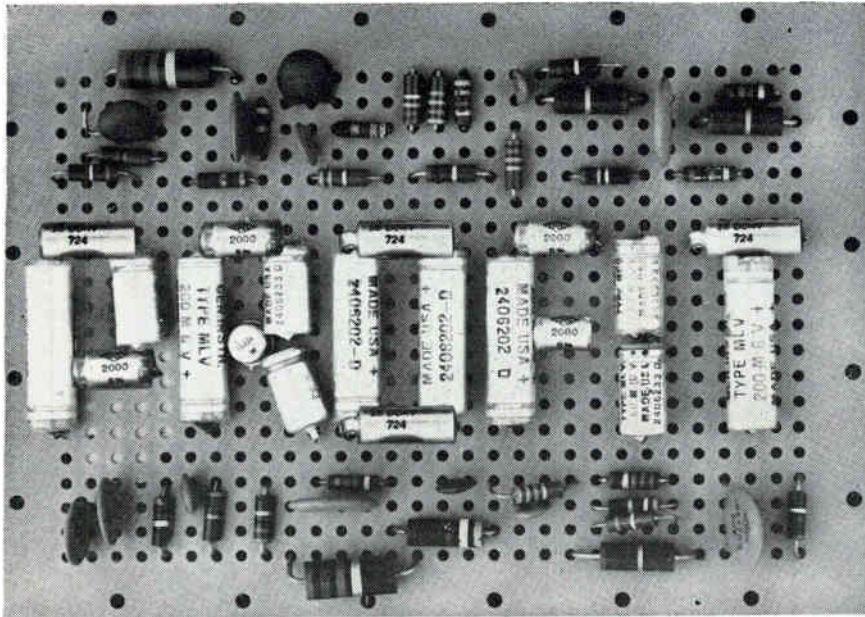

*where industry is never short-circuited...*

Plug-in anywhere in Louisiana and you'll be able to take advantage of:

Louisiana's revolutionary **Right-To-Profit Laws**, which protect industry, large and small, from unfair taxation and excessive government regulation.

Louisiana's money-saving **plant financing programs**. Build the exact production facility you require, without tying up your capital in brick and mortar.

Louisiana's **manpower training program**. Louisiana offers industry a substantial pool of labor, both trained and trainable. Where training is necessary, we'll provide it at no cost to you.

For full information on these and other ways to profit in Louisiana, write to William T. Hackett, Department of Commerce and Industry, Room 214, Capitol Annex, Baton Rouge, Louisiana 70804.

# LOUISIANA

The Right-To-Profit State

## New Components

may also be used as a tone generator.

Motorola Inc., Communications Division, 4900 W. Flournoy St., Chicago, Ill. 60644 [351]

## Trimmer capacitor occupies small space

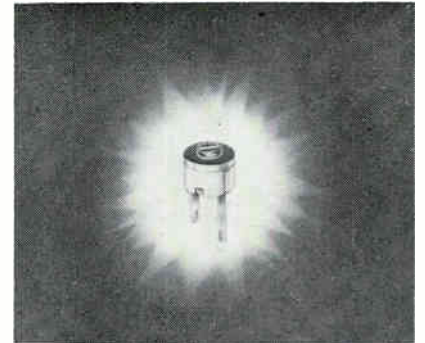

A precision trimmer capacitor, the 518, features 5 to 25 pf capacitance range and occupies less than 0.007 cu in. Diameter is 0.218 in. The unit is rated at 100 w v d-c 85° C and 50 w v d-c to 125° C. It operates efficiently in the temperature range of -55° to +125° C and has a dielectric strength of 200 v d-c to 1 to 5 seconds.

The high capacitance-to-volume capability of the 518 is made possible by the Monobloc process, whereby ceramic film dielectrics are fired into solid structures of one or more layers, yielding high-performance, monolithic dielectrics.

Erie Technological Products Inc., 644 West 12th St., Erie, Pa. [352]

## Transistor sockets weather rough usage

Miniature printed-circuit type and chassis-mount type sockets for TO-5 transistors are offered in a wide variety of panel materials, thicknesses and configurations. They are designed for airborne and severe-service applications and are reliable under the most rugged conditions, according to the manufacturer.

Over-all dimensions are as small



any  
other  
resistor  
would  
holler  
**UNCLE...**

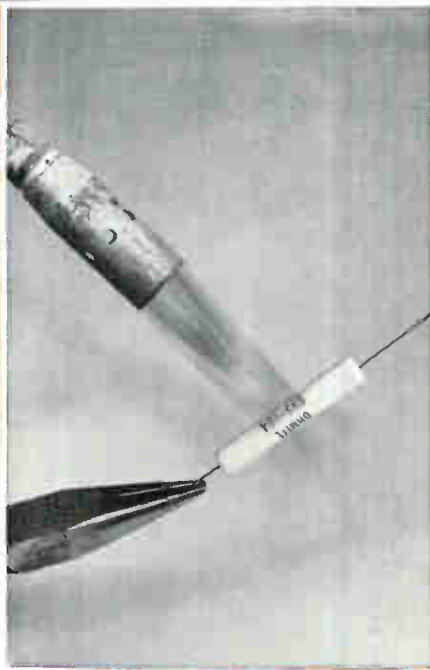

but not  
the "99"



**molded\*** in  
vitreous  
enamel

\*Patent No. 3,229,237



The Series 99 is the resistor that won't soften or deform at a cherry-red 1500°F... that clings to its markings like a leopard to its spots against the onslaught of solvents, abrasion, and extreme overloads. This is the resistor that laughs at abuse because of its tough, exclusive "molded" coating of vitreous enamel. This is the resistor of such uniform shape and size that metal clips can hold it securely and also provide a big increase in heat dissipation.

No wonder design engineers throughout industry are hollerin' for the resistor of incomparable performance

—the Series 99, molded in vitreous enamel.

Series 99 is supplied in commercial, MIL-R-26, and close tolerance types. *Commercial units are stocked in 5 sizes and 146 resistance values.*

**WATTAGES (COMMERCIAL):** 1.5, 2.25, 3.25, 5, 6.5, 9, 11 watts at 25°C.

**RESISTANCE RANGE:** 0.1 to 187K ohms.

**TOLERANCES:** 0.25% to 5%

**TEMPERATURE COEFFICIENT:** 0±30 ppm/°C at 25°C to +350°C for 10 ohms and above.

Write for Bulletin 103

**RHEOSTATS • POWER RESISTORS • PRECISION RESISTORS • VARIABLE TRANSFORMERS • RELAYS  
TAP SWITCHES • TANTALUM CAPACITORS • SEMICONDUCTOR CONTROLS • R.F. CHOKES**

**OHMITE** MANUFACTURING COMPANY  
3610 Howard Street • Skokie, Illinois 60076  
Phone: (312) ORchard 5-2600



# Automate Your Precision Operations with **KÄHLE** FULLY AUTOMATIC PRODUCTION MACHINES

Performance  
Proven on  
Miniature  
and Sub-  
Miniature  
Electronic,  
Glass and  
General  
Industrial  
Components  
and  
Finished  
Products



This Kahle precision machine produces a two-piece component lead wire by butt welding a pre-cut slug of molybdenum to a Dumet wire. The pre-cut slug is automatically fed into a six-head indexing turret. The Dumet wire is straightened, cut and welded to the slug. Available for all types of miniature and sub-miniature lamps.

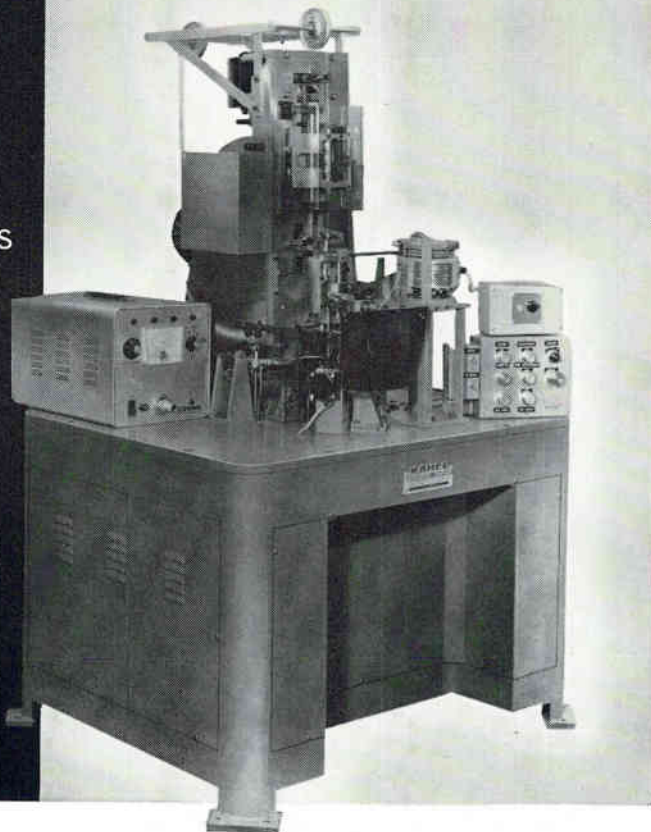

## KAHLE Automatic Production, Assembly and Quality Control

Ask KAHLE to recommend improved methods of production that will save you time and money. Fully automatic KAHLE machines can be supplied to assemble, inspect and test your components.

## KAHLE Machines are Customer-Approved under Actual Operating Conditions

Your equipment is run in our factory, using your materials in the presence of your engineers; the machine is not shipped to you unless you approve it!

**SAVE TIME AND MONEY**— Let professionals build your specialty production equipment for automation!

**KÄHLE**

Designers and Builders  
of Automatic Equipment  
for High Speed Production  
for Over 30 Years

**Kahle Engineering Company**

3324 HUDSON AVE., UNION CITY, N. J. 07087

Telephone: (201) 867-6500

KAHLE EUROPEA — Via Spartaco 16, Caravaggio (Bergamo), Italy

## New Components

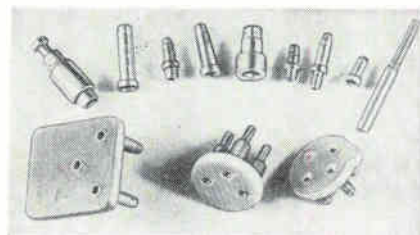

as 1/4-in. high and 3/8-in. diameter. All contacts are machined beryllium copper, hard gold plated. Sockets are available with straight terminals for dip-soldering with turret terminals for soldering in a pot, or with terminals to be riveted. Body material is normally G-10 glass epoxy. Leads may be any length from 0.125 in. upwards. Robinson Nugent Inc., 802 E. Eighth St., New Albany, Ind., 47150. [353]

## P-c reed relays offer speed, small size

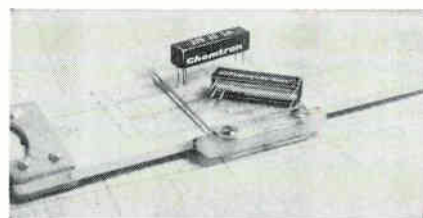

Printed circuit reed relays with a switching time of less than 0.5 msec (including bounce) are suited for aerospace and computer applications. The relay measures 0.8x0.2 in., has 0.1-in. pin spacing and simplifies p-c board layout. Direct p-c mounting eliminates the changes in reed characteristics resulting from cutting and bending axial-type leads.

To form an integrated assembly, the mounting pins are welded to the reeds and the relay is vacuum-encapsulated in epoxy resin. Voids in the encapsulant and stresses on reeds and mounting pins are eliminated during manufacturing. Automatic soldering does not change reed characteristics.

The reed's electrostatic shield minimizes coil-to-reed capacitance for low-loss switching of r-f or low-level a-c signals. A magnetic shield prevents erratic operation when the

# STEP UP

TO WIDER RANGES  
GREATER ACCURACY



## Model 630-NA

VOLT-OHM-MILLIAMMETER  
PRICE \$85.00

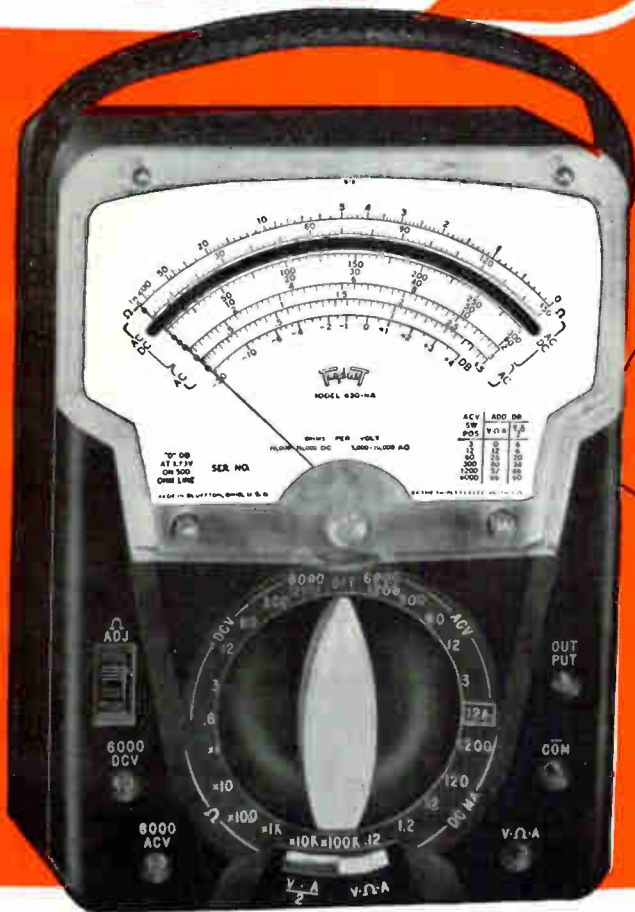

EXCLUSIVE PATENTED  
.....  
Bar-Ring Shielded Movements

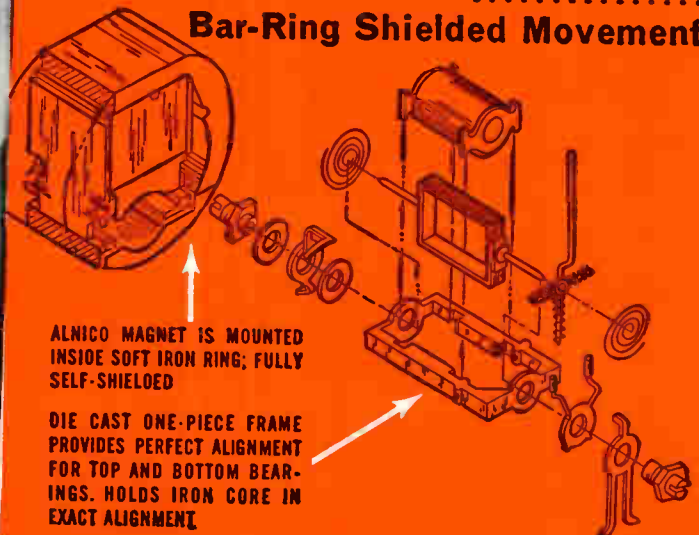

ALNICO MAGNET IS MOUNTED  
INSIDE SOFT IRON RING; FULLY  
SELF-SHIELDED

DIE CAST ONE-PIECE FRAME  
PROVIDES PERFECT ALIGNMENT  
FOR TOP AND BOTTOM BEAR-  
INGS. HOLDS IRON CORE IN  
EXACT ALIGNMENT

## FACTS MAKE FEATURES:

- 1** 70 RANGES—nearly double those of conventional testers. Un-breakable window. Mirror Scale.
- 2** HIGHEST ACCURACY—1½% DC to 1200 volts, 3% AC to 1200 volts; mirror scale and knife-edge pointer to eliminate parallax.
- 3** FREQUENCY COMPENSATED—Flat from 20 CPS to 100,000 CPS; varies from ¾ to 1¼ DB at 500,000 CPS. Temperature compensated. Meter protection against overloads.

THE TRIPLET ELECTRICAL INSTRUMENT COMPANY, BLUFFTON, OHIO

### Uses Unlimited:

- FIELD ENGINEERS ■ APPLICATION ENGINEERS ■ ELECTRICAL, RADIO, TV, AND APPLIANCE SERVICEMEN ■ ELECTRICAL CONTRACTORS ■ FACTORY MAINTENANCE MEN ■ INDUSTRIAL ELECTRONIC MAINTENANCE TECHNICIANS ■ HOME OWNERS, HOBBYISTS

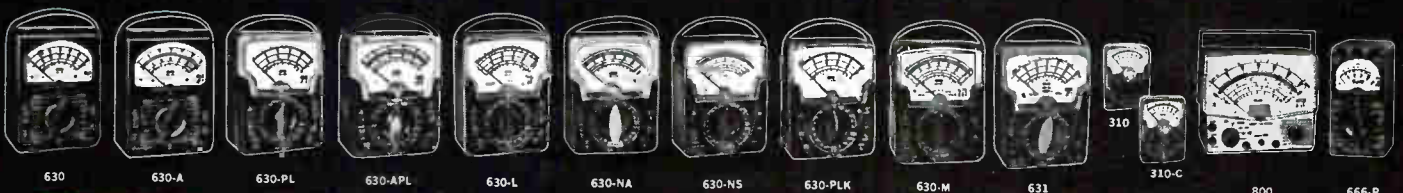

THE WORLD'S MOST COMPLETE LINE OF V-O-M'S. AVAILABLE FROM YOUR TRIPLET DISTRIBUTOR'S STOCK

# XEROX 2400 copier/duplicator relies on VICTORY THERMISTORS



## so can you

When Xerox required a dependable, precise and fast-acting temperature sensing device, they brought a space age product "down to earth".

If your products require precise temperature measurement, control or compensation with FAST RESPONSE it will pay you to investigate VECO thermistors. VECO supplies a wide range of standard thermistors in various sizes, shapes, temperature coefficients and resistance values.

VECO's engineering staff is available to assist you in product application and circuit design.

Xerox and 2400 Reg. T.M. Xerox Corporation

Write for Catalog MGP681

VECO First in Progress • First in Service



**VICTORY ENGINEERING CORP.**

122 Springfield Ave., Springfield, N. J. 07801  
Tel: 201-379-5900 TWX 710-983-440

7546

## New Components

relay is near another relay or in a magnetic field, and also serves as a protective housing. The spst contact rating when normally open is 250 ma at 250 v max into a non-inductive load. A 12-v coil is standard. The Chemtron 225 relay is designed to withstand rugged environmental conditions.

Self-Organizing Systems Inc., Box 9918, Dallas, Texas, 75214. [354]

## Switch can sense without touching

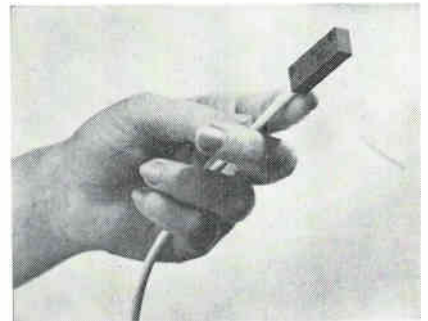

An inexpensive a-c/d-c magnetic proximity switch checks, counts and positions moving devices with high reliability. When operated within specified tolerances the permanent-magnet device has a life of many millions of operations.

Designated model 01041, the  $1\frac{1}{2} \times \frac{1}{2} \times \frac{5}{16}$  in. switch is easily installed in any position behind any nonferrous shield. It accurately detects the presence of a specific magnetic body at a predetermined distance from a reference point. Repeatability is  $\pm 0.002$  in. Unaffected by shock and vibrations up to 50 g's, the encapsulated switch will operate while immersed in any fluid or under pressure and is not affected by dirt, grease, oil, paint sprays, or other contaminating substances.

Available off the shelf in both the normally-open and normally-closed positions, the switch can be used on liquid level devices, measurement control equipment, machine tools, counters, material handling equipment, electrical interlocks, positioning controls, or industrial processing equipment.

The switches are normally sup-



For those who think big—about availability, that is. Babcock's 1/6-size Model BR10 with unique universal contacts gives you "nonstop" load performance dry circuit to 1 amp. in the same unit. Now, you can order *one* relay to meet all your high-density circuit-board requirements —at no cost premium. And you'll find that this subminiature unit has everything... MIL-R-5757 conformance, unitized construction, solder-sealed or welded versions, standard circuit-board grid pattern, and a wide choice of terminal and mounting styles. Get more information about

the BR10, and the complete Babcock line of relays, all with universal contacts. Write Babcock Relays, Division of Babcock Electronics Corp., 3501 Harbor Blvd., Costa Mesa, Calif.; (714) 540-1234.



#### SPECIFICATIONS

SIZE: .405" h. x .500" l. x .230" w.	PULL-IN POWER: Low as 80 mw.
WEIGHT: Approx. 0.15 oz.	LIFE: To 150,000 operations
CONTACT ARRANGEMENT: DPDT	TEMP. RANGE: -65° C + 125° C

## Babcock model **BR10** 1/6-size relays



**dry circuit  
to 1 amp  
universal  
contacts**

# Compare the All-New PAMOTOR Model 4500 with the miniature axial fan you're now using!



## POWERFUL MOTOR

Dependable shaded-pole motor operates with low internal heat rise. Efficient inside-out design.

## COMPACT SIZE

Only 4 11/16" x 4 11/16" x 1 1/2". Weighs just 1 1/4 lbs. Interchangeable with similar, less reliable 4 11/16" fans.

## EXCLUSIVE BROACHED BEARING SYSTEM

Hand-fitted proven broached dual-sleeve bearing system assures longer, more reliable operation.

## ALL-METAL CONSTRUCTION

Precision die cast housing, hub, impellers. Corrosion resistant. Natural heat sink. Warp-free, unlike conventional plastic fans.

## 115 CFM WITH LESS THAN 37.5 dB SIL

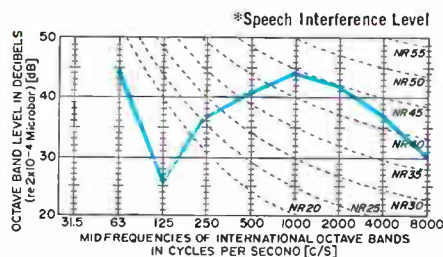
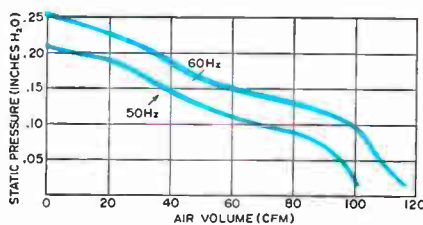

- Lubrication-free life in excess of 20,000 operational hours, continuous duty at 55° C.
- Delivers more air at a lower noise level, yet priced under similar conventional plastic fans.
- Model 4500 designed for 117 V/50-60 Hz operation, while Model 4550 operates at 230 V/50-60 Hz.
- Now available for immediate delivery through leading electronic distributors or directly from factory stock.
- Has Underwriter's Laboratories Inc. Yellow Card Component Recognition Number E41168.

Write to PAMOTOR, INC., 312 Seventh Street, San Francisco, California 94103.

# PAMOTOR, INC.

2P-G101R2

## New Components

plied with 18 inches of insulated flexible cable. Price is \$4.20 each. Electro-Tec Corp., Box 667, Ormond Beach, Fla., 32074. [355]

## Deflection assembly handles many vidicons

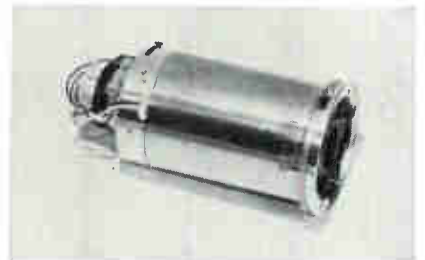

All vidicon tubes that have 40-gauss fields will work well with a new 1-inch deflection assembly.

The assembly includes a yoke, focus coil and an alignment device and offers full adjustment of individual components included within the assembly. The adjustments are: locking rotation of the yoke within the focus coil, forward and reverse positioning of the yoke, centering bushing and tube within the focus coil and adjusting and removing vidicon face mask.

Other features include four insulated feed-throughs for passage of the remote control leads of the lens from the face of the camera and deflection assembly for ease of installation. The yoke is felt-padded.

Lake Electronics Inc., 3311 Perkins Ave., Cleveland, Ohio, 44114. [356]

## Plastic cable ties secure wire bundles

One plastic cable tie replaces three older types. Two versions, TY-55 and TY-55M, are for securing wire bundles to places where breakouts from the main bundle are made. The ties are preformed and can easily be positioned and secured around the branching wires, producing a figure eight. Previously, three separate ties were required to fasten the bundle at this point.

Both ties are fabricated of nylon

# Westinghouse 0.5 to 820 amp rectifiers keep everything from TV sets to locomotives competitive into the 1970's



TV sets and locomotives have one thing in common—both need top quality silicon rectifiers with competitive price and performance.

TV rectifiers must withstand repetitive surges, be highly reliable, yet low in cost. The new Westinghouse 1N4816 series, rated at 1.5 A. half-wave average at voltages to 1000 V., meets the need. It offers plastic economy with metal case performance for TV, Hi-Fi, and other consumer applications. Exclusive manufacturing techniques insure hermeticity. Replaces 1N536, 1N1217, similar rectifiers. Price of 400 V. (1N4820) unit in 1000 quantity: only 30¢.

The new Westinghouse Type 790 rectifier, rated 240 A. at 2400 V. allows upgrading of diesel-electric locomotive performance. Alternator rectifiers must provide 3500 KW under conditions of heat, cold,

dirt, and overloads. The 790 rectifier meets this requirement. Exclusive Westinghouse Compression Bonded Encapsulation makes it immune to thermal fatigue and rugged enough for railroad service.

Anywhere between these extremes, Westinghouse has advanced-performance rectifiers for your application—low, medium, or high power; standard and high speed. High voltage stacks and potted assemblies are also available in most ratings. And most have the unique Westinghouse Lifetime Guarantee identified by this symbol ♣ on the case.

Get data now. Call your Westinghouse distributor for a copy of our Semiconductor Condensed Catalog. Or write to Westinghouse Semiconductor Division, Youngwood, Pa., 15697.

♣ Westinghouse warrants to the original purchaser that it will correct any defect or defects in workmanship, by repair or replacement f.o.b. factory, for any silicon power semiconductor bearing this symbol ♣ during the life of the equipment in which it is originally installed, provided said device is used within manufacturer's published ratings and applied in accordance with good engineering practice. This warranty shall constitute a fulfillment of all Westinghouse liabilities in respect to said products. This warranty is in lieu of all other warranties expressed or implied. Westinghouse shall not be liable for any consequential damages.

You can be sure  
if it's Westinghouse



## New Components

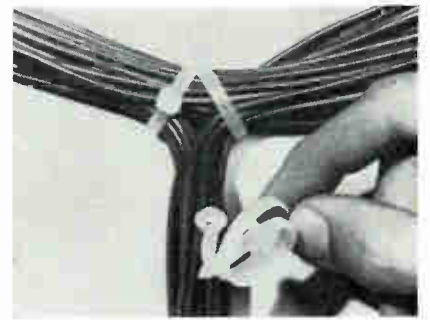

with maximum wire bundle diameter of  $\frac{3}{4}$  in. The TY-55 is twist-locking. Installation is with a Ty-Rap tool, as follows: position the tie around the bundle, thread the tip through the eye, twist and cut off. The TY-55M is self-locking and features a stainless steel tooth, mounted in the eye, that is designed to lock the tie at any given diameter.

The Thomas & Betts Co., 36 Butler St., Elizabeth, N.J. 07207. [357]

## Pads attenuate 75-ohm cables

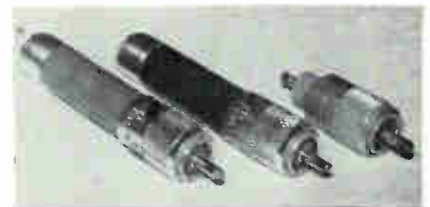

Coaxial attenuator pads have been designed for tv and radio broadcasting. The barrel of the attenuator pad is color coded according to the attenuation of the particular pad.

Type AN connectors are normally supplied and the standard impedance is 75 ohms, for attenuating 75-ohm cables.

The units are  $3\frac{5}{8}$ -in. long including connector and  $\frac{5}{8}$  in. in diameter. Pads are available with either 3-db or 6-db attenuation.

A 75-ohm termination is also available with a test point.

Price of the 3-db and 6-db pads is \$10 with three weeks delivery. The terminations are \$5 each with two-week delivery.

Fairlane Electronics Inc., Box 335, Long Valley, N.J., 07853. [358]

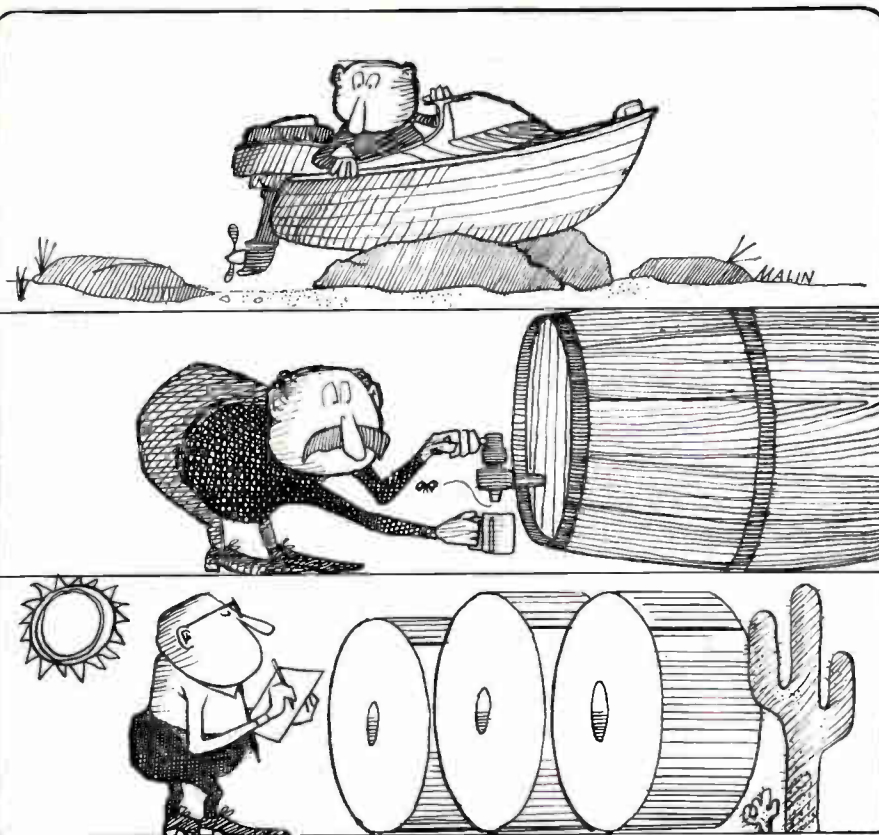

## HOW DRY IS DRY?

Republic Electro-Dry® Capacitor Foil is in a different league when compared to common water wettable foil. Capacitor foil should not only be free from oil films but also from ionizable substances. Republic Test Methods ED-511 & 512\* analyze and compare the surface condition of dry foils, thus assuring you of a product having uniform quality and consistency with far less contamination—up to ten times less residual surface substances.

Engineering foils to meet the needs of capacitor manufacturers is a specialty at Republic. Controlled dryness is just one of the extras we build into capacitor foil products to meet ever higher standards of quality.

It's part of the process we call . . . FOILSMITHING

\* WRITE FOR ED 511 Test for Ionizable Substances and ED 512 Test for Organic Residue

THE LEADING MANUFACTURER OF A COMPLETE LINE OF PLAIN & ETCHED CAPACITOR FOIL

- Electro-Dry®, Silwynd®, Electro-Slik®, Electrogage®
- LIGHT GAGE FOIL for paper and film wound capacitors
- ETCHED ANODE & CATHODE FOIL
- PLAIN FOIL FOR ETCHING
- PLAIN FOIL for electrolytic capacitors, coil winding.
- FULL TECHNICAL SERVICE

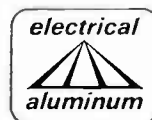

## REPUBLIC FOIL INC.

General Offices, Danbury, Conn. 06813: Tel. 203-743-2731

BRANCH SALES OFFICES

Chicago, Ill. 312-545-2142 • Salisbury, N. C. 704-633-6020 • Cleveland, Ohio 216-871-6268  
WEST COAST — Electrical Specialty Co., 213 E. Harris Ave., So. San Francisco, California  
2820 E. 12th Street, Los Angeles, California 90023

PLANTS - Danbury, Conn. - Salisbury, N. Carolina - Somerville, Mass.





prediction:

**Centralab  
push button  
switches  
will  
revolutionize  
your  
switching  
designs**

One button selection of function provides user convenience, operational simplicity, and visual appeal. Now you can incorporate push button switching in your products, within present pricing parameters.

**Competitive Price • Great Versatility • Miniature Size • Simple Connection and Mounting**

For additional information circle number 125

# Centralab push button switches\* will revolutionize your switching designs

New from Centralab! A low-cost push button switch that's small, easy to wire, easy to mount and twice as versatile as any you now use!

**PRICES** are competitive with multiple position rotary types for many applications, much lower than other push button switches. And our new modular design facilitates same day price quotations.

**SIZE** of these new switches is so small that there's room to spare in printed circuit or conventionally wired chassis. Centerline spacings are 25/64" (Model 10), 19/32" (Model 15) and 29/32" (Model 20).

**VERSATILITY** is exceptional. Switch action may be momentary, independent, push-push, row latching or even a combination of these anywhere in the same row! A zero block which releases the other blocks from the latching assembly is also available. Each switch can have two, four, six or eight double throw functions and a ganging arrangement permits up to 14 pole double throw action when required. Up to 19 switches may be ganged side-by-side on the same mounting bracket! A rear coupling is available for any switch. A line switch can be included in the assembly.

**WIRING** is particularly easy. Use standard dip or wave soldering methods with printed circuits. You can also make connections to the OTHER side of the switch with a pc board! In wired chassis, the design permits easy hand wiring and is ideal for automatic wire wrapping.

**MOUNTING** is simplified because Centralab provides a complete family of integrated hardware. Typical is a low-labor-content tab lock front mounting bracket.

Find out how you can revolutionize your designs with push button switches by writing to Centralab, The Electronics Division of Globe-Union Inc. at 5757 North Green Bay Avenue, Milwaukee, Wisconsin 53201.

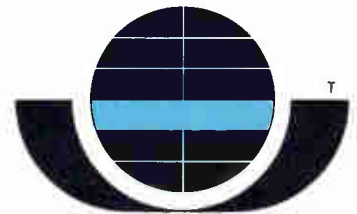

**CENTRALAB**

ELECTRONICS DIVISION  
GLOBE-UNION INC.

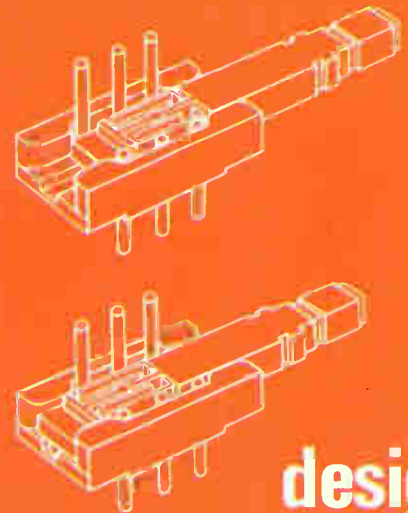
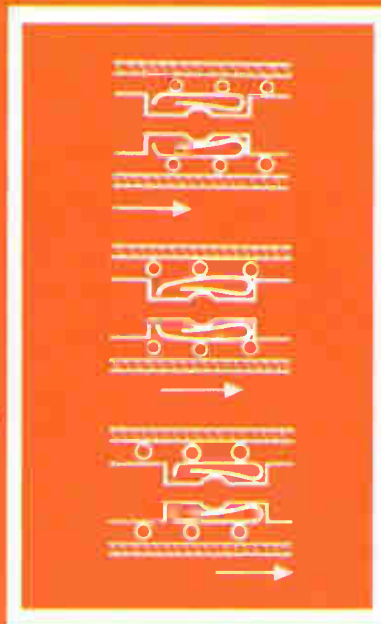
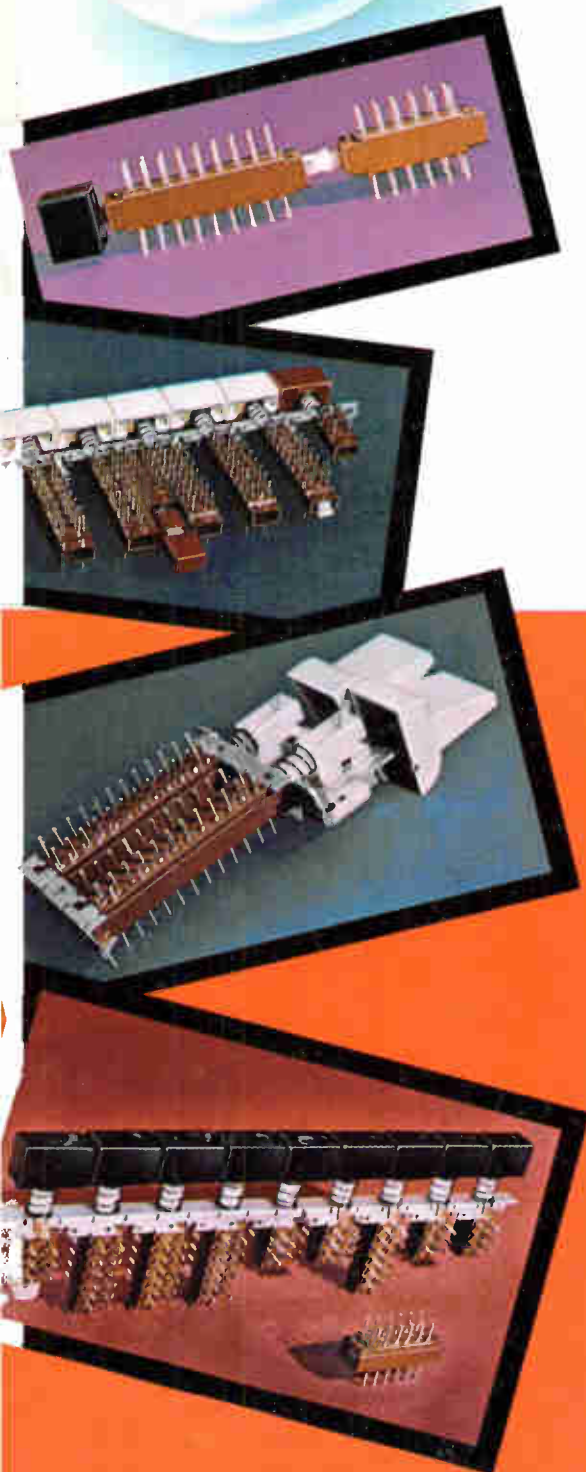

**design  
principles**

Centralab's new push button switches are completely machine-made of injection molded plastic. Even the contacts are inserted automatically for machine-quality control.

The unusual contacts provide excellent wiping action for electrically reliable performance. Their mechanical configuration assures even pressure on both fixed con-

tacts, eliminates local high stress points in the contact for long failure-free life. The sketches show the simplicity and self-aligning characteristics.

Smooth switch action is assured by the low friction plastic slider which holds the moving contacts. The switch body completely encloses the switch contacts for protection from solder and dust.

P-6615

\*Isostat licensed.

For additional information circle number 125

## Built-in sensors stabilize IC

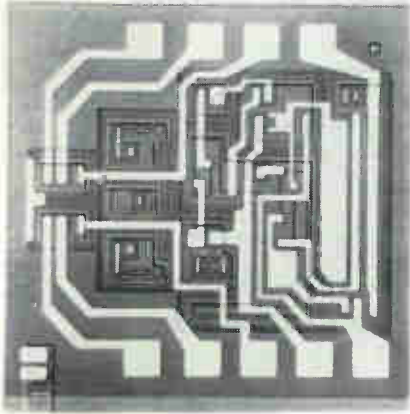

A pair of temperature-sensing transistors built into the chip help stabilize Fairchild Semiconductor's  $\mu A726$  monolithic preamplifier. The result is a device that tracks extremely well. The temperature coefficients for offset voltage and offset current are  $1 \mu V/^{\circ}C$  and  $30 \text{ pa}/^{\circ}C$ , respectively. The 45-mil-square silicon device contains a matched differential transistor pair and a substrate "heater."

The heating function is achieved by adding the emitter-base voltages of the two sensing transistors, then applying the resulting voltage across a resistor. The current through the resistor, which is inversely proportional to the chip temperature, is amplified through the two transistors, one of which is a high-power device. Power to heat the substrate is dissipated at the collector-emitter junction of the second transistor. A maximum of 1.5 watts can be sunk into the chip, which reaches a stable temperature in under 1 second as a result of its good thermal characteristics and small size. Average heating power runs about 250 milliwatts.

Engineers at Fairchild, a division of the Fairchild Camera & Instrument Corp., say the temperature sensing elements are centrally located in a unique circuit design and layout. The heating transistor is on one side of the die and the differential pair on the other; both are produced by the planar process.

The new device comes in two versions:  $\mu A726$  is guaranteed over

the full military temperature range and  $\mu A726C$  is guaranteed over a  $0^{\circ}C$  to  $85^{\circ}C$  range.

Selected units can provide an offset voltage as low as  $0.1 \mu V$  per  $^{\circ}C$ . Frequency response is about 70 Mhz. The unit, aimed at operational amplifiers and instrumentation, provides stable gain for signal levels under  $100 \mu V$ . The devices are available from stock in prices ranging from \$12.50 to \$37.50, depending on temperature range and quantity.

### Specifications

Temperature coefficient	
Offset voltage	$1 \mu V/^{\circ}C$
Offset current	$30 \text{ pa}/^{\circ}C$
Power dissipation	250 mw (min)
Frequency	70 Mhz
Noise	$4 \mu V$ peak-to-peak
Long-term stability	$5 \mu V/\text{week}$
Temperature range	$-55^{\circ}C$ to $125^{\circ}C$ ( $\mu A726$ ) $0^{\circ}C$ to $85^{\circ}C$ ( $\mu A726C$ )

Fairchild Semiconductor division, 313 Fairchild Drive, Mountain View, Calif., 94040. [361]

## Silicon diodes rated from 1 to 5 kv

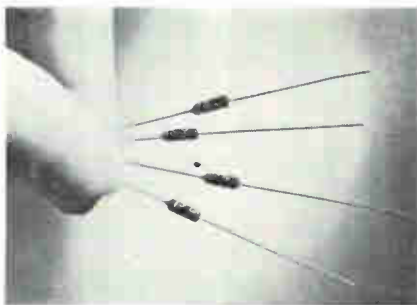

Avalanche silicon glass diodes having ratings from 1,000 to 5,000 v are available in a DO-7 package.

The MD100 series can deliver up to 50 ma from 1 kv to 5 kv and up to 100 ma from 1 kv to 4 kv. Units are designed to operate in ambient temperatures of  $-65^{\circ}C$  to  $+150^{\circ}C$  with reverse current ratings of  $1 \mu A$  maximum at  $25^{\circ}C$ , and  $10 \mu A$  maximum at  $100^{\circ}C$  provided they are operating within their rated peak inverse voltage. The avalanche voltage at 50  $\mu A$  d-c

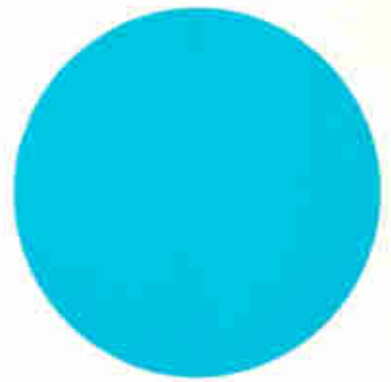

## Atlas will put the blue bead anywhere you want it . . .



But the real value is the extra testing we do to save you trouble later. The point is, most manufacturers of custom hermetically-sealed headers don't have the extensive test facilities that Atlas has . . . altitude, temperature, and humidity cycling chambers as well as Helium Mass Spectrometers for leak detection, and metallographic equipment for taking high-magnification photographs of glass-to-metal interfaces or plating thickness cross-sections.

These in-house test facilities allow Atlas to make . . . and test . . . your custom headers to your specs (or MIL specs, if you prefer), so that the rejects are weeded out before you get them. And when we say that a header with terminals spaced at  $1/4$  inch will withstand 900 volts at 70,000 feet without flashover . . . WE CAN PROVE IT!

Call our marketing department today. Or send for more detailed technical information.

**ATLAS**  
CHEMICAL INDUSTRIES, INC.  
Aerospace Components Division  
Valley Forge, Pa. 19481

# Designed for UHF APPLICATIONS

A WIDE RANGE OF

# RMC

## TEMPERATURE COMPENSATING SOLDER-INS

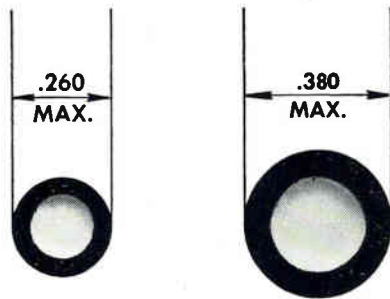

Nom. T. C.	Cap. Range	Cap. Range
NPO	1.5-10.0 pfd.	11- 22 pfd.
N-30	1.5-10.0 pfd.	11- 22 pfd.
N-75	2.2-12.0 pfd.	13- 23 pfd.
N-150	2.2-12.0 pfd.	13- 25 pfd.
N-220	2.4-15.0 pfd.	16- 27 pfd.
N-330	2.7-15.0 pfd.	16- 33 pfd.
N-470	2.7-15.0 pfd.	16- 33 pfd.
N-750	4.7-27.0 pfd.	28- 47 pfd.
N-1500	11.0-47.0 pfd.	48-105 pfd.

### SPECIFICATIONS

**CAPACITANCE:** Within tolerance @ 1 MC and 25°C

**CAPACITANCE TOLERANCES:** ±5%, ±10% or ±20% (but not less than ±.25 pf)

**WORKING VOLTAGE:** 500 VDC

**INSULATION RESISTANCE:** Greater than 7500 Megohms @ 500 VDC

**TEMPERATURE COEFFICIENT:** As noted on Capacitance chart

**FLASH TEST:** 1000 VDC for 1 second

**ELECTRODE:** Pretinned for assured solderability

These new "Solder-In" capacitors are designed for use in UHF applications requiring the absolute minimum in lead inductance effects.

If your applications require special physical or electrical characteristics, contact RMC's engineering department.

*Write today on your company letterhead for your copy of the RMC Catalog.*



DISCAP  
CERAMIC  
CAPACITORS

**RADIO MATERIALS COMPANY**  
A DIVISION OF P. R. MALLORY & CO., INC.  
GENERAL OFFICE: 4242 W. Bryn Mawr Ave., Chicago 46, Ill.  
Two RMC Plants Devoted Exclusively to Ceramic Capacitors  
FACTORIES AT CHICAGO, ILL. AND ATTICA, IND.

## New Semiconductors

is a minimum of 20% above the rated peak inverse voltage for all types.

Atlantic Semiconductor Inc., 905 Mat-tison Ave., Asbury Park, N.J. [362]

### Half-ampere, h-v npn transistors

Claimed to be the only ½ amp npn silicon transistor having a rating above 500 v, a new transistor is listed as capable of withstanding 800 v. The device has a beta of 15 (minimum) at a collector current of 500 ma and a collector-emitter voltage of 10 v. It has a beta of 30 (minimum) at a collector current of 250 ma and a collector-emitter voltage of 10 v. The collector-emitter saturation voltage is 2 v maximum at a collector current of 250 ma and a base current of 25 ma.

The gain bandwidth product is 25. Power rating is 15 watts.

The unit is available in both the TO-5 and MD-14 packages. Industro Transistor Corp., Long Island City, N.Y. [363]

### Small zener diode power-rated at 1 watt

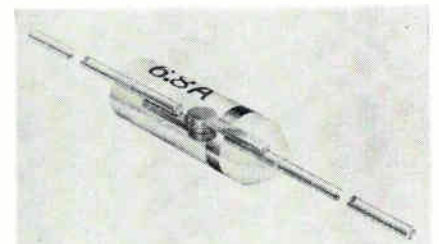

Advanced construction of a 1-watt zener diode provides a smaller package than was previously offered as a ½-w power-rated diode. The silicon wafer is aligned between two parallel, offset tantalum heat sink tabs instead of in a typical nailhead design, which places the fracture plane of the junction in the direction of lead tension.

Many such nailhead designs employ soft silver leads to reduce the strain, but this in turn destroys the moisture barrier when the soft leads extrude under tension. The

new design incorporates gold-plated nickel leads welded to the tantalum tabs. These leads do not extrude, and the long, bidirectional leakage path assures positive moisture protection. The body is high-pressure molded and has a banded and tapered cathode. The diode is 0.160 in. in diameter x  $\frac{1}{16}$  in. long. Lead lengths are  $1\frac{1}{8}$  in.

The 1-watt zener is available in 1%, 2%, 5%, 10% and 20% tolerance units, and in 21 voltages from 2.4 to 16.

Price is 32 cents each for 10% tolerance diodes, in lots of 1,000. Schauer Manufacturing Corp., Cincinnati, Ohio, 45242. [364]

## N-channel FET's are economically priced



Epoxy-encapsulated n-channel junction FET's are designed for industrial and consumer applications including amplifiers, choppers and variable resistors. The E100 series offers low leakage (10 picoamps at 20 v) and low noise figure (1.8 db typical at 1 megohm, 10 hz).

Other characteristics include 50 v typical gate-source breakdown voltage, and a 5:1 drain current ( $I_{DSS}$ ) and pinch-off voltage spread for types E101, 102 and 103. The E100 is a more loosely specified lower cost version. Maximum reverse transfer capacitance is 3 pf. The TO-18 lead configuration makes this series mechanically interchangeable with many other FET's without need for new sockets.

The E100, 101, 102 and 103 are priced at 49, 92, 74 and 60 cents each, respectively, in quantities of 1,000.

Siliconix Inc., 1140 W. Evelyn Ave., Sunnyvale, Calif., 94086. [365]

# FOR HIGH STABILITY AND LOW AGING

SPECIFY

# Bliley

## CRYSTAL CONTROLLED OSCILLATORS

- Wide frequency range 10 kHz to 100 MHz
- Precision quartz crystals designed and manufactured by Bliley
- Solid state circuitry
- Broad selection of standard models to meet individual performance requirements
- Custom designs available with voltage control and temperature compensated circuitry

### Typical Standard Models



CCO-23 Series with output frequency at 1MHz or 5 MHz  
Stability:  $5 \times 10^{-9}$  (Total Change) per day with 25°C ambient  
Aging:  $5 \times 10^{-9}$  (Total) per week after one week



CCO-75 Series with output frequency at 1MHz  
Stability:  $1 \times 10^{-7}$  (Total Change) per day with 25°C ambient  
Aging:  $1 \times 10^{-7}$  (Total) per week after two weeks

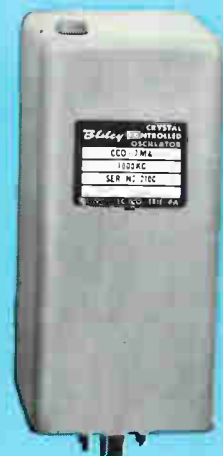

CCO-7 Series with output at 1MHz  
Stability:  $1 \times 10^{-8}$  (Total Change) per day with 25°C ambient  
Aging:  $1 \times 10^{-8}$  (Total) per week after two weeks

For CCO-23 Series request Bulletin 540B  
For CCO-75 Series request Bulletin 543A  
For CCO-7 Series request Bulletin 522

# Bliley

*if you buy quality*

**BILEY ELECTRIC COMPANY**  
ERIE, PENNSYLVANIA 16506

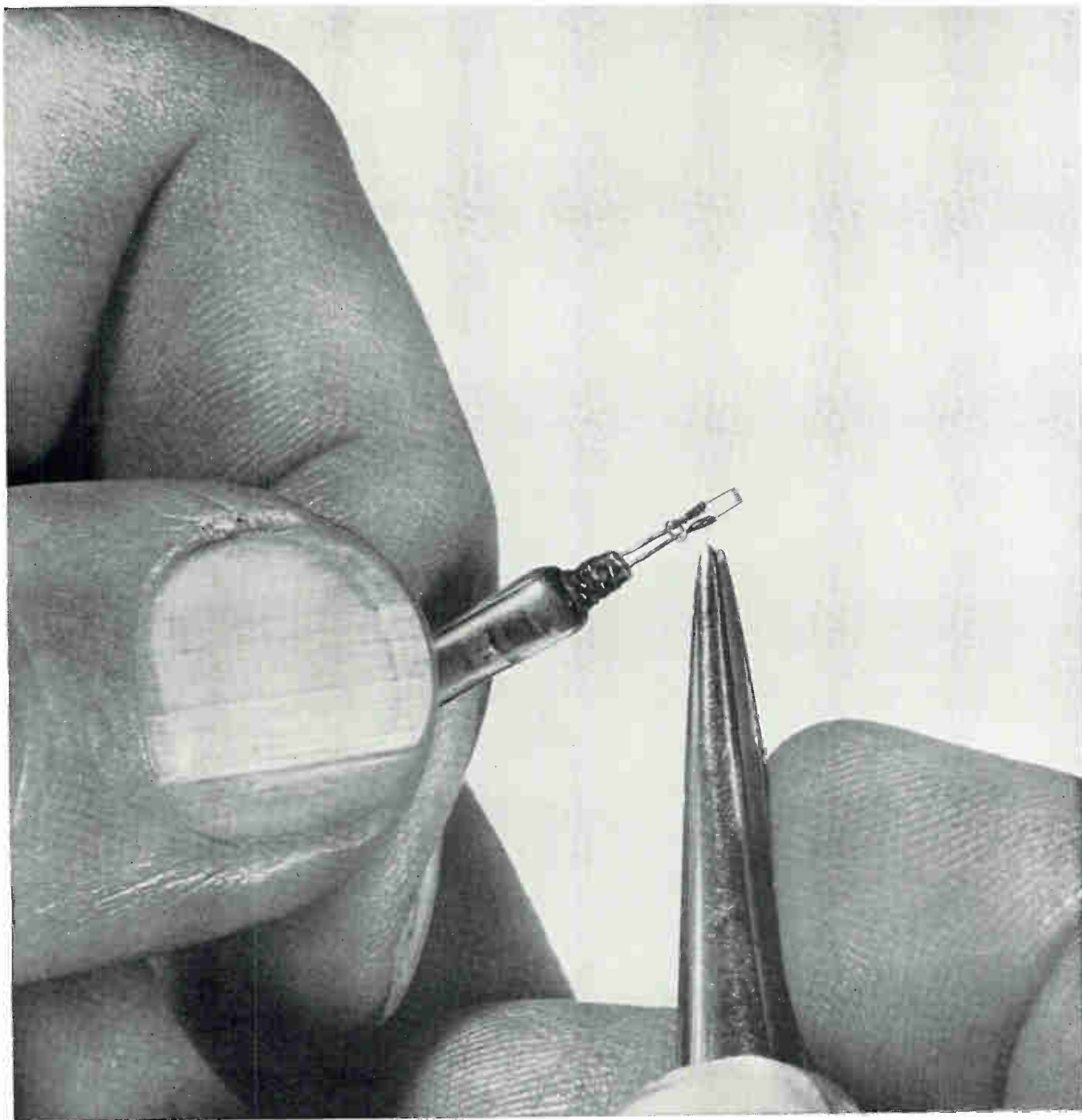

**ENGELHARD** platinum wire  
is best for H. Boehm & Co. miniature lamps.

H. Boehm & Company makes miniature lamps as small as  $\frac{1}{16}$  of an inch in diameter and  $\frac{1}{4}$  of an inch long for delicate surgical instruments. The electrical connections in these lamps are made of Engelhard platinum wire only .005" to .007" in diameter. The reasons for selecting this material are: platinum has a high melting point and excellent electrical conductivity.

Making reliable lamps from hair thin platinum wire is precise business. The platinum wire is pounded flat on one end and drawn through a die that fastens the flat end into a small tube. Then the wire is cut to an average length of  $\frac{5}{16}$  of an inch. Two wires are fastened

together with a small glass and a tungsten filament is inserted into their tubes. Finally the wires are sealed in hot glass. Since platinum and glass have the same heat expansion rate, the seal remains perfect. This is absolutely necessary for maintaining the high vacuum in the lamp.

Engelhard, a leader in precious metals, is always searching for new and better applications to improve almost any product or process. For help with your metallurgical problems, write Engelhard: *the company that is working wonders with the wonder-working metals!*

581

## Some other **ENGELHARD** products

**PLATINIZED TITANIUM ELECTRODES** recent developments in platinized titanium electrodes allow optimization of configurations and coating types affecting many new applications in chemicals production and electroplating fields.

**TEMPERATURE-SENSITIVE METALS** are available in a complete line for applications requiring temperature response from  $-100^{\circ}$  to  $+1,000^{\circ}$  F. Wilco Thermometals® are supplied in a wide range of resistivity in rolls and strips or tempered and formed to specification.

**RHODIUM PLATING** of electrical and electronic parts offers outstanding protection against surface corrosion, reduces noise level of moving parts, and improves efficiency wherever a low-resistance, long-wearing, oxide-free component is required.

**THIN WIRE AND FOIL** are produced by Engelhard's Baker Platinum Division to meet rigid electronic design requirements. Both extruded and Taylor Process thin wire are available in diameters as small as .001". Thin-gauge foil is supplied in sheets up to 8" x 18".

**SEMICONDUCTOR MATERIALS** are supplied in a wide range of precious and base metals and their alloys. These include solid sheet, wire, tape, base tab materials and clad products. New materials are constantly under development. Technical assistance is available.

**LAMINATED CONTACT MATERIALS** are produced in virtually any combination of precious metals and alloys with base metals and alloys. Types include edge, strip, inlay, spot, single or double-face laminations. Supplied in flat lengths, in strip, coil or fabricated forms.

**LIQUID GOLD** produces an excellent heat barrier when applied to metals and other surfaces. Solutions are easy to use. Resulting metallic films are often permit important weight reduction of substrate materials.



## New Instruments

### Programmer with simple touch

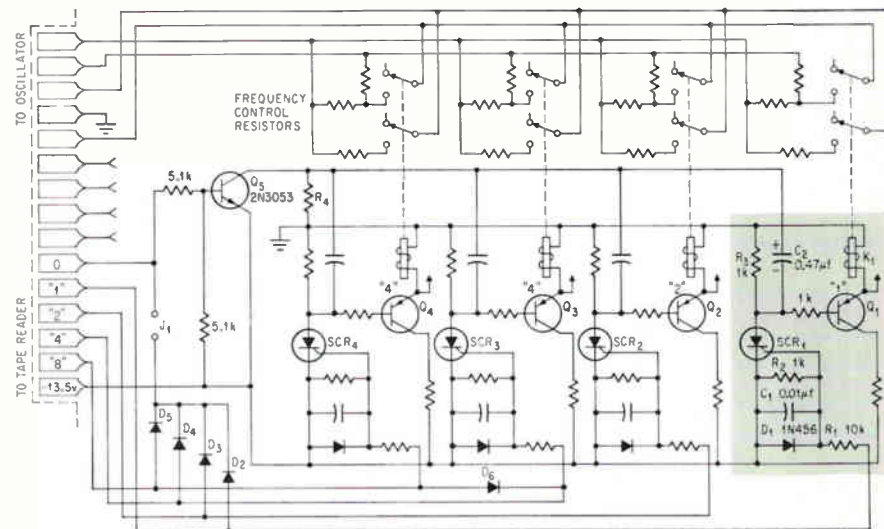

In the scr-operated transistor relay driver for one decade in Krohn-Hite's programmable oscillator, a signal from an input terminal, for instance terminal 1, is coupled to the scr's gate, in this case through  $R_1$  to SCR<sub>1</sub>. This forces Q<sub>1</sub> to conduct and energize K<sub>1</sub>. Resistor  $R_2$  in the scr's gate circuit prevents charge accumulation that would lead to the false firing of SCR<sub>1</sub>. Diode  $D_1$  protects the associated scr from an improperly polarized pulse. Q<sub>5</sub> inhibits all conducting scr's to cause automatic reset. An input from terminal 8 is coupled simultaneously to SCR<sub>3</sub> and SCR<sub>4</sub> to produce the desired 8. The diode  $D_4$  prevents a 4 input from energizing SCR<sub>4</sub>.

A programmer originally designed as an integral part of an oscillator may prove to be more marketable than the oscillator itself. The Krohn-Hite Corp. reports its programmer has several advantages that ideally suit it for applications that require converting binary-coded decimal inputs to relay closures.

Krohn-Hite's device consists of sets of transistor relay-driver circuits operated by silicon controlled rectifiers. Momentary low-current relay closures in a bcd format, such as those derived from a punched-tape reader, are all that is needed to activate the circuit. The output can be either relay contact closures or the transistor driving current itself.

Among the advantages that accrue from replacing conventional relays with the scr-operated circuits are the three-in-one function of circuit isolation, latching and automatic reset. Since the only input information necessary is in the form of short-duration switch closures, a tape programmer may contain much more information in a given space. And since no reset

command is necessary, programming is less complex.

In their normal state, the scr's are off. An input, such as the momentary closure of a tape-reader contact, triggers the associated scr on. When the scr conducts, the transistor also is turned on and the relay is energized. When used in the company's oscillator, the relays switch resistances in and out of the oscillator's frequency-controlling RC networks. Since the scr's are d-c powered, they remain on once triggered, providing inherent circuit latching.

To reset the circuit—in selecting a new frequency, for example—the scr's gate control must be reestablished. This is accomplished by an automatic reset circuit in the programmer that responds only to the start of the next frequency digit block on the tape. If the next frequency requires a different complement of relay closures, the unused scr's will be turned off but those needed for the new frequency will be left on since the on-command overrides the reset function.

Krohn-Hite's programmer is avail-

# talk algebra, log, trig.

## or talk price.

# mathatron 4280 talks your language.



Name familiar but you can't remember the face? The insides of this new Mathatron computer calculator are different, too. Log, antilog, sine, cosine, and arctan are performed at the touch of a button. Storage 4000 bits. Simplified program control. And the price-performance ratio is higher than any other computer/calculator. Starts at \$6990.

Of course, Mathatron 4280 has all the features that made the original Mathatron famous. You tap in algebraic problems and decimal numbers just the way you write them — parentheses, powers-of-10 exponents, decimal points, and square root. Electronic circuits compute answers accurate to 8 digits plus a 2-digit power-of-10 exponent and sign.

Tape printer output is a permanent record. Punched tape input is a great time and error saver for re-insertion of frequently used programs. Optional Teletype provides alpha-numeric page-fronted output, paper tape reader, and paper tape punch.

A companion like Mathatron 4280 can save hours of a technical man's day. To get acquainted, ask us to send the brochure.

**mathatron 4280:** Formula memory 480 steps • Addressable number storage, 42 registers; 82 if Formula storage is reduced • Number range  $\pm 10^{-12}$  to  $10^{+58}$  • Speed 100 accumulations per second • Basic operators: plus, minus, times, divided by, left paren, right paren, square root, exponent, log, antilog, sine, cosine, arctan.



## MATHATRONICS

a division of Barry Wright Corporation 

241 Crescent Street, Waltham, Massachusetts 02154, Telephone: 617-893-1630

## New Instruments

able with or without relays. When it was used in the oscillator, for example, the relays isolated the sensitive RC circuits from the inconsistent impedance levels among the semiconductor circuits in the driver in addition to performing the switching function. The programmer can be supplied with a straight binary code or variations of the bcd scheme. It will sell for about \$500, depending on whether or not the relays are included and the code scheme used.

Krohn-Hite Corp., 580 Massachusetts Ave., Cambridge, Mass. 02139 [366]

## Current sensors clamp around cables



Solid state transducers use magnetoresistors to detect d-c current in ranges from 0 to 100 amps to 0 to 10,000 amps. Designated type 4008, these current sensors have applications in industrial and military applications requiring the measurement and control of large d-c currents without breaking into the current carrying cable. The sensor features a removable yoke that can be clamped around cables up to 1½ in. in diameter.

There is complete electrical isolation between the current in the cable and the sensor output, allowing the sensor to be used safely with high potential lines. The device will accurately respond to current spikes as fast as 200  $\mu$ sec.

Output from the sensor is a d-c voltage suitable for remote trans-



mission or meter indication. The sensor requires a nominal excitation voltage of 24- or 28-v d-c but will operate accurately over an 18- to 36-v supply since voltage regulation is incorporated within the device.

Price is \$225 each in lots of one to nine and delivery is four weeks. American Aerospace Controls Inc., 129 Verdi St., Farmingdale, N.Y. [367]

## Phase tracking receiver operates on vlf band



Continuous tuning from 3 kilohertz to 99.95 khz, in 50 hz increments, is provided by the model 599J very-low-frequency phase tracking receiver. The instrument is of particular interest to those responsible for frequency measurement, calibration and standardization, who wish to take advantage of the full range of carrier stabilized transmissions on the vlf/l-f band.

The receiver uses a single-side-band technique in the r-f section which has eliminated the need for r-f filters. The cancelling properties of this technique reject images by at least 60 db below 30 khz and 50 db above 30 khz.

Receiver sensitivity of 10 nanovolts allows normal phase tracking anywhere in the world. Tracking is maintained at an input signal-to-noise ratio of -50 db. Short and long-term stability is better than  $\pm 0.25 \mu\text{sec}$  relative to the received carrier. Calibration accuracy is better than  $\pm 1 \times 10^{11}$  when averaging for 24 hours.

Tracor, Inc., Industrial Instruments division, 6500 Tracor Lane, Austin, Texas, 78721. [368]

## Millivoltmeter serves both lab and test line

Fully transistorized and chopper stabilized, the model 300 d-c millivoltmeter features a basic range sensitivity of 0.001 v. It offers 10

# NEMS • CLARKE (něms-klärk), n.

A total capability for Telemetry Products, synonymous with exceptional quality-high reliability and advanced solid-state design, the acknowledged leader in the field.

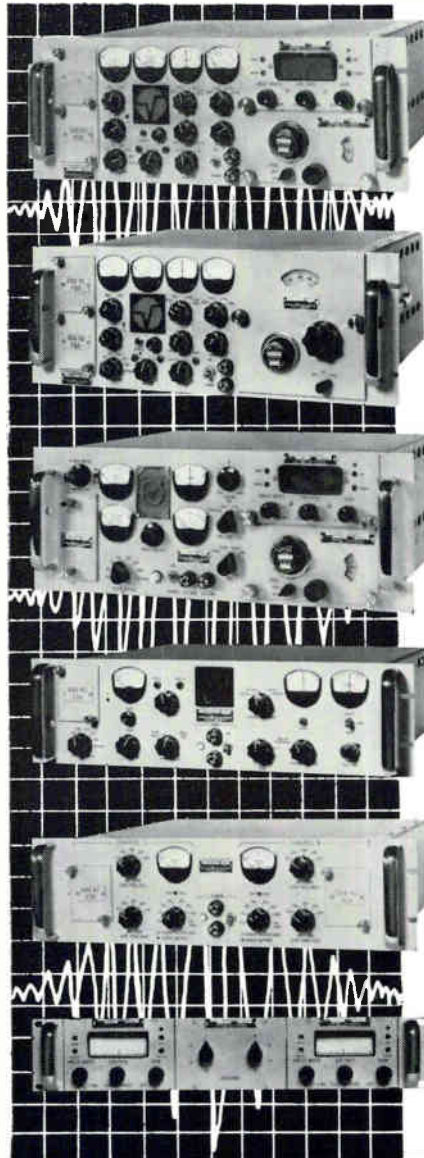

### R-1074A SOLID STATE TELEMETRY RECEIVER

Provides extremely sensitive reception of all telemetry formats from 55 to 2300 MHZ. Adaptable to Data and Conical Scan tracking. Completely modular design provides switch-selectable IF bandwidths and FM demodulators and tuners.

### R-2074A DUAL CHANNEL TELEMETRY RECEIVER

A highly compact dual-channel receiver operating in the 55 to 2300 MHZ frequency range. Offers Diversity Combining applications and is adaptable to Conical Scan and Sequential Lobing operation.

### R-1037G SOLID STATE TELEMETRY RECEIVER

The industry's most proven and versatile solid-state receiver. Operates in the 55 to 2300 MHZ range as an all-purpose, high-reliability, all-format receiver. Optional modules enable pre-detection recording and playback operation.

### DCA-5100A POST/PRE DETECTION COMBINER

A Solid-state, dual-channel, modular design combiner intended for use in polarization diversity systems. Provides Pre-D and Post-D Combining, Pre-D-Recording, Up or Down Conversion, and Demodulation.

### COD-2100 SINGLE/DUAL CHANNEL CONVERTER/DEMODULATOR

Provides 5 Selectable Record/Playback Center Frequencies, adjustable input/output levels, AGC, Demodulation, and Selectable IF and Video Bandwidths in only  $5\frac{1}{4}$ " of rack space.

### SDU-360 SERIES SPECTRUM DISPLAY UNITS

Provides 10KHZ resolution with 21.4, 30, or 60 MHZ inputs. Field proven and easy to operate. Spectrum display continuously adjustable to 4 MHZ.

The Nems-Clarke trademark is a guarantee of the highest quality and reliability in telemetry equipment. Advanced design, field-proven through years of operational use, is built into all Nems-Clarke equipment:

Telemetry Receivers and Systems • Tracking Receivers • Monopulse Receivers • General Purpose Receivers • Multi-couplers • Range Extension Units • Preamplifiers • Bandpass Filters • Transponder Systems • Automatic Scan Receiving Systems • Components.

For complete information, contact:

V-25

## Vitro ELECTRONICS

Producers of NEMS-CLARKE Equipment  
A Division Of Vitro Corporation Of America

919 Jesup-Blair Drive • Silver Spring, Maryland  
2301 Pontius Avenue • Los Angeles 64, California

*the finest*

# COUNTER TIMER

*at any price!*

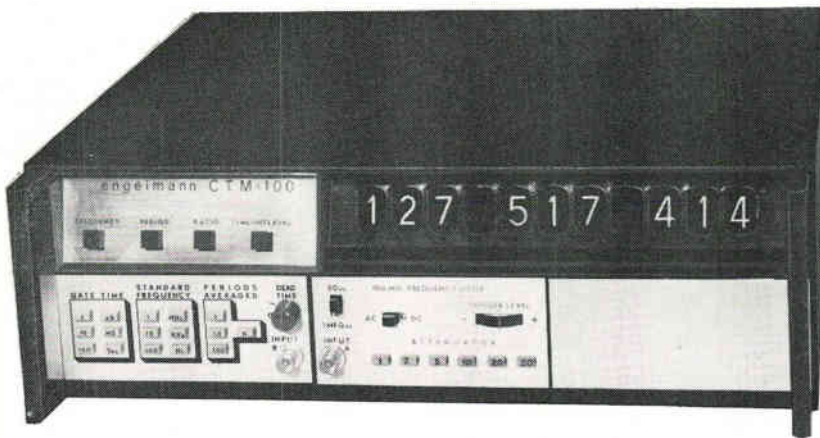

100 MHz.....\$2,475

- Touch Control ● Plug-In Versatility
- The Best of Integrated Circuits
- Engelmann Design

## HERE'S WHAT'S NEW

- 100 MHz<sub>z</sub> Response
- 10 Nanosecond Resolution
- Touch Control
- Automatic Digit Shift for Ease of Reading
- Standard Frequency from 100 MHz<sub>z</sub>
- Infinite Train Pulse Counting from 0 thru 100 MHz<sub>z</sub>
- 500 MHz<sub>z</sub> Plug-In Frequency Extender (Optional)

## RUDOLPH ENGELMANN LABORATORIES, INC.

Traffic Station, P. O. Box 3155  
Minneapolis, Minnesota 55403

Dept. E

## New Instruments

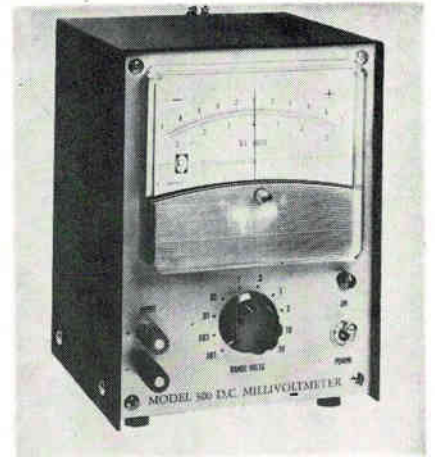

ranges, up to 30 v, floating input and an input resistance of 10 megohms.

Because of the feedback application, the stability of the instrument is such that no zero adjustment is provided. The instrument employs a zero-center meter and can be used as a null detector in bridge and potentiometer circuits. Available as an option is a zero-left modification and output terminals for graphic recorders. Accuracy of the unit is  $\pm 2\%$  of full scale.

Line operated, the instrument is available in either 115- or 230-v, 50 to 60 hertz, style.

The standard model 300 sells for \$185. Delivery is two to four weeks. IB Instruments, Inc., 7016 Euclid Ave., Cleveland, Ohio, 44103. [369]

## Transducer bridge signal conditioners

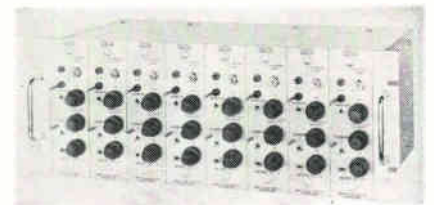

Ultrastable, transducer bridge signal conditioners, known as the SG-11 series, are constructed as plug-in modules which may be installed eight-abreast in a rack-mounting enclosure, or used individually in a portable carrying case.

Each unit consists of an all-silicon power supply and a bridge

conditioning circuit for four, six, or eight wire systems. The power supply is adjustable from 1 to 16 v d-c with line changes from 95 to 135 v and/or load changes from zero to full load. An automatic current limit makes the output short-circuit proof.

These units feature extremely high isolation from the power line—less than 0.03 picofarad—so that they can effectively serve as an adjustable battery. This permits the operation of a bridge with a floating power supply and a single-ended output.

Price of the basic plug-in unit is \$187.50.

PPM, 7016 Euclid Ave., Cleveland, Ohio, 44103. [370]

## Digital picoammeter is fast and accurate



New performance records in the automatic measurement of extremely low currents are claimed for the series 930 picoammeter. This digital device measures currents ranging from 10 picoamps to 10 milliamps, producing accurate readings as fast as 100 milliseconds. It functions automatically when measurements of extremely low currents are critical, particularly in production lines, in quality assurance programs, in engineering laboratories and in nuclear reactor monitoring and control systems.

The series 930 features all-silicon solid state components, automatic polarity, digital readout, and optional drive for printers. The instruments feature easily interpreted readings and rapid recovery time from overload transients. They can be used either as a precision laboratory instrument or as a component in a control or monitoring system.

Accuracy is from  $\pm 5\%$  to  $\pm 0.5\%$ , bandwidth to 10 khz.

Dimensions of the picoammeter are 17x17x3½ in. Price is \$2,435. EG&G Inc., 680 East Sunset Road, Las Vegas, Nev., 89101. [371]

# Taylor's total reliability plan: Glass-Epoxy Copper-clad

in sheets, panels or punched blanks to your specifications and reliability requirements

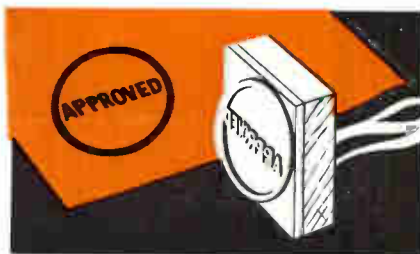

Accepted by an increasing number of major OEMs and commercial etchers who give their stamp of approval, because . . .



. . . they get highest quality level assurance from two fully-equipped copper-clad plants using white-glove techniques . . .



. . . in atmosphere-controlled white rooms, under extremely tight quality control procedures, to produce copper-clad . . .

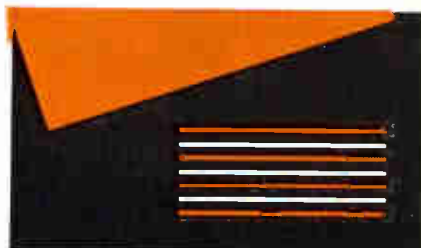

. . . to specifications and established reliability requirements in standard sheets, ultra-thin sheets and multi-layer prepregs . . .

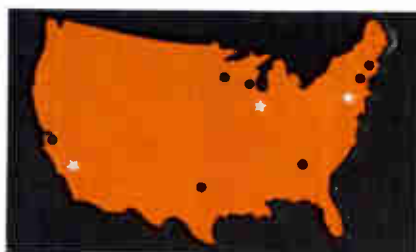

. . . then deliver when promised, or in an emergency, from plant or warehouse stocks in special packages.

Let us prove the advantages of Taylor's TOTAL RELIABILITY PLAN to you! Ask for a demonstration today. Write for a sample (give grade designation and copper combination) and Bulletin GB-2.

**Tc Taylor copper-clad**

...your assurance  
of quality

TAYLOR CORPORATION • Valley Forge, Pa. 19481

Phone: 215-666-0300 TWX: 215-666-0659

West Coast Plant: La Verne, Calif.

Also manufacturer of Taylor laminated plastics, Taylorite® vulcanized fibre and Tayloron® prepregs

When your design requires

# MOTION and ELECTRICAL POWER



## HANSEN SYNCHRON®

Motor and Slip-Ring Assembly  
supplies both in one unit!

This patented exclusive SYNCHRON design solves the annoyance and complication of combining these two functions. Here is a compact two-wire unit which provides rotating electrical power.

The Hansen Slip Ring is used with the famous Synchron Motor, and can be used with either clockwise or counterclockwise rotation, in a wide range of speeds. Priced to fit in your design budget.

Available in 50, 60 cycles; 24-volt, 110-volt, or 220-volt. Our engineers are at your service to help you with details of application. For full information, write or phone



HANSEN REPRESENTATIVES: CAREY & ASSOCIATES, Houston, Tex., R. S. HOPKINS CO., Sherman Oaks, Calif., MELCHIOR & MACPHERSON, INC., San Carlos, Calif., THE FROMM CO., Elmwood Park, Ill., H. C. JOHNSON AGENCY, INC., Rochester, N. Y., WILSON ELECTRIC CO., Essex, Conn., Narberth, Pa., and New York, N. Y. EXPORT DEPARTMENT, 64-14 Woodside Ave., Woodside, N. Y.

## New Subassemblies and Systems

### Circuit for brighter crt display

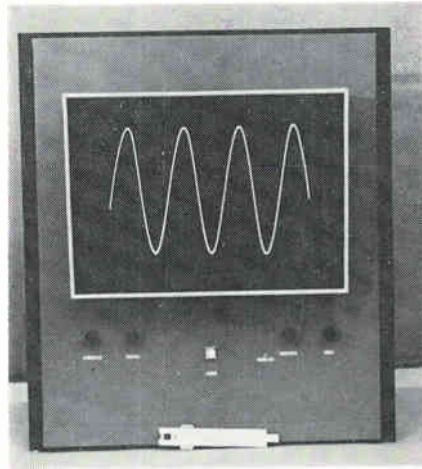

Fast sweep time afforded by a new solid-state deflection circuit results in very bright cathode-ray-tube computer displays, according to the circuit's developers, the Atlantic Technology Corp. The company says its model 8000 series of 10-, 12-, and 16-inch crt computer display systems has a deflection system that permits time-shared or chopped presentations with no loss of data.

The display dead time—the time used for slewing and settling the beam—is less than half that of earlier systems, Atlantic says, so there is greater beam dwell time and thus greater average light output; the older large-screen electrostatic computer displays use vacuum-tube circuits to position the spot. Also, solid-state circuitry cuts the new display's volume and weight by more than a third and increases reliability.

An example of how the brightness provided by this display can be exploited is found in the point plotting of random input data at a rate of 10 microseconds per point. If 5  $\mu$ sec are consumed in beam slewing and settling time, then only 5  $\mu$ sec are available for spot intensification. But if the slewing and settling time is only 2  $\mu$ sec, as is typical with the new display, then 8  $\mu$ sec are available for intensification and the average light output, or brightness, is increased by 60%. The surface brightness of the Atlantic display is about 50 foot-

lamberts; other computer displays have surface brightnesses of less than 30 foot-lamberts.

One of the biggest problems encountered by engineers working on this display was that commercially available transistors have voltage ratings of no more than 500 volts. Their solution was to connect the transistors in parallel series to develop enough voltage to drive the screen's deflection plates and enough current to charge the circuit's stray capacitance. The display's dynamic focusing techniques assure that the beam is in focus anywhere on the face of the screen.

The display uses a d-c to d-c converter operating at 7 kilohertz and regulated by feedback. High-voltage components are potted in silicone rubber in a replaceable module. All other circuits, including the power-supply regulators, are on 4½ x 6½-inch etched circuit boards that plug into a larger 7 x 17-inch motherboard; the motherboard has all interconnecting wires printed on it. Front panel controls are mounted to the motherboard, and all wiring except the cathode-ray tube socket and anode cap wires are thus eliminated.

Model 8000 displays sell for \$2,600 each in quantities of 100 and are available 60 days after receipt of order.

#### Specifications

Speed	Slew time 1 microsecond
Phase shift	0.5° to 100 khz
Bandwidth	
X and Y	d-c to 500 khz
video	d-c to 5 Mhz
Resolution	80 lines per inch
Mean time between failure	10,000 hours minimum

Atlantic Technology Corp., Somers Point, N.J. 08244 [372]

### Frequency standard has many purposes

A new plug-in crystal frequency standard fits a variety of industrial, commercial and laboratory applications. The devices can serve as a precision clock or frequency ref-



erence for commercial or industrial control equipment, precision production testing, and instrument calibration. They feature all-silicon semiconductors, internal voltage regulation, low input power and a standard octal plug-in base.

The series is available in frequencies from 100 kilohertz to 10 Mhz with stabilities of  $\pm 0.0005\%$  as standard units. Under relatively constant temperature conditions, stabilities of better than  $2 \times 10^{-7}$  are realized. The input voltage may be 12, 15 or 24 v d-c with an output of 1 v rms sine wave, or 7 v peak-to-peak square wave into 5,000 ohms.

Dimensions of the units are  $1\frac{1}{2}$  in. diameter by 3 in. high. Cost of a typical device is \$95. Robinson-Halpern Corp., 5 Union Hill Road, West Conshohocken, Pa., 19428. [373]

## Plotting system uses digital interface

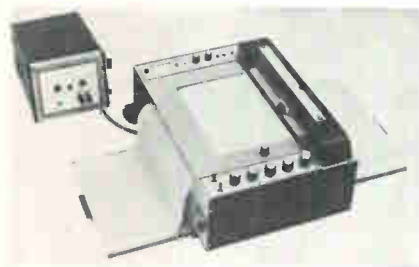

A combination of the model 6810 digital interface with model 6550 Omnigraphic plotter provides a versatile plotting system that can operate from either analog or digital data, either binary or binary-coded-decimal. Analog sensitivity

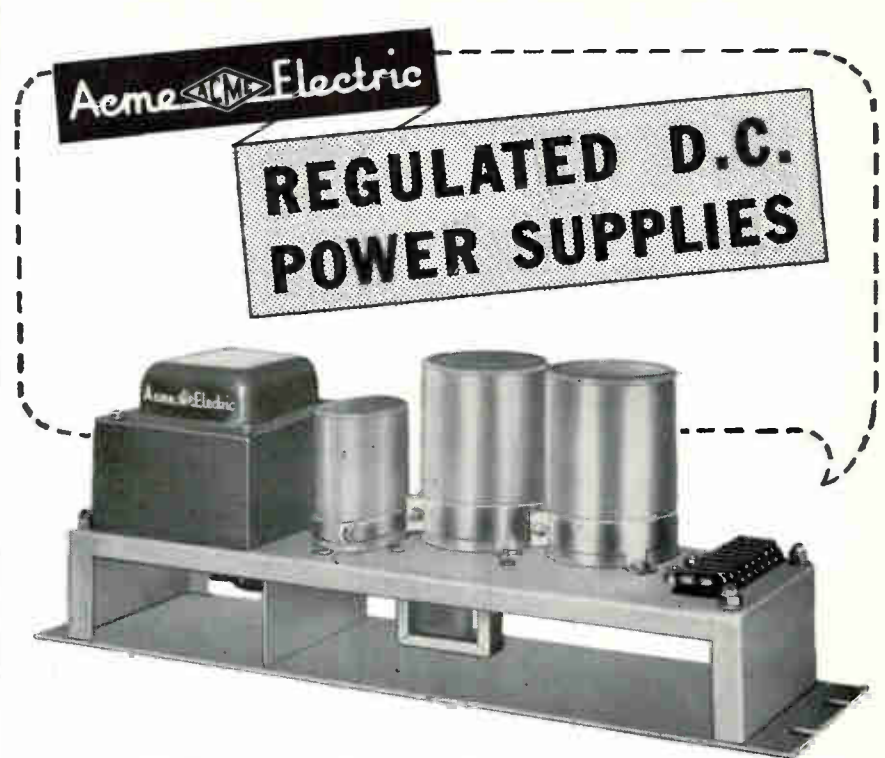

## More Performance for the Price...

When performance and reliability are principal factors in your buying, Acme Electric should be your first-choice source for D.C. Power Supplies. Converting alternating current to direct current is an old Acme Electric specialty. Over the past 35 years we have produced D.C. Power Supplies in a wide range of designs for some of the most critical applications known. Our wealth of experience is your assurance of dependable performance.

The standard stock model "off-the-shelf" D.C. Power Supplies listed below were designed to provide reliable performance at an economical price.

CATALOG NUMBER	D.C. OUTPUT			CATALOG NUMBER	D.C. OUTPUT		
	VOLTS	AMPS	WATTS		VOLTS	AMPS	WATTS
PS-47509	10	4	40	PS-47202	26	4	104
PS-47623	12	3	36	PS-57603	26	8	208
PS-47508	15	2	30	PS-47638	28	8	224
PS-57352	22	25	550	PS-47712	28	25	700
PS-41422	24	2	48	PS-57356	44	25	1100
PS-41423	24	6	144	PS-41424	48	4	192
PS-57353	24	10	240	PS-47519	48	10	480
PS-47125	24	15	360	PS-57358	48	15	720
PS-47173	24	25	600	PS-47718	100	4	400
PS-1-47127	24	50	1200	PS-41425	125	2	250
PS-1-47461	24	75	1800	PS-47201	125	3	375
PS-1-47200	24	100	2400	PS-47457	125	6	750

Write for catalog 175 and full list of "off-the-shelf" D.C. Power Supplies.

**Acme Electric**  
**Engineers and Builders of...**  
 312 WATER STREET, CUBA, NEW YORK

SAA-4007-3266

REGULATED POWER SUPPLIES  
 STATIC POWER RECTIFIERS  
 VOLTAGE STABILIZERS  
 VOLTAGE REGULATORS

# HOW

## To Solve YOUR Semiconductor Encapsulation Problems

HYSOL has more answers than anyone in the business.

HYSOL's HYFLO® epoxy molding powders have solved the problems of transfer molding encapsulation of a wide range of semiconductors, from simple to the most sophisticated.

New HYSOL liquid epoxy systems, compatible with almost every type of semiconductor, open new doors for casting or potting for short or long runs and extremely delicate items.

We have devoted thousands of laboratory man hours finding answers to the kind of encapsulation problems you may be facing right now. Our laboratories are ready to tackle new problems, as technology progresses, just as we have done in the past for scores of leading electronic component manufacturers.

For application engineering help, write, wire or phone HYSOL today. For technical data on standard semiconductor encapsulation products, ask for bulletins E-258, E-259 and E-500.



## New Subassemblies

is variable from 1 mv to 10 v per inch with a constant 100,000-ohm input impedance. Digital input is 10 bit binary or 3 digit BCD. System accuracy is 0.2% at slewing speeds up to 40 inches per second.

The plotter records up to 10 inches wide on fan-fold paper 11 inches wide and up to 144 feet long. The paper is perforated every 8½ inches at fold points, so that the recording can be separated into notebook-size 8½-by-11 or 11-by-17 inch sheets. The record can be read like a book and loaded into or removed from the recorder at any point on the record.

Price is \$3,725; availability, 45 days after receipt of order. Houston Omnigraphic Corp., 4950 Terminal Ave., Bellaire, Texas, 77401. [374]

## IC modules improve drum memory systems



Up to 256 read-write heads in a magnetic drum memory can be selected using a pair of integrated circuit modules.

The RWS-4000 at the right in photo, contains a linear preamplifier for reading, a power amplifier for writing, and a matrix decoder that selects one of 16 pairs of lines with a 4-binary-digit input. Each of the 16 pairs connects to the two ends of the windings in 16 read-write heads arranged in a single vertical column.

The SX-4002 at the left contains only a matrix decoder for selecting another set of 16 single lines. Each of these lines connects to the center tap of 16 read-write heads in a horizontal row. When a selection has been made with both the RWS-4000 and the SX-4002 the two lines will intersect at one specific read-

PROGRESSIVE PRODUCTS

**HYSOL** HYSOL CORPORATION • OLEAN, NEW YORK  
THRU CHEMICAL RESEARCH Los Angeles, California/Hysol (Canada) Ltd., Ontario/London, England

write head in a 16-by-16 array.

Both modules are made primarily of micrologic elements, but a few discrete components are required. The circuits can handle recording currents of up to 150 milliamperes and frequencies of up to 5 megahertz. Turn-on and turn-off times are less than 1 microsecond.

Vermont Research Corp., Precision Park, North Springfield, Vt., 05150. [375]

## Pulse generator acts as clock, controller

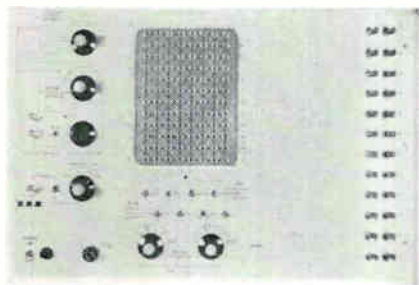

Solid state, integrated circuit logic is featured in a pulse generator that has a 16 by 12 program matrix board. Programming is accomplished by inserting diode pins. The 16 time steps make a single pass through the program, operating at stepping rates from 1 khz to 10 Mhz. Any step may be repeated, either singly or in pairs, with the number of repeats controlled by an analog timer. Trigger pulses constitute the 12 parallel channel outputs. The repeat duration control also allows very long repeat periods under the operator's manual control.

The sq-200 programable pulse generator can serve as the clock and controller for any sequencing system, such as a memory tester. It also can detect hazards in logic networks and investigate the effects of regular duty cycles.

Price is \$4,000.

Adar Associates Inc., 73 Union Square, Somerville, Mass., 02143. [376]

## Voltage memory card monitors transients

A voltage memory card provides an economical approach to the monitoring of single or repetitive voltage transients in pulse widths

# NEW

## MICROVOLTMETER NULL DETECTOR NANOAMMETER DC AMPLIFIER



Model 150B

- 0.3  $\mu\text{V}$  to 1 volt f.s. voltage range
- 1 megohm input resistance at 0.3  $\mu\text{V}$  f.s.
- 75 db ac line frequency rejection
- rechargeable-battery and line operation
- less than 5 nanovolts input noise
- 0.1 microvolt drift per day
- 100 times full scale zero suppression
- $3 \times 10^{-10}$  ampere to 1 ma f.s. current range

Here's the reliable way to precisely meet multiple measuring needs using only a *single* instrument. It's sensitive, versatile, portable—built to last under hard, all-purpose use. It will detect microvolt potentials from high resistance sources, take ultra-stable measurements from thermocouples and thermopiles—whether the circuit is grounded or not. It will do your job dependably—and do it best.

With the Keithley 150B Microvolt-Ammeter, measure with extreme ease from 0.3  $\mu\text{V}$  f.s. to 1 volt f.s. on 14 overlapping ranges. Input resistance varies from 1 megohm on the 0.3  $\mu\text{V}$  range to 100 megohms on the 30  $\mu\text{V}$  and higher ranges. Resolve signals to 70 nv when measuring from a 10 kilohm source. Enjoy convenient 100 times f.s. zero suppression that lets you measure tiny changes in steady state signals. And save set-up time with 75 db ac line frequency rejection. Can you ask for—or find—more in a voltmeter-null detector? Then add 14 ranges for measuring  $3 \times 10^{-10}$  ampere to  $10^{-3}$  ampere f.s., two recorder outputs for extra flexibility and you total low level dc versatility you can't find elsewhere.

The solid-state 150B costs \$825, including input leads. Our detailed technical engineering note costs nothing. Write for it today.

# K

KEITHLEY  
INSTRUMENTS

12415 Euclid Ave. • Cleveland, Ohio 44106  
EUROPE: 14 Ave. Villardin, 1009 Pully, Suisse

# ZIPPERTUBING® jacketing . . . the answer to harnessing problems!

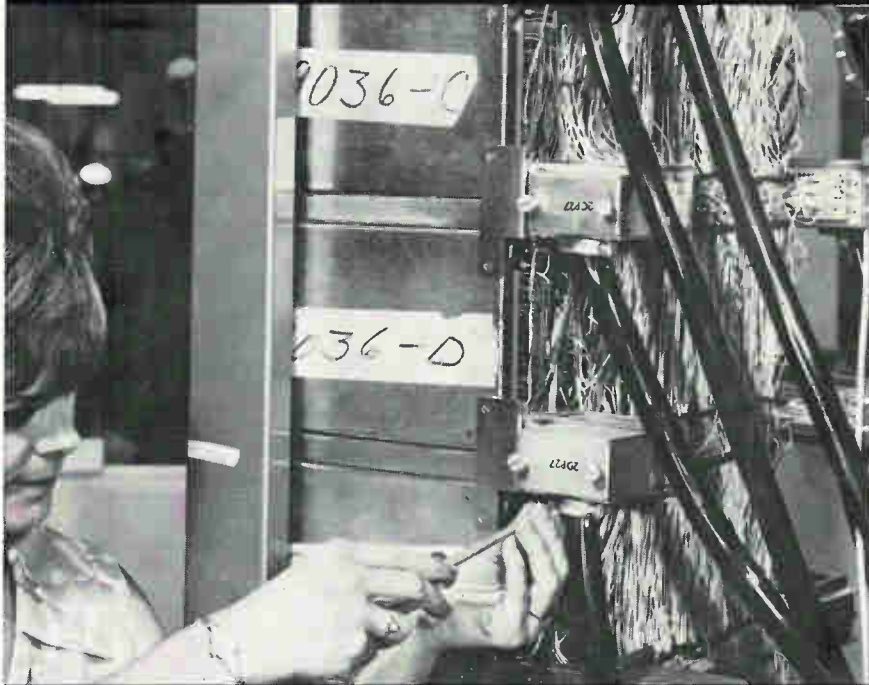

**ZT® IN ACTION**

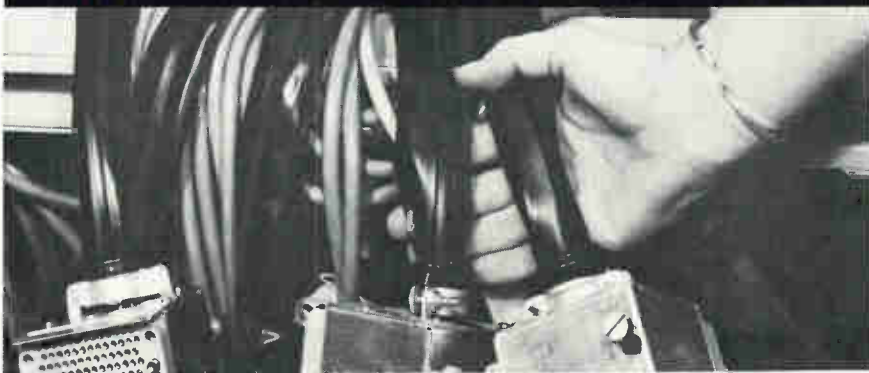

Zippertubing® jacketing as used on the power distribution cable assembly of the Ci 5000 Analog Computer manufactured by COMCOR INC., a subsidiary of ASTRODATA, INC., Anaheim, Calif.

- EASY . . . . . Zipper closure simplifies application.
- SAVINGS . . . . . Reduces assembly time and cost.
- FAST . . . . . Single operation bundling and protection.
- ACCESS . . . . . Easy re-entry for modification.

Shouldn't you be using Zippertubing®? If you would like to know more about it, we wrote a book on it. It is yours for the asking.

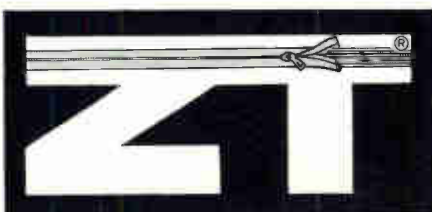

**THE Zippertubing® co.**  
13000 S. Broadway  
Los Angeles, Calif. 90061 (213) FA 1-3901  
**Eastern Office and Warehouse:**  
480 U. S. Highway 46  
S. Hackensack, N.J. 07606 (301) HU 7-6261

## New Subassemblies



from 100 microseconds to infinity. The card is used with an external meter and power supplies, and mounts in the user's equipment.

The card converts the peak amplitude of any input voltage signal of 100 microseconds or longer duration into an unvarying output and holds it indefinitely in an electronic memory until reset or until a higher amplitude input pulse is received. Input impedance is 10,000 ohms minimum. Output of the memory card is 0 to 100 microamperes d-c, full scale, and is internally adjustable to full scale for meters of 500 to 1,000 ohms internal resistance. Accuracy is  $\pm 2\%$  of full scale.

Model 5221 is a printed circuit card 6 $\frac{3}{8}$  in. long x 4 $\frac{5}{8}$  in. wide, including connector fingers. Price is \$150 each in quantities of one to nine. Discounts are available on larger quantities.

Micro Instrument Co., 12901 Crenshaw Blvd., Hawthorne, Calif., 90250. [377]

## Low-pass filters fill variety of needs

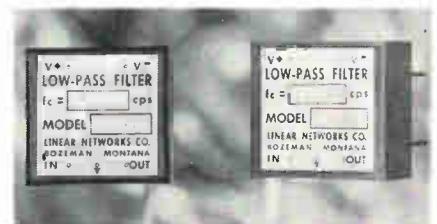

A series of epoxy-encapsulated active low-pass filter networks has been developed with a low cutoff frequency for applications that include seismology, medical electronics, sonar, oceanography and speech analysis. The networks may be used wherever small temperature-dependent d-c offset voltage



is not objectionable.

The LPB4 filters have the four-pole Butterworth (maximally-flat) frequency response characteristic in gain and phase. The operating temperature range is  $-40^{\circ}$  to  $+70^{\circ}\text{C}$ , over which the attenuation is  $3 \pm 0.5$  db at cutoff frequency; the attenuation rolloff is 24 db per octave. The filters will not be damaged if stored at temperatures between  $-55^{\circ}$  and  $+125^{\circ}\text{C}$ .

The filters have small physical size (0.8 cu in.), and low insertion loss (0.1 db); they can accommodate a wide range of source and load impedances and are insensitive to power supply variations. Standard cutoff frequencies from 1 to 1,000 hertz are available; other cutoff frequencies are available on special order.

The devices are priced from \$45 in small quantities, and are available from stock to 30 days. Linear Networks Co., 1309 S. Black Ave., Bozeman, Mont., 59715. [378]

## Pre-amplifier features remote gain switching



Premium noise performance and 1,000-megohm input impedance are provided in a pre-amplifier with remotely-switchable gain. The pre-amplifiers can be used in hydrophones, low-noise vibration work, radiometry, and in any application where widely varying signal amplitude is encountered.

Model 155 pre-amplifiers may be operated with remote gain switching at distances limited only by the output stage—typically 10,000 feet or more.

The pre-amplifier's construction is all solid state; it contains no mechanical contacts. Each unit is encapsulated and hermetically sealed in a cylindrical module  $1\frac{1}{8}$ -in. diameter and  $2\frac{1}{4}$  in. long. Versions are available with either connector or solder pin terminations.

The two switchable gain states are 20 db and 40 db, with long-

# If your signal conditioners don't stack up...

## CEC has the ones that do.

In other words, a *complete line* of dc and ac signal conditioning equipment specifically created to do the job at a realistic price. Furthermore, this wide range of instruments assures a compatible match with virtually any transducer device being used today.

Now add the advantage of single-source responsibility from event to readout, and you know why so many users prefer to come to CEC.

Taking it from the top, here are some highlights about the conditioners that make up our "signal tower":

**8-108 Bridge Balance** provides coupling between as many as eight strain gages or resistive-bridge-type pickups and any suitable recording or indicating device.

**1-162A Galvanometer Driver Amplifier** is a solid state, low-gain, wideband power amplifier for driving high frequency light beam galvanometers.

**1-165 DC Amplifier** is a differential, high-gain, wide-band instrument featuring four terminals to provide isolation between input and output and circuitry and ground, thus offering greater application versatility than a single-ended galvo driver.

**1-118 3 KHz Carrier Amplifier** is a completely self-contained four-channel carrier amplifier designed to amplify the output of strain gages and other transducers.

**1-163 DC Amplifier** can match and deflect all CEC galvanometers to full scale rated deflection, plus properly damp and drive any other available recording galvo.

**1-127 20 KHz Carrier Amplifier** raises the level of small signals produced by resistance-bridge

or variable-reluctance-type transducers to a level suitable for operation of companion CEC galvanometers.

**3-140 Voltage Supply**—a solid-state, precision power source specifically designed for excitation of strain gage transducers and other devices requiring a dc excitation voltage.

**System D** is a multi-channel, dual-purpose system incorporating both linear-integrating and carrier amplifiers. Consequently, any single oscillograph record can indicate strain, pressure, acceleration, vibration and other physical phenomena.

### APPLICATIONS

Aerospace, industry and medicine... wherever there is a need to acquire, measure and display dynamic or static data. For complete information about any or all of these signal conditioning instruments, call your nearest CEC Office, or write Consolidated Electro-dynamics, Pasadena, California 91109. A subsidiary of Bell & Howell. Bulletin Kit #307-X2.

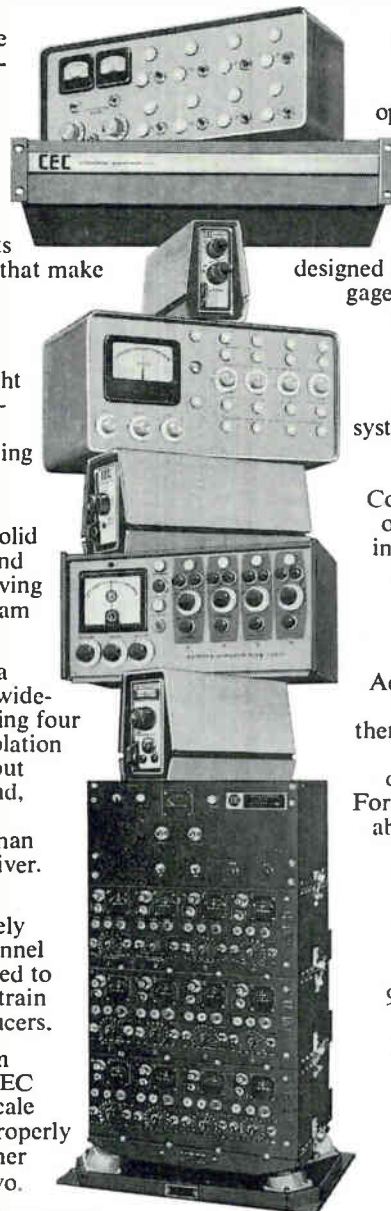

# CEC

DATAGRAPH PRODUCTS

 **BELL & HOWELL**

## to see and check subminiature operations

you, too, should use a Bausch & Lomb StereoZoom microscope. Lindberg Hevi-Duty, a Division of Sola Basic Industries, does . . . on their automatic die and wire bonders. Designed to meet the most sophisticated demands of the semiconductor industry—for production and reliability, the bonders won a coveted 1966 Master Design Award from

“Production Engineering” magazine.



StereoZoom, interlinked with a special mirror system, provides razor-sharp viewing during die pickup, positioning and bonding. StereoZoom gives a big, bright three-dimensional image—with full edge-to-edge, flat-field clarity. Continuously-variable magnification models let operator quickly zoom through a wide range to the precise setting desired. StereoZoom keeps work constantly in view, helps achieve high production rates and minimizes eye strain.

The extensive StereoZoom line lets you pick the right model for the job, or you may select individual components. Get the full story. Call your dealer, or send for Catalog 31-15.

Write Bausch & Lomb, 61438 Bausch Street, Rochester, New York 14602.

In Canada, Bausch & Lomb Optical Co., Ltd., 16 Grosvenor St., Toronto, Ontario.

*Award-Winning*  
**LINDBERG HEVI-DUTY DIE BONDERS**  
use **STEREOZOOM®**



**BAUSCH & LOMB**

## New Subassemblies

term gain stability of 1%. The passband is 0.5 hertz to 200 khz. Broadband noise, referred to the input, is 3  $\mu$ V maximum. Dynamic output impedance is 50 ohms. An internal divider network permits injection of a calibration signal.

Any two gain states in the range 10 to 50 db are available on special order. Variations in frequency response are also available.

Ithaco Inc., 413 Taughanock Blvd., Ithaca, N.Y., 14850. [379]

## Strip printer with take-up spooler

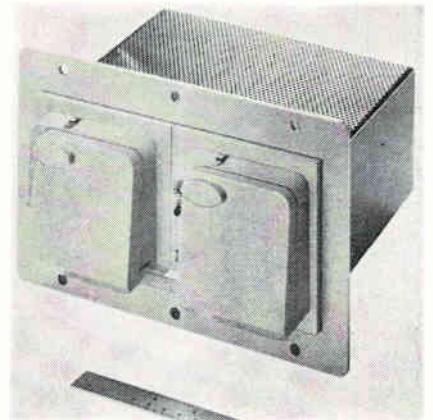

Representative of the company's military line of digital printers is the AN-16 strip printer with take-up spooler. Utilizing the on-the-fly printing technique as used in large on-line computer output printers for several years, the mechanisms have been reduced to five functional subassemblies, an indication of the simplicity and inherent reliability. The complete unit with electronics has been miniaturized for easy installation in instrument panels of large systems where hard copy data recording is required.

The AN-16 is a mil-spec alphanumeric strip printer, weighing less than 5½ lbs and occupying only 200 cu. in. It was designed to meet applicable sections of Mil-E-5400 and Mil-I-26600 and will operate under severe environment.

The printed information is presented serially to the operator at up to 25 characters per second with a selection of 64 characters, and the printer can be adapted to accept



*The Abbé Nollet decided one day  
To test the speed of electricity;  
He ran a current through a mile of monks  
And found truth through eccentricity.*

One of a series of...  
**Vignettes in Electronic History**

*A limited number of full-color reproductions of the  
Abbé Nollet painting, along with the story of his  
experiment, are available upon request.*

Today we can't rely on eccentricity. The 18th Century was a time for bizarre experiments with electricity, but today the watchwords are accuracy and reliability. With the industry's newest and most modern facility, Spectrol continues in a tradition of producing only high reliability, precision, electro-mechanical components for the electronics industry. It has been that way for a long time, and—with "Quality and Service" as a theme of operation—Spectrol

standards will continue to fly high. That is why Spectrol precision potentiometers are on more systems throughout the world than any other pots. If you like what we stand for, shouldn't you be using our products... or, perhaps, working with us to make them?

**Spectrol Electronics Corporation**  
A subsidiary of the Carrier Corporation  
17070 E. Gale Ave., City of Industry, Calif. 91745  
Copyright © 1967



**Better Components for Better Systems:** precision potentiometers • trimming potentiometers • turns-counting dials • miniature switches

# COMPONENT PART ENGINEERS

## Application – Standards – Reliability – Design – Evaluation

The Components and Materials Laboratory of Hughes Aircraft Company in Southern California has immediate needs for engineers to fill permanent positions in the following fields:

### COMPONENT APPLICATION ENGINEERS

Provide technical consultation and liaison to design activities, assist in selection and application of component parts, participate in design reviews.

### MICROELECTRONIC ENGINEERS

Evaluate integrated and thin film devices, analyze failure modes, investigate effects of environments and materials on device characteristics, determine application criteria.

### TEST ENGINEERS

Define evaluation and qualification programs, determine test methods and procedures, direct performance of tests.

### COMPONENT STANDARDS ENGINEERS

Coordinate component-equipment requirements, provide technical consultation, select vendors, determine evaluation programs, initiate procurement documentation.

### RELIABILITY ENGINEERS

Coordinate reliability programs, con-

duct component failure analyses, define and direct experiments, establish mathematical models, investigate component performance.

### INTERCONNECTION APPLICATION ENGINEERS

Provide technical consultation and liaison to design activities and prime customers in the selection and design of wire, cable and flat flexible harnesses.

### COMPONENT DEVELOPMENT ENGINEERS

Develop components using advanced techniques, investigate new design concepts, study component phenomena, direct experiments and design evaluations.

### TECHNICAL WRITERS

Write and edit technical proposals and handbooks, develop component procurement specifications and standards, prepare technical reports.

### PACKAGING ENGINEERS

Develop new concepts of interconnecting electronic assemblies. Design interconnection systems and components using advanced techniques of packaging.

### SUPERVISORS

In addition to requirements for both junior and senior engineers for these

positions, several supervisory openings are available.

### Requirements:

BS, MS or PhD in Electrical or Mechanical Engineering or in Physics. Openings are also available for non-degree engineering personnel.

Positions are available in the following and associated technical fields:

Potentiometers	Electron Tubes
Microwave	Connectors
Crystals	Capacitors
Resolvers	Relays
Microelectronics	Crystal Filters
Instruments	Mechanical
Cable	Motors
Semiconductors	Resistors
Magnetics	Wire
Hardware	Switches

U.S. CITIZENSHIP IS REQUIRED

For immediate consideration, please airmail resume to:

**Mr. Robert A. Martin**  
Head of Employment  
Hughes Aerospace Divisions

**HUGHES**

HUGHES AIRCRAFT COMPANY

11940 W. Jefferson Blvd.  
Culver City 18, California

An equal opportunity employer

## New Subassemblies

any parallel 6-line BCD code at several interface logic voltage options requiring low driving currents limited by the 5-kilohm input impedance. Integrated circuits mounted on replaceable p-c cards are used in the electronic section. The use of  $\frac{5}{16}$ -in.-wide pressure-sensitive tape eliminates the need for ribbons or ink mechanisms. Calculated mean-time-between-failure of printer and spooler is in excess of 3,000 hours.

The AN-16 with take-up spooler sells for \$4,375, with substantial quantity discounts.

Clary Corp., Military Products division, 320 W. Clary Ave., San Gabriel, Calif., 91776. [380]

## Numerical control offers many functions

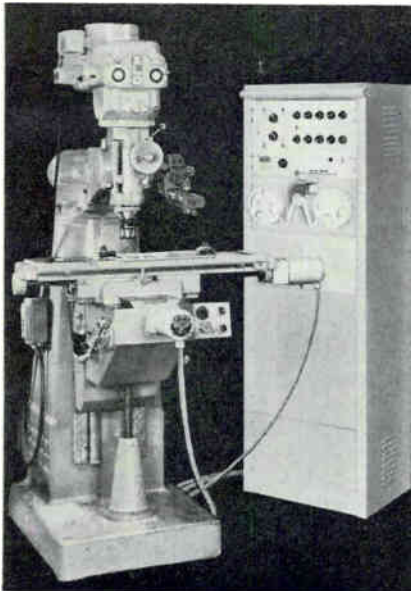

Tape-controlled initiation of two additional external functions, plus tape actuation of rapid traverse during slow feed drilling and milling machine operations, are standard features of the Slo-Syn tape-controlled indexer.

For pocket milling applications, tool feed and retract can be actuated from tape command. When used in drilling and similar applications, the tool can be actuated automatically after positioning. The tape-controlled functions are used for multiple spindle selection, coolant flow or other needs. These fea-

## where in the world can I find one 8233/E55L...?



## get on the hot-line (212) 533-5580

Get out of the "no-bid" habit and get with the action. Join the profit-making distributors who have found Transitube the reliable source for current, original boxed industrial electron tubes and semiconductors from every major manufacturer in the industry—all at below distributor cost. We are the distributor's supplier (not his competitor).

A phone call lets you enter a competitive bid on any quotation.

Tubes and semiconductors can be supplied to meet commercial or military specifications. Immediate delivery is assured from our comprehensive stock, housed within our modern 30,000 sq. foot warehouse.

**Get on the "hot-line"—we're waiting for your call.**

Transitube Inc., 300 Park Ave. South, New York 10010, phone: (212) 533-5580, cable address: Transitube, New York.



Circle 255 on reader service card

To order reprints: Fill in, cut out coupon below, insert in envelope and mail to: **Electronics Reprint Dept., 330 W. 42nd Street, New York, N.Y. 10036**

### Reprint order form

For listing of reprints available see the Reader Service Card.

**Communications Satellites. Parts I and II.**

Send me ..... reprints of Key no. R-90a at \$1.25 each.

For reprints of previous special reports fill in below:

Send me ..... reprints of Key No.(s) ..... @ ..... ¢ each.  
(For prices, see Reader Service Card)

Name .....

Number of street .....

City, State, Zip Code .....



## FIN-Fantastic

Fins and fans on the new Astrodyne 2450 heat sinks provide extremely low thermal resistance — 0.105°C/watt with 23 fins as shown (0.089°C/watt with 33 fins).

Cooling semiconductor components or thermo-electric modules, the 2450 series provides 650 watts dissipation at 1500 CFM (4x4" unit illustrated).

Standard sizes in the 2450 series —

2x2", 3x3", 4x4" and 4x6" — provide easy mounting accessibility for devices to be cooled. The number of fins may be increased to permit maximum heat dissipation and they may be adapted, on special order, to permit through-mounting of heat generating components.

A technical bulletin and prices on the 2450 series forced convection units sent on request.



**astrodyne, inc.**

SUBSIDIARY OF ROANWELL CORPORATION  
207 CAMBRIDGE STREET / BURLINGTON, MASSACHUSETTS 01803  
(617) 272-3850 TWX (710) 332-1609

Circle 256 on reader service card

## LEADER WANTED:

### Semiconductor device reliability group.

We're looking for a man to lead our new Electronic Device Reliability Group. Now forming at our Palo Alto Research Laboratory, this group will perform important studies concerning integrated circuits and solid state components. □ If you are our man, you know silicon devices and integrated circuits from both physics and engineering standpoints. You also are capable of formulating and managing research applications and development programs in a senior position. □ Your group will form a nucleus of experts on semiconductor reliability at Lockheed. The results of your short-term and long-term studies will be the basis of recommendations to our system design engineers about what's good or bad in environments, application, design, manufacturing and testing of electronic components. Emphasis will also be on analysis of sophisticated failure problems, on how to circumvent such problems, on predicting and determining device performance characteristics, while delving deeply into underlying phenomena. □ And, yes, there will be time for your own pet R&D projects if they can be fitted at all reasonably into the serious goals of this new program. In fact, we expect you'll put a lot of your own twist into our thinking. Interested? □ Write: L. G. Luoma, Professional Placement, P.O. Box 504, Sunnyvale, California. Or call collect: (408) 743-2200, up to midnight, Pacific Coast time. Lockheed is an equal opportunity employer.

**LOCKHEED**  
**MISSILES & SPACE COMPANY**  
A GROUP DIVISION OF LOCKHEED AIRCRAFT CORPORATION

## New Subassemblies

tures permit the milling of elongated holes, keyway slots or pockets while drilling the same workpieces. Positioning increments and tool actuation can be directed manually when required.

Designed for point-to-point positioning or straight-line milling applications, the indexer, model TCJ-100B, can be fitted to a wide variety of equipment including drilling, milling and boring machines, automated assembly fixtures, welders, cutters, automatic drafting and wiring machines and many others.

Superior Electric Co., Bristol, Conn., 06010. [381]

## Hybrid multiplier operates at high speed

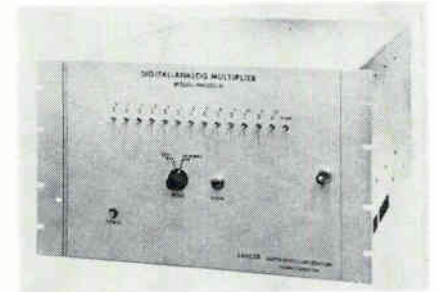

Up to eight digital-analog multiplier channels in a single rack-mountable housing are provided by a hybrid multiplier system.

It performs high speed multiplication or division between  $\pm 100$  volt analog and 14 bit digital variables. The system performs with an operational error of less than 0.01% of full scale and operates directly upon an analog input up to  $\pm 150$  v without preliminary scaling.

Digital representation of negative signed data is accepted in either one's complement or two's complement format. Digital input buffer registers are available in single rank or double rank models. Second rank storage allows for random acquisition of data, which is to be held until required for simultaneous transfer to first rank storage for next computation.

The system, model HM200, fea-

tures solid state construction with integrated circuit storage registers and FET chopper-stabilized amplifiers. System output capability per channel is  $\pm 100$  v at  $\pm 35$  ma with full power bandwidth beyond 50 khz.

Lancer Electronics Corp., Box 142, Norristown, Pa., 19404. [382]

### Solid state supply for crt displays



Compact packaging of a high-voltage power supply permits its easy design into a variety of cathode-ray-tube displays. The integrated solid state unit occupies only  $4\frac{1}{4} \times 4\frac{1}{2} \times 1\frac{1}{2}$  in. and weighs less than  $1\frac{1}{2}$  pounds.

Anode voltages up to 18 kv are available at 0.5 ma. The filament voltage is 6.3 v d-c at 1 amp. Both the focus and the grid bias outputs are adjustable and readily accessible on a single face of the package. The supply provides high voltage outputs with a stability of better than 1% from 0 to full load.

Several circuit protection features are built into the package. All outputs have full short-circuit protection. There is a built-in, 30-second high voltage delay to prevent damage from high voltage reaching the circuit before the filaments obtain operating temperature. An automatic sweep failure protection circuit is also included. If the sweep signal fails, a digital input from the sweep circuitry automatically biases the tube to cut-off in less than 10  $\mu$ sec. This prevents burnout of the tube from concentration of a single spot at the tube face.

Basic price of the crt power supplies is less than \$300 when purchased in quantity.

Mil Associates, Inc., Dracut Road, Hudson, N.H., 03051. [383]

## ENGRAVE EVERYTHING FROM 6 FT. PANELS TO TINY NAMEPLATES

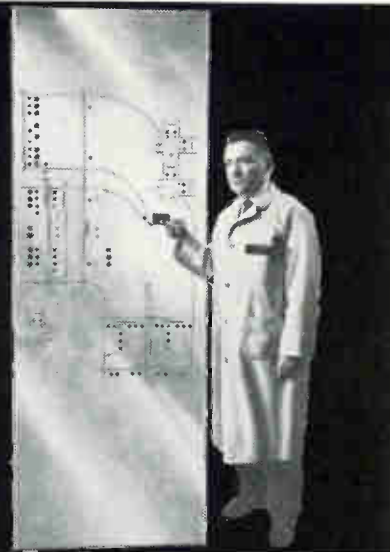

Tracer-guided arm guides the worker—  
makes everyone a skilled engraver.

**Convenient**—It's right in the plant when and where you need it.

**Accurate**—Positive depth of cut with automatic depth regulator. 15 accurate ratios.

**Speedy**—Self-centering work holder cuts set-up time in half.

Ask for complete, illustrated catalog EE-14

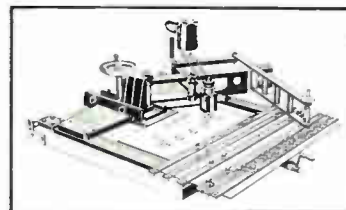

*new hermes engraving machine corp.*

154 WEST 14th ST., NEW YORK 11, N. Y. Chicago, Atlanta, Dallas, Los Angeles, Montreal

Circle 322 on reader service card

## New CDS Type 6C PHOTOCHOPPER CELLS

- High Efficiency
- Low Temperature Coefficient
- Resistance Tolerance  $\pm 50\%$
- Internal Electrostatic Shielding
- Dumet Leads

Write for new  
4-page Bulletin  
110/170 866



# CLAIREX

"The LIGHT Touch in Automation and Control"  
1239 Broadway, New York, N. Y. 10001  
212 MU 4-0940

# CONVERT RADAR, SONAR, AND IR DATA TO TV DISPLAY WITH THE ELECTROSTORE®

This TV display is a composite of a compass reference superimposed on a stored

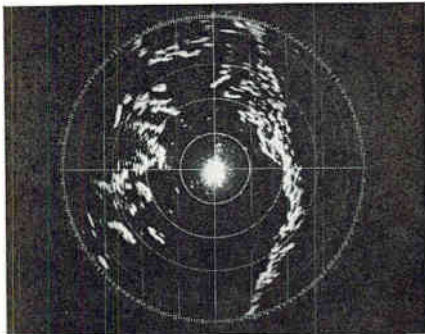

ppi display. It is an example of how the Electrostore Model 221 can convert radar data to a high resolution TV picture.

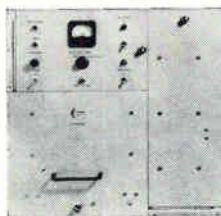

**Model 221 Electrostore**  
single-gun storage tube  
**Input/Output Response**  
10 MHz or 20 MHz  
**Input Amplitude**  
Required 0.7 volts to  
2.0 volts p-p  
**Deflection Amplitude**  
5 volts p-p  
**Deflection Response**  
DC to 800 KHz  
**Programmer Optional**

The Model 221 scan-converter utilizes a cathode-ray recording storage tube. Input video signals and deflection information are applied to the tube through various amplifiers and control circuitry. Data is stored within the tube in the form of a raster, circular, or spiral scan. This information can be read off periodically through appropriate amplifiers without destroying the stored data. The input can be up-dated periodically and the stored information erased partially or in its entirety. By introducing the proper signals, the Electrostore can convert a variety of formats to TV display, i.e. computer-to-TV, radar-to-TV, IR-to-TV, or sonar-to-TV.

Write for technical memos and application notes covering the Electrostore.

**i image**  
instruments, inc.  
223 Crescent Street  
Waltham, Mass. 02154  
Tel. (617) 894-8200

## New Microwave

### Radar klystron delivers 300 w c-w

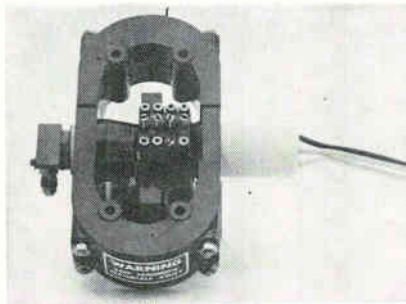

**Rugged klystron amplifiers**, which deliver at least 300 w at a center frequency located between 9.2 and 10.6 Ghz, are claimed to be ideal for airborne doppler radar. The tube has a very low inherent noise with random a-m noise at least 100 db below the carrier in a 1 khz band. The liquid-cooled amplifier weighs less than 6 lbs and measures 6.6x5.6x4.3 inches.

Models in the VA-896 series operating at any center frequency between 9.2 and 9.6 Ghz are tunable  $\pm 50$  Mhz; others within 9.6 to 10 Ghz are tunable  $\pm 100$  Mhz; and those in the 10 to 10.6 Ghz range are tunable  $\pm 125$  Mhz.

Gain is high—at least 45 db—minimizing drive power requirements. Focusing is by an integral permanent magnet, a feature that eliminates focusing adjustments and the need for extra power supplies.

Varian, Palo Alto Tube division, 611 Hansen Way, Palo Alto, Calif., 94303. [391]

### Waveguide terminations for S to Ku band

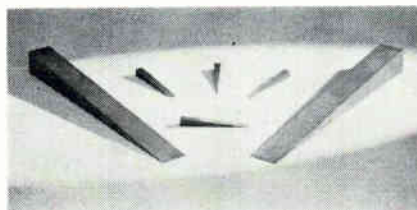

Low-power waveguide terminating elements are available for frequencies from S band to Ku band. The

terminations, shaped like wedges, are made from lossy dielectric absorbing material.

In use, one side of the wedge is mounted in contact with the bottom (broad) wall of the waveguide to provide a rugged structure that will withstand far more abuse than the pyramidal-type termination. This construction also permits greatly improved heat dissipation because of the contact of the wedge with the waveguide. Also, the wedge can be adhered to the waveguide wall with an adhesive with the same properties as the wedge material.

The wedge fineness ratio of approximately 10:1 insures very low vswr of the element over the entire waveguide band—maximum vswr is 1.01. Length of the element varies from  $2\frac{3}{4}$  in. for Ku band to  $12\frac{1}{4}$  in. for S band.

The terminations are priced from \$15 to \$75.

Emerson & Cuming Inc., Microwave Products division, Canton, Mass., 02021. [392]

### Bolometer unit covers wide band

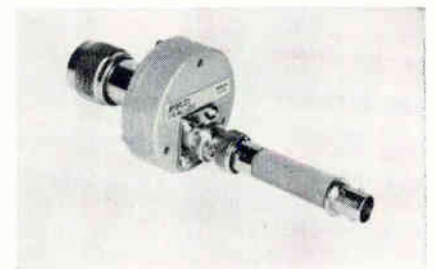

A fixed-tuned bolometer unit operates from 50 Mhz to 10 Ghz. Consisting of a length of  $\frac{3}{8}$ -in. coaxial line and a filter network, it is particularly useful for low power measurements. The bolometer's element, a thermistor, is a flat disk structure which is clamped between round flanges. Matching is provided by inductive undercuts in the mount's coaxial line and by the proper shaping of the bolometer's electrode. Maximum power rating for the type G27-AM1 is 10 milliwatts.

Connectors are type N or BNC,



# NEW MINIATURE



## NYLON CONNECTORS

Up to 15 circuit capacity with these low-cost, miniature nylon connectors! Contacts automatically crimped to leads, then securely snap-lock into the housings. Positive polarity prevents misconnections and integral mounting ears provide easy panel installation.

**Model 1625-3**  
Compact three circuit unit for independent circuit isolation.



**Model 1625-9**  
Nine circuit connections for fast, multiple circuit wiring.



**Model 1625-12**  
Twelve independent circuits are provided with this unit.



**Model 1625-15**  
Up to 15 separate circuits in this space saving connector.



Write for complete specifications and samples on any of these connectors.

**MOLEX® PRODUCTS COMPANY**  
5241 Katrine Avenue  
Downers Grove, Illinois 60515  
(312) 969-4550 TWX 910-695-3533



Circle 323 on reader service card

DIALCO

# SUB-MINIATURE INDICATOR LIGHTS

make difficult display applications easier!

NEON  
OR  
INCANDESCENT

(illus. approx. actual size)



137-8836-0931-552



174-8430-0131-203



162-8430-0931-502



134-8430-0351-201



101-3830-0971-201



177-8430-0931-503

Dialco has the widest selection of sub-miniature indicator lights to choose from ... off the shelf for quick delivery!

Designed to meet or exceed the environmental and operational requirements of MIL-L-6723 and MIL-L-3661, Dialco Incandescent units may be had for 1.35 to 28V circuits; Neon indicators for 105-125V AC-DC or 110-125V AC only. Units mount in 15/32" or 17/32" clearance hole—and lens caps unscrew from front of panel for easy lamp replacement.

Choose from a wide array of lens shapes and colors (with or without hot-stamped or engraved legends)—dimming or non-dimming features; assemblies with or without watertight construction.



Ask for new 12 page catalog today. Get all the facts!

...and choose with the satisfaction of knowing you are getting the best. Dialco has been the standard of the industry for over a quarter of a century!

SAMPLES ON REQUEST—AT ONCE—NO CHARGE

Foremost Manufacturer of Indicator Lights

**DIALIGHT** CORPORATION

60 STEWART AVE., BROOKLYN, N.Y. 11237 • AREA CODE 212 497-7600

BOOTHS 3H14-3H16 at IEEE Show

Circle 259 on reader service card

259

## New 20-70 mHz Receiver from CEI

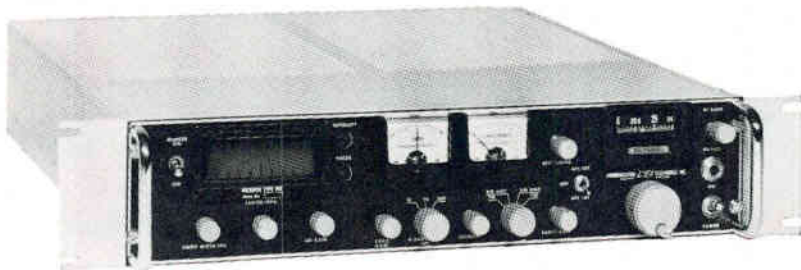

**AM, FM, CW... ultra-precise tuning ...  
3 IF bandwidths... built-in signal monitor**

CEI's unusual new Type 521 Receiver provides AM, FM and CW reception across the 20 to 70 mHz range in one band. Features include a built-in signal monitor (with maximum sweep width of 300 kHz and resolution of 2.5 kHz), audio squelch and tunable BFO. Three switch-selectable IF bandwidths are provided: 4kHz, 10 kHz, and 50 kHz.

The 521's 50-mHz tuning range is spread over 26 inches of steel tape for easy readability and resetability. For even more precise tuning, the 521 may be operated with an external counter such as CEI's Type DRO-290A, thus providing a six-digit frequency readout ( $\pm 100$  Hz over the entire range) with the receiver's local oscillator locked to the counter. For full information and specifications, please contact:



**COMMUNICATION ELECTRONICS INCORPORATED**

6006 Executive Blvd., Rockville, Md. 20852 · Phone: (301) 933-2800 · TWX: 710-824-9603

Circle 324 on reader service card

## New Microwave

and variation of fixed and tuned coaxial mounts are available on special order.

PRD Electronics, Inc., 1200 Prospect Ave., Westbury, N.Y., 11590. [393]

## Frequency translator offers high stability

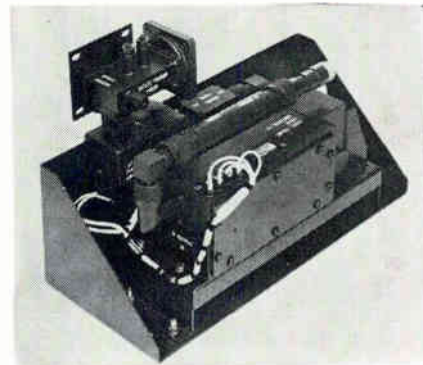

High stability under severe environments is featured in a field-transportable microwave frequency translator for communications systems. The solid state unit consists of a tunnel diode amplifier, isolator, image rejection filter, mixer/i-f amplifier and a bandpass filter.

The device converts signal inputs of 7.25 to 7.75 Ghz to outputs at 400 Mhz with an r-f to i-f gain of 50 db and a noise figure of less than 8 db. Intermodulations and spurious responses are at least 60 db below the desired output level.

The signal translator provides linear amplification to signal levels as high as +9 dbm with a 1-db bandwidth of 60 Mhz minimum. Local oscillator rejection is at least 20 db below the l-o input level.

The Micro State Electronics Corp., a subsidiary of Raytheon Co., Murray Hill, N.J. [394]

## Air-strip package operates at X band

A strip transmission line mixer is available that minimizes the response to the image frequency and requires no tuning through the entire band from 8.2 through 10 Ghz. Image rejection is greater than 25 db from 9.2 to 9.55 Ghz, and all

**EMPLOYEES  
WANTED!**

*INQUIRE INSIDE*

**Is this sign  
always on  
your door?**

GET RID OF IT IN

# South Dakota

INDUSTRY is finding a new and untapped personnel pool in SOUTH DAKOTA where a day's work for a day's pay is still a way of life. Alert, eager, trainable people with a literacy rate of 98.5 per cent . . . absenteeism is among the nation's lowest. You get into production fast and you maintain high quality standards when you have this kind of labor supply. Let us show you how SOUTH DAKOTA can fill your needs — and keep them filled.

- Free Port Law
- Abundant Water
- Available Power
- Low Corporate Tax Rates

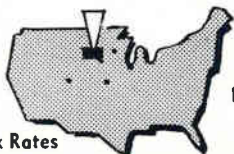

GET THE SOUTH DAKOTA STORY  
CONTACT:

**ROBERT H. MARTIN, DIRECTOR**  
Industrial Development Expansion Agency  
Room 400 Pierre, South Dakota 57501  
Phone 224-5911 Extension 307 AC 605

*if your applique sheet does not give  
crisp reproduction every time...*

*you're not using* **STANPAT**  
**THE ORIGINAL INSTANT DRAFTING**

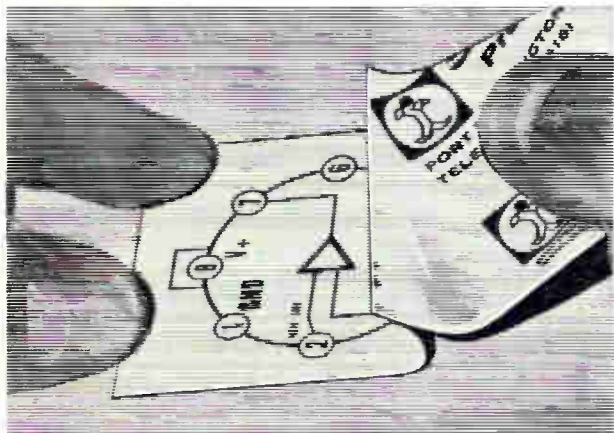

We couldn't take better care of your tracings if they were our own. And, because we've been making appliques longer than anyone else, we're quite a few steps ahead of everyone else. That's why we can guarantee that STANPAT sheets meet the most exacting requirements of draftsmen and engineers... will give perfect reproduction every time and saves costly man hours. Don't take chances with inferior imitations and ruin costly tracings. Insist on STANPAT!

- Only STANPAT pressure sensitive sheets adhere permanently. Won't wrinkle when tracings are rolled.
- Only STANPAT has a non-reflective matte surface that thrives on erasures... will never polish... is receptive to pencil or ink... assures clean, crisp reproduction, even with microfilm.
- Only STANPAT is compatible with all drafting materials and fabrics. Cannot disturb oils contained in some papers that could be leached out, causing "ghosting".
- Only STANPAT is laminated on both sides to prevent absorption of moisture and curling.
- Only STANPAT has translucent backing to allow positioning before application to your tracing.
- Only STANPAT is dated for your protection, with a one year shelf-life guarantee.

Yet, with all these performance features, STANPAT is priced low. And there's never a charge for plates or delivery. What's more, STANPAT'S new and improved production techniques cut in-plant time to three days.

Unbelievable? Then send for a free sample today and judge for yourself. Better yet, send us a sample of your repetitive artwork and we'll send you a quote. There's no obligation.

**MAKE YOUR OWN STANPAT**

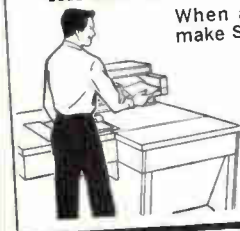

When an emergency arises, you can now make STANPAT drawing symbols in your own office. Make your repetitive symbols for any diagram, spec, detail, title block, or any other drawing, on our newly developed 8 1/2" x 11" sheets of special material. Run it through your electrostatic copier, and you have your own pre-printed transfer sheet within minutes. Reproductions are always crisp and clean.

*faithfully serving the engineer for a quarter of a century*

**STANPAT PRODUCTS INC.**

Covert and Main Street, Dept. J2  
Port Washington, N.Y. 11050  
Telephone: 516 883-8400



**NOW..**

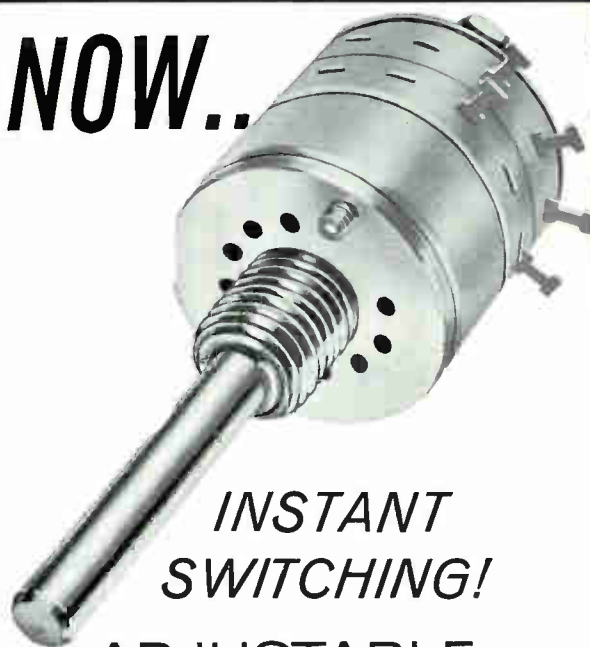

**INSTANT  
SWITCHING!**

**ADJUSTABLE  
STOPS NOW  
AVAILABLE IN**

**1/2" ROTARY  
SWITCHES**

**"Off-The-Shelf" shipments  
for INDUSTRY'S  
BEST DELIVERY!**

- ● from 2 to 12 positions (shorting or non-shorting) available merely by moving external plate!
- ● up to 6 poles available on one deck!
- ● Instant switching to any desired number of circuit positions!
- ● ideal for breadboard setups, laboratory stock, and prototype work—where rapid circuit modification may be desired.

Write for complete engineering information.

**RCL** ELECTRONICS, Inc.

General Sales Office:

One Hixon Place, Maplewood, New Jersey 07040

# Miniature High Q Air Capacitors

## New Microwave

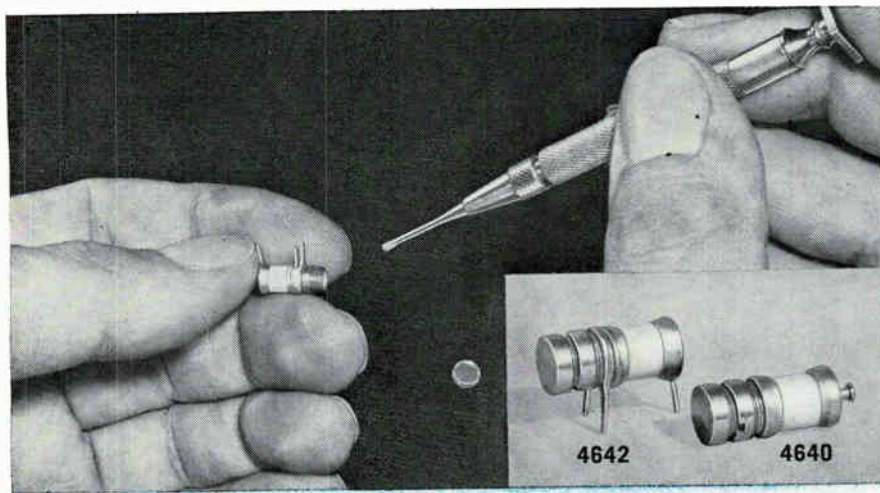

### Small Size • High Q • Rugged High Selectivity • High Sensitivity

- **Size:** .220" dia. 15/32" length
- **Q @ 100 mc:** > 5000
- **Capacitance Range:** 0.4 — 6 pf
- **Non-Magnetic**

New miniature series features high quality materials and workmanship typical of all Johanson Variable Air Capacitors.

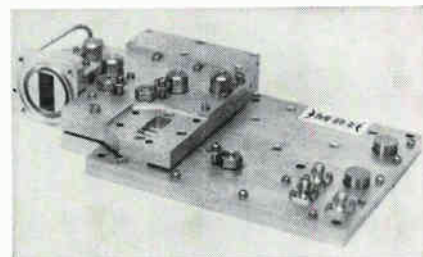
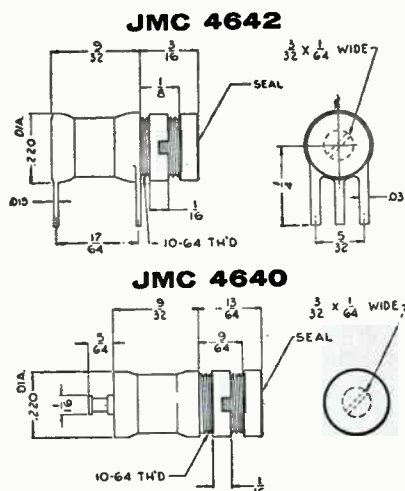

spurious signals are down more than 40 db.

The lightweight package includes a waveguide-to-coaxial transition for local oscillator input to the lower section. This section includes three isolators, a differential phase shifter and three variable attenuators for use with the mixer and other functions.

The manufacturer says the rugged package uses the latest techniques in low-loss printed strip transmission circuitry. It meets all the requirements of MIL-E-5400 including long life and ultrahigh reliability. All diodes are easily replaced because they are mounted in accessible holders.

The package is 9.1x5.3x1.6 in. and weighs less than 37 oz. Micro-Radionics Inc., Van Nuys, Calif. [395]

### Pulsed twt drives wideband radar

Designed for use as a driver or output stage in advanced wideband radar systems, a pulsed traveling-wave amplifier tube covers the 2.8- to 3.5-Ghz band. It produces a peak output greater than 7 kw with less than 5 w of drive power without mechanical or electrical adjustment at pulse lengths up to 200  $\mu$ sec.

The tube, VA-642C, is liquid cooled, electromagnetically focused, and of all metal-ceramic construction. It weighs 10 pounds; its electromagnet weighs 65 lbs. Diameter of the tube is 2.615 in. and length is 26.5 in. Coolant fittings accommodate 1/4-in. outside-diameter tubing.

Varian, Palo Alto Tube division, 611 Hansen Way, Palo Alto, Calif. 94303. [396]

Write or Phone for Details. Prices  
**Johanson MANUFACTURING CORPORATION**  
 400 Rockaway Valley Road, Bounton, N. J. 07005 • Phone (201) DEerfield 4-2676

Circle 262 on reader service card

To order reprints: Fill in, cut out coupon below, insert in envelope and mail to: **Electronics Reprint Dept., 330 W. 42nd Street, New York, N.Y. 10036**

#### Reprint order form

For listing of reprints available see the Reader Service Card.

Communications Satellites Part I

Send me ..... reprints of Key no. R-89 at 50¢ each.

For reprints of previous special reports fill in below:

Send me ..... reprints of Key No.(s) ..... @ .....¢ each.  
 (For prices, see Reader Service Card)

Name .....

Number of street .....

City, State, Zip code .....

# NEW EFFICIENCY FOR ULTRASONIC TRANSDUCERS

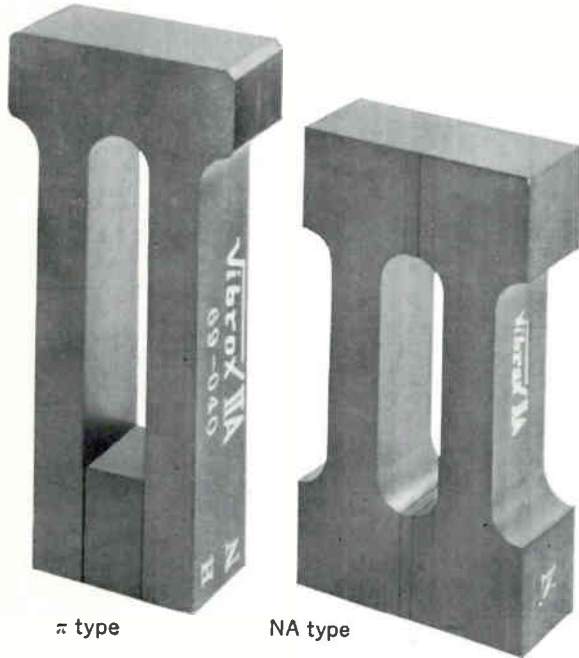

$\pi$  type

NA type

Now, adding new efficiency to ultrasonic propagation, Tohoku Metal introduces VIBROX—unique ferrite magnetostrictive vibrators. Developed by Dr. Yoshimitsu Kikuchi of Tohoku University, VIBROX has minimum eddy current loss and a far greater electro-mechanical transduction efficiency than conventional vibrators. A wide range of application embraces ultrasonic cleaning and degreasing; metal, textile, and chemical processing; and echo-sounding and navigation devices such as depth-sounder, fish-finders, etc.

Tohoku VIBROX is supplied in two shape-types with nominal frequencies ranging from 15 to 100Kc. Termed NA and  $\pi$  respectively, both make use of associated permanent magnets to totally eliminate the need for DC bias—despite the fact that VIBROX is magnetostrictive.

For further information and brochures, write to:

**Tohoku Metal Industries, Ltd.**

7-4, GINZA-HIGASHI, CHUO-KU, TOKYO, JAPAN  
Telephone: Tokyo (542) 6171 Cable Address: TOHOKUMETAL TOKYO

# Here's What Heath Means By Value . . .

**A Professional Transistor Tester  
Offering Complete  
DC Analysis  
Factory Assembled  
and Tested For \$84.95  
(kit form . . . \$54.88)**



*Provides Full Laboratory Facilities In One Compact Unit.*

Heathkit IM-30 Analysis Includes . . . base current, collector current, collector voltage, collector-to-emitter leakage (Iceo), collector-to-base leakage (Icbo), and diode forward and reverse current. Separate voltage and current range switches for both gain and leakage settings allow tests under a wide variety of conditions. DC Beta (0-150, 150-300) and DC Alpha are read directly on the calibrated Gain Scale. Requires 7 "D" cells for internal power—provisions included for external power. The IM-30 is truly an exceptional value in transistor testing facilities. 10 lbs. Kit IM-30, \$54.88. Wired IMW-30, \$84.95.

**A 10 Hz to 100 kHz Sine-Wave Audio Generator,  
Switch Selected,  
With Metered Output  
Factory Assembled  
and Tested For \$64.95  
(kit form . . . \$41.95)**



*Provides Virtually Perfect Sine-Wave Waveforms From 20 To 20,000 Hz . . . (less than 0.1% distortion).*

Invaluable For Instrument Calibration And Precise Circuit Analysis . . . an excellent instrument for production testing, since all signal characteristics are accurately resettable. The entire frequency range of 10 Hz to 100 kHz is switch selected . . . with switch positions for two significant figures plus multiplier. Signal amplitude is adjusted with a 10 db per step output attenuator and range vernier (0 to 0.003, 0.01, 0.03, 0.1, 0.3, & 1 volts RMS to 600 ohms and 0 to 3, & 10 volts RMS to high Z) . . . and output signal level is read on the panel meter in db and R.M.S. volts. Both amplitude and frequency calibration are accurate to 5%. Here is an instrument chosen by many electronics manufacturers and engineering facilities requiring a precision sine-wave audio generator. 9 lbs. Kit IG-72, \$41.95. Wired IGW-72, \$64.95.



**FREE! World's Largest  
Electronic Kit Catalog**

Includes these and over 250 other items for the service technician, engineer, ham, teacher, and hobbyist.

**HEATH COMPANY, Dept. 520-28**

Benton Harbor, Mich. 49022

In Canada, Daystrom Ltd.

Please send my FREE Heathkit Catalog.

Enclosed is \$ \_\_\_\_\_, plus postage.

Please send model(s) \_\_\_\_\_

Name \_\_\_\_\_

Address \_\_\_\_\_

City \_\_\_\_\_ State \_\_\_\_\_ Zip \_\_\_\_\_

Prices & Specifications subject to change without notice. TE-156





Screw type slotted knob that is recessed in holder body and requires use of screwdriver to remove or insert it.



Screw type knob designed for easy gripping, even with gloves. Has a "break-away" test prod hole in knob.

## BUSS Space Saver Panel Mounted Fuseholders

Fuseholder only 1 5/8 inches long, extends just 3/32 inch behind front of panel. Takes 1/4 x 1 1/4 inch fuses. Holder rated at 15 ampere for any voltage up to 250.

Military type available to meet all requirements of MIL-F-19207A.

Write for BUSS Bulletin SFH-10

INSIST ON **BUSS**  
**QUALITY**

BUSSMANN MFG. DIVISION, McGraw-Edison Co., St. Louis, Mo. 63107  
Circle 265 on reader service card

## BUSS SHIELDED FUSEHOLDERS

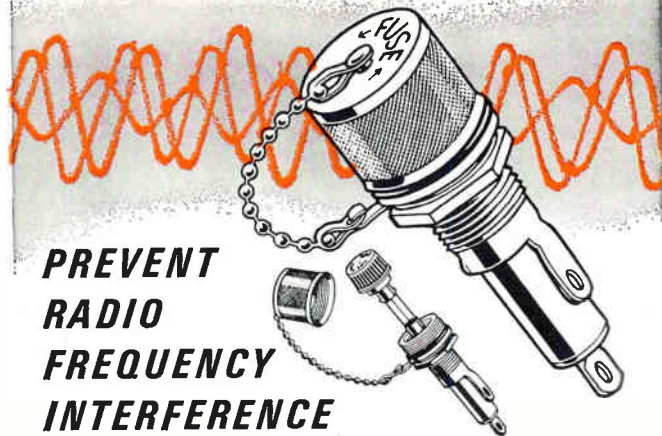

**PREVENT  
RADIO  
FREQUENCY  
INTERFERENCE**

For use where fuse and fuseholder could pick up radio frequency radiation which interferes with circuit containing fuseholder—or other nearby circuits.

Fuseholder accomplishes both shielding and grounding.

Available to take two sizes of fuses—1/4 x 1 1/4" and 1/4 x 1" fuses. Meet all requirements of both MIL-I-6181D and MIL-F-19207A.

Write for BUSS Bulletin SFH-12

INSIST ON **BUSS**  
**QUALITY**

BUSSMANN MFG. DIVISION, McGraw-Edison Co., ST. LOUIS, MO. 63107  
Circle 265 on reader service card

## BUSS: The Complete Line of Fuses and . . .

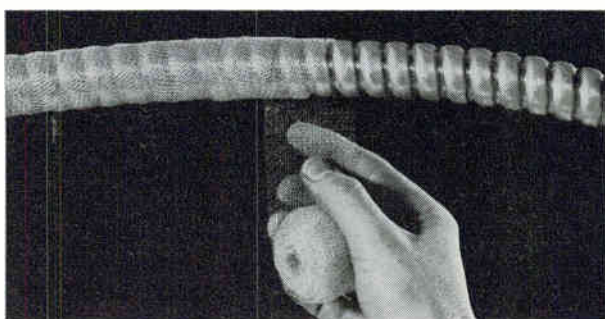

### Metex RFI Shielding Tape

...the ideal inexpensive approach for shielding cable assemblies

Shielding tapes can be provided in several materials. The most popular materials are monel, aluminum, silver plated brass and tin plated copper clad steel. These tapes can be provided in continuous lengths in widths from 1/2".

They are highly flexible and easy to apply to odd shaped cable assemblies or equipment to provide excellent shielding coverage. Write for free samples, prices, literature, or ask us for engineering assistance!

**METEX Corporation**

Walnut Avenue, Clark, New Jersey 07066  
(201) FU 1-7272 • TWX 710-744-4530

West Coast: 5057 W. Washington Blvd., Los Angeles



### NEW from Cramer



## ADJUST-A-LOK STOOLS

*Adjust to every worker like fine tools!*

Cramer Adjust-A-Lok is immediately adjustable to any workers height. Just release the safety stop, and lift or lower. It can be done just that quick. Since fatigue is a critical factor in efficiency of seated workers, it's just good economics to provide tools that minimize fatigue. With Adjust-A-Lok every worker can find his own most comfortable and efficient level. 6 seat styles and 5 base types provide 30 available models. For more information: write V. P. Sales, Cramer Industries, Inc., 625 Adams, Kansas City, Kansas 66105.

Industrial supplier  
inquiries invited



Cramer—The leader in style and quality.

## New Production Equipment

### High-speed component insertion

Insertion of components by hand into printed circuit boards, while cumbersome and time-consuming, is frequently necessary when several types of axial-leaded components have to be put in a relatively small number of boards. To cover

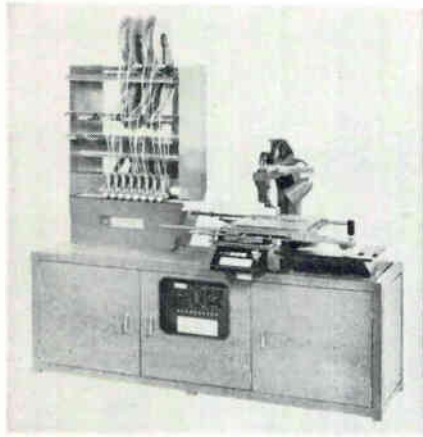

just such small production runs, the Universal Instruments Corp. has developed a machine it says will allow one operator to do the work of 15 hand-assemblers.

The company's model 6710 achieves this efficiency by combining the sequencing and insertion processes. Its three racks hold as many as 10 component reels, each as large as 16 inches in diameter. Individual components drop through dispensing stations below the racks and are carried on a chain conveyor operated by a two-way air cylinder. A sensing device poised above the belt determines the component's presence.

The actual insertion assembly is an adaptation of the company's Pantograph, an earlier machine working from only one reel. The insertion head in the center of the

machine is guided by a stylus at the extreme right. The operator moves and depresses the stylus in the proper sequence into holes on a template. A cut-and-clinch unit coming up from below the head insures uniform lead length and tightness even with components of varying diameters.

Although there is provision for only 10 reels, the model 6710 isn't restricted to production runs where the total number of components on the p-c board is 10 or less. As long as only 10 or fewer different types of components are needed, the machine can prove economical where the annual number of components to be inserted is roughly 1 million or 2 million.

The machine will make insertions on one axis only; if the leads are positioned on two axes, the board must be repositioned and a second pass-through made.

The sequencer can also be fed from magazines, but magazines hold fewer components than reels, and Universal warns that the gravity feed introduces more possi-

## Fuseholders of Unquestioned High Quality

VISUAL INDICATING FUSES



FUSE ONLY  
.270 x .250  
INCHES

GMW FUSE  
and HWA  
FUSEHOLDER

### **BUSS** SUB-MINIATURE FUSEHOLDER COMBINATION

For space-tight applications, Fuse has window for inspection of element. Fuse may be used with or without holder.

Fuse held tight in holder by beryllium copper contacts assuring low resistance.

Holder can be used with or without knob. Knob makes holder water-proof from front of panel.

Military type fuse FM01 meets all requirements of MIL-F-23419. Military type holder FHN42W meets all military requirements of MIL-F-19207A.

Write for **BUSS** Bulletin SFB

**INSIST ON BUSS  
QUALITY**

BUSSMANN MFG. DIVISION, McGraw-Edison Co., ST. LOUIS, MO. 63107

Circle 265 on reader service card



### **FUSETRON** dual-element Fuses *slow blowing*

Write for  
**BUSS**  
Bulletin SFB

"Slow blowing" fuses prevent needless outages by not opening on harmless overloads—yet provide safe, protection against short-circuits or dangerous overloads.

**INSIST ON BUSS  
QUALITY**

BUSSMANN MFG. DIVISION, McGraw-Edison Co., ST. LOUIS, MO. 63107

Circle 265 on reader circle card 265

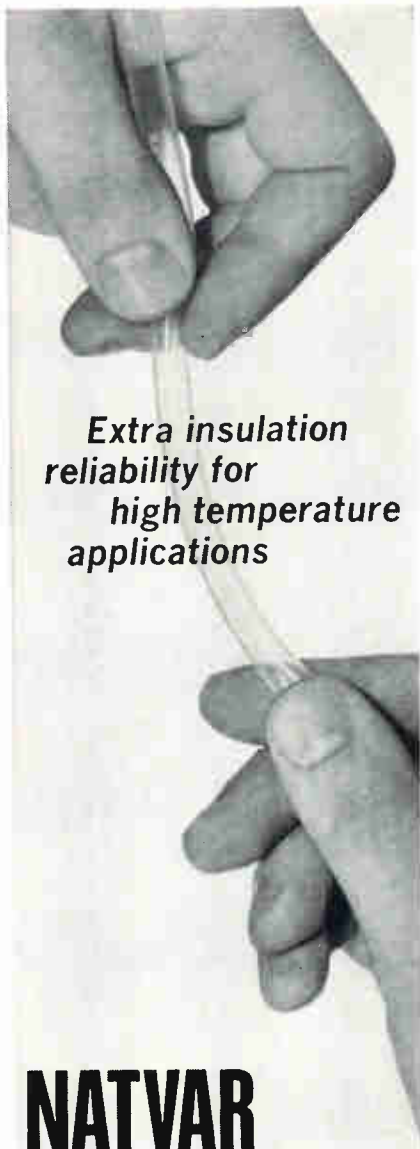

Extra insulation reliability for high temperature applications

# NATVAR 400 Vinyl Tubing

Here's an insulation you can rely on when the heat's on. Because Natvar 400 vinyl tubing has excellent thermal life. In fact, it's U.L. recognized for 105°C continuous operation. Besides that, it has exceptional resistance to oils.

Use Natvar 400 high temperature vinyl tubing to insulate leads... terminations... wiring... electronic equipment... oil filled transformers... harnesses.

Available in a wide range of sizes and colors—in continuous lengths or cut pieces. Send for FREE samples and complete technical data.

**NATVAR CORPORATION**  
P. O. Box 67, Rahway, New Jersey 07065

## Production Equipment

bilities for error.

The model 6710 is priced at \$19,000, plus the cost of the template. Universal estimates that if the operator is paid \$2.50 an hour and can hand-insert 400 components an hour, the machine can pay for itself in 63½ 7-hour working days.

### Specifications

Insertion rate	3,000/hr
Size	73 x 83 x 42 inches
Weight	1,500 lb.
Area	70 sq. ft.
Power requirements	115 v, 60 hz
Air requirements	80 psi, 1 cfm

Universal Instruments Corp., East Frederick St., Binghamton, N.Y. 13902 [401]

## Ultrasonic degreasers in a compact package



Light-duty vapor degreasers provide ultrasonic washing, spray and vapor rinsing in a compact package from which parts emerge clean and dry. The units come in three standard sizes with working volumes of 9x12x10 in., 12x18x12 in., and 24x18x12 in. They can handle between 300 and 1,200 lbs of steel parts per hour, or the equivalent in other materials.

Typical applications for the ultrasonic degreasers—which use Freon TR degreasing solvent—include the cleaning of p-c boards, switches, relays, bearings, micro-modules, precision instruments and electronic components.

A distillation system continu-



**YES!**  
**1000 uh**  
in these tiny coils



Delevan's new **MICRO*i***

- Integrated and hybrid circuit compatibility.
- Magnetically shielded — low coupling.
- No core saturation problems.
- L and Q stability excellent.
- Epoxy encapsulated for environmental protection.

This chart depicts the excellent electrical characteristics of a few coils in the complete Micro *i* Series.

Lin uh	Q MIN.	SRF MIN.	Current
.100	40	>250	460 Ma.
.47	40	175	340 Ma.
1.00	35	135	220 Ma.
5.60	40	50	100 Ma.
10.0	40	40	80 Ma.
47.0	45	15	70 Ma.
100	45	10	45 Ma.
330	45	3.3	55 Ma.
1000	35	1.8	36 Ma.

L and Q Values at Standard Q Meter Frequency

**Delevan Electronics Corporation / Division**  **AMERICAN PRECISION INDUSTRIES INC.**

270 QUAKER RD. / EAST AURORA, N.Y. 14052  
TELEPHONE 716/652-3600 TELEX 091-293



## New CAMBION integrated circuit assemblies...

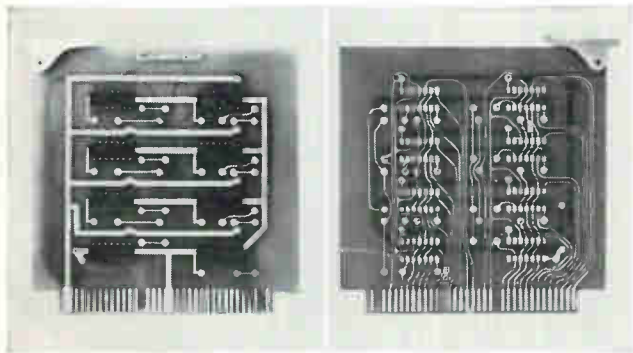

Typical Logic Assembly (4 1/2" x 4 1/2") Shown Front and Back

### 150 ways to better logic design

Start projects at the systems level. New low cost, highly flexible and universal, CAMBION IC logic assemblies comprise a broad selection of logic functions such as decoders, counters, shift registers, etc. CAMBION DTL (diode transistor logic) integrated circuit logic assemblies are characterized by high speed operation, positive logic levels, low power input, large noise threshold and 70 pin output/input configuration. **Send for our latest Fact-pak on CAMBION digital logic assemblies. It's FREE.** Cambridge Thermionic Corporation, 501 Concord Avenue, Cambridge, Massachusetts 02138. Phone: (617) 876-2800. In Los Angeles, at 8703 La Tijera Boulevard 90045. Phone: (213) 776-0472.

**CAMBRIDGE THERMIONIC CORPORATION**  
**CAMBION**

Standardize on CAMBION...21,541 guaranteed electronic components

Circle 329 on reader service card

## FREE ENGINEERING and APPLICATIONS ASSISTANCE

## REFERENCE DIODES & TC ZENERS

90% of Solitron's Zener and Diode orders are per customer spec.

For various configurations, modules and special designs, write or call Frank Wisniewski for engineering and application assistance.

**Solitron**  
**DEVICES, INC.**

Your Local Call: 800-431-1850 or TWX 914-359-2325  
256 Oak Tree Road • Tappan, New York 10983

Circle 508 on reader service card

*Super*

## SOLID CARBIDE CIRCUIT BOARD DRILLS AND ROUTERS

DESIGNED FOR PRECISION DRILLING AND  
ROUTING OF ALL CIRCUIT BOARD LAMINATES



**CBU**

A precision solid carbide circuit board drill designed with a 1/8" uniform shank for simplified chucking. Tapered webs for maximum strength. In wire gauge, fractional and metric diameters.



**CB**

The original solid carbide circuit board drill design with tapered web guaranteed to produce precision bur-free holes, as the CBU above, in single or stacked board operations where flute lengths permit. In wire gauge, fractional and metric diameters.



**DIR**

A diamond cut design solid carbide profile-router for plunge or outside profiling. The cross-hatch flute principle of this diamond-cut design provides many positive overlapping cutting edges to insure clean, sharp profiling with absolutely no delamination. In fractional size range.

Super circuit board drills and routers are guaranteed to perform efficiently in all circuit board laminates. Tolerances and concentricity are minimal to permit

exact locating or repositioning in N/C or conventional equipment. Literature No. EL-67-1 available at distributors and branches or directly from:



## SUPER TOOL COMPANY SINCE 1927

A DIVISION OF UNIVERSAL AMERICAN CORPORATION

ELK RAPIDS, MICHIGAN 49629 PHONE (616) 264-8151

**BRANCHES:**

Chicago  
5428 N. Milwaukee Ave.  
Chicago, Illinois 60630

Detroit  
Suite 508, Professional Bldg.  
Eastland Center, Detroit, Mich. 48236

New York  
350 Hudson St.  
New York, New York 10014

Los Angeles  
5908 E. Washington Blvd.  
Los Angeles, California 90022

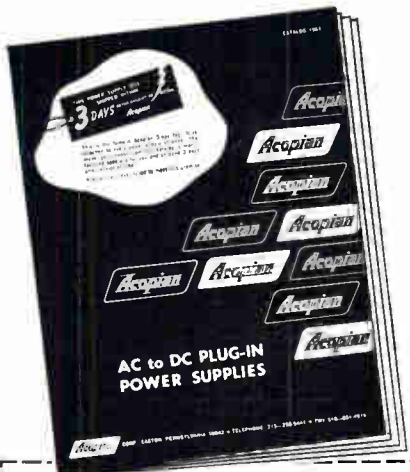

Please send me the latest Acopian catalog that lists

**62,000  
DIFFERENT  
POWER  
SUPPLIES**

available for shipment in 3 days.

Name \_\_\_\_\_

Title \_\_\_\_\_

Company \_\_\_\_\_

Address \_\_\_\_\_

City \_\_\_\_\_

State \_\_\_\_\_

ZIP \_\_\_\_\_

ACOPIAN CORP.  
EASTON, PENNSYLVANIA  
TEL: (215) 258-5441



## Production Equipment

ously purifies the ultrasonic sump by concentrating solubles, such as fluxes and oils, in the boiling area and delivering pure distillate. A recirculating filter removes particulate matter. Tanks, condensing coils and water separator are of stainless steel.

The units are equipped with the manufacturer's Sonogen A-series solid state, automatically tuned ultrasonic generators and Sonogen Z transducer elements.

Depending on options, the price of the UF series ranges from \$1,250 to \$4,450.

Branson Instruments Inc., Equipment Division, 51 Terminal Ave., Clark, N.J., 07066. [402]

## Automatic machine welds component leads



An automatic lead welding machine that can make 8,400 welds per hour is being offered by the West Germany manufacturer Witte & Sutor. The machine can handle a wide variety of components and wire sizes. Wire is fed continuously and automatically cut to any length between 0.70 and 2.5 in.

The welder accepts components ranging in body length from 0.19 in. to 0.78 in. and diameters from 0.070 in. to 0.236 in. Wire diameter sizes range from 0.019 in. up to 0.034 in. Up to 4,200 double welds can be made in an hour.

The machine's feed system and

**\* NEW**  
FROM  
**HATHAWAY**

MINIATURE  
**FORM C**

**DRIVEED  
RELAYS**



**4PDT**

RELIABILITY

**3PDT**

HIGH  
ISOLATION  
SWITCHING

**DPDT**

LONGER  
LIFE

**SPDT**

TRUE  
TRANSFERING

FAST

**80 mw, INTEGRATED CIRCUIT  
DRIVEN DEVICES AVAILABLE**

*For detail information call or write.*

**HATHAWAY INSTRUMENTS, INC.**

5250 EAST EVANS AVENUE  
DENVER, COLORADO 80222  
(303) 756-8301 • TWX 292-2935

*Distributed Nationally by  
COMPAR CORPORATION*

*Quick Adjusting . .* **COMPONENT LEADS BENDING BLOCK**

**CUTS COMPONENT LOSSES TO A MINIMUM AND ELIMINATES PLIER DAMAGE**



*MODEL 700 with gauge plate*

Quickly adjustable to any component body length from 0" to 1 3/4". Leads can be bent within .070 of end of component and up to 3" centers. Handles any diameter lead up to .045".

Dimensions: 1" x 3 3/4" x 5 3/4"  
Weight: 10 oz.

**A hand tool for bending leads on resistors, diodes, capacitors, etc., to accurately register with their holes in printed circuit panels.**

Only \$19.80 each  
**IMMEDIATE DELIVERY**

MANUFACTURED BY

**BY-BUK COMPANY**

4326 West Pico Boulevard • Los Angeles, California 90019  
Phone: 937-3511 • Long Distance Area Code 213

Circle 331 on reader service card

**FREE ENGINEERING and APPLICATIONS ASSISTANCE**

**RANDOM/WHITE NOISE**

**Solitron** — leading designers of solid state white noise modules made to customer specifications. Write or call Dr. Lon Edwards or Gary Davies for engineering and application assistance.

**Solitron**  
**DEVICES, INC.**

Your Local Call: 800-431-1850 or TWX 914-359-2325  
256 Oak Tree Road • Tappan, New York 10983

Circle 509 on reader service card



**Call your TRIAD distributor for all your transformer requirements...**

**Watch him go into action.**

Fast, dependable delivery. Ready technical assistance. Largest stock — over 1700 items off-the-shelf. Complete customer capability. Most reliable transformers you can buy. That's the kind of action you'll get from your local TRIAD distributor. Contact him for all your transformer, inductor and filter problems. TRIAD Distributor Division, 305 North Briant St., Huntington, Indiana.

**Triad Distributor Division**  
**of Litton Industries**

PROVIDING FREQUENCY  
COVERAGE INTO THE

**HF RANGES**

AS WELL AS

**VHF to 300 MHz**

**ACL**

**SR-208  
RECEIVER**

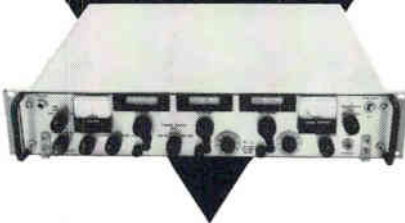

This solid state unit uses printed circuit plug-in modular construction techniques. The 20-300 MHz frequency is accomplished by 3 RF tuners with fine tuning.

**SPECIFICATIONS**

Tuning Range ..... 20-300 MHz  
Modes ..... AM, FM, CW  
Noise Figure ..... 4.0-6.5 db  
Image Rejection ..... 60-80 db  
Sensitivity ..... 2uv (20KC BW)  
4uv (300KC BW)  
IF Bandwidths ..... 20-300 KHz  
(others available)

**ACL INVITES YOUR INQUIRY**

**ACL**

**ASTRO  
COMMUNICATION  
LABORATORY, INC.**

9125 GAITHER ROAD  
GAITHERSBURG, MD. 20760  
Phone: (301) 948-5210 TWX 710-828-9706  
RF Equipment for The Systems Engineer

**Production Equipment**

component clamps are easily interchanged and specially designed electrodes eliminate the need to prepare wires before welding. The machine comes with two power packs and tooling for one component body size.

A vibratory bowl feed for components plus the necessary tooling for additional component sizes are optional.

B. Freudenberg Inc., 50 Rockefeller Plaza, New York, N.Y., 10020 [403]

**Ultrasonic lead bonder  
for semiconductors**



Leads on semiconductor devices can be bonded quickly with an ultrasonic lead bonder that has handled as many as 600 flatpacks with 14 leads of two bonds each in a day. The model 1200 has an automatic bonding cycle and two separate channels for post and chip bonding. Its operation has been made as simple as possible so that personnel training time is short and margin of error is minimized.

A key to the success of the device is a 20-watt ultrasonic generator and transducer, with a temperature compensated feedback network for operational stability. The bonder incorporates a cam locking device for superior reproducibility of bonds and elimination of costly maintenance.

The model 1200 can also handle TO-5 and TO-18 packages, with various flatpack chucks available. Hugel Industries, 587 North Mathilda Ave., Sunnyvale, Calif., 94086. [404]

**INTRODUCING**

A New Member of

The

Transformer Electronics Co.

Family of

Miniature Regulated

**POWER SUPPLIES**

THE 6 WATT  
9589 SERIES  
(23 Models)

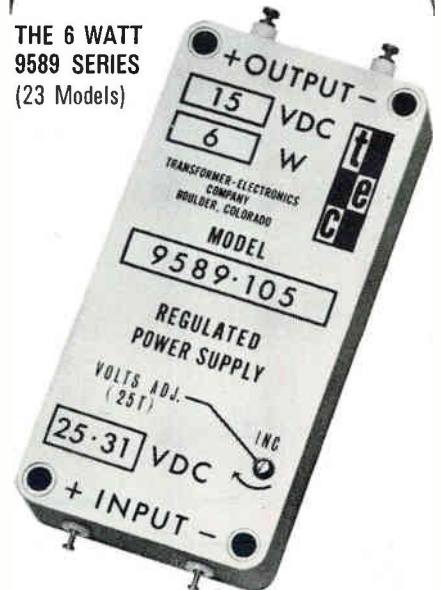

Output Power Capability: 6 watts  
Operating Temperature: -55°C to +100°C  
Input Voltage: 25-31vdc  
Line Regulation: 0.1%  
Load Regulation: <3% (½ to full load)  
Output Ripple: <0.6% p-p  
Efficiency: >46%  
No Load Current: <75 ma  
Voltage Adjustability: ±10%  
Volume: 4.3 cu. in. (1.75" x 3.5" x .7")  
Weight: 7 oz.  
Voltage Range: 5 to 5000vdc;  
±15, ±25, ±50, ±100

Other T. E. C. Power Supplies—1 WATT, 9583 Series; 3 WATT, 9567 Series; 10 WATT, 9584 Series—Write or Call for complete details.



**TRANSFORMER  
ELECTRONICS  
COMPANY**

BOULDER INDUSTRIAL PARK  
BOULDER, COLORADO

TWX 303 443-2581 PHONE (303) 442-3837

POWER SUPPLIES • INVERTERS  
CONVERTERS • TRANSFORMERS

# It pays to pick the fastest... in the computer race, it's SUHL/TTL.

We became deeply involved in TTL before anyone. That's why in TTL we're way ahead with SUHL, the fastest IC line in the industry.

Our SUHL line keeps breaking speed records—now down to 5 nsec—without compromising noise immunity and power dissipation. That's why we're the prime source for TTL and why Sylvania Universal High-level Logic ICs are being second-sourced. Several of the largest electronic equipment manufacturers standardized on SUHL ICs, even though we were the only source.

Sylvania can really deliver too. We have the most modern manufacturing facilities in the industry. We make all of our ICs with one optimum process, so we can maximize performance characteristics of every unit. Advanced automated test equipment insures the ultimate in production monitoring, final testing, and quality control.

So get SUHL's speed and reliability. Sylvania Semiconductor Division, Electronic Components Group, Woburn, Massachusetts 01801. Learn all the reasons *Sylvania really delivers ICs.*



**SYLVANIA**  
SUBSIDIARY OF  
GENERAL TELEPHONE & ELECTRONICS **GTE**

Circle 271 on reader service card



**These are our  
100MHz scopes.  
The 777 is a  
dual-beam scope.  
The 766 H/F is a  
single-beam scope  
that acts like  
a dual-beam.  
The same plug-ins  
fit both. Look at  
one soon.**

**FAIRCHILD**

## ng glass pipes light the way



**xible glass optical fibers** spooled 10,000-foot lengths are now available from the Corning Glass Works.

These light guides, strengthened with a lubricant, are encased in a polyvinylchloride (PVC) jacket. An all-plastic counterpart has already been made available in long lengths (Electronics, June 27, 1966, p. 184). Corning, claiming glass gives better light transmission than plastic, says that light transmitted with a 10-foot length of glass fiber is 40% of the input, against approximately 10% for plastic.

The glass-plus-PVC combination is also said to operate without degradation at a sustained temperature of 212°F, about 35° higher than all-plastic pipes.

The fibers are already being used in a fluid level monitoring system for automobiles by the Packard Electric division of the General Motors Co. Packard hopes to use the pipes to transmit light from the brake-fluid container's remote sides to a dashboard indicator whenever the fluid falls below the safety level. Other applications include **transmitting remote**

specification systems and high-speed printing systems.

Individual glass fibers are 0.0025 inch in diameter and the entire bundle, without jacket, is about 0.045 inch in diameter. Multiples of the standard bundle are also available.

Five spools cost about \$5,000.

### Specifications

Standard bundle	0.55 minimum
Numerical aperture	0.55 minimum
Minimum acceptance angle	65°
Spectrum (3 db points)	0.37 to 1.9 microns

Corning Glass Works, Corning, N.Y. [406]

## Epoxy molding powders for delicate devices

The soft flow characteristics of the MG6 series of epoxy Hyflo molding powders suit them for encapsulation of delicate and complex components such as solenoid coils, modules, glass diodes, relays and a variety of semiconductor devices. The material is characterized by extreme toughness, low shrinkage, excellent moisture and thermal

## Water-soluble fluxes for batch soldering

Three water-soluble fluxes have been formulated for batch soldering processes. They may be applied to printed boards by roller, spray brush or foam.

One of the fluxes, called Microflux, can be applied and allowed to dry before soldering to eliminate spattering. No precleaning is required. Flux residue is nonconductive. After soldering, boards can be cleaned using ordinary water.

Superior flux action could virtually eliminate rejects. Ease of cleaning lowers production costs associated with the soldering and cleaning operation by greater than 50% compared to similar operations using rosin fluxes, according to the company that developed the flux. Ultrasonic cleaning techniques aren't needed—preventing the possibility of component injury.

The second material, known as K-Flux, has all of the attributes of Microflux, plus a fluorescent dye. When exposed to ultraviolet light it glows a bright red, thus indicating the location of the defect. Incorporating an inspection device to ensure proper cleaning.

Microflux-A incorporates all the features of Microflux with additional advantages of very rapid drying—thus assuring no spattering and allowing the soldering operation to proceed on a continuous basis.

Krohn, Inc., 73 No. 2nd St., Easton, Pa. [408]

## Inexpensive ruby rod aids laser research

Maximum laser efficiency with the least amount of pumping is provided by a new ruby laser rod developed by the company. The rod is grown by the Czochralski process and is available in sizes 0.150-in. diameter by 1.5 in. long.

Each rod costs \$99.50.



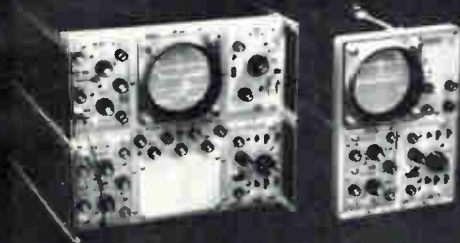

**These are our  
100MHz scopes.  
The 777 is a  
dual-beam scope.  
The 766 H/F is a  
single-beam scope  
that acts like  
a dual-beam.  
The same plug-ins  
fit both. Look at  
one soon.**

**FAIRCHILD**  
INSTRUMENTATION

FAIRCHILD INSTRUMENTATION A Division of Fairchild Camera and Instrument Corporation ■ 475 Ellis St., Mountain View, California 94040 (415) 962-2011 ■ FAX: 910-379-6944

## The Scopes:

### 766 H/F Main Frame:

Single beam, solid-state scope with 6 x 10 cm scan, 13kV accelerating potential and algebraic add. The 766 H/F accepts any of the plug-ins listed to the right, but the 79-02A amplifier and 74-17 beam switching and delaying sweep time base are recommended. With these plug-ins the scope has 100MHz bandwidth, 100mV/div sensitivity, 3.5nsec. risetime, and a 5nsec. sweep.

### 777 Main Frame:

The 777 is a true dual-beam scope, with a dual gun CRT. It has a 13kV accelerating potential and a 6 x 10 cm display area for each beam, with a 4 cm overlap. Each gun can be independently blanked or intensified. The 777 accepts any four of the plug-ins listed to the right.

For detailed information, call us, or write.

## The Plug-ins:

### Time Base Modules:

- 74-03A General purpose, 5nsec.
- 74-13A Delaying sweep with calibrated delay
- 74-14 General Purpose time base
- 74-17A Automatic beam switching delaying sweep with calibrated delay

### Vertical Amplifier Modules:

- 74-12 1mV/cm differential amplifier, 850kHz
- 74-15 20mV, 1MHz amplifier
- 74-19A Single trace, DC to 5MHz, 50mV/cm
- 76-01A Single trace, 5mV/cm, 25MHz
- 76-02A Dual trace, 5mV/cm, 25MHz
- 76-05 Single trace, 100MHz, 50 ohms input
- 76-06 Four trace, 20mV/cm, 20MHz
- 76-08 Dual trace, 5mV/cm, 50MHz
- 79-02A Dual trace, 100mV/cm, 100MHz

**Where to get them:** For immediate assistance or for the name and address of the representative or distributor in your area, contact any of these Fairchild Instrumentation Field Sales Offices:

### U.S.A.

4546 El Camino Real  
Los Altos, California 94022  
(415) 941-3111

5410 West Imperial Boulevard  
Los Angeles, California 90045  
(213) 678-3166  
TWX: 910-328-6177

50 Jericho Turnpike  
Jericho, L. I., New York 11753  
(516) 333-9311  
TWX: 510-222-4479

2105 Gulf-To-Boy Boulevard  
Suite #4  
Clearwater, Florida  
(813) 446-4619  
TWX: 810-866-0436

8517 39th Avenue, North  
New Hope, Minnesota  
(612) 544-5220  
113 Gentry Road  
Hoffman Estates  
Roselle, Illinois 60172  
(312) 894-2060

### EUROPE

FAIRCHILD INSTRUMENTATION LTD.  
Grove House, 551 London Road  
Isleworth, Middlesex, England  
Tel: 560-0838  
TELEX: 24693

Grunwolderstrasse 99  
Munich 90, West Germany  
Tel: 49 18 47  
Cable: FAIRINTA MUNICH

**FAIRCHILD**  
INSTRUMENTATION

FAIRCHILD INSTRUMENTATION / A Division of Fairchild Camera and Instrument Corporation ■ 475 Ellis, Mountain View, California 94040, (415) 962-2011 ■ TWX: 910-379-6944

# BOBBINS

...if you need them,  
**PERMACOR®**  
has them!



Name your size . . . select your shape . . . if it's Bobbins you want, we have them. As the world's largest maker of cores, we have the designers and production facilities to answer your every need, be it Bobbins or any other standard or special powdered iron cores.

IRON CORES... Plain, Hollow, Threaded, Insert, Tuning, Cup, and Toroidal Iron Cores, Iron Coil Forms, Sleeves, Flexible Magnetic Shielding, Bobbins and special shapes.

## PERMACOR®

A Division of Radio Cores, Inc.

9540 Tulley Ave., Oak Lawn, Ill. 60454  
Phone: 312-422-3353

## New Books

### Putting Fourier to work

Fourier Transforms and the Theory of Distributions

J. Arsac

Translated by Allen Nussbaum and Gretchen Heim

Prentice-Hall, Inc., 318 pp., \$14

Engineers who have taken one or two graduate courses in Fourier transforms should find this translation from the French a useful supplement, both for its mathematical exposition and for its applications section. In reviewing the transforms, much space is devoted to a simplified discussion of the theory of distributions that was developed in the 1950's. This theory establishes a firm mathematical basis for finding transforms of the common trigonometric functions — transforms involving the delta (impulse) function.

The applications section concentrates on topics pertaining to optics (Arsac works at France's Meudon Observatory). The material is general enough, however, so that engineers working in antenna theory, propagation studies, lasers and holography will find much useful information. The author's discussion of linear filters covers both resolving power theory and probability functions. Other topics are diffraction at infinity, solution of wave equations and methods of approximating Fourier functions to obtain numerical solutions.

### Designing the i-f stage

Transistor Bandpass Amplifiers

W.Th.H. Hettterscheid

Phillips Technical Library, Springer-Verlag New York Inc., 314 pp., \$12

By concentrating on transistorized selective amplifiers that are a part of the intermediate-frequency stage in every radio, television and radar receiver, the author has produced a thorough, practical design guide that should be a welcome addition to the communications or radar designer's library.

Hettterscheid gives detailed analyses of single-stage amplifiers with single-tuned and double-tuned circuits, then shows how these analyses can be modified when designing multistage amplifiers with other types of interstage

coupling. He also explains how deviations in the parameters of transistors and passive components affect the designs. In addition to discussing stability, loop gain and neutralization, the author gives a detailed comparison of tuning procedures used for aligning amplifiers.

The book is not new; it was first published in the Netherlands in 1964 but distributed in this country only recently. The information, nevertheless, is still timely.

### A pinch of impurity

The Electronic Theory of Heavily Doped Semiconductors

V.L. Bonch-Bruyevich

Translated by Robert S. Knox

American Elsevier Publishing Co., 131 pp., \$7.50

Retrieving information about the electronics industry is a continuing challenge; sifting through the many articles about solid state physics is an overwhelming task. But help has arrived from the Soviet Union with this excellent presentation of recent findings in the field of heavily doped semiconductors.

Theoretical treatments of high-level subjects can be dull. This book is not. Physical principles and mathematical steps (all clearly explained) are interwoven, yielding an interesting and smooth-flowing text that demonstrates the depth of the author's knowledge. Numerous references—many to work by the author and his students—make this a valuable guide for solid state physicists, physical chemists and scientists and engineers involved with device theory. The author assumes the reader has knowledge of the two prerequisites, quantum theory and solid state physics.

Bonch-Bruyevich, a professor at Moscow State University, begins by comparing the energy bands of both moderately and heavily doped semiconductors. Using a physical model of a lightly doped semiconductor under high injection conditions which make it similar to a heavily doped material, the author discusses screening efforts.

Physical properties, such as density of states and complex electrical conductivity, are determined



PARIS  
porte de  
versailles  
From 5 April  
through  
10 April 1967

Visitors from the 4 corners of the world take part in the 2 most important shows of the year.

INTERNATIONAL  
EXHIBITION OF

# ELECTRONIC COMPONENTS

and international  
Exhibition of

# AUDIO EQUIPMENT

The Electronic Components Exhibition, created in 1934, but International since 1958, comprises 900 manufacturers, half of whom are non-French.

At the same time, the Audio Equipment Exhibition will take place in an adjacent area, where engineers & technicians from all countries will be welcomed.

## International Seminar on Space Electronics



Paris from 10 through 15 April, 1967.  
Reservations should be made.

The aim of the seminar is to study how the electronics industry has adapted and up-dated itself in relation to the development in aerospace activities.

S.D.S.A. - RELATIONS EXTERIEURES  
16, RUE DE PRESLES - 75 - PARIS 15<sup>e</sup>

Official Carrier for the Exhibition: Call Air France for Information

## VERSATILE, EASY-TO-USE SELECTOR SWITCH

Programs  
machine tool  
set-ups quickly

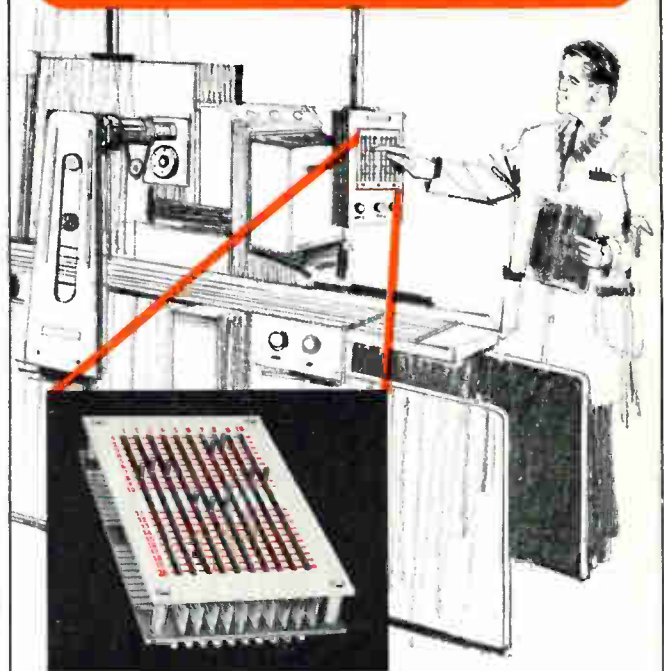

**New Cherry Selector Switch permits rapid manual set-up and sequencing of multiple operation machine tools**

Now—a manual switching device, human-engineered for rapid finger-tip selection of machine tool phases and functions. Readily changed, simply select functions from blueprints and re-program tool immediately.

The Cherry Selector Switch can be installed *quickly* because no soldering is required. And there's no jungle of wires to confuse you or cause problems. It is available in various sizes—from 100 to 2784 positions. **Write today for full details.**

**CHERRY**   
**ELECTRICAL  
PRODUCTS CORP.**

1656 Old Deerfield Road Highland Park, Illinois 60035

# lowest cost in the industry!

MEDIUM & HIGH POWER  
SP SERIES SILICON

## Deltron LAB SUPPLIES



36 MODELS . . . TO 100 VOLTS  
TO 50 AMPS . . . 1200 WATTS

### how is it done?

Deltron has substituted design sophistication for brute force methods . . . has cut number of components . . . resulting in lowest cost on the market today for lab supplies of this quality. Features include:

- Automatic cross-over — gives both voltage and current regulation.
- 0.01% regulation.
- 500 microvolts ripple.
- 71°C convection cooled.

Request technical bulletin for all the facts.

See our complete catalog  
in eem . . . Section 4000

D 102

# Deltron

WISSAHICKON AVE., NORTH WALES, PA. 19454  
PHONE: (215) 699-9261 TWX: (510) 661-8061

### New Books

using Green's function. The author establishes this function using approximation techniques, then determines the properties in detail. In heavily doped semiconductors the energy bands are not sharply defined, and no well-defined forbidden region [an energy band in which there can be no electrons] separates the conduction and valence bands. The author shows that each band has a tail that extends—or "smears out"—into the forbidden band. In studying the location of Fermi-level electrons, both the change in the density-of-state function and the presence of the band tails are taken into account.

Other topics include static electrical conductivity, absorption of electromagnetic waves and the interaction of charge-polarized oscillations of a heavily-doped semiconductor's lattice.

The author concludes with a theoretical discussion on making contact between two heavily doped semiconductors with different properties.

Ronald B. Schilling

Radio Corp. of America  
Sommerville, N.J.

### Technical snapshots

Photographic System for Engineers  
Edited by F.M. Brown, H.J. Hall and  
J. Kosar  
Society of Photographic Scientists and  
Engineers, Washington, 215 pp., \$5

The reader who assimilates this relatively short book will be well on his way to becoming an expert in the field of photography as practiced by engineers—mechanical, optical and chemical as well as electronic. The one-volume course contains papers the Society of Photographic Scientists and Engineers presented on the subject in a two-day seminar in New York in 1959 and then repeated with some updating on the West Coast in 1966.

The highly technical story unfolds in logical order and in language that is easily understood. The neophyte—no prior knowledge of photography is necessary—is first introduced to the mysteries of all image-recording machines, both theory and application. The many

### Compact electronics package?

# COOL IT...

...with a small size, long life,  
high output AiResearch fan.

Garrett-AiResearch special purpose fans are individually designed and custom built to deliver more flow and greater pressure rise with a minimum envelope size.

Take a typical AiResearch small size fan: computer-optimized for required performance under all operating environments; our own motor, engineered and manufactured for a perfect match to its fan; and up to 40 percent more airflow than any other ventilating fan of similar input, size, and weight.

Next time you need a ventilating fan for a very special airborne or ground electronics enclosure specify AiResearch. Available for high temperature and cryogenic applications, with flow rates and power requirements as specified. AiResearch Manufacturing Division, Torrance Facility, 2525 190th Street, Torrance, California 90509.

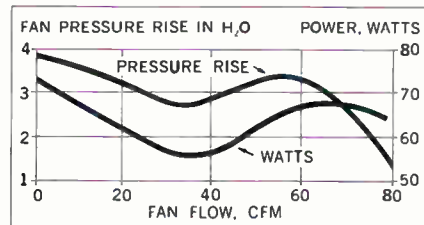

## AIRESEARCH SPECIAL PURPOSE FANS



**General Technology's  
Rubidium "atomic clock"  
records over million hours  
operational time.**

**Reliability now proven;  
MTBF established at 22,000  
hours per unit.**

Records kept since 1961 on every Rubidium Frequency Standard made by GTC show the average time between random component failures to be 87,000 hours — almost 10 years!



The Model 304-B shown here is but one in a complete family of all solid-state atomic frequency standards made by GTC for use in field and laboratory. Maximum deviation is  $\pm 5$  parts per  $10^{11}$  in a year, or better. Special versions meet environmental and other requirements for tactical and missile/aircraft use.

For solutions to your stable-oscillator problems, write General Technology Corporation, subsidiary of TRACOR, Inc., 6500 Tracor Lane, Austin, Texas 78721. Phone 512-926-2800.

**Time & Frequency  
Instruments by**



TFA - 1367

## Lighted Pushbutton Switches



**USECO offers  
greatest capacities, smallest sizes.**

USECO'S ORCON switches combine exclusive multi-circuit capacity, isolated contacts, sliding-wiping action, independent light circuit and connector convenience in  $\frac{3}{4}$ " and  $1\frac{1}{16}$ " diameter sizes. Standard and custom available. Plus indicator lights, ganged assemblies, multi-light units, adapters and accessories. For brochure, contact USECO, 13536 Saticoy Street, Van Nuys, Calif. 91409. (213) 873-3520.



Division of Litton Industries





# Qualified Electronics Technicians

(Where do you find them?)

Many Companies will tell you the best source is their present staff of technical personnel. These men have the necessary aptitude and ambition ... can be readily up-graded through a planned electronics training program.

Since 1934 Cleveland Institute has developed such programs for hundreds of leading companies ... has provided thousands of men with practical, useable knowledge of electronics theory and fundamentals. These men understand the "why" of electronics ... can install, maintain, troubleshoot, and repair the sophisticated equipment you're using today, and will be using in the years ahead. Learn how CIE can "tailor" an Electronics Training Program to your specific needs. Its effectiveness and economy will amaze you. Send coupon today for FREE brochure. Cleveland Institute of Electronics, Dept. E-27, 1776 E. 17th St., Cleveland, Ohio 44114.

**SEND COUPON TODAY**

## Cleveland Institute of Electronics

Dept. E-27, 1776 E. 17th St., Cleveland, Ohio

Gentlemen: I am interested in learning more about your Electronics Home Study Programs. Please send complete information.

Name \_\_\_\_\_

Title \_\_\_\_\_

Company \_\_\_\_\_

Address \_\_\_\_\_

City \_\_\_\_\_ State \_\_\_\_\_ Zip \_\_\_\_\_

Accredited Member, National Home Study Council.

## New Books

kinds of photography are described along with the equipment and materials used for each. Detailed explanations for processing the film are provided.

### Review of technology

**Advances in Computers, Vol. 7**  
 Edited by Franz L. Alt and Morris Rubinoff  
 Academic Press, 303 pp., \$14

The latest annual purporting to review what's new in computer technology is rather a mixed bag. Of interest to this reviewer were Wayne A. Danielson's explanation of how men and machines work together in copy editing, William R. Bozman's paper on computer-aided typesetting and Andries Van Dam's discussion of visual displays.

John C. Murtha's article on parallel information processing, however, is hard to follow. The two articles on programing languages presume extensive knowledge of the subject, but, for the neophyte, Arnold C. Satterthwait does provide a lucid explanation of just what computational linguistics is.

### Recently published

**Solid-State Electronics, Shyh Wang,**  
 McGraw-Hill Book Co., 778 pp., \$15.50

To help bridge the gap between physics and electronic engineering, the author presents the properties of solid state materials from a device standpoint. Detailed quantitative analysis is given for several physical models.

**Radio Telescopes, edited by D.V. Skobel'tsyn,**  
 Plenum Publishing Corp., 171 pp., \$22.50

The English version of the Proceedings of the P.N. Lebedev Physics Institute in Moscow arrives several years late in an inexpensive format (thin paper and soft covers). It may, however, interest those who are following the Soviets' progress in building radio telescopes such as a cross-type antenna system covering 80,000 square meters.

**Analysis and Synthesis of Tunnel Diode Circuits, J.O. Scanlan, John Wiley & Sons,**  
 274 pp., \$9.75

A discussion of the sinusoidal aspects of tunnel diodes, covering both design theory and applications for narrow- and broad-band amplifiers.

**Laplace Transforms for Electronic Engineers, James G. Holbrook, Pergamon Press,**  
 344 pp., \$10

Second, revised edition of 1959 book concentrates on practical applications of Laplace transforms in electronic engineering. Specific examples include Pascal's triangle for finding the transfer functions of iterated networks, the treatment of single-band, wide-range oscillators and charge amplifiers.

## Cut



## Strip



## Bend



## Crimp



Eubanks automatic wire strippers are fast, easy to operate, and versatile.

Eubanks makes machines that will:

... cut and strip wire as small as #32 AWG and as large as #4 AWG.

... cut, strip and bend pc board jumpers.

... fully strip wire 1½" for solderless wrapped connections.

... strip coaxial cable at one, two or three points.

... Cut, strip and crimp solid wire for insertion in pc boards.

For recommendations on ways of speeding up your wire processing, send us a description of your requirements.

**Eubanks ENGINEERING CO.**  
 P.O. BOX 563 MONROVIA, CALIF.

GLOBE

**When a small a.c. motor is too big...**



... try Globe's Type CC sub-miniature motor, one of the smallest a.c. hysteresis synchronous motors made. This tiny 2-ounce unit is only 21/32" dia. by 1.34" long. It's used extensively for MIL-spec timers, actuators, and drives requiring compact, exact-speed motors. Voltage is 26 v.a.c., 400 cps, single phase. Both 2- and 4-pole models produce .08 oz. in. sync. torque. Write for Bulletin CC, and ask us about production quantities.

Globe Industries, Inc.  
2275 Stanley Ave., Dayton, Ohio 45404, Tel: 513 222-3741

Circle 337 on reader service card

## TERMINAL BLOCKS

WITH BUILT-IN INSULATION

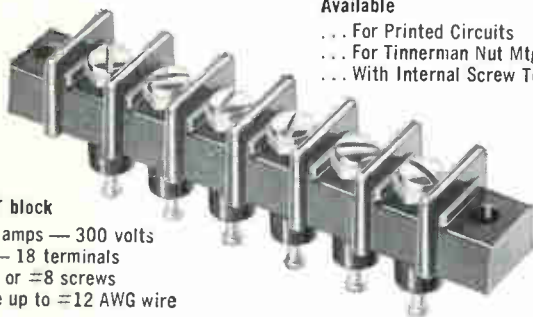

GFT block  
20 amps — 300 volts  
1 — 18 terminals  
#6 or #8 screws  
Use up to #12 AWG wire

Available  
... For Printed Circuits  
... For Tinnerman Nut Mtg.  
... With Internal Screw Term.

Versatile Curtis GFT terminal blocks eliminate costly insulating and mounting procedures, when complying with UL and CSA requirements. Fully insulated, GFT blocks give you 1/4" solder terminal to ground clearance on 1/8" thick chassis. Excellent conductivity. Terminals are bright tin plated. Get full details on all GFT variations. Write for your copy of the Curtis Catalog.



**CURTIS DEVELOPMENT & MFG. CO.**  
3203 N. 33rd St., Milwaukee, Wisconsin 53216

See us at Booth 3K15, IEEE Exhibition, New York City

Circle 338 on reader service card

NOW from **SAGE**

Two new Smaller Sizes in  
METAL SLEEVED TYPE C

*Clipper* RESISTORS

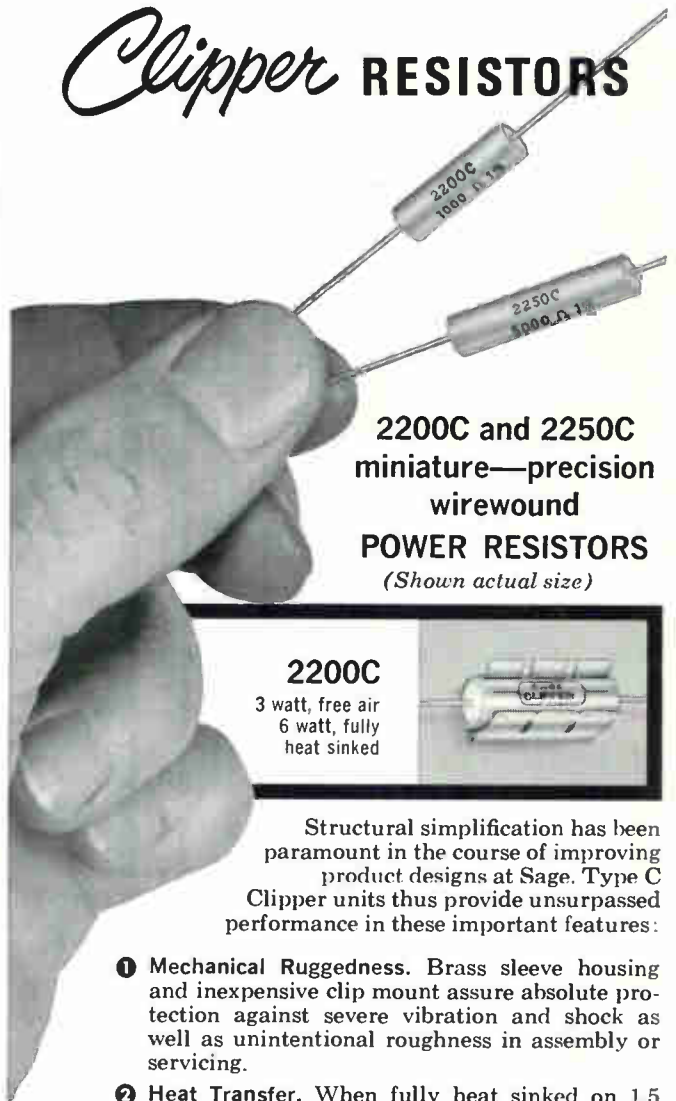

**2200C and 2250C**  
miniature—precision  
wirewound  
**POWER RESISTORS**  
(Shown actual size)

**2200C**

3 watt, free air  
6 watt, fully  
heat sunked



Structural simplification has been paramount in the course of improving product designs at Sage. Type C Clipper units thus provide unsurpassed performance in these important features:

- Mechanical Ruggedness.** Brass sleeve housing and inexpensive clip mount assure absolute protection against severe vibration and shock as well as unintentional roughness in assembly or servicing.
- Heat Transfer.** When fully heat sunked on 1.5 square inches .040" aluminum per watt, power rating is increased 2 for 1 over the free air rating.
- Reliability.** Construction is fully welded; IMPERVOHM® insulation rated for 350°C operation and 1000 volt rms dielectric strength.



STYLE	POWER RATING		RESISTANCE .05 Ω to
	Free Air	Body Mounted	
*2200C	3	6	20 K Ω
*2250C	3	6	40 K Ω
2400C	3.5	7	42 K Ω
2550C	5.5	11	88 K Ω
2600C	7	14	114 K Ω
2650C	8	16	170 K Ω
2750C	10	20	257 K Ω

\*new  
Ask for Catalog R-62 giving full details



**SAGE**

**SAGE ELECTRONICS CORP.**  
BOX 3926 • ROCHESTER, N. Y. 14610

Circle 281 on reader service card

281



# you can select your own stop!

New all through — a brand new design has replaced our former series "C" rotary selector switches.

The customer-adjustable stop is only one of many new features offered at no additional cost. Your personal files on MIL-S-3786.14A, STYLE SR-14 switches is out of date if it doesn't include our new series "C" Catalog. Write, phone or TWX Daven — We build switches like no one else can!



DIVISION OF THOMAS A. EDISON INDUSTRIES  
GRENIER FIELD, MANCHESTER, N.H. 03103  
(603) 669-0940 • TWX 603-623-4938

## Technical Abstracts

### Building LSI

Partitioning for large-scale integration  
H.R. Beelitz and H.S. Miller,  
RCA Laboratories, Princeton, N.J.  
R.J. Linhardt and R.D. Sidman  
Electronic Data Processing Division,  
Radio Corp. of America, Camden, N.J.

Large-scale integration will never be achieved if systems engineers continue to depend on current design technology. Irregularity in the control logic structure is the main limiting factor. Effective use of large-scale integration will require a new system architecture.

Many present-day computers use a memory-oriented design, where a multiplicity of registers store program instructions, addresses, machine status words, results and so forth, in one high-speed memory.

Associated with the memory is a logic loop by which data is repeatedly called forth from the memory, processed in a matrix inserted in the loop, and regenerated for storage in the memory again. A large portion of the machine's logic is circuitry that controls this data loop but is not directly associated with the data path.

The authors describe a systematic two-step partitioning procedure which overcomes this difficulty. The first step partitions the data path into registers and an associated processing matrix. In the second step, control logic is subdivided into two control functions, that is, information transfer control (instruction retrieval, data transfer) is separated from data process control. This allows functionally independent partitions to be distributed among the data path arrays.

As an example of LSI system architecture, the authors discuss Limac (large integrated monolithic array computer) a general-purpose machine being built by RCA for the Air Force and capable of solving complex navigational problems. Limac's main memory is a 4,096-word, 14-bit, 2-microsecond core array. A 100-nanosecond scratch-pad memory of 256 16-bit words is being made from arrays of complementary total oxide semiconductor transistors.

By functionally dividing the control and data path logic, Limac ends up with arrays of 30 gates or more with minimum gate-to-pin ratios of 1.4 to 1. This is an order of magnitude greater than that available in computers now in use.

Three current-mode logic circuits chosen for low power dissipation and small area, are used in the Limac computer. They include a basic array gate, an interface-buffer gate and a set-reset flip-flop.

Presented at the International Solid State Circuit Conference, Philadelphia, Pa. Feb. 16.

### Assuring IC reliability

Modern approaches to microcircuit reliability assessment  
R.C. Hilow, E.P. O'Connell, A.L. Tamburrino  
Rome Air Development Center,  
Rome, N.Y.

In selecting integrated circuits for high-reliability systems, a customer should avail himself of as much test data as he can. The problem here is that large-scale reliability testing of IC's is most economically performed by the manufacturer, and the results of these measurements are often extremely sensitive. Such data, for example, may describe proprietary processes or reveal yield figures that could affect pricing.

In this situation, the user can either press the manufacturer for this information or perform non-destructive screening tests himself.

If he takes the latter course, the customer should begin with a circuit analysis that includes pulse or a-c and d-c operations under various input and load conditions, and assesses the sensitivity of output characteristics to variations in component tolerance, drift, noise and supply voltage. The user should also evaluate the materials in the device and the packaging, including the method used to connect the die to the header. One advantage he has over the maker in conducting this study is that he can concentrate on the factors that relate directly to his application.

High stress tests can supplement this general device study. In such testing, stress is usually applied to



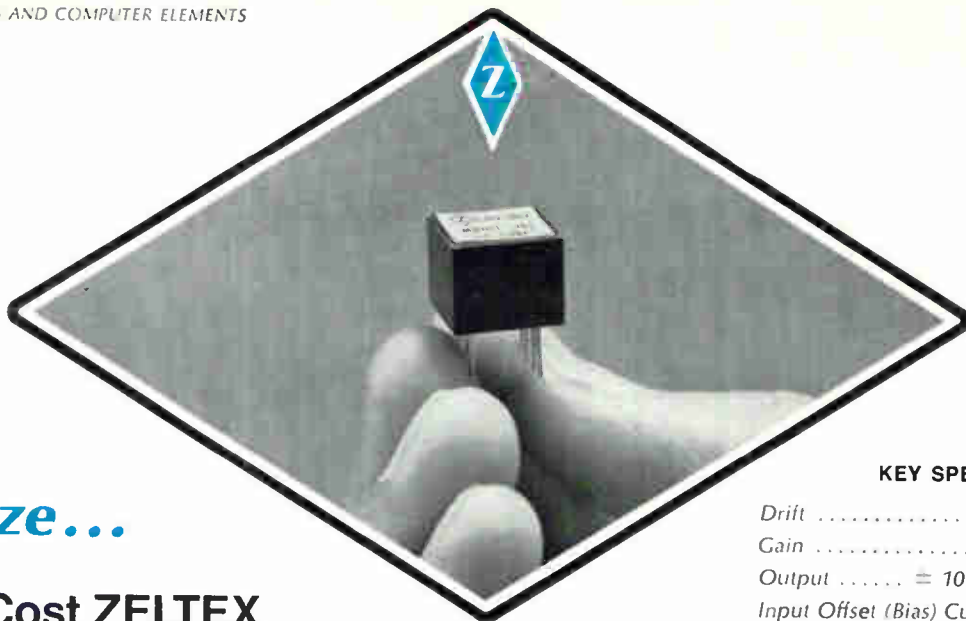

*Try this  
on for size...*

## New, Low-Cost ZELTEX "IC CUBE"\* High-Performance Diff Amps!

First of a family of Hybrid Integrated Circuit Differential Amplifiers, ZELTEX's new Model 161 is an exceptionally stable device in a new, easy to mount epoxy package at a price you'll find hard to resist. In addition to the low initial cost of only \$47.00 (100 lots), Model 161 offers savings in engineering and assembly time. All internal resistors and capacitors are built into the 161. And, the new ZELTEX (0.5" x 0.5" x 0.4") IC Cube package fits flush to the board without time consuming lead splaying.

Units for evaluation are available immediately. Order yours today!

\*IC CUBE is a trademark of ZELTEX, Inc.

### KEY SPECIFICATIONS

Drift ..... 25  $\mu\text{V}/^\circ\text{C}$   
 Gain ..... 80,000  
 Output .....  $\approx 10$  Volts at 4 mils  
 Input Offset (Bias) Current... 150 nA  
 Input Impedance ..... 20 meg $\Omega$   
 Short Circuit Proof



**ZELTEX, INC.**

1000 Chalomar Road  
 Concord, California 94520  
 Phone (415) 686-6660

Circle 339 on reader service card

*yes,*

**CCTV Cameras work best**



with **COSMICAR<sup>®</sup> LENSES**

Superior cameras deserve superior lenses. COSMICAR's proven precision performance is the combined result of advanced optical engineering and exquisite workmanship.

Now widely used, COSMICAR LENSES come in 23 models for focal lengths ranging from 12.5 mm to 500 mm, and in 3 zoom models including a remote control zoom.

Your CCTV camera and COSMICAR LENSES will make an unbeatable team. For technical data and other particulars, please write.



**ICHIZUKA  
OPTICAL CO., LTD.**

568, Shimoochiai, 2-chome, Shinjuku-ku, Tkoyo  
 CABLE ADDRESS: "MOVIEKINO TOKYO"

## COMPUTER TALK

by W. Henry du Pont, President

**SCI-TEK**

**COMPUTER CENTER, INC.**



ARE YOU A SECOND CLASS CITIZEN WHEN IT COMES TO COMPUTER TIME? Do you have to wait in line to have your problems solved because your in-house equipment is being used by some other department? Or do you buy time from some large company that sells dead time—you know, midnight to 5 A.M. or Sunday afternoon? Do you have to schedule two weeks in advance when you need an engineering problem solved? If you have any of these gripes and are fed up with these inconveniences, come to SCI-TEK where you're treated like a First Class Citizen. Our business is built on serving you when you need it.

At SCI-TEK, we have but one business. That is solving problems with the largest independently owned computer in the East. With us, you're never second fiddle because we don't provide banking service, sell airplanes, send telegrams or make chemicals. Whether your job requires five minutes or five hours, you're our only customer and we want your business.

Would you like more information about our 1107 computer, about our service or our costs? Just drop us a note and we'll send you our brochure. If you're in a big hurry, phone us!

**SCI-TEK**

**COMPUTER CENTER, INC.**

1707 GILPIN AVENUE

WILMINGTON, DELAWARE 19806

Phone: (302) 652-3967

## Technical Abstracts

vital regions of the device at a normal or rated level and then increased until failure.

Accelerated life testing can also be performed, but the customer should be warned that some circuit degradation mechanisms do not age under high stress as they would under normal conditions.

All test data the customer comes up with, however, will prove a useful complement to the manufacturer's quality-control work and failure analyses.

Presented at the 1967 Symposium on Reliability, Washington, D.C., Jan. 10-12.

### IC's and Biomedicine

Microelectronic bio-instrumentation and implants

Wen H. Ko

Case Institute of Technology, Cleveland

Applications in biomedicine currently fall into two areas—monitoring devices and stimulation systems. As a monitor, a microelectronic system could provide readings of a patient's brain waves, heart rate, blood pressure and respiration during surgery. A pattern-recognition system could rapidly scan parameters and signal any abnormalities during the operation.

Besides volume and weight considerations, the advantages of IC instruments here, as in other projected biomedical applications, are higher-speed performance, better reliability and lower cost than gear with conventional circuits.

One of the challenges facing microelectronics engineers is the development of transducers in which amplifiers and signal processors are integral parts, and in which, possibly, the sensor and associated electronics can be operated by power from biological sources.

In research work at the Case Institute, five types of single-channel telemetry transmitters have been built—three with discrete components, one with thin films and one with a multichip silicon IC. The latter device shows better frequency and temperature stability and much higher input impedance than the others, while consuming less power.

The IC transmitters have been

*New! From MESON! New!*

# ELECTRONIC TIME DELAY RELAY



- High Accuracy,  $\pm 10\%$
- Repeatability,  $\pm 3\%$
- Fast recycling time — .05 sec. max.
- Input — 115 VAC
- Up to 180 sec. delay, fixed or variable with external variable resistor.

**\$6<sup>91</sup>**  
Only **6** in 100 lots  
**IMMEDIATE DELIVERY!**

Order one for test at \$8.80. Your  
**MONEY BACK** if not satisfied!

**MESON**  
**ELECTRONICS CO. INC.**  
380 Cottage St., Rochester, N.Y. 14611  
Phone (716) 235-7070

Circle 340 on reader service card

## High Reliability Instruments

# meguro

# WOW FLUTTERMETER



**MK-661D**

### SPECIFICATIONS:

Center Frequency..... 3 kc  
Input..... -26 to +10 dBm  
Wow Flutter Range..... 0.03, 0.1, 0.3, 1, 3%  
f. s. d.  
Weighting Characteristics.....  
as per JIS C5551  
and CCIR specs.  
Calib. Osc..... 3 freqs. 3 kc (+ 3%  
and - 3%)

© Catalog sheet on request.



**MEGURO DENPA SOKKI K.K.**

(Meguro Electric Instrument Co., Ltd.)  
No. 3, 1-2-chome, Chuo-cho, Meguro-ku, Tokyo, Japan  
TEL. 711-7191 7-Cables. MEGURODENPA TOKYO

## UNIVERSAL HARNESSING TOOL

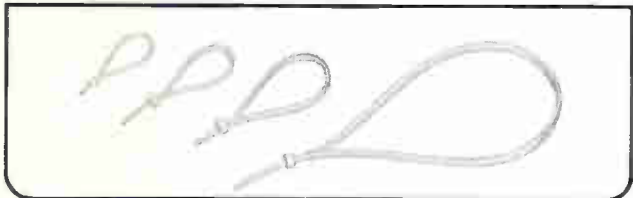

ONE PANDUIT TOOL TIES ALL THESE PAN-RAP™ TIES, from the Miniature to the Extra-Long PAN-RAP. Tool cuts nylon PAN-RAPS flush at preset tension. Results in neater bundles, lower production costs.

**PANDUIT** CORP.

Tinley Park, Ill. 60477 • Phone: 312-532-1800

FROM THE MANUFACTURERS OF  
PANDUCT® PLASTIC WIRING DUCT



At your Panduit distributor

Circle 341 on reader service card

**STRONG, STABLE,  
HARD, SMOOTH,  
Chemically Inert,  
SHOCK RESISTANT,  
highly uniform, EXCELLENT  
TRANSMITTER OF UV, VISIBLE,  
& IR RADIATION, Electrical  
Insulator...**

just a few of the properties of Meller sapphire that make this material valuable in numerous applications. Meller offers high quality sapphire rods, bars, tubes, spacers, spheres, lenses, windows, and optical flats... at a reasonable cost. Find out how sapphire can work for you... write or phone Meller now.

**MELLER**  
Founded 1921 **QUALITY**

**ADOLF MELLER CO.**  
P.O. Box 6001  
Providence, R.I. 02904  
Tel. (401) 331-3717

Circle 343 on reader service card

## Still using LC's? This might change your mind:



### Clevite's ceramic ladder filters deliver 80 db rejection in 0.1 cu.in.!

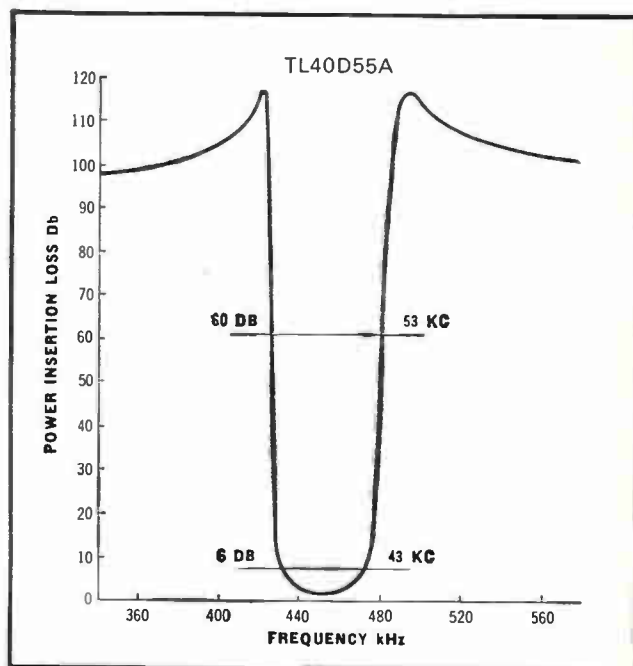

Here's a fixed-tuned filter that offers more selectivity for its size than any conventional i-f filter on the market!

Clevite's non-magnetic, non-microphonic, 17-disc ceramic ladder filter is ideal for i-f stages of high quality superheterodyne radio receivers used in airborne or ground AM and FM communications equipment. Stop band rejection: 60 or 80 db. Center frequency tolerance:  $\pm 1$  kHz for 20 kHz B/W and below;  $\pm 2$  kHz for 30 kHz B/W and above. Stability: within +0.2% for 5 years; within 0.2% from  $-40^{\circ}\text{C}$  to  $+85^{\circ}\text{C}$ . Impedance (in and out) 2500 ohms for 12 kHz bandwidth and below; 1500 ohms for 13 kHz to 29 kHz B/W; 1200 ohms for 30 kHz bandwidth and above.

Following models standard at 455 kHz (A) or 500 kHz (C) (custom models on special order):

Model Number	B/W		Model Number	B/W	
	Min. @ 6db	Max. @ 60db		Min. @ 6db	Max. @ 60db
TL-2D5 (A)	2 kHz	5 kHz	TL-20D32 (A)	20 kHz	32 kHz
TL-4D8 (A)	4 kHz	8 kHz	TL-30D45 (A)	30 kHz	45 kHz
TL-6D11 (A)	6 kHz	11 kHz	TL-40D55 (A)	40 kHz	55 kHz
TL-8D14 (A)	8 kHz	14 kHz	TL-45D65 (A)	45 kHz	65 kHz
TL-10D16 (A)	10 kHz	16 kHz	TL-50D75 (C)	50 kHz	75 kHz
TL-16D25 (A)	16 kHz	25 kHz			

**PRICES:** 1 — \$52.50; 25 — \$42.00 ea; 100 — \$36.75 ea; 500 — \$31.50 ea; 2000 — \$26.00 ea.

(Prices subject to change without notice.)

Send order or request for Bulletin 94017 to: Clevite Corporation, Piezoelectric Div., 232 Forbes Rd., Bedford, Ohio 44014, U.S.A. Or: Brush Clevite Company, Limited, Southampton, England.

# CLEVITE

Circle 285 on reader service card

285

# SINGLE CRYSTALS OF HIGH PURITY METALS

For Laser Applications, Gamma Ray Spectrometry Plates and Bending Blocks, Neutron Spectrometry Plates and Accessories, Thin Film and Acoustic Studies, Solid State Research.

Semi-Elements offers the largest variety of single crystals of high purity metals commercially available from any source. These single crystals are of extremely high purity, and are available in many as grown sizes and shapes.

- Rhenium • Cadmium
- Titanium • Indium
- Vanadium • Tin
- Cobalt • Gold
- Iron • Platinum
- Copper • Thallium
- Zirconium • Bismuth
- Silver • Antimony
- Metal Single Crystal Alloys

Metal single crystals can be grown, cut, oriented and polished to your specifications. We will be pleased to quote to your specific requirements.

*Write or call for literature.*



**semi-elements, inc.**  
Saxonburg Blvd., Saxonburg, Pa., 16056  
Phone: 412-352-1548

## Technical Abstracts

implanted in rabbits, rats and mice to telemeter electrocardiograph signals. Metal input sensors were mounted on both sides of the transmitters and the assemblies were sealed with plastic, paraffin and silastic. With some electrode placements, respiration as well as EKG readings were obtained, with the respiration rate showing up as periodic variations in the EKG's line.

Presented at the Symposium on the Engineering Significance of Biological Sciences, Pittsburgh, Jan. 26-28.

### 'Listening' for IC defects

Screening silicon integrated circuits  
B.C. Peralta  
Battele Memorial Institute,  
Columbus, Ohio

Failure-sensitive parameters are needed to detect the most common causes of integrated-circuit failure—surface phenomena or defects in bonding or metalization.

When IC chip surfaces have been purposely damaged in experiments, nonlinearities in the common-emitter families of curves have resulted. High-temperature storage aggravates the defects, and circuit analysis has shown that the nonlinearities result from negative-resistance regions. The defects are also found to be accompanied by an increase in low-frequency noise.

Devices studied were dual, two-input integrated circuits. Besides noise, the following parameters were considered for empirical screening of such devices: input, output, forward transfer and inverse transfer static characteristics; dynamic and d-c fan-out and fan-in; noise immunity, total element current, switching times and propagation delay. The surface phenomena defects appear to be related primarily to the low-frequency noise.

Areas that ought to be studied further include failures in multi-storage digital circuits, methods of stressing to enhance a failure-sensitive parameter without damaging a normal device, and improved instrumentation for measuring failure-sensitive parameters.

Presented at the 1967 Annual Symposium on Reliability, Washington, D.C., Jan. 10-12.

## NEW! DIGITAL PANEL METERS 0.1% ACCURACY



**DIGIMETER** **\$260**  
MODEL DM-25 OEM discounts available

- For every application where a conventional panel meter is inadequate
- AC or DC measurements
  - Single or multiple ranges
  - 1  $\mu$ A to 1,000 A. full scale
  - 10 mV to 10,000 V. full scale
  - Other functions & ranges to order

Send for detailed literature

**ABB E Y**   
ELECTRONICS CORP.

2 Sixth St., New Hyde Park, L. I., N. Y. 11044  
516 CH 8-0660

Circle 344 on reader service card

## NEW 1967 catalog

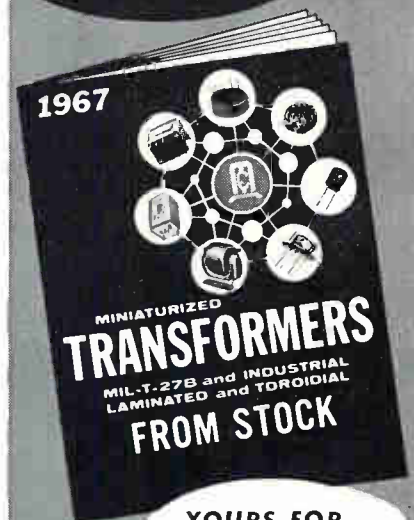

**YOURS FOR  
THE ASKING**

**MICROTRAN**  
145 E. Mineola Ave., Valley Stream, N.Y.

Circle 345 on reader service card

## New Literature

**Precision potentiometers.** New England Instrument Co., Kendall Lane, Natick, Mass. A six-page brochure summarizes the company's capabilities in custom designed, conductive plastic and wire-wound pots and elements, and provides data on standardized Waferpot and Econopot lines.  
Circle 420 on reader service card.

**Analog telemetering system.** Quindar Electronics Inc., 60 Fadem Road, Springfield, N.J., 07081, has available a four-page bulletin covering the QATS-10 analog telemetering system. [421]

**F-m discriminator.** Sonex Inc., 20 East Herman St., Philadelphia, Pa., 19144. A solid state f-m discriminator, capable of providing phase-locked-loop or pulse-averaging detection, is described in a two-color bulletin. [422]

**Transistors and IC's.** National Semiconductor Corp., Danbury, Conn., 06810, has released an 18-page catalog describing more than 500 types of silicon transistors and integrated circuits. [423]

**Ceramic capacitors.** King Electronics Inc., 150 Waverly Drive, Pasadena, Calif., 91105, offers a short-form catalog covering a complete line of micro-miniature ceramic capacitors. [424]

**A/D interfacing system.** Datametrics Corp., 8217 Lankershim Blvd., North Hollywood, Calif., 91605, has prepared a two-page data sheet on the model IS1108 analog-to-digital interfacing conversion system. [425]

**Antenna systems.** Andrew Corp., P.O. Box 807, Chicago, Ill., 60642, has released a catalog containing product information and engineering data on microwave, uhf, vhf, telemetry antennas, flexible coaxial cables and elliptical waveguides, switching and pressurization equipment and system accessories such as radomes, positioners and telescoping masts. [426]

**Spacer/bushings.** Seaelectro Corp., 225 Hoyt St., Mamaroneck, N.Y., 10543. Press-Fit Teflon spacer/bushings for mounting p-c boards to metal panels are described in an illustrated catalog sheet. [427]

**Environmental testing.** Blue M Engineering Co., a division of Blue M Electric Co., 138th & Chatham St., Blue Island, Ill., 60406. A 16-page illustrated brochure describes the company's capabilities in the environmental testing field. [428]

**Chemical specialty products.** Transene Co., 121 Conant St., Danvers, Mass., 01923, has available a technical brochure entitled "Chemical Specialty Products for Solid State, Electronics, and Aerospace Industries." [429]

**Mercury switches.** MicroSwitch, a division of Honeywell Inc., 11 W. Spring St., Freeport, Ill., 61032, has released a booklet that describes applications of mercury switches in industry. [430]

**Solid-state chopper.** Airpax Electronics Inc., Cambridge, Md., 21613. Bulletin C-121R describes a prepackaged transistorized chopper that provides total isolation between drive and signal circuits. [431]

**Digital displays.** Tung-Sol division of Wagner Electric Corp., One Summer Ave., Newark, N.J., 01704, has published a booklet describing its line of optimum contrast, illuminated digital readouts. [432]

**Miniature connectors.** Elpac Microwave, a division of Elpac Inc., 3800 Campus Drive, Newport Beach, Calif., 92660. A two-page data sheet covers the OM-105 series of miniature connectors for flange, panel, bulkhead, and stripline mounting. [433]

**Insertion-loss test set.** Weinschel Engineering, Gaithersburg, Md. Application note No. 4 illustrates and describes a dual-channel insertion-loss test set. [434]

**Data display system.** Laboratory for Electronics Inc., 1075 Commonwealth Ave., Boston, Mass., 02215. Model SM-2A data display system is fully described in an eight-page, technically oriented brochure. [435]

**Molded ceramic capacitor.** Scionics Corp., 8900 Winnetka Ave., Northridge, Calif., has available a technical data sheet covering the S-Cap 500 series micro-miniature, axial-lead, molded ceramic capacitor. [436]

**Heated-glass bonding tips.** Specialty Glass Products Inc., 2561 Wyandotte Road, Willow Grove, Pa., 19090. Bulletin 2556 gives complete technical data on recently developed heated glass capillaries that fit standard magnetic holders and cost less than one-half as much as tungsten carbide tips. [437]

**Voltage-sensing devices.** Bourns Inc., 1200 Columbia Ave., Riverside, Calif., 92507, offers two technical bulletins, one on the model 3910 dpdt voltage-sensing relay, and the other on the model 3917 spst normally-open (solid state output) voltage-sensing module. [438]

**Monolithic diode matrixes.** Radiation Inc., Microelectronics division, P.O. Box 37, Melbourne, Fla. Applications of monolithic diode matrixes to electronic data processing systems are described in a 60-page manual. [439]

**Prestressed mica.** Perfection Mica Co.,

## New, Tunable (Lock-in) Coherent Amplifier

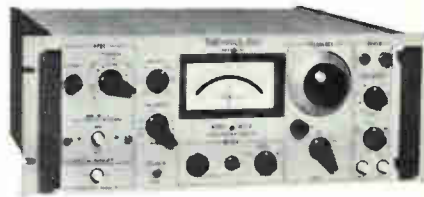

MODEL 300-A

### For Measurement of Ultra-Low Level Signals in the Presence of Noise

- Continuously tunable from 1.5 Hz - 200 kHz
- Variable Q from broadband to 25
- 160 db gain (100 nV - full scale)
- 0.1 uV equivalent noise voltage
- Plug-in preamplifiers
- Reference channel drives coaxial switch or chopper directly

#### Applications:

The Model 300-A Coherent Amplifier is useful for detection of effects of biological stimuli, photometric measurements at low S/N ratios, conversion of a communications receiver to sensitive radiometer, magnetic field effect studies, cross-correlation measurements, and general amplification and measurement of low level signals in the presence of noise.

**Write for data on the Model 300-A**  
Price \$1795 (including basic pre-amp)

Also available are: Fixed Frequency Coherent Amplifiers, Coaxial Switches, Radiometric Receivers, and Klystron Frequency Stabilizers.



**Teltronics, Inc.**

Subsidiary of Roanwell Corporation

23 Main Street, Nashua, New Hampshire 03060

603-889-6654

**PEAK LOK**  
measures and holds  
1  $\mu$ s voltage peaks

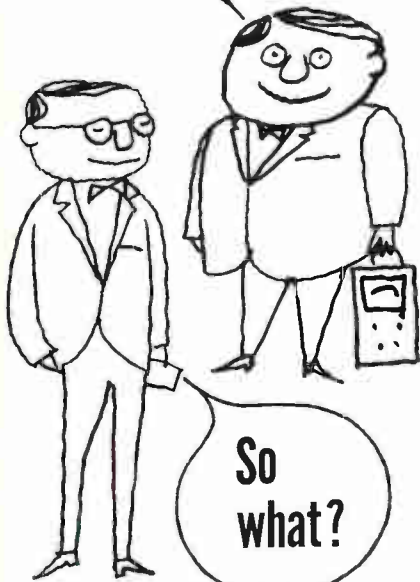

So  
what?

Here's what. Now you can sample that peak or break point—no matter how brief the duration—with a degree of accuracy not previously possible.

Peak Lok is already being used to measure transient voltage peaks, break points, shock peaks and a variety of other physical phenomena in research laboratories and industry.

Take a closer look. You'll see a number of ways you can use Peak Lok too.

With Peak Lok, measured voltage, in pulses as brief as one microsecond, is held in an analog state. DC coupling is provided and input ranges are from 0.1 to 1000 volts. Output for logging —0 to 5 volts with 1% absolute accuracy. And it's available in portable and rack mounted versions.

For a closer look, call or write PEAK LOK, Dept. 104, La Jolla Division, Control Data Corporation, 4455 Eastgate Mall, La Jolla, California 92037. Phone (714) 453-2500.



**CONTROL DATA**  
CORPORATION

4455 Eastgate Mall, La Jolla, Calif.

## New Literature

1322 No. Elston Ave., Chicago, Ill., 60622. Data sheet K-8 tells how prestressed mica reduces handling and fabrication costs when used as electrical insulation and spacers in devices incorporating resistive heating elements. [440]

**Tv connectors.** ITT Cannon Electric, 3208 Humboldt St., Los Angeles, Calif., 90031, offers technical bulletin T-497 on the series LKTMA connectors for color and monochrome tv. [441]

**Modular interconnection system.** AMP Inc., Harrisburg, Pa., 17105. An eight-page bulletin describes a modular interconnection concept for perpendicular, or parallel stacking of p-c boards. [442]

**Frequency scaler.** Fischer & Porter Co., 143 Jacksonville Road, Warminster, Pa., 18974, has available a specification sheet on its frequency scaler, a divider and shaper network which converts the actual pulse rate from a transmitter or transducer to a more conveniently handled and decimally related pulse rate/engineering unit ratio. [443]

**Parametric amplifier.** American Electronic Laboratories Inc., P.O. Box 552, Lansdale, Pa., 19446, has available a technical bulletin on an avalanche diode-pumped parametric amplifier. [444]

**Translatory potentiometers.** Gamewell division of The E.W. Bliss Co., 1238 Chestnut St., Newton, Mass. A two-page bulletin describes precision potentiometers that are used to translate linear motion into resistive values. [445]

**Tunnel mixers.** Aertech, 250 Polaris Ave., Mountain View, Calif. Standard models including mixer mounts, stripline mixers, balanced mixers and waveguide units are covered in a technical data sheet. [446]

**Memory systems.** Honeywell Inc., Computer Control division, Old Connecticut Path, Framingham, Mass., 01701. A summary brochure describes features, system organization, interface and options for the ICM-40 and ICM-47 memory systems. [447]

**Transducer amplifier systems.** Natel Engineering Co., 7129 Gerald Ave., Van Nuys, Calif., 91406, offers a four-page catalog on its a-c/d-c transducer amplifier systems. [448]

**Integrated circuits.** Transistron Electronics Corp., 168 Albion St., Wakefield, Mass. An integrated-circuit data handbook, priced at \$15, will be provided free to all qualified recipients. [449]

**Permeability-tuned oscillator.** TRW Elec-

## UNIVERSAL CALIBRATOR Model MC-10



Fast, accurate calibration of panel meters, multimeters, oscilloscopes, vtvm's, other measuring instruments. Full accuracy without correction curves. Meter indicates directly the % Error in device under test. All solid-state. Meets MIL specs for temperature, humidity, vibration, shock, RFI.

AC & DC VOLTAGE:  $\pm 0.2\%$ , 0-1000 volts in 1 millivolt steps, 0-20 mA load  
AC & DC CURRENT:  $\pm 0.2\%$ , 0-1 ampere in 1 microamp steps, 0-1 volt burden  
RESISTANCE:  $\pm 0.1\%$ , 0-1,000,000 ohms in 1 ohm steps

Send for detailed literature

**ABB E Y**  
ELECTRONICS CORP.

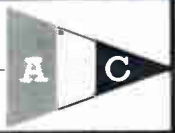

2 Sixth St., New Hyde Park, L. I., N. Y. 11044  
516 CH 8-8060

Circle 346 on reader service card

# NEW!

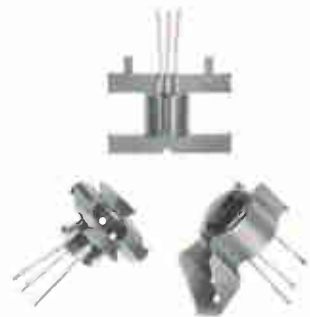

## Heat Dissipators and Retainers for Plastic and Epoxy Transistors

3 new series for RO-97A, RO-97 and X-20 devices. Maximum dissipating efficiency; added operating and safety margins. Reduce harmful effects of heat during production soldering. Cost less than a nickel in quantity. Send for data. IERC, 135 W. Magnolia Blvd., Burbank, California 91502.

**ierc** PCA  
SEMICONDUCTOR  
HEAT DISSIPATORS

A corporate division of Dynamics Corp. of America

Circle 510 on reader service card

R&D BREAKTHROUGH  
MEANS 40% SAVINGS  
ON EMBOSING TAPE.

NEW PRICES

1/4 WAS \$1.00

NOW 60¢

3/8 WAS \$1.25

NOW 75¢

1/2 WAS \$1.65

NOW \$1.00

TAPE FITS IN DYMO AND  
ROTEX BRAND EMBOSERS.

ASK YOUR SUPPLIER OR  
WRITE US DIRECT FOR  
SAMPLES & LOCAL DEALER.

GENERAL TAPE CORPORATION  
1ST NATIONAL BANK BLDG.  
ST. PAUL MINN. 55101

Circle 511 on reader service card

# EE's

Existing staff openings at

## SRRC

OPTICS  
ULTRASONICS  
CIRCUIT DESIGN  
BROADBAND SHORT  
PULSE CIRCUITRY  
COMMUNICATIONS  
ENGINEERING  
ELECTRONIC DEVICE  
DESIGN

These positions offer an excellent opportunity for growth while working in a research-oriented environment.

For immediate consideration send your resume in confidence to:

Mr. R. C. Davis

## SPERRY RAND RESEARCH CENTER

North Road Sudbury, Massachusetts 01776

An Equal Opportunity Employer

tronic Components division, Davis and Copewood Streets, Camden, N.J., 08103, offers a specification sheet for its low-cost, transistorized, permeability-tuned oscillator. [450]

Core memory stack. Electronic Memories, 12621 Chadron Ave., Hawthorne, Calif., 90250. A four-page brochure describes the Nanostak, a 2½-dimensional core memory stack, with cycle times of 650 or 900 nsec, for use in the highest speed commercial computers. [451]

Printed-circuit laminates. The Mica Corp., 4031 Elenda St., Culver City, Calif., has available an eight-page catalog on high-reliability Micaply glass/epoxy laminates for printed circuits. [452]

Circular connectors. ITT Cannon Electric, 3208 Humboldt St., Los Angeles, Calif., 90031, offers catalog K-9, which includes complete product information, specifications, and ordering instructions for its line of K circular connectors and its LKTMA tv connector. [453]

Multiconductor wiring systems. Methode Electronics Inc., 7447 West Wilson Ave., Chicago, Ill., 60656, has published a catalog on its Plycon multiconductor card extenders and wiring systems. [454]

Shaft encoder. Theta Instrument Corp., Saddle Brook, N.J., 07662. Bulletin 66-14 describes a three-digit, binary-coded decimal shaft encoder for rugged industrial and scientific applications. [455]

Operational amplifiers. Melcor Electronics Corp., 1750 New Highway, Farmingdale, N.Y., 11735. A six-page condensed catalog (C1003), describes a complete line of solid-state operational amplifiers. [456]

R-f connectors. Sealectro Corp., 225 Hoyt St., Mamaroneck, N.Y., 10543, has released catalog 468-51C covering 65 microminiature r-f connectors in a 12-page display. [457]

Tachometer transducer. Airpax Electronics Inc., Box 8488, Fort Lauderdale, Fla., 33310, offers bulletin F-111-1 on the type TDS9 self-generating transducer designed for mounting on a rotating shaft for rpm measurement. [458]

Beacon magnetrons. Microwave Associates Inc., Northwest Industrial Park, Burlington, Mass., has published a four-page illustrated booklet (SF-1503) describing its complete line of fixed-frequency and tunable beacon magnetrons. [459]

Wideband data amplifiers. Dana Laboratories Inc., Campus Drive at Von Karman Ave., Irvine, Calif., has issued two data sheets with detailed descriptions of the series 3840 wideband data amplifiers and the series 3850 dual-output amplifiers. [460]

## SINCLAIR'S YAGI ANTENNAS

RUGGED  
RELIABILITY...  
WHEN IT  
COUNTS!

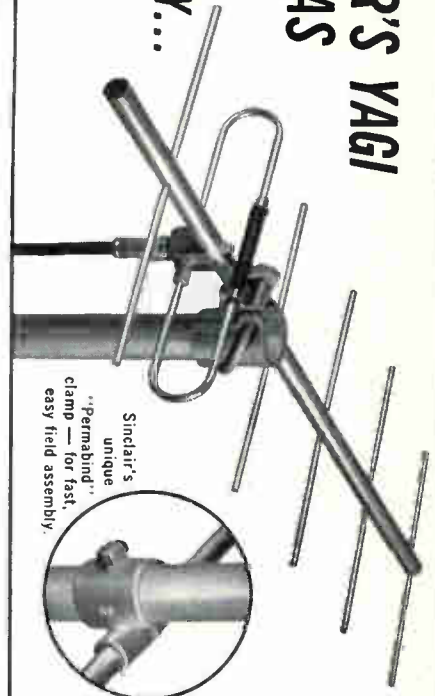

Sure, most UHF-VHF yagi antennas function effectively — when the weather's good! It's when the wind starts to howl and the weather turns from bad to worse that the unmatched rugged reliability of a Sinclair yagi really counts. Every standard Sinclair yagi is designed to withstand 110 mph winds with a ½" radial ice coating. An integral part of this rugged construction is Sinclair's unique "Permabind" clamp that makes for fast, permanent field assembly.

Standard Sinclair yagis are available in a wide frequency range from 30Mc. to 470Mc. . . . Gains from 6.5db to 17.0db . . . power ratings up to one KW. Send coupon today for complete FREE literature and prices.

**SINCLAIR RADIO LABORATORIES, INC.**  
523 FILLMORE AVENUE DEPT. 101B  
TONAWANDA, NEW YORK

### FREE LITERATURE

TO: SINCLAIR RADIO LABORATORIES, INC.  
Dept. 101B 523 Fillmore Avenue  
Tonawanda, New York 14152

Name: \_\_\_\_\_

Title: \_\_\_\_\_

Company: \_\_\_\_\_

Address: \_\_\_\_\_

City: \_\_\_\_\_

State: \_\_\_\_\_ Zip: \_\_\_\_\_

# ELECTRONIC ENGINEERS

1967 CAN BE THE START OF SOMETHING great if you invest your talents with the winning combination that is Hamilton Standard! This firmly established electronics capability has been scoring one success after another. Steady expansion in staff has matched the growth of our business volume. Soon we will be moving into a sparkling, new 200,000 square foot building. Today there are highly attractive openings throughout the organization for both engineers at the senior level and for the recent college graduate. Assignments will be involved with one or more of the following:

## PRODUCT DEVELOPMENT ENGINEERS

Airborne Controls—develop precision electromechanical airborne control components and systems utilizing digital or analog control techniques.  
Power Supplies—static power conversion equipment and generating systems.

## DESIGN AND ANALYTICAL ENGINEERS

Electronic Designers—circuit design, airborne control component equipment and data systems (analog and digital)  
Mechanical Designers—precision electromechanical components, transducers, torque motors et al.  
Systems Designer—digital control/data systems—system timing, accuracy and implementation.

## MICROCIRCUIT ENGINEERING, MATERIALS AND COMPONENTS DEVELOPMENT, MICROCIRCUIT PACKAGING

Metallurgist, Physicist, Chemical, Electrical or Mechanical Engineers for:

- Microcircuit electron beam welding techniques.
- Fine particle technology.
- Materials and process semiconductor device fabrication.
- Bonding techniques, semiconductor devices.
- Silk screening, photoengraving microcircuits.
- Semiconductor OR electronic component package design
- Microcircuit for Semiconductor.
- Low power/low frequency control OR digital microcircuit design and development.

**LET'S SET UP AN INTERVIEW** to talk over a position tailored to fulfill your personal ambitions. And to give you a first-hand view of the wonderful family living conditions in suburban Hartford. Please forward your resume, stating present salary, to Mr. David D. Howland, Personnel Dept., Hamilton Standard, Windsor Locks, Connecticut.

*An Equal Opportunity Employer*

**Hamilton  
Standard**

**U  
A**  
DIVISION OF UNITED AIRCRAFT CORPORATION

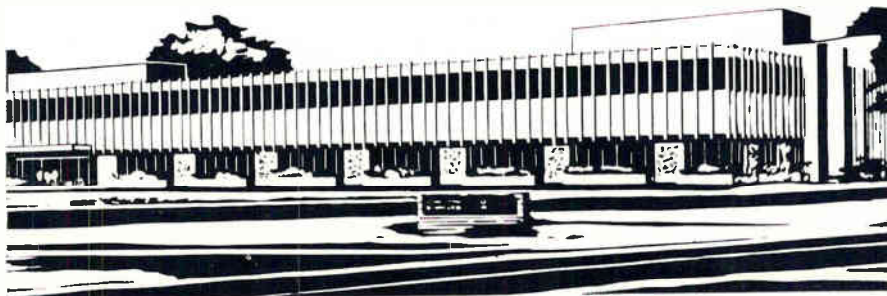

# YOU'RE H!RED

Do you need electronics engineers or technical management men? Electronics magazine is the way to recruit them. Electronics is designed specifically for the working engineer. 68,000 subscribers and an additional 133,000 pass-along readers turn to it to keep up with their industry. You can find the man that meets your qualifications with an advertisement in the Employment Opportunities Section.

For rates & information write: Electronics, a McGraw-Hill Publication. Classified Advertising Division, Post Office Box 12, New York 10036.



# HAD IT?

*Maybe it's time you moved*  
and **LIVED - HERE!**

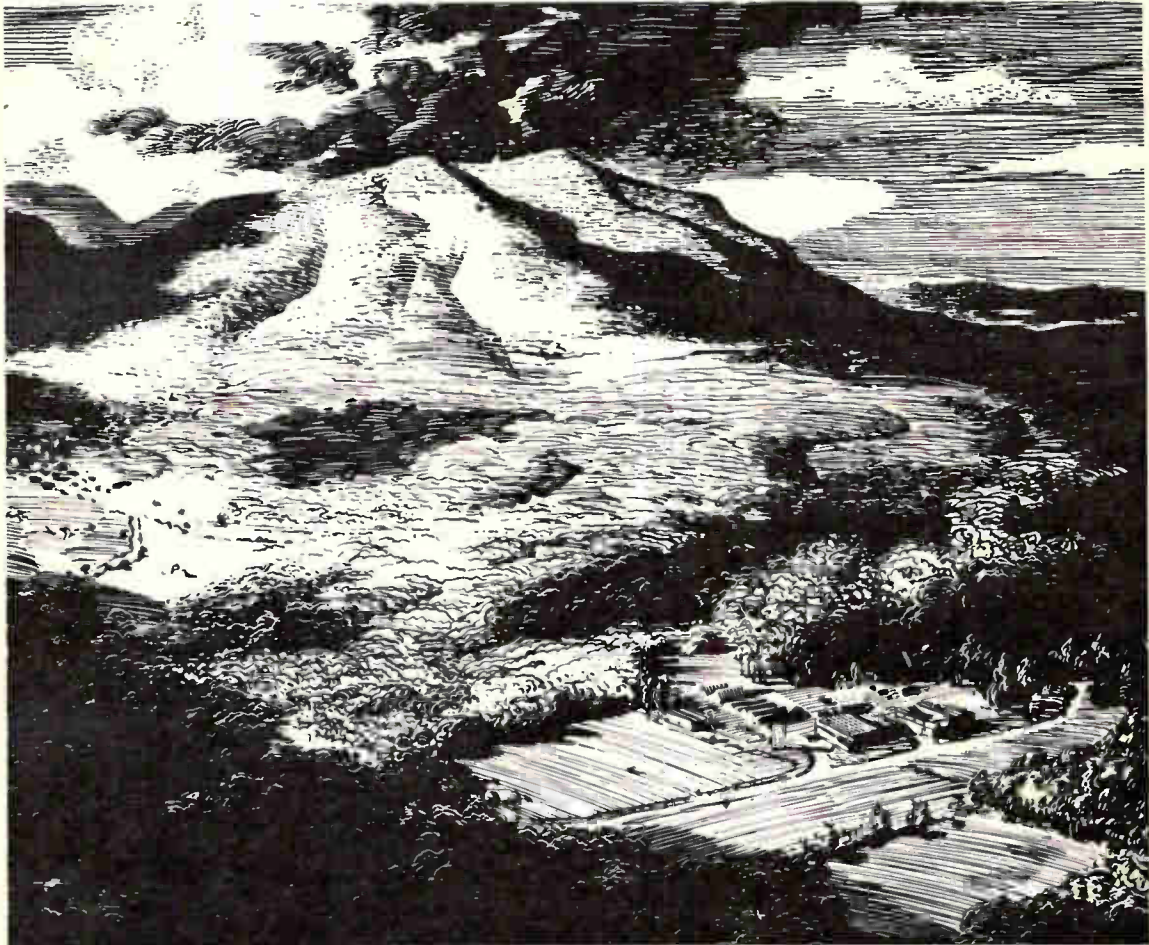

*Rotron and Overlook Mt.*

Sketch by JOHN PIKE, noted Woodstock artist

Rotron is an exciting place to work. No ruts to get into . . . no treadmills to sap your spirit and grind you down. Instead, there are as many exciting new avenues and vistas for the mind as there are for the eye.

A history of steady, promising growth since 1949 . . . annual sales exceeding \$14,000,000 . . . industry leadership manufacturing the best cooling and air-moving devices for the electronics industry . . . lucrative profit-sharing plan . . . all prove our working atmosphere and reward for initiative and creativity pay off.

Woodstock is an exciting place to live. Renowned for its art colony, this historic village now embraces the electronics industry. Professional comradery and complete spectrum of activities exist for the lover of the visual, performing and handicraft arts. Magnificent Catskills daily delight the hungry eye. School system rated excellent by educators and new residents from throughout the nation. Five minutes drive from Rotron, four-bedroom houses on ½ acre lots in tree-studded, tastefully-planned areas plentiful at \$23,000 (taxes about \$500/yr.). All this just 2 hours from New York City — But far removed from the grief and woes of captive megalopolis living. Come see for yourself — *we need an Electronics Engineer for our Product Engineering Dept.*

Write in confidence to:

**PETER W. RAKOV**  
Administrative Assistant  
To the President

**ROTRON** Manufacturing Company, Inc. Woodstock, New York 12498

An Equal Opportunity Employer



# ROTRON

# design engineers

NAVAL ARCHITECT • MARINE • MECHANICAL  
STRUCTURAL • ELECTRICAL • ELECTRONICS  
ARCHITECTURAL • CIVIL

Investigate your opportunities  
in the world's largest ship-  
building complex



The San Francisco Bay Naval Shipyard provides service to surface and underwater ships and deep submersibles. Assignments include new construction of Polaris nuclear submarines and guided missile frigates; and the repair, overhaul and conversion of all classes of ships. Other projects include research on noise reduction, ASW, replenishment-at-sea, Trieste II and Sea Lab II and III.

*Openings exist at all levels in these program areas:*

- |  |  |
|--|--|
| Ship Structure Development                     | Shipboard Mechanization  |
| Ship Weight Control                            | Plant Facilities   |
| Structural Mechanics                           | Ordnance, Guided Missile, Fleet<br>Ballistic Missile and<br>Electronic Systems |
| Nuclear and Conventional<br>Propulsion Systems | Shipboard Aeronautical Material<br>and Equipment                               |
| Navigation and Communication<br>Systems        | Shipboard Electrical and Power<br>Systems                                      |
| Sound and Vibration Control                    | Naval Tactical Data Systems  |
| Cargo Replenishment-at-Sea<br>Development      |  |

Job Locations: San Francisco Bay Naval Shipyard has two work sites located 40 miles apart: San Francisco and Vallejo, California. Each location has ready access to the full cultural advantages of San Francisco and the mild year-round climate of the "Bay Area." All types of recreation from ocean surfing to skiing on the slopes of the Sierras are within easy driving distance.

Send your resume or Standard Form 57, Application for Federal Employment, to:

**Coordinator, Professional and Technical Recruitment (Code 174A5)  
Employment Division  
San Francisco Bay Naval Shipyard  
Vallejo, California 94592**

AN EQUAL OPPORTUNITY EMPLOYER

MUST BE A U.S. CITIZEN

## In electronics it's Electronics magazine to sell used equipment!

Your advertisement will produce Results in Electronics. Engineers turn to Electronics magazine for the latest technical developments — and for the latest buying information. You can reach them inexpensively in Electronics Searchlight Section.

For information:  
Searchlight Section  
Classified Advertising Division  
Post Office Box 12  
New York 10036



ADDRESS BOX NO. REPLIES TO: Box No.  
Classified Adv. Div. of this publication.  
Send to office nearest you.  
NEW YORK, N. Y. 10036: P. O. Box 12  
CHICAGO, Ill. 60611: 645 N. Michigan Ave.  
SAN FRANCISCO, Cal. 94111: 255 California St.

**POSITION VACANT**

Major College needs Electrical, Electronics and Avionics teachers for expanding technical and vocational programs. Require bachelor's degree and recent practical experience. Send resume to Dean Edgar E. Stahl, Ferris State College, Big Rapids, Michigan 49307.

**PROFESSIONAL SERVICES**

**Donald C. Harder., Inc.**  
Magnetic Component Engineers  
Reactors—Transformers—Filters  
Serving the Research Laboratory  
2580 K Street, San Diego, Calif. 92102  
Phone (714) 239-8021

*The Consulting Engineer*

*By reason of special training, wide experience and tested ability, coupled with professional integrity, brings to his client detached engineering and economic advice that rises above local limitations and encompasses the availability of all modern developments in the fields where he practices as an expert.*

**The engineers we're looking for probably aren't looking.**

They're doing well where they are. They're well paid, they're ambitious and they're growing. Fast.

That's why Loral Electronic Systems is the sort of company they ought to be working at. Because we're successful, ambitious and growing fast, too. Things move ahead quicker. So do our people.

Right now, we're a state-of-the-art contributor to the country's defense programs in avionic systems. Our particular areas are anti-submarine warfare, electronic warfare, and navigation and display.

In these areas, we're already a major factor. And there will soon be challenging new ones for the right men to work on.

That's where you could come in. We're busy. There's a lot of good work to be done. There's no giant-company red tape to hold you back. And the road to management is open.

So even if you're not actually looking, get in touch with us anyway. We'll not-look together.

Send a resume to Mr. George Conn, Loral Electronic Systems, 825 Bronx River Ave., The Bronx, N. Y. 10472.

Immediate openings for systems, project, and design engineers in all disciplines.

**LORAL ELECTRONIC SYSTEMS**  
A Division of Loral Corporation  
An Equal Opportunity Employer



**SEARCHLIGHT SECTION**

- CLASSIFIED ADVERTISING
- BUSINESS OPPORTUNITIES
- USED OR SURPLUS EQUIPMENT

**SEARCHLIGHT EQUIPMENT LOCATING SERVICE**

No cost or obligation

This service is designed to help you, the reader of Searchlight Section, to locate used or rebuilt equipment not currently advertised.

How to use: Check the ads in this Searchlight Section, to see if what you want is advertised. If not, print clearly the specifications of the equipment and/or components wanted on the coupon below, or on your own letterhead.

This is a service to our readers. This publication does not buy, sell or stock equipment or materials of any type. Your

requirements will be brought promptly to the attention of the used equipment dealers advertising in this section. You will receive replies directly from them.

Obviously, the list of such advertisers is limited by comparison with the over 68,000 subscribers to Electronics, all directly engaged in the electronics industry. A small 'Equipment Wanted' advertisement in the Searchlight Section will bring your needs to the attention of ALL who read Electronics. The cost is low... just \$28.75 per advertising inch— $\frac{1}{8}$ "x2-3/16".

Electronics, Searchlight Equipment Locating Service, P.O. Box 12, New York 10036

Please help us locate the following used equipment:

-----

Name \_\_\_\_\_ Title \_\_\_\_\_ Company \_\_\_\_\_

Street \_\_\_\_\_ City \_\_\_\_\_ State \_\_\_\_\_ Zip Code \_\_\_\_\_



**2? 3? 4? 5? 6?**  
**FORGET 'EM ALL!**

When you do business with Number One, you can afford to forget Number 2, 3, 4, 5, and 6! We want to buy electronics and test equipment—both military and commercial.

If you have a single piece or a trainload—we'll pay you the top dollar bar none! We airmail your check the same day your goods arrive and we pay the freight! Save time, money, headaches and aggravation! Tell us what you have—what you want! And P.S.: Do it today!

**COLUMBIA ELECTRONICS, Dept. EL**  
4365 West Pico Blvd., Los Angeles, Calif. 90019  
Phone: (213) 938-3731

CIRCLE 966 ON READER SERVICE CARD

**free catalog**  
**POTTING APPLICATORS**  
**MANUAL AND DISPOSABLE**

6cc 12cc 30cc  
FOR POTTING, ENCAPSULATING, AND SEALING OF MINIATURE COMPONENTS

PHILIP FISHMAN COMPANY  
7 CAMERON ST., WELLESLEY 81, MASSACHUSETTS

CIRCLE 967 ON READER SERVICE CARD

RADAR AUTO-TRACK & TELEMETRY ANTENNA PEDESTALS  
3 & 10 CM. SCR 584 AUTOTRACK RADARS. M-33 RADAR  
TPS-1D SEARCH. APS-45 TPS-10D HT. FINDERS. WX RADARS.  
FPN-32GCA. APS-10 APS-15B APS-27 (AMTI) SEARCH. ■ ■  
APN-102 DOPPLER. DOZENS MORE. CARCINOTRONS. PFM'S.  
.25-5-1-2-3-6 MEGAWATT PULSE MODULATORS. CAVITIES.  
PULSE TRANSFORMERS. IF STRIPS. WAVEGUIDE. BENDS  
200 MC. 1 KMC. 3 KMC. 6 KMC. 9 KMC. 24 KMC. RF PKGS.

**RADIO RESEARCH INSTRUMENT CO.**  
550 5TH AVE., NEW YORK 36, N. Y. JU 6-4691

CIRCLE 968 ON READER SERVICE CARD



ANDREW

*Phase Stable*

# HELIAX<sup>®</sup> COAXIAL CABLES

- Repeatabile Phase Tracking
- Electrical Length Stability
- Precise Phase Adjustment

For phase-sensitive applications, special HELIAX coaxial cables are available in three general classes. ■ HELIAX coaxial cables can be supplied phase stabilized to provide a repeating, or "stable", phase-temperature characteristic. ■ Phase compensated cables maintain relatively flat electrical length versus temperature characteristics over selected temperature ranges. Phase-temperature coefficients of better than 1 PPM/°F over 30°F operating range have been achieved. ■ Sets of cables with connectors attached are cut to equal electrical length within very close tolerances. Phase adjustable connectors offer fine adjustment in the field. Andrew Corporation, P. O. Box 42807, Chicago, Illinois, 60642.

IN EUROPE: Andrew Antenna Systems, Lochgelly, Fife, Great Britain

1-69

*Andrew*  
CORPORATION  
30 YEARS OF ENGINEERING INTEGRITY

---

# Newsletter from Abroad

---

February 20, 1967

## Matsushita aglow over new color tube

The Matsushita Electronics Corp. has pulled ahead of the pack in the scramble to get on the market with brighter color television tubes. The firm has switched to a europium-activated yttrium oxide for the red-phosphor in all its tubes. The switch, it claims, makes the new tubes anywhere from 20% to 30% brighter than tubes using europium-activated yttrium vanadate, the prevailing "bright" red phosphor. Matsushita is a joint venture of Philips Gloeilampenfabrieken NV of the Netherlands and the Matsushita Electric Industrial Co.

Matsushita's lead, though, most likely won't last long. All the major U.S. color-tube producers are pushing phosphor technology hard and a spate of even brighter American tubes seems certain this year. In Japan, Hitachi Ltd. also has an yttrium oxide phosphor in the works. Tokyo Shibaura Electric Co. (Toshiba), the country's largest producer of color tubes, however, is standing pat for the moment with its europium-activated vanadate tubes.

## Pakistanis see satellites as way to skip over India

Pakistani telecommunications officials may turn to satellites to link their country's two regions without running cables through nearly 1,000 miles of Indian territory.

The satellites are being considered for a 20-year telecommunications expansion project now being mapped by Pakistan with support from the United Nations. The total outlay involved could run as high as \$395 million, with most of the money coming from the World Bank and the Pakistani government. The Soviet Union and Italy, reportedly, also will extend credit for equipment purchases.

## Hayakawa calculator has IC memory . . .

The Hayakawa Electric Co. jumped the gun on itself this month when it offered Japanese buyers a 14-digit desk calculator with an integrated-circuit memory. The calculator—first production model in Japan with IC's—is about a half-year ahead of the all-IC calculator Hayakawa plans to start selling late this summer or early fall.

For the IC memory, Hayakawa uses 28 identical circuit packages. On the chip: a low-speed quadruple two-input NAND circuit. The 28 packages replace a total of 112 transistors, 112 diodes and 326 resistors. Because of the IC economies, Hayakawa sells the IC version for \$972, some \$200 cheaper than the predecessor model with a discrete-component memory.

The circuit packages were developed jointly by Hayakawa and Mitsubishi Electric Corp. They are similar to the ones Hayakawa will use in its all-IC calculators.

## . . . Nippon Electric shifts to IC's for small computer

The Nippon Electric Co. has indirectly doomed the parametron, a Japanese-developed majority logic device, with a new integrated-circuit ultrasmall business computer. Although NEC still hasn't dropped—officially—the ultrasmall parametron computer from its line, the new IC model is a heads-on competitor. Both models are aimed at the small-business market.

Desk calculators excepted, NEC is the sole computer maker with parametron models. The company apparently plans to phase out its

---

# Newsletter from Abroad

---

parametron model quietly in order to ward off a flurry of returns from users renting them.

The shift to IC's makes the new computer's logic circuits 300 times as fast as the parametron. For business computations, the faster speed of the IC logic can't be fully exploited because of limitations of the input and output circuits. All the same, the new ultrasmall computer is about three times as fast as its parametron predecessor. When running scientific problems, its speed is about 30 times better.

Core memory of the IC model has an 800-word capacity that can be doubled. The memory cycle time is 5.3 microseconds and the addition time averages 400 microseconds.

## Small U.K. firm set to produce 'pocket' radar

Telta Ltd., a small London company that specializes in burglar alarms, apparently has beat Britain's electronics giants in the scramble to get into production of the matchbox-size radar developed by the Royal Radar Establishment. The Telta tiny radar probably will be on the U.K. market within a month, priced at about \$250.

Like the Royal Radar prototype, Telta's pocket radar uses a gallium arsenide Gunn-effect diode oscillator as the microwave source. Although Mullard Ltd., a subsidiary of Philips Gloeilampenfabrieken, developed the diode used in the prototype, Telta says another supplier—whom it won't name—quoted a better price than Mullard.

## Saab wings upward in computer sales

After two lean years, sales have suddenly spurted at home and abroad for Datasaab, the computer division of the Swedish aircraft and auto maker Saab AB. A half-dozen early-year orders pushed to 30 the number of Saab computers that will be in service by this summer.

The small flurry brought Datasaab its first important export business: a pair of computers each for Czechoslovakia and Finland. Datasaab officials see more export business in the offing. Gunnar Lindstrom, the division's managing director, says negotiations are under way with companies in several countries.

For the Czech orders, Datasaab bested British and American competitors at last year's Prague computer show. One of the Swedish computers will go to the University of Brno; the other will be used by a Prague construction organization.

The Finnish order for two computers came from Wartsila, a privately owned industrial group with a heavy emphasis on shipbuilding. Wartsila will swap computer programs and know-how with Kockums Mekaniska Verkstads AB, a Malmo shipbuilding outfit that together with Saab has developed a computer program to generate hull shapes.

## Computer system to aid Bobbies

Britain's Home Office—the country's law and order agency—intends to back up its policemen with a real-time computer system. The agency this month completed a feasibility study and, when details are worked out, will follow through on the project.

The system will store data on wanted men, stolen property and the like. When they run into suspicious situations, Bobbies on the beat will query the computer system by means of walkie-talkies. The Home Office already has begun to equip police with small two-way radios and all constables will have them by the spring of 1968.



# A Standout for 99¢

The E-Z-TRIM® Model 3007P adjustment potentiometer is a standout in more ways than price alone! It is a commercial unit but has many of the features of more expensive potentiometers. Terminals are gold plated and sealed to the body, making the Model 3007 suitable for production soldering processes. Subminiature size is only 0.75" x 0.16" x 0.31" ... a real space-saver! Its 20-turn self-locking adjustment screw permits precise and stable wiper setting.

The Model 3007P undergoes a regular periodic requalification program ... random sample lots are taken from production lines and tested to published specifications. This is the Bourns Reliability Assurance Program ... your quality guarantee.

Write now, or contact your nearest Bourns office or representative for detailed specifications on the Model 3007.

**Price: 99¢ for 1000-piece quantity**

Actual Size



## SPECIFICATIONS:

Standard Resistance Range	50 to 20K ohms
Resistance Tolerance	±10% standard
Resolution	0.2 to 1.0%
Power Rating:	
40°C Ambient	1.0 watt
125°C Ambient	0 watt
Operating Temperature Range	-55 to +125°C
Temperature Coefficient	100 PPM/°C max.
Mechanical Adjustment	20 turns nominal
Mechanical Stops	Wiper assembly idles
Terminals	Printed circuit type



BOURNS, INC., TRIMPOT DIVISION • 1200 COLUMBIA AVE., RIVERSIDE, CALIF.  
TELEPHONE 714 684-1700 • TWX: 910 332-1252 • CABLE: BOURNSINC.

# Plessey will design and make any memory stack

Whether you want single memory planes or stacks, Plessey can produce them. They can design them from basic applications data alone, or produce them direct from your own design. They can produce in quantity or as a special "one-off".

Performance-tested Plessey stacks are enabling large, high-speed systems to be developed for operation in the increasingly arduous environments imposed on modern computers, and the extensive facilities available for the design, manufacture and testing of stacks have been specially developed to cater for these stringent performance requirements.

This is one of the reasons why many leading international buyers come to Plessey.

If you have a memory problem or an unusual requirement involving stacks Plessey will solve it, write or telephone...

Plessey Components Group,  
The Plessey Company Limited,  
Matrix Division,  
Wood Burcote Way,  
Towcester, Northamptonshire, England  
Tel: Towcester 312. Telex 31628.

**PLESSEY**  
**Components**

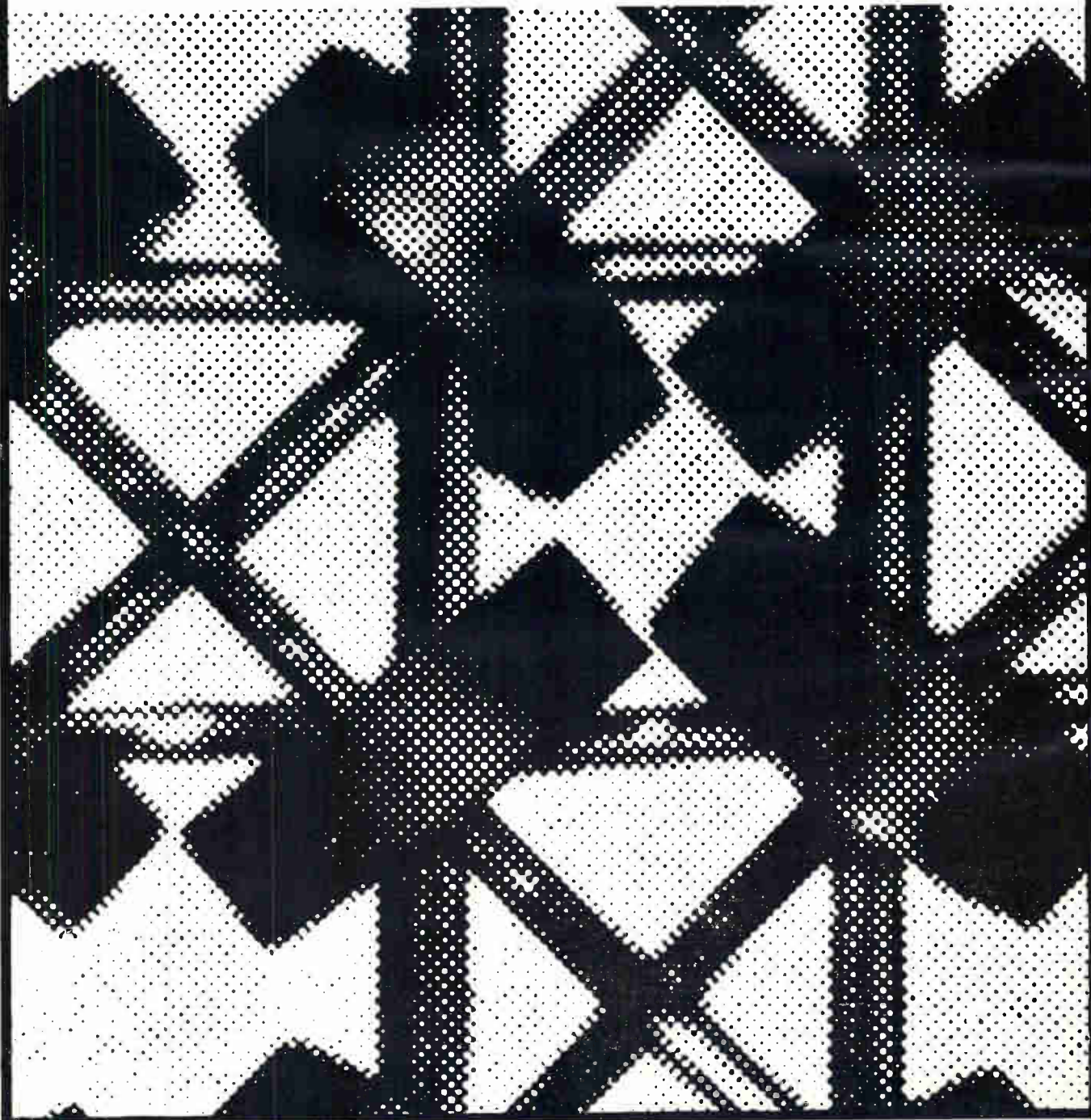



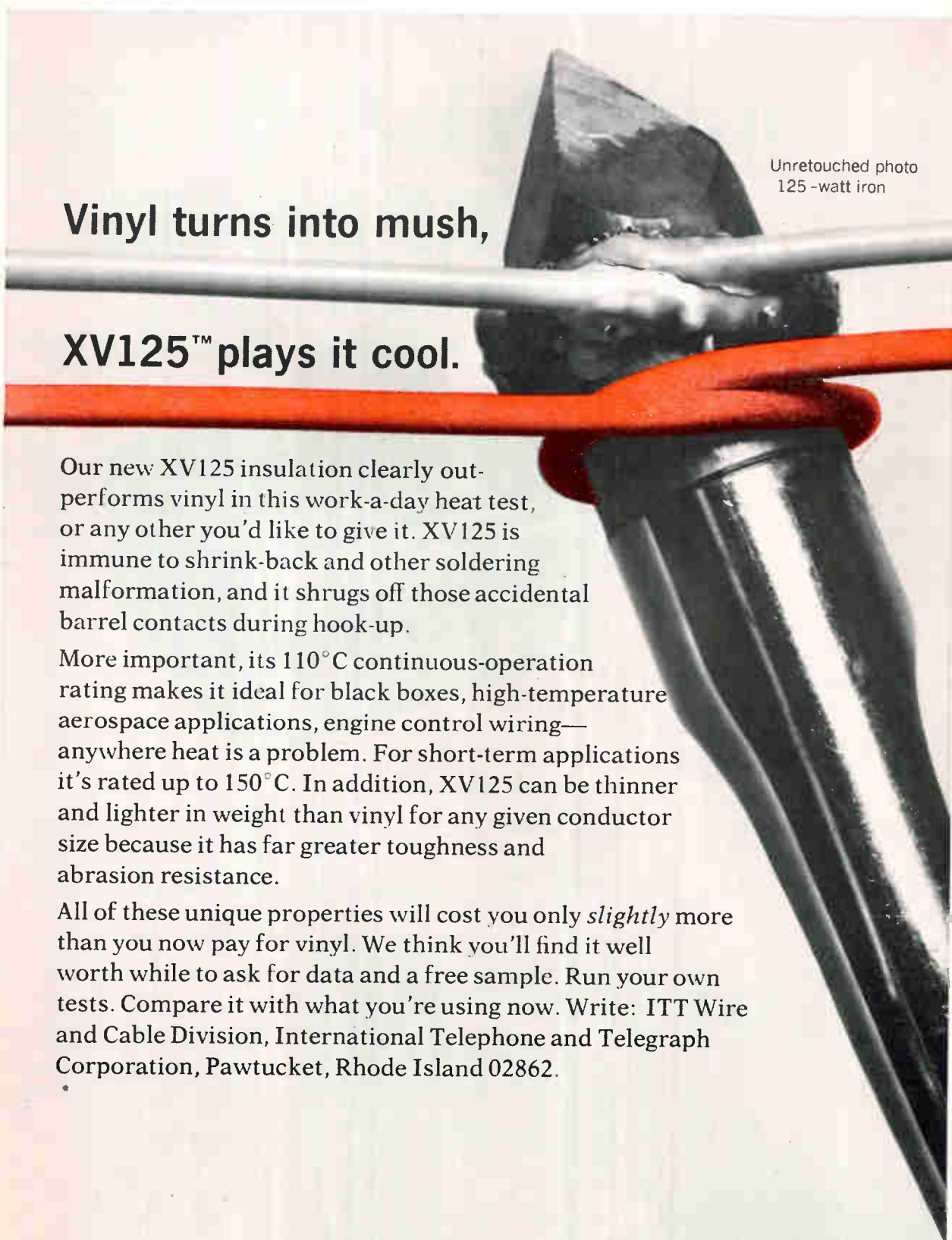

Unretouched photo  
125-watt iron

Vinyl turns into mush,

XV125™ plays it cool.

Our new XV125 insulation clearly outperforms vinyl in this work-a-day heat test, or any other you'd like to give it. XV125 is immune to shrink-back and other soldering malformation, and it shrugs off those accidental barrel contacts during hook-up.

More important, its 110°C continuous-operation rating makes it ideal for black boxes, high-temperature aerospace applications, engine control wiring—anywhere heat is a problem. For short-term applications it's rated up to 150°C. In addition, XV125 can be thinner and lighter in weight than vinyl for any given conductor size because it has far greater toughness and abrasion resistance.

All of these unique properties will cost you only *slightly* more than you now pay for vinyl. We think you'll find it well worth while to ask for data and a free sample. Run your own tests. Compare it with what you're using now. Write: ITT Wire and Cable Division, International Telephone and Telegraph Corporation, Pawtucket, Rhode Island 02862.

wire and cable division

**ITT**

dustry should widen its contacts in the de Gaulle government even though the administration has already solidly backed electronics companies in their export efforts.

**Active.** As FNIE's new president, Dontot has tread softly thus far. But people in the industry expect he'll soon pump new life into the trade association. Says an executive of La Radiotechnique SA, a subsidiary of Philips Gloeilampenfabrieken NV and a major French producer of consumer electronics and components: "Dontot will vastly strengthen FNIE's stature abroad." And one of his business associates says that under Dontot the industry association will become "much less passive and more active."

A less-passive FNIE, though, means some run-ins with the government's Ministry of Finance, which over the past two years has let a half-dozen American semiconductor producers build plants in France. The de Gaulle government justified its action on the grounds that American companies would bring in advanced technology needed for defense and space projects.

Dontot thinks the government has overdone it. He says, "When companies from one big country install plants in one smaller country and all in the same sector of a single industry, that is economic colonization."

At a time when government spending on classic military electronics has begun to drop, Dontot sees difficulties ahead in state-industry relations in research and development. From outright financing of prototypes of hardware needed for major equipment programs, the government recently has tended more and more toward "concerted actions" in which government and industry split the bill for research. Even though the sums French companies plow back into research often top—as a percentage of sales—the R&D money spent by American companies, Dontot considers the total funds available for research "greatly insufficient."

**Broader base.** Dontot, though, figures French companies could



Jacques Dontot now heads the French electronics trade association.

pour more money into research if they'd move more vigorously into export markets. In his opinion, they need immediate beachheads abroad since they don't have a huge domestic market—as do U.S. companies—to write off development costs of new products.

Dontot maintains FNIE members could learn much from their toughest competitors, American companies adept at market studies and product planning. To cope with what he terms "savage" competition, Dontot says the French industry should seek out openings in export markets where it can score. And even though FNIE runs a major components show every year [see related story p. 16], Dontot thinks sales managers should concentrate less on flashy, expensive exhibits and more on getting hustling salesmen out into export markets.

---

### Japan

---

#### Color it rosy

This month, a spate of under-\$500 color television sets started turning up in radio-tv dealers' showrooms throughout Japan, heralding the beginning of a color boom.

With the domestic market ready to take off and exports to the United States on the upswing, Japanese set makers now are geared

up to turn out more than a million color receivers this year—double the 1966 figure. Largely as a result, the electronics industry is headed for a banner year.

The Electronics Industries Association of Japan now estimates that the 1967 output of electronics will total something like \$3.16 billion. That's a gain of 22% over last year's \$2.59 billion. Although color tv will show the strongest increase, the industry's rise will range across the board. In 1966, consumer electronics output was \$1.23 billion, industrial electronics \$625 million and components \$735 million.

**Star performers.** Along with color tv, fast growth is forecast for auto radios, spurred by the demand from Japan's burgeoning auto industry. For other consumer products, production increases are estimated at somewhat less than 20%.

In industrial electronics, computers look to be the standout with an expected rise of about 35% over 1966. Video tape recorders and industrial tv equipment also are slated for strong gains, but are dwarfed in volume by computers.

---

### Italy

---

#### Color it later

Prospects for Italian television-set producers paled considerably this month. In voting funds for the country's current five-year economic plan, the Chamber of Deputies tacked onto the appropriation bill an amendment banning any government spending for color tv through 1970.

The measure, first proposed last fall by Premier Aldo Moro's coalition government and fiercely fought by the industry since, hits set producers at a time when the market for black-and-white receivers shows signs of weakening. Tv sales have held at a level of about one million sets annually in recent years, but there's been a shift to low-priced sets during the past two years. Until the government decided color tv

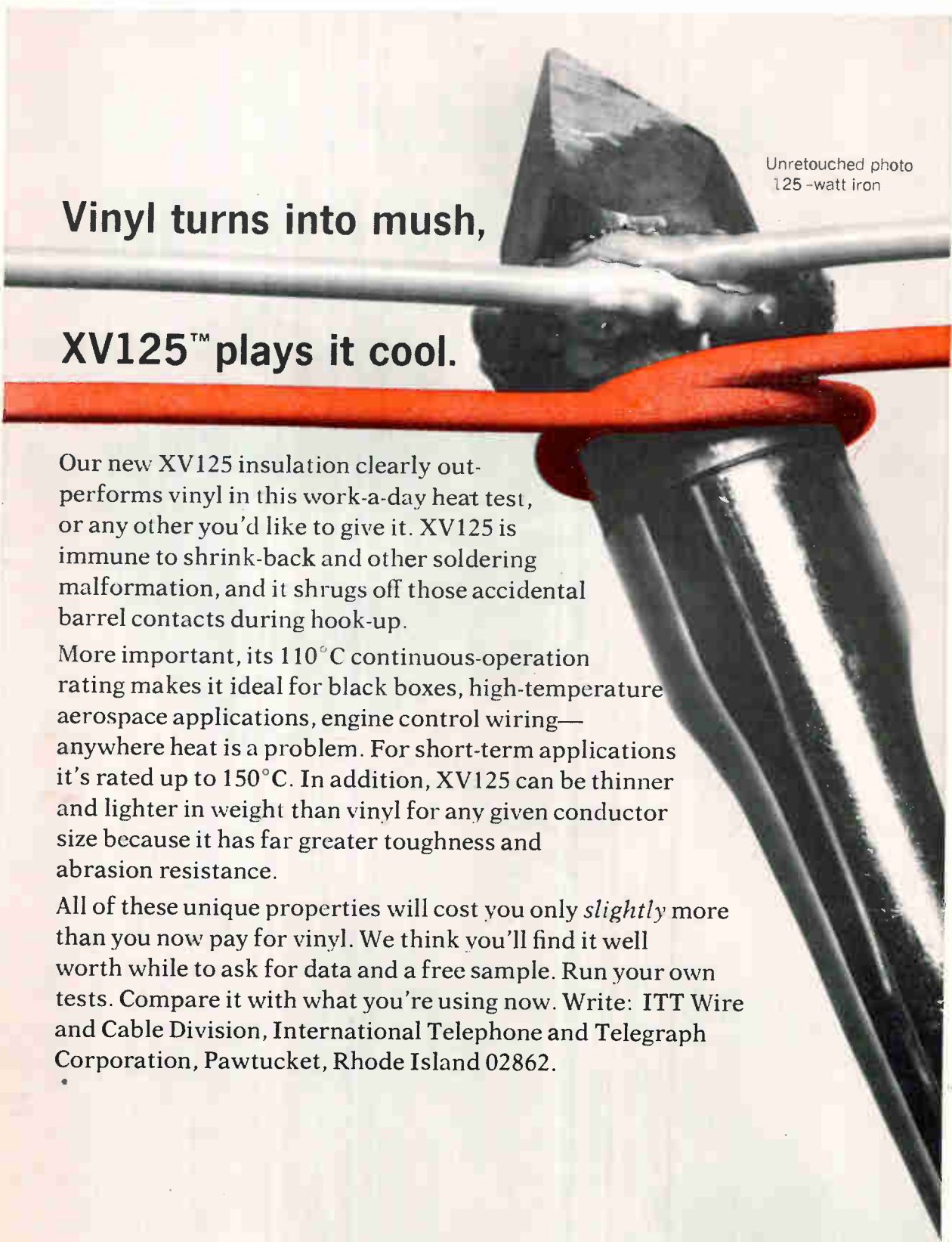

Unretouched photo  
125-watt iron

Vinyl turns into mush,

XV125™ plays it cool.

Our new XV125 insulation clearly outperforms vinyl in this work-a-day heat test, or any other you'd like to give it. XV125 is immune to shrink-back and other soldering malformation, and it shrugs off those accidental barrel contacts during hook-up.

More important, its 110°C continuous-operation rating makes it ideal for black boxes, high-temperature aerospace applications, engine control wiring—anywhere heat is a problem. For short-term applications it's rated up to 150°C. In addition, XV125 can be thinner and lighter in weight than vinyl for any given conductor size because it has far greater toughness and abrasion resistance.

All of these unique properties will cost you only *slightly* more than you now pay for vinyl. We think you'll find it well worth while to ask for data and a free sample. Run your own tests. Compare it with what you're using now. Write: ITT Wire and Cable Division, International Telephone and Telegraph Corporation, Pawtucket, Rhode Island 02862.

wire and cable division

**ITT**

dustry should widen its contacts in the de Gaulle government even though the administration has already solidly backed electronics companies in their export efforts.

**Active.** As FNIE's new president, Dontot has tread softly thus far. But people in the industry expect he'll soon pump new life into the trade association. Says an executive of La Radiotechnique SA, a subsidiary of Philips Gloeilampenfabrieken NV and a major French producer of consumer electronics and components: "Dontot will vastly strengthen FNIE's stature abroad." And one of his business associates says that under Dontot the industry association will become "much less passive and more active."

A less-passive FNIE, though, means some run-ins with the government's Ministry of Finance, which over the past two years has let a half-dozen American semiconductor producers build plants in France. The de Gaulle government justified its action on the grounds that American companies would bring in advanced technology needed for defense and space projects.

Dontot thinks the government has overdone it. He says, "When companies from one big country install plants in one smaller country and all in the same sector of a single industry, that is economic colonization."

At a time when government spending on classic military electronics has begun to drop, Dontot sees difficulties ahead in state-industry relations in research and development. From outright financing of prototypes of hardware needed for major equipment programs, the government recently has tended more and more toward "concerted actions" in which government and industry split the bill for research. Even though the sums French companies plow back into research often top—as a percentage of sales—the R&D money spent by American companies, Dontot considers the total funds available for research "greatly insufficient."

**Broader base.** Dontot, though, figures French companies could



Jacques Dontot now heads the French electronics trade association.

pour more money into research if they'd move more vigorously into export markets. In his opinion, they need immediate beachheads abroad since they don't have a huge domestic market—as do U.S. companies—to write off development costs of new products.

Dontot maintains FNIE members could learn much from their toughest competitors, American companies adept at market studies and product planning. To cope with what he terms "savage" competition, Dontot says the French industry should seek out openings in export markets where it can score. And even though FNIE runs a major components show every year [see related story p. 16], Dontot thinks sales managers should concentrate less on flashy, expensive exhibits and more on getting hustling salesmen out into export markets.

---

### Japan

---

#### Color it rosy

This month, a spate of under-\$500 color television sets started turning up in radio-tv dealers' showrooms throughout Japan, heralding the beginning of a color boom.

With the domestic market ready to take off and exports to the United States on the upswing, Japanese set makers now are geared

up to turn out more than a million color receivers this year—double the 1966 figure. Largely as a result, the electronics industry is headed for a banner year.

The Electronics Industries Association of Japan now estimates that the 1967 output of electronics will total something like \$3.16 billion. That's a gain of 22% over last year's \$2.59 billion. Although color tv will show the strongest increase, the industry's rise will range across the board. In 1966, consumer electronics output was \$1.23 billion, industrial electronics \$625 million and components \$735 million.

**Star performers.** Along with color tv, fast growth is forecast for auto radios, spurred by the demand from Japan's burgeoning auto industry. For other consumer products, production increases are estimated at somewhat less than 20%.

In industrial electronics, computers look to be the standout with an expected rise of about 35% over 1966. Video tape recorders and industrial tv equipment also are slated for strong gains, but are dwarfed in volume by computers.

---

### Italy

---

#### Color it later

Prospects for Italian television-set producers paled considerably this month. In voting funds for the country's current five-year economic plan, the Chamber of Deputies tacked onto the appropriation bill an amendment banning any government spending for color tv through 1970.

The measure, first proposed last fall by Premier Aldo Moro's coalition government and fiercely fought by the industry since, hits set producers at a time when the market for black-and-white receivers shows signs of weakening. Tv sales have held at a level of about one million sets annually in recent years, but there's been a shift to low-priced sets during the past two years. Until the government decided color tv

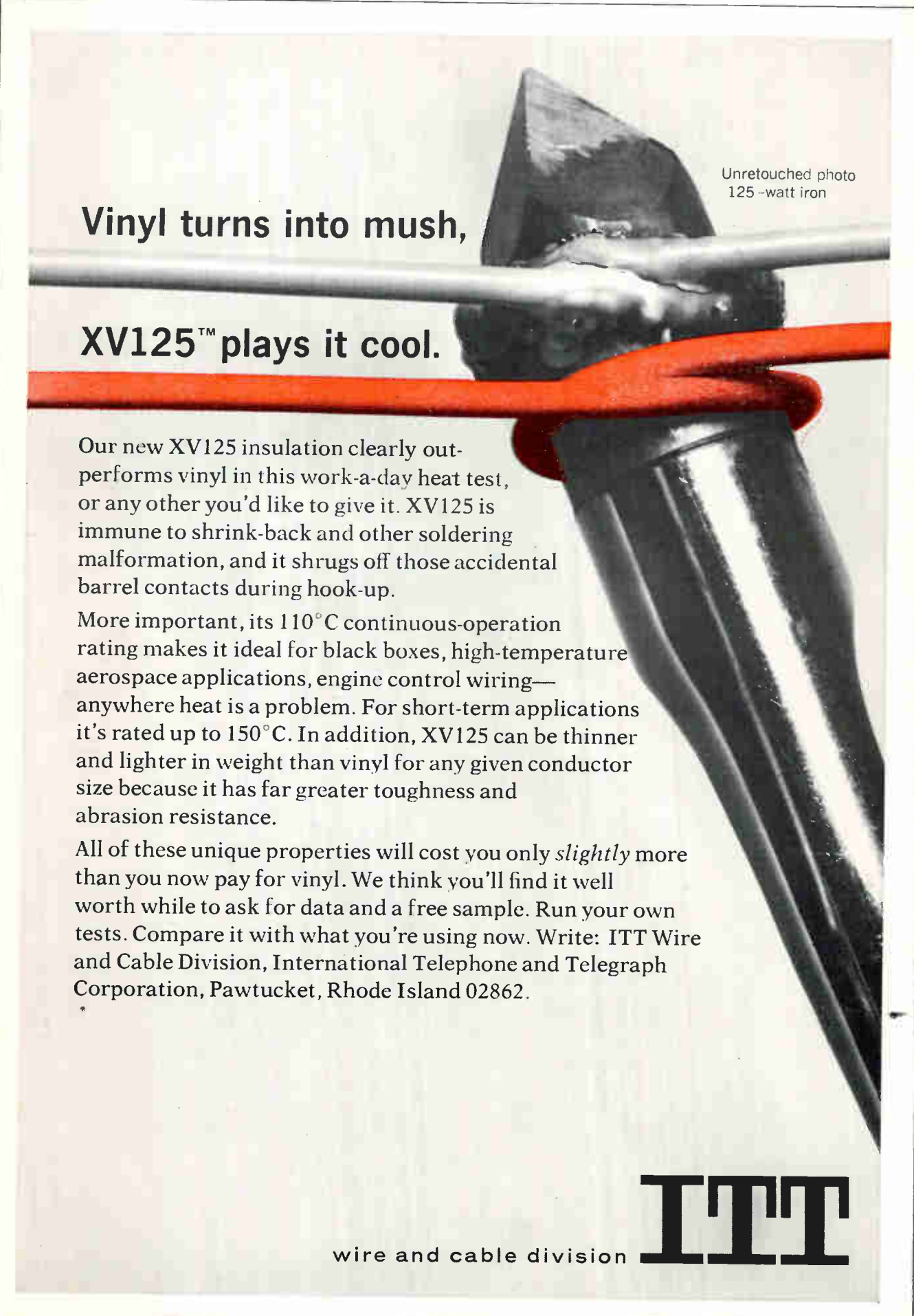

Unretouched photo  
125-watt iron

Vinyl turns into mush,

XV125™ plays it cool.

Our new XV125 insulation clearly outperforms vinyl in this work-a-day heat test, or any other you'd like to give it. XV125 is immune to shrink-back and other soldering malformation, and it shrugs off those accidental barrel contacts during hook-up.

More important, its 110°C continuous-operation rating makes it ideal for black boxes, high-temperature aerospace applications, engine control wiring—anywhere heat is a problem. For short-term applications it's rated up to 150°C. In addition, XV125 can be thinner and lighter in weight than vinyl for any given conductor size because it has far greater toughness and abrasion resistance.

All of these unique properties will cost you only *slightly* more than you now pay for vinyl. We think you'll find it well worth while to ask for data and a free sample. Run your own tests. Compare it with what you're using now. Write: ITT Wire and Cable Division, International Telephone and Telegraph Corporation, Pawtucket, Rhode Island 02862.

wire and cable division

**ITT**

Investing in a Sweep Generator with a limited frequency range can be an expensive purchase unless you're positive your requirements won't change 6 months or a year later. To avoid that embarrassing possibility, Telonic's SM-2000 is built for non-obsolescence; it is actually

## 20 SWEEP GENERATORS

in one. The chassis will accept 20 different plug-in oscillators spanning various segments of the spectrum from 20 Hz to 3000 MHz, in an area that just fits your application today, or tomorrow, or in 6 months, or next year. And since it doesn't cost any more than most single-range units, why not be a hero. Order one.



### BASIC SPECIFICATIONS\*

Frequency Range	20 Hz to 3000 MHz
Impedance	50 or 75 ohms
Operating Modes	Sweep, CW, 1 kHz Modulated Sweep or CW
Attenuation	0-60 dB in 1 dB steps
Output (Scope Horizontal)	15 volts P-P (approx.)
Frequency Markers	8 Plug-in and/or Variable
Sweep Width, Sweep Rate, Level Control, and Flatness will depend on the Plug-in Oscillator used.	

\*Complete specifications on the SM 2000 and Plug-in Oscillators, plus an extensive treatment of Sweep Frequency Measurement Applications are covered in Catalog #70. Yours on request.

*Telonic* INSTRUMENTS

Division of Telonic Industries Inc

80 N. FIRST AVE., BEECH GROVE, INDIANA 46107, TEL. (317) 787-3231 TWX-810-341-3282

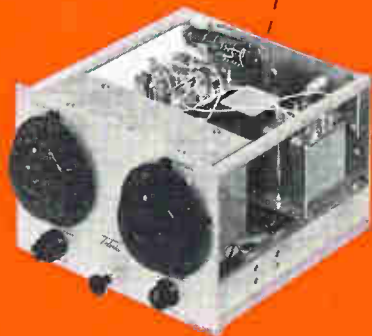

## France

### Countdown

The day of the conventional \$1,000 digital voltmeter is fast approaching an end. For producers of the instrument the question is not whether but when to switch to integrated circuits to cut its cost and package size.

France's Schneider Radio Television contends it will be another two years or so before ic's will be competitive with discrete components for digital voltmeters. And Schneider has readied for market an instrument that backs up the contention. At this April's Mesucora control and instrumentation show in Paris, Schneider will start selling a discrete-component digital volt-ohm-ammeter with a retail price tag of about \$300, equivalent to a manufacturer's price of less than \$200.

**Competitive.** To be sure, Schneider's \$300 digital multimeter doesn't come anywhere near the "less than \$100" predicted as an eventual going price for digital multimeters built around ic's—much to the annoyance of some instrument makers [Electronics, Jan. 9, p. 7]. However, Schneider's discrete-component instrument apparently will compare favorably to the first ic digital multimeters. It's a safe bet that some American instrument maker will introduce an ic digital multimeter that handles only direct-current measurements for under \$300 at next month's Institute of Electrical and Electronics Engineers exhibition. In that case, the Schneider instrument will have the edge; it handles alternating-current as well.

The Digitest, as Schneider calls its digital multimeter, is built up of discrete components arranged in cordwood modules. The circuitry is based on the double-ramp

technique, which converts the analog input into a pulse whose width is proportional to the input amplitude. Digital circuitry, with a clock-rate of 400 megahertz, converts the pulse width into a three-digit readout.

**Ranges.** The instrument measures 10 by 6 by 6 inches and is powered by five 1.5-volt dry cells. All in all, the multimeter has 23 measurement ranges. For d-c, five cover voltages from 100 microvolts to 1,000 volts and four currents from 100 nanoamperes to 1 amp. For a-c, the span is from 1 millivolt to 300 volts in five ranges and 1 microamp to 300 milliamps in four ranges. The ohmmeter's five ranges extend from 0.1 ohm to 1 megohm. Input impedance is 5 megohms for most voltage ranges and the accuracy runs from 0.5%  $\pm 1$  digit for d-c voltages to 2%  $\pm 1$  digit for a-c currents.

Schneider plans to turn out 2,000 or more of the discrete-component digital multimeters before it goes into production on an ic version

already under development. Before the ic version comes, though, Schneider will upgrade the current model with rechargeable-battery and line-operated options. Also on the way are accessories like a very-high-frequency probe, a high-voltage probe and a capacitance probe.

### Changing the guard

There's a new man in the top slot at the French electronics industry's trade association and a new direction for the industry may be in the offing.

Named last month as president of the Fédération Nationale des Industries Electroniques was Jacques Dontot, the 51-year-old managing director of Compagnie Française Thomson Houston-Hotchkiss Brandt, one of the heavyweights in the industry. Dontot is convinced that many of the industry's woes could be cured by more aggressive selling in export markets. And Dontot feels the in-



**By the numbers.** Schneider Radio Television has set a \$300 retail price for the digital multimeter it will introduce in April.

dustry should widen its contacts in the de Gaulle government even though the administration has already solidly backed electronics companies in their export efforts.

**Active.** As FNIE's new president, Dontot has tread softly thus far. But people in the industry expect he'll soon pump new life into the trade association. Says an executive of La Radiotechnique SA, a subsidiary of Philips Gloeilampenfabrieken NV and a major French producer of consumer electronics and components: "Dontot will vastly strengthen FNIE's stature abroad." And one of his business associates says that under Dontot the industry association will become "much less passive and more active."

A less-passive FNIE, though, means some run-ins with the government's Ministry of Finance, which over the past two years has let a half-dozen American semiconductor producers build plants in France. The de Gaulle government justified its action on the grounds that American companies would bring in advanced technology needed for defense and space projects.

Dontot thinks the government has overdone it. He says, "When companies from one big country install plants in one smaller country and all in the same sector of a single industry, that is economic colonization."

At a time when government spending on classic military electronics has begun to drop, Dontot sees difficulties ahead in state-industry relations in research and development. From outright financing of prototypes of hardware needed for major equipment programs, the government recently has tended more and more toward "concerted actions" in which government and industry split the bill for research. Even though the sums French companies plow back into research often top—as a percentage of sales—the R&D money spent by American companies, Dontot considers the total funds available for research "greatly insufficient."

**Broader base.** Dontot, though, figures French companies could



Jacques Dontot now heads the French electronics trade association.

pour more money into research if they'd move more vigorously into export markets. In his opinion, they need immediate beachheads abroad since they don't have a huge domestic market—as do U.S. companies—to write off development costs of new products.

Dontot maintains FNIE members could learn much from their toughest competitors, American companies adept at market studies and product planning. To cope with what he terms "savage" competition, Dontot says the French industry should seek out openings in export markets where it can score. And even though FNIE runs a major components show every year [see related story p. 16], Dontot thinks sales managers should concentrate less on flashy, expensive exhibits and more on getting hustling salesmen out into export markets.

---

### Japan

---

#### Color it rosy

This month, a spate of under-\$500 color television sets started turning up in radio-tv dealers' showrooms throughout Japan, heralding the beginning of a color boom.

With the domestic market ready to take off and exports to the United States on the upswing, Japanese set makers now are geared

up to turn out more than a million color receivers this year—double the 1966 figure. Largely as a result, the electronics industry is headed for a banner year.

The Electronics Industries Association of Japan now estimates that the 1967 output of electronics will total something like \$3.16 billion. That's a gain of 22% over last year's \$2.59 billion. Although color tv will show the strongest increase, the industry's rise will range across the board. In 1966, consumer electronics output was \$1.23 billion, industrial electronics \$625 million and components \$735 million.

**Star performers.** Along with color tv, fast growth is forecast for auto radios, spurred by the demand from Japan's burgeoning auto industry. For other consumer products, production increases are estimated at somewhat less than 20%.

In industrial electronics, computers look to be the standout with an expected rise of about 35% over 1966. Video tape recorders and industrial tv equipment also are slated for strong gains, but are dwarfed in volume by computers.

---

### Italy

---

#### Color it later

Prospects for Italian television-set producers paled considerably this month. In voting funds for the country's current five-year economic plan, the Chamber of Deputies tacked onto the appropriation bill an amendment banning any government spending for color tv through 1970.

The measure, first proposed last fall by Premier Aldo Moro's coalition government and fiercely fought by the industry since, hits set producers at a time when the market for black-and-white receivers shows signs of weakening. Tv sales have held at a level of about one million sets annually in recent years, but there's been a shift to low-priced sets during the past two years. Until the government decided color tv



was a frill the country couldn't afford, set producers had counted on a lift from color sales starting in 1968.

**Long-term worry.** Along with their short-term worries, Italian tv firms are uneasy over the foreign competition they'll have when the state-owned broadcasting network finally gets around to colorcasting. Most Italian set makers can't afford to invest money now for color-receiver development with returns years off. Meanwhile, Dutch and German producers will be picking up manufacturing and sales know-how in their domestic markets and thus will have an edge over native producers when color tv comes to Italy.

---

## Great Britain

### Caught by a wave

Along with a lot of new material for night-club comics, the recent rash of large-scale robberies and jailbreaks in Britain has spawned a fully transistorized standing-wave protection system for warehouses and similar large buildings.

Standing-wave protection gear has been fairly common in the United States for some time but so far hasn't caught on in Britain. Telta Ltd., though, sees bright prospects for its new, small, ultra-high-frequency units. Telta claims it's made the system foolproof and every time a big robbery makes the headlines, Telta gets some free sales promotion. The basic system rents for about \$850 a year.

**Watchful.** The equipment consists basically of a crystal controlled uhf transmitter that puts out a standing wave picked up by a separate receiver. When an intruder moves anywhere within a monitored space where nothing should be moving, he disturbs the standing wave. The receiver detects the disturbance and triggers an alarm.

Each transmitter-receiver pair can monitor up to about 200,000 cubic feet of space. Since most warehouses are larger than that,

Telta has designed its equipment so several pairs can be used together to cope with big buildings.

Ordinarily, more than one transmitter working in a closed space would bring interference problems. Telta says it has solved the problem but won't say how because the system's antijamming circuitry is tied in with the interference rejection. For high selectivity between adjacent channels, the receivers are double superheterodyne types.

**Discriminating.** In addition to the capability of side-by-side operation of the receiver-transmitter pairs, Telta's standing-wave equipment has an analog memory circuit that distinguishes between unimportant movements like a crate falling and a significant movement like a man prowling inside a warehouse at night. The control on intensity of the uhf field is so close that no external shielding is needed on normal walls to prevent movements on the outside from triggering the alarm. The system also compensates for temperature changes over the range from 30°F to 100°F.

The transmitter and receiver units have twin power supplies. The system normally works on line voltage but has standby batteries to keep the protection in force during line-power failures. The transmitter unit measures 6½ by 5 by 3 inches and the receiver 6½ by 8 by 3 inches.

---

## Poland

### The collector

One of the most tedious tasks for laboratory assistants anywhere is collecting distillates, counting them drop by drop. For many Polish laboratory workers, laborious drop-counting will soon be a thing of the past now that the Experimental Establishment for Scientific Apparatus in Warsaw has developed equipment that does the job automatically.

The equipment marries an electronic drop-counter and timer to

distilling gear with a servocontrolled revolving glass spout. Counting pulses are picked up by a photoresistor mounted in the spout. As each drop falls out of the spout, it interrupts a light beam played on the photoresistor and generates a pulse. The pulse is shaped and fed to a two-decade counter. The decade terminals are tied to rotary switches so that a preselected number of drops, ranging from 1 to 100, can be collected and the spout then shut off. A timer in the counting equipment provides for reset to zero after an interval of from 1 to 100 minutes.

The revolving spout can feed distillates into any of 240 standard test tubes arranged in five rings around the distilling column. Whenever a preset count is reached, the counter sends a signal to the spout servosystem which shuts off the spout and shifts it to the next test tube.

---

## West Germany

### Electronic St. Bernard

Each year, the delight of Alpine skiing suddenly becomes horror for hundreds of skiers buried under masses of snow by avalanches. Rescue teams guided by trained dogs find most victims in time but on the average, 70 lives are lost each winter.

Electronic rescue equipment that promises to reduce the death toll, however, now is finding its way into many European skiing areas. The equipment, basically a highly sensitive flux gate magnetometer, spots the small magnetic field of a tiny magnet sewn into a skier's clothing or worn as a pendant around his neck. The West German skiing association has mounted a campaign to get its members to wear the magnets whenever they're in avalanche country and skiing clubs in other Alpine countries are following suit.

**Apres ski find.** The idea of using magnetics to find skiers buried under snow first was hit upon in 1961

by a pair of scientists working for the Swiss subsidiary of Varian Associates. Varian proved the idea worked in tests first with a proton free-precession magnetometer and later with a rubidium gradiometer. Varian has sold a few \$5,000 cesium magnetometers in Europe for use as avalanche-victim detectors. The Alpine market, though, is dominated by a small South German company—Institut Dr. Foerster—whose rescue equipment sells for \$1,000 to \$1,250, depending on how sophisticated the model.

Basically, the Foerster equipment consists of a 7-pound electronic unit carried on the rescuer's back and a 5-foot hollow aluminum pole with a sensor dangling from one end. The rescuer sweeps the sensor just above the snow. A meter on the pole shows when the sensor has passed over a magnet carried by a buried skier. A spotted magnet also is signalled by a 1,000-kilohertz tone from a small loudspeaker. The equipment can pick up magnets buried under snow as deep as 10 feet.

**Sensitive.** Actually, the basic operating principles of the device are similar to those that have been used for some time in magnetic detectors for finding mines or underground pipes. However, in the avalanche-victim detector, the sensitivity is much higher. The avalanche detector measures field strengths from 1 oersted to 10 microostereds but nonetheless remains insensitive to the earth's 500 millioersted magnetic field.

The sensor is made up of a pair of probes interconnected so that the earth's field cancels out. Each probe has a high-permeability iron core that is saturated by a primary, or exciting, coil, plus a secondary measuring coil. An exciting current developed in a 10-khz stabilized oscillator magnetizes the core; and when the probe approaches the field of a skier's magnet, an output voltage proportional to the intensity of the detected field develops across the secondary coil. This voltage is filtered, amplified and rectified to deflect the meter and produce the 1,000-klhz tone.

**Second harmonic.** The high sensitivity of the field strength measurement stems from the flux waveform of the iron core. It is magnetized to saturation by a field that varies sinusoidally. The flux curve, however, is not sinusoidal because of hysteresis. Fourier analysis shows that the flux waveform contains only the fundamental frequency and odd-numbered harmonics. This is because the hysteresis loop and the magnetizing field have point symmetry about the zero axis.

The symmetry, though, is upset whenever a small magnetic field (like that of a buried-skier's magnet) is superimposed on the sinusoidal core excitation. The flux curve then contains even-numbered harmonics and their amplitudes are a measure of the intensity of the external field. In the avalanche-victim detector, only the

second harmonic is used as a gauge of field intensity. The other even harmonics are filtered out.

### Faster forecasts

Although they still can't do anything about it, meteorologists in West Germany now can talk about the weather with more assurance than ever. For their forecasts, they're getting more data—and faster—over a new 3,000-hertz teleprinter link that joins the headquarters of the U.S. Weather Bureau in Washington to the West German central meteorological office in Offenbach, near Frankfurt.

The link, put into service last month, can move data at a rate of 1,050 bauds. It replaces 240-hertz, 75-baud equipment and can handle as much data in one hour as the old link could in 15. Even better, the new bandwidth makes possible facsimile transmission of weather charts, impossible before. Washington now transmits 96 charts a day to Offenbach. Offenbach sends Washington almost as much weather data, excluding charts, as comes in.

**International.** The faster data flow aids weather forecasters throughout Europe because the air masses that determine continental climatic conditions flow from West to East. To speed the spread of the information, direct lines tie Offenbach to Paris and Bracknell, near London. All West European weather bureaus use one of these three centers as their data source for long-range forecasting. Offenbach also serves as regional forecast headquarters for the International Civil Aviation Organization and transmits flight weather bulletins to airports in Northern Europe.

**Let EDP do it.** For the time being, the data fed into Offenbach over the new link is analyzed by meteorologists who then draw up charts that show existing weather conditions and what's likely to come. Later, probably starting this summer, computers will take over.

The computer system will evaluate data fed into it by punched tape, weeding out information that doesn't fit the general weather pat-



Alpine lifesaver. Sensor dangling from aluminum pole can spot skier buried under 10 feet of snow—if he's wearing tiny permanent magnet. Electronics pack carried on rescuer's back weighs just 7 pounds.

tern. It will then print out weather charts showing current conditions and—if programed accordingly—produce charts showing the weather most likely to develop over the next few hours.

At the outset the Offenbach center will use the two Control Data Corp. computers it already has—a CDC 3400 and a CDC 3800—for the weather analysis. A CDC 1700 will be added later this year. A digital printer, to come from California Computer Products Inc., will make the charts.

## Sweden

### Talk-box takeover

The L.M. Ericsson Co., long the leader in Swedish telecommunications gear, this month moved to the forefront in intercommunication equipment as well.

In the Swedish electronics industry's biggest acquisition deal in years, Ericsson took over the intercom business of AB Gylling and Co., an expanding family-owned firm. Gylling last year had total sales of \$20 million. Some \$15 million came from intercom equipment, making Gylling a world leader in the field. The company's sales in the United States last year were \$2 million.

Ericsson will merge Gylling's intercom operations and its own in a newly formed subsidiary, L.M. Ericsson Telemateriel AB. Telemateriel will now dominate the Swedish intercom market: Gylling's share was 60% and Ericsson's 20%. The only other producer of intercoms in the country is Standard Radio and Telephone AB, a subsidiary of the International Telephone and Telegraph Corp.

**Pinched.** Despite fast-rising sales that carried it from \$2 million in 1965 to \$20 million last year, Gylling, as a family-owned company, had trouble financing its expansion and for that reason sold its intercom operation to Ericsson. Neither company will disclose the price.

Gylling, though, will stay in business to produce components and ra-



## RFL Model 3265 Gaussmeter

3 Modes of Magnetic Measurement:  
Absolute, Differential, Incremental

The Model 3265 is a precision Hall-effect gaussmeter capable of three distinct modes of operation: measurement of absolute flux densities from .02 gauss to 50 kilogauss (DC and AC to 400 Hz). Incremental determination of field variations to a resolution of 1 ppm as an expanded scale gaussmeter and a differential mode enabling simultaneous measurement of two separate fields or single field gradients.

All solid-state design provides highly stable operation for laboratory, production line or portable field use. The large seven-inch taut-band meter allows precision measurements with ease of readability.

An accessory DVM may be used for true Digital gaussmeter operation.

Phone Herb Brumbach (201) 334-3100 for engineering evaluation loan or demonstration without obligation — or write for detailed specifications.



Complete range of Hall-effect probes for transverse, axial and tangential fields.



**RFL Industries, Inc.**

FORMERLY RADIO FREQUENCY LABORATORIES, INC.

Instrumentation Division • Boonton, New Jersey 07005

Tel: 201-334-3100, TWX: 710-987-8352/CABLE: RADAIRCO, N.J.



# SOLVE YOUR TIME DELAY PROBLEMS...

With the widest selection  
of time delay devices... *from G-V*

G-V's broad line of timing devices offer you the widest selection of time delays . . . thermal and solid state . . . the widest range of operating voltages . . . the widest selection of mounting styles available. Whether your application is commercial, industrial or military, G-V's assistance is always available to help you design and produce a better product. G-V's Regional Field Engineers in your area will assist you and your design group in the application and selection of your controls. G-V's Product Engineers will help you with special applications.



**G-V CONTROLS INC.**  
LIVINGSTON, NEW JERSEY 07039  
(201) 992-6200

**INSTANT RESET  
THERMAL TIMING ELEMENT**

Instant reset during or after timing is provided by combining G-V's unique instant reset timing element with a magnetic relay. Delay time, 0.75 sec. to 6 min.; Operating ambient, 32°F to 185°F; Operating voltage, 6.3 — 230 V, AC/DC.

*only from* **G-V**

**HIGH PRECISION  
THERMAL RELAY**

Unequaled in precision, endurance, and reliability with  $\pm 5\%$  over  $-55^{\circ}\text{C}$  to  $+125^{\circ}\text{C}$  range. 20g, 2000 Hz vibration; 50g, 11 ms shock. Delays: 3 seconds to 3 minutes.

*only from* **G-V**

dio and television sets. The company currently is the top Scandinavian producer of printed circuits. Gylling also handles Swedish sales for Japan's Sony Corp.

## International

### Well spaced

Success apparently breeds success in Europe's joint satellite program.

This month, a four-company consortium headed by France's Engins Matra won a \$20 million contract to build two research satellites for the European Space Research Organization (ESRO). It was the largest contract yet awarded by ESRO and winning it meant a repeat performance for two companies in the consortium.

Matra was the major subcontractor for the first ESRO satellite, slated for launching next month. The British partner in the consortium, Hawker Siddeley Dynamics Ltd., was the main contractor. And whenever Matra and Hawker Siddeley have been involved in ESRO satellite contracts, so has the TRW Systems Group as an adviser. The other two companies in the consortium are West Germany's Entwicklungsring Nord and Saab AB of Sweden.

**Heaviest.** The \$20 million contract covers a pair of 880-pound satellites, the fourth and fifth in ESRO's current 8-year program and the heaviest ordered so far. The first of the heavy satellites will be launched in the summer of 1970 during a period of intense solar activity. Its major mission will be gathering cosmic-ray data in the ionosphere. The other satellite is scheduled for launching in the spring of 1971 and will be instrumented for observation of infrared and ultraviolet radiation from stars.

The two satellites will be launched from the Vandenberg Air Force Base in California using Thor-Delta rockets supplied by the National Aeronautics and Space Administration. ESRO has designated the satellites TD 1 and TD 2.

## Around the world

**Sweden.** The prototype of the Viggen all-purpose supersonic aircraft was test-flown for the first time this month. The Viggen project will be a mainstay for the Swedish electronics industry during the next few years but not the bonanza first thought. The original \$2 billion, 800-plane project most likely will be cut back to between 400 and 500 planes.

**Austria.** Like its West European neighbors, Austria has decided to adopt as its color television standard the West German PAL system. However, the ministry for telecommunications plans to continue backing an effort to develop a two-standard receiver compatible with the French Secam system. The reason: Austria's eastern frontier borders on Czechoslovakia and Hungary, both Secam countries.

**Kenya.** About \$1 million of data processing equipment is slated to be delivered this year to Kenya. Most will come from Britain's International Tabulators & Computers Ltd. for use by government agencies. That company sees a market in the offing for business and industrial computers and to hold its dominant position in the country already has set up a programmers school in Nairobi.

**Norway.** The David-Anderson Radio Co. of Oslo has begun to score in export markets with its riometer, an instrument that measures variations in the ionosphere. The company recently delivered 11 riometers to West Germany's Max Planck Institute and says it has other export orders on its books.

**Holland.** Philips Gloeilampenfabrieken NV has started producing color television sets for the Dutch market. The first sets will go on sale in mid-summer, priced about \$780. Eastern Holland is within range of German stations that will begin colorcasts this autumn.

**Czechoslovakia.** An international center for research in use of computers for economic planning will be set up in Czechoslovakia, most likely in Bratislava, with financial support from the United Nations.

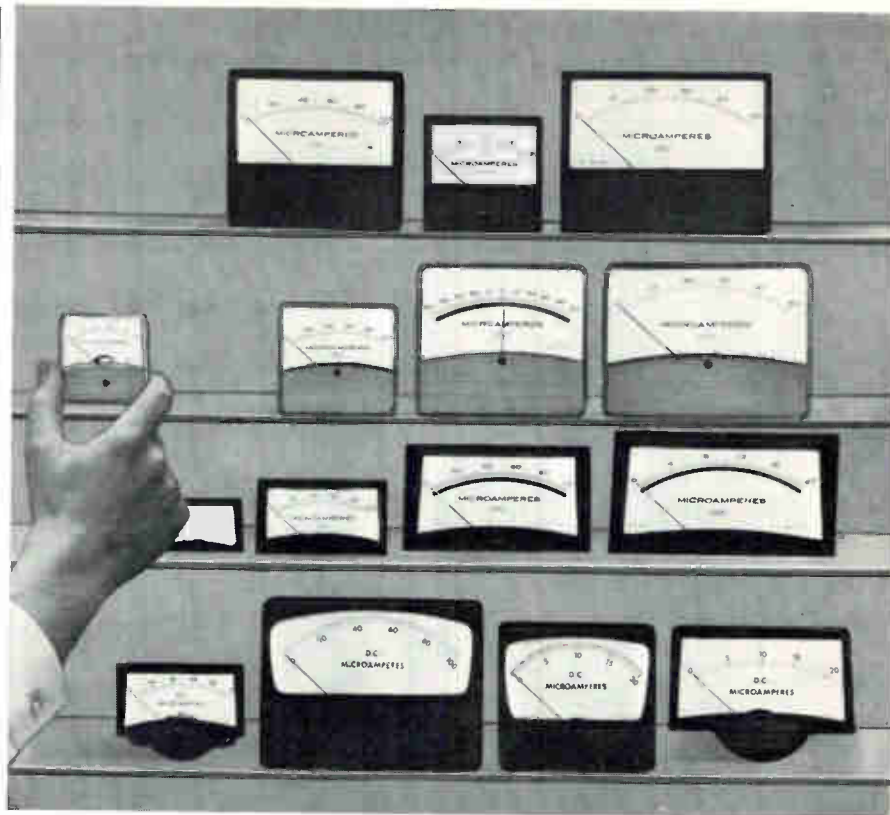

## Off-the-Shelf Only from api

- 1% tracking
- taut-band
- no extra charge
- 20 to 100  $\mu$ a

There's extra value, but no extra cost, in API's line of DC panel meters in the 20 to 100 microampere ranges. Tracking of  $\pm 1\%$  is standard. Frictionless taut-band construction produces meters that are the most accurate, sensitive to smaller signals, vibration-proof and durable.

No other manufacturer offers these bonus features at firm catalog prices.

### 15 Models in Stock

You'll get off-the-shelf delivery of the economically priced Panelist; Stylist and black phenolic meters shown above. Choose from these full-scale DC ranges:

**Microamperes:** 0-20, 0-50, 0-100

**Millivolts:** 0-5, 0-10

If ultra-precision tracking is the least you'll settle for, API offers 0.5% tracking at reasonable cost. This "super-calibration" is another API exclusive, again backed by published prices.

Ask for Bulletin 47.

Also stocked nationally by Allied Electronics and Newark Electronics.

See these instruments at IEEE Booth 2-G-39.

**api** INSTRUMENTS CO.

CHESTERLAND, OHIO 44026 (CLEVELAND-216) 729-1611 • TWX: 810-427-9230

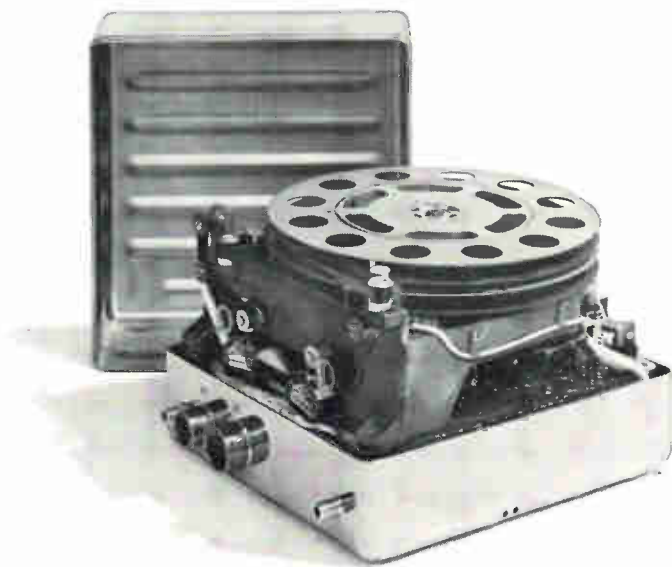
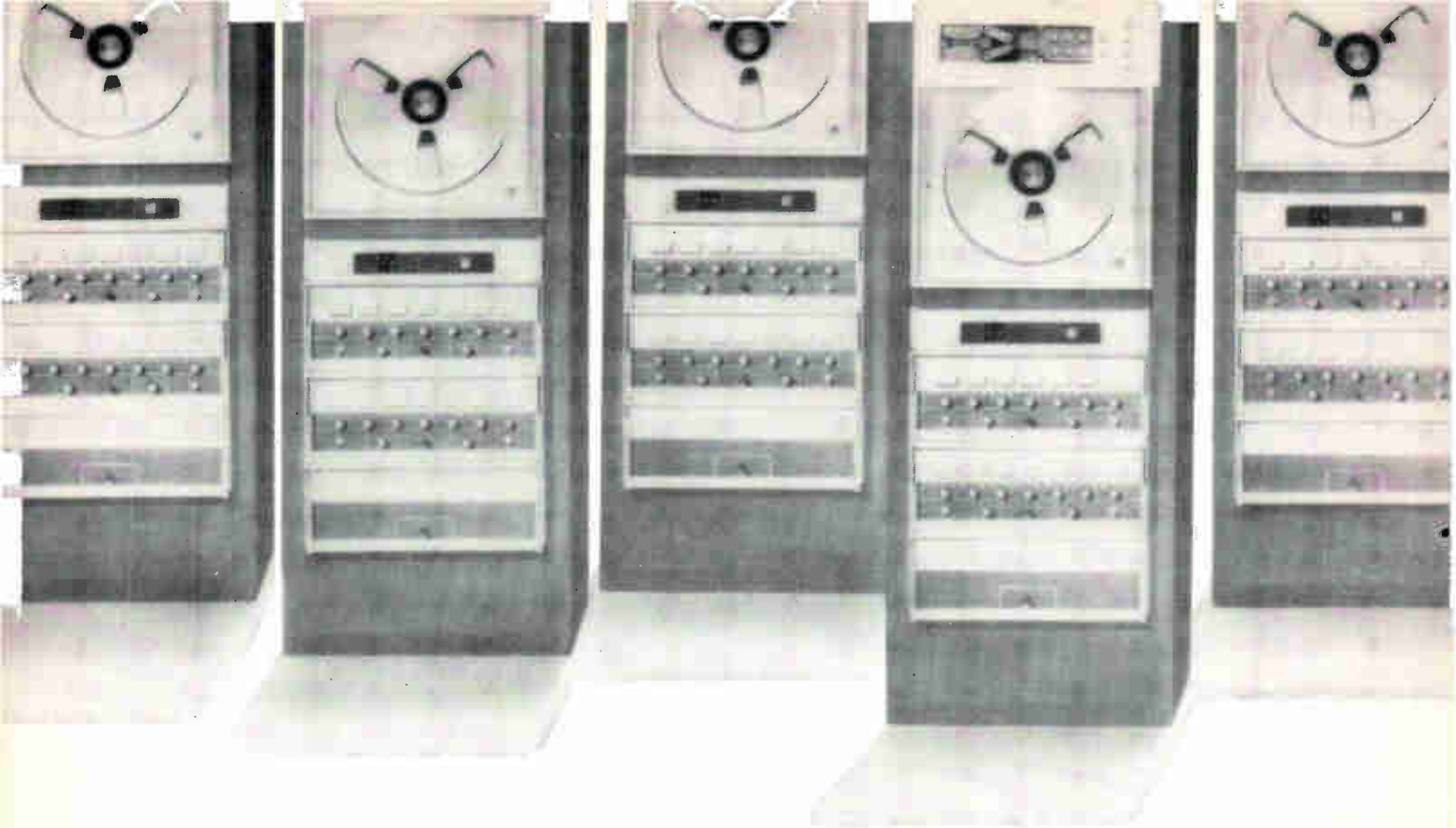

## With our custom recording systems one of a kind beats a full house

This satellite recorder, for example. To date, we've built 24 variations of it. Each was a special. No production-line unit will solve the tough recording problems we take on.

Of course, a lot of our custom projects are under tight security wraps, and we can't talk about them. But we

can show you part of our hand.

We've put together a catalog of recorder applications that aren't classified. It's called, "Technical Abstracts on Record/Reproduce Systems." Programs like LEM, Apollo, the Prime re-entry vehicle, and a host of satellites are all in it.

Ask for a free copy. It shows you why our recorders don't have to be classified to have class.

Leach Corporation, Controls Division,  
717 No. Concy Ave., Azusa, California;

**LEACH** Phone (213)334-8211  
Export: Leach  
International, S.A.

□ A.C.B. Schlumberger Hi-Fi Publicite	OAS 12	Cherry Electrical Products Corporation K & A Incorporated	277	■ Esterline Angus Instrument Company Caldwell, Larkin & Sidener Van Riper, Incorporated	102
■ Ad-Yu Electronics Incorporated P & G Advertising	208	■ Cimron, Division of Lear Siegler, Incorporated	35	■ Eubanks Engineering Company Moore-Bergstrom Company	280
■ AMP Incorporated Garceau, Hargrave & McCullough Incorporated	38	■ Cinch Manufacturing Company Stral Advertising Company	196	Fairchild Instrumentation Faust/Day Incorporated	272-273, 275
■ A.P.I. Instruments George Z. Griswold Advertising	307	■ Clairex Corporation Michel-Cather Incorporated	257	Fairchild Semiconductor Incorporated	12-13, 43-46
■ Abbey Electronics Corporation Phillips/Alogna Associates Incorporated	286, 288	■ Cleveland Institute of Electronics Foote, Cone & Belding, Rapp & Collins Division	280	Fiberfil Company Division of Rexall Chemical Company	218
■ Acme Electric Corporation Scheel Advertising Agency Incorporated	247	■ Clevite Corporation Piezoelectric Division	285	Tri-State Advertising Company	15
■ Acopian Corporation Mort Barish Associates	268	■ Carr Liggett Advertising Incorporated	97	Fluke Manufacturing Company Bonfield Associates	15
■ Adage Incorporated Horton, Church, Goff Advertising Agency	178	■ Clifton Precision Products Company Division of Litton Industries	97	G & E Bradley Limited Hyde & Partners Incorporated	192
■ Aero Jet Corporation Division of General Tire & Rubber Corporation	156	■ Ivey Advertising Incorporated	88	G-V Controls Armand Richards Advertising	308
■ Aerovox Corporation Hi-Q Division Lescarbourea Advertising Incorporated	95	■ Codex Corporation Weston Associates Incorporated	83	■ Garrett Corporation Airesearch Manufacturing Division	278
■ Airpax Electronics, Incorporated Welch, Mirabile & Company	73	■ Comcor Incorporated Subsidiary of Astrodats Incorporated	74	J. Walter Thompson Company	82
■ Allen-Bradley Company Fensholt Advertising Agency	89-90	■ Marketing Directions Communication Electronics Incorporated	260	■ General Electric Company George R. Nelson Incorporated	92
■ Amelco Semiconductor Division of Teledyne Incorporated	185	□ Compagnie des Compteurs S.P.I.	OAS 15	■ General Electric Company, Electronic Components Division	92
■ American Lava Corporation Subsidiary of Minnesota, Mining & Manufacturing Company	62	■ Computer Test Corporation James Lees Advertising	63	■ General Electric Company Polymer Products Operation Division	189
■ American Metal Climax Incorporated J.B. Rundle Incorporated	119	■ Consolidated Electrodynamics Corporation Subsidiary of Bell & Howell	251	General Instrument Corporation Semiconductor Products Division	20-21
■ Andrew Corporation Fensholt Advertising Incorporated	294	■ Hixson & Jorgensen Incorporated	210	Norman Allen Associates	2nd Cover
■ Applied Technology Incorporated The John Nelson Agency	10	■ Consolidated Vacuum Corporation Subsidiary of Bell & Howell	210	General Radio Company Horton, Church & Goff	289
■ Arnold Engineering Company Burton Browne Advertising	187	■ Wolf Associates Incorporated	86	General Tape Corporation Edwin H. Ryan Incorporated Advertising	281
■ Astro Communications Laboratory Incorporated	270	■ Consumers Power Company—Area Development	86	Globe Industries Incorporated Odiorne Industrial Advertising	281
■ Admasters Advertising Incorporated	270	■ McLain Advertising Incorporated	288	■ Globe Union Incorporated, Centralab Electronics Division	235, 236
■ Astrodyne Incorporated Tech/Reps Incorporated	256	■ Control Data Corporation La Jolla Division	288	Strall Advertising	198
■ Atlas Chemical Industries, Incorporated Aerospace Components Division	237	■ Barnes Champ Advertising	197	■ Gudebrod Brothers Silk Company Ramsdell-Buckley & Company	246
■ Harris D. McKinney Incorporated	237	■ Coors Porcelain Company Tallant/Yates Advertising	120, 121	Hansen Manufacturing Company Keller-Crescent Company	268
■ Automatic Electric Company Subsidiary of General Telephone and Electronics Corporation	84	■ Corninc Glass Works Electronic Products Division	264	Hathaway Instruments Incorporated Eby & Everson Incorporated	263
■ Tatham-Laird and Kudner	84	■ Rumrill Hoyt Incorporated	281	■ Heath Company Subsidiary of Schlumberger Limited	17
■ Babcock Relays Division of Babcock Electronics Corporation	231	■ Cramer Industries Bryan/Donald Advertising	264	Advance Advertising	17
Leland Oliver Company	231	■ Curtis Development and Manufacturing Company	281	■ Hewlett Packard Associates Lennen & Newell Incorporated	3rd Cover
■ Bausch and Lomb Incorporated Wolf Associates Incorporated	252, 311	■ Keck Advertising Agency	207	■ Hewlett Packard Colorado Springs Division	2
□ Beckman Instrument International Hixson & Jorgensen Incorporated	OAS 8	■ Cyclo-Tronics Incorporated T.W. Blakeslee Advertising	207	Lennen & Newell Incorporated	61, 85
■ Bendix Corporation Electrical Components Division	48	■ Dale Electronics Incorporated Subsidiary of Lionel Corporation	70	Tallant/Yates Advertising	40
MacManus, John & Adams Incorporated	48	■ Swanson, Sinkey, Ellis, Incorporated	214	■ Hewlett Packard F.L. Moseley Company Division	1
□ Bendix International Operations MacManus, John & Adams Incorporated	OAS 2-3	■ Damon Engineering Incorporated L.K. Frank Company Incorporated	202A	Lennen & Newell Incorporated	200
■ Bliley Electric Company Barber & Drullard Incorporated	239	■ Dana Laboratories Incorporated E.L. Van Deusen Company	282	Hoffman Electronics Corporation Jay Chiat & Associates	55
■ Boonton Electronics Corporation The Creative Group	213	■ Daven Incorporated Weston Associates Incorporated	282	Honeywell Computer Control Division Franklin P. Folts	36-37
■ Borden Chemical Company Mystik Tape Industrial Division	169	■ Weston Associates Incorporated	266	Honeywell Micro Switch Division Batten Barton, Durstine & Osborn Incorporated	91
■ Conahay & Lyon Incorporated	169	■ Delevan Electronics Corporation Stahlka, Fallier & Klenk	278	Mohr & Company, Incorporated	190
■ Bourns Incorporated Trimpot Division	24, 297	■ Deltron Incorporated Benn Associates	259	■ Houston Omnigraphic Corporation Ray Cooley & Associates	254
Lester Company	24, 297	■ Dialight Corporation H.J. Gold Company	22	Hughes Aircraft Company Foote, Cone & Belding Incorporated	248
■ Brush Instruments Division of Clevite Corporation	87	■ Digital Equipment Corporation Kalb & Schneider Incorporated	205	Hysol Corporation Barber & Drullard Incorporated	18-19
Carr Liggett Advertising Incorporated	87	■ Dorne & Margolin Incorporated Snow & Depew Advertising	216	I R C Incorporated Gray & Rogers Incorporated	283
■ Bulova Watch Company Electronics Division	224	■ Dow Corning Corporation Engineering Products Division	216	■ Ichizuka Optical Company Limited Matsushita Incorporated	258
Frank Best Company, Incorporated	76	■ Church & Guisewite Advertising	225	Image Instruments Incorporated L.K. Frank Company Incorporated	288
■ Burndy Corporation Don Kemper Company, Incorporated	186	■ DuPont de Nemours Company Mylar Division	99	International Electronic Research Corporation	288
■ Burr-Brown Research Corporation N.A. Winter Advertising Agency	79	Batten Barton Durstine & Osborn Incorporated	99	Van Der Broom, McCarron, Incorporated Advertising	288
■ Burton Research Laboratories Lester Company	79	■ DuPont de Nemours Company, Teflon Division	99		
■ Bussmann Manufacturing Division of McGraw Edison Company	264, 265	Batten Barton Durstine & Osborn Incorporated	99		
Henderson Advertising Company	269	■ Electro Tec Corporation McClellan Associates	64		
■ By-Buk Company Albert Frank, Guenther Law Advertising Incorporated	OAS 11	■ Electronic Modules Corporation Ray Thompson & Associates	177		
■ C.S.F. SPI Agency	267	□ Electronica Metallux Jachini Pietro Agency	OAS 9		
■ Cambridge Thermionic Corporation Chirurg & Cairns Incorporated	267	■ E M I Electronics Limited Bonner Hodgson & Partners Limited	OAS 10		
		■ Englehard Industries Incorporated Keyes, Martin Company	240, 241		
		■ Engelmann Laboratories Incorporated, Rudolph	244		
		The Nieland Agency Incorporated	244		



■ ITT Cannon Electric Incorporated West, Weir & Bartel Incorporated	219	■ Philbrick Researches Incorporated Culver Advertising Incorporated	100	The Sprague Electric Company Resistor Division	16
■ ITT Jennings Manufacturing Company West, Weir & Bartel Incorporated	215	Philco/Ford Company Microelectronics Division	195	■ Stackpole Carbon Company Electronic Components Division	142
ITT Semiconductors Division Neals & Hickok	223, 312	□ Philips Eindhoven T.A.G. De La Mar	OAS 1-5-16	Meek & Thomas, Incorporated	261
□ ITT Standard Telephones & Cables Limited	OAS 7	Plessey Electronics Company Roles & Parker Limited	298	Stanpat Products Incorporated Morton Advertising Incorporated	267
ITT Wire and Cable West, Weir & Bartel Incorporated	299	■ Polarad Electronics Corporation Polarad Electronics Instrument Division	101	Super Tool Company Varon Advertising	267
Jerrold Corporation Government & Industrial Division	14	Keyes Martin & Company		Sylvania Electric Products Incorporated General Telephone and Electronics	27-34, 271
■ Johanson Manufacturing Company Josephson, Cuffari & Company	262	■ Potter & Brumfield Division of American Machine & Foundry Corporation	39	Tatham-Laird & Kudner, Incorporated	
Kahle Engineering Company George Homer Martin Associates	228	Grant, Schwenck & Baker Incorporated		Sylvania Electric Products Incorporated Parts Division	6
Keithley Instruments Incorporated Bayless-Kerr Company	249	RCL Electronics Incorporated Morvay Advertising Agency	261	Tatham-Laird & Kudner, Incorporated Advertising	
Keuffel and Esser Company Gaynor and Ducas Incorporated	201, 202	RFL Industries Incorporated Instrumentation Division	305	Syntron Company De Sales Advertising Incorporated	81
■ Lambda Electronics Corporation Michel Cather Incorporated	80	Josephson, Cuffari & Company		TRW Capacitors Fuller & Smith & Ross Incorporated	77
■ Leach Corporation Jay Chiat & Associates	308	Radio Cores Incorporated Sander Rodkin Advertising Agency	276	Taylor Corporation Gray & Rogers, Incorporated	245
Litton Industries Incorporated Potentiometer Division	165	Radio Corporation of America	4 Cover, 59, 202B	■ Tektronix Incorporated Hugh Dwight Advertising Incorporated	194
Litton Industries Incorporated Triad Distributor	269	Al Paul Lefton Company		Telonic Instruments Jansen Associates Incorporated	300
Litton Industries USECO Division West, Weir & Bartel Incorporated	279	■ Radio Materials Company Division of P.R. Mallory and Company	238	Telonic Engineering Company Jansen Associates Incorporated	122
Lockheed Missiles & Space Company McCann Erickson	256	Gallay Advertising Incorporated		Teltronics Incorporated Tech/Reos Incorporated	287
Louisiana, State of, Department of Commerce and Industry	226	□ Rally Dumesnil Publicite	OAS 13	Tempress Research Company Incorporated	41
Bauerlein Incorporated		■ Republic Foil Incorporated The Graphic Group	234	Hal Lawrence Incorporated	
McCoy Electronics Company Division of Oak Electro/Netics Corporation	170	Rhode & Schwartz Company Armand Richards Advertising	67	Texas Instruments Incorporated, Semiconductor/Components Division	199
■ Machlett Laboratories Division of Raytheon Company	9	■ S B D Systems Incorporated Murray Heyert Advertising	212	Don L. Baxter Incorporated	
□ Marconi Company Limited Hampshire House Limited	OAS 4	■ S.D.S.A. Publi-Service	277	Theta Instrument Corporation Keyes, Martin & Company	60
Marconi Instrument Armand, Richards Advertising	188	Sage Electronics Corporation Mathison Advertising Incorporated	281	Tohoku Metal Industries Limited Hakuhodo Incorporated	263
Maryland Telecommunications Incorporated	155	Scientific Data Systems Doyle, Dane, Bernbach Incorporated	65	■ Tracor, Incorporated Weekley & Valenti Incorporated	279
Mathatronics Incorporated Kalb & Schneider Incorporated	242	Sci-Tek Computing Center Incorporated Stanley Richard & Fredrick Incorporated	284	Transformer Electronics Company Dacey, Wolff & Weir	270
Meguro Electronic Instrument General Advertising Agency	284	□ Selenia Sel-Rex Corporation	OAS 6	■ Transitube Incorporated Herbert Arthur Morris Advertising	255
Meller Company, Adolf Susan E. Schur Advertising	285	42		Triplet Electrical Instrument Company Burton Browne Advertising	229
Meson Electronics Company Incorporated	284	■ Semi-Elements Incorporated Cavanaugh Morris Advertising	286	Ulano & Company, J. Byrde, Richard & Pound Incorporated	93
Metex Corporation Keyes, Martin & Company	264	Semtech Corporation Burruss Advertising	58	Unimax Switch Mohr & Company Incorporated	193
■ Microtran Company Incorporated Packer Advertising Corporation	286	■ Siemens America, Incorporated Mann Wesley Incorporated	78	Union Carbide Corporation Electronics Division	183
Midwestern Instruments White Advertising Agency	184	Sierra Electronics Division, Philco Ford Hal Lawrence Incorporated	69	J.M. Mathes Incorporated	
Molex Products Company J.D. Culea Advertising Incorporated	259	Sigma Instruments Incorporated Marschalk Company Incorporated	94	■ Victory Engineering Corporation BRM Black-Russell-Morris	230
National Cash Register (Searchlight) Allen Dorsey & Hatfield	204	Sirnetics Corporation Subsidiary of Corning Glass Works	68	■ Vitro Corporation of America, Vitro Electronics	243
Natvar Corporation Sanger-Funnell Incorporated	266	Cunningham & Walsh Incorporated		Wems, Incorporated Rose Associates	96
New Hermes Engraving Machine Corporation	257	Simpson Electric Company Amerad Advertising Service Incorporated	191	Westinghouse Semiconductor Division ITSM Division of McCann Erickson	233
North Atlantic Industries Incorporated Murray Heyert Associates	47	Sinclair Radio Labs Incorporated John E. Hayes Company	289	S.S. White Company Resistor Trimmer Division	66
Ohmite Manufacturing Company Fensholt Advertising Agency	227	Sola Basic Industries, Sola Electric Division	75	W.L. Towne Company, Incorporated	
■ Pacific Measurements Incorporated Jack Herrick Advertising Incorporated	7	Marsteller Incorporated		■ Zeltex Incorporated Sturmes & Associates	283
Pamotor Incorporated Harry P. Bridge Company	232	Soliton Devices Armand Richards Advertising Agency	267, 269	The Zippertubina Company Edward S. Kellogg Company	250
Panduit Corporation Donald L. Arends, Incorporated	285	Raytheon Company, Sorensen Operation	11		
Pennsalt Chemicals Corporation Aitkin-Kynett Company Incorporated	209	James Advertising Incorporated			
		South Dakota Industrial Development Expansion Agency	260		
		Maurice Paulsen Advertising			
		Spectral Dynamics Corporation of San Diego	98		
		Mesa/Copy			
		Spectral Electronics, Sub. of Carrier Corporation	253		
		Jones, Maher Roberts Advertising			
		□ SP Electronica Jones, Maher Roberts Advertising	OAS 14		
		■ Speer Carbon Company, Division of Air Reduction Company Incorporated	57		
		Hazard Advertising Company Incorporated			
		Sperry Rand Research Center Allied Advertising Agency Incorporated	289		
		The Sprague Electric Company Harry P. Bridge Company	5		
		The Sprague Electric Company Harry P. Bridge Company	8		

## Classified Advertising

F.J. Eberle, Business Mgr.	
PROFESSIONAL SERVICES	293
EMPLOYMENT OPPORTUNITIES	290-293
EQUIPMENT (Used or Surplus New) For Sale	293
ADVERTISERS INDEX	
Columbia Electronics	293
Fishman Co., Philip	293
Hamilton Standard, Div of UAC	290
Loral Electronics Systems	293
Radio Research Instrument Co.	293
Pot'on	291
U. S. Naval San Francisco Bay Naval Shipyard	292

■ For more information on complete product line see advertisement in the latest Electronics Buyers' Guide

□ Advertisers in Overseas Advertising Section following newsletter from abroad



## Advertising sales staff

**Frank E. LeBeau** [212] 971-6464

Advertising sales manager

Wallis Clarke [212] 971-2187

Assistant to sales manager

**Donald J. Austermann** [212] 971-3139

Promotion Manager

Atlanta, Ga. 30309: Michael H. Miller, 1375 Peachtree St., N.E. [404] TR 5-0523

Boston, Mass. 02116: William S. Hodgkinson McGraw-Hill Building, Copley Square [617] CO 2-1160

Chicago, Ill. 60611: Robert M. Denmead, J. Bradley MacKimm, Ralph Hanning, 645 North Michigan Avenue, [312] MO 4-5800

Cleveland, Ohio 44113: William J. Boyle, 55 Public Square, [216] SU 1-7000

Dallas, Texas 75201: Richard P. Poole, 1800 Republic National Bank Tower, [214] RI 7-9721

Denver, Colo. 80202: Joseph C. Page, David M. Watson, Tower Bldg., 1700 Broadway, [303] 255-5484

Detroit, Michigan 48226: Ralph Hanning 856 Penobscot Building [313] 962-1793

Houston, Texas 77002: Kenneth George, 2270 Humble Bldg., [713] CA 4-8381

Los Angeles, Calif. 90017: Ian C. Hill, John G. Zisch, 1125 W. 6th St., [213] HU 2-5450

Minneapolis, Minn. 55402: J. Bradley MacKimm, 1104 Northstar Center [612] 332-7425

New York, N.Y. 10036

500 Fifth Avenue

Donald R. Furth [212] 971-3615

James R. Pierce [212] 971-3616

Stanley J. Kail, Jr. [212] 971-3617

Philadelphia, Pa. 19103:

Warren H. Gardner, Jeffrey M. Preston,

6 Penn Center Plaza,

[215] LO 8-6161

Pittsburgh, Pa. 15222: Warren H. Gardner,

4 Gateway Center, [412] 391-1314

Portland, Ore. 97204: James T. Hauptli,

218 Mohawk Building, 222 S.W. Morrison

Street, Phone [503] 223-5118

Rochester, N.Y. 14534: William J. Boyle,

9 Greylock Ridge, Pittsford, N.Y.

[716] 586-5040

St. Louis, Mo. 63105: Robert M. Denmead

The Clayton Tower, 7751 Carondelet Ave.

[314] PA 5-7285

San Francisco, Calif. 94111:

James T. Hauptli, 255 California Street,

[415] DO 2-4600

London W1: John W. Patten, Edwin S.

Murphy Jr., 34 Dover Street,

Hyde Park 1451

Milan: Robert M. Saidel

1 via Baracchini Phone: 86-90-666

Frankfurt Main: Gerd Hinske, Dieter

Rothenbach, Elsa-Brandstroem Str. 2

Phone: 72 01 81

Geneva: Michael R. Zeynel,

1, rue du Temple Phone: 31 95 60

Paris VIII: Denis Jacob, Kenneth Davey,

17 Avenue Matignon Phone: 359 6637

Tokyo: Nobuyuki Sato, 1, Kotohiracho

Shiba, Minato-Ku [502] 0656

Osaka: Ryoji Kobayashi 163, Umegae-cho

Kita-ku [362] 8771

### Business department

Wallace C. Carmichael, Manager

[212] 971-3191

Stephen R. Weiss, Production Manager

[212] 971-2044

Thomas M. Egan,

Assistant Production Manager [212] 971-3140

Dorothy Carmesin, Contracts and Billings

[212] 971-2908

### Circulation and research

Milton Drake, Manager [212] 971-3485

Isaac Siegel, Assistant Circulation Manager

[212] 971-6057

David Strassler, Assistant Research Manager

[212] 971-6058

Chloe D. Glover, Research Associate

[212] 971-6057

### Electronics buyers' guide

George F. Werner, General Manager

[212] 971-2310

Regina Hera, Directory Manager

[212] 971-2544

Thomas M. Egan, Production Manager

[212] 971-3140

**LIGHT WIRES®**  
MAY SOLVE YOUR COMPLEX  
LIGHTING AND CONTROL PROBLEMS

Bausch & Lomb Fiber Optics Light Wires enable you to conduct light to any desired location as easily as you can string an electric wire. They can be conveniently threaded through intricate mechanical and electronic components of sophisticated instrumentation. For Data Processing equipment, they can increase accuracy in automatic read-out systems, give greater speed and reliability in punched card reading and verification. Used with a single light source, they can eliminate the problem of balancing individual lamps. They are relatively immune to temperature fluctuations, are unaffected by vibrations and mechanical wear. Their unique abilities may be the answer in your application. Here's an opportunity to find out—for only \$25.

### ORDER A BAUSCH & LOMB LIGHT WIRES EXPERIMENTAL SET

#### YOU GET:

One each 48 inch x  $\frac{1}{16}$  inch, 24 inch x  $\frac{1}{32}$  inch, 18 inch x  $\frac{1}{8}$  inch covered with polyvinyl chloride sheathing and one each 12 inch x  $\frac{1}{8}$  inch, 12 inch x  $\frac{3}{16}$  inch, 6 inch x  $\frac{1}{4}$  inch covered with crush-resistant aluminum tubing.



List price of the set is regularly \$55.75—but you pay just \$25.00! When ordering, please use your company letterhead. Send with check or money order to Bausch & Lomb, 62338 Bausch Street, Rochester, New York 14602.

**BAUSCH & LOMB**

In Canada, Bausch & Lomb Optical Co., Ltd., 16 Grosvenor St., Toronto, Ontario

# Learn why

Please send me a FREE copy of "Transistor characteristics related to circuit performance," along with detailed specifications on ITT strip line transistors.

Name ..... Title .....

Company .....

Address .....

City ..... State ..... Zip .....

## ITT's exclusive strip line packaging makes VHF/UHF transistor circuits work better



The strip line package reduces or eliminates many of the difficulties that were formerly inevitable when working with high-power VHF-UHF transistors.

Consider these advantages: strip line configuration simplifies final tune-up by virtually eliminating instability; low-inductance package means easier matching to driver stages and broad bandwidth. For 400 MHz application, you may select the 3TE440 (15 watts output) or the 3TE450 (4 watts output).

For full details fill in the coupon above. Or see for yourself — sample quantities are available off the shelf from your ITT distributor or factory representative.

**ITT**  
SEMICONDUCTORS

ITT SEMICONDUCTORS IS A DIVISION OF INTERNATIONAL TELEPHONE AND TELEGRAPH CORPORATION, 3301 ELECTRONICS WAY, WEST PALM BEACH, FLORIDA. FACTORIES IN WEST PALM BEACH, FLORIDA; PALO ALTO, CALIFORNIA; LAWRENCE, MASSACHUSETTS; HARLOW AND FOOTSCRAY, ENGLAND; FREIBURG AND NURENBERG, GERMANY

# Electronics reader service

Use these handy post cards for more detailed information on: products advertised, new products, new literature.

Circle the number on the Reader Service post card that corresponds to the number at the bottom of the advertisement, new product item, or new literature in which you are interested.

Please print clearly. All written information must be legible to be efficiently processed.

If someone has beaten you to the post cards, you may obtain the needed information by writing directly to the manufacturer, or by sending your name and address, plus the Reader Service number, to Electronics Reader Service department.

All inquiries from outside the U.S. that cannot reach Electronics before the expiration dates noted on the Reader Service post card, must be mailed directly to the manufacturer. The manufacturer assumes all responsibilities for responding to inquiries. Electronics merely provides and clears requests for information from inquirer to manufacturer.

Correct amount of postage must be affixed for all mailings from outside the U.S.

### To subscribe to or to renew Electronics

Fill in the "For Subscriptions" area on the card if you desire to subscribe to or renew your present subscription to Electronics. Send no money. Electronics will bill you at the address indicated on the Reader Service post card.

### Multi-product advertisements

For information on specific items in multi-product advertisements which do not have a specific Reader Service number indicated write directly to manufacturer for information on precise product in which you are interested.

**4** Please Print Clearly February 20, 1967 Card Expires April 20, 1967 **14**

Name \_\_\_\_\_ title \_\_\_\_\_

Company \_\_\_\_\_

Address \_\_\_\_\_

City \_\_\_\_\_ state \_\_\_\_\_ zip code \_\_\_\_\_

1	20	39	58	77	96	115	134	153	172	191	210	229	248	267	286	305	324	343	362	381	400	419	438	457	476	495	514	962
2	21	40	59	78	97	116	135	154	173	192	211	230	249	268	287	306	325	344	363	382	401	420	439	458	477	496	515	963
3	22	41	60	79	98	117	136	155	174	193	212	231	250	269	288	307	326	345	364	383	402	421	440	459	478	497	516	964
4	23	42	61	80	99	118	137	156	175	194	213	232	251	270	289	308	327	346	365	384	403	422	441	460	479	498	517	965
5	24	43	62	81	100	119	138	157	176	195	214	233	252	271	290	309	328	347	366	385	404	423	442	461	480	499	518	966
6	25	44	63	82	101	120	139	158	177	196	215	234	253	272	291	310	329	348	367	386	405	424	443	462	481	500	900	967
7	26	45	64	83	102	121	140	159	178	197	216	235	254	273	292	311	330	349	368	387	406	425	444	463	482	501	901	968
8	27	46	65	84	103	122	141	160	179	198	217	236	255	274	293	312	331	350	369	388	407	426	445	464	483	502	902	969
9	28	47	66	85	104	123	142	161	180	199	218	237	256	275	294	313	332	351	370	389	408	427	446	465	484	503	951	970
10	29	48	67	86	105	124	143	162	181	200	219	238	257	276	295	314	333	352	371	390	409	428	447	466	485	504	952	971
11	30	49	68	87	106	125	144	163	182	201	220	239	258	277	296	315	334	353	372	391	410	429	448	467	486	505	953	972
12	31	50	69	88	107	126	145	164	183	202	221	240	259	278	297	316	335	354	373	392	411	430	449	468	487	506	954	973
13	32	51	70	89	108	127	146	165	184	203	222	241	260	279	298	317	336	355	374	393	412	431	450	469	488	507	955	974
14	33	52	71	90	109	128	147	166	185	204	223	242	261	280	299	318	337	356	375	394	413	432	451	470	489	508	956	975
15	34	53	72	91	110	129	148	167	186	205	224	243	262	281	300	319	338	357	376	395	414	433	452	471	490	509	957	976
16	35	54	73	92	111	130	149	168	187	206	225	244	263	282	301	320	339	358	377	396	415	434	453	472	491	510	958	977
17	36	55	74	93	112	131	150	169	188	207	226	245	264	283	302	321	340	359	378	397	416	435	454	473	492	511	959	978
18	37	56	75	94	113	132	151	170	189	208	227	246	265	284	303	322	341	360	379	398	417	436	455	474	493	512	960	979
19	38	57	76	95	114	133	152	171	190	209	228	247	266	285	304	323	342	361	380	399	418	437	456	475	494	513	961	980

For Subscriptions  
 new  renewal  
 3 years \$16.00  
 1 year \$8.00

2

**Business reply mail**  
 No postage stamp necessary if mailed in the United States

Postage will be paid by

**Electronics  
 Reader service department  
 Box 444  
 Hightstown, N.J. 08520**

First class  
 Permit no. 42  
 Hightstown, N. J.

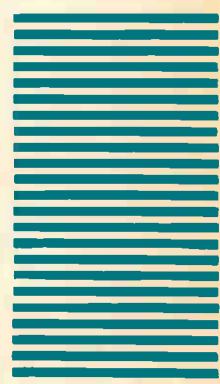

**4** Please Print Clearly February 20, 1967 Card Expires April 20, 1967 **14**

Name \_\_\_\_\_ title \_\_\_\_\_

Company \_\_\_\_\_

Address \_\_\_\_\_

City \_\_\_\_\_ state \_\_\_\_\_ zip code \_\_\_\_\_

1	20	39	58	77	96	115	134	153	172	191	210	229	248	267	286	305	324	343	362	381	400	419	438	457	476	495	514	962
2	21	40	59	78	97	116	135	154	173	192	211	230	249	268	287	306	325	344	363	382	401	420	439	458	477	496	515	963
3	22	41	60	79	98	117	136	155	174	193	212	231	250	269	288	307	326	345	364	383	402	421	440	459	478	497	516	964
4	23	42	61	80	99	118	137	156	175	194	213	232	251	270	289	308	327	346	365	384	403	422	441	460	479	498	517	965
5	24	43	62	81	100	119	138	157	176	195	214	233	252	271	290	309	328	347	366	385	404	423	442	461	480	499	518	966
6	25	44	63	82	101	120	139	158	177	196	215	234	253	272	291	310	329	348	367	386	405	424	443	462	481	500	900	967
7	26	45	64	83	102	121	140	159	178	197	216	235	254	273	292	311	330	349	368	387	406	425	444	463	482	501	901	968
8	27	46	65	84	103	122	141	160	179	198	217	236	255	274	293	312	331	350	369	388	407	426	445	464	483	502	902	969
9	28	47	66	85	104	123	142	161	180	199	218	237	256	275	294	313	332	351	370	389	408	427	446	465	484	503	951	970
10	29	48	67	86	105	124	143	162	181	200	219	238	257	276	295	314	333	352	371	390	409	428	447	466	485	504	952	971
11	30	49	68	87	106	125	144	163	182	201	220	239	258	277	296	315	334	353	372	391	410	429	448	467	486	505	953	972
12	31	50	69	88	107	126	145	164	183	202	221	240	259	278	297	316	335	354	373	392	411	430	449	468	487	506	954	973
13	32	51	70	89	108	127	146	165	184	203	222	241	260	279	298	317	336	355	374	393	412	431	450	469	488	507	955	974
14	33	52	71	90	109	128	147	166	185	204	223	242	261	280	299	318	337	356	375	394	413	432	451	470	489	508	956	975
15	34	53	72	91	110	129	148	167	186	205	224	243	262	281	300	319	338	357	376	395	414	433	452	471	490	509	957	976
16	35	54	73	92	111	130	149	168	187	206	225	244	263	282	301	320	339	358	377	396	415	434	453	472	491	510	958	977
17	36	55	74	93	112	131	150	169	188	207	226	245	264	283	302	321	340	359	378	397	416	435	454	473	492	511	959	978
18	37	56	75	94	113	132	151	170	189	208	227	246	265	284	303	322	341	360	379	398	417	436	455	474	493	512	960	979
19	38	57	76	95	114	133	152	171	190	209	228	247	266	285	304	323	342	361	380	399	418	437	456	475	494	513	961	980

For Subscriptions  
 new  renewal  
 3 years \$16.00  
 1 year \$8.00

# Reprint service

All Electronics editorial matter available in reprint form:

For reprints of special reports and feature articles see list on right side of this page. Send your order to Electronics Reprint Department at the address indicated. To expedite mailing of your order for single reprints please send cash, check or money order with your order.

Bulk reprints of editorial matter can be ordered from current or past issues. The minimum quantity is 100 copies. The higher the quantity ordered, the more economical the cost per copy. Prices quoted on request.

3

**Business reply mail**  
No postage stamp necessary if mailed in the United States

Postage will be paid by

First class  
Permit no. 42  
Hightstown, N. J.

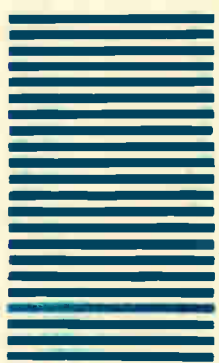

**Electronics**  
**Reader service department**  
**Box 444**  
**Hightstown, N. J. 08520**

4 Please Print Clearly February 20, 1967 Card Expires April 20, 1967 14

Name \_\_\_\_\_ title \_\_\_\_\_

Company \_\_\_\_\_

Address \_\_\_\_\_

For Subscriptions  
 new  renewal  
 3 years \$16.00  
 1 year \$8.00

City	state	zip code
1 20 39 58 77 96 115 134 153 172 191 210 229 248 267 286 305 324 343 362 381 400 419 438 457 476 495 514 962		
2 21 40 59 78 97 116 135 154 173 192 211 230 249 268 287 306 325 344 363 382 401 420 439 458 477 496 515 963		
3 22 41 60 79 98 117 136 155 174 193 212 231 250 269 288 307 326 345 364 383 402 421 440 459 478 497 516 964		
4 23 42 61 80 99 118 137 156 175 194 213 232 251 270 289 308 327 346 365 384 403 422 441 460 479 498 517 965		
5 24 43 62 81 100 119 138 157 176 195 214 233 252 271 290 309 328 347 366 385 404 423 442 461 480 499 518 966		
6 25 44 63 82 101 120 139 158 177 196 215 234 253 272 291 310 329 348 367 386 405 424 443 462 481 500 900 967		
7 26 45 64 83 102 121 140 159 178 197 216 235 254 273 292 311 330 349 368 387 406 425 444 463 482 501 901 968		
8 27 46 65 84 103 122 141 160 179 198 217 236 255 274 293 312 331 350 369 388 407 426 445 464 483 502 902 969		
9 28 47 66 85 104 123 142 161 180 199 218 237 256 275 294 313 332 351 370 389 408 427 446 465 484 503 903 970		
10 29 48 67 86 105 124 143 162 181 200 219 238 257 276 295 314 333 352 371 390 409 428 447 466 485 504 952 971		
11 30 49 68 87 106 125 144 163 182 201 220 239 258 277 296 315 334 353 372 391 410 429 448 467 486 505 953 972		
12 31 50 69 88 107 126 145 164 183 202 221 240 259 278 297 316 335 354 373 392 411 430 449 468 487 506 954 973		
13 32 51 70 89 108 127 146 165 184 203 222 241 260 279 298 317 336 355 374 393 412 431 450 469 488 507 955 974		
14 33 52 71 90 109 128 147 166 185 204 223 242 261 280 299 318 337 356 375 394 413 432 451 470 489 508 956 975		
15 34 53 72 91 110 129 148 167 186 205 224 243 262 281 300 319 338 357 376 395 414 433 452 471 490 509 957 976		
16 35 54 73 92 111 130 149 168 187 206 225 244 263 282 301 320 339 358 377 396 415 434 453 472 491 510 958 977		
17 36 55 74 93 112 131 150 169 188 207 226 245 264 283 302 321 340 359 378 397 416 435 454 473 492 511 959 978		
18 37 56 75 94 113 132 151 170 189 208 227 246 265 284 303 322 341 360 379 398 417 436 455 474 493 512 960 979		
19 38 57 76 95 114 133 152 171 190 209 228 247 266 285 304 323 342 361 380 399 418 437 456 475 494 513 961 980		

1

**Business reply mail**  
No postage stamp necessary if mailed in the United States

Postage will be paid by

First class  
Permit no. 42  
Hightstown, N. J.



**Electronics**  
**Reader service department**  
**Box 444**  
**Hightstown, N.J. 08520**

To order reprints or for further information, please write to: Electronics Reprint Department, 330 West 42nd Street, New York, N.Y. 10036.

Prices for the below listed reprints unless otherwise specified are 1-10 copies 50¢ each; 11-24 copies 35¢ each; 25-99 copies 25¢ each; price for 100 or more is 20¢ each.

You may order any of the below listed reprints by key number.

- Key no. R-01 Computer-aided Design: Part I. The Man-machine Merger. 16 pages. \$1.25.
- Key no. R-02 Vietnam Communications Network Growing Into Southeast Asia's Best. 3 pages. 25¢.
- Key no. R-03 Sense Amplifier Fits Any Product. 6 pages. 25¢.
- Key no. R-04 Multilayer Circuit Boards: Sharpening An Imperfect Art. 7 pages.
- Key no. R-05 Topology Cuts Design Drudgery. 12 pages. 50¢.
- Key no. R-06 Report on Japanese Technology: Sony. 20 pages. 50¢.
- Key no. R-07 European Electronics Markets 1967. 22 page forecast report with 4 page foldout chart. \$1.00.
- Key no. R-08 U.S. Electronics Markets 1967. 26 page forecast report with 6 page foldout. \$1.00.
- Key no. R-09 1966 Electronics Index to Technical Articles and Authors. Free.
- Key no. R-90a Communications Satellites. Parts I and II. 42 pages. \$1.25
- Key no. R-88 Belting Out Plastic Transistors On Mechanized Assembly Lines. 8 pages. 25¢
- Key no. R-87a The Packaging Revolution in Microelectronics. Parts I through VI. 64 pages. \$2.00.
- Key no. R-86a Computer Time Sharing. Parts I and II. 32 pages. \$1.00.
- Key no. R-79 MOS Integrated Circuits. 12 pages.
- Key no. R-78 The Overlay Transistor. 15 pages.
- Key no. R-75 Biotelemetry. 2 part series, 16 pages.
- Key no. R-74 Unijunction Transistors. 24 pages.
- Key no. R-64 Field Effect Transistors. Parts I, II, and III. 64 pages. \$1.00.
- Key no. R-63 Silicon Power Transistors. 8 pages. 25¢.
- Key no. R-60 Transistor Heat Dissipators. 32 pages.
- Key no. R-31 Electromagnetic Spectrum Chart. (22" x 30" foldout, chart). \$1.00

hp140A—The Scope System that gives you

# BETTER PERFORMANCE

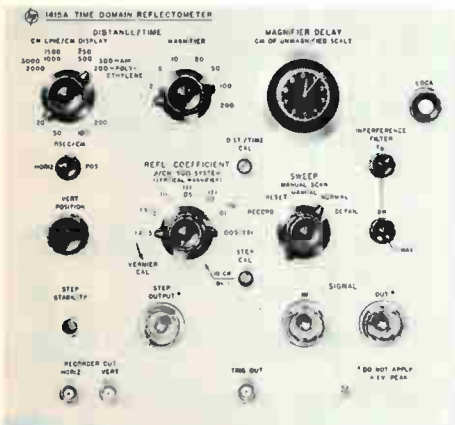
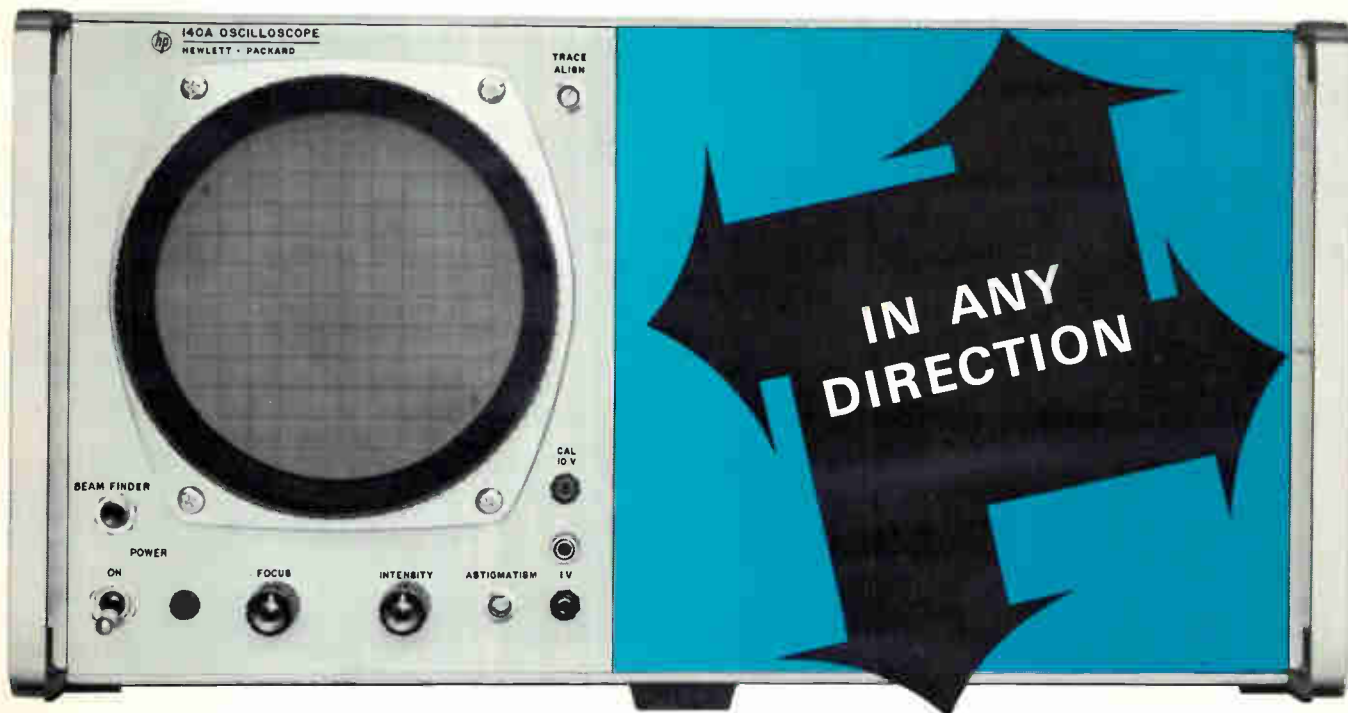

1415A—150 psec Time Domain Reflectometer

## SIMPLIFY DESIGN OF MICROWAVE AND PULSE CIRCUITS

**WITH 150 psec TDR**—The versatile hp 140A scope gives you a choice of 17 plug-ins which cover the entire spectrum of oscilloscope measurements. You can, for example, use a 1415A Time Domain Reflectometer plug-in to quickly determine the magnitude and nature of each resistive or reactive discontinuity in coaxial components such as attenuators, cables, connectors and delay lines. This 150 psec system enables you to locate each discontinuity to within an inch.

The 1415A is a completely self-contained system consisting of a fast rise pulse generator, single channel sampler, and time base. No additional vertical or horizontal amplifiers are required, eliminating introduction of additional chances of error. The vertical channel is calibrated in reflection coefficient for direct readout, with a maximum sensitivity of .005/cm for measurement of extremely small discontinuities. Full 10 cm vertical display area gives additional resolution. Distances can be read directly on the horizontal axis—air or polyethylene dielectrics. The compact control panel contains only those controls necessary for TDR measurements—making the 1415A much simpler to operate than comparable systems costing twice as much.

Accessories include Rise Time Converters which eliminate reflections beyond the bandwidth of interest, 75-ohm adapters, and a Susceptance Standard which gives direct readings of reactive discontinuities. Extensive "how-to" data is available in hp Application Notes 62, 67 and 75 and is yours for the asking.

Price of the hp 1415A TDR System with the standard hp 140A mainframe is \$1645. An alternate mainframe (141A) provides the additional advantages of variable persistence and storage. Price: \$2325. Ask your hp Sales Engineer for brochure (Data Sheet 140A) with specs on the TDR system. Or, write to Hewlett-Packard, Palo Alto, California, 94304. Phone (415) 326-7000. In Europe: 54 Route des Acacias, Geneva.



hp 140A: PERFORMANCE IN ANY DIRECTION  
20 MHz Wideband • High-Sensitivity, no drift  
• 150 ps TDR • 12.4 GHz Sampling  
• Variable Persistence and Storage

HEWLETT  PACKARD  
An extra measure of performance

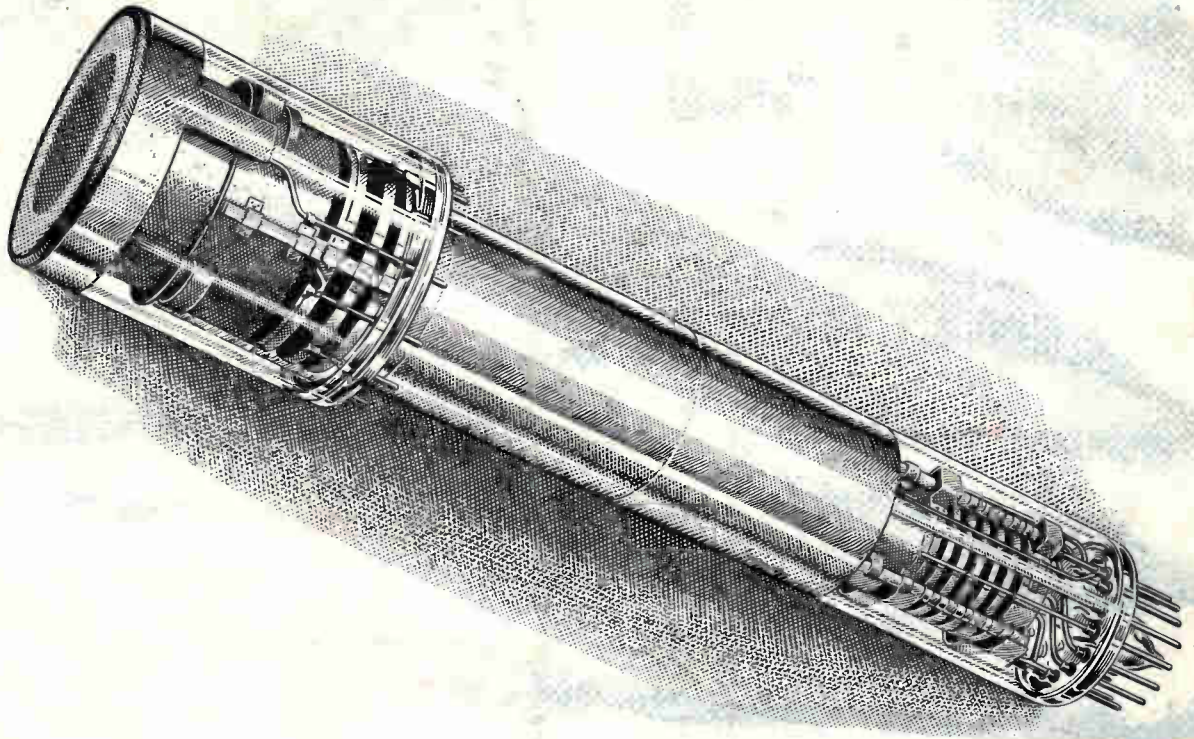

RCA-8685 — New 2-Inch Image Orthicon

# RCA BIALKALI Photocathode

Offers Unexcelled Resolution Stability and Long Life

Now... the unique properties of RCA Bialkali Photocathodes are available in RCA-8685, a new 2-inch Image Orthicon which joins the family of RCA camera tubes for color and black-and-white TV. RCA Bialkali Photocathodes significantly enhance resolution stability over an extended tube lifetime. In RCA-8685, which is both compact and inexpensive, you have a device for use with 16mm optics that is 10 times more sensitive than any camera tube previously available for this application.

RCA-8685 requires only 0.1 lm/ft<sup>2</sup> (fc) on the photocathode for high-quality pictures over a wide range of incident light levels on the object.

Employing a target of electronic-conducting glass rather than ionic-conducting glass, the new image orthicon exhibits a "no-stick" quality of operation, virtually eliminating persistence of the picture. Its features also include: close target-to-mesh spacing, separate field-

mesh connection, low-power "dark" heater requiring only 0.6 watt, and over-all precision construction for accurate geometric reproduction.

RCA-8685 is designed specifically to use the widely available and low-cost 16mm motion picture and vidicon TV optics. A companion tube, RCA developmental type C21064, is designed to use 35mm optics. See your RCA Representative for information, including price and delivery. For technical data on these new types, write: RCA Commercial Engineering, Section B19Q-3, Harrison, N.J.

ALSO AVAILABLE FROM YOUR  
RCA BROADCAST TUBE DISTRIBUTOR

RCA Electronic Components and Devices



The Most Trusted Name in Electronics