

Electronics®

Analyzing circuits numerically: page 88
Inside the Apollo computer: page 109
Electronics markets for 1967: page 123

January 9, 1967

\$1.00

A McGraw-Hill Publication

Below: Integrated electronics invade
all U.S. markets in 1967, page 129



AUDIO TRANSFORMERS

DO-T No.	Pri. Imp.	D.C. Ma.† in Pri.	Sec. Imp.	Pri. Res. DO-T	Pri. Res. DI-T	Mw Level	DI-T No.
DO-T44	80 CT 100 CT	12 10	32 split 40 split	9.8	11.5	500	DI-T44*
DO-T29	120 CT 150 CT	10 10	3.2 4	10		500	
DO-T12	150 CT 200 CT	10 10	12 16	11		500	
DO-T13	300 CT 400 CT	7 7	12 16	20		500	
DO-T19	300 CT	7	600	19	20	500	DI-T19
DO-T30	320 CT 400 CT	7 7	3.2 4	20		500	
DO-T43	400 CT 500 CT	8 6	40 split 50 split	46	50	500	DI-T43*
DO-T42	400 CT 500 CT	8 6	120 split 150 split	46		500	
DO-T41	400 CT 500 CT	8 6	400 split 500 split	46	50	500	DI-T41*
DO-T2	500 600	3 3	50 60	60	65	100	DI-T2
DO-T20	500 CT	5.5	600	31	32	500	DI-T20
DO-T4	600	3	3.2	60		100	
DO-T14	600 CT 800 CT	5 5	12 16	43		500	
DO-T31	640 CT 800 CT	5 5	3.2 4	43		500	
DO-T32	800 CT 1000 CT	4 4	3.2 4	51		500	
DO-T15	800 CT 1070 CT	4 4	12 16	51		500	
DO-T21	900 CT	4	600	53	53	500	DI-T21
DO-T3	1000 1200	3 3	50 60	115	110	100	DI-T3
DO-T45	1000 CT 1250 CT	3.5 3.5	16,000 split 20,000 split	120		100	
DO-T16	1000 CT 1330 CT	3.5 3.5	12 16	71		500	
DO-T33	1060 CT 1330 CT	3.5 3.5	3.2 4	71		500	
DO-T5	1200	2	3.2	105	110	100	DI-T5
DO-T17	1500 CT 2000 CT	3 3	12 16	108		500	
DO-T22	1500 CT	3	600	86	87	500	DI-T22
DO-T34	1600 CT 2000 CT	3 3	3.2 4	109		500	
DO-T51	2000 CT 2500 CT	3 3	2000 split 2500 split	195	180	100	DI-T51
DO-T37	2000 CT 2500 CT	3 3	8000 split 10,000 split	195	180	100	DI-T37*
DO-T52	4000 CT 5000 CT	2 2	8000 CT 10,000 CT	320	300	100	DI-T52
DO-T18	7500 CT 10,000 CT	1 1	12 16	505		100	
DO-T35	8000 CT 10,000 CT	1 1	3.2 4	505		100	
*DO-T48	8,000 CT 10,000 CT	1 1	1200 CT 1500 CT	640		100	
*DO-T47	9,000 CT 10,000 CT	1 1	9000 CT 10,000 CT	850		100	
DO-T6	10,000	1	3.2	790		100	
DO-T9	10,000 12,000	1 1	500 CT 600 CT	780	870	100	DI-T9
DO-T10	10,000 12,500	1 1	1200 CT 1500 CT	780	870	100	DI-T10
DO-T25	10,000 CT 12,000 CT	1 1	1500 CT 1800 CT	780	870	100	DI-T25
DO-T38	10,000 CT 12,000 CT	1 1	2000 split 2400 split	560	620	100	DI-T38*
DO-T11	10,000 12,500	1 1	2000 CT 2500 CT	780	870	100	DI-T11
DO-T36	10,000 CT 12,000 CT	1 1	10,000 CT 12,000 CT	975	970	100	DI-T36
DO-T1	20,000 30,000	.5 .5	800 1200	830	815	50	DI-T1
DO-T23	20,000 CT 30,000 CT	.5 .5	800 CT 1200 CT	830	815	50	DI-T23
DO-T39	20,000 CT 30,000 CT	.5 .5	1000 split 1500 split	800		50	
DO-T40	40,000 CT 50,000 CT	.25 .25	400 split 500 split	1700		50	
DO-T46	100,000 CT	0	500 CT	7900		25	
DO-T7	200,000	0	1000	8500		25	
DO-T24	200,000 CT	0	1000 CT	8500		25	
DO-TSH	Drawn Hipermalloy shield and cover 20/30 db						DI-TSH

†DCMA shown is for single ended useage (under 5% distortion—100MW—1KC) ... for push pull, DCMA can be any balanced value taken by .5W transistors (under 5% distortion—500MW—1KC) DO-T & DI-T units designed for transistor use only. U.S. Pat. No. 2,949,591; others pending. → *Units newly added to series
§Series connected; §§Parallel connected



**PIONEERS IN
MINIATURIZATION**

DO-T & DI-TTM Transistor TRANSFORMERS and INDUCTORS



**ALL ITEMS SUCCESSFULLY TESTED
TO COMPLETE MIL-T-27B
ENVIRONMENTAL REQUIREMENTS**

***16 New Items Added to Stock Line
IMMEDIATE DELIVERY FROM STOCK**

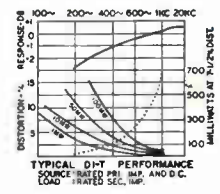
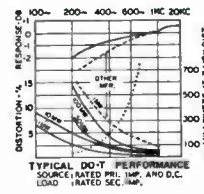

High Power Rating up to 10 times greater
Excellent Response twice as good at low end
Low Distortion reduced 80%
High Efficiency up to 30% better ... compare DCR
Moisture Proof hermetically sealed to MIL-T-27B
Rugged Grade 4, completely metal cased
Anchored Leads will withstand 10 pound pull test
Printed Circuit Use (solder melting) nylon insulated leads
Suited to Clip Mounting use Augat #6009-8A clip

INDUCTORS

DO-T No.	Inductance Hys @ ma	DO-T DCR Ω	DI-T DCR Ω	DI-T No.
*DO-T50 (2 wdgs.)	\$.075 Hy/10 ma, .06 Hy/30 ma \$.018 Hy/20 ma, .015 Hy/60 ma	10.5 2.6		
DO-T28	.3 Hy/4 ma, .15 Hy/20 ma .1 Hy/4 ma, .08 Hy/10 ma	25	25	DI-T28
DO-T27	1.25 Hys/2 ma, .5 Hy/11 ma .9 Hy/2 ma, .5 Hy/6 ma	100	105	DI-T27
DO-T8	3.5 Hys/2 ma, 1 Hy/5 ma 2.5 Hys/2 ma, .9 Hy/4 ma	560	630	DI-T8
DO-T26	6 Hys/2 ma, 1.5 Hys/5 ma 4.5 Hys/2 ma, 1.2 Hys/4 ma	2100	2300	DI-T26
*DO-T49 (2 wdgs.)	£20 Hys/1 ma, 8 Hys/3 ma £5 Hys/2 ma, 2 Hys/6 ma	5100 1275		

POWER TRANSFORMERS

*DO-T400	Pri 28V 380-1000 cycles, Sec 6.3V @ 60 ma
*DO-T410	Pri 28V 380-1000 cycles, 2-Sec 6.3 @ 30 ma each
*DO-T420	Pri 28V 380-1000 cycles, Sec 28V @ 20 ma (Isol. Electrostatic Shld.)

Write for catalog of over
1,300 UTC TOP QUALITY
STOCK ITEMS
IMMEDIATELY AVAILABLE
from your local distributor.



UNITED TRANSFORMER CO.
DIVISION OF TRW INC. • 150 VARICK STREET, NEW YORK, N. Y. 10013

New hp 651B and 652A Test Oscillators:

FLATNESS, STABILITY and ACCURACY

from 10 Hz to 10 MHz

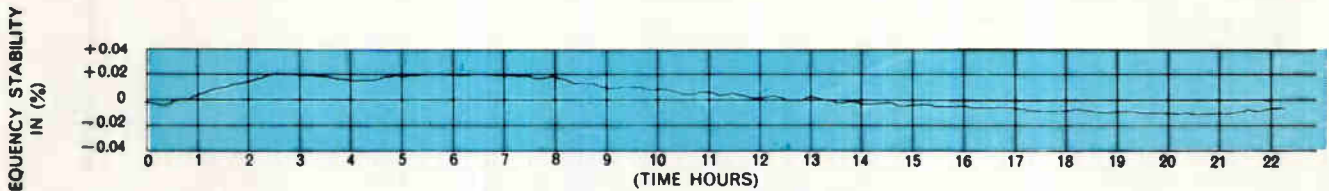
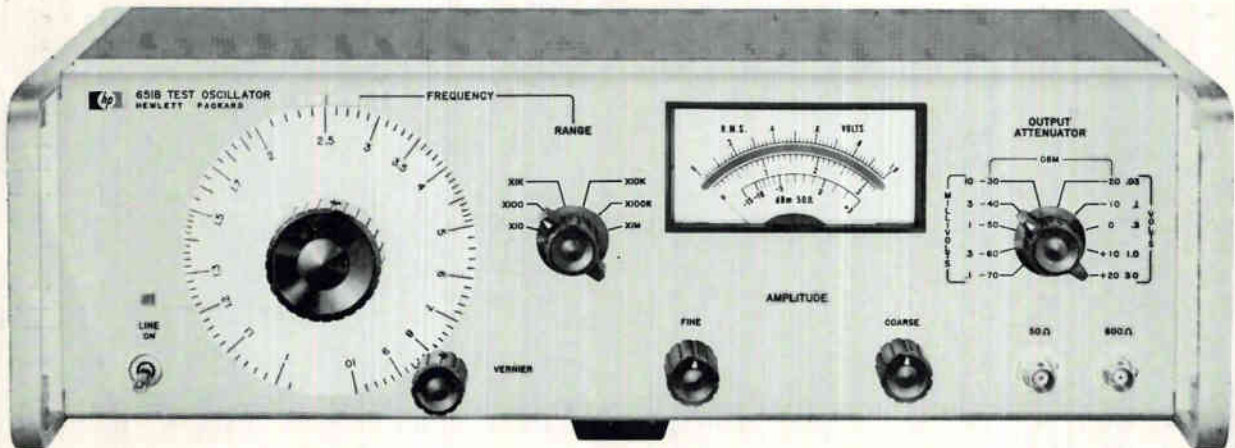

Typical Frequency Stability ($\pm 0.02\%$) at 5 MHz for 22 Hours.

- Amplitude stability $\pm 0.1\%$
- Frequency stability $\pm 0.02\%$
- 1% Accurate 90 dB output attenuator
- Two outputs: 200 mW into 50Ω, 16mW into 600Ω

APPLICATIONS: Use the new wide-band, solid-state hp 651B and 652A Test Oscillators for laboratory and production applications, in the presence of shock, vibration or high-frequency radiations. Both models are ideal for calibration of voltmeters because of accurate attenuator and output monitor.

These oscillators are specifically designed for testing television amplifiers, audio amplifiers, filter networks, tuned circuits, telephone and telegraph carrier equipment, and for testing audio and video tape.

PERFORMANCE FEATURES: Oscillator circuitry has hp precision tuning capacitor and peak detector automatic gain control to insure a flat output throughout the entire frequency range. Solid-state, low-impedance circuitry and a shielded power supply transformer reduce output hum and noise to less than 0.05%.

Output attenuator has a 90 dB range in 10 dB steps, with a 20 dB coarse and fine concentric amplitude control for increased resolution in setting output voltage. Output monitor is calibrated to read volts or dBm into a matched load.

652A: Specifications of two oscillators are identical except that the 652A has the ability to monitor output

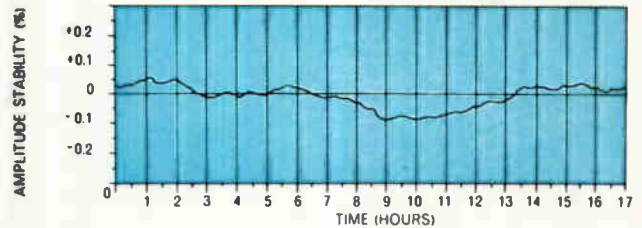

Typical Amplitude Stability ($\pm 0.1\%$) at Mid-Band Frequencies for 17 Hours.

amplitudes within 0.25% over the entire frequency range of the instrument using the X20 expanded scale. Readings on the uppermost scale of the 652A are in percent for quick reading of frequency response measurements.



652A Expanded Scale Monitor

For full specifications on the new hp 651B and 652A Test Oscillators, contact your nearest hp field engineer. Or, write to Hewlett-Packard, Palo Alto, California 94304, Tel. (415) 326-7000; Europe: 54 Route des Acacias, Geneva. Price: hp Model 651B Test Oscillator, \$590.00; hp Model 652A Test Oscillator, \$725.00.

114A

HEWLETT  **PACKARD**
An extra measure of quality

HEWLETT-PACKARD MAGNETIC RECORDING SYSTEMS THRIVE ON ANYTHING YOU FEED THEM

Hewlett-Packard 3900 Magnetic Recording Systems are ideal for everything from storage of simple physical phenomena to applications in complex telemetry ground stations. You cannot buy better record, storage and playback performance for your money.



Hewlett-Packard's advanced tape transport design delivers reliable, maintenance-free operation. Three-mode recording — FM, Direct and Pulse — covers all your simple and complex data storage and playback needs. The HP 3900 Systems include 7- or 14-channel recorders in low or intermediate bandwidths. Low bandwidth direct mode is 50 Hz to 100 kHz and FM mode is DC to 10 kHz. Intermediate bandwidth direct mode frequency range is 50 Hz to 250 kHz and FM mode is DC to 20 kHz. Signal/noise ratio is 40 db or better and harmonic distortion is 1% typical 1 kHz per second at 60 ips with 0.2% peak-to-peak flutter. Six pushbutton-selected tape speeds range from 1⁷/₈ ips to 60 ips. HP tape systems are completely IRIG compatible.

Optional equipment includes: closed loop recording adapter, frequency-compensating plug-ins for FM and Direct mode record/reproduce circuits, remote control, voice commentary channel amplifier, input signal coupler, portable cases and rack adapter.



For complete information on the 3900 Systems, their variations and optional equipment, contact your local HP Field Office or write Hewlett-Packard Co., 175 Wyman Street, Waltham, Mass. 02154.

HEWLETT  **PACKARD**
*measuring instruments
for science and industry*

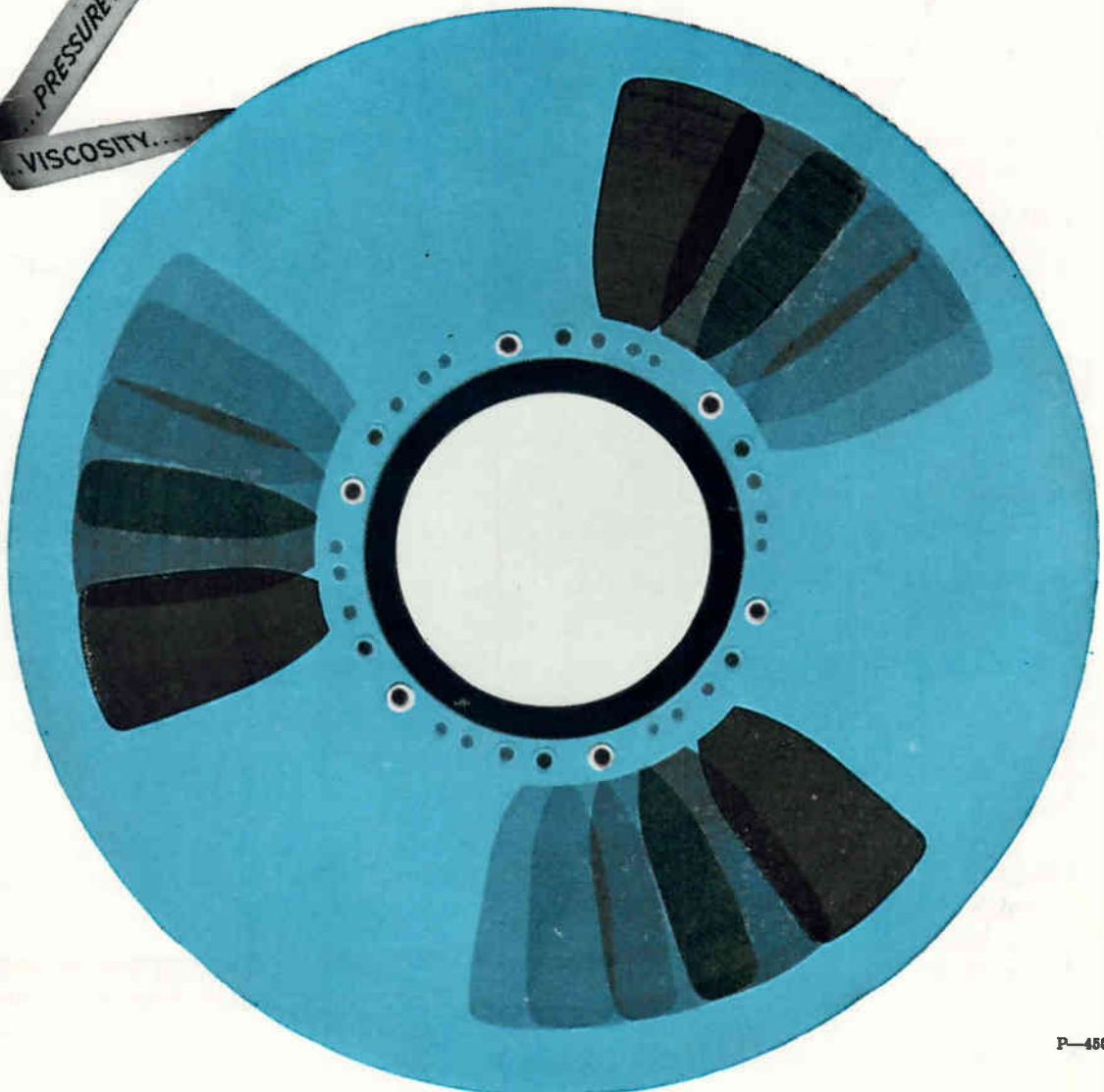

P-450

News Features

Probing the News

- 163 Support gear rides a roller coaster
168 Railroads on the automation track
172 Tactical phased-array radar gets closer in the field

Electronics Review

- 41 Manufacturing: The perfect bond
42 Military electronics: Litton's loss; Service rivalry
44 Communications: Touch and go
45 Medical electronics: Heartfelt power
46 Avionics: Only make believe; Collision course
48 Computer-aided design: Circuit course
48 Instrumentation: Giant capacitors for Apollo
50 Computers: Another Sigma
52 Space electronics: High marks for ATS
52 Industrial electronics: Market view
54 For the record

Electronics Abroad

- 251 Japan: All aboard; Fast on the punch; Murmur monitor
253 Great Britain: In the picture; White paper on color; Export exchange
254 Denmark: A new voice
254 West Germany: Stretching the fax: New frontiers
257 Czechoslovakia: Righting the balance
258 Around the world

Departments

- 4 Readers Comment
8 People
14 Meetings
16 Meetings Preview
23 Editorial
25 Electronics Newsletter
63 Washington Newsletter
185 New Products
186 New Products Index
226 New Books
230 Technical Abstracts
234 New Literature
251 Newsletter from Abroad

Title R registered U.S. Patent Office; © copyright 1967 by McGraw-Hill, Inc. All rights reserved, including the right to reproduce the contents of this publication, in whole or in part.

Technical Articles

- Design theory 88 Computer-aided design, part 4: Analyzing circuits by the numbers**
An expert describes how to use matrix algebra to handle the large volumes of data and the many sets of simultaneous equations generated when analyzing a complex circuit
Frank Branin, International Business Machines Corp.
- Circuit design 104 Designer's casebook**
- Quartz crystal synchronizes relaxation oscillator
 - Stable low frequencies with FET-bipolar pairs
 - Audio amplifier compresses input signal by 30 decibels
 - Diodes provide noise immunity for monostable multivibrators
 - Narrow-pulse one-shot recovers quickly
- Space electronics 109 Electronic navigator charts man's path to the moon**
Guiding man in the first flight to the moon is an ultrareliable computer, made reliable by designing it with a single integrated logic circuit
Albert L. Hopkins, Massachusetts Institute of Technology
- Marketing 123 Electronics markets 1967 (cover)**
A statistical analysis of Electronics' annual market survey which predicts the industry will enjoy a 13% increase over 1966
- 129 The spectacular rise continues**
Powered by increased color tv sales, Vietnam spending and continued good economic conditions, electronics markets in 1967 will again set records. Integrated electronics will make inroads in every segment of the industry
- | | |
|--------------------------|-----------------------------|
| 130 Solid state | 145 Computers |
| 135 Military electronics | 146 Communications |
| 139 Consumer electronics | 148 Microwave |
| 140 Components | 150 Educational electronics |
| 141 Medical electronics | 151 Space electronics |
| 142 Instrumentation | 152 Industrial electronics |
| 144 Avionics | |

Electronics

Editor-in-Chief: Lewis H. Young

Associate managing editors

Design: Samuel Weber
Application: George Sideris
News: Kemp Anderson
Copy: Sally Powell

Senior editor

Special projects: Donald Christiansen

Senior associate editors

John F. Mason, Robert Henkel, Joseph Mittelman

Department editors

Avionics: W.J. Evanzia
Communications: Leonard Weller
Computers: Wallace B. Riley
Design theory: Joseph Mittelman
Industrial electronics: Alfred Rosenblatt
Instrumentation: Carl Moskowitz
Military electronics: John Mason
New products: William P. O'Brien
Staff writers: William Olcott, Paul Dickson,
Jan Rahn

Section editors

Electronics abroad: Arthur Erikson
Electronics review: Stanley Zarowin
Probing the news: Eric Aiken

Regional bureaus

Domestic

Boston: Thomas Maguire, Manager; Robin Carlson
Los Angeles: William B. Wallace, manager; June Ranil
San Francisco: Walter Barney, manager; Mary Jo Jadin
Washington: Robert W. Henkel, manager; William D. Hickman,
Patricia C. Hoehling, correspondents

Foreign

Bonn: John Gosch
London: Michael Payne
Tokyo: Charles Cohen

Copy editors

David Goller, Albert Tannenbaum, James Chang

Graphic design

Art director: Saul Sussman
Assistant art directors: Ann Mella, Valerie Betz
Production editor: Arthur C. Miller

Editorial secretaries: Marlene Angrist, Claire Benell, Lynn Emery, Lorraine Fabry,
Kay Fontana, Patricia Gardner, Lorraine Longo

McGraw-Hill News Service

Director: John Wilhelm; Atlanta: Fran Ridgway; Chicago: James Rubenstein;
Cleveland: Arthur Zimmerman; Dallas: Marvin Reid;
Detroit: N. Hunter; Houston: Robert E. Lee; Los Angeles: Michael Murphy, Gerald Parkinson
San Francisco: Margaret Drossel
Seattle: Ray Bloomberg; Washington: Arthur L. Moore, Charles Gardner,
Herbert W. Cheshire, Seth Payne, Warren Burkett

McGraw-Hill World News Service

Bonn: John Johnsrud; London: John Shinn;
Mexico City: Bruce Cross; Milan: Ronald Taggiasco;
Moscow: Howard Rausch; Paris: Peter Kilborn;
Rio de Janeiro: Wes Perry; Tokyo: Marvin Petal

Reprints: Susan Nugent

Publisher: Gordon Jones

Electronics: January 9, 1967, Vol. 40, No. 1

Published every other Monday by McGraw-Hill, Inc. Founder: James H. McGraw 1860-1958.

Printed at 99 North Broadway, Albany, N.Y. 12207; second class postage paid at Albany, N.Y.

Executive, editorial, circulation and advertising addresses: McGraw-Hill Building, 330 W. 42nd Street,
New York, N.Y. 10036. Telephone (212) 971-3333. Teletype TWX N.Y. 212-640-4646. Cable address:
MCGRAWHILL N.Y.

Subscriptions are solicited only from those actively engaged in the field of the publication. Position and
company connection must be indicated on orders. Subscription prices: United States and possessions and
Canada, \$8.00 one year, \$12.00 two years, \$16.00 three years; all other countries, \$25.00 one year.
Single copies: United States and possessions and Canada, \$1.00; all other countries, \$1.75.

Officers of McGraw-Hill Publications: Joseph H. Allen, President; Bayard E. Sawyer, Executive Vice President;
Vice Presidents: J. Elton Tuohig, Operations; John R. Callahan, Editorial; Donald C. McGraw, Jr., Marketing;
John M. Holden, Marketing Services; Huber M. Gemmill, Circulation; Angelo R. Venezian, Production;
Robert M. Wilhelm, Controller.

Officers of the Corporation: Donald C. McGraw, Chairman of the Board; Shelton Fisher, President;
L. Keith Goodrich, Hugh J. Kelly and Robert E. Slaughter, Executive Vice Presidents; John J. Cooke,
Vice President and Secretary; John L. McGraw, Treasurer.

Title © registered in U.S. Patent Office; © Copyright 1967 by McGraw-Hill, Inc. All rights reserved. The contents
of this publication may not be reproduced either in whole or in part without the consent of copyright owner.

Subscribers: The publisher, upon written request to our New York office from any subscriber,
agrees to refund that part of the subscription price applying to copies not yet mailed.
Please send change of address notices or complaints to Fulfillment Manager; subscription
orders to Circulation Manager, Electronics at address below. Change of address notices
should provide old as well as new address, including postal zip code number. If possible,
attach address label from recent issue. Allow one month for change to become effective.

Postmaster: Please send form 3579 to Fulfillment Manager, Electronics,
P.O. Box 430, Hightstown, New Jersey 08520

Readers Comment

Engineer inertia

To the Editor:

In reading the article "Low-frequency noise predicts when a transistor will fail" [Nov. 28, 1966, p. 95], I was rather more surprised than pleased to note the first sentence: "A new method for predicting the life expectancy of a transistor—based on measuring the device's noise at 1,000 hertz—could make transistor reliability studies simple and more accurate." We developed this concept over five years ago.

We are not overly disturbed by the fact that credit for the origination of an important reliability tool was given some five years late to the wrong source. After all, mistakes can be made with the best intentions. But we continue to be disturbed by the fact that this concept has never been fully accepted by the engineering public, especially those who should be most interested in the ultimate in reliability, such as the military and aerospace agencies.

Quan-Tech has never claimed that noise analysis would supplant other methods of reliability testing. We have always proposed it as an additional method of weeding out failure-prone components that could not be detected by any of the more commonly accepted means.

It is a sad commentary on the rigidity of thinking and mental inertia of the majority of reliability engineers that they have been unwilling to experiment with a new concept. Their blind insistence on sticking to a purely statistical approach to reliability indicates a lack of original thinking and flexibility. After all, the failure of one transistor can endanger the life of an airplane or spacecraft pilot; yet most of the reliability people were unwilling even to investigate whether noise analysis could possibly eliminate failure-prone components.

Some two years ago we finally received a NASA contract for a statistical analysis of the relationship between noise and reliability in silicon planar transistors. Correlation between excessive noise and failure was excellent during the early part of the test; however it

Did you know Sprague makes...?

UNICIRCUIT® mW RTL INTEGRATED CIRCUITS



TO-5 CASE

Types US-0908 through US-0921... Fully interchangeable mW digital building blocks featuring power consumption of 2 mW/node and propagation delay of 40 nsec

Check 40 Reader Service Card

*SERIES SE100, NE100, US700 DTL LOGIC (Signetics CS700)

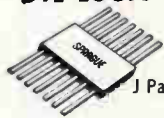

J Package

Two operating temperature ranges: -55 C to +125 C and 0 C to +70 C. NAND/NOR gates, clock and line drivers, gate expanders, RST and JK binary elements, one-shot multivibrator.

Check 41 Reader Service Card

UNICIRCUIT® RTL INTEGRATED CIRCUITS



(8X actual size)

Sprague Series US-0100... a complete line of monolithic digital building blocks featuring low power consumption (2 mW typ.)

Check 39 Reader Service Card

MULTIPLE TRANSISTORS (NPN-PNP PAIRS/QUADS)



AMPLIFIERS	SWITCHES	CHOPPERS
Pairs		Quads
2 NPN		4 NPN
2 PNP		4 PNP
1 NPN-1 PNP		2 NPN-2 PNP

Check 42 Reader Service Card

UNICIRCUIT® CUSTOM HYBRID CIRCUITS

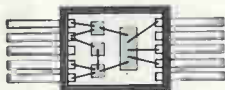

Combine monolithic silicon circuits with tantalum or Ni-Cr alloy resistors. Close resistance tolerances, low temperature coefficient. Resistor matching, $\pm 1/2\%$.

Check 43 Reader Service Card

LOW-COST HERMETICALLY- SEALED PLANAR TRANSISTORS



TO-18 CASE

TO-5 CASE

TQ SERIES (PNP)
Low Level Amplifiers
High Gain Switch/Amplifiers
High Speed Switches

TN SERIES (NPN)
High Voltage Switches
Low Level Amplifiers
High Speed Switch/Amplifiers
Choppers
Power Amplifiers
Core Drivers

Check 44 Reader Service Card

DIFFERENTIAL AMPLIFIER TRANSISTOR PAIRS



NPN or PNP • Matched characteristics.
 $h_{FE} = 10-20\%$. $\Delta V_{BE} = 5-20$ mV.
 $\Delta V_{BE}/Temp = 5-20 \mu V/^{\circ}C$.

Check 45 Reader Service Card

DIGITAL-TO-ANALOG CONVERSION CIRCUITS



UT-1000—Four-bit ladder network
UD-4001—Ladder switch for driving resistor ladder networks
UD-4024—Buffer amplifier

Check 46 Reader Service Card

TW-3000 MICROPOWER PNP SILICON HIGH-SPEED SWITCHING TRANSISTORS



TO-18 CASE

Fastest switching transistor available in the 1 to 100 μA range

$C_{ib} = 0.7$ pF typ., 1.5 pF max.

$C_{ob} = 1.5$ pF typ., 2.5 pF max.

Check 47 Reader Service Card

*Available from Sprague Electric under technology interchange with Signetics Corp.

For complete technical data on any of these products, write to:
Technical Literature Service
Sprague Electric Company
35 Marshall Street
North Adams, Mass. 01247

SPRAGUE COMPONENTS

INTEGRATED CIRCUITS
THIN-FILM MICROCIRCUITS
TRANSISTORS
CAPACITORS
RESISTORS

PULSE TRANSFORMERS
INTERFERENCE FILTERS
PULSE-FORMING NETWORKS
TOROIDAL INDUCTORS
ELECTRIC WAVE FILTERS

CERAMIC-BASE PRINTED NETWORKS
PACKAGED COMPONENT ASSEMBLIES
BOBBIN and TAPE WOUND MAGNETIC CORES
SILICON RECTIFIER GATE CONTROLS
FUNCTIONAL DIGITAL CIRCUITS

SPRAGUE®

THE MARK OF RELIABILITY

*Sprague and ® are registered trademarks of the Sprague Electric Co.

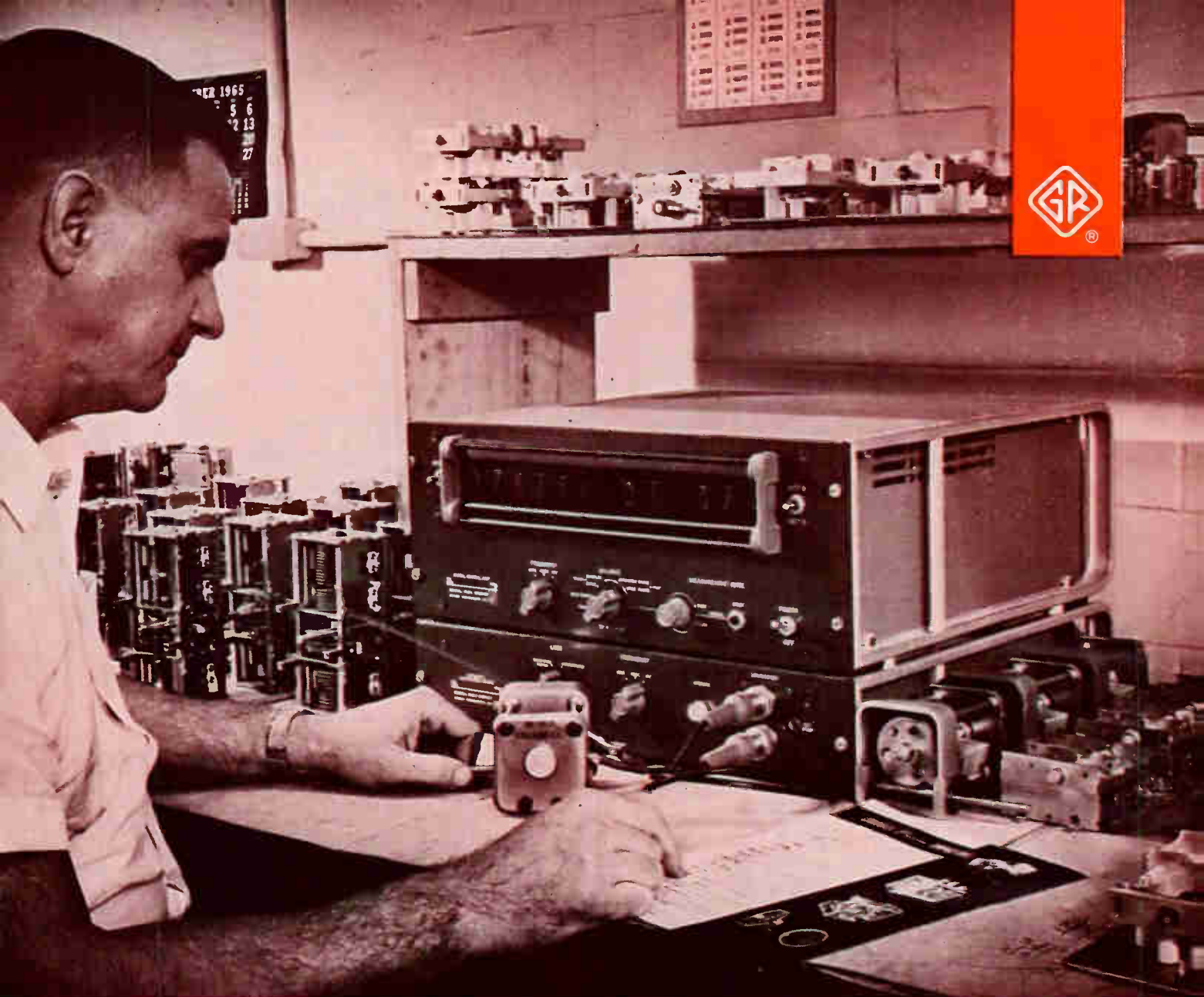

Photo courtesy of Cardwell Condenser Corporation

Customer Report:

1680-A Triples Output

Cardwell Condenser Corporation uses the Type 1680-A Automatic Capacitance Bridge Assembly to test variable air capacitors by checking them at more than five points across the dial. The 1680-A is not only more accurate than the bridge it replaced, but the remarkable speed with which it measures has tripled output and eliminated the need to hire additional test personnel. Government inspectors find this bridge thoroughly acceptable.

The 1680-A automatically selects C and D (or G) ranges, then balances and displays measurements in digital form showing decimal point and units of measurement. Measurement takes

only 0.5 second at 1 kHz under worst conditions. Basic accuracy is 0.1% of reading for C and G, 1% ± 0.001 of reading for D. Measurement range is 0.01 pF to 1000 μ F. The bridge provides BCD output; completely automated systems can be supplied. Price of 1680-A: \$4975 in U.S.A.

For complete information, write General Radio Company, 22 Baker Avenue, W. Concord, Mass. 01781; telephone: (617) 369-4400; TWX: 710 347-1051.

GENERAL RADIO

later apparently became masked by other failure mechanisms, probably due to excessive dissipation during aging of the transistors under power at high temperatures. To date the results of the study have not been released by NASA and no further action has been taken on the program.

Commercial manufacturers were much more receptive to our philosophy because they found from actual experience that it could save them money. A major manufacturer of automobile radios reduced his in-plant and field failures from approximately 3% to far less than 0.1% by noise testing all transistors before assembly into the radios. A manufacturer of electronic organs, after having to recall a large percentage of his production due to transistor failure, instituted 100% noise screening of transistors before assembly, resulting in an equally impressive reduction in failures.

John M. van Beuren
President,
Quan-Tech Laboratories Inc.
Whippany, N.J.

Questioning low-cost voltmeter

To the Editor:

The article "Digital meters for under \$100" [Nov. 28, p. 88] can lead users to believe that instrument manufacturers are pricing their equipment exorbitantly high and that they are not offering good dollar value.

The author is not being realistic in believing that the described voltmeter could be built to sell for less than \$100. At today's prices, the cost alone for the decade counters and readout is in excess of \$170. Based on best possible forecasts, this price can be expected to

remain for some time in excess of \$80. In addition, such items as power supplies, printed-circuit boards, package, switches, check-out, and wiring labor would realistically price the design as shown into a range of \$600 to \$800.

I have no quarrel with Schmid over circuit design or details, and I agree that multifunction ic's will bring prices down; however, believing that a greater-than-ten-to-one price reduction will be achievable in the near future is misleading and—at this point in time—wishful thinking.

James Nelson
Digital Voltmeter Project Manager
Dana Laboratories Inc.
Irvine, Calif.

▪ The article quite clearly stated that a \$100 price depended on mass production and certain improvements and modifications of the prototype. Its purpose was to show the kind of savings that are possible with integrated electronics, not that voltmeter prices were out of line. Industry rumors hint that a \$200 voltmeter with ic's will be introduced at the IEEE show in New York in March.

Enter the millishift

To the Editor:

The milliday [Nov. 14, 1966, p. 43] is an interesting concept. But why not a millishift? Assume an 8-hour shift plus 10 minutes grace for getting from parking lot, plus 10 more for return.

Thus a millishift is .00833 1/3 hours. And conveniently it is half a minute.

Otis N. Minot
Lexington Research
Lexington, Mass.

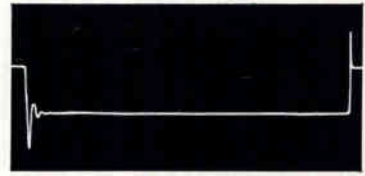

What is this?

This display is the output of a typical regulated power supply when pulse loaded with the new PM Test Set. This waveform gives you a precise measurement of transient response and DC output impedance... plus a direct indication of proper regulation and loop stability.

What is this?



The new Pacific Measurements Model 1003 Power Supply Test Set that contains an electronic load capable of pulse loading a power supply up to 20A and 70V. The PM 1003 operates in both the pulse and DC mode. Regulated load current is continuously adjustable and is monitored by a front panel meter. A guarded input differential amplifier allows measurement of microvolt ripple with an ordinary oscilloscope.

If you make, use, or sell regulated power supplies, you need this new PM Test Set.

Let us prove it — write or call

PM PACIFIC
MEASUREMENTS
INCORPORATED

940 INDUSTRIAL AVENUE,
PALO ALTO, CALIFORNIA
(415) 328-0300

SUBSCRIPTION SERVICE

Please include an Electronics Magazine address label to insure prompt service whenever you write us about your subscription.

Mail to: Fulfillment Manager
Electronics
P.O. Box 430
Hightstown, N.J. 08520

To subscribe mail this form with your payment and check new subscription renew my present subscription

Subscription rates: in the U.S.: 1 year \$8; two years, \$12; three years, \$16. Subscription rates for foreign countries available on request

CHANGE OF ADDRESS

ATTACH
LABEL
HERE

If you are moving, please let us know five weeks before changing your address. Place magazine address label here, print your new address below.

name

address

city

state

zip code



What's new in computer- grade capacitors?

New ripple ratings—
about 4 times higher
per unit case size.

New capacity ratings—
up to 280,000 mfd at 3 volts;
twice as much rating per case size.

New lower equivalent series resistance;
more efficient filtering.

Get all the news from Mallory.
Write for Bulletin 4-80.

Mallory Capacitor Company,
a division of P. R. Mallory & Co. Inc.,
Indianapolis, Indiana 46206

MALLORY

People

In his three years at NASA, **James C. Elms** has been far from the basic research laboratories; he guided operational manned flight programs. Now he's been appointed to direct NASA's Electronics Research Center in Cambridge, Mass., and he will use this experience to guide the development of much of the equipment that's used for space flight.



James C. Elms

The 50-year-old physicist succeeds Winston Kock, who recently returned to the Bendix Corp. as director of research.

Prior to his appointment as overseer of the agency's diversified and expanding research program, Elms served in Washington as NASA's deputy associate administrator for manned space flight, and earlier in Houston as deputy director of the Manned Spacecraft Center.

Tour of labs. When Elms was appointed to the Cambridge post, he arranged to visit other Government laboratories to catch up with research programs, particularly in bionics—a favorite of his—and in related areas such as real-time monitoring of medical data and the contributions of aerospace medicine to general medicine.

Elms thinks the product fallout from the space program is overstressed. He is more enthusiastic about the over-all impetus the space program has given the nation's industrial progress.

Along with his boss, NASA administrator James E. Webb, Elms looks upon the Cambridge center as an experiment in coordinating the efforts of universities, industry and Government. New procedures must constantly be worked out there to handle the flow of information from these three sources.

Differing views. Elms sees the center as experimental in another sense. "We will do research and development on the facility itself, as well as on devices and systems. It's hard to build a flexible facility and keep it flexible, but we'll try," he reports.

Adlake Mercury Wetted Relay — Application Data

Capacitance of Adlake Mercury Wetted Contact Relays Applicable for Low Signal Applications

Typical Capacitance in Picofarads — Graphs illustrate typical capacitance values for Adlake AWCA-16000 series relays. Fig. 1 is for unshielded relays. Fig. 2: Electro-statically shielded switch brought out to a separate pin. Fig. 3: Electro-statically shielded switch with case and shield tied together at a common pin. Interelectrode capacitance across contacts of a bare switch, without external wires, is less than 1.0 picofarad.

Abbreviation COMM. stands for the Combination of the Armature and Normally Closed Contact. N.O. is the abbreviation for Normally Open Contact; whereas the symbol # is the mean average for the 5 relays. Graphs are available on other styles of Adlake Mercury Wetted Contact Relays upon request. (Please state wiring configuration.)



AWCA 16011-S
Fig. 1

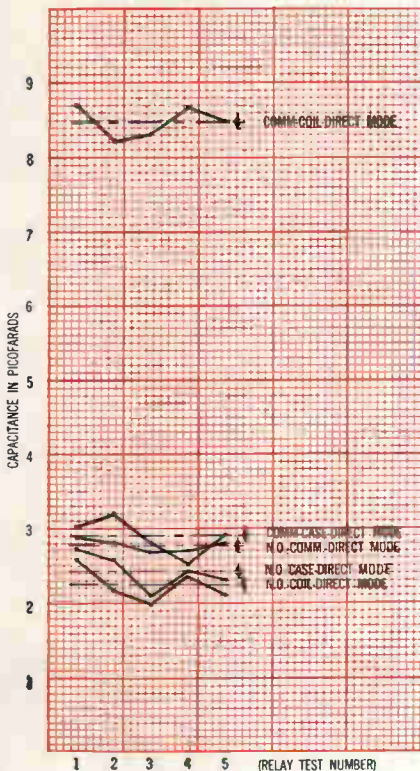

AWCA 16016
Fig. 2

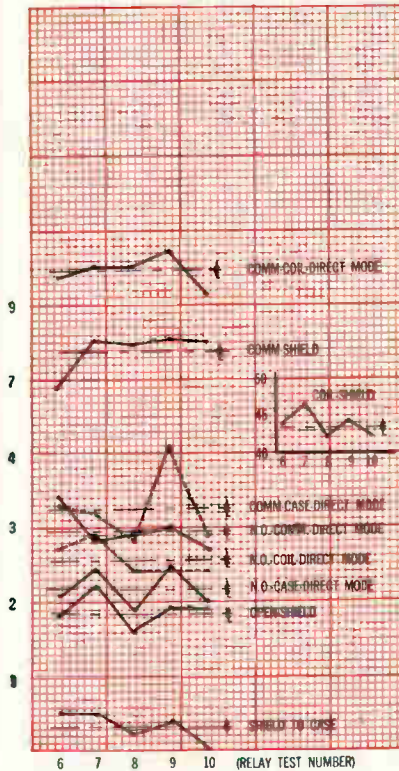

AWCA 16018
Fig. 3

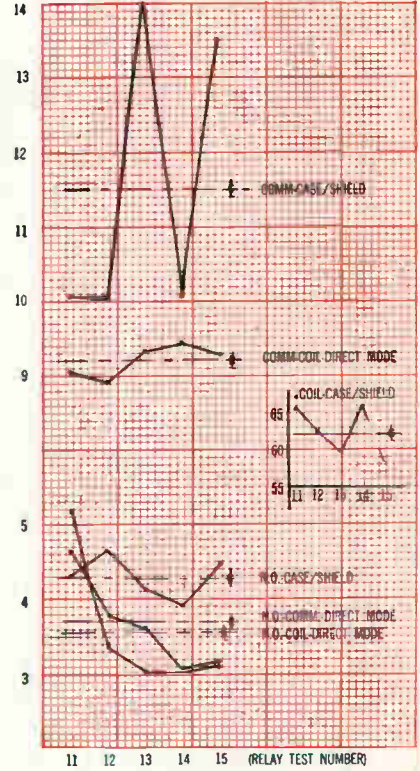

Data was obtained using a Boonton Electronics Corporation Capacitance Bridge, Model 75-A-S8 at 1MHz.

Backed by sound research and disciplined engineering, Adlake applies the industry's broadest line of mercury displacement and mercury wetted relays to the creative solution of design circuit problems. However unique or special your application, Adlake can assist you in

developing it. For prompt, personal and knowledgeable attention to your relay needs, contact the one source that is the complete source in the mercury relay field. Contact Adlake today for catalog and further information.



THE ADAMS & WESTLAKE COMPANY

Dept. 2017, Elkhart, Indiana, U.S.A. 46514 • (AC 219) 264-1141

TRANSPORTATION EQUIPMENT • ARCHITECTURAL PRODUCTS • MERCURY RELAYS • DOORS AND ENTRANCES • CONTRACT MANUFACTURING

All from Sprague!

ENERGY-STORAGE CAPACITORS for every type of discharge application

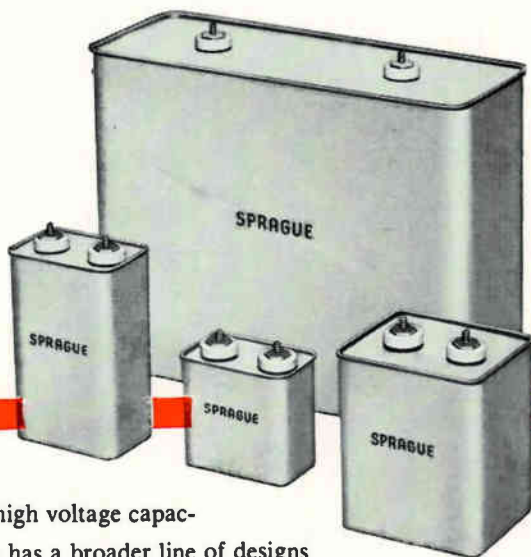

A pioneer in high voltage capacitors, Sprague has a broader line of designs for energy-storage applications than any other capacitor manufacturer. If your project involves lasers, masers, electronic photoflash, time-control circuits, exploding wire, thermonuclear fusion research, magnetization of permanent magnets, medical equipment, or similar discharge applications, Sprague can provide a capacitor to meet your specific needs.

Light, Moderate, or Heavy Duty Capacitors

Available types range from small, light-weight units for aerospace applications such as satellites, missiles, etc., to heavy-duty capacitors for high-current/high-frequency oscillatory discharges.

Broad Range of Electrical Ratings

Voltages from 2 kilovolts to 24 kilovolts. Energy ratings up to 6700 joules. Self-inductance as low as .0025 microhenry.



Energy-Storage Electrolytic Capacitors

A selected line of cylindrical types for industrial applications requiring maximum capacitance in minimum space.

Paper, Metallized Paper, and Paper/Film Designs

Metallized capacitors intended for light-weight, space-saving applications . . . one-half the size, one-third the weight of conventional capacitors. Other available designs include castor oil impregnation for extremely long life (assuring a high number of discharges), and non-flammable synthetic askarel impregnation for applications where non-combustibility is a prerequisite.

For complete information or application engineering assistance on Sprague Energy-Storage Capacitors, write to Field Engineering Department, Sprague Electric Company, 35 Marshall St., North Adams, Mass. 01248.

SPRAGUE COMPONENTS

CAPACITORS
TRANSISTORS
RESISTORS
THIN-FILM MICROCIRCUITS
INTEGRATED CIRCUITS
INTERFERENCE FILTERS

PACKAGED COMPONENT ASSEMBLIES
FUNCTIONAL DIGITAL CIRCUITS
MAGNETIC COMPONENTS
PULSE TRANSFORMERS
CERAMIC-BASE PRINTED NETWORKS
PULSE-FORMING NETWORKS



"Sprague" and "®" are registered trademarks of the Sprague Electric Co.

People

The American Telephone & Telegraph Co. has named a 60-year-old electrical engineer to its top job—chairman and chief executive officer. **H.I. Romnes** will succeed Frederick Kappel on Feb. 1.



H.I. Romnes

In his 40-year-career with AT&T, Romnes was active in management and research operations. In 1927 he joined Bell Telephone Laboratories, AT&T's research arm, to work on circuit design. Eight years later he transferred to the parent company and advanced through a number of engineering management jobs. In 1950 he became director of operations of the long lines department and two years later was named chief engineer of the company. Four years later he was elected president of the Western Electric Co., the manufacturing subsidiary. He returned to AT&T as vice-chairman in 1964 and a year later was elected president.

Romnes was the driving force behind AT&T's decision to install a direct dialing network. He is also credited with strengthening the ties between Western Electric and Bell Labs.

Ralph S. Holmes has been named division vice president of a new medical electronics group at the Radio Corp. of America. His appointment, in effect, implements RCA's recent agreement with Hoffmann-La Roche Inc., a pharmaceutical company. Under the agreement, RCA will manufacture and service electronic gear developed by the two companies and Hoffmann-La Roche will do the clinical testing and marketing.



Ralph S. Holmes

Holmes has directed several special projects for RCA in a career that spans more than 40 years.



**Now from MACHLETT:
22 high-precision, low torque,
vacuum variable capacitors
for heavy duty**



Each of these 22 ceramic vacuum variable capacitors from Machlett offer the following advantages:

- High rf current capability
- Stable operation at high temperature
- Structural rigidity
- Low capacitance variation with temperature change
- Wide capacitance range
- High Q factor (1000 or greater)
- Low operating torque
- High resistance to damage from over-voltage.

Capacitance values from 5-750 pF to 50-2300 pF; voltage rating to 15 kv; current rating to 75A. Custom design consultation for special applications is available from Machlett.

For full details on this new line, write to
The Machlett Laboratories, Inc.,
Springdale (Stamford) Conn. 06879

RAYTHEON

THE MACHLETT LABORATORIES, INC.

A SUBSIDIARY OF RAYTHEON COMPANY

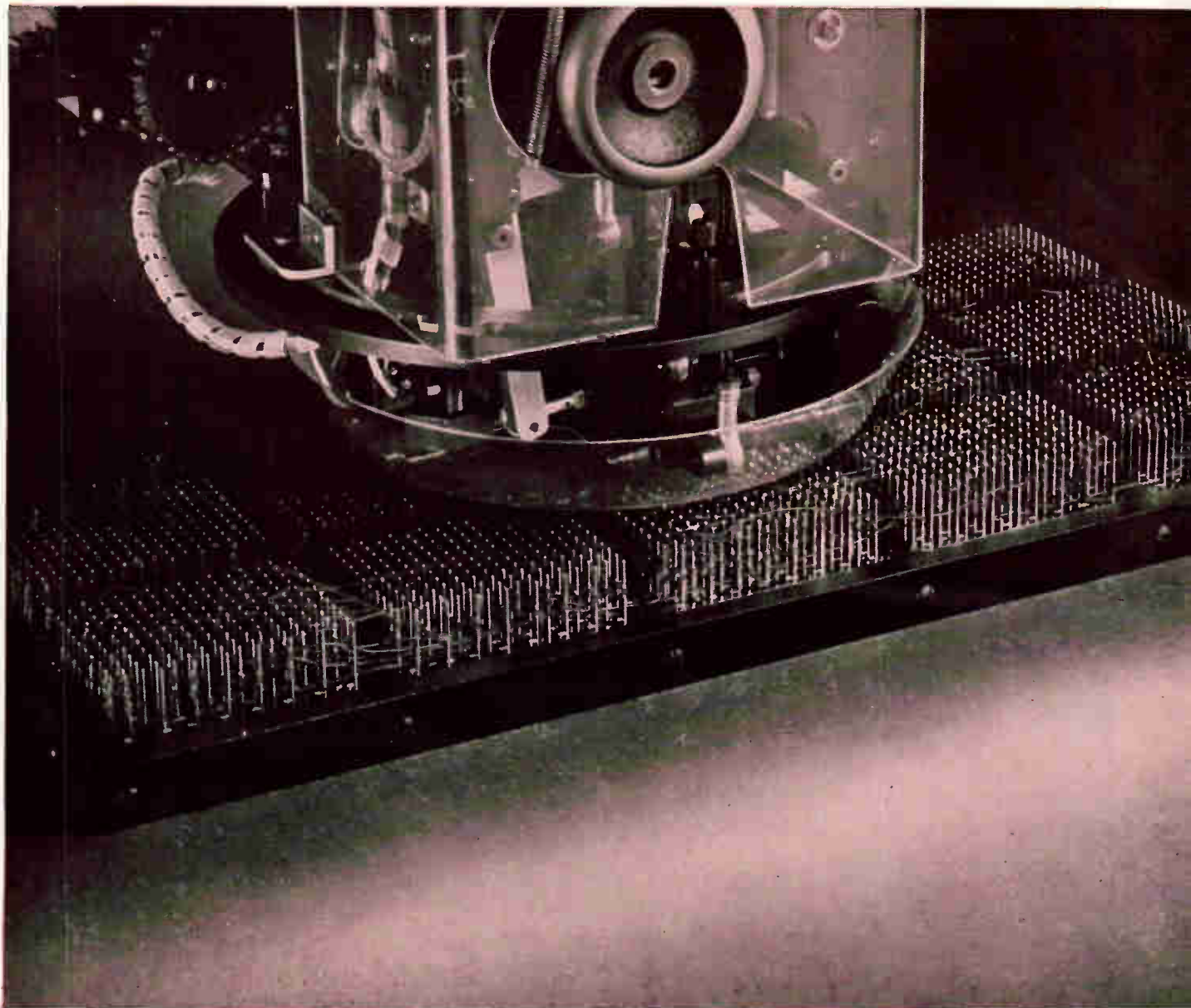

Everything you could ask for in production wiring... **TERMI-POINT*** wiring devices

For dense point-to-point wiring applications TERMI-POINT tooling and products offer you an automatic, solderless, wrapless, weldless technique for wiring computer panels as well as industrial control and communications equipment.

This technique consists of a fine grain phosphor bronze clip which secures the wire firmly to a post, utilizing the spring "memory" of the metal clip. Wires can be bulk or pre-cut, solid or stranded—even enameled or tinsel! Best of all, the gas-tight, reliable connections may be serviced without electrically disturbing other connections on the same post using only lightweight hand tools! And the entire wire lead need not be replaced, just the clip, saving half the servicing time.

For automated production, you merely program the TERMI-POINT automatic wiring machine to suit your requirements. This remarkable machine routes wires in the pre-set programmed pattern and cuts, strips, and terminates both ends of the lead in seconds. Programs are punched on economical 8-column paper tape. In addition, several types of manual TERMI-POINT tools are available for servicing, testing or limited production. A variety of TERMI-POINT clips and post sizes are offered, including .022" x .036" posts which provide grid densities of .100". In fact, TERMI-POINT products are under development which would reduce this grid size even more.

The complete line of TERMI-POINT products includes printed circuit connectors, transition

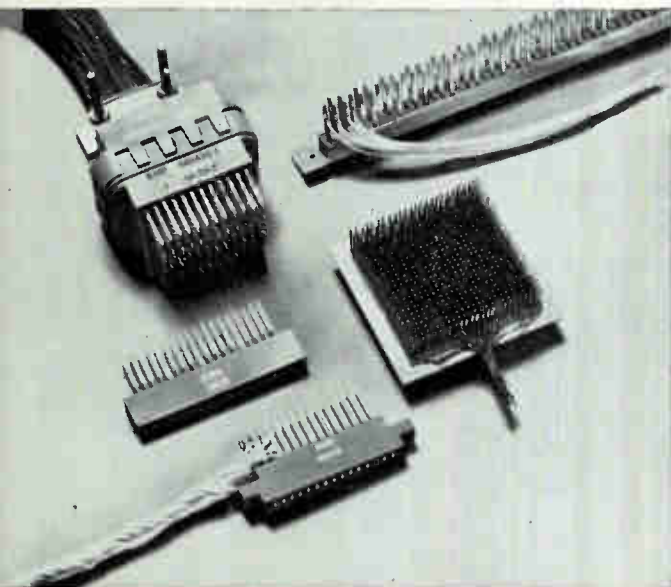
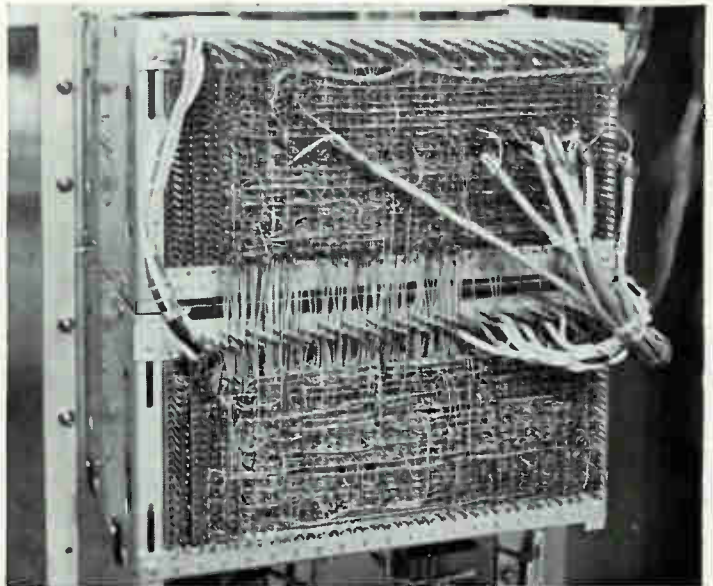
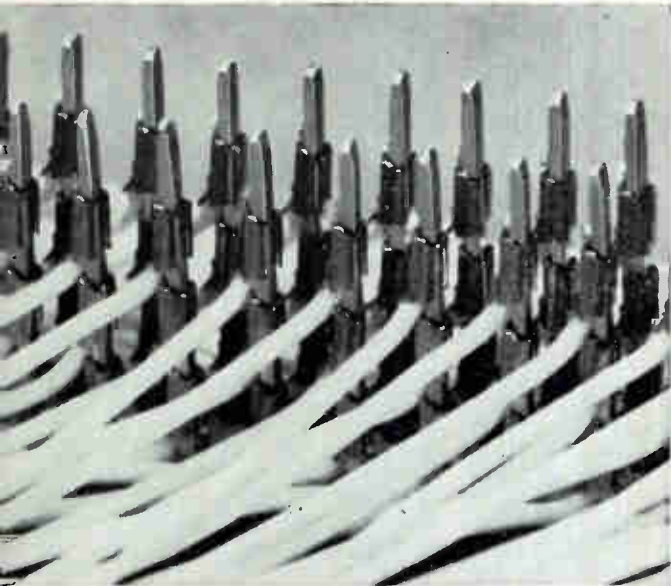

blocks, bus bars, cable connectors, junction blocks, relay blocks, and other devices. Furthermore, large-scale wiring of these products may be accomplished by mounting them on a panel and programming the TERMINI-POINT machine for high-speed automatic wiring.

Besides the speed, density, and versatility of this wiring method, it offers an unusual degree of reliability. The reason for this is AMP's special post presents relatively large contact surfaces which are wiped clean by the wire held by the TERMINI-POINT clip as the post is terminated. The resulting connection is highly resistant to the effects of corrosion, vibration, and temperature extremes. It is held with a high retention force which exceeds the yield strength of the wire itself, yet the post plating remains undamaged and the wire may be used again.

No other wiring method offers this combination of advantages!

With TERMINI-POINT clips and tools, your wiring facilities will never become outdated, because unlike other automated methods, there is no

inherent limitation in density with TERMINI-POINT wiring devices. In addition, AMP accepts total responsibility for the performance of the TERMINI-POINT products, the technique and your completed terminations. You can save considerable time and capital investment by allowing us to wire your panels or circuit boards to your specifications.

If you plan to enlarge or improve your present wiring facilities, we suggest a comparative study of this new technique at your earliest convenience. Write or call today for a demonstration; or ask for information about the TERMINI-POINT products which interest you most. Find out how this versatile new method can boost your future production!

*Trademark of AMP INCORPORATED

AMP
INCORPORATED
 Harrisburg, Pennsylvania

A-MP* products and engineering assistance are available through subsidiary companies in: Australia • Canada • England • France • Holland • Italy • Japan • Mexico • Spain • West Germany

This mixer



goes up to
500 MHz

But the price
goes below
\$180

New production techniques (you'll detect some in the outer case, for example) now make possible a lower-priced, high-performance mixer from HP.

You can use the 10514A Double Balanced Mixer for extracting the sum or difference of two frequencies, or as a modulator, spectrum generator, phase detector, current-controlled attenuator, frequency doubler, or for extending the range of spectrum analyzers.

Features include: range of 200 kHz to 500 MHz (to dc on one port), excellent balance, flat response, low noise (7 dB max. noise figure to 50 MHz; 9 dB max. to 500 MHz) and low intermodulation. And the price is low, too: \$180 each, *and even lower in quantity*. Printed circuit board version (10514B) also available.

For additional information contact your local HP field engineer, or write Hewlett-Packard, Palo Alto, California 94304. Tel. (415) 326-7000; Europe: 54 Route des Acacias, Geneva.

HEWLETT  **PACKARD**

An extra measure of quality

2249

Meetings

Symposium on Reliability, American Society for Quality Control, IEEE; Sheraton-Park Hotel, Washington, Jan. 10-12.

Computer-Aided Circuit Design Conference, Engineering Institutes; University of Wisconsin, Madison, Wis., Jan. 16-18.

Computer Aid For Reliability Analysis of Electronics Conference, Engineering Institutes; University of Wisconsin, Madison, Wis., Jan. 19-20.

Symposium on Computers and Communications, IEEE; Miramar Hotel, Santa Monica, Calif., Jan. 19.

American Society for Quality Control Meeting, American Society for Quality Control; California State Polytechnic College, Kellogg Campus, Pomona, Calif., Jan. 21.

Midwest Welding Conference, Illinois Institute of Technology Research Institute; Illinois Institute of Technology, Chicago, Jan. 24-25.

Ultrasonic Manufacturers Association Technical Symposium and Meeting, Ultrasonic Manufacturers Association; New York, Jan. 25.

Conference on Color Television Broadcasting, Society of Motion Picture and Television Engineers; Park Shelton Hotel, Detroit, Jan. 27-28.

Power Meeting, IEEE; Statler Hilton Hotel, New York, Jan. 29-Feb. 3.

Symposium on Nondestructive Testing of Welds, Illinois Institute of Technology Research Institute; Illinois Institute of Technology, Chicago, Jan. 30-Feb. 2.

American Society for Testing and Materials Meeting, American Society for Testing and Materials; Statler Hilton Hotel, Detroit, Mich., Feb. 5-10.

Winter Convention on Aerospace & Electronic Systems, IEEE; International Hotel, Los Angeles, Feb. 7-9.

Electronic Packaging Conference, Society of Automotive Engineers; Roosevelt Hotel, New York, Feb. 14-16.

International Solid State Circuits Conference, IEEE; University of Pennsylvania, Sheraton Hotel, Philadelphia, Feb. 15-17.

Airborne Photo-Optical Instrumentation Seminar, Society of Photo-Optical Instrumentation Engineers; Ramada Inn, Cocoa Beach, Fla., Feb. 20-21.

National Air Meeting on Collision Avoidance, Institute of Navigation; Dayton, Ohio, Feb. 23-24.

Numerical Control Society Conference, Statler Hilton Hotel, Detroit, March 1-3.*

Particle Accelerator Conference—Accelerator Engineering and Technology, IEEE; Shoreham Hotel, Washington, March 1-3.

International Symposium on Residual Gases in Electron Tubes and Sorption-Desorption Phenomena in High Vacuum, Italian Society of Physics; Rome, March 14-17.

International Convention, IEEE; New York Hilton Hotel and Coliseum, March 20-24.

Symposium on Modern Optics, Polytechnic Institute of Brooklyn; Waldorf-Astoria Hotel, New York, March 22-24.

Photovoltaic Specialists Conference, IEEE; Sheraton Cape Colony Inn, Cocoa Beach, Fla., March 28-30.

Call for papers

Biomedical Sciences Instrumentation Symposium, Instrument Society of America; Albuquerque, N.M.; May 15-17. **Jan. 15** is deadline for submission of abstracts to Robert Allison, director, Vascular Laboratories, Scott and White Clinic, Temple, Texas 76501.

Symposium on Microwave Power, International Microwave Power Institute; Stanford University, Stanford, Calif., March 29-31. **Jan. 16** is deadline for submission of abstracts to Donald Dunn, chairman, 1967 Symposium on Microwave Power, International Microwave Power Institute, P.O. Box 2335, Stanford, Calif.

Conference on Nuclear and Space Radiation Effects, IEEE; Ohio State University, Columbus, Ohio, July 10-14. **March 1** is deadline for submission of abstracts to John Wirth, Organization 5212, Sandia Corp., Sandia Base, Albuquerque, N.M.

* Meeting preview on page 16

THE Connector Thing

A periodical periodical designed, quite frankly, to further the sales of Microdot connectors and cables. Published entirely in the interest of profit.

MICRODOT WELCOMES AMPHENOL

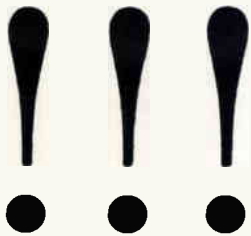

For over two years now, Microdot has had the subminiature, high density multi-pin connector market to itself. The sensational Microdot MARC 53 has been used on all the Gemini "Walks in Space" plus a multitude of military and NASA programs. Now, however, we've got competition...the brand new Amphenol Astro 348. Good to have you aboard.



IN HONOR OF THIS GREAT EVENT, MICRODOT IS HOLDING THREE (count 'em, three)



To be able to enter these contests, you've got to know a little something about the Microdot MARC 53. It's one of the real stars in the Microdot connector line...a high

density (anywhere from 7 to 91 contacts in four shell sizes), subminiature, high-performance connector. The MARC 53 can save as much as 61% in weight and 54% in panel space. *Posilock*, a push-pull lock coupling, mates easily with high density inserts with no danger of damage.

The dual locking action eliminates accidental disconnect, *Posiseal*, a multiple, environmental sealing system, guarantees an interfacial seal.

MARC 53 is approved to MIL C-38300A (USAF).

...AND ABOUT AMPHENOL.

We wish we could also tell you all about the high density (two insert arrangements of 55 and 85 contacts in two shell sizes), subminiature, high performance, bayonet lock, bonded insulator Astro 348's but we're afraid that the Microdot officers, directors, stockholders, sales engineers and maintenance crew would hang us up by the thumbs. To find out more, write Amphenol.



CONTEST #1

Open only to employees of Amphenol, their families, friends, reps, distributors and advertising agencies.



WIN A REVELL SCALE MODEL KIT OF THE GEMINI SPACE CAPSULE

In twenty-five words or more, tell us why the Astro 348 is the best subminiature multipin on the market. Neatness does not count. TEN WINNERS...the prize is calculated to tantalize you because the Microdot MARC 53 is used on the Gemini program. So there.

CONTEST #2

Open only to employees, representatives and distributors of Microdot, their families, friends and advertising agencies.



WIN A REVELL SCALE MODEL KIT OF THE U.S.S. MIDWAY. In twenty-five words or more, tell us why the MARC 53 is the best subminiature multipin on the market. Neatness counts. Ten Winners.

CONTEST #3

Open to everybody except employees of Amphenol, Microdot, their families, friends and advertising agencies.

WIN A MODEL! SHE'S YOURS...

in perfect 1/8 scale, 8 x 10 glossy, perfect for your office wall, workshop or pool hall...inscribed "With Love and You Know What to

(your name here) from Marcia".

All you have to do is write, in twenty five words or more a description of your application for the MARC 53. You notice how fast we forget the competition when we get down to business. Remember...everybody who enters Contest #3 wins!



MICRODOT INC.

Microdot, Inc., 220 Pasadena Ave., So. Pasadena, Calif. 91030

- I want to enter Contest #1. My 25 words or more are attached. I am an employee of Amphenol.
- I want to enter Contest #2. Anybody who uses company postage for this one, gets docked.
- I want to enter Contest #3. My 25 words or more are attached. How does one go about getting Marcia in a slightly larger scale, say 1/1?
- I don't want to enter any contest. Just send specs on the MARC 53.

Name _____

Title _____

Company _____

Address _____

City _____

State _____ Zip _____

MARC 53, Posilock and Posiseal are trademarks of Microdot Inc. Astro 348 is not.

These contests are not valid in any locale where the local gendarmes take umbrage.

INSTANT X-RAYS

Locate, define, modify ... speed design, development with clear, sharp radiograph prints in 10 sec.

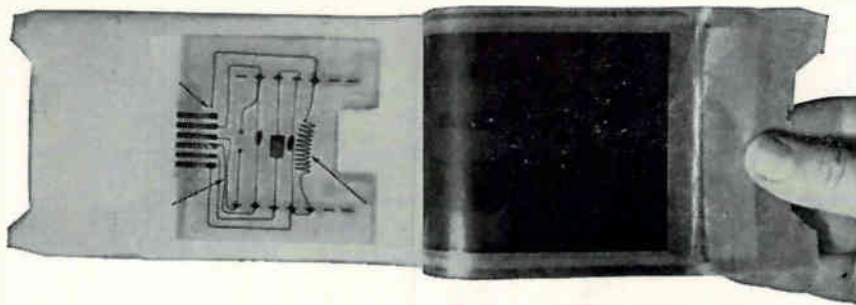

FAXITRON 804

Meet the Faxitron 804, the new personal-use research-design tool that brings advanced X-ray capability directly to your workbench, lab or production area.

Now you can look inside—quickly locate, define, solve hidden problems within metal enclosures, potted circuits, deep in solids, etc. Example: the radiograph* of an epoxy casting shown above. Note the shorted wire, an open circuit, a component (coil) that moved during casting.

With quick-processing Polaroid® Land film, the Faxitron 804 delivers clear, sharp radiographic prints on-the-spot in minutes or even seconds. No dark room. No X-ray room. No X-ray technician. Take them yourself when and where you want them — at your workbench where your problems are.

You can also use standard wet films and cassettes for conventional processing up to 14" x 17" in size. At the standard FTSD, the X-ray beam covers a circle 15" in diameter. With optional accessory extension collar, this can be increased to provide beam coverage for the full 14" x 17" area and meet MIL specifications, if desired.

Adjustable voltage from 10 to 110 kVP assures excellent contrast over a wide range of object thicknesses and densities. Thickness changes of 1 or 2% can often be observed. A small X-ray source size minimizes penumbra, enhances resolution. Operation is as routinely safe and simple as a blueprint machine.

For detailed information, send for 12-page descriptive catalog. For immediate answers to your specific application needs, call us collect—Area Code 503, 472-5101.



VOLTAGE—10 to 110 kVP, adjustable
CURRENT—3 mA, continuous
SOURCE SIZE—0.5mm
FTSD—25.5" standard. (Extension collar optional at additional cost.)
RADIOGRAPHIC COMPARTMENT—14½"H x 18¼"W x 14"D.
POWER—110-120 Volts ac, 60 Hz, 400 watts

\$1,970.00

f.o.b. McMinnville, Oregon

*EXPOSURE DATA: 60 kVP, 2.6 mA
3 min, FTSD—25.5"

**Polaroid® by Polaroid Corp.

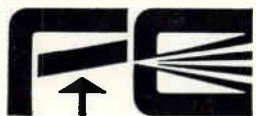

Field Emission Corporation

McMinnville, Oregon 97128

Pioneers in Pulsed Radiation Sources for Science and Industry

Meeting preview

NC by computer

Techniques for applying the computer to numerical control will highlight the Numerical Control Society's technical conference, which will be held in Detroit, March 1 to 3.

Bertram Herzog, a professor at the University of Michigan, will discuss computer-aided design, particularly the relationship of computer graphics to numerical control. Jay Bender of the General Electric Co. will analyze time sharing for programing and engineering and will give a demonstration of the technique. Other speakers will discuss the languages, such as APT and ADAPT, used to make computer commands understandable to machinery that is operated by numerical controls.

Big and small. Generally, initial equipment costs limit the use of numerical control to large companies. However, Charles Hutchins, executive vice president of the Pontiac Paint & Varnish Co., will present a case study of computer-aided programing for a small firm, and a second session will feature a case history of applications of numerical control machinery in a small shop.

On the second day of the conference, metalworking experts will examine the state of the numerical control art in Europe. Harold Burton, editor of the British magazine *Metalworking Production*, a McGraw-Hill publication, will handle the subject from the British viewpoint, while Ted Swanson of International General Electric, Frankfurt, West Germany, will discuss the same topic from the United States numerical control builder's viewpoint.

Inspection year. Another session will study inspection equipment needed for numerical control, and a panel will tackle the subject of training methods—what is being done at present and what is still required.

The final day will include a session on how to retrofit machinery for numerical control and how to adapt electronic equipment to NC applications.



The complete laser contains an encased lasertron tube and a laboratory grade DC supply, line operated. \$295

The lasertron™ tube never requires adjustment or maintenance of any kind. It is virtually a complete instrument in itself and is available as a separate unit.

It incorporates aligned internal reflectors and includes a built-in collimating lens for minimum beam divergence. The coaxial reservoir and cold cathodes insure long life — warranty: one year or 1000 hours. \$195



NEW LASERS FROM UNIVERSITY LABORATORIES INC. from \$195

The lasertron™ group: an entirely new line of continuous helium-neon gas lasers with these key achievements:

(1) The basic lasertron tube (patents pending) is a factory sealed unit which requires absolutely no alignment, adjustment, maintenance or special procedures to obtain full laser output. It is as easy to use as an ordinary light bulb. And, by virtue of its sealed construction and integral optics, it is ready for immediate operation in almost any environment—even under water!

The output wavelength is 6328Å (visible deep red); the tube automatically operates in the uniphase TEM₀₀ mode and produces collimated, unpolarized output power of over .3 milliwatts. The tube has no filaments to burn out and has no shelf life limitations.

The lasertron tube is available as a separate item (ready to operate with your power supply) or installed in a complete ULI laser system.

(2) The complete ULI laser head incorporates the lasertron tube in a rugged machined housing provided with sturdy legs for table mounting. An accessory optical bench mounting rod is available as well as a very convenient tripod which telescopes for either floor or tabletop use.

The line operated supply provides the lasertron tube with regulated, filtered DC. There are no adjustments required for this supply, just the ON-OFF switch. The laser head and this supply are ideal for most research, educational or industrial gas laser applications. The lasertron tube is warranted for one year or for 1000 hours of continuous operation when used with a ULI supply.

Lasertron Tube™ (ULI 220) \$195
 Complete Laser with Line Operated Supply (ULI 230) \$295
 Tripod \$ 16



1740 University Avenue,
 Berkeley, California 94703
 Phone: (415) 848-0491

- Please send technical data on the ULI lasers.
- Please reserve () lasertron™ tube \$195
- () Complete laser system . . . \$295

from your current production. My official purchase order and shipping instructions will follow.

Name _____
 Organization _____
 Address _____
 City _____ State _____ Zip _____

Terms are 2% discount 10 days, net 30 days. ULI products returned for any reason, prepaid and undamaged within 30 days, will receive full credit.

DC voltage

this



New Bendix modules can shrink your costs down to size, too.

These miniaturized Bendix® modules are a series of complete DC voltage regulators in TO-3, high-dome, transistor packages. Think of the space you can save over the hand-wired circuits and card-type units you're using now. It's a great way to improve your design without compromise—and cut labor costs as well as component costs in the process.

Each module contains a complete silicon, solid state, comparator amplifier assembly that weighs in at only one half ounce. These 1-amp modules come as series regulators of 5, 6, 12, 18 and 24 volts or as shunt regulators of 5, 6, 9 and 12 volts. Load regulation from no load to full load is $\pm 1\%$ with a low temperature coefficient of $0.04\%/^{\circ}\text{C}$ typical. Maximum power

dissipation at 25°C case is 25 watts. And that's not all. The TO-3 configuration fits all standard sockets and heat sinks.

Call your local Bendix office or Bendix Semiconductor Distributor. Just ask for more details about the incredible shrinking regulator. Or write us direct: Bendix Semiconductor Division, Holmdel, N. J.

Baltimore (Towson), Md.—(301) 828-6877; Chicago—(312) 637-6929; Dallas—(214) 357-1972; Detroit—(313) 548-2120; Greenwich, Conn.—(203) 869-7797; Holmdel, N. J.—(201) 946-9400; Los Angeles—(213) 776-4100; Minneapolis—(612) 926-4633; Los Altos, Calif.—W. W. Posey Co., (415) 948-7771; Seattle—Ray Johnston Co., Inc. (206) LA 4-5170; Syracuse, N. Y.—(315) 474-7531; Waltham, Mass.—(617) 899-0770; Export—Cable: "Bendixint," 605 Third Avenue, New York, (212) 973-2121; Ottawa, Ont.—Computing Devices of Canada, P.O. Box 508—(613) TALbot 8-2711.

regulator.

or this?

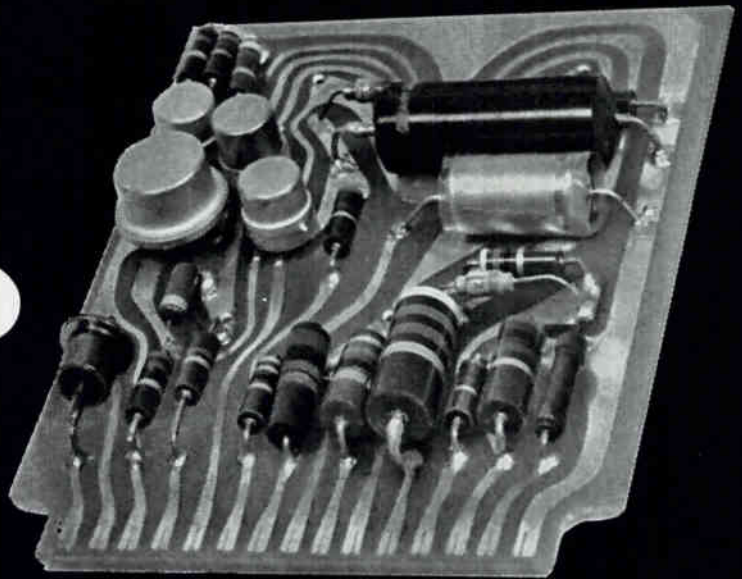

APPLICATION SCHEMATICS

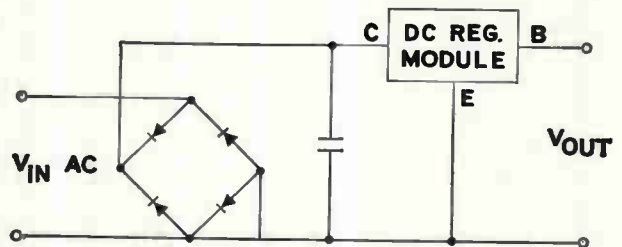
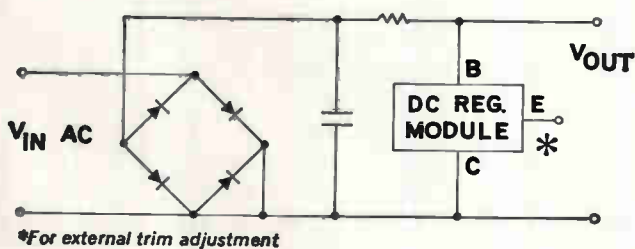

Bendix Semiconductor Division
HOLMDEL, NEW JERSEY



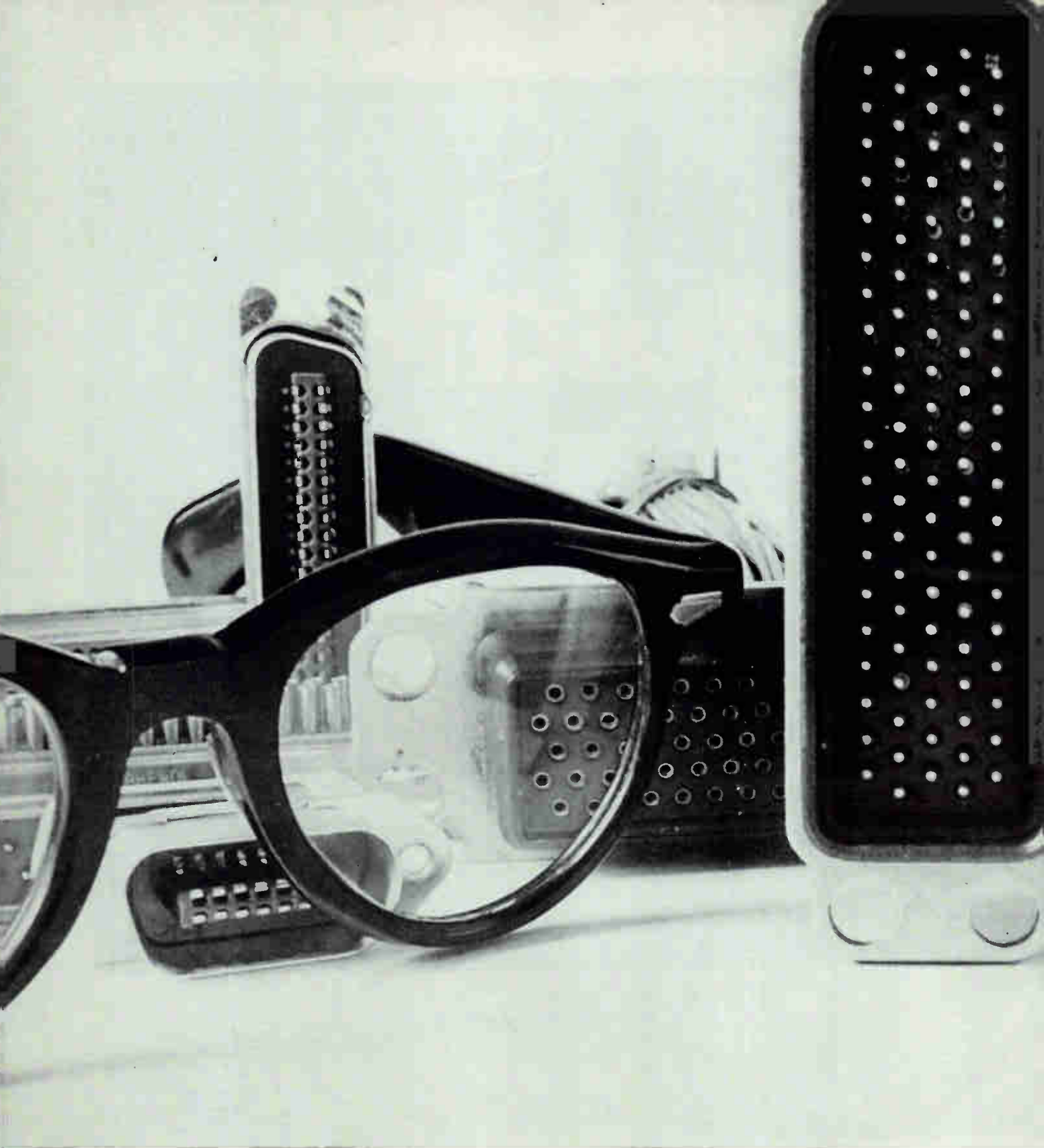

**What to look for
in a good miniature
rack and panel connector.**

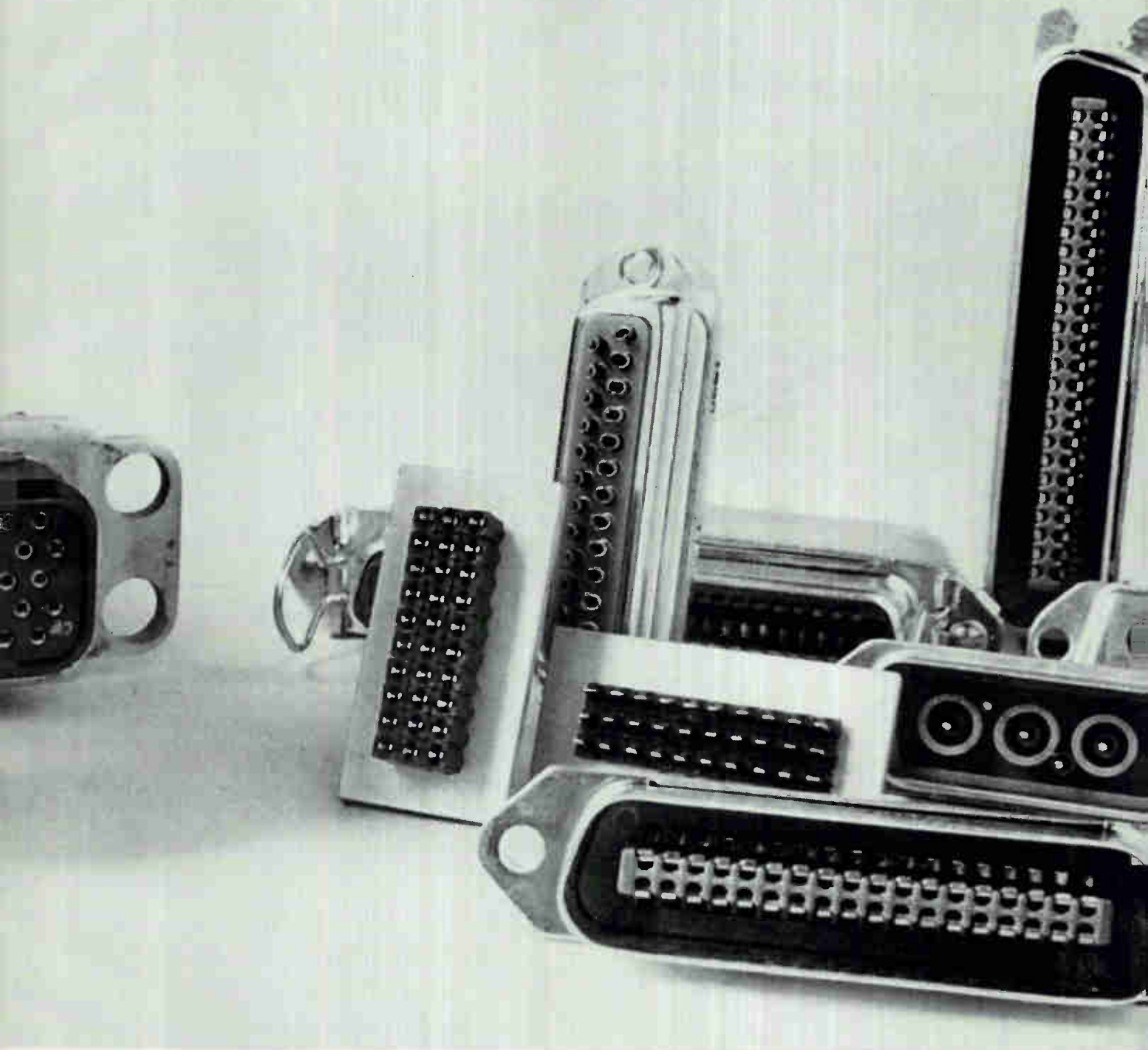

Miniaturization. Amphenol can give you rack and panel connectors with envelope dimensions of less than 2½" by ½". With positive locking devices, too.

More Contact Density. .100" contact centers to .050" in standard lines for 24-, 26- or 28-gauge wire—with

no loss of dielectric strength. Environmental or non-environmental.

Greater Shielding Use. To provide protection through the connector, Amphenol gives you shielded contacts in key product lines.

Wide Selection—Fast Delivery. Chances are most distributors have

what you need in stock. If not, call your Amphenol Sales Engineer or write **Amphenol Connector Division**, 1830 S. 54th Ave., Chicago, Ill. 60650.



AMPHENOL

TM

Specify Amphenol . . . the leading name in cable, connectors, assemblies, RF switches, potentiometers, motors, microelectronics
Circle 21 on reader service card

**When it comes
to color-TV
receiving tubes**

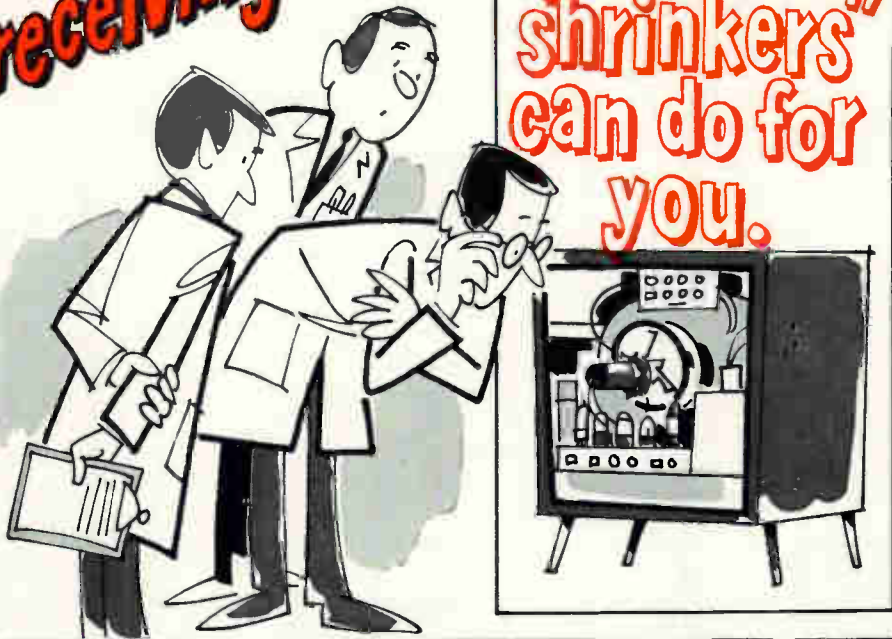

**... it's
amazing
what RCA's
"problem-
shrinkers"
can do for
you.**

Take THE CASE OF VERTICAL DEFLECTION. IT WAS A MAJOR PROBLEM—UNTIL THE PROBLEM-SHRINKERS AT RCA DESIGNED THE A40607C. THIS NEW DEVELOPMENTAL BEAM POWER TUBE HAS AN INTEGRAL DIODE, AND WITH ITS RECOMMENDED CIRCUITRY PROVIDES A MINIMUM OF INTERACTION BETWEEN THE HEIGHT AND LINEARITY CONTROLS IN THE VERTICAL DEFLECTION CIRCUIT.



More PROBLEM-SHRINKERS — THE APPLICATION-ASSISTANCE PEOPLE AT RCA — WENT ON TO DEVELOP AND PROVE NEW VERTICAL DEFLECTION CIRCUITS, MADE POSSIBLE BY THE A40607C, FOR BOTH LOW B+ AND HIGH B+ OPERATION.

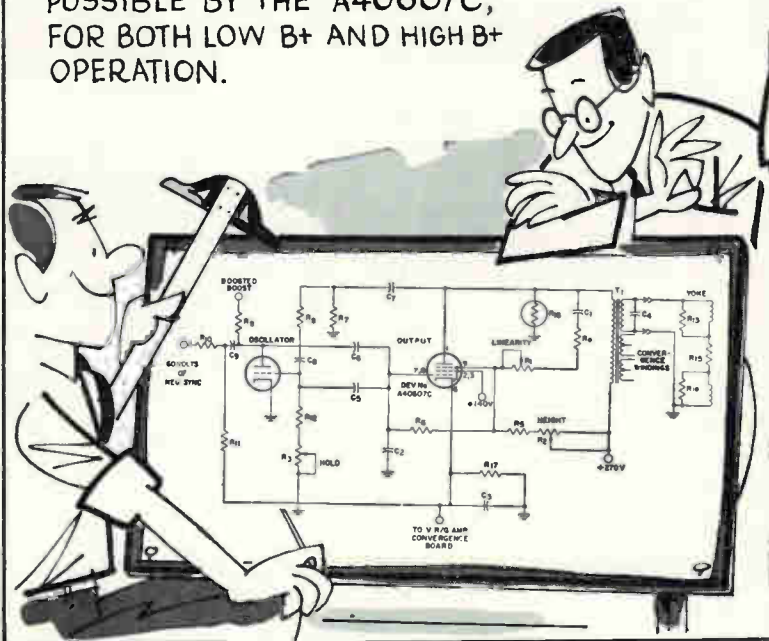

Shrink? THE PROBLEM VIRTUALLY EVAPORATED WITH THE A40607C IN A FEEDBACK-STABILIZED VERTICAL-OUTPUT CIRCUIT DEVELOPED BY RCA APPLICATION ENGINEERS. THIS CIRCUIT CAN DELIVER PERFORMANCE FEATURES NOT FOUND IN CONVENTIONAL CIRCUITS USING MORE COMPONENTS:

- EXCEPTIONALLY GOOD LINEARITY
- TRUE HEIGHT CONTROL (EQUAL EFFECT ON TOP AND BOTTOM OF PICTURE)
- GREATER INDEPENDENCE FROM VARIATIONS IN TUBE CHARACTERISTICS
- OUTPUT STAGE DEVELOPS ITS OWN BIAS
- NO LONG RC TIME DELAY DURING ADJUSTMENT OF HEIGHT AND LINEARITY

Take advantage of RCA's complete package—dependable products and painstaking service—when choosing your color-TV receiving tube components. Get in touch with your nearest RCA District Office or, for technical information on RCA Receiving Tubes, write to RCA Commercial Engineering, Harrison, N. J. 07029.

RCA DISTRICT OFFICES—OEM SALES. EAST, 2075 Millburn Ave., Maplewood, N. J. 07040, (201) 485-3900 • MID-ATLANTIC, 605 Morlan Pike, Haddonfield, N. J. 08034, (609) 428-4802 • MID-CENTRAL, 2511 East 46th St., Bldg. G2, Atkinson Square, Indianapolis, Ind. 46205, (317) 546-4001 • CENTRAL, 446 East Howard Ave., Des Plaines, Ill. 60018, (312) 827-0033 • WEST, 6363 Sunset Blvd., Hollywood, Cal 90028, (213) 461-9171 • INTERNATIONAL OPERATIONS, RCA International Division, Central and Terminal Aves., Clark, N. J. 07066, (201) 485-3900 • 118 Rue du Rhone, Geneva, Switzerland, 35 75 00.



The Most Trusted Name in Electronics

Circle 22 on reader service card

Editorial

Discovering technology

Technology, the oft-ignored stepchild of science, is coming into its own at last.

The nonengineering world has finally discovered it. Government leaders lament its lack, industrial management worries about understanding and using it, the financial community is anxious to make a profit from it. Technology is the hula hoop of 1967.

You can see this development in the profusion of meetings about technology and the proliferation of programs to spread it. In November, for example, at the dedication of the National Bureau of Standards' new facilities outside Washington, the Department of Commerce sponsored a two-day symposium on technology. While some technical men attended, the NBS's resplendent red auditorium was filled mainly with diplomats, Government observers and industrial executives.

Two weeks later, the management-oriented National Industrial Conference Board held a day-long meeting of top management men in New York City to examine what technology can do for the nation's industrial concerns. Earlier in the autumn, British Prime Minister Wilson proposed that Europe share its technology, and the president of Italy has proposed a Marshall Plan-type program to help expand technology in Europe.

None of Electronics magazine's readers, of course, are surprised to learn there is a technology. But ever since the first atom bomb was exploded in 1945, there's been a lot of talk about science and not much about technology. During descriptions of space shots on television, the "science" reporters for the networks wax rapturous about the scientific accomplishments that made it all possible. Yet there's very little science involved; it's almost entirely engineering. The weekly news magazines' science departments rarely write about science; nearly every week they write about technology and engineering and call it science.

In a recent Defense Department Report*, the myth of the importance of science in the economy has been laid to rest once and for all. A study of the development of a number of weapon systems estimates the scientific contribution at only 8% and the technological contribution at 92%. "Science" is defined in the report as theoretical and/or experimental studies of new, unexplored natural phenomena, and "technology" as the conception or demonstration of the capability of performing

a specific function using new or untried theories, principles, techniques or materials.

Under the assumptions of the report, "new" means post-1945. And the report also concludes significantly that the technical contributions covered in the study began accumulating 20 years before the engineering design dates for the systems utilizing them.

Thus, much of the widely publicized new "science" is neither new nor science.

This is what has happened in military weapon systems, probably the most sophisticated and technically advanced area of electronics endeavor. Obviously, engineers in less developed fields, such as industrial or consumer electronics, are using technology that is even older.

All this would be just an argument about semantics if the mistaken reverence for science weren't having a deleterious effect on companies and countries. The public overplaying of science has often led to the wasting of funds on basic research at the expense of sorely needed development work, and has lured a lot of young people to pure science and away from engineering. It has even encouraged some engineering schools to urge the abandonment of the study of engineering for a concentration on physics and mathematics.

Yet, time after time, the evidence clearly shows the most progress stems from the unique and creative application of some old technical idea or scientific principle. As we've pointed out before on this page, the celebrated technology gap in Europe is not really a lag in technology at all, but in application.

The overemphasis on science and theory is starting to hurt the U.S. electronics industry in another way: too many young engineers feel theoretical work in the research laboratory or the university is the only suitable employment for a college-trained engineer. So most young engineers will not work as production engineers or as designers of the complex and ingenious equipment required to manufacture electronic products automatically. Yet some of the most challenging technical problems are in this apparently prosaic area.

Over the next 10 years, the greatest growth in electronics will come from the creative application to new areas of some developments that are now well established, such as integrated electronics, lasers, systems engineering, computers and communications—not from radical new developments that no one can now envision. Some very prosaic electronics will be applied to education and medicine. Systems engineering may show the way to solving a lot of nonmilitary problems, among them automotive traffic control, air pollution, juvenile delinquency and highway planning.

The key man in such developments will be the engineer, not the scientist. These are jobs for technology, not science.

* First interim report on Project Hindsight, by C.W. Sherwin, et al. 30 June 1966; revised 13 October 1966. Office of the Director of Defense Research and Engineering; Washington, D.C.

Our ferrite division can make that many toroids in a month. In sizes as small as 80 mils, with high temperature stability, inductance values within $\pm 5\%$, and in a wide range of ferrite materials to meet practically any pulsing speed. For example: for microsecond switching we can offer our Ferramic® 0-5, 0-6, and T-1 ferrites and for nanosecond switching there's our Ferramic H and Q-1 materials.

This materials capability plus our pro-

duction capacity have made us the world's largest supplier of ferrite toroids for pulse transformers. But toroids are only a part of our business. In total we have eleven standard ferrite materials right now and will soon introduce a twelfth one. A brand new flat temperature-coefficient ferrite that will make circuit design news. We are equally big in other ferrites for digital applications such as square-loop (memory core) ferrites,

recording head ferrites, and multiaperture devices.

So whether you want 2 samples, an order of 10 million, or catalogs and technical literature, you can get immediate action by writing Mr. Ken Talbot, Manager of Sales, Indiana General Corporation, Electronics Division/Ferrites, Keasbey, New Jersey.

INDIANA GENERAL 

**Ten million pulse transformer cores
is peanuts to Indiana General.**



Electronics Newsletter

January 9, 1967

Time-sharing— is it private?

Are the memory banks of time-shared computers really secure? Or can one customer look into the memory banks of another customer—either accidentally or deliberately?

Although the operators of time-shared systems are reluctant to discuss such matters publicly, there has been evidence of breaches in security.

The home of time-sharing, the Massachusetts Institute of Technology, has been having trouble with students who break the elaborate codes that are supposed to insure the privacy of the users of its Project MAC (machine-aided cognition) computers. On one occasion, it's been reported, students tapped into lines carrying Government data, including information from the Strategic Air Command at Omaha. Some of this tinkering has had the effect of jamming the lines.

Last fall, the Federal Communications Commission established a panel to explore the question of Federal controls on time-shared operations; one of the questions to be examined is the privacy afforded users.

On-line circuit design at MIT

Computer-aided design of electronic circuits today is almost exclusively a matter of batch-processing. At the Massachusetts Institute of Technology, however, a program is under way to leapfrog to on-line circuit design in a classroom environment. By next fall, says Richard D. Thornton, an associate professor, work will start on an on-line classroom design of integrated circuits.

By then a joint program of MIT and the Bell Telephone Laboratories, called Multics (multiplexed information and computing service), will be in operation. Both Bells Labs and MIT are installing General Electric 645 computers for the timed-shared network.

Bell Labs is also moving in the direction of on-line circuit simulation for its own engineering laboratories, and several areas of cooperative effort by Bell and MIT have been opened.

One of the most pressing needs in this field is for a versatile, low-cost terminal capable of generating lines, curves and vectors in addition to numbers and letters. And one of the most promising designs under development is Bell Labs' Glimmer, a terminal driven by a local disk memory and using a direct-view cathode-ray tube.

Firms ready bids to supply avionics for Boeing SST

Although the Boeing Co. has won the competition to build the U.S. supersonic transport, many of the electronics designs for the plane haven't been specified. Four systems to be included are still in the development stage for commercial aircraft: a collision-avoidance system, clear air turbulence detectors, all-weather landing equipment and fault-locating gear.

Several manufacturers are preparing to bid on the avionics systems. The Airborne Instruments Laboratory has proposed an all-weather landing system, while the Bendix Corp. has offered a complete avionics package, including an automatic pilot, data instrument display and computer, integrated flight instrument display, inertial navigation and all-weather landing equipment. The Sperry Rand Corp.'s Sperry Gyroscope division has proposed an inertial navigation system and its Sperry Phoenix division expects to bid on an automatic flight control system.

Electronics Newsletter

NASA consolidates support contracts at Cape Kennedy

The National Aeronautics and Space Administration is consolidating its support-services contracts at Cape Kennedy in an attempt to reduce the number of companies it has to deal with and; as a result, several major electronics and aerospace concerns may be squeezed out.

The two major support contracts that will be combined by Jan. 1, 1968, are those held by Trans World Airlines for general support and Ling-Temco-Vought Inc. for information services. TWA's contract is valued at \$23 million a year and LTV's at \$10 million. The new consolidated contract will cover five years and be on a cost-plus-incentive-fee basis.

Also, requests for competitive proposals have already been issued for a single contractor to combine the instrumentation support currently being provided by the Radio Corp. of America and the communications support provided by the Federal Electric subsidiary of the International Telephone and Telegraph Corp.

Surveyor will try to upstage Luna 13

The United States will try to outdo the Soviet Union's Luna 13 in testing the lunar soil when it launches Surveyor 3 to the moon this spring. The soft lander will carry a surface sampler to dig a 17-inch-deep trench in the lunar soil. One of the spacecraft's television cameras will transmit pictures of the scooped up material to earth for analysis. The Luna 13 can only stick a probe into the moon to check soil firmness.

The next Surveyor is scheduled to be launched by March, but a busy flight schedule at Cape Kennedy may force a delay.

Plans are made to live with CAT, or perhaps bell it

Research into clear air turbulence, or CAT, has largely been a hit-or-miss affair, with work by universities, industry and the Government conducted without coordination. Now the Commerce Department has set up a committee to give some direction to these efforts.

The Government is taking two approaches in its war on CAT, which has been blamed for a dozen crashes or near-crashes over the past few years.

The Commerce Department panel will sponsor the development of CAT detectors, and the Air Force, apparently prepared to live with the menace, has awarded the Boeing Co. a \$6 million contract to develop an automatic flight controller that would sense the turbulence and adjust a plane's control gain to withstand it. With aircraft flying higher and faster, the effects of CAT are becoming more pronounced and planes' structural metal more quickly fatigued.

Addenda

Airborne Instruments Laboratory is developing an uncooled parametric amplifier that will have a noise temperature of 50°K, a level nearly equivalent to that produced by amplifiers operating at cryogenic temperatures. The critical elements of the paramps are varactor diodes with a 0 bias cutoff frequency in excess of 400 gigahertz, and improved millimeter wave klystrons. . . . The Stewart Warner Corp. plans to introduce a new desk-top facsimile machine within the next three months. . . . The Federal Aviation Administration is weighing proposals to buy solid state equipment for its 900 navigational ground stations around the country. The very-high-frequency-omnirange (VOR) stations currently use 200-watt tube transmitters.

IDEAS

from SYLVANIA Electronic Components Group

READOUTS

Breakthrough in EL panel design permits greater display flexibility

The newest advancement in electro-luminescent readouts is a panel design of all-glass construction. Display designers and users now have a solid-state readout with higher reliability than ever before which lends itself to even greater design flexibility than previously possible with EL.

Completely engineered by Sylvania, this new concept actually allows both a decrease in readout character size (to $\frac{3}{8}$ -inch) as well as increased panel size. This means more characters per panel are possible than before in hermetically sealed EL designs.

Designers still get all the inherent advantages associated with Sylvania EL readouts: solid-state reliability,

low-power consumption, wide viewing angle, light weight, low reflection, variety of characters, stable performance, no catastrophic failure, clear readability and rapid information display. Performance of the all-glass units is judged by the same standards as the metal-glass devices: brightness, spectral emission, contrast, life, etc.

What does "all-glass" really mean in this sense? While metal-glass EL panels use metal contact pins and metal sealing frames, this new design concept is completely of glass construction, with the only metal present being the connector pins. Eliminated also are conductive rubber contacts.

The user-benefit of this new construction is a higher degree of lamp

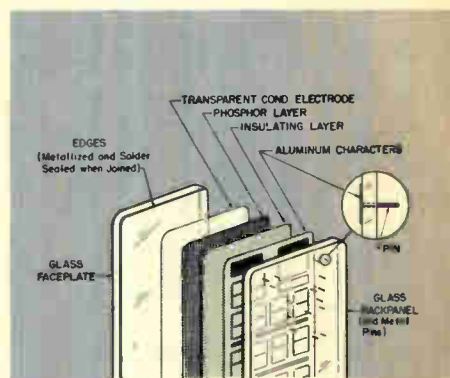

reliability for the demanding environmental and operational conditions encountered in severe aerospace applications.

The panels are designed to rigid specifications. The glass contact panel is molded as a single piece with the connector pins in place as integral parts of the panel. Combined with

(continued)

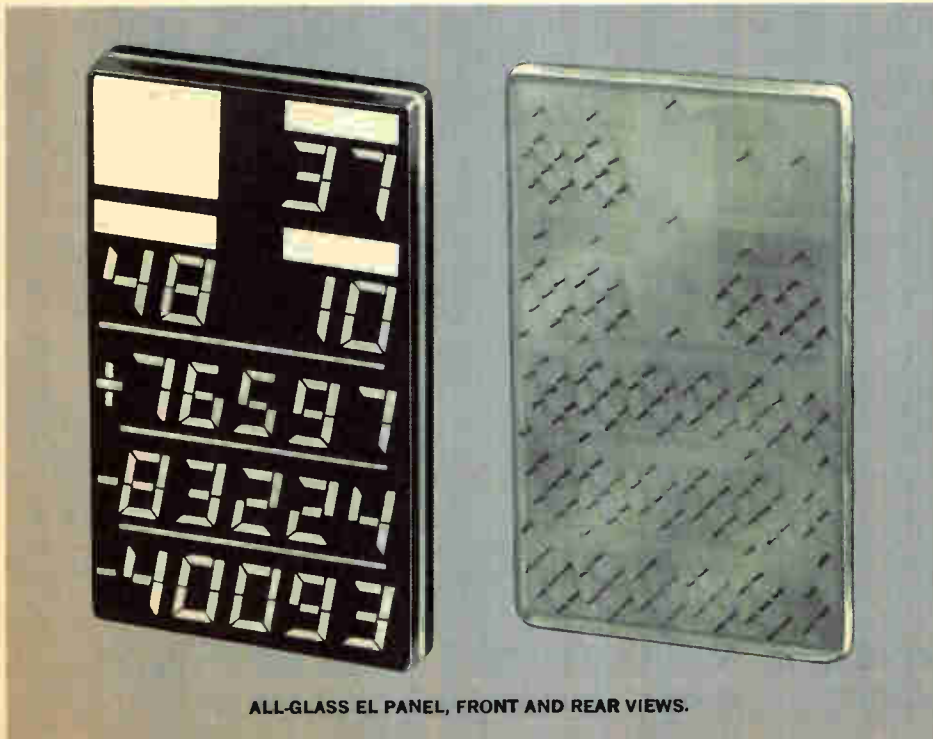

ALL-GLASS EL PANEL, FRONT AND REAR VIEWS.

This issue in capsule

Integrated Circuits—How 4-bit array registers can reduce package count while speeding storage and transfer.

Photoconductors—Combine lamps and photoconductors to get the function you need.

Microwave Diodes—Now your designs can be taken through Ka-band with Sylvania Schottkys.

Color Television—Rectangular 22" color bright 85® tube now available for 1967 sets.

Rectifiers—Glass devices from Sylvania can absorb 1000-watt reverse transients.

CRTs—New high-brightness, high-resolution tubes can be customized to your needs.

READOUTS (continued from page 1) true hermeticity, the result is panels which perform reliably at extreme changes in altitude, temperature and humidity. They are also highly resistant to shocks and vibrations.

In the new construction, the glass contact panel containing sealed connector pins is ground flat on one side. The patterned back metallic electrode is applied to this glass surface. Thus, each active area becomes an integral part of its own connector pin, eliminating any possibility of registration problems. An electrical insulating layer is then applied over the back electrode and covered by a phosphor. A transparent conducting electrode put over the entire phosphor surface is the last electrical layer.

To protect the whole assembly, a glass front panel is placed on the transparent conductor and sealed to the contact panel, using a metal-solder technique. For less critical applications, an epoxy sealant may be used.

This simple construction process makes it easy to mass produce reliable and reproducible devices. The excellent match of expansion characteristics of faceplate and contact plate assemblies minimizes stress on the hermetic seal during temperature variations. Elimination of conductive rubber contacts provides a significant improvement in lamp reliability.

Standard all-glass units are available in 115 V and 250 V versions. The lower operating level is achieved by appropriate reductions in thickness of

the EL and dielectric strata. Initial brightness is on the order of 25-30 FL at room temperature and 250 volts, 400 Hz. Spectral emission, contrast, life and half life are comparable to that of conventional EL panel design.

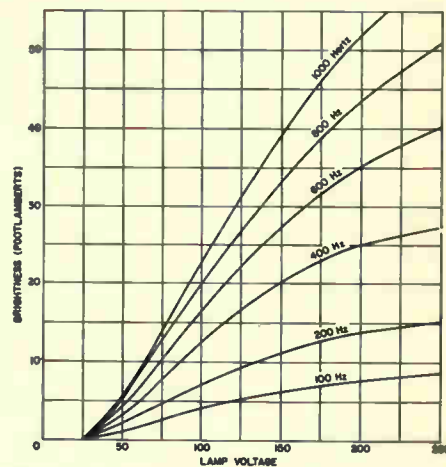

CIRCLE NUMBER 300

INTEGRATED CIRCUITS

How 4-bit array registers reduce IC package count, speed storage and transfer

Each of Sylvania's integrated four-bit binary register arrays contains the equivalent of at least 87 discrete components and the equivalent of 25 IC gates used in conventional integrated circuits. These monolithic digital functional arrays implement parallel storage or transfer of four binary bits every 15 nanoseconds. Here's how they work and how they can be used to build a temporary storage memory using only five IC packages.

Series SM-60 and SM-70 four-bit storage registers are for use as high-speed storage elements in control and arithmetic sections of digital computers. The SM-60 series has clocked inputs and clocked outputs. Further, the SM-60 output has wired OR capability which means outputs can be tied together to provide the logic OR function. The SM-70 series is operationally identical to the SM-60 except that it has a SUHL type output network and is not clocked with an enable signal. This means information

set in the device is available at the output after a propagation delay of 20 nanoseconds.

Figure 1 shows the logical operation of one of the four flip-flops in a storage register. With the data and clock inputs both at high (Logic "1"), the output of gate 1 is low (Logic "0"). This low condition appears at the input to gate 3 and forces the output of gate 3 to go high. The low output of gate 1 also appears at the input of gate 2, forcing the output of gate 2 to go high. Thus, both inputs to gate 4 are in the high condition. This means output of gate 4 is low. This low output appears at the input of gate 3, forcing the output of gate 3 high. The circuit is now latched with the output high. Once the circuit is latched, the clock input can be removed without disturbing the flip-flop.

Where data input is low (Logic "0") and clock input is high (Logic "1"), the circuit latches the flip-flop

with its output in the low condition. If the clock input is low, no data is accepted.

Figure 2 illustrates how to form a temporary storage register subsystem with common accumulator. Here, registers 1 through 4 can be enabled either separately or jointly. In the latter case, a logical OR is performed allowing masking techniques to be used. The SM-70 gives the accumulator a high fan-out. Only five packages are required and the number of external connections are cut to 1/8 of those required when conventional integrated circuits are used.

The SM-60 and SM-70 series operate over a temperature range of -55° to +125°C. Both these monolithic digital functional arrays are available in Sylvania's standard 14-lead dual in-line plug-in package and the TO-85 flat pack. They are completely compatible with the SUHL line of integrated circuits.

CIRCLE NUMBER 301

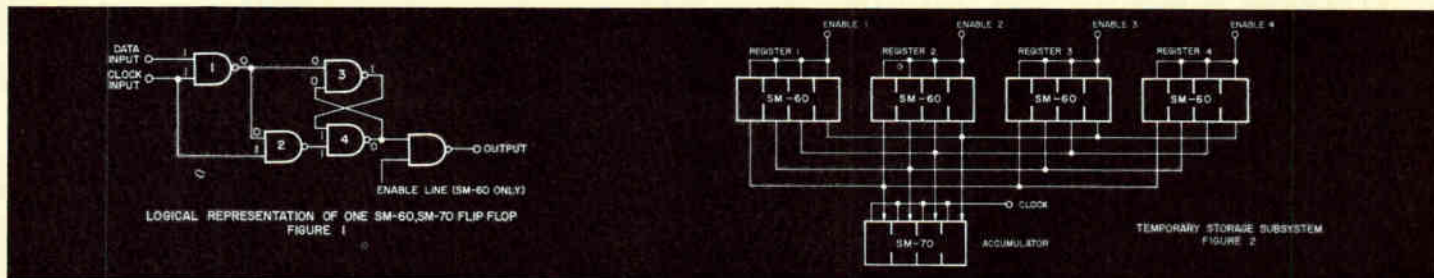

Absorb 1000-watt reverse transients with Sylvania's glass devices



Circuit designers are finding that Sylvania's glass rectifiers are better than other glass rectifiers. In this instance, the improved characteristics result in enhanced circuit performance and increased device reliability. Sylvania has coupled the inherent advantages of glass encapsulation with superior device design to make these glass diodes rugged enough for military applications. This designed-in dependability also makes this line of glass units an excellent choice for many other uses in computer, industrial and communications equipment. It is the improvements in device design that make Sylvania's glass silicon rectifier line stand out from other glass units.

In the improved devices, a large double diffused junction allows handling of 1000-watt reverse power transients while still maintaining the standard 50-amp forward surge capability. Sylvania's first glass rectifiers, can take outputs of up to 1 amp at reverse working voltage of 1000 volts without damage.

Heat dissipation is aided by welding a solid high conduction power lead to an oversized heat conduction stud. This enhances power handling capability while extending device life by keeping the unit cooler. The glass package is electrically neutral and smaller than many metal rectifiers,

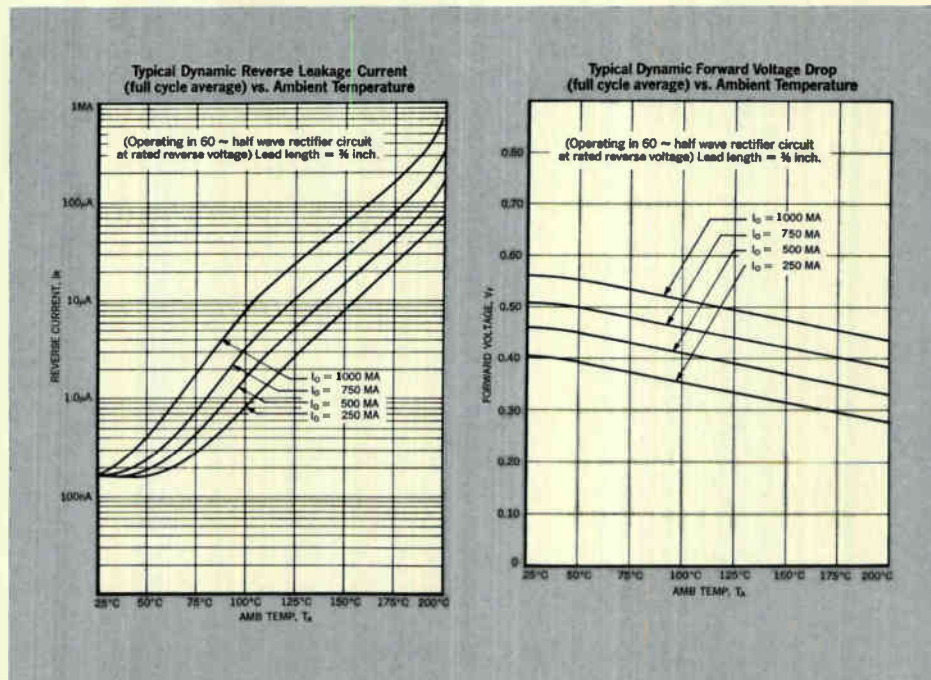

thus permitting greater stacking and card densities. With Sylvania's sealing techniques, the designer gets the benefits of improved device design without sacrificing any of the advantages of glass encapsulation. Use of a glass package means not only improved insulating characteristics but units that can be hermetically sealed. Radiflo leakage rate for these devices is less than 1×10^{-10} cc/sec. Low leak rates extend life and increase reliability. The glass body also enhances the thoroughness of in-process quality control by allowing visual inspection during production.

In addition to the ability to handle

high reverse pulses, these rectifiers have low reverse leakage current. Typical rating is 10 na at 25°C ambient and rated reverse voltage. The high voltage rating and wide temperature operating range (-65°C to 175°C) capability of these units can't be matched by ordinary non-hermetically sealed devices.

All units in the Sylvania series are packaged in the conventional DO-29 outline. They are replacing existing glass, epoxy or top hat types in applications which demand higher reliability levels. These devices meet or exceed all the standard life and design requirements of MIL-S-19500.

CIRCLE NUMBER 302

ABSOLUTE MAXIMUM RATINGS: -65°C to +175°C - Resistive and Inductive Loads - Single Phase, half wave at 60 cps.						
	Units	1N4383	1N4384	1N4385	1N4585	1N4586
Continuous Reverse Working Voltage, V_R	volts	200	400	600	800	1000
RMS Input Voltage, V_{rms}	volts	140	280	420	560	710
Average Forward Current, I_o	amps					
@ 50°C		1.0	1.0	1.0	1.0	1.0
@ 100°C		1.0	1.0	1.0	0.6	0.6
@ 150°C		0.3	0.3	0.3	0.2	0.2
Forward Surge Current, 1 cycle - I_{FSM}	amps	50	50	50	50	50
Forward Surge Current, Recurrent, I_{FSM}	amps	6	6	6	6	6
ELECTRICAL CHARACTERISTICS:						
Typ. Dynamic Forward Voltage Drop, V_F @ 1.0 amp	volts					
@ 50°C					.56	.56
@ 100°C		.52	.52	.52		
Typ. Dynamic Reverse Current, I_R @ V_R	μA @ 1.0 amps				.55	.55
@ 50°C		8	8	8		
@ 100°C		10	10	10	10	10
Typ. Reverse Current, I_R @ V_R and +25°C	na	10	10	10	10	10
Typical Junction Capacitance - All Types -	@ 0 V 80 picofarads					
	@ 10 V 21 picofarads					

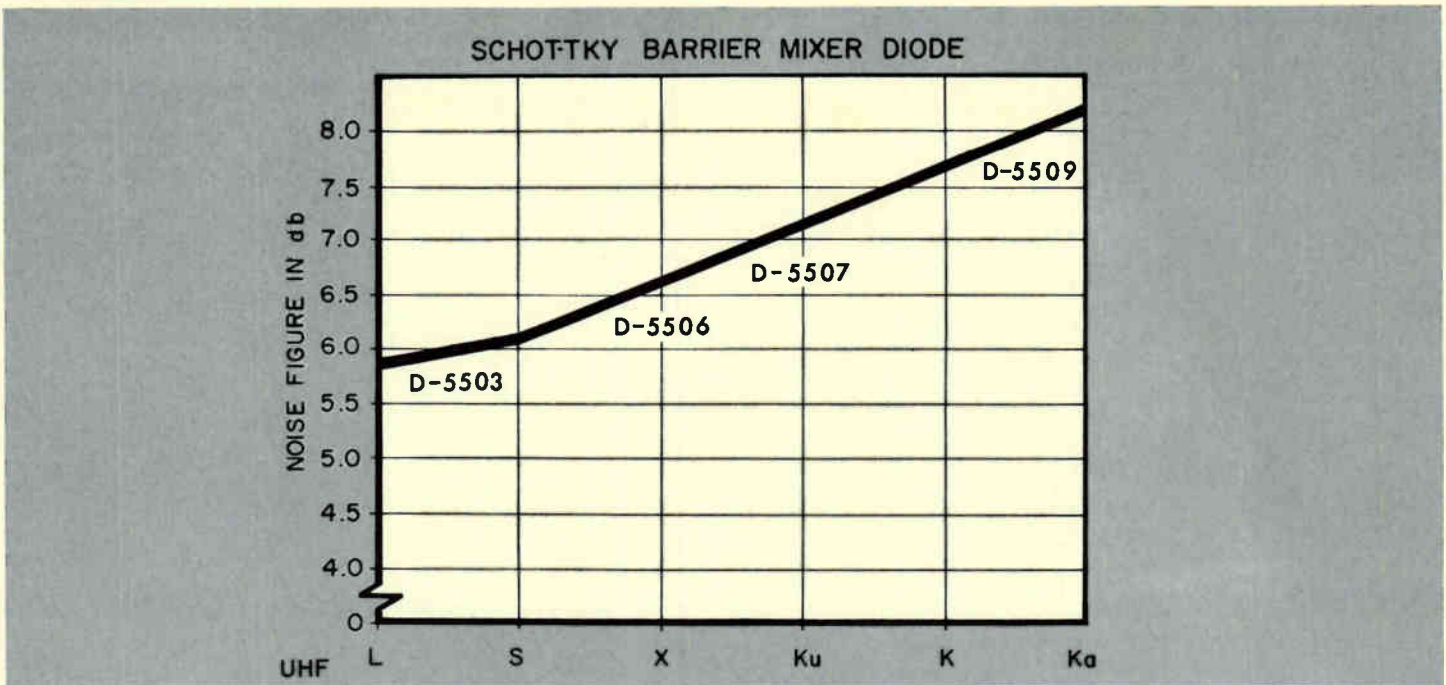

Sylvania's Schottkys can take your designs through Ka-band...reliably

In last November's IDEAS, we announced MQM-packaged Schottky Barrier diodes that operate at frequencies through X-band. We have now extended the operating range of available Schottky Barrier diodes to include Ku-, K-, and even Ka-band. These newest diodes are also in the MQM package, and feature an even lower junction capacitance than their L-, S-, and X-band counterparts.

Effective coverage through the Ka-band (26.5 to 40.0 GHz) is only one of the outstanding features of Sylvania's Series D-5509 Schottky Barrier mixer diodes. To fully describe these new devices, one must combine the operating frequency performance with the extreme broadband capability having good burnout characteristics, and with an inherently low 1/F noise characteristic.

To get all this improved performance in one device means there must be not only an optimized semiconductor, but also an optimized package. The performance level of the D-5509 units shows they have both.

Sylvania's MQM package is the key to the broadband capability of these new units. Measuring only 0.08" x 0.20" overall, this package utilizes a low dielectric glass body hermetically sealed to precision mounting pins. The result is a package capacitance

of only 0.08 pf allowing operation of a wide frequency spectrum.

In addition to its low capacitance, the MQM package features precise axial alignment of the mounting pins allowing precision design of miniature holders. Easy insertion and positive RF contact in holders are assured by a package design which has over 50% of its length devoted to circuit contact area.

Low junction capacitance of the diode permits operation in the Ka region. This low junction capacitance is the result of the superior alignment methods used in new Schottky Barrier diode processing techniques. The process employs epitaxial silicon to make devices with precisely con-

trolled impurity distribution. In this improved method, a thin insulating layer and a relatively thick metallic contact layer over the barrier are used. The insulating layer and the superior mask alignment methods combine to produce the precise etching needed to make barrier regions of low capacitance. The metallic contact and pinpoint mask alignment maintain tight registration during metallization to give a reliable contact without increasing barrier region capacitance.

The low noise figures exhibited by the units in the D-5509 series (D-5509 = 10.0 db, D-5509A = 9.0 db, D-5509C = 8.0 db) result from the low series resistance of the diode. This low series resistance is obtained by keeping the epitaxial layer extremely thin, on the order of 1 micron. Because of the low 1/F noise characteristics of these units, they are ideal for doppler applications including police radar, proximity fusing, and traffic monitoring systems.

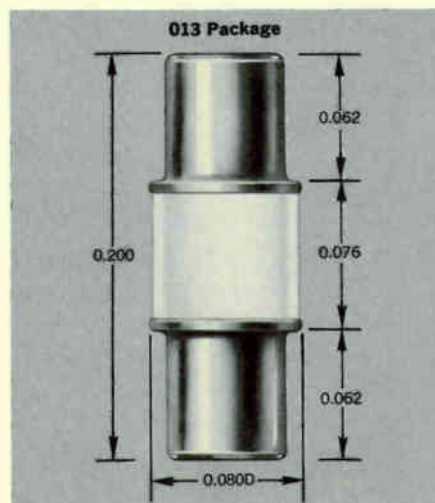

SYLVANIA'S SCHOTTKY BARRIER MIXER DIODES IN MQM PACKAGE					
Frequency Band	S & C	X	Ku	K	Ka
Sylvania Series	D-5503 C	D-5506 C	D-5507 C	D-5508 B	D-5509 B
Minimum ONF	6.0 db	6.5 db	7.0 db	7.5 db	8.0 db

Combine lamps and photoconductors to get the function you need

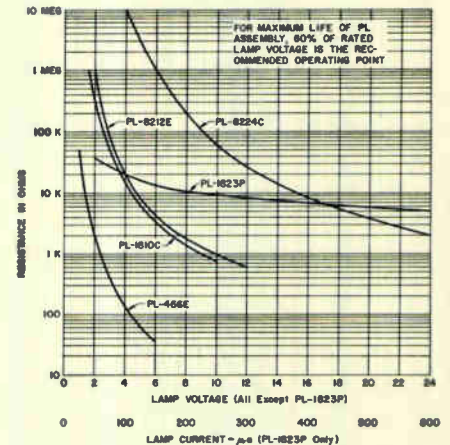
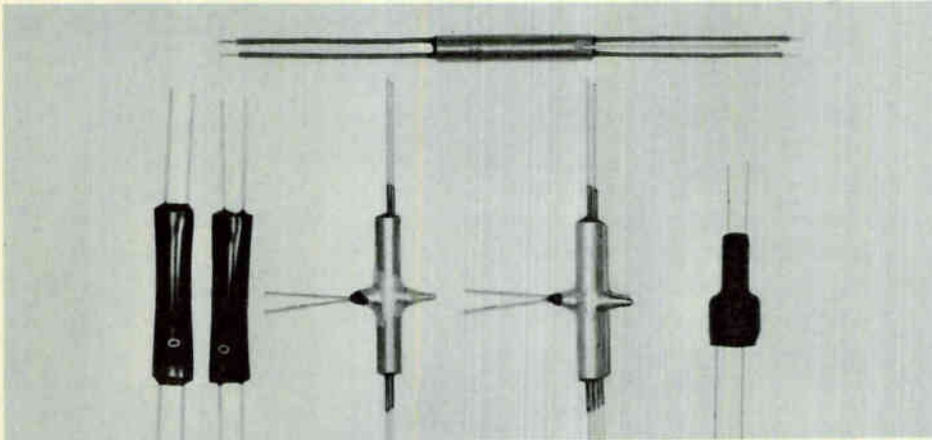

Perhaps none of Sylvania's standard photoconductor-lamp (PL) assemblies fills your specific circuit requirement. Perhaps the new units that are coming don't include one that's just the right device. What do you do? Look for Sylvania's custom PL capability to get what you need, whether it be a simple detector unit or a combination of PL devices in one package.

Custom PL assemblies from Sylvania now allow circuit designers to implement many additional potential applications of photoconductor-lamp assemblies. A wide variety of possible photoconductor and lamp combinations means special assemblies can be designed to meet the most exacting requirements.

These custom assemblies take designers beyond the standard single-throw single-pole or double-pole types. Typical of one such custom design is an assembly containing two NE23 neon lamps optically coupled to three cadmium sulfide photocon-

ductors. The photoconductors are enclosed in a lightproof metal cylinder and mounted perpendicular to the neon lamps.

Because Sylvania custom-designs, the company can offer PL combinations which more closely match the impedance level of the circuit they will be used in. For instance, with many entertainment manufacturers now becoming interested in all solid-state construction, Sylvania can deliver PL units that match impedance levels of solid-state circuits.

Availability of a wide variety of standard (shown in the table) and custom units erases limitations on the applications of PL assemblies. Because they have the characteristics of both a switch and a potentiometer and a response time in the millisecond range, they are unrivaled in many areas of remote control, low-level switching or potentiometry.

For example, for minimum hum pickup, the photoconductor can be

soldered directly into an audio circuit to be controlled. Control can be achieved by varying PL lamp voltage from a remote location. PLs can directly replace switches and relays in any application within their power handling capabilities. Indirectly they can be used as triggering devices for higher power components.

Because of their time delay, PL assemblies are used extensively in the entertainment field to produce special musical effects such as tremolo and vibrato. Also, they may be used to regulate high voltage in color television receivers and for remote volume control in broadcast studio consoles. Industrial applications include performing AND and OR logic functions and the voltage control of time delay and frequency in monostable and astable multivibrators. Used with silicon controlled rectifiers, they can provide low-voltage isolated control for high-voltage loads.

CIRCLE NUMBER 304

	PHOTOCONDUCTOR						LAMP			
	Voltage (Volts) ^{1,2}	Dissipation at 25°C (MW) ¹	Light Resistance (Ohms) ³	Dark Resistance (Megohms) ⁴	Ascent Time (MS) ^{3,5}	Descent Time (MS) ^{4,6}	Shunt Capacitance (pF) ⁷	Coupling Capacitance (pF) ⁸	Rated Voltage (Volts)	Rated Current (MA)
PL-466E	400	300	35	0.3	55	17	4.944	0.433	6	35-45
PL-1810C	300	75	800	10.0	75	20	0.550	0.264	10	15-20
PL-8212E	300	75	700	10.0	55	17	0.960	0.229	12	35-45
PL-8224C	300	75	1500	10.0	55	17	0.740 (case grounded) 1.141 (case not grounded)	0.017 (case grounded) 1.070 (case not grounded)	24	15-20
PL-1823P	300	75	2750	10.0	50	12	0.700 (case grounded) 1.030 (case not grounded)	0.025 (case grounded) 0.905 (case not grounded)	90 (Break-down), 59 (Operating)	0.3

AMBIENT OPERATING TEMPERATURE RANGE: -40° to +70°C

- NOTES:
1. Absolute maximum rating system.
 2. Measured with photoconductor in complete darkness at a pulse rate of 120 pps, 50 μs duration. Voltage in excess of rated may damage the photoconductor. Maximum DC voltage is limited by maximum dissipation and minimum dark resistance rating.
 3. Measured at rated lamp voltage.
 4. Measured 10 seconds after removal of rated lamp voltage.

5. Time to reach 63.2% of illuminated photoconductor current after application of rated lamp voltage.
6. Time to reach 36.8% of illuminated photoconductor current after removal of rated lamp voltage.
7. Measured across photoconductor leads (leads parallel to major axis) at frequency of 456 kc.
8. Measured between photoconductor and lamp leads (photoconductor leads tied together—lamp leads tied together) at frequency of 456 kc.

How a philosophy breeds IC reliability

As an engineering manager on the production side of integrated circuits, I'm necessarily involved in every facet of IC manufacturing and quality control. Occasionally, though, I'm asked to squeeze extra time into the day's occupation for, what is to me, an enjoyable diversion—showing and explaining our Woburn, Massachusetts, facilities to people who have a professional interest in ICs.

I'd like to comment on a couple of points that frequently come up in our discussions. The first is on reliability through hermeticity, especially as it relates to the dual in-line plug-in package. The second point deals with what we at Sylvania feel is a unique IC manufacturing philosophy.

The Sylvania dual in-line plug-in package was designed and constructed with the same reliability criteria in mind as the Sylvania flat pack. It is understood, then, that the cross-sectional appearance of the dual in-line package is very similar (except in size) to the flat pack.

The dual in-line (DIP) features a kovar bottom sealed to an alumina-filled glass construction in which the kovar leads have also been sealed. All of these seals take advantage of the technology gained from the kovar-to-glass seal originally developed for transistors. This is the classic kovar-oxide-glass combination. The package integrity that is achievable with this technology has been an established fact for many years.

The high degree of hermeticity that has become standard in the industry

for such older packages as the TO-18 and TO-5, is now being achieved with the Sylvania DIP construction. The one significant difference between the older transistor metal packages and the DIP is the fact that the seal length (a possible leak path) is much longer than that encountered in the metal package. If anything, this would seem to lead to an even greater hermeticity capability.

The cover of the DIP is made out of the same material as the body with the seal being a pyroceram frit. As a result of the use of these materials, the Sylvania dual in-line package is composed of thermally matched seals throughout its construction.

The integrated circuits manufacturing philosophy at Sylvania has always been to manufacture all circuits with identical care and a high degree of workmanship. Therefore, in the final analysis, Sylvania circuits need only be graded by their industrial or military capabilities as determined in the 100% final test. All Sylvania integrated circuits go through a sequence of reliability tests during their manufacture. These tests are applied after sealing the package in the following order.

First, each IC package is subjected to five cycles of -65°C to $+200^{\circ}\text{C}$ thermal cycling with fifteen-minute soak times at each of the temperature extremes. This test is assurance to both Sylvania and its customers that the package will withstand demanding stresses after sealing. Second, all packages are subjected to a 20,000 G

centrifuge test while they are in the Y_1 plane. This test insures that the wire bonds have also been subjected to a mechanical stress test. Third, all packages are bubble-tested in 150°C glycerine for any leaks that might have come about as a result of deficient sealing or due to the package stress tests discussed above. Fourth, all integrated circuits are stabilization-baked at 300°C for 48 to 60 hours. Fifth, all Sylvania circuits are subjected to the worst-case DC tests at the temperature extremes guaranteed and also for all parameters which are called for on the Sylvania data sheet or in the customer's specifications. The ultimate electrical capability of each and every integrated circuit is tested at 75°C , 125°C , -55°C and 0°C for DC parameters. Following that, every unit is tested for all dynamic characteristics at switching. This is done in Sylvania's fully automatic test equipment at the rate of one circuit every two seconds. This equipment has been dubbed "Mr. Atomic" Multiple Rapid Automatic Test Of Monolithic Integrated Circuits). It is only as a result of the test performance in "Mr. Atomic" that any differentiation between military and industrial capability is made.

Each lot of integrated circuits is then held in quarantine for quality audit of the capability of the lot. During this audit, random samples are drawn for electrical parameter check and also for a hermeticity check. The latter is performed with Sylvania's radiflo equipment. This equipment uses radioactive krypton for a tracer gas and is the most efficient means available today for determining the fine leak rate of hermetically sealed packages with sensitivity to at least 1×10^{-12} cc/sec/standard atmosphere.

It is only after the complete circuit tests and package mechanical and hermeticity tests described above have been performed that Sylvania integrated circuits are shipped to our customers.

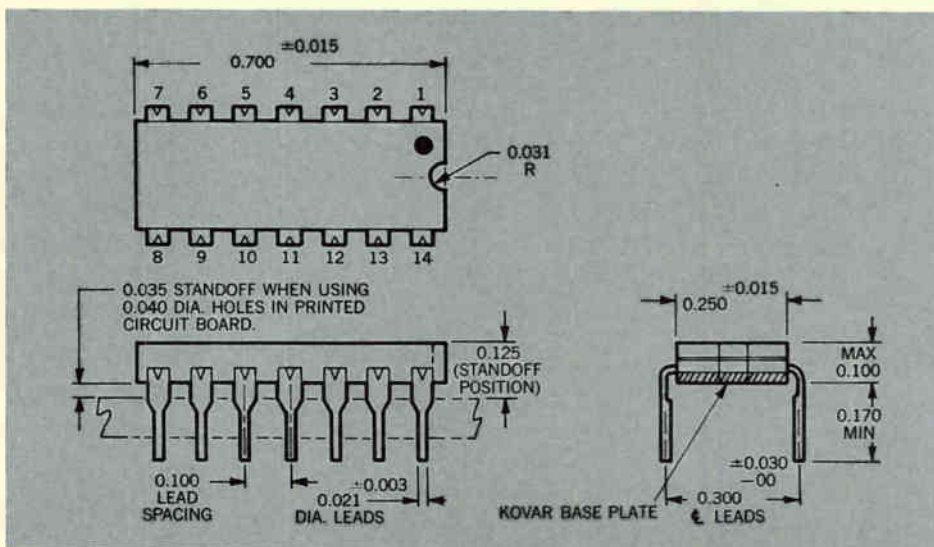

Henry Styskal
HENRY STYSKAL

New high-brightness, high-resolution tubes customized to your needs

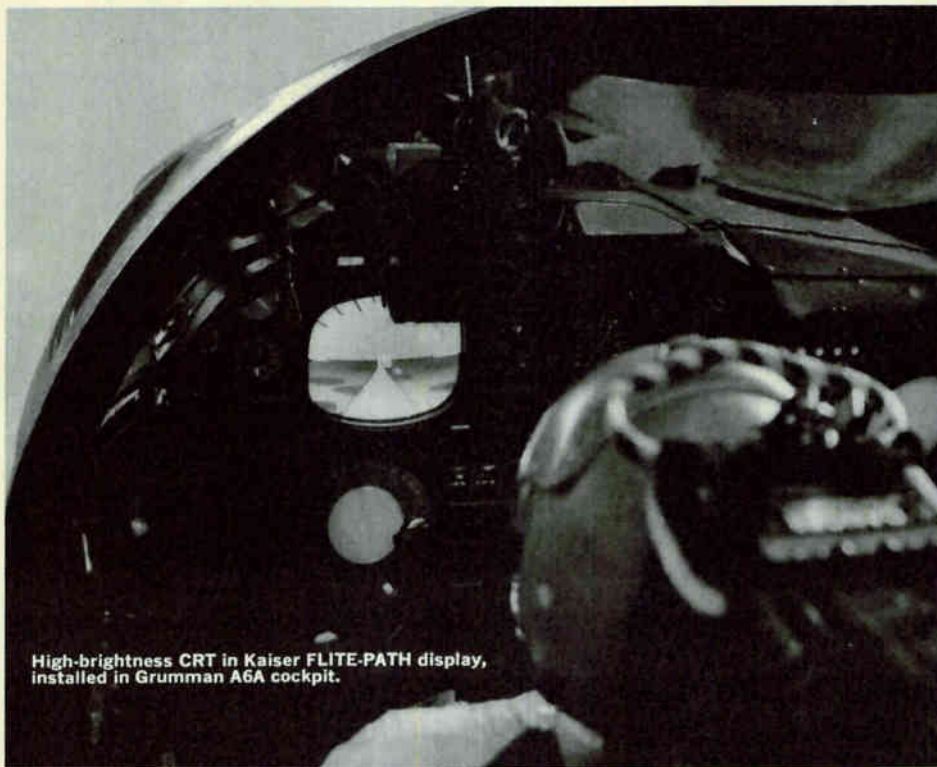

High-brightness CRT in Kaiser FLITE-PATH display, installed in Grumman A6A cockpit.

What size high-brightness, high-resolution CRTs do you require for your aerospace equipment? Now, chances are you can get precisely the right devices to fulfill this need. You can, that is, if you consider Sylvania's new family of customized high-brightness, high-resolution CRTs. We've already made many variations of the basic unit. Each still retains the superior performance characteristics of the basic design. We'll use this same custom capability to build you a CRT tailored to meet your specific needs.

Sylvania's new family of custom

high-resolution, high-brightness CRTs makes possible displays which are clearly visible even in ambients of high light levels. Combine this high-brightness, high-resolution capability with the ability to stand high altitudes and you get an ideal aerospace display device.

Other high-brightness tubes in this line can enhance quality of displays used in shipboard command systems, battlefield surveillance equipment, tv monitors or just about anywhere conventional CRT displays are washed out by high reflected or direct am-

bient light.

One important use of this new type tube has been in fighter aircraft for Vietnam. In the aircraft, a high-brightness cockpit display uses an 8" version of the tube to get an electronic photograph of the horizon. The picture the pilot sees is computer-generated by radar to give him a fix on the terrain.

Other customized versions of this tube may be the answer to your display problems. While usual applications for this family range from 3" to 8" screens, Sylvania will design and build tubes to your specific requirement.

Typical of these new tubes is type SC-4649A, with a rectangular screen having useful dimensions of 4 $\frac{3}{8}$ x 5 $\frac{3}{4}$ inches. Key features of this unit include a high voltage gun of improved design and a neck diameter of 0.870 inches. Encapsulated leads insure reliable operation at high altitudes. Typical operating conditions show a brightness of 1,000 foot-lamberts minimum at 225 μ a of anode current.

The SC-4649 series uses high voltage electrostatic focus and magnetic deflection with deflection angles of 70 degrees. An aluminized P31 phosphor gives a green fluorescence with a medium short persistence.

In addition to the SC-4649A, other versions of this series (SC-4649B through F) are available with various combinations of faceplates and bonded shield cover panel.

CIRCLE NUMBER 305



Use Sylvania's "Hot Line" inquiry service, especially if you require full particulars on any item in a hurry. It's easy and it's free. Circle the reader service number(s) you're most interested in; then fill in your name, title, company and address. We'll do the rest and see you get further information almost by return mail.

FIRST CLASS
Permit No. 2833
Buffalo, N. Y.

BUSINESS REPLY MAIL
No Postage Stamp Necessary if Mailed in the United States

POSTAGE WILL BE PAID BY

SYLVANIA ELECTRONIC COMPONENTS GROUP

Sylvania Electric Products Inc.
1100 Main Street
Buffalo, New York 14209

Now available for '67 sets, rectangular 22" color bright 85[®] tube

Even though most other color tube manufacturers now use rare earth phosphors, color bright 85 picture tubes by Sylvania are still brighter. This has been true since we first coupled Sylvania-developed rare earth phosphors with exclusive phosphor dusting and glass panel stabilizing techniques. It's still true with the latest addition to our color picture tube line.

Availability of production quantities of Sylvania's 22" color bright 85 tube gives TV set manufacturers five different extra bright tubes from which to choose. Other tubes in the color bright 85 line include 19" and 25" rectangular types. Sylvania uses

an exclusive dusting process with each of these types to make them as much as 15 percent brighter than units from other manufacturers.

The new 22" tube has minimum useful screen dimensions of 17.446" by 13.640", producing a minimum projected area of 227 square inches. Because of new FTC labeling requirements, this tube will be used in sets marketed as 20" units.

Three versions of the tube are available. The RE-22KP22 is the non-bonded configuration. Both the RE-22JP22 and RE-22LP22 have an integral protective window sealed to the faceplate. They require no separate safety glass window. Surface of

the protective window of the RE-22JP22 is treated to minimize specular reflection.

All versions are manufactured to the same high standards which characterize the color bright 85 line. Pre-stabilization of the tube's glass face panel permits near-perfect alignment between phosphor dots and shadow mask holes. Cross hair indexed electron guns provide positive alignment of the electron beam and the phosphor dots. And the mask and the face panel are aligned automatically by a computerized process which precisely establishes optimized relationship.

CIRCLE NUMBER 306

FEATURES	
Minimum useful screen dimension	17.446 × 13.640"
Minimum useful screen area	227 sq. in.
Overall length (non-bonded tube)	19.012 ± .375"
Neck length	6.693 ± .188"
Weight (approximate) (non-bonded tube)	28 pounds
Deflection angle (diagonal)	90 degrees
Maximum anode voltage	20,000V to 27,500V
Construction	Bonded-etched and unetched, unbonded
Phosphor	Sylvania rare-earth Europium

SYLVANIA

SUBSIDIARY OF
GENERAL TELEPHONE & ELECTRONICS GTE

NEW CAPABILITIES IN: ELECTRONIC TUBES • SEMICONDUCTORS • MICROWAVE DEVICES • SPECIAL COMPONENTS • DISPLAY DEVICES

This information in Sylvania Ideas is furnished without assuming any obligations.

NAME _____
 TITLE _____
 COMPANY _____
 ADDRESS _____
 CITY _____ STATE _____

Circle Numbers Corresponding to Product Item

- | | | | | |
|-----|-----|-----|-----|-----|
| 300 | 301 | 302 | 303 | 304 |
| 305 | 306 | | | |

Please have a Sales Engineer call



HOT LINE INQUIRY SERVICE

Need information in a hurry? Clip the card and mail it. Be sure to fill in all information requested. We'll rush you full particulars on any item indicated.

You can also get information using the publication's card elsewhere in this issue. Use of the card shown here will simplify handling and save time.

You didn't have to make it so soft on our account.

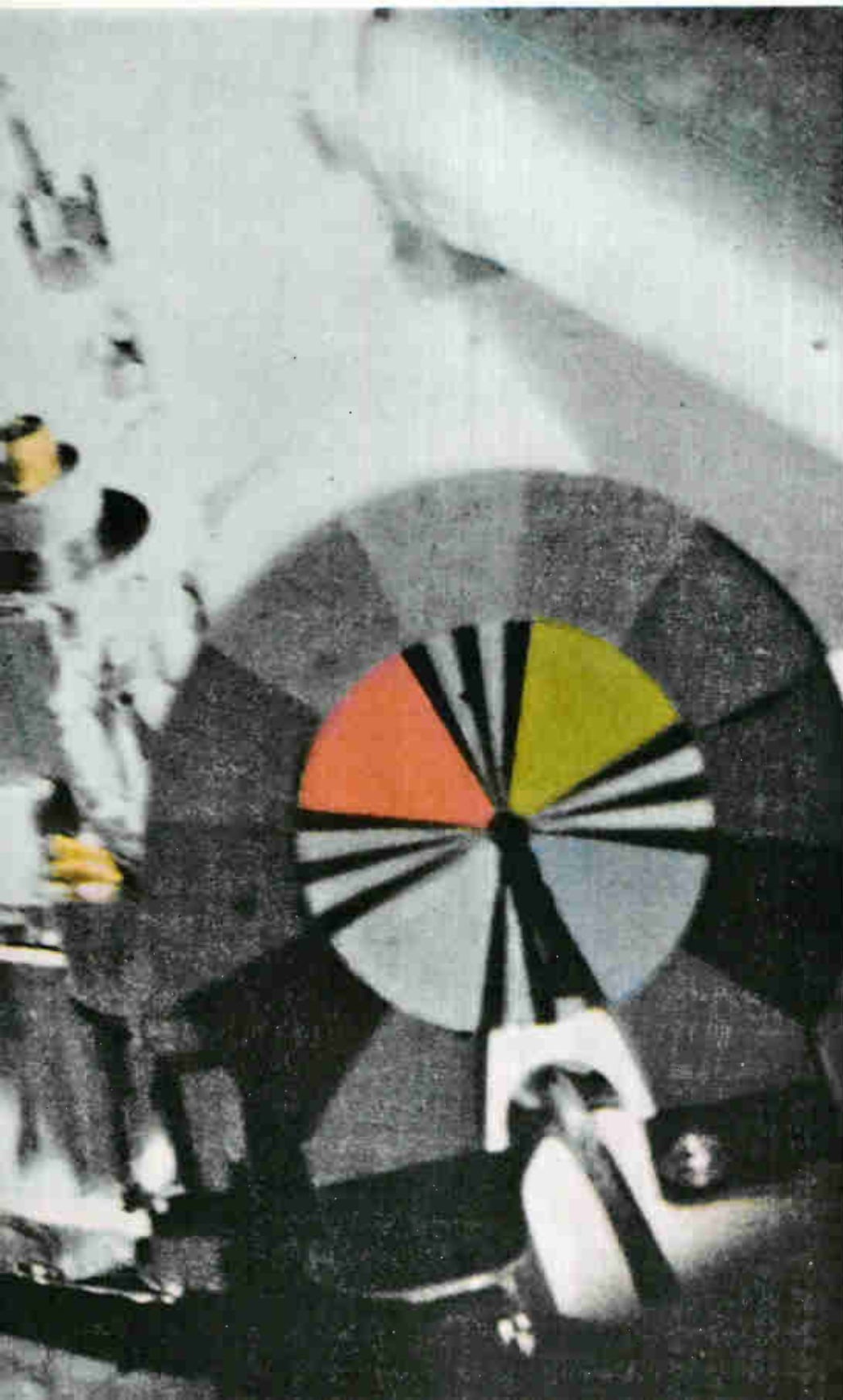

Our Kemet solid tantalum capacitors were among the least delicate components to soft-land on the moon. And, though the lunar night is -254°F ... we survived.

Kemet capacitors have such sturdy reliability you can trust them on any project. They're also the only solid tantalums available graded as to failure rates.

This is why Kemet capacitors blast off with just about every American rocket — and why they're key components in so many earthbound products.

But capacitors are only one of the activities that keep Union Carbide up front, on the frontiers of electronics. Among other things, we're also leaders in research, development and production of single crystals and crystal products; laser systems; solid state devices; fuel cells.

They're reasons to keep Union Carbide in mind before your projects reach the breadboard stage.

UNION CARBIDE
ELECTRONICS
Union Carbide Corporation, Electronics Division,
270 Park Avenue,
New York 10017.

KEMET is a registered trade mark of Union Carbide Corporation.

Circle 35 on reader service card

Guess how many different JT Pancake connectors Bendix makes.

Guess again. It's closer to 1,000,000 in all—and increasing every day. Bendix makes crimp, solder, grommetted, potted and hermetic versions. In eight different shell types and nine shell sizes—8 through 24. You can choose from 40 different insert patterns in 16-, 20-, 22- and 22M-contact sizes, that will accept a wire range of 16 through 28 gage. And they feature temperature capabilities that range to 392°F. continuous operation.

Somewhere in all that, there's bound to be the Bendix® JT Pancake connector that's right for you. (Especially if you're concerned with aircraft, rockets, missiles, submarines, torpedoes or ground support equipment.)

Why the wide acceptance of Bendix JT Pancake connectors? They cut weight up to 60%, length up to 50%. They're the smallest, lightest of their type in the industry. They're readily available from our jobbers or the plant. They're loaded with the latest connector innovations, many of which are sure to become industry standards. Like more information? Just contact us in Sidney, New York.

Scintilla Division







CONTROL KNOBS FROM RAYTHEON

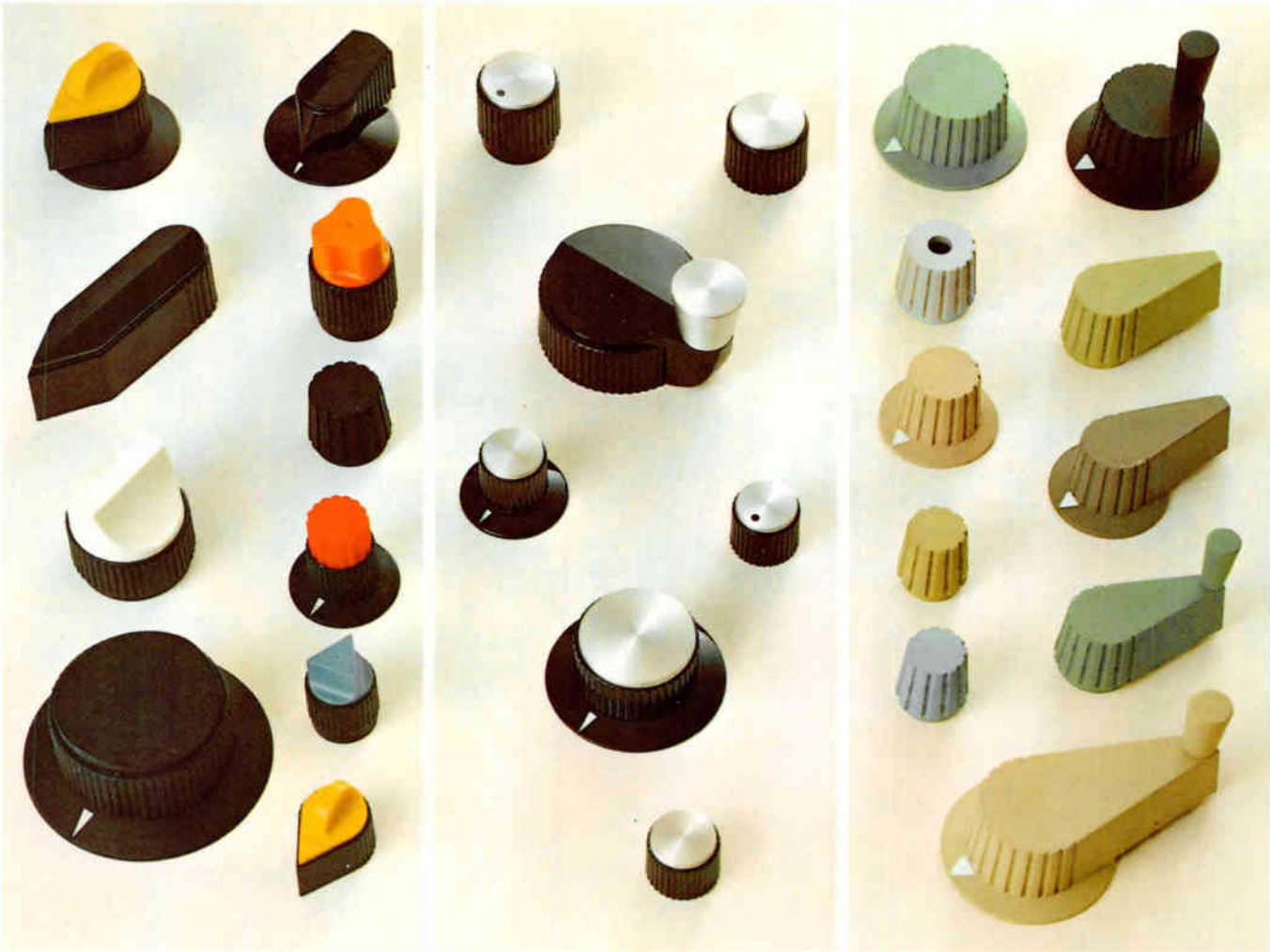

Military knobs, aluminum cap knobs, color knobs for every panel requirement

You can meet military specs, select styles and colors that harmonize or contrast with any panel design and decor — when you specify Raytheon control knobs.

Because, Raytheon offers the largest selection of military and commercial knobs. And *makes them promptly available to you through distributors from coast to coast.*

Meet MS91528C Military Specifications from more than 300 standard types. Raytheon has custom designed over 2,000 "specials."

Every knob in the Standard Series is functionally designed. All styles have an integrated design to give uniformity to your panel. And each knob meets MS91528C for resistance to flame, torque, temperature and humidity extremes, salt spray and

ultraviolet radiation. Colors include black, red, gray or to your special order.

Or, specify aluminum-cap knobs. These handsome knobs are made of strong plastic with satin finish aluminum caps. Raytheon aluminum caps are treated with an epoxy coating for corrosion resistance. Colors: black, gray, or to your order.

Color knobs highlight panels. Choose from eight colors plus black — in ten styles — to harmonize or contrast with commercial equipment design. Raytheon makes these 400 Series Knobs of durable high-impact ABS.

Call your distributor or nearest Raytheon regional sales office for catalogs and data sheets. Or, circle the reader service card. *Raytheon Company, Components Division, Lexington, Mass. 02173.*

Raytheon Components Division — A single source for Transistors/Diodes/Integrated Circuits/Industrial Tubes/Control Knobs/Panel Hardware/Circuit Modules/Display Devices

RAYTHEON

FOR LOWER COST PRECISION ROTARY SWITCHING... TRY THESE:



SERIES 4

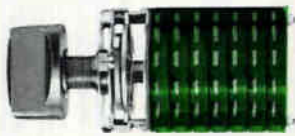

SERIES 1

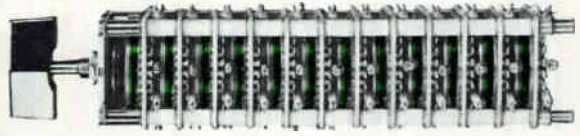

SERIES 2

FOR TRULY OUTSTANDING DRY CIRCUIT SWITCHING... TRY THESE:



SERIES 4

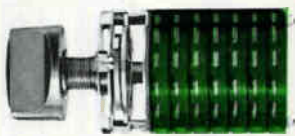

SERIES 1

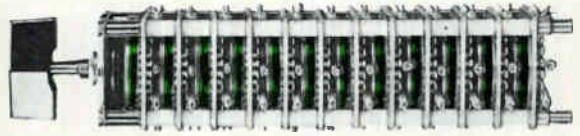

SERIES 2

FOR EASIER ROTARY SWITCH SPECIFICATION... TRY THESE:



SERIES 4



SERIES 1

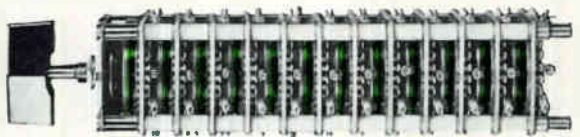

SERIES 2

FOR FASTER ROTARY SWITCH DELIVERY... TRY THESE:



SERIES 4



SERIES 1

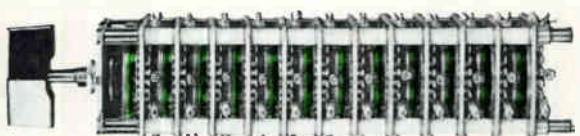

SERIES 2

IF YOU DO, you'll find that Shallcross Series 1, 2 and 4 precision rotary switch lines offer:

LOWER TOTAL COST — INITIAL COSTS ARE NORMALLY LOWER (often 25 percent or more) than those for rotary switch counterparts claiming comparable quality. **INSTALLATION COSTS ARE REDUCED** by easily wired flared terminals (identified for location) and rugged construction features that virtually eliminate switch damage during harnessing. **MAINTENANCE AND REPLACEMENT COSTS ARE REDUCED** to the vanishing point by: (1) 50 in/lb stop strength ratings, (2) multiple contact wipers (for reliable circuit "making"), (3) positive action long life detents, (4) dust protection for internal switch parts, and (5) material-design combinations that reduce voltage breakdown and insulation

resistance failures. Add these cost "savers" to lower specification costs (below), and you'll see why Shallcross has the most economical top quality rotary switch line in the industry — as a matter of fact, an investigation will prove that Shallcross switches are often less in total cost than the lowest priced "clip types."

OUTSTANDING DRY CIRCUIT SWITCHING — Negligible "thermals," low contact resistances (1-2 milliohms typical from input to output), and low switching noise provide ideal dry circuit switching.

EASIER SPECIFICATION — Comprehensive cataloging, reproducible specification sheets (for easier drawing creation), and easily used part number systems expedite specification.

FASTER DELIVERY — Day-in-day-out deliveries for standard Shallcross switches equal any in the industry (eight distributors stock 1-3 deck "standards" — production quantities are normally shipped in two to three weeks).

The best values in quality rotary switching wear this brand—try them.



SUBSIDIARY OF **CUTLER-HAMMER**

SHALLCROSS MANUFACTURING COMPANY, SELMA, N. C.,
ZIP CODE 27576 • TEL. 919 965-2341 • TWX 919 770-7839

MODEL CW-1 BOXCAR INTEGRATOR



The Model CW-1 Boxcar Integrator is a gated signal averaging device useful for the recovery of either complete repetitive waveforms or incremental portions thereof from noise. The input to the Boxcar Integrator is sampled by a variable width, variable delay gate which can be fixed at any point on, or slowly scanned across, the repetitive waveform. The sampled portion of the input waveform is averaged by a variable time constant integrator, displayed on the panel meter, and made available for external recording or other use. Because the mean value of random noise is zero, the output of the integrator will asymptotically approach the average value of that portion of the input waveform being sampled at any moment, with a corresponding suppression of the accompanying noise. The Model CW-1 may be used in such widely varied applications as pulsed nuclear resonance, laser excitation decay, and biological evoked response experiments. In general, this instrument should be of value in any application where noise interferes with the recovery of repetitive waveforms.

SPECIFICATIONS

SIGNAL CHANNEL —

Input Sensitivity: ± 0.2 volt to ± 100 volts in 1, 2, 5, sequence for ± 10 volts output.

Dynamic Range: Will accept inputs 15 times full scale requirement without overloading.

Integration Time Constants: 100 microseconds to 100 seconds in 1, 3, 10 sequence.

Holding Time: At least 10^6 times integration time constant for 10% F.S. change in output, up to 10^5 sec.

Output: (a) $\frac{1}{2}$ % Panel Meter, ± 10 volts.

(b) ± 10 volts provided at front panel at an impedance of 1 K.

(c) Recorder Output — suitable for most galvanometric and servo recorders.

GATE TIMING CIRCUITS —

Operating Modes: (a) Ext. Trigger

(b) Ext. Gate

(c) Recurrent: Time Base triggered automatically and repetitively.

(d) Continuous: Gate on continuously.

Time Base Widths: 10 microseconds to 1 second in 1, 2, 5 sequence.

Gate Pulse Width: Continuously adjustable from 1 microsecond to .11 second.

Delay: (a) Manual adjustment from 0% to 100% of Time Base Width.

(b) Automatic scanning from 0% to that % of Time Base Width selected by setting the Manual Delay Dial.

Automatic Delay Scan Periods: 1, 2, 5, 10, 20, 50, and 100 minutes.

GENERAL —

Power Requirements: 105-125 volts or 210-250 volts; 50-60 Hz; approximately 15 watts.

Size: 19"W x 5"H x 14"D.

Price: \$1,950.00. Export prices approximately 5 per cent higher (except Canada). Request Bulletin No. 127.



Electronics Review

Volume 40
Number 1

Manufacturing

The perfect bond

Three years ago, Honeywell Inc. tantalized other producers of integrated electronics systems by claiming it could get perfect molecular-diffusion bonds between an integrated-circuit chip and its leads. But Honeywell wouldn't say how it performed the trick [Electronics, Feb. 14, 1964, p. 70].

Now, one of Honeywell's rivals in aerospace electronics, Westinghouse Electric Corp., shares the secret and plans to use it to prepare multifunction assemblies of IC chips for military systems.

Whether Westinghouse puts the technique into production depends on whether it receives military funding for further development, according to Charles Denton, manager of the mechanical design group of the Westinghouse Aerospace division in Baltimore. He says that a proposal for a military contract has not yet been made, but that discussions are being held with the Naval Air Development Center in Johnsville, Pa., and with the Rome Air Development Center, Rome, N.Y.

The bonding method eliminates the usual interface between chip and lead materials and allows face bonding without the usual raised bump, ball or pad contacts. Any IC chip can be used, as long as the thin-film terminals on the chip are aluminum. The leads applied to the chip are fingers of nickel, coated with an aluminum film that fuses into the film on the chip.

Finger frame. The nickel fingers, 2 mils thick, support a 10,000-angstrom aluminum film that is the actual lead conductor.

To make them, sulfamate nickel is deposited 2 mils thick on a polished plate of stainless steel and then etched into the desired lead pattern held together by a frame of

nickel. After the aluminum is deposited on the nickel and heat-treated to make it adhere, the fingers and frame are stripped off the plate.

The fingers are positioned on the chip and bonded with a special parallel-gap welder. The assembly is heated to 300° C. Current from a programmed welding supply is passed through a fingertip, heating the joint to 600° C as the welding electrodes press the two aluminum surfaces together. A 2-millisecond surge of current heats the joint above 600° C and the bond is made. Finally, the current is gradually

eased down until the assembly has cooled to 300° C again. It all takes 150 milliseconds.

To make the bonding electrodes, a thoriated tungsten rod is ground into two identical halves with a tip radius of 2 to 6 mils. The gap between the electrodes is set by inserting a sheet of split mica, about ½ mil thick, between the two halves.

Bonds as small as 2 mils in diameter have been made, and because the bond has no interface, the fingers will break before the bonds fail. One reason the bonds are so effective is the half-moon cross-

A paper loss

A technical paper on Honeywell Inc.'s diffusion-bonding process was to have been a star attraction at the Society of Automotive Engineers' Electronic Packaging Conference next month—but nowhere in the paper was Honeywell's name mentioned.

Suddenly last week, the picture changed.

The author, Fred Walton, a former Honeywell engineer currently employed by the Westinghouse Electric Corp., withdrew his paper. Recently Walton published—despite Honeywell's protests—a paper describing a packaging system. The system turned out to be Honeywell's Micpak.

In publicizing the technical session, the society issued this description: "A unique specific technique for producing highly localized monometallic monolithic diffusion bonds suitable for microelectronic interconnection and packaging techniques will be described by Fred Walton of Westinghouse Defense and Space Center, Baltimore. This highly localized diffusion bond approach provides a bond reliability at the subsystem level comparable to that formerly available at the component level."

Honeywell, a spokesman has indicated, is displeased by Walton's actions. Walton's rejoinder is that his work on the techniques was funded by military contracts—the Air Force's Rome Air Development Center, Rome, N.Y., paid for the bonding work, he says, and the Naval Air Development Center, in Johnsville, Pa., sponsored Micpak. Honeywell funded the silicon multilayer board work.

Walton says he left Honeywell after working three and a half years on the processes at Honeywell's Aeronautical division in St. Petersburg, Fla. He left because he was convinced Honeywell would not put Micpak into production, after some \$400,000 had been spent. Westinghouse, he adds, does plan to use the process, and may invest up to \$700,000 on its version of the packaging technique.

In rebuttal, Honeywell says that while the Micpaks "will probably not be used as such, the techniques gained will probably be employed in the future." While the spokesman confirms that it has not authorized detailed reports, Honeywell has submitted a report to the military. Honeywell began work on the processes before it got the contracts, the spokesman continued, and both company and military funds went into the research and development.

section of the fingers, seen in the diagram. As the round side presses down, surface gases and oxides are squeezed aside while diffusion of the aluminum is aided by plastic flow and some evaporation and condensation.

Silicon wiring. After the fingers are bonded to the chip, the other ends of the fingers can be bonded

to aluminum wiring on a substrate that interconnects many such chips. The chips can be placed face-down on a flat substrate, or into channels in the substrate alongside the wiring.

Such assemblies are used by Honeywell in its Micpak packaging system. Honeywell has also demonstrated the bonding of

groups of chips to a silicon-crystal equivalent of a multilayer circuit board. The substrate, processed like an IC but without devices, contains a low-resistivity ground plane of p-type silicon, a high-resistivity p-type epitaxial layer with n-type diffused crossover conductors and thin-film surface bonding pads and conductors joined to the crossovers through windows in an oxide layer.

Big little packages. Westinghouse plans to use miniature multilayer ceramic boards for IC interconnection. These will be sealed, along with discrete devices, in a 1-inch-square package with 68 leads. The bonding is being done one finger at a time on a pilot line, but Westinghouse plans to qualify the process for military systems and install automatic production equipment. It hopes to develop simultaneous bonding of many leads.

The two companies are not alone on the chip and finger trail. International Telephone and Telegraph Corp. has been developing a similar lead-bonding technique [Electronics, July 12, 1965, p. 98]. And Bell Telephone Laboratories Inc.'s beam-lead technique fabricates lead fingers as part of the chip-metallization process [Electronics, June 28, 1965, p. 68, Nov. 16, 1964, p. 114, and Dec. 26, 1966, p. 111]. Bell's technique is being adopted by several firms.

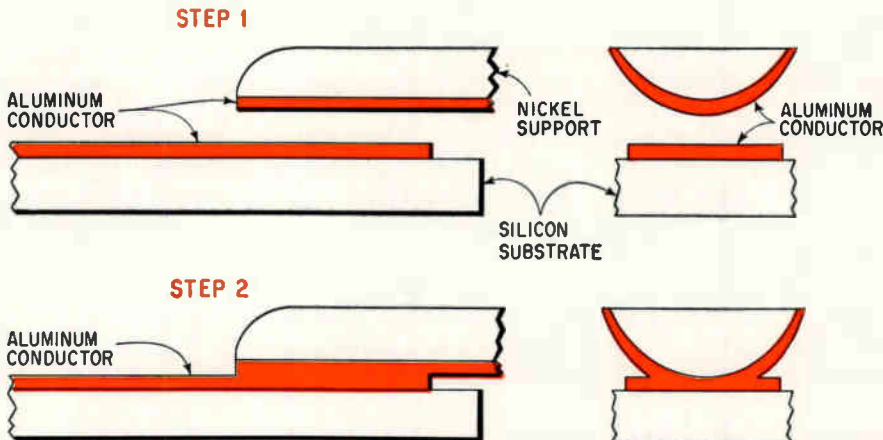

Interface-free bond is formed when molecules of aluminum film on the chip diffuse with those in the film on the substrate. The diagrams are before (top) and after views and cross-sections along the finger (left) and through the fingertip.

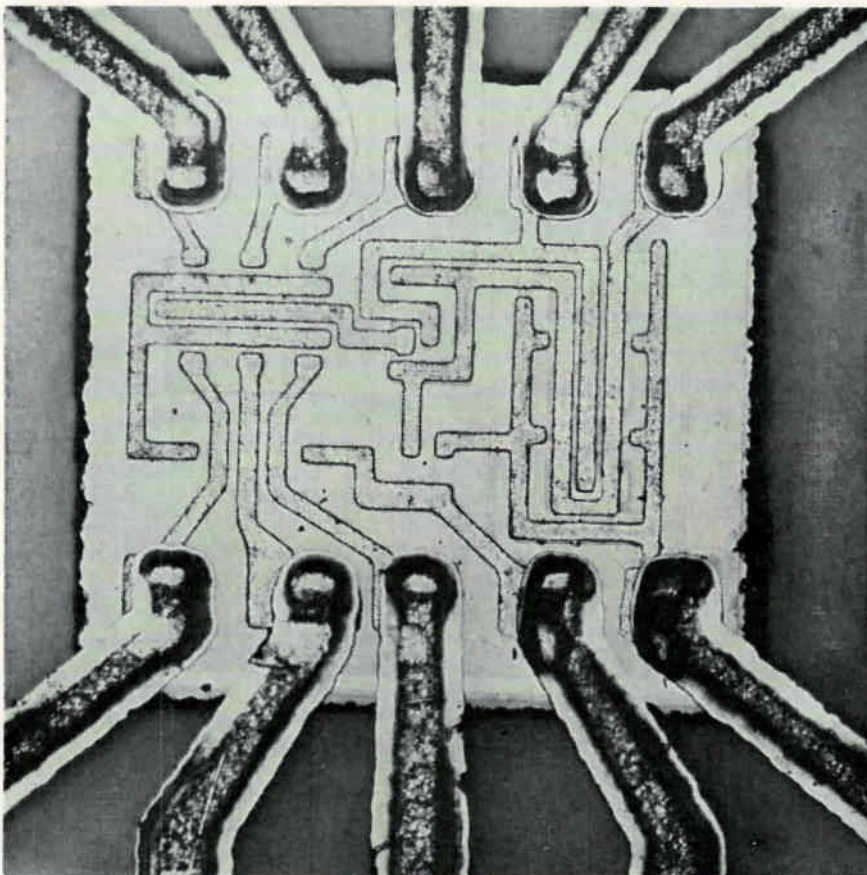

Chip and finger subassembly, ready for bonding the finger ends to an interconnecting substrate. The chip can be bonded face-down to the substrate or be inserted in channels in the substrate.

Military electronics

Litton's loss

A nearly \$20 million program to modernize the Air Force's ground-to-air communications network, 495L, has been terminated suddenly and without explanation. Late in December the Air Force said that as of Nov. 9, 1966, the contract with the Westrex Communications division of Litton Industries Inc. had been ended "by default."

The move apparently didn't catch Westrex by surprise. Only a month earlier, the division underwent a major overhaul: the top man, general manager Charles T.

Johnson, left the company. Litton brought in a new man, Joseph Smith, and upgraded the post to president of the division.

No details. Smith himself declines to elaborate on the reason for the contract cancellation, explaining that it would be inappropriate to discuss the details prior to an appeal that Litton has filed.

The cancellation is the second within three months involving a major contract for an L program—the designation given to command and control systems under development. The earlier termination involved the 473L program, an Air Force command information system [Electronics, Sept. 19, 1966, p. 201].

The decision to junk the 495L program reportedly wasn't made by the program director, Electronic Systems Division at Hanscom Field, Mass., but at a high Pentagon level. According to one industry source, the Air Force division commander, Gen. John W. O'Neill, was ordered to cut off the program.

Apparently by coincidence, the Westrex cancellation occurred at about the same time an Air Force evaluation team at Hanscom Field was completing work on contract-definition proposals of Litton and the Hughes Aircraft Co. for data-collection centers to be used in the tactical air control system, the 407L. Hughes eventually won the \$68.5 million production contract [Electronics, Dec. 26, 1966, p. 26].

On schedule. Smith said Westrex has an \$12 million contract with the Army for delivery of equipment similar to that of the 495L and that this job is proceeding "pretty much on schedule."

Westrex's president conceded that during the negotiations for the data centers the "495L question was raised," but he asserted that the military "specifically assured Litton that there was no prejudice" in the case.

The 495L program relies heavily on high-frequency, single-sideband as a primary mode of air-to-ground links. The original order, placed with Westrex two years ago, was for about \$9 million. This was subsequently raised to about \$15.5 million and would have gone to

more than \$19 million, Smith explained.

The goal of the 495L program was to upgrade the technical capability of the existing communications system, particularly for better control of the worldwide airborne fleet and to provide digital data communications. Also included were plans to extend coverage of the network to additional military users and expand the number of stations to serve additional areas of the world. The prime contractor was to equip at least one new ground station for the network, install additional equipment at existing stations and provide for integration of the existing and new subsystems.

A spokesman for Hanscom Field declined to disclose how much money has been paid to Westrex under the program.

The information officer for the user command, the Air Force Communications Service at Scott Field, Illinois, said that none of the systems developed under 495L has been turned over for operational use. He said the Air Force now plans to upgrade the worldwide ground-air system by procuring off-the-shelf hardware as needed.

Inventory gear. Westrex president Smith said he understood the Air Force will use "inventory gear" and this, he said, will mean "less capability by a long shot in sensitivity, tuning and in overcoming intermodulation loss."

According to Smith, the Air Force is buying some of the materials, such as antennas, from system subcontractors.

Smith said the first of 20 subsystems was to have been delivered in March with deliveries of two per month after that, and contract completion by the spring of 1968. In each case, he said, the equipment would have been unique.

Service rivalry

Ask an Air Force electronics procurement officer what he thinks of tx, or "testing extra," and he no doubt will tell you it's one of the most efficient and economical procedures around for assuring semiconductor reliability. Ask his Army

or Navy counterpart the same question and he'll probably say, "It's ok, but . . ."

The Air Force, which has been pushing the concept of tx for the past four years, maintains that it provides a tenfold improvement over conventional sample-testing methods and costs only a little bit more.

Reluctant move. At the persistent urging of the Air Force, the other two military services have reluctantly gone along with tx, but only for a few selected orders for transistors, diodes and rectifiers. The Air Force, on the other hand, has applied the testing technique to major orders: the F-111 and G-5A aircraft and the 487L communications system. (For more on the history of tx, see the panel below.)

Tx specs, the Air Force says, fill the gap between the loosely regulated but inexpensive sample-testing procedures, and the expen-

A slow start

Since the early 1950's, the Air Force has mulled a plan to test all components of new systems under full power, measuring the variations to screen out defects. But it was not until the F-111 program got under way three years ago that the idea was put into effect.

Engineers at the General Dynamics Corp., F-111's prime contractor, at that time drew up specifications for the aircraft around the testing-extra concept, and W.F. Stevens and his staff at the Air Force System Command's technical requirements and standards office, edited these specs only slightly before adopting them for Air Force-wide use.

Tx standards have since been applied to the Mark 2 avionics system for the F-111, the C-5A transport plane and the 457L Strategic Air Command communications system; next on the list is the new short-range attack missile (SRAM).

Air Force officials are already considering tx testing of integrated circuits; they maintain that such testing would be valid if ic designs were ever frozen. However, the other services oppose the idea on the ground that the setting of tx standards for ic's could stifle technical progress in the field.

TX versus ER

The present ER, or established reliability, standards for components haven't been basically altered since they were developed four years ago for the Minuteman missile program.

They differ from TX standards principally in that they require serialization of each component, a system involving extensive, and expensive paperwork. This procedure allows the user to trace a faulty component's full history back to its manufacturer.

Another difference is that ER standards require lifetime testing of samples before components are shipped so that a mean-time-between-failure can be figured. Components covered by TX standards can be supplied to users immediately after a burn-in lasting from 72 hours to a week. In addition to the burn-in, TX components are tested before and after high-temperature storage and high-temperature cycling.

sive ER, or established reliability, method. TX standards require that all components survive from 72 hours to a week of burn-in before shipment, while ER standards provide for a complex series of trials, including lifetime sample tests that may last as long as three months. Under the TX procedure, an entire batch of components is thrown out if 10% or more fail the "infant mortality" burn-in.

The Army and the Navy generally view the TX concept as just another test procedure in a field already crowded with some 213,000 reliability specs. But proponents of TX contend that the method is more logical than ER because components are most likely to fail in the early stages of use. Generally, reliability statistics bear out this contention.

Dollars and cents. The most striking argument offered by TX supporters is the Air Force's experience with it on the F-111 program. Conventional testing of a resistor for this program would have cost 53 cents, they say, whereas TX testing produced a reliability level nearly on a par with ER at a cost of 4 cents a component.

Further, says the Air Force, one

subsystem in the F-111 has already exceeded a mean-time-between-failure of more than 4,000 hours, though the specs called for only 150 hours.

The Air Force wants to establish TX not just to assert itself but to cut costs. It holds that if all the services adopt TX standards, dropping many of the other specs, manufacturers will be able to plan longer production runs, reduce inventories and, therefore, sharply cut component prices.

Communications

Touch and go

The major obstacle to rapid consecutive missile launches has been the tangle in communications. It takes several technicians four or five hours to manually patch circuits for communications between the control center and different launch pads. Now, the Air Force has installed a push-button switch-

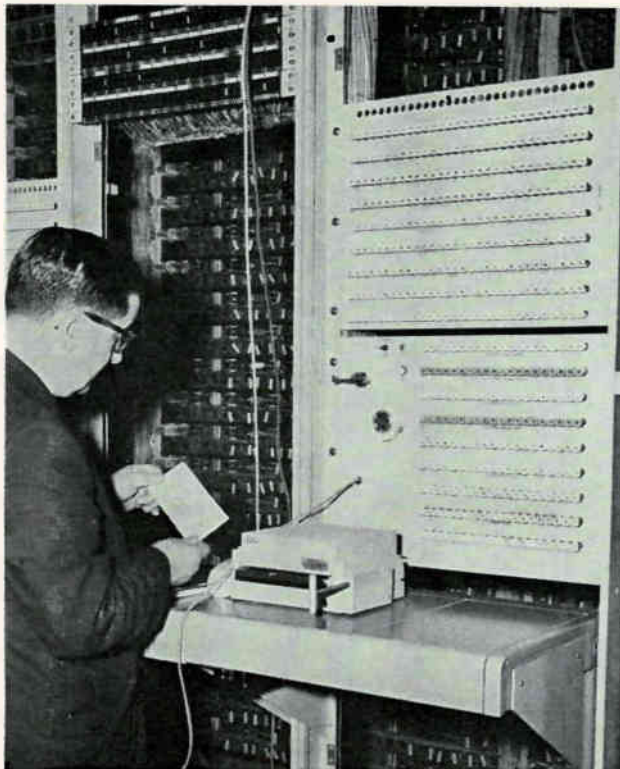
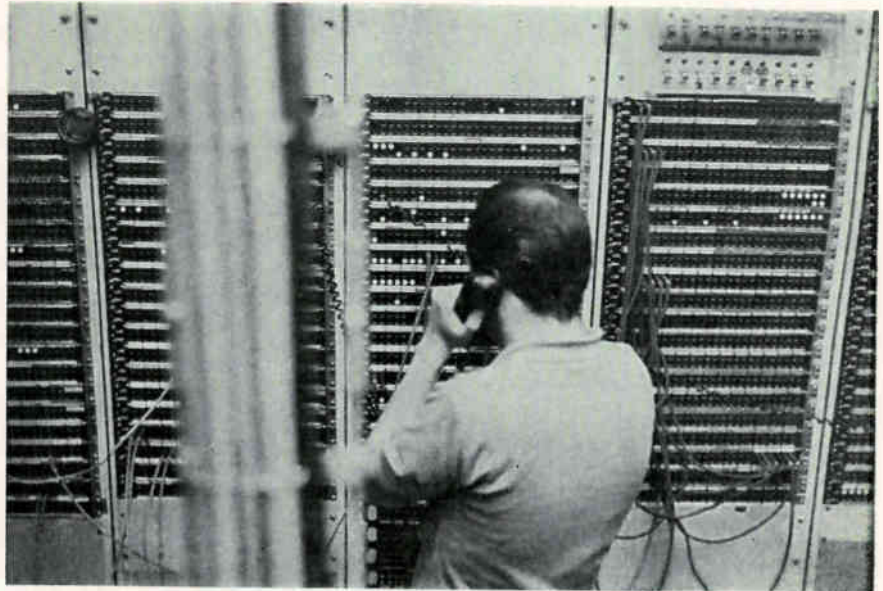

Manually patching complex communication lines for a missile launch is tedious. A technician (above) spends hours connecting circuits to establish communications between a launch control center and a launch pad. However, in a system designed by Western Electric (left), push buttons and punch cards switch all communications in less than five minutes.

ing system at the Western Test Range at Vandenberg Air Force Base, that cuts the time between shots to under 5 minutes.

Eventually the switching system, built by the Western Electric Co. for \$6 million, will enable the range to monitor simultaneously four countdowns instead of the two it can handle at present. "The rapid turnaround and improved communications osc department.

The system consists of five switching matrixes that link the control center to 30 launch pads, radio facilities, telephone lines and range instrumentation. This is in addition to existing telephone communications and data links. Lines are immediately ready to use when switched. For every link there are alternate routes.

Far ranging. Two sets of 260-line switches provide separate voice links for controllers and such range users as the Air Force Systems Command, the Strategic Air Command and the National Aeronautics and Space Administration. Another 100-line switch connects radio links, establishing communications with downrange sites on Hawaii and ships and planes in the South Pacific. One switch interconnects about 30 sky screens to monitor the initial phases of liftoff.

All switches are controlled by push buttons at the control center. Telephone communications can also be switched by inserting a pre-punched IBM card into a desk-top multiple contact reader. Holes in the card permit contacts to close various points on the switching matrix, making the desired connections. These telephone switches can make 40 connections at one time—either point-to-point or conference calls. If necessary, all 260 lines can be linked in a conference call. Because technicians don't patch manually, communications are more reliable. "The costs of a missile program make it imperative to have satisfactory communications," says Charles Edmondson, an engineering supervisor at the Vandenberg range. "It doesn't matter how good the missile is, if you can't talk, you're dead," he asserts.

No punch. A similar system—

built by the Westrex Communications division of Litton Industries Inc.—is in operation at Cape Kennedy. The system consists of two switching matrixes—one 300-line matrix for two-wire communications and a 600-line matrix for four-wire communications. The matrixes are independent and cannot be interconnected. The 600-line matrix contains provisions for conference calls and is completely nonblocking, that is, a connection can always be made. Punched cards can switch the entire system in about 30 minutes.

However, Robert Smith, project manager in Westrex's systems engineering department, says that in a typical launch it would take about 10 minutes to switch the lines since only 200 to 300 lines have to be connected.

In the Westrex system, the 300-line matrix is used for base communications and also serves as an emergency backup if regular communications fail. The 600-line phone system is the normal equipment for range and down-range communications.

Medical electronics

Heartfelt power

Were it not for the fact that the batteries of cardiac pacemakers

require replacement every few months, the tiny implanted instruments could go on steadily triggering the beat of a sick heart for years without adjustment. To get around the power-source problem, researchers have experimented with a dozen or so techniques to convert kinetic energy—of either the lungs or the heart itself—into electricity to run the pacemaker, but each attempt has run into fundamental problems. Now two researchers at the Case Institute of Technology in Cleveland have developed a technique that appears to sidestep these problems.

Power converter. The medical electronics engineers, Wen H. Ko and Michael Neuman, have borrowed one of the basic elements of the motion-to-electricity conversion technique: the piezoelectric wafer. But instead of physically attaching one end of the wafer to the moving heart, they have simply placed it near the organ. In essence, the wafer, built into an enclosure, forms a resonant chamber much like the inside of a drum. Hence, steady motions of the heart are converted into sound waves that drive the wafer and produce a small current. The technique has already been successfully tested in two dogs.

What is particularly attractive about this process is that the wafer doesn't make contact with the heart. In earlier experiments in which contact was made, the heart

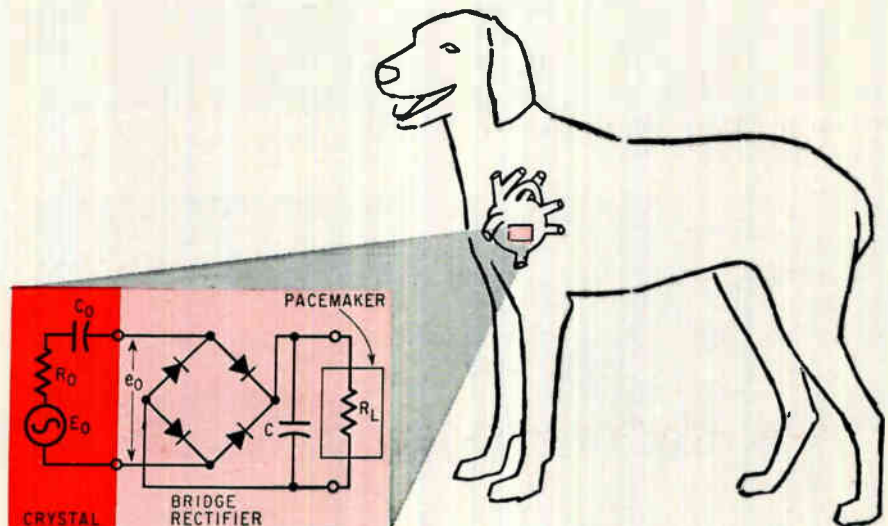

Sound waves generated by the beating heart provide enough power to generate a current to operate a cardiac pacemaker.

eventually adjusted itself at the point of contact until the wafer was no longer deflected. In the Ko-Neuman technique, the natural movement of the organ isn't affected. In addition, the instrument used can be made so small that it can be implanted directly inside the heart, the researchers say.

Beam shaped. In the unit, a ceramic wafer shaped like a cantilever beam is housed in a small enclosure. The enclosure prevents body fluids from shorting out the high-impedance crystal; the beam is weighted at one end and anchored at the other. The impact of the heartbeat causes the weighted beam to resonate, or vibrate, at a frequency that corresponds to the mechanical driving source, producing a train of electrical pulses.

The researchers have made use of the crystal's capacitance by adding a voltage doubler circuit externally. The energy converter, constructed of Clevite PZT-5H crystal, measures only 2 by 5 by 1 centimeters. At a 80 pulse-per-minute rate, the maximum output is 4 volts into a 10^5 -ohm load. This power—160 microwatts—is more than enough to drive a pacemaker.

Avionics

Only make believe

The obvious way to test the experimental design of an airplane is to build a prototype and fly it. That's the expensive way. A much cheaper method is to work out a mathematical model of the design and

crank the information into a computer for simulation. The one drawback here is that the results are totally dependent on the assumptions made in the mathematical model. North American Aviation Inc. has just won a \$5.6 million Air Force contract for a design that combines the two techniques: it will develop what's called a variable stability system (vss) for a test plane that, in effect, makes it act like any other.

Specifically, the North American contract calls for a control system for a vertical takeoff and landing (vtol) aircraft, a modified Hummingbird 2. About 250 controls in the system will be adjustable, so that by flipping a few switches and dials, the Hummingbird can be converted into any number of other experimental planes. Further, any combination of designs for such parts as wings, tails, or fuselage can be tested in flight.

Changing response. According to William T. Barker, program manager at the Los Angeles division of North American, the 250 adjustable variables will integrate 5° of freedom: roll, yaw, pitch, lift and thrust. Adjusting the variables alters the response of the aircraft, causing the handling characteristics to change.

The ultimate purpose of the vss installation in the Hummingbird is to generate data for writing a comprehensive military specification for vtol aircraft, provide a test bed for design theories and to provide design information on aerodynamics and controls. The vtol specification will describe flight characteristics and define the limiting design.

Fly by wire. The modified Hummingbird is a two-pilot airplane. The evaluation pilot will always "fly by wire"—that is, he will control the aircraft through the vss with no mechanical connection to the controls. The other pilot, for the sake of safety, will have direct access to the controls in the conventional manner and will be able to take over in the event of vss failure.

With more than 250 variable flight parameters, and with many additional fixed parameters, managing the interaction among these obviously will require a computer. North American engineers have not yet decided on the type of computer they will develop for the vss, but it will probably be an analog-digital design.

Collision course

A multimillion-dollar contest is shaping up as several avionics companies compete to build collision avoidance systems for commercial airlines. Experimental systems have already been built by the Collins Radio Co., the Bendix Corp. and the McDonnell Co. And two other avionics concerns—TRC Inc. and the National Co.—are working on collision avoidance systems. None of the systems are compatible.

In an effort to pressure the competing avionics companies to either redesign their systems, or to find ways to make them compatible, the airlines' industry group, the Air Transport Association, is trying to establish standards for the design of the avionics gear. A technical committee of the association, set up for that purpose, will begin a series of meetings this month.

Time basis. Both the Collins and the McDonnell systems use time-frequency as the basis for warning pilots that they are approaching another craft and what evasive action should be taken. McDonnell's design uses ground stations.

But in the Collins system, air-to-air synchronization and time-averaging techniques, using accurate atomic clocks, eliminate the need for the ground stations.

Both the Collins and the McDon-



It looks like a Hummingbird but it'll act like any VTOL plane.

TRW TRANSISTORS announces the Gigahertz family



35% efficiency... 5dB gain!

TRW breaks the Gigahertz barrier with this new family of Ultra High Frequency communication transistors! They are the finest broad-band transistors you can buy—the *only* power transistors capable of 1 GHz operation in simple, straight through circuits.

As doublers or triplers they'll reach 3 GHz with cool efficiency. In the 600 to 700 MHz range their gain and efficiency is phenomenal!

And there's more—you get this remarkable performance from a 28 volt power source...35% efficiency and 5dB gain!

Contact any TRW distributor or TRW Semiconductors Inc., 14520 Aviation Blvd., Lawndale, Calif. 90260. Phone: 213-679-4561. TWX 910-325-6206. *TRW Semiconductors is a subsidiary of TRW INC.*

TRW

nell designs have been outlined before the industry group. The Bendix system hasn't been presented and little is known about how it operates, except it's a cooperative system and it needs neither atomic clocks nor ground stations.

After the industry group decides on a standard, the Federal Aviation Administration gets into the act. It's the FAA which makes the final ruling on what systems can be installed in airlines, and a spokesman for the agency concedes that will probably take years before agreement will be reached.

Computer-aided design

Circuit course

The infant field of computer-aided design (CAD) is beginning to gen-

erate broad interest among electronics engineers. This is evidenced by the number of public and private courses, workshops and symposiums listed for this year.

Last month three CAD sessions were announced, one by a private consultant and two by schools. This brings to almost a dozen the number of technical sessions already scheduled.

From Jan. 24 to 26 Design Automation Inc. of Lexington, Mass., will give a course in Palo Alto, Calif., on computer-aided analysis of circuits. Specifically, it will cover the use of the NET-1 computer program. The course will be repeated in Los Angeles, starting on Jan. 31. Tuition is \$275. The company, headed by Nathan O. Sokal, was the first to be established for CAD consulting.

Cosponsors. At New York University's School of Engineering and

Science, a three-day class on circuit design by computer will be held from Jan. 31 to Feb. 2. The program is cosponsored by the National Aeronautics and Space Administration and the Office of Naval Research.

And at the University of Missouri, College of Engineering, a summer institute is planned that will devote time to CAD. The workshop program will be in three sections. The first, from Aug. 7 to 12, will include an intensive course in Fortran 4 programming, with emphasis on electronic circuit design. The second, from Aug. 14 to 18, will deal with analysis and design of electronic circuits by computer. And the third, from Aug. 21 to 25, will consist of eight concurrent sessions: time domain techniques, optimization techniques, filter design, nonlinear circuits, biomedical data processing, biomedical transducer design, digital logic design and digital simulation.

At the University of Missouri the fee per workshop is \$150.

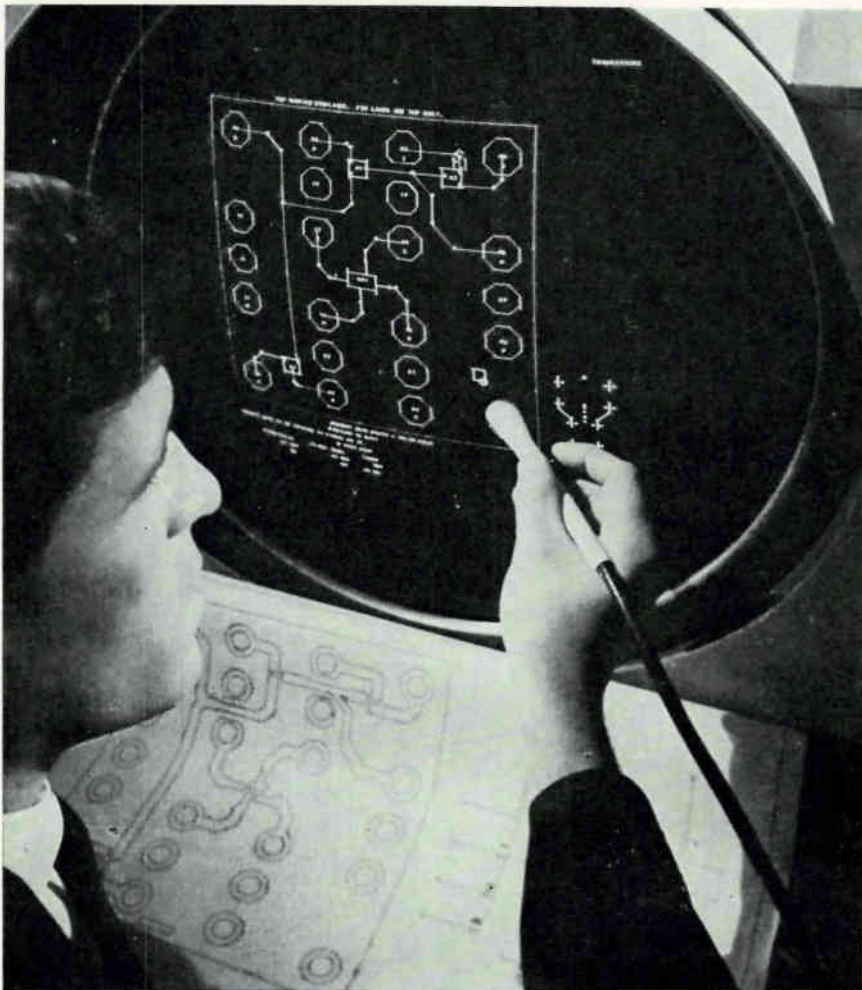

Designing circuits by computer. Engineer at IBM lab experiments with various patterns for a circuit.

Instrumentation

Giant capacitors for Apollo

The National Aeronautics and Space Administration will use the world's largest balanced capacitance bridges to monitor fuel consumption during the 1½-minute flight of the Apollo launch vehicle's initial Saturn stage. During that period, liquid oxygen and propellant fuel will slosh back and forth in the craft's tanks, with waves reaching four feet at times.

To cope with this sloshing, four 49-foot-long capacitance bridges are to be installed in the Saturn vehicle at a cost of \$10,000 each, including associated electronics. Built by Trans-Sonics Inc. of Burlington, Mass., the capacitors will each consist of 12 segments of aluminum tubing functioning as electrodes; the liquid flowing between the tubing will act as a dielectric.

Finding its level. Each segment of tubing is a 49-inch continuous

A Tektronix High Resolution Measurement Package:

- *Type 545B Oscilloscope with Advanced CRT*
- *Accurate Horizontal Delayed Sweep*
- *Type W Plug-In for Accurate Voltage Measurements*



Small spot size — uniform focus
The waveform demonstrates the small spot size and uniform focus which provides fine trace definition.

The cathode ray tube and the delayed sweep of the Tektronix Type 545B Oscilloscope, plus the voltage measurement capabilities of the Type W Plug-In Unit, combine to make an ideal package for high resolution measurements. Even greater versatility is then available because the Type 545B is compatible with all Tektronix letter and 1-series plug-ins.

Precision CRT

The Type 545B uses the advanced T5470 cathode ray tube that provides small spot size and permits uniform focus over its entire 6 x 10 cm display area. The illuminated, no-parallax internal graticule lets the operator make full use of the measurement capabilities of the oscilloscope. Risetime and falltime measurements (10 to 90%) are made using the dashed graticule lines, and the illuminated graticule simplifies photographic recording.

Horizontal Delayed Sweep

The delayed sweep capability of the Type 545B gives you the ability to make very accurate time measurements. The incremental accuracy (0.2%) of the delay-time multiplier provides a calibrated delay range which is continuously variable from 1 μ s to 10 s with an accuracy within 1%. The Type 545B provides stable triggering on small signals. It triggers internally with AC coupling from 150 Hz to 10 MHz on 2-mm deflection, increasing to 1 cm at 30 MHz.

Accurate Voltage Measurements— DC to 23 MHz

The high resolution Type W Plug-In Unit (illustrated) can measure voltages with an accuracy of $\pm 0.2\%$ V_C . It provides an effective CRT height of

$\pm 11,000$ cm, permitting evaluation of 1 mV pulses riding on signals up to ± 11 V (10 mV evaluation to ± 110 V). The common mode rejection ratio of the Type 545B is at least 20,000:1 on signals from DC to 20 kHz. Bandwidth of the instrument is DC to 23 MHz at 50 mV/cm and DC to 8 MHz at 1 mV/cm.

The Type 545B vertical amplifier is easy to maintain and calibrate with a hybrid circuit design and a compact delay line that requires no adjustments. Among the letter and 1-series plug-ins available for use with the Type 545B are spectrum analyzer units covering the spectrum from 50 Hz to 10.5 GHz, and sampling units with 90 ps risetime and TDR capabilities. With the Type 1A2 Dual Trace Plug-In, DC to 33 MHz measurements may be made with 10.5 ns T_r and 50 mV/cm deflection factor.

Type 545B (complete with probes and accessories) \$1550
Type W Plug-In Unit 575
Type 1A2 Dual Trace Plug-In Unit 325

U.S. Sales Prices FOB Beaverton, Oregon

Tektronix, Inc.



For complete information, contact your nearby Tektronix field engineer or write:
Tektronix, Inc., P.O. Box 500, Beaverton, Oregon 97005

measuring sensor and each has a discrete sensor. The segments are designed so that alternate sensors are connected to the opposite phase of the drive signal. The capacitance bridge is maintained at null by a 10-bit digital servo system. As liquid fills the first sensing unit, the output increases in value until the second sensor is reached. When the liquid is at the second sensor, the output decreases until the third is reached and so on. Discrete sensors at the interfaces identify the segment being reached. The continuous output increases on all odd-numbered segments and decreases on even-numbered segments.

The lightweight, rugged, self-calibrating system measures the liquid level to a resolution of 0.1 inch over a height of 588 inches.

The electronic unit provides a digital output with an updating time of 280 microseconds. The level, and thereby the remaining quantity of propellant, is monitored continuously from the loading of the fuel until burnout and stage separation. The information is gathered in digital form, updated 3,600 times per second and transmitted to the ground via the launch vehicle's telemetry system.

Computers

Another Sigma

The first computer with a memory cycle of less than one microsecond that sells for below \$500,000 was announced last week. The computer, the Sigma 5, has a memory cycle of 850 nanoseconds and a typical configuration costs about \$300,000.

The computer is the third in the Sigma series built by Scientific Data Systems Inc. Its predecessors are the Sigma 7, announced last March, and the Sigma 2, which came out in September. Bryan Middleditch, manager of product marketing, says the new computer is designed primarily for scientific applications; it can also be used for commercial data processing, but decimal arithmetic is more awk-

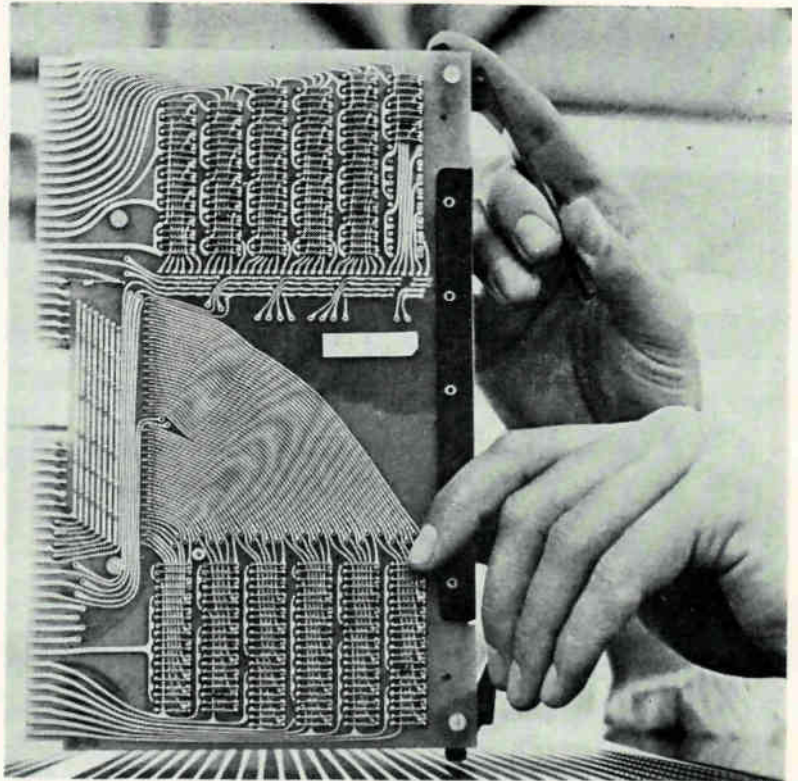

Memory module containing 4.096 eight-bit bytes. Up to 32 of these modules may be installed in the new Sigma 5 computer.

ward to handle and therefore requires more time than on the Sigma 7.

Speed second. Except for time-sharing ability, the Sigma 5 is identical to the Sigma 7 from the programmer's point of view. "In the Sigma 5, when trade offs were made, the designers favored cost rather than speed," says Dan Cota, a member of the product planning staff at sds. The Sigma 7 required additional hardware for efficient decimal arithmetic, for juggling many time-sharing inputs at high speed and for other tasks.

The Sigma 5 can execute several programs at once; it works on a high-priority foreground program as long as possible, then switches to a background program kept in its memory until it is interrupted by another foreground task.

The fast 850- μ sec memory cycle is possible because the memory organization is $2\frac{1}{2}$ -dimensional, as in the other Sigmas. The $2\frac{1}{2}$ -dimensional organization uses only three wires threading each ferrite core instead of four, reducing propagation delay and noise [Electronics, Oct. 31, 1966, p. 83].

Interleaving. One feature of the new machine, common in larger and more expensive systems, is the modular organization of the memory, with interleaving. Modular organization permits overlapping of memory cycles; a memory cycle may be started in one module while a cycle is under way in another. This results in an effective cycle time of 600 nsec. With interleaving, one module may contain only odd-numbered addresses and another only even-numbered addresses. Hence operations that refer to sequential locations in conventional memories refer instead to alternate modules whose cycles may be overlapped. Groups of four or eight modules may also be interleaved in the Sigma 5.

The low price was attained, says Paul Lebowitz, product manager for the Sigma 5 and 7, by keeping down the total number of basic components. Only 437 different parts are used, compared with about 1,000 for comparable machines. This permits the company to buy fewer parts in higher volume at lower cost. Software development cost also was low because the

ARNOLD IS



IRON POWDER CORES

From 5" dia. to Subminiature Toroids

Arnold has total capability across all design configurations—toroids, insert cores, threaded cores, plain cores, bobbin cores, sleeve and hollow cores, cup cores and subminiature toroids. All the necessary raw materials are carried in stock to provide optimum performance over the specified frequency spectrum. Our facilities include the most modern powder processing, pressing, quality control and final test equipment available in the industry.

Call us, write us, TWX us, we can handle any problem.

Arnold is also ■ Permanent Magnets ■ Tape Wound Cores ■ MPP Cores ■ Magnetic Shielding ■ Electrical Alloy Transformer Laminations ■ Transformer Cans and Hardware ■ Silectron Cores ■ Special Magnetic Materials.

 **ARNOLD**
SPECIALISTS in MAGNETIC MATERIALS

THE ARNOLD ENGINEERING COMPANY, Main Office MARENGO, ILL.
BRANCH OFFICES and REPRESENTATIVES in PRINCIPAL CITIES

AMPERITE

GLASS ENCLOSED Thermostatic DELAY RELAYS



Offer true
hermetic
sealing—

— assure
maximum
stability
and life!

Delays: 2 to 180 seconds

Actuated by a heater, they operate on A.C., D.C., or Pulsating Current . . . Being hermetically sealed, they are not affected by altitude, moisture, or climate changes . . . SPST only — normally open or normally closed . . . Compensated for ambient temperature changes from -55° to $+80^{\circ}\text{C}$. . . Heaters consume approximately 2 W. and may be operated continuously. The units are rugged, explosion-proof, long-lived, and inexpensive!
TYPES: Standard Radio Octal and 9-Pin Miniature . . . List Price, \$4.00
PROBLEM? Send for Bulletin No. TR-81.

AMPERITE

BALLAST REGULATORS

Hermetically sealed, they are not affected by changes in altitude, ambient temperature (-50° to $+70^{\circ}\text{C}$), or humidity . . . Rugged, light, compact, most inexpensive.

List Price, \$3.00

Write for
4-page
Technical
Bulletin
No. AB-51

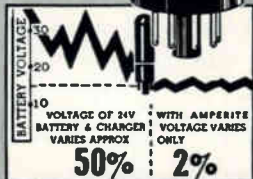

AMPERITE

600 PALISADE AVE., UNION CITY, N.J.
Telephone: 201 UNION 4-9503
In Canada: Atlas Radio Corp., Ltd.,
50 Wingold Ave., Toronto 10

Electronics Review

Sigma 5 is program-compatible with the Sigma 7.

Space electronics

High marks for ATS

Except for a few minor hitches, the first Applications Technology Satellite (ATS-1) and its ground stations are performing to specifications. The "engineer's satellite" is already proving several design concepts that will go into future hardware such as the Communications Satellite Corp.'s proposed Aeronautical Services Satellite.

Built by the Hughes Aircraft Co. [Electronics, Nov. 28, 1966, p. 121], the spin-stabilized, stationary satellite was launched on schedule Dec. 6 and is now on station over the equator east of Christmas Island in the Pacific.

It has relayed very-high-frequency voice transmissions from aircraft in flight to ground stations with fair success; it has successfully despun its phased-array antennas to put more energy into ground receivers; it has relayed color television via its wideband frequency-modulation circuitry, and it has sent back pictures of one-third of the earth's surface over a new spin-scan tv system.

Still to be accomplished, however, is a single-sideband multiple-access experiment to enable several ground stations to transmit through the satellite simultaneously.

On schedule. Operation of ATS-1 is going "pretty much on schedule, although we would like to get back a little more data," says one engineer at the Goddard Space Flight Center, Greenbelt, Md., which is running the project for the National Aeronautics and Space Administration.

The satellite's 6-gigahertz antenna is passing its first flight test with high marks, putting out about 10 decibels more gain than possible with a spun array.

The multiple-access experiment, in which the satellite receives frequency-division ssb transmissions

from ground stations and transmits them as a single phase-modulated carrier, is scheduled for this month.

Relay test. The preliminary tests of voice relay from aircraft to ground were generally successful although they did show some signal fading. They were performed with makeshift vhf aircraft antennas designed for vertically polarized line-of-sight signals.

Circularly polarized aircraft antennas, insensitive to the signal polarization resulting from such phenomena as Faraday rotation, are currently being built at Dorne & Margolin Inc. and the Bendix Corp. They will be installed on commercial planes from seven airlines for further ATS experiments. Originally slated to begin this month, these tests may not get under way until next spring—or February at the very earliest.

Industrial electronics

Market view

About 18 months ago a Dallas company, Recognition Equipment Inc., developed a 45-foot-long electronic panel for the New York Stock Exchange for displaying market transactions. Now, Trans-Lux Corp. of New York has relied heavily on semiconductors to shrink the panel down to eight feet—a more convenient size for most stock brokerage houses [Electronics, Sept. 6, 1965, p. 36]. Both designs use a continuous belt of plastic disks that are flipped into position by jets of air to spell out the numbers and letters reporting market movement.

Called Trans-Jet, the system is tied to the Big Board's nationwide stock exchange communications network to display market quotations instantly. It would replace the displays found in most brokers' offices which project the market ticker tape onto a viewing screen. The new display requires considerably less maintenance and can be placed overhead in the center of a room instead of against a wall.

Time circuits. The moving belt of the quote board is made up of

We have 47 Semiconductor Application Notes that tell you how to apply Integrated Circuits in all types of equipment.

IC APPLICATION NOTE INDEX

<input type="checkbox"/> I. CURRENT-MODE LOGIC SYSTEMS	AN 187	MECL IC Line Driver	AN 265	Choosing Very High-Speed ICs (ECL and TTL)
	AN 194	Designing Integrated Serial Counters	AN 266	MECL IC Flip-Flops
	AN 195	Designing Integrated Clocked Counters	AN 274	MECL IC Shift Registers
	AN 202	Noise Margins of MECL ICs	AN 277	Overshoot and Ringing in High-Speed Digital Systems
	AN 233	Design of Monostable Multivibrators Using MECL ICs	AN 278	Using Shift Registers as Pulse Delay Networks
	AN 239	MECL IC Schmitt Triggers	AN 280	MECL 70 MHz J-K Flip-Flop
	AN 244	The MECL Line of Digital ICs		
<input type="checkbox"/> II. RESISTOR-TRANSISTOR LOGIC SYSTEMS	AN 234	MRTL Family of ICs	AN 253	An Analysis of MRTL Integrated Logic
	AN 236	Using Motorola Milliwatt MRTL IC Family	AN 254	Using MRTL IC Flip-Flops
	AN 251	Decade Counters Using MRTL ICs	AN 264	MRTL IC Shift Registers
	AN 252	Choosing MRTL Integrated Logic Circuits	AN 279	Setup and Release Times in the MRTL J-K Flip-Flop
<input type="checkbox"/> III. DIODE-TRANSISTOR LOGIC SYSTEMS	AN 200	Variable Threshold Logic Family	AN 262	Decade Counters Using MDTL ICs
	AN 235	Using Motorola MDTL Line ICs	AN 263	Choosing DTL Integrated Logic Circuits
<input type="checkbox"/> IV. GENERAL DIGITAL APPLICATIONS	AN 148	IC Reliability	AN 256	Examining Ultra High-Speed IC System Inter-Connections
	AN 245	An Integrated Core Memory Sense Amplifier	AN 270	Nanosecond Pulse Handling Techniques
	AN 255	Comparison of Seven Digital IC Logic Lines		
<input type="checkbox"/> V. OPERATIONAL AMPLIFIERS	AN 204	High-Performance Integrated Operational Amplifiers	AN 273	More Value Out of Integrated Operational Amplifier Data Sheets
	AN 248	A High-Voltage Monolithic Operational Amplifier	AN 275	Audio Power Generation Using IC Operational Amplifiers
	AN 258	Monostable Multivibrator Design Using An IC Operational Amplifier	AN 276	Useful Frequency Range Extension for MC1530 Operational Amplifiers
	AN 261	Transistor Logarithmic Conversion Using An Integrated Operational Amplifier		
<input type="checkbox"/> VI. RF-IF AMPLIFIERS	AN 160	Application of Micro-Electronics to IF Amplifiers	AN 247	An IC RF-IF Amplifier
	AN 203	Tuned Amplifier Design With An Emitter-Coupled Integrated RF Amplifier	AN 259	Using ICs in a Stagger Tuned I-F Strip
<input type="checkbox"/> VII. GENERAL LINEAR APPLICATIONS	AN 148	IC Reliability	AN 233	Cascade Noise Figure for IC Transistors
	AN 154	An Integrated Harmonic Mixer	AN 271	Breadboard Techniques for Low Frequency IC Feedback Amplifiers
	AN 162	Audio Power Applications Using ICs		
AN 164	Designing-In Integrated Differential Amplifiers			

They'll help you learn how to use IC's in a Hurry! Send for them.

To receive the application notes in the Groups in which you are interested, write on your company letterhead indicating "Group 1, Group 2, etc." to Motorola Semiconductor Products Inc., Technical Information Center, Box 955, Phoenix, Arizona 85001. We'll have them in the mail to you right away.

-where the priceless ingredient is care!



MOTOROLA
Semiconductors

Etch your own PC boards automatically!

(In less than five minutes!)

from this—
to 11" x 14"



Shown
actual
size!

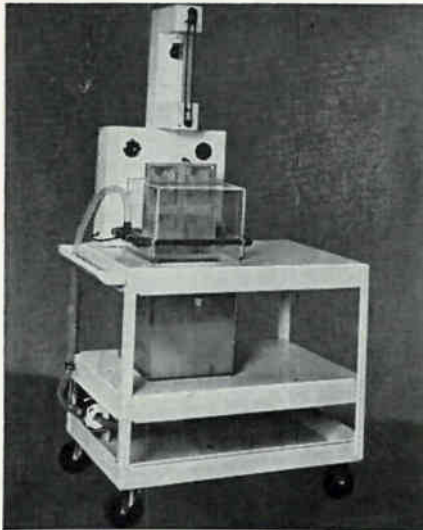

CYCLO-TRONICS "fine-line" etcher

for prototypes—limited runs

No cooling or venting required!

Etches as fine as .001"!

Cuts costs in half—saves time!

Complete photo processing instructions!

Work is illuminated while etching!

Not patterning . . . minimum undercutting!

Model No. 201 (illus.), etches two 11"x14"
one-sided boards or one
11"x14" two sided board: **\$695**

Pat. applied for

NOW IN USE BY:

Univ. of Chicago/Univ. of Colo./Univ. of Georgia/
Grad. Res. Center of the S.W./Univ. of Penn./ Dkla-
homa State Univ./Washington Univ./AMP, Inc./
Bendix/Beta Corp./Charles Bruning Co./C. G. Conn/
Esso Research/General Dynamics/IBM/Jordan Elect./
ITT Gilfillan/Keesler AFB/Lear Siegler/Micro Switch
Div. Honeywell/Microwave Elect./Sonotone/Varo
Inc./Westronics/Whirlpool/Woodward Governor

Representatives: Some Territories Still Available.

Send for complete information

CYCLO-TRONICS, INC.

3858 N. CICERO—CHICAGO, ILL. 60641
TELEPHONE: (312)-282-6141

Electronics Review

¼-inch panels, luminescent plastic disks that are black on one side and yellow on the other. Semiconductor timing circuits synchronize the belt's speed with actual market activity. Other circuits convert the serial signals coming from the stock exchange into a parallel digital code and also set up logic "quotation commands" for the 23 air jets, which control a single vertical column of disks. Each column is eight inches high.

According to the commands, the disks are flipped from their black to their colored sides. Up to 900 characters per minute can be displayed.

In developing the display, Trans-Lux used nearly every type of solid state component:

- **Integrated circuits** decode the input from the ticker tape and synchronize its speed to the speed of the display.

- **Small-signal discrete transistors** drive ferrite core pulse transformers used for buffering.

- **Silicon controlled rectifiers** and power transistors control the air jets and drive the d-c motors which move the display.

- **Photocells** help synchronize the mechanical position of the moving frame to the electrical position signals.

- **Diodes and unijunction transistors** receive the signals from the ticker tape and act as a master clock for the system.

These components are all from Texas Instruments Incorporated's Silect line—plastic packaged low-priced units for industrial applications. The IC's are series 73 units in dual-inline packages. An order for more than \$1 million worth of semiconductors has already been placed, according to Trans-Lux.

The over-all size reduction of the electronics obtained by Trans-Lux is impressive. The earlier 45-foot display required 75 plug-in printed-circuit boards housed in a separate cabinet. Trans-Lux's display needs only five plug-in boards and a motor-control board placed at one end of the moving belt. Additional size reduction is probable in the next few years when the electronics is redesigned to use metal-oxide semiconductor arrays.

For the record

Profit sharing. The Radio Corp. of America says sales and profits rose to a record in 1966. The company reports that sales will surpass \$2.5 billion and profits \$130 million. Color television manufacturing and broadcasting contributed the lion's share to the company's over-all gains. For 1967 RCA anticipates more of the same. On the other hand, the Westinghouse Electric Corp. reports that fourth quarter earnings will fall below the figures for the like period a year ago despite an increase in sales. Widespread strikes caused the decline. Nevertheless, the company expects the earnings for the entire year to top those of 1965. And the General Electric Co. expects 1966 earnings to be less than 1965's because of strikes during the final quarter.

Tape measure. The Nortronics division of the Northrop Corp. is selling a crash recorder that can record a 10-hour plane flight. Present recorders generally record only the last 15 minutes. The new unit weighs 2½ pounds and occupies less than 61 cubic inches; its outside diameter is slightly more than 4 inches. Compressed time-recording techniques result in smaller tape reel requirements. It is believed that the amount of data recorded depends on the speed of the tape. Inputs include flight crew intercom conversations, instrumentation data and a time signal code. Frequency response is in the 400-hertz to 3-kilohertz range.

Split decision. By a close vote of four to three, the Federal Communications Commission has approved the merger of the American Broadcasting Co. and the International Telephone and Telegraph Corp. The Justice Department warned of possible antitrust violations but said it planned no move to block the merger.

Ersatz quartz. The Bell Telephone Laboratories and the Western Electric Co. have developed a way to grow quartz crystals that will replace natural quartz crystals in stable, high-frequency applica-

When tiny parts are important in your plans, you need the

BIG DIFFERENCE

you get with uniformly precise small die castings and plastic moldings by

GRC®

GRC made this possible... ▶

for Westinghouse, a 1/300 ounce die casting with the smallest hole ever cast (0.009-in.) anchors extremely fine metal ribbon in their new taut band meters.

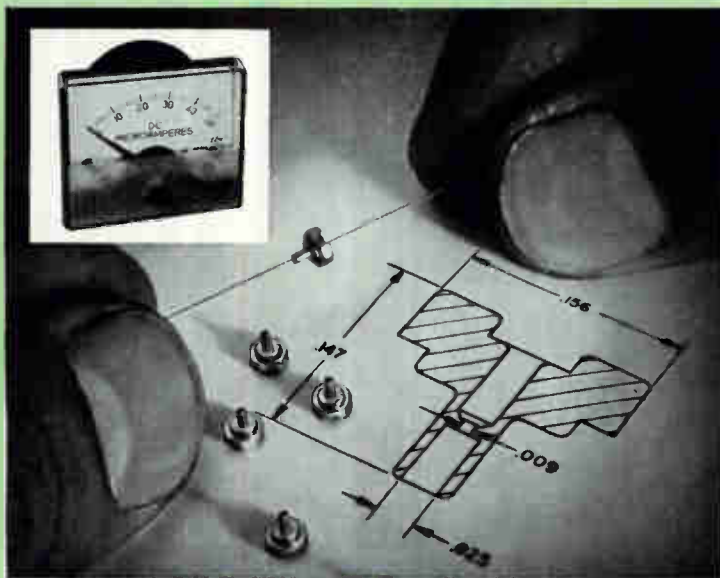

and this...



for Ingraham, tiniest gear ever molded. 60,000 acetal parts make one pound! Has 0.007-in. thick teeth, 0.005-in. radius at tooth root and 0.0186 center hole.

and this...



Willson eyeglass hinges diecast in a single automatic operation. Moveable elements cast assembled by Gries high speed, low cost "Intercast" method.

and this...

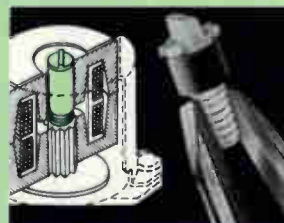

Indiana General's cup core has #1-64 polypropylene screws automatically insert-molded into delicate ferrite tubes by GRC's exclusive process.

The difference in Gries techniques, skills and machines made the *big difference* in solving problems for Westinghouse, Ingraham, Willson and Indiana General—and hundreds of other companies. Intricate, tiny, zinc alloy die castings or engineering thermoplastic moldings by GRC were the optimum value solution in each case. Do you have a small parts problem? Your products and your profits will benefit when you specify GRC. We're ready to go to work for you.

GRC SPECIAL METHODS give optimum value in tiny zinc alloy die castings and engineering thermoplastic moldings. Exclusive, patented automatic limited-cavity techniques, developed and perfected over 30 years, deliver parts in volume with highest uniformity and precision. There's a big difference when you specify GRC tiny parts.

No minimum size. Maximum: Zinc alloy—2" long; 1/2 oz.
—Plastics—1 1/4" long; .05 oz.

Write for helpful guides to achieving higher value in small parts... full information, demonstration samples... send your prints for prompt quotation.

World's foremost producer of small die castings & plastic moldings

GRIES REPRODUCER CO.
Division of Coats & Clark Inc.

151 Beechwood Ave., New Rochelle, N.Y. 10802 • (914) • 633-8600

GRIES



Plants in NEW ROCHELLE, N.Y.; WARREN, R.I.; TOCCOA, GA.



how to measure resolver or synchro position with 30 second repeatability

In both production test and ground checkout systems, North Atlantic's high performance Angle Position Indicators provide exceptional operator ease and precision in the measurement of synchro and resolver position. Features include digital readout in degrees and minutes, 30 second resolution, continuous rotation, plug-in solid-state amplifier and power supply modules. Due to the design flexibility of these units, they can be readily provided with a variety of features for specific requirements. Typical units in this line incorporate combinations of the following features:

- Single Synchro or Resolver Input
- Dual Synchro or Resolver Inputs
- Retransmit Synchro, Resolver, Potentiometer, or Encoder
- 2-Speed Synchro Input
- Multi-frequency Inputs
- DC Input
- 0-999 Counter

BASIC SPECIFICATIONS	
Range	0°-360° continuous rotation
Accuracy	6 minutes (standard)
Repeatability	30 seconds
Slew Speed	25°/second
Power	115 volts, 400 cps
Size	API-8025 1¾" h x 9½" w x 9" d
	API-8027 3½" h x 4⅞" w x 9¾" d



Your local North Atlantic representative has complete data on the API line. Call him today or write direct for technical literature.

NORTH ATLANTIC industries, inc.
 TERMINAL DRIVE, PLAINVIEW, L. I., NEW YORK • Overbrook 1-8600

tions. Synthetic quartz crystals are cheaper and can be used in virtually all communications devices. By adding lithium nitrite to sodium hydroxide, researchers found they could increase the Q of the crystals 10 times to about 1 million. Lithium nitrite is believed to keep water from forming in the grown crystal. Under certain conditions quartz crystals with Q's of 2 million have been grown, making them equivalent in Q value to natural quartz crystals.

Data key. The Keydata Corp., a Cambridge, Mass., company that offered one of the first commercial time-sharing services, [Electronics, Feb. 22, 1965, p. 17] will soon buy 20 DDF-516 computers from the Computer Control division of Honeywell Inc.

Sound technique. West Virginia University researchers have developed a method using sound waves to dry fine particles of coal that were formerly discarded because conventional drying techniques were considered uneconomical and dangerous. The high temperatures required to remove moisture from coal particles increased the threat of coal dust explosion or fire.

Bit by bit. The Western Union Telegraph Co. will soon be using the Milgo Electronics Corp.'s narrow-band modem to send 2,400 bits per second over an 800-hertz bandwidth [Electronics, Nov. 28, 1966, p. 46]. Milgo expects to deliver more than \$600,000 in modems to Western Union by mid-year but will not say how many modems are involved in the two-year contract. The manufacturer says the modem will transmit digital data from computers or related devices at high speed over Western Union's expanding communications network. [Electronics, Nov. 28, 1966, pp. 128-131].

System link. The Collins Radio Co. has completed the first step in the construction of a \$9.5 million communications network for the Air Force. Voice communications via the new high-frequency link were established recently between Clark Air Force Base in the Philippines, Scott Air Force Base in Illinois and the Pentagon.

CUT FACTS

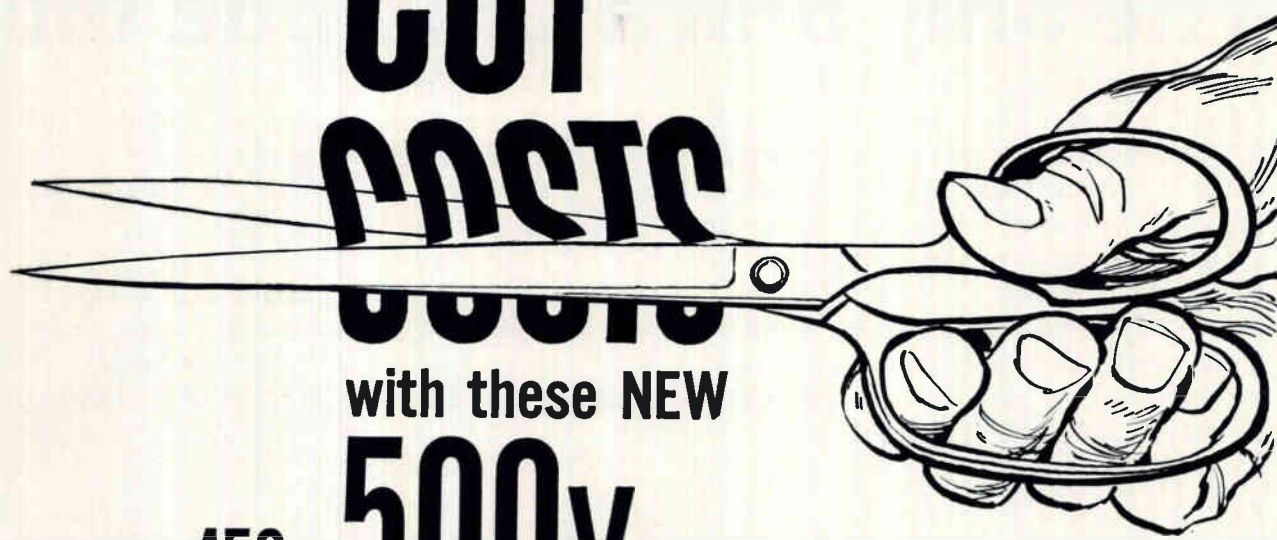

with these NEW

500v

300v 350v 400v 450v

HIGH VOLTAGE NPN Silicon Power TRANSISTORS



from

Solitron

These new silicon power transistor families, offering $V_{CE(sus)}$ up to 500-Volts, replace* similar higher priced units now on the market. A few of their many applications include vertical and horizontal TV circuits, audio amplifiers, inverters, converters and relay drivers. Priced low, they are available in the standard TO-3 package.

All of these devices are associated with the high reliability standards of Solitron!

SDT1003-1007

$V_{CE(sus)}$ 300V, 350V, 400V, 450V, 500V

SDT1013-1017

Check these Features

Gain 20-80 @ 1.0A
 $V_{CE(sat)}$ 0.8V Max @ 1.0A
 $V_{BE(sat)}$ 1.5V Max @ 1.0A
 Power 100 watts @ 75° C
 ft 5.0 MHz

Gain 15-90 @ 3.0A
 $V_{CE(sat)}$ 0.8V Max @ 3.0A
 $V_{BE(sat)}$ 1.5V Max @ 3.0A
 Power 100 watts @ 75° C
 ft 5.0 MHz

* SDT1003-1007 and SDT1013-1017 replace: DTS413, 423, 430, 431; MJ413, 423, 431; B176007, 176011, 176015, 176025, 176027, 176029; and many others.

*Contact us today for
Complete Performance Data*

TRANSISTOR DIVISION
Solitron DEVICES, INC.

1177 BLUE HERON BLVD. / RIVIERA BEACH, FLORIDA / (305) 848-4311 / TWX: (510) 952-6676

Leader in Germanium and Silicon Power Transistors, Cryogenic Thermometers, High Voltage Rectifiers, Hot Carrier Diodes, Temperature Compensated Zeners, Voltage Variable Capacitors, Random/White Noise Components, Microelectronic Circuits, and Power-Sink Interconnection Systems.

The only test a Unitrode diode

Well, almost the only test.

Because there are lots of tests that Unitrode diodes can't pass, but the only ones we've found are about as reasonable as the hack-saw kind.

Of course you may not need that kind of reliability in what you make.

Depends on whether or not you've had problems with unavoidable high surges. On whether you need diodes that have to withstand temperatures as low as -195°C and as high as 300°C . On whether

you need diodes that are capable of handling as much energy in the avalanche as in the forward direction. On whether you need diodes that will last virtually forever, with no change in electrical characteristics. If you don't, you may very well find cheaper components that will get by.

But if you *do*, the fact that we fuse all our components in hard glass at over 800°C could make a big difference in your life. That makes them voidless, so they're free of contamination. It's one



can't pass.

of the reasons Unitrode components can do all the things mentioned above.

Another reason is that the silicon is joined solidly to the terminal pins with a solid state bond that is stronger than the silicon itself.

Still another reason is that the pins are bonded over the full face of the silicon die, so that heat due to surge is carried away quickly from the silicon to the pins.

Essentially, all Unitrode components are based

upon an entirely new concept in semi-conductor design. That new concept can mean a lot to you if you need the characteristics it provides. If you do, why not get in touch with us? We'll be glad to send you complete information and samples. We're at 580 Pleasant Street, Watertown, Mass. 02172. Telephone (617) 926-0404.

UNITRODE®

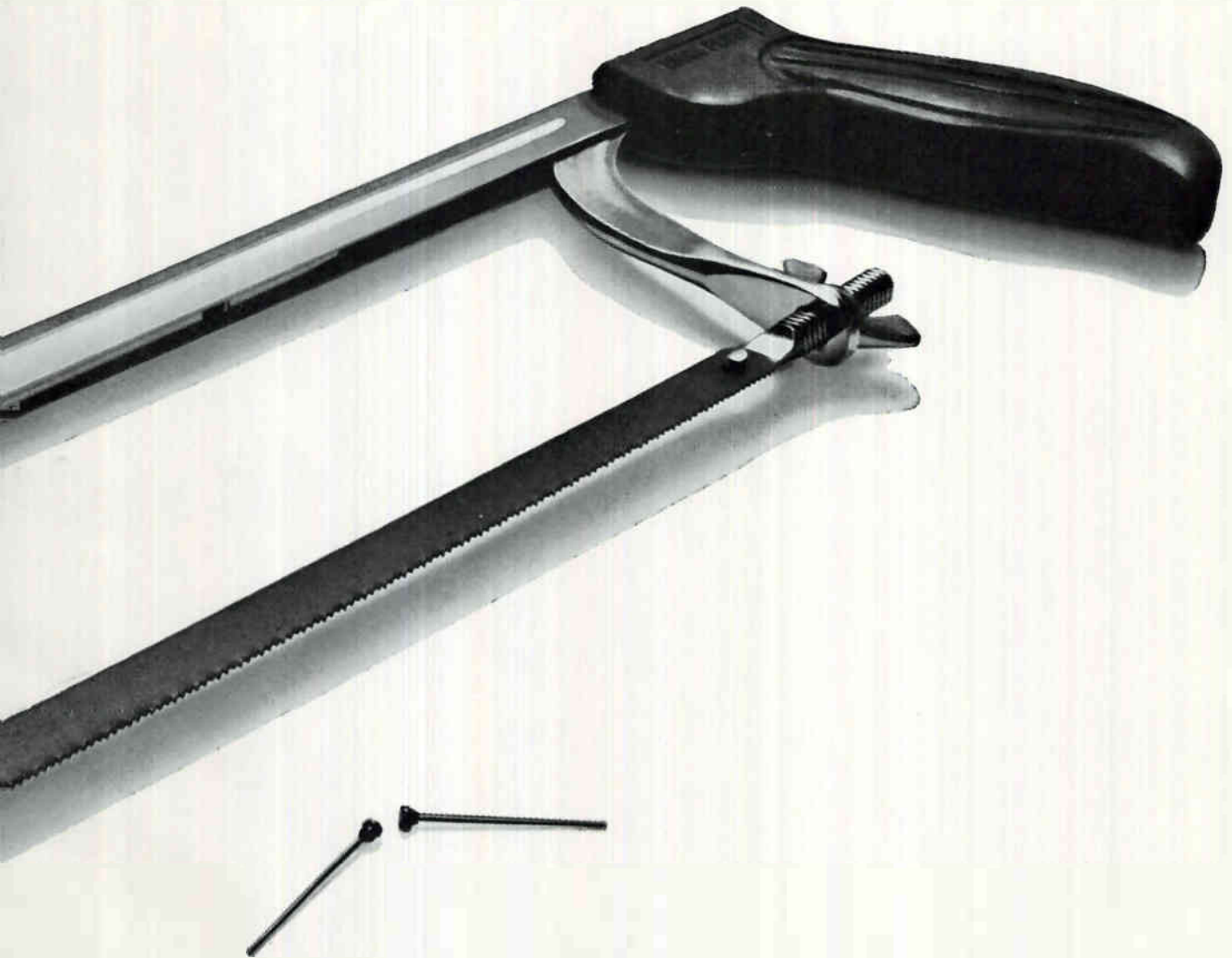

It used to be
a nagging pain
figuring out
how much
resistor precision
to buy.

Then Corning changed the rules.

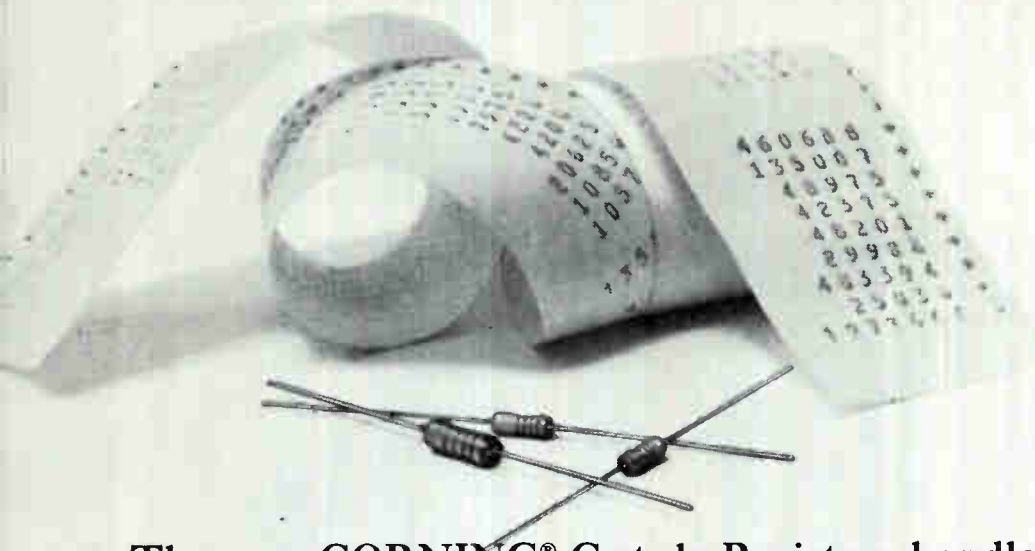

The new CORNING® C-style Resistors handle precision, semi-precision and general purpose applications. What could be easier? They offer precision stability and reliability at far less than precision prices.

100 ppm TC. 1, 2 and 5% tolerances. Performance requirements of both MIL-R-22684B and MIL-R-10509F, Char. D.

New C-Style Resistors come with 1/10, 1/8, 1/4, 1/2 watt ratings, in the 10 ohm to 499K range. Samples and complete data for the asking. Meanwhile, we're looking for more changes that will improve resistors. That's how we've earned our qualifications for exceptional stability and for reliability. That's how our line of glass tin oxide film resistors has grown to be one of the most extensive. Including precision, high reliability, low power, high power and water cooled types. Corning Glass Works, 3901 Electronics Drive, Raleigh, North Carolina.

CORNING
ELECTRONICS

E PLURIBUS UNUM

Unitized approach to
microwave source solves
multiple system problems

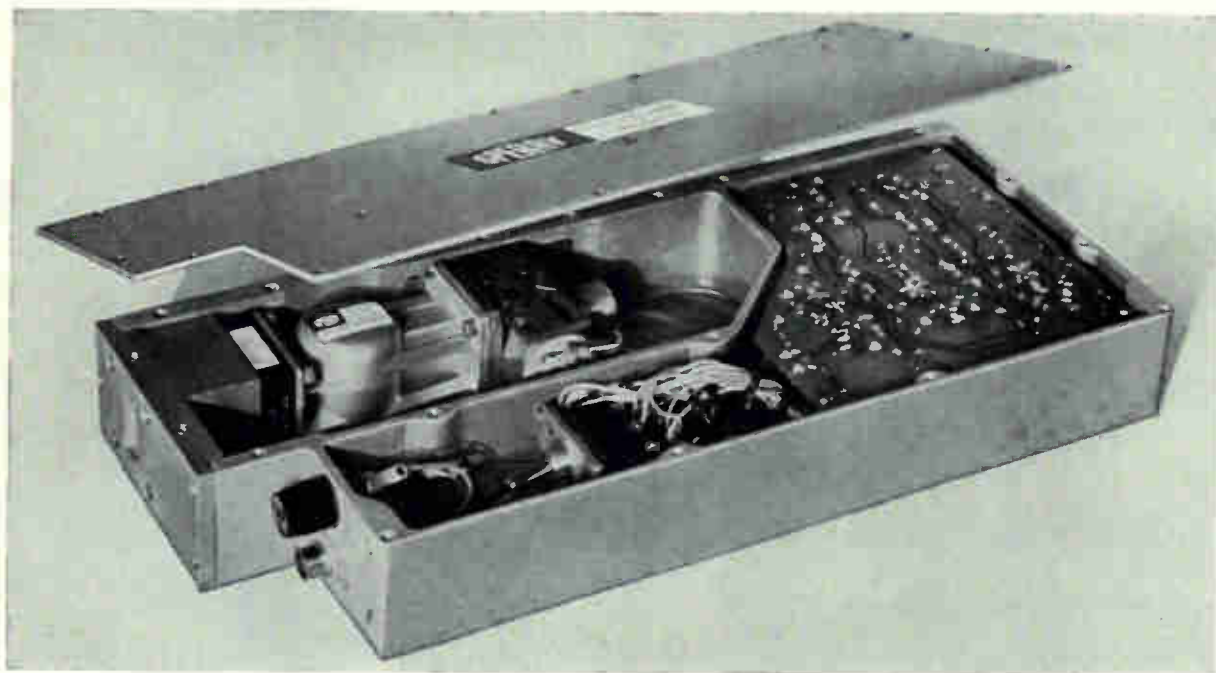

Microwave system designers are discovering a remarkable new work-saving technique — a way to get a lot of answers by asking just one question. They are asking Sperry to supply a microwave oscillator, its solid-state power supply, and associated stalo cavities and isolators (as required), in a single, fully-integrated package.

System designers simply specify a single voltage input and the microwave output characteristics they desire. Sperry does the rest.

Sperry accomplishes this by starting with a fixed reflector voltage reflex klystron. They add "instant" temperature compensation and hook up a solid-state power supply that has been specially designed to match

the characteristics of the tube. Next the required stalos and isolators are added, and the entire microwave source is packaged as a unit.

Don't fight the interface problems inherent in microwave source design — let Sperry solve them for you. Put the Sperry "Storehouse of Knowledge" to work on your system. It will give you predictable source performance at predictable cost, while freeing you to concentrate on other aspects of the system design.

the characteristics of the tube. Next the required stalos and isolators are added, and the entire microwave source is packaged as a unit.

With the proper mix of solid-state and tube techniques, Sperry is able to produce desirable secondary characteristics—such as outstanding frequency stability, low FM noise level and precise RFI control — that are beyond the reach of either technology alone.

Learn how Sperry's unitized approach to microwave sources can simplify your design problem. For your free copy of a new technical paper on the subject, contact your Cain & Co. man or write Sperry, Gainesville, Florida.

SPERRY

DIVISION OF
SPERRY RAND
CORPORATION

SPERRY ELECTRONIC TUBE DIVISION, Gainesville, Fla.

National Representatives: Cain & Co., Los Angeles, 783-4700; Boston, 665-8600; Arlington Heights, 253-3578; Dallas, 369-2897; Dayton, 228-2433; Eastchester, 337-3445; Philadelphia, 828-3861; San Francisco, 948-6533; Syracuse, 437-2933; Washington, 296-8265; South Amboy, 727-1900; Huntsville, 859-3410; Orlando, 422-3460; Montreal, 844-0089.

Washington Newsletter

January 9, 1967

**Webb brings back
\$5 billion budget
from Texas ...**

The National Aeronautics and Space Administration's chief, James E. Webb, made a profitable trip to the LBJ Ranch last month. What he brought back from Texas was a \$5 billion NASA budget for the year ending June 30, 1968. Webb did better than many people, including some at NASA, had expected. Some had predicted a drop from the current fiscal year's \$5 billion to \$4.7 billion or even \$4 billion.

Included in the NASA budget to be sent to Congress this month will be \$400 million to start the Apollo applications program, but the fate of the space agency's request for funds to start the Voyager unmanned planetary exploration program remains extremely doubtful.

**... that boosts
electronics center's
fiscal '68 outlay ...**

Getting a bigger piece of the NASA budget in fiscal 1968 is the Electronics Research Center in Cambridge, Mass. This outlay is expected to rise 67% in fiscal 1968 to \$20 million from this year's \$12 million. The total staff at one center is slated to reach 750 by mid-June and nearly 1,000 in fiscal 1968. Heading the center's priority list of research projects are laser and optical systems for communications and astronomy. An expanded effort to develop transmitter arrays radiating 10 to 20 kilowatts for such applications as direct broadcast satellites is also in the works.

**... and includes
added space shots**

Additional space flights are also covered by the new NASA budget. Two more Applications Technology Satellites equipped with 30-foot antennas [Electronics, Nov. 28, 1966, p. 52] are to be added to the currently approved program of five flights. Spacecraft shots to be added to the Mariner program include missions to Mars in 1971 [Electronics, Aug. 22, 1966, p. 69] and to Venus in 1970 and possibly 1972, all carrying probes to launch into the planets' atmospheres.

**Avionics contracts
for manned bomber**

The Air Force continues to back research and development on the avionics for its proposed advanced manned strategic aircraft, although Defense Secretary Robert S. McNamara has refused to give the program a green light. The Aerospace Systems division of General Precision Inc. is getting \$2 million to evaluate techniques for obtaining precise navigation fixes and transferring this data to the inertial systems of the plane's weapons.

Also, the Autonetics division of North American Aviation Inc. has a \$1.1 million contract to develop an advanced forward-looking radar to locate and identify ground targets under varying conditions.

**Independence of
new Congress will
affect electronics**

President Johnson's unchallenged rule in Washington seems ended and the change will affect many of the programs in which electronics companies are involved, from space exploration to Government efforts in the fields of medicine, education and air and water pollution control.

The President is on the defensive. His leadership is being questioned within his own party. This new atmosphere in the Capital will be most apparent in the new Congress convening this week.

The 90th Congress will be more conservative than its predecessor

Washington Newsletter

and far more difficult for Johnson to work with. Committee chairmen and senior members, whose authority was undermined in the 89th session by the voting strength of freshmen Democrats loyal to the President, are back in their traditional positions of power and influence. This will all have its effect as Congress considers, and possibly reshapes, programs critical to the electronics industry.

Additionally, there is a growing belief among Congressmen that the Government must seek more help and suggestions from industry in undertaking such massive projects as improving the quality of the natural environment, providing adequate housing and waging its war on poverty.

Senate to study spinoff of Federal research data

The Senate Small Business Committee's subcommittee on science and technology will hold hearings on the effectiveness of the Government's efforts to disseminate research and development information to industry and schools. **One possibility that will be discussed is the establishment of a Federally chartered corporation similar to the Communications Satellite Corp. to coordinate these efforts.** Another will be the feasibility of combining the technological information centers now operated by NASA, the Atomic Energy Commission and the Commerce Department.

Switch to Centaur means more NASA electronics spending

A decision by NASA to switch to the Atlas-Centaur launch vehicle after 1968 means more dollars for electronics subsystems. **The electronics for each Centaur will cost approximately \$6 million, equal to the total cost of the Agena stage of the agency's present launch vehicle, the Atlas-Agena.**

Dividing up the contracts for the Centaur second stage will be the prime contractor, the General Dynamics Corp.'s Convair division, the guidance contractor, Honeywell Inc.'s Aeronautical division, and the computer subcontractor, General Precision Inc.'s Librascope group.

The change to the powerful Atlas-Centaur was dictated by NASA's plans for heavier satellites. For instance, the Centaur will launch the sixth and seventh Advanced Technological Satellites, each weighing about 1,200 pounds, or about 50% more than the first ATS satellite.

Cost of world weather watch put at \$1 billion

Interest is increasing in the effort to establish a worldwide network of weather stations compatible with a computerized reporting, analysis and forecast system. To meet the cost—estimated at \$1 billion by some sources—the United States in April will seek a financial commitment for each nation of the World Meteorological Organization sponsored by the United Nations.

Construction and installation of the system is scheduled for the period from 1968 to 1971. Much of the outlay will go for electronics gear on ships, buoys, anchored barges, balloons and second-generation meteorological satellites.

Robert M. White, the administrator of the Environmental Science Services Administration, refuses to comment on initial cost of the network. But he points out that the present world weather system costs \$1 billion a year to run, and that it will cost each participating nation another \$150 million annually to operate the expanded system.

The goal of a world weather watch is to provide daily weather forecasts with 90% accuracy two weeks in advance.

What cleans parts 20 times faster?

Consolidated Electrodynamics says: FREON® Solvents and a Baron-Blakeslee degreaser

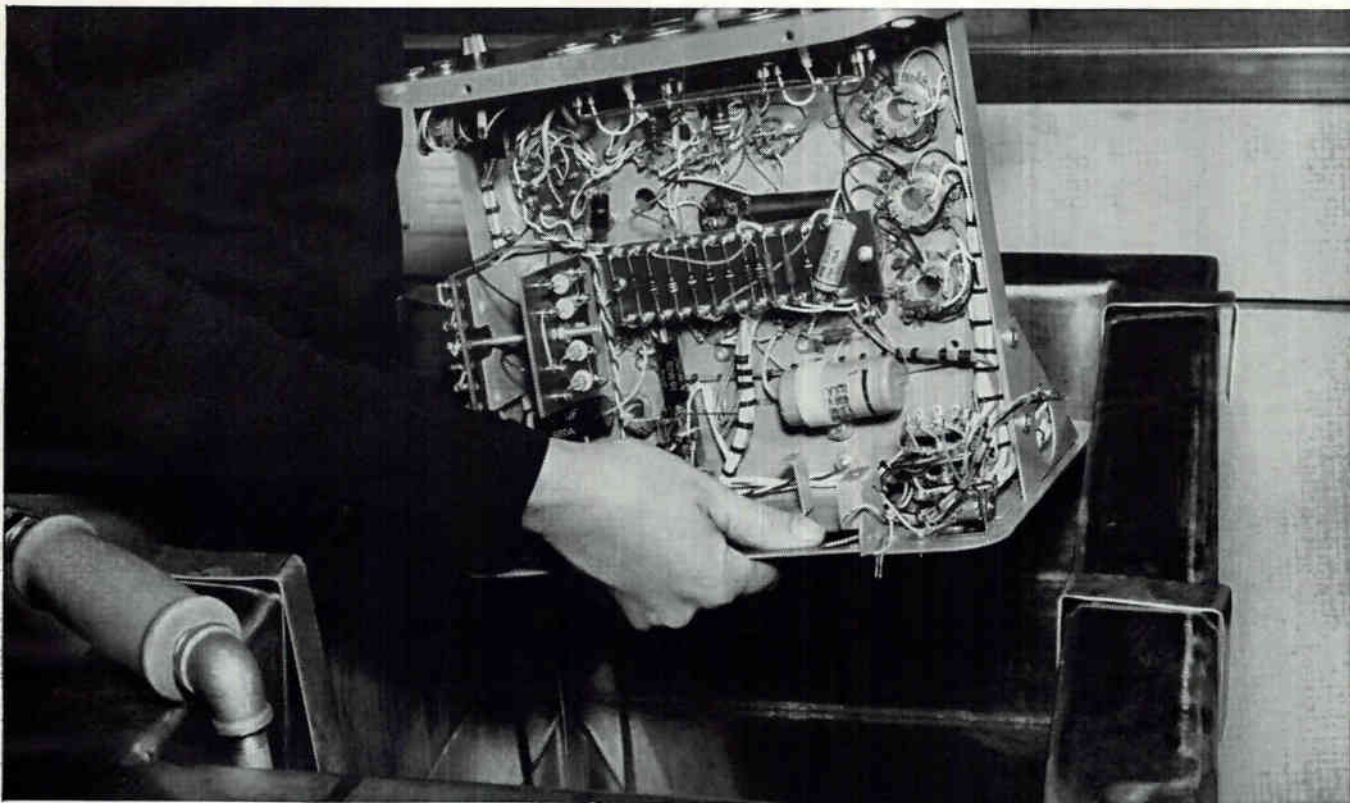

Consolidated Electrodynamics' Transducer Division in Monrovia, Calif., cleans with FREON TMC solvent in a Baron-Blakeslee Model M degreaser. FREON TMC is a patented azeotrope of FREON TF and methylene chloride . . . another tailored solvent from Du Pont. All kinds of components—from transistors to terminal boards, from subassemblies to complete chassis—are cleaned faster, better, at lower cost than ever before. For example, hand-cleaning one part used to take more than an hour. With FREON it takes just three minutes!

Besides requiring high labor costs, hand cleaning failed to do the job completely. Hidden corners and crevices went untouched. Solvent residues remained after drying. Brushes damaged delicate components. But FREON is a selective solvent—it cleans entire assemblies without harming commonly used components. And FREON has low surface tension to penetrate the smallest pores . . . high density to float away even microscopic particles. It dries quickly, leaving no residue.

Because FREON can be used over and over again, it helped cut CEC's solvent costs in half. And because FREON is nonflammable and relatively nontoxic, no special exhaust systems are needed.

FREON solvents are used for cleaning in many of CEC's divisions. Chances are FREON can give you faster, better, less costly cleaning, too. For more information, write Du Pont Co., Room 4868, Wilmington, Delaware 19898.

(In Europe, write: Du Pont de Nemours International S.A., FREON Products Div., 81 Route de l'Aire, 1211 Geneva 24, Switzerland.)



Better Things for Better Living
... through Chemistry



There's a G-E silicone

Bonding

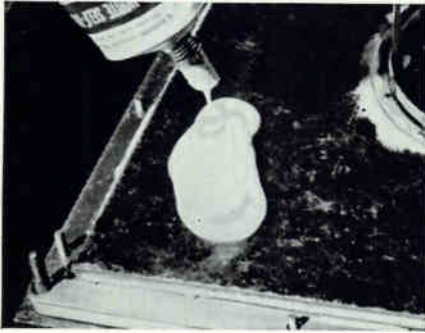

Laminated layers of mica sheeting are securely bonded with G-E RTV silicone sealant. Ready to use, it bonds to most materials, forming heat-resistant rubber.

Insulating



G-E RTV translucent sealant provides excellent see-thru insulation instantly. UL-recognized, the sealant also comes in colors.

Damping

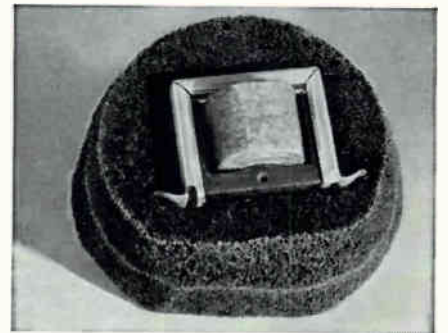

G-E RTV-7 silicone rubber foams on the spot to provide mechanical support, shock and vibration damping, and light weight electrical insulation.



Screws and drilling are eliminated by adhering identification plates with RTV adhesive sealant. It won't harden, soften, crack or shrink.

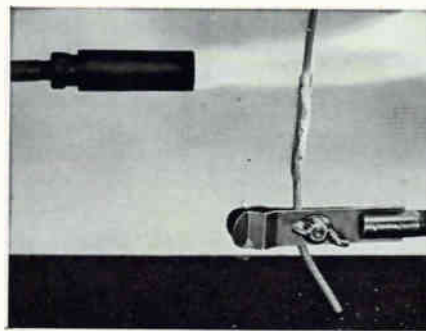

Silicone rubber wire and cable insulation passes UL vertical flame tests and is frequently used in high-voltage circuits.

Sealing

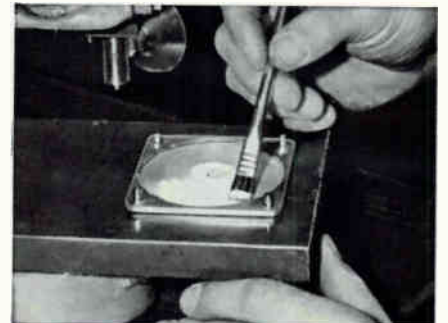

G-E two-part RTV, available in a range of viscosities, seals filament condenser plate in dielectric heater. Also protects against vibration.



G-E silicone dielectric greases, ideal heat transfer media, are easily brushed, painted, sprayed, dip-coated or applied directly from tube.



G-E RTV is ideal for high temperature moisture sealing of heating elements. It withstands temperatures as high as 600°F, as low as -75°F.

design solution for:

Moldmaking



Tough, flexible G-E RTV silicone for moldmaking reproduces detail accurately and minimizes tooling costs.

Potting and Encapsulating

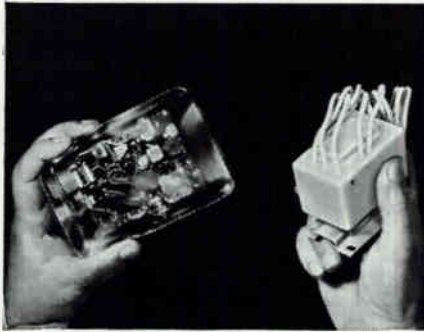

Many G-E RTV silicone compounds are available—all with good strength, outstanding electrical properties and resistance to temperature extremes.

Fluids Applications



G-E silicone dielectric fluids provide excellent electrical properties and thermal stability for many types of components.

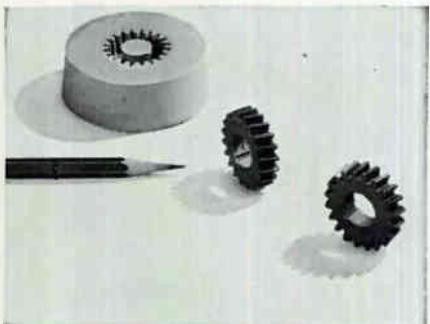

For prototypes or short-run parts production, G-E RTV is an excellent flexible moldmaking material. And it needs no release agent.

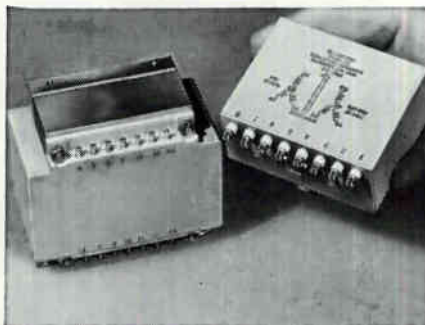

Impregnation of transformer coils with G-E RTV provides electrical insulation and environmental protection at high temperatures.

Fabricating



G-E silicone elastomers are easily used to make numerous silicone rubber parts by standard rubber fabricating techniques.

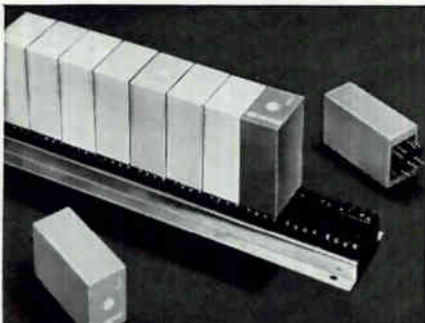

G-E RTV provides attractive, protective packaging for components. Each unit is encapsulated in a different color RTV for easy identification.

If you can't find it here, write for our Silicone Selector Guide:

Section N1254R Silicone Products Dept., General Electric Company, Waterford, New York 12188.

GENERAL  ELECTRIC

AT LAST.



a premium-grade, universal
OPERATIONAL AMPLIFIER
so stable that it...

- ☑ Maintains $3 \mu\text{v}/\text{V}$ with unregulated power supplies from ± 8 to ± 25 volts
- ☑ Is capable of replacing over 70% of all op amp types in use today.
- ☑ Provides a new degree of freedom from offset and common-mode errors.

the Nexus ultra-stable USL-1



An unprecedented breakthrough in operational amplifier technology

The USL-1 is a designer's dream . . . a high-performance operational amplifier which can operate from almost any existing power source, and which provides stability and common mode rejection orders of magnitude better than any prior state-of-the-art amplifier.

Because this new unit provides virtual immunity from input power variations, it can be operated from dry or wet batteries, automobile or aircraft electrical systems, digital equipment and computer power supplies, or any other convenient source of power providing between -8 and -25 Volts and $+8$ and $+25$ Volts. It is not even necessary that the two input voltages track each other.

The USL-1 is so nearly universal in application that it could readily replace over 70% of the operational amplifiers currently in use . . . and do a better job. It frees the designer from the power supply restrictions normally imposed by conventional amplifiers, and offers him greatly improved performance in many applications. For example, because of its extremely high common mode rejection, it functions more accurately than other op amps when used as a voltage follower, subtractor, non-inverting amplifier, etc.

The USL-1 is a premium, encapsulated unit, incorporating high-reliability military-type components and all-silicon semiconductors. A lower-cost commercial version (ESL-1) is also available for shipment. The latter, developed for use in less demanding applications, also uses all-silicon semiconductors, and provides specifications which are extraordinary compared with conventional units.

USL-1 & ESL-1 TYPICAL SPECIFICATIONS

Supply voltage (USL-1)	± 8 to ± 25 volts
Supply voltage (ESL-1)	± 8 to ± 16 volts
Output voltage & common-mode voltage	(USL-1) ± 20 volts from ± 25 V supply ± 10 volts from ± 15 V supply ± 3 volts from ± 8 V supply
Output current	± 5 mA at any supply voltage within range
Overload protection	Fully protected against short-circuits, overload, overdrive
Common-mode rejection	130dB
Input impedance	0.3 megohm
Power supply rejection	$3 \mu\text{V/Volt}$ (0.3 na/V)
Gain (into 10K load) (USL-1)	100,000
Gain (into 10K load) (ESL-1)	50,000
Temperature coefficient (USL-1)	$3 \mu\text{V}/^\circ\text{C}$
Temperature coefficient (ESL-1)	$10 \mu\text{V}/^\circ\text{C}$
Slewing rate	1.5 V/ μsec
Common-mode stability	$3 \mu\text{V/Volt}$ (0.3 na/V)
Case size	2.02" (l) x 1.14" (w) x 0.62" (h)
Price (USL-1)	\$75 (1-9)
Price (ESL-1)	\$35 (1-9)

Send today for full details on this exciting new operational amplifier

NEXUS
RESEARCH LABORATORY, INC.
480 Neponset Street, Canton, Mass. 02021 — TEL: (617) 828-9000 — TWX (617) 828-1022

Prices F.O.B. Canton, Massachusetts.
Prices slightly higher outside North America.

Circle 69 on reader service card

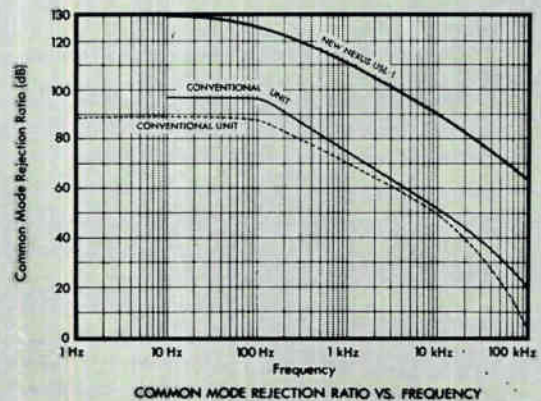
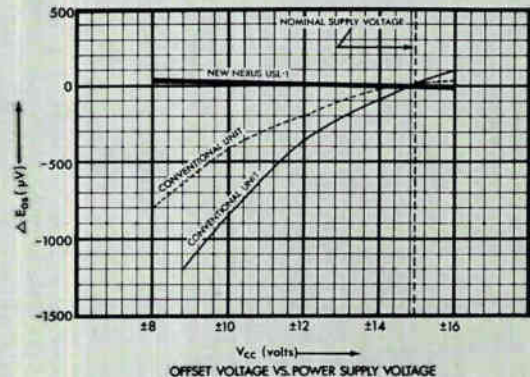
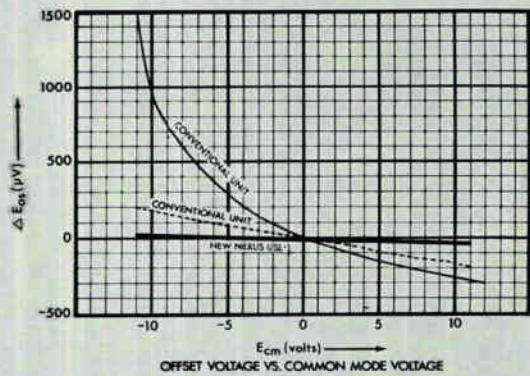
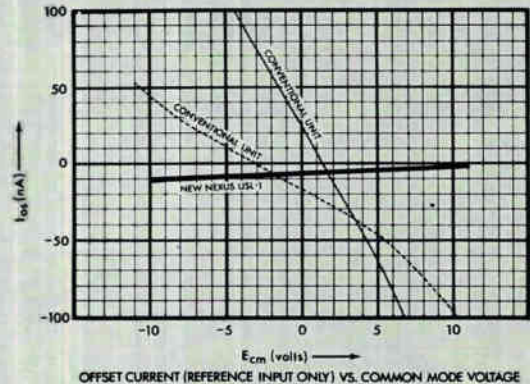
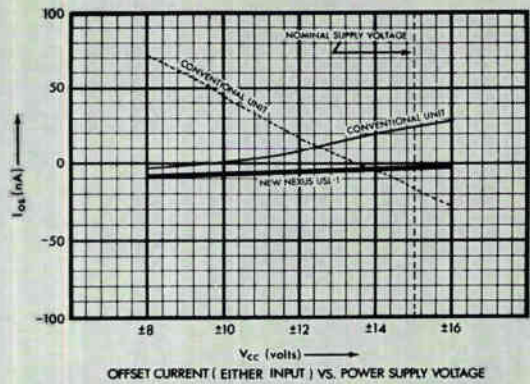

WIRE HARNESS LACING, like most manual jobs—costs money!

- Saving by using low cost lacing material seems good economy...

- ...until production lags and rejects pile up

- For real economy you need the uniformity, the high quality of GUDEBROD LACING TAPE.

- That's why this guarantee can help you cut costs in cable harnessing!



You owe it to your zero defects program to investigate Gudebrod lacing tape. Its guaranteed quality and its constant uniformity are important to you—and to your harnessing operation. Why? Because Gudebrod smooths and speeds the hand operation of lacing and knot tying. There's no need for readjusting or retying. Rejects are minimal. The result? You save time—and that saves money and hastens delivery. Gudebrod sets its manufacturing standards high and adheres to them. When you use Gudebrod tapes you can set production goals and achieve them. This is the combination that saves you money in your harness department. Ask for the Gudebrod Product Data Book.

GUDEBROD CABLE-LACER

The first hand tool engineered for wire harnessing. Handle holds bobbins, feeds tape as needed, grips tape for knotting. Speeds, eases harnessing. Pays for itself in time saving.



Area Code 215, WA 2-1122



GUDEBROD BROS. SILK CO., INC.

FOUNDED IN 1870

Electronics Division

12 SOUTH 12th STREET, PHILADELPHIA, PENNSYLVANIA 19107

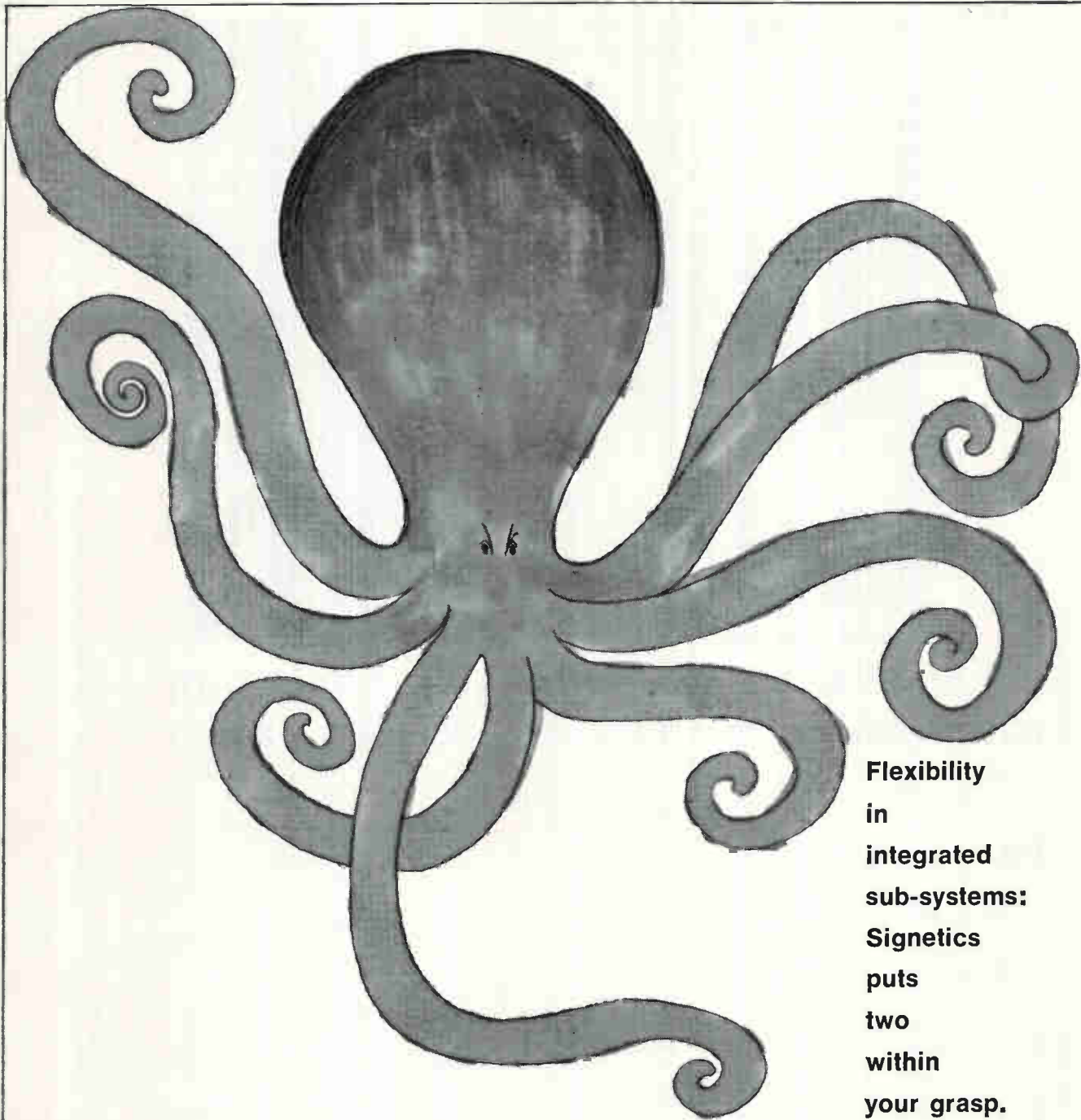

**Flexibility
in
integrated
sub-systems:
Signetics
puts
two
within
your grasp.**

Signetics has two new monolithic sub-systems that can be used for innumerable cost savings. The S1280A, for example, is a 4-Bit Decade Counter/Storage Register that can be used in either the familiar BCD mode, or, if you want a square wave output for frequency synthesis and similar applications, in the Bi-Quinary mode. The S1281A is a 4-Bit Binary Counter/Storage Register that can be set up to divide by 2, 4, 8 or 16 just by making simple external connections. Each sub-system has four J-K flip-flops and 13 gates on a single chip, or an equivalent discrete component count of 160. If you want the full story on the most flexible monolithic sub-systems available, just unbend and write: Signetics, 811 E. Arques Ave., Sunnyvale, California.

■ At the IEEE Show, be sure to check into rooms 3000A & B at the New York Coliseum, for the latest Signetics news.

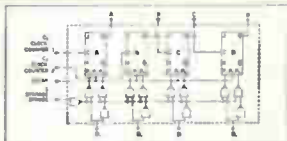
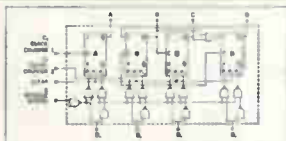

1280 Decade Counter/Storage Register 1281 Binary Counter/Storage Register

Features:

- Counting Rate: 25MHz
- Strobed Single-Ended Presets
- Power Consumption: 100 mW
- Common Clear Line

**SIGNETICS
INTEGRATED
CIRCUITS**



A SUBSIDIARY OF CORNING GLASS WORKS

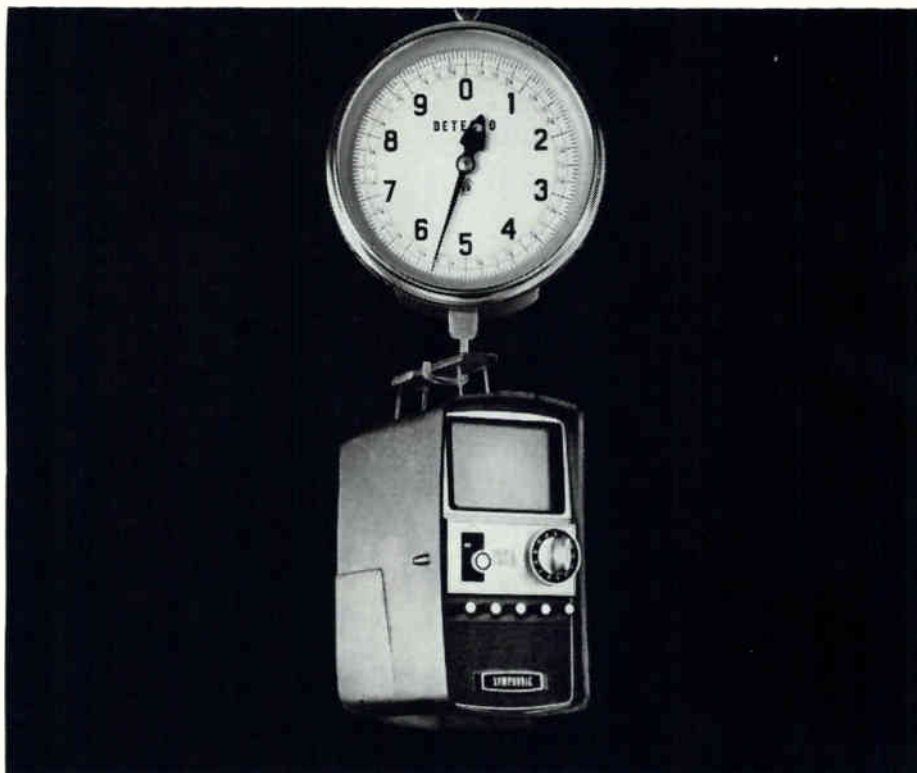

Symphonic Television needed a battery to trim pounds and dollars off its new portable "Minni TV."

Mallory made it.

What can we do for you?



Symphonic Television needed a battery. A battery for the world's smallest TV set with a self-contained, rechargeable power source. A battery so light you can hold the entire set—batteries and all—in one hand while you watch it. Yet a battery that would bring the price of the set well below that of other less-portable portables.

Mallory made it—a Duracell® rechargeable alkaline battery that costs less than half the price of other rechargeables. It's good for many rechargings. It's so light that 9 "C" cells are included in the total 5½ lb. weight of the set.

THE RECHARGEABLE BATTERIES YOU CAN AFFORD

Duracell rechargeable alkaline batteries. These are the batteries that will make a new generation of battery-operated devices prac-

tical: inexpensive TV sets; AC-DC radios; tape recorders; portable phonographs; transceivers.

The low initial cost of these batteries is one reason. The unique exposed band contact is another. It lets you design battery-operated equipment with built-in rechargers that automatically prevent charging when a primary cell is in the circuit. (See schematic)

That's not all. Duracell rechargeable alkaline batteries are lighter than most other rechargeables. They come fully charged. And one glance at the discharge-cycles graph tells you how little they cost to operate.

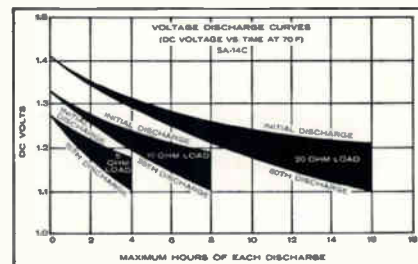
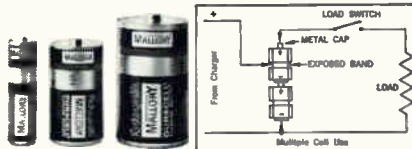

OVER 1000 DIFFERENT TYPES

Mallory currently makes over 1000 batteries of all sizes and capacities. If we're not actually producing the battery you need, we'll be happy to work with you in designing a new one. Please write the Technical Sales Department, Mallory Battery Company, a division of P. R. Mallory & Co. Inc., South Broadway, Tarrytown, New York 10591. Or call 914-591-7000. (In Canada: Mallory Battery Company of Canada Limited, Sheridan Park, Ontario.)



new disciplines in DC

**take the all-silicon models
with more power,
less weight & volume**

**20 SCR supplies provide
Constant Voltage/Constant Current operation
with automatic crossover**

Many applications require a DC power source without needing full transistor regulation or laboratory-type performance. For such requirements, Hewlett-Packard/Harrison Division now offers an unusually wide selection of SCR regulated supplies. All are characterized by moderate regulation, high efficiency, low ripple, and size and weight smaller than competitive magamp and SCR supplies. All models are fully adjustable from zero to full rated output. Inherent protection assures that no damage will be caused by any overload, including a short circuit, regardless of how long imposed. Remote programming is accomplished using either resistance or voltage control.

Remote Error Sensing • No Overshoot on Turn-On, Turn-Off, or AC Power Removal • 50 MS Transient Load Recovery • Excellent Line Transient Immunity — No "Poke-Through" Lasting 5-10 Hz • AC Line Dropout Protection Circuit on Three-Phase Supplies Turns Off Unit if Any or All Input AC Lines Lose Voltage • Overvoltage "Crowbar" Protection Option Available on All Models • Auto-Series, -Parallel, -Tracking

Contact your nearest Hewlett-Packard Sales Office for full specifications.

**HEWLETT
PACKARD**  **HARRISON
DIVISION**

100 Locust Ave., Berkeley Heights, New Jersey 07922
Telephone 201-464-1234 TWX 710-984-7972

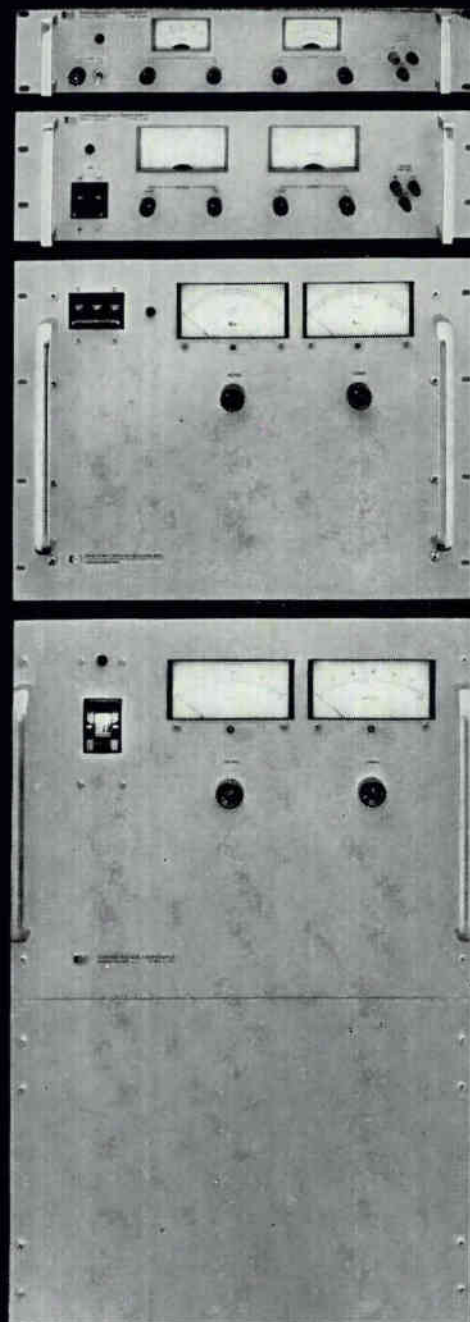

DC Output	Panel Height	Model	Price
0- 4V, 0-2000A	26¼"	6463A	\$3,500.
0- 8V, 0-1000A	26¼"	6464A	3,300.
0- 15V, 0- 200A	14"	6453A	1,375.
0- 16V, 0- 600A 0- 18V, 0- 500A	26¼"	6466A	2,600.
0- 20V, 0- 15A	3½"	6427B	380.
0- 20V, 0- 45A	5¼"	6428B	550.
0- 36V, 0- 10A	3½"	6433B	370.
0- 36V, 0- 25A	7"	520A	575.
0- 36V, 0- 100A	14"	6456B	1,275.
0- 36V, 0- 300A	26¼"	6469A	2,300.
0- 60V, 0- 5A	3½"	6438B	360.
0- 60V, 0- 15A	5¼"	6439B	550.
0- 64V, 0- 50A	14"	6459A	1,275.
0- 64V, 0- 150A	26¼"	6472A	2,600.
0-110V, 0- 100A	26¼"	6475A	2,600.
0-120V, 0- 2.5A	3½"	6443B	360.
0-220V, 0- 50A	26¼"	6477A	2,600.
0-300V, 0- 35A	26¼"	6479A	2,600.
0-440V, 0- 25A 0-500V, 0- 20A 0-600V, 0- 15A	26¼"	6483B	2,600.
0-600V, 0- 1.5A	5¼"	6448B	550.

COMPLETE COVERAGE FROM AUDIO THROUGH X-BAND

with
NEW FAMILY
of
BROADBAND
HYBRID JUNCTIONS

Merrimac's new family of broadband hybrid junctions covers the frequency range from 10 KHz (Audio) to 12.4 GHz (X-Band). Applications include in-phase or out-of-phase signal dividers, signal combiners, phase comparators, antenna steering and tracking systems, impedance comparators, reflectometers and balanced mixers. Inquiries on other impedance levels, frequency ranges, and other requirements are invited.

The latest additions to this group include the HJ and HJ-K Series. The HJ Series covers 10 KHz to 400 MHz; the HJ-K Series covers 200-2000 MHz; both are four-port broadband networks featuring high isolation, low VSWR, and low insertion loss. Filling out coverage to 12.4 GHz is Merrimac's established line of CHT-K Magic Tees.

For further information, write or phone:

MODEL HJ-0.75K



500-1000 MHz
Isolation 30 db
(40-50 db Typical)
Amplitude Balance
 ± 0.15 db
VSWR 1.35:1 (E Arm);
1.25:1 (H Arm)
Impedance 50 ohms
Insertion Loss 0.3 db
Power to 100 Watts
Average

MODEL CHT-6K MAGIC TEE

4000-8000 MHz
Isolation 30 db
(35-45 db Typical)
VSWR 1.75:1 (E Arm Max);
1.50:1 (H Arm Max)
Impedance 50 ohms
Insertion Loss 0.5 db
Equality of Split
 ± 0.2 db Max

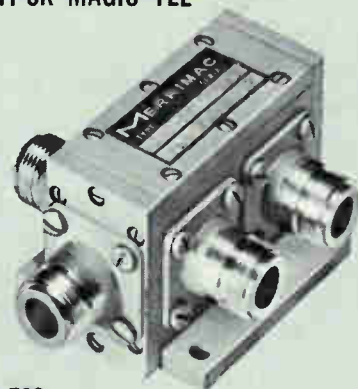

U.S. Patent # 2,935,702

MODEL HJ-55



10-100 MHz
Isolation 30 db
Amplitude Balance 0.2 db
Phase Equality
 $0/180^\circ \pm 1$
VSWR 1.3:1 (All Ports)
Impedance 50 ohms
Insertion Loss 0.5 db
Power to 5 Watts Average

Each of the above hybrid junctions is typical of its series.



MERRIMAC RESEARCH AND DEVELOPMENT, INC.

41 FAIRFIELD PLACE, WEST CALDWELL, N. J. 07006 • 201-228-3890

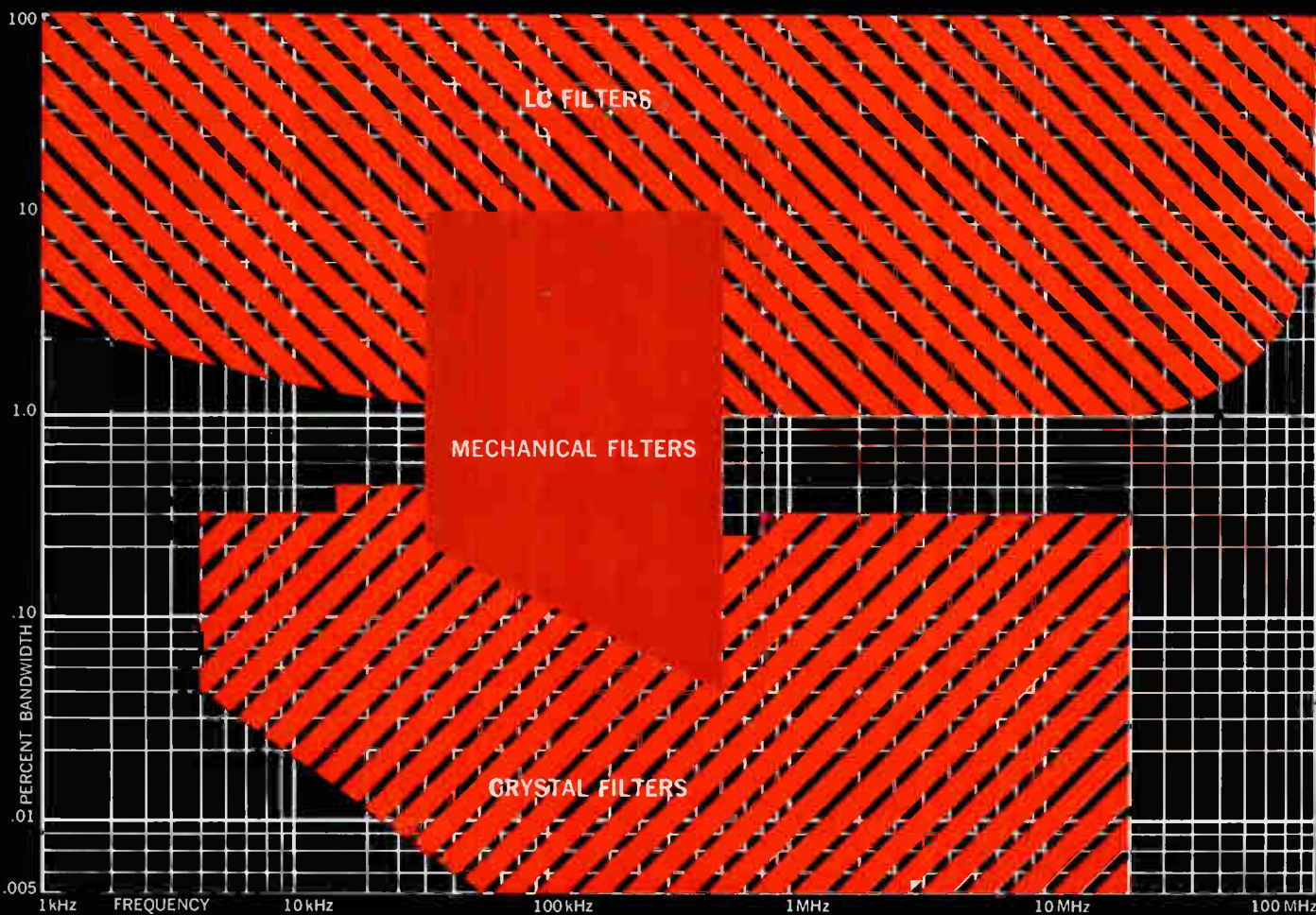

Across the spectrum . . . all your filter needs

Only Collins offers Mechanical, Crystal and LC Filters covering the practical spectrum from 1 kHz to 100 MHz. At Collins, you get the filter best suited to your need — you're not limited to the best available from a single product line. The diagram defines the areas served by Collins' computer-design program. This program means accelerated deliveries at product line prices. Hundreds of design combinations are available immediately. Take advantage of Collins' quality and reliability — and its capability of delivering large quantities on schedule.

Crystal Filters



Collins Crystal Filters meet most narrow band needs (from 5 kHz to 20 MHz) in designs such as Butterworth, Tchebycheff and Linear Phase. Prototypes to your specifications are generally available in four to six weeks. Collins Crystal Filter capability is expanding rapidly. Even if your requirement appears to fall outside the defined area, send your specifications for design analysis. As one of the largest suppliers, Collins satisfies delivery requirements for all major programs.

Mechanical Filters



Collins has sold more than a million Mechanical Filters since introducing them to the communications industry. Hundreds of designs are available from stock in frequencies from 60 to 600 kHz, and with 60-db to 6-db shape factors as low as 1.2 to 1. The filters tolerate extreme temperature changes and long, continuous service without ageing, breakdown or drift. They're smaller in size and less expensive than other filters covering their spectrum.

LC Filters



Collins toroidal coil capabilities led to development of an extensive line of LC Wave Filters covering the sub-audio to 100-MHz range. These include low-pass, high-pass, band-pass, band-rejection, and other phase or amplitude responsive networks. Modern synthesis design techniques produce high performance units in small packages. Collins is one of the world's largest suppliers of LC Filters and precision inductors.

Send or call your performance requirements to Components Division, Collins Radio Company, Newport Beach, California 92663. Phone: (714) 833-0600.

COMMUNICATION / COMPUTATION / CONTROL



COLLINS RADIO COMPANY / DALLAS, TEXAS • CEDAR RAPIDS, IOWA • NEWPORT BEACH, CALIFORNIA • TORONTO, ONTARIO
Bangkok • Beirut • Frankfurt • Hong Kong • Kuala Lumpur • Los Angeles • London • Melbourne • Mexico City • New York • Paris • Rome • Washington • Wellington

Circle 75 on reader service card



EMCOR® I—tough, beautiful protection

EMCOR I cabinets guard your valuable instrumentation. They're hard, tough, long-lasting steel. The beauty of form and the color, or colors, of your choice mask the toughness underneath.

Beauty, yes! When you see EMCOR I cabinets, you'll appreciate that they are sleek, beautiful pieces of craftsmanship.

EMCOR created the concept of the modular enclosure system, and we've

EMCOR/distinguished cabinetry

refined it to the point where EMCOR cabinetry is an art...the closest thing to perfection in electronic cabinetry. Of course, there's a shape and size to house any instrumentation.

When you need strong, beautiful protection for your equipment, call your local EMCOR Sales and Service Engineer. Or write for our EMCOR I catalog.

Albany: 436-9649; Albuquerque: 265-7766; Alexandria: 836-1800; Binghamton: 723-9661; Bridgeport: 368-4582; Buffalo: 632-2727; Chicago: 676-1100; Cleveland: 442-8080; Dallas: 631-7450; Dayton: 298-7573; Del Mar: 454-2191; Denver: 934-5505; Detroit: 357-3700; Fort Lauderdale: 564-8000; Ft. Walton Beach: 243-6424; Houston: 526-2959; Huntsville: 539-6884; Indianapolis: 356-4249; Kansas City: 444-9494; Los Angeles: 938-2073; Minneapolis: 545-4481; Newport News: 245-8272; N.Y.C. area: 695-0082; Orlando: 425-5505; Palo Alto: 968-8304; Pittsburgh: 884-5515; Phoenix: 273-1673; St. Louis: 647-4350; Seattle: 762-7800; Tucker (Atlanta Office): 939-1674; Tulsa: 742-4657; Utica: 732-3775; Valley Forge: 265-5800; Wilmington, Mass.: 944-3930; Winston-Salem: 725-5384. EMCOR Reg. U.S. Pat. Off.

Ingersoll Products 1002 West 120th St., Chicago, Illinois 60643

DIVISION OF BORG-WARNER CORPORATION

electronic
equipment



NEW!

IMMEDIATE DELIVERY
FROM STOCK
\$5,900*

300 Hz TO 31 MHz

ILLUMINATED
READOUT

METERED OUTPUT

DECADE
TUNING

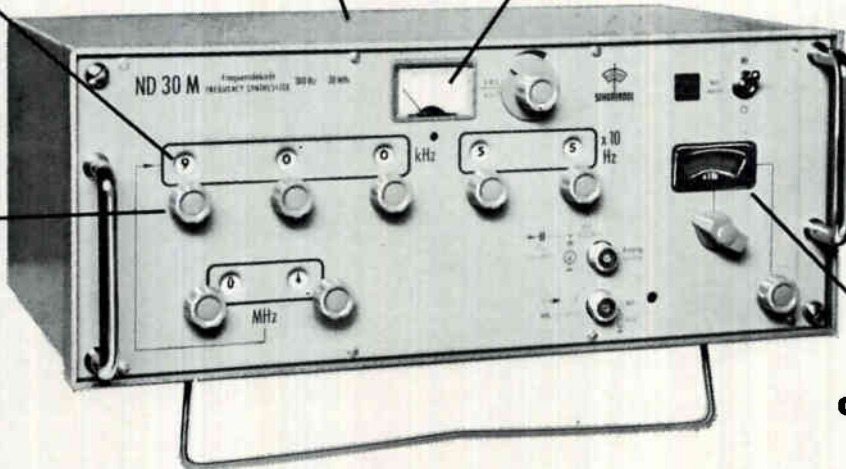

"FAD"
INTERPOLATION
OSCILLATOR

TYPE ND 30M

FREQUENCY SYNTHESIZER

FEATURES

- Built-in 1 MHz crystal has proportional oven and $5 \times 10^{-9}/^{\circ}\text{C}$ stability
- Spurious and noise suppression better than 80 dB
- All solid state design
- Modular construction
- High resolution search oscillator . . . 130 divisions
- AC or battery operated

FNA-SPEKTROGRAMM

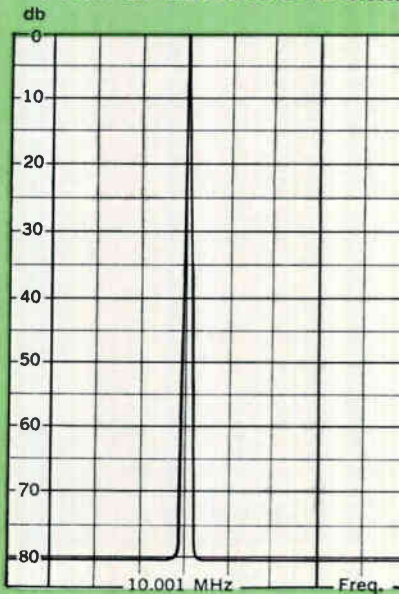

SPECTRAL PURITY OF ND 30M
FREQUENCY SYNTHESIZER
200 Hz per division Measured at BW of 10 Hz

Type ND 30M is the latest in a line of Frequency Synthesizers providing unusually high accuracy and ease of operation. Continuously variable over its range, each model provides a direct digital readout, with no tuning required. Perfect for bridge measurement, work with filters, networks, nuclear magnetic resonance, and as a source of reference frequencies for standards labs. These units can also be supplied in 19" rack mountings.

*Type ND 30M
without crystal \$5,290

Other ranges start at \$3,180
Type ND 1M (300Hz to 1.1MHz)
Type ND99K (0 to 110kHz)

Get The Extra Capability,
Greater Reliability, and
Longer Useful Life Of . . .



ROHDE & SCHWARZ

111 LEXINGTON AVENUE, PASSAIC, N. J. 07055 • (201) 773-8010

Inquiries outside the U.S.A. should be directed to: Rohde & Schwarz, Muehldorfstrasse 15, Munchen 8, West Germany.

TABLES AND GRAPHS ARE INTERESTING DON'T YOU THINK?

The ones appearing below feature our 3SK20[Ⓜ] and 3SK21[Ⓜ] FETs

3SK20[Ⓜ] N-channel insulated gate (MOS) type FET device operating in depletion mode. Features extremely high input impedance and low noise. Ideal for use as DC to high frequency amplifiers, choppers and analog switches.



3SK21[Ⓜ] N-channel insulated gate (MOS) type FET device operating in depletion mode. Features very high ON to OFF impedance ratio and high transfer admittance. Most useful as parallel or series choppers and large signal amplifiers.

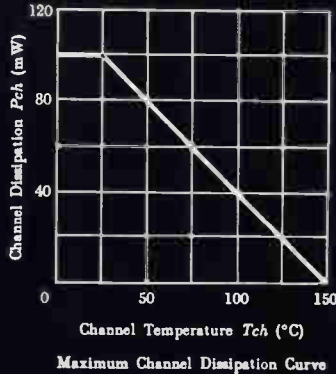

ABSOLUTE MAXIMUM RATINGS (At $T_a=25^\circ\text{C}$, $V_{GS}=0$)

Symbol	Max. Ratings	Unit
V_{DSX}^*	20	V
V_{GISX}^{**}	+5, -20	V
V_{GIS0}	+20	V
I_D	10	mA
P_{ch}	100	mW
T_{ch}	150	$^\circ\text{C}$
T_{stg}	-55~+150	$^\circ\text{C}$

*Value at $V_{GIS}=-6\text{V}$ **Value at $V_{DS}=1\text{V}$

ELECTRICAL CHARACTERISTICS (At $T_a=25^\circ\text{C}$, $V_{GS}=0$)

Symbol	Condition of Measurement	3SK 20 [Ⓜ]			3SK 21 [Ⓜ]			Unit
		min.	typ.	max.	min.	typ.	max.	
BV_{DSX}	$I_D=10\mu\text{A}$, $V_{GIS}=-6\text{V}$	20	—	—	20	—	—	V
I_{GIS}	$V_{GIS}=-6\text{V}$, $V_{DS}=0$	—	—	1.0	—	—	1.0	pA
V_{GISC}	$I_D=10\mu\text{A}$, $V_{DS}=6\text{V}$	—	—	-3.5	—	—	-5.0	V
I_{DSS}	$V_{DS}=6\text{V}$, $V_{GIS}=0$	0.6	—	2.0	4	—	11	mA
y_{fs}	$V_{DS}=6\text{V}$, $I_D=I_{DSS}$, $f=1\text{kHz}$	0.6	—	2.0	2.5	—	—	m Ω
C_{is}	$V_{DS}=6\text{V}$, $I_D=I_{DSS}$, $f=1\text{MHz}$	—	4.0	—	—	4.0	—	pF
v_n	$V_{DS}=6\text{V}$, $I_D=1\text{mA}$, $f=1\text{kHz}$, $R_g=1\text{M}\Omega$	—	0.2	—	—	—	—	$\frac{\mu\text{V}}{\sqrt{\text{Hz}}}$
R_{ON}	$V_{DS}=100\text{mV}$, $V_{GIS}=0$	—	—	—	—	150	300	Ω
R_{OFF}	$V_{DS}=100\text{mV}$, $V_{GIS}=-6\text{V}$	—	—	—	100	—	—	$\text{M}\Omega$

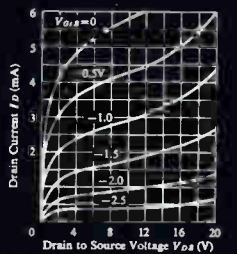

Typical Drain Characteristics

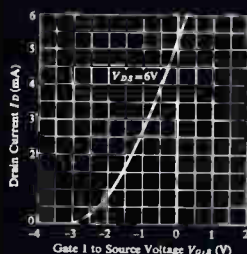

Typical Transfer Characteristic

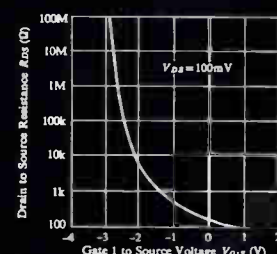

Drain to Source Resistance Characteristic

Did you find all this informative? If you would like to know more we'll be only too pleased to let you have more details. Why not write us soon.



HITACHI SALES CORPORATION: 333 N. Michigan Avenue, Chicago, Ill. 60601, U.S.A. Tel: 726-4572/4 / 666, 5th Avenue, New York, N.Y. 10019, U.S.A. Tel: 581-8844 / HITACHI, LTD., DUESSELDORF OFFICE: 4 Duesseldorf, Graf Adolf Strasse 37, West Germany Tel: 10846

are old campaigners not so much in years, but in number of cores tested on our equipment. ★ Last year alone, CTC systems were used to test 2,500,000,000 individual cores. That's more than half of all the cores used by the world's computer industry in 1965. ★ But CTC memory core, plane and stack test systems have more going for them than just big numbers. They have the speed, accuracy and stability necessary to ensure thorough, economical testing of cores—no matter how tough the specs may be! ★ All this may sound like we're tooting our bugle. But take it from a veteran bad core campaigner—it pays to put your dollars in hard-earned equipment that has proven itself. Billions of times. Like CTC's. The sure way—and the cheapest way—to test cores.

COMPUTER TEST CORPORATION
Cherry Hill, New Jersey



*We're
old campaigners
against
bad cores*



If you know Control Switch just for...

**pushbuttons,
or toggle switches,
or hermetics,
or industrial switches,**

you haven't begun to know Control Switch.

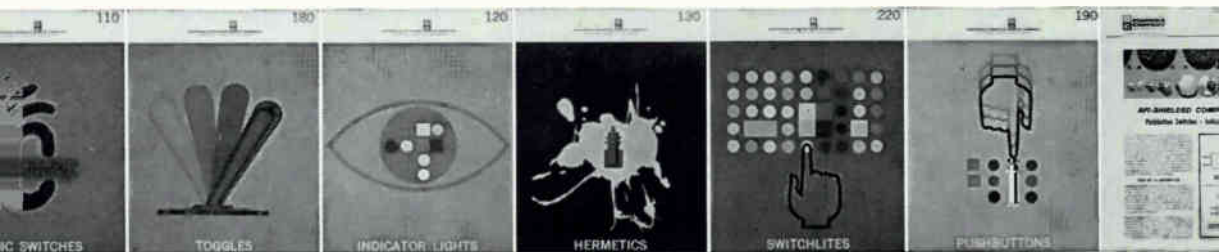

We have news for you!

Control Switch makes:

1. More types of switches than any other manufacturer. Including those mentioned above, plus RFI-shielded types, Switchlites with 1 to 4 lamps and colors, basic precision switches, as well as indicator lights.
2. Many switches that others don't make at all.
3. Many switches of advanced design. Like the world's smallest toggle switches. And the smallest indicator lights with RFI shielding.

4. Above all, quality switches. For applications where a switch must not fail!

Why not send for all the Control Switch catalogs listed below. You'll have the best switch reference file available from any source!

Just check numbers on the Reader Service Card corresponding to those on the left below for any of the Control Switch catalogs you want. Better yet, get 'em all. If Service Card is missing, write us direct.

- #497 Basic Precision Switch Catalog 110
- #498 Toggle Switch Catalog 180
- #499 Indicator Light Catalog 120
- #500 Hermetically-Sealed Switch Catalog 130
- #501 Switchlite Catalog 220
- #502 Pushbutton Switch Catalog 190
- #503 RFI-Shielded Component Bulletin 62

**CONTROLS
COMPANY
OF AMERICA**

CONTROL SWITCH DIVISION
1420 Delmar Drive, Folcroft, Pennsylvania 19032

Circle 81 on reader service

We've added an exciting new POLARAD-only feature to this second-generation 2 GHz-Dispersion Spectrum Analyzer

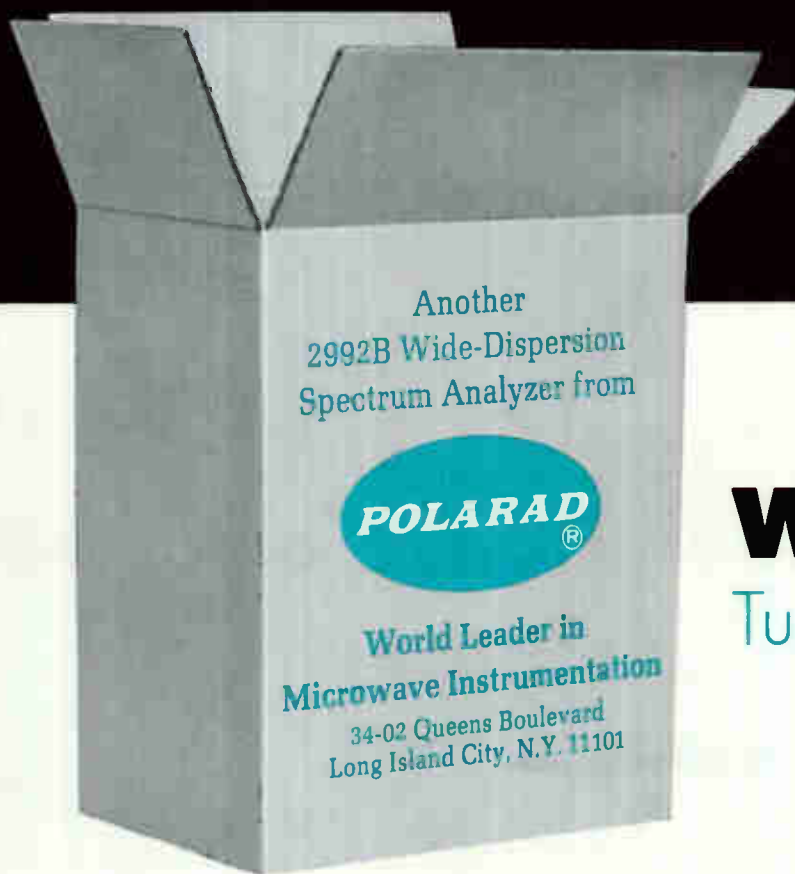

WHAT?

Turn the page...

If card has been used, please circle reader inquiry card.

POLARAD ELECTRONIC INSTRUMENTS
A Division of Polarad Electronics Corp.
34-02 Queens Blvd.
Long Island City, N.Y. 11101
Tel. No. (212) EX 2-4500



First Class
Permit No. 18
Long Island City, N.Y.

BUSINESS REPLY MAIL
Postage Will Be Paid by Addressee

No Postage Stamp Necessary If Mailed In The United States

POLARAD ELECTRONIC INSTRUMENTS
A Division of Polarad Electronics Corporation
34-02 Queens Blvd.
Long Island City, N.Y. 11101

immediate availability

...that's what!



Model 2992B

Pick up the phone and order one on approval—we'll ship it **within 24 hours**. (Call before 10:00 a.m., for same-day shipment.) Choose the 2992B, and you get the benefit of immediate availability . . .

Plus all the features you expect from a 2 GHz-dispersion Analyzer—some of them exclusively Polarad's. Check over these key specifications and features—you'll agree that the Model 2992B is the all-around best buy!

Widest Frequency Range:

10 MHz to 91 GHz

Widest Dispersion: 10 KHz to

2 GHz in 1/3/10 calibrated steps, continuously variable between steps.

Widest Resolution: 1 KHz to

1 MHz in 1/3/10 calibrated steps, continuously variable to 100 KHz.

Continuous Phase-Lock Frequency Stabilization . . . permits narrow-dispersion analysis down to 1 KHz/cm. Lowest Noise and drift in its class!

Completely Image-Free Display

2 high IFs (1000 & 2260 MHz).

Maximum Readout Flexibility:

Linear, Log, or Power Plot on big 4½" x 5½" rectangular CRT. Proper scale automatically illuminated. Use with any standard 'scope camera.

Calibrated IF Attenuator—0-81 db in 1 db steps for precision measurements.

Foolproof, Convenient Harmonic-Identification Pushbutton Positive and instantaneous!

Wide-Range Quantitative Measurements internal 60 db RF Attenuator—flat response to 12.4 GHz.

Polarad Model 2992B 2 GHz-Dispersion Microwave Spectrum Analyzer Completely Modular—Add other modules as needed, assemble as many as 17 different combinations—the most complete Spectrum Analyzer Capability ever offered.

Got your Copy Yet?

Send for it today!

(If the adjacent card has been used, please circle reader inquiry card.)

POLARAD ELECTRONIC INSTRUMENTS/A Division of Polarad Electronics Corp.
34-02 Queens Boulevard, Long Island City, New York 11101 • (212) EX 2-4500

Gentlemen:

Please have your field representative arrange for a demonstration of the Model 2992B Spectrum Analyzer.

Please send me:

My free copy of Bulletin ESA-662, "How to Select a Microwave Spectrum Analyzer"

My free copy of Bulletin EIS-663, "Selecting the best Microwave Signal Instrumentation"

My free "Mix and Match" Kit—with complete set of adhesive-backed PEI "Module Stamps" for pasting up my own systems.

I am interested in the following kinds of applications: _____

and frequency ranges: _____

Name _____

Title _____

Company _____

Address _____

City _____ State _____ Zip _____

Telephone: _____ Ext. _____



want a custom-designed electronic power supply?

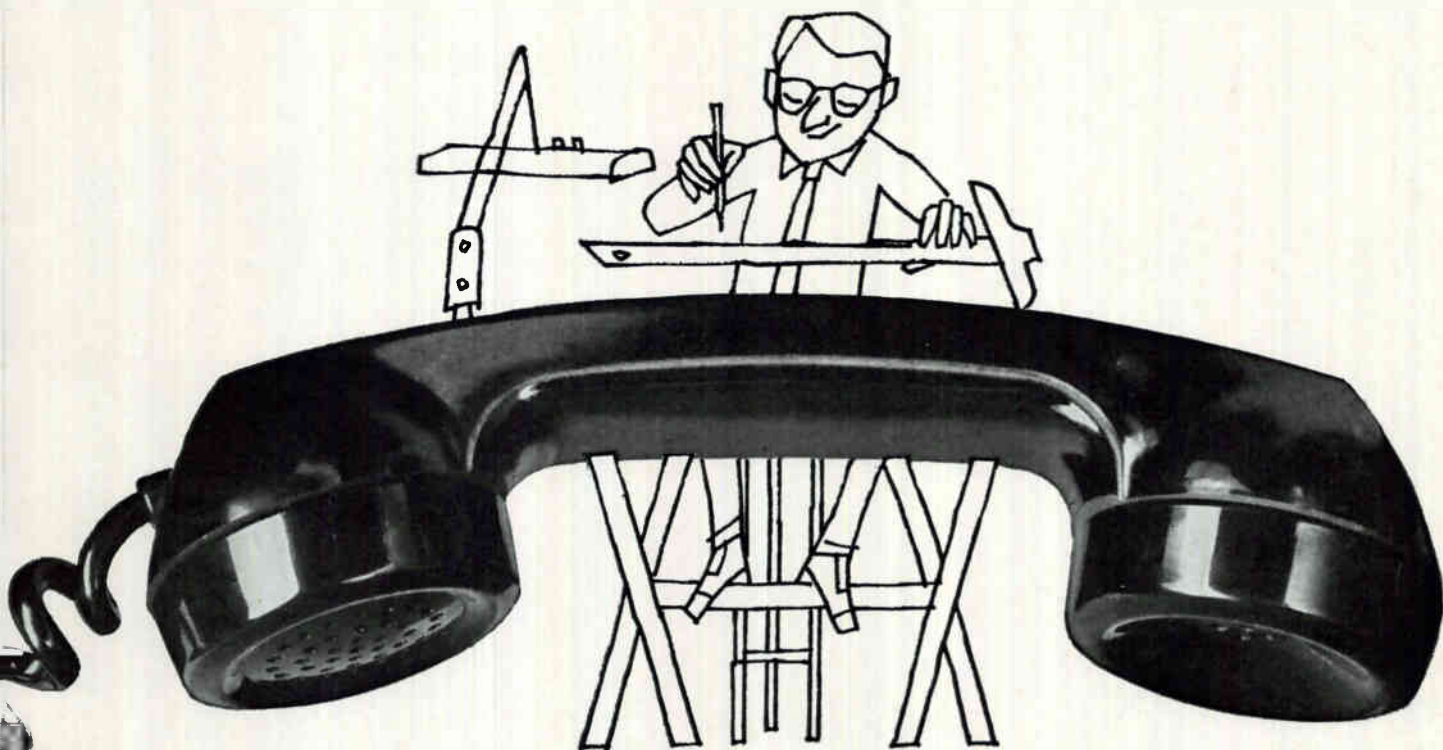

call 312 439-2800

Sola answers your tough ones:

We're geared to handle them with a team of electronic engineers and volume production facilities. High- and low-voltage transistorized power supplies, or entire power systems. For electrostatic copiers to process control,

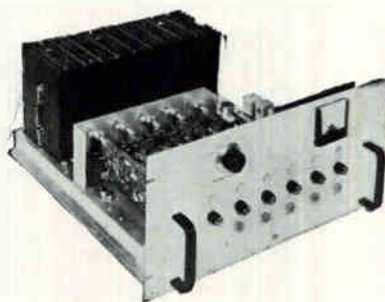

optical readers to radar.

Tell us your specs; we'll design to meet them.

Want to know more? Call Phil Snyder at 312/439-2800, or write him for catalog PS-100: 1717 Busse Road, Elk Grove Village, Illinois 60007.

SOLA ELECTRIC **SB**
DIVISION OF SOLA BASIC INDUSTRIES

OTHER DIVISIONS: ANCHOR ELECTRIC • ENGINEERED CERAMICS • HEVI-DUTY ELECTRIC • LINDBERG HEVI-DUTY • NELSON ELECTRIC

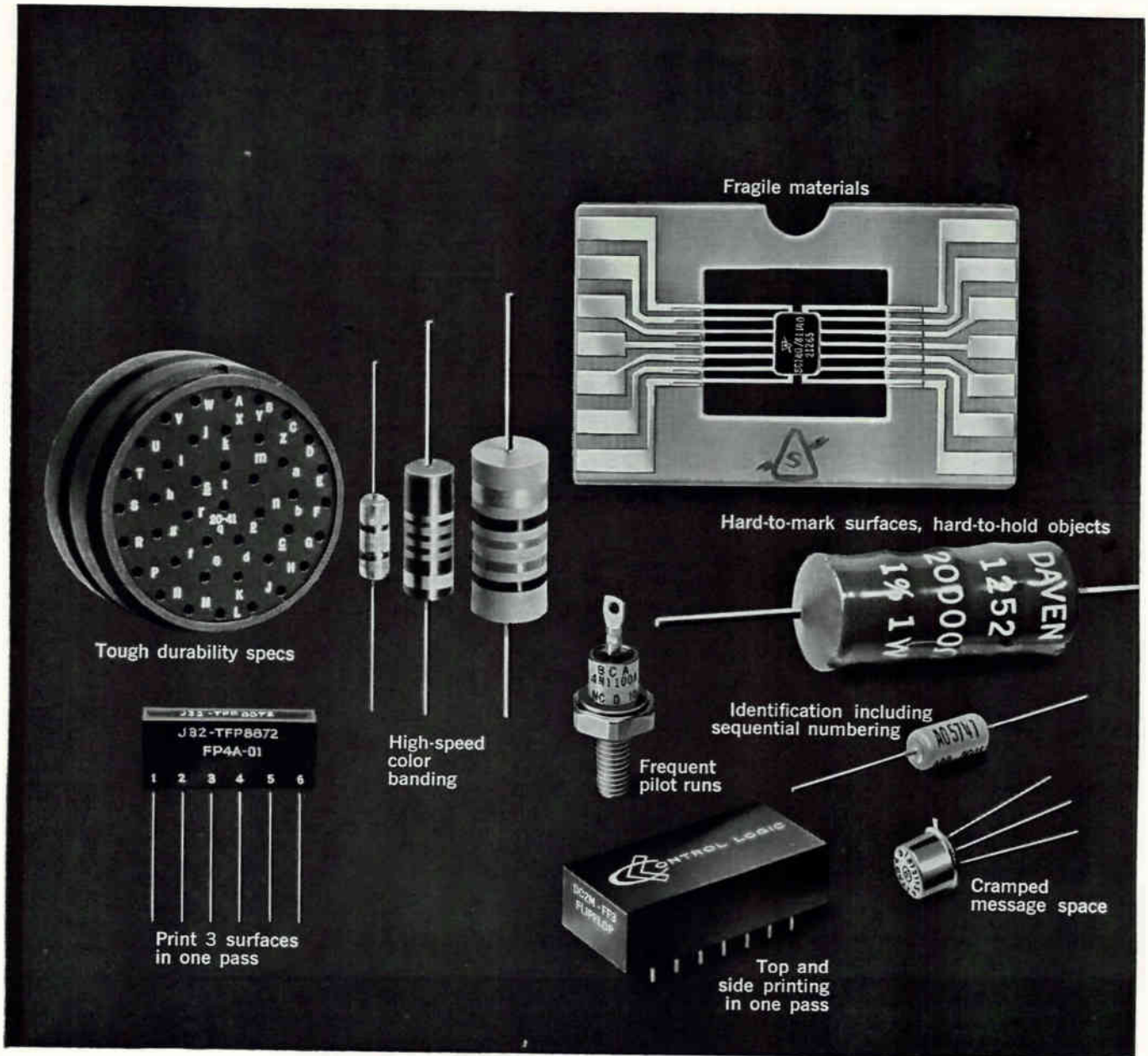

What marking job can we help you do better?

These are only a few of hundreds of marking jobs you can do more efficiently and more economically with Markem machines. So why waste time improvising and experimenting?

Call in a Markem man and get acquainted with today's broadest line of marking equipment. New high-speed color banding machines — some capable of putting three tiny bands on a miniature diode. Machines that combine sequential numbering with identification. Type so small you can print 14 characters plus trademark in an 0.125" diameter area. Quick-change type for short or pilot runs. New techniques combining special ink with flash-curing to help you meet severe durability specs. A production-speed imprinter so gentle you can safely mark flat pack ceramic components. And many other machines, specialty inks and printing elements.

Right now our research engineers and chemists are working on even better ways to mark components. We'd like to be working with you. Markem Machine Company, 305 Congress St., Keene, N.H.

MARKEM®

HELPING YOUR PRODUCT SPEAK FOR ITSELF

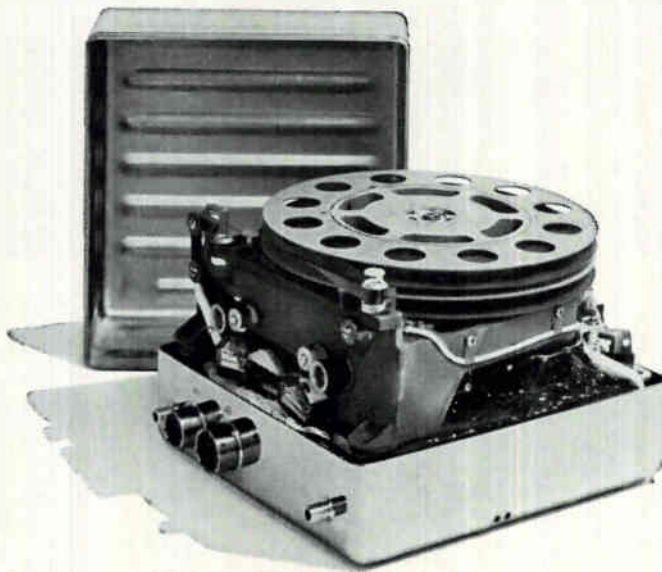

With our custom recording systems one of a kind beats a full house

This satellite recorder, for example. To date, we've built 24 variations of it. Each was a special. No production-line unit will solve the tough recording problems we take on.

Of course, a lot of our custom projects are under tight security wraps, and we can't talk about them. But we

can show you part of our hand.

We've put together a catalog of recorder applications that aren't classified. It's called, "Technical Abstracts on Record/Reproduce Systems." Programs like LEM, Apollo, the Prime re-entry vehicle, and a host of satellites are all in it.

Ask for a free copy. It shows you *why* our recorders don't have to be classified to have class.

Leach Corporation, Controls Division,
717 No. Coney Ave., Azusa, California;

Phone (213)334-8211
LEACH Export: Leach
International, S.A.

These three **NIXIE[®]** tubes will fill **80%** of your **digital-readout** requirements



STANDARD RECTANGULAR



MINIATURE RECTANGULAR



LOW-COST SIDE-VIEWING

The most popular readout ever made—Type 8422. Combines *readability* (maximum viewing distance of 30 feet), *compact size* (0.6" character in a 1.0" x 0.8" end-reading rectangular envelope) and *high reliability* (MTBF of 1 million hours at 90% confidence level). Also available in a decimal-point version, Type B-59956. For high-density packaging (0.7 cu. in.) and minimal instrument height, it's the choice of virtually every important manufacturer of digital instrumentation.

Small wonder this readout (Type B-4998) is chosen when a combination of *compact size* (0.3" character in a 0.47" x 0.63" rectangular envelope), *long life* (200,000 hours dynamic life) and *readability* (maximum viewing distance of 14 feet) are needed. For the smallest electronic readout with BCD decoding and memory, use the B-4998 with the Burroughs BIP-9401A module. Small wonder, indeed!

Our new side-viewing NIXIE tube, Type B-5440. Combines *long-life* (average life of 600,000 hours) with *low cost* (\$4.95 in 1000 quantity). Tube has low profile and narrow width for minimum panel-area opening (you can line them up on less than 0.80" centers), and its new socket is especially designed for pc-board mounting. Independently-operable decimal points are optional at slight extra cost (Type B-5441).
Call or write for full information.

(and we've got the
NIXIE tubes for that
 other 20%, too!)

Only Burroughs manufactures NIXIE Tubes



Burroughs Corporation

ELECTRONIC COMPONENTS DIVISION

Circle 86 on reader service card

PLAINFIELD, NEW JERSEY 07061

Technical Articles

Computer-aided design:
part 4, Analyzing
circuits with numbers
page 88

In the end, the computer-aided designer has to put numbers and equations into the computer. The more complex the network the more data required and the more sets of simultaneous equations. To handle such data and equations as easily as possible, the engineer can use matrix algebra. In this article, an expert on numerical processing for computer-aided design explains how to get the most out of matrix algebra in the design process.

**Electronic navigator
charts man's path to
the moon,**
page 109

When man embarks on the first truly extraterrestrial trip, the Apollo voyage to the moon, he will be guided by a box not much bigger than an unabridged dictionary. Its design, simplified to make it more reliable, is built around direct coupled transistor logic and a single integrated logic circuit.

1967 Electronics markets
page 123



For 1967, marketing managers are optimistic after enjoying the best sales year in history. Electronics' annual survey predicts industry sales will rise a whopping 10% to \$21.8 billion. Military spending, fueled by even larger increases for Vietnam will rise sharply. Vietnam may cost as much as \$25 billion. On the technical front, the stream of integrated circuits into commercial products will turn into a flood. For the cover, art director Saul Sussman illustrated this trend by superimposing a silhouette of the United States on an integrated circuit background.

**Coming
January 23**

- Integrated electronics for microwaves
- Computer-aided design, part 5: modeling
- Radar sensor for Apollo

Computer-aided design: part 4

Analyzing circuits by the numbers

Most computer-aided designs are accomplished numerically with matrix algebra, a technique still unsurpassed in solving complex network problems

By Frank Branin

International Business Machines Corp., Poughkeepsie, N.Y.

In the final analysis the computer-aided designer must feed numbers into the computer to check the performance of his design. These numbers are related to the equations that describe a given network. Since deriving the equations manually is tedious and error-prone, this approach has been abandoned in general purpose network analysis programs. Instead, the computer is exploited to derive the network equations automatically from simple input data that describes the network parameters and configuration.

Fortunately, matrix algebra, a technique which dates back to 1850, sets up these equations in a procedural form that is easy to program. With matrix algebra it is possible to handle d-c, a-c and transient network analysis problems, and the designer can derive the network equations according to the mesh, node, cutset and mixed (state-variable) methods of analysis.

Moreover, matrix algebra is a convenient shorthand that simplifies and organizes the mathematics of network analysis, making it easier to discern relationships that might otherwise be lost in details. Thus, matrix algebra is a valuable tool in computer-aided design.

A brief review of matrix algebra is given in "Understanding matrix notation" on p. 91. For clarity, the term "problem" refers to d-c, a-c or transient analysis, "method" refers to mesh, node, cutset or mixed approaches and "technique" refers to the specific steps that are applied to solve the problem such as Gaussian eliminations.

Forming a matrix of the network problem

Whether the designer must perform an a-c, d-c or transient analysis the problem is the same—to

predict the behavior of a system of interconnected elements. The physical properties of a network are completely determined by the element characteristics and how the elements are connected. Mathematically, the network problem involves the properties of an underlying topological structure called a linear graph and a superimposed algebraic structure of variables associated with the nodes, branches and meshes of the graph. The linear graph for a Wheatstone bridge, as shown, top p. 90, represents its branch-node connection pattern. The direction chosen for each branch is arbitrary. The graph is formed by replacing each branch of the network with a line connecting the same nodes. These lines are numbered arbitrarily.

When the elements of a network are interconnected, its physical variables are constrained as described by Kirchhoff's current and voltage laws. These laws are conveniently expressed in terms of topological matrixes that specify how the network is connected.

ABCD's of network topology

Four different topological matrixes, designated A, B_T, C and D, are used for obtaining the network equations. Not all the matrixes need be derived for every problem since the matrixes required are dependent on the method of analysis chosen. The flow chart, bottom p. 89, makes clear how these matrixes may be derived in sequence, starting with a table of interconnections. The table is obtained from input data that describes the network configuration. For the Wheatstone bridge, the following table contains the information from which all four topological matrixes can be derived.

The computer first converts this connection table

into a branch-node incidence matrix \bar{A} , as indicated. Each column of \bar{A} indicates which branches are connected to a particular node—a +1 indicates that the node is an initial node, and a -1 identifies a final node. If the branch is not connected, a 0 is entered.

Connection table

Branch	Initial node	Final node
1	g	f
2	b	f
3	f	c
4	c	b
5	b	g
6	c	g

The distinctive feature of the \bar{A} matrix is that each column is the negative sum of all the other columns. Hence, the matrix contains redundant information which can be removed by deleting the column corresponding to the ground or datum (reference) node. The matrix that results is called A , as shown on p. 90. In this example, node g is the reference node. Therefore, striking out column g in the \bar{A} matrix results in the A matrix.

It is always possible for a designer to select a tree in the graph. A tree is a connected set of branches that includes all nodes of the graph and does not form any closed paths or meshes. There are many ways to choose such a tree; for example, branches 1, 2 and 3 in the Wheatstone bridge network represents one tree of the network. The remaining branches are called links; each link, when added to the tree, forms a unique closed path called a basic mesh or loop. An algorithm is available for classifying the branches as tree branches or links on the computer¹.

If the A matrix is then partitioned into submatrices A_T and A_L that relate to tree-branches and links, respectively, as illustrated, the submatrix A_T is always square. The inverse of A_T is related to B_T , another topological matrix associated with the tree. Matrix B_T is called the node-to-datum path matrix.

Its columns show which branches are positively, negatively or not included in the corresponding node-to-datum path.

The relation between B_T and the inverse of A_T is given by

$$A_T^{-1} = B_T^t \quad (1)$$

where B_T^t is the transpose of B_T . An algorithm for determining the B_T matrix from the A matrix is available for the computer¹.

If the designer chooses to solve a network from mesh equations he will need C , the branch-mesh matrix, top p. 92. In forming the C matrix, the convention is adopted that each link together with the adjoining tree-branches defines a basic mesh. Thus, each basic mesh will contain only one link. The direction of each link defines the positive direction of the corresponding mesh.

Mesh 4 is formed with link 4 and branches 2

Steps in numerical network analysis

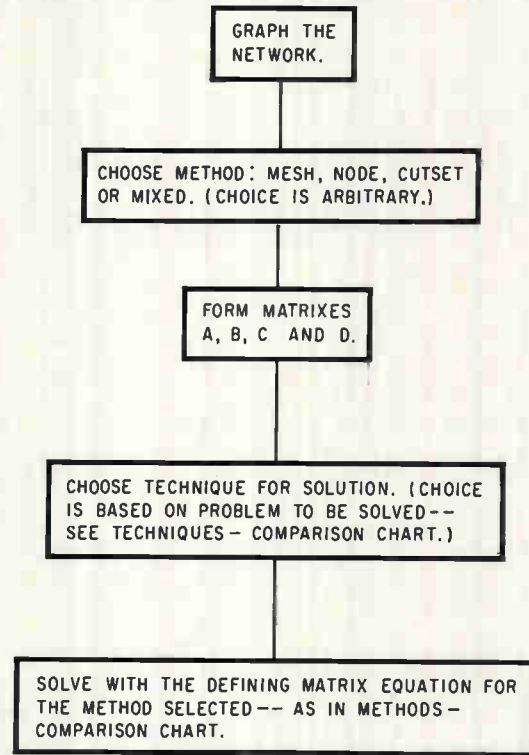

Developing the major matrixes

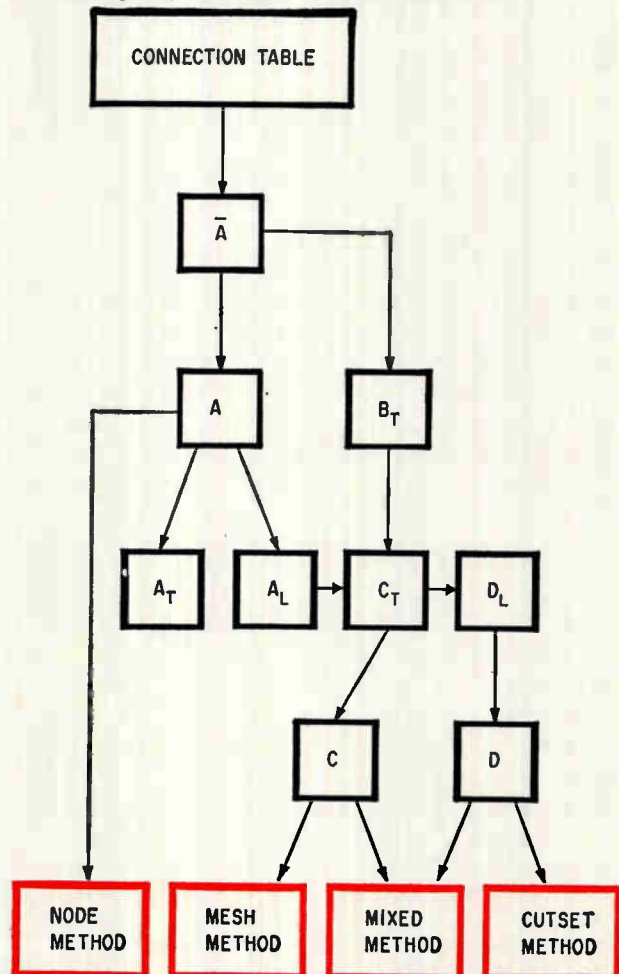

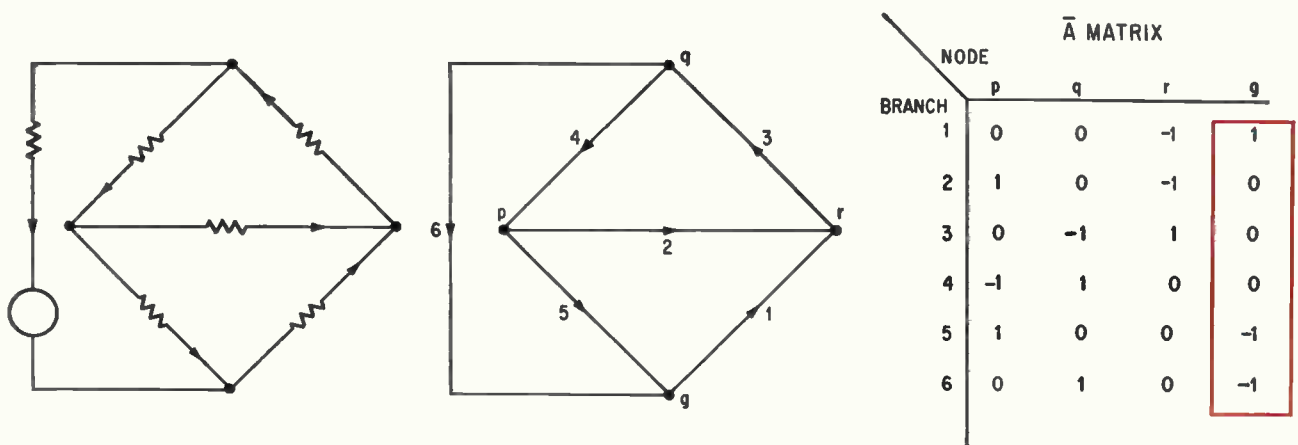

By replacing each of the elements in the circuit at the left with a line that connects between the same node points, a graph of the network is formed (center). To form the A matrix the branches are given arbitrary directions and sequential numbers. If the arrow leaves a node a +1 is entered in the column, if the arrow enters a node, a -1 is tabulated, and if a branch does not connect to a node a 0 is recorded.

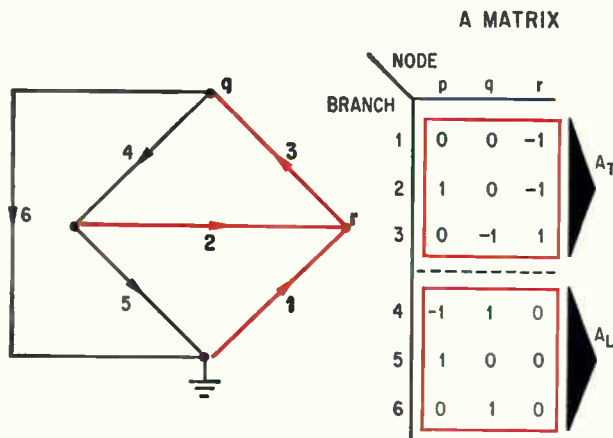

The A matrix is formed by selecting a reference node, in this case node g, and deleting that column from the Ā matrix. By selecting a tree of the graph, shown in color, the network can be resolved into two parts. The second part is the link structure of graph, shown with black lines. Submatrixes A_T and A_L are then tabulated for the tree and links by relating the arrow directions for their respective branches to the nodes of the graph.

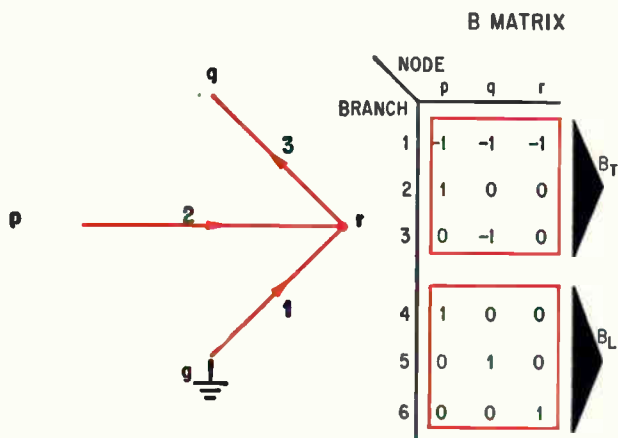

Matrix B_T is related to the tree structure of the graph and is obtained from the Ā matrix. The transpose of $-B_T$ is equal to the inverse of A_T . Matrix B_T is called the node-to-datum path matrix. Its columns indicate how the branches are included in the node-to-datum path.

and 3 included positively; mesh 5 is formed with link 5 and branch 1 included positively and 2 included negatively; mesh 6 is formed with link 6 and branches 1 and 3 included positively. Thus, each column of the C matrix shows which branches are positively, negatively or not included in the corresponding mesh. The C matrix, like the A matrix, can be partitioned—in this case into C_T and C_L submatrixes, referring to the tree-branches and links, respectively. Submatrix C_L is a unit matrix and does not have to be stored explicitly in the computer. Only the submatrix C_T is needed and this may be obtained with the aid of a theorem which states that for any linear graph, the branch-node and branch-mesh matrixes obey the fundamental relations:

$$A^t C = 0 \quad (2)$$

and

$$C^t A = 0$$

where the product is a null matrix; therefore, from the first of these expressions and with the aid of equation 1, the equation for computing C_T is

$$C_T = -B_T A_L^t \quad (3)$$

If the designer chooses to analyze a network from the cutset equations he will need the basic cutset matrix, D. A cutset is any set of branches which, when removed, separates the graph into two disconnected subgraphs—one of which may consist of a single node. Each basic cutset is uniquely associated with a single tree-branch just as each basic mesh is uniquely associated with a single link. As illustrated, each basic cutset may be identified by passing a closed circular surface through the graph so as to cut a single tree branch.

Any link cut by the surface belongs to the same basic cutset. The link is oriented positively or negatively depending on whether it passes through this surface in the same direction as the tree-branch or in an opposite direction. The D matrix may also be partitioned into submatrixes D_T and D_L , referring to the tree branches and links. Each column of the D matrix shows which branches are

Understanding matrix notation

Matrix notation is a valuable tool for manipulating many variables without being swamped by clerical details. It enables the engineer to detect relationships between systems of equations which would be obscure in conventional notation.

The idea of representing an entire array or matrix of numbers by a single symbol leads to a shorthand notation even more powerful than ordinary algebra. This idea evolved from the study of simultaneous equations as outlined in the following three steps. Consider the equations:

$$a_{11} x_1 + a_{12} x_2 + a_{13} x_3 = b_1$$

$$a_{21} x_1 + a_{22} x_2 + a_{23} x_3 = b_2$$

$$a_{31} x_1 + a_{32} x_2 + a_{33} x_3 = b_3$$

Step 1. Since it is a nuisance to write the symbols x_1, x_2, x_3 and the arithmetic operators repeatedly, the designer may write these equations in the form of a tableau, thus:

$$\begin{bmatrix} x_1 & x_2 & x_3 \end{bmatrix} \begin{bmatrix} a_{11} & a_{12} & a_{13} \\ a_{21} & a_{22} & a_{23} \\ a_{31} & a_{32} & a_{33} \end{bmatrix} = \begin{bmatrix} b_1 \\ b_2 \\ b_3 \end{bmatrix}$$

Step 2. The x 's are written in a column to the right of the matrix of coefficients a_{ij} . The result resembles the format in which we write algebraic quantities to be multiplied.

$$\begin{bmatrix} a_{11} & a_{12} & a_{13} \\ a_{21} & a_{22} & a_{23} \\ a_{31} & a_{32} & a_{33} \end{bmatrix} \begin{bmatrix} x_1 \\ x_2 \\ x_3 \end{bmatrix} = \begin{bmatrix} b_1 \\ b_2 \\ b_3 \end{bmatrix}$$

Step 3. Finally, the entire coefficient matrix and the columns of x 's and b 's are symbolized by the letters $A, x,$ and b so that the matrix equation is expressed in shorthand form.

$$Ax = b$$

All these steps symbolize the original system of equations and the rule for multiplication of the matrix A by the vector x is expressed in steps 2 and 3. Thus, the equation $Ax = b$ can represent a system of any number of equations in any number of variables. Also, when the numbers of equations and vari-

ables are equal, x may be written as

$$x = A^{-1} b$$

Here, the symbol A^{-1} stands for another matrix—the inverse of A —which, when multiplied by the vector b , gives the unknown vector x . Standard procedures exist for computing such an inverse matrix.

The operations of addition, subtraction, multiplication and inversion of matrixes are well-defined, but division is not. Addition and subtraction require operations on corresponding terms of the matrixes that are involved and commutative. Multiplication, conversely, is not usually commutative. Hence, the order of multiplication of matrixes must be respected.

Two other operations peculiar to matrixes are transposition and partitioning. A matrix is transposed by interchanging its rows and columns and this operation is indicated on A by the symbol A^t . A matrix may be partitioned either horizontally or vertically or both, producing submatrixes in the process.

There are three special types of matrixes: the null matrix, all of whose elements are zero; the unit matrix, whose diagonal elements are all 1's and whose off-diagonal elements are zero; and the diagonal matrix, which has nonzero elements only on the diagonal. The null matrix is the counterpart of the algebraic zero (under addition) while the unit matrix is the counterpart of 1 (under multiplication).

The most difficult—and fundamental—problem in matrix theory is to compute the eigenvalues λ_i and eigenvectors χ_i of a matrix. The object of this particular game—called “solving the eigenproblem”—is to solve the equation

$$A \chi_i = \lambda_i \chi_i; \quad i = 1, 2, \dots, n$$

where n is the dimension of the (square) matrix A . That is, a vector χ_i is desired such that when multiplied by A , produces another vector λ_i times as large. Here λ_i is a scalar which may be real or complex and which multiplies each element of the vector χ_i . Usually, there will be as many λ_i 's as there are rows and columns in A , but sometimes, several of these λ_i 's may have the same value.

Solving the eigenproblem may not interest all readers. However, the solution to this problem reveals much about the mathematical properties of the matrix A .

positively, negatively or not included in the corresponding basic cutset.

Since each tree-branch is assumed to be oriented positively in its own basic cutset, the submatrix D_T is a unit matrix. The submatrix D_L , which refers to the links, is the negative transpose of C_T . Thus,

$$D_L = -C_T^t$$

Hence, all of the topological matrixes $A, B_T, C,$ and D can be derived, step by step, starting with the connection table. These matrixes can now be used in expressing Kirchhoff's laws.

Electrical network laws

In addition to Kirchhoff's current and voltage laws, electrical networks obey Ohm's law—or a generalized version for nonlinear networks. Before programing the computer to derive these laws in equations, it is helpful to express these laws in matrix form. To accomplish this, it is necessary to identify certain current and voltage variables associated with a typical branch of an electrical network shown, bottom p. 92. The r^{th} branch is depicted as an impedance or admittance element Z_r , or Y_r in series with a voltage source E_r and in parallel

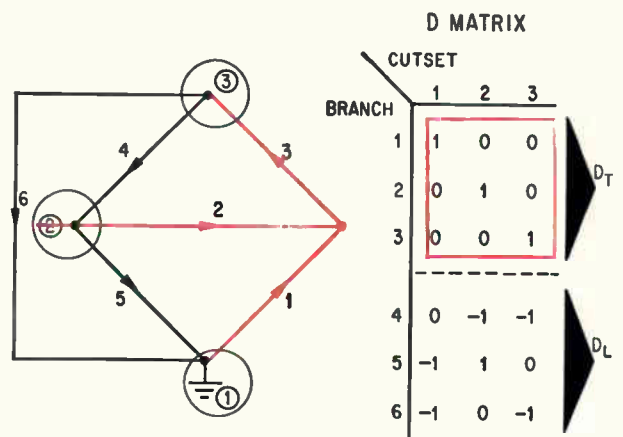
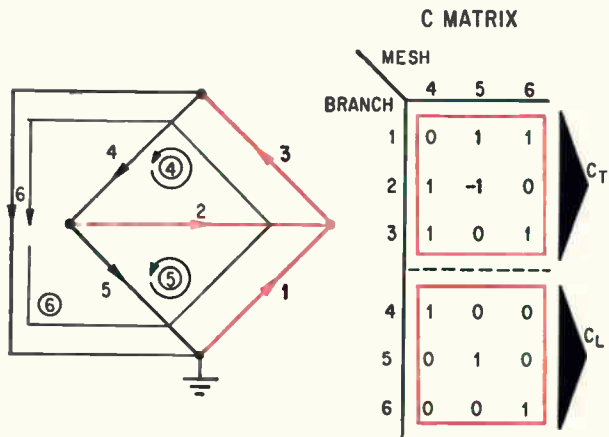

Basic meshes of the graph are selected by closing each link. The positive direction of the mesh is then determined by the direction of the link. Circled numbers inside of loops refer to the meshes. To form the C matrix the following convention is applied: a +1 is entered if the branch follows the same direction as a mesh, a -1 if it does not, and a 0 if a branch does not contact a mesh.

Cutsets of a graph are formed by circling a node to which at least one branch is connected. The circles are then numbered to indicate which branch has been cut. To form the D matrix a +1 is entered if the direction of the branch is away from a cutset, a -1 if toward the cutset, and a 0 if not in contact with the cutset. Submatrices are then formed by partitioning the tree and links of the D matrix.

with a current source I_r . Either of the sources may have any value. There are three distinct current and voltage variables to identify in this branch. Branch current i_r enters at its initial node, but the element current J_r , that passes through Z_{rr} , is defined by,

$$J_r = I_r + i_r \quad (5)$$

according to the sign conventions shown. Similarly, although the branch voltage, measured from initial to final node, is e_r , the element voltage V_r that actually appears across Z_{rr} is expressed by,

$$V_r = E_r + e_r \quad (6)$$

with the sign conventions taken as noted in the diagram.

Since E_r and I_r may be other than zero, Ohm's law for this branch must be written in terms of the element voltage and current variables V_r and J_r . Accordingly, Ohm's law for the entire network may be expressed in the shorthand notation provided by the matrix equations

$$V = ZJ \quad (7)$$

or

$$J = YV \quad (8)$$

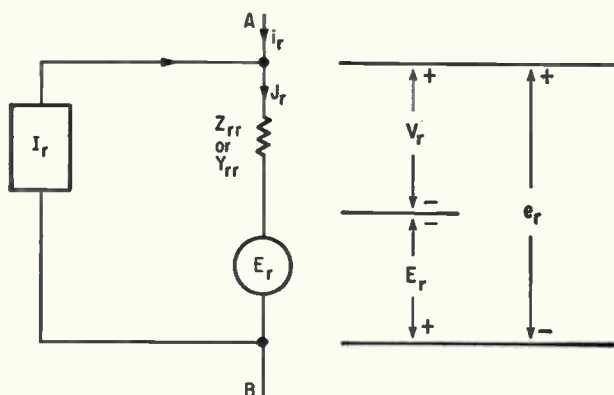

To form a matrix that expresses both Ohm's and Kirchhoff's laws the branch element is employed.

where vectors V and J consist of the entire set of element voltage and current variables for the network, and where the admittance matrix Y is the inverse of the impedance matrix Z . The diagonal terms of Z (or Y) are the self-impedances (or self-admittances) of each branch, whereas the off-diagonal terms are the trans-impedances (or trans-admittances) between pairs of branches. If corresponding off-diagonal terms are equal they are mutual impedances (or admittances).

The dependent sources that describe the behavior of active devices such as transistors may be represented by off-diagonal terms in the Z or Y matrix. In the transistor amplifier and its equivalent circuit bottom p. 93, the T-equivalent for the transistor is represented with its amplifying effect accounted for by the dependent current generator αJ_e in parallel with the collector branch. But the amplification can also be considered as a transconductance that exists between the emitter and collector branches.

The following values are obtained from a handbook for a 2N190 transistor that operates at $V_c = -5$ volts and $J_e = 1$ milliamperes: $\alpha = 0.979$, $R_c = 0.0175$ kilohm, $R_b = 0.500$ kilohm and $R_e = 1,250$ kilohms. If the 1-kilohm emitter resistor is combined with R_e to form a single branch having the value of 1.0175 kilohms and the numbering scheme on the diagram is applied, the following matrix equation expresses Ohm's law:

$$\begin{bmatrix} J_1 \\ J_2 \\ J_3 \\ J_4 \\ J_5 \\ J_6 \end{bmatrix} = \begin{bmatrix} 0.9828 & & & & & \\ & 2.00 & & & & \\ 0.9620 & & 0.0008 & & & \\ & & & 0.0200 & & \\ & & & & 0.1099 & \\ & & & & & 0.2000 \end{bmatrix} \begin{bmatrix} V_1 \\ V_2 \\ V_3 \\ V_4 \\ V_5 \\ V_6 \end{bmatrix} \quad (9)$$

where the element currents J are in milliamperes, the admittances (conductances) Y are in millimhos and the element voltages V are in volts. In this equation the transconductance $Y_{31} = 0.9620$ millimhos, which accounts for the dependent current source αJ_e in branch 3, has a value determined by $\alpha/1.0175$ since $J_1 = V_1/1.0175$. Thus the value of α can be determined for the dependent current source αJ_1 in branch 3.

Kirchhoff's current law for this network requires that $i_2 - i_4 + i_5 = 0$ at node b, $-i_3 + i_4 + i_6 = 0$ at node c, and $-i_1 - i_2 + i_3 = 0$ at node f. These relations can be combined into a single matrix

$$\begin{bmatrix} 0 & 1 & 0 & -1 & 1 & 0 \\ 0 & 0 & -1 & 1 & 1 & 1 \\ -1 & -1 & 1 & 0 & 0 & 0 \end{bmatrix} \begin{bmatrix} i_1 \\ i_2 \\ i_3 \\ i_4 \\ i_5 \\ i_6 \end{bmatrix} = \begin{bmatrix} 0 \\ 0 \\ 0 \end{bmatrix} \quad (10)$$

But the coefficient matrix in this equation is the transpose of A , the branch-node connection matrix. Hence equation 10 can be written

$$A^t i = 0 \quad (11)$$

which represents an expansion of Kirchhoff's current law.

Similarly, the individual equations for Kirchhoff's voltage law can also be expressed in the matrix form

$$\begin{bmatrix} 0 & 1 & 1 & 1 & 0 & 0 \\ 1 & -1 & 0 & 0 & 1 & 0 \\ 1 & 0 & 1 & 0 & 0 & 1 \end{bmatrix} \begin{bmatrix} e_1 \\ e_2 \\ e_3 \\ e_4 \\ e_5 \\ e_6 \end{bmatrix} = \begin{bmatrix} 0 \\ 0 \\ 0 \end{bmatrix} \quad (12)$$

which requires that the sums of the branch voltage e around each of the three meshes equal zero. Here, the coefficient matrix is the transpose of the circuit

matrix C so that Kirchhoff's voltage law can be written in the general form expressed by,

$$C^t e = 0 \quad (13)$$

Corollary forms of Kirchhoff's current and voltage laws are embodied in the statements "the branch currents are a linear combination of the mesh currents" and "the branch voltages are a linear combination of the node-to-datum voltages." These statements can be written as the matrix equations

$$i = C i' \quad (14)$$

and

$$e = A e' \quad (15)$$

where i' is the vector of mesh currents and e' is the vector of node-to-datum voltages. Here, as in equations 11 and 13, the topological matrixes A and C automatically do the bookkeeping implied by Kirchhoff's laws, no matter how large the network or how complicated its interconnections. This demonstrates the power of matrix notation.

The three basic network laws can be summarized with a transformation diagram², top p. 94, which characterizes the algebraic structure that underlies the network problem and shows the interrelations between the variables expressed by equations 5 through 15. The diagram also depicts two additional relations: $C^t E = E'$, in which the sum of voltage sources E around each mesh gives rise to an equivalent mesh-voltage source E' , and $A^t I = I'$, in which the sum of current sources I at each node gives rise to an equivalent nodal current source I' . (For nonlinear networks, the matrixes Z and Y symbolize nonlinear operators or transformations between V and J ; this is the generalization of Ohm's law. Kirchhoff's laws are unaffected by nonlinearities.)

A variety of nonelectrical systems (mechanical, acoustical and structural^{3,4}) fit into this algebraic pattern and can be treated as network problems. Moreover, this pattern of algebraic-topological relations can be extended to characterize interconnected structures that consist of surface and volume elements as well as points and lines. From this extension, a direct correspondence with the operational structure that underlies vector calculus emerges and it then becomes possible to justify the application of network models (analogies) for a

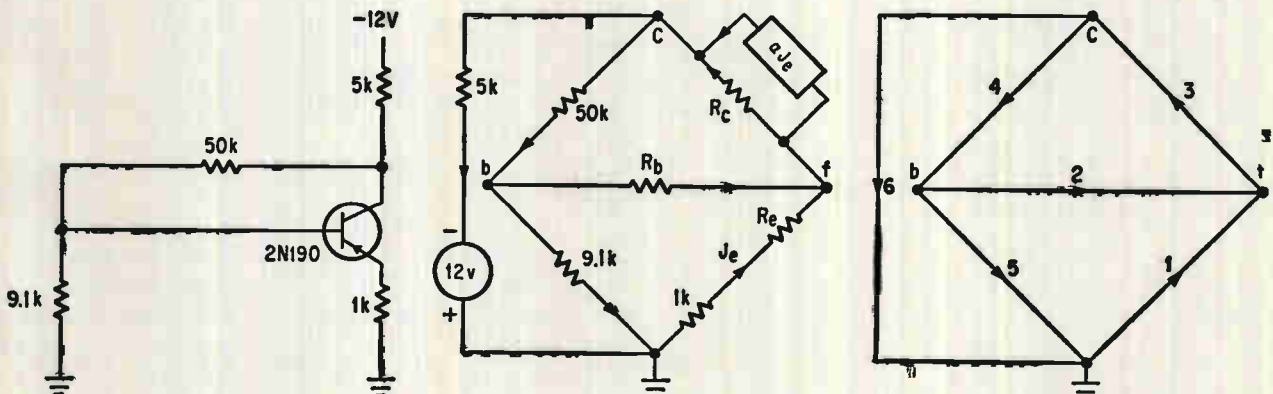

The transistor amplifier at the left is represented by an equivalent circuit (center). Graph of the circuit appears at the right. Arrow directions and numbers on the graph are arbitrarily chosen.

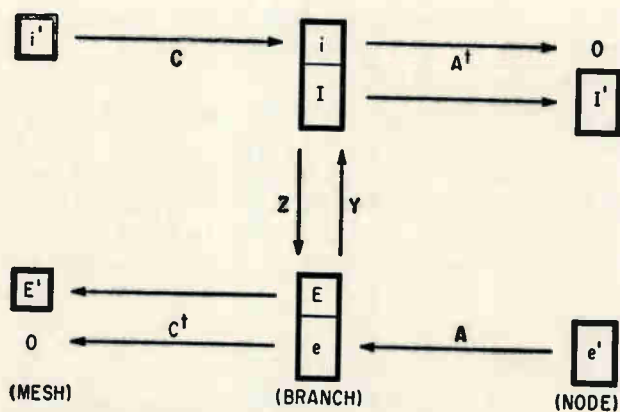

The algebraic structure of the network problem is represented by the stages shown. These express the relationships of all the four matrixes and the interrelations of the circuit parameters.

wide class of partial differential equations—including Maxwell's equations⁵.

Electrical network problem

Given the following, a network whose configuration determines the topological matrixes A and C ; the impedance matrix Z (or admittance matrix Y) and the voltage and current source vectors E and I , the electrical network problem is to find the branch voltage vector e and the branch current vector i such that $E + e = Z(I + i)$ or $I + i = Y(E + e)$; $A^t i = 0$; $C^t e = 0$.

This problem may be handled with four different methods, three of which—the mesh, node, and cutset methods—are familiar. The fourth, the mixed method, though new, can be used like the others for d-c, a-c, or transient analysis. Moreover, it underlies the state-variable approach to transient analysis^{1,6}. [See Electronics, Dec. 26, "Analyzing networks with state variables," page 63.] In all methods auxiliary variables, such as node-to-datum voltages e' or mesh currents i' must be used along with both of Kirchhoff's laws, and Ohm's law to solve the network problem.

Mesh method

If the impedance form of Ohm's law is slightly rearranged, the following relationship results,

$$(E - ZI) + e = Zi \quad (16)$$

Premultiplying by C^t and using equation 13 eliminates the vector e and results in the expression

$$C^t(E - ZI) = C^t Zi \quad (17)$$

By substituting equation 14 into equation 17 the matrix equivalent of the entire set of mesh equations is obtained. Thus,

$$C^t(E - ZI) = C^t Z C i' \quad (18)$$

Here, $C^t Z C$ is the mesh impedance matrix.

The solution for i' is obtained from

$$i' = (C^t Z C)^{-1} C^t (E - ZI) \quad (19)$$

where $(C^t Z C)^{-1}$ is the mesh solution matrix. The branch currents are computed from equation 14 and the branch voltages e from equation 16.

Node method

Applying equations 11 and 15 to the admittance form of Ohm's law yields the node equations

$$A^t (I - YE) = A^t Y A e' \quad (20)$$

where $A^t Y A$ is the nodal admittance matrix. The solution for e' is then expressed in the form

$$e' = (A^t Y A)^{-1} A^t (I - YE) \quad (21)$$

where $(A^t Y A)^{-1}$ is the nodal solution matrix. The computation of e and i is trivial.

Cutset (or tree) method

Instead of using the node-to-datum voltage e' as auxiliary variables, the tree-branch voltages e_T may be used as a linearly independent set of voltages in terms of which all the branch voltages may be computed. Thus, in place of equation 15 the relation

$$e = D e_T \quad (22)$$

may be applied, where D is the cutset matrix. The counterpart of equation 11 then becomes

$$D^t i = 0 \quad (23)$$

and these equations can be used to express Kirchhoff's voltage and current laws.

The cutset equations can then be expressed by

$$D^t (I - YE) = D^t Y D e_T \quad (24)$$

where $D^t Y D$ is the cutset admittance matrix, and the solution for e_T can be expressed in the form

$$e_T = (D^t Y D)^{-1} D^t (I - YE) \quad (25)$$

where $(D^t Y D)^{-1}$ is the cutset solution matrix. Again, the computation of e and i is trivial.

Mixed method

The idea behind the mixed method is to express Ohm's law in a mixed form, with an admittance matrix for certain branches of the network and an impedance matrix for the remainder. Using the subscripts y and z to designate admittance-branches and impedance-branches, respectively, Ohm's law may be written in the form,

$$\begin{bmatrix} I_y + i_y \\ E_z + e_z \end{bmatrix} = \begin{bmatrix} Y_y & 0 \\ 0 & Z_z \end{bmatrix} \begin{bmatrix} E_y + e_y \\ I_z + i_z \end{bmatrix} \quad (26)$$

With this as a starting point, the y -branches are analyzed by the cutset method and the z -branches by the mesh method. The two types of branches are considered as separate subnetworks with the two resulting systems of equations coupled by an appropriate topological matrix using the following procedure.

Taking all the y -branches first a computer selects all the tree links. Any y -links thus identified will define basic meshes that contain only y -tree branches, since no z -branches have been considered up to this point. The paths-in-tree for these y -meshes are designated by the submatrix C_{Ty} .

The tree-link sort is then resumed taking the z -branches into account. The z -links define basic meshes whose paths-in-tree may involve both

y-tree and z-tree branches, designated by the submatrixes C_{Tyz} and C_{Tzz} , respectively. Thus, the C_T matrix for the entire network has the form

$$C_T = \begin{bmatrix} C_{Tyy} & C_{Tyz} \\ 0 & C_{Tzz} \end{bmatrix} \quad (27)$$

where the submatrix C_{Tzy} is zero.

If the y-branch voltages e_y are expressed in terms of the y-tree branch voltages, e_{Ty} , and equations 4 and 22 employed, the result is,

$$e_y = \begin{bmatrix} e_{Ty} \\ e_{Ly} \end{bmatrix} = \begin{bmatrix} U_{Ty} \\ -C_{Tyy}^t \end{bmatrix} e_{Ty} = D_y e_{Ty} \quad (28)$$

where D_y is the cutset matrix for the y-branches alone with the z-branches regarded as open circuited.

Similarly, the z-branch currents i_z may be expressed as a linear combination of the z-link currents i_{Lz} (which are identical with the mesh currents). This yields the relation

$$i_z = \begin{bmatrix} i_{Tz} \\ i_{Lz} \end{bmatrix} = \begin{bmatrix} C_{Tzz} \\ U_{Lz} \end{bmatrix} i_{Lz} = C_z i_{Lz} \quad (29)$$

Here C_z is the circuit matrix for the z-branches alone, with the y-branches regarded as short-circuited.

The terms of equation 26 may be rearranged in the form,

$$\begin{bmatrix} (I_y - Y_y E_y) \\ (E_z - Z_z I_z) \end{bmatrix} = \begin{bmatrix} Y_y & 0 \\ 0 & Z_z \end{bmatrix} \begin{bmatrix} e_y \\ i_z \end{bmatrix} - \begin{bmatrix} i_y \\ e_z \end{bmatrix} \quad (30)$$

The next step is to premultiply the first row of equation 30 by D_y^t and the second row by C_z^t and replace e_y and i_z by the expressions given in equations 28 and 29. The result thus obtained is,

$$\begin{bmatrix} D_y^t (I_y - Y_y E_y) \\ C_z^t (E_z - Z_z I_z) \end{bmatrix} = \begin{bmatrix} D_y^t Y_y D_y & 0 \\ 0 & C_z^t Z_z C_z \end{bmatrix} \begin{bmatrix} e_{Ty} \\ i_{Lz} \end{bmatrix} - \begin{bmatrix} D_y^t i_y \\ C_z^t e_z \end{bmatrix} \quad (31)$$

Except for the second term on the right, the result expressed by equation 31 is exactly what would follow from the tree method of analysis on the y-branches, with the z-branches open-circuited, and the mesh method of analysis on the z-branches, with the y-branches short-circuited.

Since it may be shown that

$$D_y^t i_y = C_{Tyz} i_{Lz} \quad (32)$$

and

$$C_z^t e_z = -C_{Tyz}^t e_{Ty} \quad (33)$$

these relations can be applied to produce the final result, namely,

$$\begin{bmatrix} D_y^t (I_y - Y_y E_y) \\ C_z^t (E_z - Z_z I_z) \end{bmatrix} = \begin{bmatrix} D_y^t Y_y D_y - C_{Tyz} \\ C_{Tyz}^t & C_z^t Z_z C_z \end{bmatrix} \begin{bmatrix} e_{Ty} \\ i_{Lz} \end{bmatrix} \quad (34)$$

where the topological matrix C_{Tyz} effectively couples the two systems of cutset and mesh equations.

Numerical methods may be used for solving net-

work problems of three main types: d-c, a-c and transient. These methods are detailed in the flow chart on page 101.

Solving the network problem

The most straight forward method for solving d-c network problems is conventional Gaussian elimination of variables in the mesh, nodal, cutset or mixed method equations. The amount of computation required is about $n^{3/2}$ operations (multiplications and additions), where n is the number of variables. If several solutions are desired for a given network with a succession of voltage and/or current sources, the procedure usually followed is to compute the mesh solution matrix or nodal solution matrix, at a cost of about n^3 operations, and then to multiply each different source vector by this matrix, at a cost of n^2 operations per vector.

However, the matrixes involved in most network problems are so sparse, (contain relatively few nonzero terms) that it is important to take full advantage of this sparsity when programing the actual method of solution. The Gaussian technique does not take advantage of the sparsity of the matrix. Techniques developed by Sato-Tinney⁷ do exploit the sparsity of the nodal admittance matrix, so that both the number of computations and the requirements for computer memory are greatly reduced. They show that the order in which the variables are processed in the usual Gaussian elimination scheme strongly affects the number of computations involved in treating a sparse matrix. They also explain a special programing technique for storing a compact, coded form of the inverse of a sparse matrix that is more efficient to use computationally than the actual inverse.

In one piecewise analysis technique (developed by Kron^{8,9}) some tools are provided that enable the engineer to study the effect of varying a single resistance through a succession of values. This method, which is the basis of the MODIFY feature of ECAP¹⁰, permits the nodal solution matrix for the original network to be updated with changes in one or more branch resistances. The amount of computation involved is trivial compared with that required for solving the nodal equations or reinverting the nodal admittance matrix.

An extension of the mesh method⁹ leads to Kron's basic formula for updating the nodal solution matrix when one or more links are added to a given network. If Z_1 designates the nodal solution matrix for the original network, Z_L represents the impedance matrix of the links to be added and A_L represents the corresponding branch-node connection matrix, then the basic formula is given by

$$(A^t Y A)^{-1} = Z_1 - Z_1 A_L^t (A_L Z_1 A_L^t + Z_L)^{-1} A_L Z_1 \quad (35)$$

where $(A + Y A)^{-1}$ is the nodal solution matrix for the modified network. Equation 35 may be applied recursively to add one link-at-a-time until all links have been added or it may be used once to add all the links simultaneously. The latter method is more economical. Formulas similar to equation 35 update the mesh solution matrix or cutset solution

matrix but Kron's technique has not yet been applied to the mixed method.

D-c problem tackled

Designer's frequently must analyze networks for different parameter values. To illustrate how Kron's method may be used to permit the designer to change parameter values without repeating each analysis from the start, consider the following example for a transistor amplifier. With the Y matrix given in equation 9 and the A matrix in equation 10 the nodal equations can be written numerically in the form

$$\begin{bmatrix} 2.1299 & -0.0200 & -2.0000 \\ -0.0200 & 0.2208 & 0.9612 \\ -2.0000 & -0.0008 & 2.0216 \end{bmatrix} \begin{bmatrix} e'_b \\ e'_e \\ e'_r \end{bmatrix} = \begin{bmatrix} 0 \\ -2.4 \\ 0 \end{bmatrix} \quad (36)$$

which can be verified by carrying out the matrix operations indicated in equation 20. By computing the inverse of the coefficient matrix, the solution is written in the form

$$\begin{bmatrix} e'_b \\ e'_e \\ e'_r \end{bmatrix} = \begin{bmatrix} 4.1880 & 0.3937 & 3.9561 \\ -17.6269 & 2.8642 & -18.8004 \\ 4.1363 & 0.3906 & 4.4010 \end{bmatrix} \begin{bmatrix} 0 \\ -2.4 \\ 0 \end{bmatrix} \\ = \begin{bmatrix} -0.9449 \\ -6.8741 \\ -0.9375 \end{bmatrix} \quad (37)$$

Suppose that a particular value of emitter current for example, 1 milliampere is desired. This can be achieved by adjusting the bias resistor. This requires that $e'_r = -1.0175$ volts instead of -0.9375 volts as computed, and the change can be achieved by adjusting biasing resistors. If a resistor R_L is added in parallel with the 9.1-kilohm resistor in branch five, the corresponding A_L matrix is $[1 \ 0 \ 0]$. Accordingly, with the aid of equation 35

$$e' = [Z_1 - Z_1 A_L^t (A_L Z_1 A_L^t + Z_L)^{-1} A_L Z_1] \bar{I} \\ = Z_1 \bar{I} - [Z_1 A_L^t (A_L Z_1 A_L^t + Z_L)^{-1} A_L Z_1] \bar{I} \quad (38)$$

where $\bar{I} = A^t(I - YE)$. Since $Z_1 \bar{I}$ has already been evaluated in equation 37, equation 38 may be written in the form

$$\begin{bmatrix} e'_b \\ e'_e \\ e'_r \end{bmatrix} = \begin{bmatrix} -0.9449 \\ -6.8741 \\ -0.9375 \end{bmatrix} - \begin{bmatrix} 4.1880 \\ -17.6269 \\ 4.1363 \end{bmatrix} [4.1880 + R_L]^{-1} \\ \begin{bmatrix} 0 \\ -2.4 \\ 0 \end{bmatrix} \quad (39) \\ = \begin{bmatrix} -0.9449 \\ -6.8741 \\ -0.9375 \end{bmatrix} + \begin{bmatrix} 4.1880 \\ -17.6269 \\ 4.1363 \end{bmatrix} \left(\frac{0.9449}{4.1880 + R_L} \right)$$

Resistance R_L is chosen to decrease e'_r by 0.0800

volts thus bringing it to the desired value of -1.0175 volts. This requires that $(4.1363 \times 0.9449)/(4.1880 + R_L) = -0.0800$ or $R_L = -53.043$ kilohms. This negative resistance in parallel with branch five yields a net value of 10.983 kilohms in place of the original value of 9.1 kilohms. Thus, with Kron's method the exact value of biasing resistance required can be easily computed. Moreover, the nodal solution matrix does not require updating since the problem permits postmultiplying by \bar{I} . This technique of postmultiplying a matrix expression by a column vector is often an effective method of increasing computational efficiency and should be applied whenever appropriate to the problem.

By a suitable extension of equation 35, the sensitivity of the nodal solution matrix Z_1 with respect to any branch impedance Z_1 may be computed as follows:

$$\frac{\partial Z_1}{\partial z_i} = \frac{1}{z_i^2} [Z_1 A_L^t] [A_L Z_1] \quad (40)$$

where A_L is the connection matrix for the branch in question. (Second-order partial derivatives may also be computed.) Alternatively, the sensitivity of the node voltage e' to changes in E, I, or Y may be computed by differentiating the nodal equations. Thus, from equation 20 it can be shown that,

$$A^t (dI - dY E - Y dE) = A^t dY A e' + A^t Y A d e' \quad (41)$$

and by rearranging,

$$d e' = (A^t Y A)^{-1} A^t [dI - dY (E + e) - Y dE] \quad (42)$$

Here, dI is the vector specifying the perturbations of all the current sources, dE of all the voltage sources and dY of all the admittances.

Performing a sensitivity analysis

When a current gain of a transistor drifts, the output of a circuit can fall outside the desired values. A good design accounts for this drift with a sensitivity analysis. For instance, if a 1% increase in α , the current gain, results in this circuit, a corresponding increase of 0.00962 in the transconductance Y_{31} results. Hence, the dY matrix in equation 42 would consist of 0.00962 in the (3,1) position and zero everywhere else while dI and dE would be zero. These values together with and the results already computed yield

$$\begin{bmatrix} d e'_b \\ d e'_e \\ d e'_r \end{bmatrix} = \begin{bmatrix} 4.1880 & 0.3937 & 3.9561 \\ -17.6269 & 2.8642 & -18.8004 \\ 4.1363 & 0.3906 & 4.4010 \end{bmatrix} \begin{bmatrix} 0 \\ 0.009029 \\ 0.009029 \end{bmatrix} \\ = \begin{bmatrix} -0.0321 \\ 0.1958 \\ -0.0004 \end{bmatrix} \quad (43)$$

The question of how to solve nonlinear d-c problems in an important one, but difficult to answer with complete assurance. One conventional technique is the Newton-Raphson¹¹ iteration method.

Techniques for network solution

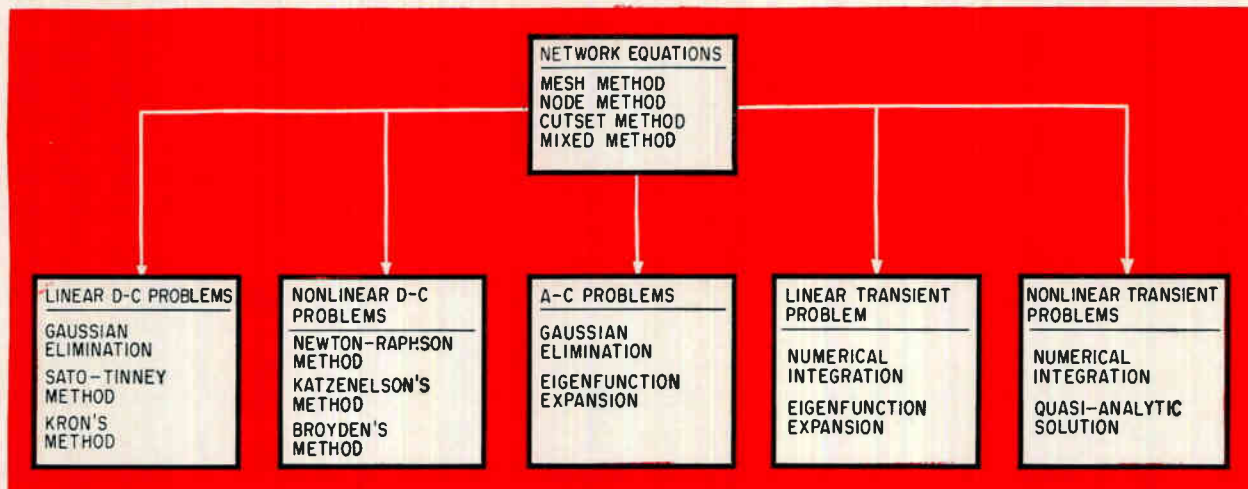

For solving a single nonlinear equation $f(x) = 0$ this method applies the recursion formula $x_{i+1} = x_i - f(x_i)/f'(x_i)$ where $f'(x_i)$ is the value of the derivative df/dx at the point x_i .

For a system of nonlinear equations $f_j(x_1, x_2, \dots, x_n) = 0$, with $j = 1, 2, \dots, n$, the notion of the derivative has to be generalized and for this purpose the Jacobian¹¹ matrix H is used. The jk^{th} element of the Jacobian matrix is $H_{jk} = \partial f_j / \partial x_k$. The recursion formula now becomes $x_{i+1} = x_i - H^{-1}f(x_i)$ where x and f are vectors. An adaptation of this method has been successfully applied in TAP^{1, 12} and in NET-1¹³.

When the iteration converges, it does so quadratically. That is, at each iteration the error is proportional to the square of the previous error. However, the method may diverge under certain circumstances—for example, in some transistor switching circuits with positive feedback.

Methods have been developed to overcome two main drawbacks of the Newton-Raphson method, namely: the need to repeatedly evaluate and invert the Jacobian matrix and the reliability of the method to diverge¹⁴. The remedy has not yet been applied to nonlinear network problems.

Another approach to solving the nonlinear network, has been described by Katzenelson¹⁵. It converges in a finite number of steps if the resistance characteristics are continuous, monotonically increasing and piecewise linear. Under these restrictions, the answer to the network problem is found by solving several linear problems, each approximating the nonlinear problem over a small range.

For each of these successive linear network problems the cutset solution matrix is slightly different. The key to the computational effectiveness of this algorithm is the application of Kron's method for updating the cutset solution matrix.

A-c network problems

Since the theoretical development given so far applies to complex numbers as well as real, the methods described may be used for a-c problems as well as d-c, but at approximately four times the

computational cost of the latter. Moreover, since the coefficient matrix is frequency dependent in a-c problems, the equations must be solved (or the matrix inverted) at each new frequency. Thus computing frequency response curves is expensive.

A new approach to the a-c problem⁶ that does not have the frequency limitation is based on the mixed method. It tackles the job of matrix inversion by first computing the eigenvalues and eigenvectors of the matrix and reduces the problem to the trivial task of inverting a diagonal matrix at each new frequency. [See "Understanding matrix notation" on p. 91.]

The method is better for computer-size problems than Laplace transform techniques that involve ratios of polynomials. The task of computing the coefficients of the polynomials is time-consuming and has serious numerical inaccuracies, especially when the polynomials are of high degree. Also, these roots may be extremely sensitive to errors in the coefficients. The eigenvalue¹¹ approach is more appropriate and gives all of the theoretical information that the Laplace transform method can provide. For example, the eigenvalues are identical with the poles of the network functions, the zeros of this equation can be computed by an iterative technique. Moreover, any network function desired may be computed directly and its sensitivity obtained, either with respect to frequency or with respect to any network parameter. Finally, even the pole sensitivities can be calculated.

The technique is based on equation 34, from which the differential equations for an RLC network can be derived in first-order form as follows:

All capacitors are treated as admittance branches and may have a nonzero conductance in parallel. Thus, the admittance matrix becomes $Y_p = pK + G$ where $p = d/dt$. The symbol K is used for capacitance so as not to conflict with the symbol C that designates the circuit matrix. Conversely, all inductors are regarded as impedance branches with a series resistance so that the impedance matrix is $Z_s = pL + R$.

With the definitions of Y_p and Z_s in equation 34,

the differential equations (for constant K and L) can be written in the form

$$\begin{bmatrix} D^tKD & 0 \\ 0 & C^tLC^t \end{bmatrix} \begin{bmatrix} p e_T \\ p i_L \end{bmatrix} + \begin{bmatrix} D^tGD & -C_{Tys} \\ C^tTys & C^tRC \end{bmatrix} \begin{bmatrix} e_T \\ i_L \end{bmatrix} = \begin{bmatrix} I_T \\ E_L \end{bmatrix} \quad (44)$$

where the symbols I_T and E_L designate the driving currents and voltages. In more compact form, equation 44 is

$$P\dot{x} + Qx = f(t) \quad (45)$$

where $\dot{x} = dx/dt$ and x is the state-variable vector of capacitive tree-branch voltages and inductive

$$\dot{x} = Ax + g(t) \quad (46)$$

link currents. Solving this expression for \dot{x} yields where $A = -P^{-1}Q$, corresponds to Bashkow's A -matrix¹⁶ and $g = P^{-1}f$. (This A matrix is not to be confused with the topological matrix A .)

For steady state a-c problems, the driving function may be written as $g(t) = g_0 e^{st}$, with g_0 a known vector and s a complex number. The steady state response is then $x(t) = x_0 e^{st}$ with the vector x_0 yet to be determined. With these relations substituted into equation 46, a linear system of equations $(sU - A)x_0 = g_0$ is obtained for the formal solution. This is given by the relationship

$$x_0 = (sU - A)^{-1} g_0 \quad (47)$$

Solving for the eigenvalues λ_i and eigenvectors χ_i the matrix A allows the engineer to express $(sU - A)^{-1}$ in a very functional form. Let Λ a diagonal matrix, containing the λ_i on its diagonal, and let \bar{X} be a matrix whose columns are the χ_i vectors. The eigenproblem can then be written as $A\bar{X} = \bar{X}\Lambda$ or

$$\bar{X}^{-1} A \bar{X} = \Lambda \quad (48)$$

This defines a transformation that diagonalizes the matrix A . But this same transformation also diagonalizes the matrix $(sU - A)$. As a consequence it can be shown that

$$(sU - A)^{-1} = \bar{X} (sU - \Lambda)^{-1} \bar{X}^{-1} \quad (49)$$

Accordingly equation 47 becomes

$$x_0 = \bar{X} (sU - \Lambda)^{-1} \bar{X}^{-1} g_0 \quad (50)$$

This is the basic relation of the new method, requiring the inversion of the diagonal matrix $(sU - \Lambda)$ at each frequency.

If $d = X^{-1} g_0$, then the i^{th} element of the x_0 vector may be computed with the relation

$$x_i = \sum_{j=1}^n \frac{x_{ij} d_j}{s - \lambda_j} \quad (51)$$

This partial fraction expansion of the state variable x_i may be evaluated at a computational cost of n operations per frequency as opposed to n^3 operations if the equation $(sU - A)x_0 = g_0$ were solved

by Gaussian elimination.

The cost of solving the eigenproblem is not negligible since it is equivalent to solving $(sU - A)x_0 = g_0$ at roughly 10 frequencies. Accordingly, the present method would not pay off if solutions were required for only a few frequencies. But for a frequency response calculation this method is very effective. It is easy to derive sensitivity formulas with this method. For example, the frequency sensitivity of x_0 is

$$\frac{dx_0}{ds} = -\bar{X} (sU - \Lambda)^{-2} \bar{X}^{-1} g_0 \quad (52)$$

This method can also be extended to the computation of driving point and transfer functions and their sensitivities.

Large range of eigenvalues

The eigenvalue method is not free of all difficulties. It is possible that numerical errors of a crippling nature may arise when networks having large eigenvalue ratios are treated. The difficulty is that although the large eigenvalues can be computed accurately, the small ones cannot. But it is the small ones which are principally responsible for determining the behavior of the network.

One possible remedy is to solve the eigenvalue problem for the inverse matrix A^{-1} . Then the situation is reversed, the large eigenvalues of A^{-1} that are obtained accurately are the reciprocals of the small eigenvalues of A . Computing A^{-1} may be error-prone. But if the matrix Q in equation 45 is nonsingular, then the relation

$$A^{-1} = Q^{-1} P \quad (53)$$

may be applied to compute a more accurate inverse for A . A more accurate technique for computing small eigenvalues of the A matrix needs to be developed.

Transient network problems

With or without a computer, nonlinear transient problems are the hardest to solve. However, linear transient problems can be solved as easily as d-c and a-c problems. Nonlinear analysis of high order differential equations is often necessary. Solving these can be extremely slow when the network has a wide spread of eigenvalues.

An approach to linear transient analysis that yields an exact solution is obtained from linear network equations of the form, $\dot{x} = Ax + g(t)$. The solution for this system of differential equations may be expressed as

$$x(t+h) = e^{Ah} x(t) + \int_0^h e^{A(h-\tau)} g(t+\tau) d\tau \quad (54)$$

where e^{Ah} is a special matrix defined by the series

$$e^{Ah} = U + Ah + \frac{(Ah)^2}{2!} + \frac{(Ah)^3}{3!} + \dots \quad (55)$$

This solution is exact, but its utility depends on the computation of e^{Ah} .

A finite number of terms may be used in the

Comparison of network analysis methods

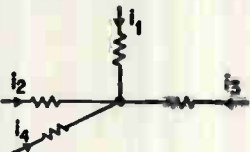
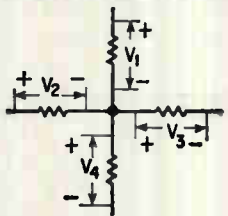
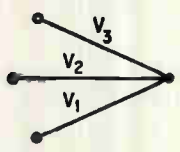
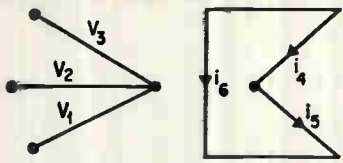
METHOD	TERMS SOUGHT	MATRICES REQUIRED	DEFINING EQUATION
MESH	i^b (BRANCH CURRENTS) 	C	$i^b = (C^t Z C)^{-1} C^t (E - ZI)$
NODE	e^b (BRANCH VOLTAGES) 	A	$e^b = (A^t Y A)^{-1} A^t (I - Y E)$
CUTSET	e_T (TREE-BRANCH VOLTAGES) 	D	$e_T = (D^t Y D)^{-1} D^t (I - Y E)$
MIXED	e_T, i_L (TREE-BRANCH VOLTAGES AND LINK CURRENTS) 	C AND D	$e_T = D_T e_T$ $i_L = C_L i_L$

series expansion of e^{Ah} . But when the matrix A has a large eigenvalue, the integration step size h must be kept small (roughly less than the reciprocal of $|\lambda_{max}|$) to permit rapid convergence of equation 55. Precisely the same limitation arises in numerical integration with methods where h must be kept small to avoid numerical instability.

If, instead of avoiding the eigenvalue problem the designer solves it, then equation 54 becomes as practical as equations 50 and 51. The transformation that diagonalizes A also diagonalizes e^{Ah} , thus yielding the relation

$$\bar{X}^{-1} e^{Ah} \bar{X} = e^{Ah} \quad (56)$$

where e^{Ah} is a diagonal matrix whose terms $e^{\lambda_i h}$ are trivial to compute. After solving this expression for e^{Ah} , equation 54 may be rewritten as

$$x(t+h) = \bar{X} e^{Ah} \bar{X}^{-1} x(t) + \int_0^h \bar{X} e^{A(h-\tau)} \bar{X}^{-1} g(t+\tau) d\tau \quad (57)$$

and all that is required is to compute the integral expression. If the driving function $g(t+\tau)$ is expressed as a polynomial in τ , however, the integration can be carried out exactly, term by term. This provides a very satisfactory way of evaluating the integral on a digital computer.

Numerical methods

Numerical methods of integration employ finite difference equations to approximate the actual dif-

ferential equations to be solved. For a single differential equation of the form $dx/dt = f(x, t)$ a solution may be effected by the general finite difference expression

$$x_n = \sum_{i=1}^M a_i x_{n-i} + h \sum_{j=0}^N b_j f_{n-j} \quad (58)$$

where h is the integration interval, $x_n = x(nh)$ and $f_{n-j} = f(x_{n-j}, (n-j)h)$. The number and values of the coefficients a_i and b_j are determined by the number of terms of the Taylor expansion of $x(nh)$ which are to be matched by the integration formula so defined.

If $b_0 = 0$, the integration formula is called a predictor since the new value of x_n is predicted in terms of previous values (x_{n-1}) and previous derivatives (f_{n-j}) only. If $b_0 \neq 0$, the formula is called a corrector since it provides a corrected value of x_n . This is accomplished using the predicted value of x_n , to compute an approximate value of the new derivative f_n which is then applied in equation 58.

For any integration scheme characterized by equation 58, there exists a characteristic polynomial whose roots p_k determine the solution of equation 58 in the form

$$x_n = \sum a_k p_k^n \quad (59)$$

where a_k are constants. Thus, x_n is a linear combination of terms p_k^n .

One of these roots p_k , lying near the point $1 + j0$

in the complex plane, will be the principal root since it primarily determines the desired approximation to the solution of the differential equation in question. All the other roots are parasitic roots and if any of these lies outside the unit circle, x_n will eventually diverge. This situation is called numerical instability and it invalidates the solution.

To prevent numerical instability, the integration step h must be kept small enough to insure that all of the parasitic roots of equation 59 remain inside the unit circle. In the case of a system of linear differential equations with constant coefficients, as typified by equation 46, the requisite condition on h for most integration formulas is

$$h|\lambda_{\max}(A)| \leq c \quad (60)$$

Here $\lambda_{\max}(A)$ is the largest eigenvalue of the coefficient matrix A . The constant c is in the order of 1 or 2, depending on the integration method applied. Even in the case of nonlinear differential equations, an equivalent restriction, involving the (instantaneously) largest eigenvalue of the Jacobian matrix, must be imposed to prevent numerical instability.

It is just this constraint on the integration interval that makes most integration techniques so painfully slow for network problems that have a wide spread of eigenvalues. The largest eigenvalue—or, its reciprocal, the smallest time constant—controls the permissible size of the integration step. Conversely, the smallest eigenvalues (largest time constants) control the network response and so determine the total length of time over which the integration must be carried out. Thus, when the ratio of largest to smallest eigenvalues is large many very small integration steps are required to obtain the solutions. This is the biggest obstacle to be overcome in the transient analysis of networks.

There are, however, some integration formulas for which the constraint on h given in equation 60 does not apply; for example, $x_n = x_{n-1} + hf_n$ and $x_n = x_{n-1} + h/2 (f_n + f_{n-1})$. Both of these have characteristic equations of the first degree and so have no parasitic roots. But the main disadvantage of these formulas is that they are inaccurate and the integration interval must often be shortened to insure sufficient correctness. Another disadvantage is that both methods require the solution of a system of linear equations at each integration step and this complicates their application.

Quasi-analytic methods

A quite different approach is needed for transient analysis of nonlinear networks. Although numerical integration can be used, the drawbacks cited above are overcome with quasi-analytic techniques. These techniques are applied for most nonlinear problems. Consider this problem: let $A = D + B$, where D contains all of the diagonal terms of A and B contains all the off-diagonal terms. Then equation 46 can be written as

$$\dot{x} = Dx + [Bx + g(t)] \quad (61)$$

with $Bx + g(t)$ a driving function. The analytic solution to equation 61 can be obtained by modifying equation (54) to read

$$x(t+h) = e^{Dh} x(t) + \int_0^h e^{D(h-\tau)} [Bx(t+\tau) + g(t+\tau)] d\tau \quad (62)$$

Here, e^{Dh} is easy to compute since it is a diagonal matrix. Furthermore, the integration can be carried out with a polynomial approximation of any desired degree for $Bx + g$.

Equation 62 has an instability problem that is avoided by choosing the integration interval whose form obeys the relation $h|\lambda_{\max}(B)| \leq c$, where c is a small constant. Thus, the largest eigenvalue of the off-diagonal matrix B controls the stability of this numerical integration process.

However, if a transformation on A is chosen having the form $T^{-1}AT = \bar{A} = \bar{D} + \bar{B}$ where $\lambda_{\max}(\bar{B})$ is arbitrarily small, the integration interval can be increased without risking instability. Indeed, if T is so chosen that $\lambda_{\max}(\bar{B})$ is zero, the eigenvalue problem is solved and the instability condition vanishes. In effect, the iterative process continually reduces $\lambda_{\max}(\bar{B})$ until it vanishes. But the eigenvalue problem does not have to be solved to obtain a significant increase in the integration interval, as the following illustrates:

This type of transformation is tantamount to changing variables and then integrating the differential equations in the domain of the new variables. Specifically, the new variables are defined as $y = T^{-1}x$ so that equation 46 becomes $T\dot{y} = ATy + g(t)$, or

$$\dot{y} = T^{-1}ATy + T^{-1}g(t) \quad (63)$$

The solution, analogous to equation 62, is

$$y(t+h) = e^{\bar{D}h} y(t) + \int_0^h e^{\bar{D}(h-\tau)} [\bar{B}y(t+\tau) + w(t+\tau)] d\tau \quad (64)$$

where $w(t) = T^{-1}g(t)$

From this expression and the relation $x = Ty$, a solution to the original problem, equation 46, may be computed. Moreover, if T has been chosen so as to reduce $\lambda_{\max}(\bar{B})$ sufficiently, a large integration step h may be used. The validity of this procedure has been verified in the following problem.

Consider an RC ladder network with five equal resistances and five equal shunt capacitors; the maximum integration step which could be taken safely with equation 62 was found to be equal to the time constant, RC . In the case of a modified network capacitor C_3 is split in half and the two halves connected by a resistor r has a very small value relative to any individual resistor R . Here, the integration step was found to be limited by the time constant rC .

Originally, the state-variable vector, for both networks, consisted of all the capacitor voltages. However, when a different combination of voltages

Network analysis techniques

Techniques	D-c problem	A-c problem	Transient problem
Gaussian elimination	<p>Advantage: Most direct method</p> <p>Disadvantage: Usually does not take advantage of matrix sparsity For linear networks only</p>	<p>Advantage: Most direct method</p> <p>Disadvantage: Usually does not take advantage of matrix sparsity</p>	
Sato-Tinney	<p>Advantage: Gaussian elimination that takes advantage of sparsity</p> <p>Disadvantage: Requires special programming techniques For linear networks only</p>	<p>Advantage: Gaussian elimination that takes advantage of sparsity</p> <p>Disadvantage: Requires special programming techniques</p>	
Kron's method	<p>Advantage: Permits change of parameters for solution of a family of related problems. For example, in a sensitivity analysis there is no need to run the program from the start for each parameter change</p> <p>Disadvantage: For linear networks only</p>	<p>Advantage: Permits change of parameters for solution of a family of related problems. For example, in a sensitivity analysis there is no need to run the program from the start for each parameter change</p>	
Newton-Raphson	<p>Advantage: Converges quadratically</p> <p>Disadvantages: May diverge and the Jacobian matrix has to be computed and converted repeatedly For nonlinear networks only</p>		
Katzenelson	<p>Advantage: Technique is based on Kron's method. Guaranteed to converge for piece-wise linear monotonic functions</p> <p>Disadvantage: For nonlinear networks only</p>		
Broyden	<p>Advantage: Generalization of Newton-Raphson method that prevents divergence and does not require repeated computation and inversion of the Jacobian matrix</p> <p>Disadvantage: For nonlinear networks only</p>		
Eigenfunction expansion		<p>Advantage: gives driving-point and transfer function, poles and zeros, sensitivity and efficient calculation of frequency response</p> <p>Disadvantage: Requires solution of the eigenproblem</p>	<p>Advantage: Gives analytic solution that is free of time constant restrictions</p> <p>Disadvantage: For linear networks only</p>
Numerical integration			<p>Advantage: Most commonly used. Accurate. For linear and nonlinear networks</p> <p>Disadvantage: Very slow for networks with a wide spread of time constants</p>
Quasi-analytic			<p>Advantage: Treats diagonal terms of A-matrix analytically and off-diagonal terms by numerical integration. With modification time-constant restrictions are avoided.</p> <p>Disadvantage: For nonlinear networks only</p>

was applied in treating the second network—namely, the voltage across capacitors C_1 , C_2 , C_4 and C_5 but the sum and difference of the voltages across the two half-size capacitors—it became possible to increase the integration step size until it was equal to that in the previous network. This simple change of variables defined a transformation which was sufficient to reduce the maximum eigenvalue of \bar{B} significantly in equation 64, but far from adequate to solve the eigenproblem.

Thus, one key to the minimum time-constant problem lies in operating on the coefficient matrix A in some meaningful way. But if the A matrix is left intact, then the limitation implicit in equation 60 must be accepted. The simplest kind of operation on the A matrix is to extract its diagonal terms and handle them analytically, as in equation 62. A more difficult operation is to transform the matrix as in equation 63. Of course the ultimate is to solve the eigenproblem completely.

These are the guidelines for tackling the integration problem for nonlinear systems, where the Jacobian matrix plays the role of the A matrix. Obviously, solving the eigenproblem repeatedly for a Jacobian matrix, which changes during the course of the solution, is far too costly. However, finding a quick and dirty transformation T to be used in conjunction with equation 64 does seem plausible. Moreover, it should not be necessary to update T at each integration step since it is likely that a given transformation could be applied for many integrations before becoming degraded to the point of uselessness.

The feasibility of this approach will depend on keeping the average computational cost per integration step to a reasonable level. If this is accomplished, the minimum time constant barrier can be breached for both linear and nonlinear problems.

In the case of linear systems, the eigenvalue approach is clearly superior for both a-c and transient analysis since it goes directly to the heart of the problem. Fortunately, the advent of the digital computer brings this powerful theoretical tool to a practical working level.

What's ahead

Much unfinished work remains in upgrading network analysis programs. In addition to adding new and improved analytical techniques, programs must provide facilities for statistical analysis of circuits, storage and retrieval of device models, handling transmission lines and treating much larger problems. Graphical presentation of output variables in a variety of forms will be essential and a much closer degree of man-machine interaction will become possible with cathode-ray tube displays and remote access to the computer.

Also, there will be a need to handle integrated and monolithic circuits. This rapidly growing area places strong demands on current analytical, numerical and programming techniques. It will inevitably force the development of more powerful methods for solving partial differential equations.

A step beyond the production of more powerful and effective network analysis programs will be the development of optimization techniques—in which the analysis tasks will likely be relegated to sub-routines. Significant steps have already been taken in this direction. Moreover, automatic network synthesis is also under investigation. It is probable, however, that for a long time computer-aided design will be based primarily on analysis and optimization techniques with the engineer playing an essential role in the design loop and controlling the entire process.

References

1. F.H. Branin Jr., "D-C and Transient Analysis of Networks using a Digital Computer," Institute of Radio Engineers International Convention Record, Part 2, March 1962, pp. 236-256.
2. J.P. Roth, "An application of Algebraic Topology to Numerical Analysis: On the Existence of a Solution to the Network Problem," Proceedings of the National Academy of Sciences, Vol. 41, 1955, pp. 599-600.
3. S.J. Fenves and F.H. Branin Jr., "A Network-Topological Formulation of Structural Analysis," Journal Struct. Div., American Society Civil Engineering, Vol. 89, August 1963, pp. 483-514.
4. S.J. Fenves, "STRESS (Structural Engineering System Solver) A Computer Programming System for Structural Engineering Problems," Technical Report T63-2, Massachusetts Institute of Technology, June 1963.
5. F.H. Branin Jr., "The Algebraic-Topological Basis for Network Analogies and the Vector Calculus," to be published in Proceedings of the Symposium on Generalized Networks, Vol. 16 of the Microwave Research Institute Symposia Series, Polytechnic Institute of Brooklyn, 1966. (Available from the author as IBM Technical Report 00.1495.)
6. F.H. Branin Jr., "A New Method for Steady State A-C Analysis of RLC Networks," Institute of Electronic and Electrical Engineers International Convention Record, Part 7, March 1966, pp. 218-223.
7. N. Sato and W.F. Tinney, "Techniques for Exploiting the Sparsity of the Network Admittance Matrix," Institute of Electronic and Electrical Engineers Transactions on Power and Apparatus, Vol. 82, Dec. 1963, pp. 944-950.
8. G. Kron, "A Set of Principles to Interconnect the Solutions of Physical Systems," Journal of Applied Physics, Vol. 24, 1953, pp. 965-980.
9. F.H. Branin Jr., "The Relation Between Kron's Method and the Classical Methods of Network Analysis," IRE WESCON Convention Record, Part 2, August 1959, pp. 3-28.
10. International Business Machines Corp., "1620 Electronic Circuit Analysis Program (ECAP)," Application Program 1620-EE-02X, International Business Machines Corp., Data Processing Division, White Plains, N.Y.
11. F.B. Hildebrand, "Introduction to Numerical Analysis," McGraw-Hill, Inc., 1956.
12. Nancy G. Brooks and H.S. Long, "A Program for Computing the Transient Response of Transistor Switching Circuits—PE TAP," Technical report 00.100, IBM Development Laboratory, Poughkeepsie, N.Y., 1959.
13. A.F. Malmberg, F.L. Cornwell, and F.N. Hofer, "NET-1 Network Analysis Program," Report LA-3119, Los Alamos Scientific Laboratory, Los Alamos, N.M., 1964.
14. C.G. Broyden, "A Class of Methods for Solving Nonlinear Simultaneous Equations," Mathematics of Computation, Vol. 19, Oct. 1965, pp. 577-593.
15. J. Katzenelson, "An Algorithm for Solving Nonlinear Resistive Networks," Bell System Technical Journal, Vol. 44, Nov. 1965, pp. 1605-1620.
16. T.R. Bashkow, "The A Matrix, New Network Concept," Institute of Radio Engineers Transactions on Circuit Theory, Vol. CT-4, Sept. 1957, pp. 111-120.
17. J. Certaine, "The Solution of Ordinary Differential Equations with Large Time Constants," Chapter 11 of Mathematical Methods for Digital Computers, John Wiley and Sons, Inc., 1960.

Bibliography

- Physical Systems," Journal of Applied Physics, Vol. 24, 1953, pp. 965-980.
- J.P. Roth, "An Application of Algebraic Topology to Numerical Analysis: On the Existence of a Solution to the Network Problem," Proceedings of the National Academy of Sciences, Vol. 41, 1955, pp. 518-521.
- J.P. Roth, "The Validity of Kron's Method of Tearing," Proceedings of the National Academy of Sciences, Vol. 41, 1955, pp. 599-600.
- J.B. Ward and H.W. Hale, "Digital Computer Solution of Power-Flow Problems," Transactions of the AIEE, Vol. 15, Part III, June 1956, pp. 298-404.

Numbers vs symbols: battle lines are drawn

Two techniques vying for application in computer-aided design are numerical and symbolic circuit analysis. Author Frank Branin, development engineer of the International Business Machines Corp., is a staunch advocate of the numerical approach. He tends to give short shrift to the symbolic method, possibly because over 75% of CAD is performed by numerical techniques. The symbolic technique was discussed in part 3 of the continuing series on computer-aided design [Electronics, Dec. 12, 1966, p. 92].



Frank Branin

Branin thinks of the two techniques in relation to internal and external operations for the computer. In the symbolic technique, he says all operations (using both letters and numbers) are done inside the computer. But with the numerical technique the programmer manually derives matrix expressions for those quantities that he desires to investigate on the computer. He then places numbers into these programs and feeds them into the computer so that the expressions may be evaluated. The computer then analyzes or designs the circuit with numerical techniques only.

Despite similarities in the two techniques some distinct points of difference are worth noting. In the symbolic approach the most critical parameters in a desired formula are highlighted because these appear as letters related to the circuit elements. In the simple expression for gain of an amplifier, $A_o = -g_m R_p / (1 + g_m R_k)$, the designer can tell at a glance

that the stage gain depends on transconductance g_m , plate resistance R_p and cathode resistance R_k . Conversely, if he knows that $A_o = 50$, his knowledge is limited to how changes in circuit parameters can affect circuit performance.

Another advantage often stated for the symbolic technique is that it presents all circuit equations as polynomials of the complex frequency variable, s . This yields expressions with which the designer is familiar, delays the evaluation of complex variables until actually needed and offers convenient frequency information in terms of the poles and zeros of the circuit.

Too many trees

A clear advantage held by the numerical technique is that it eliminates listing topological trees for a network. Most symbolic techniques require such a listing. And for a network of 11 nodes and 21 branches it is possible to have over 13,000 different trees. Thus, much valuable time and storage space can be wasted by the computer in trying to find these.

It is too soon to effectively judge which technique will eventually dominate. For most circuit designers, even those using CAD, the lines of demarcation between the two techniques are still vague. Some experts claim that the difference is purely semantic—or at best, one of degree. Perhaps with improved programs or even with programs that are not presently available, sharper distinctions will emerge. As more engineers become familiar with a variety of computer-aided design programs, perhaps one technique will dominate.

F.H. Branin Jr., "Kron's Method of Tearing and Its Applications," Proceedings of the 2d Midwest Symposium on Circuit Theory, Michigan State University, Dec. 1956.
E.R. Cohen, "Some Topics in Reactor Kinetics," Proceedings of the 2d UN International Conference on Peaceful Uses of Atomic Energy, Geneva, Switzerland, Vol. 11, 1958, pp. 302-309.
J.J. Olsztyn and T.L. Theodoroff, "GMR DYANA Programming Manuals 1 and 2," General Motors Research Laboratories, 1959.
E.R. Cohen and H.P. Flatt, "Numerical Solution of Onasi-Linear Equations," Proceedings of the Seminar on Codes for Reactor Computations, Vienna, 1960, pp. 461-484.
S. Parter, "The Use of Linear Graphs in Gauss Elimination," SIAM Review, Vol. 3, April 1961, pp. 119-130.
A.H. El-Abiad, M. Watson and G.W. Stagg, "The Load-Flow Problem: Its Formulation and Solution, Part 1," AIEE Paper G1CIP1054, 1961.
J.G.F. Francis, "The Q-R Transformation, Part 1," Computer Journal, Vol. 4, Oct. 1961, pp. 265-271, "The Q-R Transformation, Part 2," *ibid.*, Vol. 4, Jan. 1962, pp. 332-345.
P.R. Bryant, "The Explicit Form of Bashkow's A Matrix," Institute of Radio Engineers Transactions on Circuit Theory, Vol. CT-9, Sept. 1962, pp. 303-306.
F.H. Branin Jr., "Machine Analysis of Networks and Its Applications," International Business Machines Technical Report 855, 1962.
H.E. Brown, G.K. Carter, H.H. Happ and C.E. Person, "Power Flow Solution by Impedance Matrix Iterative Method," Institute of Electronic and Electrical Engineers Transactions on Power and Apparatus, Vol. 82, Aug. 1963, pp. 561-564.
R.W. Stineman, "Digital Time-Domain Analysis of Systems with Widely Separated Poles," Journal Association Computer Machines, Vol. 12, April 1965, pp. 286-293.
D. Bree Jr., "Some Remarks on the Application of Graph Theory to the Solution of Sparse Systems of Linear Equations," Thesis, Department of Mathematics, Princeton University, May 1965.
P.I. Richards, W.D. Lanning and M.D. Torrey, "Numerical Integration of Large, Highly-Damped, Nonlinear Systems," SIAM Review, Vol. 7, July 1965, pp. 376-380.
E.S. Kuh and R.A. Rohrer, "The State-Variable Approach to Network Analysis," Proceedings of the Institute of Electronic and Electrical Engineers, Vol. 53, July 1965, pp. 672-686.

M.L. Liou, "A Numerical Solution of Linear Time-Invariant Systems," Proceedings of the 3d Allerton Conference on Circuit and Systems Theory, 1965, pp. 669-676.
G.N. Polozhii, "The Method of Summary Representation for Numerical Solution of Problems of Mathematical Physics," Pergamon Press, 1965.
J.H. Wilkinson, "The Algebraic Eigenvalue Problem," Oxford University Press, London, 1965.
C.E. Treanor, "A Method for the Numerical Integration of Coupled First-Order Differential Equations with Greatly Different Time Constants," Mathematical Computers, Vol. 20, Jan. 1966.
F.H. Branin Jr., "A New Method for Steady State A-C Analysis of RLC Networks," Institute of Electronic and Electrical Engineers International Convention Record, Part 7, March 1966, pp. 218-223.
F.F. Kuo, "Network Analysis by Digital Computer," Proceedings of the Institute of Electronic and Electrical Engineers, Vol. 54, No. 6, June 1966, pp. 820-829.
J. Katzenelson, "AEDNET: A Simulator for Nonlinear Networks," Proceedings of the Institute of Electronic and Electrical Engineers, Vol. 54, Nov. 1966, pp. 1536-1552.
F.H. Branin Jr., "The Algebraic-Topological Basis for Network Analogies and the Vector Calculus," to be published in the Proceedings of the Symposium on Generalized Networks, Vol. 16 of the Microwave Research Institute Symposia Series, Polytechnic Institute of Brooklyn, 1966, (Available from the author as IBM Technical Report 00.1495.)
F.F. Kuo and J.F. Kaiser (editors), "System Analysis by Digital Computers," John Wiley and Sons, Inc., 1966.
International Business Machines, "1620 Electronic Circuit Analysis Program (ECAP)," Application Program 1620-02X, IBM Corporation, Data Processing Division, White Plains, N.Y.
S.J. Fenves and F.H. Branin Jr., "A Network-Topological Formulation of Structural Analysis," Journal Structural Division, American Society Civil Engineering, Vol. 89, Aug. 1963, pp. 483-514.
A.F. Malmberg, F.L. Cornwell and F.N. Hofer, "NET-1 Network Analysis Program," Report LA-3119, Los Alamos Scientific Laboratory, N.M., 1964.
G.G. Broyden, "A Class of Methods for Solving Nonlinear Simultaneous Equations," Mathematics of Computation, Vol. 19, Oct. 1965, pp. 577-593.

Designer's casebook

Designer's casebook is a regular feature in Electronics. Readers are invited to submit novel circuit ideas, packaging schemes, or other unusual solutions to design problems. Descriptions should be short. We'll pay \$50 for each item published.

Quartz crystal synchronizes relaxation oscillator

By Roger G. Damaye

Fontenay aux Roses, France

A simple and inexpensive clock for digital systems can be obtained with a quartz crystal and a unijunction transistor. The quartz crystal, when inserted between the emitter and base of the unijunction, oscillates in synchronism with the relaxation oscillator. Conventional unijunction relaxation oscillators are usually synchronized with a negative pulse applied to base 2 or a positive pulse applied to its emitter.

The electrical shocks created by the first few firings of the unijunction start the crystal oscillating and each subsequent firing of the transistor reinforces the oscillation. Adjustment of resistor R_1 is not critical and there is a margin of error of several degrees on either side of the optimum value. What is required is that the oscillating fre-

quency of the crystal and circuit be close.

The frequency of oscillation remains stable despite voltage fluctuations of $\pm 20\%$ in the power supply and temperature variations of 0°C to 80°C . Synchronization of the oscillator is also possible at submultiples of the crystal's fundamental frequency but operation is sensitive to temperature variations. At half the fundamental frequency, $f/2$, the temperature stability is good, but falls off rapidly at $f/3$ and $f/4$.

The circuit may be simplified by replacing capacitor, C, with a crystal. In the modified circuit a margin of adjustment is obtained for the 50 k resistor that is more than 15° on either side of the optimum.

The oscillator can lock on the fundamental or half the fundamental crystal frequency. With a 100-kilohertz crystal stable oscillations of 100 and 50 khz are obtained. By shunting the crystal with a capacitor of several hundred picofarads, oscillations of 33.33 khz can be obtained. A modified circuit produced stable oscillations at 200 and 250 khz. Tests showed that good results were possible with 1 Mhz quartz crystals having fundamental frequencies ranging from 50 to 250 khz.

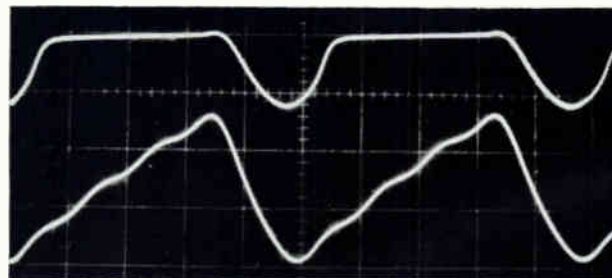
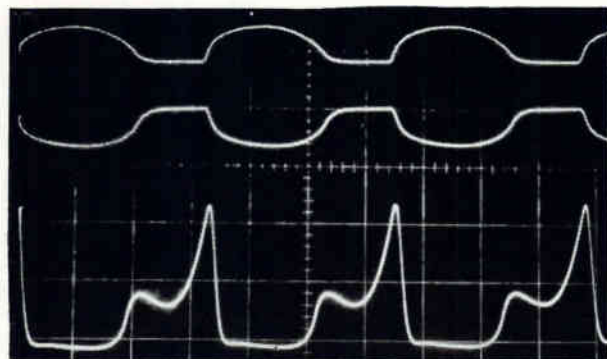

Different crystals change output waveshape. Waveshape at the left was obtained with a 60-khz crystal; and a 1-Mhz crystal above.

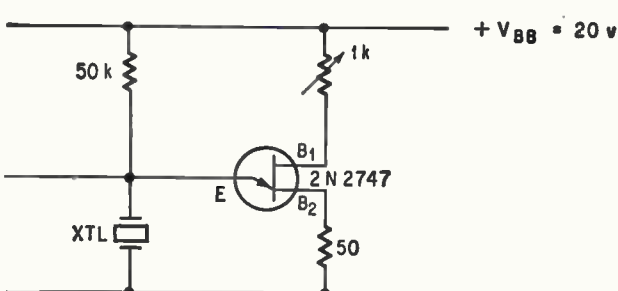
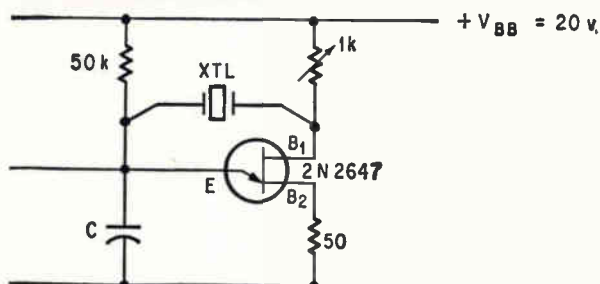

Quartz crystal inserted between emitter and base of unijunction transistor oscillator eliminates the need to apply external negative pulses to base 2 or positive pulses to the emitter for synchronization. In modified circuit at the right the capacitor C is replaced by the crystal.

Stable low frequencies with FET-bipolar pairs

By Gabriel Hanus and Yves Martinez

Institut National des Sciences Appliquees de Lyon
Villeurbanne, France

Field effect transistors produce stable low frequencies in a multivibrator circuit because of their very high input impedance. Generators of very low frequencies require a long time-constant. However, if large electrolytic capacitors are used to obtain the time constant, stability is impossible to achieve. With FET's, however, their large resistances mean it's possible to obtain the long-time constant without large capacitors.

In the circuit, two n-channel FET's (2N3436) are connected as source followers and two npn transistors serve as switches. The principle of the circuit is similar to that of an ordinary multivibrator except that the bipolar-FET combinations are the active components. This introduces the FET's high input impedance and, at the same time, provides an overall gain that makes the bipolar's collector voltage independent of the current gain of the stage.

The 2N706 transistors do not saturate because their collector voltages supply the drains of the

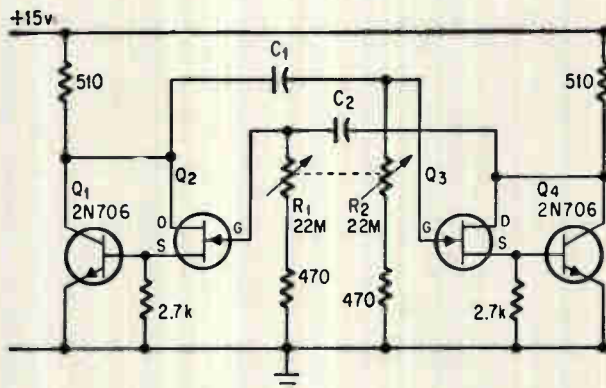

Time constants for the multivibrator are provided by the FET's and large resistance values.

FET's. This arrangement makes the oscillator self-starting; since the transistors are biased in a linear region any change in input current causes a change in collector voltage. The circuit works equally well at high frequencies.

The duration of each state is determined by the discharge of either C_1 or C_2 into the gate resistance. When the voltage reaches pinchoff, the change in source current causes the circuit to change state.

If C_1 and C_2 are each 4 microfarads, increasing R_1 and R_2 can vary the multivibrator's period from 8 milliseconds to 6 minutes. If C_1 and C_2 are 100-picofarad capacitors, the frequency can be varied from 100 hertz to 3 megahertz.

Audio amplifier compresses input signal by 30 decibels

By David L. Phippen

White Sands Test Facility, New Mexico

An amplitude compressor circuit that is inexpensive operates over a large dynamic input range by taking advantage of the characteristics of a field effect transistor. The circuit was designed to provide essentially constant amplification for a wide range of signals picked up by an acoustical transducer. The amplifier output feeds a 600 ohm line that handles maximum power levels of about 5 decibels. Because of the low distortion required at the maximum compression level and the wide dynamic range that must be accommodated, conventional compressor circuits are not suitable.

As indicated in the graph at the right, input signals can vary from 70 decibels below a milliwatt (-70 dbm) to -20 dbm and cause only 10% distortion at the output. At -20 dbm the signal

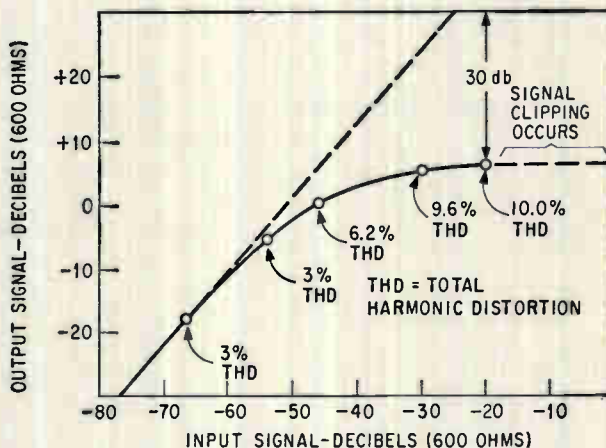

Compression response curve (solid line) tends toward a constant level as the input signal increases.

is compressed 30 db below that of a linear amplifier. Input and output impedances are 600 ohms.

Transistors Q_1 and Q_4 are the controlled stages in this compressor. Field effect transistor Q_4 operates as a variable resistor in the emitter of Q_1 . As the input signal increases, a d-c voltage on capacitor C_1 increases, biasing the gate circuit of Q_4 so

that Q_4 is driven out of saturation and toward cut-off. When the d-c voltage reaches the knee of FET's saturation curve, the FET begins to cut off. This increases Q_4 's source-to-drain resistance resulting in increased negative feedback from Q_1 's base to

its emitter. Because the feedback increases with input level, the over-all gain of the circuit is compressed and transistor Q_1 handles large input levels without large distortion. At input levels above -20 dbm, Q_1 clips the signal and the distortion rises.

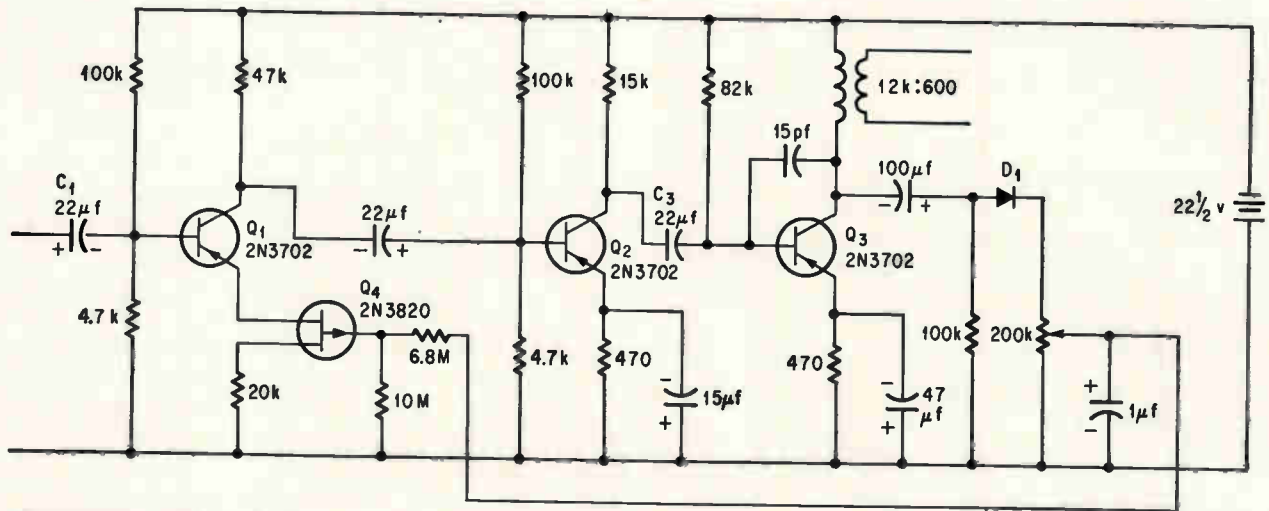

Compressor circuit controls gain by varying the source drain resistance with input signal.

Diodes provide noise immunity for monostable multivibrators

By Radivoje Ilic

Institute for Automation and Telecommunications
Belgrade, Yugoslavia

Diodes are handy components for eliminating undesired electrical pulses from multivibrators and other circuits that operate from a common power

supply. The diodes are particularly effective in multivibrators with inductive loads in their collectors, such as relays.

Two multivibrator circuits have been modified with diodes to offer complete immunity to pulses that come from the power supply and to difficulties that arise from inductors in the transistor's collector. Diode D_1 in the circuit at the left prevents the inductive load from influencing the stability of the multivibrator. The diode is kept back biased at all times when transistor Q_1 is not conducting. Thus, it also acts to block extraneous pulses from triggering the multivibrator until the potential on

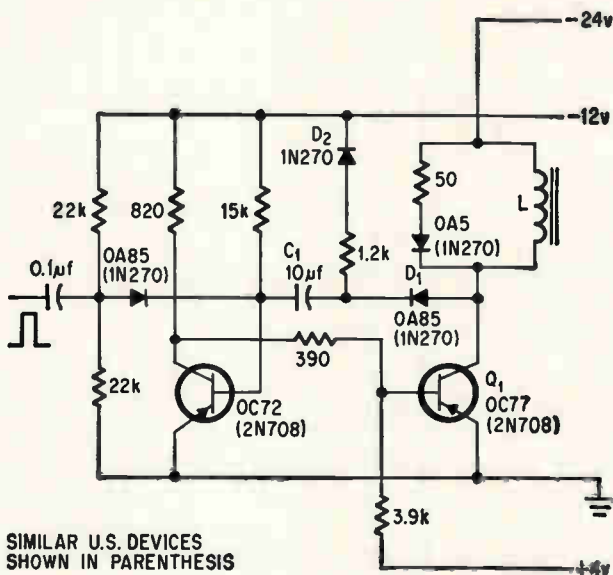

SIMILAR U.S. DEVICES SHOWN IN PARENTHESIS

Diodes, added in both circuits, provide immunity to noise pulses from a common power supply and prevent interference from inductive loads.

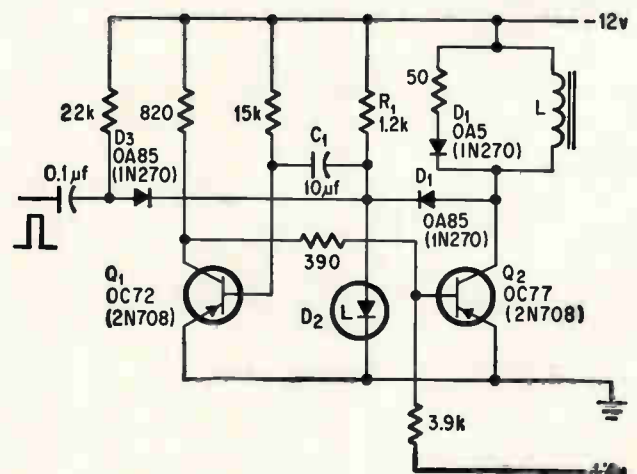

the collector of Q_1 is higher than -12 volts. When the potential on the collector of Q_1 is greater than -12 volts diode D_1 is forward biased.

Diode D_2 is added to further prevent any undesired pulses that come from the power supply from having an effect on the stability of the circuit. It functions as does diode D_1 .

In the modified circuit, right, page 106, a separate

source is not needed for the electromagnet, and the circuit functions as the previous arrangement does against inductive load problems. Here, diode D_1 and zener diode D_2 prevent pulse penetration from the power supply and inductive load. The zener diode prevents D_1 from becoming back biased and also blocks noises and voltage fluctuations through Resistor R_1 and capacitor C_1 .

Narrow-pulse one-shot recovers quickly

By John J. Moran* and Robert M. Gloriosco

University of Connecticut, Storrs

A one-shot multivibrator fits in computer and communications applications where the required pulse repetition rate is very high, dictating a rapid recovery time for the one-shot. The circuit will generate a 600-nanosecond pulse and will recover within 200 nsec. If the pulse width is increased, the recovery time is 200 nsec, or 3% of the output pulse width, whichever is greater. Circuit features low output impedance and low loss.

The short recovery time is obtained by discharging the timing capacitor C_1 through a low-impedance path formed by D_1 and Q_4 .

When a negative pulse appears at the input, it turns Q_1 off and turns Q_2 on. Capacitor C_1 charges

through Q_3 , R_1 and the base of Q_2 . The time constant of the charge path is $R_1 C_1$. When Q_2 conducts, it holds Q_1 off. The recovery time—the time necessary to turn Q_2 off—is a function of the ratio $R_2/(R_1 + R_2)$ and varies with the type of transistor.

As Q_2 turns off, Q_1 turns on and the capacitor rapidly discharges through the low impedance path formed by D_1 and Q_4 .

If the circuit is triggered rapidly so the output pulses have a large duty cycle, the pulse width might decrease slightly. To reduce this effect, resistor R_2 is made larger and connected to a negative supply. If C_1 is made larger than 0.05 microfarad, a series resistor is added to the discharge path to protect Q_4 by limiting the current.

The circuit has been applied as a pulse averaging discriminator in an f-m system with a carrier frequency of 1 megahertz, and a ± 200 -kilohertz deviation. With an f-m signal applied to the input, the integrated output is proportional to the frequency.

Another feature of the circuit is that an input applied at point X allows the output to remain clamped to the positive supply voltage for the duration of the pulse.

*Now with United Aircraft Research Laboratories, East Hartford, Conn.

Quick-recovery one-shot produces a 600-nanosecond pulse. If a negative going input level is applied at point X, the output remains clamped to the supply until the input is removed. Recovery time of 200 nanoseconds is achieved by providing low impedance path through Q_4 and D_1 .

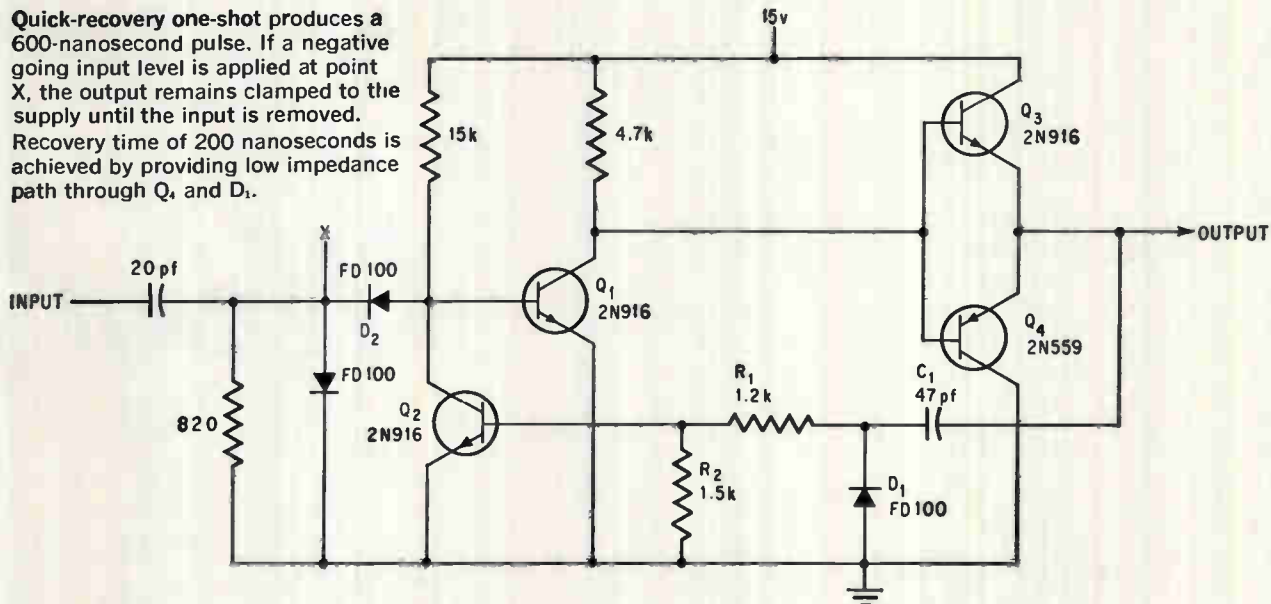

In Making Masks for
Electronic Components ...
... there's no
Margin for Error!

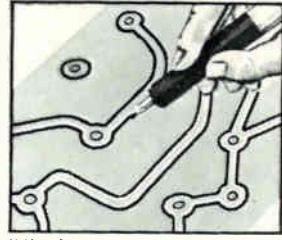

With sharp blade, outline the areas to be masked. Do not cut through the backing sheet. The Ulano Swivel Knife does the job quickly, easily.



Now carefully peel off the film as outlined leaving a completed photo mask, positive or negative, that corresponds exactly to the desired pattern.

**THAT'S WHY EXPERIENCED DESIGNERS
AND ENGINEERS ALWAYS INSIST ON...**



RUBYLITHTM

HAND-CUT MASKING FILM FOR THE GRAPHIC ARTS

**THE KNIFE-CUT, LIGHT-SAFE MASKING FILM
LAMINATED TO A STABLE POLYESTER BASE**

The most versatile line of hand-cut masking films, including

**.0075—RUBYLITH 75 DR* .005 RUBYLITH 5 DR
.005 AMBERLITH 5 DA**

These new, thick Ulano films provide the positive answers where exact register assumes a critical importance.

** Available in sheets only, cut to your specifications.*

by

UlanoTM

ulanoTM

610 DEAN STREET, BROOKLYN, N. Y. 11238

NEW YORK • CALIFORNIA • CHICAGO • ZÜRICH

in Europe: ULANO A. G., Untere Heslibachstrasse 22, Kusnacht 8700, Switzerland

Write on your letterhead for special electronic test kit (no charge) No. 2748

Electronic navigator charts man's path to the moon

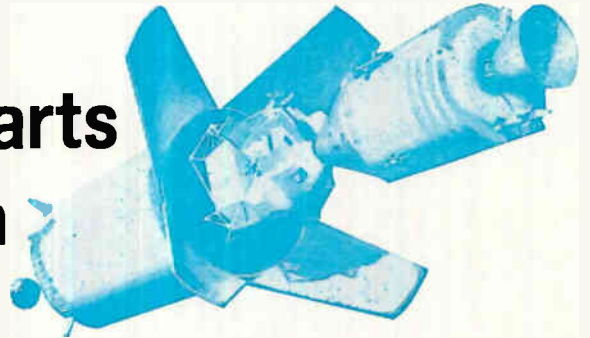

Apollo, our boldest step into space, will be guided by a computer that is both elementary and advanced. Its memory holds a fixed program but its applications are diverse and flexible

By Albert L. Hopkins

Instrumentation Laboratory, Massachusetts Institute of Technology, Cambridge, Mass.

When man embarks on his first truly extraterrestrial adventure—a trip to the moon—he will be guided by a little box not much bigger than an unabridged dictionary, but much more versatile. The box is the Apollo guidance computer, which will determine whether the astronauts are on course and help them turn corners when the time comes. Prototypes of the integrated-circuit computer are now being tested on the ground.

The computer is part of the guidance and navigation system of the Apollo Command Module and the Lunar Module. The system performs different tasks during free-fall and powered flight.

In the free-fall phases—earth and lunar orbit, lunar descent coasting, and coasting through space between the earth and the moon—the system must determine the state of the vehicle—for example, orbital elements, position or velocity. These are part of an open-loop navigation process. The system is capable of performing the navigation itself but ground-based tracking stations duplicate the process simultaneously whenever possible.

Powered phases—boost, injection, ascent and entry—are short and critical. They require automatic steering for stability and accuracy, while the system directly controls the translation and

rotation of the vehicle. These are closed-loop guidance functions. Each powered maneuver changes the velocity, as determined during navigation phases, until the guidance sensors indicate that the desired velocity is reached.

The guidance and navigation (G&N) system was designed by the Instrumentation Laboratory of the Massachusetts Institute of Technology and produced jointly by the AC Electronics division of the General Motors Corp., Kollsman Instrument Corp., a subsidiary of Standard Kollsman Industries, Inc., and the Raytheon Co. Its three major parts are:

- A three-gimbal inertial platform with three floated integrating gyros, each with a single degree of freedom, and three pulsed integrating pendulum accelerometers. The gyros and accelerometers continuously indicate changes in angular orientation (attitude) and translational velocity.
- An optical angle measuring unit—a sextant and scanning telescope in the Command Module, an alignment telescope in the Lunar Module.
- The guidance computer.

Some of the principal computer activities are correlated with navigation and guidance functions in the table on page 110. Critical phases are in color. These categories are interdependent because they share data, subroutines and interface activity. The computer's program has sections for executing dozens of jobs, but can do only about 10 at a time.

How it all began

The Apollo G&N system concept originated almost eight years ago, during a study for an unmanned space vehicle which would photograph Mars and return to Earth. The study concluded that the vehicle would require a navigation and guidance computer with inertial and optical sensors. The

The author



Albert L. Hopkins is the assistant director of MIT's Instrumentation Laboratory, where he specializes in the development of computers for inertial guidance and navigation systems.

computer logic and erasable memory would be built with core-transistor circuitry and the program would be stored in a wired-in read-only memory, called a core rope. Shortly afterward, MTR began designing the Apollo guidance computer with the same kind of circuitry plus a coincident-current ferrite-core erasable memory.

By late 1962, quantity production of monolithic integrated circuits had begun. The computer was redesigned to take advantage of the greater reliability, high speed, small size and packaging uniformity of IC's.¹ The direct-coupled transistor logic (DCTL) NOR gate was chosen as the basic circuit largely because of its simplicity. The designers chose only a single logic circuit type—a three-input NOR element, consisting of three transistors and four resistors on a monolithic silicon chip. The computer contains over 5,000 such circuits.

The decision to use the single logic circuit paid dividends for the Apollo project because micro-circuit vendors could supply Apollo NOR gates some time before they overcame problems in producing more complex circuits. A family of specialized circuits might have saved space, but space was deemed less important than reducing the problems of specification, manufacture, and test of these relatively new circuits.²

It had long been known that all Boolean logic functions could be implemented with a single circuit [see "Single-circuit design," p. 115]. Several systems—MTR's Polaris guidance computer, a digi-

tal differential analyzer, for one—used a discrete-component NOR gate as its sole logic element type. But the concept has been applied rarely in general-purpose computers because specialized circuits required using fewer discrete components.

The core rope concept³ was retained, because of the high density and the reliability advantages of nondestructive memory. The memory's main disadvantage is that it can be loaded only at the time of manufacture, but this was tolerable because program changes in any given computer are infrequent. However, each program must be completely debugged before assembling the rope.

When the decision was made to have a separate Lunar Module distinct from the Command Module, still another version of the C&N system was needed for both spacecraft. It was called Block 2 [Electronics, Dec. 12, p. 111]. The initial C&N system (Block 1) was put into production for the developmental command modules now being flown. The Block 2 guidance computer has twice the over-all speed of the Block 1, and has 50% more memory and consumes less power, with little change in size and weight.

What's in the computer

Today's typical guidance computer is about a cubic foot in volume, and can do about the same job as large-scale central processors of ten years ago. The newer, larger, earth-based data processors can spread a work load over a period of time to balance

Phases of the moon shot and G&N activity

Phases	Alignment and system test	Inertial guidance	Optics sightings	Attitude control and small translations	Thrust control	Radar	Manual steering	Navigation measurements & calculations & display	Uplink navigation parameters
Prelaunch	*	*	*						*
First stage		*					*		
Second stage		*					*		
Third stage		*					*		
Earth orbit	*		*				*		*
Injection toward moon		*					*		
Module transposition				*		*			
Coasting toward moon	*		*	*			*		*
Midcourse corrections		*			*		*		
Lunar orbit insertion		*			*		*		
Lunar orbit	*		*				*		*
Lunar module descent injection		*		*	*		*		
LM descent coast	*			*			*		
LM powered descent		*		*	*	*	*		
LM final approach		*		*	*	*	*		
LM landing		*		*	*	*	*		
LM prelaunch	*		*			*			*
LM ascent		*		*	*		*		
Midcourse rendezvous		*		*	*	*	*		
Terminal rendezvous				*		*			
Injection toward earth		*			*		*		*
Coasting toward earth	*		*	*			*		*
Entry		*		*			*		

A trip to the moon — and back

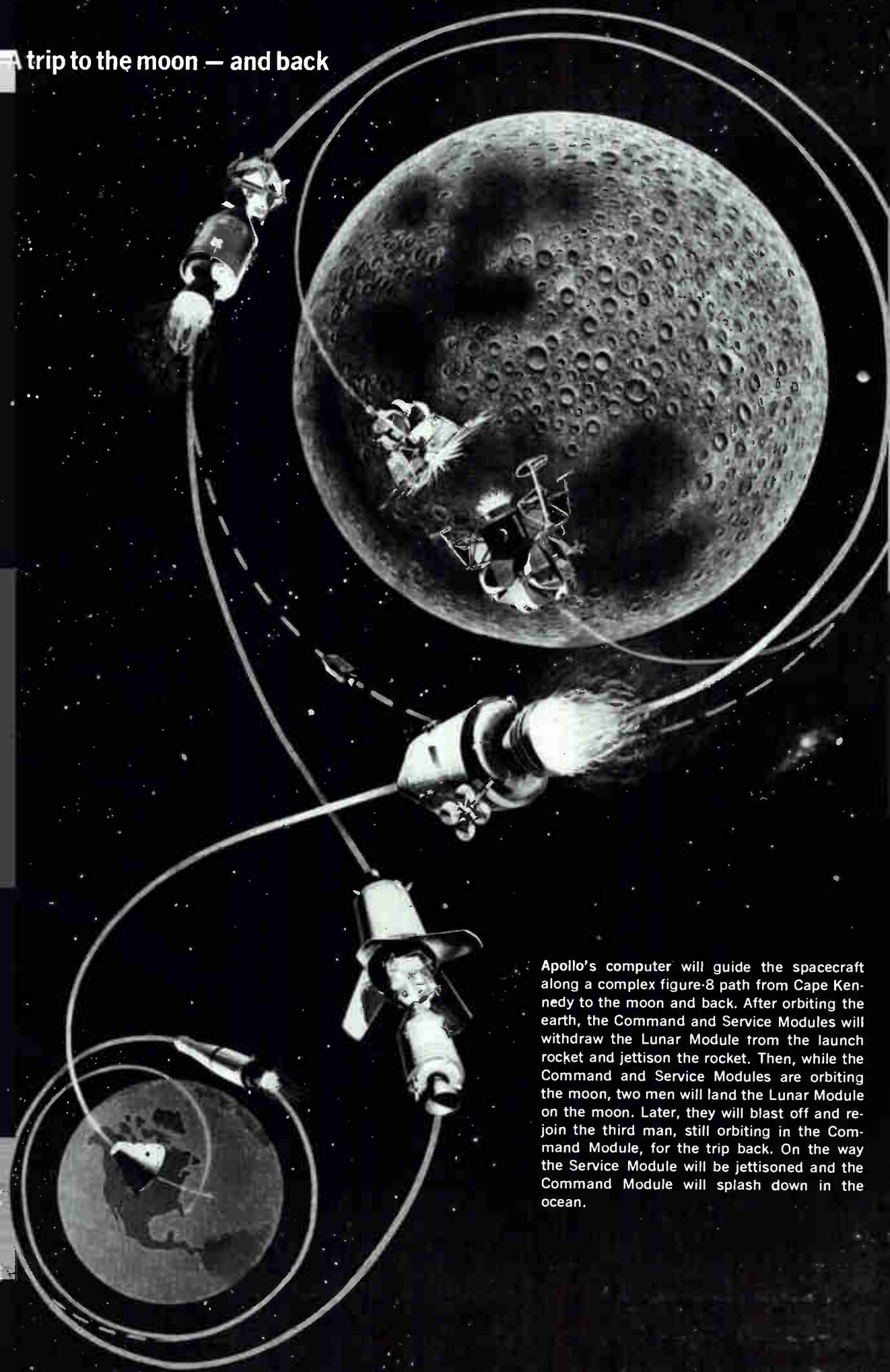

Apollo's computer will guide the spacecraft along a complex figure-8 path from Cape Kennedy to the moon and back. After orbiting the earth, the Command and Service Modules will withdraw the Lunar Module from the launch rocket and jettison the rocket. Then, while the Command and Service Modules are orbiting the moon, two men will land the Lunar Module on the moon. Later, they will blast off and rejoin the third man, still orbiting in the Command Module, for the trip back. On the way the Service Module will be jettisoned and the Command Module will splash down in the ocean.

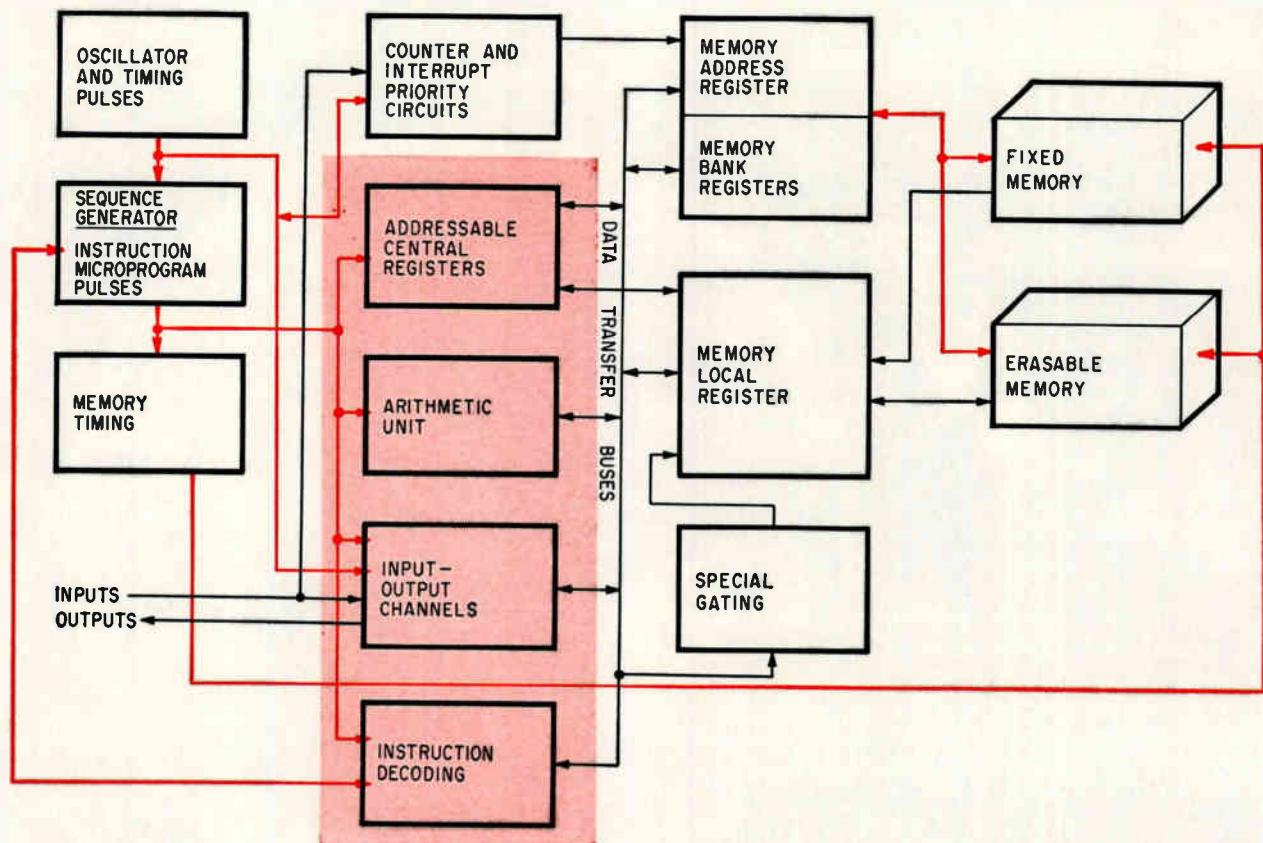

Organization of the Apollo computer shows the central processor (in tint block), the data paths (black lines) and control paths (colored lines). The data-transfer buses are the computer's backbone.

internal computing and input-output activity. For example, they can keep its various facilities busy by time-sharing. A guidance computer's central processor is also time-shared among numerous jobs, but must react to a large demand for input-output service in milliseconds rather than minutes. The Apollo computer can execute about 40,000 instructions per second.

It will be installed in the lower equipment bay of the Command Module, where the navigator will stand after his couch has been stowed. In the Lunar Module it will be behind the astronauts as they stand at their control stations. The crew can give commands to the computer and supply data and decisions when the computer requires it. The computer, in turn, supplies the crew with piloting data. The crew-computer interface is embodied in the display and keyboard unit, described later in this article. Interfacing circuits also connect the computer with other spacecraft systems.

Design of the computer

In addition to the memories, the computer has two other principal sections. The central section includes an adder, an instruction decoder, a memory address decoder and seven addressable registers. The sequence generator provides the basic memory timing and sequences of control pulses for each instruction; it also contains the interrupt priority circuitry.

The backbone of the computer is a set of 16 data-transfer buses, which interconnect the regis-

ters. Instructions can address registers in either memory, but the program cannot change the contents of the fixed part. Each memory word has 15 information bits and a parity bit. Data is stored as 14-bit words with a sign; instruction words have three order-code bits and 12 address-code bits.

Every instruction lasts an integral number of memory cycles. The normal sequence of instructions can be broken by a number of involuntary sequences, which are not under normal program control. These are triggered either by external events—an astronaut's entering data from the keyboard, for instance—or by certain overflows within the computer, such as a sum becoming too large for the register containing it. The breaks in sequence may occur between any two program steps and may be divided into two categories: counter incrementing and program interruption.

The shorter the better

Most guidance computers have word lengths of about 24 bits. The Apollo guidance computer is unique in having a 16-bit word. This short length was made possible by a decision to perform navigation calculations with multiple-precision arithmetic, in which a single quantity may occupy more than one computer word.

A guidance computer should have the shortest possible words to keep the circuitry simple, small and fast. Shorter words cut down on the number of memory sense amplifiers needed, for instance. One is needed for each bit in a word. These high-

gain class A amplifiers are considerably harder to operate with wide margins of temperature, voltage or input signal than NOR gates are. Also, the time required for carry propagation in a parallel adder is proportional to word length.

The Apollo computer's data words are generally of two classes; those for navigational computations, and those for control. The first class requires a precision of 27 to 32 bits ($10^{8.21}$). The second class of variables can usually be represented with 15 bits. The precision required for navigational variables can be satisfied by using two words. Even if word lengths were 15 to 28 bits, two words still would have been required.

To accommodate both positive and negative numbers, the logic designer must choose among at least three possible number representations: one's complement, two's complement, and sign-and-magnitude. For a binary number such as 1110001011 (equivalent to +907 in decimal notation) the one's complement is simply the complement of each individual bit, or 0001110100; the two's complement is the same as the one's complement except that a 1 is added to the right-most bit position, or 0001110101. These complements represent -907. In sign-and-magnitude notation a bit is added to represent the sign, usually 0 for positive and 1 for negative; then +907 = 01110001011 and -907 = 11110001011.

The Apollo number system is a modified one's-complement scheme using two sign bits for overflow representation in the adder. This combines the advantages of the other two systems while sidestepping their disadvantages. The extra sign bit is available because the parity bit does not pass through the adder. In the conventional one's-complement representation, an overflow alters the sign bit. In the modified scheme the sign is not altered because of the double-bit representation. An independent sign representation for multiple-precision numbers is then possible. During operations such as multiplication, two's-complement arithmetic is used.

Sign-and-magnitude representation was rejected although it is the most straightforward for human inspection. However, it requires either a magnitude comparison or conversion to one of the complement representations when positive and negative numbers are added. In straight one's-complement notation, sign reversal is easy. However, zero is ambiguously represented by a word of all 0's or of all 1's, and addition may require an extra operation called end-around-carry. Two's complement notation avoids this and is convenient for input conversions from devices such as pattern generators, encoders, or scalars; but sign reversal is awkward.

Since the computer often would be using many multiple precision words for navigation, this was considered in the choice of number system and in the organization of the instruction set. Multiple-precision representation commonly requires the sign bits of all component words to agree; neverthe-

Computer characteristics

Word transfers	Parallel
Word length	16 bits=15 data +1 parity
Number system	Modified one's complement
Memory cycle time	11.7 μ sec
Fixed memory	36,864 words
Erasable memory	2,048 words
Normal instructions	34
Involuntary instructions (interrupt, increment, etc.)	10
Interrupt options	10
Addition time	23.4 μ sec
Multiplication time: 14 x 14 bits	46.8 μ sec
Double-precision addition time	35.1 μ sec
Increment time	11.7 μ sec
Number of counters	29
Power consumption	Less than 100 watts (including two DSKY's)
Weight	58 pounds (computer only)
Size	1.0 cubic foot (computer only)

less, in the Apollo computer the signs of the components can be different [see "Multiple-precision arithmetic," p. 116].

The algorithm for double-precision multiplication is directly applicable to numbers with independent signs. A special double-precision add instruction simplifies the treatment of interflow. Independent signs are not permitted in double-precision division; both operands must be positive and the leftmost non-sign bit of the divisor must be 1.

Two memories

The 2,048-word erasable memory is a conventional coincident-current, ferrite-core array. Nothing would be gained by using a faster memory organization, since the 36,864-word fixed memory requires a relatively long cycle. Both have a cycle time of 12 microseconds.

The array is wired in 32-by-64 planes which are folded to fit into a 9-cubic-inch module. A double-ended transistor switching network generates bi-directional currents in each selection wire. One wire in 32 is selected by switch circuits in an 8-by-4 array, and one wire in 64 is selected in an 8-by-8 array. The outputs of these silicon transistor drive circuits vary with temperature so that they match the requirements of the lithium-ferrite cores from 0°C to 70°C.

The integrated-circuit sense amplifiers are considerably more complex than the integrated NOR gates, but there are only 32 per computer. Each amplifier can be carefully selected. None have failed in several million device-hours of operation, although sense amplifiers have historically been the weak link of computer memory systems.

Large fixed memories are rarely used in ground computers, but guidance computer designers favor

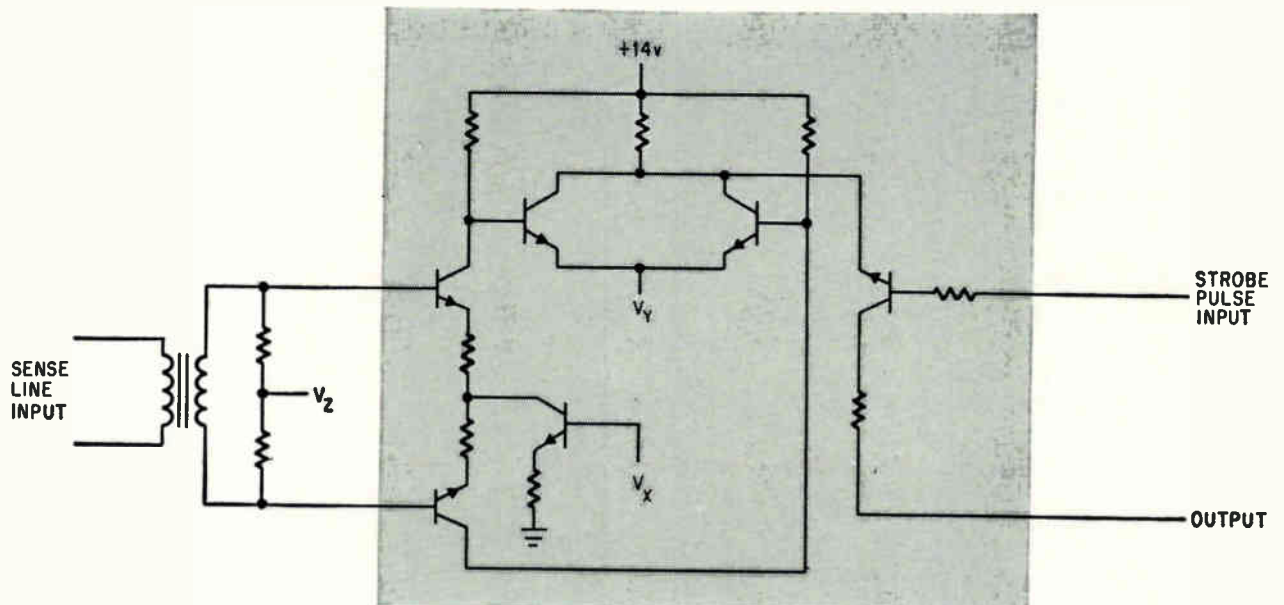

Sense amplifier circuit amplifies signals from both the fixed and the erasable memory in the Apollo computer. All components inside the tinted block are in an integrated circuit. Each computer has 32 of these amplifiers.

them. They occupy little space and are highly reliable. Fixed program and data limit alteration of mission plans, but help assure that the computer program is identical through all phases of testing and in flight. It also permits recovery from temporary malfunctions which would alter the contents of an erasable memory—as happened, for instance, during the flight of Gemini 4.

Early models of the MIT core rope memory actually resembled lengths of rope. Large numbers of wires thread through or bypass toroidal cores, as shown in sketch below, to create 1's and 0's.⁵ Address decoding is also partly wired in. As a result, its cycle time is longer than that of some

other transformer memories whose address decoding is external. However, bit density is extremely high—approximately 2,000 bits per cubic inch, including all driving and sensing circuits, interconnections, and packaging hardware.

High density is achieved by storing a large number of bits in each magnetic core. The total number of bits is the number of cores multiplied by the number of wires. Each of the Apollo memory's six modules contains 512 cores and 192 wires, or 98,304 bits of information.

A link to ground

Computer words flow over prelaunch and in-flight radio links between the computer and ground control. The upward and downward data rates are different; therefore the mechanizations differ considerably.

The downlink rate is 50 words or 800 bits per second. During one memory cycle the interface stores a full 16-bit word in a flip-flop register; then, upon command, it sends the bits serially in a burst to the communications system of the spacecraft.

Each bit received on the uplink requires a memory cycle; the maximum rate is 160 bits per second. Transfers from the computer to spacecraft display units also require one memory cycle per bit, as does data from the radar measurement subsystem. In these serial pulse trains two adjacent pulses differ in weight by a factor of two and positional notation is employed.

Information is also transferred incrementally. A sequence of pulses is transmitted over a single channel, but each pulse represents the same value, or weight. An incremental receiver counts pulses to form a word, where a serial receiver shifts pulses to form a word. The incremental transfer of information permits high precision and standardization in analog data transmission. For example, the

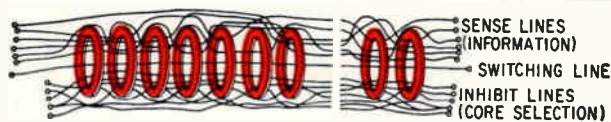
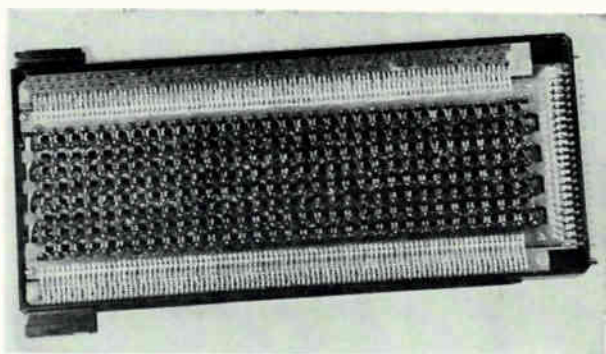

Wires through a core store a 1 in a core-rope memory while wires bypassing the core store a 0. Magnetic switching of a core, triggered by currents in the switching and inhibit lines, generates pulses in those sense wires that thread that core; 16 wires at a time are gated to sense amplifiers to read one computer word. Each of the six core-rope modules in the Apollo computer contains 512 cores and 192 wires.

Single-circuit design

Computer logic circuits are all variations on three basic logic functions: AND, OR and NOT. These three basic functions in turn can be implemented with a single circuit, the NOR gate, shown at right; it has the logical function:

$$D = \overline{A + B + C}$$

read "NOT (A or B or C)." All four variables may have either of two voltage levels. If A, B, and C are all at the more negative level, the transistors are cut off and D is at the more positive level. But if one or more inputs rise, the corresponding transistor turns on and D drops to its more negative level.

When B and C are tied to ground, D is the inverse of A and the circuit is an inverter, or NOT circuit. If the output of the circuit shown is the input to such an inverter, then the inverter's output is:

$$E = \overline{D} = \overline{\overline{A + B + C}} = A + B + C$$

and the combination of two circuits is an OR gate. Likewise if A, B and C are the outputs of such inverters, whose inputs are F, G and H, then

$$D = \overline{A + B + C} = \overline{\overline{F} + \overline{G} + \overline{H}} = \overline{\overline{F} \cdot \overline{G} \cdot \overline{H}} = FGH$$

read F and G and H; the four circuits form an AND gate. Logically the inverse of an OR function is the AND function of the individual inverted variables.

Two-way functions simply require tying the unused input to ground. For functions of four or more variables, the outputs of additional circuits are connected to each other; only one of the circuits can be connected to the +4 volt supply. The ability to drive other logic circuits is increased by connecting NOR gates in parallel.

Complex logic functions are built up of alternate layers of AND and OR gates. Successive layers of NOR gates can be considered alternately as OR gates with

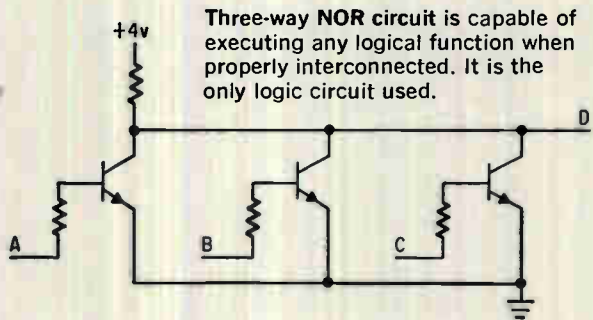

Three-way NOR circuit is capable of executing any logical function when properly interconnected. It is the only logic circuit used.

positive inputs and AND gates with negative inputs. Thus the function:

$$E = D_1 \cdot D_2 \cdot D_3 = (A_1 + B_1 + C_1) \cdot (A_2 + B_2 + C_2) \cdot (A_3 + B_3 + C_3)$$

can be realized with exactly four NOR gates. The reason is that if

$$D = \overline{A + B + C}, \text{ then } \overline{D} = A + B + C$$

and that

$$D = \overline{A + B + C} = \overline{\overline{A} \cdot \overline{B} \cdot \overline{C}}$$

Therefore,

$$E = \overline{D_1} \cdot \overline{D_2} \cdot \overline{D_3} = (A_1 + B_1 + C_1) \cdot (A_2 + B_2 + C_2) \cdot (A_3 + B_3 + C_3)$$

If the intermediate variables D are needed, they must be inverted.

For example, the block diagram shows clearly how NOR gates can be interconnected to form a register or a single bit position in each of several registers without using multiple NOR gates for each logic function. Two gates cross connected form a latch or flip-flop; both the input and the output can be gated, or the ungated ON or OFF latch output is available. A six-way OR is at the extreme right.

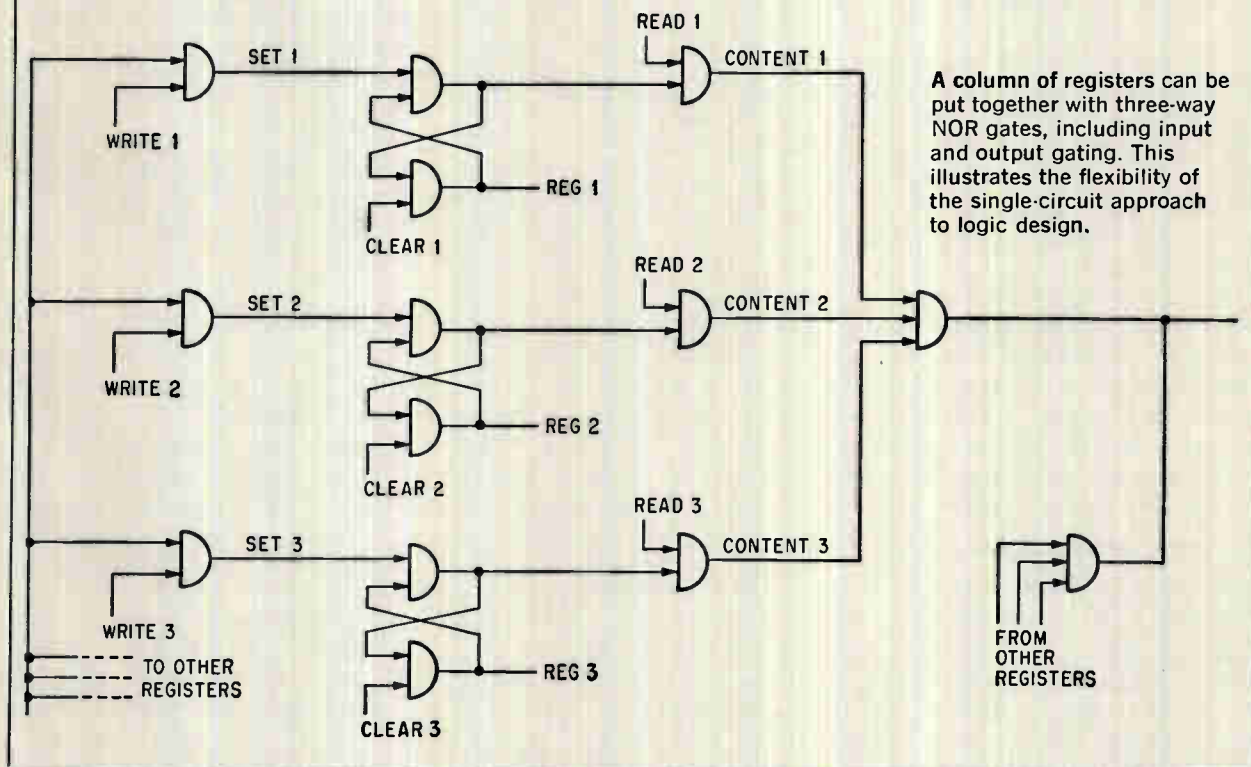

Apollo accelerometers are incremental, producing a pulse for each unit change in velocity. The computer uses incremental transfer for angle commands to the gyros and the gimbals in the inertial measuring unit, and for thrust control and certain display functions in the spacecraft. Pulses are sent in bursts at a fixed rate.

External requests for serial or incremental transfer are stored in a counter priority circuit. If at the end of an instruction no requests have been received, the next instruction is executed. If a request is present, the program is interrupted and an incrementing memory cycle is executed. Each counter is a specific word in erasable memory. During the incrementing cycle the computer reads the word, increments or shifts it, and stores the result in the original location. Overflows from one counter may be inputs to another. The computer processes all such requests before proceeding to the next instruction in the original program. This type of interrupt enters synchronous incremental or serial information into the working erasable memory.

Since counter words are in the erasable memory, any program always has ready access to them. Each increment or shift requires a memory cycle. To avoid taking too much time from guidance and navigation calculations, the aggregate counting rate is limited. This sometimes requires a logic circuit between the interface and the priority circuit to prevent the input pulse rate from exceeding a chosen level.

Commands or feedback for discrete actions are given by discrete signals—individual binary digits or small groups. These actions close switches, change mission phases, fire jets, start displays and control many other actions. Most discrete inputs to the computer are non-interrupting—that is, they are acted upon by the normal program. They are either d-c inputs through a filter to a logic gate, or a-c signals transformer-coupled to a flip-flop, which is reset after interrogation. A few special discrete inputs initiate a program interrupt—they announce their presence to the computer's sequence generator. Discrete outputs are controlled by the program.

During a program interrupt, the computer stores the contents of the program counter and transfers control to a program subroutine that processes the particular type of interrupt. When an interrupt is being processed no subsequent interrupts will be accepted, but all will be processed in turn.

The computer is the primary source of timing signals to about 20 spacecraft systems.

The man rules the machine

The crew-computer interface is the display and keyboard unit. It is abbreviated *DSKY* and pronounced "diskey." There are two *DSKY*'s in the command module, one for the navigator and one on the pilot's main panel, for use during powered flight. One *DSKY* is installed in the lunar module.

Above the *DSKY*'s keyboard is a numeric electro-

Multiple-precision arithmetic

Independent signs arise naturally in multiple-precision addition and subtraction. Forcing signs to be identical would be costly because every operation may require sign reconciliation. For example, in decimal notation,

$$(+64) + (-46) = (+18)$$

Suppose the addition is done in one-digit decimal registers that indicate both positive and negative numbers in sign-and-magnitude form, like the mechanical registers below. In multiple precision, the left-hand register carries ten times the weight of the right-hand register, so that +64 would become (+6, +4) in the two registers, and -46 would become (-4, -6). The two registers operate independently so that the operation is

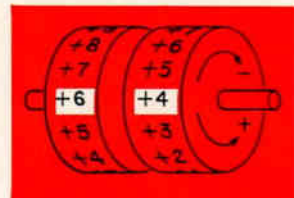

$$(+6, +4) + (-4, -6) = (+2, -2)$$

Considering the weight of the left-hand register, the result is clearly +20, -2. The sum of these is +18, but the signs are mixed unless corrected.

The same result can be obtained if operand signs are mixed. For example, +64 can be represented by either (+6, +4) or (+7, -6), so

$$(+7, -6) + (-5, +4) = (+2, -2)$$

The result again has mixed signs. On the other hand,

$$(+6, +4) + (-5, +4) = (+1, +8)$$

so that here correction is unnecessary. Still another possibility exists if the problem is stated:

$$(+7, -6) + (-4, -6) = (+3, -12)$$

The answer is still correct, but since one-digit registers contain the numbers an overflow has occurred in the right-hand register. In this case, the overflow is carried over into the left-hand register, with the proper sign:

$$(+3, -12) = (+2, -2)$$

In the Apollo computer this kind of overflow is called an interflow to distinguish it from an overflow in the left-hand register.

luminescent display of three 5-digit registers for data and three 2-digit registers for commands. The 15 bits of a computer word can be shown as 5 octal digits—the digits 0 through 7—in one register. The three registers can display the three components of a vector. Each register also includes a sign position; when a sign appears, the number is read as decimal; otherwise it is octal. The other digit displays are labeled verb, noun and program.

Each command is an imperative statement consisting of an action (verb) and an object of the action (noun). For example, "display" "time to ignition" is a request from the crew; or "load" "desired gimbal angles" is a request from the computer. These statements are expressed numerically;

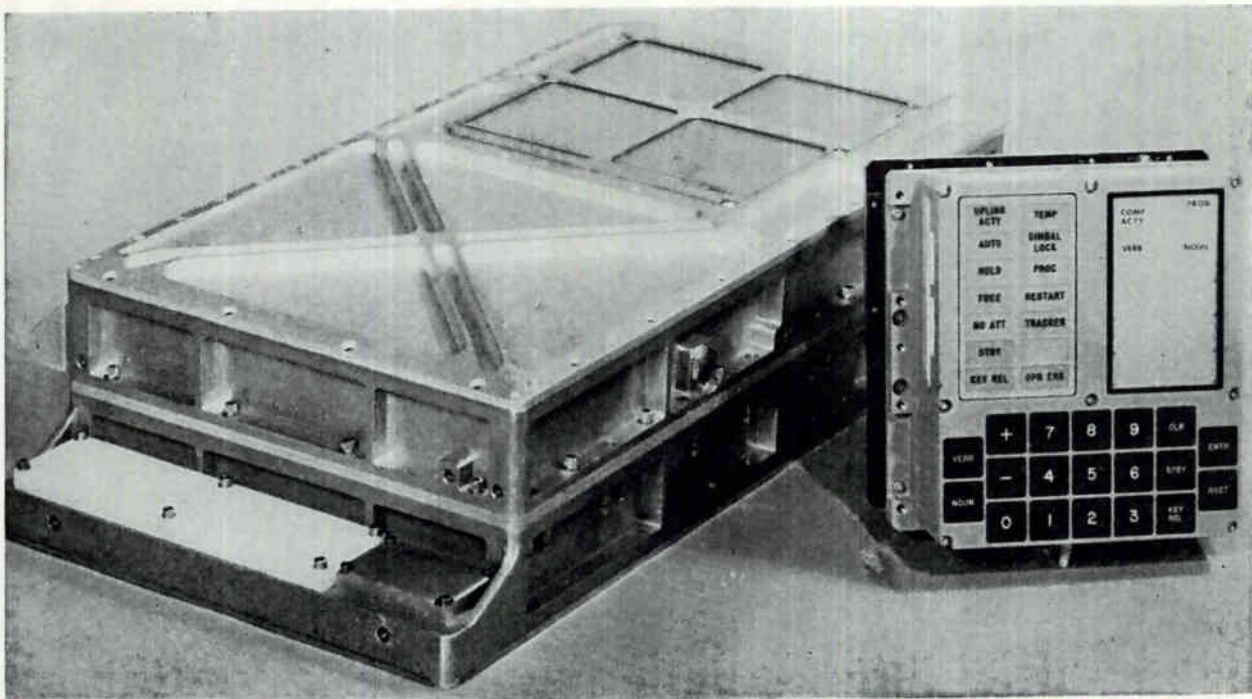

Apollo guidance computer, viewed from the rear, and its display and keyboard unit.

the crew looks up the verbs and nouns in a glossary. As a crewman keys in statements, they appear in the 2-digit registers of the display where they can be checked for accuracy. When the computer makes a request, the verb and noun display flashes on and off to indicate the computer origin of the command, and to attract the crew's attention.

Key code inputs interrupt the computer program. The keyboard's 19 pushbuttons include the 10 decimal digits, plus and minus signs, and 7 auxiliary keys. The 19 key functions are encoded into five binary signals by a diode matrix mounted directly behind the keyboard.

Program lights tell the operator what major programs the computer is running. The DSKY also has discrete alarm and condition lamps, a condition light reset key, and a key with which the operator relinquishes his use of the display lights to the computer—a function which permits the operator to decide whether his command has a higher priority than the computer's request. If a keyboard entry sequence is in progress when the computer program has a request or a result of display, a condition lamp notifies the operator of the fact. When he is ready to let the computer use the display, he depresses the release key.

Software

Guidance and navigation programs are executed under control of three special programs that ease the task of the human programmer and insure that priorities are observed in the computer. These special programs are the interpreter, the executive, and the waitlist.

Most of the guidance and navigation programs are written in a special notation and stored directly in the fixed memory. The interpreter translates

the notations into a sequence of subroutine linkages, which in turn execute the program. A program executed with the interpreter takes more time than would a machine-language program written with an automatic compiler; however, it occupies less storage space and saves the time of writing a program in basic machine language. The interpreter occupies only a few hundred words in fixed storage and requires only one instruction for relatively complex operations, whereas compiled programs would need several instructions.

All programs except interrupt routines are controlled by the executive routine. Executive-controlled programs are called "jobs" to distinguish them from "tasks," controlled by the waitlist. The routine controls job priority, permits time-sharing of erasable storage, and displays computer activity on the DSKY. As one job runs, the executive checks at least once every 20 milliseconds to see if another job of higher priority is waiting to be executed. If so, control is transferred to the new job until the first job again becomes the one with highest priority.

When a job must wait until an external event occurs, such as the attainment of a specific velocity in powered flight, the executive may suspend it, or "put it to sleep." The job's temporary storage is left intact, so the executive can "awaken" the job when the event occurs.

When a job is finished the executive transfers control to a terminating sequence which releases the job's temporary storage to be used by another job. Approximately ten jobs may be scheduled for execution at one time.

Waitlist tasks are run in the interrupt mode, and must be no more than four milliseconds long. A longer program could cause excessive delay in

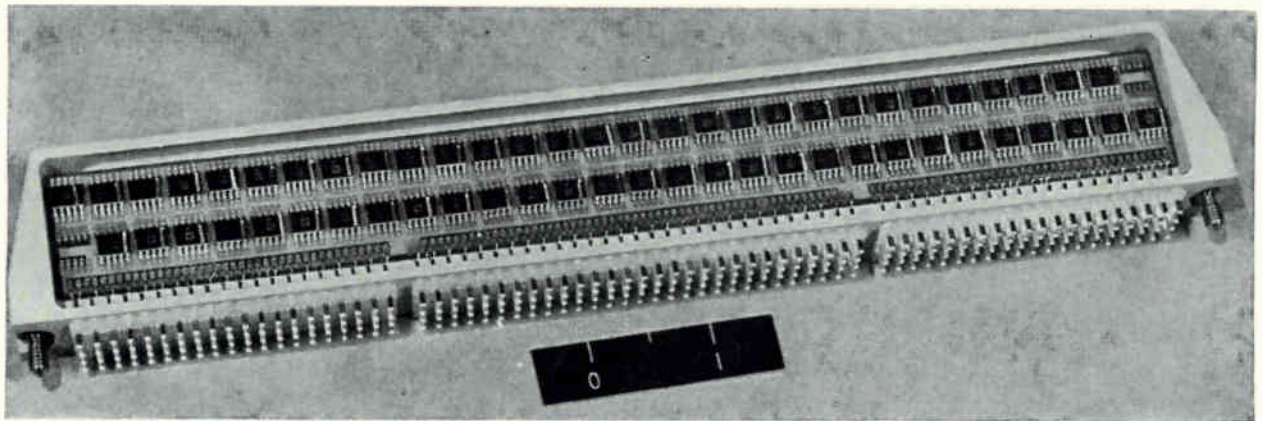
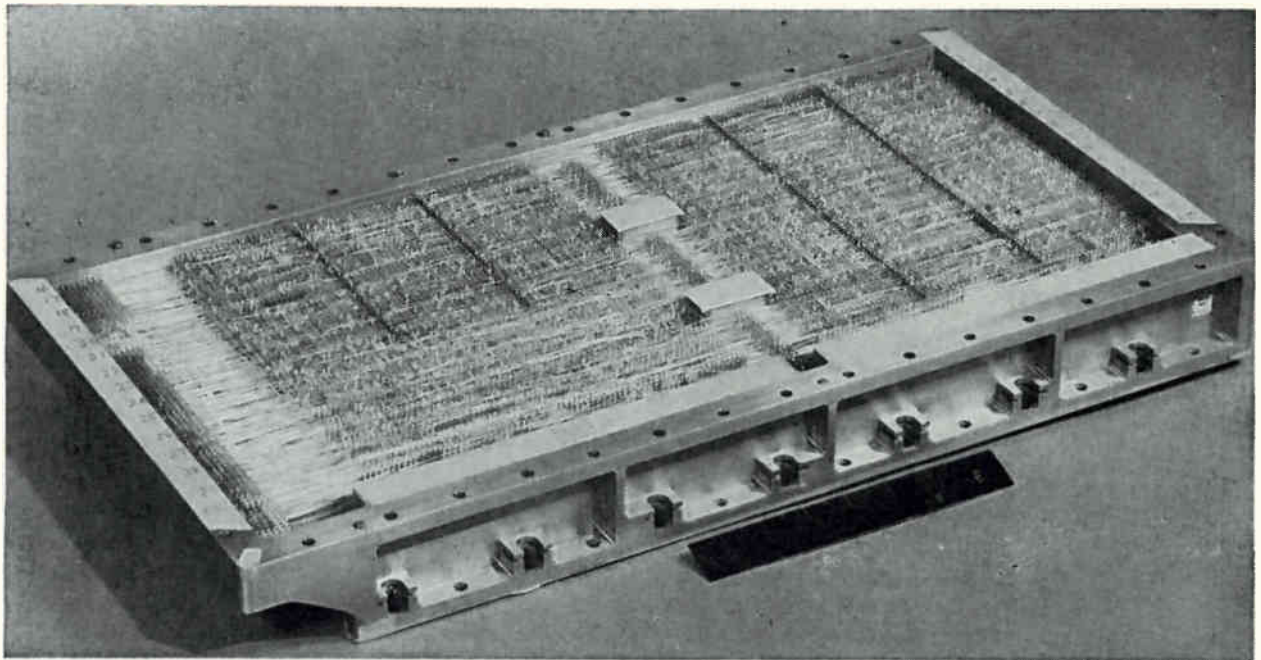

Logic module contains 120 monolithic integrated-circuit flatpacks, 60 on each side. These modules plug into a tray, whose wrapped wires interconnect the modules. A second tray holds the memory and its drive circuits.

other interrupts waiting to be serviced, since one interrupt program inhibits all others while it is running.

If the waitlist is to initiate a lengthy computation, it will call the executive routine so that the computation is performed as a job during non-interrupted time.

Modules and trays

Signal interconnections—the major mechanical problem in guidance computers—take up approximately three-quarters of the computer volume. The IC flatpacks are interconnected with multilayer boards, and wrapped wires connect the modules.

A basic design goal was small modules that could be easily installed and removed, for the sake of producibility, testing, diagnosis and maintenance. Another goal was to keep the computer's volume small. The goals were attained with 24 modules each containing two independent groups of 60 flatpacks with 72 connector pins. Two gates are on each flatpack; flatpacks and pins are connected to the board by spot welding.

All modules plug into two carriers called trays. One tray holds the logic, power supply and interface modules, and the other contains the memory, oscillator and alarm modules. The trays are magnesium alloy frames into which the modules are inserted by jacking screws. These provide a good thermal path between modules and tray, which in turn is screwed to a cold plate.

References

1. R.L. Alonso, Hugh Blair-Smith and A.L. Hopkins, "Some aspects of the logical design of a control computer: a case study," *IEEE Transactions on Electronic Computers*, Vol. EC-12, No. 5, Dec. 1963, p. 687.
2. Jayne Partridge, L.D. Hanley and E.C. Hall, "Progress report on attainable reliability of integrated circuits for systems application," *Symposium on Microelectronics and Large Systems*, Spartan Books, 1965, p. 77.
3. P. Kuttner, "The rope memory—a permanent storage device," *Proceedings, Fall Joint Computer Conference, American Federation of Information Processing Societies*, Vol. 24, p. 45; Spartan Books, 1963.
4. A.L. Hopkins, "Guidance computer design," *Space Navigation, Guidance and Control*, J.E. Miller, editor, Technivision, Ltd., Maidenhead, England, 1966.
5. R.L. Alonso and J.H. Laning, "Design principles for a general control computer," *Institute of Aeronautical Sciences, New York, S.M. Fairchild Publication Fund Paper FF-29*, April 1960.

now--a 24 channel solid state multicoupler

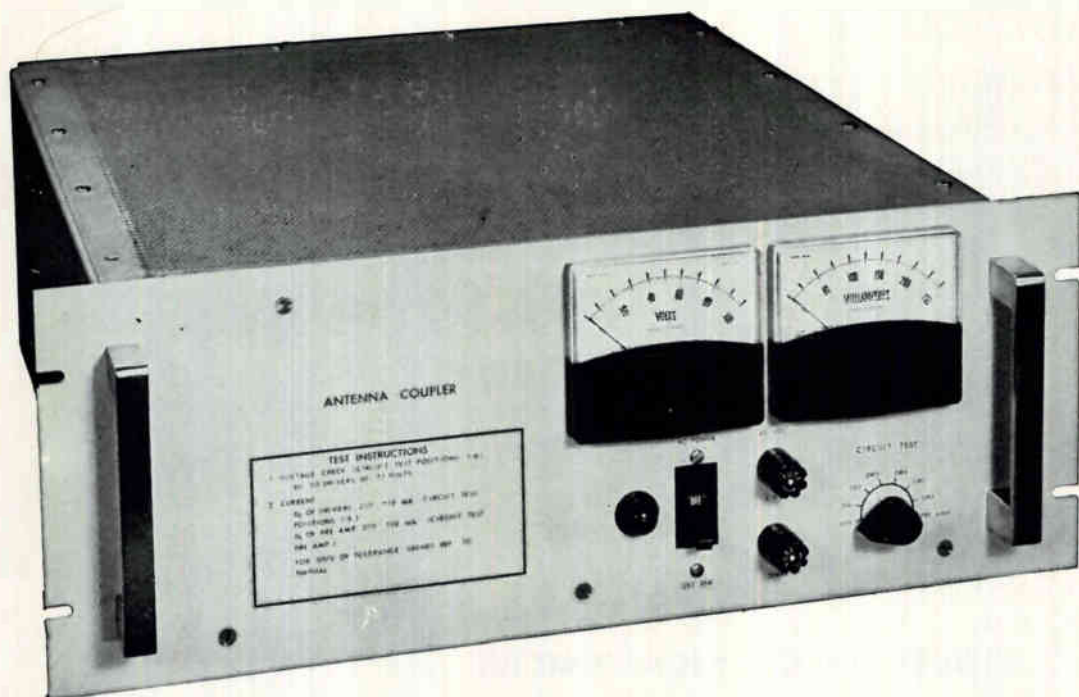

only from Conductron-MRC

MODEL Bandwidth Gain Noise Figure Intermodulation Distortion Phase Tracking Amplitude Tracking Isolation, Back to Front Isolation, Output to Output Gain Reduction (Overload) Inputs	C 325-24 2 MHz—30 MHz 2 dB±1 dB 7.5 dB: 20 MHz—30 MHz, 6.5 dB: 10 MHz—20 MHz, 6 dB: 2 MHz—10 MHz — 56.5 dB, 2nd order — 60 dB, 3rd order 2 degrees±1 degree 1 dB > 52 dB > 40 dB < 2.5 dB for .8 volt signal 1	Outputs VSWR Impedance—In Impedance—Out Power Required Dimensions Mounting Connectors MTTR MTBF Fault Isolation MIL Qualified To	24 < 1.25:1 50 ohms 50 ohms 115 V±10%, 50—60 cps or 48 V±3V, DC 19" wide x 20" deep x 7" high Standard 19" rack BNC < 30 min. > 30,000 hours Internal MIL-E-4158C, MIL-Q-9858A
---	--	---	--

If 24 for 1 sounds like good odds for your antenna coupling requirements, check the specifications above, then write Conductron—MRC Division, 2311 Green Rd., Box 614, Ann Arbor, Michigan 48107. Ask for Bulletin 11C.



CONDUCTRON - MRC Division

ANN ARBOR, MICHIGAN



SOLID STATE TIMERS

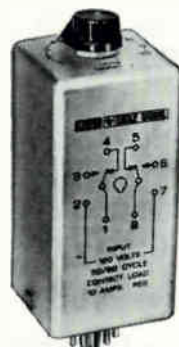

NEW
CG Timer:
Range: 50 MSL
to 60 Sec.

THE WIDEST RANGE

ELECTROMECHANICAL TIMERS

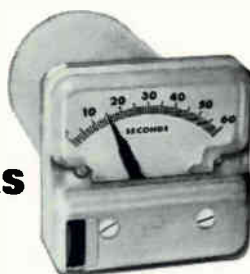

NEW
Model 88 Timer:
Range: 6 Sec.
to 48 Hrs.

The Man from E.A.G.L.E. offers virtually unlimited product/performance scope: from solid state timers such as the CG (upper)—created for short, accurate, highly-repetitive time cycles—to motor-driven electromechanical timers such as the Model 88 (lower)...and everything known to be in between. CG's qualifications: compensates for voltage changes; plugs into standard octal relay socket; quality componentry—tantalum timing capacitor; SCR control of 10 amp output relay; protection against load or output contacts being inadvertently actuated by transients or power cutoff; perfect replacement for pneumatic timers.

Accuracy, economy and reliability are hallmarks of the Eagle line...industry's most complete! Put us to the only test that counts, your most demanding time/count application. Write for CG Bulletin 158 and Model 88 Bulletin 1620, Eagle Signal Division, E. W. Bliss Company, 736 Federal St., Davenport, Iowa 52808.

BLISS



EAGLE SIGNAL

A DIVISION OF THE E. W. BLISS COMPANY

FOR INFORMATION ON CG TIMER CIRCLE READER SERVICE CARD #491
FOR INFORMATION ON MODEL 88 TIMER CIRCLE READER SERVICE CARD #492



INSTANT EAGLE RELAYS

***Test Them Immediately...
Get Production Quantities in Two Weeks!***

That's right . . . Eagle challenges you to compare them with any relay on the market. NOW you can get immediate delivery on these general-purpose or medium-power relays. Test results prove they're the finest of their kind in the world. Eliminate your relay delivery problems. Call your "Man from E.A.G.L.E.". . . listed at the right. You'll find he has full details and specifications on Eagle relays.

BLISS  **EAGLE SIGNAL**

A DIVISION OF THE E. W. BLISS COMPANY
736 Federal Street, Davenport, Iowa

YOUR "MAN FROM E.A.G.L.E."

Distributors

Burlingame, California
415-697-6244
Glendale, California
213-245-1172
Englewood, Colorado
303-781-0912
Hamden, Connecticut
203-288-9276
Orlando, Florida
305-855-3964
Baltimore, Maryland
301-484-5400
Newton Highlands, Massachusetts
617-969-7140
Minneapolis, Minnesota
612-922-7011
Clifton, New Jersey
201-471-6090
Haddonfield, New Jersey
609-429-1526
Albuquerque, New Mexico
505-265-1020
Albany, New York
518-436-8536
Depew, New York
716-684-5731
Endwell, New York
607-723-8743
Fairborn, Ohio
513-878-2631
Fairview Park, Ohio
216-333-4120
Dallas, Texas
214-363-1526
Houston, Texas
713-649-5756
Seattle, Washington
206-725-7800

Representatives

Scottsdale, Arizona
602-947-4336
Pasadena, California
213-681-4421
Jacksonville, Florida
305-388-7656
Orlando, Florida
305-422-4295
Roswell, Georgia
404-993-6498
Chicago, Illinois
312-775-5300
Chicago Illinois
312-784-7314
Baltimore, Maryland
301-276-1505
Norwood, Massachusetts
617-769-3600
Minneapolis, Minnesota
612-922-0243
St. Louis, Missouri
314-428-5313
Hackensack, New Jersey
201-342-2602
Latham, New York
518-785-5032
Rochester, New York
716-436-4410
Skaneateles, New York
315-685-6172
Fairfield, Ohio
216-333-4120
Havertown, Pennsylvania
215-528-6640
Dallas, Texas
214-748-7788
Houston, Texas
713-224-9715
Bellevue, Washington
206-454-5200
Charleston, West Virginia
304-342-2211

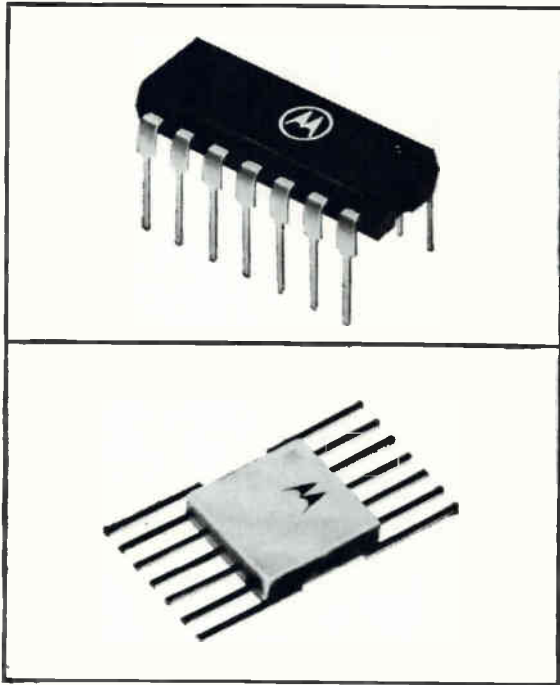

INTRODUCING...

MECL II*

...the second phase of compatible MECL* logic

Featuring:

- The fastest flip-flop in the world — 70 MHz (min) — will shift information in register applications at 70 MHz.
- Compatible with MECL I Series (use in the same system).
- Fastest useful speed of any commercially available IC's (from low to high fan-out).
- 40% faster than the MECL I Series (5 ns typical prop. delay).
- Multifunction units for minimum can count — low system cost.
- Complementary outputs — eliminates need for inverters.
- 50-ohm terminated transmission line drive capability — minimum compromise in power and speed . . . and low induced noise.
- Proven circuit design — three years of successful MECL use.
- Proven high-volume producibility — delivered in millions.

Send today for technical details on new MECL II integrated circuits. Write Box 955, Phoenix, Arizona 85001.

-where the priceless ingredient is care!

Select from these circuit functions:

Plastic Package (0 to +75°C)	Flat Package (-55°C to +125°C)	Function
MC1001P† MC1002P† MC1003P† MC1004P** MC1005P** MC1006P** MC1007P† MC1008P† MC1009P† MC1010P** MC1011P** MC1012P** MC1013P** MC1017P† MC1018P† MC1019P† MC1020P† MC1021P†	MC1201F† MC1202F† MC1203F† MC1204F** MC1205F** MC1206F** MC1207F† MC1208F† MC1209F† MC1210F** MC1211F** MC1212F** MC1213F** MC1217F† MC1218F† MC1219F† MC1220F† MC1221F†	Single 6-Input Gate Single 6-Input Gate Single 6-Input Gate Dual 4-Input Gate Dual 4-Input Gate Dual 4-Input Gate Triple 3-Input Gate Triple 3-Input Gate Triple 3-Input Gate Quad 2-Input Gate Quad 2-Input Gate Quad 2-Input Gate AC Coupled J-K Flip-Flop Translator Translator Full Adder (10 ns Add Time) Quad Line Receiver Full Subtractor
Coming Soon		
MC1014P MC1015P MC1016P MC1022P MC1023P MC1024P MC1025P	MC1214F MC1215F MC1216F MC1222F MC1224F MC1225F	Dual R-S Flip-Flop Dual R-S Flip-Flop Dual R-S Single Rail Flip-Flop Type "D" Flip-Flop Clock Driver Dual 2-Input Expandable Gate 4 and 5-Input Expander

† See your Motorola field representative for evaluation units.
 ** In stock at your nearest Motorola distributor.
 * Trademark of Motorola Inc.



MOTOROLA
Semiconductors

Electronics Markets 1967

TOTAL ELECTRONICS INDUSTRY			
(millions of dollars)			
	1966	1967	1970
ELECTRONICS INDUSTRY, TOTAL	19,699.6	21,553.9	25,205.8
Consumer electronics	3,445.6	3,697.9	4,120.4
Industrial-commercial	5,734.0	6,420.0	8,629.4
Federal (including military and government nonmilitary, adjusted for calendar year)	9,810.0	10,719.0	11,731.0
Replacement components	710.0	717.0	725.0

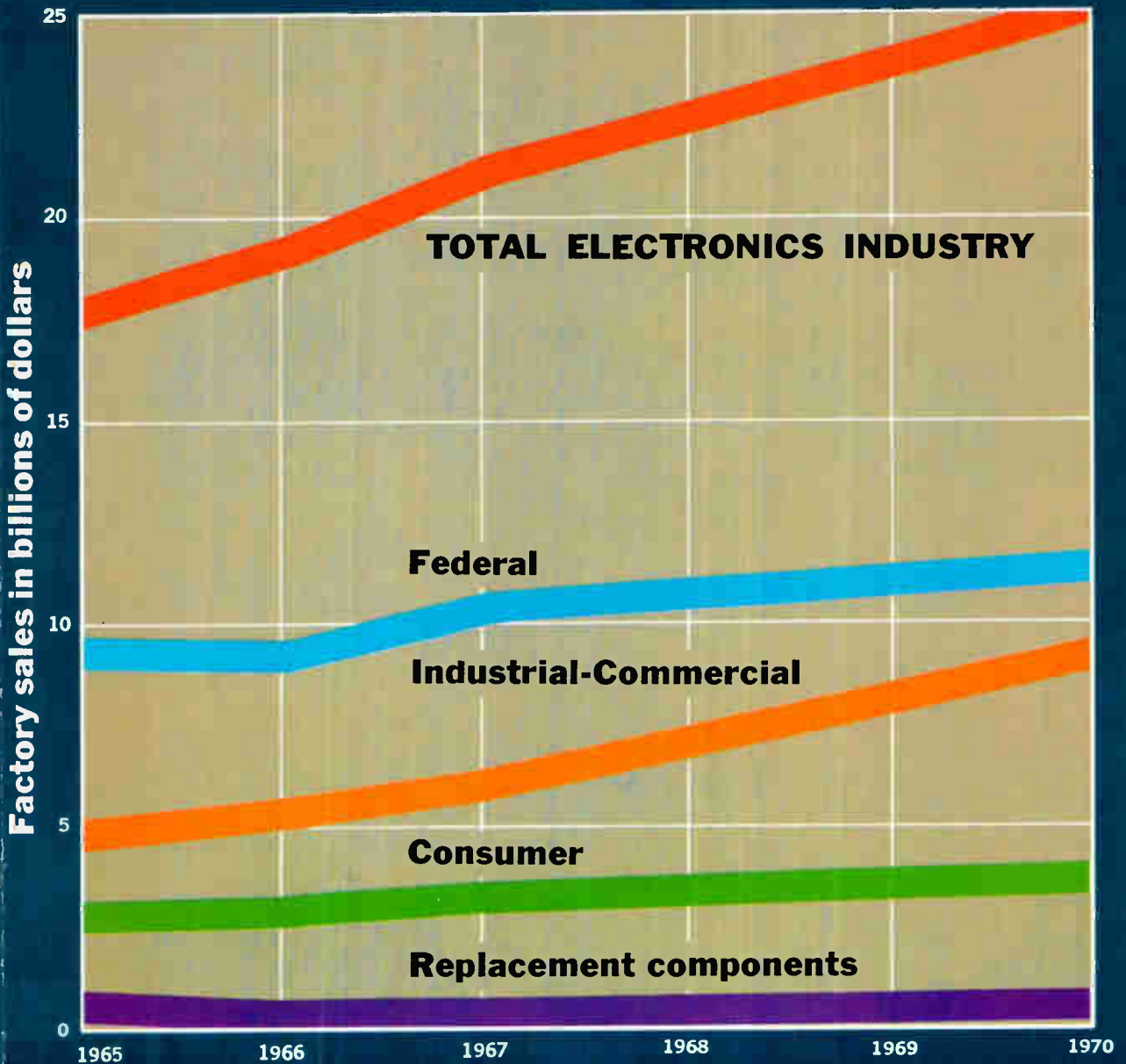

COMPONENTS

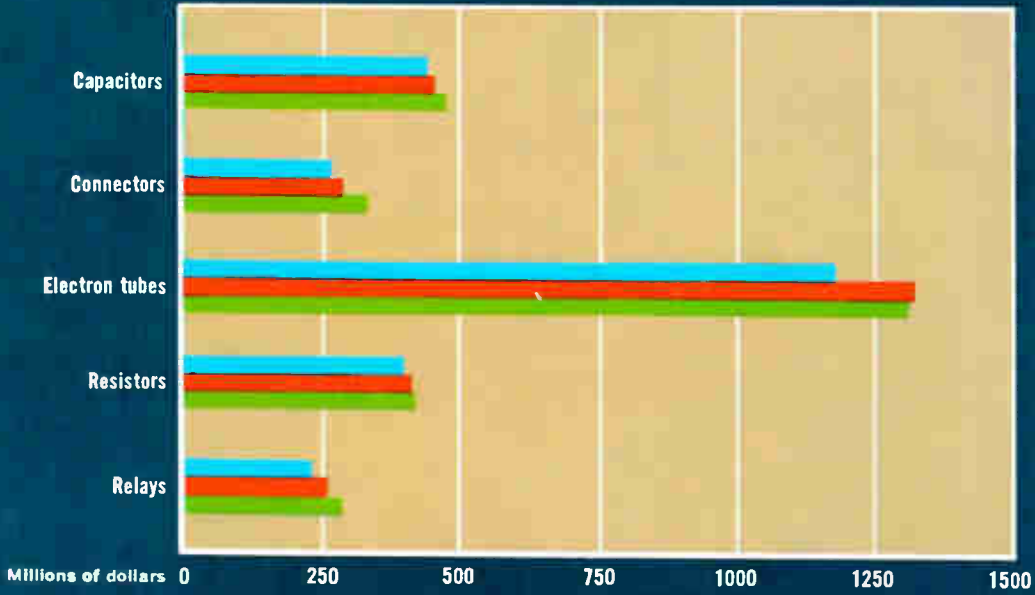

SEMICONDUCTORS, TOTAL

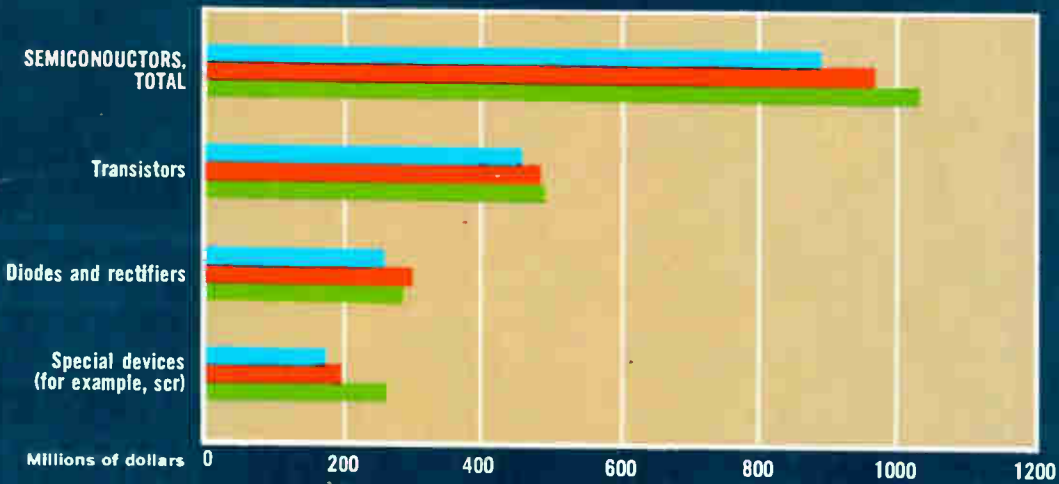

INTEGRATED ELECTRONICS



1966

1967

1970

Electronics Markets 1967

Federal Electronics				Industrial Electronics				Consumer Electronics			
	1966	1967	1970		1966	1967	1970		1966	1967	1970
	(millions of dollars)				(millions of dollars)				(millions of dollars)		
FEDERAL ELECTRONICS, TOTAL	9,810	10,719	11,731	INDUSTRIAL AND COMMERCIAL, TOTAL	5,734.0	6,420.0	8,629.4	CONSUMER ELECTRONICS, TOTAL	3,445.6	3,697.9	4,120.4
Department of Defense, electronics portion, total	7,901	8,780	9,653	Test and measuring instruments	576.0	650.8	799.5	Television receivers, total	1,819.0	2,017.0	2,223.0
Procurement, total	4,462	4,973	5,449	Medical equipment	230.6	266.2	340.1	Monochrome tv receivers	729.0	667.0	473.0
Communications	1,136	1,274	1,386	Nuclear instruments and equipment	138.2	158.6	214.6	Color tv receivers	1,090.0	1,350.0	1,750.0
Aircraft	1,283	1,420	1,561	Optoelectronic instruments and equipment	95.0	101.0	112.0	Radios, total	389.9	396.7	435.6
Missiles	1,442	1,617	1,772	Computers and related equipment	2,145.1	2,426.8	3,534.2	A-m and f-m radios	177.5	182.3	208.6
Mobile and ordnance	124	141	155	Communications equipment	1,382.5	1,490.1	1,814.4	Auto radios	212.4	214.4	227.0
Ships	477	521	575	Laser equipment	33.6	49.8	99.9	Phonographs, total	470.2	470.8	483.3
Research, development, test and evaluation	1,975	2,157	2,409	Closed circuit television	30.6	42.0	59.4	Phonographs, monaural	120.5	116.0	115.0
Operations and maintenance	1,464	1,650	1,795	Dictating devices	100.1	101.0	104.0	Phonographs, stereo	349.7	354.8	368.3
NASA, electronics portion	1,745	1,776	1,868	Power supplies	67.5	72.8	85.0	Tape recorders	114.0	131.0	160.0
Federal Aviation Agency, electronics portion	100	100	150	Industrial operations electronic equipment	934.8	1,060.9	1,466.3	Phonograph records	420.5	431.7	500.0
Atomic Energy Commission, electronics portion	64	63	60					Hi-fi components (including tuners, speakers, amplifiers, etc.)	81.5	87.5	115.0
								Kits, except toys	42.5	46.0	56.5
								Light dimmers	8.0	9.2	12.0
								Musical instruments, electronic	100.0	108.0	135.0

(Based upon factory prices)

Industrial and Commercial Markets

Industrial and Commercial Markets				Industrial and Commercial Markets				Industrial and Commercial Markets			
	1966	1967	1970		1966	1967	1970		1966	1967	1970
	(millions of dollars)				(millions of dollars)				(millions of dollars)		
Test and measuring instruments, total	576.0	650.8	799.5	Diathermy, shortwave and microwave	2.0	2.1	3.2	Marine communications	17.6	19.6	25.6
Spectrum analyzers, subaudio to 1 Ghz	14.5	15.3	17.0	Other medical electronic equipment	16.6	20.1	28.0	Airborne, including ground links	165.7	170.6	210.0
Signal generators, up to 1 Ghz	14.3	16.1	19.0	Nuclear instruments and equipment, total	138.2	158.6	214.6	Carrier current	16.3	18.6	27.2
Sweep generators, up to 1 Ghz	4.4	5.5	7.8	Analyzers, pulse height	13.5	16.8	21.2	Intercom	95.3	99.7	110.2
Pulse generators, up to 1 Ghz	5.5	6.5	8.5	Other spectrometers for nuclear applications	4.0	4.3	5.6	Commercial sound and public address	212.3	222.7	256.4
Oscillators, subaudio through video	14.6	18.1	22.3	Accelerators, linear	13.0	14.3	17.6	A-m station equipment	14.4	15.3	17.6
Waveform generators, all shapes	12.1	13.5	15.4	Accelerators, other	8.4	10.3	15.6	F-m station equipment	11.3	12.8	16.9
Waveform analyzers and distortion meters	4.0	4.6	5.6	Power supplies for nuclear equipment	6.3	7.6	15.0	Tv station equipment	128.1	130.4	130.7
Counters, time and frequency, up to 1 Ghz	30.3	33.4	37.0	Amplifiers for nuclear equipment	4.1	5.5	9.5	Amateur equipment	25.3	27.8	31.1
Timers, electronic	72.3	79.6	108.4	Pulse generators for nuclear equipment	0.6	1.0	1.7	Citizens band equipment	35.9	40.5	48.7
Panel meters	30.1	32.3	34.1	Personal dosimeters	0.7	0.8	1.0	Facsimile	22.0	25.5	30.5
Noise measuring equipment, up to 1 Ghz	11.4	12.6	14.5	Radiation monitoring, portable survey instruments	2.5	3.4	5.0	Optical (light) communications (laser, infrared)	2.5	3.0	4.5
Radio-frequency measuring instruments except counters	6.3	6.6	7.5	Radiation monitoring, fixed position	4.0	4.3	4.9	Telemetry	160.4	181.7	224.9
Voltmeters and ammeters, electronic, d-c to 1 Ghz, meter indicating	15.0	16.0	20.0	Detectors (all, separate unit or part of system), total	9.1	10.8	16.0	Communications equipment, other	45.3	56.1	79.7
Digital voltmeters	25.0	26.5	30.0	Semiconductors	3.0	3.7	5.1	Laser equipment, total	33.6	49.8	99.9
Power meters, d-c to 1 Ghz	3.1	4.3	7.6	Tubes (Geiger, gas flow, BG ₃)	2.4	3.0	4.8	Welding and machining lasers	3.2	6.5	18.4
Impedance measuring equipment, up to 1 Ghz	14.3	17.5	18.0	Scintillation, crystals and organic phosphors	3.0	3.3	5.1	Measuring and surveying lasers	6.5	9.5	20.0
Calibrators and standards, active and passive	14.1	16.0	20.3	Ionization chambers	0.7	0.8	1.0	Medical lasers	1.0	1.3	3.0
Oscilloscopes, d-c to 1 Ghz	92.1	106.6	123.5	Reactor controls	27.0	29.5	37.5	Communications lasers	2.4	3.5	6.0
Recording instruments, digital and analog	41.5	47.7	66.5	Nuclear instruments and equipment, other	45.0	50.0	64.0	Other lasers	20.5	29.0	52.5
Components testers (capacitor, transistor, tube, etc.)	21.0	22.5	27.0	Optoelectronic instruments and equipment	95.0	101.0	112.0	Closed circuit television, total	30.6	42.0	59.4
Power supplies, lab type	43.0	49.0	60.5	(including electronic densitometers, infrared generators and detectors, photoelectric template followers, etc.)				Industrial cctv	14.4	20.1	26.6
Amplifiers, lab type	7.3	8.4	11.0	Computers and related equipment, total	2,145.1	2,426.8	3,534.2	Educational cctv	10.0	13.4	19.5
Microwave measuring equipment (above 1 Ghz) total	64.8	72.6	98.0	Digital computers, except process control	1,700.0	1,920.0	2,800.0	Theater cctv	2.2	2.8	4.4
Oscilloscopes, above 1 Ghz	7.0	8.2	11.1	Analog computers, except process control	40.6	44.8	55.7	Medical cctv	4.0	5.7	8.9
Microwave phase measuring equipment	5.4	5.7	8.0	Hybrid computers, except process control	34.6	41.5	66.4	Dictating devices (for business)	100.1	101.0	104.0
Microwave impedance measuring equipment	12.0	13.5	18.0	Peripheral equipment, total	299.9	338.0	437.1	Power supplies, OEM type	67.5	72.8	85.0
Microwave power measuring equipment	3.7	4.4	6.3	Converters, A to D	9.6	11.3	16.8	Industrial operations electronic equipment, total	934.8	1,060.9	1,466.3
Spectrum analyzers, above 1 Ghz	7.3	9.1	10.7	Converters, D to A	4.9	5.8	8.5	Motor speed controls	50.2	59.5	75.0
Frequency measuring and analysis, above 1 Ghz, other	7.0	8.5	11.2	Converters, card to tape	6.5	7.0	7.5	Welding	21.3	26.7	36.5
Microwave noise measuring equipment	5.3	6.8	8.8	Readers, paper tape	21.5	24.2	29.0	Power supplies (complete equipment)	95.0	104.7	132.0
Signal generators, above 1 Ghz	7.5	8.3	9.0	Readout devices	150.0	166.8	210.5	Cryogenic equipment	55.4	66.1	90.0
Sweep generators, above 1 Ghz	6.1	7.2	8.7	Mass storage memories, total	107.4	122.9	164.8	Ultrasonic cleaning equipment	10.3	11.1	15.0
Pulse generators, above 1 Ghz	3.5	4.5	6.2	Magnetic tape machinery	58.2	64.1	80.3	Other ultrasonic equipment	12.4	14.1	19.7
Other test and measuring equipment, all frequencies	15.0	16.0	20.0	Magnetic drum memories	12.0	15.3	23.5	Infrared equipment	35.7	40.4	52.7
Medical equipment, total	230.6	266.2	340.1	Magnetic disc memories	37.2	43.5	61.0	X-ray, industrial	23.2	26.7	49.1
Radioactive tracer equipment	12.4	15.3	22.6	Data transmission equipment	70.0	82.5	175.0	Nuclear gauging and processing	65.4	76.3	110.0
X-ray equipment diagnostic	85.1	89.4	112.0	Communications equipment, total	1,382.5	1,490.1	1,814.4	Process control computer systems, total	202.2	235.8	350.3
X-ray equipment, therapeutic	15.0	24.5	30.0	Land mobile	170.5	180.0	205.0	Process control computer systems, analog	21.0	21.5	28.7
Patient-monitoring systems	10.7	15.4	25.6	Microwave and radio relay	77.4	86.3	117.2	Process control computer systems, digital	75.6	103.8	193.6
Hearing aids	50.4	55.2	58.5	Terminal and switching	97.6	100.3	122.7	Process control computer systems, hybrid	4.6	5.5	8.0
Electroencephalographs	2.9	3.7	5.3	Radar	54.6	63.4	77.0	Other process controls	101.0	105.0	120.0
Electrocardiographs	9.0	9.3	12.0	Other navigational aids	30.0	35.8	78.5	Machine tool controls, total	217.3	242.3	335.5
Electron microscopes	7.5	8.5	10.3					Point-to-point control systems	165.0	178.2	222.8
Analytical lab equipment, including blood colorimeters	13.2	15.0	20.4					Continuous contouring systems	52.3	64.1	112.7
Ultrasonic, diagnostic and therapeutic	5.8	7.7	12.2					Controllers	29.2	31.2	38.5
								Actuators, including valves	36.2	38.7	48.0
								Indicators	3.7	4.4	6.2
								Recorders	64.3	68.6	88.7
								Other industrial electronic equipment	13.0	14.3	19.1

Components Markets

Components Markets				Components Markets				Components Markets			
	1966	1967	1970		1966	1967	1970		1966	1967	1970
	(millions of dollars)				(millions of dollars)				(millions of dollars)		
ALL COMPONENTS, TOTAL	6,272.5	6,834.5	7,758.3	Ferrite devices, total	288.1	305.6	361.5	Dry reed relays	19.0	22.6	25.4
Antennas and antenna hardware	345.0	372.5	465.5	Microwave ferrite devices	17.7	19.7	25.3	Mercury wetted relays	12.5	14.4	16.0
Batteries, total	80.8	88.1	113.8	Computer cores	5.3	6.6	9.4	Resonant reed relays	1.0	1.0	1.5
Primary batteries	45.6	50.7	70.3	Transformers and chokes, except tv	230.4	236.7	267.4	Stepping switches	12.6	12.6	11.7
Secondary batteries	35.2	37.4	43.5	Tv ferrite components, including yokes, flybacks	24.5	29.7	40.2	Telephone type relays	20.3	20.6	21.4
Capacitors, total	436.3	462.1	477.3	Other ferrite products	10.2	12.9	19.2	Thermal relays	4.1	4.2	5.6
Paper and film capacitors	122.0	127.5	133.0	Filters, electronic	34.8	40.6	53.4	Other relays	139.0	145.6	154.9
Electrolytic capacitors	192.8	210.8	215.5	Integrated electronics, total	231.4	308.0	550.3	Semiconductors, total	882.3	966.7	1,034.6
Mica capacitors	30.0	31.0	32.0	Integrated circuits, monolithic	145.0	198.0	379.0	Transistors, total	453.8	480.4	483.1
Glass and vitreous enamel capacitors	9.0	9.0	8.0	Hybrid microcircuits (semiconductor and thin film components in combination)	55.9	75.5	125.0	Transistors, silicon	282.3	322.3	373.2
Ceramic capacitors	53.9	55.0	59.3	Discrete chip components	7.0	8.7	14.0	Transistors, germanium	171.5	158.1	110.5
Variable capacitors	28.6	28.8	29.5	Thin films	9.5	10.5	12.5	Diodes and rectifiers, total	257.5	286.9	286.3
Complex components (Multicomponent packages, two or more separate active or passive components in a single package)	202.5	220.0	280.0	Thick films	14.0	15.3	19.8	Diodes and rectifiers, silicon	200.2	230.3	241.5
Connectors, total	264.3	285.4	325.8	Loudspeakers	105.0	115.0	128.0	Diodes and rectifiers, germanium	35.5	35.0	25.0
Coaxial connectors, standard size	24.5	26.3	25.7	Magnetic tape, total	143.5	170.3	221.4	Rectifiers, selenium and copper oxide	21.8	21.6	19.8
Coaxial connectors, miniature	16.4	19.3	25.7	Audio tape	41.5	48.8	65.0	Special semiconductor devices, total	171.0	199.4	264.6
Cylindrical connectors	87.0	93.1	103.0	Computer tape	51.7	59.6	71.2	Silicon controlled rectifiers	49.3	57.2	78.7
Rack and panel connectors	64.0	68.4	78.0	Instrument tape	35.1	43.9	57.5	Microwave diodes, including varactors	21.2	26.3	30.3
Printed circuit connectors	37.4	40.0	44.4	Video tape	15.2	18.0	27.7	Microwave transistors	11.1	12.1	14.3
Special purpose and fused connectors	35.0	38.3	49.0	Microwave components and hardware (not including tubes and antennas)	79.6	93.4					

Electronics Markets 1967

INSTRUMENTS

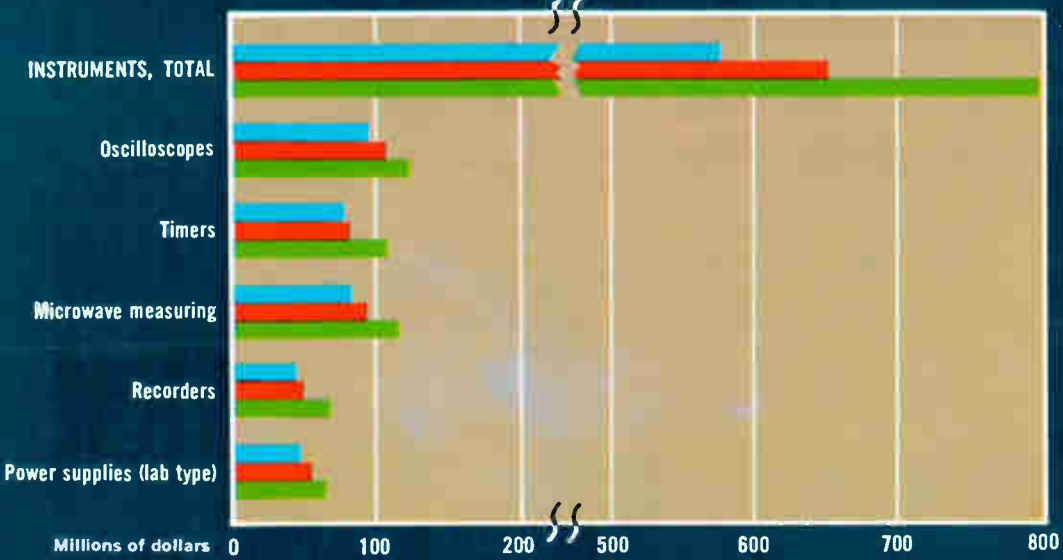

COMPUTERS AND PERIPHERAL EQUIPMENT, TOTAL



COMMUNICATIONS EQUIPMENT



1966 1967 1970

TOTAL ELECTRONICS INDUSTRY

	(millions of dollars)		
	1966	1967	1970
ELECTRONICS INDUSTRY, TOTAL	19,699.6	21,553.9	25,205.8
Consumer electronics	3,445.6	3,697.9	4,120.4
Industrial-commercial	5,734.0	6,420.0	8,629.4
Federal (including military and government nonmilitary, adjusted for calendar year)	9,810.0	10,719.0	11,731.0
Replacement components	710.0	717.0	725.0

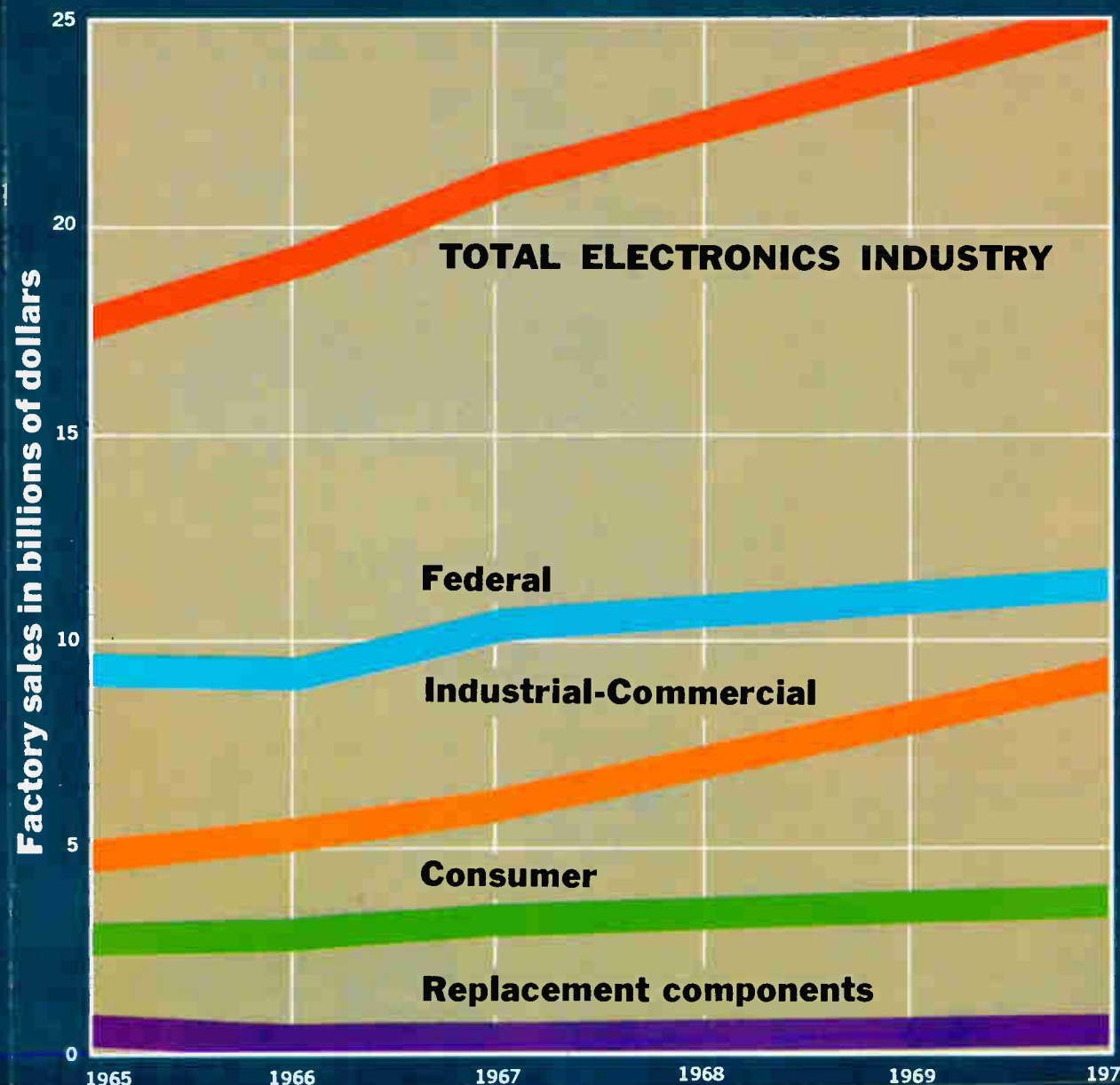

COMPONENTS

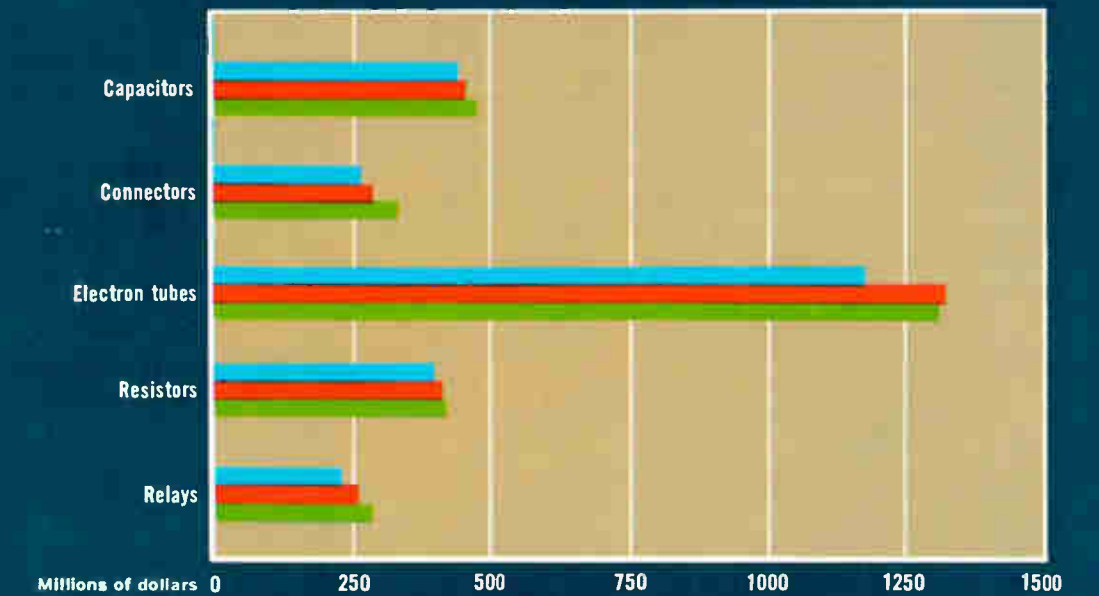

SEMICONDUCTORS, TOTAL



INTEGRATED ELECTRONICS



1966 1967 1970

Electronics firms will continue their vigorous growth in 1967; sales will hit \$21.5 billion, up 9.4% over 1966

The major reasons:

- Computer sales will climb by 13.2%
- Color television sales tabbed at 8 million units
- Military budget on the rise

Electronics markets: 1967

Spectacular rise continues

All segments of the industry are sharing in growth; television, computers and military spending are credited for the boom; integrated circuits remain major technological development

Rarely has there been such agreement on an industry's prospects. Economists, stock brokers, bankers and market analysts have chosen electronics as the golden girl of the year and Electronics magazine backs their judgment by predicting a total market of \$21.5 billion in 1967, up from \$19.6 billion in 1966. There are three reasons for the boom—television, computers and military spending.

While color-television firms have been racking up spectacular gains over the past couple of years, they've been moaning that they could have done even better if only they'd had the production capability. This finally seems to be their year. Most firms have completed broad expansion programs and, as a result, production estimates range as high as 8 million color sets. That's against a background of 4.7 million sets sold in 1966.

Computer manufacturers are on the same gravy train. They've been expanding facilities rapidly and view the sky as the limit as commercial and industrial firms snap up their output. Labor shortages and software snafus are a couple of the nagging problems that require solution.

The military budget keeps climbing, and spending for the war in Vietnam is making an impact on almost every sector of the industry, with communications, avionics and components showing marked gains.

But the outlook for growth encompasses the entire industry. From instrument makers to medical electronics firms to components companies, there's nothing but good news.

Technically, the big story continues to be integrated circuits. They will continue to make inroads everywhere. Military equipment and computers will be using more and more ic's. In consumer areas, such as color television, ic's may continue to be a novelty, but some manufacturers are developing ic technology and say that only the requirements of the market are holding them back.

While they move ahead in developing new markets for ic's, many solid-state device manufacturers are casting uneasy glances over their shoulders at a brash newcomer—large-scale integration. Although LSI won't be much of a rival in 1967, it may pose a future threat. Many labs are now working to produce prototypes.

Contents:

130	Solid state
135	Military electronics
139	Consumer electronics
140	Components
141	Medical electronics
142	Instrumentation
144	Avionics
145	Computers
146	Communications
148	Microwave
150	Educational electronics
151	Space electronics
152	Industrial electronics

Surge in semiconductors



'More and better' is the prognostication for both integrated circuits and discrete devices

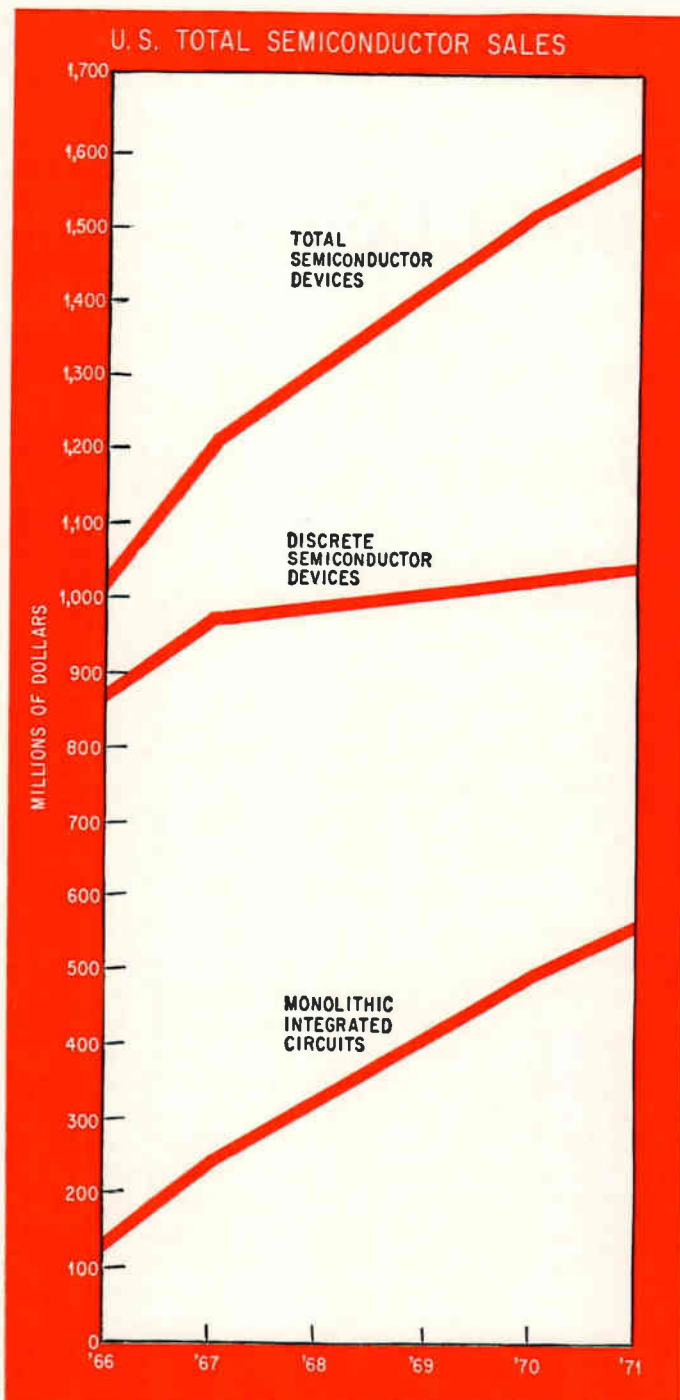

Last year's boom in integrated circuits will continue this year, "only more so." This prediction by a major IC vendor reflects the unrestrained optimism that 1966 results have engendered in the industry.

Sales of IC's last year totaled about 32 million units, and the estimated dollar volume realized—around \$145 million—was more than double the level forecast in 1965, despite a drop in the average selling price.

Electronics magazine's survey puts the 1967 IC market at about 100 million units, valued at \$250 million. And should anyone think a slowdown is in sight, Radio Corp. of America officials project 1971 industry sales of 400 million units, of which, they add, about 150 million will be linear circuits.

The percentage of dollar sales to the military is expected to decline this year to about 40% of overall volume from the approximately 55% to 60% of 1966. However, sales to consumer-equipment makers will continue to represent a relatively insignificant part of the market, as the bulk of 1967 commercial IC volume will go for business machines and industrial computers.

An important factor in the expanded market is the plastic plug-in (dual in-line) package, which last year accounted for about 10% of dollar sales of IC's and this year may contribute as much as 30%.

The popularity of the dual in-line stems from its ease of handling and mounting in conventional printed circuit boards. It is in great demand for use in applications that don't require the highest volumetric efficiency. Some plastic dual in-lines have been tested by suppliers over the full temperature range specified by the military, and some may be used this year in limited-temperature-range military ground equipment.

Texas Instruments Incorporated, which last year entered the dual in-line market with a plastic version, may hedge its bet in the first quarter this year with a hermetic, hard-glass and Kovar-sealed dual in-line. The General Electric Co. expects plastic IC packages to be in short supply during the year, and consequently anticipates no significant price erosion. Prices will hover around an average of \$1 a unit, according to GE, but because this year's circuits will be more complex than earlier versions they will yield "more circuit per dollar."

Large-scale integration—single wafers on substrates containing 100 or more circuits—probably won't make inroads in the market this year. But the major producers will undoubtedly invest much time and effort in studying lsi techniques and will develop some prototypes. Industry sources expect lsi devices to appear on the market by 1968 or early 1969, most likely in the form of custom or special circuits, such as decade counters and shift registers.

Fairchild Semiconductor, a division of Fairchild Camera & Instrument Corp., has slated relatively small quantities of medium-complexity (30 to 40 gates) arrays for mid-1967, and large arrays of up to 200 gates for late 1967. Complex arrays, Fairchild emphasizes, are still experimental and present problems in the areas of partitioning and packaging.

One question facing producers concerns whether discretionary wiring—the technique in which only good circuits on a chip are wired together with the aid of a computer—provides the most economical route to lsi. Both π and the International Business Machines Corp. have programs using discretionary wiring, but neither is committed to the techniques.

C.F. O'Donnell, vice president for the Autonetics division of North American Aviation, Inc., holds that discretionary wiring may not be the most efficient and economical means of achieving lsi. With tongue in cheek, O'Donnell says discretionary wiring may “merely further IBM's plot to take over the entire world.” Limiting the number of elements in an array to the amount consistent with very high yields may be more practical, he says. Concurring, Signetics Corp. finds it likely that face-bonded multi-chip assemblies will prove to be a far more practical approach to lsi than the “exotic notion” of discretionary wiring.

At a lower level of complexity, “complex-function” ic's, with 30 to 50 gates internally organized, may account for about 15% of the total 1967 ic market, according to π .

MOS vs bipolar

Semiconductor and metal oxide semiconductor ic's continue to vie for position in the lsi contest. O.R. Baker, Signetics' vice president for product development, gives the edge to semiconductor ic technology from the viewpoint of cost and operating speed, but says mos “may carve out a piece of the market in the low-speed, noncritical area of small desk calculators.” Signetics has backed mos programs for four years and indicates that it will continue to do so.

The General Instrument Corp. and the Philco-Ford Corp. have thus far expended the most effort in mos technology, though their claim to this title may be challenged by others this year. Fairchild aims to put its scattered mos efforts under central control and has hired Charles Sutcliffe, formerly of General Instrument, to head up its mos ic operation [Electronics, Nov. 28, 1966, p. 8]. For its part, General Instrument has consolidated its mos operations and has named J. Leland Seeley to direct them

[Electronics, Nov. 14, 1966, p. 8]. Seeley expects mos developments in three areas: multiphase computers, incremental computers and random-access memories. Mos chips for multiphase computers will feature power dissipation as low as 5 to 10 milliwatts at 1 to 2 megahertz, and clock rates up to 10 Mhz, according to Seeley. The low power dissipation will encourage larger logic arrays, and new processing methods will boost speeds and permit packing densities of up to 1 million devices per square inch, he says.

General Instrument is also developing an advanced digital integrating computer that performs calculations by summing increments. In such a

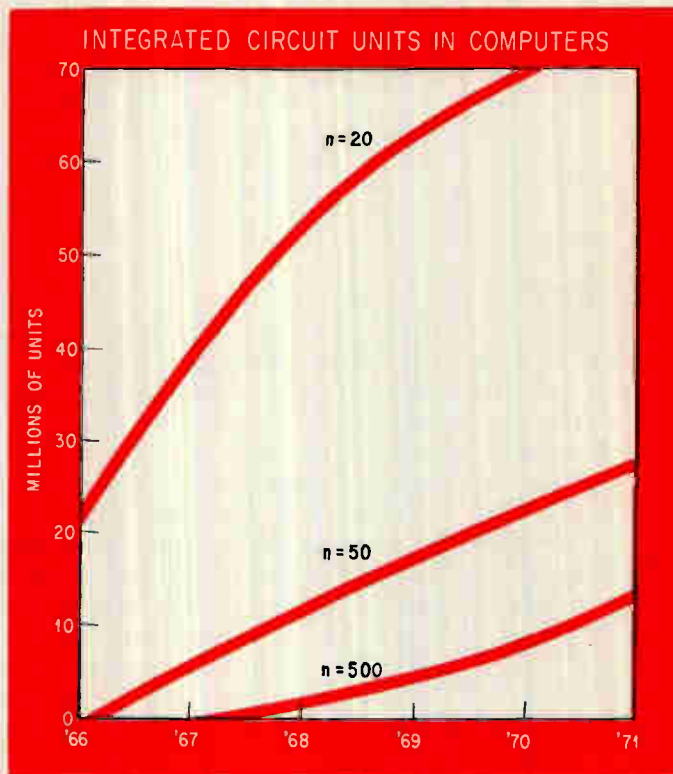

In computers of the future, more circuit elements will be included in each IC chip. Autonetics forecasts these trends in use of 20, 50 and 500 element IC's.

computer, errors aren't cumulative.

Critics of mos cite problem areas: low yields, erratic delivery and reported instability. Joseph van Poppelen, president of the semiconductor division of the International Telephone and Telegraph Corp., warns potential users not to believe today's “mos story.” IRT is concentrating on copying the Fairchild DTL (diode-transistor-logic) line of bipolar ic's, although its Palo Alto, Calif., laboratories are tackling surface problems related to mos and other semiconductor devices. The company believes mos may play a significant role in the future.

IC's under glass

Most proponents of complex integrated-circuit arrays agree that at the 100-circuit level of complexity, multilayer interconnections are needed.

For simpler circuits, diffused crossovers may be satisfactory, but it seems inevitable that lsi devices will require layer-type insulation, such as glass [Electronics, Oct. 3, 1966, p. 108].

According to Signetics engineers, the vacuum deposition of glass over the aluminum and thermally grown oxide surfaces of integrated circuits offers advantages that will be exploited heavily this year. Aside from its use in fabricating crossovers within ic's, the glass layer protects a finished chip from scratching and gouging during assembly. Also, as shown in the top photograph, the glass coating can be selectively removed (note the circular pattern) from the aluminum bonding pads. This gives the operator a target for bonding; if the target is missed, the bond can easily be lifted from atop the glass without damage to the chip.

The bottom photograph shows several crossovers made by depositing glass over the aluminum in the area to be crossed and then depositing aluminum tie-bars over the glass. Such crossovers, notes Signetics, can be made directly over active devices, so that chip size is not affected as it is with diffused crossovers.

Proprietary IC's

This year, more large industrial and military users can be expected to establish small in-house facilities for making prototype ic's, according to marketing specialists at GE's semiconductor products department. One consequence of this will be a demand for ic pellets, a market that GE sees as "small during 1967" but potentially important.

For instrument manufacturers and military-equipment makers, the establishment of in-house ic facilities seems natural. The former rely heavily on proprietary features, features that usually involve a very small percentage of the total circuitry in a device. Instrument makers are reluctant to risk loss of a proprietary design by turning it over to a device supplier to produce, and suppliers aren't anxious to become involved in developing a circuit that, at best, may represent a volume of only 3,000 to 4,000 units a year. In the case of military-equipment manufacturers, total dependence on ic suppliers can jeopardize defense orders if development delays occur. Ic's developed by military houses are more likely to become high-volume items produced by vendors.

More testing

A sharp increase in the testing of integrated circuits is seen by both makers and users. Possibly because of competitive pressures, customers are insisting on more testing, although the added time and labor costs, plus the expenses stemming from lowered yields, are invariably passed along to them. Certainly the customer gets more testing for less money with today's sophisticated test equipment. For example, d-c and a-c tests can be performed on the same run with the device plugged into the same socket, and test programs can be easily changed by modifying a tape. Nevertheless, few

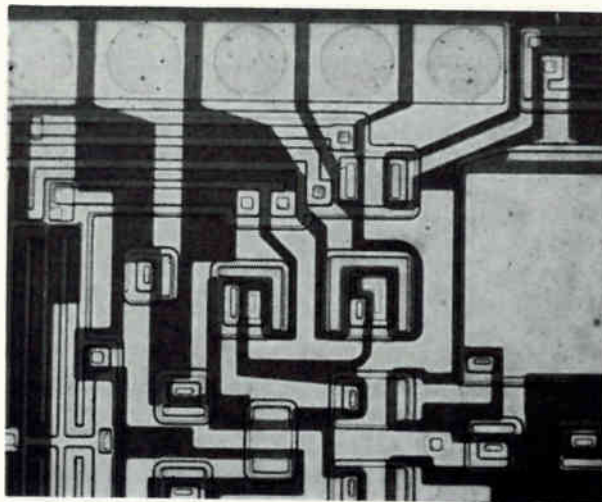

Glass layers protect IC from scratching and gouging. Circles are bonding targets from which glass has been removed.

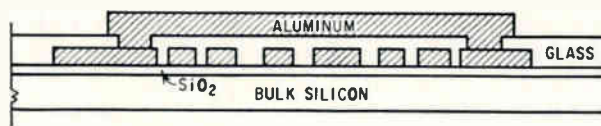

Aluminum crossovers can be made easily above glass insulating layer, avoiding diffused IC

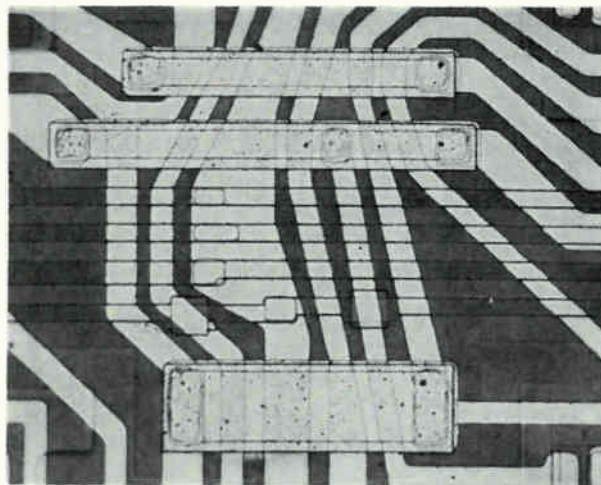

Glass islands in Signetics IC permit conducting tie-bars to be superimposed above substructure, including transistors.

observers are prepared to say exactly what the added testing is "buying" the customer.

One exception to the trend toward extra testing is a shift away from temperature testing—possibly as the result of lessened emphasis on the military market. Instead, most tests are performed at 25° C and sampling checks are made at the temperature extremes.

Material centers

Major ic vendors will intensify efforts this year to drive production costs down through the efficient utilization of "material centers"—plants at which

wafer preparation, diffusion and epitaxy are carried out. To complement the material centers, additional assembly plants will be set up in regions of low-cost labor both here and abroad. Some domestic manufacturers already find Hong Kong losing its appeal as an assembly point, since, they believe, it won't remain an area of low labor costs for long.

A trend to contract purchasing may further influence the over-all ic pricing structure; a vendor can shave prices if it knows its shipping schedule over a long term. One example of contract purchasing is the recent agreement between Fairchild Semiconductor and the Burroughs Corp. Under its terms Fairchild will ship 20 million ic's, transistors and diodes over the next two years for use in Burroughs' general-purpose computers: the B2500, B3500, B6500 and B8500. Included in the gigantic procurement is the largest order for silicon monolithic ic's ever placed. The devices are complementary transistor logic (CTL). Fairchild predicts that 1967 will be the first year that almost every major computer house will be shipping an ic system.

Discrete semiconductors

Semiconductor concerns planning to compete at a profit in 1967 must be able to do so in the face of steadily decreasing selling prices. The trend is illustrated by the price curves at the right for silicon transistors. Despite the price decline, dollar sales of discrete semiconductor devices are expected to increase from about \$950,000,000 in 1966 to about \$1,025,000,000 this year.

For the customer, the picture is bright—not only regarding prices but availability, too. Some shortages experienced last year, particularly in military equipment, will be alleviated. And manufacturers will try hard this year to catch up with customer demand for devices in inexpensive plastic packages. The availability of all small signal silicon devices, notes TI, will be excellent.

A number of the new tested-extra transistors will reach the market in 1967. These devices result from the Pentagon-sponsored program to register transistors (under the designation JAN-TX) that have undergone tests over and above those required for regular mil specs.

Boom in plastic

Most broad-line producers agree that 1967 will be "the year of the package." Low-priced packaging—including transfer molded plastic, epoxy and ceramic—will be stressed. The biggest growth, TI predicts, will be in plastic-packaged economy devices, including field-effect transistors, power transistors, scr's and unijunction transistors.

According to GE's Semiconductor Products department, 1967 will see a major breakthrough in the use of plastic-packaged devices in military and computer applications. GE itself is in the throes of a major change in its plastic "economy line" packaging, a change the company says will provide "dramatic improvement" in environmental capabilities and over-all reliability. Production will be com-

pletely converted to the new package early this year. GE adds.

Contributing heavily to the demand for inexpensive transistors will be the thriving entertainment electronics industry [see page 139]. According to GE, all-solid-state tv will grow in importance, as will hybrid tube-transistor sets. By the end of the year, the company says, almost all line-operated table radios will be solid state. GE is gearing for the anticipated transition with an audio-output family that will go into production this month; this line will be followed by several others later in the year.

Power boost

The designer of rf amplifiers, servo-amplifiers, single sideband transmitters, two-way mobile radios and the like may find welcome relief in transistors with higher power and frequency capabilities. Fairchild, for one, predicts rf power transistors with a capability of 5 watts and 1 gigahertz in the near future.

Mos transistors, says Fairchild, will make inroads

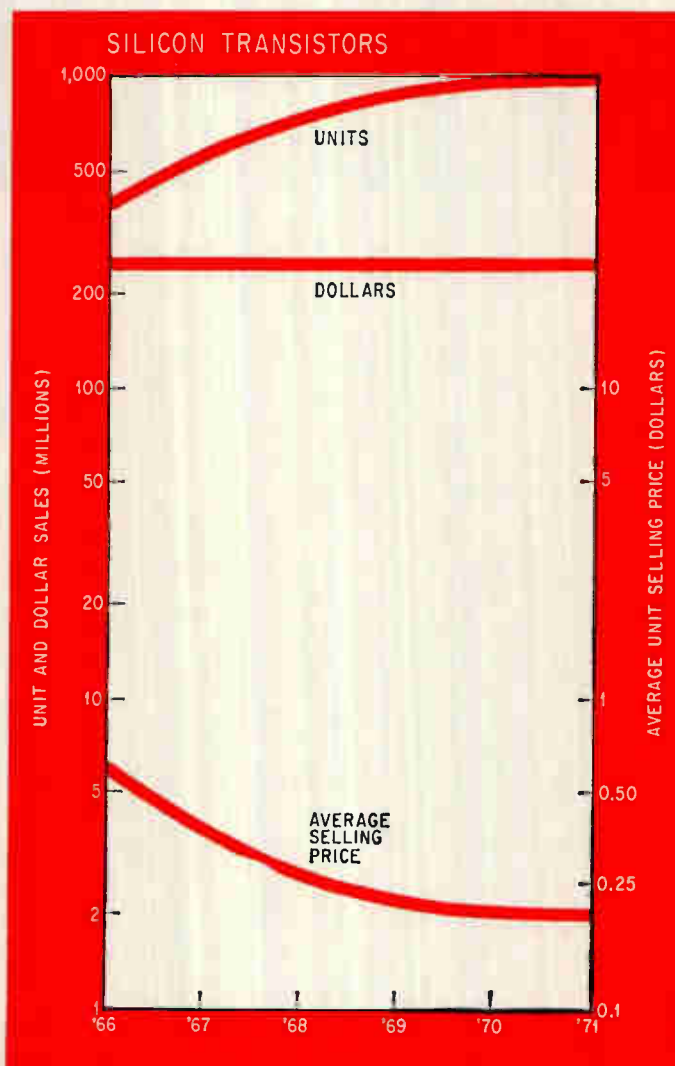

Worldwide sales of silicon transistors rise as prices decline, resulting in a steady dollar volume. Chart based on figures from ITT.

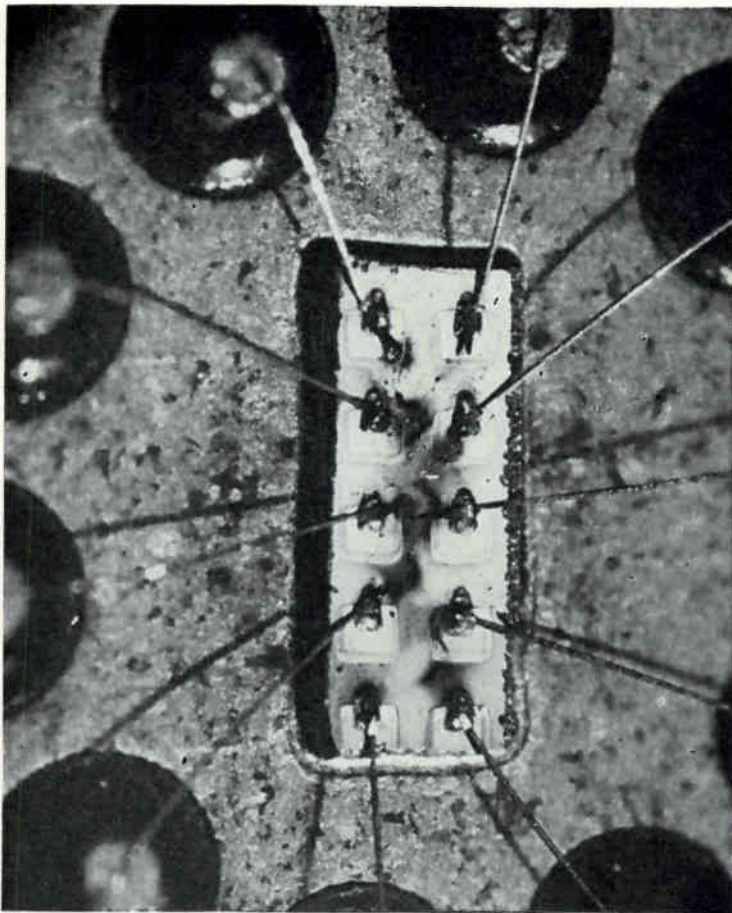

Experimental array of "pseudo-planar" tunnel diodes made by GE. Technique may find role in future computers.

in higher voltage applications, handling up to 150 v. Uses will be found for them in tuners, military communications gear and such consumer products as hi-fi and television sets.

Tunnel diode revisited

The long-discussed application of the tunnel diode as a low-cost element of high-speed computers may be closer to realization because of a new GE technique [Electronics, Dec. 12, p. 210]. Most tunnel diode manufacturers have abandoned the computer market because TD's made by existing techniques can't be priced much below a few dollars—too high for computers. Vendors of TD's have, therefore, aimed mostly at the high-performance, high-price microwave market.

But GE has come up with a technique using what its engineers call a "pseudo-planar" process to make TD's at a price of less than 50 cents a unit in large quantities. Because of this development, logic designers may be taking another look this year at the variety of hybrid (transistor-tunnel diode) logic schemes that have been proposed over the past few years.

GE reports that clock rates up to 400 Mhz have been obtained with the new device in hybrid circuits. Furthermore, the new, inexpensive TD may

find uses in integrated circuits or arrays. One experimental array containing ten of the GE devices is shown above/below.

Thyristor outlook

Chiefly because of thyristors' special switching capabilities, sales of these devices are expected to reach a record \$67 million this year, up 35% from last year's \$50 million. The workhorse of the thyristor family will continue to be the silicon controlled rectifier (scr).

As the technological and economic factors limiting the maximum current in a single scr pellet are pressed, says F.W. Gutzwiller, applications engineering manager for GE's semiconductor products department, one may expect ingenious arrays of parallel clustered devices in one assembly. The voltage blocking ability of scr's, highest of any solid state device, will put the scr in a position to displace gaseous tubes in high-power radar pulse modulators, nuclear particle accelerators and high-voltage d-c power HVDC transmission.

The possible future role of scr's in HVDC is being studied by engineers at Westinghouse, who have set up an experimental HVDC transmission simulator at the company's research laboratories at Youngwood, Pa. HVDC scr systems complement the new methods of generating electricity by direct energy conversion. Most of these methods produce d-c power, and the scr's would be ideal for inverting this power to a-c.

One of the problems of using scr's in HVDC equipment, as well as in other applications requiring high-voltage capability, is series operation. But, says GE's Gutzwiller, 1967 may well prove to be the year in which the last reservations about using long series strings of scr's for severe switching duty are finally laid to rest.

Dynamic improvement

Improvements in switching speed and other dynamic characteristics of scr's, GE notes, should be even more significant than improvements in the devices' static characteristics. They're the key to successful parallel and series operation and are also the critical parameters for power converter and inverter uses. One goal of industry researchers has been, and continues to be, the development of an scr that can turn on and off in a few microseconds at ultrasonic frequencies while handling several hundred amperes at 1000 volts or more.

At the low end of the power spectrum, scr's continue to wage a price and performance battle with power transistors in circuits operating from d-c power supplies. The place of scr's in such former sanctuaries as medium-power inverters and choppers is being challenged by transistors as the voltage and power-handling ability of the latter devices increase and their cost drops. But even here, GE says, big improvements in the speed and frequency characteristics of the scr will permit the device to retain its hold on these applications and even gain some places in other equipment.

Pentagon stresses tactical gear to meet needs of Vietnam conflict



With one major exception, the emphasis, dating from 1961, on development of tactical weapons at the expense of strategic programs will continue in 1967. The exception is the Poseidon, a submarine-launched ballistic missile that will go into production this year.

Military spending for electronics will reflect a rise in over-all Defense Department expenditures to about \$80 billion this year from \$72 billion in 1966. The electronics portion of this total, according to Electronics magazine's annual market survey, will be \$8.7 billion, up from \$7.9 billion last year.

Equipment applicable to the Vietnam war continues to top the Pentagon's buying list. The conflict costs more every month and drains off dollars from those projects unconnected with the war. Procurement of such Air Force and Navy fighter planes as McDonnell Aircraft Corp.'s F-4 and the Grumman Aircraft Engineering Corp.'s A-6 is being stepped up, and these orders mean further contracts for avionics, missile guidance systems and surface-based landing and navigation systems.

Priority will be given to electronic gear for helicopters, including fire-control systems, new armament, a stationkeeping system, air-traffic controls and navigation equipment. More money will be spent this year for communications gear—from portable radios for infantry patrols to big troposcatter terminals across the South Pacific.

Computers will be needed by all three services to handle logistics, keep personnel records and help direct battlefield operations. The military's demands for surveillance, reconnaissance and target-acquisition gear will strain the ingenuity of researchers in the fields of low-light-level television, lasers and infrared and ultraviolet light.

The Defense Department is encouraging the use of integrated circuits. According to a spokesman for the Pentagon's Director of Defense Research and Engineering, "We like to avoid as many connections as possible since they decrease reliability."

Extensive research will continue on avionics systems more advanced than such projects as the Mark 2, the Air Force system being built for the F-111A, and the Navy's integrated helicopter avionics system (IHAS) [Electronics, Nov. 14, p. 234.]

Strategic

Besides acquiring tactical gear, the Defense Department plans to beef up its force of submarine-launched ballistic missiles by ordering into production the Poseidon missile, the follow-on to Polaris. This move will open markets for inertial-

guidance and fire-control systems and electronic components, markets amounting to hundreds of millions of dollars.

Also, studies on an improved ground-based ballistic missile will be accelerated and debates will continue on the merits and disadvantages of the Nike-X antimissile missile.

Air Force

The 474-N project, a program to install radar sites along the nation's coastlines to detect sea-launched missiles will continue to provide a big market for electronics concerns. Also, research will begin on a new generation of large, phased-array radar to be used to monitor space.

The Air Force will continue to buy at least three fighters, the F-111A, A-7 and F-4, plus more C-141 cargo planes and the small OV-10 counterinsurgency aircraft. Development work on the giant C-5A cargo plane will continue.

The Air Force needs a self-contained (which usually means inertial) navigation set for tactical aircraft—the F-4 and F-105, for example. Obstacles here still involve weight, size and cost. Work will continue on an advanced instrument landing system for tactical planes.

New families of three-dimensional surveillance

Avionics for helicopters is a big market. The UH-1D troop transport (top) and UH-1B weapons escort ship (middle) are already in Vietnam. The HueyCobra will go over this year. All are built by Bell Helicopter Co.



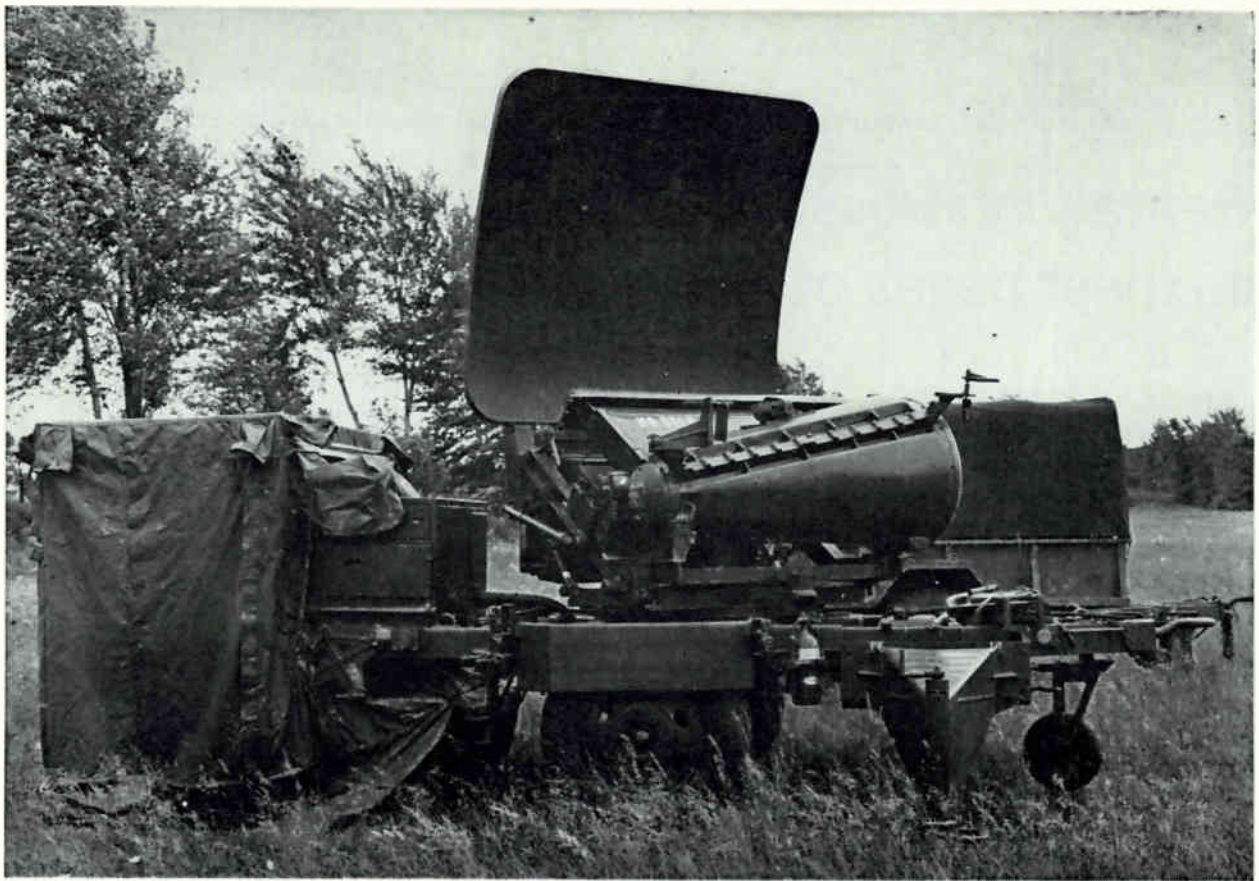

Mortar-locator radar used in Vietnam is being updated by developer, GE, while a design competition is on to develop a more advanced unit that will scan in all directions.

radar, ground-controlled-approach radar for landing planes in poor visibility conditions, and automated data-gathering centers are in various stages of procurement; all are mobile, air-transportable and built in modular configurations. The GCA program to develop the first radar in this category since World War II, is expected to result in followup purchases of compact solid state scanning radars by commercial and overseas customers as well as the military.

Reflecting the increasing emphasis on tactical weapons, the Air Force Systems Command's Electronics Systems division at Hanscom Field, Mass., has created a separate organization strictly for tactical systems. At the same time, the Mitre Corp.—the engineering systems adviser to ESD—is planning a new tactical division.

Under consideration are programs for further development of solid state Tacan navigation systems, and in the advanced planning stage are proposed techniques to modify loran systems to serve tactical requirements.

To meet surveillance needs, more work on lasers and infrared sensors can be expected. And purchases of communications gear will include more lightweight, mobile equipment of tropospheric-scatter, single sideband, vhf and uhf types.

Army

For the Army, 1967 is the year of the computer. Besides buying a number of computers to process and distribute messages, the Army will continue three big programs to automate the battlefield—a move the service began preparing for 10 years ago.

These programs are:

- The Tactical Operational System (ros) to provide field commanders with quick intelligence and logistics information and to handle fire control. It will consist of computers and electronic displays tied in with a field army's organic communications. The Control Data Corp. will build a breadboard model of ros from off-the-shelf equipment and this summer will deliver it to the Seventh Army in Europe for extensive testing.

- The Army's Combat Service Support System to test the feasibility of using an automated system on a time-sharing basis in the field to handle logistics and personnel records. The breadboard system will first go to Fort Hood, Texas, for tests, and then overseas. Industry bids on the breadboard model will be received some time this month.

- Tacfire, a research and development program aimed at automating combat artillery functions, including an entire artillery mission from receipt of target information from a forward controller to the firing of an artillery piece. Specifications will be released to the industry for bids before July.

Army officials consider this year's move toward automation very significant. Harold Silverstein, a special assistant to the Army's chief of communications-electronics, notes that in addition to increased use of computers there is a trend toward audio-visual presentation of data in command and control operations, management information and training.

Such equipment will one day be commonplace, Silverstein says. "The new generation of soldiers and officers being brought up on television and other electronic aids to education will find the

audio-visual format more familiar and easier to grasp" than the technical-manual approach.

The official adds that "the big investment in strategic, long-haul communications in Southeast Asia and other areas will continue." Not only are more large terminals and new links being built in Thailand and South Vietnam, but the network in the South Pacific is being upgraded. Data terminals, switches and high-capacity radios will be frequent items on the Army's shopping list.

Tactical communications will be a big market as Vietnam war needs grow. There is also a push to improve air-ground communications in Vietnam [Electronics, May 16, p. 101].

Mortar-locator radar to calculate the source of enemy fire by monitoring the trajectory of shells represents a big effort this year. The General Electric Co.'s AN/MPQ-4A radar is being upgraded to improve performance and ease of maintenance, and a competition is under way among IRT-Gilfillan, Inc., a subsidiary of the International Telephone and Telegraph Corp., Emerson Electric Co. and GE to develop a radar that can scan in all directions.

More emphasis will be placed this year on tying in ground-based radar with computers and voice data links to direct air attacks when visibility is poor. Two such systems are being used successfully in Vietnam now and an improved model to replace both is in the works. The Marine Corps is using GE's AN/TPQ-10 and the Air Force is using the AN/MSQ-77, a modified version of the MSQ-35, which was originally built to score practice bomb runs for the Strategic Air Command by Reeves Instrument Co., a division of the Dynamics Corp. of America. The Marine Corps and the Air Force hope to come up with a single system, to be called the AN/TPQ-27, to satisfy the needs of both services.

Pilots of helicopters ferrying troops need devices to help them locate landing zones in poor visibility conditions. Among the approaches being tested are radio homing beacons to indicate to the pilots when they're over a landing zone, and beacons to indicate the perimeters of camps. Hyperbolic grid navigation systems such as loran C and D are also being considered.

Development of a new system to control air traffic over a field army will probably get started this year. Called Safoc, for semiautomatic flight observation center, the system will consist of four principal parts: radar or a hyperbolic navigation system to determine aircraft position, a data link between the aircraft and a ground station, a computer, and displays. Except for the data-link subsystem, the Safoc is almost identical to the Army's Missile Master fire-distribution system.

Designs for terminals for the tactical communications satellite now being developed by the Army Satellite Communications Agency are still being studied by a three-service executive group but should be given to industry next month. The terminals will take a number of forms; they will be used on aircraft, ships and ground vehicles, and will be carried and set up by three-man teams. The

smaller the antennas, the more acceptable they will be; probably the biggest allowable will be six feet in diameter. They will operate in the ultrahigh-frequency or super high-frequency bands.

New ways will be considered this year to reduce equipment failure rates and maintenance costs. In this regard, the Defense Department will award contracts in May for the development of three items similar to, but sturdier than, existing equipment. The items are: a radio similar to the AN/VRC-12, the jeep-mounted vhf/f-m radio so popular in South Vietnam; a radio similar to the AN/ARC-34, a vhf command set used in several types of aircraft; and a personnel-detection radar similar to the AN/PPS-6 being developed for the Marine Corps.

Two types of manpack receivers for the loran C navigation system are being evaluated. The system is designed to help the foot soldier avoid getting lost or making dangerous excursions through enemy territory, and also to help a unit's forward air controller to get to the right spot to direct incoming planes.

The Army will continue to test every approach to improve surveillance techniques. A newly outfitted Mohawk surveillance plane that will carry side-looking radar and low-light-level television is in the works.

A prime contractor will be selected in May for SAM-D, an Army project to develop a surface-to-air missile to defend both civilian and military installations against low- and high-flying aircraft and short-range missiles.

SAM-D batteries will be mounted on tracked or wheeled vehicles and will be accompanied by a multifunction phased-array radar.

Navy

Research, development, testing and evaluation of antisubmarine-warfare techniques and equipment have been costing the Navy about \$330 million a year, and will, if anything, be expanded this year. Again the emphasis will be on improved sensors, weapons, and command and control systems. The trend toward using aircraft to search for enemy subs, rather than surface ships or submarines, will increase. Hardware procurement for the A-New command and control system, designed initially for use in the P-3 aircraft, will begin at the end of this year and reach a peak in early 1968 [Electronics, Dec. 12, p. 184].

One of the major decisions the Navy will make this spring concerns the number of F-111B's it will buy. Under its original contract with the General Dynamics Corp. the Navy is already committed to take 24. The plane is heavier than the Navy would like for carrier operations and costs are running far higher than originally expected.

Two new Navy planes are just getting into production: the Ling-Temco-Vought A-7 subsonic attack plane and North American Aviation, Inc.'s OV-10A, a prop-driven, "low-and-slow" ground-support and reconnaissance plane for use in anti-guerrilla warfare. Both aircraft are being bought by

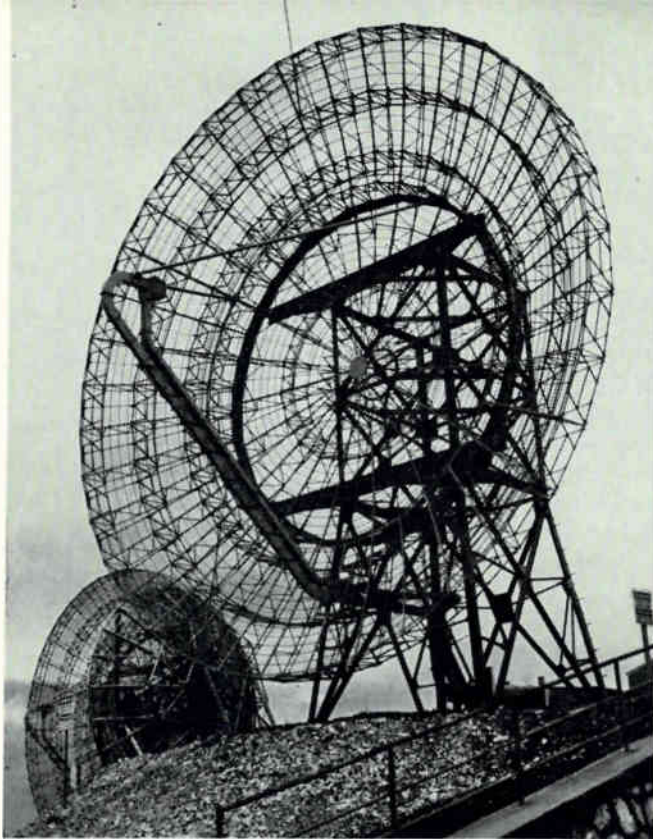

Tropo terminals in Turkey, built by REL division of Dynamics Corp. of America, link Air Force operations in Europe and the Middle East with the rest of the world.

the Air Force, too. The Navy OV-10A order—for the Marines—is expected to amount to some 100 planes costing about \$300,000 each.

In the design and development stage is the EA-6A electronic warfare aircraft. Grumman recently got a \$12.4 million contract for the prototype, and Airborne Instrument Laboratory, a division of Cutler-Hammer, Inc., is contractor for the electronics.

Still in the in-house study phase is the VFAX, a new generation fighter-attack aircraft that would replace the F-4. The Navy would like to see contract definition work funded in the fiscal 1968 budget. The project, as with the F-111, probably will be subjected to an attempt to achieve commonality with the Air Force's FX studies, from which a multiservice, multimission plane would be expected to emerge.

The Navy also wants to push its vsx, an advanced antisubmarine aircraft, into contract definition in fiscal 1968, but this request is still unsettled. The Pentagon is making a cost-effectiveness study of all elements of the antisubmarine force, such as land-based patrol craft, hunter-killer submarines and fixed-base active and passive ranging and listening devices.

In the tactical-missile field, the Maxson Electronics Corp.'s Bullpup and Texas Instruments Incorporated's antiradar Shrike are being used extensively in Vietnam, and increased production of both can be expected. The Shrike, however, has not fully lived up to expectations, and the Pentagon has awarded General Dynamics a contract to develop a weapon called the interim ARM, or antiradiation missile.

The Navy is also moving into electro-optically guided air-to-ground weaponry. The Walleye, a 1,000-pound guided bomb, has recently gone into production at Martin Co., a division of the Martin-Marietta Corp. And North American Aviation is developing the Condor, a tv-guided missile with a standoff range of about 40 miles; it will be carried by the F-111B and the A-6.

Honeywell, Inc.'s Asroc is the Navy's principal surface-to-underwater antisubmarine weapon. Outlays will be continued for development of a follow-on antisubmarine missile compatible with Asroc's launching and fire-control systems.

The principal development in the surface-to-air-missile field is the General Dynamics Standard, which is to replace the Tartar and Terrier. The Standard MR, with a range of 10 nautical miles, will supplant the Tartar, and the Standard ER, with a range of 30 nautical miles, will replace the Terrier. First funding for production is contained in the fiscal 1967 budget. General Dynamics is providing its own semiactive homing guidance system for the weapons.

Another ship-defense system being developed with fiscal 1967 money is the point defense surface missile. Preliminary tests using the air-to-air Sparrow as a ship-based system have been successful, and the Navy thinks the Sea Sparrow air-defense system will be ready soon for its line ships as well as auxiliary craft. Existing Sparrows will be used with some components from the Army's defunct Mauler system.

Looking to the future, the Navy is carrying on research and development on an advanced surface-to-air missile system. Precontract definition work is being done by the Boeing Co., GE, Raytheon, the Radio Corp. of America, the Hughes Aircraft Co., the Sperry Rand Corp. and the Westinghouse Electric Co. However, this project called ASMS, will be kept in the design stage until it can be determined, probably in 1967, how much commonality it has with the Army's SAM-D antiaircraft missile. The Navy is also exploring possible shipboard mounting of the Army's surface-to-surface Lance to provide a new short-range bombardment capability.

In the ship field, there are these developments:

- Defense Secretary Robert S. McNamara's decision to move ahead with construction of a second nuclear carrier now that reactors are more economical. But the Secretary is holding back on nuclear-powered frigates and other support vessels.

- The Navy's decision to buy the fast-deployment logistics ship on a total package basis, farming out design and the entire production run to a single shipyard. The Lockheed Aircraft Corp., General Dynamics and Litton Industries, Inc., are competing in the contract definition phase for this award, which eventually may run to \$1 billion.

- Just getting under way are plans to procure, on the same basis, the biggest thing yet in amphibious assault ships, a new type to be known as Lhas. This vessel will be able to put 1,800 troops ashore by both helicopter and landing craft.

Color tv projects a bright picture as capacity catches up with demand



Sales of color-television sets almost doubled in 1966 to provide a strong boost to the over-all consumer electronics market. However, with set makers plagued by shortages of components, material and labor, color-tv volume fell short of predictions for the year. Producers sold about 4.7 million sets in 1966, up from the 2.6 million units of 1965 but off from the 5.5 million forecast. Undaunted by this, however, the industry is back with even more optimistic predictions for 1967.

The most bullish sales forecast comes from the largest producer—the Radio Corp. of America. Delbert L. Mills, RCA's executive vice president for consumer products, puts the color-tv industry's volume this year at nearly 8 million sets. A more cautious forecast of 7 million unit sales comes from Walter C. Fisher, a Zenith Radio Corp. vice president, while Asher Cole, president of the National Video Corp., hedges a bit. "Only if the economy gets too heated up and there is a recession could the 7-million-to-8-million target be missed," he says.

For set makers, the major difference between 1967 prospects and 1966 results is one of capacity; these companies are in the final stages of the most ambitious expansion ever undertaken by a consumer industry. RCA says that with the completion of new facilities this year, its color-tv capacity will be triple what it was in 1966, while National Video expects to be able to produce 1.7 million color tubes this year, up sharply from about 1 million last year. National Video predicts that total 1967 industry production this year will climb to between 8.5 million and 9 million tubes from last year's 5 million.

Growing market

Color-television volume of \$1.3 billion this year will help lift the over-all 1967 consumer electronics market to a \$3.6 billion level from the estimated \$3.4 billion of 1966, according to Electronics magazine's annual market survey.

Other segments of the consumer-products industry are also predicting 1967 sales gains. For example, Wybo Semmelink, assistant vice president of the North American Philips Co., forecasts a 20% rise in tape-recorder sales this year from the approximately 4 million units sold in 1966. He further asserts that the tape-recorder segment of the consumer market is second only to color television in current rate of growth.

Auto tape-cartridge stereo systems posted a \$16 million sales increase last year from 1965 and,

as home products, will make an even stronger advance this year. Electronics magazine's survey predicts that sales of these systems will surge to \$131 million in 1967 from \$114 million in 1966.

Although sales of black-and-white television sets have been declining, they are still the second most important factor in the consumer electronics market and are forecast at \$667 million this year. Phonograph volume has leveled off; a \$470.8 million total is expected this year, barely topping the \$470.2 million of 1966.

Solid state slowdown

The advent of color tv has had one adverse effect: most observers agree that it has slowed the electronics industry's general shift to solid state components. Bernard T. Marren, manager of consumer products for the semiconductor division of the Fairchild Camera & Instrument Corp., attributes this slowing effect largely to the power requirements of color television. He explains that while there are power transistors available that can handle the 26,000 volts needed in a color-tv set, their prices aren't competitive with those of tubes.

Concurring in this observation that color tv has slowed the move to solid state, Clarence Bruce, manager of consumer marketing for Texas Instruments Incorporated's Semiconductor division, declares: "There's been a tremendous amount of engineering research but little conversion to solid state. We'll see some changes in 1967, but the full impact (of the trend to solid state) is some 18 months to two years off."

However, Bruce expects the marketing of more hybrid black-and-white tv sets this year, with makers introducing units with solid state tuners, picture i-f and automatic gain.

Mills of RCA says his company will soon introduce a completely transistorized, 9-inch black-and-white set and will also market a 15-inch color set containing a few transistors. The color set was originally slated for introduction last year. The executive adds that he expects to see many more hybrid sets in 1968.

The subject of integrated circuits in color tv is one that set makers approach with caution. Arthur L. Reese, executive vice president and general manager of the consumer products division of Motorola Inc., asserts that ic's are currently more of a promotional gimmick than anything else. Mills tends to agree, but holds that the use of ic's in color-tv equipment depends on marketplace requirements. "We have our homework finished and

can put them in," he comments.

Bruce says π expects to have ic's ready for color sets before the end of 1967 at prices equal to or under those of present components. Marren says Fairchild's semiconductor division this year will introduce a sound i-f integrated circuit and an amplifier circuit that makes it possible to integrate the whole sound stage of a tv set. (RCA put an i-f circuit in its top-priced color set of 1966.)

Used in only a handful of consumer products now, ic's will widen their penetration of this sector in 1967. The Westinghouse Electric Corp. will market a phonograph in which an integrated circuit replaces all electronic components. The General Electric Co. and the Philco-Ford Corp. already make radios containing ic's, and GE has also used the devices in the audio amplifiers of a phonograph, an eight-track cartridge tape player and a portable tv set. H.H. Scott, a producer of hi-fi equipment, recently introduced ic's in f-m tuner amplifiers.

Manufacturers of solid state components are making a big effort to develop products for the appliance market as well as for tv sets. Utilization of these devices in this area is still slight, but business is picking up in the small-appliance field and some solid state components are finding their way into large appliances.

Silicon control rectifiers are being used in such small appliances as power tools, home blenders and home light dimmers. As Marren notes, "Solid

state is a natural for low-cost and low-power small appliances."

Philip Thomas, manager of π 's assembled functions unit, sees increased use of solid state components this year in food mixers, power tools and floor polishers. He further predicts the conversion to solid state of 50% of the speed controls for the appliance market by 1968.

Solid state devices are now being used as variable-speed controls in washers, electric timers in dishwashers, moisture sensors in dryers and ignition systems in gas ranges. Whirlpool Corp. is reportedly readying a washer using ic's for Sears, Roebuck and Co., and a solid state ignition system built by Wilcolator Co. is slated to appear in more range lines and in three manufacturers' water heaters. Scr's will be introduced in motor controls for air conditioners and refrigerators.

Over-all, manufacturers of solid state devices see rapid growth this year in all sectors of their consumer market. Fairchild estimates that 1966 industry sales of consumer solid state components came to \$98 million, with silicon devices accounting for \$45 million of the total and germanium devices the rest. Fairchild forecasts 1967 industry volume of \$118 million, of which silicon components would have a \$70 million share. Texas Instruments sets its sights a little lower, putting the 1966 market at \$80 million and predicting a rise this year to \$110 million.

Components

Demand continues strong



Business was so good for component manufacturers last year that at times they were hard put to keep track of the orders, which amounted to a total of \$6.2 billion. And there's no slackening of pace in sight, with sales of \$6.8 billion forecast for 1967.

The major markets have been created by the heavy demand emanating from the success of color television and computers, plus the rocketing military budget.

But component manufacturers have problems. They face shortages of materials such as copper that, along with the sheer volume of orders, have caused slowdowns in delivery of products. One sector of the market that has been affected is capacitors, with anticipated sales of \$462.1 million this year. Customers have to wait for eight to 12 weeks for delivery on some types of capacitors.

The increased demand for high reliability has been another one of the major market factors, resulting in increased sales for items such as glass capacitors to the military, and opening up the com-

puter market for products, expensive tantalum capacitors for example.

Tom Yost, manager of market planning for Corning Glass Works, says: "Computer manufacturers are using tantalum capacitors because they withstand high temperatures better than aluminum types previously used. They also withstand higher surge currents and higher ripple levels and work well in low-impedance transistor circuits."

Superior temperature performance, along with stability, is also giving a boost to metal films, one of the fastest growing segments of the resistor family. Joseph P. Coughlin, director of sales for IRC, Inc., says they are in demand for precision instrumentation and digital circuitry.

Resistors are a growing segment of the component market with sales of \$401.8 million forecast by Electronics magazine for 1967, up from \$388.3 million in 1966.

Along with films, another rapid growing area is cermet resistors. Sales, which were negligible a

few years ago, climbed to about \$25 million in 1966. The big demand is in the computer business, where their small size, stability and adequate tolerance, plus their compatibility in the processing of modules, makes them especially desirable.

One specter that confronts the component manufacturer is the integrated circuit. That this is a justifiable worry can be amply documented. For instance, most operational amplifier manufacturers are now recommending that designers consider ic's for circuit applications that don't have stringent requirements. The reason is price. In another case, ic's are not only replacing components in power supplies but are creating a demand for more accurate component tolerances. Says William

McNeil, general manager of Micon Electronics, "Integrated circuits will be the death of sub-miniature radio-frequency connectors because the ic's will eventually replace the components that use this type of connector."

But component manufacturers only have to look as far as tubes to assuage some of their worries. Receiving tubes were replaced by transistors in many applications. Nevertheless, last year tube sales were higher than ever, at \$274 million, and they will be up to \$283 million in 1967. One big reason is a new market, color television.

Coughlin says continued gains in the over-all economy point to the continued growth of component sales.

Medical electronics

Heading for a \$266-million year with basics and automated time-savers



The market for medical electronics will continue to grow in 1967 and, based on Electronics magazine's market survey, should increase about 13% to \$266.2 million. Yet in an area of such vital concern and such potential for sophisticated electronics systems, it is noteworthy that the largest segment of the market is still maintained by X-ray equipment and hearing aids—two important, but less than revolutionary devices.

However, hospitals are seeking more modern electronics systems to help shoulder the increasing burden that Government programs such as medicare are placing on their facilities, and to help offset an acute shortage of trained medical personnel. Much of the electronic gear to be installed in hospitals this year will be aimed at relieving some of the work load on staffs.

Hospital test laboratories have long been a bottleneck but now the first wave of automated aids are being used to improve the efficiency of available personnel. Technicon Instruments Corp. has installed 80 of its 12-channel Autoanalyzers since last May, and Warner-Chilcott Laboratories Inc. is taking orders for its Robot Chemist, an automated chemical analyzer. Hycell Corp. reports that some 200 groups has shown interest in leasing Mark X automated analyzer.

X-rays televised

Radiologists, too, are seeking more efficient means of dealing with their procedures. Video tape recorders are being employed by some institutions for a rapid preview of X-rays before films are developed, and closed-circuit television is being



Automatic liquid sampling device provides test results in computer format for Technicon's Autoanalyzer. The reader in the system is built by IBM.

used to transmit X-rays. Tv monitors enable radiologists to tilt the patient's table and move the X-ray machine with remote control systems. "The coupling of television and radiology," says John A. Reynolds, vice-president and technical director of medical products for the Picker X-ray Corp., "has probably done as much as anything else to increase the speed in handling patients and the scope of diagnostic procedures."

Monitoring patients

Tools that extend the reach of doctors and nurses is, according to James Reeves, president of Spacelabs Inc., "creating a strong trend toward better mechanization in medical care." Reeves expects enormous expansion in the next five years as equipment becomes available for a market now ready for reliable and dependable equipment. Spacelabs will soon introduce intensive-care equipment for coronary patients based on experience gained on a job for the National Aeronautics and Space Administration. The monitoring equipment is being installed in two California institutions, Sherman Oaks Hospital and Valley Presbyterian Hospital.

Monitoring systems are also being built for hospital operating rooms. One large installation is being made by Statham Instruments Inc. with the National Institutes of Health for a cardiovascular research center at Methodist Hospital, Houston. The project, now in its initial stage, will ultimately include cardiovascular monitoring equipment for eight operating rooms and 50 intensive-care diagnostic units in the hospital. A set of analog and digital displays will assist the surgical team in

making a rapid judgment of a patient's condition and also will supply predictive measurements.

Governing factor

The agencies of the Federal Government are central to the development of medical electronics. The military, the Public Health Service and the Food and Drug Administration are examples of Government organizations that not only purchase equipment but effect developments that stimulate purchases by others.

At the Public Health Service, engineers and doctors are working on computer analysis of electrocardiograms. Work has progressed to the point where the technique is acceptable for clinical use. "Eventually," declares Dr. C.A. Caceres, chief of the agency's Instrumentation Field Station, "the computer will bring the diagnostic abilities of specialist to the individual's bedside." Once the system goes into general use, physicians will be able to spend less time reviewing normal ECG's and be free to concentrate on the difficult ones.

The FDA feels that electronic instrumentation is a natural for insuring product quality and uniformity, according to Robert T. Myers, industrial product manager of Picker X-ray. He says the FDA is pushing such techniques and that this should foster rapid growth in the market.

The American Instrument Co. has developed a device for the CIBA Pharmaceutical Co., a division of the CIBA Corp., that automatically processes solid drug products into solution and analyzes them in an ultraviolet monochrometer. The instrument can perform up to 2,000 assays per day and is used to insure content uniformity.

Instrumentation

Widening range of applications boosts sales of instruments



Higher sales and wider applications in 1967 characterize the expanding perimeters of the test and measuring instrument market. The Electronics' survey envisions a \$80.8 million rise in the market to an estimated \$650.8 million in 1967.

The oscilloscope with its numerous uses will again lead the field in sales, and one manufacturer, Tektronix Inc., sees a better year in 1967 than last year when sales jumped 25% from 1965. Byron Broms, corporate planning manager for the firm, reports that the computer industry will again be the biggest customer for Tektronix oscilloscopes. Manufacturers of scopes will also benefit from the increased use of the instrument in automation, process and machine controls and color television.

Increased use of integrated circuits in the manufacture of counters will stimulate that growing market even more. Jack Salvador, engineering director at Computer Measurement Co., says, "All major counter manufacturers are planning to increase their use of IC's in the next 12 to 24 months. Integrated-circuit construction will make possible lower costs and the expansion of current market applications."

"In addition, the use of IC's will permit smaller instruments to do a better job than their big brothers," states Michael Dow, manager of Aerojet General Corp.'s Aerometrics division. Aerometrics is marketing a line of electronic counters measuring 9 by 3 by 9 inches, and weighing less

than 7 pounds.

Ivan Easton, vice-president of the General Radio Co., reports, "People today want a complete package deal. They know what they want to measure and they say 'give us a system to do the whole business.' Now measuring systems costing \$20,000 to \$30,000 are being shipped. During 1967 we'll be shipping systems that will include small general-purpose computers as an integral part of the package."

The Vietnam war is, of course, having its effect on the instrument market. Many oscilloscopes, digital voltmeters and other test and measuring instruments have been sold for military applications. But, says Allan Dallas, director of marketing at Honeywell's Denver division, most instrumentation sales are to engineers, and it is hard to find out the actual use.

There are some drawbacks to the increased sales spurred by the war effort. "Government buying is now putting the pressure on the production area of the market at the expense of development," states Dallas. "We're getting orders for older equipment; we received one large order from the Army's Redstone Arsenal at Huntsville, Ala., for instruments that we had stopped making and a similar one from Kelly Air Force Base at San Antonio, Texas. If the Vietnam conflict ended tomorrow and the government put money into post-Apollo applications and research grants, we would be in a sounder position," Dallas says.

Manufacturers are also having problems because of material and component shortages.

Another development in counter technology is the push toward direct reading capabilities at 12.4 gigahertz and above. "This," says Salvador, "should make counters the primary source for radar communications work."

Buyer demands more

The instrument industry is getting a hand from a surprising new source—the discriminating buyer. The public's growing awareness of reliability, says Robert T. Myers, Picker X-ray Corp.'s industrial product manager, "has made it necessary for manufacturers to allocate much more money to provide the means for nondestructive testing. Prior to the public outcry for a quality product, capital appropriations for nondestructive testing devices was minimal." Myers sees a high growth rate in the coming years for the equipment because of the development of vast new markets.

Ultrasonic, X-ray and gamma-ray test and measuring instruments are finding their way into the tire, cigarette, consumer appliance and pharmaceutical industries as manufacturers see that product quality justifies spending money to buy sophisticated electronics equipment for nondestructive testing. For example, Picker recently installed X-ray inspection systems that enable tire manufacturers to detect voids and tears in treads and pipe makers to locate flaws in the welds on pipe sections.

Instrument companies are now eyeing the sys-

tems market. Honeywell Inc., for example, has combined individual products such as sensors, amplifiers and oscillographs into a complete measuring system for the diecasting industry.

"The copper shortage has delayed the delivery of transformers," says Computer Measurement Co.'s marketing director, Nyal McMullin. "Deliveries are also being pushed back on computer-grade capacitors, and in some cases 40-week deliveries are being quoted for certain tantalum capacitors," he complains.

There are some who feel 1967 will bring tougher problems and that growth will be more difficult. John Fluke, president of John Fluke Manufacturing Co., says his firm shipped test and measuring instruments valued at \$9 million in 1966, an increase of 50% from the previous year, but the company's backlog of orders changed very little over the year. "This, coupled with the tight money situation, will slow the rate of growth," Fluke asserts.

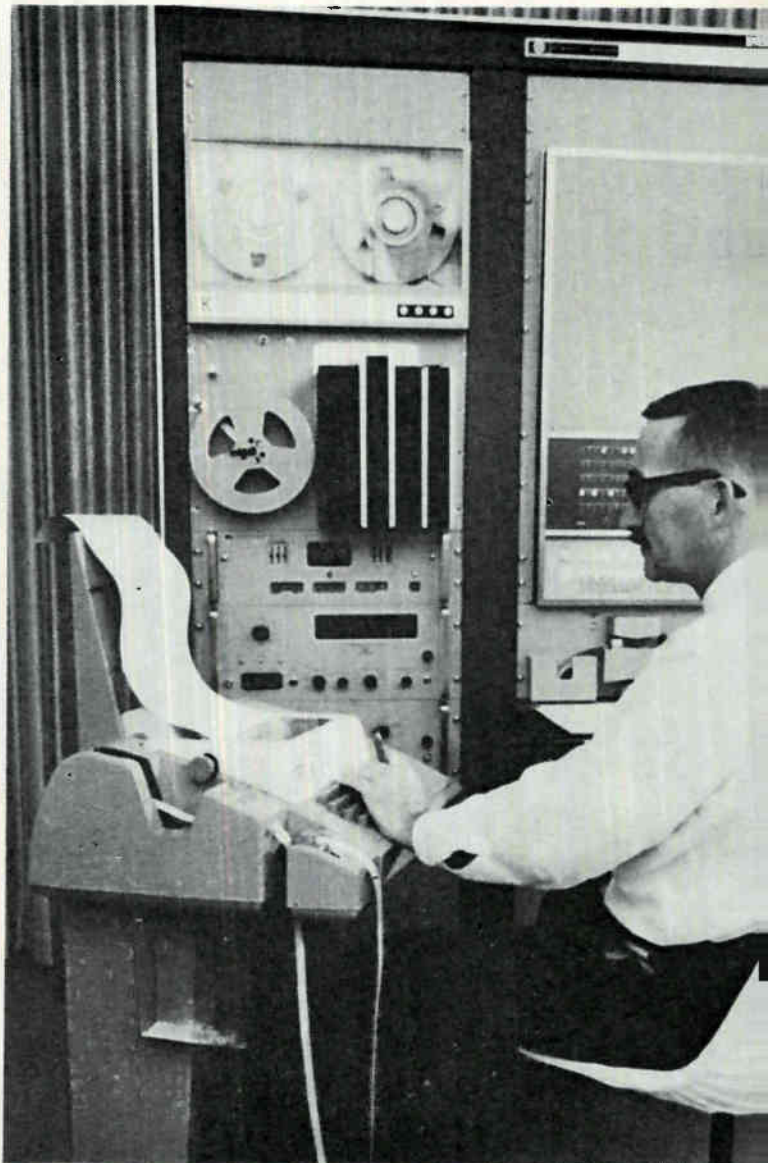

Computerized measurement systems, such as Hewlett-Packard's digital acquisition system, form a growing segment of the instrumentation market.

Stress is on safety as avionics sales continue to climb



In avionics, the accent this year is on greater safety and efficiency. The Federal Aviation Agency, which will spend an estimated \$100 million on electronics equipment this year, is continuing to develop and install a national airspace semiautomated air-control system, though its efforts in 1967 will do little to clear the increasing congestion over airports. When finished in 1970, the system will include 21 centers, each costing between \$12 and \$16 million. Operational tests for the first center will begin in Jacksonville, Fla., in June.

In the landing-aids program, supported by the FAA, the airlines are installing Category II equipment, which allows commercial carriers to operate when runway visibility is only 1,500 feet and the ceiling a bare 100 feet.

Airlines are qualifying pilots for Category II and airports are being outfitted with the equipment. This means large outlays by the airlines for flight directors, radio altimeters, autopilots and related equipment. The FAA has not set the requirements for certification for Category III, the third and final stage of the program, but the airlines are buying Category II equipment in the belief that most of it can be expanded to meet Category III standards.

Eventually landings will be made with runway visibility of only 150 feet.

Efforts are also under way to find a solution to another problem—crowded skies. Several collision-avoidance systems are being developed, but only the McDonnell Aircraft Corp. has flight tested a model. The Bendix Radio division of the Bendix Corp. is working on another possible solution to air traffic congestion, an off-course analog computer navigation system. It would direct aircraft to very-high-frequency-omnirange phantom stations, thus relieving congestion among actual navigation stations. The phantom stations, in effect, would establish a parallel network to the present paths between omnirange stations.

Commercial aviation is also adopting inertial guidance navigation, long a favorite of the military. A digital computer navigation system with an inertial platform is being installed by Pan American World Airways Inc. to provide navigation and guidance information. The Sperry Rand Corp., which built the Pan American SGN-10 system, has an order from Italy's Alitalia Airlines, and other commercial and general aviation companies have expressed interest.

The development of airborne computer systems and the success of integrated circuits in military avionics have spurred the installation of IC's in commercial aviation avionics. The circuits are now extensively used in air-data computers, inertial platform control systems and radio receivers. This year, IC's will be introduced into ground support equipment by Bendix and the Radio Corp. of America, among others.

Military and space projects have long dominated the automatic test equipment market. But in 1967, large outlays will be made for commercial applications of automatic test equipment. The Boeing Co. recently issued a request for proposals for an automatic test equipment system for its own factory. The airlines are also a potential customer for automatic testers. Rapid, accurate testing at repair facilities means quicker turnarounds for aircraft and more time in the air. According to Jack Underwood, program manager for test equipment at the Aerospace division of RCA, "Boeing is the ice-breaker; whoever gets this job will have an edge over the others in supplying test systems to all the airlines that buy Boeing jets."



Sperry's SGN-10 is the first inertial guidance system for airliners. Technician checks the gyro reference unit for flaws.

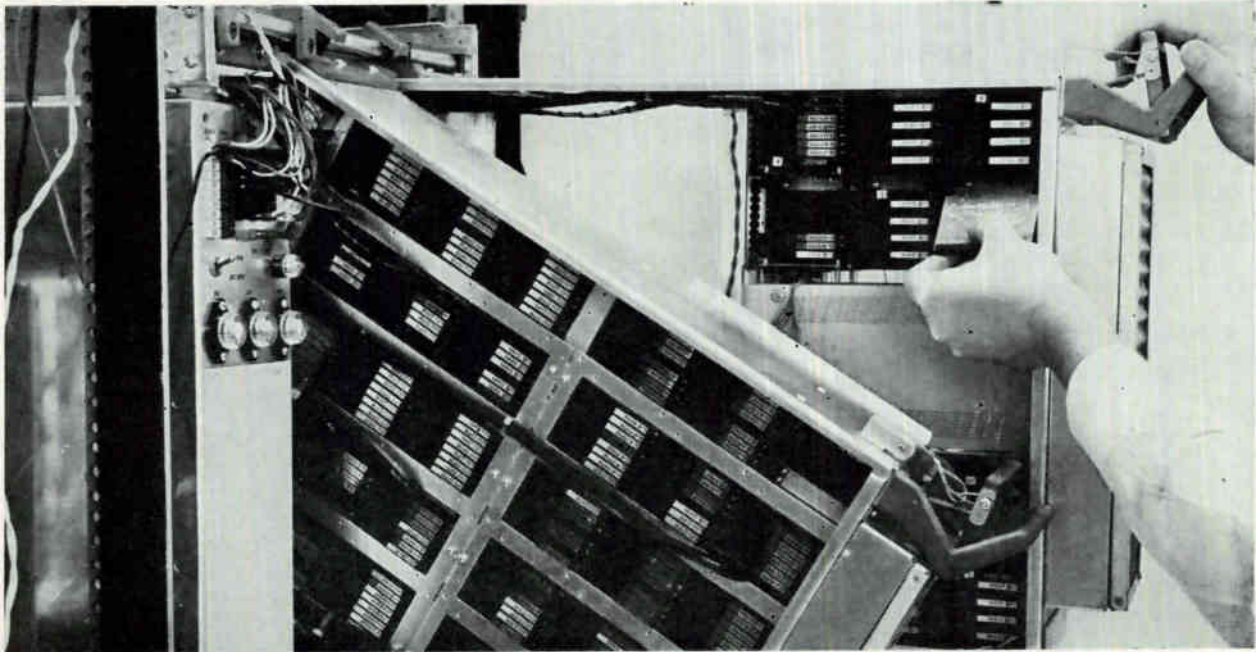

Tilt-out chassis units provide easy access to logic modules and wiring in Honeywell's new DDP-516 computer. The computer is built from integrated-circuit logic modules and uses Honeywell's standard IC core memory assembly.

Computers

Manufacturers scramble to expand as computer boom continues unabated



"A bottomless well," is the way one happy sales manager describes the demand for his company's new scientific computer. "We're making them as fast as we can, but if we had twice as many people in the plant it wouldn't be fast enough."

Nationally, the demand for computers may not be bottomless, but it is so great it has created an impressive growing market. Computers and related equipment are estimated at more than a \$2.4 billion market in 1967 by Electronics—an increase of \$281.5 million over 1966.

The Electronics survey also estimates that by 1970 the market will reach \$3.5 billion even though a drop of 10% in Government buying is anticipated during the period. An agency is now required by Public Law 89-306—called the Brooks bill—to seek unused computer capability at another department before buying new equipment.

To keep up with the current demand, computer companies are expanding production and engineering facilities. Honeywell Inc., for example, is doubling the size of its engineering laboratory in Waltham, Mass.

Other expansions include the Univac division of the Sperry Rand Corp., the National Cash Register Co. and Scientific Data Systems Inc.

"We expect to be a solid number two in the

computer market during 1967," says Robert P. Henderson, vice president for marketing in Honeywell's electronic data processing division. "But we are taking very little business from our competition. In fact we are often going in alongside his equipment—adding to it instead of replacing it." For the first time Honeywell is boasting that its data processing division is profitable.

The Hertz of the computer industry is, of course, the International Business Machines Corp., which has about 70% of the computer market. The company's multibillion dollar gamble—the IBM System 360—has already won about 30% of the market.

No one size of computer dominates the market—even the System 360 comes in nine sizes. Big businesses still favor large central processors, such as the Univac 1108 and General Electric Co.'s 635. Most large computers now can be time-shared by branch offices.

Time-sharing systems are usually private ones—the often-predicted huge-computer utility is still in its infancy. However, several companies—GE, for one—are servicing remote customers with present computers and RCA is planning a large, time-sharing version of its Spectra 70.

The newer computers perform so much better than their predecessors that many companies are

finding the intermediate sizes adequate. If the company requires time sharing, however, it's more likely to need the greater capacity of a larger machine. Sales of desk-top scientific computers are skyrocketing. The Digital Equipment Corp., for instance, has sold about 300 of its new \$10,000 PDP-8/S. And DEC says that the model has even increased its sales of larger computers. The potential customer, says DEC, finds that the small computer is not quite big enough and buys a larger model.

A time for consolidation

"Computer performance has increased 1,000 times over the past 10 years, but the next factor of 10 is nearly impossible," is the way computer technology is viewed by Max Palevsky, president of Scientific Data Systems.

"Computers today operate at speeds approaching the speed of light. To attain a small increment in performance now requires a great deal of work by many highly skilled people," he explains.

Evolution, not revolution, is expected by most system planners. For example, parallel processors—numerous small computers working together at a higher total speed than one big one—are too costly now for everyday use. Large-scale integration, an evolutionary step from present IC's, is expected to break the cost barrier. The multicircuit IC chips now in mass production are the first stepping stone.

"Hybrid IC's are dead in computers," says Donald Eckdahl, vice president and general manager of National Cash Register's electronics division. "And so are tunnel diodes and cryotrons. The semi-

conductor firms have left hybrids in their wake."

Hybrids, however, will be around for a while by sheer momentum. They are the basic ingredient, for example, in the System 360, which IBM isn't going to revamp overnight.

In high-speed memory technology, interest is increasing in thin films. Most thin-film memories contain only a few words for local high-speed access, but the Burroughs Corp.'s new D-830 and B-8500 models have thin films holding thousands of words. Large rod memories, a form of thin-film memory, are being used routinely by NCR, and Sperry Rand has big plated-wire memories for its new Univac 9000 series. Nonetheless, core memories continue to be lowest in cost and are continually getting faster, bigger and more compact per bit. They are still the dominant form of large memory.

Role growing

In the mid-1950's peripheral equipment was about 20% of system cost. Central processors have since become so much larger and able to service so many extra terminals that peripherals now exceed 50% of system cost. The card readers, tape drives and typewriters are being joined by visual displays, voice-response machines and other new classes of man-machine interfaces.

Electronic output may soon replace high-speed electromechanical printers and the filming of cathode-ray-tube-displays. Recently, the Xerox Corp. announced a low-speed electrostatic printer driven directly by a computer. One expert says such developments could in the next two or three years spell the doom of electromechanical printers.

Communications

Expanding markets seen for telemetry, mobile radio, microwave and tv gear



The electronic communications market will be marked this year by gains in sales of telemetry gear, mobile radios, broadcasting equipment and microwave systems. Another factor of increasing importance in this field is the vast data communications network taking shape in this country to link computers through common carrier facilities and private microwave systems.

Telemetry sales in 1967 will spurt to about \$181.7 million from last year's estimated \$160.4 million, according to Electronics magazine's survey, and the industry says the increase would be even greater were it not for Vietnam war costs.

Large amounts of telemetry equipment will be procured for the Apollo program as well as for the National Aeronautics and Space Administration's unmanned-satellite projects. In addition, the Air

Force Systems Command's Space Systems division will be outfitting ranges for its Manned Orbital Laboratory project.

E. Wayne Copeland, marketing manager for the data communications section of the Bendix Corp.'s Electrodynamics division, estimates that ground equipment accounted for more than 60% of the 1966 telemetry market, with about 50% of this ground-gear outlay going for decommutators and discriminators and about 30% for such equipment as decoders, signal conditioners and buffers.

The use of pulse code modulation systems will continue to grow, though Jim Terry, senior applications engineer in the analog department of Electro-Mechanical Research Inc., Sarasota, Fla., notes that "if you need fewer than 100 channels, analog is still cheaper." For this reason, industrial tele-

metry presents a strong market for analog systems.

The armed services are proceeding, though slowly, with the shift in their air-to-ground telemetry systems from vhf to L band (1,435-1,535 megahertz) and S band (2,200-2,300 Mhz), a shift slated by the Defense Department for completion by Jan. 1, 1970. Officials of the Air Force Western Test Range say Vandenberg Air Force Base will have initial S-band capability by the end of this year. Rather than adding frequency-conversion gear, they say most of the vhf equipment at Vandenberg will be replaced by S-band equipment.

Mobile land radios

An increasing number of applications are being found for mobile radios, both vehicle-mounted and portable, in consumer fields, urban transportation, and police and other public-safety activities, despite the problem presented by a shortage of frequencies in major metropolitan areas. The 1967 market is expected to rise to \$180 million from the \$170.5 million of 1965.

In the field of urban transportation, efforts by cities to improve dispatching, to combat crime on public conveyances and to generally ensure passenger safety have sharply expanded the market for mobile radios. Last August, the Radio Corp. of America received a contract to equip more than 4,000 buses in New York City, and Motorola Inc. has orders for similar installations in Detroit, St. Louis, and Dallas.

Portable radios are being increasingly used in police operations and paging systems. New York, Detroit and Washington, D.C., among others, are outfitting police with walkie-talkie radios.

With all this, however, the persistent problem of frequency shortage in urban areas may be limiting sales of business, industrial and, to an extent, public-service land mobile equipment. Robert L. Casselberry, manager of product planning at the General Electric Co.'s communications products department, notes that Federal Communications Commission figures show that market growth in urban areas is proceeding at a pace 2% to 3% slower than in rural or suburban areas.

Less affected by this frequency problem are sales of Citizens Band equipment, for which more than 100,000 licenses are being issued annually. Manufacturers are hoping that experiments in the use of communications gear to aid drivers in distress will eventually lead to the installation of CB radios in every car.

The market for CB transceivers of 100 milliwatt power or less—units that don't require licensing—will probably be as big as that for licensed CB radios, says Robert Laub of the Lafayette Radio Electronics Corp., Syosset, N.Y. More than a million transceivers in this category are imported from Japan each year, Laub observes, many of these being toys for children (a far cry from the strung-together oatmeal containers that served as field phones for an earlier generation of kids).

Sales of cameras used in originating color tele-



Demand continues high for telemetry equipment such as the Mobile L and S land tracking system built for White Sands Missile Range by Canoga Electronics Corp.

vision programs and of recorders for color video tape will reflect the over-all color-tv boom. Andrew F. Inglis, a vice president of RCA's broadcast and communications products division, estimates that sales of "live" color cameras accounted for about 30% to 40% of total studio-equipment volume last year, and color video tape recorders about 20% to 30%, with switching equipment, audio amplifiers, monitors and other types of cameras contributing the rest.

"In the next five years," says Inglis, "most U.S. stations will be completely equipped for color." A color-tv studio usually needs two cameras for live programing, each costing about \$70,000. There are about 600 tv stations in the U.S., and RCA says that only 150 of these are equipped to originate color programs.

The over-all market for television-studio gear this year is put at \$130.4 million, up from \$128.1 million in 1966.

The color-camera industry remains divided over the question of the number and types of tubes to be used. RCA produces a four-tube camera using both image-orthicon and vidicon tubes, while GE and the Marconi Co. of England make four-tube Plumbicon cameras, and North American Philips Inc. has a three-tube Plumbicon camera.

Philips claims that the three-tube Plumbicon unit is less expensive, easier to operate and less costly to maintain than any four-tube camera. Furthermore, says Robert Diamond, marketing manager for North American Philips' studio equipment division, a three-tube Plumbicon camera, with horizontal and vertical aperture correction, can produce pictures as sharp as those produced by image-orthicon equipment.

In the video tape recorder field, the trend is to

the so-called high-band units, which record a signal modulated on a carrier that is about 4 megacycles from the color signal's subcarrier.

The Ampex Corp., Redwood City, Calif., is currently the leading manufacturer of high-band recorders, but RCA last November announced that it had units in the final test stage.

Microwave systems

The expansion of common carrier facilities provides a major market for microwave equipment, with the military, as always, a big customer, according to Kerry R. Fox, assistant vice president for microwave and scatter systems at the Collins Radio Co., Dallas, Texas.

Electronics magazine's survey indicates that sales of microwave gear are expected to climb to \$86.3 million in 1967 from \$77.4 million last year.

A trend to private microwave systems may be accelerated by the impending elimination, by Government order, of the American Telephone & Telegraph Co.'s Telpak A and B bulk communications lines, which provide voice-grade channels at economy rates. Users of these two lines are potential microwave-link customers, and AT&T has indicated that it may boost rates on other Telpak lines.

Utilities and railroads are already microwave customers, and a number of other industries are considering private systems to reduce costs or improve communications. For example, Aeronautical Radio Inc., the concern that handles communications for the airlines industry, is currently evaluating proposals for a private microwave system. The broadcasting industry, which has been pushing for a private space-satellite system for television distribution, is another potential customer.

Fixed systems owned by businesses can only operate at frequencies above 12 gigahertz, and Edward J. Hart, a department manager at RCA, notes

that "with the increasing emphasis on data transmission, privately owned microwave systems in the 12-Ghz band should be a growing market."

Regarding data transmission, the linking of remote users to central computers through nationwide communications networks—exemplified by the recent establishment of a computer utility by the Western Union Telegraph Co.—portends greatly expanded markets for such interface equipment as high-speed teletypewriters, graphic displays and cathode-ray viewers.

Walter Bauer, president of Informatics Inc., Sherman Oaks, Calif., predicts that within 10 years a vast computer-utility system will include up to 95% of all computers in the U.S., and that eventually it will control switching, process messages and interconnect entire networks of computers.

James L. Hollis, president of Rixon Electronics Inc., Silver Spring, Md., notes that the computer-communications linkup is boosting sales of data modulators/demodulators, used to transmit and receive data, and says his company expects its 1967 sales of the devices to be at least double last year's.

Customers are still using modems transmitting at 1,200 to 2,400 bits per second, but Hollis indicates that the trend is to higher speeds.

Transmission by higher-speed data modems over the direct distance telephone dialing network is in the offing. Bell Telephone Laboratories Inc., will soon check out a new modem designed to transmit 3,600 bits per second over the direct-dialing network and more than 5,400 bits per second over leased lines.

Western Union expects to offer customers, on a limited basis, high-speed lines of 48,000-kilohertz bandwidth that they can dial into by request. Users will be charged only for time spent on the lines, rather than a monthly fee as with AT&T's Telpak C and D service.

Microwave

Industry seeks new markets as microwave sales climb



Comfortably counting profits after a banner year, microwave companies expect further growth this year although no one expects the boom to continue at the 1966 rate. The huge increase in defense orders that contributed heavily to last year's prosperity may be leveling off, but defense requirements are expected to remain high whether or not there is actual shooting in Vietnam.

"Microwave sales will continue to climb," says Lisle J. Smith, marketing manager of the Micro-

wave Tube division of the Hughes Aircraft Co. "There seems to be a general upward sales trend in the making that should continue for two or three years. Then sales will flatten out, but at a higher plateau than that of several years ago."

The lessons of the military cutbacks of 1964 have been learned and manufacturers have diversified, thus reducing their dependence on the Pentagon [Electronics, Aug. 8, 1966, p. 108]. And in some special areas of the technology, particularly in the

applications of microwave power, markets are beginning to jell.

"We've hit a pretty good level, and I don't expect it to drop," says Richard T. Orth, vice president in charge of Varian Associates' electron tube and device group. "A truce in Vietnam would have some impact on the microwave industry, but the reduction in orders would be small; money not going into bullets would go into surveillance and reconnaissance equipment."

Effects of Vietnam

Burton Silver, marketing manager of the Electron Tube division of Litton Industries Inc., says, "Vietnam is teaching some tactical lessons and we are getting a number of new requirements that stem from the fighting there."

Silver cites as examples the elimination of clutter in fire-control radar and the production of magnetrons with electronic frequency dithering.

"The military is throwing many requirements at us very fast," Silver says. "It wants radar to pick out slow targets in a jungle and air-to-air radar that can eliminate ocean clutter. It wants to collapse the reconnaissance time cycle, when 20 minutes from recon to air strike may be too slow."

"And the military is betting across the board. The services don't ask for just one system, they ask four or five primes to come up with perhaps three systems each. And some of the systems people are coming to us without even waiting for Government funding."

War or no war, a sizable market for microwave semiconductor technology is opening up in avionics systems such as those in the F-111, the A-7A and the F4 planes. Avionics packages, particularly those for tactical purposes such as terrain mapping and following, are getting closer to production.

Says Stephen DiBona, sales vice president of Microwave Associates, "Solid state signal generation and control for military avionics will be a heavy growth area in 1967." Even commercial airborne microwave, for weather radar and radar altimeters, is doing better than anticipated, according to DiBona.

Dean A. Watkins, president of the Watkins-Johnson Co., which makes devices for strategic reconnaissance systems, believes that the war has not materially affected w-j's fortunes. And he says a truce could only mean a shift in emphasis back to strategic weapons and thus boost sales. He lists three areas of interest: digital receivers, solid state devices with yttrium-iron-garnet tuned oscillators and telemetry; the latter is a field in which w-j is already active under contracts from the National Aeronautics and Space Administration.

Jackpot in sight

The research and development of the past few years is beginning to pay off with a stream of new microwave products, some of which may appear this year. Both Litton and Varian, for instance, are working on crossfield amplifiers, which Orth,

of Varian Associates, thinks will eventually replace the traveling-wave tube. This is pleasing news to those electronic firms that find the traveling-wave tube too costly.

Len Bernier, sales and communications manager at Litton Electron Tube, says Litton will begin pilot production in 1967 of a crossfield amplifier built on what he calls an entirely different concept. It has only one electrode, a cathode, attached to a d-c power supply that amplifies a pulse produced by a radio-frequency trigger. The device can change its pulse repetition rate and even "chirp" (change the frequency within a pulse). It amplifies 20 times.

Litton is also working on electrostatically focused klystrons, such as the one Varian's Eimac division introduced last year. Electrostatic focusing eliminates the need for huge solenoids, which weigh over 100 pounds for a conventional S-band klystron delivering 1 megawatt.

Litton is not yet interested in solid state generation of microwaves. But, Bernier says, it does plan to demonstrate this year the feasibility of an electronically variable, solid-state delay line, in which a transducer changes a microwave signal to an acoustic signal. The conversion may be performed either by piezoelectric material, such as cadmium sulfide, or by a magnetostrictive YIG device, whose dimensions change in a magnetic field. Varying the spot at which the microwave signal is converted varies the delay; delay time can range from 1 microsecond to 1 millisecond. Acoustic delay lines take advantage of the much lower propagation velocity of acoustic waves compared with those of microwaves. The wavelength of audio energy in solids is about 10^5 times shorter than that of electromagnetic waves of the same frequency. This means it's possible to have a large time delay in a small volume and assures great compactness in delay lines.

New products on the way

Varian's new light-sensing and light-emitting division will introduce at least three product lines this year: low-light-level imaging tubes, X-ray imaging tubes and photomultipliers. Some of the products will be introduced at the annual Institute of Electrical and Electronics Engineers show.

DiBona of Microwave Associates sees microwave integrated circuits ringing up some volume sales in 1967 of airborne tactical radars. Switching devices are being designed into prototypes of such avionics packages as the MARK 2, and these may be forerunners of new families of microwave devices that eliminate interconnections and offer high reliability. Dana Atchley, president of Microwave Associates, sees significant advances this year for solid state devices in portable and manpack radars, in shipboard radars and in broadband devices for electronic countermeasures.

Judging from the widespread research in microwave, the design evolution may continue for some time. One intensive research area is in solid state

oscillators. Leo Young of the Stanford Research Institute says the Gunn diode looks promising, but a serious problem is that the gallium-arsenide diodes have low resistivity and tend to burn out. The Stanford Institute is also working on very fast switches to produce pulses about ½-nanosecond long. One application could be short-range, high-resolution radar for nondestructive faultfinding.

Warming up

"The industrial microwave market is maturing nicely," says Carl Olsen, head of the Atherton division of Litton. Olsen expects the industry's approximate \$3 million in sales in 1966 to increase 25% to 30% this year. "In five years, it could be \$100 million—or it could be \$10 million," Olsen says. One reason for the uncertainty is that microwave power is the most expensive kind of heating power to generate and, therefore, the applications tend to be specialized.

Present uses are in large-scale food preparation and in chemical drying operations. John E. Gerling, who was Olsen's predecessor at Litton and is now president of the International Microwave

Power Institute, predicts that a \$100-million market is 10 to 15 years away. Both Gerling and Olsen stress that microwave's advantages are in quality control. The reason: microwave heating is uniform throughout and is nondestructive to the material being heated.

Gerling says, however, that future applications of microwave may include such far-out possibilities as providing power to maintain a 50-mile-high broadcast antenna or cooking dough stretched into an endless canapé. Litton is working on microwave to generate plasmas—highly ionized gases—to make chemical solvents or stimulate processes.

An indication of microwave's maturity is the formation of IMPI last year. The user-oriented group attracted more than 100 manufacturers and customers to its meeting in Edmonton, Alberta, last spring. This year IMPI plans a technical conference March 29 to 31 at Stanford University, Palo Alto, Calif. Enthusiasm for microwave power is so great that IMPI is afraid it won't be able to handle the demand for attendance. That seems to be one of the few fears in the microwave industry at large.

Educational electronics

Growth to continue with Federal boost



The educational electronics market, supported by Federal aid to local school districts, will continue its gradual growth in 1967.

Much of the money now being spent for electronics hardware in education buys consumer-type equipment such as audio tape recorders for language laboratories and television receivers for closed-circuit systems. The size of the market is hard to determine; the Electronics Industry Association estimates that sales amounted to \$115 million in 1965.

The total fiscal 1967 budget for the Office of Education's Bureau of Research is \$103 million—about the same as last year; some \$4 million of this is going for work on new educational media, including electronics.

The 1967 outlook is brightened by the expected impact of audio visual teaching machines and computer-aided instruction. Neither is much of a factor in current sales; only one local school district uses computer-aided instructions and few audio visual teaching machines are in operation. Several schools will get computer-aided systems this year; as many as 20 of the systems will be working by the end of 1968.

While this is far from a mass market, R. Louis Bright, associate commissioner for research in the Office of Education, predicts that sales of computer-aided instruction systems, including software, could

reach \$1.5 billion a year in five years.

Another expanding segment of the market is in equipment for educational tv broadcasting stations. These stations are growing in number as well as upgrading existing equipment. The National Association of Educational Broadcasters forecasts that capital costs for educational tv stations over the next five to six years will reach between \$350 million and \$400 million.

One small but fast growing segment of the educational electronics market is video tape recorders. One industry estimate places the size of this market at \$15 million to \$20 million in 1966, a figure which also includes related electronic equipment such as cameras and monitors when purchased as a system with video tape recorders. This portion will grow to approximately \$30 million in 1967, it is estimated. By 1972, or in five years, this market will total in excess of \$75 million.

Next year will see more vtr's sold with interchangeability—the tape from one machine can be played back on others—says John H. Trux, marketing manager for the Ampex Corp.'s Consumer and Educational Products division. Equipment will also be more flexible, including the capability of conversion to color and additional audio track. There will also be more units offered in the lower-cost field, that is, for less than \$1,000 for a vtr of the quality needed for educational use.

War budget squeezes space program but Apollo won't feel the pinch



Space spending, although restrained by military expenditures for the Vietnam war, will at least hold its own this year at \$5 billion, the same as last year. Electronics magazine's annual market survey shows that the electronics industry will receive about \$1.7 billion of space funds.

Apollo, as usual, will account for the bulk of space electronics spending in 1967. Virtually every electronics manufacturer in the country is on the list of 20,000 industrial companies working on Apollo. However, as the Saturn-Apollo system achieves operational status with the first manned flight this spring, contracts will be terminating. This, in turn, will reduce the flow of orders to subcontractors and vendors, particularly in the electronics industry, unless followup programs take up the slack.

Budget problems

At present, new programs are getting off to slow starts. The Apollo Applications Program gets under way this year with about \$100 million, far below the \$1 billion the National Aeronautics and

Space Administration would like. The Voyager program, once seen as a multibillion-dollar project, has run into budget problems caused by the Vietnam war, and it's likely that NASA will extend its Mariner program as an inexpensive substitute. Already planned are a Mariner flight to Venus this summer and two Mariner flights to Mars in 1969; other shots may be attempted in 1971, and perhaps 1973 and 1975.

Other Government agencies have programs in the works too, such as the Interior Department Geological Survey's \$20-million Earth Resources Observation Satellite and the Commerce Department Environmental Science Services Administration's Tiros-M weather satellite. In addition, the Communications Satellite Corp. will buy six Intelsat 3 satellites from TRW Inc. They will be deployed in 1968 in the global communications system.

NASA's supporting research and technology budget is expected to stay near its current level of about \$30 million. This supports research in guidance, control communications, tracking and data acquisition, data handling and processing, instrumentation and electronic components.

IC's find a home in space

Integrated circuits will be one of the headline stories of 1967 in space technology. Integrated circuits made their first major appearance in the encoder of the interplanetary monitor platform in 1966 and are used throughout the Apollo spacecraft—in the guidance computer, in the television camera and in the equipment in the Lunar Module. This is just the beginning. An informal survey by NASA indicates that IC's will account for 70% of spacecraft electronics by 1970.

Another area of activity is space astronomy. A telescope is planned for one of the early Apollo applications flights about 1969, but first electronic techniques must be developed to operate large telescopes in space. In addition to optical astronomy, NASA is interested in developing laser radar systems with high definition for global surveys of crops and various natural resources.

Parallel efforts are continuing to improve tube efficiencies and increase the power levels of solid state devices. The power is needed for transmitters for direct broadcast satellites and interplanetary spacecraft. One possible solution under study at NASA's Electronics Research Center is an array of small solid-state power transistors.

To prepare for spacecraft landings in deep space

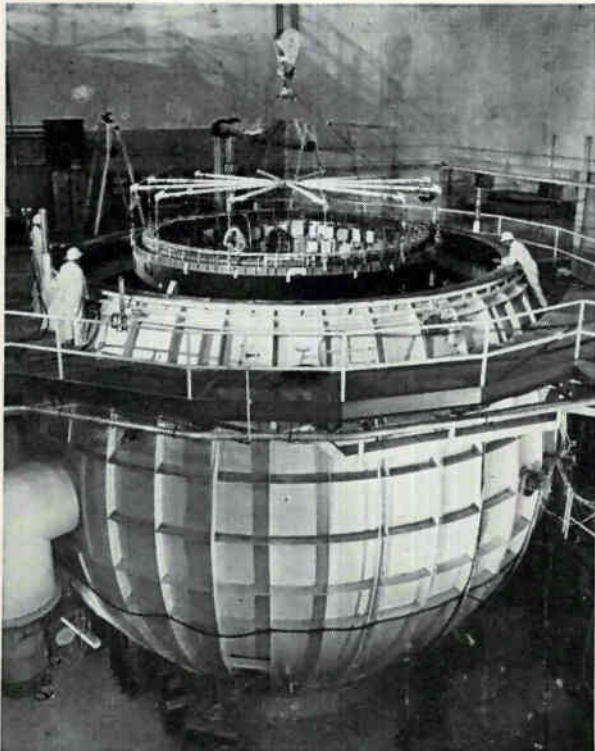

Instrument unit for Saturn rocket is being lowered into simulation chamber at Douglas Aircraft Co. for testing.

probes, the Jet Propulsion Laboratory is working on approach guidance procedures. Although Mariner 4 achieved an accuracy to within 120 miles when it passed Mars in 1965, a landing would require an accuracy improvement of an order of magnitude. The problem is defining the planetary

horizon to find the planet's center when the planet is only partially illuminated, like a half moon. The JPL approach involves a passive detector with an image dissector tube that scans the edge of the planet; the planet's center is calculated from the curvature of the edge.

Industrial electronics

Electronic controls gather momentum



Computer-based process controls and machine-tool controls will strengthen their hold this year on the number one and two spots in the industrial electronics market. By comparison, the amount of money spent for equipment in the glamor programs—air and water pollution control, high-speed railroads and highway automation—will be small.

Electronics magazine's survey estimates 1966's total market for industrial operations electronic equipment at \$934.8 million, and forecasts a 13% rise from that level in 1967. The electronics share of the 1967 market for machine-tool controls is expected to surge to \$242.3 million from last year's \$217.3 million, with numerically controlled gear accounting for 30% of this year's total machine-tool sales, against 22% in 1966.

Process Computers

Capital investment in process-control computer systems should climb to about \$235.8 million this year from the \$202.2 million of 1966. Prime customers are still the petrochemical industry and public utilities, but metals, textiles, food, paper and cement processors are signing up in increasing numbers. Last year, for example, the Leeds & Northrup Co. installed a direct digital control system at the Ideal Cement Co.'s plant in Tijeras, N. M.

By 1969 or 1970, the new customers for this equipment will have sharply boosted computer sales, according to Thomas W. Waldron, industry development manager for the International Business Machines Corp.'s control systems marketing group. He notes that companies are refitting old plants with computer systems as well as installing them in new plants.

Direct digital control of processes is making amazing progress, says T.C. Williams, of Purdue University's Laboratory for Applied Industrial Control. More than 200 DDC systems are installed or planned, he says. "Almost every company selling process controls has already adopted a DDC computer or is choosing one," he adds.

Most of the current DDC systems are backed up by conventional analog systems, since customers are still hesitant about relying entirely on a digital process. But as operating experience with DDC grows, analog backups are expected to shrink.

Big machine-tool makers are apparently trying to develop their own numerical control systems, rather than buy them from electronics firms; the electronics package can account for as much as 40% of the price of a \$300,000 machining center.

Some firms have long had their own electronics facilities, and keep up with the state of the art. For instance, The Cincinnati Milling Machine Co. is building a contour positioning control with integrated circuits. Why did the company choose to develop a contour positioner instead of a less complex point-to-point positioner? One reason, says H.V. Edwards, manager of the firm's Cimtrol division, was that engineers could learn more about applying IC's.

Railroads are so pleased with the way computers and controls have expedited their paperwork and their car-routing and train-assembly operations that they are preparing more comprehensive systems.

Sometime this summer, the Association of American Railroads hopes to select a standard car-identification system from among three being tested [Electronics, Nov. 28, p. 40]. Its goal is to tag the rail industry's entire fleet of 1.8 million cars.

Rapid Transit System

The problem of urban mass transportation is worsening, and planners hope to find answers in the Bay Area Rapid Transit District program in northern California, a vast rapid-transit commuter-train project partly financed by the Federal Government [Electronics, July 26, 1965, pp. 71-86].

A contract for BART's automatic control system should be awarded early this year. The total automatic-control outlay for this program is expected to range between \$20 million and \$30 million.

Two other potentially rich markets for electronic gear are air and water pollution control and highway traffic control. New York City will set up a \$500,000 air pollution monitoring network this year, a project that may help other cities select their pollution sensors and reporting gear. New York City, San Jose, Calif., and Wichita Falls, Texas are using digital controls to help regulate traffic flow.

Reprints of this report are available at \$1 each.
© copyright 1967, Electronics® A McGraw-Hill Publication

Six New Amelco Hi-Voltage FETs for Solid-State Conversion of Vacuum Tube Circuits



Now you can eliminate extensive redesigning of vacuum tube circuits with these six hi-voltage FETs from Amelco — each a new 'tube analog'. They're ideal for solid-state conversion of CRT deflection circuits, high-level multiplexing and large signal transfer circuits. Consider their improved flexibility: 300-volt operation, low 2 na leakage current, and gains as high as 1500 μ mhos. Have an application or two in mind? Send for a data sheet or two! We'll also enclose a copy of our definitive Tech Bulletin No. 7, "Theory and Applications of Field Effect Transistors,"— 24 pages of user-oriented FET facts. You'll find out more from Amelco, world's largest producer of n-channel FETs.

CHARACTERISTIC	2N4881	2N4882	2N4883	2N4884	2N4885	2N4886
BV_{D60} (V, min)	300	300	200	200	125	125
BV_{S60} (V, min)	100	100	100	100	75	75
g_m (μ mhos, min/max)	350/1000	600/1500	350/1000	600/1500	350/1500	600/1500
I_{SS} (na, max)	2	2	1	1	1	1
C_{in} (pf, max)	1.5	1.5	1.5	1.5	1.5	1.5

AMELCO SEMICONDUCTOR

DIVISION OF TELEDYNE, INC. • 1300 TERRA BELLA AVENUE • MOUNTAIN VIEW, CALIFORNIA • Mail Address: P. O. Box 1030, Mountain View, California • Phone: (415) 968-9241 / TWX: (415) 969-9112 / Telex: 34-8416 • REGIONAL OFFICES: Southwest — Suite 213, 8621 Bellanca Ave., Los Angeles, California 90045, (213) 678-3146 • Northwest—1300 Terra Bella Ave., Mountain View, California, (415) 968-9241 East—P. O. Box 2091, Paterson, New Jersey 07509, (201) 696-4747; P. O. Box 366, Kimberton, Pennsylvania 19442, (215) 885-1755 • Northeast—805 High Street, Westwood, Massachusetts, (617) 326-6600; 60 Broad Hollow Rd., Melville, L. I., N. Y. 11749, (516) 692-4070 • Southeast—711 Magnolia Avenue, Orlando, Florida, (305) 423-5833 • Midwest—650 West Algonquin Road, Des Plaines, Illinois, (312) 439-3250; 3020 Woodlark Lane, St. Paul, Minnesota, (612) 646-1161 • Canada—Deskin Sales, Montreal, Quebec, (514) 384-1420.

Tell us your precision switch problem...
Is it reliability?
Special characteristics?
Cost-to-quality ratio?
Delivery?

Potter & Brumfield's experience in producing top rated electromechanical relays (more than a third of a century) provides an exceptional background for the design and manufacture of precision switches.

RELIABILITY Vibration, acceleration, shock, humidity, electrical life and many other factors are tested as standard procedure. Certification of tests is supplied on request.

SPECIAL CHARACTERISTICS A well staffed engineering department is at your service for almost limitless modifications, including configuration of actuators, operating force,

contact pressures, gaps, materials, terminations or performance characteristics. Any combination of these can be designed and produced to your exact specifications.

COST-TO-QUALITY RATIO A plant designed exclusively for switch production enables us to take advantage of all modern production techniques to provide top quality craftsmanship at competitive prices.

DELIVERY We can make next day shipment on most basic switches. Your local authorized P&B switch distributor has them on his shelf for immediate delivery at factory prices.

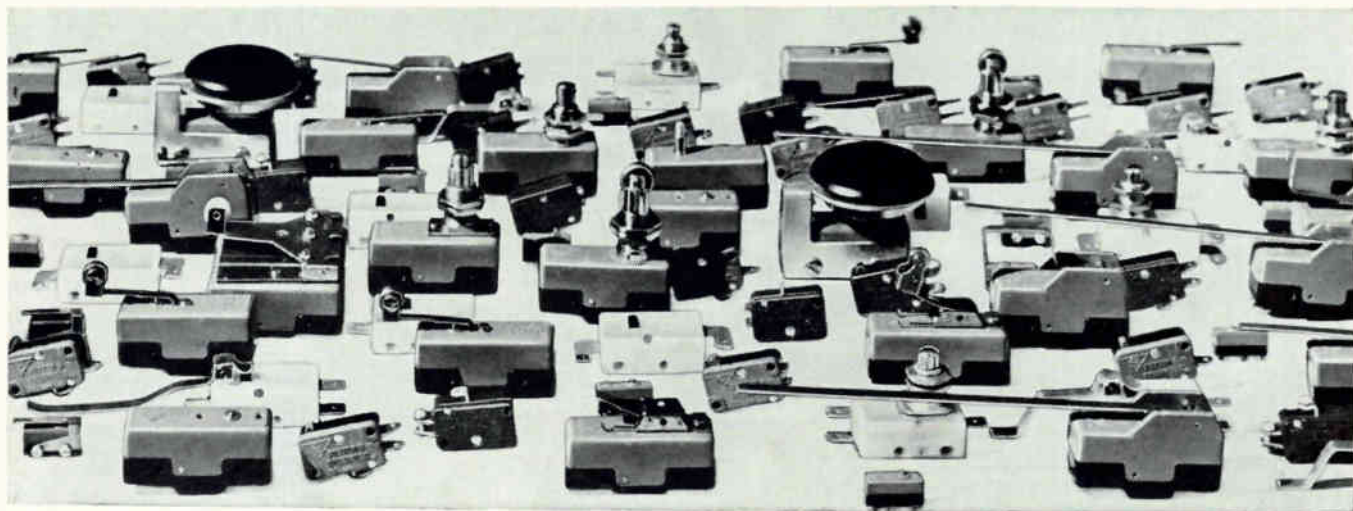

POTTER & BRUMFIELD

Division of American Machine & Foundry Company, Princeton, Ind. 47570
Export: AMF International, 261 Madison Avenue, New York, N.Y. 10016

*Better check out this big new source
for precision switches!*

*Write for your copy of
P&B's Switch Catalog 1-A*



The hope of doing each other some good prompts these advertisements

Advice to holographers:

1. KODAK "Spectroscopic" Plates, Type 649-F (comparable to flour for a baker, nets for a fisherman), can now reach you within roughly two weeks of placing the order with your supplier who, if you do not already know him, can be introduced to you by Eastman Kodak Company, Special Applications, Rochester, N.Y. 14650. If you require a size other than 4" x 5" (either .040" glass or 1/4" microflat glass), please continue to anticipate needs by 30 to 60 days.
2. Instructions for processing this product in a manner to yield relief images consisting only of variations in the height of the gelatin can be found on p. 1689 of the October, 1966 issue of *Applied Optics*. Density variations are converted to height variations with excellent linearity, leaving little other than the gelatin itself to absorb light and apparently little that affects its refractive index. A density of unity is translated to a relief height of about one-half micron. Do not assume that the linearity is maintained to the utmost limits of spatial frequency, whatever they may be. If you find this technique works well for phase holograms, the people at the address in the preceding paragraph would like to know.

What's an optician, Pop?

Many employers are seeking persons qualified in optics and optical engineering. But for fear of sacrilege, they'd pray heaven to send them. In relation to demand, applied optics and optical engineering seem among the most severely undermanned of professions. Bright kids in school don't seem to find out about this (or to believe it if told) until after committing themselves to other disciplines. As a result, many of today's optical designers and engineers have to admit to themselves in black moments that they really aren't.

To spot a genuine pro in the field, try asking him if he knows a man named Rudolf Kingslake. Most reassuring would be a reply to the effect that not only does he know Dr. Kingslake but has taken courses under him and made good grades.

Kingslake came to the University of Rochester in 1929 from Imperial College of Science and Technology in London. In 1937 he also joined us and has been our full-time head of optical design since 1939. In the past two years he and his staff have been far busier than ever before, though we are not at liberty to disclose on what. Nevertheless, by skillfully using what little time his industrial and teaching undertakings leave him, he has managed during these same two years to bring out the first three volumes* of a five-volume comprehensive treatise entitled "Applied Optics and Optical Engineering" (Academic Press, New York and London).

Under his editorship, 29 of the projected 50 chapters are now in print, a few written by him and the rest by people from our own and 17 other organizations. Where this crew found the ambition and the devotion to scholarly obligation remains a mystery explicable only in terms of the resilience of the human spirit. Probably it is too much to hope that their effort could retread any significant numbers of physicists, electrical engineers, or mechanical engineers into opticians.

We could use a few more opticians ourselves. Indeed we could. They'd be in stimulating company. The address of our Director of Technical Personnel is simply Eastman Kodak Company, Rochester, N.Y. 14650.

***Volume I:**
 photometry
 light sources for optical devices
 filters
 atmospheric effects
 optical materials
 basic geometrical optics
 diffraction
 interference and coating
 polarization
 projection screens
 precision and accuracy

Volume II:
 the eye and vision
 stereoscopy
 the photographic emulsion
 combination of lens and film
 illumination in optical images
 electro-optical devices
 television optics
 infrared detectors
 infrared equipment

Volume III:
 lens design
 optical manufacturing
 photographic objectives
 microscope objectives
 the testing of complete objectives
 spectacle lenses
 mirror and prism systems
 mirror coatings
 eyepieces and magnifiers

How one thing leads to another

This pretty person is displaying a large and a small rod of neodymium-doped KODAK Laser Glass. We unwittingly prepared ourselves for this product for a quarter-century by making rare-earth optical glass for photographic lenses.

KODAK Laser Glass correspondence is handled by Apparatus and Optical Division, Eastman Kodak Company, Rochester, N.Y. 14650.



Photography is notable among technologies for its spinoffs. The dye chemists who devise photographic sensitizing dyes don't get to color the world their favorite colors, but they are very clever. When told that a dye with absorption mechanism saturable and all concentrated near 1.06μ would

enhance its popularity, they produced one. Lasermen rejoiced. Mode-locking was achieved. Power could rise from zero to several gigawatts within a distance of 30 microns and a time around 10^{-13} sec.

EASTMAN 9740 Q-Switch Solution correspondence is handled by Distillation Products Industries, Rochester, N.Y. 14603 (Division of Eastman Kodak Company).

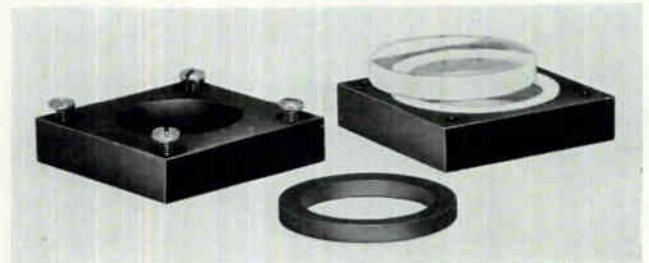

But many lasermen found their Q-switch solution short-lived and were surprised to learn that the epoxy cement in their jerry-built cells was killing it. Few spectrophotometer cells are fit for resonant optical cavities. Help was needed. We have consequently designed a cell that uses simply the pressure of two glass windows against a precision tetrafluoroethylene gasket to keep it leakproof. Selection of the glass for the windows has been guided by a lot of work on damage resistance that the laser glass development has required. It is a borosilicate crown free from striae and bubbles and good to a quarter-wavelength of visible light over the 35mm aperture. Outer surfaces are MgF_2 -coated to minimize reflection loss at 1.06μ . Forgetting in the interests of good sense the original motivation to promote neodymium, we also offer a coating tuned to pass the 0.69μ radiation of neodymium's rival, ruby. The wedge angle in the windows is not permitted to exceed 0.012° , or 0.006° on the gasket, and the thickness of the gasket fixes an optical path of $1.651 \text{ mm} \pm 25\mu$.

EASTMAN Liquid Q-Switch Cells are available at \$150 from the same Distillation Products Industries that supplies their contents. Specify No. 6088 for neodymium, No. 6097 for ruby.

Price is subject to change without notice, f.o.b. Rochester, N.Y.

Kodak

“Why do more and more executives say MICHIGAN has more of everything?”



“Fast, convenient delivery to half the nation’s population is one big reason.”



Making a good product is one thing — getting it to customers on time is another. Michigan transportation is second to none. Its 1,300 miles of toll-free, multiple-lane, divided highways make possible very rapid delivery, by nearly 1,300 carriers, to 21 major billion-dollar markets. The state’s strategic location also provides easy access to national and international markets via a network of Great Lakes ports, 16 major air carriers, and 25 railroads. More details in confidence? Write:



**Consumers
Power
Company**

Director of Area Development • 216 West Michigan Ave., Jackson, Michigan 49201 • Area Code 517-788-0500

Announcing the Brush Mark 250, first strip chart recorder for the perfectionists of the world.

Shown with 1 μ v preamplifier RD 4215-70; event markers optional.

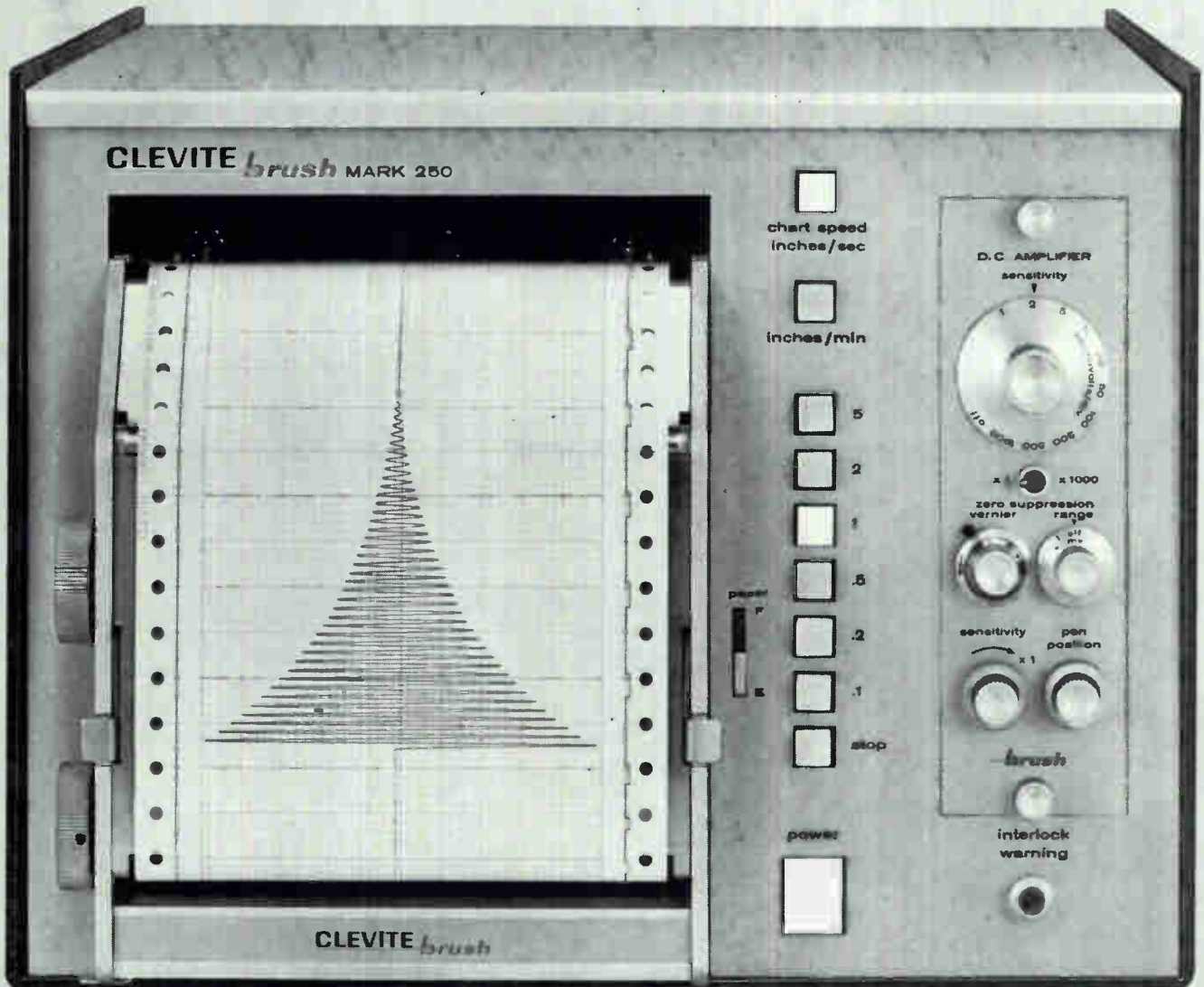

Meet the fastest, most accurate strip chart recorder on record: The new Brush Mark 250. When you read about all the features you'll know why we call it the first recorder for the perfectionists of the world!

1 Unmatched frequency response. Flat to 10 cycles on full 4½" span! Useful response to 100 cycles. Nobody has a strip chart recorder in the same league.

2 Wide selection of signal conditioners. Choose from 21 interchangeable preamps. Use one today; plug in a different one when your recording requirements change.



3 Crisp, clean rectilinear writing. Patented, pressurized inking system puts smudge-proof trace into the paper not just on it.

4 Contactless, non-wearing feedback system. Same one used in our multi-channel Mark 200 recorders. (No slide wires!) Accuracy? Better than ½%!

5 Multiple chart speeds. Pushbutton choice of twelve . . . from 5 inches/second to 1/10 of an inch/minute (up to 8 days of continuous recording).



6 Portable or Rack mounting. And either way you get the exclusive new dual position writing table.

7 Removable chart paper magazine. Great for desk top record reviews. Man-sized manual winding knobs let you roll chart forward and back. Chart re-loading is a cinch.



See what we mean? The Mark 250 is for the perfectionists of the world. Ask your Brush Sales Engineer for a demonstration. Or, write for chart sample and specifications. Clevite Corporation, Brush Instruments Division, 37th & Perkins, Cleveland, Ohio 44114.

CLEVITE
—brush INSTRUMENTS DIVISION
The Brush Mark 250 First recorder for perfectionists

9500 miles from Danang, Americans are fighting another enemy.

Inflation is a threat to every family's paycheck . . . to the strength of our nation itself. And while other Americans are engaged in the fight for freedom half way around the world, we must be increasingly alert to the dangers of inflation here at home.

American businessmen can help maintain a stable economy and curtail inflationary pressures through the Payroll Savings Plan for United States Savings Bonds. Money invested in Savings Bonds is actually an investment in the United States. It results in more effective

management of the public debt, maintains the value of the dollar and provides a firm base for family security.

In your plant or office, you can initiate and promote this program for systematic savings. Complete information is available from your State Savings Bonds Director or by writing the Treasury Department, United States Savings Bonds Division, Washington, D.C. 20226.



In your plant . . . promote the PAYROLL SAVINGS PLAN for U.S. Savings Bonds



The U.S. Government does not pay for this advertisement. It is presented as a public service in cooperation with the Treasury Department and The Advertising Council.



First full-range*
DC Voltage Calibrator
with .01% accuracy for under \$1000—

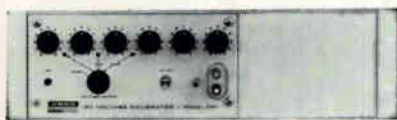

Cohu's new Model 324!

***Output voltage ranges:** 10-V Range: 0 to 11.1110 volts (10 μ V steps)
 100-V Range: 0 to 111.1110 volts (100 μ V steps)
 1000-V Range: 0 to 1111.110 volts (1 mV steps)

Output current capability: 0 to 25 milliamperes nominal at any voltage setting.

Accuracy: 0.01% of setting.

Stability: Within 30 PPM for 24 hours, 50 PPM for 30 days.

Dimensions: Cabinet: 10½" W x 5¼" H x 15½ D.
 Rackmount: 19" W x 5¼" H x 15½ D.

Price: Cabinet (324): \$995. Rackmount (324R): \$1050.
 F.O.B. San Diego. Additional export charge.

Delivery: Immediate, from stock.

For full details, contact your Cohu engineering representative.



Box 623
 San Diego, California 92112
 Phone: 714-277-6700

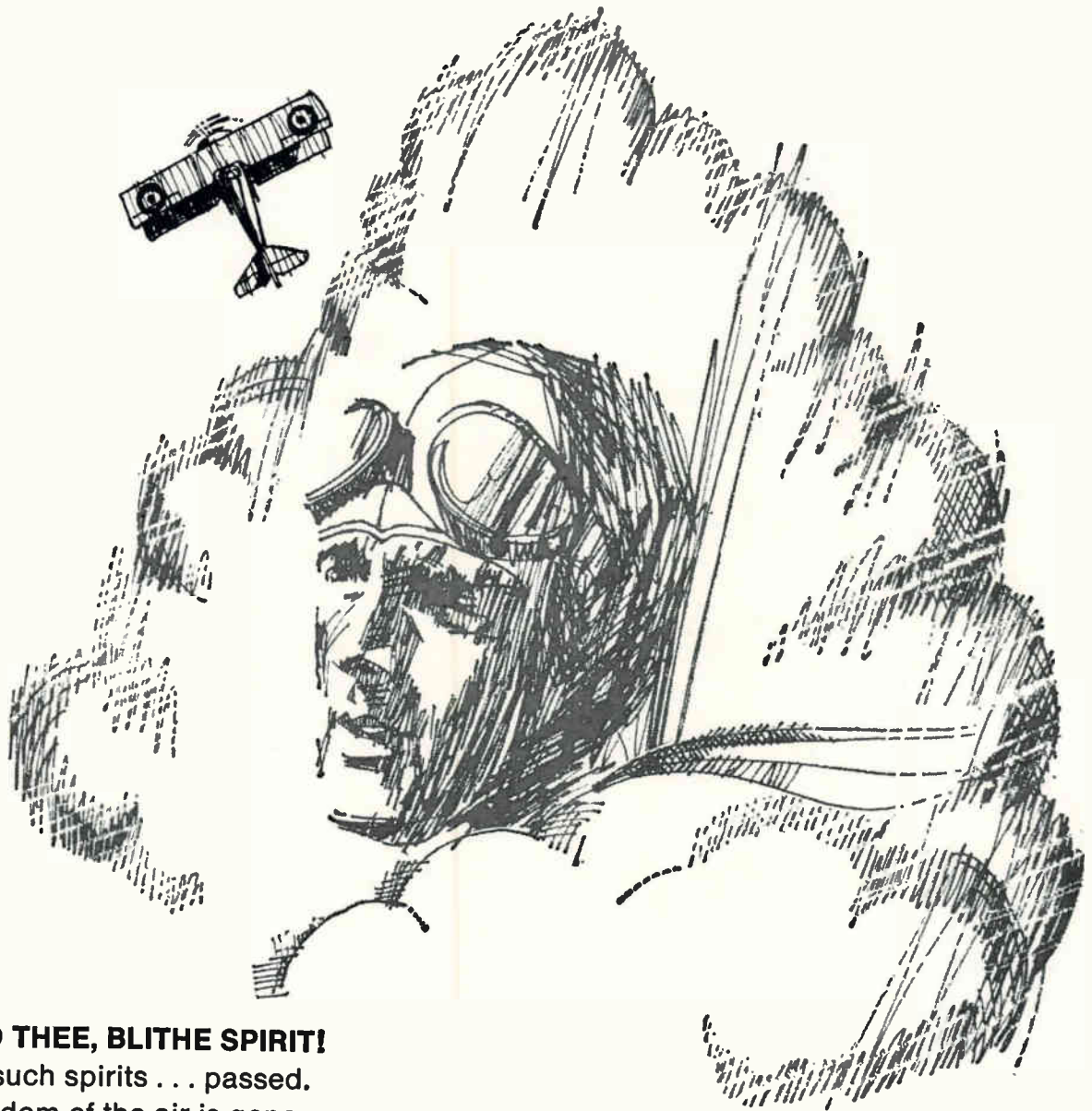

HAIL TO THEE, BLITHE SPIRIT!

And all such spirits . . . passed.
The freedom of the air is gone.
The earth controls the sky.

NATIONAL AIRSPACE SYSTEM

MITRE is currently augmenting its top-flight team of systems men in the suburban Washington, D.C. and Atlantic City, N.J. areas. Their mission: to provide the system engineering to the Federal Aviation Agency on the new National Airspace System — an air traffic control system for the 1970's. Their job encompasses such technical areas as broad level system analysis, computer program analysis, system specifications, system logical design, system test planning for design verification, and configuration management.

Working on this project you would engage in such activities as: translating system operational objectives into technical requirements for the system's subsystems; synthesizing the technical characteristics of equipment subsystems of balanced reliability, and analyzing alternatives; reviewing and analyzing, at the logic level, design submissions of system hardware contractors; conducting design optimization studies with respect to cost, reliability, and technical suitability; or synthesizing software designs for a multi-processing computer environment.

NATIONAL MILITARY COMMAND SYSTEM

Scientists and engineers are also needed in our Washington Office for systems analysis and feasibility studies, communications system analysis, systems design, integration and design verification of the NMCS. This "capping system" contains all the facilities, equipment, doctrine, procedures, and communications needed by national command authorities to give them strategic direction of the armed forces. MITRE's main concern is with the technical design and integration aspects of the NMCS and the communications between NMCS and various other command systems, including the World-Wide Military Command and Control System — a group of systems operated by the unified and specified commands.

NATIONAL RANGE DIVISION

Qualified senior engineers and scientists are needed at MITRE's office at Patrick Air Force Base, Florida, to assist in direct support programs for the National Range Division (NRD) of the Air Force Systems Command. NRD was established as central planning authority to insure the efficient use of existing and future

national range resources. The work is of vital importance to the Department of Defense space programs and in the support they are providing to NASA. MITRE's mission is to assist the National Range Division in their development of the future system requirements for the Eastern and Western Test Ranges. In addition to systems-oriented planning and operations research activities, the work includes studies of range functional subsystem categories: radar, telemetry, optics, communications, and data processing. If you have three or more years' experience and a degree in electronics, mathematics or physics, write in confidence to Vice President — Technical Operations, The MITRE Corporation, Box 208BC, Bedford, Mass.



THE
MITRE
CORPORATION

An Equal Opportunity Employer (M & F)

Pioneer in the design and development of command and control systems, MITRE was formed in 1958 to provide technical support to agencies of the United States Government. MITRE's major responsibilities include serving as technical advisor and systems engineer for the Electronic Systems Division of the Air Force Systems Command and providing technical assistance to the Federal Aviation Agency and the Department of Defense.

Get tougher-than-military ruggedness with molded-package economy...

Low mounting of circuit permits uphill bonding . . . preventing internal shorts and improving reliability.

Solid molded package supports bonding wires . . . giving maximum resistance to shock, vibration and acceleration.

Leads are firmly anchored in package for mechanical strength and hermeticity.

Mounting platform extends full length of package for up to 500 mW heat dissipation.

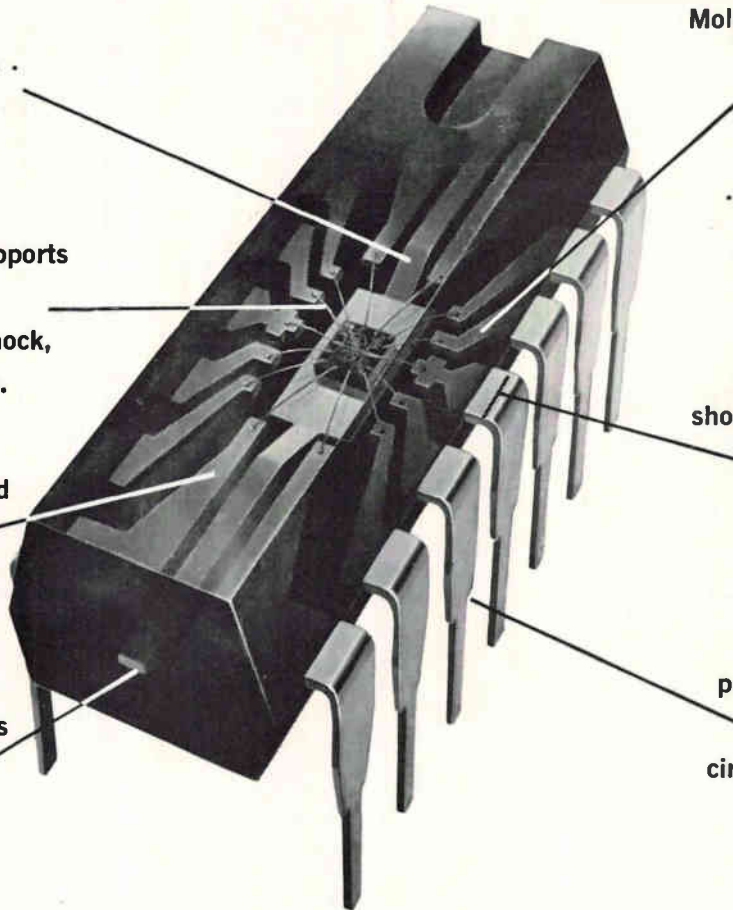

Molding compound adheres tightly to leads over temperature range of -55° to $+150^{\circ}\text{C}$. . . preventing moisture intrusion in service.

Stiff leads with 0.060" shoulders give strength and stability for automatic insertion and handling.

Pin shoulders support package above PC board . . . allowing free air circulation and preventing formation of moisture pockets.

Call WEATHERFORD for immediate delivery of TI Series 74N TTL and Series 15830N DTL integrated circuits in TI's high-reliability economy molded package

Texas Instruments has recently completed tests (many more severe than military) which clearly establish the ruggedness and reliability of TI's molded package. For your copy of the 36-page report which describes these tests in detail, circle 199 on the Reader Service card.

We carry complete stocks of both TTL and DTL integrated circuits in TI's tougher-than-military molded package. Call us for prompt service.



R. V. WEATHERFORD CO.

DISTRIBUTORS OF ELECTRONIC COMPONENTS AND EQUIPMENT

ANAHEIM, CALIFORNIA
1651 State College Blvd.
714-532-6741
714-547-7521

GLENDALE, CALIFORNIA
6921 San Fernando Road
213-849-3451

PALO ALTO, CALIFORNIA
3240 Hillview Drive
Stanford Industrial Park
415-321-5373

SALES OFFICES
Albuquerque, N.M.
505-298-5593
Phoenix, Arizona
602-272-7144

Pomona, California
714-966-8461 714-623-1261
San Diego, California
714-278-7400

NOW WITH CUSTOMIZED COMPONENTS
**WEATHERFORD
SERVICE
PLUS** 

Report from

**BELL
LABORATORIES**

Molecular-gas lasers

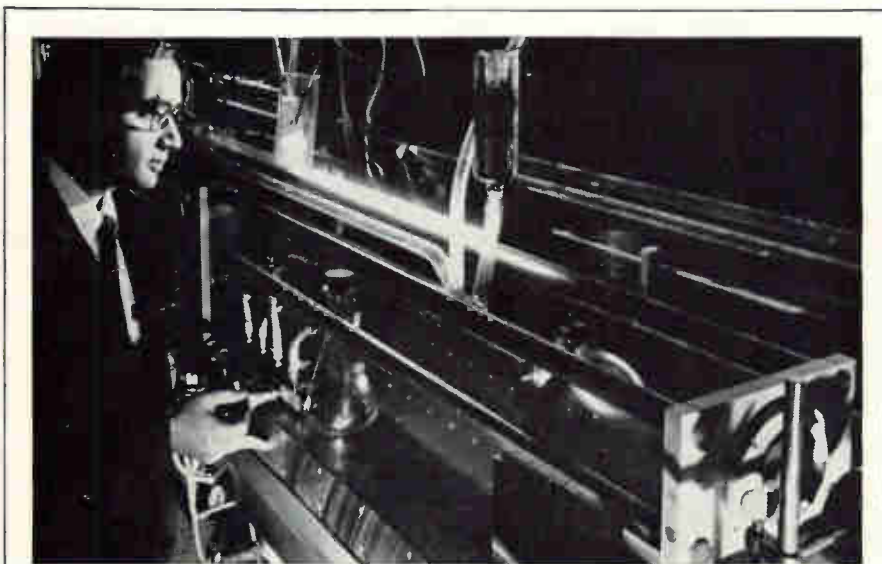

Bell Laboratories research physicist C. K. N. Patel with his experimental "flowing gas" laser. The glowing tube contains nitrogen in which electrical discharge is taking place. The active gas flows through the other, similar-sized tube and the gases meet in the optical cavity. Here, energy is transferred to the active gas through collision.

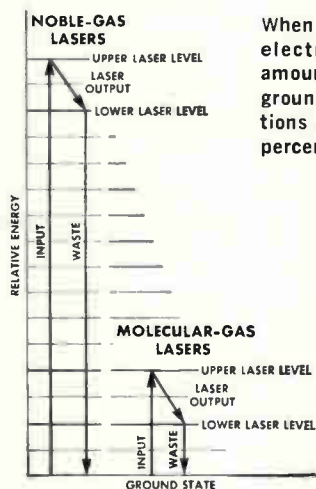

When a laser operates through energy stored in electron orbits (left), a comparatively large amount is wasted through the long return to ground state. But, when energy is stored in vibrations and rotations within a molecule (right), the percent wasted is much smaller.

The experimental setup which led to development of today's most powerful and efficient CW laser. Nitrogen, carrying vibrational and rotational excitation, mixes with the active gas within the optical cavity. Here, energy is transferred to the active gas through collision.

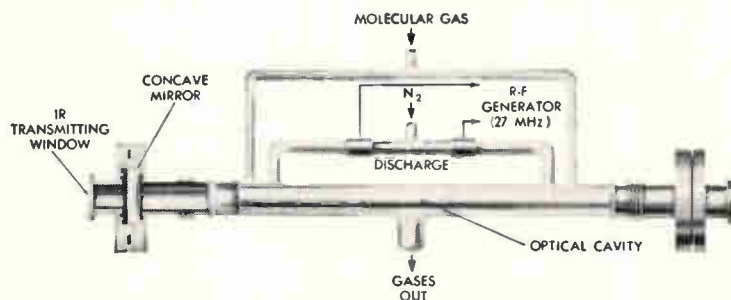

To produce a photon in a gas laser, an atom or molecule reduces its energy by dropping from the "upper laser level" to the "lower laser level" (graph). From the lower level, the energy usually decreases to absolute minimum—"ground state"—before the atom or molecule can emit another useful photon. This second drop is waste: incoherent light and heat.

Lasers using noble (atomic) gases, like helium-neon or argon, are particularly wasteful in this respect. But a laser using molecular gases, such as carbon dioxide, would operate at lower energy levels and produce less waste radiation.

In investigating new infrared lasers, therefore, scientist C. K. N. Patel of Bell Laboratories employed molecular gases. To experiment with them, he invented a new kind of laser (photo and figures) in which the active (radiation-emitting) gas flows continuously into the optical cavity. There it meets a flow of nitrogen, which is excited by an electrical discharge in a separate tube. In this way, molecules in the active gas are raised to an upper laser level by the transfer of vibrational energy from nitrogen molecules. This prevents the electrical discharge from breaking down the active gas.

With this technique, Patel demonstrated lasers based on carbon monoxide, carbon dioxide, nitrous oxide, and carbon disulphide. He found that carbon dioxide has the highest efficiency, about 15 percent compared with less than 0.1 percent from previous gas lasers.

Carbon dioxide has another advantage. It is the only known molecular gas that is chemically stable enough to function even if the discharge takes place within it. So in this instance, the "flowing-gas" technique is not required.

Patel also found that the addition of certain gases, such as helium, increases the efficiency of the carbon dioxide laser. Such lasers have been built with continuous outputs of more than 1000 watts at wavelengths of 10.6 microns (infrared).



Bell Telephone Laboratories
Research and Development Unit of the Bell System

Probing the News

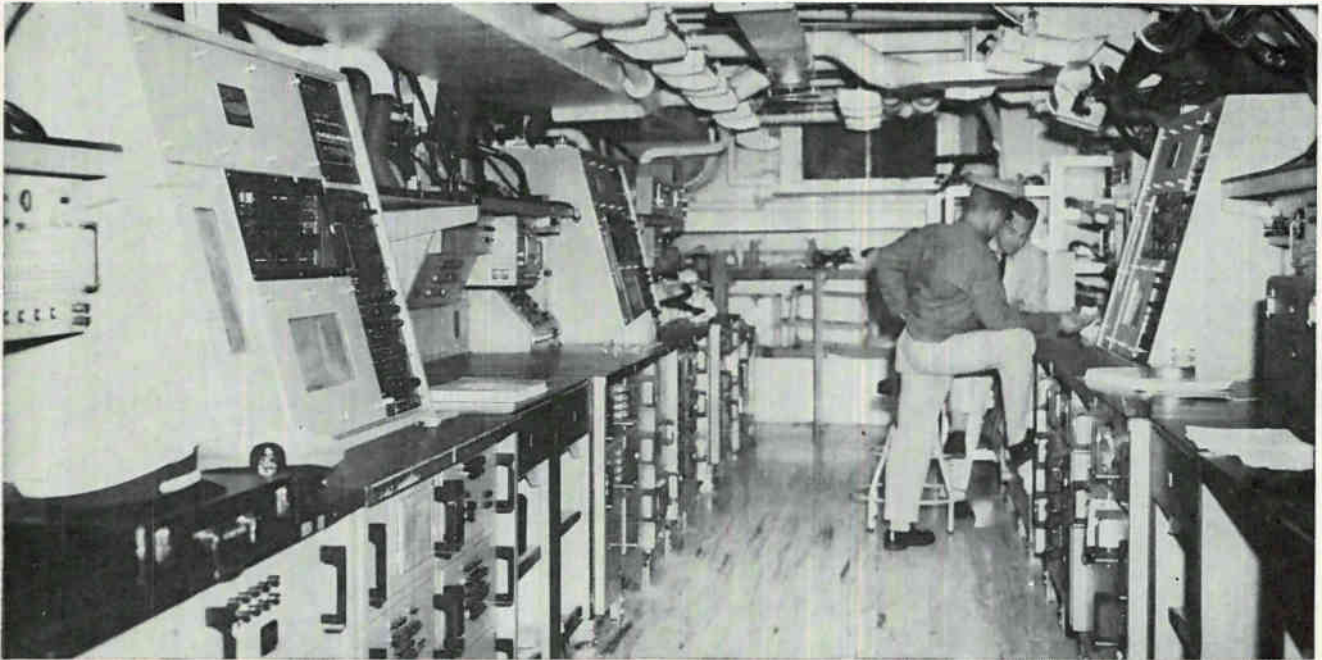

On the carrier, *Constellation*, semiautomatic checkout equipment provides operational support for E2A and A-6 aircraft.

Instrumentation

Support gear rides a roller coaster

Demand for electronic support equipment is soaring but will plummet as prime systems use more IC's

By John F. Mason

Military electronics editor

It's a cliché among support equipment engineers that systems men will one day design them out of business. The prospect is unlikely any time soon, however. Demand is booming for checkout and maintenance gear to back up and support the complex systems now being delivered to military and space agencies. Much of this apparatus incorporates some integrated circuitry. Eventually, the widespread use of IC's, in everything from gigantic radar installations to satellite telemetry, may indeed force whole sectors of the support field into retirement.

Commenting on the prospective changes Edward Dalva, director of

Grumman Aircraft Engineering Corp.'s Product Support department, says, "Built-in test capabilities and the predicted reliability of integrated circuits will eliminate the need for electronic line support equipment—the portable test gear used on flight decks and flight lines. The amount of shop support can also be expected to decrease dramatically." Shop support gear is used in the big rooms below deck on carriers and near flight lines where defective systems are brought for repair.

Dalva believes, however, that demand will increase for test and repair equipment at the military depot level since this will be the only

place where such work will be attempted. The more complicated systems will also intensify the demand for support equipment in development and production stages because of the need for tighter quality control. Dalva does not believe, however, that these three gains will offset the eventual decline of line and shop support equipment.

Long-term trends in the reliability of systems underlie the ferment in the support equipment field. When electronics gear was built primarily with vacuum tubes, there were chronic maintenance problems. The introduction of transistors and other solid state devices im-

FOR
DRILLING
AND ROUTING
CIRCUIT BOARDS
AND
REINFORCED
RESINS

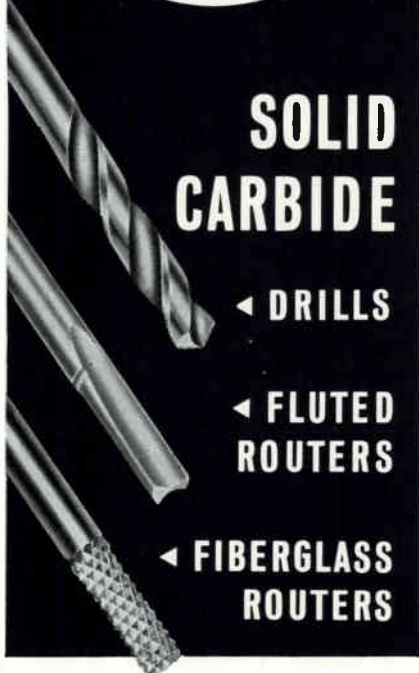

SOLID CARBIDE

◀ DRILLS

◀ FLUTED
ROUTERS

◀ FIBERGLASS
ROUTERS

UNEQUALLED METAL REMOVAL
COMPANY SERVICE, QUALITY
AND SELECTION INCLUDING:

1. World's largest inventory of centerless ground drill blanks and finished tools ready-for-shipment.
2. Fifteen centerless grinders in production of drills and rotary carbide tools.
3. Every size carbide drill, ground from-the-solid . . . the smallest — .008" diameter to the largest — 1.500" diameter.
4. Precision ground to 5 micro-inch finish or better.
5. Delivery from stock, through our distributors, of any standard solid carbide tool in 48 hours.

Your assurance of product quality, lowest cost and dependable service is the fact that the nation's leading carbide tool users are placing their tool contracts with The Metal Removal Company.

THE METAL REMOVAL COMPANY

1859 W. Columbia Avenue
Chicago, Illinois 60626

Plants Located in CHICAGO • LOS ANGELES • SAN JUAN



MASTER TOOL AND WHEEL
MAKERS FOR THE WORLD

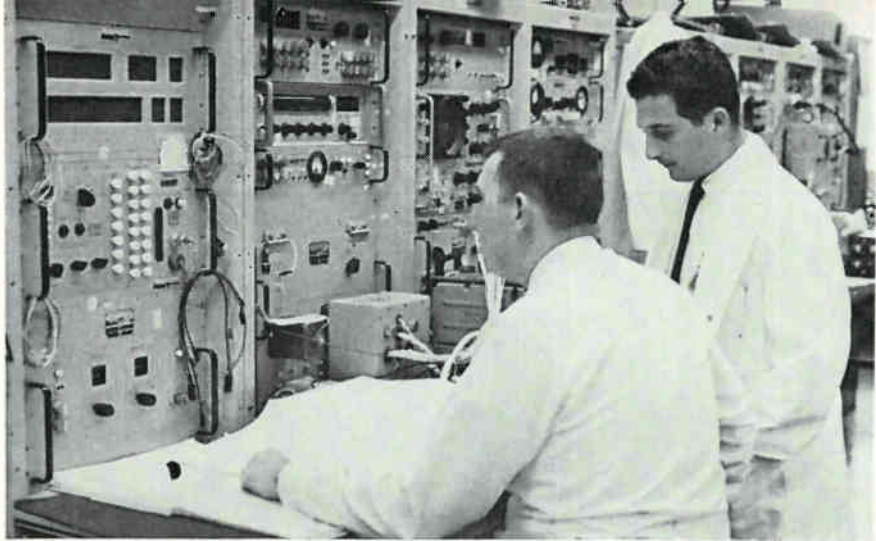

Semiautomatic checkout equipment at Grumman tests all the analog components in the F-111B avionics systems.

proved the over-all dependability, but reductions in size tempted designers to add new capabilities. The net effect was greater complexity, greater potential for failure and, hence, a greater need for support.

The availability of ic's is changing the picture again. Future military and space systems will do more jobs better than any of their predecessors and they eventually will be free of the maintenance woes that plague hybrid and solid state assemblies. But the transition will be a slow and piecemeal process. During the interim, there must be shop and line support for systems still using tubes and transistors. And until ic-equipped gear proves entirely reliable, it must be backstopped by support equipment that may not have to be used very often. Thus everyone in the systems business will be forced to provide customers the support apparatus to maintain and operate equipment.

Grumman became deeply involved in support equipment when

it was building the A-6 Intruder attack aircraft and the E2A Hawkeye early warning/command and control plane for the Navy. The Hawkeye carries more than five tons of electronics gear, about 80% of which is solid state.

Now Grumman's electronics products support business has grown from compact to Cadillac status in seven years. The operation, which employed only 200 to 300 people, has blossomed into a 2,000-man empire that accounted for 25% of last year's billion dollar volume.

Mixed blessing. Even now, the greater use of ic's is not an unalloyed blessing for support equipment manufacturers. To make their test and checkout apparatus effective at a reasonable cost, the companies are investigating new technical concepts in all five areas of the support field: development, production, line, shop and depot.

Grumman is building all five kinds of support equipment for the systems it is producing. These include apparatus with a few ic's,

Computer-adaptor (right) feeds simulated signals from a general-purpose computer through a test station (left) to avionics systems.

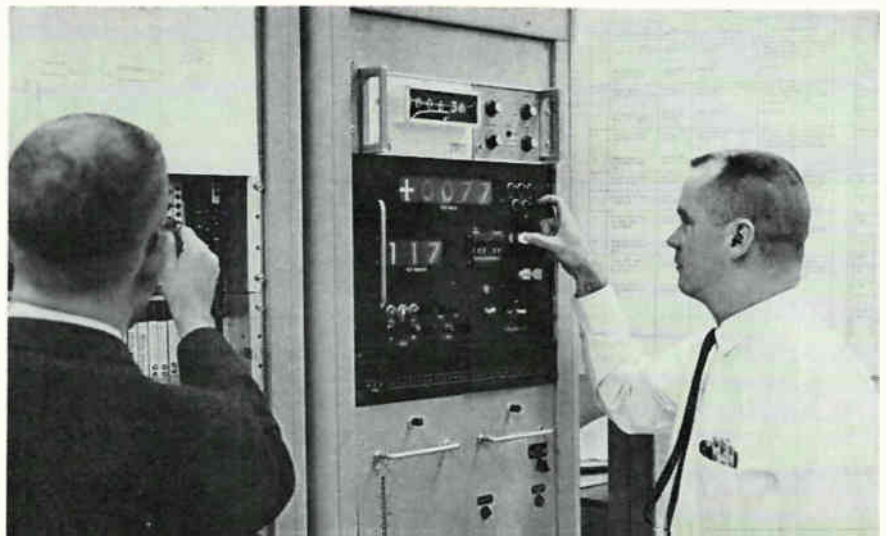

such as the avionics for the Navy's F-111B and systems for delivery in the 1970's that will be entirely given over to ic's. This creates a whole new set of problems according to George Emilio, manager of the advanced systems section in Grumman's Product Support department.

"The complexities created by even partial ic application make it clear that new test concepts are needed," he says. "For one, the number of functions per test point will increase astronomically and such current test methods as point-by-point checks will be inadequate."

I. Inside jobs

As a possible solution to the difficulties posed by ic's, Grumman and other manufacturers are investigating built-in tests. Victor Green, program marketing manager of the Data Systems division of the Autonetics division of North American Aviation Inc., says, "We believe on-board self-checking will increase markedly over the next few years, particularly fault isolation techniques to permit module substitution at the operational level. Boards that fail will be forwarded elsewhere for detailed testing" [Electronics, Oct. 17, 1966, p. 103].

A spokesman for the support department of Hughes Aircraft Co.'s Aerospace Group agrees: "It's surprising how many built-in checks can be designed into a single ic module. It's apparent that there will be sizable shifting from external test gear to internal self-test."

But, he cautions, "Built-in ic's can create problems while solving them. As built-in test equipment becomes more sophisticated and extensive, weight and reliability difficulties develop. If the test equipment fails, it is as bad as if the system itself failed."

A representative of the Nortronics division of Northrup Corp. suggests there may be absolute limits as well. According to an extensive survey made by the company, cost and reliability reduce the number of circuits that can be assigned self-test routines to 15%.

Computer testing. A number of companies use digital computers to program and control testing as well as to display data. And, to a lesser extent, computers have been assigned the job of analyzing test

from Industro...

IMMEDIATE DELIVERY!

NPN

HIGH VOLTAGE SILICON TRANSISTORS

and

PNP

COMPLEMENTS

INDUSTRO COMPLEMENTARY TYPES

NPN	PNP	V _{CEO}	Case Style
2N3439	TRSP-3504S	350V	TO-5
2N3440	TRSP-2504S	250V	TO-5
2N4063	TRSP-3515S	350V	MD-14
2N4064	TRSP-2505S	250V	MD-14

Write for full specifications.

watch...



INDUSTRO TRANSISTOR CORPORATION
35-10 36th AVENUE/LONG ISLAND CITY, NEW YORK 11106/(212) EX 2-8000

The Material of Unlimited Uses...



PICTURE YOUR VERY OWN ALLOY

We can. Down to the last quantitative detail, with this new X-ray emission spectrometer . . . and we're the only low-melting-point alloy producer to have one! You might have expected this, since we pioneered these alloys. Part of a complete analytical facility at our new bismuth alloy plant in Springdale, Conn., this fast-readout device is in continuous use for quality control, for identifying and analyzing raw materials, and for tailoring custom alloys to your every requirement. Call Cerro for straight talk and real action on fusible link, workholding, die-casting, dip molding and similar applications. □ Whether you need a standard low-melting-temperature alloy or eutectic, an established "special" alloy, or one that hasn't yet been produced, come to Cerro with your end-use specs. In bismuth alloys, as in basic materials, Cerro means leadership. □ For detailed information contact Cerro Sales Corporation, 300 Park Avenue, New York, N. Y. 10022 . . . (212) MU 8-8822.

CERRO®



Grumman's Edward Dalva says IC's will cause continuous changes in support in the next 10 years.

results. Vic Green of Autonetics says, "Computer-controlled checkout will receive increasing attention as combinations of logic levels skyrocket because of increased use of IC's."

Another increasingly favored approach is a functional test set designed to check particular circuit families, rather than an entire system. A digital test set, for example, could test the digital portions of the inertial guidance, radar and communications systems in an aircraft.

In the more distant future is the use of failure prediction techniques to detect significant degradation of components soon enough to prevent a failure. Hands-off testing is also a possibility. This is a way of diagnosing an entire situation from small symptoms as easily as a doctor can spot measles from blemishes. Autonetics, for one, has been working on noncontact testing of IC modules using infrared techniques. The company has a breadboard model which is very close to production.

II. Where the action is

Grumman is also developing test methods that go beyond manual and tape-controlled point-to-point voltage checks as well as ways of replacing voltage measurements altogether.

One approach uses a computer programed with a mathematical model of the system to be tested. Identical test signals are fed into the real system and the computer.

such as the avionics for the Navy's F-111B and systems for delivery in the 1970's that will be entirely given over to IC's. This creates a whole new set of problems according to George Emilio, manager of the advanced systems section in Grumman's Product Support department.

"The complexities created by even partial IC application make it clear that new test concepts are needed," he says. "For one, the number of functions per test point will increase astronomically and such current test methods as point-by-point checks will be inadequate."

I. Inside jobs

As a possible solution to the difficulties posed by IC's, Grumman and other manufacturers are investigating built-in tests. Victor Green, program marketing manager of the Data Systems division of the Autonetics division of North American Aviation Inc., says, "We believe on-board self-checking will increase markedly over the next few years, particularly fault isolation techniques to permit module substitution at the operational level. Boards that fail will be forwarded elsewhere for detailed testing" [Electronics, Oct. 17, 1966, p. 103].

A spokesman for the support department of Hughes Aircraft Co.'s Aerospace Group agrees: "It's surprising how many built-in checks can be designed into a single IC module. It's apparent that there will be sizable shifting from external test gear to internal self-test."

But, he cautions, "Built-in IC's can create problems while solving them. As built-in test equipment becomes more sophisticated and extensive, weight and reliability difficulties develop. If the test equipment fails, it is as bad as if the system itself failed."

A representative of the Nortronics division of Northrup Corp. suggests there may be absolute limits as well. According to an extensive survey made by the company, cost and reliability reduce the number of circuits that can be assigned self-test routines to 15%.

Computer testing. A number of companies use digital computers to program and control testing as well as to display data. And, to a lesser extent, computers have been assigned the job of analyzing test

from Industro...

IMMEDIATE DELIVERY!

NPN

HIGH VOLTAGE SILICON TRANSISTORS

and

PNP

COMPLEMENTS

INDUSTRO COMPLEMENTARY TYPES

NPN	PNP	V _{CEO}	Case Style
2N3439	TRSP-3504S	350V	TO-5
2N3440	TRSP-2504S	250V	TO-5
2N4063	TRSP-3515S	350V	MD-14
2N4064	TRSP-2505S	250V	MD-14

Write for full specifications.

watch...



INDUSTRO TRANSISTOR CORPORATION
35-10 36th AVENUE/LONG ISLAND CITY, NEW YORK 11106/(212) EX 2-8000

The Material of Unlimited Uses...



PICTURE YOUR VERY OWN ALLOY

We can. Down to the last quantitative detail, with this new X-ray emission spectrometer . . . and we're the only low-melting-point alloy producer to have one! You might have expected this, since we pioneered these alloys. Part of a complete analytical facility at our new bismuth alloy plant in Springdale, Conn., this fast-readout device is in continuous use for quality control, for identifying and analyzing raw materials, and for tailoring custom alloys to your every requirement. Call Cerro for straight talk and real action on fusible link, workholding, die-casting, dip molding and similar applications. Whether you need a standard low-melting-temperature alloy or eutectic, an established "special" alloy, or one that hasn't yet been produced, come to Cerro with your end-use specs. In bismuth alloys, as in basic materials, Cerro means leadership. For detailed information contact Cerro Sales Corporation, 300 Park Avenue, New York, N. Y. 10022 . . . (212) MU 8-8822.

CERRO®



Grumman's Edward Dalva says IC's will cause continuous changes in support in the next 10 years.

results. Vic Green of Autonetics says, "Computer-controlled check-out will receive increasing attention as combinations of logic levels skyrocket because of increased use of IC's."

Another increasingly favored approach is a functional test set designed to check particular circuit families, rather than an entire system. A digital test set, for example, could test the digital portions of the inertial guidance, radar and communications systems in an aircraft.

In the more distant future is the use of failure prediction techniques to detect significant degradation of components soon enough to prevent a failure. Hands-off testing is also a possibility. This is a way of diagnosing an entire situation from small symptoms as easily as a doctor can spot measles from blemishes. Autonetics, for one, has been working on noncontact testing of IC modules using infrared techniques. The company has a breadboard model which is very close to production.

II. Where the action is

Grumman is also developing test methods that go beyond manual and tape-controlled point-to-point voltage checks as well as ways of replacing voltage measurements altogether.

One approach uses a computer programed with a mathematical model of the system to be tested. Identical test signals are fed into the real system and the computer.

When the two outputs differ, a malfunctioning component has been detected. To isolate the fault, elements in the model are deliberately degraded until the output matches that of the real system, thus pinpointing the trouble.

Grumman engineers have also detected malfunctions in one type of digital circuit by putting a signal into the circuit and analyzing the output. No internal test points are required. Grumman plans to apply the approach to complex airborne systems. Also, an advanced mathematical technique, called the Markov Chain, has enabled engineers to analyze an airborne unit that exhibited random signal degradation and to predict future performance characteristics. The results were sufficiently accurate to convince staff members this method will prove a practical tool.

The use of transfer function techniques to isolate malfunctioning parts within the module is also under study. Previously, this method was applied only to a whole module.

Changing times. The changing character of support requirements and hardware will have a profound impact upon the logistics, training, field service, spare parts and publications side of the business.

Training military and space agency personnel to operate systems is already a big business that will grow tremendously as more complicated equipment is introduced. At the moment, the development of instruction courses and the building or buying of training devices accounts for most of this part of the market. But new techniques, including programmed learning, will be necessary to qualify personnel to operate advanced systems.

The LTV Electrosystems division of Ling-Temco-Vought Inc. says IC's will cut down on the number of company field representatives but they will have to be much better trained.

The number of service personnel to help customers maintain IC-equipped systems in the field will depend on how much maintenance the systems will need plus how successful the Defense Department is in training its own military and civilian employees to do the work. Sales of spare parts will go down if IC's are as dependable as hoped.

The Material of Unlimited Uses...

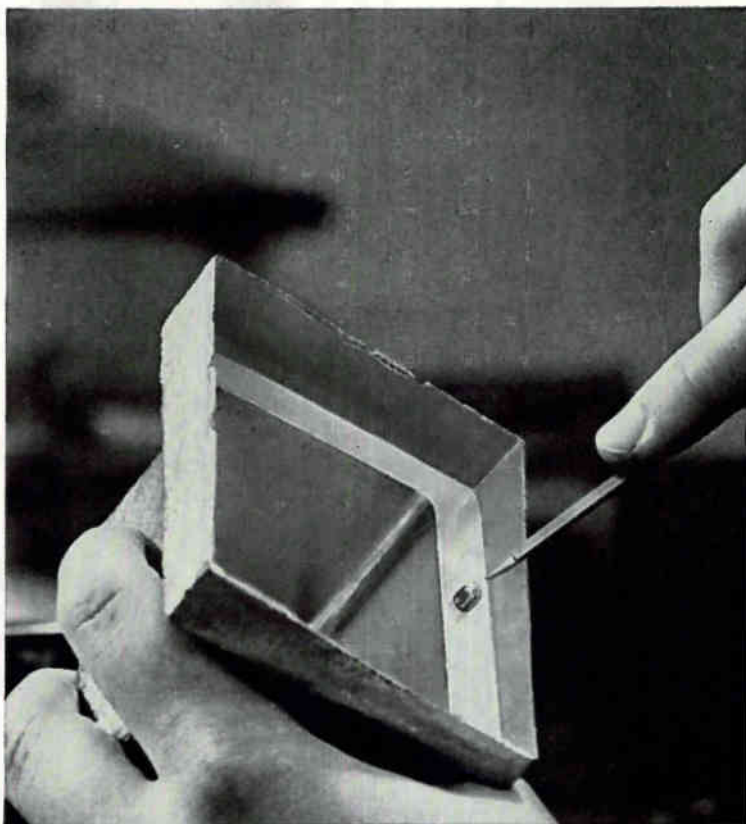

INSTANT DIP-A- MOLD

In seconds, you can make perfect molds, like this one, for potting any encapsulation, and make them economically, with low-melting CERRO® Alloys. Just dip the master in molten

alloy. A thin coating of alloy clings to the pattern. Withdraw the pattern, and you have a perfect high fidelity mold. When the encapsulating plastic cures, simply remove the CERRO Alloy. Use it over and over again, almost without limit. □ This particular alloy — CERROTRU® — does not shrink, slips easily from the pattern without parting or contaminating compounds or coatings. Because of its low melting point, it is safe and easy to handle. □ You can reproduce such unusual details as positioning lugs for transformer cases, as shown above, without the use of cores, inserts or secondary operations. □ Instant molding is just one of the many uses for CERRO Alloys. To find out more, write for your copy of our new "Quick Facts" folder or contact Cerro Sales Corporation, 300 Park Avenue, New York, N. Y. 10022 . . . (212) MU 8-8822.

CERRO®

Railroads on the automation track

They have finally realized electronic controls can help them untrack the freight cars sitting profitlessly in classification yards

Ever so tentatively, American railroads are approaching the electronics industry for more help in straightening out the costly tangle in their freight classification yards. The long-term reward for success could be \$1 billion.

It's not yet "clear the track" for computerization or even automation. But a number of projects, some near completion, others under way and more on the drawing boards, suggests that railroading, which has toyed with automatic classification for more than 10 years, may at last be receptive to the advantages of technology.

The scorecard: work has just started on a fully automated classification yard for the Union Pacific Railroad in North Platte, Neb. The job, being run by the Union Switch & Signal division (us&s) of the Westinghouse Air Brake Co., marks the debut of the International Business Machines Corp. in the railroad field. An IBM 1800 process-control computer is at the heart of the system which will be in the

hardware stage this summer.

A similar terminal yard for the Norfolk & Western Railway near Cleveland will be on-line by summer. Us&s is also coordinating this project which features a Computer Communications Corp. (ccc) 116 digit data processor.

Another us&s system with a ccc 116 computer is almost on-line at the Southern Pacific Co.'s Eugene, Ore. yard.

A big future. Further down the track is the contract for the New York Central System's giant Perlman yard in Albany, N.Y. When completed, this model 90-track facility will be the largest and most highly automated classification yard in the United States.

Isolated though they may be, such developments are a great leap forward in the light of the railroads' glaring deficiencies. There are 1,200 major classification yards scattered around the U.S. These are railroading's critical nerve centers, where incoming trains are broken down and reassembled as new trains

bound for other parts of the country. To date, only 118 yards are equipped with some automatic control equipment, but merely 37 of these systems incorporate computers and 34 of them are relatively inflexible analog units.

The advantages of electronics have been available to railroads since 1949 when semiautomatic switching of rolling stock in a classification yard was proved feasible at the Illinois Central Railroad Co.'s Markham, Ill. facility. In 1952, the first analog computer to control car switching was introduced at the Elgin, Joliet & Eastern Railroad's Gary, Ind. yard. Later that year, potentiometer control of car speed on make-up tracks proved practicable. Subsequently radar speed control worked out and in 1965 the General Electric Co. put the first digital process-control computer on-line at the Alton & Southern Railroad's Gateway yard in East St. Louis, Ill.

Slow progress. Even now, for every day the average loaded



Of the 1,200 major classification yards in the nation only 118 have automatic controls. This one, which boasts an installation with an analog computer, is in the St. Louis-San Francisco Railway Co.'s Tulsa, Okla. facility.

freight car is in a train, producing revenue ton-miles, it travels empty for another 20 hours, sits in customers' sidings for three days, and languishes in classification yards and interchanges for 15 days. The railroads' backwardness on using more control equipment is partially attributable to the strong position of unions within the industry. The roads claim the average computerized classification yard can be operated efficiently with 30 to 40 fewer men than are required in a conventional facility. As a result of labor's intransigence and the threat of strikes, railroaders are reluctant to rework existing installations. As a result most automated yards are built from scratch.

The industry's reluctance to stir up its work force is apparent from its budget. Last year only 13% of the \$56 million invested in signal and communications equipment—any apparatus having to do with electricity, in the railroader's lexicon—was allocated for automation of classification yards. The balance was spent for central traffic control on the 200,000 miles of track around the country, rapid transit and spare parts.

Largely because of the slim pickings and the reputed resistance of railroads to progress, signal and communications suppliers are a select group. Just two companies—us&s and the General Railway Signal Co (GRS)—have long divided an estimated 85% of the available market. Other electronics concerns that have occasionally sidetracked into this sector of railroading include the American Brake Shoe Co., GE and Radiation Laboratories.

The very chumminess of the field is reportedly an additional drag on progress in control systems. Due to the low margins—5% or less—on process-control business, both GRS and us&s are reluctant to work on automated yards unless they get orders for such collateral hardware as track switches and electromechanical wheel-speed retarders.

Waste of time. Nonetheless, the loss of the use of a valuable freight car for an average of 256 days a year is increasingly viewed as far too high a price to pay. It's not surprising that much of the internal push for more widespread application of electronic controls to classification yards comes from account-

how to get a quick tan

Or arctan for that matter. Trigonometric functions are solved in a few seconds on Mathatron, the \$5,000 digital computer.

Mathatron understands algebra — your language. Just tap in the expression the way you would write it. Use power-of-10 exponents, parentheses, square roots, decimal points. Answers from the tape printer are in decimal, with the point in the right place.

Mathatron is expandable, like the big computers. When you need it you can add memory, prewired programs, remote keyboard, paper tape reader/punch, or page printer. But you may prefer to keep yours small. It's a personal thing.

Over 80% of Mathatron owners have access to a big computer, but they prefer quick answers. Write us for the whole story.

mathatron: Program memory, 24 to 480 steps • Addressable storage, 4 to 88 registers • 9 significant digits, exponent, and sign • Number range $\pm 10^{-42}$ to 10^{+58} • Speed 100 accumulations per second • Optional prewired programs for special applications.

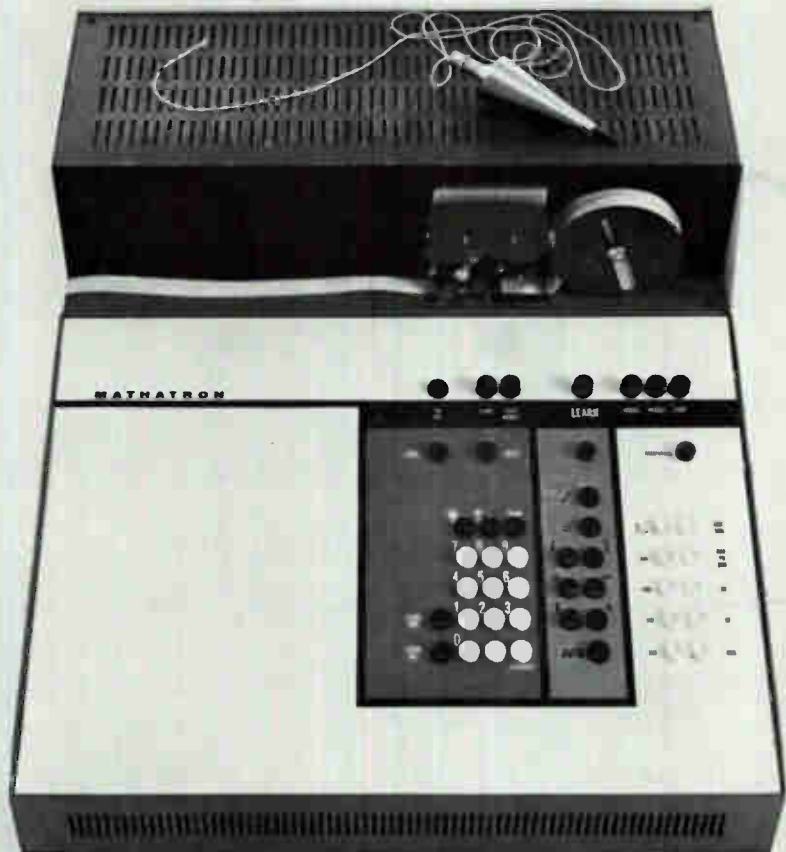

MATHATRONICS

a division of Barry Wright Corporation 

241 Crescent Street, Waltham, Massachusetts 02154, Telephone: 617-893-1630

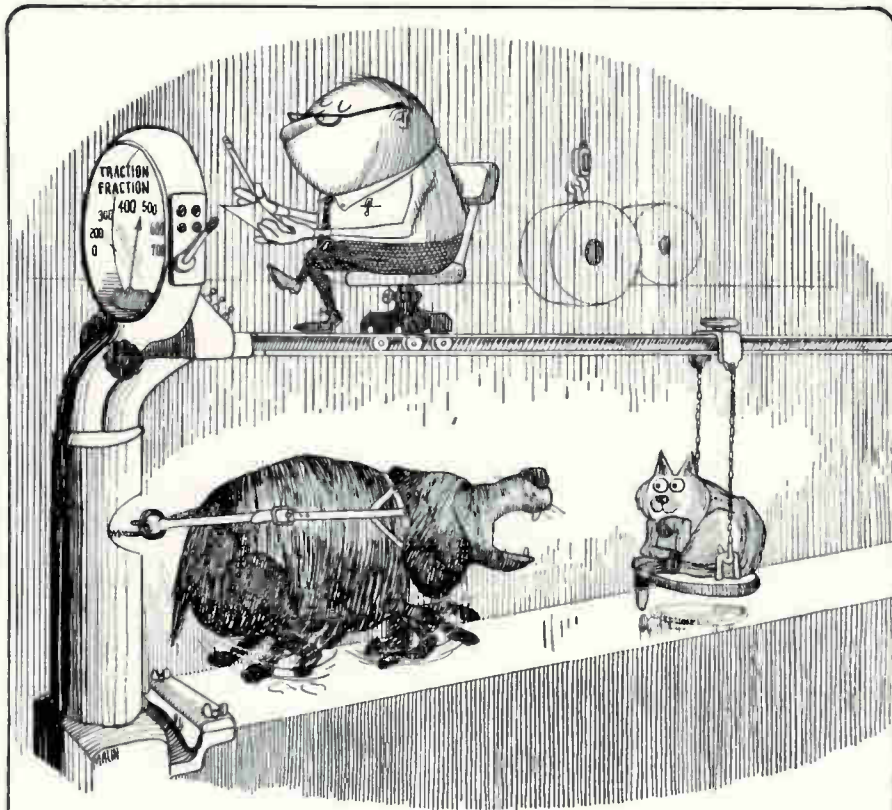

HOW SLICK IS SLICK?

Republic Foil has the answers when it comes to aluminum foil for capacitors. We measure the coefficient of friction of the foil surface because the degree of slickness has a direct bearing on performance in capacitor winding machines. By measuring surface friction and other values and working closely with customers and winding machine manufacturers we produce maximum performance foils; for example, Electro-Dry, Electroslik and Silwynd.

Engineering foils to meet the needs of capacitor manufacturers is a specialty at Republic. Controlled slickness is just one of the extras we build into capacitor foil products to meet ever higher standards of quality.

It's part of the process we call . . . FOILSMITHING.

WRITE FOR technical report E100, "Coefficient of Friction on Aluminum Foil Surfaces."

THE LEADING MANUFACTURER OF A COMPLETE LINE OF PLAIN & ETCHED CAPACITOR FOIL

- Electro-Dry®, Silwynd®, Electro-Slik®, Electrogage®
- LIGHT GAGE FOIL for paper and film wound capacitors
- ETCHED ANODE & CATHODE FOIL
- PLAIN FOIL FOR ETCHING
- PLAIN FOIL for electrolytic capacitors, coil winding.
- FULL TECHNICAL SERVICE



REPUBLIC FOIL INC.

General Offices, Danbury, Conn. 06813: Tel. 203-743-2731

BRANCH SALES OFFICES

Chicago, Ill. 312-545-2142 • Salisbury, N. C. 704-633-6020 • Cleveland, Ohio 216-871-6268
 WEST COAST — Electrical Specialty Co., 213 E. Harris Ave., So. San Francisco, California
 2820 E. 12th Street, Los Angeles, California 90023

PLANTS - Danbury, Conn. • Salisbury, N. Carolina • Somerville, Mass.

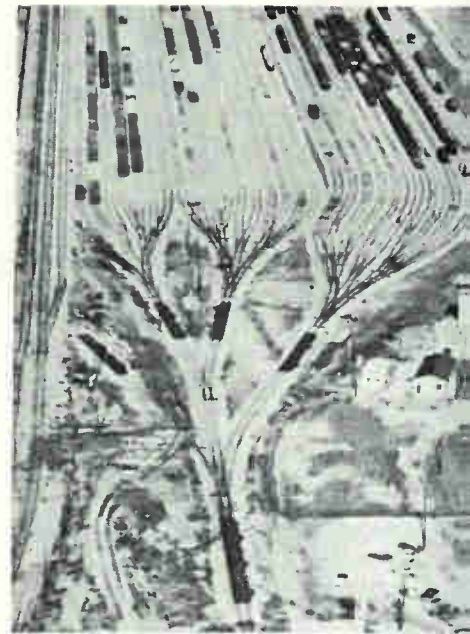

Tulsa layout shows the bottlenecks built into classification yards.

ants, rather than engineers. Accountants, concerned with securing a maximum return on all assets, are usually well-grounded in the capabilities of computers from having used such units for billing, book-keeping and related operations. Their technical colleagues, in the railroad field at least, tend to be preoccupied with problems of power rather than control.

The conception and development of the Central's Perlman yard, which will follow closely at least three other projects, could establish a faster pace for additional control installations throughout the industry. GE's direct digital control system, after some startup woes is working out well. The pioneer analog computers cannot produce the data needed to break down and make up trains fast enough, although they do facilitate track-to-track switching. Thus the chances are that the computerized classification yard systems of the future will borrow the best features of both. Digital computers programed to provide information only when something goes wrong can satisfy the railroads' need to be put more completely in the picture. These units could be connected to analog loops that actually control the switching and make-up processes. Such a configuration would be flexible and able to avoid the problem of swamping the roads with voluminous amounts of digital data that they would be at a loss to use.

FROM SILICON TRANSISTOR CORPORATION

POWER

150 WATTS AT 45°C

V_{CEO} (SUS) 30 TO 250 VOLTS



These high power diffused silicon transistors in the TO-82 package are also available as JAN devices for your military requirements.

ELECTRICAL CHARACTERISTICS

(T_c=25°C, unless otherwise noted)

CHARACTERISTIC	TEST CONDITIONS	2N1015 SERIES		2N1016 SERIES		UNITS
		MIN.	MAX.	MIN.	MAX.	
Breakdown Voltage, Collector to Emitter, V _{CEO} (sus)	*I _c =100mA, I _B =0	30 A-60 B-100 C-150 D-200 E-250		30 A-60 B-100 C-150 D-200 E-250		Volts Volts Volts Volts Volts Volts
Collector Cutoff Current, I _{CX}	V _{CE} =rated voltage V _{BE} =1.5V, T _c =150°C		20		20	mA
Emitter Cutoff Current I _{EB0}	V _{EB} =25V, I _c =0, T _c =150°C		20		20	mA
D.C. Forward Current Gain, h _{FE}	*I _c =2 Amps, V _{CE} =4V *I _c =5 Amps, V _{CE} =4V	10		10		
Saturation Resistance, r _{CE} (sat)	*I _c =2 Amps, I _B =300mA	0.3 Typical	0.75			Ohms
	*I _c =5 Amps, I _B =750mA			0.2 Typical	0.5	Ohms
Base to Emitter Voltage, V _{BE}	*I _c =2 Amps V _{CE} =4V	1.5 Typical	2.5			Volts
	*I _c =5 Amps, V _{CE} =4V			1.7 Typical	3.5	Volts

*Pulse Cond. 300 μ sec., 2% duty cycle.

Available from stock.

For further information contact your local representative, distributor or

SILICON TRANSISTOR CORPORATION



EAST GATE BLVD., GARDEN CITY, N.Y. 11532 (516) Pioneer 2-4100, TWX 510-222-8258

Tactical phased-array radar gets closer to the field

The military's increasing interest in the multifunctional capability of phased arrays is sparking a boom in tactical units

By Thomas Maguire

Electronics Boston Bureau

Electronics firms are zeroing in on the sizable new military market shaping up for tactical phased-array radars. This rugged and relatively small gear, now close to the systems test stage, will, when operational, have airborne, ship-board, and land-based applications.

While conventional electromechanical radar antennas must move about in search of targets, phased-array antennas are fixed. They have thousands of elements, the phases of which can be controlled electronically. The beam radiated by the elements can be focused like that of a conventional radar, or broken up to follow a number of targets within a 180° sector. With this beam-steering capacity, phased arrays can do double and even triple duty. They are especially practicable in such applications as tactical air defense systems for ground troops, where a large volume of data must be handled and high angular accuracies are required.

A number of companies are

working on tactical phased arrays for the Armed Forces, with the Raytheon Co. alone working on four contracts. To get ahead of the pack, Raytheon has spent \$2 million since early 1964 on the development of ferrite arrays. Its FAD project—for ferrite array demonstrator—dates back to 1961 Army studies that established requirements for gear handling simultaneous targets. The company is about to learn just how sound its investment has been.

I. First fruits

Two months from now, Raytheon will deliver an X-band phased-array antenna to the Naval Ordnance Test Station at China Lake, Calif. The Navy will use this system as a test bed in evaluating various approaches to small, lightweight, relatively inexpensive multitasking radar for weapons control aboard small warships.

Raytheon also has a \$2 million contract from the Research and Technology division at Wright-

Patterson Air Force Base, Dayton, Ohio, for a phased-array antenna operating in the Ku band. This system, similar in concept to the one being delivered to the Navy, will be used to determine the feasibility of airborne phased arrays. Multifunction capability is the principal requirement of such a unit, as a single antenna must be able to detect and track many targets simultaneously on a sampled basis. In addition, the airborne phased array would be used to warn of mountains and perform ground-mapping and reconnaissance operations.

The Rantec Corp., a subsidiary of the Emerson Electric Manufacturing Co., is also working on an airborne system similar to Raytheon's for helicopter applications.

Missile radars. Technical proposals are due next week (Jan. 15) from Raytheon, the Radio Corp. of America and the Hughes Aircraft Co. on the ground-based tactical radars for the D version of the Army's proposed SAM-D surface-to-air missile. This weapon, slated to replace both the Nike-Hercules and Hawk missiles, will be designed to defend both troops in the field and fixed facilities from attack by aircraft or short-range ballistic missiles. Selection of one or more prime contractors is expected by midyear.

Whoever nails down the SAM-D order may get some extra business. The Navy, at the behest of the Pentagon, is trying to find areas of commonality between its own Advanced Surface Missile System and the SAM-D. The development and production costs of both programs

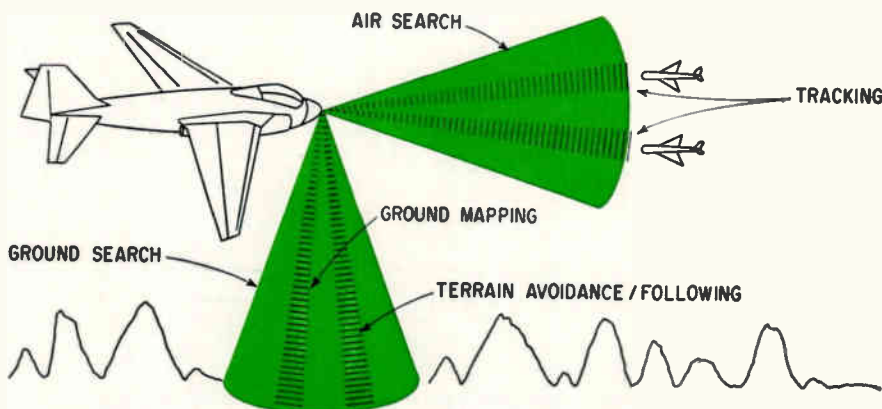

Phased arrays must be able to track and detect many targets and perform ground-mapping and reconnaissance operations in airborne applications.



**DON'T GAMBLE
with your MICROCIRCUITS!**

Specify Rugged, Reliable

ERIE BLUE CHIP[®] CAPACITORS



Actual Size

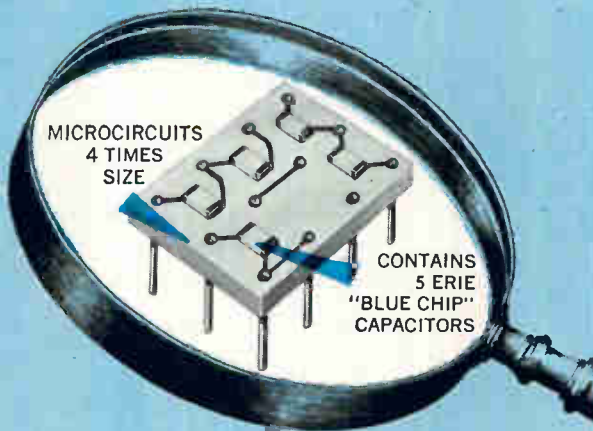

MICROCIRCUITS
4 TIMES
SIZE

CONTAINS
5 ERIE
"BLUE CHIP"
CAPACITORS

**10 to 1,000,000 pF CAPACITANCE RANGE... 50 or 100 WVdc
AVAILABLE NOW FOR MICROCIRCUIT APPLICATIONS**

When one manufacturer... ERIE... produces the most nearly perfect Ceramic Chip Capacitor in the industry... gambling with other chip brands becomes a real game of chance. Erie Chips are considered by knowledgeable engineers as more rugged in construction, they have higher temperature stability, maximum capacitance-to-volume ratio (10 pF to 1.0 mF), greater performance reliability, better solderability... and Erie offers an almost infinite variety of Chip Capacitors to suit any microcircuit requirement.

So when you visit Las Vegas... gamble. That's why you're there. But when you demand better performance from components in Microcircuit, place the only safe bet... ERIE Monobloc Ceramic Chip Capacitors.

Write for technical data on Ceramic Chip Capacitors, Request Monobloc Catalog 8000.

®Trademark for Erie Monobloc Ceramic Chip Capacitors

Another series of components in Erie's Project "ACTIVE"...
Advanced Components Through Increased Volumetric Efficiency.



Erie, Pennsylvania

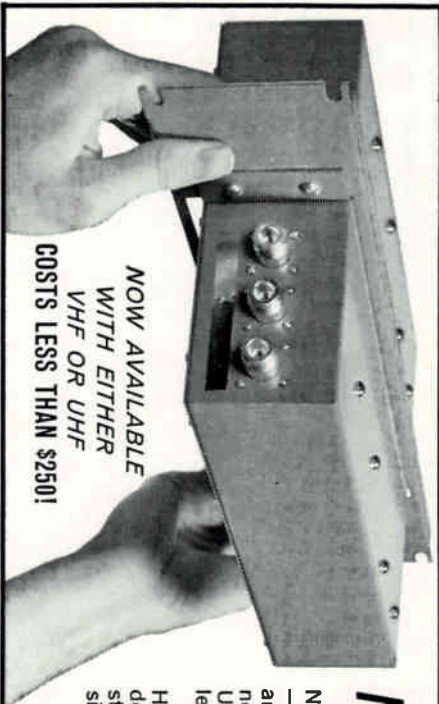

NOW AVAILABLE
WITH EITHER
VHF OR UHF
COSTS LESS THAN \$250!

NEW... SMALLEST BASE STATION DUPLER (ONLY 3 1/2" HIGH)

Now—in a fourth or less of the space formerly required—you can stack a duplexer right with your transmitter and receiver... all at eye level. Only 3" of rack space needed for Sinclair's new VHF Duplexer... 3" for the UHF model. And these surprisingly compact units cost less than \$250!

Don't let the low price throw you! These new Model H-150 and H-450 duplexers are packed with all the dependable quality features of larger Sinclair base station duplexers. They allow simultaneous transmission and reception from a common antenna with sepa-

SINCLAIR RADIO LABORATORIES, INC.

523 FILLMORE AVENUE, DEPT. 101N, TONAWANDA, NEW YORK

ration between frequencies as low as 3 Mc at 150 Mc and 5 Mc at 450 Mc. Returning to a new frequency—if desired—is easily done by retuning the cavities. Neither cable nor harness need be changed.

Though small in size, these new duplexers have standard power rates of 100 watts (optional ratings up to 200 watts are available). The temperature range of from -20°F to 150°F makes them exceptionally versatile in either base station or repeater station applications.

Investigate today! Write for complete FREE information on all Sinclair duplexers, antennas and multicoplers.

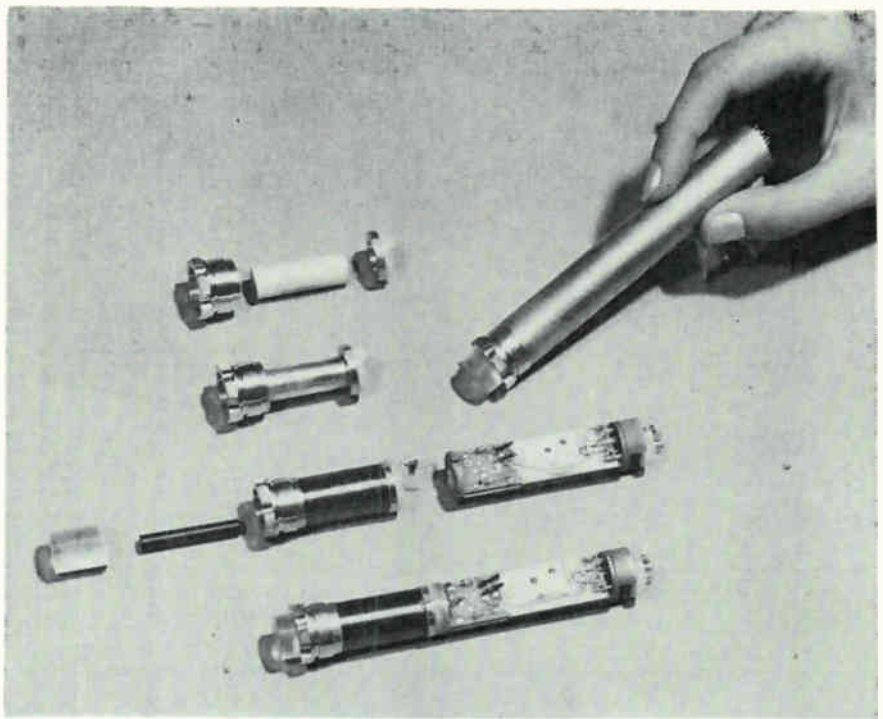

The phasing element in Raytheon's array has driver circuitry and a ferrite phase shifter, which is enclosed in a coil, and a quartz window.

would be reduced if some interchangeability of major components could be achieved.

Along with Hughes, the Westinghouse Electric Co. and rrr Gilfillan, a subsidiary of the International Telephone and Telegraph Co., Raytheon is working on a definition study of a new ground-controlled approach radar, the rpx-19. This equipment will be developed for the tactical air command and control system managed by the Air Force Electronic Systems division, Hanscom Field, Mass. [Electronics, Nov. 28, 1966, p. 25].

II. Out of phase

Raytheon's technical approach to the new tactical radars centers on optically, or space-, fed arrays. This is a technique in which the transmitter is not coupled to the elements by waveguide or cable; instead, transmitter energy is beamed onto the array. In each element the energy goes through a quartz window to a ferrite rod, where the signal is given a computer-determined phase delay and returned through the window to form a part of the radar beam.

Raytheon's choice of technology differs sharply from the corporate-feed techniques used in the phased arrays for such giant installations as the rps-85 space-track radar at Eglin Air Force Base in Florida. In

corporate-feed systems, each element is a transceiver. In transmitting, beam-forming signals are fed through a phase-shifting transmission-line network and focused on the element by an electronic lens behind the array. The signal is then radiated out by the element. The process is reversed in receiving.

The Navy way. The Navy phased-array system with a Raytheon antenna will operate in the X band and have a peak power of 100 kilowatts. Circular polarization techniques will reject rain clutter. The array will have 4,638 elements arranged in a triangular grid, and each element will have a micro-miniature driver, a ferrite phase shifter and a quartz radiating window. The elements will be individually plugged into the wirewrap panel and each will be individually controlled by a beam-steering computer.

"In such a system, failures will occur in a random manner across the array," says A. Michael Briana, manager of Advanced Phase Array Programs at Raytheon's Missile Systems division. According to Briana, the built-in redundancy means that up to 10% of the elements can fail before performance is seriously degraded.

The Navy array has an on-axis, four-horn monopulse feed, and is controlled by a special-purpose,

beam-steering computer plus row and column circuitry. The beam-steering unit requires only three inputs—two angle commands and a command proportional to the frequency—from a general-purpose or fire-control computer. On a two-axis pedestal, the array can search over 360° by combining electronic and mechanical scanning; it can also be positioned to completely scan any quadrant electronically.

The weight of the prototype Navy array, including mount and power supplies, is about 2,200 pounds. The elements each weigh 3½ ounces and cost \$70; the price of the whole array is \$325,000.

A corporate program. Westinghouse, which is also busy on several tactical phased-array projects, has opted for the corporate-feed system in its work on the TPN-19. The company plans to connect high-power transmitters to a corporate-feed network where the energy will be stepped down and supplied to individual latching ferrite phase-shifter elements. These units are expected to provide stability and permit the switching of relatively short pulses. Complex receivers with digital integrated circuitry will furnish high performance in the face of clutter and bad weather.

Westinghouse is not, however, overlooking low-cost, circularly polarized radiators with solid state transceivers. As a possible adjunct, the company is evaluating the use of a frequency-controlled local oscillator to achieve phase control for steering antenna beams.

Down the road. Tactical phased arrays operating at frequencies from the S band through the Ku band, with antenna diameters of 2½ to 8 feet and with 1,000 to 5,000 elements, will soon be available, according to Raytheon's Briana. Weights will range from 250 to 2,500 pounds, depending on the elements used and the frequency required, and costs will range from \$50,000 to \$250,000 on a volume basis.

Briana points out, however, that weight and cost are only two considerations. "With tactical phased arrays, we are trying to satisfy two new requirements," he says. "These are the capacity to handle multiple targets and perform multiple functions."

Versatility and simplicity in variable, regulated power supplies

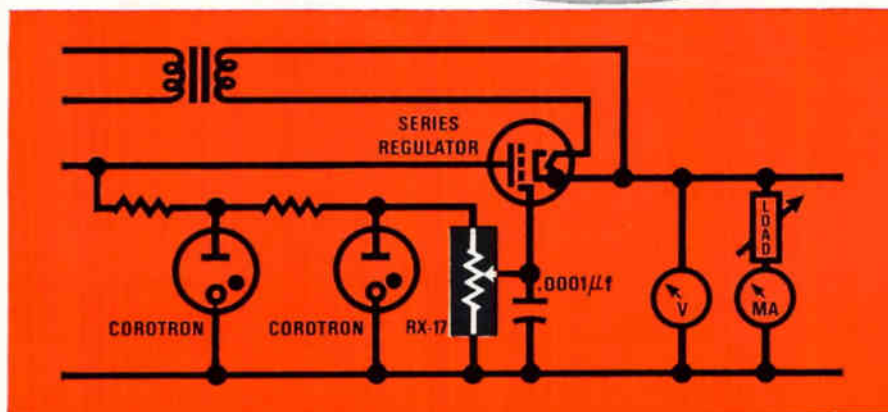
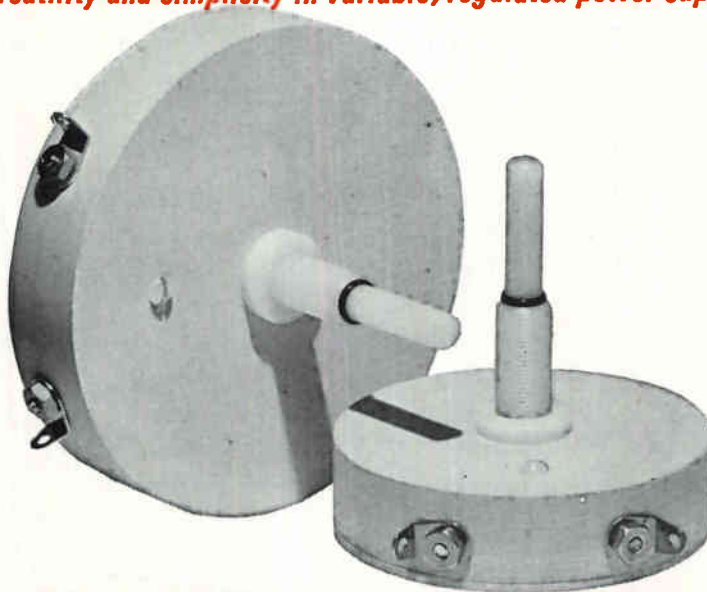

POTENTIOMETERS TO 10 KV

New Victoreen RX-17 series ceramic potentiometers, when used across a well-regulated high-voltage source, provide reference adjustment with a degree of simplicity never before available to circuit designers.

Long life, resistance stability and panel insulation capability to 20 kv make Victoreen RX-17 series potentiometers ideal for reference adjustment for variable, regulated HV supplies in CRT's, TWT's, Klystrons, GM tubes, proportional counters, etc.

Two RX-17 series are available: One for operation to 5 kv rated at 3 w, the other for 10 kv rated at 5 w. RX-17 series ceramic potentiometers are normally supplied with nominal resistance range of 1 Meg to 5000 Meg, with a linearity of ±2%. Full technical details on request to Applications Engineering Department.

6976-A

Components Division

THE VICTOREEN INSTRUMENT COMPANY

10101 WOODLAND AVENUE • CLEVELAND, OHIO 44104

EUROPEAN SALES OFFICE: GROVE HOUSE, LONDON RD., ISLEWORTH, MIDDLESEX, ENGLAND



The next big space program

Space contractors, convinced that the earth resources survey program will mean big business, are swamping the Government with proposals

Despite its present troubles, a down-to-earth satellite to survey the world's water, food and mineral resources is likely to be the United States' next major space venture. Although there has been no request for proposals, the project known as EROS for Earth Resources Observation Satellite has attracted the interest of a flock of companies. The two government agencies nurturing EROS—the Interior Department's Geological Survey and the National Aeronautics and Space Administration—have already talked informally with 15 space contractors who are convinced the program will get a go-ahead in 1967 and be important for years to come.

The EROS must, however, elbow aside other projects for a share of the limited amount of available funds. It is also plagued by friction between the government agencies involved, technology that is at present inadequate for the mission re-

quirements and the lack of a clearly defined system.

The logic of applying space technology to mundane problems is persuasive since the earth's exploding population is reportedly close to exhausting available resources. A number of independent studies agree that this trend may lead to worldwide famine by as early as 1985 unless something can be done almost immediately to improve resources utilization. The problem is equally severe with regard to the supply of potable water and is beginning to become pressing for minerals.

Unsolicited. With the need for additional resources clearly established, the Government only had to hint that it was considering a space system before it was swamped with proposals. The General Electric Co. submitted an unsolicited fixed-price proposal, and although no one is saying how much money the com-

pany asked for, it has to be less than \$20 million since that's the amount budgeted for EROS by Interior. At least two other firms are rumored to be preparing fixed-price proposals for submission in the coming weeks. This increased competition may now keep costs down despite the growing weight and complexity of the spacecraft [Electronics, Dec. 26, 1966, p. 50].

The Radio Corp. of America is also trying to move into the EROS project. RCA and GE have perennially had competing satellites—the Tiros and Nimbus weather satellites, respectively. When EROS was first announced last fall, RCA appeared to have an edge since the size and required capabilities closely resemble those of its Tiros [Electronics, Oct. 3, 1966, p. 52]. Now GE is gaining ground as the Geological Survey recognizes the need for more observation and data processing capability.

But RCA has already beefed up its basic 300-pound Tiros into a more advanced 625-pound weather satellite called Tiros-M that has some of Nimbus's extra features [Electronics, Sept. 5, 1966, p. 135]. The GE entry, called ERIC for earth pointing instrument carrier, is a 500-pound spacecraft similar to Nimbus that would carry "several hundred pounds" of instruments mounted on the base. Either satellite could use the Delta launch vehicle that the Geological Survey has selected for the project.

Also-runs. Many other companies are proposing modified versions of their existing spacecraft. Among these are the Boeing Co., Grumman Aircraft Engineering Corp., TRW Systems Group of TRW Inc. and Ball Brothers Research Corp. The International Business Machines Corp., which has never built a satellite but did a basic study for NASA on resources measurement from space, is also interested in building EROS. The Philco-Ford Corp., the

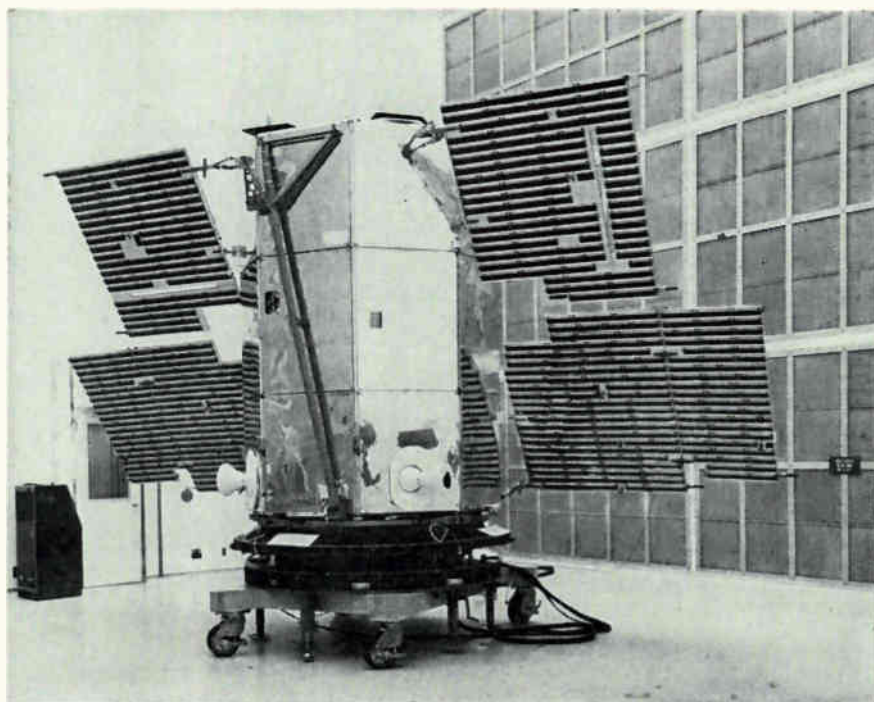

Orbiting Astronomical Observatory built by Grumman is one of many spacecraft being proposed for the EROS program.

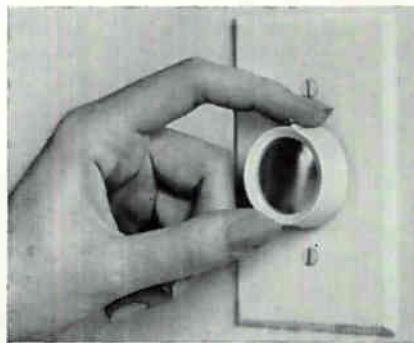

Lutron needed: the best combination of small size, reliability and low cost in capacitors for solid state dimmers.

So Lutron chose: capacitors of MYLAR®

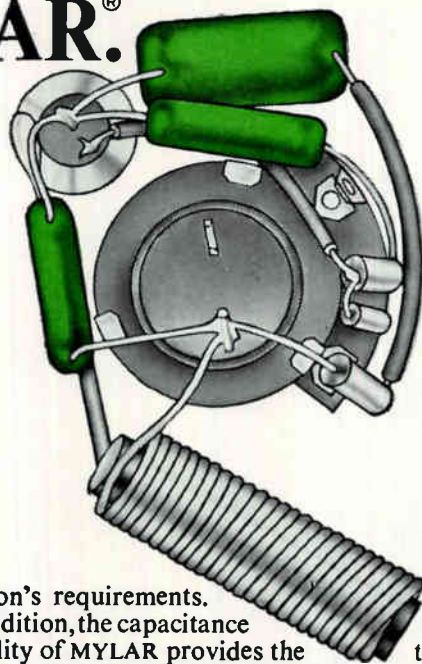

"Only capacitors of MYLAR* give us the size and reliability we must have, and at low cost," says Joseph M. Licata, Chief Engineer. Lutron Electronics Co., Inc.

Lutron's broad line of dimmers is miniaturized to fit single gang boxes for quick, easy installation. Because MYLAR has extremely high dielectric strength in thin gauges, capacitors made from this polyester film can be manufactured small enough to meet

*DU PONT'S REGISTERED TRADEMARK FOR ITS POLYESTER FILM.

Lutron's requirements. In addition, the capacitance stability of MYLAR provides the long-term reliability needed for trouble-free brightness control of all types of incandescent and fluorescent lighting.

Voltage requirements for Lutron's dimmers are 200 to 600 volts, and in many instances these units operate around the clock. Lutron's own tests and experience indicate capacitors of MYLAR

perform well in these conditions, even under extremes of humidity and temperature. Lutron has also found that in many cases, capacitors of MYLAR cost less than paper.

If capacitor size, reliability and price are important to you, check into MYLAR by writing: Du Pont Co.; Room 4671A, Wilmington, Delaware 19898. (In Canada write: Du Pont of Canada, Ltd., P.O. Box 660, Montreal, Quebec.)

Better Things for Better Living...through Chemistry

DU PONT MYLAR®
THE U.S. DU PONT

**What's your angle?
An IMC synchro or resolver
could tell you.**

We could also help you resolve Indicating, Measuring and Control problems using flag and remote angle indicators, steppers, or solenoids. They are in stock at IMC Magnetics Corp., Western Division.

For Quick service contact the Applications Section at Western Division, 6058 Walker Ave., Maywood, Calif. 90270. Phone 213 583 4785 or TWX 910 321 3089.

If you need data sheets for reference or consideration for future projects, write IMC's Marketing Division at 570 Main Street, Westbury, N.Y. 11591.

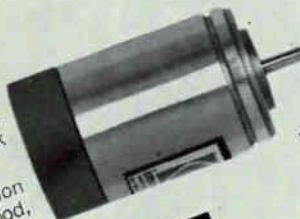

Circle 269 on reader service card

**The Boxer Fan is a standard,
interchangeable unit.
It is long lasting, reliable,
and inexpensive.**



**Say that again and you have
a Tandem Boxer.**

For Industrial, Military, and Consumer uses contact IMC Magnetics Corp., Eastern Division, 570 Main Street, Westbury, N.Y. 11591. Phone 516 334 7070 or TWX 516 333 3319.

If you need data sheets for reference or consideration for future projects, write IMC's Marketing Division at the same address.



Raytheon Co. and at least six other firms have expressed interest in some phase of the project.

When the Interior Department launched the EROS project, officials urged that an operational satellite be flown by 1969. William Fischer, project manager at the Geological Survey, still stresses this urgency. "If the food and population lines cross in 1985, we won't be able to get them uncrossed," he says.

To meet what it considers pressing needs, the Geological Survey is asking for a satellite with three capabilities: high resolution in two spectral bands, near-global coverage and at least one year of useful lifetime in orbit. The two bands are around 750 millimicrons in the solar infrared spectrum that would permit observations of the distribution of water and 550 millimicrons in the blue-green spectrum that would penetrate the atmosphere and oceans to permit studies of the earth's terrain.

The purpose is to make a thorough survey of water in the soil and in plants as well as free water and to identify geological formations with mineral potential. "We're talking minerals not geology and water rather than hydrology," says Fischer. He compares EROS to helicopter traffic reports. Both provide information as it is needed.

But before EROS flies, major improvements will have to be made in space hardware, most of them in electronics. The problem of tape recorder reliability seems insoluble. The only way around this difficulty is to put more recorders on board the satellite. Resolution is an even greater problem. The Geological Survey wants resolution to 100 feet for each 100-mile-square picture. If a television system were used, a camera capable of taking pictures with as many as 5,000 lines would be required. In commercial broadcasting, 525-line pictures are standard. Some candidates are RCA's return-beam vidicon system and the Westinghouse Electric Corp.'s image dissectors. Another possibility is the clustering of 800-line Nimbus tv cameras so that each would cover a portion of a comparable area.

Fischer estimates that EROS needs a communications bandwidth of 20 to 30 megahertz.

The band has to be wide enough to return both photos and ground-

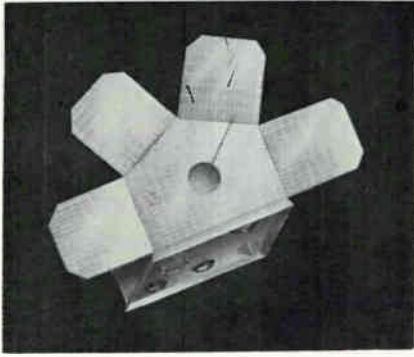

Beefed-up version of Tiros from RCA is also a contender for EROS project

based environmental data collected by EROS as it passes over specially built small transmitters located in areas selected for study. The most attractive frequency available is around 1,740 Mhz, which has been temporarily assigned to NASA. Another possibility is the 1,695 to 1,705 Mhz band used by the Environmental Science Services Administration's weather satellites.

Close tolerance. To solve the problem of stabilization, the Geological Survey favors the gravity-gradient method in which a long boom on the spacecraft extended away from the earth orients the spacecraft so that its sensors always point down. The requirement is for the spacecraft to maintain its earth orientation to within three degrees.

By placing the satellites in an orbit synchronized with the angle between sun and earth at all times, there would be no problem with shadows. With removal of this variable, the pictures could be run through an automatic analysis system that would instantly spot changes in vegetation or moisture. Aerial surveys performed by camera-carrying aircraft have always had the problem of changing light levels that make it difficult to compare photos taken at different times.

The value of space as a unique vantage point has already been confirmed by the spectacular color photos taken by the Gemini astronauts. Now the Geological Survey wants to use a space system to conduct a more accurate and cheaper aerial survey of the United States. The use of existing aircraft techniques would require 1.5 million photos, cost \$12 million and take about three years. A satellite could do the same job for \$750,000 with 400 photos in less than three weeks,

TTC



$\pm 100 \text{ ppm}/^\circ\text{C}$

What else is new with the CTS Series 185 Cermet Trimmer?

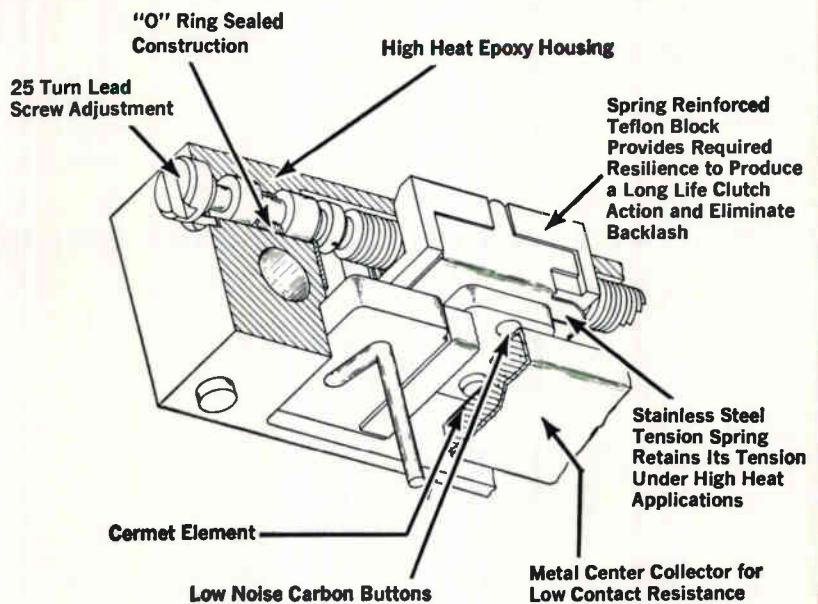

Meets MIL-R-22097B, Char. C, Style RJ11.

Rugged, sealed construction keeps out dust and water—reduces noise. Lower cost (\$2.95 ea. in 1000 quant.) due to 1/3 fewer parts than CTS Series 180.

Highly reliable cermet resistance element provides: high wattage (1 Watt @ 85°C), stability under extreme environments, wide resistance range (25 ohms to 1 megohm), low noise, long life and infinite resolution.

Printed circuit or wire leads; bushing mounting with printed circuit, wire or hook leads also available.

Request Data Sheet 3185.

Founded 1896



CTS MICROELECTRONICS, INC.

LAFAYETTE, INDIANA

Subsidiary of CTS CORPORATION, Elkhart, Indiana

Electronic Relays



AEROSPACE



DRY REED



WETTED REED

Commercial Relays



COMPACT



CONTROL



POWER

Industrial Relays

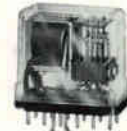

PLUG-IN



600V



MOTOR STARTERS

9 CLUES TO FINDING A RELAY... FAST!

Notice the range of the relay types above. You'll get an idea of what's available in the world's largest line of relays . . . at Struthers-Dunn. Including standards and specials. In fact, if we can't come up with the relay you're looking for, well . . . we have a feeling you'll be in for a long, hard hunt. Write for details on any type.

STRUTHERS-DUNN, Inc.

Pitman, New Jersey 08071

tel: 609-589-7500

twx: 609-589-1548



SALES ENGINEERING OFFICES IN: Albuquerque • Atlanta • Baltimore • Belmont, Calif. • Birmingham, Ala. • Boston • Buffalo • Cedar Rapids • Charlotte • Cincinnati • Clearwater, Fla. • Cleveland • Clifton • Dallas • Encino • Englewood • Glen Ellyn, Ill. • Houston • Kansas City • Memphis • New York • Phoenix • Pittsburgh • Richardson, Tex. • Rome, N.Y. • St. Louis • St. Paul • Seattle • Southfield • Wichita • Wilmette. Canadian Licensee: Renfrew Electric Co., Ltd. Export Dept.: 1505 Race St., Philadelphia, Pennsylvania 19102, U.S.A.

Fischer estimates. The benefits to the economy of having up-to-date maps of the United States are estimated at \$135 million a year. In American aid programs for underdeveloped countries, instant map substitutes gathered by satellites would cut three to five years off the time needed to survey the country in preparation for instituting agricultural and other reforms.

The space agency has an earth resources study program of its own, but it is barely visible among the high-priority, high-cost manned projects like Gemini and Apollo. NASA tends to think big and accordingly the studies have concentrated on large satellites in the Orbiting Astronomical Observatory class and manned earth orbital Apollo flights. A smaller satellite along the lines of Tiros and Nimbus, called Sorero for Small Orbiting Earth Resources Observatory, was studied for a while and then dropped last summer. The idea was revived when the Geological Survey put itself in the picture.

The space agency's position is that technology hasn't progressed far enough to jump into an operational system. A small study team at NASA that has been testing instruments in aircraft wants to continue this study program for several more years before making the transition to a space-borne system. One clue to the agency's hesitation is that the Space Act of 1958 which established NASA made it only a research and development organization rather than an operating agency. If EROS were to be an operational spacecraft, NASA would lose the project to the Interior Department. It has already turned over responsibility for communications satellites to the Communications Satellite Corp. and the Defense Department, and weather to the Environmental Science Services Administration.

The Interior Department is eager to get on with the job right now and plans to allocate funds from its current budget to make a firm start on EROS. The exact amount depends on how much the Budget Bureau will allow for the project in the next fiscal year, but Geological Survey officials plan to spread the \$20 million cost over three fiscal years. They also hope for some money from the Agriculture and State Departments.

The devil's advocate



That's one of the many roles played by our Corporate Director of Reliability. He's responsible for the reliability of all IRC products. He double-checks basic designs. Keeps an eagle eye on production. Never goes easy on inspection and testing.

He's not above stopping a shipment at the door if it doesn't meet IRC's standards. Even if it *does* meet the customer's specifications.

This IRC attitude toward total reliability has practical advantages for you. Now you can choose from several optimum economical levels of reliability in resistors, potentiometers and semiconductors. And IRC is the

first to *publish* prices for standard metal films at three reliability levels.

At IRC, reliability is a management responsibility . . . not just a specification gesture. For top management attention, address your questions on reliability to our Director of Reliability.

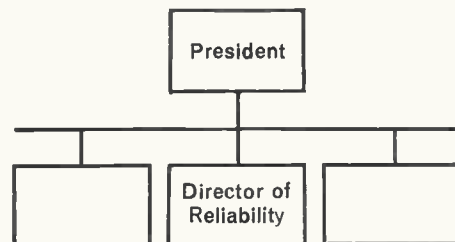

IRC, Inc., Philadelphia, Pa. 19108



NINE-IN-LINE

CIRCUIT PROTECTION and CIRCUIT CONTROL by AIRPAX ELECTRONICS

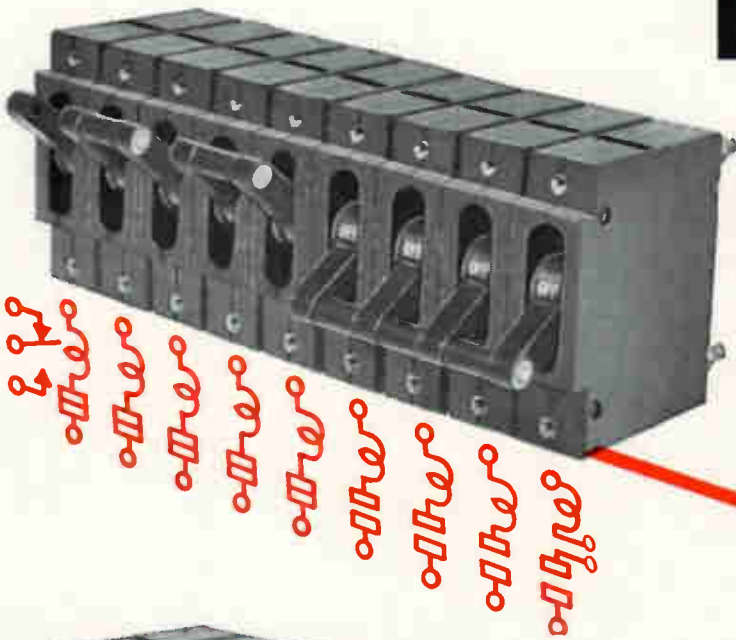

**Step 1 is ON
Step 2 is ON
Step 3 is ON
Step 4 is waiting.**

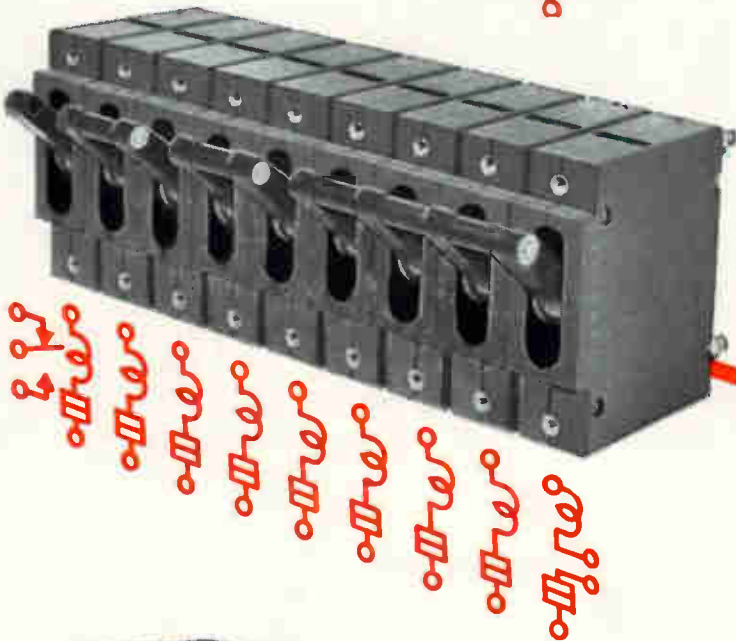

**All steps are on
and all functions
are protected.**

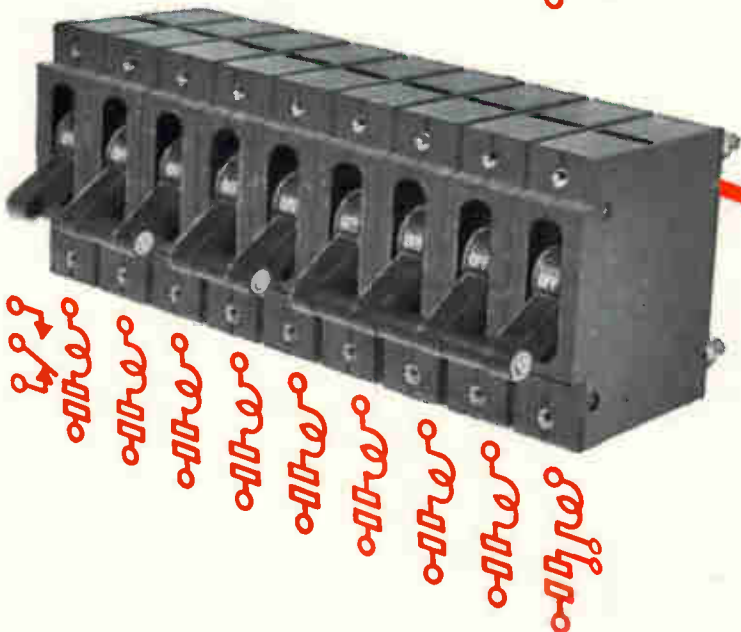

**One circuit overloads.
All protectors trip open.
All safe.**

AIRPAX ELECTRONICS
incorporated

CAMBRIDGE DIVISION, CAMBRIDGE, MD.
(301) 228-4600

The devil's advocate



That's one of the many roles played by our Corporate Director of Reliability. He's responsible for the reliability of all IRC products. He double-checks basic designs. Keeps an eagle eye on production. Never goes easy on inspection and testing.

He's not above stopping a shipment at the door if it doesn't meet IRC's standards. Even if it *does* meet the customer's specifications.

This IRC attitude toward total reliability has practical advantages for you. Now you can choose from several optimum economical levels of reliability in resistors, potentiometers and semiconductors. And IRC is the

first to *publish* prices for standard metal films at three reliability levels.

At IRC, reliability is a management responsibility . . . not just a specification gesture. For top management attention, address your questions on reliability to our Director of Reliability.

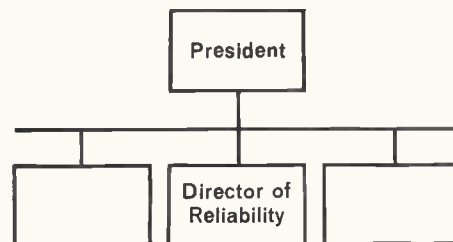

IRC, Inc., Philadelphia, Pa. 19108



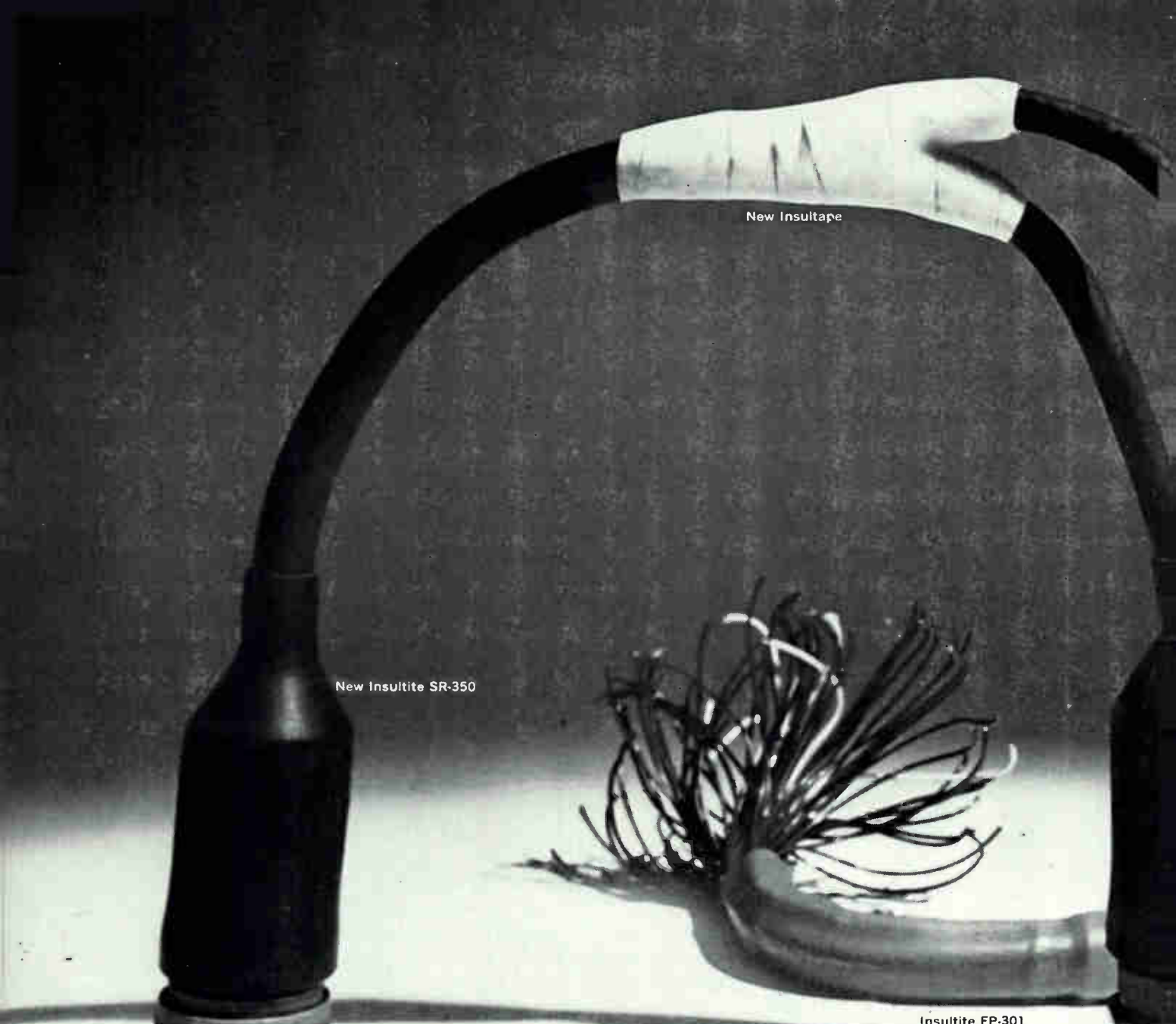

New Insultape

New Insultite SR-350

Insultite FP-301

Feed them your insulation problems.

Here's a hungry family of heat-shrinkable polyolefins that will devour almost any subject. Quickly. And totally. The Insultites. From Electronized Chemicals Corporation.

New Insultite SR-350. This semi-rigid, mil-spec, heat-shrinkable tubing has been designed specifically for insulation and encapsulation of components that are subject to shock, strain, and vibration. It features superior puncture and abrasion resistance. New SR-350 is ideal for applications requiring a combination of excellent dielectric characteristics and high structural strength. It is available in a wide variety of sizes and colors.

New Insultite SRT. This commercial-grade, semi-rigid thin-wall tubing provides polyolefin protection for capacitors, connectors, semi-conductors, and other components requiring tough, clear, abrasion-resistant, thin-wall insulation. And it costs less than vinyl for many applications.

New Exclusive Insultape. This meltable inner-wall heat-shrinkable polyolefin tape reacts to heat just like all the other Insultites. It lets you wrap-up, encapsulate, and moisture-proof hard-to-get-at and complicated components. And it is an economic alternative to costly heat-shrinkable molded items.

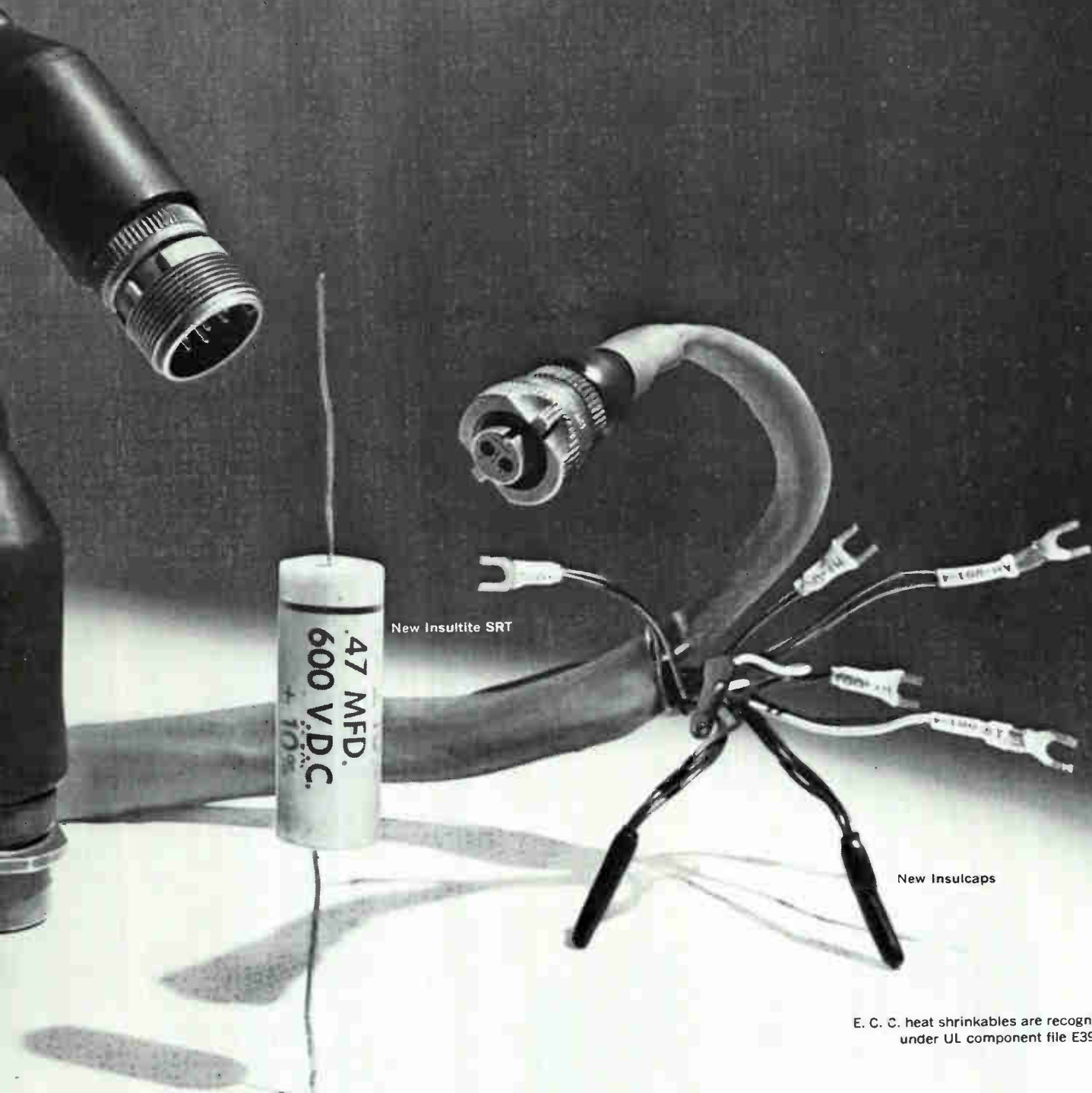

New Insultite SRT

New Insulcaps

New Insultite SR Caps. Here's a semi-rigid, rounded-end, heat-shrinkable end cap that features high abrasion and puncture resistance, excellent mechanical and electrical strength. Competitively priced with sealed and pinched end caps, Insultite SR caps eliminate worries about vibration-caused cut-throughs in adjacent wiring.

Insultite FP-301. This military-spec flexible heat-shrinkable tubing handles tough insulation problems as only an irradiated polyolefin can. Just apply heat, and like all Insultite products, FP-301 shrinks at a better than 2 to 1 shrink ratio. A commercial-

grade polyolefin version of FP-301, new Insultite CP-150 (not pictured) is ideal for computer, automotive, appliance and other commercial applications. It won't split or rupture even over the most irregular surfaces. And new CP-150 costs no more than vinyl. Think shrink with the Insultites. For additional information on the complete Insultite line and for free samples, write today (specify diameters, please).

E. C. C. heat shrinkables are recognized under UL component file E39100.



ELECTRONIZED CHEMICALS CORPORATION

A subsidiary of High Voltage Engineering Corporation
 Box 57, Burlington, Massachusetts, Area Code 617-272-2850

NINE-IN-LINE

CIRCUIT PROTECTION and CIRCUIT CONTROL by AIRPAX ELECTRONICS

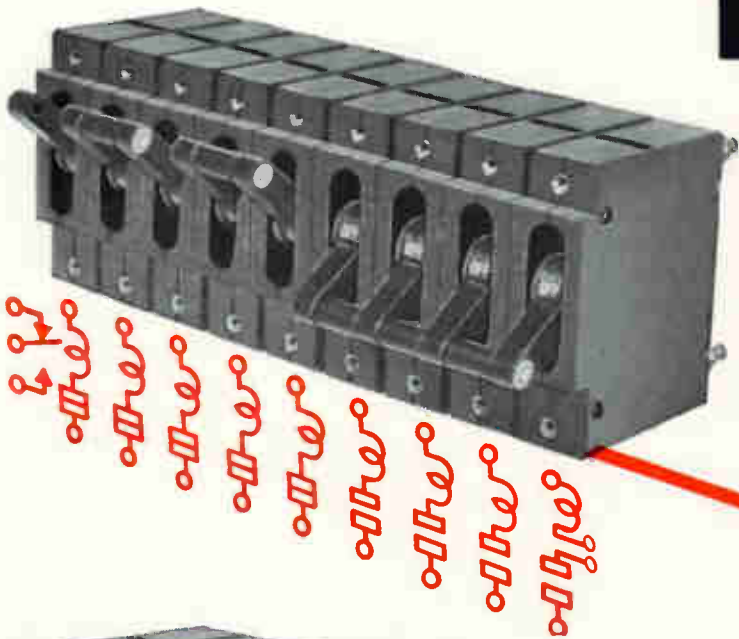

**Step 1 is ON
Step 2 is ON
Step 3 is ON
Step 4 is waiting.**

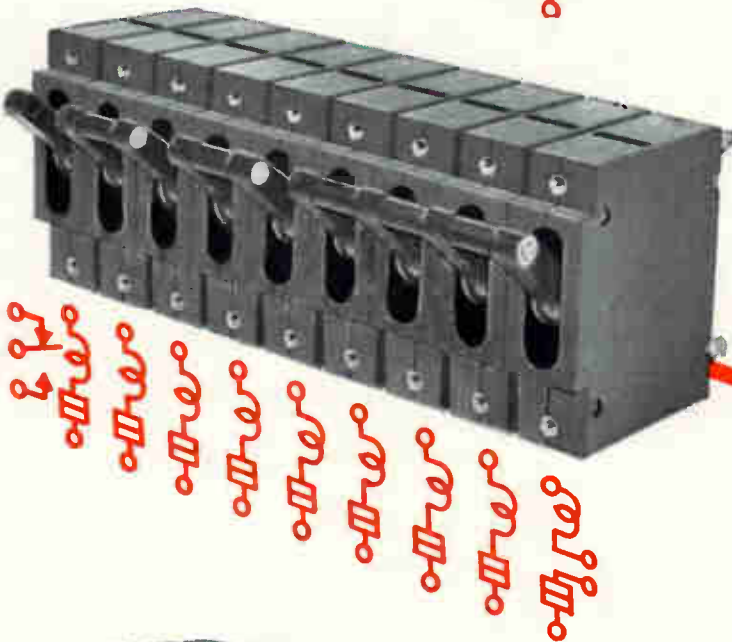

**All steps are on
and all functions
are protected.**

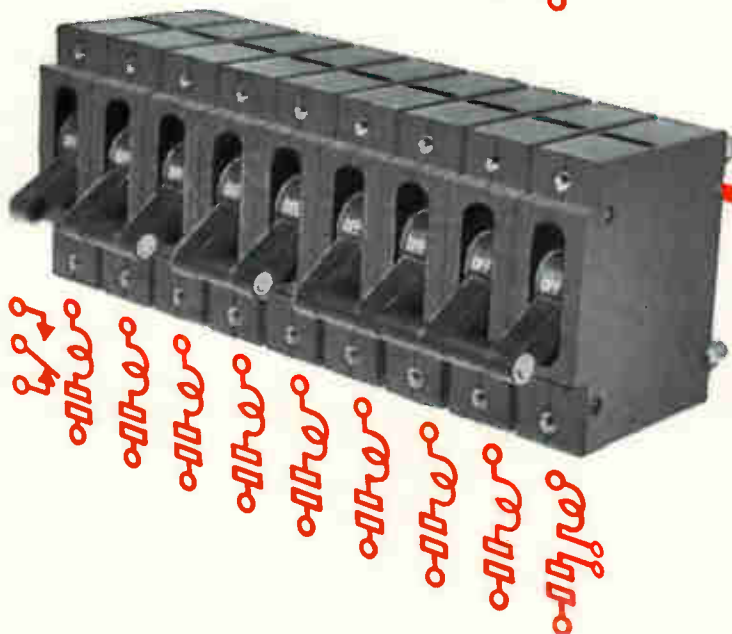

**One circuit overloads.
All protectors trip open.
All safe.**

AIRPAX ELECTRONICS
incorporated

CAMBRIDGE DIVISION, CAMBRIDGE, MD.
(301) 228-4600

Add 20 Mhz to logic speeds

J-K flip-flop that toggles at 70 Mhz is part of a line of complex integrated circuits based on current mode logic

Countering the push to saturating integrated logic circuits, Motorola Inc.'s Semiconductor division is putting a new series of nonsaturating (current mode) ic's on the market. Called MECL II, the new line comprises complex multifunction circuits.

Three of the first circuits are a monolithic full adder that replaces three half-adders, a full subtracter and a J-K flip-flop with a minimum toggle frequency of 70 megahertz, about 20 Mhz above standard competitive ic's, according to the company.

The chief advantage of nonsaturating logic over saturating logic is speed—an advantage gained by avoiding operating the transistors in their saturated regions with the attendant charge storage that has to be "swept out" prior to transistor turnoff.

The MECL II circuits, notes Motorola, will permit a reduction of 30% to 50% in the number of packages compared with older, saturating families. In a few cases the reduction may be almost 70%.

The adder (right, above) accepts 2 binary digits and a carry. Operations are performed almost simultaneously so add time and rise time both are close to the 5-nanosecond propagation delay time. It, like its cousin the full-subtractor, costs \$5.50 in lots of 1,000 to 4,999.

The J-K flip-flop (right, below) has exhibited a typical toggle frequency of about 90 Mhz but the company won't guarantee operation above 70 Mhz. Fan out in current mode logic circuits is normally good and MECL II is no exception; the circuit can drive up to 15 loads without sacrificing operating speed. In quantity, it costs \$3.50.

The circuits, like the rest of the MECL II family, will be available in 14-lead dual in-line plastic packages and ceramic flatpacks. The

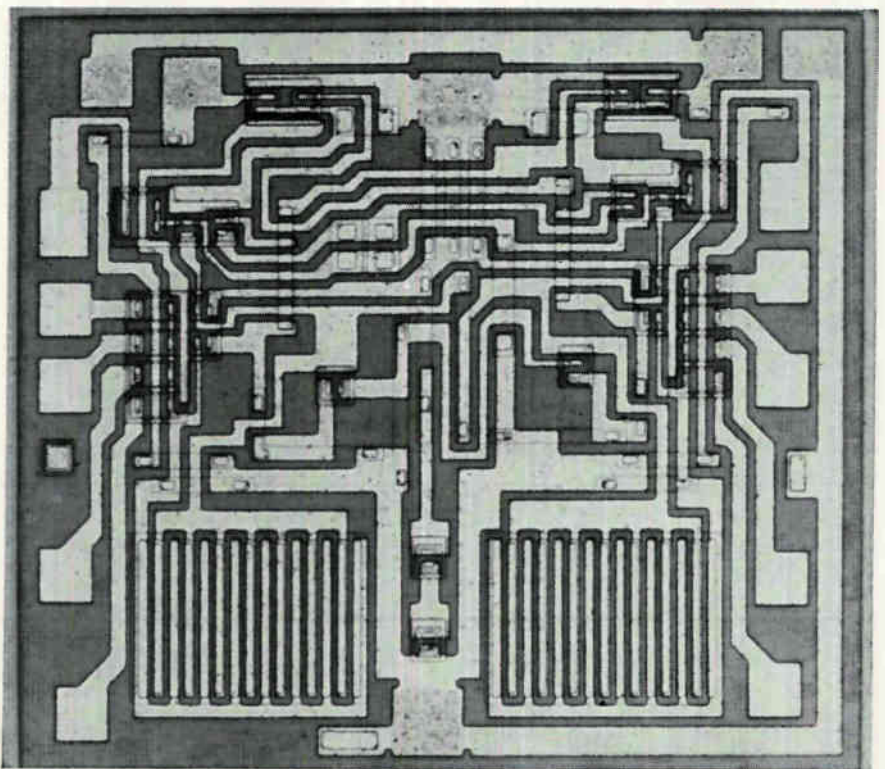
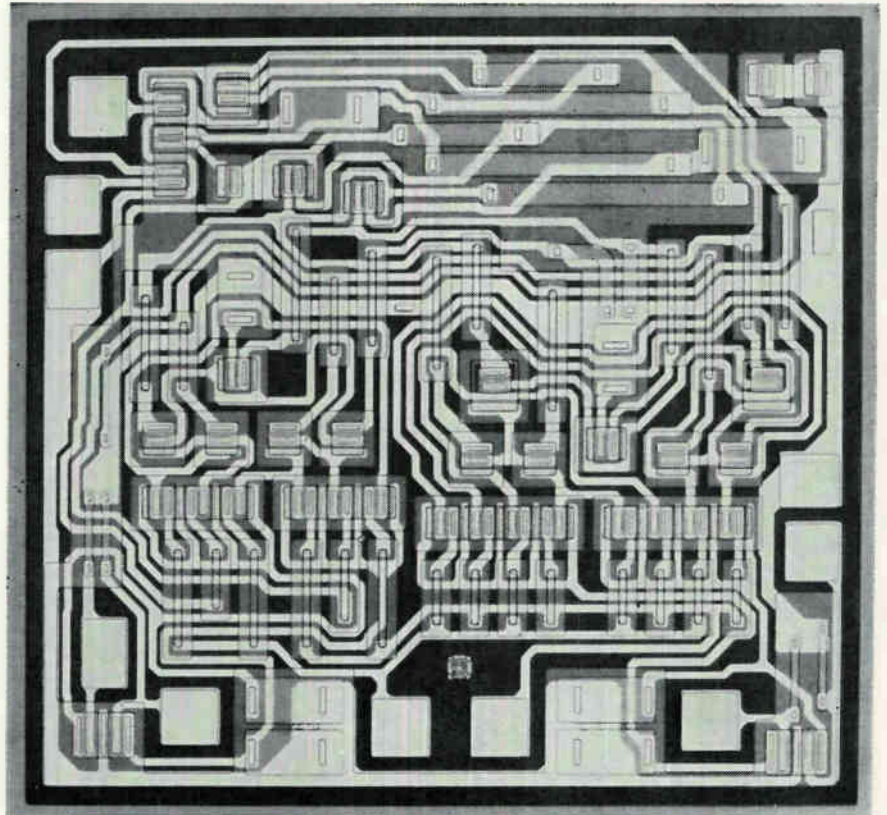

New Products

ceramic flatpacks will cost slightly more but will work from -15°C to 125°C , where the plastic's operating temperature range is 0°C to 75°C . "These are," said a Motorola spokesman, "undoubtedly the fastest logic IC's available today in plastic."

All of the MECL II family are designed to be compatible with the earlier MECL I series. When using members of the two families together, though, there can sometimes be timing problems since the earlier group has a propagation delay time of 8 nsec.

Other MECL II circuits available are 6 gates, with varying output configurations, dual 4-input gates and quad 2-input gates. Other circuits in the series will be available by the end of January.

Specifications

MECL II series

Propagation delay	5 nsec, typical
Fan out	15 a-c loads, max
Power supply voltage	-5.2 v
Logic swing	800 mv
Noise immunity	About 350 mv
Delivery	Off the shelf

MC1013 J-K flip flop

Output voltage at 25°C	
Q logical 1 (Voh)	-0.800 v , min; -0.680 v , max.
Q logical 0 (Vol)	-1.800 v , min; -1.465 v , max.
Switching speed	9 nsec

MC1019 adder,

MC1021 subtractor

Output voltage at 25°C	
high state	-0.75 v , nominal
low state	-1.55 v , nominal

Motorola Semiconductor Products Inc.,
Box 955, Phoenix, Ariz. 85001
Circle [348] on reader service card.

Versatile operational amplifier

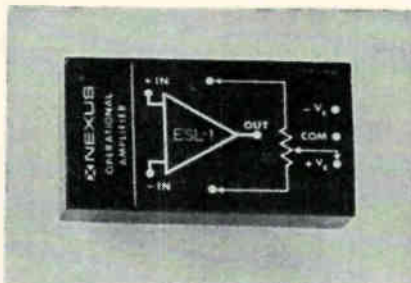

A new design in operational amplifiers could replace as many as 75% of the op amps now on the market, according to Nexus Research Laboratory, Inc., the manufacturer. The new amplifiers operate from a wide variety of either regulated or unregulated power supplies, and are practically immune to input power variations. They are fully protected against short circuits, overloads and overdrive.

Two grades of the all-silicon semiconductor, discrete component units are being offered. The top-line USL-1 has encapsulated, military-spec-qualified components. The lower-priced ESL-1 is built to less rigorous standards, but still offers specifications much superior to conventional operational amplifiers. Where the application allows use of an unregulated power supply, up to 90% can be cut from power supply cost. An additional saving can be gained with the USL-1, because its typical offset voltage of $0.1\mu\text{v}$ makes an external trim potentiom-

eter unnecessary in most cases.

Other advantages stated for the design are an initial warm-up drift of only $50\mu\text{v}$, and highly stable optimized characteristics over the rated supply voltage range. Significant improvements are claimed over currently available amplifiers, especially in offset voltage and current with respect to time and temperature during warm-up. The very high common-mode rejection of 125 db affords unusually good accuracy for use in follower, subtracter, noninverting and other amplifier designs. Versatility of the new amplifiers will allow cuts in inventories and reduce stocking problems.

Specifications

Supply voltage (USL-1)	$\pm 8\text{v}$ to $\pm 26\text{v}$
Supply voltage (ESL-1)	$\pm 8\text{v}$ to $\pm 16\text{v}$
Output and common mode voltage	$\pm 20\text{v}$ @ $\pm 25\text{v}$ supply (USL-1) $\pm 10\text{v}$ @ $\pm 15\text{v}$ supply $\pm 3\text{v}$ @ $\pm 8\text{v}$ supply
Output current	$\pm 5\text{ma}$ within supply range
Power supply rejection	$3\mu\text{v}/\text{volt}$
Input impedance	0.3 megohm
Gain into 10K load (USL-1)	200,000
Gain into 10K load (ESL-1)	100,000
Slewing rate, full output (USL-1)	1.1v/sec
Slewing rate, full output (ESL-1)	1.2v/ μsec
Case size	L, 2.02x1.14x0.62 in.
Price (USL-1)	\$75 (1-9)
Price (ESL-1)	\$35 (1-9)

Nexus Research Laboratory, Inc., 480 Neponset St., Canton, Mass. 02021 [349]

New products in this issue

- 185 Add 20 Mhz to logic speeds
- 186 Operational amplifier

Components and hardware

- 188 Photoconductive cell-lamp
- 188 Adjustment pot
- 190 High isolation switch
- 192 Crystal oscillator
- 192 Transformers
- 193 Multiturn pot
- 194 Ceramic capacitor
- 195 Flat-cable assemblies
- 196 Glass-sealed crystals
- 196 Trigger spark gaps
- 197 Compactron triodes

Semiconductors

- 198 Electroluminescent diode

- 198 Audio transistor
- 199 H-v silicon transistors
- 200 Versatile IC's
- 201 High-power rectifiers

Instruments

- 205 Voltage multiplier
- 206 Transducers measure torque
- 207 Power reference source
- 208 Frequency synthesizer
- 209 F-m multiplier

Subassemblies and systems

- 210 Line drive amplifier
- 210 H-v bench supplies
- 210 Digital transport
- 211 Differential amplifier
- 212 Core memory stack

- 213 Reference source

Microwave

- 214 Gunn-effect oscillator
- 215 Pulse source
- 215 Coaxial attenuator

Production equipment

- 216 Integrated circuit tester
- 217 Encapsulation molder
- 218 Ultrasonic cleaners
- 220 Portable coil winder

Materials

- 222 Clear epoxy impregnant
- 222 Positive photoresist
- 222 Thermoset laminate
- 224 Quartz braiding yarns

It's later than you think!

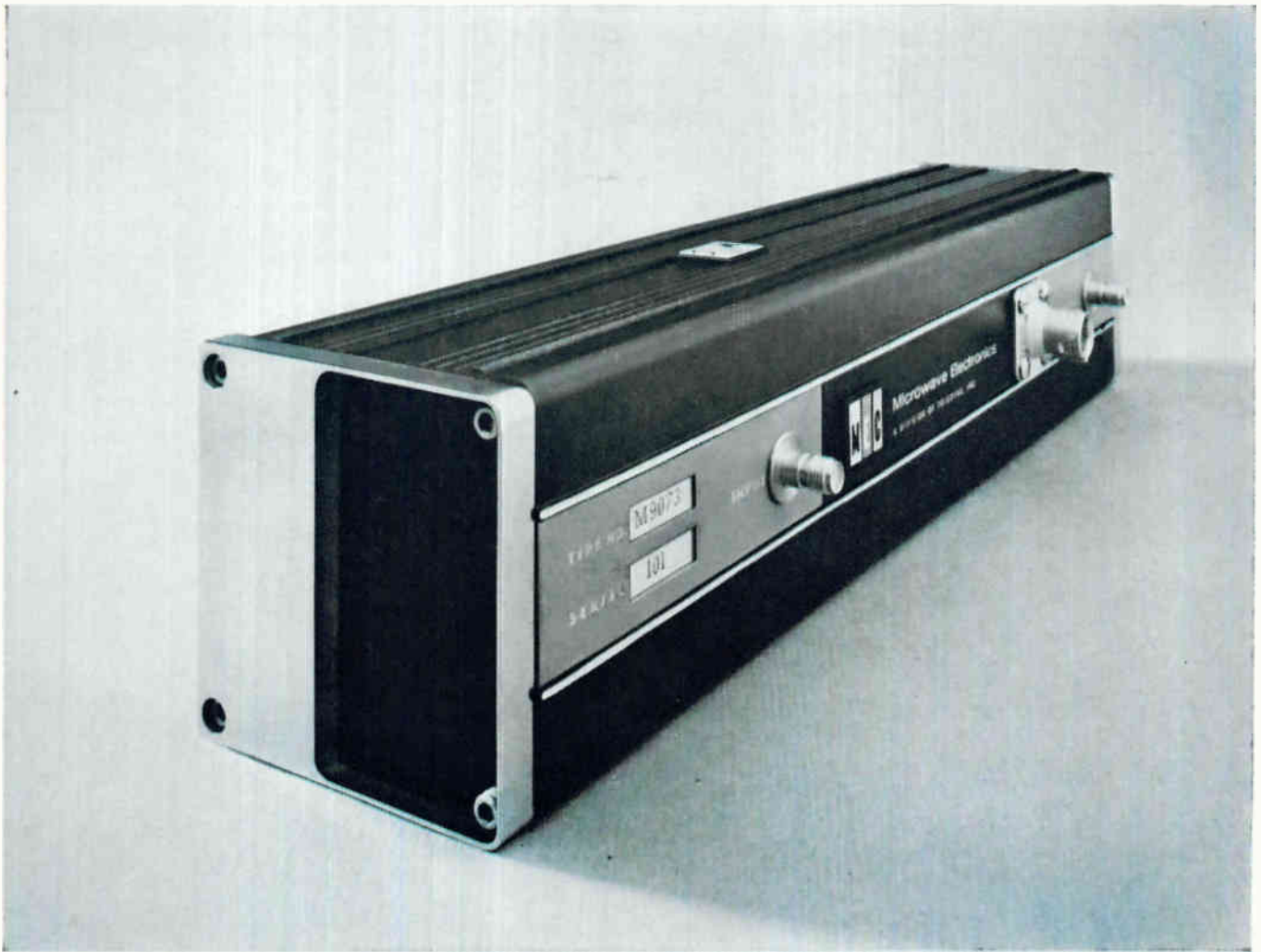

Here's the second generation TWT amplifier.



Smaller and lighter than any other integrated TWT amplifier on the market! That's the difference—the BIG difference—between MEC's new low noise TWT amplifier and all first generation versions.

Let's be specific:

- MEC's rugged package weighs less than 4 pounds.
- It's only 11³/₈ inches long and is 2³/₈ inches square.
- It operates on *either* ac or dc.
- And, it meets MIL-E-5400 Class II requirements.

That's what makes MEC's TWT amplifier ideal for airborne and other applications where space and weight are at a premium.

The package combines MEC's proven miniature low noise TWT with an advanced power supply design. For precise, efficient, and stable performance, the all-silicon, solid-state supply features integrated circuitry and micrologic networks.



The unique primary input circuit allows you to operate from either 115 volt, 48 to 420 cycles ac, or 150 volt dc at efficiencies greater than 70%. That'll really simplify your

flight line or service area testing!

Compare the specifications of integrated TWT amplifiers—then let's hear from you.

Model	Freq. (GHz)	Gain min (db)	N. F. max (db)	P sat min (dbm)
M9071	2 - 4	35	10	10
M9072	4 - 8	35	10	10
M9073	8-12.4	35	10	10
M9080	7-11	35	10	10

Please write for complete specifications.

Exceptional opportunities exist on our technical staff for qualified scientists and engineers. MEC is an equal opportunity employer.



Microwave Electronics 3165 Porter Drive, Palo Alto, California

a division of Teledyne, Inc.

COMPUTER TALK

by W. Henry du Pont, President
SCI-TEK
COMPUTER CENTER, INC.



Several people in the past few weeks have asked me to answer this question. "What is SCI-TEK?" SCI-TEK is a service organization which has been specifically designed to meet the problem solving needs of science and industry.

The problems that can be serviced by SCI-TEK are engineering calculations, coordinate geometry, mathematical programming, stress analysis, simulation and linear programming, market research, sales forecasting, and statistical calculations.

We draw most of our clientele from engineering and scientific organizations who recognize that additional profits can be realized by coming to a specialist who can replace, supplement or fill the needs of the customer who doesn't need an in-house computer.

If you ask me what is one of the big advantages in working with SCI-TEK, I would say the fact that we at SCI-TEK have but one business and that is scientific and engineering problem solving. We are not in the banking field, or the communications field, or any other field. At SCI-TEK our engineers know computers and how best to use them. We'd like to chat with you about your engineering and research problems. Please feel free to contact us.

SCI-TEK
COMPUTER CENTER, INC.
1707 GILPIN AVENUE
WILMINGTON, DELAWARE 19806
Phone: (302) 652-3967

New Components and Hardware

Frictionless 'pot' cuts noise

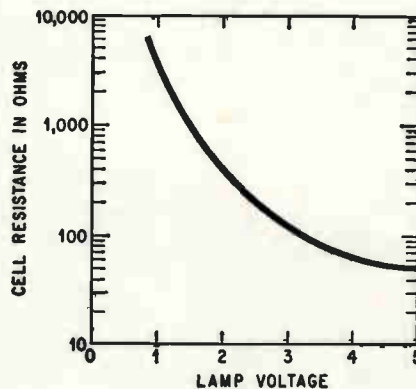

A photoconductive cell-lamp combination with greatly reduced resistance is the latest model in the General Electric Co.'s Tube department's family of "contactless potentiometers."

The model, PL5B2, contains a cadmium sulfide photoconductive cell that is controlled by varying the voltage of a miniature 5-volt lamp. Since the photoconductive cell has no moving parts, there is no mechanical noise when it is used to vary the resistance of a circuit.

The new model is much more sensitive to changes in voltage than an earlier unit, type PL5B1. The cell resistance at 1 volt is 3,400 ohms compared to the prior model's 40,000 ohms at 1 volt. At 4 volts, the B2 model has a cell resistance of 64 ohms; the B1, 260 ohms. All the figures refer to initial resistances. The units degrade with time, with the biggest change occurring in the first 150 to 200 hours. Thus, life expectancy depends on the specific application.

The primary application is in low-level audio switching and potentiometry. The photoconductive cell is electrically isolated from the lamp, so the amount of hum from long lamp-control leads is negligible.

Other application areas are in volume expansion and compression and in automatic gain control circuits.

The unit is hermetically sealed in a metal package 0.65 inch in diameter and 0.35 inch high.

Specifications

Operating temperature range	-40° to 65°C
Photoconductor power capability	100 mw, max
Photoconductor voltage	60 v, d-c or peak a-c, max
Cell resistance	50 ohms (5v on lamp) 150 kilohms, min (0v on lamp)
Lead length	1.375 inch, min, 1.625 inch max
Response time	100 msec, typical
Price	About \$2.50 each for 500 or more
Delivery	1 to 2 weeks

General Electric Co., Tube Department,
Owensboro, Ky. [350]

Adjustment pot measures $\frac{3}{8}$ sq. in.

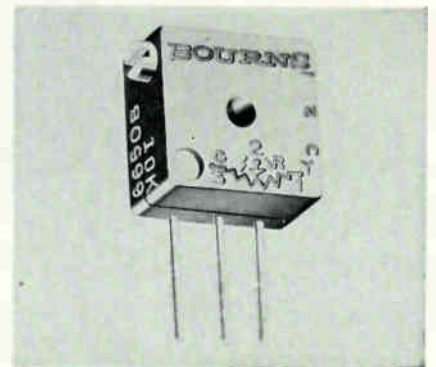

A microminiature adjustment potentiometer provides infinite resolution, has a standard resistance range of 2,000 ohms to 1 megohm and an operating temperature range of -65° to +170°C. The unit measures only $\frac{3}{8}$ in. square and weighs approximately 0.1 oz.

Resistance tolerance is $\pm 10\%$ standard; insulation resistance at 500 v d-c is 1,000 megohms minimum. Power ratings range from 1 w or 500 v maximum at 70°C ambient to 0 watt at 175°C ambient. Vibration, shock and load life per MIL-R-22097C are 30 g, 100 g and 1,000 hours respectively.

Model 3282 has positive wiper-stops at both ends of travel, and the wiper assembly idles at both ends of travel to prevent damage from forced adjustment. The model comes in five configurations.

Price is \$5.20 each in 250 to 499-



ALSiMAG
 THIN FLAT CERAMIC
SNAP-STRATES
 IN PREFERRED STYLES

Substantial production economies may result from monolithic but separable alumina ceramic substrates as pioneered and developed by American Lava. The user snaps the parent part into individual substrates AFTER all film and circuit work is completed.

We suggest you consider presently available preferred style Snap-Strates. They involve no tooling charges and are more promptly available. These Snap-Strates can be supplied in ALSiMag 614, a dense 96% alumina ceramic with a natural finish highly desirable for thick film or screened circuitry. Where a smoother natural surface is required, as in thin film, ALSiMag 772, a dense ultra-smooth 99½% alumina ceramic is supplied.

Tooling is presently available for preferred style Snap-Strates in a thickness of .020" in these sizes:

- Snap-Strate ALSiMag 614 1" x 2"
yielding four ½" x 1"
- Snap-Strate ALSiMag 614 1" x 2"
yielding eight ½" x ½"
- Snap-Strate ALSiMag 772 2" x 2"
yielding four 1" x 1"
- Snap-Strate ALSiMag 772 1½" x 2½"
yielding sixty ¼" x ¼"

New bulletin No. 661 on Ceramic Substrates and Snap-Strates will be sent on request.

The tooling is interchangeable between ALSiMag 614 and ALSiMag 772 if a slight difference in size is not critical.

As new requirements in volume are established, Snap-Strates will be made available to meet these new needs. If you have special requirements, we will be glad to make Snap-Strates to your blueprint or to work with you to find the most economical design.

CODE IDENT. NO. 70371

PHONE 615 265-3411 • CHATTANOOGA, TENNESSEE 37405, U.S.A.

American Lava Corporation **3M**
 A SUBSIDIARY OF COMPANY

For service, contact American Lava representatives in Offices of Minnesota Mining and Manufacturing Company in these cities (see your local telephone directory): Atlanta, Ga. • Boston: Needham Heights, Mass. • Chicago: Bedford Park, Ill. • Cleveland, Ohio • Dallas, Tex. • Laurens, S. C. • Los Angeles, Calif. • Metropolitan New York: Ridgefield, N. J. • Up-State New York and Canada: Baldwinsville, N. Y. • Philadelphia, Penn. • Roanoke, Va. • St. Louis: Lees Summit, Mo. • South San Francisco, Calif. Troy, Michigan • 3M International: c/o American Lava Corporation, Chattanooga, Tenn. 37405, U.S.A., Phone 615/265-3411.

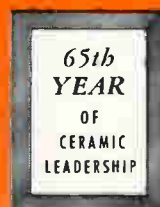

Barnstead makes the world's worst water . . . to help you make the best

Frequently, before Barnstead recommends a water still or demineralizer, we first ask to analyze a small sample of your raw water. Then we mix up a larger batch of water that closely resembles the sample in minerals, pH, sediment and other impurities — for actual trial runs.

The result? Equipment we *know* will deliver the pure water needed for your laboratory, product or process — from the water supply you must use.

It's an example of the objectivity you can expect from Barnstead because we offer such a complete, pure-water-equipment line. Stills, from ½ to 1,000 gph and larger . . . Still/storage tank combinations . . . Demineralizers in two-bed, four-bed, and mixed-bed types, up to 5000 gph. Also purity meters, pretreatment filters, tin-lined pipe, controls. We have what you need.

Write for literature on any of these products, today. Or send us a raw water sample, plus your pure water requirements — for a no-obligation recommendation.

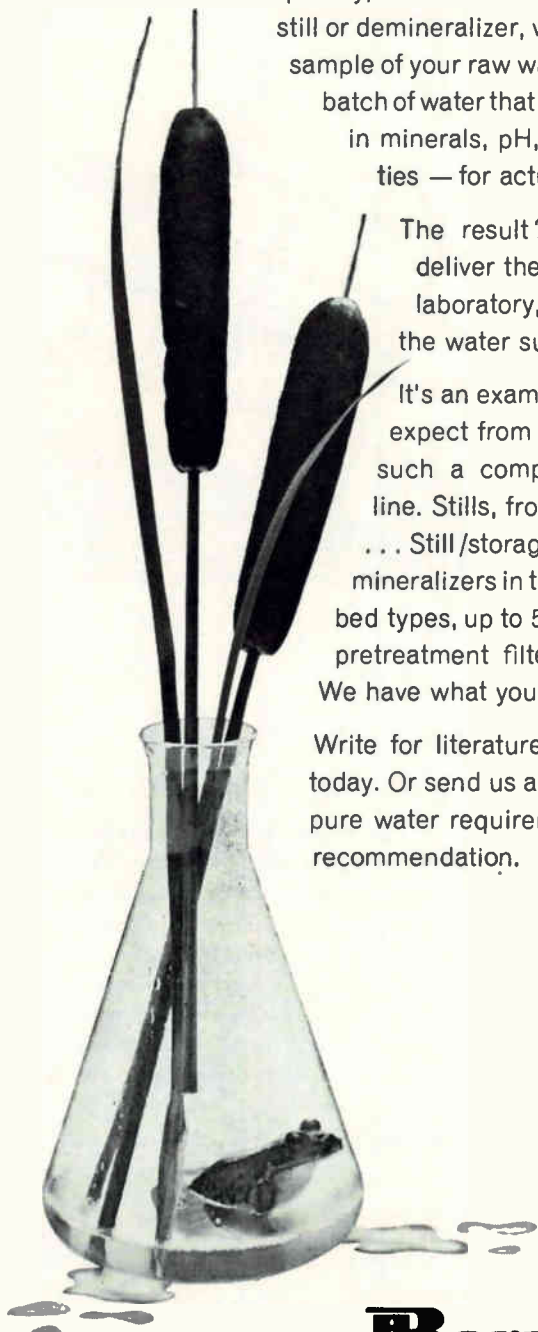

Barnstead

Still and Sterilizer Co.
2 Lanesville Terrace, Boston, Mass. 02131

New Components

piece quantities. Delivery is stock to 3 weeks.

Bourns, Inc., Trimpot division, 1200 Columbia Avenue, Riverside, Calif., 92507. [351]

Switch isolates extraneous signals

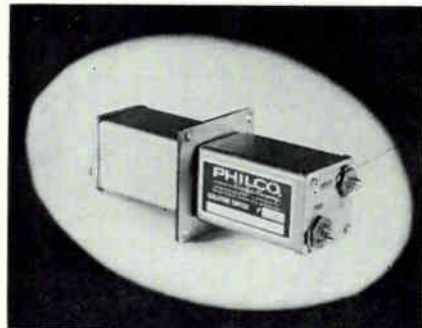

A switch that regenerates its timing signal is designed for applications that require extremely high levels of isolation to extraneous signals. Output-input isolation is in excess of 100 db (d-c to 1,000 Mhz). The same degree of input-output isolation is achieved within the signal passband with a signal-to-interfering-noise-margin of 20 db.

High isolation of the P651A switch is achieved with the L4450 photon-coupled isolator (PCI), a gallium arsenide infrared emitter coupled by a short shielded light path to a silicon photodetector. The L4450 PCI, housed in a stainless steel assembly for bulkhead mounting, is designed for rfi applications.

The P651A consists of an input circuit module that switches the incoming data-timing signals when a predetermined threshold is exceeded to appropriate levels for operating the L4450 PCI, and an output module that amplifies the detected PCI output and switches the output signal loop battery in a manner similar to a conventional solid state relay. The input and output interface characteristics are in accordance with MIL-STD-188B.

The unit has a bandwidth of 10 kilohertz with less than 1% distortion. However, there are no technical limitations for this type de-

Select Your Place In The Spectrum...

Job opportunities cover the
complete communications spectrum.

At SYLVANIA ELECTRONIC SYSTEMS the work range — from gamma rays to radio waves. Satellite tracking radars, UHF telemetry systems, lasers for optical communications, data processing and display systems, dc communications switching — Sylvania Electronic Systems is advancing the state-of-the-art across the complete spectrum of communications techniques and equipment.

The Sylvania Electronic Systems complex — east, central, and west: suburban Boston, Buffalo and San Francisco, respectively — covers the complete range of systems capabilities — from basic research through development, systems engineering, product and field engineering. This means that a complete range of opportunities exists for scientists and engineers interested in technical specialization, technical management, or program/project management.

Here's your challenge for increasing your personal and professional dimension. Current openings exist for highly capable technical specialists with BS/MS/PhD — in areas of interest that span the complete communications spectrum — from man-portable combat posts to satellite antennas. If you qualify and would like to receive more specific information on the type of work, send your resume to: Manager, Professional Staffing, Sylvania Electronic Systems, Division of Sylvania Electric Products Inc., 55 Sylvan Road, Waltham, Mass. 02154.

GT&E

GENERAL TELEPHONE & ELECTRONICS
Total Communications from a single source through

SYLVANIA ELECTRONIC SYSTEMS

RESEARCH • SYSTEMS DEVELOPMENT • PRODUCT & FIELD ENGINEERING

An equal opportunity employer m/f

The complete spectrum of opportunity — work range, location, professional satisfaction — is awaiting you at Sylvania Electronic Systems.



PORTABLE RADIO COMMAND PACK

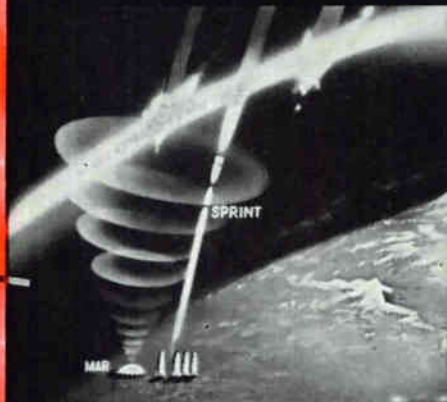

MULTI-FUNCTION ARRAY RADAR

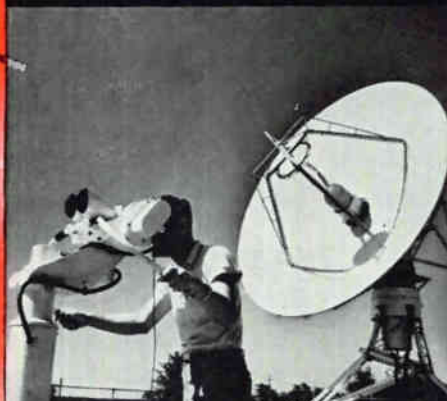

TRANSPORTABLE SAT COM TERMINAL



HIGH-POWER SINGLE-FREQUENCY LASER BEAM

VISIBLE

Heinemann Silic-O-Netic TIME-DELAY RELAYS

SEND US YOUR ADDRESS

...and we'll send you a brand new bulletin on our recently improved line of time-delay relays.

Our hydraulic-magnetic t/d relays now have gold-diffused contacting surfaces, heavier contact blades, a more efficient magnetic circuit—plus a few other design improvements you'd have to squint to see. Performance is better, but the price is still remarkably low.

We haven't modified the hydraulic-magnetic actuating element, of course. Its inherent advantages are all still there. Relatively low power consumption. Good temperature stability. And continuous-duty capability (the relays can remain energized indefinitely after actuation and hence can often eliminate the need for a separate load relay or an auxiliary lock-in circuit.)

Our relays are available in a variety of models: open-frame, hermetically sealed, plug-in. With your choice of sixteen standard timings from $\frac{1}{4}$ to 120 seconds, SPDT or DPDT switching, and any of 20 AC or DC coil voltage ratings. Contact capacities range up to 5 amps at 125 or 250V AC.

Our new Bulletin 5006 will give you full technical data. Just do as the headline suggests—we'll put your copy in the mail as soon as we hear from you. Heinemann Electric Company, 2600 Brunswick Pike, Trenton, N.J. 08602.

3662

**HEINEMANN****New Components**

vice for data rates through the h-f range.

The P651A switch is priced at \$330 in quantities of 1 to 9 with production quantities less than \$200. The L4450 photon-coupled isolator is priced at \$80 each in quantities of 1 to 9, and \$50 each in quantities of 100.

Philco-Corp., Microelectronics division, 2920 San Ysidro Way, Santa Clara, Calif. [352]

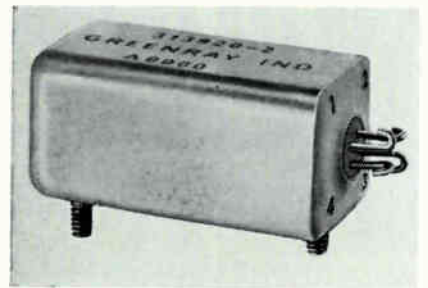
Crystal oscillator puts out 2.5 to 30 Mhz

Satellite and portable test equipment are two applications for a new crystal oscillator. The solid state device measures $\frac{3}{4} \times \frac{3}{4} \times 1\frac{1}{2}$ in. long, is hermetically sealed, meets military specs and is designed for a vibration of 20 g at 2 khz and shock of 100 g with an 11 msec pulse.

Fixed frequency output of model 105500-4 is 2.5 to 30 megahertz. Frequency tolerance over the -25° to $+85^{\circ}\text{C}$ temperature range is $\pm 0.005\%$. Waveform is sinusoidal with 10% maximum harmonic distortion. Output is 0.5 v rms into a 1,000-ohm load; input, +15 v d-c, $\pm 2\%$ regulation.

Price is \$194 each in quantities of 1 to 3 units.

Greenray Industries, Inc., East Simpson Road, Mechanicsburg, Pa. [353]

Transformers change 3-wire data to 4-wire

Converting 3-wire information to 4-wire information is achieved with a new transformer that has an overall angular accuracy of ± 30 seconds. The transformer is suited for

synchro-to-resolver and resolver-to-synchro conversion equipment. It meets the requirements of MIL-T-27B. Input to the 3-wire transformer is 90 v rms at an impedance of 200,000 ohms minimum. The 4-wire output is $4.25 \pm 2\%$ and impedance is less than 10 ohms with input shorted.

Size of the unit, type 9514, is $1\frac{1}{8} \times 15/16 \times 3/4$ in. Magnetics Inc., 6 Richter Court, East Northport, N.Y., 11731. [354]

Plastic housing cuts multiturn pot weight

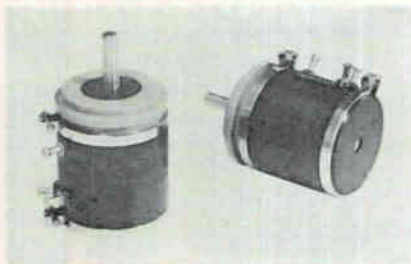

Light weight and high mechanical strength are the characteristics of a new series of size 9 precision potentiometers that are multiturned and housed in plastic. According to the manufacturer, the short-length 3-, 5-, 10- and 20-turn devices cut more than 25% from the weight of comparable units with metal housings.

The housing is a precision, transfer-molded, glass-reinforced phenolic designed to meet MIL-M-14F. All the new units meet or exceed MIL-R-12934D for rotational and load life, high and low temperature operation, temperature cycling, high frequency vibration, shock, explosion, sand and dust, salt spray, power dissipation, temperature resistance characteristic and altitude.

The units designed for precision control and compact airborne instrumentation applications, are manufactured in standard resistance ranges from 1,000 to 30,000 ohms for 3-turns, 1,000 to 50,000 ohms for 5-turns, 1,000 to 100,000 ohms for 10-turns, and 1,000 to 200,000 ohms for 20-turns. They can be provided respectively with up to 12, 20, 30 or 40 accurately positioned taps.

Single gang, 3-turns units weigh 0.5 oz per cup and measure 0.682 in. in length to the servomounting

gotta crazy curve?

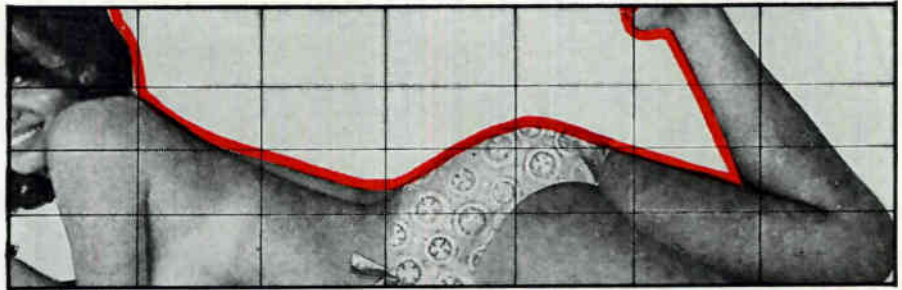

A DUNCAN NON-LINEAR POT CAN MATCH IT!

Even if your non-linear function looks like the Playmate of the Month in profile, Duncan can build a pot to match it. All you have to do is use the new "DUNCAN DO-IT-YOURSELF NON-LINEAR FUNCTION KIT," which we'll send you without obligation if you'll fill out and mail the coupon below. The kit includes a fabulous French curve* plus all other necessary ingredients and instructions. You supply us with the non-linear trace of your function and other supporting data. We'll feed it to our high-speed computer and analyze the data defining the pot's desired function. Then we'll enter the output tape into our servo-controlled machines to produce the variable-pitch winding to meet your function.

To be sure the output of the pot conforms to the specified tolerances, we'll compare it with the theoretical function on our unique conformity tester.

The result? A precision, accurate pot exactly to your specifications.

Our applications engineers can help solve your problems quickly and economically. In many cases they'll be able to match your function using pre-calculated data from our extensive tape library.

So forget about cams, differentials, and non-linear gears. For the direct approach to a complicated non-linear potentiometer problem — for airborne data computation or matching thermocouple curves — depend upon Duncan. You'll have more time to check out other interesting curves!

Send for your free Duncan "do-it-yourself" kit today. For literature only, circle the appropriate number and mail the inquiry card enclosed in this magazine.

DUNCAN ELECTRONICS INC.

Please send me my free "DUNCAN DO-IT-YOURSELF NON-LINEAR FUNCTION KIT" and complete technical literature on Duncan's family of non-linear potentiometers.

I understand that there is no obligation on my part.

Name _____ Title _____

Company _____

Address _____

City _____ State _____ zip _____

*French curve ruler by Birule Co.



DUNCAN electronics, inc.

2865 Fairview Rd., Costa Mesa, California 92626 Tel.: (714) 545-8261 TWX: 910-595-1128

NEW OPTIONS EXTEND DA410 FREQUENCY RESPONSE ANALYZER APPLICATIONS



The Weston-Boonshaft and Fuchs Standard DA410 Frequency Response Analyzer performs frequency response tests with:

- Frequency range—.001 to 1000 Hz
- Accuracy—1% amplitude, 1° phase
- Noise and harmonic rejection—>40 db
- For DC and carrier signals
- Is self-checking and self-calibrating
- All solid state—7" high
- Direct digital readout

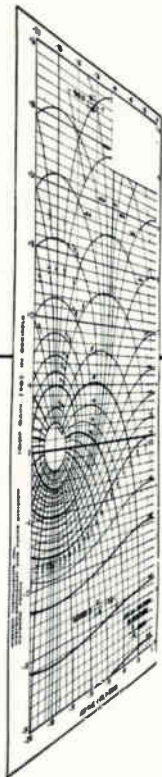

OPTIONS

- Extend frequency range to 10K Hz, 50K Hz (carrier)
- Add adjustable ± 10 volt output bias
- Reject ± 10 (± 100) volt DC on all ranges
- Permit operation from magnetic tape
- Remote programmable in frequency, range and output amplitude
- Accept floating input
- Provide BCD output of phase and amplitude to printer

The DA410 Frequency Response Analyzer with its wide range of options and accessories can perform your frequency response tests. Write for Option bulletins.

Weston Instruments Inc., Boonshaft & Fuchs Division,
Hatboro, Pa. 19040

WESTON®
prime source for precision... since 1888

New Components

register face; 5-turns weigh 0.6 oz and are 0.773 in. long; 10-turns are 1 in. long and weigh 0.7 oz; and 20-turns are 1.454 in. long and weigh 1 oz. Up to four caps can be ganged, each adding respectively 0.457, 0.548, 0.775 and 1.229 in. Stainless steel clamp bands permit precise phasing between cups.

Resolution for high resistance 10- and 20-turns ranges to better than 0.01%, with special linearities to better than 0.03%.

All units have precious metal wipers and contacts for low noise and high electrical integrity, encapsulated resistance elements, and the option of precision shaft ball bearings that reduce starting torque to well below 0.25 oz in. Technology Instrument Corp. of California, 850 Lawrence Drive, Newbury Park, Calif. [355]

Ceramic capacitor rated to 1 microfarad



Higher capacitance in a smaller package is provided by a radial-lead ceramic capacitor. The C12 Hi-D capacitances range from 0.18 μf to 1 μf . The capacitor case measures 0.300 x 0.300 x 0.100 in. up to 0.47 μf , and 0.300 x 0.300 x 0.150 in. up to 1 μf .

D-c working voltages are 50 v at 125° C for values from 0.18 to 0.27 μf and 25 v at 125° C for values from 0.33 to 1 μf . Operating temperature range is -55° to 125° C. Capacitance tolerance is $\pm 10\%$ standard, with 5% and 20% also available.

The use of a precision molded epoxy case provides both uniform-

ity and excellent insulation. An epoxy end seal insures maximum bonding and moistureproofing for optimum performance. The C12 Hi-D meets all applicable requirements of MIL-C-11015.

The capacitors lend themselves to either soldering or welding through the use of 0.025-in. diameter nickel for lead material, per MIL-STD-1276 N-1.

U.S. Capacitor Corp., 2151 No. Lincoln St., Burbank, Calif., 91504. [356]

Compact, reliable flat-cable assemblies

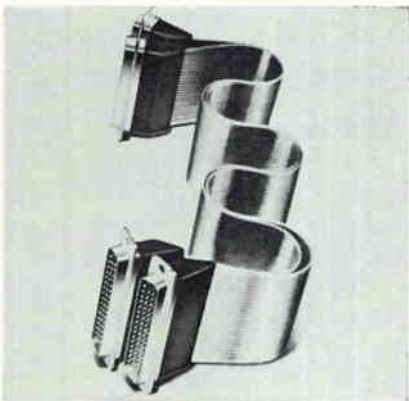

The Flex-Weld flat-cable assembly consists of multiple ribbons of flat copper conductors uniformly spaced and laminated between Mylar or Teflon insulation, straight or corrugated. The flat cable can be terminated to itself or welded to any connector with a reliable all-welded technique. Since welding is performed through the insulation, stripping of the cable is eliminated. Flexible potting around the welded junctions prevent stress concentration where a change in cross section occurs in the termination area. The result is a durable termination that matches the flex-life of the flat cable.

Tests show Flex-Weld assemblies have higher reliability and longer flex-life than conventional round-wire cable, says the manufacturer. The company also claims that Flex-Weld assemblies offer up to a 50% combined size and weight reduction over comparable round-wire cable assemblies. The larger surface area of the flat conductors provides high heat dissipation.

Available with miniature, sub-



Relay magnified 10-A.

New from Filtors . . . a 10-amp Crystal Can Miracle Worker Relay called BRF!

Manufactured in Filtors ultra-clean Blue Ribbon Room, BRF offers many outstanding features. A sealed coil chamber and flux-free electron beam welding assures reliable dry circuit switching as well as contaminant-free switching at a full 10 amps. Super-strong ruby actuators deliver high

contact forces throughout BRF's long switching life.

In addition, BRF's non-ferrous armature bearing offers excellent performance stability for your severest environments. And, Filtors exclusive Total Contamination Control

Program tops off the BRF story.

Visit our ultra-modern plant and

size up this new Miracle Worker Relay for yourself . . . and for all your high

reliability relay requirements.

Filtors big new BRF* stands 10-amps tall

*BRF IS AVAILABLE NOW: Write for specs on this high performance relay.



FILTORS INC. RELAYS

East Northport, New York 11731 / (516) ANDrew 6-1600

NOW! A PRACTICAL WAY TO MONITOR CLEAN ROOMS...

AUTOMATICALLY . . . ACCURATELY . . . DEPENDABLY

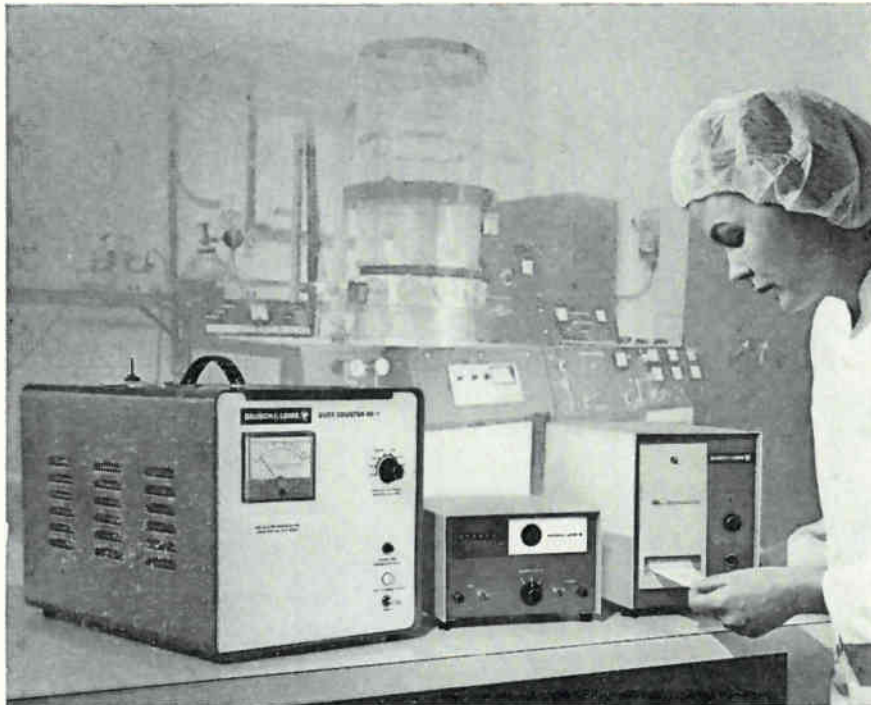

New Bausch & Lomb Aerosol Dust Counting System

The 40-1 Dust Counter with Digital Readout and Printer is a direct indicating, electro-optical system for the detection and monitoring of airborne contamination in clean rooms.

Features include:

- Directly reads and prints any particle concentration up to one million per cubic foot.
- Selective counting of all particles greater than each of seven set sizes—0.3, 0.5, 1.0, 2.0, 3.0, 5.0 and 10.0 microns.
- Size versus concentration—plotted easily.
- Near forward light scattering principle gives greater accuracy.
- Surrounding sample with a column of filtered clean air—prevents turbulence, permits continuous self-flushing.
- Concentric optical system is efficient—shape and orientation of particles doesn't affect count.
- Rapid, on-line calibration checks with built-in Bausch & Lomb Fiber Optics Light Wires.
- Simple operation—all important controls front-mounted.
- Lightweight, compact, transportable.
- All solid-state electronics.
- Real-Time counting.
- Very low dust concentrations over a given time interval detected with Digital Readout. Automatic timer provides for three fixed sampling intervals.
- Digital Printer automatically prints concentrations at preset intervals.
- V.O.M. Recorder for continuous plotting of dust concentrations available optionally.
- All three classes of clean rooms specified in Federal Standard #209 can be monitored.
- Total price of system only \$5475.

The Bausch & Lomb Aerosol Dust Counting System offers superior performance features at substantially lower cost than other commercial units. For complete information ask for our Catalog 38-2190, Bausch & Lomb, 99737 Bausch Street, Rochester, New York 14602.

"WINNER 1965 IR-100 AWARD"

BAUSCH & LOMB 

Sold and serviced exclusively in United States by Air Control, Inc.

New Components

miniature, and microminiature connector sizes, the flat cable product line can be adapted to present systems without special modification. Any shell configuration is offered including round, rectangular, or strip. Rfi shielding is optional.

Flex-Weld assemblies can be applied to gyro cables, digital data transmission lines, circuit-board jumpers, and in related applications where compactness and high reliability are necessary.

ITT Cannon Electric, a division of International Telephone and Telegraph Corp., 3208 Humboldt St., Los Angeles, Calif., 90031. [357]

Glass-encapsulated precision crystals

Higher Q, greater reliability and better frequency stability are offered by a series of miniature glass-sealed crystals than are obtained from crystal units in soldered containers.

The 76AX series units, measuring $\frac{1}{2} \times \frac{3}{8} \times \frac{5}{16}$ in., have aging rates of less than 1 part in 10^8 per day after initial stabilization, and are available in frequency ranges of 7.5 to 200 Mhz. They meet tolerances of 0.0025% over a temperature range of -55° to $+105^\circ$ C.

The new series is the equivalent of the HC-26/U leads and the HC-29/U pins.

Bulova Watch Co., Inc., 61-20 Woodside Ave., Woodside, N.Y., 11377 [358]

Trigger spark gaps handle high currents

A family of trigger spark gaps can be used as crowbars and to switch photoflash tubes. The gaps are ceramic-to-metal units capable of handling peak currents as high as 20 kiloamps.

The three spark gaps—TG-125, TG-126 and TG-127—have static breakdown ratings between the main electrodes of 15,000, 20,000 and 25,000 v d-c respectively. Minimum trigger voltage for the TG-125 is 6.3 to 3.5 kv d-c. For the TG-

An X-Y Scope With Perfectly Matched Price

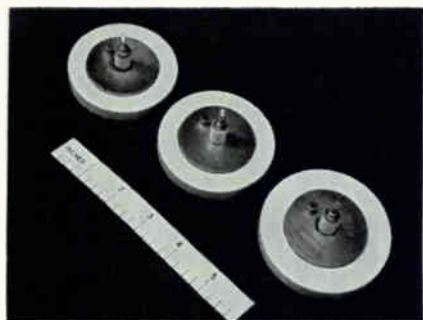

126 it is 8.0 to 4.5 kv d-c, and for the TG-127 it is 9.7 to 5.2 kv d-c. The TG-125 and TG-126 are both rated for 300 joules, and the TG-127 is rated for 400 joules. All three have a delay time rating of 0.1 μ sec.

These gaps are hermetically sealed and, the company says, exhibit excellent temperature characteristics. Height of the gap itself is 0.54 in. and over-all dimension from terminal to terminal is 1.56 in. Diameter of the TG-125 and TG-126 is 2.67 in. The TG-127 is 2.79 in. in diameter. The gaps are normally supplied with solder type terminals, although any conventional type of terminal can be provided.

Signalite Inc., 1933 Heck Ave., Neptune, N.J. [359]

Compactron triodes for color tv receivers

Two compactron beam triodes—the 6HS5 and 6EF4—have been developed for the high-voltage power supply of color tv receivers.

The 6HS5, a pulse-type regulator, was designed as a variable pulse shunt at the damping diode tap on the horizontal output transformer. It has a peak plate voltage rating of 5,500 v, a peak plate current rating of 325 ma and a plate dissipation rating of 30 w. Its amplification factor is 300 and transconductance is 65,000 μ mhos at a plate current of 300 ma.

The 6EF4 is a low-current, high-voltage tube for use as a shunt regulator, shunting across the high-voltage d-c at the picture tube anode. It has a maximum d-c plate voltage rating of 27,000 v, a maximum d-c plate current rating of 1.6 ma and a maximum plate-dissipation rating of 40 w.

General Electric Co., Tube Department, Owensboro, Ky. [360]

\$575

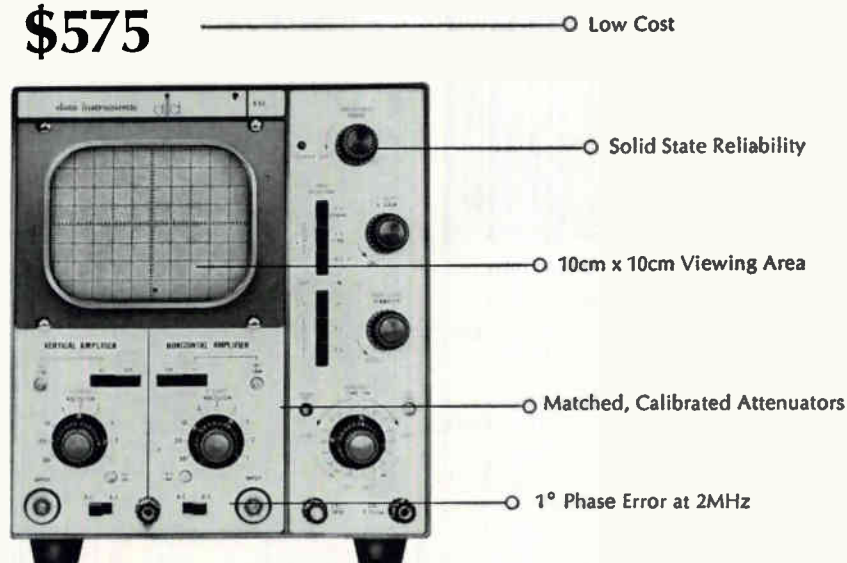

Are your amplifiers out of phase with your budget? Here's a scope that's matched in every way—Data Instruments S52. Two identical, eight stage, high gain amplifiers permit measurements and comparisons all the way to 2MHz with a phase error of only 1°. The calibrated input attenuators are also matched to assure accuracy. And the sophisticated 5 inch PDA tube operates at 2.4kv and provides a 10cm x 10cm display area. The S52 can also be used as a conventional single beam scope. A front panel control allows the Horizontal Amplifier to be switched out and the Time Base to be switched in. The Time Base is a miller type giving excellent linearity and starting time, and features automatic synchronization to 3MHz. Extensive use of solid state circuitry gives the instrument a high degree of reliability and is backed up with a full year warranty. Field and Factory Service are also provided by Data Instruments. The specifications:

X-Y AMPLIFIERS				
BANDWIDTH	SENSITIVITY/CM	ATTENUATORS	RISETIME	IMPEDANCE
DC-3MHz DC-300kHz	100mv-50v 10mv-5v	9 position Matched	0.1 μ s	1M Ω + 3pf
TIME BASE		CRT		PHYSICAL
SPEED/CM	ACCURACY	DIA.	PHOSPHOR	VOLTS
1 μ s-0.5 sec. (18 cal. ranges)	\pm 5%	5" PDA	P31 P7 optional	2.5kv
				8½" x 9¼" x 15" 24 lbs.

Few other instruments have amplifiers so completely matched over such a broad bandwidth. Still, we're not perfect. We do have that 1° phase error in performance. But not in price. At \$575 the price is perfect. And it's unmatched.

Data Instruments Division • 7300 Crescent Blvd. • Pennsauken, N.J. 08110

CONVERT RADAR, SONAR, AND IR DATA TO TV DISPLAY WITH THE ELECTROSTORE®

.....
This TV display is a composite of a compass reference superimposed on a stored

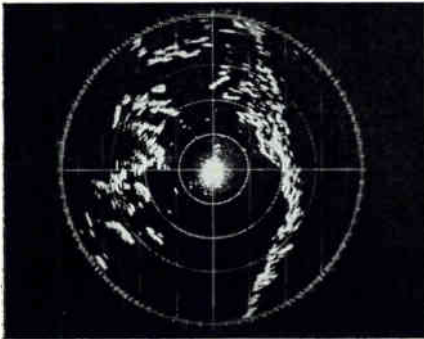

ppi display. It is an example of how the Electrostore Model 221 can convert radar data to a high resolution TV picture.

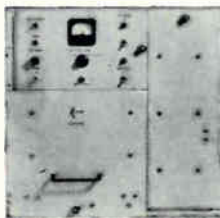

Model 221 Electrostore
single-gun storage tube
Input/Output Response
10 MHz or 20 MHz
Input Amplitude
Required 0.7 volts to
2.0 volts p-p
Deflection Amplitude
5 volts p-p
Deflection Response
DC to 800 KHz
Programmer Optional

The Model 221 scan-converter utilizes a cathode-ray recording storage tube. Input video signals and deflection information are applied to the tube through various amplifiers and control circuitry. Data is stored within the tube in the form of a raster, circular, or spiral scan. This information can be read off periodically through appropriate amplifiers without destroying the stored data. The input can be up-dated periodically and the stored information erased partially or in its entirety. By introducing the proper signals, the Electrostore can convert a variety of formats to TV display, i.e. computer-to-TV, radar-to-TV, IR-to-TV, or sonar-to-TV.

Write for technical memos and application notes covering the Electrostore.



223 Crescent Street
Waltham, Mass. 02154
Tel. (617) 894-8200

New Semiconductors

Open-air diode emits light



The electroluminescent diode that sent the Norton Co. stock jumping [Electronics, Dec. 26, 1966, p. 35] is a rectangular parallelepiped of silicon carbide that is light-green in color, emits yellow light and comes in two sizes. A big advantage, the company reports, is that the diode need not be encapsulated, since silicon carbide is an inert refractory semiconductor material and can therefore operate in air.

One size, 0.030 x 0.030 x 0.15 inch, is aimed at adding sound to 8-millimeter movies; the other, 0.060 x 0.030 x 0.020 inch, is for 16-mm movies. Of the two diodes, the latter would probably be the better suited for such applications as recording data on film and in computer encoders.

For sound movies, the diode operates by converting the amplified current from a microphone into light which then "writes" the sound on ordinary film as the movie is taken. For computer encoders, the light from the diode would have to go to a detector, say, a solar cell, and then be routed through logic circuits that would convert the analog information into binary logic.

The diode's major advantage, the company says, should be reliability. While keeping details of their process secret, pending a patent application, the company reports the crystals are grown at 2,500° centigrade and the junctions are formed at 1,500°C. These figures indicate a long operating life at room temperature can be expected. Lifetime tests at military specifications haven't been com-

pleted, so exact figures aren't available; but one diode operated for more than 1,000 hours with a current of 60 milliamps, with no sign of degradation.

Leads can be attached to the top and bottom of the prism, but usually the company just attaches metal contact strips across the top and bottom of the crystal. All four open sides emit light. Some light is invariably lost, however, in any application requiring a single beam of light, where three of the four emitting sides must be covered.

The company is also studying the diodes as rectifiers in equipment subject to high ambient temperatures. The exact operating temperature range has not been decided yet, but Norton reports that one diode operated at 500°C for 72 hours and the final figures should be at least 300°C. The diode being made for movie cameras operates only to about 200°C.

Norton is not yet in mass production of the diodes. Developmental models are currently available for \$100 each. Eventual prices, in quantity, should be in the \$5 to \$10 range, the company estimates.

Specifications

Forward current	
typical	30 ma
maximum	About 100 ma
Total output light	
power	0.33 to 3.3 μ w at 30 ma
Peak inverse voltage	10 to 20 v at 10 μ a
Efficacy range	10 ⁻⁸ to 10 ⁻⁵ photons per electron
Capacitance at 0 bias	1,000 pf
Threshold voltage	2.5 v
Breakdown voltage	30v, d-c at -1 ma
Peak emission	5,400 to 6,200 At 30 ma
Series resistance	500 ohms, max
Norton Corporate Research Division, 70 Memorial Drive, Cambridge, Mass. 02142 [361]	

Audio transistor handles over 1 watt

Flat beta, good thermal capabilities and a typical gain of 120 at a collector current of 150 ma, make the MM2264 transistor well suited for audio output stages in radios, tv

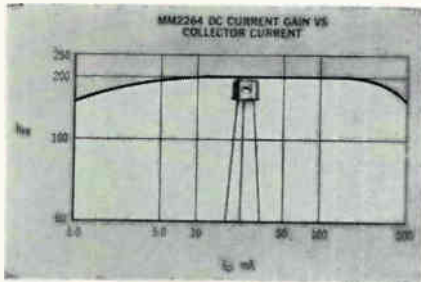

sets and as driver transistors in high power, high-fidelity entertainment circuits.

The wideband audio transistor offers high gain, low distortion, and more than 1 watt of audio power handling capability. The npn silicon device has flat beta characteristic over a collector current range of 1.0 ma to 500 ma, insuring linear operation in large signal audio amplifiers.

Thermal resistance between the junction and case, θ_{JC} , is less than $15^{\circ}\text{C}/\text{watt}$, a reduction of more than 50% for the TO-5 package. This low θ_{JC} is made possible by a solid steel header in the case and provides a power dissipation of more than 11 watts at a case temperature of 25°C . By comparison, a standard TO-5 packaged device would be rated at about 5 watts.

Specifications include a maximum collector-emitter voltage of 25 v d-c; maximum continuous collector current, 1.5 amps d-c; minimum d-c current gain ($I_C = 150$ ma d-c, $V_{CE} = 1$ v d-c), 70; current gain-bandwidth product, 50 Mhz.

Price is \$1.05 each in lots of 100 to 999.

Motorola Semiconductor Products Inc.,
P.O. Box 955, Phoenix, Ariz., 85001.
[362]

Silicon transistors for high-voltage use

By using a method of surface protection that yields low leakage currents under extended usage, the manufacturer is able to produce high-voltage, small-signal npn silicon transistors in quantity. The units meet all applicable paragraphs of MIL-S-19500.

Electrical parameters include a breakdown voltage (BV_{CRO}) ranging from 200 to 1,000 v, nominal current gain of 50 at 20 ma and a

LAPP GAS FILLED CAPACITORS ARE DESIGNED FOR

HIGH
VOLTAGE

HIGH
CURRENT

HIGH
CAPACITANCE

APPLICATIONS



These uniquely designed Lapp Gas-Filled Capacitors are completely unaffected by atmospheric or dust conditions. They are precision built and of extra strong construction to assure years of accurate, trouble-free operation. ■ Lapp Gas-Filled Capacitors are available in either fixed or variable models. All are equipped with an external safety gap to protect against internal flashover on excess voltage peaks. Capacitance available up to 30,000 mmf, safety gap settings up to 85 kv peak and current ratings up to 400 amps at 1 mc. ■ Write for Bulletin 302... get our complete Gas-Filled Capacitor story. Lapp Insulator Co., Inc., Radio Specialties Division, 201 Sumner St., LeRoy, N.Y. 14482.

Lapp

JANUS

3 MHz

INTEGRATED CIRCUIT

BIDIRECTIONAL

PRESET

COUNTER



6000 SERIES is only 3½" H, 14" D and 17" W. Displays 4 to 8 digits and polarity.

The 6000 Series counts at rates up to 3 MHz in either direction, through zero or during reversing. This instrument can be used with many Position Encoders including Laser Interferometers with high frequency, low-level quadrature outputs.

To provide system flexibility, many modes of operation are available. These include:

1. Count functions: A-B, B-A, A, B, A+B. Quadrature A-B and B-A.
2. Count to predetermined numbers in either direction and reset automatically or hold the count until reset is initiated either manually or externally.
3. Pulse or sine wave inputs: quadrature or nonquadrature.
4. Quadrature multiplication: X1, X2 and X4, standard.

Coincidence circuits prevent false triggering if pulses appear simultaneously or at less than the minimum resolving time. Many other outstanding options are available. Write for 6000 Series Bulletin.

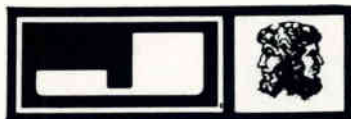

JANUS
CONTROL CORPORATION
296 Newton Street, Waltham, Mass. 02154
Tel. (617) 891-4700

New Semiconductors

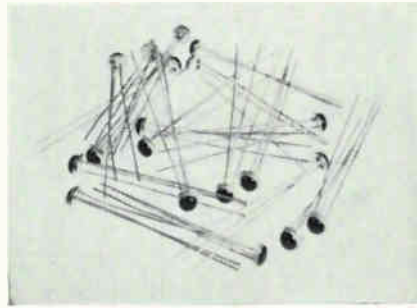

gain-bandwidth product of 20 Mhz.

The transistors, available in plastic-capped TO-46 packages, are intended as high-voltage switches for electroluminescent readout, as drivers for cathode-ray tubes, high-voltage amplifiers and as replacements for low-current silicon controlled rectifiers.

Prices start at \$3.50 each in lots of 100. Delivery is from stock. Micro Semiconductor Corp., 11250 Playa Court, Culver City, Calif., 90230. [363]

Versatile IC's priced for consumer products

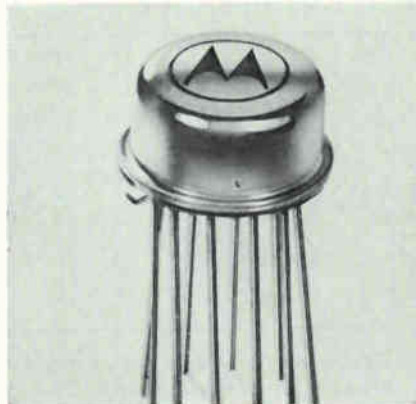

Even less expensive than some transistors, the MC1550G integrated circuit r-f/i-f amplifier has a wide-variety of applications including narrow-band and wide band tuned amplifiers, oscillators, amplitude modulators and video amplifiers.

Automatic-gain-control voltage has little effect on the input impedance of the circuit and this prevents detuning of the input circuitry. In addition, when the device amplifies complex pulse wave-



Highly reliable CAPACITORS from NTK

"MD" Metallized Polyester Film Capacitors
Epoxy Resin Sealed Type (Catalog No. E-501)

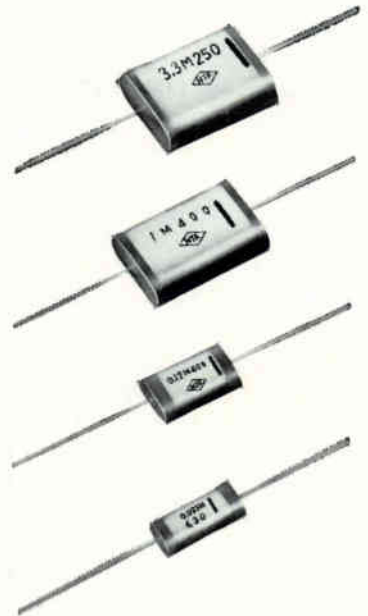

- Operating Temperature Range:
 - 40°C to + 125°C for not more than 1 mfd.
 - 40°C to + 85°C for more than 1 mfd.
- Insulation Resistance:
 - Greater than 10,000 megohm-mfd. at + 25°C
- Other Capacitors
 - ▶ "SC" Polystyrene Film (Catalog No. E-502) (Welded Type)
 - Temperature Range: - 40°C to + 85°C
 - ▶ All-welded Construction Miniature Aluminum Electrolytic (Catalog No. E-502) S (Radial Type) & W (Axial Lead Type)
 - Temperature Range:
 - 25°C to + 85°C; - 20°C to + 65°C
 - ▶ Wide Band Noise Suppressors (500KC~1000Mc, 200VAC)
 - ▶ Paper Capacitors (High Voltage Encased Glass Tube)
 - ▶ MP. Electrolytic. Etc.

• For details, see "eem" (1966-67 edition) Section 1500; Page 629! "EBG" (1967 edition) Page 631!



Sole Sales Rep.: (USA & Canada Area)
NH & W INTERNATIONAL CORP.
301 Sylvan Avenue, Englewood Cliffs, N.J.
(Tel. 201-567-9222) (N.Y. 212-244-0695)

NIPPON COMMUNICATION INDUSTRIAL CO., LTD.

260 Kitamikata, Kawasaki, Japan
(Cable: KAWASAKI NICOMM) TELEX: 286-77 NICOMM KAW

forms (as in radar and television), the agc may be grounded for maximum gain.

Other features include low internal feedback ($y_{12} < 0.001$ mmho) to insure easy alignment and high stability, high power gain (30 db at 60 Mhz) and low noise figure (5 db at 60 Mhz). They combine to bring high quality performance in the consumer product price range.

Price of the IC is \$2.85 each in quantities of 100 and up; delivery is from stock.

Motorola Semiconductor Products Inc., Box 955, Phoenix, Ariz., 85001. [364]

High-power rectifiers use matched diodes



A series of rectifiers has been designed for use in battery chargers, welders, power supplies, electroplating equipment or any other requirement for high-current rectification. Rated at up to 500 amps at from 50 to 1,200 v, the unit combines two matched, time-proven diodes mounted on a compact high-mass heat sink measuring only 3 in. square.

The matched high-power diodes eliminate the need for further testing and matching by the customer. The built-in heat sink ensures temperature stability, effective cooling and ease of mounting and handling.

Cost savings are realized through low device cost per ampere rating; savings in selection, test and assembly time; and savings in handling, mounting and inventory costs, according to the manufacturer.

Prices of the 500UDF units range from \$30 to \$168 each in lots of 25 to 99.

International Rectifier Corp., 233 Kansas St., El Segundo, Calif., 90245. [365]

We're switching 5 amps—50 va for 1 million operations with a reed switch!



We've opened up some new possibilities for design engineers to consider when using reed relays. Power parameters for reed relay operations can now be considered to extend into the 5 amp switching range, thanks to ADC's remarkable new switch that can handle 5 amps—50 VA—and rated in excess of 1 million operations. ■ Write for more information.

ADC

ADC PRODUCTS

A DIVISION OF MAGNETIC CONTROLS CO.

6405 CAMBRIDGE STREET ■ MINNEAPOLIS, MINN. 55426

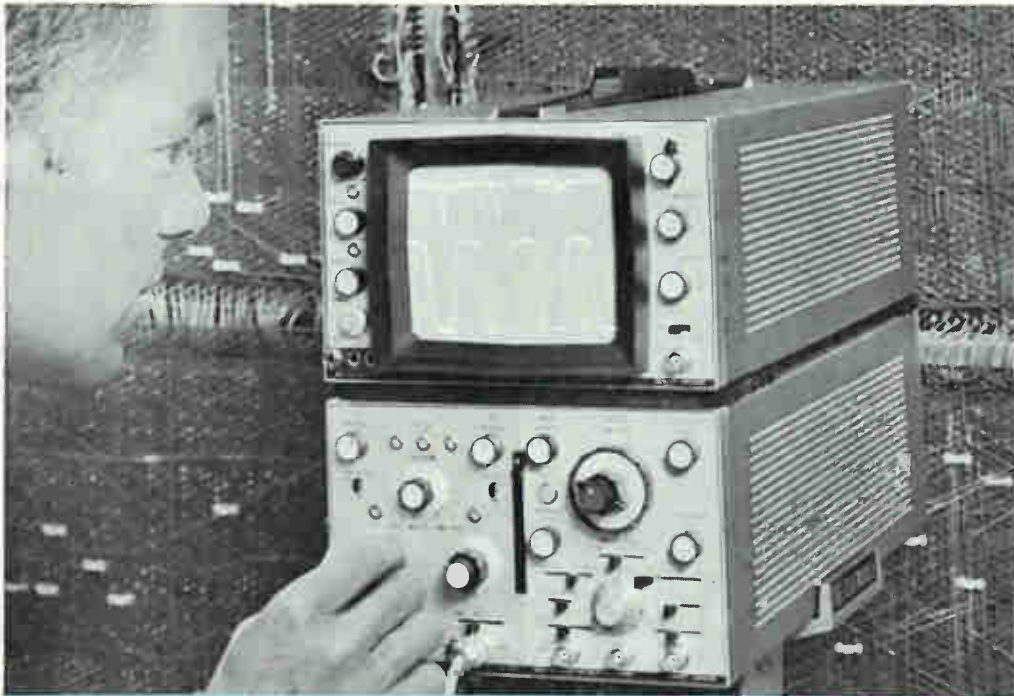

NEW hp 180A OSCILLOSCOPE

You can see *more*, do *more* with this 30-pound oscilloscope that goes anywhere—field, laboratory, or production line. Designed from the user's viewpoint in, this new dual-trace 50 MHz scope is packed with new ideas and innovations to give you big picture CRT, plug-in versatility, step-ahead all-solid-state performance, minimum weight and rugged design. These features add up to *more total performance, more usability than any other scope on the market!*

The hp 180A mainframe is the first with power supplies specifically designed for solid-state circuitry—gives you full performance benefits from solid-state devices in all present and future plug-ins. With hp's all-new big-picture 8 x 10 cm CRT, you have an extra-large display area—get bigger displays, make accurate measurements easier!

Vertical amplifiers drive the CRT vertical deflection plates directly, allowing even greater bandwidth capabilities in future plug-ins. Vertical amplifiers have low drift FET input stages for accurate DC measurements . . . plus quick 15-second warm-up. Time base plug-ins offer new easy to use delayed sweep for examining complex waveforms in detail. Tunnel diode triggering circuits lock in waveforms to 90 MHz. Exclusive hp mixed sweep feature combines display of first portion of trace at normal sweep speeds, and simultaneously expands trailing portion of trace at faster delayed sweep speed to allow magnified examination.

See the back of the actual size color photo at the right for abbreviated specifications and price. For full specifications and a demonstration of how you can see *more*, do *more* with this new, versatile, go-anywhere scope, call your nearest hp field representative. Or, write to Hewlett-Packard, Palo Alto, California, 94304. Tel. (415) 326-7000; Europe: 54 Route des Acacias, Geneva.

HEWLETT  **PACKARD**
An extra measure of performance

Tear out actual photo of 180A Oscilloscope. Set it on your bench. See what the big picture display will mean to your work. ▶

▶

**SEE
MORE!
DO
MORE!**

▶

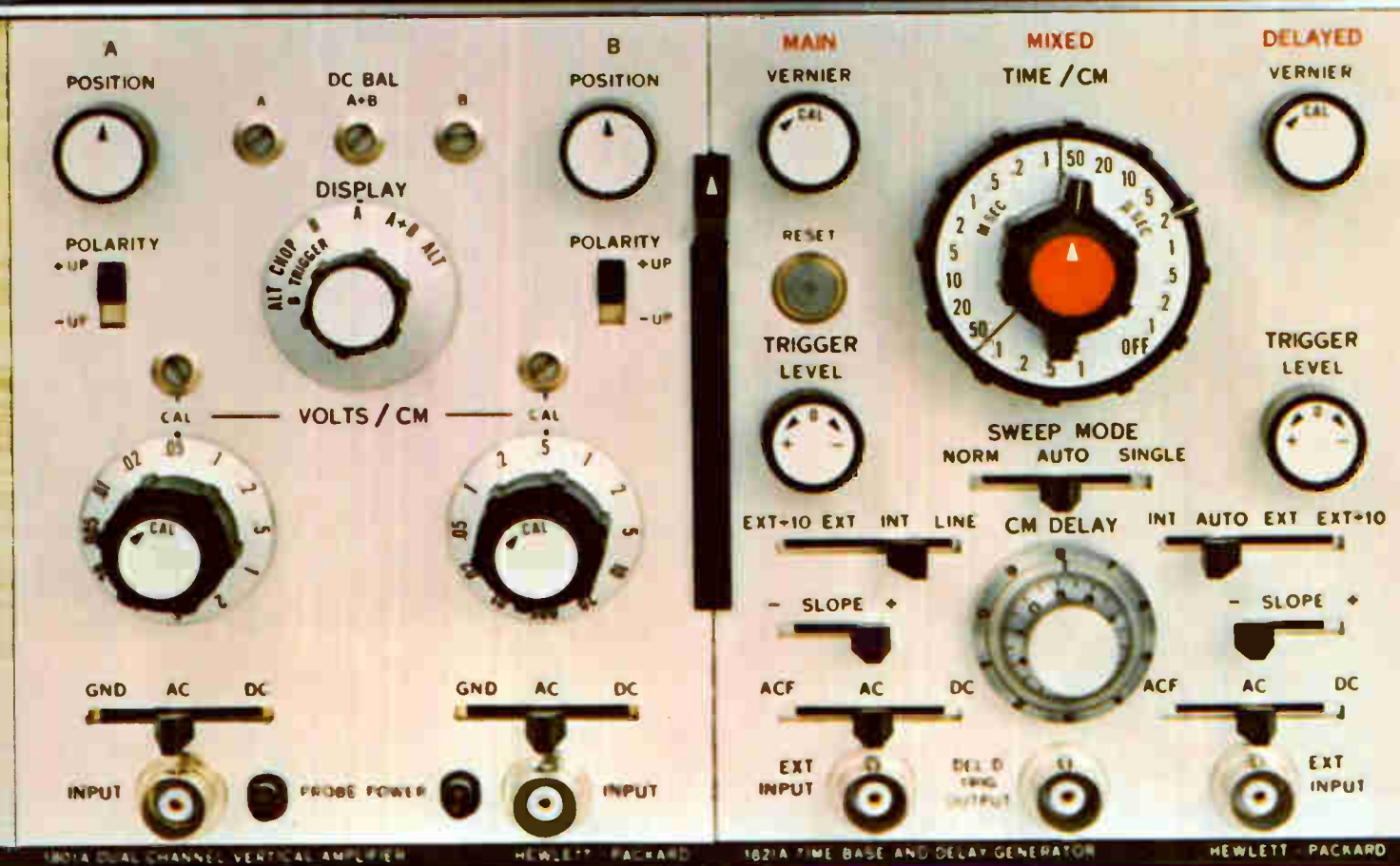
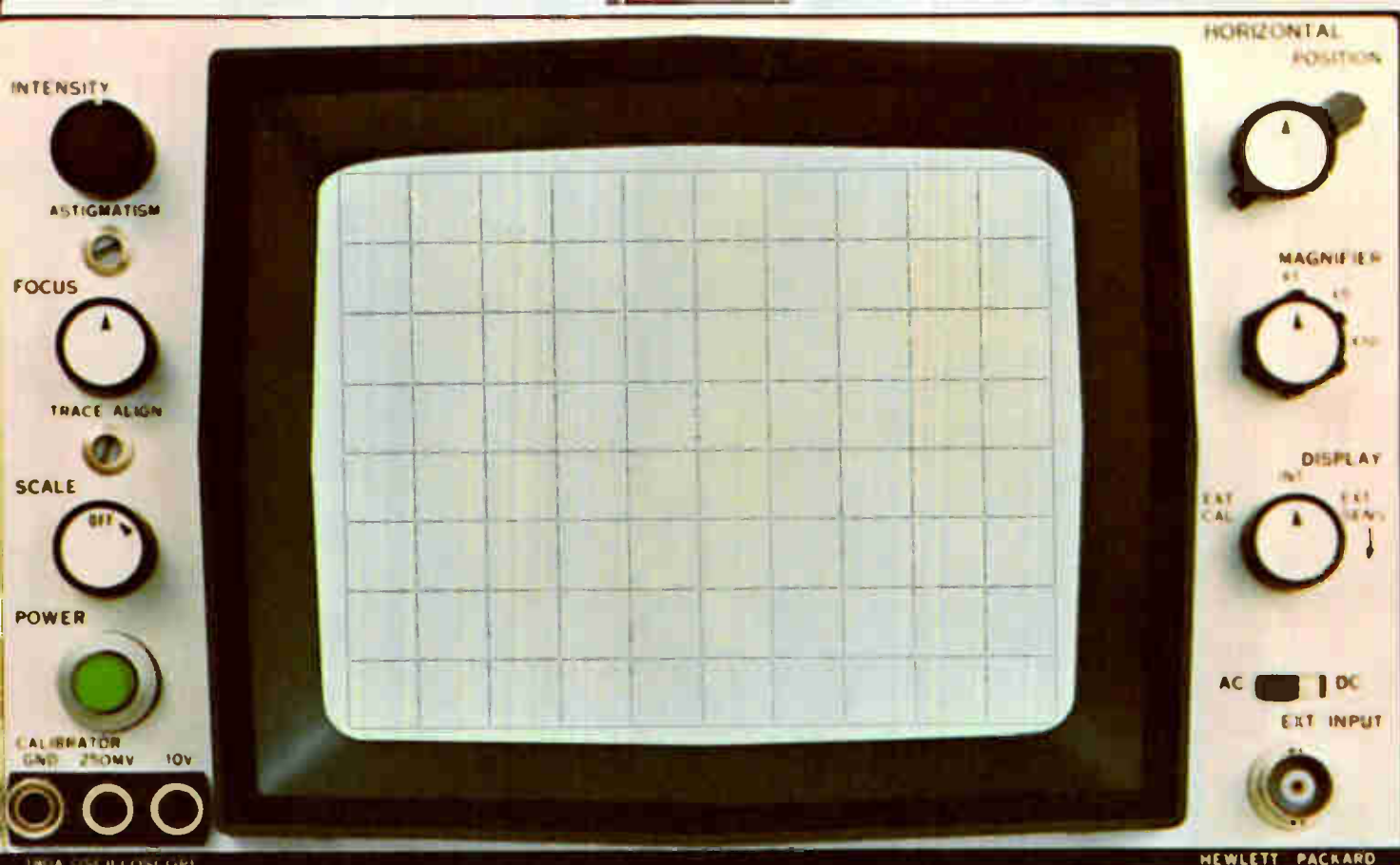

hp 180A Oscilloscope
is shown here ACTUAL SIZE:

COMPARE DISPLAY!

See how the new 180A Big Picture Display can make it easier for you to get accurate measurements. Punch out this actual size CRT area on the perforations. Place the punched-out portion over the screen of your existing high-frequency scope. You will find the hp 180A Oscilloscope has 30% to 100% larger viewing area for easier-to-see, easier-to-read traces!

COMPARE SPECIFICATIONS! (Condensed)

180A Oscilloscope

Horizontal Amplifier:

External Input: DC coupled, dc to 5 MHz; AC coupled, 5 Hz to 5 MHz. Input RC, 1 megohm shunted by approximately 30 pf.

Sweep Magnifier: X1, X5, X10; magnified sweep accuracy $\pm 5\%$.

Calibrator: 1 kHz square wave, 250 mv and 10 v p-p, $\pm 1\%$.

Cathode-ray Tube: 8 x 10 cm parallax-free internal graticule marked in centimeter squares. Post-accelerator tube, 12 kv accelerating potential; aluminized P31 phosphor.

Beam Finder: Pressing Beam Finder control brings trace on CRT screen.

Intensity Modulation: Approx. +2 volts, dc to 16 MHz, will blank trace.

Active Components: All solid state, except CRT.

Environment: 180A scope with plug-ins operates within specs over the following ranges. Temperature: -20°C to $+65^{\circ}\text{C}$. Humidity: To 95% relative humidity to 40°C . Altitude: To 15,000 ft. Vibration: Vibrated in three planes for 15 min. each with 0.010" excursion from 10 to 55 Hz.

Power: 115 or 230 volts, $\pm 10\%$, 50-1000 Hz, 95 watts, convection cooled.

Dimensions: Cabinet, overall dimensions with feet and handle: 8" x 11" x 22½" deep. Rack mount: 5¼" x 19" x 19½" deep behind front panel.

Weight: With plug-ins, net 30 pounds.

Outputs: Main and delayed gates, main and delayed sweeps.

Accessories Furnished: Two 10:1 voltage divider probes, mesh contrast filter.

Price: Without plug-ins, Model 180A, \$825.00; Model 180AR (rack), \$900.00.

1801A Dual Channel Vertical Amplifier

Modes of Operation: Chan. A alone; Chan. B alone; Chan. A and B displayed on alternate sweeps; Chan. A and B displayed by switching at 400 kHz rate, with blanking during switching; Chan. A plus Chan. B (algebraic addition).

Deflection Factor (Sensitivity): 0.005 v/cm to 20 v/cm; attenuator accuracy, $\pm 3\%$.

Bandwidth and Rise Time: DC coupled, dc to 50 MHz; AC coupled, 2Hz to 50MHz; rise time, < 7 nsec.

Input RC: 1 megohm shunted by approx. 25 pf.

Polarity Presentation: + or - Up.

Triggering: Provides sufficient signal to the time base to trigger from dc to 50 MHz.

Price: Model 1801A, \$650.00.

1820A Time Base

Sweep Range: 24 ranges, 0.05 $\mu\text{sec/cm}$ to 2 sec/cm in a 1,2,5 sequence; accuracy, $\pm 3\%$; to 5 nsec/cm with X10 magnifier. Also single sweep.

Triggering:

Internal: See vertical amplifier.

External: dc to 50 MHz from signals 0.5 v p-p, 90 MHz with 1 v p-p.

Automatic: Bright base line displayed in absence of input signal. Triggers from 40 Hz to > 50 MHz.

Trigger point and slope: Controls allow selection of level and pos. or neg. slope; trigger level on external signal adjustable ± 5 v, ± 50 v in ± 10 position.

Coupling: AC, DC, ACF.

Variable Holdoff: Permits variation of time between sweeps to allow triggering on asymmetrical pulse trains.

Price: Model 1820A, \$475.00.

1821A Time Base and Delay Generator

Main Sweep: 22 ranges, 0.1 $\mu\text{sec/cm}$ to 1 sec/cm in 1,2,5 sequence; accuracy, $\pm 3\%$; to 10 nsec/cm with X10 magnifier. Also single sweep.

Triggering:

Internal: See vertical amplifier. External: dc to 50 MHz from signals 0.5 v p-p, 90 MHz with 1 v p-p.

Automatic: Bright base line displayed in absence of an input signal. Triggers from 40 Hz to > 50 MHz.

Trigger point and slope: Controls allow selection of level and pos. and neg. slope; trigger level on external signal adjustable ± 5 v, ± 50 v in ± 10 position.

Coupling: AC, DC, ACF.

Trace Intensification: Used for setting up delayed or mixed sweep. Increases in brightness that part of main sweep to be expanded full screen in delayed sweep or made magnified part of display in mixed sweep.

Delayed Sweep: Delayed time base sweeps after time delay set by main sweep and delay controls. 18 ranges, 0.1 $\mu\text{sec/cm}$ to 50 msec/cm in 1,2,5 sequence; accuracy, $\pm 3\%$.

Triggering: Applied to intensified Main, Delayed, and Mixed Sweep modes. Automatic: Delayed sweep starts at end of delayed period. Internal, External, Slope, Level, and Coupling: same as Main Sweep.

Delay Time: (before start of delayed sweep); Continuously variable from 0.1 μsec to 10 sec; accuracy, $\pm 1\%$; linearity, $\pm 0.2\%$; time jitter, $< 0.005\%$ of maximum delay of each range.

Trigger Output: (at end of delay time): approx. 1.5 v pulse.

Mixed Sweep: Dual sweep display in which main sweep drives first portion of display and delayed sweep completes display at speeds up to 1000 times faster.

Price: Model 1821A, \$800.00.

New Instruments

Multiplying voltages in less than a usec

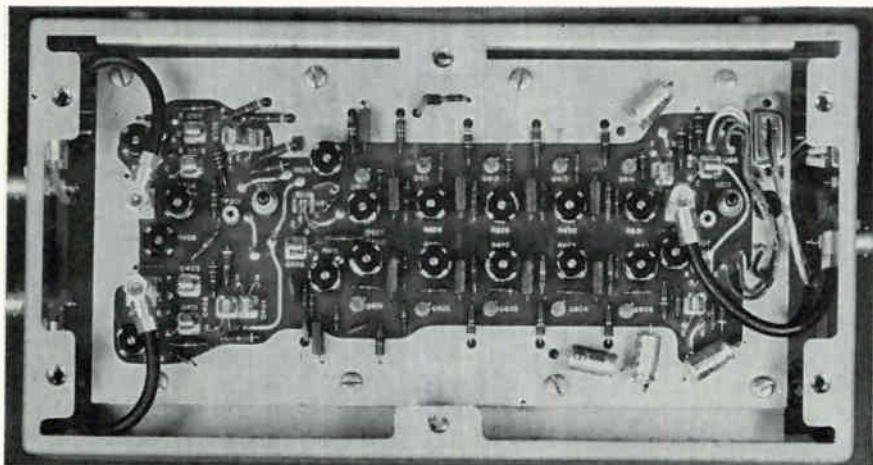

Borrowing from two standard methods of signal multiplication—the time-division method and the instantaneous method—Bendix Corp.'s Radio division has built an analog voltage multiplier that benefits from both. The instrument has the higher accuracy— $\pm 1\%$ of full scale—of the first method and the higher frequency capabilities—up to 3.5 megahertz—of the latter. It has a multiplication time of only 0.12 microsecond.

A high frequency passband is possible, Bendix says, because its solid-state amplifier circuits perform the quarter-square computation,

$$\frac{1}{4}[(x+y)^2 - (x-y)^2]$$

to obtain the product of the two input voltages.

The four-quadrant device can accept input voltages ranging from

−2 to +2 volts. The input signals are first applied to adder-amplifier circuits. Two amplifier circuits produce the $x + y$ term by adding their current signal outputs in a common resistor; an amplifier and inverter combine their current outputs in a resistor to form the $x - y$ term. These four amplifiers are linear, voltage-fed direct-coupled units with closely matched gain and linearity characteristics. The sum and difference signals are then fed to squaring circuits—direct coupled translator circuits which produce square law outputs from linear inputs. The outputs of the two squaring circuits are then coupled to a 12-decibel loss adder which produces the difference of the squared terms and simultaneously divides by four to form the xy product signal.

Originally developed to handle cross-correlated video data for ra-

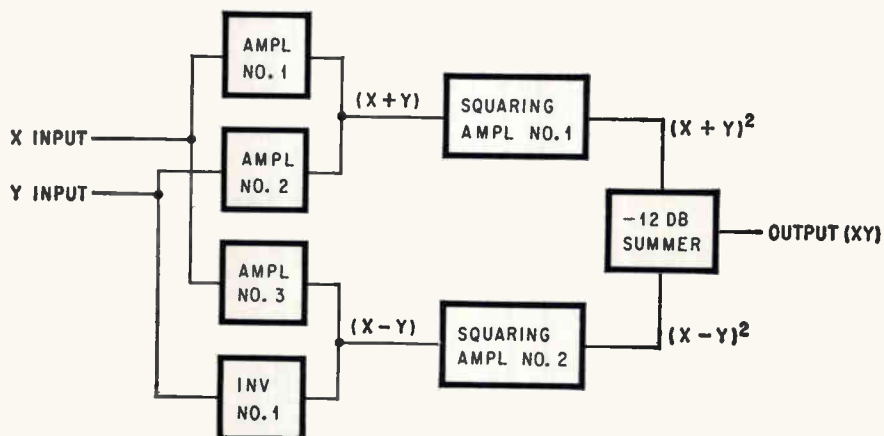

←Circle 204 on reader service card

**ONLY
TRYGON
SILICON
RACK POWER
SUPPLIES
pack 0 to 320
volts into a
3½" height!**

Meet the biggest 3½" in transistorized power supply history... and enjoy all these features:

- All silicon design
- Full power ratings to +71°C without derating, heat-sinking or forced air
- Ratings from 0-20 volts @ 7.5 amps to 0-320 volts @ 1.5 amps
- Constant current/constant voltage operation with mode indicator light on front panel



Get the facts on all Trygon's exclusive power supply advances. MAIL COUPON TODAY!



TRYGON

POWER SUPPLIES
Pleasant Avenue
Roosevelt, N.Y. 11575

Please rush me your new 52-page Power Supply Handbook—FREE

Name _____

Title _____

Company _____

Address _____

City _____ State _____ Zip _____

Circle 205 on reader service card

205



COAXIAL TERMINATIONS

- WIDE FREQUENCY COVERAGE
- WIDE POWER COVERAGE
- ECONOMICAL
- PROMPT DELIVERY
- CHOICE OF CONNECTORS, N, C, TNC, BNC

RESISTIVE
0-10.0 GHZ: 2 Watts



PRECISION
2.0-12.4 GHZ:
1.05 Max

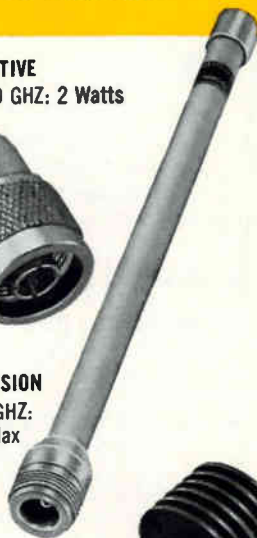

MEDIUM POWER
0-4.0 GHZ:
10 Watts



HIGH POWER
1.5-7.0 GHZ:
300 Watts



5-YEAR WARRANTY on every RDC product! For the first time in the microwave industry, this additional assurance of reliability.

A Complete Source for Microwave Components

Send for complete information . . .



RADAR DESIGN CORPORATION
510 PICKARD DR. ■ SYRACUSE, N.Y. 13211
PHONE: 315-454-4418

New Instruments

dar, the multiplier is currently being used by Bendix in pattern recognition, where the main problem is handling large quantities of data quickly and high accuracy is not needed. The company also sees application in control systems.

The accuracy of the measured output voltages will be best when the inputs, either positive or negative, are close to the ends of the voltage range because of the $\pm 1\%$ of full-scale accuracy, or ± 0.02 volt. To obtain the full accuracy, the power supplies must be regulated to better than 0.05%.

The unit is operated simply by connecting power supply voltages to it and plugging in the x and y input signals and the xy output load to the appropriate jacks. There are no operating controls. However, each day the d-c voltages should be checked and, if necessary, calibrated.

Developmental models of the signal multiplier cost \$3,500; delivery time is two months.

Specifications

Accuracy	$\pm 1\%$ of full scale, or $\pm 0.02v$
Input voltage	0 to $\pm 2v$ d-c
Input power	± 8 or $\pm 20v$ d-c; 0.05% regulation
Operating temperature range	0° to 60°C
Size	2 3/4 x 6 1/4 x 12 in.

The Bendix Corp., Radio Division, Towson, Md. [371]

Transducers measure reaction torque

The speed of rotation of a machine no longer limits the performance of a torque measuring transducer. A new fixed-shaft transducer attaches directly to the housing of the machine under test.

By using semiconductor gauges as the sensing elements, the model R reaction torque transducers produce an output of 250 mv d-c at rated torque for an input of 6v. A choice of six torque ratings is offered: 2, 5, 10, 20, 30 or 60 in.-lbs. Linearity of output signal is $\pm 0.25\%$.

The transducer measures reaction torques exerted by the housing of an operating rotary device. The

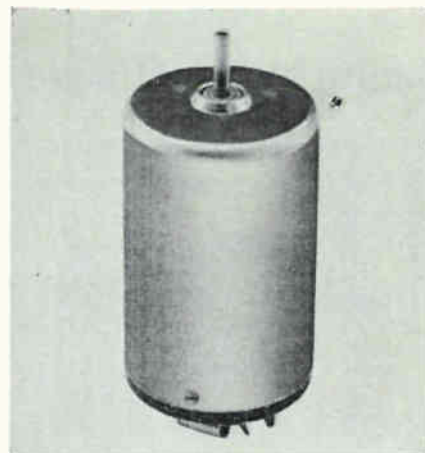

Who needs 55% efficiency in a micro motor 20mm or less in diameter?

No one.

But it is a testimony to Mitsumi's ability to meet unusual speciality micro-electronics requirements. Micro motor efficiency over 50% has been considered impossible for a motor as small as 20mm in diameter. Adoption of a new system in the magnetic circuit has upset this common concept.

Both electrical and mechanical noises have practically been eliminated by a built-in noise suppressor, and a specially constructed brush which has improved the rectifying capacity.

Ask for Mitsumi when you need a reliable, quality micro motor for portable tape-recorders, record-players, measuring instruments and 8mm 2-speed movie cameras. Over 30 types of AC or DC micro motors are immediately available.

Mitsumi is the world's leading maker of polyethylene variable capacitors, I-F transformers, synchronous motors, front-end FM tuners, UHF & VHF TV tuners, CdS photoconductive cells, trimming potentiometers, coils, sockets, trimmer capacitors, terminals, and fuse holders.



MITSUMI

MITSUMI ELECTRIC COMPANY, LIMITED
1056 Koadachi, Komae-machi, Tokyo. 415-6211
302, Cheong Hing Bldg., 72 Nathan Road, Kowloon, Hong Kong. 666-925
Marienstrasse 12, Düsseldorf, W. Germany.
MITSUMI ELECTRONICS CORPORATION
11 Broadway, New York 4, N.Y. 10004. HA5-3085
333 N. Michigan Avenue, Chicago, Ill. 60601
263-6007



Transmitting and Receiving Antennas
 Transmission Lines and Matching Networks
 Supporting Towers and Masts
 Dummy Loads and Termination Resistors
 World-wide Tower and Antenna Installation
 Antenna Switches and Control Consoles
 Insulators, Connectors, Guys, Catenaries

This 33-year concentration under one roof of sophisticated equipment and staff for the design, fabrication and installation of complete antenna and tower systems anywhere in the world may be your good fortune.



formerly WIND TURBINE COMPANY
 Elverson, Pa. 19520 (215) 942-2981—
 Circle 272 on reader service card

Switch to the Best

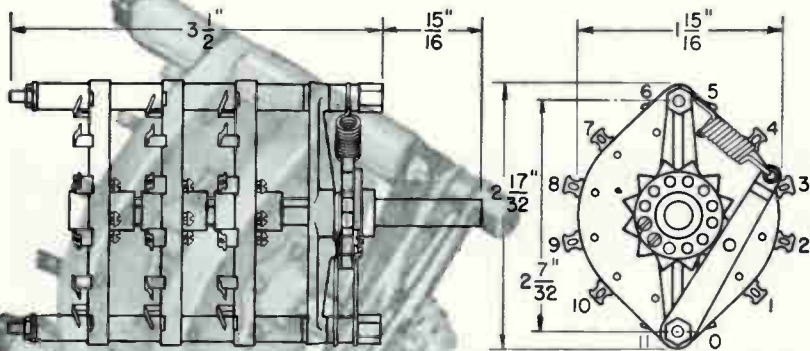

MODEL 80 SWITCH

- 4500 volt peak flashover at 60 cps
- 10 ampere current carrying capacity
- Current carrying members heavily silver plated
- Kel-F rotors • Steatite spacers and stators
- Black anodized die cast aluminum support bracket
- Nylon detent wheel • Stainless steel detent arm
- Oil impregnated bronze sleeve bearing



RADIO SWITCH CORPORATION

MARLBORO, NEW JERSEY • Telephone: HOpkins 2-6100

New Instruments

rent limiting and complete short-circuit protection.

The accuracy, stability and regulation of the model TC-260R are obtained through the use of an accurate, stabilized and temperature-controlled internal reference, and a high-gain chopper-stabilized feedback amplifier. The chopper amplifier has an open loop gain of 5×10^6 , falling off no faster than 6 db/octave to unity gain. This insures low output impedance while retaining fast transient response—25 μ sec recovery time—without ringing.

Price is \$1,250; delivery, approximately 30 days.

Princeton Applied Research Corp., P.O. Box 565, Princeton, N.J., 08540. [373]

Frequency synthesizer covers 470 to 1,000 Mhz



A solid state frequency synthesizer directly covers the range of 470 to 1,000 Mhz and eliminates the problem encountered with low frequency synthesizers. The l-f synthesizers require multiplication of the output frequency, with corresponding increase in noise and unwanted spurious levels.

The output frequency is derived from two components. The frequency of the crystal-controlled standard can be locked in 10-Mhz steps. The other is furnished by an interpolation oscillator which is tunable within these steps. Resolution is 5 khz (0.5 hz with ND30M synthesizer used as a vernier).

The built-in frequency standard is accurate in 2 parts in 10^9 . It can also be operated from an external 12-v battery.

Output voltage of type xuc syn-

thesizer into 50 ohms is continuously adjustable or adjustable in steps and between $250\mu\text{v}$ and 1.5 v. The suppression of nonharmonic spurious frequencies is more than 80 db; spurious frequency deviation is less than 0.5 hz. Frequency fluctuations due to external influences (within the tolerable limits of supply voltage, supply frequency and ambient temperature) are less than 2×10^{-9} . The mean daily frequency drift after constant use is less than 1×10^{-9} .

Type xvc is equipped for mounting in 19-in. racks and, with the exception of five uhf disk-seal triodes, uses transistors. Delivery is from stock at \$7,705.

Rohde & Schwarz, P.O. Box 148, Passaic, N.J., 07055. [374]

Instrument generates f-m multiplex signals

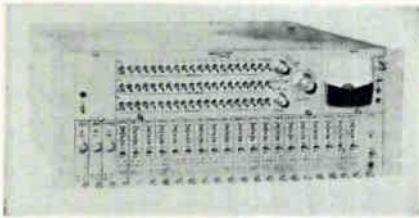

An f-m multiplexer has been developed for data acquisition or for use as a versatile test instrument in a telemetry ground station. Model 48 contains nineteen S-24 voltage-controlled oscillators and an S-41 voice annotator which provide the means for generating three independent composite f-m multiplex signals. The unit features an S-48 switch panel enabling each vco output to be independently switched into any one of the three S-29 amplifiers contained in the unit. An S-42 voltmeter is provided for monitoring all vco input and output signals.

Subcarrier frequencies between 300 hz and 1.2 Mhz, with peak deviations of 1% to 16%, can be provided through the use of plug-in channel selectors. The vco's have a linearity of better than $\pm 0.05\%$ of bandwidth and stability of $\pm 0.05\%$ of center frequency.

Model 48 f-m multiplexer fulfills the functions of an auxiliary signal mixer, data-insertion converter, signal simulator or f-m calibrator. Sonex, Inc., 20 E. Herman St., Philadelphia, Pa., 19144. [375]

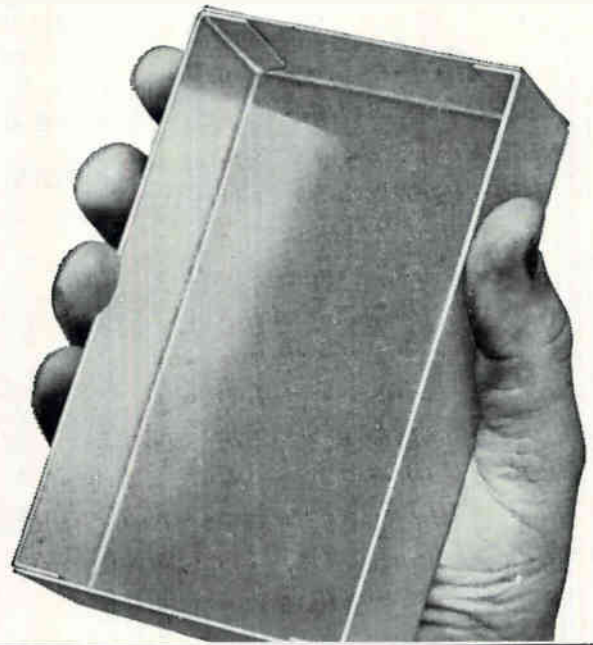

HOW TO FORM STRONGER BOXES FAST!

1

Shear up to 160 blanks per minute with lowest cost, high speed, precision shear on the market! Di-Acro Power Shear No. 36 — only \$1,350 complete!

2

Notch blanks on a Di-Acro Power Tab Notcher. Extra strong tabbed corners are self-aligning. And easier to fasten.

3

No wasted motion. Form box on a Di-Acro Hand or Power Press Brake or Di-Acro Leaf Type Brake. Read the full story in Di-Acro's newest catalog. See your distributor or write us.



DI-ACRO

division of

431 EIGHTH AVENUE
LAKE CITY, MINNESOTA 55041





New Varian Å-Scope for Surface Micro- Topography and Thin Film Measure- ments

- Range: 30 Å to 20,000 Å
- Resolution: ± 30 Å over the entire range
- Direct reading filar eyepiece
- Special plate tilt mechanism: prevents scraping between plate and sample
- 35 mm or Polaroid cameras optional

Write for complete information



varian
vacuum division
palo alto/california
Varian S. p. A., Turin, Italy

New Subassemblies and Systems

Line drive amplifier offers adjustable gain



Model 274 line drive amplifier offers a continuously adjustable gain from 1 to 1,000, a frequency response within ± 1.0 db from 3 hz to 15 khz, and an input impedance greater than 500 megohms.

The unit requires a $+28$ v $\pm 15\%$, 40 ma maximum power supply. Output is 5 v rms minimum driving through 1,500 ft of cable terminating in a 10,000 ohm load. Linearity is within 1% from best straight line, and noise is less than 25 μ v equivalent input with 0.001 shunting input. Distortion is less than 1% and gain stability is within ± 0.2 db. Operating temperature range is -55° to $+125^\circ$ C.

Price in small quantities is \$175 per unit, with delivery in 8 to 10 weeks.

Bulova Watch Co., Inc., 61-20 Woodside Ave., Woodside, N.Y., 11377. [381]

H-v bench supplies in half-rack package



High-voltage d-c power supplies feature all-silicon circuitry in a convenient, half-rack package. They

are more compact than equivalent-rated competitive supplies by a factor of three to five, according to the manufacturer.

Model 6515A, only 3½ in. high, has an output of 0 to 1,600 v d-c, 0 to 5 ma; and the 6516A, 5¼ in. high, has an output of 0 to 3,000 v d-c, 0 to 6 ma. Load regulation is 0.01% or 16 mv and line regulation is the same.

The supplies have low ripple and noise, and are short circuit-proof. A 10-turn vernier permits full adjustment with 100 mv resolution over each voltage span—no blind spots.

The units are suited for high-voltage experiments and circuit development. They are also said to be ideal for use as general-purpose d-c high-voltage sources, and for photomultiplier applications.

Hewlett-Packard, Harrison division, 100 Locust Ave., Berkeley Heights, N.J., 07922. [382]

Medium-performance digital transport

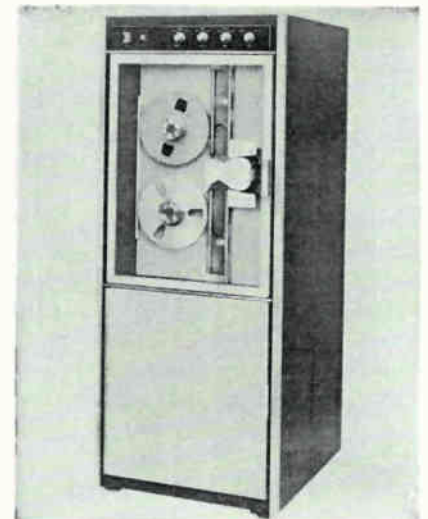

Designed for applications requiring moderate data transfer rates, the model MT-36 magnetic tape transport is suited for use with small and medium scale computers, in mass storage and sequential access applications for which high-priced, high-performance transports cannot be justified. The unit offers unrestricted tape speeds to

50 in. per sec at densities to 800 bits per in. It is qualified to meet Federal Standard 222 and MIL-16910A.

The complete system consists of the tape transport assembly, manual control unit, and a model MA-310 read/write electronic package. It is completely compatible with IBM systems, such as the 729 and 2400 series. Other conventional tape formats on either ½- or 1-in. tape are also available.

The unit has smooth start-stop profiles and no program restrictions over a command frequency rate up to 200 per sec.

Potter Instrument Co., Inc., 151 Sunnyside Blvd., Plainview, L.I., N.Y., 11803. [383]

Differential amplifier with multiple outputs

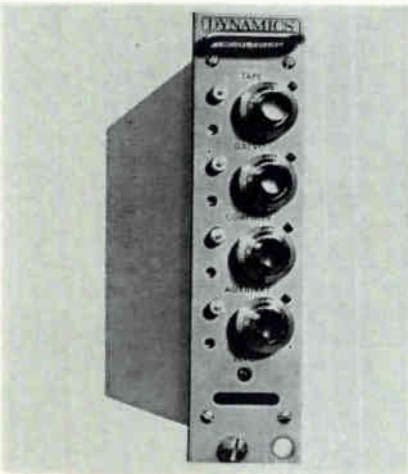

Four simultaneous outputs from a single input signal are provided by the model 7202 differential amplifier. The multiple outputs are of sufficient power to drive computers, tape recorders, and galvanometers. Galvanometer output provides a ± 10 v into a 100-ohm load; each of the other three outputs are capable of providing a ± 10 v into 1,000-ohm loads. Gain accuracy over the entire gain range is $\pm 1\%$.

A 10,000-ohm input impedance rating, individual direct-reading gain controls for each output, high common-mode rejection, and maximum input-to-output isolation features are claimed to make the model 7202's per-channel cost the most economical presently available.

Additional features include re-

Wherever Non-Contamination is Essential

MICRO-CLEANING FOR PRODUCT RELIABILITY



TEXWIPE

A disposable 100% cellulose LINT-FREE CLOTH.



OPTIC-CLOTH

for scratch-free cleaning and polishing coated optics.



FOAMWIPE

A three dimensional polyurethane clean room wiper.



"FREON" TF

Aerosol Solvent Cleaner — A selective, precision cleaning agent.

*Reg. Trade Mark of E. I. DuPont Company



TRACER GAS SPRAY PROBE

For pin-pointing leaks in a vacuum system.



MICRO-DUSTER

A compressed gas precision cleaning instrument.



FOAM-SWABS

A non-linting cleaning swab and applicator.



THE TEXWIPE COMPANY

HILLSDALE, NEW JERSEY 07642

CATALOG AVAILABLE UPON REQUEST

Circle 211 on reader service card

To order reprints: Fill in, cut out coupon below, insert in envelope and mail to: Electronics Reprint Dept., 330 W. 42nd Street, New York, N.Y. 10036

Reprint order form

For listing of reprints available see the Reader Service Card.

Communications Satellites. Parts I and II.

Send me reprints of Key no. R-90a at \$1.25 each.

For reprints of previous special reports fill in below:

Send me reprints of Key No.(s) @¢ each.

(For prices, see Reader Service Card)

Name

Number of street

City, State, Zip code



A-to-D converter

10 bit parallel binary output
10 microseconds conversion time

Model ADC-10_{ic} is a plug-in Analog-to-Digital Converter with a 10 volt input range and contains a Clock, Reference Supply, Resistor Network and Comparison Amplifier.

Also available

D-to-A converter

10 bit strobed parallel binary input
1 microsecond settling time
(same size as A-to-D converter)

Model DAC-10_{ic} is a Digital-to-Analog Converter and contains a Storage Register and high-speed Strobe System, Internal Reference Supply, Resistor Network and output Operational Amplifier.

Variations are available in input and output ranges, converting speeds, number of bits, and triggering modes.

Pastoriza also provides compatible Sample-and-Hold and Multiplexing Cards and Auxiliary Readout Equipment with self-contained power supplies to facilitate matching these units to OEM and system applications.

Write for A-to-D and D-to-A Converter literature.

PASTORIZA
ELECTRONICS, INC.

385 Elliot St., Newton Upper Falls, Mass. 02164
(617) 332-2131

New Subassemblies

cessed adjustment screws to offset each output signal positively or negatively, and a turns-counting dial on the front panel to regulate signal gain from 0 to 2.5. Input connectors may be reversed to provide inverting or noninverting gain polarity.

Dynamics Instrumentation Co., 583 Monterey Pass Road, Monterey Park, Calif., 91754. [384]

Core memory stack has high reliability

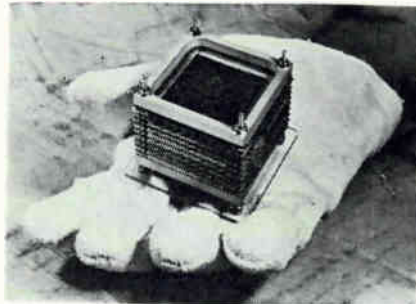

A rugged, militarized core memory stack bypasses inherent reliability problems of current memory stacks, according to the manufacturer. It provides greater system tolerances, higher resistance to shock, and built-in temperature dissipation. It stores the same amount of information in only two-thirds of the space compared with an ordinary memory stack.

Called Semstak (severe environmental memory system) it is designed for airborne and space applications where high reliability, low weight and small volume are prime considerations. The unit's construction has no bus wire connections found in many other printed-circuit-board stacks. Such connections are said to be a common source of stack failures. Planes are interconnected with half the number of solder joints usually required, using a proprietary design with etched finger contacts. In addition, the design increases solder joint reliability with a compression technique.

A built-in heat sink prevents temperature gradients within the stack from varying the output voltage, which could cause information to

for Operational Amplifiers,
Instruments and Systems

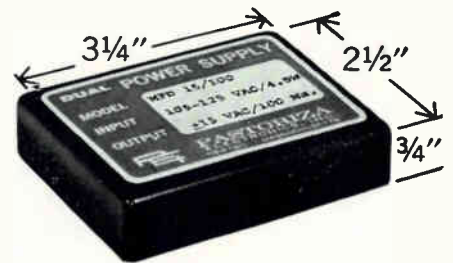

Miniature Precision Dual Power Supply

from 110 vac input to ± 15 vdc
at 100 ma output in a package $3/4$ "
high including power transformer.

The Model MPD 15/100 represents the first significant step in power supply miniaturization. This rugged unit provides 0.02% regulation (no load to full load), 0.005% regulation against line, complete short circuit protection and operates in ambients from -25°C to $+65^{\circ}\text{C}$. There are pin connectors for socket or printed circuit board mounting.

for Operational Amplifiers:

Provides both positive and negative highly regulated dc voltage required by most operational amplifiers. The designer can finally take full advantage of the size reduction in monolithic and hybrid amplifiers.

for Instruments:

Provides high regulation and capacity for precision requirements. Compact form eliminates many mechanical design problems, allowing more flexibility in package design.

for Systems:

This Power Supply becomes another member in the System Designers' Card Library; making possible simplified system design by supplying required power to local circuits.

Write for Bulletin MPD 15/100.

PASTORIZA
ELECTRONICS, INC.

385 Elliot St., Newton Upper Falls, Mass. 02164
(617) 332-2131

be lost or misinterpreted. Temperature dissipation keeps all cores within 10°C of each other regardless of power or temperature changes.

The unit can withstand vibrations that impose 30g's at 2,000 hertz. It meets applicable temperature, shock and vibration requirements of MIL-E-5400 and operates over a temperature range of -55°C to +125°C.

A typical Semstak containing 4,096 words of 24 bits each, and built with 30 mil cores, measures only 3 x 3 x 2 in. and weighs only 18 ounces. The planes are stacked only 1/2 in. apart, instead of the conventional 1/8 in.

The stack is available with capacities up to 16,384 words of any bit length.

Electronic Memories, 12621 Chadron Ave., Hawthorne, Calif. [385]

Reference source boasts high stability

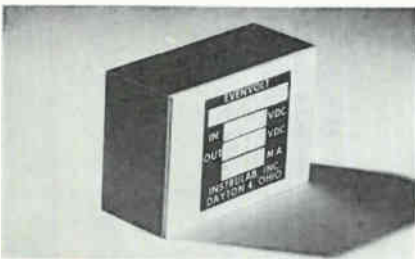

A voltage reference source designated model 771-PK-50 is a result of seven years of design and development in zener circuitry techniques, according to the manufacturer.

The device has an input voltage of 30 v d-c $\pm 1\%$ at 30 ma maximum; output voltage, 12.6 v d-c $\pm 5\%$; output current, 100 μ a; temperature coefficient, 0.00015%/°C referred to 35° over a range of 20° to 50°C; output regulation, 10 μ v maximum output change per 1% input change; short-term stability, 0.0005% per 24 hours; long-term stability, 0.0018% per 6 months; and noise, 25 μ v peak to peak maximum, d-c to 50 khz.

Prices range from \$75 to \$150 each, depending on the customer requirements.

InstruLab, Inc., 1205 Lamar St., Dayton, Ohio, 45404. [386]

YOKE SPECIFYING PROBLEM?

**ASK AN
EXPERT...**

**A SYNTRONIC
DEFLECTION
YOKE SPECIALIST**

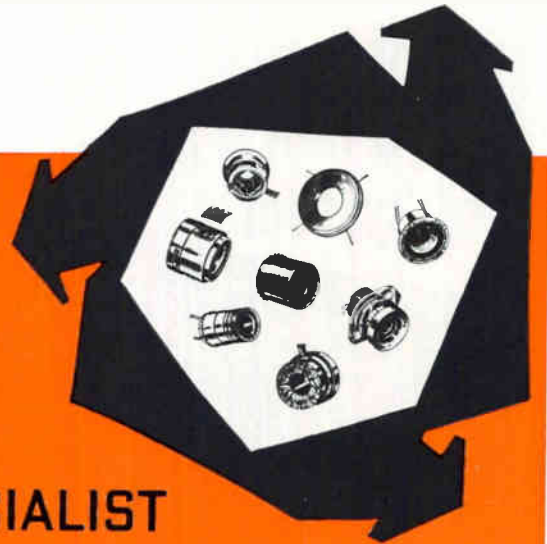

Since we make more types of yokes than anyone else, it's natural enough for our team of experts to know more about yoke design, application engineering, and quality control.

Specifying can be a challenging problem, and with this in mind, we put our experience at your disposal. Don't hesitate to call or write us when you're puzzled as to the right deflection yoke for your display.

syntronic

INSTRUMENTS, INC.

100 Industrial Road, Addison, Illinois
Phone: Area 312, 543-6444

Circle 213 on reader service card

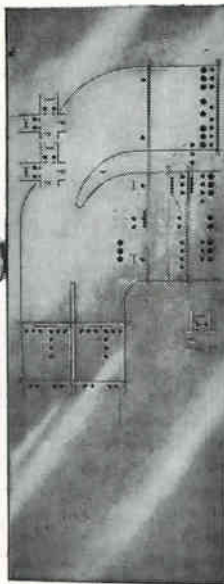

**think
BIG**

(also small)



Now engrave anything from 6 ft. panels to tiny nameplates

Engravograph tackles them all. Right in your own shop, effortlessly, speedily — ideal for unskilled workers. Adjustable ratio engraves 21 different sizes.

Write for illustrated catalog # 114

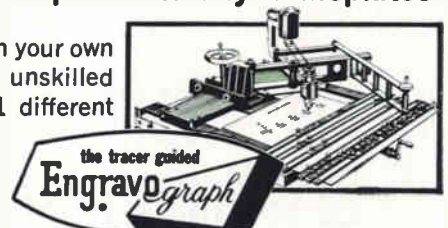

the tracer guided
Engravograph

new hermes engraving machine corp.

154 WEST 14th STREET, NEW YORK 11, N. Y. Chicago, Atlanta, Dallas, Los Angeles, Montreal

Write Directly to Manufacturer

Why the most readable readouts have a new lens system.



We've just designed a totally new lens system for our miniature rear-projection readouts, the Series 120 and the Series 220 (front plug-in model). Since we already had the most readable readouts made—even with the old lens system—why all the effort?

Frankly, the most important thing we (or any other readout manufacturer) have to sell is readability. That's why we keep on working to make the best just a little bit better. This time it really paid off. Our new lens system delivers a significant increase in character sharpness and a 50% increase in brightness! Here's what we did:

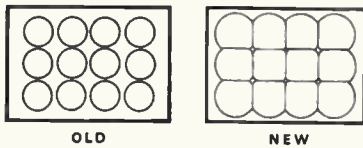

First we squared our circular lenses. That gives us greater usable lens area for a two-fold effect: the new larger lenses collect more light; magnification required is reduced. Both factors increase brightness and sharpness.

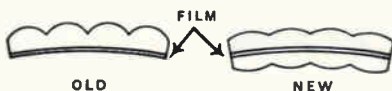

Second, we split the old single condenser lens and made a lens-film-lens sandwich. The old lens refracted light rays toward the projection lens before the rays passed through the film. Of necessity, the lens had steep curvature which limited the usable size of film. The new split-lens condenser refracts light in two stages: before it passes through film and after. By comparison, the new lenses are practically flat, permitting use of larger film and reducing aberration associated with thick lenses. The effect builds up: larger film means less magnification which in turn means greater brightness and sharpness.

So that's why the most readable readouts have their new lens system. Frankly, this new lens system may not seem earthshaking to you, unless you happen to be using readouts. In any case, send us your inquiry. We'll give you the reading on readability!

IEE INDUSTRIAL ELECTRONIC ENGINEERS, INC.

7720 LEMONA AVENUE, VAN NUYS, CALIFORNIA
PHONE: (213) 787-0311 • TWX: (910) 495-1707
© 1966 IEE Representatives in Principal Cities

New Microwave

Oscillator Gunns up to 12 Ghz

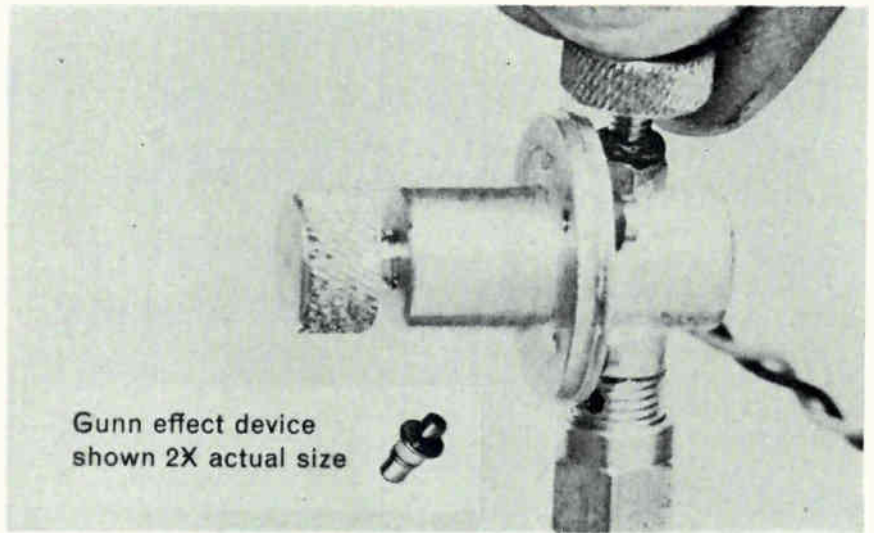

Britain may turn out to be the winner in the race to produce a commercially feasible Gunn-effect oscillator, "brain drain" notwithstanding. An American firm was the first to offer such a device [Electronics, Aug. 8, 1966, p. 221] but took it off the market when no oscillator functioned for more than 24 hours.

Reliability data for the new Gunn device is not available, but the manufacturer says that operating life "is expected to be at least 1,000 hours at its continuous rating of 5 milliwatts output."

The oscillator is the product of Mullard, Ltd., a British subsidiary of Philips Gloeilampenfabrieken NV, and is being marketed in this country by Mullard, Inc. It is designed to operate at frequencies from 7 to 12 gigahertz and requires only a 6-volt supply.

The British Royal Radar Establishment cooperated with Mullard in developing the device. One of the researchers at the radar lab has used the oscillator in a tiny low-power radar transmitter. Other possible applications include the mixer stages of microwave communication links, bench-top microwave systems for teaching demonstrations and medical radar pills for gastrointestinal diagnoses.

Gunn-effect oscillation results when an electric field exists between the two faces of a thin slice

of gallium arsenide. When the slices are thinned by a grinding and lapping, maximum operating frequency is about 4 Ghz.

However, Mullard uses epitaxial deposition that allows a very thin layer of high-resistivity GaAs to be formed on a thicker slice of the low-resistivity material. The device's active element is the high-resistivity layer, with the Gunn effect occurring throughout the layer. The company claims that the epitaxial technique not only increases the device's operating frequency, but also offers higher power dissipation and greater control of resistance in a given resistivity layer.

Others, including the Bell Telephone Laboratories, Inc., are also using epitaxial deposition to make experimental oscillators. Mullard reports its process is similar to that used by Bell Labs.

The ceramic-encapsulated device, 5 millimeters long and 3 mm in diameter, is operated by coupling it into a simple microwave cavity. It will oscillate both with fixed-frequency cavities and with those that are tuned over the entire frequency range.

Specifications

Operating frequency	7 to 12 Ghz
Operating voltage	6 v
Continuous power output	5 mw
Peak power output	20 to 30 mw
D-c current	150 ma, typ.

Metronix



SINE/SQUARE OSCILLATOR

MODEL **311** \$71.⁵⁰ (FOB JAPAN)
5 Hz ~ 560 kHz, 600 Ω



HIGH SENSITIVE AC VTVM

MODEL **121** \$66.⁵⁰ (FOB JAPAN)
full scale 1.5 mV ~ 500V, 5 Hz ~ 500 kHz

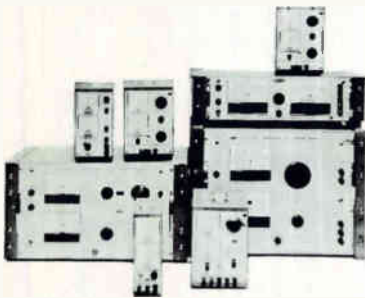

REGULATED DC POWER SUPPLIES

29 models are available. For particulars, please apply for catalog.

RIPPLE: 3mVpp

MODEL	VOLTS	AMPS	REGULATION (line or load)	FOB JAPAN \$
521A	1~18V	0.5A	±20mV	41.50
541A	1~35V	0.25A	±20mV	46.50
543	1~35V	0.5A	±20mV	73.50
531B	0~35V	1 A	±10mV	84.00
535C	0~35V	5 A	± 3mV	250.00

Specialized dealers wanted:
Write today for details.

Metronix **Metronix corp.**
76, CHOFU-CHODORI-CHO, OTA-KU, TOKYO

Only developmental models are available right now. In sample quantities, the price is about \$175, with a four- to six-week delivery time.

Mullard, Inc., 100 Finn Court, Farmingdale, N.Y. [391]

Pulse source generates high peak power



A microwave signal source designated PG5K features plug-in r-f heads and a solid state power supplier. It can generate up to 5 kw over any band in the 150 Mhz to 2,350 Mhz region, with lesser powers up to 6,100 Mhz.

The PG5K uses the grid pulsing techniques to save space and weight. It will fit into a standard 19-in. rack and is 8¾ in. high.

Units are in initial production and will soon be available from stock.

Applied Microwave Laboratory, Inc., Andover St., Andover, Mass., 01810. [392]

Continuously variable coaxial attenuator

A continuously variable attenuator that has a power capacity of 5 w c-w measures ½ cu in. and weighs only about an ounce. Frequency range is 5.2 to 10.9 Ghz and attenuation range, 0 to 10 db minimum.

The unit, a model 6604-10, is supplied with miniature APM type connectors that mate with a 1.41 in. diameter coaxial line connector such as OSM and BRM.

Maximum vswr is 1.50; maximum insertion loss, 0.5 db.

Price is approximately \$300, and small quantity delivery is eight weeks or sooner after receipt of order.

Antenna & Radome Research Associates, Inc., 27 Bond St., Westbury, N.Y. [393]

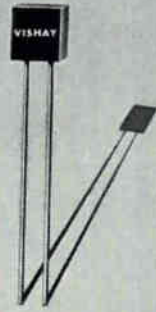

this is not a
CAPACITOR!

It is available with all these standard specs:

- 0.01% Tolerance
- $0 \pm 1 \text{ ppm}/^\circ\text{C TC}$ (0° to $+60^\circ \text{ C.}$)
- Guaranteed 25 ppm shelf life stability for one year
- Non-measurable noise
- Non-measurable inductance

With these standard specs, it could only be a Vishay Precision Resistor . . . not wire-wound . . . not conventional evaporated metal film . . . but a totally new kind of resistor, with a totally new order of precision!

How it got its unique small size . . . how it delivers its unequalled performance without parameter trade-offs . . . and where it can solve problems for you, are explained in this new, complete DATA CATALOG. Send for your free copy today.

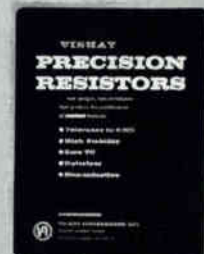

VISHAY RESISTOR PRODUCTS



a division of
Vishay Intertechnology, Inc.
63 Lincoln Highway
Malvern, Pa. 19355

10 milliwatts

10 AMPS

How do we do it?

G15 SERIES RELAY enhances the input sensitivity with a self-contained amplifier, has SPST, SPDT, DPST or DPDT outputs to fit your circuit requirements. This miniature package is available with a variety of mounting and terminal configurations compatible with Aerospace requirements. The weight but 1.6 ozs. Dimensions: 1.025" x 1.025" .935".

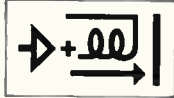

If you are looking for an extremely *small*, *lightweight*, reliable 10 Amp

relay, but don't need the low input characteristics, consider this versatile series:

G12 SERIES MODULAR RELAY. Basically the same as the G15, but without amplifier. Can be supplied as two SPDT relays in the same enclosure, with the same or different coil characteristics.



In fact, the entire G12 Series can be built up in modular units of 1, 2, 3, or 4 PDT to match your needs precisely, while keeping package size and weight to a minimum. The DPDT, for example, is just 1.2 ozs., .525" x .935" x 1.025".

GIANNINI || **VOLTEX**

12140 E. RIVERA RD., WHITTIER, CALIF. 90606
PHONE: 213-723-3371, TELETYPE: 213-685-6261

An Independent Company/An Equal Opportunity Employer

New Production Equipment

Putting IC's to the test



A \$28,000 tester for integrated circuits operates so speedily and simply that, says the manufacturer, in a production line it is more economical than a pair of \$10,000 manual testers.

Texas Instruments Incorporated explains that with the machine an unskilled operator can make an IC test in only 8 milliseconds. The machine can also be programmed for test times of 20 msec, 100 msec and indefinite (hold).

Turnaround time, or the time needed to change from one setup to another, is almost eliminated since test programs are run from a punched Mylar or paper tape. In addition, TI says, several test stations can operate from a single tester through multiplexing.

The model 668 test system can perform d-c and diagnostic tests for almost any type of IC or logic module. It can be used to probe slices and can fully test complex arrays instead of merely giving representative readings.

The programming input is a 1,000-character-per-second optical reader.

A variable word-length program allows unlimited data to be entered serially. Each function is coded with a letter address for lead identification that is then followed by three to seven digits of numerical data.

A switch on the control chassis identifies the program and can also be used to manually program one instruction at a time for special testing. Any device lead can be programmed to any d-c stimulus, ground, load resistor, detector, internal or external buss line or diode for clamping—under either momentary or static conditions.

There are three pass and nine fail categories. When devices are being classified, the most severe tests are run first. As soon as a chip or device passes all the tests in one class, a "home on pass" step can return the program to the beginning and commence testing the next unit. For example, class B tests are skipped on devices that have proved to be class A in quality.

It is also possible to program

NCC to be Sure

Here is a high quality capacitor "NCC" for space saving equipment and it costs no more than the one you are using!

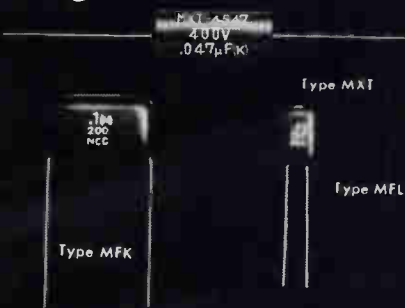

POLYESTER FILM CAPACITORS.

- Type MXT** In Plastic Tube.
Capacitance Range : .001 MFD to .22 MFD.
Voltages : 100v, 200v, 400v, 600v DC.
- Type MFK** Dipped Flat Shape. NO-Inductive Construction.
Capacitance Range : .01 MFD to .22 MFD.
Voltages : 100v, 200v, 400v, 600v DC.
- Type MFL** Dipped Flat Shape.
Capacitance Range : .001 MFD to .47 MFD.
Voltages : 35v, 50v, 100v, 200v, DC.

METALLIZED POLYESTER FILM CAPACITORS.

- Type FNX-H** Mylar Wrapped Semi oval with Epoxy End Seal.
Capacitance Range : 1 MFD to 10 MFD.
Voltages : 50v DC.

Type TAX

Type TSL

SOLID TANTALUM CAPACITORS.

- Type TAX** MIL-C-26655A Hermetically Sealed.
Capacitance Range : 1 MFD to 220 MFD.
- Type TSL** Sealed with Epoxy Resin.
Voltages : 3v, 6v, 10v, 15v, 20v, 25v, 35v DC.

for full details, contact :

MATSUO ELECTRIC CO., LTD.

3-chome, Sennari-cho, Toyonaka-shi, Osaka, Japan
Cable Address "NCC MATSUO" OSAKA

in "home on fail"—if a device fails, for instance, test number eight, the remaining tests aren't performed. For debugging tapes, checking developmental models or checking the test itself, a "stop on fail" step allows close scrutiny at the point of failure.

The basic system consists of a chassis for the tape reader and power supplies, another for program-decoding logic circuitry and a stimuli and matrix chassis.

Specifications

System leads	10 d-c, expandable to 16
Voltage ranges	0 to ± 3.99 v in 1 mv steps 0 to ± 39.99 v in 10 mv steps, both 390 ma max
Operating temperature range	15° to 35°C
Humidity	Less than 75%
Size	22x30x36 inches
Weight	400 lbs.
Table area	4.5 sq ft.
Power	100-125 v, 50 or 60 hv, 700 va

Texas Instruments Incorporated, Apparatus Division, Box 66027, Houston, Texas 77066 [401]

Encapsulation molder for components makers



A portable press, designated model EP-200, is suited for both prototype and production molding encapsulating of electronic components such as resistors, transistors, transformers, coil, semiconductors, integrated circuits and various electronic modules.

The EP-200 operates on shop line press and 100 v a-c and features controls for pressures, timing, and temperature control. Shorter lead times and inexpensive prototype tooling are among the many advantages this press offers, ac-

how to tame a temperature problem



HYGRADE

POLYTUBE 463 CLASS F Fiberglass Sleeving

retains its flexibility and electrical properties in continuous operation at temperatures up to 155°C. Even after 1000 hours, it will not crack when bent 180° around a mandrel. Constructed of closely woven fiberglass, it is thoroughly impregnated and uniformly coated with modified acrylics, making it compatible with most wire enamels and encapsulants and resistant to oils, acids, alkalis, jet fluid, lxx and water. Good resistance to abrasion and cut-through—non-wicking. Write for samples, data and prices.

MARKEL

SINCE 1922

L. FRANK MARKEL & SONS
Norristown, Pennsylvania 19404
INSULATING TUBINGS AND SLEEVINGS
HIGH TEMPERATURE WIRE AND CABLE

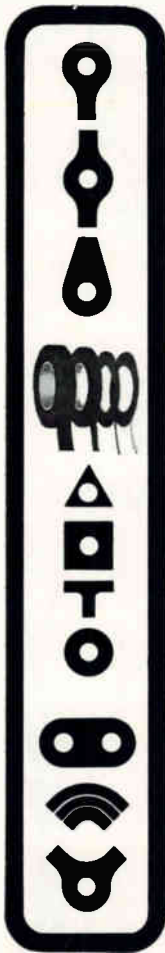

No Engineer or Draftsman should be without the **BY-BUK** handy **CROSS REFERENCE** **GUIDE** to better printed circuit drafting

which include standard sizes
as specified in MS 16912.
(NORD) conforming to MIL-P-
55110A...& its **FREE**



The booklet features over 3000 sizes of tapes, pads
and shapes for **FASTER MORE ACCURATE DISTOR-**
TION-FREE PRINTED CIRCUIT MASTER DRAWINGS.

Write today for **FREE** handy cross-reference guide, price list and
FREE samples from the most complete supplier of Printed Cir-
cuit Drafting and Masking Aids.

BY-BUK COMPANY

4326 West Pico Blvd., Los Angeles, Calif. 90019 • Phone (213) 937-3511

Circle 276 on reader service card

Production Equipment

ording to the manufacturer.

The unit occupies a bench area
of 10 x 14 in. and is 28 in. high.
Rolenn Manufacturing Co., 3151 Kan-
sas Ave., Riverside, Calif. [402]

Ultrasonic cleaners are program-controlled

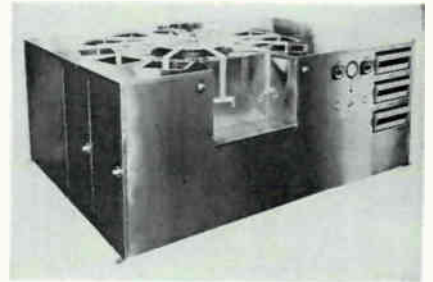

Rotary cleaning and processing
systems feature program control
and offer the option of either pneu-
matic or hydraulic operation. The
equipment can incorporate ultra-
sonics at 25 khz or 40 khz to pro-
vide fast, thorough cleaning of
semiconductors, optical compo-
nents and many other precision or
critical parts.

The basic material handler has
a maximum of five moving parts
which insures a minimum of main-
tenance downtime.

Program controls provide differ-
ential insertion and withdrawal
speeds to and from the cleaning
tanks; short-stroke vertical agita-
tion or dwell during the immersion
phase and a secondary dwell above
the liquid for drying or vapor clean-
ing.

The systems are designed with 6,
8, 10, 12 and 14 stations. Tank
openings range in size from 6x6 in.
to 24x24 in., capable of handling
work loads up to tons per hour.

Rotary cleaning systems are
available with remote service racks
for white room installations where
all pumps, filters and auxiliary
equipment are mounted in the serv-
ice area outside the white room.
This makes routine maintenance
easier and minimizes the possibil-
ity of introducing contamination
into the critical area. Integrated
systems in laminar flow enclosures
meeting Federal Standard 209 are

Primo

NEW! DYNAMIC TYPE MICROPHONE UD-842

Provided with

- ★ Tone Controller
- ★ Wind Screen
- ★ Shock Absorber
- ★ Switch



SPECIFICATIONS

- Cartridge: DM-35
- Frequency Response:
100-10,000 %
- Impedance: 50k Ω , 600
 Ω (Dual Impedance)
- Sensitivity: -51dB (50
k Ω), -71dB (600 Ω)
- Dimensions: 48 ϕ x
120mm x 177mm

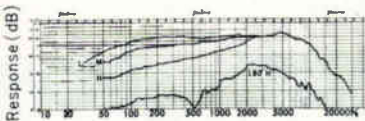

For catalog write to

PRIMO COMPANY LTD.

2043 Mure, Mitakashi, Tokyo, Japan
Tel. 0422-43-3121
Cable: "Primo Musashino Mitaka"
Telex: 0-22716 PRIMO TOK

CALCULATOR BREAKTHRU



NOW 4 WANG electronic calculators cost less than 3 ordinary units

New design permits simultane-
ous, independent operation
of 4 keyboard/display
consoles from a single, compact
electronics package.

- Individual consoles
as low as \$780
- Performs +, -, \times ,
 \div , X , X^2 , \sqrt{X} , e^x , $\log X$ at a
single keystroke
- Available with 4 additional
storage registers
- 80-step plug-in
programmer available

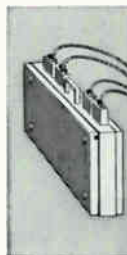

Write today for
complete information

WANG

LABORATORIES, INC.
DEPT. HH-1, 836 NORTH ST., TEWKSBURY, MASS. 01876
TEL. (617) 851-7311

4-6 WEEKS DELIVERY

in Production Quantities or Prototypes

Netic & Co-Netic Magnetic Shields

Fabricated to your exact specifications in any size or configuration. Two typical applications shown. 2-3 weeks delivery on special order.

Permanently effective Netic and Co-Netic are the recognized world standard for dependable shielding. About 80% of all magnetic shield designs in use originated here. Netic and Co-Netic are insensitive to ordinary shock, have minimal retentivity, never require periodic annealing. Total quality is controlled during manufacture. Design assistance gladly given.



Photomultiplier & CRT Shields

FREE TECHNICAL MICA MANUAL K-6

gives electrical and physical data on all types of mica

No tooling cost on numerous fabricated parts of natural and built-up mica.

Pre-punched insulating wafers to electrically isolate transistors, diodes, etc. from heat sinks.

Corrugated mica to reduce handling and fabrication costs for thermal elements.

All grades of mica offered.

Immediate delivery from stock on many items.

MAGNETIC SHIELD DIVISION

Perfection Mica Company

1322 N. ELSTON AVENUE, CHICAGO, ILLINOIS 60622

ORIGINATORS OF PERMANENTLY EFFECTIVE NETIC CO-NETIC MAGNETIC SHIELDING

PERFECTION MICA CO.

1322 No. Elston Ave.

Chicago, Illinois 60622

Phone: 312, EV 4-2122

Circle 277 on reader service card

Circle 278 on reader service card



24 hour shipment of commercial motors & fans dial 513-222-3741

A.C. MOTORS / D.C. MOTORS / GEARMOTORS

	part no.	max. dia.	length	torque oz. in.	speed rpm	volts	phase	cps
CFC**	138A100-2	1.6"	2.8"	1.25	3,600	115 a.c.	1	60
	230A107-4	1.6"	4.3"	19.0	60	115 a.c.	1	60
CMC°	144A110-2	1.2"	2.7"	.7	3,600	115 a.c.	1	60
	144A110-4	1.2"	2.7"	.7	1,800	115 a.c.	1	60
UC**	186A101-5	2.3"	2.4"	3.0	1,500	115 a.c.	1	60
	186A111-5	2.3"	2.4"	2.5	1,800	115 a.c.	1	60
UCL	186A112-1	2.3"	3.4"	6.5	3,600	115 a.c.	1	60
CMM	235A106-1	1.3"	2"	.5	17,500	24 d.c.	—	—
CLL	313A102-1	1.3"	2 3/2"	1.0	11,300	24 d.c.	—	—
SS-91	Screamer	0.9"	1.4"	.1	40,000	12 d.c.	—	—

*hysteresis synchronous

*CFC planetary gearmotor available in ratios from 4:1 to 46,656:1 with 2, 4, or 6 pole motors. Ask for Bulletin CFC.

**UC spur gearmotors stocked with output speeds of 333, 125, 100, 83, 80, 21, 16.7, 8.3, 5, and 2.5 rpm. To order, specify speed.

FANS	part no.	max. dia.	length	blade dia.	cfm @ 0" H ₂ O
CMC	19A1242	5.4"	3.7"	4.0"	110

See our listings in EEM, VSMF, & THOMAS REGISTER

Globe Industries, Inc.,

2275 Stanley Ave., Dayton, Ohio 45404, U.S.A., Tel.: 513 222-3741

Advance and be recognized!

(the password is *LEAR SIEGLER*)

If your talent is being hidden in a maze of people, or material being produced by your company, perhaps now is the time to seek new direction . . . new opportunities. And the password is Lear Siegler.

We're big enough to be active in almost every major aerospace project . . . small enough for you to advance rapidly, achieve the professional recognition you want. And you'll work with top men in the design and production of advanced flight reference, display and computer systems.

All this is located in an outdoor sports-minded, culturally-oriented community just a few minutes drive from work or play. Lear Siegler is an equal opportunity employer. Send your resume in confidence.

E. C. Mellinger

LEAR SIEGLER, INC.



INSTRUMENT DIVISION

4141 EASTERN AVE., S. E. GRAND RAPIDS, MICHIGAN 49508

Production Equipment

also available.

Prices range from \$8,000 to \$35,000 depending on the number of stations, size of tanks and the amount of auxiliary equipment. Branson Equipment Co., 51 Terminal Ave., Clark, N.J. [403]

Portable coil winder sets up rapidly

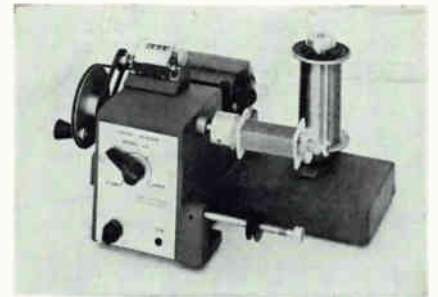

A low-cost portable coil winder features smooth-action, electronic-control motor drive, digital turns counter and extended capability for winding fine wire. The precision mechanical structure is a unit aluminum casting.

Model 4A hand-fed winder is engineered for laboratory and prototype winding of wire and filament on round or square bobbins and tubular forms. It winds electronic coils for ferrite pot cores, C-cores, rods, or laminated core stacks.

Set-up time is under 2 minutes for typical jobs. All accessories are supplied with the machine. Bobbins and wire supply spools are held between machined conical centers accommodating a wide range of dimensions.

The unit accommodates bobbins and forms $\frac{1}{8}$ in. to $1\frac{1}{8}$ in. inside diameter, up to 3 in. long. It winds wire from No. 20 to No. 48 Awg, and down to 0.001 in. on smaller forms. Speed range is 35 to 850 rpm, continuously variable. Turns counter is of the 4-digit, reset-type.

Dimensions are 8x12x7 in. high. Frame is cast aluminum. Weight is 8 lbs. Power required is nominally 120 v, 50/60 hz, 1 amp maximum.

Price is \$138; availability, from stock.

Innes Instruments, 881 W. 18th St., Costa Mesa, Calif., 92627. [404]

ACHIEVEMENT IN ELECTRICAL/ ELECTRONICS ENGINEERING

EXHIBITS
NEW YORK
COLISEUM

TECHNICAL
SESSIONS
NEW YORK HILTON

Monday through Thursday
MARCH 20-23
1967

- 69 Technical Sessions at the New York Hilton. Hours: Mon. 9:30-12:00 a.m.; 2:00-4:30 p.m. — other days 9:00-11:30 a.m.; 2:00-4:30 p.m.
- FOUR COMPLETE FLOORS OF EXHIBITS at the New York Coliseum including over 700 firms. Hours: 10 a.m.-8 p.m. 4 Days.
- Gala Annual Banquet — Wednesday 7:15 p.m. New York Hilton Grand Ballroom — \$15.00

- Free shuttle busses between the Hilton and the Coliseum — every few minutes.
- Registration — IEEE Members \$2.00 Non-members \$5.00 Ladies \$1.00 High School Students \$2.00 if accompanied by an adult. One student per adult Monday through Wednesday. Thursday only — limit of 3 students per adult. Good for all days — Technical Sessions and exhibits. In and out privileges.



'67 International
IEEE CONVENTION / EXHIBITION

I want Q curves like this . . .
 . . . specify Tohoku Neferrite
 pot cores!

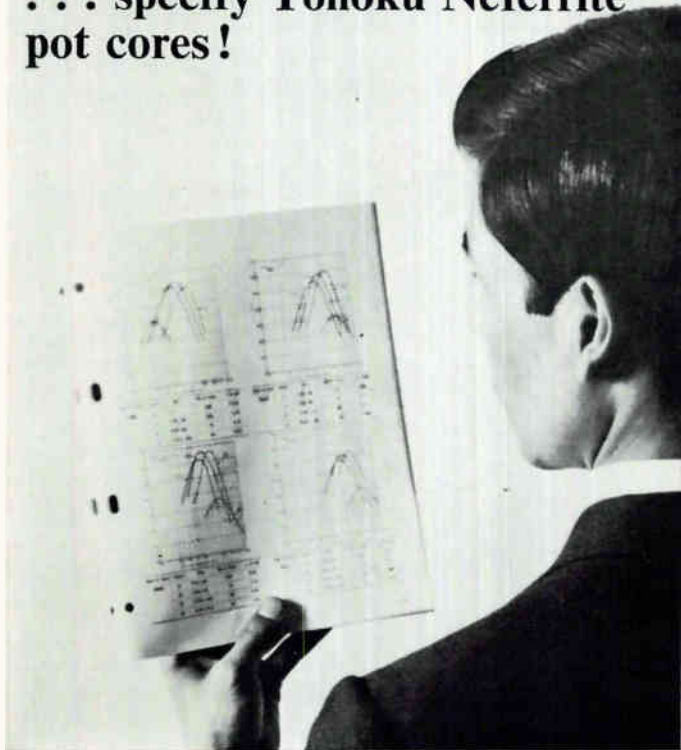

Designed in association with Japan's famous Nippon Electric Company, and featuring new NEFERRITE Mn-Zn ferromagnetic ferrite, Tohoku pot cores make possible drastic reductions in the size and weight of quality coils. NEFERRITE's own high quality standard is evidenced by the Temperature Factor of Initial Permeability ($\Delta\mu/\mu^2/0^\circ\text{C}$) which is $(0.8 \pm 0.5) \times 10^{-6}$ from 0° to 40°C —and a loss factor ($\tan \delta/\mu$) of 2×10^{-6} at 100 Kcs. These and other improved characteristics offer important design advantages—giving Tohoku pot cored coils exceptionally high Q value with low distortion over a wide frequency range.

For further information, specifications, comprehensive characteristics data and sample core, write for our free booklet, "Neferrite & Ferribroxx".



Fundamental Characteristics of NEFERRITE

Item	Grade 1	Grade 2
μ_0	2000	2000
B_{10} (Gauss)	4200	4200
Br (Gauss)	1000	1000
Hc (Oersted)	0.3	0.3
$\frac{\tan \delta}{\mu^0}$	10 Kc	0.7×10^{-6}
	100 Kc	2×10^{-6}
	500 Kc	15×10^{-6}
h_{10} (cm/A)	10 Kc	15
	100 Kc	20
T. F	$0 \sim 40^\circ\text{C}$	$\pm 0.5 \times 10^{-6}$
T. C ($^\circ\text{C}$)	180	$(0.8 \pm 0.5) \times 10^{-6}$
D. F	3×10^{-6}	180
ρ ($\Omega\text{-cm}$)	3×10^{-6}	700
	700	700

U.S. Pat. No. 3106534

Tohoku Metal Industries, Ltd.
 7-4, GINZA-HIGASHI, CHUO-KU, TOKYO, JAPAN
 Telephone: Tokyo (542) 6171 Cable Address: TOHOKUMETAL TOKYO

Circle 279 on reader service card

113 STANDARD MODELS...

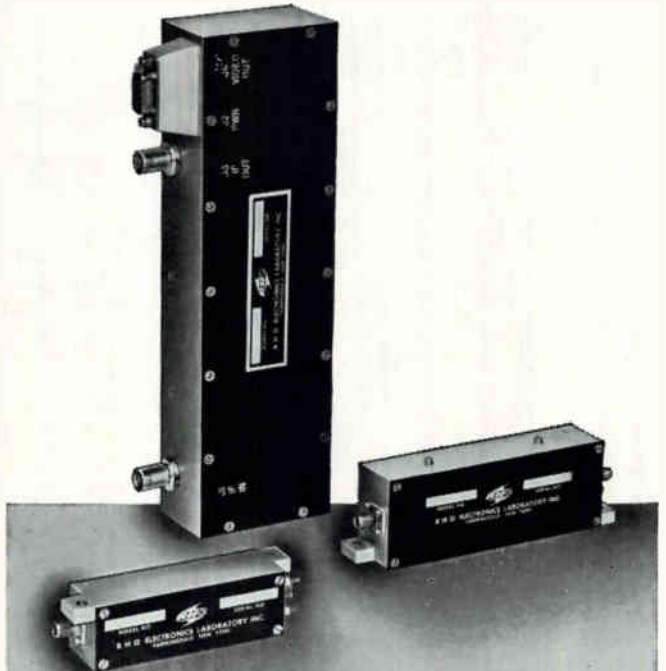

RHG IF AMPLIFIERS

FEATURING

- Linear or Log response • Solid State, Tube, and Ultra-miniature • RFI Protected • IF and Video Outputs • MIL Grade • Matched Units

RANGE OF SPECIFICATIONS

Center Frequency:	5 to 160 MHz
Bandwidth:	.25 to 100 MHz
Gain:	to 100 db
Noise Figure:	to 1.4 db
Price:	From \$185

In addition to offering the widest line of off-the-shelf units in the Industry, an additional 268 CUSTOM DESIGNS have been produced. The solution to your problem may be on file in our library now.

For specials, test our ONE-DAY-QUOTE Service. For standards, see complete listing in EEM Section 3400.

RHG

RHG ELECTRONICS LABORATORY, INC.

94 Milbar Blvd., Farmingdale, L.I., N.Y. 11735 ■ (516) 694-3100

MICROWAVE FM and AM RECEIVERS ■ MICROWAVE MIXER PREAMPS
 LINEAR and LOG IF AMPLIFIERS ■ RF and OCTAVE AMPLIFIERS

Circle 221 on reader service card

221

* ANOTHER
COMPLETE
HATHAWAY

RELAY SERIES
Form A's, B's or C's



**SERIES
MINIATURE RELAYS**

GENERAL PURPOSE Series—Automated Production for both small and large volume applications. Nylon cover—bobbin construction, film sealed coil. Choice of low level or power carrying contacts. A mechanically secure instrumentation relay. Available in all standard coil voltage & contact configurations.

Write for new condensed catalog.

HATHAWAY INSTRUMENTS, INC.
5250 EAST EVANS AVENUE
DENVER, COLORADO 80222
(303) 756-8301 • TWX 292-2935
Distributed Nationally by
COMPAR CORPORATION

New Materials

**Clear epoxy impregnant
for high temperatures**



Electrical and mechanical properties of components at high temperatures are protected by a clear epoxy impregnant. The material may be subjected to continuous use at 450°F and short exposure to 550°F.

It is primarily intended for coils, transformers, chokes, solenoids and assemblies. The dielectric constant is 3.3 and the dissipation factor, 0.006 at 1 khz. Volume resistivity is 7.6×10^{14} ohm-cm.

The material, Eccoseal W-67, is mixed just before it is used. The viscosity of the blend is about 500 centipoise at room temperature, giving excellent penetration into tight windings.

Units to be impregnated are dried and then immersed in the epoxy. A vacuum removes air from the windings and after a short draining period, the unit is cured at 250°F, and then at 350°F. Useful pot life at room temperature is several days to a month. The impregnant, available from stock, costs about \$2.75 per lb.

Emerson & Cuming, Inc., Dielectric Materials division, Canton, Mass., 02021. [406]

**Photoresist has
varied applications**

A positive-working photoresist has wide application in the printed-cir-

cuit, semiconductor and thin-film fields. It can be applied by roller-coating, dip-coating, spray and whirl or spin-coating. In addition, the company says, it is the only positive resist that can be applied in relatively thick coatings of over 0.0002 in. and still routinely achieve resolution of over 5,000 lines per inch. Also, the ability to apply thick coatings makes the over-all process more reliable and pinhole-free.

Images develop clean, having no residues on the substrate that could interfere with subsequent steps in the process. No post-baking is necessary. Adhesion to most substrates including highly phosphorus-doped silicon dioxide, is excellent.

The photoresist, AZ-111, uses a non-solvent developer that does not soften the image. This, coupled with its versatility, makes the resist practical in automated roll-to-roll processing, such as flexible printed circuits.

The resist can be easily removed by common solvents and alkaline soak cleaners, or by exposure and developing of the remaining resist.

Shibley Co., Newton, Mass [407]

**Thermoset laminate
provides flexibility**

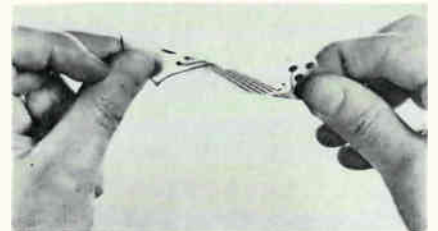

Flexiglas 6100 is a flexible epoxy-glass copper-clad laminate for contoured printed circuitry and flexible flat cabling. It is a true thermosetting plastic with premium electrical qualities but without the usual disadvantages of a thermoset polymeric system.

A 0.003-in. thickness of this Flexiglas base laminate may be wrapped around a 0.020-in. mandrel without danger of a fracture

Immediate openings for circuit design and sales engineers.



**another
ZELTEX FIRST...**

**Model 145 Operational Amplifier
with 0.5 $\mu\text{V}/^\circ\text{C}$ and 1 $\text{pa}/^\circ\text{C}$ drift!**

More amplifier news from Zeltex... announcing a miniature chopper stabilized amplifier in a rugged die cast aluminum case with exceptional drift and speed.

Use the new Model 145 for D/A conversion, precise integration, low level amplification—you name it! Write for full technical data today.

KEY SPECIFICATIONS

- Voltage drift 0.5 $\mu\text{V}/^\circ\text{C}$
- Current drift 1.0 $\text{pa}/^\circ\text{C}$
- Gain B.W. 100 MHz
- Slew rate 100 $\text{V}/\mu\text{sec}$
- DC gain 10^8
- Output $\pm 10\text{V}$ @ 20 ma

SPECIALISTS IN AMPLIFIERS AND COMPUTER ELEMENTS



ZELTEX, INC.
1000 Chalomar Road
Concord, California 94520
Phone (415) 686-6660

Circle 280 on reader service card

SCR
SILICON CONTROLLED RECTIFIERS

800 V
7 A

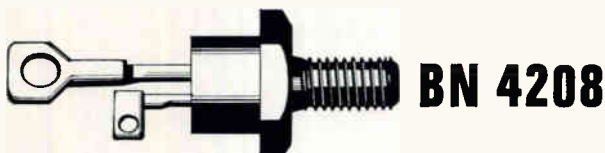

BENTRON
ELECTRONIC
(Made in Switzerland)

OEM-PRICE
1-99 \$ 36.-
100 up \$ 24.-

DIMOS AG

BADENERSTRASSE 701 · 8048 ZÜRICH · TEL. 051/62 61 40 · TELEX 52028

Circuit hot spot?

Cool it
with Sanders MINICUBE[®] Blower

Here's the easy, reliable, proven way to circulate air in confined spaces — Sanders MINICUBE Blower. Fan and motor are integrated in a rugged 1" cube. Takes less than a minute to move over 3750 times its own volume (2.2 cu. ft.) . . . eliminates hot spots around electronic devices . . . prevents fogging of optical components . . . solves a variety of problems in both military and industrial commercial applications.

*T.M., Sanders Associates, Inc.



SANDERS ASSOCIATES, INC.
INSTRUMENT DIVISION
Creating New Directions in Electronics
Mail this coupon for complete details

Sanders Associates, Inc., Instrument Division
Greiner Field, Manchester, New Hampshire 03103
Please send technical literature on Sanders MINICUBE Blowers. E-1

Name.....Title.....

Company.....

Street.....

City.....State.....Zip Code.....

Circle 281 on reader service card

Circle 223 on reader service card **223**

Sanken® Varistors

Protect your circuit

For protecting transistors, limiting noise, absorbing surge, select right one from varieties of Sanken Varistors,

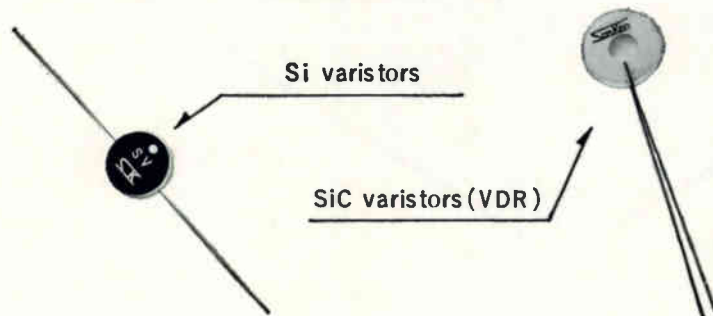

Silicon Diodes Silicon Power Transistors CdS Photoconductive Cells Selenium Rectifiers

Sanken®

Technical literature available upon request
SANKEN ELECTRIC CO., LTD.

1-22-8 NISHI-IKEBUKURO, TOSHIMA-KU, TOKYO
CABLE: SANKELE TOKYO Phone: 983 8251

Circle 224 on reader service card



If the value of an engineer is computed in terms of his contribution to technology, then the men who brought to reality such systems as Polaris and Agena are worthy indeed. They, and others like them at Lockheed, who designed and built these pacesetters of modern technology do not doubt their own importance. Their contribution is unquestioned. And their significance far transcends the glamour surrounding these achievements. Here are men of dedication. Acceptors not merely of the challenges of their own intrinsic curiosity, but of the generation in which they live as well. You too, will have the opportunity to participate in history at Lockheed. Write: Mr. R. C. Birdsall, Professional Placement Manager, P.O. Box 504, **LOCKHEED** Sunnyvale, California 94088. **MISSILES & SPACE COMPANY**
An equal opportunity employer. A GROUP DIVISION OF LOCKHEED AIRCRAFT CORPORATION

New Materials

or permanent deformation. In the past, only thermoplastics such as Mylar could provide this kind of flexibility. Thermoplastics, however, lack the high-temperature tolerance that is required in many applications. During soldering or welding operations, the flexible laminate will withstand temperatures as high as 500°F for 20 seconds without ill effects. It can be resoldered repeatedly without degradation.

The combination of flexibility, dimensional stability, bondability and extreme-temperature tolerance is particularly applicable in high-density packaging, contoured circuits and flat cables for high-temperature environments. The excellent electrical characteristics of the laminate are attributed to its very high resin content. Yet, since it is a glass-reinforced thermostat, thickness can be closely controlled. New England Laminates Co., Inc., 481 Canal St., Stamford, Conn. [408]

Quartz braiding yarns for high temperatures

Braiding yarns known as Astroquartz feature a new Teflon-based lubricant permitting great handling ease for applications in the high temperature insulation field. The new binder will broaden the range of uses for these yarns in the electronics and electrical industries for temperatures ranging from 1,200°F to 2,000°F.

Made from fine, high purity continuous filaments of fused quartz, the yarns have already found extensive use as braided insulation in thermocouple wire, coaxial cables, space separators, hook-up wire and heating elements. The new binder allows for superior flexibility. Astroquartz yarn has more than five times the yield of silica yarn, higher tensile strength and abrasion resistance, according to the manufacturer.

The new binder has high temperature resistance and completely vaporizes above 800°F, leaving no carbon residue.

J.P. Stevens & Co., Inc., 1460 Broadway, New York, N.Y. [409].

The First 50 Years

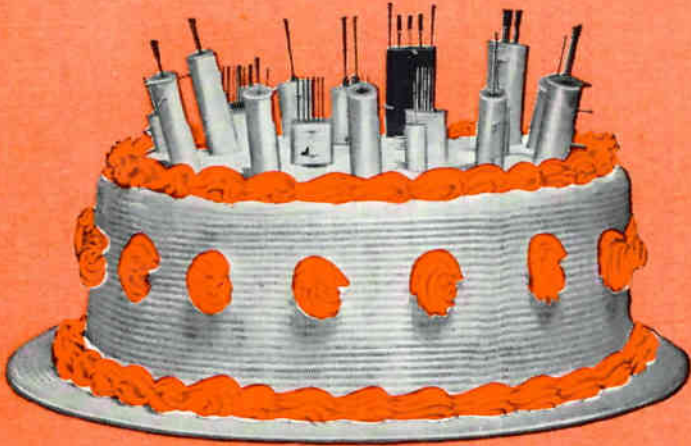

We complete our first half century of service to the electrical and electronic industries justly proud of a job well done. Starting with an assist to our Navy in World War I, we have played a major role in supplying these industries, from the gas light era to the space age. We look forward to the challenge of the next 50 years, and to your continued confidence in our ability to serve you.

Coto-Coil Company, Inc. 65 Pavilion Avenue
Providence, R. I. 02905
ELECTRICAL COIL WINDINGS • REED RELAYS AND COILS



Circle 282 on reader service card

ANOTHER WORLD'S SMALLEST Soshin's Dipped Mica Capacitors/DM05

Developed by SOSHIN ELECTRIC, the only mica capacitor maker in Japan with MIL-C-5C qualifications. This newest and its bigger brothers will meet all your requirements. Volume orders accepted.

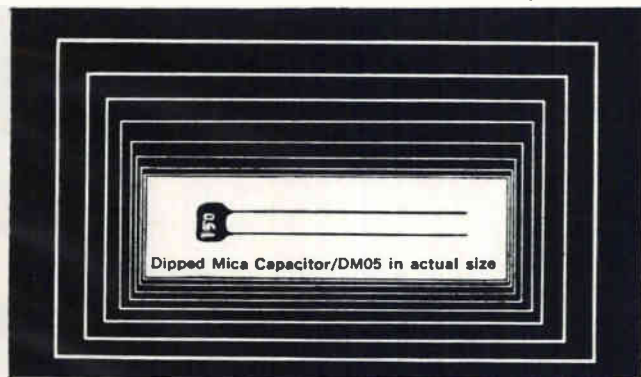

Types	Max Allowable Capacitance (pf)			Dimension (mm)								
	100 WV	300 WV	500 WV	100 WV			300 WV			500 WV		
	L	W	T	L	W	T	L	W	T	L	W	T
DM 05	200	130	—	7.0	5.0	3.5	7.0	5.0	3.5	—	—	—
DM 10	440	390	330	8.5	6.5	4.5	8.5	6.5	4.5	8.5	6.5	4.5
DM 15 (C.M05)	2000	1300	510	13.0	11.0	6.5	12.5	10.5	6.0	12.0	10.0	6.5
DM 19 (C.M05)	10000	6800	5100	18.0	15.0	8.5	18.0	15.0	8.0	17.5	15.0	7.5

For further information, write to

SOSHIN ELECTRIC CO., LTD.
18-18, Nakagome 1-chome, Ohta-ku, Tokyo, Japan
Cables: SOSHINCAPACITOR TOKYO

Audio Amplifier? AC Power Supply?

the Compact
NA Series
gives you
both!



The NA Series of AC Power Supplies are exceptionally flexible sources of audio power. Each power supply consists of a Regulated Audio Power Amplifier with interchangeable fixed or variable Plug-In Oscillators for a wide range of precision AC power

applications. The Amplifier has a full power range of 45-6,000 cycles. With the incorporation of a CML Plug-In Oscillator precise fixed or adjustable output frequencies are available anywhere within this range. For complete information, write today.

CML, Inc. 

A subsidiary of Tenney Engineering, Inc.
350 Leland Avenue - Plainfield, New Jersey
(201) 754-5502 - TWX: 201-756-2064

60

See For Yourself
By Testing Sankyo's
Family Of Micro Motors!



DMT1



MMP55

- DMT1.....Single speed (2400 rpm). With flat Sealed case. For medium grade tape recorders.
- MMS51.....Single speed (3000 rpm). For high grade tape recorders.
- MMP55.....2 speeds (2700, 4800 rpm). For 8 mm cameras.
- MMZ6.....Without governor. For Still and 8 mm cameras

SPECIFICATIONS FOR SANKYO MICRO MOTORS

	Dimension (mm) △ Length	Rated Voltage (V)	Range of Voltage (V)	Rated Torque (gr-cm)
DMT1	42 × 37	6	4.5 - 6	9
DMY15	42 × 37	6	4.5 - 6	15
DMY50	42 × 37	12	8 - 12	15
MMS44	25 × 55.5	9	6 - 10	10
MMS51	25 × 55.5	6	4.5 - 6.3	7
MMP55	20 × 45	4.5	4 - 6	10
MMZ6	16 × 29	4	4 - 6	2

	Rated Speed (rpm)	No Load Current (mA)	Load Current (mA)	Starting Torque (gr-cm)	Life (Hr)
DMT1	2400	40	130	25 (4.5V)	600
DMY15	2400	50	200	50 (4.5V)	600
DMY50	2400	50	130	50 (8V)	600
MMS44	3000	40	140	20 (6V)	600
MMS51	3000 (2900)	50	140	25 (4.5V)	1000
MMP55	2700 4800	(110)	(290)	60 (4.5V)	50
MMZ6	6000 11500	(100)	120	15 (4V)	100

Sankyo

Motor Department

AMERICAN SANKYO CORP.: Rm. 808-10, 95 Madison Ave., N.Y.C., N.Y., U.S.A. Tel: LE-2-8020
 SANKYO (EUROPE) EXPORT-IMPORT G.M.B.H.: 4 Düsseldorf, Bahnstraße 45-47, W. Germany Tel: 25652/3
 SANKYO SEIKI MFG. CO., LTD.: Shimbashi, Tokyo, Japan. Tel: 591-8371

New Books

Radio waves from afar

Radio Astronomy
John D. Kraus
McGraw-Hill Book Co., 481 pp., \$13.75

An author who attempts a comprehensive treatment of radio astronomy faces a seemingly insurmountable problem. Advances come so rapidly in this field that any book stressing the spectacular developments is likely to be outdated by the time it reaches its readers.

John Kraus, a professor at Ohio State University, has, therefore, wisely stressed the more permanent topics in his textbook. Roughly three-quarters of the text concentrates on the fundamentals and techniques which a serious student must grasp. The remainder of his text summarizes the various sources of extraterrestrial radio emission. This section is probably as up to date as is possible, and Kraus emphasizes the need for frequent references to pertinent journals.

A knowledge of vector analysis and of elementary electromagnetic and circuit theory is required of the reader. A summary of general astronomy, containing the essentials, is followed by the fundamental topics of radio astronomy, including the specification of radiation and noise, black-body radiation laws and radiation transfer. Short chapters are devoted to the description and measurement of wave polarization and wave propagation, mainly propagation through a plasma that is in a magnetic field and the Faraday rotation of linearly polarized waves. General properties of antennas, application of the spatial-frequency concept to pattern smoothing, the principles of various interferometer systems and of the lunar occultation method are all given. In addition to the general outlines, a number of actual antenna systems are described and illustrated.

The chapter on receivers was contributed by Martti E. Tiuri, a professor at the Institute of Technology in Finland. It includes the general principles of commonly used systems, the specification of

the noisiness of a device and a fairly detailed description of several types of low-noise, negative-resistance amplifiers.

Several appendixes contain useful reference material, including a number of recent lists of radio sources. Each chapter is accompanied by problems, mainly numerical exercises with answers, and a list of references, often quite long though somewhat arbitrary. Throughout the book, liberal use of instructive illustrations and tables shows the hand of an experienced teacher.

The author's clear, accurate style is marred by few errors, most of which will not trouble the alert reader. But even he may be confused by errors and misleading points in the section on radiative transfer, beginning on page 5. First, the right-hand signs are reversed in the equation of transfer which is used to calculate the change in a source's brightness due to the received radiation having passed through a cloud that both emits and absorbs radiation. Also, the theory is developed in terms of the mass absorption coefficient (m^2kg^{-1}); this is customary in optical theory but it is not used in radio.

Later in the book, in giving the actual absorption coefficient for thermal plasma, the same symbol is used for the more conventional linear coefficient: m^{-1} . Finally, it is incorrectly indicated that in an optical depth a wave's amplitude is attenuated by a factor of 1, this factor actually holds for wave's intensity, the square of amplitude.

There is also a misleading item in Tiuri's otherwise excellent discussion of receivers. The reader could calculate that an interferometer used in the phase-switching mode reduces sensitivity by a factor of four compared to the total-power mode—unless he notices that Tiuri switches standards in the middle of the table on page 258. Even a careful reading of the text leaves the actual degree of sensitivity loss ambiguous.

Within the confines Kraus has

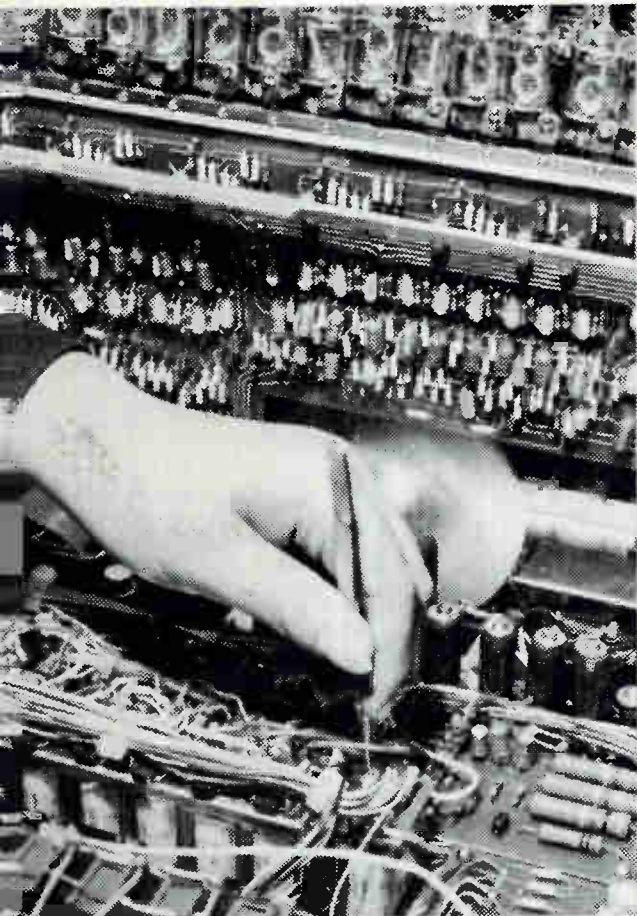

BEAUTY IS ONLY SKIN DEEP

Don't judge a Compet by its beautiful design, silent operation, or compact size. Knowledge of electronic science is the only truly important factor. Compet CS-20A is able to do more and do it faster than any motor-driven or relay type calculator. It is the product of superior know-how plus 630 transistors and 1,980 diodes assembled by some of the world's most skilled technicians.

- *special mechanism prevents pressing 2 keys at once
- *14 digits calculated instantly
- *+, -, and decimal symbols displayed automatically
- *Misuse will not cause breakdowns
- *Plug-in-circuits for easy maintenance
- *Overflow is automatically checked



COMPET Model CS-20A

SHARP

...to the point of perfection

HAYAKAWA ELECTRIC CO., LTD.

Osaka, Japan

US Subsidiary: SHARP ELECTRONICS CORP.

178 Commerce Road Carlstadt, New Jersey

VERSATILE, EASY-TO-USE SELECTOR SWITCH

Programs plain
language conversion
to computer codes

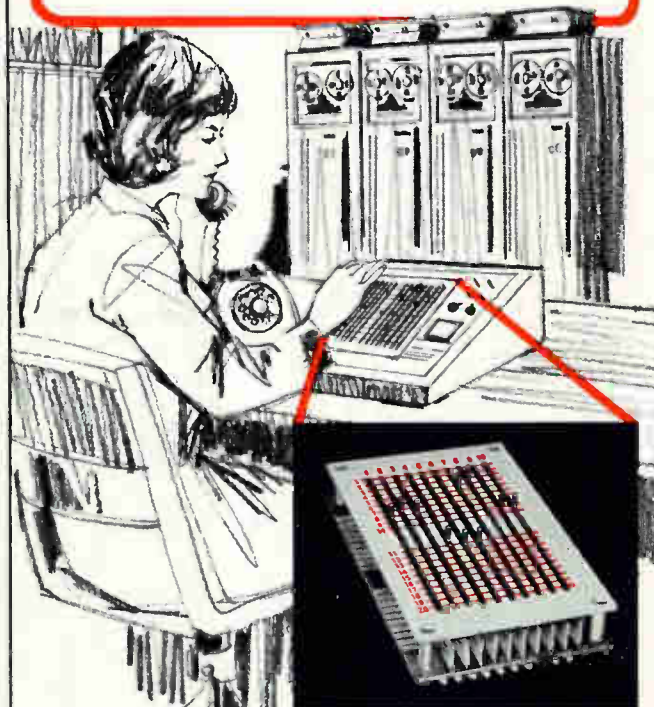

New Cherry Selector Switch enables untrained operator to communicate directly with computer

Now—a manual switching device human-engineered for rapid finger-tip selection of pre-coded alpha-numeric data—allows untrained operator to communicate *directly* with complex EDP system.

The Cherry Selector Switch can be installed *quickly* because no soldering is required. And there's no jungle of wires to confuse you or cause problems. It is available in various sizes—from 100 to 2784 positions. **Write today for full details.**

CHERRY

**ELECTRICAL
PRODUCTS CORP.**

1656 Old Deerfield Road

Highland Park, Illinois 60035

Dynamic Disciplines in
MICROWAVE
 Design, Engineering
 and Manufacturing



**Meeting Commercial,
 Industrial, Scientific
 and Governmental
 Requirements**



FREQUENCY CAPACITIES: DC TO 10GHZ

- CUSTOM CAPABILITIES
- HIGH POWER RF CW AND PULSE AMPLIFIERS AND SYSTEMS
- LARGE STOCK VARIETY OF TRIODE AND TETRODE CAVITIES (Covers 200 to 6000 MHZ)
- CW, PULSE OSCILLATORS
- CW MULTIPLIERS
- PULSE MODULATORS
- TEST EQUIPMENT
- ACCESSORIES



See Our Spread in 1967 Electronics Buyers' Guide. Write for MCL Catalog.

MICROWAVE CAVITY LABORATORIES, Inc.



10 North Beach Avenue
 La Grange, Illinois 60525
 Phone: (312) 354-4350
 Western Union Telex 25-3608

New Books

for himself, his book may be criticized for lack of balance and omissions. For example, there is a lengthy discussion, with many formulas, on general laws of black-body radiation, most of which are of marginal importance in radio astronomy. Yet relatively cursory treatment is given to the two mechanisms of greatest importance: free-free emission [free electrons which remain free after interaction with an ion are responsible for thermal radio emission from an ionized gas] and synchrotron emission [the acceleration of high-energy electrons in magnetic fields which is believed responsible for most nonthermal radio sources]. No formula is given for the radiation rate of a synchrotron electron, resulting perforce in a limited treatment of such topics as energy content and the lifetime of radio sources.

Barely a page is devoted to the principles of the Mills cross interferometer and the aperture-synthesis technique combined. No mention is made of the cross' sidelobe problems and the consequent desirability of tapering the illumination, even though the theory of the binomial array used for suppressing sidelobes has previously been developed with no indication of its potential applications. Nor is there much discussion about the relative merits of various antenna systems for particular applications. One might have hoped for an indication of the pros and cons of, say, the two-antenna interferometer with fixed baseline, the cross and the aperture-synthesis techniques for source-survey work.

Inevitably, however, different writers choose to emphasize different aspects of the subject, and Kraus, on the whole, has done a good job.

The book is probably the best available text for an introductory graduate-level course. It is likely to have a long and useful life in the classroom.

One hopes, however, that subsequent editions will retain the many merits of this first one while remedying its few flaws.

D. Walsh

The University of Michigan
 Ann Arbor

FREE WALL CHART

Eccobond® Adhesives



This fully illustrated fold-out chart in color for notebook or wall mounting gives complete physical and electrical data on over 20 adhesive systems—conductive, non-conductive—liquids, powders, pastes—for electrical or mechanical applications—various chemical types.

*This valuable Folder is yours.
 Write or use Reader Service Card.*

Emerson & Cuming, Inc.



CANTON, MASS.
 GARDENA, CALIF.
 NORTHBROOK, ILL.
 Sales Offices
 in Principal Cities

EMERSON & CUMING EUROPE N.V., Oevel, Belgium

Circle 285 on reader service

High Reliability Instrument

meguro

**WOW
 FLUTTERMETER**



MK-661D

SPECIFICATIONS:

- Center Frequency..... 3 kc
- Input..... -26 to +10 dBm
- Wow Flutter Range..... 0.03, 0.1, 0.3, 1, f. s. d.
- Weighting Characteristics..... as per JIS C5551 and CCIR specs.
- Calib. Osc..... 3 freqs. 3 kc (+3% and -3%)

© Catalog sheet on request.



MEGURO DENPA SOKKI K.

(Meguro Electronic Instrument Co. Ltd.)
 No. 5, 1-2-chome, Chuo-cho, Meguro-ku, Tokyo, Japan
 TEL: 711-7191 7 Cables: MEGURODENPA TOKYO



Great editorial is something he takes home

(What a climate for selling!)

Electronics

A McGraw-Hill Market-Directed Publication
330 West 42nd Street, New York, N.Y. 10036



Air variables from JFD

solve your high Q high frequency problems

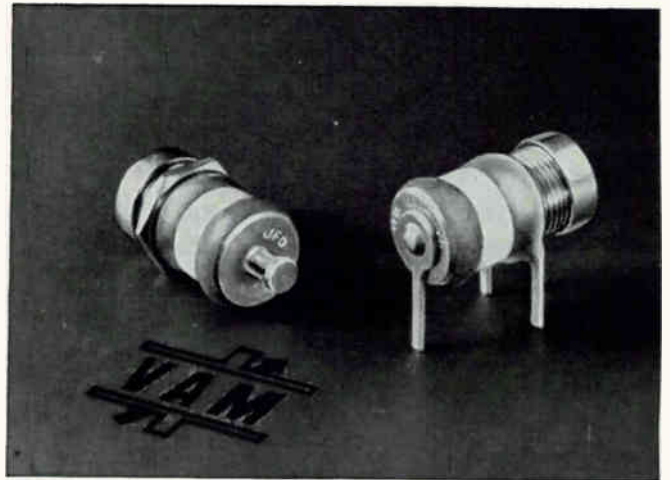

Capacitors shown enlarged 100%

These new JFD air variable capacitors are specially designed for high frequency applications that demand ultra stability, small size and high Q—greater than 2000 measured at 10 pf and 100 MC. These rugged, miniature units are offered in both printed circuit (VAM 010W) and panel mounting (VAM 010) models with capacitance ranges from 0.8 through 10.0 pf measured at 1 MC.

These units which measure less than 1/2" in length are completely interchangeable with competitive devices.

Internal air meshing shells are silver plated to provide good surface conductivity and to prevent corrosive effects. Internal contact springs assure positive electrical contact of rotor at all times. Leads on printed circuit model are tinned for ease in soldering . . . and these units are engineered to resist heat, won't come apart during soldering.

Bulletin VAM-65 gives more details. Write for your copy today.

JFD "TODAY'S COMPONENTS BUILT FOR TOMORROW'S CHALLENGES"

JFD ELECTRONICS CO. / COMPONENTS DIVISION 15th Avenue at 62nd Street
Brooklyn, N. Y. 11219 / Phone 212-331-1000 • Sales Offices—Arcadia, Calif.
Chi., Ill. / Balt., Md. / Saxonville, Mass. / Bklyn., N. Y. / New Hartford, N. Y.
Cinn., Ohio / Phila., Pa. / Pitts., Pa. / Paris, France / Azor, Israel

LIVE (REALLY LIVE) and PROFIT IN THIS ALL SEASON VACATIONLAND



*Let us show you
how to mix pleasure
with your profits!*



Millions of Americans have made SOUTH DAKOTA their ideal vacation-land . . . Now they're learning that it's also a great BUSINESS-land . . . Big, uncluttered, lots of hunting, fishing, and just plain liveability . . . Yet close to everywhere at the continent's crossroads.

5¢ postage may be all that stands between you and a new future in uncrowded SOUTH DAKOTA. Let us send you our new portfolio today.

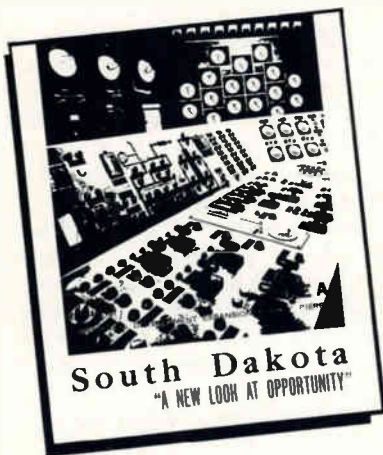

GET THE SOUTH DAKOTA
STORY

CONTACT

James W. Monroe, Director
Industrial Development & Expansion Agency

Room 1

Pierre, South Dakota 57501
Ph. 224-5911 Area Code 605

Technical Abstracts

Digital displays

The plasma display panel—a digitally addressable display with inherent memory
D.L. Bitzer and H.G. Slottow,
University of Illinois

Although plasma displays are still experimental and very small, it appears they may overcome most disadvantages of cathode-ray tube displays for computer input and output. The new displays respond directly to digital signals, can be interrogated by the computer, will display data for relatively long periods without continual regeneration and should have better resolution than crt displays if the displays are large.

In contrast, crt displays require digital-analog conversion circuitry, have no memory except phosphorescence, are bulky, need high driving voltages and signal transmission at video bandwidths. Information may be written into a crt display with a light pen, but even this appears feasible with plasma displays. It should be possible to display up to 1 million points a second on a plasma display, about five times the maximum rate for commercially available crt displays, and to provide as many as 10,000 points per square inch of display.

The experimental plasma displays consist of small matrixes of gas cells formed by three adjacent sheets of glass. On the outer sheets are orthogonal grids of transparent conductors, stripes of vapor-deposited gold. The inner sheet is a matrix of small holes, located between the intersecting conductors. The holes are filled with gas.

A plasma discharge causes the cells to glow when an alternating voltage is applied to the conductors. The glow is quenched when the applied voltage drops below the firing level. This cycle takes 50 to 75 nanoseconds.

After quenching, a charge remains on the cell walls. This charge constitutes a memory function and makes the cells bistable at intermediate voltages. If a sustaining voltage is applied to the display, the charged cells will glow without further input from the computer.

If the computer applies a balancing potential to the glowing cells, the display is erased.

To interrogate a display, the computer can apply the sustaining voltage to the cells sequentially and detect light output through photocells at the rear of the display. If primed cells are subjected to a beam of light, the release of photoelectrons from the cell walls will turn on the cells. However, it may be necessary to optically shield the cells to prevent one cell from triggering others until the entire display is lit.

Presented at the Fall Joint Computer Conference, San Francisco, Nov. 7-10.

Logic massager

Automated logic design techniques applicable to integrated circuit technology

R. Waxman, M.T. McMahon,
B.J. Crawford and A.B. DeAndrade
International Business Machines Corp.,
Hopewell Junction, N.Y.

Computer-aided design offers a happy medium between the old and the still-too-new styles of arranging integrated circuits into logic systems.

The old way, the use of similar logic units to keep the number of types of circuits low, results in low circuit density and is an inefficient way to apply monolithic ic technology. The new way, highly dense packaging of one-of-a-kind functional blocks (large-scale integration, or LSI), tends to increase the numbers of part types, presenting inventory and engineering change problems. If the LSI blocks are made from a large matrix of simple cells, the designer also runs into limits on the matrix interconnections.

LSI arrays composed of complex, but versatile cells, appears to be the solution. Interconnection of the cells with "personality" wiring can be done as almost the last step in the production process. If the intercell wiring is on the outside layer of the ic chip, the "impersonalized" arrays can be stocked, awaiting custom wiring or engineering changes.

The problem of deciding which

CONANT

where stability
and miniaturization
are primary

See our ad on page 764
in 1967 Electronics Buyers Guide

**SEMICONDUCTORS
COPPER OXIDE
AND SELENIUM**

**INSTRUMENT RECTIFIERS
RING MODULATORS
HIGH-VOLTAGE RECTIFIERS
VOLTAGE REGULATORS
SWITCHED RECTIFIERS
CHOPPERS**

**SPECIAL PURPOSE UNITS
LIST PRICES FROM 42c**

5 COPPER OXIDE CELL STYLES FROM
.080" to .500" DIA. ACTIVE AREAS .0012 to
.125 SQ. IN.

SELENIUM CELL SIZES FROM .080" round
TO 2" SQUARE. .020" TO .045" THICK.



Write for
Free Bulletins
Dept. E-67

**CONANT LABORATORIES
Lincoln, Nebraska 68505**

Circle 287 on reader service card

Leadership is no accident!

in sports
or in
industry

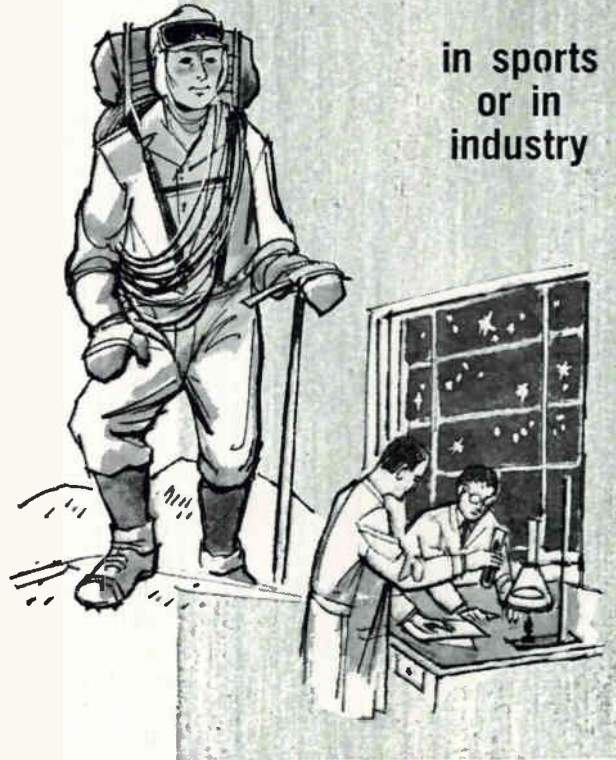

DETERMINATION is one of the reasons for ALPHA'S LEADERSHIP

Alpha is never content with being best, but is always striving to be better. The Alpha line of solders, soldering chemicals, solder preforms and ultra high purity metal fabrications for semi-conductor devices is subjected to continuous research and investigation to make certain that every product incorporates the latest and most valuable improvements made possible by scientific and technological advances. Our customers make Alpha their number one choice because they have complete confidence in products that can be depended upon to maintain consistent performance and highest yields. Additional reasons for Alpha leadership include distribution of the latest authoritative soldering information; prompt, reliable service; an outstanding Research and Development Department geared to problem solving; unequalled know-how and experience; and the most complete quality product line available anywhere.

BULLETIN A103 TELLS THE ALPHA STORY.
WRITE FOR YOUR FREE COPY TODAY.

alpha alpha metals, inc.

56 WATER STREET, JERSEY CITY, N. J. 07304 201-434-6778
Los Angeles, Calif. • Alphasoy Corp. (Div.), Chicago, Ill.
Alpha Metals, Inc. (U.K.) Ltd., Hounslow, Middlesex, Eng.

J-6989

SEE US AT NEP/CON '67 WEST—BOOTH 256

ALCO ELECTRONIC PRODUCTS, INC.

Something NEW! Simplify Component Replacement
USE THESE NEW
CERAMIC TERMINAL STRIPS

SNAP MOUNTING

DETAILED ASSEMBLY AVAILABLE

The uniform manufacturing of the miniature terminal strips gives the row after row assembly a neater appearance; adds a quality look overall. Tinned copperplate on silvered ceramic facilitates soldering of components and leads. Withstand excess heat. Available with 3-5-7-9-13-16-20 terminals.

FREE PRODUCT PLANNING SAMPLES

WRITE FOR FREE CATALOG

MANUFACTURED UNDER A LICENSE GRANTED BY TEXTRONIC INC.

ALCOSTRIP By ALCO ELECTRONIC PRODUCTS, INC. LAWRENCE, MASS.

ALCOSWITCH

DP3P

**MINIATURE
3 ACTIVE ON-ON-ON POSITIONS
TOGGLE SWITCH**

Left Center Right

ON ON ON

First of its kind! Ultra-miniature 1/2" size. 3 amps @ 115VAC. In stock. Write for details.

ALCOSWITCH

By ALCO ELECTRONIC PRODUCTS, INC., LAWRENCE, MASS.

FREE PRODUCT PLANNING SAMPLES

Circle 288 on reader service card

Circle 231 on reader service card

231

PERMACOR[®]
powdered iron cores
 ...unequaled for
**design and prompt
 delivery!**

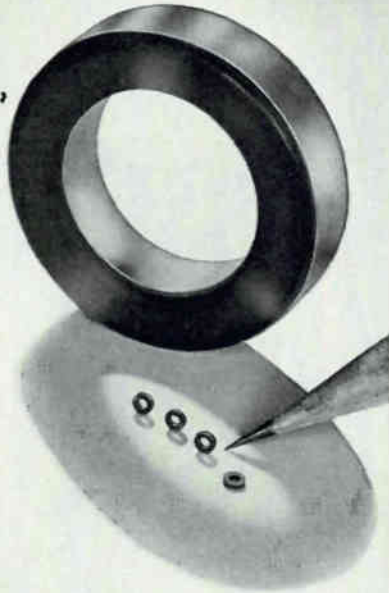

Illustrated: **TOROIDAL IRON CORES**
 available from 1/8" to 2" O.D.

As the largest maker of iron cores in the world, we offer unequalled production and design facilities for any core design problem. AND, we stock a full line of standard cores at all times.

Need the best in cores . . . Plain, Hollow, Threaded, Insert, Tuning, Cup, and Toroidal Iron Cores, Iron Coil Forms, Sleeves, Flexible Magnetic Shielding, Bobbins and special shapes . . . write and find out why we are unequalled.

PERMACOR[®]

A Division of Radio Cores, Inc.

9540 Tully Ave., Oak Lawn, Ill. 60454
 Phone: 312-422-3353

Technical Abstracts

logical functions the complex cells should generate can be attacked by applying the theory of equivalence classes. That is, each cell can perform more than one function by rearrangement of the inputs to each cell or its outputs. If either the true or the complement of a given function is available at the input or output of the cell, each cell can have four functions. If the set of input variables can also be permuted, many additional functions would be available, without changing the cell's internal circuitry.

A computer-aided design program, called the equivalence class descriptor program, has been devised to implement this concept. With its aid, a logic system can be partitioned into several hundred sections, the section functions identified by descriptors, and the equivalent functions produced as common elements. The program is written in Fortran. It is presently restricted to functions of six variables, or less. The limit is imposed by the use of a truth table; a table of six variables is the largest that can be handled in the memory of the computer used, an IBM 1620.

With the aid of instructions flashed onto a cathode-ray-tube display by the computer, the logic designer partitions sections, called clusters, from the over-all logic design. For example, a cluster may be a related group of AND, OR and inverter circuits. Each cluster is analyzed to obtain its function descriptor.

As the designer works, he determines the quantity of each equivalence class needed to replace the original logic. As portions of the logic system are partitioned out of the original diagram, the remainder is shown on the display screen for further partitioning until the redesign of the logic system has been completed. The designer can at any time review the entire system with the partitioned sections inserted into the unpartitioned remainder.

Presented at the Fall Joint Computer Conference, San Francisco, Nov. 7-10.



Your
**CCTV
 Cameras
 are
 of
 superior
 quality**

Lenses ?



Try
COSMICAR[®]

Superior cameras deserve superior lenses. COSMICAR's proven precision performance is the combined result of advanced optical engineering and exquisite workmanship.

Now widely used, COSMICAR LENSES come in 23 models for focal lengths ranging from 12.5 mm to 500 mm, and in 3 zoom models including a remote-control zoom.

Your CCTV camera and COSMICAR LENSES will make an unbeatable team. For technical data and other particulars write to:

**ICHIZUKA
 OPTICAL CO., LTD.**

568, Shimoochiai, 2-chome, Shinjuku-ku, Tokyo
 CABLE ADDRESS: "MOVIEKINO TOKYO"



NEW...AC/DC Microjoining Console has 10 Capabilities...

Module welding • Thermocompression bonding • Parallel gap welding • Multiple lead soldering • Split tip welding • Series welding • Step series welding • Single point soldering • Insulated wire welding • G.P. welding

The new Model 1200 has A.C. capability up to 1 kva and D.C. output up to 100 ws. Multi-tapped transformers provide many different pulse lengths. One head does thermocompression bonding — the other sets up nine different ways. Write for details.

Free Sampling Service

Send us sample materials for experimental bonding or welding. No obligation.

Weltek

by **WELLS ELECTRONICS, INC.**

1701 S. Main Street, South Bend, Indiana, U.S.A.

Circle 291 on reader service card

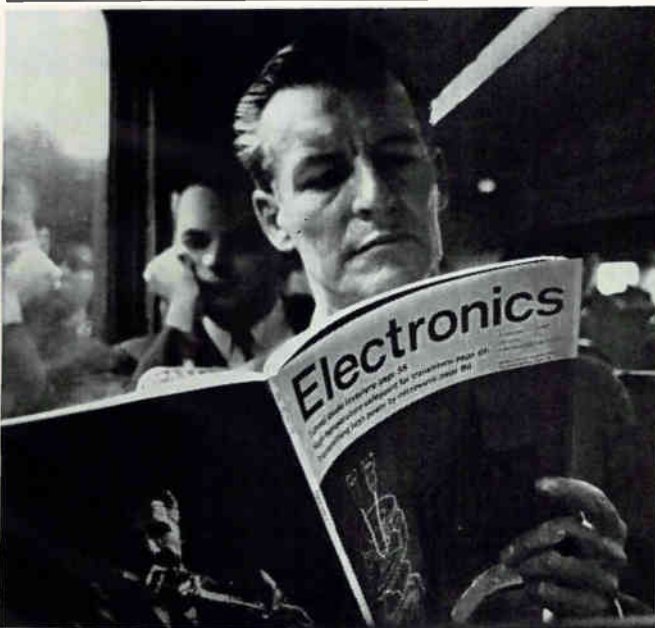

Great editorial is something he takes to work

(What a climate for selling!)

Electronics

A McGraw-Hill Market-Directed Publication
200 West 42nd Street, New York, N.Y. 10018



**FREE
ENGINEERING CATALOG
of PUSH BUTTON and
ROTARY SWITCHES,
MINIATURE ELECTRONIC
COMPONENTS, and MOLDED
PARTS IS YOURS ...
JUST MAIL THE COUPON.**



Grayhill
INC.
... the Difference
Between Excellent
and Adequate

More than a catalog!

This New Engineering Catalog provides valuable reference material on the effects of environment, duty cycle, altitude, etc., on switch performance. Shows the relationship between switch loads and useful life. Also completely describes Grayhill's line of miniature, sub-miniature and ultra-miniature electronic switches and components.

**Write for
your free copy today.**



523 Hillgrove Avenue
LaGrange, Illinois 60525
Area Code 312, Phone 354-1040

"PIONEERS IN MINIATURIZATION"

Gentlemen:

Please mail my copy of the Grayhill Engineering Catalog to:

Name _____

Title _____

Company _____

Address _____

City _____

State _____ Zip _____

get the picture!

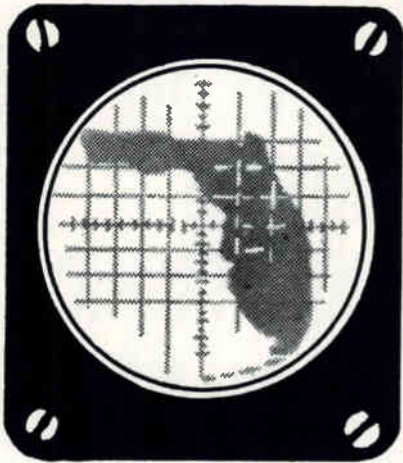

send for the facts on
**ELECTRONIC
PARK
West Palm Beach
FLORIDA**

1 Personnel Director's Delight. Easier recruitment is proven. A blind ad to test location appeal to engineers and technicians proved Florida was favored 30 to 1 over another state.

2 Blue Chip Company Neighbors. Electronic Park is the choice of ITT, and nearby in the Palm Beaches are RCA, Pratt-Whitney and Solitron Devices.

3 Excellent Transportation. Neighboring Palm Beach International Airport offers direct jet flights to major U.S. cities. Complete facilities for business aircraft. Deep-water port for Latin American trade.

4 New University. Twenty miles south is the new Florida Atlantic University.

5 Climate Ideal. Annual average temperature based on U.S. Weather Bureau observations is 74.5 degrees.

6 Recreation. Just 4 miles to public Atlantic Beach. Waterways galore. A new 18-hole championship golf course and 600-acre sail club are under way just 1½ miles from Electronic Park.

7 Location. Two miles from downtown West Palm Beach, 70 miles north of Miami and 110 miles south of Cape Kennedy.

WRITE IN CONFIDENCE TO: ELECTRONIC PARK,
P. O. BOX 1071, DEPT. E, WEST PALM BEACH,
FLORIDA 33402.



Site of International Telephone
and Telegraph Corporation's
135,000-square-foot Semiconductor Plant

New Literature

Instrument motors. Amphenol Controls division, Amphenol Corp., 120 South Main St., Janesville, Wisc., 53545. An eight-page catalog illustrates and describes models 1020, 1060 and 1080 instrument motors.
Circle 420 on reader service card.

Nonlinear functions. Bourns, Inc., 1200 Columbia Ave., Riverside, Calif., 92507, has released a four-page nonlinear function catalog sheet, featuring a wide selection of single and multiturn, precision potentiometers in servo and bushing-mount styles. [421]

Silicon stack assemblies. International Rectifier Corp., 233 Kansas St., El Segundo, Calif., 90245. Catalog D-66 lists a complete line of silicon stack assemblies, providing 80 pages of description, ratings, and specifications. [422]

General-purpose relays. Guardian Electric Manufacturing Co., 1550 West Carroll Ave., Chicago, Ill., 60607, has issued an 18-page bulletin providing complete information on its line of 23 general-purpose relays. [423]

Wire and cable. Harbour Industries, Inc., P.O. Box 188, Shelburne, Vt., has available an illustrated brochure covering its facilities for the manufacture of high temperature wires, cables and specialty components. [424]

Relay test system. Sparton Southwest, Inc., P.O. Box 1784, Albuquerque, N.M. Product data sheet number 21 contains detailed specifications and operating performance of the RTS-100 system for rapid, accurate and reliable testing of relays. [425]

Coaxial switches. Microwave Associates, Inc., Burlington, Mass. Technical bulletins 2034 and 2036 describe a series of compact and lightweight electro-mechanical coaxial switches. [426]

Solid state oscillators. Krohn-Hite Corp., 580 Massachusetts Ave., Cambridge, Mass., 02139, offers a technical bulletin on the series 4000 solid state standard oscillators that feature ultra-low distortion and stable amplitude. [427]

Subminiature connectors. ITT Cannon Electric, 3208 Humboldt St., Los Angeles, Calif., 90031, has published a catalog on the DRA line of subminiature connectors used in aircraft, missiles and ground support equipment. [428]

Solid state amplifier. Studio Electronics Corp., 11922 Valerio St., North Hollywood, Calif., offers bulletin SE-08 containing a two-page technical description of the model 1108 solid state amplifier. [429]

Film thickness measurement. Monsanto Co., 800 North Lindbergh Blvd., St. Louis, Mo., 63166. An evaluation procedure manual describes a new method of determining epitaxial silicon film thickness by spherical angle lapping. [430]

Dual-output supply. Deltron, Inc., Wisahickon Ave., North Wales, Pa., 19454. Bulletin 406A deals with a compact, low cost, dual-output, tracking power supply designed for use with almost all types of operational amplifiers and integrated circuits. [431]

Reed relays. Essex Wire Corp., Controls division, 131 Godfrey St., Logansport, Ind. Bulletin 2020 covers a complete family of standard, open-construction reed relays. [432]

Potentiometer production. SP Elettronica SpA, Via Carlo Pisacane 10/4, Pero (Milan), Italy. A four-color brochure illustrates the company's facilities for the manufacture of Spectrol precision and trimming potentiometers. [433]

Time-delay relays. Heinemann Electric Co., 252 Magnetic Drive, Trenton, N.J., 08602. Twelve-page bulletin 5006 describes the company's line of Silic-O-Netic time-delay relays. [434]

Noise generator. Signalite Inc., 1933 Heck Ave., Neptune, N.J., has issued a two-page illustrated data sheet on the type TN-1 miniature X-band noise generator. [435]

Snap-reed switch. Cherry Electrical Products Corp., P.O. Box 439, Highland Park, Ill., 60036, offers a brochure on the E66 series, which weds the mechanical utility of the snap-action switch to the electrical reliability of the reed switch in a single, compact and convenient package. [436]

Feed-through terminals. Taurus Corp., Academy Hill, Lambertville, N.J., 08530, has released a catalog on the SFU series subminiature feed-through terminals designed for snap-fit installation into predrilled or prepunched chamfered holes in electronic chassis. [437]

Carbon film resistors. Pyrofilm Resistor Co., Inc., 3 Saddle Road, Cedar Knolls, N.J. A four-page folder describes a line of hermetically glass-sealed, deposited carbon film resistors. [438]

Electronic measuring instruments. Ballantine Laboratories Inc., P.O. Box 97, Boonton, N.J., 07005. The 1967 catalog contains photos and specifications for a variety of measuring instruments, including voltmeters and ammeters, a-c/d-c volt ohmmeters, amplifiers, calibrators, capacitance meters, a-c/d-c linear converters, laboratory voltage standards, and accessories. [439]

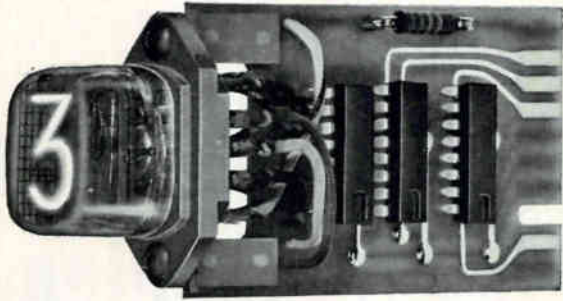

TTL IC Drivers for NATIONAL[®] Readout Tubes

From stock: Decoder / Driver, Decimal Counter / Driver and Decimal Counter / Driver with Latching Memory.

■ 15 MHz Counting Rate ■ For all side and end view National readout tubes.

NATIONAL REQUEST BULLETIN

ELECTRONICS, INC.
a varian subsidiary

PHONE: (312) 232-4300 • GENEVA, ILLINOIS, U.S.A.

Circle 292 on reader service card

Laminated plastic tubing

at its very best



all shapes and sizes



instant stock



fabricated

We're so well equipped that you can get practically any diameter, shape or wall thickness you want—in every commercial grade of Synthane laminated plastic tubing.

And we stock so many finished tubes we can often fill your order from our inventory. This saves you time if you do your own machining, gives us a flying start if we fabricate for you.

Ask for Synthane tubing by name. Write for information.

YOU FURNISH THE PRINT . . . WE'LL FURNISH THE PART

SYNTHANE CORPORATION
36 RIVER ROAD, OAKS, PENNA.
Synthane-Pacific, 518 Garfield Ave., Glendale, Calif. 91204



Circle 293 on reader service card

What price performance in a quality filter?



less than \$15
with Clevite's compact
ceramic ladder filter.*

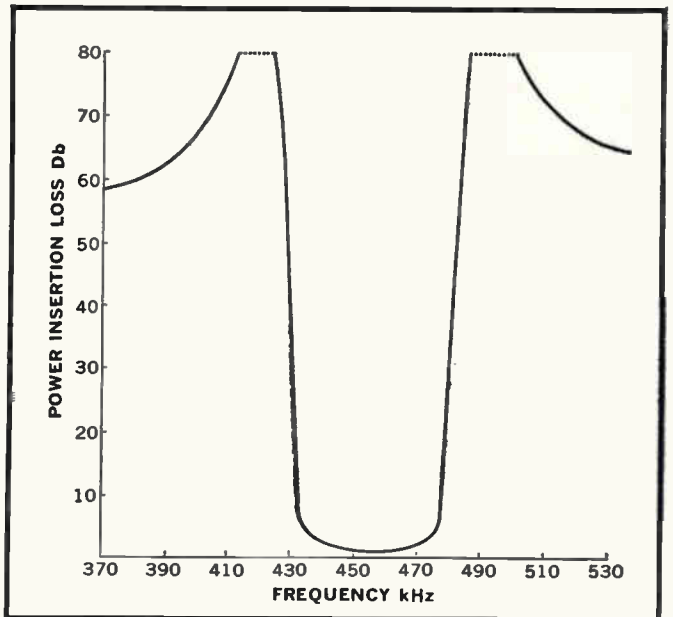

Here's the smallest (less than 0.07 cu. in.), most rugged fixed-tuned filter on the market today!

Clevite's 9-disc ceramic miniature is packaged in a hermetically-sealed cylinder, meets all military environmental specifications, is ideal for transistorized i-f amplifier circuitry in AM and FM sets plus many other applications that call for a fixed-tuned filter. Stop band rejection: 50 db. Center frequency tolerance: ± 3 kHz. Stability: within $\pm 0.2\%$ for 5 years; within 0.2% from -40°C to $+85^{\circ}\text{C}$. Impedance (in and out) @ 27°C : 10 kHz B/W 2000 ohms, 16 kHz B/W and above 1000 ohms.

Following models standard at 455 kHz (A) or 500 kHz (C) (custom models on special order):

Model Number	B/W @ 27°C	
	min. @ 6db	max. @ 60 db
TL10D9-20 (A or C)	10 kHz	20 kHz
TL16D9-32 (A or C)	16 kHz	32 kHz
TL20D9-38 (A or C)	20 kHz	38 kHz
TL30D9-57 (A or C)	30 kHz	57 kHz
TL40D9-72 (A or C)	40 kHz	72 kHz

*PRICES: 1—\$25 ea; 25—\$20 ea; 100—\$17.50 ea; 500—\$15 ea; 1000—\$13.75 ea; 2500—\$12 ea.

(Prices subject to change without notice)

Send order or request for Bulletin 94021 to:

Clevite Corp., Piezoelectric Div.,
232 Forbes Rd., Bedford,
Ohio 44014, U.S.A.
Brush Clevite Co. Ltd.,
Southampton, England

CLEVITE

Circle 235 on reader service card 235

No amplifier needed with Vernistat® a.c. pots

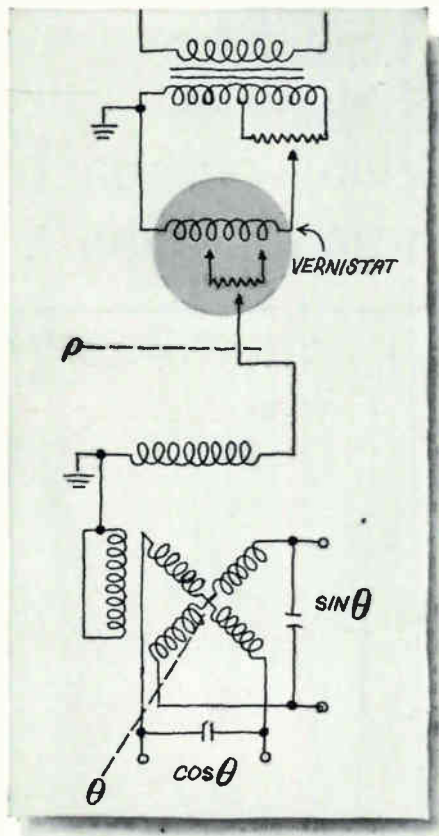

You don't need a buffer amplifier to drive a servomechanism—if you use a Vernistat a-c potentiometer. It has an output impedance low enough to drive a resolver or other low input impedance device directly. Use an a-c potentiometer to simplify circuits, improve reliability, gain greater accuracy and reduce circuit costs. For full information and data sheets, write to Electronic Products Division, Perkin-Elmer Corporation, 131 Danbury Road, Wilton, Connecticut 06897



PERKIN-ELMER

New Literature

Current-to-current converter. Fischer & Porter Co., 108 Jacksonville Rd., Warminster, Pa., 18974. Specification 50EK1000 describes a converter for transforming current signals, in selected ranges up to 50 ma, to a proportional 4 to 20 ma current signal. [440]

Tunable electronic filters. Spectrum Instruments, Inc., P.O. Box 474, Tuckahoe, N.Y., 10707, offers a technical data sheet on its line of type LH-42D spectrum analog electronic filters, which are active network devices usable singly or in pairs to accomplish a wide variety of frequency selective functions. [441]

Magnetic shielding foil. Magnetic Shield division, Perfection Mica Co., 1322 No. Elston Ave., Chicago, Ill., 60622. Four-page data manual 185 gives technical data on a new rust-inhibited Blue Netic magnetic shielding foil plus a multitude of applications for other magnetic foil shielding. [442]

Folded-array memory. Indiana General Corp., Crows Mill Road, Keasbey, N.J. A miniaturized, folded-array memory, the Microstack, is described in an eight-page booklet. [443]

Potentiometers. Helipot division of Beckman Instruments, Inc., 2500 Harbor Blvd., Fullerton, Calif., 92634, has available a 72-page catalog covering precision potentiometers, trimmers, dials and servo system components. [444]

Angular accelerometers. Gulston Industries, Inc., 212 Durham Ave., Metuchen, N.J., 08840. An illustrated bulletin describes compact, inexpensive, angular accelerometers for accurate measurement and control of roll, pitch and yaw in aircraft, missile, shipborne and industrial applications. [445]

Thermoelectric module. EG&G, Inc., Products division, 160 Brookline Ave., Boston, Mass., 02215, has published a four-page data sheet on the model H9-65 thermoelectric module, a device having an unloaded temperature differential of 65°C at 9 amps. [466]

Terminal junctions. The Deutsch Co., Electronic Components division, Municipal Airport, Banning, Calif., has released a four-page, two-color brochure describing terminal junctions, a new class of point-to-point interconnection and housing devices. [447]

Limiting amplifier. Studio Electronics Corp., Universal Audio division, 11922 Valerio St., North Hollywood, Calif., has issued a technical data sheet, bulletin SE-15, to describe the Universal Audio 176 limiting amplifier. [448]

San-Esu poly varicon



4X-20 BET

CONTRIBUTING...

To cut the production costs!
To make highly reliable quality!
To rationalize the production line!



For catalog, write to:

SAN-ESU ELECTRONICS CO., LTD.

1-2, 6-chome Nishiōi, Shinagawa-ku, Tokyo, Japan Tel. Tokyo (783) 7311
Cable: SANESVARICON TOKYO

Circle 294 on reader service card

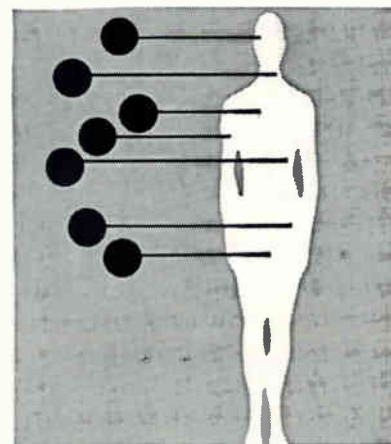

Know the seven danger signals that may mean cancer.

1. Unusual bleeding or discharge.
 2. A lump or thickening in the breast or elsewhere.
 3. A sore that does not heal.
 4. A change in bowel or bladder habits.
 5. Hoarseness or cough.
 6. Indigestion or difficulty in swallowing.
 7. Change in a wart or mole.
- None of these is a sure sign of cancer. But if one lasts more than 2 weeks, see your doctor at once. It's worth it in peace of mind alone.

American Cancer Society

THIS SPACE CONTRIBUTED BY THE PUBLISHER

NOT A SCIENCE- BUT A NEW ART: ENCOURAGEMENT OF ENGINEERING CREATIVITY

What makes one engineer more creative than another? Extra synapses in his brain? Better ability to tune in the unconscious? We at Sanders don't know the answer.

We do know that a favorable environment enhances creativity... and we put considerable effort into the brand new art of designing such an environment.

Already definable elements include: pursuit of promising off-beat hunches; better ways of teaming individuals to explore new concepts; an open door policy that keeps red tape, compartmentalization and protocol down; encouragement of post-graduate work; "cross fertilization" via in-plant seminars.

As we learn more about this art day-by-day, we incorporate the things we learn into our company.

Perhaps that is why we seem to be more successful than many others in

attracting creative people. Most of them stay with us too, sustained by the certainty that the environment is in sympathy with their individual objectives.

Blue sky? Hardly. We simply recognize that individual creativity is our most important corporate asset.

Where is this creativity directed? Into practically every area of advanced components and systems. We're heavy in phased arrays and other radar; information handling and display; long range communications; oceanographic telemetering; electro-optics; lasers; instrumentation and control; microwave; flexible printed circuits; and systems-oriented, special-purpose hardware.

Senior level openings exist in research, development, product design and manufacturing engineering. Write in confidence to Mr. Lloyd R. Ware, Staff Engineer.

SANDERS ASSOCIATES  INC.

NEW DIRECTIONS IN ELECTRONICS SYSTEMS

An Equal Opportunity Employer (M&F)

Nashua, New Hampshire

The Scientists and Engineers served by Corcoran in the last year have found the difference between "a job" and "the job."

- Whether your search for a new working environment is based on a desire for larger responsibility, wider scope of action, broader technical interests, or for financial gain, the individual attention offered by Corcoran assures a greater chance of success.

- Nationwide, we serve large and small clients on a fee paid basis. Please airmail background to:

JOSEPH P. CORCORAN
Personnel Consultants
 505 B Germantown Pike
 Lafayette Hill, Pa. 19444



E.E.'s

For **FREE PAID** positions throughout U.S.

Send Coupon Today

ATOMIC PERSONNEL, INC.

Suite L, 1518 Walnut St., Phila., Pa.

Experienced Engineers... Working "Full Time"... For You!

Send resume today. (If none, send coupon for confidential application.)

Name _____

Address _____

City _____ State _____

WIRE AND CABLE OPPORTUNITIES

- Engineer, experienced in design & production of coaxial cables and electronic wire & cables.
- Sales Mgr., to handle strong distributor organization for established manufacturer, must be experienced.
- Shop Supt., wire & cable plant, must have experience in cord set molding, assembly, production; complete supervision. Excellent opportunities for men willing to relocate. Send all particulars to

P-1933, Electronics
 645 N. Michigan Ave., Chicago, Ill. 60611

POSITION VACANT

Electronics Technician—A large midwestern university is seeking an Electronics Technician. Must be able to perform routine maintenance and repair of electronic, scientific equipment. Must have familiarity with both electron tube and solid state circuitry, and must be able to do design, construction, and modification of electronic circuitry. Apply Personnel Office, University of Missouri at Kansas City, 5100 Rockhill Road, Kansas City, Missouri.

YOU'RE HIRED

Do you need electronics engineers or technical management men? Electronics magazine is the way to recruit them. Electronics is designed specifically for the working engineer. 68,000 subscribers and an additional 133,000 pass-along readers turn to it to keep up with their industry. You can find the man that meets your qualifications with an advertisement in the Employment Opportunities Section.

For rates & information write: Electronics, a McGraw-Hill Publication. Classified Advertising Division, Post Office Box 12, New York 10036.

In electronics it's Electronics magazine to sell used equipment!

Your advertisement will produce Results in Electronics. Engineers turn to Electronics magazine for the latest technical developments — and for the latest buying information. You can reach them inexpensively in Electronics Searchlight Section.

For information:
 Searchlight Section
 Classified Advertising Division
 Post Office Box 12
 New York 10036



SEARCHLIGHT SECTION

- CLASSIFIED ADVERTISING
- BUSINESS OPPORTUNITIES
- USED OR SURPLUS EQUIPMENT

RELAYS

28 VOLT D.C. COILS
Hermetically Sealed Cases

9226-4187 LEACH MS25269—DI With 6C-5 Amp. Contacts 6 Pole D. T., Hook Lug Terminals and 4 bottom mounting studs. 1 1/2" x 1 1/2" x 3/4" High.

LOTS OF 10 — \$12.00 EACH
LOTS OF 100 — \$10.00 EACH
LOTS OF 1000 — \$9.00 EACH

MH-90057 POTTER & BLUMFIELD. DUAL. With One Pair N. C. 5 A. Contacts operated by a 2500 Ohm Coil in each section. 1" x 3" x 2" high with Hook Terminals and four mounting studs.

LOTS OF 10 — \$4.00 EACH
LOTS OF 50 — \$3.00 EACH

11HSX352-A MAGNECRAFT. DUAL. Each Section has two 200 Ohm SEPARATE Coils which may be independently energized for isolation, and two Pairs of N. C. 5 Amp. Contacts. Four stud bottom mounting and two separate headers with 8 hook terminals each. 2" x 1 1/2" x 2".

LOTS OF 10 — \$4.50 EACH
LOTS OF 50 — \$3.50 EACH

20389-4-27QANC2 PHILLIPS CONTROL 3 Pole D. T. 15 Amp. Contacts Flange mounting 6 hole Base 2 1/4" x 2 1/4", 2 1/8" x 2 1/8" x 2 1/8".

LOTS OF 10 — \$5.00 EACH
LOTS OF 50 — \$4.00 EACH

DIVERSIFIED COMPONENTS

726 WEST CLINTON STREET
ITHACA, NEW YORK 14850
(607) 272-8800

CIRCLE 971 ON READER SERVICE CARD

MINI-FLUID DISPENSER

AIR OPERATED
for miniature potting and encapsulating



Available in 3 sizes
6cc - 12cc - 30cc

\$34.00

PHILIP FISHMAN COMPANY
7 GARDNER ST., WELLESLEY, MASSACHUSETTS 02158

CIRCLE 197 ON READER SERVICE CARD

PROFESSIONAL SERVICES

GIBBS & HILL, Inc.
Consulting Engineers

Systems Engineering
Operations Research • Development
Field Studies • Design • Procurement
Power • Transportation • Communications
Water Supply • Waste Treatment
393 Seventh Avenue New York 1. N. Y.

Donald C. Harder, Inc.

Magnetic Component Engineers
Reactors—Transformers—Filters
Serving the Research Laboratory
2580 K Street, San Diego, Calif. 92102
Phone (714) 239-8021

AUTOTRACK ANTENNA MOUNT

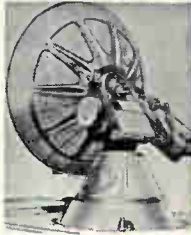

360 degree azimuth, 210 degree elevation sweep with better than 1 mil. accuracy. Missile velocity acceleration and slewing rates. Amplidyne and servo control. Will handle up to 20 ft. dish. Supplied complete with control chassis. In stock—immediate delivery. Used world over by NASA. USAF. MP-61-B. Type SCR-584. Nike Ajax mounts also in stock.

PULSE MODULATORS

MIT MODEL 9 PULSER 1 MW—HARD TUBE
Output 25kv 40 amp. Duty cycle .002. pulse lengths .25 to 2 microsec. Also .5 to 5 microsec. and .1 to .5 microsec. Uses 6C21. Input 115v 60 cycle AC. Mfg. GE. Complete with driver and high voltage power supply. Ref: MIT Rad. Lab. Series. Vol. 5, p. 152.

2 MEGAWATT PULSER
Output 30 kv at 70 amp. Duty cycle .001. Rep rates. 1 microsec 600 pps. 1 or 2 msec 200 pps. Uses 5948 hydrogen thyratron. Input 120/208 VAC 60 cycle. Mfr. GE. Complete with high voltage power supply.

15 KW PULSER—DRIVER
Biased multivibrator type pulse generator using 3E29 Output 3kv at 5 amp. Pulse lgths .5 to 5 microsec. easily adj. to .1 to .5 msec. Input 115v 60 cy AC. \$75. Ref. MIT Rad. Lab. Series. Vol. 5, pps. 157-160.

MIT MODEL 3 PULSER
Output: 144 kv (12 kv at 12 amp.) Duty ratio: .001 max. Pulse duration: .5, 1 and 2 microsec. Input: 115 v 400 to 2000 cps and 24 vdc. \$325 ea. Full desc. Vol. 5, MIT Rad. Lab. series, pg. 140.

250 KW HARD TUBE PULSER
Output 16 kv 16 amp. Duty cycle .002. Pulses can be ended. Uses 5D21, 715C or 4P180A. Input 115 v 60 cy. AC \$1200 ea.

PLAN POSITION INDICATOR CONSOLE
Complete PPI console operating from 115 volt 60 cycle AC. 10" CRT range 4 to 250 miles Digital height readout. Complete AN/TPA-25. Price \$1200.

SCR 584 AUTOTRACK RADARS
Our 584s in like new condition, ready to go, and in stock for immediate delivery. Ideal for telemetry research and development, missile tracking, satellite tracking. Fully Desc. MIT Rad. Lab. Series. Vol. 1, pps. 207-210, 228, 284-286. Comp. Inst. Bk available \$25.00 each.

TEST EQUIPMENT

For over 20 years specializing in top brands—only. Write for our latest listing. We buy complete inventories.

NORMAN

ELECTRONIC SALES

1113 Howard Street, Chicago, Illinois 60626
Telephone ROgers Park 4-0600

CIRCLE 968 ON READER SERVICE CARD

YOU'RE HIRED!

Do you need electronics engineers or technical management men? Electronics magazine is the way to recruit them. Electronics is designed specifically for the working engineer. 68,000 subscribers and an additional 133,000 pass-along readers turn to it to keep up with their industry. You can find the man that meets your qualifications with an advertisement in the Employment Opportunities Section.

For rates & information write: Electronics, a McGraw-Hill Publication. Classified Advertising Division, Post Office Box 12, New York 10036.

MICROWAVE SYSTEMS

L BAND RF PKG.

20 KW peak 990 to 1040 MC. Pulse width .7 to 1.2 micro sec. Rep. rate 180 to 420 pps. Input 115 vac incl. Receiver \$1200.

200-225 mc RADAR SYSTEM

1 Megawatt output, 200 nautical mile range for long range detection of medium and high altitude jet aircraft as well as general search. Complete system in stock. Input 120/208 V. 60 cy. Type TPR-28 Mfg Hazeltine.

C-BAND RADAR

250 KW output C-band. PPI indicator. 5C22 thyratron modulator. Antenna hl gain parabolic section Input 115 volts 60 cycle AC. complete \$2750.00

200 TO 2400 MC RF PKG.

200 to 2400 MC CW. Tuneable. Transmitter 10 to 30 Watts. Output. As new \$475.

500 KW L BAND RADAR

500 kw 1220-1359 msc 160 nautical mile search range P.P.I. and A scopes. MIT thyratron mod 5J2 magnetron. Complete system.

100 KW X BAND RADAR

Complete 100 kw output airborne system with AMT1 5C22 thyr. mod. 4J52 magnetron. PPI, 360 deg az sweep. 60 deg. elev. sweep, gyro stabilizer. hi-gain rest. Complete with all plugs and cables.

AN/GPG-1 SKY-SWEEP TRACKER

3 cm. automatic tracking radar system. Complete package with indicator system. Full target acquisition and automatic tracking. Input 115 volts 60 cycle New. In stock for immediate delivery. Entire System 6' long, 3' wide, 10" high. Ideal for infrared Tracker, Drone Tracker, Missile Tracker, R & D.

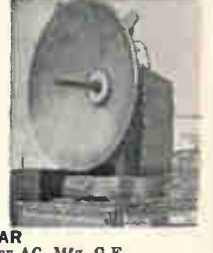

500KW S BAND RADAR

250 miles search 115V 60 cy AC. Mfg. G.E.

RADAR AUTO-TRACK & TELEMETRY ANTENNA PEDESTALS 3 & 10 CM. SCR 584 AUTOTRACK RADARS. M-33 RADAR TPR-10 SEARCH. APS-45 TPR-100 HC. FINDERS. WX RADARS. FPN-32GA. APS-10 APS-15B APS-27 (AMTI) SEARCH. APN-102 DOPPLER. DOZENS MORE. CARCINOTRONS. PPN'S. .25-.5-1.2-3.6 MEGAWATT PULSE MODULATORS. CAVITIES. PULSE TRANSFORMERS. IF STRIPS. WAVEGUIDE. BENDS 200 MC. 1 KMC. 3 KMC. 6 KMC. 9 KMC. 24 KMC. RF PKGS.

RADIO RESEARCH INSTRUMENT CO.

550 5TH AVE., NEW YORK 36, N. Y.

JU 6-4691

CIRCLE 967 ON READER SERVICE CARD

For Sale

Automatic Blank Sorter built in 1961 by Seimitsu Kogyo Co. for Transistor Dice including Feeding Mechanism.

Bauer Machinery Co.
1114-16 Frankford Ave.
Philadelphia, Pa. 19125

CIRCLE 966 ON READER SERVICE CARD

ELECTRON TUBES

KLYSTRONS • ATR & TR • MAGNETRONS
SUBMINIATURES • C.R.T. • T.W.T. • 5000-6000 SERIES

• SEND FOR NEW CATALOG A2 •
A & A ELECTRONICS CORP.
1063 PERRY ANNEX
WHITTIER, CALIF.
696-7544

CIRCLE 969 ON READER SERVICE CARD

BIG CATALOG

World's "BEST BUYS"
in GOV'T. SURPLUS
Electronic Equipment

FULL OF TOP QUALITY ITEMS—
Transmitters, Receivers, Power Supplies,
Inverters, Microphones, Filters, Meters,
Cable, Keys, Phones, Antennas, Chokes,
Dynamotors, Blowers, Switches, Test Equip-
ment, Headsets, Amplifiers, etc., etc. SEND
25¢ (stamps or coin) for CATALOG and
receive 50¢ CREDIT on your order. Address
Dept. E-6.

FAIR RADIO SALES
P.O. Box 1105 • LIMA, OHIO • 45802



Esterline Angus doesn't keep handing you the same old line!

We keep developing new graphic recorders and new features to incorporate in established recorders . . . to satisfy your needs.

We've developed a trouble-free servo motor with only one moving part. No pulleys, drive cords or gears. It delivers 2/10 second response over a 10" span and 1/8 second response over a 4 1/2" span.

Our new Multipoint has an exclusive Programmed Printing option. It lets you select points electrically with switches.

You can now order our Permanent-Mag-

net Moving-Coil recorders with magnetic amplifiers (to increase sensitivity) or with power transducers (to measure watts, volts, amperes, vars . . .).

We've designed a Rapid Response (1/10 second) Voltmeter. It records 100 millisecond voltage transients with full accuracy . . . especially valuable in monitoring power supplied to data processing units.

In addition to our best selling Ink Type Event Recorders are new Inkless and High Impedance Event Recorders. The high im-

pedance instrument can be bridged into low power (i.e., telephone) circuits without upsetting their operation.

Want to record more than one channel of information on the same chart? We now have six types of two-channel recorders, plus an Analog-Event Recorder which provides one channel of analog information and eight channels of event information.

Oscillo Graphs? Choose from nine units including portables and cabinet models. All with frequency response above 125 cps.

Write for our full line brochure. You'll discover we make more kinds of graphic recorders than just about anybody else.

Esterline Angus Instrument Co., Inc.
Box 24000E • Indianapolis, Ind. 46224



ESTERLINE ANGUS
EXCELLENCE IN INSTRUMENTATION FOR OVER 60 YEARS

Circle 240 on reader service card

Newsletter from Abroad

January 9, 1967

Color-set makers in Japan face antitrust action

Japanese set makers have their problems even though they're poised to push color television receiver output past the 1-million mark—double the 1966 figure—during the year ahead.

Late this month, hearings will begin in an antitrust action the government has launched against six major producers.

The government's fair trade commission contends that the leading producers violated Japan's antitrust laws by setting a minimum retail price of \$500 for 19-inch color sets at monthly meetings of company vice-presidents at the Palace Hotel in Tokyo. The commission has raided the companies three times to gather evidence.

The companies—Matsushita Electric Industrial Co., Hitachi Ltd., Tokyo Shibaura Electric Co., Mitsubishi Electric Corp., Sanyo Electric Co. and Hayakawa Electric Co.—admit their executives hold regular meetings. But at the hearings, they'll maintain there's been no price fixing. They claim their prices—the popular 19-inch sets are bunched around \$550 retail—are realistic.

What's more, the six producers say their meetings are justified and will continue. Their argument: exchanges of information among domestic producers is important since they'll eventually be up against strong outside competition because of the government's policy to ease restrictions on foreign investment in the country.

Production models of tiny U.K. radar year or so away

The matchbox size low-power radar developed at Britain's Royal Radar Establishment should be on the market in a year or so, predicts RRE's Cyril Hilsum. Hilsum led the research team that worked on the gallium arsenide Gunn-effect oscillator used as the radar's microwave source.

The GaAs oscillator, encapsulated in a 3 by 5 millimeter package, was developed jointly with Mullard Ltd., a subsidiary of the Dutch company Philips Gloeilampenfabrieken NV. Mullard now is getting yields of 70% on the oscillators but production versions of the radar won't be forthcoming until further development is done on the resonance cavity.

In addition to Mullard, the Plessey Co. and Standard Telephones and Cables Ltd, a subsidiary of the International Telephone and Telegraph Corp., have the "mini" radars under development.

ICT long on orders but short on cash

Success has put Britain's leading computer maker, International Computers & Tabulators Ltd., in a bind for cash and the company is looking for help from the government.

ICT came up with a best-seller with its 1900 series, introduced two years ago. Since, the company has delivered some 250 systems and has orders in hand for an additional 400. But most of the machines are rented; so ICT needs tide-over financing, at a time when money is tight, to keep up its fast expansion.

With the Labor government determined to maintain an independent computer industry, ICT can almost certainly count on some sort of aid. The company currently has talks under way with the government's export-credit agency for financing overseas deliveries and with the Ministry of Technology for domestic deliveries. But ICT's plight brings up again the perennial and perturbing question of how many computer companies the British economy can support.

Newsletter from Abroad

East German goal: national computer network by 1970

A countrywide complex of computer centers will be set up in East Germany by 1970 if the plans of Guenther Kleiber, newly appointed state secretary for data processing, pan out.

Kleiber's scheme calls for more than 100 computer installations—linked together—at major industrial firms, research institutes and government agencies. At present, there are some 25 computer centers in the country, almost all of them equipped with Bull Gamma-10 machines. But the existing centers operate individually as service bureaus.

The East Germans most likely will turn to Russia for the hardware and build their complex around Ural, Minsk and BESM computers. There's a slight chance, though, that U.S. third-generation machines would be integrated into the complex should the North Atlantic Treaty Organization ease its embargo on exports of advanced data-processing equipment to Communist-bloc countries.

Bull-GE withdraws pair of computers

The General Electric Co.'s worldwide troubles with software delivery for its 600-series computers have doomed a pair of models developed by GE's French subsidiary, Bull-General Electric. To slim down the GE computer line, Bull-GE last week dropped its Gamma 140 and Gamma 145 models, two small machines introduced last year.

With two less models to sell and service, GE expects to fare better with its larger machines in the French market. GE had to recall one 600 machine installed at the state-owned public utility Electricite de France and lost a sale—because of program difficulties—for a second machine tentatively ordered by the French weather bureau.

French fail in bid to win Austrians over to Secam

Executives at West Germany's Telefunken AG now are fairly confident that Austria will end up on the list of countries that have adopted the company's PAL (for phase-line-alternation) color-television system.

The French made a year-end bid to win Austria for their competing Secam (for sequential and memory) system but their demonstration didn't make much of an impression on Austrian broadcasting officials. Meanwhile, PAL has acquired a powerful supporter: Austria's Federal Chamber of Commerce, which represents the country's business community. The Chamber of Commerce is convinced PAL would work best in the mountainous country and would simplify exchange of color programs with neighboring West Germany and Switzerland. They both already have opted for PAL.

Nippon Electric wins USAF contract for microwave net

The United States Air Force has picked the Nippon Electric Co. as prime contractor for \$13.7-million microwave communications system in the Kanto Plains area of Japan. The system will link 24 U.S. military stations and connect into the regular Japanese communications network.

Despite the Pentagon's "Buy American" policy, Nippon won out over ITT Federal Electric Corp. Nippon is the only company now producing the 300-channel equipment that was specified for the job. Nonetheless, the system, which will cover Tokyo and four surrounding provinces, will have considerable U.S. hardware. Nippon has awarded a \$6-million contract to the Lenkurt Electric Co., a subsidiary of the General Telephone & Electronics Corp., for the multiplex equipment.

5 AU 10 AVRIL 1967 - PORTE DE VERSAILLES - PARIS

tous les jours
de 9 à 19 h



salon international des

COMPOSANTS ELECTRONIQUES

salon international de

L'ELECTROACOUSTIQUE



RENSEIGNEMENTS S. D. S. A. - 16, RUE DE PRESLES - PARIS 15°

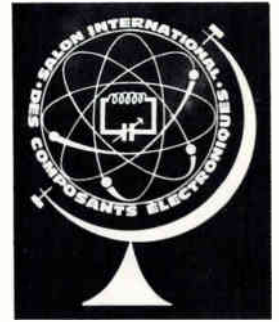

international exhibition of electronic components

THE MAIN INTERNATIONAL MEETING OF THE YEAR...

Paris - From 5 to 10 April 1967

The first Exhibition of Components was held in 1934, and the event took on its international scope in 1958.

In 1966 there were: 900 exhibitors representing 20 countries... 140.000 visitors from 70 countries...

In 1967 the International Exhibition of Electronic Components promises to be more brilliant and on a larger scale than ever.

It will be open from April 5 to 10 - the month when Paris is most attractive in the Exhibition Halls at the Porte de Versailles.

A double goal

The International Exhibition of Electronic Components has taken only a few years to become the greatest world-wide intercomparison in the field of components, semiconductors, tubes, and electronic accessories. Exclusively open to manufacturers it pursues - with constantly increasing success - two objectives:

- to present, every year, a **vast synthesis of the most recent world production**, giving manufacturers an opportunity to meet, discuss, exchange ideas, and prepare for the future;
- to offer every year, to many specialists, engineers and technicians coming from all countries, a **technical information centre** where, in the most favourable conditions of rapidity, they can discover the latest novelties in their respective fields, obtain documentation and equipment... and make an appraisal of the evolution and prospects for the Electronic Components Industry.

TECHNICAL CONFERENCES

Within the very framework of the International Exhibition of Electronic Components, a number of **Technical Conferences** will give you the possibility of reviewing the latest technological developments - Programme on request.

INTERNATIONAL EXHIBITION OF AUDIO EQUIPMENT

Held jointly with the Exhibition of Electronic Components, the Exhibition of Audio Equipment will open its doors during the same period to engineers and specialists from all over the world in adjacent halls to those of the Exhibition of Electronic Components.

For many years, Audio Equipment was presented within the Components Exhibition. The constant development of this Exhibition together with a rapid expansion of Audio Equipment have led organizers to separate these two manifestations which are, both of them, international and technical.

INTERNATIONAL CONFERENCE ON ELECTRONICS AND SPACE

From April 10 to April 15 - International Conference on Electronics and Space - Programme and conditions of registration will be sent on request.

This conference aims at investigating how the new constraints imposed by space applications have led to an adaptation or a renovation in the field of electronics.

S.D.S.A. - RELATIONS EXTERIEURES - 16, RUE DE PRESLES - 75 PARIS 15^e, FRANCE - PHONE : 273.24.70

Official Air-Lines of the Exhibition call for information : AIR FRANCE.

INTERNATIONAL EXHIBITION OF ELECTRONIC COMPONENTS

PARIS 5th to 10th APRIL



Using advanced techniques . . .

THE RESEARCH LABORATORIES AND FACTORIES OF LA RADIOTECHNIQUE - COPRIM - R.T.C.



DREUX : picture tubes Manufacturing Center

NUCLEAR INSTRUMENTS

The fastest photomultipliers in the world
150 different types

Scintillators - Photoscintillators

Semiconductor radiation detectors

(Diffused, Surface-barrier, Li-drifted Ge and Si)

SEMICONDUCTORS and MICROELECTRONICS

- III-V semiconductor compounds - Epitaxy
- Solar cells and sensors
- Lasers and electroluminescent diodes
- Optoelectronics
- Microtransistors
- Hybrid microstructures
- Integrated thin-film circuits
- Linear integrated circuits
- DTL or TTL logic integrated circuits

COLOUR TELEVISION

"Direct-view" picture tube A 63 — 11X

Magnetic shield

Special receiving tubes :

Chrominance amplifier	P and ECF 202
Booster diode	P and EY 500
Reference tubes	P and ED 500
Line output pentode	P and EL 505
EHT	GY 501

Standard semiconductors and receiving tubes

- Deflection unit • Focussing unit
- Line and EHT output transformer
- Frame output transformer
- Cushion-correction transducer
- Focus-correction coils
- Reflection glass delay-line
- PTC, NTC and VDR resistors
- Potentiometers • Capacitors
- Tube sockets . . .



CAEN : Semiconductors research-Manufacturing Center

At the disposal of the electronic industry the most complete range of tubes, semiconductors, other components and sub-assemblies.



HEAD OFFICE : 51, rue Carnot - 92 SURESNES (France)

Sales department : 130, av. Ledru-Rollin - PARIS (11^e) - Tél. 797.99.30

Factories and research laboratories :

Caen, Chartres, Dreux, Evreux, Suresnes

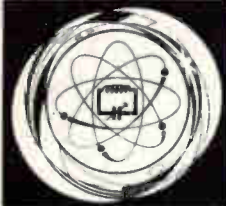

INTERNATIONAL EXHIBITION OF
ELECTRONIC COMPONENTS

PARIS 5th to 10th APRIL

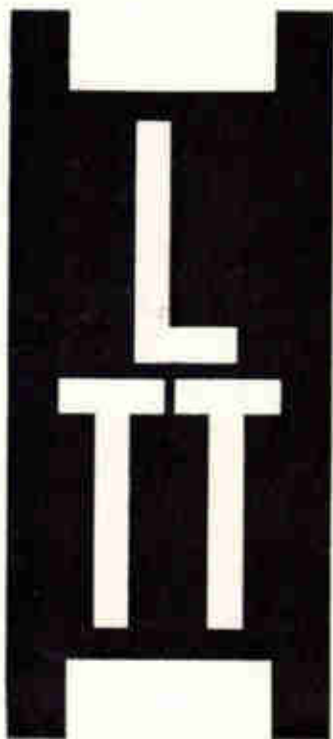

HIGH RELIABILITY COMPONENTS

Tantalum capacitors. Polystyren capacitors. Ferrite pot cores. Silicon zener diodes. Silicon planar diodes. Silicon planar transistors. Delay lines. Microwave components. Radar echo reflectors. (Luneberg Lenses).

For further information check appropriate line and mail to :
Société L. T. T., 89, rue de la Faisanderie. Paris 16^e. tél. 870.45.50
Câbles : GRALIFIL-PARIS.

- Capacitors
- Ferrite cores
- Silicon semi-conductors
- Delay lines
- Microwave components

Name

Title

Company

Address

.....

Information Technology

- Mission Simulation, Display Technology

Radar and Fire Control

- Airborne Systems and Simulators

Navigation, Stability, Guidance & Control

- Stability and Control, Computer Design, Servo Analysis

Electronic Systems

- ECM, Penetration Aids

Electronic AGE

- Microwave and Computer Design

Electronic Laboratories

- Circuit Design, Flight Test Instrumentation

Electrical Installation Design



These are a few of the long range programs at the Fort Worth Division of General Dynamics. Here you will find a highly diversified engineering and research organization assigned to the 111 programs or other advanced aircraft projects; missile assignments, space systems, mission analysis or other R&D.

You'll enjoy living in modern, metropolitan Fort Worth where superior housing, cultural advantages, a variety of sports and other recreation, graduate studies at one of three major universities, and mild weather are all part of an attractive package.

Call collect — 817 PE 2-4811 extension 3551 or send a resume of your education and experience to J. B. Ellis, Industrial Relations Administrator, Engineering, General Dynamics, Fort Worth Division, P. O. Box 748E, Fort Worth, Texas. An equal opportunity employer.

F-111A • F-111B • FB-111 • RF-111 • MARK II • F-111K

BORON FILAMENT

*and other advanced
aircraft and space programs*



GENERAL DYNAMICS
Fort Worth Division

TI takes the heat off power supplies.

Heat build-up is a serious problem in power supplies, computers and other electronic and electrical equipment.

That's why many manufacturers of these products have turned to the positive protection afforded by Texas Instruments cooling effect detectors.

The Klixon® 2ST detector is a sensor-switch combination designed to protect air-cooled electronic and electrical equipment against overheating due to the decrease of air flow and/or increase of incoming temperature. It is used in conjunction with Texas Instruments

4 MC Magnetic Circuit breaker to give warning of a dangerous condition or to cut off power.

The 2ST not only eliminates the need for vane switches and thermostats, but offers many advantages over these devices at little or no extra cost.

The 2ST functions perfectly in any position. It's rugged... can withstand the ordinary knocks of installation and maintenance. The sensor reacts to the cooling capacity of the air... it is not affected by the individual parameters of velocity and/or temperature. The sens-

ing element is a thermal analog of the equipment being protected. Its thermal characteristics can be matched to thermal limitations and requirements of the equipment. Other successful applications of the Klixon 2ST cooling effect detector include computer high-speed printers and card-reader-punch units, copying machines and projectors.

Texas Instruments and other manufacturers get together daily to solve problems. Perhaps we have the answers to help you, too. Get more information. Circle reader card 488.



Texas Instruments makes it happen in industry.

Electric utilities going solid state for power control and protection.

Electric power. It must be generated... controlled. There must be protection against blackouts... against damage to company and consumer equipment.

One unique electronic protective device is Esco Manufacturing Company's CM-78 inverse timer and control. It is made to sense overcurrent conditions in power lines and generate a command signal to trip circuit breakers before damage can be done.

The CM-78 is a custom-designed, solid-state electronic assembly made for Esco by Texas Instruments. All its semiconductor components are produced by TI... SCR's, silicon transistors, silicon rectifiers, and silicon diodes. Precision resistors and solid tantalum capacitors from TI are also employed. The circuits are solidly encapsulated in epoxy in a module only 5" x 4" x 1 1/8".

The advanced new

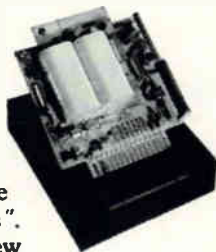

electronic module offers a multiplicity of advantages over the electromechanical devices now in general use, yet it costs no more. It's faster, more reliable, and many times smaller.

Esco came to Texas Instruments because they found that TI offers the broadest, most complete line of semiconductors in the industry and because TI can provide these products in pre-assembled, pretested electronic assemblies. This eliminated the need for large capital investments in new production facilities and extensive electronic engineering capability. Considering solid-state electronics? Send for a free packet of detailed information by circling reader service card no. 489.

TI semiconductors help brokers read market quotations easier

Texas Instruments semiconductors will soon be in brokers' offices all over the country as part of a new stock quotation display made by Trans-Lux Corporation.

The new "Trans-Jet" display is a brokerage-size, self-contained unit that can be mounted on a wall or hung in the middle of the room for viewing

from both sides. It takes incoming signals directly from the stock exchange communications network and converts them to a moving display via a new electronic-electromechanical-pneumatic system.

The new system incorporates Texas Instruments low-cost industrial integrated circuits, Silect™ plastic-encapsulated silicon bipolar and unijunction transistors, germanium transistors, silicon diodes, SCR's and semiconductor light sensors.



In the conventional display an electromechanical tape-feeding system and film projector require a separate console. The new "Trans-Jet" built-in electronic control is only 12" x 10" x 6". And maintenance has been reduced from bi-weekly to semi-annually.

Semiconductors offer a wide range of opportunities for miniaturization reliability, efficiency and economy. For information and application assistance circle reader card 490.

TEXAS INSTRUMENTS
INCORPORATED

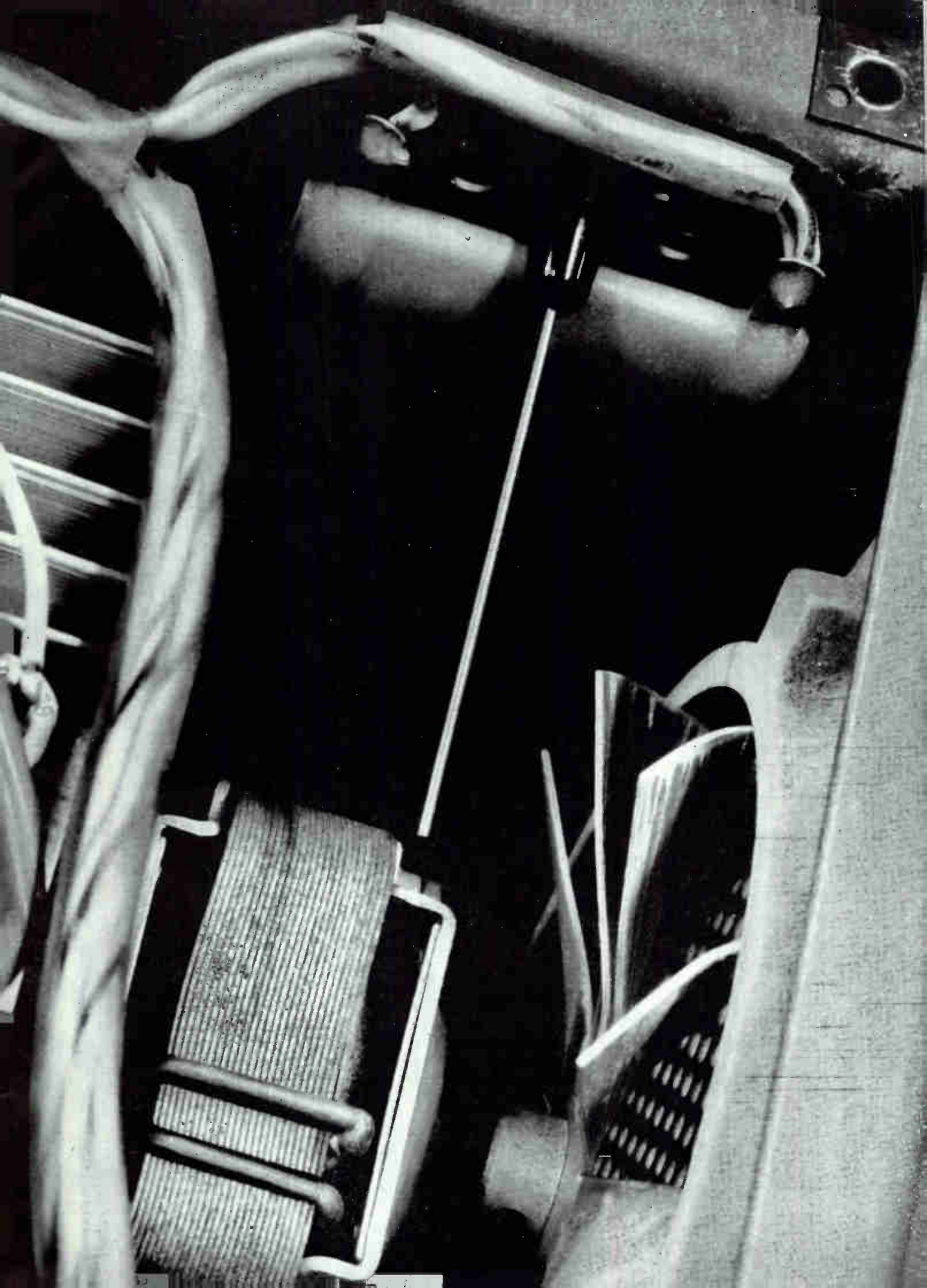

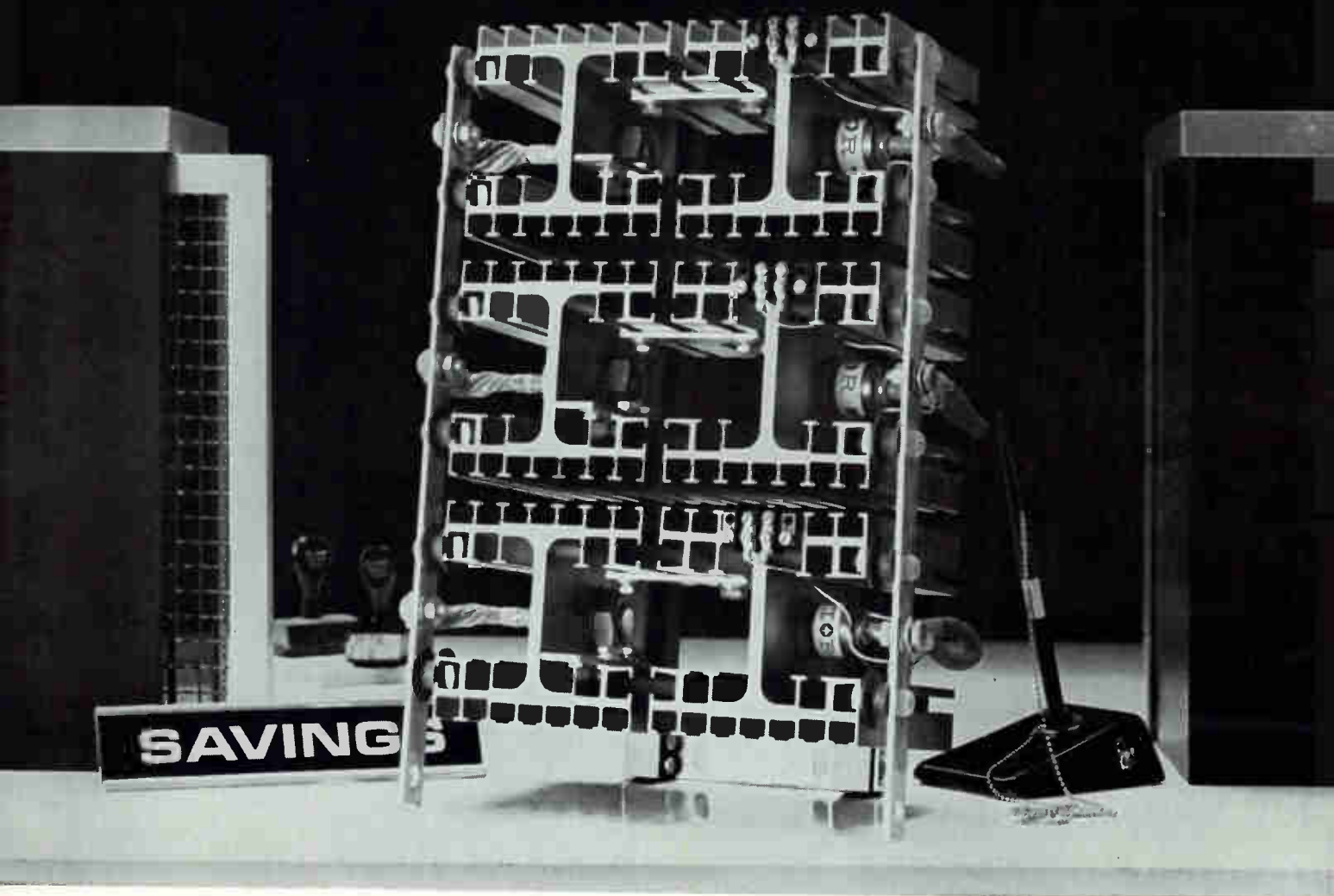

Open a silicon savings account—specify IR assemblies

Convenience without extra cost...performance guaranteed

Everybody saves when pre-engineered IR silicon power rectifier, SCR or hybrid modular assemblies are on the bill-of-materials.

Equipment Designers appreciate these proven time-savers because they make prototype production fast and accurate...and assure that units developed will be reliable in production. Mechanical Engineers like the accurate data regarding size and shape of assembly to be mounted and cooled, and Production Engineers enjoy the ease of simply bolting on and making connections to the finished assembly.

Purchasing Agents favor the convenience of one-stop shopping for heat-sink and rectifier components together...especially when they discover that pre-engineered IR Silicon Assemblies frequently cost out less than individual parts, even

without considering the inspection, assembly and testing time paid for by IR.

Perhaps the biggest savings of all are realized by the rectifiers themselves, for using IR standard or custom assemblies guarantees proper cooling and end-item performance that both manufacturer and customer can bank on..

FREE 80-PAGE CATALOG OF PRE-ENGINEERED SILICON ASSEMBLIES ranging to 2,100 amps and up to 200,000 volts...the first compilation of silicon assembly information in the industry, complete with rectifier circuit diagrams and circuit values. Write for Catalog D-66 and learn how you can save time and money in equipment design. For immediate help, contact your nearest IR Sales office.

IR INTERNATIONAL RECTIFIER
(213) OR 8-6281 • TELEX 6-74666 • EL SEGUNDO, CALIF.

Japan

All aboard

For most electronickers involved in the Lilliputian world of integrated circuits, large-scale integration means just one thing—hundreds of tiny silicon chips mounted on a common substrate and interconnected. But for circuit designers at the Hayakawa Electric Co., large-scale integration has a second meaning—hybrid circuits large in size, rather than complexity, for radios and television sets.

Hayakawa now has on the market a six-transistor radio with all 16 of the set's resistors integrated on the component side of the set's printed-circuit board. This first use of the circuits will be followed by even larger boards for frequency-modulation radios and tv sets.

The big advantage of the integrated resistors is that they eliminate a substantial number of solder joints, a major cause of rejects in transistorized consumer equipment. What's more, the integrated resistors cost less than discrete resistors, even in the pilot production Hayakawa so far has used to fabricate the boards.

Making passes. For the integrated resistors, Hayakawa uses a combination of carbon black and binders similar to the "inks" found in volume controls and multivalue printed resistors. But the company says it has a patent on the silver paste that connects the resistors to the copper terminals on the printed-circuit boards and a design patent on the idea of putting resistors directly on the board.

The resistors are laid down after the copper printed wiring has been etched on the reverse side of the board. First, a thin layer of phenolic varnish is applied to areas where the resistors will go. The varnish is baked, then the resistors screened on and baked. For a ra-

dio with resistors ranging in value between 100 and 100,000 ohms, three or four different inks with different resistivities are needed; each ink is screened on and baked in turn.

Once the resistors are in place, the silver-paste terminal areas are screened on and baked. In the process, the paste is forced into holes that connect the resistor terminals to the copper terminals on the reverse side of the board. Finishing operations include a protective phenolic varnish over the resistors and a phenolic-base solder resist over silver-filled terminals on the wiring side of the board.

Good values. The integrated resistors vary in length from about 2 millimeters to 12 mm. However, Hayakawa is trying out even smaller sizes—lengths as short as 0.5 mm. With careful screening, the process gives a resistor tolerance of $\pm 20\%$, good enough for transistor radios. For higher tolerances the values can be adjusted by shortening the resistor's active length with additional silver paint at the terminals or by abrading the resistor after baking. Stability under load is about 1% or 2%, about the same as the discrete composition resistors normally used in radios. The resistors fabricated so far are conservatively rated at $\frac{1}{2}$ watt and can range up to $\frac{1}{8}$ watt.

Although Hayakawa is in pilot-plant production with integrated-resistor boards for one of its transistor-radio models, the company still is tinkering with the technique. It is trying different resistor shapes and sizes and has work under way aimed at integrating capacitors onto the printed-circuit boards along with resistors.

Fast on the punch

Circuit designers who need high-speed pulses may soon have a new device to work with—a punch-

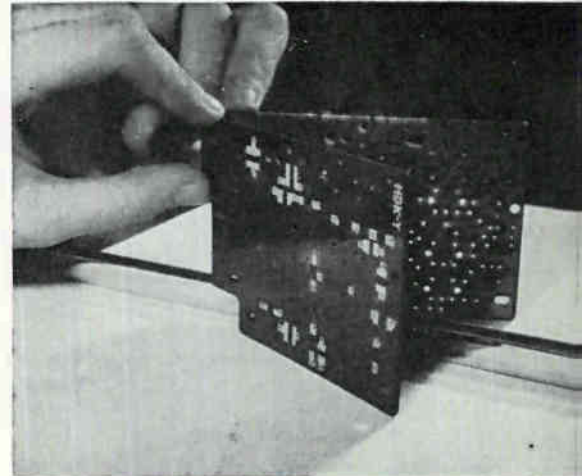

On-board. All 16 resistors for Hayakawa six-transistor radio are integrated onto printed-circuit board on side opposite copper.

through avalanche transistor.

The transistor, faster than the conventional avalanche devices often used to generate high-speed pulses, has been developed by the Electrical Communication Laboratory of the state-owned Nippon Telegraph and Telephone Public Corp. in cooperation with Fujitsu Ltd.

NTT sees the punch-through avalanche transistor (PAT) as a possibility for a high-speed pulse code modulation system it is considering. But the transistor also seems a good bet for a variety of other applications like sampling oscilloscopes, pulse generators, voltage comparators and analog-digital converters. Fujitsu currently is looking at the potential market and may put PAT into production even if NTT decides not to use it.

Short. Punch-through, sometimes called electrical reach-through, occurs in a transistor when the space charge region of the collector extends through the base layer to the emitter. Under this condition, a nondestructive short circuit develops between collector and emitter; for that reason, the effective base width narrows and the response time is not limited by car-

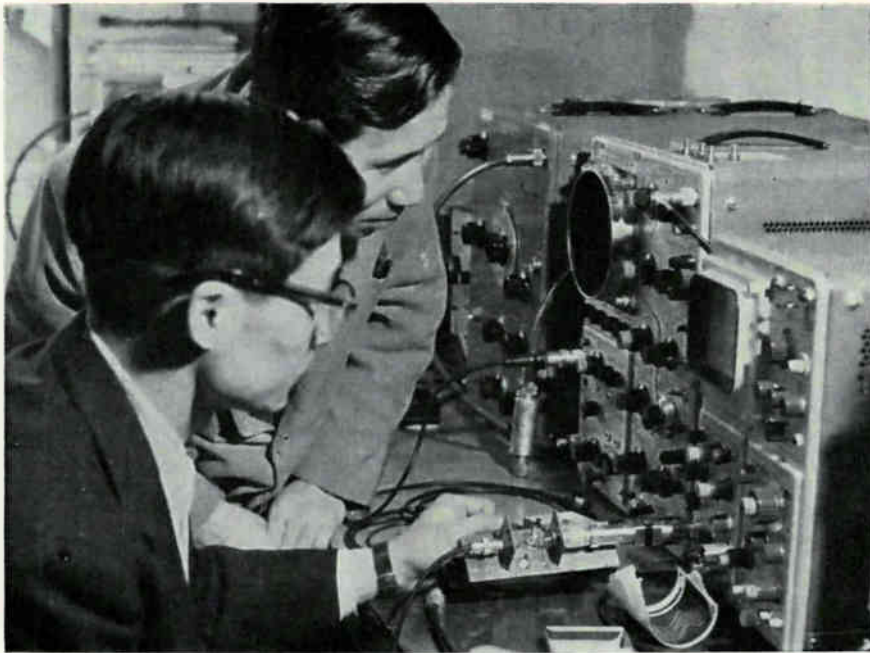

Researchers at the Electrical Communication Laboratory of the state-run Japanese telephone system check characteristics of punch-through avalanche transistor for high-speed pulse generation.

rier transit time in the base as it is in conventional avalanche transistors.

The PAT operates very close to the punch-through condition and thus has a fast response time. However, some avalanche multiplication of minority carriers is necessary in the base region to get a higher-than-one current amplification for regenerative switching. The key to the combination of near-punch-through operation with some carrier multiplication is an avalanche breakdown voltage only slightly higher than the punch-through voltage.

To hold the voltage spread, and at the same time get adequate yields in production, Fujitsu and NTT jointly developed a proprietary electrode structure and fabrication methods for the silicon npn PAT. Makato Wantanabe, the communication laboratory engineer in charge of device design, says the PAT compares favorably with two-terminal devices like snap-off diodes, tunnel diodes and hot-carrier diodes as a source of high-speed pulses but has an additional advantage—it can be tailored for various applications.

Ready for market. Fujitsu already has set tentative characteristics for the first production PAT.

It will operate either in triggered or recurrent mode and generate (at half-width) 1-nanosecond pulses. The interval between pulses is less than 5 ns and the typical trigger delay 0.5 ns. Pulse output is 1 volt into a 50-ohm line. A second version now in development will be even faster with an interval between pulses of less than 2 ns.

The PAT will work in many different circuits. It can be triggered, for example, by pulse inputs to the collector, base or emitter. About the only circuit precaution needed is to keep the total bias voltage across the emitter and collector slightly lower than the turn-on voltage; otherwise the PAT will generate pulses on its own without trigger pulses. The turn-on voltage differs slightly from device to device but remains stable over a wide temperature range so this is not a serious drawback.

Murmur monitor

Japanese doctors soon will be able to turn over to their aides the chore of screening people by the hundreds for heart defects.

Tokyo Shibaura Electric Co. (Toshiba) plans to have ready for the Japan International Trade Fair

in April the commercial version of a special-purpose analog computer that automatically spots suspicious heart sounds. Using the equipment, a nurse or a technician can run a heartbeat test in less than a minute and refer to a doctor any patient with an abnormal-sounding heart.

Toshiba isn't the first to develop an electronic heartbeat analyzer. The Humetricas division of the Thiokol Chemical Corp. produces a portable unit, for school heart-test programs, that can detect heart defects in three minutes [Electronics, Dec. 13, 1965, p. 38]. Toshiba's analyzer, though, is faster and more sophisticated. It shows what phase of the heart cycle is abnormal, not merely that something sounds wrong.

Two mikes. Inputs for the heartbeat analyzer come from two microphones. One is placed against the patient's chest to pick up the heartbeats; the other is placed against his throat to pick up his carotid pulse. A cathode-ray-tube monitor shows when the microphones have been properly placed.

The carotid pulse input identifies the start of a cycle, during which a normal heart produces two distinct sounds called first sound and second sound. The rise in the carotid pulse corresponds to the first sound and the notch in the pulse to the second sound.

The analyzer processes signals from the chest microphone in analog logic circuits, which compare the signals to normal heart-sound patterns. Because the start of the comparison is timed by the input from the throat microphone, the input from the chest microphone is delayed for 80 milliseconds to offset the time it takes for the carotid pulse to travel from the heart to the neck. The delay is obtained by passing the chest microphone signal through a continuous-loop tape recorder with the recording and playback heads spaced for an 80-msec delay.

Three beats. Toshiba's analyzer makes a checkup during just three heartbeats. In tests at the medical school at the University of Tokyo, technicians using the equipment fared as well at spotting abnormal heart sounds as general practi-

tioners using stethoscopes. The analyzer even bested the average practitioner at picking up second sounds split into two parts, a symptom very hard to detect with a stethoscope.

A lighted-panel display on the analyzer shows what suspicious sounds have been detected by the comparison in the analog logic circuits. The readouts include amplitude of the heartbeat if it's 20 decibels or more outside the norm, murmurs between first sound and second sound or between second sound and first sound, over-fast or too-slow heartbeat, split second sound and irregular beats.

There is also a chart recorder that can be switched on when a record of the heart-sound waveform is desired.

Great Britain

In the picture

Aircraft traffic control radar specialists long ago found a way to cull ground clutter—fixed echoes from high terrain or buildings—from radar displays. The technique, called moving target indication,

feeds to the display only echoes from objects that have moved in toward the radar antenna or away from it during successive sweeps.

But standard MTI can't spot an aircraft that is moving on a tangential course at right angles to the radar beam. As long as the radar is located at an airport, the tangential fade doesn't create much of a problem since the planes are flying toward or away from the radar. But with more and more remote radars going into air traffic control, the fade is becoming a serious defect. At a 60-nautical-mile distance, for example, an aircraft flying at 400 knots on a tangential course will disappear from the display for about 1.5 minutes.

Selective. Now the Solartron Electronic Group Ltd., in collaboration with Britain's Ministry of Aviation, has come up with equipment that does away with tangential fade. Essentially, the Solartron system switches in the moving target indication for sectors of the radar sweep where there's ground clutter and MTI is necessary. In all other sectors, the display shows raw radar echoes and, since there's no MTI cancellation, aircraft flying tangential courses show up.

Key to Solartron's scheme is a video plate of the sort used to make

video radar maps. The plate is opaque over most of its surface but has clear areas that match the permanent clutter pattern. The plate is used in one channel of a dual video map display and scanned by a flying spot. When the spot hits a clear area, a photomultiplier on the back of the plate develops an output that drives a transistor switching circuit. The transistor switch is biased to feed raw radar input to the display except when there's an output signal from the photomultiplier.

On trial. The selective MTI system is currently being evaluated by the Ministry of Aviation at London's air traffic control center and by Canada's Department of Transport as well. As an addition to existing Solartron video map equipment, the system will cost about \$2,000; it can also be adapted to other manufacturers' displays.

White paper on color

The Labor government last month killed any chance that Britain might go on a double-standard for her early years of color telecasting.

Despite a clamor by independent broadcasters for color on both 405-line and 625-line standards, the government in a year-end White Paper on the future of broadcasting in Britain confirmed its previous position—color tv on 625 lines in the ultrahigh-frequency band using the West German PAL (for phase-alternation-line) system. What's more, Labor made it clear that it would eventually phase out black-and-white tv broadcasting on the original British 405-line standard in order to have a uniform system throughout the country.

There was additional black news for independent broadcasters in the White Paper. In Britain there are four uhf channels available, three of them already earmarked. The commercial tv companies have long coveted the fourth channel and three years ago had a half-promise they'd get it eventually. Now the government says the precarious state of the economy makes a fourth tv channel a luxury Britain can't afford and that no allocation

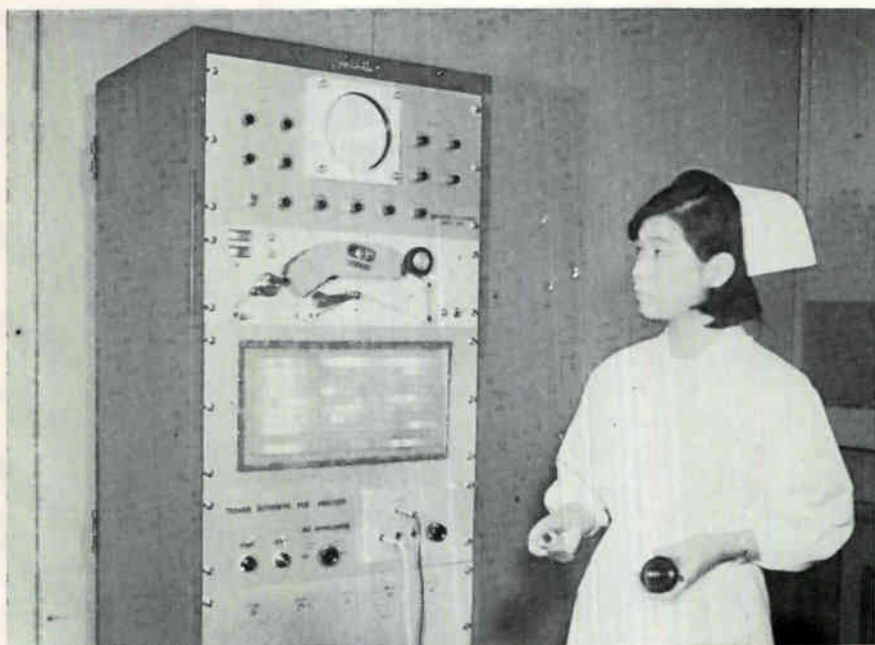

Nurse using Toshiba's analog analyzer can detect abnormal heart sounds as accurately as can the average general practitioner using a stethoscope. Analyzer checkup takes less than one minute.

of the channel will be forthcoming for at least three years.

Color broadcasts, though, will start as previously planned late this year. This early start, the government feels, will help British set makers in European export markets as well as give a lift to lagging set sales at home. The 625-line PAL system has been chosen in practically all West-European countries except France.

Transmitter manufacturers stand to pick up some new business from a policy set forth in the White Paper. Plans for radio include local very-high-frequency stations run jointly by the government-owned British Broadcasting Corp. and private interests. At present there is regional radio in Britain but no really local stations.

Export exchange

By deliberately thinking small in electronic telephone exchanges, Great Britain may have set on a way to cut a big swath in world markets for telephone gear.

Last month Britain's General Post Office, which runs the country's telephone network, put into service its first production model electronic exchange. Britain thus trailed the United States by nearly two years in getting a full-fledged electronic exchange into service. But Britain is off the mark fast in exports. Already Ericsson Telephones Ltd., the Plessey Group company that supplied the exchange, has orders for the production-line electronic exchange from telephone systems in Jamaica and New Zealand.

Big switch. The exchange, developed by Plessey in cooperation with four other major British manufacturers of telephone switching gear, has a capacity of 2,000 lines and is called the TXE-2. Although Britain has a 50,000-line exchange under development, the much smaller TXE-2 exchange will be a bread-and-butter item for communications equipment producers during the next few years. Nearly two-thirds of the exchanges in Britain have less than 2,000 lines and the Post Office plans to convert 50

exchanges to electronic switching during the next 18 months and then step up the conversion rate to 80 exchanges yearly.

The British believe that world demand for electronic exchanges will be overwhelmingly for small units. The few export sales to date bear them out; of a half-dozen exchanges, only one has large capacity, the 30,000-line system that Sweden's L.M. Ericsson Telephone Co. will deliver to the Netherlands [Electronics, Dec. 12, 1966, p. 258]. Under the arrangement set up by the Post Office to develop the TXE-2, all five major British telephone equipment makers can produce the Plessey design using their own production techniques.

Reed sections. The TXE-2 equipment consists basically of blocks of switching matrixes that connect callers, plus electronic controls. Reed relays are used for the matrix switching functions. The control electronics is built up of silicon semiconductors, tin oxide resistors, and reed relays. The circuits are fast enough to allow a single set of call control equipment to handle all the calls through the exchange in sequence.

The switching matrixes are grouped in five-by-five blocks. Each of the 25 reed relays in a block has four reeds actuated by a single coil. Two of the reeds carry the speech path, one carries a metering line and the other the actuating coil current. This arrangement is less sophisticated than the one used in the Bell System's No. 1 ESS exchange [Electronics, Oct. 19, 1964, p. 72]. However, the TXE-2 can handle all the extra facilities associated with electronic exchanges—pushbutton dialing, direct dialing to an extension, transfer of calls to another line by a subscriber and abbreviated dialing.

Denmark

A new voice

So far, the best electronic aid available to people rendered speechless by the loss of their larynx has been

a clearly visible throat transducer. But now Danavox International has come through with a cleverly disguised speech aid for men—a white-noise generator built into a pipe.

Held as if its user were a pipe-smoker who chomps on an unlit pipe, a loudspeaker in the speech aid injects into the throat a mixture of the main sound frequencies found in the human voice. The user then articulates the words he wants to say and in so doing speaks. The action resembles to a large extent natural speaking, where the larynx generates the spectrum of voice sounds and the articulation apparatus shapes them.

The pipe's sound output is a mixture of frequencies from 60 to 2,500 hertz. The basic frequencies are produced in a pair of transistorized multivibrators and then fed to an amplifier-mixer stage. Output at the mouthpiece loudspeaker is 136 decibels on a reference level of 0.0002 microbar, equivalent to a speech intensity of 65 db.

A potentiometer in the mixer stage adjusts the frequency mix to the best value for individual users. An on-off switch on the pipe bowl enables the user to inject one burst of sound for each syllable. A constant tone would make speech indistinct.

West Germany

Stretching the fax

The Kiel-based firm of Dr.-Ing. Rudolf Hell is small even by European standards. But Hell has no qualms about tackling the American market.

Last summer, Hell's computer-controlled typesetting equipment was put on the United States market through the sales and service network of the Radio Corp. of America. Now Hell has appeared on the U.S. scene again with a desktop facsimile transmission system called Zetfax.

In so doing, Hell has entered the arena with some U.S. giants like the Westrex division of Litton In-

Just one number for any electronic component

212-973-5710

(MATSUSHITA)



And we do mean any. We make more than fifty thousand different types of electronic components. In fact, we produce over *one billion* electronic components a year.

We provide all types of electronic components from *one* handy source. Examples of our custom-made components are shown above. All of them meet or exceed military specs. We'll custom-design to *your* specs, if you wish. Supply any quantity. Guaranteed delivery anywhere.

Matsushita of Japan is one of the biggest electronic component makers on earth. For more facts, including our free illustrated 464-page catalog, send us the coupon. No obligation. Do it now.

Matsushita Electric Corp. of America

Mail to:
Electronic Components and Devices
Matsushita Electric Corp. of America
P.O. Box 3980, Grand Central Station
Pan Am Bldg., 200 Park Ave.
New York, N.Y. 10017

I'd like to know more about Matsushita's simplified, one-source way of supplying electronic components. Send me full details including your free 464-page catalog. No obligation.

Name _____
Title _____
Company _____
Address _____
City _____ State _____ Zip _____

dustries Inc. and the Xerox Corp. But Hell figures its typewriter-sized Zetfax can match in performance and price the small facsimile systems of its American competitors. In Europe, Hell has already sold the equipment to banks, hospitals, libraries, hotels and industrial plants.

Quick check. In many cases, the small facsimile units do jobs that heretofore had to be done by expensive closed circuit television systems. A bank, for example, uses Zetfax to speed check handling between branches and the main office. Checks presented at branches for payment are scanned by a branch-office transmitter at the teller's booth and sent to the central office receiver.

The central office, after verifying the signature and the balance, approves the check by actuating remotely a cancellation stamp at the transmitter. At the same time, a green "accept" lamp lights up at the transmitter. A red lamp lights up at the transmitter if the central

office decides the check should not be paid. The facsimile of the check is used by the central office as a temporary voucher until the original check comes in.

Self-starter. The basic Zetfax system consists of a transmitter and a receiver but up to 10 receivers can be hooked up in parallel to a single transmitter. In the transmitter, information written on ordinary paper is scanned optically by bouncing light off the paper and onto a photocell. The scanning resolution is 100 lines per inch.

The output of the photocell, which varies as the light hits dark and light areas on the paper, is amplified by a transistor amplifier and the signals sent over a 2-wire line to the receiver. Since the bandwidth for the facsimile transmission is narrow— 1500 ± 800 hertz—the units can also be linked by radio or by a normal telephone line.

An incoming signal to the receiver automatically turns on its writing mechanism. A paper tape travels past a metal scribing point, which presses the paper against an inked writing spindle to duplicate the original copy. At the end of each message, the transmitter sends a stop signal that shuts off the receiver's writing mechanism.

The transmitter exists in two versions. One uses a 110-yard-long roll of paper strip $1\frac{1}{2}$ " wide on which messages are scribbled for transmission to the receiver. The other is designed to handle individual sheets of paper up to $6\frac{1}{2} \times 8\frac{1}{2}$ inches in size.

New frontiers

Travelers going by train from one country to another on Europe's electrified main lines must often put up with delays at border crossing points because engines have to be changed. That nuisance results from the four different power systems European countries have adopted for their electric railways. In Austria, West Germany, Switzerland, Sweden and Norway, for instance, electric trains are driven by a single-phase, 16 $\frac{2}{3}$ -hertz, 15-kilovolt power system. In the Soviet Union and most of France a single-



Silicon controlled rectifiers are basis of control circuits in German locomotive that can run on all four European rail power supplies.

phase, 50-hertz 25-kv supply is used. Belgium, Italy and some East European countries use 3-kv direct current, while the Netherlands and southwestern France have also adopted d-c but at 1.5 kv.

This variety of power supplies has led to the construction of multisystem locomotives that can run anywhere on the Continent. However, because such locomotives require complex rectification and control gear, they are far from becoming standard railway equipment, and many travelers still encounter delays at border stations.

The key to relieving the situation is the silicon controlled rectifier, which is finding application in various European railroad control projects [Electronics, Sept. 6, 1965, p. 177].

Four ways. Engineers of the Allgemeine Elektrizitäts-Gesellschaft and Fried. Krupp Maschinenfabriken have built a multisystem locomotive engine employing regulation and control techniques based on scr's. At 84 tons and 4,300 horsepower, the engine has roughly the same weight and output as the single-system types currently in operation on Germany's electrified main lines. The new locomotive, called "Europa," can travel on any electrified standard-gauge line on the Continent regardless of the power supply system used. It's the first scr-controlled, four-system



Doctor's orders. Nurse gets diagnosis by facsimile transmission over telephone lines from specialist at hospital 100 miles away.

unit ever built, according to AEG.

The first of three such engines has been delivered to the German Federal Railway to be put into operation next spring on runs between Cologne and points in Belgium and the Netherlands.

Scr bridge. High-power, AEG-made scr's are the key control elements in the engine's electric traction system. Each scr can handle up to 170 amperes at a peak voltage of 900 volts. Connected in a bridge circuit configuration, they not only function as rectifiers but also as voltage control elements. The voltage is controlled steplessly without loss of power and no mechanical control switches are required. Used in inverter circuits, the scr's act as variable-frequency dc-ac converters.

The locomotive's basic electrical system is laid out for single-phase, 16 $\frac{2}{3}$ - and 50-hz operation and is made up of transformers and scr bridge rectifiers. The transformers step down the a-c voltage derived from overhead contact wires to a level suitable for drive-motor operation. The rectifiers deliver to the four drive motors a pulsating direct current that is steplessly adjusted by the scr's. Each motor has a one-hour rating of about 800 kilowatts at 1,050 volts and 1,150 revolutions per minute.

For operation on d-c supplies of either 1.5 or 3 kv, the inverter changes the power derived from the overhead contact wire into a-c voltage. The inverter consists of two scr bridge circuits connected in series for 3-kv engine operation and connected in parallel for 1.5-kv operation.

Czechoslovakia

Righting the balance

A do-it-yourself kick in Czechoslovakia bodes no good for Western electronics firms seeking business there. To cut down on their foreign exchange deficit the Czechs are turning out their own radars, television sets and semiconductors.

The exception is computers. Four

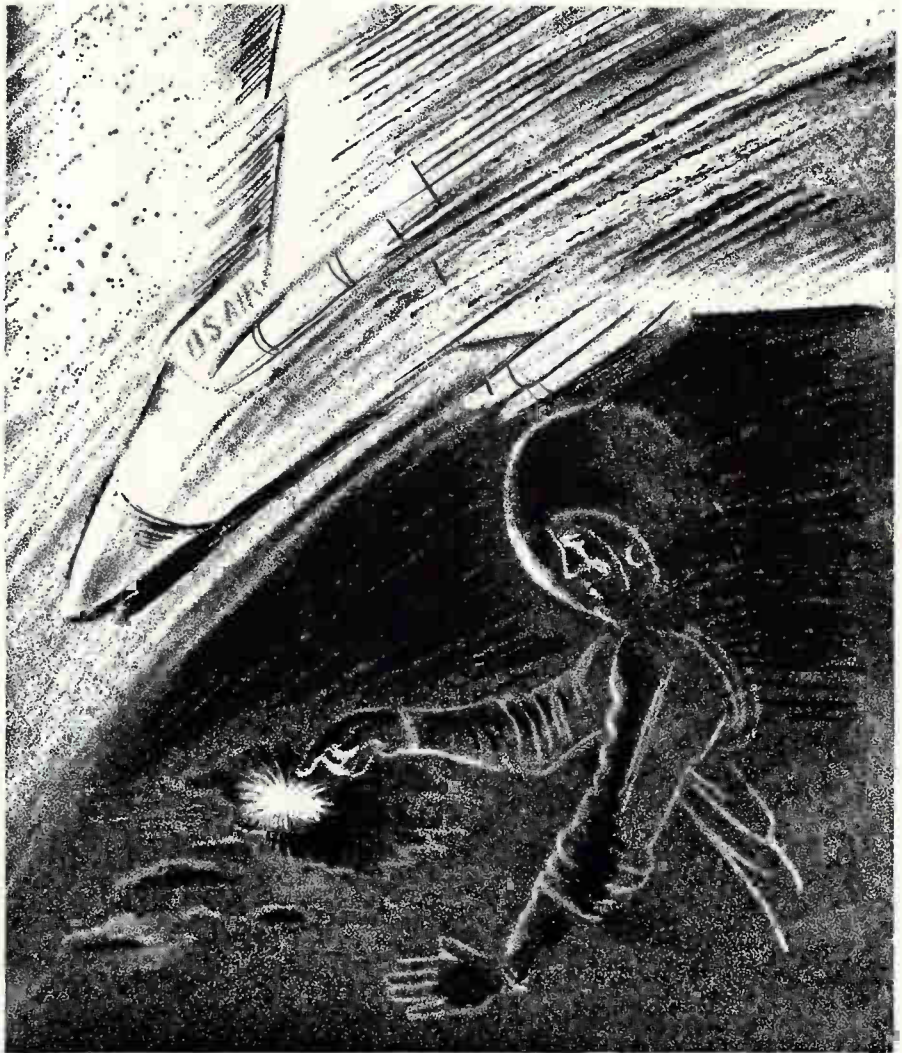

TELLING THE PHANTOM WHERE TO STRIKE



A Phantom II's pilot must pay attention to those things which he — and only he — can do. Determining the distance from his target is done continually for him by a "black box" manufactured by Eclipse Pioneer Division of Bendix. The precision conductive plastic potentiometers in this uncanny computing device are Gamewell precision products. They are included in this package as part of a unique clutch module which precisely stops the units where desired for navigational accuracy. These Gamewell conductive plastic potentiometers illustrate two aspects of our capability: (1) the ability to meet the most demanding requirements with creative new product designs, and (2) the ability to make precision electronic subassemblies.

FREE — Send for new design information on precision Gamewell potentiometers, conductive plastic and wire-wound styles in rotary or translatory configurations. Pot requirements take a turn for the better when you contact us at Gamewell Division, E. W. Bliss Company, 1301 Chestnut Street, Newton, Massachusetts 02164.



FIRST . . . WHEN PRECISION COUNTS!



A DIVISION OF THE E. W. BLISS COMPANY

Miniaturization by Mitsubishi!

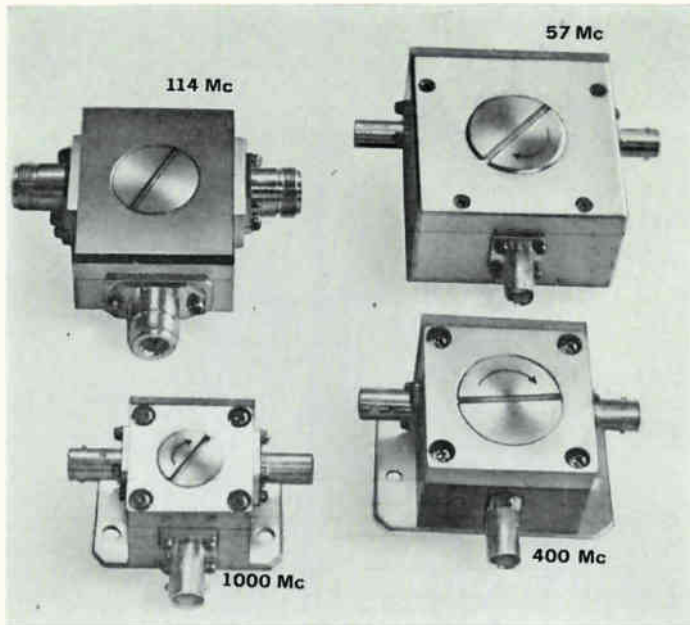

VHF—UHF circulators (isolators) small enough to fit in the palm of your hand!

Performance						
Frequency (Mc)	57	114	170	413	680	1000
Power (W)	50	40	30	30	15	10
Forward Loss (dB)	1	0.7	0.7	0.6	0.6	0.5
	[0.8]	[0.5]	[0.5]	[0.4]	[0.4]	[0.35]
Backward Loss (dB)	15	15	15	20	20	20
	[20]	[20]	[20]	[20]	[20]	[20]
Input VSWR	1.4	1.4	1.4	1.3	1.3	1.3
	[1.3]	[1.3]	[1.3]	[1.3]	[1.3]	[1.3]
Band Width (Mc) at 25°C	1	2	3	15	20	40
Temperature Range (°C)	-10 ~ +40 (usable up to +60)					
Dimensions (mm)	(approx. 50 x 70 x 33)					

These new Mitsubishi circulators stabilize amplifiers, oscillators, and multipliers in solid state circuits and reduce transmitter intermodulation. The special inner fabrication devised by Mitsubishi engineers

reduces size and weight, yet permits these circulators to be used in extremes of high and low temperature. They are protected against magnetic interference and constructed to withstand severe vibration. For complete information on the frequency ranges listed (or, for that matter, any other frequency) write to Mitsubishi's head office in Tokyo or cable directly to MELCO TOKYO.



MITSUBISHI ELECTRIC CORPORATION
Head Office: Mitsubishi Denki Bldg., Marunouchi, Tokyo. Cable Address: MELCO TOKYO

Circle 258 on reader service card

To order reprints: Fill in, cut out coupon below, insert in envelope and mail to: **Electronics Reprint Dept., 330 W. 42nd Street, New York, N.Y. 10036**

Reprint order form

For listing of reprints available see the Reader Service Card.

Communications Satellites Part I

Send me reprints of Key no. R-89 at 50¢ each.

For reprints of previous special reports fill in below:

Send me reprints of Key No.(s) @¢ each.
(For prices, see Reader Service Card)

Name

Number of street

City, State, Zip Code

Electronics Abroad

orders have recently been snagged by Western firms. But for other areas of electronics, the production drive means less dependence on foreign equipment.

In the past two years, most of the country's semiconductor production has been concentrated in the CKD enterprise at Prague-Pankrac. Transistors, diodes and power thyristors are produced.

Similarly, television sets are manufactured in the factory-village of the Tesla-Orava enterprise in the Tatra mountains near the Polish border. Production amounts to over 200,000 sets annually, some 85% of the Czech output. The Czechs even manage to export some tv sets. During 1965, the Tesla enterprise alone sold some 20,000 sets abroad, and reportedly topped that figure in 1966.

Tesla still imports picture tubes and loudspeakers from Hungary and the West, but the firm makes its own printed circuits, and buys transistors from CKD and other plants in the state Electrical and Electronics Trust.

The drive also threatens foreign supplied radars. The first trial of a Czech-built radar will be held early next year, as the Czechs seek to supply the demands for equipment for ships navigating the Danube.

However, the Czechs continue to purchase computers from the West. They recently spent \$630,000 for an Elliott-Automation Ltd. 4130 machine for the Prague National Research Institute for Computer Techniques and Automation, and \$1.4 million for an English Electric computer for the State Pension Office. Two other computers, an IBM 1410 and a 1905 from International Computers and Tabulators Ltd., have also been purchased.

Around the world

France. The computer company set up six months ago to build an all-French third generation computer under the de Gaulle government's "Plan-Calcul" finally has a name: Compagnie Internationale pour l'Informatique, INFI for short. INFI was dubbed Société "S" for

the six months it had no official name. The company joins the computer manufacturing subsidiaries of the Schneider industrial group and two major French electronics companies — Compagnie Générale d'Electricité and CSF-Compagnie Générale de Télégraphie Sans Fil [Electronics, June 27, 1966, p. 197].

Britain. Hawker Siddeley Dynamics Ltd., a leading missile maker, has developed a profitable sideline—building receiving stations to process pictures taken by weather satellites. The British Meteorological Office has bought five of the \$28,000 stations. Singapore, Cyprus and the Maldiv Islands also have stations. Plans call for a worldwide network of 50 stations to keep an eye on the weather.

Hungary. The electronic scoreboards for the 1968 Olympics in Mexico City will be built by Electro-Impex. The contract was awarded to the Hungarian company by the international Olympic committee, which will pay 85% of the cost, and by the Omega Watch Co. of Switzerland.

France. CSF-Compagnie Générale de Télégraphie Sans Fil has a contract to set up a school for electronics engineers at Dekouaneh, near Beirut in Lebanon, to help meet the nation's demand for consumer electronics. The center, with facilities for up to 200 students, will house a pilot television and radio production department. CSF will provide a technical assistance team, testing and instructional equipment and tv and radio components. Some components will eventually be made in Lebanon under CSF license.

India. The first commercial plant for development and manufacture of electronic process-control instrumentation has begun production in Jaipur, Rajasthan state. The \$10.6-million facility, built with Soviet aid, is expected to turn out an estimated \$15 million in electronic equipment annually by 1970 or 1971.

Britain. Production of semiconductor devices has outstripped thermionic tubes and related components for the past two years, according to the British tube and semiconductor manufacturers trade association.

ANNOUNCING NEW FEATURES, NEW LOW PRICES!



65°
FREE AIR
RATING



SILICON MAGITRAN®

VARIABLE HIGH-CURRENT POWER SUPPLIES

- All-Silicon Design
- Low Cost for all Systems Applications
- Long Term Stability Less Than 8 MV
- Current Ranges up to 25 Amps
- Continuously Adjustable 0 to 36 VDC
- Operating Temperature to +65°C
- Temperature Coefficient Less Than 0.01%/°C
- Closely Regulated
- Low Ripple Content
- Automatic Short Circuit Protection
- No Fuses or Circuit Breakers to Reset
- Automatic Overload Protection
- Series or Parallel Operation
- Remote Sensing
- Ungrounded Outputs
- Convection Cooled
- Functional Design—Easily Serviceable
- Minimum Size and Weight
- Front and Rear Terminals
- Relay Rack or Bench Mounting
- Removable Panel Mounts
- Removable Power Cord
- Extended Warranty

GENERAL SPECIFICATIONS

Input Voltage Range: 105-125 VAC
 Input Frequency Range: 50-400 cps
 Regulation Line: $\pm 0.01\%$ or 5 mv
 Regulation Load: 0.05% or 8 mv
 Long Term Stability: Less than 8 mv, constant line, load and temperature
 Ripple: Less than 1 mv, RMS
 Transient Response: Less than 50 μ sec
 Operating Temperature: -20°C to $+65^{\circ}\text{C}$
 Temperature Coefficient: 0.01%/°C or 3 mv
 Automatic Overload Recovery

Short Circuit Protection with automatic recovery
 Remote Sensing
 Parallel and Series Operation
 Vernier Voltage Control
 Output Terminals (Ungrounded): Location, front and rear
 Reverse Voltage Protection
 Cooling: Convection
 Metering: Separate Current and Voltage Meters

STANDARD MODELS

Model	Voltage	Current	Price
SL36-2M	0-36 VDC	0-2 amps	\$235.00
SL36-2/2M	0-36 VDC Dual	0-2 amps Dual	465.00
SL36-4M	0-36 VDC	0-4 amps	290.00
SL36-8M	0-36 VDC	0-8 amps	355.00
SL36-12M	0-36 VDC	0-12 amps	455.00
SL36-25M	0-36 VDC	0-25 amps	650.00



For complete information write for Catalog Supplement #133a.

ELECTRONIC RESEARCH ASSOCIATES, INC.

Dept. E-1, 67 Sand Park Road, Cedar Grove, N. J. • (201) CEnter 9-3000

SUBSIDIARIES: ERA Electric Co. • Advanced Acoustics Co. • ERA Dynamics Corp. • ERA Pacific, Inc.



Adams & Westlake Co. E. H. Brown Adv. Agency	9	Dimos A. G. Wilhelm Bacher Werbung	223	International Rectifier Corp. Botsford, Constantine & McCarty Inc.	250
ADC Products John Gompper & Associates	201	Duncan Electronics Incorporated Bonfield Associates	193	ITT Semiconductors Div. Neal & Hickok	262
Airpax Electronics, Inc. Welch, Mirabile & Co.	184	□ Drusch Publi-Service	OAS 4	■ J F D Electronics Co., Components Div. Michel-Cather Inc.	229
□ Alcatel Publi-Service	OAS 13	■ DuPont de Nemours & Co. Freon Division Batten, Barton, Durstine & Osborn Inc.	65	Janus Control Corp. K. Frank Co. Inc.	200
Alpha Metals Inc. Black-Russell-Morris	231	■ DuPont de Nemours Co. Mylar Division Batten, Barton, Durstine & Osborn Inc.	177	■ Johanson Mfg. Co. Josephson, Cuffari & Co.	207
■ Alco Electronic Products Inc. Marketronics Adv.	231	Eastman Kodak Co. Rumrill Hoyt Inc.	155	■ Lapp Insulator Co. Wolff Associates	199
Amelco Semiconductor Sturges & Associates	153	Electronic Research Associates Josephson, Currari & Co.	259	■ Leach Corporation Jay Chiat & Associates	85
■ American Lava Corp. Designers Inc.	189	Electronized Chemicals Corp. Kenyon & Eckhardt Inc.	182, 183	Leer Siegler Aves Adv. Inc.	220
■ AMP Inc. Garceau, Hargrave & McCullough Inc.	6, 7	Emerson & Cuming Inc. Edwin F. Hall	228	Lockheed Missiles & Space Co. McCann Erickson	224
AMP Garceau, Hargrave & McCullough Inc.	12, 13	Erie Technological Products Co. Inc. Altman-Hall Associates	173	LTT Publi-Service	246
Amperite Co. H. J. Gold Co.	52	■ Esterline Angus Instrument Co. Caldwell, Larkin & Sidener Van Riper Inc.	240	■ Machlett Laboratories Div. of Raytheon Co. Fuller, Smith & Ross Inc.	11
■ Amphenol Corp. Marsteller Inc.	20, 21	Field Emission Corp. Ken Webber Advertising	16	■ Mallory Capacitor Co. Div. of P. R. Mallory & Co. Inc. Aitkin-Kynett Co.	8
□ Arena Publi-Service	OAS 11	Filters Inc. S.M. Sachs and Assoc. Inc.	195	■ Mallory & Co. Inc. Battery Div. Needham, Harper & Steers	72
Arnold Engineering Co. Burton Browne Adv.	51	General Dynamics—Fort Worth Div. Glenn Adv. Inc.	247	□ Marconi Hampshire House Ltd.	OAS 22
■ Barnstead Still & Sterilizer Co. Creamer Trowbridge & Case Inc.	190	■ General Electric Co. Ross Roy Inc.	66, 67	■ Markel & Sons, L. Frank George Moll Adv. Inc.	217
Bausch and Lomb Inc. Wolff Associates, Inc.	196	General Radio Co. Horton, Church & Goff Associates	6	Markem Machine Co. Culver Advertising Inc.	84
Bell Telephone Laboratories N. W. Ayer & Son Inc.	162	Giannini-Voltex Co. Feldman Everett Adv.	216	Mathatronics Kalk and Schneider Inc.	169
Bendix Corp. (Scintilla-Connectors) MacManus, John & Adams Inc.	36, 37	Globe Industries Inc. Odiorne Industrial Adv.	219	Matsushita Electric Corp. Dentsu Corp. of America	255
Bendix Corp. Semiconductor Products Div.) MacManus, John & Adams Inc.	18, 19	■ Grayhill Inc. Merchandising Adv.	233	■ Matsuo Electric Co. Ltd. Fuji Agency	217
Bliss Easel Signal Feeley Adv. Agency	120, 121	Gries Reproducer Co. Harold Marshall Adv.	55	Meguro Electronic Instrument General Adv. Agency	228
■ Bliss Gamewell Division of E. W. Bliss Co. Feeley Advertising	257	■ Gudebrod Brothers Silk Co. Ramsdell-Buckley & Co.	70	Merrimac Research and Development Inc. Masson, Reed & Walker Inc.	74
Burroughs Corp. Conti Adv. Agency Inc.	86	Hathaway Instruments Inc. Eby & Everson Inc.	222	Metal Removal Co. Advertising Producers Associates	164
By-Buk Co. Albert Frank, Guenther Law Adv. Inc.	218	Hayakawa Electric Co. Ltd. Dai-ichi International	227	■ Metronix Corp. General Adv. Agency	215
Cerro Sales Corp. Feeley Advertising Agency Inc.	166, 167	Heinemann Electric Co. Thomas R. Sondheim	192	Microdot Inc. Gumpertz, Bentley & Dolan Adv.	15
Cherry Electrical Products Corp. K & A Inc.	227	■ Hewlett Packard, Colorado Springs Division Tallant, Yates	202, 203, 204	Microwave Cavity Laboratories Art Brown Writing Service	228
■ Clevite Corp. (Brush Instruments) Carr Liggett Adv. Inc.	157	■ Hewlett Packard, F & T Division Lennen & Newell Inc.	14	Microwave Electronics, Div. of Teledyne, Inc. Bonfield Associates	187
■ Clevite Corp. (Piezoelectric Div.) Carr Liggett Adv. Inc.	235	■ Hewlett Packard, Harrison Division Healy Adv. Agency	73	Mitre Corp. The Bresnick Co.	160
Cohu Electronics Erwin Wasey	159	■ Hewlett Packard, Loveland Division Tallant, Yates	1	Classified Advertising F.J. Eberle, Business Mgr.	
Collins Radio Company John G. Barnett Adv.	75	■ Hewlett Packard, Sanborn Division Culver Adv. Inc.	2	PROFESSIONAL SERVICES	239
□ Compagnie des Competeurs Publi-Service	OAS 1	Hitachi Ltd. Dentsu Advertising	78	EMPLOYMENT OPPORTUNITIES	237-238
Computer Test Corp. James Lees Adv.	79	■ IMC Magnetics Corp. Monad Advertising Inc.	178	EQUIPMENT (Used or Surplus New) For Sale	239
Conant Laboratories Ayres & Associates	231	I R C Inc. Gray & Rogers Inc.	181	ADVERTISERS INDEX	
Conductron MRC Div. Gray & Kilgore Inc.	119	■ Ichizuka Optical Co. Ltd. Matsushita, Inc.	232	A & A Electronics Corp.	239
Consumers Power Co. McLain Adv. Inc.	156	IEEE (Institute of Electrical & Electronic Eng.) Alpaugh Adv.	220	Atomic Personnel, Inc.	238
■ Control Switch Div. of Control Co. of America Harry P. Bridge Co.	80	Image Instruments Inc. L. K. Frank Co. Inc.	198	Bauer Machinery Co.	239
Corning Glass Works-Electronic Div. Rumrill Hoyt Inc.	60, 61	Indiana General Corp. Griswold & Eshleman	24	Joseph P. Corcoran, Personnel	238
Coto Coil Co. Inc. Williams Co.	225	Industrial Electronic Engineers Gumpertz, Bentley & Dolan Inc.	214	Diversified Components	239
■ CML Div. of Tenney Engineering Co. Keyes, Martin & Co.	225	■ Industro Transistor Corp. Dunwoodey Associates	165	Fair Radio Sales	239
□ C.S.F. SPI Agency	OAS 3	Ingersoll, Division Borg Warner Corporation Connor-Sager Associates	76	Norman Electronic Sales	239
■ CTS Corp. Burton Browne Adv.	179			Radio Research Instrument Co.	239
Cyclo-Tronics Inc. T. W. Blakeslee Adv.	54			Sanders Assoc., Inc.	237
■ Data Instruments Division Technical Marketing	197				
Di-Acro Corp. Div. of Houdaille Industries Inc. Charles E. Brown Adv.	209				

Classified Advertising

F.J. Eberle, Business Mgr.

PROFESSIONAL SERVICES 239

EMPLOYMENT OPPORTUNITIES 237-238

EQUIPMENT

(Used or Surplus New)
For Sale 239

ADVERTISERS INDEX

A & A Electronics Corp.	239
Atomic Personnel, Inc.	238
Bauer Machinery Co.	239
Joseph P. Corcoran, Personnel	238
Diversified Components	239
Fair Radio Sales	239
Norman Electronic Sales	239
Radio Research Instrument Co.	239
Sanders Assoc., Inc.	237

■ For more information on complete product line see advertisement in the latest Electronics Buyers' Guide

□ Advertisers in Overseas Advertising Section following newsletter from abroad



Mitsubishi Electric Corp. Hakuhodo Inc.	258	Sola Basic Industries, Sola Electric Div. Marsteller Inc.	83
Mitsumi Electric Co. Ltd. Dentsu Adv. Inc.	206	Soliton Devices, Inc. Transistor Div. Haselmire Pearson Adv.	57
Motorola Semiconductor Products Inc. Lane & Bird Adv. Inc.	53, 122	Solatron Electronic Group Ltd. Southern Adv. Ltd.	OAS 14, 15
Motorola Semiconductor The Warren Seymour Co. Ltd.	OAS 5	Soshin Electric Co. Shinwa Adv. Co. Ltd.	225
National Electronics Inc. Connor-Sager Associates	235	S. D. Industrial Development Expansion Agency Maurice Paulsen Adv.	230
New Hermes Engraving Machine Lester Harrison Adv.	213	Souriau et Cie Publi-Service	OAS 10
■ Nexus Research Laboratories Larcom Randall Adv.	68, 69	Sperry Electronic Tube Div. Neals & Hickok Inc.	62
■ Nippon Communication Industrial General Advertising Agency	200	The Sprague Electric Co. Harry P. Bridge Co.	10
North Atlantic Industries Inc. Murray Heyert Associates	56	The Sprague Electric Co. Resistor Div. Harry P. Bridge Co.	5
■ Pacific Measurements Inc. Jack Herrick Adv. Inc.	7	Struthers-Dunn, Inc. Harry P. Bridge Co.	180
Pastoriza Electronics Co. L. K. Frank Co. Inc.	212	Sylvania Electric Products Inc. Tatham-Laird & Judner	27 thru 34
■ Perfection Mica Co. Magnetic Shield Division Burton Browne Adv.	219	Sylvania Electronics Systems Briant Advertising	191
Perini Electronics Park The Rachesky Co. Inc.	234	■ Syntronic Instruments, Inc. Burton Browne Adv.	213
Perkin Elmer Corp. Gaynor & Ducas Inc.	236	Synthane Corp. Arndt, Preston, Chapin, Keen, Inc.	235
□ Phillips, Eindhoven Media International	OAS 16, 24	TRW (Systems) & Semiconductors Fuller Smith & Ross Inc.	47
□ Plessey Components Group Roles and Parker Ltd.	OAS 18, 19	■ Tektronix Inc. Hugh Dwight Adv. Inc.	49
□ Plessey Electronics Roles and Parker Ltd.	OAS 20	Texas Instruments Incorporated Marsteller Inc.	161
Polarad Electronics Corp. Keyes Martin & Co.	81, 82	Texas Instruments Incorporated Don L. Baxter Inc.	248, 249
■ Potter & Brumfield Div. of Amer. Machine & Foundry Corp. Grant, Schwenck & Baker Inc.	154	Texwipe Armand Richards Adv. Agency	211
Primo Co. Ltd. General Adv. Agency	218	□ Thomson Varian Publi-Service	OAS 12
Princeton Applied Research Corp. Mort Barish Assoc. Inc.	40	Tohoku Metal Industries Ltd. Hakuhodo Inc.	221
RTC Publi-Service	245	Trygon Electronics Solow, Weston Co. Inc.	205
■ RHG Electronics Laboratories Samuel H. Goldstein Inc.	221	Trylon, Inc. George Moll Adv. Inc.	208
Radar Design Corp. Barlow Johnson Inc.	206	Ulano & Co. J. Byrde, Richard & Pound Inc.	108
La Radio Technique Publi-Service	245	Union Carbide Corp. J. M. Mathes Inc.	35
■ Radio Cores Inc. Sander Rodkin Adv. Agency	232	■ United Transformer Co. Philip Stogel Co.	2nd cover
Radio Corporation of America Al Paul Lefton Co.	4th Cover, 22	■ Unitrode Corp. Silton, Callaway & Huffman Inc.	58, 59
Radio Switch Corp. George Homer Martin Associates	208	University Laboratories Inc. William C. Robin & Associates	17
Raytheon Co. Components Division Fuller & Smith & Ross Inc.	38	Varian Vacuum Hofer, Dieterich Brown	210
■ Republic Foil Inc. The Graphic Group	170	Varian Associates (Tube Div.) Hofer, Dieterich & Brown	3rd cover
Rohde & Schwarz Co. Armand Richards Adv. Agency	77	The Victoreen Instrument Co. Palm & Peterson Inc.	175
■ S. D. S. A. Publi-Service	243, 244	Vishay Instruments Inc. Alpern Communications	215
San-Esu Electronics Co. Ltd. General Adv. Agency	236	Wang Laboratories Larcom Randall Adv. Inc.	218
■ Sanders Associates Chirurg & Cairns Inc.	223	Wells Electronics, Inc. Weco Advertising	233
Sanken Electric Co. Ltd. Seikosha Adv. Inc.	224	Weston Instruments Inc. (Boonshaft & Fuchs Div.) Arndt, Preston Chapin Keen, Inc.	194
■ Sankyo Seiki Co. Ltd. Shinwa Adv. Co. Ltd.	226	□ Zeltex Inc. Sturges & Associates	OAS 17, 223
□ S. P. Elettronica	OAS 21		
□ Schlumberger Publi-Service	OAS 2		
Sci-tek Computing Center, Inc. Stanley, Richard & Fredrick, Inc.	188		
Shallcross Manufacturing Co. J. T. Howard Adv. Agency	39		
Signetics Corp. Sub. Corning Glass Works Cunningham & Walsh	71		
□ Silax Publi-Service	OAS 8, 9		
■ Silicon Transistor Corp. A. D. Adams Adv.	171		
Sinclair Radio Labs. Inc. John E. Hayes Co. Inc.	174		

Advertising sales staff

Frank E. LeBeau [212] 971-6464

Advertising sales manager

Wallis Clarke [212] 971-2187
Assistant to sales manager

Atlanta, Ga. 30309: **Michael H. Miller, 1375**
Peachtree St., N.E.,
[404] TR 5-0523

Boston, Mass. 02116: **William S. Hodgkinson**
McGraw-Hill Building, Copley Square,
[617] CO 2-1160

Chicago, Ill. 60611: **Robert M. Denmead,**
J. Bradley MacKimm, Ralph Hanning,
645 North Michigan Avenue,
[312] MO 4-5800

Cleveland, Ohio 44113: **William J. Boyle, 55**
Public Square, [216] SU 1-7000

Dallas, Texas 75201: **Richard P. Poole, 1800**
Republic National Bank Tower,
[214] RI 7-9721

Denver, Colo. 80202: **Joseph C. Page, David**
M. Watson, Tower Bldg., 1700 Broadway,
[303] 255-5484

Detroit, Michigan 48226: **J. Bradley**
MacKimm, 856 Penobscot Building
[313] 962-1793

Houston, Texas 77002: **Kenneth George,**
2270 Humble Bldg.,
[713] CA 4-8381

Los Angeles, Calif. 90017: **Ian C. Hill,**
John G. Zisch, 1125 W. 6th St.,
[213] HU 2-5450

Minneapolis, Minn. 55402: **J. Bradley**
MacKimm, 1104 Northstar Center
[612] 332-7425

New York, N. Y. 10036:
Donald R. Furth [212] 971-3615
James R. Pierce [212] 971-3615
George F. Werner [212] 971-3615
500 Fifth Avenue

Philadelphia, Pa. 19103:
Warren H. Gardner, Jeffrey M. Preston,
6 Penn Center Plaza,
[215] LO 8-6161

Pittsburgh, Pa. 15222: **Warren H. Gardner,**
4 Gateway Center, [412] 391-1314

Portland, Ore. 97204: **James T. Hauptli,**
218 Mohawk Building, 222 S.W. Morrison
Street, Phone [503] 223-5118

Rochester, N.Y. 14534: **William J. Boyle,**
9 Greylock Ridge, Pittsford, N.Y.,
[716] 586-5040

St. Louis, Mo. 63105: **Robert M. Denmead**
The Clayton Tower, 7751 Carondelet Ave.
[314] PA 5-7285

San Francisco, Calif. 94111:
James T. Hauptli, 255 California Street,
[415] DO 2-4600

London W1: **John W. Patten, Edwin S.**
Murphy Jr., 34 Dover Street,
Hyde Park 1451

Milan: I, via
Baracchini Phone: 86-90-617
86-90-656

Frankfurt/Main: **Gerd Hinske, Dieter**
Rothenbach, Elsa-Brandstroem Str. 2
Phone: 72 01 81

Geneva: **Michael R. Zeynel,**
1, rue du Temple
Phone: 31 95 60

Paris VIII: **Denis Jacob, Kenneth Davey,**
17 Avenue Matignon Phone: 359 6637

Tokyo: **Nobuyuki Sato, I, Kotohiracho**
Shiba, Minato-Ku [502] 0656

Osaka: **Ryoji Kobayashi, 163, Umegae-cho,**
Kita-ku [362] 8771

George F. Werner [212] 971-2310
Manager Electronics Buyers' Guide

Donald J. Austermann [212] 971-3139
Promotion manager

Milton Drake [212] 971-3485
Research and circulation manager

Wallace C. Carmichael [212] 971-3191
Business manager

Stephen R. Weiss [212] 971-2044
Production manager

Thomas M. Egan [212] 971-3140
Production manager Electronics Buyers' Guide

Learn why

Please send me a FREE copy of "Transistor characteristics related to circuit performance," along with detailed specifications on ITT strip line transistors.

Name Title

Company

Address

City State Zip

ITT's exclusive strip line packaging makes VHF/UHF transistor circuits work better



The strip line package reduces or eliminates many of the difficulties that were formerly inevitable when working with high-power VHF-UHF transistors.

Consider these advantages: strip line configuration simplifies final tune-up by virtually eliminating instability; low-inductance package means easier matching to driver stages and broad bandwidth. For 400 MHz application, you may select the 3TE440 (15 watts output) or the 3TE450 (4 watts output).

For full details fill in the coupon above. Or see for yourself — sample quantities are available off the shelf from your ITT distributor or factory representative.

ITT
SEMICONDUCTORS

ITT SEMICONDUCTORS IS A DIVISION OF INTERNATIONAL TELEPHONE AND TELEGRAPH CORPORATION, 3301 ELECTRONICS WAY, WEST PALM BEACH, FLORIDA. FACTORIES IN WEST PALM BEACH, FLORIDA; PALO ALTO, CALIFORNIA; LAWRENCE, MASSACHUSETTS; HARLOW AND FOOTSCRAY, ENGLAND; FREIBURG AND NURENBERG, GERMANY

Electronics reader service

Use these handy post cards for more detailed information on: products advertised, new products, new literature.

Circle the number on the Reader Service post card that corresponds to the number at the bottom of the advertisement, new product item, or new literature in which you are interested.

Please print clearly. All written information must be legible to be efficiently processed.

If someone has beaten you to the post cards, you may obtain the needed information by writing directly to the manufacturer, or by sending your name and address, plus the Reader Service number, to Electronics Reader Service department.

All inquiries from outside the U.S. that cannot reach Electronics before the expiration dates noted on the Reader Service post card, must be mailed directly to the manufacturer. The manufacturer assumes all responsibilities for responding to inquiries. Electronics merely provides and clears requests for information from inquirer to manufacturer.

Correct amount of postage must be affixed for all mailings from outside the U.S.

To subscribe to or to renew Electronics

Fill in the "For Subscriptions" area on the card if you desire to subscribe to or renew your present subscription to Electronics. Send no money. Electronics will bill you at the address indicated on the Reader Service post card.

Multi-product advertisements

For information on specific items in multi-product advertisements which do not have a specific Reader Service number indicated write directly to manufacturer for information on precise product in which you are interested.

1 Please Print Clearly January 9, 1967 Card Expires March 9, 1967 14

Name _____ title _____

Company _____

Address _____

City _____ state _____ zip code _____

1	20	39	58	77	96	115	134	153	172	191	210	229	248	267	286	305	324	343	362	381	400	419	438	457	476	495	514	962
2	21	40	59	78	97	116	135	154	173	192	211	230	249	268	287	306	325	344	363	382	401	420	439	458	477	496	515	963
3	22	41	60	79	98	117	136	155	174	193	212	231	250	269	288	307	326	345	364	383	402	421	440	459	478	497	516	964
4	23	42	61	80	99	118	137	156	175	194	213	232	251	270	289	308	327	346	365	384	403	422	441	460	479	498	517	965
5	24	43	62	81	100	119	138	157	176	195	214	233	252	271	290	309	328	347	366	385	404	423	442	461	480	499	518	966
6	25	44	63	82	101	120	139	158	177	196	215	234	253	272	291	310	329	348	367	386	405	424	443	462	481	500	900	967
7	26	45	64	83	102	121	140	159	178	197	216	235	254	273	292	311	330	349	368	387	406	425	444	463	482	501	901	968
8	27	46	65	84	103	122	141	160	179	198	217	236	255	274	293	312	331	350	369	388	407	426	445	464	483	502	902	969
9	28	47	66	85	104	123	142	161	180	199	218	237	256	275	294	313	332	351	370	389	408	427	446	465	484	503	951	970
10	29	48	67	86	105	124	143	162	181	200	219	238	257	276	295	314	333	352	371	390	409	428	447	466	485	504	952	971
11	30	49	68	87	106	125	144	163	182	201	220	239	258	277	296	315	334	353	372	391	410	429	448	467	486	505	953	972
12	31	50	69	88	107	126	145	164	183	202	221	240	259	278	297	316	335	354	373	392	411	430	449	468	487	506	954	973
13	32	51	70	89	108	127	146	165	184	203	222	241	260	279	298	317	336	355	374	393	412	431	450	469	488	507	955	974
14	33	52	71	90	109	128	147	166	185	204	223	242	261	280	299	318	337	356	375	394	413	432	451	470	489	508	956	975
15	34	53	72	91	110	129	148	167	186	205	224	243	262	281	300	319	338	357	376	395	414	433	452	471	490	509	957	976
16	35	54	73	92	111	130	149	168	187	206	225	244	263	282	301	320	339	358	377	396	415	434	453	472	491	510	958	977
17	36	55	74	93	112	131	150	169	188	207	226	245	264	283	302	321	340	359	378	397	416	435	454	473	492	511	959	978
18	37	56	75	94	113	132	151	170	189	208	227	246	265	284	303	322	341	360	379	398	417	436	455	474	493	512	960	979
19	38	57	76	95	114	133	152	171	190	209	228	247	266	285	304	323	342	361	380	399	418	437	456	475	494	513	961	980

2

First class
Permit no. 42
Hightstown, N. J.

Business reply mail
No postage stamp necessary if mailed in the United States

Postage will be paid by

**Electronics
Reader service department
Box 444
Hightstown, N.J. 08520**



1 Please Print Clearly January 9, 1967 Card Expires March 9, 1967 14

Name _____ title _____

Company _____

Address _____

City _____ state _____ zip code _____

1	20	39	58	77	96	115	134	153	172	191	210	229	248	267	286	305	324	343	362	381	400	419	438	457	476	495	514	962
2	21	40	59	78	97	116	135	154	173	192	211	230	249	268	287	306	325	344	363	382	401	420	439	458	477	496	515	963
3	22	41	60	79	98	117	136	155	174	193	212	231	250	269	288	307	326	345	364	383	402	421	440	459	478	497	516	964
4	23	42	61	80	99	118	137	156	175	194	213	232	251	270	289	308	327	346	365	384	403	422	441	460	479	498	517	965
5	24	43	62	81	100	119	138	157	176	195	214	233	252	271	290	309	328	347	366	385	404	423	442	461	480	499	518	966
6	25	44	63	82	101	120	139	158	177	196	215	234	253	272	291	310	329	348	367	386	405	424	443	462	481	500	900	967
7	26	45	64	83	102	121	140	159	178	197	216	235	254	273	292	311	330	349	368	387	406	425	444	463	482	501	901	968
8	27	46	65	84	103	122	141	160	179	198	217	236	255	274	293	312	331	350	369	388	407	426	445	464	483	502	902	969
9	28	47	66	85	104	123	142	161	180	199	218	237	256	275	294	313	332	351	370	389	408	427	446	465	484	503	951	970
10	29	48	67	86	105	124	143	162	181	200	219	238	257	276	295	314	333	352	371	390	409	428	447	466	485	504	952	971
11	30	49	68	87	106	125	144	163	182	201	220	239	258	277	296	315	334	353	372	391	410	429	448	467	486	505	953	972
12	31	50	69	88	107	126	145	164	183	202	221	240	259	278	297	316	335	354	373	392	411	430	449	468	487	506	954	973
13	32	51	70	89	108	127	146	165	184	203	222	241	260	279	298	317	336	355	374	393	412	431	450	469	488	507	955	974
14	33	52	71	90	109	128	147	166	185	204	223	242	261	280	299	318	337	356	375	394	413	432	451	470	489	508	956	975
15	34	53	72	91	110	129	148	167	186	205	224	243	262	281	300	319	338	357	376	395	414	433	452	471	490	509	957	976
16	35	54	73	92	111	130	149	168	187	206	225	244	263	282	301	320	339	358	377	396	415	434	453	472	491	510	958	977
17	36	55	74	93	112	131	150	169	188	207	226	245	264	283	302	321	340	359	378	397	416	435	454	473	492	511	959	978
18	37	56	75	94	113	132	151	170	189	208	227	246	265	284	303	322	341	360	379	398	417	436	455	474	493	512	960	979
19	38	57	76	95	114	133	152	171	190	209	228	247	266	285	304	323	342	361	380	399	418	437	456	475	494	513	961	980

Reprint service

All Electronics editorial matter available in reprint form:

For reprints of special reports and feature articles see list on right side of this page. Send your order to Electronics Reprint Department at the address indicated. To expedite mailing of your order for single reprints please send cash, check or money order with your order.

Bulk reprints of editorial matter can be ordered from current or past issues. The minimum quantity is 100 copies. The higher the quantity ordered, the more economical the cost per copy. Prices quoted on request.

3

Business reply mail

No postage stamp necessary if mailed in the United States

Postage will be paid by

First class
Permit no. 42
Hightstown, N. J.



Electronics
Reader service department
Box 444
Hightstown, N. J. 08520

1 Please Print Clearly January 9, 1967 Card Expires March 9, 1967 14

Name _____ title _____
Company _____
Address _____
City _____ state _____ zip code _____

For Subscriptions
 new renewal
 3 years \$16.00
 1 year \$8.00

1	2	3	4	5	6	7	8	9	10	11	12	13	14	15	16	17	18	19	20	21	22	23	24	25	26	27	28	29	30	31	32	33	34	35	36	37	38	39	40	41	42	43	44	45	46	47	48	49	50	51	52	53	54	55	56	57	58	59	60	61	62	63	64	65	66	67	68	69	70	71	72	73	74	75	76	77	78	79	80	81	82	83	84	85	86	87	88	89	90	91	92	93	94	95	96	97	98	99	00																																																																																																																																																																																																																																																																																																																																																																																																																																												
1	20	39	58	77	96	115	134	153	172	191	210	229	248	267	286	305	324	343	362	381	400	419	438	457	476	495	514	533	552	571	590	609	628	647	666	685	704	723	742	761	780	799	818	837	856	875	894	913	932	951	970	989	1008	1027	1046	1065	1084	1103	1122	1141	1160	1179	1198	1217	1236	1255	1274	1293	1312	1331	1350	1369	1388	1407	1426	1445	1464	1483	1502	1521	1540	1559	1578	1597	1616	1635	1654	1673	1692	1711	1730	1749	1768	1787	1806	1825	1844	1863	1882	1901	1920	1939	1958	1977	1996	2015	2034	2053	2072	2091	2110	2129	2148	2167	2186	2205	2224	2243	2262	2281	2300	2319	2338	2357	2376	2395	2414	2433	2452	2471	2490	2509	2528	2547	2566	2585	2604	2623	2642	2661	2680	2699	2718	2737	2756	2775	2794	2813	2832	2851	2870	2889	2908	2927	2946	2965	2984	3003	3022	3041	3060	3079	3098	3117	3136	3155	3174	3193	3212	3231	3250	3269	3288	3307	3326	3345	3364	3383	3402	3421	3440	3459	3478	3497	3516	3535	3554	3573	3592	3611	3630	3649	3668	3687	3706	3725	3744	3763	3782	3801	3820	3839	3858	3877	3896	3915	3934	3953	3972	3991	4010	4029	4048	4067	4086	4105	4124	4143	4162	4181	4200	4219	4238	4257	4276	4295	4314	4333	4352	4371	4390	4409	4428	4447	4466	4485	4504	4523	4542	4561	4580	4599	4618	4637	4656	4675	4694	4713	4732	4751	4770	4789	4808	4827	4846	4865	4884	4903	4922	4941	4960	4979	4998	5017	5036	5055	5074	5093	5112	5131	5150	5169	5188	5207	5226	5245	5264	5283	5302	5321	5340	5359	5378	5397	5416	5435	5454	5473	5492	5511	5530	5549	5568	5587	5606	5625	5644	5663	5682	5701	5720	5739	5758	5777	5796	5815	5834	5853	5872	5891	5910	5929	5948	5967	5986	6005	6024	6043	6062	6081	6100	6119	6138	6157	6176	6195	6214	6233	6252	6271	6290	6309	6328	6347	6366	6385	6404	6423	6442	6461	6480	6499	6518	6537	6556	6575	6594	6613	6632	6651	6670	6689	6708	6727	6746	6765	6784	6803	6822	6841	6860	6879	6898	6917	6936	6955	6974	6993	7012	7031	7050	7069	7088	7107	7126	7145	7164	7183	7202	7221	7240	7259	7278	7297	7316	7335	7354	7373	7392	7411	7430	7449	7468	7487	7506	7525	7544	7563	7582	7601	7620	7639	7658	7677	7696	7715	7734	7753	7772	7791	7810	7829	7848	7867	7886	7905	7924	7943	7962	7981	8000	8019	8038	8057	8076	8095	8114	8133	8152	8171	8190	8209	8228	8247	8266	8285	8304	8323	8342	8361	8380	8399	8418	8437	8456	8475	8494	8513	8532	8551	8570	8589	8608	8627	8646	8665	8684	8703	8722	8741	8760	8779	8798	8817	8836	8855	8874	8893	8912	8931	8950	8969	8988	9007	9026	9045	9064	9083	9102	9121	9140	9159	9178	9197	9216	9235	9254	9273	9292	9311	9330	9349	9368	9387	9406	9425	9444	9463	9482	9501	9520	9539	9558	9577	9596	9615	9634	9653	9672	9691	9710	9729	9748	9767	9786	9805	9824	9843	9862	9881	9900	9919	9938	9957	9976	9995	10000

1

Business reply mail

No postage stamp necessary if mailed in the United States

Postage will be paid by

First class
Permit no. 42
Hightstown, N. J.



Electronics
Reader service department
Box 444
Hightstown, N.J. 08520

To order reprints or for further information, please write to: Electronics Reprint Department, 330 West 42nd Street, New York, N.Y. 10036.

Prices for the below listed reprints unless otherwise specified are 1-10 copies 50¢ each; 11-24 copies 35¢ each; 25-99 copies 25¢ each; price for 100 or more is 20¢ each.

You may order any of the below listed reprints by key number.

- Key no. R-01 Computer-aided Design: Part I, The Man-machine Merger. 16 pages. \$1.25.
- Key no. R-02 Vietnam Communications Network Growing Into Southeast Asia's Best. 3 pages. 25¢.
- Key no. R-03 Sense Amplifier Fits Any Product. 6 pages. 25¢.
- Key no. R-04 Multilayer Circuit Boards: Sharpening An Imperfect Art. 7 pages.
- Key no. R-05 Topology Cuts Design Drudgery. 12 pages. 50¢.
- Key no. R-06 Report on Japanese Technology: Sony. 20 pages. 50¢.
- Key no. R-07 European Electronics Markets 1967. 22 page forecast report with 4 page foldout chart. \$1.00.
- Key no. R-08 U.S. Electronics Markets 1967. 26 page forecast report with 6 page foldout. \$1.00.
- Key no. R-09 1966 Electronics Index to Technical Articles and Authors. Free.
- Key no. R-90a Communications Satellites. Parts I and II. 42 pages. \$1.25
- Key no. R-88 Belting Out Plastic Transistors On Mechanized Assembly Lines. 8 pages. 25¢
- Key no. R-87a The Packaging Revolution In Microelectronics. Parts I through VI. 64 pages. \$2.00.
- Key no. R-86a Computer Time Sharing. Parts I and II. 32 pages. \$1.00.
- Key no. R-79 MOS Integrated Circuits. 12 pages.
- Key no. R-78 The Overlay Transistor. 15 pages.
- Key no. R-75 Biotelemetry. 2 part series, 16 pages
- Key no. R-74 Unijunction Transistors. 24 pages.
- Key no. R-64 Field Effect Transistors. Parts I, II, and III. 64 pages. \$1.00.
- Key no. R-63 Silicon Power Transistors. 8 pages. 25¢.
- Key no. R-60 Transistor Heat Dissipators. 32 pages.
- Key no. R-31 Electromagnetic Spectrum Chart. (22" x 30" foldout. chart). \$1.00

System: MASCOT Klystron: VARIAN



MASCOT — A "Mobile-Air-Transportable Satellite Communications Terminal". Designed, fabricated and tested by Philco-Ford Corporation's WDL Division. MASCOT consists of 3 compact, highly mobile units: antenna, electronics shelter, and power unit—each unit weighing under 5,400 pounds. Individual units can be transported by truck or helicopter, or the entire system can be moved in one C-130 aircraft. MASCOT can be completely assembled by 6 men within two hours after delivery. MASCOT supplies 1 duplex 4 kHz channel, plus 2 TTY-Standards. Growth to 4 duplex 4 kHz channels (voice, teletype, data facsimile) with increased satellite power. Has external capacity of 20 4-wire service. Is adaptable to clear, secure, and anti-jam modes. Provides continuous operation for crises communication. Has system reliability > 99% and is completely field maintainable.

KLYSTRON — A Varian klystron, the VA-881B, is a 6 kW CW RF power amplifier developed especially for use in satellite communications. This klystron was selected for MASCOT because it saves up to 400 pounds of weight without any sacrifice of reliability, linearity, or stability. This weight reduction was accomplished by utilizing permanent magnet focusing and design of an air-cooled collector that eliminates bulky liquid cooling systems.

Development of the VA-881 series of CW klystron power amplifiers is just one more example of Varian's ability to power the world's most advanced communication systems.

For more information about the VA-881 series of CW klystron amplifiers, write: Palo Alto Tube Division, 611 Hansen Way, Palo Alto, California. In Europe: Varian A. G., Zug, Switzerland. In Canada: Varian Associates of Canada, Ltd., Georgetown, Ontario.



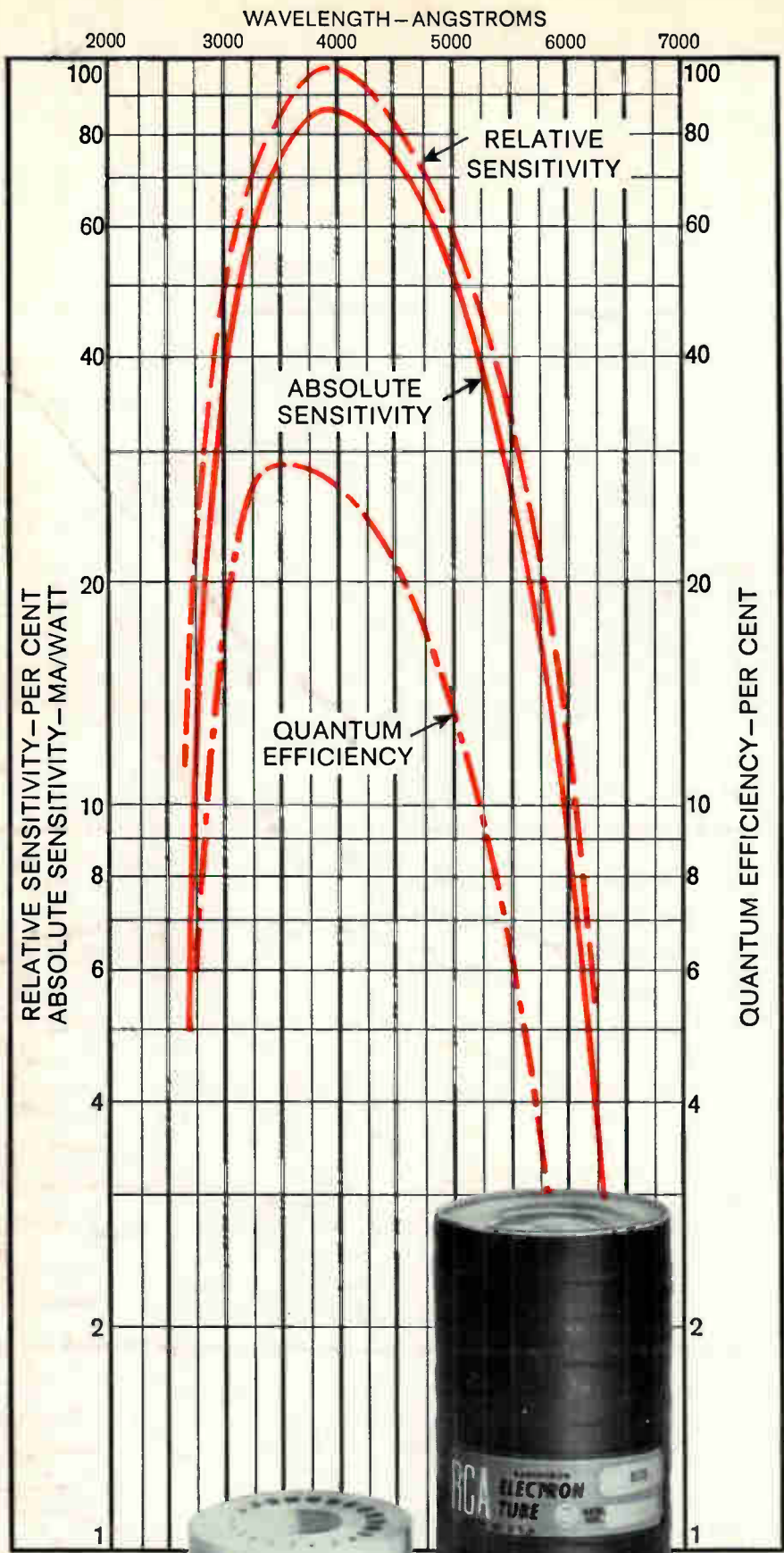

Bialkali Photocathode in RCA-8575 offers Typical QE of 28% at 3850 Å

Adapt This Photomultiplier For Your Present Equipment

Now, the highly efficient RCA Bialkali Photocathode can be employed in existing equipment through the use of an adapter, RCA-AJ2132. Designed especially for the RCA-8575 Photomultiplier, the adapter brings the excellent performance characteristics of this RCA tube type to systems now using 56AVP, 6810A, or 7264.

Proved in the unparalleled success of the RCA-8575, the RCA Bialkali Photocathode is now available in six new standard photomultiplier tube types. These new tubes offer up to a 50% increase in quantum efficiency when compared with their prototype units having S-11 response ... and a dark-current reduction of up to 100 to 1.

Designed for scintillation counting and other low-light-level measurement systems, other RCA Photomultipliers with RCA Bialkali Photocathodes are available with standard base, semi-flexible leads, or potted voltage dividers.

Ask your RCA Representative about the advantages of RCA Bialkali Photocathodes in upgrading your existing system performance. For technical data on the RCA-8575, other specific photomultipliers, and the adapter type AJ2132, write: RCA Commercial Engineering, Section A19Q-2, Harrison, N. J. 07029.

RCA PHOTOMULTIPLIERS			
Nominal Size	No. of Stages	Prototype	Bialkali Type
3/4"	10	7767	4516
1 1/2"	10	6199	4517
2"	10	6342A	4518
2"	10	8053	4523
2"	12	---	8575
3"	10	8054	4524
5"	10	8055	4525

ALSO AVAILABLE FROM YOUR RCA INDUSTRIAL TUBE DISTRIBUTOR



RCA Electronic Components and Devices



The Most Trusted Name in Electronics