

# Electronics<sup>®</sup>

Graph processing speeds network design: page 112

IC's in action, part 2: page 128

A pulser for laser diodes: page 137

November 14, 1966

75 cents

A McGraw-Hill Publication

Below: Sony's products compete around the world: page 155







# DI-T200™ SERIES

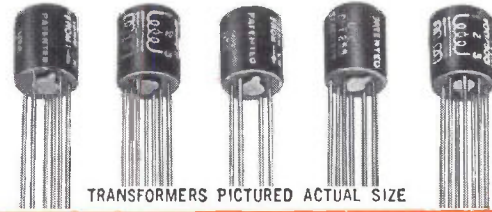

## ULTRAMINIATURE TRANSISTOR TRANSFORMERS & INDUCTORS

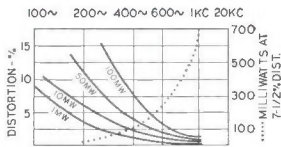

TYPICAL DI-T200 PERFORMANCE  
SOURCE: RATED PRI. IMP. AND D.C. LOAD - RATED SEC. IMP.

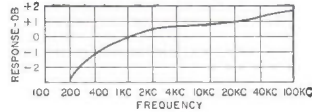

- ➔ DUMET LEADS  
(gold plated, weldable and solderable)
- ➔ STRAIGHT PIN TERMINALS  
(printed circuit application)
- ➔ HIGHEST PERFORMANCE  
for size in the industry
- ➔ METAL ENCASED  
(Grade 4, Ruggedized)

Type No.	Pri. Imp.	DC ma <sup>†</sup> in Pri.	Sec. Imp.	Pri. Res.	Mw Level	Application
DI-T225	80 CT 100 CT	12 10	32 split 40 split	10	500	Interstage
DI-T230	300 CT	7	600 CT	20	500	Output or line to line
DI-T235	400 CT 500 CT	8 6	40 split 50 Split	50	500	Interstage
DI-T240	400 CT 500 CT	8 6	400 split 500 split	50	500	Interstage or output (Ratio 2:1:1)
DI-T245	500 CT 600 CT	3 3	50 CT 60 CT	65	500	Output or matching
DI-T250	500 CT	5.5	600 CT	35	500	Output or line to line or mixing
DI-T255	1,000 CT 1,200 CT	3 3	50 CT 60 CT	110	500	Output or matching
DI-T260	1,500 CT	3	600 CT	90	500	Output to line
DI-T265	2,000 CT 2,500 CT	3 3	8,000 split 10,000 split	180	100	Isol. or interstage (Ratio 1:1:1)
DI-T270	10,000 CT 12,000 CT	1 1	500 CT 600 CT	870	100	Output or driver
DI-T273	10,000 CT 12,500 CT	1 1	1,200 CT 1,500 CT	870	100	Output or driver
DI-T276	10,000 CT 12,000 CT	1 1	2,000 CT 2,400 CT	870	100	Interstage or driver
DI-T278	10,000 CT 12,500 CT	1 1	2,000 split 2,500 split	620	100	Interstage or driver
DI-T283	10,000 CT 12,000 CT	1 1	10,000 CT 12,000 CT	970	100	Isol. or interstage (Ratio 1:1)
DI-T288	20,000 CT 30,000 CT	.5 .5	800 CT 1,200 CT	870	50	Interstage or driver
DI-T204	Split Inductor (2 wdg)	§ .1 Hys @ 4 maDC, §§ .025 Hys @ 8 maDC, .02 Hys @ 20 maDC, DCR 25Ω	.08 Hys @ 10 maDC, DCR 25Ω			
DI-T208	Split Inductor (2 wdg)	§ .9 Hys @ 2 maDC, .5 Hys @ 6 maDC, DCR 105Ω §§ .2 Hys @ 4 maDC, .1 Hys @ 12 maDC, DCR 26Ω				
DI-T212	Split Inductor (2 wdg)	§ 2.5 Hys @ 2 maDC, .9 Hys @ 4 maDC, DCR 630Ω §§ .6 Hys @ 4 maDC, .2 Hys @ 8 maDC, DCR 157Ω				
DI-T216	Split Inductor (2 wdg)	§ 4.5 Hys @ 2 maDC, 1.2 Hys @ 4 maDC, DCR 2300Ω §§ 1.1 Hys @ 4 maDC, .3 Hys @ 8 maDC, DCR 575Ω				

<sup>†</sup>DCma shown is for single ended usage (under 5% distortion—100mw—1 KC) . . . for push pull, DCma can be any balanced value taken by 5W transistors (under 5% distortion—500mw—1 KC)  
DI-T200 units have been designed for transistor application only . . . not for vacuum tube service.  
U.S. Pat. No. 2,949,591 other pending.  
Where windings are listed as split, 3/4 of the listed impedance is available by paralleling the winding.  
§Series connected; §§Parallel connected.

**ALL STOCK UNITS MIL TYPE TF4RX  
Class "S" Available on Special Order**

High Power Rating . . . . . up to 100 times greater.  
Excellent Response . . . . . twice as good at low end.  
Low Distortion . . . . . reduced 80%.  
High Efficiency . . . . . up to 30% better . . . compare DCR.  
Moisture Proof . . . . . hermetically sealed to MIL-T-27B.  
Ultraminiature Size . . . . . 5/16 Dia. x 3/8" H, 1/15 Oz.

The unique structural design of the DI-T200 series transformers and inductors provides the excellent electrical characteristics, high reliability and wide application possibilities inherent in the UTC DO-T family of miniaturized units. The DI-T200 series units employ the same high quality design found in UTC's DO-T, DI-T, and PIP lines. This unique transformer structural concept affords unprecedented power handling capabilities coupled with extremely small size. Further, the high degree of reliability has been dynamically proven in the field. These characteristics are basic in the structure, which is ruggedized, hermetically sealed, employing a completely rigid bobbin, eliminating stress and wire movement. The turns are circular in shape rather than square, eliminating turn corner stress, and effecting uniform wire lay. The coil wire and external lead are rigidly anchored terminal board fashion, employing no tapes and brought out through strain relief. The curves illustrated indicate the superior performance of these units compared to similar size units now on the market.

The leads are insulated 1" long, .016 D Dumet wire, spaced on a .1" radius circle to conform to terminal spacing techniques of the "TO-5" case semiconductors and micrologic elements.

**IMMEDIATE DELIVERY  
FROM STOCK**

Write for catalog of over  
1,300 UTC TOP QUALITY  
STOCK ITEMS  
IMMEDIATELY AVAILABLE  
from your local distributor.



**UNITED® TRANSFORMER CO.**  
DIVISION OF TRW INC. • 150 VARICK STREET, NEW YORK, N. Y. 10013



# ECONOMY!

**Versatile,  
Value-priced  
x-y recorder  
...just \$895!**

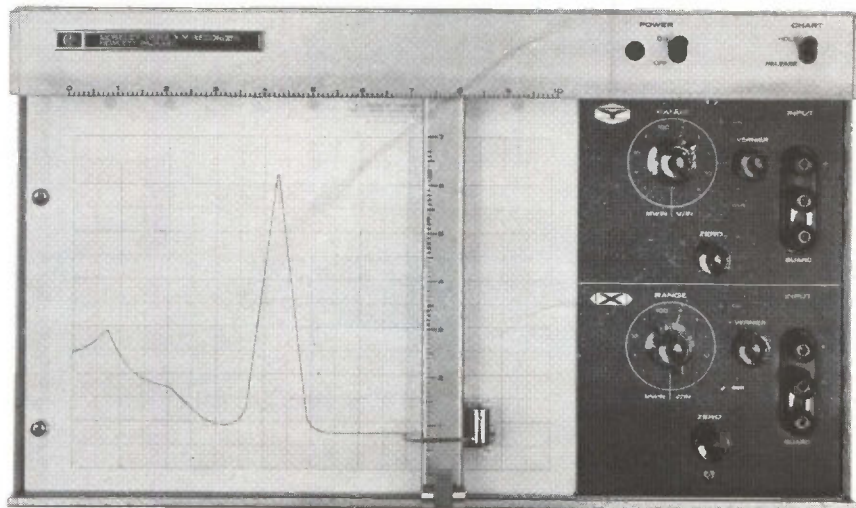

## *THE MOSELEY 7035A*

This is a high-performance, low-cost solid-state recorder for everyday applications not requiring high dynamic performance. Five fixed calibrated ranges 1 mv/inch to 10 v/inch. High input impedance, floating guarded input, 0.2% accuracy at full scale. Adjustable zero set.

Each axis of the 7035A has an independent servo system with no interaction between channels. Maintenance-free AUTOGRIP\* electric paper holddown and electric pen lift are standard. Options available include locks for zero and variable range controls, rear input, and retransmitting potentiometer for X axis.

For general-purpose applications, you can't beat the Moseley Division 7035A. Ask your Hewlett-Packard field engineer for a demonstration. Or write for complete specifications to Hewlett-Packard, Palo Alto, California 94304, Tel. (415) 326-7000; Europe: 54 Route des Acacias, Geneva.

*Data subject to change without notice.  
Price f.o.b. factory.*

**HEWLETT  
PACKARD**  **MOSELEY  
DIVISION**  
*An extra measure of quality*

\*Trade Mark Pat. pend.



# Bring on your complex, small, noisy, difficult signals.

We'll give you traces that show them for what they really are.

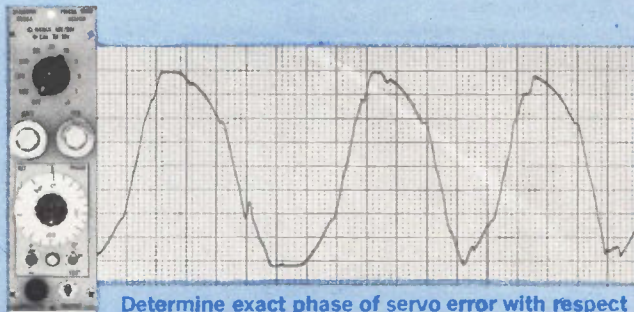

Determine exact phase of servo error with respect to reference signal of 60 Hz to 5 kHz while maximizing rejection of quadrature component.

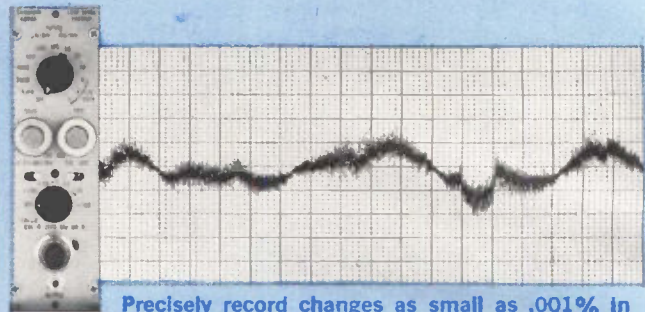

Precisely record changes as small as .001% in DC-100 Hz signals by using calibrated zero suppression.

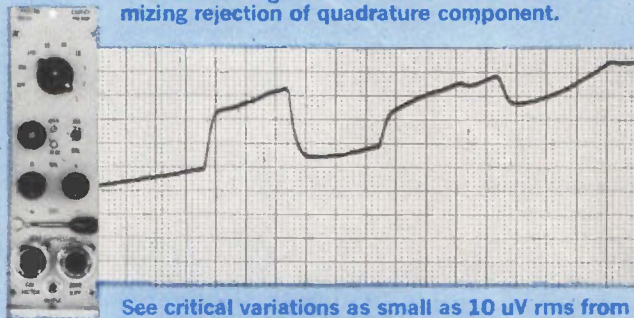

See critical variations as small as 10 uV rms from strain gages, other AC-excited transducers.

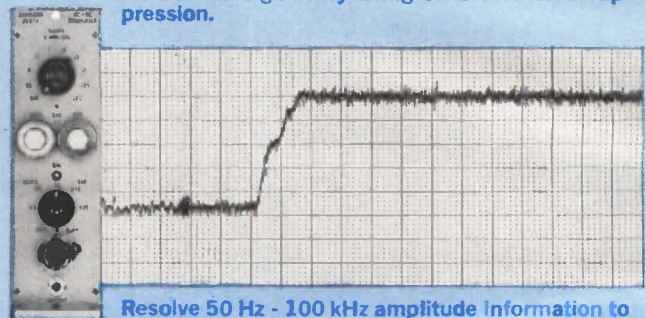

Resolve 50 Hz - 100 kHz amplitude information to 0.02% of full scale signals from 1 volt to 500 volts.

When you need the greatest possible degree of signal-conditioning precision and operational control, Sanborn 7700 Series oscillographs with solid-state "8800" plug-ins will give you chart recordings of maximum resolution and intelligibility.

Seven highly versatile signal conditioners offer unique performance capabilities: three DC types with a 1 uV - 250 V dynamic range, floating differential input and calibrated zero suppression . . . an AC-DC Converter with calibrated zero suppression and scale expansion permitting resolution better than 0.1%, 10 ms response and isolated, 1 meg. input . . . a phase-sensitive demodulator with calibrated reference phase shift, 90° calibrated dial with four quadrant selections, and a frequency range of 60 Hz to 5 kHz . . . a carrier preamp with 2400 Hz internal transducer excitation supply, calibrated zero suppression, cal. factor control and conversion gain of 10,000 . . . and a general-purpose DC preamp particularly useful for 100 mm wide chart recording.

Use any of these "8800" plug-ins in the 7700 thermal writing oscillograph matched to your packaging and channel requirements — 4-, 6- and 8-channel 7704A, 7706A and 7708A console types . . . 2-channel 7702A system in rack-mount or mobile cart versions . . . single-channel 7701A wide chart (100 mm) portable system. Every one of these thermal writers will give you permanent, rectangular-coordinate recordings whose resolution and accuracy make all your measurements more useful.



For a new brochure describing the advantages and wide choice of Sanborn thermal writing oscillographs, write Hewlett-Packard Company, Sanborn Division, 175 Wyman Street, Waltham, Mass. 02154.



**HEWLETT  
PACKARD**  **SANBORN  
DIVISION**



## News Features

### Probing the News

- 217 Oscillograph prints out 1-Mhz signal
- 221 Thinning the traffic jam
- 224 DeGaulle's foreign policy spurs growth of CSF
- 229 Learning a trade by computer
- 234 Feeling the pinch

### Electronics Review

- 43 **Computers:** Copy writing; Timely program
- 44 **Avionics:** Scattered view
- 45 **Electron devices meeting:** Sealing vacuum's fate; Light on the beam; A monolithic first; Smallest, fastest
- 47 **Antennas:** Hugging the horizon
- 48 **Communications:** Tuning Gunn?
- 50 **Advanced technology:** On tap
- 52 **Optoelectronics:** Storage on a chip
- 52 **Industrial electronics:** Light switch
- 54 **Space electronics:** Dampening the problem
- 56 **Military electronics:** Backseat driver; Reversing the fallout
- 59 **Solid state:** Satellite transistors
- 60 **Electronics notes**

### Electronics Abroad

- 343 **International:** City lights
- 344 **West Germany:** State of the market
- 344 **Japan:** IC's on the rise; Desk-bound IC's
- 345 **Great Britain:** Computers on the road; Zinc by DDC
- 346 **Canada:** Red eye in the sky; Colorful proposal
- 348 **Sweden:** Good turn
- 349 **Around the world**

### Departments

- 4 Readers Comment
- 8 People
- 14 Meetings
- 16 Meeting Preview
- 23 Editorial
- 25 Electronics Newsletter
- 73 Washington Newsletter
- 257 New Products
- 320 New Books
- 324 Technical Abstracts
- 327 New Literature
- 337 Newsletter from Abroad

Title R registered U.S. Patent Office; © copyright 1966 by McGraw-Hill, Inc. All rights reserved, including the right to reproduce the contents of this publication, in whole or in part.

## Technical Articles

### I. Design

- Design theory** 112 **Topology cuts design drudgery**  
Graphic approach to network analysis replaces time-consuming mesh and node calculations  
S.F. Chan, University of Santa Clara
- Circuit design** 122 **Designer's casebook**
  - F-m output from low-cost unijunction
  - Tuning fork drives portable frequency standard
  - Diode bias replaces batteries in log converter
  - Light-sensitive field effect transistor
  - Unijunction memory stores until readout
- Reference sheet** 126 **Nomograph finds output voltage error**  
Chart quickly evaluates performance of operational amplifiers from specified gain and offset  
Ed Schuck, Rosemount Engineering Co.
- Integrated electronics** 128 **Integrated circuits in action: part 2 Trends and trade offs**  
Designers of integrated circuits find that cost and performance ground rules are always changing  
Donald Christiansen, senior associate editor

### II. Application

- Solid state** 137 **Avalanche transistors drive laser diodes hard and fast**  
Short, high-current pulses for high-resolution optical radar are produced by pulser circuit  
H.E. Brown and R.A. Bond, University of Texas, and J.C. Bloomquist, Eglin Air Force Base
- Computers** 142 **Current dividers convert digital signals into analog voltages**  
Integrated circuits can perform the conversion by repeatedly halving a constant current
- Consumer electronics** 155 **Simpler circuits trace Sony's path to innovation**  
A portrait of the men who created a leading entertainment electronics company and examples of their design philosophy; replace complex circuits with simpler, sophisticated ones
- 156 Sony tries to be first, or at least different
- 160 Ceramic filters edge out costly i-f transformers
- 163 Sensor reverses tape direction at recording's end
- 165 Recorder gain control eliminates level indicator
- 167 Horizontal sweep with no driver stage
- 171 Two-stage gain control for portable tv set  
Charles Cohen, Tokyo regional editor, and Products Planning division, Sony Corp.



# Electronics

**Editor-in-Chief:** Lewis H. Young

**Senior editors**

**Design:** Samuel Weber

**Application:** George Sideris

**News:** Kemp Anderson Jr.

**Assistant to the editor:** Sally Powell

**Senior associate editors:** John F. Mason, Donald Christiansen, Robert Henkel, Joseph Mittleman

**Department editors**

**Avionics:** W.J. Evanzia

**Communications:** Leonard Weller

**Computers:** Wallace B. Riley

**Design theory:** Joseph Mittleman

**Electronics abroad:** Arthur Erikson

**Electronics review:** Stanley Zarowin

**Industrial electronics:** Alfred Rosenblatt

**Instrumentation:** Carl Moskowitz

**Military electronics:** John F. Mason

**New products:** William P. O'Brien

**Special projects:** Donald Christiansen

**Staff writer:** Jan Rahm

**Regional Bureaus**

**Domestic**

**Boston:** Thomas Maguire, manager; Robin Carlson

**Los Angeles:** William B. Wallace, manager; June Ranill

**San Francisco:** Walter Barney, manager; Mary Jo Jadin

**Washington:** Robert W. Henkel, manager; William D. Hickman, John Rhea, correspondents; Patricia C. Hoehling

**Foreign**

**Bonn:** John Gosch

**Tokyo:** Charles Cohen

**Copy editors**

James J. Moran, David Goller, William Olcott

**Graphic design**

**Art director:** Saul Sussman

**Assistant art director:** Ann Mella

**Production editor:** Arthur C. Miller

**Editorial secretaries:** Claire Benell, Lynn Emery, Lorraine Fabry, Kay Fontana, Patricia Gardner, Lorraine Longo

**McGraw-Hill News Service**

**Director:** John Wilhelm; **Atlanta:** Fran Ridgway; **Chicago:** Reck Johnson;

**Cleveland:** Arthur Zimmerman; **Dallas:** Marvin Reid;

**Detroit:** N. Hunter; **Houston:** Ron Lovell; **Los Angeles:** Michael Murphy, Gerald Parkinson

**San Francisco:** Margaret Drossel

**Seattle:** Ray Bloomberg; **Washington:** Arthur L. Moore, Charles Gardner,

Herbert W. Cheshire, Seth Payne, Warren Burkett, Warren Kornberg

**McGraw-Hill World News Service**

**Bonn:** John Johnsrud; **London:** John Shinn;

**Mexico City:** Bruce Cross; **Milan:** Ronald Taggiasco;

**Moscow:** Howard Rausch; **Paris:** Peter Kilborn;

**Rio de Janeiro:** Wes Perry; **Tokyo:** Marvin Petal

**Reprints:** Susan Nugent

**Circulation and Research Manager:** Milton Drake

**Publisher:** Gordon Jones

**Electronics:** November 14, 1966, Vol. 39, No. 23

Published every other Monday by McGraw-Hill, Inc. Founder: James H. McGraw 1860-1958.

Printed at 99 North Broadway, Albany, N.Y. 12207; second class postage paid at Albany, N.Y.

Executive, editorial, circulation and advertising addresses: McGraw-Hill Building, 330 W. 42nd Street, New York, N.Y. 10036. Telephone (212) 971-3333. Teletype TWX N.Y. 212-640-4646. Cable address: MCGRAWHILL N.Y.

Subscriptions are solicited only from those actively engaged in the field of the publication. Position and company connection must be indicated on orders. Subscription prices: United States and possessions and Canada, \$6.00 one year, \$9.00 two years, \$12.00 three years; all other countries, \$20.00 one year. Single copies: United States and possessions and Canada, 75¢; all other countries, \$1.50.

Officers of McGraw-Hill Publications: Joseph H. Allen, President; Bayard E. Sawyer, Executive Vice President; Vice Presidents: J. Elton Tuohig, Operations; John R. Callahan, Editorial; Donald C. McGraw, Jr., Marketing; John M. Holden, Marketing Services; Huber M. Gemmill, Circulation; Angelo R. Venezian, Production; Robert M. Wilhelmy, Controller.

Officers of the Corporation: Donald C. McGraw, Chairman of the Board; Shelton Fisher, President; L. Keith Goodrich, Hugh J. Kelly and Robert E. Slaughter, Executive Vice Presidents; John J. Cooke, Vice President and Secretary; John L. McGraw, Treasurer.

Title © registered in U.S. Patent Office; © Copyright 1966 by McGraw-Hill, Inc. All rights reserved. The contents of this publication may not be reproduced either in whole or in part without the consent of copyright owner.

**Subscribers:** The publisher, upon written request to our New York office from any subscriber, agrees to refund that part of the subscription price applying to copies not yet mailed.

Please send change of address notices or complaints to Fulfillment Manager; subscription orders to Circulation Manager, Electronics at address below. Change of address notices should provide old as well as new address, including postal zip code number. If possible, attach address label from recent issue. Allow one month for change to become effective.

**Postmaster:** Please send form 3579 to Fulfillment Manager, Electronics, P.O. Box 430, Hightstown, New Jersey 08520

## Readers Comment

### Embarrassment

To the Editor:

In the well-researched article on the IWCS program [Oct. 3, p. 167], your caption writer has embarrassed me. I am responsible for Page's engineering effort in Vietnam and Southeast Asia; over-all management responsibility is vested in Page's vice president, Lincoln Brown, with all field work under direction of vice president Loren Bailey who is resident in Saigon.

W.D. Carter

Ass't. Director, Engineering  
Page Communications Engineers,  
Inc.  
Washington, D.C.

### Changed equation

To the Editor:

It has come to my attention that there is an error in my article "FET's call the tune in active filter design" [Oct. 3, p. 98]. Equation 3 for the damping factor, p. 99, should read:

$$p = \frac{1}{M} + \frac{2}{M} (1 - K_2),$$

instead of

$$p = \frac{1}{M} + \frac{M}{2} \left( \frac{1}{1 - K_2} \right)$$

J.M. Loe

Project Engineer  
Philco-Ford Corp.  
Blue Bell, Pa.

### Adequate feedback

To the Editor:

I agree most wholeheartedly with William Perzley's letter concerning power supply reliability guidelines [Sept. 19, p. 7].

He has trouble finding power supply reliability guidelines because power supply customers have not demanded adequate reliability in the past. Needless to say, any company will not perform any unnecessary task.

It is with great pleasure that I hear a top management man acknowledging the importance of reliability as applied to any system. Far too often in the last five years, I have seen reliability treated as

# RESISTORS FOR PERSPICACIOUS DESIGN ENGINEERS

## FILMISTOR® PRECISION METAL-FILM RESISTORS

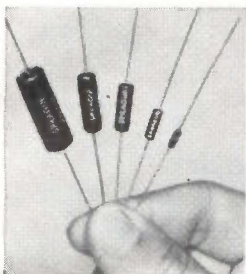

Extended-range Filmistor Resistors now give you dramatic space savings in all wattage ratings — 1/20, 1/10, 1/8, 1/4, 1/2, and 1 watt — with absolutely *no sacrifice in stability!*

Filmistors offer extended resistance values in size reductions previously unobtainable. For example, you can get a 4.5MΩ resistor in the standard 1/4 watt size, which had conventionally been limited to 1 MΩ. Filmistor Metal-Film Resistors are now the ideal selection for "tight-spot" applications in high-impedance circuits, field-effect transistor circuits, etc.

Other key features are ±1% resistance tolerance, low and controlled temperature coefficients, low inherent noise level, negligible coefficient of resistance, and rugged molded case.

Filmistors *surpass* the performance requirements of MIL-R-10509E.

Write for Engineering  
Bulletin 7025C

## ACRASIL® PRECISION/POWER WIREWOUND RESISTORS



These silicone-encapsulated resistors combine the best features of both precision and power wirewound types, giving them unusual stability and reliability.

Acrasil Resistors are available with tolerances as close as .05%, in power ratings from 1 to 10 watts. Resistance values range from 0.5 ohm to 66,000 ohms.

Their tough silicone coating, with closely matched expansion coefficient, protects against shock, vibration, moisture, and fungus.

Acrasil Resistors meet or exceed the requirements of MIL-R-26C.

Write for Engineering  
Bulletin 7450

## BLUE JACKET® VITREOUS ENAMEL PRECISION/POWER WIREWOUND RESISTORS

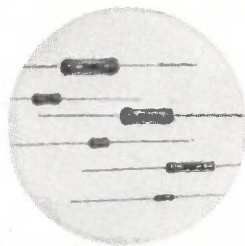

Axial-lead resistors available in ratings from 1 to 11 watts, with resistance tolerances to ±1%. Non-inductive windings available to ±2% tolerance.

All welded end-cap construction securely anchors leads to resistor body. Vitreous coating and ceramic base have closely matched expansion coefficients.

Write for Engineering  
Bulletins 7410D, 7411A



Tab-terminal Blue Jacket Resistors can be had in a wide selection of ratings from 5 to 218 watts, with several terminal styles to meet specific needs.

Tab-terminal as well as axial-lead Blue Jacket resistors can be furnished to meet the requirements of MIL-R-26C.

Write for Engineering  
Bulletins 7400B, 7401

## KOOLOHM® CERAMIC-SHELL POWER WIREWOUND RESISTORS



Koolohm Resistors are furnished in axial-lead, axial-tab, and radial-tab styles, in a broad range of ratings from 2 to 120 watts. Both standard and non-inductive windings are available.

Exclusive ceramic-insulated resistance wire permits "short-proof" multilayer windings on a special ceramic center core for higher resistance values. The tough non-porous ceramic shell provides complete moisture protection and electrical insulation. Koolohms can be mounted in direct contact with chassis or "live" components.

Axial-lead Koolohm Resistors to MIL-R-26C are available in MIL styles RW55 and RW56.

Write for Bulletins  
7300, 7305, 7310

## STACKOHM® POWER WIREWOUND RESISTORS



Sprague Stackohm Resistors are especially designed for equipment which requires power wirewound resistors of minimum height. Their flat silhouette permits stacking of resistor banks in close quarters.

Aluminum thru-bars with integral spacers act as mounting means and also conduct heat from within the resistance element. Resistance windings are welded to end terminations for maximum reliability. An outstanding vitreous coating protects the assembly against mechanical damage and moisture. Ceramic core, end terminations, and vitreous enamel are closely matched for coefficient of expansion.

Stackohm Resistors are available in both 10-watt and 20-watt ratings, and can be furnished with resistance tolerances as close as ±1%. Resistance values range from 1 ohm to 6000 ohms.

Both 10- and 20-watt types meet the stringent requirements of MIL-R-26C.

Write for Engineering  
Bulletin 7430

Send your request to Technical Literature Service, Sprague Electric Co., 35 Marshall St., North Adams, Mass. 01247, indicating the engineering bulletins in which you are interested.

ON READER-SERVICE  
CIRCLE 495

ON READER-SERVICE  
CIRCLE 496

ON READER-SERVICE  
CIRCLE 497

ON READER-SERVICE  
CIRCLE 498

ON READER-SERVICE  
CIRCLE 499

## SPRAGUE COMPONENTS

RESISTORS

CAPACITORS

TRANSISTORS

THIN-FILM MICROCIRCUITS

INTEGRATED MICROCIRCUITS

45R-5145

PULSE TRANSFORMERS

INTERFERENCE FILTERS

PULSE-FORMING NETWORKS

TOROIDAL INDUCTORS

ELECTRIC WAVE FILTERS

CERAMIC-BASE PRINTED NETWORKS

PACKAGED COMPONENT ASSEMBLIES

BOBBIN and TAPE WOUND MAGNETIC CORES

SILICON RECTIFIER GATE CONTROLS

FUNCTIONAL DIGITAL CIRCUITS

**SPRAGUE®**  
THE MARK OF RELIABILITY

\*Sprague\* and \*®\* are registered trademarks of the Sprague Electric Co.





# A NEW 100-MHz Pulse Generator...

for only  
**\$995**  
in U.S.A.

- 1 to 100 MHz generated internally; dc to 100 MHz, externally.
- 2-ns rise and fall times.
- Calibrated output, 0 to 4 volts into 50 Ω in 1/2-volt steps.
- Duty ratios up to 96%.
- Output-pulse duration variable from 4 to 99 ns in 1-ns steps.
- Trigger-level and slope controls for use with external triggering.

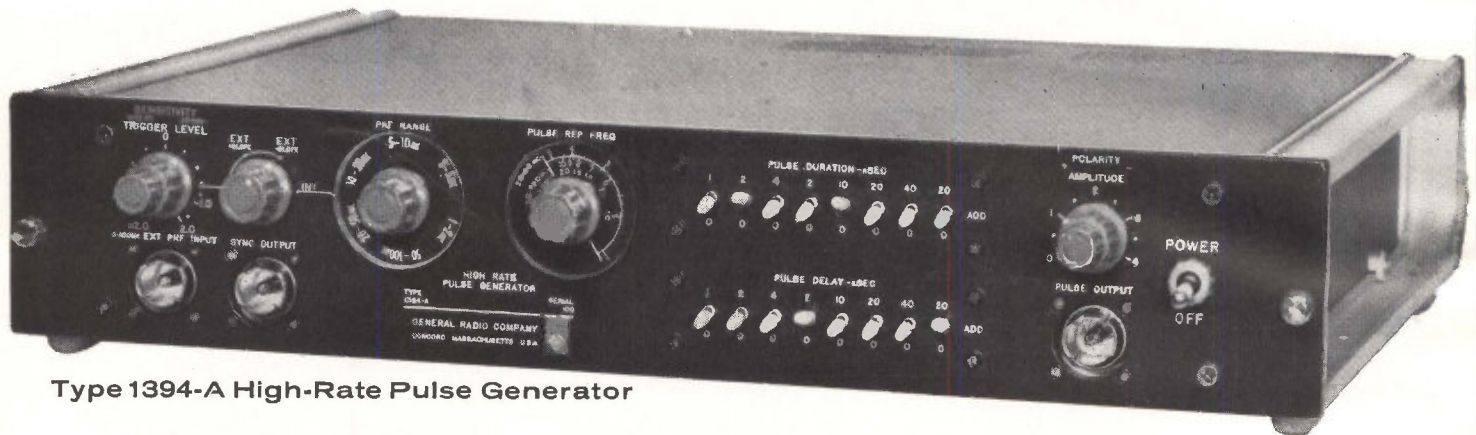

**Type 1394-A High-Rate Pulse Generator**

The development and testing of today's high-frequency digital circuitry call for a pulse generator whose output pulses have:

1. High repetition rate.
2. Fast rise and fall times.
3. Sufficient voltage to switch circuits.

GR's new pulse generator meets these requirements, and it has many other useful features for testing high-speed computers, radar systems, digital-communication systems, and other sophisticated equipment. It has, for instance, calibrated controls for pulse duration, delay, amplitude, and repetition frequency, and pulses of either polarity are available at the output. The fast-rise-time capability of the 1394-A makes it also well suited for the study of component characteristics, such as semiconductor switching speed and pulse-transformer rise time. Add to these features a price that is substantially less than that of comparable instruments and you have a pulse generator that has an unusually high performance/price index.

An accessory unit, the Type 1394-P1 Pulse-Offset Control, is available for applications requiring a dc-coupled output. This unit fixes the base line of the output pulses to any reference voltage from -2 to +2 volts and is continuously adjustable. Price: \$255 in USA.

## Other Pulse Instruments

### Type 1217-C Unit Pulse Generator

... high performance at minimum cost, prf up to 1.2 MHz. Price: \$275 in USA.

### Type 1398-A Pulse Generator

... rise and fall times less than 5 ns, 60-V output pulses, prf up to 1.2 MHz. Price: \$595 in USA.

### Type 1395-A Modular Pulse Generator

... produces practically any pulse shape or train you may want, five different modules available, main frame accommodates up to 7 modules. Price: Main Frame, \$575; Modules, \$160 to \$400 in USA.

### Type 1397-A Pulse Amplifier

... linear amplifier with 1.2-ampere output for use with Types 1217-C and 1398-A or any other pulse generator with negative output pulses. Price: \$495 in USA.

BOSTON • NEW YORK • CHICAGO • PHILADELPHIA • WASHINGTON, D.C.  
SYRACUSE • DALLAS • SAN FRANCISCO • LOS ANGELES • ORLANDO  
CLEVELAND • TORONTO • MONTREAL

BOURNE END, ENGLAND      ZURICH, SWITZERLAND

# GENERAL RADIO

WEST CONCORD, MASSACHUSETTS



a fringe benefit rather than an integral part of a system.

Reliability is fine, as long as it doesn't cost much, otherwise reliability is the first to suffer from contract cutbacks. This action seems to be inconsistent when the Department of Defense allocates approximately 10% of the procurement dollar for reliability.

This does not mean that proposals should be unrealistic. A top reliability program should not be an indirect function, but should provide adequate rapid feedback to the designers, etc. I know of two semiconductor manufacturers that have made the physics of failure aspect of reliability a direct economical benefit to their respective industries by providing adequate feedback to designers and process engineers.

E.V. Chamberlain

Reliability engineer  
Indialantic, Florida

### Too optimistic

To the Editor:

During editing, my article "Holography's practical dimension," [July 25, p. 88] acquired a decidedly more optimistic view on holographic television than had been my original intent. I must concede, however, that the readability of the paper was improved.

In my original manuscript, the section on holographic television opened with the following paragraph:

"Perhaps the ultimate bequest of holography will be holographic motion pictures and television; recently there has been again some talk in this direction. Our assessment of this possibility is decidedly pessimistic, at least for the next few decades. However, we can en-

gage in some speculation along these lines."

For the closing section, I wrote: "But recall that this discussion is in the realm of the speculative. Holographic television is not yet in sight, nor did anything transpire at the recent (March, 1966) Optical Society Meeting to bring its realization any closer."

Holographic home television, of course, is an intriguing subject for speculation, but is decidedly in the realm of the "way far out."

Emmett N. Leith

Institute of Science and Technology  
University of Michigan  
Ann Arbor

### Credit due

To the Editor:

In my article, "Scattering parameters speed design of high-frequency transistor circuits," [Sept. 5, p. 78] it inadvertently appeared that I was assuming credit for developing some of the new concepts which were presented.

I wish to acknowledge the correct source. The charts on pages 83 and 84 are derived from equations 20 through 25 on page 87. These scattering parameter design concepts were originated by George E. Bodway, who kindly made available to me his as-yet unpublished paper, "Two-port power flow analysis of linear active circuits using the generalized scattering parameters."

In this paper, Bodway derives these important new equations. Their development was entirely his, and I am eager that the credit be his.

Fritz K. Weinert

Hewlett-Packard Co.  
Palo Alto, Calif.

# Etch your own PC boards automatically!

(In less than five minutes!)

from this—  
to 11" x 14"

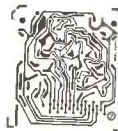

Shown actual size!

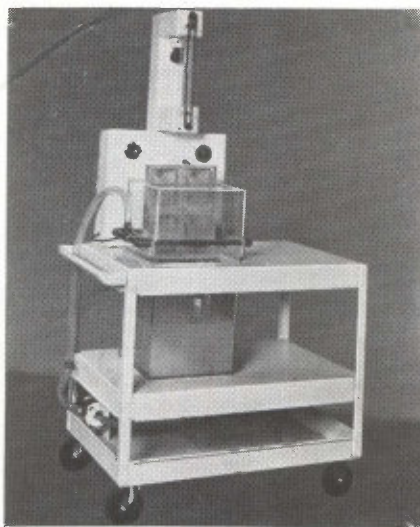

## CYCLO-TRONICS "fine line" etcher

for prototypes—limited runs

No cooling or venting required!

Etches as fine as .001"!

Cuts costs in half—saves time!

Complete photo processing instructions!

Work is illuminated while etching!

No patterning . . . minimum undercutting!

Model No. 201 (illus.), etches two 11"x14" one-sided boards or one 11"x14" two sided board: **\$695**

Pat. applied for

**NOW IN USE BY:**

AMP, Inc./The Bendix Corp./Beta Corp., Sub. of Koppers Co., Inc./Charles Bruning Co., Div. of Addressograph Corp./The University of Chicago/University of Colorado/C. G. Conn, Ltd./Fab Tool, Inc./General Dynamics/Graduate Research Center of the Southwest/IBM Corp./Jordan Electronics, Div. of Victoreen Instrument Co./Lear Siegler, Inc./Micro Switch, Div. of Honeywell/Microwave Electronics Corp., Div. of Teledyne/Oklahoma State Univ./Sonofone Corp./Westronics/Woodward Governor Co.

Representatives: Some Territories Still Available.

Send for complete information

## CYCLO-TRONICS, INC.

3858 N. CICERO—CHICAGO, ILL. 60641

TELEPHONE: (312)-282-6141

### SUBSCRIPTION SERVICE

Please include an Electronics Magazine address label to insure prompt service whenever you write us about your subscription.

Mail to: Fulfillment Manager  
Electronics  
P.O. Box 430  
Hightstown, N.J. 08520

To subscribe mail this form with your payment and check  new subscription  renew my present subscription

Subscription rates: in the U.S.: 1 year, \$6; two years, \$9; three years, \$12. Subscription rates for foreign countries available on request

### CHANGE OF ADDRESS

ATTACH LABEL HERE

If you are moving, please let us know five weeks before changing your address. Place magazine address label here, print your new address below.

name

address

city

state

zip code



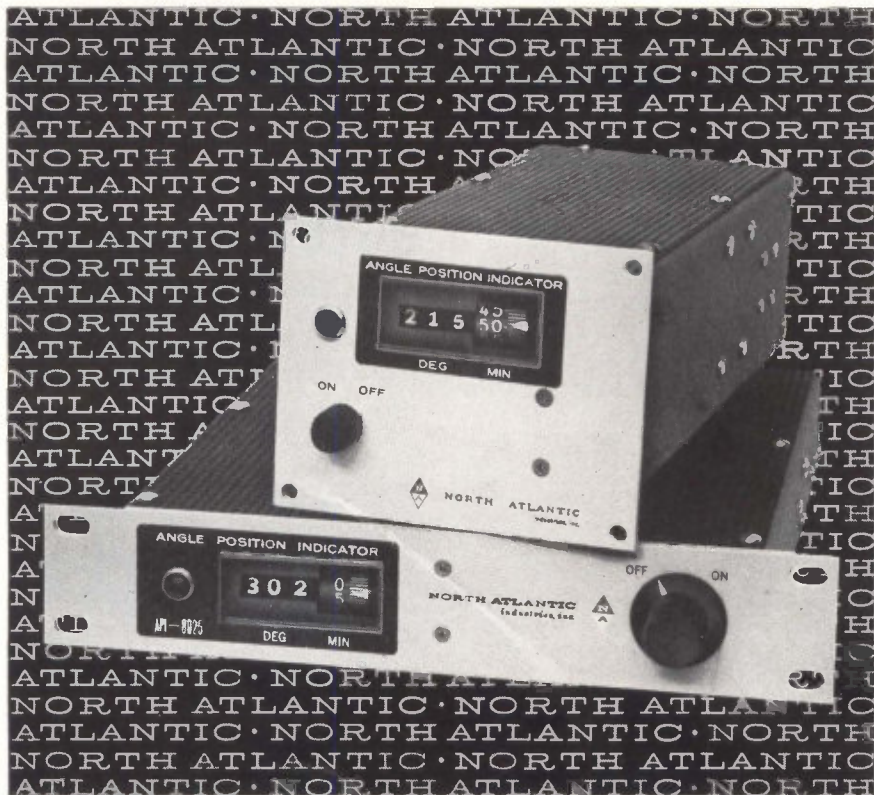

## how to measure resolver or synchro position with 30 second repeatability

In both production test and ground checkout systems, North Atlantic's high performance Angle Position Indicators provide exceptional operator ease and precision in the measurement of synchro and resolver position. Features include digital readout in degrees and minutes, 30 second resolution, continuous rotation, plug-in solid-state amplifier and power supply modules. Due to the design flexibility of these units, they can be readily provided with a variety of features for specific requirements. Typical units in this line incorporate combinations of the following features:

- Single Synchro or Resolver Input
- Dual Synchro or Resolver Inputs
- Retransmit Synchro, Resolver, Potentiometer, or Encoder
- 2-Speed Synchro Input
- Multi-frequency Inputs
- DC Input
- 0-999 Counter

### BASIC SPECIFICATIONS

Range	0°-360° continuous rotation
Accuracy	6 minutes (standard)
Repeatability	30 seconds
Slew Speed	25°/second
Power	115 volts, 400 cps
Size	API-8025 1 3/4" h x 9 1/2" w x 9" d
	API-8027 3 1/2" h x 4 7/8" w x 9 3/4" d



Your local North Atlantic representative has complete data on the API line. Call him today or write direct for technical literature.

**NORTH ATLANTIC industries, inc.**  
TERMINAL DRIVE, PLAINVIEW, L. I., NEW YORK • OVerbrook 1-8600

## People

Many semiconductor companies, content to produce conventional integrated circuits, avoid multi-chip devices and large-scale arrays because in their opinion the first is too old and the second too new. But the General Instrument Corp. is investing heavily in both technologies.



Jerome Fishel

Business is so good that the company—based in Newark, N.J.—has constructed a plant in Syosset, N.Y., to house the hybrid circuit department while the metal oxide semiconductor (MOS) department has taken over the old Hicksville, N.Y., plant completely.

The reorganization has pushed two young men into the limelight. Jerome Fishel, 38, was named director of operation for the hybrid circuit section and J. Leland Seely, 34, was put in charge of the MOS department. Each will have responsibility for development, engineering, production and marketing in his own field.



J. Leland Seely

**Teacher, too.** Fishel, an electrical engineer, has a varied background. He taught transistor electronics for five years at Adelphi University and was a vice president at the General Transistor Corp. before it merged with General Instrument in 1960.

"There's been a resurgence in hybrid circuits and many companies are now entering the field," Fishel says. He predicts sales will double this year. The new facility expands floor space and the department has been put on a two-shift basis.

Fishel claims General Instrument has a head start in the military hybrid circuits market. "We've been at it longer than anyone else," he says.

Fishel also believes the reorganization will help his section attain its goals faster. "The reorganiza-



# He-Ne CW Lasers and Electro-Optical Instruments

## LAS-101 LASER for school and laboratory

Output 0.25 mW at 6328 Å, TEM<sub>00n</sub> mode, 1 mW multimode (optional), guaranteed one year. Optional 1.15 and 3.39 μ mirrors in quick-interchange mounts. Single-isotope, double-walled tube, heated cathodes. \$660



## F-102 SOLID-STATE ETALON

Finesse of 30 over range of 4250 to 6500 Å; 10 GHz (1/2 wave-number) free spectral range. Tilt-tunable through x-y adjustable mount. Ranges of .65 to .95 μ and narrow-band 6943 Å optional. \$425



## P-102 LASER POWER SUPPLY

For the LAS-101, provides required 300 volts dc, 60 mA, and 6.3 volts ac, 1.5 A. Fully adjustable control of the discharge current. Operates from 117 volts ac ± 15%, 50-65 c/s. \$165

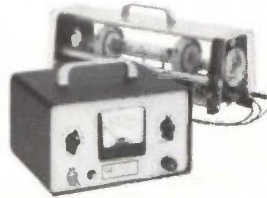

## F-103 SCANNING INTERFEROMETER

Operates from 4250 to 7000 Å, or (optional) from .7 to .95 μ or narrow-band at 6328 Å. Finesse of 30 or better, free spectral range of 1.5 GHz in standard model, variable by simple slide adjustment of reflector end plates. Electro-magnetic reflector drive. \$655



## LAS-201 LABORATORY GAS LASER

Output 0.50 mW at 6328 Å, TEM<sub>00n</sub> mode, 2 mW multimode (optional); one year warranty. Optional 1.15 and 3.39 μ mirrors in quick-interchange mounts. Single-isotope, double-walled tube, heated cathode. Integral high-voltage supply operates from line voltage. \$980



## L-101 SPECTRAL IRRADIANCE STANDARD and P-101 CURRENT SUPPLY

Calibrated, high-temperature, quartz-iodine lamp for continuous output from 2500 Å to 2.6 μ. Simple current-monitoring supply for precise lamp current control. \$475



## LAS-102 RUGGEDIZED LASER for field use

Output 0.50 mW at 6328 Å, TEM<sub>00n</sub> mode, 1 mW multimode (optional); one year warranty. Optional 1.15 and 3.39 μ mirrors. Hermetically-sealed capsule 2" diameter, 14" long. \$850 (\$750 multimode)

P-103 power supply, operates from ac line or 12-volt battery. \$325



## PRECISION REFLECTOR MOUNTS

Non-interacting, x-y adjustment. Three models shown are:

- EOA-9000 quick-interchange mount \$45
- EOA-9001 dual-micrometer vernier end plate (accepts EOA-9000 quick-interchange mount) \$170
- EOA-9002 precision mount also used on F-102 interferometer \$175



## LAS-103 SINGLE-FREQUENCY, STABLE LASER

Output 125 μW near 6328 Å, TEM<sub>00n</sub> mode, single frequency. Temperature compensated for frequency stability. Integral photodetector, electro-magnetic tuning control. Single-isotope, double-walled tube, heated cathode. Compact size, modular construction. \$1800



## PM SERIES of COOLABLE PHOTOMULTIPLIER HOUSINGS

Three basic models for PM tubes of 1 1/2" and 2" nominal diameter and up to 7" seated height. Dry ice or liquid N<sub>2</sub> gas cooling. Exclusive frost-free, fog-free EOvac® window. Improvement of S/N by up to 100. Widely used uncooled for excellent shielding properties. \$385 - \$480



\*TRADEMARK

Write or call for complete information and demonstration by technical representatives.

## ELECTRO OPTICS ASSOCIATES

981 COMMERCIAL STREET • PALO ALTO, CALIFORNIA 94303  
Telephone (415) 327-6200. Cable address: ELECTROPTICS





## New from Sprague!

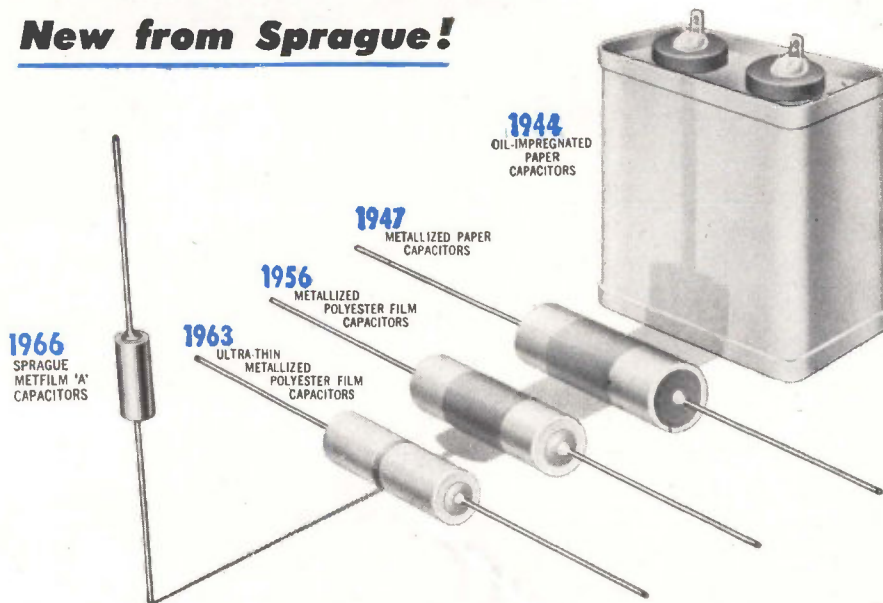

## METFILM\* 'A' CAPACITORS ... dramatically smaller in size, yet more reliable than military-grade capacitors of the past!

Just a few years ago, the only 10  $\mu$ F capacitor considered dependable enough for military applications was Type CP70 (to JAN-C-25), and was a block-busting 3 $\frac{3}{4}$ " wide x 1 $\frac{3}{4}$ " thick x 4" high. Today, you can get a military-quality 10  $\mu$ F tubular capacitor measuring only  $\frac{1}{2}$ " in diameter x 1 $\frac{1}{4}$ " long. And it's more reliable than any capacitor of the past!

Sprague Type 680P Metfilm 'A' Metallized Capacitors meet all environmental requirements of MIL-C-18312, yet they occupy only one third the volume of conventional metallized film capacitors of equivalent capacitance and voltage rating. Employing a new thin organic film dielectric system, Type 680P capacitors use a dual film totalling only 0.00008" thick, as compared to conventional polyester-film capacitors with a single film measuring 0.00015".

Another distinct advantage of the Metfilm 'A' dielectric system is minimum degradation of electrical properties during life.

Hermetically sealed in corrosion-resistant metal cases, capacitor sections are effectively of non-inductive construction, resulting in capacitors with performance characteristics superior to those of comparably-sized capacitors.

Type 680P Metfilm 'A' Capacitors are available with capacitance values to 10  $\mu$ F in both 50 and 100 volt ratings.

For complete technical data, write for *Engineering Bulletin 2650 to Technical Literature Service, Sprague Electric Company, 35 Marshall Street, North Adams, Massachusetts 01247.*

\*Trademark

### SPRAGUE COMPONENTS

CAPACITORS  
TRANSISTORS  
RESISTORS

THIN-FILM MICROCIRCUITS  
INTEGRATED CIRCUITS  
INTERFERENCE FILTERS

#50-0311H1

PACKAGED COMPONENT ASSEMBLIES  
FUNCTIONAL DIGITAL CIRCUITS  
MAGNETIC COMPONENTS  
PULSE TRANSFORMERS  
CERAMIC-BASE PRINTED NETWORKS  
PULSE-FORMING NETWORKS

**SPRAGUE**<sup>®</sup>  
THE MARK OF RELIABILITY

<sup>®</sup>Sprague and <sup>®</sup> are registered trademarks of the Sprague Electric Co.

## People

tion will give us independent operation and more control, making things easier to manage by eliminating a lot of red tape."

**Off the shelf.** The hybrid department currently is producing approximately 25 standard hybrid circuits and a wide variety of custom circuits. Fishel explained that his department manufactures circuits in cans and flatpacks. "We use a variety of transistors, both npn and pnp, junction field-effect transistors and MOS FET's," he added. Techniques employed include thermal pairing and voltage trimming of cermet resistors. Under development are flip chip and beam lead devices and complex hybrid circuits compatible with large-scale MOS arrays.

Seely earned a Ph.D. in physics from the University of Utah in 1962 and then went to work for the General Motors Corp.'s defense research laboratory in Santa Barbara, Calif. There he worked with Arnold Nordsieck, inventor of the electric vacuum gyro. Seely directed development and design of Ievitation and readout systems for the gyro.

His interest in solid state physics led him to semiconductor technology. "I felt there was a bright future for MOS and I wanted to get in on the beginning," Seely said of his decision to join General Instrument in late 1964 as a member of its original MOS group.

**More R&D.** Seely expects to place increased emphasis on the research and development aspects of MOS technology and to work toward development of bigger and more complicated modules. One area of work centers on analog to digital and digital to analog converters.

The MOS section currently produces a wide range of MOS circuits, including shift registers, MOS FET's, digital differential analyzers, multiplexers, gates and other devices.

Seely said General Instrument does not use discretionary wiring techniques but concentrates on custom design of each component—a process he calls individual tailoring.





# Machlett is the word for power in transistorized circuitry...

## Use Machlett planar triodes:

for Pulse Power: 1 kw, 2 kw, 3 kw, 4 kw to 10 kw  
for CW Power: 100 watts at 2.5 Gc .5 watts in C Band  
for High Resistance to Radiation  
for Low Noise/Frequency Ratio  
for Low Operating Cost†

## Choose from 2 Machlett planar triode lines (conventional, miniature)

Frequency: 6 Gc and higher  
Pulse Power: grid pulse to 8000v, 5a  
plate pulse to 10000v, 5a  
Modulator Service: dc voltage to 8000v  
peak pulse voltage to 10000v

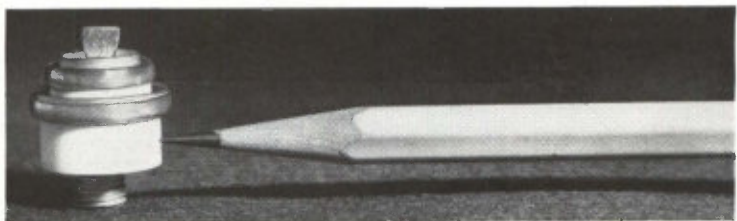

Anode Cooling: new pin radiator: 150 watts and higher,  
FAC, both conventional and miniature  
new water jacket: 400 watts and higher  
with water cooling

Write now for data on the industry's strongest line of planar triodes—  
Machlett: The word for power in transistorized circuitry.  
Address: The Machlett Laboratories Inc.—Springdale (Stamford), Conn. 06879.

**RAYTHEON**

**THE MACHLETT LABORATORIES, INC.**

A S U B S I D I A R Y O F R A Y T H E O N C O M P A N Y



# Recap Three:

Here are eight of our latest new product announcements. (You may have missed one in the past month or so—we've all been busy.) If you have a question about any of these new products, mark the corresponding number on the bingo card. Or call any Fairchild Distributor.

## 12nsec. SWITCH 24¢

Fairchild 2N4274 and 2N4275 are the fastest epoxy saturated switching devices you can get. These epoxy NPN switches are similar to the 2N2369A, and are available now from depth-stocked distributor shelves, or from Fairchild. No other devices at this price (24¢ in lots of 10,000) can come close to the performance characteristics of these transistors. Get them now from Fairchild Distributors or get our data sheets for complete information.



Specifications: (2N4275)	
$t_r$	12nsec (max.) @ 10mA
$t_f$	12nsec (max.) @ 10mA
$t_{off}$	12nsec (max.) @ 10mA
Watt	15V (max.)
$V_{CE(sat)}$	0.2V (max.) @ 10mA
$I_C$	400mA (max.) @ 10mA
$C_{ob}$	4.5pF (max.)

Reader Service No. 482

## MONOLITHIC LIMITING RF-IF AMPLIFIER \$2.75

Complete Circuit at single transistor price! The Fairchild J173 is the only monolithic RF amplifier which needs no external matching, biasing, or tuning components. In the monolithic form, you get higher efficiency and less power than you can get from a conventional circuit. The limiting network is included in the package, so that you need no external components. This allows you to reduce component count and remove the matching network. The J173 is the only monolithic, high-level RF limiting amplifier that can be used in a conventional circuit. It has a 100% duty cycle, and can be used in a limiting or a limiting and amplifying mode. It is available in quantities of 100 pieces or in large quantities. It is available in both the silicon and germanium versions for full range operation.

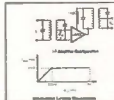

Specifications (T, at 25°C, f = 10 MHz)	
Operating Voltage Range	0.5 to 1.5V
Output Power	100mW (typical)
Input Impedance	50Ω
Output Impedance	50Ω
Input Capacitance	8 pF (typical)
Output Voltage Swing	10V
Power Gain @ 10 dB	20dB

Reader Service No. 483

## PNP 15nsec. SWITCH

Five new silicon PNP transistors are now available from Fairchild, the first of a new series of ultra-fast PNP switching devices. They offer the fastest switching speed, the highest frequencies, and the lowest capacitance. These transistors are gold-doped to make possible extremely fast switching speeds and provide lifetime control. Use them as reliable Planar II bipolar replacements for the germanium 2N960 series. Use them for high speed computer switching circuits, or other military, industrial, and commercial applications. They are available now from distributor stocks, in TO-18 cans or TO-18 epoxy packages. Get samples from your distributors or write for our data sheets. Stop giving up speed to design with silicon PNP Switch to Fairchild.

2N4277	2N4278	2N4279
$t_r$ 15nsec (max.) @ 10mA $t_f$ 15nsec (max.) @ 10mA $t_{off}$ 15nsec (max.) @ 10mA $I_C$ 400mA (max.) @ 10mA $V_{CE(sat)}$ 0.2V (max.) @ 10mA $C_{ob}$ 4.5pF (max.) @ 10mA $I_{C(sat)}$ 400mA (max.) @ 10mA	$t_r$ 15nsec (max.) @ 10mA $t_f$ 15nsec (max.) @ 10mA $t_{off}$ 15nsec (max.) @ 10mA $I_C$ 400mA (max.) @ 10mA $V_{CE(sat)}$ 0.2V (max.) @ 10mA $C_{ob}$ 4.5pF (max.) @ 10mA $I_{C(sat)}$ 400mA (max.) @ 10mA	$t_r$ 15nsec (max.) @ 10mA $t_f$ 15nsec (max.) @ 10mA $t_{off}$ 15nsec (max.) @ 10mA $I_C$ 400mA (max.) @ 10mA $V_{CE(sat)}$ 0.2V (max.) @ 10mA $C_{ob}$ 4.5pF (max.) @ 10mA $I_{C(sat)}$ 400mA (max.) @ 10mA

Reader Service No. 481

# MONOLITHIC COUNTING LOGIC

Off-the-shelf delivery. Fairchild counting MICROLOGIC<sup>®</sup> integrated circuits give you complete counting and display capabilities with a minimum of components. For example, you can get full decade count, decade, and display driver functions with just two CytL devices (CytL9598, CytL9596). You can get the only monolithic decoder/display driver on the market (CytL9596). You can get the only monolithic, mode 16 binary counter with 25MHz typical characteristics (CytL9589). Best of all, you can get them off-the-shelf in any quantity. Count on it. For details contact us or the nearest Fairchild Distributor.

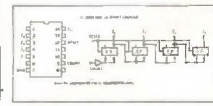
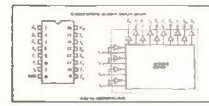
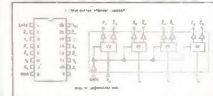
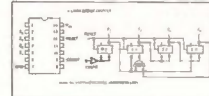

Reader Service No. 488



# MONOLITHIC FIVE-CHANNEL SWITCH

Low leakage, Planar II MOS, requires no transformer! The Fairchild  $\mu$ M3400 is the first in a new line of monolithic, Hi-Rel, Planar II MOS switching circuits. It is immediately available from stock at a cost of only \$8.00 per channel. The device consists of five MOS-FET channels, integrated on a single chip, and can be used for selecting inputs to a computer, telemetry system, or other signal routing applications. In such applications it requires no transformer (unlike alloy junction or dual emitter transistors) thereby saving space and weight, as well as reducing costs and improving reliability.



Features	Typical Specifications
150V input range	Input signal range: 0 to 150V
Planar II MOS technology	Channel ON resistance: 100Ω @ 100mA
Low leakage	Channel OFF resistance: 10 <sup>10</sup> Ω @ 100mA
2000Voc, 100V <sub>sw</sub> (max)	Channel Q1 resistance: 20Ω @ 100mA
Zero input leakage	Input leakage current: 0.005μA
-55°C to +125°C operation	Gate input capacitance: 28pF
14 lead, SC-74, 14 pin parts	Output resistance: 10Ω

Reader Service No. 486

# EPOXY JUNCTION FET 50¢

Pay less, get more! Fairchild's new 2N4360 is a low noise, low cost P-Channel junction FET you can get. You can get it immediately in any quantity, and pay much less than you would for devices with lesser performance specifications (only 50¢ in quantities of 1000). The 2N4360 features an extremely low noise figure, high gain, and high input impedance. The TO-18 epoxy package withstands an operating junction temperature of +125°C and can be stored at any temperature -55°C to +125°C. (TO-18 cans also available, 2N4381, 2N4382.) Get samples from your Fairchild Distributor, or get our data sheet.



2N4360 Typical Specifications:	
Equipment Input Noise Voltage	0.02 μV/Hz @ f=100Hz
Equivalent Input Noise Figure	0.140 @ f=100Hz
Gate to Source Breakdown Voltage (BV <sub>GS</sub> )	20V min
Forward Transconductance (g <sub>m</sub> )	4000 μmhos @ f=1kHz
Drain Current (I <sub>DS</sub> )	10mA
Gate Reverse Current (I <sub>GR</sub> )	0.15μA

Reader Service No. 484

# TTL $\mu$ L IS TTL LOGIC YOU CAN GET.

You get fast delivery on Fairchild TTL $\mu$ L integrated circuits. We're in full production, backed by the facilities and know-how that helped us deliver over 1/3 of all integrated circuits shipped this year. Get any of our six new high level TTL $\mu$ L circuits. Get them in dual in-line packages from Fairchild Distributors. Or get our data sheet.



Features (0°C to +75°C):  
 8nsec. typical propagation delay per gate function.  
 .350V guaranteed minimum noise immunity under worst case operating conditions.  
 1.2V typ. noise immunity for "1" levels.  
 0.85V typ. noise immunity for "0" levels.  
 Single 5V power supply required.  
 TTL $\mu$ L fan-out over temperature range and supply voltage.  
 High capacitive loading capability.  
 Direct physical and electrical replacement for Fairchild DT $\mu$ L 930 series circuits.

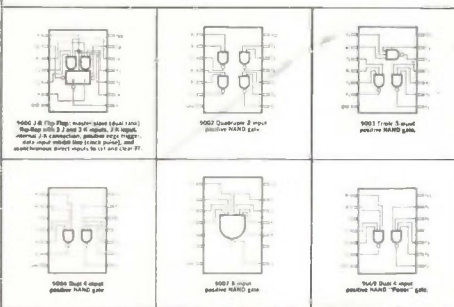

Reader Service No. 485

# A complete 4-bit arithmetic unit 1" square.

Now for the first time you can get a full arithmetic unit in a 32-lead ceramic package only 1 inch square. The Fairchild SH8080 adds two 4-bit numbers and stores the sum in an internal accumulator, ready for parallel read-out. It is made with Fairchild DT $\mu$ L integrated circuits, so that you don't sacrifice performance for size. Use 8 of these units to build a full 32-bit arithmetic unit. Each 8080 you use replaces at least 13 separate integrated circuits. It reduces your space requirements, production costs, and increases reliability. For information on Fairchild's new breed of hybrids, both custom and standard, or for complete details on the SH8080, simply drop us a line.

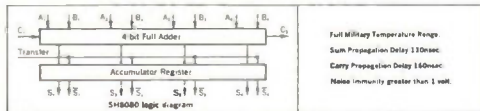

Full Military Temperature Range  
 Sum Propagation Delay 130nsec  
 Carry Propagation Delay 180nsec  
 Noise Immunity greater than 1 volt

Reader Service No. 487



## LOW MICROWAVE NOISE?

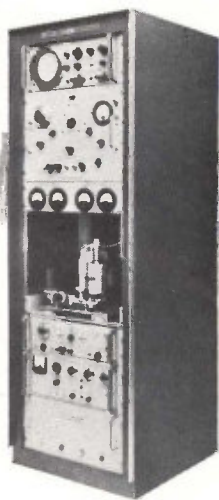

Model SE-200

### WHY NOT PROVE IT?

**SPECTRA** Microwave Noise Measuring Instruments are the only equipments yet devised that can give you the FM and AM noise content of conventional and solid state microwave sources — to accuracies as high as  $\pm 1$  DB. Proof? Maybe not, but close to it.

#### SPECTRA-EXCLUSIVES:

- RF Frequency Ranges: 1.0 Gc/s to 32 Gc/s
- Self-Calibrating for both AM & FM noise measurements
- Broad Video Frequency Coverage: 1 Kc/s to 150 Kc/s
- Residual FM Monitor: 10 cps to 1 Kc/s
- Dual Bandwidth Spectrum Analyzer: 100 cps and 1 Kc/s
- High Sensitivity: AM 135 DB below carrier level; FM .0032 cps rms deviation
- Minimum RF Input Power: 1.5 milliwatts
- Self-Contained Microwave Spectrum Analyzer
- Phase-Locked Local Oscillator

#### NEW MEASUREMENT SERVICE

A custom Noise Measurement Service is now operated by Spectra to provide accurate noise measurements of X-band sources in the frequency range from 8.5 Gc/s to 10.5 Gc/s. Readout: X-Y recordings of FM or AM noise vs. video frequency. Write today for technical data and complete details.

SPECTRA  ELECTRONICS

P.O. Box 85  
Los Altos, Calif. 94023 • (415) 948-4998

## Meetings

**Electric Welding Conference, IEEE, American Welding Society, Industrial Electrical Engineering Society; Park Shelton Hotel, Detroit, Nov. 15-17.**

**Aircraft Design and Technology Meeting, American Institute of Aeronautics and Astronautics; International Hotel, Los Angeles, Calif., Nov. 15-18.**

**Ceramic/'66 Exhibit and Seminar, Technical & Electronic Manufacturer's Association; Trade Show Building, New York City, Nov. 15-17.**

**Conference on Magnetic & Magnetics Materials, IEEE; Sheraton Park Hotel, Washington, D.C., Nov. 15-18.**

**Mid-Atlantic Engineering Conference and Tool Exposition, American Society of Tool and Manufacturing Engineers; Baltimore Civic Center, Baltimore, Md., Nov. 15-17.**

**National Conference on the Management of Aerospace Programs, American Astronautical Society; University of Missouri, Columbia, Mo., Nov. 16-18.**

**Engineering and Maintenance Conference, Air Transport Association; Century Plaza Hotel, Century City, Los Angeles, Calif., Nov. 17-18.**

**Symposium on Oceanography and Oceanology, Institute of Environmental Sciences; Henry Hudson Hotel, New York, Nov. 17.**

**Energy Conversion Exposition, American Society of Mechanical Engineers; Statler Hilton, New York City, Nov. 27-Dec. 1.**

**Meeting and Technical Display of American Institute of Aeronautics and Astronautics; War Memorial Auditorium, Prudential Center, Boston Nov. 29-Dec. 2.\***

**Vehicular Communications Conference, IEEE; Montreal, Quebec, Dec. 1-2.**

**Meeting of the National Committee of the International Scientific Radio Union; Cabana Motor Hotel, Palo Alto, Calif., Dec. 7-9.**

**Electronics Industry Plating Symposium, American Electroplaters' Society; Robert Treat Hotel, Newark, N. J., Dec. 8-9.**

**Electrical and Electronic Measurement and Test Instrument Conference, IEEE; Talisman Motor Inn, Ottawa, Canada, Jan. 9-11.**

**Symposium on Reliability, American Society for Quality Control, IEEE; Sheraton-Park Hotel, Washington, Jan. 10-12.**

**American Society for Quality Control Meeting, American Society for Quality Control; California State Polytechnic College, Kellogg Campus, Pomona, Calif., Jan. 21.**

**Midwest Welding Conference, Illinois Institute of Technology Research Institute; Illinois Institute of Technology, Chicago, Jan. 24-25.**

**Ultrasonic Manufacturers Association Technical Symposium and Meeting, Ultrasonic Manufacturers Association; New York, Jan. 25.**

**Symposium on Nondestructive Testing of Welds, Illinois Institute of Technology Research Institute; Illinois Institute of Technology, Chicago, Jan. 30-Feb. 2.**

## Call for papers

**International Conference on Communications, IEEE; Minneapolis, Minn., June 12-14. Dec. 1 is deadline for submission of a 50-word abstract and a 300-word summary to Robert J. Collins, technical program chairman, 1967 ComTech Meeting, department of electrical engineering, University of Minnesota, Minneapolis, Minn. 55455.**

**International Conference on Electronics and Space, organized by the French Institute of Electrical and Electronic Engineers and sponsored by the Electronic Industries Association of France, April 10-15. Dec. 1 is the deadline for submitting abstracts of papers to Secretariat, Colloque International sur l'Electronique et l'Espace, 16 rue de Presles, Paris 15, France.**

**Joint Automatic Control Conference, sponsored by the Instrument Society of America, at the University of Pennsylvania, June 28-30. Dec. 1 is deadline for submitting papers to Donald A. Rodgers, general chairman, Consolidated Electrodynamics Corp., Pasadena, Calif.**

**International Conference on Magnetics, magnetics group of IEEE, Shoreham Hotel, Washington, April 5-7. Dec. 7 is deadline for submission of two-page abstracts to Dr. R. F. Elfant, IBM, Thomas J. Watson Research Center, P.O. Box 218, Yorktown Heights, N.Y.**

\* Meeting preview on page 16



# The connector Thing

A periodical periodical designed, quite frankly, to further the sales of Microdot connectors and cables. Published entirely in the interest of profit.

# WIN

a pot of gold!



## Lepra/Cons Unite!

In celebration of the introduction of the highest density coax rack and panel and multi-pin connectors on the market today (the broadened Lepra/Con line), Microdot is awarding to five lucky winners (see contest rules below) five simulated gold pots (of the chamber variety) with your, repeat your, name emblazoned thereon. Perfect for desk top decoration. First, let's talk Lepra/Con.

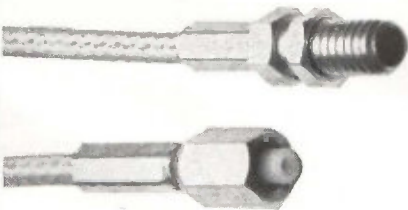

Through its stringent policy—"Never Look Back, They May Be Gaining On You"—Microdot has expanded its Lepra/Con line of ultraminiature connectors...tiny little coax jobs with an OD of only  $\frac{1}{8}$  inch and a mated length of only one inch. But why stop there.

Now there's the Lepra/Con multi-pin...all crimp, no solder; high density; uses Twist/Con pin contacts; low cost; and it's the smallest full 50 ohm coax available today.

Now there's the Lepra/Con Twist/Con /say it fast fifty times) which combines all of the above advantages in a rack and panel coax connector.

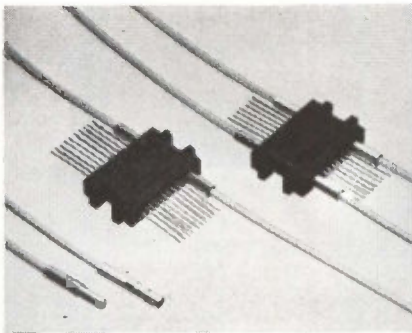

Now there's the slide-on Lepra/Con for singular ease of installation.

And, of course, there is still the old Lepra/Con (if you can call six months old).

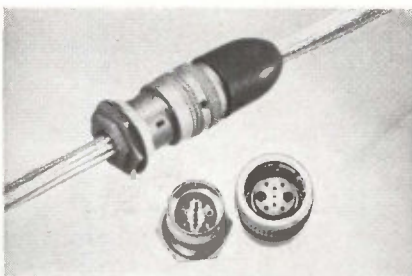

## HOW TO WIN YOUR POT OF GOLD

1. First, of course, decide whether you actually want a pot of gold. In all likelihood, your place of employment has far more up-to-date facilities. However, if you decide a pot is for you, go to step two.
2. Write down all the applications you can think of for the Lepra/Con line *on your job*. And think about it. There are probably more than the twelve you can jot down immediately without hardly thinking at all.
3. Call your Microdot representative directly or drop him a note giving him all your suggested applications, your name, company, title, address and telephone number. Do not call or write Microdot. We only make connectors. Our reps sell them. Hopefully.
4. A jury of six will judge all entries for originality, number of applications and neatness. The five best will each be awarded the simulated gold pot (of the chamber variety).
5. All entrants will win a free picture of our beloved Candy inscribed passionately and personally to you.
6. This whole shoddy affair draws to an end on December 31, 1966. Happy New Year!
7. This entire offer is not valid in any state, county, township or ward where such carryings-on are generally frowned upon.



Alabama, Tennessee  
REP. INC.  
8100 South Memorial Parkway, Huntsville, Ala.  
205-881-9270

Arizona  
COMPAR ROCKY MOUNTAIN AGENTS, INC.  
84 West First Street, Scottsdale  
602-947-4336

California (Northern), Nevada  
PETERS-de LAET INC.  
1606 Rollins Road, Burlingame, Calif.  
415-697-1800

California (Southern)  
Do call MICRODOT: 213-682-3351

Canada  
DOUGLAS RANDALL (CANADA) LTD.  
126 Manville Road, Scarborough, Ontario  
416-421-5970

Colorado, Utah  
COMPAR ROCKY MOUNTAIN AGENTS, INC.  
300 E. Hampden, Suite 315, Englewood, Colo.  
303-781-0912

Florida  
GEARTNER ASSOCIATES, INC.  
235 Lincoln Road, Miami Beach  
305-531-0200  
GEARTNER ASSOCIATES, INC.  
2101 Mohawk Trail, Maitland  
305-647-4000

Georgia  
REP. INC.  
1483 Monroe Drive, N.E., Atlanta  
404-876-1591

Illinois, Wisconsin  
CARLSON ELECTRONIC SALES  
7448 North Harlem Avenue, Chicago  
312-774-0277

Indiana  
O. E. M. SALES COMPANY  
4165 Millersville Road, Indianapolis  
317-545-1267

Kansas  
IMPALA, INC.  
6917 W. 76th Street, Overland Park  
913-648-6901

Long Island  
MICRODOT INC. (Philip J. Dolan)  
P.O. Box 815, Westbury, L.I., N.Y.  
516-333-4664

Maryland, Virginia, Washington D.C., Carolinas  
WARREN MOUNT CO.  
7735 Old Georgetown Road, Bethesda, Md.  
202-657-9312

Michigan  
ROMARC  
696 Adams, Plymouth  
313-455-0300

Minnesota, Iowa  
HOWARD W. CARLSON  
100 N. 7th Street, Room 606, Minneapolis  
612-336-2236

Missouri  
IMPALA, INC.  
47 Village Square Shopping Center, Hazelwood  
314-522-1600

New England  
MICRODOT INC. (Ernest W. Smith)  
P.O. Box 309, Bedford, Mass.  
617-244-8434

New Mexico  
COMPAR ROCKY MOUNTAIN AGENTS, INC.  
2125 San Mateo Boulevard N.E., Albuquerque  
505-265-1020

New York  
ADVANCED COMPONENTS CORP., INC.  
119 Luther Avenue, Liverpool  
315-472-7886

Ohio  
RICHARD P. CALHOUN & ASSOCIATES  
40 Southmoor Circle, Dayton  
513-299-4144

Pennsylvania  
WARREN MOUNT CO.  
837 State Road, Andalusia, Pa.  
215-788-2272

Texas, Arkansas, Louisiana, Oklahoma, Miss.  
ROBERT R. THOMAS CO.  
8616 Northwest Plaza Drive,  
Suite 207, Dallas  
214-363-8591  
ROBERT R. THOMAS CO.  
4031 Broadway, Suite 105,  
Houston/713-644-2369

Washington, Oregon  
RAY OVER SALES  
1615 103rd Avenue, S.E.,  
Bellevue, Wash.  
206-454-9187



## MICRODOT INC.

220 Pasadena Avenue  
South Pasadena, Calif. 91030

*Twist/Con and Lepra/Con are registered trademarks of Microdot Inc.*



## Meeting preview

### On all fronts

The American Institute of Aeronautics and Astronautics, traditionally concerned with the lofty concepts of space, will also consider the more mundane problems of high-speed air and ground transportation. The institute's third annual meeting will take place in Boston's War Memorial Auditorium, Nov. 29 to Dec. 2.

Retired Air Force Maj. J.C. Maxwell, whose word on the supersonic transport development program will count heavily, will describe how the Federal Aviation Agency is handling the ticklish task of selecting the winner in the SST competition.

On the final day of the meeting, members will hear arguments on both high-speed air and surface transportation in the Boston-to-Washington corridor.

William Seifert of the Massachusetts Institute of Technology will present a paper on the technical problems of a ground transportation system capable of speeds of 300 miles per hour. Seifert will analyze such problems as propulsion, guideway, communications and control.

**Rapid transit.** Edwin R. Wisner of the Budd Co. will report on development of a 160-mile-per-hour passenger train running from Washington to Boston. Wisner will compare this design with the San Francisco Bay Area Rapid Transit Authority system. He will also show how the railroads are adopting systems developed for planes.

To be sure, the meeting will not ignore space. Topics such as space science experiments, propulsion systems and the application of aerospace technology in other fields will be examined.

Sessions are scheduled for those who specialize in reliability, marine systems and management. In addition, four panel discussions will bring together the nation's top men in the fields of space policy and launch and propulsion systems. The propulsion panel will debate whether new propulsion systems are needed for lunar and planetary flight.

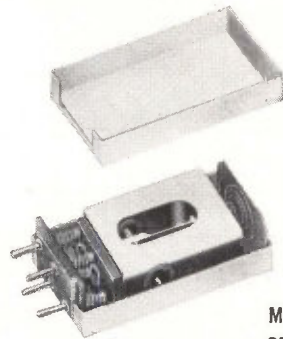

**MODEL RF20**  
contactless resonant  
reed encoder/decoder  
 $1\frac{1}{32} \times \frac{5}{8} \times 1\frac{1}{32}$

## REMOTE CONTROL SWITCHING WITH AUDIO SIGNALS

An audio tone can be generated by an electronic oscillator or resonant reed encoder circuit, then transmitted by wire or radio. The tone activates a resonant reed relay to perform a control function.

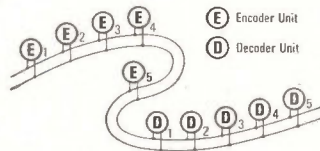

A single pair of wires, or a leased telephone line, can carry the audio signals for a complete control system.

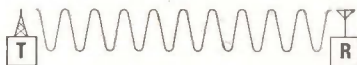

For inaccessible areas or mobile installations, a radio transmitter and receiver system can carry the signals.

Bramco reeds permit over 50 selective control frequencies within the 67 to 1600 cps spectrum. This is assured by: (1) the narrow response bandwidth of about 1% for decoders and (2) the high accuracy of Bramco reed encoders (1/10 of 1% of design frequency).

A big advantage of reeds in control switching is that they are ideally suited for simultaneous and sequential coded tone systems. The actual number of control functions possible in such a system is virtually unlimited. For example, over 3300 individual control functions are possible with only 16 frequencies coded sequentially in groups of three.

Compared to other types of tone filters, resonant reeds are small and inexpensive. They give more control functions per spectrum, per size, per dollar.

If you work with controls that select, command, regulate, or indicate, you should know about how it can be done with audio signals. We custom design and stock a broad line of encoder/decoder components and modules.

For literature write Bramco Controls Division, Ledex Inc., College and South Streets, Piqua, Ohio, or call 513-773-8271.



**BRAMCO CONTROLS DIVISION, LEDEX INC.**  
College and South Streets, Piqua, Ohio 45356

# Fast, convenient direct reading measurements of impedance and phase angle 500 kHz to 108 MHz...



## THE 4815A RF VECTOR IMPEDANCE METER

This new Vector Impedance Meter is a versatile instrument that provides fast, direct reading measurements of impedance and phase angle over the frequency range from 500 kHz to 108 MHz. It is continuous tuning over this frequency range, and does not require balancing or data interpretation. Thus, it is an extremely useful tool for the evaluation of the complex impedance of both active circuits and components. The convenience of probe measurement, ease of operation, and direct reading features make the instrument equally useful for laboratory, receiving inspection or production line measurements.

The 4815A is a convenient and powerful measuring tool for any application involving measurements over a band of frequencies or in-circuit measurements. It may be used to determine the self-resonance point of capacitors, the series and parallel resonance points of crystals, or the characteristics of high frequency transformers and transducers. Price: \$2650 f.o.b. factory. For complete specifications, contact your local Hewlett-Packard field engineer or write Hewlett-Packard, Rockaway Division, Green Pond Road, Rockaway, N. J. 07866; Europe: 54 Route des Acacias, Geneva.

### Advantages:

- Fast, continuous tuning from 500 kHz to 108 MHz
- Provides data directly in impedance and phase angle, 1 ohm to 100K ohms 0 to 360°
- Convenient probe for in-circuit measurements
- Analog outputs permit permanent data recording
- Self calibration check provides measurement confidence
- Low-level test signal minimizes circuit disturbance

HEWLETT  PACKARD  
An extra measure of quality



# Silicon or Bendix delivers

**Bendix has the plus to remember. And exclusive SOAR protection lets you forget about secondary breakdown.**

But it's more than just another plus. You'll find Bendix germanium and silicon power transistors for *every* need. With quality and performance capabilities at prices hard to believe.

Examples: Our B-5000 low-cost plastic silicon power units: 25 watts at 2.5 amps, 10 volts, 100°C—priced at less than 40¢ in volume. Or our standard commercial 2N3055; or our ultra-high reliability, radiation resistant NPN power units like the BR101.

Our germanium types—3 to 50 amps—are just as impressive. With high DC current gain, low collector cutoff current, low saturation voltage and remarkably fast switching times. Look at the charts and see.

And then there's exclusive SOAR protection—clearly defined Safe Operating Area envelopes for hundreds of these power units. As long as a given device is operated within its SOAR envelope, secondary breakdown cannot occur. There's no easier way to pick the *right* transistor.

Reliability, performance, quality of construction and price—you'll find them built into every package. Call or write your nearest sales office for full information.

700 W DC-DC CONVERTER

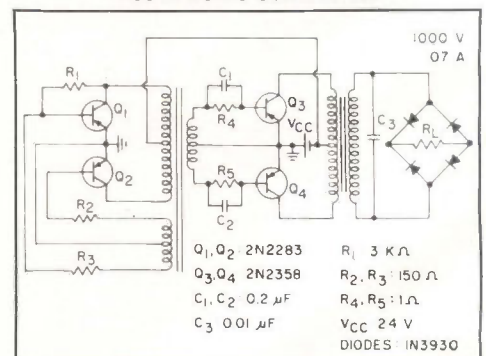

Baltimore (Towson), Md.—(301) 828-6877; Chicago—(312) 637-6929; Dallas—(214) 357-1972; Detroit—(313) Jordan 6-1420; Holmdel, N. J.—(201) 946-9400; Los Angeles—(213) 776-4100; Miami Springs, Fla.—(305) 887-5521; Minneapolis—(612) 926-4633; Redwood City, Calif.—James S. Heaton Co., (415) 369-4671; Seattle—Ray Johnston Co., Inc., (206) LA 4-5170; Syracuse, N. Y.—(315) 474-7531; Waltham, Mass.—(617) 899-0770; Export—Cable: "Bendixint," 605 Third Avenue, New York, (212) 973-2121; Ottawa, Ont.—Computing Devices of Canada, P.O. Box 508—(613) TALbot 8-2711.

# Germanium. the power-plus.

## 2N3055 SILICON NPN POWER TRANSISTOR

$V_{CB0} = 100 \text{ V}$                        $V_{CE0} = 60 \text{ V}$   
 $I_C = 15 \text{ A}$                                $P_{peak} = 900 \text{ W}$   
 $V_{CE(s)} = 0.4 \text{ V Typ at } I_C = 4 \text{ A, } I_B = 0.4 \text{ A}$   
 $t_r = 5 \mu\text{s Typ}$   
 $t_f = 1 \mu\text{s Typ}$  at  $I_C = 7.5 \text{ A}$

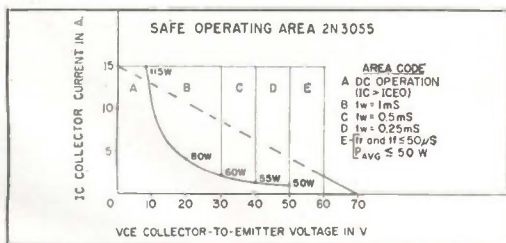

## GERMANIUM PNP ALLOY POWER TRANSISTORS

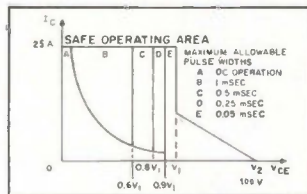

TYPE NUMBER	$I_C$ MAX A	$V_1$ V	$V_2$ V	$P_{peak}$ W	$\theta_{J-C}$ °C/W
2N514B	25	45	70	1750	0.5
2N677C, 2N678C, 2N1031C, 2N1032C	25	60	80	2000	0.8
2N1120	15	35	60	900	0.5
2N1136B-2N1138B	10	50	80	800	1.2
2N1146C, 2N1147C	20	45	70	1400	0.8
2N1166A, 2N1167A	25	45	75	1875	0.8
2N1365	6	70	100	600	0.8

## DAP® GERMANIUM PNP POWER TRANSISTORS

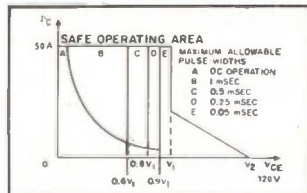

TYPE NUMBER	$I_C$ Max A	$V_1$ V	$V_2$ V
2N2284, 2N2469	3	70	110
2N1073B, 2N2290	10	70	110
2N1430	10	80	120
2N1653, 2N2287	25	60	100
2N2638	25	80	120
2N2359	50	50	90

**Bendix Semiconductor Division**  
 HOLMDEL, NEW JERSEY







With

**cdc**

it's #4

that makes

it a  
game!

*Whether it be in golf  
or in business,  
never ignore player #4*

Through the sheer impact of overwhelming advertising, many engineers and purchasing people are misled into believing there are only three broad based silicon semi-conductor manufacturers. Today, however, Continental Device Corporation can provide that essential competitive edge needed to assure high quality, low-cost semiconductor devices on firm delivery schedules.

Failure to utilize number 4 has caused many manufacturers to struggle against slow delivery and poor service. Start looking to number 4 to make it the game you would like to play.

*#4 is the name of the game.*

**1 WATT/400 mw**

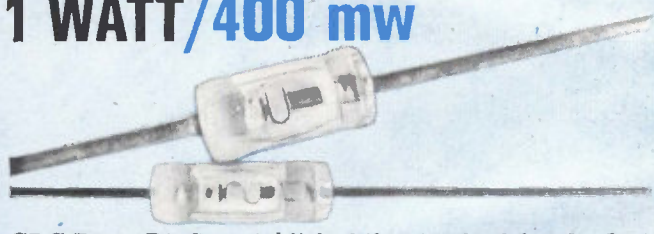

CDC Zener Diodes established the standard for the first military zener specifications. If stability and low leakage are essential, price and delivery paramount, check CDC.

JAN 1N746A-	1-99	100-999
JAN 1N759A	\$2.00	\$1.59

1 Watt Zeners are available to Mil specifications at comparable savings.

**FAST SWITCHING  
INTEGRATED POWER  
DARLINGTON  
CIRCUIT**



This device is an epitaxial integrated power circuit with all aluminum ultra-sonic bonded leads. This circuit is usable as a commutating diode, high speed power switch, regulator, high gain power gate and inverter, and linear or servo amplifier. Packaged for 20 watts rated power. Minimum gain of 1000 at 1 ampere.

2N998	1-99	100-999
2N999	\$12.00	\$ 8.05
	24.00	16.00



## SIZE UP YOUR NEEDS MINI-MONO/Mono Diode

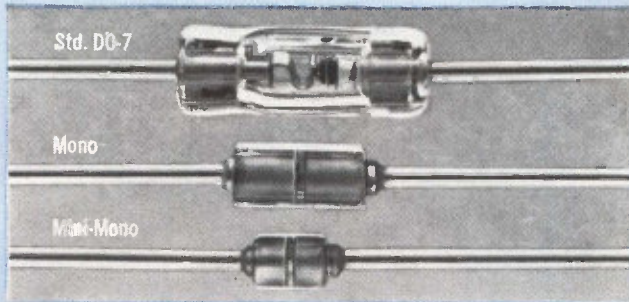

CDC's subminiature dual stud hermetic glass packaged unit is an extremely sophisticated device. Considerable dimensional and electrical flexibility exists. Units are available in O.D.'s from .060 to .100 and overall lengths from .090 to .265. Electrically, the range is from 1N457 to 1N3600.

DEVICE	STANDARD DO7		MONO-DIODE EQUIVALENT		MINI-MONO EQUIVALENT	
	1-99	100-999	1-99	100-999	1-99	100-999
JAN 1N914	\$.35	\$.24	\$.40	\$.27	\$.70	\$.57
1N916	.52	.35	.65	.43	.95	.73

## EPOXY/METAL CAN TRANSISTOR

With CDC the chip's the thing! Only the package changes. CDC uses the same stringent process controls in manufacturing dice for epoxy transistors as are used for all military and high reliability metal packaged devices.

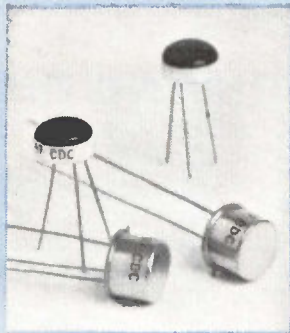

METAL CAN TRANSISTOR			EPOXY EQUIVALENT			
Device	1-99	100-999	Device	1-99	100-999	1000
JAN 2N697	\$1.00	\$.67	CS 697	\$.60	\$.40	\$.28
JAN 2N1613	1.50	1.00	CS 1613	.70	.47	.30

## PORTABLE IC TESTER... \$995.00

Model 9522 tests all DC E&I characteristics for any 2 to 14 lead integrated circuit. It is a solid state, short circuit protected device. It measures from 0-30V and from 1nA to 100mA. Also, it is adaptable for measuring switching characteristics. Has four 0 to  $\pm 15V$  power supplies with vernier control and two fixed 24V power supplies. Small, compact, easy to carry. Weighs a mere 25 lbs. Immediate delivery. \$995.00.



## RTL Mono Circuit

Continental Device Corporation's RTL family of monolithic circuits is really an extension of CDC's proven ability in the manufacture of hi-rel volume components. And when it comes to prices, CDC wins the game.



OPERATING RANGE:  $-55^{\circ}C$  to  $+125^{\circ}C$   
 $0$  to  $+100^{\circ}C$   
 $+15^{\circ}C$  to  $+55^{\circ}C$

To-5 metal can  
 To-5 metal can  
 Epoxy equivalent

DEVICE	PART NO.	PACKAGE	1-99	100-999	1,000
Buffer	CMC219001	Epoxy TO-5	\$.80	\$.54	\$.36
Dual 2-Input Gate	CMC219141	Epoxy TO-5	.80	.54	.36
JK Flip-Flop	CMC219231	Epoxy TO-5	1.50	1.00	.67

Write for  
**FREE**  
data sheets  
and new  
24-page color  
catalog!

**FREE** sample  
devices sent  
on request.

Contact your  
CDC representative or write the factory direct.



reliability...  
our first  
responsibility

# cdc

CONTINENTAL DEVICE CORPORATION  
 12515 Chadron Ave., Dept. E-14, Hawthorne, Calif. 90250  
 Phone: (213) 772-4551 • TWX: 910-325-6217



# IN MODULAR DC POWER SUPPLIES

# KEPCO'S OPERATIONAL CONCEPT MAKES THE DIFFERENCE!

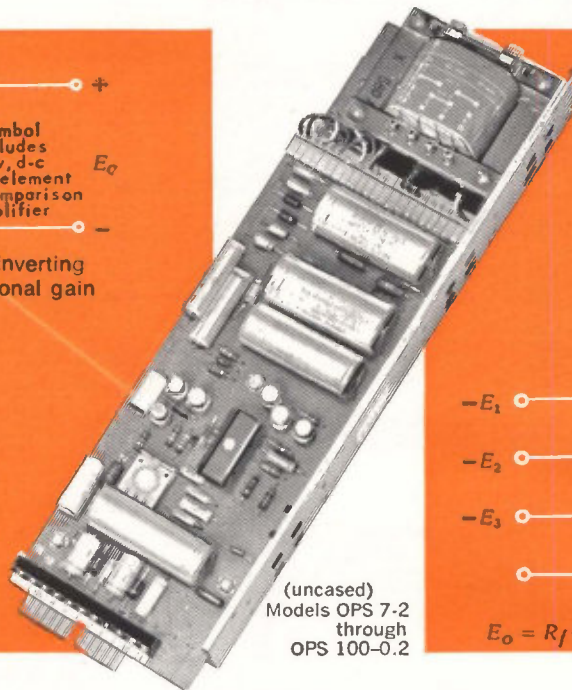
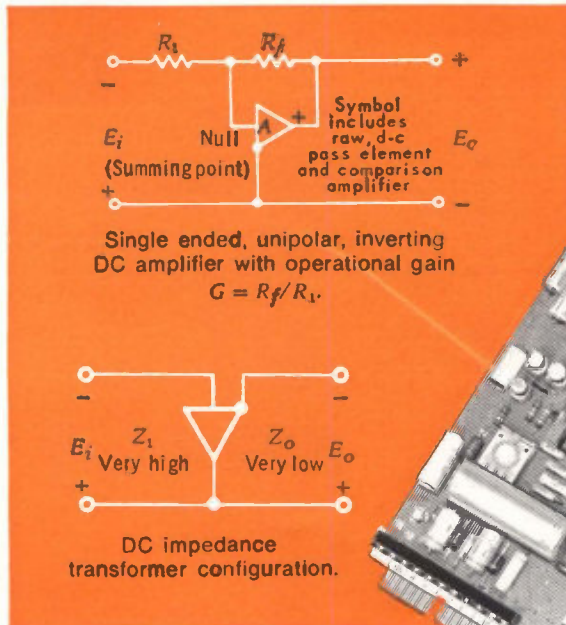

(uncased)  
Models OPS 7-2  
through  
OPS 100-0.2

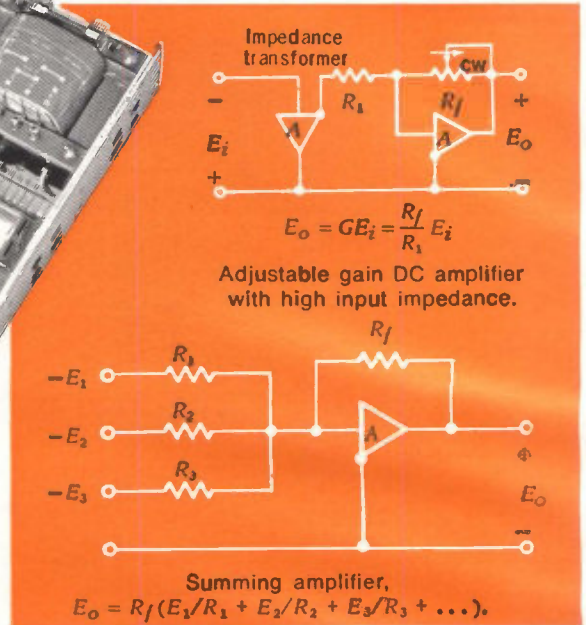

## FOR HIGH SPEED AUTOMATIC CONTROL

While operational programming is a general concept, applicable to a broad class of standard Kepco Power Supplies, its special requirements have evolved a new class of instrument called OPERATIONAL POWER SUPPLY.

OPS instruments combine in a single package; a high gain DC amplifier with adjustable offset voltage and offset current, a power booster capable of up to 20 watts, all necessary DC sources and two temperature-compensated (plus and minus 6.2V DC) reference potentials.

They are complete, needing only 115/230V AC power and input/feedback resistors to become a wideband, unipolar DC amplifier, or scaler, or impedance trans-

former, or — with feedback reactance — an integrator or differentiator.

Of course, they're also Power Supplies (What else — from Kepco?) and, connected as voltage regulators or current regulators, are capable of 0.01% regulation and stability with output CRUD\* more than 80 db below peak output.

Their exceptionally high slewing rates, in excess of 500,000 volts per second, fit the OPS module especially as a current regulator. By allowing output voltage to comply with load variations at a 0.5 volt per micro-second rate, OPS can maintain a very high source impedance over a wide bandwidth for a fast-responding, idealized current source.

\* Continuous and Random Unwanted Deviations.

### OPERATIONAL POWER SUPPLY FEATURES:

- Adjustable current limiting (Far more circuit protection than from mere short-circuit protection)
- 80 db DC voltage gain
- 500,000 volts per second slewing rate
- Built-in input voltage and current nulling
- High stability without chopper input
- Operate from 115 or 230 volt line 50-440 cycles
- Remote error sensing or programming
- Modular package
- Stable (0.01%) built-in reference

Applicable Patent Nos. furnished on request



NEW 52 PAGE CATALOG CONTAINING COMPLETE SPECIFICATIONS AND APPLICATIONS NOTES IS NOW AVAILABLE WRITE FOR YOUR FREE COPY!

MODEL	DC OUTPUT RANGE		OUTPUT IMPEDANCE		PRICE
	VOLTS	AMPS	DC	SOURCE INDUCTANCE	
* OPS-1	0-20	0-0.05	0.04	+15 $\mu$ h	\$150.00
† OPS 7-2	0-7	0-2	0.004	+15 $\mu$ h	130.00
† OPS 15-1.5	0-15	0-1.5	0.001	+15 $\mu$ h	130.00
† OPS 21-1	0-21	0-1	0.0025	+15 $\mu$ h	130.00
† OPS 40-0.5	0-40	0-0.5	0.008	+15 $\mu$ h	130.00
† OPS 72-0.3	0-72	0-0.3	0.025	+15 $\mu$ h	130.00
† OPS 100-0.2	0-100	0-0.2	0.050	+15 $\mu$ h	130.00

\* OPS-1 only: available in choice of bench style or plug-in case. † PLUG-IN CASE: add suffix "C" to model no. and \$10.00 to price.



See our complete Catalog in

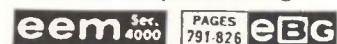

131-38 SANFORD AVENUE • FLUSHING, N.Y. 11352 • (212) IN 1-7000  
TWX # 710-582-2631 • Cable Address: KEPCOPOWER, NEWYORK



---

**Editorial**

---

## Forcing the airlines' hand

In September, the announcement by the Boeing Corp. of its determination to build the 489-passenger 747 jet aircraft obsoleted the electronic reservation system of every airline that will put the jumbo aircraft into operation. And the prospect of such huge passenger loads spotlighted the shoddiness and inadequacies of the passenger check-in and ticketing procedures of most airlines.

An editorial decrying these procedures [Sept. 19, p. 23] brought an icy protest from the Air Transport Association, an industry group that defends airlines. It also brought a flood of air-travel horror stories from fellow passengers. By horseback survey, if all the stories are true, as many as two out of every three passengers have trouble with reservations, checking in, buying a ticket or reclaiming luggage. It will be many times worse when the 747 starts flying in 1970, and even sooner because the stretched version of the DC-8 will start flying at the end of 1966 with 165-passengers and next year with more than 200 passengers.

The electronics experts who have been working to solve the passenger check-in problem—and the work has been pitifully limited primarily because the airlines have had little interest in speeding up procedures—agree that there is no technical reason for passengers to have so much difficulty when checking in for a flight. Electronics could have solved the problem three years ago. The rub has been economic feasibility. The airlines attach no monetary value to a passenger's feelings of frustration and irritation nor do they concern themselves with the time a passenger loses when he has to wait for a ticket agent or his luggage.

Happily, from the passengers' standpoint, the new 747 will force a change in the airlines' apathetic attitude. If they don't change, loading so many passengers could cause such long delays in departure that it would cost the carriers a fortune and destroy schedules. In fact, they would run so late they might even wake up the sleeping members of the Civil Aeronautics Board, the moribund, incompetent and ineffective government agency charged with protecting passengers' rights. (As an example of the CAB's current disdain for passengers, some airlines regularly run as many as 40% of their flights late without as much as a raised eyebrow from the members of the CAB.)

The first step the airlines will have to take is

to think in terms of an integrated system that uses electronics to tie the reservation system into the check-in and ticketing procedure. In almost every case so far, the airlines have tried to solve the problem piecemeal. They want to buy a piece of hardware here to do one part of the job and a piece there to do another. And the two pieces are never connected.

Secondly, the airlines will have to change some of their systems, procedures, accounting forms, rituals and checks. What has to happen can be compared almost exactly to the changes required when data processing first went into industrial companies. The financial men tried to use computers merely to mechanize bookkeeping procedures. Electronic data processing didn't really prove its worth until management recognized that a company's entire systems, procedures and forms had to be changed because of the character of the computer.

Without making a single technological development, a computer company could design a system that would make it possible for a regular traveler to telephone for a reservation, arrive at the airport and check in by inserting his credit card—with a magnetic strip—into a terminal device that would check his reservation, print out his ticket, charge his account, issue him a boarding pass, make a seat selection and provide a baggage tag for his luggage. With his boarding pass, he could get on the aircraft quickly and with a minimum of trouble. At the same time, the system would keep a running count of how many passengers had checked into that flight so the airlines could plan the handling of standby travelers in advance. The same system could work with other passengers too—the traveler making several consecutive flights on the same ticket, the no-reservation traveler, or the traveler who has to alter his ticket—by adding an agent to the loop. But the system would do most of the work of ticketing and check-in.

Unfortunately, it takes about three years to design such a system. Not because of any hardware lag but because it will take that long to understand the system and tailor hardware for it. For example, neither the airline nor the hardware people know how many passengers fly "two-leg" tickets—say New York to Chicago and return; how many arrive at the airport with no reservation; how many have consecutive flights on a single ticket, or how many passengers arrive at the airport to make a change (say from tourist to first-class service). One computer company hopes to start such a study next year if it can persuade an airline to cooperate.

With a clear assurance that electronics can simplify the check-in, ticketing and reservations, and an understanding that there will be a three-year design delay, passengers want the airlines to get on with the job of serving them.



# NEW! *Four problem-solving P&B relays . . . all immediately available at factory prices from leading electronic parts distributors*

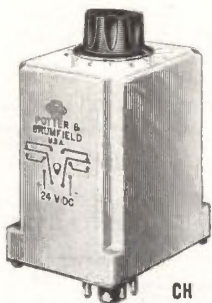

CH

## Solid State Time Delay Relays for as little as \$17.50

Here is a practical cost saving answer to many timing applications in the range of 1.0 to 180 seconds. You can save up to 60% on relay cost. They're available for AC or DC, knob adjustable, and accuracy is +10% over a -10°C to +55°C temperature range and include an internal 10 amp DPDT relay.

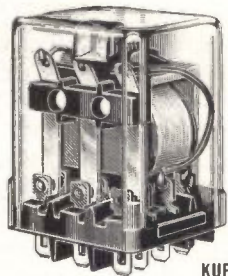

KUP

## Versatile KUP relay can be a cost-saving answer to your plug-in relay problem

Save up to \$2.00 each over similar relays with octal-type plugs. Get greater reliability, too. Relay has quick connect/solder terminals. Nylon socket (sold separately) rated for 10 amperes. One to three poles. Cover is heat and shock resistant lexan. For DC or AC operation.

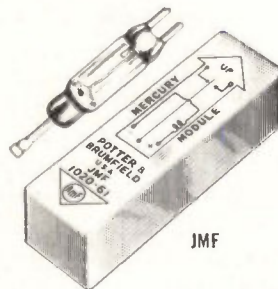

JMF

## The answer to billions of trouble free operations and speeds up to 1 millisecond

Mercury-wetted contact relay modules give you fast response, reliability, high sensitivity and extremely long life. Designed for printed-circuit mounting. Has SPDT, break-before-make (Form C) contact arrangement for single-side-stable or bi-stable operation.

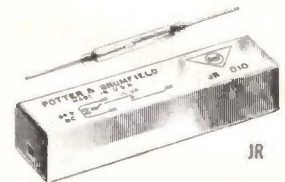

JR

## Reed Relays may replace expensive solid state devices

In many applications JR reed relays may be used in place of more expensive solid state devices over which they have one basic advantage . . . they are not subject to inadvertent switching by line transients.

For applications where fast operate time, low power and long life are required. Their high sensitivity and compact size recommend them for data processing, computer equipment, logic circuitry, for voltage or current sensing and various other types of control circuits.

*and there are 60 other basic types to choose from . . .*

*They're all in this new Stock Catalog 100. Free from your electronic parts distributor. Ask for your personal copy today.*



## POTTER & BRUMFIELD

Division of American Machine & Foundry Company, Princeton, Indiana  
Export: AMF International, 261 Madison Avenue, New York, New York



---

# Electronics Newsletter

---

November 14, 1966

## NASA pulls Voyager program out of JPL

In a surprise move the National Aeronautics and Space Administration is quietly transferring responsibilities for the Voyager unmanned planetary program from contractor-operated Jet Propulsion Laboratory to two NASA centers. Reasons reportedly involve both technical dissatisfaction and a need to keep the centers busy in the current period of declining space budgets. The action will shock industry, which had been expecting to get a large share of the Voyager program. Under the new arrangement it's expected that more of the work will be done in-house at the Marshall Space Flight Center, Huntsville, Ala., for the spacecraft, and at the Langley Research Center, Hampton, Va., for the landing capsule.

## Honeywell shifts to electrically alterable read-only memories

Honeywell, Inc., is taking a new tack in logical controls.

When it delivers its first H-8200 computer next year, the control for the big machine will be an electrically alterable read-only memory. Presumably interlocks in the memory's drive circuits will make it inaccessible to programmers, thereby preserving its control function.

Several other recently announced computers have read-only memories as their principal means of control, but the machines must be dismantled and all or part of the memory must be replaced when any part of the stored data is being changed. Such changes are sometimes required when design improvements are made or when the computer's application requires a special set of instructions.

Honeywell spokesmen will not disclose details of the new design, beyond saying that it used conventional ferrite cores with one hole, not multiaperture cores. Because of the memory's electrical alterability, its specifications will be less stringent than those of other read-only memories. Therefore, says Honeywell, it will be cheaper and easier to maintain. Also, it will be twice as fast as any other announced read-only memory, putting it in the 100- to 200-nanosecond range.

## High power at uhf with transistors

Solid state components may soon be invading one of the few remaining territories hitherto served exclusively by vacuum tubes: the generation of high-power ultrahigh frequency signals. In an experiment engineers at the Radio Corp. of America's Industrial and Power Tube division in Lancaster, Pa., have successfully combined the outputs of 64 overlay transistors to produce 1,200 watts of uhf power.

## Photovoltaic detector appears compatible with CO<sub>2</sub> lasers

The carbon dioxide laser, which at 850 watts of continuous-wave power holds the laser power record, may have found its match—a photovoltaic diode detector.

The detector, made of lead tin telluride (PbSnTe), is believed to be the first photovoltaic detector of infrared radiation in the 8- to 14-micron range. It's in this wavelength range that the CO<sub>2</sub> laser operates and, conveniently, it's in this range that transmission through the earth's atmosphere is attenuated least.

The PbSnTe work is being directed by Ivars Melngailis, head of the applied physics group at the Massachusetts Institute of Technology's Lincoln Laboratory.



---

# Electronics Newsletter

---

In a photovoltaic detector a change in the light signal produces a change in the device's output voltage. Virtually all of the previously developed detectors that were sensitive in the 8- to 14-micron range are photoconductors, that is, a change in the light signal produces a change in the device's resistance. Photovoltaic devices offer considerable advantages in some applications—such as speed of response and sensitivity.

In preliminary work photovoltaic response was observed up to 11 microns at liquid nitrogen temperature and up to 14 microns at liquid helium temperature. "This means that at 12°K we are covering the atmospheric window, and at 77°K we are able to detect the 10.6-micron radiation of a CO<sub>2</sub> laser," says Melngailis.

Although the Lincoln Lab scientist didn't say so, the development raises the possibility of tuning the detectors by varying their composition.

## Computer-controlled test gear for planes gains in industry

Computer-controlled test equipment for aircraft, already firmly established in the military field, is now moving into a civilian area.

Next week the Boeing Co. of Seattle expects to receive bids from 12 United States and British electronics companies for a four-station test and checkout system for jet aircraft production lines.

Although Boeing is the first, it's not alone in moving toward such computer-controlled gear. It's understood that Trans World Airlines, Eastern Air Lines and United Air Lines have started drawing up specifications for similar test gear, and bids for the equipment are expected to go out to industry next year. The company that wins the Boeing contract is expected to gain a lead for the airlines' contracts.

## Image-dissector gives computer eyes

Information International, Inc., of Cambridge, Mass., has developed what amounts to an eye for computers. The device, called an Eye, is an image-dissector camera similar to a low-sensitivity television camera. With it, the computer gets its input from its environment by viewing it directly instead of by the usual methods of punched cards, magnetic tape or optical readers.

Unlike a tv camera, which makes a raster scan over its entire field of view 30 times a second, the Eye has a conditional scan. It seeks out some significant part of the image, concentrates on it and then moves to other parts on order from the computer.

Controlling the Eye is a pattern recognition program with a certain degree of artificial intelligence. For example, the Eye may look at a drawing on a blackboard. First it looks at the whole blackboard, then it settles on part of a chalk line and finally it follows the line and analyzes the path to discover what kind of pattern was drawn.

## Instrument makers: IC's in-house or not

Edgerton, Germeshausen & Grier, Inc., of Bedford, Mass., a manufacturer of nuclear electro-optical and oceanographic instrumentation joins the Hewlett-Packard Co., Tektronix, Inc., and other instrument companies that have decided on in-house development and production of integrated circuits. But the General Radio Co. of West Concord, Mass., one of the oldest instrument makers in the business, hasn't yet decided on the IC path, concedes Ivan G. Easton, senior vice president.





## RCA Hometaxial-Base Transistors

A look at a power  
density problem  
called second breakdown...  
and the solution offered by  
RCA Silicon Power  
Transistors





# PROBLEM:

# Second Breakdown

## WHAT IS SECOND BREAKDOWN?

Second breakdown is a potentially destructive phenomenon resulting from the formation of localized "hot spots" induced by high-current concentrations. It is so named because it is the secondary voltage breakdown as opposed to predicted or primary breakdown. Second breakdown is characterized by an abrupt collapse in  $V_{CE}$  with a simultaneous increase in  $I_C$ . The resulting combination of high current and voltage destroys the transistor unless adequate current-limiting techniques are used. While second breakdown can occur in all transistors, it is of particular significance in power devices where high currents and voltage are encountered.

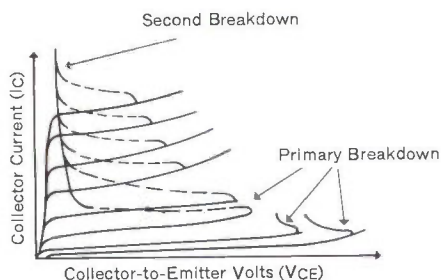

## IN WHAT MODES OF CIRCUIT OPERATION IS SECOND BREAKDOWN ENCOUNTERED?

Second breakdown can occur in both forward- and reverse-bias modes of operation of the emitter-base junction. The operating principle differs in each mode, as does the amount of energy or voltage initiating the effect. Forward-bias second breakdown occurs most often in linear circuits using power transistors. Reverse-bias second breakdown usually occurs in inductive power-switching circuits.

## WHAT HAPPENS IN FORWARD-BIAS SECOND BREAKDOWN?

During forward-bias operation, a transverse electric field is set up in the base region, and a "space-charge" layer is formed at the base-collector-junction. As current flows from the emitter to the collector, the transverse field focuses the current flow into a narrow region under the emitter edge. When the current flows through the "space-charge" layer, a significant amount of heat is generated by the combined product of current and voltage. With current flow focused into a small area, the heating effect is localized and the formation of hot spots (circled areas in diagram) may result. If unchecked, these hot spots initiate a regeneration cycle of highly focused current which may destroy the transistor.

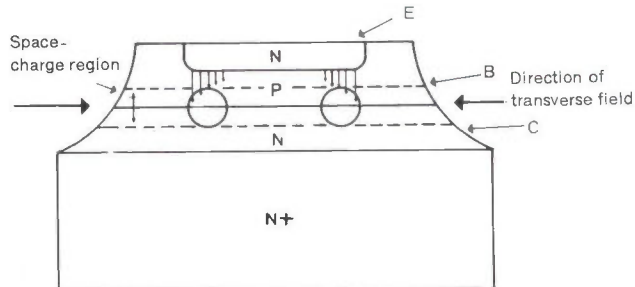

## WHAT HAPPENS IN REVERSE-BIAS SECOND BREAKDOWN?

During reverse-bias operation of the emitter, the direction of the transverse field is reversed by the polarity change. As a result, the emitter current is focused into a small region at or near the center of the emitter. Because of the crowding of current flow into a region smaller than that under forward-bias conditions, reverse-bias second breakdown can be encountered at substantially lower power levels. The resistance of a transistor to reverse-bias second breakdown is reduced

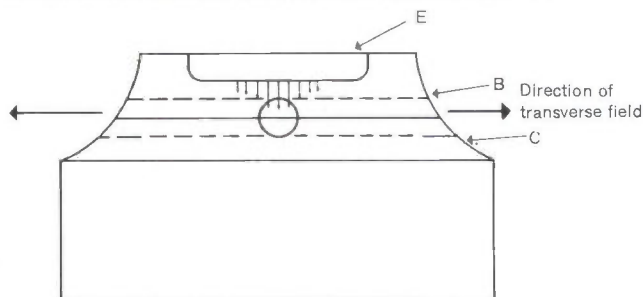

by any design alteration which increases current density or prevents emitter current from fanning out. Power transistor designs which have (1) narrow base width, (2) an accelerating base field, or (3) insufficient emitter size for their operating current generally exhibit reverse-bias second breakdown at lower power levels than transistors without these factors.

## WHAT IS THE RELATIONSHIP BETWEEN ENERGY REQUIRED FOR SECOND BREAKDOWN AND FREQUENCY CAPABILITY?

In the design of high-frequency transistors, the base width is minimized to reduce the transit time of emitter current through the device. The resulting short path does not permit significant current spreading or fan out. As a result, focused current flows across the collector junction with a resultant increase in power density and localized heating. Also, because of the narrower base region, this heating effect is more closely coupled to the emitter junction, promoting thermal regeneration and second breakdown. Designers should note that the selection of devices having higher frequency capability than needed for a given design greatly compromises circuit reliability and resistance to second breakdown.



# SOLUTION:

## RCA Hometaxial-Base Transistors

### WHAT IS RCA HOMETAXIAL-BASE TECHNOLOGY?

Hometaxial-Base technology is an RCA-developed process which has proved to be effective in preventing second breakdown. In this technology, a single-diffusion process is used to form both emitter and collector junctions in a uniformly doped silicon slice. The result is a *homogeneously* doped base region free from accelerating fields in the *axial* (collector-to-emitter) direction—hence the name Hometaxial. The Hometaxial-Base transistor is also characterized by a wide base region, further enhancing the ability of the device to resist second breakdown. The attendant simplicity of this technology has resulted in a family of reliable, low-cost power transistors.

### HOW DOES HOMETAXIAL-BASE TECHNOLOGY IMPROVE SECOND BREAKDOWN CHARACTERISTICS IN THE FORWARD-BIAS MODE?

Hometaxial-Base technology greatly minimizes the risk of second breakdown in the forward-bias mode by allowing the emitter current to fan out before it enters the collector region. Because uniform doping levels are employed, there is no field to accelerate the current. And because of the wide base width, the current fans out by electron diffusion before reaching the collector junction. Although these two factors limit somewhat the high-frequency performance of Hometaxial-Base transistors, they are most significant in preventing second breakdown.

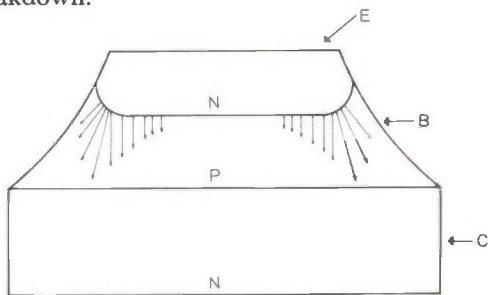

### HOW DOES HOMETAXIAL-BASE TECHNOLOGY IMPROVE SECOND BREAKDOWN CHARACTERISTICS IN THE REVERSE-BIAS MODE?

Because of the high-current densities under reverse-bias conditions, wide base structure and uniform doping are even more important than in the forward-bias mode. In addition, the collector of the Hometaxial-Base unit is designed to prevent "localized widening" of the base region into the collector layer. This "localized widening" occurs in multiple-diffused designs when the emitter current density increases beyond a value consistent with the fixed impurity doping level of the collector. The collector region of Hometaxial-Base transistors is designed to minimize this widening and the degradation of breakdown voltage which accompanies it in multiple-diffused structures.

### WHAT DEVICE RATINGS ARE AVAILABLE TO ASSURE MAXIMUM SAFE OPERATION IN THE FORWARD-BIAS MODE?

Every transistor is subject to second breakdown at some combination of voltage and current in the forward-bias mode. Accordingly, RCA has developed a series of "Safe Area of Operation" curves for both dc and pulse conditions. These curves show at what point a given transistor may be wholly limited, partially limited, or non-limited in terms of second breakdown. Such curves are now included in all recently published data for RCA Hometaxial-Base devices and are being added to the earlier published data sheets.

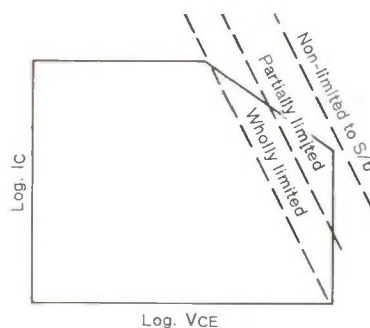

### ARE COMPARABLE DESIGN CURVES AVAILABLE TO ASSURE MAXIMUM SAFE OPERATION IN THE REVERSE-BIAS MODE?

Specifying devices for maximum safe operation in the reverse-bias mode is somewhat more complex than for forward-bias conditions. As a result, RCA supplies a series of three curves which relate source voltage, source resistance, and output inductance to the power required for second breakdown. With such a rating system, the designer can determine whether circuit operation conditions fall within the safe-operating region indicated. Again, RCA is adding such design curves to its new data sheets and is revising existing sheets to include them.

### SUMMARY

RCA's family of low-cost Hometaxial-Base transistors offers the user of silicon power devices two distinct benefits. First, it provides him with a proved transistor structure which, because of its wide-base, uniform doping, and special collector design, is inherently superior in eliminating second breakdown. Second, it provides him with a complete system of ratings curves which specify maximum safe operation in both forward- and reverse-bias modes. This combination of device design and application assistance equips the designer with a unique solution to the problem of second breakdown.

# RCA HOMETAXIAL-BASE TRANSISTORS...

a family of low-cost reliable  
silicon power transistors offering you  
freedom from the problems of second breakdown

FOR POWER APPLICATIONS UP TO 50 KHz, FROM 1A TO 30A

TO-5 $I_C$ (Max) TO 1A $P_T$ (Max) TO 5W	TO-66 $I_C$ (Max) TO 4A $P_T$ (Max) TO 29W	TO-3 $I_C$ (Max) TO 15A $P_T$ (Max) TO 117W	TO-3 $I_C$ (Max) TO 30A $P_T$ (Max) TO 150W
<b>40347</b> $h_{FE} = 20-80$ @ $I_C = 450$ mA $V_{CEV}$ (Max) = 60V	<b>40250</b> $h_{FE} = 25-100$ @ $I_C = 1.5A$ $V_{CEV}$ (Max) = 50V	<b>40251</b> $h_{FE} = 15-60$ @ $I_C = 8A$ $V_{CEV}$ (Max) = 50V	<b>2N3771</b> $h_{FE} = 15-60$ @ $I_C = 15A$ $V_{CEV}$ (Max) = 50V
<b>40348</b> $h_{FE} = 30-100$ @ $I_C = 300$ mA $V_{CEV}$ (Max) = 90V	<b>2N3054</b> $h_{FE} = 25-100$ @ $I_C = 0.5A$ $V_{CEV}$ (Max) = 90V	<b>2N3055</b> $h_{FE} = 20-70$ @ $I_C = 4A$ $V_{CEV}$ (Max) = 100V	<b>2N3772</b> $h_{FE} = 15-60$ @ $I_C = 10A$ $V_{CEV}$ (Max) = 100V
<b>40349</b> $h_{FE} = 25-100$ @ $I_C = 150$ mA $V_{CEV}$ (Max) = 160V	<b>2N3441</b> $h_{FE} = 20-80$ @ $I_C = 0.5A$ $V_{CEV}$ (Max) = 160V	<b>2N3442</b> $h_{FE} = 20-70$ @ $I_C = 3A$ $V_{CEV}$ (Max) = 160V	<b>2N3773</b> $h_{FE} = 15-60$ @ $I_C = 8A$ $V_{CEO}$ (sus) (Min) = 160V
		<b>2N4347</b> $h_{FE} = 20-70$ @ $I_C = 2A$ $V_{CEV}$ (Max) = 140V	<b>2N4348</b> $h_{FE} = 15-60$ @ $I_C = 5A$ $V_{CEV}$ (Max) = 140V

For more information on Hometaxial-Base transistors and how they help you solve the problems of second breakdown, see your local RCA representative. For technical bulletins on specific types, write Commercial Engineering, RCA Electronic Components and Devices, Harrison, N. J.

ALSO AVAILABLE THROUGH YOUR RCA DISTRIBUTOR



The Most Trusted Name in Electronics



# It's later than you think!



## Here's the second generation TWT amplifier.



*Smaller and lighter* than any other integrated TWT amplifier on the market! That's the difference—the BIG difference—between MEC's new low noise TWT amplifier and all first generation versions.

Let's be specific:

- MEC's rugged package weighs less than 4 pounds.
- It's only 11<sup>3</sup>/<sub>8</sub> inches long and is 2<sup>3</sup>/<sub>8</sub> inches square.
- It operates on *either* ac or dc.
- And, it meets MIL-E-5400 Class II requirements.

That's what makes MEC's TWT amplifier ideal for airborne and other applications where space and weight are at a premium.

The package combines MEC's proven miniature low noise TWT with an advanced power supply design. For precise, efficient, and stable performance, the all-silicon, solid-state supply features integrated circuitry and micrologic networks.



The unique primary input circuit allows you to operate from either 115 volt, 48 to 420 cycles ac, or 150 volt dc at efficiencies greater than 70%. That'll really simplify your

flight line or service area testing!

Compare the specifications of integrated TWT amplifiers—then let's hear from you.

Model	Freq. (GHz)	Gain min (db)	N. F. max (db)	P sat min (dbm)
M9071	2 - 4	35	10	10
M9072	4 - 8	35	10	10
M9073	8-12.4	35	10	10
M9080	7-11	35	10	10

Please write for complete specifications.

Exceptional opportunities exist on our technical staff for qualified scientists and engineers. MEC is an equal opportunity employer.



**Microwave Electronics** 3165 Porter Drive, Palo Alto, California

a division of Teledyne, Inc.



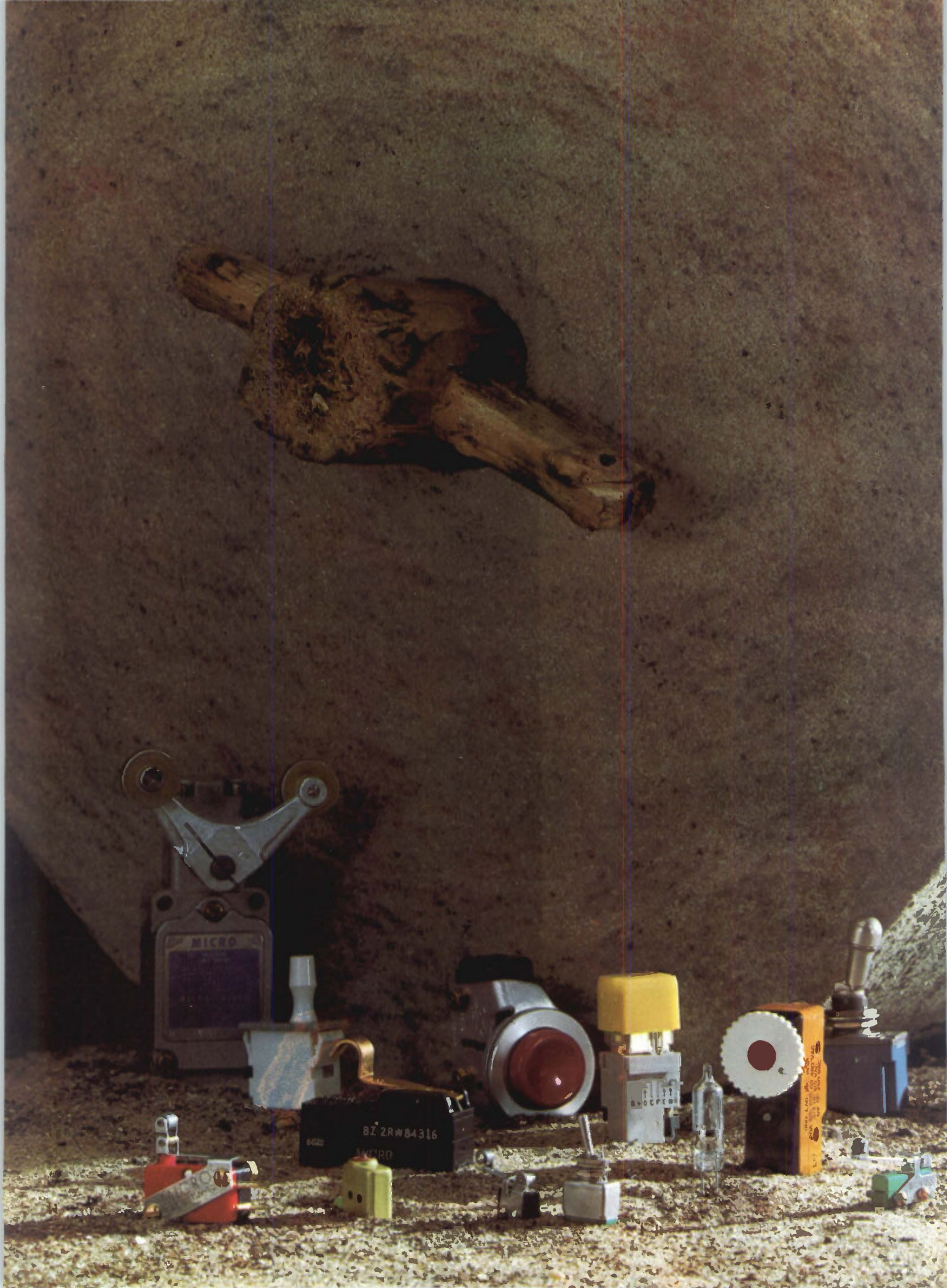





## Pioneering?

# You don't have to have someone re-invent the wheel

The answer to your latest switching problem may already have been developed. And, if there's any place in the world where you can get it right off-the-shelf, it's MICRO SWITCH.

Many of our switches would be considered specials by some people. But at MICRO SWITCH they are available without special engineering costs. They are available now. And they are application-proved reliables.

Main reason for this extra service is that we've specialized in nothing but switches for over 30 years. And in the process have come up with the world's largest selection of switches.

Engineering and application help is also available from MICRO SWITCH. Our field engineers are thoroughly experienced in solving switching problems. You will find them a cost-saving addition to your design team.

Call a local MICRO SWITCH Branch Office (See Yellow Pages, "Switches, Electric"). Or write . . .

## **MICRO SWITCH**

FREEPORT, ILLINOIS 61032

**A DIVISION OF HONEYWELL**

HONEYWELL INTERNATIONAL • Sales and service offices in all principal cities of the world.  
Manufacturing in United States, United Kingdom, Canada, Netherlands, Germany, France, Japan.

Circle 33 on reader service card



# We dropped "Chemical" from our



MATERIALS FOR FERTILIZERS AND EXPLOSIVES

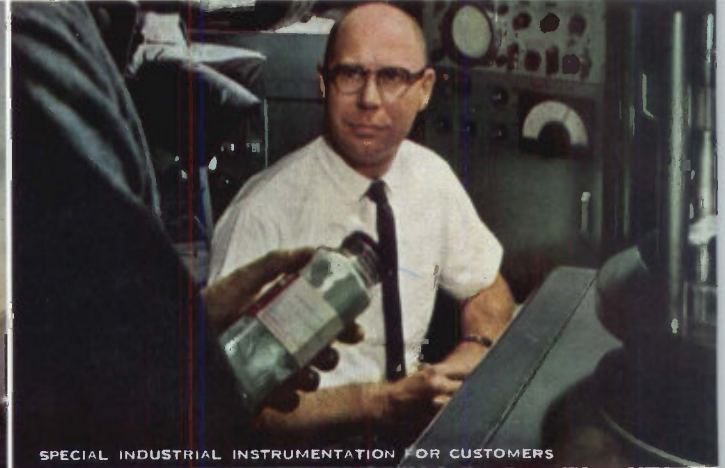

SPECIAL INDUSTRIAL INSTRUMENTATION FOR CUSTOMERS

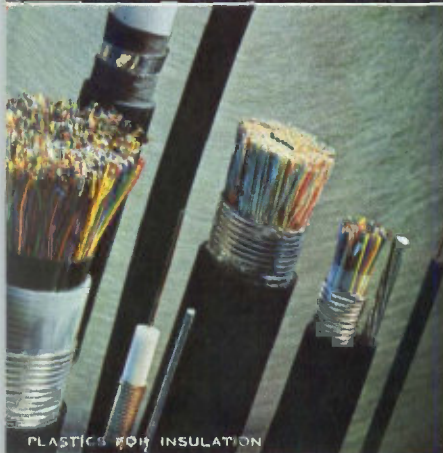

PLASTICS FOR INSULATION



ACRILAN<sup>®</sup> ACRYLIC FIBERS FOR CLOTHING

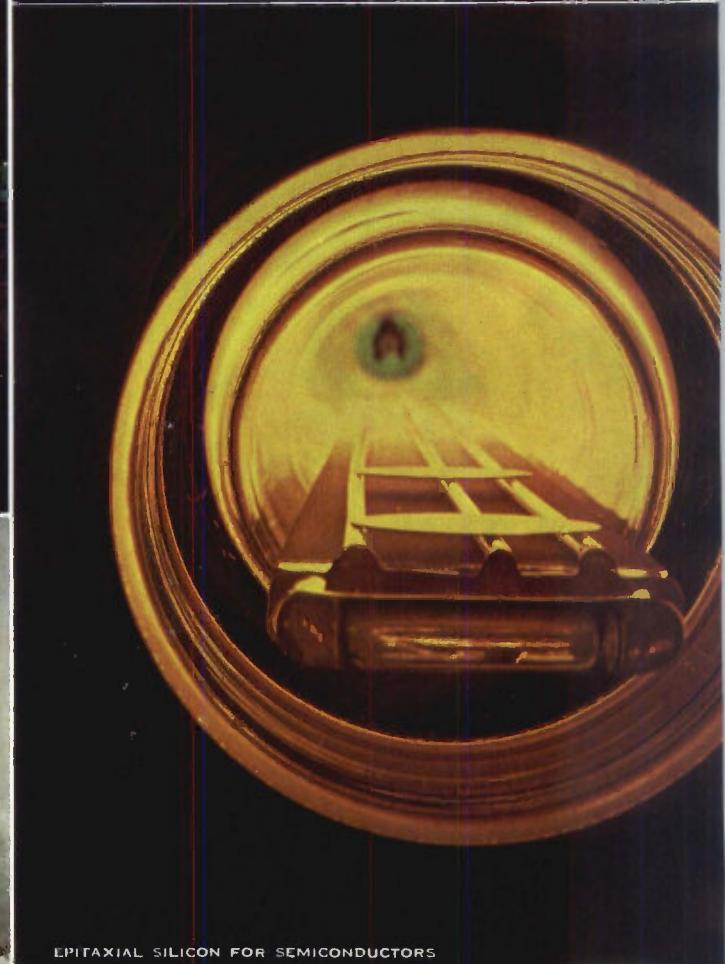

EPITAXIAL SILICON FOR SEMICONDUCTORS



HYDRAULIC FLUIDS FOR JET AIRCRAFT



# name because it pinched!



**Monsanto helps solve problems of more than 50 industries with a broad mix of 1,000 products.**



MONSANTO COUNTER/TIMER 1020

Are electronic test and measurement instruments *chemicals*? Hardly! That's one of the reasons the name pinched.

Yet we're offering you versatile, top-quality instruments featuring advanced microcircuitry today.

Last year we produced 43 basic new products of all kinds. New patents came in at the rate of one for every day of the year. We invested \$70 million on research, development, engineering and basic patent work last year, too, and the same level and quality of innovative technological effort assure you of the best in test and measuring instrumentation.

So just call us "Monsanto." And call on us when you're seeking electronic instruments to help solve *your problems*.

May we tell you more? Write Monsanto, Electronics Technical Center, 620 Passaic Avenue, West Caldwell, New Jersey 07006. Or telephone: (201) 228-3800.



ELECTRONIC<sup>®</sup>  
INSTRUMENTS

Circle 35 on reader service card







**The Fairchild 704A  
broad-band X-Y scope  
gives you a clearer,  
sharper picture.**

**It gets rid of jitters  
and of parallax problems.  
It is stable and reliable.  
And it is ten times more  
sensitive than any other  
scope of its kind.**

**Get the full picture in our  
new brochure.**







## At .0008" dia., Craftsmanship is paramount

LEAD-BONDING CAPILLARY TUBES OF TUNGSTEN CARBIDE, with bore sizes as small as .0008", are made possible by Tempress' unique ability to machine and polish ultra-hard materials in microdimensions. This has brought a new efficiency to semiconductor manufacturing. Bonding tips are held in shank by a magnetic system, permitting instant replacement, even while heated. Heated shank maintains constant tube temperature from 0° to 350°C. This unique system for thermal compression

bonding of leads to semiconductors has brought important savings in time, tools, and materials to the nation's leading semiconductor manufacturers. Equally fine craftsmanship is applied to the Tempress line of diamond scribes, lead-bonding wedges, diamond lapping points, and other miniature semiconductor manufacturing tools.



# TEMPRESS

Tempress Research Co., 566 San Xavier Ave., Sunnyvale, California

Circle 38 on reader service card

In Making Masks for  
Electronic Components ...  
... there's no  
Margin for Error!



**THAT'S WHY EXPERIENCED DESIGNERS  
AND ENGINEERS ALWAYS INSIST ON...**

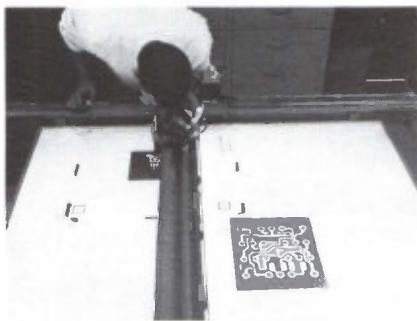

**R**UBYLITH<sup>TM</sup>

HAND-CUT MASKING FILM FOR THE GRAPHIC ARTS

the  
knife-cut  
light-safe  
masking film  
laminated  
to a stable  
polyester base

*by*

**Ulano**<sup>TM</sup>

DETAILS, SPECIFICATIONS AND TEST KIT OFFER





## HERE'S HOW...

THE ELECTRONIC INDUSTRY IS USING  
THESE FAMOUS ULANO FILMS IN  
ULTRAMINIATURE MASK TECHNOLOGY  
AND COMPLEX PRINTED CIRCUITRY

Cut a piece of the desired film large enough to cover area to be masked. Tape it down firmly at the top *with dull-side up*.

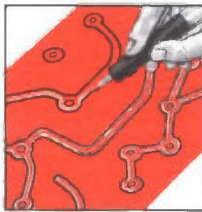
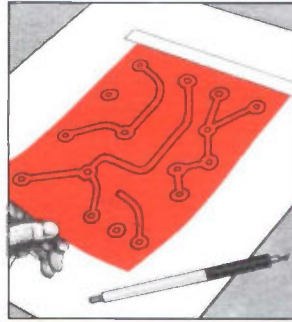

With sharp blade, outline the areas to be masked. *Do not cut through the backing sheet.* The Ulano Swivel Knife does the job quickly, easily.

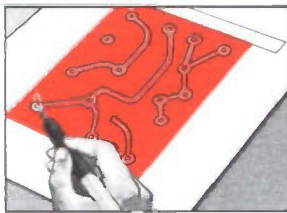

Using the tip of the blade, lift up a corner of the film thus separating it from the backing sheet.

Now carefully peel off the film as outlined leaving a completed mask, positive or negative, that corresponds exactly to the desired pattern.

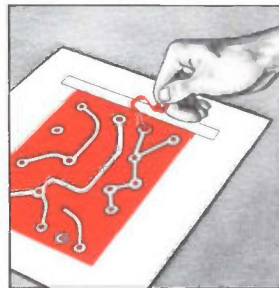

# Ulano<sup>TM</sup>

## RUBYLITH<sup>TM</sup> AMBERLITH<sup>TM</sup>

HAND CUT MASKING FILMS FOR THE GRAPHIC ARTS

ULANO RUBYLITH... a revolutionary knife cut red film is laminated to a stable transparent plastic backing sheet. The red film is "light safe" so that when contacted to a sensitized emulsion and exposed to a suitable light source, light passes through the cut-out portions only... not through the red film. ■ The polyester backing is absolutely stable... insures perfect register. ■ Special effects such as crayon tones, paste ups, benday sheets, and opaquing are easily combined with versatile ULANO RUBYLITH.

ULANO AMBERLITH... a companion to Rubyolith serves as a color separation medium used as the master on camera copy board to secure negatives or positives.

*A wide variety of Ulano films—  
in rolls and sheets—is readily available*

## Designed FOR YOUR PARTICULAR NEEDS

Ulano offers the most versatile line of hand-cut masking films, including:

.0075—RUBYLITH 75 DR\* .005—RUBYLITH 5 DR†

.005—AMBERLITH 5 DA†

Where exact register assures a critical importance, you will find these new, thick, polyester based films the positive answer.

\* Available in sheets only, cut to your specifications

† Available in rolls and sheets



**WRITE TODAY**  
*on your letterhead for free  
special sample kit B 48*

"Ulano"—"Rubyolith"—"Amberlith" are registered trade marks of the Ulano Companies.

# ulano

610 DEAN STREET, BROOKLYN, N.Y. 11238

In Europe: ULANO A.G., Untere, Heslibachstrasse No. 22, Kusnacht, Zurich, Switzerland

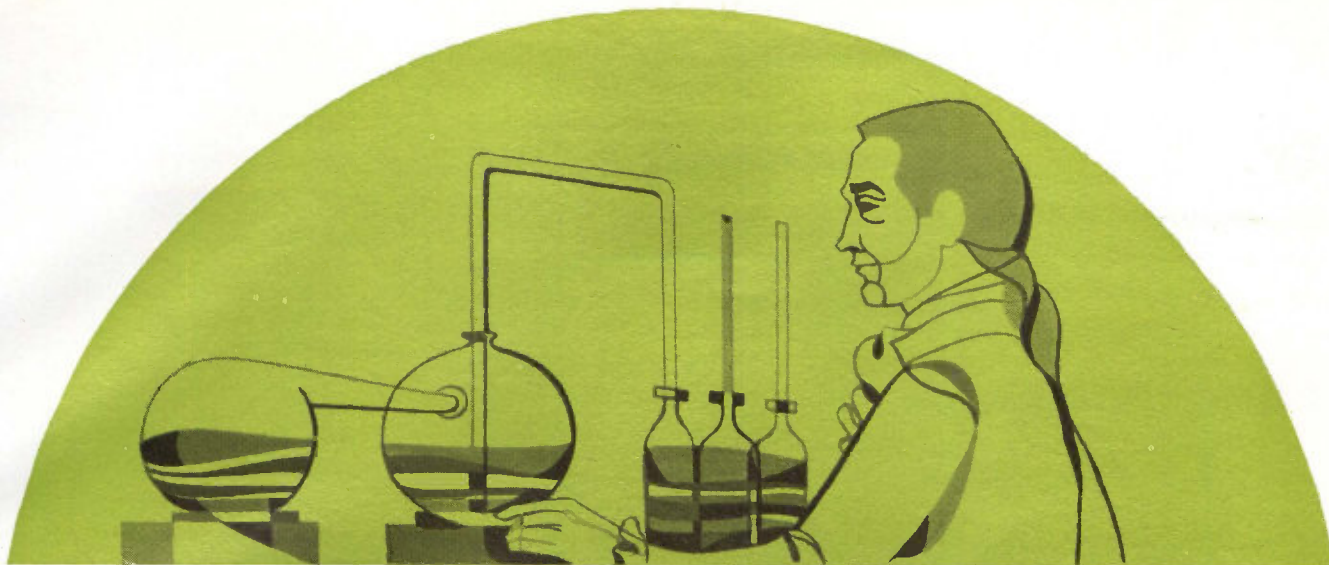

## INNOVATION IS THE PULSE OF PROGRESS

In 1757, the French chemist, Antoine Lavoisier, showed that when oxygen combines slowly with iron or certain other metals, rusting takes place and a precise increase in weight occurs. He also demonstrated that certain metal oxides, such as mercuric oxide, lose oxygen and become lighter when heated. By such novel studies, he established the existence of oxidation processes and, more importantly, the existence of discrete

elements. A genius of his time, Lavoisier pointed out that matter is neither lost nor gained in a chemical change and that as much heat is required to decompose a compound as is given off when the compound is formed. He introduced the first rational nomenclature and quantitative methods of chemistry. Lavoisier was truly one of the great chemists and is often called the founder of modern chemistry.



## THERMOFIT® ZAP GUN

In 1957 Raychem pioneered a series of innovations in the field of radiation chemistry. Among the first was the production of heat-shrinkable plastic tubing for the insulation and protection of connections and terminations . . . now an accepted device in virtually every industry. Among the many types of heat-shrinkable products is the Thermofit Solder Sleeve<sup>1</sup> which solders, seals, and encapsulates in one operation. Now, Raychem is introducing another innovation — the Zap Gun — a totally new heating device for installing solder sleeves in less than 2 seconds.

<sup>1</sup>Raychem Trademark, Patent Pending  
<sup>2</sup>U.S. Pat. No. 3,243,211



RAYCLAD TUBES INCORPORATED  
 A SUBSIDIARY OF

**RAYCHEM**  
 CORPORATION

OAKSIDE AT NORTHSIDE • REDWOOD CITY, CALIFORNIA 94063 • (415) 369-7171 • TWX 910-378-5426



**FROM PAR** Detection, Measurement or Comparison of Noisy Signals

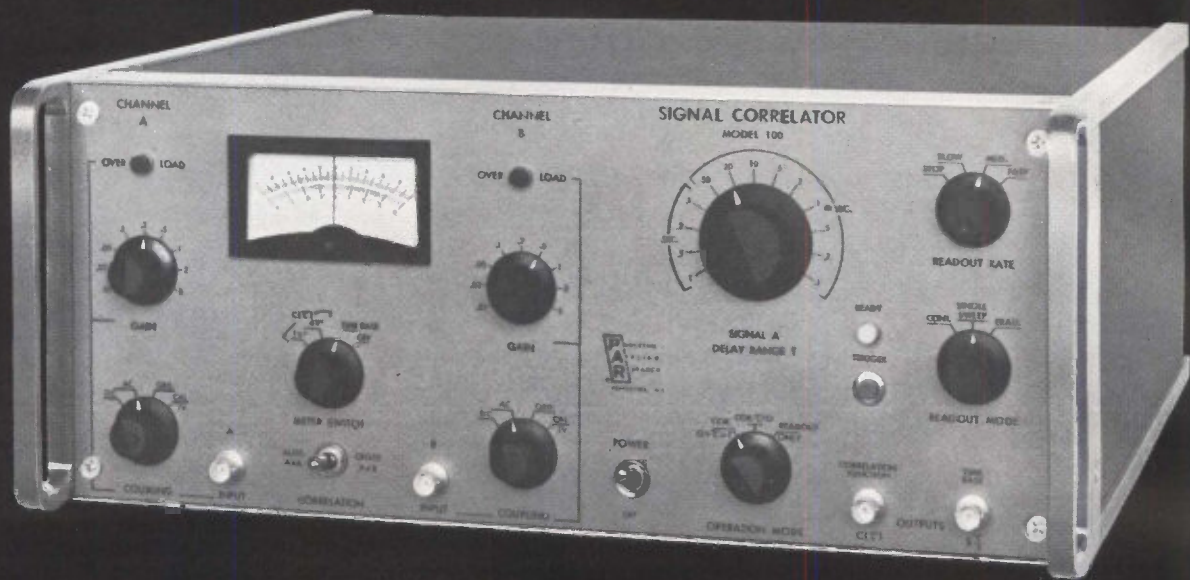

## New Signal Correlator

**PERFORMS AUTO- OR CROSSCORRELATIONS IN REAL TIME**  
**CORRELATION FUNCTION COMPUTED FOR 100 DELAY POINTS SIMULTANEOUSLY**

The PAR Model 100 Signal Correlator, a general purpose, high accuracy instrument of wide dynamic and delay range, computes the auto- or cross-correlation function of input signals and makes them available for continuous display. This system computes 100 points of the correlation function over total spans from 100 microseconds to 1 second. It operates by simultaneously multiplying one input signal by 100 separate delayed replicas of the second input signal. The resulting 100 products are individually averaged and stored in analog memory elements. Readout, which may be performed continuously as the correlation function is being computed, is accomplished by scanning the memory bank at a rate consistent with the speed of the external readout device, e.g., an oscilloscope or x-y recorder.

Correlation analysis — an extremely powerful signal processing technique in many areas of science and engineering — has heretofore been neglected, largely due to a lack of availability of suitable equipment. The

PAR Model 100 Signal Correlator will be useful in such diverse fields as aero- and hydrodynamics, plasma physics, vibration analysis, radio astronomy, radar, lasers, medical physics and geophysics.

**PAR Model 100—  
 Hundred Point Time Delay Correlator  
 SPECIFICATIONS IN BRIEF:**

**Total Delay Range:** 100  $\mu$ Sec to 1 Sec in 1, 2, 5 sequence.

**Input Signal Levels:** Peak-to-peak signals of 0.4 volts to 200 volts are accommodated without overload in each channel.

**Correlator Gain Factor:** At gain of 1 in each channel, 1 volt into each input will give 1 volt of correlated output. Gain for each channel is .01 to 5, in 1, 2, 5 sequence.

**Noise and Dynamic Range:** Base line noise with no signals,  $10^{-3}$  volts peak-to-peak. Maximum correlated output, 3.5 volts.

**Frequency Response and Resolution:** Channel amplifiers flat to 1 megacycle. Resolution: 100 sampling points on output function.

**Averaging Time - Constant:** Nominally 20 seconds; May be changed to any value from 0.1 to 100 seconds.

**Accuracy:** Better than 1%.

**Readout:** 0-3.5 volts at sweep rates of 20 per Sec, 1 per 10 Sec, 1 per 50 Sec.

**Price:** Approx. \$8500.00 Export price approximately 5% higher, except Canada.

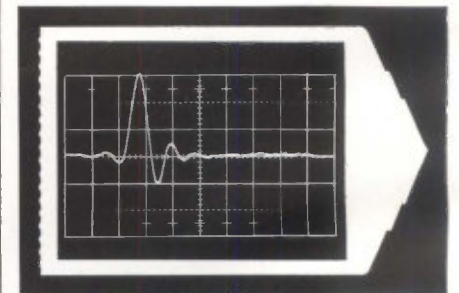

Typical Photograph of Crosscorrelation Function of Input and Output Signals of Complex Passive Network Driven by White Noise.

For more information call (609) 924-6835 or write Princeton Applied Research Corp., Dept. D, P.O. Box 565, Princeton, N. J. 08540.



**PRINCETON APPLIED RESEARCH CORP.**



## Computers

### Copy writing

Up to now an engineer using a computer writing tablet, such as the Rand tablet, had to be endowed with what amounted to split vision. He had to draw on the tablet with a special stylus, and at the same time watch a display of what he was drawing on a cathode-ray screen—a procedure that's both distracting and tiring. But a new computer writing tablet enables the engineer to write on a piece of paper with a pencil and the pencil's pressure on the paper enters the handwritten data directly into the computer.

**Proves technique.** Designer John Simek of the International Business Machines Corp.'s engineering laboratory at Endicott, N.Y., has built one model of the tablet for an adaptive learning project to prove that the technique works.

In some respects the IBM unit resembles the Rand tablet, a graphic input device developed by the Rand Corp. [Electronics, June 14, 1965, p. 42]. But the Rand tablet uses a stylus that's wired to the computer to transmit the signals, and it makes no hard copy.

The IBM tablet has a 2-by-5 inch writing surface made of a Mylar film lying on a copper-clad glass-epoxy board; a set of parallel conducting lines is etched on top of the board and a perpendicular set is printed with conductive ink on the bottom of the film. Both sets of lines are spaced 32 to the inch. A binary counter applies voltage pulses to each of the first set of lines in order; and sense amplifiers detect which of the second set is in contact with one of the first set. The sequence of pulses transfers the pattern into the computer's memory. The computer can then execute a pattern-recognition program, display the pattern on a

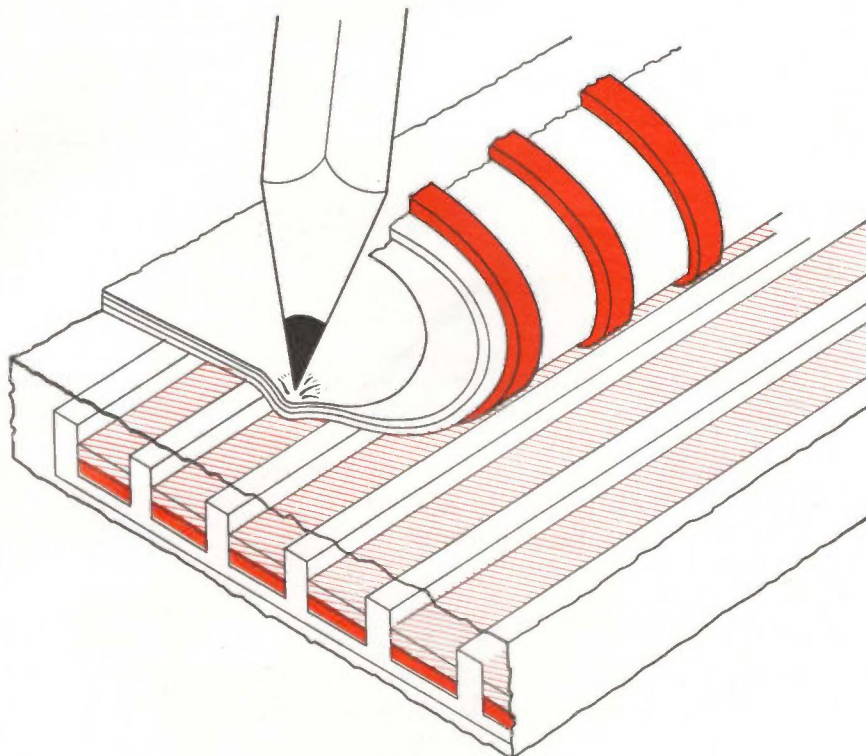

Pressure of a pencil point on IBM tablet generates computer data.

screen or process it.

**Smooth.** Both sets of lines are gold-plated to establish a low-resistance contact. The lines on the glass-epoxy board are depressed 0.0005 inch beneath the surface to avoid spurious contacts by hand pressure or wrinkles in the Mylar. The depressions are not so deep that the writing feels bumpy.

Simek uses his transducer to handprint letters into a computer, which was programmed to recognize different characters entered by different people. He divided the writing surface into 40 half-inch squares with a 16-by-16 matrix of grid lines in each square; corresponding lines in each matrix were electrically connected. Thus, patterns drawn in any square look like patterns drawn in any other square. This is sufficient for his project and reduced considerably the amount of electronics needed to drive and sense the transducer. In its present form, the transducer doesn't tell

the computer where on the tablet the letter is being written. However, says Simek, it wouldn't be too difficult to add electronics to give the system this capability.

The transducer is similar to IBM's elastic diaphragm switch announced about a year ago. That device established contact through holes in a plastic sheet, defining the path of a pencil or stylus and providing signals that could be used by a computer. Neither the elastic diaphragm switch nor the new transducer has reached IBM's commercial production line.

### Timely program

People count by tens and computers by twos. But the passage of time is counted by a complicated mixture of tens, twelves and sixties—satisfying neither man nor computer.

Frank Cilino and several engi-



neer colleagues at the Western Electric Co.'s laboratory at Princeton, N.J., have worked out a calendar scheme that should satisfy both man and machine. Their plan is to divide time into what they call millidays; one milliday is one thousandth of a day and as a unit of time it retains the advantage of the day—the cycle of human activity.

**Work-a-day.** The computation of the milliday was not meant as an idle exercise to amuse puzzle buffs. It offers a real advantage for both commercial and scientific users of computers. Consider this: a payroll program computes the pay for a workman who punched in at 8:22 a.m. and punched out at 4:08 p.m.—a mixed-modulus calculation. Or this: a data-communications computer calculates the duration of all incoming and outgoing messages to determine proper charges for telephone service; messages originating in different time zones where night rates may be in effect must be charged differently from local messages.

Cilino's choice of a milliday is sufficient to provide enough resolution—corresponding to 1.44 conventional minutes or 86.4 seconds—for most commercial needs and many scientific needs. Where finer resolution is necessary, millidays are easily divided into still smaller units.

Under the system days are numbered sequentially from 1 to 365 (366 in leap years). Then, Feb. 18 becomes day 49, and June 4 becomes day 155 (day 156 in a leap year). With this system, leap years are of no consequence except on day 366. Furthermore, 9:00 a.m. on June 4 becomes day 155.375, and 6:00 p.m. of Feb. 18 becomes day 049.750. Direct subtraction of two purely decimal numbers gives the elapsed time in decimal fractions.

**Clock puncher.** This method of measurement affords two bonuses. First, a computer can treat time and date as arithmetical quantities, without requiring special routines to change the base—except for changes between binary and decimal, which it has to do quite often anyhow. Second, an ordinary six-place decimal counter becomes a clock-calendar if it is tripped once

each milliday. Such counters can be driven by standard one-revolution-per-minute clock motors through 36-to-25 reduction gears, or by special one-revolution-per-milliday clock motors that are commercially available.

The measurement in millidays has some disadvantages, too. A milliday clock must be reset to 001.000 at midnight on New Year's Eve—exactly at midnight if it is to retain its accuracy. Conventional decimal counters reset to zero, not 001.000. And elapsed time from one year to the next must take this resetting into account. Furthermore, if the computer's measurement of time is to be included in outputs for human consumption, the days and millidays must be reconverted into standard form—at least until such time as people can be persuaded to tell time in millidays, too. This reversion would require another special computer routine.

Then there's the old bugaboo of time zones—an important consideration for computer systems that transmit and receive data over long distances. The correction is to add or subtract about 41.667 millidays for each time zone change; the exact correction is not expressible in

decimal notation, so that if this is done several times, a cumulative error can build up.

## Avionics

### Scattered view

Because the terrain-mapping radar on unmanned spacecraft flying over lunar surfaces can only measure a single angle of incidence at a time, many passes are required—a procedure that takes hours. Now, a new radar, called a Scatterometer, reduces those hours to minutes by eliminating the need to repeatedly reorient the radar antenna. One pass by the spacecraft is sufficient to measure all angles of incidence simultaneously.

The system was developed by the Ryan Aeronautical Co.'s Electronic and Space Systems division for the National Aeronautics and Space Administration.

**High and wide.** The Scatterometer—called that because it receives and records profile signals even when they are scattered by terrain—emits a 120° fan-shaped

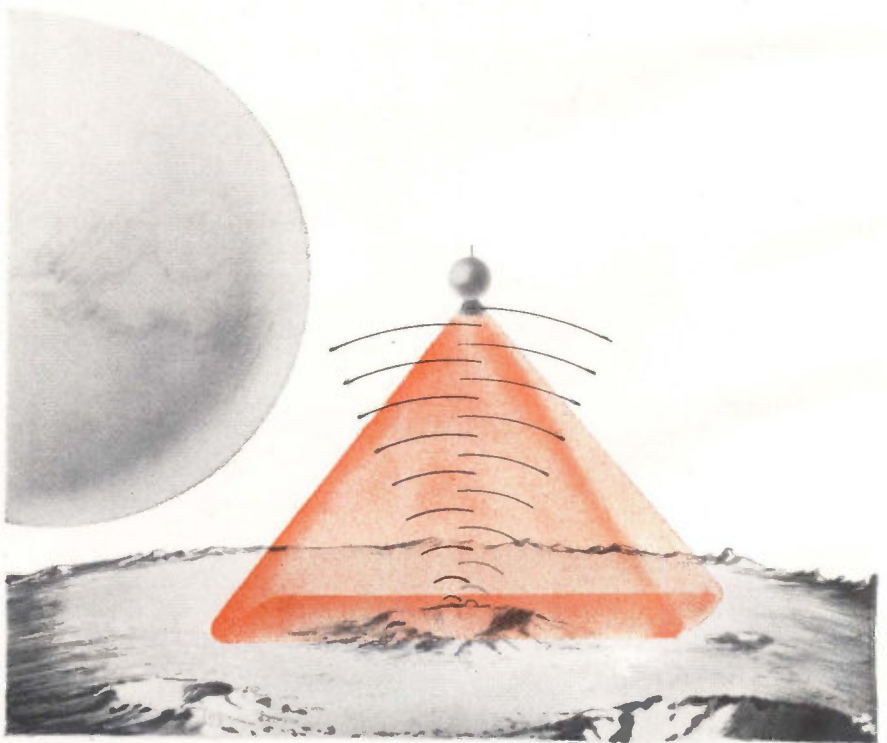

A spacecraft, using a Scatterometer, has to fly over a pock-marked area of the lunar surface only once to get a detailed profile of the terrain.



beam that simultaneously detects detailed signatures at many angles of incidence. For example, at an altitude of 30,000 feet the beam could map an area 20 miles long and 2 miles wide. By comparison, the conventional radar's pencil beam can scan an area of about 1/10 of a mile square and can detect signals returned at a single angle of incidence in a single plane.

The Ryan radar measures the backscattering cross section of the return signal by relating its amplitude at a given doppler frequency to its angle of incidence. Filters separate the reflected energy into discrete doppler frequency intervals; altitude and surface reflectivity characteristics determine signal amplitude in each frequency interval.

The doppler signals are converted into audio signals which are then stored on a wideband f-m tape recorder. After the flight, the tape is played back through a spectrum analyzer. A computer then synthesizes a topographical map by combining all the various data.

**Signature search.** Ryan engineers have mounted the system in a Douglas DC-3 flying laboratory and are making recordings of radar signatures of heavily forested land, rocky hills and deserts that are well known. These signatures will eventually be compared with radar responses from unexplored regions to prepare profile maps of these areas.

In addition, the military is considering adapting the wide-sweep radar to some down-to-earth applications. In battle areas like Vietnam, pilotless drones and manned aircraft would have to make only one pass over an area to get detailed maps of even the roughest topography.

## Electron devices meeting

### Sealing vacuum's fate

By combining the beam lead technique with a silicon nitride seal,

engineers at Bell Telephone Laboratories believe they have found a way to encapsulate transistors and integrated circuits in a batch process. The new technique makes it possible to seal thousands of devices simultaneously while they are still on a single silicon slice. Transistors made by the new sealing technique have already exhibited longer life under accelerated aging tests than hermetically sealed devices.

Potentially, the process could eliminate vacuum sealed systems, like TO-5 cans, which require that the slice be cut into individual chips that are then assembled on a header and sealed to a cover by a costly process.

The seal is formed by heating the silicon slice to 875°C in a closed chamber containing pure hydrogen. Then a mixture of silicon hydride and ammonia is introduced. On contact with the slice, the gases react to form silicon nitride, which adheres to the slice, forming a protective barrier against sodium ions and other forms of contamination.

**Window opener.** Beam lead contacts are also applied to the devices while they are on the slice. The contacts, made from multilayer combinations of titanium-platinum alloy and platinum silicide, form a strong chemical bond with the silicon nitride and seal the contact areas. To make electrical contact to the devices, windows are opened in the silicon nitride by etching.

The new process is highly effective in protecting semiconductor devices against penetration and contamination by metallic ions in the atmosphere. Sodium ions, because of their small size, are especially troublesome. Epitaxial silicon transistors sealed with the new method were exposed to sodium ions and then subjected to accelerated aging tests at normal bias but at a power level that raised the junction temperature to 300°C. Their median life exceeded the 1,000-hours of hermetically sealed transistors aged under the same conditions, but without exposure to sodium ions.

The sealing technique was described at the International Elec-

tron Devices Meeting in Washington by G.H. Scheer, W. Van Gelder, V.E. Hauser and P.F. Schmidt.

### Light on the beam

Another first for the beam lead technique was reported at the meeting in Washington. By combining planar and beam lead technologies, Bell Labs engineers W.T. Lynch and R.A. Furnange have been able to batch fabricate 4-by-4 matrix arrays of gallium arsenide

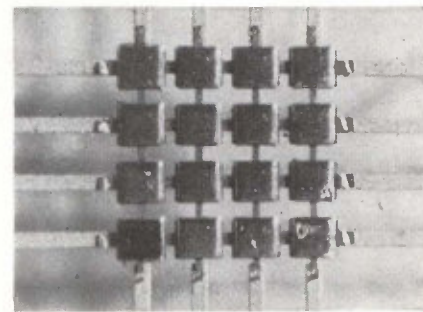

Beam leads support matrix of light-emitting diodes on 10-mil centers.

(GaAs) light-emitting diodes. This is the first time beam lead techniques have been successfully applied to gallium arsenide devices.

The diodes are arranged on 10-mil centers in a 40-mils square area. The devices are made by diffusing zinc into the GaAs after masking with alternating layers of silicon oxide (SiO<sub>2</sub>) and phosphosilicate glass. A continuous layer of SiO<sub>2</sub>, deposited after the pattern has been defined but before the diffusion step, minimizes lateral diffusion and reduces reverse current leakage to 10<sup>-11</sup> amperes or better, according to Lynch.

**Polishing the slice.** Beam leads make contact to the n and p regions of the diodes on the same side of the slices. The back of the slice is polished to a final thickness of less than 2 mils and the excess material between devices is etched away, leaving the diodes connected electrically and structurally by the heavy leads.

The process results in diode arrays of exceptional uniformity—at yields of about 90%—which indicates potentially low cost for the



arrays. Lynch and Furnange anticipate that the process can be successfully applied to matrixes as large as 10 by 10, with yields as high as 50%.

Light is emitted through the backs of the diodes. Typical quantum efficiencies are about 0.2% at excitation currents up to 100 milliamperes.

Because the spacing of the array can be closely controlled during fabrication, Lynch points out that alignment in optical systems can be made much more accurately than with individual diodes. He sees the arrays being applied as coupling interfaces with high isolation between computer subsystems and in memories.

### A monolithic first

The invasion of the microwave component field by integrated circuits continued at the International Electron Devices Meeting with the announcement of the first all monolithic microwave IC. Alfred Ertel, an engineer at Texas Instruments Incorporated, described a silicon antenna transmit-receive switch designed to operate at 9 gigahertz. The switch was developed as part of the contract TI has with the Air Force Systems Command for the investigation of molecular electronics for radar applications.

**On the substrate.** The circuit is contained on a single silicon chip 100 mils square. The active switching elements are p-i-n diodes integrated with microstrip transmission lines and thin-film capacitors on a silicon substrate. Bias to the

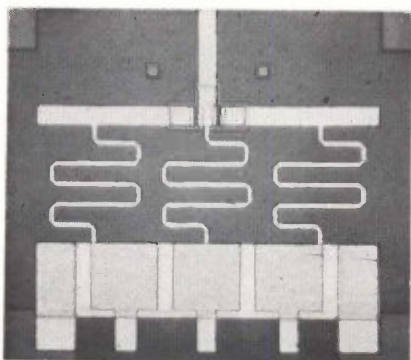

Components of first monolithic microwave IC include diodes, strip line chokes and thin-film capacitors.

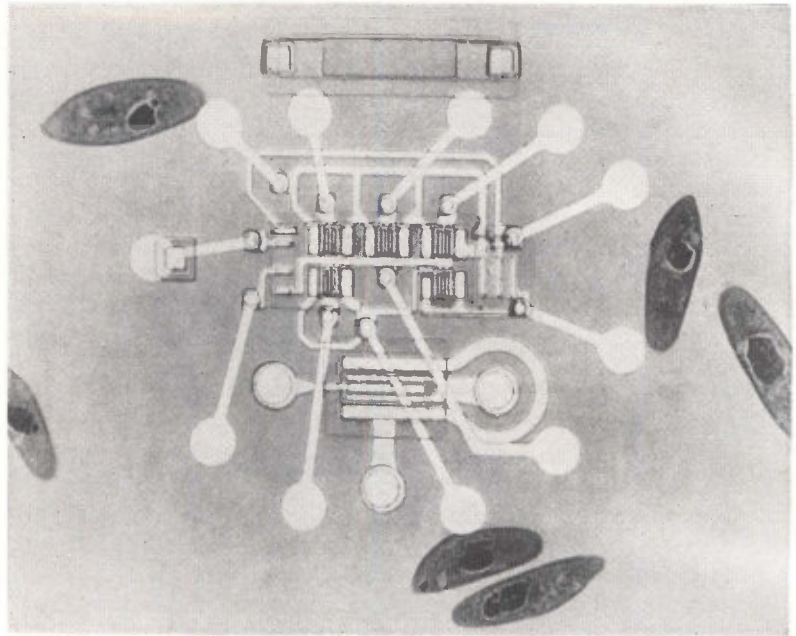

The highest speed for an integrated circuit is claimed by IBM for this 400-picosecond current mode switch. Oblong shapes are paramecia (for size comparison) not defects.

diodes is supplied through quarter wavelength meander line chokes which are bypassed to ground by the capacitors.

An important function of a transmit-receive switch is to isolate a receiver from a transmitter during transmission, thus preventing overloading of the receiver and possible burnout. The monolithic switch is capable of from 25 to 27 decibels of isolation with continuous-wave input of 1 watt, or a peak of 50 watts. The insertion loss over the frequency range of 8 to 9 GHz was 1.5 to 2 db. Voltage standing wave ratio was better than 1.5 to 1 over the range.

### Smallest, fastest

Development of a 400-picosecond current mode logic circuit in a single silicon chip that's less than 0.01 square inches, [Electronics, Oct. 17, p. 25] prompted the International Business Machines Corp. to claim a record for the smallest, fastest monolithic integrated circuit. IBM engineers at the International Electron Devices Meeting attributed the device's record performance to sharpened photolithography and masking techniques.

The circuit contains five transis-

tors and three diffused resistors. Each transistor is about 0.001 inch square and has emitter widths and emitter-to-base spacings of 0.000075 inch. The collector and emitter junction depths of the double-diffused transistors are 3,200 and 2,000 angstroms, respectively. Junction isolation and two levels of metalization are used in the IC.

Developers of the high-speed circuit, A. Dhaka and Kenneth West of IBM's Components division, reported that computer-aided transistor design techniques were used to optimize the transistors. Chief factors, they said, that affected the design were emitter area, mobile charge storage in the forward-biased emitter base junction, current crowding under the emitter and depth of the junction.

About 100 picoseconds of the new unit's 400-picosecond propagation delay, is package delay.

**Barriers pushed.** Bell Telephone Laboratories claimed two records with a 12-gigahertz oscillator diode and a 7-GHz transistor. The experimental silicon diode generates continuous-wave power double that reported for silicon pn diodes and eight times that reported for Gunn effect devices. The silicon transistor has a cutoff frequency above 7 GHz—the highest reported—and a



power gain of greater than 4 decibels at 4 Ghz.

The microwave oscillator diode, developed by Toshio Misawa, was said to provide 1.1 watts of c-w power at 12 Ghz with 8% efficiency. Misawa attributed the higher output to better mounting and bond-

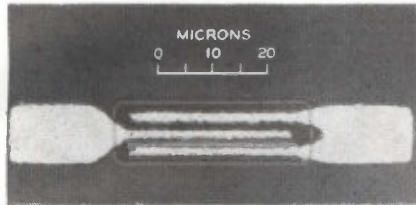

Very thin base layer and micron-wide emitter stripes are key to performance of 7-Ghz transistor.

ing, improved heat dissipation and closer control of processing. A big gain, he said, was made by mounting the diode upside down in its housing. This puts the pn junction near the metal mount and fosters better heat flow.

Processing improvements lie chiefly in controlling the impurities or doping profile of the silicon semiconductor. Misawa has experimented only with simple pn junction diodes, which are easy to fabricate because they need only one diffusion.

**Shorts possible.** Improved fabrication techniques were also credited with bettering the performance of high-frequency transistors by allowing the internal dimensions of the devices to be cut down. A key to very high frequency transistor operation is a thin base—about 0.01 microns—and a narrow emitter stripe—about a micron wide. Thin base layers, however, encourage emitter collector shorts, which result from dislocations and impurities in the silicon that are introduced during diffusions.

The developer of the transistor, Rudolf Schmidt, avoided the shorts by making both base and emitter diffusions shallow—the base is 0.3 micron and the emitter 0.2 micron, for a net active base thickness of only 0.1 micron. The shallow diffusions, Schmidt says, makes the number of defects negligible.

The emitter stripe was held to a micron by improved masks and by

depositing a thin metal layer between the silicon dioxide and photoresist layers. The metal serves to prevent interference between reflected light from the silicon surface and the incident light which causes nonuniform exposure of the photoresist and poor resolution of the pattern. Another way to cut the reflections would be to use a high optical density photoresist.

**Film transistor.** Hope looms for the much discussed all thin-film integrated circuit—in the form of an indium arsenide (InAs) high-frequency transistor. Scientists at the Westinghouse Electric Corp.'s research laboratories described the fabrication of devices made with ultra thin (only a few millionths of an inch thick) films of InAs. The experimental transistors are still comparatively crude, T.P. Brody, one of the developers, reported. The first models operate up to 8 Mhz, Brody said, but this response will be extended 100 times. The transistor's ultimate performance, he said, should reach well into the microwave region—up to several gigahertz. His prediction is based on the high mobility of the charge carriers in the InAs material—100 times greater than that of cadmium sulfide, the material traditionally used for thin-film transistors.

Indium arsenide has another notable advantage—its temperature stability over a wide range, from

near absolute zero to 300°F.

The arsenide films are made by evaporating indium and arsenic inside a vacuum chamber; vapors of the two metals combine chemically and a thin layer of InAs deposits on a glass or quartz substrate. The transistors are formed by successive depositions of InAs, metal, insulation material and metal in layers that are typically 5 to 10 millionths of an inch thick.

## Antennas

### Hugging the horizon

The day is fast approaching when airplanes will routinely transmit radio messages through communication satellites for relay to the earth or other airplanes. At present a combination of economic and technical barriers stand in the way. A solution to one technical obstacle has been devised by Electronic Communications, Inc., of St. Petersburg, Fla. The company has developed an antenna that allows a plane, say flying over North America, to communicate with a relay satellite orbiting about the equator—without having to aim the antenna at the satellite.

Conventional omnidirectional antennas produce lobes that are

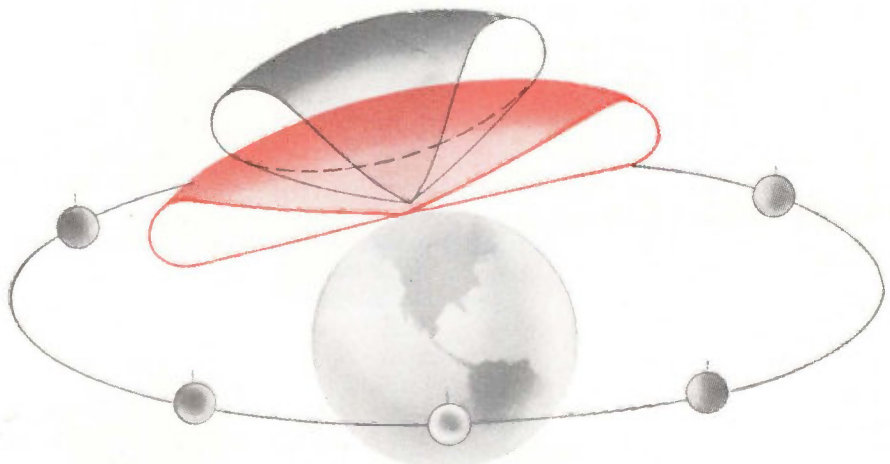

With the new antenna's low beam (in color), a plane flying over Canada could communicate with a satellite directly to the south. Conventional omnidirectional antennas produce a high-angle beam (shaded area) and could not intersect the satellite without flying farther south.





Pop art antenna, to be mounted on an aircraft's fuselage, was specifically designed to operate with satellites.

angled too high above the horizon of the earth. But the Electronic Communications antenna produces lobes that nearly hug the horizontal plane.

**A bonus.** The antenna provides a secondary advantage: its beam is circularly polarized. Hence, if because of a fault on the transmitting satellite one polarization is lost, the antenna will still pick up a loud and clear signal.

Electronic Communications designed the antenna under an Air Force contract that calls for the company to build ground, air and shipboard terminal equipment for a classified experimental satellite communications system. There is a possibility the system will be tested with a tactical satellite to be launched in 1967.

George Petrick, a project engineer at Electronic Communications ground system engineering section, said the company examined available antennas, found them unsuitable and decided to design its own. He said other companies had come up with similar antennas but these were basically linearly polarized. Helixes perpendicular to the antenna's axis and conical spirals were also considered, but these designs lacked either the bandwidth or the low beam pattern.

**Compromise.** The antenna's peak pattern reaches 30° above the

horizontal, but the beam width stretches 40° above the horizontal. Its frequency capacity ranges from 225 to 300 megahertz. Although the designers wanted a lower peak angle, they had to compromise to keep the antenna's height low. Asked to indicate the factors that influence the choice of beam angle, Petrick would only say that it depends on two factors—the satellite and the geographical area the plane must cover.

The diagram on page 47 illustrates this. If the plane were over Canada, the new antenna would have a beam (in color) that could intersect with a satellite directly south of it. But an antenna lacking the low-angle coverage (shaded area) would not be able to communicate with the satellite unless the plane flew farther south.

To be circularly polarized the antenna must possess horizontal and vertical components of polarization. The loop formed by the four curved sections at the top of the antenna constitutes the horizontally polarized portion. The four tapered stubs that link the loops and the central hub act as a vertically polarized array. The horizontal and vertical polarization components must also be 90° apart in time phase. This is accomplished by using the stubs as the feed for the loop. Since the stub sections are a quarter wavelength long (90 electrical degrees) the loops have the proper phase relationship for cross polarization. Because of the antenna's symmetry the beam pattern is omnidirectional.

**Useful design.** The tube at the bottom of the antenna is a quarter-wavelength transformer section that matches the 50-ohm impedance of the receiver or transmitter to the 125-ohm impedance of the antenna. Filled with Teflon, the transformer section acts as a coaxial line that feeds the stubs. Radial spokes protruding from the transformer shape the beam pattern at high frequencies.

Prototype antennas have been tested on KC-135 flying tankers. Production units will also be tried out on cargo transports, bombers and other aircraft.

A radome compatible with

mach 1 aircraft fits over the antenna. Although designed specifically for satellite-to-plane communications, the company says the antenna could provide communications between planes, too.

## Communications

### Tuning Gunn?

Two technicians at the Radio Corp. of America's Princeton, N.J., research laboratories have developed a tunable microwave source that is believed to oscillate by the Gunn effect. If this is the case, it holds out the hope of electronically tuning the higher-power Gunn effect oscillator.

The experimental microwave source is a modified gallium arsenide diode that oscillates at fre-

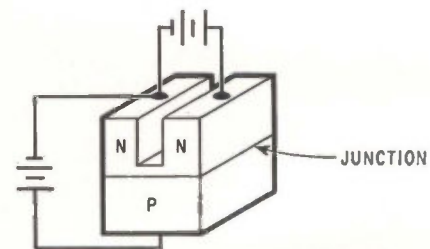

Experimental oscillator developed by RCA is a GaAs diode in which the n terminal has been divided in two. The voltage between the two resultant n terminals makes the device oscillate. The other voltage tunes the device.

quencies of 60 megahertz to 2.5 gigahertz and is tunable over a 10% frequency range. Implicit in the tuning capability is the ability to frequency modulate the oscillation. By comparison, conventional Gunn devices must be mechanically tuned—generally too slow for modulating audio or other communications signals. The two developers are Arthur Hahn and Arnold Matzelle.

Although the output with the modified diodes is only a milliwatt and efficiencies are 0.5%, it's believed that the principle can be applied to conventional Gunn effect devices to get higher power outputs while at the same time retaining





8-19

## The first JAN voltage-variable capacitor!

TRW's newest addition to the broadest line of voltage-variable capacitors...JAN 1N4801A-1N4815A Varicaps to MIL Spec 19500/329B!

Outstanding characteristics are extremely low leakage (less than 0.005  $\mu$ A at MWV) and the widest

capacitance change per volt available anywhere!

Optimum uniformity and tracking is assured by TRW proprietary alloy junction process—ideal for VCO, VCXO and delay lines. Capacitance range from 6.8 to 100 pF nominal.

Contact any TRW distributor or TRW Semiconductors Inc., 14520 Aviation Blvd., Lawndale, Calif. 90260. Phone: 679-4561. TWX 910-325-6206. *TRW Semiconductors is a subsidiary of TRW INC.*

# TRW

\*VARICAP IS THE TRADEMARK FOR SILICON VOLTAGE-VARIABLE CAPACITORS MANUFACTURED BY TRW.



the tuning capability.

**Possible applications.** Although RCA researchers believe that it's too early to say that a practical device is possible, the voltage-tuning feature has already aroused the interest of RCA's Defense Electronics division, where the applications would be obvious: wideband, rapidly tuned receivers required in radars, electronic counter-measure equipment and field communication gear.

It could also serve as a low-power transmitter. The Princeton group has frequency modulated the diode's oscillation with music and has received the signal on a standard f-m receiver. It has also modulated the device with digital information at a rate of 200,000 bits per second.

Joseph Dienst, a member of RCA's technical staff in the microwave research laboratory, explains that the device was fabricated by first cementing the p terminal of a GaAs diode to a transistor header. Then a fine saw cut a slot into the n material to a depth of 10 to 15 microns above the diode's pn junction. The cut forms two separate n terminals and transforms the diode into a three-terminal device.

If the n junctions are connected in series with a coaxial line's center conductor, the device will oscillate when a 6-volt potential is applied between the two n terminals. This oscillation is believed to be a Gunn effect mechanism.

In addition, if the p terminal is made more negative than the n terminal, the device's oscillation can be tuned by controlling the pn voltage.

**Simpler yet.** However, the p type material only serves to form a junction whose capacitance can be varied by an external voltage. It is possible to make the device with a Schottky barrier junction, which is just a metal electrode attached to the n material. "At the junction between the metal and the n material we get an effective capacitance just as we do in the depletion region of a GaAs diode," says Dienst. It is this structure that more closely suggests the possible application to a regular Gunn device.

RCA says that two electronic mechanisms appear to control the diode's operation—the Gunn effect and the field effect. However, the researchers point out that this is only a tentative conclusion and that the exact operating mechanisms are still to be determined. However, indications are promising.

When biased for oscillation, the electric field in the vicinity of the cut and above the diode junction is about 4,000 volts per centimeter. This value is the Gunn threshold for oscillation. In addition, Dienst says, "If we cut into the p type junction, no oscillations occur." Similarly, Gunn effect devices cannot be made with p material. Both facts give credence to the possibility that a Gunn mechanism is involved.

**Modify the field.** Tuning is controlled by the field effect, which in turn is related to the junction capacitance. Dienst explains that the traveling electric field produced by the Gunn effect propagates very close to the junction capacitance. "By modifying the junction capacitance with an external voltage, we modify the traveling field, which allows us to tune electronically," he adds. With a combination of mechanical and electronic tuning, RCA's devices can be tuned over more than a 2 to 1 band.

The theory of the device was advanced by Kenneth Petzinger, who is now at the University of Pennsylvania.

---

### Advanced technology

---

#### On tap

Air Force experiments with an unused class of semiconductors known as tap crystals may lead to such optoelectronic devices as a diode laser for each color in the rainbow, computer memories and yes-no decision elements, accelerometers, tuned oscillators, image intensifiers for infrared target detectors and ballistic camera triggers.

These are a few possibilities cited by Cole W. Litton and Yoon

Soo Park of the aerospace research laboratories at Wright-Patterson Air Force Base, Ohio.

Tap crystals—compound semiconductors that store current when they are stimulated by light—give up energy as flashes of light when they are physically tapped. The effect was first observed about six years ago in cadmium sulfide crystals that were cooled by liquid nitrogen to 77°K. After they were exposed to light and tapped the crystals flashed bright green, but the causes were unknown. Now, enough is known to produce variations of the effect in a family of crystals.

**Infrared trigger.** Impurity elements from Group I in the periodic table were found in the cadmium sulfide; this discovery led the researchers to the reproduction of the tap effect in other semiconductors compounded from Group II and Group VI elements. Some tap crystals can now be stimulated by heat, instead of light, and some will flash when excited by infrared energy, rather than tapping.

For example, zinc oxide doped with sodium is stimulated by exposure to light whose wavelength is shorter than 3,680 angstroms. It will flash blue-green several hundred times when mechanically excited—once for each tap. If the zinc oxide is doped with lithium, light no longer stimulates it, but raising its temperature from 77°K to about 200°K will cause it to emit light when cooled again and tapped.

After optical stimulation, emission is directional and localized. Thermally stimulated crystals glow more uniformly but give up their energy after only a few taps, Litton and Park report.

The explanations for the effects are complex—and still incomplete. In the optically stimulated crystals, holes are apparently trapped during the formation of hole-electron pairs. Energy stored by the trapping is freed during excitation by an involved sequence of effects when the holes recombine with free electrons. At room temperature, the crystals have high resistivity and are photoconductive. In the dark, at 77°K, the conductivity



# 3

## Tektronix Portable Oscilloscopes



TYPE 453



TYPE 422

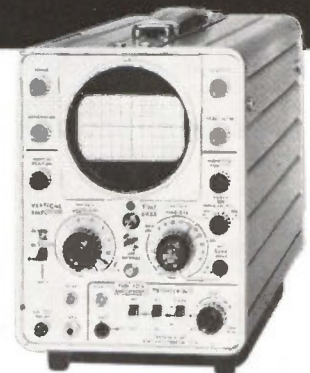

TYPE 321A

CHOOSE ONE  
FOR YOUR OWN MEASUREMENT REQUIREMENTS

	<input type="checkbox"/> TYPE 453	<input type="checkbox"/> TYPE 422	<input type="checkbox"/> TYPE 321A
Bandwidth	DC-50 MHz	DC-15 MHz	DC-6 MHz
Deflection Factor	5 mV/div to 10 V/div	10 mV/div to 20 V/div	10 mV/div to 20 V/div
Channels	Dual	Dual	Single
Delay Line	Yes	Yes	No
Sweep Delay	Yes	No	No
Size	Height	7 $\frac{1}{4}$	8 $\frac{1}{4}$
	Width	12 $\frac{1}{2}$	10
	Depth	20 $\frac{1}{2}$	14
Weight (pounds)	28 $\frac{3}{4}$	22	14
Power Requirements	AC: 96-137 V or 192-274 V; 45-440 Hz; approx 100 watts.	AC: 115 V or 230 V $\pm$ 10%; 45-440 Hz; approx. 40 watts. DC: 11.5-35 V; approx. 23 watts; accepts Tektronix 24 V battery pack.	AC: 115 V or 230 V $\pm$ 10%; 45-800 Hz; approx. 20 watts. DC: 11.5-35 V; or 10 size D batteries; approx. 700 mA
Rack Mount Available	Yes (7" Rack Height)	Yes (7" Rack Height)	No
Probes and Accessories Included	Yes	Yes	Yes
Price	\$2050	\$1400 (AC Model) *\$1750 (AC/DC Model)	*\$900

U.S. Sales Prices f.o.b.  
Beaverton, Oregon

\*without batteries

A TEKTRONIX PORTABLE will fit your specific requirements. Your Tektronix field engineer will be happy to demonstrate any of these oscilloscopes at your location. Just call him, or write Tektronix, Inc., P. O. Box 500, Beaverton, Oregon 97005.

**Tektronix, Inc.**



almost disappears. Exposure to light raises the conductivity and the crystal remains conductive when the light is removed, indicating current storage. The amount of current varies with the amount of optical stimulation.

The mechanism is different in the thermally stimulated crystals. The energy seems to be released when holes become freed and recombine with trapped electrons.

After optical stimulation, emission is directional and localized. Thermally stimulated crystals glow more uniformly but give up their energy after only a few taps, Litton and Park report.

**Pick a color.** The researchers think that injection laser diodes could be made to emit any color, from infrared to ultraviolet, by making the lasers of II-VI semiconductor crystals doped with various alkali metals. A negative-resistance characteristic—the property that helps lasing in gallium arsenide—has been observed in cadmium sulfide crystals doped with both sodium and lithium and is expected in sodium-doped zinc oxide.

Negative-resistance crystals can also be made to oscillate at predetermined frequencies in tuned circuits, they add, and so could be used to fabricate oscillators.

Since the energy stored in the optically stimulated type of crystal can be converted into light by infrared energy, Litton and Park believe a mosaic of crystals could serve as an infrared target detector and image intensifier for the military.

---

### Optoelectronics

---

#### Storage on a chip

To be sure, books have their place. But to libraries, Government agencies and virtually anybody who deals with massive amounts of printed data, the place that books take up is just too much. The Army has decided to do something about it: it's awarded a \$191,000 contract to a small Bristol, Conn., company that has developed a technique for

storing many holographic images on a slice of potassium bromide no bigger or thicker than a 35-millimeter piece of film.

If the experimental program is a success, the crystals may compete strongly with microfilm gear, which is widely used in many data-storage systems.

**Picture on command.** The contract calls for the company, Carson Laboratories, to deliver by next June a system that can store some 1,020 pages of detailed drawings and engineering tables on a single crystal, and on command search for and display the information, in sharp detail, and reproduce hard copies of any of the pictures. What, in fact, the Army is looking for is to replace a massive library with a helium-neon laser, a handful of thin potassium bromide crystals, a small real-time, random-access mechanism for hunting out the desired pages and a conventional dry photographic system.

The system will be built around a concept unveiled by Carson last spring [Electronics, May 30, p. 35]. That system was based on Bragg angle holography in which an image-carrying laser beam is fired at a potassium bromide crystal. The crystal, of a class of alkali halides that can be bleached by a red laser, stores the holographic imprint of the image on an infinitesimally thin layer of the crystal. The angle the laser hits the surface of the four-millimeter thick crystal determines at what layer in its structure the picture is stored. Thus, multiple images can be stored simply by shifting the angle of incidence. The crystal can only be bleached—hence store images—if it's warmed to about 80°C. When the crystal is cooled to 0°C, and an unmodulated laser beam is fired into it, the stored image is reconstructed, with hardly a detail of the original lost.

**Hard copy.** The military contract, from the Army Missile Command at Huntsville, Ala., calls for the system to be able to store images of pictures as large as 18 by 24 inches. And for the production of hard copy, Carson will project the holographic image on light-sensitive silver paper, a conven-

tional dry photographic process, explains Richard F. Weeks, Carson's project engineer.

The speed of the unit, says Weeks, will be limited by the indexing scheme for searching out the desired information. But generally, he adds, it will take only a matter of seconds to fish out and display the correct engineering table or diagram.

Another requirement in the Army contract is development of a technique to reproduce the entire image-laden crystal. Weeks is coy about disclosing how Carson will reproduce the crystal—either by bleaching the images into the crystal one at a time or by some mass-production process.

For positioning the critical laser angle, Weeks explains, Carson will use a mechanical positioning approach. But eventually, he notes, "we'll have to seek a faster, more accurate electronic positioning technique."

Resolution of the reproduced picture, he says, is no problem. "We've already achieved a resolution of 10 line pairs per millimeter—which is better than that produced from commercial microfilm—and we expect to improve on that."

---

### Industrial electronics

---

#### Light switch

Switching many thousands of volts with 1,000-volt silicon controlled rectifiers connected in series is, to say the least, tricky. If a current surge doesn't zap them, reverse overvoltage will, especially if each rectifier in the string isn't triggered on at precisely the same time.

To overcome the triggering problem, the Westinghouse Electric Corp.'s research development center in Pittsburgh has developed a silicon switch that is fired not by an electric signal applied to a gate, as with a conventional silicon controlled rectifier, but by a beam of light. The light is guided to the switch through fiber-optic light

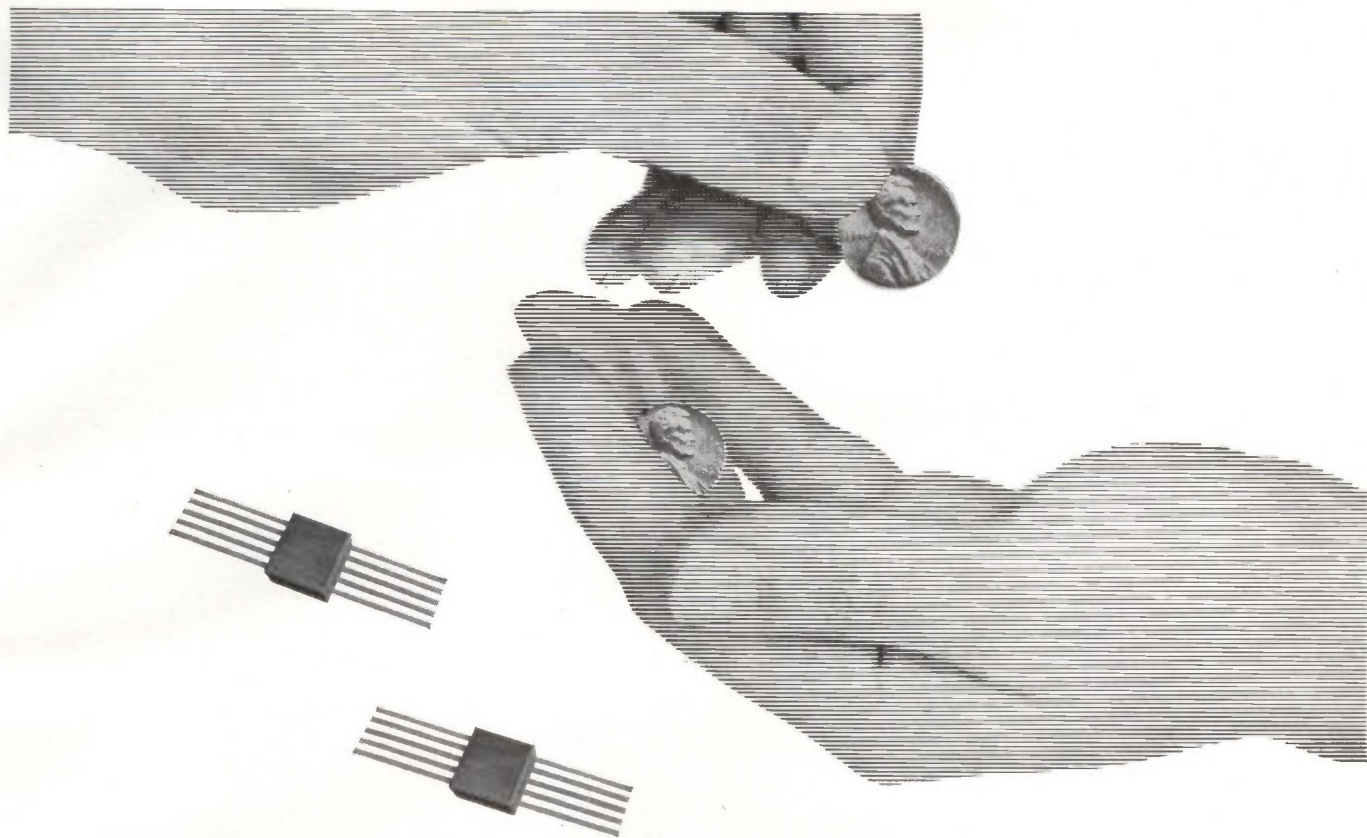

## Penny-wise and epoxy-foolish?

*Value analysis purchasing and engineering* have proven, time and again, that it often costs dollars when you try to shave pennies. Plastic packaging of semiconductor devices is a case in point—especially if you back your product with a long term warranty.

*Dow Corning® molding compound* provides the extra value...extra long term reliability demanded by today's warranties. It only takes one service adjustment, covered by a warranty, to nullify any savings accrued by using epoxy in the packaging of hundreds of devices.

*Epoxyes are not silicones!* While Dow Corning molding compound is classed as a *plastic*, it is also a *silicone*. That's why—

- Device junctions are not contaminated by silicone molding compound...fact is, silicone resins have been used for years as a barrier to contamination of junctions in packaging devices.

- Dow Corning molding compound is inherently nonburning... doesn't require the addition of *flame snuffers*.
- Silicone molding compound is unaffected by long term heat aging and thermal cycling... no need to derate devices to compensate for heat leaching.
- Soldering doesn't deform devices packaged in silicone molding compound.

Dow Corning silicone molding compound costs only part of a penny more than epoxies per device package. What does your average service adjustment, covered by long term warranty, cost in unhappy customers? discontented distributors and dealers? in actual dollars and cents? Why short change your design investment?

For technical data on Dow Corning silicone molding compound, write Department 3911, Electronic Materials, Dow Corning Corporation, Midland, Michigan 48640.

DOW CORNING



pipes, resulting not only in the elimination of complex triggering circuitry, but also complete isolation between the trigger and load circuits.

**Only two terminals.** The light-activated switch—essentially a two-terminal device—was developed by D.R. Muss, Westinghouse's manager of silicon device development, and H.E. Suarez, an engineer in the section. Their switch differs from ordinary light-activated scr's which still use a third gate terminal.

Three-terminal devices have been around for more than five years. However, they've been limited to low current ratings—less than an ampere—and voltage ratings of only several hundred volts. These ratings are much too low for the applications—radar modulators and high-power multikilovolt power system switching—Westinghouse has in mind.

Muss and Suarez report they have built a prototype array of three of the new switches which, connected in series, has been able to carry 40 amperes. Each unit has withstood anywhere from 600 to 800 volts. Equally interesting is the fact that the Westinghouse researchers are using a gallium arsenide diode laser, emitting in the infrared, as their source of light. The fiber optics connect the light to the sensitive areas of the switches.

**Match for a switch.** Long-term reliability is a major reason for using a diode laser, instead of, for example, a xenon flash tube. Another reason is that the infrared wavelengths—around 0.9 micron—lie in the most sensitive, current-producing range of the silicon. The combination of the two is almost an ideal match.

Thus, despite the low light-producing efficiency of the diode source, the over-all efficiency of the gallium arsenide-silicon system is about the same as if the high-intensity light from a xenon flash tube were used instead; this is because the xenon lamp emits most of its light at wavelengths to which the silicon does not respond.

The unit is able to carry its high

current because, according to Muss and Suarez, the light illuminates a relatively large area of the silicon under the cathode. The illuminated area is roughly 10 times greater than in a normal light-activated scr. This reduces current density in the silicon, allowing the unit to withstand surge currents of 400 amps/microsecond, again about 10 times the safe rating of a conventional scr. Turn-on time is in hundreds of nanoseconds.

**More possible.** In the future, it may be possible to raise the current-carrying capacity of the switch to 250 amperes. A single gallium arsenide diode may even be able to trigger as many as 100 switches. This should certainly make them suitable for converters on high-voltage d-c power transmission lines. D-c transmission systems are coming into increasing prominence because it actually costs less to send d-c power over long distances than a-c. There are no losses comparable to the inductive and capacitance losses on an a-c line.

Right now, converters for raising and lowering the voltage levels use mercury-vapor tubes. Solid-state devices, such as scr's or light-activated silicon switches could offer faster control-speed response and take up considerably less room in the power station—all at a sharply lower cost.

---

## Space electronics

---

### Dampening the problem

Reentry blackout has plagued every flight in the Mercury and Gemini series. The problem has been tolerated for these flights, but as NASA comes closer to the manned Apollo mission, blackout becomes increasingly serious.

Of all the proposed techniques to solve the problem, a rather unsophisticated approach that dates back to the early 1960's appears to hold the greatest chance of immediate success. The technique: spraying water into the hot sheath of ions that envelopes the craft and blocks radio signals.

A new series of detailed tests will begin in March, when the National Aeronautics and Space Administration will fire a Scout rocket down the Eastern Test Range. The project is called RAM, for radio attenuation measurements. The missile will be tipped with a specially designed nose cone that will contain, among other things, a tank of water and a 10-gigahertz antenna. As the nose cone reenters the atmosphere at 28,000 feet per second the water will be sprayed

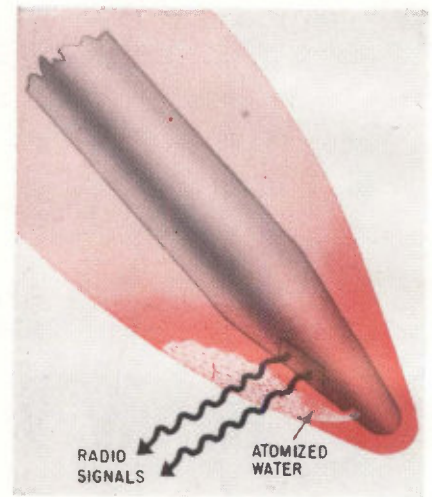

Spray of water reduces blackout encountered by spacecraft reentering the atmosphere

out, clearing a swath through the sheath.

The nose cone is being assembled at the space agency's Langley Research Center, Va., with the help of the LTV Aerospace Corp., a subsidiary of Ling-Temco-Vought, Inc. A second payload will be fired next October; it will carry such sensors as a Langmuir probe and a microwave impedance probe to take more detailed measurements of the sheath.

**Silence.** Blackout occurs when the great heat radiated by a reentering spacecraft turns the atmosphere around it into ionized gases, which is called the plasma sheath. For the recent Gemini flights, reentry was at 24,000 feet per second and the blackouts lasted only about three or four minutes. But Apollo spacecraft will be coming back from the moon at 36,000 feet per second, so it



This is the world's **SECOND** smallest power supply



Here's the **FIRST**



(Both are rugged, reliable and ready **NOW** for Advanced Aerospace Systems)

These new Bourns Power Supplies are not only the smallest available, they are the toughest! Both are specifically designed for advanced instrumentation systems where miniature size and exceptional environmental performance are mandatory. The 1/2 cubic inch Model 3960, with an output of 5VDC and 0-100mA, is ideal for multiple transducer excitation; while the even tinier Model 3965 (5VDC, 0-5mA) is suitable for single transducer use.

Both models feature a completely isolated and regulated DC output. Carefully designed circuits insure protection from reverse polarity, short circuits, and overvoltage. Bourns extensive experience in molding of plastics has resulted in sealed modules impervious to moisture and salt spray. Other outstanding environmental characteristics are wide temperature range of -55 to +100°C, 100 G shock and 20 G vibration. High quality microminiature components are used throughout the modules. Bourns Model 4210 Microtransformer is used in the converter circuits and a small TRIMPOT® potentiometer adjusts the output voltage.

Bourns famous Reliability Assurance Program guarantees performance by thorough inspection and test of each unit and by periodic requalification to all published specifications. All units receive a 100-hour burn-in prior to shipment for added reliability.

As for delivery, these units are SHELF STOCKED. Convince yourself how good these power supplies are. Send for detailed technical data. Certified test data is available on request.

**SPECIFICATIONS**

	Model 3960	Model 3965
Input Voltage Range	24-32 VDC	24-32 VDC
Nominal Output Voltage	5.000 VDC	5.000 VDC
Setability	±0.005 V	±0.010 V
Load Current	100 mA	5 mA
Line Regulation, 24-32V	0.1%	0.3%
Load Regulation	1.0%	Not applicable
Temperature Shift, max. -55 to +100°C	0.01% / °C	0.01% / °C
Output Isolation at 100V	1000 megohms	1000 megohms
Size	1" x 1" x .50"	.73" x .5" x .52"
Weight	0.60 oz.	0.24 oz.



BOURNS, INC., TRIMPOT DIVISION, 1200 COLUMBIA AVE., RIVERSIDE, CALIF. PHONE (714) 684-1700 • TWX: 714-682 9582 • CABLE: BOURNSINC.



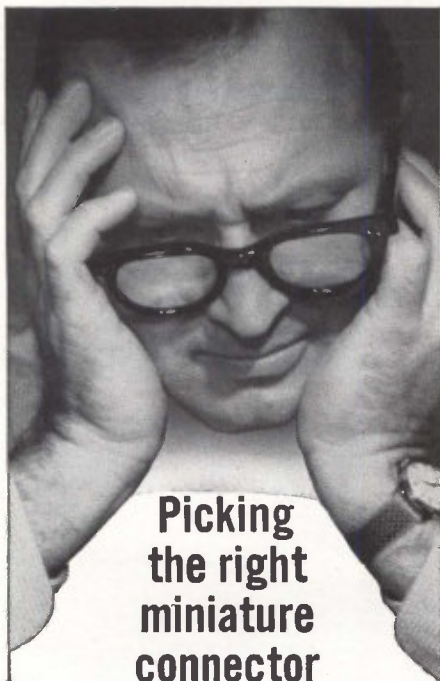

**Picking the right miniature connector is a small problem**

It's not hard to locate a miniature connector small enough to meet tight space specs. Lots of people make them. There is a small problem, though, in finding the quality you need at the price you'd like to pay.

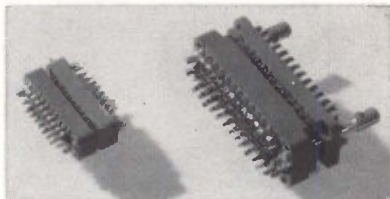

That's why business is booming at Transtron's Precision Connector Division. We design and produce miniature and subminiature connectors to exceed — not merely meet specifications. They are built to outlast the equipment you mount them on. Precision fabrication, knowledgeable design, the finest materials provide a combination that can't be surpassed by any manufacturer. Yet in quantity they cost no more than units that will barely squeeze by incoming inspection.

Send today for our new condensed catalog covering a complete line of miniature and subminiature connectors, as well as printed circuit connectors and many other types. And if you need a custom connector design, we're your source. Just give us the facts.



Precision Connector Division  
**Transtron**  
 electronic corporation  
 Wakefield, Massachusetts

will require a shallower approach angle to reduce speed safely and the blackouts are expected to range from seven to 11 minutes. A blackout of this duration hampers the ground stations in tracking spacecraft and dispatching recovery ships and helicopters to the splash-down point. The problem will be even more severe for a spacecraft returning from Mars. It will re-enter at up to 45,000 feet per second.

**No easy answer.** Laurence F. Gilchrist, deputy director of NASA's electronics and control division, doubts that the communications blackout will ever be completely eliminated. But early tests indicate the water spray technique may ease the problem.

Tests with the technique were held in the early 1960's, when ballistic flights of water-carrying rockets were test fired from Wallops Island, Va. Those flights, with the nose cone returning through the atmosphere at 18,000 feet per second, buoyed space scientists' hopes that they were on the right track. Later, similar experiments were tried on some of the Gemini flights, with equally optimistic but inconclusive success.

**Preventive medicine.** Once the RAM project is completed Gilchrist wants to get attenuation experiments on the Apollo Applications Program, a proposed follow-on to the manned lunar landing. Thus Apollo application flights could test ways of preventing the longer blackouts expected when manned spacecraft return from other planets.

The Air Force is also interested in learning more about the plasma sheath and is conducting experiments with missile reentry bodies using the smaller Trailblazer rocket. The program consists of six launches from Wallops Island to measure the blackout at 17,600 feet per second. The experiments are being conducted by the Ohio State University Research Foundation under an \$80,000 contract from the Air Force's avionics laboratory, Wright-Patterson Air Force Base, Ohio.

To be sure, other attacks on the blackout problem are being made.

The one that holds the greatest promise over the long run is a plan to use a tracking frequency of 35 gigahertz [Electronics, April 18, p. 37]. Signals at that frequency are better able to pierce the ion sheath than lower-frequency signals. But the technique faces a major obstacle. NASA has nearly completed its conversion to S band (1,550 to 5,200 megahertz) from C band (5,000 to 10,900 Mhz). The major investment in this equipment leaves NASA reluctant to make yet another switch.

**Military electronics**

**Backseat driver**

It's hardly a secret among companies designing and building satellite communications systems that their efforts are handicapped by conflict and lack of cooperation within the Government agencies responsible for particular projects.

Congressional critics have not been unaware of the growing problem. As far back as 1962, hearings conducted by lawmakers produced urgent pleas for the agencies to work together more closely. The most recent hearings, concluded only two months ago, resulted in another long list of recommendations.

The advice of the panel—the House Military Operations subcommittee—was most pointed.

It urged a speedup in the application of satellites by the Pentagon and demanded improved organization of the various programs, as well as the expenditure of more money to facilitate these recommendations. The House group also pointed out an immediate source of the troubles, namely equipment deficiencies, especially at ground terminals, that are causing delays in the program.

**Hurry it up.** The Defense Department was urged to make its Initial Defense Communications Satellite system operational as speedily as possible. The committee described the situation as "awkward" since the Government has



already spent \$112 million for the beginnings of such a limited system, which provides only two voice circuits or a handful of Teletype channels.

The committee is convinced that the Initial system's capacity can be increased 10 to 20 times with "very modest cost increases," and said this expansion should be implemented "as soon as is practicable." The Army already has begun an improvement program on ground station antennas that will boost the Initial system's capacity from 2 to 11 voice channels by mid-1967.

Because of the Aug. 26 failure to launch a second batch of Initial satellites, the third launching in the program has been moved up from March, 1967 to January, 1967. It will attempt to add eight satellites to the seven communication repeaters now in near-synchronous orbit. A fourth launch, also scheduled for early 1967, hopefully will add three more.

**Advancement.** The Initial system should be expanded by additional satellite launches and upgraded by improved hardware so that it can be used as an operational system until it is replaced in 1970 by the Advanced Defense Communications Satellite system now under study, the committee asserted. Since the original order for satellites from Philco-Ford Corp., a subsidiary of the Ford Motor Co., will be exhausted by the next two shots, more satellites are needed. And the Air Force currently is determining how many more will be procured for the Initial system.

The committee felt that the Advanced system should have capacity of at least 100 to 200 voice-grade circuits. Planning for the Advanced system has been completed, and once it is approved by Defense Secretary Robert McNamara and the Joint Chiefs of Staff, the Pentagon expects to let contracts to industry in fiscal 1967.

**Troubles.** Transportable ground terminal problems are plaguing the Initial system [Electronics, Sept. 5, p. 30]. The committee called these deficiencies the "most immediate, pressing problem" of the Initial system. The terminals will

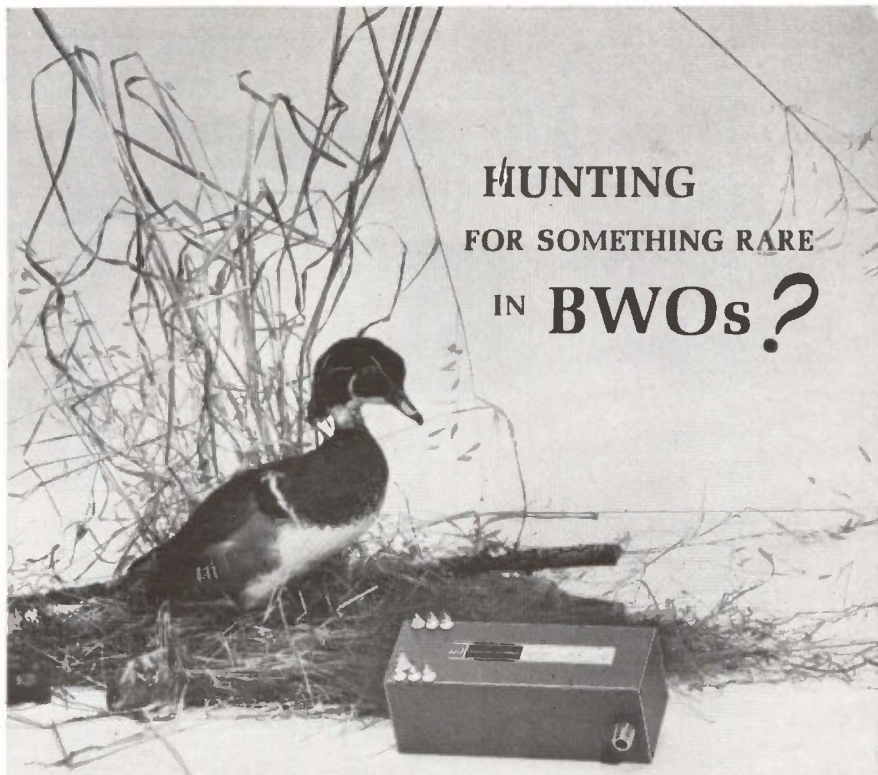

## HUNTING FOR SOMETHING RARE IN BWOs?

The wood duck is protected and so is the new WJ-2006 backward-wave oscillator for 8-12.4 GHz — featuring both full magnetic and RFI shielding! This BWO offers the advantages of easy storage and has no problems with steel decks or other magnetic materials. And its lower voltage means less power supply breakdown problems. Similiar models without RFI shielding can be delivered 1½ inches shorter. For narrow frequency band and low voltage, other models can be made as small as 2 x 2 x 6 inches. Hunt no further!

### Guaranteed Specifications — WJ-2006

Frequency Range	8.0-12.4 GHz
Power Output	50 mW Min.
Helix Voltage Range	425 Vdc Min. — 1600 Vdc Max.
Cathode Current	12 mA Max.
Length (Excluding Connectors)	8 Inches
Cross Section	3 x 3 Inches
Weight	6 Pounds
Meets both MIL-I-26600, Class 1 and MIL-I-6181D	

Information in more detail available  
from representative in your area,  
or from Applications Engineering

WATKINS — JOHNSON

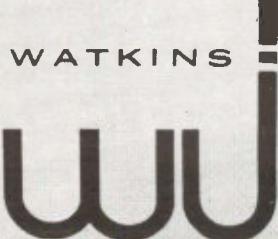

3333 HILLVIEW AVENUE  
STANFORD INDUSTRIAL PARK  
PALO ALTO, CALIFORNIA 94304



**1  
PUNCH**

**20  
HOLES**

Or 37 holes! Or 2—  
or 86! With press  
brake or punch  
press, Di-Acro Ad-  
justable Punches  
and Dies are quickly  
arranged to fit your  
layout exactly. Easy  
to repeat a setup.  
Use over and over.  
Ask for 12-page  
folder . . . Tells  
about starter-set  
too. See your dis-  
tributor or write us.

20  
HOLES

COUNT  
'EM

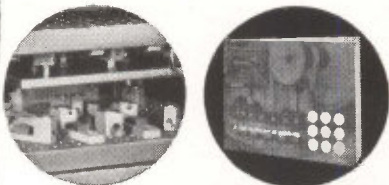

**DI-ACRO**

A Division of Houdaille Industries, Inc.  
4311 Eighth Ave., Lake City, Minn. 55041

NOTCHES  
COUNT,  
TOO

not be fully operational until the beginning of next year and preliminary system testing will take months. Some of the technical problems in Hughes Aircraft Co.'s AN/MS-46 station were so consistent that they indicated the possibility of design defects, the Army said. Fourteen of the 40-foot antenna stations are being built.

And a 23,000-pound, 18-foot cloverleaf antenna terminal, the AN/TSC-54, is also being built for the Initial system by Radiation, Inc. The ground station, which was publicly introduced Nov. 10 in Melbourne, Fla., is also behind schedule and running 40% over cost expectations. The first model of the 13 stations ordered will be delivered in April 1967, four months behind schedule.

### Reversing the fallout

Generally the direction of technological fallout is one way; first the military or the National Aeronautics and Space Administration develops a process or a concept and then industry picks it up for civilian application. But an electronic atomizer, recently developed, is an exception.

The American Petroleum Institute funded a research program aimed at replacing the not-too-reliable motor-driven pressure nozzles on home oil heaters that spray a thin film of oil into the furnace. The result was an ultrasonic device. The institute and the developer, Arthur D. Little, Inc., of Cambridge, Mass., claim the device is far superior to the old-fashioned pressure nozzle.

**No sale.** But oil furnace producers haven't exactly beaten a path to the institute's door for the product. Robert R. Perron, research staff member at Little, who directed the work explains: "You can sell reliability to a consumer, but it's tough to sell reliability to a builder if it costs him a half-dollar more." And it's the builders who buy most furnaces.

However, the nonprofit Battelle Memorial Institute of Columbus, Ohio, took a look at the product and decided that if home builders

weren't interested, maybe the Army was.

The military was most interested, and it was especially attracted by the way the atomizer sprayed the oil into a furnace—silently. The atomizer was then redesigned for use in a portable power supply whose sound wouldn't give its location away.

What's being delivered to the Army Electronic Command at Fort Monmouth, N.J., is an atomizer, operated by piezoelectric elements that vibrates at 100 kilohertz and produces a flow rate of one-tenth gallon of fuel oil per hour. The heat from the burning oil is applied to thermoelectric materials to produce 100 watts.

**On the home front.** The developers haven't given up hope of selling the ultrasonic device to the civilian market and some oil burner manufacturers still have it under evaluation.

Perron describes the unit as remarkably reliable. For example, in the test it worked for more than two years, with unfiltered No. 2 fuel oil going through it at one-half gallon per hour. The atomizer tips were cycled  $4 \times 10^{12}$  times at a stress of 11,000 pounds per square inch and still were performing satisfactorily at the end of 19,636 hours. In contrast, oil burner nozzles burn out every few years and replacement generally costs \$15.

The ultrasonic nozzle feeds oil to a furnace like this:

A fluid film is spread over the surface of a piston. The film is vibrated in a direction normal to the surface and this causes a grid of intersecting capillary wavelets to arise on the surface. The oscillatory vibration of the fluid surface causes the wavelets to increase in height and steepness until the wave tips break off and droplets escape.

The atomizer's piezoelectric transducers are driven by a vacuum tube or solid-state phase shift oscillator in which the transducer capacitance is part of the feedback circuit. Once the feedback has been adjusted, the oscillator is locked to the resonant frequency of the transducer. Two watts delivered to the transducer achieves satisfactory atomization.



## Solid state

### Satellite transistors

Designers of digital telemetry and sensing circuits for communication satellites face a dilemma. They must keep power dissipation to an absolute minimum and so require circuits that operate on microamps or even nanoamps. Yet circuits operating at very low current levels are sensitive to surface ionization effects. Such effects occur when a satellite passes through the outer Van Allen belt. Unwanted leakage currents result and shifts in other device parameters—such as turn-on voltage of a field-effect transistor (FET)—may occur.

**Limited to two.** At the Northeast Electronic Research Engineering Meeting this month A.G. Stanley of the Massachusetts Institute of Technology's Lincoln Laboratory compared available transistors with respect to performance under ionizing radiation. He concluded that the designer is restricted to microamp circuits using bipolar transistors that have a gain below 10, and the p-channel junction FET's in the nanoamp range.

Metal oxide semiconductor (MOS) FET's are not as radiation resistant as initially supposed. Under positive gate bias, Stanley noted electron irradiation up to a total dose of  $10^{14}$  electrons/centimeter<sup>2</sup> may shift the gate turn-on voltage by as much as 90 volts in the negative direction. Positive space charge generated by the radiation in the oxide induces a negative charge at the semiconductor surface which tends to keep a p-channel device in the off state and an n-channel device in the on state, he said.

The effect is enhanced by the large drift field across the insulating layer of the MOS device, causing major shifts in gate turn-on voltage at total doses as low as  $10^{12}$  e/cm<sup>2</sup>.

The metal nitride semiconductor (MNS) FET, was discounted by Stanley because it is not yet available. But he said it may sharply reduce the shift in gate turn-on voltage and reduce the source-

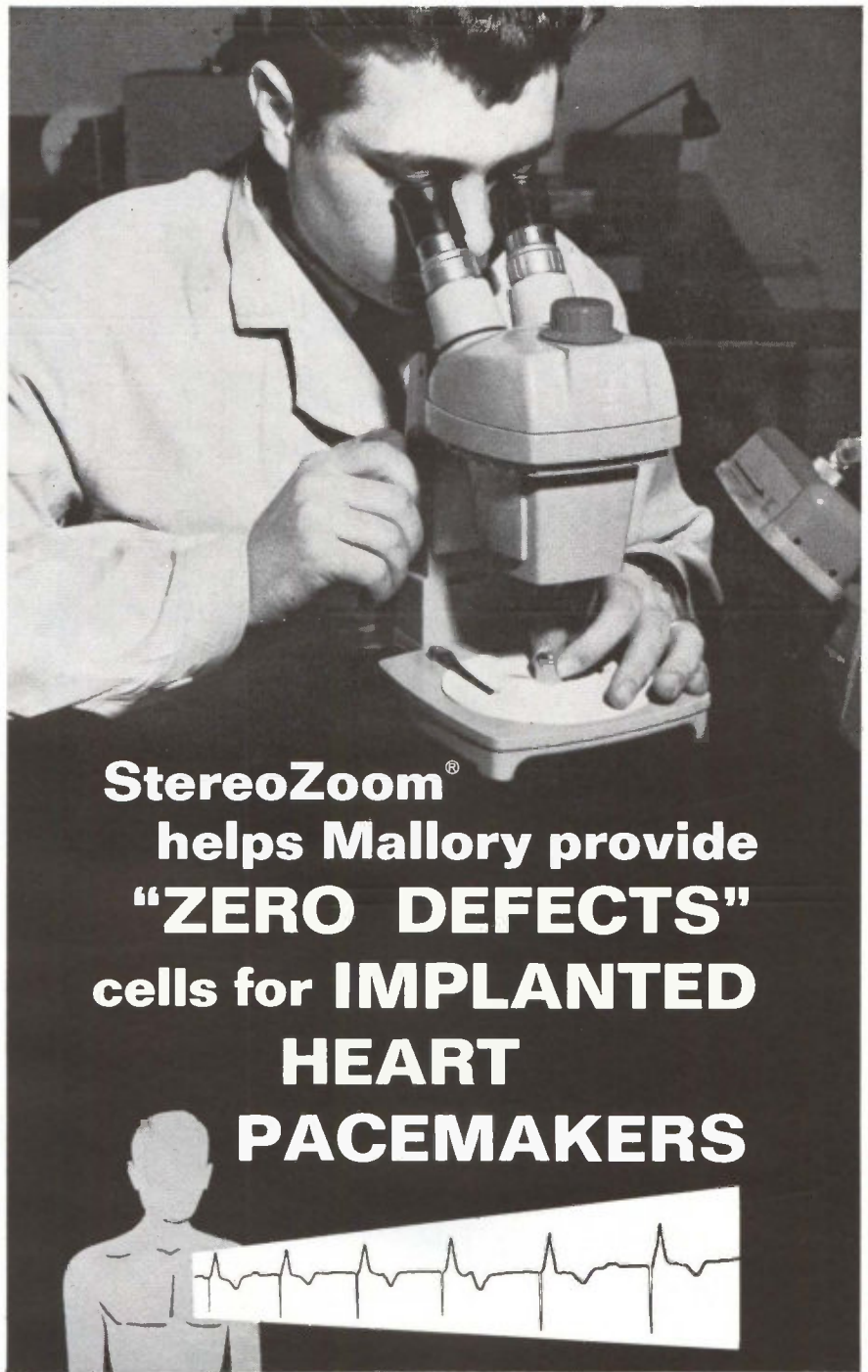

## StereoZoom<sup>®</sup> helps Mallory provide "ZERO DEFECTS" cells for IMPLANTED HEART PACEMAKERS

To meet critical pacemaker requirements, Mallory Battery Company, a division of P. R. Mallory & Co., Inc. must provide batteries of absolute reliability over a specified length of time. A unique Certified Cell program assures "zero defects" output. Every component is tested singly and pre-selected within tight limits. Fail-outs are discarded. Each shipment is certified as produced to the highest level of quality under the present state of the art. To date, no premature failures have been reported.

StereoZoom plays a vital role in the many rigid cell inspections. Continuously variable magnification lets inspectors zoom easily, quickly, through the widest range of settings to the best one for each visual task. Flat fields give images of full edge-to-edge clarity and sharpness. Flexibility of mounting parts and stand allows complete freedom of movement.

StereoZoom can help protect the quality and reliability of your product, too. There are 24 complete models as well as selected components. Call your dealer or write for Catalog 31-15, Bausch & Lomb, 99735 Bausch Street, Rochester, New York 14602.

**BAUSCH & LOMB**



# ANTENNA and TOWER INSULATORS by LAPP

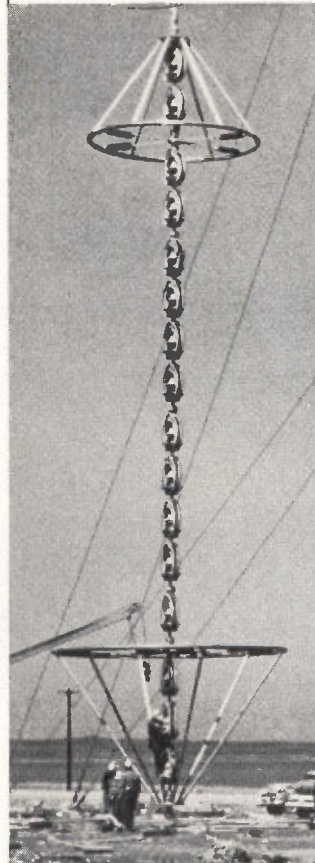
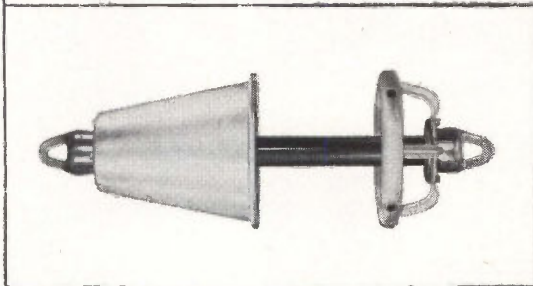
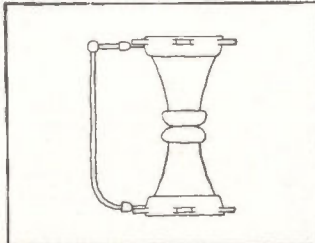
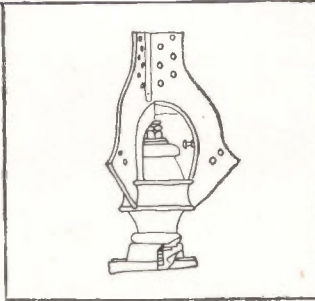

Lapp insulators support most of the world's large radio towers, both self-supporting and guyed masts. Lapp has designed and built base insulators from 80,000 lbs. to 9,000,000 lbs. ultimate strength. Lapp strain insulators have been made from 1200 lbs. to 620,000 lbs. ultimate strength. □ Lapp is also a dependable supplier of entrance, spreader and stand-off insulators for transmission lines. Other Lapp insulators and our gas filled capacitors are used in transmitters and coupling networks. □ Difficult insulating problems are welcome here at Lapp. We've been solving them for almost a half century. Write Lapp Radio Specialties Division, Lapp Insulator Co., Inc., 211 Sumner St., LeRoy, N. Y. 14482.



drain leakage below a nanoamp.

**High tolerance.** Junction field-effect transistors have a higher tolerance to radiation induced bulk damage than bipolar transistors since they are majority carrier devices, Stanley said. However, n-channel FET's are not immune from surface ionization effects. Upon irradiation, with the gate junction back biased, the gate current increases well above 1 microamp and the drain current shifts, too. The gate leakage currents of most p-channel FET's are less than 1 nanoamp. In n-channel FET's the positive space charge generated in the oxide induces an n-type inversion layer on the surface of the p-type gate region which generates the leakage current when the junction is back biased.

## Electronics notes

▪ **Multifunction kick.** Five additions to Texas Instruments Incorporated's line of complex function digital integrated circuits were announced last week at the Fall Joint Computer Conference. The circuits are even more complex than the four brought out at the IEEE Show last spring—emphasizing a trend that many observers had predicted. The big advantage of cramming more functions into one package is cost savings, with reliability an important bonus. TI estimates a saving of anywhere from 20% to 40% over simpler IC's that would be required to perform the same functions. One of the new IC's is a quadruple fuel adder that adds four 2-bit numbers. TI says that systems designers can slash costs by 41% by using this circuit instead of four single IC adders. Other devices in the line include counters and a decoder-driver.

▪ **Money for SRAM.** The Air Force has awarded the Boeing Co. a contract to develop and build a short-range missile system. SRAM, a nuclear missile, will have a range of about 100 miles. Boeing is receiving \$142.3 million to develop the system and \$93.5 million for production.

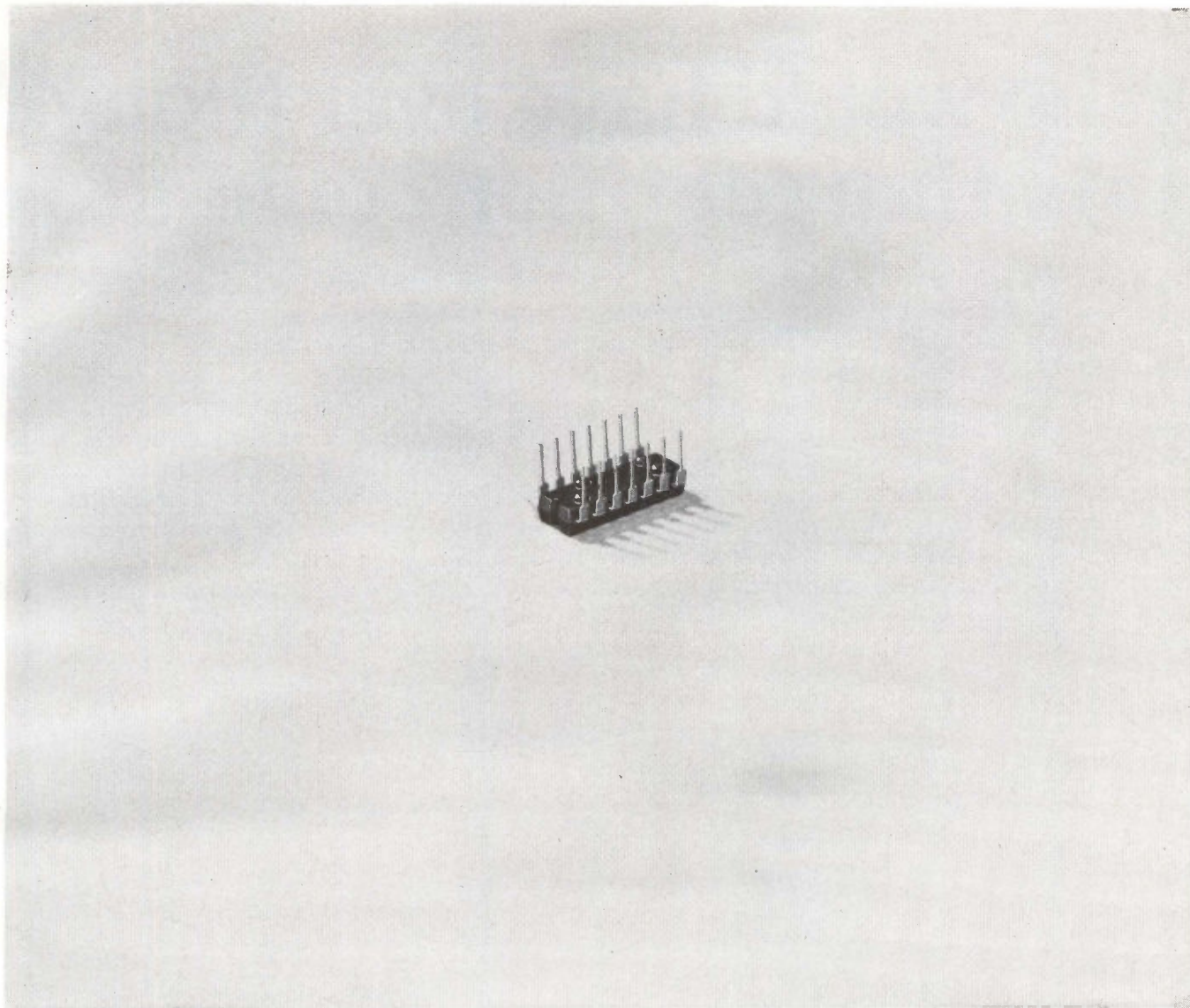

## The Semiconductor Bug.

Our production people didn't want us to show our new Unibloc\* integrated circuit dual in-line plastic package on its back like this. They said it made it look too much like a bug.

We assured them that when designers found out about the multi-function integrated circuits it contained and the ease of handling this package offers for production assembly, they wouldn't hold it against us.

We knew, too, that when the reliability and

standards boys found out that it was a solid, single-piece, pressure-molded bug, er-r-r package, that offers unusual physical strength for internal leads and connections, they would come around to our way of thinking, too.

If you're interested, we have availability on these like ants at a picnic . . . complete with MRTL\* and MDTL\* integrated circuits inside. One thing about the price though — it won't bug you.

Contact us.

\*Trademark of Motorola Inc.

*- where the priceless ingredient is care!*



**MOTOROLA**  
**Semiconductor Products Inc.**

MOTOROLA SEMICONDUCTOR PRODUCTS INC., P. O. BOX 955, PHOENIX, ARIZ. 85001 (602) 273-6900 TWX 910-951-1334



# Who would have ever thought this tiny rectifier could start

We, least of all, did . . .

In spite of the fact that the essential feature of a controlled avalanche rectifier has been a property of all Unitrode diodes ever built.

In fact, our production of these devices predated the general acceptance of the term "controlled avalanche" by some two years. But we didn't start out with the intention of creating a disturbance.

All we wanted to do was create a diode that offered high power and surge capability in small size, stability of electrical parameters *throughout*

life, mechanical ruggedness and stability, and all unaffected by any environmental testing.

Create is the word. Because, the Unitrode design did require creation of entirely new manufacturing methods. So we created. And by creating a completely new method of bonding silicon to metal and fusing the junction in a voidless, hard glass sleeve, we've come up with a line of monolithic high reliability components that beat anything else on the market.

For instance, we now offer semi-conductors that

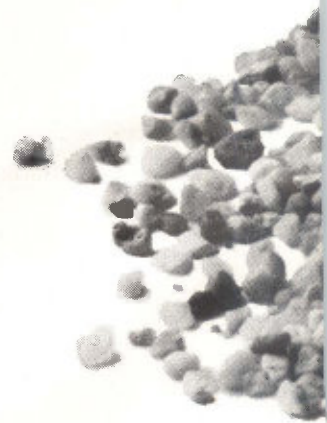

# an avalanche?

are roughly 1/100 the size and weight of their conventional counterparts. With about 20 times the power overload capacity. And capable of handling as much energy in the avalanche as in the forward direction.

We can even guarantee they'll be completely unaffected by physical shock, vibration, acceleration, temperature cycling, temperature shock and long-term temperature exposures. In fact, we can virtually guarantee that they'll never fail. Ever.

It's a good feeling to know your product is right.

And it's a good feeling to know that's why you've grown 1700% in the last five years.

If your company needs diodes with the unique characteristics of Unitrode's, why not get in touch with us? We'll be glad to send you complete information and samples, too.

We're at 580 Pleasant St., Watertown, Mass. 02172. Telephone (617) 926-0404.

## UNITRODE®





**Corning quietly announces**

**CORNING  
EP-  
1100  
148**



**the FP Resistor: new, blue, and flameproof!**

Low-power resistors that won't burn under extreme overloads will soon be available in 2, 3, 4, 5, 7 and 10 watt ratings. The same sizes and stability as in the famous CORNING® LPI Resistors. Available only from

**CORNING**  
ELECTRONICS



**ONLY HONEYWELL OFFERS  
THE SMALLEST  
...FASTEST  
...MOST POWERFUL  
16-BIT I/C COMPUTER  
AVAILABLE TODAY!**

**THE  $\mu$ -COMP DDP-516**



**SPECIFICATION SUMMARY**

Type	16-bit parallel binary
Console	Movable
Addressing	Indirect/indexing
Memory Size	Up to 32,768 words
Cycle Time	960 nanoseconds
Add	1.92 $\mu$ secs
Single Word I/O Transfer	1.92 $\mu$ secs
Automatic (Cycle Stealing) I/O Transfer	Over 1 mc (16-bit words)
Weight	250 lbs.
Temperature	0°-45°C
Hardware Index Register	

THE NEW  $\mu$ -COMP DDP-516 . . . is being manufactured and delivered today — complete with an extensive software package.

It's no surprise that the DDP-516 from Honeywell, Computer Control Division is the most advanced commercial I/C compact computer you can find today . . . a natural third generation machine from the house that built the first 16-bit compact and the first I/C computer.

**SPEED . . . YOU GET 520,000 COMPUTATIONS PER SECOND.** Memory protection and power failure interrupt are standard. High performance arithmetic unit includes high speed multiply (5.28  $\mu$ sec), divide (10.56  $\mu$ sec) and double precision add (2.88  $\mu$ sec). The 4K  $\mu$ -STORE ICM-40 core memory (expandable to 32K) features 960 nanosecond cycle time. This is the same field-proven



Above: DDP-516 with 16K I/C core memory.

memory used in the DDP-124 I/C general purpose computer . . . the same memory unit that's the favorite of many systems' builders.

And that's not all . . . the DDP-516 is ideal for on-line real-time applications because of its unusually flexible I/O. Priority interrupt (individually maskable) is standard. DMC allows economical multiplexing of up to 16 devices, all simultaneously time sharing the I/O bus. Megacycle I/O rates are duck-soup for cycle stealing DMA.

DDP-516 HIGH PERFORMANCE HARDWARE IS ALL I/C.  $\mu$ -PAC logic modules are used throughout. They are packaged in a 24" x 24" x 38" mainframe that features front access to both modules and interwiring. You'll also find that field expansion and plug-in option additions are easy because of basic hardware modular construction.

RELIABILITY SPECIFICATIONS CAN'T BE TOUCHED. MTBF: about two years under normal 40-hour week operation. That's I/C for you — and 3C.

SOFTWARE INCLUDES 250 FIELD-PROVEN PROGRAMS . . . including a complete library of subroutines plus additional software from 3C's active users' group. The compiler is ASA FORTRAN IV. The assembler operates in a selectable one—or two-pass mode and features a unique DESECTORIZING technique that lets you ignore memory addressing restrictions.

That's a lot of software. Best of all, this software kit is ready to use. 3C delivered more than 125 16-bit computers during the past two years. Since our 16-bit programs are compatible with the DDP-516, you get field-proven software ready to go on line.

PRICE: \$25,000 including total software package.

DELIVERY: software immediately, hardware in as few as 90 days. Units are now being built for use in control applications, data acquisition, message communications and laboratory work.

WRITE TODAY! Get our new  $\mu$ -COMP DDP-516 summary brochure. It gives you all the facts and it's yours for the asking. HONEYWELL, Computer Control Division, Old Connecticut Path, Framingham, Mass. 01701.



# Honeywell

 COMPUTER CONTROL DIVISION



Now you can get up to



 Westinghouse warrants to the original purchaser that it will correct any defect or defects in workmanship, by repair or replacement f.o.b. factory, for any silicon power semiconductor bearing this symbol  during the life of the equipment in which it is originally installed, provided said device is used within manufacturer's published ratings and applied in accordance with good engineering practice. This warranty shall constitute a fulfillment of all Westinghouse liabilities in respect to said products. This warranty is in lieu of all other warranties expressed or implied. Westinghouse shall not be liable for any consequential damages.



# 70% higher surge ratings in 35 to 300 amp thyristors

## Use new Westinghouse CBE devices with the Lifetime Guarantee Symbol.

You'll find the most usable thyristor characteristics in the industry with Westinghouse CBE-design SCR's. Surge and I<sup>2</sup>t ratings are up to 70% higher than previous conventional types (see table). This allows optimum fuse coordination with the intermittent loads typical of thyristor circuits.

In steady-state situations, these CBE-design thyristors can be run at higher case temperatures. You can use smaller, lower-cost heat sinks with them. Or you can use

them in 17% to 25% higher current applications with present heat sink designs.

There's a concrete, sensible reason behind the higher capabilities of Westinghouse thyristors. Exclusive CBE design (Compression-Bonded Encapsulation) eliminates solder joints. Washer-type springs join semiconductor elements by compression alone. With conventional solder joints gone, the prime cause of thermal fatigue is eliminated. And thermal

impedance is reduced 30% to 40%. This gives you the increased surge and current ratings.

Your Westinghouse distributor has CBE-design thyristors in both standard and fast-switching types. And all have the unique Westinghouse Lifetime Guarantee.\* Call your distributor for immediate delivery. Or write Westinghouse for complete technical data. Westinghouse Semiconductor Division, Youngwood, Pennsylvania.

DEVICE TYPE	UNITS COMPARED HAVE SAME CASE SIZE	SURGE CURRENT AMPS	FORWARD CURRENT AMPS @ CASE TEMP. SHOWN	THERMAL IMPEDANCE	MAX. VFB	MIN. DV/DT Exp. to VFB	SWITCHING <sup>ⓐ</sup> SPEED T <sub>OFF</sub>
219	CBE Rating Prior Rating	1200 700	35 @ 97°C. 28 @ 97°C.	.35°C/W .5°C/W	1400 1000	100V <sub>μ</sub> sec No Rating	40μsec typ. No Rating
254 (2N4361-2N4378)	CBE Rating Prior Rating	1600 1000	70 @ 82°C. 57 @ 82°C.	.28°C/W .5°C/W	1400 1000	100V <sub>μ</sub> sec No Rating	40μsec typ. No Rating
218	CBE Rating No comp. unit	3300 None	125 @ 88°C. None	.15°C/W None	1400 None	100V <sub>μ</sub> sec <sup>ⓐ</sup> None	40μsec typ. None
220 (2N3884-2N3894)	CBE Rating Prior Rating	4500 3500	175 @ 83°C. 150 @ 76°C.	.13°C/W .20°C/W	1200 600	50V <sub>μ</sub> sec No Rating	50μsec typ. No Rating
223	CBE Rating Prior Rating	5000 5000	300 <sup>ⓑ</sup> 250 <sup>ⓑ</sup>	.18°C/W .22°C/W	1200 1000	50V <sub>μ</sub> sec No Rating	50μsec typ. No Rating
2191 & 2192	CBE Rating Prior Rating	1200 500	35 @ 97°C. 23 @ 97°C.	.35°C/W .5°C/W	1000 600	100V <sub>μ</sub> sec 100V <sub>μ</sub> sec <sup>ⓐ</sup>	15 & 20μsec max. 15μsec max.
2541 & 2542	CBE Rating Prior Rating	1400 750	70 @ 67°C. 70 @ 50°C.	.28°C/W .4°C/W	1000 600	100V <sub>μ</sub> sec 100V <sub>μ</sub> sec <sup>ⓐ</sup>	15 & 20μsec max. 15μsec max.
2181	CBE Rating No comp. unit	3200 None	125 @ 88°C. None	.15°C/W None	1000 None	100V <sub>μ</sub> sec <sup>ⓐ</sup> None	20μsec max. None
2201	CBE Rating No comp. unit	4000 None	175 @ 80°C. None	.13°C/W None	1000 None	50V <sub>μ</sub> sec None	25μsec max. None
2231	CBE Rating No comp. unit	4500 None	300 <sup>ⓑ</sup> None	.18°C/W None	1000 None	50V <sub>μ</sub> sec None	30μsec max. None

ⓐ Exponential to .8 VFB    ⓑ Has integral heat sink for forced air cooling    ⓒ Linear to .8 VFB  
 ⓓ Those devices above line—standard speed, those below—fast

Westinghouse CBE design thyristors have surge ratings up to 70% higher than previous conventional types.

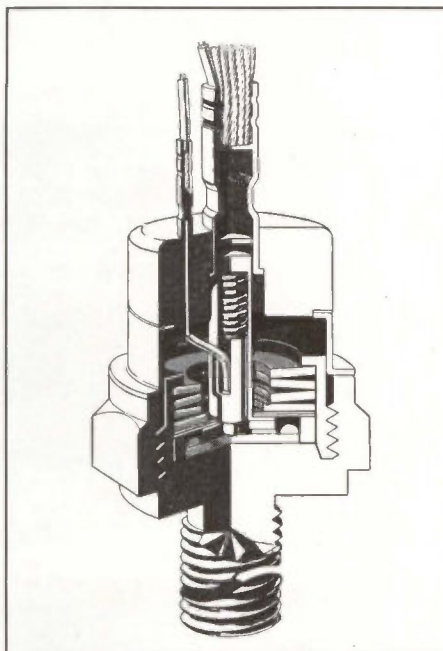

CBE design eliminates solder, uses spring washers to join thyristor elements by compression. Result: higher surge, current and I<sup>2</sup>t ratings.

## Available at these Westinghouse electronic distributors:

ALBUQUERQUE, N. M./Kierulff Electronics Corp. .... 505 268-3901  
 ATLANTA, GA./Specialty Dist. Co. .... 404 873-2521  
 BALTIMORE, MD./Kann-Eliert Electronics, Inc. .... 301 889-4242  
 BALTIMORE, MD./Valley Electronics, Inc. .... 301 668-4900  
 BINGHAMTON, N. Y./Stack Industrial Electronics .... 607 723-6326  
 BIRMINGHAM, ALA./ACK Semiconductors, Inc. .... 205 322-0588  
 BOSTON, MASS./Cramer Electronics, Inc. .... 617 969-7700  
 BUFFALO, N. Y./Genesee Radio & Parts Co., Inc. .... 716 873-9661  
 CAMDEN, N. J./General Radio Supply Co., Inc. .... 609 964-8560  
 CHARLESTON, W. VA./Charleston Elec. Sup. Co. .... 304 346-0321  
 CHICAGO, ILL./Avnet Electronics of Illinois .... 312 678-8160  
 CHICAGO, ILL./Semiconductor Specialists, Inc. .... 312 622-8860  
 CINCINNATI, O./Sheridan Sales Company .... 513 761-5432  
 CLEVELAND, O./Radio & Electronic Parts Corp. .... 216 881-6060  
 DALLAS, TEX./The Altair Co. .... 214 A0 1-5166  
 DAYTON, O./John A. Becker Co. .... 513 224-1071  
 DEARBORN, MICH./Semiconductor Spec. .... 313 271-4240  
 DENVER, COLO./Electronic Parts Co. .... 303 266-3755  
 DENVER, COLO./Kierulff Electronics Corp. .... 303 825-7033

EL PASO, TEX./Midland Specialty Co. .... 915 533-9555  
 FT. WAYNE, IND./Ft. Wayne Electronics Sup., Inc. .... 219 742-4246  
 GARLAND, TEX./Hall-Mark Electronics Corp. .... 214 276-8531  
 GREENVILLE, S. C./Gilliam Radio Co., Inc. .... 803 235-0438  
 HAMDEN, CONN./Cramer Electronics, Inc. .... 203 288-7771  
 HOUSTON, TEX./Hall-Mark Electronics Corp. .... 713 781-0011  
 HOUSTON, TEX./Lenert Company .... 713 224-2663  
 HUNTSVILLE, ALA./Electronic Wholesalers, Inc. .... 205 539-5722  
 INDIANAPOLIS, IND./Radio Distributing Co. .... 317 637-5571  
 INGLEWOOD, CAL./Newark Electronics .... 213 678-0441  
 KANSAS CITY, MO./E. C. I. Co. .... 816 931-0829  
 LOS ANGELES, CAL./Hamilton Electro Sales .... 213 870-7171  
 LOS ANGELES, CAL./K-Tronics .... 213 685-5888  
 MILWAUKEE, WIS./Taylor Electric Co. .... 414 964-4321  
 MINNEAPOLIS, MINN./Semiconductor Spec., Inc. .... 612 866-3434  
 MINNEAPOLIS, MINN./Harry Starks, Inc. .... 612 332-1325  
 MONTREAL, P. Q./Prelec Electronics Ltd. .... 389-8051  
 MOORESTOWN, N. J./Angus, Inc. .... 609 235-1900

MT. VIEW, CAL./Elmar Electronics, Inc. .... 415 961-3611  
 MT. VIEW, CAL./Hamilton Electro North .... 415 961-7000  
 NEW YORK, N. Y./Milgray Electronics, Inc. .... 212 989-1600  
 ORLANDO, FLA./Electronic Wholesalers, Inc. .... 305 841-1550  
 ORLANDO, FLA./Hall-Mark Electronics Corp. .... 305 855-4020  
 PERTH AMBOY, N. J./Atlas Electronics, Inc. .... 201 HI 2-8000  
 PHILADELPHIA, PA./Milgray Delaware Valley, Inc. .... 215 BA 8-2000  
 PHOENIX, ARIZ./Kierulff Electronics Corp. .... 602 273-7331  
 PITTSBURGH, PA./Cameradio Company .... 412 391-4000  
 SAN DIEGO, CAL./Hamilton Electro of San Diego .... 714 279-2421  
 SAN FRANCISCO, CAL./Fortune Electronics .... 415 826-8811  
 SEATTLE, WASH./Hamilton Elec. Sales/Pac. N. W. .... 206 624-5930  
 SEATTLE, WASH./Kierulff Electronics Corp. .... 206 725-1550  
 ST. LOUIS, MO./E. C. I. Co. .... 314 647-5505  
 ST. LOUIS, MO./Hall-Mark Electronics Corp. .... 314 521-3800  
 SYRACUSE, N. Y./Cramer Electronics, Inc./Eastern .... 315 455-6641  
 TORONTO, ONT./Avnet Electronics Ltd. .... 789-2621 789-4685  
 WASHINGTON, D. C./Milgray/Washington, Inc. .... 202 864-6330  
 WESTBURY, L. I., N. Y./Schweber Electronics .... 516 334-7474

You can be sure if it's Westinghouse

SC-2076-A





1961

1962

1963

1964





1965

1966



6 YEARS  
NO MISSION FAILURE

ECI's AN/ARC-89(V) communication system for SAC Airborne Command Post has been operating continuously since February 1961. New ECI miniaturized system assures an even greater dependability as established in recent USAF tests.

**Delegate  
your  
communication  
system  
dependability  
problem  
to us.**

If we haven't already solved it, we will. That goes for your size/weight, compatibility and message integrity problems too.



ELECTRONIC COMMUNICATIONS, INC.  
ST. PETERSBURG DIVISION

To investigate career opportunities in communications, call or write Mr. Chuck Kelly, Professional Placement Office, Electronic Communications Inc., P.O. Box 12248, St. Petersburg, Florida 33733. Telephone (813) 347-1121. (Equal opportunity employer, M & F.)

Circle 71 on reader service card





# THE DEATH OF AN AGGRAVATION

(An encouraging note for those concerned with the application of reflex klystrons.)

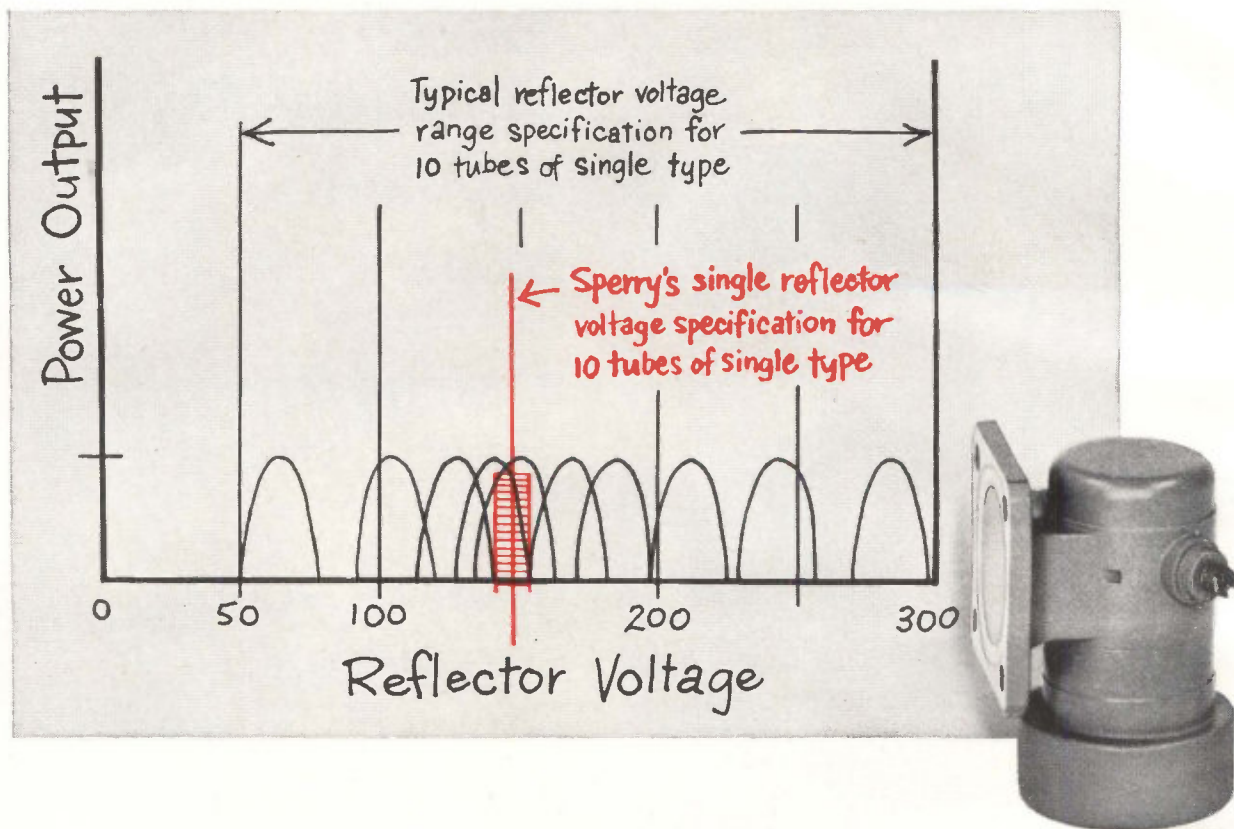

All the reflex klystrons in your next order can have the same reflector voltage! A remarkable new development from Sperry has eliminated the familiar problem of searching a wide reflector voltage range for proper tuning. Tube replacements can be made in the field with no adjustments to either tube or system.

You no longer need a power supply that can allow for large and unpredictable reflector voltage variations. You no longer need a potentiometer to adjust the reflector voltage, or the test gear required for tuning the tube in the field.

Now you simply decide what reflector voltage you want and tell us. As the chart above indicates, we

**Evaluate Sperry for Value! This new development comes from the Sperry Storehouse of Knowledge . . . for more than 25 years the outstanding source of improvements in microwave tubes. Our inventory is technology. Draw on it whenever you need outstanding performance from klystrons, traveling wave tubes, or backward wave oscillators.**

## SPERRY

DIVISION OF  
SPERRY RAND  
CORPORATION

can put the center frequency right where you want it and deliver the tube either fixed-tuned or mechanically tunable.

There's other beneficial fallout from this concept. Many characteristics, such as modulation sensitivity, are more uniform from tube to tube. And, as far as shock and vibration are concerned, our tubes are state-of-the-art.

Sperry technology has now perfected reflex klystrons that offer the new single reflector voltage principle for a variety of applications in X, U, K and V bands.

Like to know how we do it? Write for your free copy of a new technical paper by Sperry's J. D. Feehan. It has the details.

### SPERRY ELECTRONIC TUBE DIVISION, Gainesville, Fla.

National Representatives: Cain & Co., Los Angeles, 783-4700; Boston, 665-8600; Arlington Heights, 253-3578; Dallas, 369-2897; Dayton, 228-2433; Eastchester, 337-3445; Philadelphia, 828-3861; San Francisco, 948-6533; Syracuse, 463-0462; Washington, 296-8265; South Amboy, 727-1900; Huntsville, 534-7955; Dade City, 422-3460; Montreal, 844-0089.



---

# Washington Newsletter

---

November 14, 1966

## Cable may replace ailing tropo link in Southeast Asia

Technical problems with a 450-mile troposcatter communications link in Southeast Asia reportedly is the reason for the current urgency in laying an undersea cable between Saigon, South Vietnam and Bangkok, Thailand. Neither the Philco-Ford Corp., a subsidiary of the Ford Motor Co., the tropo system builder, nor the military agencies involved would confirm that the Air Force cable—439L—would replace the Army-operated tropo link when the cable is completed in April. But officials acknowledge that the tropo link, operating with parabolic antennas at 2 gigahertz, had been out of service for as much as 10% of the time earlier this year.

The troposcatter system—longest in Southeast Asia—is a recently upgraded part of the Integrated Wideband Communications System [Electronics, Oct. 3, p. 167]. The addition of high-efficiency feed horns, improved receivers and new low-noise amplifiers should solve the outage problem, maintains the Philco-Ford Corp. The \$26.3 million contract for building 439L was awarded in March to Page Communications Engineers Inc., a Northrop Corp. subsidiary.

## Navy gets 'no' on additional A-6A aircraft

In testimony still classified, Defense Secretary Robert S. McNamara reportedly told a House Armed Services special investigations subcommittee that the Navy's request for additional A-6A all-weather aircraft had to be turned down because avionics producers were too busy to take on the job.

Although McNamara didn't name the companies, the major suppliers of A-6A avionics now include Litton Industries Inc. for the digital computer and inertial navigation system; the Norden division of United Aircraft Corp. for the Ku-band radar; and the GPL division of General Precision Inc. for the doppler system. McNamara said the Navy would have to be satisfied with the A-4F, a plane in which the pilot must make a visual sighting of the target before dropping his bombs.

## NASA seeks funds for space workshop and telescope

The National Aeronautics and Space Administration, pushing ahead to get the Apollo Applications Program moving, will ask Congress for funds for initial hardware. The agency is now evaluating some 20 proposals and will seek money in 1967 for two: a telescope using sophisticated electronics to be mounted on the Apollo spacecraft to observe the sun, and an airlock so astronauts can enter a spent stage of the Saturn launch vehicle to conduct experiments requiring zero gravity. One of the two, probably the workshop, could fly as early as the fourth manned Apollo mission late next year.

## Airlines' satellite faces delay

Despite the enthusiastic response from airlines and the Federal Aviation Agency for a demonstration satellite to relay very high frequency communications from transoceanic airliners [Electronics, Oct. 3, p. 171], the current target launch date of late 1968 is beginning to look overly optimistic.

The early operational use of such a satellite was not supported by any other nation at the recent Montreal meeting of the International Civil Aviation Organization. Additionally, a cautious attitude to the Com-



# Washington Newsletter

munications Satellite Corp.'s timetable for putting up Aerocom was urged by the House Government Operations Committee in a recent report. It recommended that the FAA work closely with the National Aeronautics and Space Administration to gain more knowledge and information before contracting for the prototype system.

Vhf tests will be conducted next year on the space agency's Applications Technology Satellite.

## Second Apollo crew will search stars in key experiment

Space agency officials call one of the 16 experiments scheduled for the second Apollo flight the most complicated electronics test ever flown in a manned United States spacecraft.

The astronauts who fly the mission, planned for next summer, will have aboard four proportional counters to measure low-energy X-rays from stellar sources. The crew will have to maneuver the spacecraft to align the counters with the desired stars. The first Apollo launch, recently rescheduled from early December to mid-January, will have 11 experiments on board.

## Antimissile system still a Chinese puzzle

Despite China's successful test of a medium-range nuclear missile last month, the outlook remains dim that the fiscal 1968 budget will include funds to deploy the Nike-X antimissile system [Electronics, Oct. 3, p. 76]. Pentagon planners are examining a stripped-down version of Nike-X to counter any Red Chinese threat. It would be much less expensive than a full-scale antimissile system.

## 1967 launch date likely for second in Intelsat 2 series

Failure of the apogee motor to put the Communications Satellite Corp.'s Intelsat 2 satellite into stationary orbit over the Pacific Ocean last month has caused the postponement of the second satellite launch in the series from Nov. 23 until early next year. But Comsat is hopeful that the satellite launched Oct. 26, and now in a 12-hour elliptical orbit, will be able to relay eight to 10 hours of commercial traffic daily between Hawaii and the United States.

The satellite's primary job was to provide six channels for the space agency's Apollo communications network—something it won't be able to do. Comsat's delay in providing these circuits, however, is not expected to affect any Apollo mission schedules.

Preliminary data on last month's launch indicates the satellite's apogee engine was subjected to much colder temperatures than the design specifications called for. If this is confirmed in ground tests to be conducted at Hughes Aircraft Co., the satellite builder, protective shielding will be installed on the remaining three satellites.

## Competition coming from Comsat center

It won't be operating until 1968, but producers of satellite equipment are already worrying about competition from the Communications Satellite Corp.'s \$10-million research center. Comsat recently picked a site in Maryland, about 30 miles from Washington, and announced that it was seeking a top man from industry to head the new center.

A highly placed Comsat official gave the industry cause for concern when he said that the corporation will build some flight hardware and that he wouldn't rule out satellites. The center will work on ground station equipment and may build terminals for operational use.





**What solvent meets "white room" standards for rocket fuel systems?**

**Liquidometer says:  
FREON<sup>®</sup>  
Precision  
Cleaning Agent.**

Liquidometer Aerospace Division of Simmonds Precision Products, Inc., in Long Island City, N. Y., maintains one of the world's most efficient "white rooms" to insure the microscopic cleanliness of their rocket fuel sensing devices. That's because the slightest particle of metal, organic residue or other contaminant could endanger the success of space missions. And that's why the solvent used to clean these critical components is FREON Precision Cleaning Agent.

FREON is a selective solvent—it cleans without affecting commonly used materials of construction. Its low surface tension penetrates the smallest pores and crevices. Its high density floats away all particulate matter. Its excellent stability permits reuse after recovery by simple distillation and filtration. FREON is nonflammable, and unlike many other solvents, relatively nontoxic. Special exhaust systems are rarely needed.

Whether or not you clean to "white room" standards, chances are you can clean better, faster and at lower cost with a FREON solvent. For more information, write Du Pont Co., Room 4344, Wilmington, Delaware 19898. (In Europe, write Du Pont de Nemours International S.A., FREON Products Division, 81 Route de l'Aire, CH 1211 Geneva 24, Switzerland.)



Better Things for Better Living  
...through Chemistry



You need only half the space to get  
low, constant contact resistance

# CLARE HGSR

...the new subminiature  
Mercury-Wetted Contact Relay  
for PCB Mounting



*Actual Size*  
1<sup>9</sup>/<sub>16</sub>" long 1<sup>7</sup>/<sub>32</sub>" wide .400" high

greater switching density than ever before  
possible with mercury-wetted contacts

## Here's why you'll specify CLARE TYPE HGSR

- \* **SENSITIVE**  
20 mw bi-stable, 40mw single side stable
- \* **HIGH SPEED**  
1.0 ms nominal operate time at max coil power
- \* **LONG LIFE**  
More than  $20 \times 10^9$  operations at rated load
- \* **LOW, CONSTANT CONTACT RESISTANCE**  
20 milliohms max contact circuit resistance  
... stable within  $\pm 2$  milliohms over relay life
- \* **POSITIVE ON-OFF SWITCHING**  
No contact bounce, minimum contact noise generation
- \* **CHOICE OF CONTACTS**  
Form C or Form D

# the sensitivity, long life, and of mercury-wetted contact relays

Now you can design around the same consistent and dependable characteristics provided by the CLARE Type HGSM Relay—in half the size! That means you can fit the Type HGSR into modern electronic systems, getting mercury-wetted contact relay action on printed circuit boards.

The Type HGSR will give you complete freedom from contact bounce and chatter, with input-output isolation and high speed which qualify it as an excellent input buffer to solid state circuitry. Or, if you need high power gain as an output device from solid state systems, the Type HGSR will give you gain up to 5000.

As scanner contacts in checkout systems,

the Type HGSR can withstand hi-pot voltage of 1000 vac, with 1500 vac offered on special-order. Constant contact resistance (within  $\pm 2$  milliohms of initial value over 20-billion operation life) is extremely important in critical measuring circuits. For tape transport read-write head switching, the Type HGSR offers the remarkable combination of high speed and low contact noise generation without false signaling due to contact bounce or chatter.

Get the full story on the Clare Type HGSR, and you'll discover new opportunities for high-reliability circuits, handling low level to 100 va, ac or dc, for over 20 billion operations without derating.

## CHOOSE THE PCB RELAY YOU NEED FROM CLARE'S COMPLETE LINE

	HGSR		HGSM				HGM
	Series 10000	Series 50000	Series 10000	Series 50000	Series 1000	Series 5000	
Dimensions (l x w x h)	1 $\frac{1}{16}$ " x 1 $\frac{1}{32}$ " x .400"		2 $\frac{1}{16}$ " x $\frac{5}{8}$ " x .625"				3 $\frac{1}{64}$ " x $\frac{3}{4}$ " x $\frac{3}{4}$ "
Contacts (Note 1) Action (spdt)	1 Form D	1 Form C	1 Form D	1 Form C	1&2 Form D	1&2 Form C	1&2 Form D
Ratings Switched load (max)	2 amp, 500 v, 100 va		2 amp, 500 v, 100 va				5 amp, 500 v, 250 va
Carry load (max)	5 amp, not switched		5 amp, not switched				10 amp, not switched
Inrush load (avg) 10 ms 10 sec 100 sec	20 amp 4 amp 2 amp		20 amp 4 amp 2 amp				50 amp 10 amp 5 amp
Circuit resistance (max) (Note 2)	20 milliohms		20 milliohms				35 milliohms
	Variation less than $\pm 2$ milliohms from initial value over 20 x 10 <sup>9</sup> operations (Independent of current or voltage)						
Operating voltage	Up to 90 vdc		Up to 90 vdc				Up to 90 vdc
Operate time (nom) at max coil power	1.0 ms		1.0 ms		1.2 ms single side stable 1.0 ms bi-stable (Note 3)		As low as 2.4 ms (Note 3)
Sensitivity Bi-stable	20 mw either winding of double wound coil		20 mw either winding of double wound coil		25 mw (Note 3)		As low as 550 mw (Note 3)
Single Side Stable	40 mw single wound coil, 80 mw either winding of double wound coil		40 mw single wound coil, 80 mw either winding of double wound coil		115 mw (Note 3)		
NOTES:	<ol style="list-style-type: none"> <li>1. Except for very light loads such as thermocouples and strain gauges, contacts must be protected by a resistor-capacitor suppression circuit.</li> <li>2. Measured at 6 vdc, 100 ma.</li> <li>3. Depending on number of contacts.</li> </ol>						

Clare also offers Mercury-Wetted Contact Relays for wired assemblies... as well as in printed circuit board assemblies, combined with other components mounted on pcb's supplied by Clare or customer. See Clare Manual 201D.

For complete data, write Group 11N8 C. P. CLARE & CO. 3101 Pratt Boulevard Chicago, Illinois 60645



relays and related control components



**If you think  
you've seen  
low-priced  
multi-function  
plastic dual in-line  
integrated circuits . . .**



Box 955, Phoenix, Arizona 85001



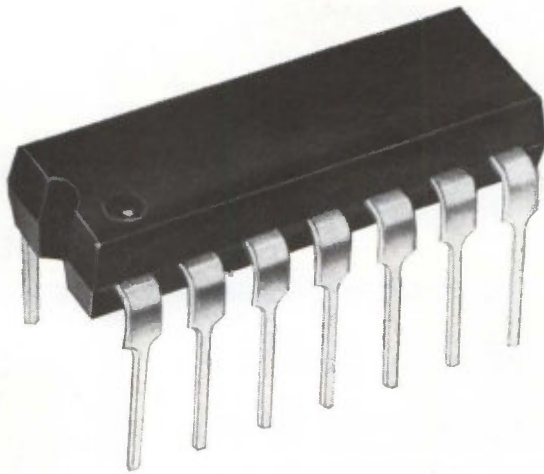

... Think again.

*Multi  
Functions*

MRTL* - MC700P Series	One-999	1000-4999
Dual 3-Input Gate (MC715P) .....	\$1.00	\$ .75
Quad 2-Input Gate (MC717P) .....	1.08	.81
Dual 3-Input Gate (MC718P) .....	1.00	.75
Dual 3-Input Gate (MC719P) .....	1.08	.81
J-K Flip-Flop (MC723P) .....	1.35	1.00
Quad 2-Input Gate (MC724P) .....	1.08	.81
Dual 4-Input Gate (MC725P) .....	1.08	.81
Dual Buffer (Non/inverting) (MC783P) .....	1.35	1.00
Hex Inverter (MC789P) .....	1.08	.81
Dual J-K Flip-Flop (MC790P) .....	2.00	1.50
Triple 3-Input Gate (MC792P) .....	1.20	.90
Triple 3-Input Gate (MC793P) .....	1.20	.90
Dual Buffer (MC798P) .....	1.35	1.00
Dual Buffer (MC799P) .....	1.08	.81
<b>MDTL* - MC830P Series</b>		
Dual 4-Input Gate (MC830P) .....	1.55	1.15
Clocked Flip-Flop (MC831P) .....	3.00	2.25
Dual Buffer (MC832P) .....	1.65	1.25
Dual Expander (MC833P) .....	1.35	1.00
Dual Power Gate (MC844P) .....	1.65	1.25
Clocked Flip-Flop (MC845P) .....	3.00	2.25
Quad 2-Input Gate (MC846P) .....	1.65	1.25
Clocked Flip-Flop (MC848P) .....	3.00	2.25
Triple 3-Input Gate (MC862P) .....	1.65	1.25

\*Trademark of Motorola Inc.

**CALL YOUR MOTOROLA DISTRIBUTOR  
RIGHT NOW!**

**MOTOROLA Semiconductors**

*- where the priceless ingredient is care!*



# What Kind of Panel Meter Do You Need ?



## crisp, classic Horizon Line?



## trim, built-in Horizon Line?

Built-in or front-mounted, General Electric HORIZON LINE® panel meters add quiet sophistication that accents, never dominates your electronic equipment. Check these distinctive HORIZON LINE features: smart, low-profile; clean, soft line; fine-precision markings. All ratings are available in 2½", 3½", and 4½".

## distinctive Big Look?

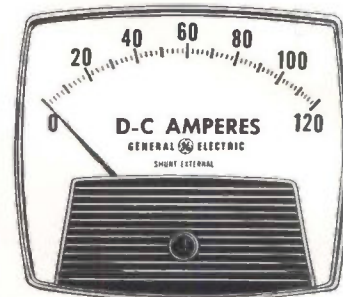

Add bold, exciting, truly distinctive styling to your electronic equipment with General Electric BIG LOOK® panel meters. Panelboards take on added flair with such BIG LOOK features as . . . big, bold numerals, uncluttered display, tapered pointer, stylish shape, plus many others. All ratings are available in 1½", 2½", 3½", 4½".

Besides saving you valuable panel space, General Electric slim-line Type 185 EDGEWISE panel meters add exceptional styling and readability to your electronic equipment. These 2¼" Type 185 EDGEWISE panel meters can be mounted individually or in space-saving clusters of two, three, or more. All ratings are available for vertical or horizontal mounting, with or without bezels.

## smart, slim edgewise?

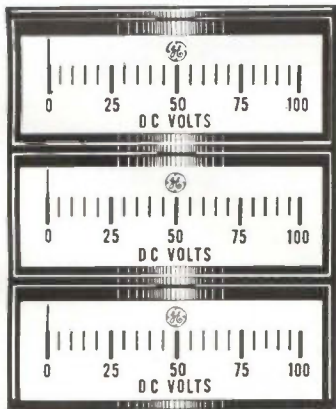

## style-matched time meters?



Distinctive BIG LOOK styling is yours with General Electric BIG LOOK elapsed time meters. These "look-alike" time meters combine to give your equipment uniformity and beauty. G-E elapsed time meters measure either hours or minutes with or without a reset knob. All ratings are available in 2½" and 3½".

## bright, bold meter relay?



Add years ahead BIG LOOK styling to your equipment with General Electric Type 195 contactless meter relays, featuring a totally new, solid-state, light-sensitive switch for the ultimate in control simplicity and readability. "Piggyback" control modules make for faster, easier installation. Companion pyrometers are also offered. All ratings are available in three sizes (2½", 3½", 4½") with single or double setpoints.

## You can get it...from General Electric's full line

And, of course, General Electric's full line of panel meters is unmatched for accuracy and reliability. They're as near as your dependable G-E electronic distributor or sales office. You get fast delivery, too. For free descriptive bulletins describing G.E.'s full line of panel meters, write General Electric Co., Section 592-25A, Schenectady, New York 12305.

GENERAL  ELECTRIC



# To put it in writing... look to the great family of *brush* recorders.

No matter what your direct writing recording requirements, look to Brush for the optimum answer. There's the famous Mark 200® series of modular systems plus a complete line of high-performance portable and general purpose recorders. All built by Brush to give you the best written records in the world.

## *brush* Recorder Mark 200® Series

### All Solid State • Series 1707 Position-Feedback Controlled

The Series 1707 line is a new generation of Brush Mark 200-Recorder System combining the advantages of all solid state electronics with modular construction and a flexibility in application never before achieved. The result is a totally new concept in instrument design which allows any system to be tailored to specific requirements by selection from a broad range of "building block" subsystems.



### Choice of Penmotors

(Mark 200 accommodates any 4; Mark 240 accommodates any 2)

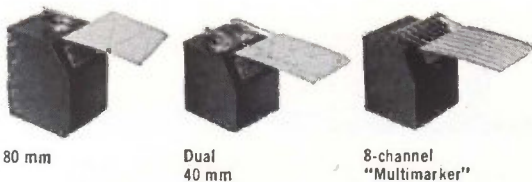

### Choice of Input Preamplifiers

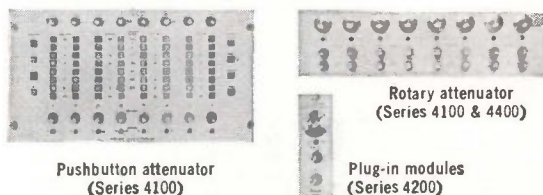

### All Solid State Recorder • Mark 240 Position-Feedback Controlled

This versatile, high accuracy direct writing recorder is a complete, self-contained system designed for a very wide range of applications where resolution and precision in measurement are required. It may be mounted vertically or horizontally in standard 19" racks to RETMA specifications, or in Brush racks, or bench-top cabinets.

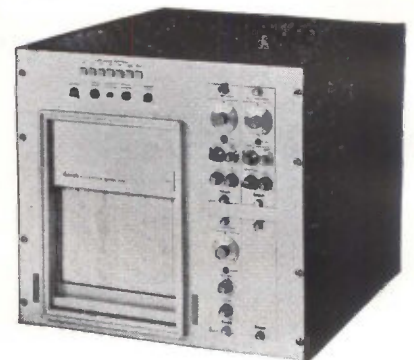

	Mark 200	Mark 240
No. of Channels	Choice of 2 to 8-40 mm ch. 1 to 4-80 mm ch. 8 to 32-event ch.	Choice of 2 to 4-40 mm ch. 1 to 2-80 mm ch. 8 to 16-event ch.
(ALL ALIKE, OR IN COMBINATION)		
Penmotor type	Position feedback	Position feedback
Writing method	Pressurized ink	Pressurized ink
Trace presentation	Rectilinear	Rectilinear
Chart speeds	0.05, 0.1, 0.2, 0.5 1, 2, 5, 10, 20, 50 100, 200mm/sec.	0.05, 0.1, 0.2, 0.5 1, 2, 5, 10, 20, 50 100, 200mm/sec.
Chart capacity	500'	275'
Frequency response 40mm penmotors 80mm penmotors	55 cps full scale; 30 cps full scale;	55 cps full scale; 30 cps full scale;
Linearity	1/2% full scale	1/2% full scale
Configuration	Vertical or horizontal oscillograph	Mounts in any position
Input characteristics	Depends on preamplifier used	Depends on preamplifier used
	4- or 8-channel 4100 SERIES (50mV, 50K) • pushbutton attenuator • rotary attenuator 4400 SERIES (1mV, 1 meg) • without calibrated zero suppression • with calibrated zero suppression <b>PLUG-IN MODULES</b> 4200 SERIES Coupling preamps (50mV, 50K) • without zero suppression • with zero suppression Medium gain (1mV, 1 meg) High gain (100 microvolts, 1 meg) • without zero suppression • with zero suppression Very high gain 100K (1 microvolt, 1 meg) • without zero suppression • with zero suppression Strain-gage (carrier) Phase-sens. demodulator Hi-voltage (1000VDC off-ground) Frequency deviation converters • 50 cps • 60 cps • 400 cps AC watts converter AC volts to DC volts AC amps to DC volts	<b>PLUG-IN MODULES</b> 4200 SERIES Coupling preamps (50mV, 50K) • without zero suppression • with zero suppression Medium gain (1mV, 1 meg) High gain (100 microvolts, 1 meg) • without zero suppression • with zero suppression Very high gain 100K (1 microvolt, 1 meg) • without zero suppression • with zero suppression Strain-gage (carrier) Phase-sens. demodulator Hi-voltage (1000VDC off-ground) Frequency deviation converters • 50 cps • 60 cps • 400 cps AC watts converter AC volts to DC volts AC amps to DC volts



### Mark 280 Dual 80mm Position Feedback Penmotor Recorder

Portable dual channel system with rectilinear forced-fluid writing. "Double-width" 80 mm channels.

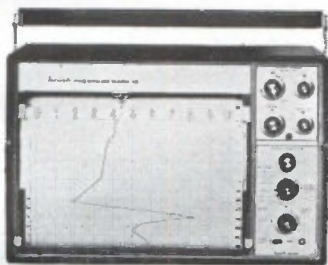

### Mark 10 Potentiometric Strip Chart Recorder

New 10" strip chart recorder. All solid state, even the ink! Lightweight, simple to use, amazingly versatile. Ten chart speeds, variable gain, broad electrical range. Ideal for lab and general purpose requirements.

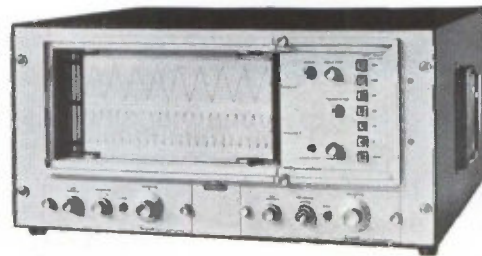

### Mark 842 Hi-torque Penmotor Recorder

Highly versatile pressure-thermal rectilinear writing system. See list of "plug-in" preamplifiers on facing page.

### Mark 2300 Lightbeam Oscillograph

Application possibilities of this versatile portable recorder are almost unlimited. Simple incandescent light-source is fail-safe.



### Mark II Portable Recorder

Lightweight, highly versatile—a complete dual channel recording system. Anyone can plug it in, put it in writing anywhere!



### Brush Operations Monitors 30-100-150 channel models

For on-off, go/no-go or other two-state operations. Pulsed writing, with built-in electronic switching. Complete with self-contained power supply and provision for internal mounting of interchangeable decade boards for electronic input switching in a variety of input modes.

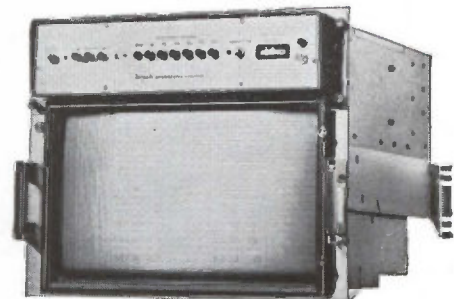

	Mark 280	Mark 842	Mark II	Mark 10	Mark 2300
No. Channels	2	2	2	1	1 to 16
Analog Event	2 standard	1 standard	2 standard	1 (accessory)	
Channel width	80mm	40mm	40mm	10"	6"
Penmotor type	Position feedback	Hi-torque d'Arsonval	d'Arsonval	Potentiometric	Lightbeam galvo
Writing method	Pressurized ink†	Pressure-thermal	Capillary ink	"Solid-state" wax-base	Tungsten† lightbeam
Trace presentation	Rectilinear	Rectilinear	Curvilinear	Rectilinear	Rectilinear
Chart speeds	0.05, 0.1, 0.2, 0.5, 1, 2, 5, 10, 20, 50, 100, 200mm/sec	0.05, 0.1, 0.2, 0.5, 1, 2, 5, 10, 20, 50, 100, 200mm/sec	1, 5, 25, 125mm/sec	1, 2, 5, 10, 20 in./min. 1, 2, 5, 10, 20 in./hr.	0.2, 0.4, 1, 2, 5, 10, 25 and 50 ips, plus above speeds ÷ 100
Frequency response	35cps full scale (80mm)	75cps full scale (40mm)	35cps full scale (40mm)	1cps full scale (10 inches)	Depends on galvo selected—to 2500 cps
Linearity	½% full scale	½% full scale	2% full scale	0.2% full scale	2% full scale
Input characteristics	0.5mv/div; 1 meg constant; floating	Interchangeable preamps (see listing at left)	10mv/div; 5 meg single-ended; 10 meg balanced	50 microvolts/div; 1 meg, constant; also potentiometric	Varies with galvo selected; impedance 100K floating with Brush galvo amplifier

\*Total chart width  
†Patent pending

Write for Literature or, for Application Assistance, Contact Your Brush Factory Branch or Representative.

Brush Instruments Division, Clevite Corporation, 37th and Perikins, Cleveland, Ohio 44114. Sales, service and warehousing centers at Boston, New York, Washington, Orlando, Cleveland, Detroit, Chicago, Denver, Houston, Los Angeles, San Francisco, and Seattle; engineering representatives in all key locations.

# CLEVITE

*brush* INSTRUMENTS DIVISION



## **NEW LOW PRICES**

### **High Voltage Silicon Power Transistors**



**The new  
DTS 410  
(200v., 3.5a)  
\$1.95 each\***



**DTS 411  
(300v., 3.5a)  
Were \$5.75 ea.,  
now \$3.15 ea.\***



**DTS 413  
(400v., 2.0a)  
Were \$6.50 ea.,  
now \$3.95 ea.\***



**DTS 423  
(400v., 3.5a)  
Were \$7.16 ea.,  
now \$4.95 ea.\***

# We just lowered the cost of lowering the cost of high-energy circuits.

From now on, the cost-cutting advantages of Delco NPN high voltage silicon power transistors cost even less. Look over the new low prices on the opposite page.

You can use these transistors in applications ranging from large screen video deflection and line operated class A audio output to high voltage, high efficiency regulators, converters and (VLF) amplifiers.

By using Delco high voltage silicon power transistors, you can reduce the number and complexity of input, output and filtering components. Fewer components mean lower assembly cost, shorter assembly time. There's less chance for breakdown—lower maintenance costs. Circuitry can be more compact, lighter and easier to keep cool.

\*Prices shown are for quantities of 1,000 or more.

These NPN silicon transistors are fabricated by our unique Delco 3-D process that provides high voltage protection, high frequency response and low saturation resistance. Each is packaged in a solid copper coldweld Delco TO3 case for low thermal resistance. Inside, they are ruggedly mounted to withstand mechanical and thermal shock due to special bonding of the emitter to base contacts.

Contact your nearest Delco sales office or distributor for complete data, application assistance or immediate delivery.

TYPE	V <sub>CEO</sub>	V <sub>CEO</sub> (sus)	I <sub>C</sub> Max	h <sub>FE</sub> Min V <sub>CE</sub> =5V @ I <sub>C</sub>	Power Diss Max
DTS 410	200V	200V (min)	3.5A	10 @ 2.5A	80W
DTS 411	300V	300V (min)	3.5A	10 @ 2.5A	100W
DTS 413	400V	325V (min)	2.0A	15 @ 1.0A	75W
DTS 423	400V	325V (min)	3.5A	10 @ 2.5A	100W

**FIELD SALES OFFICES**

UNION, NEW JERSEY** Box 1018 Chestnut Station (201) 687-3770	DETROIT, MICHIGAN 57 Harper Avenue (313) 873-6560	SANTA MONICA, CALIF.** 726 Santa Monica Blvd. (213) 393-1465
SYRACUSE, NEW YORK 1054 James Street (315) 472-2668	CHICAGO, ILLINOIS** 5151 N. Harlem Avenue (312) 775-5411	General Sales Office: 700 E. Firmin, Kokomo, Ind. (317) 459-2175

\*\*Office includes field lab and resident engineer for applications assistance

## DELCO RADIO

Division of General Motors, Kokomo, Indiana





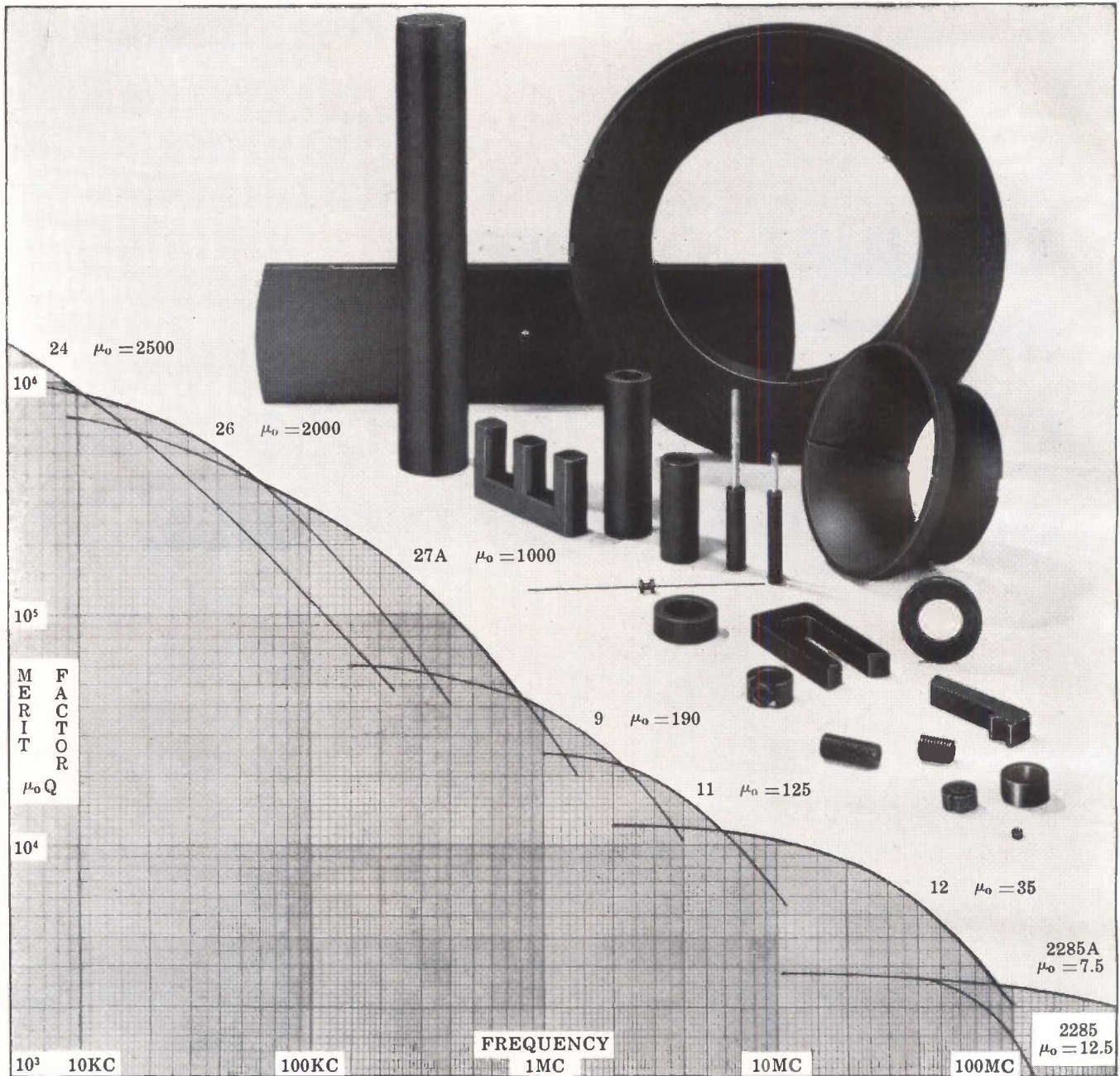

## CERAMAG® FERRITE PARTS ARE CONSISTENT

Stackpole offers over 30 grades of Ceramag® material. More are being developed continually. Such up-to-the-minute technology permits you to specify Ceramag® on every new application. Discover the unique advantages of the versatile Ceramag® ferrites: complete moldability to virtually any shape, and the important savings over steel alloys for low frequency applications. When high permeability is an important factor, Ceramag® is the answer.

Hundreds of Ceramag® parts are already tooled as toroids, cup cores, insert cores, transformer cores, deflection yokes and rectangular solids. Special tooling is also available.

Stackpole is a name long associated with quality components in the electronic field. Only the closest attention to every production detail can result in the kind of product uniformity available with Ceramag® ferrites. As one of our customers

put it, "Your ferrite cores are more consistent from order to order than any of your competitors."

If you are about to select a ferromagnetic material for a new application, or if you are dissatisfied with the performance and service of your present ferrite supplier, why not investigate Stackpole's Ceramag®? To discover how you can save and still insure superior performance, write for our Bulletin 1-A, Stackpole Carbon Company, Electronic Components Division, St. Marys, Pennsylvania 15857. Phone: 814-781-8521 — TWX: 510-693-4511.



# CHOP COSTS

**(DESIGN LIMIT CURVES PROVIDED IN SIGNETICS' SE400J SERIES SPEC SHEETS LET YOU CHOP COSTS OF DESIGN.)**

Signetics goes farther than anyone ever has before to anticipate technical questions and provide meaningful written design data. In addition to worst case figures, Signetics SE400J series data sheets provide System Design Limit Curves. These allow a designer to predict readily how a specific system design will function under conditions other than

worst case. With such information at hand, the hidden costs of design — extensive in-house characterization, and lengthy specification negotiations — are eliminated. Operative designs can be made with a minimum of meetings and phone calls. As efficient as their data sheets, the SE400J series require 40% to 70% less power than comparable devices

while maintaining equal or greater speed and noise immunity. Ideal in aerospace applications where high density packaging and the ability to drive high capacitances are important, the series features a dual 5MHz Binary Element operating on less than 9mW per flip-flop, and includes a Dual NAND Gate, Dual Driver-Buffer and a Quad NAND Gate.

Please send me your unique data sheets on the SE400J series.

Name \_\_\_\_\_

Company \_\_\_\_\_

Address \_\_\_\_\_

City \_\_\_\_\_

State \_\_\_\_\_

Zip \_\_\_\_\_

Mail to: Signetics, 811 E. Arques Ave., Sunnyvale, California

**SIGNETICS  
INTEGRATED  
CIRCUITS**   
A SUBSIDIARY OF CORNING GLASS WORKS





**Great moments in quality control!**

# EUREKA!

**Harry Farquardt has a unique idea—  
why not try 3M Brand Inert Liquids  
for testing electronic components—  
and discovers the perfect test bath.**

Harry wasn't sure what he'd fish out of the beaker. What he found was that 3M Inert Fluorochemical Liquids have all the properties of the ideal test bath.

For example, the fluorochemical liquids are completely inert. And compatible. They have *no* effect on sensitive parts or materials.

These fluids have high dielectric strengths, too. There's never any harmful arcing, when testing a part under electrical stress.

For another thing, the fluids drain clean. Tested components dry almost instantly. There's never a residue. Never a need for cleaning the part after the bath.

And, finally, the inert liquids offer a wide temperature range. So you can use the same liquids in both high and low temperature tests.

Go ahead. Profit from Harry Farquardt's discovery. Investigate the use of 3M Brand Inert Fluorochemical Liquids in your quality control testing.

**Chemical Division** **3M**  
COMPANY



Once in a blue moon you'll find a superior solid-state S-Band transmitter with high reliability, superior performance, small volume and light weight. One that's compatible with both SGLS and Unified S-Band systems. One that's built by specialists in RF equipment, a true telemetry house fully experienced in S-Band operations.

Well, Vector has this superior UHF transmitter in stock.

One model is the Vector TWB-1167 wide-band transmitter, for frequency range 2200-2300 MHz, frequency stable to  $\pm 0.002\%$ , with 5 watts output. With a negative grid tube amplifier, it delivers 10 to 25 watts at S-Band. Vector's complete range of RF equipment includes VHF, L- and S-Band transmitters, Beacon transmitters, modulators, power amplifiers and airborne command receivers for all aerospace environments including high radiation. For more information, call or write Vector, (215) 355-2700.

**Vector** DIVISION OF UNITED AIRCRAFT CORPORATION  
SOUTHAMPTON, PENNSYLVANIA

U  
A

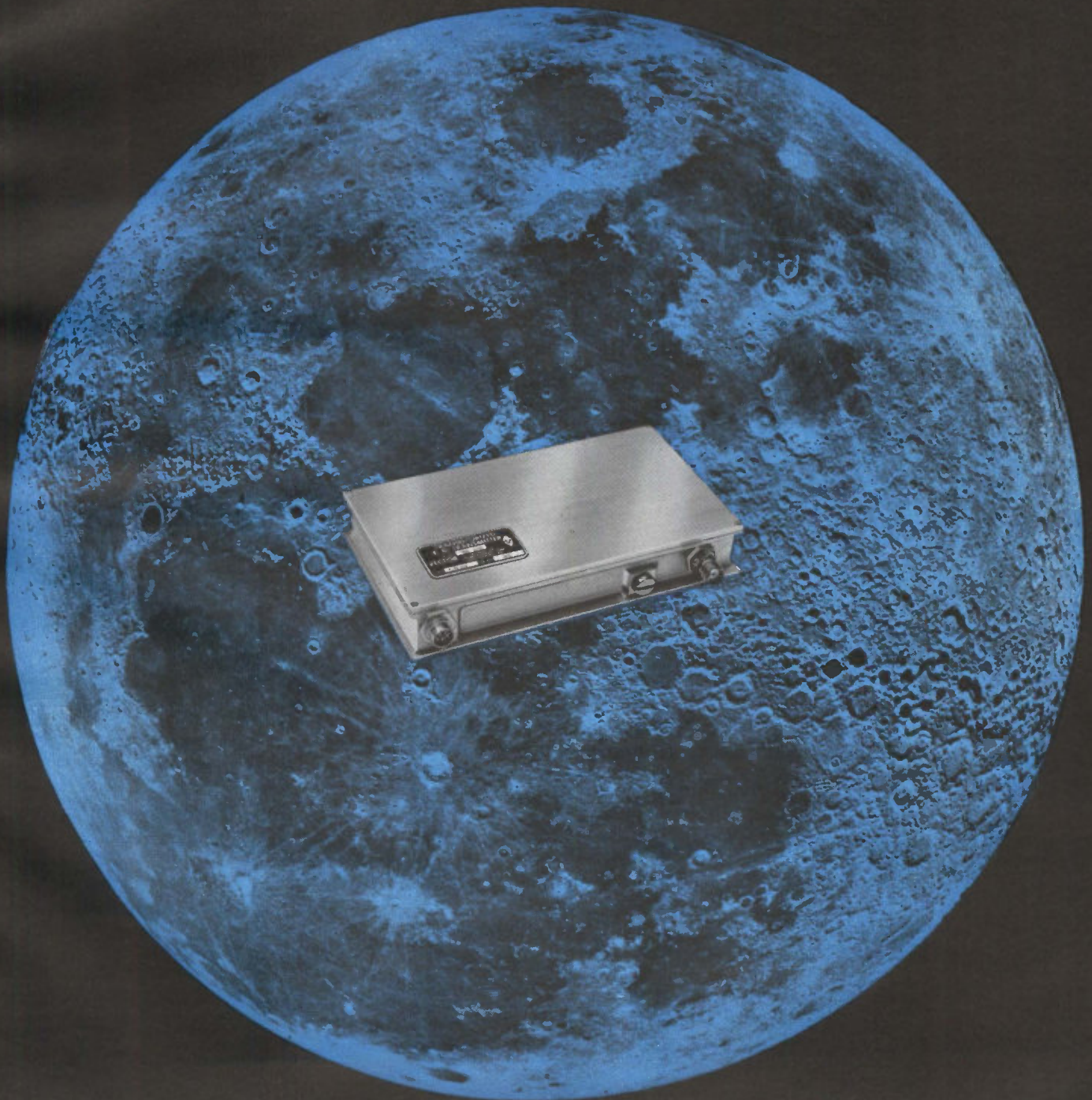





## When it comes to electrical tapes, Mystik is king!

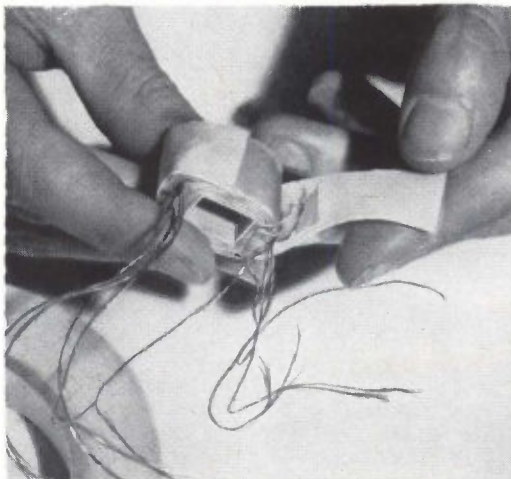

No doubt about it, Mystik leads the field in special-purpose tapes. Our extensive line of top quality products are perfect for hundreds of applications ranging from conventional industrial uses to the more sophisticated demands of the space age.

Mystik tapes are made in a wide range of materials including paper, plastic, cloth and glass cloth as well as many types of films and foils. They provide physical and performance characteristics of every description and are suitable for binding, shielding, strapping and insulating. Mystik pioneered tapes with heat-resistant silicone adhesives that grip like a vise even when exposed to high temperatures. Other new tapes are continually being developed to keep pace with the needs of the rapidly-expanding electrical industry.

We'll gladly prove our right to the "crown". Our local distributor will assist you in selecting the right tape for your application. He's in the Yellow Pages under "Tape" or write The Borden Chemical Co., Mystik Tape Div., 1700 Winnetka Ave., Northfield, Ill.



**BORDEN  
CHEMICAL**



We call them Microstacks®. They are being used in the lunar excursion module of the Apollo program, the Agena satellite, and the Minuteman missile.

They take tough temperature requirements in stride. Memory cores remain stable over a wide temperature range.

They can take a beating too. They're not built like conventional memory stacks. The "X" and "Y" axis of all the memory planes are continuously wired, then assembled in a folded array. This

design, which we originated, eliminates more than 80% of the solder joints and reduces size and weight. Stacks are ultra-reliable when packaged to meet Mil Spec shock, vibration, humidity, and other extreme-environment conditions.

When specifications call for a new core, or stack configuration, nobody can match Indiana General's design, development, and production capabilities. We make and sell more ferrite memory cores than anyone in the world. In fact,

we invented them. Many of our competitors are licensees.

If you have a military application for a high-reliability, low-power, miniaturized memory stack we'd like to send you our new Microstack Bulletin. Write to Mr. Thomas Loucas, Manager of Sales, Indiana General Corporation, Electronics Division/Memory Products, Keasbey, New Jersey.

**INDIANA GENERAL** 

**Our memory stacks play it cool  
when Mil Specs make things hot.**





What's different about OFHC® brand copper?

## Its immunity to hydrogen embrittlement

Susceptibility of conventional high-conductivity copper to embrittlement when brazed or welded in a hydrogen atmosphere results from oxygen in the copper. Unconventional OFHC® brand copper is immune. OFHC is oxygen-free, 99.99+% pure copper. There's no oxygen to unite with hot hydrogen to form pockets of water vapor. Thus, its structure is not disrupted. The metal can't become brittle and lose its strength. □ Freedom from hydrogen embrittlement plus high conductivity (averaging 101.6% IACS) is only one of the combinations of unconventional properties OFHC develops from its exceptional purity. Other practical advantages over

conventional coppers include OFHC's ductility and impact strength. □ The full story of OFHC's immunity to hydrogen embrittlement is given in OFHC Technical Bulletin H. Request your free copy today. It may open up fabricating possibilities you thought closed—until now.

# AMAX

AMERICAN METAL CLIMAX, INC.

Oxygen-Free Copper Products Group  
1270 Avenue of the Americas, New York, N. Y. 10020



These two unretouched photographs of rectifier stud mounting bases made of conventional electrolytic tough pitch copper (ETP) on the left and OFHC® brand copper on the right, both of which were heated in hydrogen to simulate brazing, tell the story of hydrogen embrittlement at a glance. The ETP stud shows blistering, symptomatic of a disrupted, brittle structure. The smoothness of the stud made of OFHC is evidence of its sound structure.

## OFHC® brand copper... the different copper



# new disciplines in DC



## take the models that are "PARTNERS IN POWER"

Two independent Constant Voltage/Constant Current supplies in one 3½" high package

Harrison Division now offers a wide selection of all-silicon, dual output DC power supplies — two 0.01% regulated supplies in one compact package, each with independent and separately adjustable output. Use the two halves as positive and negative sources, or for completely separate functions, or combined in Series or Parallel for higher voltage or current.

Two four-position multiple range meters permit setting the full scale voltmeter and ammeter values at either 100% or 10% of nominal output rating (approx.). Circuitry and meters are foolproof — no danger of burnout for any DC output combined with any meter range!

Other dual power supply combinations with higher and lower output ratings can be achieved by combining two half-rack width supplies.

Remote Programming and Sensing • All Models Conform to RFI Spec MIL-I-6181D • Overvoltage Protection "Crowbar" Optional Auto-Series, —Tracking, —Parallel • Front and Rear Output Terminals • No Overshoot on Turn-On/Off or AC Power Removal

DC VOLTS	DC AMPS	MODEL	PRICE
0-7.5	0-5	6251A	\$445.
0-20	0-3	6253A	445.
0-40	0-1.5	6255A	445.
0-60	0-1	6257A	445.
0-100	0-.75	6258A	445.
0-20/0-40	0-.6/0.3	6205B	235.*

\*Model 6205B is only one half-rack width, and features current limiting instead of constant current operation. Each output has two selectable output ranges. Also available at \$195 with two standard V/A meters.

Contact your nearest Hewlett-Packard Sales Office for full specifications

HEWLETT  
PACKARD  HARRISON  
DIVISION

100 Locust Ave., Berkeley Heights, New Jersey 07922 TELEPHONE 201-464-1234 TWX 710-984-7972

H10A

Circle 93 on reader service card



# Core, plane or stack problems?

## Take 'em to the experts. (Us.)

Core? Construction? Format? Hostile environment? Whatever your problem, we've probably seen—and solved—it before. If not, Ferroxcube experts will always find the shortest path to the right answer. For instance—

**Application:** Core memory stack for real-time display system in ship-board fire control computer.

**Problem:** Hostile thermal environment, critically limited space restrictions.

**Solution:** Single-area, double matted printed-circuit board construction; bus-wire bridging to allow air-flow cooling of 30-mil wide temperature range cores.

**Application:** Core memory stack for navigational guidance computer in commercial avionics system.

**Problem:** Mil-reliability at commercial prices; NDRO operation; volume reproducibility.

**Solution:** Single-area, single-matted plane, plastic laminated terminal frame construction; bootstrap patterns with 30-mil cores on extremely tight centers.

**Application:** Low cost core memory stack for state-of-the-art commercial-computer main memory.

**Problem:** High speed, low noise, high output uniformity, repairability, expandability, 650 ns cycle time, ease of access and interface.

**Solution:** 2½D organization; planar construction to offer lowest cost and convenient access; 20-mil cores; stack mounted diode modules.

**Application:** Core memory stack for guidance computer in missile-borne avionics package.

**Problem:** Extremely hostile mechanical and thermal environments, critical space limitations.

**Solution:** Continuously-wired, folded-stack construction; wide

temperature range cores wired using novel shock and vibration damping techniques.

What's *your* problem? Cores? We pioneered them. We have 20-, 30- and 50-mil cores in both standard and wide temperature range types covering a broad spectrum of switching and drive current parameters. Planes and stacks? We use a wide variety of printed circuit board or laminated frame-strip construction techniques, 2½D, 3D or linear select. Cost? We meet and lick this problem every day. It's part of being the experts.

Want more information? Write for Bulletins 6005 & 6006.

**Ferroxcube** 

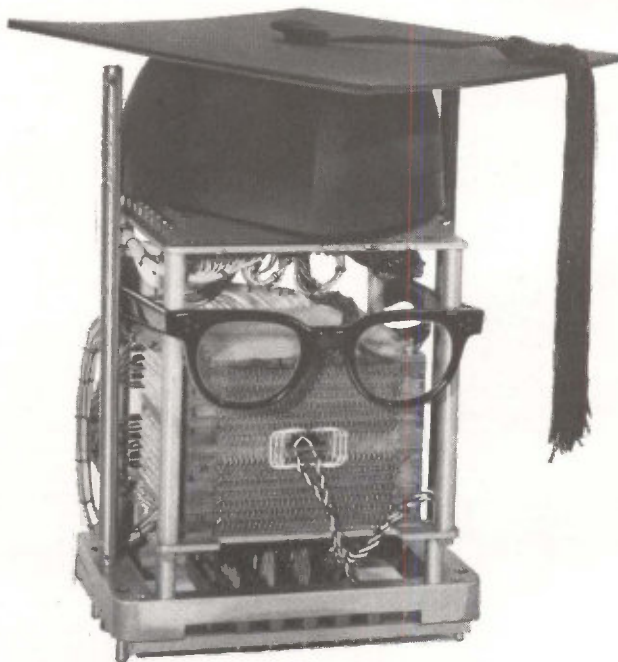

FERROXCUBE  
CORPORATION  
OF AMERICA

Saugerties, New York  
914-246-2811

Boston  
617-899-3110

Chicago  
312-261-7880

Dallas  
214-255-0441

Los Angeles  
213-837-1484

Minneapolis  
612-888-4681

New York Area  
201-267-5888

Phoenix  
602-265-1792

Philadelphia  
215-927-6262

Washington, D.C.  
703-893-4900

# Introducing the most versatile vidicon camera ever built – Cohu's new 3200 series!

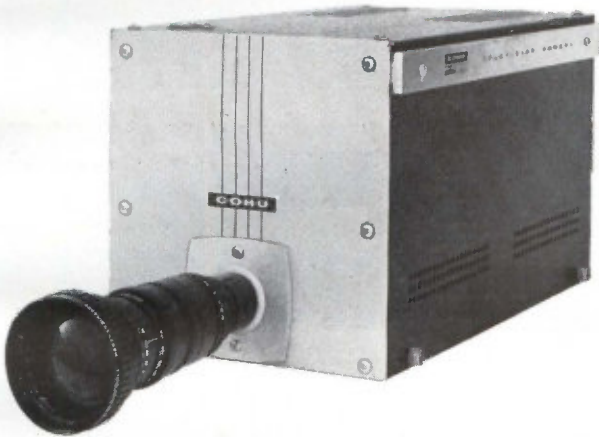

**IT'S A CCTV CAMERA** – completely self-contained. Just add a single coaxial cable to any video monitor and it's ready to operate. Want high resolution? Plug in one of four optional integrated-circuit sync generator boards for 525-, 729-, 873-, or 945-line scan patterns.



**IT'S A BROADCAST CAMERA, TOO!** Add a "mounts-in-minutes" 5-inch viewfinder and the Cohu 3200 is ideal for studio, education, or remote applications. An optional film chain adapter further enhances its versatility and provides all necessary remote controls.

For prices, delivery and full details, contact Cohu engineering representatives in major cities throughout the United States and Canada.

**COHU**  
ELECTRONICS, INC  
SAN DIEGO DIVISION

Box 623  
San Diego, California 92112  
Phone: 714-277-6700



# GO ...20 Hz to 1 GHz

## Kay 1500 Sweep & Marker Generator



### TYPICAL PLUG-INS

Model	Center Freq.	Sweep Width
P-141	20 Hz-200 KHz	20 Hz-20 KHz
P-142	35 Hz-600 KHz	20 Hz-20 KHz
P-130	100 Hz-2 MHz	200 Hz-2 MHz
P-152	10 KHz-20 MHz	10 KHz-20 MHz
P-855	2-32 MHz	5 Hz-800 KHz
P-856	10-120 MHz	10 Hz-1 MHz
P-860	2-220 MHz	10 KHz-30 MHz
P-867	220-470 MHz	20 KHz-70 MHz
PI-123	100-1000 MHz ANY SINGLE OCTAVE	5 KHz-Octave
Freq. Marker		
PM-7631	6 Pulse & Ext.	
PM-7632	6 Pulse & Ext.	
PM-932	30 Pulse	
PM-861	6 Harmonic and CW Osc.	



Pulse-Type Markers



Harmonic (or Comb) Birdie Markers



Single-Freq. Type Birdie Markers

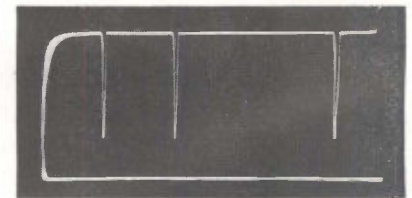

Detected Turn-Off Markers

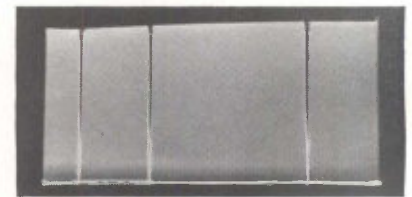

Undetected Turn-Off Markers

### ■ VOLTAGE CONTROLLED OSCILLATORS

#### ■ MARKERS

Pulse  
RF Turn-off  
Harmonic  
CW Birdie

#### ■ SWEEP

0.2 to 60 cps  
Log and Linear  
External Input  
Manual Control

The basic rack contains a variable, sawtooth sweep generator, a fast-acting AGC, frequency-marker control and output circuits, RF output circuits with precision attenuators, a calibrated output meter, an accurate RF detector, and carefully regulated power supplies.

# KAY ELECTRIC COMPANY

Pine Brook, N. J. 07058 • (201) 227-2000 • TWX: 710-734-4347

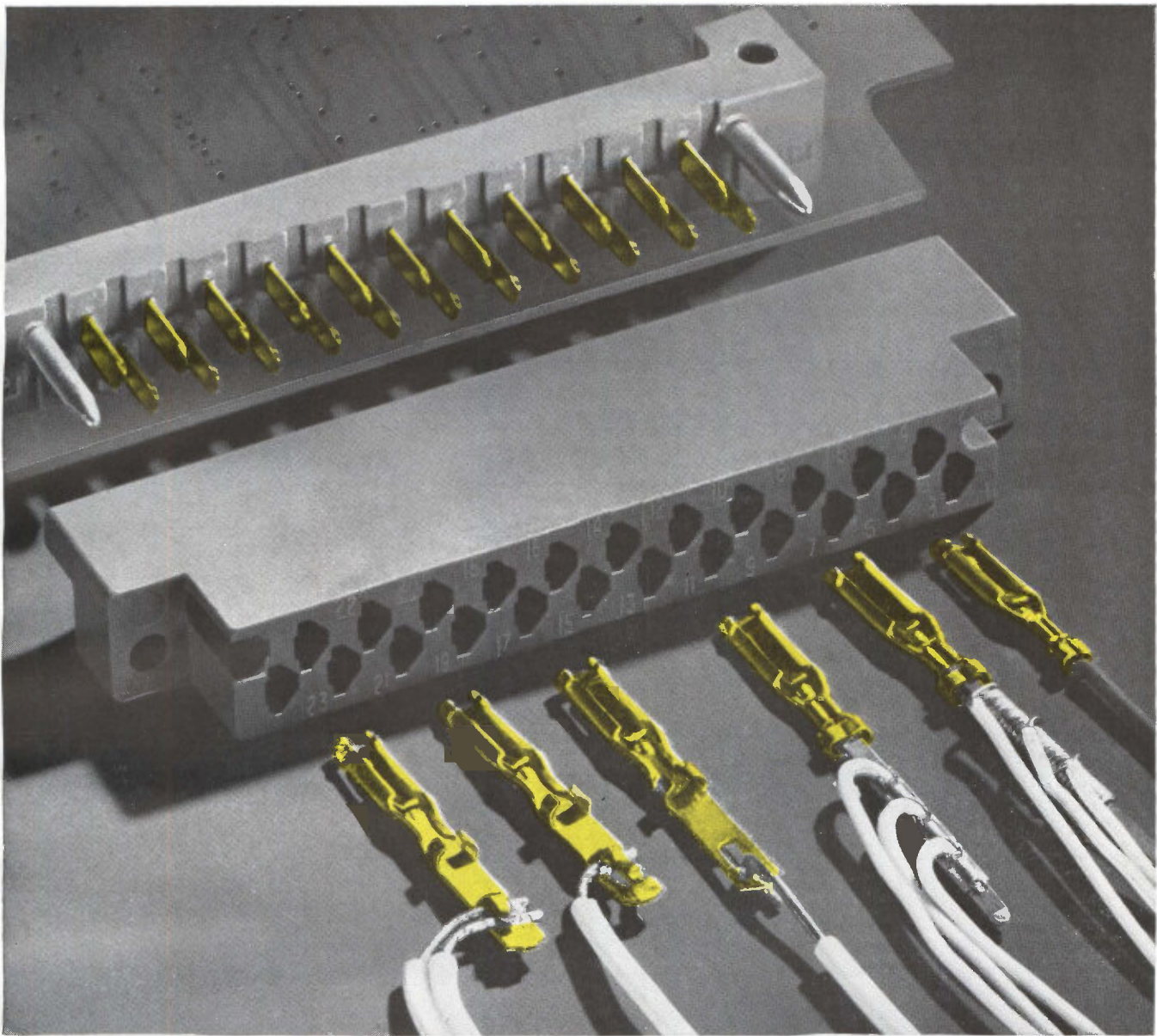

## Do it your way

Crimp, solder, weld, wrap . . . *name your method!*

If you have to live with solid wire, you can spot weld or make wrap-type terminations. If the application calls for stranded wire, soldering or crimping may be more your speed. Better yet, make TERMI-POINT\* clip applications using either *solid or stranded wire*. This new technique lets you cut, strip and terminate the conductor—all in one convenient operation—to make gas-tight, easily serviced post connections.

Here is real back end versatility in a printed circuit connector that's way out front in performance. Select any one of *five terminating methods*. Any way you wire it, our two-piece blade-type connector gives you all these precision engineered features:

- staked down half, clinched to the board, minimizes warpage
- gold over nickel plated contacts prevent oxide creep
- low porosity of contact plating assured by AMP's exclusive X-ray measurement
- three areas of contact provide maximum redundancy
- staggered cavity arrangement offers high density potential
- Available in 17, 23, 29, 35, 41 and 47 positions —for 1/16 in. and 3/32 in. boards

Write today for complete details on this two-piece connector to fit your particular termination requirements.

\*Trademark of AMP INCORPORATED



AMP\* products and engineering assistance are available through subsidiary companies in: Australia • Canada • England • France • Holland • Italy • Japan • Mexico • West Germany



# This AE Type 44 Rotary Stepping Switch Thrives on Solitude.



So do all the rest of our hermetically sealed stepping switches. That's because we build switches so they can't bind, never overthrow.

Most of the secret's in our stepping mechanism. We don't use a pawl stop block. Instead, we use a unique "free-floating" pawl—with a set of stopping teeth on the end of the armature.

This way, the armature not only steps the wiper or cam assembly to the next position—it

also *locks* the rotor in the correct position. Overthrow is impossible. So is pawl wear and bind against a pawl stop block—even at low temperatures.

*Where* can you use these sealed switches? Almost anywhere. Some people take them out in the desert or down to the bottom of the ocean. Others fly them above 40,000 feet, where the mean temperature is  $-55$  degrees Centigrade. You might want them for a particularly dusty location in your shop.

*How* can you use reliable, versatile rotary stepping switches? There's a lot of helpful design information in our Circular #1698. It's yours for the asking. Just write the Director, Relay Control Equipment Sales, Automatic Electric Company, Northlake, Illinois 60164.

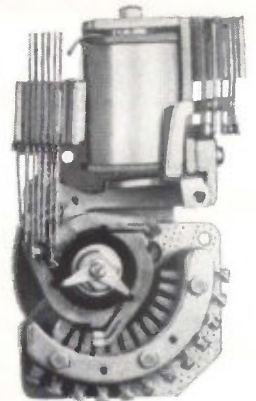

**AUTOMATIC ELECTRIC**  
SUBSIDIARY OF  
GENERAL TELEPHONE & ELECTRONICS **GT&E**

**WORLD'S LARGEST SELLING  
AND WORLD'S NEWEST**

**Hand Size V-O-M's**

**TRIPLET**

**MODEL 310-C**  
World's Newest  
Volt-Ohm-Milliammeter



**MODEL 310**  
World's Largest Selling  
Volt-Ohm-Milliammeter



**BOTH TESTERS  
SHOWN  
ACTUAL SIZE**

- 1** **HAND SIZE AND LIGHTWEIGHT**, but with the features of full-size V-O-M's.
- 2** **20,000 OHMS PER VOLT DC; 5,000 AC (310)—15,000 AC (310-C).**
- 3** **EXCLUSIVE SINGLE SELECTOR SWITCH** speeds circuit and range settings. The first miniature V-O-M's with this exclusive feature for quick, fool-proof selection of all ranges.

SELF-SHIELDED Bar-Ring instrument; permits checking in strong magnetic fields. FITTING INTERCHANGEABLE test prod tip into top of tester makes it the common probe, thereby freeing one hand. UNBREAKABLE plastic meter window. BANANA-TYPE JACKS—positive connection and long life.

Model 310—\$40.00      Model 310-C—\$50.00      Model 369 Leather Case—\$3.50

ALL PRICES ARE SUGGESTED U.S.A. USER NET, SUBJECT TO CHANGE

**THE TRIPPLET ELECTRICAL INSTRUMENT COMPANY, BLUFFTON, OHIO**

### 310-C PLUS FEATURES

1. Fully enclosed lever range switch
2. 15,000 Ohms per volt AC (20,000 O/V DC same as 310)
3. Reversing switch for DC measurements

### MODELS 100 AND 100-C

Comprehensive test sets. Model 100 includes: Model 310 V-O-M, Model 10 Clamp-on Ammeter Adapter; Model 101 Line Separator; Model 379 Leather Case; Model 311 leads. (\$73.50 Value Separate Unit Purchase Price.)

MODEL 100—U.S.A. User Net. \$70.00

MODEL 100-C — Same as above, but with Model 310-C. Net. ....\$80.00



USES UNLIMITED: FIELD ENGINEERS • ELECTRICAL, RADIO, TV, AND APPLIANCE SERVICEMEN • ELECTRICAL CONTRACTORS • FACTORY MAINTENANCE MEN • ELECTRONIC TECHNICIANS • HOME OWNERS, HOBBYISTS  
THE WORLD'S MOST COMPLETE LINE OF V-O-M's • AVAILABLE FROM YOUR TRIPPLET DISTRIBUTOR'S STOCK





## New solid-state relay with adjustable set point

*It has no moving parts, no relay contacts. Available in seven voltage ranges from 0-1 to 0-500 volts; in ten current ranges from 0-100  $\mu$ a to 0-1 amp. Temperature ranges on special order from 0-750°F to 0-3000°F. Call your Weston distributor or write Weston Instruments, Inc., 614 Frelinghuysen Avenue, Newark, New Jersey 07114.*

### **Features:**

- Response—200 milliseconds
- Load rating—1 amp at 117 volts, 50-60 Hz
- Input resistance—100 ohms for 100  $\mu$ a range
- Accuracy— $\pm 2\%$  under reference conditions (temperature effects in accordance with ASA C39.1)
- Repeatability—0.5% typical
- Operating temperature range—0-50°C
- Power—117 volts  $\pm 10\%$ , 50-60 Hz
- External temperature influence 1% for  $\pm 10^\circ\text{C}$  about 25°C
- Voltage breakdown—500 volts a-c
- Common mode rejection—250 volts d-c maximum
- Locking ring
- 320° scale
- Mounts in 3" hole; front panel, 3½" x 3½"
- Neon pilot light
- Terminal strip connector

**WESTON**<sup>®</sup> *prime source for precision... since 1888*

For space and weight savings  
in Saturn V countdown system...  
it's flexible circuitry.\*

For utmost reliability...  
it's flexible circuitry  
insulated with TEFLON® FEP FILM.

Flexible circuitry is an important improvement for the National Aeronautics and Space Administration's Saturn V countdown system. It weighs less. Takes up less space. Is easier to assemble and maintain.

To obtain these advantages—and at the same time to meet the stringent reliability requirements in the countdown system—Electro-Mechanisms chose TEFLON FEP film for the insulation.

This film offers unsurpassed dielectric properties, reliability over a wide temperature range, non-flammability and high tear resistance. Du Pont TEFLON resins have long been known as the most reliable of all insulating materials. Du Pont's TEFLON FEP film permits total encapsulation of flexible printed circuitry by heat sealing, bonding or cementing. It is transparent for quality control. It can be soldered. For your next high-reliability design, consider the advantages of TEFLON FEP film. Send for full information on properties and applications. Write: Du Pont Company, Room 4675A, Wilmington, Delaware 19898.

TEFLON® FEP FILM  
...A new dimension in TEFLON



Better Things for Better Living  
... through Chemistry



\*Uni-Cable® by Electro-Mechanisms, Methuen, Mass.



# Send us a cable.



Send us a small sample, at least one foot, of the coaxial cable you're using and tell us what you're using it for. Then we'll install the Burndy crimp removable coax contact that'll do the job best. Guaranteed.

A tough job? Not really.

Remember, crimp removable contacts began at Burndy. As a result Burndy offers the most complete line of coaxial connectors for standard, miniature and sub-miniature coaxial cables. And

they're available for all rectangular, rack and panel and terminal block configurations.

Send your sample along to Mr. M. Elkind, Product Manager, Burndy, Norwalk, Conn. He'll see that the job is done and returned quickly. You'll receive our latest coax connector catalog, too.



INTERNATIONAL SALES HEADQUARTERS AND MANUFACTURING FACILITIES:

CANADA: Scarboro, Ontario / ENGLAND: St. Helens, Lancs. / BELGIUM: Mechelen / MEXICO: Naucalpan de Juarez / BRAZIL: Sao Paulo / JAPAN: Tokyo / Sales Offices in Other Major Cities

# Adlake Mercury Wetted Relay – Application Data

## Capacitance of Adlake Mercury Wetted Contact Relays Applicable for Low Signal Applications

**Typical Capacitance in Picofarads** — Graphs illustrate typical capacitance values for Adlake AWCA-16000 series relays. Fig. 1 is for unshielded relays. Fig. 2: Electro-statically shielded switch brought out to a separate pin. Fig. 3: Electro-statically shielded switch with case and shield tied together at a common pin. Interelectrode capacitance across contacts of a bare switch, without external wires, is less than 1.0 picofarad.

Abbreviation COMM. stands for the Combination of the Armature and Normally Closed Contact. N.O. is the abbreviation for Normally Open Contact; whereas the symbol # is the mean average for the 5 relays. Graphs are available on other styles of Adlake Mercury Wetted Contact Relays upon request. (Please state wiring configuration.)

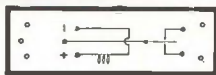

**AWCA 16011-S**  
Fig. 1

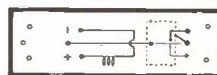

**AWCA 16016**  
Fig. 2

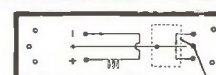

**AWCA 16018**  
Fig. 3

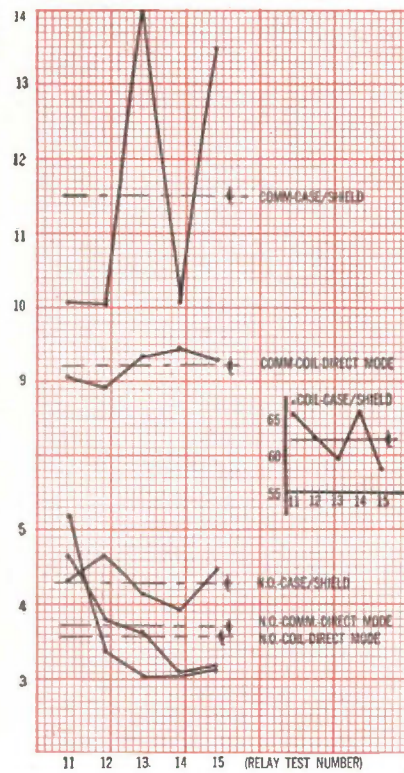
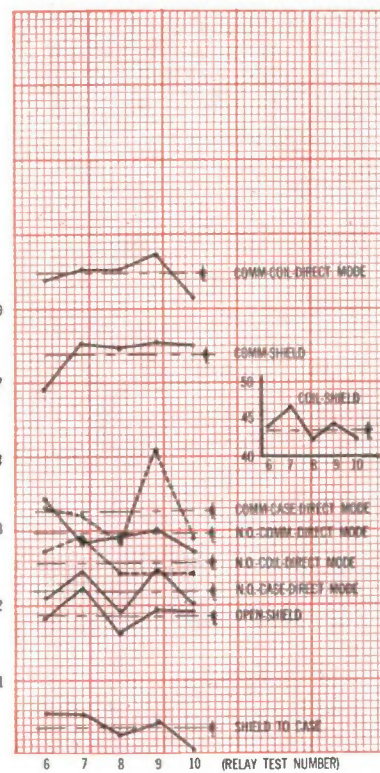
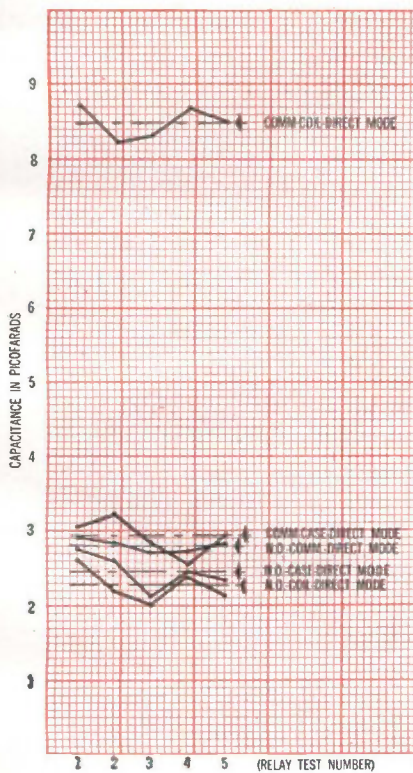

Data was obtained using a Bonton Electronics Corporation Capacitance Bridge, Model 75-A-S8 at 1MHz.

Backed by sound research and disciplined engineering, Adlake applies the industry's broadest line of mercury displacement and mercury wetted relays to the creative solution of design circuit problems. However unique or special your application, Adlake can assist you in

developing it. For prompt, personal and knowledgeable attention to your relay needs, contact the one source that is the complete source in the mercury relay field. Contact Adlake today for catalog and further information.



## THE ADAMS & WESTLAKE COMPANY

Dept. 2116, Elkhart, Indiana, U.S.A. 46514 • (AC 219) 264-1141

TRANSPORTATION EQUIPMENT • ARCHITECTURAL PRODUCTS • MERCURY RELAYS • DOORS AND ENTRANCES • CONTRACT MANUFACTURING



**Recording and controlling versatility,  
with accuracy to 40 cps —  
proven in 2 years  
of field applications!**

# DURANT UNISYSTEM

## HI-SPEED COUNTING CONTROL

On thousands of applications, under a wide range of operating conditions, these count/control systems are delivering the high accuracy required for electrical, electronic recording and controlling.

Is yours a batching application? Solid or liquid flow control? Produc-

tion control? Testing? One of the many Unisystem models available can meet your specific needs. They provide sequential counting, single and multiple level predetermining, repeat cycle predetermining, remote electrical readout, data storage and more — all at low cost. Functions which also can be used in processing, converting, scaling, printing and manufacturing of all types.

The "heart" of the Durant Unisystem is our unique Unipulser, a single-decade, high speed electromechanical counter — and our Uniset 10-step selector switch for fast, push-button settings. Its available with a choice of number of digits and type of mounting. Catalog 90 tells the complete Unisystem story. Write Durant Manufacturing Company, 612 N. Cass Street, Milwaukee, Wisconsin 53201.

Life of Unisystem is not subject to hours of usage. Accumulated data is retained even if power fails.

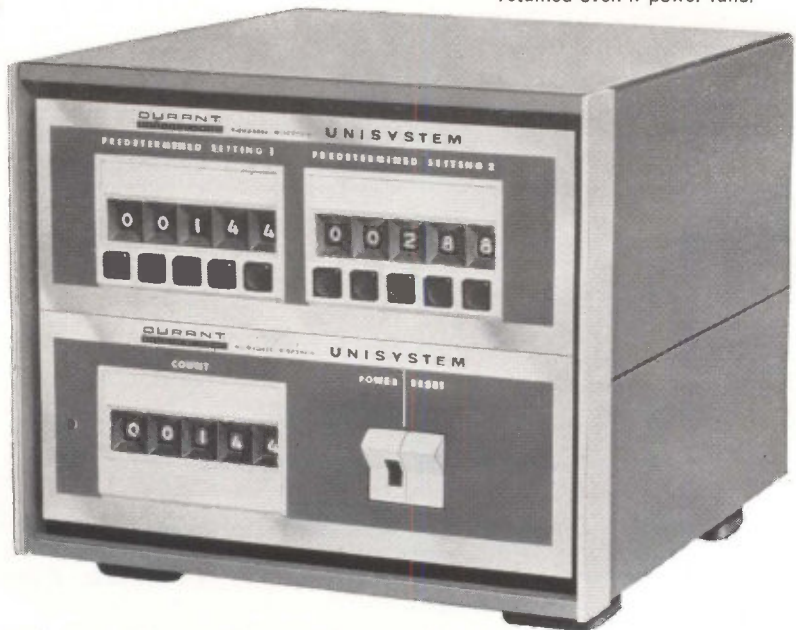
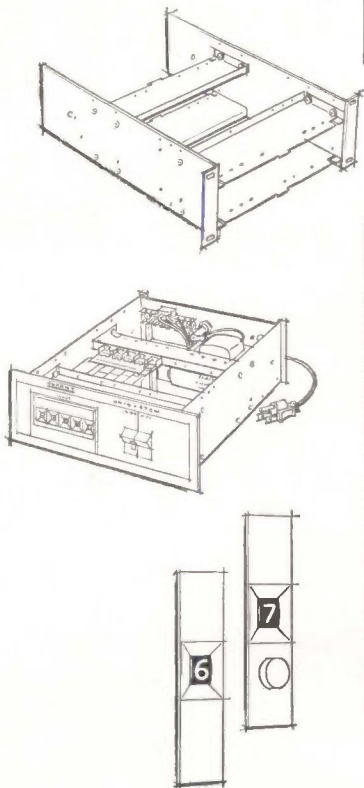

**DURANT**<sup>®</sup>  
MANUFACTURING COMPANY

MILWAUKEE, WISCONSIN  
In Europe: Durant (Europa) N. V. Barneveld, Netherlands

# Cinch gives you the tail stability you need for programmed wire wrapping — in a miniature p.c. connector

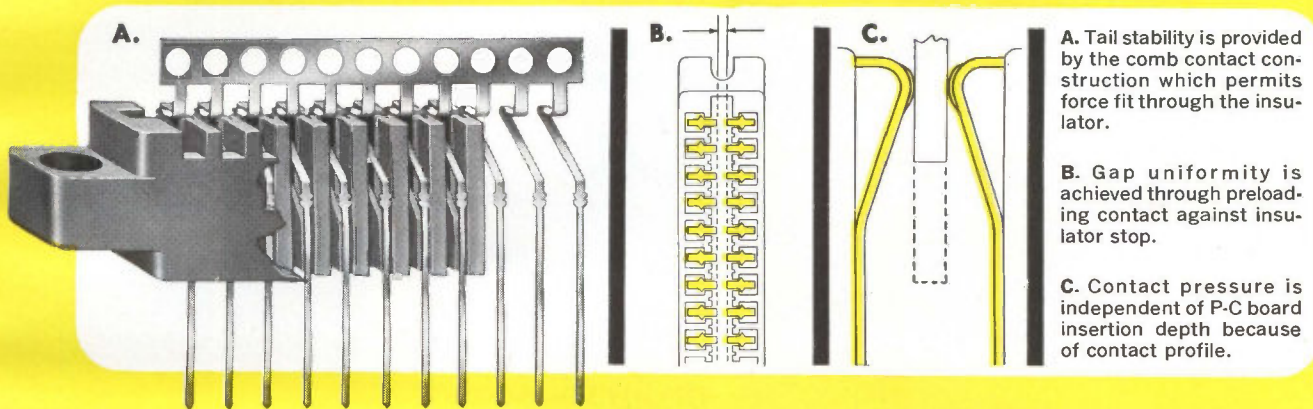
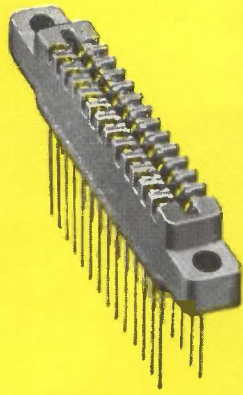

**A.** Tail stability is provided by the comb contact construction which permits force fit through the insulator.

**B.** Gap uniformity is achieved through preloading contact against insulator stop.

**C.** Contact pressure is independent of P-C board insertion depth because of contact profile.

Cinch has combined cantilevered contact reliability with .025" square tail wrapping speed. This new Cinch high contact density printed circuit board connector can be wired at a rate of up to 750 net wires per hour with a Gardner-Denver automatic wire wrap machine. This is more than 15% faster than for .045" square tail connectors.

This new connector uses a comb contact assembly which provides the gap uniformity of preloaded cantilever construction and contact pressure which is independent of printed circuit board insertion depth. Contacts are on .125" centers. Construction combines minimum insertion force with maximum contact pressure.

The connector is especially suited for programmed automatic wire wrap applications and is particularly well designed for use with the latest packaging techniques, particularly the dense packaging currently being developed for electronic data processing equipment. For cost reduction in volume applications the precision contacts can be *selectively gold plated*. This Cinch developed technique substantially reduces the amount of gold required, resulting in lower connector costs.

These precision tooled comb contacts are precisely and automatically preloaded with insertion of the comb into the insulator. The true tip location in the required position for automatic wrapping equipment is assured by the comb assembly technique. This technique employs a force fit to the insulator, assuring rigid, exact positioning. Cinch also manufactures .045" square tail rectangular terminal and other wire wrap terminated printed circuit board connectors suitable for use with the automatic wire wrap equipment manufactured by Gardner-Denver.

For additional information, write to Cinch Manufacturing Company, 1026 S. Homan Avenue, Chicago, Illinois 60624.

CM6619

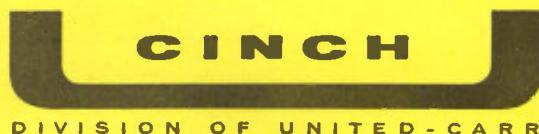

DIVISION OF UNITED-CARR





there are ordinary seals

...and then there's McCoy

The seal gets special attention at McCoy—100% inspection against temperature, altitude, vibration and shock. Only a permanent, hermetic seal can guarantee frequency stability and reliability for quality crystals. Our new *Cleanseal* process uses high pressures to flow metal enclosures together in a heatless "weld" that's more leak resistant than the metal itself. Heating distortion and

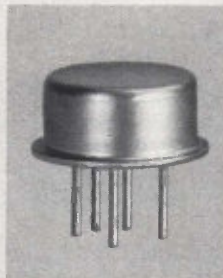

possible internal contamination by solder flux are eliminated. *Cleanseal* crystals have withstood 5000 cycles, 30 G's vibration, and 8000 G's, 0.5 millisecond pulse shock testing. Glass crystals are vacuum sealed by flame or induction heating. McCoy has the nation's most complete line of quality high and low frequency crystals. For full details, write for our new product catalog.



**MCCOY ELECTRONICS COMPANY**

A DIVISION OF OAK ELECTRO/NETICS CORP.  
MT. HOLLY SPRINGS, PA. 17065

NEW family  
of medium-  
power  
silicon NPN  
transistors  
packs BIG  
performance  
at mass  
production  
prices

Here's A Typical Value: RCA 40458

$h_{FE}$ ..... 50 min. at 300 mA  
 $V_{CEO}$  (SUS)..... 40 V min. at 100 mA  
 $V_{CE}$  (sat)..... 0.3 V max. at 300 mA  
 $f_T$ ..... 150 MHz min.  
 $I_C$ ..... 1A  
Dissipation: 2 W at 75°C Case Temp.

only 47¢\*

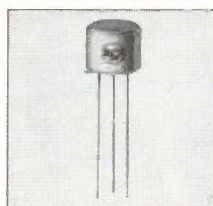

Hermetically sealed  
in a metal case

now examine the entire family of value-packed industrial types

RCA 2N3241A Silicon Epitaxial Planar Transistor Family Characteristics									
	2N3241A	2N3242A	2N4074	40397	40398	40399	40400	40458	
$BV_{CEO}$	25	40	40	25	25	18	18	40	max. volts
$h_{FE}$ 10V, 10mA	100-200	125-300	75-300	165-600	75-300	165-600	75-300	100-300 (50 min. @ 300mA)	
$f_T$ typ.	175	175	80	80	80	80	80	150 min.	MHz
$V_{CE}$ (SAT)	0.25 at 200mA $I_C$	0.3 at 300mA $I_C$	0.3 at 300mA $I_C$	0.25 at 200mA $I_C$	0.25 at 200mA $I_C$	0.2 at 100mA $I_C$	0.2 at 100mA $I_C$	0.3 at 300mA $I_C$	max. volts
Turn-on $I_C = 150mA$	75	75	—	—	—	—	—	75	max. nanoseconds
Dissipation** at 25°C Ambient	0.5	0.5	0.5	0.5	0.5	0.5	0.5	0.5	max. watts
$I_C$	Limited by $P_T$	Limited by $P_T$	0.3	0.2	0.2	0.2	0.2	1.0	max. amperes
Price*	\$0.44	\$0.50	\$0.44	\$0.40	\$0.36	\$0.33	\$0.30	\$0.47	

\* In quantities of 1,000 and up.      \*\*All types available with integral heat radiator for 1 watt dissipation at  $T_A = 25^\circ C$ . Add 4¢ per unit for these versions.

The new RCA 2N3241A family of NPN epitaxial planar transistors, designed for amplifier and switching service in audio and video frequency ranges, is as versatile as it is reliable. Applications include • relay drivers • video amplifiers • high current audio drivers • saturated switches • TV deflection drivers • medium power audio output amplifiers. All devices offer exceptionally low leakage, low saturation voltages, and high minimum beta. Check the chart for specifications...and note the low prices!

See your RCA Distributor for his price and delivery

Double the 25°C free air dissipation capability from ½ watt to 1 watt by specifying integral heat radiator versions of the devices listed above.

You won't find another family of medium-power silicon transistors with so much performance, at so little cost, available immediately in production quantities. Call your local RCA Field Office for complete information. For technical data sheets write: RCA Commercial Engineering, Section EN11-2A, Harrison, N.J. 07029.



RCA Electronic Components and Devices  
The Most Trusted Name in Electronics





# Power Supply and Transformer Modules with highly ISOLATED\* energy output

**ISOPLYS** — Isolated-output power supplies for bridge circuits. Units offer less than  $5\mu$  volt noise to ground, when used with a 350 ohm transducer. 4QC and 4QP Series with Standard Voltage Adjustment. Small, all silicon transistor regulated power supplies. Output voltage adjustable about  $\pm 10\%$  from nominal voltage. The C units are chassis mounting type with solder terminals on rear panel. The P units are horizontal plug-in modules retained normally in rack-mounted 6-slot front-panel-access housings for system use. Units have outputs from 1 volt @ 200 ma to 100 volts @ 16 ma. Regulation: .02%, T.C.: .01%/°F, Ripple: less than .005%. Remote sensing on all units. Write for Bulletin 86-1064E.



**ISOPLYS—A4TM Series.** Small lower cost germanium transistor regulated power supplies. Isolation includes .1pf intercircuit capacitance and 20pf shunt capacitance. Output voltage is adjustable approximately  $\pm 10\%$  of the nominal voltage with outputs of 5 volts @ 150 ma to 50 volts @ 40 ma. Units are stud mounting with solder terminals also on the base. Normally furnished with a slip-over ventilated shield. Has small mounting base area for chassis installation,  $1\frac{1}{2} \times 2\frac{1}{4}$ . Height is  $6\frac{1}{2}$ . Regulation: .2%, T.C.: .02%/°F, Ripple: 1 mv or .01% rms. Write for Bulletin 92-1164E.

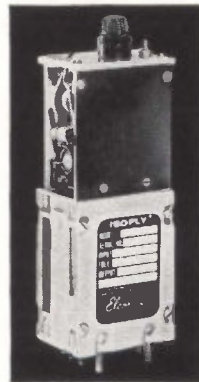

**ISOLATED REFERENCE SUPPLIES—A4R.** Small multistage compensated zener reference voltage or power source. Units offer intercircuit capacitance of .1pf and shunt capacitance of 20pf. Excellent line, temperature, and time stability. Available in outputs of 6.2V, 8.4V, 9.0V, and 11.7V and other voltages to customer specifications. For floating potentiometers, retransmitting slide wires, wide range zero controls, bias, battery replacements and many other voltage reference applications. Available in mumetal cans for reduced magnetic disturbance. Write for Bulletin 66-363E.

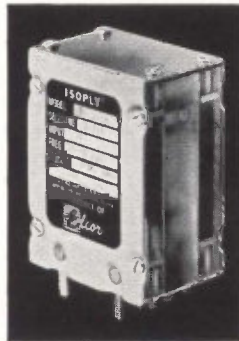

**Applications** Power modules for use with: Bridge circuits, ungrounded amplifiers, traveling wave tubes, screen rooms . . . for use as: Servo references, floating bias, direct coupling, ground loop decoupling, slide wire power supply, battery substitutes.

\* Power supplies with their entire output circuitry highly isolated conductively and capacitively from ground (case) and ac input. For dc excited devices that must be well isolated from direct local connection to ground, case, chassis, or system common. True battery equivalent.

**ISOFORMERS** — Isolation transformers. A4X and A25X Series. Small 4 and 25 watt high isolation transformers. Secondary winding and shield have a very high degree of conductive and capacitive isolation from primary and case (ground or primary common). Units offer line isolation of .05pf and ground isolation of 15pf. Output voltages from 6.3V to 150 on the 4 watt models and to 600V on the 25 watt models. Standard input at 117 VAC 50-60 cps. Other inputs from 6.3 VAC to 234 VAC available. Write for Bull. 89-1064E. **MODELS AVAILABLE UP TO 1 KVA OUTPUT POWER.**

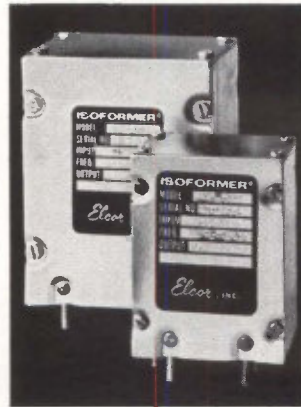

**BRIDGE SIGNAL CONDITIONING UNITS** — Models BSC-416B and BSC-416C designed to condition and prepare an electrical signal from various strain sensitive resistance transducers. Incorporates ELCOR 4 to 16 volt, 75 ma highly isolated low noise power supply. All variable controls, balance, voltage, span, and calibration are ten turn, high resolution, and low TC potentiometers. Usable with either 4, 6, or 8 wire systems. Convenient test and remote control features. Write for Bull. 80-764E.



**CURRENT NANODMMETERS AND INTEGRATORS** — For use with nuclear particle accelerators, this unit monitors and integrates direct current on twelve ranges from  $1 \times 10^{-9}$ A to  $3 \times 10^{-9}$ A or  $1 \times 10^{-4}$ A to  $3 \times 10^{-10}$  Amp. Current may be either + or -. Internal calibration for all twelve ranges. Remote control capabilities built in. Present charge with automatic termination. Long integrating interval, 280 hours, and low drift, .01% per hour. Has digital read-out, and electrical outputs for recorders. Write for Bulletins 36-1261E & 73-1063E.

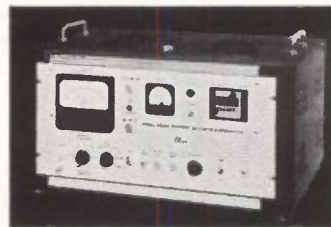

**Over 250  
Isolated Power  
Modules Available**

Write or see your local representative for full catalog information.



A DIVISION OF HALLIBURTON CO.  
2431 LINDEN LANE / SILVER SPRING, MD. 20910 / PHONE: (301) 589-6614

# RCA Announces the NEW 3N128 (MOS) FET for VHF Applications

features: □ low feedback capacitance (0.2 pF max.) □ high power gain (18 dB typ. at 200 MHz) □ high forward transconductance (5,000  $\mu$ mho min.) □ low noise (4 dB typ. at 200 MHz) □ low cross-modulation distortion □ a hermetically sealed metal case

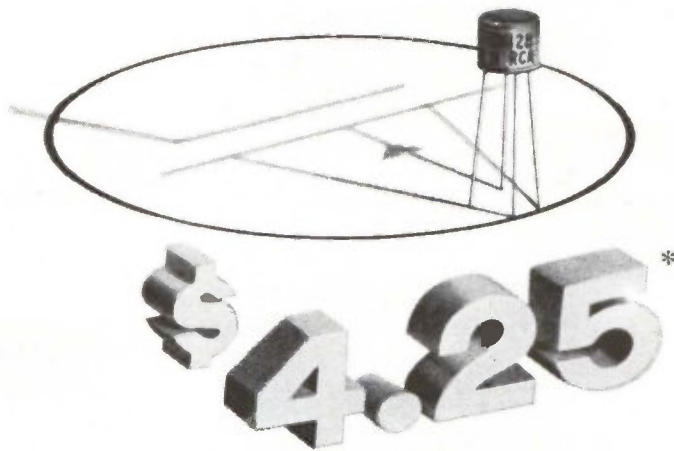

\*Price in quantities of 1,000 and up

RCA's 3N128 N-channel, depletion type, MOS field-effect transistor is now available in production quantities for communications and industrial applications. This new insulated gate MOS transistor exhibits (1) extremely low gate-leakage current (0.1 pA typ.) which permits stable operation over wide temperature ranges, (2) feedback capacitance substantially lower than that of conventional junction-gate devices, and (3) extremely high input resistance of  $10^{14}$  ohms typ.

The RCA 3N128 simplifies your designs because you can use conventional electron-tube type biasing techniques. In

addition, the drain current exhibits a negative temperature coefficient which makes thermal runaway virtually impossible. These attributes, combined with a large signal-handling capability and low cross-modulation distortion, make the 3N128 MOS a "must" for critical front-end designs.

Call your RCA Field Representative for complete technical information, price and delivery on the new 3N128 (MOS) FET. For Application Note AN-3193, or for a technical data sheet, write RCA Electronic Components and Devices, Commercial Engineering, Section EN11-2B, Harrison, N. J. 07029. SEE YOUR RCA DISTRIBUTOR FOR HIS PRICE AND DELIVERY

RCA Electronic Components and Devices



The Most Trusted Name in Electronics



# think faster think Burroughs memory systems

**IN MEMORY SYSTEMS THE FASTEST BIT  
MAKES THE DIFFERENCE . . . AND  
BURROUGHS MAKES ITS OWN BITS  
(BOTH CORE AND THIN FILM).**

The new Burroughs line of core Memory Systems is fast . . . as fast as 0.6  $\mu$ sec. full cycle time. You can also have a "not-so-fast" model at lower cost if you don't need the speed.

Now, Burroughs 14 years of experience is available to provide you with the Memory System you need for your data handling equipment.

- System cycle times of 0.6 and 1.0  $\mu$ sec.
- Modular building block construction—basic module is 8192 words by 20 bits and contains the core-memory, sense amplifiers, driver circuits and information registers.
- Associated memory control module includes timing circuits, address register and decode logic.

## FEATURES:

1. .0 mil, 2-1/2D ferrite core memory—manufactured by Burroughs.
2. Driver Circuits and sense amplifiers use Burroughs hybrid microcircuits.
3. Monolithic integrated circuits used for all logic and registers.

*If you would like your system to think faster write or call for further information on Burroughs memory systems.*

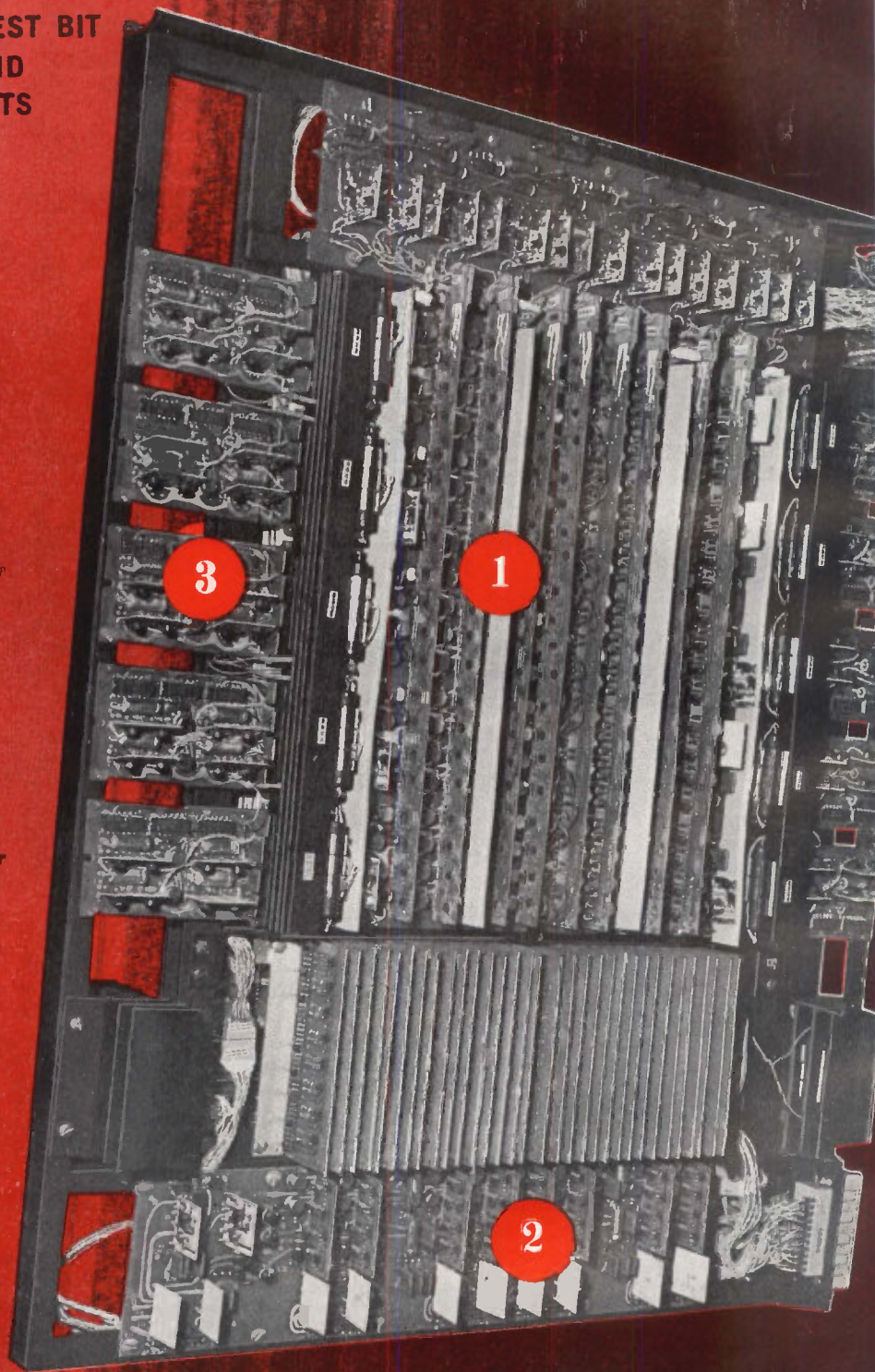
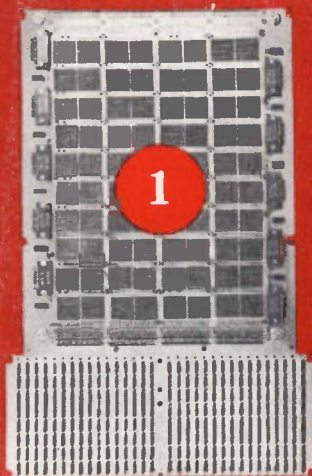

**Burroughs Corporation**

ELECTRONIC COMPONENTS DIVISION

PLAINFIELD, NEW JERSEY 07061



# Technical Articles

---

**Topology reduces design drudgery:**  
page 112

In theory, complex computations for the analysis of passive networks are fine, but in practice they can tie up engineers for days, particularly if there are more than three independent loops in the network. With a graphic approach, the engineer does not have to calculate the determinants and cofactors. Instead, he uses graphs, edges, vertices and trees to determine these elements by inspection.

**IC's in action, part 2 Trends and trade offs:**  
page 128

In the second part of this series, written for the user of integrated circuits, the compromises that must be made between design goals and practical realities are examined. The engineer finds that he must temper his design not only by the performance limitations of the circuits but also by such factors as realistic lead times for new circuits.

**Avalanche transistors drive laser diodes hard and fast:**  
page 137

One weakness of injection laser rangefinders has been the circuit to drive the laser. What's needed, of course, is a circuit that produces pulses of extremely short duration and fast rise time. Using the driving circuit described in this article, an engineer can design a rangefinder that is more accurate than conventional radar equipment.

**Sony tries to be first, or at least different:**  
page 155



Among Japanese electronics companies—and electronics firms elsewhere in the world too—Sony has the reputation for building good electronic consumer products and for aggressively developing unusual new products. Its product development philosophy is simple: the product is the thing. Some of Sony's more interesting designs are examined closely in this article. For the cover, photographer Richard Saunders lined up a variety of Sony's products from the home video tape recorder to tiny tv.

---

**Coming  
November 28**

- Design automation series
- How computers aid the design process
- Numerical circuit analysis
- Predicting transistor reliability



# Topology cuts design drudgery

Graphs, edges, vertices and trees are some of the terms of the new language of a topological technique of network analysis that eliminates time-consuming mesh and node calculations

By S.P. Chan

University of Santa Clara, Santa Clara, Calif.

In theory, complex calculations for the analysis of passive networks are fine, but what works in the classroom often is impractical on the job—particularly when more than three independent loops or nodes are involved. As the circuit grows more complex, calculations for the determinants and cofactors in mesh or node analysis become tedious, time-consuming and more prone to human error. It makes sense to try something less cumbersome in the engineering department. Now the engineer can turn to topological or graphic techniques as a shortcut in analyzing networks.

With the graphic approach, the engineer does not have to calculate the determinants and cofactors; instead he obtains them by inspection. He merely replaces all impedance elements in a network by line segments and then obtains a complete analysis of the network by following a simple sequence of steps.

Compared with conventional methods, the topological technique is faster, simpler and includes a simple check to tell the engineer if he is on the right track. The results are the same but topological methods offer some bonuses:

- The analysis results in a graphic display of the admittances at various parts of the network.
- All existing feedback loops become immedi-

**The author**



Since receiving his Ph.D from the University of Illinois in 1963, S. Park Chan has been teaching at the University of Santa Clara. Chan was the principal investigator of a National Science Foundation research project on the topological applications to switching networks.

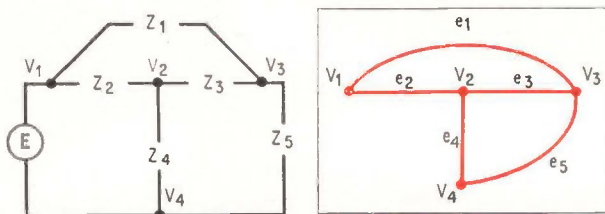

**Bridged-T network, N**, with impedance  $Z_5$  as a load represents a one-port configuration driven by a voltage source, E. Replacing all impedances with line segments forms graph of network N.

ately apparent.

- Visual inspection conveniently provides values of transmittance and input and output impedance, and quickly evaluates effects of disturbances and variations of network parameters.

- The method adapts easily to computer-aided analysis of simple or complex networks.

**Defining topology terms**

Before demonstrating an actual topological analysis, it is necessary to define the terms in the technique, with the help of bridged-T network shown above. The network is loaded by impedance  $Z_5$ , and has four nodes ( $V_1, V_2, V_3, V_4$ ) and five branches ( $Z_1, Z_2, Z_3, Z_4$  and  $Z_5$ ). The voltage E represents the source.

If each of the five branches is replaced by a line segment while retaining the four nodes, a graph, G, of the network results as shown above. Such a representation is known as a graph of the network, N, and each of the five line segments is called an edge of the graph. Each edge corresponds to a branch in the network. For the graph shown, the edges are  $e_1, e_2, e_3, e_4$ , and  $e_5$ . Each of the nodes in the network, N, corresponds to a vertex in the

graph,  $G$ . Thus,  $V_1, V_2, V_3$ , and  $V_4$  are the vertices of the graph. The number of edges connected to a given vertex is called the degree of the vertex. For example, vertex  $V_3$  has a degree of 3 since three edges connect to it. Likewise, vertex  $V_1$  has a degree of 2,  $V_2$  has a degree of 3 and  $V_4$  has a degree of 2.

The graph can be divided into a number of subgraphs,  $G_i$ . If  $G_i$  does not contain all the edges of the graph,  $G$ , it is called a proper subgraph of  $G$ . In the diagram, edges  $e_3, e_4$  and  $e_5$  would be one subgraph, in this case called a loop-set because it forms a closed loop. Two other types of subgraphs are the path-set and the tree. A path-set consists of a group of edges that link one vertex to another without repeating an edge;  $e_3, e_1$  and  $e_2$  represents one path-set because it connects vertex  $V_4$  to  $V_2$ . A tree is a connected subgraph that contains all the vertices of  $G$  but does not form any closed loops. One possible tree contains edges  $e_1, e_2$  and  $e_4$ . Two other trees of  $G$  are  $e_2, e_3$  and  $e_4$  and  $e_1, e_3$  and  $e_5$ .

By subdividing the graph further it is possible to form a 2-tree. A 2-tree of  $G$  consists of two unconnected subgraphs that do not contain loops, but when connected contain all the vertices of  $G$ . Such a 2-tree can be formed with edges  $e_1$  and  $e_4$  or  $e_2$  and  $e_5$ . Note that a 2-tree is obtained by removing one of the edges from the tree. The tree-admittance product for the tree  $e_1, e_3$  and  $e_5$  is  $Y_1 Y_3 Y_5$ , and is obtained by multiplying the admittances of the tree edges. The 2-tree admittance product of the 2-tree  $e_2$  and  $e_5$  is  $Y_2 Y_5$ .

### Network functions

Before the topological technique can be demonstrated a few basic network formulas must be established. To explore the relationships, the engineer should consider the representation of a network,  $N$ , with  $n$  independent nodes as shown at top. Node  $1'$  is the reference or datum node. Voltages  $V_1, V_2, \dots, V_n$  (which are functions of the complex frequency variable  $s$ ) are the node voltages,  $V_1, V_2, \dots, V_n$  (which are functions of time,  $t$ ) between the  $n$  nodes and the reference node  $1'$  with the plus polarity at the  $n$  nodes. Nodal analysis yields the  $n$ -independent current equations, written here in matrix form:

$$\begin{bmatrix} Y_{11} & Y_{12} & \dots & Y_{1n} \\ Y_{21} & Y_{22} & \dots & Y_{2n} \\ \vdots & \vdots & \ddots & \vdots \\ Y_{n1} & Y_{n2} & \dots & Y_{nn} \end{bmatrix} \begin{bmatrix} V_1 \\ V_2 \\ \vdots \\ V_n \end{bmatrix} = \begin{bmatrix} I_1 \\ I_2 \\ \vdots \\ I_n \end{bmatrix} \quad (1)$$

or, in abbreviated matrix notation,

$$[Y_n] [V_n] = [I_n] \quad (2)$$

where  $[Y_n]$  is the node admittance matrix,  $[V_n]$  the  $n$ -vector (defined as a column matrix of order  $n \times 1$ ) of the node voltage transforms, and  $[I_n]$  the  $n$ -vector of the transforms of the known current sources.

The engineer usually is concerned with two types of networks, the one-port and two-port. For

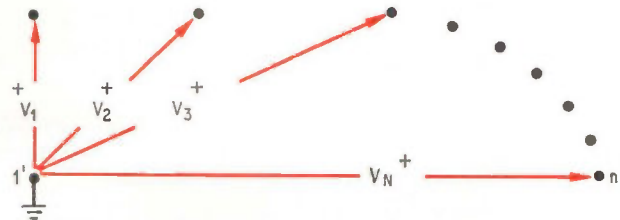

Independent nodes,  $n$  in all, schematically represents a general network  $N$ . Node  $1'$  represents the reference or datum node.

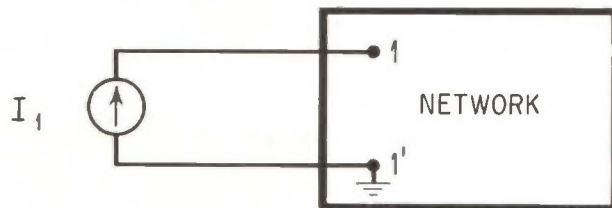

Passive one-port network with zero-initial conditions and a current source driver helps derive the driving-point impedance and admittance functions.

the one-port network he generally wants to know the input impedance,  $Z_d(s)$  or input admittance  $Y_d(s)$ . From the matrix of equation 1 expressions for  $Z_d(s)$  and  $Y_d(s)$  result in

$$Z_d(s) = \frac{V_1}{I_1} = \frac{\Delta_{11}}{\Delta} \quad (3)$$

and

$$Y_d(s) = \frac{1}{Z_d(s)} = \frac{\Delta}{\Delta_{11}} \quad (4)$$

respectively.

Equations 3 and 4 show that both  $Z_d(s)$  and  $Y_d(s)$  can be expressed in terms of the determinant of  $Y_n$ ,  $\Delta$ , and its (1,1) cofactor,  $\Delta_{11}$ . The engineer will recall that the cofactor  $\Delta_{jk}$  is obtained by striking out the  $j$ th column and  $k$ th row of the determinant,  $\Delta$ , and solving for the remaining determinant. Thus,  $\Delta_{11}$  is determined by striking out column one and row one from  $\Delta$  and solving the remainder.

Next, consider a passive two-port network driven by two current generators  $I_{r1}$  and  $I_{r2}$  at ports 1 and 2 respectively [see top p. 114]. Here the engineer is usually concerned with the  $Z$  open-circuit or  $Y$  short-circuit parameters. These are defined from a two-port analysis as follows:

$$z_{11} = \left. \frac{V_1}{I_1} \right|_{I_2=0} = \frac{\Delta_{11}}{\Delta} \quad (5a)$$

$$z_{21} = \left. \frac{V_2}{I_1} \right|_{I_2=0} = \frac{\Delta_{12} - \Delta_{12}'}{\Delta} \quad (5b)$$

$$z_{12} = \left. \frac{V_1}{I_2} \right|_{I_1=0} = \frac{\Delta_{21} - \Delta_{21}'}{\Delta} \quad (5c)$$

$$z_{22} = \left. \frac{V_2}{I_2} \right|_{I_1=0} = \frac{\Delta_{22} + \Delta_{2'2'} - 2\Delta_{22}'}{\Delta} \quad (5d)$$



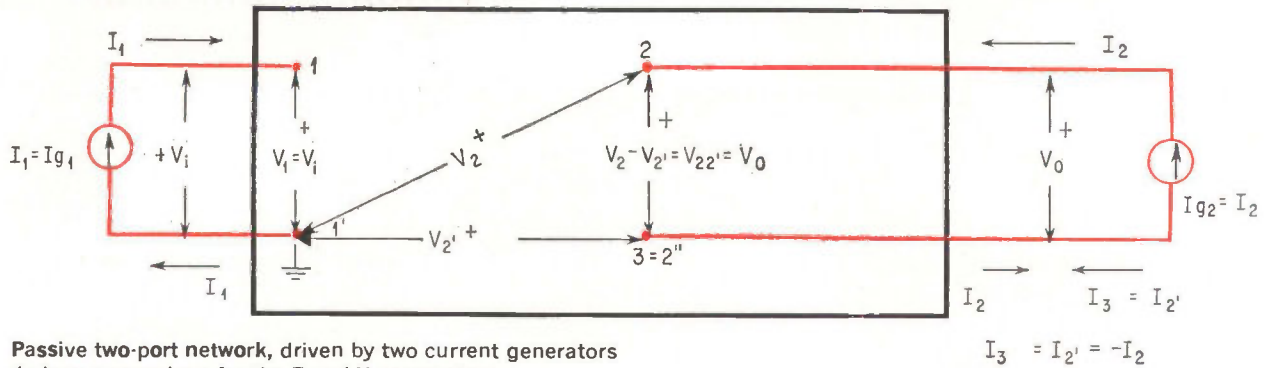

Passive two-port network, driven by two current generators derives expressions for the Z and Y parameters.

$$y_{11} = \left. \frac{I_1}{V_1} \right|_{V_0=0} = \frac{Z_{22}}{\Delta_z} \quad (5e)$$

$$y_{21} = \left. \frac{I_2}{V_1} \right|_{V_0=0} = \frac{-Z_{21}}{\Delta_z} \quad (5f)$$

$$y_{12} = \left. \frac{I_1}{V_0} \right|_{V_1=0} = \frac{-Z_{12}}{\Delta_z} \quad (5g)$$

$$y_{22} = \left. \frac{I_2}{V_0} \right|_{V_1=0} = \frac{Z_{11}}{\Delta_z} \quad (5h)$$

where

$$\Delta_z = Z_{11}Z_{22} - Z_{12}Z_{21}$$

The preceding nodal equations can be related to the topological definitions by the following:  
 $\Delta$  = the sum of all the tree admittance products for a network, N, where a tree admittance product is defined as the product of the admittances of all the branches of the tree.

$\Delta_{jj}$  = the sum of all the 2-tree admittance products of a network, N, with each 2-tree term formed from a two-part subgraph containing node j in one subgraph and node 1' in the other.

$\Delta_{ij}$  = the sum of all 2-tree admittance products of a network N with each 2-tree term formed from a two-part subgraph containing nodes i and j in one connected subgraph and the reference node 1' in the other.

For convenience, equations 3 and 4 can be rewritten as:

$$Z_d(s) = \frac{W_{1,1'}(Y)}{V(Y)} \quad (6)$$

and,

$$Y_d(s) = \frac{V(Y)}{W_{1,1'}(Y)} \quad (7)$$

Similarly, equations 5a through 5g can be rewritten to express the open-circuit parameters of a passive two-port network without mutual inductances. These are:

$$z_{11} = \frac{W_{1,1'}(Y)}{V(Y)} \quad (8a)$$

$$z_{12} = z_{21} = \frac{W_{12,1'2'}(Y) - W_{12,1'2}}{V(Y)} \quad (8b)$$

$$z_{22} = \frac{W_{2,2'}(Y)}{V(Y)} \quad (8c)$$

And, the short-circuit parameters for a passive two-port network without mutual inductances are:

$$y_{11} = \frac{W_{2,2'}}{\Sigma u} \quad (8d)$$

$$y_{12} = y_{21} = \frac{W_{12,1'2} - W_{12,1'2'}}{\Sigma u} \quad (8e)$$

$$y_{22} = \frac{W_{1,1'}}{\Sigma u} \quad (8f)$$

where,

$V(Y)$  = sum of all tree admittance products of all the trees of a network, N.

$W_{1,1'}(Y)$  = sum of the 2-tree admittance products of all the 2-trees with node 1 in one part and node 1' in the other part. These 2-trees are the same as the set of all the trees of a modified network obtained by shorting node 1 to node 1' of the original network.

$W_{2,2'}(Y)$  = sum of the 2-tree admittance products of all the 2-trees with node 2 in one part and node 2' in the other part. These 2-trees are the same as the set of all the trees of a modified network obtained by shorting node 2 to node 2' of the original network.

$W_{12,1'2'}(Y)$  = sum of the 2-tree admittance products of all the 2-trees of the network with each 2-tree having one part containing vertices 1 and 2, and the other part containing vertices 1' and 2'.

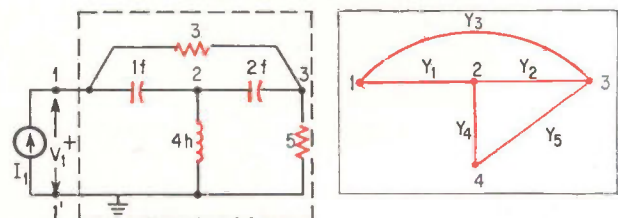

Illustration of the topological technique shows passive one-port network with zero-initial conditions used in example 1. Graph of the one-port network is formed by replacing the impedance values with line segments and their appropriate admittance values.

$W_{12',1'2}(Y) =$  sum of the 2-tree admittance products of all the 2-trees of the network, N, with each 2-tree having one part containing vertices 1 and 2', and the other part containing vertices 1' and 2.

$\Sigma U =$  sum of all 3-tree admittance products of the network, N, for the following four combinations of 3-trees:

- A subgraph with vertices 1 and 2' in one part, vertex 2 in a second part and vertex 1' in a third.
  - A subgraph with vertices 1' and 2' in one part, vertex 1 in a second part and vertex 2 in a third.
  - A subgraph with vertices 1 and 2 in one part, vertex 2' in a second part and vertex 1' in a third.
  - A subgraph with vertices 1' and 2 in one part, vertex 1 in a second part, and vertex 2' in a third.
- A 3-tree of a graph G is a proper subgraph of G consisting of three unconnected subgraphs without loops that, when the subgraphs are connected, contain all vertices of G.

### Analyzing networks by topology

With the basic relationships and definitions established, the examples that follow will help explain how to analyze networks by topology:

**Example 1.** Obtain the driving-point impedance  $Z_d(s)$  and its reciprocal  $Y_d(s)$  for the passive one-port shown at bottom left of page 114.

In accordance with equations 3 and 4 or 6 and 7, the problem is to determine both  $\Delta$  and  $\Delta_{11}$ .

**Step 1.** To find  $\Delta$ , draw the graph of the network by replacing each element with an appropriate line segment that represents the admittance of that branch as shown at bottom right of page 114.

**Step 2.** Form all tree admittance products for the network by inspecting the trees of the graph. These are shown in table 1.

**Step 3.** Form  $\Delta$  by summing all the tree admittance products. Thus,

$$\begin{aligned} \Delta &= s/2 + 2s^2/5 + 1/12 + s/15 + \\ &\quad 1/20 + 1/6 + 2s/15 + 1/60s \\ &= 2s^2/5 + 7s/10 + 3/10 + 1/60s \end{aligned}$$

**Step 4.** To find  $\Delta_{11}$  short vertex 1 to 1' and obtain a new graph of the network, called  $G_{11}'$  as shown in table 2 on page 116.

**Step 5.** Form all 2-tree admittance products of N by obtaining the set of all tree admittance products of  $G_{11}'$  as shown in table 2.

**Step 6.** Form  $\Delta_{11}$  by summing all the 2-tree admittance products. Thus,

$$\begin{aligned} \Delta_{11} &= 2s^2 + s/3 + s/5 + 2s/3 + 1/2 + \\ &\quad 2s/5 + 1/12s + 1/20s \\ &= 2s^2 + 8s/5 + 1/2 + 2/15s \end{aligned}$$

**Step 7.** Form  $Y_d(s)$  and  $Z_d(s)$  as defined in equations 3 and 4. Hence,

$$\begin{aligned} Y_d(s) &= \frac{\Delta}{\Delta_{11}} = \frac{(2s^2/5 + 7s/10 + 3/10 + 1/60s)}{(2s^2 + 8s/5 + 1/2 + 2/15s)} \\ &= \frac{(24s^3 + 42s^2 + 18s + 1)}{(120s^3 + 96s^2 + 30s + 8)} \end{aligned}$$

and  $Z_d(s) = 1/Y_d(s)$ .

When the same example is done by the conven-

**Table 1: Graph of network N in example 1**

TREES OF NETWORK N	TREE - ADMITTANCE PRODUCTS
	$Y_1 = j\omega C_1 = s$ $Y_2 = 2s$ $Y_3 = 1/R = 1/3$ $Y_4 = 1/j\omega L = 1/4s$ $Y_5 = 1/5$
	$Y_1 Y_2 Y_4 = (s)(2s)(1/4s) = s/2$
	$Y_1 Y_2 Y_5 = (s)(2s)(1/5) = 2s^2/5$
	$Y_1 Y_3 Y_4 = (s)(1/3)(1/4s) = 1/12$
	$Y_1 Y_3 Y_5 = (s)(1/3)(1/5) = s/15$
	$Y_1 Y_4 Y_5 = (s)(1/4s)(1/5) = 1/20$
	$Y_2 Y_3 Y_4 = (2s)(1/3)(1/4s) = 1/6$
	$Y_2 Y_3 Y_5 = (2s)(1/3)(1/5) = 2s/15$
	$Y_3 Y_4 Y_5 = (1/3)(1/4s)(1/5) = 1/60s$

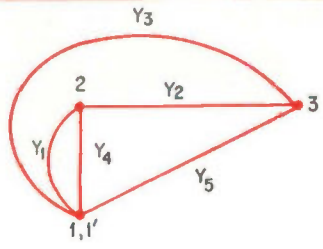
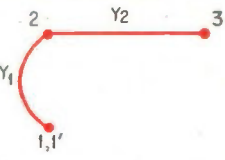
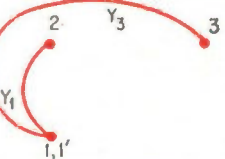
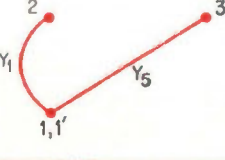
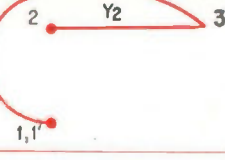
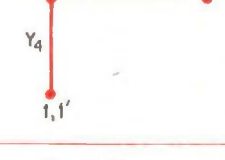
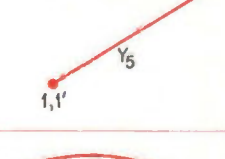
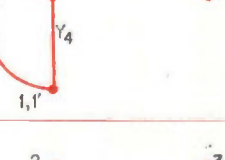
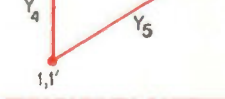

Table 2:  $G_{11}$  formed by shorting vertices 1 and 1'

2-TREES OF NETWORK	2-TREE ADMITTANCE PRODUCTS
 $Y_1 = j\omega C_1 = s$ $Y_2 = 2s$ $Y_3 = 1/3$ $Y_4 = \frac{1}{j\omega L} = 1/4s$ $Y_5 = 1/5$	
	$Y_1 Y_2 = (s)(2s) = 2s^2$
	$Y_1 Y_3 = (s)(1/3) = s/3$
	$Y_1 Y_5 = (s)(1/5) = s/5$
	$Y_2 Y_3 = (2s)(1/3) = 2s/3$
	$Y_2 Y_4 = (2s)(1/4s) = 1/2$
	$Y_2 Y_5 = (2s)(1/5) = 2s/5$
	$Y_3 Y_4 = (1/3)(1/4s) = 1/12s$
	$Y_4 Y_5 = (1/4s)(1/5) = 1/20s$

tional mesh or node technique, a set of equations must be formed for each loop or node. Then a matrix is formed for the network and much mathematical calculation is required to obtain the result for  $Z_d(s)$  and  $Y_d(s)$ . As a comparison to the topological approach consider the same network analyzed by node equations. Thus,

Step 1. Form the node equation for the network.

$$I_1 = \left(\frac{3s+1}{3}\right) V_1 - s V_2 - \frac{1}{3} V_3$$

$$0 = -s V_1 + \left(\frac{12s^2+1}{4s}\right) V_2 - 2s V_3$$

$$0 = -\frac{1}{3} V_1 - 2s V_2 + \left(\frac{30s+8}{15}\right) V_3$$

Step 2. Form the matrix equation for the results of step 1. Hence,

$$\begin{bmatrix} \left(\frac{3s+1}{3}\right) & -s & -\frac{1}{3} \\ -s & \left(\frac{12s^2+1}{4s}\right) & -2s \\ -\frac{1}{3} & -2s & \left(\frac{30s+8}{15}\right) \end{bmatrix} \begin{bmatrix} V_1 \\ V_2 \\ V_3 \end{bmatrix} = \begin{bmatrix} I_1 \\ 0 \\ 0 \end{bmatrix}$$

And,

$$\Delta = \begin{bmatrix} 1 & 2 & 3 \\ \left(\frac{3s+1}{3}\right) & -s & -\frac{1}{3} \\ -s & \left(\frac{12s^2+1}{4s}\right) & -2s \\ -\frac{1}{3} & -2s & \left(\frac{30s+8}{15}\right) \end{bmatrix} \begin{matrix} 1' \\ 2' \\ 3' \end{matrix}$$

Step 3. Expanding and simplifying,

$$\Delta = \frac{(24s^3 + 42s^2 + 18s + 1)}{60s}$$

Step 4. Evaluate the  $(1,1')$  cofactor of  $\Delta_{11}$  by expanding the  $\Delta$  determinant with column 1 and row 1' deleted. Thus,

$$\Delta_{11} = \begin{bmatrix} \left(\frac{12s^2+1}{4s}\right) & -2s \\ -2s & \frac{30s+8}{15} \end{bmatrix}$$

$$= \frac{120s^3 + 96s^2 + 30s + 8}{60s}$$

Step 5. Form  $Z_d(s)$  and  $Y_d(s)$  from equations 3 and 4. Hence,

$$Z_d(s) = \frac{\Delta_{11}'}{\Delta} = \frac{120s^3 + 96s^2 + 30s + 8}{24s^3 + 42s^2 + 18s + 1}$$

and

$$Y_d(s) = \frac{\Delta}{\Delta_{11}} = \frac{24s^3 + 42s^2 + 18s + 1}{120s^3 + 96s^2 + 30s + 8}$$

which agrees with the result obtained previously.

For a network of more than three loops or nodes expansion by minors would have been required for the matrix. This would require an enormous amount of tedious calculation.

Example 2. Obtain the Z-impedance parameters for the two-port ladder network shown below with topological techniques. The Z-impedance parameters are defined by equations 5a through 5d or equations 8a through 8c.

Step 1. Draw graph G for the two-port network as shown below.

Step 2. Form all tree combinations for the graph as in table 3.

Step 3. Form  $V(Y)$  by summing all tree admittance products of the graph G. Thus,

$$V(Y) = Y_1 Y_2 Y_3 Y_4 Y_6 + Y_1 Y_2 Y_3 Y_5 Y_6 + Y_1 Y_2 Y_4 Y_6 Y_6 + Y_1 Y_3 Y_4 Y_5 Y_6 \\ = s G_1 G_3 G_4 G_6 (C_2 + C_5) + s^2 G_1 G_6 C_2 C_5 (G_3 + G_4)$$

Step 4. Short vertex 1 to 1' to obtain the graph  $G_{11'}$ , shown in table 4 on page 118.

Step 5. Form  $W_{1,1'}(Y)$  by summing all the tree admittance products for the trees of graph  $G_{11'}$ . Thus,

$$W_{1,1'}(Y) = Y_1 Y_3 Y_4 Y_6 + Y_1 Y_3 Y_5 Y_6 + Y_1 Y_4 Y_6 Y_6 + Y_2 Y_3 Y_4 Y_6 + Y_2 Y_4 Y_5 Y_6 + Y_3 Y_4 Y_6 Y_6 \\ + Y_2 Y_3 Y_5 Y_6 \\ = G_1 G_3 G_4 G_6 + s [C_5 G_6 (G_1 G_3 + G_1 G_4 + G_3 G_4) + G_3 G_4 G_6 C_2] + s^2 C_2 C_5 G_6 (G_3 + G_4)$$

Step 6. Short vertex 2 to 2' of graph G to form graph  $G_{22'}$ , as shown in table 5 on page 118.

Step 7. Form  $W_{2,2'}(Y)$  by summing all tree admittance products for the trees of graph  $G_{22'}$ . Thus,

$$W_{2,2'}(Y) = Y_1 Y_2 Y_3 Y_4 + Y_1 Y_2 Y_3 Y_5 + Y_1 Y_2 Y_3 Y_6 + Y_1 Y_2 Y_4 Y_5 + Y_1 Y_2 Y_4 Y_6 + Y_1 Y_3 Y_4 Y_5 + Y_1 Y_3 Y_4 Y_6 \\ = s [G_1 G_3 (G_4 C_2 + G_6 C_2 + G_4 G_5) + (G_1 G_4 G_6 C_2)] + s^2 G_1 C_2 C_5 (G_3 + G_4) + G_1 G_3 G_4 G_6$$

Step 8. To obtain  $W_{12,1'2'}(Y)$  form the set of all 2-trees of G that includes vertices 1 and 2 in one subgraph, and 1' and 2' in another as shown at top page 118. The only such set for the graph G contains edges  $e_1, e_3$  and  $e_6$  in one subgraph and  $e_4$  in the other. Thus,  $W_{12,1'2'} = Y_1 Y_3 Y_4 Y_6$

Step 9. To obtain  $W_{12,1'2'}(Y)$  form the set of all 2-trees of graph G that contain vertices 1 and 2' in one subgraph and 1' and 2 in another subgraph.

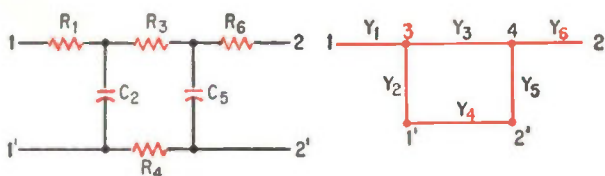

Passive two-port network and its graph aid examination of the ladder network. Graph is formed by replacing all impedance values with line segments and appropriate admittance values.

Table 3: G of the two-port network in example 2

	$Y_1 = \frac{1}{R_1} = G_1$ $Y_2 = s C_2$ $Y_3 = \frac{1}{R_3} = G_3$ $Y_4 = \frac{1}{R_4} = G_4$ $Y_5 = s C_5$ $Y_6 = \frac{1}{R_6} = G_6$
TREES OF G	TREE-ADMITTANCE PRODUCTS
	$Y_1 Y_2 Y_3 Y_4 Y_6 = s G_1 G_3 G_4 G_6 C_2$
	$Y_1 Y_2 Y_3 Y_5 Y_6 = s^2 G_1 G_3 G_6 C_2 C_5$
	$Y_1 Y_2 Y_4 Y_5 Y_6 = s^2 G_1 G_4 G_6 C_2 C_5$
	$Y_1 Y_3 Y_4 Y_5 Y_6 = s G_1 G_3 G_4 G_6 C_5$

For this example such a set does not exist. Thus,  $W_{12,1'2'} = 0$ .

Step 10. Form the Z-impedance parameters as defined by equations 8a through 8c and substitute their admittance value. Hence,

$$z_{11} = G_1 G_3 G_4 G_6 + s [C_5 G_6 (G_1 G_3 + G_1 G_4 + G_3 G_4) + G_3 G_4 G_6 C_2] + s^2 C_2 C_5 G_6 (G_3 + G_4) \\ s G_1 G_3 G_4 G_6 (C_2 + C_5) + s^2 G_1 G_6 C_2 C_5 (G_3 + G_4)$$

$$z_{12} = z_{21} = \frac{G_1 G_3 G_4 G_6}{s G_1 G_3 G_4 G_6 (C_2 + C_5) + s^2 G_1 G_6 C_2 C_5 (G_3 + G_4)} \\ s [G_1 G_3 (G_4 C_2 + G_6 C_2 + G_4 C_5) + (G_1 G_4 G_6 C_2)]$$

$$z_{22} = \frac{s^2 G_1 C_2 C_5 (G_3 + G_4) + G_1 G_3 G_4 G_6}{s G_1 G_3 G_4 G_6 (C_2 + C_5) + s^2 G_1 G_6 C_2 C_5 (G_3 + G_4)}$$

Example 3. For the two-port ladder network of



Table 4: New graph  $G_{11'}$ , formed by shorting 1 to 1'

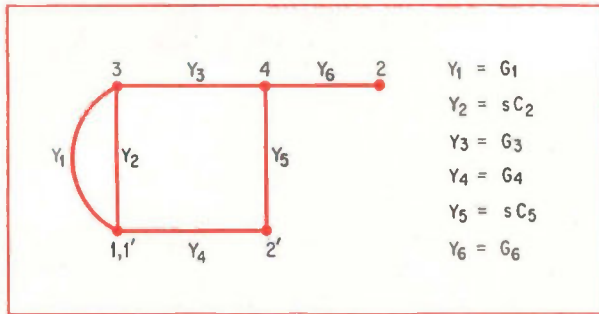
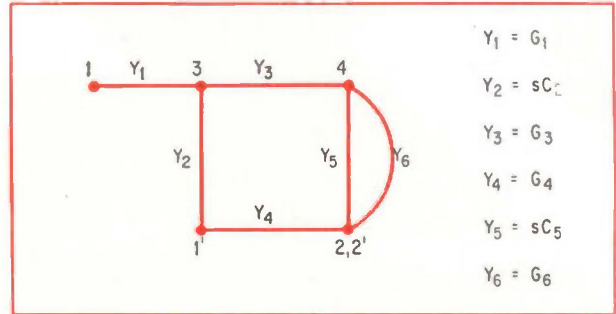

Table 5:  $G_{22'}$ , formed by shorting vertices 2 to 2'



TREES OF $G_{11'}$	TREE-ADMITTANCE PRODUCTS
	$Y_1 Y_3 Y_4 Y_6 = G_1 G_3 G_4 G_6$
	$Y_1 Y_3 Y_5 Y_6 = s G_1 G_3 G_6 C_5$
	$Y_1 Y_4 Y_5 Y_6 = s G_1 G_4 G_6 C_5$
	$Y_2 Y_3 Y_4 Y_6 = s G_3 G_4 G_6 C_2$
	$Y_2 Y_3 Y_5 Y_6 = s^2 G_3 G_6 C_2 C_5$
	$Y_2 Y_4 Y_5 Y_6 = s^2 G_4 G_6 C_2 C_5$
	$Y_3 Y_4 Y_5 Y_6 = s G_3 G_4 G_6 C_5$

TREES OF $G_{22'}$	TREE-ADMITTANCE PRODUCTS
	$Y_1 Y_2 Y_3 Y_4 = s G_1 G_3 G_4 C_2$
	$Y_1 Y_2 Y_3 Y_5 = s^2 G_1 G_3 C_2 C_5$
	$Y_1 Y_2 Y_3 Y_6 = s G_1 G_3 G_6 C_2$
	$Y_1 Y_2 Y_4 Y_5 = s^2 G_1 G_4 C_2 C_5$
	$Y_1 Y_2 Y_4 Y_6 = s G_1 G_4 G_6 C_2$
	$Y_1 Y_3 Y_4 Y_5 = s G_1 G_3 G_4 C_5$
	$Y_1 Y_3 Y_4 Y_6 = G_1 G_3 G_4 G_6$

example 2 calculate the Y short-circuit parameters.

Since the Y parameters are defined by equations 8d through 8f, the only term remaining uncalculated is  $\Sigma U$ .

Step 1. To calculate  $\Sigma U$  the engineer must form the 3-tree admittance products of the network by forming the following subgraph combinations:

- All three-part subgraphs with vertices 1 and 2' in one part, vertex 2 in a second part and vertex 1' in a third part. For this example there is only one such subgraph.

- All three-part subgraphs with vertices 1 and 2 in one part, vertex 2' in a second part and vertex 1' in the third part. For this example there is only one such subgraph.

- All three-part subgraphs with vertex 1 in one part, vertex 2' in a second part and vertices 1' and 2 in a third part. For this example there is only one such subgraph.

- All three-part subgraphs with vertex 1 in one part, vertex 2 in a second part and vertices 2' and 1' in a third part. For this example there are nine such subgraphs.

All four groups are illustrated in table 6.

Step 2. Form  $\Sigma U$  by summing all 3-tree admittance products. Thus,

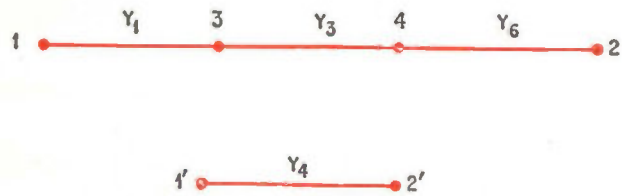

The only 2-tree of the two-port network with one part containing nodes 1 and 2, and the other nodes 1' and 2'.

$$\begin{aligned} \Sigma U = & Y_1 Y_3 Y_4 + Y_1 Y_3 Y_5 + Y_1 Y_3 Y_6 + Y_1 Y_4 Y_5 \\ & + Y_1 Y_4 Y_6 + Y_2 Y_3 Y_4 + Y_2 Y_3 Y_5 \\ & + Y_2 Y_3 Y_6 + Y_2 Y_4 Y_5 + Y_2 Y_4 Y_6 \\ & + Y_3 Y_4 Y_5 + Y_3 Y_4 Y_6 \end{aligned}$$

Step 3. Form the Y parameters using equations 8d through 8f—which can easily be performed.

Example 4. For the network shown at top page 120 find  $V(Y)$ ,  $W_{1,1'}(Y)$ ,  $W_{12,1'2'}(Y)$ ,  $W_{12,1'2'}(Y)$ ,  $W_{2,2'}(Y)$ , and  $\Sigma U$ , with topological techniques.

Step 1. Draw the graph of the network, by replacing each element with a line segment that represents the admittance as shown at top page 120.

Step 2. To calculate  $V(Y)$ , obtain the set of all tree admittance products for the network by inspecting the trees of the graph. For this network

Table 6: The 3-trees of the two-port ladder network of example 2

<p>(A) <math>Y_1 Y_3 Y_5 = sG_1 G_3 C_5</math></p>	<p>(B) <math>Y_1 Y_3 Y_6 = G_1 G_3 G_6</math></p>	<p>(C) <math>Y_2 Y_3 Y_4 = sG_3 G_4 C_2</math></p>
<p><math>Y_1 Y_3 Y_4 = G_1 G_3 G_4</math></p>	<p><math>Y_1 Y_4 Y_5 = sG_1 G_4 C_5</math></p>	<p><math>Y_1 Y_4 Y_6 = G_1 G_4 G_6</math></p>
<p><math>Y_2 Y_3 Y_4 = sG_3 G_4 C_2</math></p>	<p><math>Y_2 Y_3 Y_5 = s^2 G_3 C_2 C_5</math></p>	<p><math>Y_2 Y_4 Y_5 = s^2 G_4 C_2 C_5</math></p>
<p>(D) <math>Y_2 Y_4 Y_6 = sG_4 G_6 C_2</math></p>	<p><math>Y_3 Y_4 Y_6 = G_3 G_4 G_6</math></p>	<p><math>Y_3 Y_4 Y_5 = sG_3 G_4 C_5</math></p>



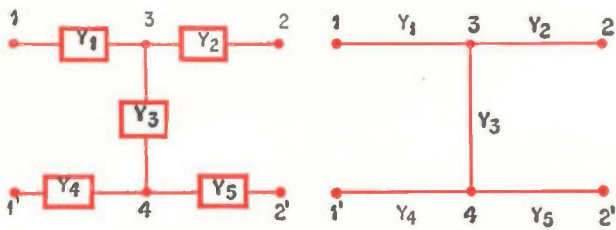

A passive two-port network and its graph used for example 4.

only one tree exists. It is formed with edges  $e_1$ ,  $e_2$ ,  $e_3$ ,  $e_4$  and  $e_5$ . Thus, the tree admittance product is the product of all admittances for these edges,

$$V(Y) = Y_1 Y_2 Y_3 Y_4 Y_5$$

Step 3. To find  $W_{1,1'}(Y)$  short circuit vertex 1 to  $1'$  and obtain a new graph of the network, called  $G_{1,1'}$  as shown in table 7.

Step 4. To evaluate  $W_{1,1'}(Y)$  sum all of the tree admittance products found in table 7. Thus,

$$W_{1,1'}(Y) = Y_1 Y_2 Y_3 Y_5 + Y_1 Y_2 Y_4 Y_5 + Y_2 Y_3 Y_4 Y_5$$

Step 5. To find  $W_{2,2'}(Y)$ , short circuit vertex 2 to  $2'$  and obtain a new graph  $G_{2,2'}$  as shown in table 8.

Step 6. To evaluate  $W_{2,2'}(Y)$  sum all of the tree admittance products found in table 8. Thus,

$$W_{2,2'}(Y) = Y_1 Y_2 Y_3 Y_4 + Y_1 Y_2 Y_4 Y_5 + Y_1 Y_3 Y_4 Y_5$$

Step 7. To obtain  $W_{12,1'2'}(Y)$  form the set of all 2-trees of  $G$  that includes vertices 1 and 2 in one subgraph, and  $1'$  and  $2'$  in another subgraph. Thus,

$$W_{12,1'2'}(Y) = Y_1 Y_2 Y_4 Y_5$$

Step 8. To obtain  $W_{1'2',12}(Y)$  form the set of all 2-trees of  $G$  that includes vertices  $1'$  and  $2'$  in one subgraph, and 1 and 2 in another subgraph. For this example there is no such subgraph. Thus,

$$W_{1'2',12}(Y) = 0$$

Step 9. To find  $\Sigma U$ , examine the 3-trees of  $G$  for the combinations:

- All three-part subgraphs with vertices 1 and  $2'$  in one part, vertex 2 in a second part and vertex  $1'$  in a third part. There is one such set for this example.

- All three-part subgraphs with vertices  $1'$  and  $2'$  in one part, vertex 1 in a second part and vertex 2 in the third part. There are two such sets for this example.

- All three-part subgraphs with vertex 1 and 2 in one part, vertex  $2'$  in a second part and vertex  $1'$  in a third part. There are two such sets for this example.

- All three-part subgraphs with vertex  $1'$  and 2 in one part, vertex 1 in a second part and vertex  $2'$  in a third part. There is one such set for this example.

Table 7: Graph  $G_{1,1'}$  for the network of example 4

TREES OF $G_{1,1'}$	TREE-ADMITTANCE PRODUCTS
	$Y_1 Y_2 Y_3 Y_5$
	$Y_1 Y_2 Y_4 Y_5$
	$Y_2 Y_3 Y_4 Y_5$

Table 8: Graph  $G_{2,2'}$  for the network of example 4

TREES OF $G_{2,2'}$	TREE-ADMITTANCE PRODUCTS
	$Y_1 Y_2 Y_3 Y_4$
	$Y_1 Y_2 Y_4 Y_5$
	$Y_1 Y_3 Y_4 Y_5$

Table 9: All 3-tree combinations for the network of example 4

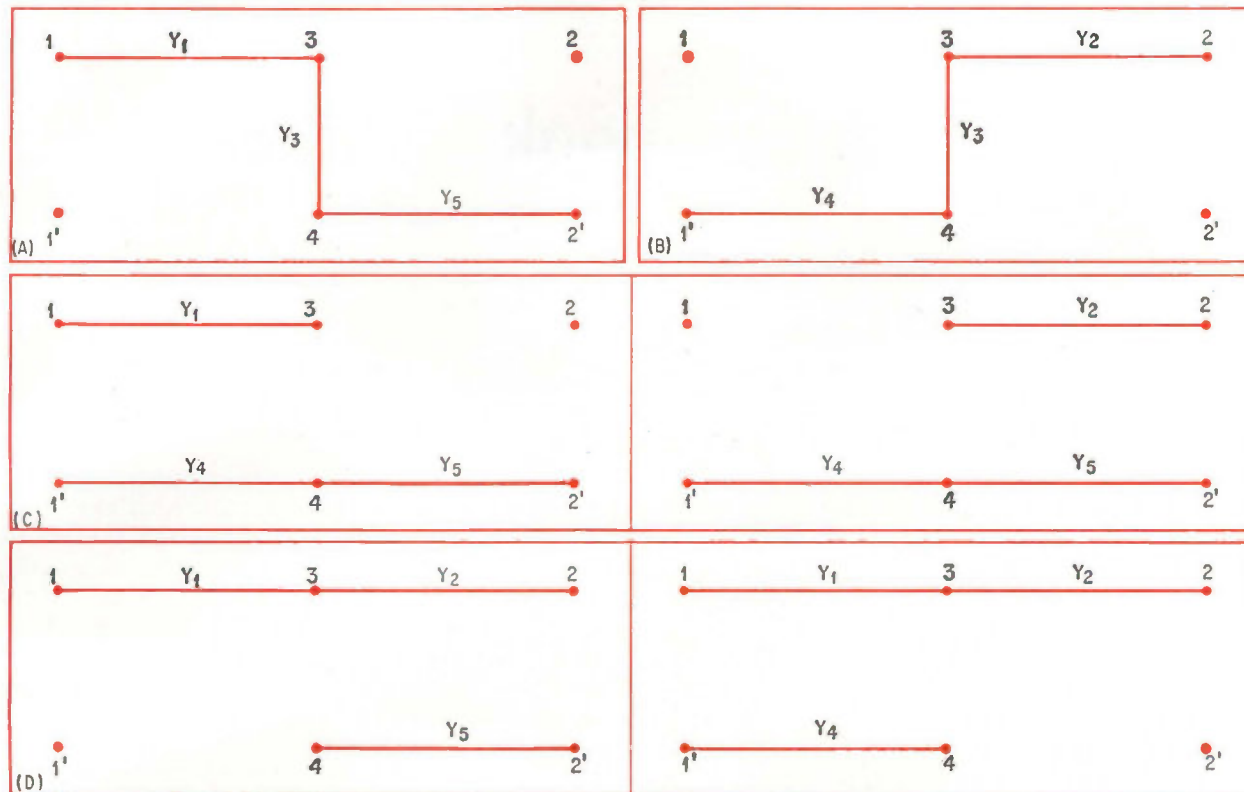

These are shown in table 9. Thus,  $\Sigma U$  is formed by summing all 3-tree admittance products of  $G$ .

$$\Sigma U = Y_1 Y_3 Y_5 + Y_1 Y_4 Y_5 + Y_2 Y_4 Y_5 + Y_1 Y_2 Y_5 + Y_1 Y_2 Y_4 + Y_2 Y_3 Y_4$$

With the data thus obtained, both the  $Z$  and  $Y$  parameters can be formed.

### Making sure you're right

Since each tree, or 2-tree, is obtained by inspection, it is quite possible that a tree may be omitted simply because of an oversight. How can the engineer be sure that all the trees, or 2-trees, have been included? The answer: by a systematic method of listing the trees and 2-trees when topological formulas are applied. One such method follows:

Since the number of edges,  $e$ , in a tree of a connected graph with  $v$  vertices is  $v-1$ , the upper boundary of the total number of trees  $T_t$ , can be determined with  $C(e, v-1)$ , where  $C(e, v-1)$  is the combination of  $e$  objects taken  $v-1$  at a time. Thus,  $T_t = C(e, v-1)$  But, from algebra,

$$C(e, v-1) = \frac{e!}{(v-1)!(e-v+1)!}$$

where, for any positive integer  $k$ ,

$$k! = k(k-1)(k-2) \dots 2 \cdot 1$$

Thus, if all the  $C(e, v-1)$  terms are listed by forming all the possible combinations of  $e$  edges taken  $v-1$  at a time and all loops of the graph are subtracted from these  $C(e, v-1)$  terms,

$$T_t = C(e, v-1) \text{ minus all loop combinations}$$

For example, consider the one-port network and its graph on page 114. This graph has five edges

and three vertices. There are 10 possible combinations of edges since

$$C(5, 3) = \frac{5!}{3!(5-3)!} = \frac{5 \cdot 4 \cdot 3 \cdot 2 \cdot 1}{3 \cdot 2 \cdot 1 \cdot 2 \cdot 1} = 10$$

Listing the edge combinations systematically yields: 123, 124, 125, 134, 135, 145, 234, 235, 245 and 345. But, by inspection of the graph, the combinations 123 and 245 form loops and therefore are not trees. Subtracting these two from the 10 possible combinations leaves eight trees of  $G$ .

The ability to check the topological analysis can be programed into a computer. Computers are used in topological network analysis, but the future success of the technique depends on cutting the time below that required by conventional techniques. This, in turn depends on having a simple tree-finding algorithm. And many investigators have, in recent years, conducted much successful research in developing network algorithms for the computer. Their contributions have been in finding topological formulas for active networks.

### Bibliography

- Percival, R.H., "Solution of Passive Electrical Networks by Means of Mathematical Trees," *Journal of the Institute of Electrical Engineers*, London Vol. 100, Part III, May 1953, pp. 143-150.
- Mayeda, W. and S. Seshu, "Topological Formulas for Network Functions," *University of Illinois Bulletin*, Vol. 55, No. 23, Nov. 1957.
- Seshu, S. and M. B. Reed, "Linear Graphs and Electrical Networks" Addison & Wesley, 1961.
- Chan, S. P. "Introductory Topological Analysis of Electrical Networks," to be published by Holt, Rinehart & Winston in 1967.



# Designer's casebook

Designer's casebook is a regular feature in Electronics. Readers are invited to submit novel circuit ideas, packaging schemes, or other unusual solutions to design problems. Descriptions should be short. We'll pay \$50 for each item published.

## Frequency-modulated output from low-cost unijunction

By Gary M. Nickus  
RDF West, Westminster, Calif.

A frequency-modulated pulse generator that has many applications in industrial control can be built for less than \$3 with a unijunction transistor. The generator is designed for synchronizing two processes or test instruments.

Operation of the generator depends on the intrinsic standoff ratio,  $n$ , of the unijunction. When the voltage on the emitter of the unijunction transistor reaches a value of  $nV_{BB}$ , a negative resistance is established between the emitter and base of  $Q_1$ , causing capacitor  $C_1$  to discharge through resistor  $R_1$ . Thus, a positive pulse is produced.

Transistor  $Q_1$  is an emitter follower that supplies a potential  $V_{BB}$  to transistor  $Q_2$ . Without an input signal,  $V_{BB}$  is 16 volts d-c. With an input signal,  $E_{in}$ , however,  $V_{BB}$  is amplitude modulated, centered around 16 volts d-c; and  $V_{BB}$  causes the output signal,  $E_o$ , to be frequency modulated. An increase in the voltage at the base of  $Q_1$  raises  $V_{BB}$ , and as  $V_{BB}$  goes up, the period between pulses at  $R_1$  also increases. The modulating signal  $E_{in}$  can have any waveshape. The amplitude of  $E_{in}$  determines the amount that the period of  $E_o$  changes; the

modulation frequency sets the rate at which  $E_o$  changes.

The period  $T$  between pulses with no input signal can be varied by changing the values of  $R_2$  and  $C_1$ . The period may be calculated from

$$T = [V_{BB}/V_{CC}] RC \ln (1/1-n)$$

With the values shown, the period is  $10^{-4}$  seconds. Periods longer than 1 second can be obtained by increasing  $C_2$ , but for values greater than 10 microfarads, additional resistance of 1 ohm per  $\mu f$  should be inserted between points A and B to protect the emitter of the unijunction transistor.

The amplitude of  $E_o$  will vary with the size of  $C_1$ , ranging from 2 volts peak to peak when  $C_1$  equals 0.001  $\mu f$  to 10 volts at 3  $\mu f$ .

## Tuning fork drives portable frequency standard

By Stuart V. Scheffel  
Scheffel Electronics, Santa Barbara, Calif.

Replacing the pulse transformer in a blocking oscillator with a tuning fork produces an accurate 400-hertz portable frequency standard. The simple, bat-

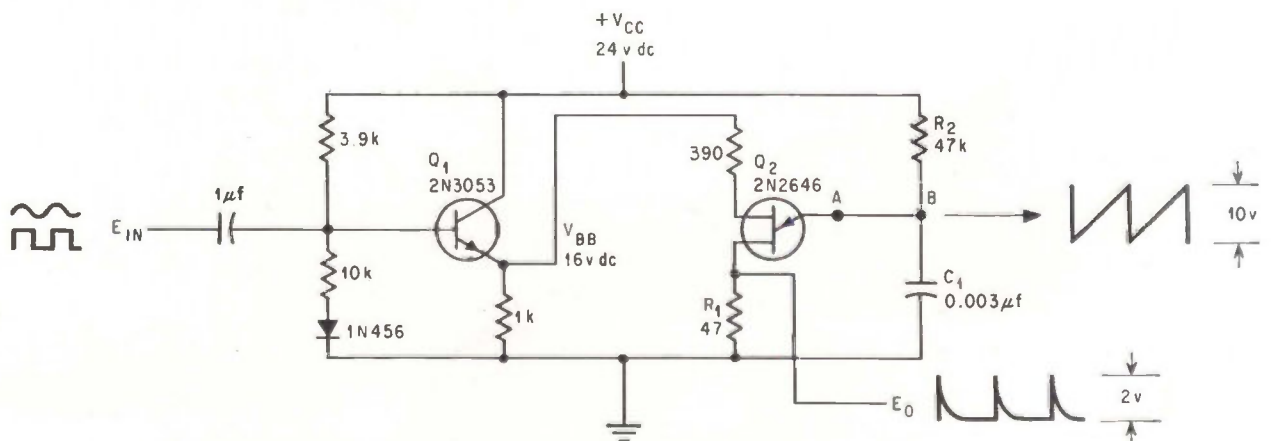

Frequency-modulated output voltage results when modulated waveshape  $V_{BB}$  is produced by  $Q_1$ . The period of the output is controlled by  $V_{BB}$  and is directly proportional to it.

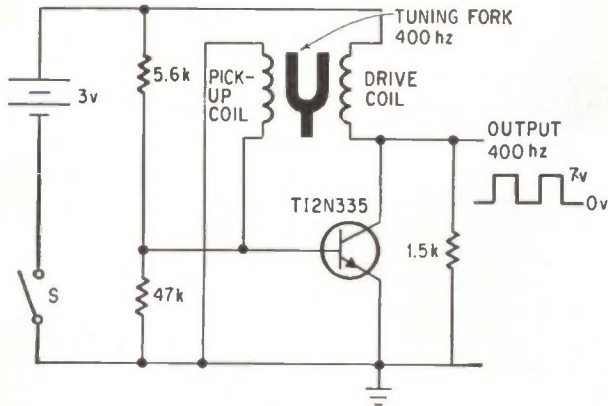

Tuning fork replaces the pulse transformer in a blocking oscillator and converts the circuit into a portable frequency standard that generates a square wave at the resonant frequency of the fork.

tery-powered circuit is ideal for checking out servo control systems in military equipment.

When switch S is closed, the transistor conducts and current flows through the drive coil of the tuning fork. The drive coil is a small electromagnet located near the top of the space between the wide steel tines. Once energized, the drive coil attracts both tines, starting fork vibration.

Another small electromagnet, the pickup coil, is mounted directly beneath the drive coil. As the tines vibrate they alternately increase and decrease the magnetic permeability of the pickup coil's core, increasing the permeability to a maximum when the tines are closest together and decreasing it to a minimum when the tines are farthest apart. The changes in permeability cause the magnetic field to expand and contract. When the field cuts across the windings of the pickup coil, a voltage is generated. An expanding flux field generates a positive voltage, a contracting flux field induces a negative signal.

At the start the positive signals increase the forward bias of the transistor when applied to the base. A larger surge of current flows through the drive coil, causing a larger deflection of the tines. The longer excursion of the tines brings them closer to the core of the pickup coil on their inward swing. When the tines are close to the core wider variations in the extent of the flux field are developed, inducing voltages of greater positive amplitude. These voltages are again applied to the base. This regenerative cycle quickly drives the transistor into saturation on positive swings of the pickup coil signal.

When the fork reaches mechanical resonance—about 15 seconds after the switch closes—the pickup coil signal is a slightly clipped sine wave with an amplitude of 1.2 volts peak to peak. The

47-kilohm resistor is placed in parallel with the pickup coil to improve the shape of the negative half-cycle of the sine wave, insuring a symmetrical output signal. The 1.2-volt peak-to-peak pickup coil voltage is larger than the base bias of 0.54 volt; therefore, the transistor is driven into saturation on positive voltage swings and is cut off on negative excursions. The resulting output signal is a crisp square-wave with a peak-to-peak amplitude of 7 volts with a frequency stabilized at 400 hz.

Because the circuit is self-contained and built with rugged components it is well suited for use in a portable field instrument. A breadboard version of the circuit oscillated for 39 hours on two AA cells. The tuning fork is a Varo Model 6250L-400.

## Diode bias replaces batteries in logarithmic converter

By R.K. Nisbett

ITT Federal Laboratories,  
San Fernando, Calif.

A converter circuit designed for data compression produces an output voltage proportional to the logarithm of an a-c input over a 36-decibel range. Bias provided by a single diode replaces the bias batteries usually needed in an a-c logarithmic converter.

In all logarithmic conversion amplifiers, the logarithm is obtained by passing the signal through a diode biased in the region where its impedance

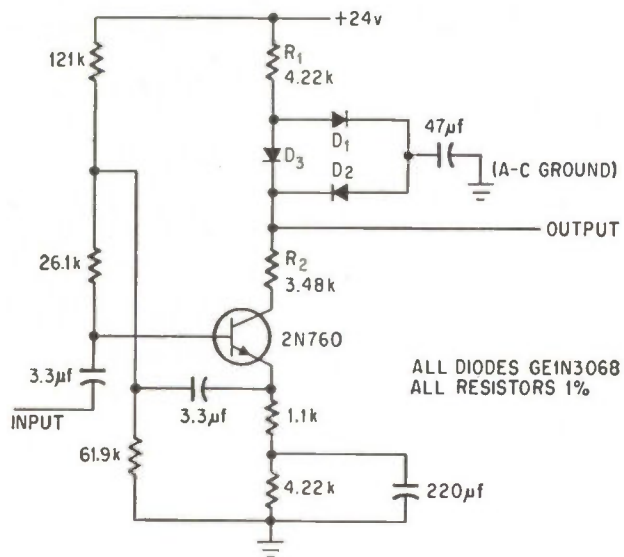

Diode D<sub>3</sub> biases converting diodes D<sub>1</sub> and D<sub>2</sub> whose impedances vary logarithmically with a-c current.



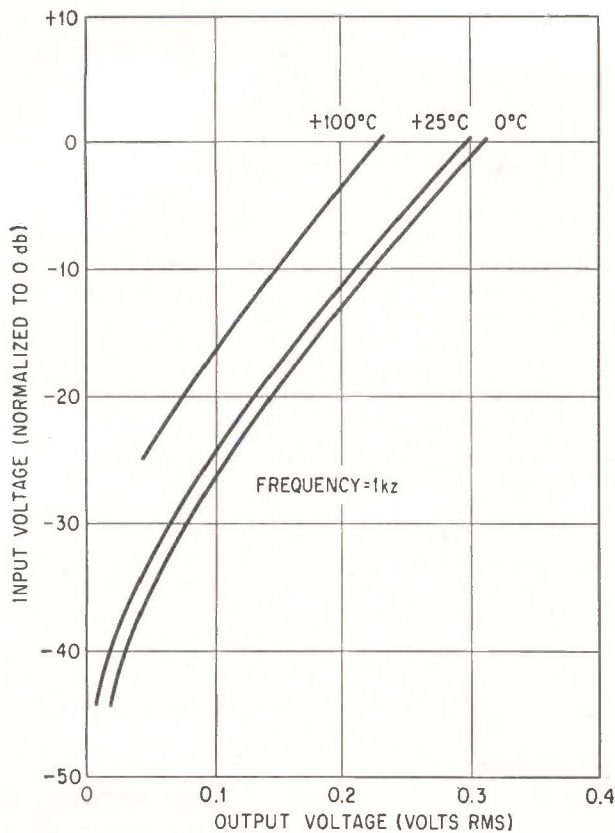

Input (normalized to 0 db) as plotted against the output voltage is linear to within  $\pm 1$  db over a 36-db range of input voltages.

is proportional to the logarithm of its current. This circuit has two converting diodes of opposite polarities. So, logarithmic compression of both the positive and negative portions of the amplified a-c waveform takes place as they pass through the 47-microfarad capacitor to a-c ground.

Diode  $D_3$  shunts nearly all of the quiescent collector current past diodes  $D_1$  and  $D_2$ . In addition, it provides each of them with the required 0.15-volt forward bias, keeping them in the logarithmic portion of the operating curve. Ordinarily this bias is supplied by a floating battery and a network of adjustable resistors. The rest of the circuit operates as a conventional common emitter amplifier. The range of input signals that the circuit can handle is limited only by the linear operating range of the converting diodes. The curves shown above are a plot of the input (normalized to 0 db) against the output voltage and show that the circuit is linear within  $\pm 1$  db over an input range of 36 db. The range can be increased to 40 db by increasing the d-c supply voltage and the size of shunting resistor  $R_1$ . This reduces the effect of a-c impedance to ground of the d-c power supply.

Compensation is required to reduce changes in voltage across the junctions of diodes  $D_1$  and  $D_2$

at elevated temperatures. Resistor  $R_2$  has a negative temperature coefficient which increases the current flow through  $D_1$  and  $D_2$ . To force more current through the diodes at higher temperatures,  $R_1$  has a positive temperature coefficient. If an additional diode voltage boost is needed, a positive thermal coefficient resistor of 10 ohms may be placed in the a-c ground circuit between the conversion diodes and the 47- $\mu$ f capacitor. Without compensation, the output voltage was found to decrease at a rate of 0.8 millivolt root mean square per degree centigrade.

## Light-sensitive FET

By Bruce R. Smith

Marshall Laboratories, Burlington, Mass.

Incident light saturates field effect transistor  $Q_1$ , shown below, and turns off npn transistor  $Q_2$  to provide a positive output voltage. When the light source is removed,  $Q_1$  remains on due to a gate circuit which feeds back the positive output to  $Q_1$ . Thus, a latching function is provided which is useful for such applications as an electronic garage-door opener, a smoke or fume detector or a warning mechanism in a paper or steel mill where a break in the sheets might require stoppage of the flow operation. The circuit is also suitable in star trackers, because of its high voltage gain (more than 100,000) and sensitivity (as great as 0.1 foot-candle).

The circuit has good noise immunity because of the diodes in the emitter and base of  $Q_2$ . Additional diodes in the emitter circuit will increase the noise immunity in the reset and turn-on lines. Reset is accomplished by a positive pulse at the reset terminal greater than the combined voltage drops of diode  $D_3$ , the base-to-emitter junction of  $Q_2$  and

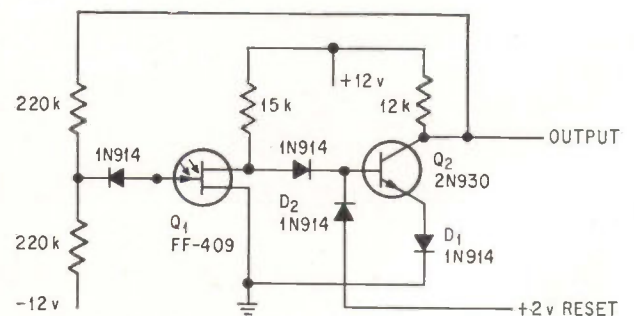

High voltage gain, good noise immunity and sensitivity are available from this arrangement. Transistor  $Q_1$  is a light-sensitive field effect that triggers a positive output voltage when light is applied.

that produced across diode  $D_1$ .

A modified version of the circuit appears at the right. Here,  $Q_2$  has been replaced by a pnp transistor. In this configuration, both  $Q_1$  and  $Q_2$  are normally off, and thus the circuit will not draw power until activated.

When light is applied,  $Q_1$  saturates  $Q_2$  and provides a positive potential, as before. This potential is fed back to the gate circuit of  $Q_1$  to provide the hold potential.

Note that the anode of diode  $D_1$  is connected directly to the gate to couple to the reset pulse and prevent positive excursions greater than 0.7 volt from appearing in the gate circuit. This version does not have as much noise immunity as the npn circuit.

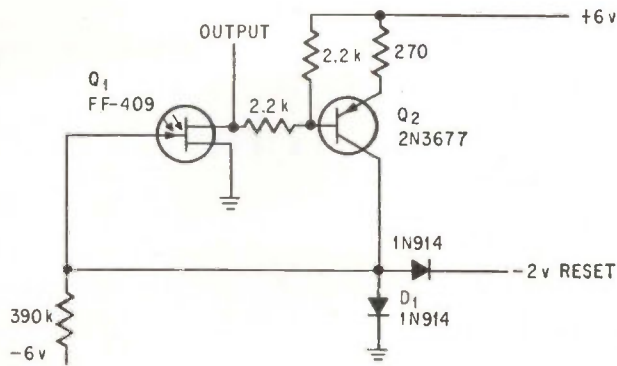

By using a pnp transistor for  $Q_2$  instead of an npn, the circuit remains in an off state until activated by the light source. Thus, no power is dissipated by the circuit. Noise immunity for this arrangement is poor.

## Unijunction memory stores until readout

By R.G. Malm

Westinghouse Electric Corp., Baltimore

A unijunction transistor can provide a simple and inexpensive memory circuit if destruction of information during readout is permitted. Storage times from 5 to 10 minutes can be readily obtained if the quality of the storage capacitor is high and the leakage of the transistor is low.

To store the information, a voltage greater than

$V_{bi}$  but less than  $V_{bi} + \eta V_{bb}$  is applied to capacitor C. The intrinsic ratio  $\eta$  is a parameter of the transistor and varies from 0.56 to 0.68 for this unijunction. Thus, the emitter-base junction remains reverse biased. When switch S is opened,  $V_{bi}$  drops until the emitter-base junction is forward biased; at which time the voltage across C, which is the negative of the normal work-function voltage, appears across resistor  $R_1$ . Capacitor C then discharges through  $R_1$  and switch S can then be closed, resetting the memory.

To detect the presence of a voltage on C, the d-c component,  $V_{bi}$ , must be subtracted from the output  $V_o$ . Without a voltage on C no output is produced, as shown in the accompanying waveforms.

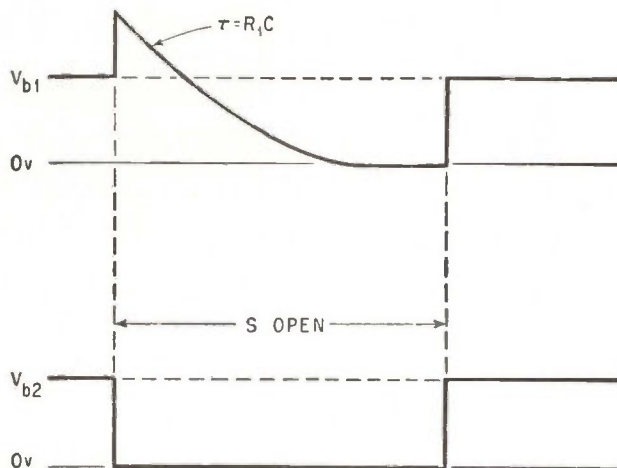
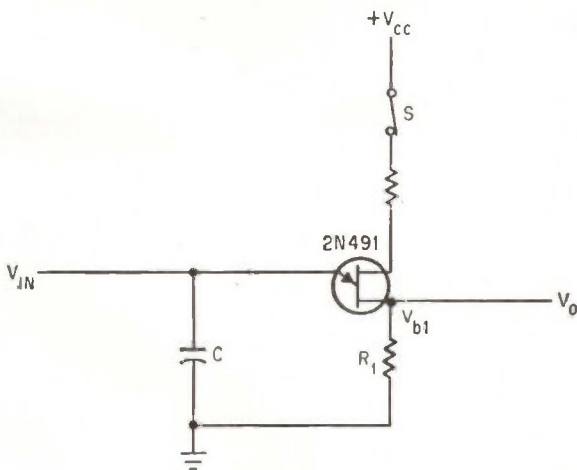

Several minutes of storage time can be obtained with the unijunction transistor in this circuit. Waveforms are a plot of output voltage,  $V_o$ , versus time. In the top waveform, with switch closed, the spike above  $V_{bi}$  initiates storage action. Bottom waveform, with switch open, shows 0 volts across C and no output voltage is produced.



# Nomograph finds output voltage error

Chart quickly evaluates performance of operational amplifiers from specified gain and offset parameters

By Ed Schuck

Rosemount Engineering Co., Minneapolis, Minn.

The design and performance of operational amplifiers can be conveniently evaluated with the nomograph on the facing page. It relates voltage gain, offset voltage and current and input impedance to output error. Although based on a simple voltage amplifier, its application can be extended to integrators, differentiators or other specific types of operational amplifiers by appropriate characterization of impedances  $Z_1$  and  $Z_2$ , as shown in the equivalent circuit below.

The standard parameters shown in the equivalent circuit are the input impedance  $R_{in}$ , offset voltage  $\pm E_{off}$ , offset current  $I_{off}$  and voltage gain  $A_v$ . They are usually specified by the manufacturer.

Offset voltage and current rep-

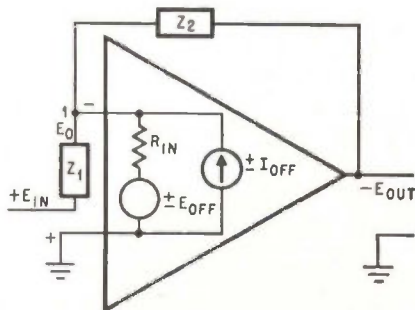

Equivalent circuit for an operational amplifier including internal impedance  $R_{in}$  and offset voltage and current,  $E_{off}$  and  $I_{off}$ , respectively. For a specific operational circuit, such as a voltage amplifier or integrator, substitute the proper values for impedances  $Z_1$  and  $Z_2$ .

resent small, undesired signals generated externally by the amplifier and appear at its input. They can never be perfectly biased away, except at one moment in time, under one particular set of conditions. Output error represents the amount of deviation between expected and actual output.

By summing the currents that enter or leave node 1, using Kirchhoff's current law, an expression for the output voltage can be found in terms of the circuit parameters. Thus:

$$\frac{(E_{in} - E_o)}{Z_1} + \frac{(\pm E_{off} - E_o)}{R_{in}} \pm I_{off} = \frac{(-E_{out} + E_o)}{Z_2} \quad (1)$$

But,

$$E_{out} = E_o A_v \quad (2)$$

And, when equation 2 is substituted into equation 1 an expression for  $E_{out}$  is derived. Hence:

$$E_{out} = \frac{-E_{in} Z_2}{Z_1} \left[ \frac{1 \pm \frac{Z_1}{R_{in}} \frac{E_{off}}{E_{in}} \pm \frac{I_{off} Z_1}{E_{in}}}{1 - \frac{1}{A_v} \left[ \frac{Z_2}{Z_1} + \frac{Z_2}{R_{in}} + 1 \right]} \right] \quad (3)$$

Equation 3 is in the form that relates  $E_{out}$  to the constants A, B and C and the external impedances  $Z_1$  and  $Z_2$ .

$$E_{out} = \frac{-E_{in} Z_2}{Z_1} \left[ \frac{(1 \pm C)}{\left(1 - \frac{1}{AB}\right)} \right] \quad (4)$$

where,

C = the offset term =

$$\pm \frac{E_{off} Z_1}{R_{in} E_{in}} \pm \frac{I_{off} Z_1}{E_{in}}$$

A = the voltage gain =  $A_v$

B = the feedback gain =

$$\frac{1}{\left[ \frac{Z_2}{Z_1} + \frac{Z_2}{R_{in}} + 1 \right]}$$

Therefore, the error equation may be represented as:

Percent of reading error = 100

$$\left[ 1 - \left[ \frac{(1 \pm C)}{\left(1 - 1/AB\right)} \right] \right] \quad (5)$$

A nomograph based on equation 5 evaluates the performance of an operational amplifier quickly and accurately.

## Using the nomograph

For this example the impedances of  $Z_1$  and  $Z_2$  were chosen as resistances  $R_1$  and  $R_2$  respectively. The values were chosen so that  $R_2 = 10 R_1$ , thus, if no error were present  $E_{out}$  would be 10 volts for an  $E_{in}$  of 1 volt. The manufacturer's data provided the following information regarding the internal parameters of the operational amplifier:

$$\begin{aligned}
 R_{in} &= 100,000 \\
 E_{off} &= +1 \text{ millivolt} \\
 I_{off} &= +0.01 \text{ microampere} \\
 A_v &= 50,000
 \end{aligned}$$

It is desired to design an operational amplifier that has a percent error of 0.02. It is first necessary to evaluate the percent error for the given parameter values.

Step 1: Calculate the values for C and AB.

$$\begin{aligned}
 C &= \left[ \frac{\pm E_{off} Z_1}{R_{in} E_{in}} \pm \frac{I_{off} Z_1}{E_{in}} \right] \\
 &= \left[ \frac{1 \times 10^{-3} \times 10^4}{100 \times 10^3 \times 1} \right. \\
 &\quad \left. + \frac{0.01 \times 10^{-6} \times 10 \times 10^3}{1} \right] \\
 &= 2 \times 10^{-4}
 \end{aligned}$$

$$A = A_v = 50,000$$

$$\begin{aligned}
 B &= \frac{1}{\left[ \frac{Z_2}{Z_1} + \frac{Z_2}{R_{in}} + 1 \right]} \\
 &= \frac{1}{\left[ 1 + \frac{100 \times 10^3}{100 \times 10^3} + \frac{100 \times 10^3}{10 \times 10^3} \right]} \\
 &= 1/12
 \end{aligned}$$

$$AB = 50,000 \times 1/12 = 4.5 \times 10^3$$

Step 2: Locate the point  $2 \times 10^{-4}$  on the C scale of the nomograph.

Step 3: Locate the point  $4.15 \times 10^3$  on the AB scale.

Step 4: With a straight edge connect the points selected in steps 2 and 3.

Step 5: Read the percent error on the center scale. For this example the percent output error is 0.045%. Therefore, if  $E_{in} = 1$  volt,  $E_{out} = 10.0045$  volts. Note that this percent error is not within the desired range.

Step 6: To determine the range,

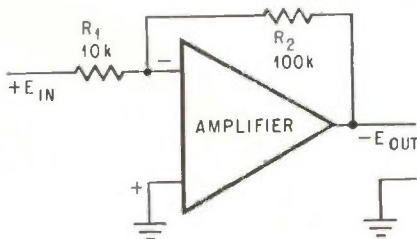

When impedances  $Z_1$  and  $Z_2$  are resistances of 10 and 100 kilohms, respectively, this circuit functions as a straightforward voltage amplifier.

Nomograph relating gain, offset and percent of reading error

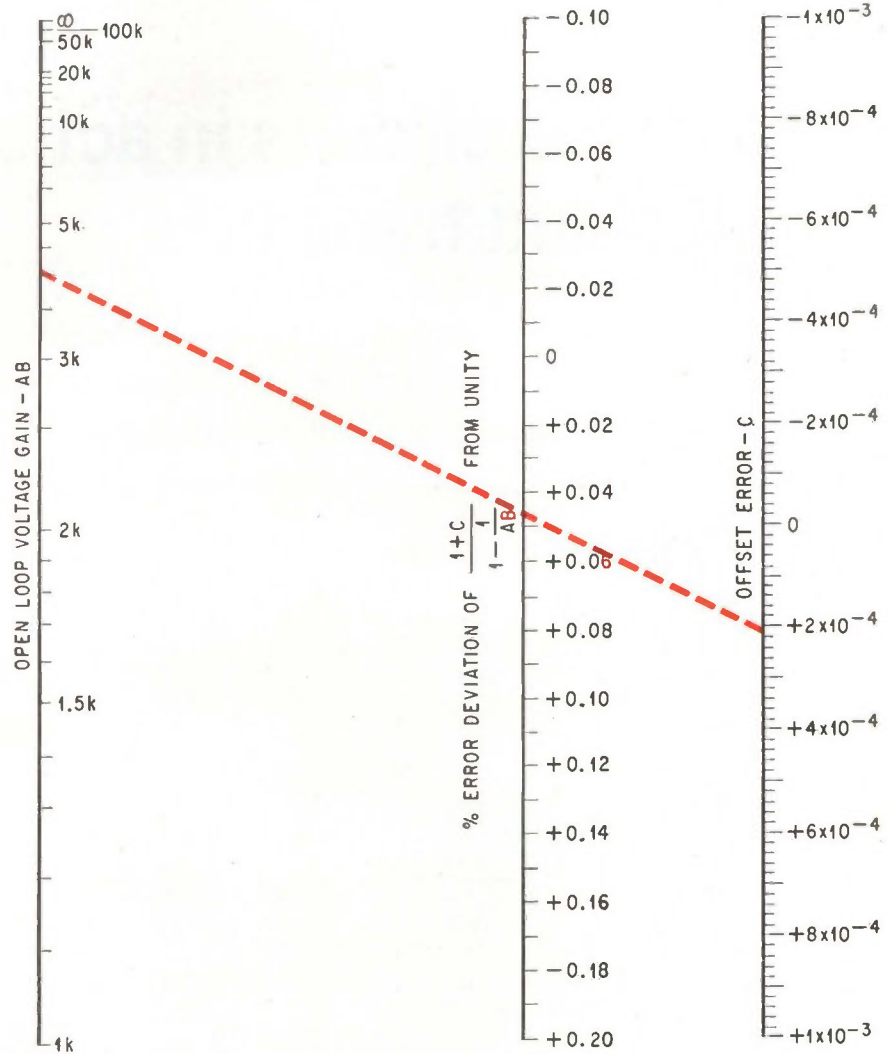

magnitude and sign of the offset term that would provide the required accuracy of 0.02%, connect the point  $4.15 \times 10^3$  on the AB scale to the point  $+0.02\%$  on the center scale by a line extending to the C scale and read the resulting offset term, which is  $-0.4 \times 10^{-4}$ . This is the upper limit of the offset range.

Step 7: To determine the lower limit, connect the point  $4.15 \times 10^3$  on the AB scale to the point of  $-0.02\%$  on the center scale and read the resulting offset term on the C scale, which is  $-4.4 \times 10^{-4}$ . Thus, the offset term C must be within the range

$$-0.4 \times 10^{-4} \leq C \leq -4.4 \times 10^{-4}$$

The amount of offset correction required is obtained by solving the following equation for  $E_{off}$  using the limits of C found from the nomograph:

$$C = \frac{Z_1}{E_{in}} \left[ \frac{\pm E_{off}}{R_{in}} \pm I_{off} \right]$$

Substitution of the C values yields:

$$-1.4 \leq E_{off} \leq -5.4 \text{ millivolts}$$

Thus, if  $E_{off}$  is compensated between these values while maintaining the same offset current as before, the required accuracy of 0.02% can be achieved. Note that the nomograph scales may be changed if necessary by multiplying scale, AB, by a constant N and dividing the other two scales by the same constant.

Since the offset current and voltage are inherent in the manufacturer's design, the user has no control over them. If he cannot find another operational amplifier with the values desired, the designer must adjust the values of  $Z_1$  and  $Z_2$  to achieve the required accuracy.



# Integrated circuits in action: part II

## Trends and trade offs

While the designer of integrated circuit equipment is attempting to pick an approach and develop guidelines for using IC's, the ground rules covering costs and performance continue to change

By Donald Christiansen

Senior associate editor

**The single factor** in the design of integrated circuit equipment that can be varied without affecting others has yet to be pinned down. Perhaps it is the color one paints the cabinet. The designer attempting to refine the performance of his IC equipment by seeking a little more gain, a little more speed or a little less volume often feels he's got hold of a wineskin—when he presses in one spot it bulges in several others.

Furthermore, since the demarcation between the IC and the equipment in which it is used is shifting, the development of rules and relationships to guide designers is a difficult task. Among those factors that affect the big picture are availability and logistics as well as performance demands imposed by the equipment specifications.

Meeting the trade off challenge thus poses some of the most difficult questions the IC user will face.

Typical of the trends generated by the use of IC's are those illustrated on page 131: decreased material and labor costs, reduced bulk, simplified maintenance and shifting engineering work loads. Frequently encountered trade offs are illustrated on page 133: power vs frequency, spares requirements vs module complexity, numbers of pins vs equipment reliability, package size and packaging techniques vs volume, and system partitioning vs cost.

### When, where and how many?

Foremost in the selection of IC's for a piece of electronic gear is the number of circuits required. Engineers at the Sperry Information and Communications division of the Sperry Rand Corp. examine what they term a yield-to-cost ratio, a figure of merit that is particularly sensitive to the number

of ICs needed but previously unavailable.

In the yield are savings resulting from reduced cost of materials, size, weight and power requirements. Also considered to be part of the yield are increases in value of the system that result from increased reliability and performance. On the debit side of the ledger, Sperry lists additional engineering labor and vendor start-up costs.

Equipment delivery date can be a strong factor in the choice of IC concept. History, if not reason, teaches that schedules always deteriorate and Sperry engineers say that long lead times needed for special IC's are no exception. Therefore, probable delivery delays must be chalked up as a cost in the yield-cost ratio.

Sperry used the yield-cost ratio as a guide in selecting both digital and linear IC's for the micro-electronic conversion of its passive-active detection and location (Padloc) sonar system (passive search and active echo ranging). For the logic in the bulk-delay and shift-register correlator the engineers chose a modified form of standard direct coupled transistor logic (DCTL). Only 3 different IC's were required: a dual NOR gate, a J-K flip-flop, and a buffer element.

In the linear data processing subsystem, a basic monolithic differential amplifier was chosen. It is used with thin film feedback circuits. A low noise version was required for the preamplifier circuit, and that was achieved through a minor masking change.

Buffer and clipper functions are accomplished using a single IC and appropriate separate feedback components. Sperry elected to go with discrete component voltage regulators, since only 10 regulator cards were required in the entire system.

## I. How trends affect decisions

**Switching to IC's** is more like trying to jump aboard a fast train than onto the proverbial bandwagon. One IC user complains that the art will not hold still. Decisions valid today are obsolete tomorrow and one often must guess and gamble.

When Interstate Electronics Corp., a subsidiary of the Interstate Engineering Corp., Anaheim, Calif., considered the design for its 1010 medium scale computer, it decided to use monolithic IC's wherever possible. But since the 1010 is a commercial general purpose computer that must compete with machines like the IBM 1800, SDC 1700 and the Sigma 2—now dominating the market—cost is a major factor. One way Interstate trimmed costs was to specify standard circuits.

Although some of the circuits were not standard at the time of design, the firm had assurances from the vendor that they would become standard and that Interstate would benefit from a price reduction. Designers at Interstate took the gamble and won.

Engineers at Sperry were vexed by similar uncertainties in the linear or analog area, which they note is even more fluid than the digital area. The display console for the Padloc system houses conventional crt electronics and unique analog functions such as servo and write amplifiers.

Although most of these circuits could be realized in IC form, Sperry elected to forego that route in favor of conventional electronics. Present costs, they noted, could not justify IC's at the time of design. The need for designing one-of-a-kind circuits would tie up too many engineers for too long and leave small hope for an immediate return on the investment.

Another course that was considered and rejected was to digitalize as many circuits as possible, but since the microelectronic Padloc was a conversion from a discrete component version, the engineering was already done for those portions of the equipment that would not be converted to IC's. Finally, any gamble on devices that were not on the immediate horizon was impractical for one-of-a-kind applications in a system destined for shipboard use, where a purchase of more than 200 systems is rare.

Designers who pick a winner from the wide choice of standard IC's may benefit from reduced prices "down the road," brought about by volume purchasing of the devices by competitors, too. For example, one large IC maker estimates that 80% of new logic designs are being implemented in transistor-transistor logic (TTL), which suggests that price and performance competition among vendors of TTL will become bitter.

### Can it be had?

Availability is unquestionably one of the most important influences on the designer's choice of IC's and IC packages, says Ralph Baer, chief engineer, equipment design, of Sanders Associates,

Nashua, N.H. Five years ago the choice was simple, he notes. "It was either resistor-capacitor-transistor logic (Texas Instruments Incorporated Series 51) or direct coupled transistor logic (Fairchild's Micrologic)—there were no other serious contenders." And IC packages and packaging techniques were, he recalls, in "just about the same aboriginal state." Today the designer can select from among a variety of logic schemes—both saturating and nonsaturating—and packages.

How design decisions are tempered by time can be seen in this example: In 1963 Sanders undertook to redesign and repackage a rack-size airborne digital computer that had been built with discrete components. The computer had to be shrunk to a volume of less than 1.5 cubic feet. Sanders' engineers leaned on their previous experience with DTL and RTL, then opted for DTL for a number of reasons—among them better noise margins, lower can-count, and good availability.

Sanders' packaging engineers then decided to mount no more than 14 DTL flatpacks on one small plug-in multilayer printed circuit card. Each flatpack had 10 leads. The small p-c card was selected for reasons that in 1963 were entirely valid: parallel-gap welded IC's were not easily replaceable, making the card throwaway, and cost for a mil spec IC averaged \$15-\$20, yielding the required throwaway cost of under several hundred dollars.

Modules of this small size are usually best organized into general purpose categories such as shift registers, multiple gate cards and line driver cards—much like their predecessor discrete component cards. Advantages of this arrangement are well known: standardization and off-the-shelf availability. The chief disadvantage stems from the complexity of the back panel wiring. Since airborne equipment cannot accept the weight and volume of a complex harness, multilayer p-c boards were used. Twenty plug-in cards were interconnected by a 5-layer p-c board.

### Today's approach

The small card approach, Sanders' engineers note, puts the burden on interconnections, and motherboard costs go up disproportionately with the number of layers. If the redesign of the airborne computer were to be attempted by Sanders today, an alternate approach based on a large subsystem, special purpose card would be used.

The large subsystem card would mount, say, 30 to 200 IC's. The approach is made feasible by the availability of 14-lead flatpacks and the reflow solder technique of attaching IC's so they can be replaced if necessary. Also, IC prices have dropped so that an entire board can be replaced at small cost.

Sanders sums up benefits of the large cards as follows: complete subsystems on one card mean fewer input-output connections—cards do not become pin-limited. In contrast, the smaller general-purpose cards often carry just a few IC's since they use up all the available pins. This is particu-



larly serious in the case of multiple gate cards. With large cards, system reliability, a function of total pin interconnections, is boosted. Motherboard wiring is simplified; costs are reduced and reliability improved. Most systems in Sanders' experience can be interconnected using 2 or, at the most, 3-layer motherboards. Special 2-layer boards developed by Sanders (and for sale to competitors) permit unrestricted throughboard connections, and are easier and less expensive to lay out than conventional 2-sided boards. Finally, when connections are made all on one board the wiring runs can be made very short. Combined with higher speed IC's, system speeds can be boosted.

Most military and commercial digital systems now being designed by Sanders use the large card concept. A typical card from a second generation data processor has 50 flatpacks per card, pretinned land areas and solder pads for IC lead attachment and card connector attachment, respectively. As the number of IC's per card increases, the likelihood of repeating cards within a system decreases, and as a result the percentage of the total system represented by spare cards increases, as shown in the curve on page 133.

Not all systems designers have settled on the large card concept. The Martin Co., a division of the Martin Marietta Corp., for one, has elected to produce computers with a versatile single integrated circuit plug-in module [Electronics, Oct. 17, p. 68]. How the module approach selected affects system reliability is shown in the table on page 133, compiled by Jack Staller of Sylvania Electronic Systems division.

### Hidden factors

Repercussions from the use of IC's are sometimes unexpected. Often overlooked in the cost of owning equipment containing large quantities of IC's is the logistic advantage of simpler maintenance and troubleshooting procedures, and the cost saving resulting from the need to order, stock, and release and keep records on fewer parts. Indeed, the system manufacturer benefits in the same way from simplified parts bookkeeping.

Higher parts densities in IC equipment virtually exclude the performance of maintenance at simple levels of system complexity. Larger modules are replaced in order to keep equipment operating. And these modules are often so complex that they are truly throwaway—field repair is virtually impossible, and maintenance depot repair is difficult and costly. With the improvement in module reliability afforded by the use of IC's, the maintenance organization as we know it today may atrophy; good maintenance technicians may become hard to find. On the other hand, even the high reliability levels achieved thus far in IC gear (0.0007%/1,000 hours for Minuteman) are insufficient for some applications, such as longtime deep space probes, and observers believe that the best answer is self-diagnosis and self-repair of this equipment.

## II. The trade off tightrope

The alternative devices available to the designer are well known. Among them are monolithic semiconductor integrated circuits, thick film circuits with semiconductor chips added, thin film circuits with chips added, and modifications and combinations of all. One difficulty in selecting an approach is that as the art is refined in each area, some phases progress more rapidly than others. Techniques that once held an advantage, say in cost or in tolerances, may be downgraded. The objective designer must be ready to switch his allegiance; standing by a favorite method on an emotional basis can be disastrous.

A case in point, notes film-circuit expert Jerry Selvin, of Sylvania's Electronic Systems division, Waltham, Mass., is the changing picture in thin versus thick films. Sylvania, a subsidiary of General Telephone & Electronics Corp., has jettisoned most of the thin film equipment used over the past several years in favor of semiautomatic and automatic methods for production of screened ceramic IC's. Such circuits, Selvin says, can be produced by Sylvania at costs as low as one-fifth that of the cost of vacuum deposited thin film circuits—and, he emphasizes, with fabrication equipment considerably less complex and costly than that used by IBM for its thick film System 360 computer circuits.

### No ideal technique

At this point in integrated electronics history, purists who say that the best integrated circuit is one produced by a single technique must be reluctantly labeled dreamers. A practical all-thin film, all-thick film or all semiconductor IC has not been developed. The monolithic IC perhaps comes closest, but even it requires a technique such as aluminum deposition to make appropriate interconnections between elements.

The battle of the techniques, most realists admit, is largely an artificial one and was born of the prejudices of device manufacturers and nourished by technical publicists and trade press writers seeking to glamorize a technology that does not require glamorizing.

Nevertheless, it can be recognized that films are more appropriate than monolithic IC's for some applications, and vice versa. It must also be recognized that, largely because the silicon monolithic IC is essentially self-contained, it is often looked at first when the designer considers IC's. He thinks of films and hybrid techniques as auxiliary methods when the silicon IC cannot do the job.

### Monolithic silicon circuits

Many industry observers rank the semiconductor IC with the tube and the transistor in importance to the electronics industry. The National Aeronautics and Space administration is backing its belief that 80% of space systems electronics will consist of IC's by 1972, and that most will be





## The name game: a clarification of terms

The label "integrated circuit" has been criticized as ambiguous while "microcircuit" and "microelectronics" have been called inapt as terms for integrated circuits and the IC art.

Recently the Institute of Electrical and Electronics Engineers approved "integrated electronics" as a generic term, defining it as "that portion of electronic art and technology in which the interdependence of material, device, circuit and system-design consideration is especially significant; more specifically, that portion of the art dealing with integrated circuits."

The rationale for discarding "microelectronics" and "microcircuits" is that they imply small size, which may be of only secondary importance in some cases. Nevertheless, "microelectronics" will probably die hard since it has gained wide acceptance. As a descriptive term to blanket the broad art that sometimes includes very small—but not integrated—devices, as well as IC's, it seems hard to beat.

Electronics magazine will generally use the IEEE terminology, reserving "microelectronics" as an exception to the rule when it seems appropriate.

### Definitions for IC's . . .

Two or more elements inseparably associated on, or within, a substrate to form an electrical network or circuit is a broad definition for an integrated circuit. But more exact definitions of IC's and their parts avoid ambiguity.

- Monolithic IC has a single semiconductor body, such as silicon crystal as its substrate.

- Thin film IC is composed of elements formed by thin films—usually less than a micron thick—deposited on a substrate by techniques such as vacuum evaporation. The elements aren't necessarily passive.

- Thick film IC is similar to thin film IC except that the films are formed by a process such as screen printing and are much thicker than deposited films.

- Hybrid thin film or thick film IC has devices—typically transistors, diodes or monolithic IC's—added to the basic film IC.

- Multichip IC is an assembly of semiconductor device chips joined within a common package by jumper wires or by an interconnection pattern on the substrate or header. Strictly speaking, a device that also has passive elements formed directly on the substrate is not a multichip IC, but rather a hybrid IC.

- Functional electronic block has often been used as another way of saying monolithic IC, but it should be reserved for monolithic IC's whose elements are difficult or impossible to identify, or whose functions can't be pinpointed to a specific area of the device.

### . . . and for IC elements

- Element is the smallest identifiable part of an IC, such as a single transistor, diode, resistor, capacitor or inductor.

- Device is a unit that can't function if its parts are separated. Integrated circuits, as well as components like transistors, are devices.

- Active element or device is one that exhibits gain. Strictly speaking, transistors—and sometimes tubes—are the active elements of IC's, but diodes are traditionally classified as active devices.

- Passive elements and devices are those that aren't active; for example a film resistor in a hybrid IC or a diffused resistor in a monolithic IC.

monolithic silicon devices, with a major study project.

At its Electronics Research Center, Cambridge, Mass., NASA is building and equipping a facility called Predict which will be used to fabricate silicon integrated circuits for its studies.

As NASA sums it up, the attributes of silicon IC's are low cost as a result of batch processing, reliability stemming from processing simplicity, and the ability to fabricate a variety of integrated devices merely by varying photographic patterns. Also, NASA cites the relatively small number of different materials required; fewer materials suggest higher reliability. Some circuits, for example, need only silicon, silicon oxide, aluminum and gold.

Many of the interconnections which were the system designer's responsibility in the days of discrete component systems have been absorbed by the integrated circuit—resulting in a system's greater inherent reliability. According to one engineer at Sperry, it becomes the designer's task to retain within the system the improvements in performance and reliability that the IC offers him.

Today, many IC's, particularly those in flatpacks, require exotic packaging technology. The density of interconnections has reached the point where manual handling is difficult, if not impossible. Also, power density is higher even though power dissipation is less per element, Sperry designers point out. The incompatibility of achievable element densities and present interconnection technology is spotlighted by the knowledge that Sperry's Univac designers could build a complex thin film memory in an inch-cube, but they wouldn't be able to make the one million connections to the cube that would be needed—and the problem of heat removal has not even been considered.

The limitations of monolithic circuits are pretty well known. Tolerances on individual elements better than 20% are difficult to achieve, and sometimes tolerances are much worse. It is possible to fabricate diffused resistors above 100 kilohms, but device manufacturers are reluctant to include resistors having a total value of 50 kilohms in standard IC's; they'd prefer to do without them altogether if possible. Likewise, IC makers feel reasonably comfortable with capacitors of about 25 picofarads, but they begin to rebel at 50 picofarads and insist that 100 picofarads is a shameful waste of valuable silicon into which several transistors could have been built.

### Metal oxide semiconductor

Metal oxide semiconductors (MOS) will compete with monolithic silicon IC's in some areas, but are expected by the experts to offer cost rather than performance advantages. Present speeds are in the 1-2 Mhz range, two or three orders of magnitude below the theoretical limit. Chief advantages are expected to be in medium speed, large, complex arrays. The MOS transistor can be used as a resistor having values up to 200 kilohms. Since resistivities are as high as 200,000 ohms per square, MOS

# Power and packaging determine IC choices

## Power-frequency trade off

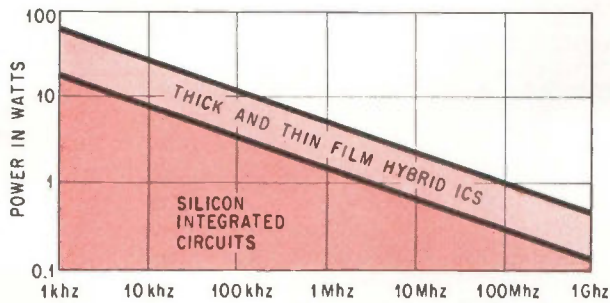

Approximate performance envelopes for monolithic integrated circuits and thick film and thin film hybrid circuits show that hybrid IC's with attached active devices are needed for higher power and frequency.

## Spares are a function of module complexity

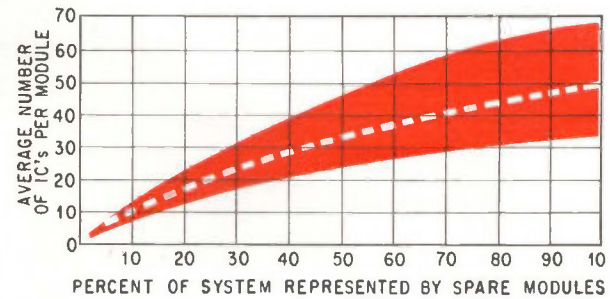

As more IC's are crammed in a module, the types of spare modules needed rises. Dotted line represents a general purpose computer containing about 3,600 IC's. Curve reflects experience at Sylvania Electronic Systems.

## How partitioning affects equipment reliability

Module approach	Smallest replaceable unit (SRU)			Total connecting pins	Failure rates			System MTBF Hours	System failures per year
	size in no. of IC's	No. of SRU's	No. of SRU types		Per SRU	In back wiring	% in back wiring		
Single assembly	3689	1	1	580	14.904	0.000	—	6710	1,306
Large card	119	31	26	5,199	0.4867	0.070	0.46	6598	1,328
Small card	9	410	15	21,900	0.0388	1.1385	6.7	5865	1,494
Individually pluggable	1	3689	15	44,848	0.0040	4.558	23.6	5178	1,692

Larger modules and fewer friction-type connector pins increase system reliability. The large, 119-IC card represents Sylvania's MSP-24 computer. Values for other sizes are extrapolated. Minuteman device and interconnection reliability is assumed.

## The impact of IC packages and packaging

Type of package	Packages per sq. in.	Packages per cu. in.	Type of packaging	Volume of IC's as a percentage of total volume*
Dual in-line	3.2	12	1-Sided PC Board	1-3
TO-5	6.3	23	2-Sided PC Board	2-6
1/4 x 1/4 Flatpack	7.0	47*-107**	Volumetric (3-D)	5-25
1/4 x 1/8 Flatpack	10.3	69*-154**		

\*Plugged in      \*\*Stacked arrays      \*At the subsystem level

Best-case packaging densities for four types of IC packages, assuming clearances are minimum and flatpacks in stacked arrays are in contact. Sylvania's findings on volumetric efficiencies are shown at the right.

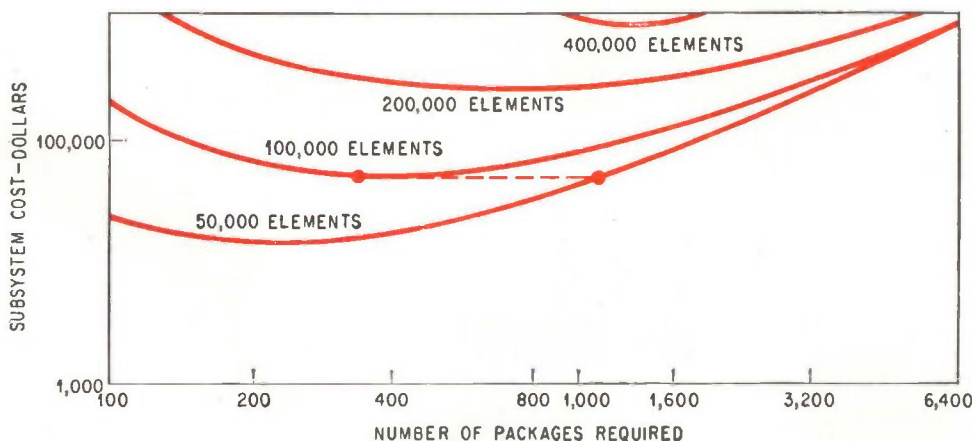

Poor computer subsystem partitioning can wipe out cost advantages gained at the logic engineering stage. In Autonetics study, based on IC's containing similar repetitive elements, subsystem cost bottoms at about 250 elements. If the 50,000-element system were partitioned at a 40 element per module level, (dotted line) it would match cost of the optimized 100,000-element system.



## Selection of integrated circuit types is guided by process capability

Integrated circuits	Monolithic		Thin film		Thick film
	Bipolar Silicon	Metal oxide Silicon	Evaporated thin film	Sputtered tantalum thin film	Screen printed thick film
Advantages	Reliability and long life low cost high density low weight standardization amenable to high production	low cost simple design high density resistivities to 20 kilohm/□ amenable to redundant design direct coupling avoids capacitors symmetrical switching capabilities	Good line definition high reliability high precision wide choice of materials permit 1:1 translation from discrete component design amenable to production of interconnections	good line definition high reliability high precision by anodizing	low cost simple production techniques amenable to production of interconnections resistivities of 1-20 kilohm/□ capacitance of 500-500,000 pf/sq. in. high power capability
Limitations	Power-frequency product high development cost loose tolerances diffused resistivities are 100-200 ohms/□	limited frequency capability	active devices must be added exhibit unique failure modes low sheet resistivity production procedures can be complex	active devices must be added specialized production processes needed	active devices must be added trimming required for close tolerances high voltage coefficient nonlinear temperature characteristic

resistors can offer savings in area usage over diffused resistors.

### Multichips

A compromise art used early in the history of IC's was the so-called chip and wire technique. This concept, in which several silicon chips, each containing relatively few elements, are connected within a single package, got around the problem of low IC yields. It helped get equipment built with IC's fast, and familiarized designers with IC's.

In some cases, the better isolation between elements that this multichip technique afforded resulted in higher circuit performance. Though fewer simple multichip circuits are built today, the concept has not necessarily reached the end of its lifespan. For example, C.F. O'Donnell, vice-president of Autonetics, points out that even with large-scale integration, the multichip approach can be used. Autonetics is a division of North American Aviation, Inc. As a monolithic array of IC's gets bigger, O'Donnell notes, yields decrease. One way around low yield is to use discretionary wiring in which only the good circuits in a wafer are connected by a unique wiring pattern. But in O'Donnell's view, discretionary wiring is the wrong way to go. He suggests that arrays should contain only those devices that represent economical yields. In other words, if X number of devices cannot be sawed from a single wafer with a high probability that

they'll all be good, then the designer is trying to get too many devices in the single chip. If necessary, smaller arrays can be joined as multichips.

The multichip approach has already been scaled up and refined for military avionics projects.

### Thick films and thin films

While the silicon IC versus film circuit controversy may be a battle of paper tigers, the thick versus thin film contest has drawn real blood. In many cases the two techniques can do the same job, albeit by different routes.

S.M. Stuhlberg, manager of Raytheon's microelectronics facility at Bedford Laboratories, Bedford, Mass., gives some rules of thumb. Stuhlberg says highly complex, close tolerance analog applications requiring extremely good resistor stability call for thin film hybrid IC's. On the other hand, he notes, when hybrid IC's are needed in high production quantities, and when a large number of different circuit types are required, thick films may be the better route. Furthermore, Stuhlberg indicates, the major need of a systems manufacturer may determine which facility he sets up; if he requires just a few complex analog IC's it may not pay to set up a thin film lab—he can buy them from outside suppliers.

Proponents of the thick film process emphasize its applicability to high volume use at relatively low cost. Several years ago, when rumors leaked

through IBM's tight security that the computer giant was experimenting with thick films, sceptics scoffed at the suggestion that a "gross" technique used to put decorative designs on china could also be used to produce circuits accurate enough to compete with thin films. Yet the technique had already been used to make resistor networks and micromodule components, and IBM turned it into a highly accurate automated process for building hybrid IC's with the power required by high-speed computers, at a time when IC's were still a risk in terms of performance and availability.

Today IBM and others are building circuits that contain components as accurate as 1% achieved by trimming them after they're formed. Thick film circuits contain screened-on conductors, resistors and capacitors atop a ceramic substrate. Selvin of Sylvania boasts of resistors in the megohm range, and of power-handling capability of 20 watts per square inch at 125 degrees C. Capacitors in the hundreds of picofarads are possible, he says, and capacitance per square inch exceeds that of tantalum thin film circuits [Electronics, Oct. 17, 1966, p. 72] which is generally given as 1.0 microfarad per square inch. Breakdown voltage of capacitors can exceed 4 times that of tantalum film capacitors, which are rated at about 25 volts, Selvin claims.

Objectors to thick films suggest that circuits just as small and reliable can be made using micro-miniature discrete components. Yet the appeal of thick films is quite obviously that they avoid many of the one-by-one interconnections needed with discrete components. And it seems likely that thick film hybrid IC's in the near future will contain just as many silicon IC's as transistors.

### Thin films smaller

Thin film boosters claim that thin film hybrid IC's can be significantly smaller than their discrete component counterparts, though they might cost more, particularly in moderate quantities.

Resistances up to a megohm can be fabricated by vacuum deposition and up to 1.5 megohms by sputtered tantalum methods. Yet makers of vacuum deposited circuits are likely to suggest that the line be held at 20 kilohms. A 50-kilohm resistor gobbles up a lot of area. Tolerances on resistors before trimming are about  $\pm 20\%$ , and on capacitors are about  $\pm 10\%$ .

In the case of tantalum circuits, resistors are adjusted and stabilized by anodizing at above 300 degrees C. Resistance is monitored during anodizing; when high precision is needed, values can be brought to within  $\pm 0.02\%$ . Sheet resistivity for the tantalum circuitry ranges from about 50 to 500 ohms per square. Power dissipation for the tantalum film circuits is above 4.5 watts per square centimeter.

Both thick and thin films offer the possibility of a one-to-one conversion from discrete component circuits—and therefore may be favored by designers faced with short equipment delivery times or beginners who have little experience with monolithic silicon IC's. Films have an obvious role in circuits requiring high value, high power resistors.

The table at the left compares IC's. The values given are a cross section of industry opinion, not the maximum values that can be achieved by exotic processes or at the expense of another parameter, such as temperature stability or reliability.

### Guidelines for selection of IC's

While cost and performance are widely recognized as criteria for evaluating alternative equipment designs, they are not much good to the designer who has to pick the best IC's for his project. They are too general. Instead, suggests C.F. O'Donnell, vice-president of research and engineering for the Autonetics division of North American Aviation, Inc., the designer can assess the suitability of IC's by examining three areas—design, fabrication and field use—and asking himself the following questions:

#### Design

- How good is the basic IC?
- Does it provide the wanted function (minimum volume, weight, power, cost)?
- Is there a good possibility that it can be produced more cheaply and that performance can be improved with time and usage?
  - Is it versatile—can it be used many times or in a variety of ways in the equipment?
  - Will it survive in operating environments?
  - Will it function over the required temperature range and meet shock, vibration and radiation requirements?
  - Will it satisfy interface tolerances (input and output signal levels and impedance matching).

#### Fabrication

- Does the IC lend itself to automated handling and package assembly?
- Does it facilitate easy testing at both subsystem and system levels?
- Is the cost of related tooling and special test equipment prohibitive?
  - Is availability and delivery of the IC's good?
  - Can the devices be easily and reliably interconnected?
  - Can meaningful, manageable specifications be written to characterize the IC?
  - Are the IC's interchangeable with similar devices from alternate sources?

#### Field use

- Can faults be easily located?
- How simple is the maintenance problem—particularly from the standpoint of stocking and handling spares?
  - How good is operating reliability?
  - Is operation availability (low down time) of equipment adequate?
  - Does the IC approach considered lend itself to the use of redundancy, self-diagnosis and/or self repair of the equipment?



# You made us what we are today...

## a brand-new Division of Union Carbide.

Thanks to you, our various electronics businesses have grown so well that we have gathered them together and created the Electronics Division of Union Carbide. This puts us in a better position than ever to fill your growing needs for:

Solid tantalum and foil-film capacitors...transistors, modular and integrated circuits, and other solid state devices... single crystals and crystal products... lasers and related equipment... fuel cells.

As well as new products in various stages

of research and development, all aimed at advanced requirements on the frontiers of electronics—all backed by the technology of Union Carbide.

Why are we telling you this?

Because we wanted you to know that we're serious about being in electronics. And so that you can realize that our diverse activities are now under more unified control.

After all, your orders did it for us.

Union Carbide Corporation, Electronics Division, 270 Park Avenue, New York 10017.



**ELECTRONICS**

# Avalanche transistors drive laser diodes hard and fast

Pulser circuit in injection lasers produces short, high-current pulses for high resolution radar

By Herman E. Brown and Robert A. Bond,  
University of Texas, Austin

and James C. Bloomquist,  
Eglin Air Force Base, Fla.

Among the men who experiment with lasers, the high-intensity, extremely narrow light beam emitted by the injection laser offers great promise in ranging applications. In fact, they reason, ranging equipment built with the laser diode ought to be more accurate than a conventional radar. So far, realizing such a range finder has been slowed by the lack of a suitable driving circuit for the laser. The resolution of a laser range finder depends on the maximum repetition rate, the rise time and the length of the laser driving pulses and these, in turn, depend on how efficiently excess heat is removed from the laser diode.

A pulser circuit, specifically designed to drive gallium-arsenide laser diodes, produces high-current pulses of extremely short duration and fast rise time. Its secret: using the avalanche mode of operation in silicon epitaxial annular transistors.

If high enough voltage is applied to the collector, avalanche multiplication of carriers will occur in the depletion region.<sup>1</sup> The transistor becomes a low-resistance, fast electronic switch, capable of providing short duration, high-current pulses.

Good quality laser diodes operating at room temperature require about 75 to 100 amperes of driving current to exceed the lasing threshold.

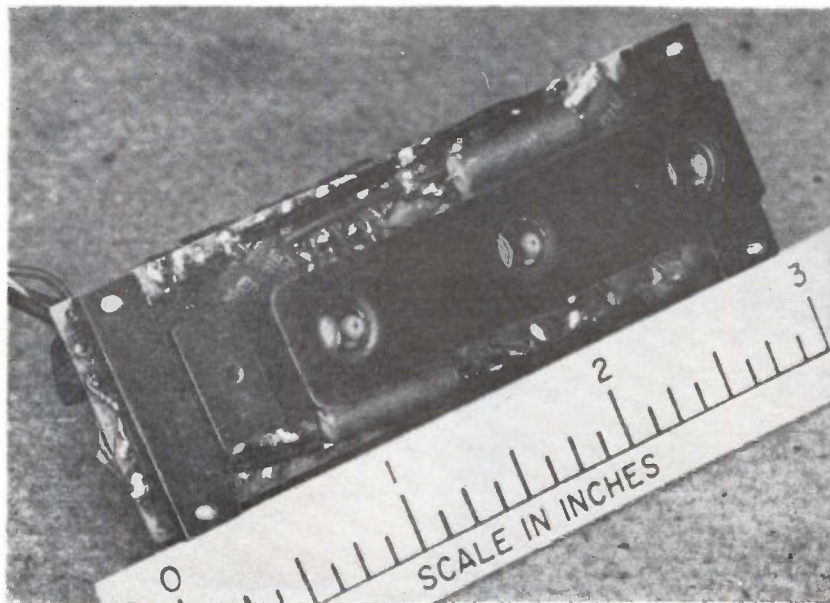

An array of three laser diodes with lenses and pulsers seen from the front (left) and back. Each section of the array, clearly indicated in the front view, generates 10 to 15 watts peak power through the entire system. The unit is less than 3 inches in length and 1 inch in depth and width.



Typically, the better diodes will radiate about 10 to 15 watts of peak power when pulsed with 150 to 200 amperes.

Since the diodes do not have sufficient area to dissipate the heat, to prevent burnout of the diode the lasing device must be pulsed instead of run continuously. At the same time, pulsing has to be carefully regulated or the power rating of the diode will be exceeded, destroying the semiconductor. Current pulses are kept as short as 50 to 100 nanoseconds to prevent such damage.

How pulse length affects resolution can be determined by the rule of thumb that a 2-nsec duration is equivalent to about 1 foot in range. In a standard radar system, rise times are in the order of 50 to 100 nsec. In the laser system, by contrast, rise times are only about 10 nsec and measurements are to within  $\pm 2.5$  feet.

The circuit below pulses room-temperature GaAs laser diodes continuously at rates up to 10 kilohertz, or up to 100 khz provided the duty cycle

(ratio of on-time to total cycle time) does not exceed that for continuous operation. Pulse length is about 60 nsec with peak currents approaching 200 amperes, depending upon the circuit's inductance and the potential that charges the collector capacitors.

### Transistors act as switches

In operation, the 0.01-microfarad capacitors are charged to the applied potential through the 100-ohm resistors and the charging diode  $D_1$ . The four parallel npn transistors operate in the avalanche mode and act as switches, opening and closing at the applied trigger rate. When a 5-volt trigger pulse is applied to each transistor base, the base-to-emitter and base-to-collector junctions break down, producing a collector-to-emitter short circuit. When breakdown occurs, the collector capacitors discharge their stored energy through the laser diode. With the transistors in the avalanche mode, the total circuit impedance is less than 1 ohm.

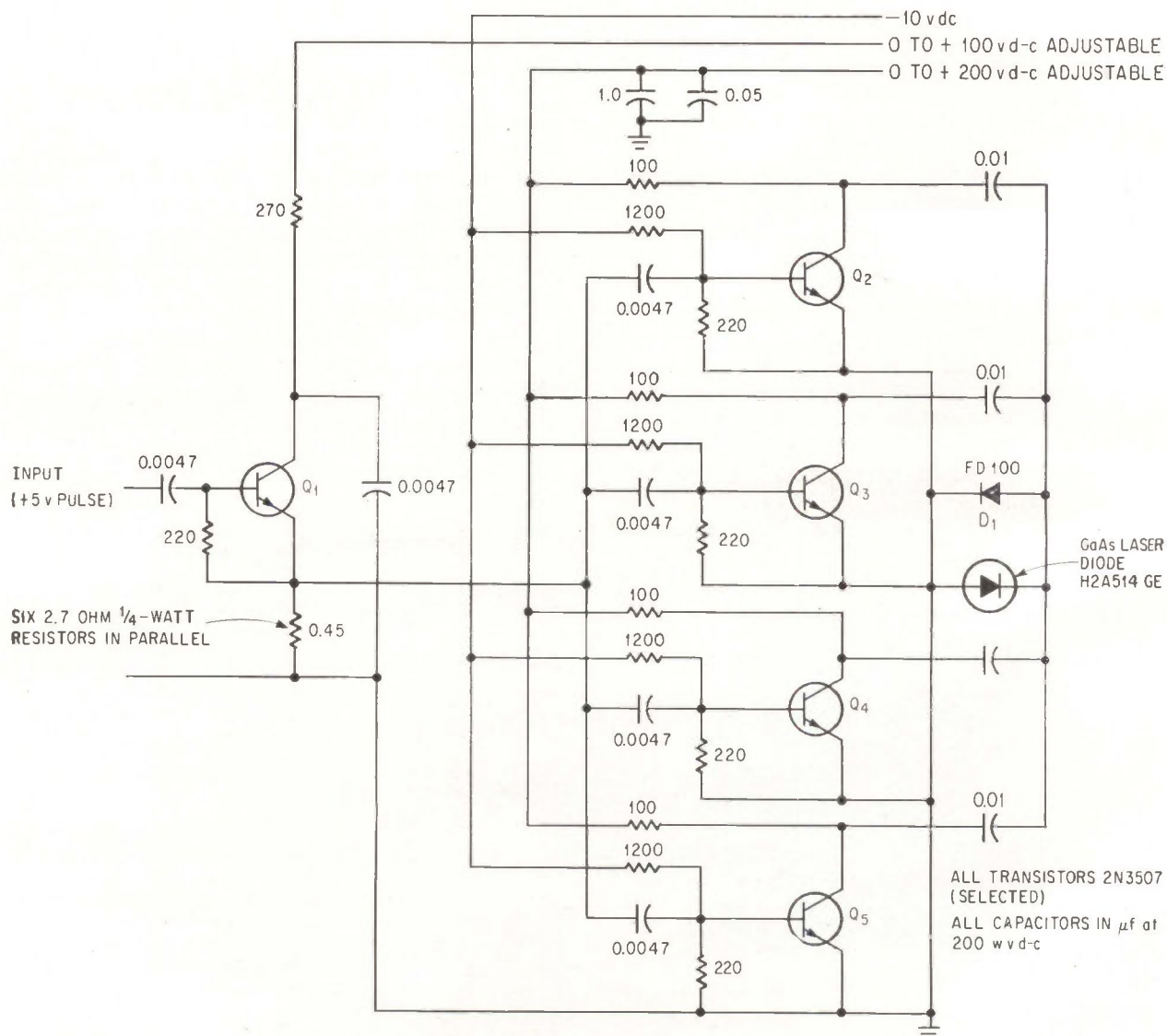

Laser diode pulser circuit with 0.01-microfarad collector capacitors are charged to potential of 150 volts through the 100-ohm load resistances and the charging diode,  $D_1$ . Collector capacitors discharge their stored energy through the laser diode during the avalanche breakdown of transistors  $Q_2$  through  $Q_5$ .

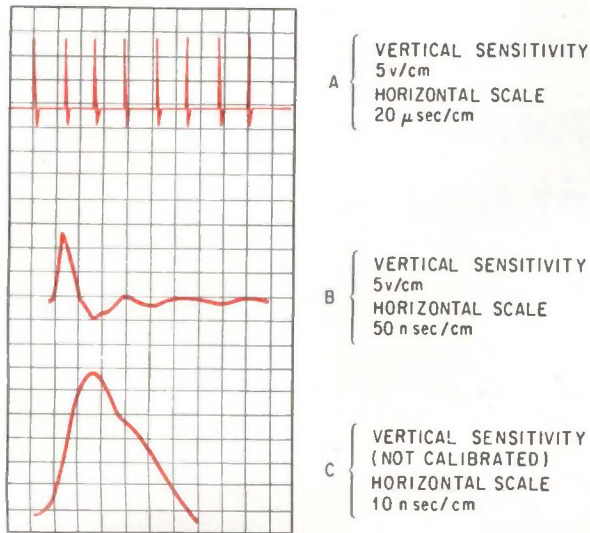

Typical current pulses reach a peak within 10 nanoseconds and last 50 nsec at a pulse rate of 45 khz. Expanded waveforms B and C show pulse in detail.

In each collector capacitor the stored energy  $E = 1/2CV^2$ , where  $V$  is the applied voltage. If the applied voltage is 150 volts, the energy will be approximately  $10^{-4}$  joules. Dissipation of this energy in  $10^{-7}$  second produces a peak power of about 1,000 watts. Since there are four parallel circuits, the total peak power will be about 4,000 watts. Efficiency of high-quality laser diodes at room temperature is about 0.3% and the beam output is about 12 watts.

The laser diode must be protected from damage caused by a shorted transistor or collector capacitor. This is accomplished by placing the laser diode in series with the collector capacitors and by paralleling it with a fast charging diode,  $D_1$ . If one or more of the pulser transistors are shorted, the d-c supply current does not pass through the laser diode. If any collector capacitors become shorted, the charging diode, which is forward biased, protects the laser diode.

Emitter follower,  $Q_1$ , is also operated in the avalanche mode to obtain the desirable fast rise time of 10 nsec and the low driving impedance for the laser pulser.

$Q_1$  is placed in the avalanche mode by applying a positive 5-volt input pulse and adjusting the collector potential until a stable avalanche condition is obtained. The emitter load resistance is adjusted by paralleling 2.7-ohm,  $1/4$ -watt resistors until the required 5-volt trigger pulse is obtained.

#### D-c breakdown key parameter

Since high peak current requires relatively high collector voltage, the most important transistor parameter for  $Q_2$  through  $Q_5$  is the d-c breakdown voltage from the collector to emitter ( $BV_{CEX}$ ). A 10% larger breakdown voltage can be obtained with the Motorola 2N3507 transistor by reverse biasing the emitter-to-base junction. After considerable study this transistor was selected for three reasons:

- It avalanches at a relatively high voltage—

usually 140 volts, but can be as high as 190 volts.

- It has a low failure rate under maximum operating conditions.

- And it requires no heat sink when operated below 10 khz because the TO-5 transistor case dissipates heat adequately.

The pulse circuit is difficult to construct primarily because inductance must be minimized. A small amount of wire in the circuit contributes a fairly large amount of inductive reactances when 50- to 100-nsec pulses with 10-nsec rise times are generated. The best way to reduce the inductance and still obtain up to 200 amperes peak current is to keep the current path very short. A complete pulser can be constructed with a volume less than  $1/2$ -cubic inch. Careful location of the components restricts the effective current path to less than  $1/2$  inch. Typical current pulses generated by the pulser are shown at the left.

The photo on page 137 shows an array of three laser diodes assembled with collimating lenses and a pulser circuit for each diode. The three diodes are aligned so that their beams are parallel; however, they can be spread into a divergent beam for less intensity but wider coverage.

#### Reference

L. Lloyd C. Hunter, "Handbook of Semiconductor Electronics," Second edition McGraw-Hill Book Co., 1962, pp. 14-26.

#### Acknowledgment

This work was done under contract with the Air Force Armament Laboratory, Research and Technology division, Eglin Air Force Base, Fla.

#### The authors



Herman E. Brown, heads the Electro-Optic Development Section of the Defense Research Laboratory at the University of Texas. His principal duties are the design, development and analysis of electro-optical systems.



Robert A. Bond supervises the electronic section of the Military Physics division at the Defense Research Laboratory. His principal interest is solid-state circuitry for high-frequency applications



James C. Bloomquist is with the Missiles Branch of the Air Force Armament Laboratory, Eglin Air Force Base, Fla. He has long been interested in advancing the state of the art of laser technology.



**Amperex announces the ATF-401...  
the operational amplifier made possible  
by our special production-line methods  
and thin film/LID circuit technology...**

**IF THIS  DOESN'T  
HYBRID LINEAR IC'S,**

**ATF-401 OP AMP QUICK REFERENCE DATA**

**VOLTAGE GAIN**  
(open loop,  $R_L = 5k$ ).....50,000 min  
**FREQUENCY FOR UNITY GAIN**...2 MHz min  
**RATED OUTPUT**..... $\pm 11V$  @  $\pm 2.2$  mA min  
**INPUT NOISE ( $R_{in} = 1k$ )**.....5  $\mu V$  max  
**INPUT VOLTAGE**  
OFFSET ..... 10 mV max  
(externally adjustable to zero)  
TEMPERATURE DRIFT.....10  $\mu V/^\circ C$  max  
**INPUT CURRENT**  
OFFSET ..... 50 nA max  
TEMPERATURE DRIFT.....2 nA/ $^\circ C$  max  
**INPUT IMPEDANCE**  
DIFFERENTIAL .....200 kilohms min  
COMMON MODE .....10 megohms min  
**POWER REQUIREMENTS**  
OPERATING (under load)  $\pm 15V$ ,  $\pm 7$  mA max  
SHORT CIRCUIT CURRENT  $\pm 20$  mA max  
**DIMENSIONS**......80 x .80 x .25 inches

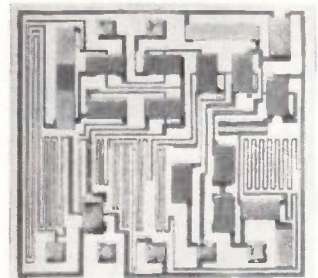

**ATF-401 OP AMP BEFORE ENCAPSULATION**

# MAKE THE CASE FOR NOTHING WILL!

**The ATF-401 is a thin film, linear, hybrid IC offering the best combination of price, size and performance of any monolithic, discrete or hybrid op amp now available**

Hybrid circuit technology, given its biggest boost in years by the introduction of Amperex LIDS last March, takes another leap forward with the introduction of the solid state ATF-401, the first commercially available linear hybrid integrated circuit employing LID technology.

Using LIDS and the advanced micro-circuit design and production technology developed at Amperex during the past several years, we are now able to produce large volume runs of all kinds of hybrid IC devices, both as off-the-shelf items and as custom production circuits to meet your special system requirements. Combining the advantage of discrete-component circuitry (performance) with the advantage of monolithic IC's (low cost), Amperex hybrids, made with Amperex LIDS offer high performance at low cost, plus the third big bonus—small size.

The ATF-401 at \$29.00 each, in hundred lots, outperforms many discrete op amps and without exception any monolithic op amp available. Further, since the ATF-401 is fully frequency-compensated it requires no external circuitry which would increase its effective size.

Take a look at these specifications:

- Open loop gain 50,000 (min)
- Full output to 10 KHz
- Gain bandwidth product of 2 MHz
- Temperature drift of only  $10\mu\text{V}/^\circ\text{C}$  and  $2\text{ nA}/^\circ\text{C}$
- Long term stability of  $25\mu\text{V}/\text{day}$
- Maximum noise contribution of  $5\mu\text{V}$  referred to input
- Common mode rejection ratio of 80 db (min)
- Complete short-circuit protection of all terminals
- All this in a small package less than 0.15 cubic inches

The ATF-401 is ideally suited for signal conditioning amplifiers, test equipment, control systems, AC and DC comparators, servo amplifiers and all instrumentation, computing and control applications where low-cost, small size, long life and low power consumption are of prime importance.

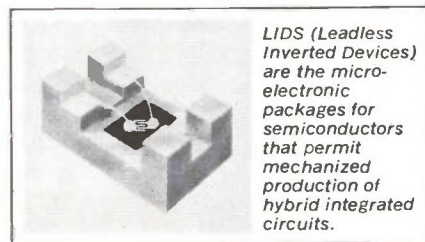

Write for additional data on the ATF-401 and for details on how Amperex can serve your custom hybrid IC requirements: Amperex Electronic Corporation, Semiconductor and Receiving Tube Div., Dept. 371, Slatersville, R. I. 02876.

**Amperex®**

TOMORROW'S THINKING IN TODAY'S PRODUCTS



# Current dividers convert digital signals into analog voltages

A constant current repeatedly halved according to the digits of a binary number drives an amplifier whose output analog voltage is proportional to the input digital signal

By Herman Schmid

General Electric Co., Johnson City, N.Y.

**A digital-to-analog converter** in a single integrated circuit package is now feasible. The new technique employs active current dividers and does not depend on precision resistors as do conventional digital-to-analog conversion techniques.

A 10-bit prototype, built with discrete components, provides an accuracy of better than  $\pm 0.05\%$  of full scale at room temperature and better than  $\pm 0.125\%$  from 0 to 75°C. It will also work, at reduced accuracy, over the full military temperature range of -55° to +125°C.

The new device also exhibits superior dynamic performance, offers significant reductions in size and weight, and will cost much less when built in quantities. The new converter thus helps to satisfy a growing need for simpler and smaller interface circuits between integrated digital control circuits and analog sensors and controls.

With present technology, a six-bit converter can be built as a single monolithic device. Converters with higher resolution can be made by putting the additional divider stages on a separate chip, with provision for external trimming resistors. As the technology improves, more stages in a single mono-

lithic package should be possible.

Most digital-to-analog converters now in use employ either the weighted resistor technique at top right or the resistor ladder technique at center right.<sup>1</sup> The performance of both designs depends directly on the resistors' precision and on the accuracy of the transistor voltage switches. Building good transistor voltage switches as monolithic integrated circuits is difficult, and building monolithic IC's that incorporate precision resistors is not practical at present.

Conventional converters present several problems, even when built with discrete components. For example, a 10-bit weighted-resistor converter requires resistors with magnitudes ranging from 1 kilohm to 1 megohm. The higher-value resistors are bulky and expensive, and the lower values present an intolerable load to the analog voltage switch. The resistor ladder network overcomes these problems, but it requires twice the number of switches like the one at bottom right; this causes a significant increase in complexity and cost. Finally, the reference voltage supply must not only produce precise voltages, but must also drive half the number of switching transistors. This heavy load cannot be underestimated, especially when several converters share the same reference supply.

## Dividing the current

The new design for a digital-to-analog converter is basically a series of cascaded current dividers each of which has two outputs as shown on page 144. One output is the current source for the next divider in the cascade; the other is gated to the output amplifier or to ground, depending on the state of a switch controlled by the binary digit to

## The author



Herman Schmid, of GE's avionics control business section, has applied for a patent on the new digital-to-analog converter. He has designed analog computing circuits since receiving his bachelor's degree in Germany in 1950. He also has a master's degree from Syracuse University.

## Conventional Converters

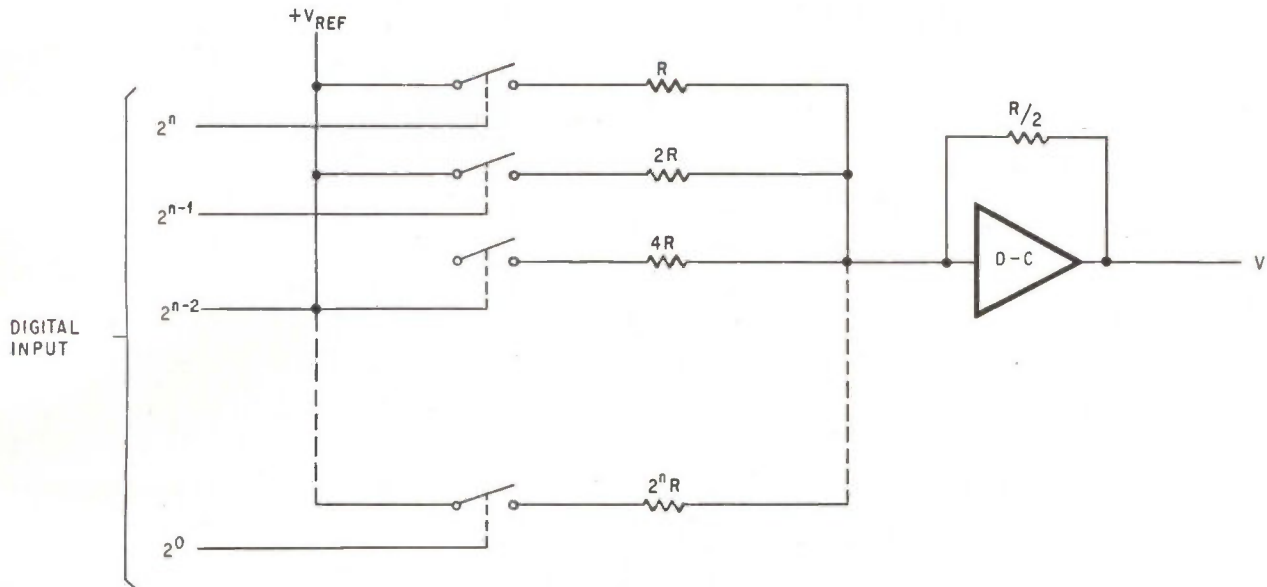

Weighted resistor digital-to-analog converter is a conventional design that requires precision resistors with a wide range of values.

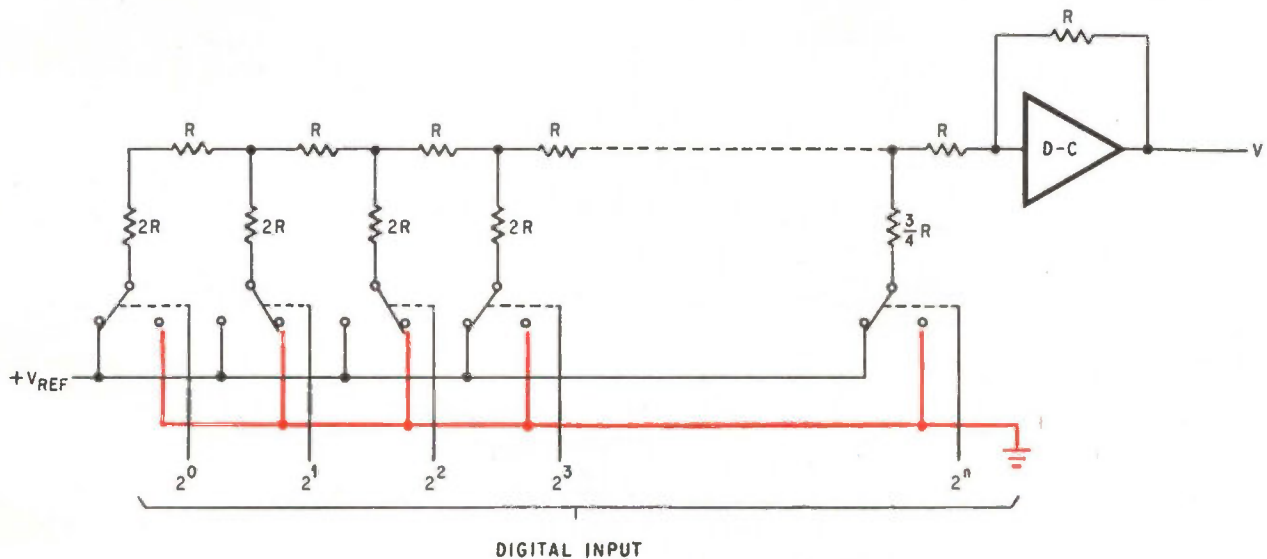

Resistor ladder network, another conventional converter, requires precision resistors and an extra set of solid state voltage switches, shown in color.

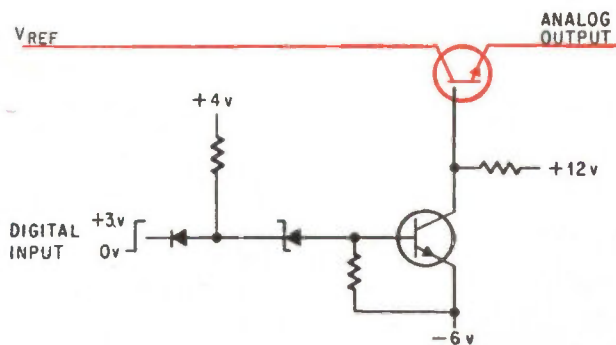

Series analog voltage switch used in some conventional digital-to-analog converters. The two transistors and the multiplicity of power supplies make it expensive and inconvenient for systems using IC's. The circuitry in black merely switches the transistor shown in color.



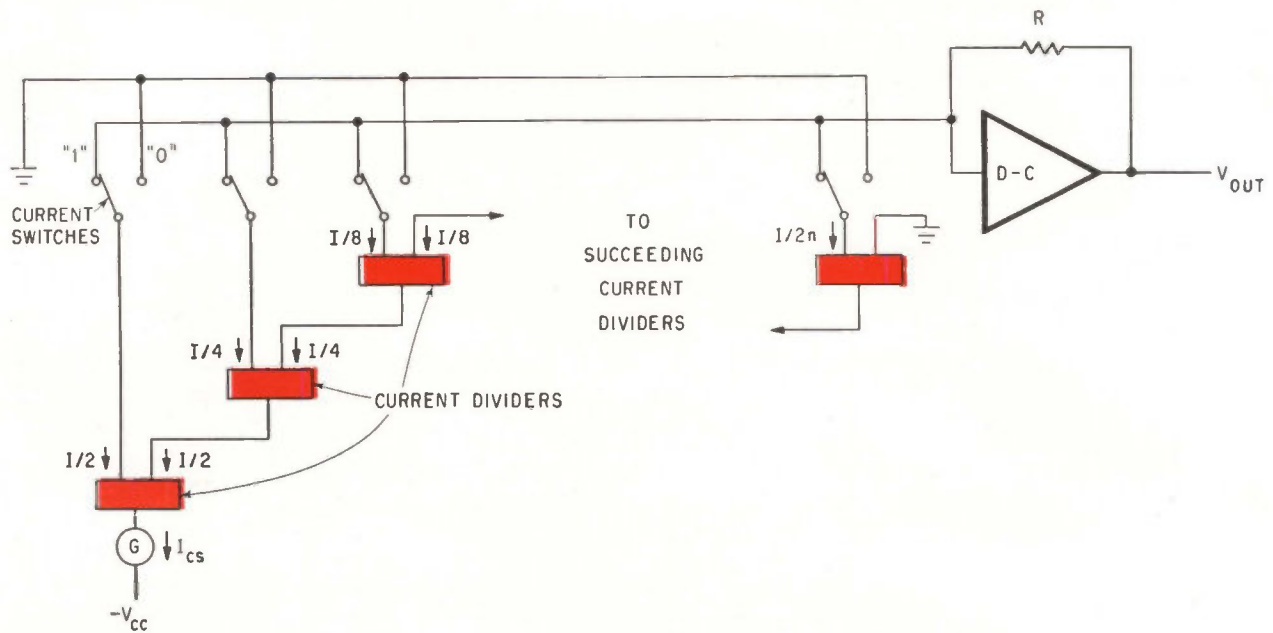

Cascaded current dividers, shown in color, provide a series of successively halved currents that are added at the input of an amplifier in accordance with the digits of a binary number. The amplifier's analog output is then proportional to the digital input.

be converted. Cascading a number of these current dividers repeatedly halves the constant current into a number of currents having magnitudes proportional to  $\frac{1}{2}$ ,  $\frac{1}{4}$ ,  $\frac{1}{8}$ , . . .  $\frac{1}{2^n}$ .

If any one of these currents were connected separately to the summing point, the output of the operational amplifier would generate a voltage proportional to that current which, in turn, would produce a current of the same magnitude but with opposite sign through the feedback resistor  $R$ . Thus the sum of the currents flowing to the summing point would be zero. Likewise when combinations of these binary current components are connected to the summing point, according to the digits of a binary number, an output voltage will be produced which is directly proportional to that number.

The key to the design is an emitter-coupled differential amplifier, whose transistors are closely matched, and whose base electrodes are returned to the same potential, thus making the collector currents equal. If in addition the ratio of collector current to base current—the  $\beta$ —is very high, then the collector currents are very nearly equal to the individual emitter currents.

The amplifier becomes a binary current divider, shown on the opposite page, if the two emitters are connected to a constant current source, the two bases to a single bias voltage source, and the two collectors through resistors to current sinks.

The ratio of the collector currents of the basic current divider is:

$$\frac{I_{C1}}{I_{C2}} \approx e^{k\Delta V_{BE}}$$

$\Delta V_{BE}$  is the difference between the two base-emit-

ter voltages and  $k$  is a semiconductor constant;  $1/k$  equals 26 millivolts. If  $\Delta V_{BE}$  is 2.6 millivolts, the ratio  $I_{C1}/I_{C2}$  is 1.11, which means that one of the collector currents is 11% greater than the other, or the two currents vary  $\pm 5.5\%$  with respect to a nominal value and  $\pm 2.75\%$  with respect to the constant-current generator, which puts out twice the nominal current. Actually the maximum experimental mismatch between  $I_{C1}$  and  $I_{C2}$  with respect to the constant-current source is less than  $\pm 2\%$  measured in 12 differential amplifiers.

In the panel opposite, the ratio of the d-c amplification factor  $\alpha_1/\alpha_2$  is shown to be close to unity for a 10% difference in  $\beta$ , and therefore, does not significantly affect the collector current match.

### Better division

The simple differential amplifier's basic division capability can be improved in various ways. The simplest way is to insert two matched resistors into the emitter leads, as shown below, thus correcting any initial difference in  $I_e$ . Experimenting with the

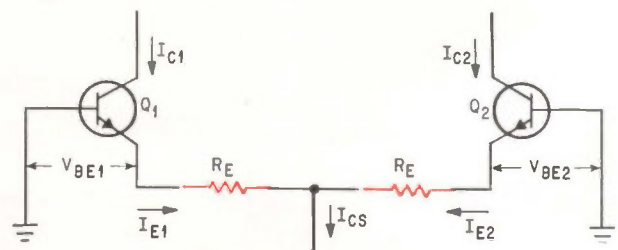

Resistors added to the emitter leads in the basic current divider improve its accuracy.

## Analyzing the current divider

The relationship between the collector currents  $I_{C1}$  and  $I_{C2}$ , as a function of the amplification factors  $\alpha_1$ ,  $\alpha_2$ , and the base-to-emitter voltages  $V_{BE1}$ ,  $V_{BE2}$  for the circuit below, can be derived from the basic equation relating the emitter diode voltage and diode current:

$$I_E = I_o \epsilon^{(q V_{BE}/kt)} \quad (1)$$

and

$$V_{BE} = \frac{kt}{q} \log \frac{I_E}{I_o} \quad (2)$$

where  $I_E$  = the emitter current

$I_o$  = the diode reverse-saturation current

$q$  = the electron charge in coulombs

$k$  = the Boltzmann constant

$t$  = the temperature in degrees Kelvin

$\frac{kt}{q}$  is about 0.026 volts at room temperature.

Equation 1 may be written for the emitter currents  $I_{E1}$  and  $I_{E2}$  of both transistors of the differential amplifier. Then, dividing  $I_{E1}$  by  $I_{E2}$  gives the ratio:

$$\frac{I_{E1}}{I_{E2}} = \frac{I_{o1} \epsilon^{(q V_{BE1}/kt)}}{I_{o2} \epsilon^{(q V_{BE2}/kt)}} \quad (3)$$

If the transistors are identical and on one chip, then  $k_1 = k_2$  approximately; equation 3 reduces to:

$$\frac{I_{E1}}{I_{E2}} \approx \frac{I_{o1}}{I_{o2}} \quad (4)$$

This means that the ratio of the emitter currents in the differential amplifier equals the ratio of the diode reverse-saturation currents.

The latter can be expressed in terms of  $\Delta V_{BE} = V_{BE1} - V_{BE2}$  by writing equation 2 for two transistors and subtracting  $V_{BE2}$  from  $V_{BE1}$ :

$$V_{BE1} - V_{BE2} = \frac{k_1 t}{q} \log \frac{I_{E1}}{I_{o1}} - \frac{k_1 t}{q} \log \frac{I_{E2}}{I_{o2}} \quad (5)$$

If  $k_1 = k_2$ , equation 5 reduces to:

$$\Delta V_{BE} = (kt/q) \log \frac{I_{E1}}{I_{E2}} \cdot \frac{I_{o2}}{I_{o1}} \quad (6)$$

However,  $V_{BE}$  is always defined in terms of a fixed

emitter current; therefore in equations 1 and 2,  $I_E$  can be considered constant. Therefore  $I_{E1} = I_{E2}$  and:

$$V_{BE} = (kt/q) \log \frac{I_{o2}}{I_{o1}} \quad (7)$$

Solving equation 7 for  $I_{o2}/I_{o1}$  gives:

$$\frac{I_{o2}}{I_{o1}} = \epsilon^{(q \Delta V_{BE}/kt)} \quad (8)$$

Substituting equation 8 into equation 4 gives

$$\frac{I_{E2}}{I_{E1}} \approx \epsilon^{(q \Delta V_{BE}/kt)} \quad (9)$$

The relation between the collector currents  $I_{C1}$  and  $I_{C2}$  can be expressed with equation 9 by using the approximation  $I_C = \alpha I_E$

$$I_{C2}/I_{C1} = (\alpha_1/\alpha_2) \cdot \epsilon^{(q \Delta V_{BE}/kt)} \quad (10)$$

However, if both transistors in a pair have a ratio of collector to base current ( $\beta$ ) over 100, and equal within 10%, the  $\alpha$  will be matched to better than 1%. Then  $\alpha_1/\alpha_2$  is approximately unity, so that equation 10 reduces to

$$I_{C2}/I_{C1} \approx \epsilon^{(q \Delta V_{BE}/kt)} \quad (11)$$

The ratio of  $I_{C2}/I_{C1}$  is thus an exponential function of the difference in  $V_{BE}$ . If  $V_{BE} = 2.6$  mv and  $kt/q = 26$  mv then  $I_{C2}/I_{C1} = e^{0.1} \approx 1.11$ . (12)

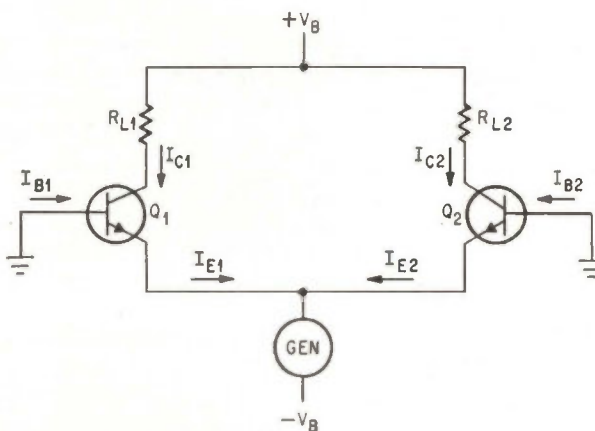

Current-divider circuit that forms the basis of the new digital-to-analog converter. An improvement on this circuit is shown on page 144.

circuit in the figure showed that resistors of 500 to 800 ohms in the emitter leads corrected collector-current differences to within 0.01% of full scale.

The magnitude of the collector current is also important. With transistor d-c gains less than infinite, the base current will have a finite value that contributes to the emitter current. Transistors with  $\beta$  greater than 500 at 25°C and greater than 100 at lower temperature are now available. Since  $\beta$  is the ratio of collector current to base current, the base current is between 0.2% and 1% of the collector current, or the collector current is 0.2% to 1%

less than the emitter current.

The loss of current to the base can be overcome in several ways. One way is to replace the individual transistors with Darlington transistor pairs. A simpler approach, less desirable in quantity production, is to increase the collector currents by connecting a large resistance between the collector and the negative bias.

### A discrete prototype

A 10-bit prototype digital-to-analog converter was built from discrete components to verify the



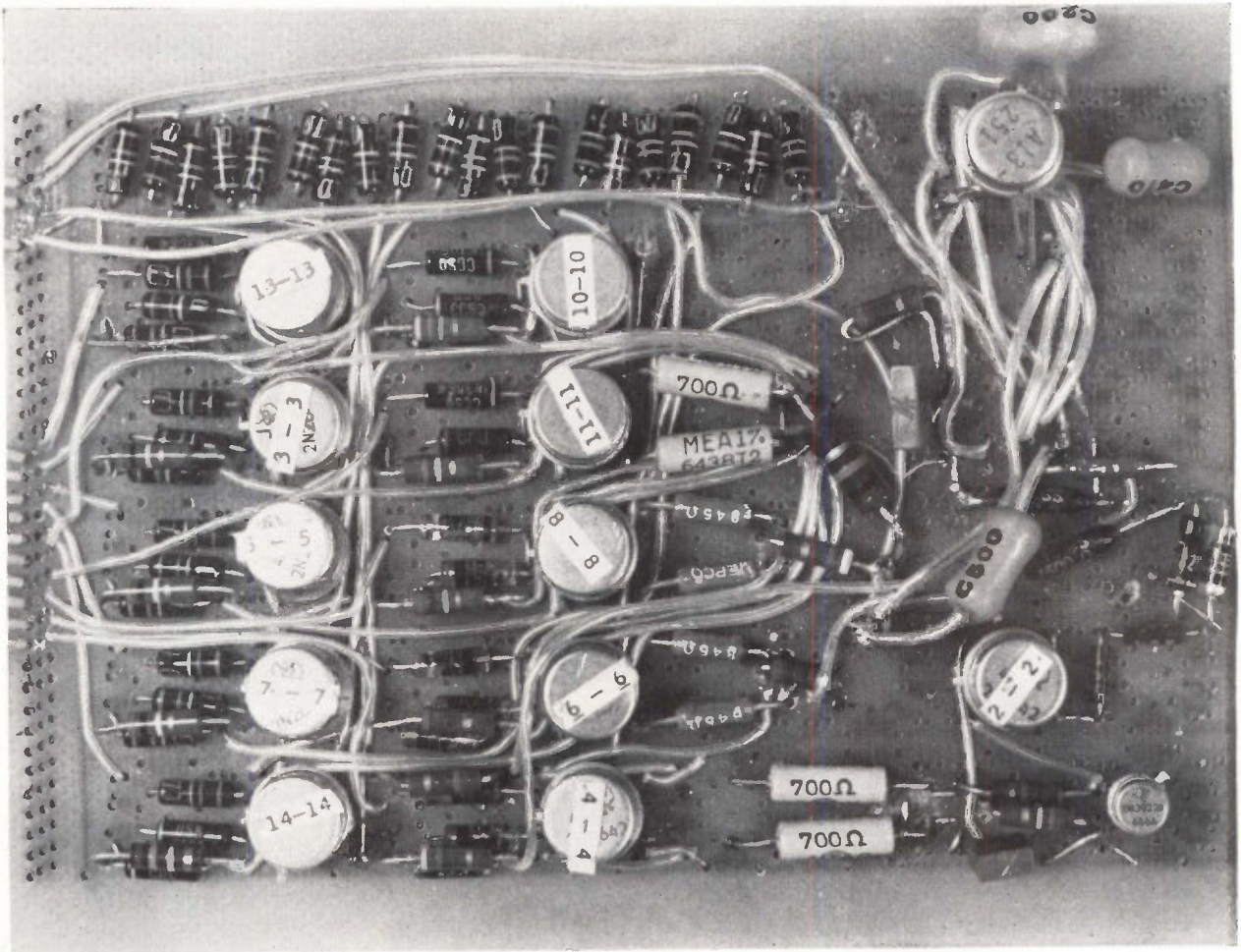

Prototype converter built with discrete components. Except for a few of the resistors, all components can be duplicated in a monolithic integrated circuit.

design. The schematic of the prototype is shown on the opposite page and a photograph is above. The device comprises one operational amplifier, 10 current switches, 10 current dividers (in the tinted area), a constant-current generator, and a bias voltage supply.

A  $\mu\text{A}$  709 integrated-circuit amplifier made by the Fairchild Semiconductor division of the Fairchild Camera & Instrument Corp. adds the currents and converts the sum to voltage. The feedback resistor of 2.5 kilohms provides a maximum output of 10 volts with a maximum input of 4 milliamperes. This low feedback impedance prevents excessive drift over the large temperature range.

The current switches are simple diode gates as shown on page 148. The anode of diode  $D_1$  is connected to the summing point, the potential of which is always zero, and the anode of diode  $D_2$  brings in the digital signal. The input signal swing is between  $-1$  volt for a logical 1 and  $+1$  volt for a logical 0.

When the input is at  $-1$  volt, diode  $D_1$  is forward-biased, diode  $D_2$  is reverse-biased, and the current from the divider flows into the amplifier summing point.

When the input is at  $+1$  volt, diode  $D_2$  is forward-biased, diode  $D_1$  is reverse-biased, and the

current from the divider flows into the source of the digital input.

### Switching problems

Although this switch is simple, it has certain drawbacks. One hindrance is that one diode or the other is always reverse-biased. The leakage current, which flows in this reverse-biased condition, subtracts from the signal current. Therefore, the circuit requires diodes that have low leakage, especially at high temperature.

A second drawback is that conventional logic circuits do not necessarily swing between  $-1$  volt and  $+1$  volt. Either the input signals must pass through level shifters, or the summing point potential must somehow be established between the logical 1 and 0 levels.

The transistor base electrodes of each differential amplifier must be connected to a low-impedance voltage source whose potential is halfway between the collector and the emitter potential. A string of diodes provides these bias voltages conveniently. Two diodes are placed between successive differential transistors in the lower significant stages, providing a potential drop of about 1.4 volts; three diodes, giving 2.1 volts, are placed in the two most significant stages. The current

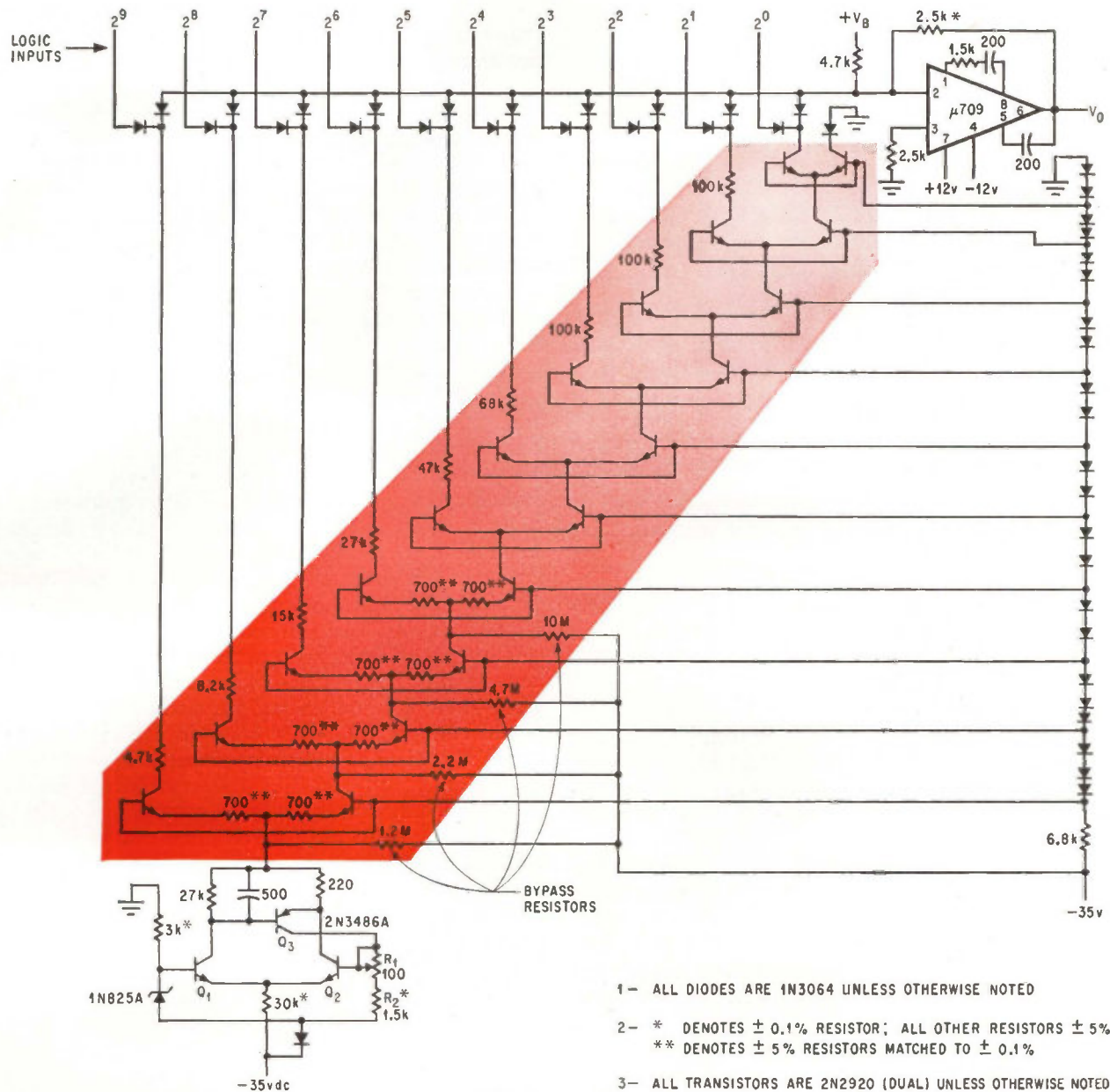

Ten-bit digital-to-analog converter uses cascaded current dividers (tinted area). The trim resistors compensate for current drawn off by the transistor bases. The string of diodes at the right provide bias voltages for the successive bases.

through the diodes can vary widely, because the value of the bias voltages provided by the diodes is not critical.

### Compensating resistors

As shown above in the schematic of the prototype, only the four highest-order dividers of the ten need emitter resistors to make them more accurate, and bypass resistors to compensate for the base currents. These emitter resistors would have to be mounted externally for a monolithic converter. However, as better current dividers are built, fewer stages will require emitter resistors. Instead of the base-current compensating resistors in the discrete-component prototype, Darlington

pairs would be used in a monolithic converter, since transistors are easier to implement than large resistors. Lower values of emitter resistors could have been used in the third and fourth divider stages, since they need not be as accurate as the high-order stages.

However, it was more convenient to make all emitter resistors the same. The actual value of these resistors is not critical, but they should be matched within the precision of the respective divider stage. That is, if the over-all precision of the converter is 0.1%, then the first stage must be precise to within 0.05%, the second stage to 0.1%, the third stage to 0.2%, and so on, doubling the percentage each time. After the first few stages



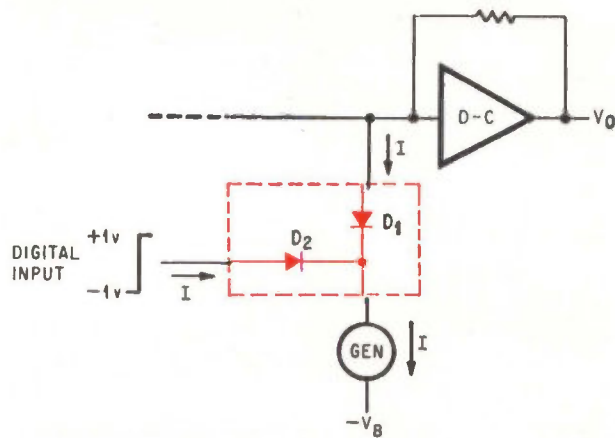

Series-shunt analog current switch that steers current toward or away from the summing node at the input to the amplifier. Only the two diodes are necessary; there are no transistors or extra power connections.

the precision can be very low without affecting the output appreciably.

The resistors in the collector circuits of the differential amplifiers make the voltage on the left-hand collectors approximately equal to that on the right-hand collectors. The tolerance of these resistors is very broad. The prototype contains  $\pm 5\%$  discrete resistors, only because they were readily available. The right-hand collector voltage is, except in the least significant stage, the voltage on the emitter of the previous stage, which is 0.7 volt—the potential drop across one diode—below the bias voltage connected to the base electrodes.

The constant current generator in the prototype has another differential amplifier to amplify the difference between the voltage across the zener diode and the voltage across the resistors  $R_1$  and  $R_2$ . This amplified difference, which is the voltage between the two collectors of transistors  $Q_1$  and  $Q_2$ , is connected across the base-emitter junction of  $Q_3$ , which operates as a series regulator in the main current path. In an IC the constant-current generator could be built either as a separate hybrid circuit or together with the most significant converter stages. The constant-current generator replaces the constant-voltage source that conventional digital-to-analog converters require.

The digital-to-analog converter can be used in either unipolar or bipolar mode. In unipolar mode, a digital input of all 0's gives an analog output of 0 volts; an all 1's input gives an output of +10 volts; and an input 1000...000 corresponds to a +5 volt output. In bipolar mode, these inputs would provide outputs of -5, +5 and 0 volts respectively.

For bipolar outputs, a 5K resistor connected between the summing point and a +10 volt reference will provide a 2 milliampere bias current. This bias current will maintain the output swing between -5 and +5 volts.

#### High score in test

The performance of the new digital-to-analog

converter depends on the quality of the differential amplifiers and other components, or on the number of compensations or corrections provided.

All static accuracy tests have been performed on the laboratory model on page 146, which is a complete digital-to-analog converter.

In the single-digit test, where each digit is actuated separately, the static accuracy for any of the 10 digits was better than  $\pm 0.02\%$  of full scale at 25°C, +0.06% from 0°C to 125°C, and -0.25% from 0°C to -55°C.

For any arbitrary combination of digital inputs, the static accuracy was  $\pm 0.05\%$  of full scale at 25°C,  $\pm 0.125\%$  from 0°C to 75°C, +0.5% from +25°C to +125°C, and -1% from 0°C to -55°C.

The largest error occurs at the lowest temperature, where the transistor amplification factors are the lowest. A significant error also occurs at high temperatures, where the leakage of the current-switching diodes is severe. Darlington pairs in the higher significant stages and low-leakage diodes in all the current switches would reduce these large errors at the extreme temperatures. At room temperature, the repeatability of the device is excellent—within +0.02% of full scale.

The constant current generator, the bias voltage supply, and the current dividers operate only statically—that is, they do not vary when the digital signal changes. Therefore they do not require the capability of fast switching. Since fast-switching diodes are readily available, the operational amplifier is the only speed-limiting device.

While dynamic tests so far have not been performed, the dynamic performance of this digital-to-analog converter is undoubtedly greatly superior to that of conventional converters.

#### A single-chip package?

The degree to which implementation with monolithic circuits is possible is still questionable. With the present state of the art, a 6-bit digital-to-analog converter in a single monolithic package is possible. A 10-bit converter could be made with a second integrated circuit containing four additional converter stages, connected between the current generator and the most significant stage of the 6-bit device. The transistor emitter leads of these additional current dividers must be accessible to permit connecting precisely matched resistors into the emitter circuits of each differential amplifier for improved accuracy. The chips can merely be put into a film-resistor network, resulting in a hybrid integrated circuit.

As the technique of manufacturing matched monolithic differential amplifiers improves, and as fewer stages require compensation by external resistors, more current divider stages can be included on a single chip.

#### Reference

1. A.K. Susskind, Notes on analog-digital conversion techniques, The Technology Press, Massachusetts Institute of Technology, 1957.



# Motorola Has the Stockpile of Mil-Type Transistors a Purchasing Agent Dreams About!

Now you can take advantage of selected Motorola Mil-Type Silicon Transistors *without waiting . . . get immediate delivery on larger quantities*. They have a built-in, extra bonus, too – extraordinary dependability and stability at higher voltages due to their patented annular structure.

Check this quick-reference capability chart against your current high-reliability requirements. Then contact your Motorola sales representative for prices (they're competitive) and delivery. Or for more information, write Motorola Semiconductor Products Inc., Dept. TIC, Box 955, Phoenix, Arizona 85001.

		Collector Current $I_C$			
		500 $\mu$ A	10 mA	30 mA	150 mA
$BV_{CEO}$ (min)	15 V		2N706 JAN (NPN) 2N918 JAN (NPN) 2N2481 USN/ JAN (NPN)		
	30 V				2N2218 JAN (PNP) 2N2219 JAN (PNP) 2N2221 JAN (NPN) 2N2222 JAN (NPN)
	35 V		2N1132 USN/ JAN (PNP)	2N1131 USN/ JAN (PNP)	
	40 V				2N2218A JAN (NPN) 2N2219A JAN (NPN) 2N2221A JAN (NPN) 2N2222A JAN (NPN) 2N2904 USN/ JAN (PNP) 2N2905 USN/ JAN (PNP) 2N2906 USN/ JAN (PNP) 2N2907 USN/ JAN (PNP)
	45 V	2N929 2N930			
	60 V		2N2904A JAN (PNP) 2N2905A JAN (PNP) 2N2906A JAN (PNP) 2N2907A JAN (PNP) 2N3250A JAN (PNP) 2N3251A JAN (PNP)		

These device types are also available under Motorola's personalized Meg-A-Life II\* program to meet your special high-reliability requirements.

\*Trademark of Motorola Inc.

*- where the priceless ingredient is care!*



**MOTOROLA**  
Semiconductors



# DESIGNER'S

P. R. MALLORY & CO. INC., INDIANAPOLIS, INDIANA 46206

## New miniature tantalum capacitor for microcircuits

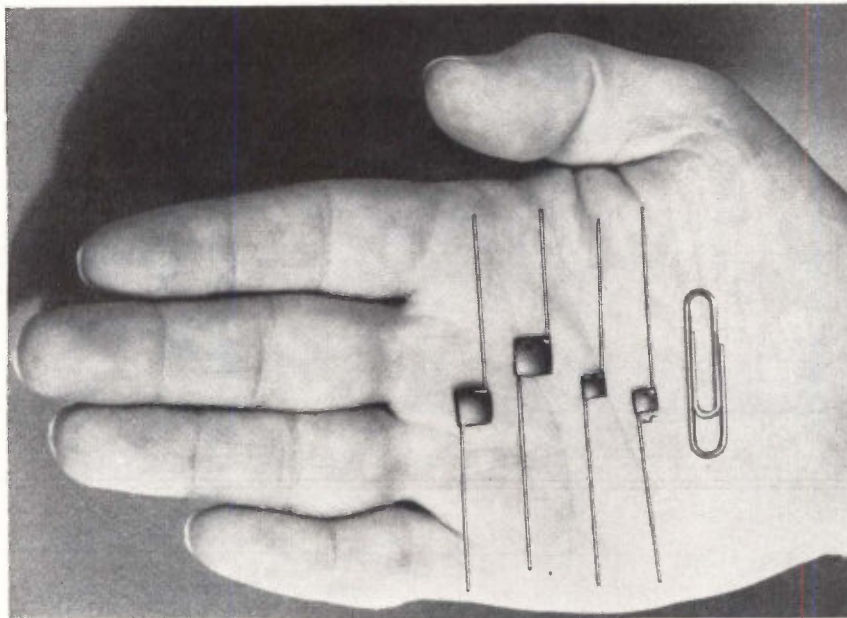

The Mallory TUR is a miniature solid electrolyte tantalum capacitor designed for use with integrated circuits, thin film and other micro-electronic circuits. It is supplied un-encapsulated to provide extremely small size per rating. It is intended for use with microcircuits where it will be encapsulated after assembly.

The TUR has a new configuration which provides maximum capacity per unit volume. It's a square chip, only .225" to .325" square, and .04" to .170" thick depending on rating. It is supplied with an electrically insulating coating on the positive side of the case, so it can be stacked or placed directly on the circuit chip or board prior to encapsulation. When properly pre-dried and encapsulated, it withstands MIL environments.

CV (capacity x voltage) product is extremely high. Ratings range from

47 mfd., 6 VDC to 15 mfd., 50 VDC. Temperature rating is  $-55^{\circ}\text{C}$  to  $+85^{\circ}\text{C}$ , de-rated linearly to  $\frac{2}{3}$  voltage at  $125^{\circ}\text{C}$ . DC leakage is low. Three configurations keyed to lead position are available. Standard units are polarized; non-polarized units on special order. Leads are gold-plated ribbons, can be welded or soldered.

### DIMENSIONS

Case Size	A Max.	B Max.	C Max.
A	.225	.225	.040
B	.225	.225	.050
C	.225	.225	.060
D	.225	.225	.075
E	.225	.225	.110
F	.325	.325	.060
G	.325	.325	.075
H	.325	.325	.110
J	.325	.325	.125
K	.325	.325	.170

## Reducing costs with Mallory packaged rectifier circuits

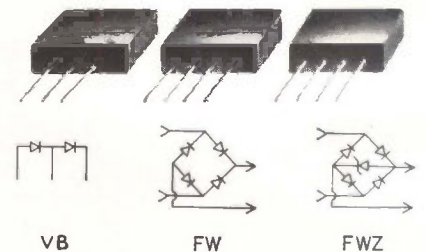

You can save both on component costs and on assembly costs, with Mallory rectifier packages. Each of these factory-connected circuits costs less than what you would pay for an equivalent number of separate rectifiers. The four-rectifier bridge package costs less than four separate rectifiers, and the full-wave and doubler packages cost less than a pair of rectifiers.

Savings in assembly come from reduction in number of soldered connections which you need to make . . . one less on a doubler or full-wave circuit, two less on a bridge. You can figure it out for your own conditions, but here's a typical analysis. At a labor rate of \$1.60 per hour, the saving is about \$300 per 25,000 doubler packages, or \$600 per 25,000 bridge packages. Extra reliability due to fewer solder joints is a plus value.

Cold-case encapsulated circuits include Type FW full wave bridge, Type VB voltage doubler, Type CT full-wave center tap with either positive or negative polarity . . . all rated for  $100^{\circ}\text{C}$ , in PRV values from 50 to 600 volts. Bridge circuits, Type FWZ, are also supplied with an integral, factory-connected zener diode across DC output terminals; all standard zener voltage ratings are available in this configuration.

CIRCLE 511 ON READER SERVICE CARD

CIRCLE 512 ON READER SERVICE CARD

## Improved heavy-duty performance now provided by Mallory Alkaline Batteries

Recent refinements in Mallory Alkaline Batteries increase their ability to deliver long life at higher values of current drain, and further improve their advantage over conventional zinc-carbon batteries both in service dependability and cost per hour.

This added capability is the result of new internal construction which increases the effective anode area in relation to cell volume. Internal impedance of the cell is reduced, particularly at low temperatures. At 70°F ambient, the Mallory alkaline system delivers up to 7 times more hours of service on continuous heavy drain than ordinary batteries (see chart). At 32°F, the improvement in performance is even better.

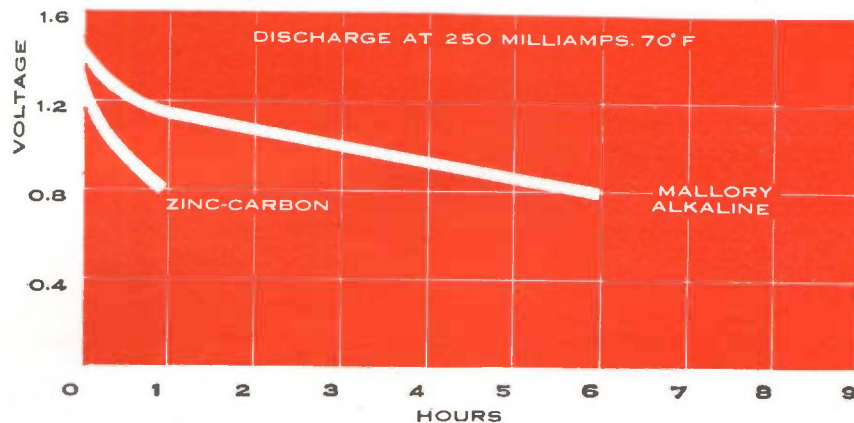

Added refinements in case and seal construction have also been made to insure reliability of the seal under even the most severe vibration.

Mallory Alkaline Batteries with the new construction are available in a broad range of standard cell configurations.

CIRCLE 513 ON READER SERVICE CARD

## Circuit breaker-switch now available on Mallory controls

The OCB breaker-switch eliminates the need for a separate circuit breaker by combining overload protection and line switch into a single, compact unit. It's an extra convenience idea for television and stereo equipment, for instruments and any products which require overload breakers under 5 amperes.

To reset the breaker after it trips, you simply turn the switch back to OFF, then to ON. You cannot hold the breaker closed against an overload.

Holding current is factory-set to your specifications; standard range is 1.25 to 1.9 amperes, with special models available up to 5 amperes.



OCB breaker switch attached to volume control.

Break current is 50% higher than holding current. The OCB switch will withstand a 10% overload for 4 hours at 65°C ambient. It will take a 50 ampere surge, peaking in 1.6 millisecond and decaying to normal in 3 millisecond, without opening or being damaged.

The OCB is supplied attached to standard Mallory volume controls as a rotary on-off switch, or can be supplied as a separate breaker switch. As a combination control-switch-breaker, it offers savings in total component and assembly cost.

CIRCLE 514 ON READER SERVICE CARD

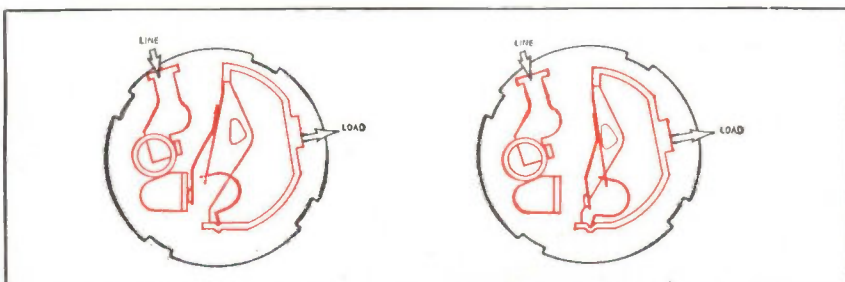

Diagrams show operation of breaker mechanism: at left, in MAKE position; at right, in BREAK position.



# Computer replaces calculator for a few dollars more.

## TI makes it happen.

Packard Instrument Company wanted to build and market a liquid scintillation spectrometer that would perform its own data reduction and computation.

That meant an on-line computer to replace the calculator on current models.

But there was a problem. Cost.

The solution? Texas Instruments integrated circuits.

Using 9 types of TI Series 73 and Series 74 monolithic integrated circuits, Packard developed the Tri-Carb® Liquid Scintillation Spectrometer System complete with a built-in computer at a cost just slightly higher than previous

models with calculators. The ICs saved 25% on assembly alone by combining a number of circuit functions on a tiny silicon chip about the size of a pinhead. For example: the full decade counters... Series 74 TTL circuits... contain the equivalent of 65 to 75 individual components or 11 circuit functions. And with only 13 IC boards required, the computer was small enough to be built right into the equipment. It was half the size... one third the cost... of Packard's estimate for a conventional system.

Now scientists no longer have to use

a separate computer facility for such critical computations as net counts per minute, channels ratio, net external standardization ratio, etc. There's no waiting for raw data to be converted into computer language, waiting for computer time, travelling to another location to use the computer.

Texas Instruments helped Packard build additional functions into their equipment yet save time, money and space. How about you? ICs could be the answer to your problems. Write Box 5012, Dallas, Texas or circle reader card No. 501.



### Texas Instruments makes it happen in industry.

#### How to save time and money testing ICs and circuit modules

Today's complex integrated circuits and electronic sub-assemblies require sophisticated testing. Now, there's a single TI system that combines two key capabilities. One, to test many ICs or circuit modules rapidly. The second, to administer a large number of different tests to each IC or circuit module. It's the TI 553 Dynamic Tester. The 553 performs tests under actual conditions experienced in use, giving more valid and reliable data for quality assurance, incoming inspection, yield and other necessary production information.

You can reduce test time and cost by using the 553. Combining it with a TI test controller adds the ability to store any number of different programs for any of your ICs or circuit modules, using core or disc memory.

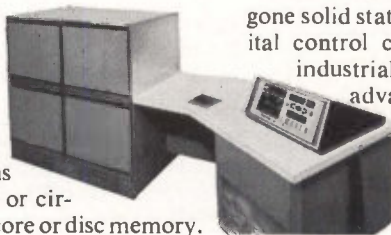

Programs are transmitted directly to the 553, and in a closed-loop arrangement test results are stored by the controller. This allows re-programming on command at any time for any one of the stored test routines, coupled with immediate access to the stored test results.

For more information about the 553 Dynamic Tester contact Texas Instruments in Houston or circle reader service No. 500.

#### Johnson automated control systems go solid state with TI transistors

The Johnson Service Company has gone solid state in their new T-6000 digital control centers for buildings and industrial complexes. Result: major advances over first-generation equipment using electro-mechanical stepping switches, relays, vacuum tubes and mechanical linkages.

The T-6000 is used for centralized monitoring of building temperature, humidity, air flow, smoke and fire hazards and all vital points essential to total building operation. Highly automated, it directs attention to off-normal conditions only.

At its heart are TI transistors—low cost switching devices backed by years of use in industrial applications and over 60 million hours of reliability data.

When Johnson Service switched to solid state: size was reduced by 80% (the original systems were as much as 70 feet long!)... speed was greatly increased (500 check points can be scanned in just six seconds as compared to 13 minutes with the previous system)... installation costs were drastically cut... reliability was improved... capacity was increased... versatility was extended.

If you're considering going solid state like Johnson Service, the place to start is at Texas Instruments. Start now by circling reader card No. 502 for full information.

**TEXAS INSTRUMENTS**  
INCORPORATED



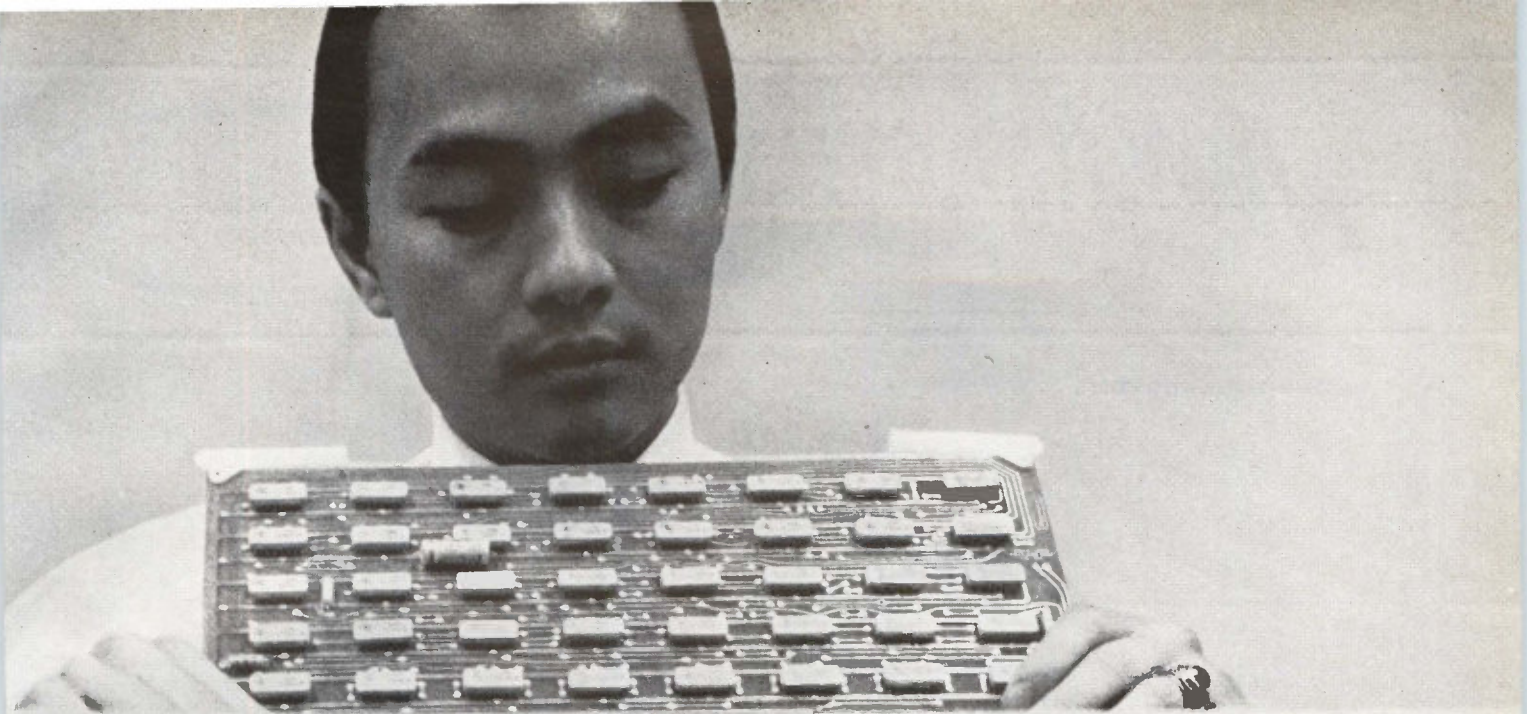

ATION SPECTROMETER

0 8 7 6 3 4 3

ELECTRONIC COMPUTER PROGRAMMER

STOP/START      RUN/PAUSE      RESET/ON

STOP/START	RUN/PAUSE	RESET/ON
OFF	ON	OFF
ON	OFF	ON
OFF	ON	OFF
ON	OFF	ON
OFF	ON	OFF
ON	OFF	ON
OFF	ON	OFF
ON	OFF	ON

LOW LEVEL SELECT

CONTROL

FUNCTION

SELECT

STOP/START

RESET/ON

STOP/START

RESET/ON

STOP/START

RESET/ON



# NEW!

IMMEDIATE DELIVERY  
FROM STOCK  
\$6,600



## TYPE SLRC

# SHF POWER SIGNAL GENERATOR

## FEATURES

- Single Tuning Range: 2.3 to 7.0 GHz
- High Output Power: 100mW to 3W
- Can Be Synchronized
- Built-In Output Attenuator: 0 to 100 dB
- Built-In Power Meter: -3 to +36 dBm in 4 ranges
- Residual FM: less than 50 kHz
- Residual AM: below -40 dB

## APPLICATIONS

Measure two and four terminal networks, narrow band resonators, microwave systems (especially radar). For antenna ranges: determine propagation and antenna characteristics, absorption, and radiation patterns. For use with slotted lines.

## UP TO 3 WATTS OUTPUT

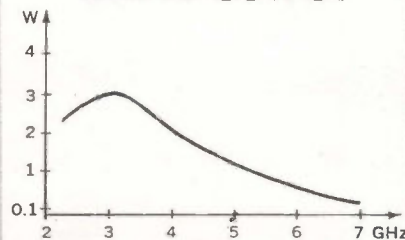

The SHF Power Signal Generator, Type SLRC, covers the wide frequency range of 2.3 GHz to 7.0 GHz in one band, and features up to a 3 watt output. It is a disc-seal triode oscillator which can be synchronized, thereby achieving crystal frequency stability. This can be accomplished through the use of R/S Type XUC Frequency Synthesizer, XME Mixer and XKG or FDS 30 Synchronizer. Using a built-in directional coupler, the output power is indicated on a panel meter. For lower power levels, a relative calibration piston attenuator is used. Frequency indication is accomplished by a large digital read-out for easy, direct reading. A calibrated antenna (Type HA262/2) which provides a defined field strength, is available.

Get The Extra Capability,  
Greater Reliability, and  
Longer Useful Life Of . . .



## ROHDE & SCHWARZ

111 LEXINGTON AVENUE, PASSAIC, N. J. 07055 • (201) 773-8010

Inquiries outside the U.S.A. should be directed to: Rohde & Schwarz, Muehldorfstrasse 15, Munchen 8, West Germany.



# Simpler circuits trace Sony's path to innovation

Though not first with the transistor, the Japanese have applied it to consumer electronics with a persistence and ingenuity that has improved entertainment products. Circuits and components have been simplified and made more reliable. Apparently simple circuits perform complex and sophisticated operations with a minimum of components. New functions have increased the versatility of products without adding substantially to their price

By the Products Planning division,  
Sony Corp., Tokyo, Japan

and Charles L. Cohen  
Tokyo regional editor, Electronics

- 156 Sony tries to be first, or at least different
- 160 Ceramic filters edge out costly i-f transformers
- 163 Sensor reverses tape direction when recording ends
- 165 Recorder gain control eliminates level indicator
- 167 Careful sweep design cuts power drain and cost
- 169 Horizontal sweep with no driver stage
- 171 Two-stage gain control for portable tv set



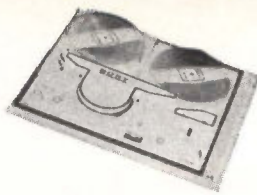

# Sony tries to be first, or at least different

The Japanese company will scrap a consumer product that's only second best; it seeks to pioneer while husbanding its limited technical resources

By Charles L. Cohen

Tokyo regional editor

In 1964, engineers at the Sony Corp. of Tokyo built a prototype of an electronic calculator, but the machine still sits on a laboratory shelf. It never went into production because its performance was not superior to electronic calculators produced by other manufacturers.

Sony's harsh rejection of the calculator illustrates how the company's demanding product development program works. If a product is not unique or better, the company will not market it. Masaru Ibuka, the diminutive engineer who founded Sony in 1946 and is now its president, insists that Sony be first with a product—at least in Japan—or offer one that is radically different from any other on the market.

His philosophy has kept the company out of some lucrative markets like the radio battery business and plunged it into some unnecessarily difficult development. For example Sony chose to market color television with a Chromatron picture tube instead of the usual shadow-mask tube so its sets would be different. But mass producing the Chromatron turned out to be far more difficult than Sony expected. In setting up the manufacture of Chromatron Sony could not match the hundreds of millions of dollars others had put into perfecting the manufacture of the shadow-mask tube.

## The product is success

To founder Ibuka, the product is the thing. He believes astute product development has been behind the company's explosive rise from a tiny instrument manufacturer operating in a burned-out store to a major consumer electronics producer whose radios, tape recorders and television sets are sold all over the world.

Although Sony boasts a handsome research and development budget, the major share of the money

goes for development. Sony does little research, leaving that activity to Japanese government laboratories and universities.

When World War 2 ended, Ibuka set up a small company to exploit the development talents of a few engineers. He called his company the Tokyo Telecommunication Laboratories and started with one product, a vacuum-tube voltmeter. The company thrived and branched into professional electronic equipment for Japan's broadcasters.

In the early 1950's, Ibuka recognized that his still-small company would always be limited so long as it stayed in the instrument and professional broadcasting equipment fields. So he decided to gamble and move into consumer electronics where the markets were gargantuan and the competition fierce.

## New name and new goals

About the same time Ibuka noticed something else: the transistor was being exploited widely in the United States in military applications but nobody was applying it to consumer products with the same fervor. Ibuka's engineers learned semiconductor technology and the company became the first in Japan to mass produce transistors. The first germanium units went into a transistor radio and Sony was on its way.

Once in the consumer business, the company changed its name to Sony because those four letters are written and pronounced the same everywhere in the world.

With its new name and an aggressive product-planning program, the company has broadened its line to include television, audio tape recorders and a video tape recorder priced for the home. At the same time it maintained its line of studio broadcast equipment, expanding it to include a

video tape recorder and electronic dubbing equipment for movies. In fact, Sony has become synonymous with Japanese consumer products and product planning.

For many years the chief product planner was president Ibuka. Now Sony has grown so large that one man can no longer create all the company's products. Today much of the advanced planning is done by committee, though on that committee, Ibuka and executive vice president Akio Morita exert a greater weight than the other members.

Sony's top management consists of a nine-man board. On it are the president, the executive vice-president, two senior managing directors and five managing directors. Ibuka still does much of the long-range planning; Morita heads up marketing; one senior managing director directs project planning and the other production. These nine men and about 30 department heads lunch together daily, discussing company problems and reaching decisions informally as they eat.

Routine product planning is performed by the product planning division, which decides how many items to make and the type of product needed in each line. But its work is subject to regular review by the nine-man executive board and the luncheon group.

### Something new

It is important to what Sony does in product planning that its vice president, Morita, a physicist who joined Ibuka in the early days, heads marketing and sales promotion. Morita uses technology to help sell the company's image and products. He tries to create the impression among customers that Sony is one step ahead today and will be even farther ahead tomorrow. He also wants customers to feel that a Sony product has something new in it.

With these concepts in mind Sony has introduced some products that were intended to do more for the company's image than its bankroll.

For example, Sony leapfrogged tubed tv when it introduced transistorized black-and-white receivers because it built its own semiconductors but not tubes. Sony did not expect the sale of many sets because at the time its transistorized set was too expensive. But many customers looked at the Sony tv and, impressed, bought a Sony radio.

More recently, when Sony decided to bring out a new small screen tv receiver, it decided to produce a 7-inch set with a black picture tube that would look different. Then Sony advertised it as the first transistorized 7-inch set in the world and its black face emphasized the difference. Although Sony capitalized on the promotional effect of the new design, there were good engineering considerations behind it. Designers had determined that from a cost standpoint the 7-inch size was almost optimum to build. Assembly of smaller sets was harder because of the size and because the miniaturized components required were more expensive. Larger sets cost more because material

costs rise with set size.

Right now Sony is proudest of the home video tape recorder it introduced last year to sell for around \$1,000 in the United States. The history of that development illustrates the philosophy that Sony tries to follow in product development.

Work first started on audio tape recorders at the company that was to become Sony in 1949. Ibuka thought that if audio recording was possible, then video recording should also be possible. The company's engineers proceeded with brute force methods: they increased tape speed and improved recording head characteristics. By 1953 they recorded a low-grade picture.

Ibuka knew others were working on video recording for broadcasting too: the Radio Corp. of America, the British Broadcasting Corp. and the Crosby Research Foundation. But he felt he was ahead. Then the Ampex Corp. caused a bombshell by introducing a perfected recorder, the Ampex VR 1000.

### A look homeward

Sony was as stunned as anybody. A shocked Ibuka had to admit that his company was behind in video recording and had failed to introduce the world's first video tape recorder. It was at this time, however, that the company had decided to put a new emphasis on consumer goods, so Ibuka began to think about a video tape recorder for the home. Since the Ampex machine cost about \$50,000, Ibuka felt a home recorder would require a radically different approach. His goal was a machine that was easier to buy and easier to run, cheaper, smaller and requiring less maintenance than the Ampex VR 1000.

The first result was the Sony SV-201, labeled an industrial video tape recorder because its price was still well above what Ibuka thought a consumer might pay. Six or seven were built and one was shown at the 1962 IRE show. Because it used mostly orthodox recording techniques—helical track recording and frequency modulation of the recording signal—the company president felt the machine was not good enough. He wanted one smaller, more compact and cheaper. So, like the electronic calculator of 1964, it's still sitting on a shelf.

But the SV-201 had one Sony innovation that was to mark all the company's future professional recorders: Sony's 1½-head recording. One head records all picture material and a second records the blanking periods which contain synchronization information. In the usual 2-head system, each head records both a picture period and a blanking period. The advantage of Sony's system is that the same head always records and plays back the picture so the heads needn't be matched closely.

At the 1963 IRE show, Sony was back with a new video tape recorder, the PV 100. Deliveries started in July of that year.

Although the machine was sold to industrial, medical and education institutions, the price of



## From a ramshackle shed . . .



It was 1947 when Masuru Ibuka, second from left, proudly posed for this picture with three coworkers in front of the dilapidated building into which he had just moved his fledgling Tokyo Telecommunications Laboratories. Ibuka had set up the firm a year earlier on the fifth floor of a burned-out department store called Shirokiya. There, his group was separated from other tenants by a board fence. When the department store owners decided to reopen their retailing business Ibuka moved to this location.

\$11,500 was far beyond a consumer's reach. But Sony decided that the machine's performance specifications exceeded the needs of home use. Turning to motion pictures for an analogy, Sony noted that theaters used 35-mm film because of the high quality but that consumers used 16-mm or even 8-mm happily even though the quality of reproduction was not as good as with the large size.

For its home recorder, Sony simplified the signal processing to cut down on electronic components. It also simplified mechanical construction. The result was the CV-2000 model which sells for about \$1,000 in the United States. Although the quality is not as good as obtained with a studio recorder, or even with the industrial PV 100, it is satisfactory for the home.

### Study in depth

Once committed to developing a product, Sony digs deeply. To perfect its video tape recorder for the home, the company's engineers delved into the metallurgy of magnetic materials to develop the company's own tape, probed the chemistry of coatings, binders, pigments and paints, studied the physics of magnetization and electromagnetic induction to produce a unique recording head and dissected the field of video recording so they could evolve a system of skipped fields that is primarily responsible for the reduction in electronic components compared with the number used in studio equipment.

Another phase of Sony's product development can be seen in the company's progress with semiconductor technology. Sony has introduced a few products primarily to improve its semiconductor manufacturing skills. It was the first company to mass produce transistors commercially in Japan. It was the first in Japan to put germanium mesa transistors in consumer products and it was the first to use silicon transistors the same way. Still, Sony won't sell its semiconductors to others. Its capability is used solely to keep the company's products at the forefront of technology and to insure its manufacturing divisions a supply of advanced devices. Sony thinks the company gets a competitive edge because it can develop products without tipping its hand on a new design through outside orders for special semiconductors.

That means the cost of all the processing development is borne by Sony alone. To afford it Sony sometimes spreads costs broadly over several products and attributes some of the expense to advertising. When the company introduced its 8-inch transistorized tv set, the high-voltage devices in the video output circuit cost \$20 to \$30 each. Sony probably lost at least a quarter of a million dollars on the set. But the company believes advertising the first transistorized television set brought in more than enough Sony radio sales to offset the loss.

Later, when Sony was ready to introduce its 5-inch screen set, which went into mass production, it could produce silicon transistors at a low cost



... to a modern manufacturing complex in 20 years

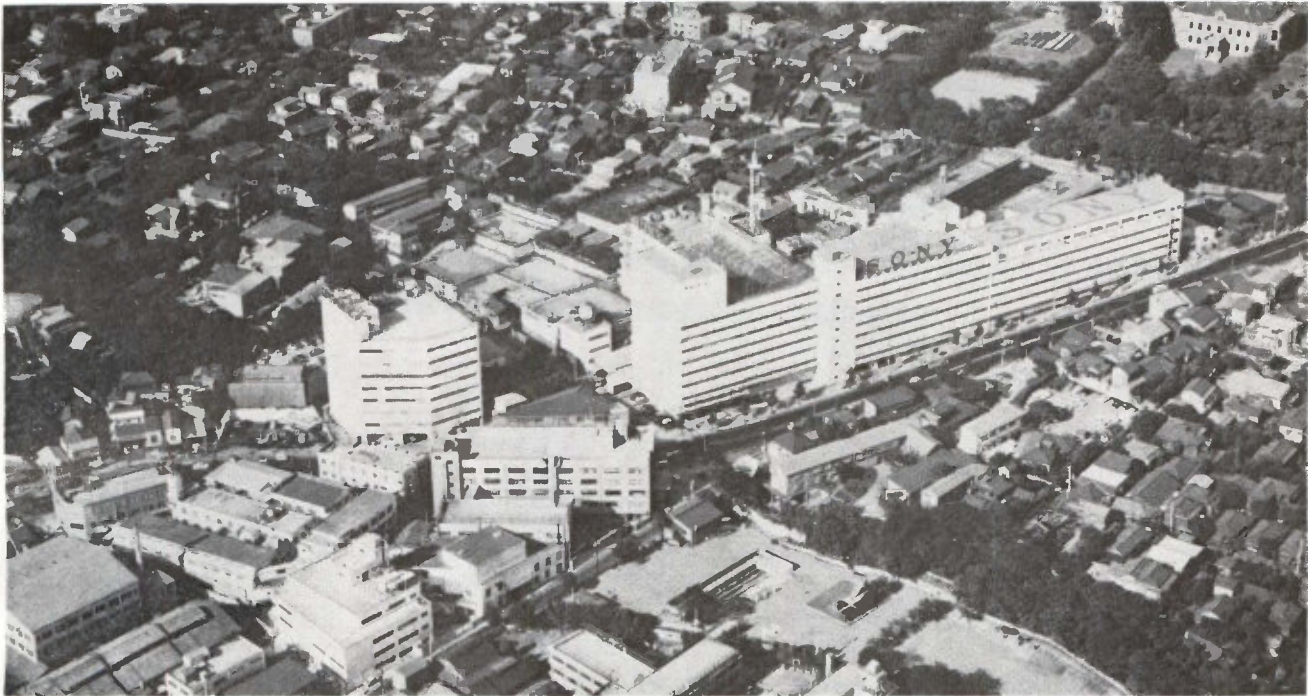

Today, on the same site, Ibuka's company, now renamed the Sony Corp., occupies several huge white-faced buildings in the heart of rebuilt Tokyo. Executive offices are on the top floor; equipment manufacturing and assembly are on the lower floors of the eight-story buildings. Semiconductor manufacturing is carried on in another plant at a different location. Sony's executives can see Mt. Fuji on a clear day, a reminder they represent a Japanese firm even though their constant aim is a world market.

because of its experience making them for the 8-inch set. At the same time other Japanese manufacturers could not compete with Sony because they did not have Sony's experience with silicon transistors.

#### Germanium still performs

Sony is using more and more silicon devices in its consumer products, but not to the exclusion of germanium devices. Its portable radios still have germanium output transistors even though silicon ones are used in other stages. That's because Sony's epoxy package cannot dissipate enough heat. In radios that have direct-coupled audio amplifiers a germanium transistor is used even in a low-level stage because Sony does not have a suitable pnp silicon transistor.

Sometimes the company will stay with older devices to husband its limited engineering resources. Thus Sony f-m sets have a germanium mesa transistor even though a silicon device could be designed and produced for less cost. Instead, the company designed an improved pnp driver transistor which has the high degree of linearity required in high-fidelity amplifiers.

The company's activity in semiconductor technology has helped it broaden its product line. For example, what was learned designing transistors for deflection circuits in tv sets has led to the development of linear transistors for high-fidelity phonographs. The linear amplifier in the vertical output stage of a tv set requires transistors with

very linear performance. Similarly the higher power transistor in the horizontal output stage must have linear characteristics even though it is operated as a switch. When turned on, the transistor in the horizontal output stage is normally saturated with a high collector current and low collector voltage. The d-c forward current gain,  $h_{fe}$ , must stay high or the driving power becomes inconveniently high. It turned out that a transistor that keeps  $h_{fe}$  from slumping during saturated operation provides highly linear current gain throughout the operating range.

Right after it switched to consumer products, Sony built its consumer goods to lower quality standards than its professional gear. This caused the company considerable grief. The formula, Sony finally discovered, was to manufacture goods to the same high quality but to design them to lower specifications, such as lower frequency response.

On pages 160 to 172, are descriptions of some of the circuits Sony engineers have designed as they've worked to carry forward the company's unusual product development program.

Presented here are some of the interesting circuits developed by the Sony Corp. None are technological breakthroughs but all represent innovation. Three are for radios, two for tape recorders and four for television sets. Each involves at least one of the design aims of consumer electronic products: miniaturization, reduction of cost without sacrifice of performance or improved performance with no increase in cost.



# Ceramic filters edge out costly i-f transformers



New piezoelectric elements eliminate i-f alignment in production; selectivity is maintained as costs drop

**Reducing costs** by reducing components is always a goal in consumer electronics. In intermediate-frequency sections of several radios, Sony is turning to ceramic filters instead of tuned-transformer stages. The result is equivalent, if not superior, selectivity with a savings in parts of as much as 10%. For example:

- Two ceramic filters—one a double-tuned, three-terminal element—are used in the model TR-1000, a 10-transistor multiband portable, list-priced in the United States at \$69.50.

- A single fixed-tuned ceramic filter provides selectivity equivalent to three transformer-tuned stages in the \$12.95 model 2R-27, an eight-transistor a-m portable.

The ceramic filters not only reduce the parts cost of the radios but the assembly cost as well. What's more, the radio in production needs no i-f alignment because the filters are supplied already fixed-tuned to their i-f frequency.

In the model TR-1000 the i-f amplifier consists

of two stages, as in the schematic on page 162. One filter, tuned at 455 kilohertz, provides emitter-to-ground bypassing for the first i-f transistor,  $Q_1$ . The other filter, double-tuned at 455 khz, provides coupling between the two i-f stages. The over-all selectivity characteristic of the i-f section of the radio essentially is the product of the two filter characteristics. It is equivalent to the selectivity of an amplifier using two conventional double-tuned transformers, but at 6% less cost.

Transformer  $T_1$  between  $Q_2$  and the second detector diode  $D_1$  is a small, fixed-tuned unit with an operating  $Q$  of about 10. It is used more for increasing gain by impedance matching than for improving selectivity.

## Piezoelectric elements

The ceramic filters use piezoelectric elements made of lead-zirconate-titanate,  $PbZrO_3-PbTiO_3$ . Both are made by Murata Manufacturing Co. from a new material mass produced with a temperature coefficient and long-term stability of the same order of magnitude as in crystal filters.

Both filters are guaranteed within  $\pm 2$  khz of their center design frequency. Though a maximum difference of 4 khz is possible between the two center frequencies, the much higher selectivity of the double-tuned filter prevents degrading of the over-all bandpass characteristic. Differences in center frequencies also have little effect on the broadband input and coupling transformers.

The emitter bypass filter, type BF-455A, is a two-terminal unit with a single, square ceramic resonator. Enclosed in a small resin case measuring only 0.14 by 0.28 inch, it can be used as an emitter bypass capacitor because its impedance falls sharply to a minimum at series resonance. The filter provides approximately the same amount of selectivity as a conventional single-tuned i-f transformer.

The coupling filter, type SF-455D, is also enclosed in a resin case 0.30 by 0.24 by 0.28 inch. Selectivity is equivalent to the total provided by a double-tuned and a single-tuned transformer.

The filter consists of two square resonating elements, each with an inner and an outer portion. An external capacitor of about 68 picofarads couples inner portions to form a double-tuned filter.

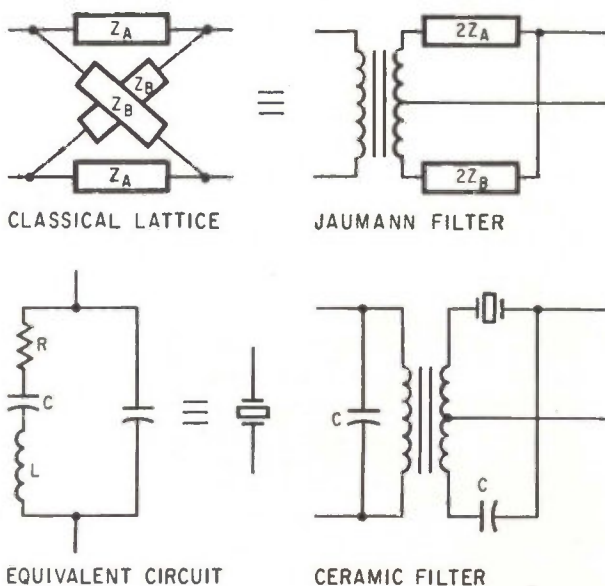

Classical circuit for a crystal filter is a single-section lattice with four resonant elements—equivalent to the Jaumann-connected filter. Selectivity of i-f stage is obtained with a single Jaumann ceramic filter. Equivalent circuit of the ceramic filter element is also shown.

The outer portion of one element connects to the input terminal; the outer portion of the other element connects to the output. The third terminal is a common connection to the reverse sides of both of the elements.

Spurious responses are usually a serious problem in ceramic filters. However, the responses of the individual elements in the double-tuned filter are not at integral multiples of the fundamental frequency. Nor are the elements completely uniform or symmetrical. And because the spurious response frequencies of the elements do not coincide, even though their fundamental frequencies are equal, the spurious responses of the over-all filter are greatly reduced.

### Low-price portable

In the model 2R-27, the 455-khz ceramic filter, part of a two-stage i-f amplifier, is connected between the converter and the first i-f transistor,  $Q_1$ , as diagramed below. The Matsushita Electric Industrial Co. manufactures the lead-zirconate-titanate filter.

Resistance-capacitance coupling is used between the two i-f transistors. However, a small, fixed-tuned transformer,  $T_2$ , with the low operating Q of 5 provides the proper impedance transformation between the i-f stage and the second detector.

The classical circuit for crystal filters is a single-section lattice, shown on page 160, which can

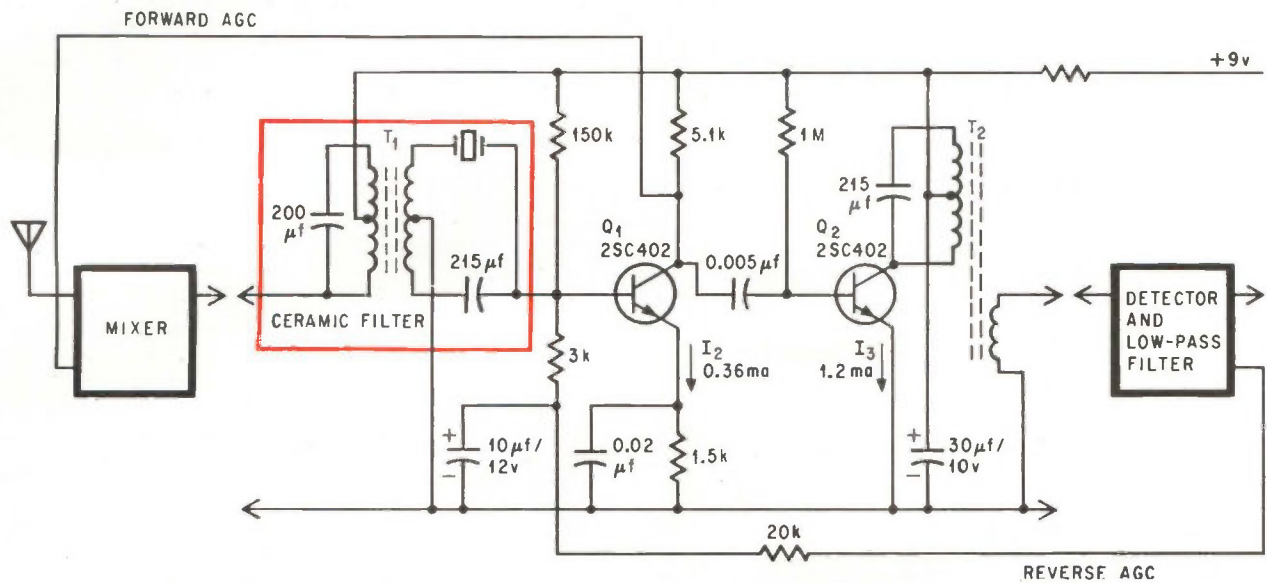

Ceramic filter in the intermediate-frequency stage of a low-cost radio provides selectivity equivalent to three single-tuned transformer stages. Use of the filter eliminates need for alignment when the radio is in production, cuts down on the number of components and the assembly time.

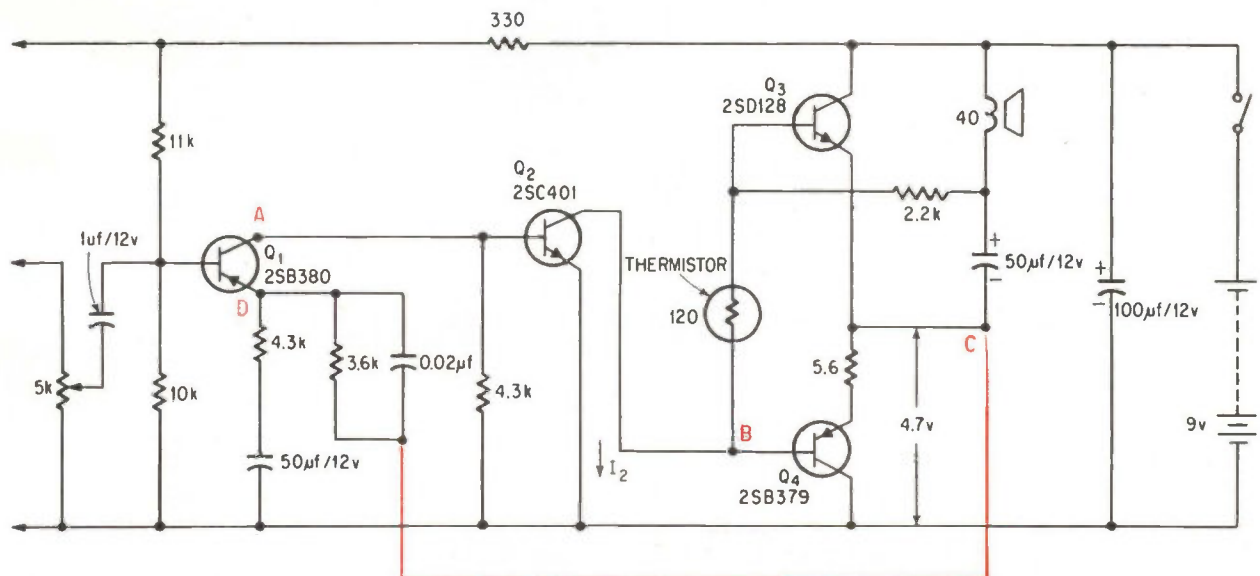

Direct coupling of the audio output stages reduces the zero-signal battery to 5.5 milliamperes, eliminates two coupling transformers. Audio stages now cost 15% less than when transformers are used.



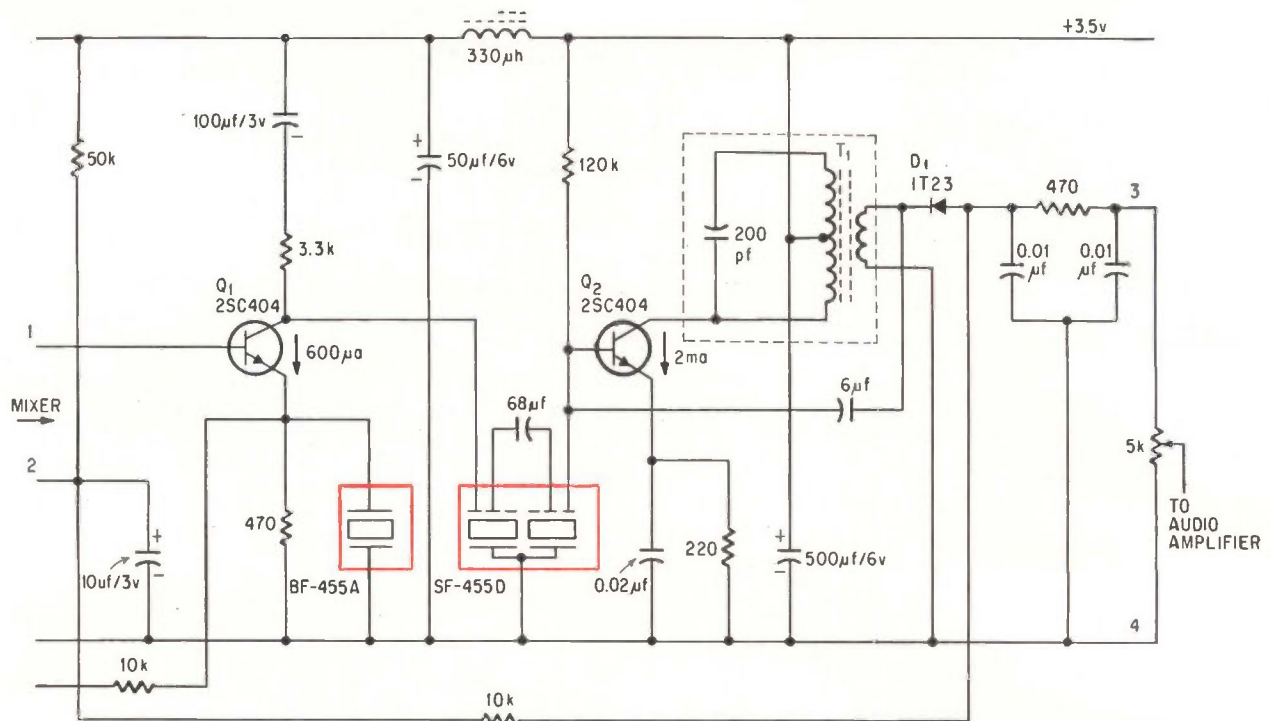

Intermediate-frequency amplifier of multiband portable uses single-tuned ceramic filters for emitter-to-ground bypassing of first i-f transistor,  $Q_1$ , and double-tuned ceramic filter to couple the stages. The amplifier is designed so that the input transformer is part of the converter module.

also be used with ceramic filters. But for such a simple radio a circuit with four ceramic resonant elements would be too expensive. Fortunately, the four-element lattice can be replaced with an equivalent circuit consisting of a center-tapped transformer and just two impedance elements. The circuit is known as the Jaumann connection, first developed in Germany in 1932. Sony modifies this connection still further in its i-f stage, using the ceramic material as one of the resonating elements in a Jaumann-connected filter.

The two-terminal ceramic element is in the form of a 0.2-inch diameter disk contained in a metal can measuring less than a half inch on a side. It is combined with a fixed-tuned transformer,  $T_1$ , and external capacitors to form the selective circuit. The resonant frequency of the filter is maintained within  $\pm 2$  kHz of the 455-kHz i-f. The difference between the resonant frequency of  $T_1$  and that of the ceramic element is less than 1.7 kHz. This close control means that the selectivity characteristic of the i-f section is quite symmetrical and distortion at the second detector caused by unequal cutting of the sidebands is kept very small. Sufficient adjacent channel attenuation is obtained with no i-f alignment.

Sony feels that in the future ceramic filters of this kind, designed with integrated circuits, will be used in most small radios. A single ceramic element, with a minimum of external connections to the integrated-circuit chip, will yield the selectivity required. There will be no need for the coupling transformer  $T_2$  because sufficient gain will be ob-

tained merely by adding an extra amplifying transistor to the chip.

#### Direct-coupled audio

To cut down on the number of parts in the audio output stages of this small portable, Sony has coupled them directly. This not only eliminates two coupling transformers but also reduces the zero-signal battery drain to only 5.5 milliamperes. Life of the 9-volt, multilayer battery is increased by about 30% over earlier Sony radios. Also, the transformerless stages cost about 15% less.

The first two stages of the three-stage audio amplifier, shown on page 161, use a complementary-symmetry cascade connection and operate class A. The output stage has a push-pull complementary-symmetry connection and operates class B.

High stability is achieved by 100% d-c negative feedback through the 3.6-kilohm resistor from the output stage to the input stage transistor  $Q_1$ . Approximately 12 db of a-c negative feedback adds to the stability. With the second stage transistor  $Q_2$  within the feedback loop, the stabilizing resistor usually needed in the emitter circuit can be removed. The bypass capacitor is also unnecessary.

The combination of pnp and npn transistors for  $Q_1$  and  $Q_2$  receives sufficient d-c negative feedback so that variations in the d-c current-amplification gains of the transistors have little effect on the over-all performance. The 2SC401 silicon transistor used for  $Q_2$  has the advantage of amplifying the audio signal linearly with a zero-signal emitter

current of only 2 milliamperes. This current flows through the speaker voice coil, which was specially designed to carry more than 12 milliamperes d-c without distortion.

The feedback loop stabilizes the d-c operating point of the audio output stage.

If a disturbance causes current at D to increase, the voltage at point A will rise and current  $I_2$  will increase. This will cause a drop in voltage at points B, C and D—which suppresses the initial increase. A variation of this basic circuit is used in many of Sony's television sets.

## Sensor reverses tape direction when the recording ends



Automatic reversing circuit monitors recorded tracks, eliminating the need to modify tape

With what Sony calls its electronic sensory perception system, the direction of tape travel on a tape recorder is reversed automatically after the recorded portion has ended. In the system, designed for four-track stereo recorders, a triggering signal need not be added to the tape; in fact no modification of the tape is required at all.

Conventional tape-reversing systems either modify the tape physically or record on it in some way. Not only does this involve extra steps in tape production, but there is always the chance that the recording or the tape may be damaged.

Well-known reversing techniques include:

- Adhesive-backed aluminum-foil contacts fastened to the tape to operate a reversing switch.
- Special signals recorded on the tape and additional circuits in the recorder to reverse the tape automatically when the signal is sensed.
- Devices to sense the end of the tape when tension suddenly increases near the end of the reel.

Instead of these, Sony's system uses the actual recording on the tape tracks as its input and automatically reverses the tape when the recording signal ceases. An obvious danger in this elementary approach is that the tape may reverse automatically between musical phrases or in the unrecorded spaces between different selections on the same tape—which average 5 or 6 seconds. Two precautions are taken.

Recordings from tracks one and four are mixed to provide a signal whose dropout reverses the tape automatically. Since the two recordings are independent—track one is recorded for forward travel and track four recorded for return travel and there is no correlation between them—the statistical probability that both signals will drop out simultaneously is quite small.

In addition, a fixed time delay,  $T_1$ , of 6 to 10 seconds between the time when the recording ends and automatic reversal begins virtually eliminates the danger of reversal during the pause between recorded parts of the tape.

Another possible source of difficulty is the unrecorded portion at the beginning of each tape which averages 10 seconds but may run as long as 15 seconds. This is longer than  $T_1$  and the recorder would automatically reverse if the  $T_1$  delay was the only protection. So, a direction-holding circuit with a time delay,  $T_2$ , of about 10 seconds is provided.

This circuit, which is coupled to a manual stop switch, operates before the  $T_1$  delay circuit becomes effective after the tape is started. Total direction-holding time,  $T_s$ , during which the recorder will not reverse after start, is about 20 seconds ( $T_s = T_1 + T_2$ ).

The direction-holding circuit also operates when the tape is stopped in the middle. After the tape starts again the circuit maintains the same tape

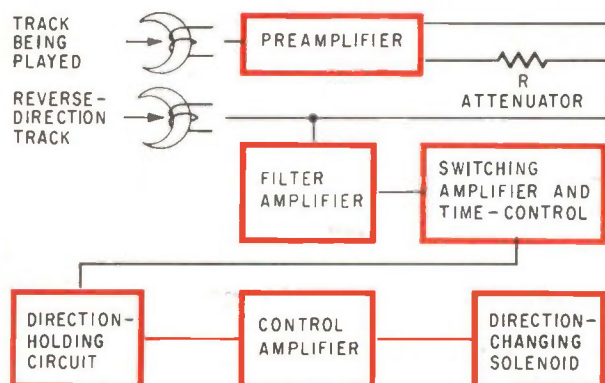

"Electronic sensory perception" system in four-track tape recorders reverses direction of tape travel automatically by detecting signals in tracks one and four. When recording on tape ends, direction-changing solenoid is triggered.



direction as before the tape was stopped.

A block diagram of the electronic sensory perception system is shown in the figure on page 163. The input signal is a composite of the signals from tracks one and four of the four-track tape. During mixing, crosstalk to the channel being reproduced must be kept more than 50 decibels below the program material. To achieve this, the track being reproduced is amplified to 0 db in the preamplifier and then attenuated in a resistive divider to the level of the reverse-direction playback head. This signal is then combined with that from the reverse track to form the composite signal.

A filter amplifier is used to boost the signal to the level required by the switching amplifier. It increases the signal-to-noise ratio by cutting all frequencies below 200 hz and all frequencies above 2,000 hz with an attenuation of 12 decibels per octave.

The switching amplifier converts the presence or absence of recorded signals, that is the presence or absence of an a-c signal, into a d-c voltage for controlling direction reversal. After the recorder has been started, the direction-holding circuit disables the switching amplifier and prevents it from producing a direction-reversing signal. However, when a direction-reversing condition is detected, the switching amplifier feeds the control amplifier which operates the reversing solenoid. This control amplifier may also be operated manually from a panel switch.

The switching amplifier is composed of transistor  $Q_1$ , resistor  $R_1$ , and capacitor  $C_1$ , as shown in the figure just below. This circuit has three time constants. The period of the recorded signal is  $T_{AC}$ . The time constant of  $R_1$  and  $C_1$  is  $T_1$ , corresponding to the delay in automatic reversal when the recording ends; the time constant of the col-

lector-to-emitter on resistance of transistor  $Q_1$  and capacitor  $C_1$  is  $T_1'$ . For proper operation of the recorder,  $T_1$  should be between 6 and 10 seconds. It is very much greater than both  $T_{AC}$  and  $T_1'$ .

When an a-c signal is impressed on the base of  $Q_1$ , the transistor conducts during positive half cycles, discharging  $C_1$ . On succeeding half cycles the transistor is cut off and  $C_1$  starts to charge. But since  $T_1$  is much greater than  $T_{AC}$ , the rise in terminal voltage across  $C_1$  is imperceptible. Also, since  $T_1'$  is much smaller than  $T_1$ , the capacitor is completely discharged on the following half cycle. Consequently the collector voltage of transistor  $Q_1$  remains at 0 volts as long as there is an a-c signal impressed upon its base.

At the instant the a-c signal ceases, voltage on the collector of  $Q_1$  rises to a predetermined value during the time interval  $T_1$ . Trimming resistor  $R_2$  adjusts the operating voltage level of the control amplifier for fine adjustment.

The control amplifier is composed of a bistable flip-flop made up of transistors  $Q_3$ ,  $Q_3'$ , and an output transistor  $Q_4$ .

When  $Q_3'$  is off,  $Q_4$  is also off and no current flows through the direction-changing solenoid. Under these conditions tape feeds in the forward direction. If the d-c control signal from the switching amplifier reaches a high enough level, the stage of the flip-flop changes so that  $Q_3'$  and  $Q_4$  are on. Current flows in the solenoid and the direction of the tape reverses.

The flip-flop differs from most others in that the time constant of  $C_3$ ,  $R_6$ , and  $R_7$  is long—20 seconds—and an additional capacitor,  $C_4$ , is in the circuit. The long time constant is there so that after the recorder reverses automatically, it won't almost immediately reverse again. This precaution is necessary because the time delay before reversal is 6

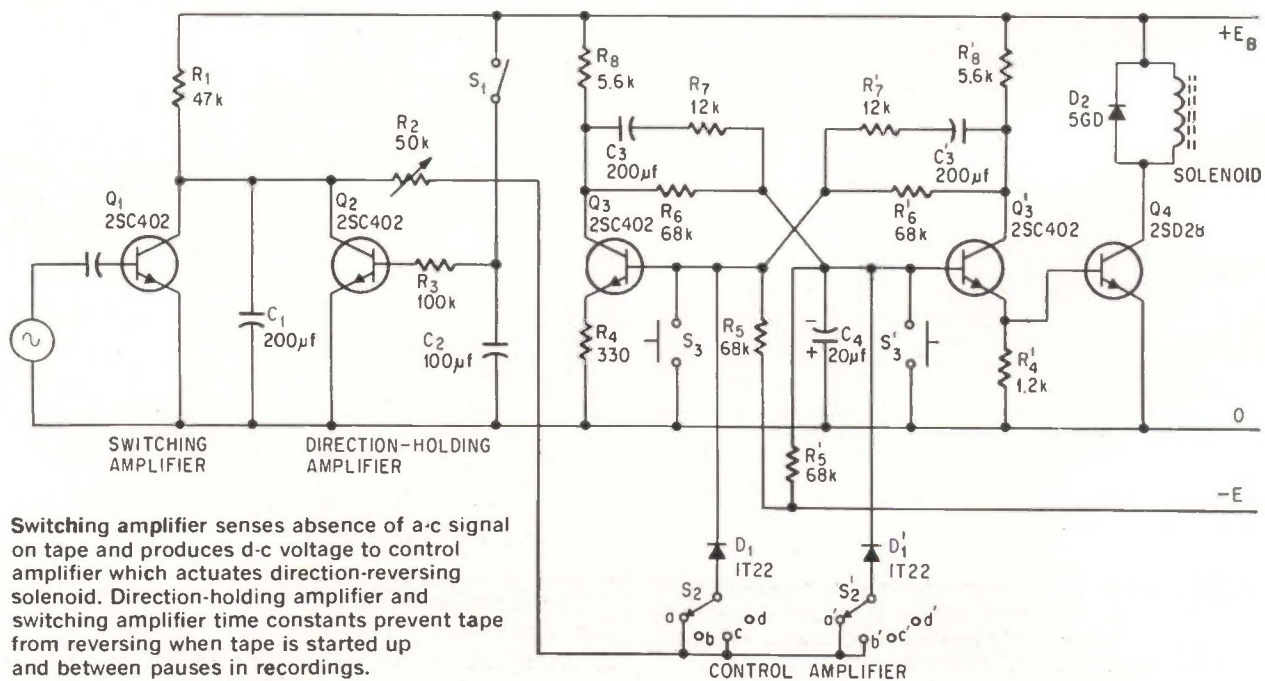

Switching amplifier senses absence of a-c signal on tape and produces d-c voltage to control amplifier which actuates direction-reversing solenoid. Direction-holding amplifier and switching amplifier time constants prevent tape from reversing when tape is started up and between pauses in recordings.

to 10 seconds. Thus, after the tape starts going in the other direction there would still be no signal.

Capacitor  $C_4$  is added so that when the recorder is first turned on transistor  $Q_3'$  will always be off and tape feed will be in the forward direction.

Transistor  $Q_2$ , with  $C_2$ ,  $R_3$  and switch  $S_1$ , make up the direction-holding circuit. Switch  $S_1$  is coupled to the stop mechanism of the tape deck and is closed when the tape is stopped. This connects the base of  $Q_2$  to the positive power supply through  $R_3$ . Transistor  $Q_2$  is turned fully on, and capacitor  $C_2$  is charged.

When the tape is started,  $S_1$  is opened. However,  $Q_2$  continues conducting during the interval  $T_2$ , the time constant of  $C_2$  and  $R_3$ . After  $Q_2$  turns off, the collector voltage of  $Q_1$  can rise to a predetermined value during the interval of the time constant determined by  $R_1$  and  $C_1$ .

During this period of about 20 seconds, the

direction-holding feature keeps the system from reversing the direction of tape travel even if there is no recorded signal.

Switches  $S_3$  and  $S_3'$  control direction manually.  $S_3'$  sets the recorder for forward travel,  $S_3$  for reverse. Whether the recorder is set for stop or play, these switches have the highest priority on operation. Switches  $S_2$  and  $S_2'$  set the mode of automatic reverse in this way:

- Position a-a'—forward, reverse, forward, reverse—repeated indefinitely.
- Position b-b'—single cycle of forward and reverse.
- Position c-c'—single cycle of reverse and forward.
- Position d-d'—automatic reverse off.

Regardless of the position of switches  $S_2$  and  $S_2'$  manual reversal of the recorder by switches  $S_3$  and  $S_3'$  is always possible.

## Recorder gain control eliminates level indicator

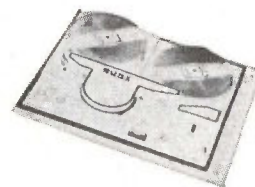

No manual adjustment is required to hold recording level within 10 decibels for input level changes as high as 30 db

An automatic gain control amplifier used in a tape recorder maintains the proper recording level automatically without any kind of manual adjustment. It holds the gain without introducing distortion or noise and without seriously degrading the dynamic range of the signal.

The circuit has been kept deliberately simple so that it can be built into even inexpensive recorders. In the Sonymatic TC-900, which lists in the United States for \$69.50, both the recording-level indicator and recording level control have been eliminated. Amplifiers with similar age circuits are used in other Sony recorders.

The circuit for a typical automatic recording amplifier, next page, can keep the recording level constant within 10 db for an input level change of 30 db. The amplifier output is shown as a function of the input in the figure at the right.

Transistors  $Q_1$  through  $Q_5$  in the circuit are amplifiers. Diode  $D_1$  is an age detector. Transistor  $Q_6$  is the age control transistor.

Collector current of  $Q_6$ , a Sony 2SB381, is a linear function of its collector voltage for small signal amplitudes. Impedance between collector and emitter,  $Z_{CE}$ , of the transistor is thus an approximately ohmic resistance that can be expressed by the equation:

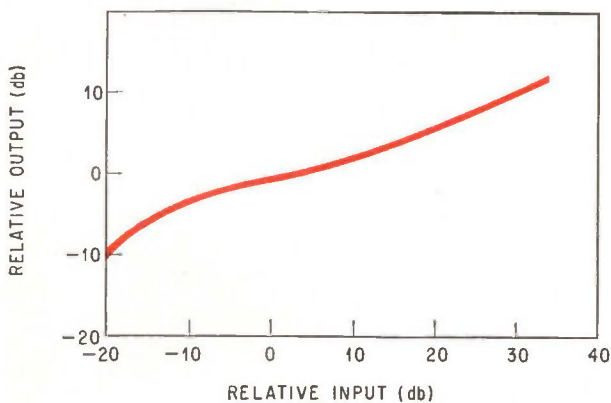

Output of automatic gain control amplifier is held to less than a 10-db change when input level changes as much as 30 db.

$$Z_{CE} = \Delta V_{CE} / \Delta I_C$$

The value of this impedance is controlled by varying  $I_b$ , the base current of the transistor.  $Z_{CE}$  is inversely proportional to  $I_b$ .

As the input signal to the recording amplifier increases, the output also increases. The gain-control signal, derived by rectifying a portion of the output signal with  $D_1$ , also increases. An increased



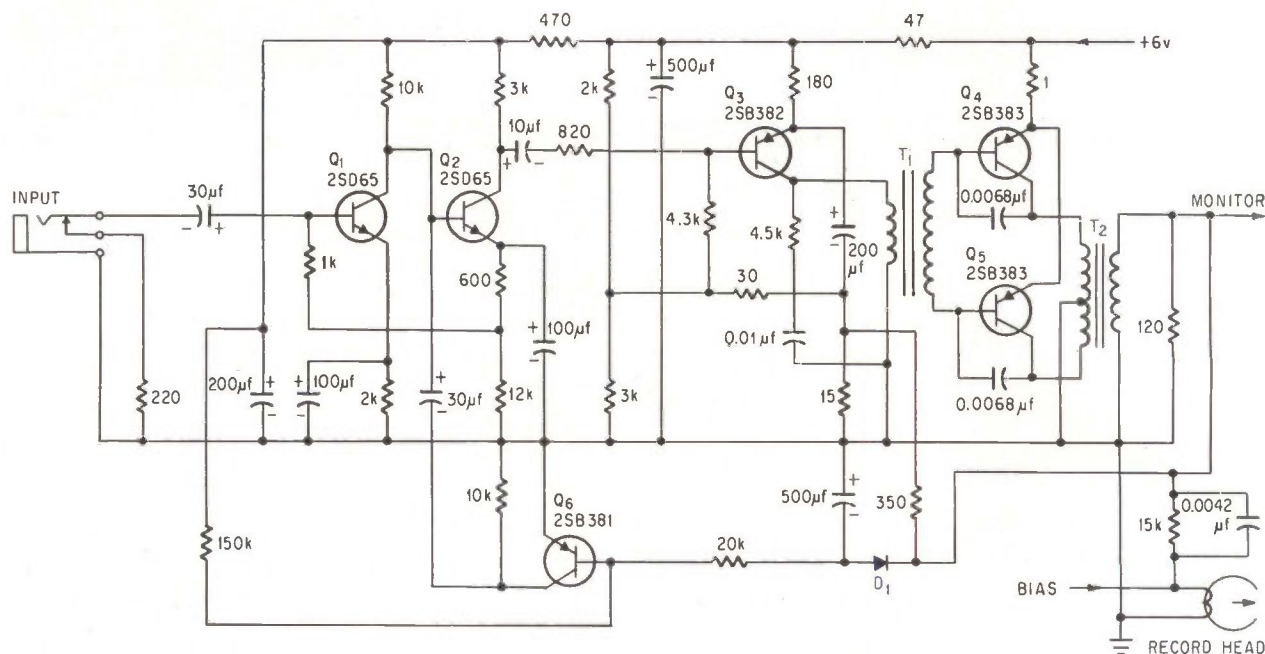

No manual gain adjustment of any kind is needed in Sonymatic TC-900 tape recorder which uses this automatic gain-controlled amplifier. Agc control transistor  $Q_6$  acts as variable shunt impedance at output of amplifier  $Q_1$  to modify gain of over-all recording amplifier.

control signal impressed on the base of  $Q_6$  decreases its collector impedance  $Z_{CE}$ . More of the signal current at the output of  $Q_1$  is shunted through  $Q_6$  and the gain of the recording amplifier goes down. The output is thus held to a value close to what it was before the increase in input signal.

### Attack and recovery

Attack time,  $T_A$ , and recovery time,  $T_R$ , both illustrated below, are important parameters in these amplifiers. Attack time is the lag between the instant the input signal level increases and the time

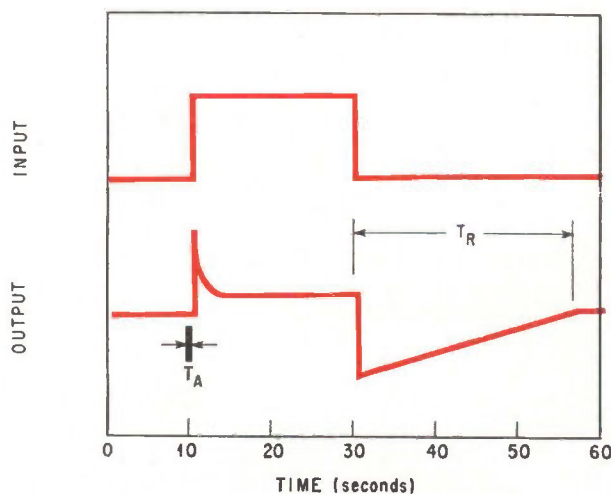

Pulse response characteristics of recording amplifier determine how it will react to input level changes. Attack time,  $T_A$ —the time it takes the amplifier to resume gain control after the input signal increases sharply—is about 0.2 second. Recovery time,  $T_R$ —response time to sharp negative input change—is about 30 seconds.

the agc circuit has completed gain control. Recovery time is the lag between the instant the input signal decreases and the time the agc circuit has completed adjustment of gain.

Attack time  $T_A$  is determined by the output resistance of the amplifier and the 500-microfarad electrolytic capacitor in the base of  $Q_6$ . A short attack time prevents distortion on initial syllables when the signal level changes abruptly. It must not be too fast, however, or short noises and electrical transients may cut the gain too much.  $T_A$ , which varies somewhat with the size of the level change, is about 0.2 second for an input level change of 20 db.

Recovery time  $T_R$ , determined by the RC components in the base of  $Q_6$ , is comparatively long, about 30 seconds for a level change of 20 db. When  $T_R$  is long, the agc circuit cannot follow a low-level signal coming immediately after a large one. Sudden gain changes do not occur and variations in amplitude of the input signal are reproduced with good fidelity. On the other hand, if  $T_R$  is too long, the agc circuit cannot follow long-period variations in input level.

The agc circuit has several other advantages:

- Its fast attack time and relatively slow recovery time almost completely eliminate audio-frequency signal components in the agc control signal, removing a source of distortion and noise.
- Comparatively long values of recovery time prevent a marked decrease in the dynamic range of the output signal.
- With the long recovery time, periodic microphone noise between phrases—when the input is zero—is blocked and the noise level of the amplifier itself does not increase.





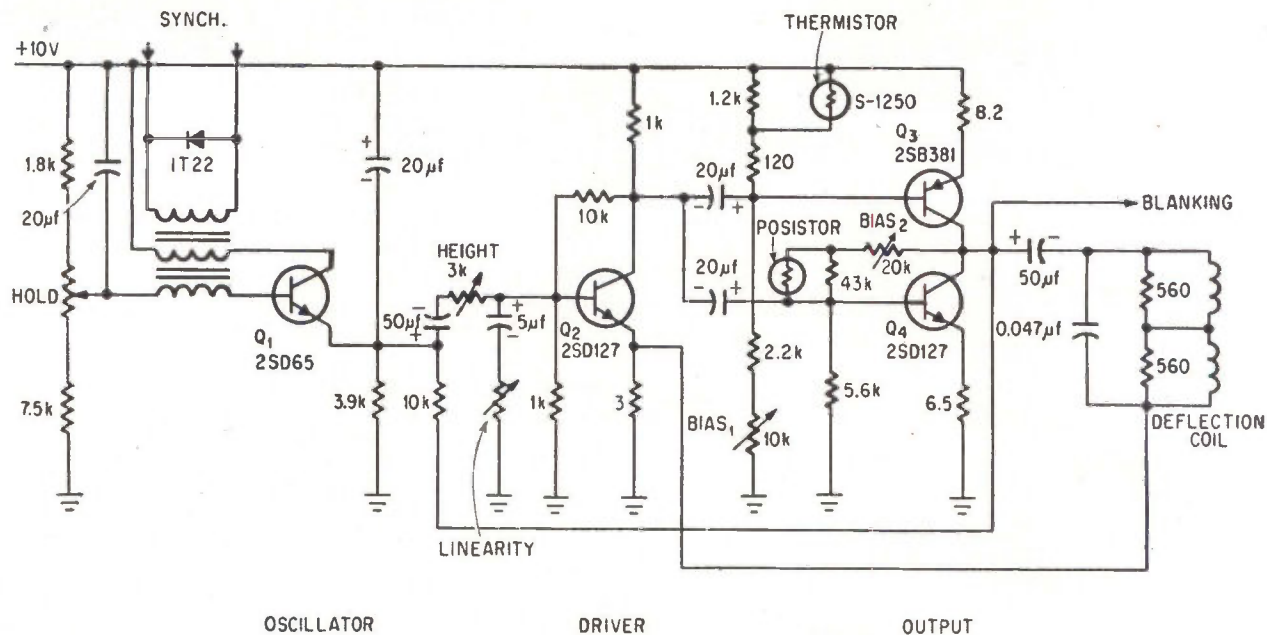

Reduced power drain desired in 4-inch 4-204UW portable, led to design of four-transistor, vertical-deflection circuit. Output stage has two transistors operated in class B, complementary-symmetry in single-ended push-pull connection. Peak-to-peak deflection current is 134 ma but d-c current is only 20 ma.

the base winding of  $T_1$ , absorbs the pulse generated when  $Q_1$  switches off.

As the value of the time constant of  $C_1$  and  $R_1$  is increased with respect to the vertical sweep period, the linearity of the generated sawtooth voltage improves. But, at the same time, the output voltage decreases so that the time constant cannot be made arbitrarily large. Values are usually between 30 and 100 milliseconds.

The sawtooth wave across  $C_1$  passes through a passive network, which includes vertical height adjustment,  $VR_2$ , and vertical linearity adjustment,  $VR_3$ , on its way to the base of the vertical output transistor,  $Q_2$ .

This transistor operates class A and requires accurate temperature compensation because its output swing is almost equal to the power supply voltage. Without compensation, the operating point of the transistor would vary, reducing its linear operating range. Compensation is provided by physically attaching a thermistor to the transistor as a heat sensor. The thermistor compensates both for changes in ambient and in transistor-junction temperature.

The linearity of the vertical-deflection current is increased by negative feedback of a signal derived from the deflection current at the base of transistor  $Q_2$ . Complete correction cannot be obtained with negative feedback without excessive reduction in gain. Additional correction is provided with a positive-feedback signal, derived from a secondary winding on the vertical-deflection choke,  $L_1$ , and fed to the sawtooth-generating circuit. The total correction provided by the two feedback circuits provides a satisfactory linear sawtooth.

If the positive feedback is increased excessively by making  $R_2$  too small, banding results. Banding

is the failure of the interlaced scanning lines of successive fields to fall midway between each other. Adjacent pairs of lines, one from each field, overlap to produce a loss of detail in the overlapped region.

The voltage-dependent resistor connected in parallel with the deflection coil protects the vertical-output transistor by limiting the vertical-retrace pulse to 50 volts. If the retrace pulse were clamped at a lower voltage, the retrace interval would be excessive. Fifty volts is about the lower limit.

#### Four-transistor circuit

The output stage of the four-transistor vertical deflection circuit in the 4-inch set uses a pnp and an npn transistor in a class-B, single-ended push-pull output circuit, instead of class A as in the 7-inch set. This circuit was designed expressly for a small set powered by a battery. Although an extra transistor is needed, power drain is held to less than half that of the class A circuit, and the heavy coupling choke is eliminated.

Output transistors  $Q_3$  and  $Q_4$  are biased for class B operation so that collector current is less than 2 milliamperes in the absence of an input signal. When a sawtooth from the driver stage is impressed on the output stage,  $Q_3$  is driven on during the negative portion of the input cycle. Transistor  $Q_4$  is off. During the positive portion of the input cycle transistor  $Q_4$  operates and transistor  $Q_3$  is off. The sum of the two currents is the sawtooth current in the deflection coil.

The circuit must be adjusted so that the two sawtooths join smoothly if the linearity of the sweep is to be preserved. During production the two vertical bias potentiometers are adjusted alternately in a manner similar to the tracking ad-

justment of a radio. This must be done several times because the two adjustments interact. Both a thermistor and a posistor (a thermistor with a positive temperature coefficient) are used to maintain the adjustment over a wide range of temperatures.

Reverse pulse voltage generated during the retrace interval of the deflection current appears as a forward bias across the collector-base diode of  $Q_3$ . The pulse is thus clipped at the 10-volt power supply level.

The value of the coupling capacitor to the deflection coil is empirically chosen to adjust the dissipation of the two transistors in proportion to their power ratings. This is necessary because the peak currents are not equal and because the two complementary transistors are not equal in power dissipating abilities: the pnp transistor can dissipate more power.

With a small enough capacitor, the ratio of voltage across the two transistors can be varied and the ratio of dissipations can be adjusted. Average current to the output stage of the vertical deflection amplifier is equal to the average collector current of  $Q_3$ . The waveform is approximately triangular, with the on interval about 8 milliseconds and its average value, including a slight additional bias of less than 2 ma, ranges from 20 to 22 ma.

Although the 4-inch set requires a peak-to-peak deflection current of 134 ma, a d-c current of only about 20 ma is sufficient with this circuit. Power drain of the output stage is about 20 ma at 10 volts, or 0.2 watt. If a standard class-A circuit were used instead of this single-ended push-pull circuit an

average current of about 70 to 75 ma would be necessary.

### Yoke circuit variations

Sony has developed variations in its vertical deflection amplifiers to permit, where possible, use of fewer components. Normally the deflection yoke is coupled to the output transistor by connecting one end of the yoke to ground and coupling the other end through a capacitor to the collector. Shunt feed prevents variations in the average current from affecting performance.

The circuit shown on page 167 evolved from this standard method. It has the advantage of eliminating the coupling capacitor.

In the three-transistor circuit Sony uses, for example, in its 9-inch set, one end of the deflection yoke connects directly to the collector of the vertical output transistor. The other end connects to the emitter of the vertical driver. Resistive voltage drops in the collector-emitter circuit balance the voltage drop through the shunt-feed choke. No coupling capacitor is needed. However, a 500-microfarad capacitor serves as both ground return for the yoke and as a decoupling capacitor between the output and preceding stages.

A variation of this circuit is used in the two-transistor configuration. The voltage drop across the 120-ohm resistor balances the voltage drop in the shunt-feed choke. Again, the 500-microfarad capacitor serves as both ground return and decoupling capacitor and the 2-ohm resistor in series with the capacitor provides a slight amount of negative feedback.

## Sweep eliminates driver stage

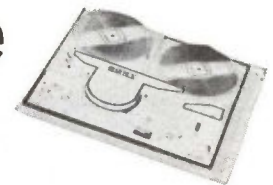

Two-transistor horizontal deflection circuit in 7-inch portable television set does the job of three transistors

For its low-priced portable television sets, Sony has redesigned the horizontal deflection circuitry, as shown on page 170, to use only two transistors, eliminating the driver stage. This economical circuit is used in the 7-inch 700U portable.

A three-transistor circuit normally is used in the horizontal deflection circuitry of a television set to sweep the electron beam across the tube's face. A blocking oscillator generates the initial sweep signal. It then goes to a driver stage where it is amplified and applied to the horizontal output stage. There it is boosted to the power level required for driving the horizontal deflection coil.

To restore the gain lost by eliminating the driver

stage, Sony engineers added a tertiary winding to the flyback transformer which feeds a positive signal to the base of transistor  $Q_2$  through capacitor  $C_1$ . In addition, a small forward bias is applied to the base of transistor  $Q_2$  through resistor  $R_1$ . Because positive feedback is applied,  $Q_2$  must have short hole-storage time to avoid introducing undesirable delay into the feedback loop.

The flyback transformer is not designed to match the impedance of the yoke as it usually does in the tube sets. During the portion of the sweep when  $Q_2$  is conducting, the flyback transformer is essentially a choke for parallel feed of collector current to the transistor. It acts as a transformer



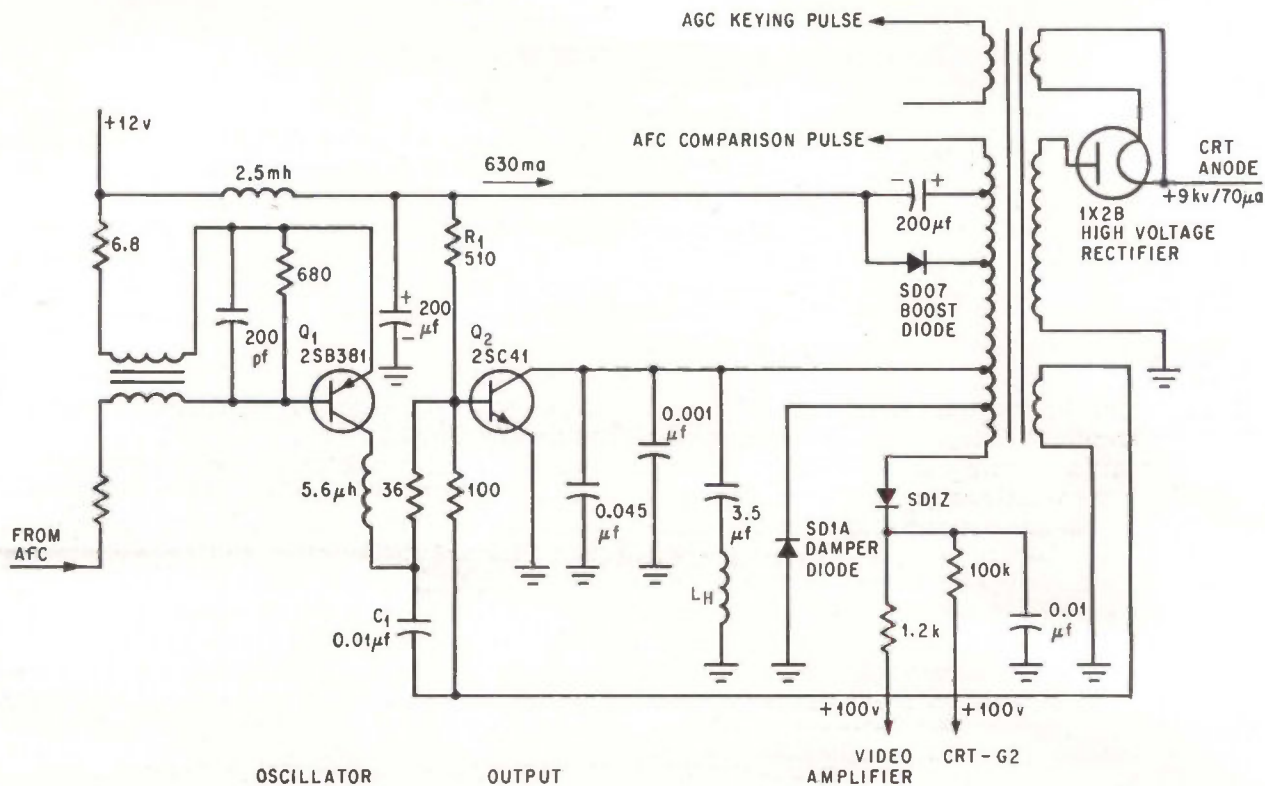

Driver stage is eliminated in two-transistor horizontal deflection circuit in Sony's 7-inch 700U tv set. A tertiary winding on flyback transformer provides a positive feedback signal to base of the output transistor  $Q_2$ , making up for the lost gain.

during flyback and while the damper diode, SD1A, handles sweep power. This use of the flyback transformer minimizes losses.

### Boost circuit

Added to the primary winding of the flyback transformer is a boost diode, shown in the schematic, which helps to increase the supply voltage to the horizontal output circuit from 12 to 18 volts. This diode rectifies the a-c derived from the tap on the flyback transformer, charging the 200 microfarad capacitor and increasing the apparent supply voltage.

Boost is important in battery-operated sets—normally limited to 12-volt supplies—because the horizontal output transistor is running close to its maximum current rating but usually not at its maximum collector voltage rating.

For a given power-switching capacity, the transistor price decreases with increasing voltage rating up to about 300 volts with present Sony production techniques. For example, Sony uses 300-volt transistors in line-operated sets which have 24-volt power supplies, boosted to 36 volts. Peak voltage on the output transistor, operating from a 12-volt battery, boosted to 18 volts, is about 110 volts.

Another reason for operating at a boosted voltage is that as the supply voltage goes up, the collector-to-emitter voltage drop—about 1 volt in the circuit here—becomes a smaller fraction of the supply voltage and efficiency of the circuit goes up.

Peak horizontal deflection energy,  $P_H$ , in joules,

required by the CT 480 picture tube in the 7-inch tv set is approximately 1.8—with units of millihenries-peak-to-peak amperes squared—at an anode potential of 9 kilovolts.  $L_H$  is the deflection yoke inductance in millihenries and  $I_{pp}$  is the peak-to-peak deflection current in amperes. This power expression is an empirical one, obtained by driving a deflection coil and measuring the energy needed for the slight overscan generally built into tv receivers. Actual inductance and current can be calculated from the equations:

$$P_H = 1/2 L_H I_{pp}^2$$

$$I_{pp} = (T_H - T_R) \frac{E_o}{L_H}$$

where:  $L_H$  = yoke inductance in henries

$I_{pp}$  = peak-to-peak deflection current in amperes

$T_H$  = time of one horizontal line in seconds

$T_R$  = horizontal retrace interval in seconds

$E_o$  = power supply voltage (including boost)

In the 525-line television system used in the United States, the horizontal sweep period  $T_H$  is 63.5 microseconds, the reciprocal of the 15,750-hertz horizontal line frequency. The horizontal blanking interval is about 10 microseconds and it is usual to keep the retrace interval,  $T_R$ , less than this.

However, in transistor television the horizontal output circuit efficiency can be increased by lengthening the retrace interval within limits that do not degrade the picture. Efficiency is increased because, with the longer retrace time, the peak-to-peak sweep current required is decreased.

Thus, with a boosted power supply voltage,  $E_0$ , of 18 volts and a 12-microsecond retrace interval ( $T_{II}$ ), the calculated deflection coil inductance  $L_{II}$  is 240 microhenries and deflection current  $I_{pp}$  is 3.8 amperes. In the actual circuit, inclusion of the flyback transformer as well as circuit resistive loss requires that the values be adjusted to  $L_{II} = 220$  microhenries and  $I_{pp} = 4$  amps.

Collector peak inverse voltage is calculated from the equation:

$$E_p = \frac{\pi}{2} \left( \frac{T_{II} - T_R}{T_R} \right)$$

Value of  $E_p$ , calculated from the equation is 122 v peak-to-peak; measured voltage is 110 v.

Switching power requirements in the horizontal output circuit is consequently  $I_{pp} \times E_p = 440$  VA peak-to-peak. Approximately 60% to 70% of this power is handled by the output transistor, with a damper diode handling the remainder.

The flyback transformer also delivers:

- Anode high-voltage power supply for the 7-inch picture tube. Anode voltage is +9 kv, current 80  $\mu$ amps (0.72 w).

- Heater power supply for the 1X2B high-voltage rectifier. Heater voltage is 1.25 v, heater current is 200 ma (0.25 w).

- Grid-two power supply for the picture tube and collector power for the video-output amplifier. Supply voltage is +100 v, total current drain is 6 ma (0.6 w).

- Keying pulse for agc (-21 v, peak-to-peak).

- Positive feedback pulse to the horizontal output circuit (-71 v, peak-to-peak).

- Comparison pulse for horizontal afc circuit (-68 v, peak-to-peak).

These power requirements are all developed by the horizontal output transistor so that the power consumption of the horizontal output stage is approximately 9.5 watts.

## Two-stage gain control for portable tv set



Two transistors handle 50-db range of input signals without distortion or overload

**Sony has devised** a two-transistor automatic gain control for its portable television receivers with a control range exceeding 50 decibels, far greater than obtained in a single stage of conventional gain-control circuitry. Large input signals are handled without distortion or overload.

One of the transistors,  $Q_2$ , shown on page 172, amplifies while the other,  $Q_1$ , forms a variable impedance in the emitter circuit of  $Q_2$  and also controls its bias.

The control signal for  $Q_1$  is derived from the age keyer circuit, which is indicated in the schematic. It is a positive-going signal fed to the base of  $Q_1$  through a network consisting of resistor  $R_1$  and bypass-capacitor  $C_1$ .

The equivalent parallel-resistance component,  $R_p$ , of the collector-to-emitter impedance of  $Q_1$  is very sensitive to changes in collector to emitter voltage  $V_{CE1}$ . In the graph of  $R_p$  as a function of  $V_{CE1}$ , with  $I_{E1}$  as a parameter, shown on page 172, if  $I_{E1}$  is held constant and  $V_{CE}$  is reduced,  $R_p$  falls to a very low value.

At the age start point,  $R_p$  is less than 70 ohms and  $Q_1$  is operating in the saturation region. Collector voltage  $V_{CE1}$  is -0.15 volts and base voltage  $V_{BE1}$  is -0.3 volts. Since  $V_{CE1} = V_{CB1} + V_{BE1}$ ,

collector-to-base  $V_{CB1}$  is +0.15 volts. Forward collector-to-base voltage brings the very low value of  $R_p$ .

### Combined transconductance

Resistance component  $R_p$  increases with increasing negative voltage bias on the collector-to-base junction and decreasing emitter current. In operation the collector voltage becomes more negative and the emitter current decreases as the bias point of  $Q_1$  shifts from the age start point, A, to the age stop point, D. Collector impedance  $R_p$  increases from less than 70 ohms at A to 35,000 ohms at D. Transistors  $Q_1$  and  $Q_2$  can be viewed as a single transistor with a combined transconductance,  $|G_m|$ , given by:

$$|G_m| = \frac{\alpha_o}{|Z_e|} \frac{1}{\sqrt{1 + \left( \frac{r_{bb'}}{Z_e} \right)^2 \left( \frac{f}{f\alpha_h} \right)^2}}$$

where:  $r_{bb'}$  = base-spreading resistance (100 ohms for the 2SA70)

$|Z_e|$  = impedance in emitter circuit of  $Q_2$ .

It depends almost completely on  $V_{CE}$  and  $I_E$  of  $Q_1$ .

$f$  = frequency of measurement, usually



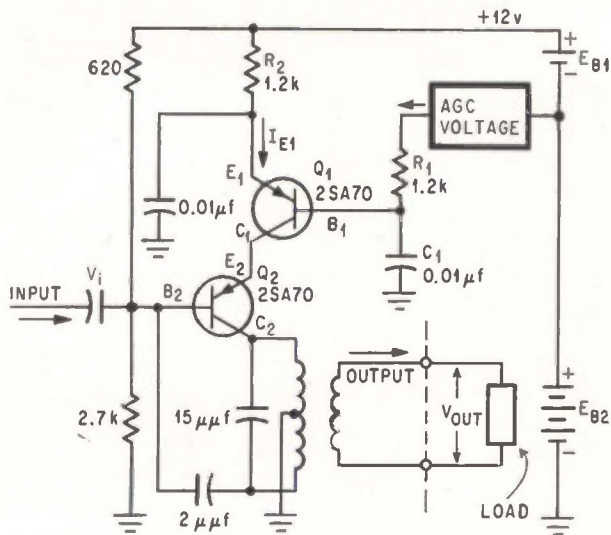

**Two-transistor gain controller in portable television receivers applies positive-going agc voltage to base of  $Q_1$ , which acts a variable emitter-circuit impedance for 26.75-Mhz i-f amplifier  $Q_2$ .**

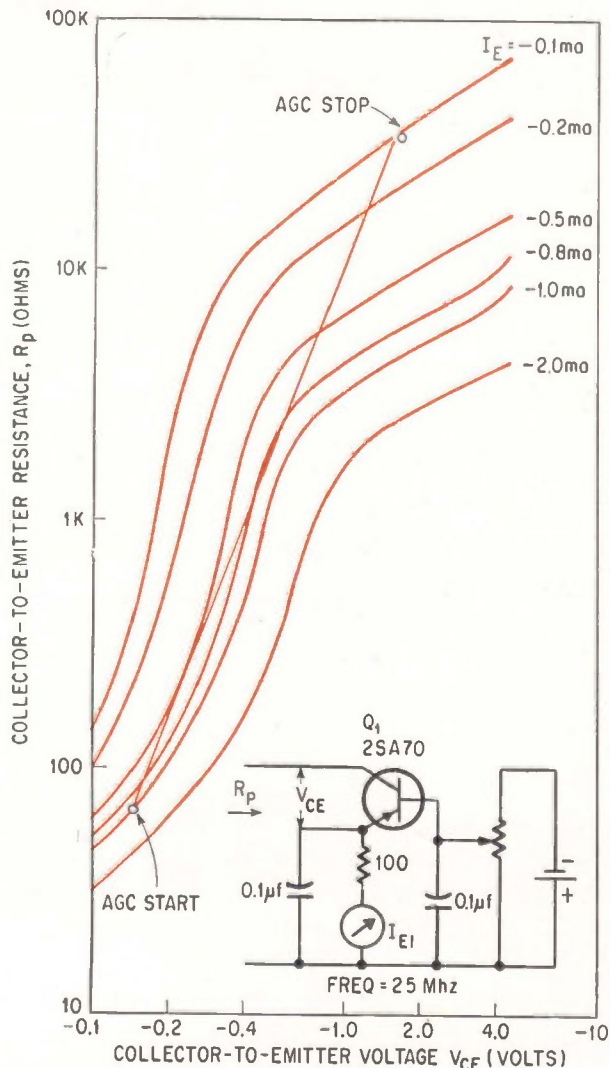

**Collector-to-emitter resistance,  $R_p$ , plotted with the help of the circuit in the lower right, is very sensitive to changes in collector-to-emitter voltage,  $V_{CE}$ . Resistance varies from about 70 ohms to 35,000 ohms.**

25 Mhz for i-f amplifiers in Japan.  
 $\alpha_{cb}$  = alpha cutoff frequency for common base connection, typically 100 Mhz for the 2SA70.

$\alpha_0$  = value of  $\alpha$  at low frequency. It can be taken as unity.

When  $I_{E1}$  is  $-1$  ma and  $|Z_e|$  is 100 ohms, the value of  $|G_m|$  is 10 millimhos. This is the approximate transconductance at point A. When  $I_{E1}$  is  $-0.1$  ma and  $|Z_e|$  is 35 kilohms then the value of transconductance has decreased to 28.6 micromhos. This is the approximate value at point D. This large decrease in transconductance gives a correspondingly large decrease in gain. The attenuation ratio can be calculated from the formula for gain:

$$A_v = (V_o/V_i) \approx (|G_m| \times R_L)$$

As the operating point of the two-transistor circuit moves from agc start to agc stop, gain attenuation is about 50 decibels.

Distortion is reduced and overload prevented by having the bias on the amplifier vary with the level of the input signal, that is, the bias follows along the load line of emitter resistor  $R_2$ .

The peak value of the input voltage,  $V_i$ , is:

$$e_p = \sqrt{2} (1 + m) \times V_i \text{ (in volts)}$$

where  $m$  = the degree of modulation (in per cent)

$V_i$  = root-mean-square input voltage.

If the degree of modulation is taken as 0.4 (40%), and  $V_i$  as 600 millivolts, then  $e_p$  is 1.2 volts by substitution in the equation.

The resistance of  $R_2$  is calculated from:

$$R_2 = e_p / \Delta I_{E1}$$

where  $\Delta I_{E1}$  is the difference between  $I_{E1}$  at the agc start point, A, and agc stop point, D.

Emitter current  $I_{E1}$  for point A is chosen as 1 ma, and for point D it is 0.1 ma. Substitution of  $e_p = 1.2$  volts gives a calculated  $R_2$  of 1,333 ohms. Since current gain  $\alpha_0$  of both transistors is at least 0.99,  $I_{E1}$  and  $I_{C2}$  are approximately equal. The collector current of  $Q_2$  at point A is  $I_{C2} = \alpha_0 I_{E1} \approx 0.98$  ma. At point D it is 0.098 ma. Bias,  $V_{BEA}$ , measured from the emitter of  $Q_1$  to the base of  $Q_2$  on the composite transistor consisting of  $Q_1$  and  $Q_2$  is 0.38 volts when there is no input signal. This bias corresponds to the condition existing at point A on the curves of  $R_p$  versus  $V_{CE}$ .

At point D on these curves, where the collector current of  $Q_2$  is about equal to the emitter current of  $Q_1$  at 0.1 milliamperes, the bias  $V_{BED}$  has increased to 1.58 volts.

Therefore, even if an input signal  $V_i$  of 600 mv rms is applied to  $Q_2$  at point D, the transistor has a high input impedance because of the expanded linearization and little distortion of the controlled signal occurs. In production sets,  $R_2$  is 1,200 ohms, the nearest standard value to the 1,333 ohms calculated, a value large enough to give the linearization desired.

Reprints of this report are available. Use the reader service card at the back of this issue.

© copyright 1966, Electronics © A McGraw-Hill Publication



# AMELCO's new 807BE OP AMP has a total input offset voltage of only 3.0 mV! (-55°C to +125°C)



The 807 is the newest addition to Amelco's successful line of monolithic operational amplifiers—unsurpassed in drift performance and now available from stock at only \$45.00\* in TO-5s or flat packs.

If your application demands **GUARANTEED** drift performance, we invite you to compare the 807 specs with any monolithic available. You won't find anything to compare with our spec limits of 50 nA INPUT OFFSET CURRENT, 5  $\mu\text{V}/^\circ\text{C}$  OFFSET VOLTAGE DRIFT, OR 500 nA INPUT BIAS CURRENT! See for yourself:

PARAMETER	CIRCUIT TYPE			UNITS
	807BE	709A	1533	
Input Offset				
Voltage (25°C)	2.5	5.0	5.0	mV
Voltage (-55°C to +125°C)	3.0	6.0	6.0	mV
Voltage Drift (untrimmed)	10	note	note	$\mu\text{V}/^\circ\text{C}$
Voltage Drift (trimmed)	5.0	note	note	$\mu\text{V}/^\circ\text{C}$
Current	50	200	150	nA

Note: Both 709A and 1533 list no guaranteed value for this parameter. Worst case calculations of  $\frac{11\text{mV}}{180^\circ\text{C}}$  show that devices with Drift of 60  $\mu\text{V}/^\circ\text{C}$  would be in spec.

\$45.00 isn't much to pay for the world's best monolithic op amp. You'll pay three to four times that much for an equivalent module-type op amp—hardly what we'd call a bargain! Your best buy is really our 807 data sheet. It's free.

\*QUANTITIES 100 AND UP

## AMELCO SEMICONDUCTOR

DIVISION OF TELEDYNE, INC. • 1300 TERRA BELLA AVENUE • MOUNTAIN VIEW, CALIFORNIA • Mail Address: P. O. Box 1030, Mountain View, California • Phone: (415) 968-9241 / TWX: (415) 969-9112 / Telex: 34-8416 • REGIONAL OFFICES: Southwest—Suite 213, 8621 Bellanca Ave., Los Angeles, California 90045, (213) 678-3146 • Northwest—1300 Terra Bella Ave., Mountain View, California, (415) 968-9241 • East—P. O. Box 2091, Paterson, New Jersey 07509, (201) 696-4747; 60 Broad Hollow Rd., Melville L. I. New York, (516) 692-4070; P. O. Box 366, Kimberton, Pennsylvania, (215) 885-1755 • Northeast—805 High Street, Westwood, Massachusetts, (617) 326-6600 • Southeast—711 Magnolia Avenue, Orlando, Florida, (305) 423-5833 • Midwest—650 West Algonquin Road, Des Plaines, Illinois, (312) 439-3250; 3020 Woodlark Lane, St. Paul, Minnesota, (612) 646-1161. • Canada—Deskin Sales, Montreal, Quebec, (514) 384-1420.



# Low fuel warning



another first for  
Ford Motor Company  
—the key is KEYSTONE



A red light glows suddenly on your Continental's instrument panel. It warns you "Low fuel," and stays bright to keep reminding. Back in the fuel tank a tiny Keystone thermistor had closed a warning circuit the moment your fuel level dropped past a predetermined limit. □ This liquid level sensor is another industry first for Ford\*. It is yet another application for quality Keystone thermistors, made for the sensitive detection and measurement of temperature variations from oven heat to the cold of outer space. Write for literature. □ KEYSTONE CARBON COMPANY, St. Marys, Pennsylvania 15857

\*OPTIONAL ON OTHER FORD-BUILT CARS

**Keystone**  
leads

in versatile Thermistor design

# NAND logic is old hat.

We've invented SDS Natural Logic for our T Series integrated-circuit modules. It's a comprehensive set of gating structures that permit the terms of any Boolean logic equation to be converted directly into hardware.

Now you won't have to manipulate equations to make them fit the restrictions of NAND or NOR gates. With Natural Logic the hardware fits the equations without unnecessary inversions.

So you won't need nearly as many circuits to build your logic system. Your system will cost you a lot less. It will be faster and more reliable. It will be easier to mechanize. And it will take up less room.

Naturally.

**Scientific Data Systems**

1649 Seventeenth Street, Santa Monica, California  
Offices in principal cities throughout the world



With NAND logic you are stuck with only this, no matter what the equations call for.

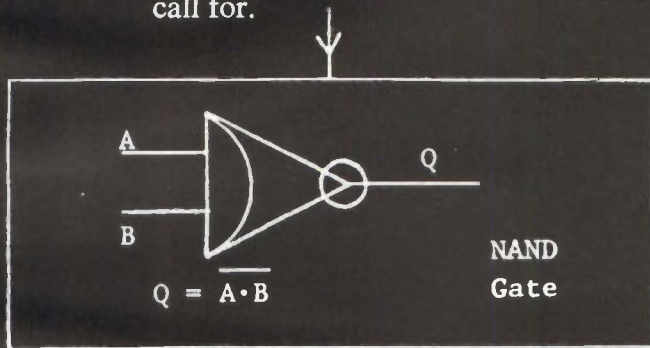

With T-Series NATURAL logic you have all these to choose from at a lower price per circuit.

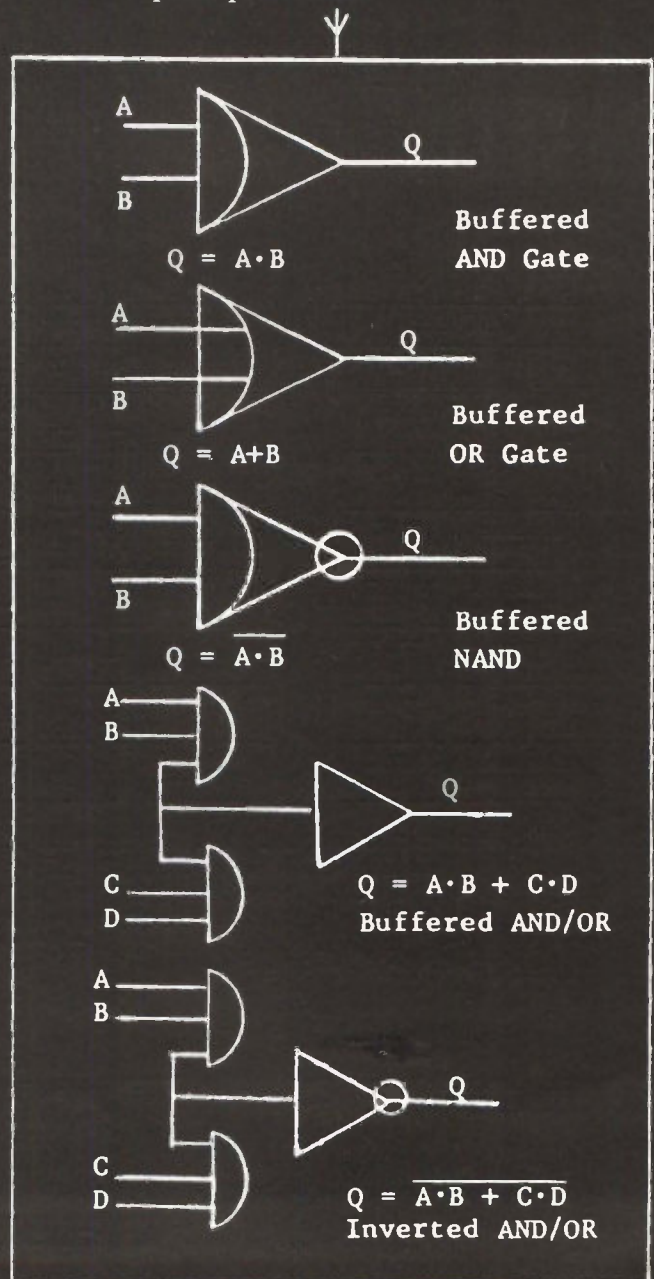



# Philbrick Operational Amplifiers for comparison shoppers

Compare their prices†

Philbrick			Prices of Comparable Models				
Feature	Model	Price	A	B	C	D	E
Parametric	SP2AU	\$138.	\$195.	—	—	—	—
FET	PP25AU	\$ 79.	\$ 85.	\$ 95.	\$75.	\$85.	\$95.
High performance, high impedance	PP35AU	\$ 54.	\$ 35.	\$ 65.	\$85.	\$42.	—
High performance, ultra-high speed	PP45AU	\$ 89.	—	\$125.	—	\$90.	—
General purpose	PP55AU	\$ 15.	\$ 19.	—	\$18.	\$17.	\$19.
General purpose, high speed	PP55AHU	\$ 19.	\$ 58.	\$ 95.	\$31.	\$35.	—
General purpose, high performance	PP85AU	\$ 25.	\$ 26.	\$ 35.	\$29.	\$24.	\$46.

These Philbrick Operational Amplifiers, which meet more than 70% of all requirements, are available in quantity for immediate delivery. Conservatively-rated, they never fail to deliver the promised performance and reliability. Compare Operational Amplifiers and we know you'll concur . . . Philbrick is usually the lowest priced, always the best value.

†U.S. unit prices from published literature—9/66

For more information, demonstration units, or engineering assistance, call your nearest Philbrick engineering representative or Philbrick Researches, Inc., 22 N Allied Drive, Route 128, Dedham, Massachusetts 02026. Phone (617) 329-1600.

**ENGINEERING REPRESENTATIVES** — Ala.: Huntsville (205) 536-8393; Ariz.: Phoenix (602) 265-3629; Cal.: Los Angeles (213) 937-0780, Mountain View (415) 969-9020, San Diego (714) 222-1121; Colo.: Denver (303) 733-3701; Conn.: West Hartford (203) 233-5503, Fairfield County (203) 661-5140; Fla.: Ft. Lauderdale (305) 564-8000, Ft. Walton Beach (904) 243-6424, Orlando (305) 425-5505; Ga.: Tucker (404) 939-1674; Ill.: Chicago (312) 676-1100, (312) 676-1101; Ind.: Indianapolis (317) 356-4249; Md.: Baltimore (301) 727-1999; Mass.: Wakefield (617) 245-5100; Mich.: Detroit (313) 838-7324; Minn.: Minneapolis (612) 545-4481; Mo.: Florissant (314) 831-0015; N.M.: Albuquerque (505) 268-3941; N.Y.: Buffalo (716) 835-6186, DeWitt (315) 446-0220, Valley Stream (516) 561-7791; N.C.: Winston-Salem (919) 725-5384, (919) 725-5385; Ohio: Dayton (513) 298-9964, Westlake (216) 871-8000; Okla.: Tulsa (918) 627-6199; Pa.: Conshohocken (215) 277-0559, Pittsburgh (412) 371-1231; Tex.: Dallas (214) 526-8316, Houston (713) 781-1441; Utah: Salt Lake City (801) 466-4924; Va.: Alexandria (703) 836-1800, Newport News (703) 245-8272; Wash.: Seattle (206) 723-3320.

**EXPORT:** N.Y.: New York (212) 246-2133. Cable TRIL 224326.  
**CANADA:** Quebec: Montreal (514) 482-9750, Ontario: Toronto (416) 789-4325.

**ELECTRONIC ANALOG COMPUTING EQUIPMENT for MODELLING, MEASURING, MANIPULATING and MUCH ELSE**



**PHILBRICK**

# When even the Best Carbon or Wirewound Pots won't do...

## CTS Cermet Pots Offer a Solution

### 6 WEEKS DELIVERY...NEW LOWER PRICES...

due to CTS automated production techniques and the industry's biggest output.

Consider these CTS Cermet Pot characteristics:

1. 20  $\Omega$  to 5 megohms resistance range.
2. Greater power/size ratio. (See captions.)
3. The environmental stability & higher wattage rating of wirewound.
4. The wide resistance range & infinite resolution of carbon.
5. Extremely high temperature capabilities.
6. Stability under extreme humidity.
7. No catastrophic failures.
8. Low noise. Long life.
9. Exceed MIL-R-23285 (Navy) metal film; far exceed MIL-R-94B.

Specify from the broadest line of thick film controls available.

New low prices begin at \$1.35 each in large quantities.



**Series 400**  
1-3/64" dia.  
3 watts @85°C



**Series 500**  
3/4" dia.  
1-1/2 watts @85°C



**Series 600**  
1/2" dia.  
3/4 watt @85°C



**Series 550**  
3/4" dia.  
2 watts @70°C

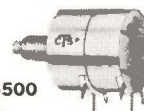

**Series 2-500**  
3/4" dia.  
1-1/2 watts @85°C  
Tandem Series 500



**Series 385**  
11/32" dia.  
1/8 watt @125°C  
For P.C. applications



**Series 660**  
3/8" dia.  
1/4 watt @125°C



**Series 600PC**  
1/2" dia.  
3/4 watt @85°C  
For P.C. applications



**Series 630**  
1/2" dia.  
1/2 watt @85°C

Request Cermet Catalog.



**CTS OF BERNE, INC.**  
BERNE, INDIANA

Subsidiary of CTS Corporation, Elkhart, Indiana



# MIL-T-713 calls for 22% to 32% wax coating on LACING TAPE.

• But what really is the right amount  
for trouble-free, tight-knot lacing?

• **GUDEBROD KNOWS.** They make yard after  
yard after yard exactly right!

• **GUDEBROD TAPE** cuts harness costs!

• Send for a sample.



Give the sample any comparative test  
you want. Let your harness crew try it.  
Send it to your lab. It's exactly what  
you'll get when you order Gudebrod  
tape—everytime.

You are often required to lace with tape that meets MIL-T Specs—  
with a specified range of wax content. But that's no assurance that  
you are using a tape that ties tight, holds tight, that probably won't  
be rejected—unless, of course, you have Gudebrod Gudelace. Like  
all Gudebrod Lacing Tapes it's manufactured under strict quality  
control including the wax coating. Every yard of Gudelace is im-  
pregnated exactly the same, exactly right. You can count on that—and on  
speedier, easier, better harnessing. That's where you save real  
money. Want to know more? Get in touch with Gudebrod.

#### GUDEBROD CABLE-LACER

The first hand tool engineered for wire harnessing.  
Handle holds bobbins, feeds tape as needed,  
grips tape for knotting. Speeds, eases  
harnessing. Pays for  
itself in time saving.



Area Code 215, WA 2-1122



**GUDEBROD BROS. SILK CO., INC.**

FOUNDED IN 1870

*Electronics Division*

12 SOUTH 12th STREET, PHILADELPHIA, PENNSYLVANIA 19107

# American Bosch

## uses Allen-Bradley Oriented Ceramic Permanent Magnets...

because of their uniformity in staying within specifications,  
and delivery schedules—though tight—are kept!

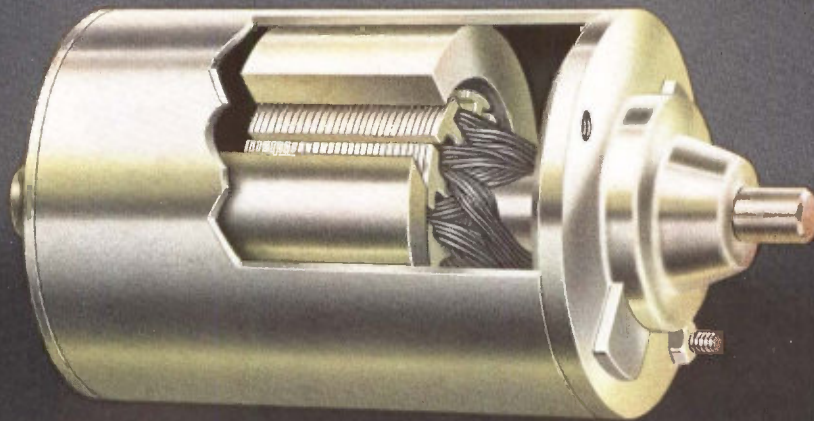

American Bosch permanent magnet motors are used for...

power windows

electric windshield wipers

power seats

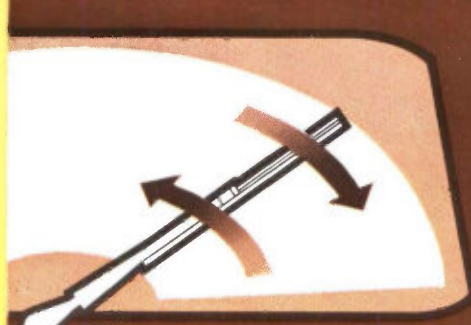
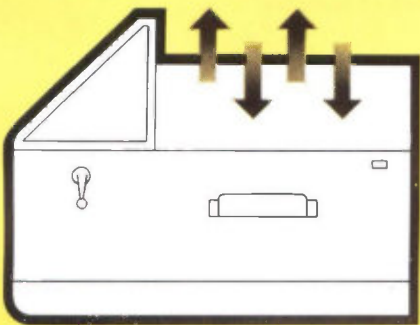

■ Allen-Bradley's quality control procedures assure the continuously uniform properties—both electrical and physical—that are essential to profitable large volume motor production. The most modern manufacturing facilities in the hands of technically experienced craftsmen produce the highest quality, radially oriented ceramic permanent magnet segments that are presently available.

Allen-Bradley ceramic permanent magnets can be furnished for a wide range of motor sizes—from  $\frac{3}{4}$ " diameter up to a 10 hp motor rating. They are available in a variety of types—having different properties—to satisfy your specific requirements. A-B application engineers will be happy to consult with you in developing your dc motors for maximum motor performance. Allen-Bradley Co., 1316 S. Second St., Milwaukee, Wis. 53204. In Canada: Allen-Bradley Canada Limited. Export Office: 630 Third Ave., N. Y., N. Y., U.S.A. 10017.

Properties of typical Allen-Bradley ceramic permanent magnets

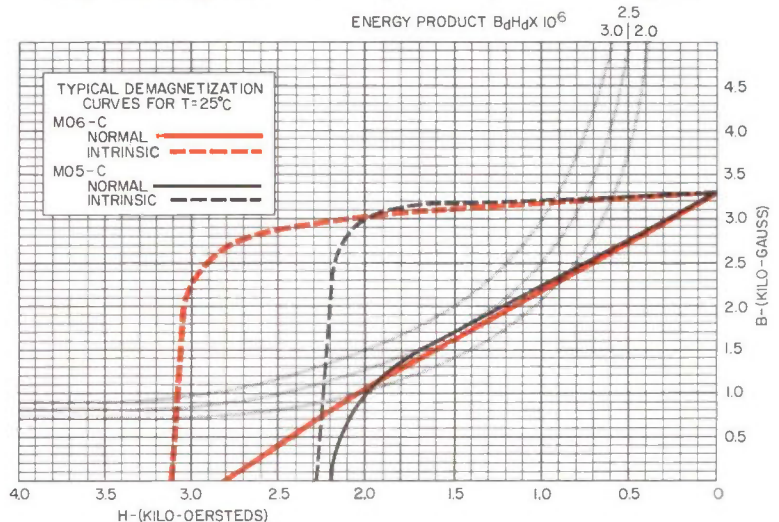

# ALLEN-BRADLEY

QUALITY MOTOR CONTROL  
QUALITY ELECTRONIC COMPONENTS





*explorer I*  
*explorer IV*  
*tiros*  
*telstar*  
*syncom*

*ranger VII*  
*ranger VIII*  
*ranger IX*  
*saturn I*  
*surveyor*



## the most honored resistor in the Space Program

■ Allen-Bradley hot molded resistors were chosen to participate in these many history-making space projects for only one vital reason—a history of proven performance that dates back for more than a quarter of a century! A record more conclusive than any testing program could possibly provide!

The superiority of Allen-Bradley resistors is found in the exclusive hot molding process. Through the use of completely automatic machines—developed and used *only* by Allen-Bradley—there is obtained such uniformity of characteristics from resistor to resistor, year after year, that the resistors' long term performance can be accurately predicted. Furthermore, no Allen-Bradley hot molded resistor has ever been found to have failed catastrophically.

The widespread use of the Allen-Bradley hot molded resistors in these space programs should convince you that to include this plus value in the equipment which you produce gives it the mark of "extra quality." Let us tell

you more about the complete line of Allen-Bradley electronic components. Please write for Publication 6024. Allen-Bradley Co., 222 W. Greenfield Ave., Milwaukee, Wis. 53204. In Canada: Allen-Bradley Canada Limited. Export Office: 630 Third Ave., N. Y., N. Y. U.S.A. 10017.



**HOT MOLDED FIXED RESISTORS** are available in all standard EIA and MIL-R-11 resistance values and tolerances, plus values above and below standard limits. Shown actual size.

TYPE BB 1/8 WATT		MIL TYPE RC 05
TYPE CB 1/4 WATT		MIL TYPE RC 07
TYPE EB 1/2 WATT		MIL TYPE RC 20
TYPE GB 1 WATT		MIL TYPE RC 32
TYPE HB 2 WATTS		MIL TYPE RC 42

# ALLEN - BRADLEY

QUALITY ELECTRONIC COMPONENTS



## FOR LOWER COST PRECISION ROTARY SWITCHING... TRY THESE:



SERIES 4

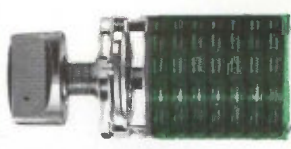

SERIES 1

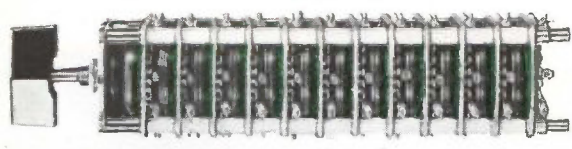

SERIES 2

## FOR TRULY OUTSTANDING DRY CIRCUIT SWITCHING... TRY THESE:



SERIES 4



SERIES 1

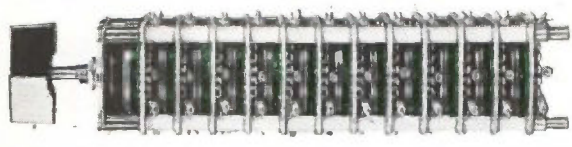

SERIES 2

## FOR EASIER ROTARY SWITCH SPECIFICATION... TRY THESE:

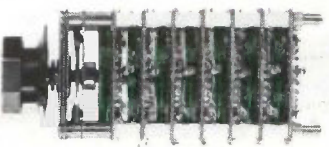

SERIES 4

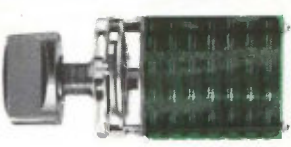

SERIES 1

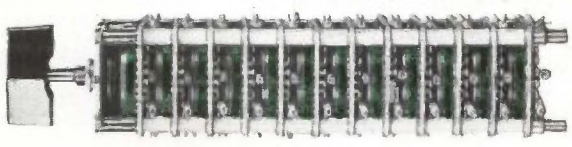

SERIES 2

## FOR FASTER ROTARY SWITCH DELIVERY... TRY THESE:



SERIES 4

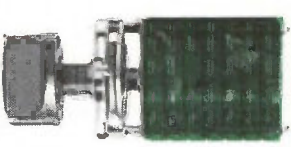

SERIES 1

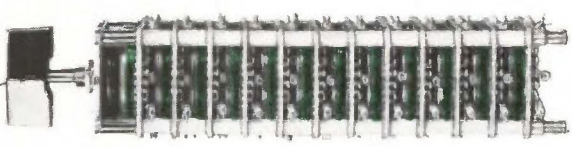

SERIES 2

IF YOU DO, you'll find that Shallcross Series 1, 2 and 4 precision rotary switch lines offer:

**LOWER TOTAL COST** — INITIAL COSTS ARE NORMALLY LOWER (often 25 percent or more) than those for rotary switch counterparts claiming comparable quality. **INSTALLATION COSTS ARE REDUCED** by easily wired flared terminals (identified for location) and rugged construction features that virtually eliminate switch damage during harnessing. **MAINTENANCE AND REPLACEMENT COSTS ARE REDUCED** to the vanishing point by: (1) 50 in/lb stop strength ratings, (2) multiple contact wipers (for reliable circuit "making"), (3) positive action long life detents, (4) dust protection for internal switch parts, and (5) material-design combinations that reduce voltage breakdown and insulation

resistance failures. Add these cost "savers" to lower specification costs (below), and you'll see why Shallcross has the most economical top quality rotary switch line in the industry — as a matter of fact, an investigation will prove that Shallcross switches are often less in total cost than the lowest priced "clip types."

**OUTSTANDING DRY CIRCUIT SWITCHING** — Negligible "thermals," low contact resistances (1-2 milliohms typical from input to output), and low switching noise provide ideal dry circuit switching.

**EASIER SPECIFICATION** — Comprehensive cataloging, reproducible specification sheets (for easier drawing creation), and easily used part number systems expedite specification.

**FASTER DELIVERY** — Day-in-day-out deliveries for standard Shallcross switches equal any in the industry (eight distributors stock 1-3 deck "standards" — production quantities are normally shipped in two to three weeks).

The best values in quality rotary switching wear this brand—try them.



*shallcross*

SUBSIDIARY OF **CUTLER-HAMMER**

SHALLCROSS MANUFACTURING COMPANY, SELMA, N.C.  
ZIP CODE 27576 • TEL. 919 965-2341 • TWX 919 770-7839



# “How can we scan temperatures at a rate of 10 points/second?”



## With an EMC Scanner System!

Proven EMC temperature scanner systems are now available for countless applications in a variety of industries.

Monitoring temperatures at a rate of up to 10 points a second from 0°C to 500°C with a demonstrated accuracy of 0.1% of full scale, these systems have already saved thousands of man-hours for users in the chemical industry.

These modularly-constructed systems are simple to install, operate and maintain. Pushbutton controls provide monitoring ease and flexibility. Modular units are interchangeable.

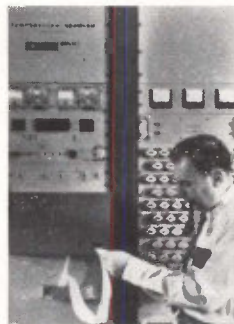

The highly reliable systems are constructed from modules with proven reliability of 4.5 million hours MTBF. This gives the typical system an MTBF in excess of 8,000 hours.

An EMC representative will be glad to provide you additional information on how EMC systems can meet your requirements for process monitoring and control.

**ELECTRONIC  
MODULES  
CORPORATION**

**Electronic Modules Corporation • SYSTEMS DIVISION**

1949 GREENSPRING DR. • TIMONIUM, MARYLAND 21093 • TEL. 301-252-2900 • TWX-301-252-0723

# Philco talked to 409 engineers before designing these two 930 DTL circuits.



Dual RS Flip Flop

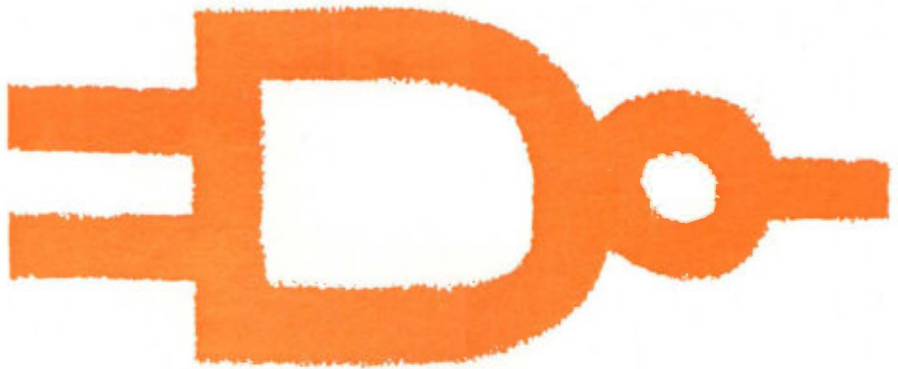

Transfer Gate Function

Two of the problems most of these engineers mentioned were: a large package unit count; and an excessive amount of external wiring on breadboards. That's why we designed these two circuits. They give you flexibility in design, 930 compatibility, and added utility to the entire 930 series.

**DUAL RS FLIP FLOP:** Two 3-input NAND gates. A basic memory operation with a double set and reset capability—all in one package.

**TRANSFER GATE:** Has four 2-input NAND gates and one inverter. It will transfer logic functions—even octal—with ease. And you won't have to use an additional package unit for phase change. This has an inverter built right in.

Philco has a complete line of 930 DTL integrated circuits—packaged in flat pack, dual inline, ceramic flat pack, and TO-5 cans. Military and limited temperature range. We would be happy to talk with you about any of these, which include: Dual 4-input Gate, JK or RS Binary, Dual Buffer, Dual 4-input Expander, Dual Power Gate, Clocked Flip Flop, Quad Gate, Binary, Hex Gate, and a one-shot Multi-vibrator. Available now.

Call for the name of your nearest distributor. **Philco Microelectronics Division Sales Offices:** 2920 San Ysidro Way, Santa Clara, California (408-245-2966) / 999 North Sepulveda, El Segundo, California (213-772-6226) / Northwest Industrial Park, Second Avenue, Burlington, Mass. (617-272-1600) / Benson Manor, Suite 114B, Washington Lane, Jenkintown, Pa. (215-885-0430) / 1215 Drew Street, Clearwater, Florida (813-446-0124) / 815 Connecticut Avenue, N.W., Washington, D.C. (202-298-7810).



PHILCO-FORD CORPORATION  
Microelectronics Division  
Santa Clara, California • 95051



# Is this your design department?

Bill can't find a small enough pushbutton.

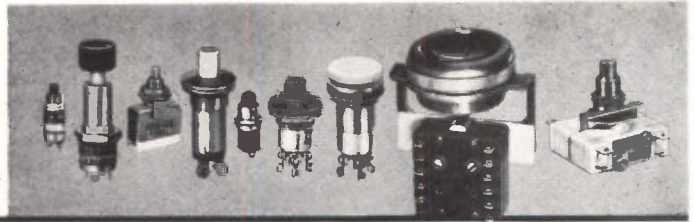

Ed wants an extra-tiny indicator light.

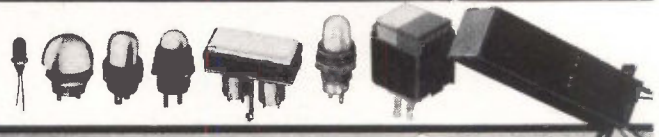

Joe's checking four sources for a toggle.



George wants a snap-in switchlite.

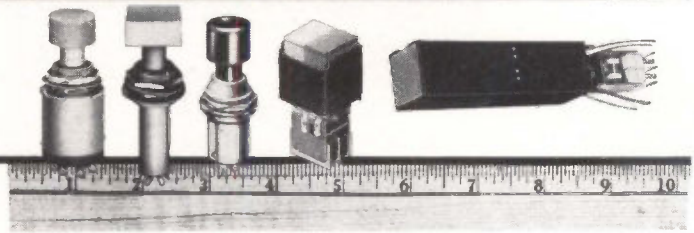

## You fellows ought to know Control Switch!

Rip out the bingo card in this book now and tick off numbers for any or all of the Control Switch catalogs listed below.

If you get all seven catalogs, you'll have the most complete file you can get from any single source!

Control Switch makes more types of switches and switchlites than anybody. So our catalogs offer the best chance of finding what you want . . . first try!

In addition, some manufacturers don't make any of the switches and lights we make.

So these catalogs save chasing all over for switches.

Finally, Control Switch makes quality switches. For applications like data processing equipment, space age projects, and instrumentation systems. So our catalogs save horsing around with switches that can't deliver. *Send that bingo card now!*

Here are the Control Switch catalogs. Check numbers on the Reader Service Card corresponding to those on the left below for the catalogs you want.



- #503 Basic Precision Switch Catalog 110
- #504 Toggle Switch Catalog 180
- #505 Indicator Light Catalog 120
- #506 Hermetically-Sealed Switch Catalog 130
- #507 Switchlite Bulletins 54, 55, 63
- #508 Switchlite Catalog 220
- #509 Pushbutton Switch Catalog 190
- #510 RFI-Shielded Component Bulletin 62

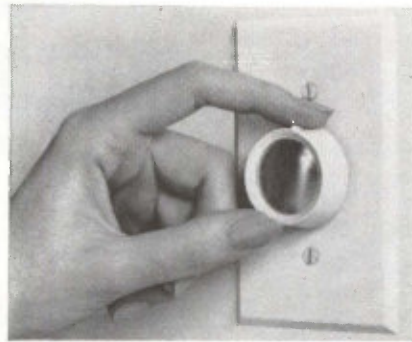

# Lutron needed: the best combination of small size, reliability and low cost in capacitors for solid state dimmers.

## So Lutron chose: capacitors of MYLAR®

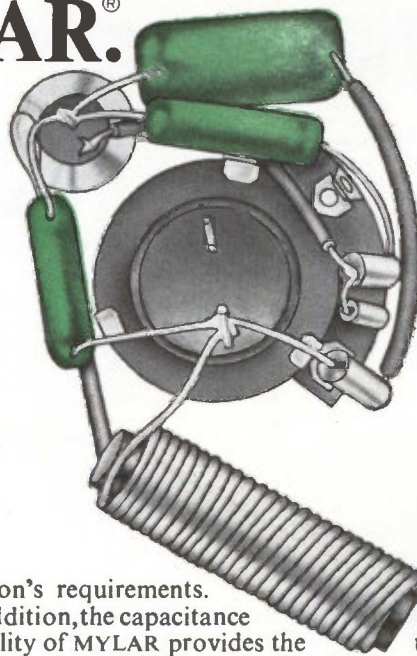

"Only capacitors of MYLAR\* give us the size and reliability we must have, and at low cost," says Joseph M. Licata, Chief Engineer. Lutron Electronics Co., Inc.

Lutron's broad line of dimmers is miniaturized to fit single gang boxes for quick, easy installation. Because MYLAR has extremely high dielectric strength in thin gauges, capacitors made from this polyester film can be manufactured small enough to meet

Lutron's requirements. In addition, the capacitance stability of MYLAR provides the long-term reliability needed for trouble-free brightness control of all types of incandescent and fluorescent lighting.

Voltage requirements for Lutron's dimmers are 200 to 600 volts, and in many instances these units operate around the clock. Lutron's own tests and experience indicate capacitors of MYLAR

perform well in these conditions, even under extremes of humidity and temperature. Lutron has also found that in many cases, capacitors of MYLAR cost less than paper.

If capacitor size, reliability and price are important to you, check into MYLAR by writing: Du Pont Co., Room 4671A, Wilmington, Delaware 19898. (In Canada write: Du Pont of Canada, Ltd., P.O. Box 660, Montreal, Quebec.)

\*DU PONT'S REGISTERED TRADEMARK FOR ITS POLYESTER FILM.

Better Things for Better Living...through Chemistry





# What attracts design engineers?



Reliability in IF and RF coils!

And you'll find the most reliable coils at CAMBION®. All types . . . all values . . . standards or specials . . . for industrial, military or research applications. CAMBION produces them all: shielded and unshielded, conventional and printed circuit, to meet any design requirement . . . Toroids, too!

Shielded styles with powdered iron cup core and cap provide outstanding protection against feed back caused oscillations and pickup from random noise. Unitized metallic housings insulate against external electrostatic and electromagnetic fields.

CAMBION unshielded coils on grade L5 silicone impregnated ceramic or phenolic forms are equipped with Perma-Torq® locking devices that provide smooth tuning, while slugs remain locked in place. You fine tune the inductance value after circuit assembly . . . precisely.

Rugged dependability in any application — encapsulation or special varnish impregnation moisture-proofs CAMBION coils for all weather environments. CAMBION coils meet

applicable MIL Specifications including the stringent requirements of MIL-C-15305 and MIL-STD-202.

And they're guaranteed . . . by CAMBION's unmatched design-to-delivery capability. Design decisions are made easier by development winding with single layer, close wound, spaced, single-pi, or multi-pi winding facilities. And statistical quality control assures uniformity in coils for prototype or production orders.

Wind up your coil design problems with CAMBION standard or custom coils. For complete information or design assistance write Cambridge Thermionic Corporation, 401 Concord Avenue, Cambridge, Massachusetts 02138. Phone: (617) 876-2800. In Los Angeles, at 8703 La Tijera Boulevard 90045. Phone: (213) 776-0472.

©REG. U.S. PAT. OFF.

**CAMBRIDGE THERMIONIC CORPORATION**  
**CAMBION®**

Standardize on CAMBION . . . 21,541 guaranteed electronic components



## WE KNOW STORAGE TUBES...AND A LOT MORE

Hughes has made as many direct view storage tubes as all other manufacturers put together. They are in use all over the world in scan converter processing equipment; seismographic survey; medical diagnostic displays; educational and security systems; airborne, marine and ground-based fire control; weather and terrain avoidance radar; air traffic control; sonar; etc.



And, one by one, Hughes customers have come to the conclusion that those who know most about tubes and their applications are also the most likely candidates to handle entire special displays. As a result, Hughes has a wealth of experience in the creation of highly specialized storage tube displays, scan converter and motion detection equipments.

Hughes is able to provide for your every commercial display requirement, from tubes alone to complete display indicators. Depend on Hughes experience... in both design and manufacture.

For further information, call or write Hughes Aircraft Company, Vacuum Tube Products Division, 2020 Oceanside Blvd., Oceanside, California 92054. Phone: (714) 722-2101. TWX: 910-322-1380.



**EAST:** 1284 No. Broad Street, Hillside, New Jersey 07205. Phone: (201) 289-7770. TWX: 710-741-4737.

**INTERNATIONAL:** Hughes International, Centinela & Teale Streets, Culver City, California 90230. Phone: (213) 391-0711. Telex number: 067-222.

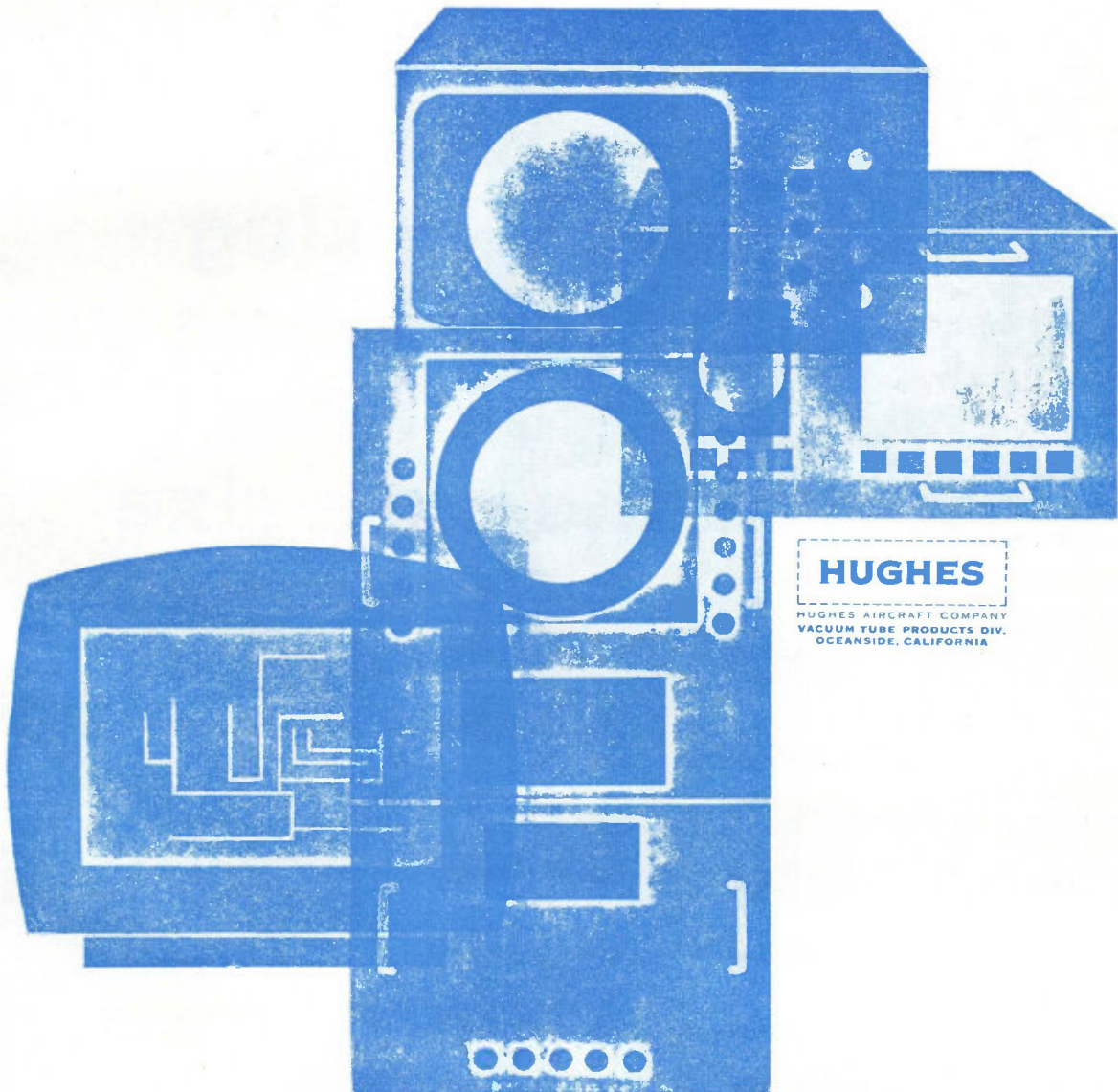

**HUGHES**  
HUGHES AIRCRAFT COMPANY  
VACUUM TUBE PRODUCTS DIV.  
OCEANSIDE, CALIFORNIA



# small



## smaller



## smallest



# G.E.'s new wet slug tantalum capacitor gives you the performance of the CL64 in only 1/2 the case size

Get the highest volt-microfarad product per unit weight and volume of any capacitor you can buy with General Electric's new 69F900 wet slug tantalum capacitor. How? General Electric reduced the case size of the military type (CL64) wet slugs by 1/2 (it's even smaller when compared to solids). Electrical characteristics and performance remain essentially the same. G.E.'s new 69F900 answers the need for a commercial wet slug capacitor with the high volumetric efficiency demanded by modern high density applications.

G.E.'s new addition to its complete line of tantalum wet slug capacitors has excellent high capacitance retention at low temperatures and can be

RATING	CASE SIZE	VOLUME
50V, 50 $\mu$ f		
solid (CS12)	.341 x .750	100%
wet slug (CL64)	.281 x .681	58%
69F900	.145 x .600	15%
15V, 80 $\mu$ f		
solid (CS12)	.341 x .750	100%
wet slug (CL64)	.281 x .681	58%
69F900	.145 x .600	15%
6V, 180 $\mu$ f		
solid (CS12)	.279 x .650	100%
wet slug (CL64)	.281 x .641	100%
69F900	.145 x .600	25%

stored to  $-65^{\circ}\text{C}$ . Its wide operating range is  $-55^{\circ}\text{C}$  to  $+85^{\circ}\text{C}$ . And it meets the parameters of larger military wet slugs: vibration to 2000 Hz, 15g acceleration!

The new sub-miniature 69F900 capacitor is fully insulated and has a low, stable leakage current. Voltage ratings are available from 6-60 volts; capacitance ranges from 3.3-450 microfarads.

Choose from a complete line of G-E wet slug tantalum capacitors to fill your slim, trim circuit needs. Write for GEA-8369 for details about the 69F900 and the other capacitors in General Electric's complete wet slug tantalum line, or ask your G-E sales engineer. Capacitor Department, Irmo, South Carolina.

ELECTRONIC COMPONENTS DIVISION

**GENERAL  ELECTRIC**

430-28

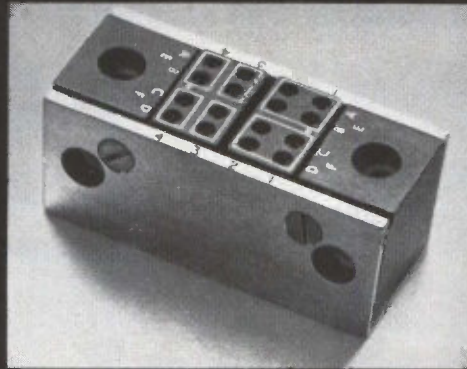

# Introducing the heat resistant, cold resistant, dust resistant, rust resistant, water resistant, re-order resistant termination device.

It's the Deutsch rear-release, environmental Terminal Junction.

Friends call it TJ for short.

With the TJ, old-fashioned terminal strips are replaced by lightweight, low-cost, high density modules that can take far tougher environments than other terminating devices.

You can use the TJ over and over again, like building blocks. (You take care of the configurations, the TJ takes care of the rest. Think of the savings.)

Details? Call Arco, the distributor who's also a manufacturer.

As a distributor, we're ready to ship you all the

Deutsch TJ's you need as fast as you need them. One piece or a thousand.

And as a manufacturer, we have all the engineering staff it takes to help you on application problems.

So call us. Ask for TJ. You'll find it irresistible.

**Arco Electronics**  
A Division of Loral Corporation  
Community Drive, Great Neck, N. Y. /  
Dallas, Texas/Pasadena, California/  
Menlo Park, California.



**DIVIDED WE STAND**

Circle 189 on reader service card



# EXTERNAL PACKAGING OF COILS NOW OBSOLETE WITH DELEVAN'S NEW:



# MICRO *i*

Micro i Inductors are physically compatible with integrated and hybrid circuit packaging. Because of their small size they can be included in miniaturized packages along with other components such as transistors and capacitors eliminating the need for placing the inductor external to the miniaturized package.

These inductors are magnetically shielded to prevent interaction with other components in a small package and have current carrying capabilities which are compatible with normal transistorized circuits. The units are epoxy encapsulated for environmental protection and use powdered iron core materials only.

Excellent inductance stability is provided under the following variable operating conditions:

1. 0 to 100% rated current (AC or DC)
2. Temperature range of -55° to +125°C.

Preferred values as noted in the chart below are available immediately from stock.

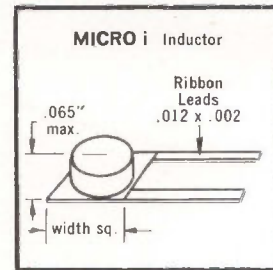

ACTUAL SIZE

MICRO <i>i</i>	SIZE	L RANGE	L(uh)	Q	SRF(mc)	DCR( $\Omega$ )	DC(ma)
	.065 Height x .100 Square	.1 uh to 10.0 uh	1.0 $\pm$ 20%	40	125	1.0	266
			4.7 $\pm$ 20%	40	100	1.8	190
			10 $\pm$ 20%	40	40	3.8	133
	.065 Height x .150 Square	12 uh to 100 uh	12 $\pm$ 10%	50	38	4.0	100
			47 $\pm$ 10%	50	19	8.0	85
			100 $\pm$ 10%	50	10	15.0	55
	.065 Height x .250 Square	120 uh to 1000 uh	120 $\pm$ 10%	50	7.5	8.0	40
			470 $\pm$ 10%	45	3.5	20.0	38
			1000 $\pm$ 10%	45	3.0	40.0	34

L and Q Values at Standard Q Meter Test Frequencies.

**MICRO *i***  
DIVISION

**Delevan Electronics  
Corporation / Division**



**AMERICAN  
PRECISION  
INDUSTRIES INC.**

270 QUAKER RD. / EAST AURORA, N. Y. / 14052  
TELEPHONE 716/652-3600

TELEX 091-293

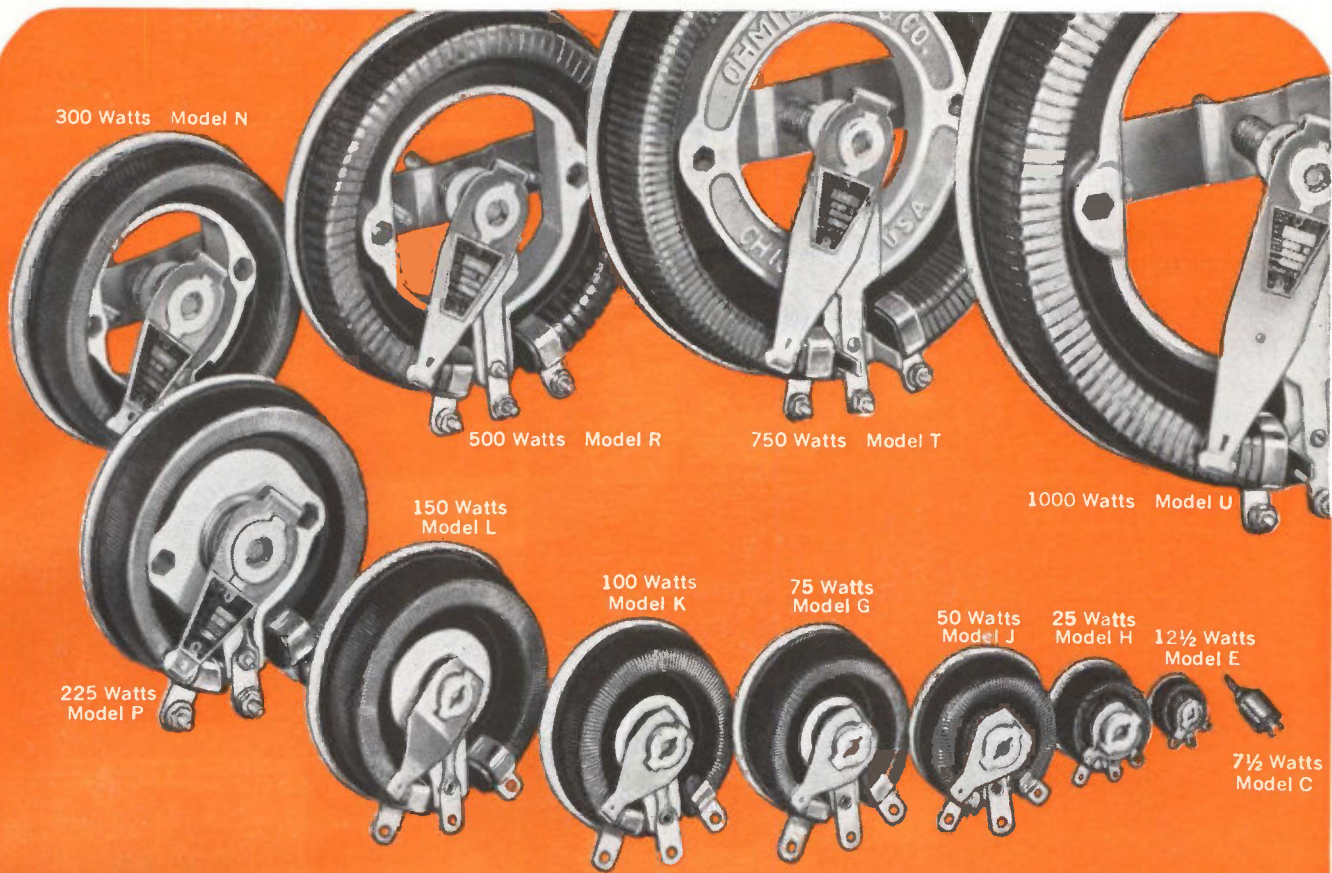

if it's a  
rheostat, you  
can get it  
from Ohmite

Need a miniature 7½-watt rheostat? Or something at the other extreme, say, 1000 watts? Ohmite makes all 12 basic sizes. With these as a starting point, you can branch out into literally hundreds of electrical, mechanical, and motor-driven variations . . . too many to even begin listing here.

Ohmite is the *only* rheostat supplier who can fill 100% of your requirements (plus many you probably will never run into).

*As Near As Your Distributor*—There are thousands of stock Ohmite rheostats in distributors' inventories from coast to coast backed up by the world's largest factory

stock. So if you need standard rheostats in a hurry, you'll find Ohmite units are the easiest and quickest to lay your hands on . . . no matter where you are located . . . no matter what size you need.

*Motor-Driven Rheostats:* Technically, these are classified as specials. But Ohmite makes so many of them that some models are practically standard.

*"Way Out" Specials?* No matter how unusual your requirement, contact the factory. For over 30 years, Ohmite has been solving tough rheostat problems. Maybe yours is even among them.

Write for Big New Catalog 200.



**OHMITE**  
MANUFACTURING COMPANY  
3610 Howard Street, Skokie, Illinois 60076  
Phone (312) ORchard 5-2600

RHEOSTATS • POWER RESISTORS • PRECISION RESISTORS • VARIABLE TRANSFORMERS • TANTALUM CAPACITORS • TAP SWITCHES • RELAYS • R.F. CHOKES • SEMICONDUCTOR DIODES



# Discovering



**QUARTZ, LUCALOX® AND ELECTRONIC GLASS...  
HARD AT WORK HELPING THE ELECTRONIC INDUSTRY MEET THE UNCOMMON CHALLENGE.**

Fused Quartz of highest purity is produced by General Electric with the most complete technical resources available today. You'll find G-E fused quartz used in crystal pulling . . . zone refining . . . semiconductor diffusion . . . research labware. Many new and varied applications are continuously being developed.



(CIRCLE 489 READERS SERVICE CARD)

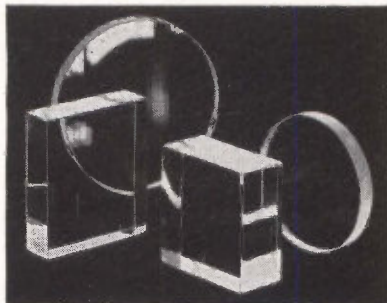

**G-E Type 151 Fused Silica**, for critical optical applications, is a schlieren grade material offering the highest ultraviolet transmission. Type 151 is ideal for use in laser optics . . . absorption cells . . . spectrophotometer optical elements . . . schlieren photography. Now used in many innovative and exciting applications, Type 151 is the newest and highest quality optical material within General Electric's numerous grades.

(CIRCLE 490 READERS SERVICE CARD)

**Lucalox®**, a highly versatile polycrystalline alumina ceramic, has an extensive number of applications in the chemical, electronic, microwave and high temperature fields. Easily fabricated to complex specifications, Lucalox applications include use as insulators . . . guides . . . microwave windows . . . bearings . . . gyros. Lucalox has high dielectric strength, purity, plus transmission capabilities of up to 90% of total light in the visible spectrum. Standard tubing, rod, plates and discs are available from stock.

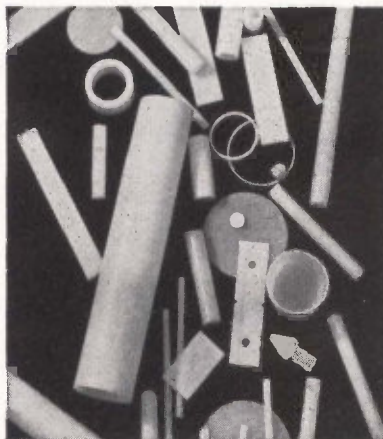

(CIRCLE 491 READERS SERVICE CARD)

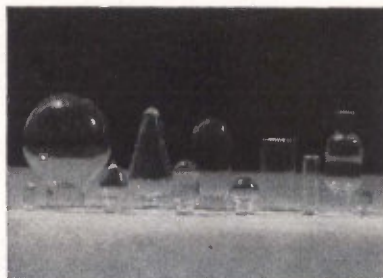

**Electronic Glass** from General Electric is available in a wide variety of shapes. Applications for the electronic and associated industries include TV repair necks

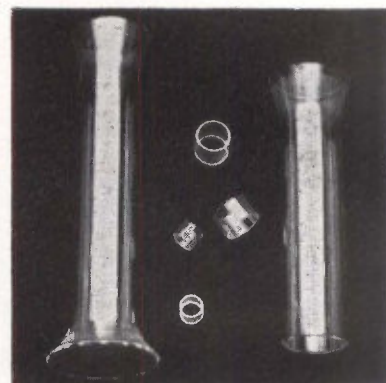

. . . electronic tubing . . . miniature bulb blanks . . . subminiature radio tube blanks . . . receiving tube blanks . . . beads and brazing pellets . . . electronic tube flares . . . pressed ware . . . re-draw tubing. General Electric research and technical representatives are always ready to work with customers on specific applications. And at General Electric we welcome new challenges.

(CIRCLE 492 READERS SERVICE CARD)

**WORLDWIDE SERVICE.** For sales and application assistance, contact your nearest regional office: **EASTERN**, 133 Boyd St., Newark, N. J.: 201 824-5200 • **NEW ENGLAND**, 50 Industrial Place, Newton Upper Falls, Mass.: 617 332-6200 • **WESTERN**, 2747 South Malt Ave., Los Angeles, Calif.: 213 723-2541 • **MIDWESTERN**, Euclid Ave. & Campbell Rd., Willoughby, Ohio: 216 266-4001 • **CANADA**, Canadian General Electric Co., 165 Dufferin St., Toronto, Ontario: 537-4481 • **INTERNATIONAL**, International General Electric Co., Export Div., 159 Madison Ave., N. Y., N. Y.: 212 PL-1-1311.

Write for illustrated technical literature

LAMP GLASS DEPARTMENT

**GENERAL ELECTRIC**

24400 Highland Road • Cleveland, Ohio 44121

MANUFACTURERS OF LUCALOX® CERAMIC—ELECTRONIC GLASSWARE—FUSED QUARTZ PRODUCTS—JET-TEMP® AND JET-B.O.P. THERMOCOUPLES.



Optical Alignment at OTI

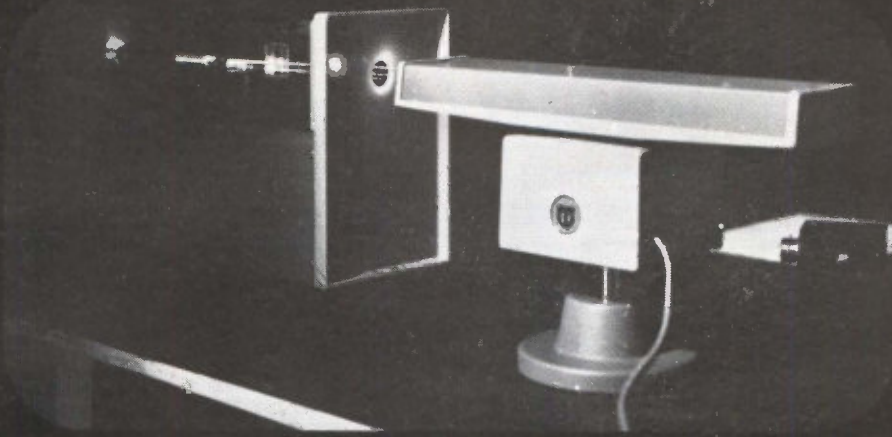

Classroom Demonstration at Stanford

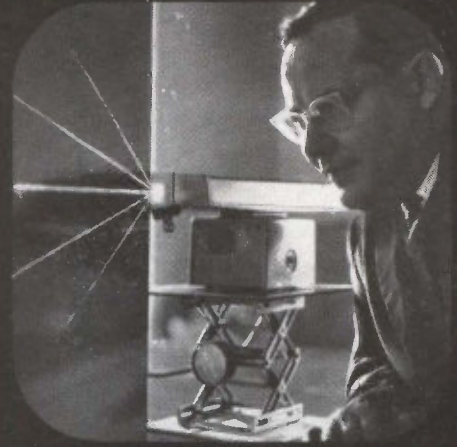

How many companies make a compact, rugged foolproof, time-tested, guaranteed continuous gas laser, hard at work in over 1,000 locations...yet costs less than \$300?

Just one.

Optics Technology. We make it, and call it the Model 170—a small, long-life laser, out in the field for more than a year. How? Know-how. After all, we've been pioneers in the field since lasers began. And now the 170 is making history in five major areas:

*Optical Alignment*—Re-reflection of a straight line made easy. This one shows alignment of our own Model 130 100 megawatt + Q-switch laser; it works just as well with camera systems and other optical components.

*Educational*—Professor A. L. Schawlow demonstrates diffraction of a laser beam to his university Physics class. We back up the 170 with a unique educational kit and a textbook (more of both to come).

*Systems*—That's Lee Groper, at Beckman's Spincro Division, with the 170. It's a component being investigated for use with their Model E Analytical Ultra-centrifuge. (Actually, we modified it for Spincro and named it the 171 Detachable Head Laser—worth a few dollars more, whenever continuous on-line use may require

instant head replacement.) Adaptability? The high-intensity light beam may be modified, modulated, and focused down to 0.005". We'll work with you on systems applications.

*Basic Research*—Friden people, such as Alan Rowland, are using the 170 for holographic studies—testing a basic concept of data storage. The 170 provides researchers with an inexpensive source of basic laser properties: coherence, extreme intensity, and monochromaticity. Makes it easy to test feasibility of theories before investing in a more costly laser.

*Mechanical Alignment*—Bob Fisher's responsibility at Granger Associates is in experimental optical communications, utilizing gallium arsenide photoemissive diodes. But the 170's ruggedness and versatility take it out of the lab, as well. In railroading, heavy construction, petroleum exploration, and other applications limited only by your own imagination—wherever a very straight line is required.

*What's your application for the 170?*

Write:

**OPTICS TECHNOLOGY INC**  
901-20 California Avenue ■ Palo Alto, California ■ 327-6600 (Area Code 415)

In Europe: Optics Technology Instruments, Ghent, Belgium

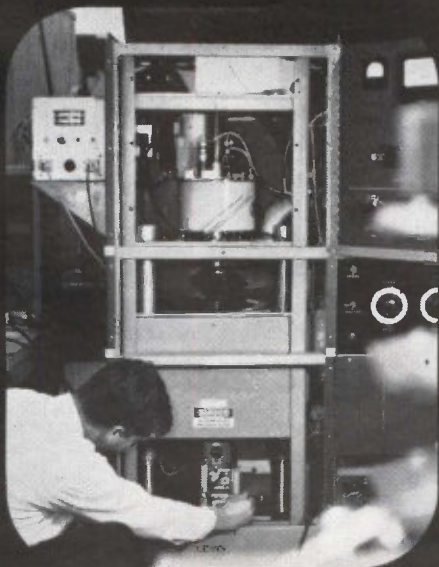

OEM Application at Beckman-Spincro



Basic Research at Friden



Mechanical Alignment at Granger Assoc.



# It's a bargain, no matter how you trim it

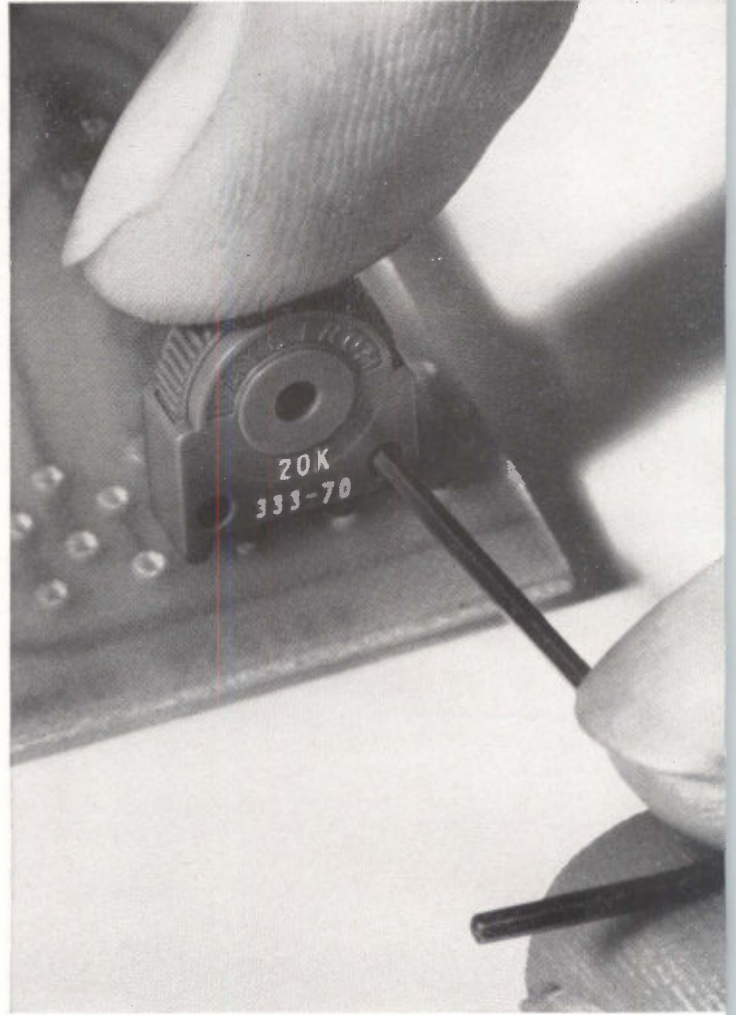
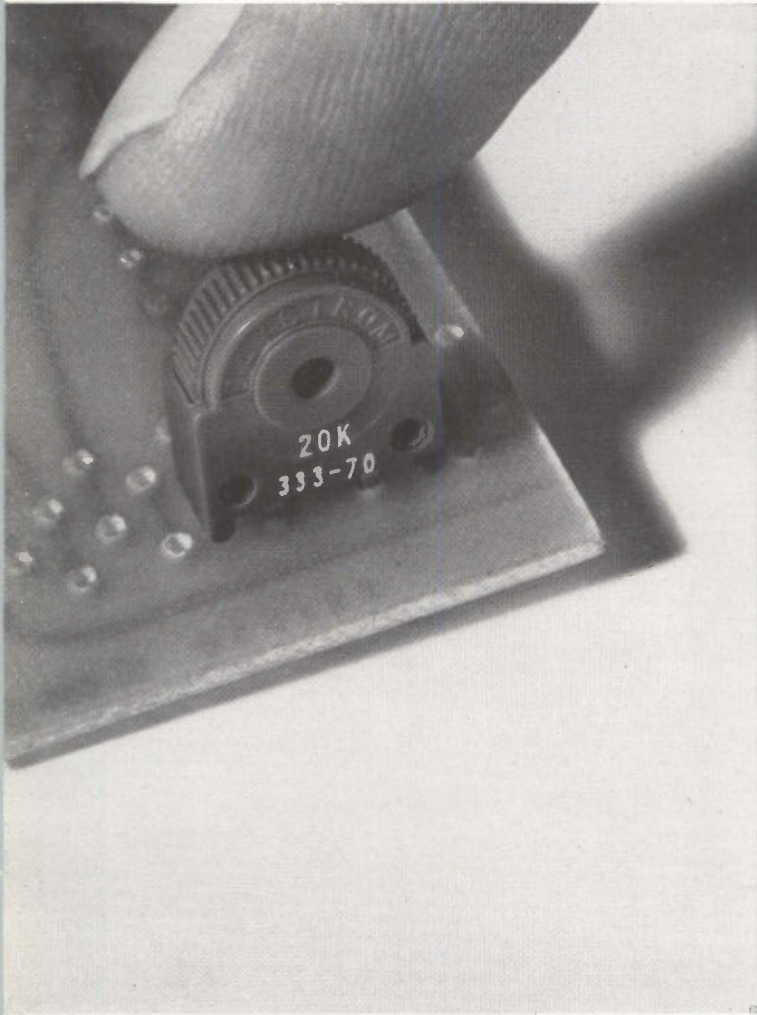

*with the flick of a finger...*

*or the turn of a key.*

*You can trim the Daystrom Model 333 pot with your thumb on the convenient knurled knob. Or, use a hex-key on the Allenhead vernier for finer (4:1) settings.*

*But dual adjust is just one of the design features that make this low-cost commercial trimmer a bargain. Others are Weston's exclusive wire-in-the-groove construction which locks linearity in and contact noise out—even under shock and vibration ... a slip clutch stop that protects the wiper at the end of rotation ... Suregard™ terminations for long-life reliability.*

*You'll recognize these features as the same used in Weston's rugged MIL-type Squaretrim® pots.*

*In addition, compact 333 series pots take up less than 1/10 square inch on your PC boards. They're designed for edge mounting, with provision for dip soldering, so they're ideal for automated production techniques. And they'll handle 0.25 watt comfortably—in still air.*

*The price is a trim \$1.25 in lots of 500. Standard values range from 50Ω to 50K. For complete details or evaluation samples, contact your Weston distributor or call:*

**Weston Instruments, Inc., Weston-Archbald Division  
Archbald, Pennsylvania 18403. Phone 717-876-1500**

**WESTON®** *prime source for precision...since 1888*

Circle 194 on reader service card

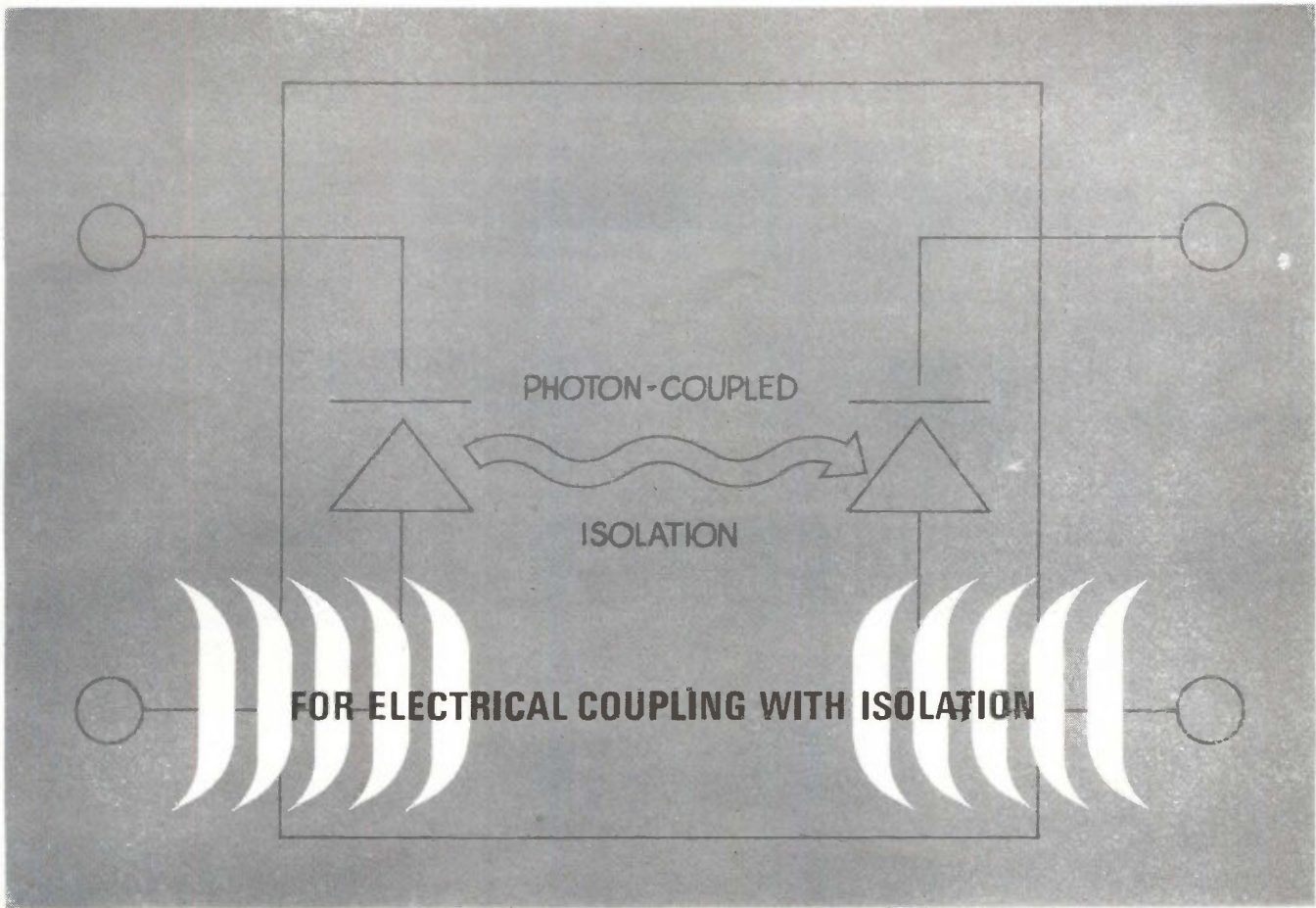

## specify photon-coupled isolators by HPA

Efficient transfer of electrical energy—with maximum isolation between circuits—is possible now with HP Associates' 4310 Photon-Coupled Isolator, newest in the line of HPA optoelectronic devices.

Packaged on a single TO-18 header, the 4310 consists of a low-leakage silicon PIN photodiode, closely coupled to a high-efficiency gallium arsenide infrared light source.

Offering high current transfer efficiency, the 4-terminal device provides electrical decoupling between input and output, dc to MHz.

Other new devices available from HP Associates include GaAs light sources and low-leakage detectors.

Contact your Hewlett-Packard field engineer for complete specifications and application information, or write HP Associates, 620 Page Mill Road, Palo Alto, Calif. 94304, Tel. (415) 321-8510.

Typical specifications HPA 4310 Miniature Photon-Coupled Isolator		
		Condition
Current transfer efficiency	0.002	GaAs I <sub>f</sub> =50 mA PIN V <sub>R</sub> =-25 V
Capacitive coupling between input and output diodes	2 pf	f=1 MHz
Resistive coupling between input and output	10 <sup>11</sup> ohms	
Output diode saturation current	10 nA max	V <sub>R</sub> =-20 V T=25°C
Maximum ratings (output diode): Peak inverse voltage Steady reverse voltage Power dissipation	200 V 50 V 125 mW	T=25°C
Maximum rating (input/output): Working voltage	200 V	
Prices: 1-9 10-99	\$55.00 \$46.75	

*Data subject to change without notice. Prices f.o.b. factory.*

**HEWLETT  
PACKARD**  **HP  
ASSOCIATES**

1023R



# We expect these 150-grid relays to be copied

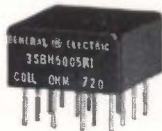

4-pole



2-pole

## And by 1967 they'll be a standard of the industry

Right now, these General Electric 2- and 4-pole relays are years ahead of the field. Their low, low profile—just 0.32 inch high—lets you stack more circuit boards in the same space.

They're not just cut-down versions, either. These 150-grid relays can perform right up with microminiature relays four times their size.

For example, closing force is about the same to provide snap-action, positive contact mating. In addition, General Electric 150-grid relays meet or exceed environmental and mechanical specs of much larger microminiature relays.

And compared to relays of comparable size, G-E 150-

grid space relays have three times the magnetic force and over twice the contact force of their nearest competitor. What's more, they're the only relays in this size range that are all welded to eliminate flux contamination.

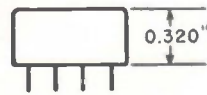

ACTUAL SIZE

Your G-E Electronic Components Sales Engineer can tell you more about 150-grid space relays and help with your individual applications. Contact him. Or write for bulletin GEA-8042B, Section 792-38, General Electric Co., Schenectady, N. Y. 12305.

*Specialty Control Department, Waynesboro, Va.*

**GENERAL  ELECTRIC**

Memory core testers bought more on price than performance are a lot like white elephants. Nice to look at, maybe. But darn expensive to have around. They have a nasty habit of letting bad cores slip by every now and then. And one bad core on the loose in a plane or stack spells high cost trouble. This kind of hit and miss testing never happens with CTC systems. They deliver driving pulses with unmatched precision and controllability; detect and measure core response with the kind of accuracy that weeds out even the borderline baddies. □ White elephants are the big reason you can't afford cheap core testers. You never really stop paying for them. With CTC memory core test systems you pay just once. And in the long run that's peanuts.

**COMPUTER TEST CORPORATION**

Cherry Hill, New Jersey



**a  
white  
elephant  
is just  
a trunkful  
of bad cores**

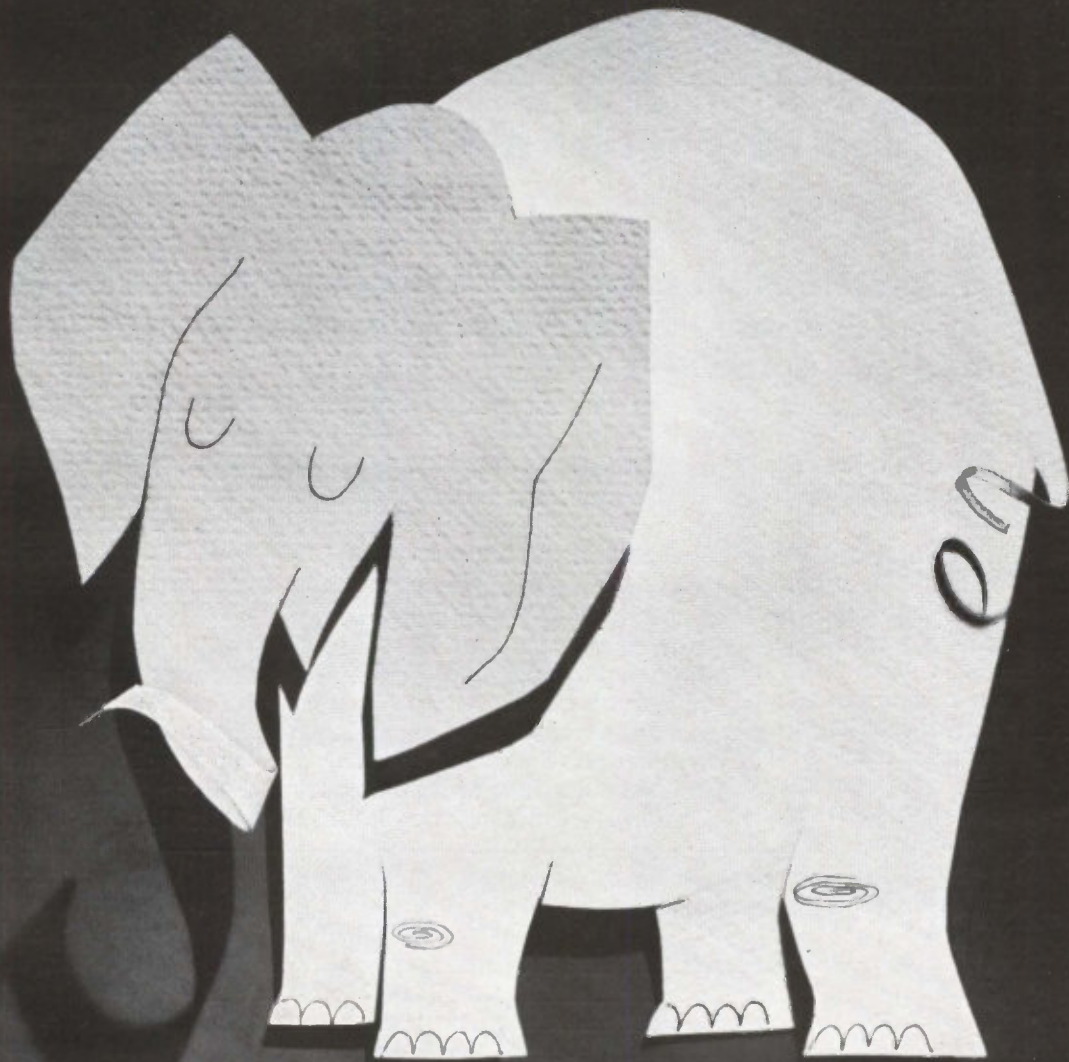



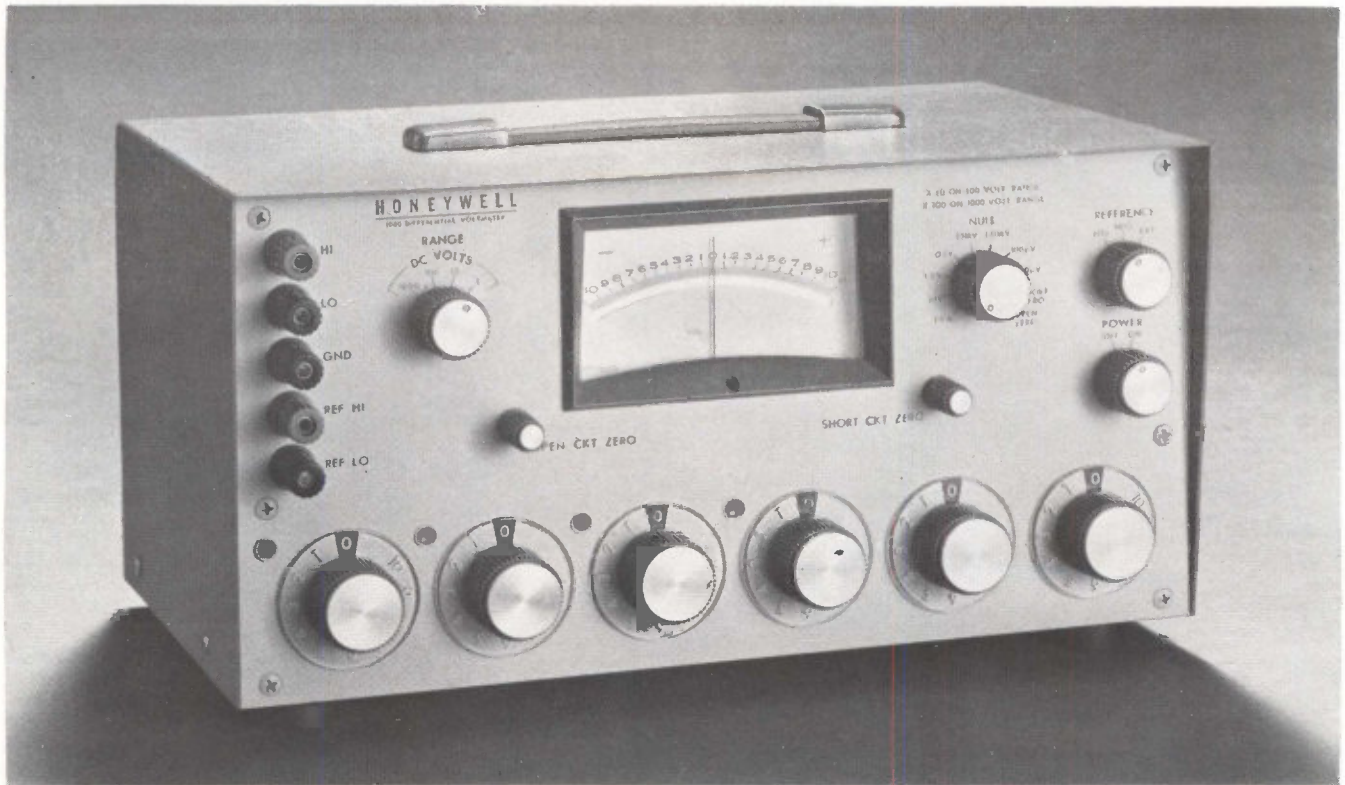

## Honeywell's new 5 in 1 Instrumentation Package:

own this Model 1000 Differential Voltmeter, and you also own a Differential Ratiometer, a Decade Voltage Divider, a Precision Voltage Reference Source, and an Electronic Null Detector!

Here's the most versatile single instrument any lab can own — five essential measuring functions combined in one neat, fully portable package! Let's look at the new Honeywell Model 1000, function by function.

As a **Precision Differential Voltmeter**, the Model 1000 provides  $\pm 0.0025\%$  accurate measurements to your DC signals. And you get 7 digit resolution from 6 decades with 10% overrange (also eliminates time consuming dial manipulation). Potentiometric input impedance to 11V provides errorless measurements to standard cells or high source impedance signals. Polarity is reversible from the front panel.

As a **Differential Ratiometer**, the 1000 gives you precise DC ratio measurements with  $\pm 0.001\%$  accuracy. External reference signal level may range up to

$\pm 100$  VDC. All Voltmeter mode convenience features are applicable when the 1000 is used as a Ratiometer.

As a **Decade Voltage Divider**, the 1000's precision, 6 decade Kelvin-Varley divider network gives accurate voltage level divisions to  $\pm 0.001\%$ . AC power not required in this mode.

As a **Precision Voltage Reference Source**, calibrated voltage levels of 6 digit resolution are provided at the 1000's rear panel. Output levels are selected by front panel dials. Levels vary from 0 to 11 VDC, and may be used for calibration of potentiometric instrumentation. Accuracy:  $\pm 0.0025\%$ .

As an **Electronic Null Detector**, the 1000 offers high sensitivity for use with balance type instrumentation or other circuitry. Silicon field effect transistors eliminate electro-mechanical choppers and assure drift-free operation. Changes as minute as 10 nanovolts or an input current of  $10^{-15}$  amperes may be detected.

**Other features** of this versatile instrument include: complete cancellation of common mode, standoff voltages; high superimposed noise rejection; Zener reference supply with 2-3 ppm stability; 4 full-scale ranges of 1, 10, 100, and 1000 VDC; ratio ranges of 1:1, 10:1, and 100:1; recorder outputs on rear panel, and silicon solid-state circuitry throughout. Ask your Honeywell Representative for a demonstration of the Model 1000, or mail coupon for literature.

Honeywell, Test Instruments Div.  
Denver, Colorado 80217

9-11A

Please send Model 1000 Literature to:

Name \_\_\_\_\_  
Company \_\_\_\_\_  
Address \_\_\_\_\_  
City \_\_\_\_\_ State \_\_\_\_\_ Zip \_\_\_\_\_

LABORATORY STANDARDS  
**Honeywell**

HONEYWELL IS WORLDWIDE • Sales and service offices in all principal cities of the world. Manufacturing in Brazil, Canada, France, Germany, Japan, Mexico, Netherlands, United Kingdom, United States.



Multibeam Cassegrain, 94GHz,  
10½" dia., 4 overlapping  
beams and reference beam

Conical Scanning Plano-  
Convex Lens, 36GHz, 9½" dia.

Azimuth Scanning Reflector-  
Lens Antenna with Radome,  
26 to 40GHz, CSC<sup>2</sup>  $\theta$  Pattern.  
Polarization manually selectable.

## *Prime source for custom-designed antennas*

For unique antennas from 300MHz to 300GHz, TRG has the experience and capability necessary to meet your requirements. Contact: TRG, Inc., 400 Border St., East Boston, Mass. 02128. Telephone (617) 569-2110.



A Subsidiary of Control Data Corporation





## Texas Instruments chooses GAF x-ray film to prove there's not the tiniest mistake



Texas Instruments Incorporated, a prime manufacturer of miniaturized electronic equipment for both industry and government, uses GAF industrial x-ray film to

prove zero defects in critical components, assemblies and sub-systems.

Diodes, rectifiers, capacitors, resistors and germanium and silicon transistors, used in everything from hearing aids to missile guidance control systems, are subjected to exhaustive radiographic examination to assure faultless performance and long life.

In the photograph above, Texas Instruments Quality Control Inspector, Mrs. Dorothy Gross, is studying a GAF Industrial 'H-D' radiograph. Industrial 'H-D' is an ultra-fine grain, very high contrast film designed to yield high image definition—even when radiographing minute subjects and very thin materials. Industrial 'H-D' is available in a wide

variety of package types and sizes.

Contact your nearest distributor of GAF x-ray products, and he'll introduce you to the GAF X-ray Representative assigned to your area. Or write directly.



**GENERAL ANILINE & FILM CORPORATION**

140 WEST 51 STREET, NEW YORK, NEW YORK 10020

Att: Customer Service Dept. E-1114

Please send me more information on GAF Industrial 'H-D' x-ray film.

Name \_\_\_\_\_

Title \_\_\_\_\_

Company \_\_\_\_\_

Address \_\_\_\_\_

City \_\_\_\_\_ State \_\_\_\_\_ Zip \_\_\_\_\_



# SAVE

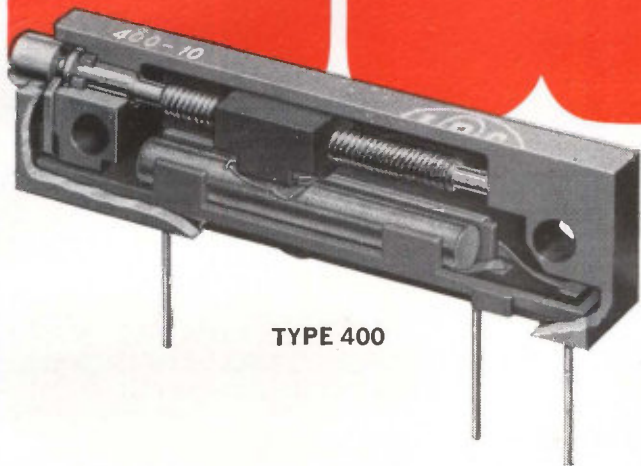

TYPE 400

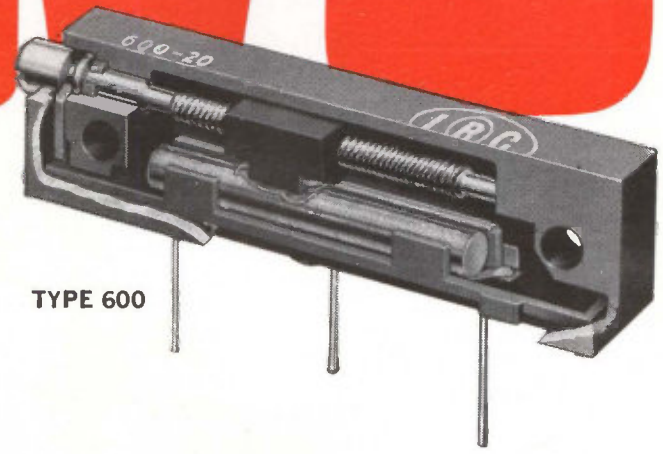

TYPE 600

## Military quality at industrial prices

IRC wirewound rectangular trimmers save space and dollars

IRC's CIRCUITRIM potentiometers offer MIL characteristics at the same price as industrial types. Benefit by upgraded performance and reliability for your industrial needs and impressive savings for your MIL applications.

Both series are designed to perform under environmental requirements of MIL-R-27208. Molded diallyl phthalate cases are rugged, light and practical for use in any military or high grade industrial application. A one-piece, corrosion-resistant shaft and specially designed wiper block system isolate electrical elements and assure "set-and-forget" stability.

The 600 series is designed to MIL-Style RT-11 and is offered with staggered P.C. pins or teflon insulated leads. The 400 series is designed to MIL-Style RT-12 with P.C. pins in-line or teflon insulated leads. It is also available in a thin-line version of RT-11 (Type 400-20) with staggered P.C. pins which offer 30% space savings and complete interchangeability on pre-printed boards.

These low-cost MIL-type units are the result of IRC's years of experience in building high-quality trimmers. Samples available

from local sales offices. For prices and data, write: IRC, Inc., 401 N. Broad St., Philadelphia, Pa. 19108.

### ONLY IRC OFFERS ALL 4 POPULAR STYLES

Wirewound or infinite resolution elements



### CAPSULE SPECIFICATIONS

MIL STYLE	TYPE 400	TYPE 600
POWER	1 W @ 70°C	1 W @ 70°C
TOLERANCE	± 5%	± 5%
RESISTANCE	10Ω to 50KΩ	10Ω to 50KΩ
TEMPERATURE	-55°C to 150°C	-55°C to 150°C

\*Plus thin-line version of RT-11 (Staggered P.C. pins)





# From .5 to 10,000 $\mu$ f, the CYFM is the second best capacitor you can buy.



*pf* for *pf*, you can't buy more stability and reliability per dollar than you get in the CORNING® CYFM Capacitor.

You get the kind of stability that only a glass dielectric can hold, that's invariable with time, temperature, and environment.

You get reliability that's inherent in the way they're made, which is basically the same process that turns out our ultra-high-reliability CYFR Capacitor.

But you save dollars on the CYFM because we don't put it through all the rigorous CYFR testing.

A CORNING CYFM Capacitor is practically indestruct-

ible under severe environmental stresses. We have boiled them in salt water, immersed them in saturated steam, subjected them to 96 hours of salt spray, without a failure or degradation.

After 2000 hours at 125°C with 150% of full rated voltage, capacitance change on a CYFM is less than 0.5%.

Why ever risk an entire system on capacitors that can't give you the assurance of Corning dielectric stability? Get all the economical facts on the CYFM Capacitor in our new CORNING® Glass Capacitor Guide. Send to Corning Glass Works, 3913 Electronics Dr., Raleigh, N.C.

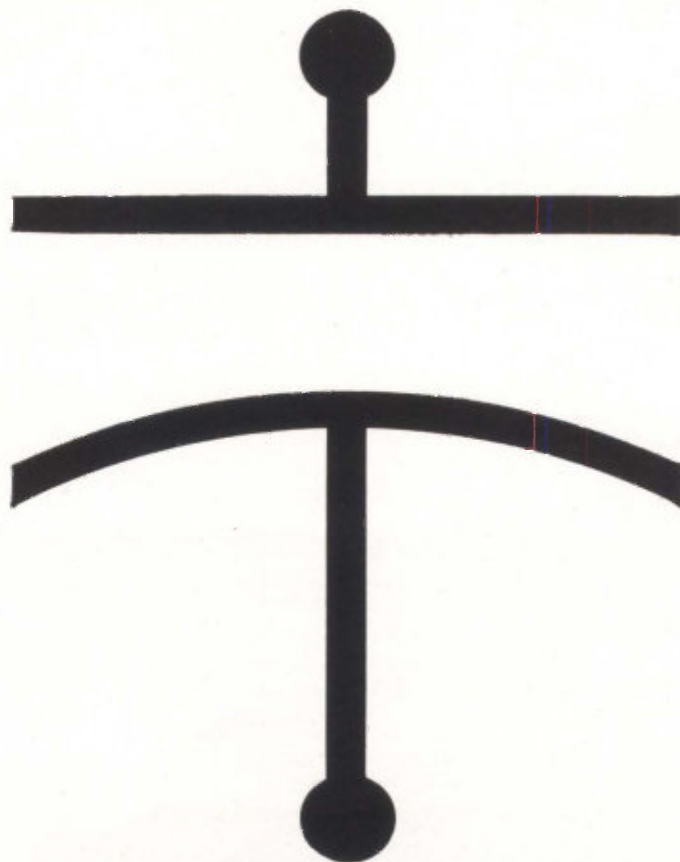

**CORNING**  
ELECTRONICS

# WE MAKE EPOXIES FOR JUST ABOUT ANYTHING YOU CAN THINK OF.

Critical electronic parts often require epoxies for low outgassing and outstanding heat resist-

ance. Plaskon® epoxies are currently being specified in a wide range of parts, including some that have been designed to meet or exceed the proposed military specifications.

ENCAPSULATION  
GRADE  
PLASKON EPOXY  
1960

HIGH HEAT  
RESISTANCE  
GRADE  
PLASKON EPOXY  
1914

However, if epoxies are not what you need, we have a complete line of other thermosets to provide the right product for the job: Diallyl®, Phenolics, Alkyd, Urea and Melamine. But all you have to worry about is a good idea. It's our job to find the right epoxy or other thermoset to make it a reality.

HIGH IMPACT  
GRADE  
PLASKON EPOXY  
1988  
(previously 1288)

CONNECTOR  
(OR ELECTRONIC)  
GRADE  
PLASKON EPOXY  
1906

PLASTICS  
DIVISION  
POST OFFICE BOX 365  
MORRISTOWN, N. J.

Allied  
Chemical

Please send me complete information on the right epoxy for \_\_\_\_\_ application.

Name \_\_\_\_\_

Address \_\_\_\_\_

Company \_\_\_\_\_

City \_\_\_\_\_ State \_\_\_\_\_ Zip Code \_\_\_\_\_



# Here's how to get more cooling with less size and weight: Use Garrett-AiResearch "ICE".

The Garrett-AiResearch systems approach to "black box" cooling is called Integrated Cooling for Electronics ("ICE"). It can save you development dollars, cut system weight, and reduce circuit enclosure size.

Simply give us your circuit design heat transfer problem and we'll do the rest: trade-off studies, interface details, heat transfer system design, and manufacturing.

You'll get an optimized system with minimum power consumption for maximum cooling, and a compact, lightweight chassis with an

integral or separate heat transport loop or heat pump.

If you're developing electronics circuits for space vehicles, weapons systems, aircraft or ground communications, or other critical applications, call in AiResearch while your package is being conceived; we'll work with you to match an "ICE" system to your specific needs. Contact AiResearch Manufacturing Company, 9851 Sepulveda Blvd., Los Angeles, California 90009.

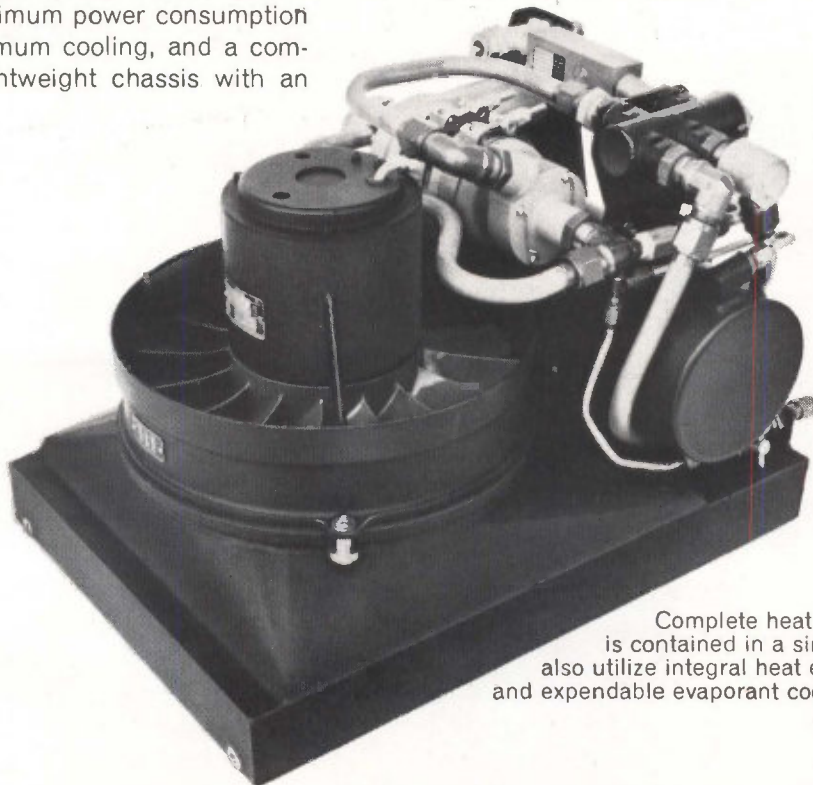

Complete heat transport system (left) is contained in a single, compact unit. We can also utilize integral heat exchangers, heat pumps, and expendable evaporant cooling methods.

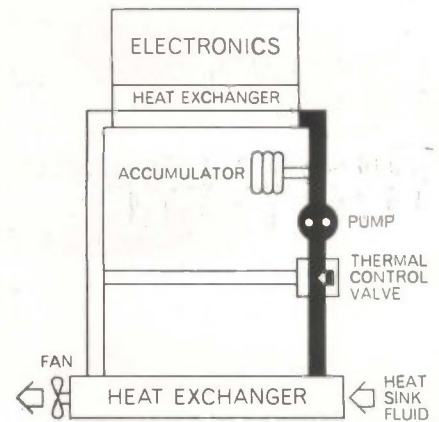

TYPICAL "ICE" SYSTEM SCHEMATIC

This AiResearch "ICE" system includes both the heat transport system and electronics enclosure with integrated heat exchanger.

**GARRETT** AiResearch  
Heat  
Transfer Systems



## Dr. Radimer explains why ammonium persulfate etching is best.

*Dr. K. J. Radimer, manager, metal applications research, FMC INORGANIC CHEMICALS DIVISION.*

It's clean. It's easy to handle and dispose of. One system can etch circuit boards having almost any common resist (solder, photoresists, waxes, and inks). And it's inexpensive to convert from other etching processes. These and other advantages are all explained in his



recent article, available in reprint form from the Product Promotion Dept., FMC CORPORATION, INORGANIC CHEMICALS DIVISION, 633 Third Ave., New York, N.Y. 10017



# All new analog recording system

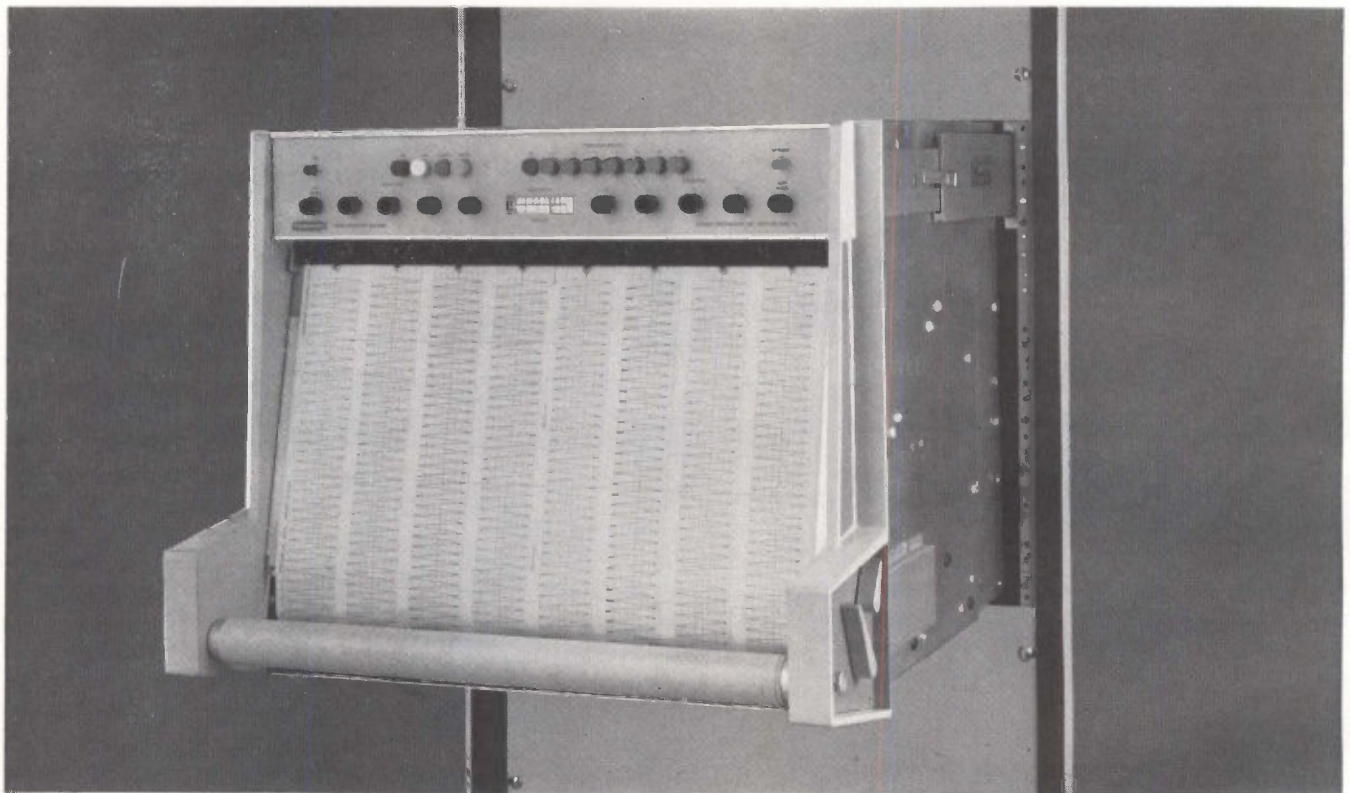

## Compare the unequalled Type R-2000 Dynograph® Recorder for:

- *Highest Frequency Response*—85 Hz full scale, 40 mm.
- *Rapid Rise Time*—Less than 3.5 ms.
- *A Complete Recording System*—Including amplifiers, power supply, writer units and paper drive.
- *A New Compact Size*—Only 15¾ inches of vertical panel space.
- *Unequalled Writing Quality*—High contrast, continuous uniform tracings.
- *All Silicon Solid-State Design*—For greater operating temperature range.

Beckman's totally new R-2000 Dynograph Recorder is a self-contained, multi-channel system delivering accurate thermal rectilinear write-out of input data. This versatile direct-writing oscillograph features new high torque writer units with a new heat stylus and positive stylus locking

cradle. Suitable, in its basic system configuration, for applications such as telemetry and analog computer read-out, the R-2000 affords even greater versatility with the addition of accessory amplifiers and input couplers to accommodate input signal conditioning for virtually all analog recording requirements. And the system will mount in any standard 19-inch rack enclosure. For complete information, contact your Beckman Dynograph recorder representative, or write direct.

**Beckman®**

INSTRUMENTS, INC.

ELECTRONIC INSTRUMENTS DIVISION  
SCHILLER PARK, ILLINOIS • 60176

INTERNATIONAL SUBSIDIARIES:

GENEVA; MUNICH; GLENROTHES, SCOTLAND; TOKYO; PARIS; CAPE TOWN; LONDON; MEXICO CITY

# ANNOUNCING . . .

## The WORLD'S most compact QUALITY **CERAMIC TRIMMER CAPACITOR**



### AMAZING 5 to 25 pF. CAPACITANCE RANGE IN LESS THAN .007 CUBIC INCH

A precious jewel? Not at all . . . This is a new subminiature Ceramic Trimmer Capacitor. It represents the most significant development in variable capacitors in more than a decade . . . and again Erie leads the State of the Art. The tiny 518 occupies only .007 cubic in. . . . and has an incredible capacitance range of 5 to 25 pF. Operating temperature range:  $-55^{\circ}\text{C}$  to  $125^{\circ}\text{C}$ . — Working voltage 100 WVdc to  $85^{\circ}\text{C}$ ; 50WVdc to  $125^{\circ}\text{C}$ . The unit exhibits remarkable ruggedness, being a development from Erie's exclusive Monobloc Process<sup>®</sup>. The Monobloc rotor with its sealed electrode provides stability under extreme environmental conditions. The 518 permits rigid mounting in both printed circuit and point to point wiring applications. Tuning linearity is assured by precision lapped bearing surfaces.

This compact little trimmer is the ultimate in volumetric efficiency . . . after all, it's only .218" in diameter — almost the size of a precious jewel.

ERIE OFFERS THE MOST COMPLETE SUBMINIATURE TRIMMER CAPACITOR LINE IN THE INDUSTRY . . .



CERAMIC



AIR



GLASS AND QUARTZ



PLASTIC



Erie, Pennsylvania

Another Series of Components in Erie's Project "ACTIVE"  
Advanced Components Through Increased Volumetric Efficiency





# LIGHTWEIGHT CHAMP

...with a one-two punch! Low cost and high performance.

Weighing in at less than 40 pounds, CEC's portable DG 5511 is unchallenged by any other thermal writing recorder. This portable, 2-channel unit is so versatile it provides a capability formerly achieved only through multiple instruments.

For example . . . CEC's DG 5511 features three plug-in signal conditioners for a wide range of voltage inputs. *No* preamp is needed for most high-level signals. And due to its solid-state, all-modular construction, users may convert from high-level signal inputs to low-level inputs by a simple change of plug-in attenuator/amplifier units.

Furthermore, *automatic electrical signal limiting* protects the stylus motor and writing assembly from transient or other high-level signals. Each analog channel is provided with electrical signal limiting built into the driver amplifiers and is adjustable to 115% of full-scale deflection.

In addition, a *timing/event marker* provides the flexibility needed to make data analysis easy.

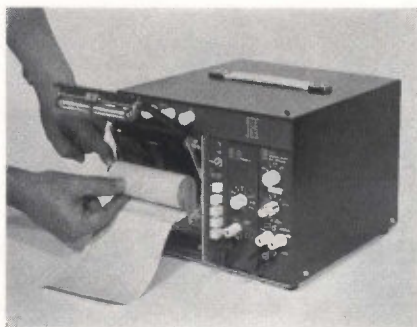

**What about operator convenience?** Thanks to its unique snap-in, front chart-loading and convenient pushbutton selectable chart speeds, the DG 5511 is the easiest-to-use direct-writing recorder available today.

**Applications?** Being a true portable, with an extremely wide frequency response and signal range, the DG 5511

is ideally suited for everything from aerospace and industrial research, design and development to production monitoring and field testing. Wherever there is a power source — and vibration, pressure or temperature to be measured — you'll find a need for this recorder.

**Service?** CEC backs the buyer with the largest, best-equipped sales/service organization in the field — *plus* a wide selection of accessories and supplies.

For all the rewarding facts about the DG 5511, contact your nearest CEC Field Office, or write for CEC Bulletin 5511-X30.

## CEC

Data Instruments Division

**CONSOLIDATED ELECTRODYNAMICS**  
A SUBSIDIARY OF BELL & HOWELL/PASADENA, CALIF. 91109  
INTERNATIONAL SUBSIDIARIES: WOKING, SURREY, ENGLAND  
AND FRIEDBERG (HESSEN), W. GERMANY



# Servo is a horizon in space



Keeping tabs on Mother Earth can be a tricky problem when you're a hundred miles overhead. That's where Servo comes in. Horizon sensing equipment, using our components, gave Gemini astronauts an added measure of confidence. The equipment offered a precise method of pinpointing the earth's horizon through miles of turbulence and haze.

The Servo Telescope Assembly Model 1390, illustrated above, utilizes a thermistor bolometer to sense the difference in the infrared energy radiated

by the earth and space. It enables satellites to maintain the correct attitude with respect to earth.

Our Infrared & Electro-Optics Division supplies heat-sensing systems for other uses: Detection of military targets. Analysis of thermal conditions.

Other Servo divisions produce unique systems and products which serve safety through science. The Servodynamics Division. The Communications & Navigation Division. And the Railroad Products Division.

servo corporation of america

# Servo

111 new south road  
hicksville, new york 11802  
516-938-9700

Circle 209 on reader service card





## Ask your best friend to shoot holes in your reasons for joining Martin in Florida

Once you investigate the big things happening at Martin Company in Orlando, Florida, you'll think you've got an airtight case for taking that giant step ahead in your career. But to make sure you're not swayed only by the thoughts of living in Florida, try these arguments on your best friend.

- 1. A challenge to work** with a top-flight engineering team now designing and producing Sprint, Walleye, RADA, Shillelagh, Pershing and many other advanced systems.
- 2. A promise of long-term professional growth** with a company that shows its faith in the future by investing over eight million dollars in new R&D facilities in the past three years.

- 3. An opportunity to select from a variety** of more than 150 special projects aimed at long-term business development.

- 4. An inspiration to produce your best work** by combining a rewarding career with year-round outdoor living for your family.

We believe a healthy discussion of these points will reconfirm your decision to move up with Martin. And just in case your friend likes the move up idea, have him call us collect. Phone 305/855-6100 and ask for Don Parsons, Manager, Professional Staffing.

**MOVE  
UP**  
**WITH MARTIN  
IN FLORIDA!**

**MARTIN COMPANY**  
ORLANDO FLORIDA

An Equal Opportunity Employer.



# If you make **ELECTRONIC** products...you'll really "make it" in **WISCONSIN!**

This is no "secret" to the electronic firms already in Wisconsin. From computer development and guidance systems, to tuner assemblies and switches, these products are made for growing markets.

We're taking this opportunity to encourage firms allied with consumer electronic products — specifically those involved with radio and television — to look us over.

Why? Projected market demand for TV set production will hit 7 million sets by 1970. That's hardly news — and yet the "scare" part of that statistic is that *there are not enough production facilities available*—to keep up with the demand. (Color TV manufacturers don't expect to catch up with present demand until 1967.)

With a high rating in available female workers, plus tremendous scientific / engineering / research back-up from the University of Wisconsin, electronic firms should realize that we're all here to help you make more profits — and enjoy the bountiful Wisconsin atmosphere while doing so.

How about you?

*We'll send you a special report on why the electronics industry LIKES IT HERE — and why "YOU'LL LIKE IT HERE" — too!*

write:  
**GOVERNOR  
WARREN P. KNOWLES**  
State Capitol, Madison, Wisconsin 53702

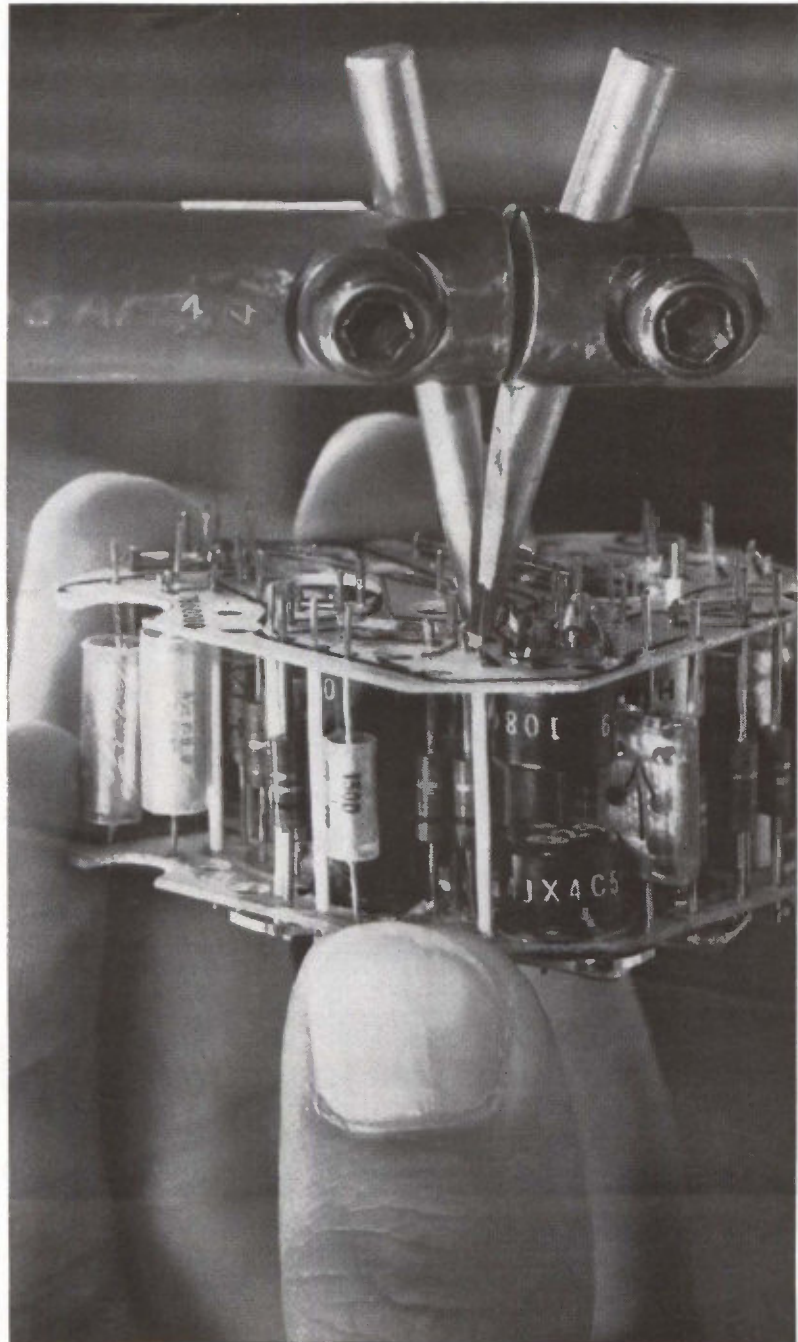

# WISCONSIN





## Which approach to Digital Plotting fulfills your needs?

If you prefer an incremental plotter:

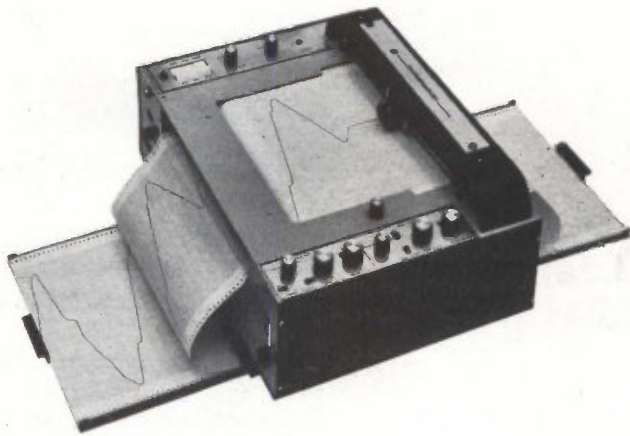

Model 6650 Omnigraphic™ Incremental Plotter is a bi-directional recorder that operates directly from digital computers, incremental encoders, pulsers, pulse generators or any incremental signal.

- ⑤ Z-Fold Paper (tears out to standard 8½" x 11")
- ⑤ 18,000 Increments/min Speed
- ⑤ 0.01" or 0.005" Resolution
- ⑤ Infinite Scale Expansion
- ⑤ \$2850

If you prefer plotting directly from parallel digital data:

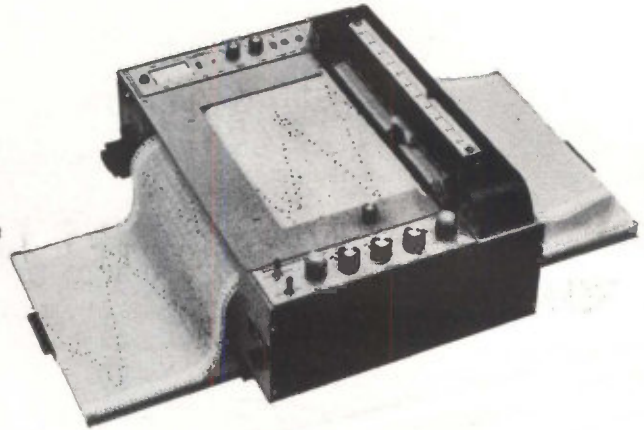

Model 6710 Omnigraphic™ Digital Plotter is a high speed point plotter which operates directly from binary or BCD data.

- ⑤ Z-fold Paper (tears out to standard 8½" x 11")
- ⑤ 2400 inch/min Slewing Speed
- ⑤ Capable of Both Digital or Analog Operations
- ⑤ 2 μsec. Access—Single Point Memory
- ⑤ \$3725



**houston OMNIGRAPHIC corporation**

*a subsidiary of houston instrument corporation*  
4950 Terminal Ave. / Bellaire, Texas 77401  
(713) 667 7403 / cable HOINCO / TWX (713) 571 2063

Even if this newest **POLARAD** modular microwave spectrum analyzer weren't the lowest-priced wide-band, wide-dispersion, high-performance design in the world...it would still be your best buy.

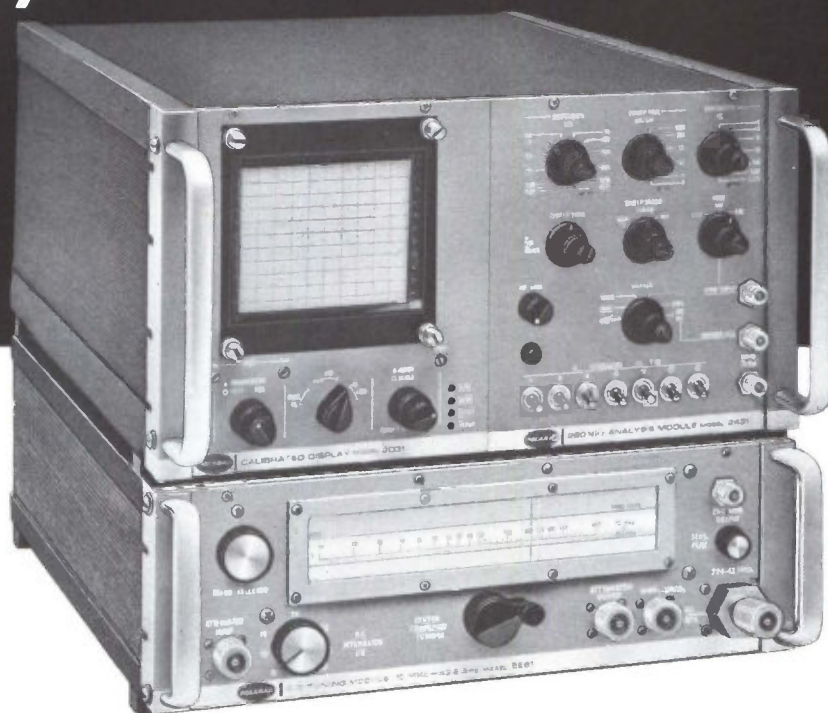

Model 2882

# Why?

Turn the page...

If card has been used, please circle reader inquiry card.

**POLARAD ELECTRONIC INSTRUMENTS**  
A Division of Polarad Electronics Corp.  
34-02 Queens Blvd.  
Long Island City, N.Y. 11101  
Tel. No. (212) EX 2-4500



First Class  
Permit No. 18  
Long Island City, N.Y.

**BUSINESS REPLY MAIL**  
Postage Will Be Paid by Addressee

No Postage Stamp Necessary If Mailed In The United States

**POLARAD ELECTRONIC INSTRUMENTS**  
A Division of Polarad Electronics Corporation  
34-02 Queens Blvd.  
Long Island City, N.Y. 11101





...because, between 10 MHz and 42 GHz

**it's got  
everything**

...including the lowest price!

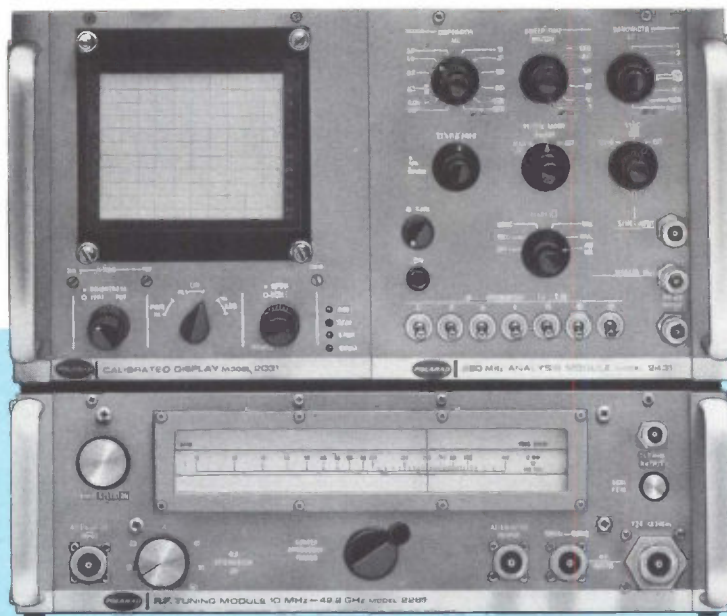

Model 2882

**It's got nine accurately-calibrated dispersion ranges** from 10 kc to 100 mc—plus continuous adjustment, 0-100 mc! (Automatic optimum bandwidth selection, too.)

**It's got four accurate, stable, calibrated crystal markers** for fast, easy frequency measurements and stability checks.

**It's got an 81-step, precisely-calibrated IF attenuator**, for accurate quantitative level measurements: 0 to 81 db in 1-db steps.

**It's got all three displays** (Log, Linear, and Power) on a big rectangular CRT (5½"x4½") with automatic corresponding scale and graticule illumination—error-free!

**It's got full functional flexibility**—use it as a receiver and synchroscope (using 60 mc predetection output for time-domain analysis) as well as a truly universal wide-dispersion spectrum analyzer with normal video output.

**It's got full modular compatibility**—with every other PEI Spectrum Analysis and Signal Module—expand and modify your measurement capability in no time . . . without waste or compromise!

... And it's got 17 more outstanding functional features, all of which are described in this new engineering bulletin—ESA-662—“How to Select a Microwave Spectrum Analyzer.”

**Send for it today!**

If card has been used, please circle reader inquiry card.

POLARAD ELECTRONIC INSTRUMENTS | 34-02 Queens Blvd.  
A Division of Polarad Electronics Corp. | Long Island City, N.Y. 11101

Gentlemen:

I want to see and try the PEI 2882. Have my local Polarad Field Engineer call me at once to arrange for a demonstration.

I may have a requirement soon. Send me Bulletin ESA-662 by return mail, and have my local Polarad Field Engineer get in touch with me shortly thereafter, to discuss my requirements.

I have no immediate requirement, but I want the complete, new Polarad Microwave Spectrum Analyzer Catalog for my files.

My application is \_\_\_\_\_

The frequency range of interest to me is \_\_\_\_\_

Name \_\_\_\_\_

Title \_\_\_\_\_

Company \_\_\_\_\_

Address \_\_\_\_\_

City \_\_\_\_\_

State \_\_\_\_\_ Zip \_\_\_\_\_

Tel. \_\_\_\_\_ Ext. \_\_\_\_\_



# Be a genius -dream up an application for our MIL-R-12934E single-turn pots-



(and win your very own certificate of genius).

Submit *any* design, simple or complex. Use one, two or any number of functions—including trigonometric, logarithmic, and non-linear empirical. And because all Litton single-turn pots are designed to meet or exceed MIL-R-12934E requirements—*especially* resolution—you can list your most stringent performance specs.

Producing single-turn pots *in production quantities* with .0004" wire is a speciality with us. So designs requiring a high degree of accuracy and superior resolution can also be submitted. These features alone make it easy for you to become a certified genius. But here are other points to enhance your design idea.

Litton pots are lined with dialyll phthalate to insure moisture resistance, dimensional and temperature stability—a unique plus that produces far greater reliability. What's more, we can easily reduce size and weight so make your design as compact as you like. And don't worry about shunts or slope changes. Our special butt welding results in a clean, even tap that prevents distortion in the functions.

Now let's see what you can come up with. Just jot down your application and we'll send your certificate by return mail. And if yours is one of the 50 best ideas we'll publish it in our next IDEA BOOK.

**LITTON INDUSTRIES**   
POTENTIOMETER DIVISION

*If your present supplier can't solve your potentiometer problems, try us. For single-turn and multiturn, linear and functional, wirewound and conductive film, ganged or unitized with servo modules—Litton begins where others leave off.*

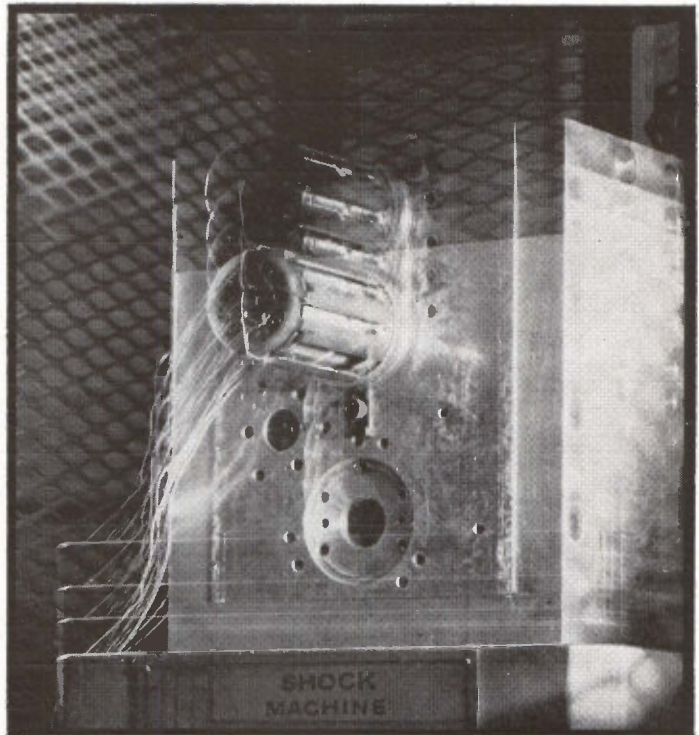

Certified testing equipment allows *simultaneous* measurement of Litton potentiometers under the extremes of environmental exposure.

Litton Industries, Potentiometer Division  
226 East Third Street, Mt. Vernon, New York 10550  
Tel.: (914) 667-6607 • TWX: 914/699-4687

My idea for an application is attached. Send my certificate of genius.

I have an idea, but need more data first. Send specs.

Name \_\_\_\_\_ Title \_\_\_\_\_

Company \_\_\_\_\_

Address \_\_\_\_\_

City \_\_\_\_\_ State \_\_\_\_\_ Zip \_\_\_\_\_



# OKAY. MAYBE YOU HAD A REASON FOR NOT USING PNP SILICON DEVICES.



Fairchild PNP Epoxy Devices

Number	$h_{FE}$	at	$I_C$	$V_{CEO}$	$f_T$	$t_{on}$	$t_{off}$	at	$I_C$	Price*
	Min.—Max.			Min.	Min.	Max.	Max.			
2N3638	30		50mA	25V	100MHz	75ns	170ns		300mA	\$.28
2N3638A	100		50mA	25V	100MHz	75ns	170ns		300mA	.43
2N3639	30-120		10mA	6V	500MHz	25ns	25ns		50mA	.31
2N3640	30-120		10mA	12V	500MHz	25ns	35ns		50mA	.35
2N3644	100-300		150mA	45V	200MHz	40ns	100ns		300mA	.43
2N3645	100-300		150mA	60V	200MHz	40ns	100ns		300mA	.55
2N4121	70-200		10mA	40V	400MHz	40ns	150ns		50mA	.38
2N4122	150-300		10mA	40V	450MHz	40ns	150ns		50mA	.41
2N4248	50		100 $\mu$ A	40V	40MHz	---	---		---	.25
2N4249	100-300		100 $\mu$ A	60V	40MHz	---	---		---	.38
2N4250	250-700		100 $\mu$ A	40V	50MHz	---	---		---	.40
2N4257	30-120		10mA	6V	500MHz	15ns	15ns		10mA	.29
2N4258	30-120		10mA	12V	700MHz	15ns	20ns		10mA	.35
2N4354	50-500		10mA	60V	100MHz	100ns	400ns		500mA	.42
2N4355	100-400		10mA	60V	100MHz	100ns	400ns		500mA	.55
2N4356	50-250		10mA	80V	100MHz	100ns	400ns		500mA	.55
2N4389	30-180		10mA	12V	400MHz	20ns	90ns		50mA	.28

\*In quantities 1000-9999

## NOW WHAT'S YOUR EXCUSE?

# Probing the News

Instrumentation

## Oscillograph prints out 1-Mhz signal

New machine uses electron beam and transverse recording to achieve fantastic speeds

By Walter Barney

San Francisco regional editor

**Oscillographs**, which produce on a paper chart a direct printed readout of waveforms, have been pretty much limited in frequency response by the speed at which the paper can be moved. At higher frequencies, the tracings tend to jam up and make a big black bar instead of separate lines. A new machine developed at the Denver division of Honeywell, Inc., however, uses a cathode-ray tube's electron beam as the pen, writes across the paper instead of down it, and achieves printout of one million cycles per second—almost a hundred times as fast as the fastest oscillographs now on the market. Even at the 1-megahertz rate, the Honeywell machine writes with peak-to-peak spacing of 0.1 centimeter.

The new oscillograph, the first to make use of transverse recording, is a direct outgrowth of one which Honeywell built two years ago for a Department of Defense customer whose name and need are still secret. Neither machine could have been made without a new kind of crt, whose face is a fiber-optic plate. On a normal tube, light from the phosphorus on the inside of the plate will spread as it passes through the glass, so that by the

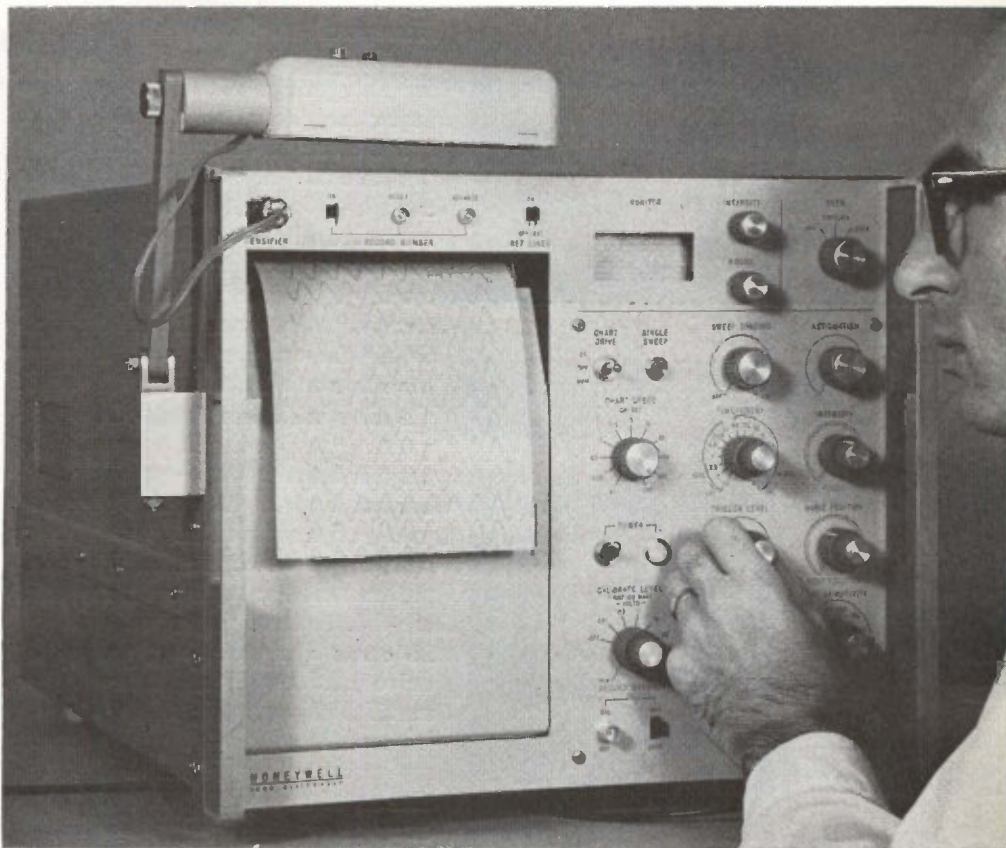

Operator adjusts trigger level. A small monitor oscilloscope enables checking the intensity and focus of the waveform before recording.

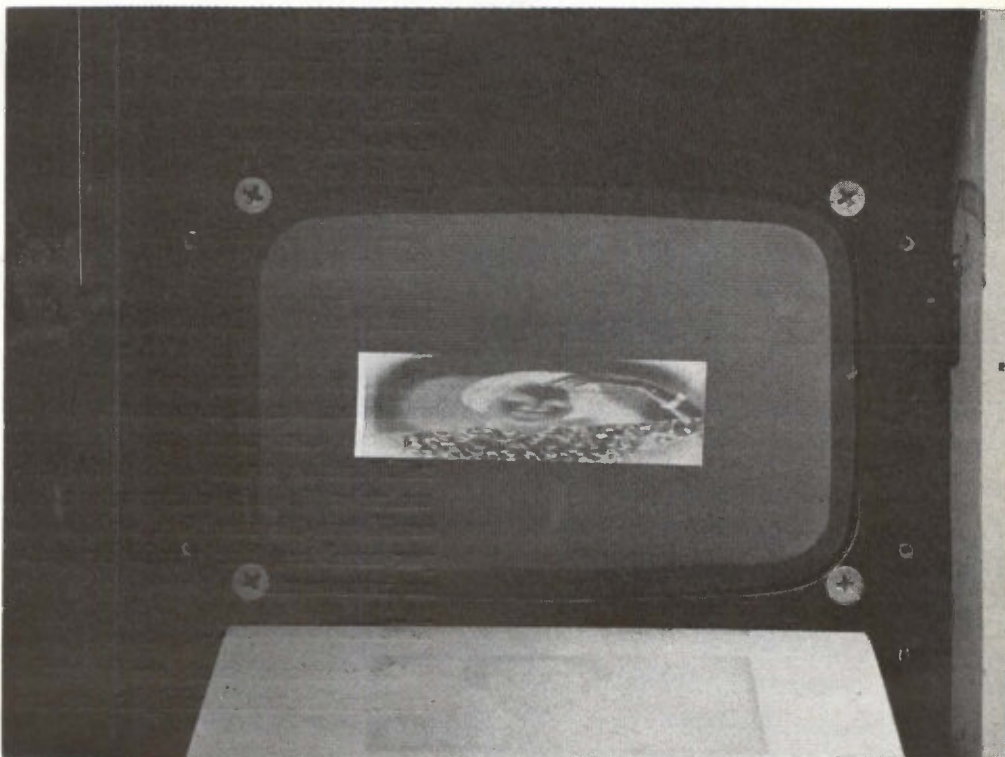

Picture on tube is squeezed to half its normal size. The recording below tube is a true reproduction; paper movement restores original dimensions.





time it reaches the outside world, the light spot is too fat to write with. The fiber optics keep the spot at its original size.

The numbers associated with the Honeywell machine, designated the Model 1806 Fiber-optic Visicorder, are staggering. Writing across the paper increases the effective chart speed from the nominal 100 inches per second at which the paper travels to over 40,000 inches per second, and the writing speed (the measure of how far the curve would reach if it were pulled into a straight line) from a conventional 50,000 inches per second to more than four million inches per second.

Along with the tremendous frequency response, Honeywell has provided the customer with a number of extras. The 1806 can be used as a superfast x-y plotter, spitting out complicated Lissajous patterns like so many games of tic-tac-toe. To save paper, which costs 20 cents a square foot, the paper drive can be triggered internally by vertical information; transients can be monitored in this way without reviewing miles of normal operation as well. It prints its own reference lines. And most spectacular of all, because the intensity of the electron beam can be modulated like that of any other crt, the 1806 will also pick off individual frames from a television transmission and print them out at the regulation 30 to the second [see photo strip at the left]. Peak Z-axis modulation—the rate at which the beam can be switched on and off—is 3.5 Mhz.

Honeywell thinks that the potentialities of the 1806 are limitless. It has already delivered one to the Pentagon. The Sandia Corp. is reportedly interested in using one to plot a temperature profile across a pulse reactor. A representative of a large component manufacturer said that he could think of 20 laboratories in his company which could use the machine. At \$20,000 per machine, that would be quite an investment.

#### I. Transverse mode

Conventional fast oscillographs write with beams of light that are

Tracings of an actual sequence of tv frames illustrate the speed of the fiber-optic oscillograph.

deflected onto photosensitive paper by tiny galvanometers bearing tinier mirrors. The galvanometers merely move back and forth on one axis, and it is the motion of the paper that provides the time base. At 10 kilohertz, the tracings on paper moving at 200 inches per second—just about the limit for present paper drives—will be jammed together at 50 cycles per inch. At that density, it's pretty hard to analyze a complex waveform. It's even hard to see it.

In the 1806, the paper is pressed against the face of the crt and driven by a silicon controlled rectifier motor at a top speed of 100 inches per second. As the paper emerges from the machine, it passes under an ultraviolet light source that brings out the tracings.

**Continuous output.** There are other instruments which will record at high frequencies, but none which will provide this direct continuous output. Polaroid high-speed films, for instance, will pick off an instantaneous trace—but the record is not continuous. A high-speed camera will give a continuous record, but the film must be developed. Magnetic tape can record at high frequencies and then be played back at slower speeds, but the process is not direct and the tape recorder itself is not cheap.

The impetus for the development of a machine that would print directly from a cathode-ray tube came from the Pentagon, which gave Honeywell a contract in October of 1962. A little over two years later, the company delivered a prototype of an enormous machine that fits in two 6-foot racks, writes through a 9-inch strip of fiber optics only one-fourth inch wide. The system used commercially available electronics and paper drive; and because the fiber optic strip was so narrow, it could not provide vertical deflection, and the tracings were longitudinal—down the paper. Its response is 10 khz but the system did have Z-axis modulation.

Before the military prototype was even built, Honeywell had begun thinking about commercial applications, and in July, 1964, Don Shafer, a young engineer who had worked on the Pentagon's recorder, was put in charge of the demobilization. It was clear that only transverse recording would permit high-



frequency response. Since the oscilloscope itself writes horizontally, there would seem to be no problem: merely make the whole face of the crt of fiber optics, instead of only a thin strip, and follow the bouncing ball. That essentially is what Honeywell did—but it wasn't that easy.

## II. Through thick and thin

Normally, a cathode-ray tube is made of a single glass bulb, but if the face is to be made of fiber optics, then face and body must be bonded together. Since fiber optics are weaker than glass, the face plate must be thicker, or the tube will implode when air is pumped out; and bonding a thick plate to a thin tube causes expansion problems.

The 3-by-5 inch plate on the Honeywell machine is a half-inch thick. It contains more than 35 million fibers, each 10 to 15 microns in diameter in hexagonal bundles  $\frac{1}{8}$  inch across.

**Tender care.** Honeywell buys its crt's from the Electron Tube division of Sylvania Electric Products, Inc., a subsidiary of the General Telephone & Electronics Corp. Sylvania, in turn, buys the fiber-optic plate from the Mosaic Fabrications Co., of Sturbridge, Mass. It was Mosaic which solved the bonding problem—with tender loving care. Mosaic reportedly brings the tube up to bonding temperature (400°C) at about half a degree a minute and cools it at the same rate. Sylvania follows this same tedious process in the exhaustion and final sealing process. Still, the manufacture is so tricky that Honeywell reports a tube failure rate of from 20% to 30%. Shafer says, though, that he does not regard the failure rate as serious at this stage of development.

Sylvania contributed an improved gun, which provides greater initial spot resolution. The spot diameter on the inside of a typical laboratory oscilloscope is 15 to 30 mils. The Sylvania gun makes spots that are 4 to 7 mils across.

## III. Many circuits, small package

Given this essential component, Honeywell designed a completely new oscillograph that is solid state except for the crt itself and some cold-cathode devices in the high-

# gotta crazy curve?

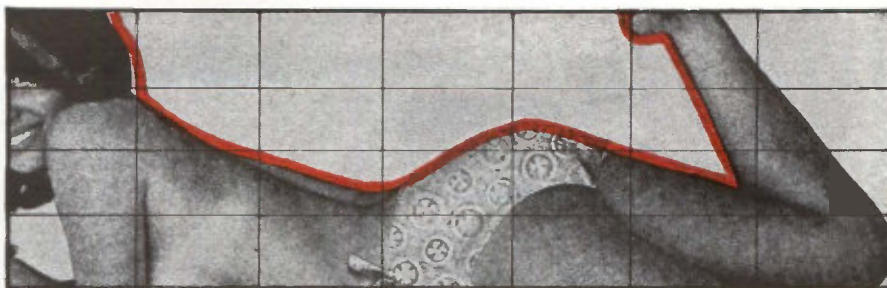

## A DUNCAN NON-LINEAR POT CAN MATCH IT!

Even if your non-linear function looks like the Playmate of the Month in profile, Duncan can build a pot to match it. All you have to do is use the new "DUNCAN DO-IT-YOURSELF NON-LINEAR FUNCTION KIT," which we'll send you without obligation if you'll fill out and mail the coupon below. The kit includes a fabulous French curve\* plus all other necessary ingredients and instructions. You supply us with the non-linear trace of your function and other supporting data. We'll feed it to our high-speed computer and analyze the data defining the pot's desired function. Then we'll enter the output tape into our servo-controlled machines to produce the variable-pitch winding to meet your function.

To be sure the output of the pot conforms to the specified tolerances, we'll compare it with the theoretical function on our unique conformity tester.

The result? A precision, accurate pot exactly to your specifications.

Our applications engineers can help solve your problems quickly and economically. In many cases they'll be able to match your function using pre-calculated data from our extensive tape library.

So forget about cams, differentials, and non-linear gears. For the direct approach to a complicated non-linear potentiometer problem — for airborne data computation or matching thermocouple curves — depend upon Duncan. You'll have more time to check out other interesting curves!

Send for your free Duncan "do-it-yourself" kit today. For literature only, circle the appropriate number and mail the inquiry card enclosed in this magazine.

### DUNCAN ELECTRONICS INC.

Please send me my free "DUNCAN DO-IT-YOURSELF NON-LINEAR FUNCTION KIT" and complete technical literature on Duncan's family of non-linear potentiometers.

I understand that there is no obligation on my part.

Name \_\_\_\_\_ Title \_\_\_\_\_

Company \_\_\_\_\_

Address \_\_\_\_\_

City \_\_\_\_\_ State \_\_\_\_\_ zip \_\_\_\_\_

\*French curve ruler by Birule Co.



DUNCAN electronics, inc.

2865 Fairview Rd., Costa Mesa, California 92626 Tel.: (714) 545-8261 TWX: 910-595-1128



# VECO THERMISTOR SENSOR ASSEMBLIES



VECO Thermistor Sensor Assemblies are complete ready-to-mount, temperature sensing units designed for a variety of applications. They can be readily attached by bolts or screws; threaded into walls or surfaces; inserted into sockets or affixed by solder, tape or cement to any convenient surface.

VECO Thermistor Sensor Assemblies are precision mechanical and electrical devices incorporating thermistors that exhibit a high negative temperature coefficient of resistance. Standard assemblies are stocked in a wide variety of housings and electrical characteristics. Special designs for specific customer requirements are available.

- Fast response
- High accuracy
- Shock resistant
- Compact
- Light weight
- No moving parts
- AC-DC-Low power consumption

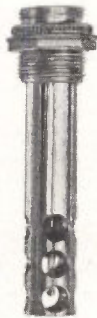

## APPLICATIONS

- In-flight telemetry of surface, liquid and gas temperature data from aircraft, high-altitude weather balloons, missiles and satellites;
- Temperature measurement in geological and oceanographic studies;
- Temperature and temperature gradient measurements in micro-meteorological studies;
- Skin temperature measurements in psychological and physiological studies;
- Temperature measurement and control of electronic equipment, chemical processes, storage and conveyance facilities for the handling of perishable goods, and all types of heating, air conditioning and refrigeration processes;
- Liquid level control and measurement;
- Flow measurement and control of liquids and gases;
- Temperature monitoring and alarm such as in overheat protection of heavy machinery and fire control.

Write for Technical Bulletin MS081

VECO First in Progress • First in Service

J-6908

**VECO VICTORY ENGINEERING CORP.**  
122-50 Springfield Ave., Springfield, N. J. 07081  
Tel: 201 • 379-5900 TWX: 710-983-4430

voltage supply and regulator circuits, and which, though more versatile than the huge military system, measures only 14 inches by 16¾ inches by 22¾ inches, and weighs only 120 pounds. The electronics are on 15 printed circuit boards.

To keep the transverse tracings from sloping to the right because of the paper movement, there is a skew correction circuit that tilts the waveform down to the left. Paper speed, sensed by a tachometer, governs the voltage ramp generated by a Miller integrator. Every time a gating pulse from the oscilloscope's sweep generator discharges the capacitor in the integrator, the ramp is summed into the scope's vertical amplifier circuit.

**Video signals.** If the input is a video signal, rather than a waveform, the paper speed must be compensated for in a different way, since normally it would tend to stretch the picture. Attenuating the vertical deflection squeezes the picture on the crt, by about half, so that the paper movement stretches it into the right dimensions.

The 1806 does not actually pick up every sweep of a video signal, because a tv raster builds its 525-line frame by scanning down 263 lines, then jumping back and filling in the remaining 262. Since the paper has moved past the top of the frame by the time the beam starts filling in the so-called interlace pattern, the 1806 must blank out half the picture.

## IV. More to come

The 1806 has achieved printout at the rate of 4 Mhz in the laboratory, and in theory, there is no reason why it could not go even higher, if sweep speed were increased so that discernible peak-to-peak spacings were maintained at the higher frequencies.

Sweep speed in the present machine is 10 microseconds per centimeter, or 120 μsec per sweep across the 5-inch tube. Shafer explains that this speed was originally chosen for a peak response of 100 khz. When Honeywell found that the 1806 would actually respond to 1 Mhz, there was no time to go back and redesign to change sweep speed. In any case, a faster sweep

would give rise to totally new problems, since the electron beam would stay on each spot for a much shorter time, and the light intensity would be correspondingly lower.

More sensitive paper might ameliorate that problem. Gene Haugen, product manager, says that the paper manufacturers—principally Kodak, but including Ansco and du Pont—"seem to improve it about twice a year." The easiest answer would be to increase the intensity of the electron beam by increasing the anode-cathode potential—but here again there are problems.

In the present tube, the total acceleration potential is 7,500 volts, the sum of minus 2,500 volts supplied to the cathode and plus 5,000 volts. This low potential was specifically chosen to allow the deflection plates to operate near ground, which is essential for solid state circuitry.

If the potential were increased, the deflection plates would need more and more voltage to swing the beam, and transistors would not be able to handle the job. Moreover, there would be heat dissipation difficulties.

For the present, Honeywell will be satisfied with a 1-Mhz response. It will have the high-frequency field to itself; its chief competitor, the Consolidated Electrodynamics Corp. of Pasadena, Calif., has no plans to make a fiber-optic scope.

**No marketing worries.** Honeywell does not, however, intend to stand still with the 1806. "I see this as a whole product line," says Haugen. "We plan a multiple channel oscillograph, with as many as six external inputs time-shared by high-speed commutation. We are also thinking of a portable, battery-operated unit, with a smaller scope, that will use more integrated circuits and would cost between \$3,000 and \$5,000."

From the excitement generated earlier, when Honeywell let it be known that it had a 100-khz oscillograph in development, Haugen is not worried about marketing the new machine. Prospective buyers who came to see 100 khz remained to goggle at 1 Mhz. "People will dream up applications we haven't even thought of," Haugen says cheerfully. The Pentagon is probably busily thinking of some even now.



# Thinning the traffic jam

San Jose, Calif., uses a computer system to gather data and formulate strategy for improved vehicular flow

**H. L. Mencken saw it coming.** The first time he found a "No Parking" sign in front of his Baltimore Sun office, he abandoned his car and never drove again. That was 40 years ago; today America's city streets are clogged with the automobiles of those who did not follow his example. Of all the annoyances of modern city life—smog, noise, overcrowding, and the cover charge—the traffic jam may well be the most exasperating.

Some cities are turning to electronics, in the shape of a digital computer and a variety of sensors, to spread the jam more thinly. San Jose, Calif., has the biggest computerized traffic control system now operating in the United States. For the past two years, San Jose, with a population of about 330,000, and the International Business Machines Corp. have been cooperating on a program in which an IBM 1710 collects data and controls traffic light strategies for 59 intersections along one main artery and in a downtown grid [Electronics, Nov. 29, 1965, p. 30].

IBM contributed the use of the 1710 for the project, but that computer system proved to be too slow to allow San Jose to expand the area under control in the future. The city, which will be on its own when the arrangement with IBM expires at the end of the year, has purchased a much faster 1800, at a cost of \$200,000.

Because the system measures traffic flow rather than the progress of individual cars, it cannot make a decision for each car at each light. Eugene E. Mahoney, city traffic engineer in charge of the project, says, however, that total delay for all cars in the area of control has been reduced by 17%.

Although Mahoney has data to show that queues at red lights are now much shorter, he admits that the average San Jose driver may

not realize that he is getting through traffic any faster.

"We're nibbling away at seconds, but it adds up to a lot of seconds for a lot of cars," he explains.

## I. The approach

IBM's approach ties all elements of the system—lights, controllers, traffic detectors—directly into the central computer. The computer, through a simple local controller, handles each intersection. Therefore, as many as 128 timing patterns can be implemented at each intersection by reaching into a magnetic disk storage drive containing programs, subroutines and complete traffic operating tables required by the system. On a citywide basis an almost unlimited combination of traffic signal timings is available, and the timings can be experimented with simply by changing a program. In addition, certain critical intersections can be controlled by vehicle detectors instead of by computer. If the computer should fail the system reverts to a standard three-dial mode of control.

"IBM is not going into a city with a complete traffic package all tied up in a pink ribbon," points out Oser I. Bermant, program manager for vehicular traffic systems. Rather, the company offers a tool—the combination of the 1800 computer and its programming package. This allows the traffic engineer to deal with the total problem. He can gather information, make decisions on how the information should be used, execute the decisions and then see what effect the control has had on the over-all system.

**System in Texas.** IBM also has an 1800 computer installed for traffic control in Wichita Falls, Texas. It is also negotiating with a large midwestern city about double the size of San Jose, and

two others about the size of San Jose, according to Bermant. Another digital system is being designed for New York City by Sperry Gyroscope Co., a division of the Sperry Rand Corp., which helped to design a system now in use in Toronto.

"Any city of at least 100,000 population will find digital computer-controlled traffic systems competitive with the analog control systems that are available. And digital systems give you so much more flexibility," Bermant asserts.

## II. Traffic a go-go

What San Jose has, basically, is an enormous data collection system. A network of 320 induction loop sensors, each with its own curbside amplifier, and 80 pressure pads, collects information. The computer uses this data to make six measurements.

- **Volume.** The number of cars passing over detectors for each approach lane to each signal is noted at five-minute intervals; the computer can be programmed to reject measurements that are out of line (more than 2% away from the average).

- **Speed.** This is calculated as a five-minute average on 50 of the detectors—but not always the same 50—using an average vehicle length of 17.1 feet. The speed figure has a high inverse correlation to congestion.

- **Stops.** The computer does not actually count stops, since it has no way of detecting them. Knowing, however, the distance from the loop to the stopline, the average speed, and the condition of the traffic light, it can register as "stopped" any car that has passed the approach loop without enough time to catch the green light. Those which speed up on the yellow signal it considers statistically insignificant. If a queue stretches past



**Exclusive!**

# Single Dial Source and Detector



## *Simultaneous Tuning of Source and Detector with New Wayne Kerr SR268 (100kHz-100MHz)*

With other systems, it is necessary to tune the source to a specific frequency and then the detector must be tuned to the exact same frequency.

The new Wayne Kerr SR268 Source & Detector performs both functions simultaneously in a single operation over the range 100kHz-100MHz at a short-term frequency stability of 0.01%. Frequency accuracy over this range is  $\pm 2\%$ .

The simplicity of operation provided by ganged tuning is furthered by the incorporation of common-mode rejection transformers in the input and output networks, reducing any interference or cross-talk from unwanted signals.

Operable simultaneously from an external nine-volt battery and a six-volt battery for pilot light indications, SR268 is ideal for field work, too. SR268 is an ideal companion instrument to Wayne Kerr R. F. Bridge B601, VHF Bridge B801B and precision R. F. Bridge B201.

### SPECIFICATIONS

Frequency Range:	100kHz to 100MHz in 9 bands:
BAND 1	100kHz - 216kHz
BAND 2	216kHz - 465kHz
BAND 3	465kHz - 1000kHz
BAND 4	1.00MHz - 2.16MHz
BAND 5	2.16MHz - 4.65MHz
BAND 6	4.65MHz - 10.0MHz
BAND 7	10.0MHz - 21.6MHz
BAND 8	21.6MHz - 46.5MHz
BAND 9	46.5MHz - 100MHz

#### Oscillator Output Level:

Maximum output into 75 $\Omega$ : BANDS 1-7, 2V rms; BAND 8, 1V rms; BAND 9, 0.5V rms

Output Level Control: 39dB in 3dB Steps (75 $\Omega$ )

#### Detector Sensitivity:

Maximum Input Required for 10% Meter Reflection: BANDS 1-6, 1 $\mu$ V x (fMHz)<sup>1/2</sup>; BANDS 7-8, 10 $\mu$ V; BAND 9, 30 $\mu$ V 46.5MHz - 70MHz, 20 $\mu$ V 70MHz - 90MHz, 10 $\mu$ V 90MHz - 100MHz  
Input Level Control: 4 Steps of 20dB (nominal)

For literature and detailed specifications, write:



## **Wayne Kerr CORPORATION**

18B Frink St., Montclair, N. J. 07042 • Phone (201) 745-2438

INNOVATIONS IN INSTRUMENTATION

**... the computer can  
evaluate traffic daily ...**

the detector loop, of course, the computer cannot count the last cars.

▪ **Demand.** This is the number of vehicles per green-yellow-red cycle which approach a signal in each lane.

▪ **Delay.** This figure, the most important in evaluating the system, is calculated from the number of stops, and is measured in vehicle-seconds.

▪ **Lane occupancy.** Fifty detectors—again not always the same 50—are used to obtain this figure as a five-minute average.

The measurements—some 500,000 a day—are the basis for making changes in the only three variables in a traffic light system: cycle, split, and offset. Cycle is the length of a green-yellow-red sequence, split is the ratio of red time to green time in any given cycle, and offset is the difference in time between green lights at neighboring intersections.

These variables may be manipulated in a number of different patterns. San Jose experimented with six:

▪ A single fixed pattern which does not change at all.

▪ A program of three patterns which are put into effect at fixed times each day.

▪ A program of three patterns which are put into effect according to fluctuations in traffic volume at certain detectors.

▪ A multiple cycle selector system, in which as many as six patterns are available and choice is determined by the volume of flow.

▪ An expansion of the above method, in which any number of patterns derived from previous day's data, may be put into effect either at fixed times or at times determined by traffic volume.

▪ What IBM calls the "micro-loop" strategy, in which the split may be varied at individual intersections depending on the traffic conditions.

Clearly, each successive strategy has been more complex than the one which preceded it. With the exception of microloop, however, all apply stored programs; micro-loop takes advantage of spare seconds in arterial traffic to accom-



modate across traffic, left turns, and pedestrians—the latter are the bane of any traffic control system.

For all its sophistication, however, even microloop can only vary the split by a few seconds.

### III. Model solution

Although only six strategies are being employed, each offers a great many tactical variations. Split, for example, can be divided in a number of ways, and differently for selected intersections.

In order to get an idea of how new strategies and tactics will work without actually trying them in traffic, Albert Chang of the research and development laboratory at IBM's San Jose plant, has built a mathematical model of the 59 controlled intersections. Chang uses about four hours a month on an IBM 7094 computer to test new strategies, using data collected by the traffic control system.

Chang believes that the biggest achievement of the computerized traffic system is in the data collection that makes simulation and further study possible. "Everything being done in San Jose now could be performed with conventional equipment," he says, "but we couldn't lay out new designs without the data collected by the computer."

**Long way to go.** "Sure," says Mahoney, who combines boundless enthusiasm for his system's potentialities with a healthy skepticism for what it can do now, "there are a lot of kinks to be ironed out. We're just getting started. In the beginning, we didn't even know what the detectors were telling us and finding out helped eat up the two years.

"With the computer you can evaluate the traffic system daily. We get data so quickly that an engineer doesn't have time to sit back and say 'What do I do now'? He has an instrument that tells him to get off the dime. Of course, the instrument isn't perfect. Sometimes, in fact, the boys here go nuts because the drivers don't do what the computer thinks they should do. It's all a matter of collecting more data; I am not satisfied yet that we have enough information to show what truly makes changes in traffic performance."

for maximum **SOLID CARBIDE** drilling precision

## SERIES 125 - 1/8" SHANK SOLID CARBIDE CIRCUIT BOARD DRILLS

the rigid stability  
of 1/8" shanks  
with EVERY size drill

Series 125 Circuit Board Drills are made with Metal Removal Company specifications of point configuration (Four Facet Point), helix angle, very fine flute finish and exacting size tolerances.

**The Series 125 Circuit Board Drill is an advancement of drill design to its present optimum. Among many features, it offers:**

- Strength and rigidity of the 1/8" shank permits location and hole size tolerance to close limits.
- Drill bushings completely eliminated where used with precision spindles and collets.
- Also available in double end style with 1/8" shanks.
- 1/8" common shank size for all drill diameters eliminates inventory of collets for each size drill.
- Drill point is concentric to drill diameter within .0005"; drill diameter to shank concentricity is within .0003".
- Permits ultra high speed drilling at rates up to 150,000 RPM and 5 feet per second feed.
- Can be manufactured with geometry variation for clearances required for fast feed, high RPM operation.

For complete information write for Bulletin CB66.

**THE METAL REMOVAL COMPANY**

1859 West Columbia Avenue  
Chicago, Illinois 60626

Plants Located in CHICAGO • LOS ANGELES • SAN JUAN



MASTER TOOL AND WHEEL MAKERS FOR THE WORLD



# Electronics for grandeur: De Gaulle's foreign policy spurs growth of CSF

Advanced avionics and space hardware are helping President Charles de Gaulle transform his dream of grandeur for France into reality. Much of the electronics is coming from CSF-Compagnie Generale de Telegraphie Sans Fil

By Peter Kilborn

Paris News Bureau

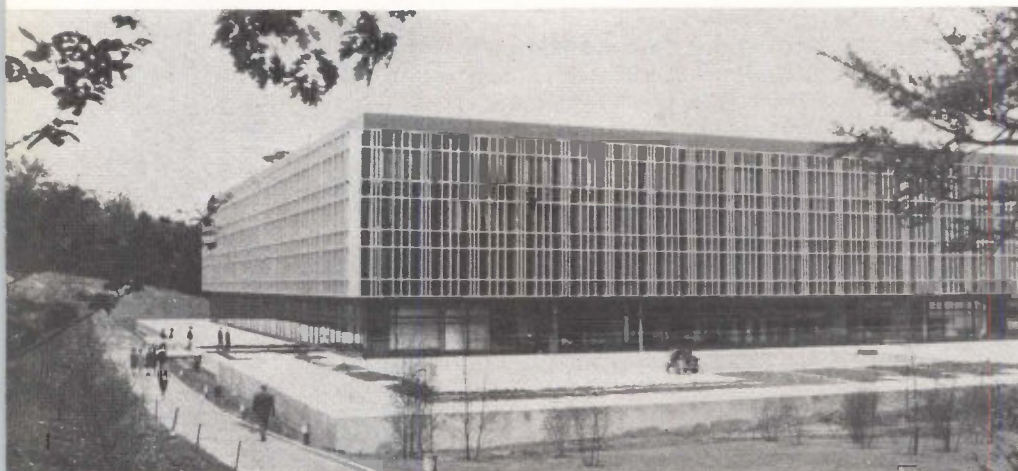

CSF outgrew its old headquarters in downtown Paris and now company is run from sleek new building at Rocquencourt, near Versailles.

Charles de Gaulle's notions of grandeur for France often seem a throwback to 19th century nationalism, but they've kept the country's electronics industry in the forefront of 20th century technology. Perhaps no other company has benefited as much from the French leader's single-mindedness as France's best-known electronics company, CSF-Compagnie Générale de Télégraphie Sans Fil.

To strengthen his say in world affairs, de Gaulle has eschewed the mutual defense of the North Atlantic Treaty Organization—dominated by the United States—and mounted his own nuclear striking force, the "force de frappe." Determined not to let space communications wind up as a monopoly of the U.S. and the Soviet Un-

ion, de Gaulle has put France into space. Prompted by prestige, France alone of the major West European countries has picked its own Secam system for color television. And convinced that computers are crucial to industrial independence, de Gaulle has moved to build a durable domestic computer industry.

**Pros and cons.** All these efforts have brought business to CSF; so much so that the government is far and away CSF's best customer. But what's good for Gaullist grandeur isn't always good for CSF. The company, for example, has seen its military business with the United States dwindle as de Gaulle's foreign policy clashed with American interests. And de Gaulle's desire for a world-class nuclear

striking force has opened the doors to some tough competition—U.S. semiconductor manufacturers who set up plants in France to make advanced components.

Aware that too much dependence on government business might be disastrous in the long run, 64-year-old CSF president Maurice Ponte has started to form alliances with other European electronics companies with a view to strengthening CSF's position in consumer and industrial markets.

## I. On the bandwagon

Riding the bandwagon fueled by Gaullist ambition, CSF has shown strong growth in recent years. Last year, sales of the parent company and its affiliates totalled \$276 million, up in three years from \$188 million. Only about 8% of the total came from consumer electronics; thus CSF ranks as France's largest producer of military and industrial electronics equipment. Nonetheless, CSF remains a fairly small company even on a European scale; on a list of the top dozen Western European electronics companies, CSF is near the bottom.

CSF, though, has the stature of an electronics giant in Gaullist France. A pair of CSF transmitters, for example, is transmitting data back from the D-1A satellite launched last February and still being tracked by six CSF-equipped ground stations.

Last month, Defense Minister Pierre Messmer turned up at CSF's new headquarters at Rocquencourt,



near Versailles, to hail the production of the 500th "Cyrano" airborne fire control radar. The Cyrano is the kingpin item of avionics equipment in France's Mirage III fighter planes. Other CSF avionics hardware is on Mirage IV strategic bombers, the first-generation delivery vehicle for the force de frappe. When the second-generation missiles go operational in 1969, they'll carry CSF guidance gear.

CSF klystrons power French nuclear research particle accelerators. CSF transmitters and microwave links cover France for the government-owned broadcasting network. CSF owns a third of the Compagnie Française de Télévision, which has the rights to the Secam color-tv system that the de Gaulle government has backed in earnest to bolster French prestige. And CSF has a one-third holding in "Société S," the company formed at the government's instigation to develop a line of medium computers [Electronics, June 27, p. 197].

**Best customer.** All in all, direct sales to the government accounted for 42% of CSF's business last year. And Ponte, the company's president, estimates that another 20% to 30% of sales was for CSF-produced components that wound up in hardware ordered by the government. Even the remaining third of sales—mostly industrial equipment and radio and tv receivers—is heavily affected by government policies.

Along with the business it has spawned for CSF in France, de Gaulle's pursuit of independence from the U.S. has made for a good selling climate in Soviet-bloc countries. Russia, of course, has adopted the Secam color-tv system and brought with her into the Secam fold all the countries of Eastern Europe. Russia also will buy CSF know-how to build a color-tube factory that will be turning out between 1 million and 1.5 million tubes annually by 1970.

With the government's help, CSF has sold complete semiconductor factories to Rumania and Bulgaria and a tv-receiver plant to Bulgaria. What's more, a number of East European countries have bought CSF studio equipment and transmitters. And Secam will add to CSF's sales to East

Europe. Ponte predicts that sales there of CSF studio equipment and components for receivers may total \$20 million by 1970. This is in addition to the company's share of some \$10 million in Secam royalties that Compagnie Française de Télévision expects to harvest by 1970.

And de Gaulle's foreign policy hasn't hurt CSF in its traditional major export markets for telecommunications equipment—Africa and Latin America. De Gaulle has a strong aid program for French-speaking African countries and he woos Latin American countries whenever he can.

**Mating.** Throughout his reign, de Gaulle has waged a campaign to form strong French companies in vital industries through mergers and cooperation agreements. To get companies to join forces he dangles the carrot of government research contracts and hardware buying; when that doesn't work he applies the stick of government pressure.

So far, CSF has had everything to gain by going along with this facet of Gaullism. In 1964, CSF and the Compagnie Générale d'Electricité, another heavyweight in the French electronics industry, signed an agreement that lumped together seven of their subsidiaries specializing in computers, data transmission and automation into a jointly owned company called Compagnie pour l'Informatique et les Techniques Electroniques de Controle (Citec). It was formed, with strong government backing, just after the General Electric Co. swallowed what was then France's only important computer maker, Compagnie des Machines-Bull.

Now de Gaulle's "Plan-Calcul" has whipped the only other firm with significant computer manufacturing potential into Citec. The new member is the Schneider group's Société d'Electronique et d'Automatisme (SAE), which like CSF and CGE owns 30% of the new Société S, so titled until its backers find a suitable name.

Ponte is confident that the new group has the materials and markets to make the operation pay. He cites the success of a Citec subsidiary belonging to CSF—Compagnie Européenne d'Automatisme



Maurice Ponte, president of CSF, says de Gaulle's drive for grandeur helps company grow . . .



. . . Ponte figures government buying accounted for nearly three-fourths of CSF's sales last year . . .



. . . But he says, "French policy, while an important factor in our development, isn't always favorable."



**CUSTOM  
DESIGNED  
POWER  
SUPPLIES  
TO**

**Mil-E-16400**

**Mil-E-5400**

**Mil-E-4158**

**Mil-T-21200**

**Mil-P-11268**

**NASA-200-2**

**Mil-I-983**

**Mil-F-18870**

*Detailed data on facilities,  
capabilities and contract  
accomplishments on request.*



90 ROME STREET  
FARMINGDALE, NEW YORK 11735  
Phone 516-694-5484  
TWX 516-694-1505

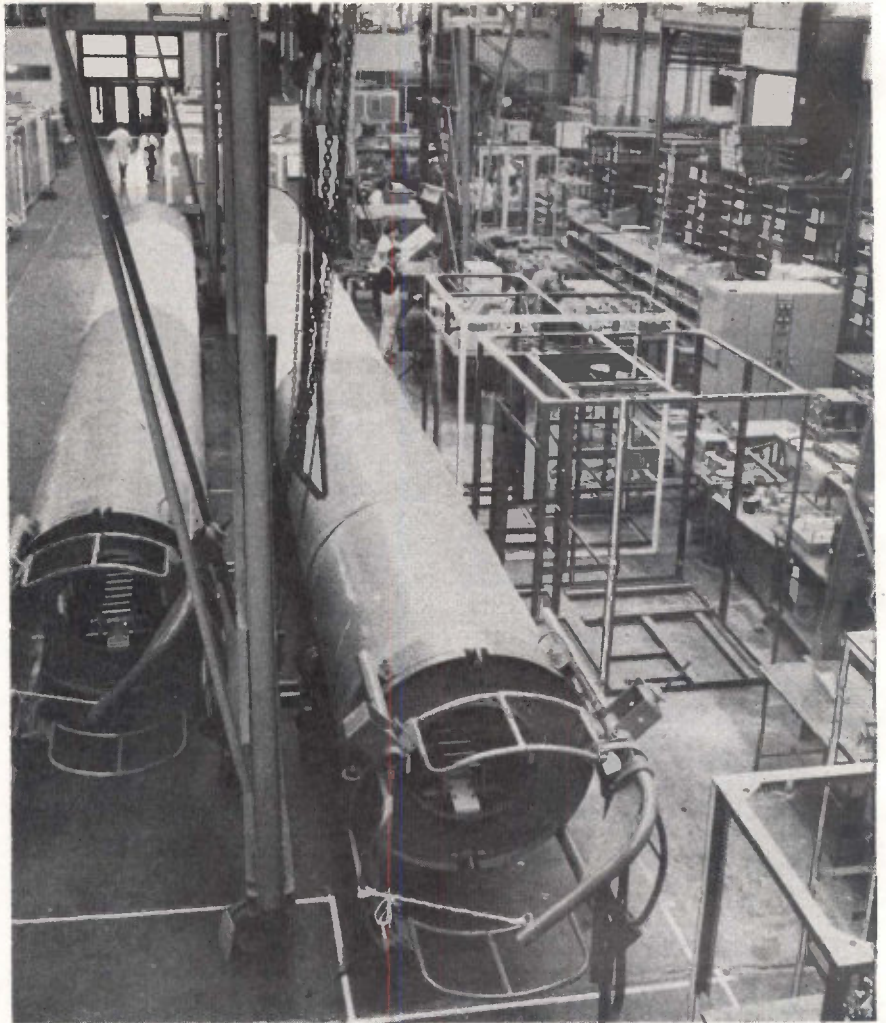

CSF is supplying 28 of these 100-kilowatts ultra high-frequency tv transmitter antennas to the state-run French broadcasting network.

Electronique (CAE). Its 1965 sales leaped 180% over 1964 and accounted for 9% of all computers sold in France. All other French computer builders collected only 5% of the market, and the rest went mostly to the International Business Machines Corp. and Bull-GE.

Going along with de Gaulle's policy has resulted in one strange bedfellow for CSF—one of its stiffest competitors for military and industrial business, Compagnie Française Thomson Houston-Hotchkiss Brandt. The two companies will work together in research on integrated circuits. And CSF has joined with a company called Société Industrielle de Liaisons Electriques to develop microelectronic components for export.

## II. Backlash

Although the French government is CSF's best customer and a bulwark for the company, the

Gaullist scheme of things doesn't always work out to CSF's advantage. "French policy, while an important factor in our development, isn't always favorable," Ponte admits. And says Pierre Braillard, CSF secretary-general, "Let's say the government is a little cumbersome."

A cumbersome diplomatic move, startling when one considers French expertise in the art of diplomacy, helped lose Western Europe for the Secam color-tv system. In an apparent attempt to set up a stampede for the French system, Russia and France announced on the eve of the 1964 International Radio Consultative Committee (CCIR) meeting at Vienna, (where an effort was made to settle on a common color standard for Europe) that they'd teamed up to develop Secam. The heavy-handed attempt turned several wavering countries into supporters of PAL, the West German system that all



the major Western European countries—France excepted—have since adopted.

De Gaulle's refusal to let Great Britain enter the Common Market probably hurt CSF's market in England, too, but there's no real way to gauge how much. CSF officials are convinced, though, they'd do better in Britain if she were in the six-nation trading bloc.

**U.S. drought.** And Ponte says the current friction between U.S. policies and de Gaulle's has been partly responsible for the loss of substantial military business. Until five or six years ago, CSF was picking up about \$2 million annually in U.S. Air Force and Navy research contracts. "Those have gone way way down," he says. Radar and high-power tube sales to the U.S. military averaged another \$2 million then; that market, too, has nearly dried up.

Some of the retaliation against Gaullist policy has been felt by CSF's two U.S.-based operations, Warnecke Electron Tubes Inc., and the American Radio Co. American Radio is primarily CSF's American sales outlet, but it also makes bright display tubes for airport radar and tv cameras. Bright display and camera production have slipped considerably, but CSF attributes that more to saturated markets than to politics. Warnecke, on the other hand, manufactures equipment developed by CSF under military research contracts and with fewer contracts for CSF, Warnecke's business has dropped.

Whatever these companies' troubles, CSF has no plans to pull out of the U.S. market. Ponte thinks Warnecke might eventually need some sort of overhaul. The Hallcrafters Co. is CSF's partner in Warnecke. "What we really need there," Ponte says, "is a bigger partner," and CSF's technical director, Roger Aubert, has not yet written off the U.S. Department of Defense as a potential customer. CSF still has "a few" important contracts, among them one to develop a special microwave tube for the Air Force.

**Hurt at home.** De Gaulle's domestic policies sometimes hurt too. Up until last year, CSF had the habit of bringing off sales growth of about 10% yearly. But 1965 brought a slowdown to 7% growth,

largely because of the government's rigid price stabilization program. Now that stabilization measures have been eased, Ponte sees another 10% gain in sales for 1966.

However, there's no end in sight to the government's policy of letting U.S. companies set up plants in France if they bring with them advanced technology useful to de Gaulle's military and space programs. Texas Instruments Incorporated, Motorola Inc., Fairchild Camera & Instrument, and Transatron Electronic Corp. all have manufacturing facilities operating in France or about to.

Although this backyard Yankee competition hasn't hurt CSF badly—the company's semiconductor manufacturing subsidiaries are turning out about 13 million transistors and diodes a month and exporting about three-fourths of them—it has kept the output of other French companies well below capacity. Above all, the presence of the U.S. semiconductor giants in France will tend to brake CSF's entry into the integrated circuit business since it will be just another—but perhaps preferred—supplier to the government. So far, CSF's integrated-circuit product line consists solely of transistor-transistor-logic circuits.

### III. Beyond de Gaulle

For all the political stability de Gaulle's Fifth Republic has brought to France, there's still plenty of apprehension about what will happen when the General is no longer there to guide the country toward grandeur. Ready for the day when the government might become a less avid buyer of electronics, Ponte has been steering CSF into alliances that will strengthen it in consumer and industrial markets.

With the Common Market wiping out trade barriers in Western Europe and with the domestic market becoming increasingly inadequate to write off the high cost of new-product development, Ponte has started thinking European. CSF's long-term survival, he feels, may even be as part of a "Compagnie Européenne d'Electronique."

"I'm convinced France can't stand alone," he says, "especially with the fantastic rate of techno-



...35 YEARS LEADERSHIP  
IN ROTARY SWITCHES

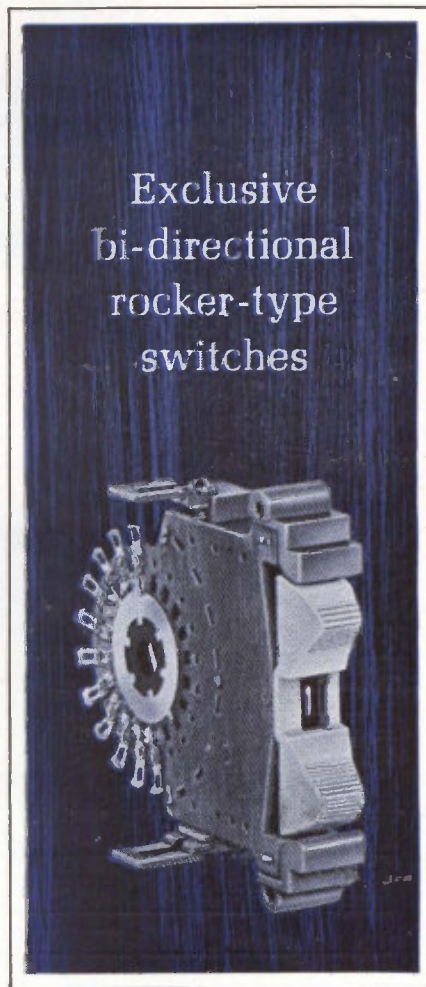

Exclusive  
bi-directional  
rocker-type  
switches

New Oak® Rocker Switches are ideally designed for panel mounting. Module principle permits mounting a single switch, or horizontal or vertical module arrangements of as many switches as desired. All have sturdy mounting frames. Fingers never touch readout characters—Oak's exclusive recessed numerals assure continued legibility. You get bi-directional, multi-position operation, choice of alpha or numeric readout. Can be read from right or left. Can be operated with gloves on for military use. Made with Oak-pioneered double-wiping action contacts.

For full details, write for Bulletin SP-202.

**OAK MANUFACTURING CO.**

A DIVISION OF OAK ELECTRO/NETICS CORP.  
CRYSTAL LAKE, ILLINOIS 60014 • Telephone: 815-459-5000  
TWX: 815-459-5628 • Cable Address OAKMANCO



# UNIQUE, NEW BURR-BROWN OPERATIONAL AMPLIFIERS

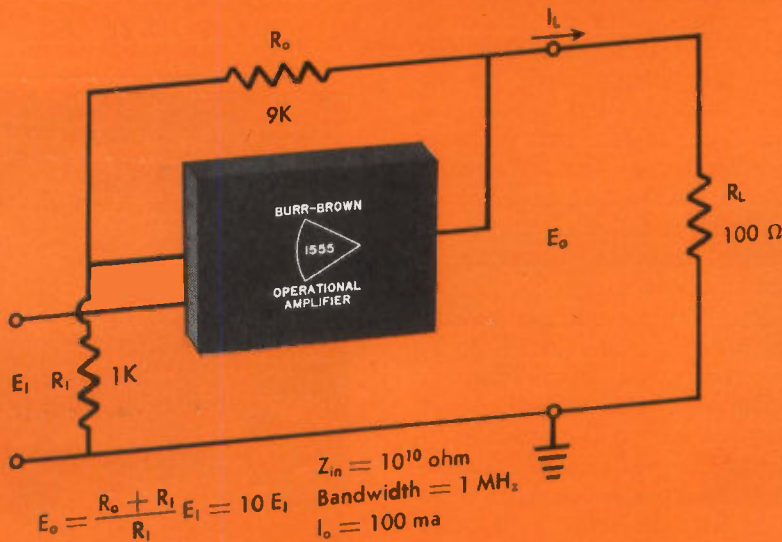

**PROVIDE WIDEBAND, FAST RESPONSE OPERATION IN BOTH INVERTING AND NON-INVERTING CIRCUITS**

These three new Burr-Brown units offer bandwidths and slewing rates that are ten to fifty times better than most other general purpose amplifiers on the market today. Since you can operate both inputs, you can employ them in a wide variety of inverting, non-inverting, and differential configurations. The modular 0.6" x 1.8" x 2.4" epoxy package is ideally suited for any application. All three units are immediately available from stock.

### HIGHLIGHT SPECIFICATIONS

MODEL NUMBER	DESCRIPTION	RATED OUTPUT		BANDWIDTH		SLEW RATE	INPUT VOLTAGE DRIFT	INPUT CURRENT OFFSET	UNIT PRICE
		min	min	Unity Gain	Full Power				
		Volts	mA	typ Mc/s	min Kc/s	typ V/μs	typ μV/°C	typ nA	
1525	general purpose differential input	±10	±20	15	500	50	±10	±5	\$95
1555	differential input FET 10 <sup>10</sup> ohm input Z	±10	±100	15	1000	100	±10	±0.1	\$175
1527	differential input 100 mA output	±10	±100	15	1000	100	±10	±5	\$135

THESE NEW AMPLIFIERS ARE AVAILABLE FROM . . .

**JET STOCK**

Burr-Brown's "Jet Stock" program provides immediate or over-night delivery (U. S. only) of Burr-Brown operational amplifiers, connectors and accessories for your prototype design needs. Your order is shipped from your local Representative's "Jet-Stock." Call him, today.

ENGINEERING REPRESENTATIVES: ALABAMA, HUNTSVILLE (205) 534 1648  
 ALASKA, ANCHORAGE (907) 272 5231 / ARIZONA, PHOENIX (602) 254 6085  
 CALIF., LOS ANGELES (213) 245 9501, SAN FRANCISCO (415) 968 1608  
 COLO., DENVER (303) 388 4391 / CONN., MILFORD (203) 874 9222 / FLORIDA,  
 ORLANDO (305) 425 2764 / ILLINOIS, CHICAGO (312) 286 6824 / MD., SILVER  
 SPRING (301) 593 7144 / MASS., BOSTON (617) 245 4870 / MICH., DETROIT  
 (313) 353 3822 / MINN., MINNEAPOLIS (612) 781 1611 / MO., ST. LOUIS (314)  
 524 4800 / N.C., GREENSBORO (919) 273 1918 / N.J., CAMDEN (609) 365 2450  
 N.M., ALBUQUERQUE (505) 255 1638 / N.Y., ALBANY (518) 436 9649, BING-  
 HAMTON (607) 723 9661, BUFFALO (716) 632 2722, MT., VERNON (914)  
 968 2200, NEW HARTFORD (315) 732 3775 / OHIO, CINCINNATI (513)  
 761 5432, CLEVELAND (216) 884 2001, DAYTON (513) 277 8911 / OKLA., TULSA  
 (918) 835 2481 / OREGON, PORTLAND (503) 292 8762 / TEXAS, DALLAS (214)  
 363 1671, HOUSTON (713) 928 5251 / UTAH, SALT LAKE CITY (801) 466 8709  
 WASH., SEATTLE (206) 622 0177 / CANADA, TORONTO (416) 293 7011, VAN-  
 COUVER (604) 736 6377, WINNIPEG (204) 338 2884

FOR COMPLETE TECHNICAL INFORMATION including detailed Specification Sheets, Short-Form Catalog covering all products, and prices, use this publication's reader service card, call your nearest Burr-Brown Representative, or contact Burr-Brown direct.

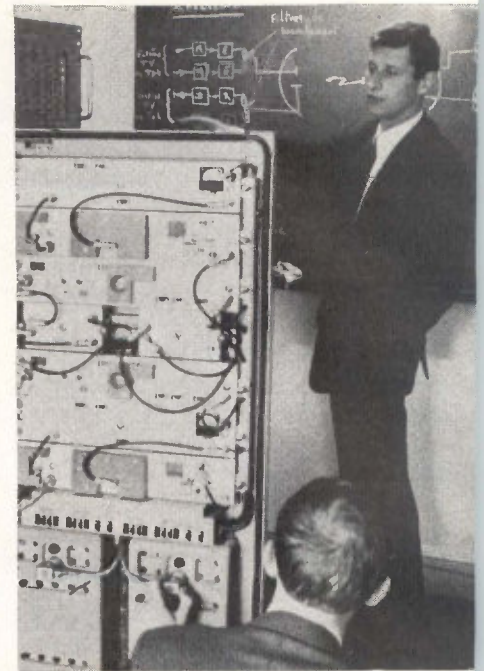

Engineer explains new terminal equipment for microwave data-transmission link.

logical development outside France. We can't do everything. Cooperation with others is vital."

**Teamed up.** Already Ponte has entered into alliances with two major West German companies. Last month, the CSF computer subsidiary CAE signed an agreement with Telefunken AG to market and service hybrid computers. A month earlier, CSF had picked up a strong partner in the entertainment market when it made a deal with Grundig GmbH. The two companies will work together to develop color-tv receivers—with Grundig's marketing experience complementing CSF's capabilities in IC's.

Although it has tied up with larger companies in its German alliances and some of its joint ventures in France, CSF has managed to obtain equal footing with its partners because of its strength in research. CSF has always been strong in high-power microwave tubes and feels it can keep pace in research with U.S. companies in integrated circuits, the key to everyone's future in electronics. Where CSF runs into trouble is getting promising prototypes into profitable mass production. The domestic market all too often isn't big enough to write off production start-up costs. CSF's alliances point to a solution—expanding the basic market to all Europe.



# Learning a trade by computer

Developments in automated teaching promise to provide vocational training by simulating on-the-job conditions

By John Rhea

Electronics Washington Bureau

Ever since the military adopted the famous Link trainer to teach pilots to fly in World War 2, the use of simulators to train specialists has steadily increased. Now government, industry and schools are making plans to use the simulation technique on a much broader scale—for vocational education.

Development is under way of computer-aided instruction systems that will simulate on-the-job conditions and give students computer-guided experience with mock-ups of the equipment they actually will be using in their jobs. The computer instructs the student, gives him problems to solve and grades the results. Most important, the computer simulates in real time the actual functions of the equipment the student is learning to operate.

The computer is not an ordinary teaching machine, such as those now used in elementary schools. With present typewriter keyboard systems, students must communicate with the computer in alphanumeric form; in the new system, a computer converts analog data into digital information for processing.

"The mission of laboratory and vocational training facilities is to provide practical experience," says George Hallgren, laboratory director at the International Business Machines Corp.'s Federal Systems division at Gaithersburg, Md. "This practical experience," he adds, "cannot be realized by a mathematical machine that deals only in numbers rather than physical reality. A punched card cannot substitute for a rheostat or a printed page for a tachometer."

Work is already under way in developing the new technique. IBM has developed a prototype

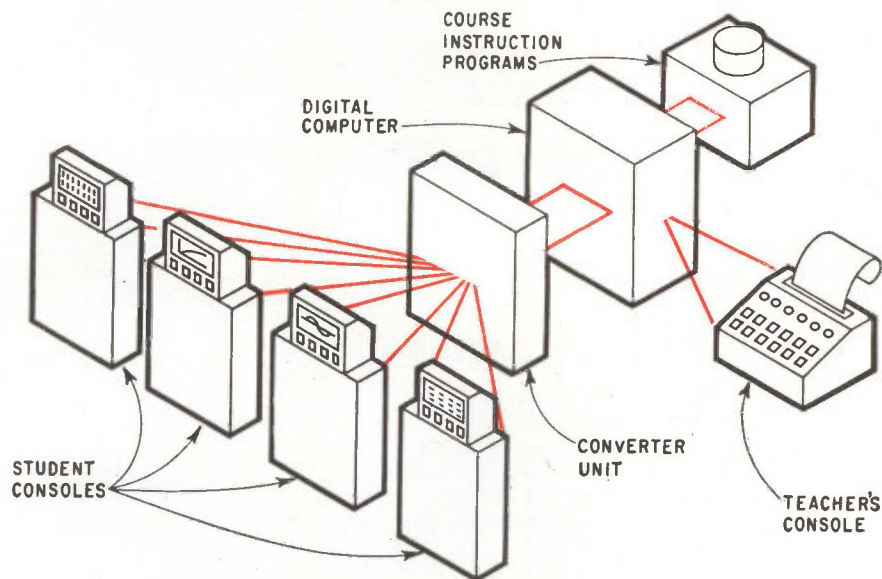

Computer system for vocational education would use student consoles that simulate the actual device the student is learning to operate. His responses, which are in analog form, are converted by the computer for digital processing.

system with company funds. The military—which promises to be the biggest single customer for the new method—is spending \$4 million a year on research on automated education.

## I. Old hat, new feathers

Although the simulation technique is based on military experience in the field, the new programs go several steps further.

Today's compact, high-speed computers automatically record a student's results and permit teachers to analyze individual progress. Computers are available with individual student consoles tailored for each training application. And the list of new innovations is growing to where only economic restraints and the ability to write programs limit the possible uses of computer-aided instruction. Oper-

ation of a nuclear reactor, locomotive or oil refinery could all be simulated in real time to give students practical experience, proponents of the technique say.

**Market waiting.** As is the case with most other technological innovations, the Government is both the spur to research and the biggest customer for finished hardware. Such organizations as the Department of Defense and the Office of Education are working out plans to apply computer-aided instructional systems.

Electronics marketing officials and the educators who will use the equipment are both cagey about making any sales predictions. But the most often heard estimate is that the market will rise from essentially zero at the moment to around \$1.5 billion a year by 1972, including both academic and vo-



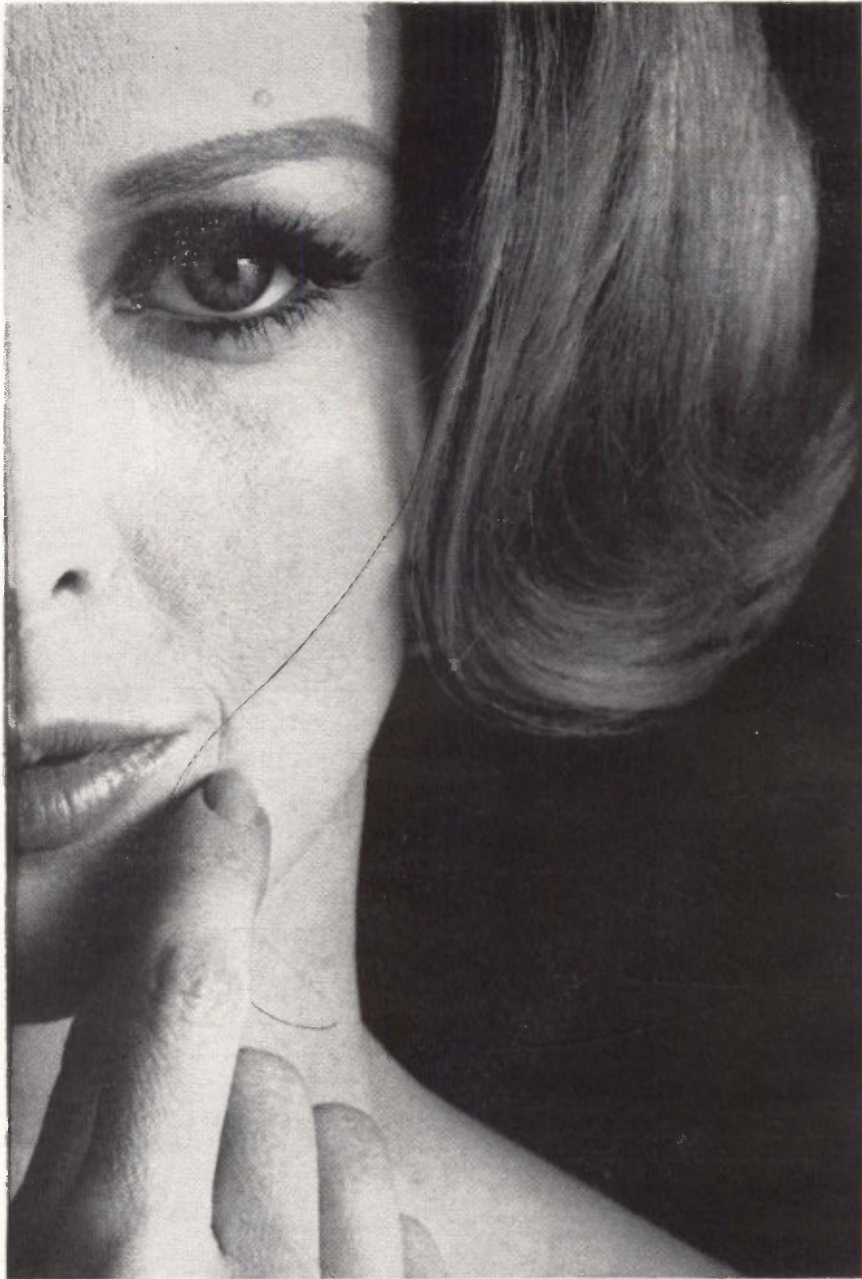

Her fine hair is  
25 times thicker than our foil

Depending on the material, we roll to 0.0001 inch or *thinner*. We do it with your alloys, with Hamilton-developed proprietary alloys, or with off-the-shelf metals. We roll them to *exact* specifications within the closest tolerances with the precise finish you direct. We retain the required metallurgical properties and characteristics. Further, we guarantee the finished product.

We have the capacity and ability to provide the closest-to-perfect precision metals. We have the craftsmen, the knowledge, the experience, and the equipment.

Would you like to know more in greater depth? Write. Teletype. Phone. Ask for our brochure PM-51.

## HAMILTON PRECISION METALS

division of Hamilton Watch Company • Lancaster, Pennsylvania 17604

Phone: 717-394-7161

TWX 717-560-4417

cational education.

The electronics industry, however, will have to tailor equipment for the education market. Richard Louis Bright, associate commissioner for research at the Office of Education, complains that the industry is trying to sell the schools equipment designed for other purposes. A tape recorder designed for commercial recording is not best for an effective language laboratory, and home television sets are more effective for entertainment than for education, he says. "Most certainly, computers designed for business data processing are not ideally suited for computerized classrooms," says Bright.

**Big or small.** Bright points out that one of the basic questions yet to be worked out is whether a large central computer hooked to hundreds of terminals via telephone lines is preferable to small computers at the local school level, each with only 30 to 100 consoles. "My guess is that educational institutions will probably go in the direction of large central computers with terminals in many schools," he says. However, he says that if an audio capability is found necessary, small computers will have to be used because audio tapes will have to be stored at each console.

The problem of adapting computer technology to educational needs is more one of redesign than state-of-the-art breakthroughs, according to Bright. The single exception he cites is picture storage and display. With the current technology, adequate speeds are possible only with cathode-ray tube devices. A potentially more economical approach is to digitally code single-frame pictures for read-out on demand, something that electronics firms are already researching.

### II. IBM stresses software

With an eye to the new market, IBM has built a prototype vocational education system. Hallgren calls the firm's approach "integrated training aid systems" to emphasize that software and peripheral devices, rather than the computer, are the keys to the concept. The console is a mock-up of the equipment the student is learning to operate and is linked to an interface unit, or buffer, that permits



analog functions performed by the student to be processed digitally.

The console in the prototype is a custom-built voltmeter like one a student in a basic electronics course would use to measure voltages. Instructions are printed out on an electric typewriter by the computer. If each measurement is made properly, the computer tells the student to go on to the next problem; if the measurement is wrong, it offers hints until the student masters the technique.

**Computer ready?** The computer for an operational system would "be in the ball park" of an IBM system 360, model 30, or the old standard IBM 1401, according to Hallgren. An instructor's console would be in the loop, but off-line so that he would not be in the process until the student became so bogged down that he could not proceed without help. Having the teacher available reduces programming costs since the computer memory doesn't have to store corrective actions for every possible wrong answer. It also adds a human dimension to an impersonal system.

At the console, the student would be given problems by any suitable output device on the computer. The console could be a simulated control panel for any industrial application—or more novel applications. Hallgren, for instance, keeps in his office a transparent model automobile with color-coded parts that he says could be used in a computerized system to teach automotive mechanics. He also has a small transparent model of the human body that could be used in a system to teach hygiene.

### III. Computers being drafted

The military, which pioneered automated training methods, is potentially the biggest customer for such equipment although it has not yet installed any major computer-aided instruction systems, vocational or academic. The Defense Department spends \$4 billion a year on a wide range of training programs and has an annual "class" of 500,000 recruits. Advanced training costs \$2,000 to \$12,000 per man. Pilot training, which runs as high as \$250,000 for a single jet pilot, totals \$1 billion a year for all services.

To cut these staggering costs as

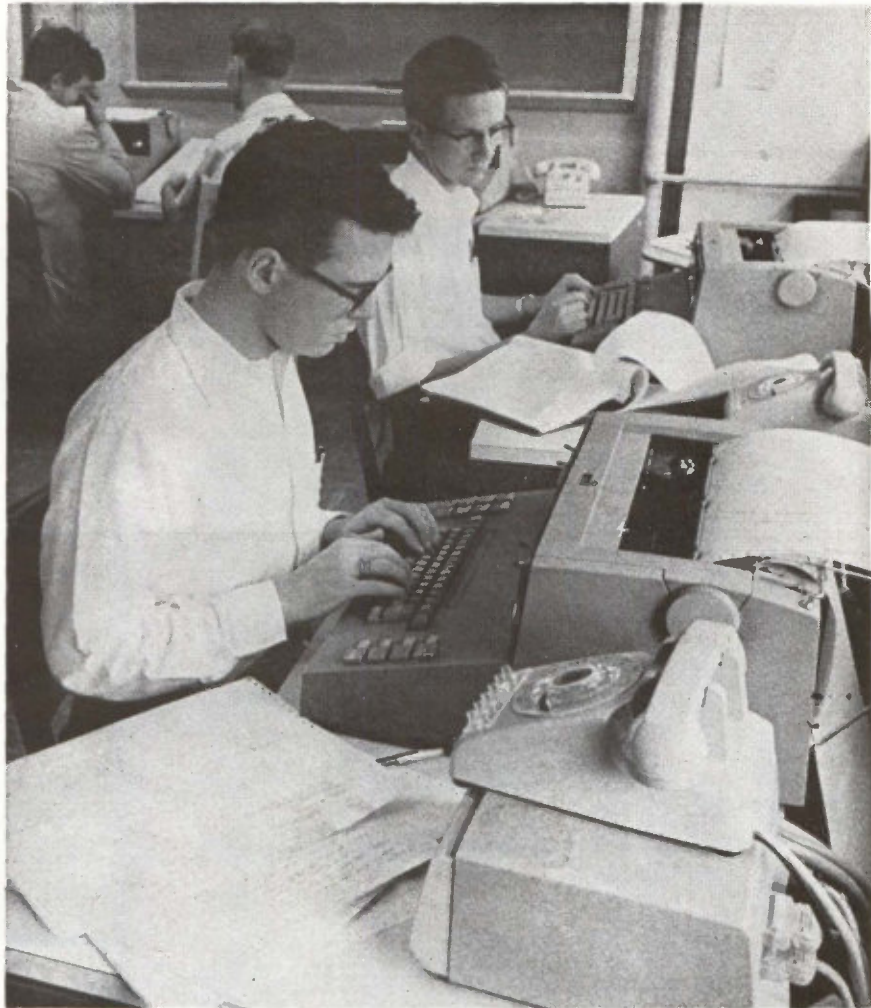

Students at the Massachusetts Institute of Technology use typewriter-like terminals linked by telephone lines to the computer center. With an IBM System/360 time-sharing computer complex, 200 people can use one computer.

well as the time spent in training, the Defense Department spends \$4 million a year on research on automated education. All three services are involved: the Army through the Human Resources Research Branch, operated under contract by George Washington University; the Air Force Personnel Research Laboratory, Lackland Air Force Base, Texas; and the Naval Personnel Research Laboratory, San Diego.

Among the test projects initiated are programmed instruction courses in basic electronics (but without a computer) at Keesler Air Force Base, Miss., and Lowery Air Force Base, Colo.; a \$1-million automated medical training facility being installed at the Brooks Army Medical Center, Texas; and a closed-circuit television system for basic training at Fort Gordon, Ga.

**Computer philosophers.** Two projects in computer-aided train-

ing are under way at the University of Illinois: Plato, an acronym for program logic for automated teaching operations, and Socrates, an acronym for system of organizing content to review and teach educational subjects. The work is being directed by the Office of Naval Research and is funded by the Advanced Research Projects Agency. Both techniques link student consoles to a central computer and have been used in teaching some engineering courses.

As results of the projects begin to trickle in, it is becoming obvious that automated methods reduce course time, lower entrance requirements and reduce dropouts, according to Air Force Lt. Col. Ruth Lucas, who coordinates the educational technology programs for the Defense Department. In the electronics course at Lowery Air Force Base, for example, the programmed instruction approach





## Put out because you can't get a reliable 10 amp magnetic latch relay? Next time call Leach!

Our 10-amp, 2 pdt, c1 Series is just the answer. Of course we can't deliver bundles right now (it's just going into production), but we can meet your prototype requirements. And immediately.

This relay not only meets MIL-R-5757, but it's been tested against all your previous magnetic latch relay complaints. And it more than stands up to all of them.

For example, the c1 magnetic assembly is a closed loop design which minimizes interaction with magnetic fields or other relays. And it only takes a 15msec pulse to switch and hold—no continuous power is required.

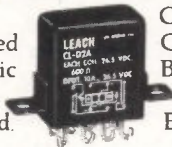

It's the smallest (1.100 high). The lightest (1.6 oz.). And directly interchangeable with other magnetic latch relays.

The c1 Series is rated at 50g shock; 30g at 2000 cps vibration. Pretty tough. And construction is all welded and sealed, contaminant free, with an electron beam.

So don't be soured by other types you might have tried.

Order ours. You'll get them. No ifs, ands, or . . .

Call Leach Corporation, Relay Division, 5915 Avalon Blvd., Los Angeles, California 90003.

Phone Area code (213) 323-8221  
Export: LEACH INTERNATIONAL, S. A.

# LEACH





An IBM 1440 computer asked this fifth grade student if the figure on the display was an isosceles triangle. When she replied 'yes', it advanced to a new problem.

cut course time from 420 to 230 hours and permitted entrance requirements to be lowered by 25%.

**Fighting times.** These benefits are particularly important to the military since electronics technicians go through 45 weeks of training and generally are the top personnel entering the services. Reducing entrance requirements creates a bigger pool of manpower and speeding up the courses gets the men to the battlefield quicker.

The problem now, according to Lucas, is to develop training courses concurrently with new weapons systems so the men will be able to operate them when the weapons reach the field.

#### IV. No money, no program

The Office of Education's problems in implementing automated vocational education techniques can be summed up in one word: money. It doesn't have the funds to conduct the major research programs it wants, and the school districts that will be using the voca-

tional education systems can't afford the heavy investments.

The Federal agency is also interested in job retraining and put \$4 million into pilot vocational educational projects during the current fiscal year. But the office will not be able to initiate any new projects because of budget cuts just voted by Congress.

**Majority unskilled.** David Bushnell, director of adult and vocational research in the Education Office's Bureau of Research, says the present programs will be continued at their current rate, but that a bigger effort will soon be necessary. He notes that less than 10% of the nation's school children get any vocational education. Since 19% graduate from college and thus get academic vocational preparation, this leaves 71% of the population that has to pick up skills on the job.

Congressional concern is evidenced by hearings held this summer before the Joint Economic Committee of Congress chaired by Rep. Wright Patman (D., Tex.). The committee, which has pushed the application of automation in other fields, noted in its final report that developments in the storage, processing and communication of information arising from the new technologies are creating a revolution in the nation's system of education. Patman was particularly interested in automated vocational training, which he says, "makes it possible to reduce drastically adult illiteracy and lower earning power caused by inadequate education."

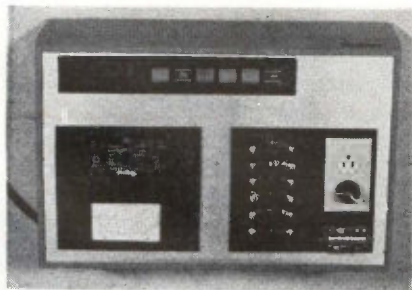

Console, by IBM, will teach electricians to measure voltages. A computer guides an electric typewriter that prints out instructions, mistakes and corrections.

Best  
place to  
look for  
Platinum  
Products



Helpful  
data on the Platinum Group Metals

The full story on Sheet, Strip, Foil & Wire

What you need to know  
about Tubing, Gauze,  
Spinnerets and Bushings

All types of Laboratory  
Apparatus are detailed

Salts, Solutions, Powders,  
Pellets, Catalytic Chemicals  
and Platinum Reclaiming  
Facilities are covered

Get the "full-size" story. Write for Bulletin  
P-7, "Platinum Metals Products."

**BISHOP**



**J. BISHOP & CO.  
PLATINUM WORKS**

Mechanical & Chemical Products Divisions  
MALVERN, PENNSYLVANIA 19355

Phone: (215) 644-3100

A Johnson, Matthey Associate



## Where the avionics packages will go . . .



Light observation helicopter, above, will use an avionics package called Lohap that Sylvania is building for the Army.

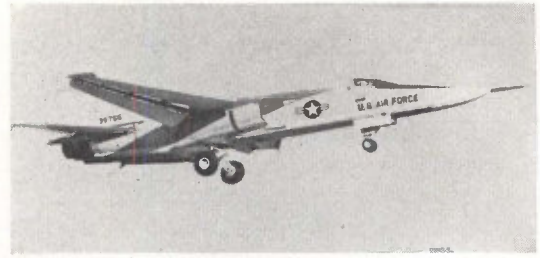

Air Force F-111A will be equipped with the Mark 2 avionics package from the Autonetics division of North American Aviation Corp.



Marine Corp's heavy assault helicopter Sea Stallion, CH-53, above, and the medium helicopter, CH-46 Sea Knight, will use the Navy's IHAS.



Advanced aerial fire support system will use components from several avionics systems. Early models may use the IHAS computer.

## Avionics

# Feeling the pinch

The trend is still toward integrated avionics systems, but Vietnam costs threaten one program

By William Hickman

Electronics Washington Bureau

The steadily mounting demand for funds for Vietnam is racking up another casualty. This time it's in a concept the Defense Department has been pushing since 1963—integrated avionics.

At present there are five programs under way. One—the integrated light attack avionics system (Ilass)—is threatened with cancellation. According to Department of Defense spokesman Vietnam is putting the squeeze on mili-

tary projects not contributing directly to the war effort.

Additionally, integrated avionics contractors have another problem. Congress, worried that there might be duplication in the five programs managed by three services, is talking about investigations.

### I. No end to trend

However, the trend to put integrated avionics systems in new aircraft continues. Development is

going forward on the Mark 2, the Air Force system being built by the Autonetics division of the North American Aviation Corp. for the F-111A, an aircraft the Defense Department intends to use as a fighter-bomber. And the Electronics Systems division of Sylvania Electric Products, Inc., a subsidiary of the General Telephone and Electronics Corp., is building the light observation helicopter avionics package (Lohap) for the Army.



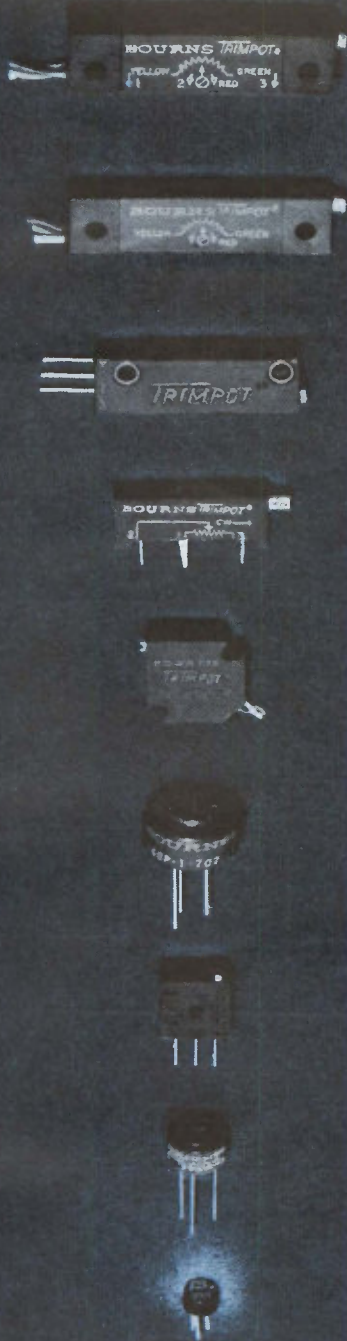



## WHO ELSE WOULD DEVELOP THE WORLD'S SMALLEST POTENTIOMETER?

It should come as no surprise that Bourns has introduced the world's smallest adjustment potentiometer. We started the trend in 1952 with the original compact TRIMPOT® Potentiometer. Now, the commercial, single-turn Model 3317 is Bourns' newest answer to industry's need for even smaller components. It measures  $\frac{3}{16}$ " in diameter, is less than  $\frac{1}{8}$ " high, has only six parts for greater reliability, and costs under \$2.00 in quantity. Offered with top or side adjustment, the wirewound 3317 has flat gold-plated grade A nickel leads for improved solderability and weldability.

While it is a true commercial potentiometer . . . not a downgraded military type . . . the Model 3317 receives the same closely controlled in-process and final inspections as all Bourns products. Periodic environmental requalification is provided by Bourns exclusive Reliability Assurance Testing Program. In size, price and performance, the model 3317 Adjustment Potentiometer is unmatched. Write today for complete technical data.

### Standard Specifications

	Model 3317P 	Model 3317W 
Resistance range	20 ohms to 5K ohms	
Resistance tolerance	±10 percent	
Temperature range	-65 to +105°C	
Power rating	0.2 watt at 25°C	
Shock	20G	
Vibration	10G	
Size — 3317P	.188" dia. x .105" high	
Weight — "	.08 grams	



BOURNS, INC., TRIMPOT DIVISION • 1200 COLUMBIA AVE., RIVERSIDE, CALIF.  
PHONE (714) 684-1700 • TWX: 714-682 9582 • CABLE: BOURNSINC.

TRIMPOT® AND PRECISION POTENTIOMETERS — RELAYS — MICROCOMPONENTS: TRANSFORMERS, INDUCTORS, RESISTORS AND CAPACITORS

Circle 235 on reader service card



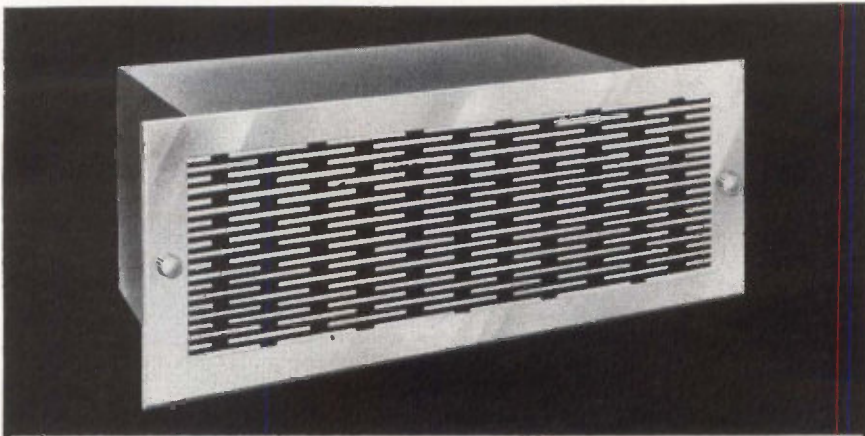

## McLEAN BLOWERS

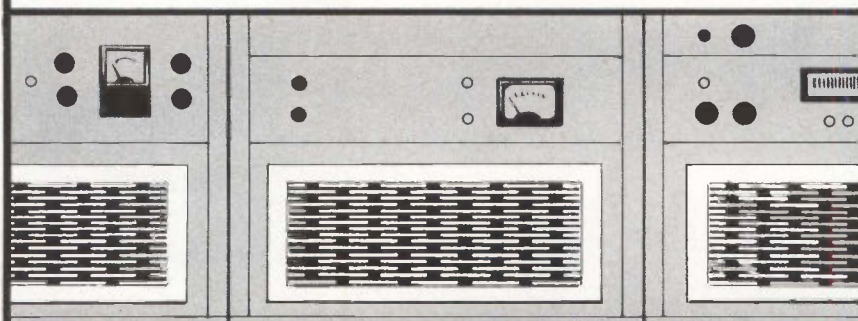

## INSTALL 'EM



## FORGET 'EM

That's the way to solve your cooling requirements. No maintenance problems . . . no failures! Low audible noise level! That's why most companies specify packaged McLean blowers. That's why you should too!

SEND FOR  
NEW 1966  
44-PAGE  
CATALOG



**McLEAN** ENGINEERING  
LABORATORIES

P.O. Box 228, Princeton, N. J. 08540  
Phone 609-799-0100 • TWX 609-799-0245  
TELEX 083-4345



Lohap is a communications complex that will be used in a number of rotary-wing and low-performance, fixed-wing planes.

Prototype testing will begin next month for another program, the Navy's integrated helicopter avionics system (IHAS), but the final avionics package for the advanced aerial fire support system (Aafss) is still up in the air. This package will consist of successful elements from other packages being developed before Aafss. To date, however, no one knows exactly which ones they will be. Lockheed Aircraft Corp. is contractor for the Army program, in charge of both the aircraft and avionics.

**Future systems.** In addition to the five programs under development, at least three additional integrated systems are on the drawing board:

- A package for the Navy's over-weight F-111B. The Navy has not awarded a contract for an avionics system for the F-111B, but it probably will if and when a decision is made to begin production next year. If the Pentagon does order the Navy version of the TFX, the aircraft will carry the Phoenix missile fire control subsystem, coupled with some of the equipment now under development for Ilaas.

- An integrated system is being studied for the improved Mohawk, the next model in Grumman Aircraft Engineering Corp.'s surveillance aircraft series.

- The integrated surveillance and target acquisition system (Istas) is being studied in-house by the Army but has yet to be defined or studied by contractors. Neither the Istas nor the Mohawk system is expected to be funded until expenditures for the Vietnam war are reduced.

**An investigation?** Congressional groups overseeing the defense budget are all for the concept of integrated avionics, but they don't want duplicated effort. In the summer of 1965 the House Armed Services Committee cut \$3.7 million out of the Navy's budget for Ilaas to encourage the services to unify on integrated avionics development.

The committee expressed "concern about the possible overlap" between Ilaas, IHAS and the Mark 2. It trimmed the budget to "encourage more careful integration" of the three systems to "lower



## Money for avionics

Program	Committed (in millions of dollars)	Estimated total
Ilaas	17.9	100
IHAS	26.7	100
Mark 2	38.9	200

development costs."

The committee is still worried about the possible duplication of effort and its concern may be growing. A spokesman says that the committee plans to look with "great interest" at the services' fiscal 1968 budget requests for integrated avionics projects. He hints a Congressional investigation may be ordered.

### II. The three basic systems

The Ilaas program is being developed for the Navy by Sperry Gyroscope Co., a division of the Sperry Rand Corp. The only approved aircraft program that could employ it is the A-7A, and the Navy has indicated it won't be used on that plane, at least the first ones. Two weeks ago, the Navy was ready to announce cancellation of the entire system as far as the A-7A was concerned, but just before the decision was announced, it was determined to examine the system again. If Ilaas does live through the current squeeze, it might emerge with less steam. Navy officials estimate that Ilaas would cost about \$230,000 more per unit than existing, less effective, avionics systems.

Sperry's initial contract for Ilaas was \$17.9 million. If the system goes into production, the total contract may hit \$100 million. Company spokesmen insist that the budget squeeze on military research and development will not slow up the program and they disagree with earlier reports of its possible cancellation [Electronics, Oct. 3, p. 75].

Major Ilaas subcontractors include the Univac division of Sperry which will build the navigation and weapons delivery computer; Autonetics division of North American Aviation Corp., the forward looking radar; LFE Electronics, a division of Laboratory for Electronics, Inc., the data conversion equipment; the AC Electronics division of General Motors Corp., inertial navigation sets; Elliott Automation, Ltd., the

# YOUR TOTAL REQUIREMENT 12,400 down to **2** mc COVERED WITH JUST FOUR ANTENNAS

## 1 DM AR168AS

FREQ. RANGE: 1000-12,400 mc  
VSWR: <2.5 to 1  
SIZE: 20" dia. x 18" overall

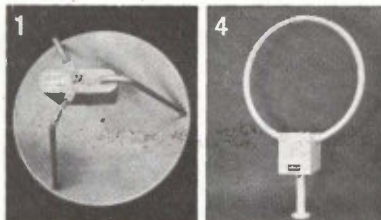

## 2 DM AR122-1

FREQ. RANGE: 150-1000 mc  
VSWR: <2 to 1  
SIZE: 22 7/8" x 37 1/4" x 1"

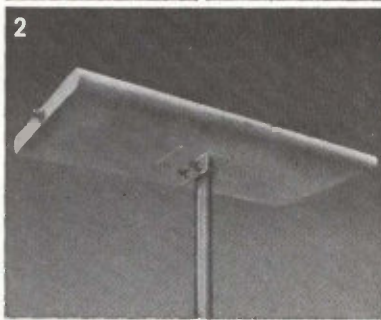

## 3 DM ARM160-2

FREQ. RANGE: 30 to 200 mc  
VSWR: <3 to 1  
SIZE: 14' x 10'2" x 2 1/4"

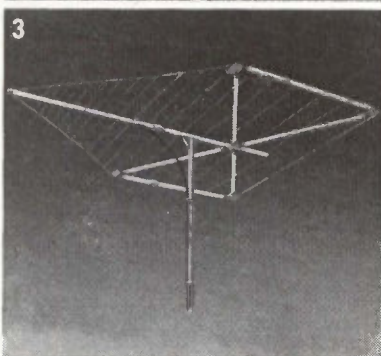

## 4 DM R23-1

FREQ. RANGE: 2 to 30 mc  
VSWR: Not applicable to 2 mc  
SIZE: 20 1/2" dia. x 32" high

Excellent performance is now available from 2 to 12,400 mc/s from a compact mobile package of only four antennas. This antenna system is easily transported and can be quickly erected for tactical applications.

Dorne and Margolin's continued leadership in the development of reduced size and mobile L-P antennas for all applications makes this full spectrum package available now at "off the shelf" prices.

# dorne and margolin

I N C O R P O R A T E D

20 Years of Leadership in Aircraft and Missile Antennas

HEADQUARTERS: 2950 VETERANS MEMORIAL HWY., BOHEMIA, N. Y.  
ZIP 11716 • TEL. 516 585-4000 • TWX 516 588-1246

AEROSPACE DIV.: 9730 COZYCROFT AVE., CHATSWORTH, CALIF.  
ZIP 91311 • TEL. 213 341-4010 • TWX 213 341-4646





**"All right, Jeff, we'll buy your system, but you'll have to specify a more advanced X/Y recorder. We need greater versatility and more reliable operation on the job. Any ideas?"**

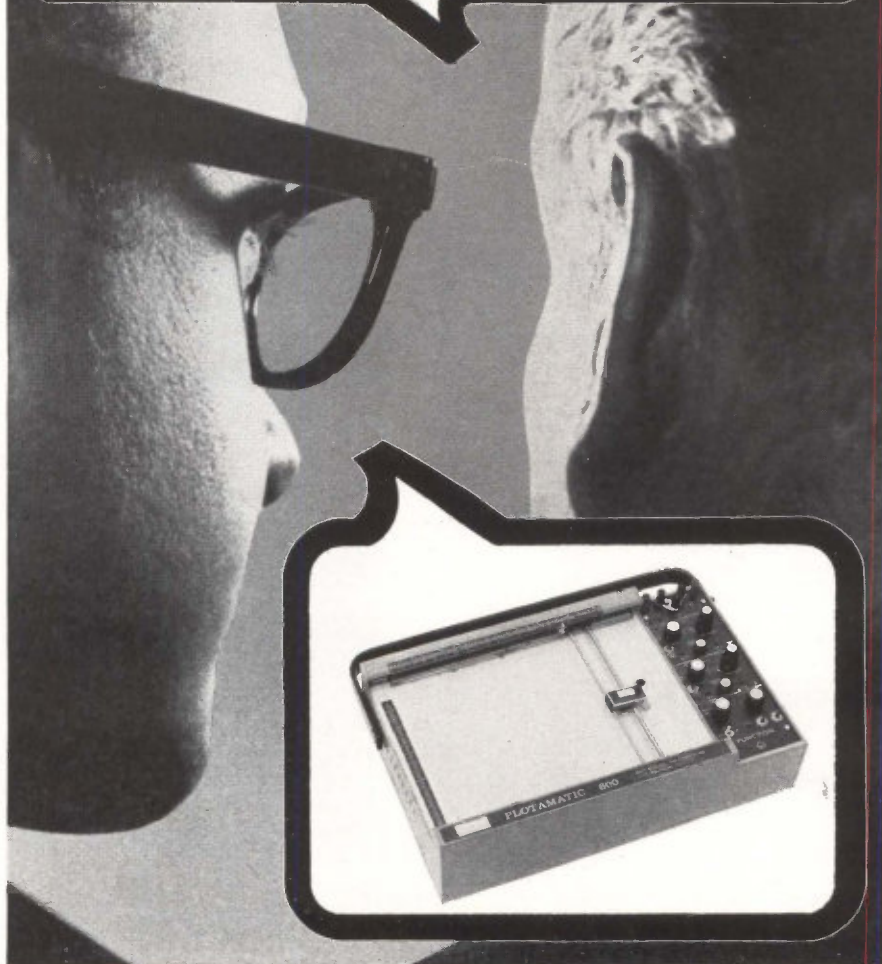

"If you like, Craig, I'll give you the system with the latest X/Y recorder on the market: The PLOTAMATIC® built by Bolt Beranek and Newman's Data Equipment Division. Other users swear by them. The PLOTAMATIC has a paper hold-down system that always works, never gets dirty, and yet allows you to adjust the paper for proper alignment after it's mounted. Input resistance is greater than one megohm, independent of gain setting. Accuracy and input versatility are as good as anything on the market,

and you don't have to buy time base if you don't want it. No high voltages to produce RFI problems, either. Just between us, Craig, I think our people are in a rut with those X/Y recorders we've been using. They use them out of habit, and aren't up on the latest the market has to offer."

BBN's PLOTAMATIC line includes a variety of 8½" x 11" and 11" x 17" X/Y recorders for virtually every application. Keep up with the market—write us for a catalog.



**BOLT BERANEK AND NEWMAN INC**  
 DATA EQUIPMENT DIVISION  
 2126 SOUTH LYON ST., SANTA ANA, CALIF. 92705 (714) 546-5300

heads-up display; and Norden division of United Aircraft Corp., the vertical situation display.

**Mark 2.** The largest integrated avionics program to date is the Mark 2, which the Air Force is developing for the General Dynamics Corp.'s F-111A supersonic fighter-bomber. Autonetics and its subcontractors will share as much as \$200 million in this program [Electronics, July 11, p. 139]. A \$38.9-million contract for the development of this system was awarded to Autonetics, and the first units will be delivered in less than three years.

Subcontractors to Autonetics include Texas Instruments Incorporated, for terrain-following radar; Canadian Marconic Co., for the doppler navigator; Norden for displays; the Kearfott Systems division of General Precision Inc., for cockpit weapons control system; ITT Gilfillan, a division of International Telephone and Telegraph Corp., for the horizontal tactical display; Federal Systems division of the International Business Machines Corp., for computers; and Autonetics itself for the inertial platform and attack radar.

**IHAS.** Moving along on schedule in its second year of development is the Navy's integrated helicopter avionics system (IHAS), which will go on Army, Marine and Navy rotary-wing aircraft.

A major IHAS feature is a computer with a functionally modular design that permits it to perform a variety of tasks, depending on the modules being used. The Navy controls the IHAS development, but the Army, which has an even stronger stake in helicopters, is providing 40% of the money.

The IHAS—and its prime contractor, Teledyne, Inc.—received a minor setback when the Army and Lockheed decided against using all of it in the Aafss, at least in the early models. The avionics configuration for the Aafss is still under study, but the best guess from one Army source is that little more than the IHAS ASN-74(V) computer will be used in the craft. A Navy officer close to the program, however, said he expected the total IHAS package to be used in later models of the Aafss.

The IHAS contract, which was awarded in the spring of 1965, will



provide avionics initially for the CH-53A heavy assault helicopter being built by the Sikorsky Aircraft division of United Aircraft Corp., and the CH-46A medium assault helicopter, under construction by the Vertol division of the Boeing Co. Both craft will be used by the Marine Corps.

The Navy and Army both hope to get more users for the IHAS because it would lower the per unit cost by spreading the development cost over more systems and make production cheaper.

Teledyne's development contract for the IHAS is \$26.7 million. The ultimate production effort may exceed \$100 million in value, but no firm estimates are available.

The Marine helicopters, which will be the first users of the IHAS equipment, will also be equipped with the Lohap system that the government will furnish to Teledyne for integration and installation. Subcontractors to Teledyne for the actual IHAS equipment will include LFE Electronics, for horizontal tactical display; Norden for forward-looking terrain-following radar; TRG, Inc. for the station keeping radar; and Canadian Marconic Co. for the doppler navigator.

### III. A hybrid

For Aafss, a helicopter with wings, Lockheed is combining the central computer from the IHAS, adding the Lohap integrated communications system and installing other subsystems as a part of the total aircraft contract. Lockheed won this contract last spring. The prototype will be tested late next year.

Aafss, which has been having its own cost-justification troubles, is also involved in an interservice struggle—Army versus Air Force. The dispute is over what the Pentagon terms "roles and missions."

In a roles and missions agreement last April, the services decided generally that the Army was to be given the responsibility for owning and operating rotary-wing aircraft and the Air Force for fixed wing planes. The Aafss, which has both rotary wings and fixed wings, then came along and confused the issue. Betting in the Pentagon is on biservice use of the helicopter.

**Lohap.** Sylvania will begin delivery of the light observation heli-

**"Welsh, have you heard of the new "GRAFACON" for digitizing graphic data? I hear all you do is trace with a pen and the system digitizes at rates up to 40 inches per second. Know anything about it?"**

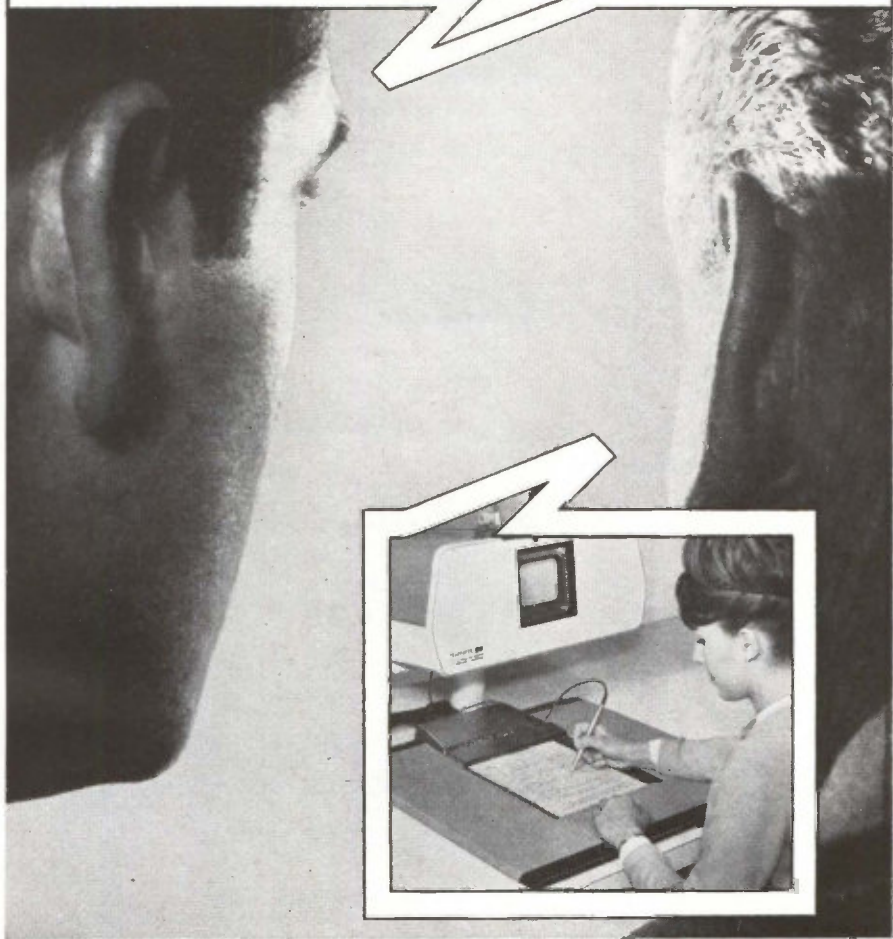

"I saw one of those systems last month, Bryant, and it was a real whiz. They were using it at the time to digitize handwriting, but I understand it'll handle anything from oscillograph records to fingerprints. GRAFACON systems are based upon the "RAND Tablet," a device for directly encoding position information without any encumbering cursors and cross-hairs. No servo-systems, shaft encoders or A/D converters are used. The system encodes the position of a hand-held stylus anywhere on a 10" x 10" working surface, even through several thicknesses of paper. It's set up for rear projection of film data, too, and produces 10 bits of X and 10 bits of Y information once every 220 microseconds."

Off-line GRAFACON systems are available for producing digital records of graphic and pictorial data on punched-paper and digital magnetic tape, and on punched cards. The GRAFACON can also be connected on-line to IBM System/360 machines and to most other computers. Write us for complete details.



**BOLT BERANEK AND NEWMAN INC**

DATA EQUIPMENT DIVISION

2126 SOUTH LYON ST., SANTA ANA, CALIF. 92705 (714) 546-5300

GRAFACON is built under license from Rand Corporation.



# FENWAL ELECTRONICS THERMISTORS

## how they measure and control temperature

Thermistors come close to being ideal temperature sensors. Until recently, however, it was simply not possible to produce units which had identical resistance-temperature characteristics. As a result, thermistors could not be supplied which were directly interchangeable, and thermistor calibration or re-adjustment of other circuit components was necessary.

### Iso-Curve\* Thermistors

Fenwal Electronics has introduced a series of *new* Iso-Curve thermistors which are precision-matched (to within  $\pm 0.2^\circ\text{F}$  if required) to a standardized resistance-temperature curve. A complete line of units is now available to match five standard curves, and are presently in use in many hundreds of industrial and aerospace applications.

The five standard curves which range in resistance from 370 to 100K ohms at the standard reference temperature ( $77^\circ\text{F}$ ) are shown in figure 1 and cover a temperature span of  $-100$  to plus  $600^\circ\text{F}$  in useful increments. These values provide for over 95% of all normal temperature measurement applications.

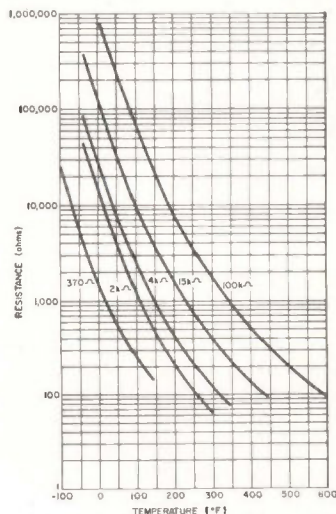

Fig. 1. — Standard Iso-curve resistance vs. temperature characteristics.

\*MADE UNDER PAT. 3109227 AND OTHERS. ISO-CURVE IS A TRADEMARK OF F.E.I.



FREE new 24-page Capsule Thermistor Course Book. A complete primer on thermistors, their characteristics and uses.

63 FOUNTAIN STREET, FRAMINGHAM, MASSACHUSETTS

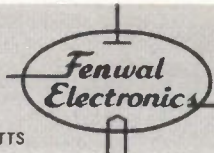

### Selecting Resistance Value

Selection of a suitable resistance value is usually based on the following considerations: temperature span, resistance values at temperature span extremes, sensitivity.

In general the lower resistance units are better suited for sensing lower temperatures, while the high-resistance units cover higher temperatures.

Maximum resistance at low temperature must not be too high to meet needs of associated circuitry such as amplifier, read-out, etc. A very high resistance at low temperature may induce spurious signal pickup. If high resistance is required, then the use of shielded lines, filters, or DC may be desirable.

Minimum resistance at high temperature must not be too low since error in read-out may result due to contact resistance, line resistance, and line resistance variation with changes in ambient temperature.

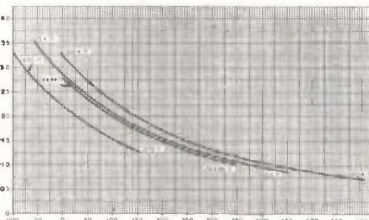

Fig. 2. — Sensitivity (% resistance change/ $^\circ\text{F}$ ) vs. temperature of standard Iso-curve thermistors.

Sensitivity ( $\%$  change in resistance per  $^\circ\text{F}$ ) shown in figure 2 should not saturate or overdrive associated circuitry at low temperature; and at the high temperatures, the resistance change should be adequate to provide the required degree of resolution or control — e.g., the 100K Iso-Curve\* thermistor at  $0^\circ\text{F}$  will have a resistance change of  $3.25\%/^\circ\text{F}$  and at  $600^\circ\text{F}$   $0.7\%$ .

Iso-Curve\* thermistors provide all of the functional advantages of regular thermistors and are available as beads or glass probes and in metal probe assemblies.

copter avionics package (Lohap) in late 1968 for installation on Hughes Aircraft Co.'s OV-6A.

Sylvania expects Lohap to bring in up to \$60 million in business over the next few years. The present contract calls for 1,825 of the units under a development-initial production award of \$16.1 million.

Except for the identification-friend-or-foe unit which will be furnished by the government, Sylvania is building all the major subsystems.

**Lohap for airborne relay.** The OH-6A, a light observation helicopter, is designed primarily for light tactical transportation use and visual battlefield surveillance. Ordnance delivery systems may be added, but it is unlikely that they will require electronics.

One of the most significant missions of the craft may turn out to be its use as an airborne radio relay station. In addition to three transceivers, which can be installed on the OH-6A, the craft is equipped with a vhf/f-m auxiliary receiver for voice and data reception and a C-6533/ARC communications control unit for switching control. This permits the Lohap system to receive and retransmit voice and data signals, acting as an aerial relay to increase the range of line-of-sight ground equipment.

At least two of the three transceivers in the system will be in each OH-6A. The AN/ARC-114 vhf/f-m transceiver and the R-1297/ARC vhf/f-m auxiliary receiver both operate at 30 to 76 megahertz. The AN/ARC-115 vhf/a-m transceiver operates at 116-150 Mhz and the AN/ARC-116 uhf/a-m transceiver is set at 225-400-Mhz.

The mix of transceivers and receivers gives the Lohap system a compatibility with all other aircraft, including high performance fighters; with ground troops using units such as the AN/PRC-25-9 or -10; with vehicular sets such as the jeep mounted AN/VRC-25 or -54; and with large transportable units like the AN/TRC-87.

The Lohap, roughly one-third as heavy as the equipment it is replacing, is all solid state and offers complete modularity while being designed for maximum commonality.

The system also includes an automatic direction finder.



Blendalloy® 33-12 Controlled Expansion Iron-Nickel-Cobalt Alloy



# LESS THAN 0.005% CARBON CONTENT

through powder metallurgy

Blendalloy® 33-12, Magnetics' new controlled expansion iron-nickel-cobalt alloy, assures vacuum-tight strain-free seals, eliminates the need for decarburizing, and matches the expansion characteristics of Corning 7056, 7040 and 7052 glass.

In electron tubes, the wire or rod form of the alloy serves as electrode material. As a glass-to-metal hermetic seal, Blendalloy 33-12 seals out dirt and moisture and permits atmospheric pressure to be maintained at high altitudes.

Powder metallurgy techniques permit carbon content to be held to less than 0.005% (typical analysis shows 0.002%). Tramp elements are eliminated. Excellent surface characteristics result from extremely low gas content. Reproducibility is guaranteed.

Other precision alloys produced by Magnetics include Blendalloy 52, our 52% nickel alloy used in dry reed switches and mercury-wetted relays. It matches the expansion characteristics of Corning 0120 glass.

Blendalloy metals are custom blended in quantities from one pound to 50 tons or more.

Blendalloy 33-12 is now available in bar, wire and rod. For more information, write for *Metals from Magnetics*, Dept. EL-101 Magnetics Inc., Butler, Pa. 16001.

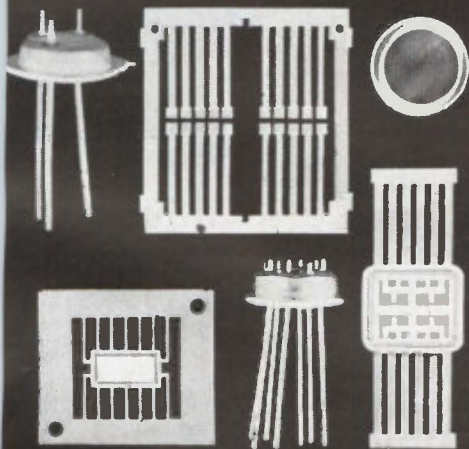

EXPANSION COEFFICIENT CURVE

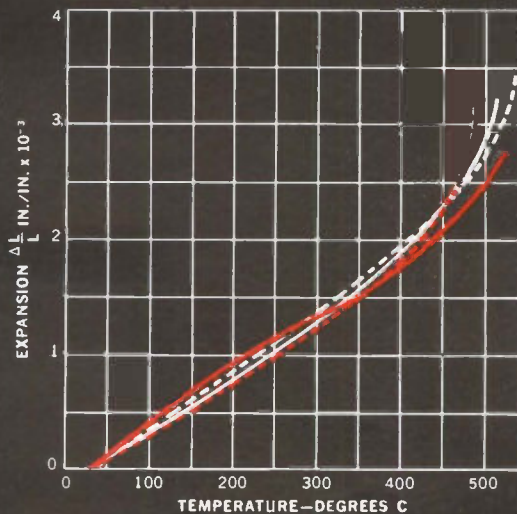

Blendalloy 33-12  
 Corning 7052 Glass  
 7040 Glass  
 7056 Glass

**METALS FROM MAGNETICS**  
 Guaranteed Performance  
 Reproducibility through  
 Powder Metallurgy  
 Techniques



COPYRIGHT 1966 MAGNETICS INC.

Circle 241 on reader service card



# Why Lockheed is for Engineers who work with speed.



**Subsonic.**



**Supersonic.**



**Hypersonic.**

There are no speed limits on progress in developmental aviation at Lockheed. An unusually diverse range of advanced programs is offered in three speed regimes—hypersonic, supersonic, subsonic. A diversity that is unmatched elsewhere in the aerospace industry today.

Working towards the day when high priority passengers and cargo will travel at speeds many times faster than sound, Lockheed is using the SCRAMJET approach in manned hypersonic test and cruise vehicles.

In the supersonic speed regime, Lockheed is designing an exceptionally advanced airplane with capabili-

ties far superior to any craft in the skies today. At the same time, other remarkable aircraft, for Mach 3 flight, are in development. In commercial aviation, Lockheed is working on America's SST Program, a major and growing endeavor. Other supersonic programs include extremely advanced versions of Lockheed's famed F-104 Starfighter.

A revolutionary composite rotary-wing craft, able to stop, fold, or start blades in forward flight, is one of Lockheed's most promising subsonic endeavors. Also, work on the Army's Advanced Aerial Fire Support System—AAFSS—goes rapidly ahead.

In addition, mass short-haul travel between major cities is another focal point of Lockheed's expanding subsonic STOL and V/STOL research and development programs.

A large number of significant positions are open for engineers and scientists on these and other sub, super, and hypersonic programs. For information, write: Mr. E. W. Des Lauriers, Professional Placement Manager, Dept. 1508, 2404 North Hollywood Way, Burbank, California. Lockheed is an equal opportunity employer.

**LOCKHEED-CALIFORNIA COMPANY**  
A DIVISION OF LOCKHEED AIRCRAFT CORPORATION





**These  
new  
heat shrinkables  
devour vinyl  
spec  
by spec.**

E. C. C. heat shrinkables are recognized under UL component file E39100.

Yet cost no more. That's because new Insultite CP-150 and Insultite SRT are polyolefins. Heat shrinkable, irradiated polyolefins that provide polyolefin protection at a polyvinyl price.

**Take new CP-150.** It insulates and encapsulates any subject. Quickly. Tightly. Permanently. Won't split or rupture. Even over the most irregular surfaces. And it's particularly ideal for commercial, automotive, appliance, and computer applications.

**As for new SRT?** Wrap up your capacitor insulation problems once and for all. This clear, tough, thin-wall polyolefin is perfect for components that are subject to shock and strain, and where space and visual identification are considerations.

Both CP-150 and SRT devour vinyl specs. Like low temperature flexibility, abrasion resistance, structural strength, voltage standoff, and dielectric characteristics. And they shrink at a *better* than 2 to 1 shrink ratio. Come in a variety of printable colors and sizes. From  $\frac{3}{4}$ " to 2" ID.

Think shrink with the Insultites. We offer commercial, military grade, flexible and semi-rigid tubing, heat-shrinkable end caps, and exclusive meltable inner-wall tape. Write for free samples today. (Specify diameters, please.)



**ELECTRONIZED CHEMICALS CORPORATION**

A subsidiary of High Voltage Engineering Corporation

Box 57, Burlington, Massachusetts, Area Code 617-272-2850





by courtesy of H.M. Postmaster General

## 20 MHz AND NO MAINS LEAD

The Bradley Type 150 Oscilloscope is a portable fully solid state instrument having a D.C. to 20 MHz band-width over full screen deflection.

The Y sensitivity is 5mV per division and the sweep rate varies from 200 nanoseconds to 0.5 seconds per division. Integral batteries give 4 hours operation on one charge from its self-contained charging unit, or the instrument can be operated from A.C. mains. Other features are a high intensity P.D.A. tube and an internal square wave calibrator. The oscilloscope is lightweight and fully portable.

In addition, the Bradley range includes the Type 148A, a general-purpose battery or mains operated oscilloscope with a band-width of 4 MHz and which is used not only for electronic research but also in industry.

*We shall be pleased to send full details of Bradley oscilloscopes on request.*



### G. & E. BRADLEY LIMITED

Electral House, Neasden Lane, London, N.W.10

Telephone: Dollis Hill 7811    Telegrams: Bradelec London N.W.10    Telex: 25583

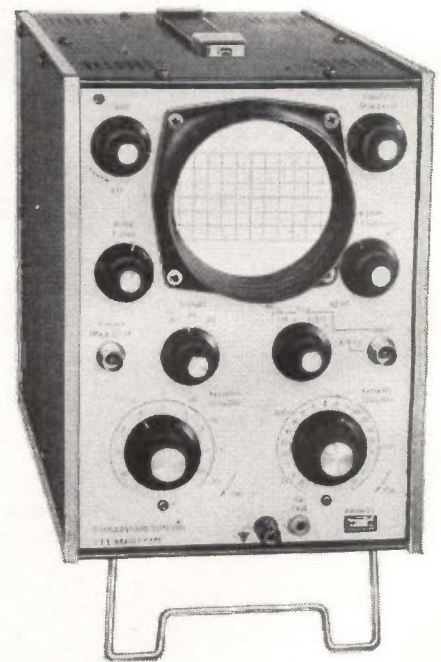

American enquiries to: Edwin Industries Corporation, Pickard Buildings,  
East Molloy Road, Syracuse, N.Y. 13211, U.S.A.  
Telephone: (315) 454-4407



## GENERAL PURPOSE Control

Dunco 219 Frame relays in  
three stock contact arrangements

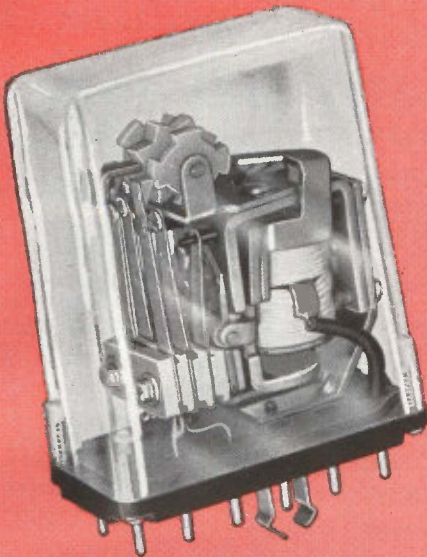

### Single Coil **SEQUENCE**

NEW! — Dunco Frame 211  
relays provide thousands of  
control sequences

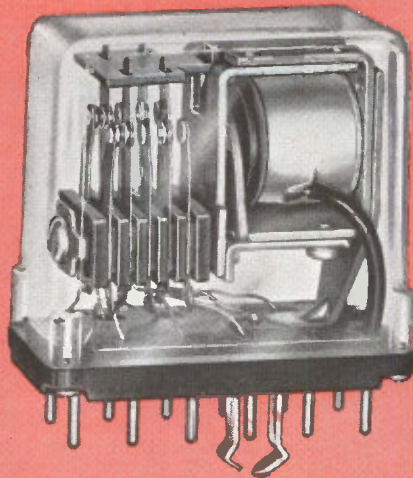

### 2-Coil **"MEMORY"**

NEW! — mechanical latch,  
electrical reset Frame 255 relays



# A COMPLETE RELAY LINE FOR Simplified, Economical Industrial Control

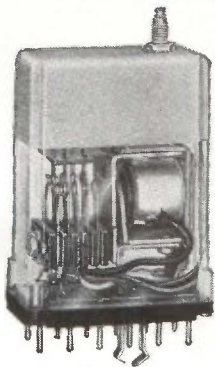

Operates directly  
from 115 volts,  
60 cycles

### **TIME DELAY CONTROL RELAY**

Combines a high quality RC network triggering a 4-level transistor with the Dunco general-purpose control relay. Timing is adjustable over a 90:1 scale in two standard ranges: 0.2 to 18 seconds; or 2 to 180 seconds. Write for Data Bulletin 6235.

These four Dunco industrial control relays simplify and economize control panels which, in the past, have often been "over-relayed" with larger, more costly types or types entailing more complicated circuitry. All four relays are in matched designs using 12-pin plugs and heavy-duty industrial sockets. Contacts are conservatively rated 10 amperes. Standard 150 volt electrical spacings are used throughout. Write for Data Bulletin on any type to STRUTHERS-DUNN, Inc., Pitman, N. J.

# STRUTHERS-DUNN

WORLD'S LARGEST ASSORTMENT OF RELAY TYPES

SALES ENGINEERING OFFICES IN: Albuquerque • Atlanta • Baltimore • Belmont, Calif. • Birmingham, Ala. • Boston • Buffalo • Cedar Rapids • Charlotte • Cincinnati • Clearwater, Fla. • Cleveland • Clifton • Dallas • Encino • Englewood • Glen Ellyn, Ill. • Houston • Kansas City • Las Vegas • Memphis • New York • Phoenix • Pittsburgh • Richardson, Tex. • Rome, N.Y. • St. Louis • St. Paul • Salt Lake City • Seattle • Southfield • Wichita • Wilmette. Canadian Licensee: Renfrew Electric Co., Ltd. Export Dept.: 1505 Race St., Philadelphia, Pennsylvania 19102, U.S.A.





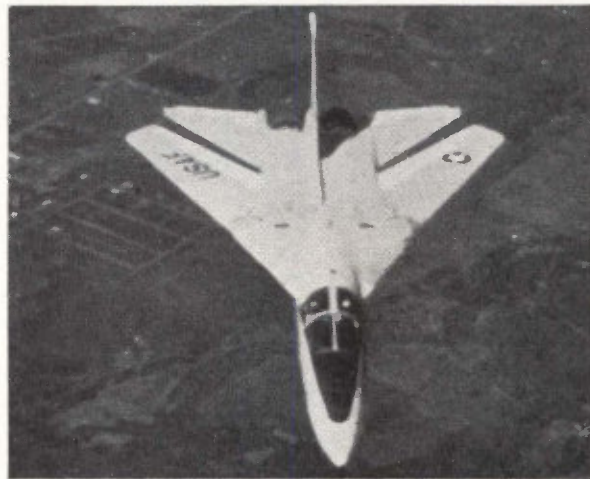
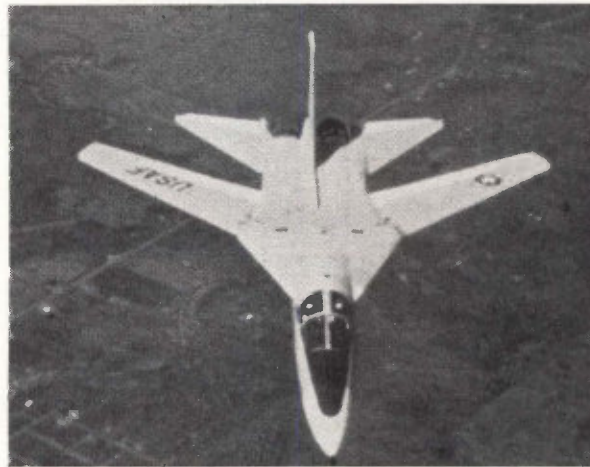
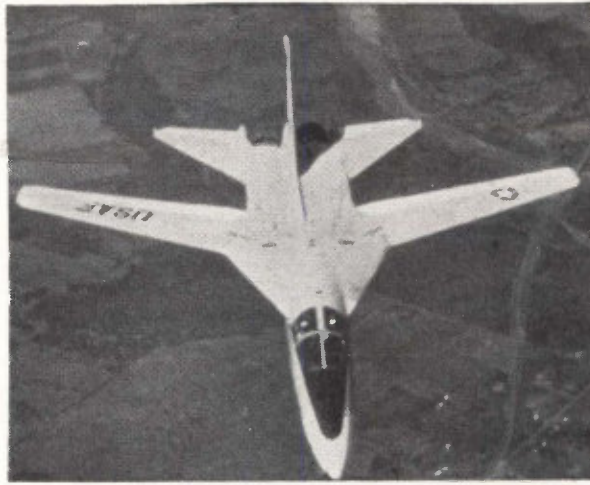

# F-111A • F-111B • FB-111 F-111K • RF-111 • MARK II BORON FILAMENT

AND OTHER ADVANCED  
AIRCRAFT AND SPACE PROGRAMS

These are a few of the long range programs at the Fort Worth Division of General Dynamics. Here you will find a highly diversified engineering and research organization assigned to the above 111 programs or other advanced aircraft projects; missile assignments, space systems, mission analysis, or other R&D.

You'll enjoy living in modern, metropolitan Fort Worth where superior housing, cultural advantages, a variety of sports and other recreation, graduate studies at one of three major universities, and mild weather are all part of an attractive package.

Call collect—817-PE 2-4811 extension 3551 or send a resume of your education and experience to J. B. Ellis, Industrial Relations Administrator, Engineering, General Dynamics, Fort Worth Division, P. O. Box 748E, Fort Worth, Texas. An equal opportunity employer.

## Information Technology

- Mission Simulation, Display Technology

## Radar and Fire Control

- Airborne Systems and Simulators

## Navigation, Stability, Guidance & Control

- Stability and Control, Computer Design, Servo Analysis

## Electronic Systems

- ECM, Penetration Aids

## Electronic AGE

- Microwave and Computer Design

## Electronic Laboratories

- Circuit Design, Flight Test Instrumentation

## Electrical Installation Design

**GENERAL DYNAMICS**

*Fort Worth Division*





## DO YOU NEED CUSTOMIZED COMPONENTS FAST?

Need special marking? Need electrical testing? Need environmental checkout? Special packaging? Parametric selection? All this and more?

Call Weatherford today. We've got components from industry's biggest producer — Texas Instruments. This guarantees your widest selection, broadest line, fastest service. And now we're offering **CUSTOMIZED COMPONENTS** to suit your most exacting requirements. Look at some of the services we can provide:

- Parametric selection
- Numerical Data
- 100% electrical inspection
- 100% mechanical inspection
- Matching parameters
- Tighter tolerance units
- End-limit samples
- Special marking
- Special packaging
- X-Ray inspection
- Environmental testing
- Sleeving (insulation)

- Correlation samples
- Evaluation samples
- Production packaging (lead taping, etc.)

And, ask your Weatherford salesman about the other service pluses we can offer, including: *applications assistance* to help you solve your semiconductor design problems; *product data* coming to you in many forms including Weatherford technical seminars, the monthly Weatherford Report news magazine, and a full library of product literature; *emergency deliveries* speeded by special emergency telephone numbers; *controlled inventory* assuring complete and accurate stocks, and *instant communications* through a private telephone network to provide fast information and order service. **Whatever your needs or special requirements, call Weatherford. We're customizers!**



# R. V. WEATHERFORD CO.

DISTRIBUTORS OF ELECTRONIC COMPONENTS AND EQUIPMENT

NOW WITH CUSTOMIZED COMPONENTS

WEATHERFORD  
SERVICE  
PLUS



<b>ANAHEIM, CALIFORNIA</b> 1651 State College Blvd. 714-532-6741 714-547-7521	<b>GLENDALE, CALIFORNIA</b> 6921 San Fernando Road 213-849-3451	<b>PALO ALTO, CALIFORNIA</b> 3240 Hillview Drive Stanford Industrial Park 415-321-5373
--	---	---

**SALES OFFICES**

<b>Albuquerque, N.M.</b> 505-298-5593	<b>Pomona, California</b> 714-966-8461 714-623-1261
<b>Phoenix, Arizona</b> 602-272-7144	<b>San Diego, California</b> 714-278-7400



# We eliminate down-time in rotary switches

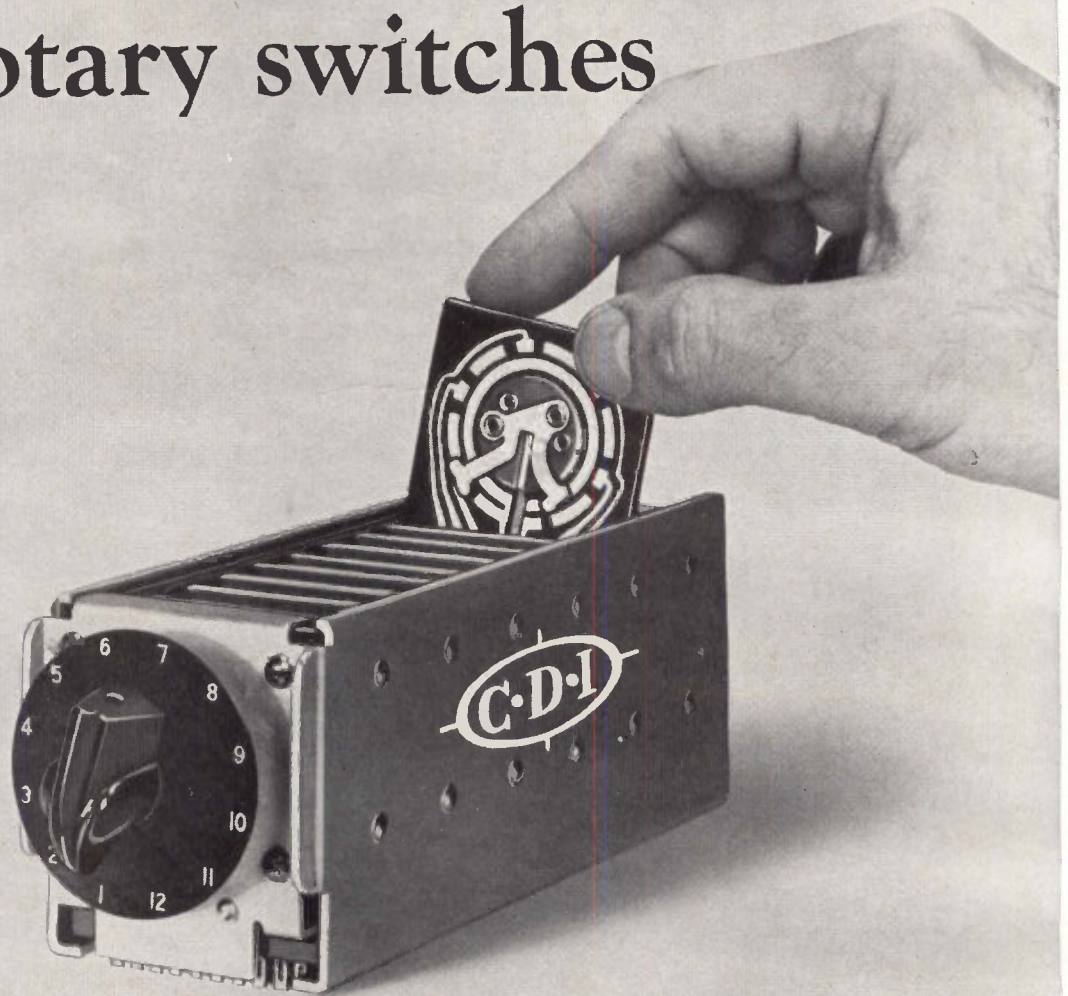

Unique 5 second wafer replacement obsoletes other switches

**No unsoldering . . . no disassembling . . . no wire removing . . . no more hours of down-time. Replace any wafer in seconds. Simply lift out old wafer, slip in new wafer.**

CDI patented switches with dust covers are available in sizes 2" x 2", 3" x 3" and 4" x 4" with lengths to accommodate up to 36 wafers. Switches can be customized to your specifications. Unlimited choice of switch circuit configurations. P.C. wafers may be varied to suit your needs, including provisions for transistors, diodes, resistors, or other components. Up to 400 switch positions are available, varying with size and type switch used. P.C. boards are silver, gold or rhodium plated on a copper base. All connections are to a single bank of receptacles, conveniently accessible from one side of the vibration resistant aluminum housing.

CDI switches may be manually, motor or solenoid operated for use in any rotary selector switch application. Presently being supplied for numerous military and commercial applications.

**Competent CDI Sales Engineers, backed by CDI's laboratory and engineering departments are always available for assistance and recommendations.**

Mfd. under Tabet U.S. Patents: 2,841,660, 2,971,066, 3,015,000, 2,956,131, 2,988,607



## CHICAGO DYNAMIC INDUSTRIES, INC.

PRECISION PRODUCTS DIVISION 1725 Diversey Blvd., Chicago, Illinois 60614 Phone: (312) 935-4600



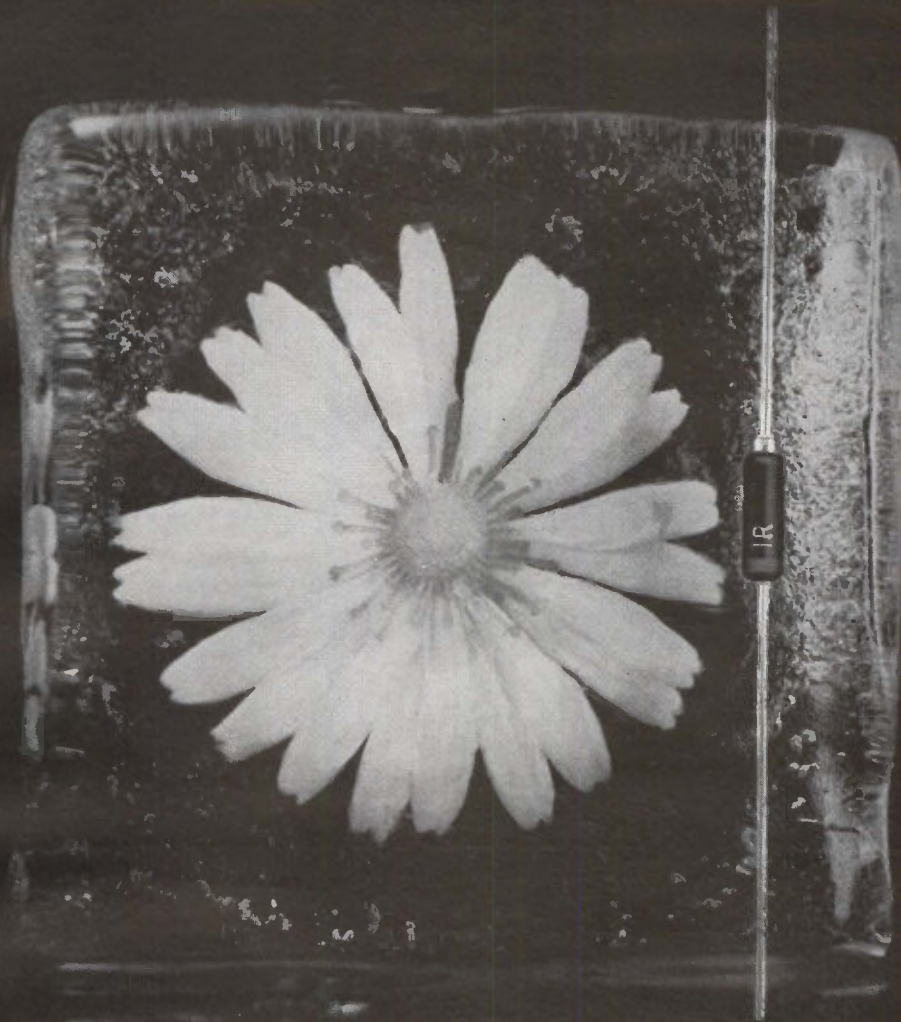

## Will your zener in December be as faithful as in May?

**IR reference zeners refuse to drift...  
won't budge at  $-55^{\circ}\text{C}$ ... won't wilt at  $+150^{\circ}\text{C}$**

Check the temperature specifications before selecting your reference zener... then you can sell precision with no strings attached! International Rectifier can help you clamp voltage drift to  $\pm 0.001\%/^{\circ}\text{C}$  from  $-55$  to  $+100^{\circ}\text{C}$  (the IN827A), or to  $\pm 0.0005\%/^{\circ}\text{C}$  from  $-55$  to  $+150^{\circ}\text{C}$  (the IN938B). With performance like this for the asking, there is no adequate reason for building voltage drift into your circuits today.

At IR you can pick and choose from a total-coverage line of devices, and know that you can get delivery when you need it. Chances are, every device you will need for the next five years is in our catalog today, and can be shipped tomorrow directly from IR or from any of 50 "stocking" Authorized Industrial Distributors which IR maintains across

the nation. At IR we know that specs in the catalog have meaning only when the device is delivered.

**CHECK THE SPECIFICATIONS ON IR ZENERS**  
Reference elements, regulators from 250 MW to 50 Watts and up to 200 Volts, and a big selection of silicon diodes, rectifiers and small assemblies are all in Catalog C-66. Write for this free 60-page book today... it's loaded with application ideas and data. For immediate help, contact your nearest IR Sales Office or Authorized Industrial Distributor.

**IR INTERNATIONAL RECTIFIER**  
(213) OR 8-6281 • TELEX 6-74666 • EL SEGUNDO, CALIF.







# Searching for electronic components that are hard to describe and even harder to find?

## Stop.

# Let the Northern Plains Industrial Catalog search for you.

Northern's Industrial Catalog can locate a source for most any part or assembly. It is a unique find-it-in-a-hurry service of Northern Natural Gas Company that will quickly locate reliable suppliers, sub-contractors and sources for parts, components and sub-assemblies made to your exact specifications. In technical terms, the Northern

Plains Industrial Catalog is a computerized compilation of all industrial fabricators in the Northern Plains area—Iowa, Kansas, Minnesota, Nebraska, South Dakota and western Wisconsin. It's the source of information that can tell you where to buy wisely, profitably and quickly. And the service is free. So if you're interested in electronic

components, plastics, short run stampings, motors, precision machined parts, instruments, die castings or whatever, fill out the coupon. You'll receive complete information. And if you attach a sketch or specifications of your required components, Northern Natural Gas will send you a specially compiled list of qualified producers.

**INDUSTRIAL CATALOG**  
Area Development Dept. K-2

Northern Natural Gas Co., Omaha, Nebr. 68101

Dear Sirs: Please send Sources of Supply information on: \_\_\_\_\_  
\_\_\_\_\_  Drawings enclosed.

 Northern Natural Gas Company

NAME \_\_\_\_\_ TITLE \_\_\_\_\_  
COMPANY \_\_\_\_\_  
ADDRESS \_\_\_\_\_  
CITY \_\_\_\_\_ STATE \_\_\_\_\_

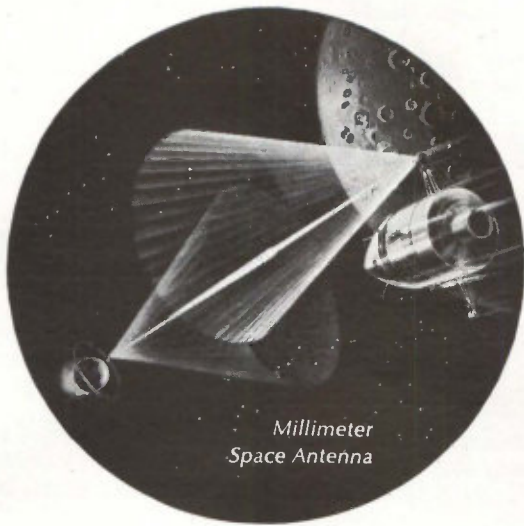

Millimeter  
Space Antenna



Airborne  
UHF Relay

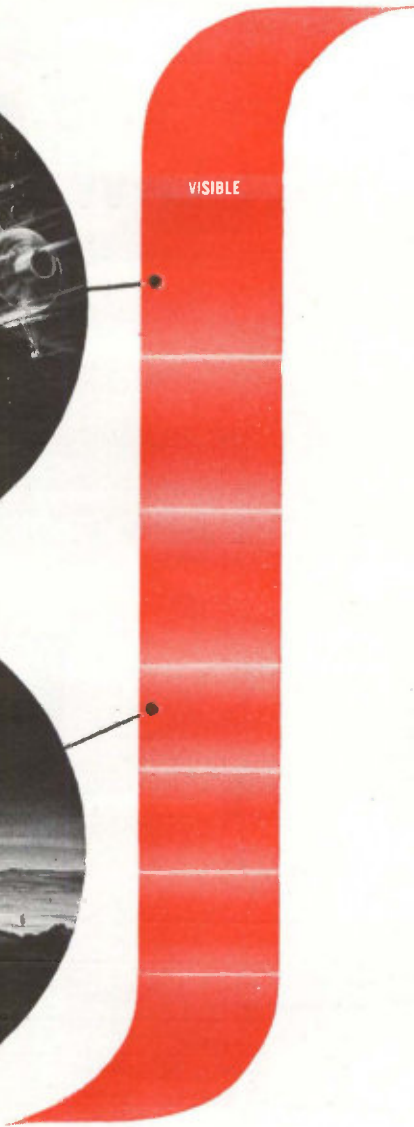

**HIGHER  
AND  
HIGHER**

**AIRBORNE UHF RELAYS AND MILLIMETER SPACE ANTENNAS IN THE COMPLETE COMMUNICATIONS SPECTRUM**

**Recent developments at Sylvania Electronic Systems:**

■ ■ Seizing the high ground in tactical UHF radio communications, Sylvania Electronic Systems has demonstrated a UHF relay that is rugged, compact and reliable enough to be borne aloft by a balloon or drone aircraft. With this airborne repeater our Armed Forces can achieve full two-way voice and teletype communications over 500-mile ranges even in the jungles and mountains of Viet Nam.

■ ■ Higher still, orbiting spacecraft must find each other swiftly and communicate enormous amounts of data. Sylvania Electronic Systems has produced a millimeter wave antenna system that will pinpoint another satellite antenna in less than a second. With 10 times the information-handling capacity of conventional lower-frequency systems, millimeter waves meet the needs of space communications.

To meet communications needs from jungle to orbit, Sylvania Electronic Systems is seeking technical and management specialists across the full spectrum of research, development, production and testing. Major centers are in suburban **Boston, Buffalo, and San Francisco**. If you are a qualified candidate and would like to receive more specific information on the engineering opportunities, send your resume to: Manager, Professional Staffing, Sylvania Electronic Systems, Division of Sylvania Electric Products Inc., 57 Sylvan Road, Waltham, Mass. 02154.

*The complete spectrum of opportunity—job diversification, geographic location, professional satisfaction—is awaiting you at Sylvania Electronic Systems.*



**GENERAL TELEPHONE & ELECTRONICS**  
Total Communications from a single source through

*An equal opportunity employer*

RESEARCH • SYSTEMS DEVELOPMENT • PRODUCT & FIELD ENGINEERING

**SYLVANIA ELECTRONIC SYSTEMS**





# REEVES-HOFFMAN

## "chips" away at the space problem with new COLD-WELDED CRYSTALS

Reeves-Hoffman's newest series of crystals, packaged in cold-welded TO-5 transistor cans, are designed for operation at frequencies from 3 to 125 MHz. Frequency tolerance over the temperature range from  $-55^{\circ}\text{C}$  to  $+105^{\circ}\text{C}$  is  $\pm 0.004\%$ . (Upon special request,  $\pm 0.0025\%$  can be provided.) Shock and vibration ratings exceed the requirements of MIL-Spec 3098D. Aging at  $65^{\circ}\text{C}$  is 6 parts in  $10^6$  per year.

Cold welding eliminates solder and attendant flux and heat, removes undesirable damping and corrosion, solves problems of thermal isolation. Leak rate is better than  $10^{-9}\text{cc}$  of helium per second. The results: substantial increases in the reliability and stability of crystal units, oscillators and filters; further opportunity for miniaturization.

For example, by using microminiature circuitry "chips," it is possible to produce a cold-welded crystal oscillator that occupies the space normally used for the crystal alone. The oscillator shown at left, for example, is in the A-4 holder shown below. Can this new micromodule technique solve space problems for you? We invite your inquiry.

A-4

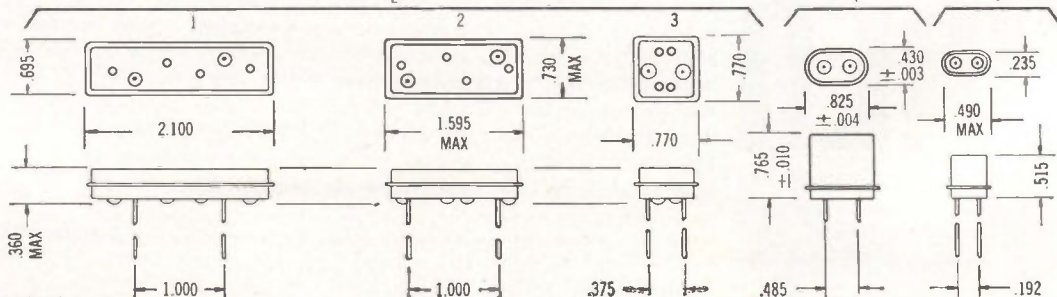
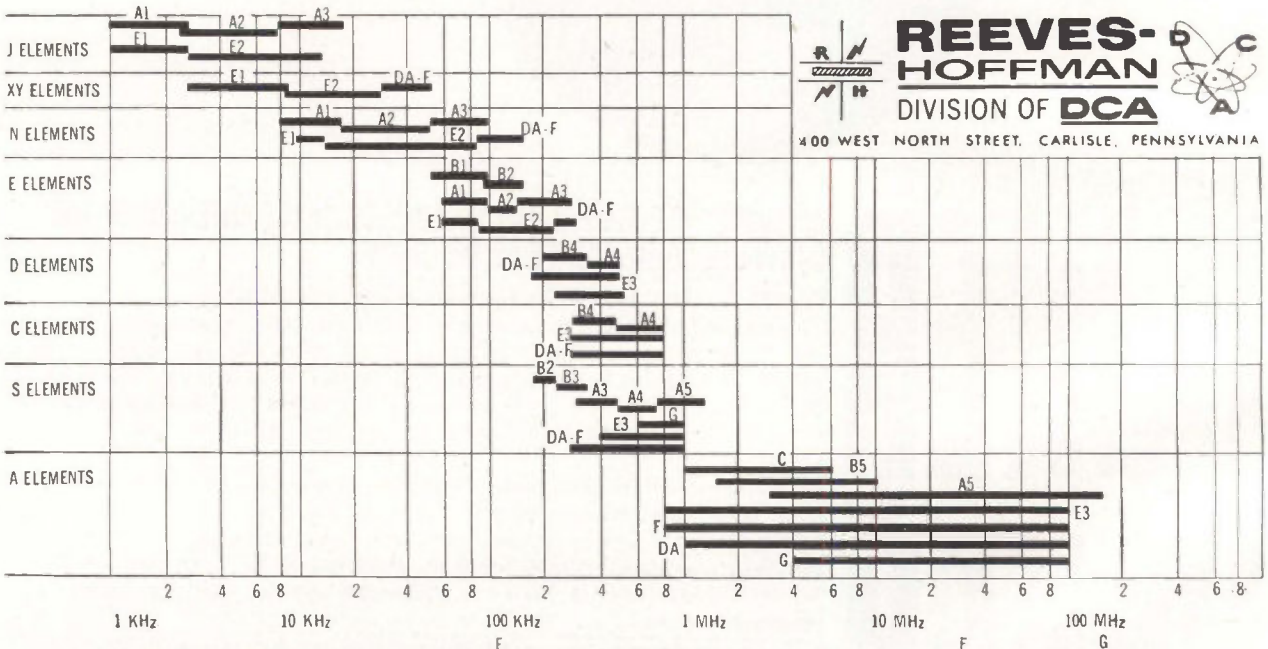
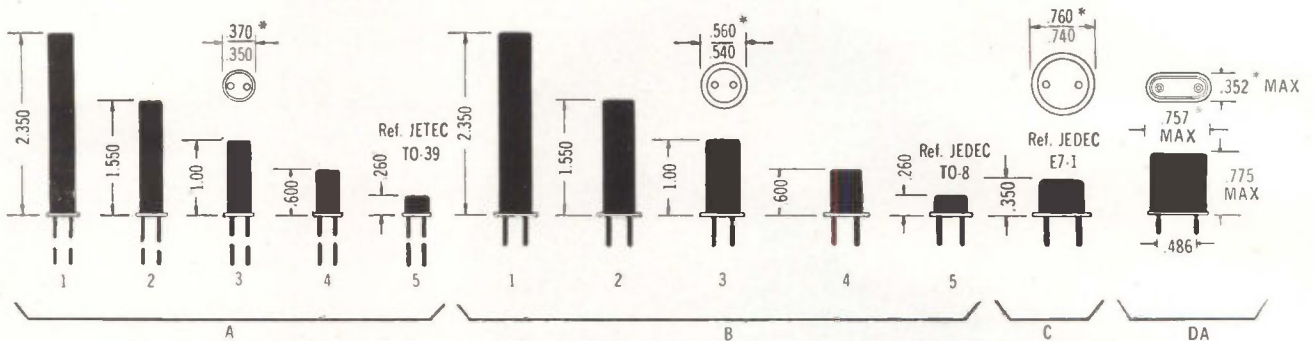

\*Dimensions after trimming.





## Our handbook is chock-full of miniature round connectors.

They're compact, lightweight, polarized and exceptionally rugged.

Including 1 to 12-contact panel or cable types with or without hoods, and single, double and triple contact subminiatures. They're ideal for a comprehensive variety of applications, from medical electronics to juke boxes.

You'll get a lot out of the smallest connectors in our book. Start reading today.

Write: Winchester Electronics,  
Main St. & Hillside Ave., Oakville, Conn.



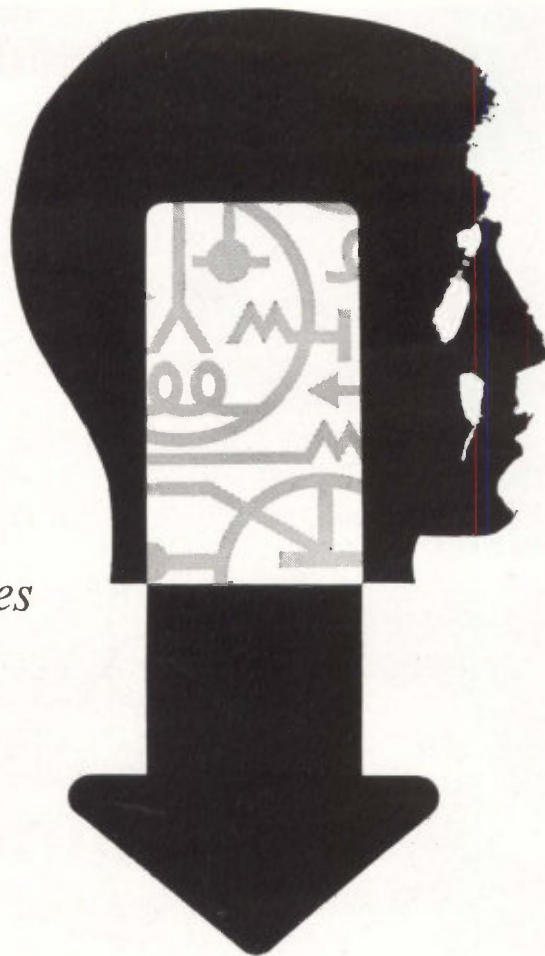

*Look into the vehicles  
of opportunity  
at Lockheed...*

**FOR CIRCUIT  
DESIGNERS.**

Opportunity broad enough to interest every circuit designer, that's the sweep of electronics assignments at Lockheed. Big, wide-ranging programs that extend from deep sea to deep space. And with ever-growing commitments comes an increasing need for new concepts and major technical advances in flight controls, communications, antennas and state-of-the-art electronics check-out equipment in both spacecraft and fleet ballistic missiles. In addition to its major vehicle programs... Agena, Poseidon, and Polaris, Lockheed is involved in deep submersibles; unique advanced land vehicles; information systems for states and hospitals; and many other technically alluring programs. For complete information, write Mr. K. R. Kiddoo, Professional Employment Manager, P. O. Box 504, Sunnyvale, California. Lockheed is an equal opportunity employer.

**LOCKHEED**  
**MISSILES & SPACE COMPANY**  
A GROUP DIVISION OF LOCKHEED AIRCRAFT CORPORATION

If we can't make the best thermostats,  
we'd rather not make any.  
That's why we sell Edison.

We know Edison thermostats are best  
because we measure them by the same per-  
formance and reliability standards our own  
manufacturing people use for missile guid-  
ance and communications components.

We know another thing, too. We couldn't  
make better thermostats than Edison, how-  
ever much we tried.

Luckily, we don't have to.

As a manufacturer who's also a distributor,  
we're able to bring you the top lines in  
the various product categories. Whoever  
makes them.

So when it comes to thermostats, we bring  
you Edison.

You get the fast off-the-shelf delivery you  
expect from a national distributor like Arco.

And you get the engineering assistance  
and help with application problems you'd  
normally expect from a manufacturer.

Buy Edison thermostats and time-delay  
relays from Arco and you get the best of  
both of us, manufacturer and distributor.



DIVIDED WE STAND.

**Arco Electronics**  
A Division of Loral Corporation  
Community Drive, Great Neck, N. Y.  
Dallas, Texas, Pasadena, California,  
Menlo Park, California.

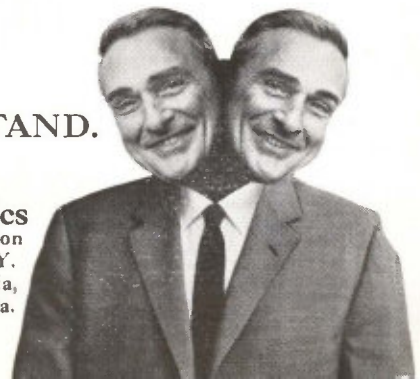



# CIRCUIT CONTROL AND PROTECTION BY AIRPAX

style **AP**

Style AP is all magnetic trip, hermetically sealed, meets MIL-C-39019, available 1, 2 or 3 pole, 10 ma to 20 amperes AC or DC, interrupts 1000 ampere fault at 240 volts AC.

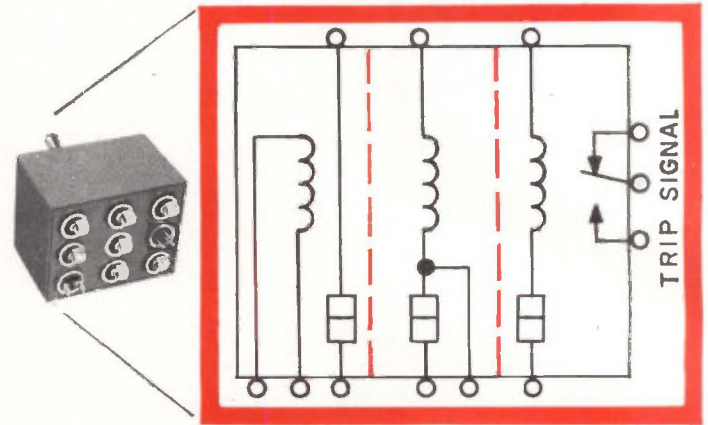

style **50-APL**

Style 50-APL is entirely magnetic trip (no heating elements), available 1, 2, 3, 4 and up to 10 poles, 10 ma to 50 amperes AC or DC, will open a 5000 ampere fault at 240 volts AC.

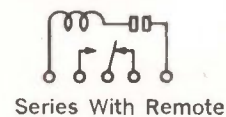
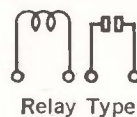
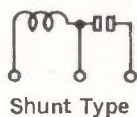
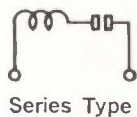
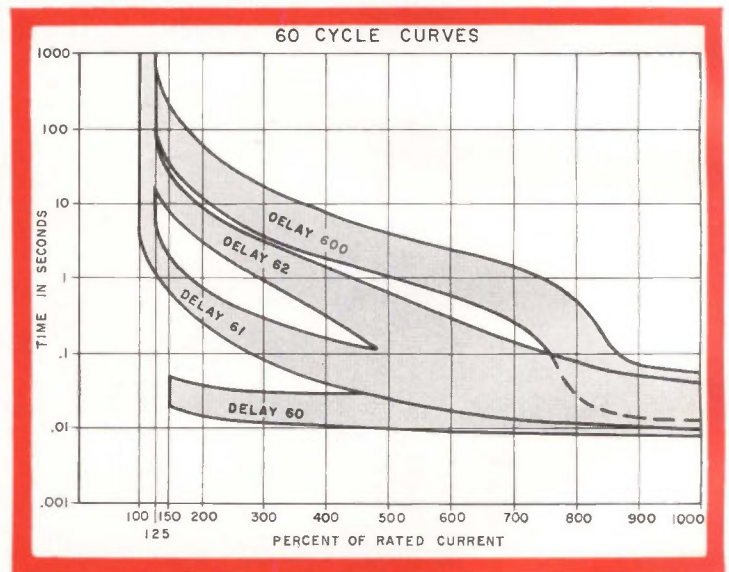

Completely magnetic circuit breakers depend on current only trip. Any coil or combination within listed ranges can be supplied for immediate delivery.

AIRPAX ELECTRONICS  
incorporated  
Cambridge, Maryland  
(301) 228-4600

AIRPAX ELECTRONICS  
incorporated  
Ft. Lauderdale, Fla.  
(305) 587-1100

AIRPAX ELECTRONICS  
incorporated  
Van Nuys, Calif.  
(213) 781-2821

**AIRPAX ELECTRONICS** incorporated Cambridge Division, Cambridge, Maryland

# Flutter meter replaces six instruments

Device checks on mechanical performance of magnetic tape transports by detecting small variations in tape speeds

As a designer of telemetry systems, Victor A. Ratner often complained about the procedures available for testing wideband tape recorders (1 megahertz and above). He found the test equipment and methods obsolete and criticized the lack of standardization in recorder specifications. As a user he could do little more than complain. But now, as president of the Video Research Corp., Ratner has done something to help end a situation he claims "is impeding the progress of telemetry and its applications" [Electronics, Jan. 25, 1965, p. 90].

His new company's first commercial product measures tape recorder flutter and replaces the half-dozen separate instruments usually required to make the same measurement. Furthermore, Ratner says, "it is the first flutter meter on the market to operate to the new Inter-Range Instrumentation Group (IRIG) flutter standard 106-66."

Video Research's model VR-3 flutter meter is a self-contained instrument to the point of having its own crystal controlled reference generator. Flutter values as high as 5% can be read directly on the



instrument's dual range peak reading panel meter or observed on an oscilloscope. The instrument can make flutter measurements at all standard tape recorder speeds from 1 7/8 to 120 inches per second. A peak eliminator circuit removes output transients caused by tape dropouts and 60 decibels of limiting suppresses amplitude variation effects. The instrument's bandwidth and filter characteristics comply with the recently revised IRIG standard at the seven standard tape speeds.

Accurate measurement of flutter is important. Many consider it the parameter which most comprehensively describes the mechanical performance of a magnetic tape transport. Much effort in the design and manufacture of all types

of tape recorders is directed toward minimizing flutter. The flutter specification is often used to compare competing machines and as a precise field check for mechanical wear or improper adjustment. In addition to implementing the new standard techniques, the VR-3 simplifies flutter measurements since it eliminates the need for operator adjustments and calibration. The new instrument also can be battery operated for field use.

The crystal reference generator output is fed to binary dividers where the reference tone frequency is selected. The reference tone frequency varies from 3.13 khz for a speed of 1 7/8 inches per second to 100 khz for the 120 ips speed. The tone stability is within 0.01%. The reference is recorded on the tape recorder under test. During playback, flutter, which is directly proportional to short-term speed errors in the tape transport mechanism, shows up as a deviation from the applied reference frequency. A very sensitive discriminator in the instrument detects frequency deviations and an output is provided which can be displayed on an oscilloscope, chart recorder or the panel meter. With a scope, the panel meter eliminates human error from comparative tests by indicating the presence of spikes which often go unnoticed with long sweep periods.

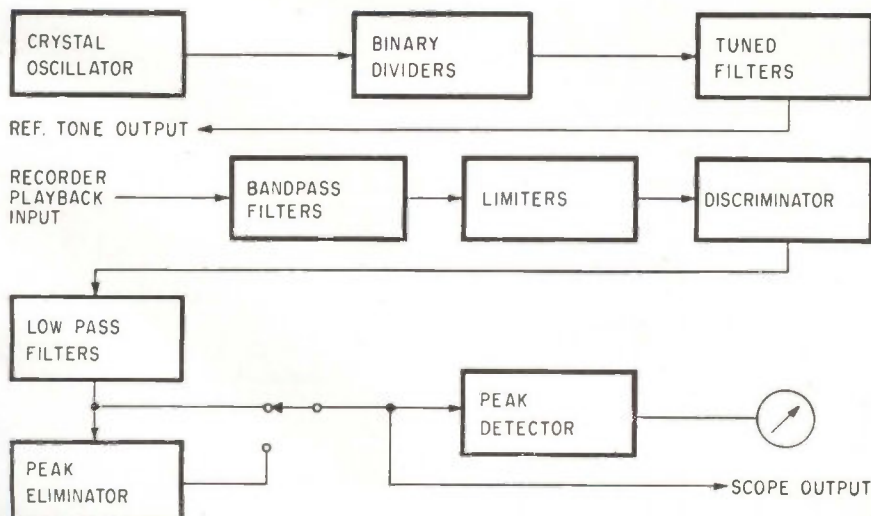

## Specifications

Reference frequency	3.13 to 100 khz
Reference output level	1 v peak to peak
Reference output impedance	75 ohms
Recorder playback input level	1 v peak to peak
Recorder playback input impedance	10,000 ohms
Meter ranges	0 to 5% full scale or 0 to 0.5% full scale
Price	\$1,750

Video Research Corp., P.O. Box 1428, Rockville, Md. 20850  
Circle 350 on reader service card.



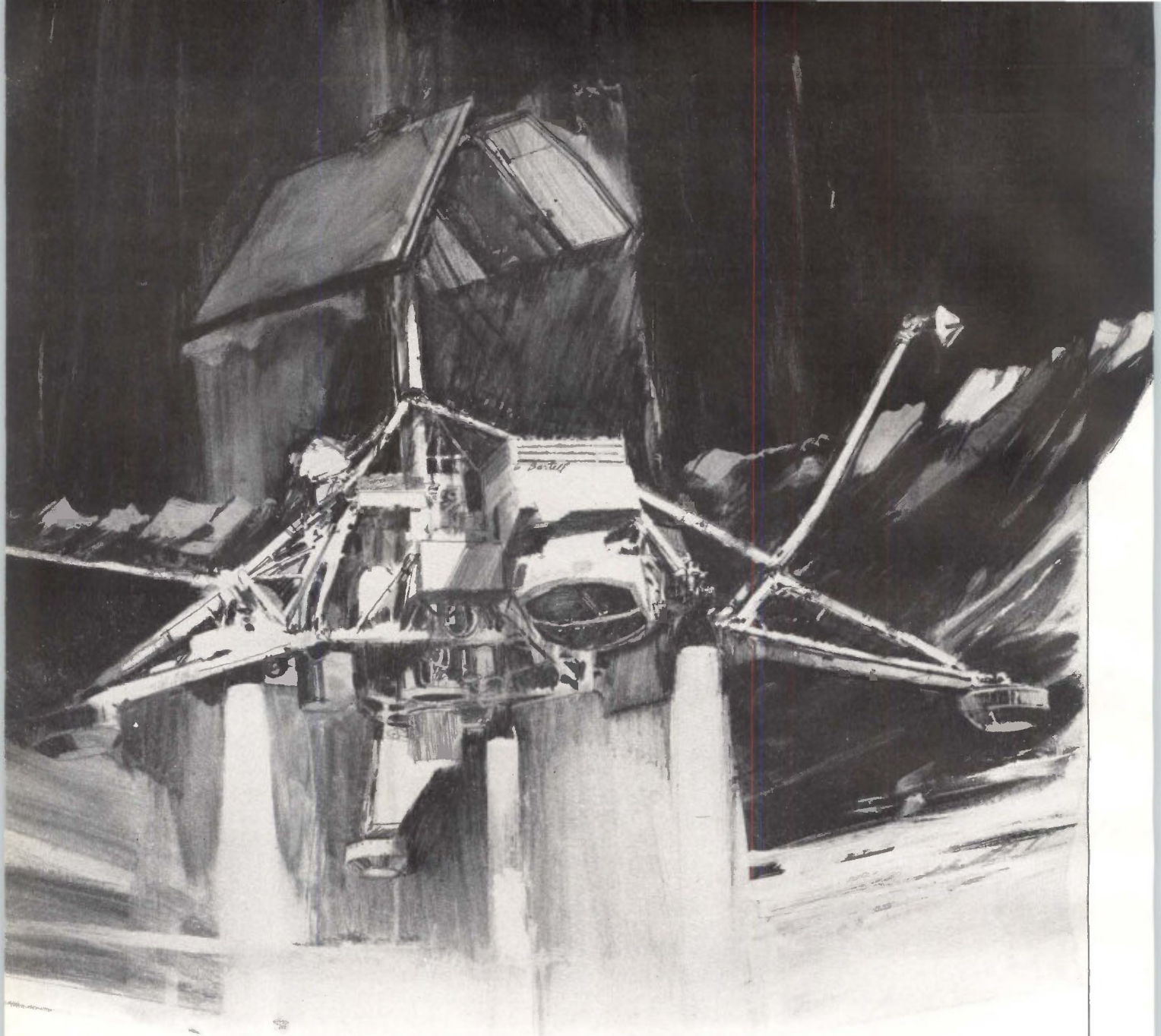

## Now you can ask for the moon in rack and panel connectors.

Before NASA's Surveyor I scored its touchdown we were content to say there's a CANNON® Plug designed to meet virtually any microminiature, subminiature or heavy-duty application and environment.

Now we can promise you the moon, because that's where our rack and panel connectors (as well as our other types) have proved themselves in critical circuitry applications

and challenging environments.

Only ITT Cannon, world's largest supplier of rack and panel connectors, offers a complete assortment of shell sizes, styles and layouts

Only ITT Cannon connectors deliver such great environmental capability in so many different contact densities and wire sizes.

What's considered "special" elsewhere

is usually standard with ITT Cannon when you need rack and panel plugs fast. If by chance we don't have your special on hand, then we'll develop it for you.

Write for our rack and panel catalog.  
ITT Cannon Electric, 3208  
Humboldt Street, Los Angeles,  
California 90031. A division of  
International Telephone and  
Telegraph Corp.



# CANNON ITT



## New Components and Hardware

### Time delay relays offer instant recycle

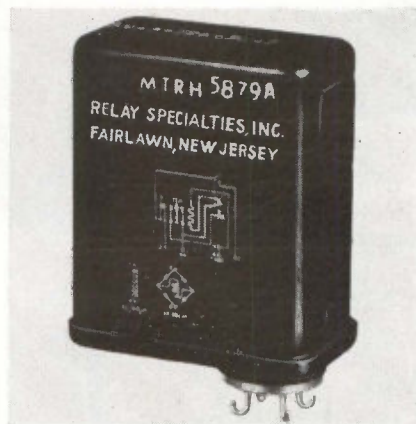

Time delay relays feature instantaneous return time and accurate recycling periods. This is obtained by utilizing both the heating and cooling time of a thermal element.

The relay has a drop-out time of only 5 msec and may be immediately reoperated with virtually 100% rated time-delay period. Heater resistance appears only during the first third of the timing cycle, while the relay coil is energized for the balance of the delay time.

The units are miniature, voltage and temperature compensated, hermetically sealed and the series MTRH8 conforms to the applicable portions of MIL-R-5757C and MIL-R-19648. The operating delay range is 15 to 300 seconds; voltage range, 24 to 29 v d-c; and vibration, 10 to 2,000 hz at 15 g. Relay Specialties, 3 Godwin Ave., P.O. Box 223, Fair Lawn, N.J., 07410. [351]

### Sensing relay responds rapidly

An over-and-under frequency and voltage sensing relay provides rapid response times and protects sensitive electronic equipment from damage by current variations. The compact is particularly suitable for portable power supply systems.

The HFVSR series is available in 60 or 400 hz models. A 20% change out of current specifications will

effect relay action in 60 msec on 60 hz operation; 40 msec on 400 hz.

Typical 3-phase sensing provides a frequency drop-out maximum of 57 and 63 hz  $\pm 1$  on 60 hz; 380 and 420 hz on 400 hz operation. Frequency pull-in maximum is 58 and 62 hz  $\pm 1$  on 60 hz; 385 and 415 hz on 400 hz operation. Voltage drop-out maximum is 100 and 130 v for both models; voltage pull-in maximum, 105 and 125 v for both models. Sensing can be adjusted to meet specific requirements.

Environmental specifications include an ambient temperature range of  $-40^{\circ}$  to  $+65^{\circ}$  C, 50 g shock for 11 msec and greater than 50,000 cycles of life.

Power requirements are 5 w max-

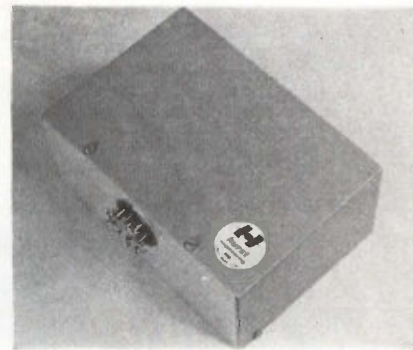

imum; dielectric strength, 1,000 v rms at 60 hz; insulation resistance, 100 megohms minimum. The relay meets requirements of MIL-R-5757. Hurst Engineering, Inc., 851 18th St., Costa Mesa, Calif., 92627. [352]

### Resistor design dissipates heat

A wire-wound resistor dissipates heat, reduces temperature coefficient and maintains stable resistance values via the heat-sink principle. The Mighty-Mite design consists of a wire-wound resistor on a ceramic core. This element is solidly embedded in a finned radiator that amplifies more than 10 times the conduction area of the tubular resistor surface to air convection currents. Various lengths of finned radiators are available to comply with space limitations or

### HERE ARE YOUR AUTHORIZED CANNON DISTRIBUTORS

- ALABAMA**  
Nelson Radio & Supply Company, Inc.  
Mobile  
Phone: (205) 479-1471
- ARIZONA**  
Kimball Electronics, Inc.  
Phoenix  
Phone: (602) 264-4438
- CALIFORNIA**  
ABC Connectors, Inc.  
North Hollywood  
Phone: (213) 875-0665, 765-8881, 983-1738
- K-Tronics  
Los Angeles  
Phone: (213) 685-5888
- Kierulff Electronics, Inc.  
Mountain View  
Phone: (415) 968-6292
- Liberty Electronics Corp.  
Inglewood  
Phone: (213) DR 8-8111
- Richey Electronics, Inc.  
North Hollywood  
Phone: (213) 761-6133 or 877-2651
- San Deicor, Inc.  
San Diego  
Phone: (714) BR 4-3131, 276-2653
- COLORADO**  
Waco Electronics  
Denver  
Phone: (303) 322-7708
- CONNECTICUT**  
Connector Corporation of America  
New Haven  
Phone: (203) MA 4-0127
- FLORIDA**  
Electro Air of Florida, Inc.  
Orlando  
Phone: (305) 241-5461
- Industrial Electronics Associates, Inc.  
Palm Beach Gardens  
Phone: (305) 848-8686, WX-8686
- GEORGIA**  
Electro Air Corp.  
Atlanta  
Phone: (404) 351-3545
- ILLINOIS**  
Merquip Electronics, Inc.  
Chicago  
Phone: (312) AV 2-5400
- Radio Distributing Company, Inc.  
Chicago  
Phone: (312) 379-2121
- INDIANA**  
Radio Distributing Company  
Indianapolis  
Phone: (317) ME 7-5571
- Radio Distributing Co., Inc.  
South Bend  
Phone: (219) 287-2911
- KANSAS**  
Radio Supply Company, Inc.  
Wichita  
Phone: (316) AM 7-5214
- LOUISIANA**  
Southern Radio Supply Company, Inc.  
New Orleans  
Phone: (504) 524-2345
- MARYLAND**  
Radio Distributing Co.  
Baltimore  
Phone: (301) 377-6402 or 377-4616
- MASSACHUSETTS**  
Lafayette Industrial Electronics  
Natick  
Phone: Boston (617) 969-6100  
Natick (617) 875-1358
- Schweber Electronics  
Waltham  
Phone: (617) 891-8484
- MICHIGAN**  
Newark-Detroit Electronics, Inc.  
Detroit  
Phone: (313) 548-0250
- MINNESOTA**  
Lew Bonn Co. (Industrial Sales Division)  
Minneapolis  
Phone: (612) 339-9461
- MISSISSIPPI**  
Ellington Electronic Supply, Inc.  
Jackson  
Phone: (601) 355-0561
- MISSOURI**  
Electronic Components for Industry Co.  
St. Louis  
Phone: (314) MI 7-5505
- Radiolab, Inc.  
Kansas City  
Phone: (816) LO 1-9935
- MONTANA**  
Electronic Supply Company  
Billings  
Phone: (406) 252-2197
- NEW MEXICO**  
Waco Electronics, Inc.  
Albuquerque  
Phone: (505) 268-2409
- NEW YORK**  
Progress Electronics, Inc.  
Plainview, L. I.  
Phone: (516) GE 3-1700
- Schweber Electronics  
Westbury  
Phone: (516) ED 4-7474
- Stack Industrial Electronics, Inc.  
Binghamton  
Phone: (607) 723-6326
- Summit Distributors, Inc.  
Buffalo  
Phone: (716) 884-3450
- Time Electronic Sales  
Great Neck, L. I.  
Phone: (516) HU 7-0100
- NORTH CAROLINA**  
Kirkman Electronics, Inc.  
Winston-Salem  
Phone: (919) 724-0541
- OHIO**  
Hughes Peters, Inc.  
Cincinnati  
Phone: (513) 381-7625
- Hughes Peters, Inc.  
Columbus  
Phone: (614) 294-5351
- Radio Distributing Company, Inc.  
Cleveland  
Phone: (216) 475-4770
- OKLAHOMA**  
Oil Capitol Electronics Corp.  
Tulsa  
Phone: (918) TE 6-2541
- Van Dusen Aircraft Supplies, Inc.  
Oklahoma City  
Phone: (405) MU 5-5577
- PENNSYLVANIA**  
Aercon, Inc.  
Clifton Heights  
Phone: (215) MA 2-2500
- Philadelphia Electronics, Inc.  
Philadelphia  
Phone: (215) LO 8-7444
- Radio Parts Co., Inc.  
Pittsburgh  
Phone: (412) 361-4600
- TENNESSEE**  
Laybender Radio & TV Supply, Inc.  
Memphis  
Phone: (901) BR 6-2756
- TEXAS**  
Hall-Mark Electronics Corp.  
Garland  
Phone: (214) BR 6-8531
- Harrison Equipment Co., Inc.  
Houston  
Phone: (713) CA 4-9131
- McNicol, Inc.  
El Paso  
Phone: (915) 566-2936
- Sterling Electronics, Inc.  
Dallas  
Phone: (214) FL 1-9921, FL 7-9131
- Wholesale Electronic Supply, Inc.  
Dallas  
Phone: (214) TA 4-3001
- UTAH**  
Kimball Electronics, Inc.  
Salt Lake City  
Phone: (801) 328-2075
- WASHINGTON**  
C & G Electronics Co.  
Seattle  
Phone: (206) MA 4-4354



# KEEPING COOLANT FROM KILLING POWER TUBES...

*One way Barnstead pure-water equipment works for electronics engineers.*

Barnstead Coolant Repurifying Loops add thousands of hours to the life expectancy of transmitting tubes and other electronic power gear such as radar components, lasers, and magnets.

They keep water or ethylene glycol coolant free from impurities, oxygen and submicron particles that cause hot-point deposits, corrosion, premature burnouts; and maintain the coolant's electrical resistance.

Shown below: commercial Model PL- $\frac{1}{2}$ , for systems up to 150 gallons. Others available for systems up to 12,000 gals. and larger.

*Other Barnstead equipment designed for you.*

Barnstead Transistor Washers and Microelectronic Cleaning Stations make a few gallons of hot, pure water — do the work of thousands.

Barnstead Demineralizers, Stills, Storage Tanks and Piping put pure water on tap wherever, whenever your process or equipment needs it.

Ask us for a no-obligation recommendation concerning your pure-water needs!

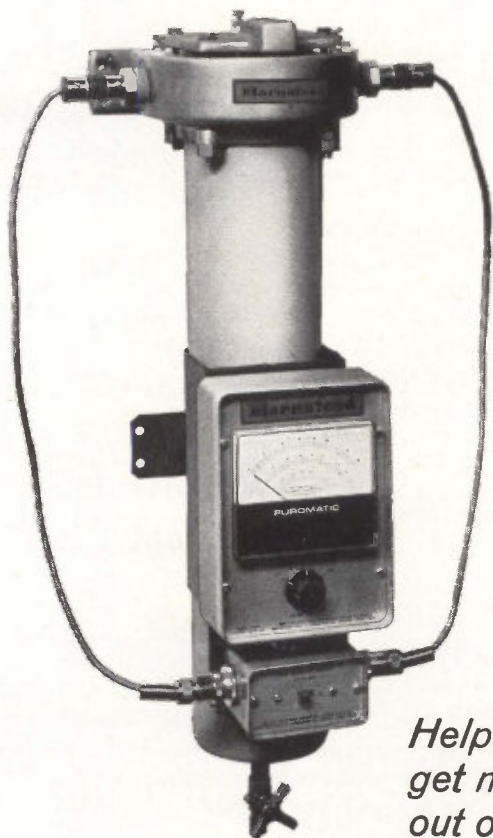

*Helping you  
get more  
out of water!*

**Barnstead**  
STILL AND STERILIZER COMPANY  
330 Lanesville Terrace  
Boston, Mass. 02131

## New Components

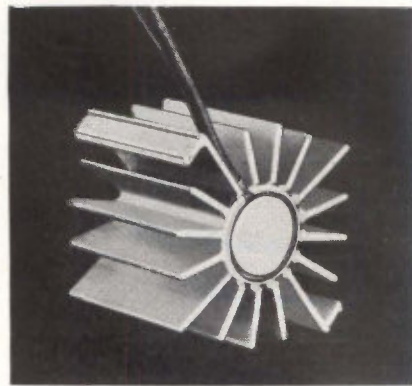

convection cooling requirements of the application. They can also be furnished with forced draft cooling.

The units are intended for high wattage applications such as a dimming or motor control for smooth acceleration of loads or speed regulation.

Mighty-Mite resistors are standardized in design elements to provide a wide range of operating values. The ceramic core is wound with suitable quality wire for the voltage input and circuit resistance value desired.

Thermal Engineering & Design Co., 217 Ash St., Akron, Ohio. [353]

## Planar triode enables compact system design

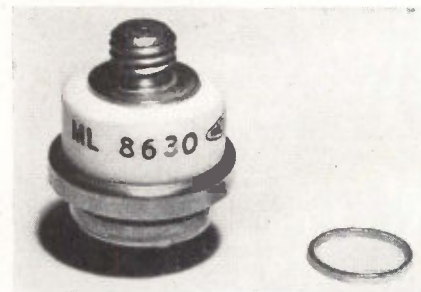

Gold-plating planar triode tubes are helping to reduce size for distance measuring equipment and transponder devices in air traffic control systems. The unit has a thin coating of 24K gold on all exposed metallic surfaces. This permits easy solderizing of connections of the tube to the associated circuit components inside the equipment, thus enabling the design of more compact control units



**Cedar Standard  
Motor-Tachs give you  
TOP QUALITY  
FAST DELIVERY  
REAL ECONOMY**

Nine out of ten of our size 8 or 10 motor-tachometers use identical housings, stacks, shaft and rotor assemblies, tuning plugs and bearings.

And yet, they still meet a wide variety of our customers' specifications. For, each unit has a different winding and pinion. Each unit performs in a different way—any way you prescribe. You still set the parameters. You still get the torque, speed, input voltages, pinions, tachometer gradients and other parameters you want.

What does this mean to you?

Standardization permits large volume manufacture . . . allows more intensive engineering and testing . . . and provides an on-hand inventory for immediate use.

This standard hardware approach has made Cedar the nation's largest manufacturer of size 8 and 10 motor-tachometers. We can deliver prototypes of standard size 8 or 10 motor-tachs in two weeks. Let's talk about it. Call or write Cedar today.



5806 West 36th Street, Minneapolis, Minn. 55416  
Phone (612) 929-1681

**At \$105, these three  
linear amplifiers  
would be a good buy.**

**At \$50, they would be  
a great bargain.**

**At \$25<sup>50</sup>, they're  
a steal.**



**Steal yours today.**

Here's a chance for you to test and evaluate each of these three Philco integrated circuit linear amplifiers in your own design—at a price that makes it worthwhile! \$25.50 for all three!

- PA 7600: Extremely high gain bandwidth (9000 MHz).
- PA 7601: Extreme linearity with AGC. Passband from 40 to 150 MHz.
- PA 7713: High gain bandwidth at low power. 18 mW at 500 MHz.

Use them for: video, audio, RF or IF applications. This special offer is good only until December 31, 1966. Send to Philco today for the Designer's Kit Certificate. Take it to your local Philco distributor and steal away with all three amplifiers (for just \$25.50!).

Suggested Resale Price.

Call for the name of your nearest distributor. **Philco Microelectronics Division Sales Offices:** 2920 San Ysidro Way, Santa Clara, California (408-245-2966)/999 North Sepulveda, El Segundo, California (213-772-6226)/Northwest Industrial Park, Second Avenue, Burlington, Mass. (617-272-1600)/Benson Manor, Suite 114B, Washington Lane, Jenkintown, Pa. (215-885-0430)/1215 Drew Street, Clearwater, Florida (813-446-0124)/815 Connecticut Avenue, N. W., Washington, D. C. (202-298-7810).

**PHILCO**



PHILCO-FORD CORPORATION  
Microelectronics Division  
Santa Clara, California • 95051



# DVM WITH A MEMORY



## ... and with a 50 nanosecond sample-and-hold aperture time!

The Micro Instrument Model 5202 is a dc to 20 MHz DVM that never forgets — and won't let you forget! Actually, its three instruments in one: a dc DVM; a single or repetitive pulse peak-reading DVM; and a sample-and-hold DVM.

The Model 5202 can be gated to accept any 50 nanosecond or longer segment of a waveform, hold it indefinitely, and digitize it for read-out on its 3-digit Nixie® tube display. And it makes no difference whether pulses are single or repetitive.

Check the following features. You'll see why the all solid-state Model 5202 is your best buy when it comes to monitoring random occurring transients and other voltages.

- No dead-time or loss of input, even during reset
- High input impedance — to 10 megohms
- Added flexibility through either ac or dc coupling
- Analog recorder and printer outputs
- 10-, 100-, and 1000-volt ranges

All of the Micro Instrument Model 5202's exceptional features are fully described in our technical literature. Send today for your copy of our 4-page brochure covering the theory of operation and specifications. No obligation, of course.

The Model 5202 illustrated is also available in rack-mounting configuration for \$1495.



12901 CRENSHAW BLVD., HAWTHORNE, CALIFORNIA 90250  
TELEPHONES: (213) 679-8237 & 772-1275

## New Components

for planes and airports.

Inside the 8600 series tube, a microscopically thin gold coating on the 0.0008-in. diameter tungsten wire grid, spaced with more than 150 turns per inch, suppresses electron emission from the grid, which operates at temperatures above 1,500°F without deformation and consequent tube detuning. The gold solution for electroplating the surface and inside grid of the tubes was developed by Engelhard Industries, Inc.

The Machlett Laboratories, Inc., Springdale, Conn., 06879. [354]

## Hermetically sealed quartz crystals



A series of Koldweld quartz crystal units for frequency control show extremely low aging rates. Each crystal is hermetically sealed in a pure nickel can with a nickel-plated copper-clad Kovar base. The units are available in volume quantities. The Koldweld process eliminates contaminants from the can's atmosphere, prevents the crystal frequency shift sometimes caused by the heat and flux of solder seals and provides units that are ultra-stable. The container's design meets tentative military specifications for the HC-33/U holder and is supplied either in an evacuated condition or with an atmosphere of dry nitrogen or other inert gas.

The crystal units meet or exceed the most stringent military specifications. Preliminary studies indicate aging of less than  $3 \times 10^{-8}$ /week



**this will explode  
all your old ideas  
about programming devices..**

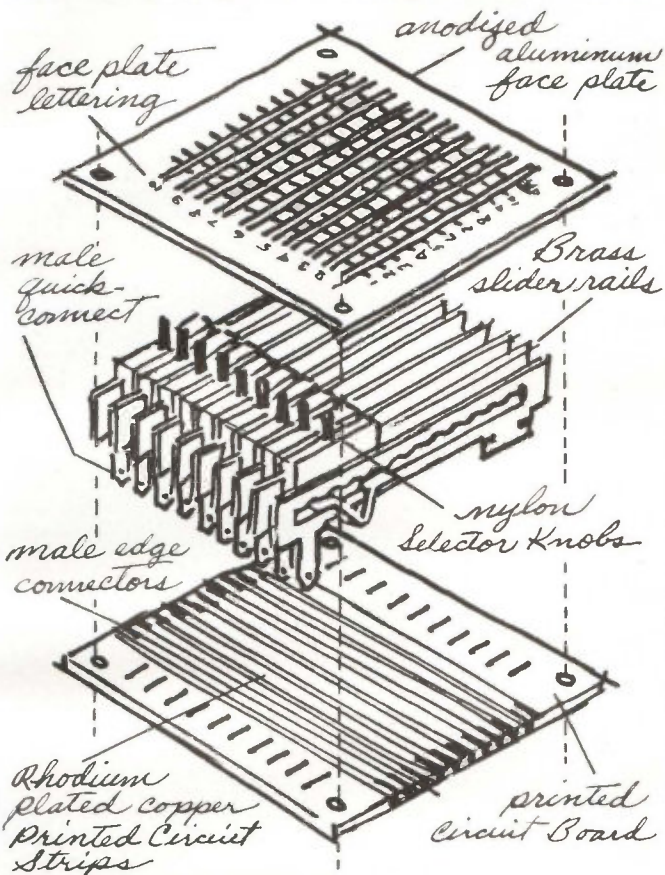

**NEW CHERRY SELECTOR SWITCH CONNECTS ANY ONE OF 48 INPUT CIRCUITS TO ANY ONE OF 58 OUTPUT CIRCUITS**—to program practically any device. And it does it *without* costly time-consuming soldering or slow, involved assembly work—and with complete visual clarity.

Like to learn more about this unusual programmer?

Write today for full details on the Cherry Selector Switch.

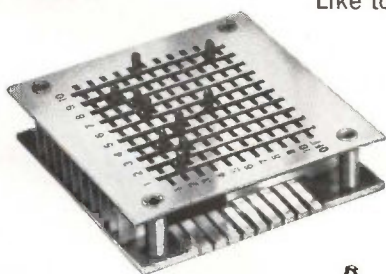

C10-20A

**CHERRY**   
**ELECTRICAL  
PRODUCTS CORP.**

1656 Old Deerfield Road • Highland Park, Ill. 60035

Circle 522 on reader service card

**NOW..**



**INSTANT  
SWITCHING!**

**ADJUSTABLE  
STOPS NOW  
AVAILABLE IN**

**1/2" ROTARY  
SWITCHES**

**"Off-The-Shelf" shipments  
for INDUSTRY'S  
BEST DELIVERY!**

- • from 2 to 12 positions (shorting or non-shorting) available merely by moving external plate!
- • up to 6 poles available on one deck!
- • Instant switching to any desired number of circuit positions!
- • ideal for breadboard setups, laboratory stock, and prototype work—where rapid circuit modification may be desired.

Write for complete engineering information.

**RCL** **ELECTRONICS, Inc.**

General Sales Office:  
One Hixon Place, Maplewood, New Jersey 07040

Circle 263 on reader service card

263



# nanodelaytol \*

\* An out-of-the-blue word to drive home the capability of Phelps Dodge Electronics coaxial cable delay lines to consistently and uniformly meet  $\pm .02$  nanosecond delay tolerances.

But, that's not all. Here is broader band operation, lower attenuation per nanosecond of delay, greater stability at microwave frequencies. And, all conventional packaging techniques are available: containers, shock mounting, standard rack-panel mounting, strapping, potted or encapsulated coils, with mounting brackets and connectors. Delay lines can also be chemically-treated, painted, or enclosed in standard or customized racks or carrying cases. Design parameters' frequencies from 60 CPS to 12 Gc, power from milliwatts to kilowatts, impedances from 50 to 125 ohms, delay line from .3 to 1.0 microseconds.

Want more detail? Write for Bulletin DL, Issue 2.

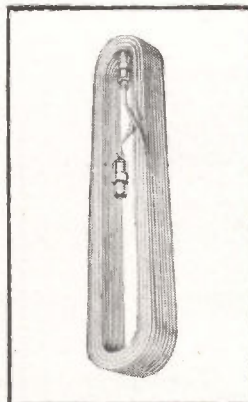

**PHELPS DODGE** ELECTRONIC PRODUCTS  
NORTH HAVEN, CONNECTICUT



## New Components

in a 75° C environment after a three-week stabilization period. Frequency ranges available are 1 to 30 Mhz for fundamental types and up to 210 Mhz for overtone types.

Delivery in volume quantities may be obtained four weeks after receipt of order.

Tedford Crystal Laboratories, Inc., 4126 Colerain Ave., Cincinnati, Ohio, 45223. [355]

## Miniature capacitors sealed hermetically

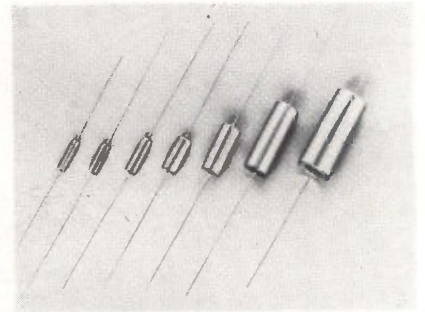

A line of miniature, metallized polycarbonate capacitors is available in hermetically sealed glass-to-metal tubular metallic cases. Series 410 capacitors have been designed for applications in sophisticated circuits where extreme miniaturization and stability at high temperatures are necessary.

The capacitors are available in voltage ratings from 100 to 400 v d-c and have a dissipation factor at +25°C of less than 0.3% at 1,000 hz. No voltage derating is required over the entire operating temperature range.

The Gudeman Co., 340 West Huron St., Chicago, Ill., 60610. [356]

## Wire-wound trimmer takes less space

A wire-wound trimmer offers offset printed circuit pins that not only meet the requirements of military style RT-11 but also offer a 30% space saving and are interchangeable with standard RT-11 size units. The trimmer is a thin-

# NEW

# MINIATURE



## NYLON CONNECTORS

Up to 15 circuit capacity with these low-cost, miniature nylon connectors! Contacts automatically crimped to leads, then securely snap-lock into the housings. Positive polarity prevents misconnections and integral mounting ears provide easy panel installation.

### Model 1625-3

Compact three circuit unit for independent circuit isolation.



### Model 1625-9

Nine circuit connections for fast, multiple circuit wiring.

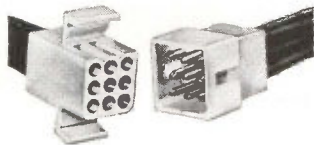

### Model 1625-12

Twelve independent circuits are provided with this unit.

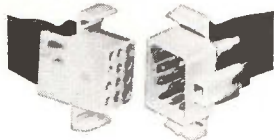

### Model 1625-15

Up to 15 separate circuits in this space saving connector.

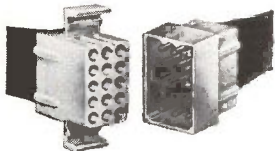

Write for complete specifications and samples on any of these connectors.

**MOLEX® PRODUCTS COMPANY**

5241 Katrine Avenue

Downers Grove, Illinois 60515

(312) 969-4550

TWX 910-695-3533



# 20 STANDARD MODELS...

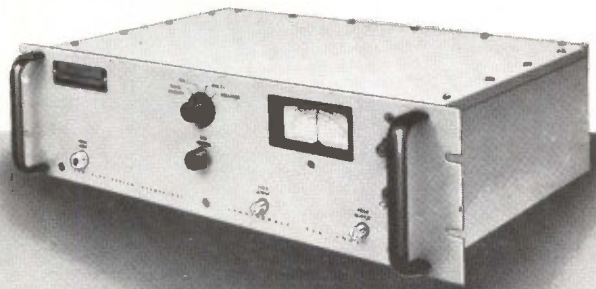

## RHG MICROWAVE FM RECEIVERS

### FEATURING

- Bandwidths to 60 MHz • Solid State Reliability • Coverage L, S, C, or X Band • Baseband 2 Hz to 10 MHz • Diversity Reception • RFI Tested to MIL-I-6181D

### FOR APPLICATION IN

- High Resolution FM TV
- Microwave Relay Links
- FM Video Data Links

Only RHG can provide 20 off-the-shelf FM Receivers backed by an additional 33 CUSTOM DESIGNS which have been produced. The solution to your problem may be on file in our library now.

For specials, test our ONE-DAY-QUOTE Service. For standards, see complete listing in EEM Section 3400.

# RHG

**RHG ELECTRONICS LABORATORY, INC.**

94 Milbar Blvd., Farmingdale, L.I., N.Y. 11735 • (516) 694-3100

MICROWAVE FM and AM RECEIVERS ■ MICROWAVE MIXER PREAMPS  
LINEAR and LOG IF AMPLIFIERS ■ RF and OCTAVE AMPLIFIERS



# You just discovered how to build a 3.9 volt power supply from any DC source in minutes.

By using a super/reg<sup>®</sup> synthesized zener diode, you make simple and quick the design of precision DC power supplies having .01% regulation and .5mv ripple.

Because typical super/reg impedances are 2 to 8 milliohms, lowest ever yet achieved.

Its unique "third" terminal lets you trim the output voltage a full  $\pm 10\%$  from nominal, with no derating or degradation.

.01%/°C temperature compensation at high power levels; thermal stability 100-times greater than that of the standard zener.

Zener voltages from 3.9 to 56V.

Full 3-ampere steady-state rating up to 75 watts.

A super/reg diode breaks the zener barrier by means of its "syn-

thesized" construction: embodies a sensing bridge, operational amplifier, thermally compensated zener diode, in standard TO-36 case.

Looks, mounts like any other diode. Performance-proven reliability; patent pending design. Designed for MIL applications.

Write or call for complete data and application bulletins.

Semi-conductor Division, Trio Laboratories, Inc., Plainview, L.I., N.Y. (516) OV-1-0400.

TWX: (510) 221-1861.



© 1966, TRIO LABORATORIES, INC. • ORIGINAL CONCEPTS IN INSTRUMENTATION



This is the super/reg<sup>®</sup> synthesized zener diode.

## New Components

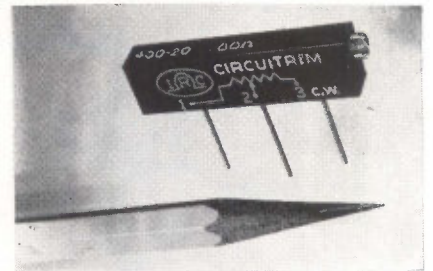

line version of military style RT-11 and meets requirements of MIL-R-1 27208. The moisture-sealed diallyl phthalate case measures only 0.190 in. wide.

This latest version of the company's wire-wound rectangular trimmer, type 400-20, is available in resistance values from 10 to 50,000 ohms,  $\pm 5\%$  tolerance. They are rated at 1.0 w at 70°C.

Units require 4 weeks for delivery. Price is \$3.56 each in lots of 100.

IRC, Inc., 401 N. Broad St., Philadelphia, Pa., 19108. [357]

## Tiny adjustment pot is rated 0.2 w at 25°C



The single-turn model 3317, said to be the smallest adjustment potentiometer available, may be obtained in two versions—3317-P for top adjustment and 3317-W for side adjustment.

The unit, in a lightweight all-plastic case, has a resistance range of 20 to 5,000 ohms, a power rating of 0.2 w at 25°C, and an operating temperature range of  $-55^\circ$  to  $+105^\circ$ C. It measures 3/16 in. x 0.105 in. Other specifications include a resistance tolerance of  $\pm 10\%$  standard; vibration, 10 g; shock, 20 g; humidity, MIL-STD-

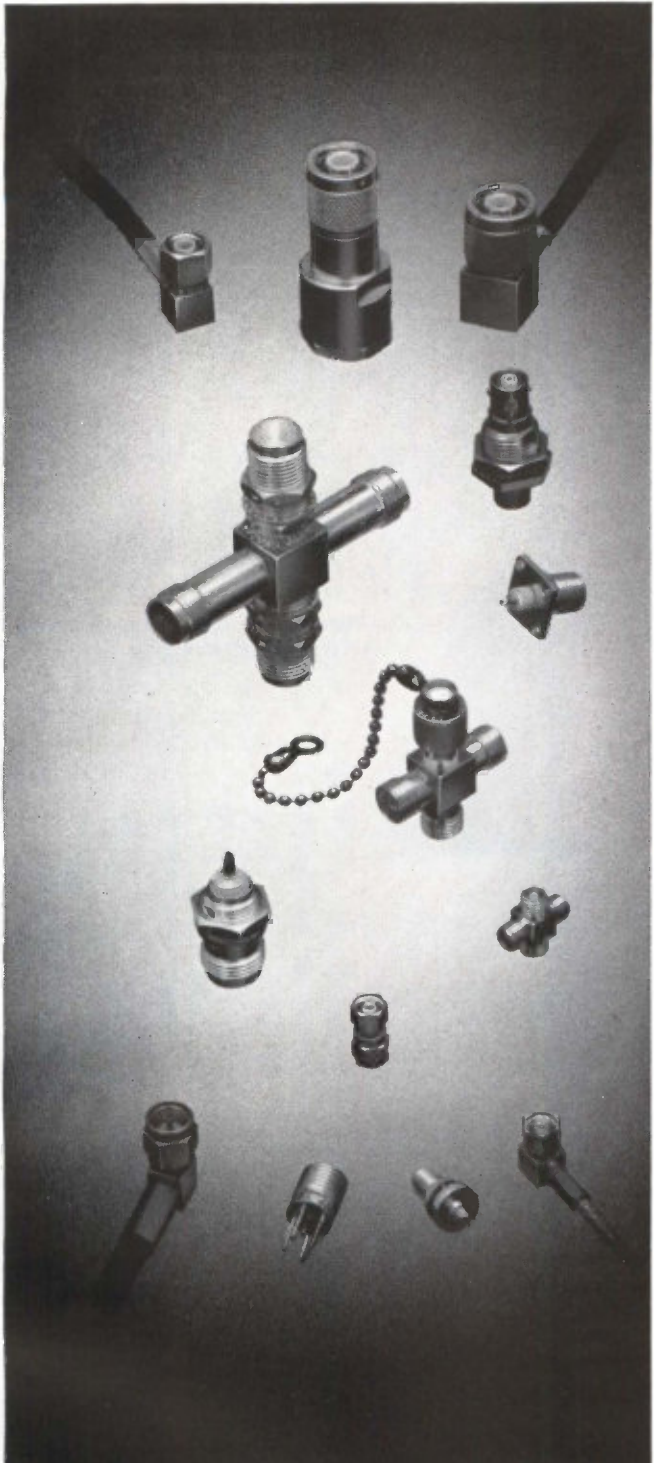

## THE SPOTLIGHT IS ON...

...GENERAL RF FITTINGS precision coaxial connectors! The finest available anywhere! GRFF Manufactures TNC, TM, GM, TPS, and SERIES 2900 (which mate with OSM and BRM types) connectors in a wide range of standard and crimp configurations.

GRFF also manufactures a completely NEW line of PRECISION MICROWAVE COMPONENTS. Complete descriptive literature is immediately available.

### General RF Fittings, Inc.

702 BEACON ST. / BOSTON, MASS. 02215  
Telephone: 617 267-5120

Circle 524 on reader service card

## Announcing new low-cost Ceramic Disc Variable Capacitors

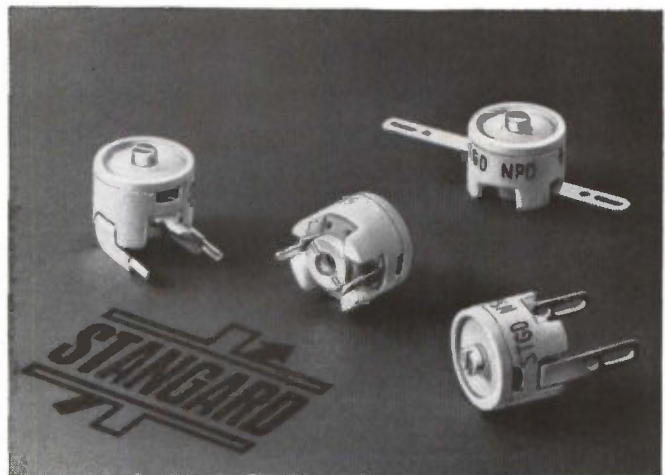

Capacitors shown enlarged 50%

## JFD Stangard DVC Capacitors

These new Stangard variable ceramic disc capacitors represent an optimum balance of high quality and low cost for commercial and industrial applications.

Eight wide  $\Delta C$  ranges, each available in 4 versatile mounting configurations, offer high Q and excellent stability in applications such as test equipment, communications equipment, low power transmitters, filters, delay lines, broadcast and television receivers, and other devices requiring adjustable capacitors.

Stangard DVC's offer a unique feature... easy adjustment... from either top or bottom. These  $\frac{3}{8}$ " diameter ceramic disc Stangard capacitors meet or exceed the applicable specifications of MIL-C-81.

Write for Bulletin STD-65.

**JFD** "TODAY'S COMPONENTS BUILT FOR TOMORROW'S CHALLENGES"

JFD ELECTRONICS CO. / COMPONENTS DIVISION 15th Avenue at 62nd Street  
Brooklyn, N. Y. 11219 / Phone 212-331-1000 • Sales Offices—Arcadia, Calif.  
Chi., Ill. / Balt., Md. / Saxonville, Mass. / Bklyn., N. Y. / New Hartford, N. Y.  
Cinn., Ohio / Phila., Pa. / Pitts., Pa. / Paris, France / Azor, Israel

Circle 267 on reader service card

267



# Glass-Epoxy Copper-clad

## through TAYLOR'S TOTAL RELIABILITY PLAN:

Raw materials, panels or punched blanks to your reliability requirements. You get what you order from a fully integrated source.

**FAST DELIVERY** from two fully equipped plants — one at Valley Forge, Pa., the other at La Verne, Calif. Or from warehouses in Chicago, Ill. and other key locations.

**FULL SIZE SHEETS, CUT-TO-SIZE PANELS or PUNCHED BLANKS** to satisfy fabricating and processing requirements. Ease of fabrication is a plus value in printed circuit production.

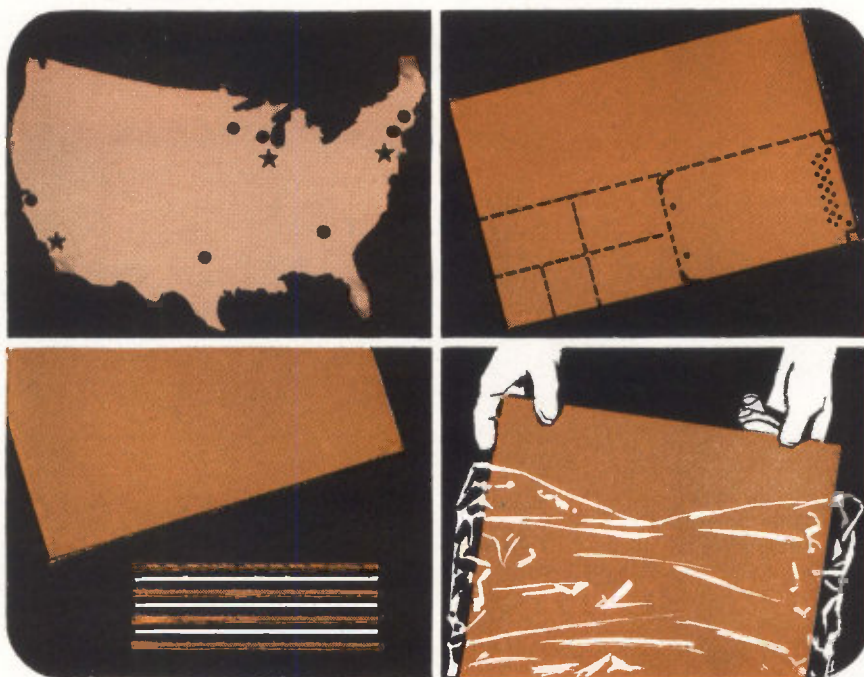

**STANDARD AND ULTRA-THIN FORMS.** Standard sheets in all grades. Ultra-thin sheets and multilayer prepreps in GEC 500 (G-10) and Fireban 600 (G-10, FR-4).

**WHITE GLOVE HANDLING** in atmosphere-controlled white rooms, careful processing, extremely tight quality control and special packaging assure top performance.

Taylor's copper-clad has proven total reliability demonstrated by an ever increasing number of major OEM's and commercial etchers. This acceptance substantiates our claim for unsurpassed quality, ease of fabrication and delivery to your scheduled requirements. Let us demonstrate this reliability to you. Ask for a sample (give grade designation and copper combination) and a copy of Bulletin GB-2.



## Taylor copper-clad

TAYLOR CORPORATION • Valley Forge, Pa. 19481

Phone: 215-666-0300 TWX: 215-666-0659

West Coast Plant: La Verne, Calif.

Also manufacturer of Taylor laminated plastics, Taylorite® vulcanized fibre and Tayloron® prepreps

## New Components

202B, Method 103; weight, approximately 0.08 gram.

Multiple wire welded terminations and flat leads are designed to improve soldering and welding. Stops are provided at each end of travel.

Price is \$2.64 each in 100-to 249-piece quantities; delivery, stock to 3 weeks.

Bourns, Inc., Trimpot division, 1200 Columbia Ave., Riverside, Calif., 92507. [358]

## IC sockets mount in-line packages

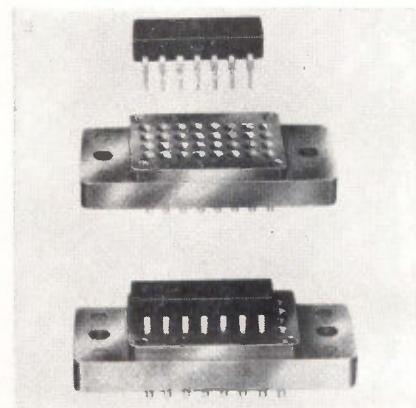

All standard in-line circuit packages incorporating 14 to 32 pins can be accommodated by the Cambion series 3792-3799 integrated-circuit sockets. Socket jacks feature cage or flat spring inserts fabricated from beryllium copper and heat treated for long-term electrical contact reliability. Long life is ensured by gold plating on all jack housings and inserts.

Jacks with cage inserts accept pins of 0.020-in. diameter. Jacks with flat ribbon inserts accept all standard flat in-line pins. With either jack style, there is a selection of external configurations. Solder terminal, solder pot, Wire-Wrap or pin/plug terminals may be specified. Nonrotation flats on all jacks ensure uniform positioning in the two-piece molded diallyl socket body. The holder body can be permanently mounted to a circuit board by machine screws and nuts.

The sockets are available from



# TROPEL SPECIAL PURPOSE LENSES AND INSTRUMENTS

## TROPEL CATHOSCAN CRT RECORDING LENSES

TropeL Cathoscan Lenses are specifically designed for rendering high contrast images from cathode ray tube sources.

Cathoscan 380 and 390 Lenses are achromatized for maximum performance with the P-16 phosphor.

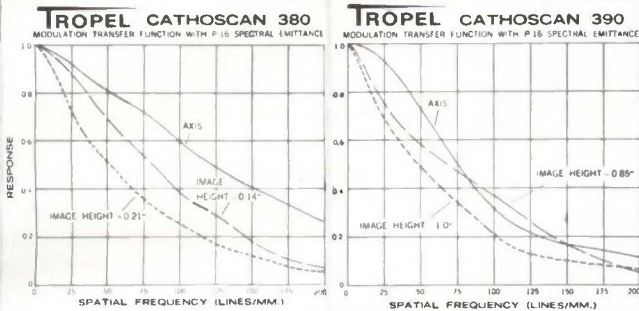

**TROPEL CATHOSCAN 380**  
 MODULATION TRANSFER FUNCTION WITH P-16 SPECTRAL EMITTANCE  
 F/1.3, 34.24mm E.F.L.  
 1:10 magnification  
 Object diameter 4.25"  
 Image diameter 0.425"

**TROPEL CATHOSCAN 390**  
 MODULATION TRANSFER FUNCTION WITH P-16 SPECTRAL EMITTANCE  
 F/4.0, 228.7mm E.F.L.  
 1:2.5 magnification  
 Object diameter 5.0"  
 Image diameter 2.0"

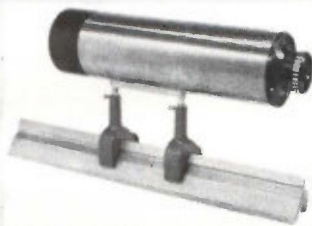

## TROPEL MODEL 1557 LASER COLLIMATORS

These afocal lens systems consist of two 3 element objectives for expanding gas laser beams up to 4 inches diameter. Collimator is corrected within 0.1λ in the region from 4500Å to 9000Å.

## TROPEL MODEL 1557 LASER LENSES

Assembled objective lenses of the type designed for the above Model 1557 Laser Collimator can be used for concentrating laser radiation to an exceptionally sharp focus. These objectives are three element lenses of F/4.0 relative aperture mounted in plain barrel with mounting thread. Special Laser Objectives of relative aperture of F/2.0 or faster can be supplied upon order.

Model Number	Focal Length	Clear Aperture
1557-06	6 mm.	1.5 mm.
1557-12	12 mm.	3 mm.
1557-24	24 mm.	6 mm.
1557-48	48 mm.	12 mm.
1557-100	100 mm.	25 mm.
1557-200	200 mm.	50 mm.
1557-400	400 mm.	100 mm.

Modifications of any of our products or Optical and Mechanical Engineering to your special requirements available on request. Send for literature.

**TROPEL, INC.** • 52 WEST AVE. • FAIRPORT, N. Y.  
 CONSULTANTS & DESIGNERS OF OPTICAL SYSTEMS  
 MANUFACTURERS OF PROTOTYPE LENSES & INSTRUMENTS



## Miniature Push Button Switches...

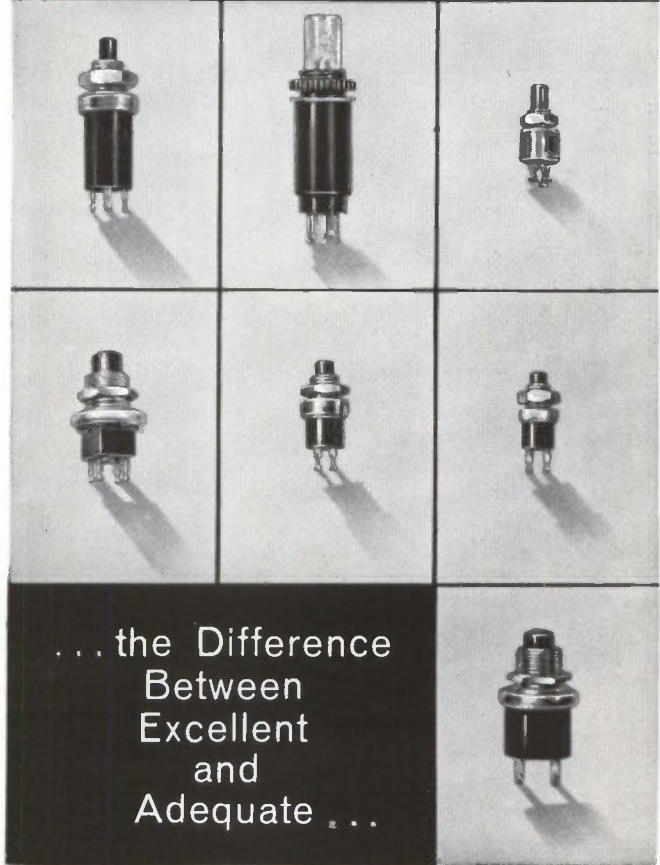

... the Difference Between Excellent and Adequate ...

### Select Materials:

- **Contacts:** Fine Silver
- **Springs:** Tinned Music Wire
- **Housing:** Molded Phenolic per Mil Specs
- **"Faston" Terminal:** Brass, Tin Plated
- **Shorting Bar:** Brass, Silver Plated

### Construction:

- Momentary Contact Snap-Action
- Silent Action
- Push-Pull
- Lighted
- SPST, DPST, SPDT, DPDT

### Ratings:

- Life Expectancy 50,000 to 1,000,000 Operations
- 1/4 Amp. to 10 Amp.
- 115 VAC, Resistive
- Contact Resistance .003 Ohms Typical

## ... in Design Materials Construction

Send for Engineering Data Book Push Button—Rotary Switches and Other Components



523 Hillgrove Avenue  
 LaGrange, Illinois 60526  
 Area Code 312, Phone 354-1040



"PIONEERS IN MINIATURIZATION"



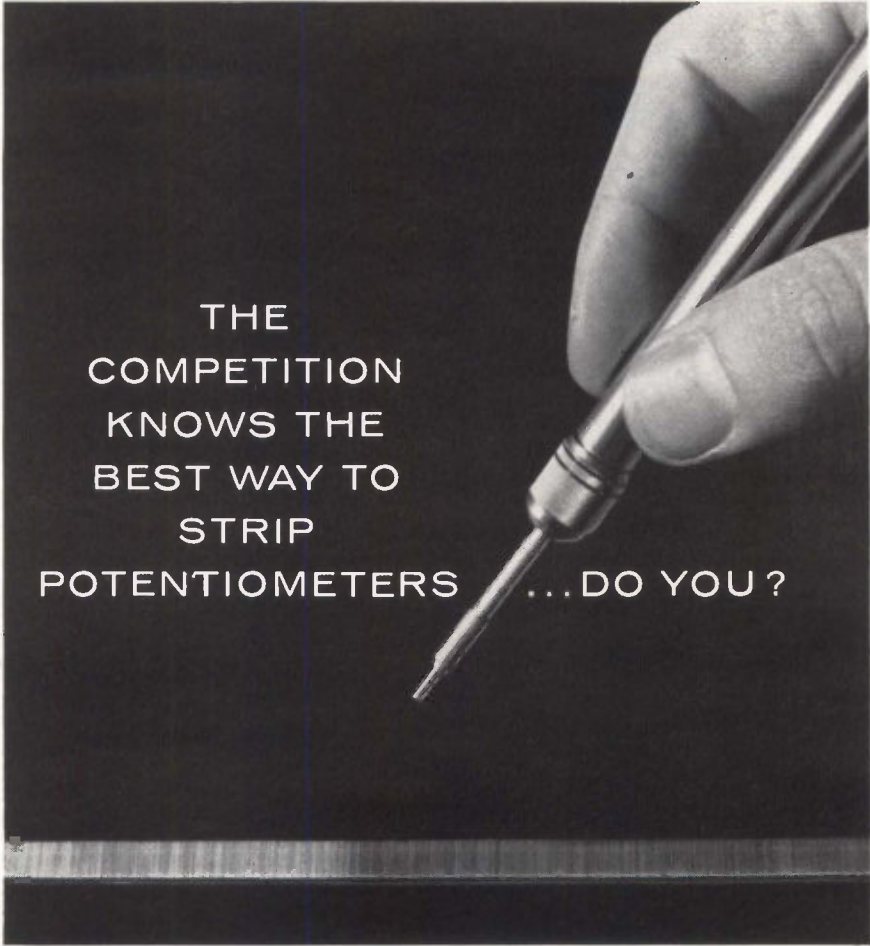

THE  
COMPETITION  
KNOWS THE  
BEST WAY TO  
STRIP  
POTENTIOMETERS ...DO YOU?

If you're still trying to strip potentiometers without an S. S. White Airbrasive unit, you're a victim of unfair competition. For 90% of your competitors know how to do it the easy, cheap, fast, and uniform way—the Airbrasive way. Airbrasive directs a precisely-controlled jet of graded abrasive particles at supersonic speeds for cool, shockless, non-distorting abrasion. Cuts away varnish without altering the electrical properties of substrate winding wire. Result: Faster stripping; fewer rejects; more uniform product.

**One company cut rejects by 65%; time from 30 minutes to 2 minutes.** This has been the typical experience of the industry.

Other Airbrasive applications include: adjusting microresistors; lead cleaning; micromodule fabrication; dicing germanium; shaping semiconductor materials, all flashing and deburring operations. Airbrasive is easily automated, adapts to use with jigs, lathes, templates. It can cut, abrade, machine, drill, deburr any hard, brittle refractory material.

**Investment is low**—less than \$1,000 sets you up.

If you're still skeptical, call us collect for an Airbrasive demonstration or send us samples of your problem-child for a free evaluation. All your competitors can't be wrong.

**S. S. WHITE CO., INDUSTRIAL DIVISION**  
Dept. EU, 201 East 42nd Street, N.Y., N.Y. 10017  
Telephone 212-661-3320

SEND FOR  
BULLETIN 6407A  
Complete  
information



**S.S. WHITE COMPANY**  
Industrial Division

## New Components

stock and are priced from \$2.60 in quantities of 50 to 99. Cambridge Thermionic Corp., 445 Concord Ave., Cambridge, Mass., 02138. [359]

## Image-orthicon tubes for tv broadcasting

The 8673 and 8674 image-orthicon tubes have been designed for high-quality color and black-and-white tv broadcast cameras. The manufacturer reports that both tubes show exceptional stability of sensitivity and resolution capability during extended life and improved electron-optical performance. The tubes have a new high-sensitivity photocathode. The redesigned image section in the tubes reduces distortion and eliminates ghosts, permitting a more closely matched set of three tubes in the color cameras.

The photocathode used in the tubes is a bialkali combination with an efficiency high enough to eliminate the need for an S11 tube in a color trio. Since the bialkali cathode is used in each channel, the transfer characteristics of the three channels may be very closely matched.

The new image section and the new photocathode are combined with a nonstick glass target, field mesh, precision construction, proven electron gun and dynode assembly. Construction of the tubes differs only in the spacing of the mesh from the target. The 8673 has a target-to-mesh capacitance of about 200 pf and so optimizes the signal-to-noise ratio to give quality performance where illumination is sufficient. The 8674 has a target-to-mesh capacitance of about 100 pf and a correspondingly greater sensitivity for use in applications where illumination is limited.

Both tubes are warranted for 1,200 hours.

Mated versions of the 8673 and 8674 image orthicons, for use in color signal transmission have been designated 8673/S and 8674/S. RCA Electronic Components and Devices, Harrison, N.J. 07029. [360]

# NIFEGON



servo-  
components  
with  
built-in  
quality

Servo components are not all alike, in spite of the fact that international standards dictate identical external appearance. The difference is in the component — reliability and life expectancy — two characteristics which depend solely on quality. The Nifegon trademark symbolizes precision servo components with built-in quality.



#### SYNCHROS

(for torque applications and servo system)  
Sizes 11, 18 and 23 — 2", 3" and 5" respectively.



#### RESOLVERS

(compensated and uncompensated)  
Sizes 11 and 18 — 2"



**SERVOMOTORS**  
Size 11



**MOTOR-GENERATORS**  
Size 11



**GEARHEADS**  
Size 11

SVENSKA ACKUMULATOR AKTIEBOLAGET

## JUNGER

INSTRUMENTFABRIKEN · STOCKHOLM

Riddargatan 17 • Stockholm 14 • Sweden  
Telephone: Sweden 22 23 40 • Cables: NIFE  
Telex: 1592

## Blackstone's new vapor rinse series for big, bulky assemblies.

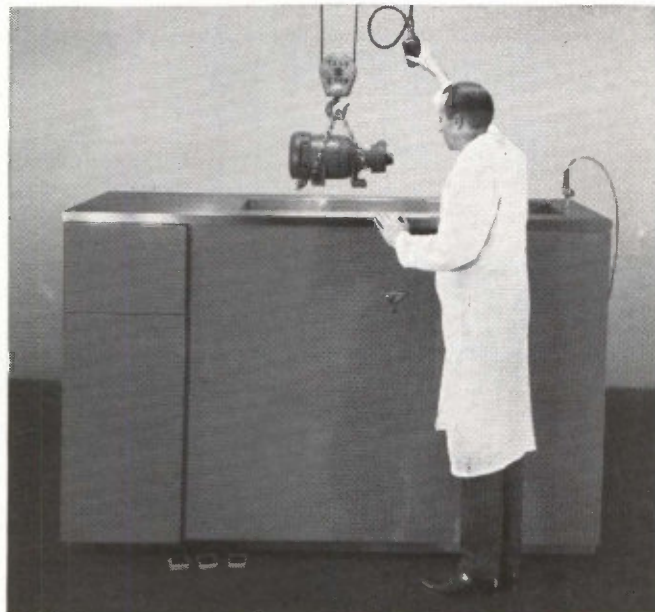

[like motors, for instance.]

Now get both ultrasonic scrubbing and vapor rinsing for large, hard-to-clean assemblies with this entirely new Blackstone cleaner.

Available with ultrasonic and vapor rinse tanks in sizes from 12" x 12" x 9" to 24" x 18" x 19", and designed for use with DuPont "Freon"® cleaning solvents, the Large VR features continuous filtration and two control systems. A foot switch controls ultrasonic wash, spray and rinse cycles. The photoelectric control may be used on pre-set ultrasonic cycles for repeated cleaning of like parts.

And consider these other Blackstone features:

- **Rounded-corner 316L Stainless steel tanks**—for easy maintenance and corrosion resistance.
- **Solid-state generator**—providing manual power control from 0 to 100%, a Blackstone exclusive.
- **Automatic timer control**—enabling pre-set wash, spray and rinse sequencing.
- **Vapor tank contamination indicator (optional)**—permits positive control over contamination build-up.
- **Hand-operated spray wand (optional)**—for manual spraying of the cleaned part.

Write and tell us about your cleaning problem. We'll report right back on what a Blackstone VR unit can do for you.



AUTHORIZED SALES AGENT



## BLACKSTONE ULTRASONICS, INC.

1400 Howard St. • Sheffield, Pa.



available immediately  
from your local  
**ELECTRONIC  
DISTRIBUTORS**

THE WAY  
TO CONQUER  
**Electromagnetic  
Interference**

**SHIELD MU**

*Tape  
and Foil*



SHIELDMU is a high permeability, fully processed, ready-to-use material for shielding sensitive electronic and electrical components from stray magnetic fields.

**BENEFITS:**

- 2 to 3 times more shielding efficiency than material currently available
- an easy way to form shields in place around inductive components to save space, time, expense
- ductility without significant degradation of magnetic shielding properties
- 4 levels of permeability performance

**AND:**

- Your local electronic distributor has it:
- packaged to meet your needs on spools and in individual sampler albums

Distributed nationally through local electronic distributors by:

*Russell Industries, Inc.*

Write, wire or call 96 Station Plaza, Lynbrook, N. Y. 11563. Phone: (516) 887-9000.

- Products of **MAGNETIC METALS COMPANY**; also manufacturers of:
- Transformer Laminations
  - Motor Laminations
  - Tape Wound Cores
  - Powdered Molybdenum Permalloy Cores
  - Electromagnetic Shielding
  - Metallurgical Services
  - Custom Heat Treating

**New Semiconductors**

**Unijunctions with Annular process**

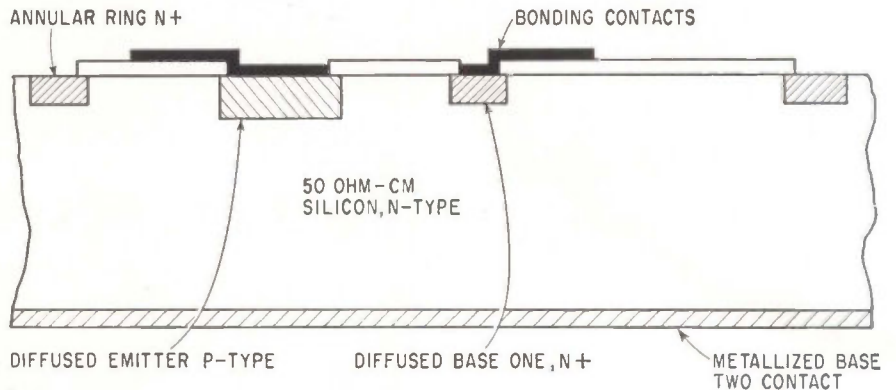

Mass production of unijunction transistors with a patented Annular process has begun at the Semiconductor Products division of Motorola, Inc. The company is producing three new types in TO-18 cans and expects to have its first plastic unijunction and an improved version of the current ones in production early next year.

Jack Haenichen, operations manager for thyristors, estimates the market for unijunctions could eventually be in the range of 10 million units annually. "A strong demand developed in the past year, and the capacity was just not there to meet it. We are still catching up—with production of 50,000-plus units a week—but we feel that by the end of the year we will have caught up with the back orders."

The market now is military and industrial, pulse, timing, sensing and thyristor trigger circuits. But Haenichen expects the less expensive plastic units to replace mechanical timers in home appliances and to be used in television oscillator circuits.

In developing a mass-production technique for the Annular process, Haenichen feels the company has made a significant breakthrough. Motorola can produce unijunctions at a lower cost than with the "tedious and costly one-at-a-time process such as the alloy cube structure method."

"We are using a batch-processing technique which allows simultaneous processing of thousands of devices," he explains. "At the same

**Specifications**

Model number	2N4851	2N4852	2N4853
Peak-point emitter current, max	2.0 $\mu$ a	2.0 $\mu$ a	0.4 $\mu$ a
Emitter reverse current, max	0.10 $\mu$ a	0.10 $\mu$ a	0.05 $\mu$ a
Frequency of oscillation, min	1 Mhz	1 Mhz	1 Mhz
Interbase resistance temperature coefficient	From 0.20%/°C to 0.80%/°C		
Intrinsic stand-off ratio, max	0.74	0.85	0.85
Emitter saturation, typical	2.5v	2.5v	2.5v
Valley-point current, min	2.0 ma	4.0 ma	6.0 ma
Modulated inter-base current	15 ma	15 ma	15 ma
Base-one peak pulse, min	3v	5 v	6 v
Price	\$.80	\$.90	\$1.50

time, we get significant performance improvements. Our devices have peak current as low as 400 nanoamperes and leakage as low as 50 nanoamps."

Haenichen says next year's device will better this performance by an order of magnitude. It will work at voltages under 5 volts, so it can operate in battery-powered equipment. The present devices are designed for 10 v or more; at 5 v or less, their characteristics change and they start operating as diodes.

The plastic-packaged device, also due next year, will have characteristics similar to the present types, but will cost only about 50 cents each in large quantities.

In the Annular production process, many devices are formed simultaneously on each wafer of silicon. The silicon's resistivity is 50 ohm-centimeters, about 10 times the usual value. The emitter impurity is diffused through holes etched in the oxide. The wafer is

Circuit Designers/Process and Systems Engineers



## PHILCO-FORD HAS STARTED A REVOLUTION IN MICROELECTRONICS

**WE NEED GENERALS**  
(And Some Lieutenants, Too)

The Philco-Ford Microelectronics Division is revolutionizing the entire electronics industry. We're even rewriting the basic textbooks because our research has added so much new data. We have room for some Generals and Lieutenants to help direct our growing army of dedicated scientists and engineers. If you are experienced in integrated or hybrid circuits or microwave components . . . or if you are a process and device development engineer . . . or if you are interested in MOS and are challenged by it, Philco-Ford has an exciting career for you. You will work either in the San Francisco Bay area or in the suburbs of Philadelphia.

### FOR CALIFORNIA INTERVIEWS

Send your resume to Mr. Richard C. Gardner  
Supervisor, Employment, Philco-Ford  
Microelectronics Division, Dept. 45  
2920 San Ysidro Way  
Santa Clara, California 95051

### FOR PHILADELPHIA INTERVIEWS

Send your resume to Mr. L. L. Baldwin  
Supervisor, Salaried Personnel, Philco-Ford  
Microelectronics Division, Dept. 45  
Blue Bell, Pennsylvania 19422



MICROELECTRONICS DIVISION  
An Equal Opportunity Employer M/F

# 109 dB

is the upper range of a Telonic rotary attenuator that operates over a DC to 1000 MHz frequency spread, is adjustable in 1 dB steps from zero and shows the attenuation **digitally**. Internally, it is constructed with individual pi-pads and precision resistors for optimum accuracy, avoiding tolerance build-up and maintaining a constant, low insertion loss. This unit is the TA-109E. Other rotary models cover 0 to 50 dB in 10 dB steps, 0 to 10 dB in 1 dB steps, 0 to 59 dB in 1 dB steps, 0 to 1 dB in .1 dB steps and 0 to 10.9 in .1 dB steps.

But if you prefer a toggle switch type, there's the TG series in models ranging to 82.5 dB in

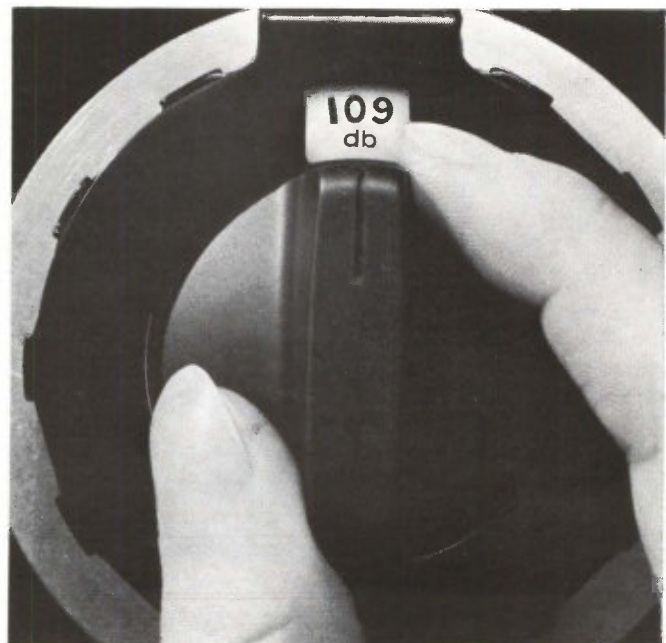



# 21

**MATTER-OF-FACT**

**REASONS**

**WHY...**

## BAUSCH & LOMB V.O.M. RECORDERS ASSURE YOU OUTSTANDING PERFORMANCE

1. Directly measure and record d-c voltage, current and resistance
2. Five built-in variable chart speeds
3. Built-in event marker
4. 17 different input ranges
5. Zener diode reference supply
6. High off-balance input impedance
7. Can be used in three positions—flat on bench, at a 30° tilt or wall mounted
8. Photoelectric modulator
9. Full scale zero set—anywhere on chart span
10. Floating input with separate chassis ground
11. Built-in 100' take-up reel
12. Modular assembly and plug-in connections for rapid access service and maintenance
13. Serve as accurate vacuum tube voltmeters in measure position
14. Lightweight and portable
15. All calibration adjustments made without disassembling units
16. Zener diode d-c supply for ohms scale
17. Adjustable damping
18. Efficient pen design
19. Low cost, high quality chart paper
20. Backed by years of experience in engineering sophisticated electronic circuitry
21. An entire division is devoted exclusively to the development and production of electronic products

Bausch & Lomb V.O.M. Recorders are available in a variety of models with different full scale sensitivity. We have a wide range of accessories that make our recorders equal to just about any task required. For your special needs, we have the capability of designing customized recorders . . . modified to handle whatever applications you have in mind. Let us hear about your recorder requirements. Write for Catalog 37-2068. Better yet, ask for a personal demonstration. Bausch & Lomb, 62335 Bausch Street, Rochester, New York 14602.

**BAUSCH & LOMB**   
ELECTRONICS DIVISION

## New Semiconductors

oxidized and etched again and the n+ annular ring and base diffusions are made [see diagram]. The wafer is oxidized and etched a third time, to allow evaporation of the aluminum contacts.

Motorola will use the same molding technique for the plastic uni-junctions as it now uses for other plastic transistors.

Motorola Semiconductor Products, Inc., Box 955, Phoenix, Ariz. 85001 [361]

## P-i-n photodiode detects extremely low light

Packaged in a miniature Kovar-ceramic package with a glass lens, the 4205 ultrafast, silicon planar p-i-n photodiode is designed for application in card and tape readers, optical encoders and similar equipment where space is at a premium. This detector also performs as a movement indicator, optical transducer or laser detector. Laser pulses of less than 0.1 nsec can be detected. A gallium-arsenide infrared light source (the 4107) is available in an identical package; the two devices form a convenient and rugged photon-coupled pair.

The diode's response time is less than 1 nsec. Frequency response extends from d-c to greater than 1 Ghz. Dark current is less than 150 picoamps, so extremely low light levels can be detected; and the quantum detection response is constant over six decades of light intensity.

These photodiodes are available from stock. Price is \$22.50 in quantities of 1 to 9, and \$19.15 from 10 to 99.

HP Associates, an affiliate of Hewlett-Packard Co., 620 Page Mill Road, Palo Alto, Calif., 94304 [362]

## Germanium transistors offer high power gain

A germanium transistor series offers maximum efficiency because of low collector saturation voltage, low input voltage and high current gain. Highest pulse power



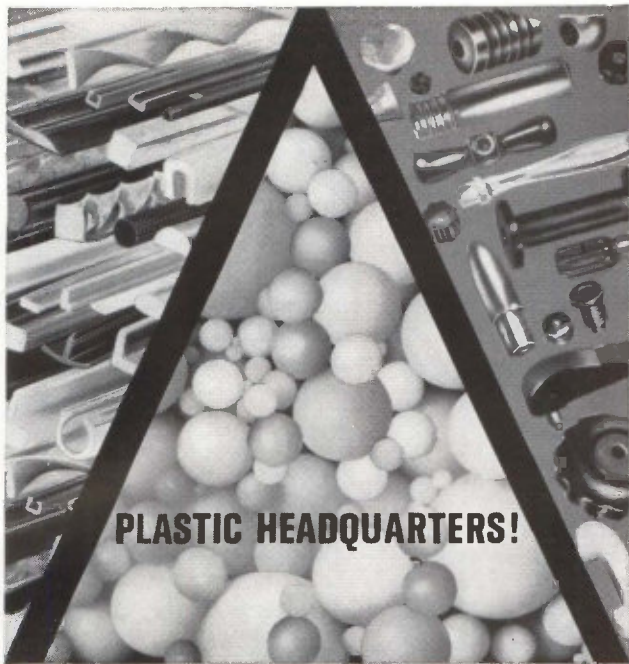

**PLASTIC HEADQUARTERS!**

**Extrusions, balls and parts**



ACE is one of America's leading mass producers of an almost unlimited variety of plastic products. Extrusions, seamless balls, fabricated parts, etc.—in almost any size, quantity, color, tolerance, shape, form or plastic including nylon, teflon\*, acrylic or you name it. Small runs or large runs. In stock or specials. Write, wire or call for samples, price lists and technical bulletins. \*Teflon is DuPont's registered trademark for fluorocarbon resin.

ACE PLASTIC CO., INC. (91-20) VAN WYCK EXPWY., JAMAICA, N.Y. • (212) JA 3-5500  
Circle 527 on reader service card

# Audio Amplifier? AC Power Supply?

the Compact  
NA Series  
gives you  
both!



The NA Series of AC Power Supplies are exceptionally flexible sources of audio power. Each power supply consists of a Regulated Audio Power Amplifier with interchangeable fixed or variable Plug-In Oscillators for a wide range of precision AC power

applications. The Amplifier has a full power range of 45-6,000 cycles. With the incorporation of a CML Plug-In Oscillator precise fixed or adjustable output frequencies are available anywhere within this range. For complete information, write today.

**CML, Inc.** 

A subsidiary of Tenney Engineering, Inc.  
350 Leland Avenue - Plainfield, New Jersey  
(201) 754-5502 - TWX: 201-756-2064

60

# 0.5 dB

steps, and to 42 and 102 dB in 1 dB steps. To assure long life and precise repeatability these Telonic toggle switch attenuators are heavy-duty type incorporating switch controls with a double knife edge and self-wiping action. Pads are shielded, individually, to prevent leakage, and to permit maximum range. The attenuators operate to 250-300 MHz, and can be furnished in 50 or 75-ohm versions. The unit shown below is a Model TG-9050A with additive steps of .5, 1, 2, 3, 6, 10, 20, 20, and 20 dB.

If you're using these attenuators (or other RF equipment) up to

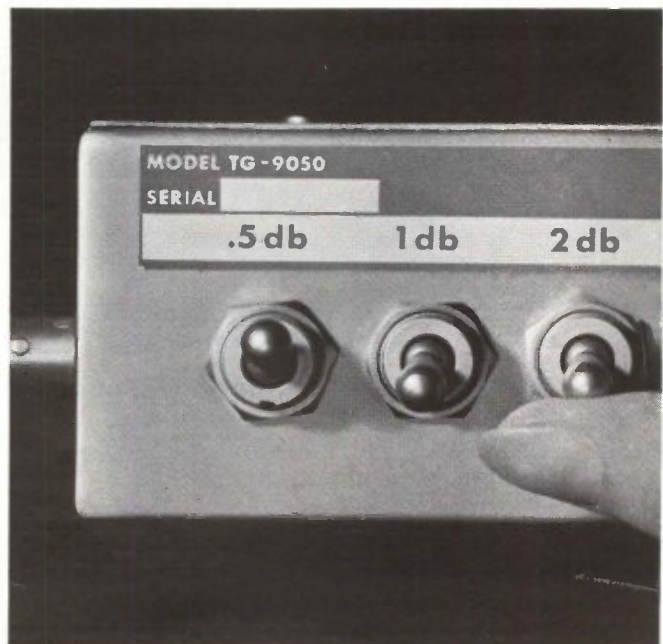

Circle 275 on reader service card 275

Circle 528 on reader service card



# DO YOU MAKE THESE FIVE COMMON MISTAKES IN EVALUATING CAREER GROWTH OPPORTUNITIES?

1. Do you consider only the largest companies in your particular field? Size of opportunity is not necessarily proportional to size of company. Many medium size companies, such as ECI, offer faster achievement of professional recognition and personal satisfaction than do the "industry giants."
2. Do you fail to consider breadth of product/customer base? It's difficult to achieve career stability in a company that is closely tied to a narrow range of products and technologies and which sells them to a limited number of customers. You'll do better at ECI, where major projects in VHF/UHF communications, multiplex, space instrumentation, microelectronics, systems integration and advanced communications techniques are in progress simultaneously. ECI's broad customer base includes Army, Navy, Air Force, Marine Corps, NASA and foreign governments.
3. Do you consider joining a company which has insufficient R&D programs? Lack of aggressive R&D could mean future trouble for the company... and you. ECI has a wide range of Company and customer-funded development programs, particularly in the promising fields of microelectronics, telemetry, space instrumentation and digital switching systems.
4. Are you overly impressed with "boom" growth conditions? Growth that's too fast can point to future instability. Look for a record like ECI's, where years of stable, predictable growth demonstrate management's ability for both sound planning and successful execution.
5. Do you settle for less-than-optimum living conditions in the name of opportunity? You needn't! In addition to all the foregoing advantages, a career at ECI will let you and your family enjoy life to the fullest in St. Petersburg, Florida. This segment of Florida's Gulf Coast offers an unequalled combination of sunshine, beaches, golf, boating, and fishing plus cultural, educational and professional engineering opportunity.

## RF ENGINEERS SYSTEMS INTEGRATION ENGINEERS DIGITAL SWITCHING ENGINEERS

Make a new career evaluation today! Investigate the immediate and attractive opportunities at ECI by sending your resume, in confidence, to K. S. Nipper, Director of Professional Placement, Electronic Communications, Inc., Box 12248E, St. Petersburg, Florida 33733. (An equal opportunity employer.)



St. Petersburg Division  
Electronic Communications, Inc.

## New Semiconductors

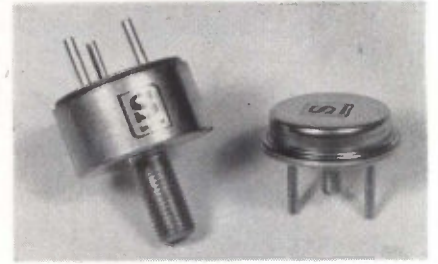

applications result from efficient emitter operation, controlled processing, and improved thermal characteristics.

Series SDT1860 and SDT1960 are available in the industry standard TO-36 package as well as a double-ended package that offers a less restrictive hookup of large conductors. As an option, both packages come in flattened or pierced terminals, eliminating an additional terminal connector. A terminal hole size of 0.120 x 0.190 in. can be provided.

Characteristics include a collector-to-emitter saturation voltage of 0.3 v, and a beta of 20 minimum at a full 65 amps of collector current; also, collector-to-emitter voltage readings through 80 v.

Available from factory the devices are suited for motor speed control, converters and other switching and amplifier applications.

Solitron Devices, Inc., 1177 Blue Heron Blvd., Riviera Beach, Fla. [363]

## Sense amplifier with 40-nsec response

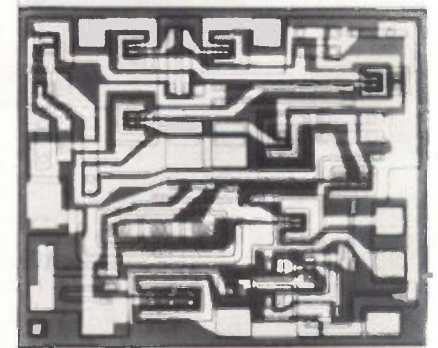

Recent improvements in integrated circuit techniques have made possible the MC1540G monolithic

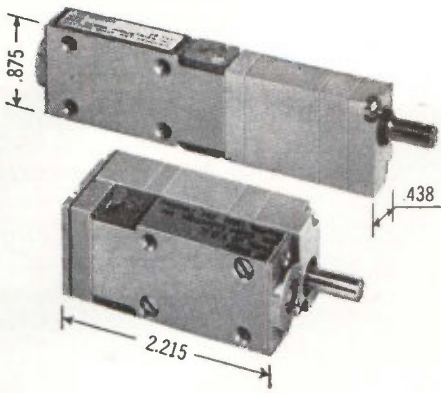

## NEW FLAT GEARMOTORS

most compact / most torque

Globe Type VS d.c. gearmotors give up to 70 oz. in. torque (35 oz. in. continuous duty) in two packages, one with a frontal area as small as 0.4 sq. in.! Motor develops .0025 hp in the 8,000 to 17,000 rpm range; many standard armatures, 3 to 50 v.d.c. End mounted gearbox: 62 standard ratios from 7.88:1 to 25,573.65:1. Side mounted gearbox: 27 standard ratios. Case hardened gears. Units designed to meet MIL specs. Bulletin VSG.



Globe Industries, Inc., 2275 Stanley Avenue  
Dayton, Ohio 45404, U.S.A., Tel.: 513 222-3741

Circle 529 on reader service card

# FREE NEW 1967 ALLIED INDUSTRIAL ELECTRONICS CATALOG

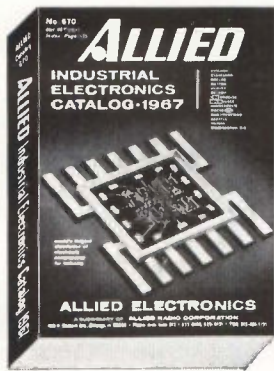

### 552 Value-Packed Pages

Here's the standard of the industry from Allied, the world's largest distributor of electronic components and equipment. 552 pages. 64,000 items, scores of new products. Factory OEM prices. Same-day shipment. Get your personal copy now.

**ALLIED**—WORLD'S LARGEST DISTRIBUTORS  
OF FAMOUS QUALITY BRANDS, FEATURES



**WIDEST SELECTION • SAME-DAY SHIPMENT**  
See your Allied Catalog for Potter & Brumfield Relays: General Purpose, Special Purpose, Power, High Performance, Mercury Wetted Contact, Telephone types—all in stock at Allied.

For FREE catalog, check reader service card or write direct to:

## ALLIED ELECTRONICS

Our 46th Year

Subsidiary of ALLIED RADIO CORPORATION  
100 N. Western Ave., Dept. 82-L, Chicago, Ill. 60680

Circle 530 on reader service card

# 1 GHz

frequency, you will find Telonic's Coaxial Switches a boon in establishing test systems, checkout stations, or in any area of RF circuitry switching. Silver-plated with point-contact design, they give excellent service life and repeatability. The frequency range permits application to microwave, video, VHF and UHF systems. Two series and six models permit selection of 2 or 4 poles, 2 or 6 positions and an optional ganged wafer switch. Shown; the TS-103A, 4 pole, 2 position on both coax and wafer sections.



INSTRUMENTS  
Division of Telonic Industries Inc.

60 North First Avenue, Beech Grove, Indiana 46107  
TEL. (317) 787-3231 TWX: 810-341-3202



Send for  
Catalog 70

SALES REPRESENTATIVES THROUGHOUT THE WORLD. FACTORY OFFICES IN FRANKFURT, GERMANY AND MAIDENHEAD, ENGLAND

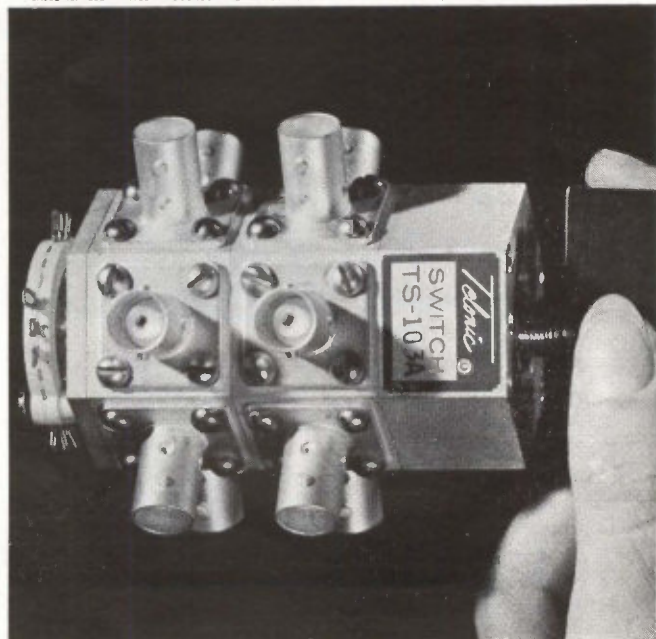

Circle 277 on reader service card

277





ACTUAL SIZE

# Is the Spectrol Model 140 really so great ?

## No, it just acts that way!

This precision pot is priced like a trimmer, and yet it outperforms many higher priced models.

Here's a half-inch, single-turn, precision potentiometer with rear terminals for optimum packaging density...a new type mechanical stop that provides exceptionally high stop strength...and a unique wiper design that assures positive contact under severe conditions of shock and vibration per MIL-R-12934. Also, here's a miniature pot with high "specability!" From our standard data sheet, you can choose from more than 100 mechanical and electrical options, in addition to resistance ratings from 50 ohms to 70K ohms.

On second thought maybe it really is so great! Why don't you find out for yourself? You'll find the standard Model 140 (with stops) stocked at your local distributor. Want more data? Send for the 140 data sheet and ask for our new Short Form Catalog, too. The Model 140 comes from a great family.



Spectrol Electronics Corporation  
17070 East Gale Avenue  
City of Industry, Calif. 91745

*Better Components for Better Systems*

## New Semiconductors

sense amplifier. These improvements allow greater gain stability with large variations in temperature, a narrow uncertainty region over a wide temperature range, a fast response time of 40 nsec plus short recovery times of 50 nsec with a 2-v common mode signal and 80 nsec with a 400-mv differential mode signal.

The MC1540G is designed to detect bipolar differential signals originating from a core memory with cycle times as low as 0.5  $\mu$ sec, and to translate these signals into saturated logic output signals. It consists of a wideband, two-stage, differential amplifier, a d-c restoration circuit with facilities to externally adjust the input threshold level from 10 to 25 mv without changing the width of the transition region. When pin 6 of the 10-pin TO-5 package is held to -6 v, the nominal threshold is 17 mv.

Also included on the monolithic die is a DTL output gate which makes strobing the sense amplifier possible from any saturated logic family.

Motorola Semiconductor Products Inc.,  
Box 955, Phoenix, Ariz., 85001. [364]

## Hermetically sealed thyristor diode

High power and high voltage are features of a new thyristor diode developed by Unitrode. The diode offers firing voltages ranging from 40 to 300 v. Continuous current rating is 1.5 amp and the device will withstand short duration surges as high as 500 amps; 8.3-msec surge rating is 15 amps.

The body size is less than  $\frac{1}{4}$  in. long with a maximum diameter of 0.085 in. These devices all feature the manufacturer's construction that uses two cylindrical metal pins bonded to both faces of a silicon die. The resultant structure is then fused in hard glass which forms a void-free hermetic seal around the junction.

Prices of this UF series vary from \$5 to \$15, depending on the voltage tolerance and quantity. Unitrode Corp., 580 Pleasant St., Watertown, Mass. [365]

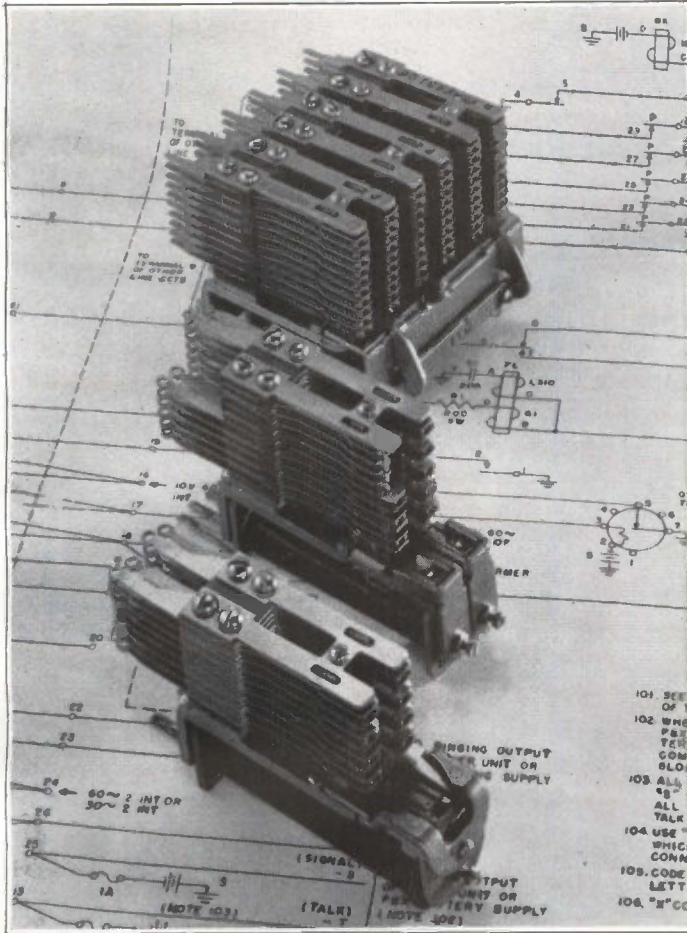

# telephone quality relays

There is no higher standard for relays. Specify famous Stromberg-Carlson . . . known to telephony since 1894.

**TYPE A:** general-purpose relay. Up to 20 Form "A" spring combinations.

**TYPE B:** multi-contact relay. Up to 60 Form "A" spring combinations.

**TYPE BB:** multi-contact relay. Up to 100 Form "A" springs.

**TYPE C:** two relays on one frame; mounts in same space as one Type A.

**TYPE E:** general-purpose relay; universal mounting; interchangeable with relays of other manufacturers.

Write for complete technical data.

## Stromberg-Carlson

A SUBSIDIARY OF GENERAL DYNAMICS CORPORATION

114 Carlson Road • Rochester, N. Y. 14603

Circle 531 on reader service card

*there are two sides to DigiTec:*  
low cost • high performance



Model 252  
from \$585

**ALL SOLID STATE digital instrumentation**  
the series 250 digital voltmeter

featuring

- High Accuracy 0.05% of Reading
- BCD Output
- Data Acquisition to 20 Readings/Sec.
- "Plug-in" Versatility
- Ultra Long Life Nixie Readout—4 digits
- Automatic Polarity Selection and Indication
- Constant 10 megohms Input Impedance
- No Blinking Readout
- Buffer Storage
- AC Rejection 75 DB @ 60 Hz
- 50% Calibrated Over-range
- Compatible with existing DigiTec instruments
- Maximum Reading—15000 digits

DIGITEC

by UNITED SYSTEMS CORPORATION

918 Woodley Rd., Dayton, Ohio 45403

For Complete Specifications request new catalog D-67

Stocking Representatives Throughout the World



# ONLY TRYGON HR-B Series POWER SUPPLIES give you all these features

- All silicon —60°C operation
- Constant voltage/constant current
- .01% regulation; 0.5 mv ripple
- Up to 300 watts—voltages to 160V.
- Remote sensing—remote programming
- TRYLINK® precision current mode
- Automatic overvoltage protection option
- Half Rack Size—Bench or rack mount



**TRYGON**  
ELECTRONICS, INC.  
Roosevelt, N.Y. 11575

Please rush me your new 52-page Power Supply Handbook—FREE

Name \_\_\_\_\_  
 Title \_\_\_\_\_  
 Company \_\_\_\_\_  
 Address \_\_\_\_\_  
 City \_\_\_\_\_ State \_\_\_\_\_ Zip \_\_\_\_\_

## New Instruments

### Log converter keeps up with scope

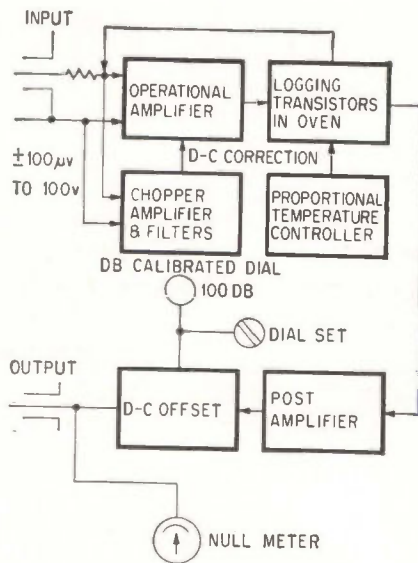

A logarithmic converter that responds fast enough to work with an oscilloscope is now available from Pacific Measurements, Inc. It's the first of its kind to operate with scopes, according to the company. The instrument also operates with digital voltmeters, recorders, high-speed graphic recorders and other common readout devices.

The converter has a wide dynamic range, covering fully just about any phenomenon in a single range without the usual adjustments.

Model 1002 accepts input signals from a low of 100 microvolts to a high of 100 volts. Above 100 millivolts its response time is 2 microseconds; below 100 millivolts, the response time derates—20  $\mu$ sec at 10 mv, 200  $\mu$ sec at 1 mv and 2 msec at 100  $\mu$ v. The dynamic range is 120 decibels (a million-to-one ratio) so a change of 1 db in the input signal results in an output signal change of 50 mv.

Output voltage can be adjusted with a 10-turn potentiometer so that any convenient point can be used as a zero reference level. The potentiometer has a calibrated dial which can be set to a major division when the offset is adjusted, making it easy to add or subtract decibels when reading the output.

An operational amplifier needs high d-c stability and low drift to handle such a wide range of signals. Pacific Measurements provides d-c correction with a chopper amplifier that has an efficient, and silent, photo-chopper at its input.

Drift correction comes from a feedback element—two silicon transistors, one for positive signals, the other for negative signals. For both, the emitter-to-base voltage is proportional to the log of the collector current over a change of eight or nine decades. Since the emitter-to-base potential is also proportional to the absolute temperature of the case, the transistors were placed in an oven. A proportional temperature controller keeps the transistors at a steady temperature.

After leaving the logging transistor, the signal level is only about 3.2 mv per db. A post amplifier strengthens the signal to 50 mv

#### Specifications

Dynamic range	120 db
Input signal range	100 $\mu$ v to 100 v
Output signal level	0.05 v/db change in output
Response speed	31.6 mv to 100 v, 30 db/ $\mu$ sec derates linearly from 30 db/ $\mu$ sec at 31.6 mv to 3 db/ $\mu$ sec at 100 $\mu$ v
Input impedance	100,000 ohms $\pm$ 1%
Output impedance	Under 100 ohms
Accuracy	Better than 0.01 db per db
Signal-to-noise ratio	Better than 10:1, 100 $\mu$ v to 31.6 mv; better than 50:1, 31.6 mv to 100 v
Drift	Under 10 $\mu$ v referred to input
Power	50-60 hz, 115-230 v
Price	\$660

per db, or 1 volt per decade. At this level, the signal can be fed into a readout device without risking serious interference from the power line or other sources. Possible interference from stray signals at the input is prevented by a differential input connection which cancels signals common to the interconnecting cable's center conductor and its shield.

The solid state unit is compact: 5 inches high, 5 1/4 in. wide and





Technically speaking, men who know meters say nothing in the industry can measure up to the new Auto-Torque. It's built to take it. The

first and only band-type meter built by automated machines for reliability never before possible in conventional meters.

More reliable because Auto-Torque meters have half as

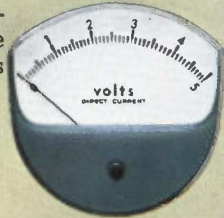

many parts. No screws. No nuts. No hairsprings. No pivots and jewels. And best of all, no "sticks". The mechanism is self-shielded, too, so it can be mounted on any panel without special calibration. Accuracy is unaffected by external fields.

Another thing. The moving system of the Auto-Torque mechanism is suspended on metal bands under tension. So there's no friction and wear.

What's more, (and this may surprise



you) new Auto-Torque meters can actually save you money! Prices to volume buyers are below those for comparable pivot and jewel meters. And there are all kinds of styles to choose from — in fact, the widest selection of band-type meters available today. And they're all a knockout. If you want more information, write to Honeywell Precision Meter Division in Manchester, New Hampshire 03105.

**Honeywell**  
**Auto-Torque Meters**

**Auto-Torque is a technical knockout.**





**Who cares how long  
a heart keeps beating?**



With the help of "Heartwatch"—G.E.'s new intensive care system — hospitals gain round-the-clock heart-beat monitoring of critically ill cardiac patients.

**Who cares about hitting  
the keyhole in the sky?**

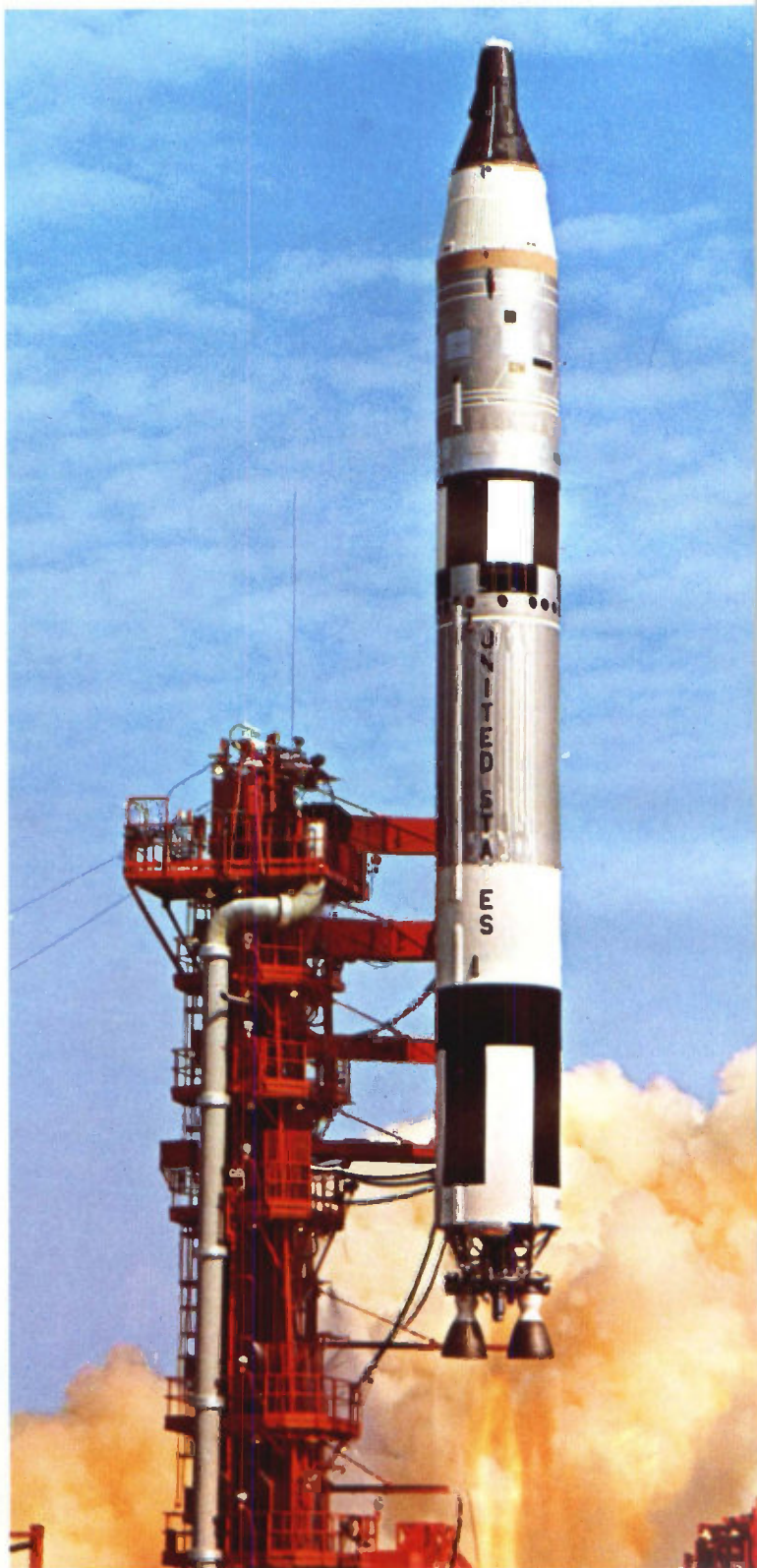

G.E.'s radio guidance system controls altitude, trajectory and velocity at launch. Like Gemini above, it has helped place all manned U.S. spacecraft safely in orbit.



**Who cares about  
color you can carry?**



"Porta-color," G.E.'s latest TV innovation, combines the space-saving advantages of multi-function Compactron tubes with an all-new, 11-inch color picture tube.

## **General Electric cares**

**(and brings you continuing innovations in all areas of electronics to prove it)**

At the heart of every G-E innovation lies engineering — the single most important factor in electronics. Engineering opens doors to new and improved equipment designs, to better product quality, to lower component prices, and to new market opportunities for both your business and ours.

As your partner in innovation, G.E. will continually work with you to assure the growth of our industry—not just in dollars, but in jobs and in markets as well.

Who cares about the benefits you get through continuing electronic innovation? General Electric cares. Just ask the people who represent us, your G-E engineer/salesman or distributor.

900-07

*Progress Is Our Most Important Product*

**GENERAL  ELECTRIC**



# Who is the leader in . . .

## High Temperature Wire/Cable

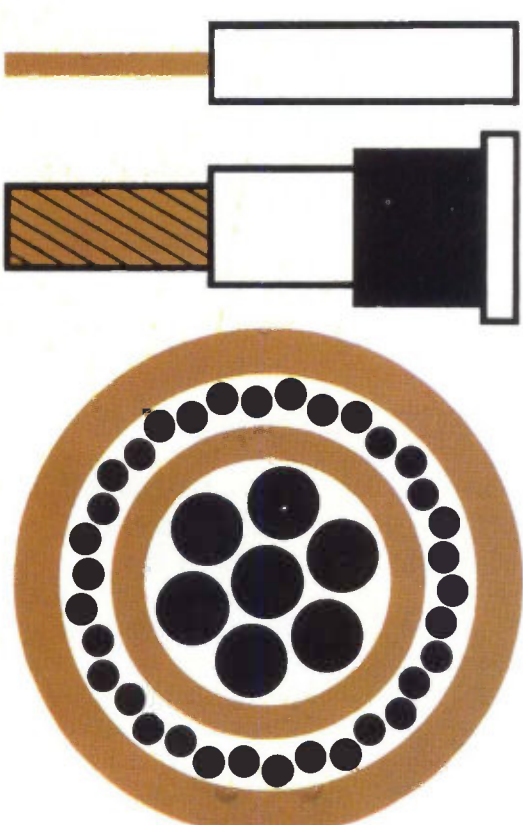

The diagrams illustrate various high-temperature wire and cable designs. At the top, a single wire with a thin brown coating is shown next to a rectangular component. Below it, a more complex cable with a hatched brown outer layer, a white inner section, and a black terminal is shown. At the bottom, a circular cross-section of a multi-conductor cable is shown, featuring a central core of five large black circles, surrounded by a ring of smaller black circles, all enclosed in a thick brown outer sheath.

**SUPER TEMP WIRE**—Specialized high-temperature insulated wire/cable designs . . . from film coated wires, finer than a human hair, to complex multi-conductor and coaxial cables . . . for critical electrical/electronic applications, mark Haveg contributions to wiring projects on Gemini and Apollo man-on-the-moon programs, as well as on the Polaris, Saturn and Titan missile and rocket programs.

## Custom Molded Plastics



The image shows a custom molded plastic component, likely a dielectric insulator or connector. It has a complex, T-shaped profile with a central white oval cutout. The main body is a reddish-brown color, with black rectangular features on the sides. The bottom section is a grey, cylindrical component with a threaded section at the very end.

**PRECISION MOLDING**—Versatility of materials technology, die making, and quality-controlled processing allow Haveg engineers to design and manufacture critical components from thermosets, thermoplastics, and HAVELEX®—the inorganic plastic with superior dimensional stability and high dielectric strength. Precision Molding specializes in electrical/electronic components molded to fine tolerances.

©Trademark of Haveg Industries Inc.

# Haveg is

Haveg Industries, Inc. has been an innovator in the development and fabrication of custom-engineered plastics since 1929. Today, Haveg maintains numerous plant operations and divisions in both the eastern and western United States, with product technology as diversified and unique as . . . corrosion resistant chemical process equipment . . . precision molded plastics for electrical/electronic applications . . . aircraft seals and aerospace vehicle components . . . corrugated plastic conduit for underground cabling . . . specialized high-temperature wire and cable . . . high-strength, filament-wound fiberglass structures . . . extruded plastic pipe for water distribution service . . . proprietary foamed plastics for consumer and industrial markets . . . high-temperature silica fabric insulations for missiles and industry.

In all of these areas Haveg offers a unique combination of engineering skills, craftsmanship, and experience in depth. Every Haveg division is a specialist in its field, oriented toward product development and backed by the latest in fabricating and manufacturing facilities.

Haveg's divisions, with their specialized capabilities, welcome the opportunity to apply their knowledge to solving your out-of-the-ordinary problems in plastics engineering and processing . . .

- Aircraft Products
- Amco Pipe
- American Molding
- Chemical Equipment
- Commercial Products
- Corflo Products
- Precision Molding
- Reinhold Aerospace
- Sil-Temp Materials
- Spiralloy Structures
- Super Temp Wire

For prompt assistance from any of these divisions, write today. If you would like more information about Haveg's diversification and exclusive manufacturing techniques, send for our new corporate capabilities brochure or specific divisional brochures.

**HAVEG INDUSTRIES INC** 

Subsidiary Hercules Incorporated

918 Greenbank Road, Wilmington, Delaware 19808

## New Instruments

10½ in. deep; it weighs 7 pounds. Dale M. Barger, president of Pacific Measurements, expects the unit to find applications in vibration testing, both general quality control and final testing, nuclear engineering, acoustics, geophysical research, electro-optics, medical electronics and data processing. Pacific Measurements, Inc., 940 Industrial Ave., Palo Alto, Calif. [371]

### Gauge control unit comes in 3 models

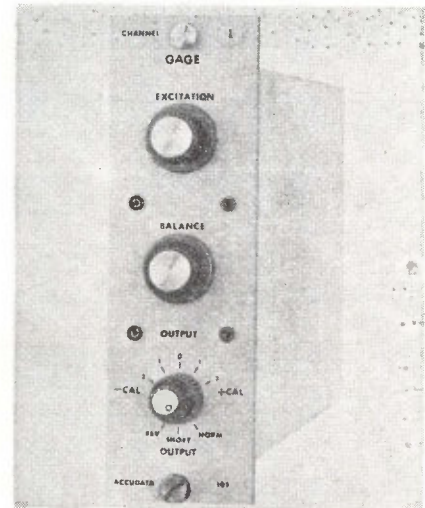

A second-generation signal conditioning unit has been designed for control of strain gauge and thermistor-type transducers. The Accudata 105 series is available in three models—the 105-1, 105-2 and 105-3.

Each model offers new control features for balance and calibration, according to the manufacturer, and provides additional operator convenience in the form of new output switching arrangements and front-mounted monitoring jacks.

The basic model, 105-1, controls excitation, balance and sensitivity of both strain gauge and thermistor transducers.

The 105-2, in addition to providing the same functions as the basic unit, contains its own excitation supply. This 12-v model, with its 350-ma output, also may serve as a direct-current source for up to



# Ballantine AC-DC Digital Voltmeter

Model 355

Price: \$620

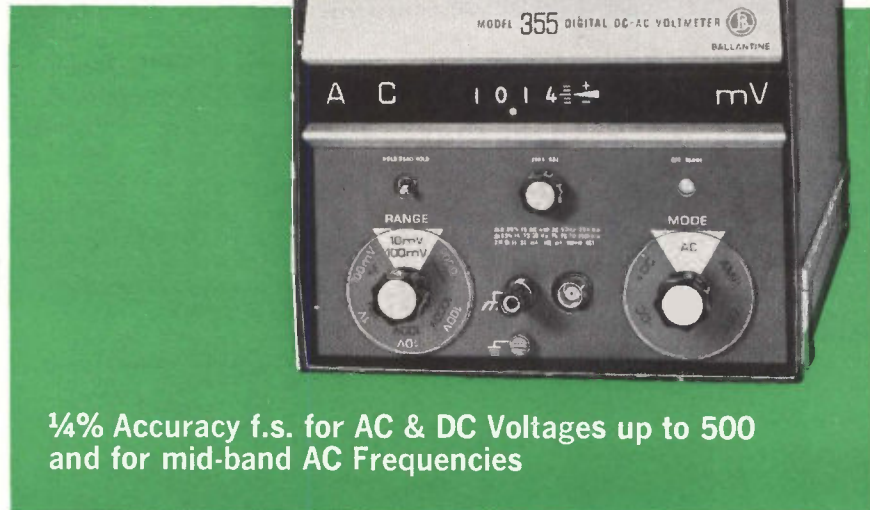

1/4% Accuracy f.s. for AC & DC Voltages up to 500 and for mid-band AC Frequencies

## Measures Full Scale ac to 10 mV ...ac & dc from 0 to 1,000 V

Ballantine's Model 355 is the only digital voltmeter of its type in the U.S.A. . . with a versatility that makes it ideal for production line and quality control applications.

Use the 355 in place of analog instruments, for example, in reducing personnel errors, for speeding up production. You can depend on Ballantine's high standards of accuracy, precision, and reliability to reward you with savings of time and money the first day you place it in service.

The instrument features a servo-driven, three-digit counter with over-ranging . . . combines many virtues of both digital and analog voltmeters in one small, compact, economical package. Its large, well-lighted readout with illuminated decimal point, range and mode information, allows fast, clear readings, while the indicator can follow and allow observation of slowly varying signals. The position of the last digit can be interpolated to the nearest tenth, thus avoiding the typical " $\pm 1$  digit" restriction of a fully digitized display.

Desire even faster production? An optional foot-operated switch of the Model 355 retains voltage readings, and enables you to cut materially the time between readings. Another aid in reducing personnel errors is provided by an over-range indicator that signals excessive input of the wrong polarity.

### PARTIAL SPECIFICATIONS

Voltage Range	AC	DC	Accuracy in % of Full Scale	AC	DC
Full scale, most sensitive range	0 to 1000 10 mV	0 to 1000 100 mV	1 mV to 500 V	1/4%, 50 Hz to 10 kHz 1/2%, 30 Hz to 50 kHz 1%, 50 kHz to 250 kHz	1/4%
Frequency Range	30 Hz to 250 kHz	DC	Power Requirements	115/230 V, 50-60 Hz, 52 W	
Optional Model 600 Resistors	are available for measuring current directly in volts	Relay Rack Version	Model 800 rack mounting kit is optional		

Write for brochure giving many more details  
Member Scientific Apparatus Makers Association

— Since 1932 —



**BALLANTINE LABORATORIES INC.**  
Boonton, New Jersey

CHECK WITH BALLANTINE FIRST FOR DC AND AC ELECTRONIC VOLTMETERS/AMMETERS/OHMETERS, REGARDLESS OF YOUR REQUIREMENTS. WE HAVE A LARGE LINE, WITH ADDITIONS EACH YEAR. ALSO AC/DC LINEAR CONVERTERS, AC/DC CALIBRATORS, WIDE BAND AMPLIFIERS, DIRECT-READING CAPACITANCE METERS, AND A LINE OF LABORATORY VOLTAGE STANDARDS FOR 0 TO 1,000 MHZ.

## New Instruments

eight 350-ohm gauges.

The 105-3 provides the same functions as the 105-1 and also serves as an individual d-c excitation source with existing or future signal conditioning amplifiers.

Price range of the Accudata 105 series is \$105 to \$195.

Honeywell Inc., Test Instruments division, 4800 East Dry Creek Road, Denver, Colo., 80217. [372]

## Electronic controller offers economy

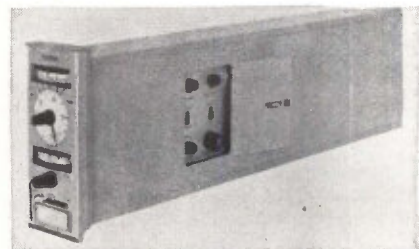

An electronic indicating controller that fills industry's need for a more reliable, economical instrument for process-flow applications is being offered, according to the manufacturer, at a price competitive with pneumatic indicating controllers. Current base price of model 61H is \$325 without shelf and accessories.

A built-in force-balance transmitter power supply and a remote-local switch allows the controller to be set electrically by an external device or to be set manually. Components of the proportional-plus-reset controller are on a single, vertically mounted circuit board. All calibration adjustments are potentiometers and there are no selected wire-wound resistors.

Controller operating adjustments include deviation and valve output meters, calibrated set point dial, manual knob and automatic/manual transfer switch.

A four-position automatic/manual transfer switch and a fully transistorized amplification system assure smooth, bumpless transfer of control.

Control mode adjustments, remote/local switch and increase-decrease switch are located on the



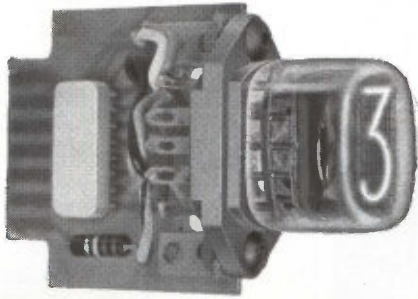

## NATIONAL<sup>®</sup> Readout Tube Drivers

TTL Integrated Circuit Drivers  
designed for National Readout Tubes.

Now available: Decoder/Driver  
and Decimal Counter/Driver.

- 15 MHz Counting Rate
- Compatible with all side view  
and end view readout tubes.

**NATIONAL** REQUEST  
BULLETIN

**ELECTRONICS, INC.**  
a varian subsidiary

PHONE: (312) 232-4300 - GENEVA, ILLINOIS, U.S.A.

Circle 532 on reader service card

**ALCO** ELECTRONIC PRODUCTS, INC.

**BNE**  
Series



**BNF**  
Series



**BND**  
Series



### MINIATURE NEON PILOT LIGHT ASSEMBLIES

1-piece body ideal for space limitations. BNE SERIES has compact lens system protruding slightly above panel. BNF SERIES' lens system extends more for greater illumination. BND SERIES' pilot assembly protrudes beyond panel to provide maximum light intensity.

**ALCO** ELECTRONIC  
PRODUCTS, INC.  
LAWRENCE, MASSACHUSETTS

**ALCO** ELECTRONIC PRODUCTS, INC.

## LOW COST \$9.95

# NUMERIC READOUT

QUANTITY PRICES  
AVAILABLE

MINIATURE SIZE, compact, incandescent numeric readouts have new-type, long-life 30,000 hour lamps. Machined aluminum stack-plate design permits close side-by-side mounting. Digit size 3/4" high. Specify 6V or 14V model.

SHIPPED PREPAID WHEN CHECK ACCOMPANIES ORDER

**ALCO** ELECTRONIC  
PRODUCTS, INC.  
LAWRENCE, MASSACHUSETTS



Circle 533 on reader service card

Which **FILM**  
**HYBRID MICROCIRCUIT**  
requirement is most  
important to you?

- High Density
- Improved Reliability
- High Volume Production
- Lower Prices

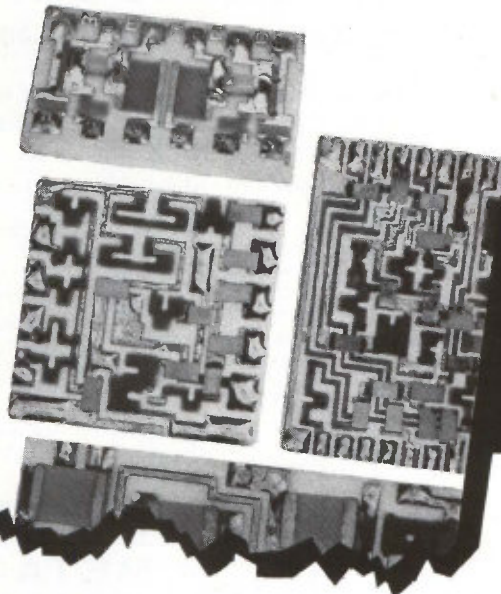

With Mepco's new S.M.A.C.\* technique you get all 4!  
And consider these exceptional product features . . .

- Shrink your existing linear or digital circuits to micro-packages.
- Ratio matches to .001.
- Power dissipation — 10 watts per sq. inch.
- Temperature coefficient tracking of  $\pm 20$  PPM.

Write or call today for FHMC Data Sheet.

\*Simultaneous Mass Attachment of Components

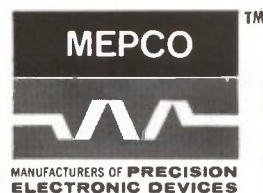

**MEPCO, INC.**

COLUMBIA ROAD, MORRISTOWN  
NEW JERSEY 07960  
(201) 539-2000

Circle 287 on reader service card

287



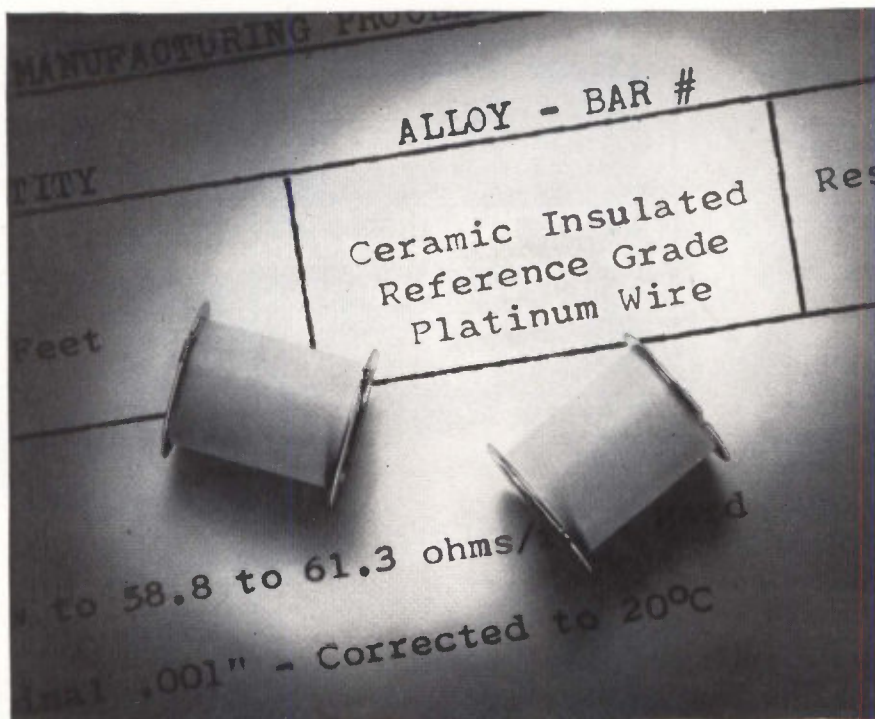

## EXCLUSIVE!

(you can't get it from anyone else!)

Secon's way out front this time. This wire and insulation are designed for the resistance thermometer field.

We are the only producer of reference grade platinum that can supply it with a ceramic insulation, that allows the wire to be fully recrystallized without harm to the insulation. The ceramic insulated wire can be supplied as small as .0007". The ceramic insulation handles temperatures in excess of 1500°F. We also straight-draw bare reference grade platinum

wire to a diameter of .0005". Conventional insulations are also available.

If your requirements are for high quality, reference-grade platinum, bare or insulated, you will want a copy of our brochure on wire products for resistance thermometers. It lists the physical and electrical properties of available materials.

Please write on your letterhead; no obligation of course.



7 INTERVALE STREET, WHITE PLAINS, N.Y. 10606 ■ (914) WH 9-4757

Circle 288 on reader service card

To order reprints: Fill in, cut out coupon below, insert in envelope and mail to: **Electronics Reprint Dept., 330 W. 42nd Street, New York, N.Y. 10036**

### Reprint order form

For listing of reprints available see the Reader Service Card.

Communications Satellites Part I

Send me ..... reprints of Key no. R-89 at 50¢ each.

For reprints of previous special reports fill in below:

Send me ..... reprints of Key No.(s) ..... @ .....¢ each.

(For prices, see Reader Service Card)

Name .....

Number of street .....

City, State, Zip code .....

## New Instruments

side of the pull-out chassis. A self-storing cord allows the controller to be withdrawn from its panel without interrupting process control.

Optionally available is a new manual memory pointer for the output meter to indicate normal valve position. Also optional are a backlighted nameplate that serves as a visual alarm and a Vu-Line deviation display. When measurement deviates from set point by a predetermined amount, a brilliant red pointer appears from behind a black mask on the deviation meter to warn of an off-normal condition.

The flow controller's 10 to 50 ma d-c input/output signal is compatible with all other controllers, recorders, indicators and auxiliary stations in the electronic Consotrol line. The instrument includes a universal power transformer for operation on nominal 100, 118, 220 and 238 v,  $\pm 10\%$ , 50 or 60 hz.

The Foxboro Co., Foxboro, Mass., 02035. [373]

## Ratio divider box offers 1 ppm accuracy

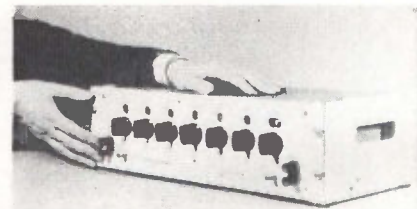

Inductive decade ratio divider model RB-504T allows any input-output signal ratio in the range 0 to 1.111110 to be set up with 0.3 part-per-million resolution and 1 ppm accuracy (traceable to NBS), using five front-panel decade switches and a calibrated potentiometer in the sixth decade position. By using a built-in phase reversing transformer, the divider's range is extended to negative ratios, spanning the range -1.111110 to +1.111110 with the same 0.3-ppm resolution and accuracy reduced to 3 ppm.

Frequency range is 50 hz to 3

## print electronic components ...efficiently

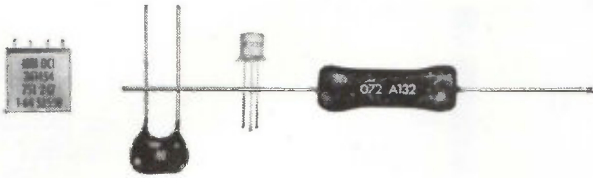

Clear, easy to read identification on small parts can be applied efficiently at speeds equal to your production with a Matthews Off-set "In-Line" Rotary Printer.

Standard printers work equally well on round, flat, or contoured surfaces, with the parts handling section designed for each part. Special inks available for various surface conditions. Inquire today for photos with sample.



**JAS. H. MATTHEWS & CO.**  
Industrial Marking Products Division  
6516 PENN AVENUE • PITTSBURGH, PA. 15206  
MARKING METHODS SINCE 1850

Circle 534 on reader service card

## NEW lower-cost, epoxy flame-retardant copper-clad laminate

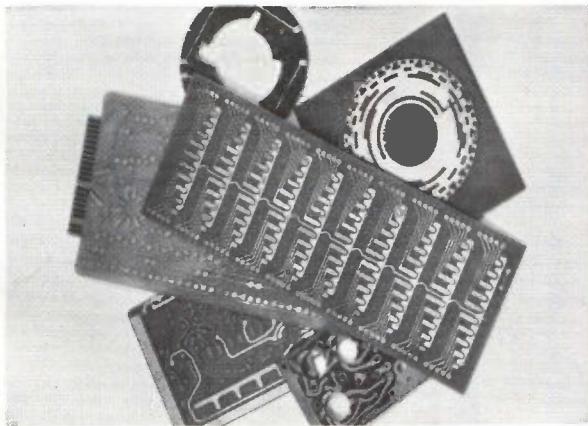

In response to the demand for a more economical epoxy grade of laminated plastic, Synthane now offers new grade FR-16.

FR-16 is reinforced with a random-oriented glass fiber mat which, because it can be produced on a modified paper machine, costs less than fabric reinforcements used in other flame-retardant grades.

FR-16 is excellent for printed circuits. It is mechanically strong, moisture-resistant, has a low dielectric loss and a high dielectric breakdown. Write Synthane Corporation, 36 River Road, Oaks, Pa. for the FR-16 Engineering Data Bulletin.

**SYNTHANE**  
CORPORATION  OAKS, PENNA.

Laminated Plastic Sheets, Rods,  
Tubes and Fabricated Parts

Circle 535 on reader service card

## Tu-Pin Molded Base Lamps

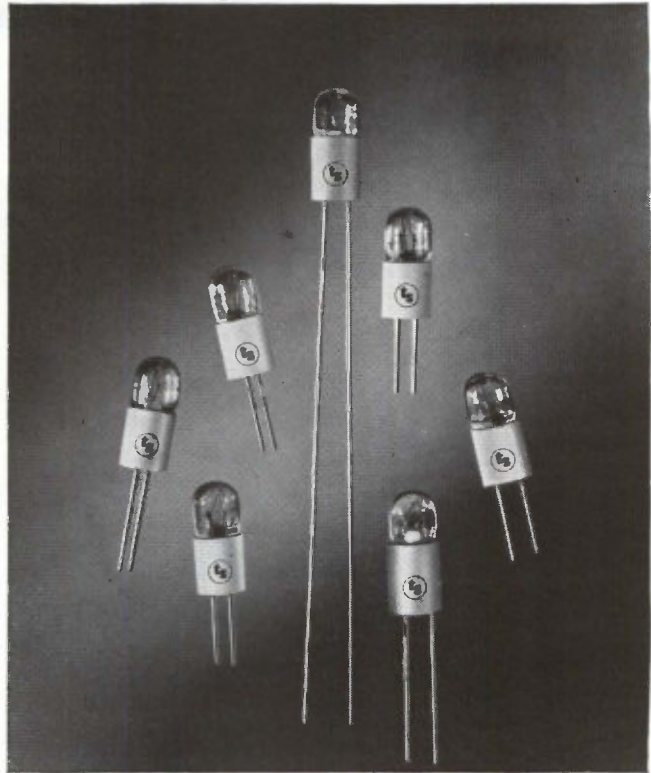

## A complete light source that requires no mounting socket

Tu-Pin Lamps are standard subminiature bulbs molded into Nylon bases. Bulb and base are an integral unit. The conventional metal base and socket are eliminated.

Fewer parts and connections reduce assembly procedures and contribute to greater product reliability.

Tu-Pin Lamps are ideal for circuit board applications. They can be installed with automated equipment.

All leads are internally sealed against corrosion. Exposed leads can be of non-corrosive material. Molded bases can be color coded for production accuracy.

In addition to Tu-Pin types, Tung-Sol supplies molded base lamps with long leads for computer modules and photocell applications. Complex base configurations can be supplied to specifications. Write for more information.

**TUNG-SOL® MOLDED BASE SUBMINIATURE LAMPS**

WAGNER ELECTRIC CORPORATION, TUNG-SOL DIVISION  
One Summer Avenue, Newark, N. J. 07104

Circle 289 on reader service card

289



# NEW BATTERY POWERED, OPERATES 1500 VOLTS OFF-GROUND ELECTROMETER

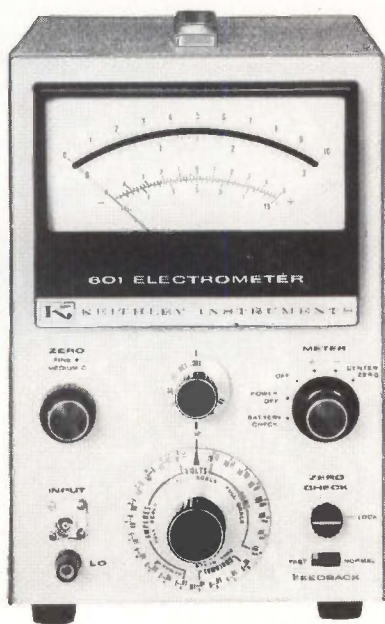

## MODEL 601

- 1 mv f.s. to 10v, with  $10^{14} \Omega$  input resistance
- $10^{-14}$  amp. f.s. to 0.3 amp.
- 100 ohms f.s. to  $10^{13}$  ohms
- $10^{-12}$  coulomb to  $10^{-6}$  coulomb
- 200  $\mu$ v/hr. zero stability
- 1,000-hour battery life even when recording
- \$595 with input leads

Everything about this handy portable is new . . . except the name electrometer! Its 3-terminal input allows complete low terminal isolation, full high terminal guarding, from the case. It also permits 1500 volt off-ground capability—a feature offered only by the 601. Extra flexibility is provided by 73 ranges for measuring voltage, current, resistance, charge and three outputs, highlighted by a 0.005% accuracy unity-gain amplifier. And perhaps best . . . now measure continuously for 1000 hours while using a 1 ma recorder! Makes recharging interruptions during long-term experiments unnecessary. These are only a few reasons why the carry-around 601 electrometer is outstandingly new. More are detailed in our free Engineering Note. Send for it today!



**KEITHLEY  
INSTRUMENTS**

12415 Euclid Ave. • Cleveland, Ohio 44106  
EUROPE: 14 Ave. Villardin, 1009 Pully, Suisse

## New Instruments

khz, with wider bandwidth operation at reduced accuracy. Maximum applied voltage is 350 v, with input voltage (V) related to operating frequency (F) by  $V=0.75F$ . Phase shift is less than 1 minute of arc.

Input impedance of the divider without the inverting transformer in circuit is above 200,000 ohms. Impedance is above 10,000 ohms with the transformer in use. Maximum output impedance without the inverting transformer is 8.5 ohms and 10 ohms maximum with the transformer in the circuit.

Price for the complete divider is \$890.

North Atlantic Industries, Inc., Terminal Drive, Plainview, N.Y. [374]

## Spectrum analyzer uses modular design

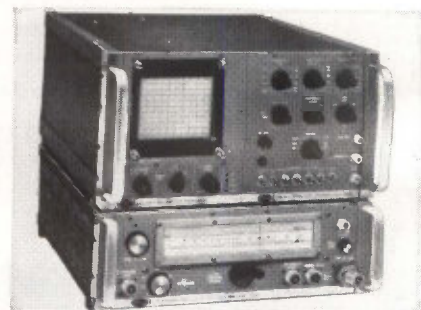

Modular design of the model 2882 microwave spectrum analyzer is mechanically and electrically compatible with the other seven modules in the company's spectrum analyzer line and employs the interchangeable display unit in all modular analyzers.

Model 2882 features a frequency range of 10 Mhz to 40 Ghz; high sensitivity on all bands; nine calibrated dispersion ranges from 10 khz to 100 Mhz, plus continuous adjustment, 0 to 100 Mhz; and automatic optimum bandwidth selection for best resolution.

Other features are: four calibrated crystal markers for simplified accurate frequency measurements and stability checks and 60-Mhz predetection output (in addition to normal video output) for time domain analysis. The in-

## New plant site? JOIN THE SUCCESSFULS on the Niagara Frontier

SIZE DOESN'T COUNT. Of 66 electronics and electrical producers in Erie County, 45 employ under 50. Big and small benefit from ample supplies of skilled talent . . . raw material . . . cheap power . . . and easy access to both U.S. and Canadian markets. For full details write Erie County Executive Edward Rath, Erie County Hall, Dept. E-1, Buffalo, N. Y. 14201. He'll send the new book that tells why Erie County offers the best profit opportunities for your new plant.

### The future is here on the Niagara Frontier

(Buffalo and Erie County)

Circle 536 on reader service card

## ANOTHER WORLD'S SMALLEST Soshin's Dipped Mica Capacitors/DM05

Developed by SOSHIN ELECTRIC, the only mica capacitor maker in Japan with MIL-C-5C qualifications. This newest and its bigger brothers will meet all your requirements. Volume orders accepted.



Dipped Mica Capacitor/DM05 in actual size

Types	Max Allowable Capacitance (pF)			Dimension (mm)								
	100 WV	300 WV	500 WV	100 WV			300 WV			500 WV		
Standard				L	W	T	L	W	T	L	W	T
				Max	Max	Max	Max	Max	Max	Max	Max	Max
DM05	200	130	—	7.0	5.0	3.5	7.0	5.0	3.5	—	—	—
DM10	440	390	330	8.5	5.5	3.5	8.5	5.5	3.5	8.5	5.5	3.5
DM15 (CM05)	2000	1200	510	13.0	11.0	6.5	12.5	10.5	6.0	13.0	10.0	5.5
DM19 (CM09)	10000	6800	5100	18.0	15.0	8.5	18.0	15.0	8.0	17.5	15.0	7.5

For further information, write to

**SOSHIN SOSHINELECTRIC CO., LTD.**  
18-18, Nakamagome 1-chome, Ohta-ku, Tokyo, Japan  
Cables: SOSHINCAPACITOR TOKYO

Circle 537 on reader service card

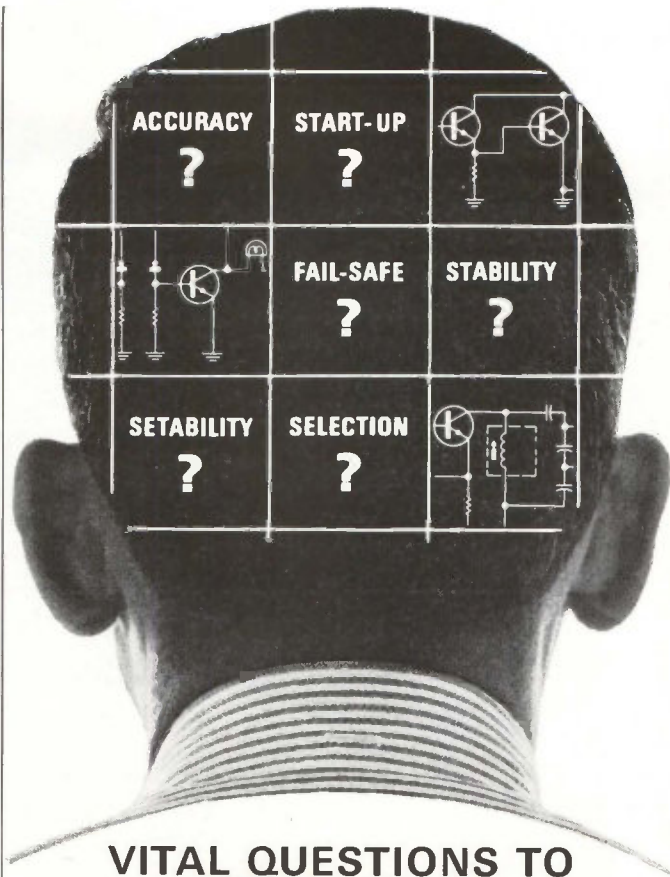

## VITAL QUESTIONS TO CONSIDER WHEN YOU BUY FREQUENCY STANDARDS

**Exceptional Accuracy:** Motorola frequency standards are set on frequency within 1 part in  $10^{10}$  absolute. They are pre-aged prior to shipment to assure you of unsurpassed stability.

**Warmed Up and Ready To Go:** Your unit is shipped air express under power provided by an optional battery pack. It's operating on frequency and ready to use on arrival.

**Built-in Emergency Power:** If your AC power fails, a special internal battery takes over instantly to keep your unit operating for 30 hours. Built-in alarms warn of any power or frequency losses.

**Millisecond Stability:** An optional, spectrally-pure output filter provides the ultimate in frequency stability. This signal is only a few hertz wide even when multiplied to the gigahertz region.

**Precise Settings:** A highly linear vernier control indicates frequency changes directly in parts in  $10^{10}$ . Permits  $2 \times 10^{12}$  setability.

**Wide Selection:** Motorola offers a variety of solid-state frequency standards, including a unique portable model, and accessories to meet all your needs.

**Write Today** for more information to: Dept. EO1 Motorola Communications & Electronics Inc., 4501 Augusta Boulevard, Chicago, Illinois 60651. A Subsidiary of Motorola Inc.



**MOTOROLA**  
PRECISION INSTRUMENT PRODUCTS

Circle 291 on reader service card 291



# NEW TORQUE MOTOR DRIVER

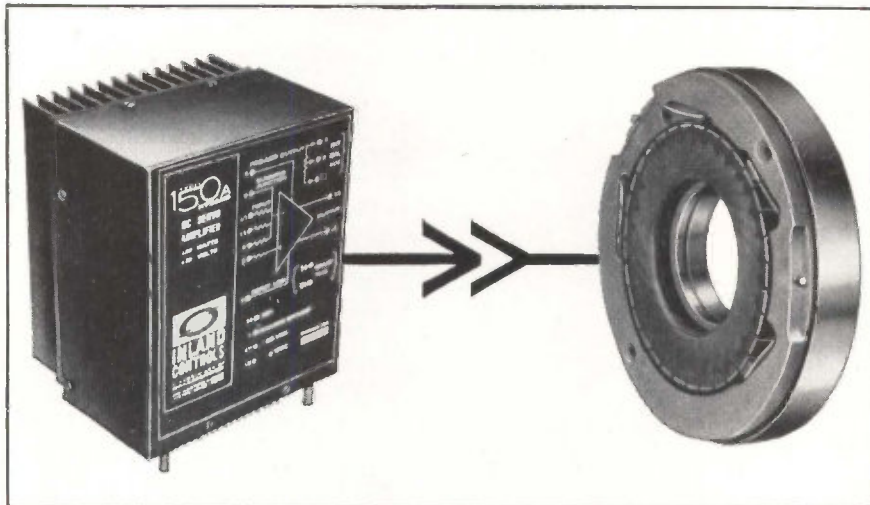

## Cut costs and time with off-the-shelf HYBAND DC Servo Power Amplifiers by INLAND

Inland Controls specializes in the design and manufacture of reversible polarity, wide bandwidth DC servo power amplifiers that help you:

- ELIMINATE design and development **costs**
- ACCELERATE delivery **schedules**
- AVOID motor/amplifier interface **problems**

Ranging from 50 watts to 3000 watts, these amplifiers, designed specifically for driving Inland Motor\* DC torque motors, are available in either compact modular design or standard rack-mounted design. Current-limiting, short-circuit protection, multiple summing inputs, high gain preamplifier and provisions for servo compensation networks are built-in standard features of the HYBAND amplifiers.

To avoid your interface problem entirely, why not let Inland Controls supply guaranteed match-

ing amplifiers, or complete amplifier and torque motor blocks? We can do this and satisfy your most demanding needs. Don't let interface and transfer function problems get you down . . . call on the INLAND team and relax . . . our amplifiers offer proven and outstanding compatibility, reliability and availability.

A CONDENSED SELECTION GUIDE giving detailed information on HYBAND dc servo power modular and rack mounted amplifiers is now available and we'll be happy to send you a copy. All of the amplifiers described in this guide are manufactured for general sale and are available off-the-shelf. MIL-SPEC versions are available on special order.

Or, if you prefer, a demonstrator kit designed to illustrate exactly how these amplifiers operate in a closed loop servo system can be shown in your plant at your convenience. All it takes is a call or a letter from you.



**INLAND  
CONTROLS**

A SUBSIDIARY OF  
**KOLLMORGEN**

342 WESTERN AVENUE • BOSTON, MASSACHUSETTS 02135  
Telephone: 617 254-0442

\*Inland Motor Corporation  
is also a subsidiary of Kollmorgen

TWX: 710 330-0143

## New Instruments

strument can serve as a synchroscope or receiver and its large rectangular crt (5½ in. x 4½ in.) offers better accuracy and resolution than any other analyzer display on the market, according to the company. It has a calibrated i-f attenuator for precision measurements of 0 to 8 db in 1-db steps.

The new design provides choice of log, linear and power displays with automatic corresponding scale and graticule illumination plus continuous broadband sweep, with no gap in coverage.

Applications include analysis of nanosecond r-f and video pulses, determining harmonic and spurious responses in signals, measuring noise spectra and noise-source bandwidth, for rapidly locating leakage signals for rfi, calibrating filters and attenuators and measuring spectral purity of signals over a large dynamic range for countermeasures and jamming.

At its single-unit price of \$6,300, the model 2882 is from 15% to 35% lower in price than similar equipment, the company claims. Delivery is 30 days from receipt of order.

Polarad Electronic Instruments, a division of Polarad Electronics Corp., Long Island City, N.Y. [375]

## IC tester features modular design

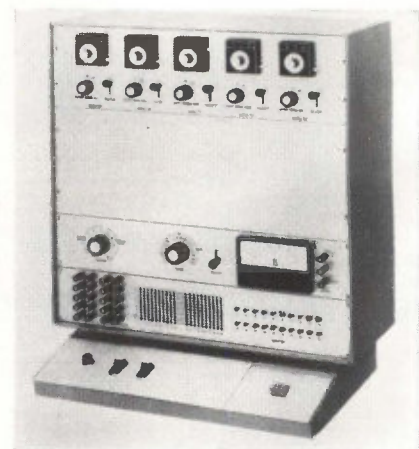

The need for widely varying capabilities in an integrated circuit tester is answered in a modular-design test set, according to the

## For solderless wrapped connections, a new automatic wire stripper

The Model 841 Solderless-Wrap Wire Stripper offers high speed preparation of 20-30 AWG solid conductor wire for insertion in a wrapping tool. It cuts wire to lengths of 1" to 50' and fully strips 1/8" to 1 9/16" from each end without nicking or scraping, whether the insulation be PVC or something as tough as Mil-Ene, Teflon or Kynar. With optional assemblies, you can also use it for shorter stripping of 10-32 AWG stranded wire. Write for information on this and other Eubanks wire strippers.



Wire is fully stripped, ready for wrapping tool.



Remaining insulation can be short as 1/2".



**Eubanks ENGINEERING COMPANY**

225 West Duarte Road • Monrovia, California

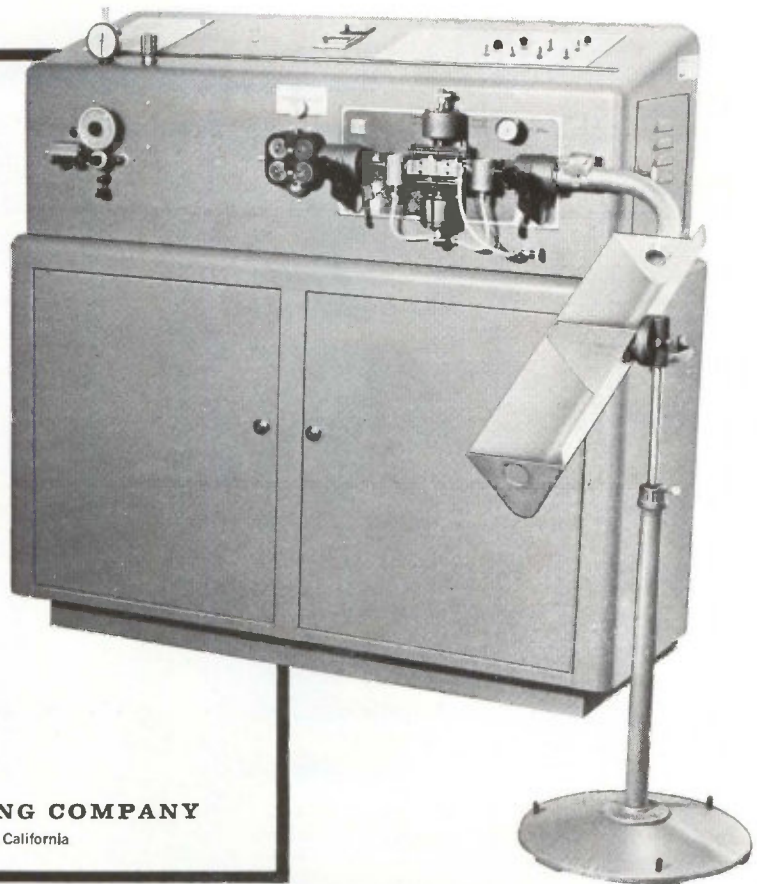

Circle 538 on reader service card

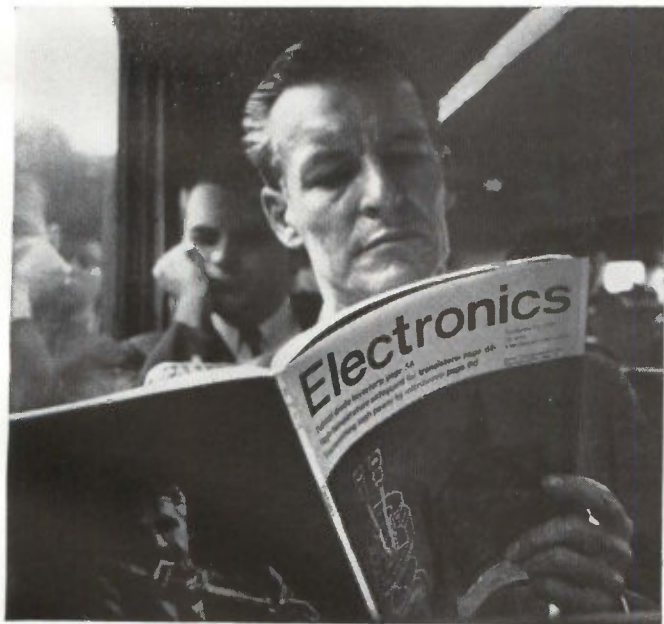

**Great editorial is  
something he takes to work**  
(What a climate for selling!)

**Electronics**

A McGraw-Hill Market-Directed Publication  
120 West 21st Street, New York, N.Y. 10011



## Helipot's Model 78 Cermet Trimmer

\$

lists for

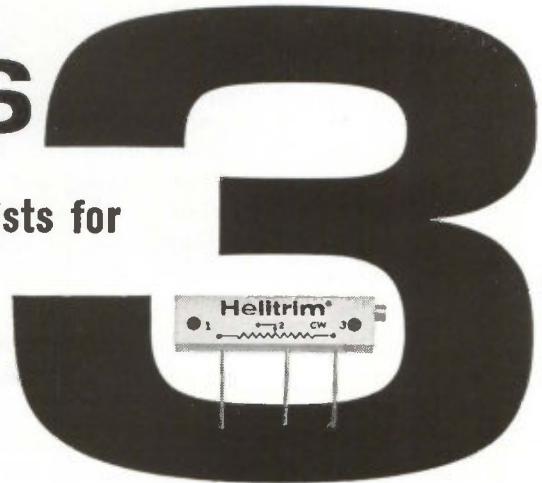

The *most* you'll ever pay for a Model 78 trimming potentiometer is \$3. In quantity, they sell for around \$2—a real bargain for a sealed trimmer with cermet element and virtually infinite resolution. Model 78 trimmers are stocked in standard resistance values from 10 ohms to 2 megohms. Operating temperature range is -25 to +125°C, and units have a power rating of 3/4 watt at +70°C. Models have plastic housings less than 0.200" thick, and are available with pins, leads or lugs. Write or call for complete details.

**Beckman**

INSTRUMENTS, INC.

HELIPOT DIVISION

FULLERTON, CALIFORNIA • 92634

INTERNATIONAL SUBSIDIARIES: GENEVA; MUNICH; GLENROTHES, SCOTLAND; TOKYO; PARIS; CAPETOWN; LONDON; MEXICO CITY





**The new, improved model of our Type A time-delay relay has gold-diffused contact surfaces, heavier contact blades, and a more efficient magnetic circuit. Performance is better, but the price is still remarkably low. Our enclosed and plug-in time-delay relay models have been similarly upgraded. All can be had in a diversity of standard timings from 1/4 to 120 seconds, with SPDT or DPDT switching. All have continuous-duty coils and can thus be used without an auxiliary load relay for the majority of applications. Our Bulletin 5006 will give you full technical information on the entire line. Write us for a copy. Heinemann Electric Company, 2600 Brunswick Pike, Trenton, N.J. 08602.**

 **HEINEMANN**

8403

## New Instruments

manufacturer. Model 800 IC tester can be ordered with varied combinations of modules and optional features.

The basic unit is a housing with a base, test socket, and switches, to which can be added in several combinations: a 10x20 or 10x40 crossbar matrix, which allows sequential testing of similar parameters without reprogramming; provision for five external inputs or outputs; five analog or digitally-programmable power supplies; panel readout meter and ranging switches; connection for an external digital voltmeter or oscilloscope; internal resistance and capacitance loading and a pulse generator.

Model 800 tests all present IC configurations and any foreseeable future developments in the field, according to the manufacturer. Readout is directly from a built-in meter accurate to 1% of full scale. Basic cabinet and modules are standard in size. Solid-state components and integrated circuitry are used throughout.

Price starts at \$1,500 for a typical unit; delivery, 60 days.

The Birtcher Corp., Instrument division, 1200 Monterey Pass Road, Monterey Park, Calif., 91754. [376]

## Accelerometer operates from $-300^{\circ}$ to $+750^{\circ}$ F

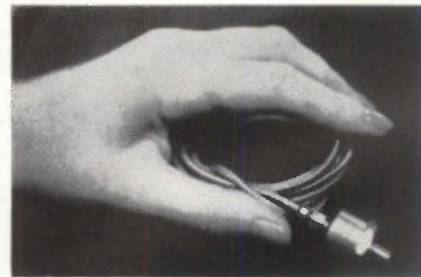

An ultrahigh temperature accelerometer for aircraft and rocket engine testing is well suited to applications requiring exposure to high solar heat fluxes and gamma radiation.

Designated model AQB-4280, the rugged instrument utilizes a sensing element of newly formu-



lated ceramic. The new material allows operation over the extremely broad temperature range of  $-300^{\circ}$  to  $+750^{\circ}\text{F}$ . The accelerometer maintains its charge sensitivity within  $\pm 10\%$  of its room ambient value (nominally 5.0 picocoulombs/g) over the same temperature range. No external cooling or special installation techniques are needed.

Internally ungrounded, the hermetically sealed instrument has 3% maximum transverse-axis sensitivity and resonant frequency of 30,000 hz minimum.

Weight is  $1\frac{1}{4}$  oz maximum and dimensions are  $11/16$  in. hexagonal x 0.75 in. high, exclusive of stud and connector.

Gulton Industries, 212 Durham Ave., Metuchen, N.J., 08840. [377]

## Analyzer functions as bandpass monitor

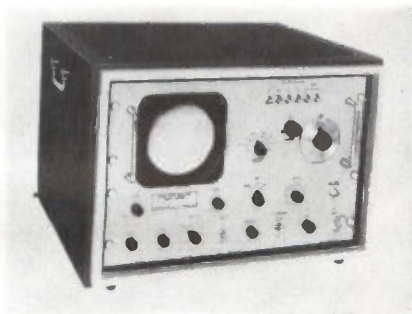

A spectrum analyzer has been designed for ssb and narrow-band r-f transmitters and exciter waveform envelopes. Model MD500E, with an input center frequency of 500 khz, serves as a bandpass monitor when used with communications receivers for narrow-band, high-resolution analysis of communication channels.

Bandpass amplitude response is  $\pm 10\%$ ; sweep width is variable from 0 hz to 100 khz calibrated dial, 0 hz to 2 khz calibrated dial (afc); sweep width preset—150 hz, 500 hz, 2 khz and 10 khz; sweep rate—0.1 hz, 1 hz, and 1 hz to 30 hz variable; variable resolution, 10 hz to 2.7 khz; sensitivity—direct, 20  $\mu\text{V}$  full-scale linear conversion and 2 mv full-scale log; amplitude scale—20 db linear, 40 db log; outputs—vertical, horizontal and sync. Probescope Co., Inc., 211 Robbins Lane, Syosset, L.I., N.Y. [378]

# NOW! A PRACTICAL WAY TO MONITOR CLEAN ROOMS...

AUTOMATICALLY... ACCURATELY... DEPENDABLY

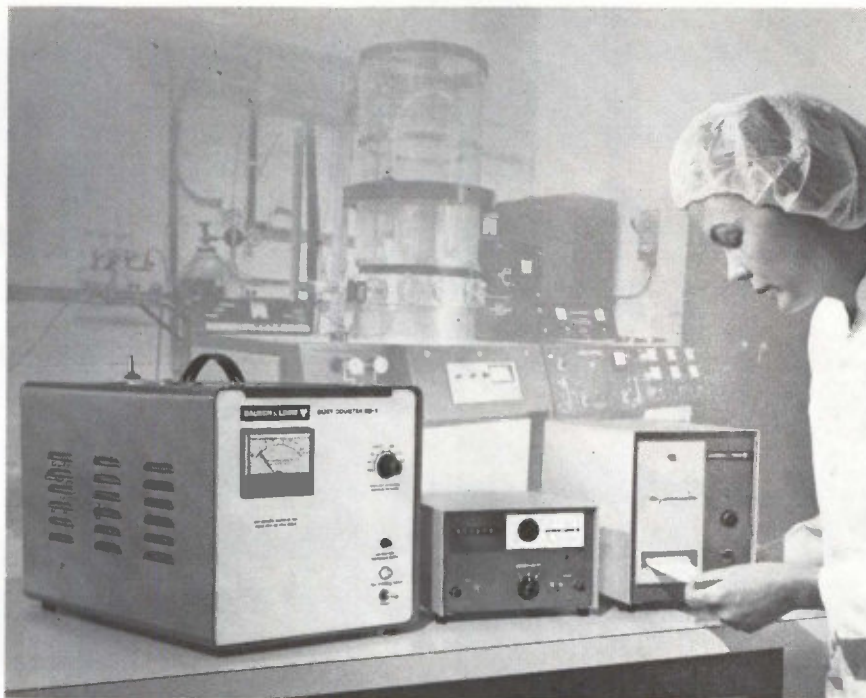

## New Bausch & Lomb Aerosol Dust Counting System

The 40-1 Dust Counter with Digital Readout and Printer is a direct indicating, electro-optical system for the detection and monitoring of airborne contamination in clean rooms.

### Features include:

- Directly reads and prints any particle concentration up to one million per cubic foot.
- Selective counting of all particles greater than each of seven set sizes—0.3, 0.5, 1.0, 2.0, 3.0, 5.0 and 10.0 microns.
- Size versus concentration—plotted easily.
- Near forward light scattering principle gives greater accuracy.
- Surrounding sample with a column of filtered clean air—prevents turbulence, permits continuous self-flushing.
- Concentric optical system is efficient—shape and orientation of particles doesn't affect count.
- Rapid, on-line calibration checks with built-in Bausch & Lomb Fiber Optics Light Wires.
- Simple operation—all important controls front-mounted.
- Lightweight, compact, transportable.
- All solid-state electronics.
- Real-Time counting.
- Very low dust concentrations over a given time interval detected with Digital Readout. Automatic timer provides for three fixed sampling intervals.
- Digital Printer automatically prints concentrations at preset intervals.
- V.O.M. Recorder for continuous plotting of dust concentrations available optionally.
- All three classes of clean rooms specified in Federal Standard #209 can be monitored.
- Total price of system only \$5475.

The Bausch & Lomb Aerosol Dust Counting System offers superior performance features at substantially lower cost than other commercial units. For complete information ask for our Catalog 38-2190, Bausch & Lomb, 61435 Bausch Street, Rochester, New York 14602.

**BAUSCH & LOMB** 

Sold and serviced exclusively in United States by Air Control, Inc.



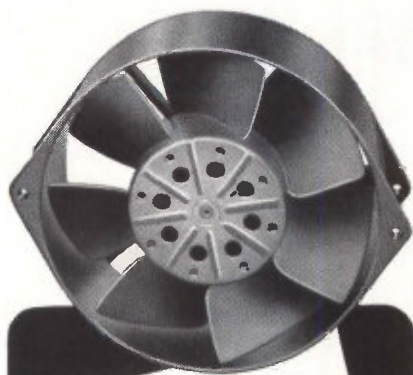

**300 cfm  
in a  
5 1/2" Package!**

## **PAMOTOR Model 6500 SHADED-POLE Axial Fans**

- Over 20,000 operational hours without maintenance
- Outstanding performance at moderate cost (under \$30.00 for single units)
- Only 2" deep
- 110 v or 220 v operation

**IN STOCK FOR  
IMMEDIATE DELIVERY!**

Write for technical data on the Model 6500 and other PAMOTOR axial fans to:

**PAMOTOR, INC.**  
312 SEVENTH STREET • SAN FRANCISCO, CALIF.

## **New Subassemblies and Systems**

### **Control computer is small but speedy**

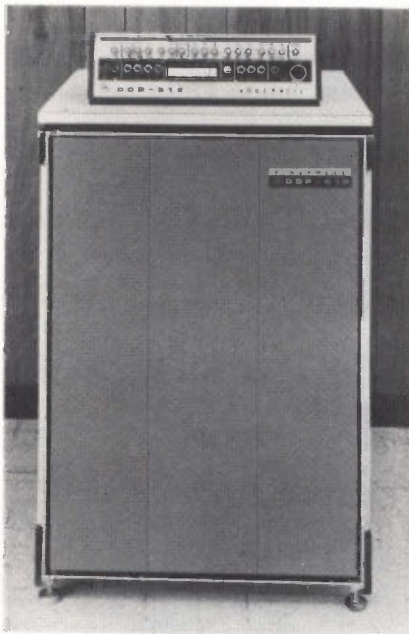

A 16-bit computer built with monolithic integrated circuits has entered the market for small, fast control computers. The machine, called the  $\mu$ -Comp DDP-516, was built by the Computer Control division of Honeywell, Inc. It has a 960-nanosecond memory cycle time. The computer supersedes the company's DDP-116 and the two machines are completely program-compatible. However, the new computer does 1.4 to 1.7 times as much work and is about \$3,000 cheaper. Its basic price is \$25,000, including an ASR-33 teletypewriter.

The computer is the first major product introduced by the Honeywell division, formerly the Computer Control Co., since it was acquired last May. The first computer has already been delivered and 90-day delivery is promised for all new orders.

The new machine is designed for real-time, on-line applications in physics research and data acquisition, as well as in railroad and process control.

Memory capacity is 4,096 to 32,768 words. The core memory is the division's ICM-40 integrated

circuit memory [Electronics, November 29, 1965, p. 116]. The integrated circuit logic modules are the company's own  $\mu$ -Pac line. Texas Instruments Incorporated supplied the integrated circuits.

Most operations can be performed in 1.92 microseconds. A single command can address 1,024 memory words. Features include fully parallel organization, indexing, multilevel indirect addressing and a 72-command instruction repertoire with byte manipulation capability. It also has priority interrupt, individually buffered input-output channels and power-failure protection.

Plug-in options include time-sharing, direct memory access when input-output transfer rates of 1 megahertz are needed, a high-speed arithmetic package, memory lockout for program protection, memory parity and a real-time clock.

The computer weighs 250 pounds and fits into a 24-x24-x28-inch cabinet or a 19-inch rack, with the control console a separate and movable unit. Three vertical leaves, which tilt out for easy access, contain the system power supply,

#### **Specifications**

Model	$\mu$ -Comp DDP-516 computer
Memory cycle time	0.96 $\mu$ sec
Add or subtract	1.92 $\mu$ sec
Multiply	5.28 $\mu$ sec
Divide	10.56 $\mu$ sec
Single word I/O transfer	1.92 $\mu$ sec

the central processor and the memory. Mean time between failures is two years under a normal 40-hour week of operation, or 4,000 hours. The system draws 1 kilowatt of line power.

The standard 250-program package includes a Fortran IV one-pass compiler and a real-time monitor program for time-sharing the computer between real-time and free-time tasks. It has another monitor program for direct memory addressing and a library of sup-

port programs such as test program updating routines. Computer Control division, Honeywell, Inc., Old Connecticut Path, Framingham, Mass. 01701. [379]

### Repeat cycle timers perform dual function

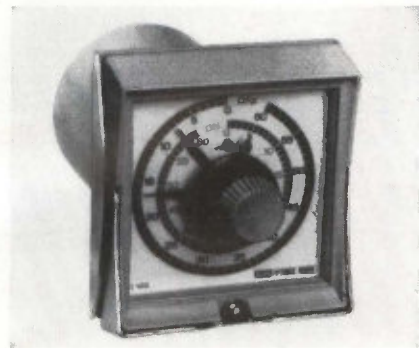

Plug-in electromechanical timers, designated the HG100 series Flexopulse, repeatedly close and open their single-pole double-throw contacts. They perform tasks formerly requiring two separate timers in a flip-flop arrangement.

As long as the HG100 is energized it oscillates through continuous "off" and "on" periods. Every time the unit's cycle progress pointer passes "0", its two heavy-duty 10-amp contacts transfer. These periods are controlled by setting the color-keyed pointers on the face of the unit. "Off" times are set by the black control knob and pointer on a black scale. "On" times are set by the blue knob and pointer on a blue scale. The HG100's red cycle progress pointer moves between these two settings so its position in its cycle can be readily determined.

An unusually flexible unit, the timer will accept new settings at any time. Should power be cut off, the HG100 holds its position in the cycle and does not reset. When power is restored, the unit begins again at cycle point of power withdrawal.

Other features include a unidirectional motor which eliminates complicated reversing switches and gearing, all susceptible to wear. Reliability is further enhanced by use of a single motor instead of dual units. The HG100's stainless steel directional control

# NO MATTER WHERE YOU'RE GETTING THESE MIL & INDUSTRIAL TRIMMERS AND POTS



## WE CAN SUPPLY THE IDENTICAL ITEMS AT LOWER COST... FROM STOCK!

**WE'LL PROVE IT! MAIL THIS COUPON.**

**FAIRCHILD CONTROLS**

A DIVISION OF FAIRCHILD CAMERA AND INSTRUMENT CORPORATION

225 PARK AVENUE, HICKSVILLE, L. I., NEW YORK  
 TELEPHONE: (516) 938-5600 • TWX: (510) 231 1854  
 CABLE: FAIRCON-HICKSVILLE, NEW YORK, U. S. A.

Please quote me on the following items:

Type Number \_\_\_\_\_ Quantity \_\_\_\_\_

Type Number \_\_\_\_\_ Quantity \_\_\_\_\_

Type Number \_\_\_\_\_ Quantity \_\_\_\_\_

Name \_\_\_\_\_ Title \_\_\_\_\_

Company \_\_\_\_\_

Address \_\_\_\_\_

City \_\_\_\_\_ State/Zip \_\_\_\_\_

EL14



# Do you have SPACE problems?



## Solve them with TELEDYNE's MICROMINIATURE COMMUTATORS and MULTICODERS

Our microminiature commutators and multicoders use functionally oriented MEMA's\* to save you 50% in space and weight over discrete component units. They're reliable and tough too . . . tough enough to withstand the extreme environmental conditions encountered in missile, satellite, space probe and aircraft data handling applications.

Three basic types to meet every commutator and/or multicoder application: SERIES 305 HIGH LEVEL, SERIES 365 DIFFERENTIAL LOW LEVEL and SERIES 377 MIXED LEVEL. Each type offers a great number of options on a standard product "off-the-shelf" delivery basis.

- |   |  |
|---|--|
| <input type="checkbox"/> Up to 90 channels per pole<br>— one or two poles | <input type="checkbox"/> IRIG PAM, PDM and<br>PDM record output. |
| <input type="checkbox"/> Backcurrents below<br>$\pm 0.1 \mu$ amps         | <input type="checkbox"/> Low level gains from<br>1 to 1000       |
| <input type="checkbox"/> Offset and scatter below<br>$\pm 25 \mu$ volts   | <input type="checkbox"/> Mixed levels in 8-channel<br>increments |

If YOU have space problems . . . let **TELEDYNE TELEMETRY COMPANY** solve them.

\*MicroElectronic Modular Assemblies, a high density integrated circuit packaging concept developed by TELEDYNE, Inc.

### TELEDYNE TELEMETRY COMPANY

A Division of Teledyne, Inc.

#### AEROSPACE DIVISION

12964 Panama Street  
Los Angeles, California 90066  
Telephone (213) 870-9831  
TWX: 910 343 6855

#### DYNAPLEX DIVISION

P.O. Box 341 Alexander Road  
Princeton, New Jersey 08540  
Telephone (609) 452-2550  
TWX: 510 685 2379

## New Subassemblies

mechanism has proven life of over 10 million operations, the company reports.

Standard time ranges extend from 30 seconds to 60 hours with a repeat cycle accuracy of 1/2 of 1% of the dial setting.

The dual-function timers measure 6 in. long x 3 13/16 in. wide x 4 1/2 in. high.

Indicated applications include periodic sampling of processes, conveyor control and signal or warning systems.

E.W. Bliss Co., Eagle Signal division,  
736 Federal St., Davenport, Iowa.  
[380]

## Current driver delivers dual pulses

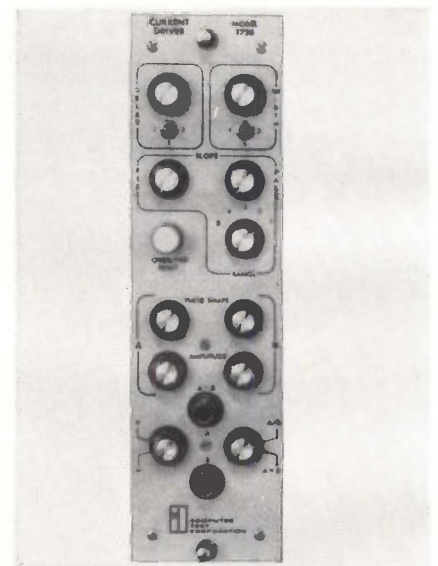

Current driver model 1720 has been designed to deliver dual current pulses identical in rise time, fall time, pulse delay and pulse width. In many memory test applications employing coincident current storage techniques, the 1720 can serve effectively as two individual drivers. Output A can drive an X-axis line while output B drives a Y-axis line. Since the current pulse parameters of both outputs are adjusted coincidentally with a single set of controls, the dual output design markedly diminishes test set-up time.

Current amplitudes of the out-

put pulses can be adjusted independent of one another over a continuous range of from 50 milliamperes to 600 ma. The full rated 1-amp output of the driver can be achieved by throwing a front-panel switch which busses the two outputs together internally.

The 1720 is also a true bipolar current driver, developing positive or negative pulses d-c referenced to ground by the simple flick of a front-panel polarity switch. The output voltage rating is 60 volts, positive or negative, and the driver is capable of withstanding a back electromotive force of the same magnitude without damage. The 60 v output, coupled with a low output capacitance of 40 picofarads [worst case], combine to equip the driver with the ability to drive large inductive loads.

The output current pulse has very fast linear rise and fall slopes, extending into the sub-10 nanosecond region. Both rise and fall time can be adjusted independently of one another. Pulse shape is square-cornered, free of any pulse overshoot, ringing or droop. Pulse width is variable from 10 nsec and pulse delay from 0 to 10 microseconds.

The 1720 is both short circuit stable and open circuit stable. Automatic current limiting is provided to a maximum average of 200 ma. When this average current is exceeded, trigger pulses to the driver are automatically disconnected within 5  $\mu$ sec. Thus, any duty cycle up to approximately 95% can be achieved with the driver.

Computer Test Corp., 3 Computer Drive, Cherry Hill, N.J. [381]

## Variable attenuators for low-frequency use

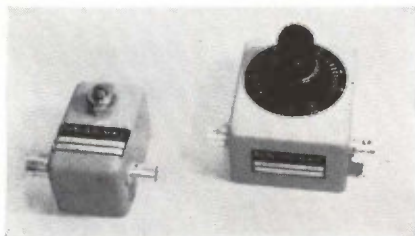

A series of continuously variable attenuators rated at 1 watt in the d-c to 10 Mhz frequency range can

**If you use  
75 cylinders  
or more  
a month of  
any of these  
specialty gases...**

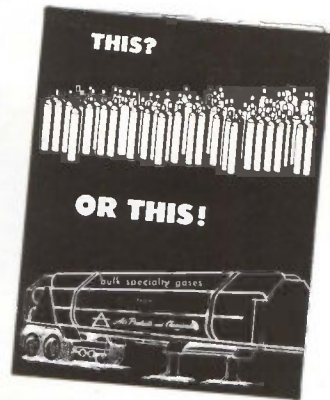

**...SEND FOR THIS FOLDER WHICH OUTLINES THE COST BENEFITS OF BULK DELIVERY FROM AIR PRODUCTS.**

Acetylene	ethylene	Iodine Pentafluoride	Nitrosyl Chloride
Air	Cyanogen	Isobutane	Nitrous Oxide
Allene	Cyclopropane	Isobutylene	Nitrosyl Fluoride
Ammonia			Oxygen
Argon	Deuterium	Krypton	Perfluorobutene-2
Boron Trichloride	Difluorodiazine	Methyl Allene	Perfluoropropane
Boron Trifluoride	Dimethylamine	Methyl Fluoride	Phosphorus
Bromine	Dimethyl Ether	Methane	Pentafluoride
Pentafluoride	2,2-Dimethylpropane	Methyl Acetylene	Propylene
Bromine Trifluoride	Ethane	Methyl Bromide	Silane
Bromotrifluoro-	Ethyl Acetylene	2-Methylbutene-1	Silicon Tetrafluoride
ethylene	Ethyl Fluoride	2-Methylbutene-2	Sulfur Dioxide
1,3 Butadiene	Ethyl Chloride	3-Methylbutene-1	Sulfur Hexafluoride
1-Butene	Ethylene	Methyl Chloride	Sulfur Tetrafluoride
cis-2-Butene		Methyl Mercaptan	Sulfuryl Fluoride
trans-2-Butene	Fluorine	Monoethylamine	Thionyl Fluoride
cis- and trans-2-		Monomethylamine	Tetrafluorohydrazine
Butene	Helium	Neon	Trimethylamine
Carbonyl Fluoride	Hydrogen	Nickel Carbonyl	Tetrafluoroethylene
Carbon Monoxide	Hydrogen Bromide	Nitric Oxide	Vinyl Chloride
Carbonyl Sulfide	Hydrogen Chloride	Nitrogen	Vinyl Fluoride
Chlorine	Hydrogen Fluoride	Nitrogen Dioxide	Vinyl Methyl Ether
Chlorine Trifluoride	Hydrogen Iodide	Nitrogen Trifluoride	Xenon
Chlorotrifluoro-	Hydrogen Sulfide	Nitrogen Trioxide	
	Hexafluoropropylene		

(PLUS THOUSANDS OF GAS MIXTURES)

Specialty Gas Dept. E11  
Air Products and Chemicals, Inc.  
P.O. Box 538, Allentown, Pa. 18105  
Phone: 215-395-8257

Gentlemen: Please send me a copy of your bulk specialty gas brochure and "spec" sheets on each of the following gases.

1. \_\_\_\_\_ 2. \_\_\_\_\_ 3. \_\_\_\_\_  
4. \_\_\_\_\_ 5. \_\_\_\_\_ 6. \_\_\_\_\_

Name \_\_\_\_\_  
Title \_\_\_\_\_  
Company \_\_\_\_\_  
Address \_\_\_\_\_  
City \_\_\_\_\_ State \_\_\_\_\_ Zip \_\_\_\_\_

 **Air Products and Chemicals**  
INC.  
ALLENTOWN, PENNSYLVANIA



**A specialty of the house...**

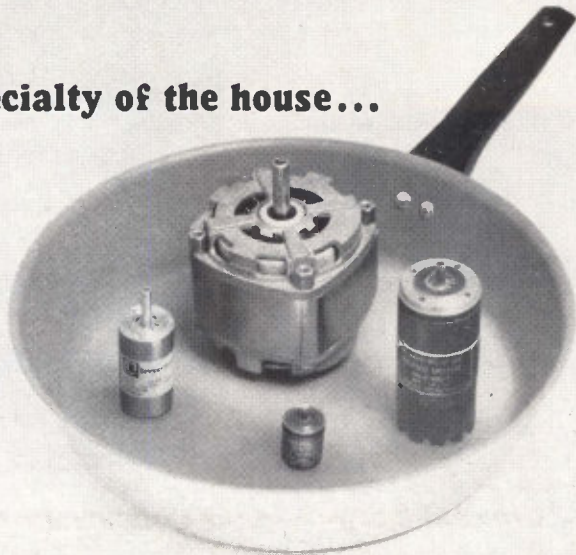

**cooking up new ideas in electric motors.**

Like the GT1612 that runs up to 60,000 rpm on hydrostatic air bearings. Extreme accuracy in locating the beryllium shaft helps make this possible. Other specialties to help you serve up exactly what's needed include induction, hysteresis, torque, synchronous, AC drive, DC drive and servo motors, in the milli- to integral-horsepower range, and without the compromise of run-of-mill

mass-produced motors. For motors for spacecraft, avionics, control, computer peripherals and other systems, contact IMC Magnetics Corp., Eastern Division, 570 Main St., Westbury, N.Y. Phone (516) 334-7070 or TWX 516 333 3319. If you need information for future projects write IMC's Marketing Div., at the same address, or circle the bingo number at the bottom of this ad.



Circle 567 on reader service card

**This is our 3 step.  
Give us a call and see all  
the steps in our routine.**

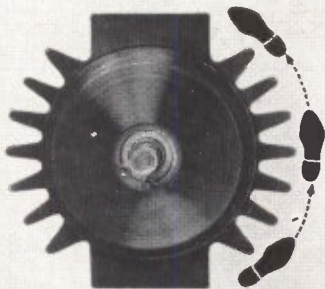

If you really want to swing you can also step 4, 8, 12, 24, 48, and 200 increments without gears.

Or to Indicate, Measure and Control using flag and remote angle indicators, synchros, resolvers, steppers, or solenoids. They are in stock at IMC Magnetics Corp., Western Division. For quick service contact the Applications Section at Western Division, 6058 Walker Ave., Maywood, Calif. 90270. Phone 213 583 4785 or TWX 910 321 3089.

If you need data sheets for references or consideration for future projects, write IMC's Marketing Division at 570 Main Street, Westbury, New York 11591.

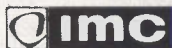

300 Circle 300 on reader service card

**New Subassemblies**

also operate above 30 Mhz with only slightly reduced performance characteristics.

The well-matched attenuators have many low-frequency applications, including audio, video and i-f level setting and control both in the laboratory and in the field.

The series consists of two models with identical electrical characteristics. Model AR-1 is uncalibrated and a screwdriver adjusts the attenuation level. Model AR-2 is calibrated with an accuracy of 0.5 db and features a direct reading dial and knob adjustment. Both units have locks.

Specifications include: attenuation range, 0 to 20 db; insertion loss, less than 0.75 db; vswr, typically less than 1.2:1; standard model impedance, 50 ohms; resettability (granularity), 0.1 db; connectors, BNC type; and dimensions (AR-1), 1.44x2.31x1.40 in., (AR-2) 2.67x2.31x1.38 in.

AR-1 is priced at \$60, and AR-2 at \$80; delivery is from stock to 30 days.

Merrimac Research and Development, Inc., 41 Fairfield Place, West Caldwell, N.J., 07007 [382]

**IC pcm systems  
occupy small space**

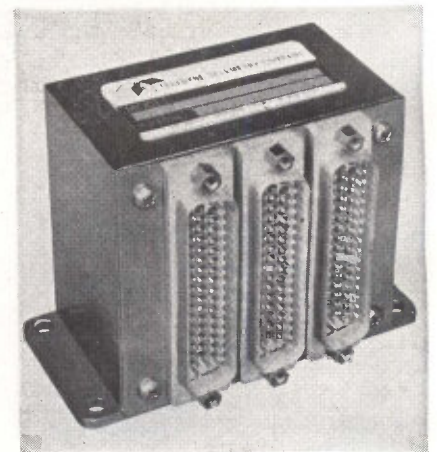

Using integrated circuits, the 710 pulse code modulation systems require less than one-third the volume of systems with discrete components.

The systems can be programed for any number of high-level, low-



level or digital inputs, divisible by eight, up to 256 channels. Input channel mix can be programmed for preselected gains from 1 to 1,000 in multiples of eight data inputs.

Sampling rates from 1 to 50,000 words per second are available. Bit rate stability is determined by an internal multivibrator or crystal-controlled clock. Standard channel programming is accomplished sequentially. Random access and sequencing on command are available as options. Standard pcm output is a serial NRZ-C or NRZ-M 10-bit word pulse train.

Other features of type 710 pcm systems include: over-all accuracy up to 0.5%, back currents below 0.1  $\mu$ a, offset and scatter below 25  $\mu$ v, field effect transistor analog input gates, differential input impedance greater than 500,000 ohms, high-level input impedance greater than 5 megohms, linearity better than 0.05%, crosstalk less than 0.1%, odd parity bit and word sync bit for each word and two 10-bit frame sync words inserted into the output serial pulse train.

Teledyne Telemetry Co., DynaPlex division, Box 341, Princeton, N.J., 08540. [383]

## Memory disks provide large capacities

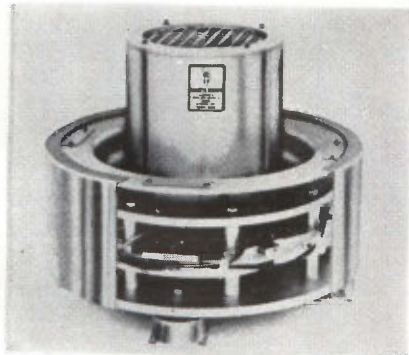

Thirteen models of magnetic memory disks are offered with storage capacities ranging from approximately 100,000 to over 10 million bits. They are available in four series, utilizing 7, 9, 11 and 13-in. diameter disks.

Features include bit packaging densities to 1,000 per inch non-return-to-zero, [600 per inch phase modulation]; a signal-to-noise ratio of 20 db; versatility of operation, with variable motor speeds avail-

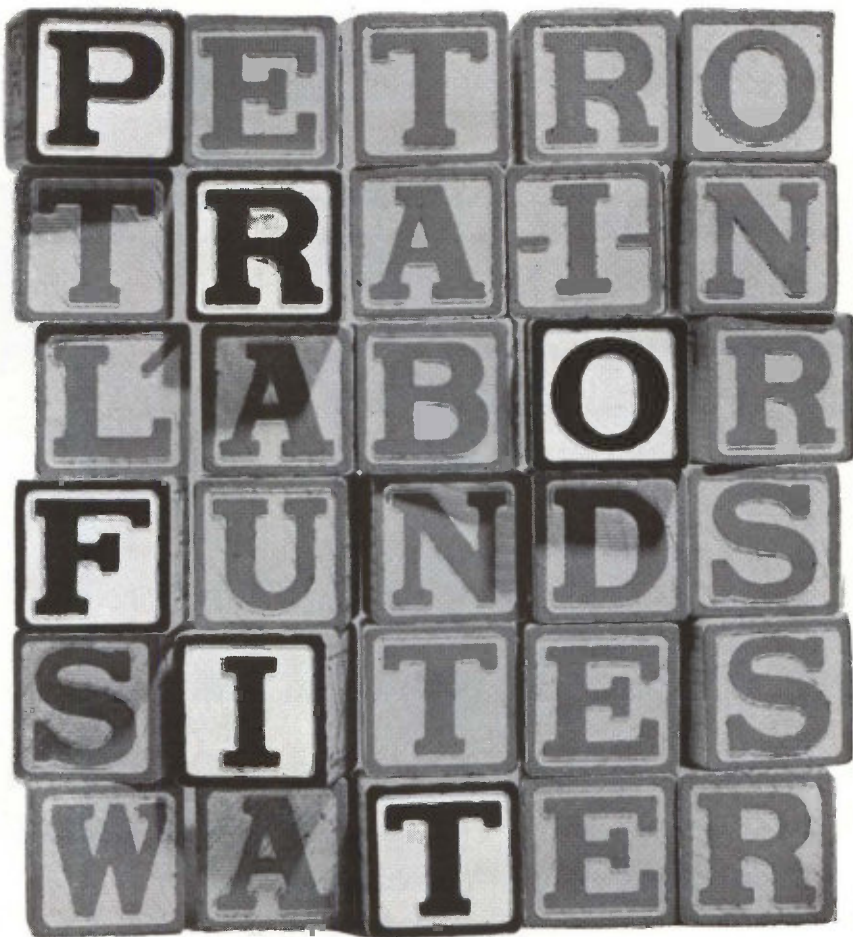

*where industry is never blocked...*

How did Louisiana remove the stumbling blocks to profit? With its progressive **Right-To-Profit Laws**. They protect industry, large and small, from unfair taxation and excessive government regulation.

The **Right-To-Profit Laws** are a major reason why over a billion dollars worth of new industry has located in Louisiana in the last two years. This is the greatest growth period in the State's history.

For information on The Right-To-Profit Laws—and the other factors in Louisiana's industrial renaissance—write to W. T. Hackett, Department of Commerce and Industry, Room 214, Capitol Annex, Baton Rouge, Louisiana 70804.

# LOUISIANA

## The Right-To-Profit State



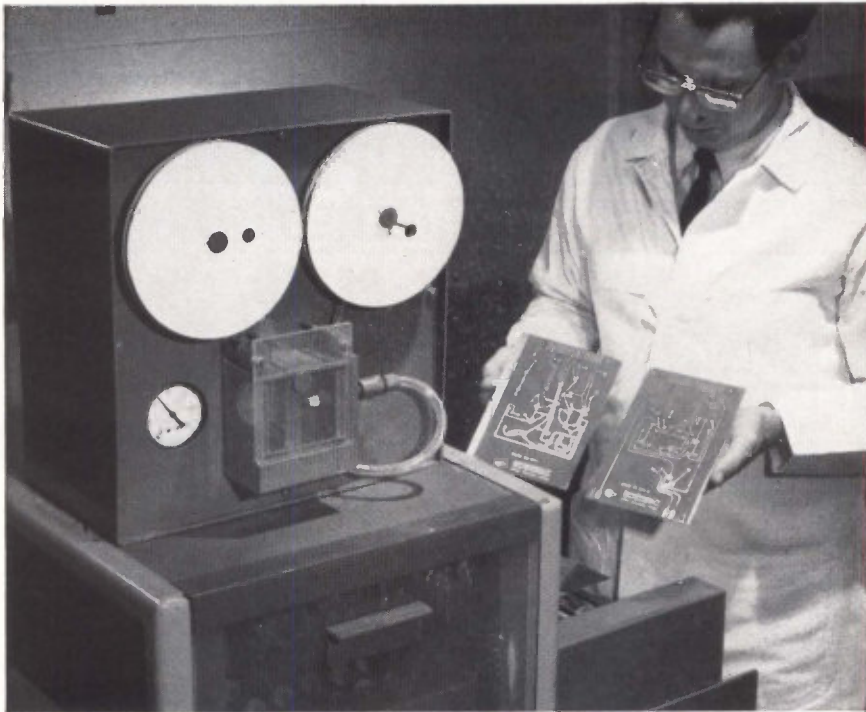

## New Automatic Conveyor Control assures uniform etching of printed circuits regardless of length of production run

This new Automatic Conveyor Control monitors and adjusts etching time to make sure that the last piece to come off the etcher is exactly the same as the first. Variations in quality due to etchant depletion are eliminated, and no boards are lost due to over or under etching. You get complete use of the etchant to economical depletion. The machine operator, freed from in-process qc testing, can give full attention to overall production.

This new control system is available as optional equipment on Chemcut models 502 and 1000 horizontal conveyorized spray etchers. Since operating voltages for the system are obtained from the control panels supplied with 502 and 1000 etchers, the Automatic Conveyor Control can easily be retrofitted to etchers already in service.



We invite your inquiry.  
**CHEMCUT CORPORATION**  
 500 Science Park, State College, Pa. 16801  
 Circle 302 on reader service card

To order reprints: Fill in, cut out coupon below, insert in envelope and mail to: **Electronics Reprint Dept., 330 W. 42nd Street, New York, N.Y. 10036**

### Reprint order form

For listing of reprints available see the Reader Service Card.  
**Communications Satellites Part II**

Send me ..... reprints of Key no. R-90 at 75¢ each.

For reprints of previous special reports fill in below:

Send me ..... reprints of Key No.(s) ..... @ ..... ¢ each.  
 (For prices, see Reader Service Card)

Name .....  
 Number of street .....  
 City, State, Zip code .....

## New Subassemblies

able and record head inductance adjustable to any electronic interface.

Disks range in price [single units] from \$3,000 for model 71-64, with total bit capacity of about 600,000, to \$13,000 for model 134-512, with bit capacity of 10 million. General Instrument Corp., Magne-Head division, 13040 South Cerise Ave., Hawthorne, Calif., 90250. [384]

## Delay module achieves 2,000-µsec range

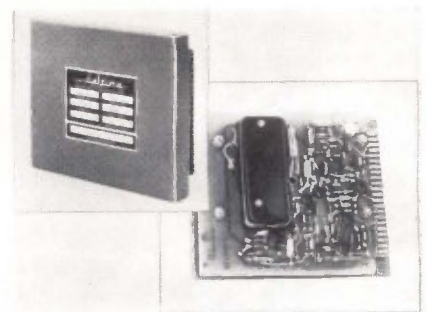

A Delttime delay module offers a 2,000-µsec time delay with 1-Mhz pulse repetition frequency. Model 192A/RZ-1, combines circuitry with a delay line. A digital write-read amplifier for magnetostrictive delay line applications is packaged as a single compact module. The write amplifier drives the delay line; the read amplifier amplifies the delay line output and restores the input pulse waveform. External clocking with a feedback loop results in a recirculating system for digital data storage.

The input logic level of the new module is between -4.6 and -7.8 v; the input pulse width at 50% amplitude is between 0.35 and 0.55 µsec. The delayed output logic level has a range of -6.4 to -7.1 v, with an output current of 0 to 10 ma at -6.6 v. The range of output pulse width at 50% amplitude is 0.45 to 0.50 µsec. These output specifications are quoted for a 25°C ambient temperature.

The unit has a power supply voltage of +12 ±10%, 16 ma maximum; -12 ±10%, 70 ma maximum at 1 khz prf, 120 ma maximum at 1 Mhz prf. Operating



temperature range is 0 to +55°C, although it can be stored at temperatures between -55°C and +80°C.

Sealectro Corp., Mamaroneck, N.Y. 10543. [385]

## D-c modular supplies in 11 case sizes

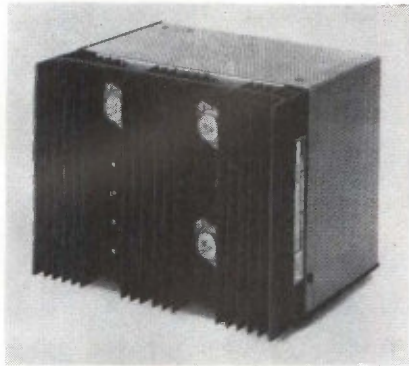

All-silicon, d-c modular power supplies are available with outputs covering the entire range from 0 to 400 v at 0.1 to 20 amperes in 11 different case sizes. All models are available with either 0.5% or 0.01% regulation. Solid state design permits lightweight, compact packaging requiring no forced-air cooling, heat sinking or derating at operating temperatures up to 71°C.

All regulation and control circuits are mounted on a plug-in printed-circuit board. All filter capacitors are computer grade. Automatic overload and short-circuit protection, remote programming and remote sensing are standard features with over-voltage protection available on most models.

ACDC Electronics Inc., 2979 North Ontario St., Burbank, Calif. [386]

## Operational amplifier boasts high gain

A d-c differential operational amplifier makes a general-purpose circuit building block for applications requiring high gain combined with wide voltage swing and large output current. Model L-161 has 150,000 d-c gain, ±10 ma output current, and ±20 v (40-v spring) output drive.

Additional features include 1.5-

# Acme Electric STOCK MODEL POWER SUPPLIES ARE ENGINEERED TO CUSTOM DESIGN PERFORMANCE

Acme Electric magnetically regulated power supplies were designed for industrial control and systems applications where high reliability of performance is of prime importance.

Simplicity of design, employing a minimum of components, avoids the possibility of failure present in more complex circuits. Components are conservatively rated for continuous duty at full output under conditions of industrial use.

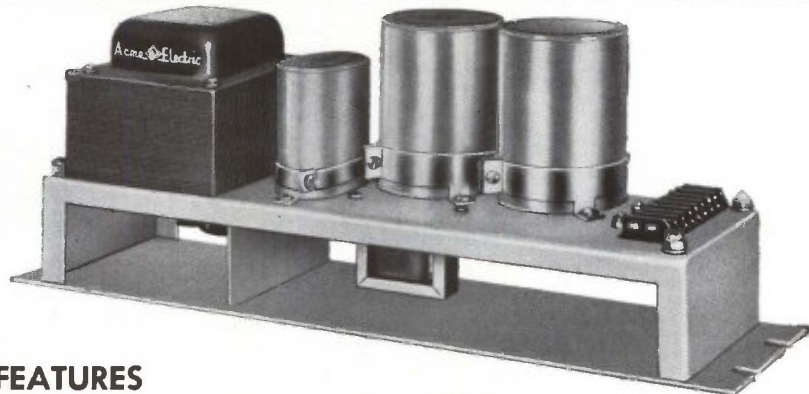

## FEATURES

All solid state components for stability and reliability. Convection cooled — no fan or other moving parts. Available for operation on 50 cycles as well as standard 60-cycle frequency. May be paralleled in operation for multiplying current capacity. Fast response to line and load changes.

## REGULATION

Line: ±1% for ±13% line voltage change. Load: ±2% for any load change between ½ load and full load. Ripple: 1% RMS maximum. Operating temperature range: 0°C. to 50°C.

### PARTIAL LISTING OF STOCK MODELS AVAILABLE SINGLE PHASE, 100-130 VOLTS; INPUT, 60 OR 50 CYCLES

CATALOG NUMBER	D.C. OUTPUT			CATALOG NUMBER	D.C. OUTPUT		
	Volts	Amps	Watts		Volts	Amps	Watts
PS-47509	10	4	40	PS-47638	28	8	224
PS-47508	15	2	30	PS-47712	28	25	700
PS-41422	24	2	48	PS-41424	48	4	192
PS-41423	24	6	144	PS-47519	48	10	480
PS-47125	24	15	360	PS-47718	100	4	400
PS-47173	24	25	600	PS-41425	125	2	250
PS-1-47127	24	50	1200	PS-47457	125	6	750
PS-1-47461	24	75	1800	PS-41426	150	2	300
PS-1-47200	24	100	2400	PS-41427	200	1	200
PS-47202	26	4	104	PS-41428	250	1	250

Acme **ACME** Electric

Engineers and Builders of...

3111 WATER STREET, CUBA, NEW YORK

SAA-3854-3154

REGULATED POWER SUPPLIES  
STATIC POWER RECTIFIERS  
VOLTAGE STABILIZERS  
VOLTAGE REGULATORS



When Motor Specifications  
demand

- HIGH INITIAL TORQUE
- FLEXIBLE SPEEDS
- CONTINUOUS USE
- RESISTANCE TO HEAT OR COLD



turn the job over to  
**SYNCHRON® MOTORS!**

No matter whether you need a motor that can "do tricks" or handle simple routine work, think of a SYNCHRON Motor first. Here at Hansen Manufacturing Co., we've helped designers and production people solve problems ranging from unusual cycling patterns, to meeting swiftly varying temperatures, and a hundred other special applications. And of course we've supplied industry with literally millions of motors for uncomplicated designs. We can help you, too; write or phone us!

**HANSEN**

MANUFACTURING COMPANY, INC.



PRINCETON,  
INDIANA

HANSEN REPRESENTATIVES: CAREY & ASSOCIATES, Houston, Tex.; R. S. HOPKINS CO., Sherman Oaks, Calif.; MELCHIOR & MACPHERSON, INC., San Carlos, Calif.; THE FROMM CO., Elmwood Park, Ill.; H. C. JOHNSON AGENCY, INC., Rochester, N. Y.; WILSON ELECTRIC CO., Essex, Conn.; Norberth, Pa.; and New York, N. Y. EXPORT DEPARTMENT, 64-14 Woodside Ave., Woodside, N. Y.

## New Subassemblies

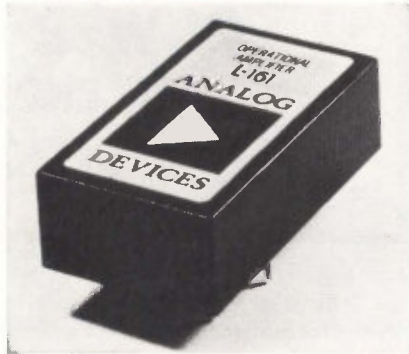

Mhz gain-bandwidth, 20-khz full-power output, 1.2-v/ $\mu$ sec slewing rate, 20- $\mu$ v/ $^{\circ}$ C drift, 20-na maximum offset at 25 $^{\circ}$ C, 1.5-na/ $^{\circ}$ C maximum current drift from -25 $^{\circ}$ C to +85 $^{\circ}$ C, 150,000 ohms and 50 megohms differential and common-mode input impedance, 4- $\mu$ v noise, and  $\pm$ 20-v common-mode rating. (The common-mode rating is claimed to be higher than competitive operational amplifiers designed for  $\pm$ 20-v output.)

Typical uses for the amplifier occur in multiplier and logarithmic circuits, where nonlinear feedback is used. The unit operates from power supplies in the  $\pm$ 23- to  $\pm$ 25-v range and special units can be selected for a particular supply voltage in this range.

The complete amplifier, which is encapsulated into a 1 $\frac{1}{4}$ -cu-in. p-c mounting module, costs \$65. Analog Devices, 221 Fifth St., Cambridge, Mass. 02142. [387]

## Power module can take high temperatures

A family of high-temperature converters operates under continuous full-load at 212 $^{\circ}$ F (100 $^{\circ}$ C). The U3D/GB3 series converts 400-hz power to any required output voltage from 5 to 3,650 v d-c at 30 w. Modular packaging techniques are applied to produce a unit which measures 2 $\frac{3}{4}$  in. by 3 in. by 3 $\frac{1}{4}$  in. and weighs less than 2.3 lbs.

All silicon semiconductors, tantalum capacitors and MIL-T-27A class T transformers are typical components. True hermetic sealing and full encapsulation enable units

## MINIATURE REGULATED POWER SUPPLIES

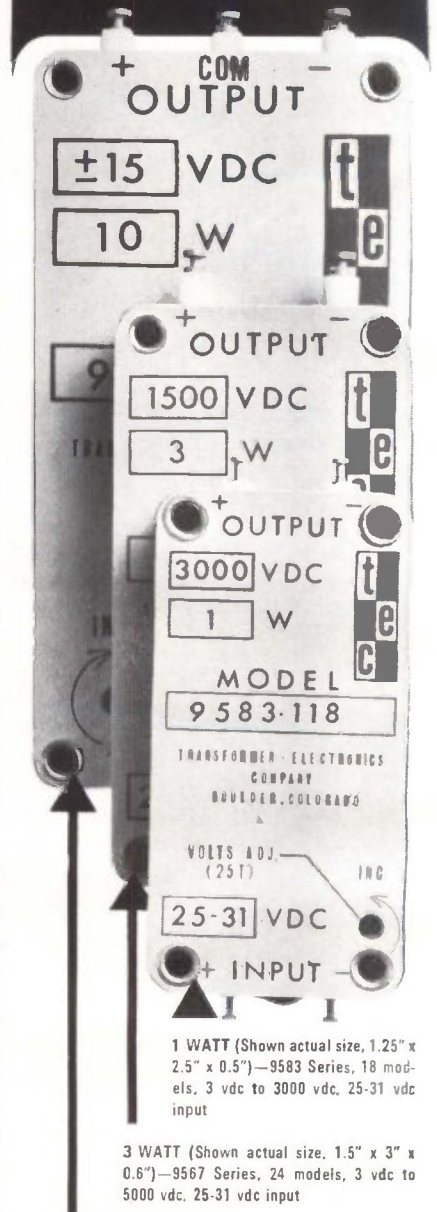

1 WATT (Shown actual size, 1.25" x 2.5" x 0.5")—9583 Series, 18 models, 3 vdc to 3000 vdc, 25-31 vdc input

3 WATT (Shown actual size, 1.5" x 3" x 0.6")—9567 Series, 24 models, 3 vdc to 5000 vdc, 25-31 vdc input

10 WATT (Shown actual size, 2" x 4" x 0.8")—9584 Series, 23 models, 5 vdc to 5000 vdc, 25-31 vdc input

Cost-Performance Optimized • Reduces System Design Effort • Meets Extreme Environments



TRANSFORMER  
ELECTRONICS  
COMPANY

BOULDER INDUSTRIAL PARK  
BOULDER, COLORADO

TWX 303 443-2569 PHONE (303) 442-3833

POWER SUPPLIES • INVERTERS  
CONVERTERS • TRANSFORMERS



to meet the rugged environment of MIL-E-5272C at the higher temperature of 100°C. The modules are designed for the high-temperature environments of aerospace systems.

Short-circuit protection is built in on all GB3 models and special



fail-safe, short-circuit protection is available on U3 models. In addition these converters feature complete isolation of inputs and outputs and an adjustment range of 12% from the nominal output voltage. Design characteristics insure close regulation (0.2%) for line variations of 105 to 125 v a-c. Output ripple is less than 0.2% rms.

Price is \$365 each; delivery, 5 to 6 weeks.

Abbott Transistor Laboratories, Inc., 3055 Buckingham Rd., Los Angeles, Calif., 90016. [388]

## Noiseless attenuators actuated magnetically

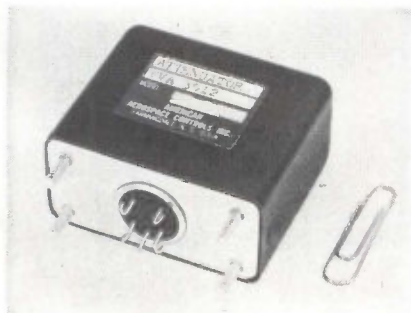

Current variable attenuators utilizing magnetoresistors designated type CVA 3012, are infinite resolution and noiseless attenuators. They can be used for remote volume or gain control circuits as well as electrically isolated signal mixing and

The Kodak Instamatic M6 Movie Camera's battery-powered electric eye, with Vactec Cadmium Sulfide photocells, operates through the lens for high exposure accuracy.



## Part of Kodak's automatic ease

"You aim through here, and press here." That's the simplicity of Kodak Instamatic Cameras. And Vactec furnishes part of the ease—photocells that automatically control exposure settings. Come to think of it, that's controlling quite a lot.

# vactec photocells

Vactec Selenium photocells are among the important components that help the Kodak Instamatic 804 Camera automatically integrate film speed, shutter speed, lens aperture and existing light to compute and set exposures faster than you could yourself.

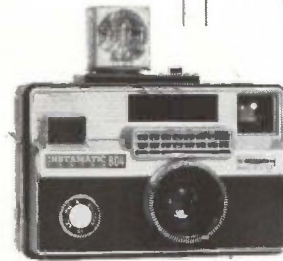

You can always expect the finest in light sensitive devices from Vactec. A complete line of photocells is available for your products. Or, we will custom design units to meet special needs.

Write for Bulletin PCD-3 for Cadmium Sulfide and Selenide types; Bulletin SPV-4 for Selenium photoelectric types.

**VACTEC**  **INC.**

2423 Northline Industrial Blvd.  
Maryland Hts., Mo. 63045  
Area Code 314, HE. 2-4200

See Vactec's Listing in Sec. 3700 EEM and the Photocell Section of EBG

Circle 540 on reader service card

## POSITIVE SAFETY FACTORS provided by patented **PRESS-TO-TEST INDICATOR LIGHTS**

MEET REQUIREMENTS OF MIL-L-7961B

Checks lamps—instantly—without removal from the assembly. Light pressure on the lens cap assembly breaks the normal circuit and makes a test circuit. If the lamp lights when pressed in, it is proven satisfactory. If the lamp fails to light when pressed in, it is defective; (lamps can be quickly replaced from the front of panel). Release of finger pressure restores the lens cap assembly to operating position.

Press-to-Test Indicator Lights mount from back of panel in a 15/32", 5/8" or 1" clearance hole, and are available in a wide range of lens styles and colors. Many of the units are offered with or without dimmer caps.

SAMPLES ON REQUEST—AT ONCE—NO CHARGE.



801-1030-0331-504  
(MS25041-2)



812-1030-0971-506



803-1710-0331-504  
(MS25331-6)

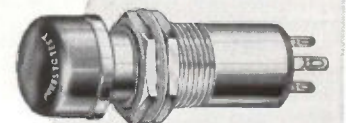

828-1710-1431-504

(Illus. approx. 3/4 actual size)

Every assembly is available complete with lamp.

For complete data, request current catalog.

**DIALCO**®

Foremost Manufacturer of Indicator Lights

**DIALIGHT** CORPORATION

60 STEWART AVENUE, BROOKLYN, N.Y. 11237 212 HYACINTH 7-7600



# NOW

FROM



## A Complete Automotive and Ignition Tune-Up System



### MARK TEN

Capacitive Discharge Ignition System

\$44<sup>95</sup> Assembled

\$29<sup>95</sup> Kit Form

Get mileage you never dreamed of! 3 to 10 times spark plug life. Instant starts in all weather. Installs in only 10 minutes. Up to 20% gas savings. Dramatic increase in engine performance and acceleration.

## 2 NEW AUTO TUNE UP INSTRUMENTS



**DWELL**  
METER  
\$12.95  
Ppd.

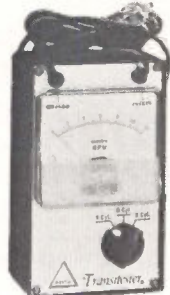

**TACH**  
METER  
\$14.95  
Ppd.

These two new cousins to the world famous proven MARK TEN now give you the capability to tune your own car inexpensively, easily, with remarkable precision. These separate instruments are low cost, portable and the easiest to read you've ever seen.

- Delta's famous printed circuit design
- Superior in precision, quality and performance to instruments selling for FIVE TIMES as much
- Large dial, high quality jewel D'Arsonval meters
- Operates with standard, transistor or capacitive discharge systems as well as magnetos
- Instant readings — no confusing scales

Send Your Order Today



## DELTA PRODUCTS, INC.

P.O. Box 1147 E • Grand Junction, Colo.

Enclosed is \$\_\_\_\_\_ Ship prepaid.

Ship C.O.D.

Please send:

- Owell Meters @ \$12.95  
 Tach Meters @ \$14.95  
 Mark Tens (Assembled) @ \$44.95  
 Mark Tens (Delta Kit) @ \$29.95

(12 volt positive or negative ground only)

SPECIFY —  Positive  Negative  
 6 or  12 Volt

Car Year \_\_\_\_\_ Make \_\_\_\_\_

Name \_\_\_\_\_

Address \_\_\_\_\_

City/State \_\_\_\_\_ Zip \_\_\_\_\_

DP 6-11

## New Subassemblies

remote variation of the gain controlling feedback resistor in operational amplifiers.

The magnetically actuated attenuator is completely encapsulated and is suitable for military and industrial applications.

Control current in the range of 0 to 10 ma d-c to 0 to 40 ma d-c, depending on model selected, produces a voltage attenuation change of 6 db. This corresponds to a resistance ratio change of 3 to 1 between two resistors in series. One of these resistances is sensitive to magnetic flux, therefore the resistance changes with current. Nominal resistance of each resistor in the attenuator circuit is 500 ohms.

The CVA3012 attenuator circuit is rated for d-c or a-c voltages to 10 v and will operate over a temperature range of -55°C to +75°C. The unit is 1 x 1 3/4 x 2 1/8 in. and weighs 5.3 oz.

Price is \$69.50 in lots of 1 to 9; delivery, 4 weeks.

American Aerospace Controls, Inc., 129 Verdi St., Farmingdale, N.Y. [389]

## Oscillator plug-ins are frequency stable

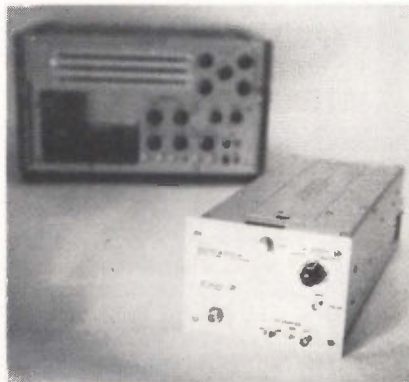

Low-frequency sweep oscillator plug-in units operate from 250 to 500 Mhz and 500 to 1,000 Mhz. Designed for the company's 650 series sweep oscillator, the units extend the range of the instrument from 250 Mhz to 40 Ghz.

The new oscillator plug-in units include magnetically and rf-shielded, voltage tunable magnetrans. To assure maximum fre-

rely on

# PERMACOR®

where

"custom" cores

are almost

"stock items"

At PERMACOR, custom powdered iron core production is a way of life. Our engineers are always ready to help you solve your design problems. And production problems are solved quickly, too. This is one reason why we are the largest maker of cores in the world. If you want stock cores, we can give you immediate delivery in quantity. "Custom" cores take slightly longer.

Write for the full story.



# PERMACOR®

A Division of Radio Cores, Inc.

9540 Tully Ave.,

Oak Lawn, Ill. 60454

Phone: 312-422-3353



quency stability, isolation is provided. Oscillator plug-in units may be either externally or internally leveled. The leveling signal is always applied to a p-i-n diode leveler modulator. Output power is characteristically 50 mw, leveled within  $\pm 0.3$  db.

Models 651A-S2 and 651A-S3, which are for external leveling, are priced at \$1,875. Models 651AK-S2 and 651AK-S3, which include an internal r-f sampler for leveling, are priced at \$2,350. Delivery is 30 days.

Alfred Electronics, 3176 Porter Drive, Palo Alto, Calif. [390]

### Computing system in a portable cabinet

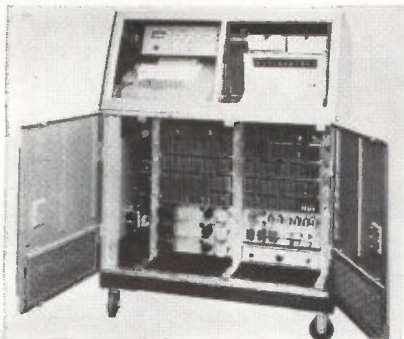

A general-purpose data acquisition and on-line computing system, contained in a single, portable cabinet, can scan and digitize up to 10 analog signals, perform computations on input data and provide output records in typewritten and punched tape form.

Input instructions for model 2315 may be entered through either the computer or the teletypewriter keyboard. Programed instructions are read from dual card readers having a capacity of 160 instructions or from punched tape with an unlimited program capacity. A 3-reel tape handler is built in.

The system includes a total of sixteen 10-digit and ten 4-digit storage registers. It has a built-in self-testing capability.

First application for the new system, according to the manufacturer, is monitoring and analyzing a bank of pyrometers in a midwestern steel mill.

Wang Laboratories, Inc., 836 North St., Tewksbury, Mass. [411]

# 4-6 WEEKS DELIVERY



*in Production Quantities or Prototypes*

## Netic & Co-Netic Magnetic Shields

Fabricated to your exact specifications in any size or configuration. Two typical applications shown. 2-3 weeks delivery on special order.

Permanently effective Netic and Co-Netic are the recognized world standard for dependable shielding. About 80% of all magnetic shield designs in use originated here. Netic and Co-Netic are insensitive to ordinary shock, have minimal retentivity, never require periodic annealing. Total quality is controlled during manufacture. Design assistance gladly given.



Photomultiplier & CTR Shields

## MAGNETIC SHIELD DIVISION

Perfection Mica Company

1322 N. ELSTON AVENUE, CHICAGO, ILLINOIS 60622

ORIGINATORS OF PERMANENTLY EFFECTIVE NETIC CO-NETIC MAGNETIC SHIELDING

Circle 541 on reader service card

## NEW! The only bench type pantograph with 1:1 RATIO

Drills PRINTED CIRCUITS pneumatically  
Engraves up to 100:1

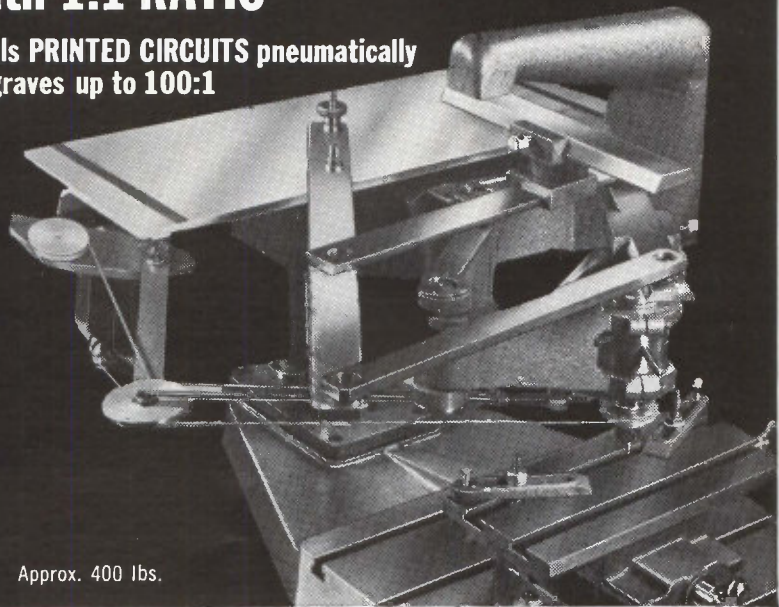

Approx. 400 lbs.

The most versatile machine tool for pantographic production drilling and routing. Reproduces your printed circuit prototype in full scale or in any ratio to 100:1. Ideal for unskilled labor. No changing of tools. One tool for all diameter holes and profiles. Close tolerances. Send for catalog # 139.

*new hermes engraving machine corp.*

154 WEST 14th STREET, NEW YORK 11, N. Y. Chicago. Atlanta. Dallas. Los Angeles. Dayton. Detroit. Mexico City. Montreal





# Ultra-sensitive relays

## HELPFUL DATA FOR YOUR CIRCUITRY IDEA FILE

The circuit drawing below indicates just one of the hundreds of ways many manufacturers utilize Micropositioner® polarized relays to solve complex control problems.

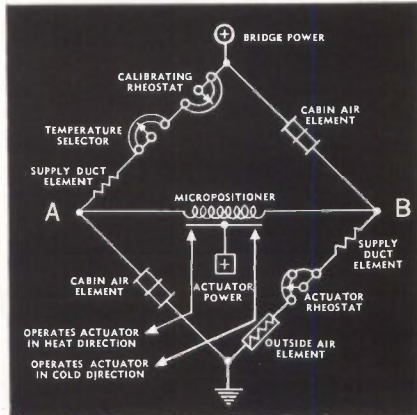

### TEMPERATURE CONTROL

One of the most common applications of the Barber-Colman Micropositioner is in Wheatstone Bridge control circuits. In the above diagram of a temperature control application, the bridge arms incorporate temperature-sensitive transducers.

The Micropositioner is a polarity sensitive relay, so the direction of current flow in AB will close one or the other of its contacts from the normally floating neutral position. This causes a reversible control valve actuator to make desired temperature corrections in the supply air. A rheostat coupled to the actuator provides position feedback.

The same technique can control cycling (on-off) of an electrical heater. By using potentiometers or fixed resistors, the basic Wheatstone Bridge circuit adapts to positioning and synchronizing controls, or to automatic impedance test instruments.

#### BARBER-COLMAN MICROPOSITIONER®

##### POLARIZED D-C RELAYS

Operate on input power as low as 40 microwatts. Available in null-seeking and magnetic-latching "memory" types of adjustment. Also transistorized types with built-in preamplifier. Write for our latest catalog with full information on polarized relays.

**BARBER-COLMAN COMPANY**  
Electro-Mechanical Products Division

Dept K, 1259 Rock Street, Rockford Illinois



## New Microwave

### Avalanche diode pumps amplifier

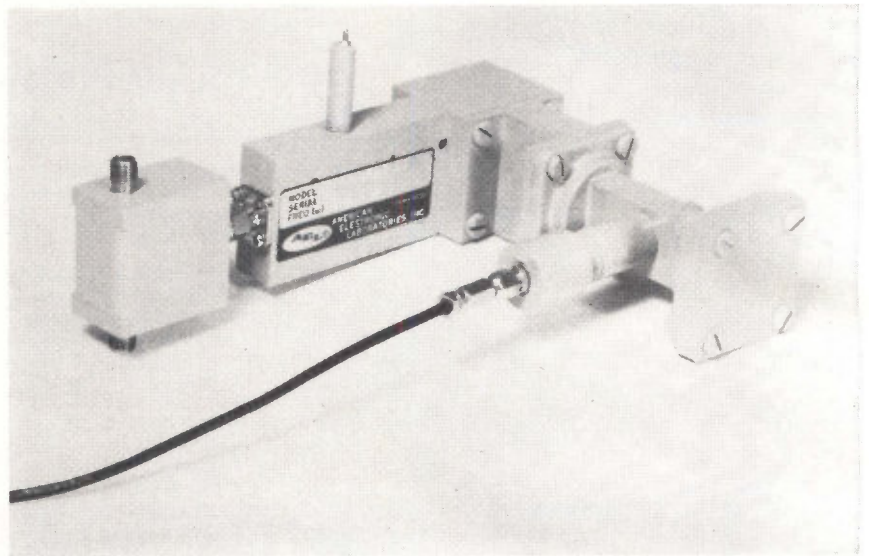

An avalanche diode oscillator is the pump source for a recently developed parametric amplifier for S band. Its manufacturer, the American Electronic Laboratories, Inc., believes that this is the first parametric amplifier to utilize avalanche diodes and will result in reduced costs. AEL builds its own diodes for the amplifier.

The avalanche diode converts d-c directly to the 13.5-gigahertz pump frequency needed to amplify at the S-band telemetry frequencies of 2.2 to 2.3 Ghz. The diode replaces the commonly used varactor multiplier stages or klystron pump sources. Consequently the pump efficiency is higher and the pump unit is smaller. In the new circuit, a varactor diode still serves as the parametric amplifier element, making the unit completely solid state.

As for costs, Jim Kellett, section head of AEL's microwave components laboratory says, "At least at parametric amplifier frequencies through 6 Ghz, we feel that avalanche diode pumps will result in the least expensive parametric system." Kellett indicates that the new amplifier's \$4,595 price tag—with power supply—is extremely competitive with klystron-pumped units and is below that of amplifiers

#### Specifications

Unit Model	Parametric amplifier
Tuneable frequency range	PAR 1612A
Instantaneous bandwidth	2.2 to 2.3 Ghz
Maximum noise figure	35 Mhz
Nominal gain	2.5 db
Maximum input at 1 db compression point	17 db
Size	-35 dbm
Parametric amplifier Power supply	5 1/8 x 4 x 1 5/16 in.
Delivery	3 1/4 x 3 1/4 x 5 in.
	90-120 days

pumped with varactor multipliers. The approximate cost of the avalanche diode pump alone is \$600—about a fifth the cost of a varactor-multiplier pump, he says.

It had been thought that an avalanche diode would be noisy [Electronics, Aug. 8, p. 129], and might degrade the amplifier's low noise performance. AEL discovered, however, that the diode does not degrade the amplifier's noise figure. Tests are under way to evaluate the amplifier's operational life and characteristics under extreme environmental conditions.

The photograph shows a prototype version of the model; the unit for sale includes some slight modifications to reduce size. The commercial model also features a four-port strip-line circulator as the output coupler instead of the prototype's three-port circulator. A 60-



volt, 20-milliamperere supply produces both the power for the pump and the bias for the varactor diode.

American Electronics Laboratories, Inc.  
Richardson Road, Colmar, Pa. [391]

### Signal sources offer modular construction

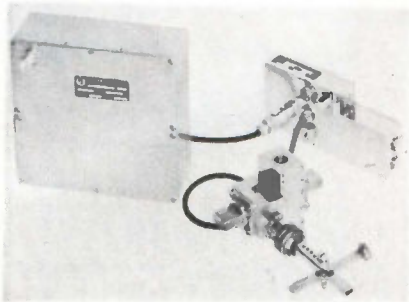

High power and low noise at frequencies up to O band (60-90 Ghz) are provided by Bradley solid state, microwave signal sources. Typically, 1 watt is available at X band and 100 mw at Q band (26.5 to 40 Ghz). The output of the O band source in the photograph is 10 mw.

The very low noise makes these sources ideal for doppler radar or other high stability applications. Measured noise is less than 140 db below a watt per hz.

The modular construction is useful in applications where space is at a premium. Also, costs are competitive with klystrons particularly at the higher frequencies.

Edwin Industries Corp., 5858 East Molloy Road, Syracuse, N.Y., 13211 [392]

### Horn antennas suppress sidelobes by 25 db

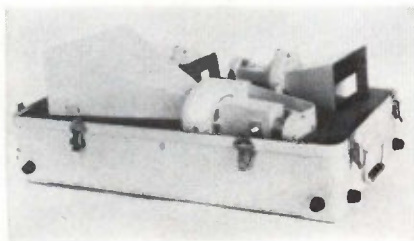

Three horn antennas with compensated apertures have been developed for electrical boresighting airborne antennas. The antennas suppress sidelobes by 25 db in both

# YOKE SPECIALISTS

## FOR INFORMATION DISPLAYS

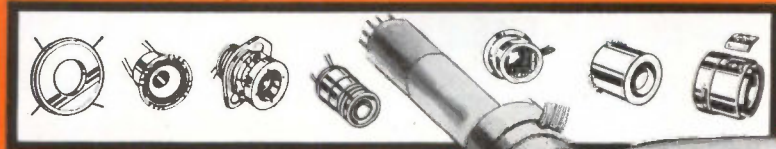

Syntronic's devotion to precision and attention to detail assure skillfully engineered deflection yokes in prototype or full production quantities. A complete line of value engineered yokes offer cost saving solutions to your CRT projects. Consult scientifically oriented Syntronic Yoke Specialists for the right yoke for your display.

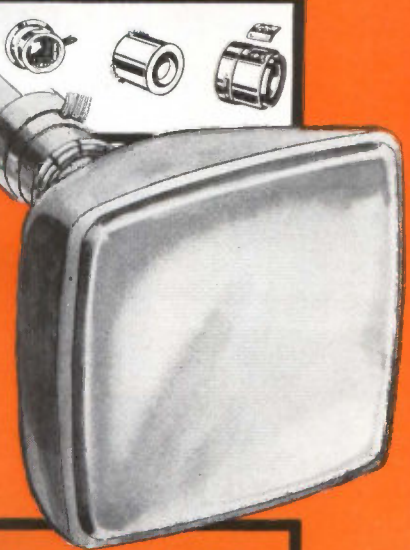

*Syntronic* INSTRUMENTS, INC.  
100 Industrial Road, Addison, Ill.  
Phone: Area 312, 543-6444

Circle 542 on reader service card

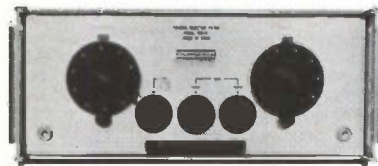

## Rejection to 100 DB with Fairchild's Tuneable Filters 14 KC to 1000 MC in five separate, shielded units

■ The TRF Series tuneable rejection filters cover the range from 14 KC to 1 GC by means of five individual precision units, each having a typical rejection capability of 100 DB for a signal within its range. And NO interchangeable plug-in coils!

■ Individual pass band for each of the five filters encompasses the complete range from DC to 1 GC, with typical insertion loss less than 3 DB outside the notch. Spurious filter response is 15 DB or less.

■ At 20 DB down the band rejection width is approximately 20% of the notch center frequency, while at 60 DB down the width is approximately 0.2%.

■ Filters can be obtained individually, or as a complete set. Each comes in its own well-shielded housing for use in laboratory or field measurements involving RFI/EMC instruments, or for other applications requiring rejection of interfering signals.

■ For complete technical information, contact:

**FAIRCHILD**

**ELECTRO-METRICS CORPORATION**  
A SUBSIDIARY OF FAIRCHILD CAMERA AND INSTRUMENT CORPORATION

88 CHURCH ST., AMSTERDAM, NEW YORK 12011



# WHAT DC TO AC MODULATOR IS BEST\*

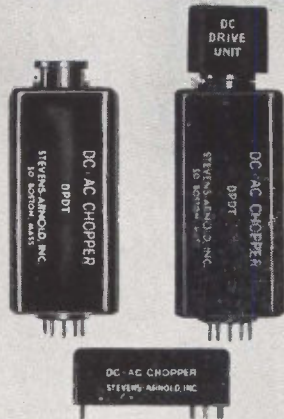

**Mechanical Chopper**  
For Low Voltage  
(nanovolts)

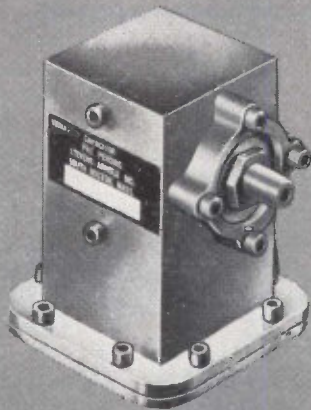

**Vibrating Capacitor**  
For Low Current  
(femtoamps)

\* For Measurement, Recording,  
and Control Applications



Write for  
Modulator  
Catalogs.

## STEVENS INCORPORATED ARNOLD

7 ELKINS ST., SO. BOSTON, MASS. 02127

S/A 40

## New Microwave

the E- and H-plane. The horns cover the 2.1 to 12.4 Ghz band in three steps—2.1 to 4, 4 to 7.8, and 7.8 to 12.4 Ghz.

Sidelobe suppression is accomplished by precisely positioning four baffle plates in the pyramidal section of each horn, resulting in binomial aperture distribution in the horn's E-plane. A cosine illumination taper is approximated by coupling the proper amount of energy into each of the horn sectors formed by the baffle plates.

Each horn antenna is bearing-mounted in a precision flange assembly which exactly aligns the electrical and mechanical axis. The bearing surfaces permit horn rotations through a 0 to 90° sector. Further, mechanical limit stops and ball-detent locks, which are precisely located at 0° and 90° points, permit selection of desired E- or H-plane polarization.

Maximum vswr of the antenna is 1.6:1 at the type N female input connector. At the center frequency, the nominal beamwidth is 26° in both planes and the nominal gain is 18 db.

Sperry Microwave Electronics Co., P.O. Box 1828, Clearwater, Fla. [393]

## Telemetry transmitter rated at 20-w output

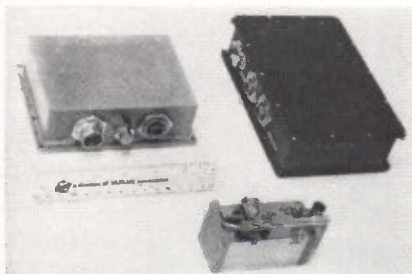

A high-power S-band telemetry transmitter is available for use in missile environments. The EM4528 is rated at 20 watts output power, operating at 2.2 to 2.3 Ghz. Frequency stability is  $\pm 0.0025\%$ , and is provided through a crystal-referenced automatic-frequency-control servoloop.

The three-module system includes an exciter, a power amplifier, and a preregulated d-c/d-c

# YOU CAN'T OVERLOOK US! ...WE INTEND TO BE PERSISTENT!



## Let Us Send You The Facts On PROFIT-LIVABILITY! FOR ELECTRONICS FIRMS!

70 South Dakota communities have industrial development corporations ready to assist you in locating your new plant. We believe that you'll be pleasantly surprised with the advantages South Dakota has to offer new and expanding industry.

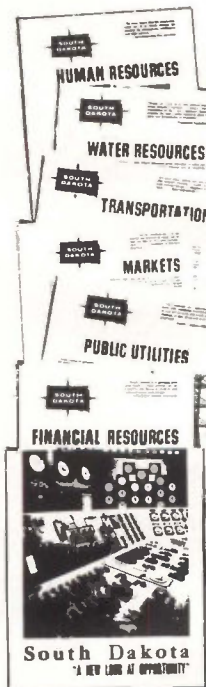

### PROVED LABOR PRODUCTIVITY

Value added by manufacture per worker is one of the nation's highest. Eager, alert labor force with work stoppages at absolute minimum.

### FINANCING & TAXES

Local development corporations ready to serve all industries. Revenue bond financing available. Debt-free state with no corporate or personal income tax... plus a free port law!

### CENTRAL LOCATION

You're closer to everyone and everywhere in South Dakota, geographical center of the U.S. and the heartland of the entire North American continent.

### ENERGY FOR YOU

Electrical power available at low cost rates from hydro, fossil and atomic plants to serve the most demanding production needs.

### GREAT OUTDOOR ADVENTURE

The beautiful Black Hills, Missouri Great Lakes, fantastic fishing, fabulous big and small game hunting, water resources that challenge the imagination... all combine for a recreation bonanza at your doorstep.

GET THE  
SOUTH DAKOTA  
STORY

CALL OR WRITE

**JAMES W. MONROE, DIRECTOR**  
Industrial Development Expansion Agency  
ROOM J

PIERRE, SOUTH DAKOTA 57501  
PHONE 224-5511 EXT. 307 AREA CODE 605



converter. All circuits are solid state, except for a rugged planar triode r-f power oscillator. Volume is 110 cu in.; weight, 7.8 lbs.

The EM4528 telemetry transmitter systems will provide high r-f power for any slant range, and will transmit reliably during the stress of missile lift-off. The telemetry system may be field-tuned without special equipment, and is said to be the only one of its kind which has operated successfully during missile launch and flight.

The transmitter system features efficiency of more than 13%, and its high power helps to overcome null and ionization problems which usually occur during down-range transmission. Spurious radiation is avoided because the transmitter generates r-f power directly at the output frequency.

Eimac, division of Varian, 301 Industrial Way, San Carlos, Calif., 94070. [394]

## Variable attenuators come in 3 models

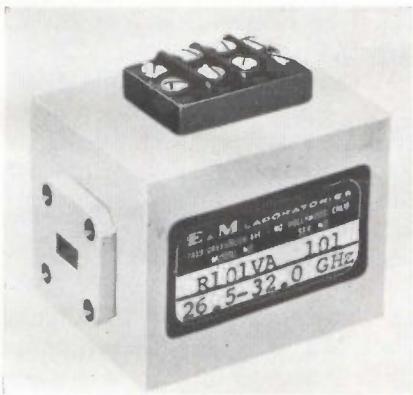

Ferrite variable attenuators, available in three models, provide complete coverage of the Ka band, 26.5 to 40.0 Ghz.

Each model provides continuous, bilateral attenuation to 25 db minimum. Insertion loss is 1.0 db maximum and vswr is 1.3 maximum. Maximum coil current for 25-db minimum attenuation is 100 ma. Model R102VA covers the range from 31.0 to 36.5 Ghz.

These precision units (weighing 3 oz nominal) are suited for applications such as level-set attenuators, servo loop gain controls, on-off switches and amplitude modulators.

Prices may be obtained on re-

### TRYLON ROTATABLE LOG PERIODIC ANTENNA

Single-layer, horizontally polarized,  
for 6.5 to 32 mc. 65° azimuth beamwidth.  
6 db gain/std. dipole. Power to 50 kw PEP



**"One cannot continually disappoint a Continent."  
We have designed, constructed, and installed  
antenna and tower systems in North America,  
South America, Europe, Asia, Africa, Antarctica.  
We wish someone from Australia would call us.**



Circle 544 on reader service card



## Miniature High Q Air Capacitors!

- SIZE: .220" dia. 15/32" length
- Q @ 100 mc: >5000
- CAPACITANCE RANGE: 0.4 — 6 pf
- NON-MAGNETIC

New miniature series features high quality materials and workmanship typical of all Johanson Variable Air Capacitors.

Write or Phone

**Johanson MANUFACTURING CORPORATION**

400 Rockaway Valley Road, Boonton, N. J. Phone (201) DEerfield 4-2676





# IF-to-Tape... CONVERTERS ... Tape-to-IF

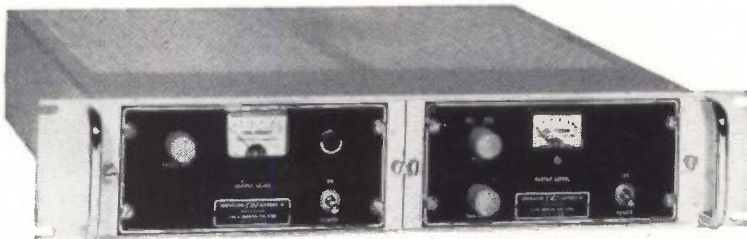

Type TF-201

Type FT-201A

## For Wideband Predetection Recording Uses

CEI developed these compact, solid-state converters to facilitate predetection recording of 21.4-mHz center frequencies. Type FT-201A (IF-to-tape) translates the 21.4-mHz IF output from a CEI or other receiver to a frequency that can be recorded on a wideband tape recorder. Data bandwidth is 100 kHz to 1.4 MHz with a 750-kHz output center frequency; other output center frequencies may be obtained by changing the crystal. Type TF-201 (tape-to-IF) translates tape recorder output signals up to 21.4 MHz, providing a data bandwidth of up to 1.3 MHz (when the input center frequency is 750 kHz). In both units, response over the data bandwidth varies less than 2 db.

These converters are available in half-rack configuration—as shown above—and in 19" full-rack versions. For further information and specifications, please contact:

### COMMUNICATION ELECTRONICS INCORPORATED

6006 Executive Boulevard, Rockville, Md. 20852 · Phone: (301) 933-2800 · TWX: 710-824-9603

Circle 546 on reader service card

## New Microwave

quest. Delivery is 30 to 45 days after receipt of order.

E&M Laboratories, 7419 Greenbush Ave., North Hollywood, Calif. [395]

## Waveguide waterload spans 2.7 to 3.8 Ghz

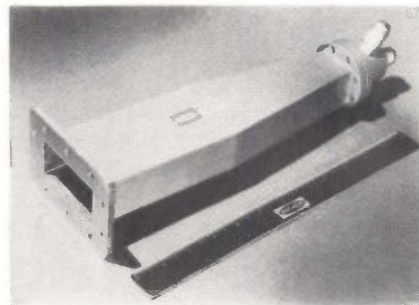

A calorimetric waterload has been developed for high power S-band radars. The G2000T is designed for a variety of applications such as antenna tracking, mobile units, and shipboard and airborne systems. The rugged, compact waveguide waterload measures only 14 5/8 in. long and weighs less than 5 lbs.

When used with the proper thermopile and metering, the unit is said to offer an excellent means for reading average power, since its low fluid volume requirement results in unusually fast response in calorimetric measurements.

Frequency range for the G2000T is 2.7 to 3.8 Ghz with a 15% bandwidth. Vswr is 1.15 maximum at 80°C. Peak power is 1.5 Mw; average power, 30 kw.

Raytheon Co., Microwave and Power Tube division, Waltham, Mass. [396]

## Oscillator tube puts out 50 mw

A backward-wave oscillator tube delivers at least 50 mw over a 14-to-17-Ghz tuning range. The magnetically-shielded unit is claimed to be an ideal airborne local oscillator, sweep oscillator, and local oscillator for systems with special packaging requirements. The VA-470N is permanent—magnet-focused.

The compact, convection-cooled



**Ebert**  
Guaranteed  
Reliability

**NEW EBERT Hi-power<sup>®</sup> METAL TUBE MERCURY RELAYS ARE GUARANTEED TO PROVIDE LONG, MAINTENANCE-FREE LIFE EVEN IN PROBLEM ENVIRONMENTS**

**FACT:** Ebert Hi-Power Mercury Relays are available in 1, 2 and 3-pole units. Load ratings up to 40KW or 100 Amps. Load voltages up to 550 V.A.C. They are unmatched for continuous in-use reliability, durability, compactness and ease of installation. **FACT:** Their hermetically sealed, mercury-to-mercury action eliminates contact problems. **FACT:** Their epoxy-clad, metal tube construction withstands physical shock or rough handling. **FACT:** Once you've tried an Ebert Hi-Power Relay you won't be satisfied with any other!

\*Guaranteed for one year against defects in materials and workmanship.

Also available in solid state time delay and solid state hi-sensitive models

WRITE FOR FREE MANUAL AND 30-DAY FREE TEST DETAILS  
**EBERT ELECTRONICS CORP.**  
130-12 JERICHO TURNPIKE, FLORAL PARK, N.Y. 11002



## GRAPHIC VISUAL CONTROL

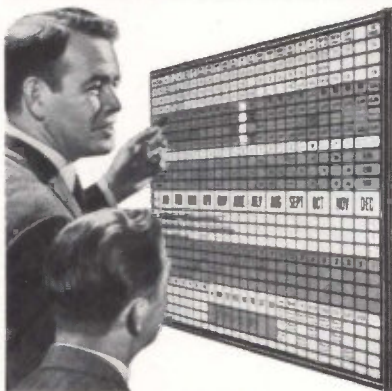

**You SEE How To Get Things Done With The BOARDMASTER System**

You see a Graphic Picture of your operations, spotlighted in color. You have facts at Eye Level. Saves time, cuts costs and prevents errors.

Ideal for Production, Maintenance, Scheduling, Inventory, Sales, Traffic, Personnel and many other uses.

Simple and flexible tool. You write or type on cards and post on board. All cards are interchangeable.

Compact and Attractive. Made of Aluminum. Over 1,000,000 in use.

Complete Price \$49<sup>50</sup> Including Cards

**FREE** 24-Page BOOKLET No. C-10 Mailed Without Obligation

Write Today for Your Copy

**GRAPHIC SYSTEMS**  
925 Danville Road • Yanceyville, N.C.





## We thought of putting a false bottom on it.

We toyed briefly with the idea of making our PVB (Potentiometric Voltmeter-Bridge) bigger than it had to be. We were worried about the skeptics who wouldn't believe we could combine seven high-accuracy measurement functions in a portable case the size of a typewriter.

But we resisted temptation. We designed the PVB as compact as solid-state technology permits. And we said to the skeptics, "Seeing is believing. If you don't think that one \$750 instrument can deliver 0.02% accuracy or better on voltage, resistance, current and ratio measurements—just watch."

The skeptics watched and they became believers. They passed the word along to friends and made the PVB one of our best sellers. (If word hasn't reached you yet, write us direct.) They showed us this instrument has more uses than even we knew—including potentiometric temperature measurement, checking of dc power supplies, measuring pH and calibration applications galore.

We should have known that false bottoms went out with the bustle. ESI, 13900 NW Science Park Drive, Portland, Oregon 97229.

Electro Scientific Industries **esi**®

Circle 548 on reader service card

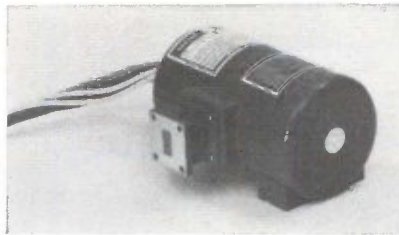

unit is only 3 in. in diameter and 6 in. long, and weighs just 4 lbs. Lighter and smaller models can be supplied for applications requiring less output power and bandwidth.

Frequency adjustments are made by varying only the helix voltage. The voltage-versus-frequency curve is exponential and has no discontinuities. A nonintercepting, negative control grid provides means for amplitude modulation without drawing current in the modulation circuit.

Other features include: sturdy metal-ceramic construction, smooth output characteristics, excellent a-m, f-m, and spurious-noise performance, as well as fast sweep-rate capability and outstanding stability, according to the manufacturer.

Small quantity price is under \$1,500 each. Delivery takes approximately 60 days.

Varian, Palo Alto Tube division, 611 Hansen Way, Palo Alto, Calif., 94303. [397]

## X-band pulsed twt suited for radar

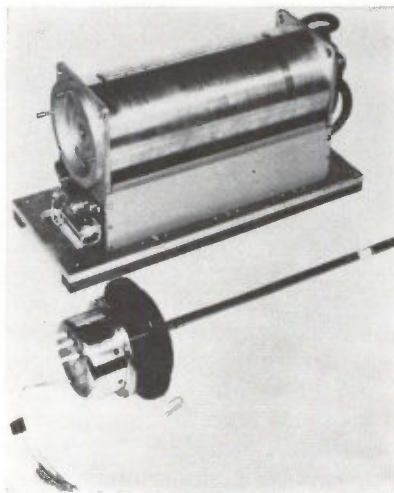

The high power, pulsed traveling-wave amplifier, type TWX16, is suitable for radar applications. It

Circle 313 on reader service card →

Sigmund Cohn Corp.

## Gold Bonding Wire (99.99%)

### Stays Put:

because every foot of wire is respooled on precision winding equipment designed by our plant engineers . . .

### Stays Put:

because winding tension and pitch are fully controlled; thus the single layer winding can not shift, can not slip . . .

### Stays Put:

because the wire is wound on **M.E.** Matched Expansion spools—another exclusive developed by our staff . . .

The single layer shipping package is designed for:

400 feet of .0007"  
400 feet of .0010"  
250 feet of .0015"  
150 feet of .002"



Write for Engineering Data

**Sigmund Cohn Corp.**

121 So. Columbus Avenue  
Mt. Vernon, N.Y.





**Sensitive Research**

**solve your  
problems with**

**1/4%**

**Accuracies**

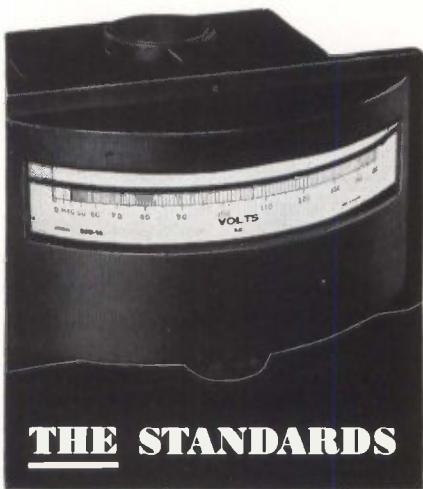

**IN AC/DC VOLTAGE, CURRENT,  
POWER, AND POWER FACTOR  
PANEL METERS**

- Accuracies to 0.25%
- Multi-range switching
- 5" or 7" scale lengths
- Edgewise or rectangular designs
- NBS traceability
- Reliable, friction-free diamond-tipped pivots

For complete data on the broad selection of *Sensitive Research* precision panel instruments, contact your local Singer Instrumentation representative, or write to: The Singer Company, Metrics Division, 915 Pembroke St., Bridgeport, Conn. 06608.



S-66-12

## New Microwave

gives over 40 db gain at 5 kw peak output power over a bandwidth of 500 Mhz in the 8 to 9.3 Ghz range. Average power is 30 watts and saturated peak power is 5 to 20 kw.

The tube is of metal-ceramic construction with a ring-and-bar slow wave structure that reduces unwanted oscillations. A solenoid mount assembly, type SMX16, focuses the tube and also incorporates the r-f couplings and provides conduction cooling.

The TWX16 operates with the helix maintained at d-c potential to simplify pulse power supply requirements.

The M-O Valve Co. Ltd., a subsidiary of The General Electric Co. Ltd., Brook Green Works, London W.6, England [398]

## Step recovery diode for telemetry use

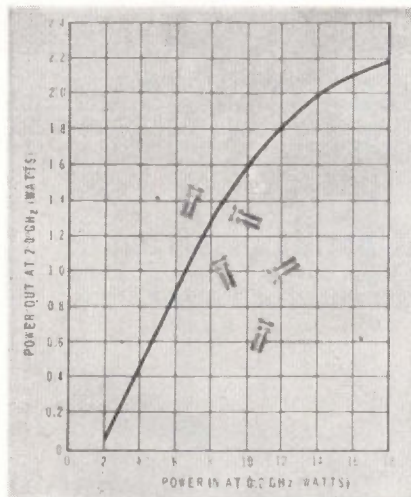

Fifteen watts in at 200 Mhz yields 2 watts out at 2 Ghz with the model 0300 step recovery diode. This meets military environmental specifications and one of the unit's important applications is expected to be 2 Ghz telemetry.

The diodes are epitaxial, surface-passivated silicon devices with very abrupt junctions. They are capable of generating high harmonic orders in single stages with good efficiency, the company reports. Maximum power dissipation is 15 w at 50° C case temperature.

The 0300 package features a

# Coaxial Cables do double duty with **POMONA** BNC Adaptors

You can increase the flexibility and utility of your laboratory test equipment—and reduce the quantity and variety of coaxial cables—by using BNC Adaptors from Pomona Electronics.



**MODEL 1269**  
BNC Receptacle to  
Double Banana Plug



**MODEL 1296**  
Binding Posts  
to BNC Plug

Select from these popular adaptors to cover most of your needs... or choose from ten different combinations listed in our General Catalog, sent free upon request.



**MODEL 1645**  
BNC Receptacle to  
Shielded Banana Plugs



**MODEL 2631 "BREAKOUT"**  
BNC Receptacle to Minigator Clips

Select from these popular adaptors to cover most of your needs... or choose from ten different combinations listed in our General Catalog, sent free upon request.

**POMONA**  
**ELECTRONICS CO., INC.**  
1500 East Ninth Street, Pomona, California 91766  
Telephone (714) 623-3463



# Why the most readable readouts have a new lens system.



SERIES 120  
3/4 ACTUAL SIZE

We've just designed a totally new lens system for our miniature rear-projection readouts, the Series 120 and the Series 220 (front plug-in model). Since we already had the most readable readouts made—even with the old lens system—why all the effort?

Frankly, the most important thing we (or any other readout manufacturer) have to sell is readability. That's why we keep on working to make the best just a little bit better. This time it really paid off. Our new lens system delivers a significant increase in character sharpness and a 50% increase in brightness! Here's what we did:

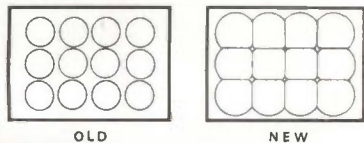

First we squared our circular lenses. That gives us greater usable lens area for a two-fold effect: the new larger lenses collect more light; magnification required is reduced. Both factors increase brightness and sharpness.

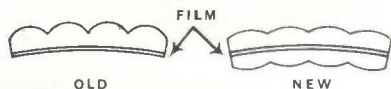

Second, we split the old single condenser lens and made a lens-film-lens sandwich. The old lens refracted light rays toward the projection lens before the rays passed through the film. Of necessity, the lens had steep curvature which limited the usable size of film. The new split-lens condenser refracts light in two stages: before it passes through film and after. By comparison, the new lenses are practically flat, permitting use of larger film and reducing aberration associated with thick lenses. The effect builds up: larger film means less magnification which in turn means greater brightness and sharpness.

So that's why the most readable readouts have their new lens system. Frankly, this new lens system may not seem earthshaking to you, unless you happen to be using readouts. In any case, send us your inquiry. We'll give you the reading on readability!

**IEE INDUSTRIAL ELECTRONIC ENGINEERS, INC.**

7720 LEMONA AVENUE, VAN NUYS, CALIFORNIA  
PHONE: (213) 787-0311 • TWX: (910) 495-1707  
© 1966 IEE Representatives in Principal Cities

Circle 549 on reader service card

threaded base for easy assembly and high power dissipation, and a ground plane flange for positive seating in the holder.

Prices are \$55 each in quantities of 1 to 9; \$45 each in quantities of 10 to 99. Current delivery estimate is two weeks.

HP Associates, 1501 Page Mill Road, Palo Alto, Calif., 94304. [399]

## Phase shifter operates in the 805-Mhz range

A varactor-controlled solid state phase shifter has been developed for operation in the 805-Mhz frequency range.

The MA-8352-2L1T features low drive power requirements (typically 0 to 120 v at less than 100  $\mu$ a), continuously variable phase shift from 0 to 180°, and rapid phase control. Maximum insertion loss is 1.5 db and the vswr is 1.5. The unit can handle power levels up to 100 mw.

The device is employed as an error correction element in a linear accelerator. Other applications include use as a variable phase standard in a microwave impedance bridge, a phase control device in the low level stages of an amplifier chain, and as a modulator for applying audio, video or other data to a microwave carrier.

Availability is 60 to 90 days. Microwave Associates, Burlington, Mass. [400]

## Crystal protector features stability

A V-band crystal protector, the BLS-517, is designed for pulsed systems operating between 69.5 and 71.5 Ghz. High-temperature fabrication and processing provide long life and stable operation over a wide temperature range.

General characteristics include a recovery time of 0.5  $\mu$ sec; insertion loss, 0.8 db; noise figure 0.9 db (including total contribution from insertion loss, ignitor interaction, and ignitor noise); input vswr, 1.3:1; weight, 2 oz; operating temperature, -40° to +85° C; shock, 50 g.

Varian, Bomac division, Salem Road, Beverly, Mass. [401]

# The neatest jacket on the Cape



## ZT IN ACTION

GP-20 clear Zippertubing<sup>®</sup> is used for electrical insulation and mechanical protection of the distribution panel on Complex 49 of Saturn launch vehicles at Cape Kennedy.

ZT<sup>®</sup> jacketing was installed over the completed cables, with no dismantling required. Zipper closure permits simple wrap-around installation, then jacketing is zipped shut.

There are 18 different types of Zippertubing<sup>®</sup> designed to jacket and/or shield cables in a single zip-on application that permits easy re-entry for modification or repairs.

If you'd like to know how Zipper tubing<sup>®</sup> can help solve your cable problems, write for our latest catalog.



THE Zippertubing<sup>®</sup> co.

Main Office and Plant:  
13000 S. Broadway, Los Angeles 61, Cal. • FA 1-3901  
Eastern Office and Warehouse:  
480 U.S. Hwy. 46, S. Hackensack, N.J. • HU 7-6261

Circle 315 on reader service card 315



semi-elements  
YOUR  
PRIME  
SOURCE  
FOR

SEMI-CONDUCTOR SINGLE  
CRYSTALS and MATERIALS

- II-VI Compounds  
Cadmium Sulfide, Selenide,  
Telluride  
Zinc Sulfide, Selenide, Telluride  
Custom Compounds II-VIs
- III-V Compounds  
Gallium Arsenide, Antimonide  
Indium Phosphide, Arsenide,  
Antimonide  
Custom Compounds of III-Vs

SINGLE CRYSTAL FERRITES

- YIG  
YTTRIUM IRON GARNETS
- YGIG  
YTTRIUM GALLIUM IRON GARNETS
- EIG  
ERBIUM IRON GARNETS
- NIF  
NICKEL IRON FERRITES
- MIF  
MANGANESE IRON FERRITE
- LiN  
LITHIUM NIOBATE
- BaT  
BARIUM TITANATE

Literature sent promptly on request



semi-elements, inc.  
Saxonburg Blvd., Saxonburg, Pa., 16056  
Phone: 412-352-1548

New Production Equipment

Soldering head joins  
multilead flatpacks

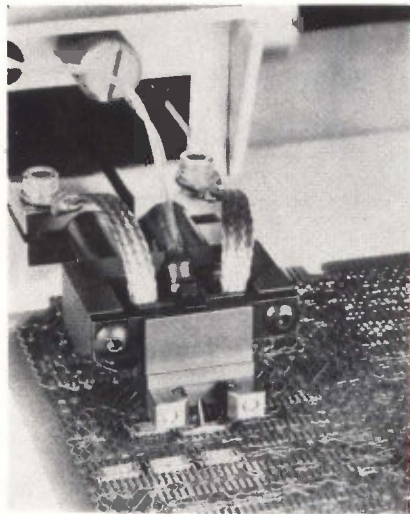

Model 3007 soldering head allows the attachment of up to seven flat-pack leads simultaneously. It features no lead-to-lead voltage gradients, self-alignment, low thermal mass and inertia, and temperature control.

A heated element, specially processed to prevent the application of voltage differentials from lead to lead, reflows the solder on pretinned leads to solder-plated circuit board pads. The patented thermocouple control is employed to sense temperature of the system and terminate the heating rise cycle. The head is spring force limited in the vertical direction and is self-aligning to compensate for boards or fixtures which are not parallel to the surface of the heating element.

Price of the model 3007 seven-lead soldering head is \$295. Development Associates Controls, 123 West Padre St., Santa Barbara, Calif. [402]

Epitaxial system  
produces films fast

A large epitaxial reactor system, the PMC600, has been developed to meet the requirement for epitaxial slices in the manufacture of micro-

circuits and discrete component transistors and diodes. The system produces extremely uniform films at the rate of 60 slices per run, says its manufacturer. Until now, according to the manufacturer, the largest systems offered commercially have been under 25 slices per run.

The system is said to produce epitaxial films to specific thickness and resistivity specifications, such as:  $\pm 5\%$  film thickness variance within a slice, and  $\pm 3\%$  thickness variance slice to slice within the run.

The PMC600 includes a power supply, a 60-slice reactor and a gas control console that can be operated automatically or manually. Price is \$41,950 complete; delivery, a maximum of four months. Pittsburgh Materials & Chemicals Corp., 3400 Old Wm. Penn Highway, Murrysville, Pa., 15668. [403]

Wiring tool separates  
leads from braiding

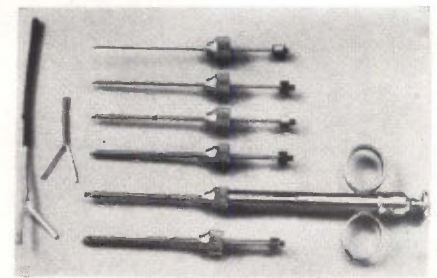

The lead ejector is a syringe-like tool that separates the inner lead of a shielded cable from the braiding, making a neatly finished pigtail in one swift operation without breaking wires. No further trimming is needed so the danger from loose wire whiskers getting into electronic equipment is eliminated, the company claims.

Besides aiding in quality control, use of the lead ejector cuts production time and improves the appearance of wiring. It is designed for continuous use and needs little skill to operate. An internal adjustment programs the ejector to produce identical pigtails of any length the



# REVOLUTIONARY ELECTRONIC CALCULATOR

- Unmatched speed, versatility
- Simple to operate
- Single keystrokes provide all these functions

+ - ÷ x x<sup>2</sup> √x e<sup>x</sup> log<sub>e</sub>x

- Two independent accumulators for random data entry and retrieval
  - Low price — from \$1690 to \$2095. Additional keyboard units from \$450
  - Time sharing units also available
  - Models with 4 additional storage registers available for \$400 extra
  - Accessory programmers also available
- Write for complete details

**WANG**  
LABORATORIES, INC.

Dept. HH-11, 836 North St., Tewksbury, Mass. 01876  
Tel. (617) 851-7311



Circle 550 on reader service card

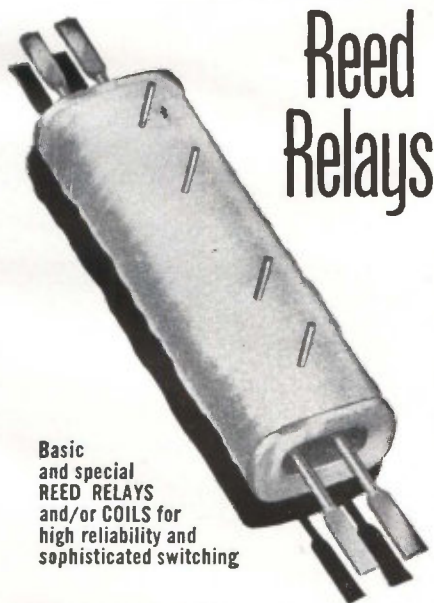

## Reed Relays

Basic and special REED RELAYS and/or COILS for high reliability and sophisticated switching

Operating Inputs: low as 1mA. and 15mW.  
Standard Coil Voltages: 6, 12, 24, 32, 48V in stock for immediate delivery.

Special Voltage or Resistance, multiple windings for flip flop, memory and crosspoint selection applications — to customer specifications.

Relay Contacts in Form A, B, C and latching. Also high vacuum type 5000V Form A.

Write for Bulletin and Prices

**Coto-Coil**

COMPANY INC.

61 Pavilion Ave.  
Providence, R. I. 02905  
Phone: (401) 941-3355

Circle 551 on reader service card

user may require.

The tool is supplied with a kit of six interchangeable plungers to fit cable inner lead diameters from 0.039 to 0.140 in. Other sizes of plunger are available to special order.

Price is \$36.50; delivery, immediate.

The Bailey Co., 5919 Massachusetts Ave., Washington, D.C., 20016. [404]

## Photoresist spinner coats substrates

A four-spindle photoresist spinner, model 1200, has been designed for the uniform coating of semiconductor substrates up to 1½ in. in diameter. It provides independent vacuum switching to allow discriminate use of chucks. Fully controlled solid-state electronic circuitry gives continuously variable 0 to 5,000 or 0 to 15,000-rpm operation with 1- to 99-second time cycling. A front-panel arrest button permits the cycle to be aborted at any time. Dynamic braking imparts instant deceleration. An independent electronic tachometer gives a constant speed check.

A high-quality motor turns the spindles through a power system derived from high-speed grinding-machine-drive principles. The motor is 1/10 h-p, 7,500 rpm, and there are neither clutches nor seals to wear.

Snap-on vacuum chucks run in 3¼-in. diameter resilient polypropylene cups, which retain excess material as well as serving as soft throw-off shields. The cups are easily removed for cleaning and are inexpensive to replace.

Physically, the new spinner is arranged to permit the convenient side-by-side location of as many as three machines for the use of a single operator. The integral design permits easy moving and requires no cutting or drilling. The unit is functionally color harmonized to promote operator-machine compatibility. Controls are grouped for maximum accessibility, convenience, and simplicity to minimize operator error.

Model 1200 spinner is available from stock at a price of \$975. Macronetics, Inc., 220 California Ave., Palo Alto, Calif., 94306 [405]

## Wide Band Frequency Converters

HIGH DYNAMIC RANGE

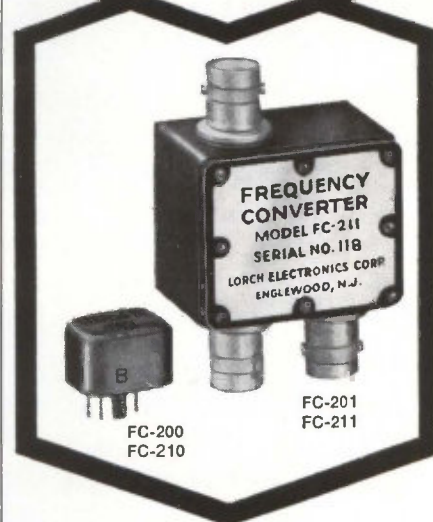

If 135 db of dynamic range sounds interesting to you—read on! Lorch Electronics Frequency Converters, Models FC-210 and FC-211 provide this dynamic range over the entire frequency band from 400 KHz to 120 MHz without adjustment. General purpose Models FC-200 and FC-201 cover 250 KHz to 225 MHz with a dynamic range of "only" 125 db. Conversion losses are from 6 to 8 db, depending upon model and frequency. The important spurious responses are held at least 90 db down. Maximum signal handling capability is plus 14 dbm for the high dynamic range models and plus 3 dbm for the general purpose units.

Printed circuit applications: Use Models FC-200 or FC-210; three solder pins, 0.17 cu. inches.

General laboratory use or for replacement: Models FC-201 or FC-211; three BNC (or TNC) connectors, 1.6 cu. inches.

If yours is to be a truly outstanding receiver design, you can hardly ignore Lorch Electronics Frequency Converters. Want to know more about them? Request our Catalog FC-668.

**LORCH ELECTRONICS CORP.**  
105 CEDAR LANE  
ENGLEWOOD, NEW JERSEY 07631  
201-569-8282

Circle 317 on reader service card 317



# LAM-O-LUME

## PURE FUSED QUARTZ

HIGH INTENSITY XENON OR  
ULTRA-VIOLET LIGHT SOURCE

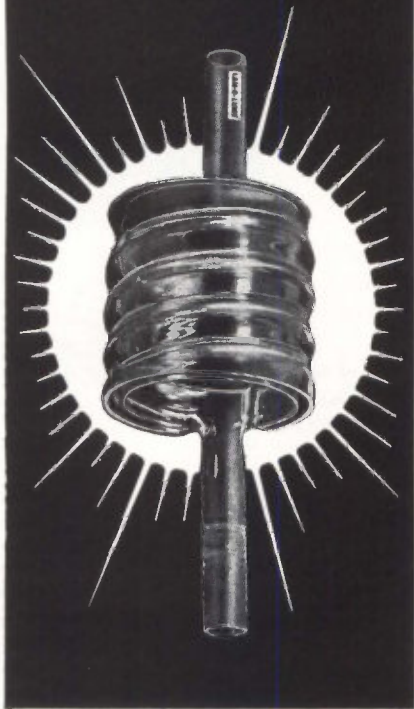

This unitized, dimensionally accurate, pure fused quartz envelope (coil), of rugged design, provides an excellent source for Xenon high intensity lighting or ultra-violet irradiation. The LAM-O-LUME can be supplied as a plain envelope or as a completed tube with electrodes and rare gas.

FOR XENON SERVICE, which provides light intensities brighter than the sun, for outdoor lighting, photography, etc., the unitized THERMAL AMERICAN LAM-O-LUME power supply comes complete with built-in capacitors and trigger circuit; provides 600 joule output with operating range between 1000 and 1800 volts; delivers 35-50 lumens per watt second and a life of 10,000 flashes at rated input.

FOR ULTRA-VIOLET LIGHT SOURCE for irradiation, laboratory heat exchangers, laser pumping, etc., the LAM-O-LUME power supply is available with standard 400 watt average capacity.

Write for details.



## New Materials

### Translucent silicone pours from tube



RTV-118, a clear, pre-catalyzed liquid silicone rubber is packaged in applicator-type tubes and cartridges as well as bulk containers. The silicone can be used as a potting compound for detailed electrical terminals and apparatus, or as a coating that provides mechanical protection for components. It has a low viscosity (approximately 350 poises at 25°C) in the uncured state.

Following application by brushing, spraying or pouring, RTV-118 cures at room temperature to a flexible, resilient rubber. The curing process starts when the material is exposed to moisture from the air. The material contains no solvent, cures with almost no shrinkage and adheres to most surfaces without the aid of a primer.

The time required for the material to form a good bond varies with thickness, humidity and temperature. Adhesion continues to improve up to seven days after application. Shear strength on an unprimed surface will be in the range of 80 to 100 psi after 70 hours at 77°F. Priming will improve strength by as much as 50%. The bond strengths obtained with this type of material are claimed to be about 75% to 80% of those achieved with paste-like, one-part RTV silicone sealants.

RTV-118 has a tensile strength of approximately 350 psi after seven-day cure, which is identical to the paste-like, one-part silicone ad-

hesive sealants. It can be employed continuously at temperatures in the -85° to 300°F range but temperatures can be raised to 500°F for short periods. This is similar to the temperature performance of standard silicone adhesive sealants.

Maximum quantity prices are: 3-oz tubes, \$1.19 each; 12-oz tubes, \$4.60 each; 6-oz polyethylene cartridges, \$2.46 each; and 5-gallon pails, \$4.90 per lb (45 lbs). General Electric Co., Waterford, N.Y. [406]

### Reactive solvent removes urethanes

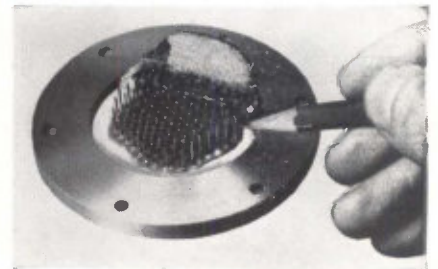

Cured urethane resins can be removed from electronic components by a new reactive solvent. Amicon Uresolve HF will dissolve cured urethanes without harming or attacking other plastic materials or metals used in electronic packaging, the company claims.

In addition to removing resins from coils, modules, p-c boards, connectors, transformers and controls, Uresolve HF is said to be ideal for reclaiming expensive components and repairing reject assemblies. Other products, the company points out, will either swell or change plastic materials, making reclamation impossible.

Another application relates to packaging. Because of the solvent's slow etching action on DAP and anhydride-cured epoxies, epoxy and other encapsulants adhere better.

Immersing the component in the solvent will completely remove all urethane material. Time depends on the amount of material to be removed. For example, a 1-inch cube of rigid foam will dissolve in one hour or less at room tempera-



ture. Printed-circuit board coatings will dissolve in less than an hour. Coatings can be partially removed by brushing or dabbing with a cotton pad, followed by a rinse in water.

Uresolve HF is packaged in containers ranging from 1 quart to 55 gallons. Prices are: 1 quart, \$10; 1 gallon, \$20; 5 gallons, \$15 per gallon and 55 gallon drums, \$6.95 per gallon.

Dynaloy, Inc., 408 Adams St., Newark, N.J., 07114. [407]

## Etch resist-coating for p-c board makers

A nonactivated rosin-base etch resist and protective coating is designed to help manufacture printed-circuit boards faster and more economically.

Called Etchcoat No. 934, the material can be screened onto the raw copper laminate surface in a well-defined pattern and its use eliminates a number of intermediate cleaning and surface protection operations of conventional p-c board manufacture. The Etchcoat was specifically developed to act as an etch resist before etching; after etching it serves as a long-term solderable protective coating which is compatible with all of the company's rosin base fluxes.

Once it's established that the raw copper laminate is solderable, the Etchcoat is screened onto the dry board surface according to a pattern and then cured. A typical curing process would take five minutes at 200°F (93°C). The boards may be etched immediately after curing or can be stored for etching later. Typical etchants—ferric chloride or ammonium persulfate—may be used during etching.

After etching, the boards may be punched and either soldered immediately or stored. Since the Etchcoat also acts as a protective coating, the boards may be stored for long periods without degrading the solderability of the underlying copper surface. The boards may then be taken from storage and soldered (using a rosin base flux) without removing the Etchcoat.

Etchcoat is available in quart, gallon and five-gallon containers. Alpha Metals, Inc., 56 Water St., Jersey City, N.J., 07304. [408]

## Switch to the Best

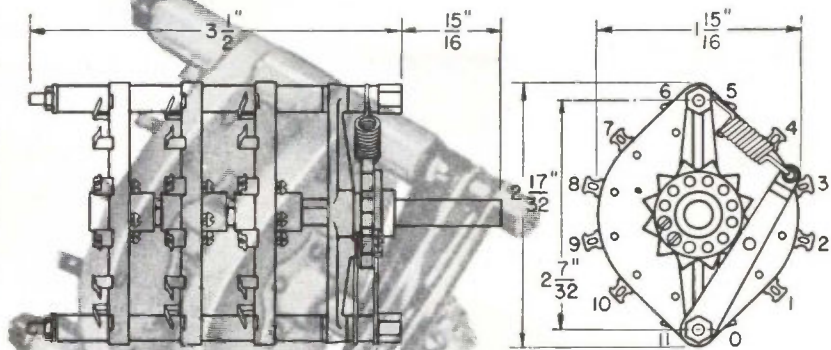

MODEL 80 SWITCH

- 4500 volt peak flashover at 60 cps
- 10 ampere current carrying capacity
- Current carrying members heavily silver plated
- Kel-F rotors • Steatite spacers and stators
- Black anodized die cast aluminum support bracket
- Nylon detent wheel • Stainless steel detent arm
- Oil impregnated bronze sleeve bearing



**RADIO SWITCH CORPORATION**

MARLBORO, NEW JERSEY • Telephone: HOpkins 2-6100

Circle 553 on reader service card

## Lundey Clinch-Loc® Terminals... use a million (or more)? Some of our customers do!



609-TH 499-LP 599-W-3 499-W-2 599-DTH 599-WW 499-TH 601-TH 599-TH

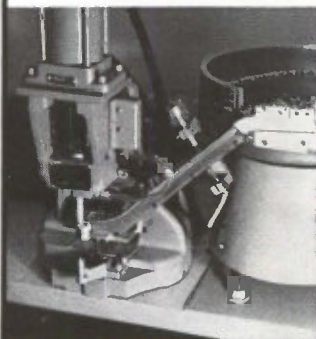

This automatic machine was developed to assemble Clinch-Loc Terminals with speed and flexibility for volume users. With an alternate track any Clinch-Loc Terminal can be used in this machine.

A unitary assembly (no loose parts) for significant assembly cost reduction.

Lundey Clinch-Loc Terminals guarantee substantial savings because of low initial cost, significant assembly cost reduction and elimination of loose parts.

Our engineering facilities for standard, special and production applications are at your disposal. Write for detailed information or send special requirements for quotes.

U. S. Patents 3,047,653 3,126,445 3,166,634	Canadian Patents 683,120 727,204	Patents applied for in France, Italy, Germany and Japan
--	--	---

High Quality Products of The Lundey Line

**Lundey Associates, Inc.**

694 Main Street Waltham, Mass. 02154  
Phone 893-6064





## The shape of tomorrow, today

For more than 20 years, Ultra Carbon consistently has provided industry with advanced graphite technology. "F" purity graphite for the AEC . . . semiconductor crystal crucibles, boats, headers and fixtures made from *Ultra purity* graphite—these are typical of our past contributions to the electronic industries.

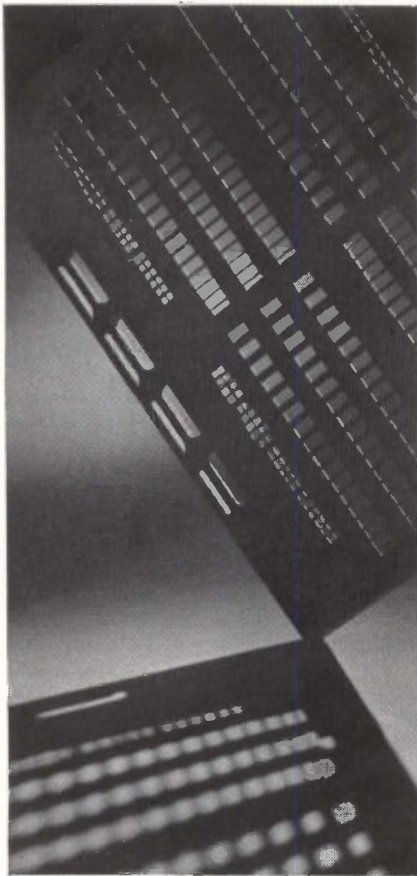

ULTRA/GRAPHITE masks, for processing thin film deposition circuits, are precisely machined. Write for information to Ultra Carbon Corporation, Box 747, Bay City, Mich. 48709.

## New Books

### Technical writing

Effective Writing for Engineers, Managers, Scientists  
Henrietta Tichy  
John Wiley & Sons, Inc., 377 pp., \$5.95

Henrietta Tichy, an associate professor of English at Hunter College in New York and an authority on technical writing, has produced a guide for those who are tired of formula approaches to better writing and are ready for some serious study.

It is not for the man who wants to settle an occasional argument on grammar. It is, rather, a treatise on organization, emphasis, paragraph development, style, word choice and all the other things that make good writing such hard work. It is a book to be read slowly, earnestly, patiently. The rewards are many: splendid sections on effective organization and fallacies to forget; rich lists of tautologisms and elegant variations, an occasional aphorism ("A little learning can make a very tiring writer"), and some comic relief ("As a suffering reader of many long dissertations, I am often inclined to think that Ph.D. stands for Phony Diction").

Professor Tichy doesn't just solve problems; she annihilates them. To the writer who has trouble beginning a paper she offers "Two Dozen Ways to Begin." If he can begin but is lost for a way to develop his thoughts, she offers analogy, analysis, cause and effect, comparison, definition, details and particulars, examples and illustrations, reiteration and endless variations of these.

"A reader of informational prose," the author says, "is busy and hurried; he wants to grasp as much in as little time as possible." Yet she herself occasionally belabors a point, as in the section on outlining and revising. Sometimes she gives advice that borders on the inane; for instance, the following on instruction manuals: "Words alone may not be enough; illustrations may be necessary." The result is a book that, however excellent, is not for the busy and hurried.

In matters of grammar, Professor

Tichy, a very proper writer herself, does her best to sound liberal, at times overdoing it. Her advice on how to avoid the frequent confusion between "disinterested" and "uninterested," for example, is to abandon "disinterested" entirely. Even the permissive Bergen Evans in "A Dictionary of Contemporary American Usage" thinks the distinction worth preserving, and I believe most serious writers would agree.

The author illustrates her points with barrages of quotations, most of which are from technical publications. Except for the repetitions and truisms already noted, she does not talk down to her readers, most of whom will be grateful to be spared a review of fifth-grade syntax. Technically trained readers will also appreciate her logical approaches to paragraph development.

"Effective Writing" may find its chief audience among those who teach writing, both in engineering schools and in industry. This is as it should be, for the author is an old pro at such business. And, through the discipline and pacing of classroom instruction, her excellent material might eventually reach its avowed destination.

Frederick Van Veen

General Radio Co.  
West Concord, Mass.

### Switching machines

Communication Switching Systems  
Murry Rubin and C.E. Haller  
Reinhold Publishing Corp., 394 pp., \$16.50

The authors have attempted—with considerable success—to cover most of the important factors in the planning and design of communication switching systems. While it is evident their interest is primarily in telegraphy and data switching, they have not neglected voice systems. The text is not confined to switching machines alone, but includes the fundamentals of transmission and traffic. The method of transmitting and the volume to be carried are the most important factors to consider



# If you are in the Electronics Industry . . . you probably belong in MARYLAND

## AVAILABILITY OF LABOR

The availability of personnel, particularly engineers and scientists, is recognized as a chief criterion governing the location of an electronics firm.

There are almost 30,000 scientists and over 25,000 engineers living and working in Maryland and the District of Columbia. And the number is increasing every day.

## PROXIMITY TO FEDERAL AGENCIES

Proximity to major decision makers in the industry, such as federal agencies in Washington, D. C., afford the unique advantage of constant personal contact, which is considered an increasingly important locational criterion.

No other state is as convenient to as many Federal agencies as Maryland. For example, Maryland's major government scientific installations include NASA, AEC, NIH, the National Bureau of Standards, plus some 20 others.

**THESE PRIME  
REQUIREMENTS,  
(plus others)  
CAN BE MET IN  
MARYLAND!**

Get All The Facts  
Write, Wire or Phone Collect

**MARYLAND**  
DEPARTMENT OF  
ECONOMIC DEVELOPMENT

Division E • State Office Bldg • Annapolis, Md

when designing switching equipment.

The treatment is broad, yet usually deep enough to give an appreciation of details. In some cases, however, brevity may leave unanswered questions and force the reader to rely on the references included with each chapter. There is no extensive discussion of design techniques.

Today's communications plant is the result of a long evolutionary process. Recognizing this, the authors devote the first chapter and passages throughout the book to the history of communications systems. This is interesting background and important information in a field where new developments must often be compatible with and dependent upon a vast existing system.

The authors delve into the principles of logic circuits on which the design of a switching machine is based, the principles of the transmission circuits that connect these machines, the patterns of trunking and routing between machines in a network and the nature of the traffic carried by the network. Almost all methods useful in designing combinational and sequential circuits are presented. Unfortunately, as in real life, the choice of which method to use, and when, is left to the reader. Components used for switching, memory and logic operations are described and illustrated with typical circuits. There is sufficient detail to explain how a device functions in a particular system. Chapters on networks and traffic are similarly treated, bringing out the relation to the system as a whole.

After covering fundamentals, the authors launch into the difficult task of describing system synthesis. This reviewer has observed that a vast gap exists between methods for designing small circuits having a few logic elements whose requirements can be precisely stated and the problem of designing a large system whose requirements can be stated only in general terms. The usual way, and the one taken here, is to invent one or more solutions and evaluate them against requirements. The examples are well chosen and illustrate methods now in use.

A final chapter describes a num-

## Cool Control Stabilize Calibrate More Precisely With EG&G Thermoelectric Modules

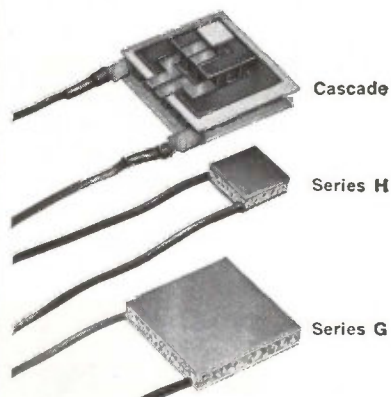

If you're involved with components such as infra-red sensors, photomultiplier tubes, lasers, field-effect transistors, particle detectors, klystrons, dew-point indicators, the calibration of ferrite memory cores, transistors and thermistors, or the stabilization of oil baths, gyros, voltage standard cells and accelerometers, you'll be interested in EG&G's new thermoelectric modules.

These modules have a high breakdown voltage, compactness, rapid response, high cooling capabilities, and versatile physical design. Single-stage modules can achieve 65°C differentials from 27°C heat sink temperatures (85°C differentials from 100°C heat sink) and standard cascade units achieve 120°C differentials.

The Series H and Series G modules provide an unloaded temperature differential of 65°C at an electrical current of 9 amperes. Series H modules have a maximum loaded heat pump capacity of 3.9 watts, are ¼" thick and weigh 7 grams; Series G units have a heat pump capacity of 19.5 watts, are .210 ± .0005" thick and weigh 19 grams. Small single-stage modules are also available for direct attachment to a semiconductor chip inside a transistor case. For this purpose, modules with ¼" x ½" and ¾" x ¼" cross-sections are available.

For more information, write EG&G, Inc., 166 Brookline Avenue, Boston, Mass. 02215. Phone: 617-267-9700. TWX: 617-262-9317.

 **EG&G INC.**



NEW CHEMELEC®  
TFE SOCKETS FEATURE

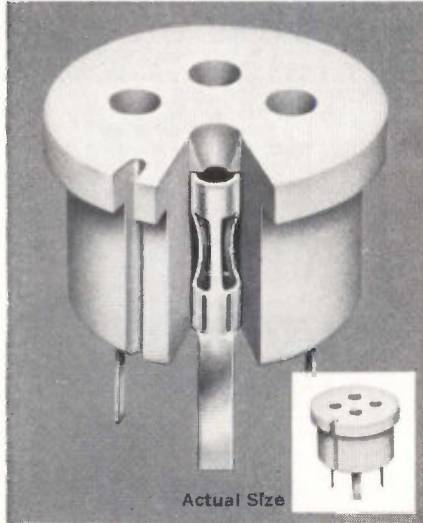

# THREE-LEAF CONTACTS FOR EXTRA RELIABILITY

Unique contact design gives Chemelec sockets their extra reliability: In each pin hole are three beryllium copper leaves that bow in toward the center. When a lead is inserted, the leaves deflect to let it slide in easily, but press firmly against it to assure good contact. A built-in barb prevents accidental pull-out of the contact assembly.

The design gives practically unlimited life . . . low contact resistance (less than .010 ohm) . . . and insertion force of less than 1 oz. per lead.

These low profile ¼" high sockets of TFE fluorocarbon plastic—to MIL-M-55068—have orientation notches visible from above and below . . . tapered entry to guide leads in easily, quickly . . . and are available with flat, flat right-angle, or flexible mounting tabs, with 3 to 14 contacts in .100 to .250 pin circles.

For more information, write for Bulletin SPC-1.

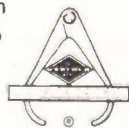

**GARLOCK**  
ELECTRONIC PRODUCTS  
GARLOCK INC.

Cherry Hill, N.J. 08034 • Phone (609) 424-1470  
In Europe: Europélec S.A., Les Clayes-Sous-Bois, France  
In the United Kingdom: Lectropon, Ltd., Slough, England

## New Books

ber of switching systems that have been built. Time has proved at least one of the systems, the British Post Office's Highgate Wood time-division multiplex, to be of doubtful success. And no mention is made of an important new system, the Bell System's Electronic Switching System Number 1, which has recently gone into production. It is not surprising that this chapter is somewhat out of date since the art is moving so rapidly.

An excellent survey like this covering the principles and techniques underlying large systems for communication switching has long been needed. The technical journals contain many papers dealing with various aspects of this complex subject, but engineers who have not grown up with the art have difficulty placing this information in context with the over-all system. This volume should help them and should be of particular value to those entering this rapidly expanding area.

William Keister

Bell Telephone Laboratories, Inc.  
Holmdel, N.J.

### Quantum physics for physicists

Advanced Quantum Theory  
Paul Roman  
Addison-Wesley Publishing Co., Inc.,  
735 pp., \$17.50

Paul Roman, a professor of physics at Boston University, has brought together many interesting topics in quantum theory, mainly those concerning the application of the theory to nuclear physics. His book will be of interest chiefly to advanced students of nuclear physics. In his effort to cover comprehensively many of the more subtle points of quantum mechanics and quantum theory, the author devotes little space to the basics which would probably be more useful to electronics engineers. The foundations of quantum theory are given, but briefly, and apparently more for the sake of completeness than for informative purposes. Also, practical applications are missing.

All of which cannot be considered a drawback to a book entitled "Advanced Quantum Theory." Ro-

# MICO

## NEW MODEL 885 SEVEN RATIO WIDE-RANGE ENGRAVER

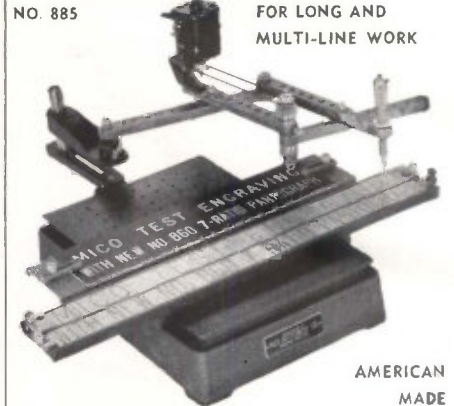

- A time-saver for large plate work.
- Engraves 3" x 19" area in one set-up.
- Seven pantograph ratios—from 1.5:1 to 6:1.
- Choice of 3-ball-bearing spindle assemblies for ¼", 3/16" or taper-shank cutters.
- HSS, COBALT and Solid Carbide Cutters.
- Single and multi-line copy carriers for holding blanks ¼" to 3½" high.
- Accommodates Mico standard accessories.

Send for bulletins and prices

**MICO INSTRUMENT CO.**  
77 Trowbridge St. Cambridge, Mass. 02138  
Circle 555 on reader service card

### THE BEST OF BOSTON

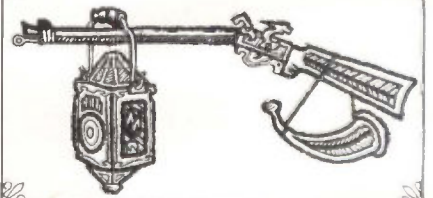

History is made at the Boston Statler Hilton . . . where the big business decisions are made and the big social events take place. It's a grand-old, brand-new V. I. P. hotel.  
Home of the new  
Trader Vic's.

*The Boston  
Statler  
Hilton*





Superior cameras deserve superior lenses. COSMICAR's proven precision performance is the combined result of advanced optical engineering and exquisite workmanship.

Now widely used, COSMICAR LENSES come in 23 models for focal lengths ranging from 12.5 mm to 500 mm, and in 3 zoom models including a remote-control zoom.

Your CCTV camera and COSMICAR LENSES will make an unbeatable team. For technical data and other particulars write to:

**ICHIZUKA OPTICAL CO., LTD.**  
 568, Shimoochiai, 2-chome, Shinjuku-ku, Tokyo  
 CABLE ADDRESS: "MOVIEKINO TOKYO"

Circle 557 on reader service card

man has done a good job of reviewing and examining various elements of modern advanced quantum theory. He treats each subject clearly and concisely, beginning with first principles, however briefly, and extending to recent results. Unlike some books dealing with recent theories, the notation is consistent throughout.

The book is well written and has a commendable set of problems, together with a number of references and four fine appendixes. Among the recent advances discussed are Richard Feynman's integral equation formulation and the quantum theory of the newly discovered subatomic particles.

Because the text is directed to a specialized audience, engineers not working in nuclear physics should look elsewhere for the answers to their questions about quantum theory.

Albert W. Merrill  
 University of Southern California  
 Los Angeles

**Recently published**

**Amplifier Handbook**, Richard F. Shea, editor, McGraw-Hill Book Co., 1,495 pp. \$37.50

This massive volume may prove to be a classic reference. Twenty-nine authors contributed. The tome is divided into three sections: fundamental network theory, major amplifying devices and amplifier circuits.

**Phaselock Techniques**, Floyd M. Gardner, John Wiley & Sons, Inc., 182 pp., \$8.95

Phaselock problems, from principles through application and testing. Appendixes give mathematical review, design examples, nomenclature and useful formulas. Bibliography is nine pages and references, four and a half.

**The Electronic Theory of Heavily Doped Semiconductors**, V.L. Bonch-Bruyevich, American Elsevier Publishing Co., 131 pp., \$7.50

A review of the quantitative progress made in both the quantum and statistical mechanical aspects of the theory of heavily doped semiconductors by a professor at the Moscow State University. The translation editor, Robert S. Knox, is a physics professor at the University of Rochester.

**The Particle Kinetics of Plasmas**, I.P. Shkarofsky, T.W. Johnston, M.P. Bachynski, Addison-Wesley Publishing Co., 518 pp., \$17.50

The authors, who work at the RCA Victor Research Labs in Montreal, apply the fundamentals of particle kinetics in gas plasmas to develop basic equations for plasmas under a variety of conditions.

**Electron Diffraction and the Nature of Defects in Crystals**, Pergamon Press, not paged, \$14

Extended abstracts (two and four pages long) of papers presented at a double-barreled conference in Melbourne, Australia, in August, 1965.

**RADITE from RDC**

FOR DEPENDABILITY IN MICROWAVE ABSORPTION STOCK AND FUNCTIONAL PARTS

Prompt delivery on standard or engineered Radite products.



Bar and Plate Stock

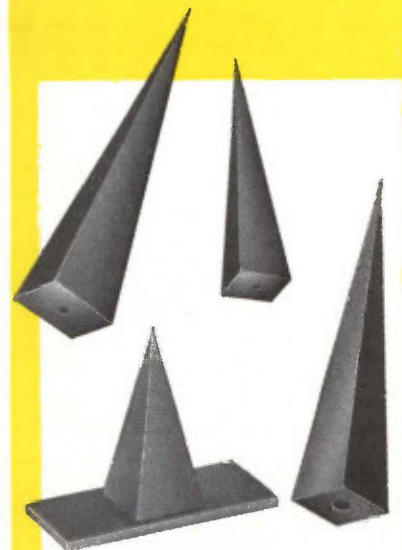

Broadband Load Inserts



**5-YEAR WARRANTY** on every RDC product! For the first time in the microwave industry, this additional assurance of reliability.

A Complete Source for Microwave Components.



Send for complete information...  
**RADAR DESIGN CORPORATION**  
 510 PICKARD DR. ■ SYRACUSE, N.Y. 13211  
 PHONE: 315-454-4418

Circle 323 on reader service card



# space-saving controllers



Compack I

Compack II

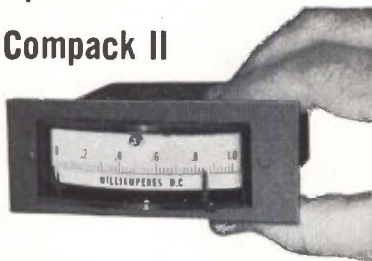

## Same Circuitry... Different Housing

These two new API controllers operate off any common variable that puts out a current or voltage signal—AC, DC, or temperature (thermocouple). They're completely self-contained.

Signals don't require amplification—hence they don't get distorted. Signal noise isn't a bugaboo because input and output are completely isolated. Infinite common mode rejection, which is inherent, prevents units from confusing each other.

Simply choose the controller whose configuration best fits your application, either OEM or in-plant. Its price is as small as its size.

### Note these features:

- Solid-state circuitry designed to fail safe.
- Continuous indication over entire dial.
- Taut-band meter movement in sensitive ranges is highly repeatable, sensitive, long-lived.
- Electrical cold-junction compensation for pyrometers.
- On/Off, cycling or limit control—plus time-proportioning and 5CR driver models in pyrometers.
- Load relays rated at 5 amperes, 125 VAC.
- Compack I offers 3 sizes of meter cases—3¼", 4½", 5½". Circular cutout only 2.82" dia.
- Compack II panel dimensions 4.19" x 1.4".

Ask for Bulletin 48

**api**  
**INSTRUMENTS CO.**  
Formerly Assembly Products, Inc.

CHESTERLAND, OHIO • PHONE: 216-423-3131

## Technical Abstracts

### Frequency finder

Using frequency synthesizers to evaluate other precision frequency sources

Atherton Noyes Jr.  
General Radio Co.  
Bolton, Mass.

Unknown frequencies can be measured and displayed instantaneously if a frequency synthesizer is used as a measuring instrument as well as a signal source. The accuracy of the measurement is as good as that of the synthesizer and the frequency measured is limited only by the range of the synthesizer.

Frequencies are generally measured by counting or heterodyning methods. Counting has the disadvantage of giving only the average frequency during the counting interval. It also requires a long interval to resolve the measurement to fractions of a hertz. But it does provide measurement in discrete steps. Heterodyning gives instantaneous measurement, but not discrete steps.

With a frequency synthesizer, discrete frequencies can be measured instantaneously, by finding the zero beat—or direct match—between the unknown frequency and that set on the synthesizer. The synthesizer acts as a frequency standard whose output is equal to the unknown one, or an exact multiple or submultiple of the unknown frequency.

The instant at which a match is found can be determined on an oscilloscope by watching the Lissajous figure. For example, if two stable and supposedly identical frequencies differ by only one millihertz, the discrepancy is apparent in the one-to-one goose egg pattern on the scope. Any phase jitter present will also be apparent. The discrepancy in the frequencies can be determined by adjusting the synthesizer until the Lissajous pattern is a normal one.

The counting technique would require 1,000 seconds to determine that a 1-millihertz discrepancy existed. Any momentary wandering of the unknown frequency during this time would be obscured in the averaging process and could only

be detected after many repetitive measurements and statistical analysis of the results.

Suitable frequency synthesizers include those which resolve in steps any desired frequency by means of a repetitive series of circuits. Several available synthesizers of this type have independent controls for setting each digit in the number that defines the output frequency. Most of the available synthesizers also contain a voltage-tunable oscillator that can be continuously adjusted and inserted into the digit train to replace any of the step-adjusted digits.

Since frequency synthesizers are standard laboratory instruments, their use as a measuring device can supplant conventional instruments like error multipliers—used only to compare two frequencies.

Presented at the 21st Annual Instrument Society Conference and Exhibit, New York, Oct. 24-27.

### F-m recording

A period modulated carrier technique for data recording  
M.A. Maclean  
Defense Research Telecommunications Establishment, Ottawa, Ontario

Linearly modulating the period of a carrier overcomes the harmonic generation problem posed by conventional frequency-modulation recorders when the signals recorded have very low frequency components. A harmonic suppression filter isn't needed in the recorder's discriminator and deficiencies in low-frequency response and linearity are bypassed.

The linearly modulated signal provides the discriminator with two independent pieces of timing information—the intervals between peaks of the playback waveform and between zero crossings of the waveform. The duration of each half cycle is a linear function of the amplitude of the signal waveform at the end of a half cycle.

Each reversal of the carrier causes the discriminator to sample a linear voltage ramp. The samples and a peak detector ahead of the demodulator are used to recon-



# Metronix



## SINE/SQUARE OSCILLATOR

MODEL **311** \$71.<sup>50</sup> (FOB JAPAN)

5Hz ~ 560kHz, 600 Ω



## HIGH SENSITIVE AC VTVM

MODEL **121** \$66.<sup>50</sup> (FOB JAPAN)

full scale 1.5mV ~ 500V, 5Hz ~ 500kHz

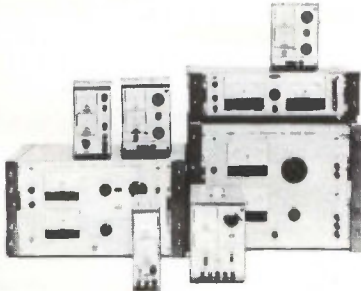

## REGULATED DC POWER SUPPLIES

29 models are available. For particulars, please apply for catalog.

RIPPLE: 3mVpp

MODEL	VOLTS	AMPS	REGULATION (line or load)	FOB JAPAN \$
521A	1~18V	0.5A	±20mV	41.50
541A	1~35V	0.25A	±20mV	46.50
543	1~35V	0.5A	±20mV	73.50
531B	0~35V	1 A	±10mV	84.00
535C	0~35V	5 A	± 3mV	250.00

Specialized dealers wanted:  
Write today for details.

**Metronix corp.**

76, CHOFU-CHIDORI-CHO, OTA-KU, TOKYO

struct the original signal.

Second harmonic output is low because the durations of the carrier half cycles are equal. However, the positive and negative cycles must be symmetrical to prevent noise.

Presented at the Aerospace and Electronics Conference, Washington, Oct. 3-6.

### Combining network

40-watt solid state uhf transmitter  
R.A. Gardenghi and W.R. Olson  
Westinghouse Electric Corp.,  
Baltimore, Md.

Although the maximum power output of available ultrahigh-frequency transistors was only five watts, a solid-state transmitter was built that delivers up to 40 watts at 225 to 400 megahertz. The outputs of eight transistors were combined. At lower frequencies, the outputs of up to 60 transistors have been combined.

The basic module in the power stages is a 5-watt amplifier built with a 2N3375 transistor. Gain ranges from 8 decibels at 225 Mhz to nearly 4 db at 400 Mhz. One module forms the first stage, two the predriver stage, four the driver stage and eight the output amplifier. The module outputs are tuned at the outputs of the power combiner networks.

Combining networks are made of transmission-line transformers. N coherent sources are connected to a load,  $Z_L$ , through a quarter-wave transmission line whose characteristic impedance equals  $NZ_L$ . Isolation between sources is achieved by a star arrangement of resistances equal to  $Z_L$  with one point of the star attached to each output. No power is dissipated in the star as long as the sources at each input are coherent.

The 2:1 combiner consists of two quarter-wave transmission lines tied together at one end and having a 100-ohm resistor between the other ends. The 4:1 combiner also follows the basic design. The 8:1 combiner is made from two 4:1 combiners and one 2:1 combiner. Turned around, the combiners function as dividers.

An appropriate sequence of combiners and dividers is used to combine the power from each stage, share it among the amplifiers of the succeeding stage and combine the final outputs. The modulation

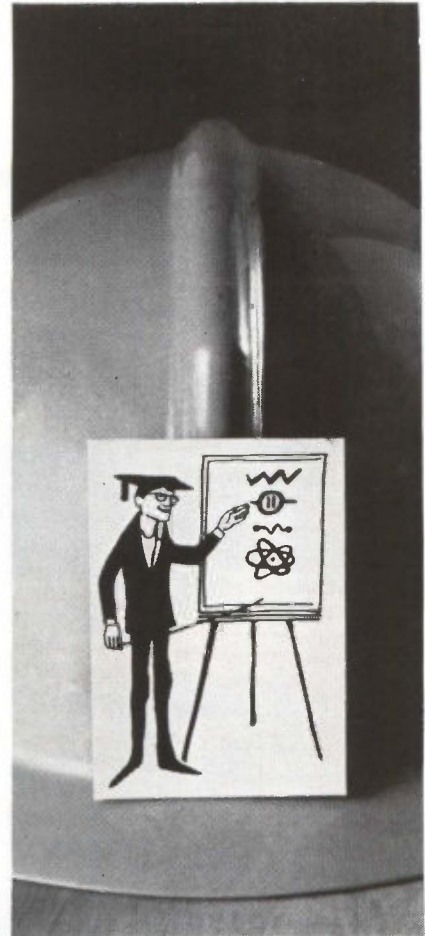

## workability

(pre-production training)



WESTern PENNSylvania has a proved-in-use plan by which adaptable, productive people with a variety of industrial aptitudes will be trained in advance for YOUR operation, usually at no cost to you. You can also save on labor-turnover costs in WESTern PENNSylvania where the "Voluntary Quit rate" is only one-third the national average. This workability and training program . . . plus 100% financing at low, low interest rates . . . fair tax climate . . . four-season livability . . . give WESTern PENNSylvania a top combination of plant-location values.

### West Penn Power

Part of the Allegheny Power System

Area Development Department, Room 663  
WEST PENN POWER—Greensburg, Pa. 15601  
Phone: 412—837-3000

In strict confidence, I'd like to know more about WESTern PENNSylvania's:  Pre-Production Training  Financing Plans  Fair Tax Climate  Industrial Properties and Shell Buildings  
 Please have your Plant Location Specialist call.

Name \_\_\_\_\_

Title \_\_\_\_\_

Company \_\_\_\_\_

Address \_\_\_\_\_

City \_\_\_\_\_ State \_\_\_\_\_

Zip Code \_\_\_\_\_ Phone \_\_\_\_\_



**CONTROL ENVIRONMENTS**  
with **K·S·E**  
**ENCLOSURES**

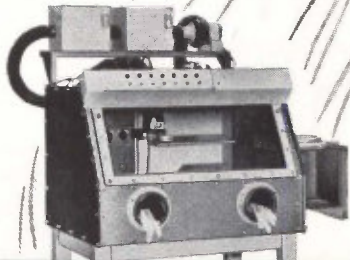

**RADIOCHEMISTRY**  
No. 2C351-20 and 28

The CBR laboratory shown is primarily set for use with alpha or weak beta emitters.

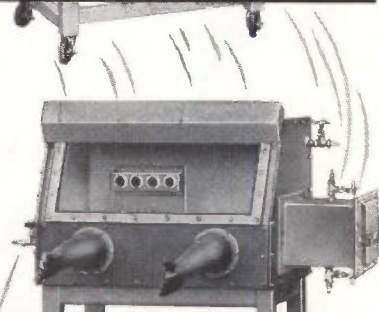

**CONTROLLED ATMOSPHERE**  
No. 2C381-20 and 28

This totally enclosed and controlled enclosure operates at a slight positive pressure of any selected environmental atmosphere.

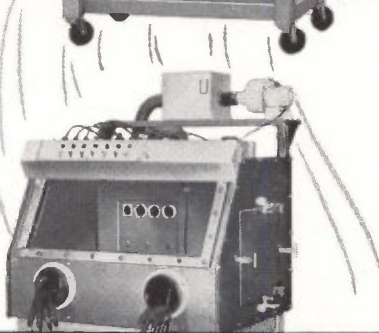

**BACTERIOLOGY AND VIROLOGY**  
No. 2C361

Both the product and the worker are equally protected at all times during the processing.

If we don't show the exact enclosure you need, "the odds are" we can adapt to your laboratory or production needs from stock parts. Send for our catalog... No obligation.

**K·S·E**

KEWAUNEE  
SCIENTIFIC  
EQUIPMENT  
ADRIAN,  
MICHIGAN

4015 LOGAN STREET

**Technical Abstracts**

signals are applied to the collectors of the drivers and output transistors.

Over-all, the system provides the 53 db of gain needed for a continuous-wave output of 40 watts or 10 watts of carrier output for amplitude modulation. It can also be used as a phase or frequency modulated amplifier.

Presented at the National Electronics Conference Chicago, Oct. 3-5

**Tuned antennas**

The rectangular cavity slot antenna— theory and design  
A.T. Adams,  
Syracuse University, Syracuse, N.Y.

Experiments indicate that cavity backed slot antennas can be tuned over a broad band with an applied magnetic field when the antenna is loaded with dielectric, powdered ferrite or solid ferrite.

To build a foundation for his report on the experimental antennas, the author first describes admittance characteristics and calculations, followed by design guides and optimization procedures for operating frequency, bandwidth and efficiency. Experimental data on aperture admittance and operating frequency agreed within a few percent of theoretical data. Efficiency was within 10% of calculations and bandwidth within 20%.

Several different models were made, for operation at frequencies around 300 megahertz. In size and weight, the models were far smaller than air-loaded antennas—as small as 15 cubic inches for an antenna loaded with solid ferrite compared with 2,250 cubic inches for an air-loaded antenna. However, bandwidth and efficiency were also lower. Bandwidth ranged from about one-third to one-sixth that of the large antenna. Efficiency ranged from 30% to 85% compared with 90% for the air-loaded antenna. Directivity was 5 decibels compared with 5.8 db.

The resonant frequency of a ferrite-loaded antenna was raised from 243 Mhz to 320 Mhz, by increasing the applied magnetic field from zero to above one kilogauss.

Presented at the National Electronics Conference, Chicago, Oct. 3-5

**72 HOUR DELIVERY**

ON THESE



REGULATED DC  
**POWER SUPPLIES**

- Fully accessible, fully repairable
- Large quantity discounts
- Low Cost
- 0.5 to 60 vdc coverage
- 0.05% or 0.5% combined regulation
- Temperature coefficient from  $\pm 0.1\%/^{\circ}\text{C}$
- Two year warranty
- Many optional modifications

See 1966-67 EEM pages 1632-1633



**DYNAGE, INC.**  
390 CAPITOL AVENUE, HARTFORD, CONN. 06106  
TELEPHONE (203) 249-5654

Circle 559 on reader service card

**More torque,  
Less weight**

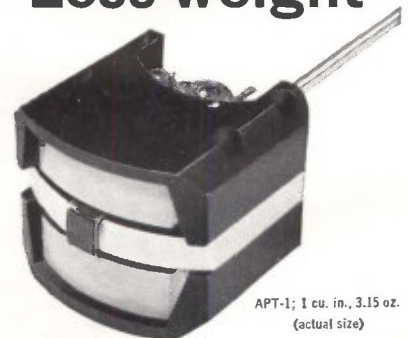

APT-1; 1 cu. in., 3.15 oz.  
(actual size)

**in moving coil mechanism**

Stable, linear, accurate mechanism for indicating, control or recording systems. 1% linearity over 18-0-18° and greater accuracy assured by coil design with over 75% of winding "working" in high energy, uniform field air gap. Coil system weighs 0.85 gm, develops 26.4 mmg of torque; 31:1 T/W. Vibration resonance negligible; acceleration errors sharply attenuated. Standard pivots and jewels—custom damping—wide range of sensitivities.

**AMMON**

AMMON INSTRUMENTS, INC.  
345 Kelley Street, Manchester, N. H. 03105

Circle 560 on reader service card



## New Literature

**MOS monolithic subsystems.** Philco-Ford Corp., a subsidiary of Ford Motor Co., 2920 San Ysidro Way, Santa Clara, Calif., 95051. A booklet compiled by the company's engineering staff serves as an introduction to the metal oxide silicon monolithic subsystem, a device that offers the same advantages over the conventional double-diffused IC that the transistor originally had over the tube. Circle 420 on reader service card.

**A-c to d-c converter.** North Atlantic Industries, Inc., Terminal Drive, Plainview, N.Y., has issued a two-page data sheet on the model PSC-419, a phase-sensitive a-c to d-c converter. [421]

**Engineering plastics.** General Electric Co., Pittsfield, Mass. Brochure CDC-450 lists the mechanical, electrical and thermal properties of Lexan polycarbonate resin, PPO polyphenylene oxide resin, Noryl resin and phenolic molding compounds. [422]

**Basic reed switch unit.** MicroSwitch, a division of Honeywell, Inc., 11 W. Spring St., Freeport, Ill., 61032, has a bulletin on the 1KM series miniature basic dry reed switch unit, that contains two reed switches and a spring-loaded permanent magnet attached to the switch plunger. [423]

**Microwave swept oscillators.** E-H Research Laboratories, Inc., 163 Adeline St., Oakland, Calif., 94607, has issued a six-page color brochure on the model 570 series microwave swept oscillators which cover the 1 to 40-Ghz range. [424]

**Precision fine wire facilities.** Fort Wayne Metals, Inc., 3211 MacArthur Drive, Fort Wayne, Ind., 46809. A four-page brochure, Monograph No. 1, describes the company's facilities to manufacture drawn brazed-strand precision alloy wire. [425]

**Switches.** The Digitran Co., 855 South Arroyo Parkway, Pasadena, Calif., offers a 54-page thumbwheel switch catalog that includes descriptions of all Digitrans and Miniswitch units with complete technical data on each. [426]

**R-f terminations.** Bird Electronic Corp., 30303 Aurora Road, Cleveland, Ohio 44139. Catalog TLR-5-600-66 lists the company's line of dry and oil-cooled terminations in the power ranges between 5 watts and 600 watts. [427]

**Transistor parameter measurements.** Hewlett-Packard Co., 1501 Page Mill Road, Palo Alto, Calif., 94304. Application Note 77-1 describes an important scattering technique for measuring the characteristics of transistors in the 100 to 1,000 Mhz range. [428]

**Differential amplifier.** Computer Test

Corp., Cherry Hill, N.J. Engineering bulletin 66-1 describes model 2261, a differential sense amplifier with a 50-Mhz upper bandpass. [429]

**Electronic kits.** Heath Co., Benton Harbor, Mich., has available the 108-page 1967 edition of the Heathkit catalog, illustrating over 250 easy-to-build electronic kits. [430]

**Resistor networks.** CTS Research, Inc., 1201 Cumberland Ave., West Lafayette, Ind. Data sheet 3770 gives complete technical details on a line of high-power resistor networks with cermet reliability. [431]

**IC logic cards.** Engineered Electronics Co., 1401 East Chestnut Ave., Santa Ana, Calif., 92702, has published a 20-page technical catalog describing dual in-line integrated-circuit logic cards and related equipment. [432]

**Backward-wave oscillators.** Watkins-Johnson Co., 3333 Hillview Ave., Palo Alto, Calif., 94304. A four-page folder illustrates and describes backward-wave oscillators for military and commercial applications. [433]

**Germanium transistors.** General Instrument Corp., Semiconductor Products Group, 600 W. John St., Hicksville, N.Y., 11802. A comprehensive germanium transistor application guide lists over 130 types manufactured by the company. [434]

**Power supplies.** Electronic Research Associates, Inc., 67 Sand Park Road, Cedar Grove, N.J., 07009. A catalog presents a complete range of power supplies including a-c to d-c, d-c to a-c, a-c to a-c and d-c to d-c models for industry and the military. [435]

**Decade counter.** United Computer Co., 930 W. 23rd St., Unit 8, Tempe, Ariz., 85281, has published a bulletin on the model 1841B decade counter, a compact unit featuring 3-v operation, high reliability integrated circuits, plus 8-line BCD output. [436]

**Economy semiconductors.** Texas Instruments Incorporated, P.O. Box 5012, Dallas, Tex., A 12-page booklet covers product characteristics, application advantages and typical uses of plastic-encapsulated, economy semiconductors for commercial, military and industrial purposes. [437]

**Millisecond operation recorder.** Fischer & Porter Co., 997 Jacksonville Road, Warminster, Pa., 18974. Specification sheet 30A1400 describes the MOR (millisecond operation recorder) that provides an automatic, permanent record of plant operations. [438]

**Servo analyzer.** Canoga Electronics Corp., 8966 Comanche Ave., Chats-

# DUAL OUTPUT POWER SUPPLIES

Guaranteed  
3-DAY  
Shipment!

Dual output power supplies are housed in one case 3-5/16" x 4-5/32" x 4-11/16" high. Identical or different output voltages from 1.5 to 75 are available in 1 volt increments for each of the DC outputs. The graph below furnishes maximum current corresponding to output voltage. Select the two outputs needed and telephone Acopian for all the details — plus guaranteed 3-day shipment after receipt of your order.

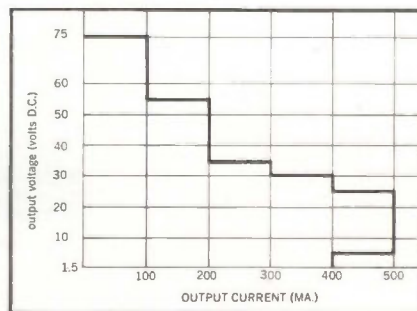

### TYPICAL SPECIFICATIONS

Input Voltage: 105 to 125 VAC

Line Regulation:  $\pm 0.5$  to  $\pm 0.05\%$   
(depending on model)

Load Regulation:  $\pm 1.0$  to  $\pm 0.05\%$   
(depending on model)

Ripple: 5 to 1 mv (depending on model)

No additional external heat sinking required.

Write for Acopian's 16-page catalog and price list to: Acopian Corp., Easton, Penna., or call collect (215) 258-5441.

**Acopian**



# HATHAWAY

## NO. 1 DRIVEED RELAY



# can take it

Predictable performance through the spectrum is made possible by our Controlled Reed process. Whether single function or in multiple form applications, these relays will contribute greatly to optimum system performance. To 300 MHz— $\mu$ A to .5A in the same integrated switching package if desired. Write for new condensed catalog.

**HATHAWAY INSTRUMENTS, INC.**

5250 EAST EVANS AVENUE  
DENVER, COLORADO 80222  
(303) 756-9301 • TWX 292-2935

Distributed Nationally by  
**COMPAR CORPORATION**

### New Literature

worth, Calif., 91311, has issued a two-page data sheet on the model 910A Servodyne, a general purpose servo analyzer. [439]

**Custom power supplies.** Sola Electric division of Sola Basic Industries, 1717 Busse Rd., Elk Grove Village, Ill. Custom-designed power supplies are described in 24-page brochure PS-100. [440]

**Solid state counters.** Anadex Instruments Inc., 7833 Haskell Ave., Van Nuys, Calif., has available a six-page catalog dealing with over 30 standard and special application solid-state counters. [441]

**Bandpass variable filter.** Krohn-Hite Corp., 580 Massachusetts Ave., Cambridge, Mass., 02139. A two-page technical data sheet describes the model 3100 solid-state, bandpass variable filter. [442]

**D-c to a-c converters.** Carter Motor Co., 2762A W. George St., Chicago, Ill., 60618, has released its 1967 catalog, No. 167, covering a line of d-c to a-c converters. [443]

**Electron tubes.** Amperex Electronic Corp., Hicksville, L.I., N.Y., 11802. A condensed catalog, containing descriptions and basic specifications of the company's tube line, serves as a quick reference guide for designers as well as for replacement tube buyers. [444]

**Resistors.** Dale Electronics, Inc., Box 609, Columbus, Neb., 68601, has available a 48-page catalog covering its entire line of standard wire-wound and film resistors. [445]

**Relays.** Adams & Westlake Co., Elkhart, Ind., 46514. Characteristics of an extensive line of mercury-wetted contact relays are discussed in a revised 22-page catalog. [446]

**Camera channel.** The Marconi Co., Ltd., Basildon, Essex, England, offers a brochure that illustrates and describes the V321 vidicon camera channel, which consists basically of a camera and a control unit interconnected by a multi-colored cable. [447]

**Analog modules.** Burr-Brown Research Corp., International Airport Industrial Park, Tucson, Ariz., 85706, offers a catalog describing several broad lines of analog modules including operational amplifiers, function modules, instrumentation amplifiers, power supplies and accessories. [448]

**Deflection yokes.** Syntronic Instruments, Inc., 100 Industrial Road, Addison, Ill. Bulletin 66-6 discusses two new shielded, scan-converter deflection yokes designed for 1½-in. neck diameter scan-converter storage tubes. [449]

## NORTON Magnetic Tape Heads



2502—  
¼" Tape

2504—½" Tape

2507—1" Tape

### SERIES 2500

- CROSSTALK—60DB
- +75°C Temperature Operation

Send now for complete technical literature.

**NORTON**  
ASSOCIATES, INC.

240 Old Country Road, Hicksville, N. Y.

Circle 561 on reader service card

### PLASTICS/CERAMICS for ELECTRONICS CONDENSED CATALOG



New folder describes product lines—casting resins, adhesives, foams, sheet stock, coatings, silicones, microwave absorbers, anechoic chambers, shielding materials, etc. Post card included for obtaining more details.

Write or Use Reader Service Card

**EMERSON & CUMING, INC.**

Canton, Mass.

604 W. 182nd St.  
Gordena, Calif.

3450 Commercial Ave.  
Northbrook, Ill.

Emerson & Cuming Europe N. V.  
Oevel, Belgium





See For Yourself  
By Testing Sankyo's  
Family Of Micro Motors!

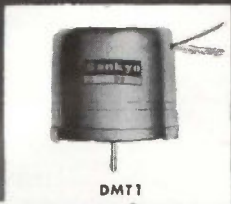

DMT1



MMP55

- DMT1.....Single speed (2400rpm). With flat Sealed case. For medium grade tape recorders.  
MMS51.....Single speed (3000rpm). For high grade tape recorders.  
MMP55.....2 speeds. (2700, 4800 rpm). For 8mm cameras.  
MMZ6.....Without governor. For Still and 8mm cameras

SPECIFICATIONS FOR SANKYO MICRO MOTORS

	Dimension (mm) φ Length	Rated Voltage (V)	Range of Voltage (V)	Rated Torque (gr-cm)
DMT1	42 x 37	6	4.5 - 6	9
DMY15	42 x 37	6	4.5 - 6	15
DMY50	42 x 37	12	8 - 12	15
MMS44	25 x 55.5	9	6 - 10	10
MMS51	25 x 55.5	6	4.5 - 6.3	7
MMP55	20 x 45	4.5	4 - 6	10
MMZ6	16 x 29	4	4 - 6	2

	Rated Speed (rpm)	No Load Current (mA)	Load Current (mA)	Starting Torque (gr-cm)	Life (Hr)
DMT1	2400	40	130	25(4.5V)	600
DMY15	2400	50	200	50(4.5V)	600
DMY50	2400	50	130	50(8V)	600
MMS44	3000	40	140	20(6V)	600
MMS51	3000 (2900)	50	140	25(4.5V)	1000
MMP55	2700 4800	(110)	(290)	60(4.5V)	50
MMZ6	6000 11500	(100)	120	15(4V)	100

# Sankyo

## Motor Department

AMERICAN SANKYO CORP.: Rm. 808-10, 95 Madison Ave., N.Y.C., N.Y., U.S.A. Tel: LE-2-8020  
SANKYO (EUROPE) EXPORT-IMPORT G.M.B.H.: 4 Düsseldorf, Bahnstraße 45-47, W. Germany Tel: 25652/3  
SANKYO SEIKI MFG. CO., LTD.: Shimbashi, Tokyo, Japan. Tel. 591-8371

## New Literature

Adjustable stop switches. RCL Electronics, Inc., One Hixon Place, Maplewood, N.J., 07040. A four-page bulletin contains information on a series of 1/2-in. rotary switches with adjustable stops. [450]

Pressure transducer. Taber Instrument Corp., 107 Goundry St., North Tonawanda, N.Y. Product sheet P-66F7 gives specifications for the F-7, a general purpose pressure transducer. [451]

Tape recorder/reproducer. Leach Corp., 1123 Wilshire Blvd., Los Angeles, Calif., 90017. An eight-page brochure details complete data on a 54-lb portable tape recorder/reproducer that provides instrumentation-quality recording, storage and reproduction of direct, f-m and digital data. [452]

Amplifier and power supply. Massa division, Dynamics Corp. of America, 280 Lincoln St., Hingham, Mass., 02043, has available a data sheet on the model AM-1, a 60-db solid state amplifier and power supply. [453]

IC products. Cambridge Thermionic Corp., 445 Concord Ave., Cambridge, Mass., 02138. Two new product folders introduce a comprehensive line of advanced integrated circuit logic assemblies and accessories. [454]

Counter-display instrument. Janus Control Corp., 296 Newton St., Waltham, Mass. Bulletin A076-022 describes the model 650/630, a 5-Mhz, bidirectional digital counter-display instrument. [455]

Pressure transducers. Sparton Corp., P.O. Box 1784, Albuquerque, N.M. Product data sheets 19 and 20 give detailed descriptions and specifications on the types 880 and 890 pressure transducers for use in aerospace and severe environments. [456]

Mixer/modulator. Aertech, 250 Polaris Ave., Mountain View, Calif. A data sheet covers specifications and applications information for model MX500, a vhf mixer/modulator. [457]

Operational amplifiers. Analog Devices, Inc., 221 Fifth St., Cambridge, Mass., offers an application note, which is part 4 of a series entitled "Offset And Drift In Operational Amplifiers." [458]

Power supplies. Elasco Inc., 33 Simmons St., Boston, Mass., 02120. Bulletin 666 describes the 2MS series of dual-source power supplies and the Q series of Microsource power supplies. [459]

Microminature relays. C.P. Clare & Co., 3101 Pratt Blvd., Chicago, Ill., 60645. Type MF (sixth-size) crystal can relays are described in detail in data sheet No. 756. [460]

# VHF/UHF RECEIVERS

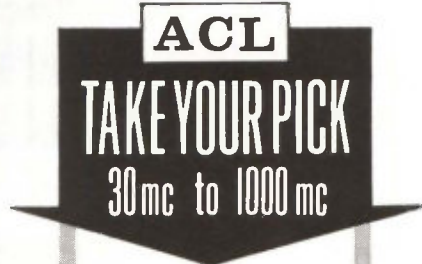

WITH  
PLUG-INS  
TYPE SR-209

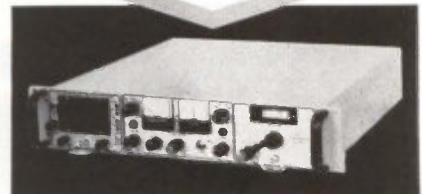

WITHOUT  
PLUG-INS  
TYPE SR-212

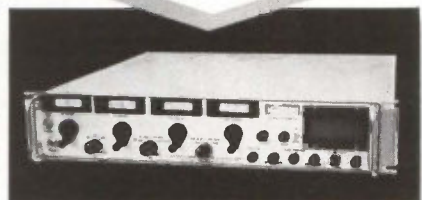

FOR PRECISION  
SPECIAL PURPOSE RECEIVERS  
CONTACT ACL

From 2mc to 4000mc ACL has a receiving system to meet your requirements. They are all SOLID STATE-MODULAR construction with greater reliability and proven outstanding performance.

**ACL** ASTRO COMMUNICATION LABORATORY INC.

801 Gaither Road  
Gaithersburg, Maryland 20760  
Phone: (301) 948-5210 TWX 710-828-9706  
"RF Equipment for The Systems Engineer"



FOR THE NEW ADVANCES IN AVIONICS—KEEP AN EYE ON



## With all the companies offering the same positions, how do you find the right one?

Look to the company consistently active in major projects. Lear Siegler hardware is involved in all the significant aerospace programs. LSI Instrument Division products are currently in use on over 70 aircraft, spacecraft and missiles. And, we have been actively applying new concepts in the design and production of advanced flight navigation and reference systems and cockpit displays for more than 30 years.

Exercise and elbow room are what you get at LSI. In a half-million square feet of newly-completed aerospace facilities. For the right position: **CIRCUIT DESIGN ENGINEERS — TEST EQUIPMENT DESIGN ENGINEERS — NAVIGATION & COMMUNICATIONS SYSTEMS ENGINEERS—A.G.E. DESIGN ENGINEERS . . .** send your resume in confidence, or write for information to:

E. B. Mellinger  
Professional Employment Manager

LEAR SIEGLER, INC.



INSTRUMENT DIVISION

4141 EASTERN AVE., S. E., GRAND RAPIDS, MICHIGAN 49508

## INSTRUMENT TECHNICIANS

### THE OAK RIDGE NATIONAL LABORATORY

Highly skilled instrument technicians to assist in the installation and maintenance of process control instrumentation systems and devices for chemical pilot plants, nuclear reactors and other large experimental installations.

High school education, plus additional training in either the physical sciences, instrumentation, or electronics, and at least 4 years experience in installation and maintenance of complex instrumentation and control systems. Entrance rate \$3.39 per hour; \$3.45 per hour after six months. Reasonable interview and relocation expenses paid by Company.

Excellent Working Conditions  
and  
Employee Benefit Plans  
An Equal Opportunity Employer

Send detailed resume to:  
Central Employment Office  
**UNION CARBIDE CORPORATION**  
Nuclear Division  
P. O. Box M  
Oak Ridge, Tennessee 37830



**E.E.'s**  
For FEE PAID positions  
throughout U.S.  
Send Coupon Today  
**ATOMIC PERSONNEL, INC.**  
Suite L, 1518 Walnut St., Phila., Pa.  
Experienced Engineers... Working  
"Full Time"... For You!

Send resume today. (If none, send coupon for confidential application.)

Name \_\_\_\_\_

Address \_\_\_\_\_

City \_\_\_\_\_ State \_\_\_\_\_

EMPLOYMENT

# Electronics

OPPORTUNITIES

## QUALIFICATION FORM FOR POSITIONS AVAILABLE

### ATTENTION: ENGINEERS, SCIENTISTS, PHYSICISTS

This Qualification Form is designed to help you advance in the electronics industry. It is unique and compact. Designed with the assistance of professional personnel management, it isolates specific experience in electronics and deals only in essential background information. The advertisers listed here are seeking professional experience. Fill in the Qualification Form below.

**STRICTLY CONFIDENTIAL:** Your Qualification form will be handled as "Strictly Confidential" by Electronics. Our processing system is such that your form will be forwarded within 24 hours to the proper executives in the companies you select. You will be contacted at your home by the interested companies.

**WHAT TO DO.** (1.) Review the positions in the advertisements. (2.) Select those for which you qualify. (3.) Notice the key numbers. (4.) Circle the corresponding key number below the Qualification Form. (5.) Fill out the form completely. Please print clearly. (6.) Mail to: Classified Advtg. Div., Electronics, Box 12, N. Y. 10036.

COMPANY	Page #	KEY #
ATOMIC PERSONNEL, INC.	330	1
CONDUCTRON-MISSOURI	147*	2
GENERAL DYNAMICS Electronics Div.	145*	3
GENERAL DYNAMICS Fort Worth	246	4
GENERAL ELECTRIC	146*	5
GRUMMAN AIRCRAFT	332	6
HAVAS INTERNATIONAL	335	7

COMPANY	Page #	KEY #
IBM CORP. Boulder, Colo.	332	8
LEAR SIEGLER, INC.	330	9
LOCKEED-CALIFORNIA CO.	242	10
LOCKHEED MISSILES & SPACE CO.	254	11
MARTIN COMPANY	210	12
PHILCO TECH. REP.	273	13
RAYTHEON CO.	334	14
SANDERS ASSOCIATES, INC.	333	15
SYLVANIA ELECTRONICS PRODUCTS, INC.	251	16
UNION CARBIDE CORP.	330	17
V-M CORP.	147*	18

\* These advertisements appeared in the Oct. 31st issue.

### PERSONAL BACKGROUND

Name \_\_\_\_\_

Home Address \_\_\_\_\_

City \_\_\_\_\_ Zone \_\_\_\_\_ State \_\_\_\_\_

Home Telephone \_\_\_\_\_

### EDUCATION

Professional Degree(s) \_\_\_\_\_

Major(s) \_\_\_\_\_

University \_\_\_\_\_

Date(s) \_\_\_\_\_

### FIELDS OF EXPERIENCE (Please Check) 11-14-66

<input type="checkbox"/> Aerospace	<input type="checkbox"/> Medicine
<input type="checkbox"/> Antennas	<input type="checkbox"/> Microwave
<input type="checkbox"/> ASW	<input type="checkbox"/> Navigation
<input type="checkbox"/> Circuits	<input type="checkbox"/> Operation Research
<input type="checkbox"/> Communications	<input type="checkbox"/> Optics
<input type="checkbox"/> Components	<input type="checkbox"/> Packaging
<input type="checkbox"/> Computers	<input type="checkbox"/> Radar
<input type="checkbox"/> ECM	<input type="checkbox"/> Radio—TV
<input type="checkbox"/> Electron Tubes	<input type="checkbox"/> Simulators
<input type="checkbox"/> Engineering Writing	<input type="checkbox"/> Solid State
<input type="checkbox"/> Fire Control	<input type="checkbox"/> Telemetry
<input type="checkbox"/> Human Factors	<input type="checkbox"/> Transformers
<input type="checkbox"/> Infrared	<input type="checkbox"/> Other _____
<input type="checkbox"/> Instrumentation	<input type="checkbox"/> _____

### CATEGORY OF SPECIALIZATION

Please Indicate number of months experience on proper lines.

	Technical Experience (Months)	Supervisory Experience (Months)
RESEARCH (pure, fundamental, basic)	.....	.....
RESEARCH (Applied)	.....	.....
SYSTEMS (New Concepts)	.....	.....
DEVELOPMENT (Model)	.....	.....
DESIGN (Products)	.....	.....
MANUFACTURING (Product)	.....	.....
FIELD (Service)	.....	.....
SALES (Proposals & Products)	.....	.....

CIRCLE KEY NUMBERS OF ABOVE COMPANIES' POSITIONS THAT INTEREST YOU 1 2 3 4 5 6 7 8 9 10 11 12 13 14 15 16 17 18 19 20 21 22

**POINT:** GROWTH POTENTIAL IS IMPORTANT TO YOUR FUTURE



## **FACT:**

### **G.E. CREATED 217 RADAR/SONAR JOBS IN 1965**

■ G.E.'s Heavy Military Electronics Department gives an engineer room to stretch-out . . . breathe . . . obtain professional growth and personal satisfaction. Your immediate contributions at HMED are but starting points to new responsibilities and challenges.

Our radar/sonar engineers need not adopt present successes as the ultimate. They can grow with their ideas—realizing that at least one-third of the products and equipment General Electric will be making in the 1970's are not in existence today. Just last year HMED created 217 engineering positions to support its new contracts and to meet its increased responsibility for designing and developing major radar/sonar systems.

Technical challenge, advanced education and fine community living—all this is part of the climate conducive to your professional growth at HMED. There is ample opportunity for creative work and self-expression thanks to the big and exciting radar/sonar defense contracts held by the Department. Formal graduate study, through our Tuition Refund Plan, is also available at educational facilities in the area; and a wide variety of "in-plant" technical courses are open to you each year. Our engineers and their families are able to take advantage of the excellent recreational activities in the Syracuse community, too.

**SEND FOR SPECIFIC JOB INFORMATION.** Remember, opportunities for growth and advancement are available in the radar/sonar field right now. To make sure we send the most appropriate job information, send a resume in confidence to: L. M. Bessant, Manager, Professional Placement, Box 45, Bldg. 4, Court Street, Heavy Military Electronics Department, General Electric Co., Syracuse, N. Y. 13201.

177-84

## **ACT:**

**WRITE NOW FOR MORE FACTS**

HEAVY MILITARY ELECTRONICS DEPARTMENT

**GENERAL  ELECTRIC**

*An Equal Opportunity Employer*



# FIELD ENGINEERS

## FOR EXTREMELY COMPLEX ELECTRONIC EQUIPMENTS



The A-6A Intruder now being produced by Grumman for the U. S. Navy is a unique system of airborne electronics, radar, computers, cockpit displays and inertial navigational systems. A low-level, terrain-following aircraft, it can, with a wide variety of means, detect and destroy targets completely obscured by weather or darkness.



The E-2A Hawkeye designed by Grumman for the U. S. Navy is an early warning and control aircraft. Housing radar, IFF detection, tracking, height finding, radio relay, automatic surveillance and data link equipment, the E-2A can fly higher and for longer duration than any other carrier-based early warning aircraft in existence.

The two aircraft described above contain some of the most advanced electronic equipment yet devised. Comprehensive training at Grumman and subsequent field experience with the equipment will prove a "badge" of extremely high technical proficiency to the talented Electronic Field Engineers we are seeking. Possessing the mental outlook found in leaders everywhere, successful candidates will require all-around drive and a desire to understand and master "systems." He may be ready to team captain now or develop this capacity as his comprehension of the equipment is achieved.

These are challenging career positions for qualified Weapons or ECM Systems Engineers experienced in search and track radars, computers, inertial guidance systems who are familiar with digital techniques and transistor circuits. BS degree in Electronics or Physics (or equivalent), with a minimum of 6 years' experience desirable. In-plant training will be given to the applicants chosen.

To arrange an immediate interview,  
SEND COMPREHENSIVE RESUME to Mr. Peter E. Van Putter  
Director of Employment, Dept. GR-76.



## GRUMMAN

AIRCRAFT ENGINEERING CORPORATION  
Bethpage • Long Island • New York

An equal opportunity employer, (M/F)

ADDRESS BOX NO. REPLIES TO: Box No.  
Classified Adv. Div. of this publication.  
Send to office nearest you.  
NEW YORK, N. Y. 10036: P. O. Box 12  
CHICAGO, Ill. 60611: 645 N. Michigan Ave.  
SAN FRANCISCO, Cal. 94111: 255 California St.

### POSITION VACANT

**Electronic Shop Supervisor** 3 years experience in nuclear instrumentation including multichannel analyzers. Job includes maintenance of nuclear reactor and counting room systems, and requires experience in interfacing. Position is with a university owned non-profit corporation with liberal fringe benefits. (An Equal Opportunity Employer) Contact: Mr. Paul T. Burnett, Operations Manager WNY Nuclear Research Center Power Drive, Buffalo, New York 14214.

### EMPLOYMENT SERVICES

Your Resume—Make it sell You! Instructions, samples: \$2. Executive, Box 246EL, Montclair, N.J. 07042.

**R.U.** <sup>1</sup> answering more than  
advertisement? Then please send a  
separate reply to each box number. It  
will help you get an answer sooner.

Skiing, Hunting,  
Beautiful Surroundings,  
Hiking, The University  
of Colorado, Culture,  
Stimulating People,  
A Tremendous Climate . . .

### And IBM Boulder, Colorado

Who could ask for anything more? You could, if you're looking for a career with a future.

And that's what you'll find at IBM's New Boulder, Colorado facility—an opportunity to develop and grow in your career as rapidly and as far as your talents and ambitions will allow.

You'll be working for one of America's leaders in science and technology. And you'll be working on almost everything new in the world today. New knowledge, new problems, and new solutions to older problems. But most of all you'll be working in a climate of creative freedom and career opportunity.

So ask for one thing more. An interview with an IBM representative. Openings exist in the following areas:

**Magnetic Head Design:** BSME or BSEE. Must have two years' experience in magnetic head design. Must be familiar with procedures required in magnetic head development, building and evaluation. Ferrite experience desired.

**Magnetic Head Manufacturing:** BSME or BSEE. Must have three years' experience in magnetic head manufacturing, including initial tooling and process control for product engineering work on magnetic heads in production.

**Electrical Engineers:** Must have experience in circuit design, digital and linear amplifiers, plus experience in magnetic recording, encoding and detection circuits.

**Quality Engineers:** BSEE, BSME with at least 2 years' experience in quality control. Must plan quality programs, perform design analysis, define quality oriented product. Experience in evaluation of data processing systems and statistical applications desirable.

Please write, outlining your qualifications and interests, to: Mr. K. E. McIntyre, Dept. 554Y2M, IBM Corporation, P.O. Box 1900, Boulder, Colorado. IBM is an equal opportunity employer.

# IBM



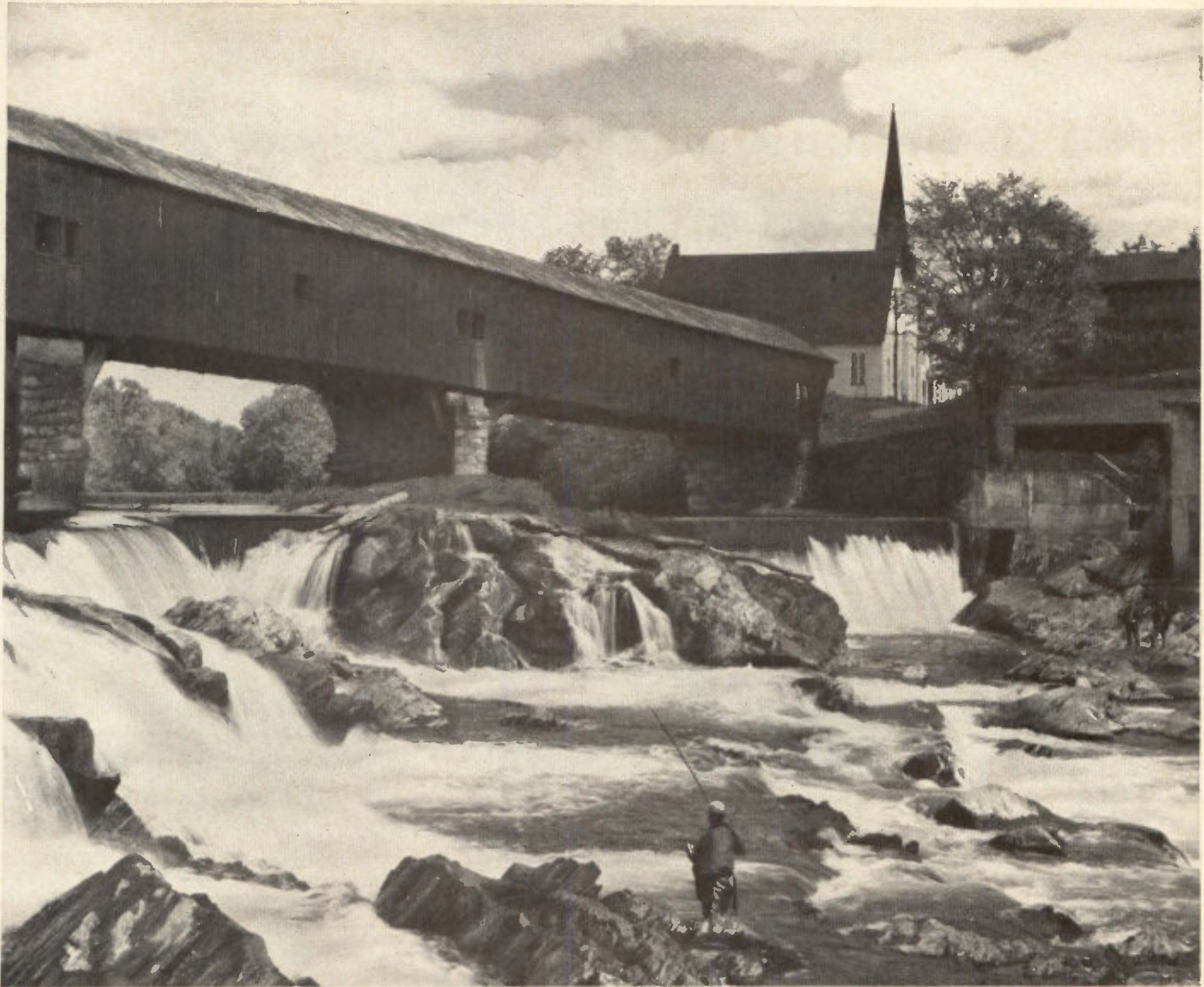

## decompression chamber

Around Nashua, New Hampshire, where we are located, the living is easy. No traffic jams. No housing problems. No worries about the quality of public education. Plenty of lakes, seashore and mountains close at hand. And for pleasure more urbane, Boston is no great distance away.

The economic pressure is off, too. There's no state income tax, and skills and services can be come by quite inexpensively.

About the job. You'll be working in depth; probably helping to evolve an advanced systems technology. The working atmosphere is free. (Should you ever find it especially heady, top management's door is always open.)

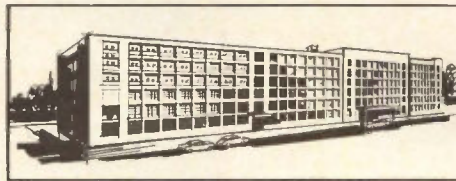

We're one of the top defense contractors in the country. Our electronics technology leads the field in many areas. We're heavy in: phased arrays and other radar; information handling and display; long range communications; oceanographic telemetering; electro-optics; lasers; instrumentation and control, microwaves, flexible printed circuits and systems-oriented, special-purpose hardware. Send us your resume. We'll show you what we mean about pressure-safe living and working at Sanders.

Immediate senior level openings exist in research, development, product design and manufacturing engineering. Write in confidence to Mr. Lloyd Ware, Staff Engineer.

# sanders associates, inc.

Nashua, New Hampshire



NEW DIRECTIONS IN  
ELECTRONICS SYSTEMS

An Equal Opportunity Employer



# Tired of building "paper" phased arrays?

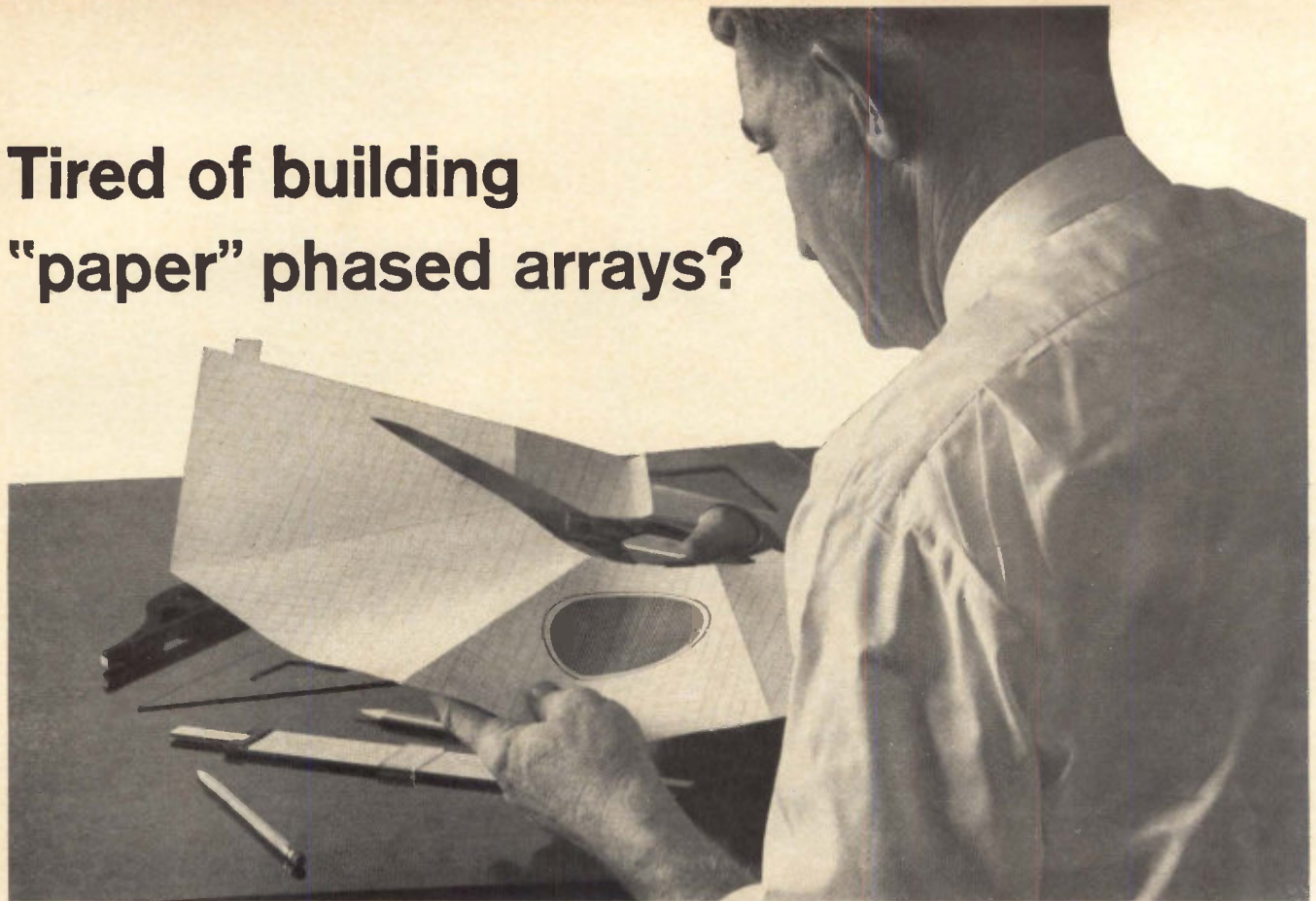

**GET HARDWARE-ORIENTED.** Move to where the action is . . . at Raytheon. We have worked on Phased Array systems for airborne, shipboard and ground-based applications. We've developed, built and tested radomes, arrays, beam steering computers, and components of all sizes and shapes. We have accumulated more hardware experience in this field than any of our competitors.

If you are tired of being a "paper tiger", you'll enjoy helping us build the hardware that is changing the face of radar. A variety of funded Phased Array programs are in urgent need of superior engineering skills: Nike-X (Missile Site Radar); NOTS Test Array; Overland Radar Program; RARF (Radome, Antenna & RF Circuitry).

Why spin your wheels on paper projects? Move into one of the exciting, hardware-based career openings that exist at Raytheon now for:

- Microwave Engineers (antennas & components)
- Digital Engineers (circuit & logic design)
- Radar Systems Engineers
- Product Designers
- Transmitter Engineers
- Mechanical & Structural Engineers

Investigate the changing face of radar at Raytheon today. Call or send resume to: *Frank DeChristopher, Employment Manager, Raytheon Company, Missile Systems Division, Hartwell Road, Bedford, Mass. Tel: (617) 274-7100 collect.*

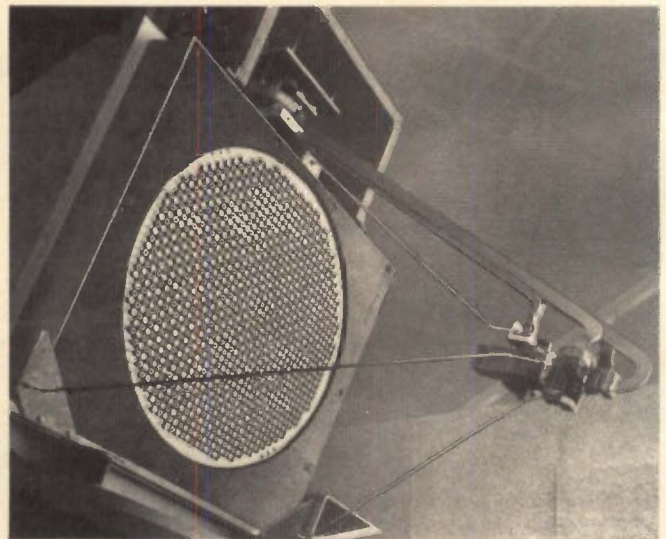

Ferrite array demonstration in operation for over 18 months to prove out advanced concepts.

**RAYTHEON**

AN EQUAL OPPORTUNITY EMPLOYER



7283940563498217890456372712345092718  
 8394056349821789045637271234509271890  
 1890991728394056349821789045637271234

**PLEASE USE  
 BOX NUMBER**

when answering classified advertisements in Electronics. It is the only way we can identify the advertisement you're answering.

9917283940563498217890456372712345092  
 2839405634982178904563727123450927189  
 0456372712345092718909917283940563498

**For Your Business—in FRANCE**

Dynamic engineers staff seeks contact with electronics equipment manufacturers in USA or EUROPE wishing for a sales office, a representative office, or a quick development of their present issue in FRANCE.

We offer:

- A sales service which is very well introduced in industries, army and civil services with up to date sales methods.
- A technical service for check out, technical assistance and repairs.
- A forecast on French market and a competition analysis for your products.
- Experience and connections with customers in all of France for the following technics:
  - Aerospace electronics
  - Environmental testing
  - Tape recorders systems
  - Acoustical and vibrational measuring equipments
  - Physical measuring equipments and transducers
  - Laboratory electronics equipments
  - AF, RF, and VHF measuring systems

Write: 171978, Havas International, 11 Boulevard Italiens, Paris 2° (France)

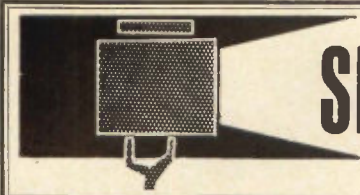

**SEARCHLIGHT SECTION**

- CLASSIFIED ADVERTISING
- BUSINESS OPPORTUNITIES
- USED OR SURPLUS EQUIPMENT

**TEST EQUIPMENT SALE**

Entire inventory of a small, but complete calibration lab is offered for sale at very reasonable prices.

Send for list!

F. W. ADAMS

1735 Dale St. Honolulu, Hi. 96822

CIRCLE 969 ON READER SERVICE CARD

**Patent Rights Offered**

Pulse Series Extenders US Pat. #3,267,448 Use a single transmission channel to sample many signals from RC to similar circuits just long enough to pick up 2 or more pulses from each; then obtain sustained series for readout by vibrating reed frequency meters.

R. E. GUNTHER  
 Princeton Jct., N.J.

CIRCLE 970 ON READER SERVICE CARD

**MINI-FLUID DISPENSER**

AIR OPERATED

for miniature potting and encapsulating

Available in 3 sizes  
 6cc - 12cc - 30cc

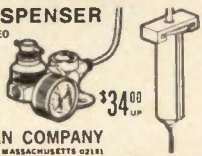

\$34.00 up

PHILIP FISHMAN COMPANY  
 7 CARRON ST., WELLSLEY, MASSACHUSETTS 02151

CIRCLE 971 ON READER SERVICE CARD

**FOR SALE**

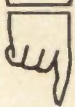

When you have used electronics equipment to sell, advertise in Electronics Searchlight Section for fastest results.

For information:  
 Searchlight Section  
 Classified Advertising Division  
 Post Office Box 12  
 New York 10036

**AUTOTRACK ANTENNA MOUNT**



360 degree azimuth, 210 degree elevation sweep with better than 1 mil. accuracy. Missile velocity acceleration and slewing rates. Amplidyne and servo control. Will handle up to 20 ft. dish. Supplied complete with control chassis. In stock—immediate delivery. Used world over by NASA. USAF. MP-61-B. Type SCR-584. Nike Ajax mounts also in stock.

**PULSE MODULATORS**

**MIT MODEL 9 PULSER 1 MW—HARD TUBE**  
 Output 25kv 40 amp. Duty cycle .002. Pulse lengths 25 to 2 microsec. Also .5 to 5 microsec. and 1 to .5 microsec. Uses 8C21. Input 115v 60 cycle AC. Mfg. GE. Complete with driver and high voltage power supply. Ref: MIT Rad. Lab. Series, Vol. 5, p. 152.

**2 MEGAWATT PULSER**  
 Output 30 kv at 70 amp. Duty cycle .001. Rep rates. 1 microsec 600 pps. 1 or 2 msec 300 pps. Uses 5948 hydrogen thyratron. Input 120/208 VAC 60 cycle. Mfr. GE. Complete with high voltage power supply.

**15 KW PULSER—DRIVER**  
 Biased multivibrator type pulse generator using 3E29 Output 3kv at 5 amp. Pulse lgths .5 to 5 microsec. easily adj. to .1 to .5 msec. Input 115v 60 cy AC. \$375. Ref: MIT Rad. Lab. Series, Vol. 5, pps. 157-160.

**MIT MODEL 3 PULSER**  
 Output: 144 kw (12 kv at 12 amp.) Duty ratio: .001 max. Pulse duration: .5, 1 and 2 microsec. Input: 115 v 400 to 2000 cps and 24 vdc. \$325 ea. Full desc. Vol. 5. MIT Rad. Lab. series. pg. 140.

**250 KW HARD TUBE PULSER**  
 Output 16 kv 16 amp. Duty cycle .002. Pulses can be coded. Uses 5D21, 715C or 4PR60A. Input 115 v 60 cy. AC \$1200 ea.

**PLAN POSITION INDICATOR CONSOLE**  
 Complete PPI console operating from 115 volt 60 cycle AC. 10" CRT range 4 to 250 miles. Digital height readout. Complete AN/UPA-25. Price \$1200.

**SCR 584 AUTOTRACK RADARS**  
 Our 584s in like new condition, ready to go, and in stock for immediate delivery. Ideal for telemetry research and development, missile tracking, satellite tracking. Fully Desc. MIT Rad. Lab. Series, Vol. 1, pps. 207-210, 228, 284-286. Comp. Inst. Bk available \$25.00 each.

**MICROWAVE SYSTEMS**

**L BAND RF PKG.**

20 KW peak 990 to 1040 MC. Pulse width .7 to 1.2 micro sec. Rep. rate 180 to 420 pps. Input 115 vac. Incl. Receiver \$1200.

**200-225 mc RADAR SYSTEM**

1 Megawatt output, 200 nautical mile range for long range detection of medium and high altitude jet aircraft as well as general search. Complete system in stock. Input 120/208 V. 60 cy. Type TPS-28. Mfg. Hazeltine.

**C-BAND RADAR**

250 KW output. C-band. PPI indicator. 5C22 thyratron modulator. Antenna hl gain parabolic section. Input 115 volts 60 cycle AC. complete \$2750.00.

**200 TO 2400 MC RF PKG.**

200 to 2400 MC CW. Tuneable. Transmitter 10 to 30 Watts. Output. As new \$475.

**500 KW L BAND RADAR**

500 kw 1220-1359 msc. 150 nautical mile search range P.P.I. and A scopes. MTI. thyratron mod 5J26 magnetron. Complete system.

**100 KW X BAND RADAR**

Complete 100 kw output airborne system with AMTI. 5C22 thyr. mod. 4J52 magnetron. PPI. 360 deg az sweep. 60 deg. elev. sweep, gyro stabilizer, hl-gain revr. Complete with all plugs and cables.

**AN/GPG-1 SKY-SWEEP TRACKER**

3 cm. automatic tracking radar system. Complete package with indicator system. Full target acquisition and automatic tracking. Input 115 volts 60 cycle. New. In stock for immediate delivery. Entire System 6' long, 8' wide, 10' high. Ideal for Infrared Tracker. Drone Tracker, Missile Tracker. R. & D.



**500KW S BAND RADAR**

250 miles search 115V 60 AC. Mfg. G.E.

RADAR AUTO-TRACK & TELEMETRY ANTENNA PEDESTALS 3 & 10 CM. SCR 584. AUTOTRACK RADARS-M 32 RADAR TPS-1D SEARCH. APS-45 TPS-100 HT. FINDERS. WX RADARS. FPN-32GCA. APS-10 APS-15e APS-27 (AMT) SEARCH. APN-102 DOPPLER. DOZENS MORE. CARCINOTRONS. PFM'S. 25-5-1-2-3-6 MEGAWATT PULSE MOODULATORS. CAVITIES. PULSE TRANSFORMERS. IF STRIPS. WAVEGUIDE. BENOS 200 MC. 1 KMC. 3 KMC. 5 KMC. 9 KMC. 24 KMC. RF PKGS.

**RADIO RESEARCH INSTRUMENT CO.**  
 550 5TH AVE., NEW YORK 36, N. Y. JU 6-4691

CIRCLE 966 ON READER SERVICE CARD

**TEST EQUIPMENT**

For over 20 years specializing in top brands only. Write for our latest listing. We buy complete inventories.

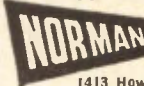

**ELECTRONIC SALES**

1413 Howard Street, Chicago, Illinois 60626  
 Telephone Rogers Park 4-0600

CIRCLE 967 ON READER SERVICE CARD

**ELECTRON TUBES**

KLYSTRONS • ATR & TR • MAGNETRONS  
 SUBMINIATURES • C.R.T. • T.W.T. • 5000-6000 SERIES  
 • SEND FOR NEW CATALOG A2 •  
 A & A ELECTRONICS CORP.  
 1063 PERRY ANNEX  
 WHITTIER, CALIF. 946-7544

CIRCLE 968 ON READER SERVICE CARD

**BIG CATALOG**

World's "BEST BUYS" in GOV'T. SURPLUS Electronic Equipment

FULL OF TOP QUALITY ITEMS—Transmitters, Receivers, Power Supplies, Inverters, Microphones, Filters, Meters, Cable, Keys, Phones, Antennas, Chokes, Dynamotors, Blowers, Switches, Test Equipment, Headsets, Amplifiers, etc., etc. SEND 25¢ (stamps or coin) for CATALOG and receive 50¢ CREDIT on your order. Address Dept. E-6.

**FAIR RADIO SALES**  
 P. O. Box 1105 • LIMA, OHIO • 45802



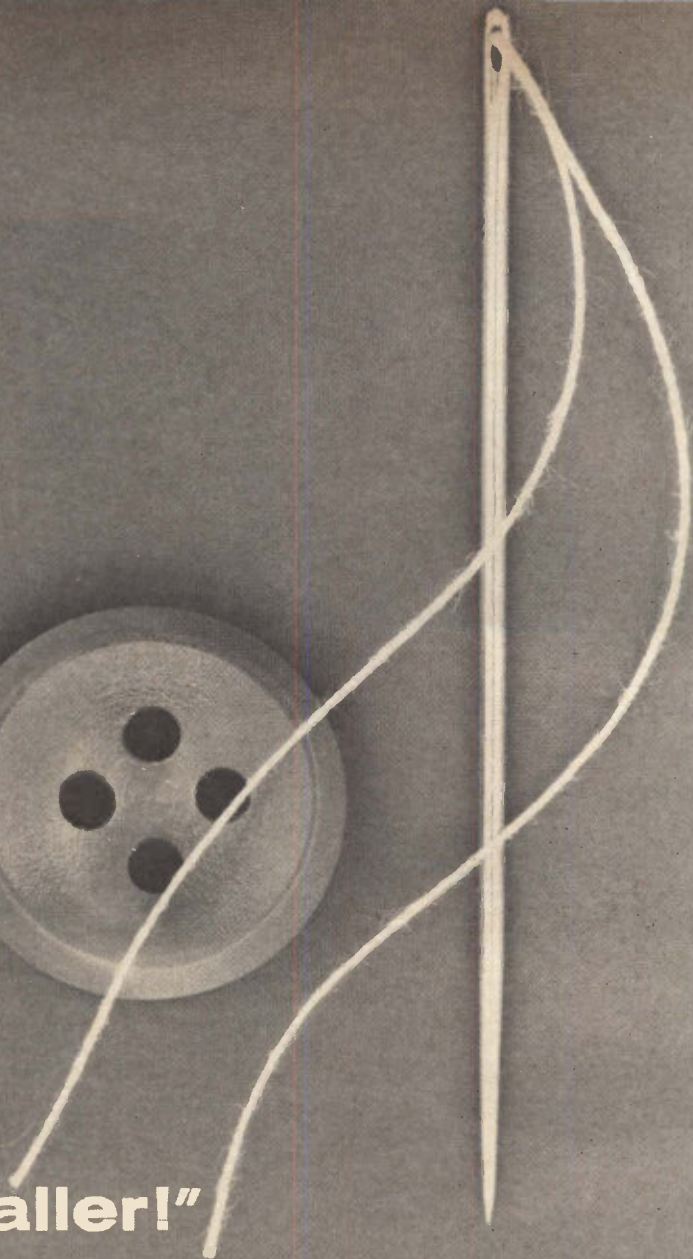
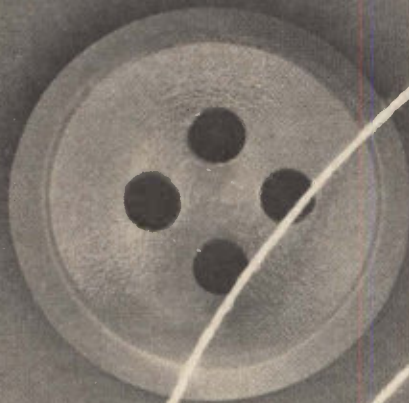

**"Make It Smaller!"**

From miniature to sub-miniature to micro, the electronics industry is constantly striving to reduce the size of electronic components. As a result, there is an increasing demand for ceramic in smaller and smaller sizes. Coors is meeting this demand by making small-scale ceramic parts in mass production quantities at precision tolerances. Write for Design Data Sheet 7002, describing Coors manufacturing methods and facilities for small ceramic parts, and latest examples. Or call your nearest Coors Regional Sales Manager: SOUTHERN CALIFORNIA: R. E. Ousley, (213) 347-3060, Los Angeles, Calif.; BAY AREA AND NORTHWEST: W. Everitt, (408) 245-2595, Sunnyvale, Calif.; MIDWEST: Tom Daly, (312) 529-2510, Chicago, Ill.; CENTRAL: Don Lewis, (216) 228-1000, Cleveland, Ohio; EAST COAST: Robert F. Doran, (516) 427-9506, Huntington, N.Y.; Herbert W. Larisch, (215) 563-4487, Philadelphia, Pa.; NEW ENGLAND: Warren G. McDonald, (617) 222-9520, Attleboro, Mass.; SOUTHWEST: William H. Ramsey, (713) 864-6369, Houston, Tex.; John West, (214) AD 1-4661, Richardson, Tex.

**Coors**  
**CERAMICS**

ALUMINAS • BERYLLIAS • MAGNESIAS • SPECIAL OXIDES  
Coors Porcelain Co., Golden, Colo.

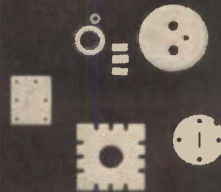

ACTUAL SIZE

Circle 336 on reader service card



---

# Newsletter from Abroad

---

November 14, 1966

## IC's a dilemma for some Britons

The Labor government's latest move to foster advanced technology poses a dilemma over integrated circuits for all but the largest companies.

Starting this month, British components makers can shelter behind a tariff barrier of 30%, part of the Laborites' effort to nudge companies into advanced techniques like IC's. But some in the electronics industry think the move could backfire. If too many firms go into IC production, they say, all but a few will become casualties. What's more, American companies like Fairchild Camera & Instrument Corp. and Texas Instruments Incorporated already have reacted to the high tariff. To cope with it, they plan to step up output of their British subsidiaries, promising rough competition for British companies that want to get into IC production.

As a result, prospects are dim for anyone who tries to get into the IC field from scratch. E.M.I. Electronics Ltd., for example, recently joined forces with the Hughes Aircraft Co. to strengthen its IC position. Elliott-Automation Ltd. has a tie with Fairchild. However, Elliott is rushing construction on a \$560,000 research facility where it will develop its own IC technology.

Even some large firms like The Plessey Co. are having second thoughts about spending big money to get into IC's when a shakeout looks inevitable. For smaller companies the dilemma is even worse. If they don't switch to IC's soon they may well find themselves with no business by the early 1970's. On the other hand, committing capital now for IC development is difficult. The money market is tight and prospects for a profit are practically nil for the short term.

## India reviews television's role

The Indian government plans to take a second look at its policy on the widespread introduction of television. Current plans call for holding off any mass debut until the early 1970's; only five educational tv stations are scheduled to be on the air before then. However, some government planners now think an extensive tv network would be the best way to get information for improving agricultural productivity out to the villages. This puts tv in a new light. As an investment to better the lot of villagers, tv would have high priority. So far, it has been considered a frill.

The review of the government's stance on tv will be part of an effort to implement a recent study that put India's electronics requirements at \$3 billion for the 10-year period ending in 1975. To fill them, plant investments totaling \$650 million will be needed. Although it is actively wooing foreign companies, the government is sticking to its requirement that companies setting up production plants also do some research and development in India.

## Labor promises to buy Australian

Electronics has become a campaign issue in Australia. The opposition Labor Party has picked up the cry of the electronics industry that the government has been passing over home firms and buying defense equipment overseas, mainly in the United States. The industry was especially incensed by recent Australian army acceptance trials of imported tactical radar sets. No domestic supplier was asked to submit designs.

In their bid for victory in the Nov. 26 general election, the Laborites have promised to steer defense orders to Australian companies if their



---

# Newsletter from Abroad

---

party is returned to power after the ballots are counted.

The campaign pledge comes as the industry is in the midst of a major expansion aimed at cutting imports of military equipment. Manufacturing capacity has been substantially increased in the past few years. Companies like Amalgamated Wireless Ltd., Fairchild Camera & Instrument Corp., Plessey Ltd., EMI Electronics Ltd., Texas Instruments Incorporated and Standard Telephones and Cables Ltd., a subsidiary of the International Telephone and Telegraph Corp., all have spent heavily recently to expand their Australian research and manufacturing facilities.

## French maneuver may win Spain for Secam

France now seems to have the upper hand in the jousting to determine which color television system Spain will adopt—PAL or Secam.

After discussions with France's Alain Peyrefitte, Spain's Minister of Industry, Gregorio Lopez Bravo, has agreed to let a team of Secam experts come to Spain next year. The French team will help the state-owned network Television Espanola prepare for color telecasting and then report to the Spanish government, which has the final word on the choice. Secam (for sequential and memory) was developed in France and already has been adopted there and in the Soviet-bloc countries. PAL (for phase-alternation-line) has most of the other European countries in its camp.

The French move surprised backers of PAL and puts them behind in the struggle to win the Iberian market. Both Portugal and Morocco will follow Spain's lead in color tv. [Electronics, Oct. 3, p. 251].

PAL, however, is not yet out of the running. The West German government might well insist on an equal chance for the system, developed by Telefunken AG. West Germany could apply considerable pressure on Spain since the Spanish government is counting heavily on West German backing in its bid for entry into the Common Market.

## British to try garnet crystals for flat display

A British researcher has come up with a twist that points to still another promising candidate for flat-screen displays to replace bulky cathode-ray tubes. The twist: garnet crystals whose dipoles rotate clockwise or counterclockwise depending on the direction magnetizing current passes through a grid of wires in the display. Rotated clockwise, the dipoles pass light; rotated counterclockwise, they block light. A similar display, but with submicroscopic dipoles dispersed in liquid, has been proposed by Marks Polarized Corp., a U.S. firm [Electronics, July 25, p. 41].

According to A.W. Simpson of the University of Sussex, who invented the device, a 10-inch screen would have 70,000 garnet crystals. Because the crystals are not transparent to visible light, polarized infrared light is beamed on them. The infrared light that passes through the crystals rotated clockwise to form an image is made readable by an infrared converter.

Along with its thinness—the device is about 1-inch thick—the display has the advantage of inherent memory: each crystal remains magnetized in one direction until a current pulse in the opposite direction switches it. As a result, bandwidth needed to change images is only about 500 kilohertz, much lower than a conventional television display.

The British government's National Research Development Corp. sees enough promise in the garnet crystal display to fund feasibility studies on the device. Target date for a prototype is fall 1968.



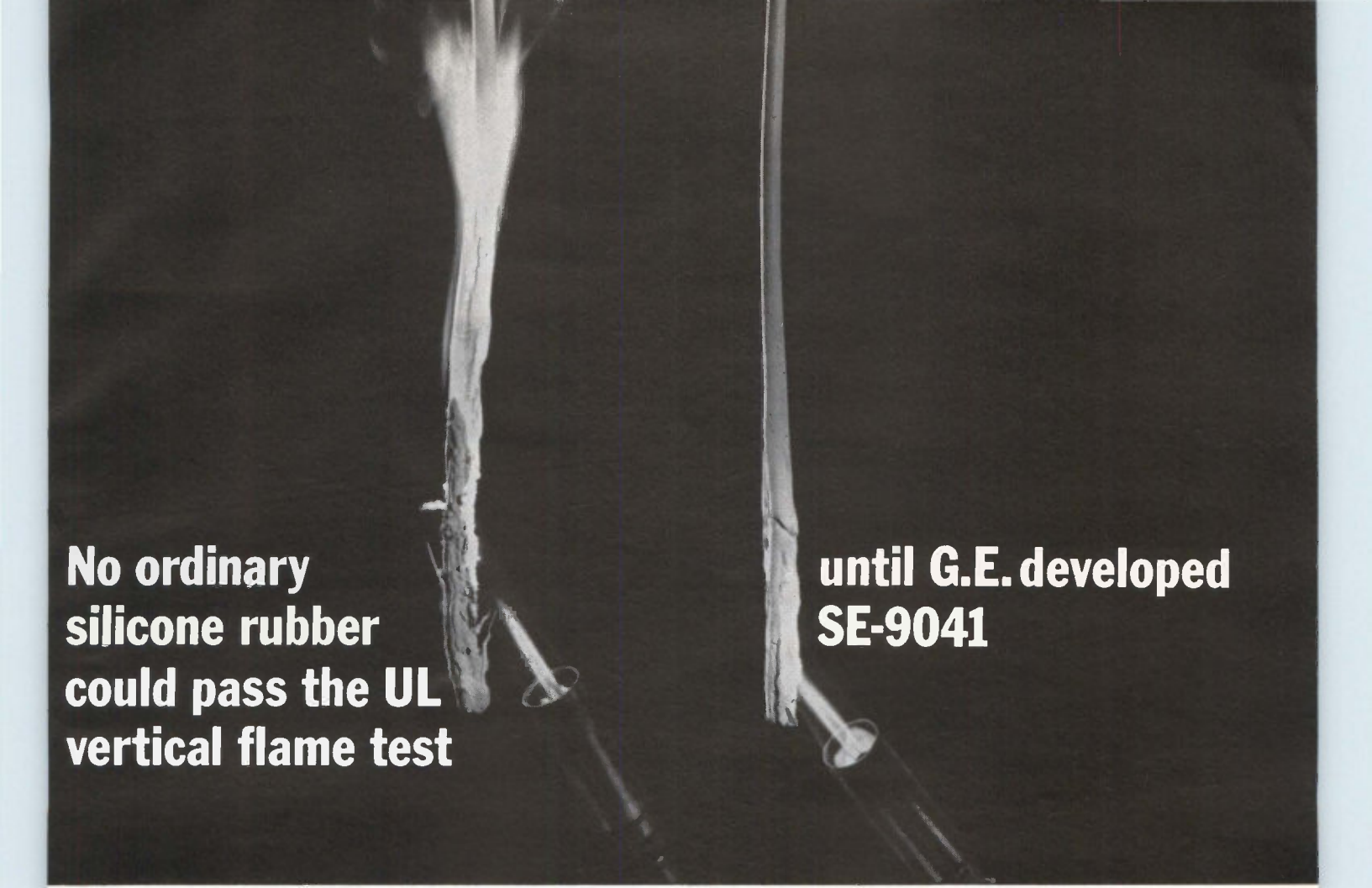

No ordinary  
silicone rubber  
could pass the UL  
vertical flame test

until G.E. developed  
SE-9041

Ordinary silicone rubber wire insulation was only half-safe. It met Underwriters' Laboratories requirements when held *horizontally* over a flame, but flunked UL's *vertical* flame test. That's why General Electric developed SE-9041 — the first economical silicone rubber insulation to pass *both* UL flame tests. New SE-9041 meets UL specifications as insulation for any size conductors without flame-retardant exterior braids or saturants.

**SE-9041 is versatile too.** Although it was originally developed specifically for television wiring, this new

silicone compound can be used in any high voltage circuit from ignition wiring to klystron wiring. In electrostatic precipitators or magnetrons, for example.

**But that's only part of the story.** SE-9041 is also superior in dielectric strength. A No. 22 AWG conductor insulated with a 75 mil wall of SE-9041 would have a typical breakdown voltage of 500 volts/mil a-c. About 50% higher than values obtained with previous silicone rubber compounds! We especially formulated this new silicone rubber insulation to hold high-voltage stresses for prolonged periods of time.

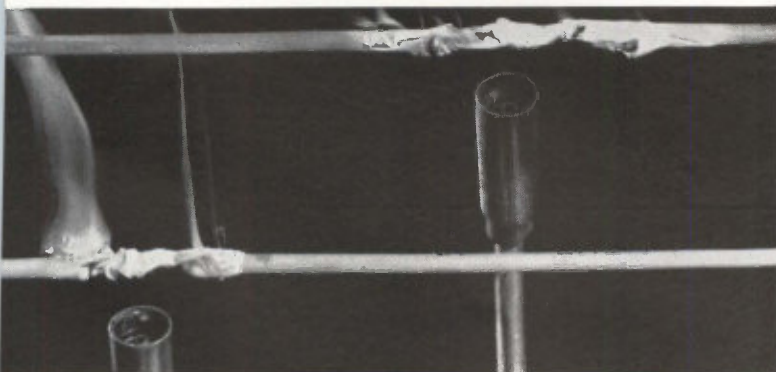

For horizontal wiring requirements, any silicone rubber insulation provides superior resistance to flame propagation. It's on the vertical jobs that SE-9041 built a reputation as a firefighter. First among lower-priced silicone insulations to pass the demanding UL vertical flame test.

Want a sample for evaluation? Be our guest.

Section N11236, Silicone Products Dept.  
General Electric Co., Waterford, N. Y. 12188

Send me a free sample of SE-9041, plus all the literature you can put your hands on.

Name \_\_\_\_\_

Title \_\_\_\_\_

Company \_\_\_\_\_

Address \_\_\_\_\_

City \_\_\_\_\_ State \_\_\_\_\_ Zip \_\_\_\_\_

GENERAL  ELECTRIC

Circle 339 on reader service card



# RCA's new 1- $\mu$ s Integrated Circuit Memory System is expandable up to 32,768 words X 36 bits

Integrated circuits in this new RCA memory system increase speed, reduce size, and lower power needs. Complete front-panel accessibility provides easy maintenance... panels slide out and open like a book. Field-proved RCA circuit modules assure high reliability. And you have maximum flexibility with such optional features as: expandable memory size, a self-tester, Read/Modify/Write operation, and easy interfacing. Ask about the new RCA 30/18 high-speed cores that make this system unique... and reduce the cost to you. A new 2- $\mu$ s system is also available. Call, write or wire your RCA Field Representative today for price and delivery information. For a technical data brochure, write RCA Electronic Components & Devices, Commercial Engineering, Section FN11-2, Harrison, N. J. 07029.

RCA ELECTRONIC COMPONENTS AND DEVICES

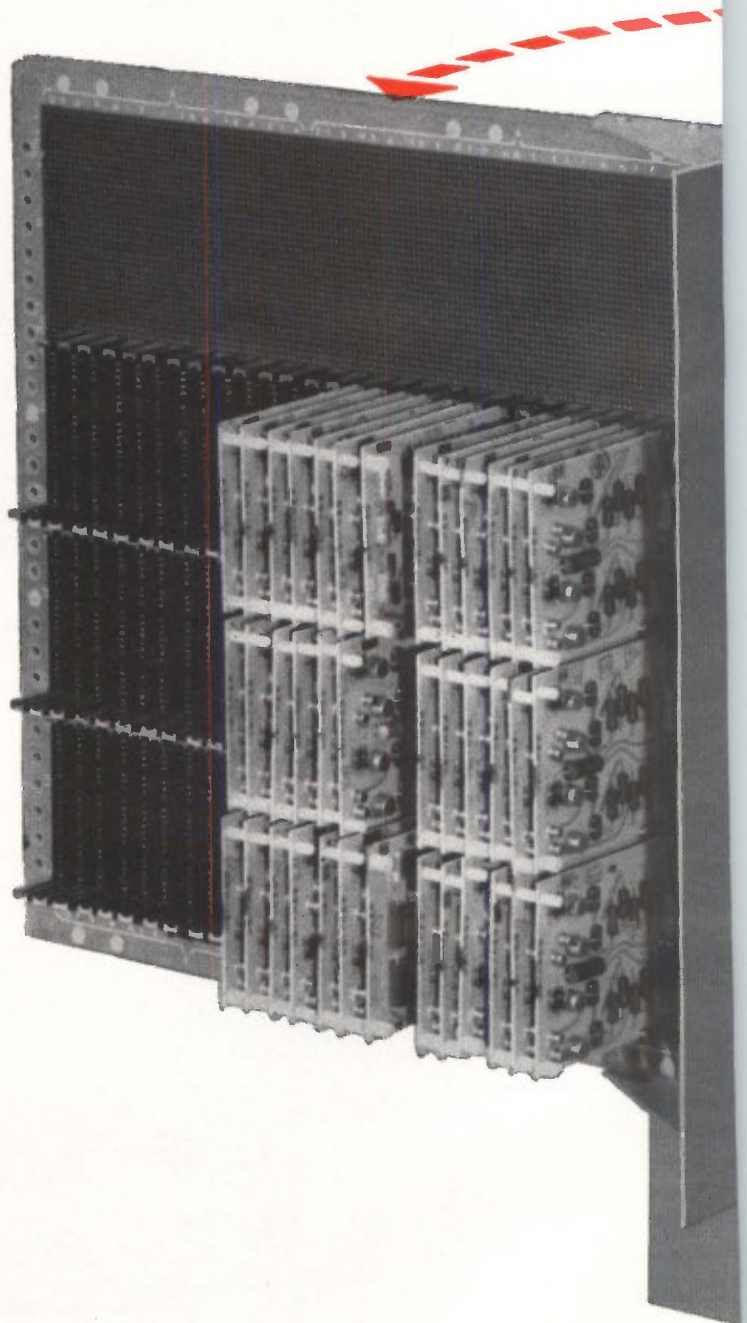

The Most Trusted Name in Electronics



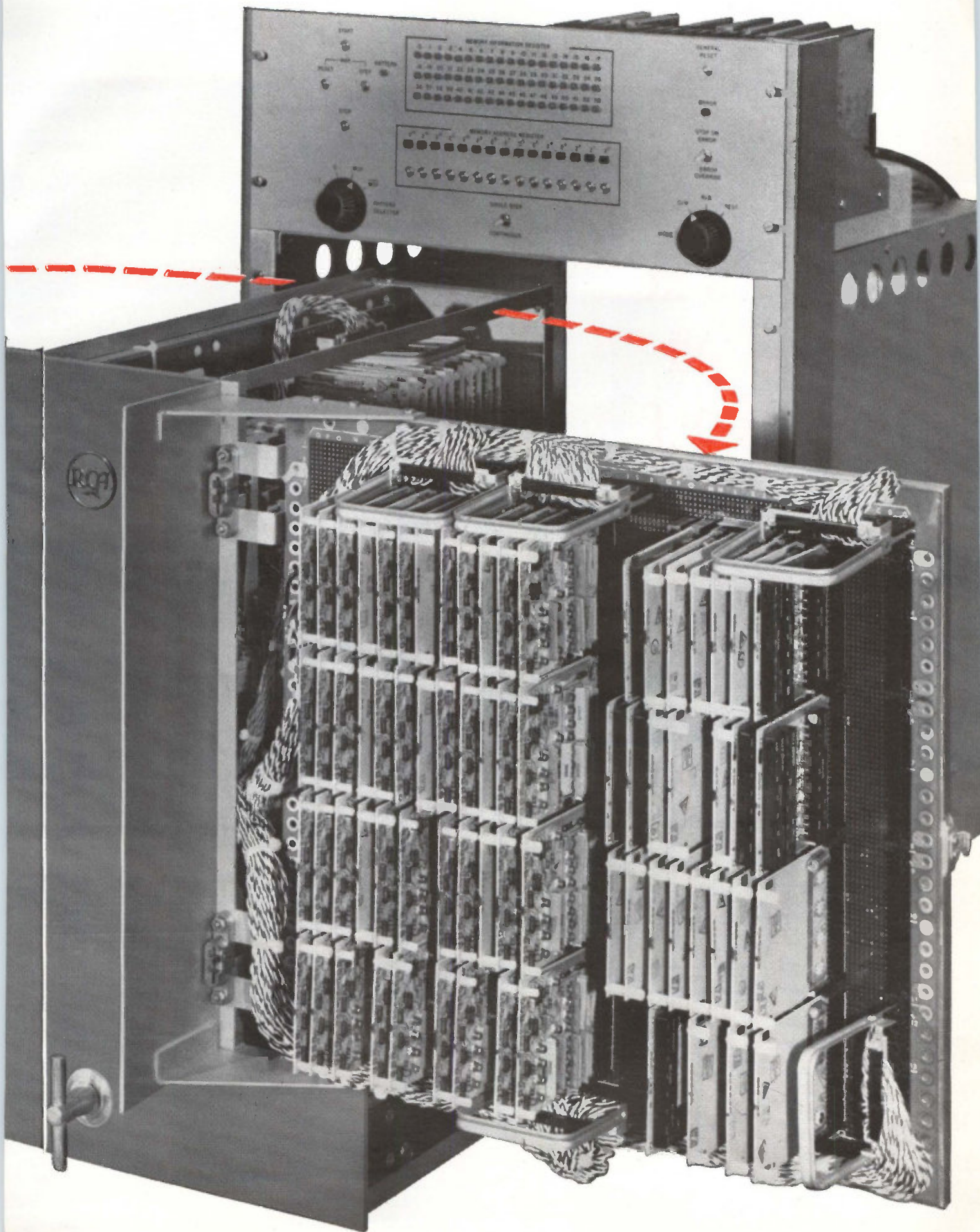



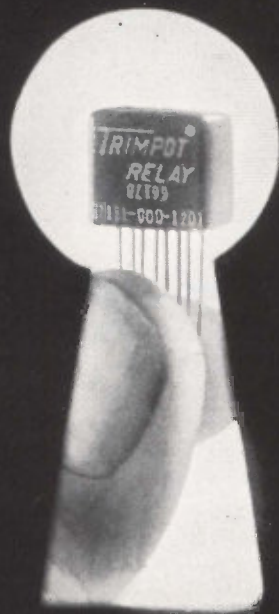

## What design doors can you open with the world's smallest industrial relay?

Our new Model 3118 TRIMPOT® DPDT Relay weighs in at 1.8 grams, yet switches a one-amp load along with the heavy-weights. Only 1/6 the size of a conventional crystal-can unit, it's the smallest industrial relay in existence. It brings high quality and performance to your applications at low cost.

Designed specifically for industrial use, the Model 3118 clearly reflects Bourns' long experience in military relays. It has the same type motor assembly and structure as the highest quality MIL unit and provides the same 100,000-cycle life. Also, it undergoes the same 5000-operation run-in as well as the rigorous final inspection for coil resistance, dielectric strength, operate and release time, pickup and dropout values, contact resistance and contact bounce. In addition, its damped return spring and balanced armature design assure excellent resistance to shock and vibration.

The 0.1" grid spaced pins let you plug the Model 3118 right into your printed circuits. Units are available immediately from the

factory with operating voltages of 6, 12 and 26.5 VDC, and in three terminal types. Write today for complete technical data.

Size:	0.26" x 0.53" x 0.43"
Pick-up sensitivity:	200 mw, max.
Contacts: DPDT; rating:	1.0 amp resistive at 28 VDC
Operating temp. range:	-55 to +85°C
Shock:	50 G, 11 ms
Vibration:	10 G, 5-3000 cps
Std. coil resistances:	60Ω to 1200Ω
Life:	100,000 cycles at rated load
Pin spacing:	0.10" grid



TRIMPOT means BOURNS—BOURNS means QUALITY  
TRIMPOT is a registered trademark of Bourns, Inc.

BOURNS, INC., TRIMPOT DIVISION, 1200 COLUMBIA AVE., RIVERSIDE, CALIF.  
PHONE 684-1700 • TWX: 714-682 9582 • CABLE: BOURNSINC.

TRIMPOT® AND PRECISION POTENTIOMETERS — RELAYS — MICROCOMPONENTS: TRANSFORMERS, INDUCTORS, RESISTORS AND CAPACITORS

Circle 342 on reader service card



# Electronics Abroad

Volume 39  
Number 23

## International

### City lights

New York excepted, major cities around the world are faring well with their efforts to unsnarl traffic jams by digital-computer control of stop lights.

Late this month or early next, for example, a Siemens VSR 16,000 computer will take charge of 14 key intersections in Hamburg, first phase of a system that eventually will cover all the major intersections in the city. London traffic authorities haven't run into any snags so far in their scheme to control 68 intersections starting next spring with a Plessey XL digital computer. And the installation of an 80-light experimental system based on a Marconi Myriad computer is proceeding without a hitch in Glasgow.

It's not likely that the troubles New York City is having with its upcoming system, by far the most ambitious yet planned, will scare city fathers elsewhere away from computer traffic control. New York's troubles are with the radar traffic sensors [Electronics, Aug. 22, p. 37]; nearly every one else uses induction loops as sensors. What's more, the systems already operating abroad have performed superbly, so much so that most are being expanded.

**Toronto.** The first major city to use computer control in a big way was Toronto, which now has a \$5 million investment in its system. On its investment, the city has had a substantial return. Its traffic commissioner estimates that trip times have been reduced by as much as 20% and that the number of involuntary stops has been slashed by more than half.

Toronto now has some 500 traffic lights—covering the major arteries—under computer control. Next year, the remaining 250 sig-

nals on lightly traveled streets will be tied into the system, which uses a Univac 1107 as its primary computer.

Working with the 1107 is a modified Univac 418 that serves as an on-line input-output buffer for the main computer. With this setup, all automatic control of the lights would be lost should the Univac 1107 go out of operation. Toronto city officials may eliminate that possibility. They are thinking of adding a small magnetic drum memory and two tape units to the Univac 418 so it could carry on alone if the 1107 goes out of operation.

**West Berlin.** Although they've had nearly 20 months of experience with it, West Berlin city officials still regard their 10-intersection system as experimental. But the results have been good enough for them to plan to add another 27 intersections soon.

A Siemens VSR 16,000 computer (VSR is the acronym for the German words meaning traffic signal computer) rides herd on the present system [Electronics, Sept. 6, 1965, p. 178]. At two intersections,

the stop lights are controlled in a pattern that varies with traffic flow. For the other eight intersections, there's a fixed-time program independent of traffic flow.

One of the 10 intersections controlled still retains the original ultrasonic and pressure-tube sensors, but it will be shifted entirely to induction loops as the other nine have been.

A second VSR 16,000 computer will be added to the system when it is expanded to cover 27 more intersections.

**Munich.** From the original 10 intersections they started out with last February, Munich traffic officials will be up to 160 computer-controlled intersections by the end of this year or early next.

The Munich system uses a British computer, Elliott-Automation Ltd.'s Arch 1000 and selects the flow pattern—from a repertoire of 40 programs—that best matches traffic conditions [Electronics, May 17, 1965, p. 162]. Strategy of the programing is to speed outflow of traffic from congested areas and at the same time hold down inflow. To better do this, a second Elliott



Computer-controlled traffic lights have worked well in European cities where they've been tried. Most cities are expanding their systems.



computer—a 4120—will be added to the system, probably next month. Its primary purpose will be to continuously adapt to existing traffic conditions the preset programs of the Arch 1000.

Munich originally tried radar sensors, but since has shifted to induction loops. Ultrasonic detectors still are used, but only to spot the best locations to install permanent induction loops.

For a report on traffic control in San Jose, Calif., see page 221.

### West Germany

#### State of the market

Even though the major West German companies—as usual— withheld their wares, this year's Electronica components show nonetheless offered a good fix on the 1967 semiconductor market.

At the week-long show in Munich last month, German market experts predicted semiconductor sales would bounce up nearly 12% next year to about \$82 million.

As at all component shows recently, integrated circuits were the star attraction at Munich. But IC sales in West Germany are just at their beginnings. A ten-fold increase expected next year will bring IC sales to only \$8 million, just about 10% of the total semiconductor market. Although IC's will continue to zoom over the next few years, marketing men generally see plenty of growth ahead for discrete semiconductors.

**Plastics on the rise.** The discrete component now regarded as most likely to succeed over the short run is the plastic encapsulated transistor [Electronics, July 25, p. 229]. Radios, television sets and phonographs account for about half the semiconductor sales in Germany and it is in entertainment sets especially that plastic transistors are making their inroads.

Prices of plastic transistors have dropped to about 30 cents apiece; they cost \$1 a year ago. From a current market share of about 5% in consumer electronics, plastic

transistors are expected to climb to 36% next year and on up to 85% by 1968. Additional momentum for plastic transistor sales is expected to come from automotive applications and controls for washing machines and dishwashers.

**Niche.** Integrated circuit production generally is regarded as the preserve of giant companies, but alert showgoers at Munich spotted an obscure West German company that is making headway in the tough IC market.

The company, Lueberg Technik, has made a niche for itself in custom-made and U.S. military specification thin-film and thick-film circuits. Its production runs range from 1,000 to 10,000 units, volumes the giants generally find unprofitable.

Even when Lueberg runs into competition from a larger company willing to take on limited production, it usually comes in with the low bid. Its prime advantages: low labor costs in the rural district of Lower Bavaria where its plant is located and no license fees to pay. Technologically, Lueberg stands on its own feet except for some production equipment it buys from U.S. companies. And Lueberg often snaps up orders because of its fast delivery times—usually not more than six weeks.

Lueberg's customers are mainly instrument firms in the U.S., West Germany, Belgium and France. Its main products are IC digital input devices, linear amplifiers, buffer stages, digital-to-analog converters and coding disks.

### Japan

#### IC's on the rise

All signs point to a dramatic upsurge next year for sales of Japanese integrated circuits and Hitachi Ltd. doesn't intend to be caught napping.

The company has started to gear up to produce somewhere between 80,000 and 100,000 IC's a month by next fall. To do so, it will spend an additional \$4 million for IC pro-

duction lines; Hitachi already has invested \$3 million in development and pilot lines.

At a level of 100,000 circuits a month, Hitachi will still be outdistanced by the Japanese industry's leader, Nippon Electric Co. NEC currently turns out some 60,000 circuits monthly and plans to shoot up to 300,000 by next spring. Hitachi, by contrast, doesn't expect to hit that level until 1968, when it estimates its production will be somewhere between 300,000 and 500,000 circuits monthly. From

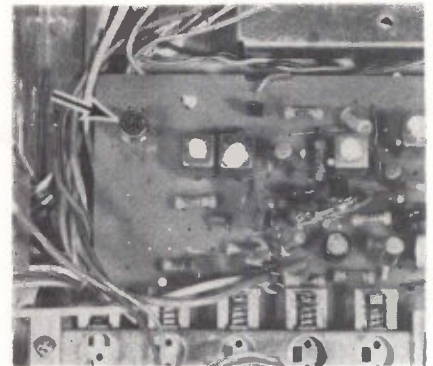

Splendid isolation. Hitachi linear IC that replaces 24 discrete components leaves wide open spaces on the printed circuit board of an experimental f-m receiver.

there, the company plans to climb in 1969 to about 1 million.

**Customers first.** At the outset, Hitachi's emphasis will be on metal oxide semiconductor circuits for desk calculators. Present plans call for production of at least 60,000 MOS chips monthly by next fall. For them, Hitachi marketing men see a ready-made market. Japanese desk calculator producers are stepping their output up so fast that shortages of discrete components could develop next year unless there's a switch to IC's. The country's leading desk calculator producer, Hayakawa Electric Co., hopes to have a third-generation model on the market late next year [see following story].

To be sure, Hitachi's early production plans include current mode logic circuits for house use. The circuits will go into Hitachi's 8000 series computers, the version of Radio Corp. of America's Spectra 70 that Hitachi will produce under



license. Initially, though, Hitachi will import most of the circuits needed for the 8000 series. Hitachi's marketing strategy, apparently, is to line up a stable of IC customers before it starts to produce heavily for itself.

**Sound strategy.** Hitachi also has linear IC's on its list. The target is some 10,000 circuits a month by next fall. The initial circuit will be an intermediate-frequency amplifier, limiter, discriminator and first audio stage for television sound channels and frequency-modulation radios. The circuit was pioneered by RCA [Electronics, March 21, p. 137].

Hitachi also plans to develop diode-transistor logic and transistor-transistor logic (TTL). Hitachi has an in-house application for DTL and there may be a whopping domestic market eventually for TTL because it's likely to be the choice of the Nippon Telegraph and Telephone Public Corp. for electronic telephone exchanges.

### Desk-bound IC's

Determined to hold its dominant position in the fast-growing Japanese desk calculator field, the Hayakawa Electric Co. intends to market a calculator using integrated circuits sometime during the latter half of 1967.

If Hayakawa holds to its timetable, it will become the first desk-calculator manufacturer in Japan to move up to IC's. But it will trail by almost a year the United States pioneer in the field, the Victor Comptometer Corp. Victor will start delivering its IC calculator to customers next month.

**Shopping.** Hayakawa recently showed an experimental 12-digit IC calculator, but hasn't built the prototype of a production model. In its experimental calculator, the company used special transistor-transistor-logic circuits that it has developed. They are slower than standard TTL circuits for big computers, but Hayakawa thinks the circuits might be produced for less than computer IC's. Hayakawa currently is shopping around to see what sort of prices semiconductor

producers would want to manufacture the special circuits.

However, Hayakawa may still use standard TTL circuits. With the major semiconductor producers getting ready to boost their IC outputs, prices of standard computer circuits might well drop below the level at which Hayakawa's low-cost design could be fabricated. Another possibility is metal oxide semiconductor circuits. Hitachi Ltd. is on the lookout for customers for the MOS units it will have in production next fall [see story above]. Hayakawa's schedule calls for a decision on the IC's by the end of next March, so production can start in the second half of the year.

**Savings.** In the experimental model, 145 IC packages replace the 350 silicon transistors, 1,100 germanium transistors, 1,200 resistors and 400 capacitors that a comparable 12-digit calculator built of discrete components would require for the logic circuits. The savings in size and power consumption are substantial. Instead of a unit the size of a small overnight bag (9.6 inches high by 15.8 inches wide by 19 inches deep), the experimental IC version is cosmetic-case size (5.4 by 11.8 by 11.7 inches). Its power drain is 15 volt-amperes, compared to 22 va for its discrete counterpart.

The production IC calculator may be even smaller than the experimental unit. A major constraint on the package size is the space needed for the Nixie-like readout tubes and the company has a group at work developing a smaller one. By the time it is ready to start production, Hayakawa expects to have tubes about 1/2-inch in diameter instead of the 3/4-inch tubes it now uses.

---

### Great Britain

---

#### Computers on the road

With integrated circuit voltage regulators slated to go into most 1968 models of American cars and more IC automotive applications certain to follow, the auto industry

already looks like one of the most promising growth markets for electronics.

An added fillip for the market may be in store from a new British development: a fuel injection system controlled by a small analog computer. To be sure, the prototype version recently introduced by Associated Engineering Ltd. has discrete components. But it points the way to another IC application should a big auto producer adopt the system.

Until it lines up an auto maker, Associated will sell the system as a custom conversion kit at a price upwards of \$200. This is more costly than a conventional single-carburetor system but competitive with fancy multiple-carburetor layouts. Associated claims the computer, by keeping the richness of the fuel mixture constantly matched to the engine operating conditions, brings fuel savings of up to 10%.

**Clean air.** And by whacking down excessive richness the system keeps at a low level unburned hydrocarbons in the exhaust, a chief cause of air pollution by automobiles. Associated also maintains that existing antipollution requirements could be met without afterburners by a combination of computer-controlled fuel injection and combustion chambers designed for low-pollutant emission.

The system controls injection of fuel into each cylinder of an engine by feeding pulses of varying duration to solenoid-operated injectors. The pulse length ranges from 1 millisecond to 10 msec, and the pulse rate is one-half the engine speed since a triggering pulse from a mechanically driven distributor switches the output of the generator onto the injector of the cylinder whose turn it is to fire.

The analog computer develops a pair of output voltage signals that control the duration of the pulses. One prime output to the computer circuit is engine speed, fed in by a discriminator preset to develop a speed signal that matches the volumetric efficiency, or "breathing" capacity, of the engine.

**Four sensors.** The other computer inputs come from a quartet



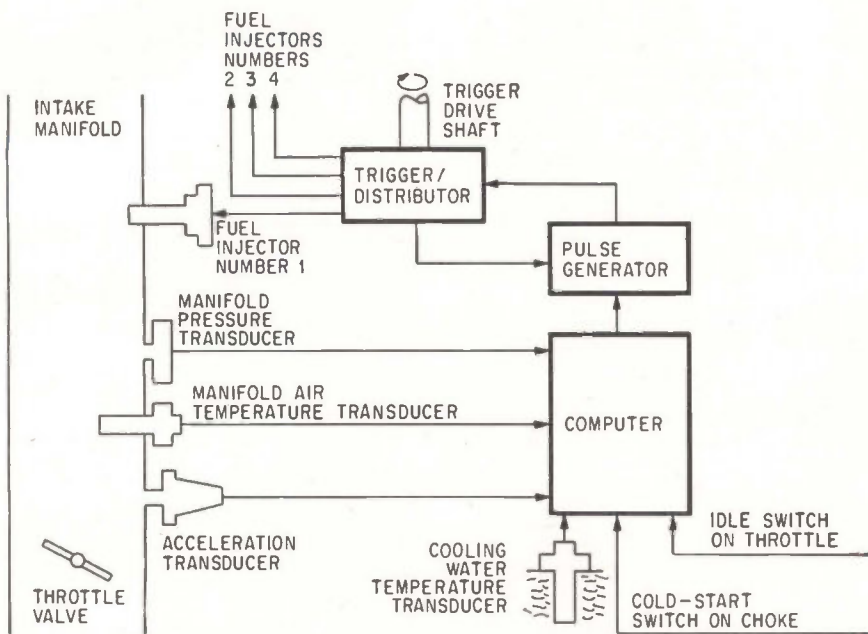

Analog computer controls pulse generator so that solenoid-actuated injectors feed an amount of fuel that matches engine conditions.

of transducers. One thermistor monitors the temperature of the engine's cooling-water; this input makes the fuel mixture leaner as the engine warms up. Another thermistor in the intake manifold measures air temperature. This input, along with that of a diaphragm-driven potentiometer that measures absolute pressure, gives an air-density reading for the manifold. A second pressure transducer feeds in a signal when there's a sharp rise in pressure near the butterfly valve in the intake manifold, indicating the driver has pushed the accelerator pedal further down.

In addition to the four transducers for normal running conditions there are two switches that feed in special inputs to the computer. One switch on the choke provides a cold-start signal that increases the richness of the mixture. Another on the accelerator pedal adjusts the mixture for idling.

### Zinc by DDC

Direct digital control, fast invading what previously was the exclusive domain of analog systems, added an impressive conquest last month. A system worth nearly \$3 million was ordered for a \$40 million zinc refining plant now under construc-

tion at Avonmouth in western England. The plant is being built for the Imperial Smelting Corp., a subsidiary of Rio Tinto Zinc Corp.

The DDC system will put under computer control a combination sintering and smelting facility with capacity of 90,000 tons a year. The plant will simultaneously extract both zinc and lead from low-grade ores. To control the process, the computer will handle inputs from more than 500 sensors and 800-odd position-sensing switches. In all, there will be over 120 DDC loops. Elliott-Automation Ltd., supplier of the control hardware, believes the Avonmouth plant will have the most elaborate DDC system in existence when it goes on stream in 1968.

Elliott will use for the control system its Arch 2000 computer. Cycle time will be 2 microseconds, even though the memory will be crammed with 16,384 words of process-control information. Much of the program for the computer will have to be written specially for the DDC control, but Elliott expects that standard programs can be used for parts of the operation.

**Sort of Siamese.** Actually, the Arch 2000 at the outset will serve as a common brain for two separate control systems, one for the smelting plant and the other for the sin-

tering plant. However, after it gains initial operating experience in the plant, Imperial Smelting Corp. plans to expand the computer control to interweave the two systems intimately.

Initially, the computer will take charge of blending ores from various sources and weighing them as they go into the sintering plant, the first step in the process. Sixteen DDC loops will control the weight of ore fed into the oven and another 16 loops will regulate the speed of the conveyor belt passing through it.

In the smelter, actually a short blast furnace, eight loops will control the job of preparing charges of sintered ore and coke for the furnace. Additional computer-controlled operations in the smelter include combustion in the coke preheater, cycling of air into the furnace, distribution of gases within the furnace, alarm scanning and data logging.

**More in store.** Although the Avonmouth plant will have one of the most sophisticated control systems in the world when it starts up, Ivan E. Lowe, Imperial's chief engineer for instrumentation, already talks about optimizing the entire facility through a more extensive use of the computer in the future.

For one thing, Lowe has in mind a scheme to analyze the slag that comes from the furnace and feed the results back into the system to hold zinc or lead waste in the slag to a minimum. Still another idea is to check the quality of the sintering plant output by X-ray fluorescence and keep the smelting furnace continuously adjusted to match variations in the sinter.

### Canada

#### Red eye in the sky

While Smokey the Bear wages his campaign to convert careless American campers into careful ones, Canadian authorities have turned to electronics to prevent forest fires. During this year's forest-fire



season they've used a lightweight, airborne infrared detector to spot smoldering lightning-struck tree stumps, the chief cause of fires in the vast Canadian forests.

The 60-pound system, flown on small forest patrol planes, was developed by Computing Devices of Canada Ltd. Its optical system focuses infrared energy in the 5-micron range onto a thermistor bolometer. The bolometer output is amplified to drive audio and visual alarms in the cockpit. In addition, the infrared pattern is recorded by a camera.

The scanning system searches the terrain 60° on either side of the plane's line of flight. The scan drive is tied into the visual alarm circuitry so that a direction indicator light flashes whenever the system picks up a hot spot. The pilot then can bank around for a closer look.

Temperature differentials as small as 5°C can be spotted by the system. From an altitude of 5,000 feet, for example, the detector can pick up charcoal glowing in a barbecue cooker just two feet square. This gives off about the same heat energy as a smoldering tree stump, which can stay smokeless for days, then burst into flame.

Computer Devices expects its airborne infrared system will find a lot of other non-military uses in addition to forest-fire prevention. With slight modifications, it could



Infrared detector that spots incipient forest fires mounts in small pod on fuselage of patrol plane.

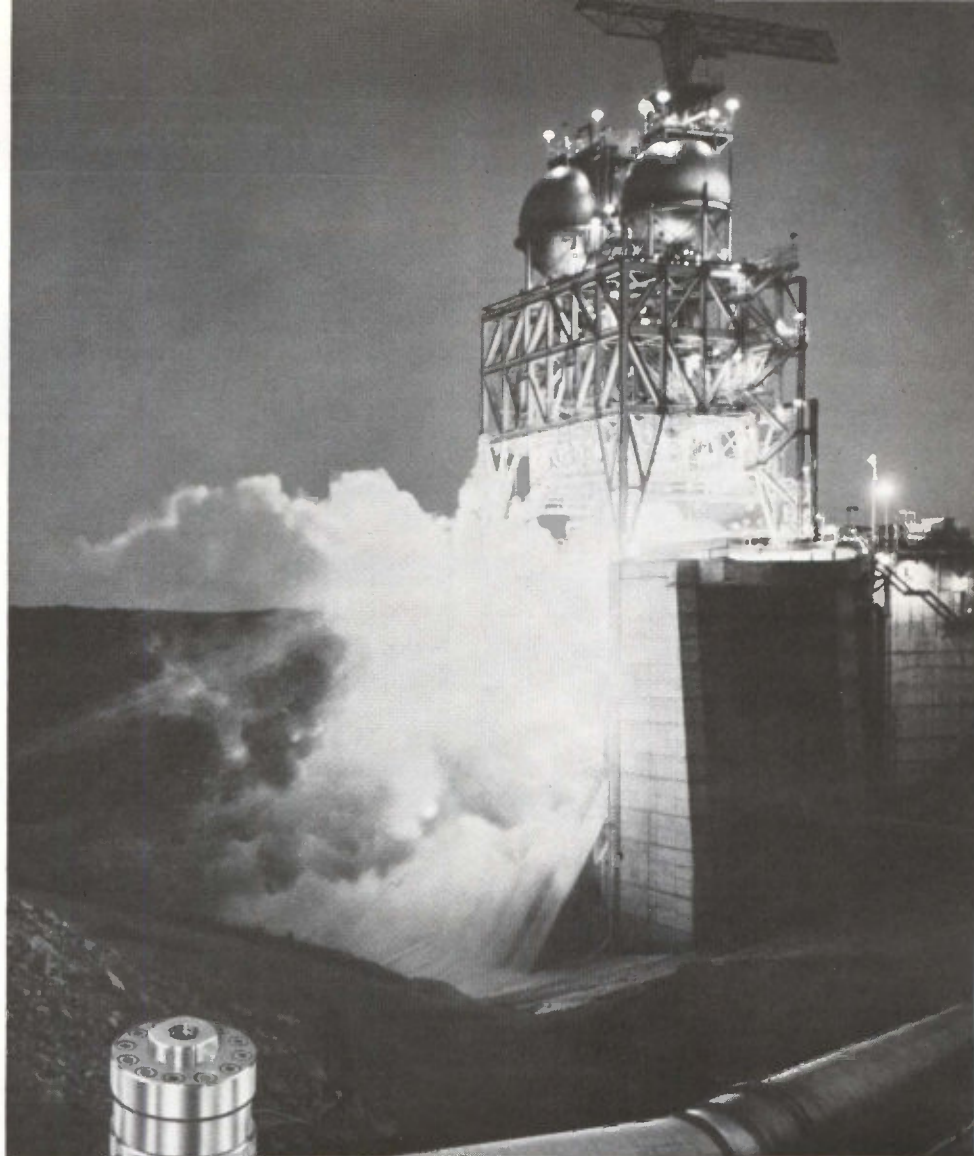

## *Rocketdyne* *uses Taber* TELEDYNE® FOR F-1 ENGINE DEVELOPMENT

The F-1 is the most powerful rocket engine to be placed in production by the U.S. It was designed and developed by Rocketdyne, a division of North American Aviation, Inc., under the technical direction of NASA's Marshall Space Flight Center, Huntsville, Ala. The F-1, in a cluster of five generating 7,500,000 pounds of thrust, will power the first stage of the Saturn V space vehicle that will launch the first American astronauts to the moon in the Apollo spacecraft.

Taber TELEDYNE® Pressure Transducers are used by Rocketdyne for steady-state pressure measurements during static testing of both F-1 and Saturn V second and third stage J-2 engines. Pressure transducers must be accurate, rugged and dependable to withstand the extreme vibrations and pressures the engines encounter during static testing.

If that's what you're looking for in Pressure Measurement Instrumentation, Taber has probably already developed just what you need. To find out, write: Taber Instrument Corp., Section 158, 107 Goundry St., North Tonawanda, New York.





FOR SPECIAL-PURPOSE  
ELECTRON TUBES...



**Draw  
deep  
on our capabilities**

Give us your specifications for special-purpose electron tube parts. Vidicons, orthicons and pencil tubes, for fiber optics, infrared and similar applications.

We'll match them up with our depth of deep-draw know-how, and our high-production transfer presses.

Draw deep on our capabilities to tool and produce the precision parts you need—to your specifications, on time, and at the lowest possible cost. Call or write today.

**Volkert STAMPINGS, INC.**

Subsidiary of The Stanley Works

222-35 96th Avenue  
Queens Village, L.I., N.Y. 11429  
Telephone 212-464-8400

## Electronics Abroad

be used to plot thermal gradients in water for fast oceanographic mapping or to locate pollution streams. Other possibilities are spotting icebergs obscured by fog, detecting crevasses in ice fields and mapping thermal gradients on land to locate underlying formations.

### Colorful proposal

The order books of Canadian electronics companies will bulge for the next three years if an ambitious Ontario broadcaster has his way.

The broadcaster, 55-year-old Kenneth Soble of Hamilton, wants to set up a \$75 million satellite-fed television network that would cover Canada from Newfoundland to the Northwest Territories. Under the scheme, 97 unmanned transmitters linked to 65 ground stations would be broadcasting color-tv programs by 1970.

For all its pie-in-the-sky aspects, Soble's proposal is receiving serious consideration from Canada's Board of Broadcast Governors (BBG), the government body that grants television licenses. For one thing, BBG last spring authorized Soble to undertake a study for the organization of a third Canadian tv network. And Soble has the backing of the Power Corp. of Canada, one of the country's richest companies. Further, the financing proposed offers big pieces of the action to both the government and the public.

Under the proposal, two companies would be formed—National Television Network (NTV) and the Canadian Satellite Corp. (Cansat). Power Corp. would provide the initial working capital, but 70% of NTV's stock would be offered to the government and the public. NTV, in turn, would own 40% of Cansat, with the rest going to the public.

**Pair up there.** To feed the 65 ground stations, Soble envisions a pair of 950-pound satellites in a stationary orbit 22,400 miles above the equator. A U.S. launch vehicle would put them there. One satellite would be active, the other a spare. Unused channels, six per satellite,

would be leased to other broadcasters and communications companies.

The broadcast board will make its determination on Soble's proposal sometime next spring. If the decision is affirmative, RCA Victor Co., an affiliate of the Radio Corp. of America, stands to get the prime contract for the satellites. But with 97 transmitters and 65 ground stations also needed for the network, just about every important electronics producer in the country would get business from NTV.

### Sweden

#### Good turn

Motorists in Sweden will have to break a long-time habit next fall and Svenska Philips AB hopes to help them do it.

Ever since Swedes first had autos, they've been driving them—as in Britain—on the left hand side of the road. But next September Sweden will swing into line with the rest of the Continent and switch to the right.

Swedish traffic authorities expect that at the outset of the switch-over motorists will take particular pains to drive on the right side. But they fear lapses—and collisions as drivers swing by habit to the left side after a turn—when the first blush of attentiveness fades.

All sorts of warning systems, including radio devices and radar units, have been suggested only to be rejected as too costly. But Svenska Philips has come up with a \$60 solution, a roadside system that flashes panic lamps whenever a car enters a traffic lane from the wrong direction.

The portable Philips equipment is powered by a 12-volt auto battery and dry cells so it can be set up in a hurry at potentially dangerous intersections. The company, an affiliate of Philips Gloeilampenfabrieken NV of the Netherlands, also expects the system will catch on as a warning signal that police can set up at accidents.

**Multivibrators.** The system uses



a pair of transistorized multivibrators to sense that a car is passing a checkpoint going the wrong way.

Inputs to these two multivibrators come from rubber-tube pressure switches, the same as used in car-counting equipment, spaced about 10 feet apart. When a car runs over the upstream tube, it switches on a multivibrator with a time constant of 4 seconds. The output of the first multivibrator is applied to the second multivibrator as is the short pulse developed when the car crosses the downstream tube. The second multivibrator—when two inputs are present at the same time—switches on a third multivibrator that flashes the warning lamps for 10 seconds and then resets all the circuits.

With this arrangement, a car running over the rubber tubes in the right direction can't trigger the warning lamps since the first multivibrator isn't turned on when the downstream tube feeds its input to the second multivibrator. The 4-second time constant for the first multivibrator was selected to hold to a minimum false actuation by combinations of cars and trucks following each other in the right direction.

### Around the world

**Sweden.** The Civil Defense Board will reequip itself with 500 fixed and 4,500 mobile very high frequency radio stations over a three-year period ending in 1970. In peacetime, the 320-channel stations are used by police forces, fire brigades and local governments. The 5,000 stations will cost \$11 million; suppliers are Svenska Radio AB and Standard Radio and Telefon AB, a subsidiary of the International Telephone and Telegraph Corp.

**Italy.** The General Instrument Corp. has made its first major move into Europe with the acquisition of Pirelli Applicazioni Elettroniche (PAE), the electronics subsidiary of the Pirelli industrial group. PAE produces a broad line of components, including semiconductors

## A·vacuum relay:

- Carries high rf currents due to large surface area of contacts.
- Smallest size for its power rating.
- Operates faster than other high voltage relays due to small contact separation.
- Will interrupt high dc power.
- Has highest voltage ratings due to vacuum dielectric.
- Has long contact life.
- Low and stable contact resistance from dc through 30 mc.
- Requires no contact maintenance.

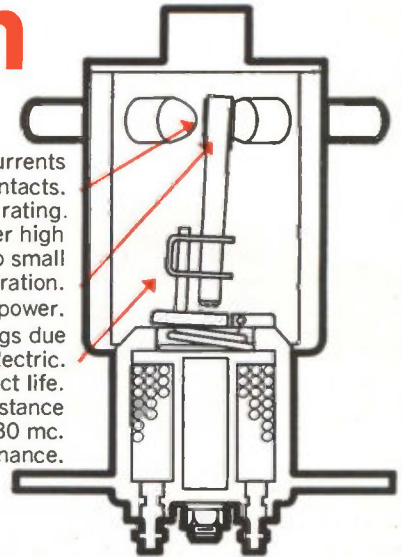







## Jennings vacuum relays:

Have the additional benefit of 18 years of constant development effort and manufacturing experience. All Jennings vacuum relays have been field tested and proven successful in countless applications.

## consequently:

Jennings vacuum relays are unexcelled for use in high voltage communication systems particularly in aerospace, land, or marine vehicles that cannot tolerate heavy weight and have limited space. Within their size and voltage range they also have no equal for switching dc or pulse forming networks.

Thorough knowledge of the characteristics of vacuum relays is a most useful tool in any electronic engineer's hands. It can easily be obtained by requesting Jennings new vacuum relay catalog No. 103. Jennings Radio Manufacturing Corporation, a subsidiary of International Telephone and Telegraph Corporation, 970 McLaughlin Avenue, San Jose, California 95108.

						
	RJ1A	RJ2A	RF10	RB7A	RB1E	RB4
Contact Arrangement	SPDT	SPDT	SPDT	DPDT	SPDT	4PDT
Test Voltage (Peak KV)	5	18	20	9	18	17
Operate Voltage (Peak KV) (16 mc)	2	8	10	3	8	10
Continuous Current Amps RMS (16 mc)	7	15	30	4	6	6
Interrupt DC Power (KW)	N/A	1	50	1	1	1
Contact Resistance (Max. ohms)	.010	.012	.012	.020	.012	.010

**ITT Jennings**



# Has Telonic Made VSWR Measurement

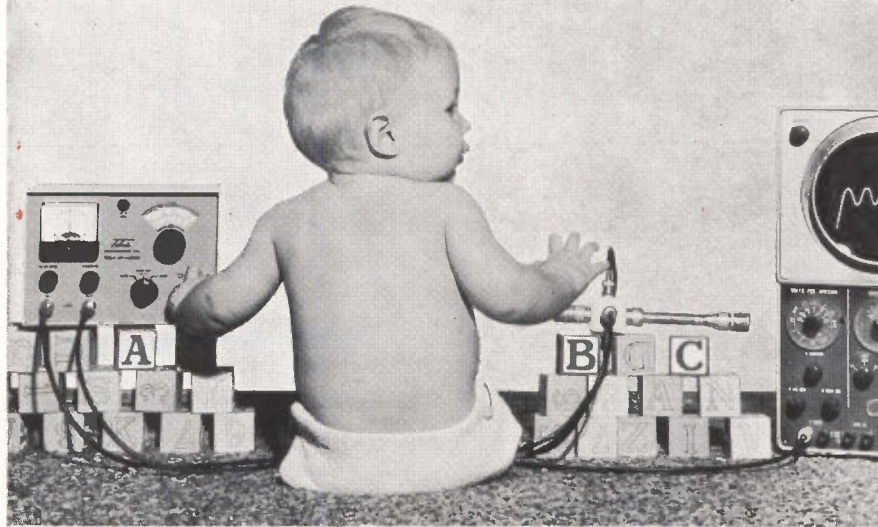

## Too Easy?

Now, with Telonic's new Rho-Meter [A], the Rho-Tector [B] and Standard Terminations [C], measuring VSWR from 500 KHz to 4 GHz is as easy as . . . [A], [B], [C]. The system permits *direct readout* of VSWR or dB attenuation using any swept, CW, or AM source. VSWR from 1.02:1 to 3.00:1 and attenuation from 0 to 20 dB can be quickly and precisely measured and, if desired, displayed on a standard or storage-type oscilloscope, or xy recorder without calibrated graticules or special accessories.

The Rho-Tector, an impedance comparison device, is used with the Rho-Meter to provide direct VSWR readings. The system offers many advantages over reflectometer and slotted line techniques:

- Wide impedance range—25 to 100 ohms
- Low residual VSWR
- Broad frequency coverage .5 MHz-4 GHz
- Low Cost

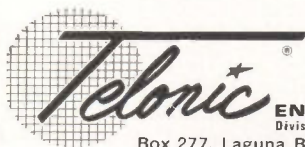

Box 277, Laguna Beach, California  
Tel: (714) 494-9401 • TWX 910-596-1320

Representatives in all major cities in the U.S. and foreign countries.  
Factory offices located at Maidenhead, England and Frankfurt, Germany

Telonic's new catalog C-101 contains a complete description of instruments and techniques for VSWR measurement. It's yours on request.



and tantalum capacitors; General Instrument plans a substantial expansion of the product line.

**Zambia.** Transistor radios and phonographs have started to come off the production line of Supersonic Radio Zambia Ltd., the country's first electronics plant. The plant now employs over 100 people, making it Zambia's largest industrial enterprise except for the copper industry.

Supersonic will export part of its radio output to neighboring African countries. Later it will add television sets and telecommunications equipment to its product line as markets for them develop. The company is a subsidiary of the International Telephone and Telegraph Corp.

**Great Britain.** Elliott-Automation Ltd. has begun a major expansion in Scotland. On the worklist are two new computer plants, one for Elliott's 4100 series and one for its 900 series. In addition, Elliott is rushing construction of a \$560,000 research facility for integrated circuits. The company has a long-term IC know-how agreement with Fairchild Camera & Instrument Corp. but wants an independent source of IC technology.

**France.** Two electronics companies whose mainstay is government business are diversifying into medical electronics.

Intertechnique S.A., whose specialty is nuclear instrumentation, will form a medical division next year. The first product most likely will be a low-beta counter for hospitals.

Electronique Marcel Dassault, the avionics producing subsidiary of airframe manufacturer Générale Aéronautique Marcel Dassault will make its start in medical electronics with electrocardiology instruments.

**Japan.** Tokyo Shibaura Electric Co. will start selling brushless direct-current motors next year. In the motors, silicon controlled rectifiers replace the conventional mechanical commutator and brushes.

**Sweden.** Up against a chronic shortage of personnel, Swedish hospitals are expected to spend about \$500 million by 1970 for computers and other electronic equipment to automate medical care.





<b>Ace Plastic Company</b>	275	<b>Communication Electronics Incorporated</b>	312	<b>G &amp; E Bradley Ltd.</b>	244
Krate/Weinberger Inc.		<b>Computer Test Corporation</b>	197	Hyde & Partners Ltd.	
■ <b>AMP Incorporated</b>	97	James Lees Advertising		<b>Garlock Company Incorporated</b>	322
Garceau, Hargrave & McCullough Inc.		<b>Consolidated Electrodynamics Corporation</b>	208	Richardson, Thomas & Bushman Inc.	
A. P. I. Instruments	324	Hixson & Jorgensen Incorporated		<b>Garrett Aircsearch Mfg. Corporation</b>	204
George Z. Griswold Advertising		<b>Continental Device Corporation</b>	20, 21	J. Walter Thompson Company	
■ <b>Acme Electric Corporation</b>	303	Bear Advertising		<b>General Aniline &amp; Film Corporation</b>	200
Scheel Advertising Agency Inc.		■ <b>Control Switch Division of Controls Company of America</b>	184	Hazard Advertising Company Inc.	
■ <b>Acopian Corporation</b>	327	Harry P. Bridge Company		<b>General Dynamics Fort/Worth Division</b>	246
Mort Barish Associates Inc.		■ <b>Coors Procelain Company</b>	336	Glenn Advertising Inc.	
Adams & Westlake Company	103	Tallant/Yates Advertising		■ <b>General Electric Company 80, 81, 282, 283</b>	
E.H. Brown Advertising Agency Inc.		<b>Corning Glass Works, Electronics Division</b>	64, 65	George R. Nelson Incorporated	
Airtax Electronics Inc.	256	Rumrill Hoyt Incorporated		■ <b>General Electric Components Division</b>	188
Welch, Mrabile & Company Inc.		<b>Corning Glass Works, Capacitor Division</b>	202	George R. Nelson Incorporated	
■ <b>Air Products &amp; Chemicals Inc.</b>	299	Rumrill Hoyt Incorporated		■ <b>General Electric Lamp Metals &amp; Components Division</b>	192
Arthur Falconer Associates		<b>Coto Coil Company Incorporated</b>	317	Dix & Eaton Incorporated	
■ <b>Alco Electronic Products Inc.</b>	287	The Williams Company		■ <b>General Electric Silicone Products Division</b>	339
Marketronics Advertising		<b>Cyclo-Tronics Inc.</b>	7	Ross Roy Incorporated	
<b>Allen Bradley Company</b>	179, 180	T.W. Blakeslee Advertising		■ <b>General Electric Specialty Control Division</b>	196
Fensholt Advertising Agency Inc.		■ <b>Delco Radio Corporation</b>	84, 85	George R. Nelson Incorporated	
■ <b>Allied Chemical Corporation</b>	203	Campbell Ewald Company		<b>General R-F Fittings Incorporated</b>	267
McCann Erickson Inc.		□ <b>Delavan Electronics Corporation</b>	190, OAS 4	Van Christo Associates	
■ <b>Allied Radio Corporation</b>	277	Stahka, Faller & Klenk Inc.		<b>General Radio Company</b>	6
Marvin H. Frank Company		■ <b>Delta Products Incorporated</b>	306	K.E. Morang Company	
■ <b>Amelco Semiconductor Corporation</b>	173	De Roin Associates		<b>Globe Industries Inc.</b>	277
Sturges & Associates		■ <b>Di-Acro Corporation</b>	58	Odiorne Industrial Advertising	
<b>American Metal Climax Incorporated</b>	92	Charles E. Brown Advertising		□ <b>Globe Union International Division</b>	OAS 3
J.B. Rundle Inc.		<b>Dialight Corporation</b>	305	Strall Advertising Company Inc.	
■ <b>Ammon Instruments Inc.</b>	326	H.J. Gold Company		Graphic Systems	312
Culver Advertising Inc.		■ <b>Dorne &amp; Margolin Inc.</b>	237	■ <b>Grayhill Incorporated</b>	269
■ <b>Amperex Electronics Corporation</b>	140, 141	Snow & Depew Advertising		Merchandising Advertisers	
Sam Groden Inc.		<b>Dow Corning Corporation, Silicones Division</b>	53	■ <b>Gudebrod Brothers Silk Company</b>	178
<b>Arco Electronics</b>	189, 255	Church & Guisewite Advertising Inc.		Ramsdell-Buckley & Company	
Campbell Ewald Company		<b>Duncan Electronics Incorporated</b>	219	<b>Hamilton Watch Company</b>	230
<b>Astro Communication Laboratories Inc.</b>	329	Bonfield Associates Incorporated		Beaumont, Heller & Sperling Inc.	
Admasters Advertising Inc.		■ <b>DuPont de Nemours &amp; Company Freon Division</b>	75	<b>Hansen Mfg. Company Inc.</b>	304
<b>Automatic Electric Corporation</b>	98	Batten Barton Durstine & Osborn Inc.		Keller-Crescent Company	
Tatham-Laird & Kudner Inc.		<b>DuPont de Nemours &amp; Company Mylar Division</b>	185	<b>Hathaway Instrumnts Incorporated</b>	328
■ <b>Ballantine Laboratories</b>	286	Batten Barton Durstine & Osborn Inc.		Eby & Everson Incorporated	
Lang-Lawrence Inc.		<b>DuPont de Nemours &amp; Company Teflon Division</b>	101	<b>Havag Industries</b>	284, 285
<b>Barber Colman Company</b>	308	Batten Barton Durstine & Osborn Inc.		Garceau, Hargrave & McCullough Inc.	
Howark H. Monk Associates		<b>Durant Manufacturing Company</b>	104	<b>Heinemann Electric Company</b>	294
■ <b>Barnstead Still &amp; Sterilizer Company</b>	260	Franklin/Mautner Advertising		Thomas R. Sundheim Inc.	
Creamer, Trowbridge & Case Inc.		<b>Dynage Incorporated</b>	326	■ <b>Hewlett Packard Associates</b>	195
■ <b>Bausch &amp; Lomb Inc.</b>	59, 274, 295	F.W. Prella Company		Lennen & Newell Incorporated	
Wolff Associates Inc.		<b>EG &amp; G Incorporated</b>	321	■ <b>Hewlett Packard Colorado Springs Division</b>	3rd Cover
■ <b>Beckman Instruments Inc. Helipot Division</b>	293	Culver Advertising Incorporated		Tallant/Yates Incorporated	
Hixson & Jorgensen Inc.		<b>Ebert Electronics Corporation</b>	312	■ <b>Hewlett Packard Harrison Division</b>	93
<b>Beckman Instruments Inc. Offner Division</b>	206	Flamm Advertising Inc.		Healy Advertising Agency	
Hixson & Jorgensen Inc.		<b>Elcor</b>	108	■ <b>Hewlett Packard Moseley Division</b>	1
<b>Bendix Corporation Semiconductor Division</b>	18, 19	G. Bruce West Incorporated		■ <b>Hewlett Packard Newell Incorporated</b>	
MacManus, John & Adams Inc.		<b>Electro-Optics Associates</b>	9	■ <b>Hewlett Packard Rockaway Division</b>	17
<b>Bishop &amp; Company, J.</b>	233	Jack Herrick Advertising Inc.		George Homer Martin Associates	
Richardson Thomas & Bushman Inc.		<b>Electro Scientific Industries</b>	313	■ <b>Hewlett Packard Sanborn Division</b>	2
<b>Blackstone Corporation</b>	271	Nadler & Larimer Incorporated		Culver Advertising Incorporated	
Carr Liggett Advertising Inc.		<b>Electronic Communications Inc.</b>	70, 71, 276	<b>Honeywell Computer Control Division</b>	66, 67
<b>Bolt, Beranek &amp; Newman Inc.</b>	238, 239	Nelas & Hickok Inc.		Franklin P. Folts Incorporated	
Leland Oliver Company		<b>Electronic Modules Corporation</b>	182	<b>Honeywell Company Micro Switch Division</b>	32, 33
<b>Borden Chemical Corporation</b>	90	Ray Thompson & Associates		Batten Barton Durstine & Osborn Inc.	
Conahay & Lyon Incorporated		<b>Electronized Chemicals Corporation</b>	243	<b>Honeywell PMD Division</b>	281
<b>Bourns Incorporated</b>	55, 235, 342	Kenyon & Eckhardt Inc.		Batten Barton Durstine & Osborn Inc.	
The Lester Company		<b>Emerson &amp; Cuming Incorporated</b>	328	<b>Honeywell Test Instruments</b>	198
■ <b>Brush Instruments Div. of Clevite Corporation</b>	82, 83	Edwin F. Hall Inc.		■ <b>Houston Omnigraphic Corporation</b>	212
Carr Liggett Advertising Inc.		<b>Erie, County of</b>	291	Ray Cooley & Associates	
■ <b>Burdyn Corporation</b>	102	Comstock & Company		<b>Hughes Aircraft Company</b>	187
Ted Gravenson Incorporated		<b>Erie Technological Products Company Inc.</b>	207	Foote, Cone & Belding Company	
■ <b>Burr Brown Research Corporation</b>	228	Altman Hall Associates		■ <b>IMC Magnetcs Corporation</b>	300
N.A. Winter Advertising Agency		<b>Eubanks Engineering Company</b>	293	Monad Advertising Design	
<b>Burroughs Corporation</b>	110	Moore & Bergstrom Company		<b>IRC Incorporated</b>	201
Conti Advertising Agency		<b>FMC Corporation</b>	205	Gray & Rogers Incorporated	
■ <b>CML Incorporated</b>	275	Muller Jordan & Herrick Inc.		■ <b>Ichizuka Optical Company Ltd.</b>	323
Keyes Martin & Company		<b>Fairchild Controls Company</b>	297	Matsushita Inc.	
□ <b>C. S. F.</b>	OAS 7	Dunwoodie Associates Inc.		<b>Indiana General Corporation</b>	91
SPI		<b>Fairchild Electro Metrics Corp.</b>	309	Griswold & Eshleman Company	
■ <b>CTS Corporation</b>	177	Herbert Lindauer Associates		<b>Industrial Electronic Engineers Inc.</b>	315
Burton Browne Advertising		<b>Fairchild Instrumentation</b>	36, 37	Gumpertz, Bentley & Dolan Inc.	
<b>Cambridge Thermionic Corporation</b>	186	Faust/Day Incorporated		<b>Inland Control Incorporated</b>	292
Chirurg & Cairns Incorporated		<b>Fairchild Semiconductor Incorporated</b>	12, 13, 216	S. Gunnar Myrbeck & Company	
<b>Cedar Engineering Div. of Control Data Corporation</b>	261	Faust/Day Incorporated		<b>International Rectifier Corporation</b>	249
Cole & McVoy Advertising Inc.		<b>Fenwal Electronics Incorporated</b>	240	Botsford, Constantine & McCarty Inc.	
<b>Chemcut Corporation</b>	302	Larcom Randall Advertising Inc.		■ <b>ITT Cannon Electric Incorporated</b>	258, 259
Adams Associates Inc.		<b>Ferroxcube Corporation of America</b>	94	West Weir & Bartel Incorporated	
<b>Cherry Electrical Products Corporation</b>	263	Solow/Wexton Inc.			
K & A Incorporated					
■ <b>Chicago Dynamic Industries Inc.</b>	248				
Burton Browne Advertising					
■ <b>Cinch Manufacturing Company</b>	105				
Stral Advertising Company					
<b>C.P. Clare &amp; Company</b>	76, 77				
Reincke, Meyer & Finn Inc.					
■ <b>Cohn Corporation, Sigmund</b>	313				
William G. Seidenbaum & Company					
<b>Cohu Electronics</b>	95				
Erwin Wasey, Ruthrauff & Ryan Inc.					

■ For more information on complete product line see advertisement in the latest Electronics Buyers' Guide  
 □ Advertisers in Overseas Advertising Section following newsletter from abroad







# Electronics advertisers



# HIGH VOLTAGE LOW COST SILICON POWER TRANSISTORS

from

# Solitron



Here are three new family additions to Solitron's line of High Voltage Silicon Power Transistors. New production techniques have reduced the cost of these popular devices . . . and their performance matches that of similar higher priced units now on the market. A few of the many uses of these devices, available in a TO-3 package, include TV Circuits, Audio Amplifiers, Converters, Inverters and Relay Drivers.

## 2N 3055

V<sub>ceo</sub> = 60 volts I<sub>c</sub> max = 15 amp

Gain 20-70 @ 4A  
VCE (sat) 1.1 Max @ 4A  
VBE 1.8 max @ 4A  
V(BR)/CEX 100V Min  
Power 115 watts @ 25°C

**\$150\***

## 2N 3773

V<sub>ceo</sub> = 140 volts I<sub>c</sub> max = 30 amp

Gain 15-60 @ 8A  
VCE (sat) 1.4 Max @ 8A  
VBE 2.2 Max @ 8A  
V(BR)/CEX 160V Min  
Power 150 watts @ 25°C

**\$350\***

## SDT 1000 SERIES

V<sub>ceo</sub> = 400 volts I<sub>c</sub> max = 10 amp

Gain 30-90 @ 1.0A  
VCE (sat) 0.8V Max @ 1.0A  
VBE (sat) 1.5V Max @ 1.0A  
V(BR)/CEX 400V Min  
Power 100 watts @ 25°C

**\$700\***

All of these devices have built-in protection against secondary breakdown and are associated with the high reliability standards of Solitron.

**CONTACT US TODAY  
FOR COMPLETE PERFORMANCE DATA.**

\*Prices indicated are for quantities of 1,000 and up.

TRANSISTOR DIVISION

# Solitron

## DEVICES, INC.

1177 BLUE HERON BLVD.  
RIVIERA BEACH, FLORIDA  
(305) 848-4311 / TWX: (510) 952-6676

## Advertising sales staff

**Frank E. LeBeau [212] 971-6464**

Advertising sales manager

Atlanta, Ga. 30309: Michael H. Miller, 1375 Peachtree St., N.E., [404] TR 5-0523

Boston, Mass. 02116: William S. Hodgkinson McGraw-Hill Building, Copley Square, [617] CO 2-1160

Chicago, Ill. 60611: Robert M. Denmead, J. Bradley MacKimm, 645 North Michigan Avenue, [312] MO 4-5800

Cleveland, Ohio 44113: William J. Boyle, 55 Public Square, [216] SU 1-7000

Dallas, Texas 75201: Richard P. Poole, 1800 Republic National Bank Tower, [214] RI 7-9721

Denver, Colo. 80202: Joseph C. Page, David M. Watson, Tower Bldg., 1700 Broadway, [303] 255-5484

Detroit, Michigan 48226: J. Bradley MacKimm, 856 Penobscot Building [313] 962-1793

Houston, Texas 77002: Kenneth George, 2270 Humble Bldg., [713] CA 4-8381

Los Angeles, Calif. 90017: Ian C. Hill, John G. Zisch, 1125 W. 6th St., [213] HU 2-5450

Minneapolis, Minn. 55402: J. Bradley MacKimm, 1104 Northstar Center [612] 332-7425

New York, N. Y. 10036: Donald R. Furth [212] 971-3615  
James R. Pierce [212] 971-3615  
George F. Werner [212] 971-3615  
500 Fifth Avenue

Philadelphia, Pa. 19103: Warren H. Gardner, Jeffrey M. Preston, 6 Penn Center Plaza, [215] LO 8-6161

Pittsburgh, Pa. 15222: Warren H. Gardner, 4 Gateway Center, [412] 391-1314

Portland, Ore. 97204: James T. Hauptli, 218 Mohawk Building, 222 S.W. Morrison Street, Phone [503] 223-5118

Rochester, N.Y. 14534: William J. Boyle, nine Greylock Ridge, Pittsford, N.Y., [716] 586-5040

St. Louis, Mo. 63105: Robert M. Denmead The Clayton Tower, 7751 Carondelet Ave. [314] PA 5-7285

San Francisco, Calif. 94111: James T. Hauptli, 255 California Street, [415] DO 2-4600

London W1: John W. Patten, Edwin S. Murphy Jr., 34 Dover Street, Hyde Park 1451

Milan: 1, via Baracchini Phone: 86-90-617 86-90-656

Frankfurt/Main: Gerd Hinske, Dieter Rothenbach, Elsa-Brandstroem Str. 2 Phone: 72 01 81

Geneva: Michael R. Zeynel, 1, rue du Temple Phone: 31 95 60

Paris VIII: Denis Jacob, Kenneth Davey, 17 Avenue Matignon Phone: 359 6637

Tokyo: Nobuyuki Sato, 1, Kotohiracho Shiba, Minato-Ku [502] 0656

Osaka: Ryosji Kobayashi, 163, Umegee-cho, Kita-ku [362] 8771

Wallace C. Carmichael [212] 971-3191  
Manager Electronics Buyers' Guide

David M. Tempest [212] 971-3139  
Promotion manager

Milton Drake [212] 971-3485  
Research and circulation manager

Wallis Clarke [212] 971-2187  
Assistant to sales manager

Wallace C. Carmichael [212] 971-3191  
Business manager

Stephen R. Weiss [212] 971-2044  
Production manager

Thomas M. Egan [212] 971-3140  
Production manager Electronics Buyers' Guide

United Systems Corporation Advertising & Merchandising Incorporated 279  
■ United Transformer Company Philip Stogel Company 2nd Cover  
■ Unifrode Corporation Silton, Callaway & Hoffman Incorporated 62, 63

■ Vactec Incorporated Coleman & Associates Inc. 305  
■ Victory Engineering Corporation Black-Russell-Morris Incorporated Volkert Stampings Fred Wittner Company 220 348

Wang Laboratories Larcom Randall Advertising Incorporated 317  
Watkins-Johnson Company Williams C. Estler Public Relations Wayne Kerr Corporation Josephson, Cuffari Company Westinghouse Semiconductor Corporation ITSM Division of McCann Erickson West Penn Power Company Fuller & Smith & Ross Incorporated Weston Instruments Archbold Division Arndt, Preston, Chapin, Lamb & Keen Incorporated ■ Weston Instruments Newark Division Arndt, Preston, Chapin, Lamb & Keen Incorporated S.S. White Company W.L. Towne Company Inc. State of Wisconsin Department of Resource Development The Cramer-Krasselt Company 317 57 222 68, 69 325 194 100 270 211

Zippertubing Company, The Edward S. Kellogg Company 315

## Classified Advertising

F.J. Eberle, Business Mgr.

EMPLOYMENT OPPORTUNITIES 330-335

EQUIPMENT (Used or Surplus New) For Sale 335

## ADVERTISERS INDEX

A & A Electronics 335  
Adams, F. W. 335  
Atomic Personnel, Inc. 330  
Fair Radio Sales 335  
Fishman Co., Phillip 335  
General Electric 331  
Grumman Aircraft Engineering Corp. 332  
Gunther, R. E. 335  
Havas International 335  
International Business Machines 332  
Lear Siegler, Inc. 330  
Norman Electronic Sales 335  
Radio Research Instrument Co. 335  
Raytheon Co. 334  
Sanders Associates, Inc. 333  
Union Carbide Corp. 330

■ For more information on complete product line see advertisement in the latest Electronics Buyers' Guide

□ Advertisers in Overseas Advertising Section following newsletter from abroad



# Whose dual in-line 930 DTL?

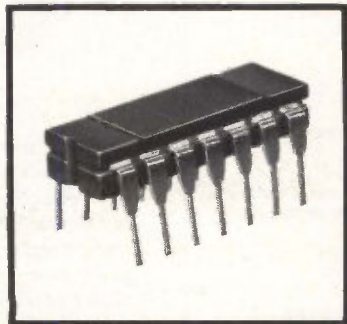

**ITT**



**OTHERS**

**Only your  
purchasing agent knows  
for sure!**

ITT offers all series 930 DTL circuits in a dual in-line package. Circuits manufactured by ITT are identical to and perfectly interchangeable with the other leading brand.

If you're convinced that dual in-line packaging is your answer — if you want

the lower component insertion cost, heavier leads and all-ceramic construction that only dual in-line can give you, evaluate ITT.

You can order any series 930 DTL in dual in-line today! Call your ITT distributor or factory representative.

**ITT**  
SEMICONDUCTORS

ITT SEMICONDUCTORS IS A DIVISION OF THE INTERNATIONAL TELEPHONE AND TELEGRAPH CORPORATION  
FACTORIES IN WEST PALM BEACH, FLORIDA; PALO ALTO, CALIFORNIA; LAWRENCE, MASSACHUSETTS; HARLOW AND FOOTSCRAY, ENGLAND; FREIBURG AND NURENBERG, GERMANY

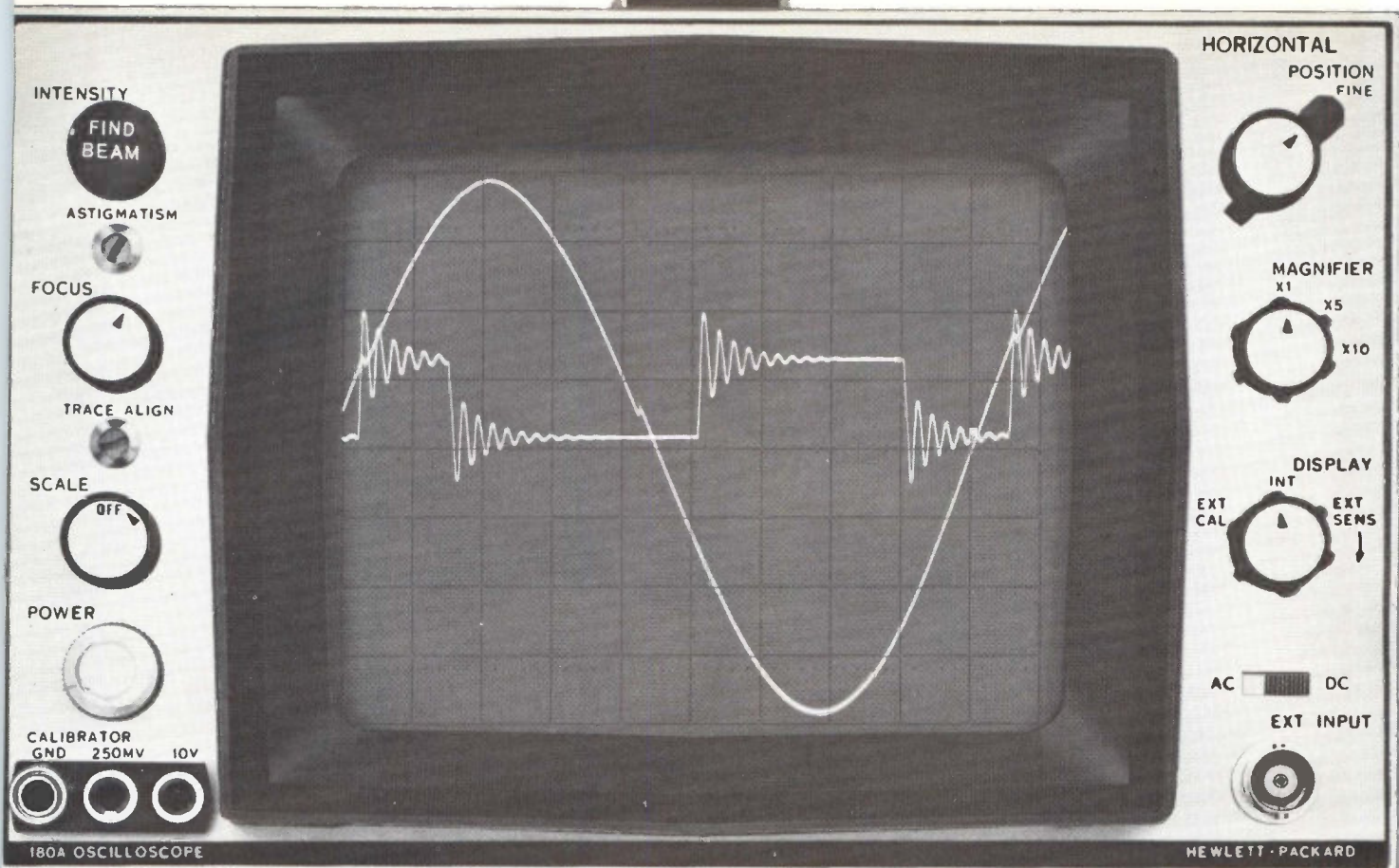

*See More! Do More!*

## LARGE AREA 8x10 cm CRT MAKES ACCURATE MEASUREMENTS—EASIER!

• 50 MHz at 5 mv/cm • 30 POUNDS • ALL-SOLID-STATE • PLUG-IN VERSATILITY

Accurate measurements are easier to read . . . easier to make on the new hp 180A *Big-Picture* Oscilloscope. New hp design breakthrough offers an extra-large 8 x 10 cm CRT display area—30% to 100% greater than any other high-frequency scope! You get sharp, crisp traces for resolution of waveform details. The black internal graticule, calibrated in centimeters, and bright trace — give you maximum contrast, make measurements easier to read, more accurate. Parallax error is eliminated. The 12 kv accelerating potential produces bright, easy-to-see traces, even at 5 nsec/cm sweeps. Flood guns in the CRT allow variable background illumination for optimum contrast of graticule and trace for excellent photographic recording.

Mainframe and plug-ins of the hp 180A are all-solid-state. Mainframe is the first with power supplies specifically designed for solid-state circuitry — gives you full performance benefits from solid-state devices in all present and future plug-ins.

The dual channel 50 MHz at 5 mv/cm vertical amplifiers have low-drift FET input stages for accurate DC measurement—plus quick 15-second warm-up. Vertical plug-in amplifiers drive the CRT vertical deflection plates directly requiring only 3 v/cm. This allows even greater bandwidth capabilities in future plug-ins.

Time base plug-ins offer new easy-to-use delayed sweep. Tunnel diode triggering circuits lock-in complex waveforms to beyond 90 MHz. Exclusive hp mixed sweep features combine display of first portion of trace at normal sweep speeds, and simultaneously expands trailing portion of trace at faster delayed sweep speed to allow magnified examination.

Get the BIG picture! Ask your nearest hp field representative for a demonstration of how you can see more, do more with the new versatile, go-anywhere, 30-pound hp 180A Oscilloscope. Or, write to Hewlett Packard, Palo Alto, California 94304, Tel. (415) 326-7000; Europe: 54 Route des Acacias, Geneva. Price: hp Model 180A Oscilloscope, \$825.00; hp Model 180AR (rack) Oscilloscope, \$900.00; hp Model 1801A Dual Channel Vertical Amplifier, \$650.00; hp Model 1820A Time Base, \$475.00; hp Model 1821A Time Base and Delay Generator, \$800.00.

**HEWLETT**  **PACKARD**  
An extra measure of performance

ACTUAL SIZE

Circle 901 on reader service card



**For critical  
chopper applications...  
RCA's new MOS transistor  
will even work**

# UPSIDE DOWN

RCA's new 40460 is an N-channel, depletion type, insulated-full-gate MOS which, because of its symmetry, can be operated "upside down"...works equally well with either positive or negative incoming signals...does the work of two bipolar transistors.

RCA's full-gate MOS is especially useful for chopper applications at extremely low voltage levels...handles input signals from microvolts to volts. It has an inherent offset voltage of zero. This means that the RCA 40460 has none of the tracking problems of matched bipolar devices, caused by temperature changes and extended operation.

A high "off" resistance of 1000 megohms and a low "on" drain-to-source resistance of only 250 ohms make the RCA 40460 perform like a mechanical chopper, without its drawbacks. And you get all the advantages of solid-state reliability. In addition, long-term stability is assured by a fully metallized gate and a hermetically sealed JEDEC TO-72 4-lead metal case.

**TO GET THE MOST FROM YOUR RCA 40460 CHOPPER, use the new RCA 40461 MOS transistor in your chopper amplifier stage, as well as for other critical audio and wideband applications.**

Try these devices and see how they improve your chopper design. Check your RCA Field Representative for complete information. For technical bulletins, write RCA Commercial Engineering, Section CN 12-2, Harrison, N. J. 07029.

ALSO AVAILABLE THROUGH YOUR RCA DISTRIBUTOR

RCA's New 40460 MOS Transistor Features ZERO OFFSET VOLTAGE\*

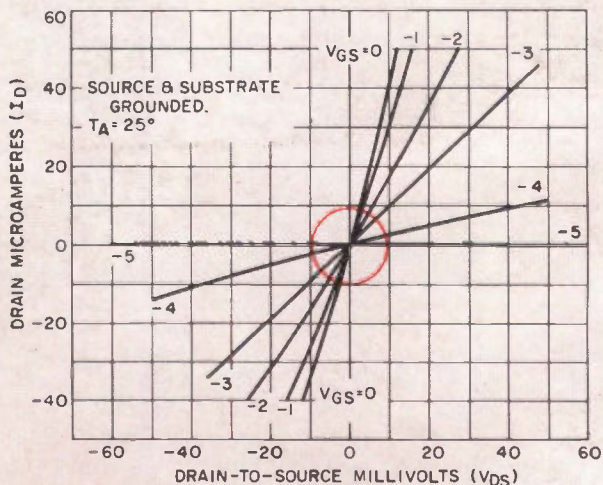

\*Thermocouple effects and contact potentials may cause erroneous readings



RCA ELECTRONIC COMPONENTS AND DEVICES

The Most Trusted Name in Electronics