

Electronics®

Exploiting vortexes in superconductors: page 100

Scr's in kilowatt transmitters: page 119

Switching saves power in digital systems: page 135

June 13, 1966

75 cents

A McGraw-Hill Publication

Below: Stamped foil automates IC module welding: page 128





**Type 1232-A
Tuned Amplifier and Null Detector**

... a battery-operated, solid-state instrument consisting of a low-noise preamplifier, followed by a frequency selective stage and an amplifier-compressor stage.

A Versatile Tuned Amplifier for Lab Use

- **HIGH SENSITIVITY** • **HIGH SELECTIVITY** • **VERY LOW NOISE LEVEL**

A superb null detector, the GR Type 1232-A is also an excellent low-noise laboratory amplifier. You can use it either as a 20-Hz to 20-kHz tunable amplifier (approximately 5% bandwidth at any setting, 2nd harmonic rejection is down at least 34 dB), as a flat 20-Hz to 100-kHz amplifier (frequency characteristic constant to ± 3 dB), or as a fixed-frequency amplifier at either 50 kHz or 100 kHz. When used as a tuned amplifier, short-circuit noise is less than 0.1 μ V over most of the tuned range and open-circuit noise is less than 10 pA . . .

in fact, noise is virtually independent of source impedance. Voltage gain is adjustable to 120 dB over the tunable ranges, and to more than 100 dB for the flat-range and the fixed 50-kHz and 100-kHz settings. Distortion in the FLAT position is less than 5%. Output is 1 volt into 10,000 ohms.

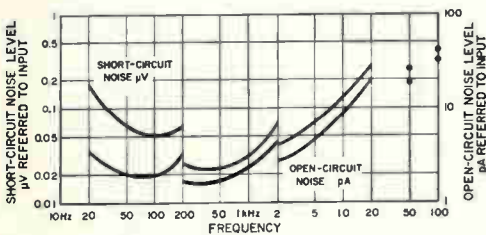

Short- and open-circuit noise as a function of frequency.

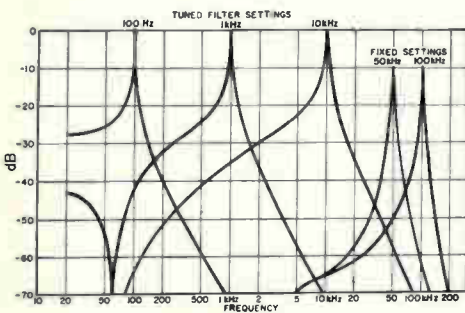

Typical selectivity curves when used in tunable mode.

SENSITIVITY AS A NULL DETECTOR:

Typically better than 0.1 μ V over most of frequency range. 1 μ V will provide full-scale meter deflection when used as a tuned null detector; 20 μ V full scale, when used in "flat" mode.

METER RESPONSE:

Either linear or logarithmic. Compression reduces full-scale sensitivity by 40 dB . . . does not affect sensitivity at bottom end of meter scale.

MAX. INPUT VOLTAGE: 200 V ac or 400 V dc

INPUT IMPEDANCE: 50 k Ω to 1 M Ω depending on gain-control setting

OUTPUT IMPEDANCE: Internal impedance is 3000 Ω

POWER: 12 V dc; 9 mercury cells give 1500-hour operation.

PRICE: \$360 in U.S.A.

Write for complete information

BOSTON • NEW YORK • CHICAGO • PHILADELPHIA • WASHINGTON, D.C.
SYRACUSE • DALLAS • SAN FRANCISCO • LOS ANGELES • ORLANDO
CLEVELAND • TORONTO • MONTREAL
BOURNE END, ENGLAND ZURICH, SWITZERLAND

GENERAL RADIO
WEST CONCORD, MASSACHUSETTS

Circle 900 on reader service card

INKLESS

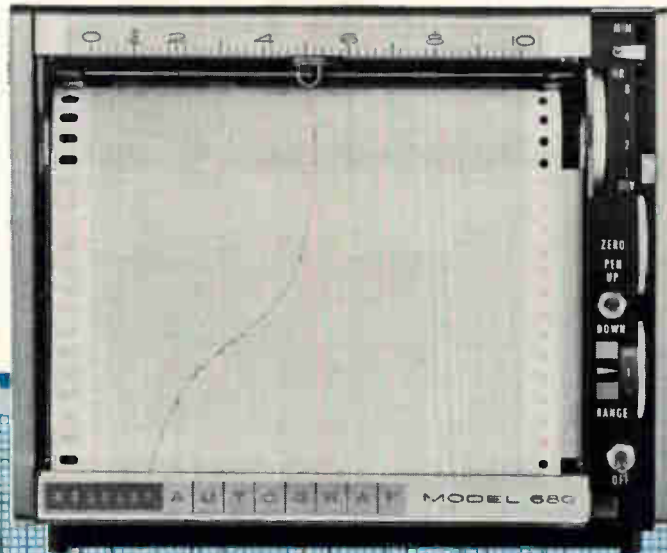

NEW STRIP-CHART WRITING TECHNIQUE:

- Ends pen clogging, ink drying
- Gives clear, clean traces
- Provides new economy

New Hewlett-Packard electrosensitive paper, available as a standard option on Moseley 680 and 7100 Series Strip-Chart Recorders, ends the problems associated with pen-and-ink writing techniques... at an economical price and without the disadvantages inherent in other available electric writing methods.

The Hewlett-Packard electrosensitive paper is a special electro-chemical coated chart paper. The coating is current sensitive, changing to a dark brown trace with application of voltage from the recorder stylus. The new technique eliminates the familiar arc method of electric writing on carbon-backed paper.

With Hewlett-Packard electric writing, you can use your strip-chart recorders for long-term, unattended monitoring, with increased performance at slow writing speeds, as well as at high writing speed. It is non-

pressure sensitive, so that you can't damage or obscure your recordings.

Here's another advance in recording capability from Hewlett-Packard. Call your Hewlett-Packard field engineer for information on converting your strip-chart recorder to maintenance-free electric writing. Or write for information: Hewlett-Packard, Palo Alto, California 94304, Tel. (415) 326-7000; Europe: 54 Route des Acacias, Geneva.

Data subject to change without notice.

**HEWLETT
PACKARD**  **MOSELEY
DIVISION**

New value-priced sweeper...

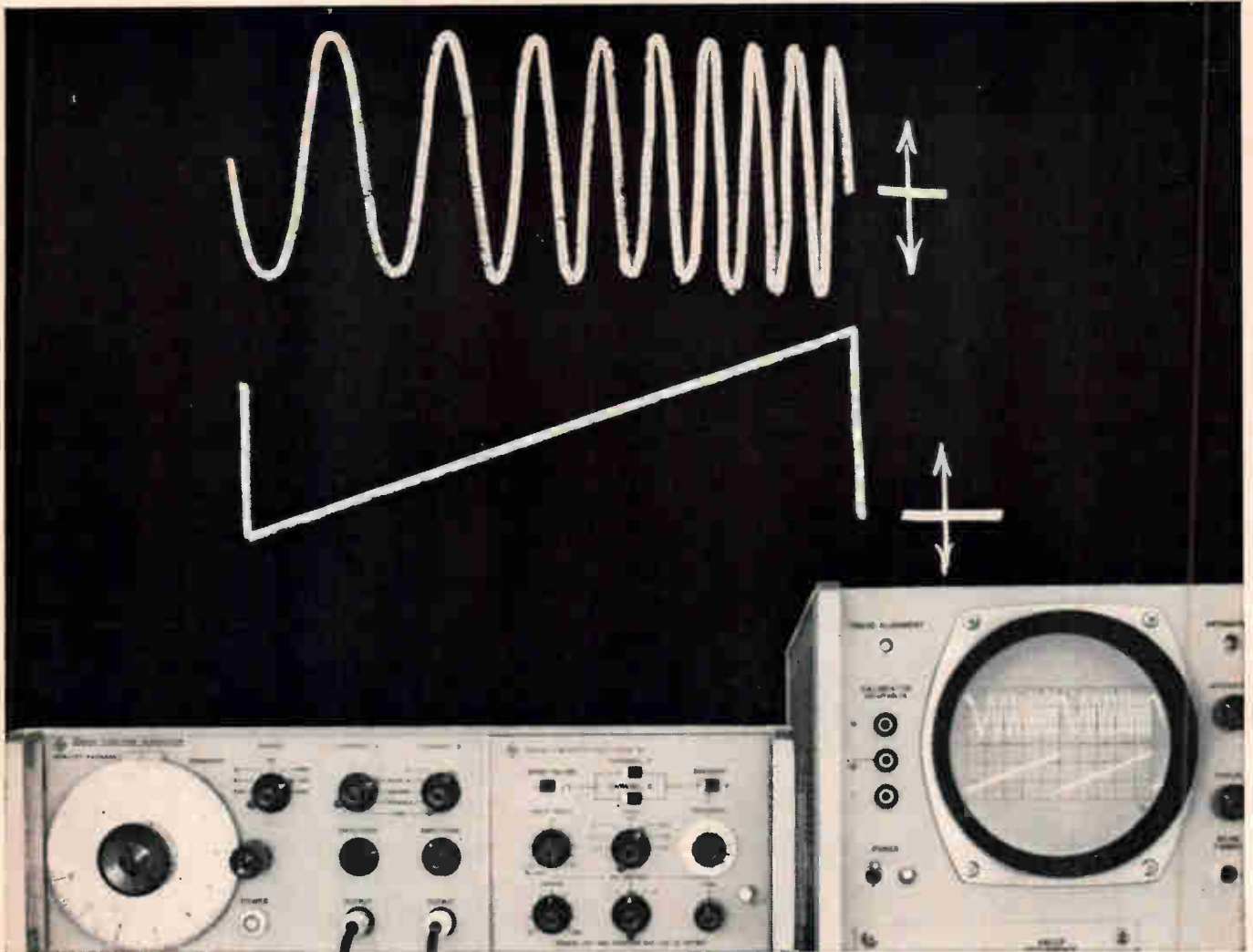

with a dc offset plug-in for your Hewlett-Packard 3300A Function Generator

Here's a low cost (\$210) plug-in, 3304A, for the Hewlett-Packard 3300A Function Generator that provides internal sweeping, up to ± 16 v of dc offset on all functions, plus sawtooth and offset square-wave outputs.

This is an instrument package you need to use on your bench . . . it provides more flexibility than words can describe. The new plug-in sweeps internally over a decade. The sweep starts at the main frame frequency setting and is controlled at the top end by the "Sweep Width" control. Any function can be offset with stability of ± 50 mv over 24 hours. The 3304A plug-in sawtooth is independent of the 3300A main frame frequency and can be used for driving external systems. The offset square wave clamps the top or bottom of the waveform either to the dc offset voltage or to ground potential.

The plug-in provides the offset with coarse and vernier control, a 15 v sawtooth (adjustable) and the square wave over the same frequency range as the main frame. The main frame, the 3300A itself, is the first plug-in function generator to offer variable phase, phase-lock capability with accurate sine, square, triangular output, amplitude controlled, 0.01 Hz to

100 kHz. It offers linear voltage programmability, single-cycle, multi-cycle, free-run operation, external trigger capability. It provides isolated dual output amplifiers, plus a sync pulse output for oscilloscope or recorder.

All this for just \$570, plus the cost of one of these plug-ins: 3301A Operational Plug-in, \$20; 3302A Trigger/Phase-Lock Plug-in, \$190; 3304A Sweeper/Offset Plug-in, \$210.

Ask for a demonstration. Have your Hewlett-Packard field engineer turn it on and show you what this remarkably versatile instrument can give you. Or write for a special chart showing all the outputs available from this instrument and its plug-ins: Hewlett-Packard, Palo Alto, California 94304, Tel. (415) 326-7000; Europe: 54 Route des Acacias, Geneva.

Data subject to change without notice. Prices f.o.b. factory.

HEWLETT  **PACKARD**
An extra measure of quality

1369

Electronics

June 13, 1966
Volume 39, Number 12

Page 4	Readers Comment
8	People
14	Meetings
16	Meeting Preview
23	Editorial
25	Electronics Newsletter
67	Washington Newsletter
183	New Products
240	New Books
245	Technical Abstracts
246	New Literature

Page	35	Triumphant Surveyor	38	Cement by numbers
	36	Qualified success	40	Heartprint
	36	. . . on the other hand	42	Beating time
	37	Dual role	42	Two-pound radar
	37	Absorbing memories	44	Team work
	38	Up in the air	46	The race is on
	38	Critical reviews		

Electronics Review

Probing the News

151	Process control: big boom in Britain
161	Europe split on color tv
167	Testing missiles by the dozens

Electronics Abroad

255	Fast characters	257	Laser in the mill
256	Standards time	258	Eased growing pains
257	Weather-watcher		

Technical Articles

I. Design

Advanced technology	100	Vortexes create a stir in superconductors Control may lead to new computer devices Judea Pearl, Radio Corp. of America
Circuit design	106	Designer's casebook <ul style="list-style-type: none">■ One-megahertz flip-flop saves standby power■ Circuit protects meter from current spikes■ Current generator compensates for drift■ D-c amplifier cuts cost of voltmeter■ Diode, resistor increase Schmitt resistance■ Control is accurate to 0.01° C
Reference sheet	112	Charting the bandwidth of isolating r-f chokes Graphic aid speeds design of chokes for suppressing spurious currents Ernest T. Harper, Army Electronics Command
Instrumentation	114	Six clues to nanovolt signals Minimum detectable signal analysis aids design of low-level measurement systems Wayne A. Rhinehart and Louis Moulam Jr.
Communications	119	Adding scr's to get high transmitter power Combining outputs results in a compact unit G.R. Brainerd, W.R. Olson and E.H. Hooper, Westinghouse Electric Corp.
Manufacturing	128	Strips of nickel foil automate IC welding Numerical control expedites production V.M. White, H.F. Sweitzer Jr. and W.T. McMorran
Computers	135	Power switching trims digital system weight, cost Turning off unused power reduces hardware Rodger A. Cliff, Goddard Space Flight Center
Opinion	142	The myth of obsolescent knowledge An engineer offers a hedge against the future Gerd D. Wallenstein, Lenkurt Electric Co.

Title R registered
U.S. Patent Office;
© copyright 1966
by McGraw-Hill, Inc.
All rights reserved,
including the right to
reproduce the contents
of this publication,
in whole or in part.

Electronics

Editor: Lewis H. Young

Senior editors

Design: Samuel Weber
Application: George Sideris
News: Kemp Anderson Jr.

Assistant to the editor: Sally Powell

Senior associate editors: John F. Mason, Don Christiansen

Department editors

Avionics: W.J. Evezia
Communications: Leonard Weller
Computers: Wallace B. Riley
Electronics abroad: Arthur Erikson
Electronics review: Stanley Zarowin
Instrumentation: Carl Moskowitz
Military electronics: John F. Mason
New products: William P. O'Brien
Solid state: Jerome Eimbinder
Space electronics: Robert Henkel
Special projects: Don Christiansen
Staff writer: Jan Rahm

Regional editors

Domestic

Boston: Thomas Maguire, editor; Robin Carlson
Los Angeles: William B. Wallace, editor; June Ranill
San Francisco: Walter Barney, editor; Mary Jo Jadin

Foreign

European: Derek Barlow, (London)
Bonn: John Gosch
Tokyo: Charles Cohen

Copy editors

James J. Moran, David Goller

Graphic design

Art director: Saul Sussman
Assistant art directors: Donna M. Griffiths, Ann Mella
Production editor: Arthur C. Miller

Editorial secretaries: Claire Benell, Lynn Emery, Lorraine Fabry,
Kay Fontana, Lorraine Longo, Carolyn Michnowic-

McGraw-Hill News Service

Director: John Wilhelm; Atlanta: Fran Ridgway; Chicago: Reck Johnson;
Cleveland: Arthur Zimmerman; Dallas: Marvin Reid;
Detroit: N. Hunter; Houston: Ron Lovell; Los Angeles: Michael Murphy, Gerald Parkinson
San Francisco: Margaret Drossel
Seattle: Ray Bloomberg; Washington: Arthur L. Moore, Charles Gardner,
Herbert W. Cheshire, Seth Payne, Warren Burkett, Warren Kornberg

McGraw-Hill World News Service

Bonn: John Johnsrud; London: John Shinn;
Mexico City: Bruce Cross; Milan: Ronald Taggiasco;
Moscow: Donald Winston; Paris: Peter Kilborn;
Rio de Janeiro: Wes Perry; Tokyo: Marvin Petal

Reprints: Thomas M. Egan

Publisher: Gordon Jones

Electronics: June 13, 1966, Vol. 39, No. 12

Printed at 99 North Broadway, Albany, N.Y., 12207
Second class postage paid at Albany, N.Y.

Subscriptions are solicited only from those actively engaged in the field of the publication. Position and company connection must be indicated on orders. Subscription prices: United States and Possessions and Canada, \$6.00 one year, \$9.00 two years, \$12.00 three years. All other countries \$20.00 one year. Single copies, United States and Possessions and Canada 75¢. Single copies all other countries \$1.50.

Published every other Monday by McGraw-Hill Inc. 330 West 42nd Street, New York, N.Y. 10036. Founder: James H. McGraw, 1860-1948. Corporate officers: Shelton Fisher, President; John J. Cooke, Secretary; John L. McGraw, Treasurer.

Subscribers: The Publisher, upon written request to our New York office from any subscriber, agrees to refund that part of the subscription price applying to copies not yet mailed. Please send change of address notices, subscription orders or complaints to Fulfillment Manager, Electronics, at the address below. Change of address notices should provide old as well as new address, including postal zone number if any. If possible, attach address label from recent issue. Allow one month for change to become effective.

Postmaster: Please send Form 3579 to Fulfillment Manager, Electronics, P.O. Box 430, Hightstown, New Jersey 08520

Readers Comment

Transient protection

To the Editor:

The article "Voltage transients tamed by spark-gap arresters" [April 18, p. 109] describes very well the advantages of gas-filled surge voltage protectors over conventional protection methods. I would like to emphasize that such gas-filled spark gaps are not only of great interest to the telephone industry but also, increasingly, to the electronics industry to protect solid state circuitry.

In the past, little attention was paid to this problem, partly because engineers had not fully realized the danger of transients to semiconductors and partly because suitable spark gaps were not available.

A protector for this kind of application should meet certain requirements with regard to the breakdown voltage, the breakdown speed and the size. These requirements are now met with newly designed gas-filled surge voltage protectors which have just been introduced. The breakdown voltage is only 90 volts and a high breakdown speed is assured by incorporating radioactive isotopes into the protector. Its size (.38 inch diameter and one-quarter inch long) is such that the unit can easily be used in printed circuit boards.

In the telephone industry, until just recently, one difficulty in using gas-filled spark gaps was that the installation of these devices in existing hardware presented some difficulty. New designs of holding devices for protectors, however, have also solved this problem satisfactorily.

G. Zappe

Telecommunications Division
Siemens America Inc.
New York

Light-gathering

To the Editor:

The new product story, "Cathode-ray tube displays fast transients," [April 18, p. 165], contains some serious technical errors indicating the editor's knowledge of optics is not equal to his probable

You Can Get All These Microcircuits from Sprague Electric:

SERIES SU300, LU300 UTILOGIC



K Package

For use in commercial, industrial, ground support applications. Available in two operating temperature ranges, -20 C to +85 C, and +10 C to +55 C. Propagation delay of 15 to 40 nanoseconds.

*Trademark of Signetics Corp.

Circle 501 on reader service card

*SERIES SE400, NE400 LOW POWER LOGIC

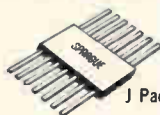

J Package

Operating temperature ranges: -55 C to +125 C, and 0 C to +70 C. For use in Aerospace and other applications where low power drain is required. Optimized speed, noise margin.

Circle 502 on reader service card

*SERIES SE500 LINEAR AMPLIFIERS



K Package

Operating temperature range: -55 C to +125 C. Two linear circuits available in 10-lead low silhouette TO-5 case. SE501K is a video amplifier, SE505K is a general purpose differential amplifier.

Circle 503 on reader service card

UNICIRCUIT® RTL LOGIC



(8x actual size)

Sprague Series US-0100 . . . a complete line of silicon monolithic digital building blocks featuring low power consumption (2 mW typ.)

Circle 504 on reader service card

UNICIRCUIT® mW RTL LOGIC



TO-5 Case

Types US-0908 through US-0921 . . . Fully interchangeable mW digital building blocks featuring power consumption of 4 mW/node and propagation delay of 40 nsec.

Circle 505 on reader service card

UNICIRCUIT® CUSTOM HYBRID CIRCUITS



Combine monolithic silicon circuits with tantalum or Ni-Cr alloy resistors. Close resistance tolerances, low temperature coefficient. Resistor matching, $\pm 1/2\%$.

Circle 506 on reader service card

DIGITAL-TO-ANALOG CONVERSION CIRCUITS



UT-1000—Four-bit ladder network
UT-4001—Ladder switch for driving resistor ladder networks
UT-4024—Buffer amplifier

Circle 507 on reader service card

*Series SE100, NE100,
CS700, SU300, LU300,
SE400, NE400, SE500
are all available
from Sprague Electric
under technology interchange
with Signetics Corp.

For data sheets on the microcircuits in which you are interested, write to:

Technical Literature Service
Sprague Electric Company
35 Marshall Street
North Adams, Mass. 01247

SPRAGUE COMPONENTS

INTEGRATED CIRCUITS
THIN-FILM MICROCIRCUITS
TRANSISTORS
CAPACITORS
RESISTORS

PULSE TRANSFORMERS
INTERFERENCE FILTERS
PULSE-FORMING NETWORKS
TOROIDAL INDUCTORS
ELECTRIC WAVE FILTERS

CERAMIC-BASE PRINTED NETWORKS
PACKAGED COMPONENT ASSEMBLIES
BOBBIN and TAPE WOUND MAGNETIC CORES
SILICON RECTIFIER GATE CONTROLS
FUNCTIONAL DIGITAL CIRCUITS

SPRAGUE®
THE MARK OF RELIABILITY

*Sprague and ® are registered trademarks of the Sprague Electric Co.

precision dc voltage standards now available with— accuracies to 0.003% stability to 15 ppm from Cohu Electronics



Model 326

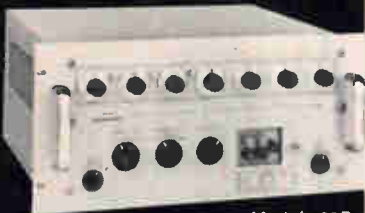

Model 303B



Model 313

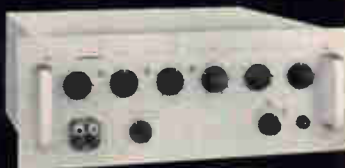

Model 321

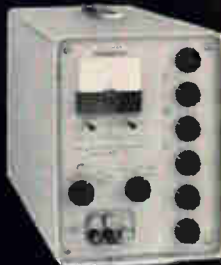

Model 323-01

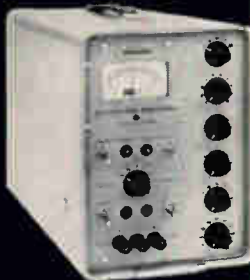

Model 302



Model 325

■ **COHU'S NEW MODEL 326 DC VOLTAGE STANDARD:** an exceptionally accurate and stable source with a wide range of voltages at extremely low output impedance. Output voltages from 0 to ± 1222.2221 volts in 3 decade ranges, with steps as small as $1 \mu\text{V}$, and an accuracy of 0.003% of setting; stability within 15 ppm for 7 days, 25 ppm for 6 months; output current to 50 mA; output impedance less than $(0.00025 + 0.00005E_{\text{out}})$ ohms at DC; noise and hum less than $20 \mu\text{V rms}$. \$2490.00.

■ **MODEL 303B DC VOLTAGE STANDARD:** highly accurate, direct setting, stable output over a wide range of voltages. Specifications: output voltage accuracy to within 0.01% of setting; output voltage from 0 to ± 1111.1110 volts in 3 decade ranges, steps as small as $1 \mu\text{V}$; output current to 25 mA; stability within 25 ppm for 7 days, 50 ppm for 6 months; noise and hum less than $40 \mu\text{V rms}$. \$2000.00.

■ **MODEL 313 PROGRAMMABLE DC VOLTAGE STANDARD:** from 0 to ± 1111.1110 volts in any desired sequence. The instrument automatically responds to any program applied in the form of parallel entry, 1-2-4-4 BCD signals; output voltage accuracy is within 0.01%; stability is within 25 ppm for 8 hours and 50 ppm for 30 days; noise and hum is less than $40 \mu\text{V rms}$; output current up to 25 mA; maximum settling time of output approx. 1 second. \$3995.00.

■ **MODEL 321/323 DC VOLTAGE STANDARDS:** accurate, stable voltages, to 25 mA current in rackmount or cabinet configurations. Voltage range 0 to ± 1111.110 volts with steps as small as $10 \mu\text{V}$; output voltage accuracy within 0.01% of dial settings; stability is within 25 ppm for 8 hours and 50 ppm for 30 days; output noise and hum less than $40 \mu\text{V rms}$; Model 321 (rackmount) or 323 (cabinet) versions available with or without nullmeter. \$1600.00 to \$1900.00.

■ **MODEL 302 DC VOLTAGE STANDARD AND NULL VOLTMETER:** range 1.000 to 502.110V; short term stability, $\pm 25 \text{ ppm} \pm 25 \mu\text{V}$; output current to 20 mA; accuracy within 0.01% of setting $\pm 200 \mu\text{V}$. \$1495.00.

■ **MODEL 325 DC VOLTAGE CALIBRATOR:** a stable dc voltage source with an accuracy within 0.02%. Output voltage is from 0 to $\pm 1111.110\text{V}$ in steps as small as $10 \mu\text{V}$; output current to 25 mA; lightweight; portable. \$995.00.

Send for complete product information on these dc voltage standards, or any of COHU's line of precision instruments. Representatives in all major cities.



See Us At WESCON, Hollywood Park, Booth 111

Box 623, San Diego, California 92112
Phone 714-277-6700

knowledge of electronics.

In this article the stated gain in crt recording speed of 30 to 40 times is entirely attributed to the greater light gathering power of a fiber bundle compared to a lens of a speed of $f/1.0$. If a working speed of $f/1.0$ was meant, then the greatest gain possible from greater angular collection is a factor about equal to π , instead of the 30 to 40 times. A collection greater than an aperture ratio of $f/0.5$ is not possible theoretically, whereas a collection equivalent to $f/0.05$ is claimed—wrong by a factor of 10!

No doubt the greatest gain comes from using a more concentrated electron beam, and perhaps some additional gain from the use of a faster film for the recording.

Oran E. Miller

Photographic Technology Division

Eastman Kodak Co.
Rochester, N. Y.

The author replies:

Oran Miller is in error in his remarks concerning the greater light-gathering power of a fiber bundle compared to a lens of a speed of $f/1.0$. The working speed of $f/1.0$ was not intended; the ratio of focal length to diameter was meant.

The theoretical gain of the fiber bundle over that of an $f/1.0$ camera lens is 9 times. However, the gain is generally greater for all practical purposes, since a camera lens is seldom perfectly clean. Therefore, the gain indicated in the article is essentially correct.

The equivalent lens speed of the fiber optic display should be $f/0.5$, an apparent typographical error or a misinterpretation when the in-

formation was checked over the telephone.

Robert Koppelon

Senior Engineer
Fairchild Dumont
Laboratories
Clifton, N. J.

Stills are still adequate

To the Editor:

In your editorial "School market waits." [May 16, p. 23] you rightly state that engineers may be too sophisticated in their learning system design.

The glamor of television and computers has obscured the real needs of learners, whether in schools, industry, government or home study. Still pictures, preferably in color, are adequate, and there is little need for real-time transmission since most learning data changes slowly. A postage-stamp-size, offset-printed area can carry adequate visual data, and a Super-8 frame of Kodachrome II has potentially 50 times as much information as an ordinary television frame.

Five companies, including ourselves, manufacture audio-visual teaching machines. In a recent conference, the lack of support for audio-visual teaching machines was apparent, but we believe it will increase.

Loyd G. Dorsett

President
Dorsett Industries, Inc.
Norman, Okla.

■ As a recent Gallup poll showed, much of the support is already here from parents, who are demanding advanced teaching aids. Now the educators must be convinced.

THIS IS A SPECTRA NOISE MEASUREMENT



Spectra's exclusive Microwave Noise Measurement Service provides accurate measurements of customers' X-band sources from 8.5 Gc/s to 10.5 Gc/s.

THIS IS A SPECTRA NOISE MEASURER



Spectra's SE-200 Series instruments are the only equipments that can give you the FM and AM noise content of conventional and solid state microwave sources — to accuracies of ± 1 DB.

THIS IS A SPECTRA LEASING CONTRACT!



Spectra's Microwave Noise Measuring Instruments can now be leased for a monthly amount that's actually less than the salary of a good technician! Ask your Spectra representative to tell you the whole story — or write us today. It's exciting.

SPECTRA  ELECTRONICS

P.O. Box 85
Los Altos, Calif. 94023 • (415) 948-4998

SUBSCRIPTION SERVICE

Please include an Electronics Magazine address label to insure prompt service whenever you write us about your subscription.

Mail to: Fulfillment Manager
Electronics
P.O. Box 430
Hightstown, N.J. 08520

To subscribe mail this form with your payment and check new subscription renew my present subscription

Subscription rates: In the U.S.: 1 year, \$6; two years, \$9; three years, \$12. Subscription rates for foreign countries available on request

CHANGE OF ADDRESS

ATTACH LABEL HERE

If you are moving, please let us know five weeks before changing your address. Place magazine address label here, print your new address below.

name

address

city

state

zip code

How can you get the most squint-proof detail on closed-circuit TV?

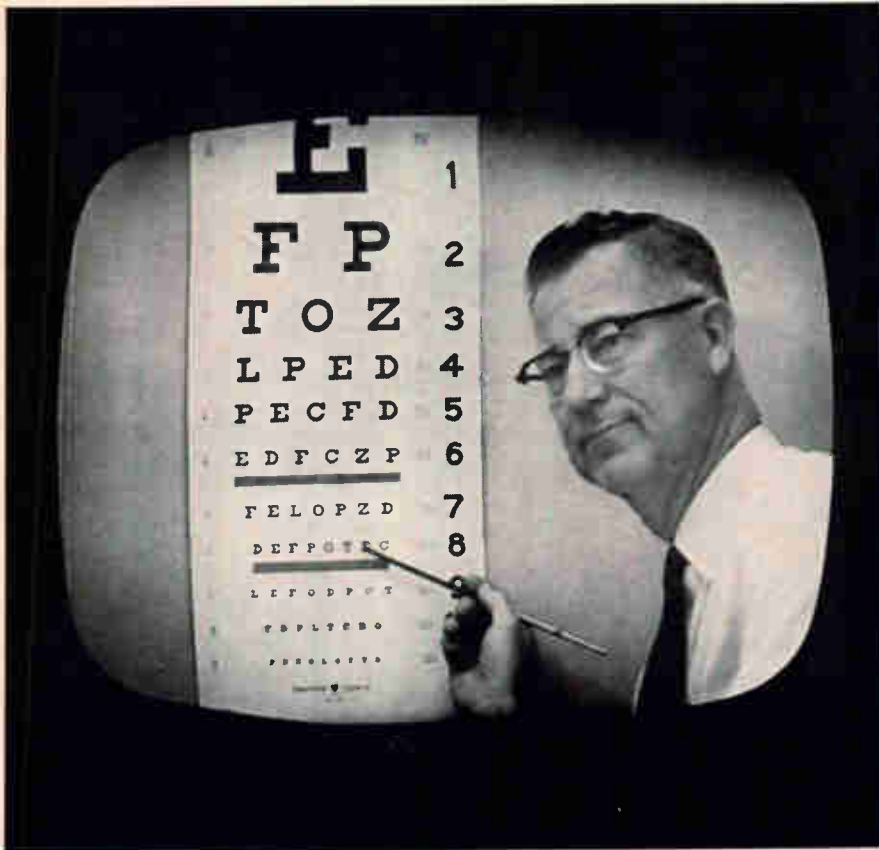

Unretouched photo of monitor screen

Granger Associates has the answer

now

G/A's new high-resolution TV system lets you read a letter or digit occupying only 1/15,000 of the picture area. You can view broad scenes—like a situation display, an airport runway, or a bank of panel meters—and see all the critical details. Or you can put an entire letter-size document on the screen and read any part. Series V1000 TV systems use as many as 1225 scanning lines and a 30 Mc video bandwidth to produce pictures with four times the clarity of conventional 525-line, 8 Mc systems. Get in touch with G/A for the most advanced closed-circuit TV systems available anywhere today.



66

AN EQUAL OPPORTUNITY EMPLOYER

1601 California Ave., Palo Alto, California / Telephone: 321-4175 / TWX: 910-373-1291
Granger Associates Ltd., Fox Oak (Flat), Seven Hills Road, Walton-on-Thames, Surrey, England / Weybridge 44842

People

Michael T. Gray was one of the engineers at Scantlin Electronics, Inc. who helped develop a computer-operated display system that provides information on stock prices and other financial data. Gray has now joined the Edex Corp. as chief engineer; there, he will be applying his experience in computer-operated display systems to the field of education.



Edex is a four-year-old company that was acquired last year by the Raytheon Co. to get into the education business. Edex's principal products are teaching machines that provide feedback—so a teacher can gauge whether his lessons are being understood by the student.

"The next logical step," Gray says, "is a computer tie-in to get a detailed analysis of the student's responses. My job is to develop computer-oriented systems that provide interface equipment so schools can make use of their computer facilities to analyze student response and progress."

Since 1963 Chalmers W. Sherwin has been at the Pentagon as deputy director of defense research and engineering for research and technology. An innovator, he initiated Project Hindsight (the effort to determine what actually makes new weapon systems better than the systems they replace) and the reshuffling of the Defense Department's in-house laboratory organization. Next month, Sherwin will move to the Commerce Department. His title there will be deputy assistant secretary for science and technology and there's little doubt he'll bring his spirit of innovation with him.



Sherwin will guide the research



Machlett is the word for power in transistorized circuitry...

Use Machlett planar triodes:

for Pulse Power: 1 kw, 2 kw, 3 kw, 4 kw to 10 kw
for CW Power: 100 watts at 2.5 Gc .5 watts in C Band
for High Resistance to Radiation
for Low Noise/Frequency Ratio
for Low Operating Cost

Choose from 2 Machlett planar triode lines (conventional, miniature)

Frequency: 6 Gc and higher
Pulse Power: grid pulse to 8000v, 5a
 plate pulse to 10000v, 5a
Modulator Service: dc voltage to 8000v
 peak pulse voltage
 to 10000v



Anode Cooling: new pin radiator: 150 watts and higher,
 FAC, both conventional
 and miniature
 new water jacket: 400 watts and higher
 with water cooling

Write now for data on the industry's strongest line of planar triodes—
Machlett: The word for power in transistorized circuitry.
Address: The Machlett Laboratories Inc.—Springdale (Stamford), Conn. 06879.















THE MACHLETT LABORATORIES, INC.

A S U B S I D I A R Y O F R A Y T H E O N C O M P A N Y

All from Sprague!

TWELVE OF OUR MOST POPULAR METALLIZED CAPACITOR TYPES

SPRAGUE TYPE	Case And Configuration	Dielectric	Temperature Range	Military Equivalent	Eng. Bulletin
 680P	hermetically-sealed metal-clad tubular	metallized Metfilm* 'A'	-55 C, +85 C	no specification	2650
 431P	film-wrapped axial-lead tubular	metallized Metfilm* 'E' (polyester film)	-55 C, +85 C	no specification	2445
 155P, 156P	molded phenolic axial-lead tubular	metallized paper	-40 C, +85 C	no specification	2030
 218P	hermetically-sealed metal-clad tubular	metallized Metfilm* 'E' (polyester film)	-55 C, +105 C	CH08, CH09 Characteristic R	2450A
 260P	hermetically-sealed metal-clad tubular	metallized Metfilm* 'K' (polycarbonate film)	-55 C, +105 C	no specification	2705
 121P	hermetically-sealed metal-clad tubular	metallized paper	-55 C, +125 C	no specification	2210C
 118P	hermetically-sealed metal-clad tubular	metallized Difilm® (polyester film and paper)	-55 C, +125 C	CH08, CH09 Characteristic N	2211D
 143P	hermetically-sealed metal-clad "bathtub" case	metallized paper	-55 C, +125 C	no specification	2220A
 144P	hermetically-sealed metal-clad "bathtub" case	metallized Difilm® (polyester film and paper)	-55 C, +125 C	CH53, CH54, CH55 Characteristic N	2221A
 284P	hermetically-sealed metal-clad rectangular case	metallized paper	-55 C, +105 C	no specification	2222
 283P	hermetically-sealed metal-clad rectangular case	metallized Difilm® (polyester film and paper)	-55 C, +125 C	CH72 Characteristic N	2223
 282P (energy storage)	drawn metal case, ceramic pillar terminals	metallized paper	0 C, +40 C	no specification	2148A

*Trademark

For additional information, write Technical Literature Service, Sprague Electric Company, 35 Marshall St., North Adams, Mass. 01247, indicating the engineering bulletins in which you are interested.

SPRAGUE COMPONENTS

CAPACITORS
TRANSISTORS
RESISTORS
THIN-FILM MICROCIRCUITS
INTEGRATED CIRCUITS
INTERFERENCE FILTERS

PACKAGED COMPONENT ASSEMBLIES
FUNCTIONAL DIGITAL CIRCUITS
MAGNETIC COMPONENTS
PULSE TRANSFORMERS
CERAMIC-BASE PRINTED NETWORKS
PULSE-FORMING NETWORKS



*Sprague and ® are registered trademarks of the Sprague Electric Co.

People

efforts of the National Bureau of Standards, the Patent Office and the Environmental Science Service Administration. He says he will continue his search for the "mechanism" for translating science and technology into useful systems.

"The civilian areas," Sherwin adds, "are where the logical expansion of the nation's scientific and technological efforts ought to be."

Garth Heisig, a 44-year-old electronics engineer, has been named assistant to the chairman at Motorola, Inc. The job is tantamount to the post of chief technical adviser, providing Motorola chairman Robert Galvin a bridge between the technical and financial sides of the company.



Heisig has been with Motorola for the past 21 years. His latest post was group director of consumer products engineering. Before joining Motorola, Heisig was a researcher at the Massachusetts Institute of Technology.

Named to fill Heisig's job is Richard A. Kraft, 37, Motorola's chief television engineer. One of Kraft's chief functions will be to set up new cost and quality controls for all consumer products. In addition, he says, a bold effort will be made to expand the company's participation in the radio and stereo markets.



Although no major revisions are planned, some reorganization is under way. One is the unification of some support groups that back up product engineering; several of these groups are being placed under one head in an effort to raise the quality of engineering.

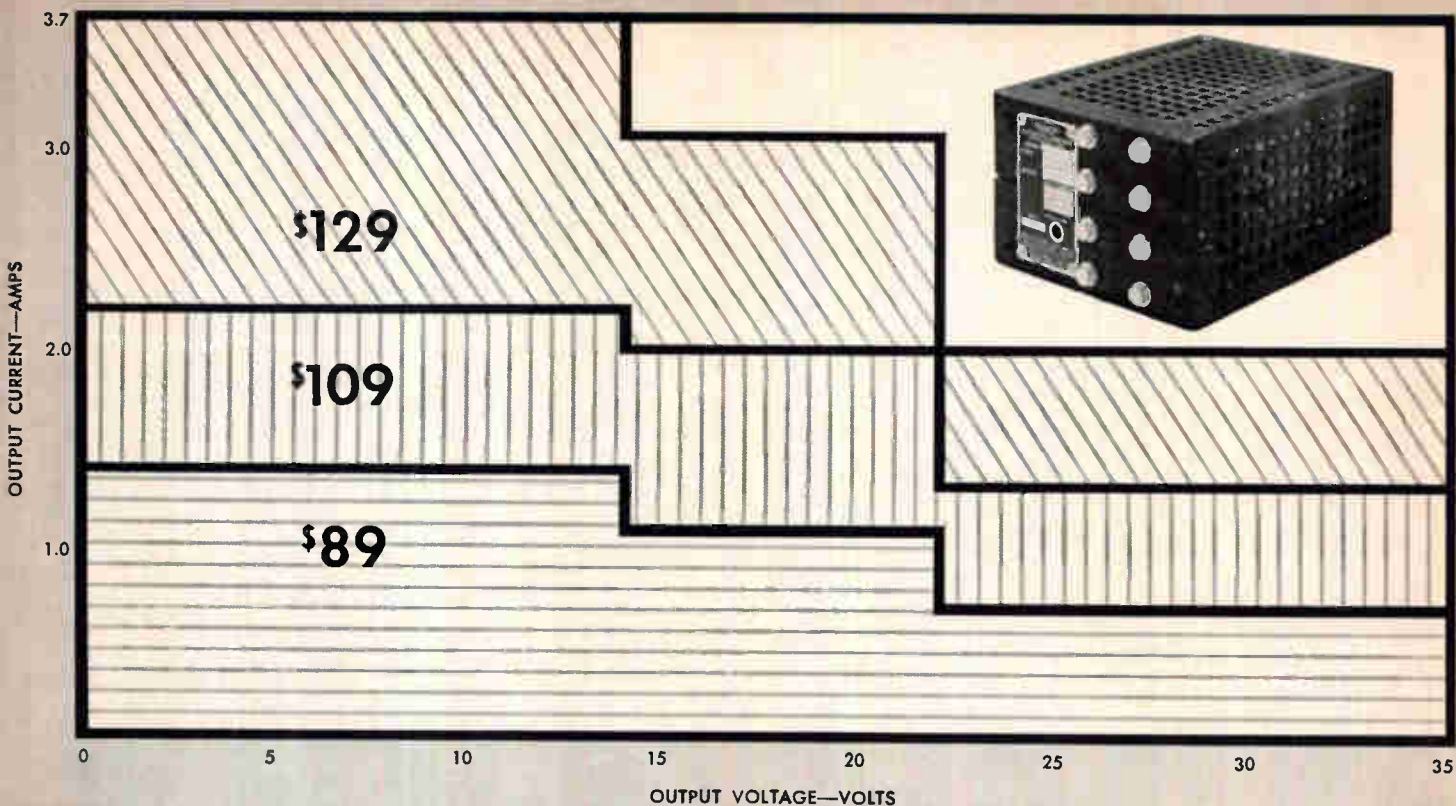

All-silicon QSA Series: 12 models; regulation $\pm .005\%$; response time 20 μs .

New Sorensen Modular Power Supplies

The new Sorensen QSA Series offers the only modular power supply line in the 0 to 35 volt range that combines $\pm .005\%$ regulation line and load, 20 μs . response time, 71°C operating temperatures, 300 μV ripple—all at prices below other lines having lesser performance specifications. Sorensen's QSA Series modules are ideal for OEM, lab or system applications. They can be used as bench models (mounted in any position) or mounted in combinations of 3 or 4 in an optional 19" (3½" high) rack adapter. Other design features include: Load current vs. temperature, 110% @ 40°C—100% @ 50°C—85% @ 60°C—66% @ 71°C • Temperature coefficient 0.01%/°C • Stability

0.025%/8 hrs. • Models QSA10-1.4, QSA10-2.2 and QSA10-3.7 permit operation of up to 20 units in series; other units permit operation of 2 units in series; All models permit operation of 4 units in parallel • No turn-on/turn-off overshoots • Remote sensing • Remote programming • Ripple voltage peak to peak 3mV. All Sorensen power sources conform to proposed NEMA standards. For additional QSA Series details or for data on other standard/custom DC power supplies, AC line regulators or frequency changers, call your local Sorensen representative, or write: Raytheon Company, Sorensen Operation, Richards Avenue, Norwalk, Conn. Tel: 203-838-6571, TWX: 710-468-2940.

SPECIFICATIONS

MODELS (RANGES)	QSA10-1.4 (0-10V, 1.4A) QSA12-1.4 (8-14V, 1.4A) QSA18-1.1 (14-22V, 1.1A) QSA28-.7 (22-35V, .7A)	QSA10-2.2 (0-10V, 2.2A) QSA12-2.2 (8-14V, 2.2A) QSA18-2.0 (14-22V, 2.0A) QSA28-1.3 (22-35V, 1.3A)	QSA10-3.7 (0-10V, 3.7A) QSA12-3.7 (8-14V, 3.7A) QSA18-3.0 (14-22V, 3.0A) QSA28-2.0 (22-35V, 2.0A)
SIZES (IN.)	7 x 3-5/16 x 3-7/8	7 x 3-5/16 x 5-1/8	10 x 3-5/16 x 5-1/8
PRICES (U.S. List)	\$89	\$109	\$129

RAYTHEON

Circle 11 on reader service card

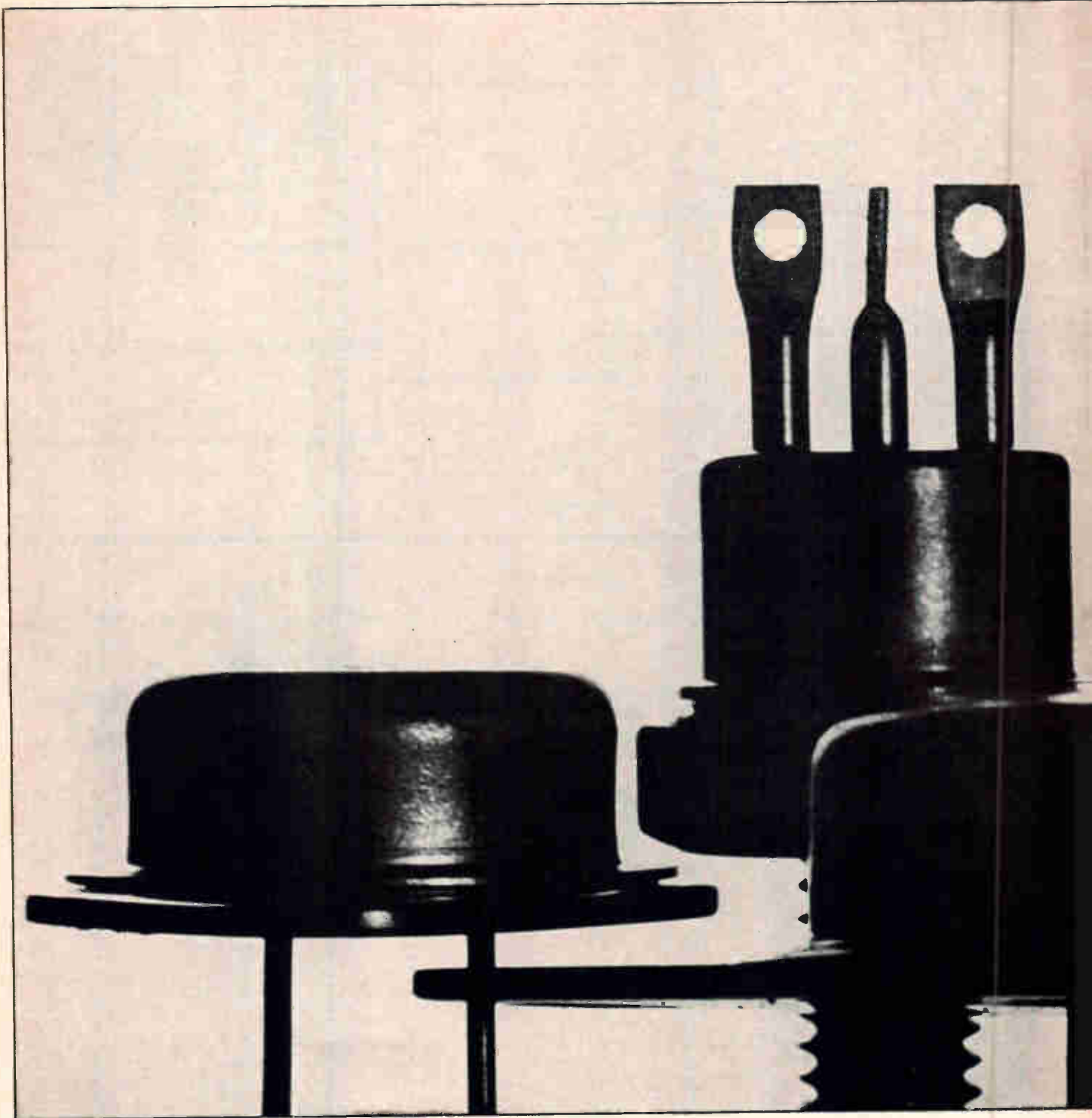

Planar is a patented Fairchild process.

FAIRCHILD SEMICONDUCTOR / A Division of Fairchild Camera and Instrument Corporation ■ 313 Fairchild Drive, Mountain View, California (415) 962-5011 ■ TWX: 910-379-6435

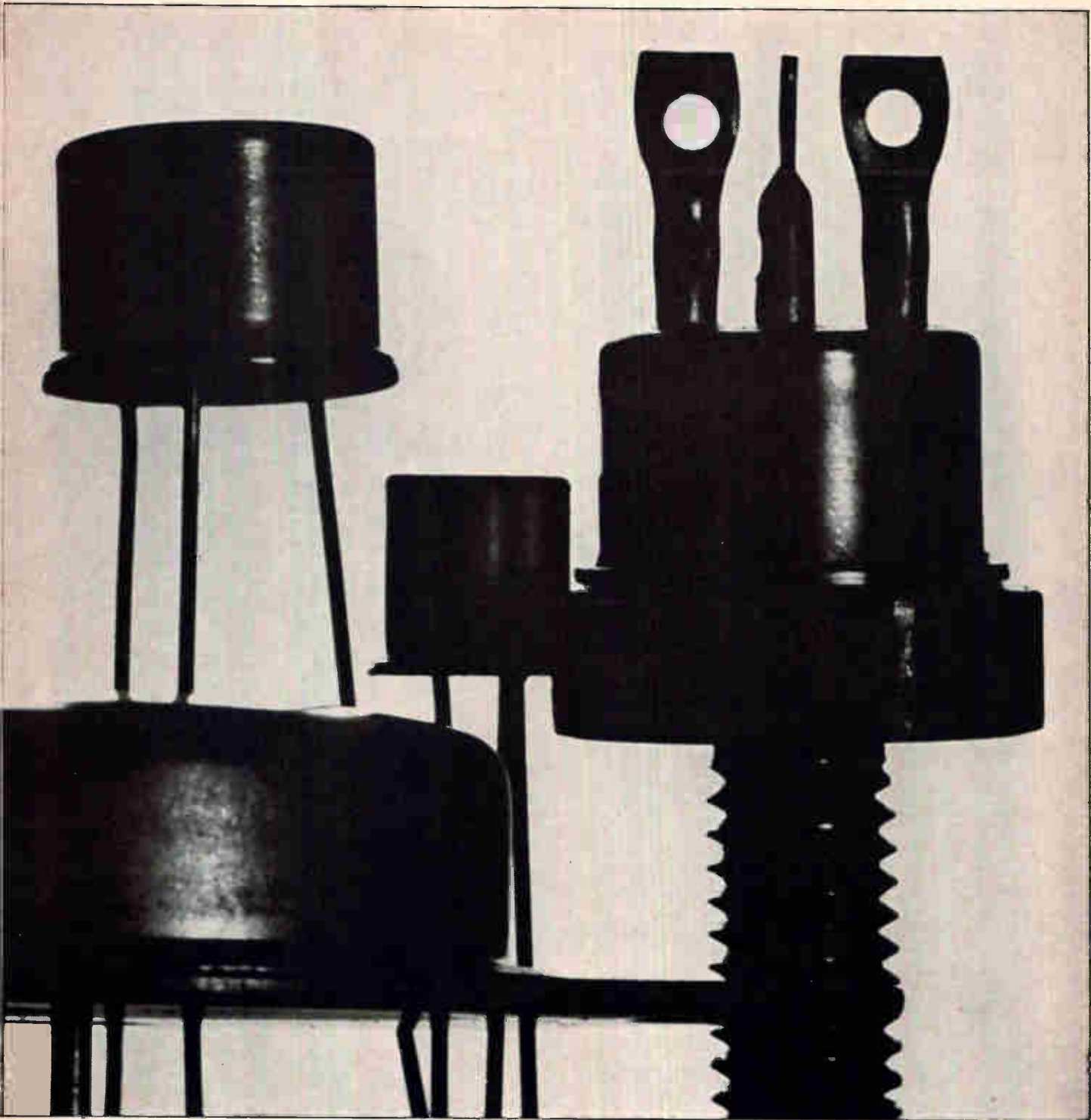

Planar and power are no longer contradictory terms. You can now buy Fairchild Planar power devices with up to 60W power dissipation, up to 12A current, with voltages up to 300V. Here's why: we deposit nickel-chromium resistors in series with the emitters, right on the chip. This technique inhibits secondary breakdown and keeps all the inherent advantages of Planar devices:

Greater temperature stability due to lower leakage currents. Passivated junctions which prevent surface degradation. And higher yields, which mean that Fairchild Planar power costs you less. Prove it to yourself. We've prepared two sample kits which are available through Fairchild Distributors: Sample Kit No. 1 contains 14 power transistors with $V_{CE0} = 80$ Volts and IC up to 10 Amps (\$300 value for \$49.50); Sample Kit No. 2 contains 12 SCR's with ranges up to 200 Volts and 10 Amps (\$120 value for \$29.50). Fairchild reserves the right to limit quantities. This offer expires July 30, 1966.

PLANAR POWER **FAIRCHILD** SEMICONDUCTOR



Jerrold's new Model 900-C is the most conceited sweep signal generator on the market!

We get a little embarrassed. The many thousands of Model 900's now in the field have built up such a tremendous reputation for dependability and service that they're beginning to act smug. They "show off" with gut features like built-in oscilloscope pre-amp, four mode operation and continuously variable sweep widths from 10 kHz to 400 MHz (center frequencies from 500 kHz to 1200 MHz) — just to name a few.

But that's not the worst of it.

The New 900-C really gets overbearing when it starts performing. Say you want to observe the entire frequency range of a unit under test: ... or examine a narrow 10 kHz beamwidth ... or make a quantitative analysis of the response of a wide range of electronic devices such as receivers, amplifiers, filters, transformers, or transmission lines.

It does these chores so easily, so accurately, and so efficiently, we despair of ever deflating its ego.

One small revenge. Our New Model 900-C literature is very, very modest. Send for a copy.

JERROLD MEASUREMENT AND
TEST INSTRUMENTATION

JERROLD ELECTRONICS CORPORATION
Government and Industrial Division
Philadelphia, Pa. 19105

Meetings

Cryogenic Engineering Conference, National Bureau of Standards, Boulder, Colo., June 13-15.

National Congress of Applied Mechanics, AFOSR, ONR, ARO; University of Minnesota, Minneapolis, June 14-16.

International Communications Conference, IEEE, University of Pennsylvania; Sheraton Hotel, Philadelphia, June 15-17.

International Scientific Congress on Electronics, Ministry for Post and Telecommunications, Institute of Post and Telecommunications, Ugo Bordoni Foundation; Palazzo dei Congressi, Rome, June 15-20.

International Exhibition of Electronics, Nuclear Energy, Wireless, Television and Cine, International Congresses and Exhibitions of Electronics and Atomic Energy; Palazzo dei Congressi, Rome, June 15-26.

Science Seminar, AFOSR; Western Skies Motor Hotel, Albuquerque, N. Mex., June 15-22.

American Society for Engineering Education, ASEE; Washington State University, Pullman, Wash., June 20-23.

International Federation of Automatic Control Meeting, IFAC; London, June 20-25.

Symposium in Advances in Quantum Electronics, Colorado State University; Estes Park Chalet, Estes Park, Colo., June 20-July 1.

System Effectiveness Conference, Armed Forces Management Association; Washington Hilton, Washington, June 20-22.

National Electronic Packaging and Production Conference, Electronic Packaging and Production Magazine; Americana Hotel, Coliseum, New York, June 21-23.

Precision Electromagnetic Measurements Conference, National Bureau of Standards; NBS Laboratory, Boulder, Colo. June 21-23.

International Data Processing Conference and Business Exposition, Data Processing Management Association; Conrad Hilton Hotel, Chicago, June 21-24.

Institute of Navigation Conference, IEEE; Town House Motel, Cedar Rapids, Iowa, June 22-24.

Conference on Coherence and Quantum Optics, AFOSR, AFCRL; University of Rochester, Rochester, N.Y., June 22-24.

ASTM Meeting and Materials Testing Exhibit, ASTM; Chalfonte-Haddon Hall, Atlantic City, N.J., June 26-July 1.

Aerospace Sciences Meeting, AIAA; International Hotel, Los Angeles, June 27-29.

Marine Technology Conference and Exhibit, Marine Technology Society; Sheraton Park Hotel, Washington, June 27-29.

Advance Planning Briefing for Industry on Electronic Systems (classified), Electronic Systems Div., Air Force Systems Command and NSIA; L.G. Hanscom Field, Bedford, Mass., June 28-30.

Institute in Technical and Industrial Communications, Colorado State University; Fort Collins, Colo., July 5-9.

Aerospace Systems Conference, IEEE; Olympic Hotel, Seattle, Wash., July 11-15.*

Symposium on Electromagnetic Compatibility, San Francisco Chapter of the IEEE; San Francisco, July 11-13.

Call for papers

Electron Devices Meeting, IEEE; Sheraton Park Hotel, Washington, Oct. 26-28. **Aug. 1** is deadline for submission of 200-word abstract on integrated circuits, electron tubes and solid state, quantum electronic and energy conversion devices to Joseph F. Hull, Litton Industries, 960 Industrial Road, San Carlos, Calif.

Antenna and Propagation Symposium, IEEE; Cabana Motor Hotel, Palo Alto, Calif., Dec. 5-7. **Aug. 1** is deadline for submission of 600-word summary on plasma physics, electromagnetic theory, radio physics, radio wave propagation, and antennas to Ray L. Leadabrand, chairman, technical program committee, 1966 International Symposium on Antennas and Propagation, Radio Physics Laboratory, Stanford Research Institute, Menlo Park, Calif.

* Meeting preview on page 16

AC metrology will never be the same after the Fluke 931A, the first true rms differential voltmeter. Measure the precise rms value of virtually any waveform within 0.05% from 30 Hz to 50 KHz. Overall frequency response is 10 Hz to 1 MHz. Range is 0.01 to 1100 volts. Ten to one crest factor accounts for effects caused by voltage spikes and pulse trains. Comes with or without probe. Both line or combination line/rechargeable battery powered versions are offered. Base price is \$895.

The new Fluke Model 931A True RMS Differential Voltmeter yields accurate rms measurements of any waveform which previously could be made only by ac to dc comparison with a thermal transfer standard. Other features include high input impedance, in-line digital readout (lighted decimal), solid state design, and linear recorder output.

The null meter indicates percent deviation from the dialed voltage.

Ten percent overranging minimizes range changing.

Battery operation gives ideal isolation from ground loops.

Model 931A meets MIL-SPEC shock and vibration requirements.

For complete information, please call your Fluke Sales Engineer or write.



FLUKE • Box 7428, Seattle, Washington 98133 • Phone: (206) 776-1171 • TWX: (910) 449-2850

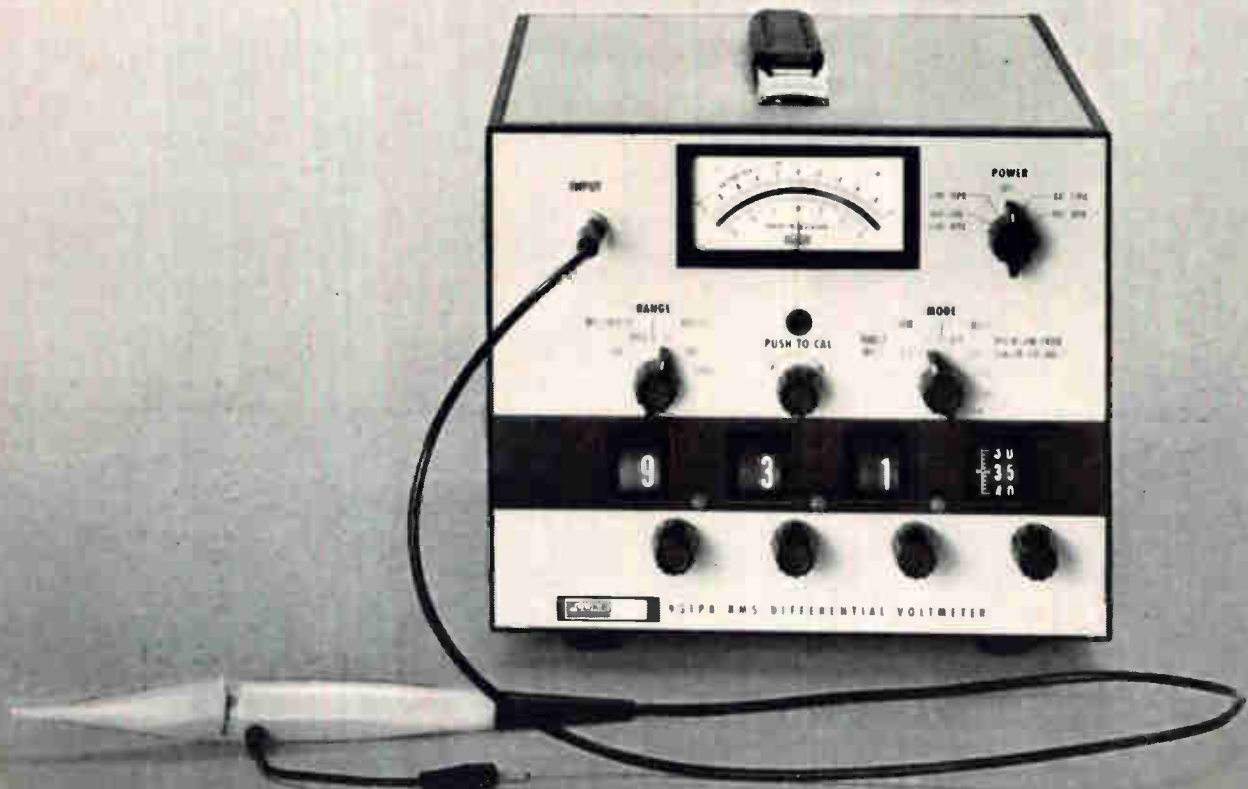

New from Sprague!

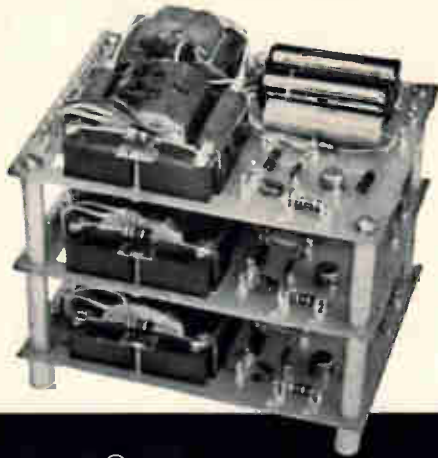

Silicontrol[®] High Gate Drives Stop SCR Failures Caused by di/dt Effect

- Silicontrol Gate Drives are ideally suited for completely balanced, reliable SCR firing in 3-phase a-c or d-c power control.
- High-output gate drive with fast-rise-time pulse avoids SCR failures due to di/dt effect.
- No bias for pulse reset required—failsafe—load and control circuits fully isolated.
- Each gate signal output is a pulse of substantially constant amplitude in excess of 210° wide at full SCR conduction.
- Gate pulse output: 18 volts min. (open circuit), 1.7 amperes (short circuit), less than 1 μ sec pulse rise time to meet gate firing requirements of high current SCRs.
- Available in half-wave or full-wave designs—Series VS6532 produces one gate pulse per cycle per phase, while Series VS6732 provides two isolated gate pulses per card for a total of six gate pulses per cycle.

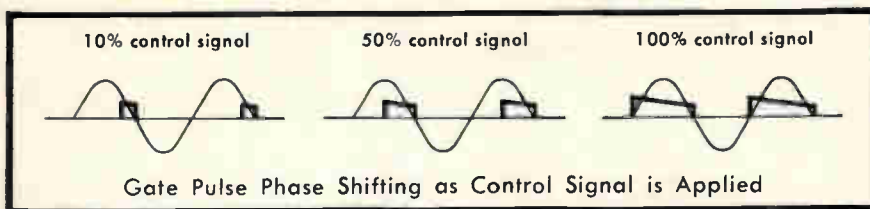

For complete technical data, write for Engineering Bulletin 85525 to the Technical Literature Service, Sprague Electric Co., 35 Marshall St., North Adams, Mass. 01248.

SPRAGUE COMPONENTS

PACKAGED COMPONENT ASSEMBLIES
THIN-FILM MICROCIRCUITS
INTEGRATED CIRCUITS
CERAMIC-BASE PRINTED NETWORKS
FUNCTIONAL DIGITAL CIRCUITS
PULSE-FORMING NETWORKS

CAPACITORS
TRANSISTORS
RESISTORS
INTERFERENCE FILTERS
MAGNETIC COMPONENTS
PULSE TRANSFORMERS

SPRAGUE[®]
THE MARK OF RELIABILITY

Sprague and [®] are registered trademarks of the Sprague Electric Co.

Meeting preview

Aerospace systems

The first systems-oriented aerospace conference of the Institute of Electrical and Electronics Engineers will draw an estimated 1,000 engineers to Seattle's Olympic Hotel July 11 to 15.

It will bring together four groups—space electronics and telemetry, aerospace and navigational electronics, military electronics and aerospace—that previously met separately, with much overlapping in subjects and attendance. Six symposiums will deal with flight vehicle systems, energy conversion, instrumentation and telemetry, navigation, support systems and simulation. No more than four meetings will be held at any one time, however, to ease the selection problem.

Management of electronics systems in space vehicles will be discussed at a joint meeting of all four groups. Fran Gardiner, lunar excursion module (LEM) project manager for the Radio Corp. of America will moderate a panel in which the participants will be George Stoner, a Boeing Co. vice president and manager of its space division; Joseph Gavin, a vice president of and LEM project manager for the Grumman Aircraft Engineering Corp.; Thomas Roger, deputy director for electronics and information systems in the Defense Department, and Leonard Packham, deputy chief of the electronics lab at the National Aeronautics and Space Administration's Manned Spacecraft Center.

Satellite talk. Experiments in maintaining continuous voice communication with airplanes via satellites will be the subject of a panel to be led by William Carnes, manager of avionics engineering, Annapolis Science Center.

Video data techniques will be discussed at the session of the instrumentation and telemetry systems symposium. R.J. Cotton and G.R. Ströhmeyer of the Philco Corp. will analyze delta modulation image-encoding systems. P.E. Drapkin of the Lockheed Aircraft Corp. will speak on data compressing and L.A. Freedman of RCA will give details of a dielectric tape camera system.

JOYFUL NOISE |

How Sperry uses design to replace de-rating of TWTs for ECM systems

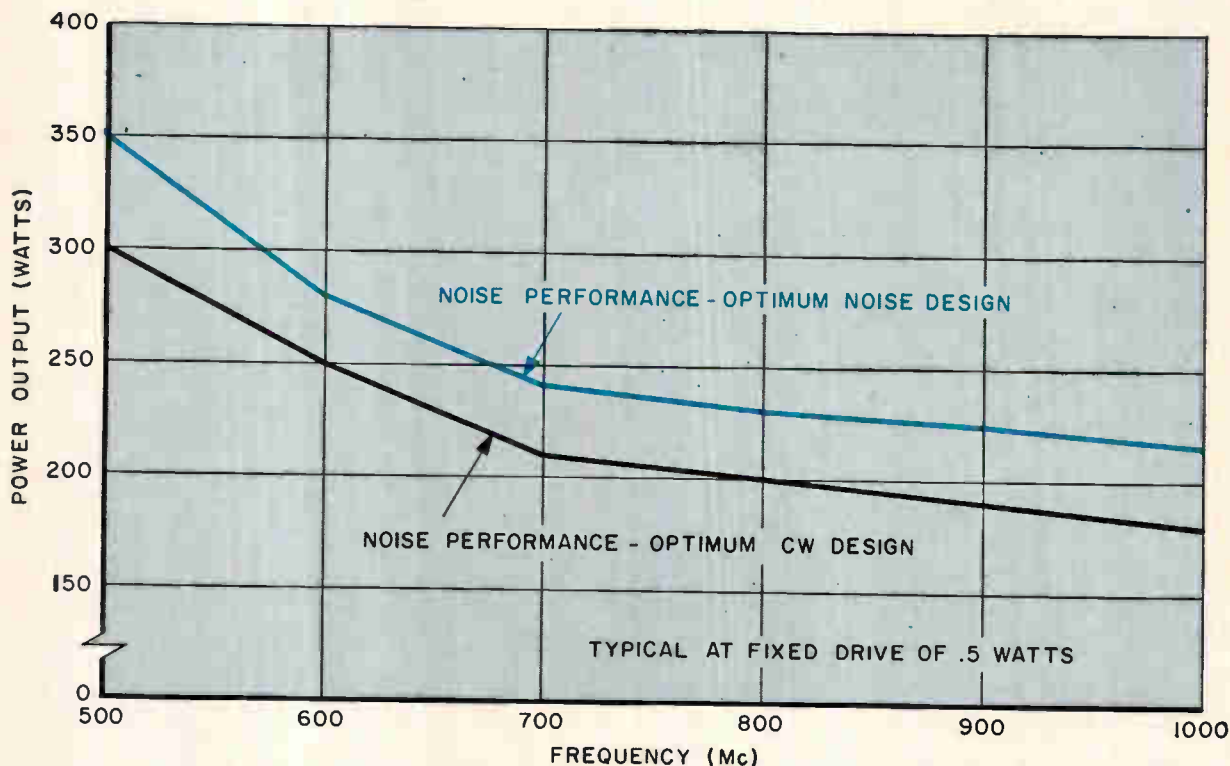

For the ordinary CW traveling wave tube, amplifying noise is hard work. If you've been specifying tubes for ECM systems, you probably know the old rule of thumb . . . pick a likely looking CW tube and de-rate it about one-third if the application calls for amplifying noise.

Now the rule of thumb is out of date. System designers who order noise amplifiers from Sperry are replacing degraded performance with designed performance. They no longer buy more CW tube than they need. They achieve their specified noise level with a Sperry traveling wave tube that's customized and rated for optimum noise performance. Naturally such tubes improve system size, weight, and over-all efficiency.

Sperry's growing proficiency in high-noise design is a result of extensive studies in that area of traveling wave tube technology. Noise amplification requirements have led to serious in-

vestigation of the "capture effect" . . . the tendency of low frequency noise to utilize a disproportionate share of the tube's output at the expense of noise amplification near the high edge of the band.

Significant improvements in noise performance (see curve above) have resulted from such techniques as helix tapering, controlled over-voltages and variations in permeance. These techniques have been fully proved during high-production runs.

For your next high-noise application, Sperry suggests this: tell us all about your noise source and send us a sample, if possible. We'll go to work on design refinements that will give you joyful noise . . . not the degraded performance of a tube designed for CW work.

Engineering details of Sperry's high-noise discoveries are available in a new technical paper. For your free copy, write today to Sperry, Gainesville, Florida.

Design refinements to fit changing system requirements . . . that's the big bonus from Sperry's Storehouse of Knowledge. For high-noise applications or other system demands requiring state-of-the-art TWTs, klystrons or BWOs, always start with Sperry.

SPERRY

DIVISION OF
SPERRY RAND
CORPORATION

SPERRY ELECTRONIC TUBE DIVISION, Gainesville, Fla.

National Representatives: Cain & Co., Los Angeles, 783-4700; Boston, 665-8893; Arlington Heights, 253-3578; Dallas, 357-8645; Dayton, 228-2433; East Chester, 337-3445; Philadelphia, 828-3861; San Francisco, 948-6533; Syracuse, 463-0462; Washington, 296-8265; South Amboy, 727-1900; Huntsville, 534-7955; Montreal, 844-0089.

Siemens components

are

developed and produced by one of the world's leading electrical organizations, employing 257,000 people—15,000 in R & D alone—manufacturing in 33 countries and represented in over 100.

include

**Ferrite materials
Capacitors
Electron tubes
Microwave tubes
Rectifiers**

offer

**advanced design,
reliability,
long life,
versatility**



SIEMENS

FERRITE MEMORY CORES

Now from Siemens, one of the world leaders in the development and production of high quality ferrite materials—ferrite memory cores.

For use in electronic computer coincidence memories or in other data processing equipment, Siemens quality cores are available in all standard sizes and with switching times measured in nanoseconds.

Exceptionally high AQL levels are assured by individual testing on auto-

mated equipment, in accordance with customers' specifications.

Wide temperature range (WTB) and **normal temperature range (NTB)** memory cores are competitively priced and available out of stock or in accordance with customers' production schedules.

Siemens specialized engineers are available to consult on all components projects and problems. We are happy to work with you as early as the design stage or at any point further along in production. Write for full information.

SIEMENS AMERICA INCORPORATED
Components Division
230 Ferris Avenue, White Plains, N.Y. 10603

In Canada: SIEMENS CANADA LIMITED
407 McGill Street, Montreal 1, P.Q.

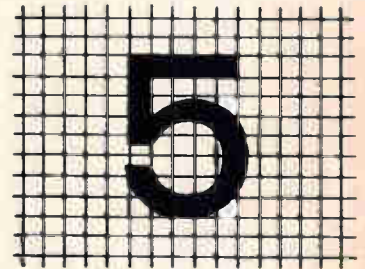
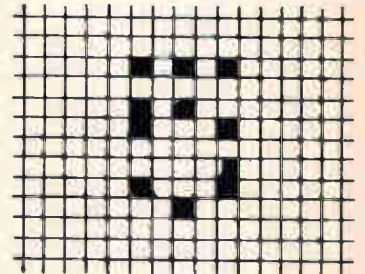
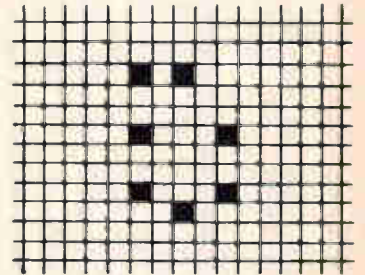



**There once was a PDP-8
that lacked a peripheral mate.
A module or two —
some rice and a shoe —
how simple it is to relate.**

Marriage is a serious business, even between an on-line scientific computer and a user's experiment. This union should be easily entered into, quick to adapt to new situations, happy and fully compatible.

The PDP-8 is a compact, high speed, core memory, real time, eminently marriageable general purpose computer. It sits right there on the lab table taking inputs directly from an experiment and pouring out collated, integrated, analyzed data. It can feed, and be fed by, a host of easily attached equipment.

Partly, this is because there are 35 standard plug-in options. A 320 page catalog of standard, readily available modules helps. A 68 page interface manual tells you what to use and how to use it for special inputs and outputs. 85 DIGITAL field engineers are available for counselling. And, of course, the computer itself was designed for marriage.

If the PDP-8 is not perfectly suitable, other eligibles include the LINC-8 and the larger PDP-7.

digital
COMPUTERS • MODULES

DIGITAL EQUIPMENT CORPORATION, Maynard, Massachusetts 01754. Telephone: (617) 897-8821 • Cambridge, Mass. • Washington, D. C. • Parsippany, N. J. • Rochester, N.Y. • Philadelphia • Huntsville • Orlando • Pittsburgh • Chicago • Denver • Ann Arbor • Los Angeles • Palo Alto • Seattle • Carleton Place and Toronto, Ont. • Reading, England • Paris, France • Munich and Cologne, Germany • Sydney and West Perth, Australia • Modules distributed also through Allied Radio



SIEMENS

FERRITE MEMORY CORES

Now from Siemens, one of the world leaders in the development and production of high quality ferrite materials—ferrite memory cores.

For use in electronic computer coincidence memories or in other data processing equipment, Siemens quality cores are available in all standard sizes and with switching times measured in nanoseconds.

Exceptionally high AQL levels are assured by individual testing on auto-

mated equipment, in accordance with customers' specifications.

Wide temperature range (WTB) and normal temperature range (NTB) memory cores are competitively priced and available out of stock or in accordance with customers' production schedules.

Siemens specialized engineers are available to consult on all components projects and problems. We are happy to work with you as early as the design stage or at any point further along in production. Write for full information.

SIEMENS AMERICA INCORPORATED
Components Division
230 Ferris Avenue, White Plains, N. Y. 10603

In Canada: SIEMENS CANADA LIMITED
407 McGill Street, Montreal 1, P.Q.

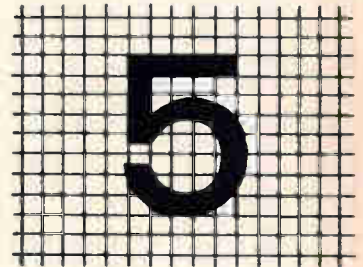
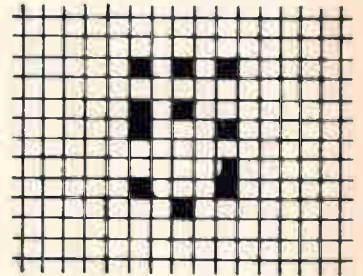
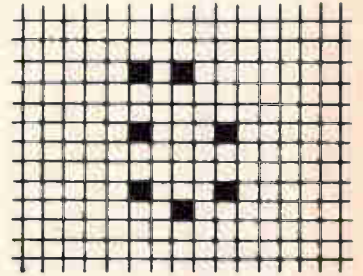

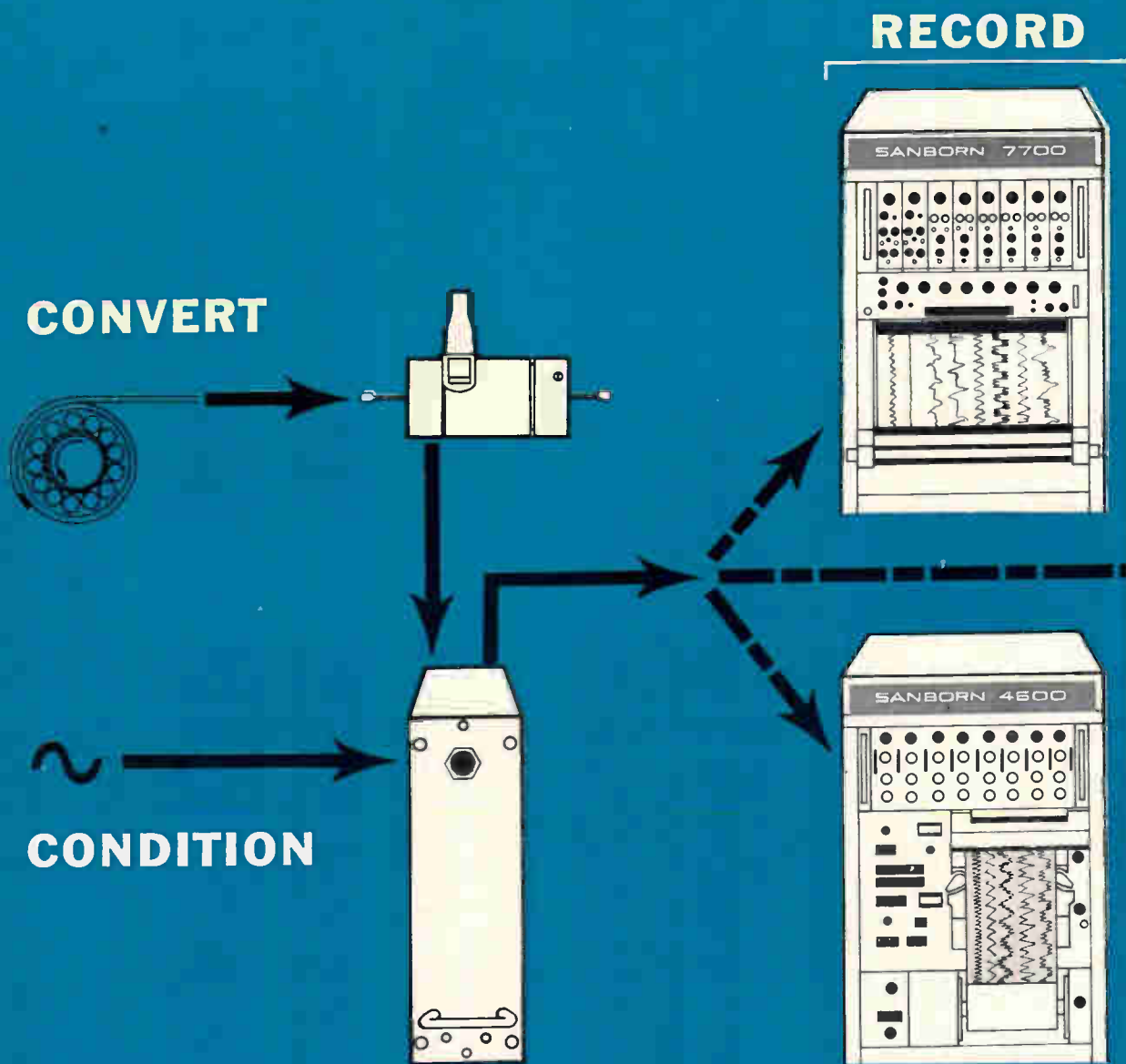

Put your data in the form most useful to you

Reliable Sanborn instrumentation puts your data in the form most useful to you, with minimum set-up time and simple, straightforward operating control. Only a few of the many possible functions and versatile variations of these compatible instruments are shown here—for measurement and data handling applications in scientific and industrial research, production and environmental testing, quality control, communications, telemetry and process control.

To translate and signal-condition variables, Sanborn makes a wide range of compact, low-cost linear motion, velocity, pressure and force transducers of the differential transformer type . . . wideband and narrow band dc data amplifiers with floating inputs isolated from floating outputs . . . and individual signal conditioners,

for use in Sanborn systems or as unit amplifiers to drive scopes, meters, etc., in general purpose dc, carrier, phase-sensitive demodulator, logarithmic, high gain, frequency meter, frequency deviation and accelerometer types.

To get clear, permanent proof of dc to 150 cps test or measurement results in graphic, analog form—with rectangular coordinate traces of 4 cycles/mm resolution even at small amplitudes—Sanborn thermal writing oscillographs give you complete freedom of choice in number of channels, signal conditioning flexibility, packaging and price. Wide choice of plug-in signal conditioners equip any channel to your specific inputs . . . or when individual-channel flexibility is not needed (e.g., up to 8 channels of strain gage or low level DC signals), systems can be equipped with low cost 8-

amplifier-channel modules on a single chassis. Systems range from portable 100 mm wide chart single-channel models to 6- and 8-channel systems with all-solid-state plug-in signal conditioners. Most have response range from dc to 150 cps within 3 db, at 10 div p-p. Max. sensitivity depends on signal conditioner used, can be as high as 1 uv/div. Two chart speeds in 1-channel systems, four in dual-channel systems, nine in 4- to 8-channel systems (all electrically controlled, except dual-channel systems).

For immediate readout of dc to 5 kc signals, high frequency optical oscillographs provide up to 25 channels of precise traces on 8" ultraviolet-sensitive charts, with one set of galvanometers. Choice of four types of 8-channel amplifier modules allows recording sensitivities from 500 uv/inch to 500 mv/inch; optional plug-in permits sys-

STORE

DISPLAY

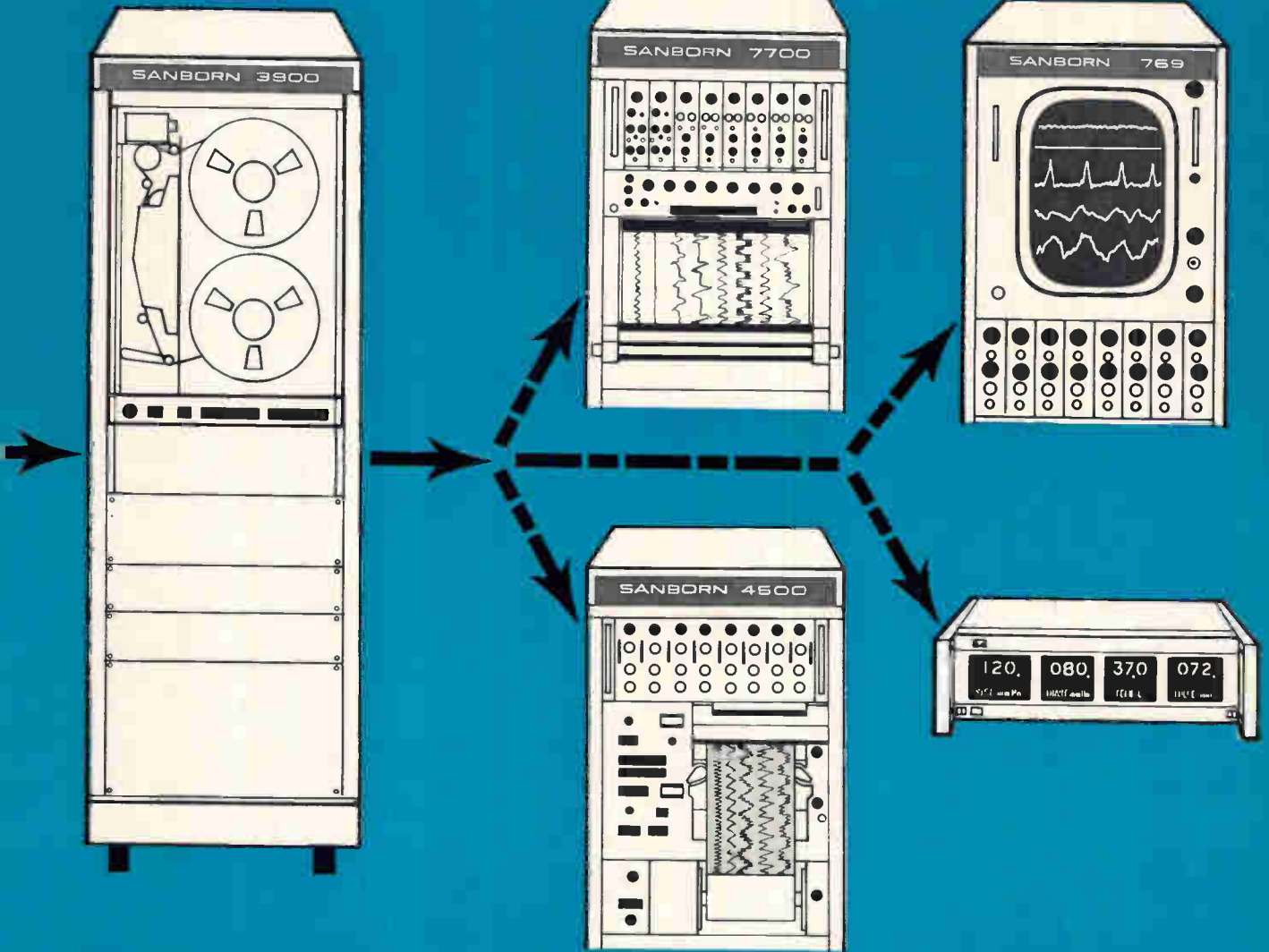

... see Sanborn

Circle 21 on reader service card

tem to drive 3900 Series tape recorders; front panel controls position traces anywhere on chart without mechanical positioning of galvanometer; traces may overlap and occupy full chart width. Paper loading in normal room light, full development a few seconds after exposure, permanency by chemical fixing if desired, and nine paper speeds from 0.25 to 100 inches/sec are additional features of these new 4500 Series optical oscillographs. Complete 8-channel systems from \$6950.

To store data from dc to 250 kc in its original electrical form and play it back with the time base expanded or compressed by ratios as high as 32:1 — on a scope, graphic recorder or numerical readout — new 3900 Series Tape Systems offer IRIG-compatible instrumentation performance at substantial savings. System prices from \$8900 (7-channel)

nel) to \$13,370 (14-channel). All have unique new H-P transport of simple design with high, maintenance-free reliability . . . 6 electrical speeds with no capstan change . . . 40 db or better S/N ratio, 0.2% p-p flutter (0-1 kc, 30 & 60 ips) . . . all-solid-state plug-in electronics, with record and reproduce amplifiers on the same cards . . . integral footage counter accurate to 99.95% . . . easy snap-on reel loading . . . console, rack or portable case housing. Bandwidths available are (at 60 ips) Direct: 100-100,000 cps. Std., 100-250,000 cps Wideband; FM: 0-10,000 cps Std., 0-20,000 cps Wideband. Low-cost 4-channel 1/4" tape systems also available with different transport, same electronics, portable case packaging.

To display variables under investigation — in analog or numerical form — Sanborn 760 Series scopes present up to eight bril-

liant traces simultaneously on a long-persistence 17" screen, allow positioning and amplitude adjustment of individual traces . . . and compact new 5601A Numerical Readout displays three 0.6"-high illuminated numerals and decimal point in each of four channels, with adjustable sampling rate, flashing decimal point for rate display, and capability of driving H-P 562A Digital Recorder for print-out.

Call your local Hewlett-Packard Sales Engineer for specifications and expert application help on any of these Sanborn instruments, or write: Hewlett-Packard, Sanborn Division, 175 Wyman Street, Waltham, Mass. 02154

**HEWLETT
PACKARD**  **SANBORN
DIVISION**

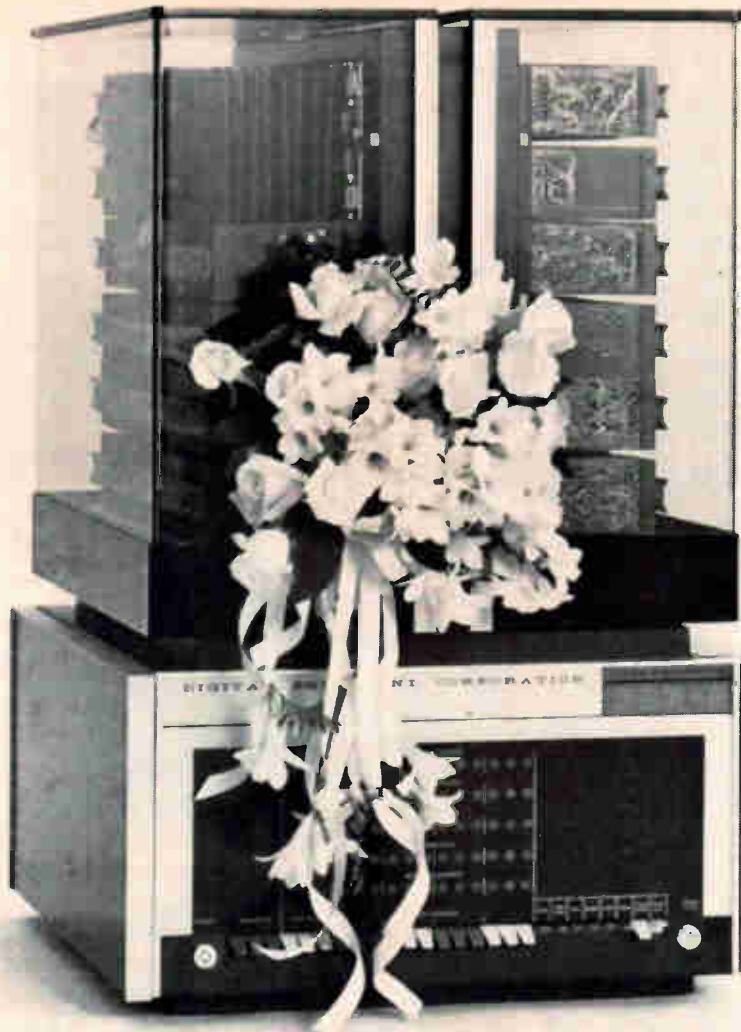

**There once was a PDP-8
that lacked a peripheral mate.
A module or two —
some rice and a shoe —
how simple it is to relate.**

Marriage is a serious business, even between an on-line scientific computer and a user's experiment. This union should be easily entered into, quick to adapt to new situations, happy and fully compatible.

The PDP-8 is a compact, high speed, core memory, real time, eminently marriageable general purpose computer. It sits right there on the lab table taking inputs directly from an experiment and pouring out collated, integrated, analyzed data. It can feed, and be fed by, a host of easily attached equipment.

Partly, this is because there are 35 standard plug-in options. A 320 page catalog of standard, readily available modules helps. A 68 page interface manual tells you what to use and how to use it for special inputs and outputs. 85 DIGITAL field engineers are available for counselling. And, of course, the computer itself was designed for marriage.

If the PDP-8 is not perfectly suitable, other eligibles include the LINC-8 and the larger PDP-7.

digital
COMPUTERS • MODULES

Editorial

The fear of obsolescence

According to the recruiters, many engineers over the age of 30 suffer from a serious handicap: their technical knowledge is obsolescent. These engineers, say the personnel men, can't handle such technical problems as packaging integrated circuit equipment, working with computer-aided design or exploiting bulk-effect phenomena to generate microwaves. Thus, in spite of a serious engineering shortage, many engineers in the United States are rated unhirable at a time when they should be approaching their technical prime.

"The fast pace of technology is making engineering knowledge obsolesce quickly," explained a recruiter, as he prepared to hop from city to city looking for new talent.

More and more people, however, are concluding that obsolescence is not an inevitable concomitant of technical knowledge. On page 142, Gerd Wallenstein, an engineering executive who has practiced his craft all over the world, examines the subject of technical obsolescence from that point of view.

According to Wallenstein, there is a natural tendency to give heightened importance to new developments. He claims we can evaluate such developments properly only after a certain amount of time has elapsed.

This, he says, explains why many companies frantically search for young specialists in narrow slices of the technology, yet paradoxically hire 60- to 65-year old engineers as consultants because the older men have broad experience.

Some educators have plotted curves to show how fast technical knowledge is growing. Examining these curves leads to the conclusion that the engineering graduate of 1970 will find his knowledge obsolete before he receives his diploma.

That piece of nonsense should be the tip-off that something is wrong with such reasoning. Wallenstein urges engineers to acquire engineering fundamentals—knowledge that does not change drastically—like network and feedback theory, mathematics or an understanding of the properties of materials. And he believes that engineers should read copiously, both technical and nontechnical material. According to him, readings in Shakespeare and Kafka are as important to flesh out an engineer's knowledge as articles on laser modulation and integrated circuit design.

In brief, what Wallenstein is saying is that an engineer soundly equipped with fundamental knowledge and an inquiring mind will always find a good place in industry.

Though Wallenstein's argument is sound and rational, its tenets are being ignored by most of the companies searching for engineers. The recruiters' orders—and you have only to read the help-wanted advertisements to see them—are to bring in the narrow specialist, the instant expert, the engineer who is already doing this job for a competitor.

In today's very tight employment market, an engineer over 35 may be ignored either because the personnel man cannot evaluate his broad knowledge or because the company is unwilling to pay for him.

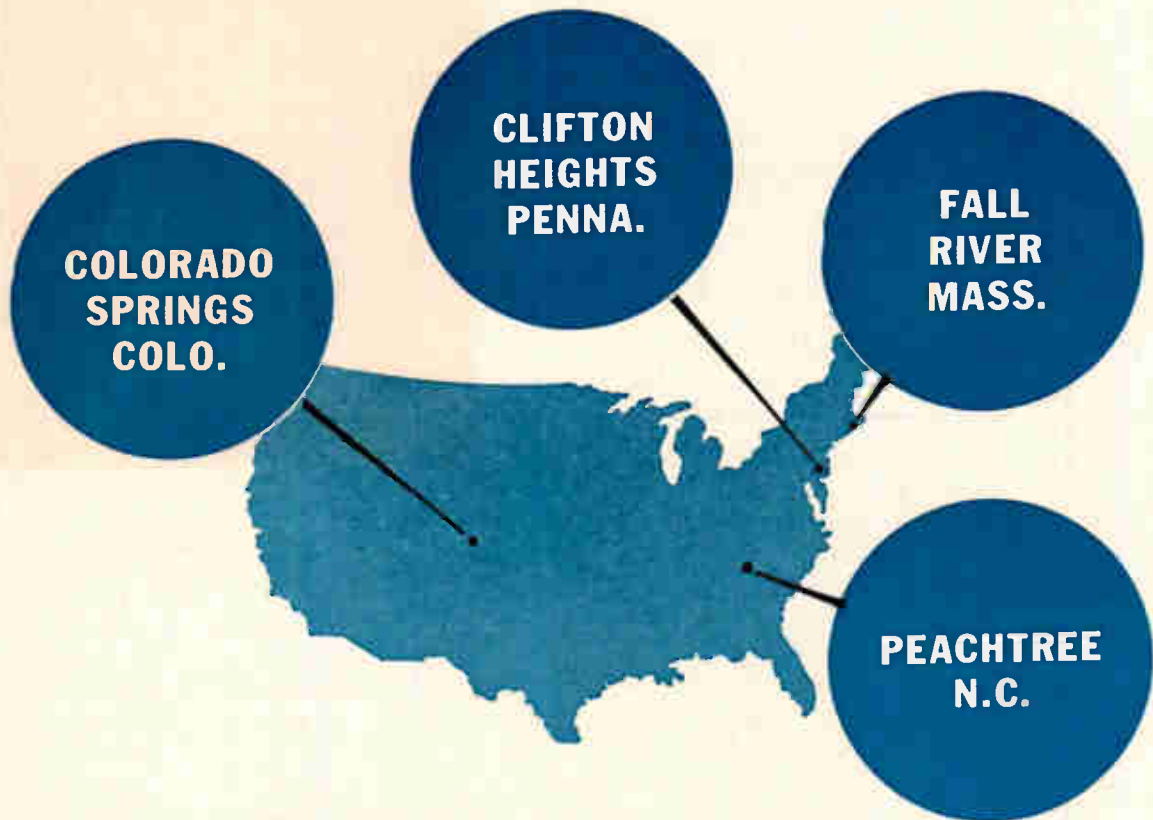

Now 4 Clifton Plants for Greater Synchro Production



Last winter we expanded into a modern 40,000 sq. ft. facility in Fall River, Mass. It is already helping significantly to increase our synchro production.

This summer, construction of our newest synchro plant will be under way in Peachtree, North Carolina. Peachtree will be a 30,000 sq. ft. plant expandable to 100,000 sq. ft. It will further increase our synchro capacity.

Meanwhile, in nearby Murphy, N.C. where we have been doing synchro work for the past two years in temporary quarters, production is being pushed and expanded as rapidly as is feasible. This is true also at Clifton Heights and Colorado Springs.

Our every effort is toward increased production from all 4 plants.



Electronics Newsletter

June 13, 1966

Comsat to propose U.S.-to-Europe circuit rate cuts

The fight over providing additional communication service to the Puerto Rico-Virgin Islands area is heating up. Oddly, the size of an expected rate cut for transatlantic satellite communications may hinge on the outcome.

The Communications Satellite Corp. has petitioned the Federal Communications Commission for permission to build a \$6-million satellite ground station on St. Croix, V.I. Apparently to sweeten the petition, Comsat will shortly file a request to cut transatlantic rates by between 16% and 20% if the ground station bid is approved by the FCC. On the other hand, Comsat expects to seek only a 4% rate cut if its request is rejected.

Competing with Comsat are the American Telephone and Telegraph Co. and the International Telephone and Telegraph Corp. The carriers want to lay a new type of 720-channel underwater cable, the first cable developed that can transmit good quality television signals. ITT says there is enough potential business to warrant both the cable and the ground station; its Virgin Islands affiliate is joining AT&T in pushing for the cable while a Puerto Rican affiliate has asked to build and operate a satellite ground station. Either ground station would serve to hook up the entire eastern Caribbean area with the global satellite network proposed by Comsat.

The new Comsat rates are being filed in conjunction with the launching later this year of its latest satellite, 303-A. The present charge by Comsat for one channel per year via one of Early Bird's 240 circuits is \$50,400 between the U.S. and Europe.

ELDO threatened by British stand

Great Britain seemingly has quashed chances for an ambitious Europe-wide effort in space communications. The Labor Government has announced it would pull out of the European Launcher Development Organization, formed four years ago to develop the Europa-1 rocket, unless Britain's 40% share of costs in the \$500-million project were slashed. ELDO countries met late last week in Paris to decide Europa 1's fate.

There's a strong chance, some observers think, that French President Charles de Gaulle will pick up enough of Britain's tab to keep the project alive. An ELDO collapse would leave the potentially lucrative communications satellite launcher business to the United States—and de Gaulle is violently opposed to that prospect.

Problems slow IBM production, but record is hit

The International Business Machines Corp. is turning out a record number of computers despite yield problems in the production of hybrid microcircuit modules. Presumably these problems have caused IBM to slip behind its production schedule for System 360 computers. In the past four months IBM has produced 1,000 computers.

There are delays of two to three months in building the first model 90's, the largest of the series, which were to have been installed early next year. Similar delays were announced last fall in shipping dates for the first of the smaller models in the series.

On another matter IBM will announce this month or next a line of low-cost airborne computers aimed at the commercial market. IBM's Federal Systems division will build the computers, which represent commercial spin-off from its work in systems for military and aerospace projects.

Electronics Newsletter

NASA picks microwave radar for Apollo

The space agency has selected microwave radar, rather than an optical tracker, for the rendezvous system that will guide the Apollo lunar module from the moon surface to the orbiting mother ship. The National Aeronautics and Space Administration has ordered the Radio Corp. of America to continue development of a radar system, which is similar to the one used in Gemini rendezvous missions. The RCA contract is estimated at \$58.5 million.

The Hughes Aircraft Co., contractor for the optical tracker, has been ordered to continue its work—but at a reduced rate—for possible experimental tests on an earth-orbiting lunar module. The Hughes contract is now estimated at \$29.8 million.

Traffic light counts for safety

Count-Down Signal Manufacturing, Inc., of Abilene, Texas, is marketing a traffic light that tells a motorist how soon the green light will change. The amber portion of the traffic light displays, by means of flashing 12-inch numbers, the last nine seconds before the green light changes. When the countdown reaches zero, the green signal light goes off and the amber stays on for an additional three seconds before the light turns red. The system is composed of a solid state control box and 18 light bulbs arranged inside the amber lens. City officials in Abilene say the light helped reduce accidents by 48% at one intersection in the past nine months.

U.S., Japanese firms compete on contract for Air Force job

An updated military microwave communications network will be built in the Kanto Plains area of Japan. The job is known as subsystem B of Project Wet Wash, the Pacific area communications system. The Air Force has invited cost bids from the Federal Electric Corp., Paramus, N.J., and from the Nippon Electric Co. of Japan. Federal Electric is a subsidiary of the International Telephone and Telegraph Corp.

Honeywell's target: industrial computers

Honeywell, Inc., is aiming at a bigger stake in computer-run industrial process control. The acquisition of the Computer Control Co. of Framingham, Mass., "has given us a base for a substantial expansion of our activities in industrial process control computers," says Honeywell chairman, James H. Binger. Benjamin Kessel, president of Computer Control before its acquisition last month, becomes a Honeywell vice president and general manager of the newly formed Computer Control division. The control systems department, at Fort Washington, Pa., until now a part of the industrial division, becomes a part of Kessel's computer division.

The prime mover in Honeywell's steady march into data processing is Walter W. Finke, who moves up to group vice president heading the new Computer Control division as well as his own creation, the Electronic Data Processing division in Wellesley Hills, Mass.

Electronics sales to hit high in '66

Factory sales of electronic products are expected to rise 11.5% to a record \$19.3 billion in 1966 from \$17.3 billion in 1965, the Electronic Industries Association told its members at its annual convention this month. The biggest rise will occur in the consumer electronics industry, which will show a year-to-year boost of nearly 21% to \$3.7 billion. Spending for electronics by the government will climb 7% to \$9.5 billion.

In Making Masks for
Electronic Components...
...there's no
Margin for Error!

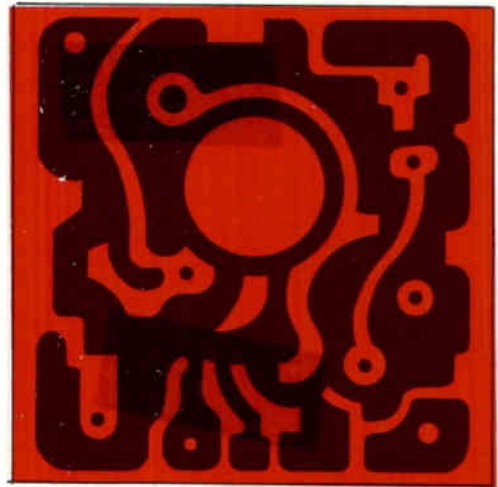

**THAT'S WHY EXPERIENCED DESIGNERS
AND ENGINEERS ALWAYS INSIST ON...**



RUBYLITHTM

HAND-CUT MASKING FILM FOR THE GRAPHIC ARTS

the
knife-cut
light-safe
masking film
laminated
to a stable
polyester base

by

UlanoTM

DETAILS, SPECIFICATIONS AND TEST KIT OFFER



HERE'S HOW...

THE ELECTRONIC INDUSTRY IS USING
THESE FAMOUS ULANO FILMS IN
ULTRAMINIATURE MASK TECHNOLOGY
AND COMPLEX PRINTED CIRCUITRY

UlanoTM

RUBYLITHTM

AMBERLITHTM

HAND CUT MASKING FILMS FOR THE GRAPHIC ARTS

ULANO RUBYLITH... a revolutionary knife cut red film is laminated to a stable transparent plastic backing sheet. The red film is "light safe" so that when contacted to a sensitized emulsion and exposed to a suitable light source, light passes through the cut-out portions only... not through the red film. ■ The polyester backing is absolutely stable... insures perfect register. ■ Special effects such as crayon tones, paste ups, benday sheets, and opaquing are easily combined with versatile ULANO RUBYLITH.

ULANO AMBERLITH... a companion to Rubylith serves as a color separation medium used as the master on camera copy board to secure negatives or positives.

*A wide variety of Ulano films—
in rolls and sheets—is readily available*

Cut a piece of the desired film large enough to cover area to be masked. Tape it down firmly at the top with dull-side up.

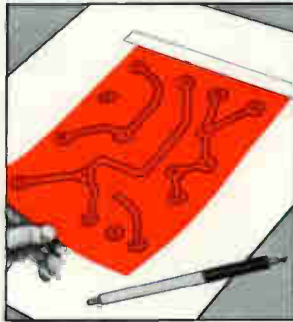

With sharp blade, outline the areas to be masked. *Do not cut through the backing sheet.* The Ulano Swivel Knife does the job quickly, easily.

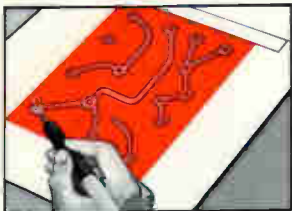

Using the tip of the blade, lift up a corner of the film thus separating it from the backing sheet.

Now carefully peel off the film as outlined leaving a completed mask, positive or negative, that corresponds exactly to the desired pattern.

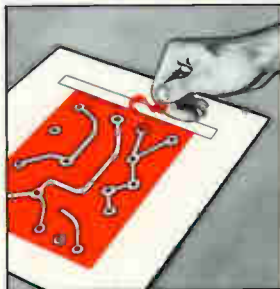

Designed FOR YOUR PARTICULAR NEEDS

Ulano offers the most versatile line of hand-cut masking films, including:

.0075—RUBYLITH 75 DR* .005—RUBYLITH 5 DR†

.005—AMBERLITH 5 DA†

Where exact register assures a critical importance, you will find these new, thick, polyester based films the positive answer.

* Available in sheets only, cut to your specifications

† Available in rolls and sheets



WRITE TODAY
on your letterhead for free
special sample kit B 48

"Ulano"—"Rubylith"—"Amberlith" are registered trade marks of the Ulano Companies.

ulano

610 DEAN STREET, BROOKLYN, N.Y. 11238

In Europe: ULANO A.G., Untere, Heselbachstrasse No. 22, Kusnacht, Zurich, Switzerland



Ball .002" dia., Iteration $\pm 5\%$

TEMPRESS HYDROGEN FLAME-OFF TORCHES FOR LEAD-BONDING MACHINES ARE STAINLESS STEEL, WITH SAPPHIRE ORIFICE INSERTS that maintain size and shape accuracy of the 2166°C hydrogen flame. The highly polished inner surface of the sapphire insert assures this by eliminating gas turbulence and a resultant distortion of the flame. The end result is essentially identical gold balls on every lead, from start to finish of a production run. 14X magnification of operation shows flame-off torch at left, with orifice partially visible. Gold wire, with perfectly formed ball, protrudes from Tempress tungsten

carbide capillary tube, ready for next bonding cycle. This extreme precision symbolizes the Tempress approach to every project... explains why it requires 11 months to train an operator for many Tempress production operations. Other Tempress products include automatic scribing machines, diamond scribes, diamond lapping points, and tungsten carbide probe contact needles.

Lead-bonding, Model DTN-1, at Union Carbide Electronics.



TEMPRESS

Tempress Research Co., 566 San Xavier Ave., Sunnyvale, Calif.

Circle 29 on reader service card

**Who cares how long
a heart keeps beating?**



With the help of "Heartwatch"—G.E.'s new intensive care system—hospitals gain round-the-clock heart-beat monitoring of critically ill cardiac patients.

**Who cares about hitting
the keyhole in the sky?**



G.E.'s radio guidance system controls altitude, trajectory and velocity at launch. Like Gemini above, it has helped place all manned U.S. spacecraft safely in orbit.

**Who cares about
color you can carry?**



“Porta-color,” G.E.’s latest TV innovation, combines the space-saving advantages of multi-function Compactron tubes with an all-new, 11-inch color picture tube.

General Electric cares

(and brings you continuing innovations in all areas of electronics to prove it)

At the heart of every G-E innovation lies engineering — the single most important factor in electronics. Engineering opens doors to new and improved equipment designs, to better product quality, to lower component prices, and to new market opportunities for both your business and ours.

As your partner in innovation, G.E. will continually work with you to assure the growth of our industry—not just in dollars, but in jobs and in markets as well.

Who cares about the benefits you get through continuing electronic innovation? General Electric cares. Just ask the people who represent us, your G-E engineer/salesman or distributor.

900-07

Progress Is Our Most Important Product

GENERAL  ELECTRIC



Cooking up a NEW product?

*Add a dash of extra sales appeal
(and save a little money)
with Heinemann's good-looking
'instant color' circuit breaker.*

For years we've been making homely circuit breakers that work beautifully.

Our new Series JA breaker has changed things a bit. It's sort of handsome. For a circuit breaker.

The pictures opposite will show you how nicely a JA with a spot of color can dress up a panel.

The functional possibilities are intriguing, too. JA breakers in color are a very practical way to indicate a specific switching sequence. Keyed to matching pilot lights, they can neatly simplify equipment operation.

It takes just one second to color the JA in any of nine different hues. Slip a cap over the breaker's mounting boss and the job's done. (The caps cost a few pennies; the white handle comes at no extra charge when you buy the rest of the breaker.)

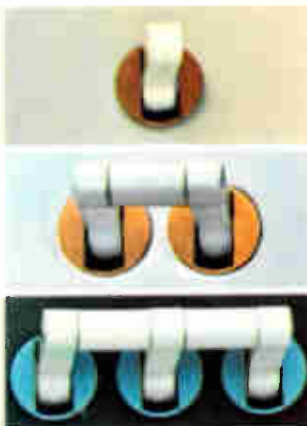

Price is another attractive feature. The JA runs about ten percent less than our Series AM12, which has long been the most popular OEM model on the market. Yet it has similar functional capabilities. It offers the same kind of precise overload response. And it can be had with all our usual options—custom current ratings, choice of time delays, special-function internal circuits.

Series JA breakers are available in one-, two-, and three-pole models, in any integral or fractional current rating from 0.100 to 20 amps. Standard maximum voltages are 250 vac, 60 or 400 cps; 50 vdc. Our Bulletin 3350 will give you full details. A copy is yours for the asking. Heinemann Electric Company, 2600 Brunswick Pike, Trenton, New Jersey 08602.



HEINEMANN

We asked 20 of your fellow engineers

“WHY DO YOU CHOOSE CTS SWITCHES?”

HERE ARE THEIR REASONS:

“NO BREAKAGE”

They don't break on production lines or on finished equipment if dropped or jarred . . . CTS glass alkyd wafers are not brittle like phenolic . . . easy to handle.

“NO SHIFTING”

Precision molded construction eliminates mechanical shifting of stator circuitry and terminals.

“MORE COMPACT”

No spacers needed when stacking wafers . . . Maximum switching capability with minimum depth . . . Smaller diameter—only 1-1/8" (Series 212 wafers)

“VERSATILITY OF CIRCUITS”

Many circuit variations available due to varied rotor contact configurations. External jumpers eliminated by CTS internal connections between positions.

“AVAILABILITY OF POWER SWITCHES”:

Available with 4 types of power switches and/or numerous potentiometers.

“SUPERIOR INSULATION”

Glass alkyd is superior to phenolic insulation.

- Soldering heat can't loosen terminals.
- Meet MIL-S-3786 A&B, Style SR03 (Series 211 and 212.)
- Balanced contact spring.
- Natural solder barrier provided by glass alkyd insulation.

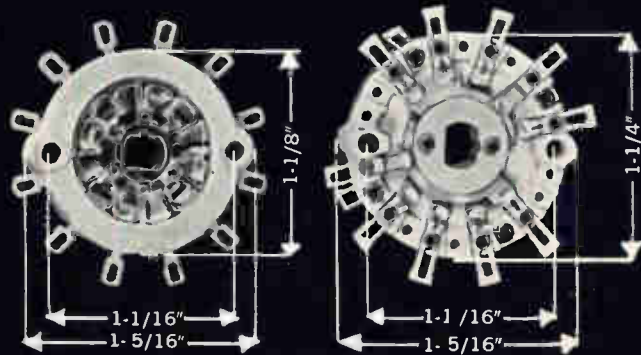
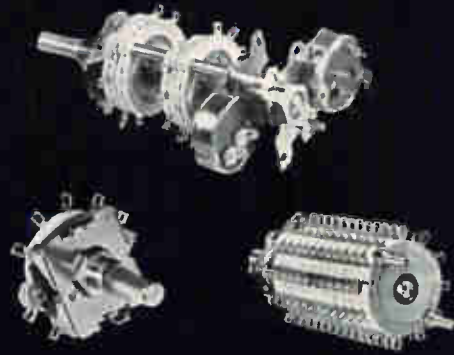

Series 212 Wafer

Series 216 Wafer

DETENTS



Type 211—STAR WHEEL DETENT

HIGHEST QUALITY • POSITIVE FEEL
• 250,000 CYCLE LIFE • FREE FROM
END AND SIDE THRUST • HIGH
SWITCHING TORQUE 15–60" OZ.



Type 212—HILL AND VALLEY DETENT

LOW COST • DESIGNED FOR HOME
ENTERTAINMENT AND LOW COST IN-
STRUMENT APPLICATIONS • 25,000
CYCLE LIFE • SWITCHING TORQUE
20–48" OZ.



Type 212 ND—DIE CAST DETENT

LOWEST COST OF ALL DETENTS
• LOW COST STAKED CONSTRUCTION
• AVAILABLE FOR 1 AND 2
WAFER SWITCHES • 20,000 CYCLE
LIFE • SWITCHING TORQUE 18–
40" OZ.



Type 215—DOUBLE BALL DETENT

DESIGNED PRIMARILY FOR INSTRU-
MENT MARKET • HIGH QUALITY
• CRISP FEEL • 100,000 CYCLE LIFE
• SWITCHING TORQUE 6–35" OZ.



SUB-MINIATURE

1/2" DIAMETER SWITCH

WILL MEET MIL-S-3786B, Style SR20
Series 210

Discover for yourself the advantages of working with CTS for your switch requirements. Switches produced in Elkhart, California and Canada. Request Catalog 4000 containing the full CTS Switch line.



Founded 1896

CTS
CORPORATION
Elkhart, Indiana

Sales Offices and Representatives conveniently located throughout the world

Principal Products

Variable Resistors
Selector Switches
Loudspeakers
Trimming Potentiometers
Microminiature Components
& Circuit Packages
Crystals, Filters,
Oscillators & Ovens

Subsidiaries:

CTS of Asheville, Inc., Skyland, N. C.
CTS of Berne, Inc., Berne, Indiana
CTS of Paducah, Inc., Paducah, Kentucky
Chicago Telephone of California, Inc.,
South Pasadena, California
CTS of Canada, Ltd., Streetsville, Ontario
CTS Microelectronics, Inc., Lafayette, Ind.
CTS Research, Inc., Lafayette, Indiana
CTS Knights, Inc., Sandwich, Illinois



Power dissipaters (B. S.)*

Pictures serve admirably, in this case, to tell the story of a striking new product development. Upstaging the familiar bulk of a conventional 1000-watt coaxial load to your left is a little (under 2 lbs.) conduction-cooled number from Sierra's new Model 460 Series. It also dissipates 1000 watts.

A radically new design concept, permitting use of conduction cooling, accounts for the miniaturization of 50-ohm loads. Ideal for tight-squeeze situations, they attach readily to equipment cabinets, bulkheads, airframes — anything serviceable as a heat sink.

Series 460 loads dissipate power in ratings of 150-, 400-, and 1000-watts (from DC to 4000 Mc), while weighing only 6 oz. to 1 lb. 10 oz. They contain no dielectric, operate in any position, work imperturbably at any altitude. There's no derating factor to apply. The two "bigger" models accept Sierra "Twist-Off" connectors.

Prices are \$235 (150 w), \$325 (400 w), and \$450 (1000 w). For more information, write Sierra/Philco, 3885 Bohannon Drive, Menlo Park, California 94025.

*Before Sierra

†After Sierra

Circle 34 on reader service card

(A. S.)†

SIERRA ELECTRONIC DIV.

OF

PHILCO

A SUBSIDIARY OF *Ford Motor Company*

Electronics Review

Volume 39
Number 12

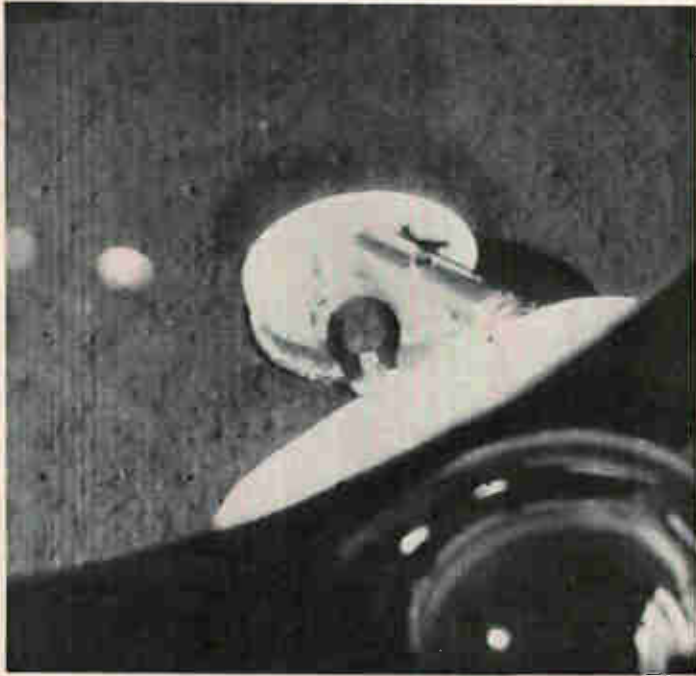

Surveyor tv camera shoots landing foot resting on lunar surface six feet away.



Lunar surface, smooth except for pebbles and a 6- by 12-in. rock, as televised to earth.

Space electronics

Triumphant Surveyor

On the morning of June 14 the sun will set on a flat lunar plain called Ocean of Storms and on a spacecraft sitting near the crater Flamsteed. Later on—probably 10 to 30 hours after sunset—the -250°F cold and darkness of the lunar night may silence America's first "soft lander." But not until Surveyor 1 has performed its complex mission flawlessly.

It was the United States' first try at soft landing and radioing back television pictures from the moon's surface—and no one had expected a completely successful mission. But Surveyor, which only last year had been called by Congress the "least orderly, most poorly executed" of any space agency projects, landed without scratching its gold plating and was sending back large batches of photos of the lunar

countryside.

Scientists who were so sure earlier that Surveyor 1 would not last through the frigid lunar night, are now hedging. The craft is proving so rugged there is a chance it will continue to operate indefinitely. Surveyor was reported in better shape after a week on the moon, and ultimately may have to be shut off somehow from earth.

Late and expensive. It was nearly three years late and it was costing 10 times more money than anticipated, but Surveyor made heroes out of project personnel at the Hughes Aircraft Co., the builder, and at the Jet Propulsion Laboratory, the manager. What the first three-legged insect-like craft accomplished was supposed to have taken four or five launches—perhaps all seven of the engineering models.

In accomplishing all of its primary and secondary goals, Surveyor 1 "put us at least a year ahead of where we would have

been had the program proceeded as expected," one jubilant National Aeronautics and Space Administration official declared.

While Surveyor's success won't cut a day from the already tight Apollo program, it brought sighs of relief from Bethpage, N. Y., where the Grumman Aircraft Engineering Corp. is putting together the first flight model of the Apollo Lunar Excursion Model (LEM). This is because LEM will employ practically the same type of soft-landing system when it lands two astronauts on the moon by 1969.

The Surveyor landing system had worked only twice before, and only on the New Mexico desert just last month. But it put the 620-pound craft down on the moon at a gentle 7 to 8 miles per hour, slowing it down from 6,000 mph.

Two radars in the closed-loop system determined how high the spacecraft was and how fast it was dropping. This data was fed to gyros and gating logic to control

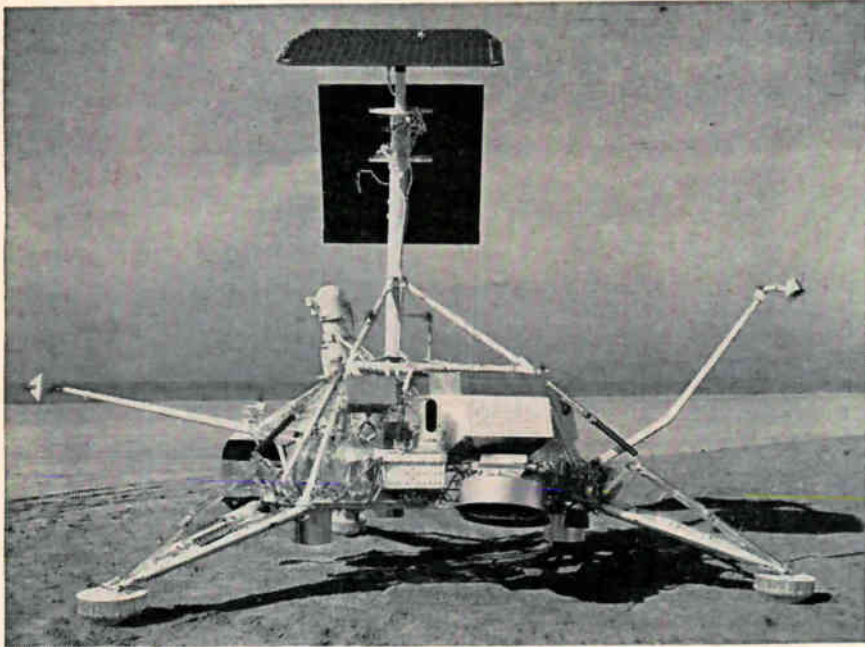

Research version of Surveyor 1 with extended directional antenna and solar cell array sits on a California beach.

the three vernier engines which slowed the craft's speed during the last 25 miles. The radars, a beefed-up version of a helicopter navigation set, were built by the Ryan Aeronautical Co.

No surprises. Surveyor's snooping camera found that the lunar surface was about what scientists had expected and hoped for—firm enough for LEM to land on and man to walk on, at least at this site.

Surveyor's electronics worked like a charm. Except for an omnidirectional antenna that temporarily didn't unfold, no problems were encountered. On-board electronics were complex—the craft could respond to 256 commands and some 300 flight control people were needed at JPL.

One prospective manned landing site has been found and follow-on Surveyors will take a look at other likely spots. Now undergoing final tests at Hughes is Surveyor B, which will be ready to go by August. This is the last Surveyor to be launched this year. It's too early to say whether Surveyor 1, by accomplishing so much, will have any effect on remaining flights.

Besides the seven engineering models, NASA is planning to order the final three heavier, operational

spacecraft next month. But these three, which will carry equipment for five additional experiments and another camera, can't be launched until mid-1968. NASA could decide not to fly all the Surveyors or not to buy the last three.

The propaganda race. In rocky highlands some 600 miles from where Surveyor landed is the Soviet Union's Luna 9, which sent back the first tv photos from the moon's surface four months ago. Beyond this feat, however, the crash-proof, uncontrolled capsule was clearly outdistanced by the bigger, more sophisticated Surveyor.

NASA scientists say Luna 9 did not make a true soft landing and was similar to the U.S. Ranger Block 5 series, which was canceled to save money. Luna 9 sent back only a handful of pictures since its batteries gave out after a couple of days. It had no solar cell array to recharge its batteries, such as Surveyor carries.

Qualified success

Although gremlins plagued the Gemini 9 mission from start to finish, the mission could hardly be considered a failure: it provided

three experience-packed days that added to America's flight time in space.

Far from delaying the Apollo man-on-the-moon program, last week's Gemini mission went a long way toward sharpening the skills needed for rendezvous in space. Although troubles with two docking vehicles barred the astronauts from docking in space, the more difficult task of rendezvous—something the Russians have yet to demonstrate—was performed three times with the augmented target docking adaptor.

More delays. The first of the many problems occurred when the expensive Agena target vehicle veered off course and plunged into the Atlantic—delaying Gemini's lift-off for two days. Then, before the next launch opportunity, electrical problems in the Atlas resulted in a second scrub. Another two-day delay occurred when two \$5 digital logic modules, out of 2,500 in a ground-based inertial guidance system, failed after the stand-in docking craft was lofted.

Finally, after a 16-day delay, the Gemini lifted off into its planned orbit. And problems continued. After two successful rendezvous, Lt. Col. Thomas Stafford began to doubt the figures being cranked out of his onboard computer. During his third rendezvous attempt, he pulled out pencil and paper and calculated his own rendezvous figures by hand.

A record two-hour-and-nine-minute walk in space was marred when Lt. Cmdr. Eugene Cernan did not disconnect the 25-foot umbilical cord and operate independently with a 166-pound back pack. Stafford vetoed the first attempt at using the maneuvering unit because communications were breaking up between the craft and Cernan's uhf radio, and moisture fogged Cernan's helmet visor.

... on the other hand

The space agency needs all the breaks if it is to meet its ambitious schedule of putting man on the moon sometime in late 1968 or 1969. But this tight Apollo sched-

ule may have been dealt a blow by an explosion on May 28 that damaged the only test stand capable of ground testing the second stage of the Saturn 5—the booster that will propel astronauts to the moon.

It was particularly worrisome to National Aeronautics and Space Administration officials since the S 2 second stage, being developed by North American Aviation, Inc.'s Space and Information division, has been described as the pacing item on the entire Apollo program.

Dual role

The space agency is planning a more versatile weather eye in the sky. The National Aeronautics and Space Administration has awarded the Radio Corp. of America an \$800,000 contract to design the satellite, which will be launched in 1968.

The two weather eyes that are currently operational, Essa 1 and 2, are limited in the way they transmit photos to the earth. Essa 1 stores a series of pictures taken at rapid intervals and "dumps" them only on order from a ground station. Hence, a composite weather map of much of the world can be built up at a single station. Essa 2, on the other hand, does not store the pictures; it continuously transmits what it sees in real time and the photos are picked up only by stations within range of the orbiting craft; thus the weather pictures picked up by any one station cover the area in its general vicinity. The new craft will be able to do both jobs.

It will weigh nearly 500 pounds and be 5 feet tall and 4½ feet in diameter. The earlier satellites were 2 feet tall by 3½ feet in diameter.

Better aim. Improvements call for stabilizing the new craft in pitch, yaw and roll so that it always points toward earth. A flywheel and magnetic attitude control system will be used for this job. The present satellites are spin-stabilized; their cameras pointing away from the earth much of the time.

With the new stabilization, the

satellite can be outfitted with infrared radiometers for reporting on night cloud cover and cloud heights and temperatures.

Once developed, the new satellite will be operated by the Commerce Department's Environmental Science Services Administration—origin of the Essa acronym. The agency is exploring a plan with the International Business Machines Corp. and the Communications Satellite Corp. for high-speed world weather exchange via satellite.

In August, the agency hopes to begin launching its weather satellite from the West Coast—where it's easier to achieve polar orbits for better earth coverage. A complex dogleg maneuver is necessary from Cape Kennedy.

By 1969, the agency wants to begin putting its meteorological satellites into synchronous orbits, 22,300 miles high, so each will continuously monitor the same area of the world.

Advanced technology

Absorbing memories

A reversible photochromic reaction, characteristic of two common chemical compounds, may prove to be the basis of relatively simple, high-speed memories with large storage capacity and infinite lifetime.

While computers are shrinking in size and increasing in problem-handling ability, the problem of memory size and access time is still a serious limitation to system design. Conventional core memories are reasonably fast, but with their driving electronics they are quite bulky when large storage capacity is required. Thin-film memories are fast, too, but they aren't as economical as cores.

Joseph Rennert, an assistant professor of chemistry at the City College of New York, now believes that the organic compounds he has been studying can be used to form small, highly dense memories with access times of nanoseconds.

Light change. One compound, cinnamic acid, is a colorless solid material that is readily available commercially. It has the property of being highly absorptive to radiation in the near ultraviolet portion of the spectrum, but on exposure to such radiation, the material changes its molecular structure and becomes another compound called alpha truxillic acid. In this form, the optical properties of the material exhibit a marked change from those of the starting material, and it becomes highly absorptive to radiation at a different frequency. The process also is reversible, and the reaction time is limited only by the lifetime of the excited molecules, which is about a nanosecond.

Rennert speculates that one possible memory arrangement would take the form of a substrate disk on which is deposited a layer of cinnamic acid. The disk would be mounted on the face of a cathode-ray tube with the phosphor of the tube selected to emit radiation at the desired absorption wavelength. Ultraviolet phosphors are readily available, Rennert points out.

Writing would be performed by selectively irradiating locations on the disk with the electron beam of the crt. For readout, a detector would be mounted in front of the memory. Its output would be fed into a second crt, the sweep of which is synchronized with that of the first crt. In the read mode, the radiation from the faceplate of the first crt would be reduced to a low intensity—too low to effect a chemical change of the deposited layer. Readout would be nondestructive.

Dense memory. The deposited layer of cinnamic acid has a potential theoretical density of 10^{14} bits per square centimeter, according to Rennert. This would be reduced a bit by the width of the beam.

According to the chemist, another material exhibiting the effect—but with reduced speed and sensitivity—is a yellow solution of naphthoquinone, which, when irradiated with visible violet light, becomes colorless and shifts its absorption properties into the ultraviolet portion of the spectrum. This might be useful, Rennert says, in

small low-cost memories for processing control that do not require the density of the other type. Memories could be formed from small capsules of the solution arranged in arrays.

Communications

Up in the air

The Federal Communications Commission, with a major assist from private industry, is trying to get an adequate and efficient public airplane telephone service off the ground.

The problem has been in the laps of the FCC and industry for a long time. When the demand for a public air-ground service arose, the commission permitted use of the marine radio service and public coast stations—designed for use by ships at sea. But the growth of private boating after World War II overloaded these facilities.

Between 1958 and 1963, the FCC authorized, for experimental and developmental purposes, construction of 10 separate ground stations for air-ground service, using an f-m system with six channels. This proved inadequate. And, about a year ago, the commission asked industry to come up with a new approach employing a single-sideband system providing for at least 60 two-way voice channels.

Standard-setter. A special committee of the Radio Technical Commission for Aeronautics, headed by E.O. Hart of the Bendix Corp.'s Radio division, drew up the technical specifications and standards for the proposed system. These, designed to be flexible enough to permit innovation and broad development, were adopted by the FCC last month as an amendment to its original rule-making proposal.

If such a system can be developed—it's still mostly in the minds of a few engineers—the FCC will allocate for its use 454.675 to 455 and 459.675 to 460 megahertz on the spectrum. It also

will authorize construction of at least 80 ground stations in the U.S. to receive and transmit radio-telephone calls for aircraft.

Because the standards were formulated by an industry group, the commission—which has given interested parties until Oct. 3 to comment—expects no serious objections. The committee expects implementation of the system beginning in 1971.

Controversy. But this target date may be more than a little optimistic. There was considerable controversy within the committee over the relative merits of the f-m and single-sideband systems. Motorola, Inc., supported in part by the General Electric Co., General Motors Corp., and American Telephone and Telegraph Co., says that an improved f-m system may prove superior and more stable than single sideband.

AT&T went even further: "In our opinion, based on theoretical studies conducted by our laboratories, there is substantial reason to doubt the feasibility of developing a commercially workable single-sideband air-ground system meeting the design criteria specified by the commission. How far the present state of the art and accompanying economic considerations would permit approaching these design criteria could only be determined by an extended development program requiring an estimated three to five years. In our opinion, the chances of achieving the major objectives specified are not sufficient to warrant launching such a program at this time."

Others represented on the industry committee were the Collins Radio Co., Amp, Inc., the National Business Aircraft Association, the Aircraft Owners and Pilots Association and Aeronautical Radio, Inc.

Consumer electronics

Critical reviews

Two legal actions last month have made the future uncertain for both

community antenna television (CATV) and pay-tv. First, a federal court in New York ruled that a CATV firm cannot intercept a motion picture televised over the air without first paying a royalty to the film's producer. Then, California's attorney general asked the United States Supreme Court to rule whether a referendum can outlaw pay-tv.

The CATV decision bodes well for pay-tv, because the increased cost of operating CATV stations would make pay-tv more competitive with CATV. But the growth of pay-tv might be stunted if the Supreme Court decides that the people of a state can ban pay-tv by a referendum.

The CATV case, in litigation for about six years, involves the American Cable Vision Co., which is almost certain to appeal, and United Artists Associated.

Ban the ban? The California case dates back to a state referendum in November, 1964, which banned pay-tv. Last March the state Supreme Court declared the ban unconstitutional. It is this ruling that the California attorney general has asked the nation's highest court to overturn.

Caught by surprise by the appeal was Subscription Television, Inc., which had operated a pay-tv network in California until the referendum, and has since made tentative plans to resume operations. Ironically, on the same day that California motion was recorded by the U.S. Supreme Court, a Subscription Television officer reported to stockholders at the annual meeting: "We're fairly confident the California attorney general won't appeal, but if he does, we'll fight it vigorously."

Industrial electronics

Cement by the numbers

"When we started planning for our \$25-million cement plant we had the choice of being the last to install an analog computer system or

**this AMELCO FET
combines low R_{ON} ,
low $I_{D(OFF)}$ and low C_{DG}
better than
ever before...**

2N4091

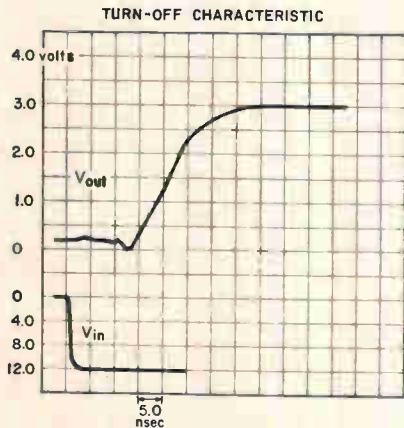

SPECIFICATIONS:

R_{ON}	30 ohms MAX	t_{OFF}	40 nsec MAX
$I_{D(OFF)}$	200 pA MAX	V_P	10 V MAX
C_{DG}	5 pf MAX	I_{DSS}	30 mA MIN
t_{ON}	25 nsec MAX	BV_{DGO}	40 V MIN

Now being mass produced, this FET switch is available from Amelco Distributor stock for only \$12.30, in quantities of 100 or more.

Amelco's new 2N4091 FET switch offers extra high speed with the highest switching ratio ever available in a standard device. If you are working with multiplexing, commutating, analog switching or DC chopping, consider these facts . . . R_{ON} is 30 ohms max., the lowest of any FET on the market with C_{DG} of less than 5 pf; I_D (on)/ I_D (off) ratio is better than 10^8 . Designers may now consider FET devices where previously the requirement for very low on resistance demanded use of bipolar transistors. In addition, applications presently using FET's can benefit from this improved performance.

**AMELCO
SEMICONDUCTOR**

DIVISION OF TELEDYNE, INC.

1300 TERRA BELLA AVENUE • MOUNTAIN VIEW, CALIFORNIA

Mail Address: P. O. Box 1030, Mountain View, California

Phone: (415) 968-9241 / TWX: (415) 969-9112 / Telex: 34-8416

REGIONAL OFFICES

Southwest—Suite 213, 8621 Bellanca Ave., Los Angeles, California 90045, (213) 678-3146 • Northwest—1300 Terra Bella Avenue, Mountain View, California, (415) 968-9241 • East—P. O. Box 2091, Paterson, New Jersey 07509, (516) 334-7997 • Northeast—543 High Street, Westwood, Massachusetts, (617) 326-6600 • Midwest—650 West Algonquin Road, Des Plaines, Illinois, (312) 439-3250; 3020 Woodlark Lane, St. Paul, Minnesota, (612) 646-1161.

the first to employ direct digital control," says Worth Loomis, a vice president of the Medusa Portland Cement Co. The decision: direct digital controls.

"Aside from the technical advantages," he adds, "the system will save us about \$150,000 because it uses less peripheral equipment than an analog system."

For the electronic hardware, Medusa turned to the Foxboro Co. of Foxboro, Mass., and ordered a PCP-88 multiple-computer system and supporting electronics that controls the cement-making operation from mixing the raw materials to shipping the finished product. The cost of the system is estimated at about \$750,000. The plant at Charlevoix, Mich., will have a capacity of four million barrels a year when completed in mid-1967.

Analog systems. In the United States alone, there are about 15 cement plants that currently use analog systems to control production operations. Such systems require both an analog and a digital computer; the analog computer picks up analog signals from the sensors and converts them into digital signals for a supervisory digital computer. [Electronics, Aug. 10, 1964, p. 34].

The Medusa system will continuously scan signals from about 150 sensors and adjust almost 50 valves, motors and kiln dampers. Foxboro's PCP-88 has two digital computers: a master—which supervises the production and calculates whether any of the operating set-points must be changed—and the slave—which contains the direct digital control process.

His master's voice. In the event the slave should fail, the master halts the control functions and takes over operation of the plant. In analog system, if either computer fails, the entire production operation shuts down.

Also, the use of two digital computers—rather than one digital and one analog—eases the language problem. Since analog computers can't operate on the same language as digital computers, engineers working with analog control sys-

tems must be familiar with two computer programs. Furthermore, making changes in a program with dual languages is considerably more difficult than with a single language.

The Medusa system will use Fortran, a relatively easy language to master, Loomis explains, so that the engineers and chemists who experiment with the cement-making operation will be able to do their own programming to develop the most efficient production process.

Medical electronics

Heartprint

"I've been listening to heart sounds for years, trying to make sure of the differences," says Dr. Mortimer L. Schwartz. "Now I can see them in distinct patterns."

He was viewing two spectral maps from the outputs of a sound spectrograph which had analyzed two sound-alike heart murmurs, one in the aortic area and the other in a pulmonary artery.

The \$12,500 spectrograph has been widely used to help law enforcement agencies identify people from their "voiceprints," and it is now being applied to a variety of medical research areas.

Turn to medicine. At the New Jersey College of Medicine and Dentistry, Jersey City, the inventor of the spectrograph, Lawrence G. Kersta, is putting the device and the technique to work to aid heart research by Dr. Schwartz. Kersta, who developed the machine while at Bell Telephone Laboratories, retired this spring to form his own company, Voiceprint Laboratories, in Somerville, N.J.

Usually, a heart specialist decides whether he is dealing with an aortic or a pulmonic murmur by studying electrocardiograms and by listening through a stethoscope. If he is still undecided, it may be necessary to probe the heart area with a catheter. The new technique promises to provide valuable heart-

prints—like fingerprints—by analyzing recordings made from an electronic stethoscope. By comparing the patterns with those from known conditions, it may be possible to eliminate the need for catheterization.

At Will Rogers Memorial Hospital, Saranac Lake, N.Y., the sound spectrograph is exploring ways of measuring the severity of emphysema in patients. At the research laboratories of a drug company, the technique is measuring the changing emotional levels of a schizophrenic. When emotional disturbance increases, the pitch frequency of the voice rises and syllabic rate changes as well as other characteristics of speech.

Police role. "The possible medical applications are my principal interest," says inventor Kersta. But police and investigative projects have kept him hopping, both when he was with Bell Labs and since.

Early this month, his testimony before a Los Angeles grand jury helped indict an 18-year-old suspect on charges arising out of the Watts area riot. The youth's voiceprint matched that on the tape of a television network documentary in which an anonymous youth boasted details of arson and violence.

The voiceprint technique also played a role in a court-martial at Travis Air Force Base, Calif., when a serviceman was convicted of making obscene telephone calls. Last April, voiceprint evidence was admitted at a perjury trial in White Plains, N.Y.

Some law enforcement agencies are beginning to compile tapes and spectral patterns of individuals, according to Kersta. All investigative agencies of the federal government are actively planning projects along this line, he says. A dozen of the machines have been purchased by government agencies, including the Defense Department.

In addition to probing medical applications, Kersta is working on computer classification and matching of sound spectrograms to replace trained human observers. "No computer system today has either the hardware or the soft-

COMPONENT COMMENTS *From Speer*

How to find the carbon composition resistor that does the most for you...when all U.S. brands are good

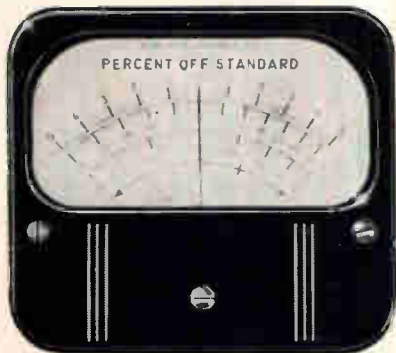

Before we show you how to do it, let's clear up some of the confusion surrounding this question of resistor reliability.

You have been exposed to some 4-color full-page advertising citing "10 billion field proven resistors" and "not even one catastrophic failure."

When you get right down to cases—unless U. S. made composition resistors are badly abused, failures are virtually nil. As a rule, malfunctions are the result of failures of other circuit elements. Long life and reliable performance are sure fire results when operating conditions are reasonable.

It's true that composition resistors are susceptible to ambient influences. But if you plan your design to accommodate the modest and completely defined resistance changes that might occur, you'll be more than compensated by the resistors' work-horse performance. (Not to mention their rock-bottom price.)

Which brings us back to our original problem—how to find the best composition resistor among the many equally reliable U.S. brands.

Solution? Come to Speer.

Before you accuse us of shameless subjectivity, consider the following points. (1) We produce billions of completely reliable carbon composition resistors for hundreds of satisfied repeat customers. (2) We have

a high-volume production schedule, which permits us to offer realistic pricing without sacrificing product quality.

And (3) we offer quite a bit more in the way of technical support and service.

We'd be delighted to send you complete documentation on Speer resistor characteristics. Just mail us the coupon.

Did you catch our new act at one of the Shows?

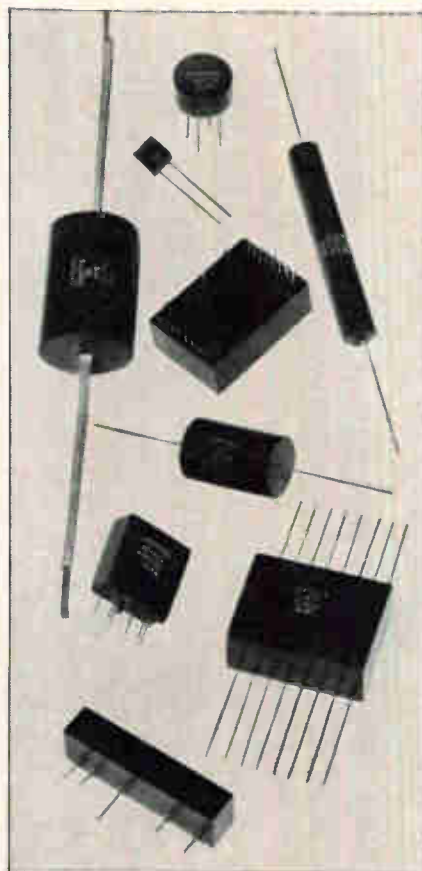

Frankly, our new precision resistor networks and packaged assemblies drew such large audiences at the IEEE and SWIEEEO Shows that it's a trifle difficult to remember just who was there and who wasn't.

All we know for sure is that audience reactions seemed highly favorable.

Stands to reason, too—when you consider that these new custom networks can be calibrated to tolerances better than .02%, with characteristics of very low temperature coefficient of resistance and compatible stability. What's more, they can be designed to meet almost any network application. And they offer broad environmental capabilities, at the lowest possible cost, with the shortest delivery schedule.

If you didn't happen to see these talented performers in action—well, that's show business. It's still not too late to get acquainted with them, of course. Simply use the coupon, and we'll send you complete information about our Jeffers Electronics Division's new networks.



SPEER® Carbon Co.

SPEER CARBON COMPANY
St. Marys, Pennsylvania 15857

A Division of
Air Reduction Company, Inc.

- Show me why I should switch to Speer carbon composition resistors.
 Tell me more about your new metal film resistor networks.

Name _____

Title _____

Company _____

Address _____

City _____ State _____ Zip _____

LAM-O-LUME

PURE FUSED QUARTZ

HIGH INTENSITY XENON OR
ULTRA-VIOLET LIGHT SOURCE

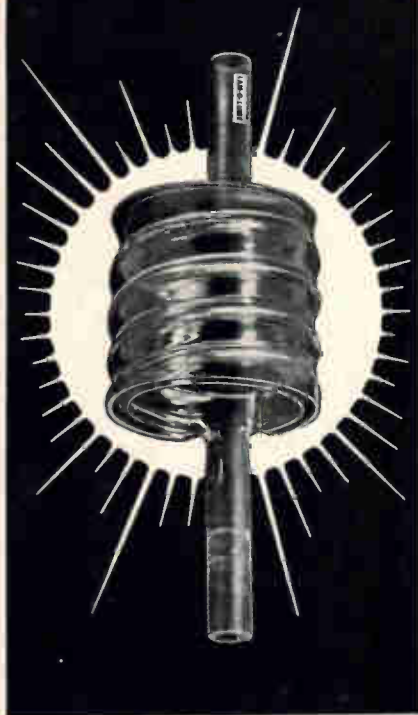

This unitized, dimensionally accurate, pure fused quartz envelope (coil), of rugged design, provides an excellent source for Xenon high intensity lighting or ultra-violet irradiation. The LAM-O-LUME can be supplied as a plain envelope or as a completed tube with electrodes and rare gas.

FOR XENON SERVICE, which provides light intensities brighter than the sun, for outdoor lighting, photography, etc., the unitized THERMAL AMERICAN LAM-O-LUME power supply comes complete with built-in capacitors and trigger circuit; provides 600 joule output with operating range between 1000 and 1800 volts; delivers 35-50 lumens per watt second and a life of 10,000 flashes at rated input.

FOR ULTRA-VIOLET LIGHT SOURCE for irradiation, laboratory heat exchangers, laser pumping, etc., the LAM-O-LUME power supply is available with standard 400 watt average capacity.

Write for details.

42



Electronics Review

ware to make a unique identification," says Kersta. "It's part of the over-all problem of pattern recognition by machine."

Narrow the search. As in fingerprint identification, however, computers can narrow the scope of search, Kersta told the Acoustical Society of America at its national meeting in Boston earlier this month. For automated search, the sound spectrograms are classified by a 10-digit binary code. This is based on commonly used words that are picked out of a conversation and scanned. The acoustic signals are converted into electrical signals and these are recorded on a contour map that plots time, frequency and intensity, or loudness.

The sound spectrograph thus produces a contour voiceprint for each cue word selected. This voiceprint is fed into a computer, which assigns it to a 10-digit signature determined by the contour characteristics in 10 segments of the spectral pattern.

For matching, the computer searches its memory file and prints out the index number of each classification code that agrees with that of the unknown voice. A trained person makes the final identification from among the possibilities selected by the computer.

Beating time

Pacemakers help many victims of heart block lead fairly normal lives but the battery doesn't last and must be replaced surgically about every other year.

Now the Atomic Energy Commission has awarded a contract to the Nuclear Materials and Equipment Corp. to design and develop a new pacemaker—one that will make life a lot easier for heart patients.

The new model—about two-thirds the size of a cigarette pack—would operate for a minimum of 10 years. The pacemaker's fuel is plutonium-238, which provides the heat for thermoelectric conversion. The radioisotope generator produces 162 microwatts of power.

Safety first. Two problems had to be solved in the design. The first was safety—the device had to be

made so the patient would not be subjected to dangerous amounts of radiation. Bert Schwartz, Nuclear Materials' assistant to the president, said the design of the radioisotope generator exposes the patient to less radiation than the five milliroentgens-per-hour limit set by the AEC.

The second problem was to prevent the nuclear fuel from escaping from its container in case the patient was involved in an accident. The company will put the plutonium-238 in a triple-walled capsule—the outer wall of titanium, the middle wall of Hastalloy-C, and the inner wall of tantalum alloy. Schwartz says this capsule design can withstand a direct hit with a bullet from a high-powered rifle, temperatures greater than 1,200°C or even an acid bath without releasing the radioactive fuel.

Military electronics

Two-pound radar

The Radio Corp. of America has developed a radar that weighs only two pounds and is attempting to sell it to the Army for use in Vietnam. The radar detects a man at 300 meters and a vehicle at 1,000 meters and can zero in on an area so small that it is able to aim machine guns and bazookas. RCA says it has also developed a new output stage modulator for the unit that promises to increase the radar's detection range to 1,500 meters for men and more than a mile for vehicles.

The radar, developed by RCA's Missiles and Surface Radar division, Moorestown, N.J., was demonstrated at the Armed Forces Communications and Electronics Association meeting in Washington, June 7 to 9.

Although portable radars are under development, none is as light as the RCA unit and none is currently being used in Vietnam. The lightest system now in Vietnam weighs 140 pounds. The Marines are testing a unit built by General Instruments Corp. which weighs 10 pounds. The General Dynamics

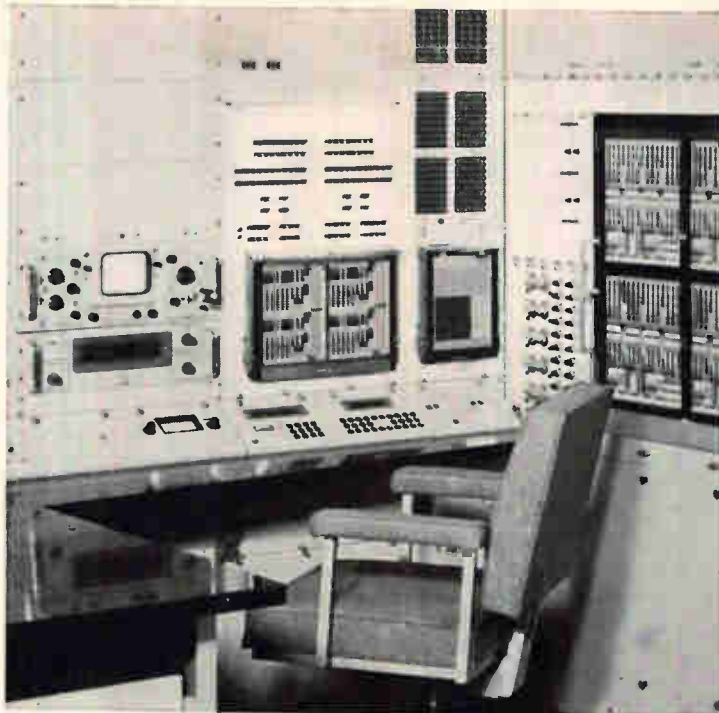
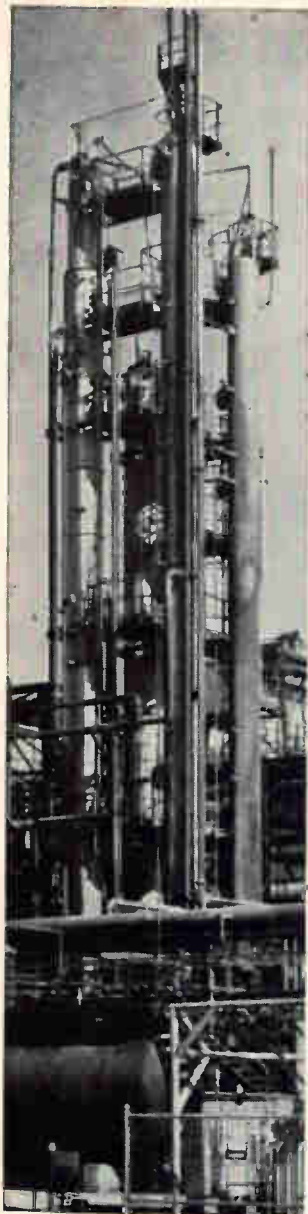

Is everything under control?

The answer is emphatically, yes . . . if you've got an A-MP* Universal Patchcord Programming System in command.

Everything on the outside—data detection, recording, processing equipment—is completely under control. Up to 5120 inputs or more can be controlled from a single panel without the slightest hint of an intermittent contact. Whatever you're programming, you'll keep it under control by selecting a universal system that is right for your application from industry's broadest line.

Everything is controlled on the inside, too. Reliability is enhanced by the use of a minimum number of parts, quality controlled throughout. "Zero entry" patchboards are equipped with our patented double wiping action which pre-cleans all contacts every time the front board is engaged. Your choice of taper pins or precision crimped LANCELOK* terminals wired to the rear bay assure a smooth, dependable path for each line under the roughest conditions.

These universal patchboards actually exceed the standards required in both military and commercial requirements. Do you need this quality? When you consider that

the programming system is an important part of your equipment, we believe you would want the best. That's why the following important features are designed into our systems:

- Double-wiping contact action
- Gold-over-nickel plated contacts
- Easy, rapid post patching
- Choice of panel mount, rack mount, fixed panel, and anti-vibration systems *

What price can be placed on quality? What price can be placed on system reliability? For complete specifications, write now for Catalog No. 642.

*Trademark of AMP INCORPORATED

AMP
INCORPORATED
Harrisburg, Pennsylvania

A-MP* products and engineering assistance available through subsidiary companies in: Australia • Canada • England • France • Holland • Italy • Japan • Mexico • Spain • West Germany

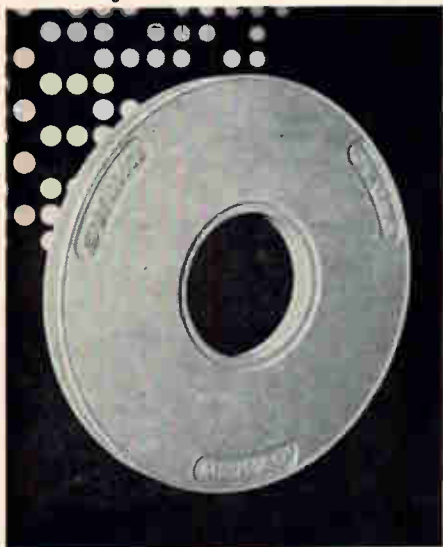

Styrafil tape reels for UNIVAC® COMPUTERS are molded for the Sperry Rand Corporation's Univac Division by Data Packaging Corporation, Cambridge, Massachusetts.

Styrafil keeps wide flanges stiff on UNIVAC magnetic tape reels!

Warpage would be a problem with computer data tapes

If the wide flanges on a tape reel warp, the reel will wobble and the tape will rub which can cause problems for a computer.

The reels that hold magnetic tape that stores the data for UNIVAC COMPUTERS are molded from Fiberfil Styrafil, fiberglass reinforced polystyrene. By choosing fiberglass reinforced material with extra compressive strength, stiffness, and dimensional stability, the Sperry Rand Corp.'s Univac Division eliminated the danger of warped flanges.

The extra performance of the FRTP's can improve your product. Check the facts.

Compare physical properties

	Unit	Unreinforced polystyrene	Styrafil G-30/30
Tensile Strength @ 73°F	PSI	5,000	14,000
Izod Impact Strength @ 73°F	Fl./lb./in.	0.25	2.5
Flexural Strength	PSI	8,700	20,000
Compressive Strength	PSI	11,500	17,000
Coefficient Linear Thermal Expansion	°F/In./In.	4.4 x 10 ⁻⁵	2.19 x 10 ⁻⁵
Heat Distortion Temp. @ 264 PSI	°F	205	220

Styrafil is just one of many fiberglass reinforced thermoplastics by Fiberfil. As originators of the FRTP's only Fiberfil can give you complete technical data and widest practical experience on all the fiberglass reinforced thermoplastics.

Send for your free copy of the Fiberfil engineering manual, 24 pages of detailed information. Write Fiberfil, Inc., Evansville, Indiana 47717.



Fiberglass Reinforced Thermoplastics

Electronics Review

Corp. is developing a radar which will weigh less than 10 pounds.

Compact model. RCA says its radar has an antenna beamwidth of 5° and an accuracy of within 20 yards. Its power consumption is three watts; a two-pound battery operates the unit for 10 hours and one weighing only a few ounces can power the unit on patrols for up to a half hour.

The nine-gigahertz radar works on a continuous-wave, doppler principle. It is all solid state, including the transmitter-power amplifier. One integrated circuit is in the time-delay circuit of each of the 10-range bins.

The operator can hear targets that are moving at velocities between two feet per second and 45 miles per hour. The radar also has a beam spoiler to widen its beam up to 45° to scan a wider area.

Communications, too. Besides functioning as a radar, the device is also a narrow-beam radio for voice communication with twice the range of the radar. Interception by an enemy would be difficult. Because of the narrow beam, the enemy would have to be physically in the transmission path;

and because both radar and communication modes use a pseudo-random code, the enemy would hear only a garbled noise unless he had an identical unit.

RCA also predicts civilian applications for the unit. Its ability to measure rate-of-closure would make it useful on automobiles; it could serve as a radar altimeter and ground-speed indicator for small aircraft; and it could be used in a burglar alarm system.

Team work

The Defense Department, reacting to industry criticism, is attempting to clear the air on team-bidding procedures for military development contracts. "Normally," the Pentagon pledges, it will "recognize the integrity and validity" of team arrangements and "will not require or encourage their dissolution."

The policy statement refers to instances when potential prime contractors line up teams of subcontractors in submitting competing proposals for the development contract of a complex military system.



Two-pound radar developed by the Radio Corp. of America. Unit can detect a man 300 meters away and a vehicle at 1,000 meters. A model with far-better range is being developed.

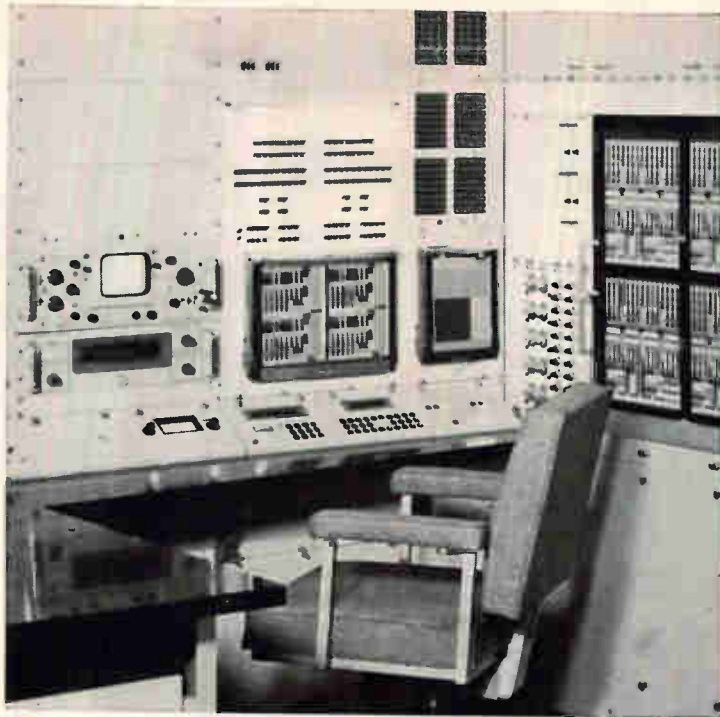
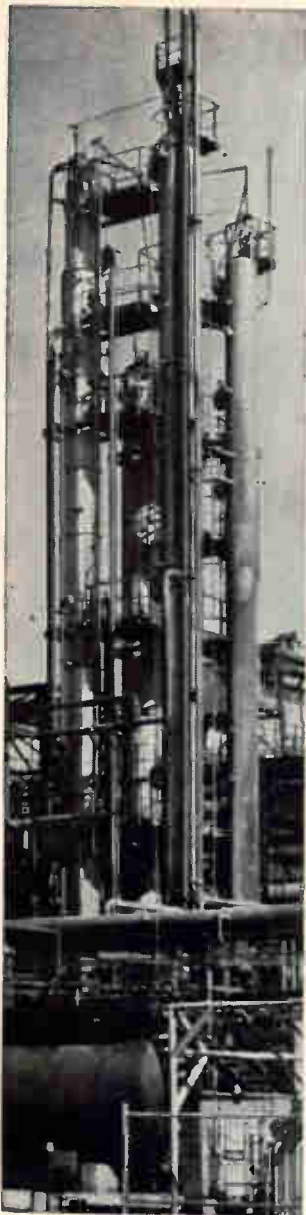

Is everything under control?

The answer is emphatically, yes... if you've got an A-MP* Universal Patchcord Programming System in command.

Everything on the outside—data detection, recording, processing equipment—is completely under control. Up to 5120 inputs or more can be controlled from a single panel without the slightest hint of an intermittent contact. Whatever you're programming, you'll keep it under control by selecting a universal system that is right for your application from industry's broadest line.

Everything is controlled on the inside, too. Reliability is enhanced by the use of a minimum number of parts, quality controlled throughout. "Zero entry" patchboards are equipped with our patented double wiping action which pre-cleans all contacts every time the front board is engaged. Your choice of taper pins or precision crimped LANCELOK* terminals wired to the rear bay assure a smooth, dependable path for each line under the roughest conditions.

These universal patchboards actually exceed the standards required in both military and commercial requirements. Do you need this quality? When you consider that

the programming system is an important part of your equipment, we believe you would want the best. That's why the following important features are designed into our systems:

- Double-wiping contact action
- Gold-over-nickel plated contacts
- Easy, rapid post patching
- Choice of panel mount, rack mount, fixed panel, and anti-vibration systems*

What price can be placed on quality? What price can be placed on system reliability? For complete specifications, write now for Catalog No. 642.

*Trademark of AMP INCORPORATED

AMP
INCORPORATED
Harrisburg, Pennsylvania

A-MP* products and engineering assistance available through subsidiary companies in: Australia • Canada • England • France • Holland • Italy • Japan • Mexico • Spain • West Germany



Styrafil tape reels for UNIVAC® COMPUTERS are molded for the Sperry Rand Corporation's Univac Division by Data Packaging Corporation, Cambridge, Massachusetts.

Styrafil keeps wide flanges stiff on UNIVAC magnetic tape reels!

Warpage would be a problem with computer data tapes

If the wide flanges on a tape reel warp, the reel will wobble and the tape will rub which can cause problems for a computer.

The reels that hold magnetic tape that stores the data for UNIVAC COMPUTERS are molded from Fiberfil Styrafil, fiberglass reinforced polystyrene. By choosing fiberglass reinforced material with extra compressive strength, stiffness, and dimensional stability, the Sperry Rand Corp.'s Univac Division eliminated the danger of warped flanges.

The extra performance of the FRTP's can improve your product. Check the facts.

Compare physical properties

	Unit	Unreinforced polystyrene	Styrafil G-30/30
Tensile Strength @ 73°F	PSI	5,000	14,000
Izod Impact Strength @ 73°F	Ft./lb./in.	0.25	2.5
Flexural Strength	PSI	8,700	20,000
Compressive Strength	PSI	11,500	17,000
Coefficient Linear Thermal Expansion	°F/In./In.	4.4 x 10 ⁻⁵	2.19 x 10 ⁻⁵
Heat Distortion Temp. @ 264 PSI	°F	205	220

Styrafil is just one of many fiberglass reinforced thermoplastics by Fiberfil. As originators of the FRTP's only Fiberfil can give you complete technical data and widest practical experience on all the fiberglass reinforced thermoplastics.

Send for your free copy of the Fiberfil engineering manual, 24 pages of detailed information. Write Fiberfil, Inc., Evansville, Indiana 47717.



Fiberglass Reinforced Thermoplastics

Electronics Review

Corp. is developing a radar which will weigh less than 10 pounds.

Compact model. RCA says its radar has an antenna beamwidth of 5° and an accuracy of within 20 yards. Its power consumption is three watts; a two-pound battery operates the unit for 10 hours and one weighing only a few ounces can power the unit on patrols for up to a half hour.

The nine-gigahertz radar works on a continuous-wave, doppler principle. It is all solid state, including the transmitter-power amplifier. One integrated circuit is in the time-delay circuit of each of the 10-range bins.

The operator can hear targets that are moving at velocities between two feet per second and 45 miles per hour. The radar also has a beam spoiler to widen its beam up to 45° to scan a wider area.

Communications, too. Besides functioning as a radar, the device is also a narrow-beam radio for voice communication with twice the range of the radar. Interception by an enemy would be difficult. Because of the narrow beam, the enemy would have to be physically in the transmission path;

and because both radar and communication modes use a pseudo-random code, the enemy would hear only a garbled noise unless he had an identical unit.

RCA also predicts civilian applications for the unit. Its ability to measure rate-of-closure would make it useful on automobiles; it could serve as a radar altimeter and ground-speed indicator for small aircraft; and it could be used in a burglar alarm system.

Team work

The Defense Department, reacting to industry criticism, is attempting to clear the air on team-bidding procedures for military development contracts. "Normally," the Pentagon pledges, it will "recognize the integrity and validity" of team arrangements and "will not require or encourage their dissolution."

The policy statement refers to instances when potential prime contractors line up teams of sub-contractors in submitting competing proposals for the development contract of a complex military system.



Two-pound radar developed by the Radio Corp. of America. Unit can detect a man 300 meters away and a vehicle at 1,000 meters. A model with far-better range is being developed.

The Pentagon, on occasion, has upset these lineups once the prime contractor has been selected, by insisting that subcontracts be opened for competition. It touched off a flurry of industry controversy when it required the competition in subcontracts for the Manned Orbiting Laboratory and the C-5A transport plane.

Smaller companies that normally act as subcontractors protested on the ground that the policy creates a kind of double jeopardy. The companies go to the trouble and expense of drawing up a proposal, getting on one of the teams and sweating out the months and sometimes more than a year required for the review and selection. Then, if their team is fortunate enough to be a winner, they suddenly find their participation is not assured and they must fight for position again in a competitive round.

Two sides. Industry is divided on the question. Some companies—particularly the larger ones that are usually prime contractors—assert there is no inherent guarantee to a subcontractor that an original team position exempts him from competition to revalidate his proposal.

The Pentagon policy acknowledges that "there are times when it may be desirable—both from government and industry standpoints—for industry organizations to enter into a team arrangement." The objective should be "to complement the unique capabilities of each team member and to offer the Defense Department the optimum combination of capabilities to achieve the desired operational performance, cost and schedule of the system being procured."

However, the Pentagon made it clear that "in any such proposal, the prime contractor will still be fully responsible for the performance of the contract."

Furthermore, the Pentagon says it will retain the right to:

- Approve the proposed subcontracts.
- Direct the substitution of a specific team member for "a substantive reason," such as presenting an "unsatisfactory or marginal proposal."
- Conduct technical transfusion

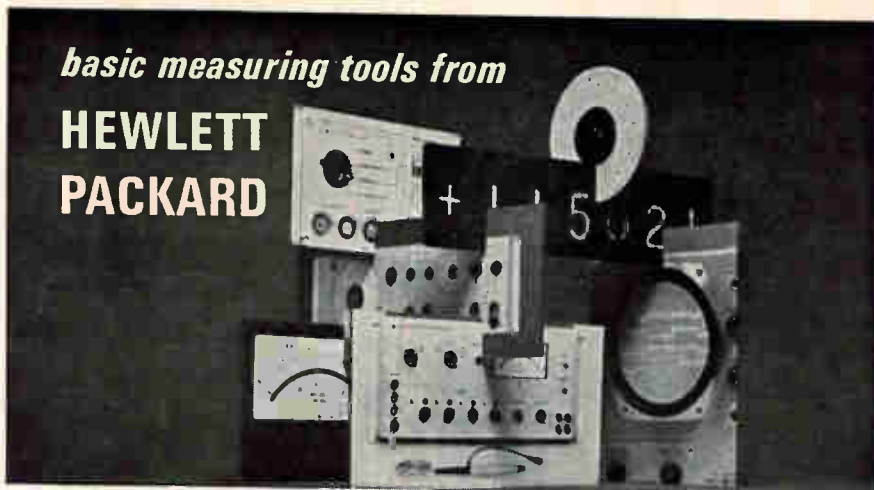

Field-proven 461A, 462A Amplifiers

Selectable 20 and 40 db gain
 Rise time < 4 nanoseconds
 ± 1 db, 1 kHz to 150 MHz
 50-ohm input/output impedance

Use it for:

- Loop gain measurements
- Wide-band noise and vhf signal measurements
- Preamplification for voltmeters, scopes, counters
- Amplification of fractional microsecond pulses
- Linear amplification
- Wide-band video amplification
- General-purpose lab amplification

Here are two solid-state amplifiers offering wide frequency range, low distortion and portable application. The 461A offers a maximum output of 0.5 v into 50 Ω , 1 kHz to 150 MHz, frequency response ± 1 db, distortion less than 5% at maximum output and rated load. Price: \$325.

The 462A is ideal for fast-pulse applications, TV, pulse, general lab and vhf work. Rise time < 4 nsec, overshoot < 5%. Pulse duration for 10% droop is

30 μ sec. Output 1 v p-p into 50-ohm resistive load. Price: \$325.

Relate these amplifiers to your particular application, then call your Hewlett-Packard field engineer for complete information or a demonstration. Or write: Hewlett-Packard, Palo Alto, Calif. 94304, Tel. (415) 326-7000; Europe: 54 Route des Acacias, Geneva.

Data subject to change without notice. Prices f.o.b. factory.

HEWLETT  **PACKARD**
 An extra measure of quality

1043



461A

462A



One of these connectors will outlast the equipment it was built for . . .

THE OTHER WON'T!

Some connectors are built so that they barely scrape by minimum acceptance specs . . . others are designed with long, satisfactory life, as well as specifications, in mind. And often there's little or no price differential between them.



TRANSITRON PCD* printed circuit connectors, for example. Pick one up and you know it's built to last. You can see and feel precision in the molded body, in the spacing and setting of the contacts, in the finish of the metal.

And there's hidden quality . . . where it counts. In the patented Tri-Spring contacts, triple, independent leaf-spring action grips the board firmly over the entire contact area, significantly reducing wear, peel-back, and scoring. Inductive effect is entirely eliminated by shorting paths between board contact and wired tab.

And, interestingly enough, Transitron PCD Printed Circuit Connectors are no more expensive, in quantity, than many units which barely meet specifications.



Send today for this new condensed catalog which provides complete data on these and other fine PCD connectors.



Precision Connector Division

Transitron

electronic corporation

Wakefield, Massachusetts

—that is, taking the best features of the losing team's proposal and incorporating them into specifications for the final contract.

- Insist on competitive subcontracting and component breakout (providing government-furnished equipment in lieu of contractor-furnished components) after production has begun.

Avionics

The race is on

For years, it seemed as though an electronics researcher who tried to design a workable aircraft collision avoidance system might just as well have been looking for a perpetual motion machine.

The Federal Aviation Agency over the past decade has received, evaluated and scrubbed more than 200 collision avoidance ideas. Some major electronics firms had all but decided the job just couldn't be done—at least not at a price that would make it saleable to the world's airlines. FAA's Collision Prevention Advisory Group—representing military and civilian airspace users—hadn't even held a meeting for two years, until this month.

But the meeting was told that collision avoidance equipment is almost within reach. And suddenly a race is on to provide it.

Three companies are involved, and ironically none of them is a traditional airline supplier. Development has reached the stage where the FAA is drawing up specifications for test equipment, and probably will put out a formal request for proposals before the summer is out. At stake: possibly \$100 million to equip airline, military and civilian planes.

The McDonnell Aircraft Corp. appears the front-runner now [Electronics, April 4, p. 26]. McDonnell already has an operational time-frequency system that it is using to keep its own planes from colliding on test flights. And the company almost had an FAA contract—but pulled out, ap-

parently for fear that FAA modifications during the test program could have threatened its exclusive patent rights.

One drawback. Both McDonnell and airline officials are confident that the system can be modified for use in the crowded air of an airport terminal area. But McDonnell's system has one drawback—ground stations are needed to maintain synchronization of the airborne "clocks" that would control the transmission of each airplane's identification signal within an assigned two-millisecond time slot. As many as 60 stations might be needed to blanket the U.S.

The National Co. has a way around the ground stations—but it's expensive. In National's system, a time standard would be provided by a cesium beam clock within each aircraft.

TRG, Inc., a subsidiary of the Control Data Corp., believes it has a cheaper way of doing it—and is seeking a patent. TRG would rely on a masterless system. Synchronization would be achieved not by reference to a ground station but rather by continual exchange of interrogation and reply signals between random pairs of aircraft.

The challenge. National and TRG both have developed time-frequency equipment for military use, but neither has put together a collision avoidance system and flown it. In effect, the challenge to them is to produce the hardware before McDonnell can modify its system to eliminate the need for ground stations.

But from a business point of view, the winner may not take all. The contract the FAA will offer presumably would require whichever company provides the test equipment to license other manufacturers to use its patents. This would give traditional electronics airline suppliers a crack at the production contracts. And in the race to sell and service known customers, the traditional suppliers would have the head start.

FAA also is expected soon to award a study contract for evaluating the application of time-frequency techniques for other purposes.

NEW from Transitron

140V V_{CE0} TRANSISTORS feature low cost... broad power range

LOW POWER

30 ma TO-18

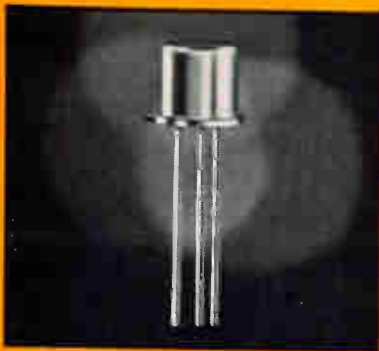

TYPE 2N4269 . . . in a standard TO-18 hermetically-sealed package, this NPN planar device offers excellent general purpose performance with 140V V_{CE0} . Ideal for use as Nixie drivers, other high-voltage, low-current switching and amplifier applications.

1000-quantity price . . . only **80¢**

30 ma TO-5

TYPE 2N4270 . . . in a TO-5 package with isolated collector. Same electrical performance as the 2N4269 above, but offers a very low-cost isolated collector device for critical applications.

1000-quantity price . . . only **90¢**

MEDIUM POWER

10-watt . . . 1 amp

TYPE 2N4271 . . . hermetically-sealed in a TO-5 package with solid header, this high voltage medium power NPN planar device is rated at 10W at 25°C case temperature. Basic character-

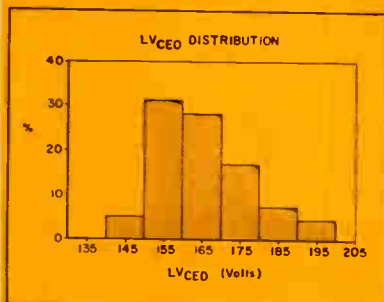

Typical distribution of V_{CE0} for Type 2N4271 140-volt transistors

istics include 50na leakage, minimum h_{FE} of 10 at 1 amp, maximum $V_{CE(sat)}$ of 3V at 750ma/250ma, and f_T over 20mc.

Designed for use in high-voltage switching, relay and solenoid driving, relay replacement, high-voltage amplifiers, etc.

1000-quantity price . . . only **\$1.50**

Transitron
electronic corporation
Wakefield Massachusetts

HIGH POWER

25-watt.. 2.5 amp

TYPE 2N4273 . . . in a TO-66 package. Rated at 25 watts at 25°C case temperature, this planar NPN device offers a tremendous combination of performance characteristics at low cost.



The minimum h_{FE} of 15 at 2.5A, maximum $V_{CE(sat)}$ of 2.0V at 2.0A/.66A, minimum f_T of 10mc and low leakages give an excellent general-purpose, high-voltage device.

1000-quantity price . . . only **\$2.10**

10-watt.. 2.5 amp

TYPE 2N4272 . . . rated at 10W at 25°C case, this hermetically sealed TO-5 package with solid header offers the same electrical characteristics as the 2N4273 described above, but offers smaller package.

1000-quantity price . . . only **\$2.50**

**IF YOU'RE NOT USING
INDUSTRIAL INTEGRATED
CIRCUITS BECAUSE OF
COSTS, FUNCTIONS OR
APPLICATIONS HELP..
BETTER FIND A NEW EXCUSE!**

PRICES NOW 40% OFF Fairchild linear integrated circuits allow you to design at the lowest cost per function in the history of electronics. Here are three examples, each now available at 40% off 1965 prices:

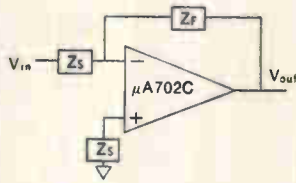

702C Wideband Differential Amplifier
 Compensated
 Bandwidth 30MHz
 Input offset Voltage 5mv
 Input Resistance 20KΩ

\$9.60

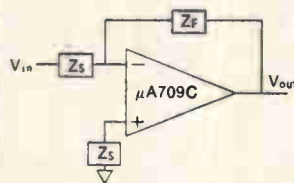

709C High Gain Operational Amplifier
 Open loop
 Voltage Gain 45,000
 Output Voltage Swing .. ± 14V
 Input Resistance 250KΩ
 Input offset Voltage 2mv

\$15.00

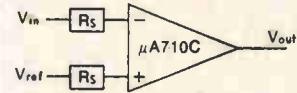

710C Voltage Comparator
 Resolution 2mv
 Response time 40 nsec
 Input Voltage Range ± 5V

\$5.50

NEW APPLICATIONS BROCHURE We've packaged a group of the latest applications from the Fairchild Industrial Applications Library. Included are 32 applications for the three circuits shown above.

NEW FAST ACTION INDUSTRIAL DATA SERVICE Whatever you need... samples, delivery, applications data... Fairchild's Industrial Assistance Group is standing by, ready to help. Use the **fast action** post card facing this page to order our new applications brochure. Also, if you'll indicate the product area you'd like more information about and/or the type of product you are designing, we'll pull a custom selection of applications notes from our Industrial Applications Library and send them along as fast as possible. We'll also add you to our applications mailing list. How else can we help? You tell us. We'll do it. **MAIL THE POST CARD. TODAY.**

FAIRCHILD
 SEMICONDUCTOR



Motorola needed a battery for its 2-way radio that a fireman could stake his life on.

Mallory made it.

What can we do for you?



Motorola needed a high-energy battery for their new HT "Handie-Talkie" 2-way radio. A battery that would add little weight to this hand-held transceiver. A battery that would last up to 60 operating hours without replacement. Yet a battery powerful enough to put out 2 watts of radio energy—any time a fireman or law enforcement officer might need it in an emergency! Motorola brought their specifications to Mallory. Mallory

made the battery — a 16.8 volt Duracell® mercury battery weighing less than a pound, yet powerful enough to meet the rigid R.I.A. transmitting specification!

MORE ENERGY PER POUND

Today, more and more products like the Motorola "Handie-Talkie" radios are being designed "all-transistor" or "all-microcircuit". They're more compact, truly portable—and require portable power sources. Mallory mercury and Mallory alkaline batteries answer that need. With energy densities exceeding 45 watt-hours per pound for the mercury system, over 30 watt-hours per pound for the manganese-alkaline system, these batteries shrink the size and weight of portable power sources. In

® Registered trademark of P. R. Mallory & Co. Inc.
Motorola and "Handie-Talkie" are trademarks of Motorola, Inc.

NORMAL RATINGS WATT-HOURS PER POUND

MALLORY MERCURY		40-50
MANGANESE ALKALINE		25-35
ZINC-CARBON		10-20

effect, they match the "miniaturizing" effect of the transistor or micro-circuit design.

And in transistor designs, Mallory battery systems give an extra bonus of long life and high performance. The mercury battery, for example, outlasts a comparable zinc-carbon battery by better than 4 to 1.

OVER 1,000 TYPES IN PRODUCTION

Mallory is currently producing over 1,000 batteries of all sizes and capacities. And if we're not actually producing the battery you need, we'll be happy to work with you in designing a new one. Please write us at the Application Engineering Department, Mallory Battery Company, a division of P. R. Mallory & Co. Inc., South Broadway, Tarrytown, N. Y. 10591. Or call 914-591-7000. (In Canada: Mallory Battery Company of Canada Limited, Clarkson, Ontario.)

It's good business to do business with Mallory





**MAKE
BIG**

Coors produces the largest isostatically formed ceramic parts now available to industry. Complete homogeneity of ceramic is assured because of this unique Coors process used in forming large parts. Homogeneity is essential in high-frequency, high-power application—radomes, envelopes and windows—because hot spots and punctures created by voids and air pockets are virtually eliminated by Coors. Complete uniformity also means reliable, uniform strength properties. In addition to fabricating large precision ceramics, Coors can metallize such king-size ceramic parts as shown here. Write for Data Sheet 3001, "Coors Forming Methods Give New Latitude in Designing with Ceramics," or call your nearest Regional Sales Manager: SOUTHERN CALIFORNIA: R. E. Ousley, (213) 347-3060, Los Angeles, Calif.; BAY AREA AND NORTH WEST: W. Everitt, (408) 245-2595, Sunnyvale, Calif.; MIDWEST: Tom Daly, (312) 529-2510, Chicago, Ill.; CENTRAL: Don Lewis, (216) 228-1000, Cleveland, Ohio; EAST COAST: Robert F. Doran, (516) 427-9506, Huntington, N.Y.; Herbert W. Larisch, (215) 563-4487, Philadelphia, Pa.; NEW ENGLAND: Warren G. McDonald, (617) 222-9520, Attleboro, Mass.; SOUTHWEST: William H. Ramsey, (713) 864-6369, Houston, Tex.; John West, (214) AD 1-4661, Richardson, Tex.

Coors
CERAMICS

ALUMINAS • BERYLLIAS • MAGNESIAS • SPECIAL OXIDES
Coors Porcelain Co., Golden, Colo.





Data Display Devices from Raytheon



New Raytheon Recording Storage Tubes extend your system capabilities

Two new miniature types, new high resolution tube added to Raytheon's broad line.

Raytheon's wide range of Recording Storage Tubes enable you to design additional capability into any system which stores and transfers electronic information. Applications include: scan conversion, stop motion, integration for signal-to-noise improvement, time delay or phase shift, correlation and slow-down video.

The new miniature types—Raytheon's CK1516 and CK1519—are designed for compact packaging, such as in airborne and space satellite applications. Both tubes provide high resolution and erase capability in a fraction of a second. The CK1521 is a new standard type featuring ultra-high resolution of 2500 TV lines and fast erasure in milliseconds.

Raytheon Recording Storage Tubes are electronic input-output

devices which feature: fast write, immediate and nondestructive read, long storage, high resolution, and fast erase. Information can be written and stored using sequential scan techniques or by random access writing. Erasure can be complete or selective. Dual and single gun types are available.

For more information or demonstrations, contact your Raytheon Regional Sales Office.



Raytheon Decade Counter Tubes are gas-filled, cold-cathode, glow discharge, bi-directional stepping devices, capable of operation at frequencies up to 100 kilocycles/sec. They provide both electrical and visual readout and are characterized by very long life, low current requirements, relatively few external components necessary for proper operation, and low operating temperature. These characteristics make them very useful as counters in such applications as radiation measuring equipment, timers, programmable counters and scalars, sorting apparatus, and many others. In these applications they can be used as scale-of-ten counters or as devices capable of operation at any desired preset scale.

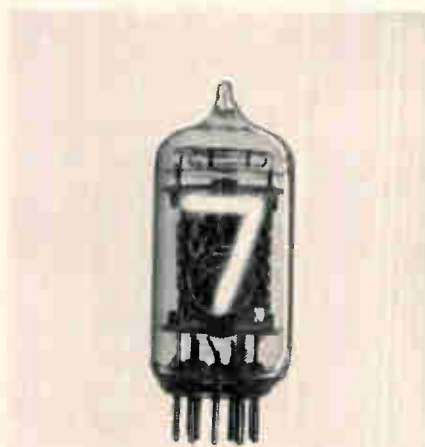

Datavue* Side-View Tubes. New type CK8650, with numerals close to front, permits wide-angle viewing. These side-view, in-line visual readout tubes display singly numerals 0 through 9 or preselected symbols such as + and - signs. Their $\frac{5}{8}$ " high characters are easily read from a distance of 30 feet. Less than \$5 in 500 lots, they also cost less to use because the bezel and filter assembly can be eliminated and because their mating sockets are inexpensive.



New Symbolray* CRT. This new tube provides alphanumeric inputs for computer readout devices. The tube's 2" target can be scanned electronically to select symbols, characters, and punctuation marks in sequence to form readout on a display tube. Designated type CK1414, this tube provides an economical method of generating characters for hard copy print-out or for cathode-ray display. Designs with 64 or 100 characters are available.



Datavue* End-View Tubes. These tubes are easily read in high ambient light—do not wash out like other displays. Erroneous readings due to segment failure do not occur because the characters are fully formed. Raytheon Datavue End-View Tubes fit existing sockets and conform to EIA ratings. Models include round (CK8421) and rectangular (CK8422). All are designed for ultra long life—an expectancy of 200,000 hours or more in dynamic operation.



Send the reader service card for literature kit containing data sheets and catalogs on these products:

- Recording Storage Tubes
- Datastrobe Digital Readout Subsystem
- Datavue Numerical Indicator Tubes
- Cathode Ray Tubes
- Decade Counter Tubes

Or call your nearest Raytheon regional sales office, or write to Raytheon Company, Components Division, 141 Spring Street, Lexington, Massachusetts 02173.

*Trademark of Raytheon Company



Raytheon Components Division—A single source for Transistors/Diodes/Integrated Circuits/Industrial Tubes/Control Knobs/Panel Hardware/Circuit Modules/Display Devices.

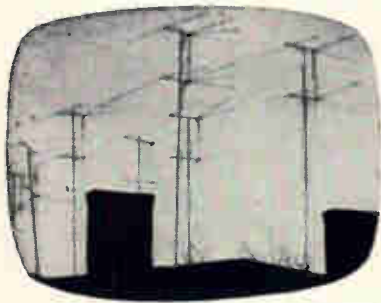

Stackpole Ceramag® ferrite components have been the accepted standard of the Television Industry for over twenty years.

In 1965, Stackpole began supplying Automatic Pincushion Correction Cores, a major advance, for color television receivers. 1964 saw the introduction of Stackpole 90° color components including Flyback, Yoke and Convergence Cores. As far back as 1954, these same components were introduced for the 70° color Deflection Systems.

The list of contributions Stackpole engineering and production know-how has made to the growth of color in television is long and varied. This same capability has been applied to the continual improvement of

black and white receiving equipment as well.

To be first with such items as Horizontal Output Transformer Cores and Automatic Pincushion Correction is not enough. Innovation must stand the test of performance. Stackpole Ceramag® components have, since 1947. Small wonder most manufacturers have come to depend so heavily on Stackpole's experience and quality. Stackpole Carbon Company, Electronic Components Division, St. Marys, Pennsylvania 15857. Phone: 814-781-8521. TWX: 510-693-4511.

Ceramag® Ferrite Components are Coloring the Entire Television Picture

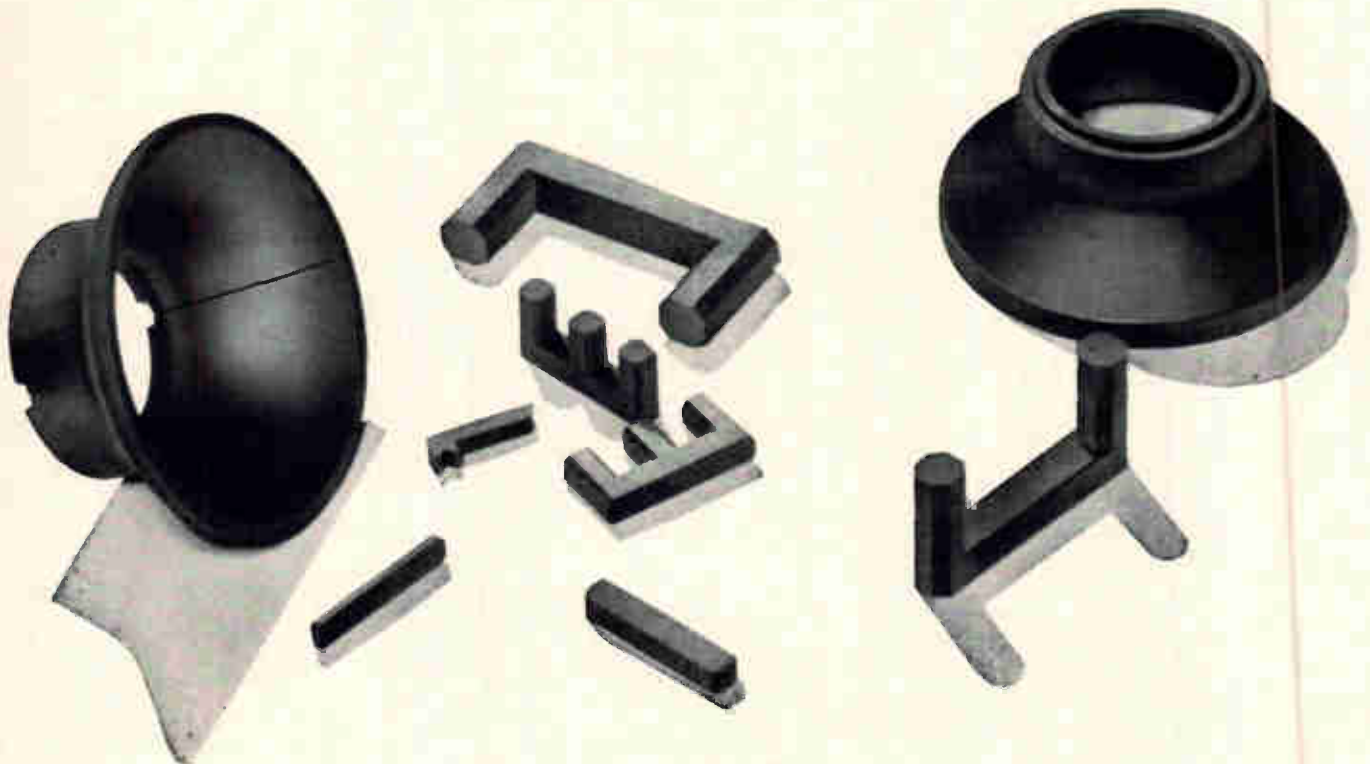

STACKPOLE

ELECTRONIC COMPONENTS DIVISION
"OUR 60th YEAR"

TEA ?

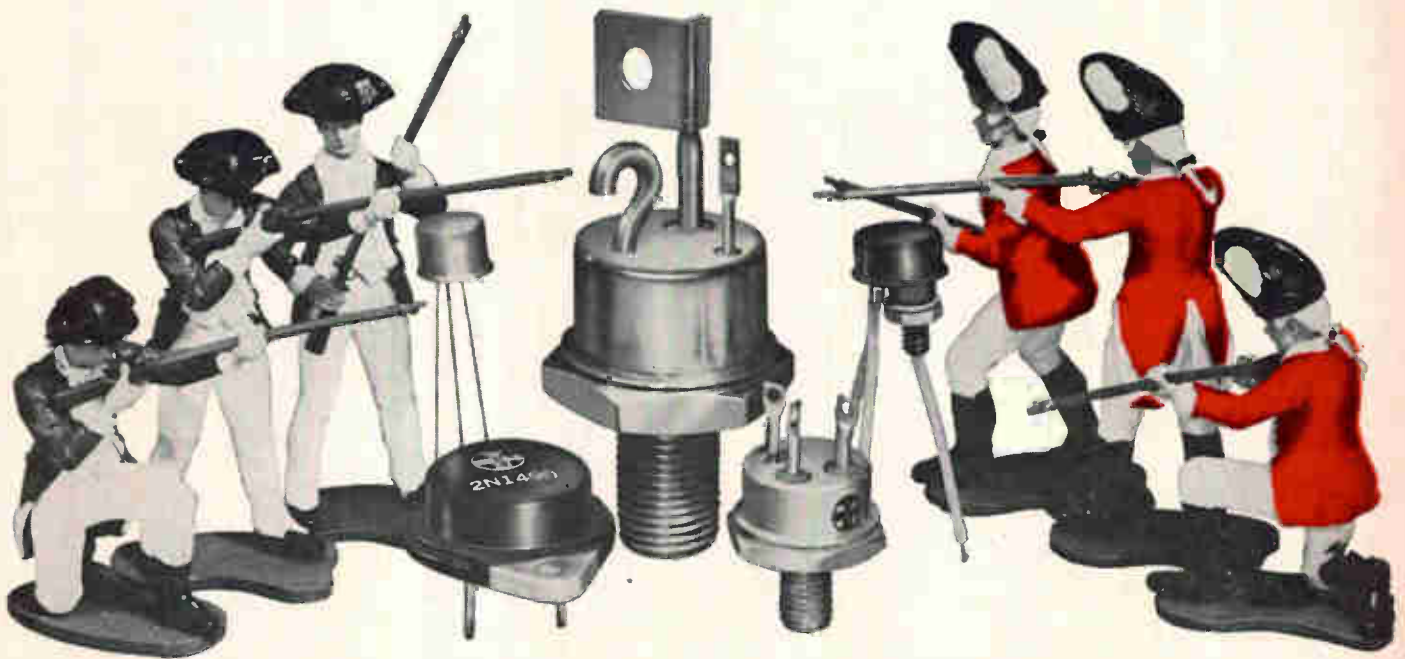

independence and dependability . . . You've both when you do manufacturing battle with Silicon Transistor Corporation on your side. Silicon Transistor Corporation: the invincible source for silicon power devices. Up to 500 watts in a single, military quality silicon transistor. As little as 3 watts . . . each with the highest versatility in packaging. Planars, PNP's, NPN's. Join forces with Silicon Transistor Corporation and victory is assured. (We may even have a tea party.) Call

**SILICON
TRANSISTOR
CORPORATION**



EAST GATE BLVD., GARDEN CITY, NEW YORK 11532
516 Pioneer 2-4100. TWX 510-222-8258

REGIONAL OFFICES

CHICAGO, ILL. 60625, 5555 NORTH LINCOLN AVE.,
312-271-0366-7, TWX 910-221-1304

LOS ALTOS, CALIF. 94022, 1 FIRST ST., 415-941-2843

Got a pencil handy?

Check these 11 provable statements about the accuracy of Sangamo's versatile family of recorders

AND BE PREPARED FOR SOME SURPRISES!

- Highest Linearity
- Lowest Drift
- Highest PCM Packing Density
- Lowest Static plus Dynamic Skew
- Highest Direct S/N
- High FM S/N
- Highest Long-term Speed Accuracy
- Highest Servo Performance
- Low Flutter
- 4000 to 1 Time-base Expansion/Contraction
- 68 db Dynamic Range

CHECK? Now check with us on your recording needs and problems.

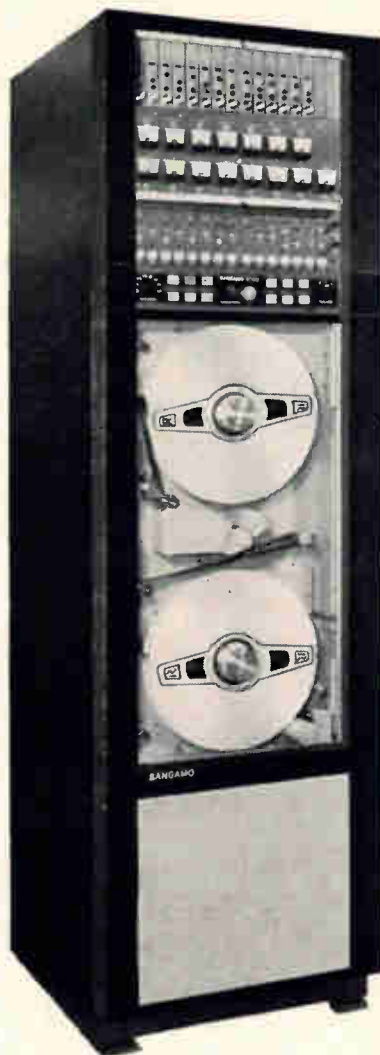

4700 GENERAL PURPOSE SYSTEM



RA-5

Long term, continuous monitoring recorder and its companion reproducer



PA-5



Sangamo/Geotech

3700

Long term, slow-speed recorder



AR-2L

Two-level Attenuator/Restorer

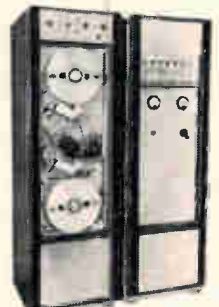

480

Time delay/auto cross-correlation recorder

NEW SANGAMO PORTABLE
Soon to be introduced... a new advance in the state of the art.



ELECTRONIC SYSTEMS

SANGAMO ELECTRIC COMPANY

ELECTRONIC SYSTEMS DIVISIONS

P. O. Box 359, Springfield, Illinois 62705

Phone: 217 544-6411 TWX: 217 546-0947

It took years to achieve a gaussmeter *this* easy to use!

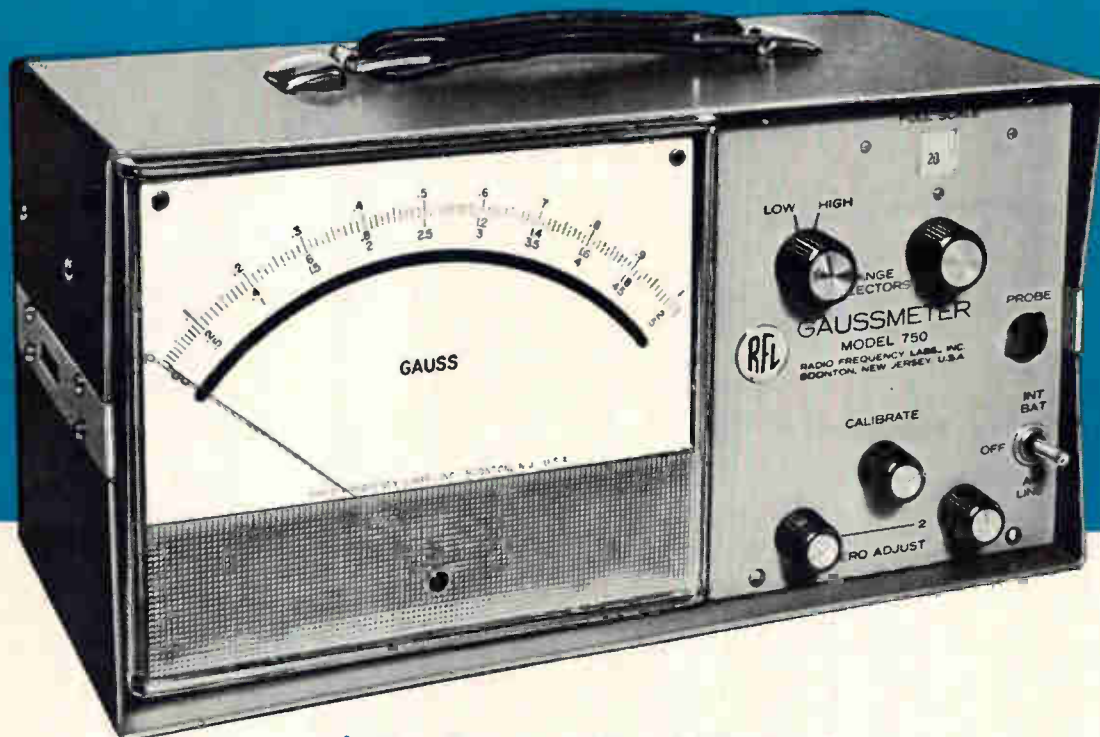

Introducing the NEW RFL Model 750 Hall Effect Gaussmeter

RFL's Model 750 is the most advanced Hall effect gaussmeter in the world today! The largest TBS meter, greatest resolution, widest range, simplified balancing controls and positive in-range indication make it the easiest-reading, simplest operating gaussmeter yet produced.

24 Overlapping Full-Scale Ranges—The Model 750 has 24 overlapping full-scale ranges from 0-0.1 gauss to 50 kilogauss. It gives flux density measurements of permanent magnet, DC and AC fields to 400 Hz. Simplified balancing controls speed measurements. Positive range-in-use indication helps prevent reading errors.

"Tilts" on Optional Base—A cradle base, available at slight additional cost, allows the Model 750 to tilt for best possible meter viewing. This same base protects the controls and meter during transport. Rack mounting is also available at slight additional cost.



7-Inch TBS Meter—A 7-inch TBS mirror scale meter—makes reading almost effortless. Resolution is 1/10 scale division. Parallax correction is included for more accurate reading.

Completely Solid State—No warm-up is required because the Model 750 is completely solid state. It operates on 115/230 volt power supply. And provision for internal batteries is also provided.

Transverse, Axial or Tangential Probes—The Model 750 uses Hall-effect probes for measuring transverse, axial, or tangential fields. All probes are calibrated on standards traceable to NBS. Accuracy is $\pm 1\%$ + reference magnet accuracy.



FREE Literature—for free literature that gives complete information on the Model 750, including technical specs, probes and performance, write or call Jack Janicke at RFL (201) 334-3100 or your nearest RFL Representative listed below.



Radio Frequency Labs., Inc.

Test and Service Division / BOONTON, N.J. 07005 • U.S.A.
Tel: 201-334-3100 / TWX: 510-235-8322 / CABLE: RADAIRCO, N.J.

• Mass., Needham Heights, Cowperthwait & Brodhead—617-444-9410 • New York, Skaneateles, L-Tron Corporation—315-685-6172 • New York, Latham, L-Tron Corporation—518-785-5032 • New York, Rochester, L-Tron Corporation—716-436-4410 • New Jersey, Saddle Brook, L & M Associates—201-343-3070 (NJ) 212-563-5636 (NYC) • Pennsylvania, Philadelphia, L & M Associates—215-438-5666 • Washington, D.C., Arco Corporation—202-296-8735 • Alabama, Huntsville, Space Engineering Sales, Inc.—205-837-6060 • Florida, Orlando, Space Engineering Sales, Inc.—305-841-2271 • Louisiana, Slidell, Space Engineering Sales, Inc.—504-643-7065 • Texas, Azle, Space Engineering Sales, Inc.—817-336-0672 • Ohio, Cleveland, Electro Sales Associates—216-486-1140 • Ohio, Dayton, Electro Sales Associates—513-426-5551 • Michigan, Detroit, Electro Sales Associates—313-886-2280 • Pennsylvania, Pittsburgh, Electro Sales Associates—412-371-8497 • Illinois, Chicago, Hugh Marsland & Co., Inc.—312-676-1100 • Indiana, Indianapolis, Hugh Marsland & Co., Inc.—317-356-4249 • Minnesota, Minneapolis, Hugh Marsland & Co., Inc.—612-545-4481 • Missouri, Florissant, Hugh Marsland & Co., Inc.—314-741-3779 • Colorado, Denver, Hytronic Measurements, Inc.—303-733-3701 • New Mexico, Albuquerque, Hytronic Measurements, Inc.—505-268-3941 • Arizona, Phoenix, Hytronic Measurements, Inc.—602-253-7452 • Utah, Salt Lake City, Hytronic Measurements, Inc.—801-466-4924 • Texas, Dallas, Scientific Sales Co.—214-528-0553 • Texas, Houston, Scientific Sales Co.—713-528-6904 • California, North Hollywood, O'Halloran Associates—213-877-0173 • California, Palo Alto, O'Halloran Associates—415-326-1493 • California, San Diego, O'Halloran Associates—714-224-2824 • Washington, Seattle, Dewar & Associates—206-722-1724

SLATER DOESN'T WANT JUST YOUR RECTIFIER ORDERS.

WE WANT YOUR SEMICONDUCTOR PROBLEMS.

We have solved some very tough semiconductor design problems for many of the biggest companies in every phase of electronics. We are a specialist in the design, development and production of high reliability silicon rectifiers and assemblies.

Slater produces in volume *single junction* diffused 1 and 2 ampere silicon diodes with up to 2000 volts PIV. All units are controlled avalanche. In addition all units provide a 20% safety factor on all specifications.

Slater manufactures 1 ampere hermetically sealed diodes up to 1000 volts PIV with guaranteed maximum recovery times of less than 100 nanoseconds. These units permit operation in high frequency applications such as inverters, ultrasonic generators and power supplies.

Slater supplies combinations of specifications in their

assemblies previously unavailable in the industry. The Slater rectifiers SLA-01 to SLA-020 are less than 1/5 the size of comparable rectifiers. They feature up to 20,000 volts PIV and 200 Mils average rectified current with extremely low leakage and low forward voltage drop. Additional units up to 100 KV PIV are also available. Our specialized production skills enable us to state that we have the lowest price per voltage and ampere rating in the industry.

We know that we must perform to get your business. Test us! Give Slater your problems to solve. When you are in need of a source of high voltage rectifiers, full-wave bridges, miniature assemblies, or 1N3189 series diodes to MIL-S-19500/155 . . . try looking in a direction you may not have explored before. Look to Slater. We think you'll like the results.



SLATER ELECTRIC INC.
SEMICONDUCTORS DIVISION
45 Sea Cliff Avenue • Glen Cove, N. Y.

Are you getting this good
a trace from your
heated stylus recorder?

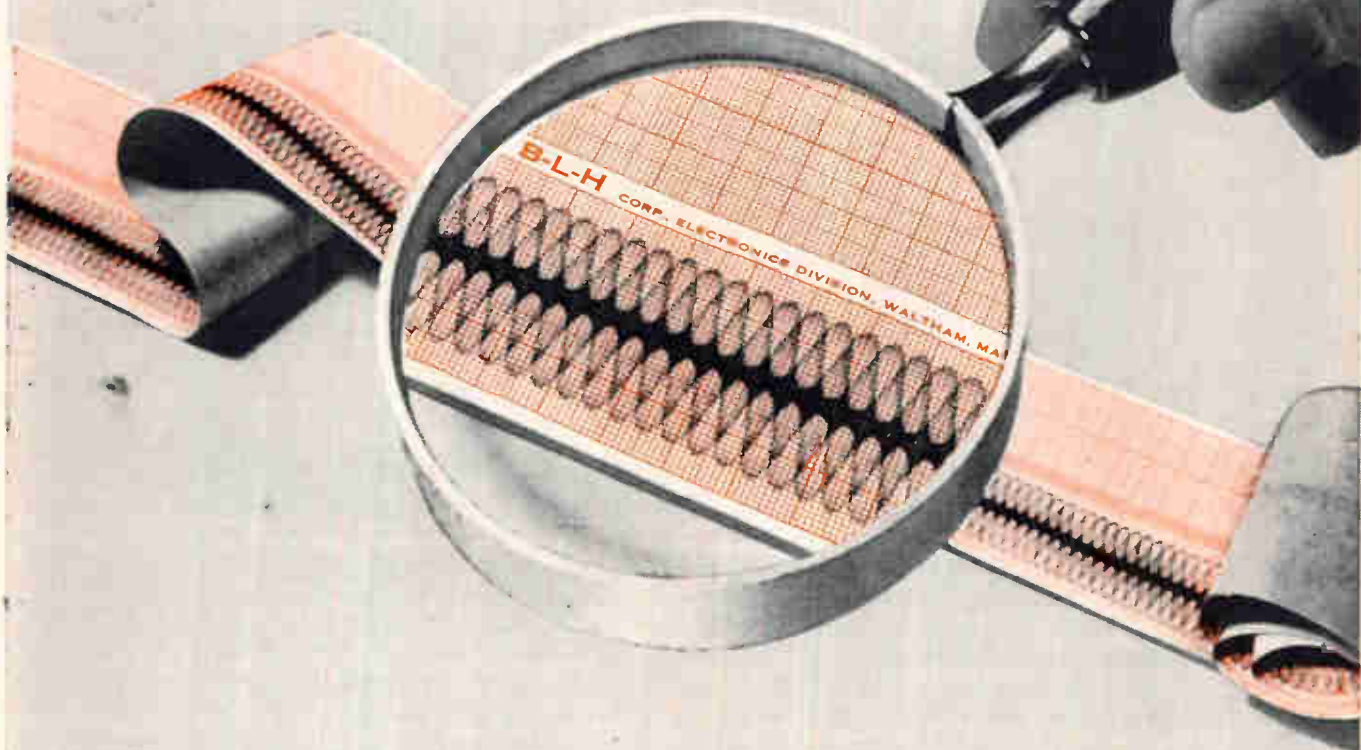

If not, look into this unique BLH recorder with new THERMOTIP stylus. Requires $\frac{1}{4}$ th the power of conventional styli. No paper burnouts! Greater definition and resolution! True rectilinear writing!

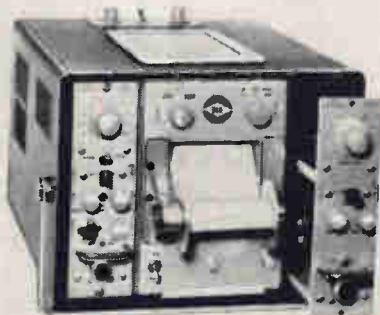

Converts to rectilinear ink writing in minutes! New pen motor with three times greater torque to self inertia ratio. Available in the industry's lightest 2-channel portable with plug-in preamplifiers. Call 617 TW 4-6700 (Waltham, Mass.), or see your BLH Sales Engineering Representative TO ARRANGE FOR A DEMONSTRATION IN YOUR PLANT, PLUS DETAILED INFORMATION ON THIS MAJOR ADVANCE IN MEDIUM FREQUENCY OSCILLOGRAPHIC RECORDING.

BLH ELECTRONICS

A division of BALDWIN-LIMA-HAMILTON

Waltham, Mass.



Plants: Waltham, Mass. • Pasadena, Calif. • Darmstadt, West Germany

1

HIGHEST QUALITY

Quality and reliability demonstrated by a proven 4½ million hours MTBF

2

GREATEST VERSATILITY

Complete families of rugged potted germanium and silicon modules

3

LOWEST COST

For example, 100 Kcps S-R flip-flop module \$3.95 each in quantities of 100

Practical reasons why so many engineers choose EMC



digital logic modules potted in *TIMONIUM*

Complete families of digital logic modules operate over an ambient temperature range of -55°C to +125°C

**ELECTRONIC
MODULES
CORPORATION**

Electronic Modules Corporation • COMPONENTS DIVISION
1949 GREENSPRING DRIVE • TIMONIUM, MARYLAND • TEL. (301) 252-2900 • TWX-301-252-0723

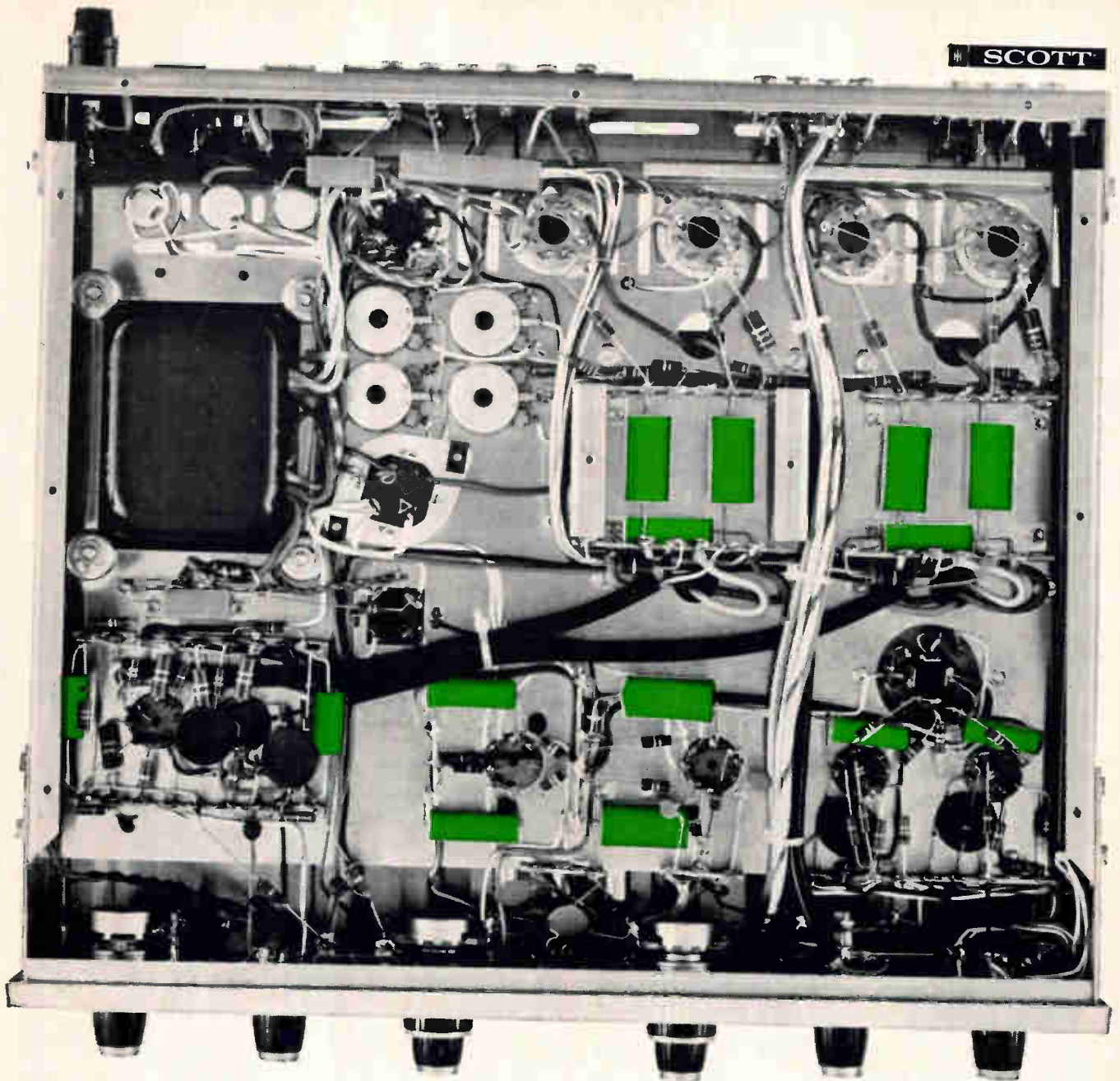

Capacitor reliability? Take Scott's word for it: MYLAR®

H. H. Scott manufactures some of the world's most widely used stereo amplifiers. They are recommended by many leading independent testing organizations. Because this kind of reputation depends on capacitor reliability, engineers at Scott use capacitors of MYLAR* exclusively for audio circuits from .047 to .47 microfarads:

"We don't have to worry about performance with capacitors of MYLAR in our components and consoles," says Chief Engineer Dah von Recklinghausen. "We use capacitors of MYLAR because of their low leakage, extremely long life, excellent capacitance stability and ability to withstand the wide temperature and humidity



ranges encountered in high-power hi-fi amplifiers." MYLAR also offers high dielectric strength in thin gauges, so capacitors can be made smaller, leaving space for more circuitry. And, in many cases, capacitors of MYLAR cost less than paper.

Scott components and consoles are known for excellence in quality, performance and reliability. So are capacitors of MYLAR. For complete information write Du Pont Co., Room 3370A, Wilmington, Delaware 19898. (In Canada, write Du Pont of Canada Ltd., P.O. Box 660, Montreal 3, Quebec.)



Better Things for Better Living
through Chemistry



*DU PONT'S REGISTERED TRADEMARK FOR ITS POLYESTER FILM.

"Visit us at the National Plastics Exposition Show, Booth #2128"

Got problems below $10^{-6}g$?

A challenge to inertial instrumentation is the requirement to measure low g accelerations (in the range $10^{-6}g$ to $10^{-12}g$) associated with orbital atmospheric drag, solar pressures, electrical thrusters and the gradient of the earth's gravitational field. MESA meets this challenge. It measures atmospheric drag at 20,000 miles altitude . . . measures gravity gradient accelerations directly . . . measures satellite attitude without a horizon scanner . . . measures slosh . . . measures you name it. MESA (Miniature Electrostatic Accelerometer) was developed with funding from USAF and NASA. Units have already been delivered for a Saturn vehicle evaluation which will measure $10^{-8}g$. If ranges below $10^{-4}g$ are your problem, MESA is your answer.

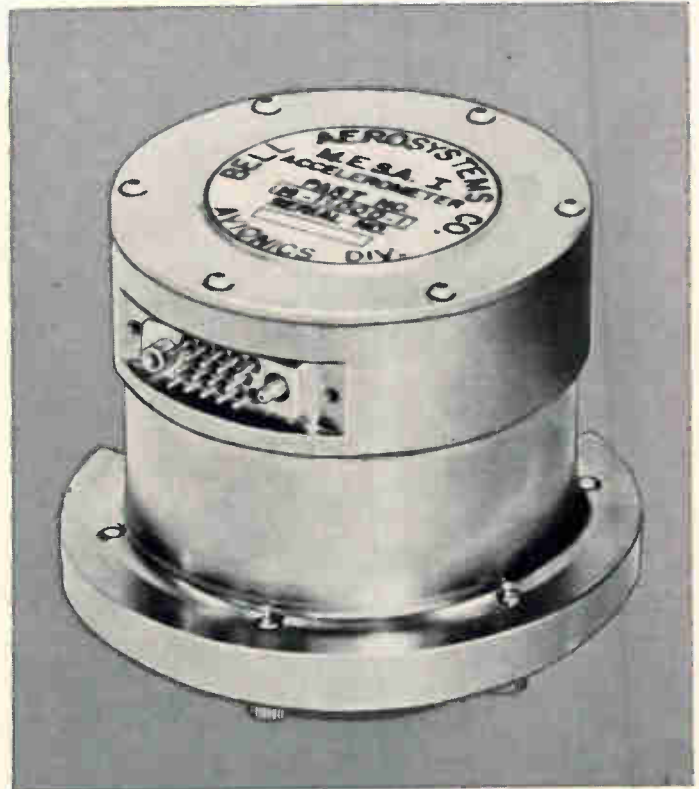

NASA's Miniature Electrostatic Accelerometer

MESA is an electrostatically suspended and electrostatically pulse-rebalanced accelerometer. The proof mass is a beryllium cylinder with a flange at the center. The sensitive axis is along the longitudinal axis of the cylinder. The cross axis suspension system is passive, requiring a minimum of electronic circuitry. Along the sensitive axis, a capacitive bridge pickoff system is used to trigger a precise voltage time integral pulse each time the proof mass moves through the trigger position as a result of external acceleration. The cylindrical proof mass is restored by the electrostatic forces derived from this precision voltage pulse. The output of the MESA is, therefore, a pulse rate proportional to the input acceleration. Each pulse signifies a discrete velocity increment that the MESA experienced. The scaling is flexible over a wide range from 0.000001 ft/sec/pulse to 0.1 ft/sec/pulse depending on the requirement.

MESA is available with range scaling within the limits of 1 g to $10^{-12}g$ as specified for the application. A 1 g capability is provided for ground checkout. The in-flight g scaling provides a preselected dynamic range of 10^6 .

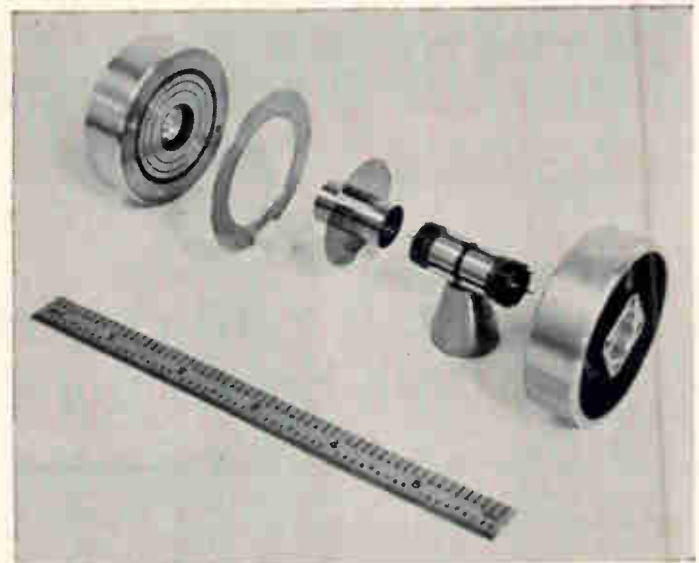

Primary mechanical elements . . . only one moving part.



Brochure covering various details of design, construction, installation and operation, plus information for your specific applications, available from: Product Manager, Inertial Guidance, Bell Aerosystems Company, P.O. Box 1, Buffalo, N.Y. 14240.

BELL AEROSYSTEMS — A **textron** COMPANY Buffalo, New York

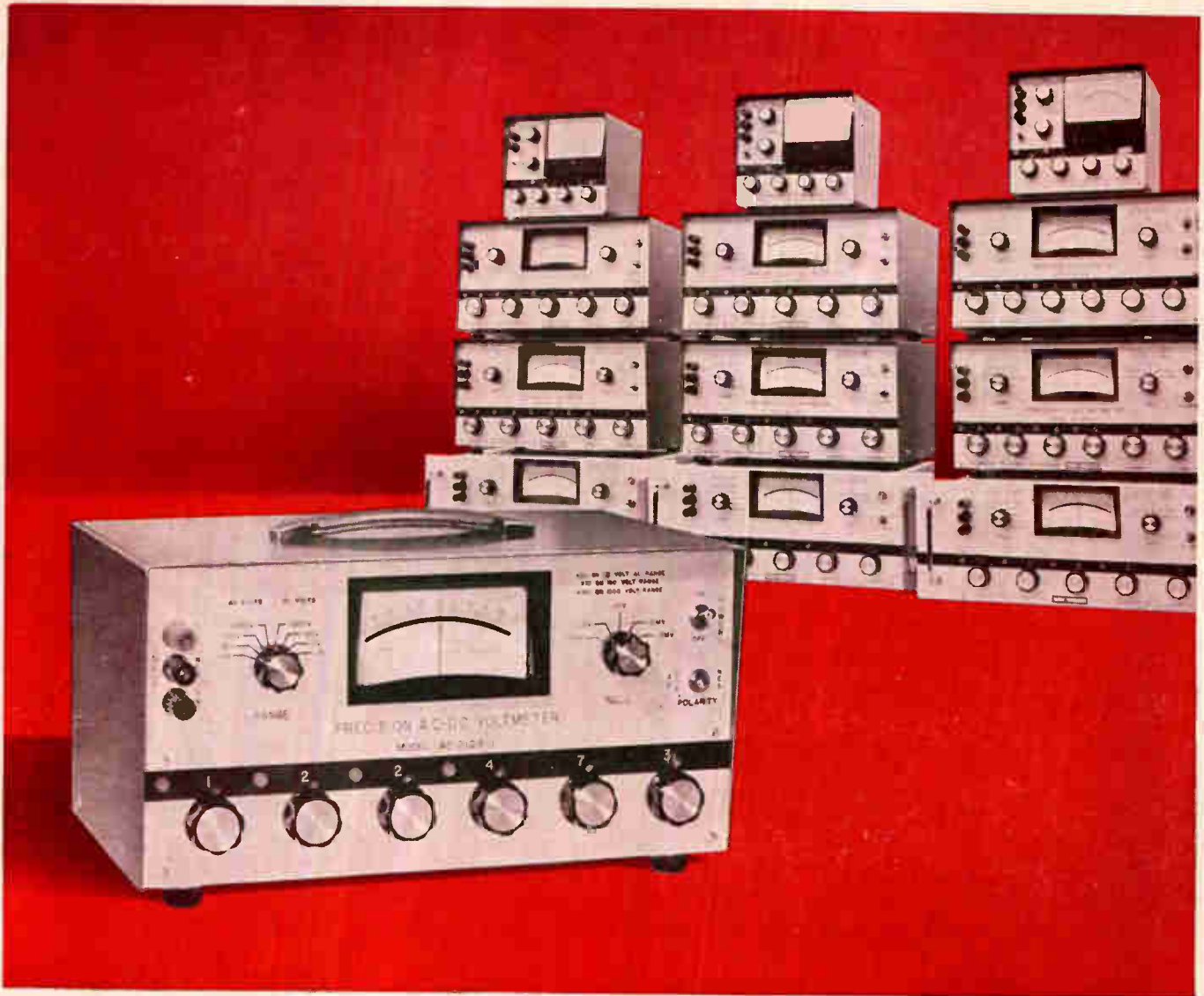

Now 10 solid state differential voltmeter models for immediate off-the-shelf delivery!

(±.05% to ±.005%)

Immediate delivery is now offered on these 10 precision AC-DC differential voltmeter models.

Why the choice of models? To fit your measurement accuracy requirements and budget limitations! Accuracy from ±.05% to ±.005%, priced from \$455 to \$1925.

Key Voltmeter Features—Selected and aged precision wire wound resistors • Ultra stable Zener reference operates in a proportional control oven • KVD output accessible from rear panel • Specified accuracies are of reading, not full scale • All silicon, transistorized circuitry • Voltage range 0-1,000 volts AC and DC in 5 ranges • Potentiometric input impedance to 10 volts • 4½" taut band meter for maximum visual resolution • Lightweight portable, compact size.

CHECK YOUR CHOICE	MODEL	*DC ACCURACY (+5 μV)	*AC ACCURACY (+25 μV)	PRICE	DECADES OF RESOLUTION
<input type="checkbox"/>	DC-100B	±.05%	—	\$455.00	5
<input type="checkbox"/>	AC-100B-1	±.05%	±.20%	855.00	5
<input type="checkbox"/>	DC-110B	±.02%	—	575.00	5
<input type="checkbox"/>	AC-110B-1	±.02%	±.10%	995.00	5
<input type="checkbox"/>	DC-150B	±.01%	—	775.00	5
<input type="checkbox"/>	AC-150B-1	±.01%	±.10%	1190.00	5
<input type="checkbox"/>	DC-200B	±.0075%	—	965.00	6
<input type="checkbox"/>	AC-200B-1	±.0075%	±.10%	1390.00	6
<input type="checkbox"/>	DC-210B	±.005%	—	1480.00	6
<input type="checkbox"/>	AC-210B-1	±.005%	±.10%	1925.00	6

*Accuracy specified over temperature range of 15°C - 35°C

metric input impedance to 10 volts • 4½" taut band meter for maximum visual resolution • Lightweight portable, compact size.

Check off the model which best fits your needs. then for immediate delivery, contact your nearest Honeywell sales office or write to: Honeywell, Test Instruments Division, San Diego Operation, 8611 Balboa Ave., San Diego, California 92112.

DATA HANDLING SYSTEMS

Honeywell

HONEYWELL IS WORLDWIDE • Sales and service offices in all principal cities of the world. Manufacturing in Brazil, Canada, France, Germany, Japan, Mexico, Netherlands, United Kingdom, United States.

4

DALE

BONUS FEATURES! New G & HG resistors offer more versatility than any other wirewounds!

1. MORE POWER in MIL SPEC SIZE

G SERIES*							HG SERIES							
DALE TYPE	MIL-R-26C TYPE	MIL-R-23379 TYPE	POWER RATING (WATTS)		RESISTANCE RANGE (OHMS)			DALE TYPE	MIL-R-18546C TYPE	POWER RATING (WATTS)		RESISTANCE RANGE (OHMS)		
			Dale	Mil.	.05%, .1%, .25%	.5%, 1%, 3%	Dale			Mil.	.05%, .1%, .25%	.5%, 1%, 3%		
G-1	—	—	1.0	—	10 to 950	1 to 3.4K	HG 5	None	15	—	1 to 6.5K	1 to 24.5K		
G-3	RW-70	RWP-18	2.25	1	1 to 2.7K	.1 to 10.4K	HG-10	RE-65	20	10	1 to 12.7K	.1 to 47.1K		
G-5C	RW-69	RWP-20	5	3	1 to 8.6K	.1 to 32.3K	HG-25	RE-70	35	15	.5 to 25.7K	.1 to 95.2K		
G-15	RW-68	RWP-23	15	10	.5 to 73.4K	.1 to 273K	HG-50	RE-75	50	20	.5 to 73.4K	.1 to 273K		

Major Environmental Specifications: LOAD LIFE: 1% Max ΔR in 1000 hours at full power. OVERLOAD: .5% Max. ΔR at 3, 5, or 10 times momentary overload per applicable Mil. Spec. OPERATING TEMPERATURE: -55°C to $+275^{\circ}\text{C}$

*G Series models are typical: 10 resistors in complete line.

2. THE SAME POWER in LESS SPACE

1 Watt Silicone Coated Resistor

Conventional MIL-R-26C and MIL-R-23379



DALE G-1

15 Watt Mil. Rated Housed Power Resistor

Conventional MIL-R-18546C Size

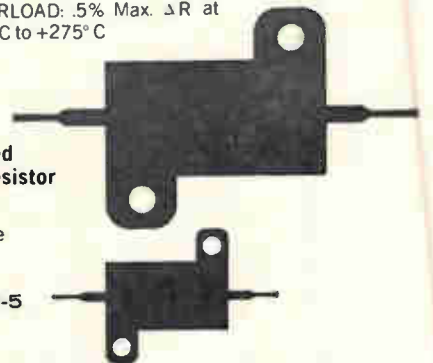

DALE HG-5

3. EXCEPTIONAL STABILITY at CONVENTIONAL RATINGS

Two RW-69, MIL-R-26C resistors (Dale G-5C and conventional silicone-coated wirewound) operated at Mil power levels.

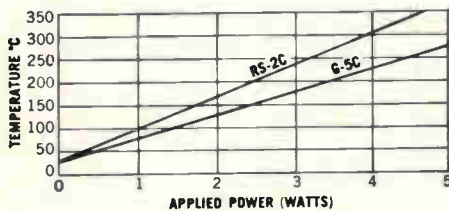

Two RE-65, MIL-R-18546C resistors (Dale HG-10 and conventional housed power wirewound, RH-10) operated at Mil power levels.

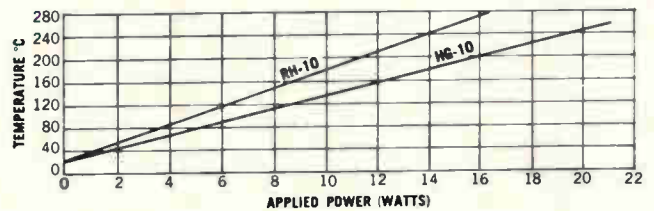

4. IMPROVED THERMAL EFFICIENCY

The chart at right shows the outstanding heat dissipation advantages which the beryllium oxide cores used in Dale G and HG resistors have over conventional core materials. To complement this advantage, Dale uses a special high temperature silicone coating on the G Series and a new extruded aluminum housing for the HG Series.

Core Conductivity at 275° C

BTU-Ft
Ft²-Hr-°F

ALUMINUM - 130
BERYLLIUM OXIDE (BeO) - 64
STEEL - 33
ALUMINUM OXIDE - 8
STEATITE - 1.5

FOR COMPLETE INFORMATION
WRITE FOR CATALOG A



DALE ELECTRONICS, INC.
1300 28th Avenue, Columbus, Nebraska

DALE

Washington Newsletter

June 13, 1966

**TRW gambles:
satellite started
despite dispute**

The State Department is entering a dispute between the Communications Satellite Corp. and the Federal Communications Commission over the wisdom of spending some \$40 million for six 1,200-channel communications satellites [Electronics, May 30, p. 149]. The FCC has withheld approval of a contract between Comsat and TRW, Inc. The agency contends that the six satellites seem inadequate to meet the burgeoning demand for domestic and international service. The FCC claims that Comsat may save money and serve its customers better in the long run if it went directly to a 6,000-channel satellite system.

There have been repercussions from the committee that represents the International Telecommunications Satellite Consortium. The group has passed a resolution accusing the U.S. government of delaying development of the global satellite communications system. Because of the delicate international situation, the State Department is holding meetings with the FCC, but so far the FCC has refused to back down.

Meanwhile, TRW is letting the storm rage and is taking a calculated risk by using its own money to fund the project.

Acting FCC Commissioner Rosel H. Hyde is reported to have told the State Department that if the parties involved are unhappy with the FCC's action, then they should take it up with Congress, which passed the Communications Satellite Act in 1962.

It is more likely, however, that White House intervention will seek to move FCC in the direction of the international view, probably eliminating the need for an appeal to Congress for new legislation.

**Build Nike X now,
say Joint Chiefs**

Newly released congressional testimony emphasizes the sharpness of the split between Defense Secretary Robert S. McNamara and the Joint Chiefs of Staff over production of the Nike X antimissile system.

Gen. Earle G. Wheeler, chairman of the Joint Chiefs, told the House Armed Services Committee that the Joint Chiefs favor production of a full-scale system capable of defending against a Russian threat. "And now—starting now," he emphasized.

But McNamara said, "I seriously question whether it is wise to proceed with an antiballistic-missile defense against the Soviet Union. Among other reasons, I question it because I do not believe the American public—or the American Congress—will accept the prerequisite for such a defense, which is a full fallout-shelter program."

McNamara repeated his assertion that a less sophisticated system capable of coping with a Chinese missile threat seems desirable. But he believes the threat is sufficiently distant to allow a year to pass before a decision is needed.

Both Senate and House Armed Services Committees have approved \$170 million to tool up for deployment of Nike X. But they did so without attempting to define the type of deployment or its scope—nor did they provide funds for fallout shelters.

**Air Force hopes
bomber blueprint
will unleash funds**

In July the Air Force expects to tell the Pentagon chief exactly what it wants in a new manned bomber. The Air Force hopes the proposal will spur a go-ahead for contract-definition competition.

In the complicated dispute over the need for a new bomber, McNamara

Washington Newsletter

has so far denied funds to start contract definition on the ground that the Air Force has never presented a "clear" proposal on the bomber. Gen. John P. McConnell, Air Force chief of staff, and Air Force Secretary Harold Brown, while agreeing on need for a bomber, have differed in the past on its general concept.

Now they are moving toward a united recommendation. And, in anticipation of a stronger case by the Air Force, both Senate and House Armed Services Committees have voted \$11.8 million for contract definition.

However, the Air Force must still convince McNamara. He feels the present bombers—the late model B-52's and the bomber version of the F-111—will provide a bomber-missile mix into the mid-1970's. After that he anticipates missiles alone will provide all the capability needed.

**McNamara says:
more for MOL
if need is proved**

Defense Secretary McNamara says the Air Force will get more money for the Manned Orbital Laboratory (MOL) if it needs it. The Air Force originally sought \$395 million for the coming fiscal year. McNamara cut this to \$159 million because the program had fallen behind schedule. The Air Force agreed that because of the schedule delay it could not justify its original request. But Air Force officials and McNamara are still \$85 million apart in estimates of what will be needed.

McNamara told Congress he will get the money from his emergency fund or by reprogramming "if I prove in error." He heartened MOL advocates by saying: "This is a project I initially strongly recommended . . . and I'm just as anxious as the Air Force that it proceed expeditiously. But I don't want money to be spent that can't be spent properly."

Prime contractor for MOL is the Douglas Aircraft Co. The Westinghouse Electric Corp. will build the craft's experiments packages.

**FCC may gain
fresh controls
over r-f pollution**

The House is expected to approve—but not till late in the session—a Senate bill giving the Federal Communications Commission the power to regulate the manufacture of devices that can interfere with radio reception. The FCC already has power to regulate the use of such devices; the new authority will permit rulings on manufacture, sale or shipment of garage-door openers, electronic heating devices, diathermy machines, welding devices, and even radio and television receivers that may inadvertently radiate interference because of poor design.

**Military shifts
several officials
in electronics field**

Brig. Gen. Walter E. Lotz, the assistant chief of staff for communications and electronics for the U.S. command in Vietnam, is being transferred to the Pentagon to become the Army's chief of communications and electronics. He will succeed Maj. Gen. David P. Gibbs.

Lotz will be replaced in Vietnam by Air Force Brig. Gen. Sam L. Huey, commander of the Tactical Air Command communications region of Air Force Communications Service, Langley Air Force Base, Va.

Lt. Gen. Joseph R. Holzapple, director of the Defense Department's weapons systems evaluation group, will become Air Force deputy chief of staff for research and development, effective Sept. 1. Holzapple succeeds Lt. Gen. James Ferguson who is becoming commander of the Air Force Systems Command.

President Johnson has announced his intention to nominate Robert Alan Frosch as assistant secretary of the Navy for research and development. He will replace Robert W. Morse, who is resigning July 1 to become president of the Case Institute of Technology in Cleveland.

Want a new slant on how much capacitor performance you can get in a low cost molded plastic case?

Test our MTA molded electrolytic!

Here's how it stacks up for performance:

Life at High Temperature—zero failures in one million piece-hours at 85°C. Only one failure in 2½ million piece-hours at 65°C.

Stability at Low Temperature—equal to or better than most metal-case miniatures down to -30°C.

Maximum Values—800 mfd, 3 VDC, to 85 mfd, 50 VDC.

For sample order, call Jim Shaffer, collect, at 317-636-5353, Extension 403.

Available from stock at factory prices in quantities to 2499 from franchised Mallory distributors

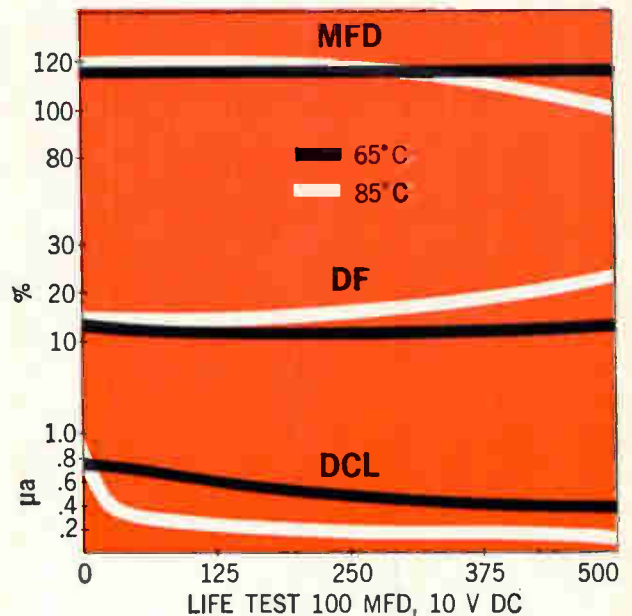
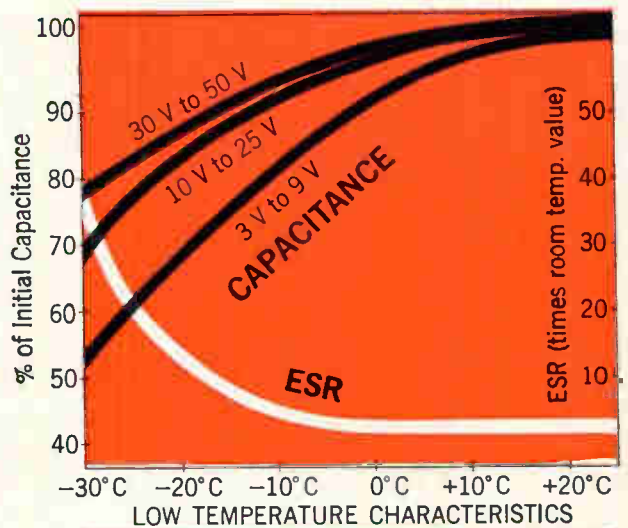

MALLORY CAPACITOR COMPANY
 a division of P. R. MALLORY & CO. INC.
 3029 E. Washington St., Indianapolis, Indiana 46206



You need a pushbutton switch.



Bill, at the next board, needs a toggle switch.



Sam's looking for placard indicators.



Joe wants a switchlite.



Harry wants a hermetically-sealed switch.



Here's the easy way to get all the answers at once!

Just check the bingo card in this book for any or all of the Control Switch catalogs listed below. Or send us a card of your own.

If you get all of our catalogs you'll have it made.

First, because these catalogs cover a combination of switch types and switchlites that no other manufacturer can offer. So you get a concentrated reference.

Second, because some switch manufacturers don't make *any* of the switches we make. So Control Switch catalogs save wild goose chases.

Third, because we make only quality switches. For computers, aircraft, missiles, control panels, and such. So our catalogs (and your nearest Control Switch distributor) save time screening out switches that haven't got it.

Here's the list. Check the Reader Service Card number at the left for the catalogs you want.

- #245 *Condensed Switch Catalog 100*
- #246 *Basic Snap-Action Switch Catalog 110*
- #247 *Toggle Catalog 180*
- #248 *Indicator Light Catalog 120*
- #249 *Hermetic Switch Catalog 130*
- #250 *Switchlite Catalog 220*
- #251 *Pushbutton Catalog 190*



**CONTROLS
COMPANY**
OF AMERICA
CONTROL SWITCH DIVISION
1420 Delmar Drive, Folcroft, Pennsylvania 19032



PPO[®]

POLYPHENYLENE OXIDE



is self extinguishing

(UL GROUP I)

Even in a section just 30 mils thick, PPO[®] polyphenylene oxide is self extinguishing and nondripping. That's one-half the thickness of the minimum of 62 mils demanded by UL for our Group I rating (the toughest there is). Furthermore, PPO can be dip soldered, copper clad, staked and easily cleaned with Freon TF.

These are key features of PPO, the new wide temperature range engineering thermoplastic from General Electric.

PPO also has superior electrical properties. Dissipation factor and dielectric constant are very low... and very constant... over a wide tempera-

ture and frequency range. Dielectric strength is high.

As an engineering material, PPO offers: 1) a heat deflection point of 375°F @ 264 psi. 2) a tensile modulus of 310,000 psi at 300°F. 3) only 1% creep after 10,000 hours at 73°F and *under 2% at 200°F*. 4) excellent dimensional stability, with a maximum water absorption of 0.12 percent. 5) moldability to close tolerances.

What design of yours would go better in PPO? For a starter, look at the pictures. You'll see a tv tuner strip... connector... tv deflection yoke... thin-walled electrical shell... and molded printed circuit board. Each of

takes dip soldering

(UP TO 800°F)

them end up better and less expensive in PPO. The same characteristics make PPO a candidate for double insulated housings.

Our technical people know of many more areas where you can benefit with PPO. They'll be glad to help solve your problem. Call your local Chemical Materials Sales Representative, or write Section 6F2, Polymer Products Operation, General Electric Company, One Plastics Ave., Pittsfield, Mass.

(By the way, PPO is also the greatest hot water resistant engineering thermoplastic yet developed.)

GENERAL  ELECTRIC

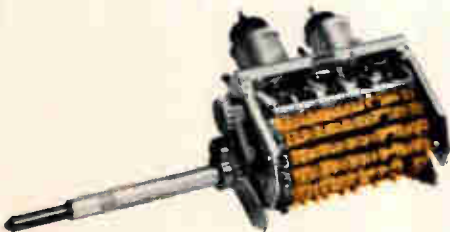

Circle 71 on reader service card

The capabilities of microwave technology

Solving today's scientific and industrial problems frequently requires the application of new disciplines. How two of these problems are being solved—by microwave technology—is described here.

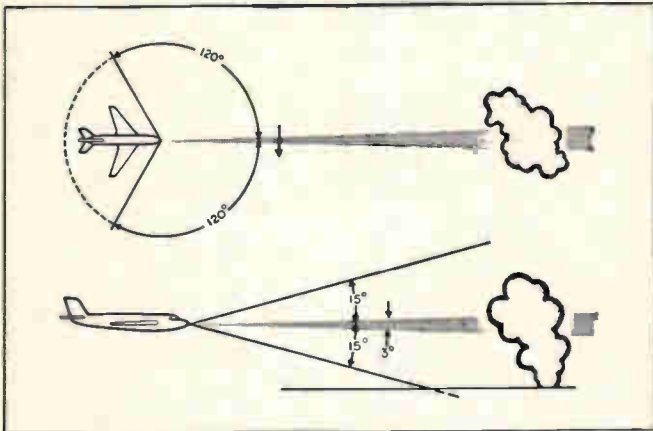

The problem: Build an ultra-reliable magnetron and modulator package for an airborne radar system that "sees" weather 180 miles ahead.

The advanced system is the Bendix Corporation's RDR-1E airborne weather radar, now widely used on commercial jet aircraft.

For this Bendix system, Raytheon's Microwave & Power Tube Division combined several capabilities. It built a magnetron tube and a pulse modulator package designed to work extremely well together to provide Bendix with an ultra-reliable system.

The magnetron is a Type 2J55, a super-high frequency oscillator capable of delivering 70 kw of peak power. The modulator package is a complete module containing pulse transformer, pulse forming network and charging choke. All are combined into one compact package that is dynamically tested with the tube to ensure matching the characteristics of the magnetron. Because of this compatibility, the magnetron's life is extended and the system's efficiency improved.

By utilizing the single Raytheon magnetron-modulator source, Bendix gained reductions in system size, more reliable operation, and significant engineering savings.



The problem: Build a laser system to pierce—on a mass production basis—diamond dies used in drawing small diameter copper wire.

The laser system for Western Electric's Buffalo plant had to be capable of one pulse per second operation—with extremely high repeatability—while piercing holes in diamonds.

To meet Western Electric's requirements, Raytheon's Laser Advanced Development Center developed the LE-1 laser system. This system combines an efficient water cooling method and optical pumping scheme by which, once set, variations in output energy are virtually negligible. Controllability is essential in piercing holes having extremely small diameters. With a modified LE-1 system, hole diameters as small as 0.0025 inch through $\frac{1}{16}$ "-thick diamonds are feasible.

The LE-1 is capable of producing more than 10 joules of energy per pulse at the rate of one pulse per second. Pulse width is variable from 1 to 10 milliseconds.

Building lasers for production line use indicates the ability of Raytheon laser technology to meet the needs of today's industrial requirements.

For additional examples of our capabilities in solving scientific and industrial problems, write to Raytheon Company, Microwave & Power Tube Division, Dept. A, Willow Street, Waltham, Mass. 02154.



to build high-reliability ceramic capacitors this small...

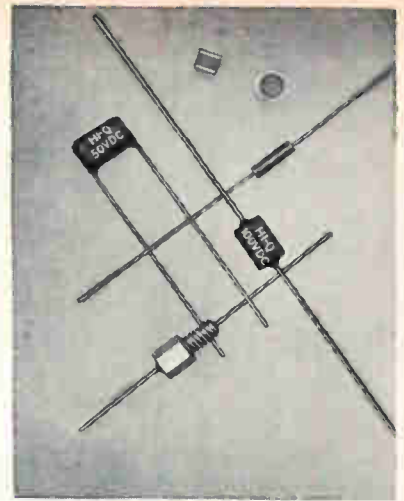

11,000 sq. ft. of clean room facilities



Modern electronics places some strange demands on the manufacture of components. For example: while Hi-Q capacitors have grown smaller and smaller, the facilities in which we "build" them have grown bigger until we now boast more than 11,000 square feet of "clean room" facilities. The 7,200 sq./ft. room above, at Olean, New York satisfies every detail of Air Force Specification T.O. 00-25-203. This is a manufacturing facility that is considerably more anti-septic than many hospital operating rooms, but it's necessary to achieve the high reliability needed for Hi-Q products going into equipment costing many millions of dollars.

"Clean rooms" are just one of the ways Hi-Q works harder to provide complete answers to the problems of mod-

ern electronics technology. Technical breakthroughs such as our new CERLAM capacitors are really only typical of our advances in the state-of-the-art for capacitors. And Hi-Q achievements are never laboratory oddities. They're quickly transformed into production items ready to meet customer problems. In fact, most are developed specifically to solve a customer's problem. Got a problem? Try us.



AEROVOX
CORPORATION
OLEAN, N. Y.

Selected commercial and military Hi-Q products are available off the shelf from authorized Aerovox Distributors

Wouldn't it be great if you could buy a 2N3055 with this lifetime guarantee?

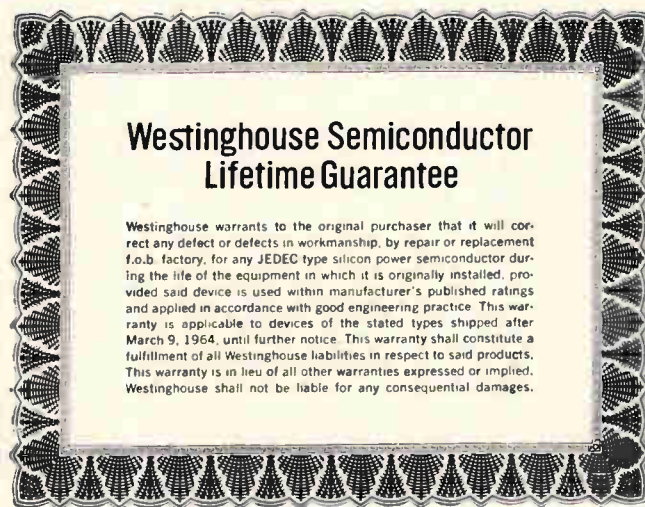

SG-2056

Now you can!

(2N3232-5 and 2N3442 too-call your Westinghouse distributor.)

You can be sure if it's Westinghouse



These cycle controlled tools give a precise, consistent crimp every time for terminals, lugs, splice fittings, RF fittings, connectors and special devices. They're light and have high-leverage action allowing low-closing hand pressure. Less operator fatigue means higher production . . . lower cost per crimp.

In-line die action and ratchet control provide the most uniform crimping. Tools are corrosion resistant. Available in standard and miniature models.

CT Terminal Tools crimp MS-25036 terminal lugs and MS-25181 thru-splices and other fittings. "Dial-for-Size" selector for quick crimp depth selection. Terminal locator properly positions fittings and wire for crimping. The CT-S standard-size tool crimps fittings 12-10 through 26-24. The miniature CT-M tool crimps fittings 16-14 through 26-24.



1077 Floral Avenue • Union, New Jersey
(201) 289-8200 • Telex 1-25471
a subsidiary of Elastic Stop Nut Corporation of America

CH Tools Crimp Co-axial and Shielded Fittings and Connectors—Dies are interchangeable and positive bottoming. These tools will crimp BNC, TNC, and N series connectors, and many other fittings requiring hex crimps. Miniature models also available.

CD Tools for Special Custom Applications are furnished with blank dies or special dies as required.

Write today for complete information on these high performance crimping tools.



New Die-type tools Crimp easiest- fastest!



"CT" Tools for Terminals, Splices and End Caps

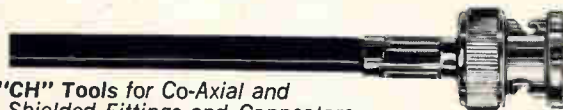

"CH" Tools for Co-Axial and Shielded Fittings and Connectors



"CD" Tools for Special Custom Applications

New Tektronix Type 556 DC-to-50 MHz, dual-beam, sweep-delay oscilloscope

The Type 556 and rack-mount Type R556 use any combination of Tektronix letter or 1-series plug-ins

The UPPER BEAM can display a signal from either *left* or *right* plug-in; with either Time Base A, Time Base B, or external signals; triggered from a composite vertical signal, plug-in single channel signal (with 1A1 or 1A2), external, or line.

The LOWER BEAM can display a signal from the *right* plug-in; with either Time Base B or external signals; triggered from a composite vertical signal, plug-in single channel signal (with 1A1 or 1A2), external, or line.

Independent Vertical Systems use Type 1A1 or 1A2 Plug-In Units for 50 MHz operation; also accept any other 1-series or letter-series plug-ins.

Independent Sweep Systems provide 24 calibrated steps from 0.1 $\mu\text{s}/\text{cm}$ to 5 s/cm ; the X10 Magnifier extends the fastest sweep rates to 10 ns/cm .

Calibrated Sweep Delay extends continuously from 0.1 microsecond to 50 seconds.

Single-Sweep Operation enables one-shot displays of normal or *delayed* sweeps.

Independent Triggering Systems provide stable displays to beyond 50 MHz. Either input signal can be used to trigger either or both time-bases.

New Dual-Beam CRT (with illuminated internal graticule) provides "zero-parallax" viewing of small spot size and uniform focus over the 8 cm by 10 cm display area. Each beam has 6 cm vertical scan, with overlap scan of 4 cm by 10 cm.

EMI (RFI) Suppression — meets interference specifications of MIL-I-6181D over these frequency ranges: 150 kHz to 1 GHz — Radiated (with CRT mesh filter installed), and 150 kHz to 25 MHz — Conducted (power line).

Size is 15" x 17" x 24".

Weight is \approx 80 pounds, without plug-ins.

Power Requirement is 100-130 V or 200-260 V, 50-60 Hz \approx 850 watts.

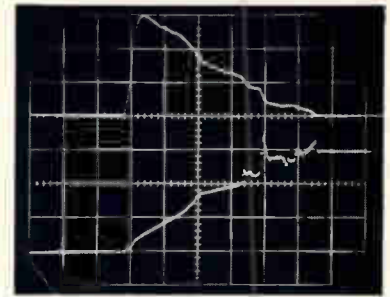

Simultaneous Single-Shot Displays. Current versus voltage display of a .75 ampere, fast-blow fuse during destructive overload. Both beams are driven by B Time-Base at 50 $\mu\text{s}/\text{cm}$ which is delayed by pre-triggered A Time-Base to provide base reference lines before and after the event. The upper beam shows the current waveform at 30 A/cm while the lower beam shows the corresponding voltage across the fuse at 100 V/cm.

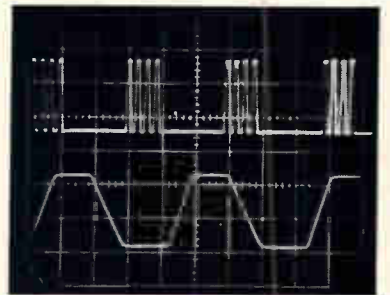

Single-Input Dual-Beam Displays. Upper beam shows bursts of 2.5 MHz pulses on Time Base A with time variation between bursts. This shows up as increasing time-jitter between the first and successive bursts. The lower beam shows B Sweep (0.1 $\mu\text{s}/\text{cm}$) delayed by A Sweep and triggered on the second pulse of the last burst to provide a jitter-free expanded display of the A Sweep intensified zone. The use of only one probe and one plug-in input simplifies signal connection and provides minimum loading on the source.

Plug-ins illustrated

Type 1A1 Dual-Trace Unit . . . \$600 (Dual-Trace—50 mV/cm at DC-to-50 MHz, 5 mV/cm at DC-to-28 MHz. Single-Trace—500 $\mu\text{V}/\text{cm}$ at 2 Hz-to-15 MHz. 5 Display Modes—Channel 1, Channel 2, Alternate, Chopped, Added Algebraically. Front-panel signal output.)

Type W Differential Comparator Unit . . . \$575 (Conventional Preamplifier—50 mV/cm at DC-to-23 MHz to 1 mV/cm at DC-to-8 MHz. Decade Input Attenuator to X1000. Differential Input Preamplifier—CMRR of 20,000 to 1, DC-to-20 kHz. Max. Peak Input of ± 15 V, X1 Attenuation. Calibrated Differential Comparator—Vc Supply of 0 to ± 11 V. Accuracy of $\pm 0.15\%$ of output $\pm 0.05\%$ FS.)

Type 556 Dual-Beam Oscilloscope . . . \$3150
Rack Mount Type R556 Oscilloscope . . . \$3250

U.S. Sales Prices, f.o.b. Beaverton, Oregon

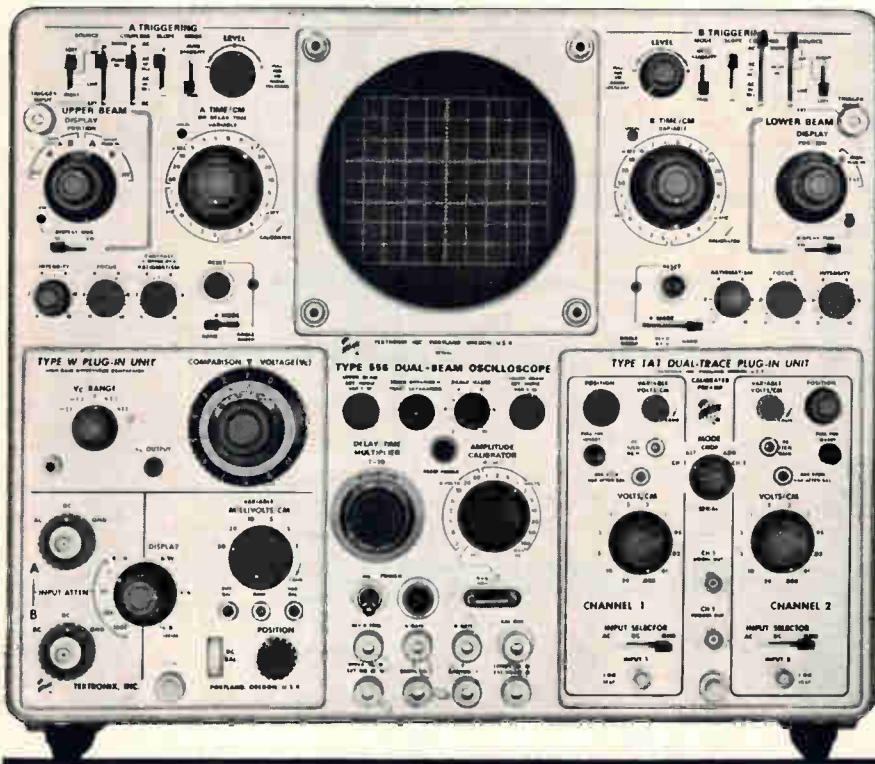

Tektronix, Inc.



For complete information, contact your nearby Tektronix field engineer or write:
Tektronix, Inc., P.O. Box 500, Beaverton, Oregon 97005

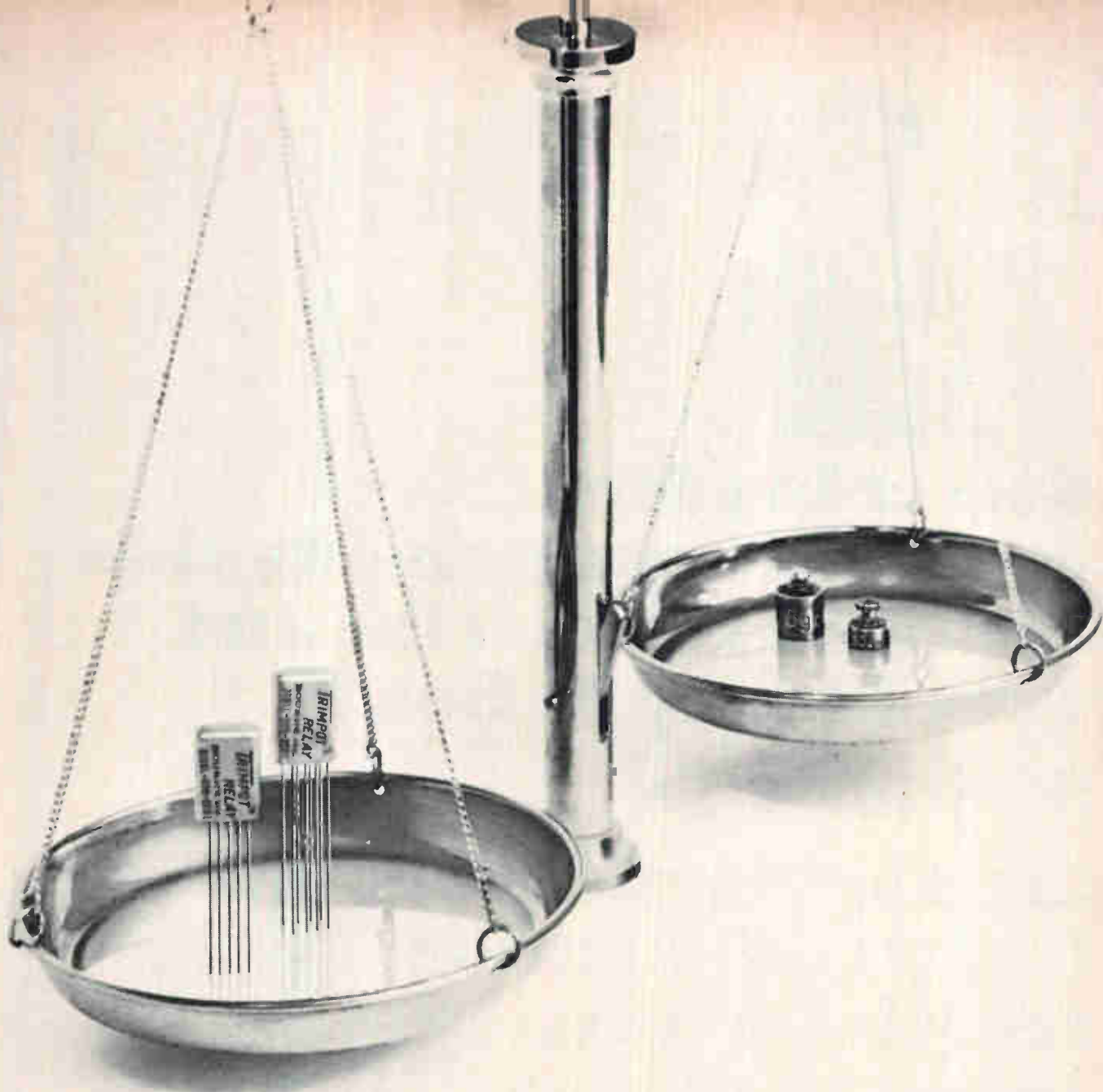

Relay Reliability in 3-Gram Packages

You can cut problems down to size with the Bourns TRIMPOT® Model 3100 SPDT and Model 3101 DPDT relays. These proven units give you MIL-Spec reliability and 160 mw sensitivity in a package size of less than 1/20 cubic inch. Punish them with 150G shock or 40G, 3000 cps vibration, and you still get the performance that's on the published data sheet. Features include highly efficient magnetic circuit, rotary balanced armature, hermetically sealed case and self-cleaning contacts. Environmentally they exceed requirements of MIL-R-5757D.

With these relays, there is little chance of "infant mortality" in your circuits. Bourns double-checks each unit with a 5000-operation run-in followed by 100% final inspection for all important characteristics, including mass-spectrometer leak testing. Furthermore, Bourns tests samples quarterly in the famous Reliability Assurance Program that it created for TRIMPOT potentiometers. In short, you can trust the name TRIMPOT in relays, too.

Other TRIMPOT relay products available from Bourns: Model 3105 subminiature AC DPDT and a full line of miniature adjust-

able time-delay and voltage-sensing relays and modules. Delivery is immediate. Write today for complete technical data.

Size:	0.2" x 0.4" x 0.6"
Max. operating temp.:	125°C
Contact rating:	1.0 amp resistive, 26 VDC
Pickup sensitivity:	100 mw (Model 3100) 160 mw (Model 3101)
Standard coil resistances:	50 to 2000Ω (Model 3100) 65 to 2000Ω (Model 3101)

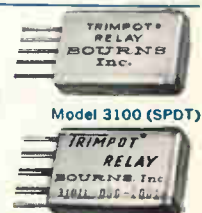

units shown actual size



BOURNS, INC., TRIMPOT DIVISION, 1200 COLUMBIA AVE., RIVERSIDE, CALIF.
PHONE 684-1700 • TWX: 714-682 9582 • CABLE: BOURNSINC.

TRIMPOT means BOURNS—BOURNS means QUALITY
TRIMPOT is a registered trademark of Bourns, Inc.

TRIMPOT® AND PRECISION POTENTIOMETERS — RELAYS — MICROCOMPONENTS: TRANSFORMERS, INDUCTORS, RESISTORS AND CAPACITORS



**Searching for
electronic components that
are hard to describe and
even harder to find?**

Stop.

**Let the Northern Plains
Industrial Catalog
search for you.**

Northern's Industrial Catalog can locate a source for most any part or assembly. It is a unique find-it-in-a-hurry service of Northern Natural Gas Company that will quickly locate reliable suppliers, sub-contractors and sources for parts, components and sub-assemblies made to your exact specifications. In technical terms, the Northern

Plains Industrial Catalog is a computerized compilation of all industrial fabricators in the Northern Plains area—Iowa, Kansas, Minnesota, Nebraska, South Dakota and western Wisconsin. It's the source of information that can tell you where to buy wisely, profitably and quickly. And the service is free. So if you're interested in electronic

components, plastics, short run stampings, motors, precision machined parts, instruments, die castings or whatever, fill out the coupon. You'll receive complete information. And if you attach a sketch or specifications of your required components, Northern Natural Gas will send you a specially compiled list of qualified producers.

INDUSTRIAL CATALOG
Area Development Dept. K-1
Northern Natural Gas Co., Omaha, Nebr. 68101

 Northern Natural Gas Company

Dear Sirs: Please send Sources of Supply information on: _____
 Drawings enclosed.

NAME _____ TITLE _____
COMPANY _____
ADDRESS _____
CITY _____ STATE _____

TRW
Varicap
DIODES
STRETCH
YOUR
TUNING
RANGE

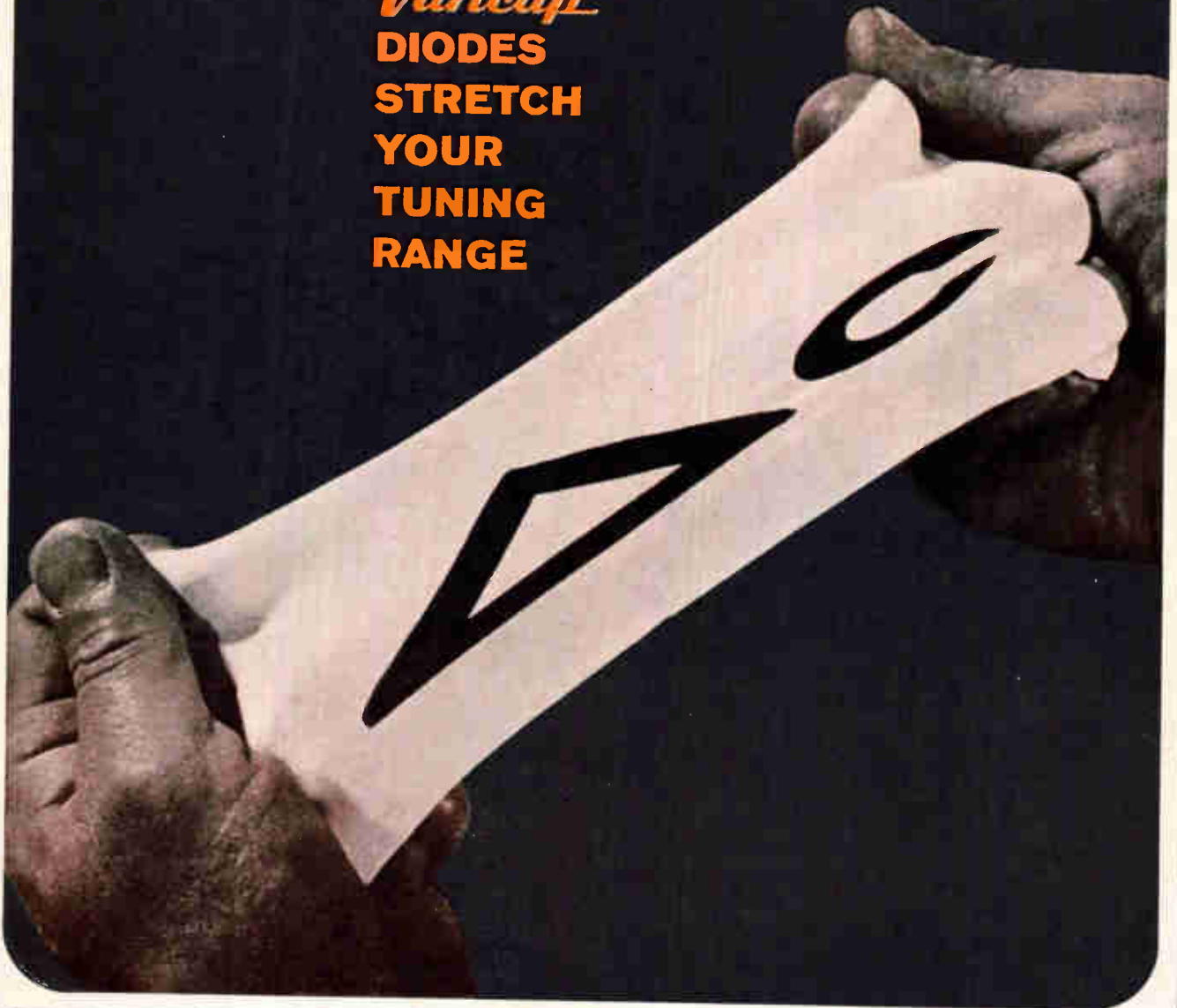

...up to 20% greater Δc !

TRW Varicap voltage-variable capacitors provide a capacitance change ratio which is a reflection of the square law function. This greater Δc when applied to a tuning circuit results in substantially increased Δf (controlled tuning range).

Characteristics inherent in the TRW abrupt junction Varicap assure C vs. V tracking, uniformity, repeatability and predictability unequalled in the industry. The

unique DO-14 package makes certain these inherent characteristics will "stay put" as proved in nearly every major space and missile program.

For complete details on the extensive line of TRW Varicap diodes contact TRW Semiconductors Inc., 14520 Aviation Boulevard., Lawndale, California. Phone: (213) 679-4561. TWX: 910-325-6206.

Varicap is the trademark of silicon voltage-variable capacitors manufactured by TRW Semiconductors Inc.

TRW SEMICONDUCTORS

Would you believe 1000? This is one of a library of more than one thousand DATEX encoder code patterns. One of them is available in the right code (Binary, Gray, BCD, Monostrophic,* etc.) the right size and the right resolution to meet your needs. These encoders interface with integrated circuit logic levels. Won't you use our library? Stop in and browse. For more information call any of the numbers listed or write.

Dallas, Texas (214)
EM 3-6417 ■ Dayton,
Ohio (513) 299-5565 ■
Des Plaines, Illinois
(312) 827-8141 ■ Hunts-
ville, Alabama (205)
539-9396 ■ Monrovia,
California (213)
359-5381 ■ New York,
New York (212) 661-4070
■ Pasadena, California
(213) 681-7152 ■ Wash-
ington, D.C. (202)
244-8700

*Monostrophic: See page 24 of DATEX
"How to Use Shaft Encoders" textbook.

DATEX

GIANNINI CONTROLS CORPORATION

1307 S. MYRTLE AVE., MONROVIA, CALIFORNIA 91017

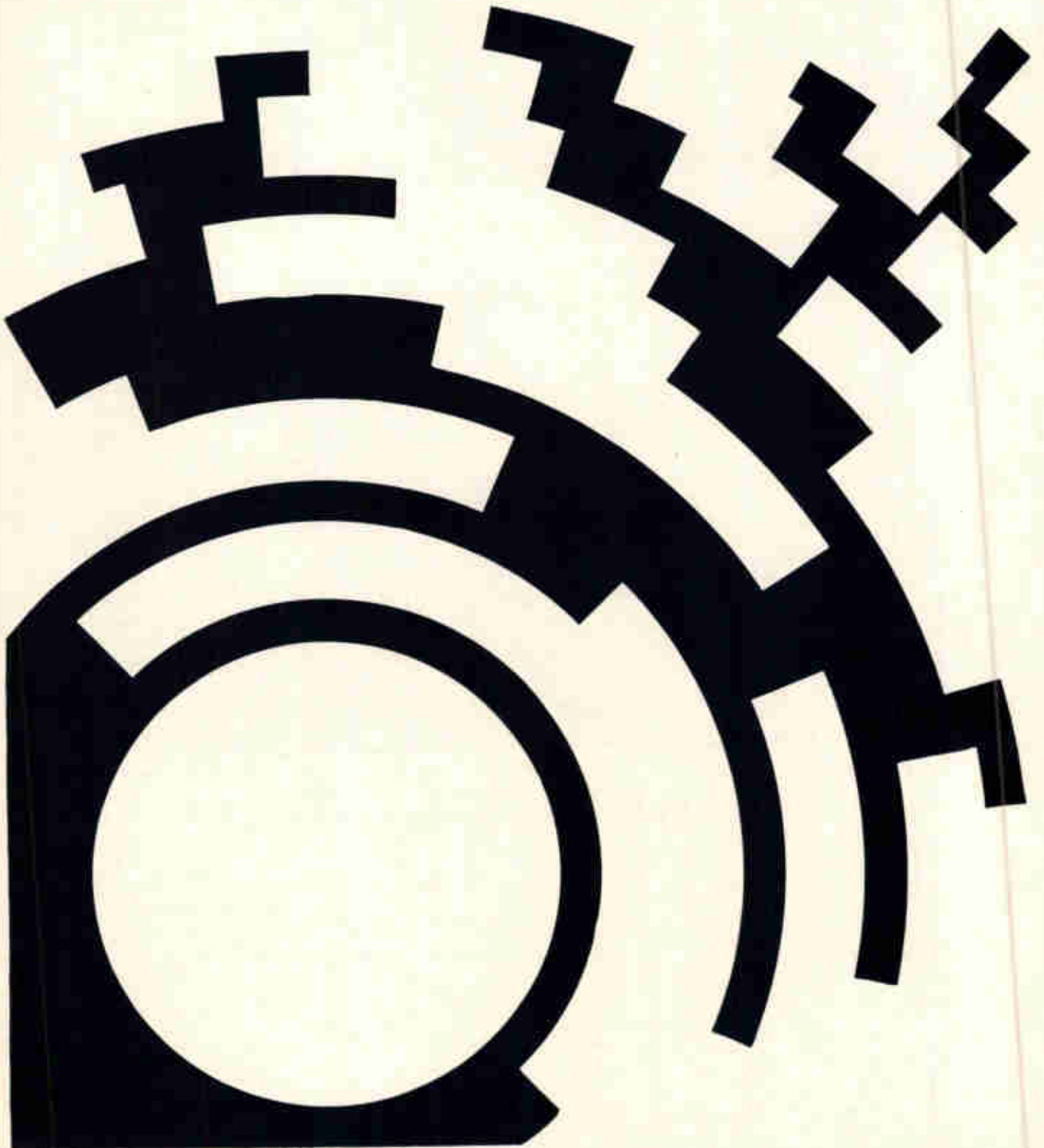

Boeing wants it that way. One Microstack provides permanent nondestructive memory for operating instructions and data words with a design reliability goal of 100,000 hours MTBF. The other provides a temporary memory for incoming and outgoing messages with a design reliability goal of 5,000,000 hours MTBF.

One of the reasons Boeing uses Microstacks is their unique design. A folded-array originated by Indiana General. The

"X" and "Y" axis of all the memory planes are continuously wired. This reduces solder connections 80%, greatly increasing reliability as well as cutting size and weight. This folded-array is specially-packaged to meet Mil. Spec. temperature, humidity, shock and vibration, and extreme environment requirements.

Another reason was our ability to develop cores to Boeing's specifications. We invented the ferrite memory core and

make and sell more of them than anyone. Our facilities for developing and producing cores and stacks are second to none.

If you need Mil. Spec. type memory units find out about Microstacks and our core capabilities. Write Mr. Thomas Loucas, Manager of Sales, Indiana General Corporation, Electronics Division/Memory Products, Keasbey, N. J.

INDIANA GENERAL 

**There are two Microstack[®] memory units
in Minuteman II. One remembers. The other forgets.**

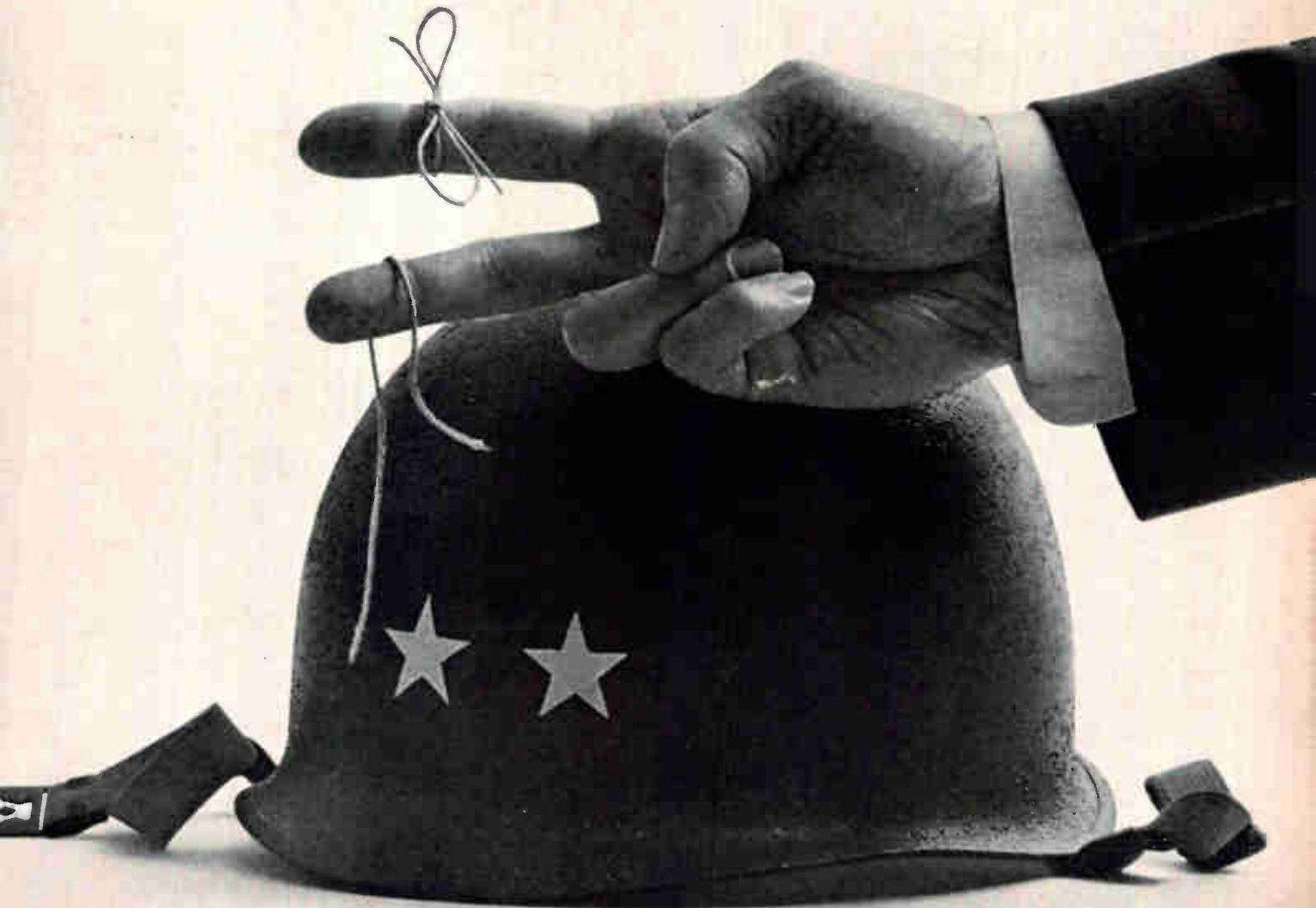

Semiconductor Report



NEW PRODUCTS, DESIGN AND APPLICATION INFORMATION FROM MOTOROLA

Motorola EPICAP Diodes 1N5139-48 & 1N5139A-48A

TYPE	CAPACITANCE VALUE pF 1 MHz & 4V Typ.	FIGURE OF MERIT Q 50 MHz & 4Vdc Min.	PRICE 100-up
1N5139	6.8	350	\$3.90
1N5140	10	300	3.90
1N5141	12	300	3.90
1N5142	15	250	3.90
1N5143	18	250	3.90
1N5144	22	200	3.90
1N5145	27	200	3.90
1N5146	33	200	3.90
1N5147	39	200	3.90
1N5148	47	200	3.90

† "A" versions are priced at \$4.30 (100-up)

NEW MOTOROLA EPICAP* DIODES GREATLY SIMPLIFY ELECTRONIC TUNING

If you've been struggling with cumbersome mechanical assemblies, or low Q electric tuning devices, and "living with" limited reliability in your tuning circuits — RELAX!

Now, you can enjoy all the advantages of automatic, electronic tuning — at about half the price you might expect to pay — with new, high Q EPICAP diodes from Motorola.

For example, in Electronic Countermeasures (ECM) equipment, the EPICAP diode can be used with a "saw-tooth wave" design to automatically sweep a broad frequency range (200 to 400 MHz); and, in the process, eliminate the need for a clumsy sweep generator motor. (Drop a note to our applications group if you'd like more information on this one.)

You'll also find EPICAPS well-suited for difficult tuning jobs in other RF applications such as FM tuning, aircraft radio, etc. In fact, in every application above 200 MHz, you'll get faster, more reliable performance — the highest performance/lowest cost combination in the industry, for applications up to 500 MHz.

These new voltage-variable capacitors feature improved fabrication techniques which yield a low leakage and a Figure of Merit (Q) that's specified at a minimum of 200 at 50 MHz and a bias of 4 volts dc. In addition, EPICAPS boast a 20 nanoamp reverse leakage current, due to the good, "clean" surfaces you'd expect in a high quality diode — your assurance of maximum reliability. And, the rugged, new Ramrod* (straight-through) DO-7 glass diode package adds another measure of increased reliability.

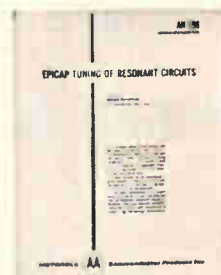

"HOW TO TUNE RESONANT CIRCUITS" COVERED IN NOTE

A comprehensive report that details a step-by-step design procedure and helps you select the optimum EPICAP for your specific application is the subject matter of Motorola Application Note 196. Circuit schematics, equations and a family of curves are used for determination of tuning range as a function of maximum EPICAP capacity to circuit capacity as a parameter.

Figures 1 and 2 (left) show the most common forms taken by EPICAP resonant circuits. The equations and graphs of the report apply to both. For example, a graph has been developed to predict tuning range, using the voltage tunable capacitance and external circuit parameters. The discussion and use of that graph is the major thesis of AN 196. You're sure to find this well-written technical report a valuable addition to your semiconductor library. Write for it today, to Technical Information Center, Motorola Semiconductor Products Inc., P. O. Box 955, Phoenix, Arizona 85001.

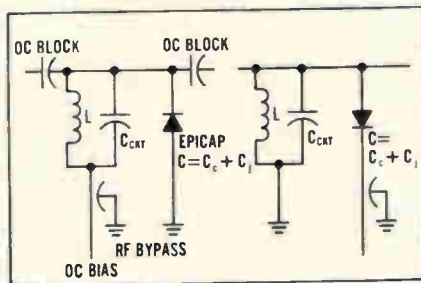

FIGURE 1 — TWO EPICAP TUNED PARALLEL RESONANT CIRCUITS

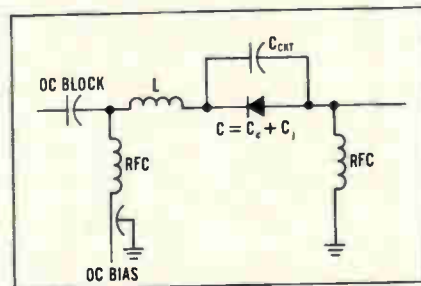

FIGURE 2 — EPICAP TUNED SERIES RESONANT CIRCUIT

*Trademarks of Motorola Inc.



MOTOROLA Semiconductors

Call your nearby Motorola Franchised Distributor for "off-the-shelf" delivery.

Objective:

**To pierce the night
and spot the enemy
with a compact
surveillance
system.**

**Achieved by another
American Optical development:**

**Wide-angle
reconnaissance
lens system
smaller than
a bread box.**

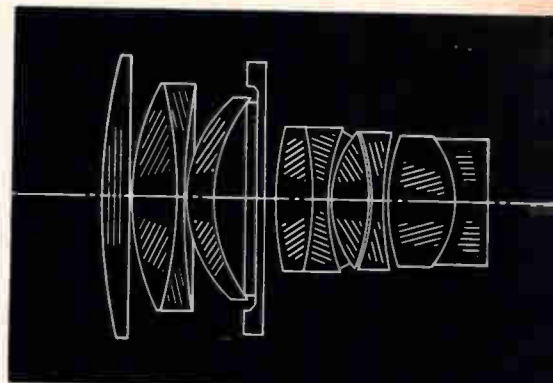

Passive observation of terrain, under the cover of darkness, is essential for up-to-date intelligence. To accomplish this task, airborne systems further require minimum weight and space characteristics. Combining its recent innovations in fiber optics and optical design, American Optical produced the compact but powerful 136 Hytar lens system. Speed : $f/0.8$ (adjustable to $f/16$ for daytime

operation) ; range : 7 ft. to infinity ; field angle : 40° . The 8-lb., shock-resistant package can be tucked neatly into the underbelly of a helicopter or mounted in any tactical orientation.

Let American Optical contribute to the solution of your problem. For 132 years we have been advancing optical technology. Our capabilities include materials research, instrument development and production, and systems integration. For help with your optical problem, consult the leader in optics. Write American Optical Company, Space-Defense Division, Dept. 400, Southbridge, Massachusetts 01551.

Investigate these other AO products: 1) Custom Optics, 2) Aspheric Lens, 3) Sights, 4) Laser Glass, 5) Thin Film Coatings

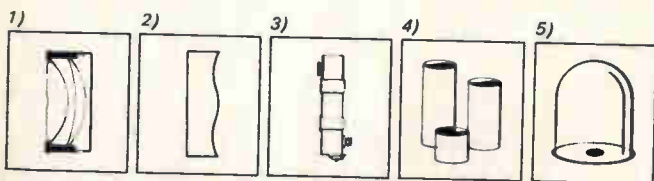

AMERICAN OPTICAL COMPANY
SPACE-DEFENSE DIVISION—SOUTHBRIDGE, MASSACHUSETTS

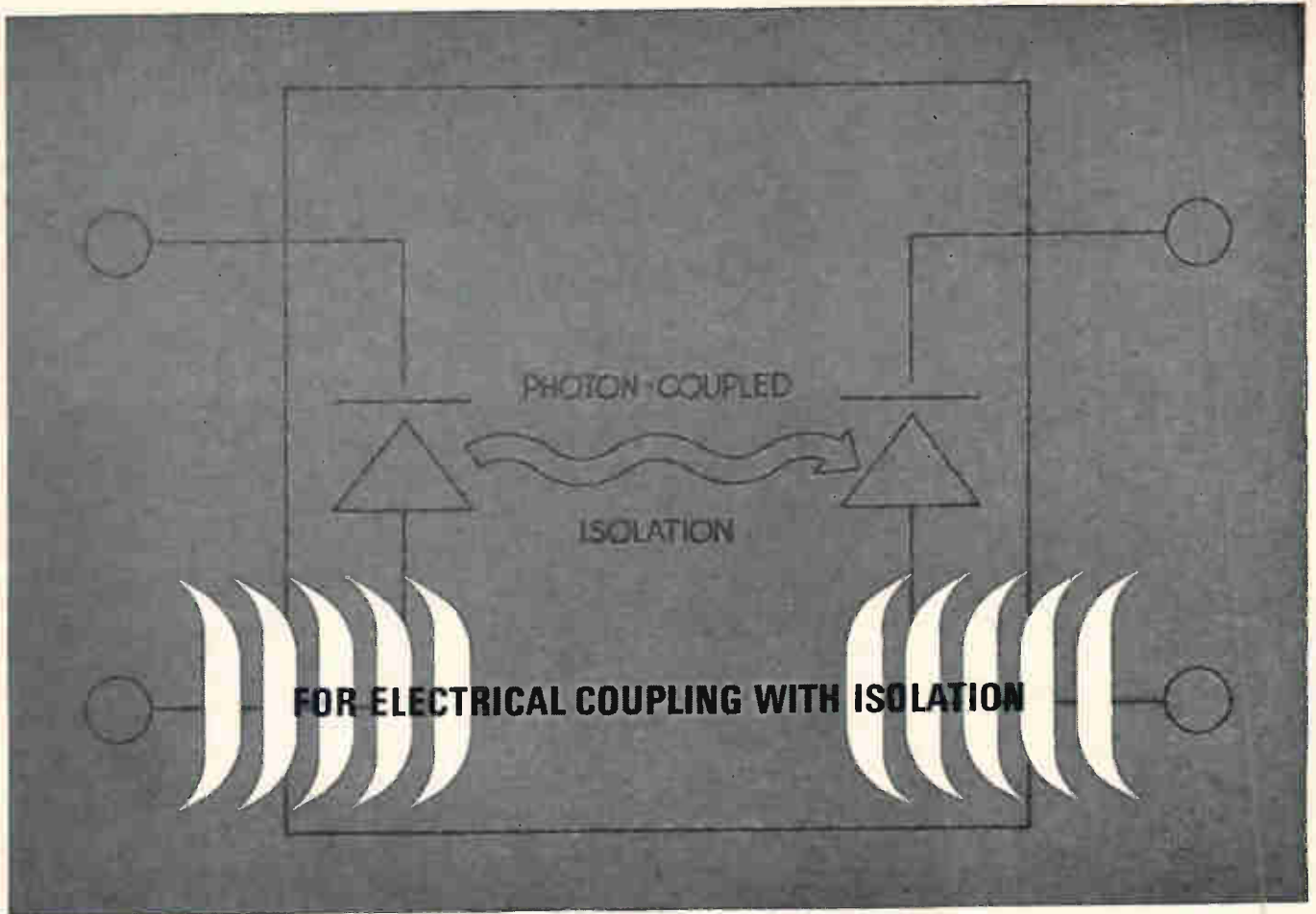

**specify
photon-coupled
isolators
by hpa**

Efficient transfer of electrical energy—with maximum isolation between circuits—is possible now with hp associates' 4310 Photon-Coupled Isolator, newest in the line of hpa optoelectronic devices.

Packaged on a single TO-18 header, the 4310 consists of a low-leakage silicon PIN photodiode, closely coupled to a high-efficiency gallium arsenide infrared light source.

Offering high current transfer efficiency, the 4-terminal device provides electrical decoupling between input and output, DC to MHz.

Other new devices available from hp associates include GaAs light sources and low-leakage detectors.

Contact your Hewlett-Packard field engineer for complete specifications and application information.

Typical specifications, hpa 4310 Miniature Photon-Coupled Isolator		
		Condition
Current transfer efficiency	0.002	GaAs $I_f=50$ mA PIN $V_r=-25$ V
Capacitive coupling between input and output diodes	2 pf	$f=1$ MHz
Resistive coupling between input and output	10^{11} ohms	
Output diode saturation current	10 nA max	$V_r=-20$ V $T=25^\circ\text{C}$
Maximum ratings (output diode): Peak inverse voltage Steady reverse voltage Power dissipation	200 V 50 V 125 mW	$T=25^\circ\text{C}$
Maximum rating (input/output): Working voltage	200 V	
Prices: 1-9 10-99	\$55.00 \$46.75	

Data subject to change without notice. Prices f.o.b. factory.

1023



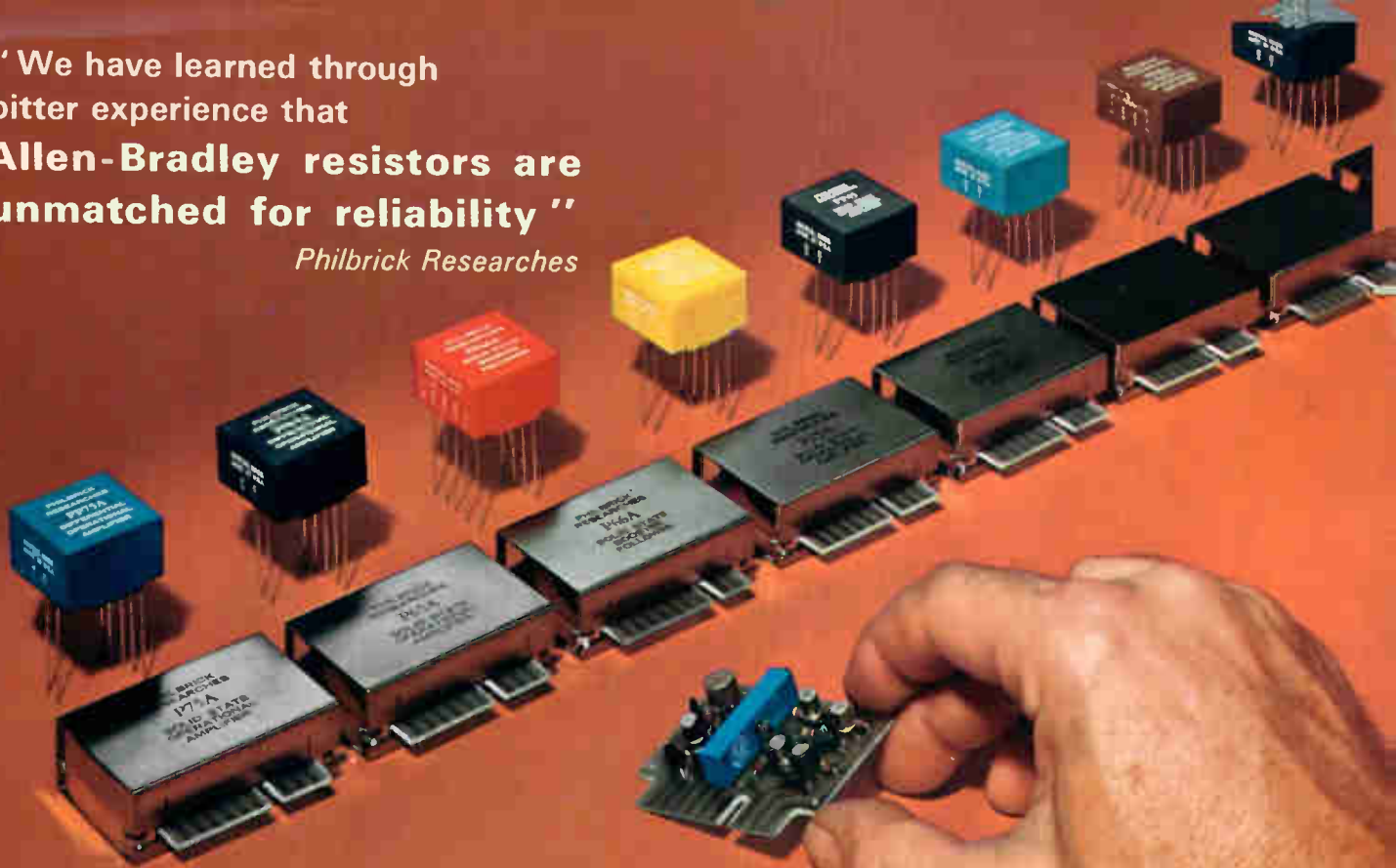

hp associates 620 PAGE MILL ROAD,
PALO ALTO, CALIF. 94304, (415) 321-8510
An Affiliate of Hewlett-Packard

"We have learned through bitter experience that Allen-Bradley resistors are unmatched for reliability"

Philbrick Researches



Typical Philbrick solid state operational amplifiers. The Model P65A differential operational amplifier with cover removed shows the use of Allen-Bradley hot molded fixed resistors and an Allen-Bradley Type N adjustable fixed resistor for zero balance adjustment.

TYPE BB 1/8 WATT		MIL TYPE RC 05
TYPE CB 1/4 WATT		MIL TYPE RC 07
TYPE EB 1/2 WATT		MIL TYPE RC 20
TYPE GB 1 WATT		MIL TYPE RC 32
TYPE HB 2 WATTS		MIL TYPE RC 42

HOT MOLDED FIXED RESISTORS are available in all standard EIA and MIL-R-11 resistance values and tolerances, plus values above and below standard limits. Shown actual size.

The need for a yearly production capacity of well over a billion units is a testimonial to the uniformity and reliability of all Allen-Bradley hot molded resistors.

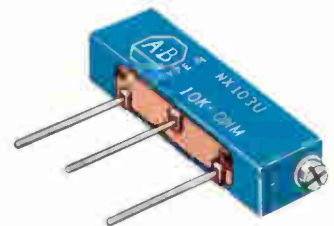

Type N hot molded adjustable fixed resistor rated 1/8 watt at 50°C ambient. Available with nominal resistance values from 100 ohms to 2.5 megohms with tolerances of ±10% and ±20%.

■ "Why have Allen-Bradley hot molded resistors been our first choice since the late 1940's? In a word: Reliability!" states Philbrick—the leading manufacturer of operational amplifiers. There's nothing accidental about this superiority of A-B resistors. A unique hot molding process using completely automatic machines, eliminates the "human element" and produces such uniformity from one resistor to the next—year in and year out—that long resistor performance can be accurately predicted. No instance of "catastrophic failures" has ever come to our attention.

Allen-Bradley Type N adjustable fixed resistors likewise use a solid hot molded resistance track. Adjustment is so smooth, it approaches infinite resolution—and settings remain fixed. Being noninductive, Type N controls can be used at high frequency, where wire-wound units would be completely unsatisfactory.

For more details on the full line of Allen-Bradley quality electronic components, please write for Publication 6024: Allen-Bradley Co., 222 W. Greenfield Ave., Milwaukee, Wis. 53204. Export Office: 630 Third Ave., New York, N.Y., U.S.A. 10017.



ALLEN-BRADLEY
QUALITY ELECTRONIC COMPONENTS

Yes—Allen-Bradley hot molded potentiometers cost more, but—

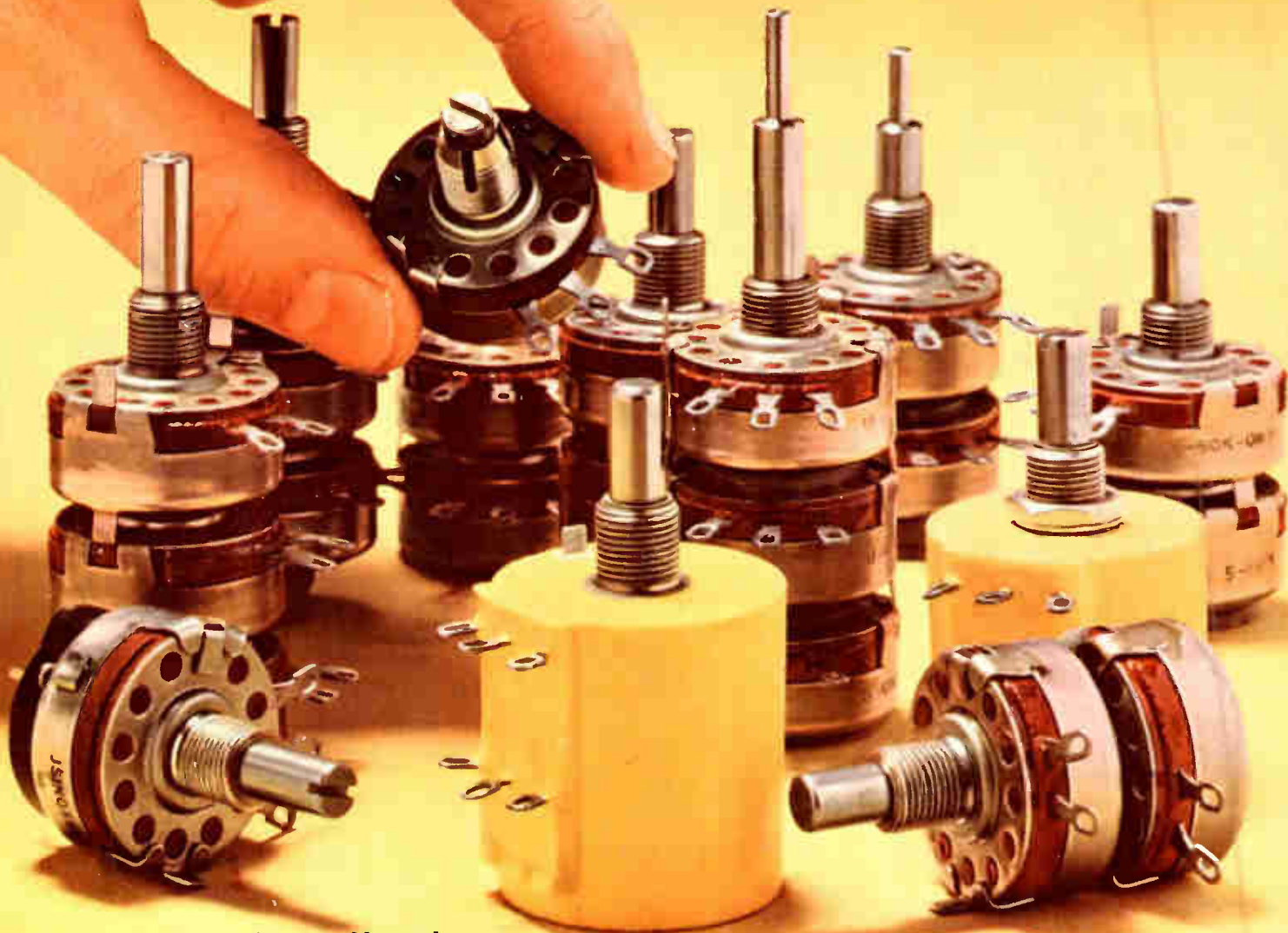

for critical applications
they prove themselves far superior—and well worth the price

■ When a potentiometer in your equipment does not provide the kind of service expected of it—or fails completely—it is only natural for the user to blame you, the manufacturer of the respective instrument. After all, you selected the lower cost component, and your engineer or your purchasing agent decided that “it was good enough.” Correcting the mistake usually runs into real money—it does not necessarily eliminate your customer’s dissatisfaction. However, you can protect yourself and your customers against such potentiometer failures by joining the ever growing list of the nationally recognized equipment manufacturers who are standardizing on Allen-Bradley potentiometers.

The resistance track of all Allen-Bradley potentiometers is hot molded—a process developed and used only by Allen-Bradley. Resistance adjustment is always smooth—never an abrupt change. Though the initial noise level is very low, it is still further improved with use. The long life of all A-B potentiometers is a fact, established by

performance during the many years that these controls have been on the market. For instance, on “speeded up” tests this “life” will exceed 100,000 complete operations, with less than 10% resistance change. And during the 30-year history of this control there has never been recorded a single catastrophic failure.

Protect your reputation as a quality equipment manufacturer by having your purchasing specification call for Allen-Bradley hot molded potentiometers. They are available in single, dual, and triple units. Can be equipped with a 2 ampere 125 volt line switch. Dual units can be supplied with vernier control that provides 20 times finer setability than obtainable with a single control. Units for T, L, and Bridged T and H attenuators are also available. Yes—Allen-Bradley controls *cost slightly more*, but they are *worth much more*. For more details please write: Allen-Bradley Co., 222 W. Greenfield Ave., Milwaukee, Wisconsin 53204. In Canada: Allen-Bradley Canada Ltd. Export Office: 630 Third Ave., N.Y., N.Y., U.S.A. 10017.



ALLEN-BRADLEY
QUALITY ELECTRONIC COMPONENTS

Kynar* is Tough! That's why it's used on...

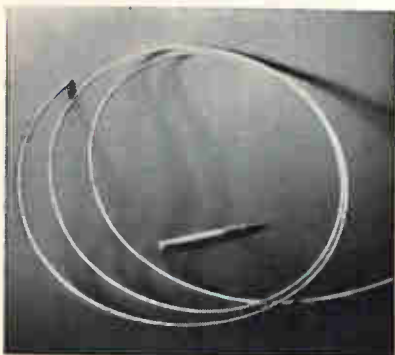

cable jackets

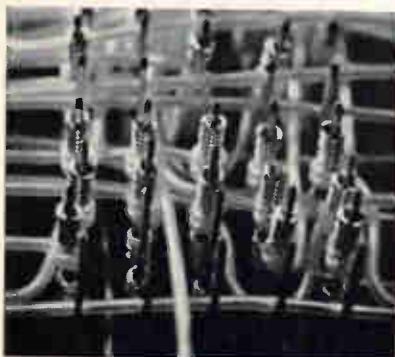

hook-up wire

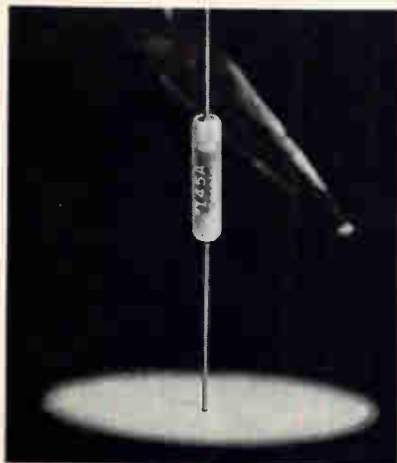

component sleeves

In all three cases, insulation of Kynar* was selected because of its outstanding toughness . . . resistance to cut-through and abrasion, dimensional stability and mechanical strength.

What's more KYNAR won't degrade with age or severe environmental conditions. It is resistant to a wide variety of solvents and

provides excellent protection under conditions of flex and vibration at temperatures from -80° to 300° F.

If your design calls for an insulating material that's tough . . . really tough . . . ask your supplier about Kynar. Or, write Plastics Department, Pennsalt Chemicals Corporation, 3 Penn Center, Philadelphia, Pa. 19102

Kynar...the fluoroplastic that's tough!

*Kynar is a registered trademark of Pennsalt Chemicals Corporation.





When it comes to electrical tapes, Mystik is king!

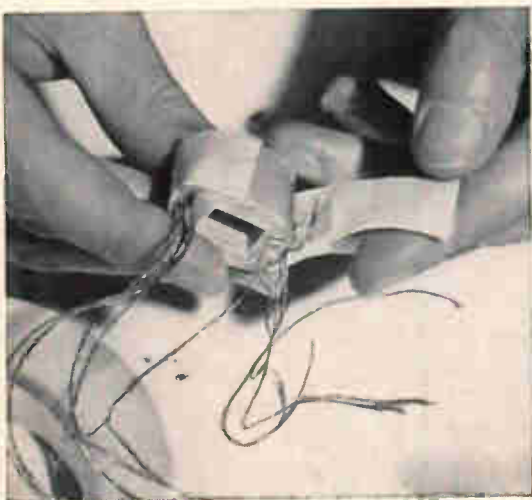

No doubt about it, Mystik leads the field in special-purpose tapes. Our extensive line of top quality products are perfect for hundreds of applications ranging from conventional industrial uses to the more sophisticated demands of the space age.

Mystik tapes are made in a wide range of materials including paper, plastic, cloth and glass cloth as well as many types of films and foils. They provide physical and performance characteristics of every description and are suitable for binding, shielding, strapping and insulating. Mystik pioneered tapes with heat-resistant silicone adhesives that grip like a vise even when exposed to high temperatures. Other new tapes are continually being developed to keep pace with the needs of the rapidly-expanding electrical industry.

We'll gladly prove our right to the "crown". Our local distributor will assist you in selecting the right tape for your application. He's in the Yellow Pages under "Tape" or write The Borden Chemical Co., Mystik Tape Div., 1700 Winnetka Ave., Northfield, Ill.



**BORDEN
CHEMICAL**

© 1966



For A New Source Of Quality Components Visit

JAPAN ELECTRONICS SHOW '66

Tokyo
September
20-29

MITSUMI
COMPONENTS



New Flat Tip
MICRO-MOTOR

The M35A-1 flat DC motor is newly developed for tape recorders use.

MODEL (M35A-1)

Voltage range	6.5-9V
Rated voltage	8V
Current no-load	40mA
Rated load	15 gcm
Current rated load	130mA
Speed at rated load	2,000±50 rpm
Starting torque	60 gcm
Outer dimensions	dia. 35×length 30mm
Bearing	Oil-impregnated metal

Main Products

Polyvaricon·IFT·Oscillator coil·Antennacoil·Composite coil·Specialeoil·Micromotor·Synchronous motor·Trimming potentiometer·FM tuner TV tuner
·Various sockets·CdS photoconductive cell.



MITSUMI ELECTRIC CO., LTD.

Mitsumi Electronics Corporation: 11 Broadway, New York 4, N.Y. 10004, U.S.A.
Tel: HA-5-3085, -3086
Chicago Branch: 333, N. Michigan Avenue, Chicago, Illinois, 60601, U.S.A.
Tel: 263-6007
Düsseldorf Office: Marienstrasse 12, Düsseldorf, W. Germany.
Mitsumi Co., Ltd: 302, Cheong Hing Building, 72, Nathan Road, Kowloon, Hong Kong.
Main Office: 1056, Koadachi, Komae-machi, Kitatama-gun, Tokyo, Japan.
Tel: Tokyo-415-6211/23

JAPAN ELECTRONICS SHOW '66

porthole to the progress of the Japanese Electronics Industry



THE IDEAL OPPORTUNITY TO SATISFY ALL YOUR REQUIREMENTS

Place: Tokyo International Trade Center, Harumi, Tokyo

Exhibits: All Types of Electronic and related Equipment and Parts including International Exhibits

Services: *Free Admission: traders are invited during Sept. 20-22
*Official Show Catalogue *English Speaking Guide Service *Shuttle Bus Service, etc.



ELECTRONIC INDUSTRIES ASSOCIATION OF JAPAN

14 Marunouchi 3-Chome, Chiyoda-ku, Tokyo Cable: ELINDASO TOKYO

Information also available through:

Electronics Sec.
Japan Light Machinery Information Center
437 5th Ave., New York Phone: Mu 6-0731

Light Machinery Center JETRO
Duesseldorf, Berliner Allee 32 Phone: 12351-3



For A New Source Of Quality Components Visit
JAPAN ELECTRONICS SHOW '66

Tokyo
 September
 20-29

New reliability in radio and teleprinter communications from Mitsubishi

Mitsubishi Electric presents a recently developed parametric ARQ terminal system designed to increase the reliability of radio telegraph circuits. Designated the TZ-4 ARQ, this equipment reduces error rates in teleprinter traffic, while bringing a level of accuracy in radio traffic that approaches that of the cable circuit.

Model TZ-4 ARQ provides a duplex system (2 x 2 ch.) or a quadruplex system (1 x 4 ch.) in a single cabinet. Eight-extendors and four-subdividers are also included. Model TZ-4 ARQ is designed in accordance with new CCIR recommendation No. 342. For further information, a card bearing your name and address and sent to Mitsubishi Electric, Tokyo, Japan, will bring full particulars.



MITSUBISHI ELECTRIC CORPORATION
 Head Office: Mitsubishi Denki Bldg., Marunouchi, Tokyo. Cable Address: MELCO TOKYO

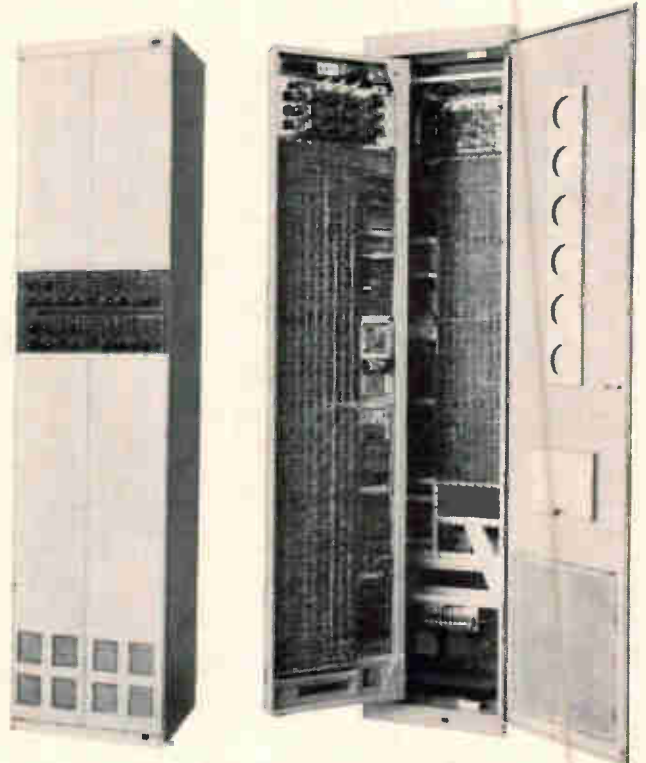

Circle 473 on reader service card



"Statitt" — Technical Ceramics developed by Nihon Steatite

Steatite, Forsterite, Alumina
 Low-loss, High strength, Close dimensional tolerance, Smooth surface.

- for Film resistor substrate
- photo conductor substrate
- Trimmer substrate
- Film resistor bobbin

Special orders accepted

Manufacturer:



NIHON STEATITE INDUSTRY CO., LTD.
 Ohno Bldg., No. 5, 4-chome, Nihonboshi, Chiyoda-ku, Tokyo, Japan.

Authorized sole exporter:



SANSEI ELECTRONICS CORPORATION.
 Kinsan Bldg., No. 5, 4-chome, Nihonboshi, Muromachi, Chuo-ku, Tokyo, Japan

DX TV ANTENNAS ARE RENOWNED THROUGHOUT THE WORLD!!



BUSINESS ACTIVITIES

- Manufacture of DX Television Antenna's.
- Sales of DX Television Antenna's Accessories.
- Sales of DX Twin Lead Wires & Cables.
- Sales of Various apparatus for TV Community Reception.

MANUFACTURERS
DX ANTENNA CO., LTD.
 No. 6, Irie-dori 5-chome, Hyogo-ku, Kobe, Japan.

Metronix

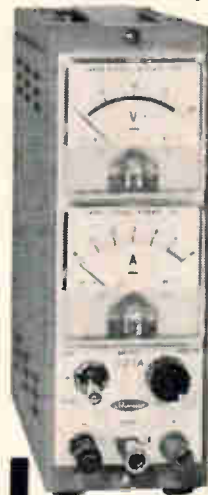

REGULATED DC POWER SUPPLIES

MODEL **521A**

RIPPLE: 3mVp-p

MODEL	VOLTS	AMPS	REGULATION (line or load)
521A	1-18V	0.5A	± 20mV
541A	1-35V	0.25A	± 20mV
543	1-35V	0.5A	± 20mV
531B	0-35V	1A	± 10mV
535C	0-35V	5A	± 3mV

Metronix corp.
 76, CHOFU-CHIDORI-CHO, OTA-KU, TOKYO, JAPAN



For A New Source Of Quality Components Visit

JAPAN ELECTRONICS SHOW '66

Tokyo
September
20-29

Primo

DM-1332

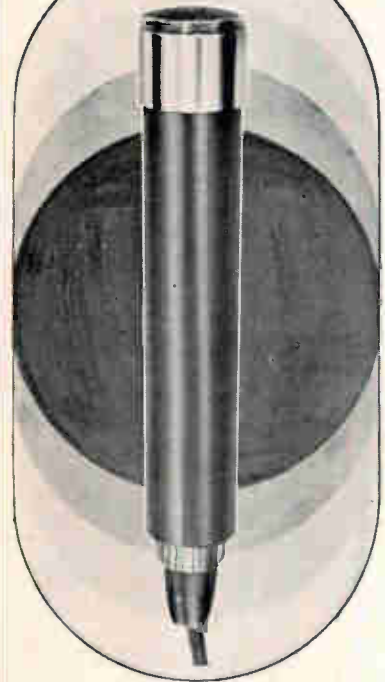

Super High Sensitivity
SOUND LEVEL METER
MICROPHONE (DYNAMIC TYPE)

Specifications

- Frequency Response: 20-16,000%
±1.5dB
- Impedance: 50 Ω ±10%
- Sensitivity: -84dB ±2dB
- Dimensions: 35φ x 220mm
- Weight: 730 gm.

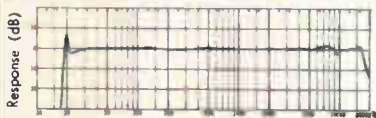

For catalog write to

PRIMO COMPANY LTD.

HEAD OFFICE:
2043 MURE, MITAKASHI, TOKYO, JAPAN
TEL. 0422-43-3121

TBM VOLUME CONTROL



Photos: Actual Size

102-S₂

Tsubame Radio Co., Ltd.,
a leading manufacturer of
Volume Controls, provides the
highest reliability available,
for your specific requirements.

Above shown Model 102-S₂ is
suitable for any narrow corner
for TR Radio and Hearing Aid.



• For more details write to:

TSUBAME RADIO CO., LTD.

18-2-1-chome Omori-Higashi Ohta ku
Tokyo Japan

Circle 477 on reader service card

Improving
quality and sound
when using

Orion Speaker

**New
product:**

Model: CMF-65

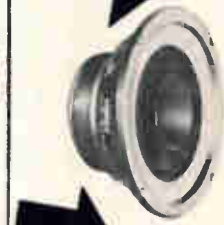

Size: 6"
Rated power: 8W
Frequency range:
40 c/s-16,000 c/s
Magnet weight: 13 oz

We manufacture various
kinds of speakers for :

1. Radio & TV,
2. Tape Recorders,
3. Autos,
4. Public Addresses,
5. Outdoors,
6. Intercom,
7. Electric Guitars,
8. High-Fidelity Systems.

Please write for further information to:
TONEGEN ELECTRIC CO., LTD.

37, 1-chome, Furuichi Minamidori, Joto-ku, Osaka, Japan.
Cable Address TONEGEN OSAKA

Circle 478 on reader service card

High selectivity and stability



CERAMIC FILTER

Murata ceramic filters
include the series type, the
by-pass type and ladder type.

These filters are compact,
require no alignment or tun-
ing, remain perfectly flat
regardless of temperature
changes and stay in A-I oper-
ating condition for years. And
they're designed to provide
effective operation beyond
the scope and capacity of
IFT.

Write today for detailed
information to:

MURATA MFG. CO., LTD.

Nagaoka, Kyoto, Japan
Cable Address: MURATA KYOTO

MURATA CORP. OF AMERICA
440 Park Avenue South, New York
N. Y. 10016

Circle 91 on reader service card

Circle 476 on reader service card



For A New Source Of Quality Components Visit **JAPAN ELECTRONICS SHOW '66**

Tokyo
September
20-29

TAKAMISAWA CHALLENGE THE FUTURE

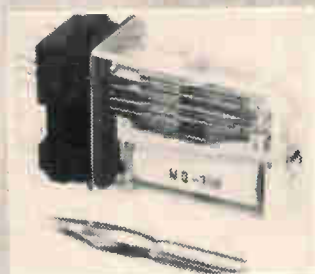

MQ Series; miniature DC relay



MA Series; plug-in Power relay

Tiny toys to Computers,
Takamisawa Electric Co.,
Ltd. manufacture all kinds
of RELAY for 50 years.
Takamisawa Electric Co.,
Ltd. conquer the future
with quality.



TAKAMISAWA ELECTRIC CO., LTD.

1-4-35 Koyama-cho
Shinagawa-ku, Tokyo, Japan
For catalogs, please write to Planning Dept. H.T

MEASUREMENTS OF WOW AND FLUTTER

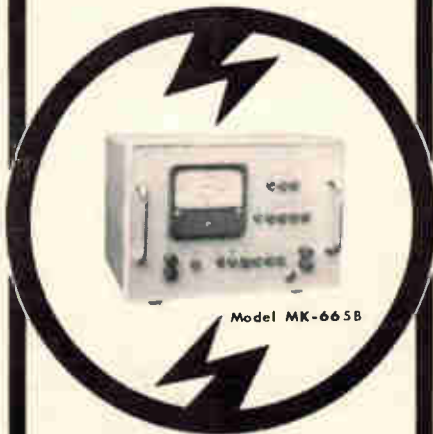

Model MK-66 5B

A solid state sensitive and compact instrument for rapid and accurate determination of wow and flutter in sound recorders and reproducers.

Main Products:

- Standard Signal Generator
- Sweep Generator
- Distortion Meter
- Wow Flutter Meter
- AC and DC Vacuum Tube Voltmeter
- Q Meter

● Catalog sheet on request



MEGURO DENPA SOKKI K.K.

Measuring Electronic Instruments Co. Ltd.
5-1, 2-chome, Chuo-cho, Meguro-ku, Tokyo, Japan
TEL. 311-7191 7 Lines, MEGURODENPA TOKYO

Circle 481 on reader service card

COSMOS

GUARANTEED HIGH QUALITY



COMMUNICATION RECEIVERS for fire calls and police calls



Model RPA 30-175

RPA 30-175

SPECIFICATIONS:

Frequency range: 30~50, 148~175
mega-cycles
Sensitivity: Same as RPA 30-50 &
RPA 148-175
Audio output: 0.8 watts
(Less than 10% distortion)
RF input impedance: 50~70 ohms
Input power required: 117V AC60eps, 50 watts
Dimensions: 328(W)×190(D)×127(H)

TOKYO COSMOS ELECTRIC CO., LTD.

Head Office: 303, Horinouchi 1-chome,
Suginami-ku, Tokyo, Japan
Phone: 313-1111 (Rep.)
CABLES: "COSMOSDENKI" TOKYO



Your
CCTV
Cameras
are
of
superior
quality

Lenses ?



Try
COSMICAR®

Superior cameras deserve superior lenses. COSMICAR's proven precision performance is the combined result of advanced optical engineering and exquisite workmanship.

Now widely used, COSMICAR LENSES come in 23 models for focal lengths ranging from 12.5 mm to 500 mm, and in 3 zoom models including a remote-control zoom.

Your CCTV camera and COSMICAR LENSES will make an unbeatable team. For technical data and other particulars write to:



ICHIZUKA OPTICAL CO., LTD.

568, Shimoochiai, 2-chome, Shinjuku-ku, Tokyo
CABLE ADDRESS: "MOVIEKINO TOKYO"



For A New Source Of Quality Components Visit JAPAN ELECTRONICS SHOW '66

Tokyo
September
20-29

+00001234567890

$$H = \frac{1}{2} \left(\frac{1}{R_1} + \frac{1}{R_2} \right) = \frac{EN+GL-2FM}{EG-F^2}$$

$$K = \frac{1}{R_1 R_2} = \frac{LN-M^2}{GL-F^2}$$

+00001234567890

+0001234567890

MATHEMATICS MADE EASY...

by the quietly efficient COMPET ELECTRONIC DESK CALCULATOR MODEL CS-20A. With many features to be found in no other similar calculator • a special mechanism to ensure that no two keys can be pressed simultaneously • capable of calculating to 14 digits instantaneously • display +, - and decimal symbols automatically • no breakdowns, even when misused • plug-in circuits for easy maintenance •

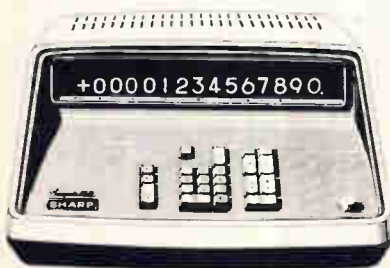

COMPET Model CS-20A



SHARP

... to the point of perfection

HAYAKAWA ELECTRIC CO., LTD.

Osaka, Japan

US Subsidiary: **SHARP ELECTRONICS CORP.**
178 Commerce Road Carlstadt, New Jersey

Circle 483 on reader service card

Meet the **NEW** Marcon MC PACK



Actual size

Set-reset type Flip-Flop Model D-3010, the Marcon MC Pack is a newly-developed thick film circuit. Solid, flat and packed, it gives excellent performance and durability. Ideal for digital and analog circuits. Offers greater applicability because it can be hybridized with semi-conductor IC's.

●●●●●●●● Write today for detailed information.

Other Superior Products: Aluminum Electrolytic Capacitors Tantalum Solid Electrolytic Capacitors Tantalum Foil Electrolytic Capacitors Metallized Paper Capacitors Oil Filled Capacitors

 **TOKYO DENKI CO., LTD.**
9, 4-chome, Nihonbashi-Honcho Chuo-ku, Tokyo, Japan
Cable Address: ELECTROMARCON TOKYO

Circle 484 on reader service card

VISIGRAPH-P

(Direct-recording Oscillograph)

- Up to 6 sharp traced lines which simultaneously records timing grid lines.
- Uses low cost low heat tungsten light source.
- Weighs only eighteen pounds.
- Recording speed, 2, 10, 20, 100 cm/sec.
- Uses new high contrast pink paper.

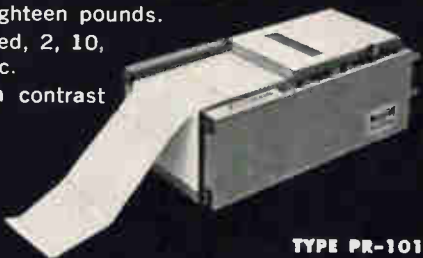

TYPE PR-101

Main Products

"VISIGRAPH" (Direct-recording Oscillograph)	Electroencephalograph
Ink-writing Oscillograph	EEG Frequency Analyzer
Galvanograph	Electromyograph
DC Amplifier	Polygraph
Dynamic Strain Amplifier	"Bedmonitor"
Oscilloscope Continuous Recorder	"Heartscope"
	"Pulsemeter"

For further information, please write to:

 **SAN-EI INSTRUMENT CO., LTD.**
Specialist in the field of oscillography
Ito Bldg., 1-89, Kashiwagi, Shinjuku-ku, Tokyo, Japan
Cable: "SANEIINSTRUMENT" Tokyo

Circle 93 on reader service card



For A New Source Of Quality Components Visit JAPAN ELECTRONICS SHOW '66

Tokyo
September
20-29

NCC to be Sure

400V
.047µFMS

Type MXT



Type MFK



Type MFL

POLYESTER FILM CAPACITORS.

Type MXT

In Plastic Tube.

Capacitance

Range : .001 MFD to .22 MFD.

Voltages : 100v, 200v, 400v, 600v DC.

Type MFK

Dipped Flat Shape. Non-Inductive

Construction.

Capacitance

Range : .01 MFD to .22 MFD.

Voltages : 100v, 200v, 400v, 500v DC.

Type MFL

Dipped Flat Shape.

Capacitance

Range : .001 MFD to .47 MFD.

Voltages : 35v, 50v, 100v, 200v DC.

FNX 05W1H
10µF
50VDC

METALLIZED POLYESTER FILM CAPACITORS.

Type FNX-H

Mylar Wrapped Semi oval with Epoxy

End Seal.

Capacitance

Range : 1 MFD to 10 MFD.

Voltages : 50v DC.

Type TAX

25V

Type TAS

SOLID TANTALUM CAPACITORS.

Type TAX

Capacitance

MIL-C-26655A Hermetically Sealed. Range : 1 MFD to 220 MFD.

Type TAS

Voltages : 3v, 6v, 10v, 15v,

Sealed with Epoxy Resin.

20v, 25v, 35v DC.

for full details, contact :

MATSUO ELECTRIC CO., LTD.

3-chome, Sennori-cho, Toyonoko-shi, Osaka, Japan
Cable Address "NCC MATSUO" OSAKA

See For Yourself By Testing Sankyo's Family Of Micro Motors and Time Switches !



DFC



TS60-S

DFC.....Automatic defrost timer for refrigerators. Defrost time 30 minutes for every 12 hours. Other specifications are available. 100 to 240 VAC, 50 or 60 cps, 1 to 5 amp.

TS60-S.... Spring wound time switch, 60 minutes, 100 to 240 VAC, 50 or 60 cps, 5 amp. Other models for 5, 15 and 45 minute timers are also available.



MMP55



DMT1

DMT1.....Single speed (2400 rpm). With flat Sealed case. For medium grade tape recorders.

MMP55.... 2 speeds (2700, 4800 rpm). For 8 mm cameras.

SPECIFICATIONS FOR SANKYO MICRO MOTORS

	Dimension (mm)	Rated Voltage (V)	Range of Voltage (V)	Rated Torque (gr-cm)
	φ Length			
DMT1	42 × 37	6	4.5 - 6	9
DY15	42 × 37	6	4.5 - 6	15
DY50	42 × 37	12	8 - 12	15
MMS44	25 × 55.5	9	6 - 10	10
MMS51	25 × 55.5	6	4.5 - 6.3	7
MMP55	20 × 45	4.5	4 - 6	10
MMZ6	16 × 29	4	4 - 6	2

	Rated Speed (rpm)	No Load Current (mA)	Load Current (mA)	Starting Torque (gr-cm)	Life (Hr)
DMT1	2400	40	130	25(4.5V)	600
DY15	2400	50	200	50(4.5V)	600
DY50	2400	50	130	50(8V)	600
MMS44	3000	40	140	20(6V)	600
MMS51	3000 (2900)	50	140	25(4.5V)	1000
MMP55	2700 (4800)	(110)	(290)	60(4.5V)	50
MMZ6	6000 (11500)	(100)	120	15(4V)	100

Sankyo

AMERICAN SANKYO CORP.: Rm. 808-10, 95 Madison Ave., N.Y.C., N.Y., U.S.A. Tel: LE-2 8020
SANKYO EUROPE: c/o DEUTSCHE MITSUBISHI, Dusseldorf, Ludwig-Zimmermann-Strabe, West Germany Tel: 8691
SANKYO SEIKI MFG. CO., LTD.: Shimbashi, Tokyo, Japan.

6 BIT A TO D CONVERTER 15,000,000 CONVERSIONS PER SECOND



MODEL 834A ANALOG TO DIGITAL CONVERTER

Well-suited for telemetering or process control Long life and high stability All solid state, silicon semi-conductors

SPECIFICATIONS

Method: successive comparison. Digital Output: B.C.D. 12 bit parallel. Stability: ±0.2%/6 months. Conversion time: approximately 240µs. Operating temperature: -10°C to +50°C. Width: 480 mm. Height: 199 mm. Depth: 225Dm/m. AC Input: 100/110/220/240V±10% 50 or 60 c/s.

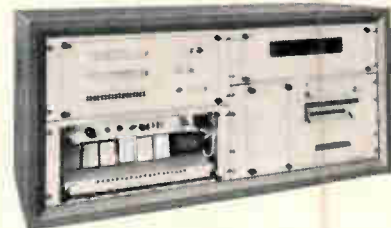

MODEL 198C DATA LOGGING SYSTEM

All solid state Random access analog scanner High reliability and accuracy Operates over large temperature ranges Low cost

SPECIFICATIONS

Scanning capability: 16 channels. Scanning speed: up to 5 channels per second. Accuracy: 0.1%. Output: printing paper tape. Logging cycles: 10 seconds to 1 hour (specify on ordering). AC Input: 100/110/220/240V ±10% 50 or 60 cps (specify on ordering).



MODEL 507C DIGITAL VOLTMETER

All solid state and high speed.

SPECIFICATIONS

Measuring range: (1) 0.001 to 1.599 volts
(2) 0.01 to 15.99 volts
(3) 0.1 to 159.9 volts
(4) 1 to 1,599 volts

Accuracy: 0.1% of full scale. A/D conversion time: 600µs. Max. repetition rate: 1 kc. Reading mode auto: 100 c/s repetition rate. Digital output: 4 digit decimal 10C1, parallel code connectable to the line printer Operating temperature: 0 to 40°C. Width: 480mm. Height: 199mm. Depth: 350mm. Weight: approx. 13 kg. AC Input: 100/110/220/240V 50 or 60 cps.

CHUO ELECTRONICS CO., LTD.

No., 21 Motohongo-machi, Hachioji-shi, Tokyo, Japan



For A New Source Of Quality Components Visit JAPAN ELECTRONICS SHOW '66

Tokyo
September
20-29

HARMONIOUSLY SUPERIOR COMMUNICATIONS A MUST IN MODERN BUSINESS!

Modern communications equipment designed to meet today's fast-paced business methods has placed Oki Electric among the world's largest, most respected manufacturers of electronics products.

The fully transistorized TRSB-100BE transmitter-receiver system by Oki Electric is a boon to modern business communications, combining sensitive transistorized circuitry with carefully integrated miniature components and silicon epitaxial planar-type transistors developed by Oki.

It offers an advanced yet practical and easily maintained modular construction with plug-in printed panels in nearly all stages, an assurance of stable uniformity and operation regardless of weather, variable voltage or other troublesome conditions.

An Oki-perfected rotary solenoid channel selector is incorporated with front panel push-buttons connected to six pre-set channels ranging from 2 to 18 Mc for quick, easy selection.

And a voice operated key function provides a quasi-duplex communication capability permitting extension of toll telephone communications to out-of-the-way areas without commercial telephone facilities, thus providing the user a quick, economical communication to extremely remote areas.

Optional accessories for the TRSB-100BE include phone-patch and extension telephone, remote control, linear amplifier, hybrid and FS adaptors and Morse key.

MODEL TRSB-100BE



SPECIFICATIONS

Frequency range	2-18 Mc
Channels	6 channels
Weight and dimensions	Transmitter-Receiver unit: 400 x 240 x 471 mm, 30 Kg (approx.)
	Separate power unit: 160 x 220 x 455 mm, 20 Kg (approx.)
	SSB keyed tone 125 W SSB suppressed carrier 125 W P.E.P. Better than 2.5 μ V for 20dB signal-to-noise ratio at 100 mV audio output
Power output	
Sensitivity	

Circle 489 on reader service card

OKI
electric industry
co., ltd. TOKYO JAPAN

10, Shiba Kotohira-cho, Minato-ku, Tokyo, Japan
Telex: TK 2627 Cable Add.: "OKIDENKI TOKYO"
New York Office:
202 East 44th Street, New York 17, New York
Tel: Area 212: 682-2989

Transformer for

MICROPHONE



YOUR assurance of best quality
and quantity
The secret 2-Q's
behind
every Nishimura products



Nishimura Musen-Denki Co., Ltd.

21, Owada-cho, Shibuya-ku,
Tokyo, Japan

Circle 487 on reader service card

TAIYO OHM FIXED COMPOSITION RESISTOR

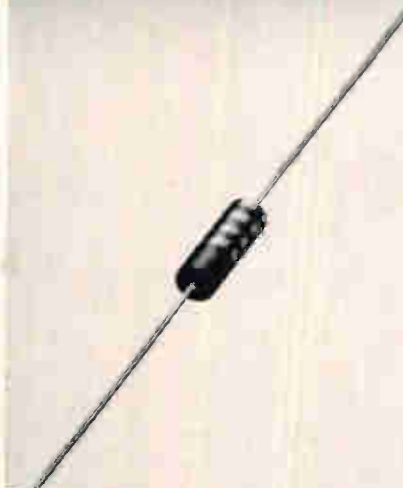

TAIYO DENKI CO., LTD.

1-12, 3-chome, Sunamichi,
Sakai C., Japan.
Phone: Sakai-3-6 8 4 1

Circle 488 on reader service card

NTK CAPACITORS QUALITY absolutely guaranteed!

- ▶ All-welded Construction Miniature Aluminum Electrolytic Capacitors
- ▶ "MD" Metallized Polyester Film Capacitors (Epoxy Resin Sealed Type)
- ▶ "SC" Polystyrene Film Capacitors
- ▶ Filstar (Noise Suppressors)

Other Capacitors:

- MP • Paper Glass Tube, etc.) • Electrolytic Tantalum, Aluminum) • Plastic Film • Mica • Etc.



Sole Sales Rep: (USA & Canada Area)

MH & W INTERNATIONAL CORPORATION

301 Sylvan Avenue, Englewood Cliffs,
New Jersey 07632, U.S.A.

Tel. Area Code: 201-567-9222

N.Y. Tel. Area Code: 212-244-0695



NIPPON COMMUNICATION INDUSTRIAL CO., LTD.

Kawasaki, Japan

Circle 95 on reader service card



For A New Source Of Quality Components Visit

JAPAN ELECTRONICS SHOW '66

Tokyo
September
20-29

NOBLE

METAL FILM and METAL GLAZED RESISTORS

• SEMI-VARIABLE
MODEL: TF6 (METAL FILM)
TM6 (METAL GLAZED)



• FIXED
MODEL: BNI-060-1 (METAL FILM)



• VARIABLE
MODEL: TF10C (METAL FILM)
TM10C (METAL GLAZED)



• COMPOSITE MODULE
MODEL: BPRM52001 (METAL GLAZED
RESISTOR-CAPACITOR)

Photos: Actual Size

MAIN PRODUCTS: Variable Resistor • Electronic Switch • Capacitor • CR Composite Parts • Fixed Resistor • Coil & IFT • Power Resistor



TEIKOKU TSUSHIN KOGYO CO., LTD.

335, Nishinaka-Machi, Kariyado, Kawasaki-City, Japan
PHONE: NAKAHARA(3)3171 TELE X: 286-55
CABLE: KAWASAKI-TEITSU

Circle 490 on reader service card

ULTIMATE IN PERFORMANCE

TOHOKU
METAL'S
NEFERRITE
POT
CORES



NEFERRITE — A new type magnetic ferrite material which offers higher magnetic permeability and a low core loss coefficient even at high frequency. Highly suitable for tele-communication s and electronic equipment.

NEFERRITE CORE Utilized for coils and transformers over a wide frequency range, it tremendously improves functional characteristics and helps reduce their size and weight.

SPECIFICATIONS :

Item	Grade 1		Grade 2		Item	Grade 1		Grade 2	
	10 kc	100 kc	10 kc	100 kc		10 kc	100 kc	10 kc	100 kc
μ	3000	4000	2000	3000	h cm A	15	15	20	20
B Gauss	4200	4200	1000	1000	T F	0.5-10 ⁴	0.8-0.5-10 ⁴	180	180
Br Gauss	1000	1000	0.3	0.3	T F	3-10 ⁴	3-10 ⁴	700	700
Hc Oersted	0.3	0.3	0.7-10 ⁴	0.7-10 ⁴	D F	700	700		
tan δ	10 kc	2-10 ⁴	2-10 ⁴	2-10 ⁴	Φ m				
μ	100 kc	2-10 ⁴	2-10 ⁴	2-10 ⁴					
	500 kc	15-10 ⁴	15-10 ⁴	15-10 ⁴					

U S PAT. No. 3106534

Further information, please write to :

Tohoku Metal Industries, Ltd.

7-4, GINZA-HIGASHI, CHUO-KU, TOKYO, JAPAN
Tel. Tokyo (542) 6171 Cable Address: "TOHOKUMETAL TOKYO"

HIGHEST PERFORMANCE ELECTROHYDRAULIC PULSE MOTOR

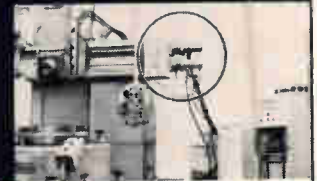
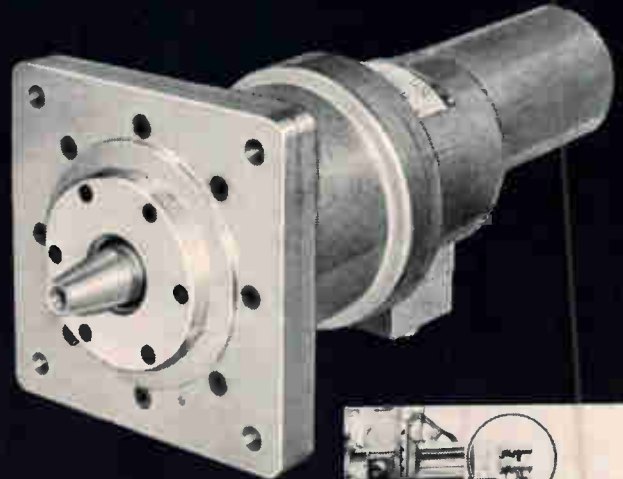

- Needs no external digital-to-analog converter
- Positions without external feedback loop

FUJITSU Electrohydraulic Pulse Motor (EHPM) consists of an electric pulse motor as a digital to analog (D-A) converter and a hydraulic servomechanism for power amplification combined in a single unit. In the EHPM the rotating angle is proportional to the number of input pulses applied and the rotating speed to the pulse rate of the input pulse train.

NEW SPECIFICATIONS OF ELECTROHYDRAULIC PULSE MOTOR

ITEM	MODEL	1.5 SSS	1.2 SSS	1 SSS	3 SSS
Angular increment per pulse, deg.		1.5			
Max. pulse rate, pps		8,000			4,000
Max. starting pulse rate, pps		2,000			
Torque output, kg/cm (at 2,000 pps, 70 kg/cm ²)		35	103	195	600
Power output, hp (at 70 kg/cm ²)		0.8	2	4	6
		at 8,000 pps			at 4,000 pps
Approx. weight, kgs		6	14	18	30

For more detailed information, write FUJITSU EXPORT DEPT. or:

SIEMENS-SCHUCKERTWERKE A.G.
TECHNISCHE STAMMABTEILUNG 31,
8520 Erlangen 2,
Werner-von-Siemens-Str. 50,
West Germany. Phone: 09131811

C. ITOH & CO., (AMERICA) INC.
5th floor, ITT Bldg.
320 Park Ave.
New York 22, N.Y. 10022.
Phone: PLazo 1-4330



FUJITSU LIMITED

Communications and Electronics
Marunouchi, Tokyo, Japan

Circle 491 on reader service card
Circle 97 on reader service card

200,000 OHMS PER VOLT



**Model 630-NS
VOLT-OHM-MICROAMMETER**

TRIPL'ET SUSPENSION MOVEMENT

*no pivots . . . no jewels . . .
no hair springs . . . thus NO FRICTION.*

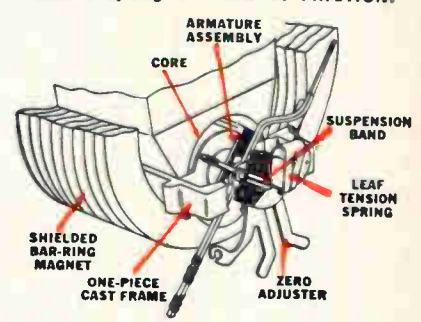

\$10000
SUGGESTED
U.S.A. UPPER NET

FACTS MAKE FEATURES

- 1** 200,000 OHMS PER VOLT D.C. for greater accuracy on high resistance circuits. 20,000 OHMS PER VOLT A.C.
- 2** 5 μ a SUSPENSION METER MOVEMENT. No pivots, bearings, hair-springs, or rolling friction. Extremely RUGGED. Greater sensitivity and repeatability.
- 3** 62 Ranges, usable with frequencies through 100 Kc. Temperature compensated. 1½% D.C. ACCURACY, 3% A.C.

Low voltage ranges and high input impedance make the 630-NS especially useful in transistor circuit measurement and testing. Input impedance, at 55 volts D.C. and above, is higher than most vacuum tube voltmeters.

The unit is designed to withstand overloads and offers greater reading accuracy. Reads from 0.1 μ a on 5 μ a range. Special resistors are rigidly mounted and directly connected to the switch to form a simplified unit. Carrying cases with stands are priced from \$11.00.

TRIPL'ET ELECTRICAL INSTRUMENT CO., INC., 8100 STEEL, OHIO

62 RANGES

D.C. VOLTS	0-0.6-3-12-60-300-1200 at 100,000 Ohms/Volt. 0-0.3-1.5-6-30-150-600 at 200,000 Ohms/Volt. 0-0.150 at 60 μ a
A.C. VOLTS	0-3-12-60-300-1200 at 10,000 Ohms/Volt. 0-1.5-6-30-150-600 at 20,000 Ohms/Volt.
DB	-20 to 77 in 10 ranges.
D.C. MICRO-AMPERES	0-5 at 300 MV. 0-60-600 at 150 MV. 0-120 at 300 MV.
D.C. MILLI-AMPERES	0-6-60-600 at 150 MV. 0-1.2-12-120-1200 at 300 MV.
D.C. AMPERES	0-6 at 150 MV. 0-12 at 300 MV.
OHMS	0-1K-10K-100K (4.4-44-440 at center scale)
MEG OHMS	0-1-10-100 (4400-44,000-440,000 Ohms center scale)

OUTPUT: Condenser in series with A.C. Volt ranges.

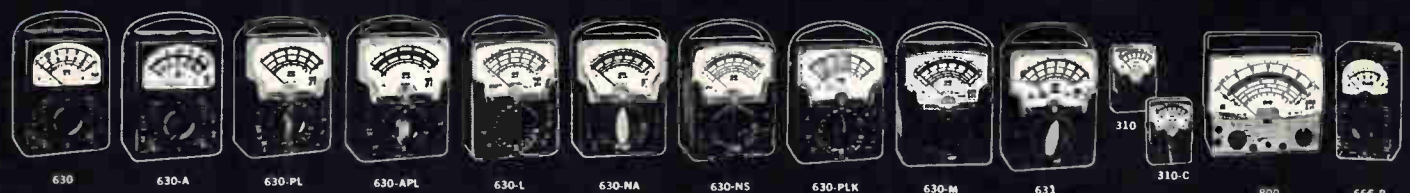

THE WORLD'S MOST COMPLETE LINE OF V-O-M'S. AVAILABLE FROM YOUR TRIPL'ET DISTRIBUTOR'S STOCK.

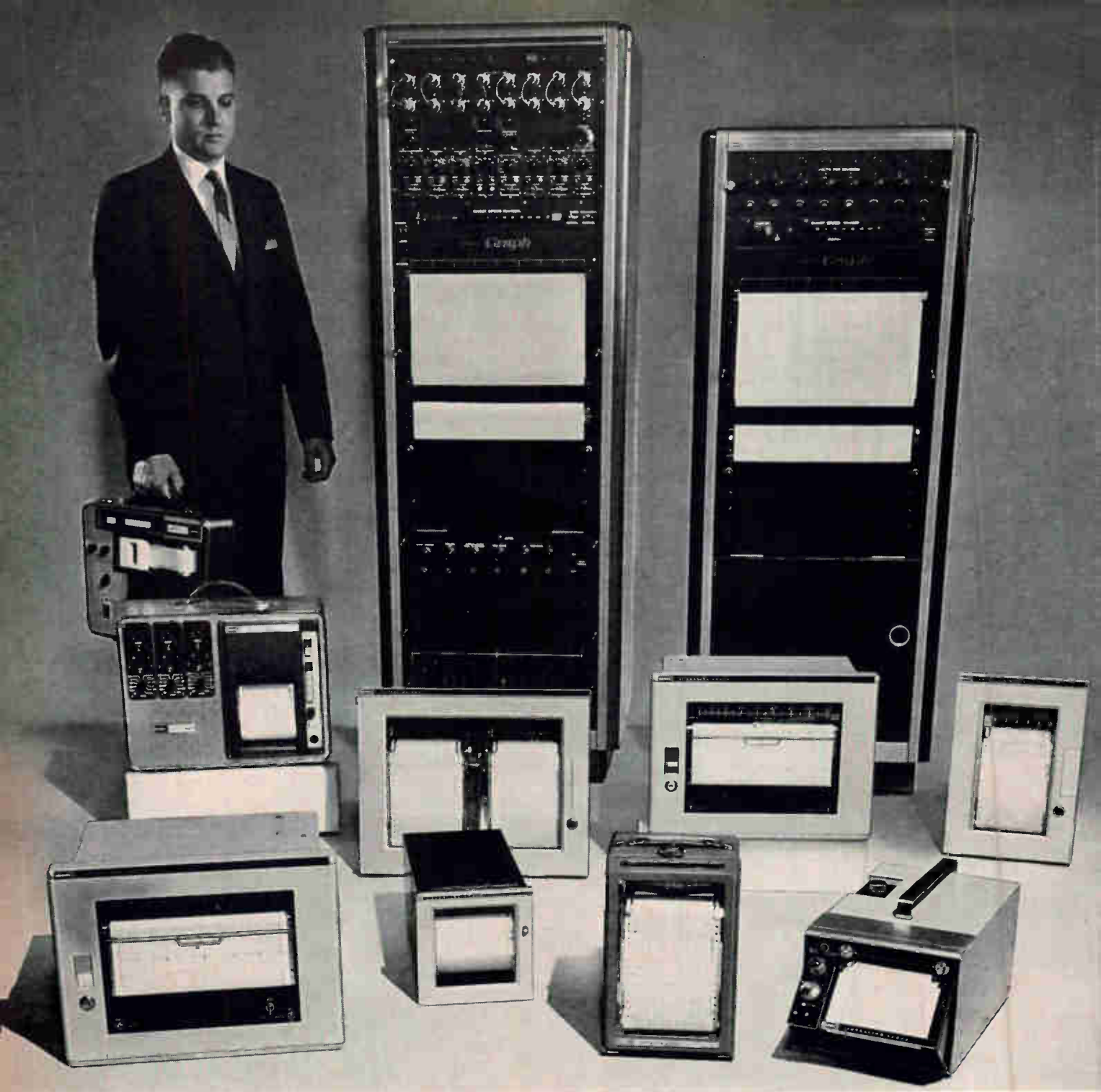

Esterline Angus doesn't keep handing you the same old line!

We keep developing new graphic recorders and new features to incorporate in established recorders . . . to satisfy your needs.

We've developed a trouble-free servo motor with only one moving part. No pulleys, drive cords or gears. It delivers 2/10 second response over a 10" span and 1/8 second response over a 4 1/2" span.

Our new Multipoint has an exclusive Programmed Printing option. It lets you select points electrically with switches.

You can now order our Permanent-Mag-

net Moving-Coil recorders with magnetic amplifiers (to increase sensitivity) or with power transducers (to measure watts, volts, amperes, vars . . .).

We've designed a Rapid Response (1/10 second) Voltmeter. It records 100 millisecond voltage transients with full accuracy . . . especially valuable in monitoring power supplied to data processing units.

In addition to our best selling Ink Type Event Recorders are new Inkless and High Impedance Event Recorders. The high im-

pedance instrument can be bridged into low power (i.e., telephone) circuits without upsetting their operation.

Want to record more than one channel of information on the same chart? We now have six types of two-channel recorders, plus an Analog-Event Recorder which provides one channel of analog information and eight channels of event information.

Oscillo Graphs? Choose from nine units including portables and cabinet models. All with frequency response above 125 cps.

Write for our full line brochure. You'll discover we make more kinds of graphic recorders than just about anybody else.

Esterline Angus Instrument Co., Inc.
Box 24000E • Indianapolis, Ind. 46224



ESTERLINE ANGUS
EXCELLENCE IN INSTRUMENTATION FOR OVER 60 YEARS

Circle 98 on reader service card

Technical Articles

**Vortexes stir up
superconductors:
page 100**

Tiny whirlpools of magnetic flux in superconductors have been postulated for years to explain some of the properties of superconductors. Recent work has indicated that control of these vortexes could lead to new types of d-c motors and generators, computer memories, logic elements and other magnetic devices.

**Summed scr outputs
boost transmitter
power:
page 119**

Getting high r-f power at low frequencies usually dictates a brute force approach—huge tubes, inherently unreliable, hooked up in parallel. Now the silicon controlled rectifier provides an efficient source of 150 kilowatts in a compact solid state transmitter operating in the low and very low frequency bands.

**Welding IC modules
automatically:
page 128**

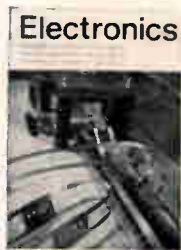

Electronics
Although welded construction is inherently reliable, it has been a costly method of integrated circuit assembly. A new module design that allows numerical control equipment to weld and test interconnections and even coordinate the electrical design, makes welding competitive. Key to the module design is the use of punched nickel foil laminations for signal wiring between IC flatpacks. The foil-punching equipment, now producing Apollo computer modules at the Raytheon Co., was photographed for our cover by Robert A. Johnson.

**Do engineers
obsolesce?
page 142**

In the premiere of a new Electronics department, a successful engineer reflects that the well-rounded technical man who draws on the entire human experience rather than just scientific expertise need not fear the future.

**Coming
June 27**

- Three-dimensional radar
- Japanese computers
- Improving integrated circuits with feedback

Vortexes are creating a stir in the superconductor field

Researchers are developing new types of memories, transformers and logic devices by controlling the magnetic-field penetration of superconductors

By Judea Pearl*

Radio Corp. of America, Princeton, N.J.

For years physicists have been intrigued by the effects of vortexes—tiny cylinders of normal (non-superconducting) metal that pass magnetic flux through superconductors. Superconductors, which have practically no resistance to current at or near absolute zero, are usually a barrier to magnetic flux.

Control of vortexes could mean development of new types of direct-current generators, motors and transformers, computer memories and logic elements. Revolutionary devices analogous to the transistor could spring from this peculiar magnetic excitation.

Vortexes are quantum mechanical in nature, localized in space and can maintain their identity indefinitely. Variations in the applied magnetic field can make vortexes appear and disappear, move, and annihilate each other.

Computer memories that would exploit vortexes in superconducting storage mediums have been under development for several years.¹ Studies indicate potential for a faster, more compact, random-access computer memory that could store up to a billion bits of information, about 100 times the capacity of present memories. Switching would be accomplished by forming pairs of vortexes of different polarities, which can be made to move in

* Now with Electronic Memories, Inc., Hawthorne, Calif.

The author



Judea Pearl, who got the first of his four degrees at the Technion in Israel, helped develop superconductive parametric devices at RCA Labs as part of the cryoelectric computer research group. Since 1964, his research in superconductive memories has emphasized the theory and applications of vortex dynamics.

prescribed ways by applying current.

Controlling the relocation of vortexes that represent information bits could enable both storage and logic operations to be performed at the same location in a superconducting memory.

A device analogous to a drum memory is another possible application. Bits in the form of vortexes would be written onto a drum with pulses and would travel around the drum's circumference while the drum remained stationary.

A d-c generator that takes advantage of vortex motion has been built. It has no brushes and operates at cryogenic temperatures with an efficiency of about 9%.

Superconductive vortexes behave like charged particles in many respects. For example, while the transport of electrical charges produces a steady magnetic field, the transport of vortexes is analogous to a current of magnetic monopoles and produces a steady electric field. Electric charges accelerate along the electric field lines, while vortexes accelerate along the magnetic field lines (produced by the transport currents). Superconductors seem to be the first known medium in which the similarity between electric and magnetic charges has found a physical embodiment. This similarity could be exploited by engineers to yield devices like the vacuum tube and the transistor, operating by transport of magnetic monopoles instead of electrons.

The mixed state

Besides complete loss of electrical resistance, a basic property of superconductors is their ability to expel magnetic fields from their interior. This phenomenon is known as the Meissner effect.² Ordinarily magnetic fields cannot penetrate a superconductor. However, if the field is raised above a

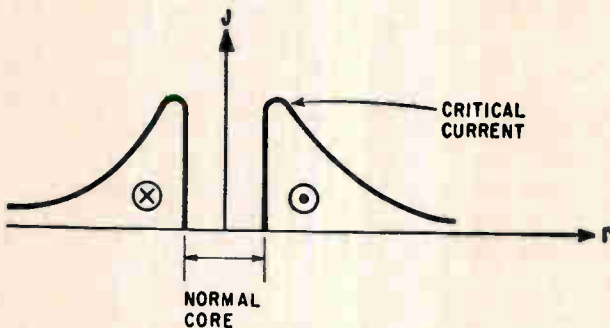
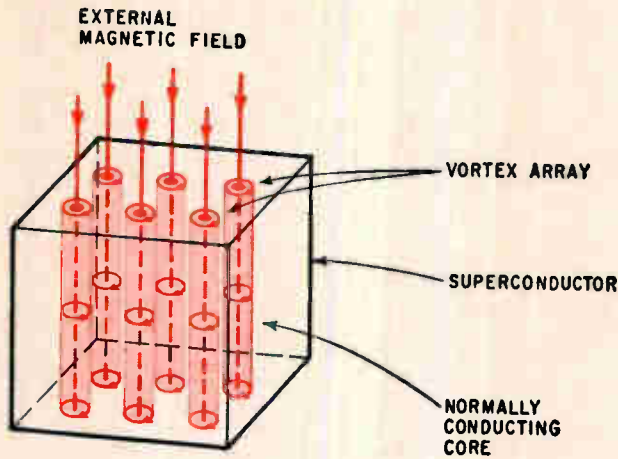

Abrikosov's vortex model, showing partial field penetration through cylindrical volumes, or flux tubes, of normal material, in color, within a superconductor. The structure of an individual vortex, directly above, shows spatial distribution of circulating currents around a normal core whose radius is a few hundred angstroms.

certain level, it will drive the superconductor into the normal state, and immediately penetrate it.

Certain metals, on the other hand, do not exhibit this effect, but are partially penetrated by magnetic fields even while in the superconducting state. At first, partial penetration was attributed to defects and impurities in the metal, but investigation³ shows that the Meissner effect is incomplete in certain metals and would remain incomplete in a highly pure and defect-free state. These materials were named type II superconductors; the designation type I characterizes superconductors that exhibit a complete Meissner effect.

How magnetic fields partially penetrate superconductors was analyzed by A. A. Abrikosov in 1957.⁴ According to his model, shown above, external magnetic fields can penetrate type II superconductors in the form of a periodic array of flux tubes, or vortices. A vortex's cylindrical core of normally conducting metal has a radius, r , of about a few hundred angstroms. The magnetic flux is sustained in a vortex by persistent currents that circulate around the core, shown above, where J is the density of the superconducting current. Vortices are also believed to exist in thin films of type I superconductors in perpendicular fields, where the geometrical shape of the film forces a premature field penetration.

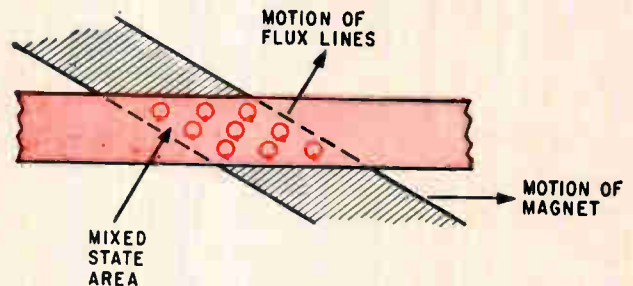
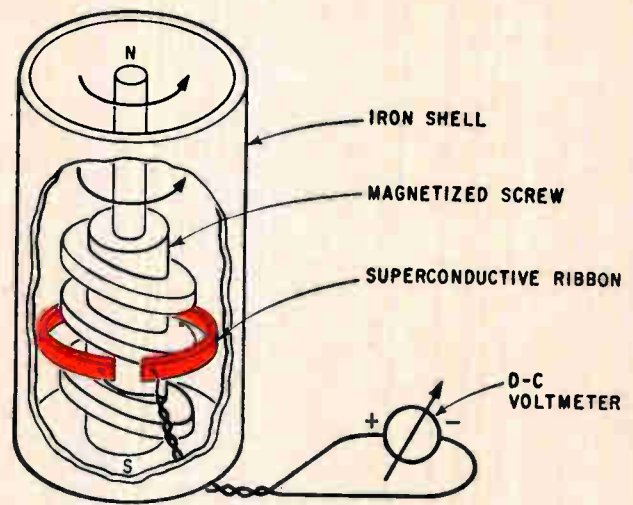

Experimental arrangement which could be used as a generator. Magnetized screw rotates inside coil of superconducting ribbon, in color, producing a d-c voltage across the ribbon as the lines of flux are cut. A magnified view of a portion of superconductive ribbon shows motion of the mixed state area, in color, and motion of the flux lines.

Fact or theory?

Abrikosov's vortex model of the mixed state (partially superconducting and partially resistive) of superconductors has a wealth of experimental verifications. Among the most significant of the experiments are magnetization measurements, neutron diffraction,⁵ and experiments on microscopic geometries.⁶

While Abrikosov's theory successfully explained equilibrium properties of superconductors, it has been difficult to apply it to dissipative processes. Since most of a superconductor in the mixed state is still superconducting, it should be able to transport electric currents with no resistance. Surprisingly, superconductors in the mixed state do exhibit a little resistance, or dissipation of power, even for very low densities of vortices. The motion of Abrikosov's vortex lines appeared to account for this phenomenon.^{7,8} When transport currents pass through a superconductor, a force is exerted on the vortices that causes them to move uniformly at right angles to the current flow, top of page 102. The continuous motion of flux lines cutting the sample should produce an induction type of electromotive force in a direction perpendicular to the vortex motion. So, the voltage appearing across the sample was not considered an ordinary ohmic

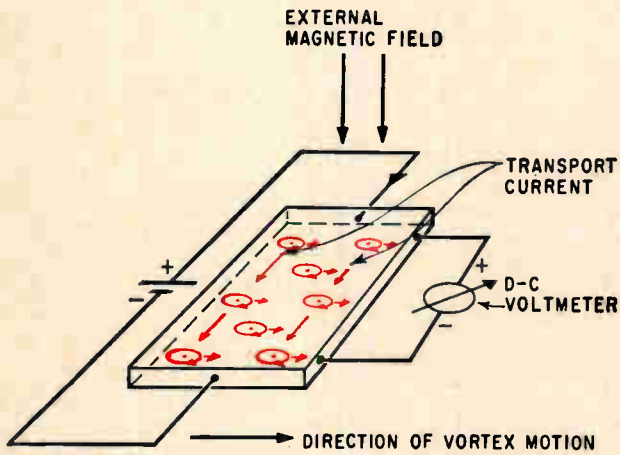

Model of magnetic flux flow explains why resistance appears when portions of a superconductor are superconducting. The voltage across the superconductor sample is an induced back emf due to flux cutting. Vortexes and their direction of motion are shown in color.

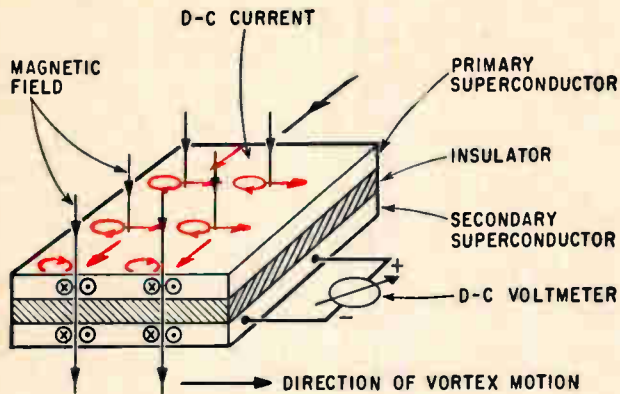

Direct-current electrical energy can be transferred from the primary to the secondary circuit as in an ordinary transformer. Because the vortexes in the two strips, in color, are magnetically coupled, current-induced motion of vortexes in the primary results in motion of vortexes in the secondary, demonstrated by the appearance of a d-c voltage across its length. Such a transformer could be used to charge superconducting magnets.

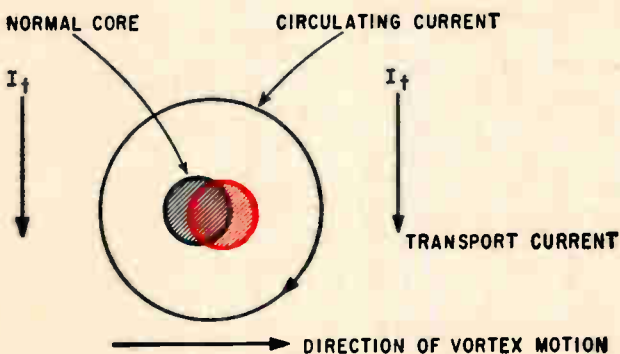

Vortex motion can be explained by examining the critical transitions at the core boundary. The vortex position shifts because the transport and circulating currents add at the right of the core, driving more material there into the normal state. Some of the material at the left reverts to the superconducting state. The net effect is motion of the vortex to the right. The shifted position is shown in color.

potential drop but was believed to be an induced back emf due to flux cutting.

This flux-flow model⁹ explained a number of dissipative phenomena of the mixed state. However, the basic ideas were repeatedly criticized, and the question of whether vortex motion did cause dissipation remained unanswered. The model was difficult to accept because there is no apparent explanation for the driving force (called the Lorentz force). Exact calculations of the magnetic interaction between the transport current and the vortex currents do not yield the force given by the flux-flow model. Second, the induction of a d-c voltage in a stationary circuit that encloses a constant magnetic flux appears to be incompatible with the fundamental laws of electromagnetic induction.

Experimental proof

An experiment was needed to prove or disprove the validity of the flux-motion model. The model can be tested¹⁰ by causing a continuous motion of flux lines in a currentless superconductor and then searching for a d-c voltage across it. Only when the superconductor carries no current can the induced voltage be attributed to motion of vortexes with the certainty that it is not ordinary ohmic voltage. Two experiments proved the theory.

In one,¹¹ the vortexes were moved by rotating a magnet near a superconductive ribbon as on page 101. A permanently magnetized screw is coaxially inserted in a coil made of 150 turns of the ribbon (only one turn is shown in the figure). A cylindrical iron shell provides an easy return path for the magnetic lines, and forces the magnetic field at the ribbon to assume a radial direction. This arrangement is actually a superconductive version of a d-c generator.

At regions of high field intensity, the magnetic field penetrates the ribbon and forms a mixed-state area aligned with the spiral threads, lower right figure, page 101. As the screw rotates, the mixed-state area tends to stay aligned with the threads, since this constitutes the lowest energy state for the vortexes. The vortexes follow the screw motion because a force is exerted on them in the direction of the energy gradient. The vortex motion has a component transverse to the length of the ribbon, and so, a continuous motion of flux lines is established across the ribbon.

A unique feature of the spiral magnetic arrangement is that vortexes are forced to move while the mixed-state area extends across the entire width of the strip. Also, there is no change in the total flux linking the coil, since the ribbon is wrapped symmetrically around the screw.

These are also the conditions in the flux-flow model used to measure resistance, shown at the top. According to this model, there should be a d-c voltage across the ribbon. Rotation speeds ranging from one to five revolutions per second were used, and d-c voltages roughly proportional to speed and as high as 100 microvolts were observed. The polarity of the voltage agreed with that predicted

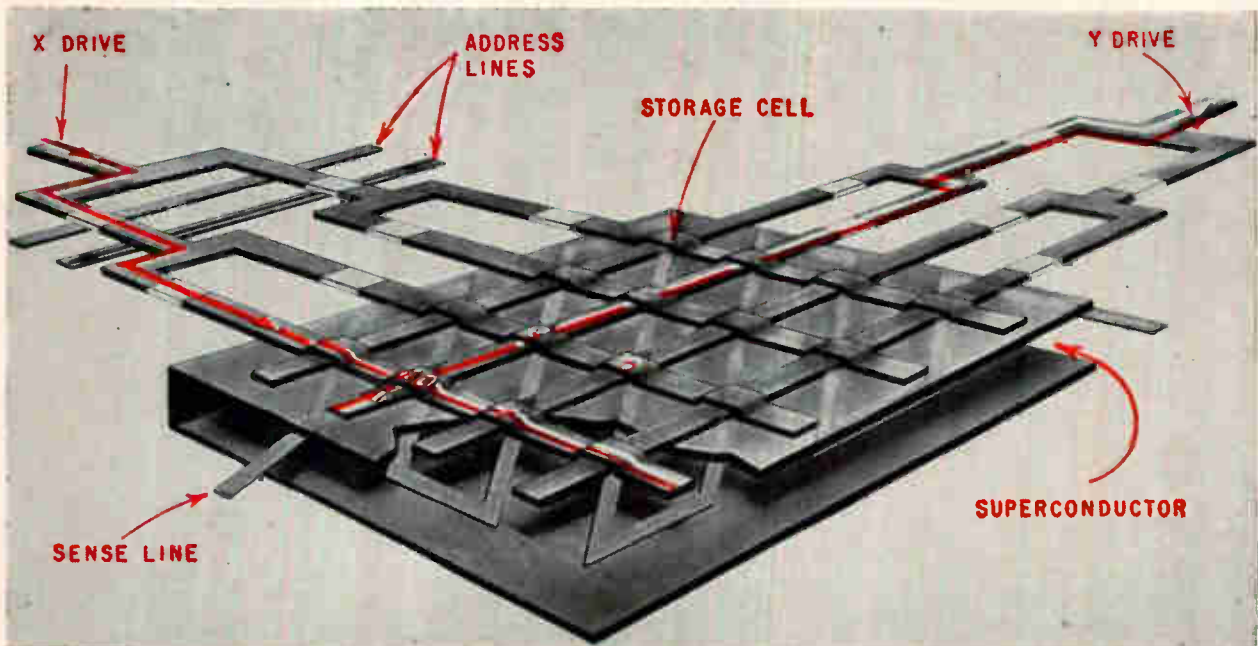

Superconducting memories could store up to a billion bits of information. This model consists of a continuous sheet of superconductor with two perpendicular grids of lead drive lines. Switching consists of the annihilation or creation of vortices at the x-y intersections. In color are the x and y drive lines through which current is sent to initiate switching. At the right is a single memory cell showing vortices, in color, formed by the magnetic field at the drive lines' intersection.

on the basis of the flux-flow equations and could be reversed by reversing the direction of rotation. As the temperature increased to the point where the vortex structure disappeared, the induced voltage also vanished.

According to the flux-flow model, if current were passed through the ribbon, a force would be exerted on the vortex lines which could cause them to move and drag the magnet into continuous rotation. This would correspond to operating the generator in the top right figure, page 101, as a d-c motor. With proper modification of the design, motor action can be demonstrated.

Another experiment^{12,13} combines the motor and generator actions to form a d-c transformer. Two superimposed superconducting strips, separated by a thin insulating layer, are placed in a perpendicular magnetic field—the middle figure on page 102. When d-c current is applied to the primary, a d-c voltage is induced in the secondary. The vortices in the secondary strip are magnetically coupled to those in the primary, so current-induced motion of vortices in the primary exerts a force on the vortices in the secondary. When this dragging force overcomes the pinning forces due to defects, the vortices continuously move in the currentless secondary, and a d-c voltage is induced across the length of the secondary.

The two experiments show that the vortices move, but not why. Nor do they explain what mechanism is responsible for generating a d-c emf along the superconductor when the vortices move.

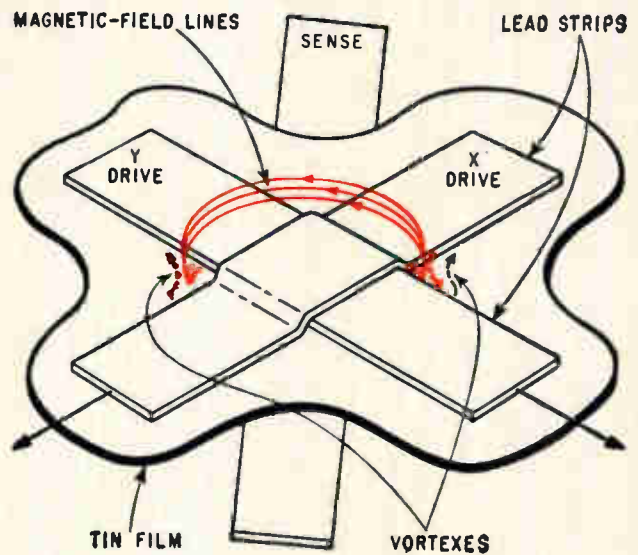

That a vortex cannot remain stationary in the presence of transport currents is demonstrated in the graph at the top of page 101. The boundary of the normal core remains stationary when the current density at the boundary does not exceed the critical current density of the superconductor. Therefore, the current density at the core boundary is just below its critical value.

However, if a transport current I_t is superimposed on the circulating vortex current, bottom of page 102, the vortex will move. The two current components will add on the right side of the vortex and oppose each other on the left side. The sum of the current I_t and the circulating current is sufficient to drive a small area at the right of the core into the normal state. At the same time, the current density at the left edge of the core is reduced below the critical value, and therefore drives a small portion at the left edge of the core from its normal state to its superconducting state. The

net effect of the transport current is to cause the whole vortex, with its currents and fields, to move to the right, as indicated by the arrow.

This picture of vortex motion can be used in more complicated configurations to predict where motion should occur. To find the magnitude of the driving force a simplified hydrodynamic approach can be used, and the difference in hydraulic pressure on both sides of the vortex can be calculated. According to Bernoulli's law, the pressure in a fluid decreases as the square of the fluid velocity. The pressure on the right side of the vortex (see the figure at the bottom of page 102), which carries a high current density, is lower than the pressure on the left side, where the current density is low, and consequently the vortex will tend to move to the right. This effect is similar to the tendency of rotating bodies to move sideways when immersed in a moving fluid,¹⁴ a phenomenon first noted by a German scientist named Magnus about a century ago. The calculated magnitude of the Magnus force for superconducting vortices is identical with the Lorentz force predicted by the flux-motion model.

A similar model explains the origin of d-c emfs induced by vortex motion. When a rotating cylinder is moving in a stationary fluid, a pressure difference develops because of the difference in fluid velocity on both sides of the cylinder, tending to pump the fluid in a direction perpendicular to the cylinder motion. In superconductors, the fluid consists of charged particles, and the hydraulic pressure is manifested as voltage. The voltage direction is such that the resulting electric current slows down the vortex motion. The magnitude of the induced voltage, when computed on the basis of the pressure due to the Magnus force, is again identical with the prediction of the flux-flow model where the voltage was incorrectly attributed to Faraday induction.

Applications of vortex motion

The ability to produce and detect a controlled motion of vortex lines in superconductors has great potential applications to energy conversion and computer devices. The arrangement at the top of page 101 could be used as a high-current, d-c generator and motor. Its current-carrying capacity is determined by the critical current of the superconductor used. Excess load current tends to slow down the motion of the vortices and thus reduces the output voltage. Its equivalent internal resistance is just the flow resistance of the mixed state. Initial calculations show that such a generator would run with an efficiency of about 16%. Taking into account the energy required to refrigerate the system, the efficiency reduces to only 9%. However, it would require no brushes or commutators.

An immediate use of these generators would be charging high-current superconducting magnets, where the heat-conducting, high-current leads could be replaced by a single rotating shaft. A greater economy could be achieved when the moving magnetic field shown in the lower figure at the top

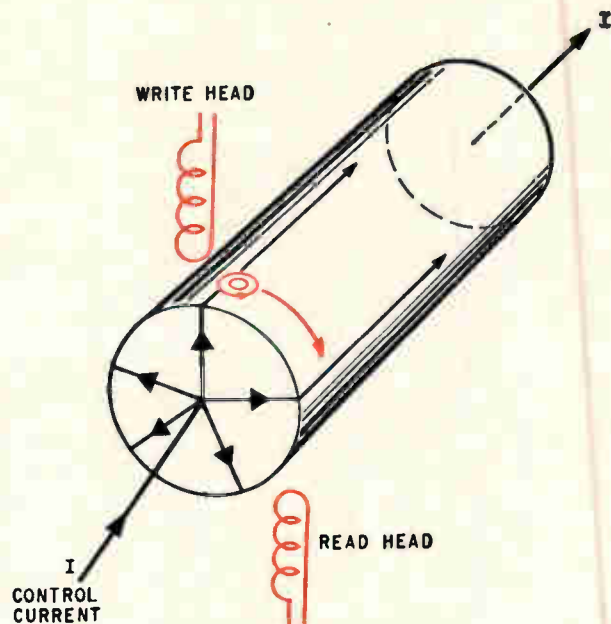

Shift register or nonrotating drum memories could be developed as an application of vortex motion. The control current causes the vortices, in color, to rotate continuously around the cylindrical surface of the drum, while the drum remains stationary.

of page 101 is produced by a stationary circuit carrying alternating currents in a three-phase arrangement. An alternate way of avoiding the need for rotating parts is to use the d-c transformer, middle of page 102, to step up a d-c current for charging a superconducting magnet. Current step-up is achieved by constructing many pairs of the type shown in the figure, with all the primaries connected in series and all the secondaries in parallel.

The use of these devices in other high-power, energy conversion applications is still limited. Cost and size of the refrigerating system still overshadow the merits of their simplicity. However, in naturally cold environments like those encountered in space missions, large-scale superconducting energy-conversion devices might be used to advantage.

Superconductive memories

In its simplest form, a continuous-sheet superconductive memory consists of the arrangement in the figure on page 103 with the structure of a single memory cell below it.

There are two orthogonal grids of lead drive lines above a thin superconductive tin sheet. The arrangement is similar to a bit-organized, coincident-current core memory with destructive read-out. The selection of a single element in this array is made by sending current pulses in one of the x drive lines and one of the y drive lines simultaneously. The current level of one drive line is not sufficient to cause flux switching. When the combined field of the x and y pulses is higher than the critical field, it causes switching at the appropriate x-y intersection. A zigzag sense line links all the memory cells, and the appearance of a sense signal at its terminals indicates that switching has oc-

curred at the addressed location.

The selection of the appropriate x line is performed by a tree-type network of cryotrons—switches that change from the superconductive state to the resistive state in the presence of a magnetic field. The currents flowing in the address lines provide the magnetic field that controls the superconductive state of the cryotrons, which determines the path of the current flow. Each binary combination of the address line currents corresponds to only one superconductive path that is chosen to carry the drive current to the selected memory location.

Recent experiments on the magnetic flux distribution on the surface of a superconducting film explain the switching, storage and readout action of the memory. When the drive currents terminate, some flux remains trapped along the diagonal of the intersection area as shown in color in the diagram of the cell. The building blocks of the memory cell apparently consist of microscopic superconductive vortexes (or bundles of vortexes). Switching occurs when the magnetic field beneath the drive lines' intersection is sufficient to cause the formation of pairs of equal and opposite vortexes. The current flowing at the memory plane drives the vortexes along the diagonal toward the opposite corners of the intersection area. When the driving currents terminate, the two vortex groups are attracted to each other but are prevented from moving together by pinning forces. Pinning forces arise from defects in the film and from the diamagnetic nature of the drive lines themselves. Thus, the vortexes are stored in the film.

When the memory cell is interrogated, the currents are applied to the drive lines in opposite directions. A driving force is exerted on the stored vortexes which enhances the mutual attraction between the two groups. When the combined attraction force exceeds the pinning force, vortexes from the two opposite groups begin to enter the intersection area and approach each other at high speeds. Since the polarity of the magnetic field (and of the angular momentum) is opposite in the two vortex groups, when vortexes meet at the center of the intersection area they annihilate each other until all the stored flux vanishes. During this process a voltage pulse is induced in the sense line. The polarity of the pulse depends on the relative direction of the stored flux.

From this model one can see that all the important characteristics of the memory cell such as critical currents, switching speeds, disturbs (the noise caused by a current passing in a drive, insufficient to cause switching) and sense-signal amplitude depend on the dynamics of moving vortexes in superconducting films.¹⁵ Better understanding and control of such films are essential for better superconductive memories.

Storage and logic

It is also apparent that information bits could

be moved from one location to another in a controlled way in superconducting films. Thus, both storage and logic operations could be performed at the same location.

The next example demonstrates some of the hidden possibilities of this form of vortex dynamics¹⁶. In the structure on page 104, a superconductive sheet forms the surface of a cylinder. Vortexes may be excited on the cylindrical surface by applying current to the write head and may be detected by voltages induced in the read head.

If a vortex is established near the write head and a direct control current I is applied to the surface in a direction parallel to the axis of the cylinder, the vortex will continuously circulate around the cylinder. When the vortex passes under the read head, its magnetic lines of flux induce a read voltage in the read head. The output is an alternating current; its frequency is proportional to the amplitude of the control current I , since that determines the circulation rate.

The device can operate as a shift register. Binary bits may be written along the cylindrical surface by applying pulses to the write head. The binary bit 1 may be represented by the presence of a vortex, while the binary bit zero may be represented by the absence of a vortex. The back and forth shifting of the vortex string may be controlled by the magnitude and polarity of the control current.

If there are many write and read heads along the length of the cylinder, a device analogous to a drum memory can be constructed. Binary digits are written onto the cylindrical surface by applying pulses to the write heads, while the control current I remains constant. This causes the bits being written onto the stationary drum to circulate along their respective tracks around the drum circumference at a fixed speed proportional to the control current. This is analogous to the physical rotation of the drum. This is the first time that current-controlled motion of storage patterns in a stationary medium has been achieved.

References

1. L.L. Burns Jr., G.A. Alphonse and G.W. Leck, Transactions of the IRE, Vol. EC-10, p. 438 (1961).
2. W. Meissner and R. Ochsenfeld, Naturwissenschaften, Vol. 21, p. 787 (1933).
3. N.N. Zavaritskii, Doklady Akademii Nauk SSSR, Vol. 86, p. 501 (1952).
4. A.A. Abrikosov, Zhurnal Eksperimental'noi i Teoreticheskoi Fiziki, Vol. 32, p. 1,442 (1957); English translation, Soviet Physics, J.E.T.P., Vol. 5, p. 1,177 (1957).
5. D. Cribier, B. Jacrot, L.M. Rao and B. Farnous, Physics Letters, Vol. 2, p. 119 (1963).
6. R.D. Parks and J.M. Model, Physical Review Letters, Vol. 11, p. 354 (1963).
7. C.J. Gorter, Physica, Vol. 23, p. 45 (1957).
8. Y.B. Kim, C.F. Hempstead and A.R. Strnad, Review of Modern Physics, Vol. 36, p. 43 (1964).
9. A.R. Strnad, C.F. Hempstead and Y.B. Kim, Physical Review Letters, Vol. 13, p. 794 (1964).
10. J. Pearl, Physics Letters, Vol. 17, p. 12 (1965).
11. J. Pearl, Physical Review Letters, Vol. 16, p. 99 (1966).
12. I. Giaever, Physical Review Letters, Vol. 15, p. 825 (1965).
13. P.R. Solomon, Physical Review Letters, Vol. 16, p. 50 (1966).
14. H. Rouse, "Elementary Mechanics of Fluids," John Wiley and Sons, Inc., New York, 1946, p. 272.
15. J. Pearl, "Vortex Theory of Superconductive Memories," Thesis, Polytechnic Institute of Brooklyn, June, 1965.
16. J. Pearl, U.S. Patent 3,201,765, Aug. 17, 1965.

Designer's casebook

Designer's casebook is a regular feature in Electronics. Readers are invited to submit novel circuit ideas, packaging schemes, or other unusual solutions to design problems. Descriptions should be short. We'll pay \$50 for each item published.

One-megahertz flip-flop saves standby power

By M.E. McGee and J.H. Wujek Jr.

Lawrence Radiation Laboratory
University of California, Livermore

A complementary flip-flop with a power dissipation of less than two milliwatts at one megahertz has been designed for use aboard space vehicles. This dissipation level represents an improvement by a factor of five over presently available integrated circuits. Required standby power of 150 microwatts is 50 times less than required by IC's.

The complementary-pair concept of flip-flop design has long been recognized as a means of conserving power. The circuit below does not use collector resistors, hence power dissipation occurs only in the saturated transistors and the resistors supplying the "turn-on" base drive. As the

transistors are switched through the active region, instantaneous power dissipation increases. The average power dissipation is given by the empirical expression:

$$P \approx 150 + f(1.55)$$

where P is in microwatts, f is the trigger rate in khz, and $0 \leq f \leq 1,000$.

The circuit consists of two interconnected flip-flops, sharing a common diode steering network at the input. Diodes D₁, D₄, D₅ and D₈ protect the emitter-base junctions from breakdown and also increase switching speed by clamping the back-bias levels at the base of the transistors.

In the packaging schemes used, the anodes of D₄ and D₈ are not connected internally, but were brought out for d-c set and reset purposes. The table to the right of the circuit diagram describes the function of various circuit points. A current pulse of 10 microamperes sets or resets the flip-flop.

When operated as a scaler, DS and DR are connected to ground. Similarly, the resistors R₂ and R₆ are not connected internally to the output, thus providing a shift register function capability.

In the quiescent state, only about 12 μa is sup-

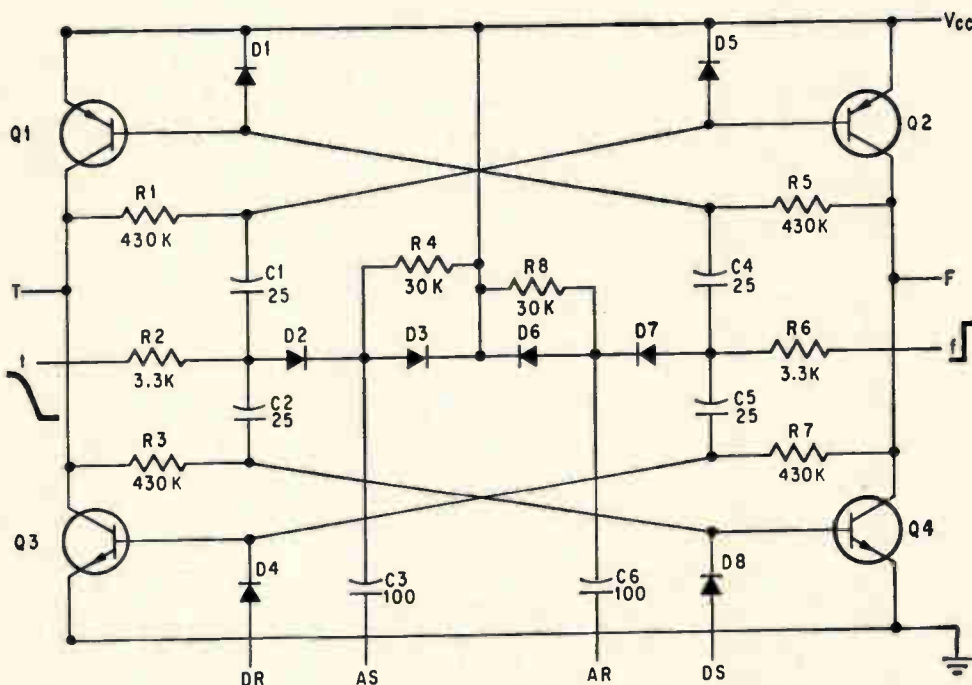

POINT	FUNCTION
V _{cc}	6V
T & F	OUTPUT
t & f	CONNECT TO T AND F FOR BINARY OPERATION
DS	DC SET
DR	DC RESET
DS & DR	CONNECT TO GROUND FOR BINARY OPERATION
AS	AC SET
AR	AC RESET

1. Q1 & Q2: SELECTED 2N3251.
2. Q3 & Q4: COMPLEMENT TO 2N3251
3. D1-D8: IN3206 OR IN914

One megahertz flip-flop is designed for binary operation, as a scaler or shift register. The complementary-pair design achieves the low power dissipation.

Parameters for selection of transistors.

Characteristic (T = 25°C unless noted)	Limits		Test Conditions
	Min	Max	
h_{FE}	40		$V_{CE}=5V, I_C=10 \mu a$
h_{FE}	80	240	$V_{CE}=5V, I_C=100 \mu a$
$h_{FE} (-55^\circ C)$	15		$V_{CE}=5V, I_C=100 \mu a$
h_{fe}	1.25		$I_C=500 \mu a, V_{CE}=1V$ $f=100 \text{ Mhz}$
BV_{CBO} (volts)	40		$I_C=10 \text{ ma}, I_B=0,$ $300 \mu s \text{ pulse at}$ $1\% \text{ duty cycle}$
BV_{CBO} (volts)	50		$I_C=10 \mu a, I_E=0$
BV_{EBO} (volts)	5.0		$I_E=10 \mu a, I_C=0$
C_{ob} (pf)		6	$V_{CB}=10 V,$ $f=100 \text{ khz}$
$V_{CE} \text{ (sat)}$ (volts) ..		0.25	$I_C=10 \text{ ma}, I_B=1 \text{ ma}$
$V_{BE} \text{ (sat)}$ (volts) ..		0.90	$I_C=10 \text{ ma}, I_B=1 \text{ ma}$

plied to the bases of the saturated transistors. Thus, the transistors must have good low-level characteristics. The table above lists the salient parameters selected from the 2N3251 family. Both npn and pnp devices are individually packaged in a TO-46 case.

A fan out of 7 at 1 megahertz is obtained over the temperature range $-10^\circ C$ to $+100^\circ C$ for a power supply tolerance of $\pm 5\%$. A fan out of 10 is possible at 200 khz from $-50^\circ C$ to $+100^\circ C$ at a $\pm 5\%$ power supply tolerance. Fan out as a function of temperature and minimum supply voltage is shown in the graph at the right.

Two different circuit packages were developed. An unencapsulated polyester film "cordwood" package is used where volume and weight are not primary considerations. In the hybrid package the resistors and capacitors are deposited thin films, on a miniature printed-circuit board, on which the semiconductor active elements are mounted. The total package weighs less than two grams. The circuit has not been made in monolithic form because diffusing four transistors on one chip, with the required low-level performance, results in very low yields. Added to the yield problem is the problem of depositing high-valued resistors on a small surface area. Since this circuit requires a total resistance of about 1.7 megohms, a large surface is required. About half the $\frac{5}{8}$ - x $\frac{1}{2}$ -inch thin-film substrate is used for the resistor pattern, the remainder bearing the capacitor and conductor pattern.

Performance testing indicates a noise immunity exceeding 1.5 volts for a one-nanosecond rise time over -50° to $+100^\circ C$. Results are shown in the graph at the right. Transistors with high values of f_t and h_{FE} were used to give pessimistic results. The devices used had an f_t of about 150 Mhz at 150 μa and h_{FE} of 150 at 100 μa .

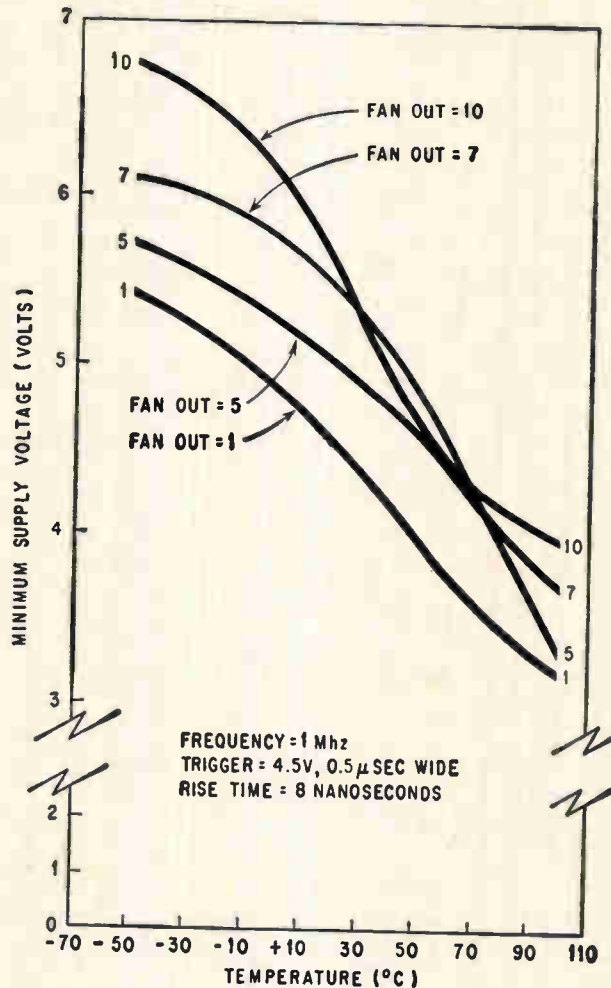

Fan out varies as a function of the minimum supply voltage and the temperature. When the ambient temperature is lowered, the supply voltage must be increased in order to drive the same number of flip-flops that are driven at higher temperatures.

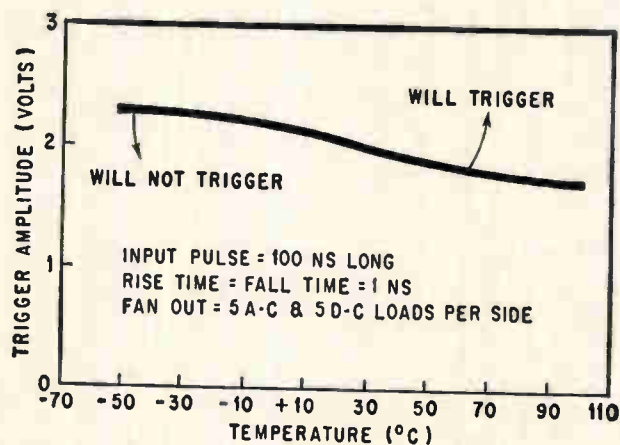

Curve shows noise immunity in excess of 1.5 volts for temperature range $-50^\circ C$ to $+100^\circ C$. A d-c load is defined as 75,000 ohms returned to +6 volts; a-c load is 3,000 ohms in series with 100 pf to ground.

Circuit protects meter from periodic current spikes

By Cornelius Pittman and Bill Birnbaum

Beckman Instruments, Inc., Fullerton, Calif.

In instrumentation setups, where a transducer must be pulsed, it is desirable to isolate the readout so that a "spike" produced by the pulsing current does not appear at the meter.

The circuit at the right makes an output meter insensitive to disturbances at the input during a predetermined period of time. In effect, the circuit stores the transducer output while the transducer is momentarily disconnected during the pulse period. A relay drive circuit, operating coincidentally with the transducer pulse drive, opens relay S_1 to provide the isolation between the operational amplifier output and the meter voltage. When S_1 is opened, the meter voltage is stored by capacitor C during the pulse period.

Between pulses, S_1 is closed and no storage occurs. The output of the system's operational amplifier, a voltage proportional to the transducer current, is conducted to the meter with a gain of approximately one and is displayed as an indication of the current. During this period, the response time of the circuit, $T_R = (r_{b1}/B_1 + R_1) C = 1.5$ milliseconds, where B_1 is Q_1 's short-circuit current gain, 40, r_{b1} is its base resistance, 2,000 ohms, and R_1 is a resistor added to reduce the effects of magnetic induction if S_1 is a magnetic device.

When S_1 is opened and the storage cycle begins, the output theoretically should not change. Actually, C continues to charge toward +15 volts with

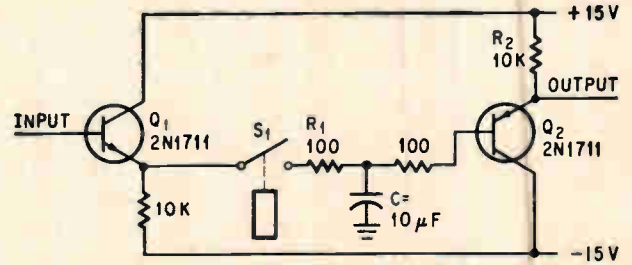

Capacitor C stores the voltage when relay S_1 opens.

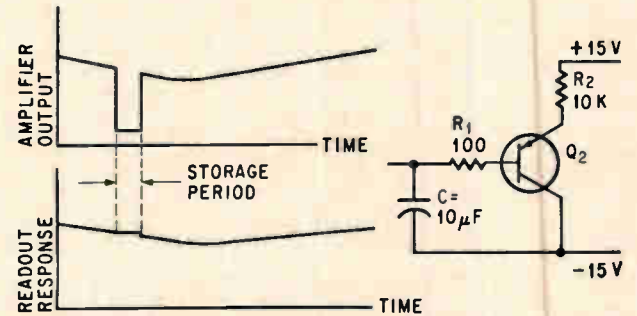

Charging of C increases readout voltage during storage.

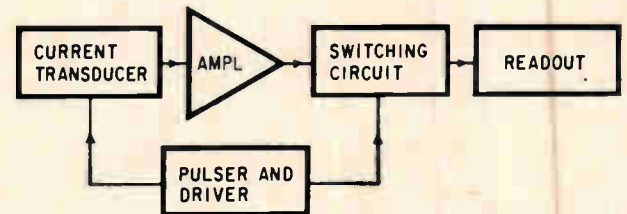

Driver opens switching circuit.

time constant, $T_s = B_2 R_2 C = 40 (10 \text{ K}) (10) = 4$ seconds as shown above. Since the storage time constant is more than 1,000 times greater than the response time, the increase in output voltage shown in the characteristic response curve above, is negligible during the storage period.

Low-drift current generator compensates for temperature

By Charles C. Hanson

International Business Machines Corp., Rochester, Minn.

The temperature-compensated current generator on the facing page solves the problem of obtaining sufficient input base current in circuits where common-mode voltages are applied at the input terminals. The solution is based on the fact that matched transistor pairs—as used in differential

amplifiers and precision voltage comparators—have base-current temperature coefficients which are predictable as a function of operating current.

The base-current temperature coefficient of matched pairs, at collector currents from 10 to 50 microamperes is approximately 0.8% per degree centigrade of I_c , where I_c is the base current at 25°C. Therefore, a generator whose output changes with temperature at the same rate is needed. Resistor networks cannot provide the high common-mode input impedance required to maintain accuracy with changes in common-mode voltage.

The current generator circuit diagramed presents 1,000 megohms of output impedance while supplying up to 200 nanoamperes of temperature-compensated current. The allowable range of common-

mode voltage is +6 to -25 volts. The three 1N695 germanium diodes D_1 , D_2 and D_3 provide the necessary compensating network. They operate at 1.3 milliamperes and are closely controlled for a forward drop, V_f of 0.3 volt and a temperature coefficient of 1.95 millivolts/ $^{\circ}\text{C}$. Therefore,

$$V_x = 3 V_f - V_{BE1} = 3(0.3) - 0.55 = 0.35 \text{ volt}$$

where V_{BE1} is the base to emitter voltage of Q_1 . The temperature coefficient at V_x ,

$$\frac{dV_x}{dT} = 3(1.95 \text{ mv}/^{\circ}\text{C}) - 2.75 \text{ mv}/^{\circ}\text{C} = 3.1 \text{ mv}/^{\circ}\text{C}$$

where 2.75 $\text{mv}/^{\circ}\text{C}$ is temperature coefficient of Q_1 .

$$V_y = \left(\frac{51\text{K}}{R_x}\right)(V_x); \text{ therefore,}$$

$$\frac{dV_y}{dT} = \frac{51\text{K}}{R_x} \left(\frac{dV_x}{dT}\right) = \left(\frac{51\text{K}}{R_x}\right)(3.1 \text{ mv}/^{\circ}\text{C})$$

The percentage change in V_y per degree centigrade is the same as that of V_x . At 25 $^{\circ}\text{C}$ this equals

$$\% \frac{dV_x}{dT} = \frac{0.0031}{0.35} (100\%/^{\circ}\text{C}) = 0.90\%/^{\circ}\text{C}$$

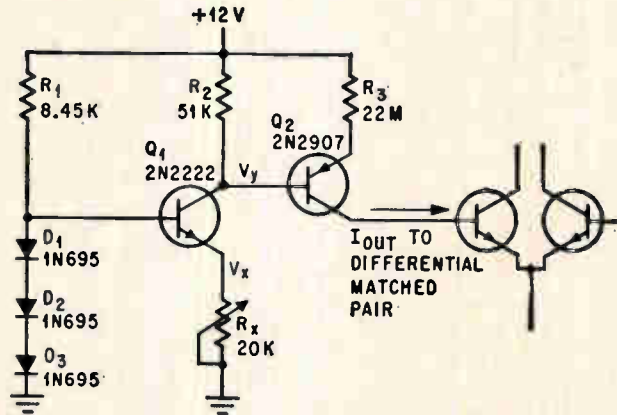

Temperature-compensated current generator's output changes at the same percentage per degree centigrade whatever the output current, set by adjusting R_x .

With an output current of 100 nanoamperes, V_{BE} —the base-to-emitter voltage of Q_2 —drifts in a direction opposite to V_x and V_y at a rate of 0.1%/ $^{\circ}\text{C}$. The net reduction in voltage across R_3 is 0.8%/ $^{\circ}\text{C}$ and the output current is reduced at the same rate.

The output-current drift of the generator when combined with an operational amplifier will be as low as 0.1 nanoamperes/ $^{\circ}\text{C}$ from 10 $^{\circ}\text{C}$ to 55 $^{\circ}\text{C}$.

Direct-coupled amplifier cuts cost of d-c voltmeter

By James M. Colwell

Hewlett-Packard Co., Loveland, Colo.

High input impedance and low drift can be achieved at low cost in a d-c voltmeter by a modification of conventional techniques. The new circuit is based on the familiar technique of using a d-c amplifier to drive the voltmeter. Usually the amplifier is chopper-stabilized, but this adds to the cost of the instrument. A direct-coupled d-c amplifier is used because it reduces the cost and achieves high input impedance and low drift, either with a vacuum tube differential input or with hybrid circuits having high gain and large amounts of feedback.

The circuit at the right is a direct-coupled amplifier with approximately unity gain. It is comprised of three bipolar transistors and one field effect transistor (FET) yielding high input impedance and low drift at low cost. It is suitable for a d-c voltmeter with a low range of 0.1-volt full

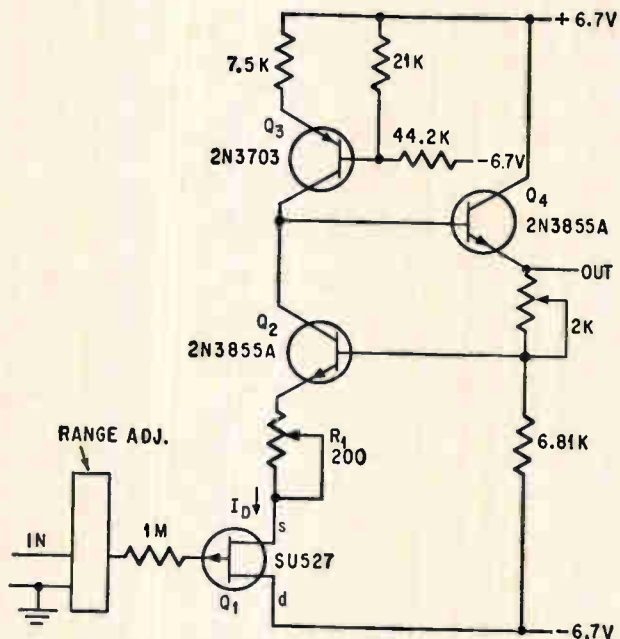

Direct-coupled amplifier has unity gain and achieves high-input impedance and low drift using FET.

scale. FET Q_1 is biased, as illustrated in the curves on page 110, to obtain the required impedance conversion and to balance the effect of temperature

on bipolar transistor base-emitter voltages.

The drain current for Q_1 is supplied from the constant current source Q_3 , which, along with the power supply voltage, sets the FET operating point—designated in the curves as point Q. This point is at the intersection of I_{d0} and V_{dso} on the $V_{gs} = +E$ characteristic. Since I_{d0} is constant and independent of the d-c input, the FET load line is along this characteristic at ambient temperature. E is the d-c voltage drop from gate to the source of the FET and is approximately one volt.

For a positive d-c input referenced to ground, operation shifts on the load line in the direction of A. For a negative d-c input, the operating point moves toward B. Since the voltage drop from gate to source remains unchanged, the unknown input signal from the high impedance gate is converted to the low impedance of the source; after going through the slightly-greater-than-unity gain amplifier, it is fed to the low impedance point at the output from which the meter is driven.

As the temperature changes, I_{d0} will not change appreciably; however, V_{gs0} will change if I_{d0} departs from the value of the critical drain current. This makes it possible to choose a value of I_{d0} so that $V_{gs0} = +E$ —(the FET load line)—has a temperature coefficient equal in magnitude but opposite in sign to the temperature coefficient of the rest of the amplifier. The drift of the bipolar part of this amplifier comes mostly from the base-emitter junction of Q_2 . Accordingly, the temperature co-

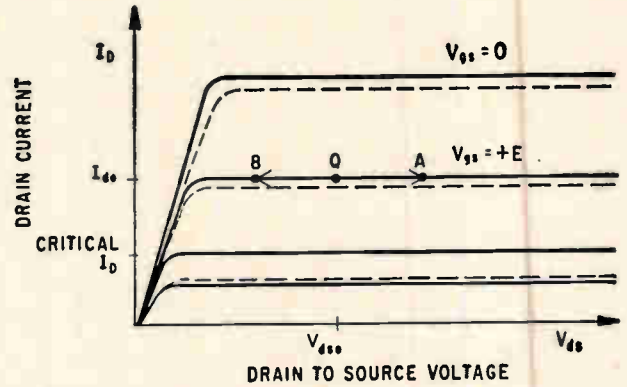

Bias curves show the FET load line as $V_{gs} = +E$ at ambient temperature. Dotted lines show how V_{gs} shifts to compensate for temperature variations.

efficient of V_{gs} of Q_1 for the values given is approximately -2.7 millivolts per degree centigrade. This value sets I_{d0} remote from the critical values of drain current and where the temperature coefficient of V_{gs} is primarily dependent upon FET mobility carrier variations. Mobility varies little with temperature between FET's.

With precision components, the over-all temperature coefficient of this amplifier is less than 0.5 mv/ $^{\circ}$ C in the range 0° C to 50° C if the input is shunted by less than one megohm. The maximum drift over this range is 30 mv.

The variable resistor R_1 balances the small amplifier drift at very high and low temperatures.

Diode and resistor increase input resistance of Schmitt

By Joseph Gaon

JMR Electronics Corp., Bayside, N.Y.

A slight modification of the conventional Schmitt trigger circuit significantly increases its input impedance, permitting the preceding circuit to drive many more stages. Since the modified circuit no longer loads the driving stage, the driving voltage may be used to trigger simultaneously several circuits requiring different turn-on voltages. A single stage can drive 12 modified Schmitt circuits.

In a conventional Schmitt trigger circuit, at the right, when the input exceeds about 6.5 volts, Q_1 is turned on and the input signal remains clamped to this level. As a result, the input signal cannot drive any additional circuits which may have higher trigger levels. The approximate load seen by the driving circuit when Q_1 is on is about 1,680 ohms

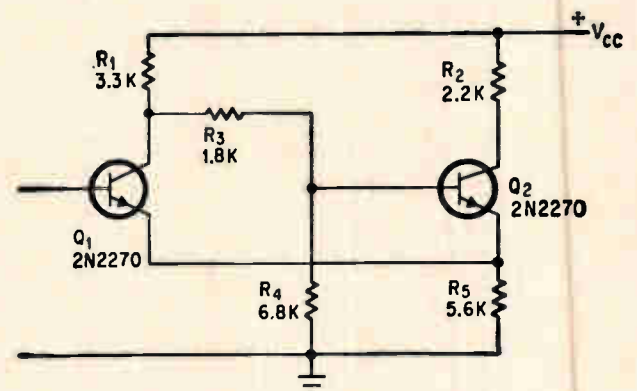

Conventional Schmitt trigger circuit clamps input signal level and prevents driver from triggering other stages requiring higher trip levels.

and consists of R_1 in parallel with R_5 and $R_3 + R_4$. Adding R_6 and D_1 to the modified trigger circuit significantly reduces the loading. Resistor R_6 is selected to saturate Q_1 with no input.

When the input voltage exceeds the trip point, which is still about 6.5 volts, D_1 is reverse-biased. The only loading of the input signal is the leakage

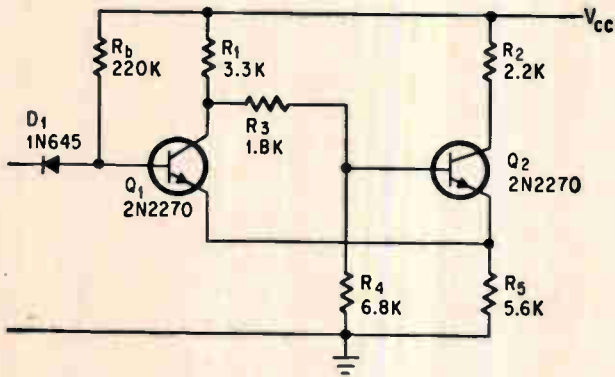

Modified Schmitt trigger includes diode D_1 and resistor R_b to prevent the input signal from being clamped.

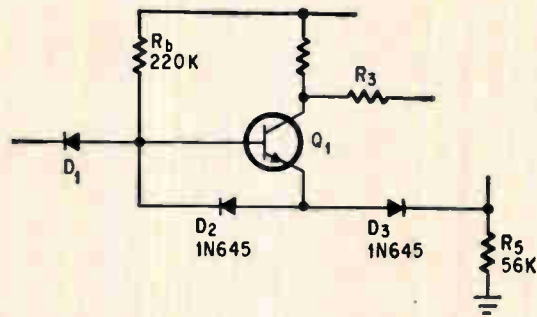

Two diodes can be added to the modified circuit to prevent reverse breakdown of Q_1 's emitter-base junction.

current of diode D_1 above the trip point and R_b , and the base leakage current of Q_1 below the trip point. Since R_b is much larger than R_1 or R_5 , the modified circuit exhibits a much higher input resistance than the conventional circuit.

The figure, above right, shows an additional modification for circuits in which the V_{ebo} rating of

Q_1 is exceeded when Q_1 is turned off. (V_{ebo} is defined as the reverse emitter-base voltage measured with the collector open.) When the input voltage falls below the trip point, the emitter of Q_1 is clamped to its base through D_2 . This prevents breakdown of Q_1 's base-to-emitter junction. Diode D_3 is reverse-biased, and the input unloaded.

Control is accurate to 0.01°C

By Kees van der Geer

Jutphaas, the Netherlands

An economical thermostat, designed to maintain the temperature of a liquid bath to within 0.01° from 15 to 35°C .

The operation centers around thermistor R_2 , which has a linear temperature coefficient of -6% per degree centigrade over the desired range. The

thermistor is one element in a relaxation oscillator consisting of unijunction transistor Q_1 , capacitor C_1 , and resistors R_3 and R_4 and R_1 .

When the temperature falls below the calibrated setting on R_1 , the resistance of thermistor R_2 increases. The voltage on the emitter of Q_1 increases and oscillations begin. Oscillations on base B_1 of transistor Q_1 are rectified and filtered by R_4 , D_1 and C_1 . After amplification by Q_2 , the d-c voltage actuates the relay, closing the heating circuit.

The relay opens when the voltage at point A is decreased by about 1.4 millivolts. The result is a temperature sensitivity of about 0.01°C .

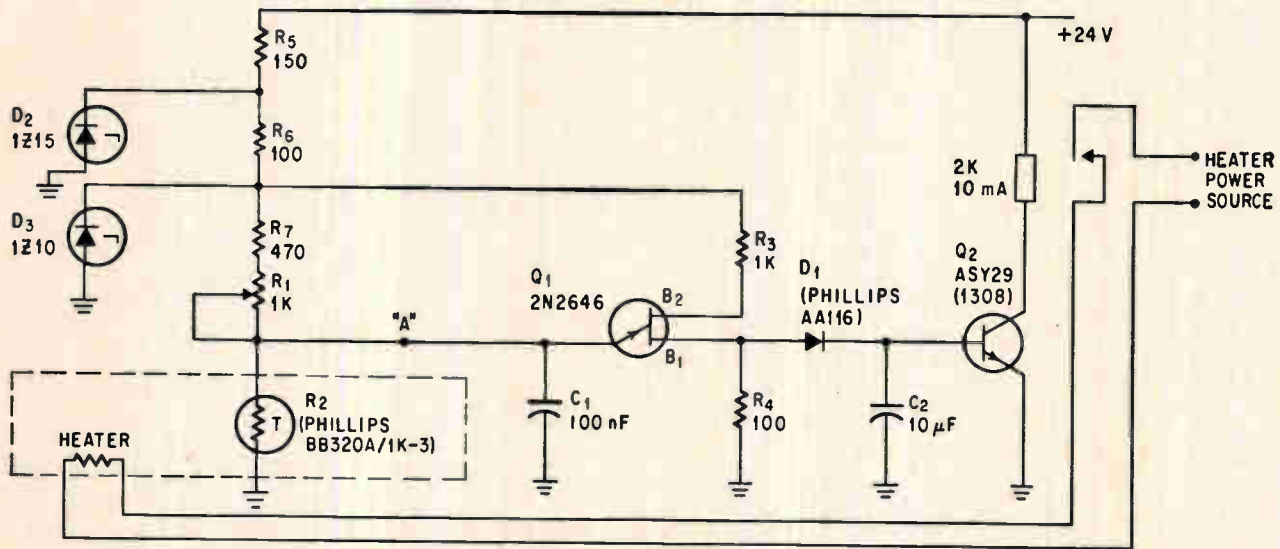

Thermistor temperature sensor is part of unijunction transistor oscillator that controls heater.

Charting the bandwidth of isolating r-f chokes

To suppress troublesome currents on the surface of coaxial cables, a toroidal choke is an effective device. A chart helps design by establishing usable choke bandwidth

By Ernest T. Harper

U.S. Army Electronics Command
Fort Monmouth, N.J.

Cable chokes, devices consisting of flexible miniature coaxial cable wound on a ferrite core¹, furnish a new approach to radio-frequency isolation between points on a conductor. When measuring the electrical characteristics of small antennas, particularly at high and very high frequencies, accuracy may be affected by currents flowing on the surface of the braided outer conductor of the coaxial feed cable that usually connects the antenna to the measuring equipment. The currents are a source of additional losses and can produce extraneous fields that contribute to the antenna's radiated field.

Cable chokes can suppress the currents by providing a high r-f impedance between opposite ends of the outer conductor, as illustrated in the sketch at the top of the facing page.

This concept for providing broadband r-f isolation is new. Traditionally, a tuned circuit consisting of an inductor shunted by a variable capacitor is resonated. Although it works well, the approach is frequency-dependent, necessitating a retuning of the capacitor with every operating-frequency change. Obviously, this can be inconvenient. Furthermore, the inductor may be easily detuned by changes in environment such as temperature, espe-

cially if it is in a high-Q circuit.

The new approach depends on operating the choke within a band centered at its self-resonant frequency, the frequency at which the inductor resonates with its own capacitance between turns and any additional stray capacitance. To so operate a choke the absolute value of its admittance must be below some specified value over the required frequency band.

Assuming the electrical length of the winding is much shorter than a half wavelength at the highest operating frequency, the equivalent circuit of a coil consists, to a first approximation, of an inductor L shunted by a capacitor C . This circuit is true for most ferrite core inductors, particularly for a toroidal inductor wound on a ferrite core, and designed for use in the h-f band.

The conductance, representing the conductor's ohmic losses and the magnetic losses in the ferrite material, is in parallel with both the susceptive elements L and C . The susceptance of the coil is

$$b = \omega C - \frac{1}{\omega L} \quad (1)$$

If b_0 , the maximum acceptable susceptance for isolation purposes, is assumed to be much larger than the conductance at resonance, then the frequency limits for which $b = \pm b_0$ is found by

$$f_{1,2} = \frac{\pm b_0}{4\pi C} \left[1 \pm \sqrt{1 + \frac{4C^2}{b_0^2 L}} \right] \quad (2)$$

The plus signs correspond to the upper frequency limit f_2 , and the minus signs correspond to the lower frequency limit f_1 . The useful bandwidth is

The author

Ernest T. Harper is a captain on active duty with the Army Electronics Command, currently assigned to antenna research at the Institute for Exploratory Research. He received his master's degree from the University of Washington in 1964, where he developed novel microwave traveling-wave antennas in the course of completing his graduate thesis.

expressed by

$$f_2 - f_1 = \frac{b_0}{2\pi C} \quad (3)$$

Throughout this band, the susceptance, and therefore the absolute value of the admittance, will be less than b_0 mhos.

A convenient method for determining the bandwidth is derived from a technique devised by W.P. Czerwinski for obtaining the dynamic characteristics of parallel resonant circuits². An example is provided by considering a toroidal inductor formed from a core of Q-1 Ferramic, available from the Electronics division of the Indiana General Corp., wound with 16 turns of RG-196/U miniature coaxial cable. The chart at right, center, is a plot of capacitance derived from measurements made with a Wayne Kerr model B801 admittance bridge, and presented as a function of the inverse frequency squared.

In the graph, the value of L is determined from the slope of the straight line joining the experimental data values. The value of capacitance C is read as the intercept of this line with the vertical axis. In the example, $L = 59.2 \mu\text{h}$ and $C = 1.9 \text{ pf}$. Assuming a reasonable working value for b_0 of 0.2 millimho, and substituting in equation 2, the limiting frequencies are found to be $f_1 = 8.8 \text{ Mhz}$, $f_2 = 25.6 \text{ Mhz}$. The admittance bandwidth of this inductor is therefore 16.8 Mhz. Throughout this frequency band, the admittance will remain less than 0.2 millimho.

The second chart illustrates the effect of additional self-capacitance on the bandwidth and the frequency limits of the toroid in the example. Such an effect would result from placing the toroid within a container that itself contributed stray capacitance. The chart shows that the lower frequency limit decreases slightly with increasing capacitance, while the upper frequency limit decreases rapidly with additional capacitance, as does the total bandwidth.

To design a coil with a certain tolerance that allows for additional stray capacitance, the effective bandwidth should be calculated by computing f_2 with the stray capacitance omitted.

With the technique described, it is possible to design a minimum number of chokes to provide a specified isolation over a wide frequency band. The entire h-f band from 2 to 30 Mhz can be covered with only three chokes, providing 5,000 ohms of r-f isolation.

The application of this technique need not be confined to measurement, nor is it restricted to antennas. The technique may be used wherever it is necessary to suppress radio-frequency energy over a wide frequency band.

References

1. E.T. Harper, "Ferrite Cable Chokes," Technical Report ECOM 2675, March, 1966.
2. W.P. Czerwinski, "Obtaining the equivalent circuits of inductors graphically," Electronics, p. 70 Aug. 26, 1960.

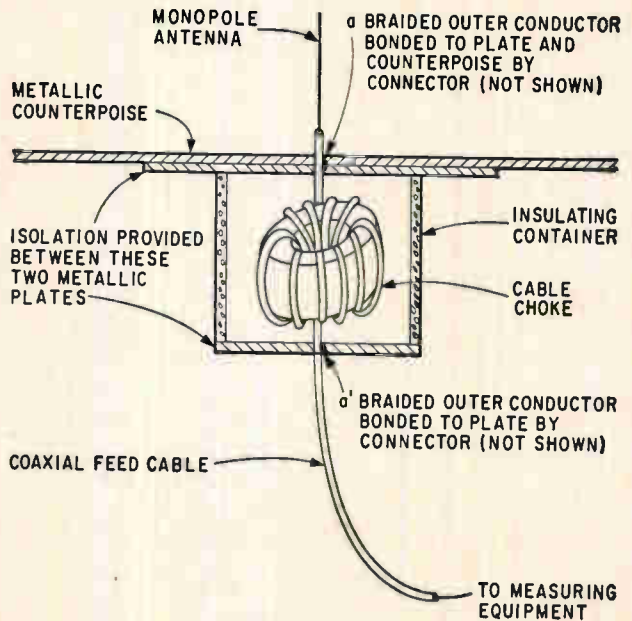

Isolator formed from miniature coaxial cable wound over a ferrite core provides high r-f impedance between points a and a'. Spurious currents in the outer conductor of the coaxial feed cable are effectively suppressed.

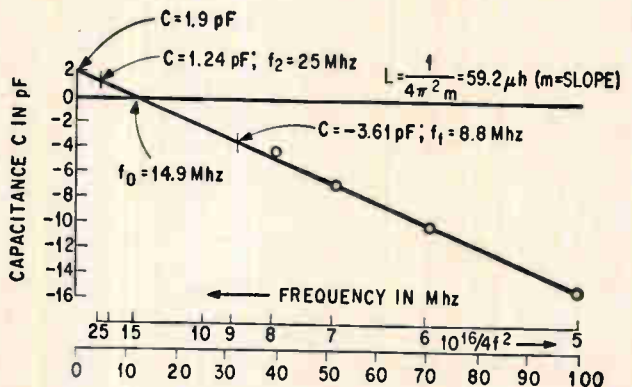

Inductance and capacitance values are determined from measured admittance data plotted as a function of the inverse frequency squared. Effective bandwidth of the choke is easily calculated from the values.

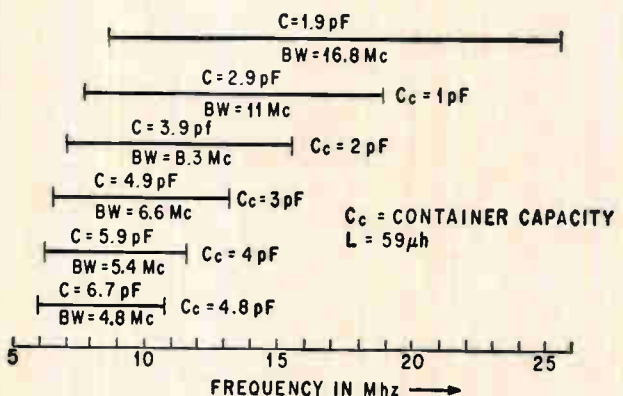

Effect of stray capacitance on choke bandwidth is shown by chart. In each instance the susceptance of the choke is less than 0.2 millimho.

Six clues to nanovolt signals

Minimum detectable signal analysis provides a tool for designing systems that measure low-level signals

By Wayne A. Rhinehart and Louis Mourlam Jr.

Institute for Atomic Research, Iowa State University, Ames

The design of a low-level, low-frequency measuring system poses many questions.

- To achieve maximum sensitivity, should the greatest effort be put to designing an ultralow-noise amplifier?
- Should an input transformer be placed between the amplifier and source? If so, what should be the turns ratio for maximum sensitivity?
- Is it better to match impedances or operate mismatched?
- Should the input resistance of the amplifier be 1 megohm or 50 megohms, or does it matter?
- Is the signal source resistance the sole limitation on system resolution?
- And finally, can the answers to these questions be found without resorting to intuitive reasoning?

The answer to the last question is yes. Low-level measuring systems can be analyzed quite rigorously to determine the effects of the described factors on the minimum detectable signal (MDS). The result of the following analysis is an equation for the MDS as a function of the noise of the source resist-

ance, the short-circuited input noise of the amplifier, the input resistance of the amplifier, and the turns ratio of the input transformer. This expression enables the designer to quantitatively answer all the questions posed at the outset and to optimize the system for his own requirements.

Analyzing the problem

Most low-level, low-frequency measuring systems can be represented by the simplified diagram on page 115. The voltage source can be either a bridge circuit or any type of low-level transducer. The detection amplifier is usually a high-gain, low-noise, narrow-band device.

For purposes of analysis, the diagram can be further reduced to an equivalent circuit, where

- R_s = internal resistance of the source
- e_{R_s} = thermal noise of the source resistance at the operating temperature and bandwidth of the amplifier
- e_s = desired signal from the source
- N = ratio of secondary to primary turns of input transformer
- R_{in} = input resistance of the amplifier (includes external resistors combined in parallel with tube or transistor input resistance)
- $e_{R_{in}}$ = thermal noise of R_{in} at the operating temperature and bandwidth of the amplifier
- R_{NA} = equivalent noise resistance of the amplifier with the input short circuited
- e_{NA} = thermal noise of R_{NA} ; measured short-circuited input noise of the amplifier

The input capacitance of the detection amplifier is assumed negligible. However, this assumption restricts the results to low-frequency use. The resistors in the equivalent circuit are noiseless and the amplifier is a voltage-controlled device. The characteristics are typical of high-impedance field-effect-transistor and vacuum-tube amplifier circuits.

For the analysis, it is assumed also that the transformer is ideal, which is a reasonable approximation of a practical case. The primary resistance is usually negligible when compared with the

The authors



Wayne A. Rhinehart, head of the instrumentation group at the Institute at Iowa, is no stranger to the problems of low-level measurements. He previously reported the design of a sensitive null detector based on field effect transistors [Electronics, Sept. 20, 1965, p. 88].



Louis Mourlam Jr. was coauthor of the earlier article on the null detector. He is a nuclear instrumentation designer at the Iowa Institute, where he devotes much time to low-level design techniques.

source resistance; and the secondary resistance is usually negligible compared with the reflected source resistance. The circuit to be analyzed, at right, is the equivalent circuit with the source parameters reflected into the transformer secondary.

The definition of the minimum detectable signal is based on the signal-to-noise ratio at the input of the amplifier. Disagreement often arises as to how small this ratio can be made and still distinguish the signal from the noise; here a signal-to-noise ratio of unity is assumed to yield the smallest retrievable signal.

Equating the signal voltage to noise voltage at the input to the amplifier gives

$$\frac{N e_s R_{in}}{N^2 R_s + R_{in}} = \left[\left(\frac{N e_{R_s} R_{in}}{N^2 R_s + R_{in}} \right)^2 + \left(\frac{e_{R_{in}} N^2 R_s}{N^2 R_s + R_{in}} \right)^2 + (e_{NA})^2 \right]^{1/2}$$

The right hand terms of this equation represent the combined root mean square voltage appearing at the amplifier's input because of the three uncorrelated noise sources, e_{R_s} , $e_{R_{in}}$ and e_{NA} .

Simplifying, the expression for the minimum detectable signal is

$$\text{MDS} = \left[(e_{R_s})^2 + \left(e_{R_{in}} \frac{NR_s}{R_{in}} \right)^2 + \left(e_{NA} \frac{NR_s}{R_{in}} + \frac{e_{NA}}{N} \right)^2 \right]^{1/2} \quad (1)$$

Increasing the resolution

Equation 1 shows that the minimum detectable signal is influenced by more than just the source resistance. The first term, the noise of the source, represents the absolute low limit for the minimum detectable signal. Where the choice of source resistance is possible, the smaller the value, the better the resulting MDS. Since the last two terms contain factors normally under the designer's control, parameters are sought to cause these two terms to vanish. In practice, however, this cannot be done completely, and the remaining parameters are chosen to minimize the last two terms.

Those terms in equation 1 which contain the transformer turns ratio N provide insight into the effects of the transformer on the MDS. The last two terms of equation 1 give

$$f(N) = \left(e_{R_{in}} \frac{NR_s}{R_{in}} \right)^2 + \left(e_{NA} \frac{NR_s}{R_{in}} + \frac{e_{NA}}{N} \right)^2$$

The best turns ratio is found by expanding this equation, taking the derivative and equating it to zero to minimize it with respect to N . From this

$$N_{opt} = \left[\frac{R_s}{R_{in}} \frac{e_{NA}}{(e_{R_{in}}^2 + e_{NA}^2)^{1/2}} \right]^{1/2} \quad (2)$$

For specified amplifier input noise and resistance, and the source resistance and corresponding thermal noise, equation 2 gives the exact turns ratio

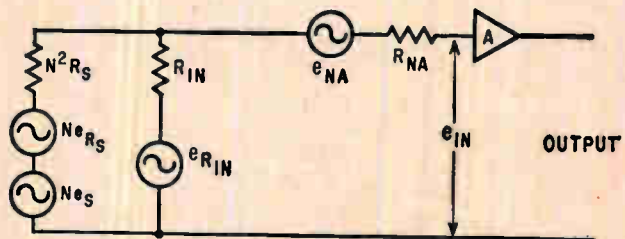
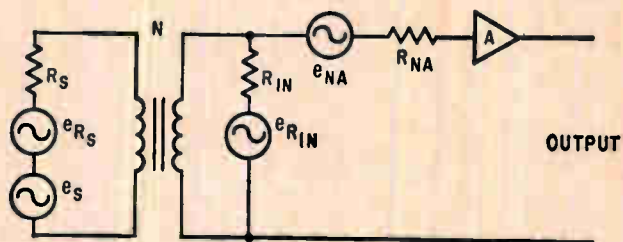
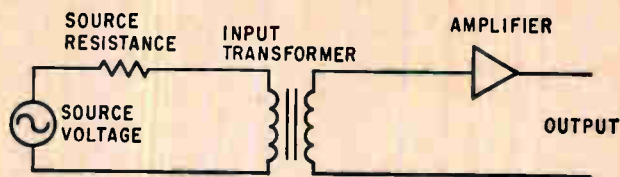

System for measuring low-level signals can be represented by the diagram at the top. For analysis purposes, it is reduced to the equivalent circuit in the center. Reflecting the source parameters to the transformer secondary yields the final form for analysis of the minimum detectable signal.

that will minimize the last two terms of equation 1, resulting in the best possible MDS. If the optimum turns ratio turns out to equal one, there is no need for a transformer. Most of the time, an input transformer is required.

A practical example would be where the value of an unknown resistance must be determined with an a-c bridge. The problem is to choose the turns ratio for the input transformer that will yield the smallest MDS and the best bridge balance. The bridge null detector is a narrow-band amplifier. From the amplifier specifications, $R_{in} = 15 \times 10^6$ ohms, the noise bandwidth is 2 hertz and the short-circuited input noise, $e_{NA} = 10^{-7}$ volt. The bridge output impedance is 10 ohms. The Johnson, or thermal, noise of the source e_s is calculated to be 5.6×10^{10} volts and the noise of the amplifier input resistance $e_{R_{in}}$ is calculated to be 75×10^{-8} volt. Substituting these values into equation 2 results in an optimum turns ratio of 445, and the minimum detectable signal, found from equation 1, is approximately 0.65 nanovolt.

A point-by-point plot of the minimum detectable signal for different values of the turns ratio exhibits a relatively flat portion near the optimum value of N . It is quite satisfactory, therefore, to use transformers with turns ratios close to that value. If the source resistance is changed to 3,000 ohms, N_{opt} becomes 25. The same curve clearly shows the effect of N on system sensitivity. With no input transformer ($N = 1$) there is achieved an MDS of 10^{-7}

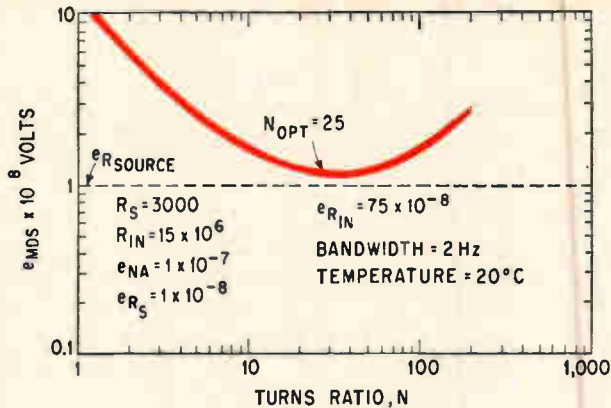
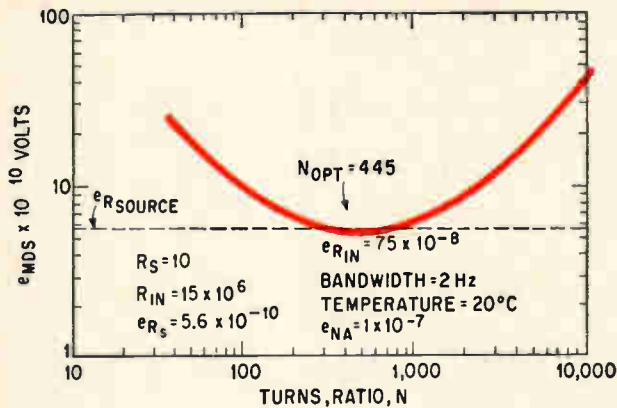

Optimum transformer need not be exactly the calculated value of N . The flatness of the curve in the region of N_{opt} allows some latitude in this value without too great an effect on the minimum detectable signal. The MDS versus N shifts markedly with respect to a change in the value of the source resistance.

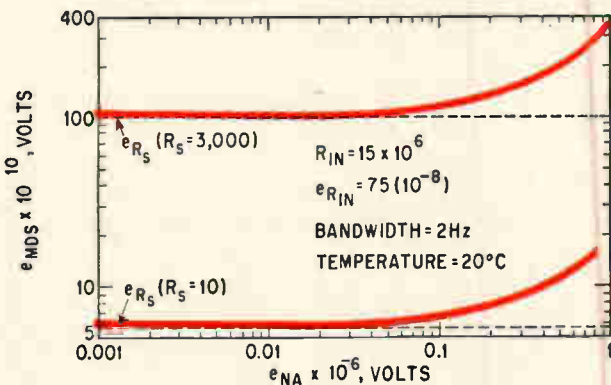
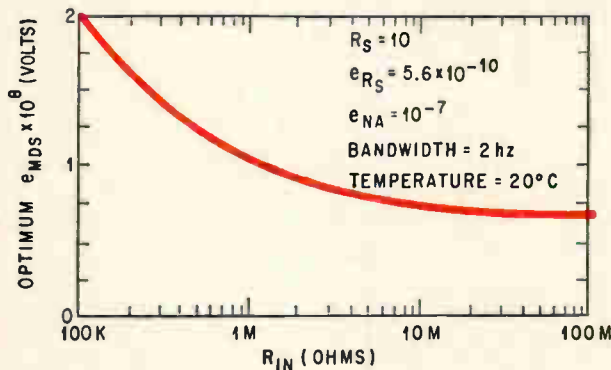

The law of diminishing returns applies when input resistance R_{in} is multiplied in an effort to improve system sensitivity (minimum detectable signal).

Amplifier noise affects system sensitivity. However, in one case, reducing noise below 100 nanovolts does not result in a significant gain in sensitivity.

volt, which is the noise of the detecting amplifier. If the turns ratio is arbitrarily made as large as possible, for example $N = 1,000$, the MDS is even worse. The equation for N_{opt} serves as an accurate guide for selecting that input transformer which results in a system sensitivity as near the theoretical limit as possible under the conditions given.

The equation for the optimum turns ratio indicates that matched impedances do not produce the lowest possible minimum detectable signal. Though matched impedances provide the most efficient transfer of the signal to the amplifier when using a transformer, a mismatch improves the signal-to-noise ratio. With two diverging factors, some sort of compromise is needed. Equation 2 exactly defines the degree of mismatch that exists between the reflected source resistance at the amplifier input and R_{in} when $N = N_{opt}$, and hence yields the best MDS. Because the optimum mismatch percentage is not constant for all situations, the optimum turns ratio must be recalculated whenever any parameters in the equivalent circuit are changed.

As shown in equation 1, the best value for the amplifier's input resistance, R_{in} is one that minimizes the last two terms in the equation, resulting in the lowest MDS. Theoretically, an infinite input resistance yields the best MDS. Actually, there is an upper limit to this resistance. A large R_{in} calls

for a large optimum turns ratio—often difficult to obtain in practice.

When applying this optimizing technique to high-input resistance amplifiers, the possible effect on the amplifier input capacitance should be carefully examined. The reactance of the input capacitance at the frequency of operation must be large when compared with the input resistance of the amplifier. The figure above shows how the optimum MDS varies with different values of R_{in} . The value of N_{opt} was calculated for each point on the curve.

How noise in the detecting amplifier affects system sensitivity can be demonstrated by returning to the bridge-balancing problem described, but with two amplifiers available as the detector. Except for short-circuited input noise, they are identical. The noise of one is assumed to be 100 nanovolts, the other 10. It would appear that the amplifier with less noise would result in 10 times more sensitivity than the other. But, that is not so. If the optimum transformer for each amplifier found from equation 2 is used, the resulting MDS values are 0.65 and 0.57 nanovolt. Reducing the short-circuited noise by 10 improves the MDS by a factor of 1.14.

The figure above shows that reducing e_{NA} below 100 nanovolts does not result in a significant gain in sensitivity. But as e_{NA} increases above 100 nanovolts, the sensitivity deteriorates rapidly.

Looking for a closed cycle cryogenic cooling system that will last the life of an aircraft without an overhaul?

How soon do you want delivery?

Garrett-AiResearch has the cooling system you're looking for. It's our version of the Joule-Thomson approach to closed cycle cryogenic cooling for airborne systems.

This is the system that will let you forget major maintenance for the life of the average aircraft. Actual test data show that its compressor unit will operate unattended for 2500 hours.

The only attention the system normally needs is replacement of an adsorber coil after 500 hours. And that's no problem because the coil is fitted with quick disconnects.



There are two major reasons for our high system reliability. First, our design concept uses few moving parts, so there are few things to go



wrong. Second, we have 20 years of experience in building compressors, motors, fans, heat exchangers and valves. That's your assurance that the remaining moving parts will keep moving.

The AiResearch closed cycle system is well suited to cooling infrared sensors. It's flexible. You can install the 14-pound compressor wherever it's convenient—as much as 100 feet away from the point at which the cooling is required. AiResearch even has a solution to the interface problem between a gimbaled infrared detector system and the Joule-Thomson cooler. The cooler in no way interferes with operation of the gimbaled infrared system. With the AiResearch system it's even possible to cool two infrared detector dewars using a single AiResearch compressor module—for example, an infrared tail warning system and an infrared forward looking search and track system. What about actual performance? A typical AiResearch system cools an



infrared electronics package system to 77°K within three minutes.

Some other kinds of systems take as long as 13 minutes to get going. You probably have some important questions. We'll be happy to answer them. We can also send you detailed information on this and other AiResearch cryogenic cooling systems.

You'll find the unique capability to solve your particular cryogenic cooling problem at Garrett's AiResearch Manufacturing Division, Los Angeles, because...

AiResearch cryogenic systems



*AiResearch Manufacturing Divisions
Los Angeles • Phoenix*

We expect these 150-grid relays to be copied



4-pole



2-pole

And by 1967 they'll be a standard of the industry

Right now, these General Electric 2- and 4-pole relays are years ahead of the field. Their low, low profile—just 0.32 inch high—lets you stack more circuit boards in the same space.

They're not just cut-down versions, either. These 150-grid relays can perform right up with microminiature relays four times their size.

For example, closing force is about the same to provide snap-action, positive contact mating. In addition, General Electric 150-grid relays meet or exceed environmental and mechanical specs of much larger microminiature relays.

And compared to relays of comparable size, G-E 150-

grid space relays have three times the magnetic force and over twice the contact force of their nearest competitor. What's more, they're the only relays in this size range that are all welded to eliminate flux contamination.

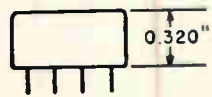

ACTUAL SIZE

Your G-E Electronic Components Sales Engineer can tell you more about 150-grid space relays and help with your individual applications. Contact him. Or write for bulletin GEA-8042B, Section 792-38, General Electric Co., Schenectady, N. Y. 12305.

Specialty Control Department, Waynesboro, Va.

GENERAL  **ELECTRIC**

Adding scr's to get high power means smaller transmitters

Combining the outputs of many silicon controlled rectifiers results in a small, high-power, solid state transmitter for low-frequency and very low frequency communications

By G.R. Brainerd, W.R. Olson and E.H. Hooper

Westinghouse Defense and Space Center
Westinghouse Electric Corp., Baltimore

Silicon controlled rectifiers can put more punch per pound in communication and navigation transmitters operating at frequencies up to 300 kilohertz. Digitally triggered scr circuits are smaller, waste less power and are more reliable than high-power vacuum tubes.

Previously, a brute-force solution—huge transmitting tubes—was necessary to obtain the high power needed for long-range transmission. No transistors can handle the power, but solid state transmitters with outputs up to several hundred kilowatts can be built with scr's connected in a high-frequency version of a d-c to a-c inverter circuit.¹ The scr's are used instead of vacuum tubes in a new 150-kw transmitter that operates in portions of the very low frequency (3 to 30 khz) and low frequency (30 to 300 khz) bands.

The new transmitter was designed for a Navy communications program, but is on loan to the Stanford Research Institute of Stanford University for a year. Operating in Antarctica as part of Operation Deep Freeze, the polar research and exploration program. It is employed in the study of magnetic fields that propagate whistlers, the natural vlf signals generated by lightning. For this purpose the transmitter has been modified slightly to feed a dipole antenna that is 21 miles long.

A power output of 150 kilowatts is obtained at frequencies of 10 to 30 khz but it falls to 10 kw at 90 khz, the upper operating frequency of the system. Similar designs could produce much higher power outputs at the upper frequencies, and it is anticipated that an scr transmitter could deliver an output of 20 kw at frequencies as high as 300 khz.

The Navy's transmitter's size is 100 cubic feet,

only one-tenth the size of a comparable tube transmitter. The photograph on page 120 is an artist's version of one way the unit might be built.

The transmitter's efficiency in converting d-c to radio-frequency power reaches 86%, compared with 50% to 65% for conventional tube transmitters. Based on a cost of one cent per kw hour, this improvement is sufficient to save \$2,500 to \$5,000 a year on the cost of electrical power alone.

One of the reasons that the system is so efficient is that the scr's—there are 96 of them—operate as a high-gain power amplifier. Driven by a 30-milliwatt digital signal, the scr's achieve an effective power gain of 5 million-to-1, or 67 decibels.

Furthermore, the scr's are the type used as high-power switches for industrial control applications; such scr's can efficiently control 40 kw or more and their reliability has been proved through years of use in industry. However, in industrial applications, the scr's haven't generally been switched at frequencies above 400 hertz.

Rapid-fire switches

Employing scr's at communication frequencies requires circuitry and techniques to circumvent the scr's relatively slow switching speeds. Although an scr will turn on in a microsecond or two, it takes as long as 20 microseconds to turn off. This slow switching speed would appear to limit the scr to generating frequencies that are less than one-half the reciprocal of 20 microseconds, or specifically less than 25 khz. This is high enough for most of the vlf band (to 30 khz) but too low for the l-f band (30 to 300 khz).

To circumvent long recovery time, the scr's in

the transmitter are grouped into sections which are triggered in sequential order by precisely timed, low-power gate signals. A simplified block diagram of a four-section scr transmitter shown below illustrates the basic scheme. By the time the last section is triggered by the exciter, the first scr section has recovered and can be triggered again.

The current pulses are portions of a transient oscillation that occurs when the scr begins to conduct. By making the pulses exactly one-half cycle of the desired frequency and by combining the outputs of the four sections in a common load, the resultant waveform closely resembles a continuous wave. Filtering this signal removes the distortion components and yields the desired sine wave. Because the sequential method of firing the scr's suggests the fire-and-recover principle used in early machine guns, Westinghouse engineers refer to this triggering scheme as the gatling gun technique.

Basic circuits

The basis of the technique employed in the scr amplifier is illustrated by the simple series-resonant circuit in the top diagram on page 121. When the switch is closed, the transient current, $i(t)$, is an exponentially decaying sine wave. The voltage, $v(t)$, appearing across the capacitor has a similar transient, but it oscillates about the supply voltage, E .

If the switch is replaced with an scr, as in the second diagram on page 121, gating-on the scr will result in the same current and voltage waveforms. However, the scr will conduct only until the current returns to zero and attempts to reverse its direction. At this time the scr will automatically turn off. Because of the characteristics of the oscil-

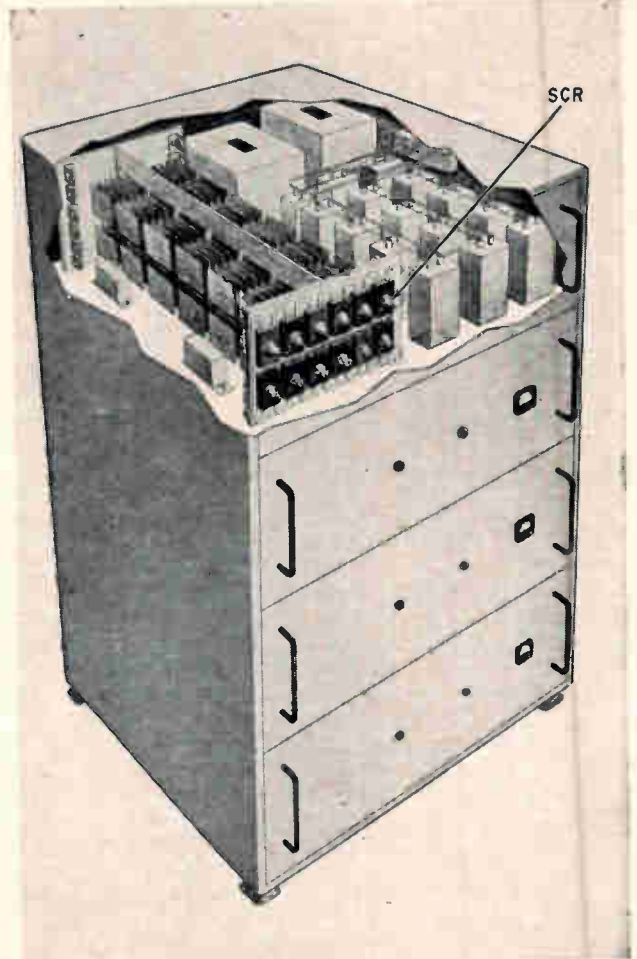

Transmitter consists of four sections, each with 24 scr's mounted on water-cooled heat sinks. This is an artist's conception of a packaged transmitter.

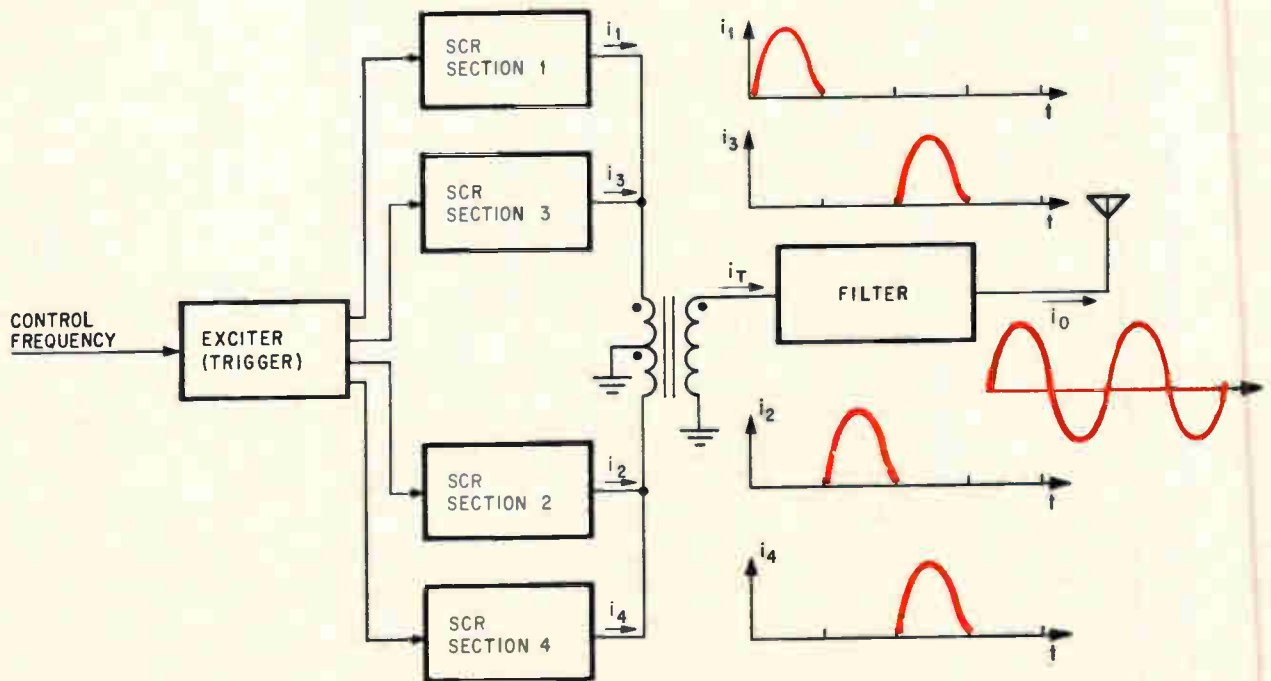

High-power current pulses developed in each scr section are combined in the load to produce a sine wave. The trigger, or exciter circuit, controls the firing of the scr's and determines the load frequency.

latory transient, the voltage across the capacitor at this time is greater in magnitude than the supply voltage, E. This back voltage on the scr is the source of reverse current which turns off the scr.

A desirable feature of the oscillatory transient is that it produces a pulse similar to a half-sine wave which reduces the harmonics at the output. For such a transient to exist the circuit must be underdamped, requiring that

$$R \leq 2 \sqrt{\frac{L}{C}} \text{ or } \left(\frac{R}{2L}\right)^2 \leq \left(\frac{1}{LC}\right) \quad (1)$$

In this simple circuit the transient's characteristic frequency is given by

$$f = \frac{1}{2\pi} \sqrt{\frac{1}{LC} - \left(\frac{R}{2L}\right)^2} \quad (2)$$

Equation 2 determines the frequency of the transients, not the transmitter frequency. That is determined by the rate at which the exciter triggers the scr's.

A single-section resonant inverter to convert d-c to a-c is formed when two scr circuits are combined as in the bottom diagram on the right in which the capacitor and load resistor are common to both resonant loops. The series-resonant loops are complementary in the sense that the back voltage placed on the capacitor by one scr is a forward voltage for the other scr. This requires that the scr's forward-blocking rating—the maximum anode-to-cathode voltage that the scr can withstand without conducting—be equal to the sum of the d-c voltage and capacitor voltage.

By triggering on one scr and then the other, pulses of current—corresponding to half cycles of the transients—flow through the load resistor R. It is desirable for the transient to oscillate at the transmitter frequency to improve the efficiency by maintaining a large duty cycle and to reduce the harmonic content of the combined wave. The harmonic content is reduced by making the width of each current pulse exactly half the period of the operating frequency, resulting in an output current that is nearly sinusoidal.

Adding inverters

The maximum frequency at which the simple resonant inverter can operate is limited by the recovery time of the scr. That is, in a single section resonant inverter, the scr must be able to recover in a time less than half the period of the desired operating frequency.

To obtain a higher-frequency of operation, additional resonant inverters are connected across the load as in the figure at the top of page 123. In this diagram of a three-section circuit, the numbers D₁ to D₆ show which scr's develop the various portions of the resultant waveform i_T(t).

In this circuit, an scr such as D₁ is triggered only once every three cycles rather than every cycle as in the single-section circuit. This permits an scr which has a limited switching speed to be

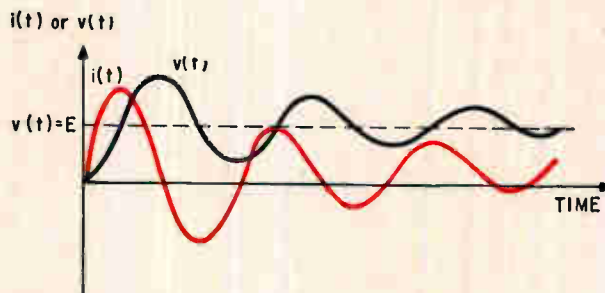
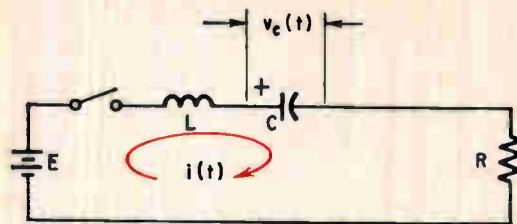

Basic concept employed in the scr transmitter is illustrated by this simple switch circuit. An underdamped series-resonant circuit causes an oscillatory current transient, in color, when the switch is closed.

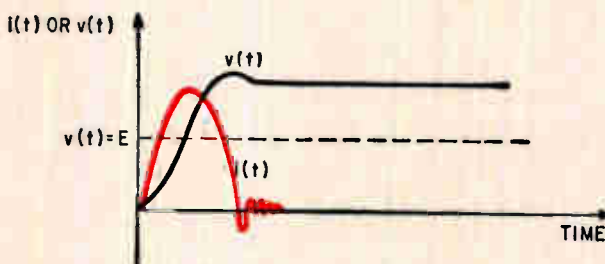
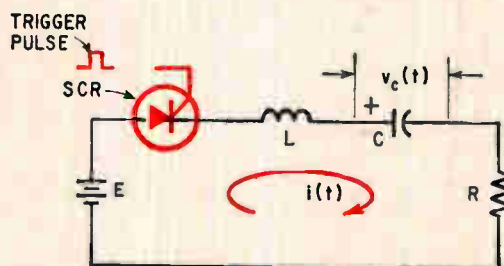

The scr conducts only if the current is positive. The pulse shown in color is the resultant current waveform.

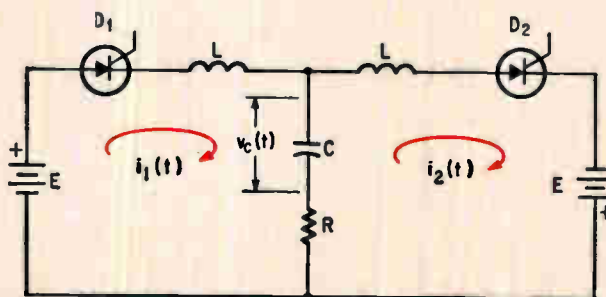

Alternately triggering the scr's in dual-scr resonant inverter produces current pulses that are summed in the load to produce the desired waveform.

Analysis of idealized scr amplifier

By assuming that the silicon controlled rectifier transmitter has high Q circuits in the scr sections, it is possible to make a relatively simple analysis that provides an estimate of the output voltage, capacitor voltage and output power. In the circuit in the diagram at the right the load is replaced by a generator that represents the voltage developed across the filter circuit. However, because the resistance of this generator is assumed to be zero, and thus in equation 2 on page 121, $R/2L$ is zero for this circuit, the angular frequency of the current pulses is

$$\omega = \frac{1}{\sqrt{LC}} \quad (A)$$

It is assumed that the output has the same angular frequency, so that as one scr turns off the other scr is just turning on. Further it is assumed that the circuit has operated for a long time so that "steady-state" conditions exist, and that scr, D_1 , is triggered at a reference time $t = 0$. Solving for the current $i_1(t)$ results in the solution

$$i_1(t) = \left[\frac{E - v_c(0)}{\sqrt{L/C}} - \frac{V_o}{2L} t \right] \sin \sqrt{LC} t \quad (B)$$

where $0 \leq t \leq \pi \sqrt{LC}$

$v_c(0)$ = voltage remaining on the capacitor when D_2 is turned off in the previous cycle

V_o = the maximum magnitude of the output voltage

$\pi \sqrt{LC}$ = the half period of the resonant frequency

Equation B is plotted in the top graph in the diagram on the right with the portion of the waveform corresponding to restrictions placed on the time, t , shown in color.

During the same time, the voltage $v_c(t)$ on the capacitor is given by

$$v_c(t) = E - \left[E - v_c(0) - \frac{1}{\sqrt{LC}} \frac{V_o}{2} t \right] \times \left[\cos \frac{t}{\sqrt{LC}} \right] - \frac{V_o}{2} \sin \frac{t}{\sqrt{LC}} \quad (C)$$

$0 \leq t \leq \pi \sqrt{LC}$

Equation C is plotted at the bottom of the diagram at the right. The time, t , for which equation C is valid is also shown in color.

At $t = \pi \sqrt{LC}$, when D_2 would be triggered again, the voltage across the capacitor as determined from equation C is

$$v_c(t = \pi \sqrt{LC}) = 2E - v_c(0) - \frac{\pi}{2} V_o \quad (D)$$

Peak output voltage

During steady-state operation the two loops operate symmetrically. At the end of every half cycle the magnitudes of the capacitor voltages are equal but reversed in sign. The current in D_2 is similar to the current in D_1 but is of opposite sign

and, of course, occurs a half cycle later. Referring specifically to the first two current pulses considered, these statements imply

$$v_c(0) = -v_c(t = \pi \sqrt{LC}) \quad (E)$$

$$i_2(0) = -i_1(t = \pi \sqrt{LC}) \quad (F)$$

Substituting E in D, the peak voltage across the loads is related to the source voltage by

$$V_o = \frac{4}{\pi} E \quad (G)$$

Capacitor voltage

By requiring that the voltage across the scr be equal to or less than zero after the scr has turned off, it is possible to determine the minimum value of the capacitor voltage that is required to maintain the scr back-biased. If D_1 has just turned off, then the

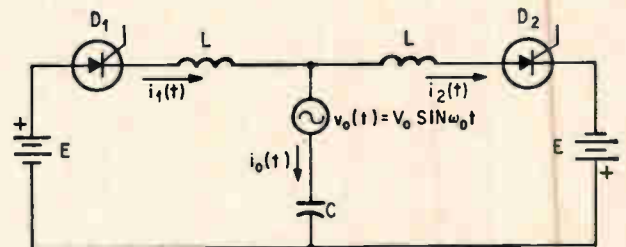

Idealized lossless inverter circuit, in which the load is represented by a sinusoidal generator $v_o(t)$, is used to analyze a section of the scr transmitter. All other sections would be analyzed in a similar manner and the results added to obtain the proper waveforms.

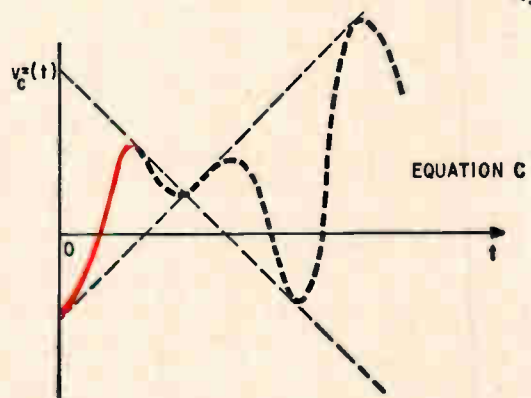
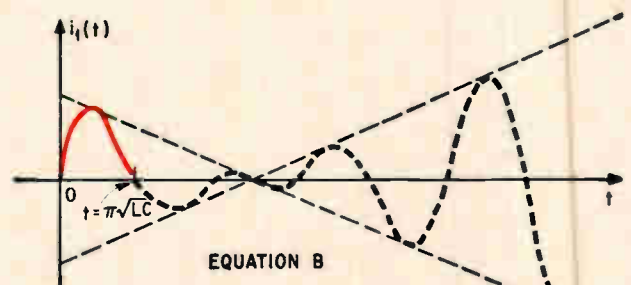

Equations B and C are represented by the curves above. Segments in color indicate the portions of the waveforms that are valid for this analysis.

voltage across D_1 is given by the expression

$$V_{D1} = E - v_C(t = \pi \sqrt{LC}) - v_O(t) \leq 0 \quad (H)$$

valid for $\pi \sqrt{LC} \leq t \leq 2\pi \sqrt{LC}$

Since the output voltage will be swinging negative during this cycle

$$v_O(t)|_{min} = -V_O \quad (I)$$

Substituting equation I into equation H

$$v_C(t = \pi \sqrt{LC}) \geq E + V_O \quad (J)$$

Equation J implies that the capacitor voltage at turn-off must be at least the sum of the supply voltage and the maximum output voltage, V_O , if the scr—specifically D_1 in this example—is not to be forward biased while D_2 is on. The reactance of L and C are made sufficiently high compared with the impedance of the tuned load, so that this inequality is maintained.

Substituting equation G into equation J, the capacitor voltage may be related to the source voltage by

$$v_C(t = \pi \sqrt{LC}) \geq \left(1 + \frac{4}{\pi}\right) E = 2.27E \quad (K)$$

Employing equation E

$$-v_C(0) \geq 2.27E \quad (L)$$

Power

The power delivered to the load is given by

$$P_O = -\frac{1}{\pi \sqrt{LC}} \int_0^{\pi \sqrt{LC}} i_1(t) v_O(t) dt \quad (M)$$

where $v_O(t) = V_O \sin(t/\sqrt{LC})$ and $i_1(t)$ is given by equation B. All terms in $i_1(t)$ and $V_O(t)$ have been related to circuit parameters except that $v_C(0)$ is given only in terms of an inequality in equation L. If equality is assumed then the integral may be evaluated as

$$P_O = \frac{4 V_O [E - v_C(0)] - \pi (V_O)^2}{8 \sqrt{\frac{L}{C}}} = \frac{1.45 E^2}{\sqrt{\frac{L}{C}}} \quad (N)$$

The power may be approximated by

$$P_O = \frac{V_O}{\sqrt{2}} \frac{I_{pk}}{\sqrt{2}} \quad (O)$$

where I_{pk} is the peak current in the scr. Solving for I_{pk} and substituting equations G and N, the peak current is approximately

$$I_{pk} = 2.3 \sqrt{\frac{E}{\frac{L}{C}}} \quad (P)$$

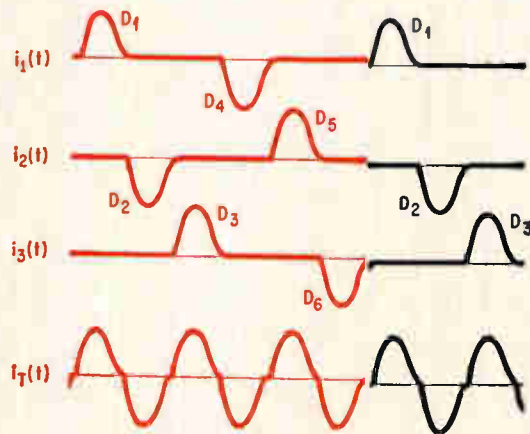
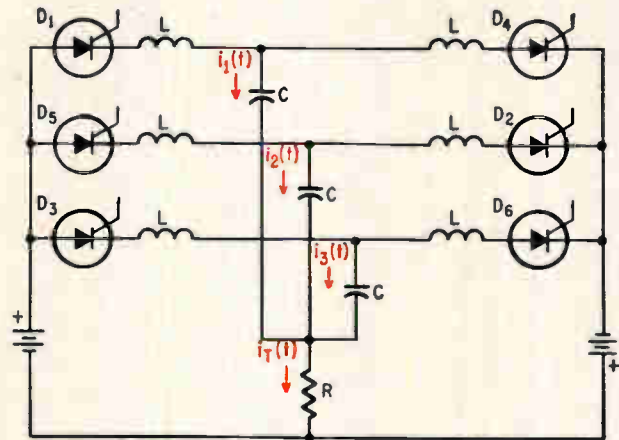

High-frequency operation requires that additional scr sections be added so that one scr is being turned off while another is triggered. The curves in color represent one complete cycling of the scr section.

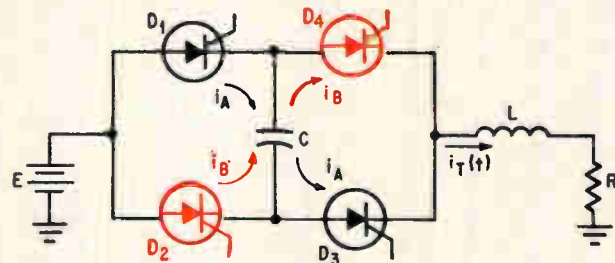

Improved scr section operates with one power supply. Two scr's are triggered to establish a conducting path.

used in a high-frequency circuit. Also, rather than sequentially triggering both scr's in one section and then proceeding to the next section, a single scr is triggered in each section. This insures that an scr, such as D_1 which is supposed to turn off, is not inadvertently forward biased, turning D_1 on again when D_2 in the same section is triggered. This procedure is required because each scr requires about 20 microseconds to turn off.

Filtered waveforms

The distorted waveform, $i_T(t)$, is not suitable for communications and must be filtered. The filter is



Digital modules make up the exciter circuit which measures 6 x 6 x 8 inches. The circuit has a frequency response extending to 300 kilohertz.

connected to the scr sections and the resistive load, and is designed to present a high-input impedance at the desired frequency and a low impedance at the harmonics. As a result, the voltage across the filter input is nearly sinusoidal for any complex, periodic-current waveform whose fundamental frequency is the same as the resonant frequency of the filter. In the analysis of the circuit presented in the panel on page 122 this fact is used to represent the load as a sinusoidal voltage source whose voltage magnitude corresponds to the actual voltage

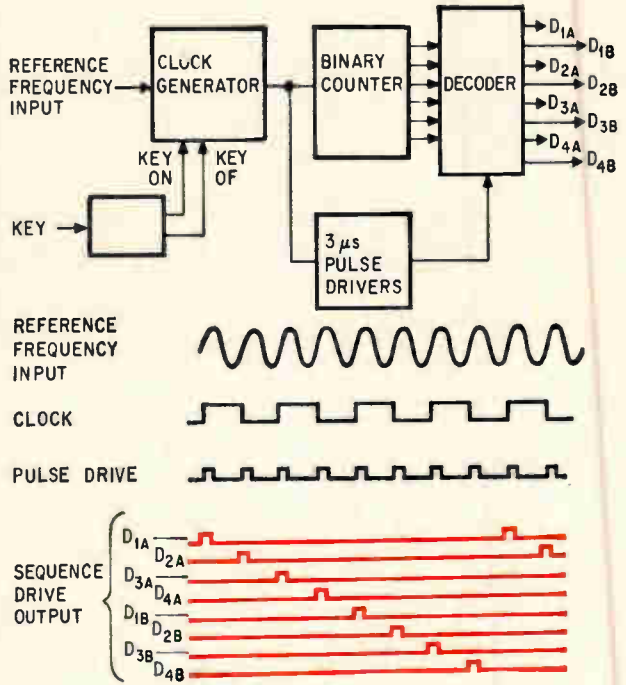

Exciter generates pulses, whose period is determined by the reference frequency. D_{1A} to D_{1B} correspond to the scr's in the diagram on page 125.

that would appear across the filter.

To operate with a single power supply, the actual transmitter employs sections similar to the one in the bottom diagram on page 123. In a typical condition, scr's D_1 and D_3 would conduct and D_2 and D_4 would be off. In contrast to the inverter circuits discussed above, the current through the load will be in the same direction if either D_1 and D_3 or D_2 and D_4 are conducting. This is not a problem, because in the actual circuit on the top of the next page the sections are connected on either side of

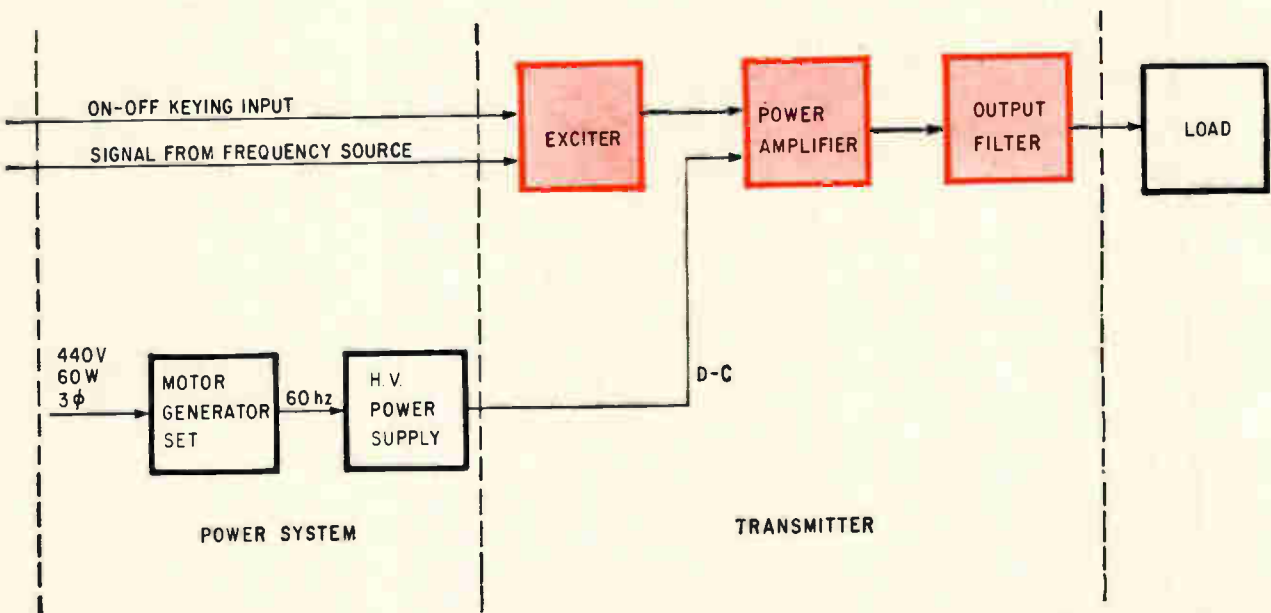

Vlf/lf transmitter includes a motor-generator set and power supply to generate direct current, and an exciter and scr section that are the source and power amplifier for the radio-frequency output. Frequency at the input controls the transmitter frequency. Keying input permits code to be transmitted.

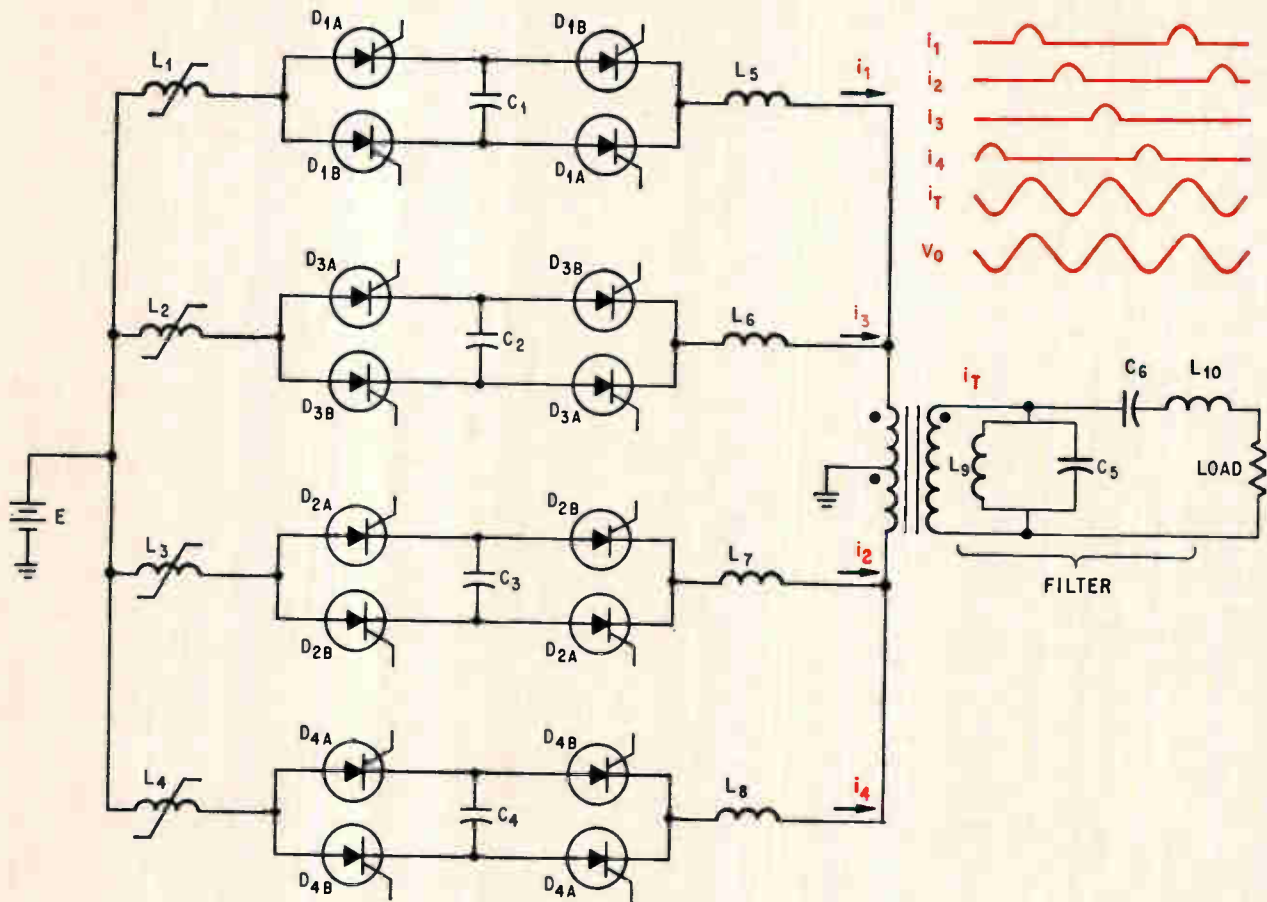

Power amplifier represented by four scr sections combines the current pulses through a center-tapped transformer that inverts the pulses from the two bottom sections. Scr's are fired alternately on either side of the transformer. Saturable reactors L_1 to L_8 protect the scr's during turn-on by preventing sudden current surges that might burn out scr junctions. To obtain a sinusoidal waveform scr's are triggered in the sequence D_{3A} , D_{2A} , D_{3A} , D_{4A} , D_{1B} , D_{2B} , D_{3B} , and D_{4B} . In the actual transmitter, six scr's in series are used for every scr in the diagram.

a center-tapped transformer to obtain a polarity reversal for every other current pulse.

An operating system

The major components of the vlf/lf transmitter that is now in operation in the Antarctic include a power supply, an exciter, power amplifier, output filter and load—as in the bottom diagram on page 124. The exciter supplies the gating pulses necessary to trigger the various scr's in proper sequence. Inputs to the exciter are a sinusoidal wave from a frequency synthesizer and a keying voltage that pulse modulates the output. A water-cooled transformer matches the power amplifier to the 400-to-800-ohm impedance of the load and provides the proper phasing for combining the current pulses. The d-c power is derived from a high-voltage power supply that is driven by a motor-generator set. The final Navy system will have a 400-hertz power source rather than a 60-hertz one and will be matched to a 50-ohm load.

The radio-frequency range of the transmitter extends from 10 to 90 khz. Over the frequency range from 10 to 30 khz, which is covered in four bands, the output power is 150 kilowatts. At frequencies from 30 to 90 khz, which are covered in five bands,

the output power varies from 150 kw to 10 kw.

For each of the nine bands, the tuning inductance, L , and capacitance, C , of each resonant-inverter section and the tuning elements of the filter are changed to operate at a midband frequency, f_0 . Within a bandwidth ranging from $0.8 f_0$ to $1.2 f_0$, the transmitter frequency is changed by varying the frequency source. The filter preceding the load in the diagram above rejects frequencies above the second harmonic, reducing all harmonics to at least 50 db below the fundamental.

Transmitter power output is directly related to the d-c supply voltage. A d-c voltage of about 900 volts is required to produce 150 kw output while 750 volts is needed for 100 kw. Peak scr currents are on the order of 300 amperes for full power.

Exciter

The exciter in the photograph on page 124 is a solid state logic circuit that generates output pulses that are timed by a master clock source which operates at twice the desired transmitter frequency. In the block diagram of the exciter at the top of page 124, the numbers at the sequence-drive output designate the sequence of triggering the scr's in the power amplifier diagram on page 125.

A frequency synthesizer controls the transmitter's frequency, and at any frequency the value of the components in the power amplifier affect both the efficiency of the conversion from d-c to r-f and the phase relationship between the input source and the amplified signal. At all times the radiated frequency is half the pulse rate of the exciter. Special tests have proved that the system can generate a signal stable enough for navigational systems—another application for long-range vlf transmission besides communications.

Power amplifier

Because of the power and frequency requirements, a four-section power amplifier was employed in the actual transmitter in the diagram on page 125. For simplicity, each scr in the block diagram represents six scr's in series. There are actually 96 scr's in four parallel sections, each with 24 scr's. Additional power amplifier sections could be paralleled and their outputs summed to produce higher power than a single amplifier.

The scr's are Westinghouse Electric Corp.'s type 809M that are rated for a 600-volt forward-blocking voltage and a half-cycle surge-current of 1,000 amperes. In this circuit the maximum d-c voltage is about 900 volts, the capacitor voltage is about 2,200 volts and the peak load voltage is about 1,200 volts. In the series loop, 12 scr's must support the sum of these voltages—4,300 volts—or each scr must support 360 volts.

One reason for connecting the scr's in series rather than in parallel is to avoid current-equalization problems. If the scr's were connected in parallel, their impedance characteristics would have to be carefully matched to insure that they share the current load equally; a difficult procedure. In addition, because the maximum voltage that can be placed across the scr is limited; the power supply voltage would have to be reduced and the operating current increased to maintain the desired power output. As a result, larger components would be required to carry the higher currents.

Connected in series, each scr must be able to carry the peak surge current of the string and to share the voltage drop equally. Scr's such as Westinghouse's type 809M have the required current ratings and approximately the same voltage drops for a given current flow.

A series configuration also allows higher-inductance coils to be employed. In the series arrangement the coils, L_5 to L_8 , require inductances of 10 to 50 microhenries. In parallel operation the lower circuit impedance require tuning coils of about 0.33 to 1.3 microhenries—values so low that they would be affected by lead inductance.

Saturable reactors L_1 to L_4 prevent damage to the scr's when the scr's are operating at high frequencies and at high powers.

During turn-on, conduction begins at localized areas within the junction. High currents in the localized areas could destroy the scr before the full junction area becomes effective. The saturable

reactors prevent this by delaying full current flow for about 10 microseconds after any group of 12 scr's are gated on. After it saturates, the reactor does not impede current flow. Although scr's with high switching speeds reduce the turn-on problem, saturable reactors are still required.

Versatile

In addition to transmitting continuous waves, the transmitter may operate with other types of modulation including pulsed continuous wave, frequency, phase or amplitude modulation and frequency shift keying. In a pulsed c-w system the keying circuit in the exciter circuit is opened to remove gate drive from the scr and hence momentarily stops the transmitter output. Frequency or phase modulation and frequency shift keying are produced by frequency or phase modulating the reference frequency at the input of the exciter. Since the output frequency is dependent solely on this input clock frequency, it will follow this modulating signal. By varying the supply voltage, the transmitter may be amplitude modulated.

Acknowledgment

This work was sponsored by the Bureau of Ships and monitored by the Naval Shore Electronic Engineering Center.

References

1. G.R. Brainerd, W.R. Olson and E.H. Hooper, "Sine Wave Generator Comprising a Plurality of Resonant Circuits Discharged into a Resonant Load," Patent No. 3,243,728, March 29, 1966.

The authors



G.R. Brainerd, manager of the solid state technology section at the Westinghouse Defense and Space Center, directs efforts in solid state design and microelectronics. He received his MSEE from Ohio State University in 1953.



Wayne R. Olson, a graduate of Northwestern University, is a supervisory engineer at Westinghouse. He is in charge of advanced development projects that include high-power solid state transmitters and microelectronic frequency synthesizers.



E.H. Hooper, a project engineer, has been working on high-power solid state transmitters for the vlf band. He graduated from Auburn University in 1956 and has done graduate work at the University of Pittsburgh.

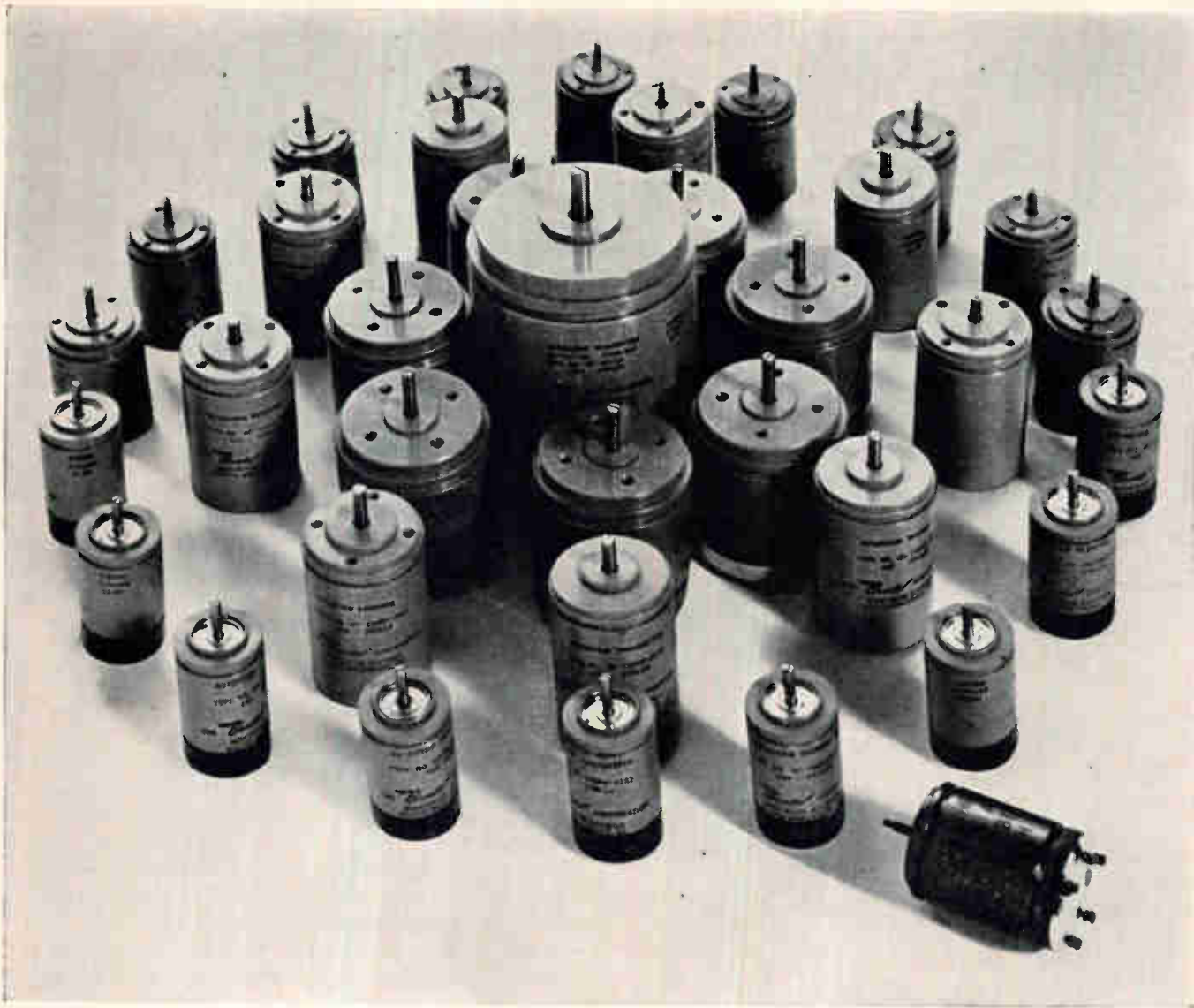

Just when we've solved your synchro problem, somebody comes up with a new one.

Designing and producing Autosyn® Synchronizers to fill the everyday needs of our customers isn't enough. We also specialize in meeting the unique need and solving your specific requirements.

Fact: engineers needed smaller, lighter-weight synchronizers for space-critical designs. Solution: the new series of 16 Size 08 Autosyn Synchronizers.

Fact: supersonic aircraft applications demanded synchronizers that could consistently operate at ultra-high

temperatures. Solution: eleven different Autosyn Synchronizers will perform accurately at temperatures up to 800°F.

Fact: we've built many of them to be corrosion- and radiation-resistant.

AUTOSYN® SYNCHROS

Size	Max. Diameter (In.)	Typical Weight (Oz.)	No. of Models
08	0.750	1.3	16
10	0.937	1.7	25
11	1.062	3.2	29
15	1.437	4.7	24
22	2.161	18	5

And we're able to provide synchronizers with tolerances as close as 50 millionths of an inch.

Meeting all needs has been our way of business since we began business in the 1920's. That's why the Bendix line of Autosyn Synchronizers (and Mil-Spec synchronizers) is the most extensive you can find. And it's why we're ready to solve your synchro problem. Try us. Phone (717) 278-1161, Montrose, Pennsylvania. Or write for our new 42-page catalog.

Montrose Division



Strips of nickel foil automate welding of flatpack assemblies

Numerically controlled punching, welding and test equipment programmed by logic-design data manufactures integrated-circuit modules for high-reliability programs requiring rapid design changes

By Victor M. White, Harry F. Sweitzer Jr., and William T. McMorran*

Space and Information Systems Division, Raytheon Co., Sudbury, Mass.

Welding has been kept competitive with other integrated-circuit assembly methods by a module design that allows the assemblies to be made and tested with numerically controlled equipment. The production processes are coordinated with electrical design so that the manufacturing systems are programmed directly from the design data.

* Now with Litton Industries, Inc., Woodland Hills, Calif.

The authors

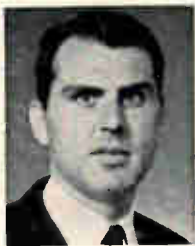

Victor M. White is section manager of prototype development. Formerly a specialist in test procedures and equipment, he now designs and develops automatic equipment, prototype hardware and new manufacturing processes.



Harry F. Sweitzer Jr., manages the reliability and specification compliance department. He was environmental test and system engineer as well as component specification engineer on the Sparrow missile program and product assurance manager for the Polaris program at Raytheon.



William T. McMorran was manager of the guidance and advanced packaging section at Raytheon. He spent four years as a counter-measures officer in the Air Force, evaluating electronic equipment.

The modules were developed for aerospace digital systems, an application that demands small size and high reliability. It often requires the ability to put design changes into production overnight. The welded-matrix modules accomplish all three.

A typical module construction is summarized in the diagram at the right. Two 21-flatpack subassemblies are mounted back-to-back in a connector housing about 2 inches long, 1½ inches high and ½ inch thick. Flatpack leads are welded to tabs projecting from a laminated stack of signal wiring punched from nickel foil. The connections between the stacks and the subassembly leads are welded to tabs at the rear.

A similar design is now being used in the on-board guidance computer of the Apollo spacecraft.

Welding was selected as the joining method because of its reliability advantages. Welded joints have had a failure rate of only 0.0018×10^{-6} per joint hour in modules previously made by the Raytheon Co. for the Polaris and Apollo programs. These were discrete-component assemblies of the crossed-wire matrix and cordwood type. The new modules are conceptually akin to the crossed-wire matrixes (see p. 133) and resemble cordwood modules in that the only fabricated joints are welds between component leads and wiring. However, the fabrication techniques for the integrated-circuit modules are new, as well as the design.

Matrix fabrication

The machine that punches the nickel foil has a pneumatically operated set of punches, a tape reader, a logic and timing section which actuates the punches according to directions on the tape, and feeding and takeup mechanisms for the foil. The stock material is ductile nickel ribbon that is

one inch wide and two mils (0.002 inch) thick.

The punch and wiring strips are shown on the cover and the machine is on page 130. About 50 modules' worth of strips can be punched during an eight-hour shift. The punches operate in a common die block, holding registration within one mil. A cumulative tolerance of two mils can be held over a strip length of 10 inches.

The first punch forms a universal pattern of 50-mil slots on either side of a center conductor, as in the diagram below. As the strip advances in 50-mil increments, the next three punches remove unwanted tabs and unwanted portions of the center conductor. Keying holes, to guide the laminating, are punched at the ends of the strip and the part number is printed on the strip.

The excess material at the ends and sides of the wiring serves as a handling aid and is trimmed off after the stack is laminated. Lamination consists of interleaving the wiring with insulating adhesive tape or glass fabric impregnated with partially cured epoxy. After curing, trimming and assembly of the stacks between the subassembly's spacers, the tabs projecting from the stack are bent flush with the spacers.

The subassembly, complete except for the integrated circuits, is examined for wiring continuity and resistance by a numerically controlled tester. The side of the wiring matrixes is covered with insulating adhesive tape and the flatpacks are positioned on the tape.

Automatic welder

The technique usually employed to weld flatpack leads to printed circuits, parallel-gap welding,

welds the flatpack leads to the tabs. In parallel-gap welding both electrodes contact one surface of the material.

The power supplies of the welding machine, on page 130, are of a feedback-controlled type commercially available. The combination of two supplies and five welding heads allows different weld schedules (settings for weld-pulse voltage and duration, electrode gap and pressure) to be set and calibrated in advance. The buses at the rear of the assembly, which are welded on the same machine, and the lead welding require different schedules. Also, different types of IC's may require different schedules because of minor variations in lead materials and dimensions.

The tape-controlled console selects the required power supply and head combination for each weld, and moves the positioning table to locate joints to be welded under the selected heads. Positioning accuracy is five mils. The control system includes a lockout feature which detects, through the power-supply feedback control, whether the weld was made. If not, the weld operation is automatically repeated.

The welded assembly is examined for performance in a tape-controlled tester. The test is repeated after encapsulation. The modules are generally encapsulated with urethane foam, which can be removed by solvents harmless to the assembly if rework should be required.

System assembly

The M3X computer, briefly described in a previous article,¹ was built during 1965 as a test vehicle for the matrix technique and to work out

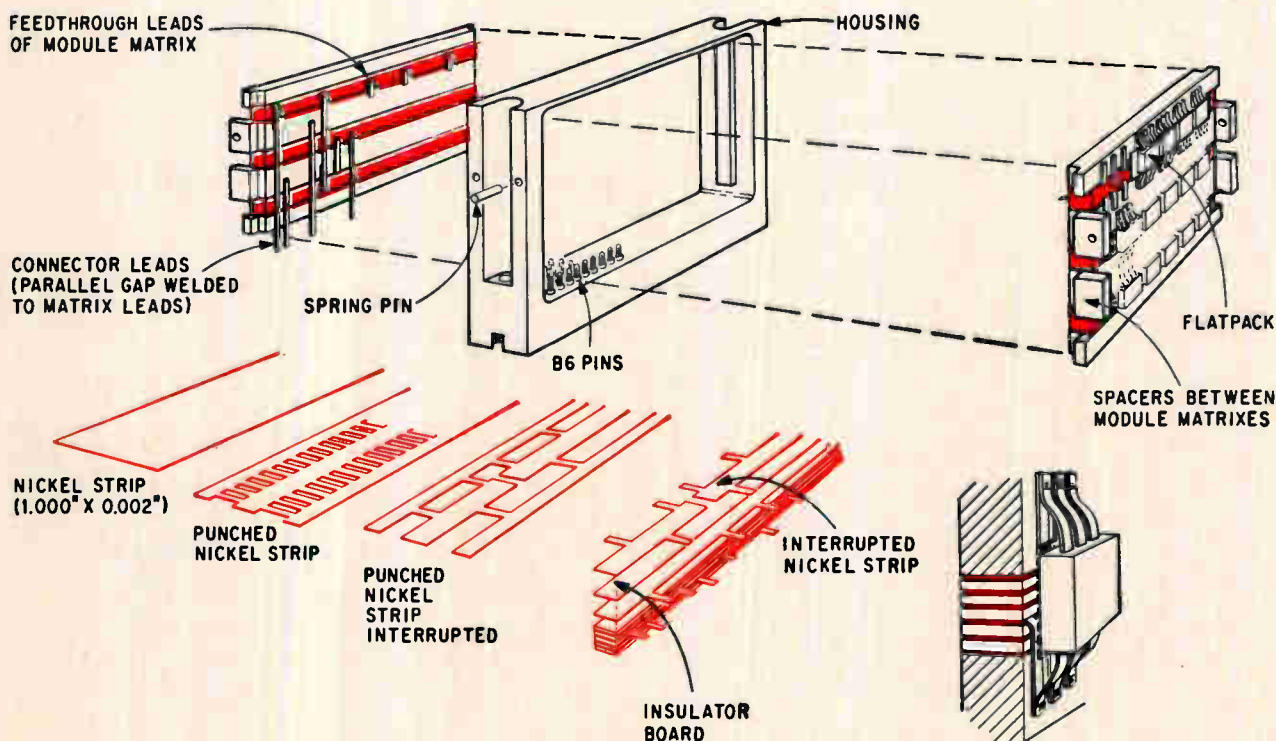

Welded-matrix modules are built with two flatpack assemblies that fit into a common housing. The flatpack leads are welded to tabs on a stack of punched-foil conductors. Conductor fabrication is shown in color.

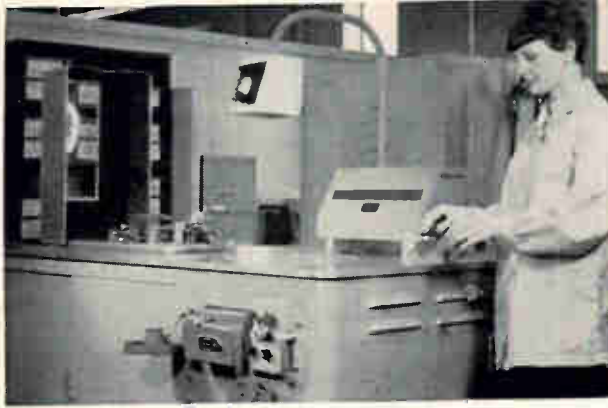

Strip-punching machine has a solid state logic and timing section which actuates the punching mechanism according to instructions punched on tape. The punching mechanism and strip are shown on the cover.

system packaging design. The computer, on page 131, consists of 14 matrix modules—containing 850 logic gates in dual-gate IC's—plus the three discrete-component modules on page 132.

The modules plug into a master connector of female connectors terminating in pins that are spaced on 100-mil centers. These pins are interconnected by wrapped-joint wiring with a machine programmed by punched cards. This interconnection method was also chosen because it permits automation, rapid design changes and high reliability. Raytheon has made more than 2½ million wrapped joints in flight systems. None of the

joints has failed. The wiring withstands severe environments when it is potted with urethane foam.

With its case, the M3X measures 2 by 6½ by 7 inches. It weighs six pounds. If a smaller, lighter assembly is needed, the master interconnection can be a welded wiring matrix, a printed circuit board or other lighter type of interconnection. The modules can also be made larger, to reduce the amount of interconnection needed.

The M3X is a serially operating, digital differential analyzer with shift-register memory. The program is wired-in—that is, the interconnection-wiring pattern determines the class of problem it solves. The welded-matrix technique is ideal for this type of system, because of the ease with which wiring changes can be put into production. The M3X and versions of it have been proposed for applications such as missile guidance and aircraft penetration-aid systems.

Programming the design

The meshing of the manufacturing operations with system design is outlined in the diagram at the right. The engineering steps result in logic flow and interconnection routing data on standardized layout forms. This data is rewritten as a wiring list and matrix layout. Four computer programs convert these into the control tapes for the production and test equipment.

The layout procedure is being converted to a computer program. This will provide for direct computer preparation of programs for all the

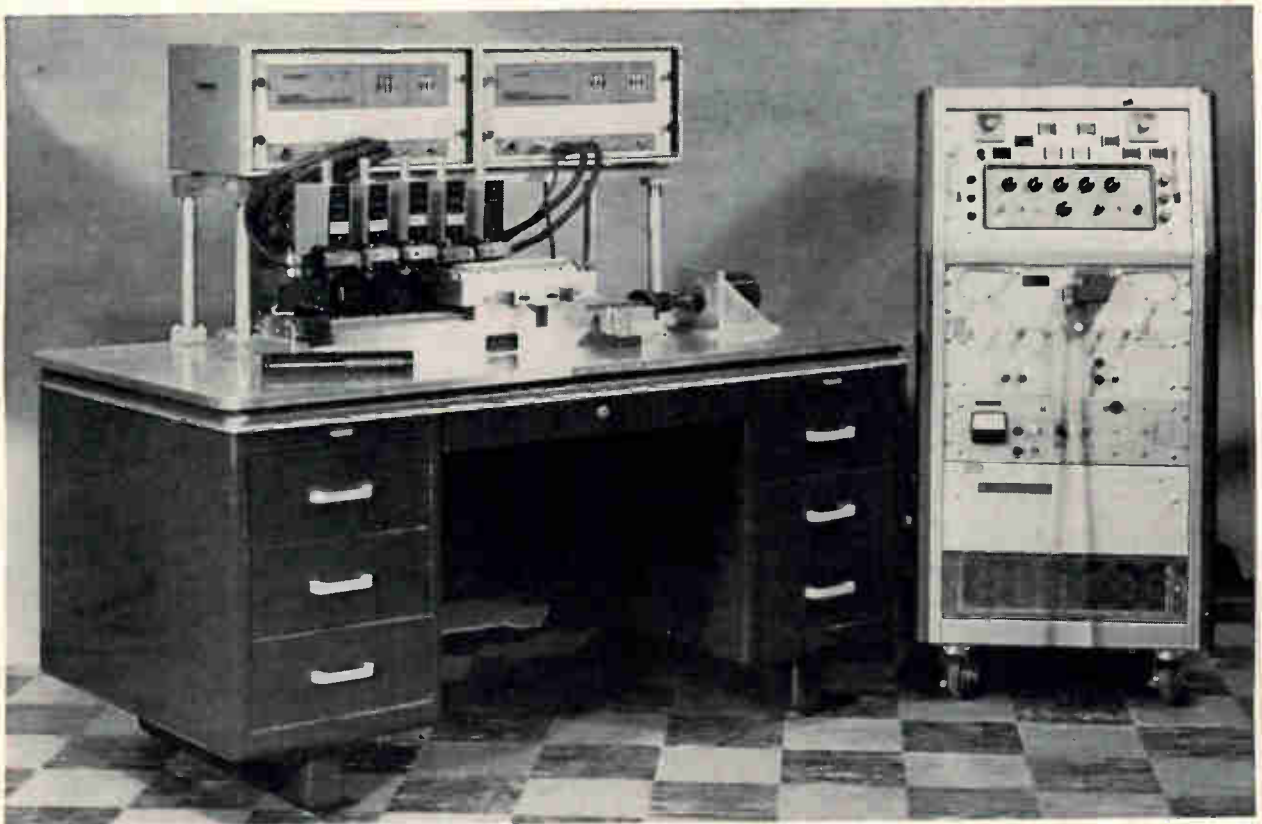

Automatic parallel-gap welder which bonds the flatpack leads to the matrix tabs. From top to bottom, the machine sections are a dual power supply, five welding heads and a matrix positioning table. The control is at right.

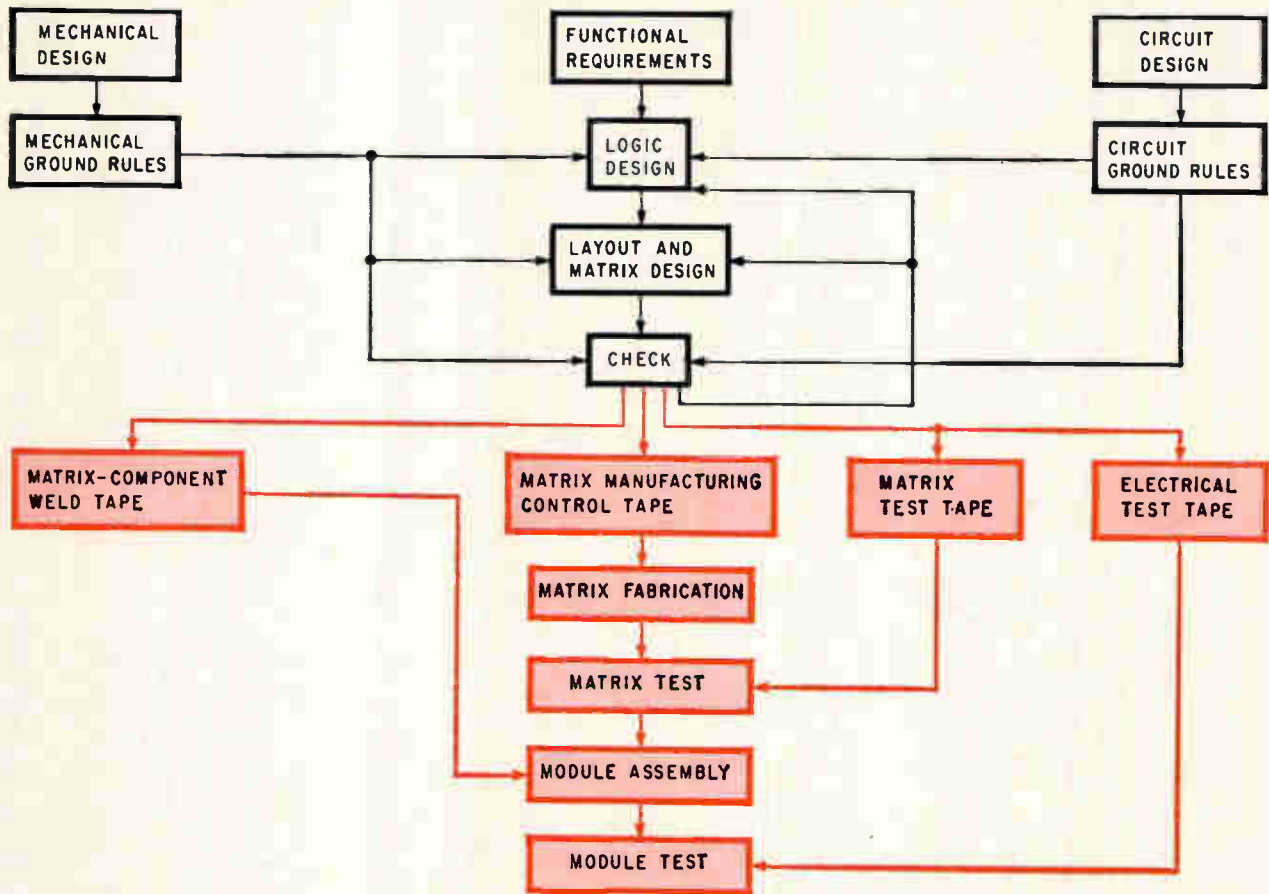

Welded matrix design, production and test flow. The operations shown in color have been automated. Computers will be used for layout and matrix design of large systems.

mechanized manufacturing and test equipment, including system testing. Computer-assisted design procedures are becoming a necessity in digital systems engineering because the manual layout routines become cumbersome and wasteful of engineering manpower when the number of logic elements rises into the many hundreds—as it often does in modern digital systems. Once computers are employed for design, it costs little more to prepare the machine programs.

The existing procedures already permit a significant savings in time, cost and paper work. These factors are particularly important in aerospace projects, where a development program may require frequent design changes and production runs are often short.

The production of printed circuits—now the most popular form of IC interconnection—can be automated at high cost, but setting up to produce a new design is a lengthy procedure. Production involves preparation of precision artwork and tool films, etching, drilling, plating and multiples of these steps if multilayer boards are being made.

The welding technique requires little or no setup and eliminates much of the conventional production documentation and diagrams. The few manual steps, such as stack lamination and the welding of the subassembly leads to the module connector, require only simple visual aids.

(continued on next page)

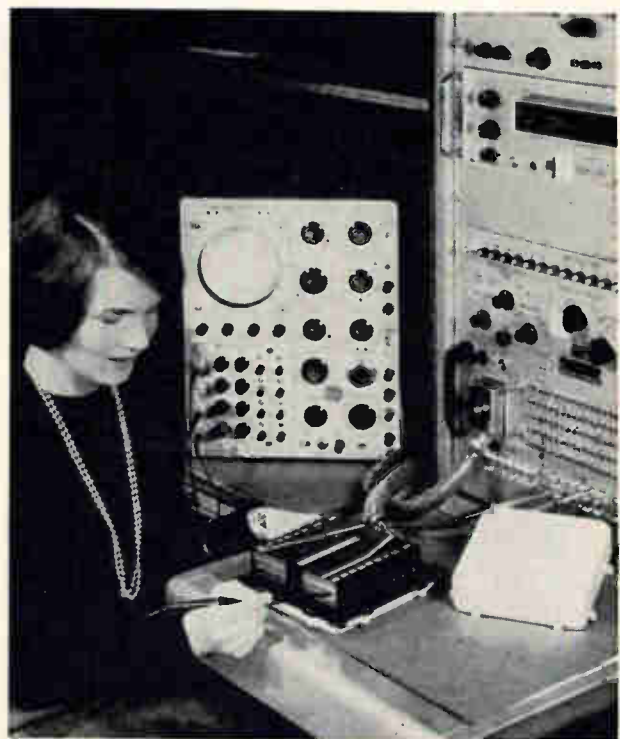

Computer built with matrix modules to prove out the packaging design contains eight logic and six memory modules with integrated circuits. The discrete-component modules at the rear and the one in the center of the computer are shown on page 132.

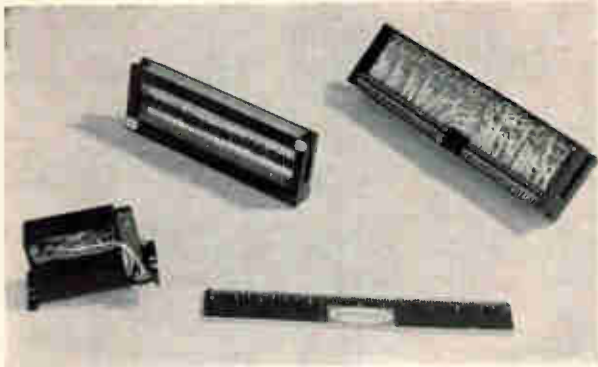

Discrete-component assemblies that supplement the welded-matrix logic modules are made as modules whose sizes are multiples of the matrix modules. These modules are the clock oscillator, isolation test and output modules of the miniature computer on page 131.

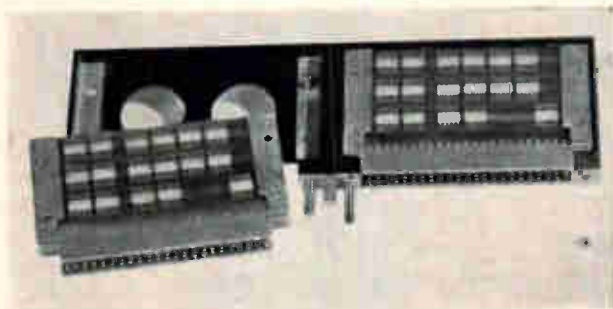

Side-by-side assembly of welded-matrix subassemblies was designed to improve reparability. Each section can be replaced independently. The encapsulant is semirigid urethane, which can be opened for repairs.

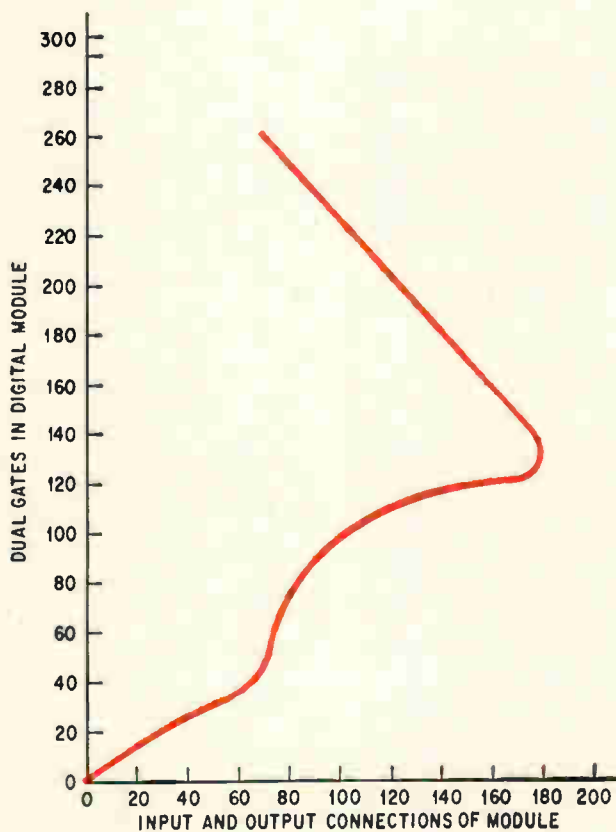

The same number of connector pins required for input and output to a 42-flatpack module could service one with about 270 flatpacks, if logic design is efficient.

The choice of welding

Other module-making methods were considered, including soldering or welding the flatpacks to multilayer boards, deposited-film interconnections and matrixes similar to the present design but made with etched foil. All are workable techniques, but the design selected avoids some of their shortcomings and retains reliability advantages of prior welding methods.

The only joining materials are the lead materials; there are no additional materials such as soldering flux which might cause contamination. Weld heat cycles are controlled and short—a few milliseconds—avoiding damage to heat-sensitive IC's. Welded assemblies are denser and more rugged than conventional printed circuits; packaging density of the matrix modules is almost as high as small multilayer boards.

The matrix modules have few joints; there is only one joint per flatpack lead, plus the bus and connector lead joints at the rear of the subassemblies. All of these joints are external where they can be inspected and reworked if needed. Multilayer boards may have several additional joints and material interfaces buried between the layers. These hidden joints represent major quality control, repair and reliability problems. The reliability of the joints is more important in integrated-circuit systems than in discrete-component systems. As an integral component, IC's have more leads than discrete components, so the joints have a greater influence on system reliability—and cost—than in the past. Avoidable reliability hazards should be sidestepped because the IC's themselves pose reliability problems. A pyramiding of one partially reliable step after another can result in unreliability.

Finally, the automation of production and testing reduces the opportunities for human error as well as holding down costs.

Other design guidelines

The matrixes were scaled for flatpacks, but it was also necessary to have a module design compatible with discrete components. Flatpacks were selected because they allow the maximum reduction in system volume. Although flatpack body dimensions and lead numbers vary, most types of flatpacks can be used in the modules because lead spacing generally conforms to the 50-mil spacing of the matrix tabs.

Dimensional multiples of the matrix modules are employed for discrete-component assemblies, such as those left, above. Such assemblies, with added heat-sinking capacity, are required in most systems because IC's cannot satisfy all circuitry needs. Similar modules accept hybrid integrated circuits. In its adaptability to a variety of module sizes and types of components, the module design is similar to the Navy's module-standardization concept² and could be adapted to it with no change in the basic techniques.

The modules described above satisfy present



Earlier form of welded logic module has welded cross-wire matrixes that interconnect discrete components. The matrixes are made on numerically controlled machines.

guidelines for replacement cost in military systems. Assembly replacement cost is reduced by the style in the photo left, center, which provides a separate connector for each subassembly. If larger plug-in units and fewer interconnections are desired, the matrixes can be 10 inches long, or longer. The graph on page 132 illustrates how large modules reduce the number of connector pins.

High-speed digital systems require a wiring structure in which crosstalk noise, capacitance and delays between logic elements are small. Usually, the shorter the wiring paths, the less the problem. The small size of the matrixes and their organization within the module make them highly efficient for digital wiring patterns. If the logic is serial, the signal paths are usually no longer than the tab and lead lengths, plus the separation between flatpacks. Electrical problems can also be overcome by inserting shielding strips or special dielectric materials in the laminated stacks; or, widths and locations of the conductors can be varied by varying the punching equipment.

Origins of the techniques

The matrix techniques stem from lessons learned during prior production of cordwood and crossed-wire modules with opposed-electrode welders. This type of welding, in which the electrodes press against opposite sides of the lead materials, has also been automated. Numerically controlled machines were developed by Raytheon following crossed-wire matrix development by the Instrumentation Laboratory of the Massachusetts Institute of Technology, Francis Associates and Raytheon.³

Nickel was selected as the matrix material because it is the most weldable conductor, with excellent chemical and dimensional stability—both critical to consistent weld quality. Kovar and Dumet, the usual semiconductor-device lead materials, are readily welded to it. Mechanically produced wiring generally has better dimensional accuracy than etched wiring, hence the matrix wiring

is punched. Etched copper circuitry rates low on the weldability scale.

However, opposed electrodes require room around the joint for placement of the electrodes and give best results when the mating materials are round, as in the case of component leads and wire. The parallel-gap type of welding, developed for welding of flatpack leads to planar wiring, is better for rectangular-to-rectangular mating sections. Backing up the joint with a smooth, rigid surface provides the pressure consistency that may be lacking in opposed-electrode welding of rectangular leads.

No special problems were encountered in applying parallel-gap welding to matrix fabrication. The technique is readily automated by having the matrix joints in line so that the electrodes can be stepped along the line.

Process and vendor control

A mixed blessing in quality control is that no simple, nondestructive test for weld strength exists. Missed or obviously bad welds are disclosed by visual examination and high resistance in electrical tests disclose improperly fused joints. But metallurgical and pull tests are required to make a precise determination of weld quality and to statistically determine the optimum weld schedules for different lots of materials and parts.

This discipline forces a perfectionist attitude on everyone involved, as well as a heavy investment in welding talent and tools. Welding machines are selected for their ability to maintain calibration, and are calibrated to within 0.01% of the specified schedule. Sample welds are pull tested before each shift and after calibration.

The weld joints between the flatpack leads and the matrix tabs have a pull strength of seven pounds per square inch. In a typical weld schedule, the weld-pulse voltage is 80 millivolts, the pulse duration is 1.2 milliseconds, the electrode gap is 0.020 inch and the electrode force is 4.5 pounds. The voltage pulse is square.

Since consistency of materials is all-important during a production run, chemical and spectrographic analyses are made during incoming inspection. This is backed up by a vendor-control program. Vendors must agree to document their critical processes and not to change them without Raytheon's approval.

Operators of opposed-electrode, hand-welding machines (used for cordwood modules and to weld the matrix-to-connector leads) are trained for two weeks, retrained if the work is deficient and retrained at intervals of three months under the normal program.

References

1. F.A. Plemenos, "The packaging revolution, part VI: converting to microelectronics," *Electronics*, Feb. 21, 1966, p. 103.
2. "Standard Hardware Interface Program," U.S. Navy Data Handbook OD30355, April 7, 1965 (see also "Navy's all-purpose circuits," *Electronics*, April 5, 1965, p. 119).
3. E.C. Hall and R.M. Jansson, "3-D Packaging Reduces Size of Electronic Units," *Electronics*, Oct. 9, 1959, p. 62.



test under actual load conditions...

... the ultimate test for integrated circuits, transistors, diodes, thin films, logic cards or modules. The Model 553 Dynamic Test System performs both static (dc) and dynamic tests from dc to 50 megacycles on multi-lead devices in a single socket! Variable word-length mnemonic machine language simplifies programming ... operators can be trained in a few hours. Unique program modification eliminates repetitive instructions, speeds additions and deletions to save up to two-thirds in programming time.

Let us tell you more about the 553.

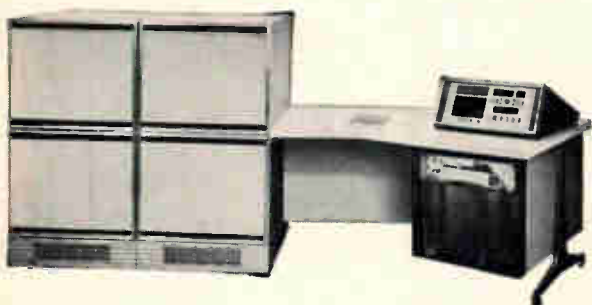

**TEXAS INSTRUMENTS
INCORPORATED**

APPARATUS DIVISION
P. O. BOX 66027 HOUSTON, TEXAS 77006
118 RUE DU RHONE GENEVA, SWITZERLAND

777

Power switching trims digital system weight, cost

Shutting off power in a space computer at the right time reduces battery needs, cuts down on gating hardware and conserves weight, reducing circuit and launch costs

By Rodger A. Cliff

Goddard Space Flight Center, Greenbelt, Md.

Power consumption in digital systems can be substantially reduced simply by turning off power to parts of the system not being used. This obvious technique is not practical in most general-purpose systems because something is always happening in every major part of the system. However, power switching is most effective in special-purpose systems, where parts of the system are more likely to be used in sequence, rather than all at once.

Power switching can also eliminate some of the gating hardware that isolates subsystems from one another, because subsystems without power are effectively isolated without gating.

Power switching is attractive in aerospace applications where power must be conserved because batteries and solar cells are heavy; the cost of spacecraft launching increases steeply as the weight increases. Use of integrated circuits increases the need for power conservation because IC's—although smaller and lighter—draw more power than discrete-component circuits. For example, a typical flip-flop IC draws 3 milliwatts; a similar discrete-component circuit draws only $\frac{1}{2}$ milliwatt.

All that is needed to control the power in a

digital system is a simple series switch. Modifications can readily provide auxiliary functions such as a reset pulse, when power turns on, and a turn-off delay. A series switch has been designed for the orientation and position computer of a new spacecraft, the anchored interplanetary monitoring platform. A small spacecraft weighing about 200 pounds, the AIMP is scheduled for lunar orbit this summer. Its mission is to investigate the interplanetary magnetic field, solar plasma flux, interplanetary dust distributions, solar and galactic cosmic rays, and the magnetohydrodynamic wake of the earth in the vicinity of the moon.¹

The craft is to be spin stabilized by rotation about its axis of largest moment of inertia. It will keep track of its orientation and position with an optical aspect system that makes measurements on the earth, the moon and the sun. Measurement data will be stored in a subsystem called the optical aspect computer.

Power limitation

Because the spacecraft is small, its weight and consequently its power consumption are limited severely. Only 4.3 watts of average power are allotted for the five experiments. All of the instruments combined—including the optical aspect system—are allowed 1.3 watts average. The optical aspect system itself is allotted 950 milliwatts average, and the optical aspect computer, one-third of the optical aspect system, is limited to less than 400 milliwatts. As a frame of reference, a single Christmas tree light dissipates about $7\frac{1}{2}$ watts. To meet these stringent requirements, the computer relies on power switching techniques.

It contains a 120-bit shift-register buffer memory

The author



Rodger A. Cliff graduated from the Massachusetts Institute of Technology in 1961; since then, at the Goddard Space Flight Center, he has investigated data processing and compression methods for small scientific spacecraft.

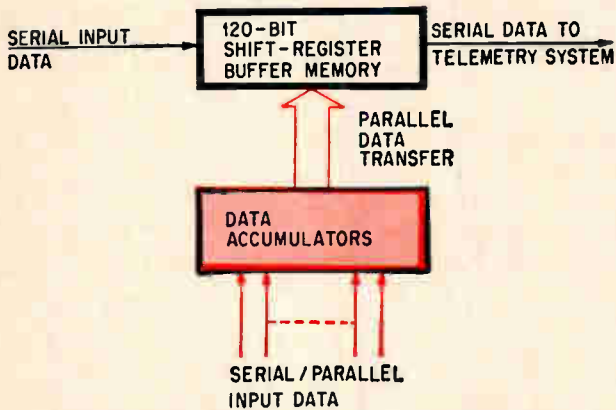

Optical aspect computer in anchored interplanetary monitoring platform has two modes of operation. Data may be transferred in parallel to buffer memory from data accumulator (color); or it may be transferred directly from the source. Either way it is shifted out serially to telemetry system.

and a 105-bit data accumulator as indicated in the block diagram above. Data may be collected in the accumulator, and transferred in parallel to the buffer memory; or data may be read serially into the buffer memory. In either mode, the stored data is serially shifted out to the telemetry system at the proper time.

A double saving results because the parallel data transfer between the accumulator and the buffer memory is controlled by power switching rather than by a set of gating circuits. The power that would be dissipated in the gates—320 mw—is saved, and the gates themselves—one for each of the 105 bits in the accumulator, representing a significant amount of hardware—are eliminated as shown in the table above, right, which summarizes the power savings obtained by switching.

In either mode there is a constant dissipation of about 100 mw by synchronization signal amplifiers connected to the telemetry system. The amplifiers must always be on because signals can come any time; therefore power switching is not applicable to the amplifiers.

How power switching works

In the inset diagram at the top left of the opposite page—a simple power switching circuit—when the control voltage is at ground, transistors Q_1 and Q_2 are cut off. The switched power is off and no power is dissipated in the switch or in any part of the system fed from the switch. But when the control voltage is sufficiently positive, Q_2 turns on, Q_1 becomes saturated, and power is fed to the system.

Several improvements were made to the simple series switch before it could be used in a digital system as complex as the spacecraft's—a rise-time capacitor, an automatic reset, and a power turn-off delay were added.

A rise-time capacitor was placed between the base and the collector of transistor Q_1 . The capacitor slows down the rise time of the switched power, limiting it to about 100 microseconds. This

Milliwatts saved with switching

	Duty cycle	Parallel transfer mode		
		Power drain (milliwatts)		
		Without switching	With switching	Saving
Computer subsystem	1	100	100	0
Amplifiers	1	100	100	0
Buffer memory	$\frac{1}{8}$	600	75	525
Accumulator	$\frac{1}{4}$	320	80	240
Data transfer gates	0	320	0	320
Total		1,340	255	1,085
		Serial mode		
Amplifiers	1	100	100	0
Buffer memory	$\frac{1}{8}$	600	225	375
Accumulator	0	320	0	320
Data transfer gates	0	320	0	320
Total		1,340	325	1,015

minimizes the settling time of the powered circuits.

A second improvement provides a reset pulse to guarantee that the controlled circuits will be in the proper initial state. The pulse can be generated by a transistor and diode connected to the rise-time capacitor, as shown on page 137. When the power is turned on, the capacitor C_R will discharge through the transistor Q_3 to the collector of Q_1 . This discharge continues as long as the output voltage is rising. When the voltage reaches its maximum value, C_R is fully discharged, Q_3 cuts off, and the reset output returns to ground. C_R charges up to $+V_{cc}$ volts through Q_1 and D_1 as power is turned off.

The usefulness of the series power switch can be further increased by adding turn-off delay to the circuit, so that control signal overlap is unnecessary. Then the same signal can turn off the power in one section and turn it on in the next section; at the same time power will be on in both sections while data is being transferred from one to the next. This simplifies the logic that generates the control signals.

Turn-off delay is obtained in the power switch with the circuitry connected to transistor Q_4 . When the control signal is at ground, capacitor C_D is charged to $+V_{cc}$ volts, but the switched power is off and no current flows anywhere in the circuit. When the control signal rises, turning on the power, Q_4 also turns on, and C_D discharges through Q_4 and D_4 . When the control signal returns to ground

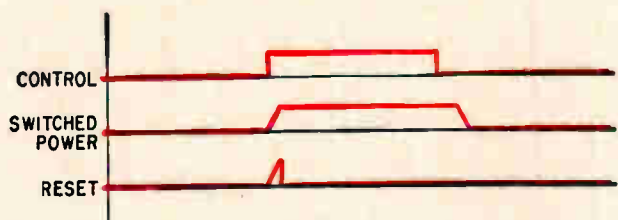

Timing diagram of the power switching circuit on the opposite page.

Power switching circuit used in anchored interplanetary monitoring platform. Transistors Q_1 and Q_2 make up the switch itself; Q_3 generates an automatic reset pulse when power turns on. When the control signal falls, Q_1 and its circuitry delay the power turn-off. The circuit is based upon the simple series power switch shown in color at the top left. When the control line is at ground, no power is supplied on the output line.

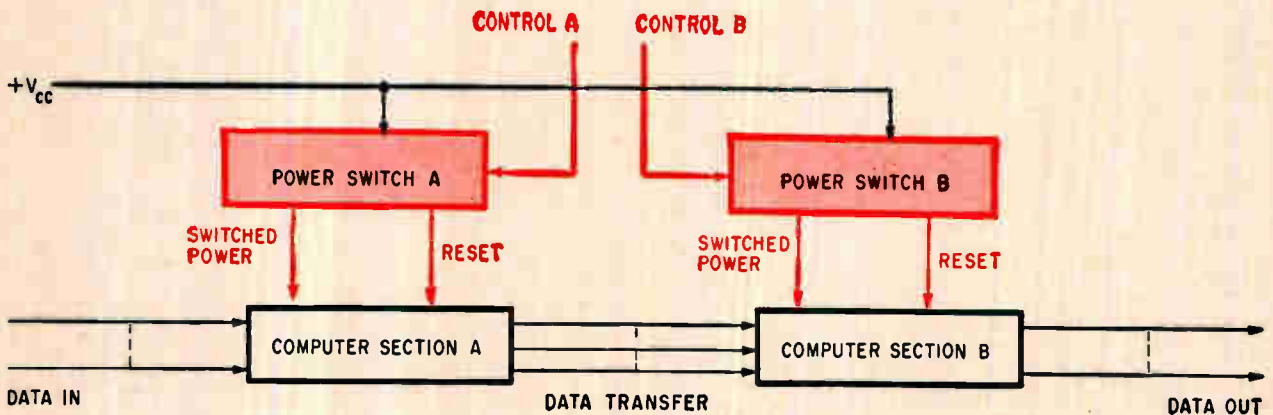
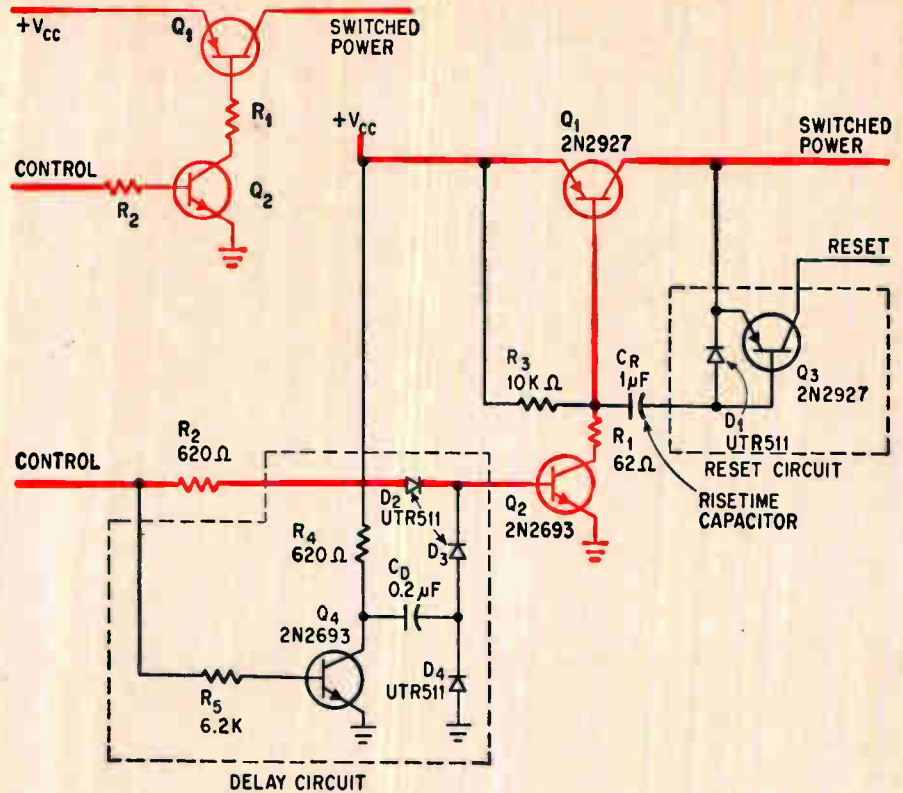

Digital system utilizes power switching to conserve power while controlling data flow. The timing of the power switching is illustrated on the next page.

some time later, Q_4 turns off and C_D charges through R_4 and D_3 , keeping Q_2 , and the switched power, on. Q_2 turns off only when C_D is again fully charged. The delay time is determined by the time constant $R_4 C_D$.

The waveforms for the control, switched power and reset signals are shown in the timing diagram on the opposite page. When the control voltage rises, the switched power and the reset signal rise together, reaching a maximum in 100 microseconds. At that time the reset falls and the controlled circuits begin to operate.

After computation is complete, the control voltage returns to ground, but power stays on for about two milliseconds while data is transferred from

the section controlled by this power switch into the next section. At the end of the turn-off delay, the power turns off with a fall time of four milliseconds; thereafter no more power is dissipated in the switch or in the circuitry controlled by the switch.

Transferring data

The spacecraft's computer is an example of a digital system with two sections, labeled A and B in the diagram above. Each section may have its own power switch with a separate control for each switch. The accumulator and buffer memory are examples of such sections.

When control A voltage rises, power to com-

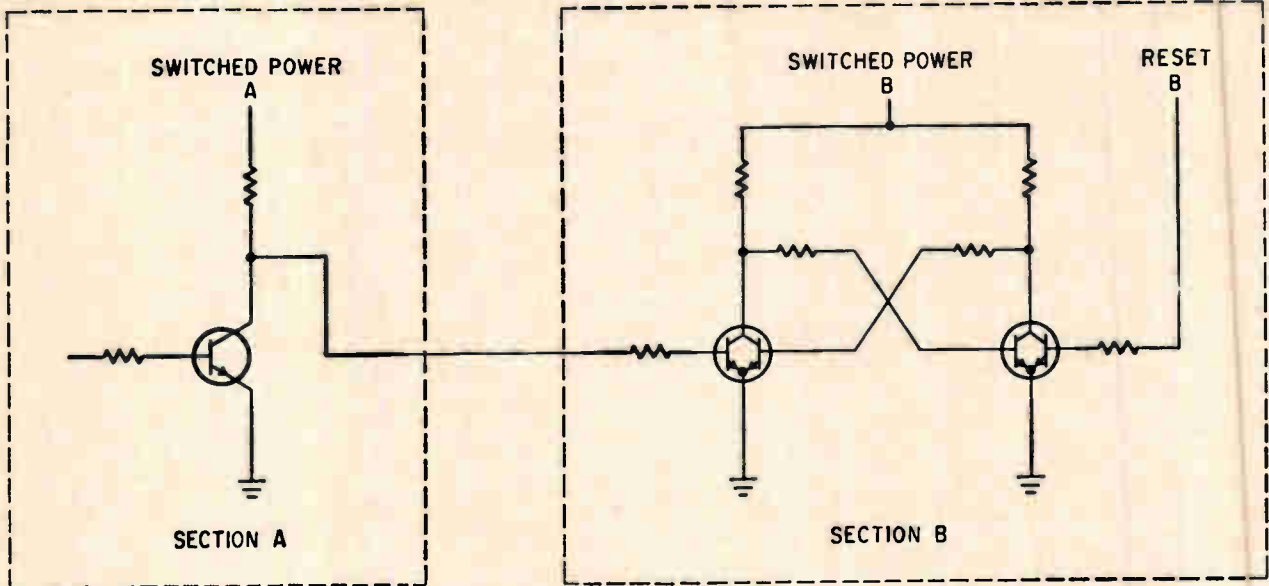

Data transfer between sections of a digital system is controlled by turning the power on and off in the various sections at the right time. No gates are required in the data path.

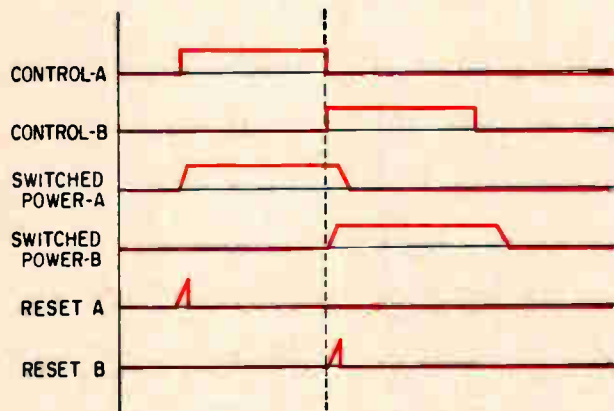

Timing diagram of power switching in digital system.

puter section A turns on and the section resets. Then data enters section A and computation begins. When it is complete, control A returns to ground and control B rises. Power to computer section B turns on and the section resets. The power to section A stays on because of the turn-off delay in the power switch A. The important waveforms for two such sections are shown above.

The schematic diagram at the top of the page shows how the data transfers from section A to section B through action of the power switches. In section B one stage of a register is shown. When the power to section B turns on, the reset signal resets the register to the 0 state. As soon as the reset signal falls, and if the output from section A is a 1, the register stage is set to the 1 state. At the end of the turn-off delay, the power to section A goes down and section A has no further effect on section B.

Power switching, of course, is not limited to a system with two sections. Any number of sections can be cascaded, or even connected into recirculat-

ing loops. Although apparently no large power-switching systems have been built, there is no size limit for reasons of design.

Nor is there a data-rate limit. Even if a subsystem has a duty-cycle ratio of greater than one-half, its power can be turned off when it is not working. If a new input signal appears before the input section has completed the previous input, two or more similar processors working in parallel can share the load, and still save power because gating between sections is not required.

Power switching is not usually applicable to general-purpose computers, because they are not organized to take advantage of it. [One new general-purpose computer that uses power switching—in its scratch-pad memory—is the Scientific Data Systems, Inc.'s Sigma 7; *Electronics*, April 4, 1966, p. 118]. But many special-purpose computers can use it.

For example, a computer in a spacecraft's scientific experiment package might include a counter for events like the number of particles registered by a Geiger counter in a specified time. Sometimes the count is transferred to a floating-point converter, where the data is logarithmically compressed before it is telemetered to earth. The floating-point conversion may be made only once every 10 seconds and it may take only 100 microseconds to perform the conversion. Nevertheless, power would generally be supplied to the converter at all times. Power switching would conserve the power in the time intervals between conversions and would reduce the amount of hardware needed.

Reference

1. AIMP Summary Description, Document X672-65-313; National Aeronautics and Space Administration, Goddard Space Flight Center, August, 1965.

EIMAC introduces new family of rugged triodes for industrial heating

From Eimac comes a new family of water-cooled triodes designed especially for induction and dielectric industrial heating service. The tubes feature a new cast silicon-bronze cooler design with constant cross-section spiral water channels. This design insures uniform anode cooling with minimum water flow and back pressure. For example, the 3CW20,000H3 requires only 4 GPM water flow at 3.5 psi for 20 kW plate dissipation. The new tubes feature filament connecting leads—no sockets are required—and have grid flanges for low inductance connection to the grid. This new industrial family is rated at full power to 90 Mc, with reduced ratings to 140 Mc. All include anode tabs for ease of mounting into industrial machinery plus rugged, high-dissipation grids for industrial oscillator service. Write Power Grid Product Manager for additional technical information, or contact your nearest Eimac distributor.

CHARACTERISTICS				
	Plate Dissipation (kW)	Filament Voltage (Volts)	Input Power (kW)	Useful Output (kW)
3CW5,000H3	5.0	7.5	30	15.5 to 22.5
3CW10,000H3	10.0	7.5	40	25.0 to 30.0
3CW20,000H3	20.0	6.3	60	42.0 to 45.0
3CW30,000H3	30.0	10.0	80	55.0 to 60.0
3CW40,000H3	40.0	13.0	120	75.0 to 90.0

EIMAC
 Division of Varian
 San Carlos, California 94070

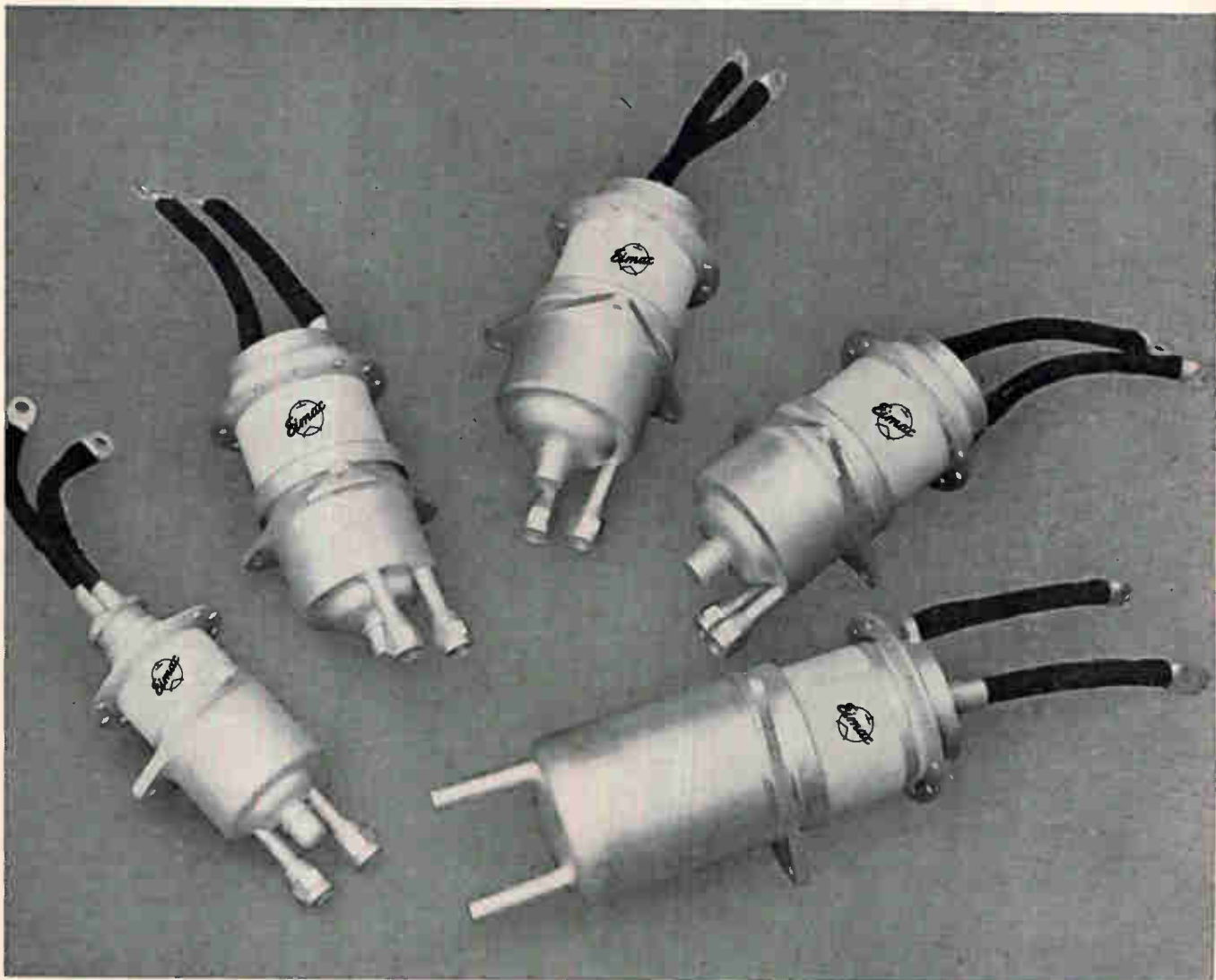

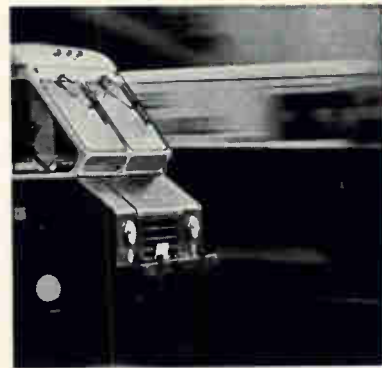
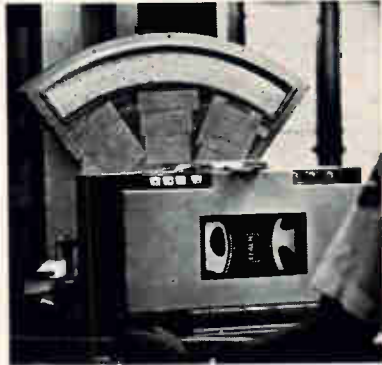

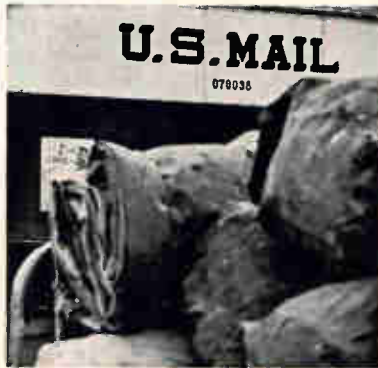
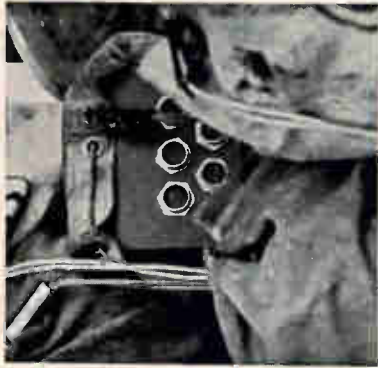

last week
we mailed a customer
one of our tape
recorders and forgot
to mark it "fragile."

we didn't have to.

It came through like a phone bill. The recorder, our MTR-3200, weighed in at 44 pounds. That's pretty compact for a unit that has to store and reproduce data in the severest of environments. And the small size is an added benefit. For another, it needs only 55 watts of 28 vdc power, and operates through 10g shock with less than 6% peak to peak flutter.

The MTR-3200 withstands accelerations up to 25g while ignoring temperatures from -40° to $+71^{\circ}$ C. Humidity up to 95% won't seep in, and it will run at altitudes up to 150,000 feet.

Convenient plug-in modules provide 14 analog or FM, or 16 digital channels. They can be used in any combination. Six tape speeds are available in standard pairs which are electrically selectable.

The MTR-3200 provides 2400 feet of laboratory performance in a "breadbox," while conforming to IRIG standards for data reduction equipment.

If we haven't mentioned all of your requirements, and they're tough ones, let us know.

Just write your specs on anything handy. Like the back of a purchase order.

Send it to Leach Corporation, Controls Division, 717 North Coney Avenue, Azusa, California.

LEACH Export: Leach International, S.A.
Or read them to us over the
phone: (213) 334-8211.

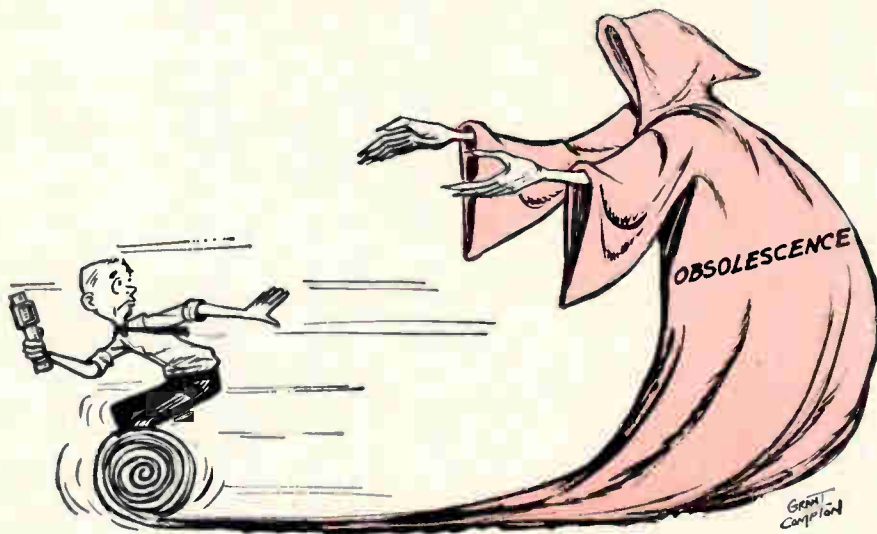

Opinion

The myth of obsolescent knowledge

A successful engineer offers his colleagues a theory to dispel the fear of obsolescence; it's based on the premise that a certain kind of knowledge never loses its value

Gerd D. Wallenstein

Vice President, Lenkurt Electric Co., a subsidiary of General Telephone & Electronics Corp., San Carlos, Calif.

A new fear besets scientists and engineers: the fear of obsolescence. They worry that the training and skills they use today will be useless tomorrow. Every week one of our leading scientists or educators warns that knowledge acquired yesterday is depreciating today and will be permanently obsolete

The author



Gerd D. Wallenstein's interest in a broad education goes back to his high school days in Berlin when he took a classical curriculum. Though he received an engineering education at Technische Hochschule, Berlin, he still managed to study French, Spanish and Chinese languages intensively. He left Germany for China because of the

Nazi persecution and there worked as an engineer for RCA Victor of China. In 1947 he came to the United States and joined the Lenkurt Co. as an applications engineer; then advanced to chief applications engineer, vice president for product planning and finally to his present position, vice president for planning.

tomorrow. But such a fear does not make sense, because an engineer's future is built on his knowledge of the past as well as his understanding of present and future technology.

To buttress the argument that obsolescence is an imminent danger, curves have been constructed to show how rapidly the acceleration of obsolescence takes place; these curves usually follow a law of squares. The argument says that knowledge and inventions multiply at a logarithmic rate, producing equivalent amounts of progress in shortening periods of time. The duration of each period, according to this law, is approximately the square root of the length of the preceding period. When a quantitative measure of invention is plotted over a logarithmic time base, an exponential curve results,

In articles of opinion, authors are given complete freedom for the expression of their views. The editors welcome comments on this author's thesis and will publish those letters which are most interesting.

rising steeply, while a plot of usefulness of knowledge on the same base falls proportionately [see curve at right].

According to this reasoning, an engineering graduate of 1900 could use his knowledge for 40 years; his colleague of 1930, for only 20 years. Since the curve approaches an asymptote, we can conclude that the graduate of 1970 will be obsolete by the time the ink is dry on his diploma.

Along with the notion of accelerated obsolescence has come a demand for more people with Ph.D. degrees. The demand seems to be for the narrow specialist: the graduate with a Ph.D. in laser theory or solid state phenomenon, or digital memories. These laboriously acquired degrees, it seems, will entitle the bearer to immediate obsolescence.

The path from vacuum tube to transistor to integrated circuit apparently confirms the law of squares. An engineer trained to design vacuum-tube circuits became obsolete with the introduction of transistors. Now, 10 years later, the transistor circuit designer is to be replaced by thin-film experts who will plan monolithic and hybrid micro-electronic circuitry. Yet there is a paradox here. While this is happening, many older engineers in their sixties command large fees as consultants. What is the value of that long-obsolete knowledge they can sell so successfully? Could it be that these older scientists and engineers acquired knowledge of a more lasting kind when they were not afraid of obsolescence?

What so many people fail to grasp is that the need is for acquiring nonobsolescent knowledge. Leibnitz, Napier, Fourier and Courant (who is still living) did not and will not become obsolete for students of mathematics. In electronics, subjects such as Kirchhoff's laws, network theory, feedback theory, statistics, modulation theory and resonant circuits are nonobsolescent.

Nonobsolescent knowledge encompasses the total range of human experience, recorded and discovered, remembered and imagined. Most of this experience is timeless in value, thus educational and character-forming in any period. The human tragedies of Romeo and Juliet and Hamlet are as meaningful today as when they were written over 300 years ago. The knowledge acquired by ancient Romans to build systems for clean water supply and drainage of wastes would help many modern cities.

The theory of accelerating obsolescence is compatible with a theory expounded by Henry Adams, called the law of acceleration of scientific discovery and history. Adams despaired of mankind's ability to perpetuate humanity while climbing a vertical asymptote. Gerald Piel, publisher of Scientific American magazine, presented a modern look at this acceleration law in

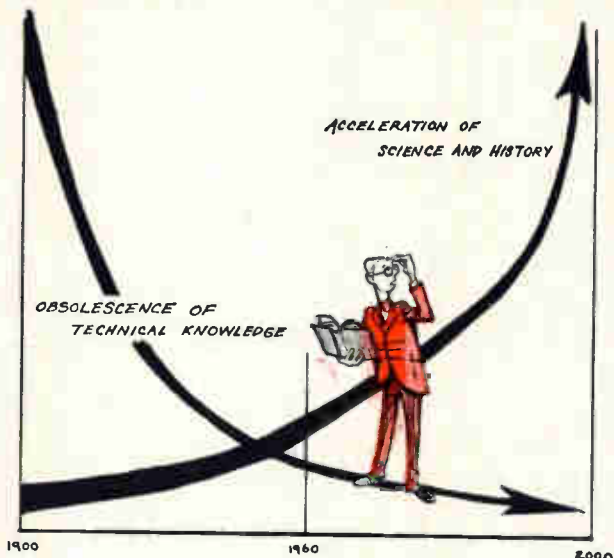

a talk at Phillips Academy in Andover, Mass., in 1963. Piel indicates there is a solution, fortunately for us and our descendants. Science, he says, is the ultimate source of value in the life of mankind. The implication is that we must learn to apply science beneficially at the rate demanded by the asymptote.

No wonder our educators worry. The production of a continuous flow of scientists whose knowledge would expand continuously to offset instant obsolescence is beyond their capabilities. But fortunately there are no such requirements in real life.

The asymptotes we are offered are indeed unsatisfactory and frightening, as Henry Adams felt. Only jugglers can climb a vertical line with no visible place for a foothold. The simile is more appropriate than might be expected: in Italian, juggler is prestidigitatore. And what could more aptly describe today's obsolescence syndrome than the combination of prestige and digital data, powerful forces in our technical economy?

All this scientific reasoning about obsolescence may have gone astray because the statistics used for our asymptotic achievement curves are one-sided. The worriers have taken a narrow sampling

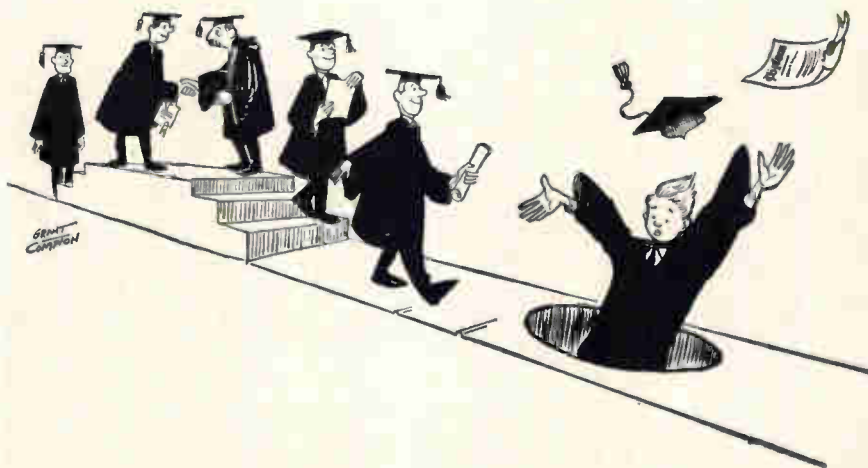



of humanity; namely, ourselves in our technical society. They record and plot scientific contributions as if these represented absolute values contributed to humanity.

But in reality, all these values are relative, compared to the total needs of all humanity including that of the nontechnical members of society. They ignore some impressive concentrations of stagnation. The nonscientific masses of places like Watts (scene of the 1965 Los Angeles riots and destruction), Leopoldville, Shanghai and Calcutta continue in squalor and suffer from malnutrition and intellectual hopelessness. The impressive increase—logarithmically—of calories afforded and kilowatt-hours of power generated per person in the United States is lost if one computes calories and energy on a world per capita basis instead.

If present and future scientific contributions are to make any sense, they must be made from a knowledge of humanity and the humanities as a whole. The need is not for more technical people specialized in the new skills which are just developing, but for more people steeped in the accumulated knowledge of the past.

This knowledge of the past has to include a wide range of nontechnical information. The engineer needs some idea of the contributions made to our complex civilization by the ethics of the ancient Jews, the philosophy of the Greeks, the remarkably proto-American practical civilization of the Romans. His ability to cope with changing monetary values is sharpened by knowledge that during the 12th century a paper money inflation accelerated the collapse of a Chinese dynasty at war.

To develop this knowledge, an engineer need do no more than read. He could start with Bertrand Russell's "History of Western Philosophy," go on to a novel or short story by Franz Kafka ("The Trial," or "The Metamorphosis"); then try a sociological study like "The Lonely Crowd" by David Riesman. Books like scientist-manager R.G.H. Siu's

"The Tao of Science" can open unusual vistas to the engineer. This one relates ancient Chinese wisdom to the problems of modern scientific organizations.

In addition to reading, the human experience conveyed by music, painting, and sculpture represents knowledge of immeasurable value. Paintings of the Sung period, a thousand years old, convey a sense of harmony and balance which might be an inspiration for struggling electronic circuit designers. Ancient pottery of many cultures (American Indian, Chinese, Middle Eastern), in recognizable functional beauty, points the way to better functional design in our civilization suffocating in the over-ornate, the ugly clutter of short-lived,

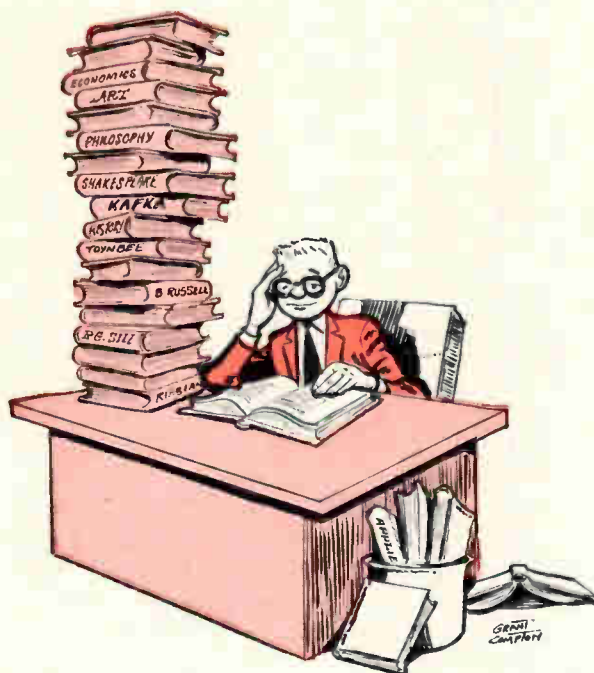

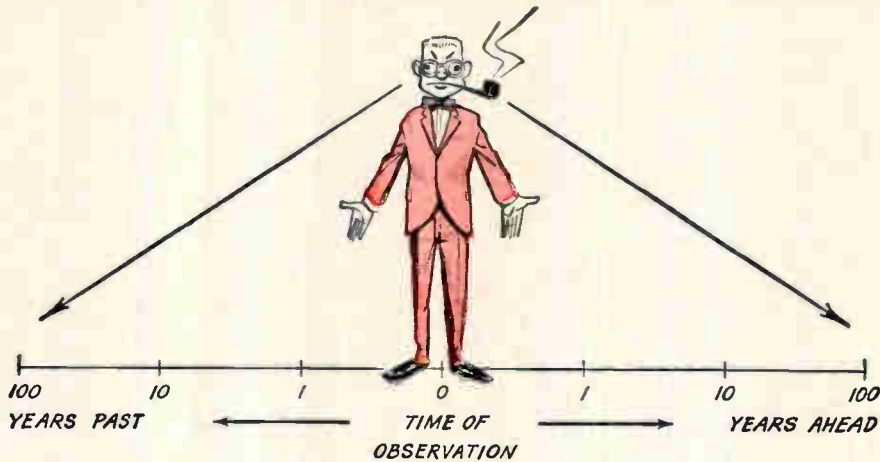

sometimes useless products.

Only when he is thus equipped can a scientist and engineer look to the future without fear of obsolescence. His mental facilities will be sharpened by evaluating the relative merits of past discoveries which can be viewed dispassionately only in retrospect. He can understand the limits of technology by studying the clash between innovation and contemporary crafts which occurred and continues to occur when science progresses without humanism. Most importantly, he will gain perspective for his own work, and for that of his contemporaries, seeing the significance of all this work to other people in other places and at other times.

A new theory of perspective

Perspective offers an answer which is more in tune with human life. The law of squares is correct, but the error lies in applying it in only one direction and in absolute terms. According to this new theory of perspective, we project our life and thinking logarithmically in both forward and backward directions.

Herein lies hope, and perhaps the only rational reconciliation of acceleration laws with the realistic need for gradual progression along a nonasymptotic line. This theory tells us that the view of 1966 emphasizes the inventions, social and political happenings of the one and 10 year periods ahead by the same magnitude as it does the equivalent happenings of the corresponding past periods. And it tells us that our view in 1950 magnified the coming year in the same relative way it magnified the next 10 years.

Looking in the two directions, we see the immediate year behind and the year ahead closest to our observation in equal im-

portance. The inventions and happenings of these immediate periods will have the greatest significance, but only for a time. Thus, in 1966, we think of the progress made in integrated circuits during 1965, and concern ourselves with their growing applications during the current year. But, five years ago, in 1961, we were similarly concerned with the increasing abundance of low-cost, very reliable transistor types just released the year before, and saw their application in equipment as the major technical problem of the then current year.

In 1960 we saw the vacuum-tube technology, in logarithmically receding perspective, spreading over a time longer than the transistor technology. But, another 10 years or so later, around 1970, our viewpoint will have moved both transistor and vacuum-tube technology closer together while emphasizing the newest technological development of the year just past and immediately ahead.

As the years pass, the most vital knowledge of a given year recedes in over-all significance. It is as if the engineer stood on a slowly moving train from which he watched past events gradually ap-

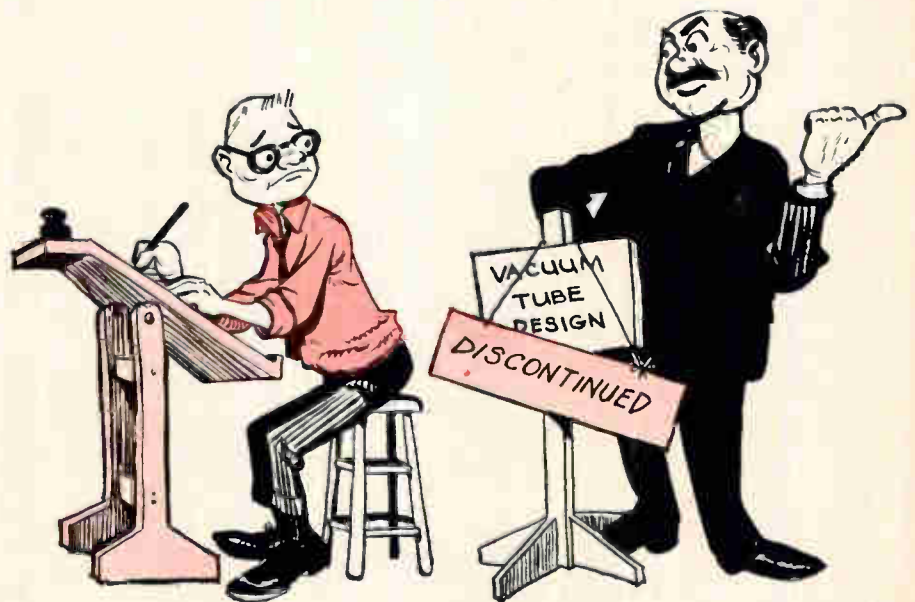

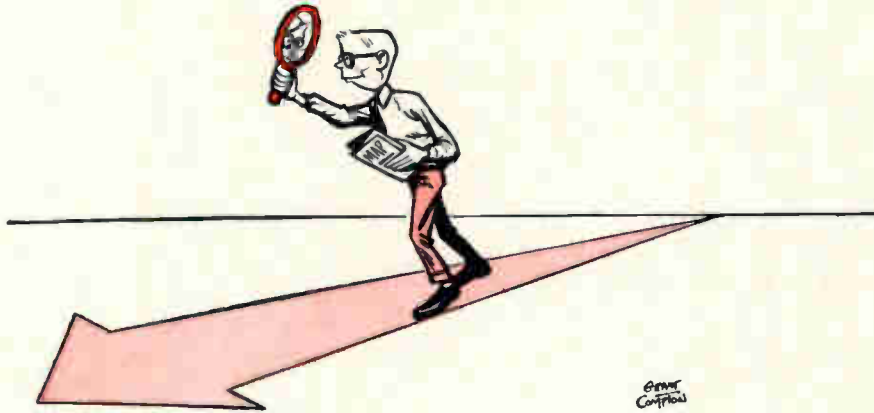

pear more and more crowded.

If to this horizontal moving point of perspective is added a vertical scale of values, the engineer can still see extraordinary past contributions rising above the perspective horizon even hundreds of years in the past. For example, to relate the total effect of inventions, social, and political happenings properly, we may plot history on a perspective line as in the graph below.

If, against a base of time, we now plot an indicator such as food calories available per living human being, or perhaps a complex factor combining food calories, living space, education and industrial power generation, the curve is a slowly rising line. Separate magnification of intervals would show the dramatic up and down departures from the trend when they occurred during certain periods.

If the engineer or scientist can orient himself by understanding the perspective of past and future, he can see a place where he can make a contribution at any time in history. We can even try to put some numbers on the learning potential, though the purpose of this representation is to establish the concept of perspective. I make no claim for numerical accuracy and an accurate computation of values would be meaningless. The numbers only help explain the idea.

In any year of graduation, from his perspective

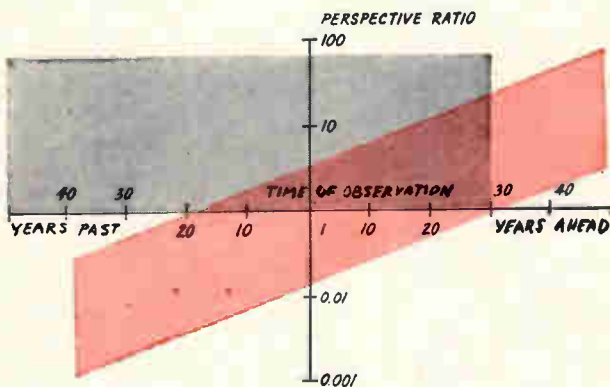

An engineer's view changes as he grows older, according to a plot of perspective ratio that compares the value of available knowledge with the value of new specialist knowledge.

as a young graduate, the engineer values his total knowledge acquired so far at a figure somewhat less than the lifetime worth of specialist's knowledge lying ahead of him. This is expressed by the value of the perspective ratio:

$$1 > P > 0.1$$

where P is defined as:

$$P = \frac{\text{Value of available personal knowledge}}{\text{Value of future specialized knowledge}}$$

By applying this formula, we can say that if a graduate values his knowledge at \$100,000, his future specialist's knowledge will be worth \$1 million.

Perspective also tells him that he is inclined to overemphasize the endspurt of the year just past and the impressions of the first year of his professional career just ahead. Off in the future, he can see the acquisition of new knowledge increasing his store of available useful knowledge, so that the perspective ratio P becomes larger than one. The range in the curve at the left allows for wide individual variations, depending on ambition, ability and chance.

Thirty to 40 years later, at the end of his professional career, his outlook will include a small contribution of new specialist knowledge to be acquired for a few more years, but mainly a solid value encompassing all available knowledge of the past. Age will not have altered his human emphasis of periods just past and ahead. He will value in great detail the projects and achievements of the year immediately past and the future year.

Equipped with this theory of perspective, the engineer can be cured of the disease of asymptotes. He knows that future acceleration of knowledge is manageable because he realizes that his view is foreshortened, and that a new foreshortened view has to be constructed at each new point of time. At the same time, educators realize that the frightening asymptotes are just another symptom of our confused groping times. Such symptoms have been experienced before in such historical periods as after the collapse of the Roman empire and during Napoleon's reign.

The theory of perspective provides the attitude to seek learning without fear of obsolescence.

You made us what we are today...

a brand-new Division of Union Carbide.

Thanks to you, our various electronics businesses have grown so well that we have gathered them together and created the Electronics Division of Union Carbide. This puts us in a better position than ever to fill your growing needs for:

Solid tantalum and foil-film capacitors...transistors, modular and integrated circuits, and other solid state devices...single crystals and crystal products...lasers and related equipment...fuel cells.

As well as new products in various stages

of research and development, all aimed at advanced requirements on the frontiers of electronics—all backed by the technology of Union Carbide.

Why are we telling you this?

Because we wanted you to know that we're serious about being in electronics. And so that you can realize that our diverse activities are now under more unified control.

After all, your orders did it for us.

Union Carbide Corporation, Electronics Division, 270 Park Avenue, New York 10017.



ELECTRONICS

**WHAT GIVES YOU AN UNNEUTRALIZED, 3-STAGE TV-IF
WITH 90db STABLE GAIN, HAS LOW FEEDBACK CAPACITANCE,
CUTS COMPONENT COSTS, MINIMIZES ALIGNMENT TIME
AND HAS NEVER BEEN USED IN A SINGLE TV SET?**



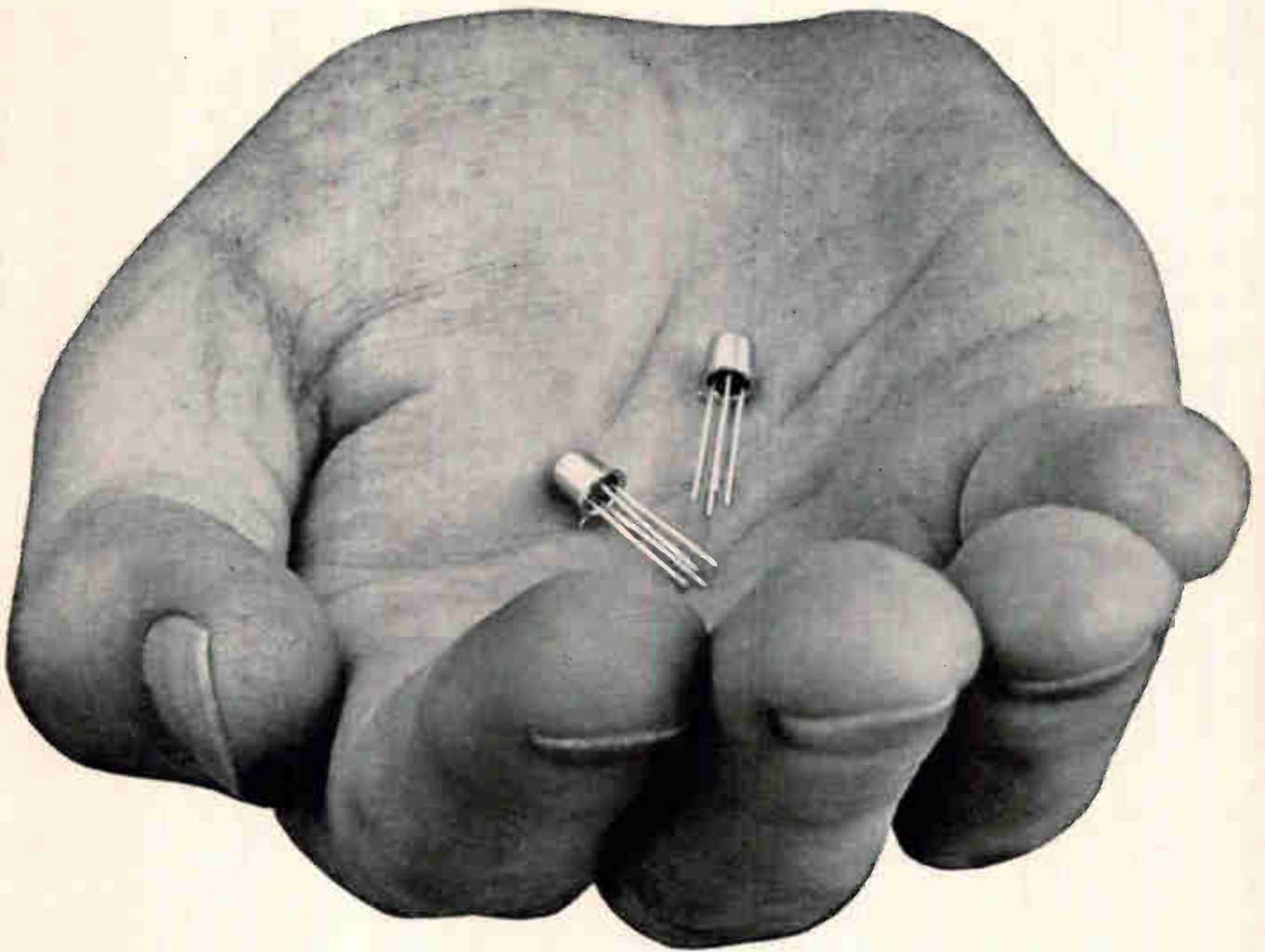

Integrated-Shield Transistors. How come they've never been used before? Simple. They've never been available before; they're brand new from Amperex.

Until now, the big problem in designing transistorized TV-IF's has been the transistor feedback capacitance. Amperex's breakthrough to integrated shielding has now produced the types A467 and A473 with feedback capacitance so low that the need for neutralizing the circuit is completely eliminated.

In the Amperex Integrated-Shielding process, we diffuse a special shield between the collector and the base lead

"tab" to clamp the base at the emitter RF potential. In common emitter circuits of the type used in TV-IF amplifiers the net effect is the elimination of the major source of feedback capacitance: the capacity between the collector and the base-lead "tab." Thus the C_{re} for the type A467 is a low 150 mpf and only 220 mpf for the type A473.

Now you can build a three-stage, unneutralized video IF amplifier, using the A467 and two A473's to produce an overall minimum stable gain of 90db at 44mHz. The gain control range of the type A467 stage is 55db minimum; in

the output stage the A473 will provide swings of 7.7 volts undistorted into 2700 ohms.

For complete data and application information, write: Amperex Electronic Corporation, Semiconductor and Receiving Tube Division, Slatersville, Rhode Island, 02876.

Type	f_T	C_{re}	AGC Range	45 Mc Useable Gain	10.7 Mc Useable Gain
A467	330 Mc	150 mpf	55 db	33 db	—
A473	550 Mc	230 mpf	—	34 db	36 db

Amperex®

IF YOU CAN'T AFFORD TO DESIGN WITH FAIRCHILD DT μ L, YOU CAN'T AFFORD TO DESIGN.

Industrial IC's at about \$1.00 per Function: Fairchild Diode-Transistor Micrologic® Integrated Circuits are now available at prices you can afford. Take your pick of dual in-line packaging for production line use (at about \$1.00 per function at distributor quantities) or Mil spec rated 1/4" x 1/4" Cerpaks. Either way you get high performance monolithic logic elements for a wide variety of applications.

Complete, versatile line: Fairchild DT μ L circuits offer unique design features: A complete line which includes both binary and gate elements, completely compatible with one another./

Gates may be wire OR'ed at the output./Expander inputs can be used with 930, 932, and 944 elements./Low input current leakage./High noise immunity.

We can deliver: Fairchild DT μ L circuits are available now, in production quantities, on distributors' shelves. You can get immediate delivery on virtually any number. Don't take our word for it. Call any Fairchild Distributor, now. Or, ask for our complete data sheets.

FAIRCHILD
SEMICONDUCTOR

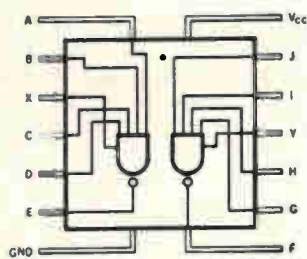

Dual gate
DT μ L 930, DT μ L 961

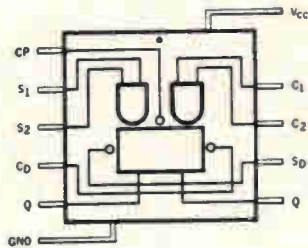

Clocked flip-flops
DT μ L 931, DT μ L 945, DT μ L 948

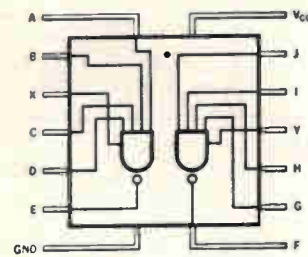

Dual buffer — DT μ L 932
Dual power gate — DT μ L 944

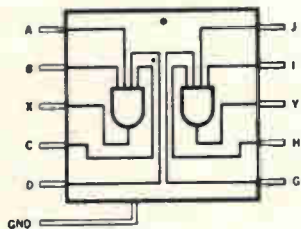

Dual four-input extender
DT μ L 933

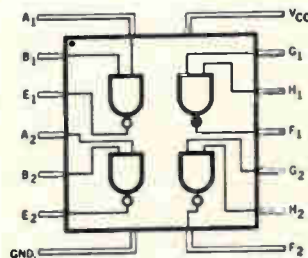

Quad two-input gate
DT μ L 946, DT μ L 949

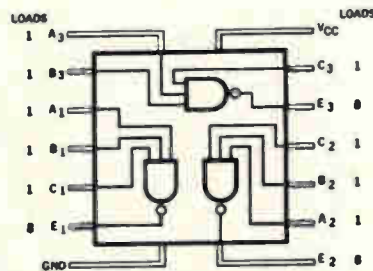

Triple three-input gate
DT μ L 962, DT μ L 963

Probing the News

Industrial electronics

Process control: big boom in Britain

Britain's push to automate its plants has created a huge demand for process control computers and techniques for man-machine communication, mimic design representation, and speech and character recognition

By Derek Barlow

European Editor

British industrial computer makers must be doing something right. Business is booming and the major British firms making such equipment have bulging order books. They have sold and installed approximately 100 process control computers and another 50 are either on order or almost so.

The upsurge is a result of Britain's drive to automate her plants—a drive pushed by Technology Minister Frank Cousins to help the United Kingdom compete in the world market.

One manufacturer said: "Our sales curve is rising exponentially and orders are doubling each year. The majority of these are for micro-miniature systems using integrated circuit components."

The boom in industrial electronics was evident at the Instrument, Electronics and Automation Exhibition in London last month. Process control computers dominated the show but there were also new display techniques for man-machine communication, for computer-aided design, for mimic diagram representation and speech and character recognition.

Why the boom. One company executive explained the industrial computer boom: "Customers now know what they are talking about in computer control. Microminaturization is doing for the process computer industry what the second generation of business computers did for data processing. Systems are now running a year without any failures on a 24-hour-a-day basis."

Britain, however, does not have the market to herself. United States firms—such as the Foxboro Co., Honeywell Inc., Ampex Corp. and Potter Instrument Co.—already hold a major position in the industrial control market and are out to improve that position.

At the exhibition more than 50 American companies displayed their products. Business was so good that several are planning to set up plants in Britain.

To offset American competition at home, British firms are pushing their overseas sales. Eastern European countries are considered good

markets for industrial controls and computer installations. English Electric-Leo Marconi Computers Ltd. has received orders for three large computer installations, one from a railroad in Czechoslovakia and the other two from a Czech steelworks.

The British have developed a profitable market in Sweden by selling American computers. Associated Electrical Industries Ltd. already has sold General Electric's Con Pac computers for use in Sweden's nuclear reactor and two other Con Pac 4040 computers—worth \$300,000—are on order. One

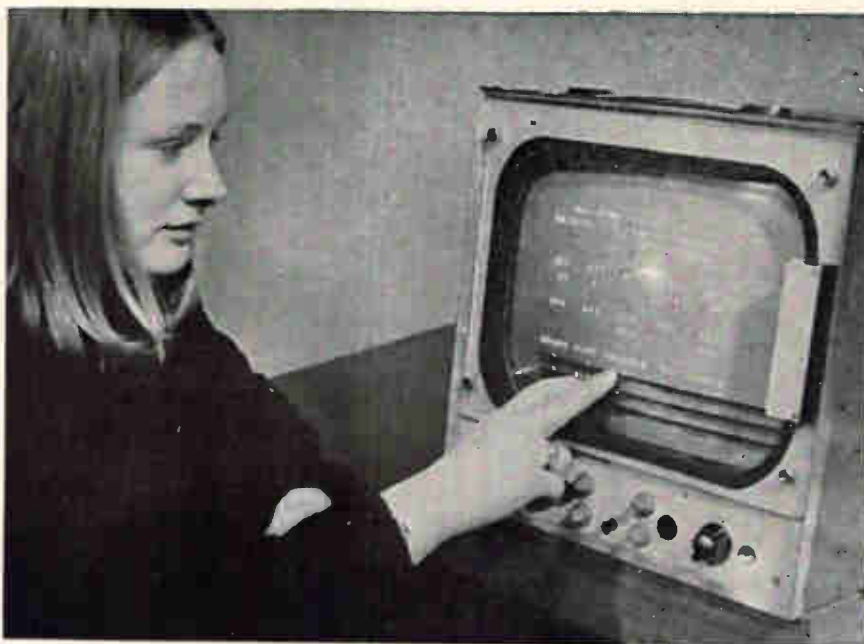

"Wrong wire touched. Try again," is the message the operator gets on the cathode-ray tube when her query does not make sense to the computer.

will control a Swedish paper mill and the other will direct power distribution to a paper mill complex.

I. Land, sea and air

Ferranti Ltd., one manufacturer of integrated-circuit process control computers, is producing 24 Argus 400 machines. Fifteen of these—valued at \$1.4 million—have been sold and negotiations are under way for the other nine. Installations are for applications ranging from civil air traffic control centers to ships.

One Ferranti model is planned for the new \$75-million Cunard ocean liner, code named the Q4. The 58,000-ton vessel will be launched in April, 1967 and delivered in 1968. The Argus 400 computer will perform data logging in the engine room. It will also make life easier for the ship's purser by keeping track of food inventories and personnel records.

The Ferranti computer will be used at Jodrell Bank, Britain's radio astronomy center, to control the radio telescope and to run X-ray diffraction meters that analyze nuclear measurements.

The computer also will be put to work in coal mines. At the Longannet installation in Scotland, four coal mines are to be linked to form a single complex. The mines will supply a nearby power station with 10,000 tons of coal a day, and the computer's job will be to make sure the entire output is kept within specific limits of ash content.

British police may use a Ferranti computer to check fingerprints more rapidly. A punched tape input carries the coded pattern of a fingerprint. If the computer recognizes the print, it provides a pattern description.

A parallel version of the Argus 400, the Argus 500, is under development and already has been ordered for power station and chemical industry applications. One of Britain's biggest chemical firms will use two of the new computers for mass spectrometry analysis. Four computers, paralleled in pairs, will directly control the reactors in a direct, digital-control system at a nuclear power station due to be operational in 1970. The control equations of the reactors are included in the computer program. Control valves and actuators are

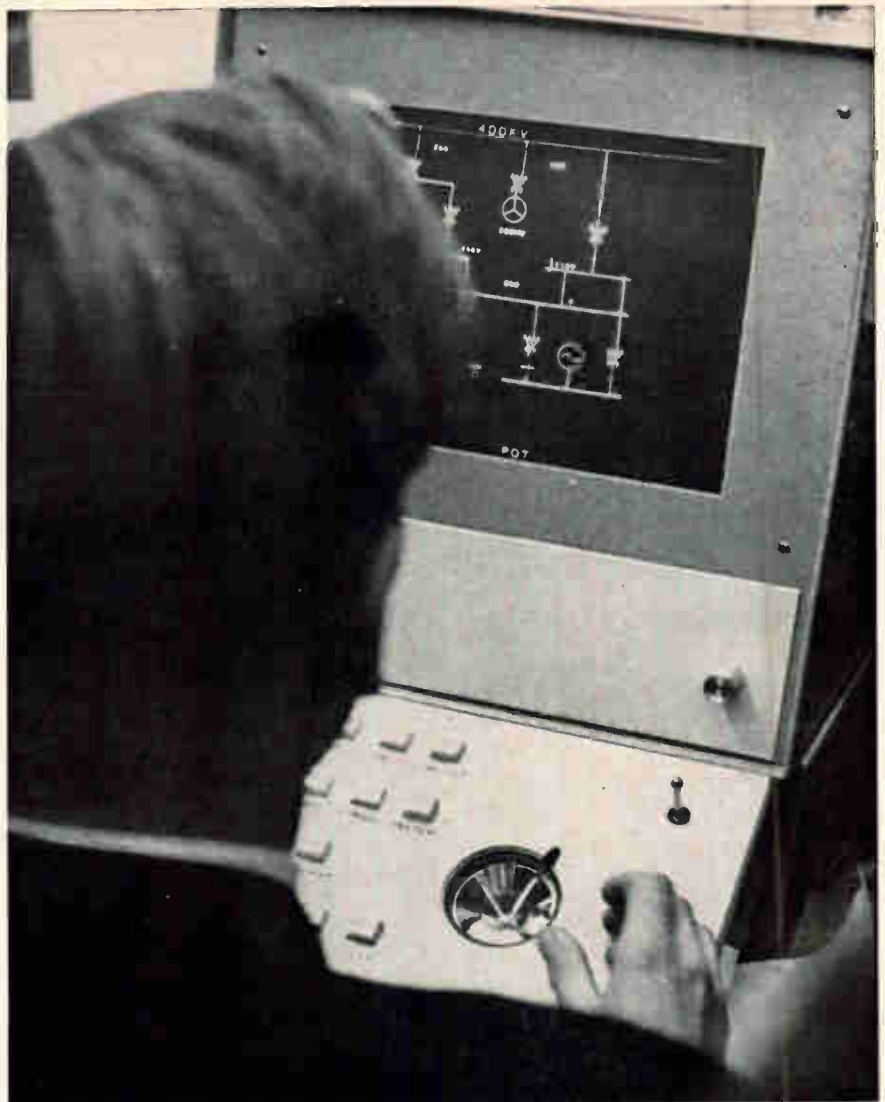

Micrologic drawing machine gives the operator complete freedom to draw any shape or diagram he wants. Drawings are then stored in the process computer.

linked directly to the computer.

II. Man talks to machine

Both Marconi Ltd. and Plessey Automation Ltd. are developing a new display technique for man-machine communication—a touch-wire system. A closed-circuit television monitor is the base of the system. The display is divided into two parts—the upper part displays descriptive data while the lower portion displays the series of choices available to the operator.

The operator queries the computer by touching one of a number of wires placed on the face of a cathode-ray tube. His choice of wire is determined by the alphanumeric display characters indicated against each wire by the computer. The system works not only as a conventional display but also as a keyboard with inquiries computer-controlled and generated.

The wires are $\frac{3}{4}$ -inch-long pieces of copper attached to a mask fitted in front of the cathode-ray tube. Normally, 16 wires are used but there is no limit. The wires are placed so the computer can write items of information against each one. Connections from the wires link them to one arm of an a-c bridge.

When the operator touches a wire, the bridge is unbalanced. Logic circuits set up a number corresponding to the wire touched and signal this to the computer. The computer then starts a new routine to change the display or call down more data. Antidither circuits prevent operators from repeatedly activating the display before the completion of each item of dialogue.

Keep in touch. The system was originally developed by the government's Royal Radar Establishment for air traffic control applications

in which controllers can communicate with the computer.

Initially, the display lists only the call signs of the aircraft in the controller's area. These call signs are repeated against each of the touch wires. When the controller receives information from one of the aircraft, he touches the appropriate wire which calls down data on the aircraft's flight plan. At the same instant, the keyboard writing against the touch wires changes and is replaced by flight plan data such as altitude and checkpoints.

If the controller wants to change the plane's arrival time at a checkpoint, he calls down checkpoint data by touching the proper wire. The keyboard then changes to a row of digits from which the controller can update the entry.

In the displays being developed by Plessey Automation, a dot pattern generates the alphanumeric characters to provide 16 lines of 64 characters each on the type face.

III. A mechanical artist

A micrologic drawing machine soon will be available in Britain to link process control computers with a display mimic diagram of a plant being controlled. In its experimental version, the system developed by Ferranti differs from other cathode-ray tube display and drawing systems in that the operator has complete flexibility to draw any shapes or diagrams he wants. The drawings are then stored in the process computer.

There is no limit on the number of characters that can be generated. The software program permits generation of different character sizes once the character has been formed.

Computer input is controlled by a joy stick and a Teletype keyboard. Sophisticated displays can be built by using six different operating modes—one of these is a straight tabular display of lines containing 16, 32 or 64 characters per line.

Symbol generation is from a vector line, the position of which is set by the joy stick control. Resolution is better than one part in 256 as any point on a 256 by 256 matrix can be connected with another.

Special programs generate circles whose diameters and positions are controlled by the joy stick. Graphical plotting of the computer output is also possible to a resolu-

for maximum **SOLID CARBIDE** drilling precision

SERIES 125 - 1/8" SHANK SOLID CARBIDE CIRCUIT BOARD DRILLS

**the rigid stability
of 1/8" shanks
with EVERY size drill**

Series 125 Circuit Board Drills are made with Metal Removal Company specifications of point configuration (Four Facet Point), helix angle, very fine flute finish and exacting size tolerances.

The Series 125 Circuit Board Drill is an advancement of drill design to its present optimum. Among many features, it offers:

- Strength and rigidity of the 1/8" shank permits location and hole size tolerance to close limits.
- Drill bushings completely eliminated where used with precision spindles and collets.
- Also available in double end style with 1/8" shanks.
- 1/8" common shank size for all drill diameters eliminates inventory of collets for each size drill.
- Drill point is concentric to drill diameter within .0005"; drill diameter to shank concentricity is within .0003".
- Permits ultra high speed drilling at rates up to 150,000 RPM and 5 feet per second feed.
- Can be manufactured with geometry variation for clearances required for fast feed, high RPM operation.

For complete information write for Bulletin CB66.

THE METAL REMOVAL COMPANY

1859 West Columbia Avenue
Chicago, Illinois 60626

Plants Located in CHICAGO • LOS ANGELES • SAN JUAN

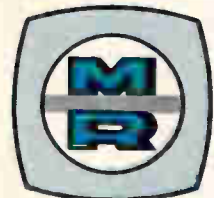

MASTER TOOL AND WHEEL MAKERS FOR THE WORLD

IF
 you use,
 need or
 specify
DC POWER
 you'll want
 this new
TRYGON
POWER
SUPPLY
HANDBOOK

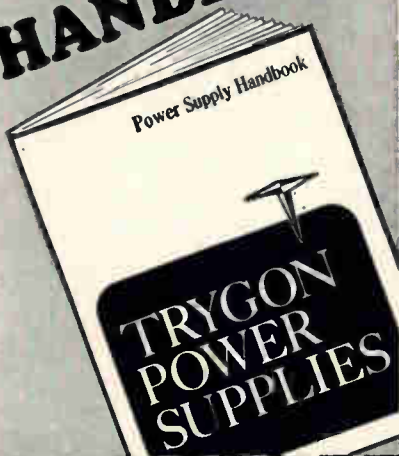

TRYGON Electronics, Inc.
 Roosevelt, L.I., N.Y. 11575

Gentlemen:
 Please RUSH me your newly published
 HANDBOOK—Free.

Name

Title

Company

Address

CityState.....Zip.....

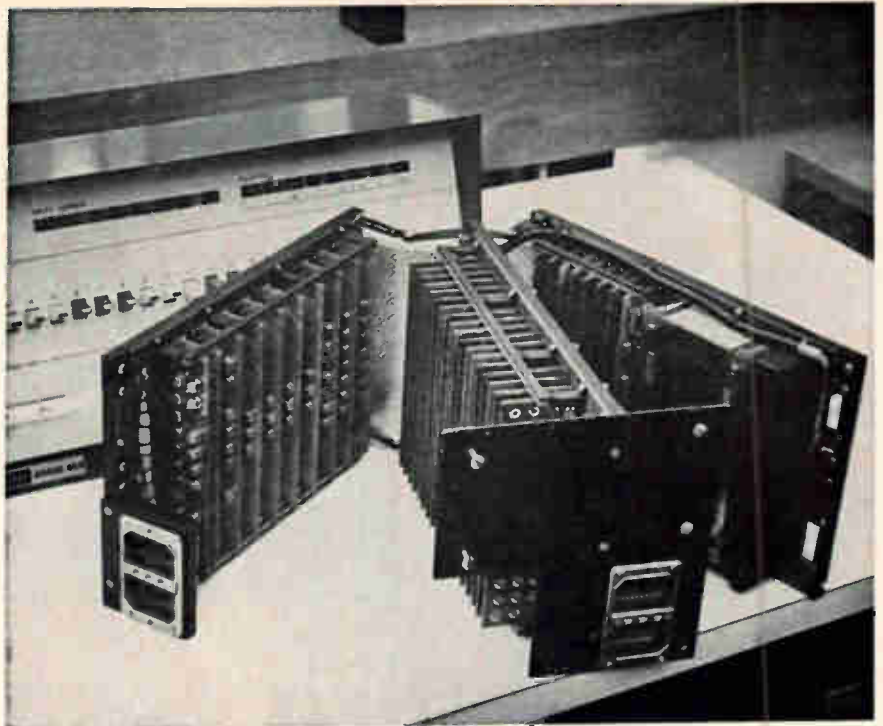

Argus 400, Ferranti Ltd.'s process control computer, using IC's, controls air traffic and keeps track of food inventories on ships.

tion of one part in 1,024.

The system's main use will be to generate diagrams in machine language form that can be employed in other process control applications. The system is connected directly to the computer store and will display mimic diagrams of any section of the plant the controller wants watched.

IV. Road to design automation

Design automation is gathering steam in Britain. Two firms, Marconi and Racal, Ltd. are approaching computer-aided design from different directions.

Racal is designing all video amplifiers with an Elliott 4100 computer. Three programs have been written to design a standard-configuration, three-transistor amplifier. Designers specify the gain, frequency range, stability margins and temperature environment. The program first determines the resistor values to insure correct bias levels and then defines capacitor values to meet the frequency response. The frequency response for both ends of the range is finally calculated and printed out. Total design time is 15 minutes.

Marconi is concentrating its efforts on the drafting room problem, the actual drawing of the design after requirements have been deter-

mined. Marconi's technicians are studying software requirements to use with its Myriad microminiature computer. Several questions still remain to be answered—how should perspective alterations be programmed into the system, and should the system provide automatic dimensioning and automatic production of projection drawings? The entire operation will be a long-term one for Marconi.

V. What did he say?

Speech and character recognition are part of a long-term computer input program being conducted by Plessey Automation. Experimental techniques using autocorrelation are able to recognize spoken numerals. Speech inputs are split into 20-cycle bandwidths and are then digitized. The computer program then searches for unique patterns, sampling the input every 25 milliseconds. Plessey is now studying methods of analyzing tonal effects of the voice. On recognition of words, a Plessey spokesman says: "we are on a level with the rest."

Plessey also has developed a number recognition system as part of the Ministry of Technology's advance computer technology study. The system can read any font, or type, or number by interchanging plug-in units.

in stock...in quantity 6x8 monolithic diode matrices

Exclusive dielectrically isolated circuits and fusing techniques provide unlimited matrix designs

Radiation's highly flexible 6 x 8 matrix is available for immediate shipment in quantity. These circuits contain 48 active devices per chip. A fusible link in series with each diode permits unlimited matrix patterns to be formed. In addition, matrices can be combined to provide an infinite variety of matrix sizes and configurations—6 x 8, 6 x 16, 12 x 8, 12 x 16 ... $n_1 \times n_2$!

In addition to *flexibility*, Radiation matrices provide other important benefits: *System reliability* is increased by monolithic construction. *Space requirements* and weight are slashed through use of fewer packages. And, assembly of discrete diodes is eliminated.

Only Radiation supplies monolithic diode matrices. Write or phone for our detailed data sheets which include worst-case limits and all information required by design engineers. Radiation Incorporated, Physical Electronics, Department EL-06, Melbourne, Florida 32901. Phone: (305) 723-1511, extension 554.

flexibility
reliability
size & weight

All Radiation integrated circuits are dielectrically isolated.



**RADIATION
INCORPORATED**

Radiation RM-30 Diode Matrix*

CHARACTERISTIC	TYP LIMITS	TEST CONDITIONS
Forward drop $V_F(20)$ $V_F(1)$	1.0 v 0.7 v	$(T_A = +25^\circ\text{C})$ $I_F = 20 \text{ ma}$ $I_F = 1 \text{ ma}$
Reverse breakdown BV_R	60 v	$I_R = 100 \mu\text{a}$
Reverse current I_R	7 na	$V_R = 25 \text{ v}$
Reverse recovery t_{rr}	7 nsec	$I_F = 10 \text{ ma}$ $I_R = 10 \text{ ma}$ Recover to 1 ma
Crosspoint capacitance C_{cp}	1.9 pf	$V_R = 5 \text{ v}$, $f = 1 \text{ Mc}$
Coupling coefficient I_{cl}	20 na	

*Supplied in TO-84 packages.

Sales offices: Suite 622, 650 North Sepulveda Blvd., El Segundo, Calif. (213) 772-6371—Suite 438, 600 Old Country Road, Garden City, N. Y. (516) 747-3730—P.O. Box 37, Melbourne, Florida (305) 723-1511.

THIS VOM WON'T FOOL YOU ON TRANSISTOR CIRCUIT CURRENT

Low 50-Millivolt drop on current ranges gives accurate measurements

Now, you can make transistor current measurements with a VOM . . . and with 0.05 volts or less change in operating conditions. ■ This new, self-shielded, taut band member of Simpson's famous 260® family of VOMs is made for use in transistor circuits. Regular VOMs often give wrong current readings because their high resistance actually changes the operating conditions by as much as 300 millivolts. ■ Model 250 also has provisions for using Simpson "Add-A-Tester" adapters and all other 260-family probes and accessories. Sensitivity is 20,000 ohms per volt DC, 5000 ohms per volt AC. Accessories include three DC high voltage probes, an AC high voltage probe, plus several styles of leads and carrying cases — eleven accessories in all. If your work includes checking current in transistor circuitry, call your electronic distributor for fast delivery **\$59⁹⁵** of a Simpson Model 250. Complete with test leads and operator's manual

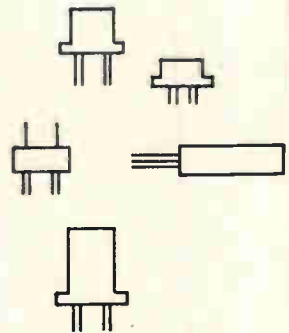

RANGES

DC VDLTS: 0-0.050; 0-0.250; 0-2.5; 0-10; 0-50; 0-250; 0-500; 0-1000
 AC VDLTS: 0-2.5; 0-10; 0-50; 0-250; 0-500; 0-1000
 DC MICRDAMPERS: 0-50 (Both 50 and 250 MV Drop)
 DC MILLIAMPERES: 0-1; 0-10; 0-100; 0-500 (50 MV Drop)
 DC AMPERES: 0-10 (50 MV Drop)
 DB SCALE (1MW-600Ω): -20 to +10; -8 to +22; +6 to +36; +20 to +50
 RESISTANCE RANGES: R X 1 0-2000Ω (12Ω center); R X 100 0-200kΩ (1200Ω center);
 R X 10K 0-20 megΩ (120KΩ center)

ACCURACIES

0-50 MV; 0-250 MV; 0-2.5
 to 0-1000 V DC: ±2% F.S.
 0-50 MICRDAMPERS: ±1% F.S.
 0-1 MA to 0-10 A DC: ±2% F.S.
 RX1: ±2.5° of Arc
 RX100, RX10,000: ±2.0° of Arc
 0-2.5 to 0-1000 V AC: ±3% F.S.



SIMPSON ELECTRIC COMPANY
 5203 W. Kinzie Street, Chicago, Ill. 60644 • Phone: (312) ESTebrook 9-1121
 Representatives in Principal Cities . . . See Telephone Yellow Pages
 Export Dept.: 400 W. Madison St., Chicago, Ill. 60606 Cable, Simelco
 In Canada: Bach-Simpson Ltd., London, Ontario
 In India: Ruttonsha-Simpson Private Ltd., Vikhroli, Bombay

WORLD'S LARGEST MANUFACTURERS OF ELECTRONIC TEST EQUIPMENT

C-5A to diagnose its own ills

An elaborate system to detect malfunctions is one of the major electronics innovations in the world's largest aircraft

When the Air Force's C-5A cargo planes take to the air starting in late 1968, they will carry aboard a phantom crew of highly skilled troubleshooters—the engineers who designed and developed the major subsystems for the mammoth aircraft.

For hard-to-diagnose faults that develop while the plane is airborne, flight engineers in a sense will consult the design engineers through an elaborate malfunction detection, analysis and recording system (Madar). For easy-to-diagnose malfunctions, the system will pinpoint automatically the unit that has stopped working properly—a hydraulic pump, for example, or a generator—and print out its identification number.

Along with its kingpin mission of inflight troubleshooting, Madar also will record data vital for scheduling preventive maintenance on major equipment like the plane's jet engines.

The Lockheed Aircraft Corp., which won a \$1.4-billion contract to build 58 of the 360-ton cargo planes, rates the malfunction detection system as one of the major innovations in electronics going into the C-5A, which will be far and away the world's largest aircraft. Madar, now near final design, goes far beyond the earlier malfunction detection recorder Lockheed developed for the Air Force. The Madrec system, used on the B-52 and B-47, tape-records malfunction data during flight for later analysis by computers on the ground. This is just one of several jobs the Madar system will do.

I. Man or computer?

In Madar, Lockheed struck a balance between the two current extremes in diagnosing malfunctions. On today's aircraft, most troubleshooting takes place on the ground. The test equipment relies heavily on manual monitoring and often

requires skilled technicians to interpret readings. On the other hand, in advanced small aircraft, the trend is toward automatic inflight diagnosis—hundreds of inputs fed to an airborne computer programmed to detect and identify malfunctions. Madar combines both these approaches.

The Madar system keeps tabs on some 1,000 test points throughout the plane. About half of them are monitored manually. F. J. Overcash, deputy chief subsystems engineer of Lockheed-Georgia Co., the Lockheed affiliate building the C-5A, believes this division is the best for the mammoth cargo plane. He says striking this balance was the crucial design decision in developing the system and that the actual technology had all been tried out previously elsewhere in bits and pieces.

Stable. For quick turnaround at airports, the C-5A is designed for fast servicing and throughout the craft assemblies like pumps, motors, actuators and electronic hardware are conceived as line replacement units, LRU's. When an assembly develops a fault, the plane does not have to stay grounded during a lengthy repair; instead,

a mechanic replaces the unit.

Lockheed assigned the LRU's to automatic or manual maintenance monitoring according to the complexity of the signals that tell whether or not the unit is working properly. About half of the monitored test points—hydraulic pressures, temperatures, motor currents and the like—produce signals that vary within predictable limits. Lockheed classes signals like these as stable parameters and handles them automatically in Madar to make go, no-go decisions.

However, there's not a simple one-for-one ratio between an out-of-tolerance stable parameter and a faulty LRU. A data signal indicating low pressure at a pump output, for example, doesn't necessarily mean the pump has failed. The low pressure could also be caused by a faulty bypass valve, a low reservoir, or an open circuit to the pump motor. For that reason, the Madar's memory stores for each automatically monitored LRU a logic equation linking as many as six stable parameters. When the data signals from an LRU don't satisfy its equation, it's faulty.

Dynamic. Precise limits needed for automatic go, no-go malfunc-

Madar may have split personality

In the next few weeks, the Air Force, the Lockheed Aircraft Corp. and the Nortronics division of the Northrup Corp. will decide whether or not Madar will have a split personality.

Lockheed has a fixed-price contract for the C-5A and wants to keep the cost of avionics from getting out of hand. One obvious way to hold the line, without a sacrifice of the aircraft's over-all capability, would be to assign part of the computations necessary for automatic malfunction monitoring to the navigational computer.

Lockheed studies show that the calculations needed to determine engine health, which are far more complex than straight go, no-go malfunction decisions, would add only 3 microseconds to the 214-microsecond major loop time of the navigational computer.

Nortronics, subcontractor for the navigation system, admits the computer has the time to spare for the engine health calculations. But Lockheed and Nortronics currently are bickering over what the contract revision will cost. Lockheed has designed Madar so that it could work with a single, general-purpose computer or with part of the calculations farmed out to the navigational computer.

VECO THERMISTORS MILITARY GRADE*

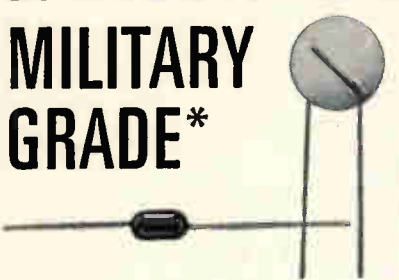

VECO Military Grade disk and rod thermistors manufactured to the requirements of MIL-T-23648 are rugged, high-reliability, general-purpose, insulated thermistors suitable for use over the temperature range of -55°C to $+125^{\circ}\text{C}$. They find widespread use in the areas of temperature measurement or control and especially in temperature compensation in transistor circuitry.

accuracy

VECO's unequalled investment in the most precise test equipment, standards, and controlled environmental baths and chambers provides unparalleled thermistor calibration accuracy. Calibrations are performed with accuracies of 0.01% or better on resistance and 0.01°C or better on temperature.

reliability assurance

VECO's Reliability Assured Components Program has gained VECO an enviable reputation for high quality and reliability achievement. Every VECO thermistor undergoes a complete array of tests and inspections during its manufacture.

experience

VECO has pioneered in the development of thermistors and has consistently been the pacemaker to the industry expanding thermistor technology and establishing new standards of performance. VECO's staff of experienced engineers is available for R and D projects requiring further advances in the state of the art.

Specify VECO thermistors whenever accuracy, stability and reliability are required. VECO stocks a wide range of thermistor types in a variety of resistance values for immediate delivery. Remember—the most reliable thermistors are VECO thermistors.

Write for Technical Bulletin MMT102

VECO First in Progress • First in Service

J-6906

VECO VICTORY ENGINEERING CORP.
122 Springfield Ave., Springfield, N.J. 07081
Tel: 201 • 379-5900 TWX: 710-983-4430

tion decisions, however, can't be set for complex waveforms—signals from autopilots, inertial platforms, heading servos, doppler radar equipment, radar video circuits and the like. These dynamic parameters are displayed on a cathode ray tube so the flight engineer can analyze them.

This method of determining which LRU in a subsystem is acting up has a definite drawback: ordinarily it takes a skilled avionics technician to interpret the waveforms. Madar gets around this by projecting reference waveforms alongside the cathode tube's display. All the flight engineer has to do is match the live waveform to a reference waveform. The reference display then indicates which LRU is at fault and what to do about it.

When the flight engineer uses the reference waveforms, which are stored in the equipment on 16-millimeter film, he indirectly consults the design engineers who developed the subsystem he's checking. The reference waveforms will come from analyses made by design engineers who have deliberately set up on LRU's all the possible malfunctions they can think of. As the C-5A's go into service, flight engineers will record any undefined waveforms so they can be analyzed on the ground and the film store updated.

II. Automatic mode

Critical to the automatic malfunction detection system is its data processor, essentially a general-purpose, core-memory computer that stores the limits for the stable parameters that are automatically monitored.

Data signals from 32 remote signal acquisition units throughout the plane are funneled into the data processor where they are compared with the predetermined limits. Each acquisition unit can handle up to 32 analog data channels, sampling among them at rates of 10 kilohertz.

Address and compare. The signal acquisition units are addressed and sampled through a central multiplexer adapter. Up to 20 channels are applied at one time to the multiplexer's data gates, where one is selected by decoding address bits. Data in the selected channel passes to an analog-digital con-

verter and then goes into the limit-comparison program in the computer.

It takes between 8 and 10 microseconds to sample a channel, digitize the data, make the limit comparison and store it. As many as six different parameters can be involved in one malfunction check. If the results of limit comparisons satisfy the logic equation for the LRU, the output is a go signal that triggers the automatic checking sequence for the next LRU.

If the equation is not satisfied, the malfunction check produces a no-go signal. This signal actuates the print-out unit, which identifies by number the faulty LRU. At the same time, a light on the control panel warns the flight engineer of the fault. He then has three possible courses of action: replace the faulty LRU if the job can be done in flight; radio ahead the LRU number so a ground crew can be ready with a replacement; or probe further into the fault. This he does by diagnosing it with the help of Madar's 10,000-frame troubleshooting film library.

Engine health. Along with continuous automatic checking for malfunctions in the major subsystems of the C-5A, the Madar makes a magnetic-tape record of the health of the jet engines. The tapes are analyzed by a computer on the ground to help tell when preventive maintenance and overhauls should be scheduled.

III. Diagnostic mode

The flight engineer, aided by the phantom crew of highly skilled troubleshooters, takes over when a fault is too tricky to diagnose automatically. Essentially, it's a matter of pushing buttons—often as directed—on the control console.

After punching the switch for the suspect subsystem, the flight engineer can get preprogrammed troubleshooting instructions by flipping a program initiation switch. The instructions, stored on film, are projected onto a screen alongside the face of the cathode tube. The program control in the console includes interlock circuits that prevent advancing to the next step in a test procedure before all the previous steps have been carried out. Real-time waveforms and voltage levels can also be called up.

BWO innovations from Varian

1955 First permanent magnet focused BWO.

1956 First low-voltage BWO—requiring less than 700 V to operate.

1957 First BWO incorporating ion drain—for low-noise performance.

1958 First high performance BWO for X band.

1959 First production BWO covering the 18.0 to 26.5 GHz range, and incorporating all the above techniques.

1960 First production BWO covering the 26.5 to 40 GHz range.

1961 First BWO with long-life impregnated cathodes—significantly reducing cost per operating hour.

1962 First BWO with magnetic shielding.

1963 First complete line of BWO's—covering the 1 to 40 GHz range.

1964 First line of magnetically shielded BWO's for the 2 to 40 GHz range.

1965 First miniature shielded BWO's for the 7 to 40 GHz range.

1966 First complete line of magnetically and RFI shielded BWO's covering the 1 to 40 GHz range.

These innovations evolved from working closely with America's foremost designers of microwave equipment. We'd like to share these 11 years of BWO knowledge and experience with you.

Write: Palo Alto Tube Division, 611 Hansen Way, Palo Alto, California. In Europe: Varian A.G., Zug, Switzerland. In Canada: Varian Associates of Canada, Ltd., Georgetown, Ontario.



Miniature Rectangular BWO's



Miniature Shielded BWO's



Standard Shielded BWO's



Familiar with **TEFLON**? Try this quiz.

①	TEFLON is transparent!	TRUE	FALSE
②	TEFLON can be cemented!	TRUE	FALSE
③	TEFLON can be heat sealed, thermoformed, heat bonded!	TRUE	FALSE
④	A TEFLON film is made by Du Pont!	TRUE	FALSE

All are true with **TEFLON**® FEP film: a new dimension in TEFLON

Let us tell you more.

Du Pont Company, Room 4240, Wilmington, Delaware 19898

TEFLON FEP fluorocarbon film brings the familiar properties of TEFLON *plus* a new form, versatility and ease of fabrication for applications like: conveyor belting, critical industrial packaging, gaskets, roll covers, reinforced plastics curing, closures, high temperature electrical insulation, flexible flat cable, printed circuitry.

The application I am considering is _____

To do the job, a material with the following critical properties is required:

TEFLON FEP FILM

Mechanical high impact, abrasion, tear strength. Useful at cryogenic temperatures
 Thermal resistance from -240 to +200°C. continuously
 Chemical resistance the most inert of all plastics
 Release, anti-stick superior
 Electrical No tracking, non-wettable, non-flammable, low power factor and dielectric constant, dielectric strength: 4,000 vpm for 2 mil film.
 Weatherability high transmittance of ultraviolet and all but far infrared, inert to outdoor exposure
 I am interested in these forms and processing techniques:
 Film thickness ½, 1, 2, 5, 10, 20 mil.
 Heat bonding directly to metals.
 Heat sealing provides a plastic weld at 300°C.
 Cementing available with one or both surfaces treated to accept conventional adhesives, for laminating to metals, rubber, glass cloth, asbestos fabric, etc.
 Thermoforming a true thermoplastic, thermoform at 525°F., with conventional equipment.

MY REQUIREMENTS

from _____ to _____
 to _____
 yes _____ no _____

thickness _____
 substrate _____
 yes _____ no _____
 substrate _____
 one side _____
 both sides _____
 yes _____ no _____
 shape _____

Please send full appropriate technical data.

Name _____ Address _____
 Company _____ City _____ State _____ Zip _____
 Job Responsibility _____ Business Phone _____



TEFLON® FEP fluorocarbon film

BETTER THINGS FOR BETTER LIVING... THROUGH CHEMISTRY

Europe split on color tv

Slim chance seen for single standard as countries committed to Secam or PAL prepare for color broadcasts

By Arthur Erikson

Electronics Abroad Editor

The long squabble among European countries over color-tv standards seems destined to end in a stalemate this summer.

A last attempt to settle on a single standard will be made at a month-long plenary assembly of the International Radio Consultative Committee (CCIR) in Oslo starting June 22. Erik Esping of the Swedish Telecommunications Authority, longtime chairman of CCIR's color-tv study group, plans to open the session with an appeal for unity. No matter how moving the appeal, though, it's doubtful the officials of Europe's government-run tv networks will be swayed. Most are heading to Oslo committed to one or the other of two competing—and incompatible—systems and are more concerned with starting color-tv broadcasts than with compromise.

French tv officials are determined to stick with their Secam system. And they have the Soviet bloc for support. The other major European countries have lined up behind the West German PAL system. Both camps are resigned to a standoff—and a double color-tv standard for Europe. Neither side can count on enough last-minute shifts of position to trigger the stampede needed for a unanimous vote and a clear-cut recommendation for one system. Instead, CCIR almost certainly will bury the issue, forwarding for approval to its parent body—the International Telecommunications Union—a recommendation that both Secam and PAL be adopted.

Contributions to this report were made by Derek Barlow, London; Paul Catz, Amsterdam; Charles Cohen, Tokyo; John Gosch, Bonn; Peter Kilborn, Paris; Robert Skole, Stockholm; Ronald Taggiasco, Milan; and Donald Winston, Moscow.

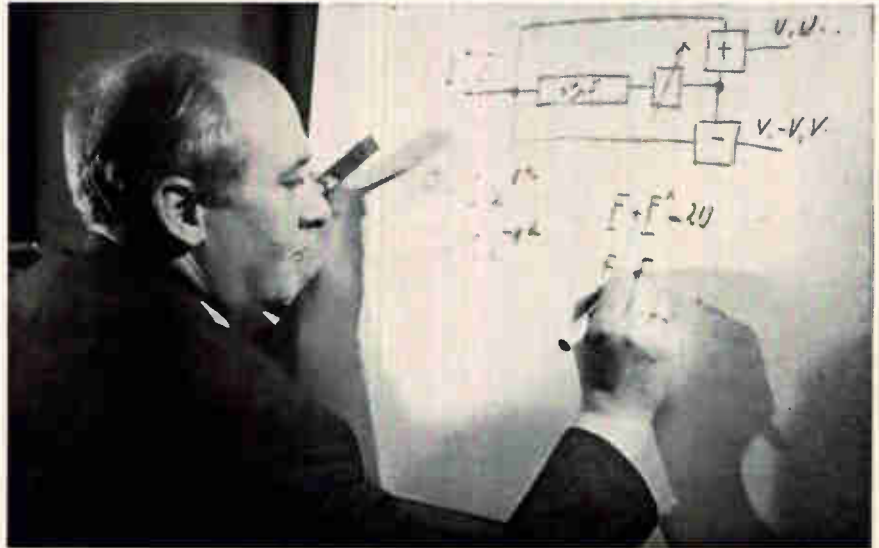

Walter Bruch of Telefunken first hit on the fundamental ideal of PAL—eliminate hue and saturation variations by alternating the phase of chrominance modulation from line to line to average out color errors,

Although delegations from some 50 countries will merely go through the motions of trying to hit on a compromise, a flurry of last-minute politicking will come as backers of the two systems seek to add to the territories they already have.

The stakes are tremendous. Maurice Ponte, head of France's largest electronics company CSF (Compagnie Générale de Télégraphie sans Fil) estimates that at least 25-million color-tv sets will be sold in Europe by 1976.

With the United States' NTSC system no longer in contention for Europe, the American delegation will boost PAL rather than Secam. PAL is an offshoot of NTSC [Electronics, March 22, 1965, p. 97]. Japan, too, probably will push PAL since it has followed the U.S. with NTSC; Japanese industry certainly will find PAL countries better export markets than Secam countries, which will need radically different receivers.

Other key items on the Oslo agenda include standards for stereo broadcasts, for mobile, marine, selective-calling systems, and for satellite communications. The U.S. has a direct interest in all three [see story on page 256].

I. PAL pushers

Unless the unexpected occurs at Oslo, the major industrial countries of Western Europe—France excepted—will start color-tv broadcasts during the next two or three years using PAL. All would have preferred a single standard. But in light of the hopelessness of the split that developed at least year's interim CCIR meeting in Vienna, no one felt it would be wise to hold off selecting a system until either PAL or Secam eventually wore down the opposition.

Eager isle. Great Britain, especially, wanted color in a hurry. With its black-and-white market saturated, British set makers clam-

Tube cutting headache?

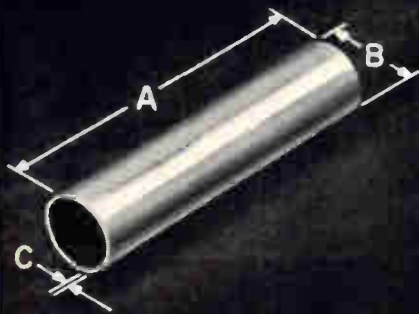

	A	B	C
Max. Dim.	7"	.500"	
Min. Dim.	.125"	.090"	.014"

Forget it! Let Art Wire do it.

Tubing cut to precise spec is another of those maddening jobs that are best farmed out and forgotten. Art Wire can probably do the job a lot faster than you can. Our Automatic machines are already set up. At less cost, too, considering down-time and overhead.

Nice thing about it is that Art Wire takes over the problems, as well. Delivery, quality control and high-volume production are our worry, not yours.

Any non-ferrous metal tubing cut to dimensions shown above. Send us a part or a print. Phone 201-621-7272 if you're in a hurry.

We do wire forming and small part stamping, too. Bulletin 501 shows what we can do. Ask for it.



ART WIRE & STAMPING CO.

13 Boyden Place, Newark, N. J. 07102

ored for color broadcasts to buoy sinking sales of receivers. To the industry's delight, postmaster general Anthony Wedgewood Benn early this year announced the networks would go on the air with color in the fall of 1967—and with PAL. As far as British electronics companies are concerned, then, the CCIR plenary session will be largely a meaningless ritual.

Because Britain wanted color as quickly as possible, she originally backed NTSC as the only thoroughly tested system of the three original contenders. But Britain switched to PAL at Vienna, largely to head off an overwhelming swing to Secam. Since then, British officials have taken a second look at PAL and found it more to their liking than NTSC for purely technical reasons.

One big factor was a reevaluation of comparative set costs. Originally, British set makers estimated

a PAL set would cost 3.5% more to build than an NTSC set. They believed the difference wasn't worth PAL's big advantage—elimination of hue and saturation controls because of the error averaging obtained through alternating the phase of color information from line to line.

But the cost comparisons were first made against an NTSC set with a single 625-line standard for black-and-white reception. For a set capable of receiving both the 405-line and 625-line broadcasts current in Britain, the difference drops to just 1%. What's more, the British feel that refinements in the PAL system during the past year [Electronics, Jan. 10, p. 239] give it an added edge.

British set makers now say the first 25-inch color-tv sets they'll put on the market will retail at around \$750. Despite the price, they expect substantial sales at the out-



British manufacturers, such as the Marconi Co., have already started to cash in on color television through sales of studio equipment.

set, especially since renting, rather than outright buying, is a strong trend in Britain. Reports a spokesman for the British Radio Equipment Manufacturers Association: "All the private surveys by set makers highlighted a great customer interest in color. We hope to sell 150,000 sets in the first two years. After that we anticipate production to reach around 250,000 sets a year by the fifth year."

Along with the set makers, E.M.I. Electronics Ltd. is due for a windfall from color tv. Through its cross-licensing agreement with Telefunken AG, the West German company that developed PAL, E.M.I. has an exclusive license for Great Britain for the system. E.M.I. doesn't plan to build sets but will collect royalties on all that are built in the country.

Slow start. The West German electronics industry will, of course, turn up at Oslo committed to PAL. So solidly does the industry stick to the system developed by Telefunken that plans are firm to start PAL broadcasts during the Radio, Television and Phonograph Exhibition at West Berlin in August, 1967.

Prestige, rather than profits, will be the major fallout to West Germany's burgeoning electronics industry during the first few years of color. Market forecasts put sales at between 50,000 and 100,000 sets during 1967. A year later, the market is not expected to go much beyond 150,000 sets. Market analysts are hard put to predict sales of a still-untried product after 1968, but one manufacturer thinks sales could total 500,000 sets through 1970.

The snail's pace, though, doesn't trouble set makers. They've got a booming black-and-white market going. Only 60% of the 20 million German households now have sets and the domestic sales outlook for the year is some 1.2 million receivers. Exports will boost total production to near 2.5 million.

When the color boom does come to West Germany, the General Electric Co. should find itself in a strong position. GE recently took over Kuba/Imperial, a major West German set maker. Kuba expects it will gain an edge over other producers from the know-how it will acquire building NTSC sets for the American market. The company

Water Shortage

(Wisconsin style)

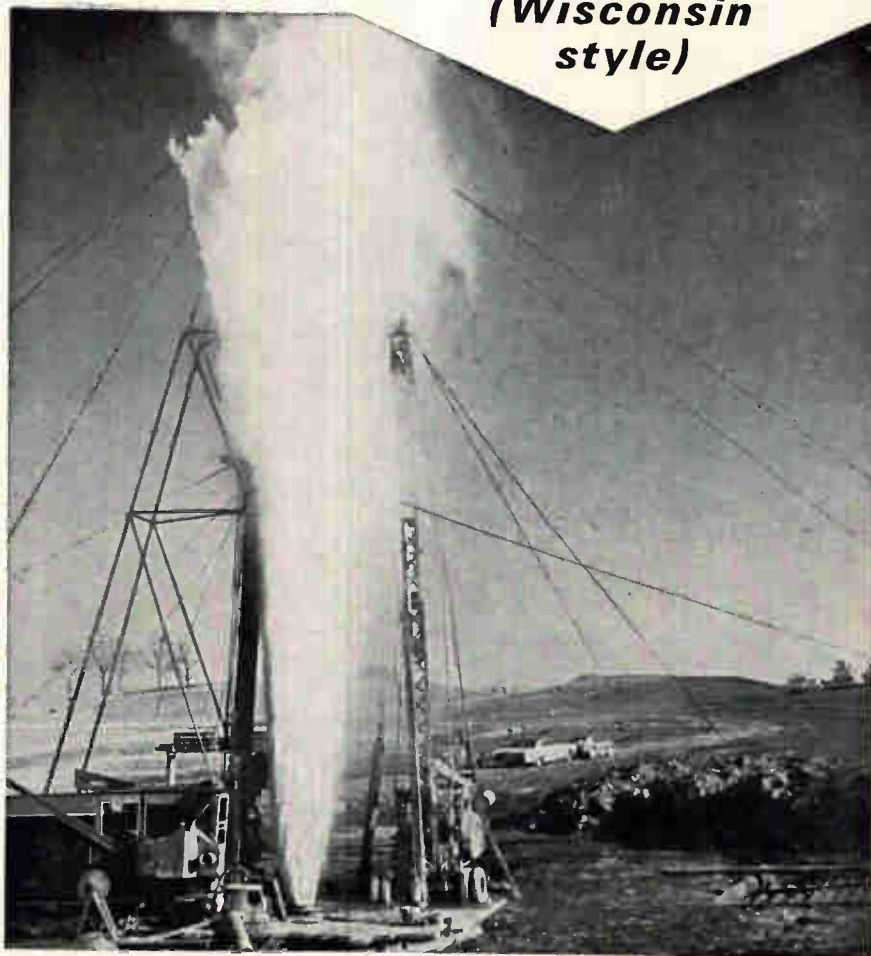

If water is important to your industry, Wisconsin is important to you! There's plenty. In fact, Wisconsin has 99 times *more* than is used annually. It's cool, clean water. Over 90% of the waterworks in Wisconsin use wells. (Photograph shows a new artesian well coming in.) Then, add 8,830 lakes . . . 35,000 miles of streams. And two of the largest Great Lakes. There's water for you in Wisconsin. And — it's clean water, because Wisconsin was the first state to establish a pollution control program.

More information? Write Industrial Development Dept. H Wisconsin Power and Light Company, P.O. Box 192, Madison, Wis. 53701.



Take the profitable leap to better living

WISCONSIN POWER & LIGHT

. . . investor owned

new model DB-1 DEVIATION BRIDGE

PROVIDES
HIGH PRECISION,
REPEATABILITY
AND SPEED



FOR LABORATORY
OR PRODUCTION
LINE TESTING
OF RESISTORS

The completely new Model DB-1 Deviation Bridge can be operated as a balanced or unbalanced Wheatstone Bridge for high-speed production and incoming inspection of resistors. The highly advanced unit can be used for indication of percentage deviation from an internal standard; comparison of resistors to a sample resistor; matching pairs of resistors; and for general resistance measurements by the null method.

FEATURES:

- Low bridge voltage (2 volts) reduces heating effects.
- Ranges $\pm 1\%$, $\pm 2\%$, $\pm 5\%$ and $\pm 20\%$ full scale on 6" meter.
- Accuracy $\pm 0.1\%$ over most of range.
- Built-in resistance decade standards.
- High gain—low drift DC amplifier.
- Universal jig adaptable to most components.
- Cabinet or relay rack mounting.



Write today for complete data.

Beckman INSTRUMENTS, INC.

CEDAR GROVE OPERATIONS
89 Commerce Road
Cedar Grove, New Jersey 07009

Formerly Industrial Instruments, Inc.

plans to start producing 50,000 sets this fall using U.S.-built color tubes.

Telefunken, of course, stands to collect handsome royalties from its PAL system. The company claims its fees could run up to 0.5% of manufacturer's factory price. Still to be worked out is how Telefunken would split its royalties with the Radio Corp. of America, holder of many of the patents for the NTSC system of which PAL is a variation.

Follow the leaders. In Holland, PAL has another backer which switched from NTSC. Philips Gloeilampenfabrieken N.V., the Eindhoven-based giant, pushed early and hard for the U.S. system, and actually started experimental broadcasts using it last year. But when Dutch broadcasting authorities followed the lead of Britain and West Germany, Philips adapted the transmitter and receivers and went over to PAL. Broadcasts by the government-run network should start in 1968.

By and large, all the Nordic countries lean toward PAL, although Belgium could possibly wind up as Secam territory.

Italy, too, can be counted in the PAL camp although government officials shy away from pronouncements on color tv. A casual inquiry about color usually provokes a reply something like this from a dealer: "We'll have PAL sets available some time toward mid-1967 and they'll retail for about \$640."

The government-run Italian broadcasting network has pretty much promised manufacturers that nationwide, color-tv programs will begin in September next year. In fact, the network already has set up its first color studio in Rome. But Italian set makers don't see a color boom in the offing. They expect it will take five or six years for color to catch on strongly unless set prices can be lowered.

II. Color them Secam

All through the color-tv squabble, the most extensive politicking has been done by the French, who have made the Secam system a point of national pride. As the opening date for the Oslo meeting approached, barnstorming Secam salesmen turned up in Lisbon and Moscow in late May. In early June, they hit Belgrade in an effort to ward off



Henri de France spurred development of the Secam color-television system.

any trend toward color-tv independence among Soviet satellites.

These stops capped a two-year hard sell of Secam by government and industry officials who have demonstrated the system from Argentina to the Soviet Union. Secam backers have broadcast color across the Mediterranean, in the Alps, and between Moscow and Paris by satellite. Still, French officials can count on solid support at Oslo only from their own delegation and the Soviet bloc. Their wooing also may eventually bring Portugal and Spain into their camp.

The other West European countries by and large shied away from Secam because they feel it's still too untried industrially. They admit, though, that in tests the system eliminates NTSC's major drawback—variations in hue and saturation caused by phase shifts in the quadrature-modulated chrominance signals.

Politics. In fact, Soviet acceptance of Secam apparently was based more on political reasons than cold technical evaluation. For example, when RCA tried to sell Russia on the NTSC system the company came in with a team of engineers and a truckload of equipment to show how the American system had worked successfully on both short and long transmission for over a decade. The French, however, made their pitch in Moscow with experimental equipment. But for every engineer they brought, they took along a political negotiator. To clinch the deal they offered the Soviets hardware guarantees that RCA couldn't match.

Furthermore, the Soviet-French

color agreement was tied in with the bilateral trade agreement between the two countries. So when the Soviets wanted to modify Secam, switching from frequency modulation for the chrominance carrier to PAL-like amplitude modulation [Electronics, Feb. 7, p. 197], they had to back down since they were tied up with equipment deals with French firms. The Russians are eager to start color broadcasts to celebrate the 50th anniversary of their revolution next year.

The French option for Secam will make the going rough in the years to come for French receiver makers who want to make their mark in other West European markets. And although their own black-and-white market has turned listless in recent months—though it's nowhere near saturation—French manufacturers don't expect a quick lift from color-tv even though broadcasts start this fall. Some, in fact, feel the early introduction of color will depress, rather than boost, tv-set sales.

Still, the major manufacturers are geared up to get sets on the market by September, when the broadcasts will start. Two of the major manufacturers, Compagnie Francaise Thomson-Houston and the Philips affiliate, La Radiotechnique, say the sets will carry price tags of about \$1,000 at the outset. But they say they may well be able to halve that within two or three years if color catches on. CSF, more a producer of military and industrial hardware than consumer goods, says it may be able to turn out a set that would sell for \$800 at the outset. For set makers, then, it will be prestige rather than profits for a long time.

Rights to the Secam system belong to the Compagnie Francaise de Télévision (CFT), set up by CSF and Compagnie de St. Gobain, a glass and chemical producer. CFT stands to collect a substantial payoff in Secam royalties but its real money maker may be a color tube it has developed. It has the usual three guns, but a wire grid instead of a shadow mask and brighter electrodes to cut gun power [Electronics, May 3, 1965, p. 157]. If, as CFT claims, the tube can be produced at two-thirds the cost of a shadow-mask tube, CFT may be the big winner in the European color-tv sweepstakes.

Taylor's total reliability plan: Glass-Epoxy Copper-clad

in sheets, panels or punched blanks to your specifications and reliability requirements

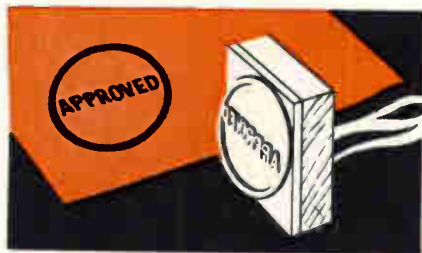

Accepted by an increasing number of major OEMs and commercial etchers who give their stamp of approval, because . . .



. . . they get highest quality level assurance from two fully-equipped copper-clad plants using white-glove techniques . . .



. . . in atmosphere-controlled white rooms, under extremely tight quality control procedures, to produce copper-clad . . .



. . . to specifications and established reliability requirements in standard sheets, ultra-thin sheets and multi-layer prepregs . . .



. . . then deliver when promised, or in an emergency, from plant or warehouse stocks in special packages.

Let us prove the advantages of Taylor's TOTAL RELIABILITY PLAN to you! Ask for a demonstration today. Write for a sample (give grade designation and copper combination) and Bulletin GB-2.



... your assurance
of quality

Taylor copper-clad

TAYLOR CORPORATION • Valley Forge, Pa. 19481

Phone: 215-666-0300 TWX: 215-666-0659

West Coast Plant: La Verne, Calif.

Also manufacturer of Taylor laminated plastics, Taylorite® vulcanized fibre and Tayloron® prepregs

MORE AIRCRAFT UP TIME—LESS DOWN TIME

With **NEW** Automatic Wiring Analyzer

Keeping today's complex aircraft ready for action is a major challenge. Dalmo Victor is helping meet the challenge with the AN/USM-185*, a mobile, versatile wiring analyzer that checks electrical integrity of oft-neglected aircraft wiring by automatically making error-free resistance, leakage and continuity tests. Though developed specifically for the F-105 and F4C, this analyzer can be used for **depot or field** maintenance to check out all present and future aircraft in all commands... all services.

Results of Air Force Project CAST and earlier related studies plus current operational command field tests that compare automatic and manual methods of checking aircraft wiring integrity indicate the true significance of automatic wiring analyzers. For example, automatic equipment revealed marginal and faulty wiring normally not detected by manual means... test accuracy was significantly increased... and reduction in test times consistently averaged **minutes (vs. hours)**.

These studies also indicated that wiring age equals marginal wiring. Translated into more dramatic—but valid—terms, automatic wiring analyzers can contribute heavily to more aircraft up time, improved mission success and **saved aircraft**.

The USM-185 will make maximum contributions in these areas. With the simplest tape programming yet devised, the USM-185 is designed to automatically make go/no-go tests on a 5,000 point harness in only 36 minutes. Maximum test capacity is 40,000 points. Operational versatility is provided with automatic, semi-automatic, "manual" and self-programming operating modes. The central data processor is expandable for **functional versatility**. Self-test features ensure dependability and maintainability. When required, the USM-185 is readily adapted to card programming.

For more information, contact Dalmo Victor's Automatic Test Equipment Product Manager today.

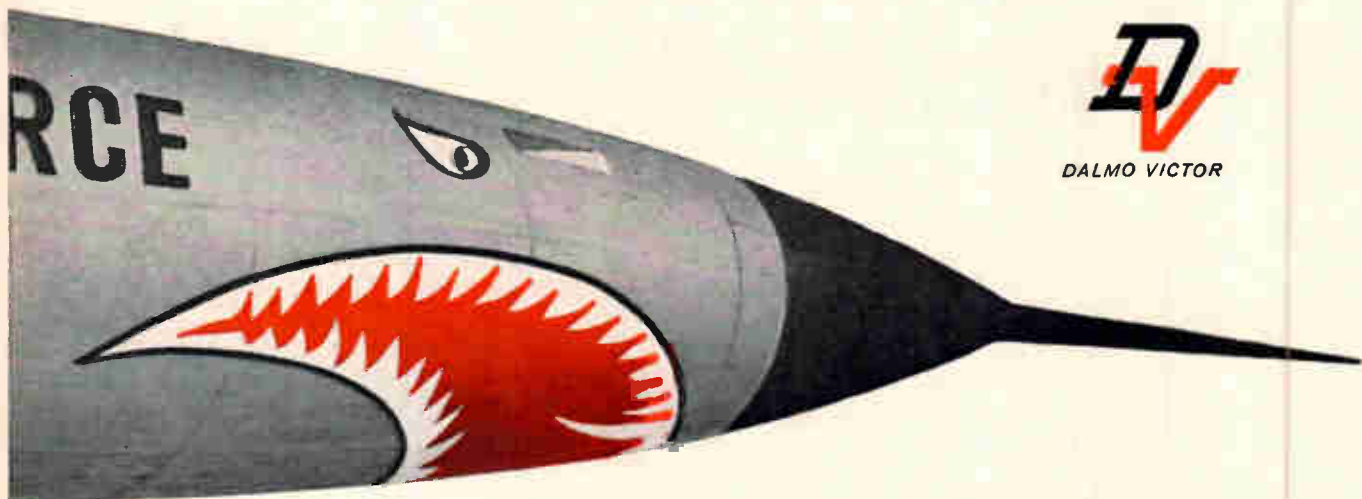

*AN/USM-185, completely militarized automatic wiring analyzer being developed by Dalmo Victor under contract to the Aeronautical Systems Division, Air Force Systems Command, USAF, Wright-Patterson AFB, Ohio. This analyzer meets or exceeds requirements of MIL-T-38218A, MIL-T-21200 and MIL-R-26667. Contract terms call for delivery of the first unit early this summer.

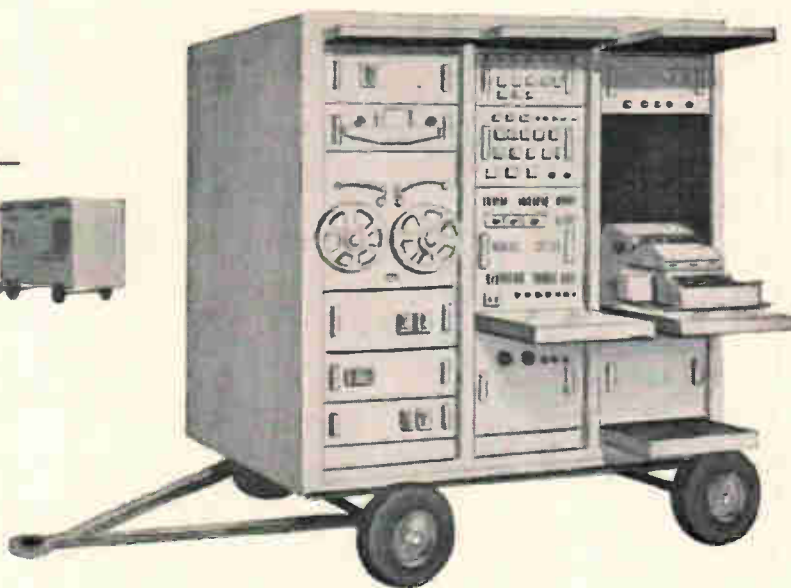

DALMO VICTOR

1515 INDUSTRIAL WAY • BELMONT, CALIFORNIA 94002
TELEPHONE: 415/591-1414 TWX: 910/376-4400

A **textron** DIVISION

Testing missiles by the dozens

A \$40-million complex is being built at White Sands Missile Range to launch, control and track the 3,000 missiles that will be fired this year

By Walter C. Barney
San Francisco Regional Editor

The White Sands Missile Range may well be the busiest chunk of desert in the world. Operated by the Army for testing rockets for the military and the space agency, the range is a 4,000-square-mile tract of sand and sagebrush in New Mexico where some 3,000 missiles will be fired this year. It has handled as many as 61 shots a day. Keeping track of this barrage are more than 700 radars, scores of telescopes and cameras, telemetry receivers, communications links and computers. The amount of information this complex spews forth is almost too much for the range controllers to handle and the strain of scheduling, performing and reporting on so many tests is beginning to swamp the facilities at White Sands. But a \$40-million project promises to bring relief.

Being erected across the street from the post's headquarters, and scheduled for completion in September, is a three-story building that will house the main elements of a new control system called Artrac, which will take over many control functions and will automatically convert tracking data into commands in real time. When work began on the system in 1959, the acronym Artrac stood for "advanced real-time range control." Since then, however, the system concept has expanded to encompass additional functions, such as the preparation of a final test report, and the meaning has changed to "advanced range testing, reporting and control."

Regardless of what the letters stand for, Artrac will be the most complex control system at any of the nation's missile ranges. The reason White Sands needs the system more than the Eastern Test

Range at Cape Kennedy or the Western Test Range at Vandenberg Air Force Base, Calif., is simple—White Sands conducts more test launchings than the other two. In fact, while Vandenberg only now is getting the capability to handle two launchings at one time, Artrac, when it is operational in 1969, will handle 10 tests of varying complexity at a time.

I. Past, present, future

The \$40-million price tag for Artrac is an estimate from George Perkins, physical science administrator at White Sands. It includes

some hardware the range already owns, such as timing systems, status display, and interface equipment. But most of the money will buy new equipment.

Perkins is extremely cautious about breaking down the \$40 million, because a number of contracts are still to be negotiated. However, the buildings, including the 48,000-square-foot control center under construction and several satellite structures, will account for about \$5 million. In-house design and systems engineering will cost another \$3 million. The central data processor, known as a "multi-inter-

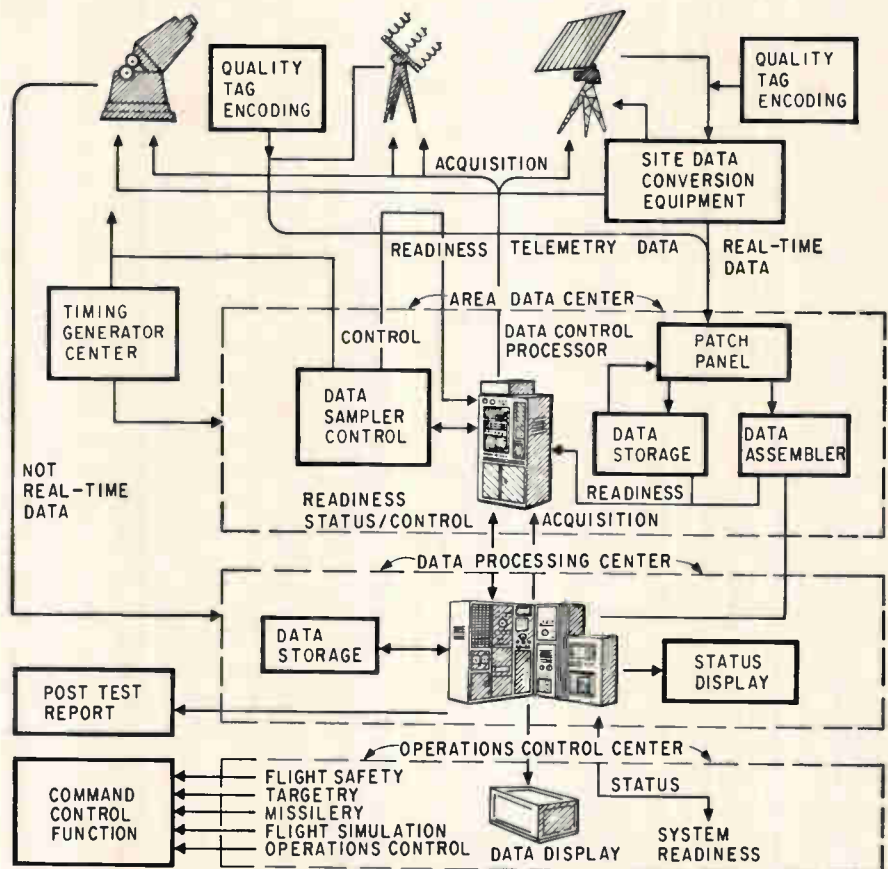

Data flows from hundreds of sensors in the 4,000-square-mile range through area data centers and data processing centers to operations control.

Reliability and Quality are a product of experience. Jennings has 24 years experience manufacturing vacuum capacitors. Time enough to design a lot of them. Here are a few:

CADB 30



Capacity (Range) 3-30 pf
Peak Test Voltage 15 KV
RF Current Rating 40 Amps RMS
Length 4.55"
Width 1.312"

USLS 465



Capacity (Range) 5-465 pf
Peak Test Voltage 5 KV
RF Current Rating 42 Amps RMS
Length 5.52"
Width 2.312"

VMMC 5000



Capacity (Range) 100-5000 pf
Peak Test Voltage 15 KV
RF Current Rating 125 Amps RMS
Length 21.31"
Width 9.25"

JSLF 5000



Capacity (Range) 5000 pf
Peak Test Voltage 5 KV
RF Current Rating 100 Amps RMS
Length 2.875"
Width 4.125"

CVJW 200 (Water-Cooled)



Capacity (Range) 25-200 pf
Peak Test Voltage 100 KV
RF Current Rating 1000 Amps RMS
Length 15.50"
Width 8.00"

CVHC 650 (Air-Cooled)



Capacity (Range) 25-650
Peak Test Voltage 45 KV
RF Current Rating 250 Amps RMS
Length 10.75"
Width 7.56"

Close to 100% of the Free World's high frequency transmitters use vacuum capacitors of Jennings design. In fact, practically every major advancement in vacuum capacitors has originated at Jennings. These include capacitor designs ranging from 100 watts to over a megawatt power ratings. Which means that in all likelihood the capacitor you need has already been designed, field tested, and proven reliable—plus possessing all the latest advances in vacuum capacitor design.

The vacuum capacitors shown here are only a few of the hundreds of standard designs available from Jennings to fit practically every RF application. If a

new design is necessary however, Jennings has an experienced applications engineering staff and Quick-Reaction Laboratory ready to solve your problem in the shortest possible time. Jennings also offers the only complete rf lab in existence for proper testing of vacuum capacitors in high power rf circuits through 100 kw that duplicate actual operating conditions.

For detailed information about Jennings vacuum capacitors request our new catalog #101. Jennings Radio Manufacturing Corporation, Subsidiary of International Telephone and Telegraph Corporation, 970 McLaughlin Avenue, San Jose, California 95108.



connected modular computer," or Mic-Mc, will cost about \$10 million. Perkins says that it will be comparable to such recently introduced third-generation computers as the IBM System 360, the Honeywell, Inc. Series 200, or the Scientific Data System, Inc. Sigma 7. Requests for proposals on the Mic-Mc, however, will not go out for a year or so. Until about mid-1969, White Sands will use an IBM 7094-7044 combination.

After the buildings are completed, the next portion of Artrac to be delivered will come from Astrodata, Inc., of Anaheim, Calif., which is responsible, under a \$7.2-million contract for three subsystems: a readiness and control system, an instrument data system and a data transmission system. The latter, a microwave link to replace existing, overtaxed equipment at White Sands, was subcontracted to the Lenkurt Electric Co., Inc., a subsidiary of the General Telephone & Electronics Corp., for \$1.8 million. Astrodata's share of the contract in the 1966 fiscal year is \$1.7 million.

Contract plum. The next contract to be awarded will be for a telemetry data center, which will consist of readouts, displays, and control consoles for data reduction. The center will either route data to the control center for real-time use, or store it until the final test report is prepared. Beckman Instruments, Inc., the International Business Machines Corp., and Radiation, Inc. are in the running for the contract, which is expected to be awarded in a few weeks.

The telemetry center will be worth at least several million dollars. Software will cost another substantial amount since the programs for Artrac will be of staggering complexity. Also, some contracts will be extended. "There is provision in the Astrodata contract," Perkins says, "for follow-on negotiations, even though the specifications for the equipment haven't been written, yet." Lenkurt expects to deliver \$3 million worth of equipment and services in the next five years.

II. A multipurpose system

What will White Sands have when Artrac is fully operational? Essentially, it will be a system

capable of meeting every user requirement automatically. It will:

- Evaluate a test program to determine how well the range can perform with existing equipment.

- Decide which range facilities will be needed, and assign the correct radars, telemetry receivers, telescopes and data links.

- Schedule the test, taking into account other range priorities and the availability of instrumentation.

- Check out automatically all parts of the system.

- Activate and monitor a test, providing real-time control of instrument sites, computer activities, displays, recorders, and subsystems; analyzing test data to select the best for real-time solutions and distributing real-time data to the range control.

- Prepare preliminary or quick-look reports and finished test reports for users.

- Evaluate its own performance.

At present, many of these functions—particularly the scheduling of tests and the assignment of instrumentation—are carried out in daily conferences. And even when all of Artrac's hardware is assembled, Perkins says, it will be a long while before the scheduling can be fully automated.

"The problem is to know at all times what our capability is and to use that capability to meet a number of range requirements," he explains. "It's a dynamic situation—the capability changes with the demand—so I would say that it will be well after 1969 before we are able to schedule automatically."

Among the first benefits of the system will be the preparation of quick-look reports in a matter of minutes, and final reports in hours. At present, final reports take a month or more to write.

III. Data flow

Artrac's basic function is to manage data. To simplify the demands made on the data processing center, information from the sensors is routed first to their area data center. These centers are both on and off the range. There are six on the range—and several at off-range sites for shots that originate elsewhere in New Mexico and Utah. The data message is put into standard form at the sensor by site data conversion equipment. Its 120-bit

word structure is divided: 5 bits for synchronization, 9 bits as a quality tag, 10 bits for identification, and 24 to 96 bits for measurement.

The area data centers take care of timing distribution, data storage, data control and readiness and status distribution. Data is sent by microwave link to the data processing center, where nonreal-time data is stored on tape. The data processing center has access to all stored data on request, for use after completion of the tests.

An DDP 124 computer manufactured by the Computer Control Corp. provides pointing information for range instrumentation in Astrodata's instrument data system. The DDP 124 is called a coordinate converter controller; it will be located at the primary computer and will provide look angles for 150 instruments with a sample rate of 20 per second.

IV. Control hierarchy

Artrac's control operations are organized into a matrix of systems and missions, and further into submatrixes of subsystems and missions, so that one group of controllers can monitor up to 10 missile tests, which may be in various stages of progress, with no one man exclusively concerned with a single test. The range controller has a console that shows the status of data systems, safety, target control, weather and other systems for each test or mission. A systems controller has a similar console showing subsystem status for each mission; for data systems, for instance, the horizontal rows are for data processing, communications, electronic trajectory, telemetry and optics. The data systems controller has other consoles that permit him to isolate trouble to a single unit in the field.

Display windows on all consoles are divided into four quadrants that glow green for "go," blue for "no problem expected," amber for "trouble" and red for "hold."

The readiness control system also has a DDP 124 as a memory and logic unit which receives data from the remote sensors and distributes it to more than 20 consoles. The individual sensors are linked by telephone lines through a readiness reporting unit to a line-finder

multiplexer. Data from 64 units can be transmitted from the multiplexer to the computer, by frequency shift-keying modulation, over a microwave link.

A timing unit updates the information on the consoles once a second and notes the changes on tape for analysis when the test is finished.

Lenkurt's data transmission equipment will be capable of sending up to 24,000 bits per second with an error rate of less than one bit per million. The microwave link will have a capacity of 1,200 voice channels.

V. The master computer

Although the central data processor for Artrac is still nothing but a name—the Mic-Mc—its functions have been laid out. The Mic-Mc will receive data and readiness inputs from the area data centers, and transmit them to the operations control center. From the data, and from status and readiness information sent by operations control, it will calculate acquisition and status control data to send to the area data centers.

But the computer is more than a real-time tool for flight control; it will figure in every part of a mission, from original mission analysis and scheduling, through system check-out and preflight and postflight assessments. To handle all of these tasks simultaneously for a number of missions, the computer will use three types of programs: a master control program to coordinate the work of the entire computer complex; executive activity programs for each of the operational activities; and operating programs to perform specific computing tasks for the master control and executive programs.

Test data will enter the system at the operating program level, but all other data will be inserted through the master control program, where priorities are determined. Every scheduled operation will be assigned a time of day, and a computer routine with a clock can interrupt other master control programs to begin scheduled operations. The master control program also will allocate computer memory space.

Step by step. The computer's first job will be to analyze require-

S.M.A.C.

Simultaneous Mass Attachment of Components means HIGH DENSITY Hybrid Film Microcircuits

Mepco's advanced production concepts include the application of unique add-on components to high density circuit substrates, thus permitting maximum utilization of all available space in the production of film type microcircuits. This HIGH DENSITY is saving space for you.

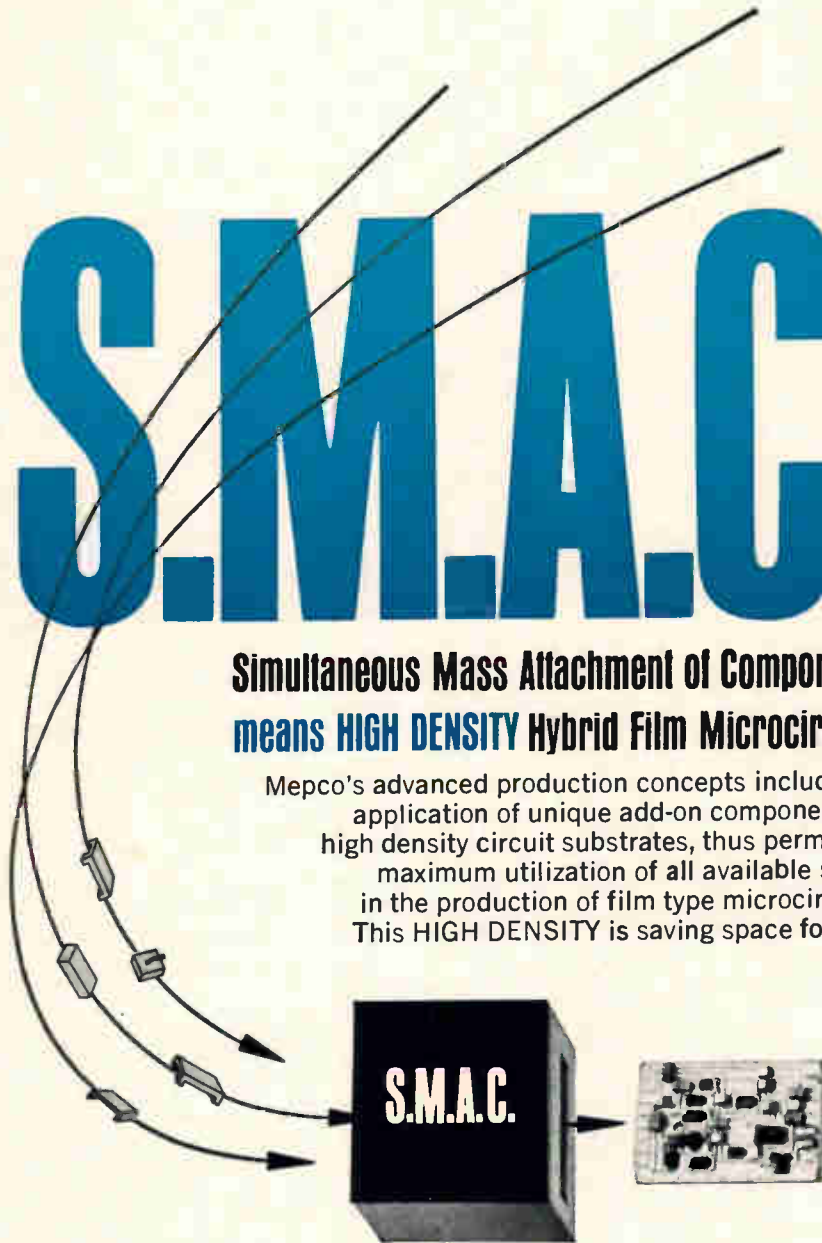

If your programs call for custom-designed film hybrid microcircuits, in high volume, at lower costs, and with faster delivery dates than you thought possible, then be sure to call Mepco . . . Ask about S.M.A.C. Find out how this new breakthrough in mass-producing film hybrid microcircuits can benefit your production plans.



MEPCO, INC.

COLUMBIA ROAD, MORRISTOWN, NEW JERSEY
07960 (201) 539-2000

ments of the test and decide which sensors and other resources, such as timing, communications, data-storage, command-control, displays, and data-processing equipment, are needed to meet them. These measurement plans, plus weather forecasts and range policy decisions, will be used in making up weekly and daily schedules and 30- to 60-day mission forecasts. The system will include such details as post-test data reduction, preventive maintenance, personnel needed to man stations and roadblocks and evacuation schedules both on and off the test range.

VI. Double check

Check-out of the range resources and all major schedule changes will be made each day. An automatic fault-analysis program will locate difficulties, which will be corrected manually or by automatically substituting backup equipment.

Preflight activity—the count-down period—includes the final preparation of the range resources called for in the measurement plan. During flight, the computer will process data in real time, selecting the best from the area data control centers by considering the location of the instrument, its quality tag and historical performance. The computer also will distribute the data to operational control consoles for conversion to command and control signals for test vehicles and instrument sites.

The computer will combine data in two ways: it will analyze all radar information, for instance, to compute trajectory; or it will take information from several types of instruments in the same area, such as radars, telemetry receivers, and optical trackers, to make the same computation. The quality of the data determines the method selected.

Quick-look data will be provided within two hours after a test; final reports will be ready in 24 hours.

When the system is fully operational, an agency wanting to use the test range will be able to book a test at White Sands as easily as a passenger today reserves a seat on an airliner. The range won't have the airlines' problem of the "no-shows," but the customer won't get a cocktail, either. Artrac doesn't have that capability, yet.

SERIES 930 DTL

Evaluate ITT

ITT
SEMICONDUCTORS

ITT SEMICONDUCTORS IS A DIVISION OF THE INTERNATIONAL TELEPHONE AND TELEGRAPH CORPORATION
FACTORIES IN WEST PALM BEACH, FLORIDA, PALO ALTO, CALIFORNIA, LAWRENCE, MASSACHUSETTS, HARLOW AND FOOTSCRAY, ENGLAND, FREIBURG AND NURENBERG, GERMANY

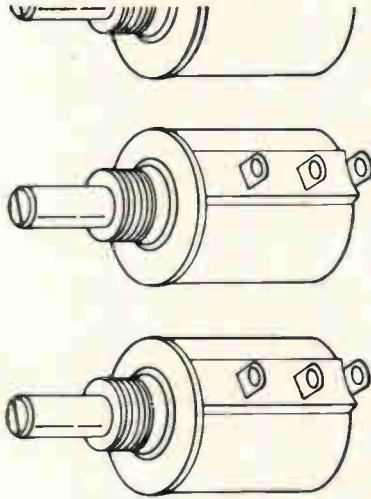

WITH FAIRCON MULTITURNS

**The
Only Difference
is
Quality & Price**



ACTUAL SIZE

HERE IT IS! The FAIRCON multiturn potentiometer with all the features of precision 10 turns yet at a price that fits the industrial OEM budget. Check these features: Standard linearity $\pm 0.2\%$ —resistance values from 500 to 125,000 ohms—high humidity, vibration, shock and acceleration resistance—2 watts power dissipation at 40°C—plus excellent resolution, long life, low noise... and complies with applicable environmental requirements of MIL-R-12934C... all for an amazingly low price. Write for our new FAIRCON short form catalog. And for immediate delivery from stock... Call ARCO.

FAIRCHILD

CONTROLS

A DIVISION OF FAIRCHILD CAMERA AND INSTRUMENT CORPORATION
225 PARK AVENUE, HICKSVILLE, L. I., NEW YORK
TELEPHONE: (516) 938-5600 • TWX: (510) 231-1854
CABLE: FAIRCON-HICKSVILLE, NEW YORK, U. S. A.

FAIRDIAL™

TURNS COUNTING DIALS
for
Multiturn Potentiometers

- Miniature size
- Easy to read
- Accurate indication of 1 part in 1000
- Low price



(Shown mounted to Faircon MF78 Pot.)

ANALOG READOUT—TYPE DFA

Constant friction lock provides easy setting undisturbed by extreme vibration. One inch diameter allows full use of panel space for high density packaging. Registers a total count of 999. Type DFA-L with flip lock secures setting against the most extreme torquing moments.



DIGITAL READOUT—TYPE DFD

Features flip lock for positive locking control. Three digit readout indicates 000 to 999. Small size permits mounting in space normally allotted for concentric dial types. New rectangular design permits high density packaging of 12 to the foot—and up to 72 per square foot of panel space.

Available at all ARCO locations.
Specifications and prices on request.

FAIRCHILD

CONTROLS

A DIVISION OF FAIRCHILD CAMERA AND INSTRUMENT CORPORATION
225 PARK AVENUE, HICKSVILLE, L. I., NEW YORK
TELEPHONE: (516) 938-5600 • TWX: (510) 231-1854
CABLE: FAIRCON-HICKSVILLE, NEW YORK, U. S. A.

Try a new source

for planar 2N2222 & 2N2369 families

If you've been wishing for a new source of silicon planar general purpose amplifiers or high speed switches, ITT has now provided the answer.

ITT is in full production on the popular 2N2222 amplifier family and the 2N2369 high-speed switching family. You can have the same transistor performance you've been getting from other suppliers, plus the supplier

performance you can only get from ITT.

If you're buying silicon planars from either of these families, evaluate the new source. Order them today . . . get them today . . . from any distributor of ITT Semiconductors. ITT Semiconductors, 3301 Electronics Way, West Palm Beach, Florida, is a division of the International Telephone and Telegraph Corporation.

The logo for ITT Semiconductors, featuring the letters 'ITT' in a large, bold, stylized font above the word 'SEMICONDUCTORS' in a smaller, all-caps font. A red hand-drawn circle surrounds the logo.

ITT
SEMICONDUCTORS

FACTORIES IN PALO ALTO, CALIFORNIA, LAWRENCE, MASSACHUSETTS, WEST PALM BEACH, FLORIDA, HARLOW AND BODOTSLEY, ENGLAND, FREIBURG AND NURENBERG, GERMANY

Unique concept advances frequency bandwidth of CEC recorders

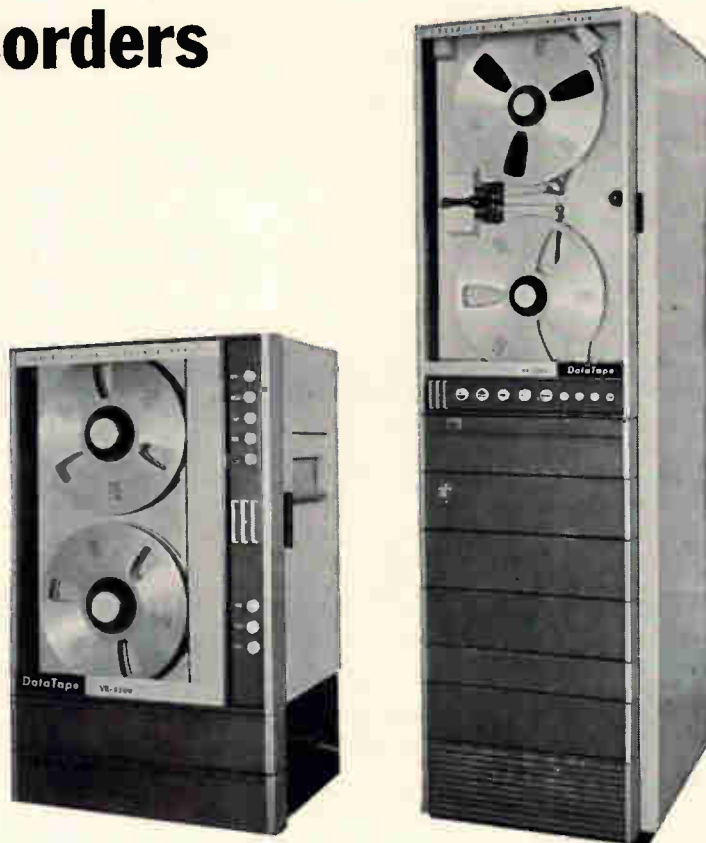

CEC's multipurpose VR-2800 and VR-3300 Magnetic Tape Recorder/Reproducers now offer an extended frequency range of 100 cps to 300 kc. Most significant, this increased bandwidth was accomplished *without* the use of head drivers or reproduce preamplifiers, using field-proven heads and electronics.

Reason: the advanced capabilities of CEC's exclusive all-metal-surface magnetic heads.

Result: greater simplicity, performance and reliability at considerably less cost.

CEC magnetic heads are so reliable that many have logged more than 10,000 hours — and are still going strong.

As you may know, the six-foot VR-2800 laboratory recorder (right) and com-

pact VR-3300 portable recorder (left) are among the recorder/reproducers most in demand in industrial and military use today. Although they differ in dimensions and applications, both share the same basic performance advantages and incorporate *interchangeable* electronics.

Other outstanding features:

- ☐ Complete 7 or 14 channel record/reproduce systems.
- ☐ Six speeds from 1 7/8 to 60 ips.
- ☐ Loop adapters available on both systems.
- ☐ Direct, FM and PDM electronics.
- ☐ Records data at 1/2 the speed required for conventional recorders.
- ☐ Uniform tape tension at all recording speeds.
- ☐ All components immediately accessible from the front.
- ☐ Solid-state electronics throughout.

For complete information about these outstanding recorders, call or write CEC for Bulletins 2800V-X6 and 3300V-X6.

CEC

Data Instruments Division

CONSOLIDATED ELECTRODYNAMICS

A SUBSIDIARY OF BELL & HOWELL/PASADENA, CALIF. 91109
INTERNATIONAL SUBSIDIARIES: WOKING, SURREY, ENGLAND
AND FRIEDBERG (HESSSEN), W. GERMANY



Millimeter
Space Antenna



Airborne
UHF Relay

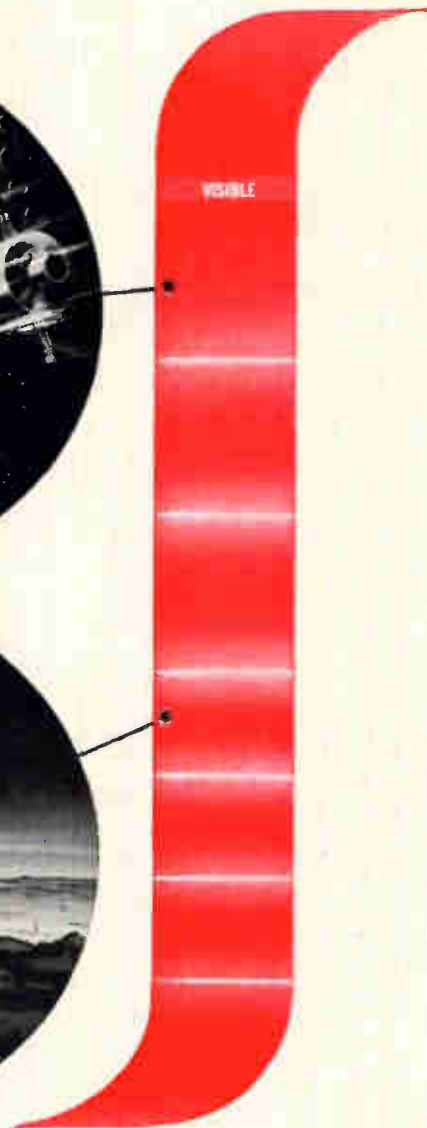

VISIBLE

HIGHER
AND
HIGHER

AIRBORNE UHF RELAYS AND MILLIMETER SPACE ANTENNAS IN THE COMPLETE COMMUNICATIONS SPECTRUM

Recent developments at Sylvania Electronic Systems:

- ■ Seizing the high ground in tactical UHF radio communications, Sylvania Electronic Systems has demonstrated a UHF relay that is rugged, compact and reliable enough to be borne aloft by a balloon or drone aircraft. With this airborne repeater our Armed Forces can achieve full two-way voice and teletype communications over 500-mile ranges even in the jungles and mountains of Viet Nam.

- ■ Higher still, orbiting spacecraft must find each other swiftly and communicate enormous amounts of data. Sylvania Electronic Systems has produced a millimeter wave antenna system that will pinpoint another satellite antenna in less than a second. With 10 times the information-handling capacity of conventional lower-frequency systems, millimeter waves meet the needs of space communications.

To meet communications needs from jungle to orbit, Sylvania Electronic Systems is seeking technical and management specialists across the full spectrum of research, development, production and testing. Major centers are in suburban **Boston, Buffalo, and San Francisco**. If you are a qualified candidate and would like to receive more specific information on the engineering opportunities, send your resume to: Manager, Professional Staffing, Sylvania Electronic Systems, Division of Sylvania Electric Products Inc., 57 Sylvan Road, Waltham, Mass. 02154.

The complete spectrum of opportunity—job diversification, geographic location, professional satisfaction—is awaiting you at Sylvania Electronic Systems.

GT&E

GENERAL TELEPHONE & ELECTRONICS
Total Communications from a single source through

An equal opportunity employer

RESEARCH • SYSTEMS DEVELOPMENT • PRODUCT & FIELD ENGINEERING

SYLVANIA ELECTRONIC SYSTEMS

What is it ?

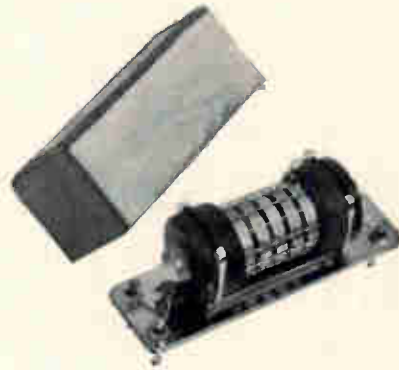

Clue No. 1: Its development made application of single sideband practical.

Clue No. 2: Its applications range from Citizens Band radios to such highly complex telemetry systems as that of the Saturn Rocket.

Clue No. 3: It offers the greatest combination of selectivity, simplicity, compactness and reliability ever developed in a component designed for its particular purpose.

Clue No. 4: It resists aging to such a remarkable degree in accelerated tests that aging need not be a consideration.

Clue No. 5: It's a classic circuit component associated universally with the Collins name.

Answer: It's the Collins Mechanical Filter. It's used in single

sideband applications. High performance transmission and receiving equipment. Missile guidance systems. Multiplexing equipment. Frequency synthesizers. Doppler radar. Data transmission systems. Precision navigation equipment. Spectrum analyzers. FM communication receivers and Citizens Band transceivers.

It's available in frequencies from 60 KC to 600 KC, and in bandwidths of .1% to 10%.

If you build any of this equipment and have a selectivity/reliability requirement, call Collins Radio Company, Components Sales Department, 19700 Jamboree Road, Newport Beach, Calif. Phone: (714) 833-0600. Or call your authorized Collins components sales representative.



HELIPOT CUTS THE SIZE OF ITS 10-TURN POT



but there's not a spec of difference

It's true . . . Helipot *actually* cut the length of its $\frac{7}{8}$ " diameter 10-turn in half. No hocus pocus. The new Model 7266 is $\frac{3}{4}$ " long . . . the shortest 10-turn $\frac{7}{8}$ " diameter precision potentiometer you can buy. Yet its precision performance is unscathed, and the wirewound resistance element is actually *longer* than that of its predecessor. It is a *precision* pot in every respect. Resolution is better, the total resistance range is still 10 ohms to 125K, with $\pm 0.2\%$ linearity as good as ever.

How much was the price raised? Not a penny — it's priced at \$10 for 1—9 pieces and well below \$8 in quantity. (And you get two for the size of one.) Complete product information is available now from your local Helipot sales office.

Beckman[®]

INSTRUMENTS, INC.

HELIPOT DIVISION

FULLERTON, CALIFORNIA • 92634

INTERNATIONAL SUBSIDIARIES: GENEVA; MUNICH;
GLENROTHES, SCOTLAND; TOKYO; PARIS; CAPETOWN; LONDON

10 gram guard



Reverse-voltage defense is just one more reason for G-E tantalum foil

Forget about a surprise reverse with G-E tantalum foil capacitors. They're designed to take it. And reverse-voltage defense is just one reason for using G-E tantalum foil. Here are three others:

PROVED IN-CIRCUIT RELIABILITY: They've been proved—and improved—for over 17 years. More than 20 million have been successfully applied. G-E tantalum foil earned a 0.00023 reliability record (per 1000 hours) on Minuteman reliability tests,

based on the Minuteman acceleration factor.

NO CATASTROPHIC FAILURES: Low impedance circuits and catastrophic failures are no problem with G-E tantalum foils. They're self healing. **LONG SHELF LIFE:** We're up to the 14 year mark . . . with less than a 5% capacitance change at 25C. That's shelf life!

G-E tantalum foil capacitors are available in ratings up to 450VDC, 0.15 to 3500uf, —55 to 85 or 125C. They're

virtually risk-proof. And may cost more. But isn't a proved line your best defense?

For all the facts on G-E tantalum foil reliability, write for Reliability Report, Section 430-25, General Electric Co., Schenectady, N. Y. 12305.

ELECTRONIC COMPONENTS DIVISION

GENERAL  ELECTRIC



NEW CVC *QUICK-START* ION PUMPS

Start Faster.

**Achieve Highest
Argon Speeds.**

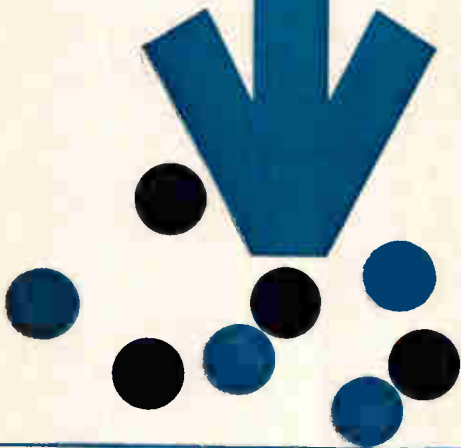

With new Quick-Start pumps you will get faster, more reliable starts than you every thought possible in ion pumping. Quick-Start high throughputs permit higher pressure starting—as high as 50-100 microns—and quicker pumpdown. These excellent characteristics result from a new power supply that has been engineered to match the pressure-current requirements of the pump.

The more efficient design of Quick-Start gives faster pumping of

argon and other inert gases—a necessity for best performance at typical 10^{-11} torr ultimates. Three-element Quick-Start has an argon speed that is 30% of air speed; typical two-element pumps will pump approximately 1%.

Other Quick-Start advantages: Dependable solid-state power supply with semiconductor rectification and a logarithmic readout of pressure on one scale from 4×10^{-9} to 2×10^{-5} torr (no vacuum gauge

needed). Improved flanges for lower ultimates. Minimum element life of three years at 10^{-6} torr. Magnets bakeable to 400° C installed on the pump.

Quick-Start pumps are available in sizes with nominal nitrogen speeds of 30 L/sec., 110 L/sec., and 360 L/sec. Write for our new catalogs: Consolidated Vacuum Corporation, 1775 Mt. Read Blvd., Rochester, N.Y., 14603.



Consolidated Vacuum Corporation

ROCHESTER, N. Y. 14603 • A SUBSIDIARY OF BELL & HOWELL
International Subsidiaries: Woking, Surrey, England
& Friedberg, West Germany

**Utah...
'The Hub of
the West'**

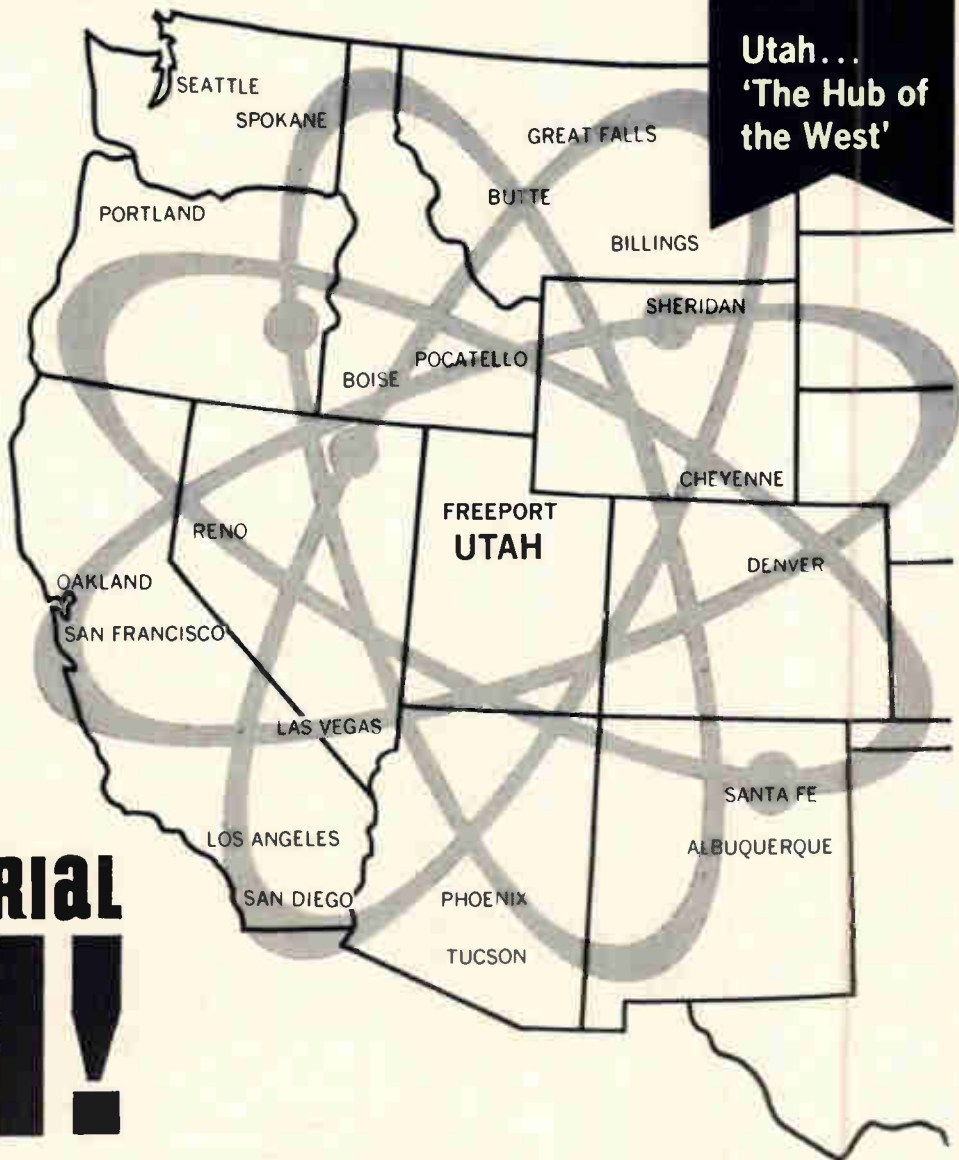

For your Western
**Electronics
Expansion**
look to the

new INDUSTRIAL UTAH!

Electronics manufacturers looking for a quality work force, low-cost western factory sites, new sources of raw materials and strategic transportation facilities to serve the growing West can find them all — in UTAH.

Good workers . . . The availability of engineers, scientists and other skilled workers, is just one of the reasons for looking at Utah. Utah's education standards pace the nation in many respects. Utah produces more engineers and scientists per capita than any other state.

Plant Sites . . . Low-Cost plant sites are available in industrial or in rural areas adjacent to rail and truck lines.

Natural Resources . . . Utah has more types of industrial raw materials than any other comparable area, as well as many finished and semi-finished products.

Location . . . Utah is right in the middle of western America and just a day away from most of the leading markets.

Transportation . . . Utah is the hub of a modern, efficient transportation wheel, the cross-roads of the West.

Freeport State . . . Utah has one of the most liberal freeport laws in the nation offering welcome tax savings to manufacturers.

Utah also offers a delightful four-season climate, unusually fine recreational facilities in the Center of Scenic America.

Now is the time to get in on the ground floor of Utah's surging industrial growth.

FREE

Write for information on "The New Industrial Utah" or ask for special recommendations tailored to your industry.

new INDUSTRIAL UTAH!

Utah Industrial Promotion Commission, Dept. 119
167 Social Hall Avenue • Salt Lake City, Utah 84111

Send information on:.....

Company.....

Address.....

City.....State.....

Name and Title.....

Mullard components for Television, Radio & Audio

**world famous
performance**

**world proven
reliability**

Many of the world's leading manufacturers of radio, television and audio equipment are users of Mullard electronic valves, tubes, semiconductors and components. They are served by an international network of Mullard companies, agents and distributors, supported by a complete technical information and advisory service.

There is almost certainly a distributor in your own country even if he is not included in the short list below. Please write to us for details and let us know in which field of electronic applications you are particularly interested. We will, in any case, be pleased to see that you receive the Mullard Bulletin, which will keep you informed of our latest developments.

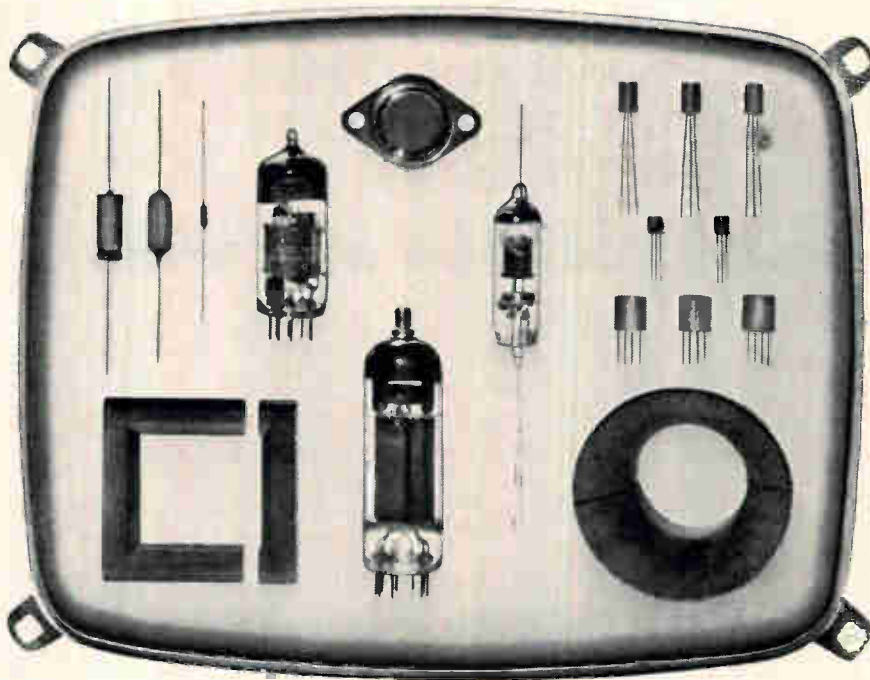

world wide availability

A short list of important Mullard overseas companies and agents.

AUSTRALIA
Mullard-Australia (Pty) Ltd.
Sydney Tel: 29-2006

DENMARK
Mullard A/S
Bagsværd Tel: 982666

ITALY
Britelec S.r.L.
Milan Tel: 68 82 194

NEW ZEALAND
Electronic Development and
Application Co. Ltd., Wellington C3
Tel: 54-039, 54-130

NORWAY
E. Borge Haga A/S
Oslo 5
Tel: 38 03 80

RHODESIA
Rhodesian Electronics (Pvt) Ltd.
Bulawayo Tel: 64477

SOUTH AFRICA
E D A C (Pty) Ltd.
New Doornfontein
Tel: 24-2047

SWEDEN
Svenska Mullard AB
Stockholm No.
Tel: 08/67 01 20 Vaxel

For information about distribution in other countries, please write to:

MULLARD LIMITED Torrington Place, London WC1. Tel: LANgham 6633. Telex: 22281. Cables: Mulelectron London WC1



Mullard makers of Britain's most comprehensive range of electronic components

ZENERS

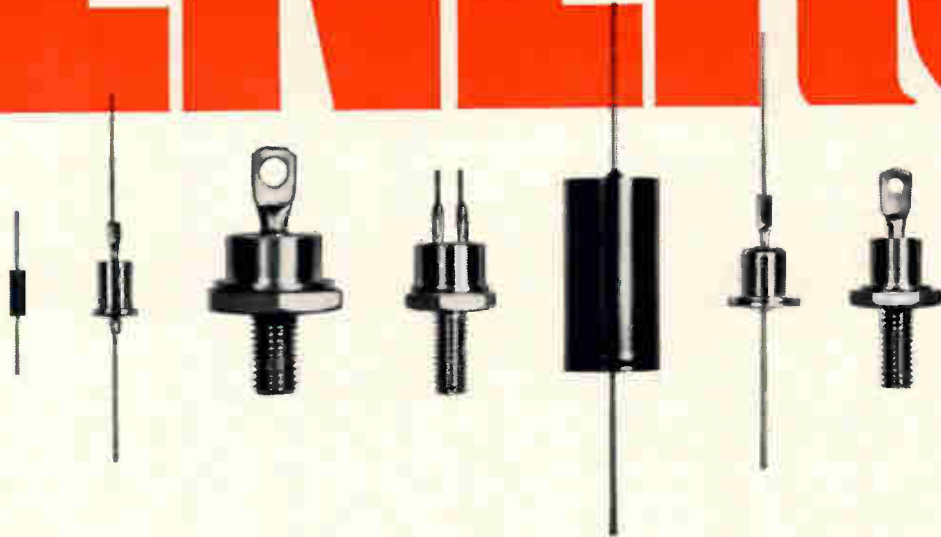

IRC can fill all your MIL and industrial needs

Now, IRC offers one of the industry's largest selections of MIL and industrial zener diodes. And, with the addition of new production facilities, they are immediately available from stock to meet all your application, environment and price requirements.

- 229 MIL devices—power ratings range from 250mW up to 10 watts
- All popular industrial-type devices—power ratings up to 50 watts
- The industry's only 1-watt zener in a DO-7 package

- New high-strength Poly-Sil zeners—up to 30% smaller and up to 2½ times more wattage dissipation than glass packages. Over 400 JEDEC types
- Complete selection of package styles and mechanical configurations

If you specify or buy zener diodes, you should know about the money-saving advantages of IRC's complete zener diode line. Write for new catalog, prices and samples to: IRC, Inc., Semiconductor Division (formerly North American Electronics), 71 Linden Street, West Lynn, Massachusetts 01905.



RECTIFIERS

Complete choice, including sub-miniature, fast recovery and high-power types. All popular configurations.



AXIAL LEAD RECTIFIERS

AR16—AR24 replaces 363 JEDEC devices for 50 to 1000 V/.25 to 1A needs. Cost less than stud types.



SCR'S

MIL and industrial devices, including fast-switching types. Choice of ratings and package shapes.



SPECIAL ASSEMBLIES

Rectifier stacks, potted bridges, epoxy resin encapsulations and high voltage assemblies.



Pressure switch eliminates contacts

Solid state sensor material can detect pressures over wide range and carry high power

A solid state pressure switch is now available that can pass up to one ampere of current and needs no amplifier to actuate control or display devices. The switch, made by Advance Components Corp., eliminates the "contact chatter" and arcing associated with a mechanical switch and is sensitive enough to determine critical pressure levels as low as 0.1 psi.

The basic switch package consists of the sensor and a separate control unit to speed up the sensor's response time by high speed electronic shaping of the sensing pulse. The switch can withstand extreme environmental conditions and wide pressure ranges and can be used as a pressure or liquid level detector in missiles and aircraft, having been developed originally for the Air Force. In environmental tests the switch has withstood random vibrations of 2 to 2,000 hertz to 65 g's and sinusoidal oscillations of 2 to 2,000 hertz up to 100 g's. It also has survived a shock of 1,000 g's.

The sensor's capability depends on new material, which Advance Components is keeping secret. The material's resistance varies sharply when it is compressed by a diaphragm which is depressed by

either gas or liquid. The new sensor can swing from an infinite resistance at no load to less than one ohm at full load. When the switch is connected in series with a power source and the load, a predetermined pressure on the switch's diaphragm causes the resistance of the sensor to fall sharply and the load is actuated. When the pressure is removed the load is deactivated with no power loss since no current flows through the switch when the resistance is infinite. The manufacturer is offering models covering a pressure range from 0.1 to 20,000 psi. Each switch covers a discrete range of pressures and is calibrated before use to respond to a specific pressure with an error of 1/2%.

Advance Components says the load-sensitive device differs from standard load cells in that it can carry much more current, and thus requires no amplifier.

To sharpen the difference of the switch's on and off pressure, called the deadband, a transistorized control unit is provided in a separate small package. The control provides a voltage to excite the sensor, which in turn generates a voltage proportional to its own change in resistance. This voltage is compared with a pulsating voltage gen-

erated by a portion of the control circuit. When the pulsating voltage and the sensor voltage are equal, a d-c voltage from the control unit then actuates the load at some calibrated pressure.

To vary the range of pressures handled by one switch, the manufacturer changes either or both the size of the actuating diaphragm or the chemical composition of the material. There also is a mechanical adjustment on the sensor which allows the actuating pressure to be set at any level within the range determined by the particular sensor.

The firm says that units with multiple switching and load capabilities above 20,000 psi are available upon request.

The switch also can be used to detect critical levels of liquids.

No price has been announced for the switch, but the firm says the complete package—sensor and control unit—is competitive with the cost of mechanical overcenter-type of pressure switches.

The sensor alone can also be used as an inexpensive on-off switch in applications that do not require sharp on-off times or when the deadband is not a problem.

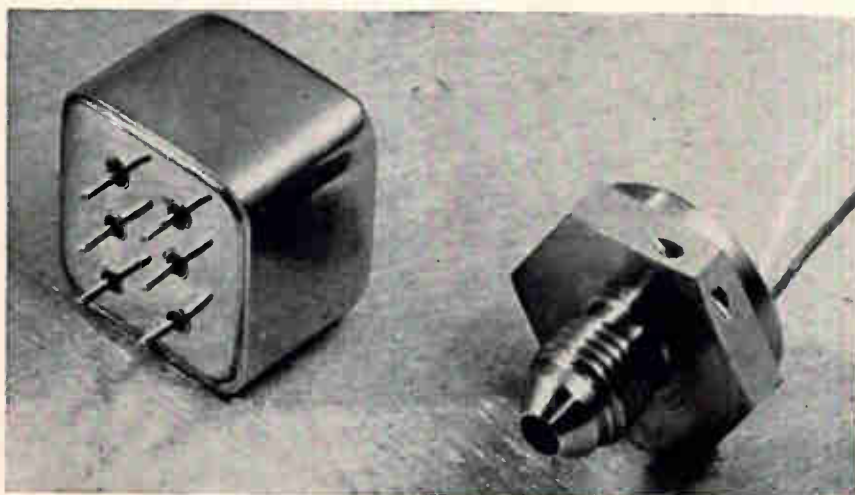

Specifications

Pressure ranges in psi	0.1 to 3, 3 to 10, 10 to 25, 25 to 100, 100 to 500, 500 to 1,000, 1,000 to 3,000, 3,000 to 20,000
Input voltage	28 v d-c
Output voltage	0 to 18 v d-c
Load current	0 to 1 amp, inductive, 18 v
Switching life	Exceeds 10 million operations
Operating speed	Less than 25 milliseconds
Operating temperature	-65° to +165°C
Sensor dimensions	1/4 x 1/2 x 1 1/2 in.
Controller dimensions	1 x 1 x 3/4 in.
Price	On request
Delivery	30 days

Advance Components Corp., 1017 Victory Place, Burbank, Calif., 91605
Circle 350 on reader service card.

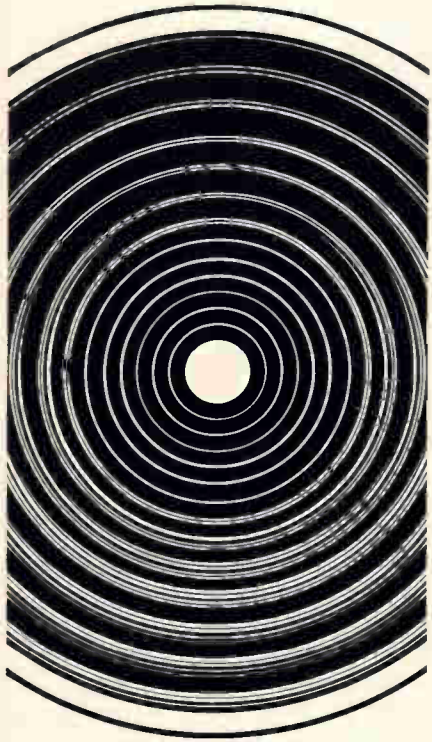

PRECISION

is relative. It means hitting the moon with a rocket or casting a dry fly where the trout are. To us, precision means drawing and finishing metal tubing to meet the specific requirements of any application. To you, such precision in tubing could mean improving your product's performance or reducing production costs . . . or both.

This new symbol of Precision identifies the world's most dependable source for nonferrous metal tubing, Bourdon tubing, pointer tubing, custom-fabricated tubular parts, 'Coaxitube' semirigid coaxial cable. May we send you information?

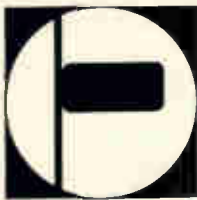

PRECISION TUBE COMPANY, INC.
 Tube Mill Division • Special Products Division
 North Wales, Pennsylvania 19454

New Components and Hardware

Small connectors are easy to assemble



Subminiature cylindrical connectors that are easy to assemble and almost completely "fool-proof" will be available in a few months, reports Amphenol Corp.'s connector division.

The subminiatures, dubbed Astro 348, have more than double the contact densities of standard miniature cylindrical connectors and, like the miniatures, have front-release, rear-removable serviceable crimp contacts. After crimping, the contacts are inserted with a special tool into a retention disk molded from a vinylidene-fluoride plastic which returns to its original shape after deformation. Tightening a locking nut on the rear of the connector moves the disk's individual retention risers into confinement, locking the contacts in the disk. Contacts are removed by loosening the locking nut and applying pressure with a special tool to expand the risers.

Amphenol claims that there is no chance of accidental "fall-out" of contacts when the locking nut is loosened because there is still a 5-pound minimum retention value. The locking force initially is 15 lbs, and is at least 10 lbs after 10 maintenance cycles.

Contacts can be assembled into the retention disk and contact positions checked visually while the shell is detached. The male pins are recessed inside the shell, reducing the possibility of pin bending due to accidental contact with the mating shell during blind mating. The front socket inserts are

molded from a strong, glass-fiber-filled compound. Their hard surface prevents mating if the male pins are badly displaced, but helps guide slightly misaligned pins.

One-piece construction of the connectors assures dielectric separation of contacts and eliminates space voids within the connectors. Dual sealing for moisture protection is another construction feature. The mated inserts compress a seal that fills all insert face depressions and provides a dielectric separation for contacts. Inside the shell is an "O" ring seal.

Amphenol says its new connectors have the fewest components of any of the easily assembled sub-miniatures on the market. For example, a size 18 shell, which has 85 contacts, has only 17 other parts.

An optional grounding ring for protection against electromagnetic and radio-frequency interference can be fitted into the shell. The ring can be clamped or soldered to the housing or a ferrule. A straight

Specifications

Connector length	1.830 in.
Wire size	22, 24, and 26
Spacing between contacts	0.085 in.
Dielectric separation	0.020 in.
Dielectric strength	1,400 v, rms, at sea level 500 v, rms, at 70,000 ft.
Contact resistance	22 mv at 5 amps across mated contacts
Moisture resistance	More than 1,000 meg-ohms
Mechanical shock	100 g's in 3 separate planes for 3 msec
Thermal shock	From -55°C to 150°C—5 cycles of 30 min. duration per temperature extreme

Bourns Introduces INFINITRON™ Element 10-Turn Precision Potentiometers*

Here at last are multi-turn precision potentiometers that offer long life and essentially infinite resolution without asking you to compromise on your specifications. Noise in Bourns INFINITRON-element units is so low you can test them as if they were wirewounds. You don't have to hook up special filter circuits or contrive "output smoothness" tests. No need, either, to limit these potentiometers to voltage-divider applications or to guess where the resistance element starts and ends. Precise end-points make our linearity specification a reality in your circuits.

Convince yourself of the higher performance that Bourns INFINITRON-element 10-turn potentiometers can bring to your designs. Write today for product information and actual test data.

STANDARD SPECIFICATIONS

1/8" Diameter, 10-Turn, Bushing-Mount Model 3501
1/4" Diameter, 10-Turn, Servo-Mount Model 3551

Noise Performance:	100 ohms or 1% of total resistance, whichever is greater
Humidity Performance:	MIL-STD-202, Method 103
Independent Linearity:	±0.5%
Temperature Coefficient, All Resistances:	±300 PPM/°C
Total Resistance Tolerance:	±5%
Rotational Life:	Model 3501: 4,000,000 shaft revolutions Model 3551: 10,000,000 shaft revolutions
End Resistance:	1 ohm or .1% max., whichever is greater
Electrical Rotation:	3600° (+10°/-2°)
Power Rating:	2 watts at 70°C
Operating Temperature Range:	-65°C to +125°C
Environmental Stability:	Resistance shift < 5%
Approximate Weight:	1 oz.
Resistance Range:	1K to 500K
Price, 1-9 pieces:	Model 3501 (Bushing Mount): \$14.00 Model 3551 (Servo Mount): \$30.00

Long-life, ball-bearing shaft supports, standard in the servo-mount model, are also available in the bushing-mount unit.

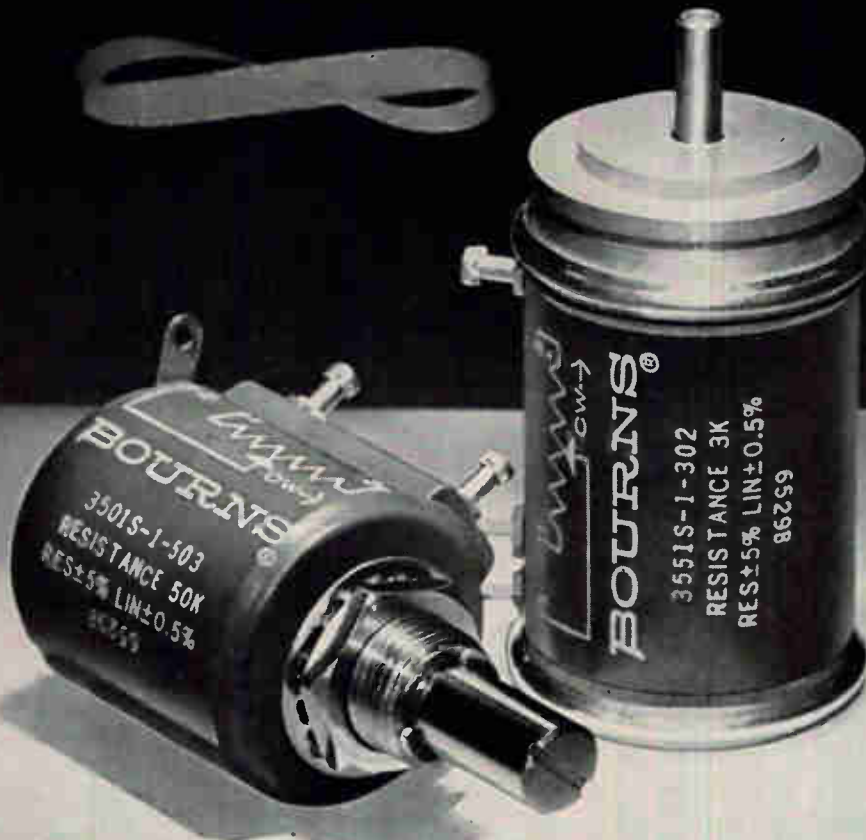

*Patent pending

MANUFACTURER: TRIMPOT® & PRECISION POTENTIOMETERS, RELAYS, TRANSDUCERS FOR PRESSURE, POSITION, ACCELERATION. PLANTS: RIVERSIDE, CALIFORNIA; AMES, IOWA; TORONTO, CANADA

4 ways to beat a hot system

1. Centrifugal Blowers
2. Propeller Fans
3. Vaneaxial Fans
4. Tubeaxial Fans

Learn about them from a 12 page booklet called the "Airmover Selector." It has a technical information section to aid you in your choice of airmovers. On the remaining pages we have plugs for our products which help pay the cost of free booklets. Or a better bargain is our 136 page catalog given free when

you meet with our technical sales reps. For very quick service contact: IMC Magnetics Corp., Eastern Division, 570 Main Street, Westbury, N.Y. 11591. Phone 516 334 7070 or TWX 516 333 3319. For the "Airmover Selector" write: Marketing Division at the same address, or circle the Bingo number below.



Circle 448 on reader service card

**This is our 3 step.
Give us a call and see all
the steps in our routine.**

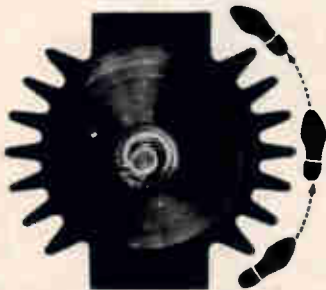

If you really want to swing you can also step 4, 8, 12, 24, 48, and 200 increments without gears.

Or to Indicate, Measure and Control using flag and remote angle indicators, synchros, resolvers, steppers, or solenoids. They are in stock at IMC Magnetics Corp., Western Division. For quick service contact the Applications Section at Western Division, 6058 Walker Ave., Maywood, Calif. 90270. Phone 213 583 4785 or TWX 910 321 3089.

If you need data sheets for references or consideration for future projects, write IMC's Marketing Division at 570 Main Street, Westbury, New York 11591.



New Components

or right-angle cable clamp and a jacketed or shielded cable adaptor, all available this fall, can be attached to the basic plug unit on the back of the connector.

Prices will not be definite until July, about a month before the first of the connectors—sizes 16 and 18—will be available. Size 16 will have 55 contacts and 10, with 37 contacts and 10, with 12 contacts, will be available in October. Size 8, with 4 contacts, will be out early next year. Amphenol estimates the price at approximately \$25 to \$30 a pair.

Amphenol Connector Division, 1830 S. 54th Ave., Chicago, Ill., 60650 [351]

Servo-differential solid state relay

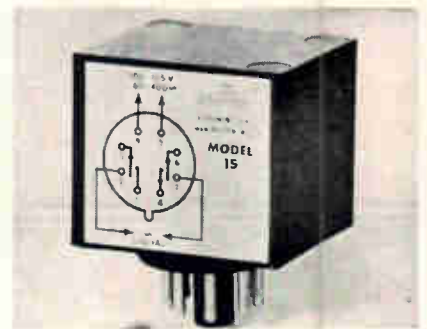

Model 15 servo-differential relay incorporates a high-gain silicon solid state amplifier requiring a primary power source and a phase-sensing signal source derived from that same primary power source. The relay output consists of individual dry reeds with a-c or d-c switching capacity of 15 watts. Current amplification factor is 10^8 . Primary power requirements are 1 watt, 120 v \pm 15%, 60 to 500 hz. Other primary voltages or frequencies are available on order.

The relay is designed for use directly with low-level transducers, such as strain gages, linear variable differential transducers, or low-resistance temperature sensors. The signal input impedance is 20,000 ohms.

The signal sensitivity for switch pull-in is 5 mv \pm 180°. The switch drop-out is not more than 10%

ONLY 3C OFFERS . . .

NEW MODULES, HARDWARE, ACCESSORIES ADDED TO THE EXTENSIVE I/C μ -PAC DIGITAL LOGIC MODULE LINE



New Model BT-332 TILT DRAWER BLOC houses 240 μ -PACS™ in only 5½" of rack panel height — pulls out, tilts down for PAC access, up to expose wire wrap terminals. Detents hold the BT-332 in any position from . . .



. . . horizontal to full vertical for convenient PAC replacement, testing, wiring, or system assembly. To further facilitate system fabrication, new mounting panels are available to adapt standard μ -PAC hardware for 19" . . .



. . . rack installation. In addition, 3C offers custom system assembly and wiring capability for the special purpose system builder or volume manufacturer using μ -PACS.

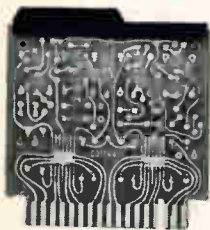

LD-331 HIGH-DRIVE LAMP DRIVER PAC contains 8 independent micro-electronic lamp-driver circuits with discrete output transistors. Each driver is capable of switching up to 300 ma at 35 volts from standard μ -PAC signals.

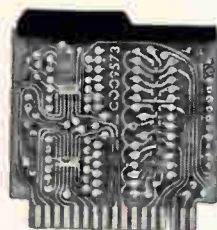

LD-335 NEGATIVE LOGIC LEVEL DRIVER PAC contains 8 two-input AND gates, followed by level shifters. Standard μ -PAC signals (+6 V and 0 V) are converted to negative logic levels (0 V to -25 V at 60 ma per circuit).

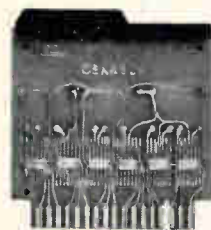

PN-335 NON-INVERTING POWER AMPLIFIER PAC contains 6 three-input AND gates. Each gate contains two inverting amplifiers in series which provide the non-inverted output. Electrically common outputs and built in short circuit protection are standard features.

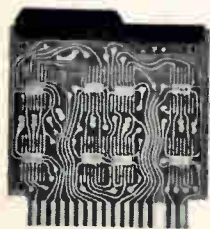

SR-335 SHIFT REGISTER PAC contains 8 prewired integrated circuit shift register stages. Up to 16 custom assembled stages can be supplied to meet customer design requirements.



TP-330 TEST POINT PAC provides convenient system trouble shooting capability without wire side probing for observation of waveform characteristics. Isolated test points for 34 PAC fingers are furnished.



AS-330 COPPER CLAD BLANK PAC kit provides a basic μ -PAC card with 5.5 sq. in of copper plate on each side for custom etching of interconnections. PAC handle and fastener are included.

μ -PACS feature 5 mc operation, high packaging density, low cost per logic function, inherent reliability, low power consumption, and noise protection in excess of one volt utilizing NAND logic with DC coupled circuitry.

Write for complete catalog of μ -PAC monolithic integrated circuit digital logic modules, power supplies, hardware, and system design and fabrication accessories.



COMPUTER CONTROL COMPANY, INC.
OLD CONNECTICUT PATH, FRAMINGHAM, MASSACHUSETTS 01702

3C SALES OFFICES: NEEDHAM, MASS.; FOREST HILLS, N.Y.; LEVITTOWN, PA.; SYRACUSE, N.Y.; SILVER SPRING, MD.; HOUSTON, TEXAS; HUNTSVILLE, ALA.; COCOA BEACH, FLA.; DES PLAINES, ILL.; DETROIT, MICH.; WEST CARROLLTON, OHIO; LOS ANGELES, CALIF.; KENT, WASH.; ALBUQUERQUE, N.M.

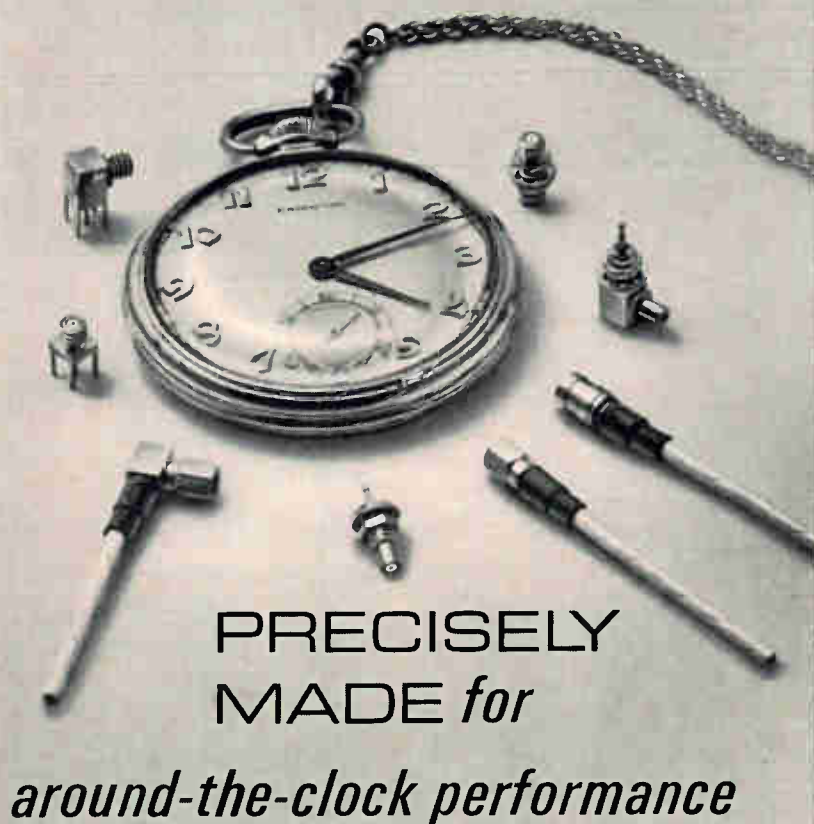

PRECISELY
MADE for

around-the-clock performance



MICROMINIATURE R.F. CONNECTORS

For use with integrated circuit packages, micro-modules, and flat-packs, MicroheX units offer full-time performance through 10 GHz with less than 1.15:1 VSWR. All from a precision R.F. connector that measures less than .400" (typical) in its largest dimension.

The complete MicroheX line has more than 65 units for RG-178/U, RG-196/U, and Semi-Rigid cables; Printed Circuit and Bulkhead mounting types; Slide-on, Screw-on, and Snap-on mating engagements; Strip-Line connectors, and adaptors.

If you need connectors every bit as small as your micro-miniature equipment, write for the MicroheX catalog. We're sure we have just the connector you need.



R. F. COMPONENTS DIVISION

SEAELECTRO
CORPORATION

MAMARONECK, NEW YORK

Phone: 914 698-5600 TWX: 710-566-1110

Sealectro Ltd., Portsmouth, Hants, England

New Components

lower than the pull-in. When used with a 10-v signal source, the model 15 has a differential resolution of 1 in 2,000 thereby permitting high positional or control accuracy when used in servo, temperature or other go, no-go applications. Its operation resembles that of an operational amplifier without requiring a feedback loop. The relay is virtually unaffected by shock, vibration or temperature variations in its operating range of -40° to $+85^{\circ}\text{C}$. Single unit price is \$31.95.

Sensitak Instrument Corp., 531 Front St., Manchester, N.H. [352]

Miniature reed relays for printed circuits

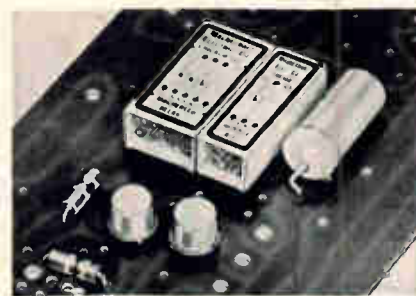

Miniaturized reed relays only $\frac{3}{8}$ in. high—slightly higher than a conventional one-watt composition resistor—have been developed for printed-circuit applications.

Units are available in dry-reed contact configurations up to 3 pst normally open or dpdt, and in mercury-wetted contact configurations of spst normally open or dpst normally open. Virtually any coil characteristics may be specified.

Dry-reed contacts are rated for 10 v-a noninductive loads at up to 250 ma or 100 v maximum; mercury-wetted contacts are rated for 28 v-a noninductive loads at up to 1 amp or 100 v maximum. Operate time is 1 msec or less.

In design, special consideration was given to obtain minimum noise levels for low voltage and dry-circuit applications. All connections in the switching circuits are welded not only for maximum strength but for minimum electrical resistance; all connections are of similar metallic composition to minimize

They Asked us to make A LOT Less Noise

SCHOTTKY-BARRIER junction mixer diodes, in production quantities and specially RF characterized, are now available with noise figures less than 5.5 dB.

A *bilithic* encapsulating process for the metal-silicon junction assures *unmatched* reliability. Batch photoetching and deposition techniques guarantee reproducibility. Less shot noise and higher reverse breakdown voltage allow greater dynamic range.

Inquiries on microminiature glass, micropill ceramic and other low parasitic packages are invited.

TEST SPECIFICATIONS (25°C):

Model Number	Test Freq. (MHz)	Max. Noise Figure (dB)	C _t @0 Volts Max. (pf)	I _r Min. @VF = IV (mA)	Z _{IF} at RF 1.0 mW (ohms)	Z _{RF} Typ. (ohms)	CW Burnout (watts)	Burnout Repetitive Pulsing (ergs)
MA-4850	3060	9.0	1.0	50	200-400	50	1.0	20
MA-4851	3060	7.5	0.7	25	300-450	50	1.0	10
MA-4855	3060	6.5	0.5	20	350-550	50	0.5	7
MA-4856	9375	7.5	0.35	20	200-500	50	0.5	5

All units case style 54.

MEASURED NOISE FIGURE VS. FREQ.

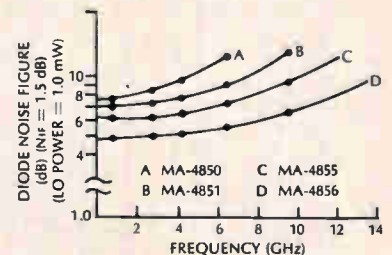

MICROWAVE ASSOCIATES

Burlington, Massachusetts
 Offices: Burlington, Mass.; 9911 Inglewood Ave., Inglewood, Cal.
 Hyde House, Edgware Rd., London NW9, England.
 Subsidiary: Microwave Associates, Ltd., Luton, Beds, England.

You just discovered how super/reg[®] pin-pointed regulation eliminates your worries about cross-talk and line losses in DC power systems.

Typical super/reg zener impedances of 2 to 8 milliohms — lowest ever yet achieved — makes possible .01% regulation and .5mv ripple.

Its unique "third" terminal lets you trim the output voltage a full $\pm 10\%$ from nominal, with no derating or degradation.

.01%/°C temperature compensation at high power levels; thermal stability 100-times greater than that of the standard zener.

Zener voltages from 3.9 to 56V.

Full 3-ampere steady-state rating up to 75 watts.

A super/reg diode breaks the zener barrier by means of its "synthesized" construction: embodies a sensing bridge, operational amplifier,

thermally compensated zener diode, in standard TO-36 case.

Looks, mounts like any other diode. Performance-proven reliability; patent pending design. Designed for MIL applications.

Write or call for complete data and application bulletins.

Semi-conductor Division, Trio Laboratories, Inc., Plainview, L.I., N.Y. (516) OV-1-0400.

TWX: (510) 221-1861.



© 1966, TRIO LABORATORIES, INC. • ORIGINAL CONCEPTS IN INSTRUMENTATION



This is the super/reg[®] synthesized zener diode.

New Components

noise generation common to dissimilar junctions.

Magnecraft Electric Co., 5575 North Lynch Ave., Chicago, Ill., 60630. [353]

Dual-gun storage tube processes video data



A high-resolution version of the dual-gun RW-5 miniature storage tube is now available for video data processing. Designated the RW-5EM, the tube is capable of resolving a minimum of 1,200 tv lines on a target of 1-in. diameter. Storage times from a fraction of a second up to a few minutes can be provided.

The tube uses electromagnetic focus and deflection on both write and read sides. In size and shape, it is identical to the RW-5, which the company claims has found wide acceptance as a video data processor in both ground and airborne applications. The RW-5EM meets the airborne environmental requirements of MIL-E-5400. Single quantity price is \$1,400, and deliveries can be made in 15 to 30 days.

Warnecke Electron Tubes, Inc., 175 W. Oakton St., Des Plaines, Ill. [354]

Magnetic-reed rotary switches

A complete line of versatile, magnetic-reed rotary switches consists of eight models. They are available with either form A or form C contacts, or in combination of both, and have isolated contacts, making it possible for each stack to handle up to 12 individual circuits.

The switches are light—as little as 3 oz for a 12-position switch—and have an improved ball and sprocket detenting mechanism and no sliding contacts, which greatly reduces operating force and elimi-

Design a new circuit? It only takes 10 seconds to find out that maybe you didn't.

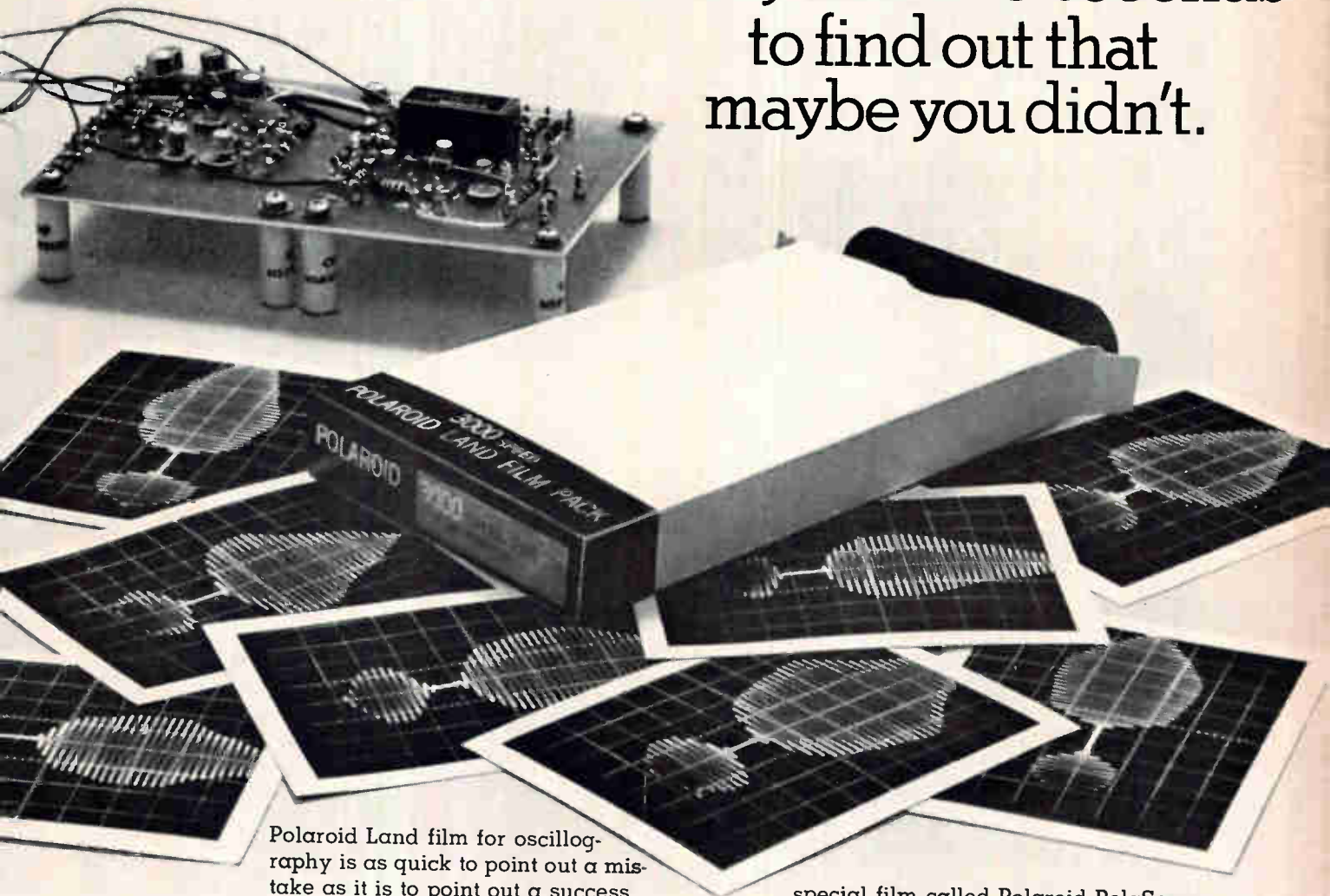

Polaroid Land film for oscillography is as quick to point out a mistake as it is to point out a success.

You never have to wait for darkroom development only to find out that your new breadboard needs more work.

You get your results in 10 seconds flat. And it's always a sharply detailed, high-contrast trace recording.

You can study it, attach it to a report, send it as a test record along with a product shipment, or file it for future use.

Choice of films? Yes. There are four different films for oscilloscope recording in pack, roll, and 4 x 5 formats.

The standard film speed has an ASA equivalent rating of 3000.

If you want to take a picture of a trace so fast you can't even see it, we've got a

special film called Polaroid PolaScope Land film with an ASA equivalent rating of 10,000. It's the fastest film around. It will actually record a scintillation pulse with a rise time of less than 3 nanoseconds.

To use these films on your scope, you need a camera with a Polaroid Land Camera Back. Most manufacturers have them (Analab, BNK Associates, Coleman Engineering, EG & G, Fairchild, General Atronics, Hewlett-Packard, Tektronix).

You can get complete details from one of these manufacturers, or by writing to Polaroid Corporation, Technical Sales, Dept. 30, Cambridge, Massachusetts 02139.

Polaroid Land Film for Oscilloscope Trace Recording

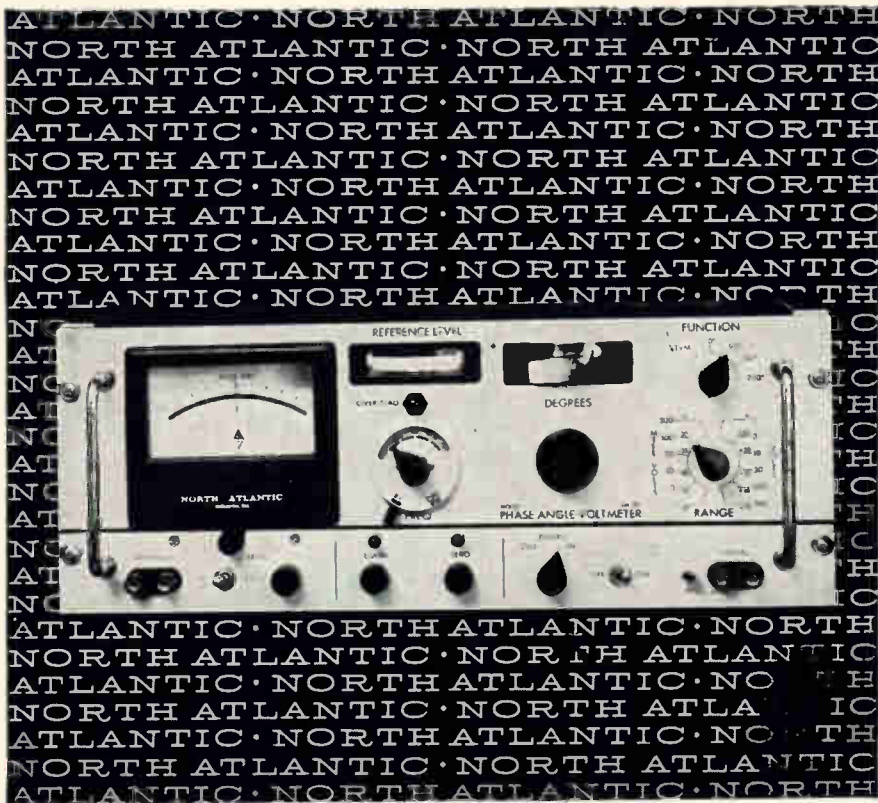

how to measure in-phase, quadrature and angle while sweeping frequency to 100 kc

North Atlantic's latest addition to the PAV line of Phase Angle Voltmeters* enables you to make measurements while frequency is varying over half-decades without recalibration. The VM-301 Broadband Phase Angle Voltmeter* provides complete coverage from 10 cps to 100 kc, and incorporates plug-in filters to reduce the effects of harmonics in the range of 50 cps to 10 kc with only 16 sets of filters. Vibration analysis and servo analysis are only two of the many applications for this unit. Abridged specifications are listed below:

Voltage Range.....	1 mv to 300 volts full scale
Voltage Accuracy.....	2% full scale
Phase Dial Range.....	0° to 90° with 0.1° resolution (plus 4 quadrants)
Phase Accuracy.....	0.25°
Input Impedance.....	10 megohms, 30μf for all ranges (signal and reference inputs)
Reference Level Range.....	0.15 to 130 volts
Harmonic Rejection.....	50 db
Nulling Sensitivity.....	less than 2 microvolts
Size.....	19" x 7" x 10" deep
Price.....	\$2290.00 plus \$160.00 per set of filters

North Atlantic's sales representative in your area can tell you all about this unit as well as other Phase Angle Voltmeters* for both production test and ground support applications. Send for our data sheet today.



NORTH ATLANTIC industries, inc.
 TERMINAL DRIVE, PLAINVIEW, L. I., NEW YORK • OVERbrook 1-8600

*Trademark

New Components

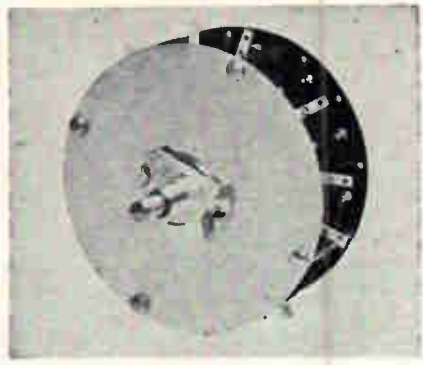

nates contact wear. Rhodium contacts, hermetically sealed in pure nitrogen, make them ideal for hazardous locations, dry-circuit applications, and reliable operation with low contact resistance in all environmental conditions. Some models handle up to a maximum of 1,000 v and currents as high as 15 amps inrush and 3 amps steady. Contact life at rated current is 100 million operations and infinite at dry circuit.

Hart Mfg. Co., 110 Bartholomew Ave., Hartford, Conn. [355]

Platinum insets measure temperature

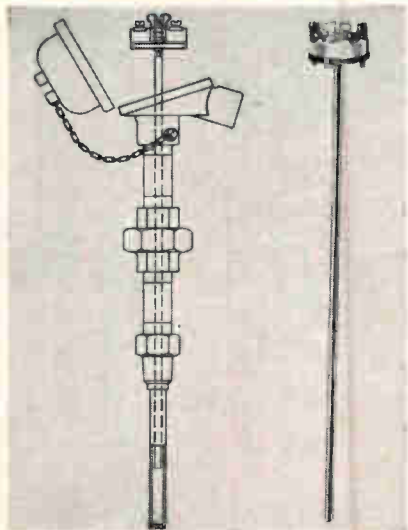

A resistance thermometer inset is announced for precise temperature measurement in industry and laboratories. The insets are self-contained, 100-ohm platinum sensors designed primarily for use in protection tubes or thermowells. They are installed through the connection head, and can be replaced

quickly without disturbing plant operation.

The standard insets, each consisting of a glass or ceramic element hermetically sealed into a 1/4-in. D nickel tube, are spring loaded to insure good thermal contact with the bottom of the well. They are made to a 0°C tolerance of ± 0.1 ohm and are recommended for use between -250°C and $+850^{\circ}\text{C}$.

Electric Thermometers, Inc., 615 Schuyler Ave., Kearny, N.J. 07032. [356]

Two-pole analog switches are solid state

The 202 series of two-pole, solid state analog switches are intended for wide application in high- and low-level time-division multiplexers, commutators and chopper applications. They feature field-effect switching devices and are capable of continuous on or off operation, as well as sampling up to 50,000 samples per second.

Each two-pole unit is a solidly encapsulated 0.632- x 0.632- x 0.5-in. block with a weldable-solderable nine-lead interconnection configuration. Custom packaging and specialized performance specification inquiries are invited. Pricing on most models is less than \$50 in quantity of 100 or more. Delivery is stock to four weeks.

Scientific Control Systems, Inc., 14008 Distribution Way, Dallas 34, Tex. [357]

Ruggedly built trimming pots

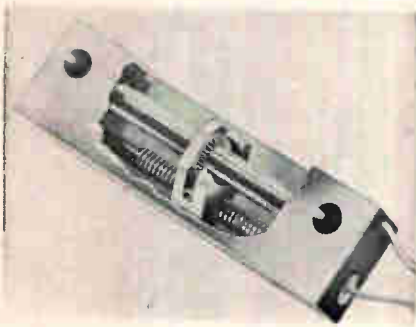

The Nu-Trim wire-wound trimming potentiometer is designed with a ring of multiple contacts around the resistance element to provide smooth, light and even contact pressure in all directions. During

diffitrans*

* Stumped? Don't be. We made up the word to emphatically set forth the ability of Phelps Dodge coaxial cable assemblies to solve very difficult transmission and installation problems.

A coaxial cable assembly, designed to specific requirements, is often the ingenious solution to cable connections in close physical confines or under difficult environmental conditions. Very tight specs can be met: delay time, $\pm .02$ NS — phase length, 0.4° relative — VSWR, 1.01; insertion loss, 0 to 40 db ± 0.5 db and 40 to 60 db ± 1.0 db — impedance, absolute value of average, 0.2%.

Phelps Dodge Electronics coaxial cable assemblies have been designed and built as tracking antenna harnesses, special oscillator and receiver lines, transitions to waveguide, airborne vibration isolators, matching sections, and for equalizing and balancing networks. We have a new catalog that describes many more. Please write for it. Bulletin CC, Issue 1.

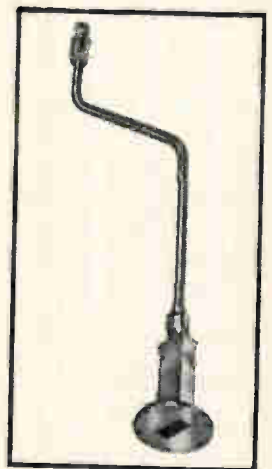

PHELPS DODGE ELECTRONIC PRODUCTS
NORTH HAVEN, CONNECTICUT



ADC FILTERS ARE A LITTLE BETTER

HERE

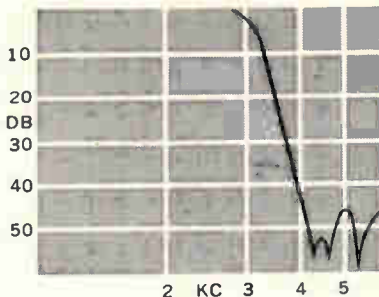
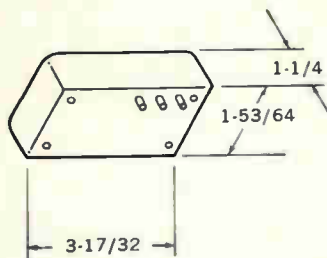

This filter requirement called for an impedance curve that would permit the presence of a signal tone in the stop band ■ A high impedance exists in the signal tone region to prevent lowering of line impedance ■ ADC engineers offer a free consulting service to assist you in establishing your filter requirements.

SPECIFICATIONS

3KC Low pass service channel filter for operation in 600 ohm circuit, with controlled input and output return loss. Input impedance is high over range of 4265 to 7645 Cps, in stop band.

0-2KC: .5DB max.
2KC-3KC: .75DB max.
4KC and above: 35DB min.

ADC FILTERS ARE A LITTLE BETTER

HERE

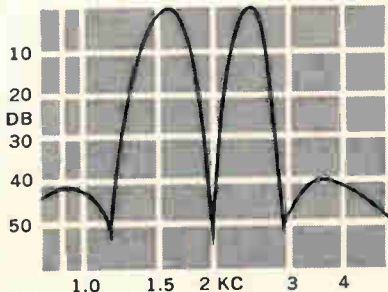
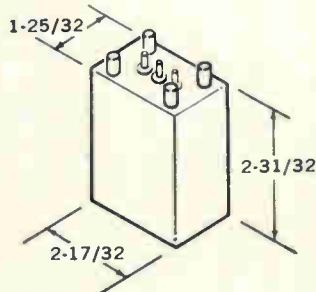

This filter required a departure from standard design procedures because of the need for two separated pass bands with attenuation between the bands ■ This filter, like many other ADC designs, meets applicable military specifications ■ ADC engineers solved this filter problem. We think we can solve your filter problems too.

SPECIFICATIONS

1575 Cps and 2425 Cps dual band pass filters, with maximum rejection at 2000 Cps 600 ohms impedance. Operating levels up to +25DBM. Temp. range -55°C to +70°C. Meets environmental conditions of MIL-F-18327B.

ADC ADC PRODUCTS

6405 CAMBRIDGE STREET ■ MINNEAPOLIS, MINN. 55426

New Components

adjustment, the Nu-Trim (spring ring) makes many sequential contacts on each turn of resistance wire as the line of contact moves in a spiral motion. As a result of the spring-ring concept, resolution is increased and the wiper contact noise is less than 20 ohms at vibration levels in excess of 100 g.

Other features include resolution better than 0.1%, welded lead construction, reliable all-metal clutch, rugged diallyl phthalate glass-filled housing, no exposed metal, 2-watt power rating and 50-ppm temperature coefficient. Potentiometers are available in a wide variety of cases and lead configurations. Resistances range from 10 ohms to 100,000 ohms.

Price is \$3.50 to \$8.46, depending on quantity and resistance. Availability is one to three weeks.

The Newport Instrument Corp., 893 W. 16th St., Newport Beach, Calif., 92660. [358]

Cathode-ray tube is compact and light

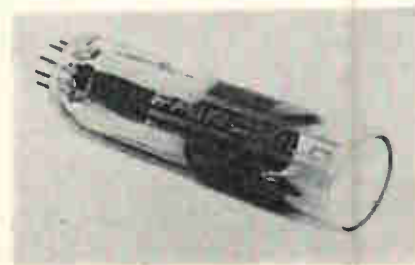

A one-inch cathode-ray tube is announced for applications where compact size is required together with unusual performance characteristics for such a small tube. The KC2437 measures 1 in. in diameter, 3.2 in. in length and has a usable face of 0.8 in. in diameter. The lightweight, compact tube is designed primarily for photographic purposes.

Deflection and focus are electrostatic. Spot size is held to 0.007 in. The faceplate of the tube is made of optically treated glass that is coated with a blemish-free phosphor, which contributes to improved resolution, reduced spot size, and increased brightness. Beam acceleration employs rela-

tively low voltages, which also enhances deflection sensitivity.

The manufacturer recommends the tube for special-purpose applications in airborne use or where packaging or panel-instrument density are primary considerations.

DuMont Electron Tubes, 750 Bloomfield Ave., Clifton, N.J. [359]

Small vacuum relay can switch to 10 kv

A high-voltage vacuum relay now offered can switch up to 10 kv d-c in a package measuring $\frac{1}{2}$ in. in diameter by $2\frac{3}{4}$ in. long and carries up to 4 amps. Model H-5/S-10 single-pole single-throw relay has a maximum operating time of 10 msec. Standard coil resistance is 170 ohms, and coil voltage is 24 v d-c. The unit will withstand vibration to 10 g at 55 cps and shock to 15 g at 11 msec.

Applications include radar, communications, electronic countermeasures, sonar, discharging lethal voltages, switching antenna loading coils, switching in explosive atmospheres and others.

Delivery is stock to 30 days; price in quantities of 1 to 9, approximately \$130.

High Vacuum Electronics, Inc., 538 Mission St., South Pasadena, Calif. [360]

Metal glaze resistor meets MIL-R-22684

A low-cost metal glaze resistor has been designed to meet or exceed the performance requirements of MIL-R-22684.

Designated the RC07, the unit is RL07 size. The molded body construction of the versatile resistor adds mechanical ruggedness to the proven electrical stability, reliability, and precision of metal glaze.

The unit is rated $\frac{1}{4}$ watt at 70°C and is available in EIA resistance values over the range of 51 ohms to 150,000 ohms, with $\pm 2\%$ and $\pm 5\%$ tolerance.

In lots of 5,000, the price of the resistors is \$89 per thousand for $\pm 5\%$ purchase tolerance; delivery, three weeks.

IRC, Inc., 401 North Broad St., Philadelphia, Pa., 19108. [361]

Automate Your Precision Operations

with **KÄHLE**

FULLY AUTOMATIC

PRODUCTION MACHINES

Performance Proven on Miniature and Sub-Miniature Electronic, Glass and General Industrial Components and Finished Products



This Kahle precision machine produces a two-piece component lead wire by butt welding a pre-cut slug of molybdenum to a Dumet wire. The pre-cut slug is automatically fed into a six-head indexing turret. The Dumet wire is straightened, cut and welded to the slug. Available for all types of miniature and sub-miniature lamps.

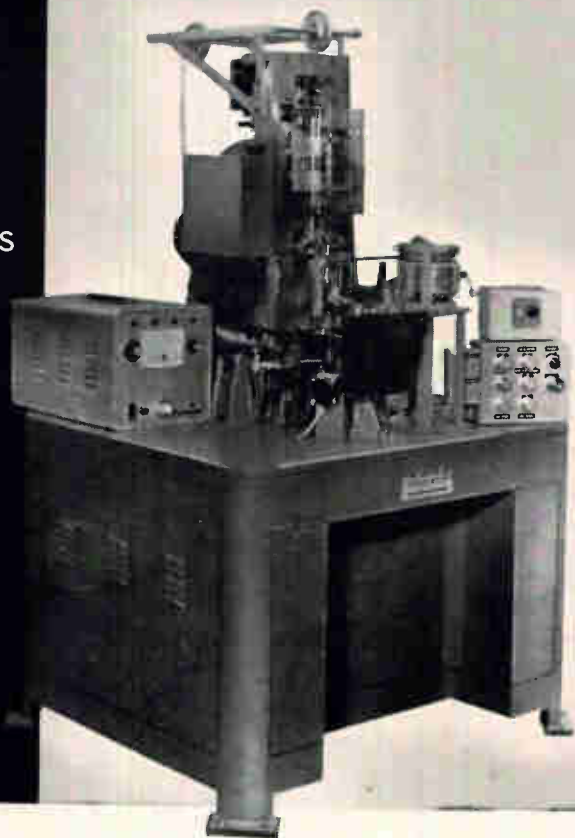

KAHLE Automatic Production, Assembly and Quality Control

Ask KAHLE to recommend improved methods of production that will save you time and money. Fully automatic KAHLE machines can be supplied to assemble, inspect and test your components.

KAHLE Machines are Customer-Approved under Actual Operating Conditions

Your equipment is run in our factory, using your materials in the presence of your engineers; the machine is not shipped to you unless you approve it!

SAVE TIME AND MONEY — Let professionals build your specialty production equipment for automation!

KÄHLE

Designers and Builders of Automatic Equipment for High Speed Production for Over 30 Years

Kahle Engineering Company

3324 HUDSON AVE., UNION CITY, N. J. 07087

Telephone: (201) 867-6500

KAHLE EUROPEA — Via Spartaco 16, Caravaggio (Bergamo), Italy

**GEC
tv "sight
system"
spots the
target**



The three principal components of any television weapon guidance system — the window, the lens and the vidicon — are shown above. Designed and manufactured by GEC, they illustrate our total electro-optical capability.

Whether you need components or a complete television guidance system, see GEC.



**GENERAL ELECTRODYNAMICS
CORPORATION**

4430 FOREST LANE • GARLAND, TEXAS 75041 • BR 6-1161

GEC . . . a total electro-optical capability

New Semiconductors

**Tuning varactors
provide high Q**

Two high Q silicon planar epitaxial tuning varactors are available for use at vhf and uhf frequencies. Type members are MC301 and MC302. Both are encased in either the coaxial MD package (with a maximum cylindrical dimension of 0.125 in. and an over-all height of 0.215 in.) or the DO-7 package.

A circuit designer can specify any capacitance value in the 6 to 25 pf range for the MC301, and 26 to 47 pf range for the MC302. The flexibility of this new product line is further measured by the availability of $\pm 2\%$ and $\pm 3\%$ capacitance tolerances. Typical Q at 100 Mhz is 350; minimum Q, 300.

Both devices have a maximum rated working inverse voltage of 40 v, a power dissipation rating of 500 mw, and an operating temperature range of -65°C to $+175^{\circ}\text{C}$ with a power derating factor of 1.67 mw per $^{\circ}\text{C}$ from 25°C .

Fairchild Semiconductor, a division of Fairchild Camera and Instrument Corp., 313 Fairchild Drive, Mountain View, Calif. [362]

**High-voltage, silicon
power transistors**

A line of high-voltage, silicon power transistors has been expanded. The new transistors are 10-amp planar npn devices featuring sustaining voltages from 200 v to 300 v. They are offered in a TO-66 package with a power rating of 25 w at 100°C case temperature.

According to the manufacturer, the transistors are ideally suited for use in high-voltage inverters, converters, switching regulators, tv deflection circuits as well as all line-voltage switching and amplifier applications.

The new series is identified as the MHT 7901 through MHT 7904. Collector-to-base reverse current is less than $1 \mu\text{a}$; collector-to-emitter saturation voltage, less than 0.5 v at 5 amps.

Solitron Devices, Inc., 1177 Blue Heron Blvd., Riviera Beach, Fla. [363]

TECHNO

**NOW!
top and side
adjust 1/4"
trimmers**

Enjoy the design freedom and versatility in $\frac{1}{4}$ " multiturn (25:1), wire-wound precision trimmers available only from TECHNO. You get the size you want in the style you want without sacrificing performance.

Resistance range: 100 ohms to 25K ohms. Temperature coefficient: of 20 PPM/ $^{\circ}\text{C}$. Operating temperature: -65° to 175°C . Power rating: 0.5 watt at 50°C . Call or write for complete technical data:

TECHNO-COMPONENTS CORP.
7803 Lemona Avenue
Van Nuys, California 91405
(213) 781-1642



MODEL 12
TOP ADJUST
(ACTUAL SIZE)



MODEL 14
SIDE ADJUST
(ACTUAL SIZE)



TECHNO

New addition to Varian's broad line of quality microwave components—



Low-noise Low-power TWT's.

Through a recent acquisition, Varian has gained over 10 years of research, development, and production experience in low-noise TWT's. These tubes are now available from Varian—with or without integral power supplies.

This acquisition marks the completion of a total TWT capability at Varian: in high-power, medium-power, and low-power TWT's. We will continue working to advance the state-of-the-art in this field. And we welcome the chance to work with you—to help you advance the state-of-the-art in your own industry.

Write for details: Palo Alto Tube Division, 601 California Avenue, Palo Alto, California. In Europe: Varian A.G., Zug, Switzerland. In Canada: Varian Associates of Canada, Ltd., Georgetown, Ontario.



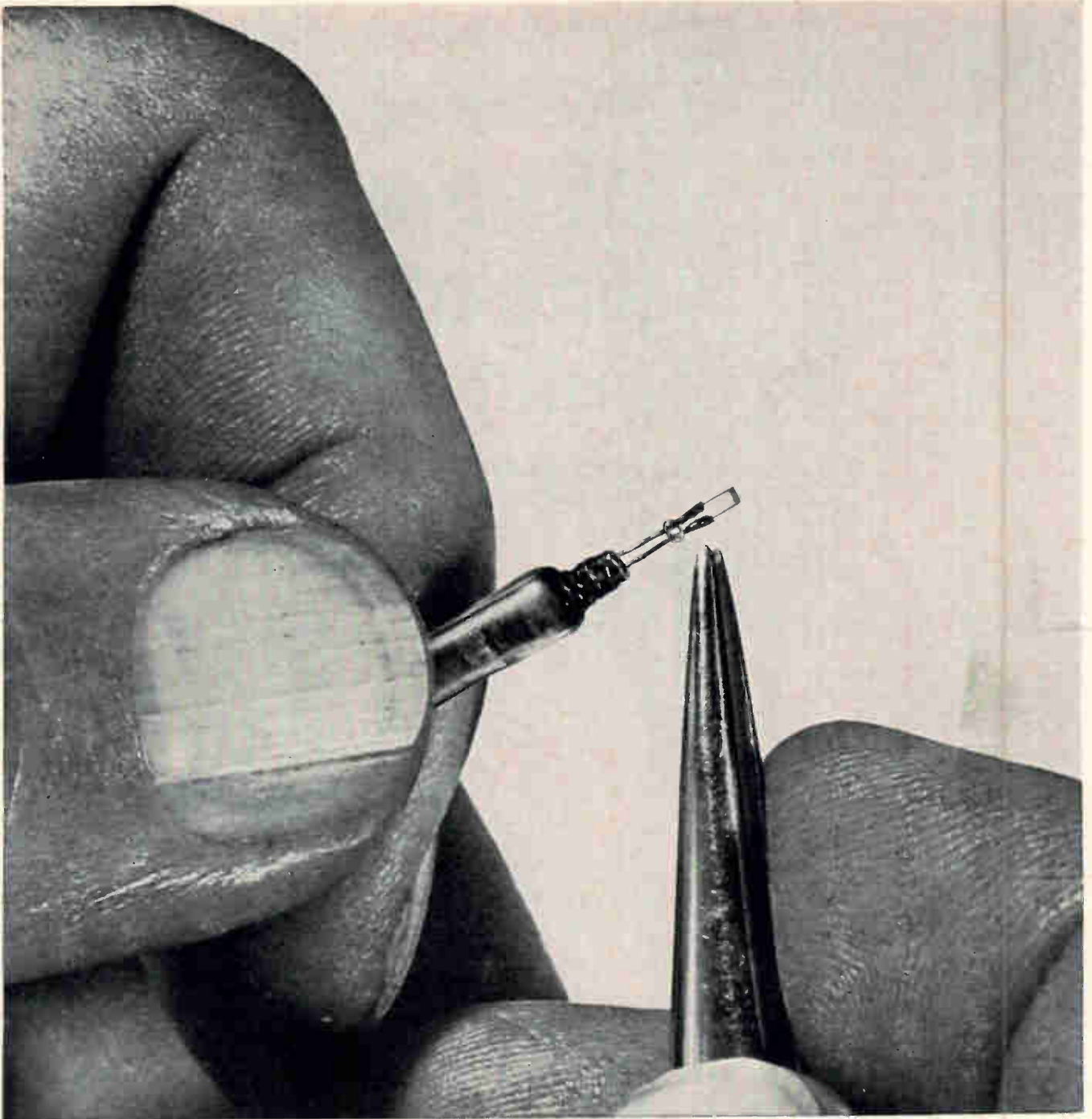

ENGELHARD platinum wire
is best for H. Boehm & Co. miniature lamps.

H. Boehm & Company makes miniature lamps as small as $\frac{1}{16}$ of an inch in diameter and $\frac{1}{4}$ of an inch long for delicate surgical instruments. The electrical connections in these lamps are made of Engelhard platinum wire only .005" to .007" in diameter. The reasons for selecting this material are: platinum has a high melting point and excellent electrical conductivity.

Making reliable lamps from hair thin platinum wire is precise business. The platinum wire is pounded flat on one end and drawn through a die that fastens the flat end into a small tube. Then the wire is cut to an average length of $\frac{3}{16}$ of an inch. Two wires are fastened

together with a small glass and a tungsten filament is inserted into their tubes. Finally the wires are sealed in hot glass. Since platinum and glass have the same heat expansion rate, the seal remains perfect. This is absolutely necessary for maintaining the high vacuum in the lamp.

Engelhard, a leader in precious metals, is always searching for new and better applications to improve almost any product or process. For help with your metallurgical problems, write Engelhard: *the company that is working wonders with the wonder-working metals!*

581

Some other **ENGELHARD** products

PLATINIZED TITANIUM ELECTRODES

recent developments in platinized titanium electrodes allow optimization of configurations and coating types affecting many new applications in chemicals production and electroplating fields.

TEMPERATURE-SENSITIVE METALS

are available in a complete line for applications requiring temperature response from -100° to $+1,000^{\circ}$ F. Wilco Thermometals® are supplied in a wide range of resistivity in rolls and strips or tempered and formed to specification.

RHODIUM PLATING

of electrical and electronic parts offers outstanding protection against surface corrosion, reduces noise level of moving parts, and improves efficiency wherever a low-resistance, long-wearing, oxide-free component is required.

THIN WIRE AND FOIL

are produced by Engelhard's Baker Platinum Division to meet rigid electronic design requirements. Both extruded and Taylor Process thin wire are available in diameters as small as .001". Thin-gauge foil is supplied in sheets up to 8" x 18".

SEMICONDUCTOR MATERIALS

are supplied in a wide range of precious and base metals and their alloys. These include solid sheet, wire, tape, base tab materials and clad products. New materials are constantly under development. Technical assistance is available.

LAMINATED CONTACT MATERIALS

are produced in virtually any combination of precious metals and alloys with base metals and alloys. Types include edge, strip, inlay, spot, single or double-face laminations. Supplied in flat lengths, in strip, coil or fabricated forms.

LIQUID GOLD

produces an excellent heat barrier when applied to metals and other surfaces. Solutions are easy to use. Resulting metallic films are often permit important weight reduction of substrate materials.



New Instruments

Counter measures higher frequencies

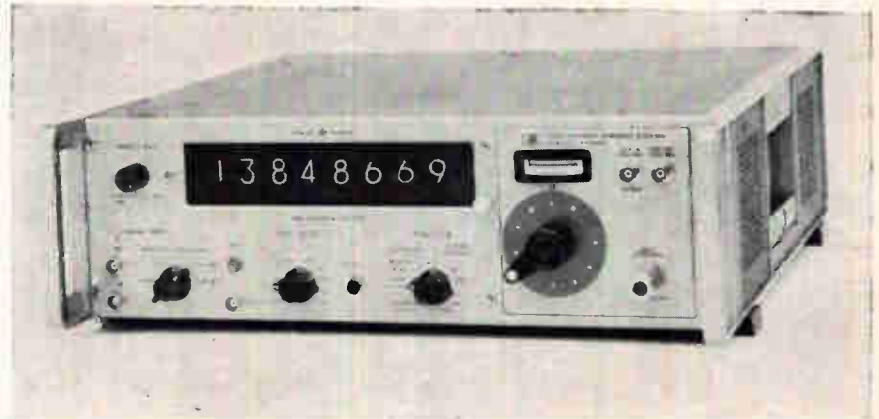

Rapid, highly accurate measurements of continuous-wave frequencies from 3 to 12.4 gigahertz can now be made with Hewlett-Packard Co.'s model 5255A heterodyne converter, designed to fit into the plug-in compartment of the company's model 5245L counter. The combination is accurate to within \pm one count (\pm the counter's time base accuracy) and has a resolution of one hertz. The company claims the 5255A and 5245L enable c-w frequency measurements through X band to be made with greater speed, accuracy and simplicity, and at a price comparable with other methods.

Hewlett-Packard claims that the wide frequency-measuring range, in excess of four-to-one, and the top frequency of 12.4 Ghz are unique in the microwave field. The company attributes much of the instrument's capability to a newly designed tuning cavity, the details of which the firm is jealously guarding.

Despite the high frequency and wide range, the company emphasizes that the model 5255A has no spurious responses, its dial calibration is virtually linear and sensitivity—100 millivolts root-mean-square—is constant over the entire measurement range.

To take a measurement, the converter is plugged into the counter and the counter's controls are set. Then, starting from the lowest frequency, the dial on the 5255A is tuned until the first usable response

is achieved. This is indicated when the pointer of a front-panel meter enters the green area on the meter face. At this time, the electronic counter gate, which was automatically inhibited during tuning by special circuits in the converter, is enabled and counting starts. In about four seconds, the counter displays a reading. This is the heterodyne difference frequency, which the operator simply adds to the converter's dial reading to determine the unknown frequency.

The heterodyne signal frequency is derived from the 5245L counter's time base. Therefore, the converter's accuracy equals that of the counter.

The converter can also extend the direct reading frequency range of the counter to 200 Mhz and increase its sensitivity to 5 millivolts. This is possible since any input applied to the auxiliary input terminal is divided by four in the converter's prescaler. The unit can also be used as a receiver.

Previously, frequency measure-

Specifications

Range	As a converter for H-P Model 5245L counter, 3 to 12.4 Ghz using mixing frequencies of 2.8 to 12.4 Ghz in 200 Mhz steps. As a prescaler, 1 Mhz to 200 Mhz
Input sensitivity	100 mv rms (-7 dbm) as a converter 5 mv rms as a prescaler
Input impedance	50 ohms nominal (vswr $<$ 2 up to 12.4 Ghz)
Maximum input	+10 dbm
Auxiliary output	1 Mhz to 200 Mhz difference signal from video amplifier
Price	\$1,650

National Electric Coil,*
demands



*dielectric
strength*

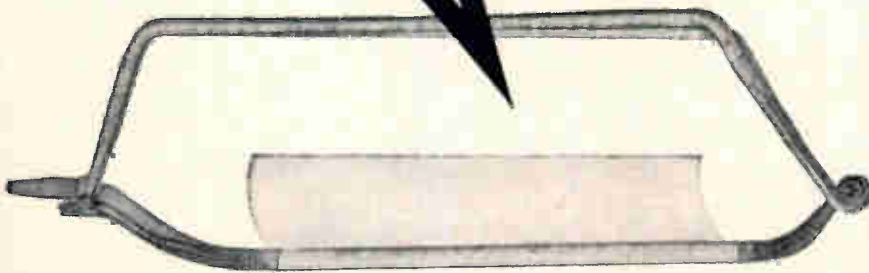

If **Scotchpar**[®] polyester film is tough enough for motor coils . . . how about your needs?

National needed an insulation system for large motor coils. They chose "SAMICA" Brand mica paper for the ground insulation in the slot section . . . but, they still needed a thin, tough, heat resistant wrapper to protect the mica paper and add to the system dielectric strength.

"SCOTCHPAR" Polyester Film No. 2570 was the answer. Its high tensile strength and one mil thinness permitted the maximum number of mica paper wraps possible . . . while still keeping the total slot section insulation thickness within the limits of the slot width. "SCOTCHPAR" Film is thinner than other insulations, adds dielectric strength, provides heat and solvent resistance as well as toughness required for motor coil use. Its puncture resistant, smooth surface protects the mica paper and makes for easy slot insertion. If "SCOTCHPAR" Film can handle stringent requirements like these, how about your needs? For more facts about this tough film, write Film and Allied Products Division, 3M Company, 2501 Hudson Road, St. Paul, Minnesota 55119, Department ICL-66.



*A DIVISION OF MCGRAW EDISON

SCOTCHPAR AND **SAMICA** ARE REG. T.M.'S OF 3M CO.

New Instruments

ments in this range could only be made with transfer oscillators since heterodyne converters for operation beyond 3 Ghz were not available. In the older technique, the transfer oscillator is tuned until a phase lock occurs between the measured frequency and one of the oscillator's harmonics. The fundamental frequency of the transfer oscillator is then read with a suitable counter and the measured frequency determined by multiplying this reading by the harmonic number.

Hewlett-Packard Co., 1501 Page Mill Road, Palo Alto, Calif. [364]

Multichannel, 17-inch display oscilloscope

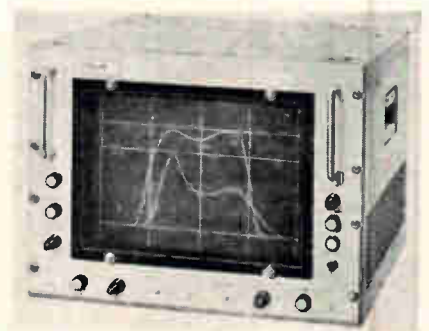

The DU-17 large screen, multichannel, display oscilloscope permits the display and resolution of frequency response curves and can be used with almost any frequency-sweep generator. Two high sensitivity Y-amplifiers and one medium sensitivity Y-amplifier are provided permitting the simultaneous display of three frequency response curves. The display can be referenced with the aid of two adjustable reference lines; the horizontal amplifier (frequency axis) accepts without distortion sinusoidal, triangular, or sawtooth waveforms (waveforms which are normally produced by frequency-sweep generators).

Both the X and Y amplifiers are d-c coupled, so that narrow-band measurements can be carried out at slow sweep speeds. A polarity reversing switch in each input channel quickly adapts the instrument to r-f probes with either posi-

tive or negative diode outputs.

A special feature is the internal frequency marker unit, which enables the frequency marker pulses of the frequency-sweep generator to be displayed as vertical frequency-marker lines; these extend the full height of the screen, and facilitate the determination of frequencies when filters with steeply rising frequency response curves have to be measured.

The display tube has a usable area of 8 x 12 in. with a deflection linearity of 5% in the X and Y axes. The crt is a medium persistence P-7 phosphor. Physical dimensions are 19½ x 15 x 18¼ in. and weight is 72 lbs. Price is \$1,375.

Texscan Corp., 51 South Koweba Lane, Indianapolis, Ind., 46207 [365]

Selective voltmeters offered in 2 models

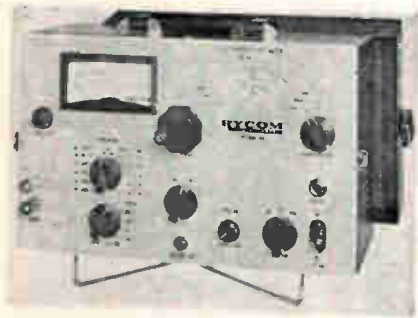

Two transistorized selective voltmeters—models 3121 and 3126—have been announced. Each unit incorporates a new two-speed, gear-driven dial assembly for accurate frequency adjustment and tuning. Each is also supplied with a 250-hz crystal filter for accurate measurements and a 2,500-hz crystal filter for measurement and aural monitoring throughout a frequency range of from 1 kHz to 1,500 kHz with a calibrated level of -78 db to +22 db (full scale readings). Accurate voltage readings are from inputs of 75 ohms, 135 ohms, and 600 ohms plus bridging (supplied on the model 3121 only).

Model 3126 offers the users of Western Electric systems inputs for direction switching at 600-ohm or 135-ohm balanced inputs. Both instruments are supplied with a Nicad rechargeable battery and internal charging circuits. A built-in speaker for aural monitoring of a-m or single sideband signals, an



SMG1 SMG1 SMG1 SMG1

STEREO GENERATOR



*with Composite Output
and 90MHz FM Multiplex Output*

The versatile SMG1 generates a high quality stereo signal in accordance with FCC standards for stereophonic broadcasting. Incorporation of the 90MHz output, frequency modulated by the composite signal, eliminates the need for separate RF signal generators in most applications. Thus the SMG1 serves as either a complete stereo modulator or a multiplex FM station at your fingertips — for development, production test and checking of stereo receivers, adapters and systems.

Modulation is provided by the internal oscillator with a choice of 80Hz, 1kHz or 10kHz — or by an external oscillator or complete stereo-program source. The 19kHz pilot signal may be switched in or out as required.

SPECIAL FEATURES

- Fully transistorized and self contained
- Both composite and RF outputs
- Pushbutton operation — quick and positive
- Modulation Operational Modes
 - Internal: R=L, R=-L, R ONLY, L ONLY
 - External: R=L, R=-L, R+L, Stereo Program
- Meter, Calibrated in % deviation, monitors composite and 19kHz pilot signals
- Standard 50 or 75 u sec. pre-emphasis — switchable in or out

Price: \$975 — Want all the facts? Write for booklet today!

THE LONDON COMPANY

811 SHARON DRIVE, WESTLAKE, OHIO 44091

RADIOMETER  COPENHAGEN

Bach-Simpson Limited, Box 2484, London, Ontario

NEW!

Highly Stable Porcelain Capacitors with Zero T.C.

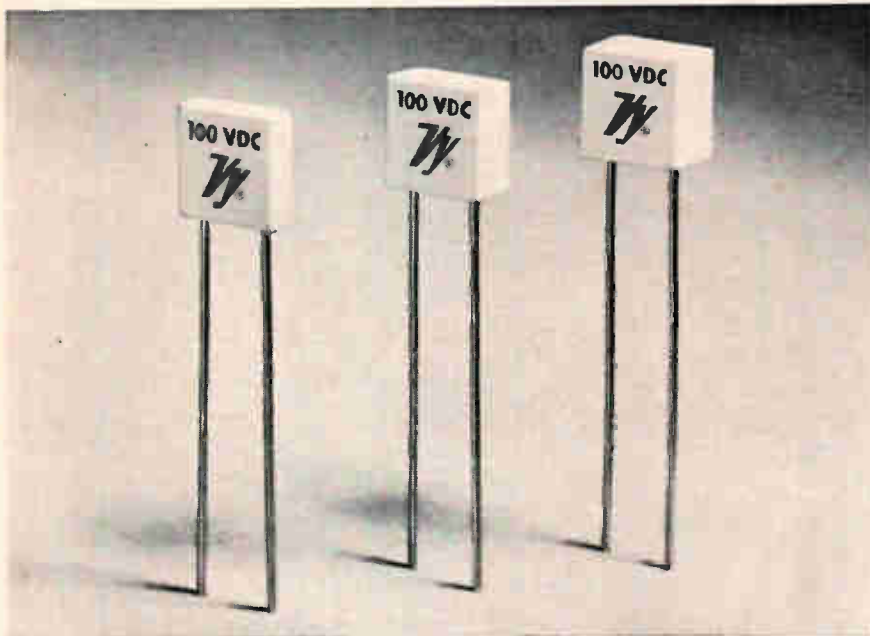

VY 03 Capacitors Feature Small Case Size and .200" Lead Spacing

The new VY 03 Porcelain Capacitors feature a standard 0 ± 25 ppm/ $^{\circ}\text{C}$ temperature coefficient, .200" lead spacing, and voltage ratings to 200 VDC. New electrode and termination designs, built exclusively for these capacitors, assure high volumetric efficiency. High stability, low-loss are assured by the Vitramon, Incorporated monolithic porcelain capacitor construction method — pioneered in 1948.

The VY 03 porcelain capacitors are ideal for .100" grid spacing printed circuits, and operate trouble-free in critical circuits and rigorous environments. Cases are .300" square (max.), .100", .150", and .200" thick. Write for Data Sheet P 16 for complete specifications.

SPECIFICATIONS:

- Capacitance Range: 4.7 pf to 1000 pf
- Temperature Range: -55°C to $+125^{\circ}\text{C}$ (with voltage derating, to 150°C)
- Temperature Coefficient: 0 ± 25 ppm/ $^{\circ}\text{C}$
- Voltage Rating: 50 VDC to 200 VDC
- Tolerances: $\pm 5\%$ and $\pm 10\%$

© Vitramon, Inc. 1966

Vitramon[®]

VITRAMON, INCORPORATED
BOX 544
BRIDGEPORT, CONN. 06601

In Greater Europe contact:
VITRAMON EUROPE
Bourne End, Bucks, England

New Instruments

internal calibration circuit, and carrier reinsertion circuit have been incorporated in these units.

Over-all weight is 13 lbs. Size is 11 x 9 $\frac{3}{4}$ x 7 in. with cover. Rycom Instruments, Inc., 9351 E. 59th St., Raytown, Mo. [366]

Vacuum film-thickness monitored in evaporation



A temperature-compensated film-thickness monitor has a sensitivity better than 10^{-9} gm/cm. The instrument measures vacuum film deposition by means of a change in the mass on the surface of a quartz crystal during the actual evaporation process. Rate measurement as well as cutoff at a given thickness is possible.

Range is ± 200 khz frequency shift. Crystal frequency is 2 Mhz to 15 Mhz in pairs. Typical loading for 10 Mhz crystals is 1% accuracy to ± 100 khz (equivalent to 0.37 to 18,500 angstroms of aluminum) and 2% accuracy to ± 200 khz (0.37 to 37,000 angstroms of aluminum).

The four models available include single-channel instruments and dual-channel monitors for alloying applications. They can be furnished with or without frequency meter display and relay cutoff circuit.

Heraeus-Engelhard Vacuum, Inc., Monroeville, Pa. [367]

Sampling recorder achieves high speed

A two-channel sampling recorder, type 1520-A, offers a sampling rate of 3 khz per channel. It achieves its high speed through a bank of 101 fixed styli, which, when energized, produce plots on electro-sensitive chart paper.

The maximum recordable fre-



quency is determined by the sampling rate and the paper speed, which can be set as fast as 10 inches per second. A vertical rise time as short as 300 μ sec can be determined from the chart.

Calibrated voltage ranges are 1 v to 500 v (linear) and 20 and 50 db (log) full-scale. The recorder prints its own coordinates as well as voltage and time scales. Overall accuracy of the recorder is $\pm 1\%$. Price is \$2,950.

General Radio Co., West Concord, Mass., 01781. [368]

Stable generator offsets input frequency

Model 155 generates a stable output frequency that is offset by a selectable amount from an input frequency of 1 Mhz. The output frequency can be set at 1 Mhz plus or minus the desired fractional frequency offset.

The range of offsets available is from 0 to 1.050 parts in 10^{-11} , 10^{-10} , 10^{-9} , 10^{-8} , 10^{-7} , or 10^{-6} . Exact offsets are provided in 50 part steps, which are phase-locked to submultiples of the 1-Mhz input frequency. Over the entire range from 0 to 1.050 parts, the offset can also be phase-locked to an external signal, or it can be furnished from an internal continuously variable oscillator at moderate accuracy and stability.

The offset generator is a single self-contained unit that is optimum for making present and future conversions from one frequency standard time scale to another. Other important applications include measurements of narrow-band filters, frequency discriminators, and frequency sources, and investigations of phase-locked frequency control systems.

This state-of-the-art instrument employs a unique method for syn-

150 db Common Mode Rejection SHIELDED TRANSFORMERS

by *JAMES*®

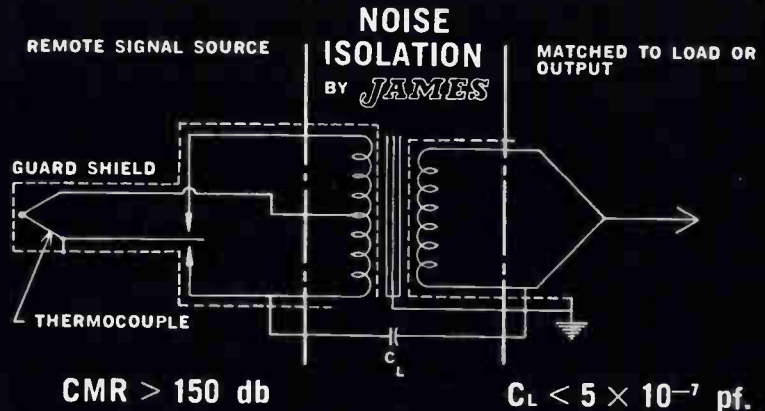

SIGNAL-GUARD TRANSFORMERS

Low and Medium Frequency (DC to 100 KC) response

Designed for use in analog acquisition and computation equipment use. Signal Guard provides isolation, voltage comparison, impedance matching, and common mode rejection.

DATA-GUARD TRANSFORMERS

High Frequency Signal (1 kc—20 mc)

Designed and shielded to isolate and terminate high frequency signal data in the form of pulses, AM and FM modulated carriers, multiplexed signals, and other low to high frequency data.

ELECTRO-GUARD TRANSFORMERS

Power (1 watt to 100 VA)

Electrostatically shielded for use in signal conditioners, bridge supplies, and Zener reference supplies to isolate circuits from noise transients and undesirable common mode voltages commonly carried on electrical power lines.

Write for complete technical details and specifications.

KEY SUPPLIER
OF COMPUTER
CONTROLS

JAMES®

ELECTRONICS INC.

4050 North Rockwell • Chicago, Illinois 60618 • 312-463-6500 • TWX 312-222-0745

collage

A random collection of fact, opinion and miscellany... some of it a blatant attempt to peddle the products and capabilities of Motorola's Military Electronics Division.

HOLY INTERFEROMETERS!
We've been one-upped by the camp followers.



While we're not trying to pass judgment on the American public's taste (or lack thereof), we *are* disturbed by the recent TV popularity of that comic-book character with the dumb-looking mask and cape. The reason is that we suspect we were responsible for the Batman revival... and we're not getting any of the credit, blame or money.

About a year ago we ran a tongue-in-cheek advertisement comparing Motorola radar to bat radar. Our point was that while bats have nice little functional echolocation systems, they can hardly compare with Motorola's airborne radar in terms of range, reliability, maintainability and versatility.

Not everyone liked our irreverent approach, and word must have gotten around in show biz circles that there was a lot of sympathy going for bat-type creatures. The rest is history. We're not sure if we have grounds for a suit, but the legal department is checking.

Anyway, if you make it to the AFCEA Exhibit this June, stop by our booth for your very own Motorola BATKIT. Or write to either of our Centers and we'll send you one, along with some other data on highly sophisticated (if not high camp) radar systems.

Continued on page 225

New Instruments

thesizing very small frequency increments with high precision and low noise content. The short-term stability is better than 1 part in 10^{10} for 1 second observation time. The construction is entirely solid state, utilizing only silicon semiconductors and integrated circuits; no electromechanical devices, such as resolvers or phase shifters, are used to generate the offset frequency.

Price is \$4,925. Delivery can be made within 60 days after receipt of order.

Parzen Research, Inc., 48 Urban Ave., Westbury, L.I., N.Y., 11590. [369]

Signal averager displays four inputs



A compact, versatile signal averager for biomedical and nuclear research work, model 1051, uses integrated circuits and incorporates features that formerly required multiple instrumentation.

The unit has four input channels, which can be displayed simultaneously on the integral oscilloscope. Each input signal is digitized to 512 points. The digitizer produces 512 numbers which are stored in magnetic-core memory and read out on the oscilloscope. The numbers directly equal the voltage applied to the digitizer in millivolts. This readout does not depend upon sweep speed.

The instrument also features a provision for automatically stopping the signal averaging after a definite number of sweeps. Sweep speeds are 50, 100, and 200 μ sec per point or factors of 10, 100, and 1,000 times these values.

Model 1051 uses a fast optical printer as a plug-in option. The

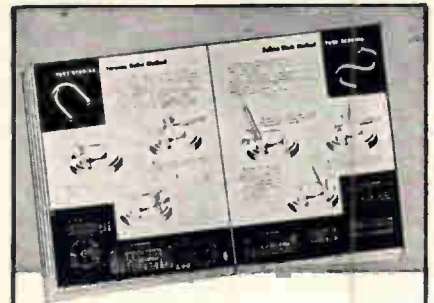

How to form it by BENDING...

Free Manual shows techniques of forming round, square, or hex bar stock... tubing... channel... angle... flat and other materials.

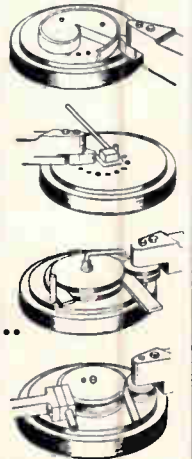

Di-Acro Hydra Power Bender

It's easy to bend a wide variety of material when you know how—profitable too because bending can simplify product design—make one curved piece do the job of two or more. Bending can improve product appearance and lower your production costs!

This 32-page illustrated manual shows how to make center eye and off center bends, circles, zero radius bends, scrolls, squares, springs and coils, loops and spirals—all with *one versatile machine*. Booklet also tells how to tool for tubular, channel, angles and other special bending needs.

ORDER YOUR FREE COPY TODAY. SEE YOUR NEAREST DISTRIBUTOR OR WRITE US.



DI-ACRO

A Division of Houdaille Industries, Inc., 436 Eighth Ave., Lake City, Minn. 55041

unit also has facilities for connecting paper tape punch or pen recorder.

Precise trigger delays controlled by a crystal oscillator allow for both post-analysis or preanalysis delays. Convenient, easy-to-read controls let researchers perform a variety of measurements with simple adjustments. Frequency histograms, interval histograms and positive and negative signal averaging measurement modes are selected with one knob.

The 45-lb unit is priced at approximately \$9,500.

Fabri-Tek, Inc., Instrument division,
P.O. Box 4218, Madison, Wis. [370]

Digital phase meter requires no warm-up

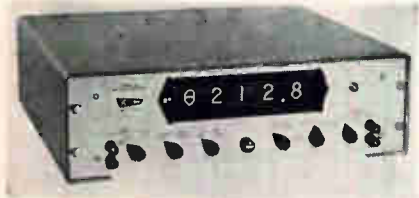

Digital phase meter 331 provides direct, four-digit angle reading from 0° to 360°, with 0.1° resolution. The precision transistorized instrument requires no warm-up or adjustments and is highly stable throughout the operating period.

The unit operates with inputs from 0.2 to 150 v in a range from 200 hz to 35 khz for half-degree accuracy (5 hz to 500 khz useful range). Provisions are made for addition of automatic ranging d-c digital voltmeter and ratiometer, a-c digital voltmeter and printer readout for all measurement parameters.

Model 331, available in either rack-mounting or table-top versions, is suited for laboratory use, quality control, production checkout and servicing of such equipment as audio amplifiers, synchros, transformers, potentiometers, servos and communications equipment.

Controls include a function switch for selecting the various basic instrument and accessory capabilities, phase level control, phase switch, sensitivity, printer switch, and power off-on.

Acton Laboratories, Inc., subsidiary of Bowmar Instrument Corp., 531 Main St., Acton, Mass. [371]

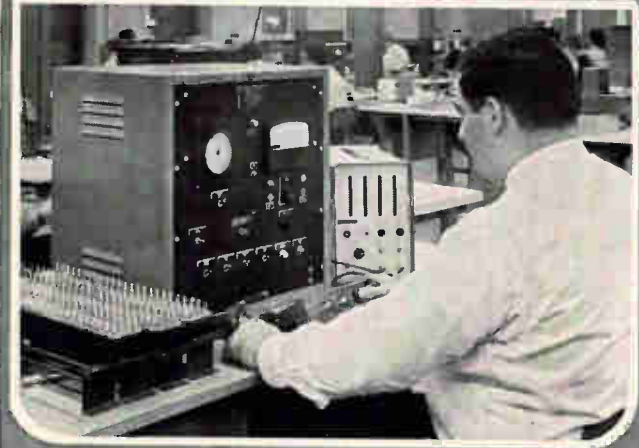
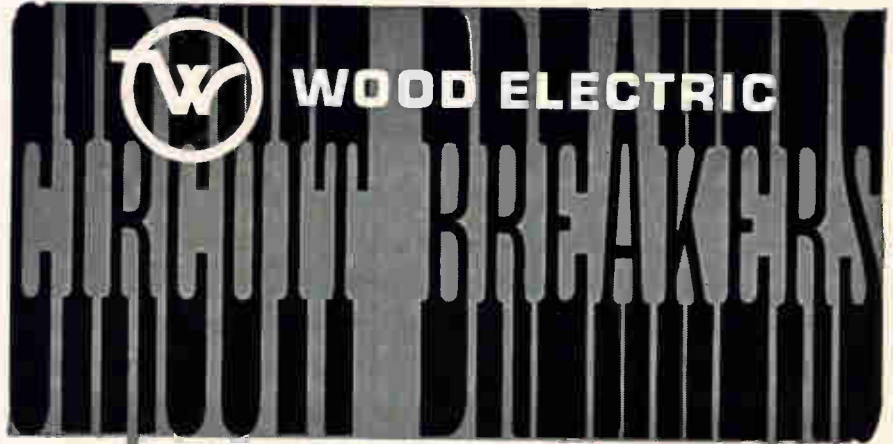

When the specs say ...
"Must trip instantly
regardless of temperature"

You can depend on us!

The above photograph shows Magnetic Circuit Breakers being calibrated to trip in less than 15 milliseconds at 120% of rated current. Other Magnetic types are adjusted to trip between 15 and 70 seconds at 125% and 150% of rated current. All Magnetic types will hold 100% of rated current indefinitely and operate at calibrated trip settings regardless of ambient temperatures.

There are other specs and other tests, lots of them, but they all have one purpose in common — to assure the most reliable performance in the industry. If it's by Wood Electric — you can depend on it!

Wood Electric also manufactures a complete line of Thermal Circuit Breakers with trip times from 0.5 to 90 seconds. Choose from a wide variety of proven commercial and military type Circuit Breakers to meet the specific needs of your application. Models are available with ratings from ½ to 50 amps . . . AC or DC . . . single pole, two pole and three pole.

Write for Circuit Breaker Catalog CB-10-65



**WOOD ELECTRIC
CORPORATION**

244 Broad St. Lynn, Massachusetts (617) 598-5313

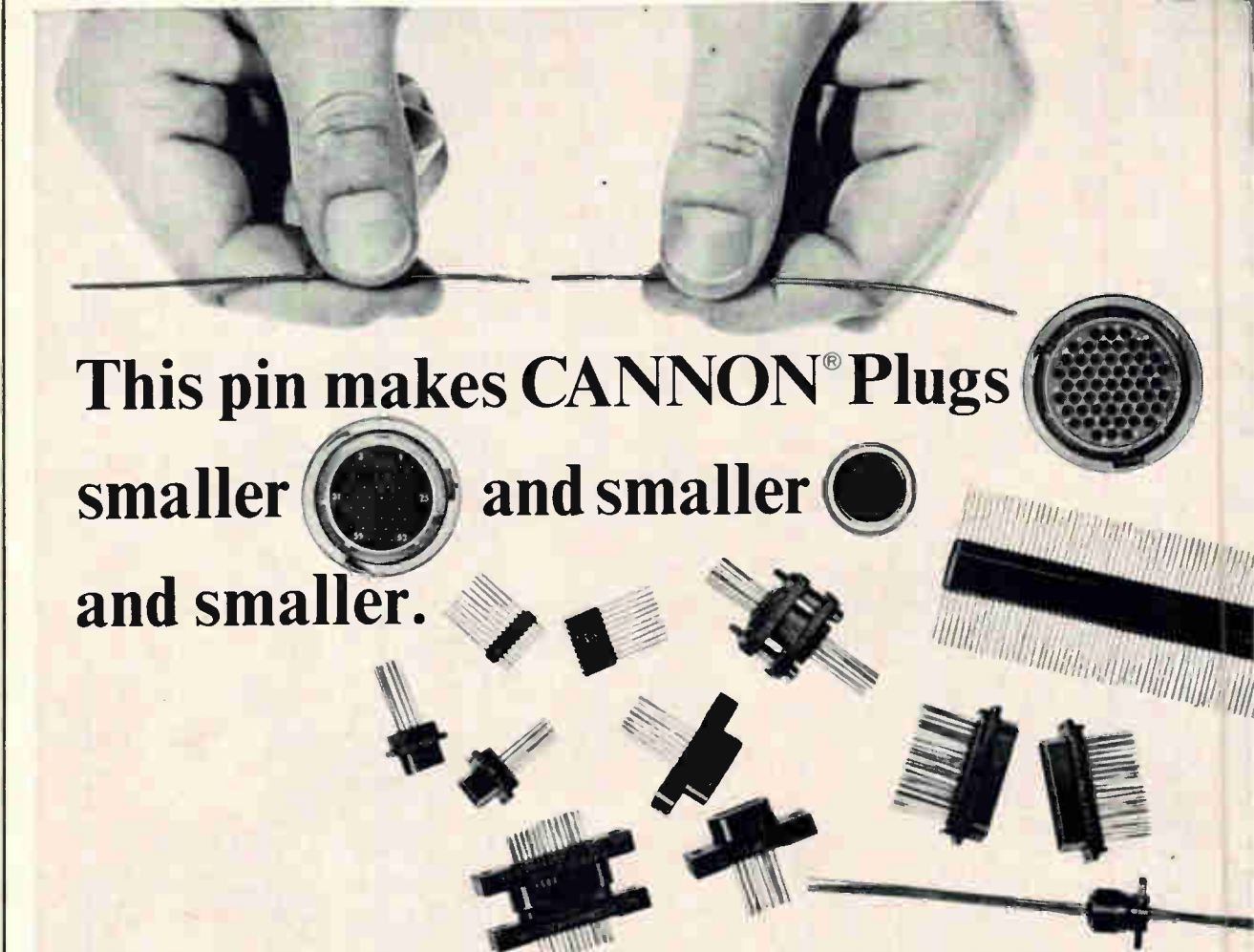

**This pin makes CANNON® Plugs
smaller and smaller
and smaller.**

Where will it all end? You tell us. Five years and 12 million MICRO-PIN® contacts since ITT Cannon Electric produced its first micro-miniature connectors, customers like you are still asking us to think smaller.

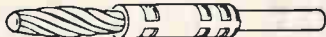

So we stepped up the contact density of our plugs, thanks to this flexible pin that's made up of seven strands of gold-plated spring copper alloy helically wound around three copper core wires. When the MICROPIN contact is engaged,

these seven spiral lines maintain constant contact and very low noise level even under extreme vibration and shock.

This is the same pin that enabled ITT Cannon Electric to pioneer in micro-miniaturization...like taking a standard 55-contact MIL-C-26482 type connector and designing the same number of contacts into the smaller, and smaller, circular plugs shown above...the CENTI-K™ (.100" centers) and the MICRO-K™ (.050" centers).

Big deal? You bet. The standard micro lines also include our 50-MIL STRIP™ connectors for low profile

applications with up to 120 contacts in a single row and up to 6" long.

Or look into our MICRO-D™ rack and panel connectors, available in seven shell sizes to accommodate 9 to 51 contacts on .050" centers.

For a complete description of micro plugs with contacts on .050", .075" and .100" centers, write for our new all-microminiature catalog. ITT Cannon Electric, 3208 Humboldt Street, Los Angeles, California 90031. A Division of International Telephone and Telegraph Corp.



CANNON ITT

TWISTED PIN CONTACTS ARE MANUFACTURED UNDER LICENSE FROM THE NEW TWIST CONNECTOR CORPORATION

FOR FAST DELIVERY CONTACT YOUR CANNON DISTRIBUTOR

ALABAMA

Nelson Radio & Supply
Company, Inc.
1541 S. Bell Line Highway
Mobile
Phone: (205) 479-1471

ARIZONA

Kimball Electronics, Inc.
3614 N. 16th St.
Phoenix 85016
Phone: (602) 264-4438

CALIFORNIA

ABC Connectors, Inc.
11639 Vanowen St.
North Hollywood
Phone: (213) 875-0665,
765-8881, 983-1738

Kierulff Electronics, Inc.
2484 Middlefield Rd.
Mountain View
Phone: (415) 968-6292

Liberty Electronics Corp.
339 S. Isis Ave.
Inglewood 1
Phone: (213) OR 8-8111

Richey Electronics, Inc.
5505 Riverton Ave.
North Hollywood 91601
Phone: (213) 761-6133
or 877-2651

San Deacor, Inc.
4618 Santa Fe St.
San Diego 92109
Phone: (714) BR 4-3131,
276-2953

K-TRONICS

5645 E. Washington Blvd.
Los Angeles 90022
Phone: (213) 685-8888

COLORADO

Waco Electronics
4975 Jackson St.
Denver 80216
Phone: (303) 322-7708

CONNECTICUT

Connector Corporation
of America
137 Hamilton St.
New Haven
Phone: (203) MA 4-0127

FLORIDA

Electro Air of Florida, Inc.
410 27th St., Orlando
Phone: (305) 241-5461

Industrial Electronics
Associates, Inc.
Riverside Dr.
P.O. Box 12444
Palm Beach Gardens
Phone: (305) 848-8686,
WX-8886

GEORGIA

Electro Air Corp.
645 Antone St., N.W.
Atlanta 30325
Phone: (404) 351-3545

ILLINOIS

Merquip Electronics, Inc.
4939 N. Elston Ave.
Chicago 30
Phone: (312) AV 2-5400

Radio Distributing
Company, Inc.
4636 W. Washington Blvd.
Chicago 60644
Phone: (312) 379-2121

INDIANA

Radio Distributing
Company
814 N. Senate Ave.
Indianapolis 6
Phone: (317) ME 7-5571

Radio Distributing Co., Inc.
1212 High St.
South Bend 46624
Phone: (219) 287-2911

KANSAS

Radio Supply Company, Inc.
115 Laura (P.O. Box 1220)
Wichita 67201
Phone: (316) AM 7-5214

LOUISIANA

Southern Radio Supply
Company, Inc.
1909 Tulane Ave.
New Orleans 16
Phone: (504) 524-2345

MARYLAND

Aercon, Inc.
15 C Street, Laurel
Phone: Baltimore
(301) 792-9067
Washington
(202) 776-5590

MASSACHUSETTS

Lafayette Industrial
Electronics
1400 Worcester St.
Natick
Phone: Boston
(617) 969-6100
Natick
(617) 875-1358

MICHIGAN

Newark-Detroit
Electronics, Inc.
20700 Hubbard Ave.
Detroit 37
Phone: (313) 548-0250

MINNESOTA

Lew Bonn Co.
(Industrial Sales Division)
1211 La Salle
Minneapolis 3
Phone: (612) 339-9461

MISSISSIPPI

Ellington Electronic
Supply, Inc.
824 South Gallatin St.
Jackson
Phone: (601) 355-0561

MISSOURI

Electronic Components
for Industry Co.
2605 S. Hanley Rd.
St. Louis 63144
Phone: (314) MI 7-5505

MONTANA

Electronic Supply Company
250 11th Street W.
Billings
Phone: (406) 252-2197

NEW MEXICO

Waco Electronics, Inc.
3223 Silver Avenue, S.E.
Albuquerque
Phone: (505) 268-2409

NEW YORK

Progress Electronics, Inc.
Engineers Hill
Plainview, L.I. 11803
Phone: (516) GE 3-1700

Schwaber Electronics
Westbury 11591
Phone: (516) ED 4-7474

Stack Industrial
Electronics, Inc.
454-B Washington St.
Box 88, Binghamton
Phone: (607) 723-6326

Summit Distributors, Inc.
915 Main St.
Buffalo 14202
Phone: (716) 884-3450

Time Electronic Sales
Community Dr.
Great Neck, L.I.
Phone: (516) HU 7-0100

NORTH CAROLINA

Kirkman Electronics, Inc.
823 South Marshall Street
Drawer K, Salem Station
Winston-Salem 27108
Phone: (919) 724-0541

OHIO

Hughes Peters, Inc.
1128 Sycamore St.
Cincinnati 45210
Phone: (513) 381-7625

Hughes Peters, Inc.
481 East 11th Ave.
Columbus 43211
Phone: (614) 294-5351

Radio Distributing
Company, Inc.
18236 So. Miles Parkway
Cleveland 44128
Phone: (216) 475-4770

OKLAHOMA

Oil Capitol
Electronics Corp.
706 S. Sheridan
Tulsa 74115
Phone: (918) TE 6-2541

Van Dusen
Aircraft Supplies, Inc.
3805 S. Meridan
Oklahoma City
Phone: (405) MU 5-5577

PENNSYLVANIA

Bercon, Inc.
359 E. Madison Ave.
Clifton Heights
Phone: (215) MA 2-2500

Philadelphia
Electronics, Inc.
1225 Vine St.
Philadelphia 19107
Phone: (215) LO 8-7444

Radio Parts Co., Inc.
6101 Penn Ave.
Pittsburgh 15206
Phone: (412) 361-4600

TENNESSEE

Lavender Radio &
TV Supply, Inc.
180 So. Cooper
Memphis
Phone: (901) BR 6-2756

TEXAS

Hall-Mark Electronics Corp.
326 Kirby St., Garland
Phone: (214) BR 6 8531

Harrison Equipment
Co., Inc.
1422 San Jacinto St.
P.O. Box 3268
Houston 77001
Phone: (713) CA 4-9131

McNicol, Inc.
3012 E. Yandell, El Paso
Phone: (915) 568-2936

Sterling Electronics, Inc.
2642 Andon Drive
P.O. Box 20069
Dallas 75220
Phone: (214) FL 1-9921,
FL 7-9131

Wholesale Electronic
Supply, Inc.
2809 Ross Ave., Dallas 1
Phone: (214) TA 4-3001

UTAH

Kimball Electronics, Inc.
350 Pierpont Ave.
Salt Lake City 1
Phone: (801) 328-2075

WASHINGTON

C & G Electronics Co.
2600 2nd Ave.
Seattle 98121
Phone: (206) MA 4-4354

New Subassemblies and Systems

One-step data scaling saves time

Direct multiplication of analog and digital signals is now possible with a one-step digital-to-analog converter developed by Adage, Inc. The device facilitates a "quick look" at analog data in instrumentation setups and greatly speeds up function generation from digital information in hybrid computing systems.

The unit operates much like a conventional digital-to-analog converter. It uses an operational amplifier to sum fixed currents generated by a reference voltage applied across resistors in parallel. The resistors are switched into and out of the circuit by bits in the digital register so that the currents presented to the adding amplifier correspond to digital information. The Adage unit allows the reference voltage to vary with an independent analog signal and thus achieves multiplication of the digital value in the register with the varying analog signal.

Heat problems with the solid state devices and sign-changing problems with diodes in the conventional converter circuit proved to be the big design problems which had to be solved to enable the reference voltage to vary over the full scale of positive or negative input voltages and accommodate a freely varying analog signal.

The converter promises to speed up and simplify the preliminary examination of incoming analog data that has to be scaled before it is meaningful. Formerly the analog data had to be converted to digital form, scaled by digital computer, and then reconverted to analog form for presentation to a scope, meter or plotter. Now the scaling can be done in one step eliminating the analog-to-digital converter

and saving precious computer time.

In hybrid computing systems where the unit is used to convert the digital output of a computer to analog form for further processing, it can perform the additional task of function generation. Several of the units can be used together to process the data, including multiple correlations. Analog computing time is saved since the unit can generate a function much faster than conventional methods which require the setting of potentiometers. In one application a function of three variables was correlated in less than 50 microseconds.

Specifications

Output	100 v
Resolution	12- or 15-bits
Updating rate	500 khz
Buffering	Single or double buffered
Size	5-in. x 8-in. cards, 8 units per std. 19-in. rack
Price	\$930 to \$1150

Adage, Inc., 1079 Commonwealth Ave., Boston, Mass. [372]

Power source offers 5 modulation modes

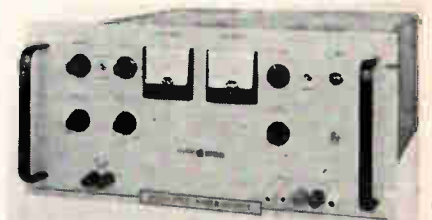

A solid state, modulated 5-amp d-c power source has output voltage adjustable from 18 to 37 v. Model CH-50 offers five modulation modes: random noise, square wave, transient, voltage spikes and external input.

Random noise modulation from 10 hz to 100 khz is provided by an internal white noise generator. Square-wave modulation from d-c to 10 khz is accomplished by internal squaring of an external sine wave input. Modulation amplitude for these two modes is adjustable from 0 to 10 v (peak-to-peak).

The transient modulation mode

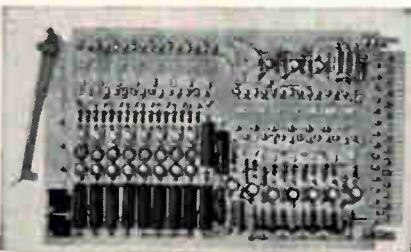

CANNON

ITT

Aeme Electric SHOULD BE YOUR BEST SOURCE

FOR REGULATED D. C. POWER SUPPLIES

If design experience and performance reliability are factors to be considered in your buying, then Acme Electric should be your first-choice source for D. C. Power Supplies. Converting alternating current to direct current is an old Acme Electric specialty. In over 35 years we have produced millions of low-voltage power supplies for battery charging and thousands of high voltage power supplies for electrostatic precipitators. We've had our hand in the "state-of-the-art" for a long time and know the limits of each component for each application.

The standard stock model "off-the-shelf" D. C. Power Supplies listed below were designed to provide reliable performance at an economical price.

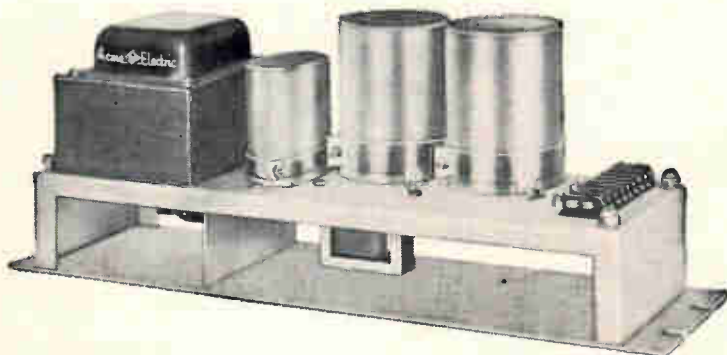

Check these features:

- ✓ All solid state components are rated for continuous duty.
- ✓ Convection cooled — no fan or other moving parts.
- ✓ May be paralleled for multiplying ampacity.
- ✓ Fast response to line and load changes.
- ✓ Line regulation, $\pm 1\%$.
- ✓ Load regulation $\pm 2\%$.
- ✓ Ripple, 1% RMS maximum.
- ✓ Operating temperature range, 0 C. to 50 C.

PARTIAL LISTING OF STOCK MODELS AVAILABLE SINGLE PHASE, 100-130 Volts; Input 50 or 60 Cycles

Catalog Number	D. C. OUTPUT			Catalog Number	D. C. OUTPUT		
	Volts	Amps	Watts		Volts	Amps	Watts
PS-47509	10	4	40	PS-1-47461	24	75	1800
PS-47623	12	3	36	PS-1-47200	24	100	2400
PS-47508	15	2	30	PS-47202	26	4	104
PS-57352	22	25	550	PS-47638	28	8	224
+PS-41422	24	2	48	PS-47712	28	25	700
+PS-41423	24	6	144	PS-57355	28	30	840
PS-57353	24	10	240	PS-57356	44	25	1100
+PS-47125	24	15	360	PS-41424	38	4	192
PS-57354	24	20	480	PS-57357	48	6	288
+PS-47173	24	25	600	PS-47519	48	10	480
PS-1-47127	24	50	1200	PS-57358	48	15	720

+ 24 volt output units of same current rating can be paralleled to multiply current capacity.

Write for catalog 175 and full list of "off-the-shelf" D. C. Power Supplies.

Aeme Electric

Engineers and Builders of...

316 WATER STREET, CUBA, NEW YORK
Canadian Representative: Polygon Services, Ltd.
50 Northline Rd., Toronto 16, Ont.

SAA-3932-3220

REGULATED POWER SUPPLIES
STATIC POWER RECTIFIERS
VOLTAGE STABILIZERS
VOLTAGE REGULATORS

New Subassemblies

offers 20 msec pulses of positive 15 or negative 30 v. Voltage spikes of 80 v (peak) and 10 μ sec duration can also be superimposed on the d-c output voltage. Transients and spikes can be inserted singularly or repeatedly at 10 pps. An external modulation source can also be accommodated, and may be sine wave, square wave, or any waveform whose harmonic content does not require frequency response in excess of 150 khz. Magnetic tape recording of power bus variations can be used as an external modulation source to determine equipment performance under actual operating conditions.

Although the primary design consideration was to provide a modulated voltage source for conducting audio susceptibility tests in accordance with certain NASA specs, the CH-50 offers the flexibility required to facilitate performance tests on flight hardware under various conditions of noise and transients on the power bus.

Other features are adjustable output impedance from 0.1 to 16 ohms, 0.5% regulation, short circuit protection, voltmeter and ammeter, rack mounting (8 $\frac{3}{4}$ in. high x 19 in. wide x 18 in. deep). Power required is 600 w maximum at 117 v 60 hz. The unit weighs 66 lbs. Chrysler Corp., Department 4770, Huntsville, Ala., 35807. [373]

Operational amplifier sells for \$19

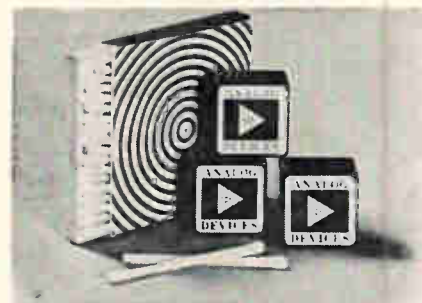

Engineers can use the model 105 d-c differential operational amplifier as a universal analog building block to avoid designing circuits from the ground up. The amplifier's advanced specifications save engineering time and actually improve

many circuits, according to the manufacturer.

External feedback components turn the amplifier into a null detector, comparator, active filter, current or voltage source, summer, ramp generator, meter driver, photocell amplifier, bridge amplifier, integrator and other devices. Ohm's law fixes feedback values, and makes circuit performance virtually independent of the operational amplifier's internal specifications.

The model 105 features excellent drift specifications of $20 \mu\text{V}/^\circ\text{C}$ and $1.5 \text{ na}/^\circ\text{C}$ over the full range of -25° to $+85^\circ\text{C}$, coupled with 1 in. square by $\frac{1}{2}$ in. high packaging. Price is \$19 in unit quantities (\$14 in 1,000 lots).

Analog Devices, Inc., 221 Fifth St., Cambridge, Mass. 02142. [374]

Broadband amplifier drives galvanometers

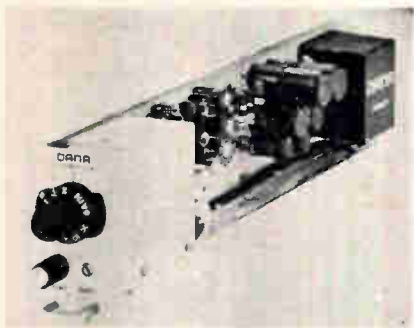

Model 2720 amplifier is designed for use in driving wideband galvanometers and other analog recording devices. A major feature is the ability to adjust the zero point of the amplifier output by $\pm 10 \text{ v}$, which is equivalent to the instrument's full-scale output. This is accomplished by turning a front-panel control to the left or right. The effect is to provide the operator with a method of electronically zeroing the galvanometer traces from the amplifier rack, rather than following the time-consuming procedure of mechanically zeroing each galvanometer mirror with a screwdriver adjustment.

The amplifier has eight gain settings, ranging from 0.1 to 20, and a vernier gain adjustment that allows each gain setting to be increased by a factor of 2.5 to 1. The result is a continuously adjust-

BE THE FIRST TO SEE THE NEW STEREOZOOM[®] 7*

NEP/CON SHOW COLISEUM, N. Y. C. BOOTH 229 / JUNE 21-23

Bausch & Lomb has created a superlative new series of three-dimensional microscopes. They're designed with the increased demands of the electronics industry as a foremost consideration. New advances in microcircuitry and solid-state miniaturization require a more advanced stereomicroscope. Stereozoom 7 is it!

Magnification, 7 to 1 ratio—higher than ever before available in a 3-D zoom microscope.

Resolution—so good you can't believe it until you see it. Prove it to your complete satisfaction at the B&L Booth (No. 229).

If you can't be at the show, write Bausch & Lomb, 61430 Bausch Street, Rochester, New York 14602 for your copy of Stereozoom 7 Advance Data Kit.

*Available for delivery, Fall 1966

BAUSCH & LOMB 

Smallest available chassis mount resistor offers a new LOW in miniaturization, a new HIGH in reliability.



Style 3105M expands the usefulness of Sage's long established line of Type M precision power resistors. Body size is considerably below that of RE65, the smallest MIL-R-18546C style. MIL performance requirements are fully met or exceeded.

PRECISION and **STABILITY** are synonymous with the Sage trademark. Style 3105M, like all Sage resistors, is typically made to 1% or closer tolerance. TC ± 20 ppm/ $^{\circ}$ C. Standard resistance range .05 Ω to 20,000 Ω .

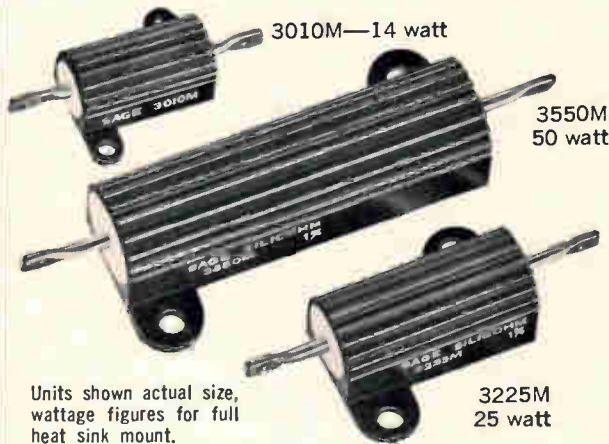

Units shown actual size, wattage figures for full heat sink mount.

Check these outstanding Sage features:

- Exclusive IMPERVOHM[®] 350 $^{\circ}$ C silicone encapsulation is the only insulating material between winding and housing. It provides superior thermal conductivity as well as unmatched endurance against applied voltage, moisture, temperature shock and prolonged high temperature operation.
- Special high thermal conductivity ceramic cores.
- Welded construction throughout.
- Black anodized aluminum housing is finned for increased heat radiation.

Write for catalog data sheet



SAGE

SAGE ELECTRONICS CORP.
BOX 3926 • ROCHESTER, N. Y. 14610

New Subassemblies

able gain that spans the range from 0.1 to 50. Model 2720 may therefore be used as a universal instrument for both low-level transducers. In general, gains from 2 to 50 would be used for medium and low-level transducers, such as thermocouples and strain gages, while gain settings from 0.1 to 1.0 would be applicable to high-level signals, such as those generated by discriminators and pots.

Circuitry includes terminals for mounting resistors to match the amplifier and cable resistance with the required galvanometer damping resistance. The output impedance of the model 2720 itself is both low and stable across a broad frequency range. At 10 khz, the output impedance is less than 5 ohms.

A three-terminal, single-ended amplifier, the unit has a high degree of isolation between any terminal and the amplifier case or power ground. The isolation amounts to over 100 megohms in parallel with less than 500 picofarads.

Model 2720 is a broadband instrument, with a small-signal 3-db point or better than 50 khz. Phase shift introduced by the amplifier is less than 1 degree from d-c to 400 hz. Step-function settling time is less than 50 μ sec and the recovery time from a 500% overload is less than 200 μ sec.

Up to eight amplifiers may be mounted in a single rack enclosure, 5 $\frac{1}{4}$ in. high. The enclosures supplied by the manufacturer are equipped with individual printed-circuit connectors.

Dana Laboratories, Inc., Irvine, Calif., 92664. [375]

Versatile converter for industrial use

Model PI-600 is a frequency to d-c converter designed for a wide variety of industrial applications. For example, in flow rate or speed monitoring and control, this one unit provides both regulated voltage and current outputs over a wide range of input frequencies.

Full scale input frequencies are

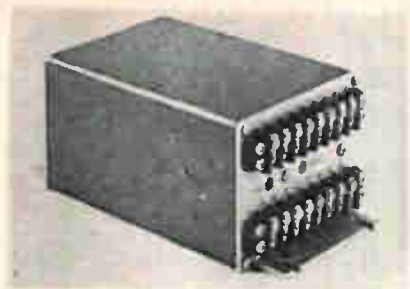

adjustable from 250 to 3,000 hz. The user may easily modify it to provide higher or lower frequency ranges.

Three full-scale outputs, selected by terminal strip jumpers, are provided: 0 to 5 v, 1 to 5 ma, and 4 to 20 ma. Input of the model PI-600 is transformer coupled and the unit will accept sine wave, square wave, or pulses. It also features high common mode rejection and sensitivity of 0.01 v rms. Linearity is better than $\pm 0.05\%$.

Components are housed in a flange-mounted, rugged case which also permits easy access for modification and servicing. Other features include high stability, low ripple, and excellent linearity.

The frequency to d-c converter is priced at \$350. Delivery is three to four weeks after receipt of order. Anadex Instruments Inc., 7833 Haskell Ave., Van Nuys, Calif. [376]

Servo amplifier delivers 3.5 to 10 w



A 60-hz (cycles per second) transistorized servo amplifier can deliver output power ranging from 3.5 to 10 watts. Identified as C70 3302 001, the unit delivers 3.5 to 7 watts of power at a maximum temperature of $+125^{\circ}\text{C}$. and up to 10 watts when the operating base temperature does not exceed 100°C . Voltage gain depends on the load, varying from 2,500 at 3.5 w to 970 at 10 w.

Designed to drive 60-hz, 36-v



PERFORMANCE AT VARIOUS VOLTAGES FOR CONST.
PERFORMANCE OF DOUBLE SQUIRREL CAGE MOTOR
1 READ, R3, R4, XDIF, VTHEV, FREQ
SLIP = .025
3 P12 = (R3 * R4) * (R3 + R4) + (R3 * XDIF ** 2) * (SLIP ** 2)
4 DR12 = (R3 + R4) ** 2 + (XDIF ** 2) * SLIP ** 2
5 R12 = P12 / DR12
6 TX12 = (R3 ** 2) * XDIF
7 DX12 = (R3 + R4) ** 2 + (XDIF ** 2) * SLIP ** 2
8 X12 = TX12 / DX12
9 RSUM2 = 7.08 + R12
10 R20VS = RSUM2 / SLIP
11 CT = 20VS + 48

Our Computers talk a strange language ... but you can bet we understand it!

This cryptic computer readout tells part of the story of why McLean makes the finest cooling blowers you can buy. It is one of the means we use to arrive at a motor design that mates to perfection with a specific blower application.

To do the job honestly requires much engineering, and complex calculations. But McLean's versatile computers can evaluate a nearly-ideal motor design, instantly, accurately — then tirelessly alter it until the strictest tolerances are achieved.

The results are motor-blower units of the utmost reliability and efficiency — units you can count on to save time, trouble, and money.

The Finest Motors and Cooling Equipment for Electronics

McLean's engineering judgment is based on that which is best for you . . . and not what is available!

SEND FOR
NEW 1966
44-PAGE
CATALOG



**McLEAN ENGINEERING
LABORATORIES**

P.O. Box 228, Princeton, N. J. 08540
Phone 609-799-0100 • TWX 609-799-0245
TELEX 083-4345



LAPP GAS FILLED CAPACITORS

ARE DESIGNED FOR

HIGH
VOLTAGE

HIGH
CURRENT

HIGH
CAPACITANCE

APPLICATIONS



These uniquely designed Lapp Gas-Filled Capacitors are completely unaffected by atmospheric or dust conditions. They are precision built and of extra strong construction to assure years of accurate, trouble-free operation. ■ Lapp Gas-Filled Capacitors are available in either fixed or variable models. All are equipped with an external safety gap to protect against internal flashover on excess voltage peaks. Capacitance available up to 30,000 mmf, safety gap settings up to 85 kv peak and current ratings up to 400 amps at 1 mc. ■ Write for Bulletin 302 . . . get our complete Gas-Filled Capacitor story. Lapp Insulator Co., Inc., Radio Specialties Division, 246 Sumner St., LeRoy, N.Y. 14482.

New Subassemblies

servomotors having control phase impedances between 130 ohms and 372 ohms, the amplifier exhibits 0° phase shift and a gain stability of ± 3 db.

Only 3.8 cu in. in volume, the unit weighs 5.2 oz, requires an input signal of 30 v maximum, 28 v d-c $\pm 10\%$ of input power at 300 ma for a 3.5-w motor load, ranging up to 800 ma for a 10-w load. A shunt resistor of proper value is used to achieve the appropriate gain corresponding to the motor load.

General Precision Inc., Aerospace Group, 1150 McBride Ave., Little Falls, N.J., 07424. [377]

Operational amplifier is chopper stabilized



A solid state, chopper stabilized operational amplifier is announced. Designated model 140B-HV, its output is ± 150 v peak at 5 ma or ± 100 v peak at 50 ma. The higher voltage is suitable for 100 v rms digital-to-analog converters. The higher voltage results from a change in the output components and circuit design of the company's 140B low-cost, 100-v operational amplifier.

The new amplifier uses what is said to be uniquely compensated field-effect transistor chopper circuitry with internal drive for 2 $\mu\text{V}/^\circ\text{C}$ drift. Zero offset voltage adjustment is built in. Additional features are 10^7 open loop d-c gain and 0.5 Mhz (megacycle per second) gain-bandwidth product.

Price is \$165 in quantities of 1 to 9, and availability is immediate. Zeltex, Inc., 1000 Chalomar Road, Concord, Calif. [378]

Electronic multiplier in a tiny package

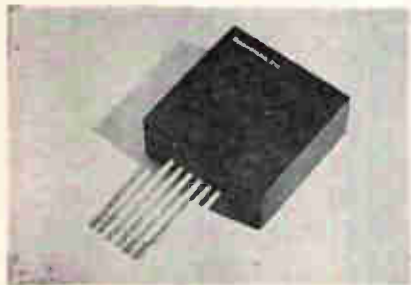

A true electronic multiplier is available in a microcircuit package measuring only 1¼ in. x 1¼ in. x 0.250 in. The device is capable of accepting two electronic signals, performing a multiplication, and providing an output signal that conforms to the mathematical product of the two signals. The multiplier will operate in all four quadrants, and can accommodate input signal frequencies from d-c to 100 khz (kilocycles per second). Linearity is 0.1% and accuracy is 0.5% over a temperature range from -40° to +100°C.

The multiplier has wide application in analog computers, system simulation, guidance systems, control systems, and modulation systems. It may be employed as a squaring circuit, square root function generator, and divider.

Spacelabs, Inc., 15521 Lanark St., Van Nuys, Calif. [379]

Operational amplifier saves circuitry space



Model 115D is a differential operational amplifier of small modular construction for general purpose applications where economy is a major consideration. Designed as an amplifying black-box component for p-c cards with 0.1-in. hole spacing, it affords the designer versatility, convenience, and space sav-

WE'VE TRIMMED AEROSPACE RELAY SIZES again!

And broadened the world's largest relay line ... again!

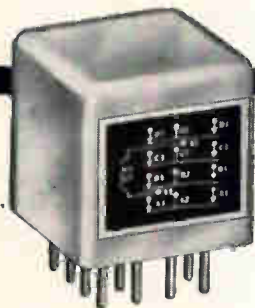

NEW! EXCLUSIVE! 1-INCH CUBE, 10 AMP RELAY

Extra compact, high-reliability 4PDT relay. Assembled under rigid white room conditions. Designed to MIL-R-6106E. Rated for 50,000 operations, 10 amps resistive at 28v dc or 115/200v 400 cycles. Weight only 3.2 oz. Type FCM-410.

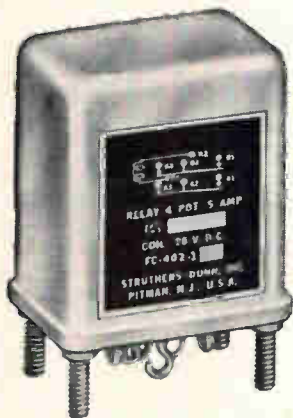

NEW! COMPACT! 2PDT, 10 AMP AC, DC COILS

Hermetically-sealed. Rated for 10 amp resistive loads at 28v dc, or 115v 400 cycles. Designed to MS 25273. Type FC-402-1 with d-c coil nominally rated at 28v, 0.25 amp. Type FC-402-2 with self-contained rectifier for a-c operation at 115v, 400 cycles, 0.07 amp.

**PLUS . . . a full line of other
miniaturized relays, including . . .**



FC-1 series. DPDT.
2 amp. MIL-R-5757D



FC-400 series. 4PDT.
10 amp. MIL-R-6106E
FC-404 series. 4PDT.
5 amp. MIL-R-6106E
FC-406 series. 6PDT.
5 amp. MIL-R-6106E



FC-4-250 & FC-6-250.
4 & 6PDT. 2 amp.
MIL-R-5757/7&/1



FC-215 series. DPDT.
10 amp. MIL-R-5757D

STRUTHERS-DUNN, Inc.

Pitman, New Jersey 08071

tel: 609-589-7500

twx: 609-589-1548



SALES ENGINEERING OFFICES IN: Albuquerque • Atlanta • Belmont, Calif. • Birmingham, Ala. • Boston
Buffalo • Cedar Rapids • Charlotte • Cincinnati • Clearwater, Fla. • Cleveland • Clifton • Dallas • Encino
Englewood • Glen Ellyn, Ill. • Houston • Kansas City • Las Vegas • Memphis • New York • Phoenix • Pitts-
burgh • St. Louis • St. Paul • Salt Lake City • Richardson, Tex. • Seattle • Southfield • Towson, Md.
Wichita • Wilmette. Canadian Licensee: Renfrew Electric Co., Ltd., Toronto. Export Dept.: 1505 Race St.,
Philadelphia, Pennsylvania 19102, U.S.A.

For precise temperature testing from -300°F to $+525^{\circ}\text{F}$

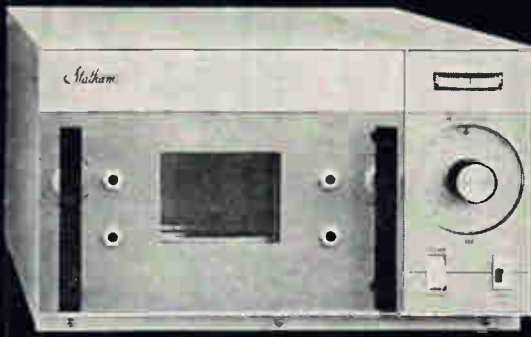

**STATHAM MODELS SD6 AND SD3
ARE 700 CU. IN. CAPACITY CHAMBERS
FEATURING $\pm\frac{1}{4}^{\circ}\text{F}$ CONTROL ACCURACY**

Designed for precise temperature testing of electronic components, Statham Models SD6 and SD3 chambers feature true proportional control of heater power by all solid-state circuitry.

This new generation of test chambers eliminates the conventional heater power relay, prevents cycling about the control point, and substantially *reduces* RFI noise.

The controller maintains a set-point temperature within $.01^{\circ}\text{F}$ per $^{\circ}\text{F}$ ambient. An improved controller design provides excellent temperature uniformity with gradients of $\pm 1.3^{\circ}\text{F}$ at 300°F .

SUPERIOR TEMPERATURE CONTROL



24 Inch Dial Control

Models SD6 and SD3 feature 24 linear inches of calibrated set-point scale. Temperature readout is obtained by a deviation meter calibrated in one-degree increments. This expanded scale approach provides a level of accuracy and readability not attainable in conventional chambers.

Optional Push-Button Control



Frequently repeated temperature settings can be made faster and more accurately with Statham's *push-button* temperature selection control. The buttons, which may be set at any desired temperature, provide precise repeatability.

Cycle Time Controller



Statham cycle time controllers permit programming the chambers in any required sequence of hot-ambient-cold-ambient, etc.



Statham Instruments, Inc.
Environmental Products Division
2221 Statham Blvd., Oxnard, Calif.
HUnter 6-8386 (Area Code 805)

Write for Statham's new 12-page Temperature Test Chamber Brochure.

New Subassemblies

ing in subsystem circuitry.

Output is $\pm 10\text{ v}$ at 4 ma ; bandwidth (unity gain), 1 Mhz ; voltage drift, $25\ \mu\text{v}/^{\circ}\text{C}$; current drift, $5\text{ nanoamps}/^{\circ}\text{C}$; input noise (narrow band), $10\ \mu\text{v}$ peak; package size, $1.125\text{ in.} \times 1.125\text{ in.} \times 0.625\text{ in.}$ (molded epoxy). Cost for quantities from 1 to 9 is $\$19$ each and availability is immediate.

Zeltex, Inc., 1000 Chalomar Rd., Concord, Calif. [380]

**Encoding systems
with added modules**

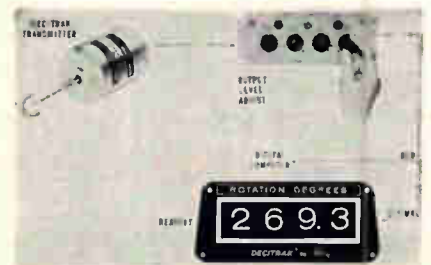

Modules added to the Decittrak encoding systems offer the choice of digital electrical outputs from -28 v d-c to $+28\text{ v d-c}$. Voltages of any polarity are available in either the on or off state.

Standard Decittrak systems are used to digitize electrical and mechanical analogs for remote digital display. The new modules allow digital signals from the display system to be precisely interfaced with most digital computers. The variety of voltage and current levels also facilitates the use of commercially available displays and printers without costly conversion equipment.

System input is mechanical or electrical analog; system output, 4 or 6-digit illuminated display plus simultaneous BCD output. Code format is parallel and absolute.

The Theta Instrument Corp., Saddle Brook, N.J., 07663. [381]

**Erection amplifiers
supply gyro inputs**

Series C70 3184 transistorized erection amplifiers supply the T4101 vertical gyros with all necessary inputs and act as junction boxes



for all gyro interconnections. Modular construction simplifies modifications for most system applications. The C70 3184 001 operates from 115 v rms, 3 phase, 400 hz, while C70 3184 003 operates from 115 v rms, single phase, 400 hz. Both require 28 v d-c for relay excitation. The amplifiers perform four functions.

They close the loop between vertical sensing elements and control phases of pitch and roll torquers through adjustable-gain power amplifiers.

They supply 400 hz excitation voltages for vertical sensing elements, synchros, and torquer fixed phases.

They provide normal and time-delay sequencing circuits for initial, normal, and fast erection in addition to a manual erection mode of operation.

They provide for roll erection cut-out when used with a rate switch.

General Precision Inc., Aerospace Group, 1150 McBride Ave., Little Falls, N.J. 07424. [382]

Data channel features speed, versatility

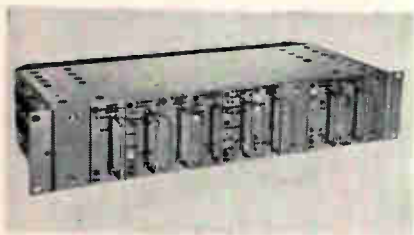

A data channel has been designed to meet the demand for high speed data transmission as well as for transmission at moderate data rates. Designated model 2056, this frequency shift keying channel is capable of full and half duplex circuit operation and will interface with a wide range of data communication equipment, including

How do you get a 1,200-ft. satellite antenna on an itty-bitty spool?

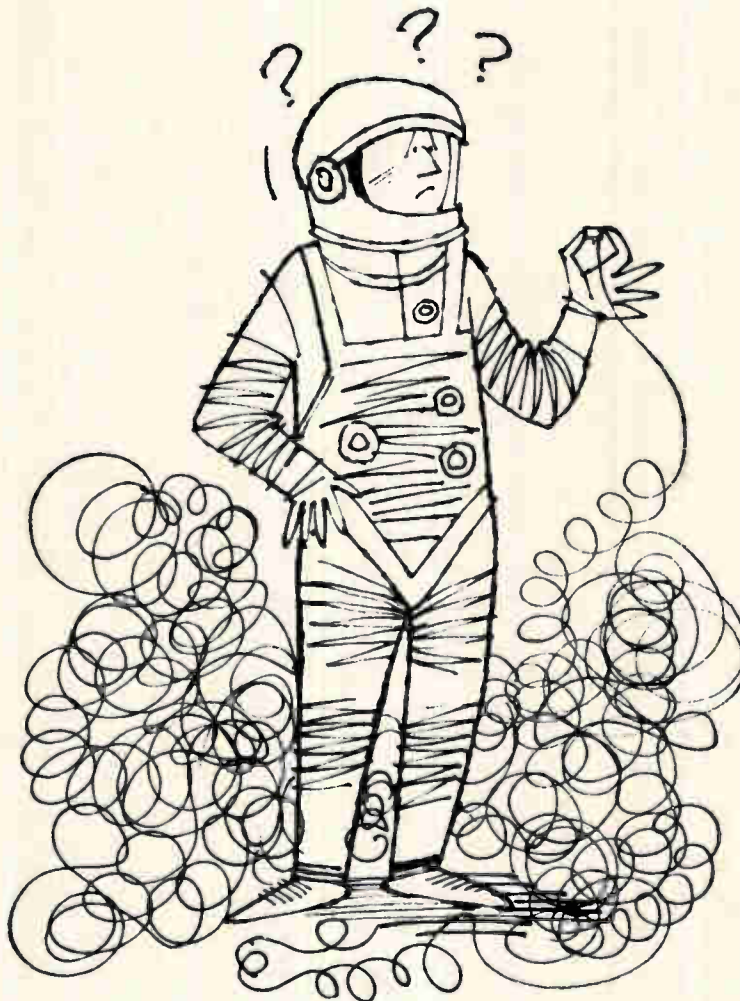

To provide improved radio communications with space satellites, a 1,200-ft. antenna is stored on a tiny reel in the capsule. The antenna itself is a strip of precision-rolled beryllium copper 2" wide by .002" thick. It is heat treated, then uniquely formed to become a self-supporting tube antenna when unreeled.

This precision-rolled, heat-treated strip is supplied by Hamilton Precision Metals—a prime source of rolled or drawn metals made to rigid tolerances in mass production quantities. With its expanded facilities, Hamilton is now producing 7 proprietary metals, 112 commercial alloys and 12 pure metals—in quantity.

Check with Hamilton Precision Metals on your electronic metals requirements for precision strip, foil or wire. Write today for a completely new brochure giving full information about our capabilities as well as detailed properties of over 100 metals.

HAMILTON PRECISION METALS

division of Hamilton Watch Company ■ Lancaster, Pa. 17604

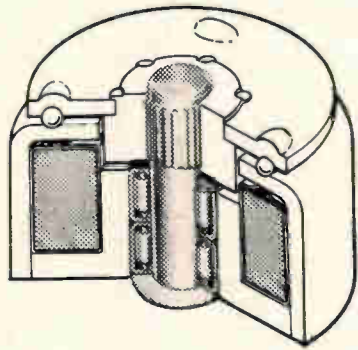

100 MILLION ACTUATIONS

This is a Ledex Endurance Engineered rotary solenoid.

Life expectancy without any field relubrication is 50 million cycles—100 million when you apply our Lube 2 every 10 million cycles.

A precision needle bearing, plus special materials, heat treatments and surface finishes make the difference.

Six sizes are available, with torque output from 12 to 445 ounce-inches.



Rotary strokes up to 45°

Available in left or right hand stroke

Snap action in milliseconds, with spring return to starting position

High torque to size rotary motion and high thrust-to-size piston action

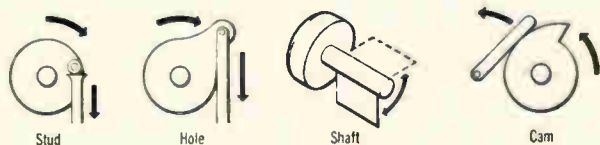

Stud

Hole

Shaft

Cam

Drive linkage can be designed to suit your application

Ledex rotary solenoids are used to step, turn, pull, push, index, hammer, punch or trigger—wherever there's a need for fast, remote action.

Have an actuating problem? Longlife requirements? We'll design a solution for you. Write or phone 513-224-9891. Let's talk it over.



32-page catalog describes endurance engineered, standard and stock model rotary solenoids. Ask for C-264.



LEDEX INC., 123 WEBSTER STREET, DAYTON, OHIO 45402
Designers & Manufacturers Electronic & Electro-Mechanical Components
& Remote Control Switching Systems

New Subassemblies

those designed to EIA RS-232-A standards.

The reliable, nonsynchronous 2056 series is capable of up to 2,000 bit speed operation in a voice band. Higher rates are possible over wide-band facilities. The transmission media can, however, restrict the speed of operation.

A wide choice of channels with different carrier frequencies and bandwidths is available. The series offers three frequency channels, used by some supervisory control systems for sending additional data over the same channel. The transmitter includes an optional circuit to turn the carrier off or on.

Easily maintained through the use of plug-in modules, the data channel features high quality components, resulting in a predicted mean-time-between-failure of 50,000 hours for a typical transceiver.

Silicon transistors have been used in most of the circuits of the channel and tantalum capacitors are used throughout.

Radio Frequency Laboratories, Inc., Boonton, N.J. [383]

Direct-coupled silicon amplifiers

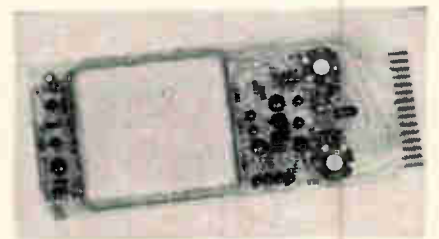

Two d-c differential amplifiers are announced. Model AD-10 output is 10 v, 100 ma; model AD-20 output is 20 v, 50 ma. Both are open-loop amplifiers suitable for connection in operational or potentiometric circuits, etc. D-c gain is 2×10^8 . Unity-gain, crossover frequency is 5 Mhz, for small signals; the output slewing limit is 20 v per μsec . Input offsets are 1 μv per $^\circ\text{C}$, and 2 pico-amperes.

These all-silicon amplifiers are direct-coupled, free of chopper noise and intermodulation distortion. They have high input impedance even at high frequencies, and

recover quickly from overload. They are stable, even with 100% feedback.

Unit price is \$200; availability, stock to 40 days.

Newport Laboratories, Inc., P.O. Box 2087, Newport Beach, Calif., [384]

Versatile, wide-range gate generator



The GG200 gate generator provides six outputs, including system logic and gate signals and their complements. Delayed positive and negative trigger signals at the end of each gating cycle permit use as a delay generator.

Timing is independent of rate. Gating time range is extended down to 100 nsec and up to 11 sec in eight overlapping ranges. The timing cycle may be started and stopped by ± 5 v to ± 50 v pulses as well as logic signals. Output gate and logic signals may be vetoed by logic signals. All outputs drive 50-ohm loads and are fully protected from overload damage.

EG&G, Inc., 35 Congress St., Salem, Mass., 01971 [385]

Current regulators are precision devices

The CR series of precision constant current regulators produce highly stable currents to excite strain gages, resistance thermometers, potentiometers, timing capacitors, and chemical time integrators. Models are available with temperature coefficients from 0.002% to 0.03 per°C, nominal outputs of 1, 5, or 10 ma, and retain tolerances from -10° to $+85^\circ$ C.

Units can be powered in parallel

KLIXON
PRECISION CONTROLS

New TI cooling effect detector revolutionizes overheat protection of forced-air-cooled equipment!

KLIXON® 2ST Cooling Effect Detectors combine unprecedented sensitivity, reliability, simplicity and economy to prevent harmful overheating in computers, radar and microwave systems, copying machines, film projectors and other fan-cooled equipment. They completely eliminate the need for vane switches and thermostats.

Reliable solid-state sensing makes the difference! The sensor is a self-heated NTC (negative temperature coefficient) resistor. Mounted in the air stream and connected in series with a special rating of the KLIXON 4MC magnetic circuit breaker, it monitors the cooling capacity of the air stream. Loss of cooling effect as a result of clogged inlets, fan failure, air conditioner loss, or any combination of these causes a sharp drop in sensor resistance. The resultant increased current will trip the circuit breaker.

Unlike conventional thermistors, KLIXON 2ST Detectors sense over their entire surface, instead of only one point. This simplifies installation and mounting. Moreover, they can handle directly a current large enough to actuate a circuit breaker without intermediate amplification. They can be designed to operate at any voltage between 3 and 24 v-dc/60 cycle ac.

Bulletin PRET-16 gives you all the facts you need to evaluate these exclusive TI developments. Write for your copy today.



METALS & CONTROLS INC.
5006 FOREST ST., ATTLEBORO, MASS.
A CORPORATE DIVISION OF
TEXAS INSTRUMENTS
INCORPORATED

Another First by Weston-Rotek:
Wideband True RMS To DC Converter



True RMS to 0.05% from your DVM

Model PR840

For use with existing DVM's and other precision dc measuring instruments, this unit provides accurate, reliable and automatic true rms measurements of sinusoids, square, triangular and other complex wave forms. It eliminates errors caused by distortion in "average computing" precision voltmeters.

Features: .05% Accuracy 10 volts dc full scale
.01% Repeatability output
30 mv to 1000 volts 7:1 Crest Factor
full scale) All Silicon
10 Hz to 100 KHz Guarded and Isolated

Ask for Bulletin 840. Weston Instruments, Inc., Rotek
Division, 11 Galen Street, Watertown, Mass. 02172

WESTON®

prime source for precision... since 1888

Circle 218 on reader service card

To order reprints: Fill in, cut out coupon below, insert in envelope and mail to: **Electronics Reprint Dept., 330 W. 42nd Street, New York, N.Y. 10036**

Reprint order form

For listing of reprints available see the **Reader Service Card**.

Communications Satellites Part I

Send me reprints of Key no R-89 at 75¢ each.

For reprints of previous special reports fill in below:

Send me reprints of Key No.(s) @ ¢ each.

(For prices, see Reader Service Card)

Name

Number of street

City, State, Zip Code

New Subassemblies

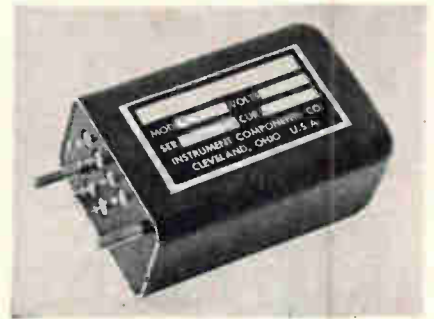

from unregulated 25 to 35 v d-c power sources for use in multichannel instrument or control systems. Regulation is in the order of 0.002% against line and load. Volume is less than 8 cubic in. and two regulators are supplied in each package. Prices are \$110 to \$150 depending on temperature coefficient, and availability is stock to 4 weeks. Instrument Components Co., Lyndhurst, Ohio, 44124. [386]

A-c line conditioner offers fast response

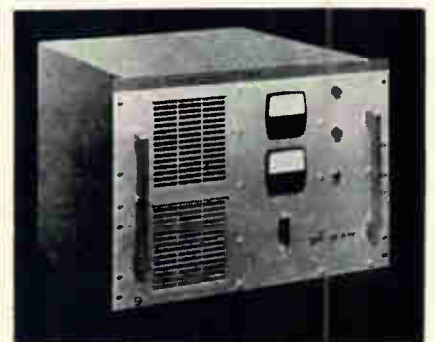

Series 3000 a-c line conditioner completely isolates sensitive electronic equipment from all forms of power-line disturbance. With response time of less than 50 μ sec, input/output isolation of 100 db, maximum output distortion of 0.25% and regulation of $\pm 0.05\%$, these conditioners provide 2½ kva of pure, transient-free, precisely regulated a-c power.

Design is silicon solid state and to instrumentation standards. Models are available to operate at 47 to 53, 57 to 63, and 380 to 420 hz, and 115 v or 230 v power. Elgar Corp., 5267 Linda Vista Road, San Diego, Calif., 92110. [387]

Lawrence Radiation Laboratory

The continuing emphasis on basic and applied nuclear research programs at Lawrence has created a number of outstanding career opportunities.

ELECTRONICS ENGINEERS

R&D ASSIGNMENTS AVAILABLE IN:

- Systems Engineering
- Microwave
- Digital Computers
- Instrumentation
- Solid State Circuit Design
- Components
- Measurement Standards

APPLIED RESEARCH PROGRAMS

- PLOWSHARE—peaceful applications of nuclear explosives
- BIO-MEDICAL—radiation effects on the biosphere
- SHERWOOD—controlled thermonuclear fusion
- WHITNEY—nuclear weapons for national defense
- SPACE REACTOR—reactors for power in space

For further information about our programs and a listing of current openings, write:
B. R. Graf, Personnel Department



Lawrence Radiation Laboratory

UNIVERSITY of CALIFORNIA

P.O. Box 808 18-66
Livermore, California 94550
(415) 447-1100

An Equal Opportunity Employer
U.S. Citizenship Required

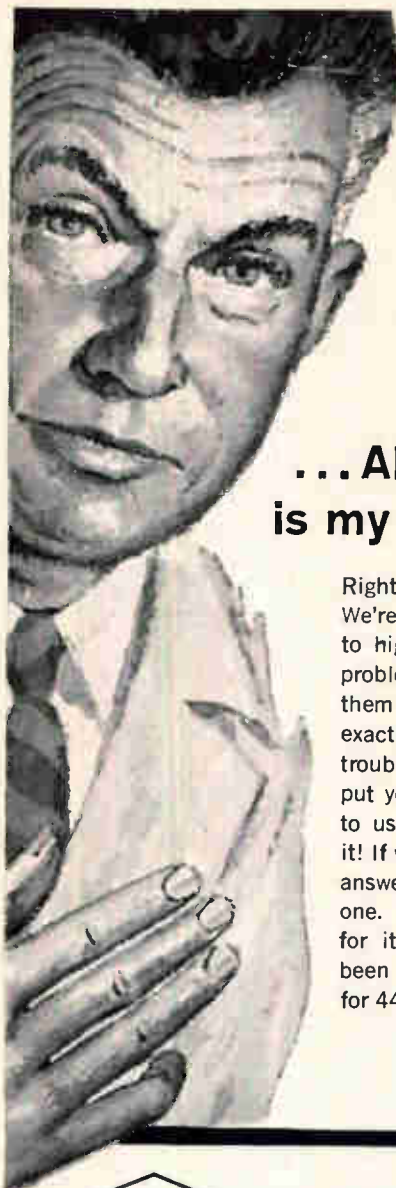

... All you want
is my **PROBLEM?**

Right . . . just the problem! We're loaded with *solutions* to high temperature wiring problems. Quite likely one of them matches your problem exactly. So save yourself the trouble we've already had . . . put your wiring problem up to us the minute you spot it! If we don't have the right answer on tap, we'll find one. You can take our word for it . . . because we've been insulation specialists for 44 years.



HIGH TEMPERATURE WIRE AND CABLE

A wide variety of standard leadwire constructions, insulated with Teflon (TFE and FEP) or silicone rubber, are available for applications up to 1000 V. and 200°C. FLEXLEAD can also be supplied in many special wire and cable constructions to meet your specific requirements. These may combine insulations (Teflon, silicone rubber, fiberglass, nylon-shielding, fillers, liners, and jacket materials), and provide single, twisted pair or multiple conductors . . . for any temperature from -90°C to 260°C. The line also includes both standard and special RG/U coaxial cables, fused twisted pair, and MB bondable Teflon wire. Ask for a FLEXLEAD Selector. Write . . .

L. FRANK MARKEL & SONS
SINCE 1922

Norristown, Pa.

215-272-8960

INSULATING TUBINGS & SLEEVINGS • HIGH TEMPERATURE WIRE & CABLE

TRON SUB-MINIATURE PIGTAIL FUSES

BODY SIZE ONLY
.145 x .300 INCHES

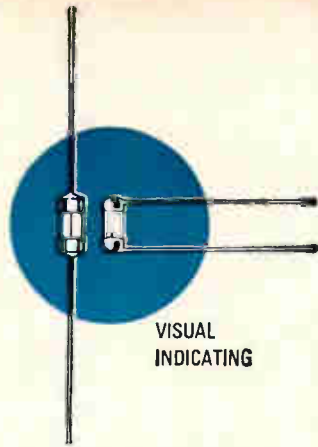

For use on miniaturized devices, or on gigantic space tight multi-circuit electronic devices.

Glass tube construction permits visual inspection of element.

Smallest fuses available with wide ampere range. Twenty-three ampere sizes from 1/100 thru 15 amps.

Hermetically sealed for potting without danger of sealing material affecting operation. Extremely high resistance to shock or vibration. Operate without exterior venting.

Tell us what you need or . . .

Write for Buss Bulletin SFB

INSIST ON **BUSS**
QUALITY

BUSSMANN MFG. DIVISION McGraw-Edison Co., St. Louis, Mo. 63107
Circle 221 on reader service card

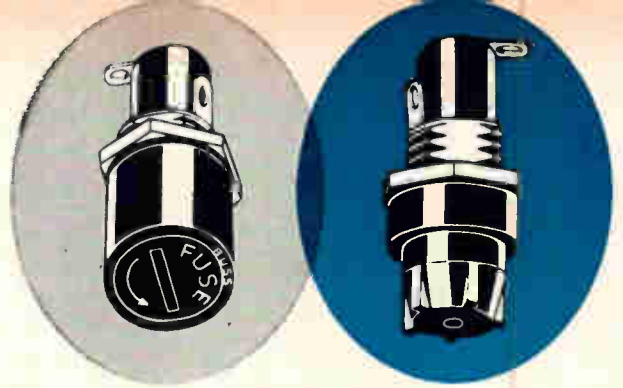

Screw type slotted knob that is recessed in holder body and requires use of screwdriver to remove or insert it.

Screw type knob designed for easy gripping, even with gloves. Has a "break-away" test prod hole in knob.

BUSS Space Saver Panel Mounted Fuseholders

Fuseholder only 1 3/8 inches long, extends just 3/32 inch behind front of panel Takes 1/4 x 1 1/4 inch fuses. Holder rated at 15 ampere for any voltage up to 250.

Military type available to meet all requirements of MIL-F-19207A.

Write for BUSS Bulletin SFH-10

INSIST ON **BUSS**
QUALITY

BUSSMANN MFG. DIVISION, McGraw-Edison Co., St. Louis, Mo. 63107
Circle 221 on reader service card

BUSS: The Complete Line of Fuses and . . .

New DC Scope! ... the Heathkit® 10-14

- Sets New Standard for Performance & Value . . . \$299.00
- Kit . . . \$399.00 Assembled
- DC to 8 mc Bandwidth—0.04 usec. rise time • Calibrated Vertical Attenuator — .05 v/cm to 600 v. (max.) Input • Triggered Sweep — 18 calibrated rates • Delay-Line Vertical Amplifiers for Fast Rise Signal Analysis • Electronically Regulated Power Supplies — Forced Air Cooling • Built for Continuous-Duty Industrial & Lab Use

A 5" DC scope with calibrated time base & 5X sweep magnifier. For 115/230 volt, 50-60 cycle operation.
Kit 10-14, 45 lbs. . . . \$299.00
Assembled 10W-14,
45 lbs. \$399.00



FREE CATALOG!



Fully Describes Over 250 Heathkit Electronic Products

Heath Company, Dept. 67-5
Benton Harbor, Michigan 49022

- Please send FREE Heathkit Catalog & Information describing the New Heathkit 10-14 Oscilloscope
- Enclosed is \$ _____, plus shipping. Please send model _____.

Name _____
Address _____
City _____ State _____ Zip _____

Prices & specifications subject to change without notice.

TE-141

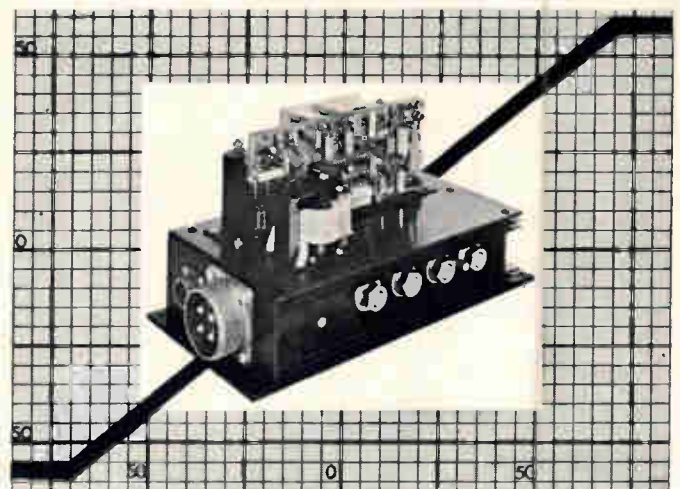

Bi-directional, Full wave MOTOR CONTROL

The new Model A480, 17 KW power output servo amplifier is designed to drive 1 to 8 HP DC motors in applications where superior performance is required. The output of the amplifier features smooth, full wave, bi-directional control with linear operation through null. Adjustable current limiting and three signal inputs with 100 K input impedance are standard features. The amplifier is 12 x 6 x 6 and weighs only 14 lbs.

Servo Amplifiers / Static Inverters / Power Supplies

WESTAMP

1542 15TH ST., SANTA MONICA, CALIF. 90404, 213-393-0401

New Microwave

Small amplifier for high power

Packing a lot of power in a small device that will have a long life is the goal of much research—and the Raytheon Co. says it has succeeded in doing that with a new reentrant type forward-wave amplifier. The amplifier combines cold cathode operation and an efficient slow-wave structure to produce 3 kilowatts average power and 100 kw peak power in a tube that weighs only 35 pounds. The manufacturer believes its amplifier tube—QKS-1319—is the smallest for this power output on the market.

Raytheon also says it anticipates the life of the tube to be more than 10,000 hours since it requires no heater that can burn out and because the cathode operates only

slightly above room temperature which prevents evaporation of the cathode material.

A forward-wave amplifier is a class of traveling-wave tube which operates as a crossed-field device with a magnetic field at right angles to the electric field. As in a traveling-wave tube, it employs a slow-wave structure that reduces the phase velocity of the radio-frequency wave to the velocity of the beam, allowing energy to be extracted from the beam. In a reentrant tube, the electrons that pass through the interaction space are not collected, but move into a drift space and then back to the interaction space. This increases the efficiency of the tube over that

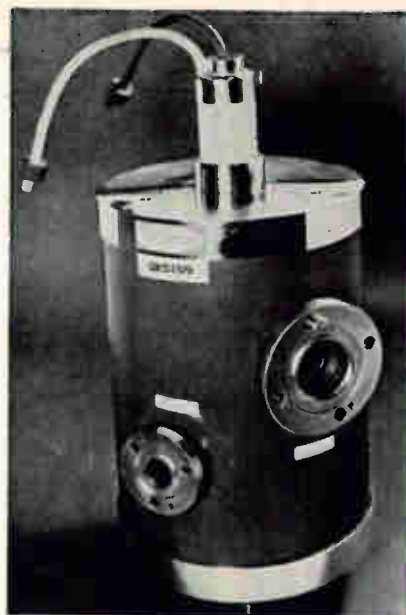

of a nonreentrant type.

In addition to its high average power-level, the QKS-1319 provides flexibility in pulse coding and pulse duration that makes it suit-

Fuseholders of Unquestioned High Quality

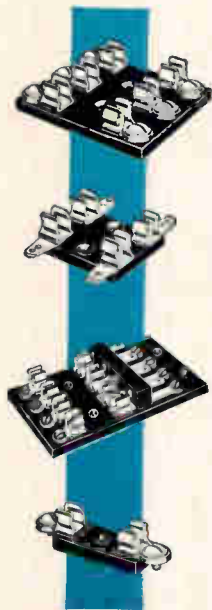

BLOCKS for BUSS FUSES

TYPES AVAILABLE
FOR ALL
APPLICATIONS

Single pole, multiple pole, small base, full base, molded base, laminated base, porcelain base for fuses from $\frac{1}{4}$ x $\frac{1}{8}$ inches up. Also signal type fuse blocks and special blocks of all types.

Tell us what you need or . . .

Write for BUSS Bulletin SFB

INSIST ON **BUSS**
QUALITY

BUSSMANN MFG. DIVISION McGraw-Edison Co., St. Louis, Mo. 63107

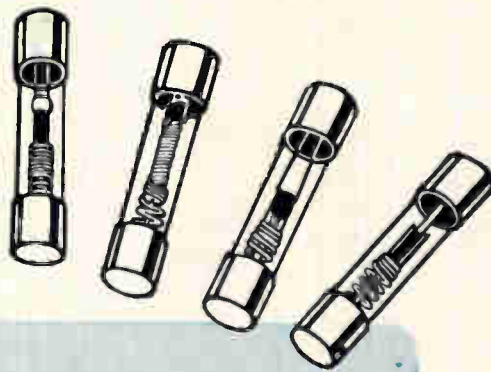

FUSETRON dual-element Fuses *slow blowing*

Write for
BUSS
Bulletin SFB

"Slow blowing" fuses prevent needless outages by not opening on harmless overloads—yet provide safe, protection against short-circuits or dangerous overloads.

INSIST ON **BUSS**
QUALITY

BUSSMANN MFG. DIVISION, McGraw-Edison Co., ST. LOUIS, MO. 63107

WE
SHOOT
DOWN
TRANS-
ISTOR
PRICES

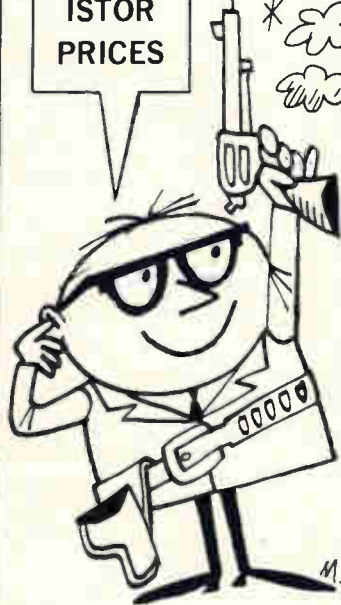

NPC High Reliability Germanium Transistors

2N404, 2N404A, 2N1302 through 2N1309 and other NPN and PNP types in TO-5 case.

Designed for medium speed computer or switching applications, these NPC germanium alloy junction type transistors feature rigid processing control to insure high reliability and stability.

Lower cost is achieved by NPC's unique, automated, high volume production methods.

As one of the world's largest manufacturers of germanium transistors, Nucleonic is known for quality, quick response delivery . . . and the most competitive prices in the industry. Write or call NPC for details.

NPC
NUCLEONIC
PRODUCTS
CO., INC.

3133 East 12th St., Los Angeles
Calif. 90023 • Tel: (213) 268-3464
TWX: 910-321-3077

New Microwave

able for high performance, light-weight radars for mobile installation. Its gain in the 1,200 to 1,400 megahertz range is 15 decibels and efficiency is 50%. Self-contained magnetic shielding prevents interaction with other electronic equipment.

Ten kilovolts are applied between the cathode and the anode at all times, but the tube does not conduct until the r-f signal is applied at the input port. The r-f pulse ionizes some of the residual gas in the tube, releasing electrons which strike the cathode. In about 10 nanoseconds, the cathode, acting as a secondary emitter, develops sufficient space charge to operate the tube at a full anode current of 20 amperes. To shut off the tube, the r-f signal is removed and a positive voltage is applied to a control electrode in the drift space to collect the electrons, collapsing the beam.

The design of the slow-wave structure—called a meander line—contributes to the high power-handling capabilities and gain of the tube. The meander line's high coupling impedance permits greater gain per unit length. Because of its construction, cooling liquid may be pumped directly through the meander line, permitting the tube to operate at high power levels. The meander line has a broad and controllable bandwidth and is rugged and amenable to mass production techniques.

Because of the choice of power levels, the tube may operate with coaxial lines instead of waveguide lines. In addition, since the anode voltage does not have to be varied over the bandwidth, a smaller fixed

Specifications

Type	QKS-1319 forward-wave amplifier
Frequency range	1,200-1,400 mhz
Power output	
Peak	100 kw
Average	3 kw
Pulse lengths	1/2 to 300 microseconds
Gain	15 db
Anode voltage	Ground
Cathode voltage	-10 kilovolts
Control pulses	
Voltage	3 kilovolts
Current	Less than 2 amperes
Pulse length	Less than 0.1 microsecond
Weight	35 pounds
Cooling	Liquid
Price and delivery	On request

DUAL OUTPUT POWER SUPPLIES



Dual output power supplies are housed in one case 3-5/16" x 4-5/32" x 4-11/16" high. Identical or different output voltages from 1.5 to 75 are available in 1 volt increments for each of the DC outputs. The graph below furnishes maximum current corresponding to output voltage. Select the two outputs needed and telephone Acopian for all the details — plus guaranteed 3-day shipment after receipt of your order.

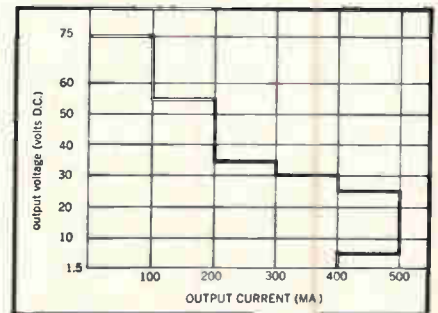

TYPICAL SPECIFICATIONS

Input Voltage: 105 to 125 VAC
Line Regulation: ± 0.5 to $\pm 0.05\%$
(depending on model)
Load Regulation: ± 1.0 to $\pm 0.05\%$
(depending on model)
Ripple: 5 to 1 mv (depending on model)
No additional external heat sinking required.

Write for Acopian's 16-page catalog and price list to: Acopian Corp., Easton, Penna., or call collect (215) 258-5441.

Acopian

voltage supply can be used in the variable supply. Both factors help reduce the weight of accessory equipment.

Raytheon also is developing a forward-wave-amplifier tube that will produce 1 megawatt of peak power at S band.

Raytheon Co., Microwave and Power Tube division, Waltham, Mass. [388]

Coaxial attenuators cover d-c to 12 Ghz



Four miniature Copad coaxial connectors have been developed—each covering d-c to 12 Ghz and using male and female ¼-36 miniature connectors. The four models—9317-3, 9317-6, 9317-10, and 9317-20, respectively—provide attenuation values of 3, 6, 10, and 20 db. V_{swr} is less than 1.30 for all models, and the power rating is 1 watt. All models have square cross-sections, which prevent them from rolling off benches.

Unit price is \$35. Orders are being filled from stock.

Sage Laboratories, Inc., Natick, Mass. [389]

Waveguide terminations For 3 to 4 Ghz band

The MSP-11 high-power termination or load is intended for use in the 3 to 4 Ghz frequency band. It features a short length, approximately 9 in. Standing wave ratios are less than 1.08 over the frequency range and are considerably lower than this value at the high frequency end of the band.

The load may be supplied with either round or rectangular flanges

“bugged” BY A PRINTED CIRCUIT PRODUCTION PROBLEM?

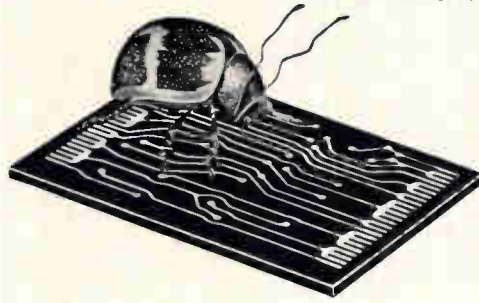

**NEP/CON
BOOTHS
509-513**

BRING IT TO CHEMCUT

Whether it's a microminiature or mammoth board, Chemcut has the spray etcher to produce it for you—accurately and economically. Chemcut, the pioneer and leader in the spray etching field, has units ranging in size from laboratory models to fully automatic, conveyorized systems for high volume production. (Model 502 horizontal,

conveyorized etcher is shown at left.) Also available is a complete line of Chemcut equipment for printing, developing, resist removal and other auxiliary functions. There are over 1800 units in use throughout the world. One that will fill your production needs is available through your nearby Chemcut distributor.

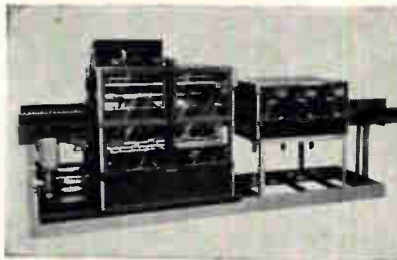

HOW ABOUT PART PRODUCTION?

With continued emphasis on miniaturization, manufacturers of electronic devices are finding spray etchers ideally suited to the production of a variety of parts. We welcome the opportunity of exploring your part production problems with you.

CHEMCUT Corporation

500 Science Park,
State College, Pennsylvania 16801.

Circle 223 on reader service card

To order reprints: Fill in, cut out coupon below, insert in envelope and mail to: **Electronics Reprint Dept., 330 W. 42nd Street, New York, N.Y. 10036**

Reprint order form

For listing of reprints available see the Reader Service Card.

Communications Satellites Part II

Send me reprints of Key no. R-90 at 75¢ each.

For reprints of previous special reports fill in below:

Send me reprints of Key No.(s) @ ¢ each.

(For prices, see Reader Service Card)

Name

Number of street

City, State, Zip code

CEI Type 354 Receiver



Covers ELF-MF (1-600 KHz) Frequencies

CEI's new Type 354 receiver tunes from 1 to 600 KHz in a single band, receiving AM, SSB, CW, MCW and FSK signals with low noise and exceptional sensitivity. A steel tape dial is employed for tuning ease and accuracy.

All solid state, the Type 354 offers four IF bandwidths (150 Hz, 1, 3 and 6 KHz) and a choice of input attenuation (0, -20, -40 and -60 db), all selectable from the front panel. BFO can be adjusted ± 3 KHz, while incidental FM is less than 10 Hz peak deviation.

The same receiver is also available with a digital frequency display for extra convenience and precision. This is designated Type 351. For further information about these compact and ultra-reliable new receivers, please write:



COMMUNICATION ELECTRONICS INCORPORATED

6006 Executive Blvd., Rockville, Md. 20852 • Phone: (301) 933-2800 • TWX: 710-824-9603

Circle 453 on reader service card

GET ALL 5



IN 1 NEW PHOTOCELL...



Now, the 5 best characteristics of CdSe and CdS are combined in 1 new Clairex CdS photosensitive material, the type "5H".

1. High speed (1-2 millisecond response)
2. Low temperature coefficient (0.5%/°C)
3. Low memory (15 X lower than CdSe)
4. High linearity (slope of 0.9 from 0.1 to 100 FC)
5. Uniform color temperature response (100% - 106%, 2854°K-6700°K)

Detailed information on type "5H" photocells plus the new Clairex 16 page Designers' Manual free on request.

CLAIREX

"The LIGHT Touch in Automation and Control"

1239 Broadway, New York, N. Y. 10001, 212 MU 4-0940

New Microwave

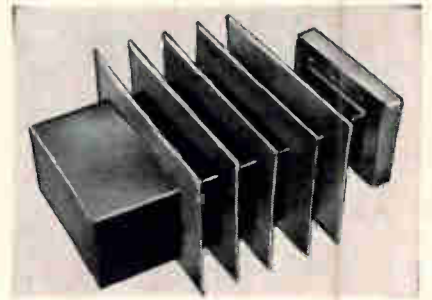

and in either bronze or aluminum waveguide. Construction is of the dissipative wall type with absorbed heat radiated by means of radiating fins. The bronze waveguide unit weighs approximately 7 $\frac{3}{4}$ lbs, while the aluminum unit weighs approximately 4 $\frac{3}{4}$ lbs. The unit may be used effectively at peak powers up to 1 Mw and average powers up to 500 w. Fin temperature without fan cooling with 500-w dissipation is approximately 400°F.

Terminations for other frequency ranges are also available. Estimated price is \$350. Availability is 60 days after receipt of order.

Metcom, Inc., 76 Lafayette St., Salem, Mass. [390]

Klystron delivers 1.5 watts minimum

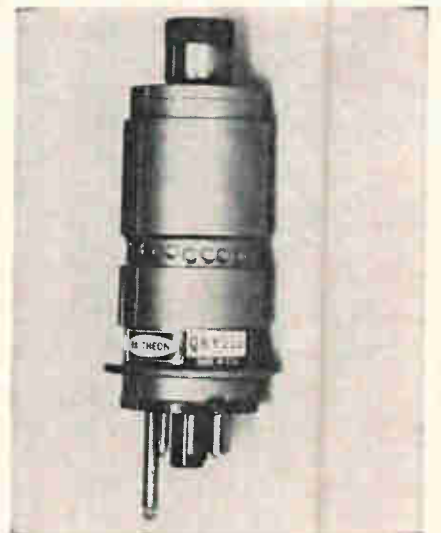

Premium performance is warranted for 15,000 hours or two years with the A line communications klystrons. Seven high reliability, standard-price tubes cover fre-

**20 to 100 μ a—
no charge for
1% tracking
or taut-band**

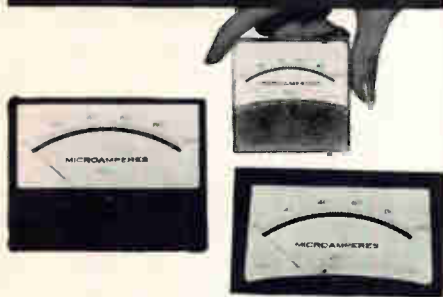

Offered only by **api**

API is the only manufacturer who offers $\pm 1\%$ tracking and frictionless taut-band construction as standard specifications for production-quantity meters, at no extra cost.

Precise tracking is the most useful attribute of a panel meter in modern electronic applications. Taut-band meters give truer readings, respond to smaller signals, resist damage from shock or vibration and do not deteriorate in operation.

Order from Stock

Best of all, API also offers quick delivery from stock of DC panel meters with the double-header bonus of taut-band plus 1% tracking.

You get all this in the most popular ranges of nine models in API's economically priced Stylist and Panelist lines (illustrated). Take your pick of these full-scale DC ranges:

Microamperes	Millivolts
0—20	0—5
0—50	0—10
0—100	

(You also get the double header in the 0-25 millivolt range, but it isn't stocked.)

If precise tracking is a real fetish with you, don't forget that API can give you 0.5% tracking at reasonable extra cost. No other manufacturer features this "super-calibration" and backs it up with catalog prices.

*Bulletin 47-A describes all
API panel meters and pyrometers*

api
INSTRUMENTS CO.
CHESTERLAND, OHIO - PHONE: 216-423-3131

quencies from 3.7 to 8.4 Ghz.

The powerful A klystrons deliver 1.5 watt, minimum, and typically 2.0 watts at 750 volts beam. They feature greater repeller modulation sensitivity: 0.30 Mhz per volt minimum and typically 0.40 Mhz per volt.

Each klystron features broad electronic tuning—typically 40 Mhz (at 3 db). When used with a QKK1320A vapor-phase cooling jacket, the tubes are completely isolated from ambient temperature variations and exhibit a maximum frequency excursion of 600 khz despite an ambient change of 90°C (from -30° to +60°C). The cooling jacket also prolongs klystron life by maintaining an essentially constant anode temperature. Raytheon Co., Microwave and Power Tube division, Willow St., Waltham, Mass., 02154. [391]

High-directivity hybrid coupler

A 3-db quadrature hybrid features high directivity and low cost. Series CA is a 4-port device with both ends of the auxiliary line available. It can be used as a broadband, high isolation power divider, or, by terminating one port, as a 3-db directional coupler.

The unit features 25-db directivity over a full octave frequency range, with a coupling deviation of ± 1 db. Mainline vswr is 1.15. It is completely potted to withstand shock, vibration, and temperature extremes. Six units cover from 200 to 4,000 Mhz in overlapping octave bandwidths, with either N or TNC connectors.

Priced from \$90, the CA series hybrids are available from stock. Microlab/FXR, Livingston, N.J. [392]

Waveguide isolators rated at 1 kw c-w

A series of water-cooled, high-power waveguide isolators is available for microwave systems use. These large and small X-band units are designed to provide tube protection and stable system operation at high average power levels. Units are rated at 1 kw c-w power when terminated in a load vswr of

collage

*More Motorola Melange,
continued from page 204*



Dirty GI socks Dept.

Or, a hatful of I/C

Our Chicago Center is in the throes of developing a silicon linear integrated circuit helmet radio for tactical ground use. This little receiver ... latest in our line of personal communications gear ... may be a boon to military communications, but we have serious doubts if a GI can wash out his socks in one of the helmets. Thus, whether our new gadget can be called progress or not, is yet to be determined. Write for our goodie book on this and other hardware that's just shot full of integrated circuits.



Our Western Center is likewise in the hat business. They're developing a low-profile microwave antenna for the Apollo spacesuit helmet. The antenna is a shiny little thing about the size and shape of a pig's tail. In fact, it's so cute our secretaries are smuggling out prototypes to use on *their* hats. For anything from the latest in chapeau antennas to satellite tracking arrays, write us for data.

IN QUEST OF THE XB-70 WITH GUN, CAMERA & MICROWAVE

We have a fascinating story about how our Chicago Center guys installed a data acquisition and telemetry microwave relaying system along the high-speed test range that runs from Wendover Field in Utah to Edwards AFB, and thence to Vandenberg. In use since the first XB-70 flight, the system comes in for careful scrutiny in our next Engineering Bulletin. Write for your copy.

Continued on page 261

THE HULL STORY...
ENCAPSULATION
BY TRANSFER MOLDING

For components
like these...

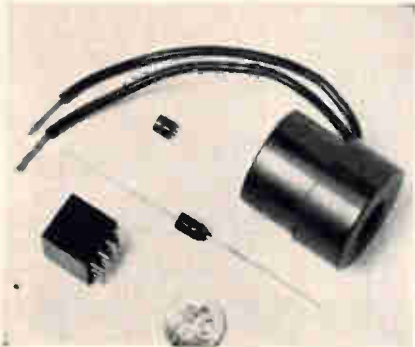

why do the world's
leading manufacturers*
depend on Hull
packaged systems?

Here's why:

RECOMMENDATIONS BASED UPON OVER 500 INSTALLATIONS—Since 1956, Hull has accumulated a wealth of encapsulation know-how to guide selection of the *right* production equipment.

UNDIVIDED SYSTEM RESPONSIBILITY—The Hull "package" includes press, molds, loading frames, and auxiliary handling equipment . . . assuring smooth, economical flow of production parts.

INTO PRODUCTION, FASTER, SURER—Hull can help steer system design for optimum encapsulation while product is at "bread-board" stage . . . minimizing lost motion and delays.

LOW-COST, QUALITY PRODUCT ASSURED—Hull encapsulation systems offer a *proven* method for rapid, precise, and economical packaging of electronic components and circuits, large or small.

FOR MORE OF THE HULL STORY on encapsulation by transfer molding, write for a copy of Bulletin P963. **HULL CORPORATION**, 6034 Davisville Road, Hatboro, Pa. 19040. Telephone: (215) 675-5000. Export: 1505 Race St., Phila., Pa. 19102.

*Texas Instruments, General Electric, IBM, Motorola, Philips, Fairchild Semiconductor, Siemens & Halske—to name a few.

Visit us at NEP/CON, Booth 608



New Microwave

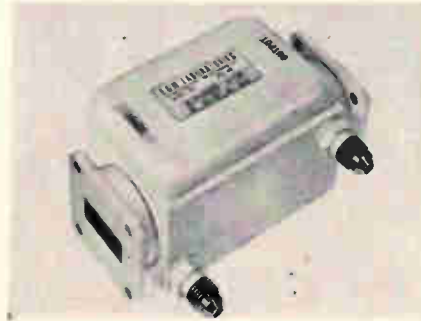

1.5 maximum. Flow rate of 0.5 gallon a minute is required.

Typical characteristics for the model X896HI are: frequency range, 8.5 to 9.6 gigacycles; isolation, 20 decibel minimum; insertion loss, 0.5 db maximum; bilateral vswr, 1.10 maximum.

Price may be obtained on request. Delivery is 30 days after order is received.

E&M Laboratories, 7419 Greenbush Ave., N. Hollywood, Calif. [393]

Temperature-stable L-band oscillator

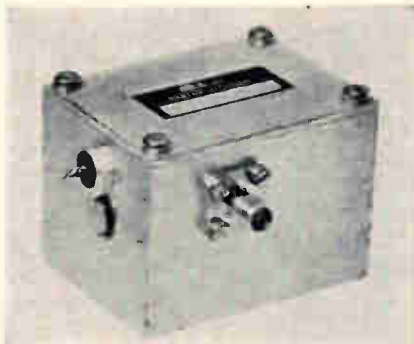

Model RTO is a temperature-stable, silicon solid state, L-band oscillator. Typical stability of 50 khz/°C from -35° to +125°C is achieved with up to 10 mw output capability. The mechanical tuning provides for a wide choice of center frequencies, while the electronic tuning ability provides for automatic frequency control when used as a receiver local oscillator.

Frequency range is 1 to 2 Ghz; power output, 10 mw at 1.5 Ghz; electronic tuning range, ±50 Mhz minimum; sensitivity, 20 Mhz/volt; size, 2 in. x 1.5 in. x 1.5 in.; price, \$450; delivery, 30 to 45 days after receipt of order.

LEL division, Varian Associates, 1365 Akron St., Copiague, N.Y., 11726. [394]

HIGH-VOLTAGE CABLE INSULATED WITH G-E SILICONE RUBBER SURVIVES 3 TOUGH CONDITIONS

One, it carries high currents at 7,000 volts rms. in an airborne power supply.

Two, it withstands temperatures that continuously fluctuate between -55°C and 125°C.

Three, it operates at altitudes as high as 70,000 feet.

Of all the cable insulating materials checked by the manufacturer, G-E silicone rubber proved reliable under every condition. Resisting ozone and corona, it extended cable life to at least 1,000 hours.

Saves \$2.00 per unit

By using silicone rubber as both a dielectric and a potting sealant for a standard connector, the manufacturer got a bonus — a void-free, all silicone system with a minimum of labor.

Compared to installation of individual insulating sleeves for connector contacts, cost savings amounted to \$2.00 a unit. And reliability was improved.

FREE NEW DATA BOOK

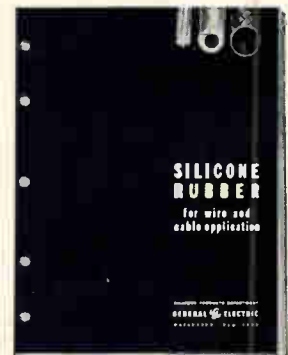

For more ways on how G-E silicone rubber can save money, get Technical Data Book CDS-592, a comprehensive 36-page guide to high performance wire and cable.

Write to Sect. N6204, Silicone Products Dept., General Electric Co., Waterford, N. Y. 12188.

GENERAL  ELECTRIC

Circle 456 on reader service card

What's Bendix doing with over 250,000 different connector engineering drawings?

Offering you new connector innovations almost daily.

High on our ever-growing list of impressive newcomers is the new line of Bendix® JT "Pancake" connectors. These featherweights offer up to 128 contacts, yet reduce connector weight and length almost 60% to win hands down as the industry's smallest, lightest, off-the-shelf connectors now available. All are available with crimp or solder terminations, in nine shell sizes, eight shell styles, temperature range to 392° F

and 34 different insert patterns with 16-, 20-, 22-, and 24-contact sizes that will accept a wire range of 16 through 28 gage.

Keeping pace with developments like this are our other types of connectors. Included are series for pressurized and environmental-resistant requirements. Also Heavy-Duty and Waterproof types for power and control circuits in ground support equipment. Even Fireproof, High Voltage, Ordnance, Radio Shielded,

Potted, Dwarf, Pygmy®, Rack & Panel, Micro-Packaging and Printed Circuit models . . . for a grand total of 250,000 basic drawings covering 8 million different connectors all told. Every last one of them boasts design concepts and test procedures developed by Bendix which, more often than not, go on to become industry standards.

For complete information, contact us in Sidney, N.Y. Phone: (607) 563-9511.



Scintilla Division



Circle 227 on reader service card

**Your plant
may be ready
for new
electronics
equipment...**

**but how about
your people?**



Every day more sophisticated electronic equipment is used by more companies to perform more critical operations. Computers. Calculators. Control systems. Process instrumentation. Communications equipment. It's highly efficient... as long as you have qualified electronic technicians who understand it, know how to maintain it... and can fix it fast if it ever fails.

A good way to build a competent staff of skilled electronics technicians is to up-grade your present technical personnel. And a good way to do it is with a Cleveland Institute of Electronics Training Program. CIE "AUTO-PROGRAMMED" Courses are fast, effective and economical. What's more they can be "tailored" to your specific training needs. There are other advantages, too... and hundreds of satisfied users. Learn about them. Send coupon today for FREE details. Cleveland Institute of Electronics, Dept. E-22, 1776 E. 17th St., Cleveland, Ohio 44114.

SEND COUPON TODAY

**Cleveland Institute
of Electronics**

Dept. E-22, 1776 E. 17th St., Cleveland, Ohio

Gentlemen: I am interested in learning more about your Electronics Home Study Programs. Please send complete information.

Name _____

Title _____

Company _____

Address _____

City _____ State _____ Zip _____

Accredited Member, National Home Study Council.

New Production Equipment

Solderer bonds 7 leads at a time

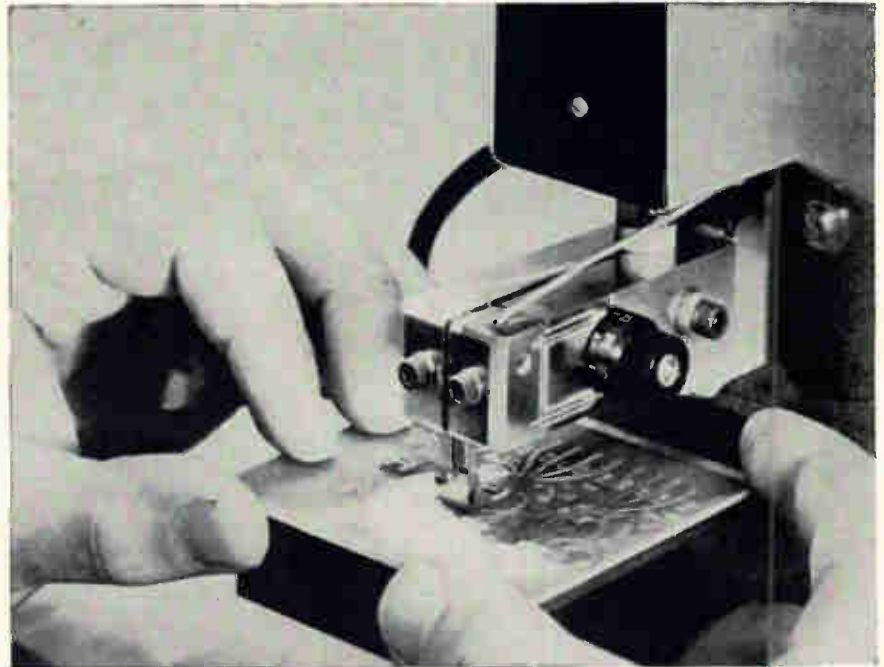

An ingenious, but simple, resistance heater design allows a new reflow soldering machine to bond simultaneously seven leads of an integrated circuit flatpack. Equal temperatures are maintained in each of the seven molybdenum heater bars, even if the joints being bonded have different heat-sinking properties or if the machine is used to bond fewer than seven leads. With manual positioning of the packs, three 14-lead packs a minute can be connected, reports the manufacturer, the welder department of the Hughes Aircraft Co.

The heating tip on the model MLS/EL is a folded metal sheet with "fingers" cut into the folded edge and spaced on 0.050 inch centers—a space corresponding to the leads of most standard flatpacks. The inside of the sheet is coated with an insulating material. A positive lead is connected to one edge opposite the fold and a negative lead to the other edge, so the current flows from the positive edge through the folded fingers to the negative edge.

If all the fingers have the same temperature, the current will be equally distributed through them. If one has a lower temperature than the others, its lower electrical

resistance will cause more current to flow through it until its temperature stabilizes with the rest. If one is hotter, the reverse will happen. This is the key feature which makes it possible to solder different sized pads and to compensate for missing leads.

An oversized pad will draw more heat from its corresponding finger, thus pulling a larger percentage of the available current. If the pack has fewer than seven leads, the fingers corresponding to the missing leads will heat up much faster than the rest, drawing less current.

The operator sets the pulse duration—from less than 50 milliseconds to more than 5 seconds—and amplitude to produce whatever temperature is needed to do the job. The temperature of the tip is controlled by a feedback circuit which automatically compensates for differences in the mass of the solder and the leads and the terminals, and prevents thermal run-aways.

With minor modifications, Hughes says, the soldering system can be used for cross-wire welding, parallel-gap welding, parallel-gap soldering or brazing and diffusion bonding. In addition, multilead soldering capabilities can

INFRARED ENGINEERS AND SCIENTISTS:

Can you contribute to the development of products like these?

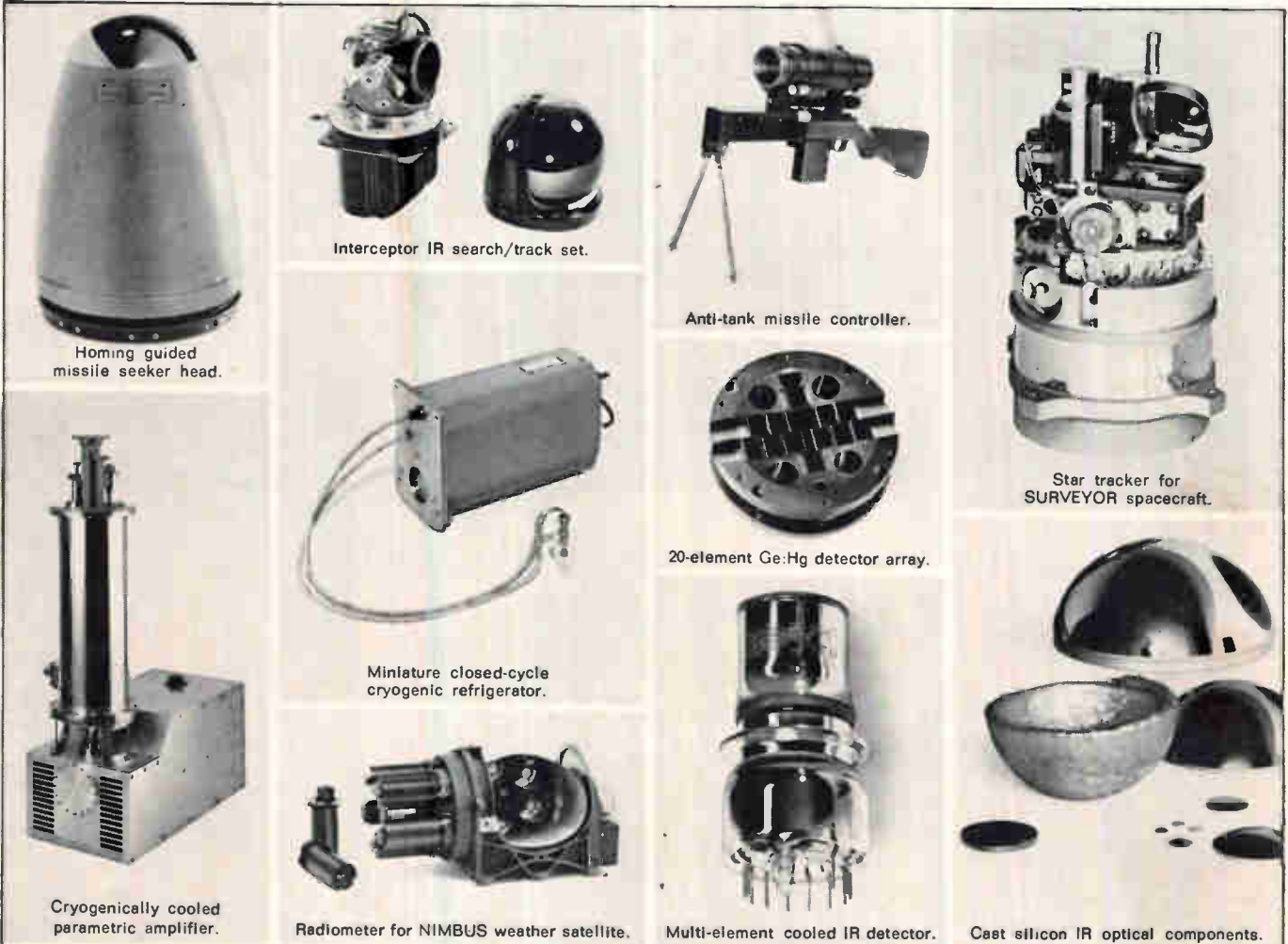

Rapid growth of Hughes infrared activities in the Aerospace Divisions and the Santa Barbara Research Center has created many responsible positions for qualified engineers and scientists in all phases of IR systems development from conception through production engineering.

Immediately available assignments include openings in such diverse technologies as optical design, semiconductor physics, cryogenics, mechanical engineering, precision electro-mech-

anisms, electronic circuit design, servo systems... and many other areas.

Current Hughes IR contracts include advanced systems for: space exploration, weather satellites, anti-ballistic missile defense, night reconnaissance, aircraft and space vehicle defense, and tactical weapon guidance and fire control.

Professional experience, an accredited degree and U.S. citizenship required.

For immediate consideration, please air-mail your resume to:

Mr. Robert A. Martin
 Head of Employment
 Hughes Aerospace Divisions
 11940 W. Jefferson Blvd.
 Culver City 12, California

HUGHES
 HUGHES AIRCRAFT COMPANY
 AEROSPACE DIVISIONS

An equal opportunity employer

TRYLON ROTATABLE LOG PERIODIC ANTENNA
 Single-layer, horizontally polarized,
 for 6.5 to 32 mc, 65° azimuth beamwidth.
 6 db gain/std. dipole. Power to 50 kw PEP

**"One cannot continually disappoint a Continent."
 We have designed, constructed, and installed
 antenna and tower systems in North America,
 South America, Europe, Asia, Africa, Antarctica.
 We wish someone from Australia would call us.**



Circle 457 on reader service card

Production Equipment

be added to existing Hughes micro-circuit welding systems.

Included with the model MLS/EL is its own power supply, soldering head, microscope, foot actuator and base plate.

Specifications

Power input	110 v, 60 hz at 75 watts
Power output	20 mv, up to 800 amps
Maximum temperature	More than 1,000°F
Price	\$2,885
Delivery	6 weeks

Hughes Welders, 2020 Oceanside Blvd., Oceanside Calif. [395]

Fingertip control in semiconductor probe

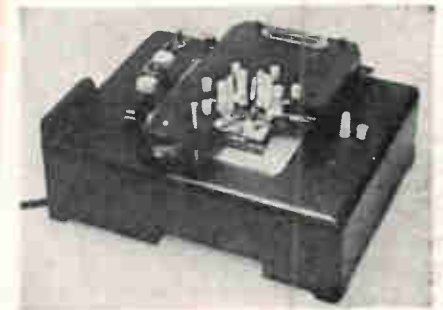

A manually operated probe enables economical probing of a mounted semiconductor device for failure analysis. Design features of the Autopsy Probe include fingertip control of five individually mounted probe points, an array of lens-shaped lamps that provide shadow-free illumination of the device under test, and a gold-plated vacuum chuck that enables probing of mounted devices such as TO5 cans.

Modular in design, the Autopsy Probe consists of a base, gold-plated vacuum chuck, x-y mechanical stage, an air-operated probe head and individually-mounted probe point assemblies. The vacuum chuck is manually rotational for a full 360° and mounts directly on the x-y mechanical stage.

Advanced design, the company says, provides a unique method of penetrating outer oxide surfaces of semiconductor devices — probe points displace surface oxide, hori-

MICO

NEW MODEL 885 SEVEN RATIO WIDE-RANGE ENGRAVER

NO. 885

FOR LONG AND
MULTI-LINE WORK

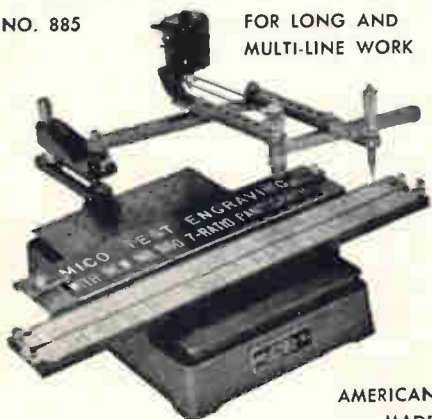

AMERICAN
MADE

- A time-saver for large plate work.
- Engraves 3" x 19" area in one set-up.
- Seven pantograph ratios—from 1.5:1 to 6:1.
- Choice of 3-ball-bearing spindle assemblies for 1/8", 3/16" or taper-shank cutters.
- HSS, COBALT and Solid Carbide Cutters.
- Single and multi-line copy carriers for holding blanks 3/4" to 3 1/2" high.
- Accommodates Mico standard accessories.

Send for bulletins and prices

MICO INSTRUMENT CO.

77 Trowbridge St. Cambridge, Mass. 02138

230 Circle 230 on reader service card

DIGITAL CLOCKS

for

- ✓ REAL TIME
- ✓ ELAPSED TIME
- ✓ COUNTDOWN APPLICATIONS

with accuracy and reliability established during eight years of actual field operation. You can use these precision instruments with utmost confidence to provide date and time for:

- Data-handling systems
- Data loggers
- Data transmission systems
- Time displays
- Telemetry systems
- Computer systems

Both solid state and electro-mechanical models are available. And our prices are far lower than you might think.

To get the full story on the entire line, write for complete technical literature, or phone (215) EL-6-6771.



CHRONO-LOG CORP.

2563 W. CHESTER PIKE, BROOMALL, PA.

Circle 458 on reader service card

OFF-THE-SHELF INTER-WIRING



With a Garlock Free-Flex® circuit, interwiring becomes an off-the-shelf item, as easy to use as any other electronic component. ■ Order a quantity of Free-Flex circuits . . . pre-engineered mechanically and electrically especially to fit your product, making connections between components and sub-assemblies *in one piece* . . . and from that point on, interwiring will be as simple as reaching into your stock for the right component, as you need it. ■ Free-Flex circuits take the headache out of interwiring because it's impossible to hook them up wrong or use the wrong one . . . they're goof-proof. And they take less time to assemble, are more reliable, and more economical than conventional interwiring. ■ Write us for your copy of *Flexible Circuits in "Teflon" FEP Have Come of Age* reprinted from The Journal of Teflon, published by E. I. du Pont de Nemours and Company . . . and for the FREE-FLEX Circuitry Manual.

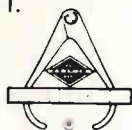

GARLOCK
ELECTRONIC PRODUCTS
GARLOCK INC.

Cherry Hill, N.J. 08034 • Phone (609) 424-1470

In Europe: Europélec S.A., Les Clayes-Sous-Bois, France
In the United Kingdom: Lectropon, Ltd., Slough, England

zontally, and in direct proportion to the probe force applied—without skidding and without whipping. Reliability of probe action assures valid test results—a vital necessity in preparing failure analysis evaluation. When required, probe points are replaceable at a cost of 15 cents each.

Price of the Autopsy Probe is under \$2,000; delivery, 10 days. Weldmatic division, Unitek Corp., 950 Royal Oaks Drive, Monrovia, Calif. [396]

Marking machine for small connectors

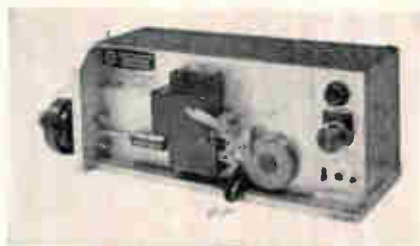

A table-model marking machine automatically marks and ejects small electronic connectors with dimensions up to ¼-in. diameter and 1½-in. length. Called the model 2408, the machine has a variable speed selector that will permit marking up to 15,000 parts per hour, plus the advantage of changeable marking dies.

In operation, the small parts drop into a vibrating, gravity feed hopper, where in the process of falling, they are aligned for marking, then rolled against the marking die. An adjustment of its pneumatic diaphragm controls the depth of the mark.

Model 2408 measures 8 in. x 8 in. x 16 in., weighs 50 lbs and operates on a combination of 110 v 60 hz voltage and 80 psi air supply. Jas. H. Matthews & Co., 6574., Penn Ave., Pittsburgh, Pa., 15206 [397]

Ultrasonic degreaser cleans components

A semiautomatic, ultrasonic vapor degreaser is available for high-volume cleaning of electronic components. Basket or rack loads are placed on a platform elevator, and

COMMUNICATIONS ENGINEERS

RF ENGINEERING

ECI, a recognized leader in high performance RF communications equipment, has immediate and challenging opportunities for outstanding RF engineers.

The AN/ART-47 and AN/ARR-71, an airborne transmitter/receiver combination, typify the challenges being met at ECI. This equipment has 1 kW transmitter output, and it covers 3500 UHF channels with AM or FM duplex capability. Yet the transmitter/receiver combination occupies only 2.65 cubic feet.

Many other equally ambitious programs are in progress. They include communication equipment for satellite, airborne, shipboard and



AN/ART-47 and AN/ARR-71
transmitter/receiver combination.

ground transportable applications in voice or data link systems.

You can work on these exciting programs — and live in one of America's most desirable locations — if you are an unusually competent RF engineer. You'll need at least a BS degree, three years of appropriate experience and sound knowledge of solid-state design theory.

Find out about ECI opportunities in RF equipment design. Send your resume, in confidence, to Budd Cobb, ECI, Box 12248E, St. Petersburg, Florida, or call him collect at (813) 347-1121. (An equal opportunity employer.)



ELECTRONIC COMMUNICATIONS, INC.
St. Petersburg, Florida

New Stability Specs

vibrating capacitors

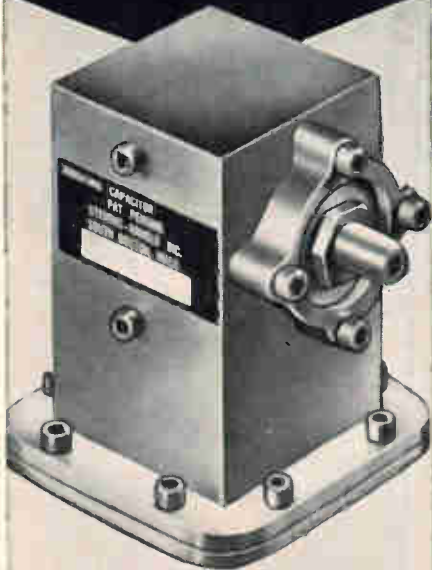

Difficult Electrometers made easy.

Drift with constant temperature 0.05 to 0.1 mv/24 hours noncumulative.

Models for AC drive or oscillator drive.

Particularly suited for long term stability.

Write for Catalog 523 G



STEVENS INCORPORATED ARNOLD

QUALITY SINCE 1943
7 ELKINS ST., SOUTH BOSTON 27, MASS.

S/A-35-1/2V

Production Equipment



then automatically sequenced through a vapor clean, ultrasonic clean, vapor rinse, and dry operation. The cycle time can be changed to fit the particular application and liquid used.

Three 1-kw spaced-lamination, magnetostrictive transducers are bottom-mounted on the tank to provide ultrasonic action at a nominal frequency of 20 khz. They are powered by a single 3-kw Magnetrak ser generator, side-mounted in a NEMA-12 cabinet.

The tank accommodates a basket or rack approximately 24 x 20 x 12 in. deep.

The ultrasonic bath is equipped with a continuously operating recirculating and filtering system that removes insolubles. A distillation cycle removes soluble matter.

The new ultrasonic degreaser is priced at \$12,000, with delivery in eight weeks.

Westinghouse Electric Corp., Box 868, Pittsburgh, Pa. 15230. [398]

Bench-mounted relay tester

A production-line tester has been developed to facilitate inspection and adjustment of electromagnetic relays. Model RT-6000, a bench-mounted unit, uses a crystal-controlled pulse generator as a timing reference and a high-speed counter, gated by the relay under test, as the time interval indicator. Power to the relay coil is controlled by a momentary or latching contact on the panel. Time interval of the desired relay action is read directly on a 3-digit Nixie display



Cramped for space?

Use Couch 1/7-size Relays

Space/weight problem? The new Couch 2X 1/7-size crystal can relay gives you tremendous savings in space and weight. 0.1" grid — plus many outstanding specs — all in *microminiature*. Thoroughly field-proven in electronics and space applications.

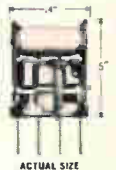

	2X (DPDT)	1X (SPDT)
Size	0.2" x 0.4" x 0.5"	same
Contacts	0.5 amp @ 30 VDC	same
Coil Operating Power	100 mw 150 mw	70 mw 100 mw
Coil Resistance	60 to 4000 ohms	125 to 4000 ohms
Temperature	-65°C to 125°C	same
Vibration	20 G	same
Shock	75 G	same

Broad choice of terminals, coil resistances, mounting styles. Write for detailed data sheets.

RUGGED ROTARY RELAYS  Dynamically and Statically Balanced

COUCH ORDNANCE INC.

3 Arlington St., North Quincy, Mass. 02171, Area Code 617, CYPress 8-4147 • A subsidiary of S. H. COUCH COMPANY, INC.

ACCURACY

To $\pm\frac{1}{2}$ the least significant bit



212 A/D Converter

If your conversion problem requires speed and accuracy with repeatability, take a look at the new 212 A/D Converter by Control Data. Total conversion time is 15 microseconds, and maximum sample rate is 50 KC. In actual systems use, the 212 is producing a conversion accuracy of $\pm\frac{1}{2}$ the least significant bit. Precision construction and components eliminate the need for conventional "tweaking" or daily calibration.

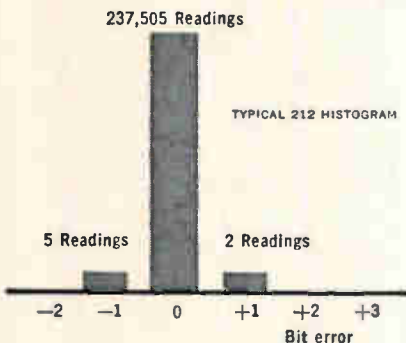

The histogram shown here is typical of that produced by 212's for inflection points over the total input range. Inputs are offered up to ± 100 volts.

Control Data produces a complete line of data converters and multiplexers for applications where performance and reliability are paramount.

Control Data, building complete data acquisition systems, offers a full line of converters and multiplexers. For information concerning these "systems proven" instruments, contact: La Jolla Division, Dept. 309, Control Data Corporation, 4455 Miramar Road, La Jolla, California. (Phone 714, 453-2500).

CONTROL DATA
CORPORATION

4455 Miramar Road, La Jolla, Calif.

covering the range 0.1 msec to 999 seconds.

With the RT-6000, relays can be tested for time interval between any start and stop points in the relay operating cycle selected by the operator. Simple front-panel adjustments allow the operator to measure the time from application of coil power to the closing of a normally-open contact, the time between two successive contacts, or between opening of a normally-closed contact to closing of a normally-open contact. The instrument can accommodate relays of any voltage rating, with coil currents up to 2 amperes. Facilities for printing time measurements on paper tape are available as an optional extra.

Price of the RT-6000 relay tester is approximately \$1,000.

Modular Instrument division, Astrosonics, Inc., 190 Michael Drive, Syosset, N.Y. [399]

System encapsulates under high vacuum

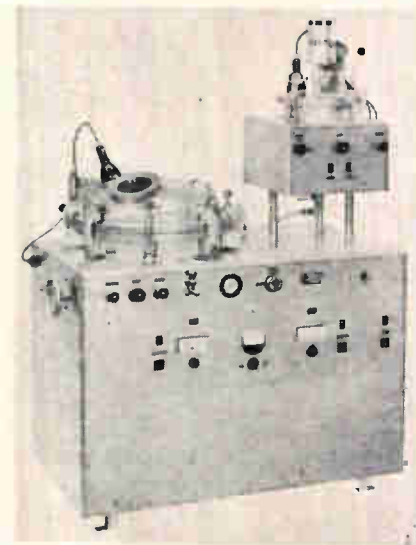

A high-vacuum epoxy encapsulation system gives complete control over all process variables. It carries out all phases of the encapsulating process, each independently of the other, and at different levels of vacuum and pressure. The system will heat, mix, and deaerate resins; heat, dry, and deaerate work pieces; and fill molds under high vacuum. Processed under these integrated techniques, components undergo complete outgassing,

ELECTRONICS ENGINEERS

SPACE ELECTRONICS

Exciting things are happening in space electronics at ECI. Present programs include flight control computers for Saturn IB and Saturn V; digital switch selectors; solid-state telemetry transmitters from VHF to X band; solid-state receivers and transmitters for ICBM launch sites, and an advanced microminiaturization program for the flight control computer.

ECI has immediate professional openings for development, senior and staff engineers on these and other space instrumentation programs. To qualify, you'll need experience in digital systems design, analog instrumentation or RF circuit design. And you'll need the kind of in-depth technical understanding that lets an engineer make genuine contributions to state-of-the-art programs.

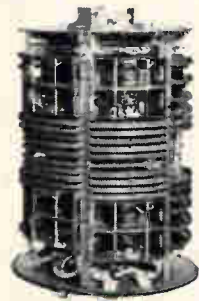

ECI's flight control computer for Saturn IB.

You'll work in a unique, highly stimulating professional environment. And while you work at one of America's most respected and most stable communications companies, you and your family will enjoy living in St. Petersburg, Florida — one of America's truly desirable residential locations.

Get the details today. Send your resume, in confidence, to Budd Cobb, ECI, Box 12248E, St. Petersburg, Florida, or call him at (813) 347-1121. (An equal opportunity employer.)



ELECTRONIC COMMUNICATIONS, INC.
St. Petersburg, Florida

***NEW**
FOR TELEMETRY
FROM



S-BAND FM
SIGNAL
GENERATOR

- ACL TYPE SG-307
- FM, CW, PCM/FM
- 2200-2300 MHz
- SOLID STATE
- MODULAR
- TABLE OR RACK MOUNTED
- EXTREMELY LOW RESIDUAL FM
- OUTSTANDING PERFORMANCE

SEND FOR DETAILED SPECIFICATIONS

ACL **ASTRO COMMUNICATION LABORATORY INC.**

801 Gaither Road
 Gaithersburg, Maryland
 Phone: (301) 948-5210 TWX 710-828-9706

"RF Equipment for The Systems Engineer"

Production Equipment

which helps insure high product reliability.

Many sizes of work pieces can be accommodated, each indexed so that it is centered under the filling head. The system is easy to view, operate and control. All sections that contact resins are quickly disassembled for cleaning.

A wide range of pressures is provided—down to 100 microns, up to 100 psi. The system handles two- or three-part epoxies, with or without abrasive fillers. Many sizes and capacities of tanks are available.

Designated model ESL, the system is ASME and NEMA coded. A building block design enables the user to choose the features he needs, at minimum cost. The system is shipped ready for connection to the power source.

Red Point Corp., 105 W. Spazier Ave., Burbank, Calif., 90153 [400]

Automatic machine
cuts and forms leads

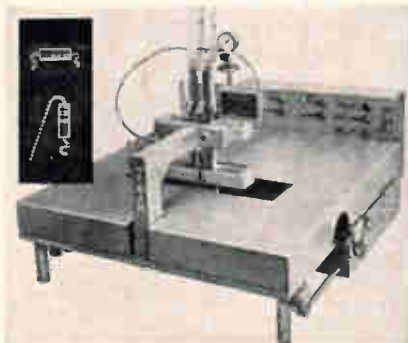

Model UF2RL Auto-Former was developed to automatically cut and form axial lead components. It forms components both vertically and horizontally.

The machine processes up to 5,000 components per hour, firmly clamps the lead during forming, permitting the use of fragile components, such as diodes, etc. It separates the scrap from formed components.

The Auto-Former is rugged, easy to maintain, electrically controlled and pneumatically operated. It is equipped with toggle switches and

DELTA
CASTINGS

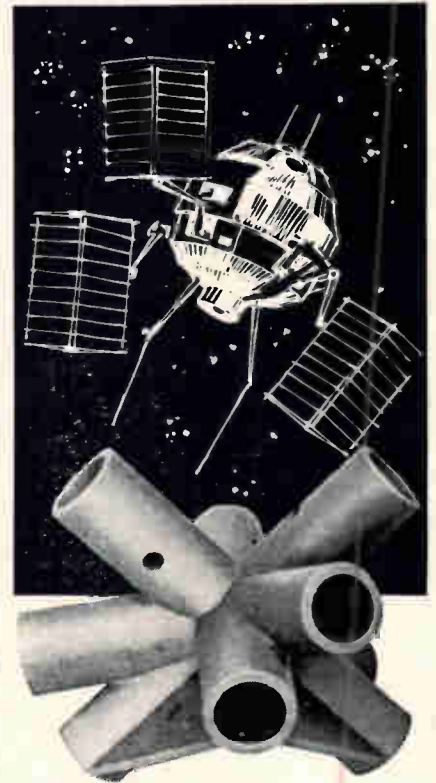

STRUCTURAL ELEMENT
FOR A
COMMUNICATIONS
SATELLITE

The customer wanted strength and precision in a high standard, brazable 71A aluminum alloy. Delta, whose experience in casting aluminum, beryllium copper, and other nonferrous alloys to the rigid specifications required for electronic and mechanical components, produced this part to unusual center-to-center tolerances.

Delta's knowledge of tool design and ability to produce castings to the ultimate in finish, tolerance, and performance characteristics makes it very probable that you, too, can profit by dealing with Delta.



DELTA **MICROWAVE CORPORATION**

HACKENSACK, NEW JERSEY 07601
 Tel. (201) 343-2484

a subsidiary of
HITCHINER MANUFACTURING CO., INC.

**YOU CAN'T
OVERLOOK US!
...WE INTEND TO
BE PERSISTENT!**



**Let Us Send You The Facts On
PROFIT-LIVABILITY!
FOR ELECTRONICS FIRMS!**

70 South Dakota communities have industrial development corporations ready to assist you in locating your new plant. We believe that you'll be pleasantly surprised with the advantages South Dakota has to offer new and expanding industry.



**PROVED LABOR
PRODUCTIVITY**

Value added by manufacture per worker is one of the nation's highest. Eager, alert labor force with work stoppages at absolute minimum.

FINANCING & TAXES

Local development corporations ready to serve all industries. Revenue bond financing available. Debt-free state with no corporate or personal income tax... plus a free port law!

CENTRAL LOCATION

You're closer to everyone and everywhere in South Dakota, geographical center of the U.S. and the heartland of the entire North American continent.

ENERGY FOR YOU

Electrical power available at low cost rates from hydro, fossil and atomic plants to serve the most demanding production needs.

**GREAT OUTDOOR
ADVENTURE**

The beautiful Black Hills, Missouri Great Lakes, fantastic fishing, fabulous big and small game hunting, water resources that challenge the imagination... all combine for a recreation bonanza at your doorstep.

**GET THE
SOUTH DAKOTA
STORY**

CALL OR WRITE
JAMES W. MONROE, DIRECTOR
Industrial Development Expansion Agency
ROOM F
PIERRE, SOUTH DAKOTA 57501
PHONE 224-5911 EXT. 307 AREA CODE 605

signal lights for manual, pedal and automatic control. Electrical requirements are 115 v, 60 hz, 1 phase. The unit requires 60 lbs per square inch of compressed air. Size is 25 in. x 30 in.; weight, 89 lbs. Wybar Electronics Inc., 1068 S. Clinton St., Syracuse, N.Y. [401]

**Microcircuit packages
printed at 200 a minute**

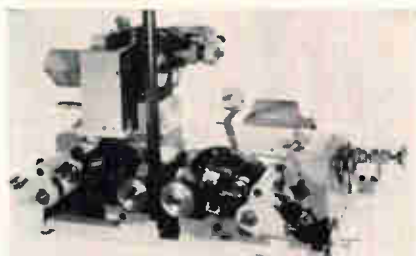

Model U1146 microcircuit package printer is especially designed for marking electrical data on flat microcircuits on as many as three different sides at once. Operating at a rate from 80 to 200 pieces per minute, the U1146 has a feed chute arrangement that provides easy loading of packages and is easily changed to accept units of various sizes and configurations.

Other variations such as thickness and length are handled with adjustments built into the machine. The U1146 is a completely new machine employing the manufacturer's basic printing heads and inking systems.

Markem Machine Co., Keene, N.H. [402]

**Precision, high speed
photoresist spinner**

The EC100 photoresist spinner offers an unusual spinning capacity. It will apply photosensitive films to flat surfaces ranging in size from semiconductor wafers to large glass, metal or ceramic plates.

A closed-loop, d-c servo system provides high acceleration and precise regulation of the spinning speed, assuring the permanent repeatability of a specified process. Electronic control permits adjustment of the speed up to 10,000 rpm.

An interlock switch senses the

**COMMUNICATIONS
ENGINEERS**

**SYSTEMS
INTEGRATION**

If you're the kind of engineer who enjoys the challenge of complex system interface situations, ECI has the opportunity you are seeking.

At ECI, system integration touches many phases of communication: radio systems in all frequency ranges, multiplexing, telemetry, switching systems, etc. Programs involve satellite communication systems, airborne command posts on two continents and over the Pacific, communications for the Marine Tactical Data System and other air-ship-ground combinations of command and control systems.

Opportunities are immediate and attractive for professionals who are highly knowledgeable in aircraft, ground terminal and shipboard electronic communication systems and who

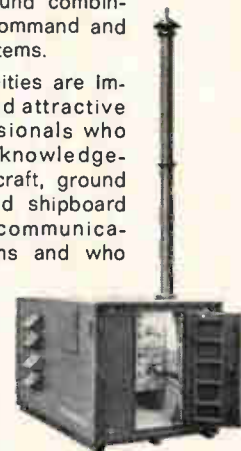

Communications Central for MTDS,
System Integration by ECI.

are familiar with complex communication equipment installation and field test programs.

You will work for an aggressive, professionally oriented company and live in the pleasant atmosphere of Florida's Gulf Coast. Positions are available in St. Petersburg, Florida, with or without occasional field assignments.

For details send your resume, in confidence, to Budd Cobb, ECI, Box 12248E, St. Petersburg, Florida, or call him collect at (813) 347-1121. (An equal opportunity employer.)



ELECTRONIC COMMUNICATIONS, INC.
St. Petersburg, Florida

OFF-THE-SHELF MAGNETIC SHIELDS



About 80% of all magnetic shield designs now in use originated here.

Maybe it's because our designs work. Maybe our designs work because we've had the most experience. All are good reasons to contact us.

Netic and Co-Netic magnetic shields are the recognized standard all over the world for military, laboratory, industrial and commercial applications. They are insensitive to ordinary shock, do not require periodic annealing, and have minimal retentivity. A few typical applications are illustrated. Our design department is yours.

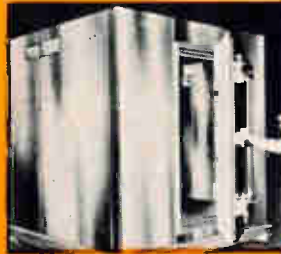

Magnetically Shielded Room



CRT Shield Complex



Scan Converter Shield

Sectionalized P.M. Shield



Nesting Cans

MAGNETIC SHIELD DIVISION

Perfection Mica Company

1322 N. ELSTON AVENUE, CHICAGO, ILLINOIS 60622

ORIGINATORS OF PERMANENTLY EFFECTIVE NETIC CO-NETIC MAGNETIC SHIELDING

Circle 236 on reader service card

DIGITAL LOGIC DESIGN

ELECTRICAL DESIGN ENGINEER — SENIOR Design experience including schematic diagram presentation, electrical/electronic components, design installation and related circuit design and analysis for automatic checkout equipment.

ELECTRICAL DESIGN ENGINEER Design experience including preparation of schematics and wiring diagrams. Able to work from checkout parameter criteria and evolve checkout equipment circuitry utilizing current state-of-the-art components for electrical checkout equipment design.

ELECTRICAL DESIGN ENGINEER — JUNIOR Prefer recent college graduates with industrial design experience involving solid state circuitry and/or logistic presentation to assist in the design of automatic electrical checkout equipment.

BS in E.E. or Physics required for all of the above positions.

Write: K. R. Kiddoo, Professional Placement Manager, Lockheed Missiles & Space Company, P.O. Box 504, Sunnyvale, California. An Equal Opportunity Employer.

LOCKHEED
MISSILES & SPACE COMPANY
A GROUP DIVISION OF LOCKHEED AIRCRAFT CORPORATION

Production Equipment



vacuum holding the substrate to the chuck. If the vacuum is too low, or the substrate is not properly seated, the spinner will not operate. If the vacuum drops below a safe level during operation, the motor will stop before the substrate can be thrown.

Vacuum is applied to the chuck through the motor shaft. A vacuum seal which couples the lower end of the motor shaft to the vacuum source is located below the motor bearings. This provides isolation from photoresist which might enter the chuck.

For clean bench installations, the fume-vented low profile design is recommended. Multiple head assemblies of any geometry are practical for special loading techniques. An indicating tachometer and a remote control switch station are included as standard equipment.

Headway Research, Inc., P.O. Box 848, Richardson, Tex., 75080. [403]

Automatic coil winder reduces costs

Winding costs of relays, solenoids, transformers and motor coils are claimed to be reduced by up to 80% with an inexpensive, automatic multiple-spindle machine that can wind at 78,000 turns a minute when fitted with three winding heads.

Each winding head of the Mk IV Rotawinder consists of four spindles revolving at 6,500 turns a minute and giving a total capacity of 26,000 turns a minute. Up to three heads may be fitted to the machine, and these can be used either to produce three different windings on four coils simultaneously, or to increase output by winding 12 coils

THEY TAKE YOUR MEASURE — PRECISELY

CEC Electromanometers are the "efficiency experts" of *pressure measurement*. Originally created as secondary standards, they have also become the ideal answer for industry—from food and petrochemical applications to power generation and computer process control.

A case in point

A typical electromanometer application is that of a major tank farm concerned with liquid processing for the food industry. Until recently, they had been employing dip sticks to keep an inventory of the product in each tank — with an error of some 300,000 lbs. a year. The solution was easy. CEC Electromanometers were connected to the bottom of each tank to provide a reading which could be fed into a computer. Thus, by measuring the *pressure* at the bottom of the tanks, the exact weight (or amount) of the contents could be determined. The modest cost of the systems, compared with previous losses, is certain to result in an annual saving of many thousands of dollars.

You can't beat the system

Basically, a CEC Electromanometer consists of a transducer and a servo amplifier. Known as the Precision Pressure Balance, the transducer operates on the nondisplacement force-balance principle, affording accuracy and long-term calibration stability. So precise is the system in measuring pressure, it assures an overall 0.05% accuracy — irrespective of operator technique.

For complete information about the various CEC Electromanometer Systems available, call your nearest CEC Sales and Service Office, or write for CEC Bulletin Kit 9024-X1.

CEC

Data Instruments Division

CONSOLIDATED ELECTRODYNAMICS

A SUBSIDIARY OF BELL & HOWELL/PASADENA, CALIF. 91109
INTERNATIONAL SUBSIDIARIES: WOKING, SURREY, ENGLAND
AND FRIEDBERG (HESSEN), W. GERMANY

simultaneously.

The winding heads and supply coils are not turret mounted. This allows a high utilization of winding capacity and a simple transfer turret, it is claimed. It also enables large supply reels to be accommodated and the machine to be set up quickly.

A wire-laying mechanism allows coil lengths up to 2 in. to be wound, although a special version will permit the winding of longer coils. Wire gauges from 21 Awg to 42 Awg can be accommodated.

A transfer unit, consisting of an indexing turret with winding jigs on four levels, transfers four bobbins, armatures or mandrels from the loading position to a four-spindle winding unit. Each winding unit is powered by a ½ hp motor.

Price of the machine with four-spindle head is \$6,600.

Associated American Winding Machinery Inc., 750 St. Ann's Ave., Bronx, N.Y. [404]

Roller coaters for p-c blanks



Roller coaters have been developed for the efficient application of photo resist chemical coatings to printed-circuit blanks. The unit has a 4-in. diameter chrome plated coating roll with a 2¾-in. doctor roll, both mounted in self-aligning ball bearings. The spring-loaded doctor roll can be precisely adjusted to control the film thickness of the coating material.

Thin coatings of photo resist material can be applied accurately resulting in considerable economy with expensive coating materials. With proper control of machine adjustment and resist coating viscos-

COMMUNICATIONS ENGINEERS

MICROELECTRONICS

Unusual ground-floor opportunities in microcircuit design are available at ECI for engineers who have exceptional competence in this technology. An extensive capability in microelectronics has been built and continues to develop at ECI.

A UHF digital frequency synthesizer employing integrated circuits, one of the first in the industry, is an example of technical achievements recently attained at ECI. Continuing programs deal with application of microelectronic technology to multiplex, data link, and telemetry systems and with its greater exploitation in radio communications.

Immediate professional openings involve theory and application of thermodynamics, mechanics of materials and electronic component design in the development and application of microelectronic circuitry. If you have experience and career interest in these fields, plus a BS or MS in EE or physics, you can capitalize on ECI opportunities today.



1-inch microcircuit developed at ECI for UHF digital synthesizer.

For challenging assignments in microcircuit applications programs, for opportunity in an unusual professional atmosphere, and for pleasant living on Florida's "Sun Coast," investigate ECI now.

Send your resume, in confidence, to Budd Cobb, ECI, Box 12248E, St. Petersburg, Florida, or call him collect at (813) 347-1121. (An equal opportunity employer.)



ELECTRONIC COMMUNICATIONS, INC.
St. Petersburg, Florida

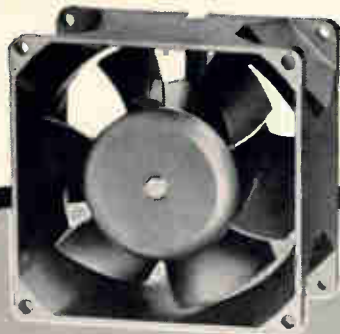

New

3 1/2"

INDUCTION Model 3000 PAMOTOR Miniature Axial Fans

- 20,000 + operational hours at 45°C
- All metal construction
- Low-cost design
- Maximum air delivery at higher back pressures
- Unexcelled performance and reliability
- 50-60 cycles at 110 or 220 vac
- In stock for immediate delivery

Write for technical data on the Model 3000 and other PAMOTOR axial fans to:

PAMOTOR, INC.
312 SEVENTH STREET • SAN FRANCISCO, CALIF.

Production Equipment

ity, it is possible to coat the surface of a blank without filling small holes or depressions, an advantage in many applications.

The series 5 roller coaters can be equipped with variable speed drives for regulation of quality and production speed. They can be furnished with coating rolls from 14 in. to 50 in. wide, single or double coating. The machine can be adjusted to accept material up to 4 in. thick.

The Union Tool Corp., Warsaw, Ind. [405]

Firing furnace ups resistor production

The IQ series of resistor firing furnaces was designed for volume production of thick film resistors and conductors. On a continuous load basis, the firing capacity of the furnace amounts to 7,000 1/2-in.-square pieces per hour or 56,000 pieces per 8-hour shift. Due to their rugged construction and reliable performance, the IQ series furnaces can be put to 24-hour duty.

In order to insure proper furnace atmosphere, the new furnaces have an adjustable incline to approximately 2° from the horizontal (entrance high). This incline induces a laminar flow of air which in turn increases the purity of the atmosphere for the product as it travels through the furnace. Company engineers developed a combination hearth and thermocouple system for the achievement of maximum sensitivity to both load and heaters. This system will detect the presence of an alumina substrate 1/2 in. x 1/2 in. x 3/8 in. on the belt and produce equal results for any load between one substrate and full belt loading. Right to left control produces temperature uniformity of ±1°C across an 8-in. belt.

The furnaces are available with 4, 5, or 7 zones operating in the 200°C to 1,100°C temperature range, completely instrumented and ready for line connection. BTU Engineering Corp., Bear Hill, Waltham, Mass., 02154. [406]



NEW **ECCOFOAM®** **FREE**

Plastics/Ceramics Foam Chart

Complete physical and electrical data are displayed for twenty foams—liquids, powders, sheet stock—plastics, ceramics and even artificial dielectrics.

Two fold-out charts in full color for notebook or wall mounting are yours. Write or Use Reader Service Card.

EMERSON & CUMING, INC.



Canton, Mass.

604 W. 182nd St.
Gardena, Calif.

3450 Commercial Ave.
Northbrook, Ill.

Emerson & Cuming Europe N.V.
Oevel, Belgium

Circle 464 on reader service card

LOOKING FOR PROFIT?

THE FACTS FAVOR NEBRASKA



Sample the facts in a free survey.

Authoritative studies give you the facts on labor, taxes, resources, utilities, local economy, services in 57 Nebraska communities. If the information you want about Nebraska is not at hand, we'll research it for you.

CONSUMERS POWER DISTRICT

Community Development Dept.
1401 O Street, Lincoln, Nebr. 68508

Send sample survey and basic data sheet to:

NAME _____

ADDRESS _____

CITY _____

STATE _____ ZIP _____

(Please attach specific requests for other data.)



telephone quality components

There is no higher standard for switching components. Specify famous Stromberg-Carlson . . . known to telephony since 1894.

RELAYS: Types A, B, BB, C and E. All standard spring combinations are available. Send for Bulletin T-5000R3.

KEYS: Broad selection of push-button, cam and twist types. Send for Bulletin T-5002R2.

HANDSETS: High-efficiency instruments; standard or with switch assemblies. Send for Bulletin T-5017R.

Full-line data on request.

STROMBERG-CARLSON

A Subsidiary of General Dynamics

114 Carlson Road • Rochester, N. Y. 14603

Circle 466 Readers Service Card



OGP
ARISTO
PRECISION
LAYOUT
MACHINES

Industries Choice for Performance and Reliability—

ARISTO Precision Layout Machines, (Coordinatographs), are the most widely used instruments of their kind in industry today ■ Rugged construction for ease and precision in operation ■ Standard accuracy to .0008" anywhere in plotting area—(for higher accuracy a .0001" optical readout accessory is available) ■ Horizontal arrangement for complete flexibility for drawing or scribing on glass, metal, plastic, films or paper ■ For making circuit layouts, templates, transistor masks, comparator chart-gages, dials, scales or reticle masters there's an ARISTO Model to suit your needs ■ Optical readout, electronic digital display or fully automated versions can be supplied ■ Contact your local OGP Representative, or write for NEW ARISTO catalog.

OPTICAL GAGING PRODUCTS, INC., ROCHESTER, N. Y.
Representing Unitech Corp., Clifton, N.J.—Sole Distributor in U.S. and Canada

Circle 467 Readers Service Card

AND ONE TO GROW ON

Substrates of single crystal sapphire provide an excellent surface for epitaxial deposition of silicon . . . as well as for other thin film growth processes.

Available from Adolf Meller Co., in several standard sizes, are randomly oriented sapphire substrates polished to a finish of 250 Å or better, with dimensional tolerances of $\pm .001$ ".

Custom fabrication services allow you to specify crystal orientation, size, material (including spinel, magnesium oxide, ruby, quartz, and rutile), and additional machining operations.

Expand your knowledge of how sapphire can be of value in your work — write or phone Meller for "A Summary of Available Data on the Physical Properties of Synthetic Sapphire."

MELLER
Founded in 1921 **QUALITY**

ADOLF MELLER CO.
P.O. Box 6001-C
Providence, R.I. 02904
Tel: 401-331-3717

Circle 239 Readers Service Card

239

ELGENCO Noise Generators



Model 610A

SOLID STATE NOISE GENERATORS

Model 602A 5 cps to 5 mc, 3 Ranges \$ 290
 Model 603A 5cps to 5 mc, 3 Ranges \$ 495
 Model 610A 5 cps to 5 mc, 8 Ranges \$1,175
 Series 624 (Fixed frequency) 5 cps to 500 kc
 \$245 to \$490. Write for details on frequency
 ranges and spectral flatness.



Model 312A

VACUUM TUBE NOISE GENERATORS

Model 301A DC to 40 cps \$1,995
 Model 311A Two outputs DC to
 40 cps and 10 cps to 20 kc. . . . \$2,395
 Model 312A Two outputs DC to
 120 cps and 10 cps to 20 kc. . . . \$2,495
 Model 321A DC to 120 cps. \$2,095
 Model 331A 10 cps to 20 kc. \$1,275

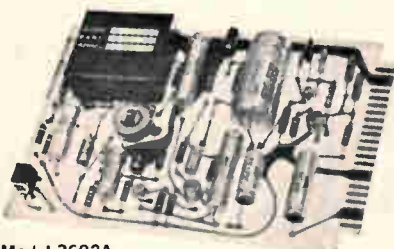

Model 3602A

NOISE GENERATOR CARDS

Series 3602, 3603, and 3606 \$144 to \$389
 Various frequency ranges and output flat-
 ness available. Size: 4½" x 6½" x 1". Write
 for details.

ENCAPSULATED NOISE SOURCE MODULES

Series 1602, 1603, and 1606. . \$95 to \$340
 Various frequency ranges and output flat-
 ness available. Size: 1¾" x 1½" x ¾". Write
 for details.

ELGENCO INCORPORATED



1550 Euclid Street
 Santa Monica, California
 Phone: (213) 451-1635
 TWX: (213) 879-0091

For a more complete listing, write for
 our short form catalog.

New Books

Traveling-wave tubes

Nonlinear Electron-Wave
 Interaction Phenomena
 Joseph E. Rowe
 Academic Press, Inc., 591 pp., \$18

The author, a professor at the University of Michigan, and his students have gained wide recognition for their work with the theory of nonlinear interaction of electron beams and electromagnetic waves. Their research represents, with perhaps the exception of the Russians, the major effort in this field and the book is a welcome addition to the literature.

Rowe follows the usual exposition of the subject by first developing an equation which represents the parameters of the equivalent waveguiding circuit. Next, he analyzes the influence of the electron beam and establishes relationships for the coupling of the waveguiding circuit and the electron beam. The theory is then applied to the analysis of different kinds of traveling-wave tubes, multicavity klystrons, O-type oscillators, crossed-field amplifiers, crossed-field backward-wave oscillators, traveling-wave energy converters and multibeam and beam-plasma amplifiers.

In describing the effects of the beam, Euler's equations of motion, which are used in small-signal theory, are replaced by Lagrange's equation. The difference and peculiarities of the two approaches are discussed in great detail. The Lagrange formulation leads to integral equations which are solved by using Green's function. The actual solutions are calculated on a digital computer.

One difficulty with the book's exposition is that the detailed mathematical analyses are summarized by only a few graphs. There is a sudden gap, and the reader is left hanging. And one cannot find in the book the Fortran programs necessary to generate a more extensive compendium of graphs.

It would be difficult to use this book as a guide for designing a tube. Less emphasis on the mathematical approach, and more extensive examples of practical tube design would have been preferable.

Although Rowe says that his analyses are not restricted to the tube field and can be applied wherever there are charged particle interactions, the book is definitely highly specialized. A series of problems would also have been useful for a text at the graduate level.

Rarely are Rowe's theoretical conclusions compared with corresponding experimental results. This may cause some readers to assume that the solutions given lead naturally to valid designs, despite the approximations used in the mathematical models and in the computations. While there is absolutely no reason to doubt that an experimental tube would follow the theory, some documented reassurance would have been welcome.

This reviewer holds that more straightforward mathematical methods based on the distribution theory of L. Schwartz are superior to the Green function approach.

P.A. Clavier

National Engineering Science Co.
 Pasadena, Calif.

Plans for outer space

Space Research: Directions for the
 Future

Report of a Study by the Space Science
 Board, Woods Hole, 1965
 National Academy of Sciences—
 National Research Council,
 656 pp., \$7.50

Last summer 125 specialists met at Woods Hole to consider planetary and lunar exploration, the needs of astronomy in space and the role of man in space research. The three parts of their report, first issued individually, have now been compiled in one volume.

The first section, on planetary and lunar exploration for the years 1970 through 1985, recommends priority for an unmanned exploration of Mars. This should be followed by more detailed investigation of the moon's surface and unmanned exploration of Venus.

One of the recommendations in the second section is that initial studies be made on the feasibility of two immense orbiting telescopes—one, a 120-inch optical telescope and the other, a radio telescope,

Tu-Pin Molded Base Lamps

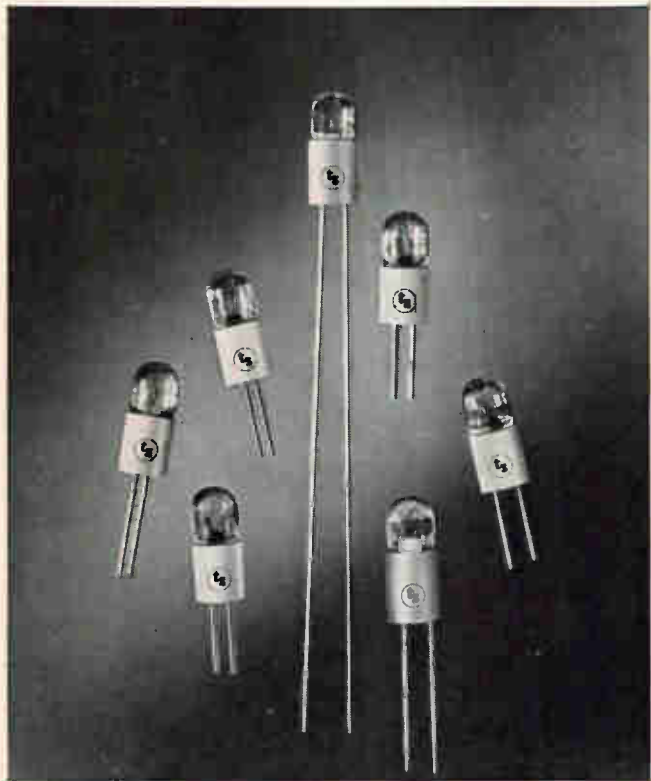

A complete light source that requires no mounting socket

Tu-Pin Lamps are standard subminiature bulbs molded into Nylon bases. Bulb and base are an integral unit. The conventional metal base and socket are eliminated.

Fewer parts and connections reduce assembly procedures and contribute to greater product reliability.

Tu-Pin Lamps are ideal for circuit board applications. They can be installed with automated equipment.

All leads are internally sealed against corrosion. Exposed leads can be of non-corrosive material. Molded bases can be color coded for production accuracy.

In addition to Tu-Pin types, Tung-Sol supplies molded base lamps with long leads for computer modules and photocell applications. Complex base configurations can be supplied to specifications. Write for more information. Tung-Sol Industries, Inc., Newark, N.J. 07104.

TUNG-SOL*

*Registered trademark of Tung-Sol Electric Inc.

Circle 461 on reader service card

414 STANDARD MODELS...



RHG MIXER PREAMPLIFIERS

FEATURING

- SSB Noise figures to 7.0 db • "G" Series or "hot-carrier" diodes • MIL Grade • RFI Protected • Coaxial or Waveguide • Ultraminiature models

RANGE OF SPECIFICATIONS

RF Frequency:	250 MHz to 36 GHz
IF Frequency:	10 MHz to 300 MHz
IF Bandwidth:	2 MHz to 250 MHz
Gain:	20 db to 80 db
Price:	From \$525

Utilizing a complete complement of microwave test instrumentation backed by engineering know-how, an additional 346 CUSTOM DESIGNS have been produced. The solution to your problem may be on file in our library now.

For specials, test our ONE-DAY-QUOTE Service. For standards, see complete listing in EEM Section 3400.

RHG

RHG ELECTRONICS LABORATORY, INC.

94 Milbar Blvd., Farmingdale, L.I., N.Y. 11735 ■ (516) 694-3100

MICROWAVE FM and AM RECEIVERS ■ MICROWAVE MIXER PREAMPS
LINEAR and LOG IF AMPLIFIERS ■ RF and OCTAVE AMPLIFIERS

Circle 241 on reader service card

241

Opportunities for Professional Growth

in the famed San Francisco Bay Area

Widen your technical horizons! Here advanced techniques, stimulating projects, and creative activity offer unusual opportunities in equipment, systems, test, design and fabrication of surface and underwater vessels, both conventional and nuclear powered.

ENGINEERING POSITIONS AVAILABLE:

**Naval Architects • Marine • Mechanical
Nuclear Power • Structural • Electrical
Electronics • Chemical • Welding • Civil**

New materials require the development of new processes. High-strength, light-weight material is required for the Navy's needs. Super-strength steel fabrication requires exotic welding methods and unique testing techniques to attain zero defect quality control. Ships design includes equipment and systems for the Navy's modern fleet, both surface and submersible. Engineers check out, test and evaluate the installation of nuclear and conventional marine propulsion systems; perform field engineering on electrical

and miniaturized sophisticated electronic systems including sonar, communication and radar equipment; learn new concepts in hull design and fabrication techniques such as explosive forming for deep submergence; and apply computer application to missile and Naval Tactical Data Systems.

These, and many other fascinating phases of the Navy's fleet requirements, will offer you a challenge in any engineering discipline at the San Francisco Bay Naval Shipyard.

OPENINGS EXIST AT ALL LEVELS IN THESE PROGRAM AREAS:

**Ship Structure Development
Ship Weight Control
Structural Mechanics
Nuclear and Conventional Propulsion Systems
Navigation and Communication Systems
Sound and Vibration Control
Cargo Replenishment-at-sea Development**

**Shipboard Mechanization
Ordnance, Guided Missile, Fleet Ballistic Missile and Electronic Systems
Value Engineering
Shipboard Aeronautical Material and Equipment
Shipboard Electrical and Power Systems
Naval Tactical Data Systems
Quality Assurance**

Present construction, repair, alteration and conversion workload alone assures stability of employment for at least five years. Opportunities are available for promotion in all fields.

In professional and personal growth potential, financial and career benefits, today's San Francisco Bay Naval Shipyard openings offer unmatched opportunities. Requirements include a B.S. degree in engineering or naval architecture from an accredited university. Opportunities are available for experienced engineers and those newly graduated. Starting salaries up to \$10,619 depending upon experience.

JOB LOCATIONS: San Francisco Bay Naval Shipyard has two work sites located 40 miles apart: Hunters Point in

San Francisco and Mare Island in Vallejo, California. Each location has ready access to the full cultural advantages of San Francisco and the mild year-round climate of the "Bay Area." All types of recreation from ocean surfing to skiing on the slopes of the Sierras are within easy driving distance.

HOW TO APPLY: You may investigate these openings by sending your resume or Standard Form 57 (Application for Federal Employment) to:

Coordinator, Professional and Technical Recruitment (Code 174P)

Employment Division

San Francisco Bay Naval Shipyard
Vallejo, California 94592

An Equal Opportunity Employer

New Books

possibly of wires, having an aperture when fully extended of approximately 12 miles. Other subjects covered are X-ray and gamma-ray astronomy, solar astronomy, and physics and geophysics.

In addition to the role of man in space research, the last section discusses rocket and satellite research, biology, medicine and physiology, and university programs in space research.

Who's getting what

Aerospace and Defense Research Contracts Roster, fiscal year 1965
Compiled by Frost & Sullivan, Inc.
Bowker Associates, Inc., 1,285 pp., \$35

The publishers of "Who's Who" have now done for government contracts what they have been doing for important people. The new book is a compilation of 11,000 research and development contracts awarded by government agencies to companies and universities. The main index, arranged alphabetically, lists the name of the awardee with division and address. It gives the dollar amount and date of the award, name and address of the awarding agency, program name, phase and general description of the contract.

There are five other indexes which list awards by systems products, hardware products, programs (including a glossary of acronyms), awarding agencies and states (each of the 50 received at least one; California and Massachusetts, considerably more).

To compile the book, selected data on magnetic tape from the master file of Frost & Sullivan, a market research company, was fed through a computer which read out the indexed text.

Recently published

Wave and Oscillatory Phenomena in Electron Beams at Microwave Frequencies, V.N. Shevchik, G.N. Shvedov and A.V. Soboleva, translated from the Russian by O.M. Blunn, Pergamon Press, 362 pp., \$15

Progress in Radio Science, 1960-1963, Vol. 6, Radio Waves and Circuits, edited by F.L.H.M. Stumpers, American Elsevier Publishing Co., 325 pp., \$24.50

Optical Page Reading Devices, Robert A. Wilson, Reinhold Publishing Corp., 197 pp., \$10

**Leadership is
no accident!**

in sports
or in
industry

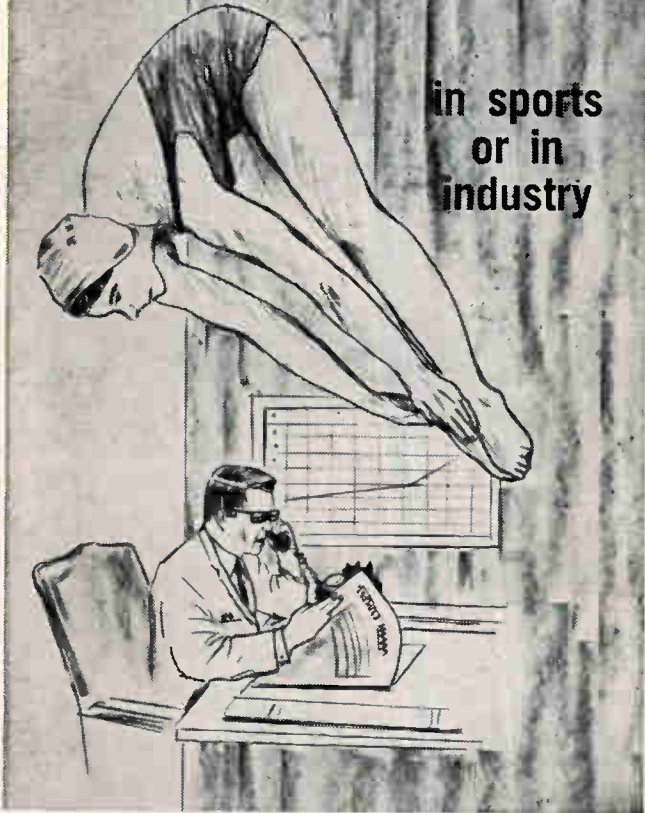

SERVICE
is one of the
reasons for **ALPHA'S**
LEADERSHIP

Service is a way of life at Alpha. It includes everything from making that extra effort toward helping a customer with a pressing requirement, to solving major design and manufacturing problems for the soldering industry in the Alpha Customer Service Laboratory. Alpha Field Engineers are always available to help you make the right selections. They thoroughly evaluate your needs before making a recommendation. After these selections have been made, you can depend on Alpha to meet your requirements or satisfy those engineering demands as they arise.

Additional reasons for Alpha's Leadership include distribution of the latest authoritative soldering information; an outstanding Research and Development Department geared to problem solving; unequalled know-how and experience; and the most complete quality product line available anywhere.

**BULLETIN A103 TELLS THE ALPHA STORY.
WRITE FOR YOUR FREE COPY TODAY.**

alpha **alpha metals, inc.**

56 WATER STREET, JERSEY CITY, N. J. 07304 201-434-6778

Los Angeles, Calif. • Alphasoy Corp. (Div.), Chicago, Ill.
Alpha Metals, Inc. (U.K.) Ltd., Hounslow, Middlesex, Eng.

J-6827

SEE US AT NEP/CON—BOOTH 610

Circle 459 on reader service card

THE



**MULTI-TRACK
MIND...**

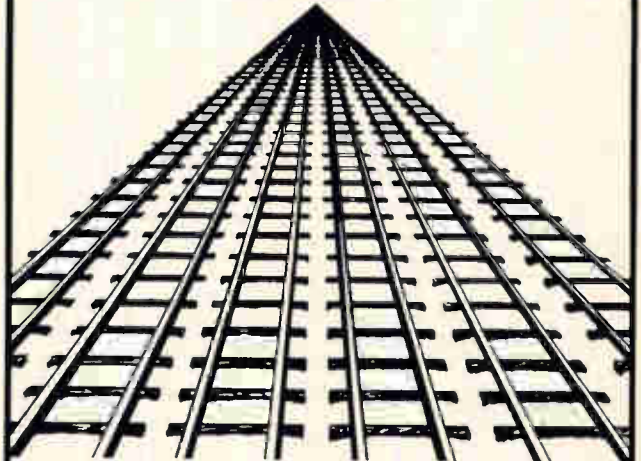

Want to handle several PCM links simultaneously?
Need to rapidly switch from format to format?
DCS has the efficient answer—

**Series 1100
PCM SYSTEMS**



Look at these features:

- *Multilink simultaneous processing, 2 to 16 links*
- *IBM compatible tapes*
- *Multilink time correlation*
- *Immediate format switching*
- *Pre-switching synchronization and data validity checking*
- *Memory not used for format synchronization*

INTERESTED?

Write for your free copy of the new **DCS Series 1100 PCM PROCESSING SYSTEMS** brochure... or call the **DCS** office nearest you.

Dept. E1, East Liberty Street, Danbury, Conn. 06813
Telephone: 203-743-9241 • TWX 744-1990



DATA-CONTROL SYSTEMS INC.
Instrumentation for Research

Sales Offices
Silver Spring, Md., Huntsville, Winter Park, Long Beach, Santa Clara,
Albuquerque

Copenhagen London Rome Paris Munich Amsterdam

DCS 266

Circle 243 on reader service card

243

ENGINEERS & SCIENTISTS

Move Up with Martin in Florida

Program variety extends career horizons!

Stimulating variety awaits the creative engineer at Martin. Current assignments range from tactical weapon systems, to aerospace defense, command & control, communications, and ordnance. Projects with immediate career openings include Walleye, RADA, Sprint, Shillelagh, Pershing, Bullpup, and advanced system development.



PROFESSIONAL TOOLS FOSTER CREATIVE FREEDOM

Engineering freedom is standard operating procedure at Martin. It's the policy that frees the problem-solver from detail and supports him with the very best technical facilities. As evidence, the recent opening of Martin's Guidance Development Center climaxes an \$8 million R&D facilities expansion program begun only three years ago. This multi-lab complex, along with six new research laboratories and numerous tests sites, equip the Martin engineer with some of the world's most advanced tools for problem-solving.



**MOVE
UP** WITH MARTIN

If you're the professional engineer who can exploit the very best facilities in achieving technical excellence, you have a promising future at Martin in Florida!

MARTIN COMPANY

ORLANDO DIVISION, ORLANDO FLORIDA

An Equal Opportunity Employer. Positions open to both men and women.

NOW!

COMPUTER SCIENCES

- Logic Design
- Computer Controlled Switching Devices
- Peripheral Equipment Design
- Core Memory Studies
- Machine Language Programming — Real Time Applications

ADVANCED ELECTRONIC PACKAGING

- Microminiaturization Techniques
- Thermal Design
- Airborne and Ground Packaging Applications
- Package Structures

ADVANCED SYSTEMS

- Functional Analysis and Systems Integration
- Guidance (Seeker-Sensor Design and Analysis)
- Control System Analysis and Simulation
- Reliability Analysis
- Operations Research

STRUCTURES

- Structural Dynamics
- Stress Analysis
- Loads
- Structural Design
- Ablative Materials

MOVE UP WITH MARTIN

ADVANCE PROFESSIONALLY by gaining graduate and PhD engineering degrees in Orlando at Rollins College or University of Florida's Graduate Engineering Education Program.

SEND YOUR RESUME in confidence to C. H. Lang, Sec. 1132 Martin Company, Orlando, Florida.

Technical Abstracts

Low-loss filter

A tunable bandpass filter
William B. Ribbens
Department of Electrical Engineering
The University of Michigan, Ann Arbor

Ferrite-loaded, magnetically tunable, microwave bandpass filters that operate in X band (5.2 to 10.9 gigahertz) with bandwidths from 230 Mhz to 17 Mhz have been developed. The filters are tunable over more than 1,200 Mhz and have an insertion loss of only about 1 decibel. They are practically free of spurious responses and make fine preselectors.

The filter is a ferrite slab placed in a waveguide section between two obstacles. In the rejection band, the obstacles reflect the incident power giving a relatively high attenuation. In the passband, the susceptances of the obstacles tend to resonate with each other at a frequency determined by the susceptances and the electrical distance between them. Tuning is accomplished by altering a biasing magnetic field which varies the ferrite's permeability and hence the electrical length of the ferrite-loaded section. The obstacle's susceptance and spacing determine the filter bandwidth.

In this paper, design formulas provide analyses and predictions of the filter's performance characteristics. The principal properties are determined from a computation of the complex transmission coefficient from a source to a termination, both matched to the empty waveguide's impedance. In an X-band filter tunable over 1,500 Mhz and having a 1.5-db insertion loss, the actual bandwidth differed from the design value by less than 10%, sufficiently accurate for most engineering purposes.

Several factors influence tunability, including the material permeability and the sample volume, and is larger for larger samples. For sufficiently large samples, a number of resonant modes exist, some of which are degenerate at critical biasing fields, where mode conversions can occur with accompanying undesirable effects on bandwidth and insertion loss. The optimum ferrite width for which

reasonable tunability is achieved without serious mode conversions is about 0.100 inch.

Presented at the International Conference on Magnetism, Stuttgart, Germany, April 20-22.

Fungicidal

Microbial deterioration of engineering materials
Oscar H. Calderon, M. Rupert Sandoval and E. E. Staffeldt
White Sands Missile Range, N.M.

A single strand of fungi, forming a barely visible bridge between components, can carry 45 volts d-c and cause electrical failure. Usually, when one strand sprouts, others follow. The degradation caused by such microorganisms has been controlled by biocides, biostats, drying methods and packaging the components in inert atmospheres. But, the authors suggest, methods that have been effective in the past may not be effective for new materials. Better methods of testing and evaluating resistance to microorganisms will be needed.

There are many thousands of species of fungi, bacteria and streptomycetes that feed on organic materials. Many of them attack wood, cellulose and leather. Some attack the newer engineering materials, including silicone rubber, epoxies and polytetrafluoroethylene. The usual fungus resistance tests may make a material appear to be resistant to microorganisms, when actually the material may be degraded by another microorganism. Bacteria, for example, do more harm to neoprene than fungi or streptomycetes. In one case, a fungus growth masked a colony of bacteria that was also feeding on polyvinyl chloride.

The usual tests for resistance to microorganisms may not prove that a new engineering material will resist degradation. As the materials change, the organisms that attack the materials may also change. The attack may not be a direct one; tests show that organic acids, which are exuded by microorganisms landing on an exposed surface, corrode metals.

Presented at the Seventh Annual IEEE Conference on Electronic Reliability, New York, May 20.

Telrex

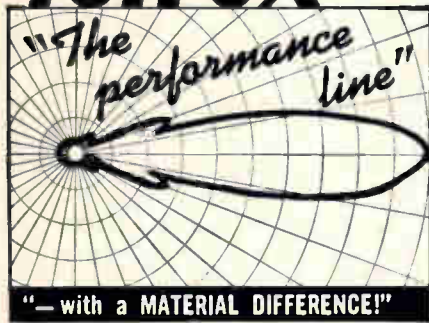

The Choice of the Discriminating Communication Engineer . . . The Man who Never Settles for Anything Less than THE-VERY-BEST!

telrex "BEAMED-POWER" ANTENNAS and ANTENNA SYSTEMS

Provide optimum performance and reliability per element, per dollar. Antennas from 500 Kc to 1500 Mc. Free PL88 condensed data and pricing catalog, describes military and commercial antennas, systems, accessories, Towers, Masts, Rotators, "Baluns" and transmission line data.



Asbury Park 41, New Jersey, U.S.A.

Circle 469 on reader service card

Reprint order form

Send to: Electronics Reprint Dept.
330 West 42nd Street
New York, N. Y. 10036

For listing of reprints available see the reader service card.

To help expedite mailing of your reprints please send cash, check or money order with your order.

For reprints of the latest special report:

Communications Satellites Part I

Send me . . . reprints of key no R-89 at 75¢ each.

For reprints of previous special reports fill in below:

Send me . . . reprints of key no.(s) . . . at . . . ¢ each.

For prices see the reader service card.

Name

Number & Street

City, State

Zip code

New Literature

Pellet resistors. Pyrofilm Resistor Co., Inc., 3 Saddle Road, Cedar Knolls, N.J., has released a technical data sheet on its latest development—miniature carbon-film pellet resistors. Circle 420 on reader service card.

Industrial relay. Sigma Instruments, Inc., 170 Pearl St., Braintree, Mass., 02185. A catalog bulletin describes the series 55 a-c and d-c heavy-duty industrial relay for 2-, 3-, and 4-pole switching of 15-ampere/pole resistive loads at 230 v a-c. [421]

Totalizer. United Computer Co., 930 W. 23rd St., Unit 8, Tempe, Ariz., 85281. Bulletin C6-6 covers the model PR-42 totalizer, which features counting speeds to over 1 million counts per second, extensive use of integrated circuits, and BCD and 10-line decimal electrical outputs. [422]

Modular amplifier system. Century Electronics and Instruments, a subsidiary of Century Geophysical Corp., 6540 E. Apache St., Tulsa, Okla., 74115, announces a two-page brochure describing two configurations for the model 530 single or double instrumentation amplifier modules. [423]

Cable ties. The Thomas & Betts Co., 36 Butler St., Elizabeth, N.J., 07207, offers a 20 in. x 30 in. wall chart illustrating the variety and use of Ty-Rap cable ties and other harness fabrication accessories. [424]

Varactor diodes. American Electronic Laboratories, Inc., P.O. Box 552, Lansdale, Pa., 19446. A six-page brochure describes a line of varactor diodes that are available in low-loss microwave packages; package design varies according to required power dissipation, package capacitance and inductance, and physical size. [425]

Millimeter microwave components. TRG, a subsidiary of Control Data Corp., Route 110, Melville, N.Y., 11749. An illustrated 20-page, short-form catalog covers the company's entire millimeter microwave component and antenna line. [426]

Digital circuit modules. Radix, Inc., 1560 Orangethorpe Way, Anaheim, Calif., 92801, has published a four-page data sheet containing general electrical and mechanical specifications for 1-Mhz welded digital logic modules. [427]

F-m telemetry calibrator. Century Electronics and Instruments, a subsidiary of Century Geophysical Corp., 6540 E. Apache St., Tulsa, Okla., 74115. A four-page brochure describes the theory, operation and specifications for the model 850 f-m telemetry calibrator. [428]

Proximity switch. Micro Switch, a division of Honeywell, 11 W. Spring St., Freeport, Ill., 61032, offers a 75-page manual on proximity switches, a handbook for users as a source of reference information in 5 major sections. [429]

Microwave amplifiers. Alto Scientific Co., Inc., 4083 Transport St., Palo Alto, Calif., 94303. Catalog HLFE lists over 150 standard microwave amplifiers covering from 0.5 to 18 Ghz in octave bandwidths and power outputs from 1 w to 100 w c-w. [430]

Permanent-magnet data. The General Magnetic Corp., 10001 Erwin Ave., Detroit, Mich., 48234. A 16-page booklet contains technical data covering the effects of temperature and radiation on permanent-magnet materials. [431]

Pressure transducers. Data Sensors, Inc., 13112 Crenshaw Blvd., Gardena, Calif., announces a short-form catalog on bonded strain gage pressure transducers for aerospace and industrial applications. [432]

D-c motors. American Electronics, Inc., 1600 E. Valencia Drive, Fullerton, Calif., has published a 12-page booklet describing the design and application of miniature d-c motors. [433]

Coaxial circulators. The Raytheon Co., Special Microwave Devices Operation, 130 Second Ave., Waltham, Mass. High-power coaxial circulators are described and illustrated in a four-page brochure. [434]

Pulse transformers. Valor Electronics, Inc., 13214 Crenshaw Blvd., Gardena, Calif., 90249. An eight-page folder displays products, facilities and capabilities of the company in the manufacture of pulse transformers. [435]

R-f connectors. The Sealectro Corp., Hoyt St., Mamaroneck, N.Y., has released a 12-page catalog describing 27 types of MicroHex microminiature r-f connectors. [436]

Photoconductive cells. The Clairex Corp., 1239 Broadway, New York, N.Y., 10001, has published a designer's guide to utilization of photoconductive cells. The 16-page manual covers photocell theory, design and properties from the application viewpoint. [437]

Photo choppers. Airpax Electronics Inc., Cambridge, Md., 21613. Bulletin PC-118 provides definitive information on photo chopper types 5510 a-c drive and 5514 d-c drive. Internal schematics and a typical application of a photo chopper in a modulator circuit are detailed. [438]

Hitching Post for High-Spirited Electrons...



JOHNSON'S NEW
MINIATURE "5-WAY"
111-200 BINDING POST

- * Compact Pre-Assembled Design
- * Short Front Panel Projection
- * 5,000 VDC Breakdown

Hold your horses! Look first at Johnson for binding posts . . . for instance, at the #111-200 series designed for compact test equipment applications. Tough, low-loss polyamide body fully insulates stud, provides higher voltage breakdown. Front projection 25/32" max. with thumb nut open . . . only 21/32" closed. Thumb nut is self-captivated . . . cannot work loose. Equipped with single 1/4"-32 nut for fast mounting - no time consuming spacers or mounting hardware required. 5-Way feature permits connection by tip plug, alligator clip to stud, wire wrapped around stud and clamped, wire (max. size #12) through center hole and clamped, clamped spade lug.

ELECTRICAL CHARACTERISTICS:

Current rating 15 amps. thumb nut to terminal; five amps. tip jack to terminal.
Capacitance to 1/8" panel 3 pf.
Insulation resistance greater than 200 megohms after MIL-T-5422B humidity test.

Also available in Series 111-100 (15 amps, 8,000 VDC Breakdown) and Series 111-300 (40 amps, 7,000 VDC Breakdown).

WRITE NOW FOR FREE SAMPLE
AND COMPLETE INFORMATION ON
JOHNSON CONNECTOR LINE



E. F. JOHNSON COMPANY
3034 Tenth Ave. S.W. • Waseca, Minnesota 56093

SERIES **GM** MICROMINIATURE RF COAXIAL CONNECTORS

To meet the demands for reliable operating performance in a microminiature connector, GRFF perfected its own GM Series! Completely compatible with recently available tiny, lightweight cables, the GM Series are the *only* microminiature connectors featuring a *protective finger design* which couples the ground path to the mating connector! The GM Series are available in a wide range of plugs, jacks, etc. Most important, the GM Series are also available in new CRIMP configurations (only 3 basic parts) for fast and easy assembly!

GM Connectors are immediately available from stock!

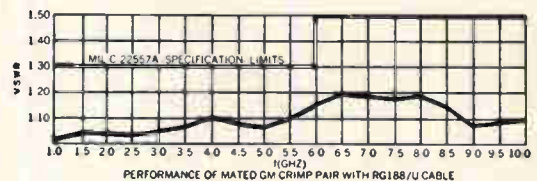

In addition to the GM, TM, TNC Series, GRFF also produces the miniature TPS Series; the new miniature 2900 Series which mate with OSM (and others); and custom microwave components to individual customer requirements.

Connectors shown above are actual size. Non-standard applications solved quickly and efficiently!

General RF Fittings, Inc.

702 BEACON ST. / BOSTON, MASS. 02215

Telephone: 617 267-5120

See GRFF at WESCON Booth no. 1409

Can you make a career out of this picture?



■ Lou Bessant hopes so. Lou's a Manager of Professional Placement for a large company. He's looking for electronics engineers who prefer a little challenge in life. He figures that if you're this kind of engineer, you're clever enough to use this picture to find out where he works and to get him your resume.

177-86

P.S. Lou is simply all heart. That's why he left 14 clues to help you find him. How many do you see?

QUALIFICATION FORM FOR POSITIONS AVAILABLE

ATTENTION: ENGINEERS, SCIENTISTS, PHYSICISTS

This Qualification Form is designed to help you advance in the electronics industry. It is unique and compact. Designed with the assistance of professional personnel management, it isolates specific experience in electronics and deals only in essential background information.

The advertisers listed here are seeking professional experience. Fill in the Qualification Form below.

STRICTLY CONFIDENTIAL

Your Qualification form will be handled as "Strictly Confidential" by Electronics. Our processing system is such that your form will be forwarded within 24 hours to the proper executives in the companies you select. You will be contacted at your home by the interested companies.

WHAT TO DO

1. Review the positions in the advertisements.
2. Select those for which you qualify.
3. Notice the key numbers.
4. Circle the corresponding key number below the Qualification Form.
5. Fill out the form completely. Please print clearly.
6. Mail to: Classified Advertising Div., Electronics, Box 12, New York, N. Y. 10036.

COMPANY	PAGE#	KEY#
AMPEX CORPORATION Redwood City, Calif. 94063	213*	1
ATOMIC PERSONNEL INC. Phila., Pa.	251	2
BAUSCH & LOMB Rochester, N. Y.	251	3
BOEING Commercial Airplane Div. Renton, Washington 98055	252	4
CORCORAN PERSONNEL CONSULTANTS, B.P. Lafayette Hill, Pa. 19444	251	5
ELECTRONIC COMMUNICATIONS INC. St. Petersburg, Fla.	231, 233, 235, 237	6
GENERAL DYNAMICS Fort Worth Div. Fort Worth, Texas	132*	7
GENERAL ELECTRIC Heavy Military Electronics Dept. Syracuse, N. Y. 13201	164*	8
GENERAL ELECTRIC Ordnance Dept. Pittsfield, Mass.	250, 251*	9
HUGHES AIRCRAFT CO. Culver City, Calif.	229	10
LAWRENCE RADIATION LABORATORY Livermore, Calif. 94550	219	11
LOCKHEED MISSILES & SPACE CO. Sunnyvale, Calif.	236	12
MARTIN COMPANY Orlando Div. Orlando, Fla.	244 & 245	13
SYLVANIA ELECTRONIC SYSTEMS Div. of Sylvania Electric Products Inc. Waltham, Mass.	175	14
U. S. NAVY San Francisco Bay Naval Shipyard, Vallejo, Calif.	242	15
UPJOHN COMPANY Kalamazoo, Michigan	213*	16

* These advertisements appeared in the May 30, 1966 issue.

(cut here)

Electronics QUALIFICATION FORM FOR POSITIONS AVAILABLE

(Please type or print clearly. Necessary for reproduction.)

(cut here)

Personal Background

NAME
HOME ADDRESS
CITY ZONE STATE
HOME TELEPHONE

Education

PROFESSIONAL DEGREE(S)
MAJOR(S)
UNIVERSITY
DATE(S)

FIELDS OF EXPERIENCE (Please Check)

6/13/66

- | | | |
|--|--|---------------------------------------|
| <input type="checkbox"/> Aerospace | <input type="checkbox"/> Fire Control | <input type="checkbox"/> Radar |
| <input type="checkbox"/> Antennas | <input type="checkbox"/> Human Factors | <input type="checkbox"/> Radio-TV |
| <input type="checkbox"/> ASW | <input type="checkbox"/> Infrared | <input type="checkbox"/> Simulators |
| <input type="checkbox"/> Circuits | <input type="checkbox"/> Instrumentation | <input type="checkbox"/> Solid State |
| <input type="checkbox"/> Communications | <input type="checkbox"/> Medicine | <input type="checkbox"/> Telemetry |
| <input type="checkbox"/> Components | <input type="checkbox"/> Microwave | <input type="checkbox"/> Transformers |
| <input type="checkbox"/> Computers | <input type="checkbox"/> Navigation | <input type="checkbox"/> Other |
| <input type="checkbox"/> ECM | <input type="checkbox"/> Operations Research | <input type="checkbox"/> |
| <input type="checkbox"/> Electron Tubes | <input type="checkbox"/> Optics | <input type="checkbox"/> |
| <input type="checkbox"/> Engineering Writing | <input type="checkbox"/> Packaging | <input type="checkbox"/> |

CATEGORY OF SPECIALIZATION

Please indicate number of months experience on proper lines.

	Technical Experience (Months)	Supervisory Experience (Months)
RESEARCH (pure, fundamental, basic)
RESEARCH (Applied)
SYSTEMS (New Concepts)
DEVELOPMENT (Model)
DESIGN (Product)
MANUFACTURING (Product)
FIELD (Service)
SALES (Proposals & Products)

CIRCLE KEY NUMBERS OF ABOVE COMPANIES' POSITIONS THAT INTEREST YOU

1 2 3 4 5 6 7 8 9 10 11 12 13 14 15 16

When we tell you these jobs take deeper insight, we've got **POSEIDON'S "aims"** in mind.

(All sixteen of them).

As though coming up with two generations of fire control systems and inertial platforms for Polaris — each appreciably more complex and more fool-proof than the one before it — wasn't tough enough. Now we've really got to make sixteen the hard way.

Because each of POSEIDON'S sixteen missiles will carry double the payload with twice the accuracy plus a good deal more and faster targeting flexibility than the most advanced Polaris system going. And with even less room to spare.

Unlike Cape Kennedy where time and space are easier to come by, and where the launch pad is conveniently stationary, the system you help us design for shoe-horning into a submarine will have to have the bedrock reliability to withstand extraordinary environmental extremes and operational hazards...and to do its job (including elaborate

self-checking) with instant infallibility. To make things worse (or better, if you happen to like some depth to your engineering challenges) the target trajectory is a mass of variables — among them the sub's position and direction at the moment of launch, its motion such as pitch, roll, yaw and velocity, not to mention the weather topside.

One thing's for sure. Whether you're helping us develop standardized micro-module building block circuits, helping us configure them in advanced and easily accessible ways, helping us develop a precise 3-gimbal temperature-constant guidance platform, or the fire control system, or the support equipment, there's no room for shallow thinking.

On the other hand, the room and the opportunity for engineers with insight is practically unlimited. So why not look into the jobs listed to the right, and then send us a copy of your resume.

Ordnance Department

GENERAL  ELECTRIC

Think deep

DIGITAL LOGIC DESIGN ENGINEERS—Responsible for the subsystem mechanization of development digital control systems. Keep abreast of new knowledge about digital memory design software techniques and microminiature modules and apply this knowledge to the logic design of control systems. Experience in mechanization techniques, tape readers, printer and compiler organization.

SYSTEMS ENGINEERS—Conceive and analyze the feasibility of concepts for weapon control systems. Develop the digital analog and combined analog digital approaches to the solution of weapon systems problems. Determine the methods and data requirements for the evaluation of a given weapons system.

COMPONENTS ENGINEERS—Determine tests necessary for evaluation of new components to be used in special circuits. Investigate integrated circuits and supply design criteria and specifications to technical personnel. Position requires a dynamic and enthusiastic personality; some background in circuits is desired.

INERTIAL GUIDANCE CONTROL DEVELOPMENT ENGINEERS—Responsible for designing servo controls for inertial systems. Should be capable of servo loop analysis and of supervising the design of required solid state circuitry. Individuals must possess initiative and creativity to promote development work and to supervise other technical personnel.

ELECTRONIC CIRCUIT ENGINEERS—Develop, design, package and evaluate digital and analog electronic circuits to meet requirements of Weapon Control systems and subsystems. Analyze, design and evaluate circuits and packaging techniques—using both discrete solid-state components and integrated microelectronic circuits for applications such as submarine fire control, gun mount and antenna drives, digital servos, sophisticated space power conversion and control equipments.

COMPUTER APPLICATION ENGINEER—To direct technical efforts of engineering group providing the conception, development and evaluation of new and unique designs associated with the application of General Purpose Computers to Weapon Control Systems. Responsible for establishing requirements for general purpose computing subsystems. Requires direct knowledge of Logical Design techniques, General Purpose Computer organization and programming. Knowledge of numerical techniques and analytical methods is desirable.

QUALITY INFORMATION EQUIPMENT ENGINEERS—To develop, design and evaluate production test consoles to assure the performance of inertial guidance, attitude reference and fire control equipments. Emphasis on advanced design of electronic measurement and control circuits, functional simulation of interfacing of analog and digital subsystems, and application of tape controlled automatic test equipment. Incumbents have project responsibility from development through installation requiring integration with internal operations and the customer.

If you have the qualifications, and interest, please send full details including salary requirements to: Mr. D. F. Kline, General Electric Co., Room 61-G, Ordnance Department, 100 Plastics Avenue, Pittsfield, Mass.

Ordnance Department

GENERAL  ELECTRIC

An Equal Opportunity Employer

Bausch & Lomb has openings for

ELECTRONIC ENGINEERS

B.S. or M.S. with one to five years experience in the design of analog and digital circuits and systems. Good theoretical background in math, physics and network analyses desirable. Experience in control systems and low signal level circuit techniques helpful. Projects involve development of sophisticated instruments in biomedical, chemical, optical and electronic fields at the applied research stage.

Please send resume in confidence, including salary requirements to: E. J. Walter, Employment Specialist, Bausch & Lomb, 620 St. Paul St., Rochester, N.Y. 14602.

BAUSCH & LOMB 

An Equal Opportunity Employer

YOU'RE H!RED

Do you need electronics engineers or technical management men? Electronics magazine is the way to recruit them. Electronics is designed specifically for the working engineer. 68,000 subscribers and an additional 133,000 pass-along readers turn to it to keep up with their industry. You can find the man that meets your qualifications with an advertisement in the Employment Opportunities Section.

For rates & information write: Electronics, a McGraw-Hill Publication. Classified Advertising Division, Post Office Box 12, New York 10036.

The Scientists and Engineers served by Corcoran in the last year have found the difference between "a job" and "the job."

- Nationwide. Fee paid.
- Please airmail background to:

JOSEPH P. CORCORAN
Personnel Consultants

505 B Germantown Pike
Lafayette Hill, Pa. 19444
Member IEEE

PROFESSIONAL SERVICE

GIBBS & HILL, Inc.
Consulting Engineers
Systems Engineering
Operations Research • Development
Field Studies • Design • Procurement
Power • Transportation • Communications
Water Supply • Waste Treatment
393 Seventh Avenue New York 1, N. Y.



E.E.'s

For FEE PAID positions throughout U.S.

Send Coupon Today

ATOMIC PERSONNEL, INC.

Suite L, 1518 Walnut St., Phila., Pa.

Experienced Engineers... Working "Full Time"... For You!

Send resume today. (If none, send coupon for confidential application.)

Name _____

Address _____

City _____

State _____

Boeing engineering assignments...



1957: 707



1963: 727



1966: 737



© 1968: 747

Boeing's newly announced giant 747 jetliner is the latest example of challenging growth assignments in Seattle. The 747, which seats from 350 to 490 passengers, will be the largest commercial jet in aviation history. Boeing's present \$3 billion company backlog can only mean unprecedented ground-floor opportunities for engineers and scientists seeking career advancement.

Boeing is expanding its electrical/electronic engineering groups, opening career positions at all levels of experience, responsibility and income. They combine the stability of the substantial backlog with the challenge and advancement potential of new programs in an unparalleled period of growth.

Typical assignments include: electrical/electronic design, electrical/electronic development, electro-optical systems, flight test instrumentation, navigation and guidance systems, radar technology, operations research analysis, systems research analysis, mathematical statistics and re-

grow on you

search, analog and hybrid flight simulation, and computer programming and systems analysis incorporating commercial, manufacturing support, and engineering and scientific applications.

These openings are with Boeing's Commercial Airplane and Supersonic Transport divisions located at Seattle. You'll enjoy unlimited recreational, entertainment and cultural activities, including year-round golf, boating and fishing. Only an hour's drive separates sea-level and ski-level; the rugged Cascade Mountains and island-flecked Puget Sound are only minutes away from your home. Seattle-area schools are top-ranked, and the city's Opera House, Repertory Theater, Pacific Science Center and Symphony have gained national acclaim.

Investigate the career and living advantages of these assignments today. Boeing is an equal opportunity employer.

Call (collect), visit or write the Boeing Employment Office nearest you. Address: Boeing Employment Office, Dept. CDD, Chicago: (312) 726-8955, 120 South LaSalle St., Chicago, Ill. 60603. Phoenix: (602) 264-1238, Del Webb Towne House, Suite 1263, 100 West Clarendon, Phoenix, Arizona 85012. Minneapolis: (612) 338-5896, 404 Roanoke Bldg., 109 South 7th St., Minneapolis, Minn. 55402. San Francisco: (415) 434-0438, Suite 304, 16 California St., San Francisco, Calif. 94111. Houston: (713) RI 8-0305, Houston Siteman Bldg., Suite 522, 6900 Fannin Blvd., Houston, Texas 77025. Detroit: (313) 962-5850, Suite 1157, The Guardian Bldg., 500 Griswold St., Detroit, Mich. 48226. New York: (212) 697-8838, Suite 1604, 535 5th Ave., New York City, N.Y. 10017. Seattle: (206) 237-4659, Mr. Thomas Sheppard, Commercial Airplane Division, P.O. Box 707, Renton, Wash. 98055.

BOEING

COMMERCIAL AIRPLANE DIVISION
SUPERSONIC TRANSPORT DIVISION

AUTOTRACK ANTENNA MOUNT

360 degree azimuth, 210 degree elevation sweep with better than 1 mil. accuracy. Missile velocity acceleration and slowing rates. Amplitude and zero control. Will handle up to 20 ft. dish. Supplied complete with control chassis. In stock—immediate delivery. Used world over by NASA, USAF. TYPE MP #1 B. SCR-584. NIKE AJAX mounts also in stock plus several airborne trackers.

SCR 584 AUTOMATIC TRACKING RADARS

Our 584s in like new condition, ready to go, and in stock for immediate delivery. Ideal for telemetry research and development, missile tracking, satellite tracking, balloon tracking. Used on Atlantic Missile Range, Pacific Missile Range, N.A.S.A. Wallops Island, A.B.M.A. Write us. Fully Desc. MIT Rad. Lab. Series, Vol. 1, pps. 207-210, 228, 284-286. Compl. Inst. Bk. avail. \$25.00 each

AN/GPG-1 SKYSWEEP TRACKER

3 cm. automatic tracking radar system. Complete package with indicator system. Full target acquisition and automatic tracking. Input 115 volts 60 cycle. New. In stock for immediate delivery. Entire System 6' long, 3' wide, 10' high. Ideal for Infrared Tracker, Drone Tracker, Missile, Tracker, R. & D.



PULSE MODULATORS

MIT MODEL 9 PULSER 1 MEGAWATT-HARD TUBE

Output 25 kv 40 amp. Duty cycle .002. Pulse lengths .25 to 2 microsec. Also .5 to 5 microsec. and 1 to .5 microsec. Uses 6C21. Input 115v 60 cycle AC. Mfr. GE. Complete with driver and high voltage power supply. Ref: MIT Rad. Lab. Series, Vol. 5, pps. 152-160.

2 MEGAWATT PULSER

Output 30 kv at 70 amp. Duty cycle .001. Rep rates: 1 microsec 600 pps, 1 or 2 msec 300 pps. Uses 5948 hydrogen thyratron. Input 120/208 VAC 60 cycle. Mfr. GE. Complete with high voltage power supply.

MIT MODEL 3 PULSER

Output: 144 kv (12 kv at 12 amp.) Duty ratio: .001 max. Pulse duration: .5, 1 and 2 microsec. Input: 115 v 400 to 2000 cps and 24 vdc. \$325 ea. Full desc. Vol. 5, MIT Rad. Lab. series, pg. 140.

250KW HARD TUBE PULSER

Output 16 kv 16 amp. duty cycle .002. Pulses can be coded. Uses 5D21, 715C or 4PR80A. Input 115 v 60 cycle ac. Incl. H.V. pwr supply \$1200 ea.

200 KW LINE PULSER

16 KV 16A .25 microsec 4000 PPS. Duty .0012. 5C22 thyr. Input 115V 60 cy AC. \$450.00.

MICROWAVE SYSTEMS

200-225 mc RADAR SYSTEM

1 megawatt output. 200 nautical mile range for long range detection of medium and high altitude jet aircraft as well as general search. Complete system in stock. Input 120/208 V, 60 cy. Type AN/TPS-28. Mfr. Hazeltine.

E-4 FIRE CONTROL SYSTEM

Hughes Aircraft X Band. Complete. In stock.

C-BAND RADAR

250 KW output, C-band, PPI indicator, 5C22 thyratron modulator. Antenna hi gain parabolic section. Input 115 volts 60 cycle AC, complete \$2750.00.

300 TO 2400MC RF PKG.

300 to 2400 MC CW Tuneable. Transmitter 10 to 30 Watts. Output. As new \$475.

500W "L" BAND RADAR

500 kw 1220-1359 mes. 160 nautical mile search range P.P.I. and A Scopes. MTT. thyratron mod. 5J26 magnetron. Complete system.

PHILCO MICROWAVE LINKS

C Band Microwave Link terminal bays and repeater bays in stock. New \$1500 each or \$2500 per pr.

100W 3CM. RADAR

Complete 100 kw output airborne system with AMTI, 5C22 thyr. mod. 4J52 magnetron, PPI, 360 deg az sweep, 60 deg. elev. sweep, gyro stabilizer, hi-gain rectr. Complete with all plugs and cables.

M-33 AUTO-TRACK RADAR SYSTEM

X band with plotting board, automatic range tracking, etc. Complete with 1 megawatt acq. radar.

SEND FOR OUR NEW 8 PAGE CATALOG LISTING THE LARGEST INVENTORY OF RADAR AND MICROWAVE EQUIPMENT IN THE WORLD.

PPI CONSOLE

Complete plan position indicator, 10", with 115 volt 60 cy input pwr supply. Also mis. synchro for RII readout. Type AN/CPA 25 \$1200.00 ea.

RADAR MAPPING CONSOLE

Complete with 115 volt 60 cy AC pwr supply. Mfr: IBM/Bendix. \$1200.00 ea.

AIRPORT SURVEILLANCE RADAR

General Electric type ASR-2. 500 KW. S Band. will detect even small light Acft at 250 miles. Compl system incl. standby equip. As-new.

3KW RCA PHONE & TELEG XMR

2-30 MC. 10 Autotone channels plus MO. Input 220 vac. 50/60 cycles.

MICROWAVE TUBES

CM-710A CARCINOTRON

2400 to 3100 mc tuneable, 200 watts CW output nom. Mfr: CSE. Govt. acq. cost \$6000.00 Price \$975.00.

1154 RCA T.W.T.

1.5 to 4.5 gc. I-S-C Band, 10 milliwatts output. Wide band low level amp. u/w AN/ALQ-19 Countermeasure Set. Govt. Acq. cost \$4000.00 Price \$250.00.

1161 RCA T.W.T.

1.9 to 4.1 gc: 1 watt output grid controlled. Wide Band medium power amp. Tube or CW operation. u/w AN/ALQ-19 Countermeasures Set. Govt. Acq. cost \$4000.00 Price \$250.00.

C BAND KLYSTRON

7125 to 7425 mc. Tuneable. 1 watt CW output. Mfr: Sylvania.

SMC-11A KLYSTRON

4640 to 4670 mc. Amplifier-multiplier. 1 watt CW output. Req. 775 to 778 mc driver. Mfr: Sperry.

SMX-32 KLYSTRON

9 to 10.5 kmc. Amplifier multiplier, 2 watts CW output. Req. 4500 to 5250 mc driver. Mfr: Sperry.

VA-800 KLYSTRON

1.7 to 2.4kmc. Tuneable. 10 kw CW output. Mfr: Varian

VA-1520 MAGNET

For use with VA-800 \$750.

VA-137 TWT

.85 T 1.95 GC. 5 KW peak, 350 Watts Avg. 130MC Bandwidth.

HUGHES 302H BWO

Kf Band backward wave Osc.

RADAR AUTO-TRACK & TELEMETRY ANTENNA PEDESTALS 3 & 10 CM. SCR 584 AUTOTRACK RADARS. M-33 RADAR TPS-1D SEARCH. APS-45 TPS-10D HT. FINDERS. WX RADARS. FPN-32GCA. APS-10. APS-15B. APS-27 (AMTI) SEARCH. APN-102 DOPPLER. DOZENS MORE. CARCINOTRONS. PPN'S. 2S-5-1-2-3-6 MEGAWATT PULSE MOODULATORS. CAVITIES. PULSE TRANSFORMERS. IF STRIPS. WAVEGUIDE. BENOS 200 MC. 1 KMC. 3 KMC. 6 KMC. 9 KMC. 24 KMC. RF PKGS. RADIO RESEARCH INSTRUMENT CO. 550 5TH AVE., NEW YORK 36, N. Y. JU 6-4691

CASH REWARD!!!

YOU will be rewarded with cold, hard cash by selling us your new, used, excess or unwanted electronic equipment. WE WANT TO BUY YOUR: AN/AIN 21, AN ARC 54, AN/ARC 52, 55, any ARN or ARC equipment, ID Indicators, Military Type T-1 Equip-ment, Collins and Bendix equn. Instruments and instrumentation. Tell us what you have—collect the reward!

J. J. CANDEE CO. Dept. E

2525 W. Burbank Blvd., Burbank, Calif. 91505

CIRCLE 973 ON READER SERVICE CARD

SPOT WELDING TWEEZERS



TWI - 36" Lead \$11.65

AC and Stored Energy Power Supplies and Welding Heads

E W A L D INSTRUMENTS CORP.
KENT, CONN. 06757

CIRCLE 967 ON READER SERVICE CARD

ENVIRONMENTAL TEST EQUIPMENT

MB #C-SHE SHAKER HEAD with T-51MCB Electronic Supply \$1750.00
MB #C-6C SHAKER HEAD with T-75MCA Electronic Supply \$5250.00
BARRY TYPE 20V-1 SHOCK TESTER 2100 Calibrated. (sand) \$1550.00
Other types and sizes in stock. Calidyne, All-Amer., etc.
HARBER INDUSTRIALS 812 W. Lake St. Chicago, Ill.

CIRCLE 972 ON READER SERVICE CARD

Color DIAL TELEPHONES \$10.95

Factory rebuilt Western Electric in white, beige, ivory, pink, green, or blue. If 3 prong plug is required add \$2.00. Fully guaranteed. Write for free list. All shipments FOB.



SURPLUS SAVING CENTER
Dept. E-6136
Waymart, Pa.

CIRCLE 968 ON READER SERVICE CARD

ELECTRON TUBES

KLYSTRONS • ATR & TR • MAGNETRONS
SUBMINIATURES • C.R.T. • T.W.T. • 5000-6000 SERIES
• SEND FOR NEW CATALOG A2 •
A & A ELECTRONICS CORP.
1063 PERRY ANNEX
WHITTIER, CALIF.
696-7544

CIRCLE 971 ON READER SERVICE CARD

TEST EQUIPMENT

For over 20 years specializing in top brands only. Write for our latest listing. We buy complete inventories.
NORMAN ELECTRONIC SALES
1413 Howard Street, Chicago, Illinois 60626
Telephone ROgers Park 4-0600

CIRCLE 970 ON READER SERVICE CARD

CIRCLE 966 ON READER SERVICE CARD

**SYNCHROS • GENERATORS
INVERTORS • SERVOS**

- 23TR6 Torque Receiver \$32.50
- 23TX6 Torque Transmitter 32.50
- 23CX6 Control Transmitter 32.50
- 1 F Motor 115/90 V. 60 Cy. 24.95
- 1 G Generator 115 V. 60 Cy. 24.95
- 1 HDG Differential Gen. 24.95
- 5 G Navy Ord. Size 115V. 60 Cy. 24.95
- 5 F Navy Ord. Size 115V. 60 Cy. 24.95
- 6 G Navy Ord. Size 115V. 60 Cy. 29.50
- 7 G Navy Ord. Size 115V. 60 Cy. 39.50
- Bendix Inverter E-1617-1, 24V. Input, 115V. 400 Cy. 3 Ph. s50 V.A. Output 25.00
- Jack-Heintz Inverter E-1617-1, 24V. Input Output 115/230 V. 1/3 Ph. 400 Cy. 2250 V.A. 75.00
- General Electric E-1823- 120/208 V. 400 Cy. Generator 60 KVA 250.00
- Jack-Heintz Inverter E-1725-1 24V. Input, Output 115/230 V. 1/3 Ph. 400 Cy. 2250 V.A. 75.00
- Westinghouse, Generator 120/208 V. 3 Ph. 400 Cy. 75.00
- Pioneer Instrument Invertor 12123-1A Input 24 V. Output 115 V. 3 Ph. 400 Cy. 25.00
- Elinco Generator PM2 18.95
- Deihl FPE49-7 Servo Motor & Tach. 29.95
- Deihl PM Motor 27.5 VDC 4.95

AC • DC MOTORS
FANS-BLOWERS • RESOLVERS
GEARED MOTORS • ACTUATORS
LARGE STOCK OF ROTATING DEVICES
All Items F.O.B. Oakland
Send for Free Catalog
(On Company Letterhead, Please)
ELECTRO GADGET SUPPLY
DOOLITTLE & LANGLEY STREETS
Oakland Airport Oakland, Calif.
Phone 562-6641

CIRCLE 969 ON READER SERVICE CARD

ADDRESS BOX NO. REPLIES TO: Box No. Classified Ad. Div. of this publication. Send to office nearest you.
NEW YORK, N. Y. 10036: P. O. Box 12
CHICAGO, Ill. 60611: 645 N. Michigan Ave.
SAN FRANCISCO, Cal. 94111: 255 California St.

BUSINESS OPPORTUNITY

Europe of Six—For firms desiring to expand their activities into Europe of Six we dispose perfect commercial, organization and plant capacity approx. 10,000 sq. feet in the center of Brussels, with Power 100 KVA, compressor, machines, presses, etc. . . . Complete cession at very moderate capital, or joint venture. Write to BO-9213, Electronics. Intermediaries abstain.

NINE-IN-LINE

CIRCUIT PROTECTION and CIRCUIT CONTROL by AIRPAX ELECTRONICS

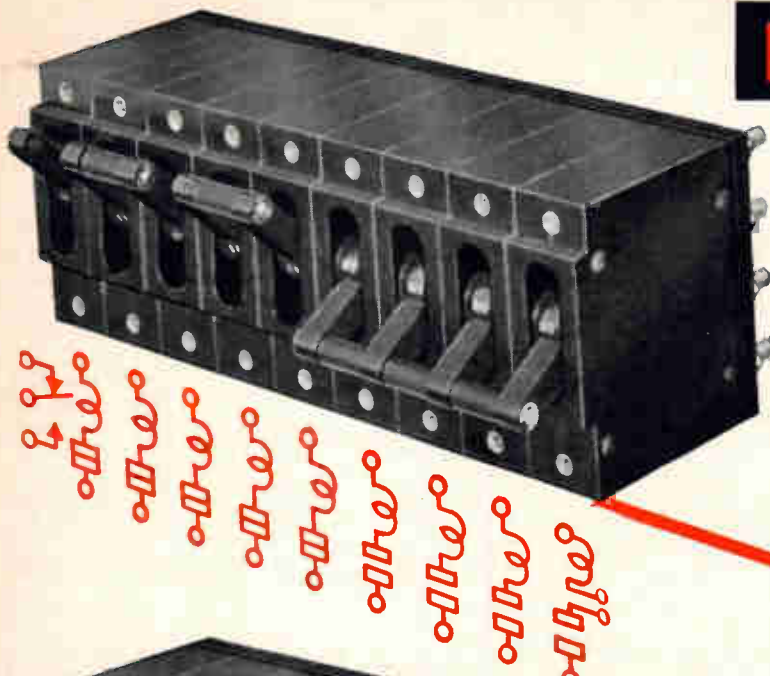

Step 1 is ON
Step 2 is ON
Step 3 is ON
Step 4 is waiting.



All steps are on
and all functions
are protected.

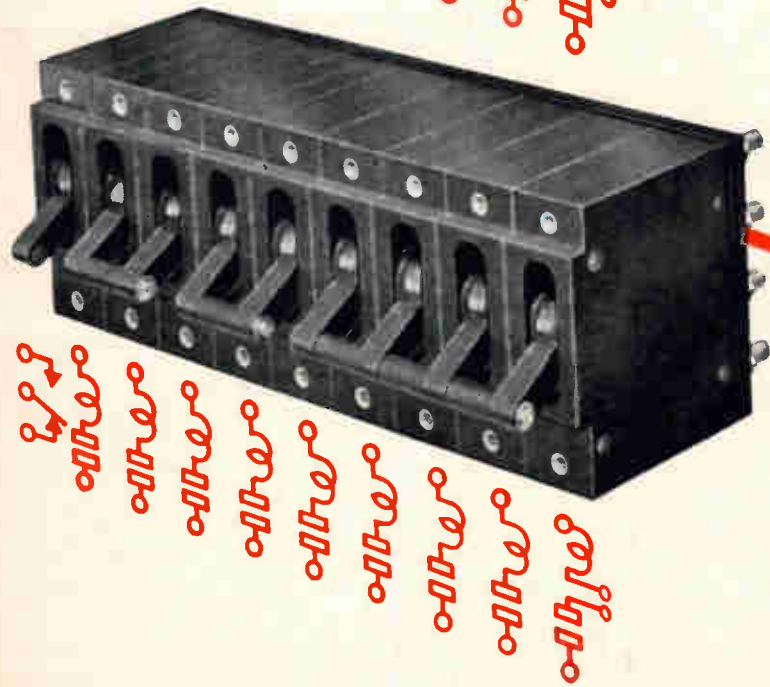

One circuit overloads.
All protectors trip open.
All safe.

AIRPAX ELECTRONICS

incorporated

CAMBRIDGE DIVISION, CAMBRIDGE, MD.
(301) 228-4600

Electronics Abroad

West Germany

Fast characters

Ever since Johannes Gutenberg invented movable type some five centuries ago, Germany has been in the vanguard of printing technology. Lately, however, the German position has been threatened—even on home ground—by the United States. At five of the six newspaper plants currently printing with computer-controlled typesetting, for example, the data-processing equipment is U.S. made.

West Germany may well recoup some of its lost stature in printing with a photographic typesetter introduced last month by the Kiel-based firm of Dr.-Ing. Rudolf Hell. The machine, called Digiset, turns out 600 characters per second, or well over two million an hour.

Slower but cheaper. Hell admits that Digiset is not the fastest typesetter around. The Mergenthaler Linotype Co., a subsidiary of the Eltra Corp., will deliver later this year to the U.S. government printing office a machine called the Linotron that sets copy without error at 1,000 characters per second. Mergenthaler developed the system jointly with CBS Laboratories, a division of the Columbia Broadcasting System, Inc. Linotron installations, though, can run from \$300,000 all the way up to more than \$1 million. Digiset, by contrast, sells for as little as \$150,000.

At that price, Hell figures its machine will sell like Volkswagens. The first will be sent in a few weeks to a Stuttgart publishing house. Another will go to a Danish printer, and five more systems are slated for delivery to other European customers. "We could easily sell thirty or more units a year if we had the capacity to produce them," claims Fritz Schueller, sales manager of Hell's computer

division. Schueller also expects Digiset to make inroads in the U. S. market, where the Radio Corp. of America will handle sales and service. RCA called the typesetting machine "Videocomp".

On the beam. Digiset combines digital techniques and electron-beam deflection. Pulses that represent characters are stored in a magnetic core in the machine. When the pulses are read out of the memory, they deflect the beam so it traces the character on the face of a cathode-ray tube. The images are projected through an optical system onto light-sensitive bromide paper or film. Line resolution is about 500 lines per inch. Film or paper strips up to 26 inches long with type set on them are developed and dried automatically in the machine in about a minute.

The memory is loaded with character information by means of a punched paper tape. To prepare the basic tapes, Hell covers oversized characters for each font with a grid, then scans them electronically to obtain pulses that are transferred to the memory tape. Characters range in size from 4 to 24 points and there's no limitation on type faces. Hell supplies even Chinese and Cyrillic characters—if a printer wants them—as part of the software package that goes with the system.

The magnetic core can handle up to 16,384 sixteen-bit computer words. That works out to about 380 characters for small and medium sizes which the machine sets at a rate of 600 per second. Character capacity and setting speed are halved for larger sizes.

Texts to be set by the machine are punched into paper tape. From the information on the tape, the Digiset control unit "looks up" characters one-by-one in the core and feeds the pulses into the crt deflection circuitry. The text tape also contains instructions for starting new lines and advancing the



Type-composition machine combines computer and television techniques. Holes in the tape supply information needed to position dots that make up characters. The information is stored in the typesetter's core memory and can be recalled and projected onto photosensitive paper to set up to 900 lines of type a minute.

paper or film drive accordingly.

Good break. The tapes for the typesetter come from a computer called the Digi-com. Its input is an "idiot tape" punched by a keyboard operator—without any concern about line width—from the text.

The computer's magnetic core store adds the width of successive characters and spaces between words until they total slightly less than the preset column width. Then the computer figures out how much to adjust the spaces between words to fill out the line.

If the gaps would be too large,

the computer hyphenates the next word. To do so, it consults a logic store that includes a set of rules for breaking words and exceptions to the rules. When the computer hits upon a word that can't be split according to the stored logic, it prints out the word in full. A correction then has to be made by a proofreader but the word is added to the exceptions store so it can be split automatically from then on.

First installation of a Digicom computer (the tape it prepares can be used with conventional photographic typesetters) will be at the printing plant of a Nuremberg newspaper. The Digicom, whose cost ranges from \$62,500 to \$100,000, will take over the job from a much more expensive Siemens 3003 computer.

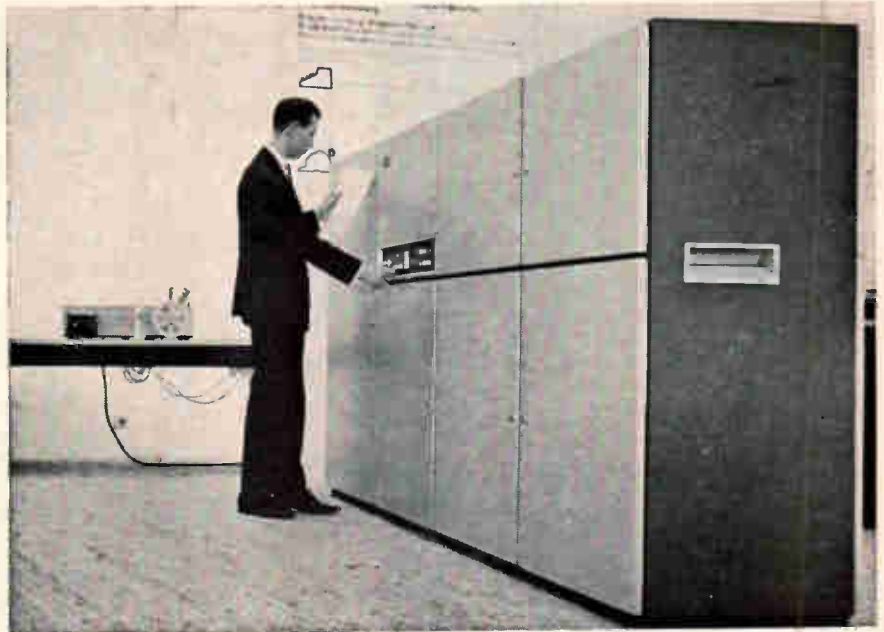

Digieset photographic typesetting machine turns out up to 600 characters per second by "looking up" digital information stored in its memory and applying the pulses to the deflection circuits of a cathode-ray tube to trace character images.

International

Standards time

Color tv tops the agenda for the plenary session of the International Radio Consultative Committee (CCIR) that starts its 30-day run at Oslo on June 22 (see story p. 161). But the delegations from some 50 countries will have other standards to wrangle over while the squabble over Secam and PAL drags on.

Three items that will test American delegates' persuasive skills are stereo broadcasting, maritime mobile norms, and satellite communications. For all three, the U.S. has proposals to push.

And the delegation will be lobbying outside the study groups that do the technical spadework in CCIR in an effort to have Jack W. Herbstreit elected director of the consultative committee. Herbstreit is currently deputy director of the Department of Commerce's Institute for Telecommunication Sciences and Aeronomy.

Left and right. At Oslo, the U.S. will plump for ratification of the American pilot-tone system for stereo frequency-modulation broadcasts as the worldwide standard.

The pilot-tone system modulates the main carrier with the sum of the left- and right-hand channel signals. Along with the main carrier, the station transmits a low-level 19-kilohertz carrier and a 38-khz suppressed carrier multiplex channel that is amplitude-modulated by a left-minus-right signal. The sum and difference signals are matrixed in the receiver to obtain separate left- and right-channel signals for two speakers.

Also in contention are a Russian system, with quadrature modulation on a 31.5-khz subcarrier, and a Swedish system that compresses the stereo signals at the transmitter and expands them in the receiver.

The U.S. and Swedish systems will be tested side-by-side at Oslo with broadcasts from a station in Sweden near the Norwegian border. No matter what the outcome of the test comparison, however, the Swedish system seems to have little chance for wide acceptance. West European countries that have gone in for stereo f-m broadcasts in a big way use pilot tone. The Russian system, though, may well get approval as an alternative standard since the 75-khz channel swing of

pilot tone brings with it interference problems for Russian stations, which have a 50-khz swing.

Calls at sea. In maritime mobile broadcast standards, the U.S. hopes to convince other countries to hold off a while before ratifying a proposal that would make a selective-calling system developed by West Germany's Siemens & Halske AG the approved one.

The Siemens system won nearly unanimous support at an interim CCIR meeting last year after it had been pitted against a U.S. and a Japanese system. Instead of voice calling of ships at sea, the Siemens system would raise a ship called from shore by a five-digit code number transmitted as a series of code tones lasting less than one second. The code signal switches on a light to warn the operator the ship is being called.

Now AMP Inc. has readied a system which U.S. officials feel would do the job much better than Siemens'. Instead of code tones, the AMP equipment transmits, in digital form, a teletype code lasting one-half second. Along with the ship's identification number, the code would identify the calling station and could also send a selec-

tion signal, say, to turn on a tape puncher to record messages when the radio operator's not on duty. AMP will demonstrate solid state hardware for this selective-calling system at Oslo. U.S. delegates hope the demonstration will create some doubts among supporters of Siemens' system.

Jockeying. In space communications, the outlook for Oslo is an agreement on slightly higher power levels for satellites and their ground stations in the 4-gigahertz and 6-gigahertz channels they share with terrestrial microwave links. The United States, for example, wants to wipe off the books the current restriction on satellite total power flux for f-m transmissions. The limit now is -130 decibel-watts per square meter. This would leave in effect the limit of -149 dbw/m² over any 4-kilohertz band. Proposals like this won't generate much heat in the cool Norwegian summer.

Austria

Cheap weather-watcher

Around the world there are 150 automatic picture transmitting stations receiving pictures from the weather satellite Nimbus II. That is, there are 150 official stations. To these must be added at least one unofficial station, a \$300 system at Vienna Polytechnicum.

The system was put together by a graduate student, Helmut Kindl, who had the support of the Institute for High-Frequency Technology. The station receives weather pictures which are then beamed by television to some 10 million Central Europeans, including four million people in Hungary, Czechoslovakia and Yugoslavia.

Station equipment. An antenna, preamplifier, tape recorder, signal conversion unit, modified tv receiver and a camera make up the low-cost station. It picks up the 136.95 megahertz transmission signals of the five-watt transmitter of Nimbus II and converts them into a tv image that is photographed

and then retransmitted by the government-run television network. The Nimbus II signal is frequency modulated over a bandwidth from 0-1,600 hertz with a 2.4 kilohertz subcarrier.

The antenna is a helical-coil type with six windings. It has a wire-mesh reflector that measures 4.92 feet square. Gain is seven decibels. The signal from the antenna is fed over a 60-ohm cable to a transistorized 136-138 mhz preamplifier followed by a normal f-m stage with optimum bandwidth of 30 khz.

Both the 2.4 khz carrier frequency and a 200 cycle reference frequency are recorded on tape. The reference frequency is used to compensate for variations in the tape speed.

Reproduction. The signal conversion unit was built at the Vienna Institute. The two recorded frequencies (2.4 khz and 200 hertz) are separated in a frequency divider since the 2.4 khz subcarrier is amplitude modulated. After amplification, the signal is fed into a rectifier to separate the side bands. The demodulated signal is fed to a video amplifier and then displayed on a 14-inch screen.

The horizontal deflection for the video circuits is derived from the 200-hertz reference frequency,

which is clipped and converted to a signal of four pulses per second. The vertical deflection comes from a monostable multivibrator that has a period of 208 seconds. Because of the low frequencies involved in the scanning, all the power amplifiers are d-c.

Great Britain

Laser in the mill

Much to the annoyance of many a product development manager, the laser has been slow in getting out of the laboratory and into the rough and tumble of industry. Some companies, in fact, are wondering if the money they've invested in lasers ever will pay dividends.

For Britain's Decca Radar Ltd., though, the wondering has ended. The company sees big business ahead for a laser doppler system it has developed to measure the speed of moving surfaces.

Already Decca Radar has checked out an experimental laser doppler system on an extrusion press at the British Aluminium Co. In this case, switching from human estimates of the speed of the ex-

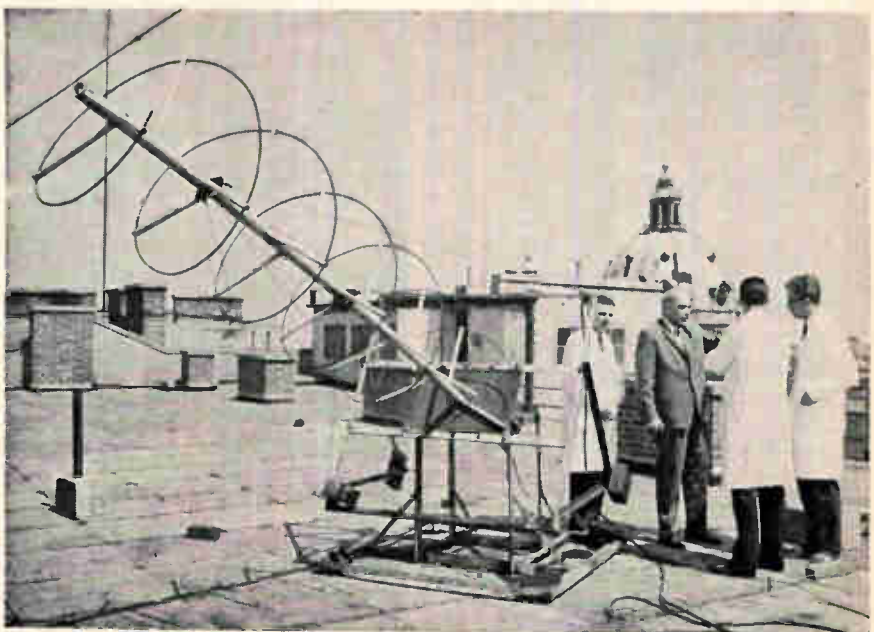

Graduate student at Vienna Polytechnicum put together for \$300 a station that produces photos from signals transmitted by Nimbus II weather satellite.

truded bar eliminated variations in production that ran as high as 20%. Bolstered by this success, Decca has two other installations in the works, both to measure the speed of hot steel plates through mills.

Accurate. Under ideal conditions, the Decca system can measure the velocity of a moving surface with an accuracy of 1 part in 100,000; this, though, requires a mirror-like surface. For the conditions generally encountered in mills the accuracy drops to 1 part in 1,000, still very high for industrial applications.

Using the laser, the measurements require no physical contact with the moving surface and they are independent of temperature.

Backscattered. Decca's doppler hardware bounces a low-power helium-neon gas laser beam off the moving surface being measured. Backscattered laser light is picked up by an optical lens system and applied, along with a part of the outgoing beam, to balanced photodiode detectors. The photodiode circuits detect the frequency difference between the two.

Doppler frequency shift depends both on the velocity of the surface off which the beam is bounced and the angle of the beam. At a laser wavelength of 6,328 angstroms, for example, a surface moving directly away from the beam generates a frequency shift of 80 cycles for each 0.001 inch of movement. With the same laser beam striking at an angle of 75° a surface moving at 20 feet per minute, the shift is 83 kilohertz.

The principle of the system, then, is relatively simple. Getting it to work, though, was another matter especially since the level of back-scattered light is low with the surfaces usually encountered in industry. Decca is closemouthed about the techniques it developed to obtain satisfactory signal-to-noise ratios for the system. However, Decca has let on that the balanced photodiode detection circuits eliminate spurious laser modes and also improve the signal-to-noise ratio by 50 decibels.

Frequency locked. Special tracking circuits allow the system to

measure speed even when the surface is intermittently obscured. No matter how good the lens system, the laser beam hits the surface at slightly different angles and the frequency output of the photodiode detectors actually is a spectrum around a mean value.

The tracking circuits work as a frequency-locked servo system generating a pure waveform at the mean frequency of the doppler spectrum. This waveform is continuously compared through a frequency discriminator against the photodiode output spectrum to keep it locked on the center frequency. The tracker's frequency output is counted down and displayed to indicate the speed of the surface being checked. That way, the count continues even when dirt, steam or the like temporarily blocks off the light.

Eased growing pains

Researchers at Britain's Royal Radar Establishment have hit on a technique that may make crystal growing—the first stage in the manufacture of solid state devices—almost as easy for gallium arsenide and indium arsenide as it is for germanium. Their idea: encapsulate the crystal melt with an inert liquid.

When it comes to GaAs and InAs, bulk semiconductor produc-

ers have growing pains. At the melting point of the arsenide compound, usually between 1240°C and 1250°C for GaAs, the arsenide dissociates from the melt. To stop arsenide loss, the vessel in which the crystal is grown must be sealed off. It must also be kept heated to between 550° and 600°C so the vapor pressure of the arsenide inside equals the dissociation pressure. Under this condition, the arsenide stays in the melt, but the crystal has to be pulled using a magnet or a syringe.

Cover up. The Royal Radar Establishment technique seals off the melt at its surface with a one-centimeter layer of molten boric oxide. RRE settled on boric oxide for the liquid encapsulant because it is less dense than GaAs or InAs (and therefore floats on the semiconductor melt), inert, transparent, and impenetrable to volatile arsenides. With encapsulation, GaAs or InAs crystals can be pulled from the melt without resorting to a magnetic or syringe puller and with the walls of the containing vessel at room temperature. The crystal grows at the interface of the boric oxide layer and the melt; since the encapsulating layer is transparent, the operator can watch the seed grow. As the growing crystal is pulled through the encapsulating layer, a thin film of oxide remains on the crystal and prevents arsenide loss.

Several American producers of bulk semiconductors have tried pulling GaAs and InAs crystals with liquid encapsulation but apparently no one yet has come up with a commercial technique. RRE researchers, though, maintain that liquid encapsulation works on conventional machines used to pull germanium crystals and report they've already pulled GaAs crystals 3 inches long and 15 millimeters in diameter. What's more, they expect the encapsulation technique will make zone refining easier for compounds that have volatile components.

As for purity of the grown crystals, RRE says there's no detectable trace of contamination from the encapsulating liquid.

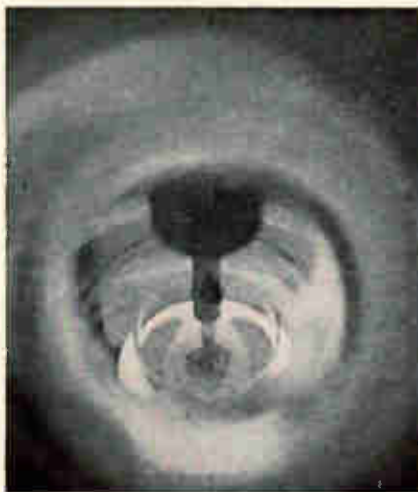

Indium arsenide crystal emerges from transparent molten layer of boric oxide.

Crown copyright

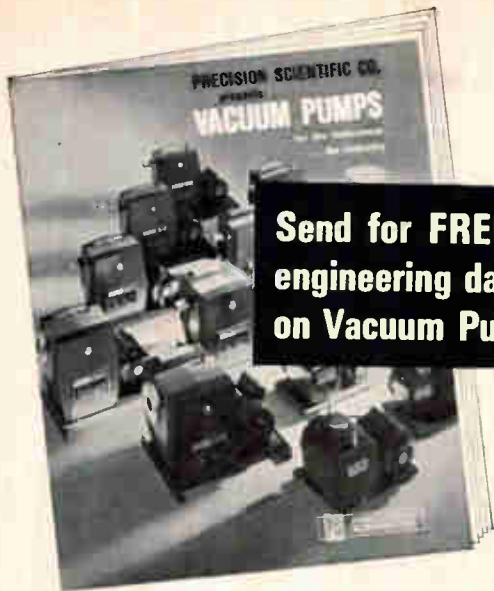

Send for **FREE**
engineering data
on Vacuum Pumps

Precision High Vacuum Pumps are job-rated

From this newest, most complete line of internal vane mechanical vacuum pumps you can select a model with guaranteed performance matched to your requirements. For lab use, for roughing or backing a system, or for integral use in your product—take your choice of both single and two stage models in capacities from 25 to 1500 liters/minute (free air) at prices from \$100 to \$1500. Guaranteed ultimate vacuum runs to 0.1 micron of mercury. And these pumps are quieter, smaller and more efficient than any on the market today. Consult your Precision Scientific distributor, or send for 24-page Bulletin 650.



**PRECISION
SCIENTIFIC CO.**

3737 W. Cortland St., Chicago, Ill. 60647

Local Offices: New York • Chicago • Los Angeles

Circle 492 on reader service card

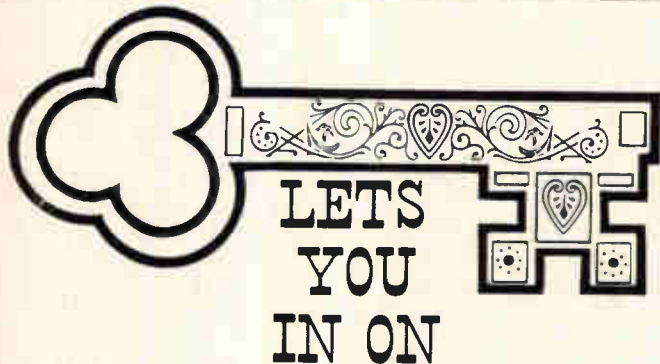

the latest in Heat Sink Extrusions

WAKEFIELD DISTRIBUTOR PRODUCTS CATALOG

Your authorized WAKEFIELD Electronic Distributor stocks a wide variety of Heat Sink Extrusions in 3 ft. \pm 1/4" lengths. This catalog will give you the name of your nearest distributor and full product information: milliwatt to high power coolers, circuit board heat sinks, extrusions, thermal joint compound DELTA BOND 152 Thermally Conductive Adhesive.

FOR YOUR COPY, WRITE



**WAKEFIELD
ENGINEERING, INC.**



139 FOUNDRY ST. / WAKEFIELD, MASS. (617) 245-5900 • TWX 617-245-9213

Circle 493 on reader service card



If you thought
our "Compact" was
great @ \$17.50...

look what we have
for \$9.*

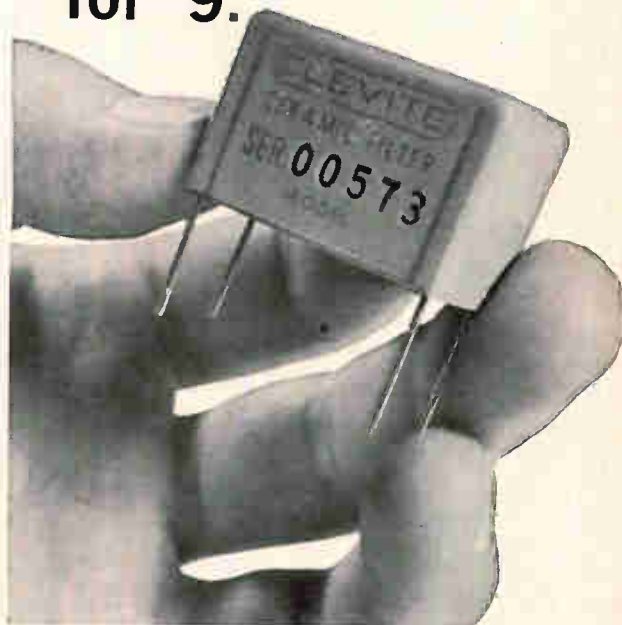

It's our new TCD filter. And for the money, it's the finest filter around. Bandwidth @ 6 db is 8 kc (minimum); at 60 db—20 kc (maximum). Transformer input provides a DC path and an input impedance of 40 K ohms, suitable for transistor and vacuum tube circuits. We designed it specifically for CB, mobile, aircraft and marine radios... put it in a package that's less than .6 cu. in. The following specs are for our standard model (but say the word and we'll custom design to your special requirements):

TCD-4-8D20A	@ 27°C		Impedance	
Center Freq: 455 \pm 1kc Temp. Stability: less than 800 cps variation -20 to +60°C	B/W (@ 6db 8kc min. @ 60db 20kc max.	Insertion loss 6db max.	In 40 K ohms	Out 1.5 K ohms

*For orders of 100 to 499. Complete TCD Prices: 1-24 — \$15 ea; 25-99 — \$12 ea.; 100-499 — \$9 ea.; 500-199' — \$7.50 ea.; 2000-4999 — \$6.50 ea. (Prices subject to change without notice.)

Send order or request for free Technical Brochure to:
Clevite Corporation, Piezoelectric Division, 232 Forbes Road,
Bedford, Ohio 44014.

CLEVITE

Circle 259 on reader service card

259

Electronics advertisers

June 13, 1966



A D C Products John Gompper & Associates	194	Computer Control Co. Inc. Franklin P. Folts Inc.	187	General Electric Company, Silicon Products Div. Ross Roy Inc.	226
A M P Incorporated Garceau, Hargrave & McCullough Inc.	43	Consolidated Electrodynamics Corporation Hixson & Jorgensen Inc.	174, 237	General Electric Company, Specialty Control Dept. George R. Nelson Inc.	118
A P I Instruments George Z. Griswold Advertising	225	Consolidated Vacuum Corporation Wolff Associates Inc.	179	General Electrodynamics Corporation Evans, Young, Wyatt Advertising	196
Acme Electric Corporation Scheel Advertising Agency Inc.	208	Consumer Public Power District Swanson, Sinkey, Ellis Inc.	238	General R-F Fittings Inc. Van Christo Associates	247
Acopian Corporation Mort Barish Associates Inc.	222	Control Data Corporation Barnes Champ Advertising	233	General Radio Company K. E. Morang Company	2nd Cover
Aerovox Corporation, Hi-Q Div. Lescarboura Advertising Inc.	73	Control Switch Div. of Controls Co. of America Harry P. Bridge Company, The	70	Granger Associates West Associates	8
Airpax Electronics Inc. Welch Mirabile & Company Inc.	254	Coors Porcelain Company Tallant/Yates Advertising	53	Hamilton Watch Company Beaumont, Heller & Sperling Inc.	215
Allen Bradley Company Fensholt Advertising Agency	85 & 86	Couch Ordnance Inc. Culver Advertising Inc.	232	Hayakawa Electronics Co., Ltd. Dai-ichi International Inc.	93
Alpha Metals Inc. Black, Russell-Morris Inc.	243	Dale Electronics Inc. Swanson, Sinkey, Ellis Inc.	66	Heath Company Advance Advertising Service Inc.	220
Amelco Semiconductor Div. of Teledyne Inc. Sturges & Associates	39	Dalmo Victor Company Pierce & Strain Advertising	166	Heinemann Electric Company Thomas R. Sundheim Inc.	32
American Lava Corporation Designers Inc.	262	Data Control Systems Bodge-Eade Incorporated	243	Hewlett Packard Associates Lennen & Newell Inc.	84
American Optical Company Fuller & Smith & Ross Inc.	83	Datex Faust/Day Inc.	80	Hewlett Packard, Loveland Division Lennen & Newell Inc.	2, 45
Amperex Electronics Corporation Sam Groden Inc.	148, 149	Delta Microwave S. Gunnar Myrbeck Company	234	Hewlett Packard, Moseley Co. Div. Lennen & Newell Inc.	1
Art Wire & Stamping Company Williams & London Advertising	162	Di-Acro Corporation Charles E. Brown Advertising Agency	204	Hewlett Packard, Sanborn Co. Div. Culver Advertising	20, 21
Astro Communication Laboratories Inc. Admasters Advertising Inc.	234	Digital Equipment Corporation Kalb & Schneider Inc.	22	Honeywell Test Instruments Campbell Mithun Inc.	65
Baldwin Lima Hamilton Gray & Rogers Inc.	61	Dupont & Company Mylar Division Batten, Barton, Durstine & Osborn Inc.	63	Hughes Aircraft Company Foote, Cone & Belding Inc.	229
Bausch & Lomb Inc. Wolff Associates Inc.	209	DuPont & Company Teflon Division Batten, Barton, Durstine & Osborn Inc.	160	Hull Corporation Michener Company Advertising	226
Beckman Instruments Inc. Lescarboura Advertising Inc.	164	D X Antenna Company Inc. Osaka Koken Company Ltd.	90	IMC Magnetics Corporation Monad Advertising Design	186
Beckman Instruments Inc. Helipot Div. Hixson & Jorgensen Inc.	177	Elmac Div. of Varian Associates Hoefer, Dieterich & Brown Inc.	139	Ichizuka Optical Company Inc. Matsushita Inc.	92
Bell Aerosystems Company Comstock Advertising Inc.	64	Electronic Communication Inc. Neals & Hickok Inc.	231, 233, 235, 237		
Bendix Corporation, Montrose Division MacManus, John & Adams Inc.	127	Electronic Industries Association of Japan Asia Advertising Agency	89		
Bendix Corporation, Scintilla Division MacManus, John & Adams Inc.	227	Electronic Modules Corporation Ray Thompson & Associates	62		
Borden Chemical Company, Mystik Industrial Div. Robert Conahay Inc.	88	Elgenco Inc. Wesco Advertising	240		
Bourns Incorporated Trimpot Division Allen, Dorsey & Hatfield Inc.	77, 185	Emerson & Cuming Inc. Edwin F. Hall Inc.	238		
Brush Instrument Division of Clevite Corp. Carr Liggett Advertising Inc.	3rd Cover	Engelhard Industries Inc. Keyes Martin & Company	198, 199		
Buchanan Electrical Products Corp. Keyes, Martin & Company	75	Esterline Angus Instrument Company Caldwell, Larkin & Sidener-Van Riper Inc.	98		
Bussman Mfg. Co., Div. of McGraw-Edison Company Henderson Adv. Co.	220, 221	Ex-Cello Corporation Campbell Ewald Company	239		
CTS Corporation Burton Browne Advertising	33	Fairchild Controls Dunwoodie Associates Inc.	172		
Chemcut Corporation Adams Associates Inc.	223	Fairchild Semiconductor Inc. Faust/Day Inc.	48, 49, 50, 51		
Chrono-Log Hill Associates	230	Fairchild Semiconductor Inc. Faust/Day Inc.	12, 13, 150		
Chuo Denshi K.K. Standard Advertising Inc.	94	Fiberfil Inc. Tri-State Adv. Co. Inc.	44		
Clairex Corporation Michel-Cather Inc.	224	Fluke Mfg. Co., John Bonfield Associates Inc.	15		
Cleveland Institute of Electronics Rapp & Collins Div. of Foote, Cone & Belding Inc.	228	Fujitsu Ltd. Fuji Agency	96		
Clevite Corporation, Piezoelectric Div. Carr Liggett Advertising Inc.	259	Garlock Company Inc. Richardson, Thomas & Bushman Inc.	231		
Clifton Precision Products Company Ivey Advertising Agency	24	Garrett Corporation J. Walter Thompson & Co.	117		
Cohu Electronics Erwin Wasey Inc.	6	General Electric Company George R. Nelson Inc.	30, 31, 178		
Collins Radio Company John G. Burnett Adv. Agency	176	General Electric Company, Polymer Products Div. Ross Roy Inc.	71		
Communication Electronics Inc.	224				

Classified advertising

F. J. Eberle, Business Mgr.

BUSINESS OPPORTUNITIES
Offered 253

EQUIPMENT
(Used or Surplus New)
For Sales 253

ADVERTISERS INDEX

A & A Electronics Corp.	253
Atomic Personnel Inc.	251
Bausch & Lomb	251
Boeing Co.	252
Candee Co., J. J.	253
Corcoran Personnel Consultants, J. P.	251
Electro Gadger Supply	253
Ewald Instruments Corp.	253
General Electric Co.	250, 251
Ordnance Dept.	250, 251
Harber Industrials	253
Norman Electronic Sales	253
Radio Research Instrument Co.	253
Surplus Saving Center	253

■ For more information on complete product line see advertisement in the latest Electronics Buyers' Guide

□ Advertisers in Overseas Advertising Section

Executive, editorial, circulation and advertising offices: McGraw-Hill Building, 330 West 42nd Street, New York, N.Y., 10036. Telephone (212) 971-3333. Teletype TWX N.Y. 212 640-4646. Cable: McGrawHill, N.Y. Officers of the McGraw-Hill Publications: Joseph H. Allen, President; Bayard E. Sawyer, Executive Vice President; Vice Presidents: J. Elton Tuohis, Operations; John R. Callahan, Editorial; Ervin E. DeGraff, Circulation; Donald C. McGraw, Jr., Advertising Sales; Angelo R. Venezian, Production; Robert M. Wilhelm, Controller. Officers of the Corporation: Donald C. McGraw, Chairman of the Board; Shelton Fisher, President; L. Keith Goodrich, Hugh J. Kelly and Robert E. Slaughter, Executive Vice Presidents; John J. Cooke, Vice President and Secretary; John L. McGraw, Treasurer. Title R registered U.S. Patent Office; © copyright 1966 by McGraw-Hill, Inc. All rights reserved, including the right to reproduce the contents of this publication, in whole or in part.

Electronics advertisers

June 13, 1966

Indiana General Corp. Griswold & Eshleman Company	81	Northern Natural Gas Company Bozell & Jacobs Inc.	78
IRC Gray & Rogers Inc.	182	Nucleonic Products Company Enyart & Rose Advertising Inc.	222
■ ITT Cannon Electric Inc. West, Weir & Bartel Inc.	206, 207	■ Oki Electric Industries Ltd. Standard Advertising Inc.	95
■ ITT Jennings Radio Mfg. Co. L. H. Waldron Adv. Agency	168	Pamotor Inc. Harry P. Bridge Company, The	238
ITT Semiconductor Neals & Hickok Inc.	171, 173	■ Pennsalt Chemicals Corp. Aitkin-Kynett Company Inc.	87
James Electronics Incorporated Burton Browne Advertising	203	Perfection Mica Company, Magnetic Shield Division Burton Browne Advertising	236
Jerrold Corporation Irving Gould Advertising Inc.	14	Phelps Dodge Electronic Products Corporation Smith, Dorian & Burman Inc.	193
Johnson Company, E. F. Midland Associates Inc.	247	Philco/Sierra Company Hal Lawrence Inc.	34
Kahle Engineering Company George Homer Martin Associates	195	Polaroid Corporation Doyle, Dane, Bernbach Inc.	191
■ Lapp Insulator Company Inc. Wolff Associates Inc.	212	Precision Scientific Company Tri-State Advertising Company Inc.	259
Lawrence Radiation Laboratory Hofer Dieterich & Brown Inc.	219	■ Precision Tube Company George Moll Advertising Inc.	184
■ Leach Corporation Jay Chiat & Associates	140, 141	■ Primo Company Ltd. General Adv. Agency	91
Ledex Incorporated Yeck & Yeck Inc.	216	RHG Electronics Labs Inc. S. M. Sachs & Associates Inc.	241
Lockheed Missiles & Space Company McCann Erickson Inc.	236	Radiation Inc. Basford Inc.	155
London Company, The Ritchie & Sattler Inc.	201	Radio Corporation of America Al Paul Lefton Company	4th Cover
Machlett Laboratories Inc. Div. of Raytheon Co. Fuller & Smith & Ross Inc.	9	■ Radio Frequency Labs Inc. Keyes, Martin & Company	59
■ Mallory & Company, P. R. Battery Div. Needham, Harper & Steers Inc.	52	Raytheon Company, Components Div. 54, Fuller & Smith & Ross Inc.	55
■ Mallory & Company, P. R. Mfg. Div. Aitkin-Kynett Company Inc.	69	Raytheon Microwave & Power Tube Div Fuller & Smith & Ross Inc.	72
■ Markel & Sons, L. Frank George Moll Advertising Inc.	219	■ Sage Electronics Corporation Mathison Adv. Inc.	210
Martin Company Shattack Roether Advertising	244, 245	Sankyo Adv. Co. Ltd. Shinwa Adv. Co. Ltd.	94
■ Matsuo Electric Company, Ltd. Fuji Agency	94	San-Ei Instrument Co. Ltd. Standard Adv. Inc.	93
■ McLean Engineering Laboratories Healy Advertising Agency	211	Sangamo Electric Company Winius-Brandon Company	58
■ Meguro Electronic Instrument Company General Advertising Agency	92	S. D. Industrial Development Expansion Agency Maurice Paulsen Adv.	235
Adolf Meller Company Susan e. Schur Advertising	239	Seaelectro Corporation Lescarboura Adv. Inc.	188
Mepco Inc. Ray Ellis Advertising Corp.	170	Siemens America Inc. Mann Wesley Advertising	18, 19
Metals & Controls Div. of Texas Instruments Inc. Horton, Church & Goff Inc.	217	■ Silicon Transistor Corporation A. D. Adams Inc.	57
■ Metal Removal Company The Advertising Producers Associates	153	Simpson Electric Company The Fensholt Advertising Agency	156
Metronix Corporation Standard Advertising Inc.	90	Slater Electric Inc. Kane Light Gladney Inc.	60
Mico Instrument Co.	230	■ Sorensen Operation, Raytheon Company James Advertising Inc.	11
Microwave Associates Inc. Kalb & Schneider Inc.	189	■ Spectra-Electronics Marketing Services	7
Minnesota Mining & Mfg. Co. Scotchpar Div. Klau-Van Pietersom—Dunlap, Inc.	200	Speer Carbon Company Hazard Advertising Company Inc.	41
■ Mitsubishi Electric Corporation Hakuodo Inc.	90	Sperry Electronic Tube Division Neals & Hickok Inc.	17
■ Mitsumi Electric Company Ltd. Dentsu Advertising Ltd.	89	Sprague Electric Company, The Harry P. Bridge Company, The	5, 10, 16
Motorola Inc. Military Electronics Inc. Charles Bowes Adv. Inc.	204, 225, 261	Stackpole Carbon Company, Electronic Components Div. Meek & Thomas Inc.	56
Motorola Semiconductor Products Inc. Lane & Bird Advertising Inc.		Statham Instruments Inc. David Johnson Advertising	214
Mullard Ltd. Roles & Parker Ltd.	181	■ Stevens-Arnold Inc. Meissner & Company Inc.	232
Murata Mfg. Co. Ltd. Dentsu Advertising Ltd.	91	Stromberg Carlson Corporation Rumrill Hoyt Inc.	239
Nihon Steatite Industry Co. Ltd. General Advertising Agency	90	Struthers-Dunn Inc. Harry P. Bridge Company	213
Nippon Communication Industrial Co. Ltd. General Advertising Agency	95	Sylvania Electronics Systems Briant Advertising	175
Nishimura Musen Denki Co. Ltd. Nichiden Advertising Ltd.	95	■ For more information on complete product line see advertisement in the latest Elec- tronics Buyers' Guide.	
North Atlantic Industries Inc. Murray Heyert Associates	192	□ Advertisers in Overseas Advertising Section	

collage

More Motorola Melange,
continued from page 225

Meanwhile, up in the ivory tower...

speaking of polysyllables & polyfrequency

Our Chicago Center's Communications R & D Lab is all atwitter over something they call digital frequency synthesis. It has to do with an I/E approach in military radio sets that permits quick and reliable multi-channel operation. They've written about it in our new Engineering Bulletin, and we'll send you a copy if you can take words such as "Polyfrequency... Neoteric approach to frequency synthesis"... and like that.

A personal note
to all native ☆☆☆
Americans ☆☆☆



(except Navajos who are already hip)

Our microwave people at the Chicago Center sold a gigantic microwave communications system to the Navajo Indian Reservation. It will link parts of Utah, Colorado, Arizona and New Mexico, providing party and private-line telephone circuits for Navajo police, utilities, rangers, construction crews and so forth. Whether or not you're a member of an Indian nation, write for our problem-solving microwave systems diagrams and folders... keep up with the Navajo!

Holy Trademarks!

They took that, too!

Look at our Motorola symbol down there. Those bat guys even stole that for their TV show. Where will it all end? (It began on the first page of this 3-page saga.)

GREAT INFORMATIVES! Write to the appropriate center — address below — for information about anything described on these pages!



MOTOROLA
Military Electronics Division

CHICAGO CENTER

1450 N. Cicero Ave., Dept. 4, Chicago, Illinois

WESTERN CENTER

8201 E. McDowell Rd., Dept. 4, Scottsdale, Arizona

MULTI-CAP CAPACITORS

for high
capacitance-to-volume
ratio in micro-circuits and
in equipment miniaturization



An exclusive manufacturing process insures a strong lamination of the high quality AISiMag thin strong ceramic dielectric and the electrode layers and virtually eliminates any tendency to delaminate. The edge termination is readily solderable for quick, reliable assembly.

These unencapsulated capacitors range from .152 x .052 x .055 inches to .375 x .155 x .065 inches with capacitance from 330 pf to .5 mfd, at voltages of 25-50, 100-200 D.C. Production quantities in this range are promptly available.

NEW NPO CERAMIC

A K46 material with lower losses and better dielectric properties than conventional mica or glass capacitors.

CUSTOM PROTOTYPES

The laminated thin ceramic-electrode principle can be applied in a great variety of electronic uses. Prototypes can be made to your specifications for your evaluation over a wide range of sizes and capabilities and at reasonable cost.

Write for Data Sheet CM

American Lava Corporation **3M**

Titania Division
Chattanooga, Tennessee 37405
Sixty-Fifth Year of Ceramic Leadership

TRW Semiconductor Div. Fuller & Smith & Ross Inc.	79
■ Taiyo Denki Company Ltd. Sanko Sha Adv. Co.	95
Takamisawa Electric Company Ltd. Nambokusha Advertising	92
Taylor Corporation Gray & Rogers Inc.	165
Techno-Components Corporation J. R. Bloome Company	196
Teikoku Tsushin Kogyo Co. Ltd. General Advertising Agency	96
■ Tektronix Inc. Hugh Dwight Adv. Inc.	76
Telrex Labs. George Homer Martin Associates	246
Tempres Research Co. Inc. Hal Lawrence Inc.	29
Texas Instruments Incorporated, Industrial Products Group Robinson-Gerrard Inc.	134
Thermal American Fused Quartz Company Kniep Associates	42
Tokyo Cosmos Electric Company Ltd. Advertising Art Center	92
Tokyo Denki Company Ltd. General Advertising Agency	93
Tohoku Metal Industries Ltd. Kokusai Tsushin Sha KK	96
Tongen Electric Co. Ltd. Japan Business Service Ltd.	91
Transitron Electronic Corporation Larcom Randall Advertising Inc.	46, 47
Trio Laboratories Inc. Zam & Kirshner Inc.	190
Triplett Electrical Instrument Co. Burton Browne Advertising	97
Trygon Electronics Solow/Weston Company Inc.	154
■ Trylon Incorporated George Moll Advertising Inc.	230
Tsubame Radio Company Ltd. General Advertising Agency	91
■ Tung Sol Electric Inc. E. M. Freystadt Associates	241
Ulano & Company J. Byrde, Richard & Pound Inc.	27, 28
Union Carbide Corporation, Linde Division J. M. Mathes Inc.	147
□ United Aircraft International Cunningham & Walsh Inc.	OAS 2
U. S. Navy Buxton Adv. Agency	242
Utah Industrial Promotion Commission David W. Evans & Associates	180
Varian Associates Tube Division Hoefer, Dieterich & Brown Inc.	159, 197
Victory Engineering Corporation Black-Russell Morris Inc.	158
Vitramon Inc. Ted Sommers Inc.	202
Wakefield Engineering Inc. Sales Promotion Services	259
□ Weinschel Engineering Company George T. Persche Advertising	OAS 1
Westamp Inc. Siegmeister-Grant	220
Westinghouse Semiconductor Div. ITSM Div. of McCann-Erickson	74
Weston Instruments Arndt, Preston, Chapin Lamb & Keen Inc.	218
Wisconsin Power & Light Company Ralph Timmons Company	163
Wood Electric Company L. K. Frank Company Inc.	205
<p>■ For more information on complete product line see advertisement in the latest Electronics Buyers' Guide</p> <p>□ Advertisers In Overseas Advertising Section</p>	

Advertising sales staff

Frank E. LeBeau [212] 971-6464
Advertising sales manager

Atlanta, Ga. 30309: Gus H. Krimsier,
Michael H. Miller, 1375 Peachtree St. N.E.,
[404] TR 5-0523

Boston, Mass. 02116: William S. Hodgkinson
McGraw-Hill Building, Copley Square
[617] CO 2-1160

Chicago, Ill. 60611: Robert M. Denmead,
J. Bradley MacKimm, Roland Werth
645 North Michigan Avenue,
[312] MO 4-5800

Cleveland, Ohio 44113: Paul T. Fegley, 55
Public Square, [216] SU 1-7000

Dallas, Texas 75201: Richard P. Poole, The
Vaughn Building, 1712 Commerce Street,
[214] RI 7-9721

Denver, Colo. 80202: Joseph C. Page, David
M. Watson, Tower Bldg., 1700 Broadway,
[303] 255-5484

Detroit, Michigan 48226: Paul T. Fegley
856 Penobscot Building
[313] 962-1793

Houston, Texas 77002: Kenneth George,
2270 Humble Bldg.,
[713] CA 4-8381

Los Angeles, Calif. 90017: Ian C. Hill,
John G. Zisch, 1125 W. 6th St.,
[213] HU 2-5450

Minneapolis, Minn. 55402: J. Bradley
MacKimm, 1104 Northstar Center
[612] 332-7425

New York, N. Y. 10036:
Donald R. Furth [212] 971-3615
James R. Pierce [212] 971-3616
George F. Werner [212] 971-3617
500 Fifth Avenue

Philadelphia, Pa. 19103: William J. Boyle,
Warren H. Gardner, 6 Penn Center Plaza,
[215] LO 8-6161

Pittsburgh, Pa. 15222: Paul T. Fegley,
4 Gateway Center, [412] 391-1314

Portland, Ore. 97204: James T. Hauptli,
Pacific Building, Yamhill Street,
[503] CA 3-5118

St. Louis, Mo. 63105: Robert M. Denmead
The Clayton Tower, 7751 Carondelet Ave.
[314] PA 5-7285

San Francisco, Calif. 94111:
James T. Hauptli, 255 California Street,
[415] DO 2-4600

London W1: John W. Patten, Edwin S.
Murphy Jr., 34 Dover Street,
Hyde Park 1451

Milan: 1, via
Baracchini Phone: 86-90-617
86-90-656

Frankfurt/Main: Gerd Hinske, Joseph
Wuensch, 85 Westendstrasse
Phone: 77 26 65 and 77 30 59

Geneva: Michael R. Zeynel,
1, rue du Temple
Phone: 31 95 60

Paris VIII: Denis Jacob, 17 Avenue
Matignon ALMA-0452

Tokyo: Nobuyuki Sato, 1, Kotohiracho
Shiba, Minato-Ku [502] 0656

Osaka: Ryosi Kobayashi, 163, Umegee-cho,
Kita-ku [362] 8771

Wallace C. Carmichael [212] 971-3191
Manager Electronics Buyers' Guide

David M. Tempest: [212] 971-3139
Promotion manager

Milton Drake: [212] 971-3485
Research and circulation manager

Wallace C. Carmichael [212] 971-3191
Business manager

Stephen R. Weiss [212] 971-2044
Production manager

Another Brush Innovation in Recording:

The Brush Mark 280.
Once you've seen
it work,
the chain makes
a lot of sense.



People who use the Brush Mark 280 can get pretty possessive.

No wonder.

True rectilinear traces so crisp and clear you'll never miss the message. Dual recording channels a full 80 millimeters wide. Resolution the likes of which you've never seen. A pressurized inking system. Metri-site pen positioning. Low cost chart

paper. Pushbutton choice of 12 chart speeds. Solid state electronics. Response as high as 200 cps at useable amplitude and better than 30 cps full scale. System accuracy of 1/2%!

And now get set for the big surprise: the performance-packed Brush Mark 280 measures just 10 1/2" x 18 3/8" x 11 1/2"!

Search no more for a full perform-

ance portable. No one *but no one* has anything to compare with the amazing Mark 280. Ask your Brush representative for a demonstration. Or write today for our free booklet. Brush Instruments Division, Clevite Corporation, 37th and Perkins, Cleveland, Ohio 44114.



brush INSTRUMENTS DIVISION
CLEVITE

LOW COST 600-volt SCR's with peak surge currents

12X I_{rms}

30X I_{rms}

16X I_{rms}



2N4101 \$1.85*



2N4102 \$1.85*



2N4103 \$6.00*

for high-voltage supplies • instrumentation • commercial
space heaters • ignition systems (auto and boat)
• DC power supplies • motor controls

Now available in production quantities...these new all-diffused SCR's are the latest additions to RCA's family of economy devices specifically designed for *low cost* power-control and power-switching applications. Built-in overload protection further decreases your circuit costs, and standard, easy-to-mount packages are readily adaptable for printed-circuit boards and metal heat sinks. For more information on RCA 2N4101, 2, and 3 and their companion types, as well as copies of Application Notes SMA-38 and SMA-39, write RCA Electronic Components and Devices, Commercial Engineering, Section RN6-2, Harrison, New Jersey.
Also Available Through Your RCA Distributor.

	2N3528	2N3529	2N4102	2N3228	2N3525	2N4101	2N3668	2N3669	2N3670	2N4103
Standard AC Supply	120V	240V	High-Voltage Supply	120V	240V	High-Voltage Supply	Low-Voltage Supply	120V	240V	High-Voltage Supply
V _{RM} (rep)	200V	400V	600V	200V	400V	600V	100V	200V	400V	600V
V _{FBOM} (rep)	600V	600V	700V	600V	600V	700V	600V	600V	600V	700V
I _{RMS}	2.0A	2.0A	2.0A	5.0A	5.0A	5.0A	12.5A	12.5A	12.5A	12.5A

*(Prices in quantities of 1000 and up.)