

Electronics®

Which digital voltmeter? page 84

Sensors for celestial guidance: page 94

Transistors can multiply, divide: page 109

April 4, 1966

75 cents

A McGraw-Hill Publication

Below: Scratch-pad memory increases computer capability: page 118

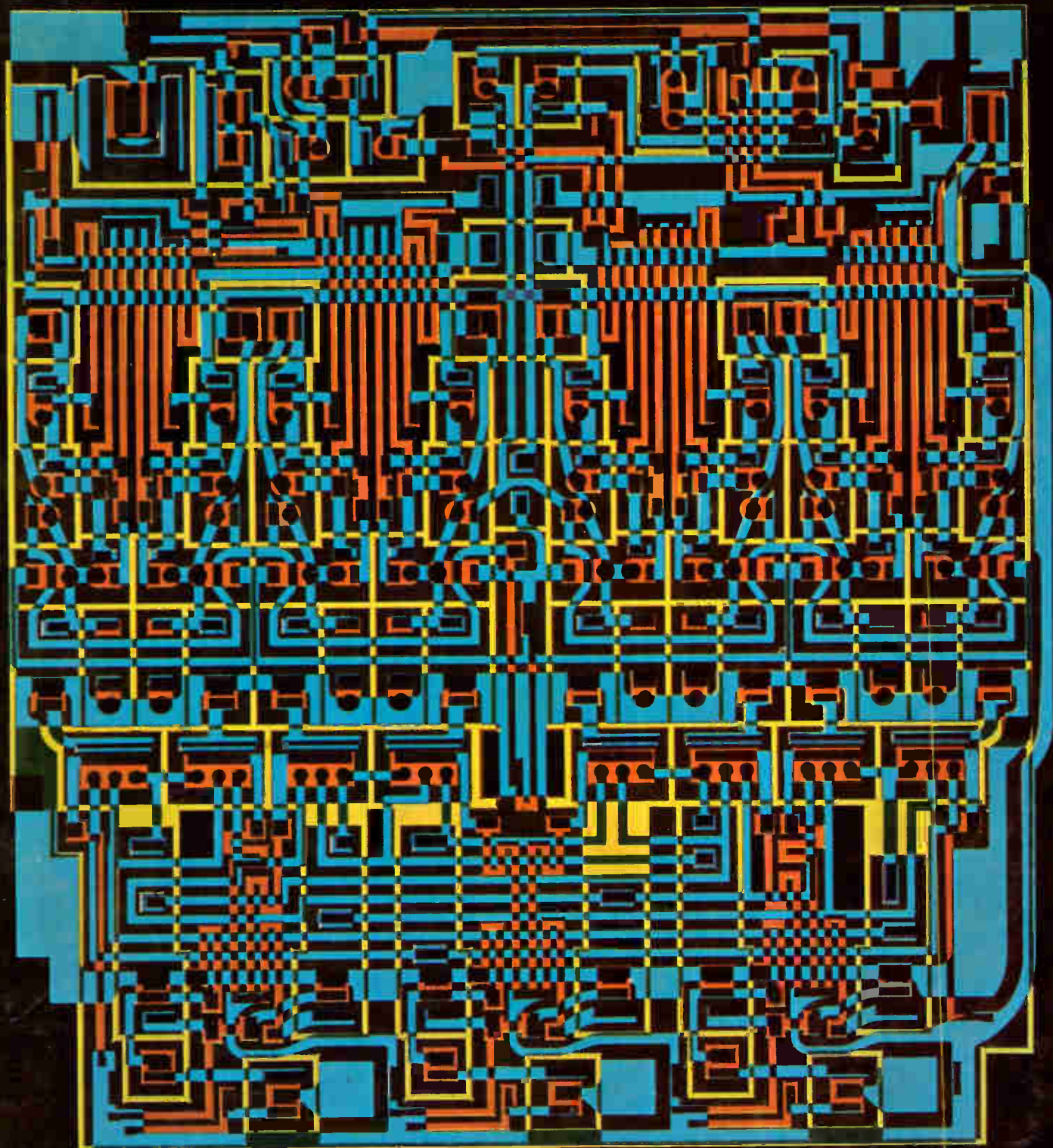



NEW



ULTRAMINIATURE TRANSISTOR TRANSFORMERS & INDUCTORS

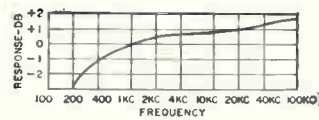
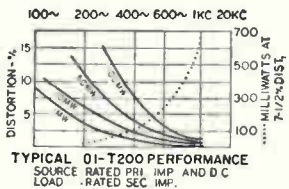

- ➔ DUMET LEADS
(gold plated, weldable and solderable)
- ➔ STRAIGHT PIN TERMINALS
(printed circuit application)
- ➔ HIGHEST PERFORMANCE
for size in the industry
- ➔ METAL ENCASED
(Grade 4, Ruggedized)

Type No.	Pri. Imp.	DCma [†] in Pri.	Sec. Imp.	Pri. Res.	Mw Level	Application
DI-T225	80 CT 100 CT	12 10	32 split 40 split	10	500	Interstage
DI-T230	300 CT	7	600 CT	20	500	Output or line to line
DI-T235	400 CT 500 CT	8 6	40 split 50 split	50	500	Interstage
DI-T240	400 CT 500 CT	8 6	400 split 500 split	50	500	Interstage or output (Ratio 2:1:1)
DI-T245	500 CT 600 CT	3 3	50 CT 60 CT	65	500	Output or matching
DI-T250	500 CT	5.5	600 CT	35	500	Output or line to line or mixing
DI-T255	1,000 CT 1,200 CT	3 3	50 CT 60 CT	110	500	Output or matching
DI-T260	1,500 CT	3	600 CT	90	500	Output to line
DI-T265	2,000 CT 2,500 CT	3 3	8,000 split 10,000 split	180	100	Isol. or interstage (Ratio 1:1:1)
DI-T270	10,000 CT 12,000 CT	1 1	500 CT 600 CT	870	100	Output or driver
DI-T273	10,000 CT 12,500 CT	1 1	1,200 CT 1,500 CT	870	100	Output or driver
DI-T276	10,000 CT 12,000 CT	1 1	2,000 CT 2,400 CT	870	100	Interstage or driver
DI-T278	10,000 CT 12,500 CT	1 1	2,000 split 2,500 split	620	100	Interstage or driver
DI-T283	10,000 CT 12,000 CT	1 1	10,000 CT 12,000 CT	970	100	Isol. or interstage (Ratio 1:1)
DI-T288	20,000 CT 30,000 CT	.5 .5	800 CT 1,200 CT	870	50	Interstage or driver
DI-T204	Split Inductor (2 wdg)	§ .1 Hys @ 4 maDC, .08 Hys @ 10 maDC, DCR 25Ω §§ .025 Hys @ 8 maDC, .02 Hys @ 20 maDC, DCR 6Ω				
DI-T208	Split Inductor (2 wdg)	§ .9 Hys @ 2 maDC, .5 Hys @ 6 maDC, DCR 105Ω §§ .2 Hys @ 4 maDC, .1 Hys @ 12 maDC, DCR 26Ω				
DI-T212	Split Inductor (2 wdg)	§ 2.5 Hys @ 2 maDC, .9 Hys @ 4 maDC, DCR 630Ω §§ .6 Hys @ 4 maDC, .2 Hys @ 8 maDC, DCR 157Ω				
DI-T216	Split Inductor (2 wdg)	§ 4.5 Hys @ 2 maDC, 1.2 Hys @ 4 maDC, DCR 2300Ω §§ 1.1 Hys @ 4 maDC, .3 Hys @ 8 maDC, DCR 575Ω				

[†]DCma shown is for single ended usage (under 5% distortion—100mw—1KC)... for push pull, DCma can be any balanced value taken by 5W transistors (under 5% distortion—500mw—1KC)
DI-T200 units have been designed for transistor application only... not for vacuum tube service.
U.S. Pat. No. 2,949,591 other pending.
Where windings are listed as split, 1/4 of the listed impedance is available by paralleling the winding.
§Series connected; §§Parallel connected.

**ALL STOCK UNITS MIL TYPE TF4RX
Class "S" Available on Special Order**

High Power Rating..... up to 100 times greater.
Excellent Response..... twice as good at low end.
Low Distortion..... reduced 80%.
High Efficiency..... up to 30% better... compare DCR.
Moisture Proof..... hermetically sealed to MIL-T-27B.
Ultraminiature Size..... 5/16 Dia. x 3/8" H, 1/15 Oz.

The unique structural design of the DI-T200 series transformers and inductors provides the excellent electrical characteristics, high reliability and wide application possibilities inherent in the UTC DO-T family of miniaturized units. The DI-T200 series units employ the same high quality design found in UTC's DO-T, DI-T, and PIP lines. This unique transformer structural concept affords unprecedented power handling capabilities coupled with extremely small size. Further, the high degree of reliability has been dynamically proven in the field. These characteristics are basic in the structure, which is ruggedized, hermetically sealed, employing a completely rigid bobbin, eliminating stress and wire movement. The turns are circular in shape rather than square, eliminating turn corner stress, and effecting uniform wire lay. The coil wire and external lead are rigidly anchored terminal board fashion, employing no tapes and brought out through strain relief. The curves illustrated indicate the superior performance of these units compared to similar size units now on the market.

The leads are uninsulated 1" long, .016 D Dumet wire, spaced on a .1" radius circle to conform to terminal spacing techniques of the "TO-5" case semiconductors and micrologic elements.

**IMMEDIATE DELIVERY
FROM STOCK**

Write for catalog of over
1,300 UTC TOP QUALITY
STOCK ITEMS
IMMEDIATELY AVAILABLE
from your local distributor.



UNITED TRANSFORMER CORP.

150 VARICK STREET, NEW YORK 13, N. Y.

PACIFIC MFG. DIVISION: 3630 EASTHAM DRIVE, CULVER CITY, CALIF.
EXPORT DIVISION: 13 EAST 40th STREET, NEW YORK 16, N. Y. CABLE: "ARLAB"

COMPLETE VERSATILITY... 2 MHz counting 0.25 μ sec reversing



New Hewlett-Packard **REVERSIBLE** Counter

Here's an instrument offering all six counting modes necessary for today's laboratory and industrial measurement requirements, plus the high 2 MHz counting rate, 250 nsec reversing time, and standard features not found combined in other instruments, except, in some cases, as costly optional "extras."

With the new 5280A Reversible Counter and 5285A Universal Plug-in, you can count input channel A or B, or count A upwards or downwards, depending upon the polarity of B, at 2 MHz. Reversing time in the latter mode is 250 nsec. Or, you can count A+B, A-B, or count up or down, depending upon the phase relationship of A and B, up to 1 MHz. The latter mode is ideal for use with laser interferometers and other transducers for precision length and x-y positioning measurements.

An anti-coincidence circuit prevents loss of count if A and B arrive simultaneously in the A-B or A+B modes. Polarity switch permits reversing input signal directional sense. Trigger level controls provided (± 100 volt range).

Measure such parameters as length, thickness, angular displacement, flow rate, liquid level, weight; use in such application areas as automatic process control, automatic machine

tools, chemical, plastic or metal fabrication, readout of gyro test table position, inertial guidance element testing, readout of pulses in remote control or telemetering systems and comparison of frequencies.

The 5280A offers 100 mv input sensitivity, ac and dc coupling, 1 megohm input impedance, 6-digit in-line readout with \pm sign, and with 7th and 8th digit available as options. Overflow of readout is indicated by a front-panel neon light. Versatile manual and remote controls are provided; four-line BCD outputs for recording and control also are standard.

Add to this the reliability and standard design features of Hewlett-Packard solid-state electronic counters, plus convenient and complete field applications assistance and service, and you have a new counter offering measuring capabilities previously unavailable in a single instrument. 5280A Reversible Counter, \$1450 (plug-in required); 5285A Universal Input Plug-in, \$450.

Ask your Hewlett-Packard field engineer for a demonstration or write for complete specifications to Hewlett-Packard, Palo Alto, California 94304, Tel. (415) 326-7000; Europe: 54 Route des Acacias, Geneva.

*Data subject to change without notice.
Prices f.o.b. factory.*

HEWLETT  **PACKARD**
An extra measure of quality

1298

INSTRUMENTATION SPECS in 250 KC tape recording

...now start at under \$9966

(7 CHANNELS, 6 SPEEDS, DIRECT MODE)

The design approach that made possible Sanborn true IRIG instrumentation performance at lower cost in low bandwidth tape recording is now available in intermediate band systems. Sanborn Models 3917B and 3924B 7- and 14-channel systems record and reproduce data up to 250 kc in direct mode, to 20 kc in FM mode. Pulse mode enables digital information as short as 2 μ sec wide to be recorded and reproduced. A complete 6-speed system ready for direct recording, reproducing costs \$9966 for 7 channels, \$15,977 for 14 channels. (Same systems may be ordered with fewer tape speed plug-ins, at correspondingly lower costs.)

These new systems have the same improvements in performance, reliability and operating ease as the low bandwidth models, for instrumentation tape recording with complete IRIG compatibility. The tape transport, key to superior system performance, is of a rugged and simple Hewlett-Packard design which reduces costs without sacrificing uniform tape motion: six electrical speeds are pushbutton-selected (1% to 60 ips) without idler or capstan change. Other standard features include provision for edge track for voice commentary, adjustable input out levels, built-in 4-digit footage counter accurate to $\pm 0.5\%$, and easy snap-on reel loading. The transport needs no maintenance except occasional cleaning of the tape path.

Check the system specifications here and call the H-P Field Engineer in your locality for complete technical data and application engineering assistance. Offices in 48 U.S. and Canadian cities, and major areas overseas. Sanborn Division, Hewlett-Packard Company, Waltham, Massachusetts 02154. Europe: Hewlett-Packard S.A., 54 Route des Acacias, Geneva, Switzerland.



representative specifications

DIRECT MODE

Tape Speed	Bandwidth	Frequency Response	S/N Ratio Filtered	Minimum RMS Unfiltered
60 ips	300-250 KC	± 3 db	35 db	29 db
15 ips	100-62.5 KC 300-44 KC	± 3 db	32 db 38 db	27 db
1 7/8 ips	50-7 KC 300-5 KC	± 3 db	30 db 39 db	26 db

*Measured with bandpass filter at output with an 18 db/octave rolloff

FM MODE

Tape Speed	Bandwidth	Frequency Response	FM Center Carrier Frequency (Nominal)	S/N Ratio* Without Flutter Comp.	Total Harmonic Distortion
60 ips	0-20 KC	+0, -1db	108 KC	45 db	1.5%
15 ips	0-5 KC	+0, -1db	27.0 KC	45 db	1.5%
1 7/8 ips	0-625 cps	+0, -1db	3.38 KC	40 db	1.8%

*Noise measured over full bandwidth, min. rms at zero freq. dev., with lowpass filter placed at output. Filter has 18 db/octave rolloffs.

TAPE TRANSPORT

Maximum Interchannel Time Displacement Error: ± 1 microsecond at 60 IPS, between two adjacent tracks on same head.

Tape Speeds: 60, 30, 15, 7 1/2, 3 3/4, 1 7/8 ips standard; 0.3 to 120 ips optionally available.

Tape: 3600 feet, 1.0 mil, 1/2" (7 channel), 1" (14 channel).

Controls: Line (Power), Stop, Play, Reverse, Forward (fast) and Record are pushbutton relays. A receptacle at the rear of the transport is provided for remote control operation.

Drive Speed Accuracy: $\pm 0.25\%$.

FLUTTER

Speed	Bandwidth	Flutter (p-p)
60 ips	0-200 cps	0.2 %
	0-10 KC	0.6 %
30 ips	0-200 cps	0.2 %
	0-5 KC	0.8 %
15 ips	0-200 cps	0.25 %
	0-2.5 KC	0.6 %
7 1/2 ips	0-200 cps	0.5 %
	0-1.25 KC	0.65 %
3 3/4 ips	0-200 cps	0.5 %
	0-625 cps	0.8 %
1 7/8 ips	0-200 cps	0.8 %
	0-312 cps	1.2 %

HEWLETT
PACKARD  SANBORN
DIVISION

Circle 2 on reader service card

Electronics

April 4, 1966
Volume 39, Number 7

Page	4	Readers Comment
	8	People
	14	Meetings
	16	Meeting Preview
	23	Editorial
	25	Electronics Newsletter
	69	Washington Newsletter
	175	New Products
	222	New Books
	224	Technical Abstracts
	230	New Literature

Electronics Review

Page	35	Clearer fiber-optics	40	One-man tv crew
	35	More scratch pads	42	Breeding computers
	36	Fast computer	44	TI DIP's in
	37	Conversational program	45	Army drafts IC's
	37	Invisible sentry	46	Ten-way masks
	38	Banking on computers	46	Recruiting at IEEE
	40	Taking heart	48	IEEE jotting

Probing the News

151	Avionics for a more mobile army
156	Why some people fall often: EMG signals studied for clues
161	Electronics booming in East Germany

Electronics Abroad

233	Spot check	235	Competition for Comsat?
234	X rays on tape	236	Thin-film filters
234	Down with defects	237	Around the world

Technical articles

I. Design

Instrumentation	84	Technical articles Selecting the right digital voltmeter; now there are four choices Billy G. Kay, Hewlett-Packard Co.
------------------------	----	--

Circuit design	91	Designer's casebook <ul style="list-style-type: none">■ Overload protection for d-c amplifier■ Latching gate removes counter ambiguity■ Delay circuit varies turn-on and turn-off■ Transistors control small d-c motor
-----------------------	----	--

II. Application

Advanced technology	94	Automatic celestial guidance, part II Now that the principles are known, the next step is to develop hardware R.L. Lillestrand, J.E. Carroll and J.S. Newcomb, Control Data Corp.
----------------------------	----	---

Circuit design	109	Using transistors to multiply and divide The logarithmic relationship between current and voltage in a pn function is put to work George E. Platzer Jr., Chrysler Corp.
-----------------------	-----	--

Computers	118	Integrated scratch pads sire a new generation of computers (cover) With eight bits on a single silicon chip, the scratch pad becomes economically feasible G.B. Potter, Scientific Data Systems and S. Sirkin, Signetics Corp.
------------------	-----	--

Electronics

Editor: Lewis H. Young

Senior editors

Technical: Samuel Weber
News: Kemp Anderson Jr.

Senior associate editors: John F. Mason, George Sideris

Department editors

Advanced technology: Joan Blum
Avionics: W.J. Evezia
Computers: Wallace B. Riley
Consumer electronics: Richard Lipkin
Electronics abroad: Arthur Erikson
Electronics review: Stanley Zarowin
Instrumentation: Carl Moskowitz
Manufacturing: George Sideris
Military electronics: John F. Mason
New products: William P. O'Brien
Solid state: Jerome Eimbinder
Space electronics: Robert Henkel

Regional editors

Domestic

Boston: Thomas Maguire, editor; Robin Carlson
Los Angeles: William B. Wallace, Walter Barney, editors; June Ranill
San Francisco: Laurence D. Shergalis, Edmond G. Addeo, editors; Mary Jo Jadin

Foreign

European: Derek Barlow, (London)
Bonn: John Gosch
Tokyo: Charles Cohen

Copy editors

Howard Rausch, Sally Powell, Kenneth Munn, James J. Moran

Graphic design

Art director: Saul Sussman

Assistant art directors: Donna M. Griffiths, Ann Mella

Production editor: Arthur C. Miller

Editorial secretaries: Claire Benell, Mary D'Angelo, Lynn Emery,
Lorraine Fabry, Kay Fontana, Lorraine Longo, Carolyn Michnowicz

McGraw-Hill News Service

Director: John Wilhelm; Atlanta: Fran Ridgway; Chicago: Reck Johnson;
Cleveland: Arthur Zimmerman; Dallas: Marvin Reid;
Detroit: N. Hunter; Houston: Ron Lovell; Los Angeles: Michael Murphy, Gerald Parkinson;
San Francisco: Margaret Ralston;
Seattle: Ray Bloomberg; Washington: Arthur L. Moore, Charles Gardner,
Herbert W. Cheshire, Seth Payne, Warren Burkett, Warren Kornberg

McGraw-Hill World News Service

Bonn: John Johnsrud; London: John Shinn;
Mexico City: Bruce Cross; Milan: Ronald Taggiasco;
Moscow: Donald Winston; Paris: Peter Kilborn;
Rio de Janeiro: Wes Perry; Tokyo: Marvin Petal

Circulation manager: Hugh J. Quinn

Reprints: T.M. Egan

Publisher: C.C. Randolph

Electronics: April 4, 1966, Vol. 39, No. 7

Printed at 99 North Broadway, Albany, N.Y., 12207
Second class postage paid at Albany, N.Y.

Subscriptions are solicited only from those actively engaged in the field of the publication. Position and company connection must be indicated on orders. Subscription prices: United States and Possessions and Canada, \$6.00 one year, \$9.00 two years, \$12.00 three years. All other countries \$20.00 one year. Single copies, United States and Possessions and Canada 75¢. Single copies all other countries \$1.50.

Published every other Monday by McGraw-Hill Inc. 330 West 42nd Street, New York, N.Y. 10036. Founder: James H. McGraw, 1860-1948. Corporate officers: Shelton Fisher, President; John J. Cooke, Secretary; John L. McGraw, Treasurer.

Subscribers: The Publisher, upon written request to our New York office from any subscriber, agrees to refund that part of the subscription price applying to copies not yet mailed. Please send change of address notices, subscription orders or complaints to Fulfillment Manager, Electronics, at the address below. Change of address notices should provide old as well as new address, including postal zone number if any. If possible, attach address label from recent issue. Allow one month for change to become effective.

Postmaster: Please send Form 3579 to Fulfillment Manager, Electronics, P.O. Box 430, Hightstown, New Jersey 08520

Readers Comment

Strip line discussion

To the Editor:

In my opinion the article, "Using strip transmission line to design microwave circuits" [Feb. 7, p. 72] contains a number of misleading ideas.

The authors state that the strip transmission line is formed by etching one side of a doubly-clad board and using pressure plates for rigidity. The Electronized Chemical Corp. of Burlington, Mass., manufactures a low-loss material, Polyguide, which can be purchased with aluminum backing adhered to the dielectric.

The authors also imply that the coupling arrangement shown on page 74 of the article is the only acceptable form. On the contrary, coplanar coupling as described is useful only for loose to moderate coupling.

The lumped-element equivalents are almost completely erroneous. The equation shown by Dangel and Steele for the characteristic impedance of strip line is useful only for $w/b < 0.35$. With center conductors etched from one- or two-ounce copper and $w/b < 0.35$, only characteristic impedances greater than 100 ohms are possible.

The authors also show a means for creating a series inductance in strip line and describe how series capacitances can be formed. An abrupt change in the width of the center conductor actually behaves as a transformer, while a transverse slit acts as a Pi-network having a series capacitance and two shunt inductances. The equation as given for the series inductance, if this simplification is to be used, should read:

$$\frac{X_L}{Z_{o2}} = \left[\frac{2W_2 + (4b/\pi) \ln 2}{\lambda} \right] \ln \text{CSC} \left(\frac{\pi}{2} \frac{Z_{o2}}{Z_{o1}} \right)$$

Steven March

HRB-Singer, Inc.
State College, Pa.

• The authors reply:

The authors are indebted to Mr.

New Bridge Design For Safe, Accurate, Easy Measurement of 'Lytic Capacitors



The Sprague Model 1W2A Capacitance Bridge introduces new, improved technical refinements as well as restyling for added attractiveness and ease of operation. Built by capacitor engineers for capacitor users, it incorporates the best features of bridges used for many years in Sprague laboratories and production facilities.

Precision Measurements over Entire Range from 0 to 120,000 μF

The internal generator of the 1W2A Bridge is a line-driven frequency converter, and detection is obtained from an internal tuned transistor amplifier-null detector, whose sensitivity increases as the balance point is approached. It has provision for 2-terminal, 3-terminal, and 4-terminal capacitance measurements, which are essential for accurate measurement... $\pm 1\%$ of reading $+ 10\mu\mu\text{F}$... of medium, low, and high capacitance values, respectively.

No Damage to Capacitors

The model 1W2A Capacitance Bridge will not cause degradation or failure in electrolytic or low-voltage ceramic capacitors during test, as is the case in many conventional bridges and test circuits. The 120 cycle A-C voltage, applied to capacitors under test from a built-in source, never exceeds 0.5 volt! It is usually unnecessary to apply d-c polarizing voltage to electrolytic capacitors because of this safe, low voltage.

Complete Specifications Available

For complete technical data on this precision instrument, write for Engineering Bulletin 90,010A to Technical Literature Service, Sprague Electric Company, 35 Marshall Street, North Adams, Massachusetts.

488P-128-83

Circle 4 on reader service card

New from Sprague!



Silicontrol[®] High Gate Drives Stop SCR Failures Caused by di/dt Effect

- Silicontrol Gate Drives are ideally suited for completely balanced, reliable SCR firing in 3-phase a-c or d-c power control.
- High-output gate drive with fast-rise-time pulse avoids SCR failures due to di/dt effect.
- No bias for pulse reset required—failsafe—load and control circuits fully isolated.
- Each gate signal output is a pulse of substantially constant amplitude in excess of 210° wide at full SCR conduction.
- Gate pulse output: 18 volts min. (open circuit), 1.7 amperes (short circuit), less than 1 μsec pulse rise time to meet gate firing requirements of high current SCRs.
- Available in half-wave or full-wave designs—Series VS6532 produces one gate pulse per cycle per phase, while Series VS6732 provides two isolated gate pulses per card for a total of six gate pulses per cycle.

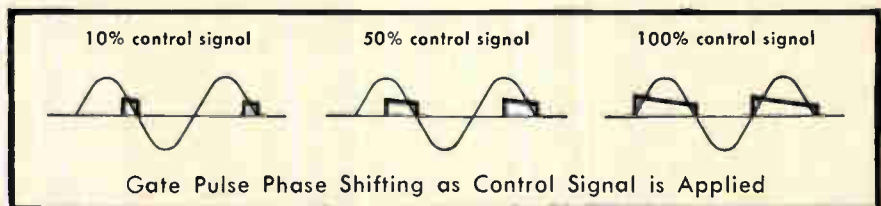

For complete technical data, write for Engineering Bulletin 85525 to the Technical Literature Service, Sprague Electric Co., 35 Marshall St., North Adams, Mass. 01248.

SPRAGUE COMPONENTS

PACKAGED COMPONENT ASSEMBLIES
THIN-FILM MICROCIRCUITS
INTEGRATED CIRCUITS
CERAMIC-BASE PRINTED NETWORKS
FUNCTIONAL DIGITAL CIRCUITS
PULSE-FORMING NETWORKS

CAPACITORS
TRANSISTORS
RESISTORS
INTERFERENCE FILTERS
MAGNETIC COMPONENTS
PULSE TRANSFORMERS

485C-5134 R2



[®] Sprague and [®] are registered trademarks of the Sprague Electric Co.

Circle 5 on reader service card



Here's Our Latest All-Solid-State Oscillator

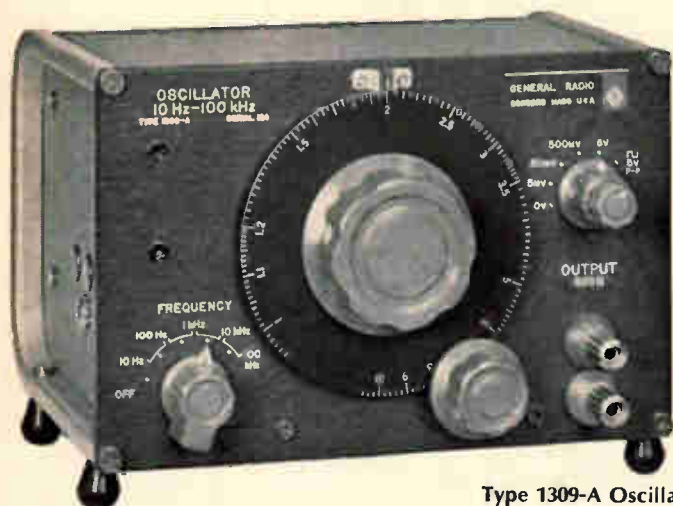

- 10 Hz to 100 kHz
- < 0.05% DISTORTION

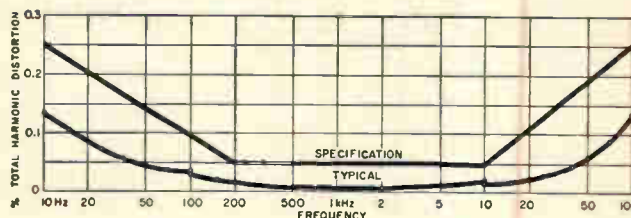

Type 1309-A Oscillator, 10 Hz to 100 kHz, \$325 in U.S.A.

Excellent Output Characteristics: Waveform purity is unmatched by that of any other oscillator in this price class. Hum is only 0.001% of full output. Open-circuit output is 5 V and is typically constant to 0.5%; guaranteed to be constant within $\pm 2\%$ over the entire frequency range. Amplitude stability is $\pm 0.2\%$ per hour, typically.

Calibrated 60-dB Attenuator: Constant 600 Ω output impedance is maintained through a 60-dB step attenuator and a 20-dB continuous control; output levels from 5 V to 500 μV can be selected. In addition, a switch position of zero volts behind 600 Ω provides a convenient, transient-free way of reducing the output to zero without shorting the terminals or upsetting the continuous attenuator setting.

Square Waves as well as Sine Waves: Symmetrical positive-going square waves with typical rise times of 40 ns into 50 Ω are also available. Output is greater than 5 V, p-to-p, and is dc coupled, so the waveform is flat-topped, even down to 10 Hz.

Synchronization, a unique feature: This oscillator can be synchronized to an external signal, or it can furnish a sync signal to other equipment. The sync output is greater than 1.5 V, open-circuit, behind 12 k Ω and is in phase with the primary output. A small sync-input voltage will effectively phase-lock the instrument; one volt, for example, provides a $\pm 3\%$ locking range (2 volts provide 6% locking range, etc).

Other Oscillators in this New Series:

Type 1310-A
with 2-Hz to 2-MHz range and 20-volt, open-circuit output . . . \$295 in U.S.A.

Type 1311-A
supplies 11 audio frequencies at one-watt; tapped-transformer output . . . \$215 in U.S.A.

Write for more information

BOSTON • NEW YORK • CHICAGO • PHILADELPHIA • WASHINGTON, D.C.
SYRACUSE • DALLAS • SAN FRANCISCO • LOS ANGELES • ORLANDO
CLEVELAND • TORONTO • MONTREAL
GENERAL RADIO COMPANY (Overseas), ZURICH, SWITZERLAND
GENERAL RADIO COMPANY (U.K.) Ltd., BOURNE END, ENGLAND

GENERAL RADIO
WEST CONCORD, MASSACHUSETTS

March for pointing out the obvious omission in the equation for series inductance.

But we disagree with his comments about material with adhering aluminum backing. It is the experience of the authors that final production designs often incorporate such items as mounting bosses, line stretchers, and isolators in the backing plate structure. In these cases, the separately fabricated pressure plates serve a dual purpose and are therefore advantageous.

His comments on coupling and simplified lumped circuit equivalents indicate possible misunderstanding of the purpose of these sections in the article. The sections are purposely limited in scope to the minimum felt necessary to understand the circuits presented in later paragraphs. The references designated in the article also provide additional information, including graphs, for the design engineer requiring detailed data.

J. R. Dangl
K. Steele

Sylvania Electronic Systems
Williamsville, N. Y.

Applauds stand

To the Editor:

As an IEEE member and active participant at the section and group levels since 1946, please accept my heartfelt thanks for penetrating the shroud of silence covering internal IEEE policies through your perceptive editorial entitled "IEEE settles for second rate sessions" and for publishing the letter headed "Raising the standards" [March 21, 1966]. It takes raw courage and dedication to shout that the Emperor is naked!

The IEEE establishment, in addition to ineptly handling the quality of the 1966 convention's technical sessions, appears to lack the sense of command responsibility that can cope with mundane problems such as a tricky computer that switched my address from Doylestown, PENNSYLVANIA, to Doylestown, OHIO, with the subsequent loss and diversion of IEEE publications and notices. During the past 10 months, I contacted the former and present IEEE presidents, the headquarters staff including the general manager, the Philadelphia section chairman and officers while trying to soften an ossified structure. Only the regional director had the administrative maturity to inquire, question and call for remedial action.

Maybe it is the time to re-examine the power structure of the IEEE and recognize that the presidency should not be a sort of super fellowship, an accolade that is automatically bestowed yearly, but is indeed a hot seat for attempting to get an unwieldy monster on its feet.

Your editorial highlights a potentially lethal IEEE deficiency: there are no IEEE channels at conventions, section and group meetings, nor in the correspondence columns of IEEE publications for the rank-and-file to discuss vital internal questions relating to technical-programs substance, quality and atmosphere; criteria for selecting fellows; fiscal solvency; office procedures and practices. It does you at Electronics great credit that a feedback path to the IEEE leadership has been completed.

Sam Levine

Senior member, IEEE
Doylestown, Pa.

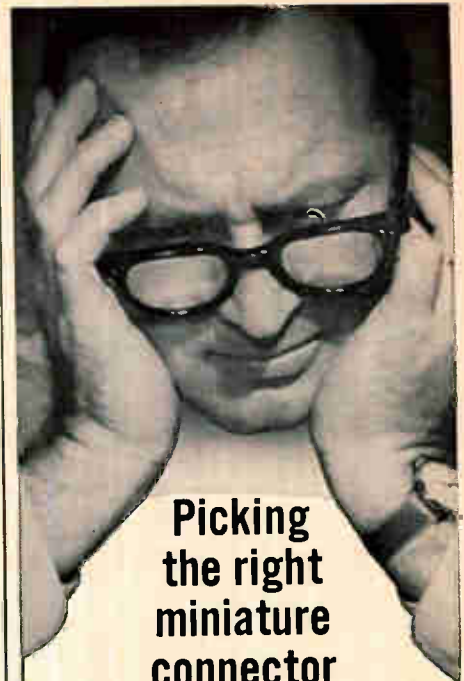

Picking the right miniature connector is a small problem

It's not hard to locate a miniature connector small enough to meet tight space specs. Lots of people make them.

There is a small problem, though, in finding the quality you need at the price you'd like to pay.



That's why business is booming at Transiron's Precision Connector Division. We design and produce miniature and subminiature connectors to exceed — not merely meet specifications. They are built to outlast the equipment you mount them on. Precision fabrication, knowledgeable design, the finest materials provide a combination that can't be surpassed by any manufacturer. Yet in quantity they cost no more than units that will barely squeeze by incoming inspection.

Send today for our new condensed catalog covering a complete line of miniature and subminiature connectors, as well as printed circuit connectors and many other types. And if you need a custom connector design, we're your source. Just give us the facts.



Precision Connector Division
Transiron
electronic corporation
Wakefield, Massachusetts

SUBSCRIPTION SERVICE

Please include an Electronics Magazine address label to insure prompt service whenever you write us about your subscription.

Mail to: Fulfillment Manager
Electronics
P.O. Box 430
Hightstown, N.J. 08520

To subscribe mail this form with your payment and check new subscription renew my present subscription

Subscription rates: in the U.S.: 1 year, \$6; two years, \$9; three years, \$12. Subscription rates for foreign countries available on request

CHANGE OF ADDRESS

ATTACH LABEL HERE

If you are moving, please let us know five weeks before changing your address. Place magazine address label here, print your new address below.

name

address

city

state

zip code



New from PENTA: Beam Pentode with -40db 3rd-Order Distortion at 300w PEP Output

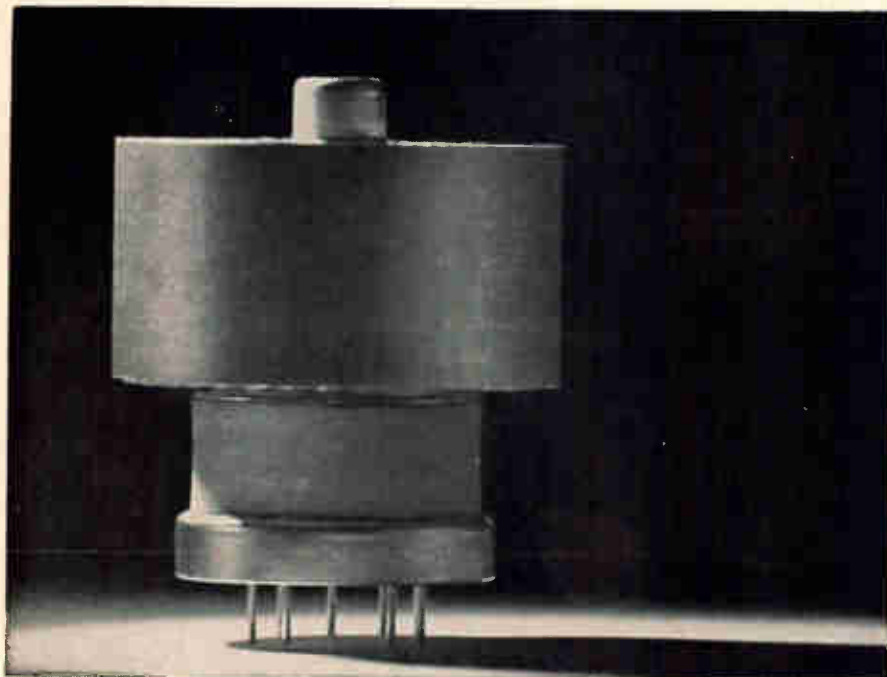

The new PL-8583/267 Penta beam pentode for 300-400 watt linear amplifier application offers a minimum of -40db 3rd-order intermodulation distortion, without feedback, at 300 watts PEP output. This PL-8583/267 in multiplex service significantly reduces co-channel interference to permit addition of new channels in new equipment or to greatly improve performance in existing equipment. Precision alignment of electrodes contributes to both low distortion figures and low drive requirements.

The PL-8583/267 electrical characteristics:

Heater voltage for oxide unipotential cathode	26.5 volts
Heater current	1.0 amperes
Maximum ratings—CCS	
DC plate voltage	2,000 volts
DC plate current	300 ma
Anode dissipation	350 watts

Size: 2.16" height x 1.75" diameter

For full details, write The Machlett Laboratories, Inc.—Penta Plant, 312 N. Nopal St., Santa Barbara, California 93102

RAYTHEON

THE MACHLETT LABORATORIES, INC.
A SUBSIDIARY OF RAYTHEON COMPANY

People

The field of education is opening new vistas to electronics engineers, says **Richard L. Bright**, 40, the recently appointed director of research at the United States Office of Education. But before engineers can apply their design talents to the development of electronic teaching equipment, they will have to know what's needed. "Our job is to find out and to tell them," Bright points out.



Bright, who holds a doctorate in electrical engineering, is the first science-oriented person to head the Office of Education's research department. At the Westinghouse Electric Co. he directed a study on computerized classrooms and earlier was engaged in semiconductor and computer research.

Computerized classrooms. His appointment comes on the eve of a revolution in the field of education. "Within the next 10 or 15 years," Bright says, "classrooms around the country will probably be completely computerized."

To provide the foundation for this revolution, Congress in 1965 allocated \$100 million over the next five years to develop new educational techniques and the electronic equipment to go with them. In addition, Congress gave the Office of Education the authority to contract with industry to develop the educational technology. The techniques will be programed instruction and the hardware will include computers and closed-circuit television networks. Within a month, Bright says, the first requests for proposals for electronic teaching equipment will probably be issued to industry.

Selling the idea. Developing equipment and techniques is only part of the problem of developing computerized classrooms, Bright explains. Equally important is the task of selling the idea to the customers: 26,000 separate school boards around the country and 2



**Now from MACHLETT:
22 high-precision, low torque,
vacuum variable capacitors
for heavy duty**



Each of these 22 ceramic vacuum variable capacitors from Machlett offer the following advantages:

- High rf current capability
- Stable operation at high temperature
- Structural rigidity
- Low capacitance variation with temperature change
- Wide capacitance range
- High Q factor (1000 or greater)
- Low operating torque
- High resistance to damage from over-voltage.

Capacitance values from 5-750 pF to 50-2300 pF; voltage rating to 15 kv; current rating to 75A. Custom design consultation for special applications is available from Machlett.

For full details on this new line, write to The Machlett Laboratories, Inc., Springdale (Stamford) Conn. 06879



THE MACHLETT LABORATORIES, INC.

A SUBSIDIARY OF RAYTHEON COMPANY

All from Sprague!

ENERGY-STORAGE CAPACITORS for every type of discharge application

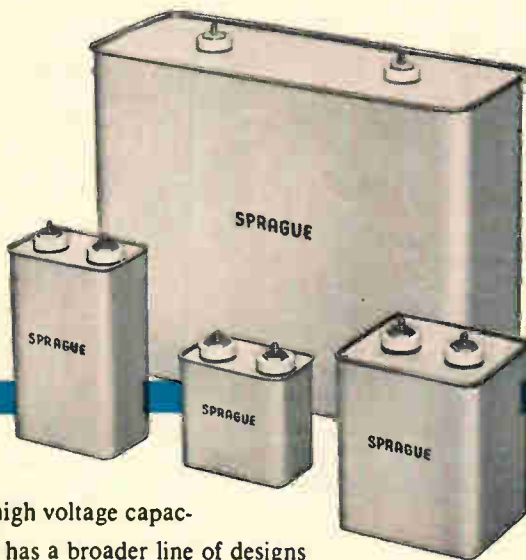

A pioneer in high voltage capacitors, Sprague has a broader line of designs for energy-storage applications than any other capacitor manufacturer. If your project involves lasers, masers, electronic photoflash, time-control circuits, exploding wire, thermonuclear fusion research, magnetization of permanent magnets, medical equipment, or similar discharge applications, Sprague can provide a capacitor to meet your specific needs.

Light, Moderate, or Heavy Duty Capacitors

Available types range from small, light-weight units for aerospace applications such as satellites, missiles, etc., to heavy-duty capacitors for high-current/high-frequency oscillatory discharges.

Broad Range of Electrical Ratings

Voltages from 2 kilovolts to 24 kilovolts. Energy ratings up to 6700 joules. Self-inductance as low as .0025 microhenry.

Paper, Metallized Paper, and Paper/Film Designs

Metallized capacitors intended for light-weight, space-saving applications . . . one-half the size, one-third the weight of conventional capacitors. Other available designs include castor oil impregnation for extremely long life (assuring a high number of discharges), and non-flammable synthetic askarel impregnation for applications where non-combustibility is a prerequisite.



Energy-Storage Electrolytic Capacitors

A selected line of cylindrical types for industrial applications requiring maximum capacitance in minimum space.

For complete information or application engineering assistance on Sprague Energy-Storage Capacitors, write to Field Engineering Department, Sprague Electric Company, 35 Marshall St., North Adams, Mass. 01248.

SPRAGUE COMPONENTS

CAPACITORS
TRANSISTORS
RESISTORS
THIN-FILM MICROCIRCUITS
INTEGRATED CIRCUITS
INTERFERENCE FILTERS

PACKAGED COMPONENT ASSEMBLIES
FUNCTIONAL DIGITAL CIRCUITS
MAGNETIC COMPONENTS
PULSE TRANSFORMERS
CERAMIC-BASE PRINTED NETWORKS
PULSE-FORMING NETWORKS



"Sprague" and "®" are registered trademarks of the Sprague Electric Co.

People

million teachers and 100,000 school administrators.

Unfortunately, the director says, many educators fear automation in education. "Our responsibility, then, is to convince them that the machine will never replace the teacher."

The machine, he adds, will change the teacher's role from one of presenting information to the student to one of fostering "creative communications" between the teacher and the student. "A machine can teach a kid a fact, but it takes a teacher to teach him to apply knowledge to a new situation."

Never angry. Bright explains that computers free the teacher from routine teaching chores; the student gets constant individual attention; good students will never be bored and poor students will never be lost.

And he adds: "The computer will never get angry with the frustratingly slow student."

Electronics also will play a major role in teaching the teachers, Bright points out. For example, in the past few months the Office of Education has been opening technical centers throughout the country that store copies of research studies on education. The material is stored on microfilm—called microfiche—and is available to all educators. Although the storage system isn't electronic yet, the Office of Education expects eventually to support an information-retrieval system modeled after one which is operating at the University of Michigan. In that system, an educator searching for special material, puts a code into a push-button telephone. The code represents the key words of the subject. A computer then sifts through the available material and automatically provides the user with summaries of the studies. The educator can then get photo copies of any study.

A new field. Industry is moving quickly to enter the new market. Within the past year many large electronics companies have formed either their own educational subsidiary or have acquired an established publishing concern.

RESOLVER/SYNCHRO INSTRUMENTATION

A very short course for engineers engaged in testing and evaluation of resolvers and synchros as components or as system transducers.

Selecting a resolver/synchro test instrument for any engineering, production or system requirement is remarkably simple from North Atlantic's family of resolver and synchro instrumentation. Because this group has been developed to cover every area of need in both manual and automatic testing, obtaining the desired combination of performance and package configuration usually demands no more than 1) determining what you need and 2) asking for it.

Remote Readout of Angular Position

For remote indication of resolver or synchro transmitters in system testing, North Atlantic's Angle Position Indicators (Figure 1) provide the advantages of low cost and continuous counter or pointer readout. These high-performance instrument servos are accurate to 4 minutes of arc, with 30 arc seconds repeatability and 25°/second slew speed. Dual-mode capability, multi-speed inputs, integral retransmit components and other optional features are available to match application needs. Priced from \$895.



Figure 1. Angle Position Indicators are available in half-rack, quarter-rack and 3-inch round servo packages.

High-Accuracy Testing Of Receivers And Transmitters

Measuring receiver and transmitter performance to state-of-art accuracy is readily accomplished with North Atlantic's Resolver/Synchro Simulators and Bridges (Figure 2). Each of these dual-mode instruments tests both resolvers and synchros, and provides direct in-line readout of shaft angle, accurate to 2 arc seconds. Simulators supply

from 11.8 to 115 volts from either 26 or 115 volts excitation, and so can be used to test any standard receivers. Bridges have constant null voltage gradients, making them ideally suited for rapid deviation measurements. Simulators and Bridges each occupy only 3½ inches of panel height and are available in a choice of resolutions. They are priced in the \$1500 to \$3000 range.

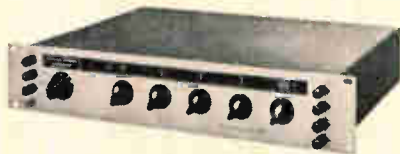

Figure 2. Resolver/Synchro Simulator provides ideal source for receiver testing.

Automatic Measurement And Conversion

Where systems require continuous or on-command conversion of resolver or synchro angles to digits, North Atlantic's Automatic Angle Position Indicators (Figure 3) handle the job without motors, gears or relays. These solid-state automatic bridges accommodate all standard line-to-line voltages and provide both Nixie display and printer output, accurate to 0.01° and with less than 1 second update time. Many variations, including 10 arc second accuracy; binary, BCD or decimal outputs; multiplexed channels and multispeed operation, are available for specific requirements. Ballpark price: \$5900.



Figure 3. Model 5450 Automatic Angle Position Indicator. It measures shaft angles, converts them to digital data.

Measuring Electrical Characteristics

Combine a Resolver/Synchro Bridge and a Simulator with a North Atlantic Ratio Box, a Phase Angle Voltmeter and a test selection panel and you have an integrated test facility for determining all electrical characteristics of resolvers and synchros in component production or Quality Control. An example is the North Atlantic Resolver/Synchro Test Console shown in Figure 4. It measures phasing, electrical zero, total and fundamental nulls, phase shift and input current, as well as angular accuracy. Standard North Atlantic instruments are used as modules, making it a simple matter to fill the exact need. The unit shown sells for about \$7500.

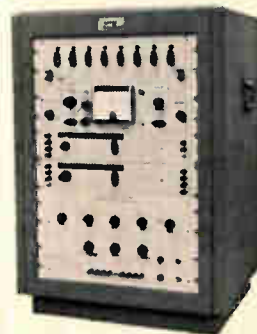

Figure 4. Model RTS-573 Test Console is a complete facility for the production line or in quality control.

If you require performance, reliability and convenience in resolver and synchro testing, we want to send you detailed technical information on these instruments (also on related instruments for computer system interface). Or, if you prefer, we will arrange a comprehensive technical seminar at your plant. Simply write to: North Atlantic Industries, Inc., 200 Terminal Drive, Plainview, N. Y. 11803 • TWX 516-433-9271 • Phone (516) 861-8600.



EXPANDED DTL line 7 nsec at 10

speed ↑
isolation ↑ dissipation ↓

All Radiation integrated circuits are *dielectrically* isolated.

provides mw

Having procurement problems? Check our delivery time on monolithic DTL circuits!

Why compromise on DTL performance or delivery? Radiation offers immediate shipment of industry's finest line of circuits! Radiation's dielectric isolation technique assures the best combination of speed, power dissipation and noise immunity.

And Radiation supplies a full line of DTL integrated circuits—17 in all. They include Series 200 and 300, designed for military use, and Series 500 for industrial applications. Compatible fan outs in each series are maintained over the full specified temperature ranges.

Other characteristics include: 7.0 nsec propagation delay (t_{pd}); 250mv "0" output voltage (V_{sat}); and 10.0ma "1" input current (I_{in1}).

All circuits are specially engineered to provide superior performance for their specific applications. All are supplied in TO-84 flat packages.

Why not keep up to date on the latest advances in integrated circuits! Write or phone for our data sheets which include worst-case limits, and contain all information required by design engineers. We'll also send a brochure describing our broad range of engineering and manufacturing capabilities.

Radiation Incorporated, Physical Electronics, Department EL-04, Melbourne, Florida 32901. Phone: (305) 723-1511, extension 554.

Expanded Radiation DTL Line*

Circuit	RD 200 SERIES		RD 300 SERIES		RD 500 SERIES	
	Type	FO†	Type	FO†	Type	FO†
Gates						
Dual 4	210	8	310	5	510	8
Triple 3	205	8	305	5	505	8
Quad 2	206	8	306	5	506	8
RS Flip Flop	208	7	308	4	508	7
Line Driver	209	12	309	8	509	12
Expander	111	—	111	—	711	—

*New high-speed JK Flip Flop soon to be introduced.
†Maintained over full temperature range.

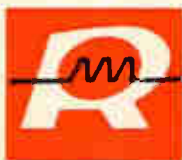
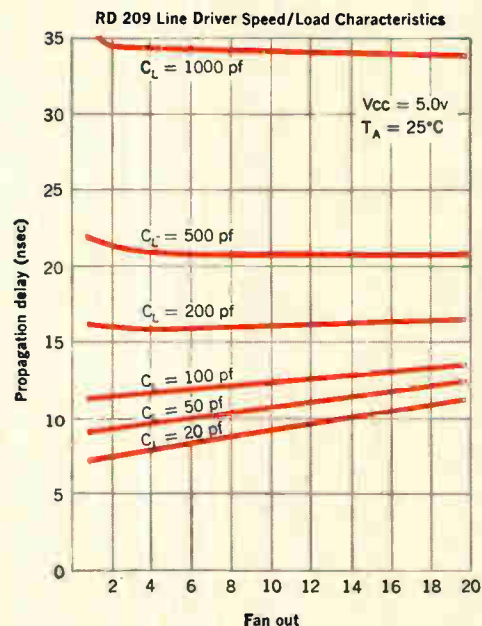

**RADIATION
INCORPORATED**

Test to High Reliability Standards With General Electric's New Helium Mass Spectrometer Leak Detector



■ **SENSITIVITY:** Get higher product quality. Test with the highest sensitivity available— 2×10^{-11} std. cc/second. And get fast response and recovery as well.

■ **SPEED:** Test more pieces faster. Pump down to 20 microns in 15 seconds. Complete an entire test cycle in as little as 25 seconds with G.E.'s Helium Mass Spectrometer Leak Detector.

■ **SOLID STATE ELECTRONICS:** Minimize downtime. Five-sided access assures easy maintenance.

■ **ACT NOW:** Get complete data sheets on G.E.'s high sensitivity, high speed Leak Detector. Contact any one of G.E.'s nationwide Vacuum Products Sales Specialists and ask for publication GEZ-4154.

Or write to Mr. R. T. Clark, Manager—Marketing, Vacuum Products Operation, General Electric Company, Schenectady, New York 12305.

P.S. The price is attractive, too.

GENERAL ELECTRIC
268-18

Meetings

Conference on Ground-Based Aeronomic Studies of the Lower Ionosphere, AFCRL, DRTE; Defense Research Telecommunications Establishment, Ottawa, Canada, April 11-15.

IEEE Region III Convention, IEEE; Mariotta Motor Inn, Atlanta, April 11-13.

Cleveland Electronics Conference, Cleveland section of IEEE; Engineering and Scientific Center, Cleveland, April 12-14.

Symposium on Electronics Measurement and Controls in Ships and Shipbuilding, IEE, IERE; University of Strathclyde, Scotland, April 12-15.

Symposium on Remote Sensing of Environment, Office of Naval Research; University of Michigan, Ann Arbor, April 12-14.

Quantum Electronics Conference, IEEE Groups on Electron Devices and Microwave Techniques; Towne House, Phoenix, April 12-14.

International Symposium on Generalized Networks, Polytechnic Institute of Brooklyn, AFOSR; Hotel Commodore, New York, April 12-14.

Technical Meeting and Equipment Exposition, Institute of Environmental Sciences; El Cortez Hotel, San Diego, April 13-15.

Jurema International Seminar and Exhibition, Federal Council of Automation for Yugoslavia; Zagreb, Yugoslavia, Apr. 16-24.

International Conference on Electron and Ion Beam Science and Technology, Institute of Metals, Metallurgical Society of AIME, Electrochemical Society; Park Sheraton Hotel, N. Y., Apr. 17-20.

Symposium on Process Automation, Beckman Instruments, Inc., Consolidated Electrodynamics Corp., Control Data Corp., et al; Newporter Inn, Newport Beach, Calif., April 18-20.

International Scientific Radio Union Meeting (URSI), National Academy of Sciences, National Research Council; Washington, D.C., April 18-21.

International Seminar on Automatic Control in Production and Distribution of Electrical Power, Institut Belge de

Regulation et D'Automatisme; Brussels, Belgium, April 18-22.

Frequency Control Symposium, U.S. Army Electronics Command; Shelburne Hotel, Atlantic City, April 19-21.

Colloquium on Microwave Communication, Dept. of Technical Science of the Hungarian Academy of Sciences, Scientific Society of Telecommunication; Budapest, Hungary, April 19-22.

International Conference on Magnetics (INTERMAG), Magnetics Group of the IEEE, Stuttgart, Germany, April 20-22.

Conference on Interservice Data Exchange, Grumman Aircraft Engineering Corp.; Waldorf Astoria Hotel, N.Y.C., April 20-22.

Naval Material Support Establishment System Performance Effectiveness Conference (NMSE SPECON 2), Navy; State Department Auditorium, Washington, April 21-22.

Spring Joint Computer Conference, American Federation of Information Processing; Boston, Mass., April 26-28.*

Call for papers

Electronics Materials Conference, Metallurgical Society of the AIME; Sheraton-Boston Hotel, Boston, Aug. 29-31. **May 1** is deadline for submission of 300-word abstracts on the preparation and properties of electronic materials for the control of radiative processes, light-emission detection, modulation and microwave generation (including Gunn effect and Reade diode), to E. P. Warekois, Lincoln Laboratory of the Massachusetts Institute of Technology, Lexington, Mass. 02173.

Symposium on Reliability, ASQC, IEEE, IES, SNT; Sheraton Park Hotel, Washington, Jan. 10-12, 1967. **May 6** is deadline for submission of five copies of 800-word abstracts, on recent technical developments in reliability analysis of space projects, system analysis, and component parts to H. D. Hulme, program chairman, Westinghouse Electric Corp., R&D Center, Bldg. 601-1B46, Pittsburgh, Pa. 15235.

* Meeting preview on page 16



How do you unscramble signals from a moon-bug?

At top speed and accuracy, using the most advanced data reduction system ever designed. Months before the first Americans blast off toward the moon, an Astrodata system is already at work digesting and displaying messages from the bug-like Lunar Excursion Module. No other data reduction system in operation today has been able to handle data with as much speed and flexibility . . . *automatically!*

Astrodata systems superiority comes from mating proven components with functionally-oriented software. For example, all telemetry conversion units are directly under computer program control. Stored commands therefore automatically calibrate all sub-systems: selecting bandwidths, frequencies, rates,

formats and outputs; control speeds, tracks; provide tape search, and other data traffic functions conventionally requiring extraneous controls and adjustments.

In effect, this means significantly less error, greater speed, optimum performance and economy in your data reduction system.

Perhaps you're not headed for the moon, but you do have other problems in data acquisition and processing, telemetry, or range instrumentation. Then Astrodata's expert know-how should be of interest to you. Write for your free copy of our 20-page brochure "Astrodata's Systems Experience."



ASTRODATA

P.O. Box 3003 ■ 240 E. Palais Road, Anaheim, California ■ 92803

An Operational

AUTOMATIC MICROWAVE SPECTRUM SURVEILLANCE SYSTEM



The new Watkins-Johnson microwave collection system combines the most sophisticated techniques and proven materials to receive, detect and analyze electromagnetic emissions in the frequency range of 1 to 18 GHz. Whether airborne, aboard ship, in a mobile van or at a fixed location, the WJ-1007 performs automatically and continuously for ferret, ELINT and reconnaissance applications.

- The WJ-1007 requires no mechanical tuning — it is fitted with electrically-tracked preselectors and oscillators. It provides continuous coverage through automatic switching of full octave and waveguide frequency bands.
- Digital tuning and direct digital readout delivers automatic data for transmission and teletype reproduction.
- The ability of the system to measure frequency to an accuracy of .01 percent is the result of a solid-state local oscillator development unique at W-J.
- The system is of solid-state design throughout, except for TWT's and CRT's.
- A core memory unit provides a "lock out" and recall capability.
- The modular design provides for ease of system expansion to cover the 18 to 40 GHz range as well as frequency bands lower than 1 GHz.
- Each module is fully self-contained with its own power supply (diplexers, local oscillator synthesizer, spectrum display, DF display, demodulator, digital tuner, receiver control, frequency memory, IF pan display, analysis indicator and so forth), resulting in a perfectly synchronized system.
- Supplementary equipment is available to suit any application.

The team that delivered the WJ-1007 as promised can be engaged to any similar systems program calling for refined skills and engineering ingenuity.

WATKINS | JOHNSON



3333 HILLVIEW AVENUE
STANFORD INDUSTRIAL PARK
PALO ALTO, CALIFORNIA 94304

Meeting preview

SJCC in Boston

Time-sharing techniques and the use of computers in simulation will be major subjects at the Spring Joint Computer Conference in Boston, April 26 to 28, sponsored by the American Federation of Information Processing Societies.

An opening-day session on time sharing will be followed, on Wednesday, by a panel discussion with six experts examining time sharing in "a realistic content" says the program chairman, Jack L. Mitchell of the Lincoln Laboratory, Massachusetts Institute of Technology. The panelists are James D. Babcock, Allen-Babcock Computing, Inc.; L. R. Hague, the Westinghouse Electric Corp.; Thomas E. Kurtz, Dartmouth College; K. F. Powell, International Business Machines Education Center; Ivan E. Sutherland, Advanced Research Projects Agency of the Department of Defense; and James R. Ziegler, The National Cash Register Co.

Hybrid techniques. Two sessions are scheduled on simulation: one on simulation and model-building, the other on the successful use of hybrid techniques in simulation and data processing. In addition, there will be a panel discussion on hybrid computation.

R. Belluardo, R. Gocht and G. Paquette, all of the United Aircraft Corp. Research Laboratories, will report on a time-shared hybrid simulation facility in the session on hybrid techniques; they will also serve on the panel.

A session on coherent optical information processing will include a paper on requirements for hologram construction by Emmett N. Leith and Juris Upatnieks, both of the University of Michigan's Institute of Science and Technology.

Waveform processing and current developments in peripheral hardware will be discussed at other sessions.

After four papers are delivered on results achieved using computer techniques in pattern recognition, Marvin L. Minsky, professor of electrical engineering at MIT, plans to give a critique of the presentations. He is being billed as the devil's advocate.



NEW CVC *QUICK-START* ION PUMPS

Start Faster.

**Achieve Highest
Argon Speeds.**

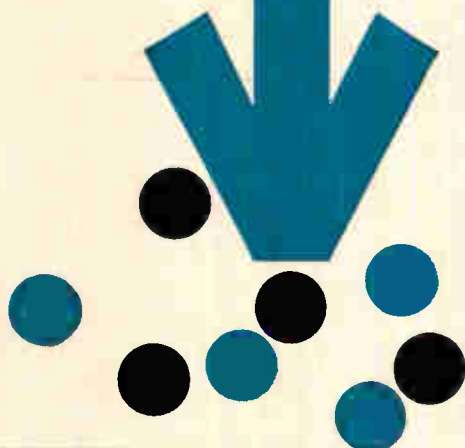

With new Quick-Start pumps you will get faster, more reliable starts than you every thought possible in ion pumping. Quick-Start high throughputs permit higher pressure starting—as high as 50-100 microns—and quicker pumpdown. These excellent characteristics result from a new power supply that has been engineered to match the pressure-current requirements of the pump.

The more efficient design of Quick-Start gives faster pumping of

argon and other inert gases—a necessity for best performance at typical 10^{-11} torr ultimates. Three-element Quick-Start has an argon speed that is 30% of air speed; typical two-element pumps will pump approximately 1%.

Other Quick-Start advantages: Dependable solid-state power supply with semiconductor rectification and a logarithmic readout of pressure on one scale from 4×10^{-9} to 2×10^{-5} torr (no vacuum gauge

needed). Improved flanges for lower ultimates. Minimum element life of three years at 10^{-6} torr. Magnets bakeable to 400° C installed on the pump.

Quick-Start pumps are available in sizes with nominal nitrogen speeds of 30 L/sec., 110 L/sec., and 360 L/sec. Write for our new catalogs: Consolidated Vacuum Corporation, 1775 Mt. Read Blvd., Rochester, N.Y., 14603.



Consolidated Vacuum Corporation

ROCHESTER, N. Y. 14603 • A SUBSIDIARY OF BELL & HOWELL
International Subsidiaries: Woking, Surrey, England
& Friedberg, West Germany

New Tektronix *Automatic* Oscilloscope System SEEKS and presents a measurable display

New Type 3B5 Time Base Unit Makes Automatic Operation Possible

The Tektronix Automatic Oscilloscope System, with the new Type 3B5 Automatic/Programmable Time Base Unit, now makes DC-to-15 MHz measurements faster and simpler than ever before.

The automatic system package includes the Type 3B5, the companion Type 3A5 Automatic/Programmable Amplifier Plug-in Unit, a P6030 Probe and a Type 561A, RM561A, 564 or RM564 oscilloscope.

Using the P6030 Probe and Automatic/Programmable Plug-In Units simplifies trouble-shooting, other applications where measurements on electrical equipment can be made without remaining within arm's length of the oscilloscope.

Upon SEEK command, the oscilloscope automatically presents an optimum display. The SEEK command to the plug-in units automatically controls the time and amplitude settings, eliminating the need for continuous front-panel adjustments. Indicators on the plug-ins light automatically to show these settings. Measurements can then be made quickly and accurately from the CRT display.

● AUTOMATIC SEEKING

... will operate upon SEEK command from the probe or from the Automatic/Programmable Plug-Ins.

● MANUAL OPERATION

... overrides the SEEK command
... extends sweep range and deflection factors beyond capability of Automatic Seeking Mode. Indicators light to show SWP MAG'D and UNCAL warnings, set manually.

● REMOTE PROGRAMMING

... overrides the SEEK command and Manual Operation.
... uses the Type 263 Programmer for remote control of the Automatic/Programmable Plug-In Units.

WHEN PLUG-INS RECEIVE SEEK COMMAND



TYPE 3A5

automatically establishes the optimum deflection factor. Indicators light to show readout with input coupling, such as .5 V/DIV, DC (coupled) WITH PROBE.



TYPE 3B5

automatically establishes optimum trigger settings and automatically selects time per division setting. Indicators light to show readout, such as .2 μ s/DIV, and to show NOT TRIG'D condition.

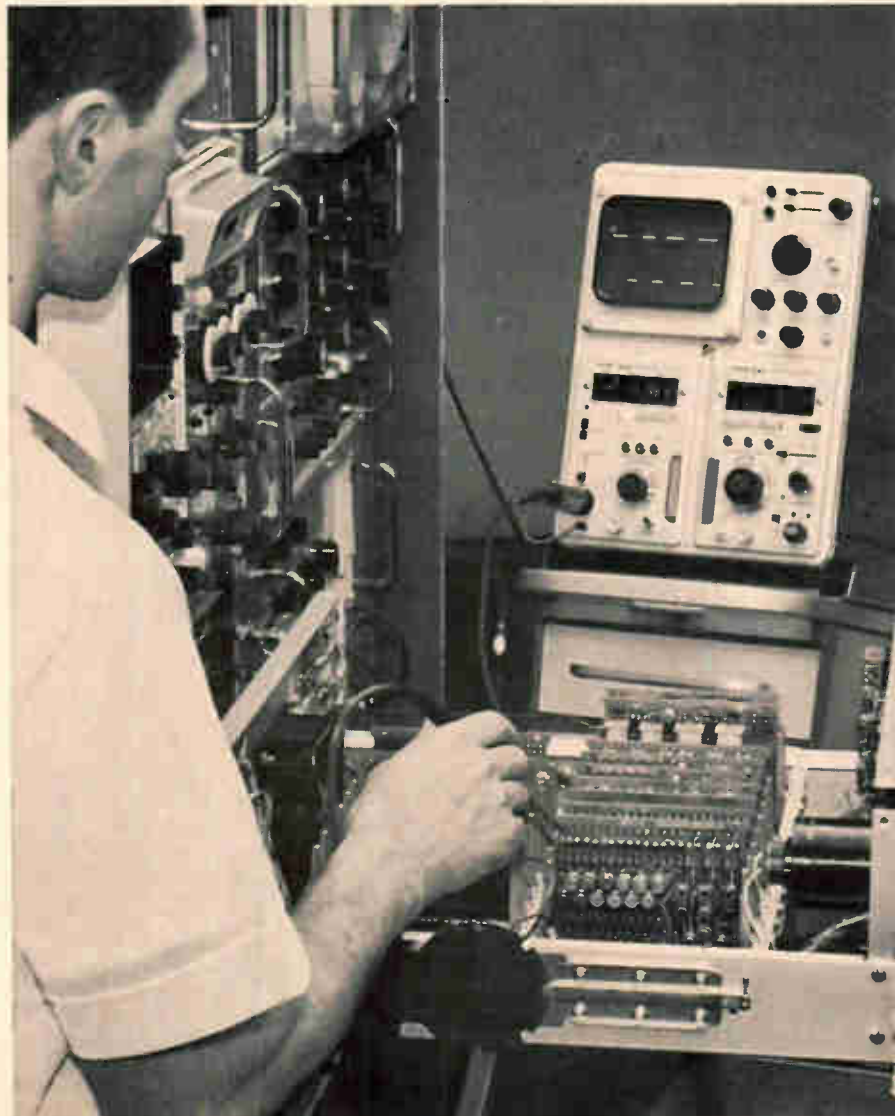

Add a Type 263 Programmer and Speed Up Sequential Measurements



TYPE 3A5

Operating Modes: SEEK, Manual, and External.

Deflection Factor: 10 mV/div to 50 V/div in SEEK and External Modes. 1 mV/div to 50 V/div in Manual Mode.

Bandwidth: DC-to- ≥ 15 MHz, from 10 mV/div to 50 V/div. 5 MHz at 1, 2, or 5 mV/div, in Manual Mode only.

Risetime: ≤ 23 ns at a deflection factor of 10 mV/div to 50 V/div.

Input RC: 1 megohm by ≈ 24 pF.

Programmable Functions: V/div, 10X probe attenuation, and AC, DC or AC stabilized coupling, by contact closure to ground. Vertical positioning by analog current.

P6030 Probe supplied with Type 3A5—has SEEK COMMAND button and 6 ft. cable.
Type 3A5 Automatic Programmable Amplifier Unit \$760

TYPE 3B5

Operating Modes: SEEK, Manual, and External.

Sweep Range: 5 s/div to 0.1 μ s/div in SEEK Mode.

5 s/div to 10 ns/div in Manual and External Modes.

Delayed Sweep Magnifier: X10 or X100. A calibrated delay control selects starting point of the magnified sweep, allows viewing of both the normal sweep (before start of the magnified sweep) and the delayed magnified sweep. With the magnifier operative, readout is automatically corrected to indicate the setting and SWP MAG'D condition.

Trigger Modes: Internal, either AC-coupled or AUTO (combined level-seeking and bright-line Automatic); External, either AC-coupled or DC-coupled.

Programmable Functions: Time/div, magnifier range, trigger mode with coupling, and trigger slope, by contact closure to ground. Horizontal positioning, trigger level, and magnifier delay, by analog current.

Type 3B5 Automatic/Programmable Time-Base Unit \$890

• **Remote Program Feature** in the Automatic Oscilloscope System permits the instrument to be externally preset for a given measurement. With selection of eleven different programmable functions from Automatic/Programmable Plug-Ins, the combination offers new convenience for applications involving many measurements, as in production-line testing and systems checkouts, and also simplifies "away-from-the-oscilloscope" tests, where manual manipulation of the front-panel controls would be inconvenient.

• **Plug-In Type Program Card Feature**
The Type 263 accepts up to six plug-in type program cards, each of which can be programmed for a specific measurement. Each program card, after initial set-up, establishes the plug-in control functions required for a particular test or measure-

ment. Programming each card can be done simply by changing jumper wires and potentiometer settings. Any number of programmers can be cascaded for applications requiring pushbutton control of more than six measurement set-ups.

Once set up, the programs on the Automatic Oscilloscope System can be carried out by non-technical personnel with little or no training, since the instrument settings are all pre-selected. Actual measurements can be made conveniently from the CRT display, as usual.

Type 263 Programmer \$325
(complete with 6 program cards)

(Size: 5½" by 8⅝" by 9";

Weight: \approx 5 lbs.)

U.S. Sales Prices, f.o.b. Beaverton, Oregon

Using the Type 263 Programmer and Automatic/Programmable Plug-In Units facilitates such applications as production testing on limited production items not justifying full automation, where most or all of the controls can be preset for each test.



For complete information, call your nearby Tektronix field engineer, or write Tektronix Inc., P. O. Box 500, Beaverton, Oregon 97005.

Tektronix, Inc.

FOUR SPECIALISTS

(and what they can do for you)



These four high power Nu-Base germanium transistors were created to relieve some special problems where reliable peak power handling is a requirement. Each is in a class by itself with special benefits for ignition, TV horizontal sweep circuits and high power audio output (tentative specifications are provided).

These are rugged, durable transistors with built-in protection against secondary breakdown (thanks to Delco's Hydrokinetic Alloy process). Extreme parameter stability is a result of our Surface Passivation and Ambient Control (SPAC).

The drive requirements for your circuits are substantially reduced because of the high saturated current gain of this special application transistor.

THE DTG-1010

A 325-volt 15-amp transistor, this device's higher voltage offers many advantages. It's ideal for switching high inductive loads as found in many CRT deflection circuits.

THE DTG-1110

This is a 200-volt 15-amp transistor with high power dissipation characteristics, low thermal resistance and a rugged performance record.

THE DTG-1200

With a (VCE Sus) rating of -120 volts, it offers excellent gain, high speed and high sustaining voltage characteristics.

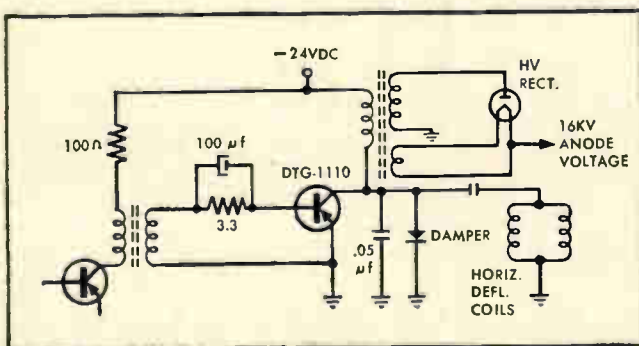

TV horizontal deflection incorporating the DTG-1110.

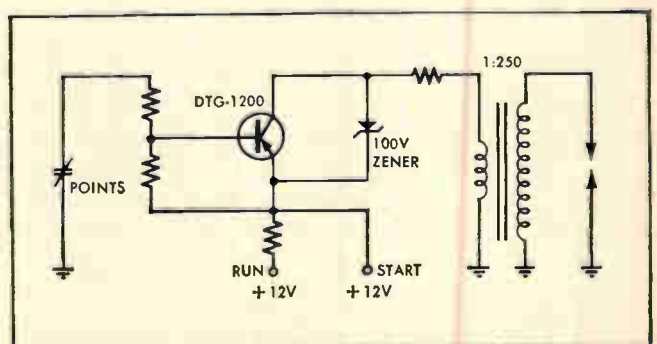

Automobile ignition circuit with the DTG-1200.

It's the ideal transistor for an ignition circuit. Also can be used in fluorescent light power inverter circuits. Mobile or portable operation is possible and fluorescent tube efficiency is improved due to higher oscillation frequency.

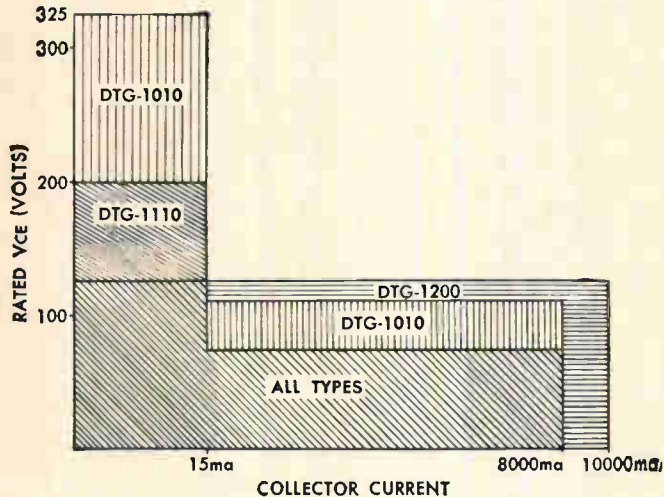

Tested sustaining voltage areas of the DTG-1110, DTG-1010 and DTG-1200.

THE DTG-110B

The DTG-110B is a high power transistor which will substantially reduce component costs and improve the reliability of quality home entertainment audio output circuits. It's designed especially for use in high fidelity amplifiers.

The linear gain and the specific gain band-width product of the DTG-110B offer low distortion and improved amplifier gain-phase characteristics.

Exceptional efficiency in the driver stages is possible because of the DTG-110B's superb transconductance properties.

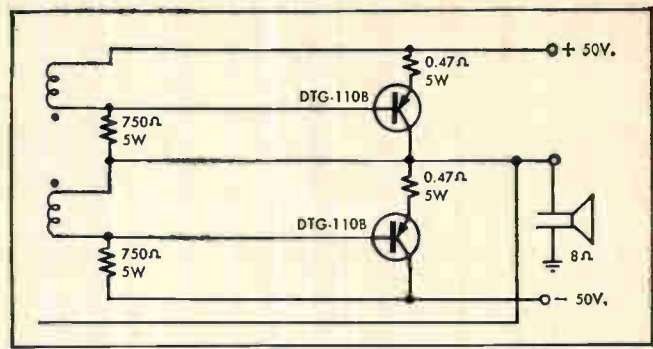

This two-stage output circuit produces well in excess of 50 watts RMS audio power with a simple drive requirement.

THE TO-3 PACKAGE

Delco Radio's TO-3 package wraps up this group of transistors.

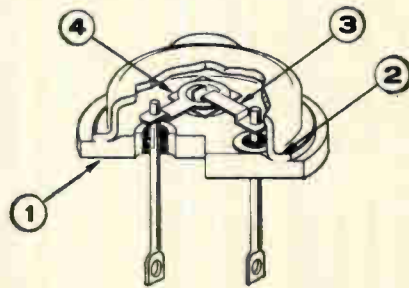

With its solid copper base (1), maximum thermal resistance is just 0.8° per watt, and freedom from conventional weld contamination is assured with Delco cold weld construction (2). The TO-3 heavy-duty connectors (3) offer high current ruggedness, and the large germanium wafer (4) delivers high continuous and peak power handling ability.

Totally, four Nu-Base specialists in Delco TO-3 packages. For data, prices and delivery, call one of our sales offices or your Delco Radio Semiconductor Distributor.

	DTG-1110	DTG-1010	DTG-1200	DTG-110B
Collector Emitter Voltage (VCE SUS)			-120V	-40V
Collector to Emitter Voltage (VCEX)	-200V	-325V		-90V
Collector Emitter Voltage (VCEO)				-40V
*Emitter Diode Voltage (VEBO)	-1.0V	-1.0V	-1.0V	-2V
Collector Current (IC)	-15A	-15A	-15A	-25A
Base Current (IB)	-3A	-3A	-3A	-5A
Maximum Junction Temperature	110°C	110°C	110°C	110°C
Minimum Junction Temperature	-65°C	-65°C	-65°C	-65°C
Lead Temperature $\frac{1}{16}'' = \frac{1}{32}''$ from case for 2 seconds	245°C	245°C	245°C	245°C

*This voltage can be exceeded provided the maximum IB and device dissipation limits are not exceeded.

FIELD SALES OFFICES

UNION, NEW JERSEY*
Box 1018 Chestnut Station
(201) 687-3770

SYRACUSE, NEW YORK
1054 James Street
(315) 472-2668

DETROIT, MICHIGAN
57 Harper Avenue
(313) 873-6560

CHICAGO, ILLINOIS*
5151 N. Harlem Avenue
(312) 775-5411

SANTA MONICA, CALIFORNIA*
726 Santa Monica Blvd.
(213) 870-8807

General Sales Office:
700 E. Firmin, Kokomo, Ind.
(317) 457-8461—Ext. 2175

*Office includes field lab and resident engineer for application assistance.

DELCO RADIO

Division of General Motors, Kokomo, Indiana

KEPCO PBX MODULES

REGULATED  DC SUPPLY

6 BRAND NEW PROGRAMMABLE SUPPLIES
OFFER MORE PRECISE REGULATION
GREATER POWER AND HIGHER
OPERATING TEMPERATURES

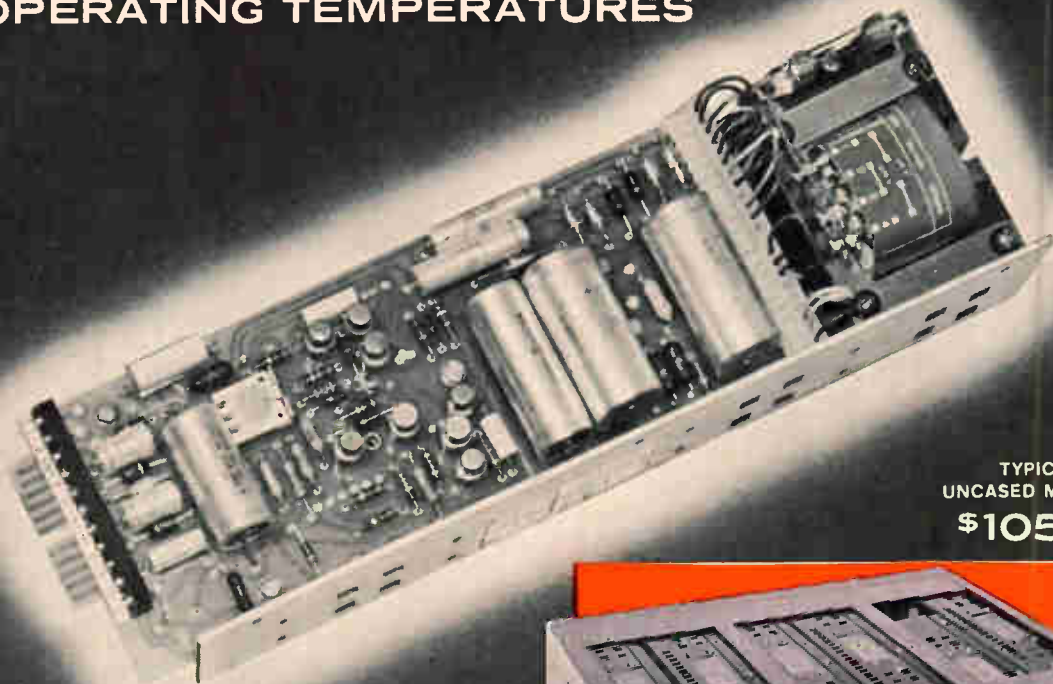

TYPICAL
UNCASED MODULE
\$105.00



6 cased modules
with Panel Adapters in
Rack Cabinet RA 6-6

In introducing the all silicon PBX Group, Kepco has packed *more power and more features* into a low cost power supply module than ever before. Designed to complement the popular PAX Group, the new PBX modules share the same hardware, rack enclosures and mounting flexibility.

- **PACKAGE:** Identical to the popular PAX plug-in modules
- **POWER:** Twice the PAX rating
- **REGULATION and STABILITY:** 0.01%
- **RIPPLE:** Less than 0.1 mv rms
- **HIGH TEMPERATURES:** Up to 71°C
- **CURRENT LIMITING:** Now so sharp, it's practically automatic crossover current regulation
- **PROGRAMMING:** By resistance, voltage or current.

0.01% REGULATION and STABILITY*

MODEL	DC OUTPUT		RIPPLE (MAX) RMS MV	MAX.* INPUT AMPS
	VOLTS	AMPS		
PBX 7-2	0-7	0-2	0.1	0.6
PBX 15-1.5	0-15	0-1.5	0.1	0.7
PBX 21-1	0-21	0-1	0.1	0.5
PBX 40-0.5	0-40	0-0.5	0.1	0.5
PBX 72-0.3	0-72	0-0.3	0.1	0.5
PBX 100-0.2	0-100	0-0.2	0.1	0.5

*At 125V AC

See our complete Catalog in

eem Sec. 4000 **PAGES** 791-826 **EEG**



For complete specifications write for New Catalog B-663.

KEPCO, INC. • 131-38 SANFORD AVENUE • FLUSHING, N.Y. 11352 • (212) 461-7000 • TWX #212-539-6623 • Cable: KEPCOPOWER NEWYORK

Editorial

Playing both sides of the street

Now that it's clear that integrated circuits are moving into industrial, commercial and consumer equipment far faster than anybody expected a couple of years ago, makers of instruments, subassemblies and systems are seriously pondering whether they should make their own integrated circuits or buy them—a question that has been nagging equipment people almost since the IC was born. The way they answer this question will affect almost everybody in the electronics industry. It will determine where a lot of the engineering will be done—at the equipment maker's or semiconductor producer's plants—and what technical direction many companies will take.

Makers of integrated circuits are quick to point out that there are large-scale economies to be reaped if equipment makers buy off-the-shelf IC's from a semiconductor specialist. The customers also receive, the argument continues, the advantage of the best and latest technology, because a specialist in semiconductors is the man who has to keep pace with fast-moving technology, who must keep abreast of the technology or drop out of the business.

David Packard, president of the Hewlett-Packard Co., the large instrument, microwave and medical equipment producer, concedes there is an economic advantage to buying off-the-shelf integrated circuits, but he feels that is only one part of the picture. He says, "If you design around available circuits, you get some cost advantages, but the equipment is limited. To improve the equipment design, we have to design our own circuits."

That's why Hewlett-Packard is setting up integrated-circuit production facilities at three separate divisions, and why Packard says that soon every H-P division will have its own integrated-circuit manufacturing facility. The IC facility at H-P's Frequency and Time division in Palo Alto, Calif., is already in operation and one at the company's Dymec division nearby is al-

most ready. Space has been cleared for an IC facility at the company's Loveland (Colorado) division and development work should start there next month.

Packard has concluded that the technology of designing with IC's differs so radically from that of designing with discrete components that the IC shop has to be near the engineers. "Maybe you can design computers whose circuits are repetitious and whose logic design is often more important than the hardware without a micro-circuit capability," he says. "But you can't design sophisticated instruments without your own integrated facilities."

He adds, "If you go to a store and buy a lot of parts which we then assemble, anybody else can go to the same store, buy the same parts and produce the same thing. If we have depth, do our own design and engineering, then we can make products that other people cannot make."

With its many IC facilities, H-P expects to develop both monolithic and hybrid circuits as well as digital and linear circuits. In his business Packard believes that monolithic techniques lend themselves better to digital circuitry, and many of the applications in instrument and microwave fields are better done with linear circuits. For example, hybrid techniques will be applied to one of the first projects that the Loveland facility will tackle: an integrated-circuit sampling probe, which is a diode gate—and some linear circuitry—that's turned on and off at a rapid rate by a pulse generator.

Though Hewlett-Packard's chief reason for setting up its own facilities is to retain design initiative, there is another important consideration. The company has contracts for design projects with three separate integrated-circuit suppliers, and every single project has been delayed, falling way behind schedule. Packard says sadly, "We've had difficulty getting what we want from outside suppliers. They are so busy filling orders from the computer makers they don't have time for us. Our volume could never match that needed by a computer maker so we take a back seat."

At least a handful of other equipment suppliers feel as David Packard does about integrated-circuit facilities. In Boston, both the Digital Equipment Corp. and the Computer Control Corp. have set up their own IC facilities. The latter has a policy that might well become the pattern for the electronics industry. It has set up a model shop that builds pilot quantities of newly designed circuits, then turns over the designs to an outside contractor for production runs. "That kind of capability," comments Packard, "lets you play both sides of the street."

*Will this new
General Purpose P&B relay make
our best seller obsolete?*

Never!

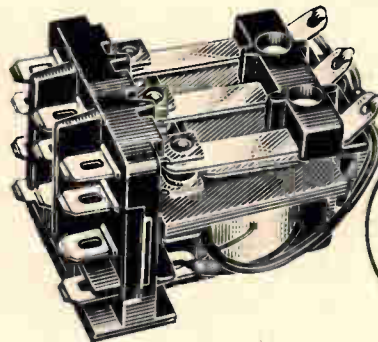

Never?

*Well,
maybe!*

Our new KU relay is quite exceptional. For many relay users, it will be more convenient, more versatile, easier to install and replace . . . and cost substantially less money. Here's why.

MODERN, COST SAVING TERMINALS

Quick-connect terminals mean faster installation on your production line . . . easier replacement in the field. Standard models have .187" terminals, but .205" may be ordered. All terminals are punched for those who prefer solder connections. Barriers molded into the sturdy front meet U/L and CSA requirements.



TRUE 10 AMP NYLON SOCKET

A nylon socket—rated for carrying 10-amperes—can be supplied to make the KU a handy plug-in relay. Covered (KUP) relays, incidentally, cost



dramatically less than similar relays having octal-type plugs.

You may specify five- or ten-ampere KU relays. Longer movable arms and a unique method of staking the stationary contacts to the header contribute to the improved reliability and longer life of this new series.



WIDE CHOICE OF FEATURES

Two styles of heat and shock resistant polycarbonate dust covers are available. One, with slotted flanges, provides a quick, convenient method for mounting the relay directly to a chassis. A handy push-button which operates the movable contacts can also be supplied for manually checking circuits. KUP relays are



available with a neon lamp wired in parallel with their coils to indicate that power is reaching the relays.

Longer life, improved reliability, exceptional versatility and, in the case of covered relays, substantially lower costs are all part of the KU Series. Interested? Call your P&B sales representative today, or get in touch with us direct.

KU SERIES SPECIFICATIONS

- GENERAL:**
Description: 5 or 10 amperes General Purpose Relay.
Expected Life: 10,000,000 cycles, Mech.
Breakdown Voltage: 1,500V rms 60 Hz between all elements; 500V rms 60 Hz between open contacts.
- CONTACTS:**
Arrangements: Up to 3 Form C.
Rating: 5 or 10 amps @ 28V DC or 115V AC resistive.
- COILS:**
Voltage: DC to 110V; AC to 230V 60 Hz.
Power: DC 1.2 W; AC 1 and 2 poles 2.0 VA; AC 3 poles 2.7 VA.
Resistance: 16,500 ohms max.
- MOUNTING:**
 (open relay) 5/32" mtg. stud, 7/32" locating tab on 7/16" centers. Socket available.

STANDARD P&B RELAYS ARE AVAILABLE AT LEADING ELECTRONIC PARTS DISTRIBUTORS



POTTER & BRUMFIELD

Division of American Machine & Foundry Company, Princeton, Indiana
 Export: AMF International, 261 Madison Avenue, New York, N. Y.

Electronics Newsletter

April 4, 1966

Hewlett-Packard plans to build IC's at all its divisions

The Hewlett-Packard Co. has decided that it must have its own facilities for the production of integrated circuits. What's more, there must be separate facilities at each of the company's divisions, says David Packard, chairman of the producer of instruments, microwave equipment and medical electronics.

Packard's reason: the coordination between IC makers and equipment designers must be very close, much closer in fact than the coordination between circuit designers and the designers of equipment using discrete components; also, the company has been experiencing delays in getting special circuit orders filled by contractors (see Editorial, page 23).

Color tv recorder designed to sell for less than \$500

The Illinois Institute of Technology's Research Center says it has developed a home color television tape recorder that could sell for between \$300 and \$500. Several companies have home black-and-white recorders on the market, selling for about \$1,000, but no one is offering a home color recorder.

The institute's 30-pound recorder has a stationary recording and playback head, rather than a rotating head, which is used on typical black-and-white recorders. The quarter-inch tape moves at 120 inches per second; it has a two-megacycle bandwidth. In studio color tv recorders, the effective speed of the tape past the head is 1,000 to 3,600 inches per second.

The institute says it is negotiating license agreements with certain manufacturers; however, it declines to identify them.

Hybrid IC's due in '66 Philco tv's

This year the Philco Corp. will introduce black-and-white television sets that use hybrid integrated circuits. The disclosure was made following word that the Radio Corp. of America and the Admiral Corp. are introducing sets that use monolithic integrated circuits. Philco, a subsidiary of the Ford Motor Co., is already using thick-film IC's in car radios in the 1967 Ford line. Philco's IC's are made by bonding transistor and capacitor chips to ceramic-based passive circuits. The IC's are being used in tv receivers' horizontal phase comparators.

Philco has stopped producing all-tube color sets. A combination of tubes and transistors makes up the circuits in all its new color tv sets. A spokesman said that the use of IC's in color sets is under study.

Honeywell plans two acquisitions

Honeywell, Inc., plans two diversification moves: the acquisition of the Computer Control Corp. of Framingham, Mass., a maker of digital computers and digital computer equipment, and the purchase of Electro-Instruments, Inc., of San Diego, a producer of digital voltmeters and printers.

Electro-Instruments will probably become Honeywell's test instrumentation division, filling many gaps in Honeywell's commercial lines.

Three years ago Computer Control moved heavily into the integrated circuit field. During the past year the company introduced a line of monolithic IC logic modules, an all-IC computer and an all-IC core memory.

Honeywell has never set up in-house production of integrated circuits.

Electronics Newsletter

Gemini 9 to keep May date in space

The next Gemini space shot will meet its mid-May schedule despite Gemini 8's brush with disaster. Gemini 9 will dock with a new Agena and possibly also with the Agena that was launched for the Gemini 8 mission. The three-day flight will repeat Gemini 8 mission objectives. In addition, astronaut Eugene A. Crenan will "walk" in space with a rocket-powered backpack.

Gemini 8's near-disaster is causing space officials to reevaluate considerations for a space rescue service. Currently, officials of the National Aeronautics and Space Administration say they lack the techniques for space rescue. One major problem: the need for a way to fire a rescue craft into space on a few hours' notice; it now takes weeks of planning before a spaceship can be launched.

A moving thought

Future astronauts may have to think twice before they think because thought impulses may be used to activate systems and machinery. The National Aeronautics and Space Administration has awarded a contract to the Case Institute of Technology to study the possibility of using sensors to pick up a man's electromyographic signals and a computer to translate them into an order for a machine (see page 156).

Airlines may test system to bar midair crashes

By the end of the year domestic airlines may flight test a collision-avoidance system that would warn a pilot of an impending collision and tell him how to avert it, the Air Transport Association says. Its forecast is based on McDonnell Aircraft Corp.'s announcement that it has been testing a collision-avoidance system.

In the McDonnell system, each aircraft would transmit a signal at 1,545 megacycles every two seconds at an assigned two-millisecond period; this would provide 1,000 separate airplane-identification codes. One plane would determine the closing speed with another by measuring the doppler shift of the received signal. A warning would be flashed to a pilot 60 seconds before a possible collision. At 40-seconds-to-collision, the system would direct one pilot to climb and the other to descend.

About 60 ground stations throughout the United States may be needed to provide continual resetting of the "clocks" the planes would carry to maintain the millisecond accuracy of the transmitters.

Others working on similar systems are the Collins Radio Co., Bendix Corp., National Co., Sierra Research Corp. and Control Data Corp. Installation of operational units could begin within three years.

Paris eases stand on U. S. investments

United States electronics companies apparently can count on special treatment when they apply for permission to build plants in France. Late last month the de Gaulle government made much ado about the fact that it had taken only two months for Motorola, Inc., to get a go-ahead for its plan to build a \$10-million semiconductor plant in Southwest France. Ordinarily, French officials drag their heels for as much as two years when U. S. companies apply for plant-building permits.

All of the "Big Three" U.S. semiconductor producers will be represented in France when Motorola's plant starts up in late 1967 near Toulouse. Texas Instruments Incorporated has a plant near Nice; SGS-Fairchild, an affiliate of Fairchild Camera & Instrument Corp., has one at Rennes.

this trademark found in your scientific apparatus automatically rates you as a "quality" manufacturer

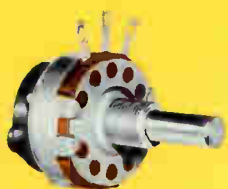
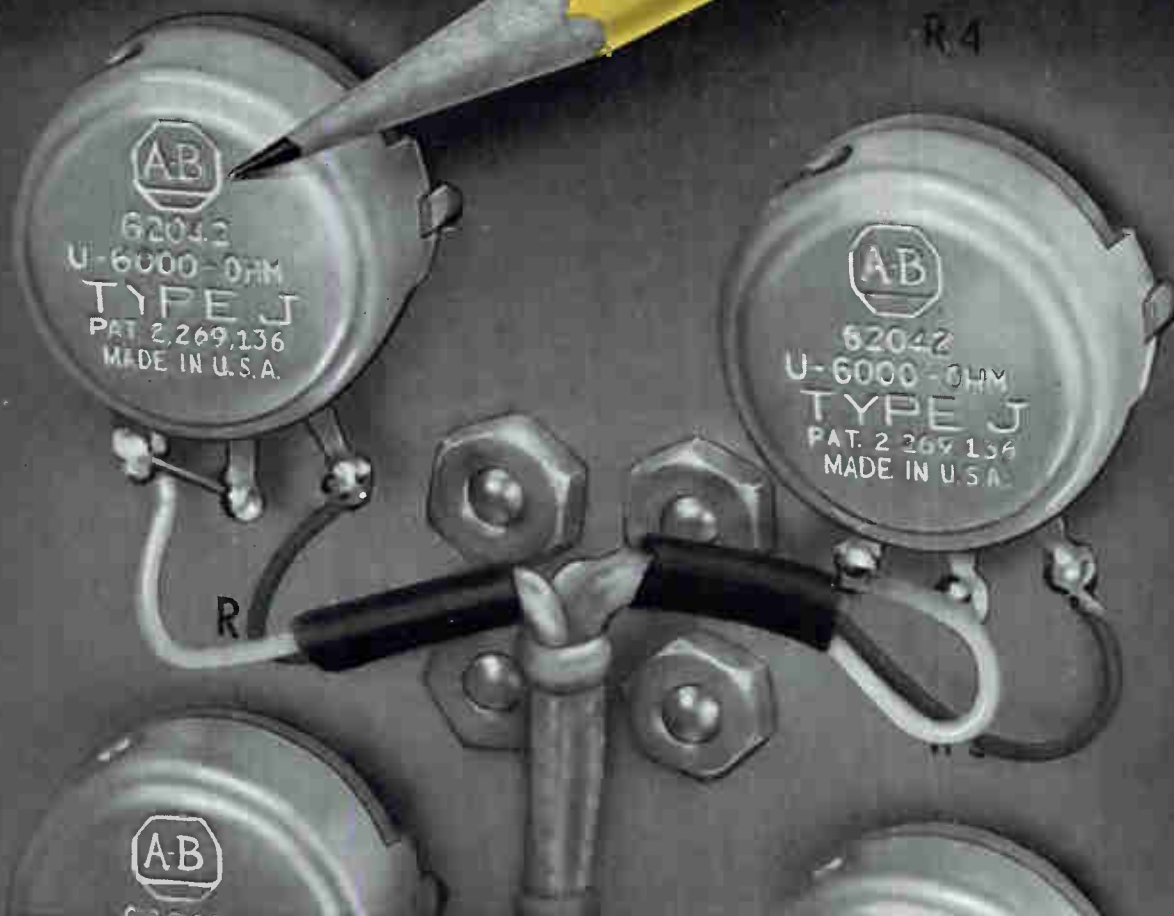

Type JS single unit with line switch

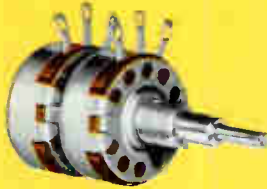

Type JJC dual unit with concentric shaft

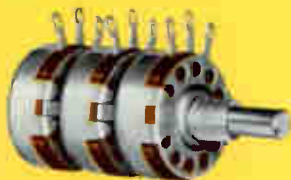

Type JJJ triple unit



Type JL single unit with lock bushing

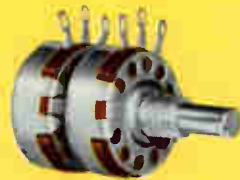

Type JJ dual unit



Type JJV dual unit with vernier adjustment

■ The A-B trademark on variable resistors is proof of design integrity — you have resisted the temptation of saving pennies by substituting marginal performing "entertainment type" controls. By thus assuring your customers of the "quality" of your apparatus, the extra price you pay becomes a good investment.

Allen-Bradley Type J variable resistors have a solid molded resistance element made by A-B's exclusive hot molding process. Operation is always smooth — there are never any sudden jumps in resistance during adjustment. Furthermore, the Type J exhibits an exceptionally low noise level when new — it becomes even lower with use. On life tests, the Type J will provide well over 100,000 complete rotational cycles with less than a 10% resistance change at the completion of the test.

For more details on the complete line of A-B quality electronic components, please write for Publication 6024: Allen-Bradley Co., 222 West Greenfield Avenue, Milwaukee, Wisconsin 53204.

Export Office: 630 Third Avenue, New York, N.Y., U.S.A. 10017.



ALLEN-BRADLEY

QUALITY ELECTRONIC COMPONENTS

This Wilcox Model 914 ATC transponder uses Allen-Bradley Type CB ¼-watt and Type EB ½-watt fixed resistors, Type G variable resistors, and Type R adjustable fixed resistors. The Model 914 transponder is for aircraft operating under ground control radar.

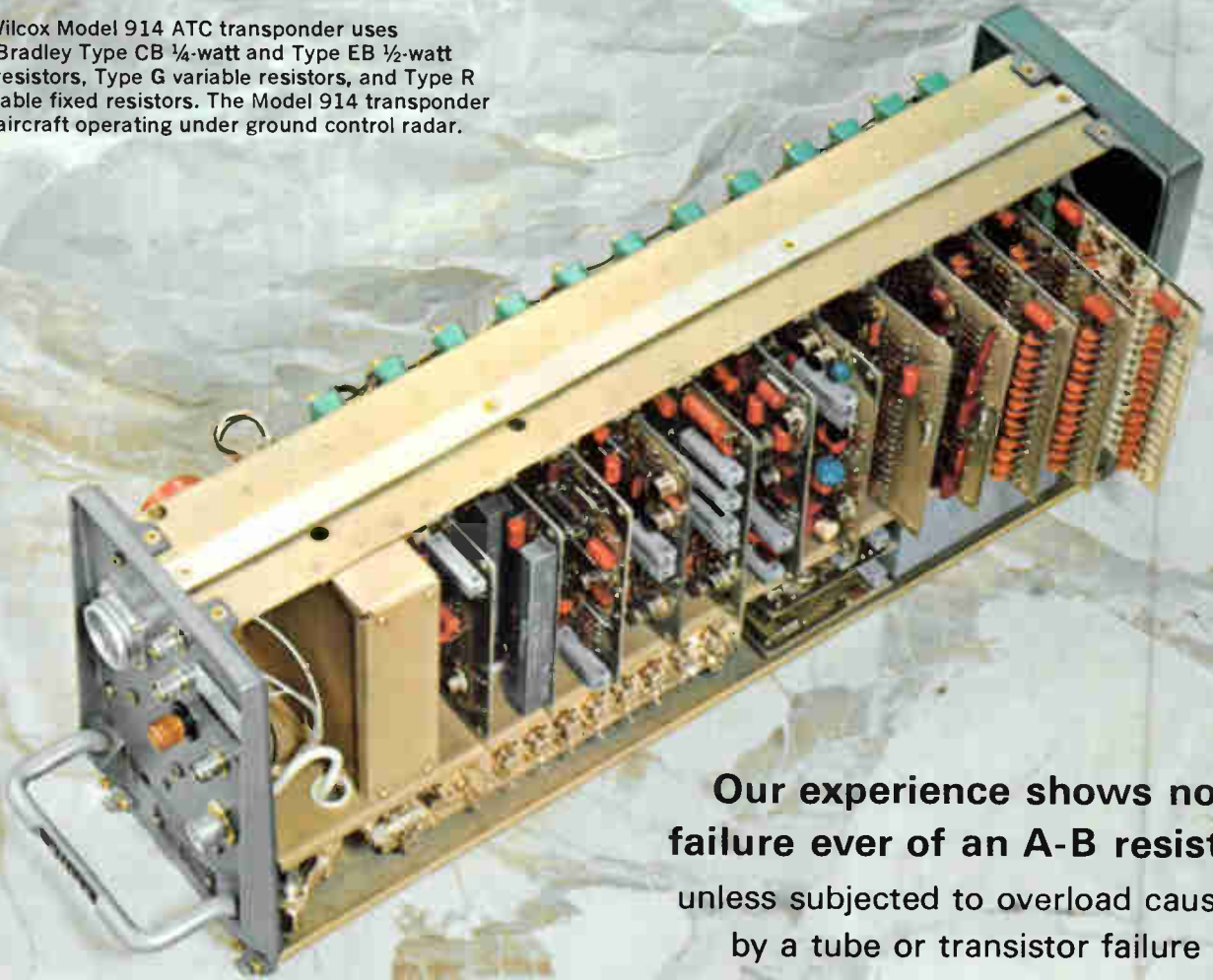

Our experience shows no failure ever of an A-B resistor unless subjected to overload caused by a tube or transistor failure

Wilcox Electric Co., Inc.

Prompt shipment of **HOT MOLDED FIXED RESISTORS** in all standard EIA and MIL-R-11 resistance values and tolerances. Values above and below standard limits can be furnished. Resistors are shown actual size.

TYPE BB 1/8 WATT	MIL TYPE RC 05
TYPE CB 1/4 WATT	MIL TYPE RC 07
TYPE EB 1/2 WATT	MIL TYPE RC 20
TYPE GB 1 WATT	MIL TYPE RC 32
TYPE HB 2 WATTS	MIL TYPE RC 42

Type R Hot Molded Adjustable Fixed Resistors are rated ¼ watt at 70°C. Supplied in resistance values from 100 ohms to 2.5 megohms.

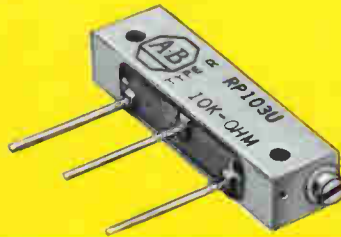

Type G Hot Molded Variable Resistors are rated ½ watt at 70°C. Resistance values from 100 ohms to 5.0 megohms.



“No failure ever” is an impressive record, especially since Allen-Bradley fixed and variable resistors have been used in Wilcox transponders for around ten years.

The reason for this consistently high performance is the unique hot molding process developed and used only by Allen-Bradley. In fixed resistors, it produces such complete uniformity that long term A-B resistor performance can be accurately predicted. Catastrophic failures don't occur with Allen-Bradley hot molded resistors.

Use of the hot molded resistance element in the Allen-Bradley Type G variable resistors assures very smooth operation—there are never any abrupt changes in resistance during adjustment. The Type G controls have

a very low initial noise factor, becoming lower with use.

Type R adjustable fixed resistors also have a solid molded resistance track. Adjustment of resistance is so smooth, it approaches infinite resolution. Settings will remain fixed under severe vibration or shock. The Type R molded enclosure is dustproof and watertight—it can be potted after adjustment.

For more complete details on the full line of A-B quality electronic components, please write for Publication 6024: Allen-Bradley Co., 222 W. Greenfield Ave., Milwaukee, Wisconsin 53204.

Export Office: 630 Third Ave., N.Y., N.Y., U.S.A. 10017.



ALLEN-BRADLEY
QUALITY ELECTRONIC COMPONENTS

VCG does not stand for "very cold gin."

It does stand for Voltage Controlled Generator — a term we coined more than two years ago when we invented the first one.



Very cold gin.

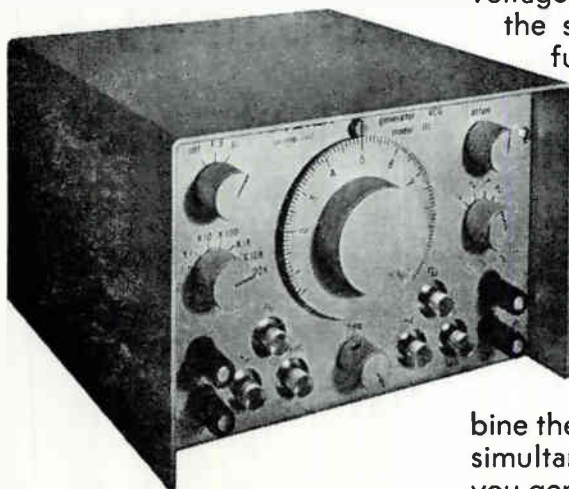

Voltage controlled generator.

Most everybody knows what a VCO is. The VCG is similar but it generates many functions over

a very broad frequency range.

The new Model 111 VCG generates sine, square, triangle and ramp waves—simultaneously—in fixed phase relationships. It gives you precise control of frequency through external voltage input — either dc programming or wideband ac frequency modulation.

This voltage input operates in parallel with the panel controls. You determine the generated frequency by (1) the range selector switch and the frequency dial, and (2) the voltage applied to the VCG input. A positive voltage increases the frequency while a negative voltage decreases it. If you apply no voltage, the instrument operates the same as our Model 110 function generator (\$395).

External programming with a square wave input results in frequency shift keying. A sine wave gives you frequency modulation. And a ramp input gives you frequency sweeping.

Also, you can combine the VCG capability with the simultaneous outputs. This lets you generate variable-duty-cycle square waves and sawtooth waveforms.

The Model 111 sells for just \$545. And you can get a Model

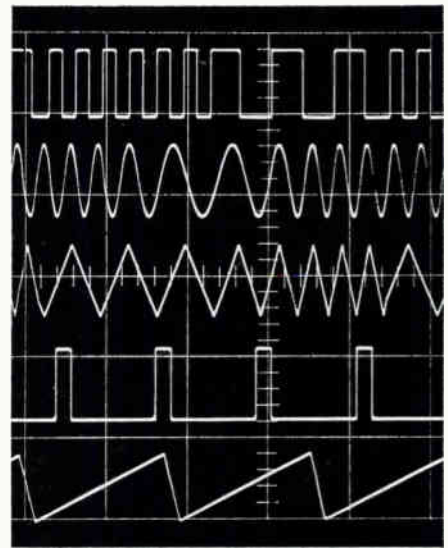

Frequency shift keying, frequency modulation, frequency sweeping, variable-duty-cycle square wave, and sawtooth.

111B with rechargeable batteries for just \$595.

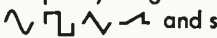
Frequency range 0.0015 Hz to 1 MHz
 and sync pulse
 7 simultaneous calibrated outputs
 VCG range 20:1 frequency ratio in
 3 ranges
 VCG linearity $\pm 0.1\%$ frequency
 vs. input voltage
 Stability 0.05% short term
 Sine wave distortion 0.5%

Now all you need to know is what it's like to use one.

WAVETEK

8159 Engineer Rd., San Diego, Calif., Tel. 279-2200
 European Sales: 3000 Bern 9, Seidenweg 17, Switzerland



M I C R O S W I T C H P r e c i s i o n S w i t c h e s



How to make sure you are not in the dark on the latest in Lighted Pushbutton Switches

Take a new look into the complete line available from MICRO SWITCH.

Ever since MICRO SWITCH introduced the first modular pushbutton switch with lighted legends, the line has been expanding. New modules, new assemblies, new ideas now offer you more opportunities to work out custom answers to today's panel requirements.

In addition to the popular Series 2 which started the modular trend, the line now includes Series 2N and Series 2C200. All three offer unequalled freedom of design—in

sheer number of possible control and display combinations—in ease of installation—and in panel appearance.

MICRO SWITCH gives you another bonus: application experience. Our specially trained field engineers will be glad to discuss your requirements. They are backed by the industry's most elaborate research and development facilities.

For information, contact a Branch Office or Distributor (see Yellow Pages, under "Switches, Electric") or write for literature.

MICRO SWITCH—the line providing unequalled freedom of design with all this versatility

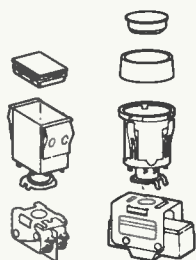

Series 2 offers both rectangular and round display, permitting shape-coding of stations or group functions. Snap-in mounting. Solenoid pull-in and/or hold-in coil for remote control.



Series 2C200. Snap-in mounting. Relamp without tools. Available with RFI shield, and solenoid pull-in or hold-in coil for remote control.



Series 2N. Shock-resistant spring-lock mounting. Hold-in coil. Relamp without tools. Molded-color housings.

in BUTTONS—Choice of 1, 2, 3, or 4-section buttons.

in COLOR—Wide selection of transmitted and projected (filtered) color schemes, and 1 to 4 lamps for up to 4-color display.

in CIRCUITRY—Up to 4-pole double-throw and 2-circuit double-break contact arrangements.

in RATINGS—Wide selection of modules for handling low energy to heavy duty electrical loads.

in WIRING—Solder, screw or quick connect wiring terminations.

in MOUNTING—Snap-in flange and barrier mountings or spring-lock panel attachment.

in REMOTE CONTROL—Only MICRO SWITCH has both remote actuation and release of switching contacts.

MICRO SWITCH

FREEPORT, ILLINOIS 61032

A DIVISION OF HONEYWELL

Would it help your future if you were the originator of a program that cut high-density connection costs by 50%, provided absolute reliability, and required no capital investment by your company?

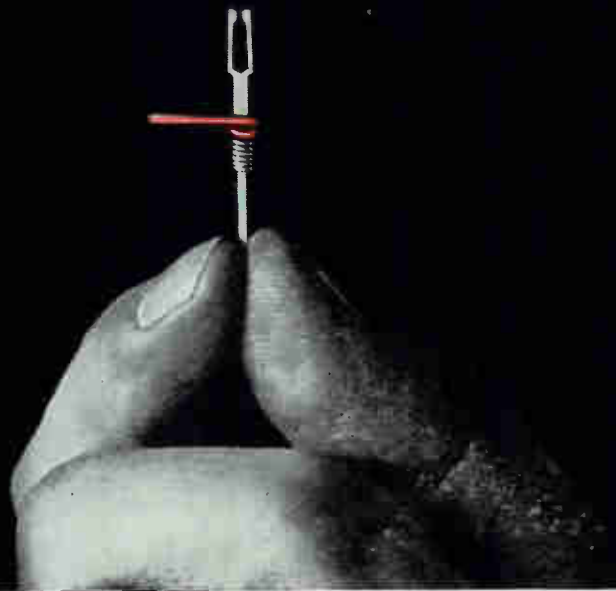

In addition to making you a company hero, Raytheon's new \$1 million automatic wire wrapping service will completely eliminate production line welding and soldering, operator training, and human error. The solderless wire wrap interconnection concept has been used by leading manufacturers in more than 30 key military programs (meets and exceeds MIL-STD-1130) including Apollo and Polaris. To date, over 37 billion commercial and military wire wrapped interconnections have been produced with no field failures. For complete information on Raytheon's unique nationwide service plus a form that will enable you to estimate your company's cost saving, mail this coupon today or call: C. E. Russ at (617) 899-8400 extension 2668, 9.

RAYTHEON

Manager, Wire Wrapping Service
Raytheon Company
20 Seyon Street
Waltham, Massachusetts 02154

Please rush me full particulars on Wire Wrapping.

Name _____ Title _____

Company _____

Address _____

City & State _____ Zip Code _____

CTS Cermet Trimmers

± 100 PPM/°C T.C. Available (Series 185)



Series 180*
1-1/4" x .325 x .295
Rectilinear



Series 170*
1/2" Square



Series 171*
1/2" Square



Series 180PC*
1-1/4" x .325 x .295
Rectilinear



Series 385*
11/32" dia., single turn



Series 172*
1/2" Square



Series 660PC
3/8" dia., single turn



Series 600LT*
2" dia., single turn
locking bushing



Series 630
1/2" dia., single turn



NEW Series 630 P
1/2" dia.
single turn



NEW Series B180
1.30 X .378 X .385
Rectilinear



NEW Series B185
1.30 X .378 X .385
Rectilinear



NEW Series 185 PC
1-1/4" x .345 x .290
Rectilinear



NEW Series 185
1-1/4" x .345 x .290
Rectilinear

CTS Wirewound Trimmers

Infinite Resolution Available. Stability .025% (Series IRW)



Series K350*
1/2" dia., single turn
knob operated



Series 110*
3/4" dia., single turn



Series 112*
3/4" dia., single turn



Series P115*
3/4" dia., single turn



Series 115
3/4" dia., single turn



Series 350*
1/2" dia., single turn



Series XPC110
3/4" dia., single turn

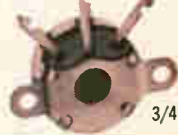

Series 117*
3/4" dia., single turn



Exclusive Series IRW
1-1/4" x .325 x .295
Rectilinear spiral
infinite resolution

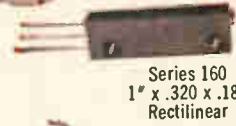

Series 160
1" x .320 x .180
Rectilinear



NEW Series 116
3/4" dia.
single turn

CTS Carbon Trimmers

for Lowest Prices



Series C140*
1-1/4" x .325 x .295
Rectilinear



Series C140PC*
1-1/4" x .325 x .295
Rectilinear



Series 220*
7/16" x 1/2" single turn



Series 330
1/2" dia., single turn



Series U201*
19/32" dia., single turn
knob operated









Series X201*
19/32" dia., single turn
knob operated



NEW Series 330 P
1/2" dia.
single turn

7 New Trimmers added to CTS' Extensive Line

CTS TECHNOLOGICAL SUPERIORITY GIVES YOU:

-  Broadest Line of cermet trimmers.
-  Wide range of wirewound and carbon trimmers.
-  Prices from 10¢ to \$17.60 for industrial, military and entertainment applications.
-  Engineering versatility for challenging design requirements.
-  Precision controlled production from raw materials to finished product.
-  Unsurpassed mass production capability.

**Immediately available from distributor stocks.*

CTS will also design to your exact specifications. CTS is a major trimmer supplier.

Founded 1896

CTS
CORPORATION
Elkhart, Indiana

Request New Time-Saving Trimmer Selection Catalog. Contains complete technical data for every CTS trimmer.

Sales Offices and Representatives conveniently located throughout the world.

Principal Products

Variable Resistors
Selector Switches
Loudspeakers
Trimming Potentiometers
Microminiature Components & Circuit Packages
Crystals, Filters,
Oscillators & Diodes

Subsidiaries:

CTS of Asheville, Inc., Skyland, N.C.
CTS of Berne, Inc., Berne, Indiana
CTS of Paducah, Inc., Paducah, Kentucky
Chicago Telephone of California, Inc.,
South Pasadena, California
CTS of Canada, Ltd., Streetsville, Ontario
CTS Microelectronics, Inc., Lafayette, Ind.
CTS Research, Inc., Lafayette, Indiana
CTS Knights, Inc., Sandwich, Illinois



MODEL TDH-9 PAR Waveform Educator



The PAR WAVEFORM EDUCATOR extracts repetitive waveforms or transients from noise.

Experimental information in the form of repetitive waveforms can best be extracted from noisy signal channels by obtaining the cross-correlation function of the waveform-plus-noise with a train of delta-functions having the same repetition rate. The cross-correlation function will be the waveform of interest, noise having averaged to zero. Approximations of this operation may be performed digitally, but generally there are drawbacks in time efficiency, speed, and expense. The PAR TDH-9 WAVEFORM EDUCATOR is an analog averaging instrument having one hundred channels of capacitor memory. The cross-correlation approximation is obtained by dividing that part of the input waveform of interest into one hundred segments. These are switched sequentially and synchronously through a resistor to the memory capacitors where the average is obtained and stored. The information in the memory bank is continuously observable on a monitor scope and the average can finally be photographed or read out on an X-Y or strip-chart recorder. The TDH-9 has the advantages of speed, efficiency, and low price.

SPECIFICATIONS

Resolution: 100 channels. Output smoothing provides continuous output waveform rather than "stairstep."

Sweep Duration: Continuously adjustable from 100 μ S to 11 Sec in five ranges. (Dwell time/channel: 1 μ S to 110 mS.)

Characteristic Time Constants: 5 Sec to 100 Sec in 1-2-5 sequence. The characteristic time constant is that time constant with which the output waveform responds to changes in the input waveform. Because the stored waveform is held during the time between sweeps, the observed time constant can be larger than the setting of the Characteristic Time Constant Switch.

Sweep Delay: A delay of 10 μ S to 11 Sec can be inserted between receipt of trigger pulse and initiation of sweep.

Output: Full scale is ± 10 volts, capable of driving oscilloscopes, X-Y recorders, and strip chart recorders. Readout can be as slow as 100 Sec (dwell time/channel 1 Sec).

Dynamic Range: Noise and interference five times the full-scale input will not cause overload. Output noise

with shorted input for most combinations of Sweep Duration and Characteristic Time Constant is below 0.2% of full scale.

Power: 105-125 or 210-250 volts AC, 50-60 Hz; 25 watts.

Price: \$4200.00 Request Bulletin 126.

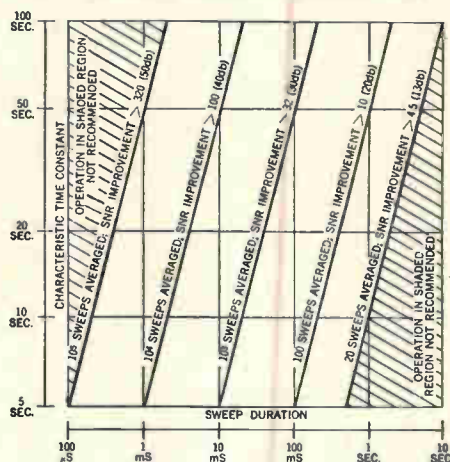

NUMBER OF SWEEPS AVERAGED AND VOLTAGE SIGNAL-TO-NOISE RATIO IMPROVEMENT AS A FUNCTION OF CHARACTERISTIC TIME CONSTANT AND SWEEP DURATION

PAR PRINCETON APPLIED RESEARCH CORP.
Dept. D
Box 565, Princeton, N. J., Tel. (609) 799-1222

Displays

A clear view

Images transmitted through fiber-optics cables generally lack resolution, and techniques for improving the images are costly and complex. Now, a small electronics concern in Plainview, N.Y., Optomechanisms, Inc., says it has developed a simple method of nearly doubling the resolution capabilities of the cable.

Spinning lenses. Basic to the image-enhancement system is a set of lenses—one at each end of the fiber-optics cable. Two synchronous electric motors rotate the lenses and keep their spin rates in phase. The president of the company, Andre R. Brault, explains that details on the lenses and the way they're rotated are proprietary because patents are still pending on many parts of the system.

He says the unit improves the resolution of images transmitted through fiber-optics cables. Ordinarily, resolution is limited by three factors: the size of each individual rod in the fiber-optics bundle, breaks in a rod and gaps between each rod. The gaps, or discontinuities, are caused by epoxy, which is used to bond both ends of the bundle. The effect is like seeing a picture through a screen door. What's more, broken rods in the fiber bundle cause black spots in the final picture.

With image enhancement, Brault says, these discontinuities are minimal. Without enhancement, most optical cables provide a resolution of about 35 line pairs per millimeter, but with Optomechanisms' enhancement system, resolution is boosted to 66 line pairs per mm.

'Not talking.' The image-enhancement system isn't really a new development, says Brault, but until now "we haven't been talking about it in public." The executive indicated that all sales had been



Technician welding by remote control watches the operation through a stereoscopic unit connected to a fiber-optics cable. First he sees the "raw" image at the left, but after the image is "treated" by an image-enhancement system he gets the clear picture at the right.

limited to the military, presumably for classified reconnaissance projects.

Brault says that the National Aeronautics and Space Administration plans to use the unit in the Apollo spacecraft to peek around corners and look into places where it is difficult to position a camera.

Computers

More scratch pads

Less than a month after Scientific Data Systems, Inc., introduced its Sigma 7 (details on page 118), a computer that relies heavily on integrated circuit scratch pads, the

Burroughs Corp. has announced that it, too, is going to offer computers that use many IC scratch pads.

The Burroughs' computers, the B2500 and the B3500, are compatible with the company's much larger B5500 and the B8500 [Electronics, July 12, 1965, p. 17], and will replace the older B200 and B300 series.

The central processors of both are built exclusively of monolithic integrated circuits made by the Fairchild Semiconductor division of Fairchild Camera & Instrument Corp. IC's are also used for memory decoding, driving and sensing. Only the core memory itself and the peripheral equipment use discrete components. Fairchild and Burroughs engineers worked

closely in developing the IC's, which will be available in Fairchild's complementary transistor logic line.

Fast processing. The scratch-pad memories operate in a 100-nano-second cycle and have capacities of 24 to 120 words; they reduce the machines' dependence on the main memory and permit significantly faster processing than similar machines without scratch pads.

The machines will compete with computers such as International Business Machines Corp.'s System 360, models 30, 40 and 44, and Radio Corp. of America's Spectra 70/25 and 70/35. Compatibility with the 360 requires installation of a modified read-only memory containing a special microprogram, called an emulator. The machines will rent for \$4,195 to \$20,720 per month.

Fast combination

The fastest commercial computer today is able to perform nearly three million calculations per second. But to Daniel L. Slotnick, a professor of computer science at the University of Illinois, that's slow going compared with his goal: a billion computations per second.

Although Slotnick is still a few years away from proving that his design, the Illiac 4, can reach that bewildering speed, neither he nor his sponsor—the Pentaton's Advanced Research Projects Agency—doubts he'll succeed. Seven computer makers, vying to build the giant machine, are also convinced.

Work in tandem. Slotnick's approach is based on the principle of repetition. He reasons that if one computer can perform several million calculations in a single second, then a few hundred computers, linked together and working simultaneously on parts of the problem, can operate at the rate of a billion per second. Admittedly, the cost will be high, but for some applications—like processing the rapid-sequence signals from a phased-array radar—the user will gladly absorb the cost.

A few months ago, bids to build the hardware were submitted by

the Burroughs Corp.; General Electric Co.; International Business Machines Corp.; Radio Corp. of America; Sylvania Electric Products, Inc., a subsidiary of the General Telephone and Electronics Corp.; the Univac division of Sperry Rand Corp., and Westinghouse Electric Co.

This spring three companies will be selected to carry out a six-month study of details of the machine. After that, one of them will be chosen to construct it. Completion will be in late 1968.

The basic building blocks of the Illiac 4 will be a relatively conventional group of circuits capable of executing simple arithmetic operations on 32-bit words or on 8- or 16-bit fractional words. However, the speed Slotnick expects is pushing the current state of the art: 250 nanoseconds for the basic cycle of each block.

Parallel construction. Sixteen of these basic blocks will be connected in parallel to the memory. This means that sixteen 32-bit words will have to be read out from the memory at once, so that the

memory word length must be 512 bits—an extraordinary length. Slotnick asserts there is no technological barrier to such a word length.

Each of the 16 blocks will execute the same instructions on its own data; the instructions will come from a single control unit that will supervise all 16 blocks. The control unit, in turn, will receive sixteen 32-bit instructions from one 512-bit memory word, passing them in sequence to the 16 basic units.

This combination, or layer—one control unit, one long-word memory and 16 basic arithmetic units—all executing the same instructions on different data—is repeated up to eight times. The fact that all the units are operating in parallel produces an over-all system speed that's at least 128 times (that is, 16 blocks times eight layers) faster than the speed of any other machine now envisioned.

Swap data. The 16 basic blocks in each layer will swap data back and forth among themselves as well as to and from the memory. In addition, there will be commu-

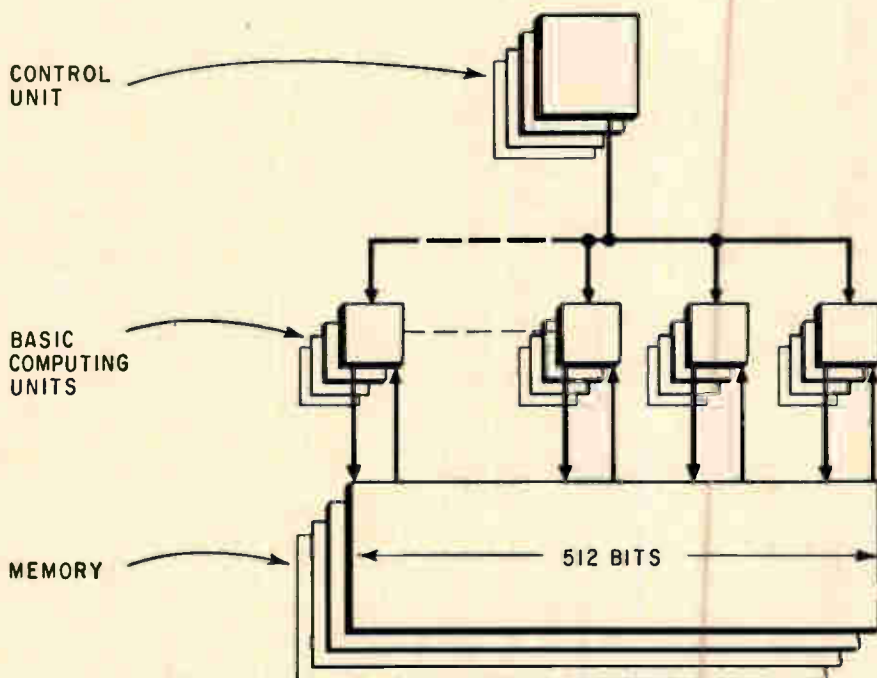

Repetitive processing by a large number of relatively small processors adds up to a computer of extraordinary speed. The Illiac 4, being designed at the University of Illinois, will be able to perform a billion calculations a second. Words of 512 bits from the memory will provide each of 16 basic processors with a 32-bit word of data, all at once; the data is processed under control of a single unit. The combination of memory, control and 16 processors will be repeated up to eight times in the complete system.

nication among each of the blocks in the different layers.

Beyond the military applications, Slotnick sees Illiac 4's being used for such problems as the evaluation of high-order determinants, which requires an enormous number of simple calculations.

Conversational program

Soon anyone who can hunt and peck on a typewriter will be able to converse with a computer. An experimental software program, called Deacon, is already being used to help a computer understand and answer simple questions in colloquial English.

Deacon, which stands for direct English access and control, is being developed by Tempo, General Electric Co.'s center for advanced studies in Santa Barbara, Calif. Eventually, it will be possible for an operator to use a computer without any knowledge of computer language or programming.

Simple questions. GE says the final version of Deacon will answer questions asked in relatively complex conversational English, such as: "What are all the ways of generating microwaves?" For the time being, however, it will deal with simpler questions.

It will have no difficulty distinguishing among: "What is the location of the cruiser Phoenix?"; "Where is the Phoenix?"; Find the ship Phoenix!" Regardless of which way the question is asked, Deacon should be able to provide the correct answer.

Computer grammar. The Deacon system is based on the interaction of three parts of the program: a dictionary, which lists the words the computer can recognize; a rules catalog, which contains the grammar of the system; and a data base, which provides the interconnections among words that gives the system its "intelligence."

When queried, Deacon first searches for the important words in the dictionary. If a word is not there, the computer will ask the operator to rephrase his question or define his terms. Eventually, when all the words are found, linkages

are established through the data base; this tells the computer what is being asked. For example, if the question is "What is the location of the cruiser Phoenix?", the computer would recognize that "location," "cruiser" and "Phoenix" are important words and search for linkages among them.

Linkages are often complex. For example, the memory might contain data about the Phoenix on weight or manpower; the locations and other facts on cruisers named Dallas, Cleveland or Miami; and data about a city, an insurance company and a mythical bird, all named "Phoenix."

The program may have to follow more than one track to make sure it doesn't give a correct but inappropriate answer. The question "Where is Phoenix?" could be answered: "The cruiser Phoenix is in San Francisco Bay"; the city Phoenix is in Arizona," and so on.

Recondite language. Most information-retrieval systems now in use require that questions be asked in a specialized language, using key words and standard forms. Also, many of them can tell only where to find the answer.

Deacon is being developed on relatively unsophisticated hardware. The computer is a GE 225 with one magnetic disk file that has a capacity of 18 million six-bit characters. Communication with the computer is through a teleprinter or a GE Datanet 760, which acts like a teleprinter but produces an image on a cathode-ray tube instead of printing on paper. The teleprinters and the Datanet 760 communicate with the GE 225 central processor through a GE Datanet 15.

Herbert R. J. Grosch, director of the project, says he does not think the kind of equipment being used will limit the Deacon project, "because I am certain that hardware development will keep ahead of our needs."

The system's speed and versatility could be improved, however, by giving it an associative memory—a development still in the experimental phase. An associative memory can pluck a bit of information from storage by making an adroit

association rather than going sequentially through its memory until the information sought is reached. It would know immediately if it "recognized" a specific word in a question without having to look it up in its dictionary.

Instrumentation

Invisible sentry

Most electronic sentries have two crucial disadvantages: if they are active, an intruder can detect their radiation; if they are passive, they can't be detected but have a range of only one or two feet. A passive infrared sentry that can sense an intruder up to 250 feet away has been developed by the Huggins Laboratories, Inc., of Sunnyvale, Calif.

With the Huggins system, the intruder inadvertently does all the work, by supplying the two components that activate the alarm—motion and a radiometric signal. The front of the detector is covered with a grid. Any motion of an infrared source creates a low-frequency modulation of the radiometric signal as it is interrupted by the grid. The resulting signal is amplified and used as a d-c trigger for firing the circuit. No current flows in the system until an intruder comes into range. Before that, the system is dormant and safe from detection.

Target temperature. For the infrared sensor of the motion detector Huggins used a capacitor bolometer it had developed earlier. The capacitor bolometer's frequency response is at least five times greater than that of the thermistor bolometer usually employed in infrared systems, making the sentry responsive to rapid movement. The bolometer is arranged in a double-ended bridge circuit that adjusts to changes in the ambient temperature. It then will react to radiometric signals that differ as little as 1°F from the ambient temperature. Tests showed the differences between a person's clothing and ambient temperature were usually

more than 1°F—even at the pants' cuff.

A lens with flat transmission characteristics from 4.2 to 15 microns is used to increase optical efficiency. The 9.3-micron wavelength of human infrared radiation is well within the lens' range. A filter in front of the lens prevents sunlight from affecting the detector. The sentry will function effectively at ambient temperatures from 25° to 120°F. This range can be lowered or raised by adjusting the detectors' electronics.

Other systems. Active intruder detectors, such as ultrasonic sentries, are detected easily with electronic sensors. Even acoustic systems, which are only partially passive because they limit r-f radiation, can be detected; they have the added disadvantage of being sensitive to random noises, such as the ring of a telephone or the sound of a passing car. Doppler radar systems, besides being very expensive, can be detected with a wide-band crystal detector. Systems that use a change in capacitance or inductance of a tuned oscillator circuit approach being passive but have a range of about two feet.

A disadvantage of the Huggins' sentry is that it would be triggered by any moving infrared source in the 4.2- to 15-micron range, and this includes everything from squirrels to grizzly bears. The Air Force has had a similar problem with a capacitance-type detection system for its Minuteman missile site at Ellsworth Air Force Base in South Dakota. The system is reportedly so touchy that high-leaping grasshoppers periodically set it off. A modified version of a doppler radar detection system at Titan II missile sites can distinguish between men

and animals by measuring differences in frequency and intensity of the returning radar signal. [Electronics, Nov. 16, 1964, p. 32].

Friend or foe. William E. Osborne, chief scientist at Huggins, says the Air Force is interested in the infrared sentry for perimeter surveillance. The Army also sees a potential as a weapon: it could be used to trigger antipersonnel mines from a safe position.

"The next step," Osborne says, "is to develop a system that can distinguish between friend and foe.

Osborne says he has discussed possible traffic control applications with officials in several cities. Detectors could be used at highways to monitor traffic. If traffic slowed to a predetermined rate and stayed that way for a time, the sentry would trigger signs warning motorists of the congestion, would re-route traffic or would prevent more cars from entering the highway.

Data processing

Banking on computers

The banking industry is on the verge of being overwhelmed—by a mountain of checks. Some 70 million are now cashed daily, and each year the number grows. To move each of these millions of bits of paper—from the place where it is written to the issuer's bank for deduction—banks spend some \$3.3 billion a year.

A solution, however, is in sight.

Slowly, in still uncoordinated steps, the banking industry is establishing a nationwide financial utility that eventually will tie the money transaction of banks and

customers into a vast computerized network. Some time from now, many bankers agree, checks will be as obsolete as Indian pennies.

Pay the phone. A precursor of the network was started last month in Wilmington, Del. [Electronics, Nov. 15, 1965, p. 41]. A person with an account at the Bank of Delaware can pay for a purchase at nearby Stroms department stores even if he has left his wallet home and has no credit account at Stroms. After a purchase, the salesman simply "dials" the number of the bank on a touch-tone telephone, enters a code that identifies the customer and then enters the amount of the purchase. Automatically, through a team of International Business Machines Corp. computers, the purchase amount is deducted from the customer's checking account—without the writing of a check.

The Bank of Delaware is already planning a step beyond. This year it will conduct an experiment in which customers will use touch-tone telephones at home, paying bills to companies with accounts in the bank.

Novel as the system is, it gives only a hint of what's in store. Within a decade many bankers foresee a network in which banks will be tied to retailers through a central computer clearing house. From there, the banking network could expand. Employee payrolls, for example, could automatically feed from corporate accounts into individual accounts; and the employee's regular monthly payments—mortgage, utilities and savings—would be automatically deducted. The Treasury Department could tie in: income tax withholding payments and social security payments could be deducted. The Federal Reserve System, in a side benefit,

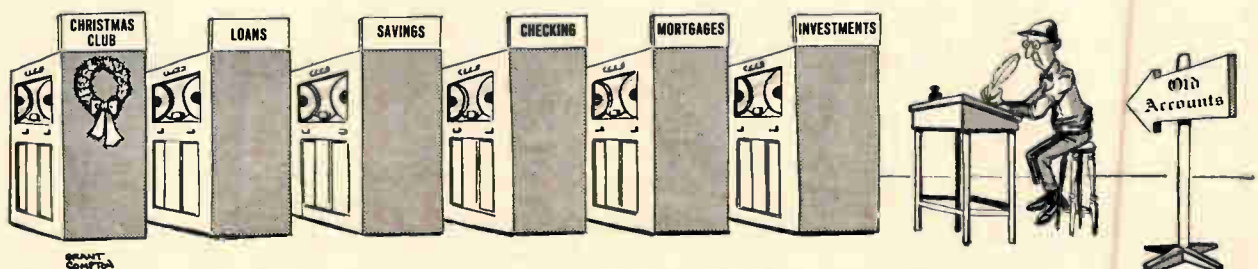

TRW ANNOUNCES

10 W 400 Mc 60% η

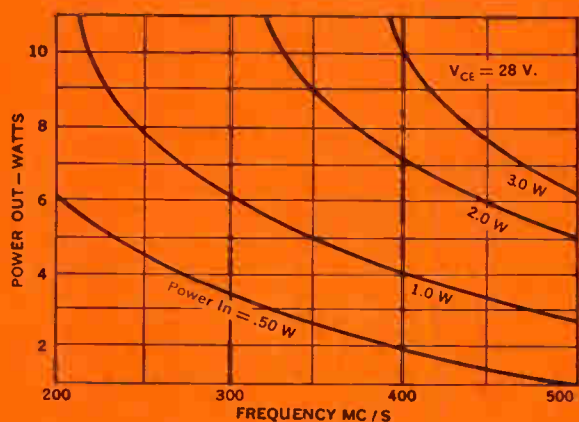

NEW UHF POWER TRANSISTOR

The new TRW 10W/400Mc (2N4040) UHF Power Transistor provides full rated performance in conventional circuits...no need to resort to emitter tuning or other techniques which contribute to circuit instability. TRW 2N4040 is *available now* at competitive prices.

For detailed technical information phone, write or wire: TRW Semiconductors, Transistor Plant, 14520 Aviation Blvd., Lawndale, Calif. 90260. Phone: (213) 679-4561, Ext. 477 TWX: 213 647-5113

TRW designs and manufactures high performance transistors for the communications industry and specialized types for military and industrial applications.

TRW SEMICONDUCTORS

could monitor the flow of money across the nation, gaining instant and precise information on the state of the economy.

In general, the federal government favors the trend. And, as George W. Mitchell, a member of the Federal Reserve Board, notes: "... these experimental operations will provide a solid foundation for a banking system of the future."

Seek a share. Plans to establish this financial utility are being pressed hard by the American Telephone & Telegraph Co., which already has the inside track: the terminals (touch-tone phones) and the communications lines. But other companies are seeking a share of the market. The major communications common carriers, including the International Telephone and Telegraph Corp. and Western Union, are trying to develop competing systems.

Bankers concede, however, that a fully computerized operation is still years away, and in the meantime they face that growing mountain of checks. One proposal, by W. Putnam Livingston of Bankers Trust Co. of New York, is to stop a check's movement at the first bank it is presented; then, rather than shipping the paper back to the check writer's bank and subsequently to his home, move only the information on the check by computer.

"The fact is that money is, basically information," says Martin Greenberger, an associate professor at the Massachusetts Institute of Technology. As such, he sees banking and finance as one component of the information business. Thus, the financial utility could easily tie in with marketing-research program, securities trading and credit control.

Medical electronics

Taking heart

Cardiac victims may soon have a simple wrist device that will be a heart line to expert medical atten-

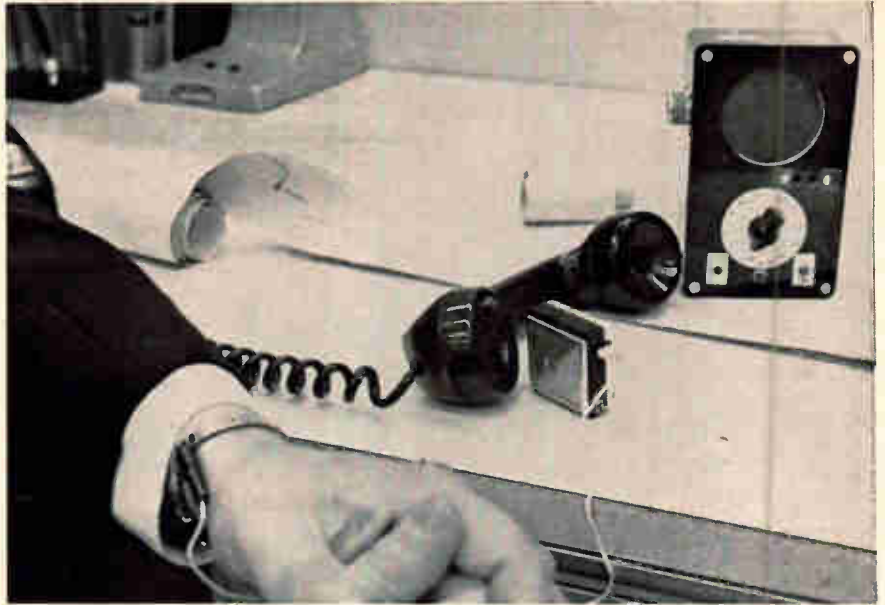

Electrocardiograph by telephone. The patient connects two electrodes from wrist bracelets to a small transmitter that relays audio signals to a doctor's office. There, a demodulator changes the signals into a pulse that is recorded by an electrocardiograph. The larger transmitter in the background is a prototype.

tion. The wrist sensors are part of an electrocardiograph (EKG) telemetry system that links patient and EKG apparatus by telephone to a doctor.

With the proposed system, a patient takes his own electrocardiograph by clipping a pair of electrodes from expansion bracelets on each wrist into a transmitter. The EKG signals are sent by telephone to an EKG print-out machine in the doctor's office at the other end of the line. There, a demodulator turns the audio signal into a series of pulses that is recorded as a line graph.

Dr. Travis Winsor of the Winsor Memorial Heart Research Foundation in Los Angeles is developing the EKG telemetry system with technical assistance from the Missiles and Space division of the Lockheed Aircraft Corp. and the Electronics Systems division of TRW Systems, Inc.

Woman's compact. TRW has come up with an integrated-circuit version of the prototype transmitter that had more than 40 discrete components—transistors, diodes, resistors, capacitors and inductors—plus a battery power supply and a speaker, packed into a box about 3 by 4 by 5 inches.

The IC version has been cut to

a loudspeaker, a battery, a few discrete components and three integrated circuits; it fits into a box that's the size of a woman's compact. But Donald McWilliams, assistant chief of semiconductor technology at TRW's microelectronics center isn't satisfied yet. He hopes to get the package down to the size of a wristwatch.

McWilliams also plans to replace the inductive coupling used in the Lockheed receiver with non-inductive coupling to avoid picking up normal 60-cycle-per-second a-c noise.

Reports from cardiac patients testing the system already indicate it will be a success, Dr. Winsor says. He receives 40 or 50 "electrocardiograph" calls a day at the foundation from patients too far away to come and see him.

Communications

One-man tv crew

The Westel Co. of Redwood, Calif., says it has developed a television camera and audio-visual recording system that can be carried and operated by one man and yet



Low-cost digital frequency meters for mobile communications

Communications engineers who must now have more accurate measurements can get them with Beckman Models 6120 and 6121 Frequency Meters. These 25-mc and 50-mc instruments are the lowest cost digital frequency meters available employing direct counting techniques... 6120—\$1,750; 6121—\$1,950. They give you the benefits of direct digital display, simple controls, data logging (with option for printer), plus accuracy that can't be had in an analog device. For aircraft, marine, and surface mobile communications, these solid-state instruments have four plug-in extenders: a 400-mc prescaler, 1-gc heterodyne, DVM, and

preamplifier. Your Beckman Berkeley sales engineer has the full story on the Models 6120 and 6121 and how they can help you solve frequency measuring problems... with more accuracy at the lowest possible cost. For complete details, call or write today.

Beckman

INSTRUMENTS, INC.
ELECTRONIC INSTRUMENTS DIVISION
RICHMOND, CALIFORNIA • 94804

INTERNATIONAL SUBSIDIARIES: GENEVA; MUNICH;
GLENROTHES, SCOTLAND; TOKYO; PARIS; CAPETOWN; LONDON





The shape of tomorrow, today

For more than 20 years, Ultra Carbon consistently has provided industry with advanced graphite technology. "F" purity graphite for the AEC ... semiconductor crystal crucibles, boats, headers and fixtures made from *Ultra purity* graphite—these are typical of our past contributions to the electronic industries.

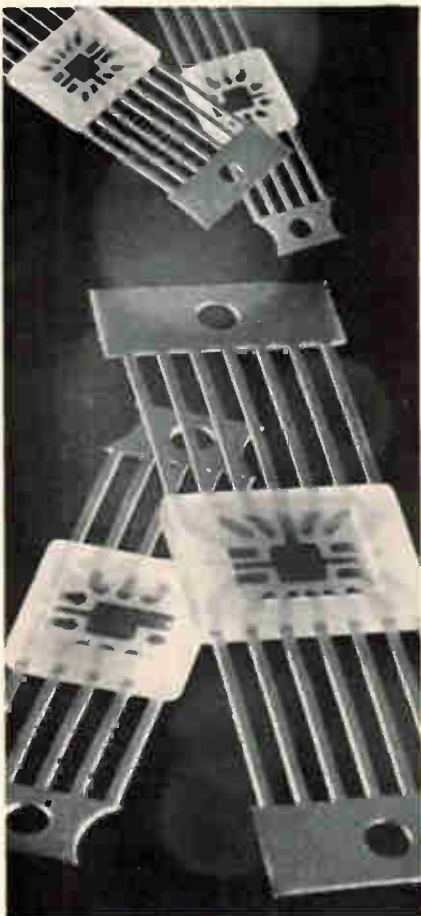

ULTRA/FGP® flat glass packs for integrated circuits in 14 lead $\frac{1}{4} \times \frac{3}{8}$ inch and 10 lead $\frac{1}{4} \times \frac{1}{4}$ inch are now in production. Write Ultra Carbon Corporation, Box 747, Bay City, Michigan 48709.

Electronics Review



Taping for television: taking pictures on the go.

meets all broadcast standards.

The recorder unit fits into a small suitcase weighing 23 pounds. It includes nickel-cadmium rechargeable batteries and a 30-minute supply of one-inch video tape. The camera weighs seven pounds. All operating controls and indicators are on the back of the camera head for convenient operation.

First of its kind. Westel says the system is the first single-head helical-scan video-recorder with professional broadcast quality. In most helical-scan recorders, the tape is wrapped around a cylindrical drum in helical fashion as it passes from reel to reel. Inside the drum, two revolving heads in sequence sweep across the tape, recording the picture. Westel uses a drum, which is an inverted, truncated cone, so that the tape overlaps itself as it passes around the drum. Because of this overlap, only one head need be continually in contact with the tape, making it possible to eliminate all head-to-head switching circuitry. Westel calls its recording technique Coniscan.

To keep the weight of the WRC-150 recording camera down, Westel includes no playback, rewind or fast-forward capabilities. For playback of tapes recorded in the

field, Westel has a much more elaborate studio-recorder, the WTR-100. It will accept video signals from any studio source and can be converted to accept color, says Westel, with the addition of only a small plug-in module. Westel claims that the studio model can maintain a color signal stability of less than 3° of phase error. A phase-error of 10° is considered the maximum allowable error for a complete studio-transmitter chain.

The 150 costs \$10,500 and the 100, \$15,000.

Advanced technology

Family planning

Will computers ever be able to breed computers?

"I don't yet see any specifics on the horizon, but I do smell the possibility of such a technological revolution," says Jerome Rothstein, senior staff scientist at Laboratory for Electronics, Inc., of Boston. "Maybe in five years we'll begin to see something in rudimentary form."

Rothstein's research in the field of molecular cybernetics, is sponsored by the Bionics Laboratory at Wright-Patterson Air Force Base in Dayton, Ohio. He will report on his work at the Bionics Conference to be held there May 3 to 5.

The concept of the computer-breeding computer has been applied to machines that help design the logic wiring diagrams or programs of a next-generation computer. But this is not the context in which Rothstein discusses the possibility of self-reproducing machines.

His goal is to discover how living systems store sufficient information to duplicate themselves, what laws of physics and chemistry make self-replicating information storage possible and how such information and control processes can be imitated in a man-made machine.

Evolution. Such a machine would be self-organizing, self-repairing,



Jerome Rothstein: it takes inspiration.

self-correcting and adaptive. In a word, it would be evolutionary.

Much of the activity in bionics today consists of investigations of circuits and networks designed to perform biomorphic functions. But Rothstein is exploring information and control processes in biochemical systems at the molecular level.

In the face of a staggering complexity of variables, Rothstein plays it like a chess game—but not like a computer playing chess. The computer gets swamped trying to cope with the large number and combinations of variables. A skillful human player learns the principles, discovers tactics and strategies and throws out the time-consuming and irrelevant cases, he explains.

Using information. In genetic structures, from virus to man, there must be storage of information at the molecular level. Rothstein's investigations have led to grouping configurations of molecules into "families." Control actions determine whether a molecule can change its configuration from one family to another; catalysts exert such controls.

Rothstein investigates chain molecules—beads connected by links; the order of beads constitutes a message. Such messages are the catalysts that make control possible.

"It is this family structure—or something like it—an extra structure that may be exploited by the living organism to permit at a chemical level the control processes that we know in engineering,"

basic measuring tools from

**HEWLETT
PACKARD**

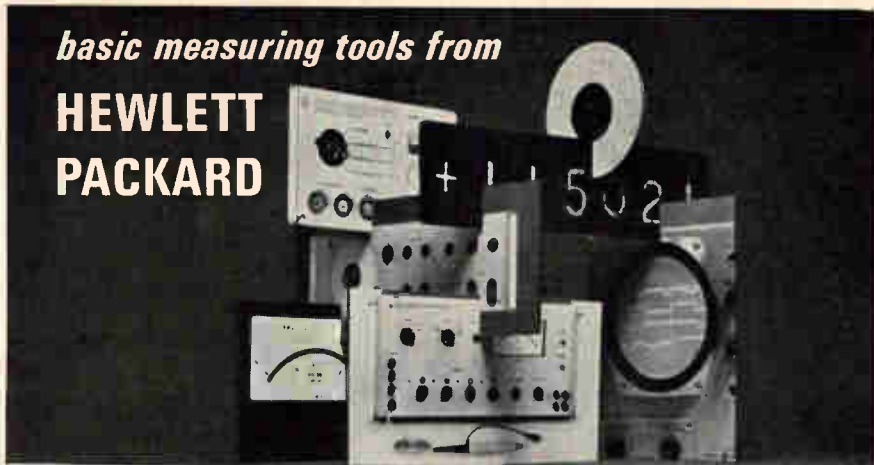

hp 203A

Variable-Phase Function Generator

provides reference and variable-phase sine, square waves
range 0.00005 Hz to 60 kHz
distortion less than 0.06%
continuously variable phase shift 0-360°
four simultaneous adjustable outputs 0-30 v peak-to-peak

Use it for:

- phase shift measurements
- low-distortion signal generation
- vibration studies
- frequency response measurements
- servo applications
- medical research
- geophysical problems
- subsonic, audio testing

Here is a solid-state function generator offering simultaneous sine and square-wave signals 0.005 Hz to 60 kHz in 7 overlapping bands (two optional bands available, down to 0.00005 Hz). Total harmonic distortion hum and noise (0.06%) is less than 64 db below fundamental.

Accurate 1% frequency dial calibration with 180 dial division, vernier drive for precise adjustment. All four floating output circuits have individual 40 db continuously adjustable attenuators. One each of the sine and square-wave outputs

contain the 0-360° phase shifter. A front-panel calibration provision permits easy line-frequency calibration of the oscillator to the environment in which it's being used. Price, \$1200.

For a demonstration of the unique 203A call your Hewlett-Packard field engineer. Or write for complete specifications to Hewlett-Packard, Palo Alto, California 94304, Tel. (415) 326-7000; Europe: 54 Route des Acacias, Geneva.

*Data subject to change without notice.
Price f.o.b. factory.*

HEWLETT *hp* PACKARD
An extra measure of quality

1186



6 BIT A TO D CONVERTER 15,000,000 CONVERSIONS PER SECOND



MODEL 834A ANALOG TO DIGITAL CONVERTER

Well-suited for telemetering or process control
Long life and high stability
All solid state, silicon semi-conductors

SPECIFICATIONS

Method: successive comparison.
Digital output: B.C.D. 12 bit parallel. Stability: $\pm 0.2\%$ /6 months. Conversion time: approximately 240 μ s. Operating temperature: -10°C to $+50^{\circ}\text{C}$. Width: 480 mm. Height: 199 mm. Depth: 225D m/m. AC Input: 100/110/220/240V $\pm 10\%$ 50 or 60 c/s.

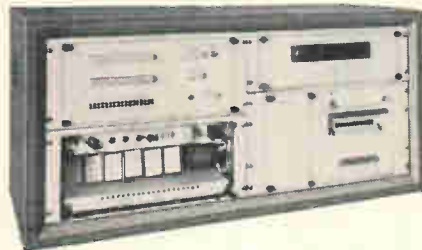

MODEL 198C DATA LOGGING SYSTEM

All solid state
Random access analog scanner
High reliability and accuracy
Operates over large temperature ranges
Low cost

SPECIFICATIONS

Scanning capability: 16 channels. Scanning speed: up to 5 channels per second. Accuracy: 0.1%. Output: printing paper tape. Logging cycles: 10 seconds to 1 hour (specify on ordering). AC Input: 100/110/220/240V $\pm 10\%$ 50 or 60 cps (specify on ordering).



MODEL 507C DIGITAL VOLTMETER

All solid state and high speed.

SPECIFICATIONS

Measuring range: (1) 0.001 to 1.599 volts
(2) 0.01 to 15.99 volts
(3) 0.1 to 159.9 volts
(4) 1 to 1,599 volts

Accuracy: 0.1% of full scale. A/D conversion time: 600 μ s.
Max. repetition rate: 1 kc. Reading mode auto: 100 c/s repetition rate.

Digital output:

4 digit decimal $10C_1$ parallel code connectable to the line printer Operating temperature: 0 to 40°C .
Width: 480 mm. Height: 199 mm. Depth: 350 mm. Weight: approx. 13 kg. AC Input: 100/110/220/240V 50 or 60 cps.

CHUO ELECTRONICS CO., LTD.
No. 21 Motohongo-machi Hachioji-shi,
Tokyo, Japan

Electronics Review

the physicist explains.

Through complex transition diagrams, Rothstein maps some of the ways in which molecules could form chains, migrate into varying configurations and otherwise manifest order and control.

A new math. If and when the replicating processes in molecules are sufficiently understood, it is believed they could be imitated by a computer with a sufficiently large number of elements.

With today's integrated circuits, Rothstein says, very rudimentary kinds of adaptive systems can be built. "But it is not yet worthwhile to try to do this for the complex systems envisioned. For a long time, the most sensible tactic is to model such systems, including the molecular structures under study, on computers." His lab has under development a thin-film matrix memory that makes modeling of growth and self-replicative behavior possible.

What will it take to make the transition from computer modeling to prototype self-reproducing machines capable of carrying out complex tasks?

"Inspiration," says Rothstein.

IEEE

TI DIP's in

Texas Instruments Incorporated has quietly joined its competitors in offering integrated circuits in the dual-in-line package style (DIP). The DIP was shown at TI's booth at the Institute of Electrical and Electronics Engineers show in New York. TI had been one of the last major IC manufacturers holding out against DIP's [Electronics, Aug. 23, 1965, p. 118]. The Signetics Corp., a subsidiary of Corning Glass Works, introduced a DIP just before the show.

The new TI package has the same pattern as previous DIP's—14 leads spaced 100 mils apart in two rows 300 mils apart. The company's regular plug-in package has 16 leads in two rows 200 mils apart. Each IC manufacturer has picked

a slightly different body design for its DIP. TI followed suit, it is molding them in one piece with silicone plastic, instead of using the sealed sandwich of epoxy or ceramic that others have used. The body indexing aid is also different—a depression in the top of the package body.

DIP picker. Unfazed by the apparent inability of IC manufacturers to standardize DIP bodies, the Universal Instrument Corp.

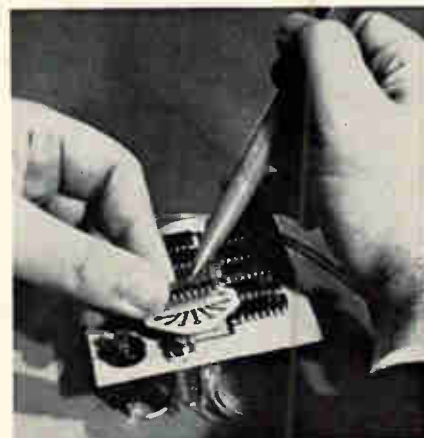

A new plastic carrier for the Signetics Corp.'s DIP is used as a hand-insertion alignment jig. The carrier is positioned on the circuit board and the package pushed down to plug in the IC leads.

has designed a machine that will be able to plug anybody's DIP into a circuit board. For a time, it seemed that systems manufacturers who wanted to assemble DIP's by machine would have to buy a different machine or a different pickup mechanism for each body style, because of the dimensional variations [Electronics, Sept. 6, 1965, p. 40].

Universal Instrument's solution is one the company has been using in its machines made for automatic insertion of the hybrid-circuit plug-in modules of the International Business Machines Corp.'s System 360 computers [Electronics, Nov. 1, 1965, p. 90]. The machine—to be built on custom orders—won't grasp the package. Instead, it will pick up and insert the IC's with a suction tool applied to the top of the package bodies.

The different IC's required by an assembly will be loaded—facing

NEW TORQUE MOTOR DRIVER

in the right direction—into a series of slots in an inclined tray. A tape-programmed numerical control unit will move the pickup head to the right slot and move the circuit board into the right position to accept the selected DIP.

Army drafts IC's

The Army is moving surely—but slowly—toward the use of monolithic integrated circuits in ground electronic equipment.

"Their use by the Army is no longer subject to question," declares Robert Geisler, a project officer with the Army's Electronics Research and Development Command at Fort Monmouth, N. J.

However, he thinks that for the next three years the Army equipment will continue to use the same number of conventional printed-circuit assemblies, with tubes and transistors.

Integrated circuits are already going into ground equipment, but primarily in digital systems and in the decoding and coding portions of gear with scramblers for secure communications.

Geisler expressed these views at a meeting in New York of the Institute of Printed Circuits on the outlook for printed circuits during the next five years.

Flatpacks or DIP's? Geisler predicted that three to five years from now IC's will be in general use in Army electronics. After that, monolithic arrays and complex integrated circuits will come into use [Electronics, March 21, p. 144].

Still unresolved, he said, is the type of IC package that the Army will settle on as a standard. Initially, the IC's are being bought in flatpacks and TO-5 cans, but Geisler thinks that the larger, dual-inline package (DIP) type of plug-in will eventually win out. The reason is that the Army wants as few multi-layer boards as possible in its systems. Not only are conventional circuit boards less expensive, he pointed out, but they make assembly and repair easier. The DIP's were designed for soldering into such boards.

Arrays will also reduce require-

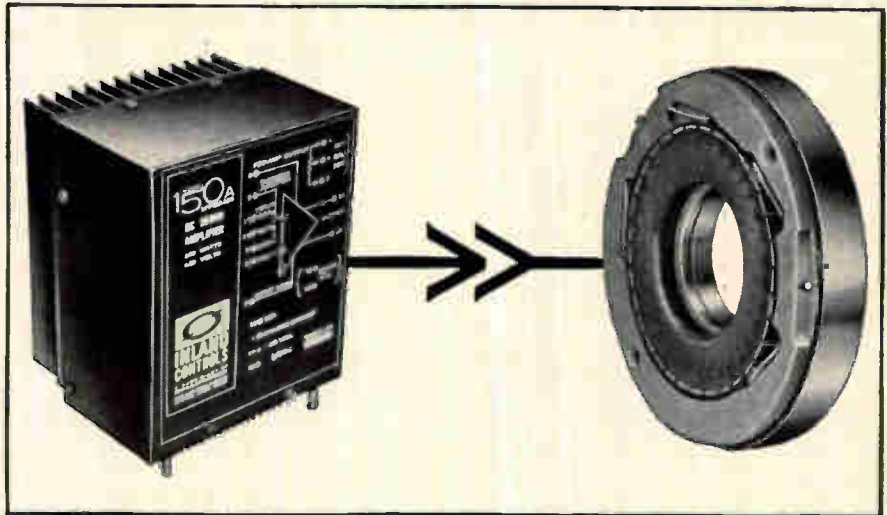

Cut costs and time with off-the-shelf HYBAND DC Servo Power Amplifiers by INLAND

Inland Controls specializes in the design and manufacture of reversible and transfer polarity, wide bandwidth DC servo power amplifiers that help you:

- ELIMINATE design and development costs
- ACCELERATE delivery *schedules*
- AVOID motor/amplifier interface *problems*

Ranging from 50 watts to 3000 watts, these amplifiers, designed specifically for driving Inland Motor* DC torque motors, are available in either compact modular design or standard rack-mounted design. Current-limiting, short-circuit protection, multiple summing inputs, high gain preamplifier, and provisions for servo compensation networks are built-in standard features of the HYBAND amplifiers.

To avoid your interface problem entirely, why not let Inland Controls supply guaranteed matching amplifiers, or complete amplifier and torque motor blocks? We can do this

and satisfy your most demanding needs. Don't let interface and transfer function problems get you down . . . call on the INLAND team and relax . . . our amplifiers offer proven and outstanding compatibility, reliability, and availability.

A Condensed Selection guide offering detailed information on the HYBAND amplifiers is available immediately and we will be happy to send you a copy.



This Demonstrator Kit, designed to illustrate exactly how these amplifiers operate in a closed-loop servo, can be shown in your plant at your convenience. All it takes is a call or letter from you.



**INLAND
CONTROLS**

A SUBSIDIARY OF
KOLLMORGEN

342 WESTERN AVENUE • BOSTON, MASSACHUSETTS 02135
Telephone: 617 254-0442

*Inland Motor Corporation
is also a subsidiary of Kollmorgen

TWX: 710 330-0143



Use
**TUNING FORK
 OSCILLATORS**
 For Low Cost Frequency Control



New Inexpensive Model G
 Frequency—from below 1 CPS to 30 KC with choice of accuracy for each of five temperature ranges. Standardized construction allows excellent delivery of prototypes or production runs. Many special features are available.

Long-term stability—2-year guarantee.

Prices start at \$35.00. Send for complete information.

Other style cases available, including models for printed circuit use.



Catalogued in **eem VSMF**

FORK
STANDARDS, INC.

221 Main Street • West Chicago, Ill. 60185
 Telephone: Area Code 312 • 231-3511

ments for multilayer boards, Geisler believes, since much of the interconnections for the circuitry of systems built with arrays is done by thin-film wiring on the silicon chips.

Hot computers. Another speaker at the meeting, E. G. Lorenz of the International Business Machines Corp., predicted the continued use of multilayer boards in computers, with radical changes in wiring size, board materials and fabrication methods.

Besides the continued use of multilayer transmission-line interconnections [Electronics, Nov. 1, 1965, p. 90], Lorenz expects increased use of operational circuitry made by printed-circuit techniques. One example is capacitor type, read-only memories. These are made by etching wiring electrode arrays on either side of dielectric layers.

Because IC's result in increased functional density, he predicts that wiring line widths will shrink from present minimum widths of about 10 mils down to about 1 mil (0.001 inch). The wiring patterns will probably be fabricated by high-energy beams; he sees the boards being designed, made and tested under computer control.

The high circuit density, Lorenz says, may result in operating temperatures ranging from 400° to 600° F. Since the dielectrics will have to hold dimensional tolerances as tight as 0.1 mil, organic dielectrics may be discarded in favor of ceramics.

Ten-way masks

Thanks to some optical legerdemain, engineers at the Martin Marietta Corp.'s Martin division in Orlando, Fla., have invented a way to make as many as 10 different deposition or etching masks from a single master artwork pattern.

The process eliminates the tedious preparation of individual patterns for each mask needed to make a multilayer thin-film circuit or printed circuit. Because Martin uses a single master pattern, all the masks are automatically in near-perfect registration.

Now you see it . . . Martin's

invention was described at the IEEE Convention by Burton J. Askowith during a session on microcircuit fabrication.

The master pattern is prepared with six different kinds of birefringent tape. Each time the incident angle of polarized light is changed, a different mask pattern on the master pattern becomes opaque. When different wavelengths of light are used, as many as 10 different patterns can be seen, one at a time.

This allows the entire pattern to be made as one piece of artwork. For a simple thin-film circuit one type of tape would be used for the resistor deposition mask; another type would be used for the electrode mask and a third for the interconnections.

Slow light. Birefringent tapes are made by stressing plastic materials so that they have two optical axes with different indexes of refraction. One axis passes polarized light faster than the other. Depending on the film thickness, the slow axis retards the passage of light one-half or one-quarter wave-length.

Martin cuts the tapes lengthwise to the fast axis, crosswise and on biases of 45° and 135° to get the six different kinds of tape. The masks are made by exposing photographic film to light shining through a polarizer, the pattern and analyzers.

The polarizer and analyzers are rotated to correspond with the kind of tape forming the pattern for each circuit layer.

Help!

The rules said "no recruiting" during the IEEE show in New York. But one company official summed up the intensity of the talent search when he said: "The show was a success. Our company lost only three men."

Outside the Coliseum a shouting match took place between recruiters and IEEE officials who tried to move the recruiters away from the entrance to the show. In hotels nearby, engineers awoke to find job offers stuffed under their doors. An agency representing 42 companies seeking talent ran a shuttle

If you can't believe an electrolytic can be this good unless it's in a metal can...

Test the molded-case MTA yourself.

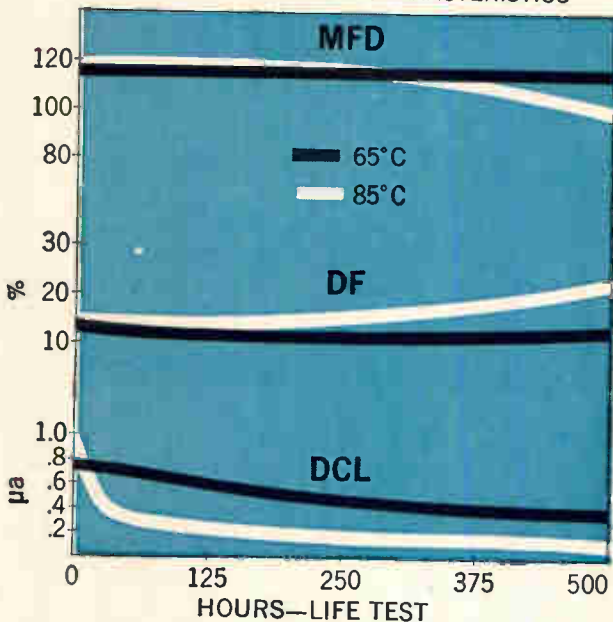
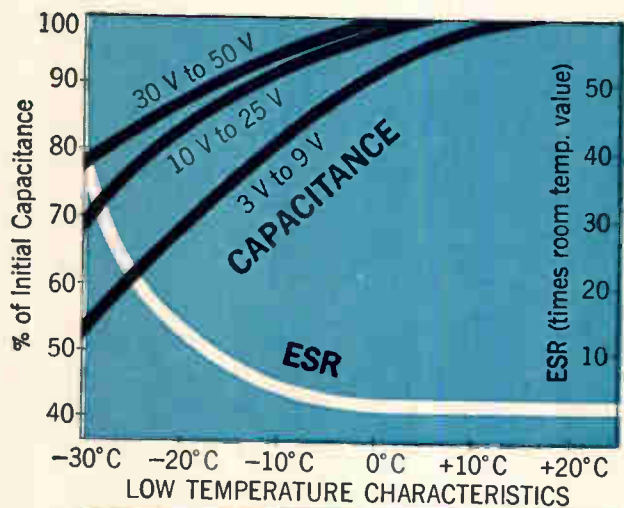

Here's what you'll find:

Life at High Temperature—zero failures in one million piece-hours at 85°C. Only one failure in 2½ million piece-hours at 65°C.

Stability at Low Temperature—equal to or better than most metal-case miniatures down to -30°C.

Maximum Values—800 mfd, 3 VDC, to 85 mfd, 50 VDC.

*Call Jim Shaffer,
collect at 317-636-5353,
extension 403,
for sample order*

Available from stock at factory prices in quantities to 2499 from franchised Mallory distributors

50th
ANNIVERSARY

MALLORY CAPACITOR COMPANY
a division of P. R. MALLORY & CO. INC.
3029 E. Washington St., Indianapolis, Indiana 46206

MALLORY

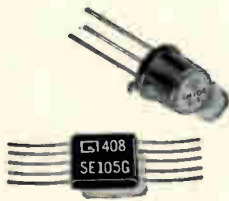

Need to say a lot
in a little space?

(or make markings
more **durable**...or
more **economical**...
or at **higher rates**?)

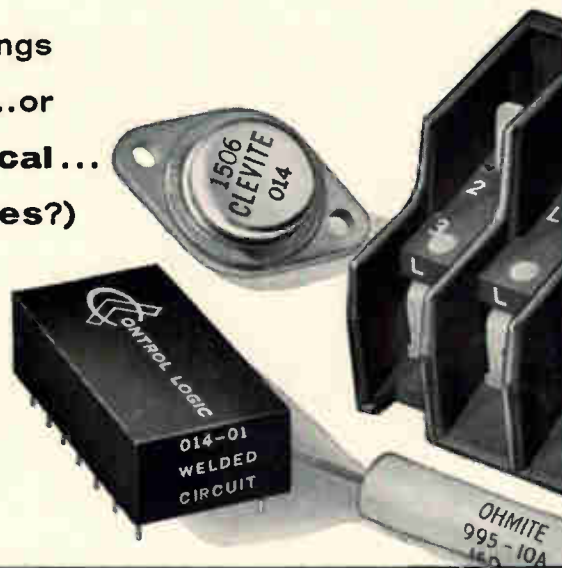

We can show you how

We can show you how to identify products so they will resist extreme amounts of handling, abrasion, many solvents and other atmospheric conditions . . . or how to sequentially number and identify components with savings of more than \$50 per 1000 . . . or how to print trademark, type number, value and date code on 90 units a minute . . . or how to produce an imprint that remains readable after 1000 hours at 200°C. . . or get 10 digits and 2 letters in a micro-circuit area of 0.090" — or 21 characters on a TO-5 case with interchangeable type number and date code . . . or save 75 cents of every dollar you now spend on buying, applying, inventorying and discarding obsolete preprinted labels.

The answers are in proven Markem machines, type and specialty inks, which daily produce better product or package identification by reducing costs, smoothing production control and increasing customer acceptance. And while Markem machines, type and inks are helping to produce better products through more complete and lasting identification, they frequently pay for themselves in the savings they make possible. Tell us what *you* make, what it must say, and for how long: we'll give you a specific recommendation and cost estimate right away. Write Electrical Division, Markem Machine Co., 305 Congress St., Keene, New Hampshire 03431.

MARKEM

bus from the Coliseum to the agency's headquarters.

The effort poured into recruitment left no doubt about the engineering shortage. It's here—and because of the upswing in business it probably will last.

One company reported losing several components people at twice the salary they had been making. Recent graduates with masters' degrees commanded up to \$11,500.

Recruiters primarily sought the specialist—in integrated circuits, in microwave, in instrumentation—with 5 to 10 years' experience. But sales and marketing people were also approached.

IEEE jotting

Other items of interest:

- **Unijunction.** In the fall of 1964 Texas Instruments Incorporated introduced a plastic planar unijunction—the only one on the market. But in a short time TI discontinued sales, reportedly because it was having trouble obtaining good stability with it. Now, however, TI is trying again, this time using a technique that yields a one-piece package. The device, designated the TIS43, sells for 72 cents in quantities from 100 to 999. The new transistor has a maximum emitter leakage current of only 10 nanoamperes at 25°C; conventional unijunctions have leakage current of from 200 to 2,000 nanoamperes. The TIS43 can withstand 60,000 G's of constant acceleration without damage, the company says.

- **Triacs.** The first triacs priced at under \$1 were introduced by the Radio Corp. of America. A triac consists of a pair of silicon controlled rectifiers connected back-to-back (sometimes known as a reverse-parallel connection) on a single chip. The RCA units, the TA2892 and the TA2893, need only one to three milliamperes of gate current for triggering. In many circuits, this will allow the elimination of the unijunction transistor normally required to initiate the conduction cycle.

The new devices have a 2.5-ampere current-handling capability and a steady-state anode-to-anode typical voltage drop of 1.1 volts.

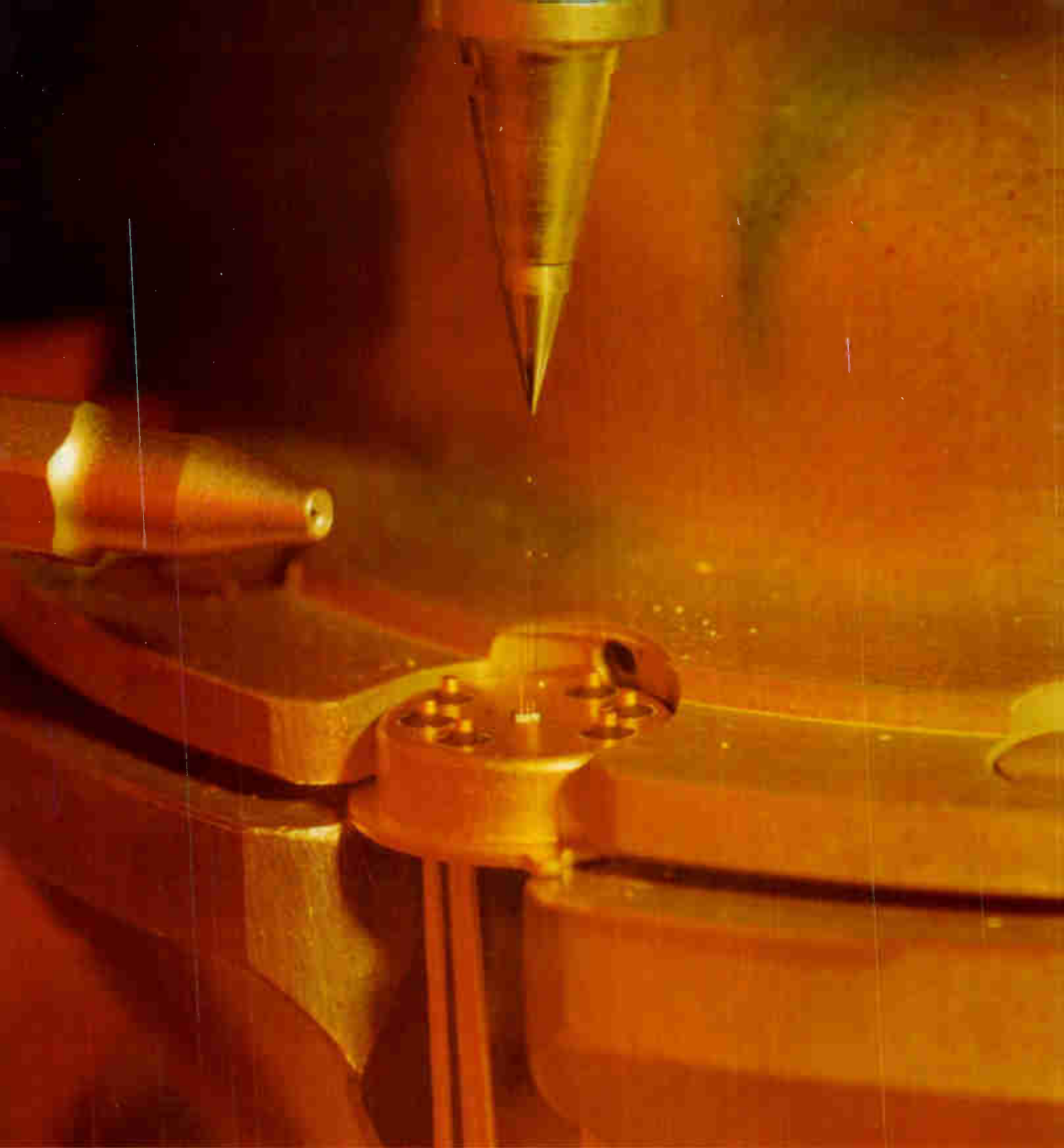

Ball .002" dia., Iteration $\pm 5\%$

TEMPRESS HYDROGEN FLAME-OFF TORCHES FOR LEAD-BONDING MACHINES ARE STAINLESS STEEL, WITH SAPPHIRE ORIFICE INSERTS that maintain size and shape accuracy of the 2166°C hydrogen flame. The highly polished inner surface of the sapphire insert assures this by eliminating gas turbulence and a resultant distortion of the flame. The end result is essentially identical gold balls on every lead, from start to finish of a production run. 14X magnification of operation shows flame-off torch at left, with orifice partially visible. Gold wire, with perfectly formed ball, protrudes from Tempress tungsten

carbide capillary tube, ready for next bonding cycle. This extreme precision symbolizes the Tempress approach to every project . . . explains why it requires 11 months to train an operator for many Tempress production operations. Other Tempress products include automatic scribing machines, diamond scribes, diamond lapping points, and tungsten carbide probe contact needles.

Lead-bonding, Model DTN-1, at Union Carbide Electronics.



TEMPRESS

Tempress Research Co., 566 San Xavier Ave., Sunnyvale, Calif.



Reduce friction and keep cool with Mystik Teflon® Tapes

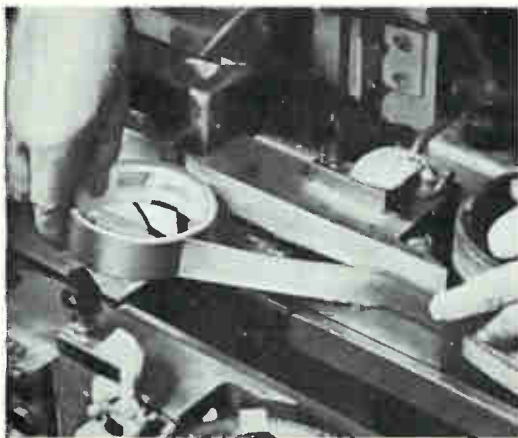

Mystik's Teflon tapes combine the advantages of TFE Teflon film with a silicone pressure-sensitive adhesive. As a result, they offer high dielectric strength, low coefficient of friction, and high performance within a temperature range from -100°F to $+450^{\circ}\text{F}$.

These remarkable tapes are particularly useful in reducing friction on high speed equipment and as insulators of electrical apparatus, but they have many other applications in the electrical and electronic industry.

Of course, Mystik Teflon Tapes represent only a few of the high quality paper, film, and glass cloth tapes available for special applications. For assistance in selecting the best ones for your needs, contact your local Mystik distributor. He's listed in the Yellow Pages under "Tape" or write The Borden Chemical Co., Mystik Tape Div., 1700 Winnetka Avenue, Northfield, Illinois 60093.



**BORDEN
CHEMICAL**



A DC VOLT-OHMMETER WITH NO RANGE SWITCH!

More time saved—Put an end to tedious, time-consuming manual range switching with the new Hewlett-Packard 414A Autovoltmeter. Just touch and read... range and polarity change automatically. You read range and polarity on the digital readout above the analog meter.

More accuracy—And the analog meter lets you measure ± 5 mv to ± 1500 v full scale, 12 ranges, with an accuracy of $\pm 0.5\%$ of full scale $\pm 0.5\%$ of reading; 5 ohms to 1.5 megohms, 12 ranges, accuracy 1% of reading $\pm 0.5\%$ of full scale.

All this for just \$650!

More uses—The 414A is the world's first "touch-and-read" analog volt-ohmmeter with accuracy anywhere approaching what you require for trouble shooting, tweaking, peaking and nulling, probing a circuit without a schematic. Use it for maintenance testing, on the production line, in the lab.

In the dc voltage function you simply touch the point to be measured and in less than 300 msec read the range and polarity on the digital display and the precise dc measurement on the individually calibrated, mirror-backed taut-band meter. Automatic ranges are selected and displayed for resistance measurements, too.

More noise rejection—Ranges also can be selected and held manually, and a Down Range control feature lets you drop to the next lower range merely by pushing a front-panel button.

Input resistance is 10 megohms on the 5 and 15 mv ranges, 100 megohms on 50 mv range and above. The 414A is insensitive to 60 cps signals with peak value less than 7 times the full-scale dc level of range in use in "Hold" position (rejection is 20% of reading when using Auto-ranging).

To get the true significance of this automatic instrument, you need to see it perform on your bench. Call your Hewlett-Packard field engineer for that convincing demonstration. Or write for complete information to Hewlett-Packard, Palo Alto, Calif. 94304, Tel. (415) 326-7000; Europe: 54 Route des Acacias, Geneva.

Data subject to change without notice. Price f.o.b. factory.

HEWLETT  **PACKARD**
An extra measure of quality

1033



there are ordinary seals

...and then there's McCoy

The seal gets special attention at McCoy—100% inspection against temperature, altitude, vibration and shock. Only a permanent, hermetic seal can guarantee frequency stability and reliability for quality crystals. Our new *Cleanseal* process uses high pressures to flow metal enclosures together in a heatless “weld” that’s more leak resistant than the metal itself. Heating distortion and



possible internal contamination by solder flux are eliminated. *Cleanseal* crystals have withstood 5000 cycles, 30 G's vibration, and 8000 G's, 0.5 millisecond pulse shock testing. Glass crystals are vacuum sealed by flame or induction heating. McCoy has the nation's most complete line of quality high and low frequency crystals. For full details, write for our new product catalog.



MCCOY ELECTRONICS COMPANY

A DIVISION OF OAK ELECTRO/NETICS CORP.
MT. HOLLY SPRINGS, PA. 17065

now

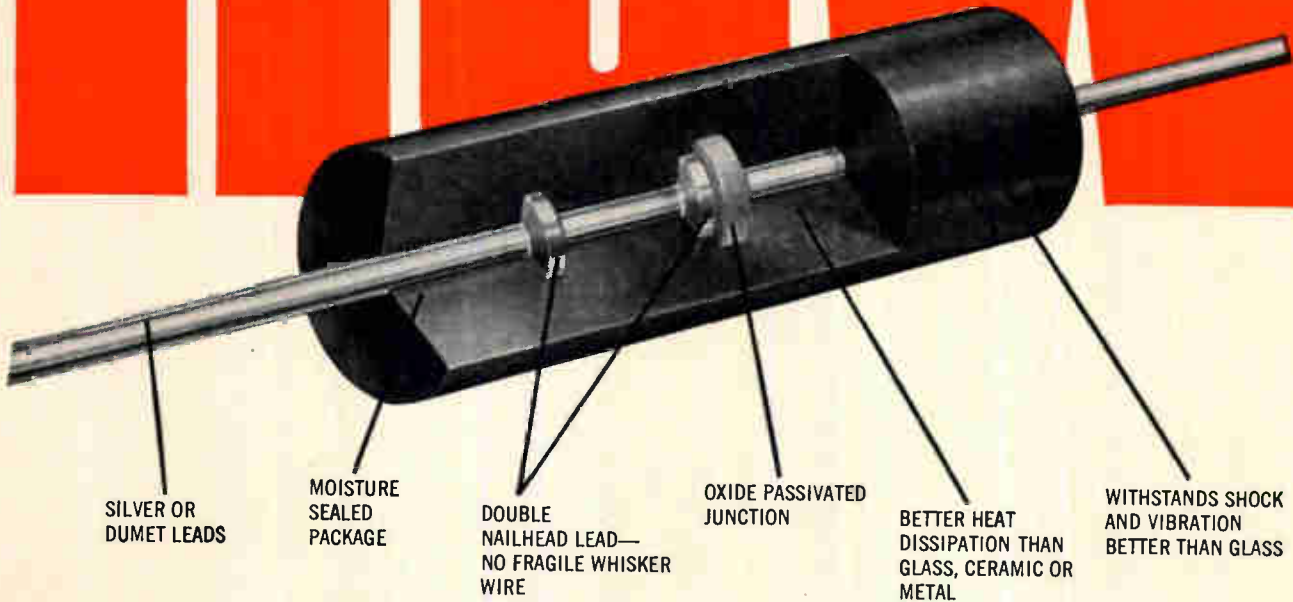

IRC Poly-Sil Zeners

Production quantities at production prices

With the addition of new production facilities, IRC Poly-Sil zeners are now immediately available from stock to meet your volume requirements. And with prices lower than ever you can use them for all your low-power zener applications with considerable cost savings.

Poly-Sil zener diodes are space savers too. They are up to 30% smaller than comparable units. Wattage dissipation is as much as 2½ times higher than glass packages of the same physical size.

Extremely tough and durable, Poly-Sil completely surrounds all internal parts. This solid construction provides greater thermal and mechanical strength and more dependable performance. Poly-Sil zeners are available in over 400 different JEDEC types. Write for samples, literature and quantity prices to:

IRC, Inc., Semiconductor Division (formerly North American Electronics, Inc.), 71 Linden Street, West Lynn, Massachusetts 01905.

CAPSULE SPECIFICATIONS

actual size

MIL:	Designed to meet MIL-S-19500
WATTAGES:	Up to 1 watt @70°C
VOLTAGES:	6.8 to 200 volts
DIMENSIONS:	DO-7 (.265" long x .10" dia.)
TOLERANCES:	±5%, ±10%, ±20%
LEADS:	Silver or Dumet



Analog write-out for real time systems

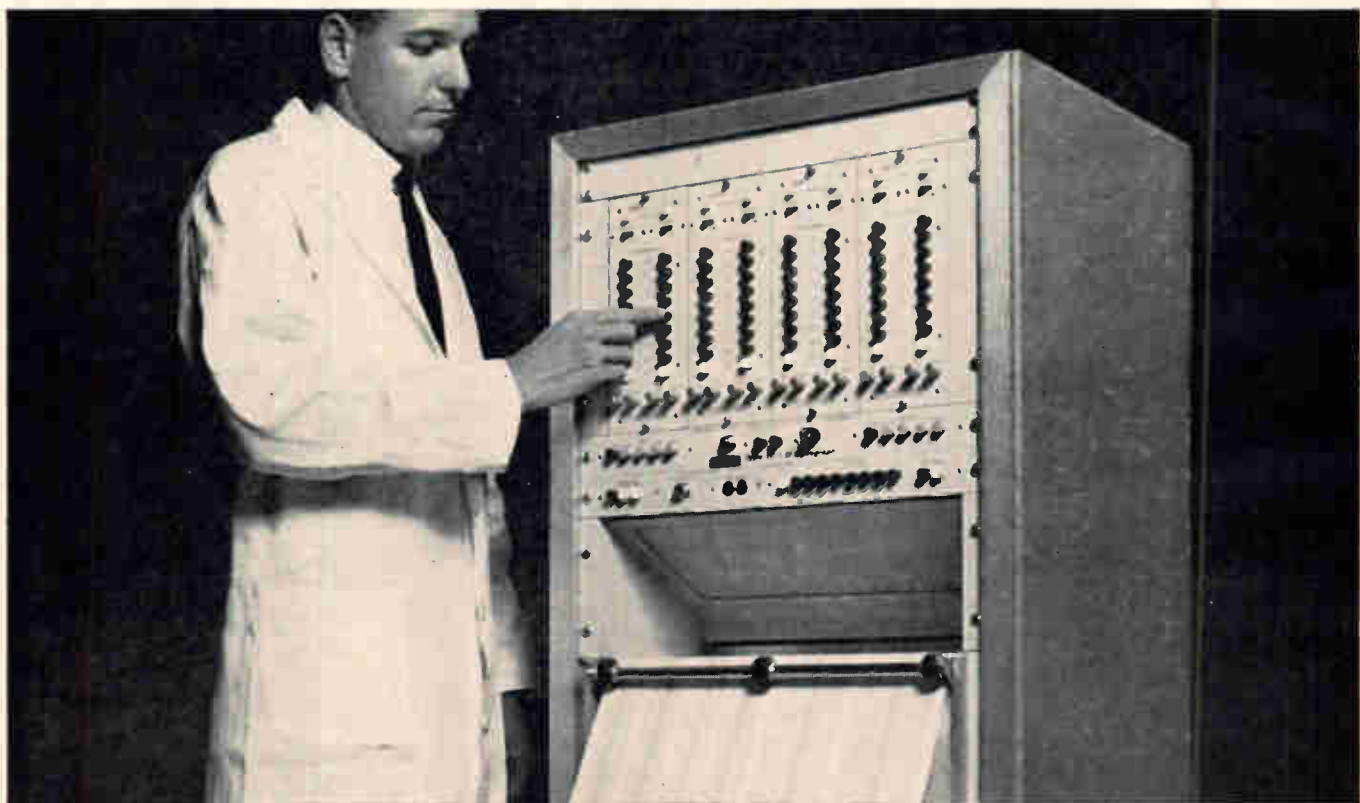
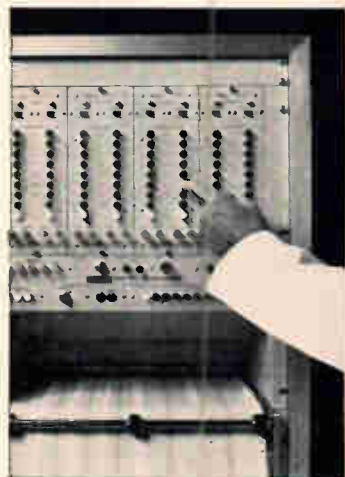

The pressurized-ink rectilinear Type SC-II Dynograph® Recorder is the ultimate in direct-writing recorders... all modular solid-state and human engineered... for your analog computer, telemetry, or special instrument systems. The easy-to-read high contrast records are permanent, reproducible, and continuous with constant line width.

Tracing linearity of $\pm 0.25\%$, full scale, is *locked in* at the stylus tip by an exclusive pen-positioning system. Straight-edge design guarantees absolute pen alignment with all channels and the time base of the chart paper. The system accuracy is further preserved by the *zero-weave* Dynograph paper drive which prevents base line distortions caused by lateral weave.

All level and function controls are quickly and accurately selectable by push buttons. Applications versatility of the Type SC-II is enhanced by the availability of either horizontal or vertical paper drives, as well as a separate mobile

chart drive console that accommodates up to 12 analog channels. The modular components can be supplied in any of three standard enclosures, or mounted directly into any standard 19" rack where they occupy less than 37" of panel space.

For the full rundown on this advanced, versatile, all solid-state recorder... and how it can help you... contact your local Offner Division Sales Engineering Representative, or write direct.

Beckman® INSTRUMENTS, INC.
OFFNER DIVISION
SCHILLER PARK, ILLINOIS 60176

INTERNATIONAL SUBSIDIARIES: GENEVA; MUNICH; GLENROTHES, SCOTLAND; TOKYO; PARIS; CAPE TOWN; LONDON

Cinch capabilities in micro-electronic interconnection can solve your packaging problems

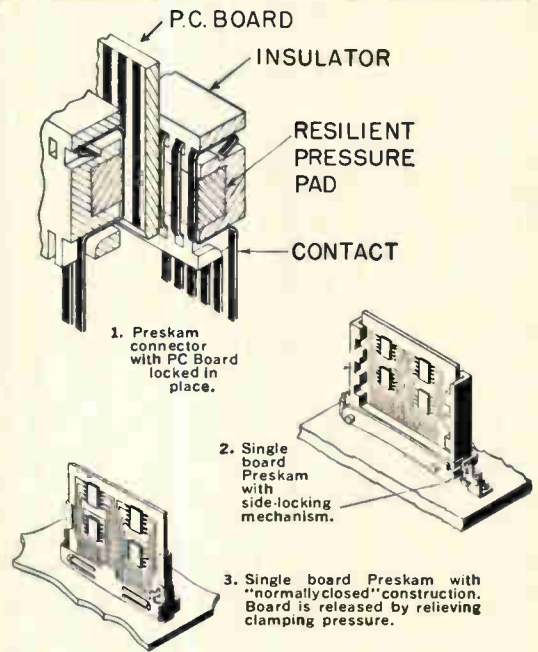
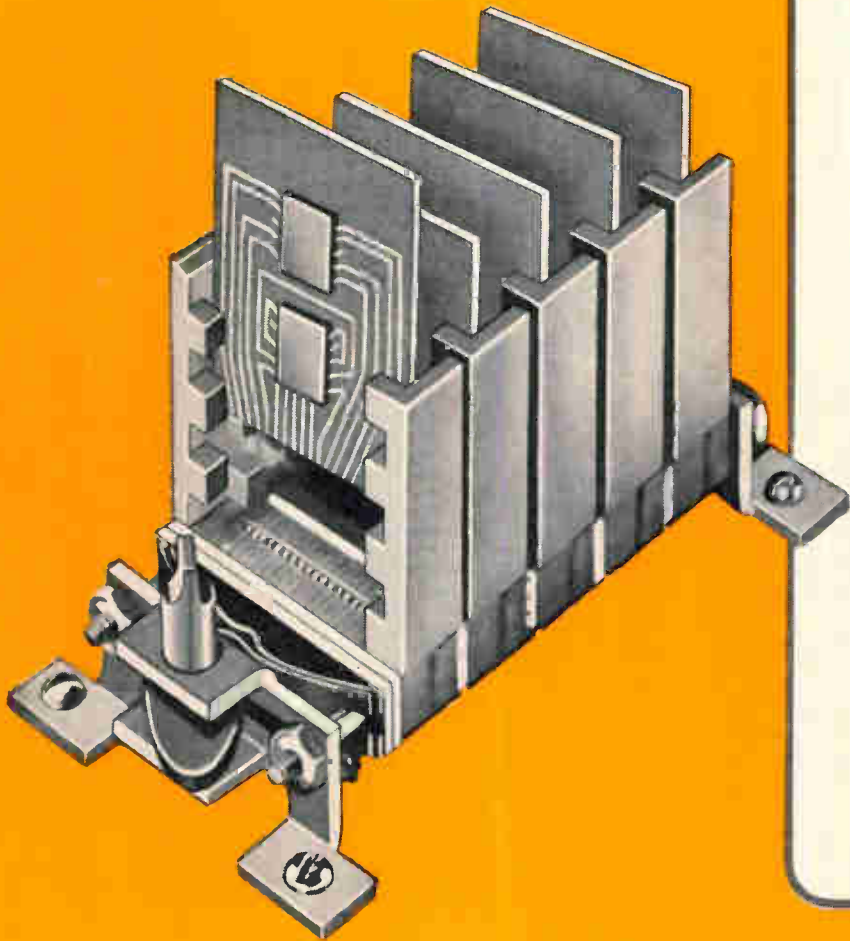

Ask Cinch about the new Preskam* System that permits connections that don't dwarf the circuits they join.

Either a board or male connector is dropped into place and then a cam actuated insulating bar clamps the board into the connector. High uniform contact pressure is maintained over an up to 70% greater contact area than in conventional connection means.

Contacts are on 25-mil centers and boards can be as little as 100-mils apart. Multiple boards may be controlled by the same locking device.

With contact disengagement before board insertion or withdrawal, the most fragile thin glass or ceramic substrate is undamaged even from repetitive insertions.

RELATE YOUR PRODUCT PLANNING TO THE STATE-OF-THE-ART INTERCONNECTION SYSTEMS WHICH ARE AVAILABLE FROM THE CINCH RESEARCH AND DEVELOPMENT PROGRAM. ASK CINCH FIRST: THEY MAY HAVE ALREADY SOLVED YOUR INTERCONNECTION PROBLEM.

Write Cinch Manufacturing Company, at 1026 South Homan Avenue, Chicago, Illinois 60624.

*Patent Pending

CINCH

DIVISION OF UNITED-CARR
Circle 55 on reader service card

Facts about soft magnetic alloys which nobody else will tell you.

Any one of them could help you improve the design or production of relays, solenoids and magnetic switches.

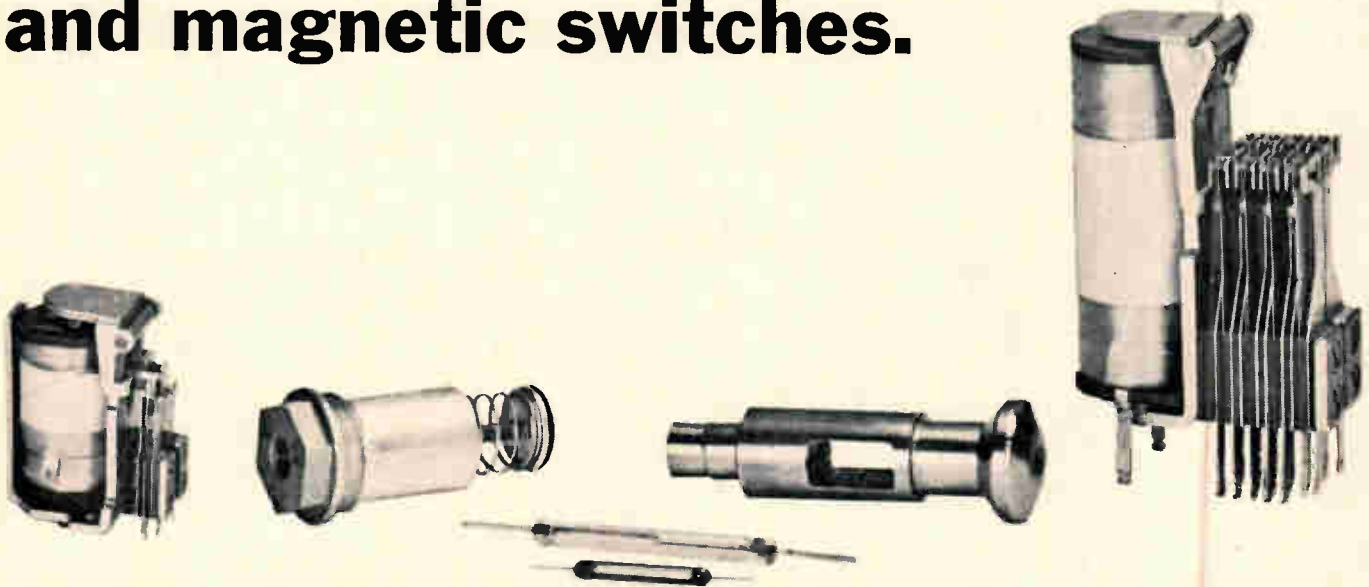

FACT NO. 1: You can get Silicon core irons with improved machinability without sacrificing magnetic or physical properties. For example: Carpenter's recently introduced Silicon Core Irons "A-FM" and "B-FM" for more economical volume screw machine operations.

FACT NO. 2: You can get corrosion resistance and still have low residual magnetism at high magnetizing force. How? By using Carpenter Type 430F Solenoid Grade.

FACT NO. 3: You can usually eliminate sticking relays by switching to a Carpenter soft magnetic alloy with less residual magnetism. For example: Carpenter High Permeability "49".

FACT NO. 4: You can get Carpenter Consumet Core Iron and Vacumet Core Iron with low gas content and minimum residual elements through vacuum melting. And Carpenter is the recognized leader in vacuum melting.

FACT NO. 5: You can get DC maximum permeabilities in excess of 200,000 for solid and laminated cores using standard design techniques. For example: Carpenter's HyMu "80".

FACT NO. 6: You can increase the operating efficiency of your solenoids by as much as 50% with proper heat treatment. We'll be glad to show you how to heat treat

these alloys so as to obtain optimum magnetic characteristics.

FACT NO. 7: You can have a wider choice of soft magnetic alloys. Carpenter offers you the most complete line available. And there are specialists to help you . . . experts who offer you the benefits of Carpenter's extensive experience and know-how in the development and production of soft magnetic alloys. We're waiting to serve you. Contact your Carpenter representative for qualified assistance. Or, if you prefer, write for our 68-page booklet, "Alloys for Electronic, Magnetic and Electrical Applications". The Carpenter Steel Company, 170 W. Bern St., Reading, Pa. 19603

Carpenter steel
IN A WORD, **CONFIDENCE**

ELECTRONIC, MAGNETIC AND ELECTRICAL ALLOYS • STAINLESS STEELS • HIGH TEMPERATURE ALLOYS
• TOOL AND DIE STEELS • SPECIAL-PURPOSE STEELS • TUBING AND PIPE • FINE WIRE SPECIALTIES

CONSIDER THE SOURCE!

Avoid systems problems by careful evaluation of klystrons vs. solid-state

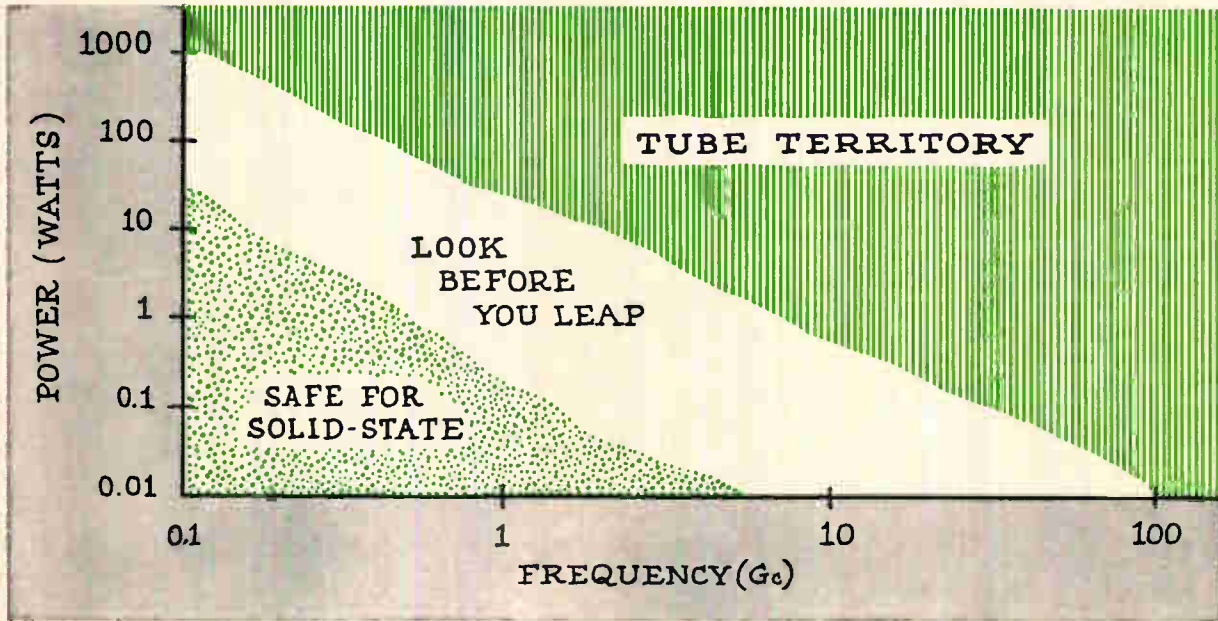

A premature stampede to solid-state for microwave power sources can cause serious problems for system designers. This is the major finding of recent Sperry studies which objectively compared solid-state sources with klystron oscillators.

While substantial solid-state progress cannot and should not be denigrated, comparative data prove that the era of the klystron is far from over. For system designers, the net result is this: microwave source selection now demands more careful attention than ever.

The drawing above approximates today's state-of-the-art. Solid-state sources show clear superiority only at low levels. The dominance of the klystron is unchallenged for high-level applications, and source selection in the large mid-range area demands extremely careful consideration.

In general, power-frequency requirements will be the most influential factors in making the choice. Solid-state devices offer many

advantages when operated well within the design envelope. However, when solid-state devices are applied too near their state-of-the-art, some performance degradation and loss of reliability must be accepted. Power handling considerations are particularly critical, because of the extreme temperature sensitivity of solid-state devices.

Klystrons, on the other hand, still enjoy numerous inherent advantages. At frequencies of X band or higher they are usually the more attractive choice, even for low- and medium-power applications.

In general, klystrons satisfy bandwidth requirements better than solid-state sources. They also offer superior AM and FM noise characteristics, much better temperature stability and longer, more predictable life.

Details of Sperry's comparative studies are available on request. For your free copy of this unusually useful technical paper, contact your Cain & Co. representative or write today to Sperry, Gainesville, Florida.

When system designers need a basis for comparison of complex alternatives, where can they turn? To Sperry's Storehouse of Knowledge. Objective, in-depth technical information is a major advantage of keeping in touch with the world's first builder of klystron tubes.

SPERRY

DIVISION OF
SPERRY RAND
CORPORATION

SPERRY ELECTRONIC TUBE DIVISION, Gainesville, Fla.

National Representatives: Cain & Co., Los Angeles, 783-4700; Boston, 665-8893; Arlington Heights, 253-3578; Dallas, 357-8645; Dayton, 228-2433; East Chester, 337-3445; Philadelphia, 828-3861; San Francisco, 948-6533; Syracuse, 463-0462; Washington, 296-8265; South Amboy, 727-1900; Huntsville, 534-7955; Montreal, 844-0089.

Four low-cost compacts for 6 circuit functions

These little rotary stepping switches from Automatic Electric are as versatile as they are economical. Capabilities for counting, controlling, monitoring, selecting, indicating or timing are built into each switch.

They're remarkably reliable, too. When the armature steps the wiper assembly to the next position, it also *locks* the rotor. Overthrow is impossible, thanks to this *positive positioning*—a unique AE design feature. There are no armature pawl stops to wear out, or get out of adjustment. Also... improved shock-resistant spring assemblies; excellent low-maintenance record.

You can get these AE compact stepping switches in numerous variations—many available directly from stock. If you need a "custom" variant, we can tailor it to your specifications, quickly and economically.

For helpful application information, get the 160-page book, "How to Use Rotary Stepping Switches." Just ask your AE representative, or write Director, Relay Control

Equipment Sales, Automatic Electric, Northlake, Ill. 60164.

(A) TYPE 40 No bigger than a pack of king-size cigarettes. A decimal switch with up to five bank levels—but only 10 points per level. Eliminates extra steps when counting decimally.

(B) TYPE 80 A decimal switch with a larger capacity than the Type 40. From six to twelve 10-point levels.

(C) TYPE 44 Available with up to eight 10-point levels—or 11 points on all levels where specified.

(D) TYPE 88 A larger-capacity version of the Type 44, with up to twelve 11-point levels where specified.

AUTOMATIC ELECTRIC
SUBSIDIARY OF
GENERAL TELEPHONE & ELECTRONICS **GTE**

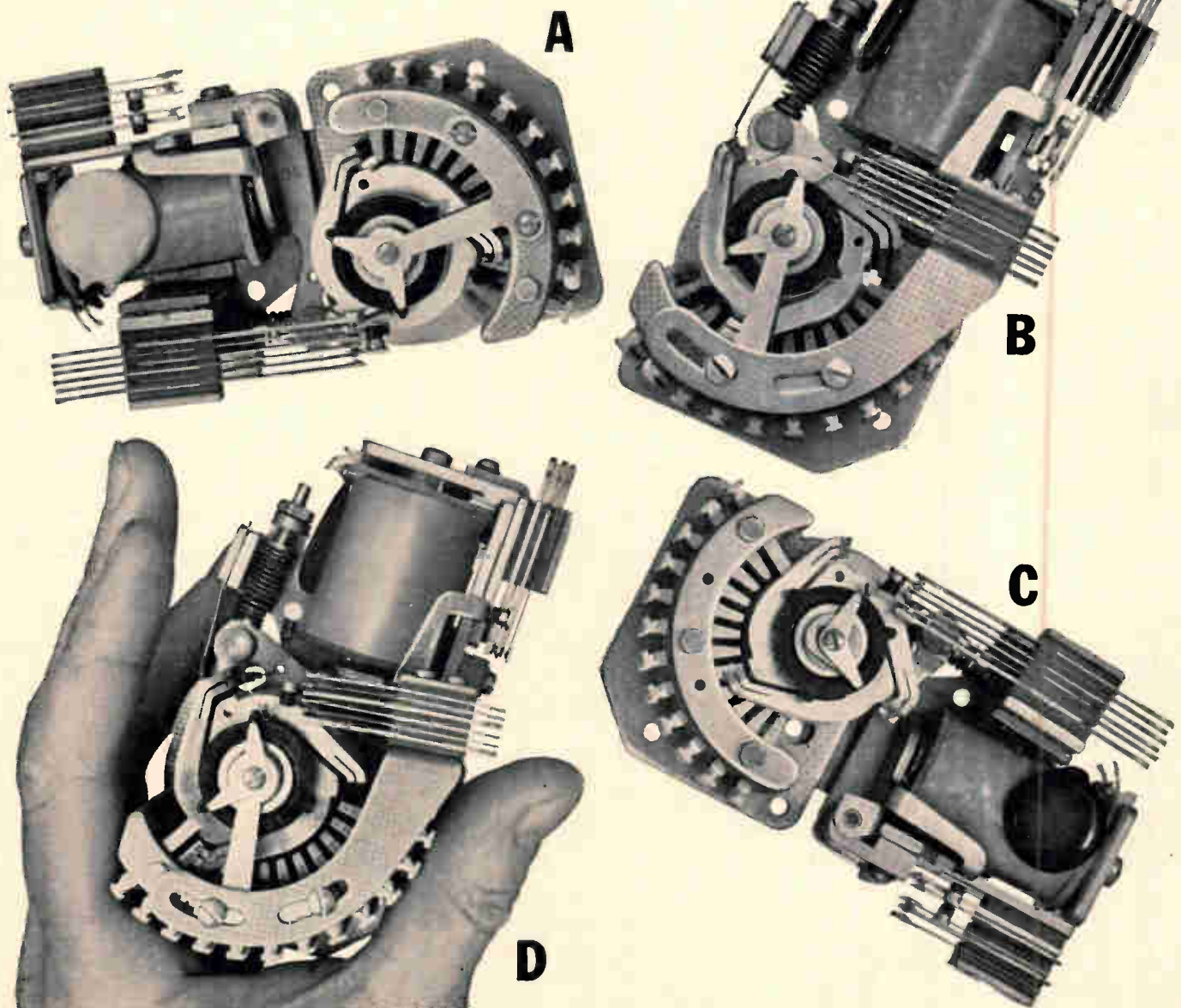

If your blip is a blooper, you'll know it in 10 seconds.

Once you start using Polaroid Land film, you'll wonder how you and your oscilloscope ever got along without it.

In 10 seconds, you get an on-the-spot record. You can study it, attach it to a report, send it as a test record along with a product shipment, or file it for future reference.

You have a choice of 5 films for oscilloscope recording.

The standard film has an A.S.A. equivalent rating of 3000. You can get it both in pack film [Type 107] and roll film [Type 47]. They both give you 8 pictures $3\frac{1}{4} \times 4\frac{1}{4}$ inches. This emulsion is also available in 4 x 5 sheets [Type 57].

And for extremely high-speed oscilloscope recording, there's Polaroid PolaScope Land film [a roll film, Type 410].

It has an A.S.A. equivalent rating of 10,000. It can discover traces too

fleeting for the human eye: such as a scintillation pulse with a rise time of less than 3 nanoseconds.

Because these films are so sensitive, you can use small camera apertures and low-intensity settings. Every shot is a sharp, high-contrast image that's easy to read.

To put these films to work on your scope, you need a camera equipped with a Polaroid Land Camera Back.

Most oscilloscope camera manufacturers have one.

For instance: Analab, BNK Associates, Coleman Engineering, EG&G, Fairchild, General Atronics, Hewlett-Packard and Tektronix.

You can get the full story by writing to Polaroid Corporation, Technical Sales Department, Cambridge, Massachusetts 02139 [or directly to the manufacturers mentioned above].

About the only thing we can't tell you is how to keep your blips from being bloopers.

"Polaroid" and "PolaScope"®

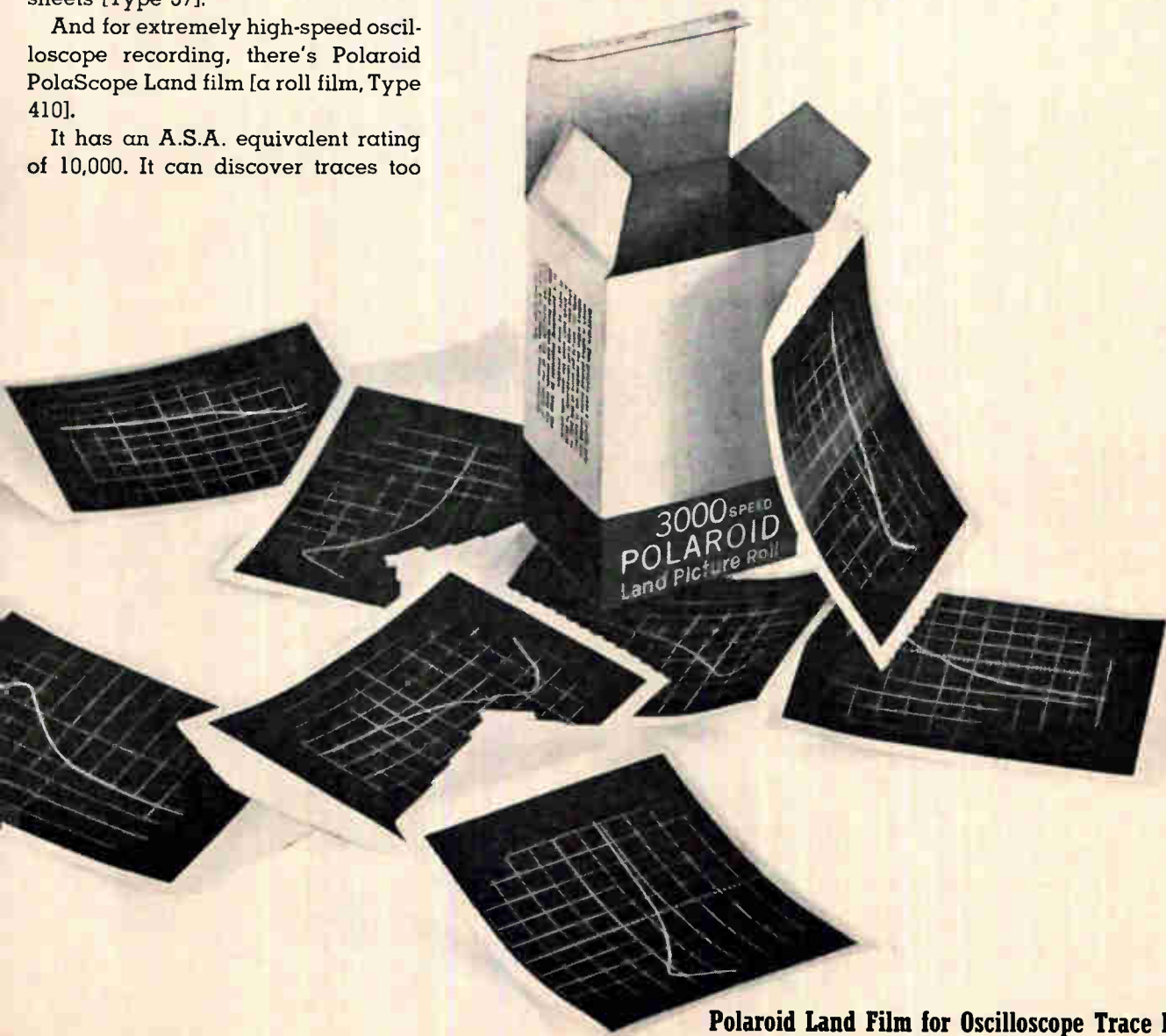

Polaroid Land Film for Oscilloscope Trace Recording.

GO ... 20 Hz to 1 GHz

Kay 1500 Sweep & Marker Generator



TYPICAL PLUG-INS

Model	Center Freq.	Sweep Width
P-141	20 Hz-200 KHz	20 Hz-20 KHz
P-142	35 Hz-600 KHz	20 Hz-20 KHz
P-130	100 Hz-2 MHz	200 Hz-2 MHz
P-152	10 KHz-20 MHz	10 KHz-20 MHz
P-855	2-32 MHz	5 Hz-800 KHz
P-856	10-120 MHz	10 Hz-1 MHz
P-860	2-220 MHz	10 KHz-30 MHz
P-867	220-470 MHz	20 KHz-30 MHz
PI-123	100-1000 MHz ANY SINGLE OCTAVE	5 KHz-Octave
Freq. Marker		
PM-7631	6 Pulse & Ext.	
PM-7632	6 Pulse & Ext.	
PM-932	30 Pulse	
PM-861	6 Harmonic and CW Osc.	



Pulse-Type Markers



Harmonic (or Comb) Birdie Markers



Single-Freq. Type Birdie Markers

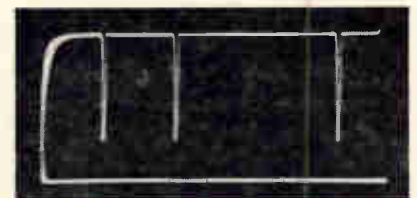

Detected Turn-Off Markers

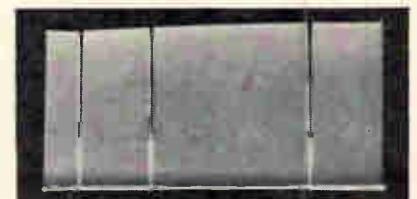

Undetected Turn-Off Markers

■ VOLTAGE CONTROLLED OSCILLATORS

■ MARKERS

Pulse
RF Turn-off
Harmonic
CW Birdie

■ SWEEP

0.2 to 60 cps
Log and Linear
External Input
Manual Control

The basic rack contains a variable, sawtooth sweep generator, a fast-acting AGC, frequency-marker control and output circuits, RF output circuits with precision attenuators, a calibrated output meter, an accurate RF detector, and carefully regulated power supplies.

KAY ELECTRIC COMPANY

Pine Brook, N. J. 07058 • (201) 227-2000 • TWX: 710-734-4347

ONLY 3C OFFERS **30 DAY DELIVERY** ON THE HOTTEST COMPUTER IN THE \$28,500 PRICE RANGE

DDP-116 computers are now operational in over 50 installations including communications, data acquisition, hybrid and other real-time control applications. Specifications include: 16-bit word, 1.7 μ sec cycle, expandable 4096-word memory and keyboard with paper tape I/O unit.

Software is a proven factor! The compact DDP-116 offers as many as 134 subroutines in its ASA FORTRAN IV library. Also, it is compatible with the DAP assembler and desectorizing loader. A/D and D/A subsystems, a full peripheral line and special purpose systems capability are available to extend the flexibility of the basic DDP-116.

Write for full details, or telephone today to test operate the DDP-116 at a selected 3C regional office nearest you.

DDP-116



See Us at SJCC, Booth No. 201-205

COMPUTER CONTROL COMPANY, INC.
OLD CONNECTICUT PATH, FRAMINGHAM, MASSACHUSETTS, U.S.A.
LONDON **PARIS** **FRANKFURT**

3C SALES OFFICES: NEEDHAM, MASS.; FOREST HILLS, N.Y.; LEVITOWN, PA.; SYRACUSE, N.Y.; SILVER SPRING, MD.; HOUSTON, TEXAS; HUNTSVILLE, ALA.; COCOA BEACH, FLA.; DES PLAINES, ILL.; DETROIT, MICH.; WEST CARROLLTON, OHIO; LOS ANGELES, CALIF.; KENT, WASH.; ALBUQUERQUE, N.M.

(advertisement)

How to extend measurements past the limits of present instruments:

**Use the Below Coupon To
Order Editorial Reprints
From Electronics!**

Fill in, cut out the coupon, insert in envelope
and mail to:

Electronics Reprint Department
330 West 42nd Street, New York, N.Y. 10036

Reprints Available:

(Price: 50¢ each unless otherwise noted.)

- Key no. R-83 **A Look at Japanese Electronics Technology**, 36 pages.
- Key no. R-82 **Computer Time Sharing**, 20 pages.
- Key no. R-80 **The Packaging Revolution In Microelectronics** (2 part series, 32 pages.) \$1.00.
- Key no. R-79 **MOS Integrated Circuits Save Space and Money**, 16 pages.
- Key no. R-78 **The Overlay Transistor**, 4 color special feature, 15 pages.
- Key no. R-77 **Cold Cathode Tubes** (3 part series, 28 pages).
- Key no. R-76 **Automated Trains: Who's On The Right Track?** 16 pages.
- Key no. R-74 **Unijunction Transistors**, 24 pages.

Reprint order form

(See the above list, please order by key number.)

To help expedite mailing of your reprints, please send cash, check, or money order when you order.

Send me reprint(s) of key no(s) at ¢ each.

Name

Number & Street

City, State, Zip Code

Get the extra capability, greater reliability, and longer useful life of Rohde & Schwarz!

Since 1933, Rohde & Schwarz' group of unusually creative engineers have been designing electronic instruments that are truly unique. These instruments are constantly ahead of what is considered to be the state-of-the-art. They are more precise. They are easier to use and read. Many perform extra functions. Some do jobs never done before. All are constructed with uncompromising quality—drastically reducing maintenance requirements. As a result, they do not become obsolete as fast as ordinary instruments—they provide more years of useful life. As you might expect, you pay a little more initially for some of these—but an investment in Rohde & Schwarz saves you plenty in the long run!

Get extreme accuracy with these new solid state FREQUENCY SYNTHESIZERS!

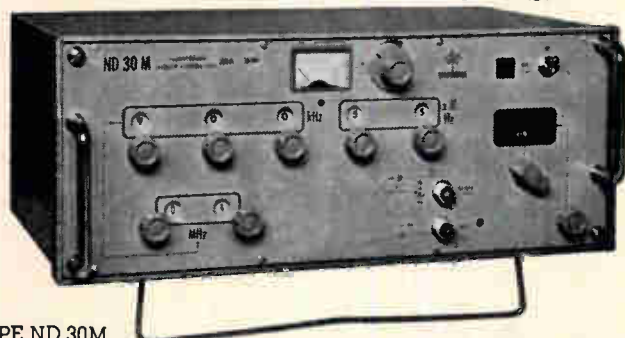

TYPE ND 30M
For more information, CIRCLE 80 ON READER SERVICE CARD

A line of signal generators providing unusually high accuracy and ease of operation. Continuously variable over its range, each model provides a direct digital read-out, with no tuning required. Perfect for bridge measurement, work with filters, networks, nuclear magnetic resonance, and as a source of reference frequencies for standards labs. All are fully transistorized and designed for AC or battery operation.

FREQUENCY RANGES: Type ND30M... 300 Hz to 31 MHz
Type ND1M... 300 Hz to 1.1 MHz
Type ND99K... 0 to 110 kHz

FEATURES:

- Built-in 1 MHz crystal has proportional oven and $5 \times 10^{-9}/^{\circ}\text{C}$ stability
- Spurious and noise suppression better than 80 dB
- Decade tuning
- Modular construction
- Completely transistorized
- High resolution search oscillator—130 divisions

A Crystal Measuring Set Built to IEC, IEEE & DIN Recommendations!

The Rohde & Schwarz RQZ Crystal Measuring Set provides a truly uniform method of measuring equivalent circuit parameters of oscillator or filter crystals. Frequency range is 0 to 300 MHz, and measuring head will work over a range of -20° to $+70^{\circ}\text{C}$. Provision is made for remote measuring.



FEATURES:

- Measures motional capacitance, resistance, and inductance, and series resonance frequency.
- Measures crystals over wide range of drive levels
- Ranges of motional resistance 0 to 17 k Ω
- Built-in load capacitances of 12, 30, and 50 pF

For more information, CIRCLE 81 ON READER SERVICE CARD

Make rapid, reliable measurements of semiconductor parameters

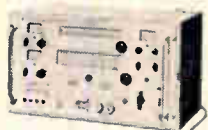

TYPE TYM
For more information,
CIRCLE 82 ON READER
SERVICE CARD

The Rohde & Schwarz Transistor-Y Meter is a transistorized precision instrument which provides a complete measuring system for both dynamic and static parameters associated with diodes, transistors and other semiconductor devices and circuits. Also suitable for impedance measurements on other components, it is designed for low power consumption, thus reducing operating temperatures and increasing reliability.

FEATURES:

- Directly measures Y_{11e} , Y_{22e} , $|Y_{21e}|$, d_{12e}
- Measurements at 8 switchable fixed frequencies from 20 kHz to 37 MHz
- Test jigs for TO-5 and TO-18 packages; others available
- Output provided for measurement of phase (R&S Phasemeter Type PDF available as option)

Use this Microvoltmeter for applications never before possible!



TYPE USVH
For more information,
CIRCLE 83 ON READER SERVICE CARD

Rohde & Schwarz's USVH Selective Microvoltmeter features unusual sensitivity and sharpness in tuning that permits measurement of • selective attenuation and frequency response on 4-terminal networks • RF distortion and waveform analysis • depth of modulation • receiver and amplifier inter- and cross-modulation • RF leakage • spurious frequencies and noise—all without the need for additional equipment!

FEATURES:

- 10 kHz to 30 MHz frequency range
- Full scale deflections of $1\mu\text{V}$ to 1V
- Selectable bandwidth of 500 Hz or 5 kHz
- Six input impedances from 50 Ω to 500 k Ω
- Expanded scale with suppressed zero for 3 dB point measurements

Rohde & Schwarz, 111 Lexington Ave., Passaic, N.J., 07056 Phone: PRescott 3-8010

Inquiries outside the U.S.A. should be directed to: Rohde & Schwarz, Muehldorfstrasse 15, Munchen 8, West Germany.



test under actual load conditions...

... the ultimate test for integrated circuits, transistors, diodes, thin films, logic cards or modules. The Model 553 Dynamic Test System performs both static (dc) and dynamic tests from dc to 50 megacycles on multi-lead devices in a single socket! Variable word-length mnemonic machine language simplifies programming ... operators can be trained in a few hours. Unique program modification eliminates repetitive instructions, speeds additions and deletions to save up to two-thirds in programming time.

Let us tell you more about the 553.

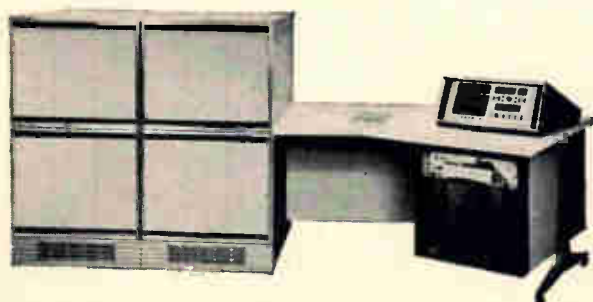

TEXAS INSTRUMENTS
INCORPORATED

APPARATUS DIVISION
P. O. BOX 66027 HOUSTON, TEXAS 77006
118 RUE du RHONE GENEVA, SWITZERLAND

777



new 260[®] SERIES 5 VOM

We're at it again... making the 260[®] a better buy than ever. This latest improvement is built-in meter protection... standard on regular* 260 volt-ohm milliammeters—Series 5 and 5M.

It prevents mechanical damage to the moving element in the movement from instantaneous overloads up to 1,000,000%, or steady state overloads up to 500,000%. It also stops overheating or burnout of the armature coil, damage to hair springs, and calibration change due to high overloads. Otherwise the famous 260 remains unchanged.

If you now have a Series 1, 2, 3, or 4, 260 VOM, you can install your own meter protection. Ask your electronics distributor for a Simpson meter "safe/guard[®]." It takes only minutes to install.

260-5 with new meter protection..... \$52⁹⁵

260-5M (mirror scale) with meter protection..... \$54⁹⁵

*260-5P has both meter and circuit protection except on the 1000V and 5000V DC and AC ranges, and the 10-amp DC range. Price \$79.95

RANGES (20,000 Ω /V DC; 5000 Ω /V AC)

DC VOLTS: 0-0.25; 0-2.5; 0-10; 0-50; 0-250; 0-1000; 0-5000

AC VOLTS: 0-2.5; 0-10; 0-50; 0-250; 0-1000; 0-5000

DC MICROAMPERES: 0-50 (250 MV Drop)

DC MILLIAMPERES: 0-1; 0-10; 0-100; 0-500

DC AMPERES: 0-10 (250 MV Drop)

RESISTANCE RANGES: RX1 0-2000 ohms (12 ohms center) RX100 0-200K ohms (1200 ohms center) RX10K 0-20 megohms (120K ohms center)

ACCURACY: DC, $\pm 2\%$ F.S.; AC, $\pm 3\%$ F.S.

Write for Bulletin 2072 showing the entire line of Simpson VOM's



Simpson
INSTRUMENTS THAT STAY ACCURATE

SIMPSON ELECTRIC COMPANY
5203 W. Kinzie Street, Chicago, Ill. 60644 • Phone: (312) ESTbrook 9-1121
Representatives in Principal Cities... See Telephone Yellow Pages
Export Dept: 400 W. Madison St., Chicago, Ill. 60606 Cable, Amergaco
In Canada: Bach-Simpson Ltd., London, Ontario
In India: Ruttonsha-Simpson Private Ltd., Vikhroli, Bombay

WORLD'S LARGEST MANUFACTURER OF ELECTRONIC TEST EQUIPMENT

Check
your
lacing
tape
requirements
here 

- HIGH TEMPERATURE**
General use Gudebrod Tapes are unaffected by temperatures to 250°F.; specially designed tapes are essentially stable in excess of 1500°F.
- LOW TEMPERATURES**
Most popular Gudebrod Tapes are stable down to -67°F., others are designed to take temperatures as low as -100°F.
- BURNPROOF**
Gudebrod has lacing tapes of completely fireproof materials, others will not support a flame.
- OUTER SPACE**
Gudebrod has a tape that won't outgas in outer space—especially suitable for space, or industrial applications in vacuum.
- FUNGISTATIC**
Whenever possible with the material of construction Gudebrod guarantees its tapes to be fungistatic or fungicidal.
- MIL-T-713A**
Gudebrod's Gudelace 18 meets all requirements of specification MIL-T-713A, type P, class two. Other Gudebrod Tapes meet or surpass these specs.
- TENSILE STRENGTH**
All Gudebrod Tapes are available in a number of widths and thicknesses to meet varying size requirements.
- CUT LENGTHS**
Gudebrod Tapes can be supplied in handy dispenser packs of cut lengths to suit your harnessing needs.
- COMPATIBLE MATERIALS**
From the wide range of basic materials and finishes used in Gudebrod Tapes the selection of a tape compatible to your insulation is easy.
- COLOR CODED TAPES**
For complicated circuitry, color coding with Gudebrod Lacing Tapes makes assembly and tracing easy.
- SPECIAL APPLICATIONS**
Gudebrod will work with your engineers to develop a special tape to meet sophisticated requirements.

THEN GET THE RIGHT TAPE FROM **GUDEBROD!**

Perhaps you are regularly using Gudebrod Gudelace 18, the standard, wax impregnated nylon tape that's known round-the-world for its non-slip knotting (meets MIL-T-713A specs, too). You are doing well then—with the finest tape and saving money on harnesses, too!

But when you are making gear for tropic or arctic use, if you are involved with outer space or

special industrial applications—come to Gudebrod. Here is your one best source for lacing tape information. Ask for a copy of our Product Data Book describing the more than 200 different tapes in our regular stock. In it you'll probably find the tape that fits your requirements—but if you don't, inquire about having one made to your particular specifications.



GUDEBROD BROS. SILK CO., INC.

FOUNDED IN 1870

Electronics Division

12 SOUTH 12th STREET, PHILADELPHIA, PENNSYLVANIA 19107

Area Code 215, WA 2-1122

NEW Honeywell's Auto-Torque METERS

Now available in many styles!

This revolutionary new meter comes in conventional Bakelite models in 2½, 3½, and 4½-inch sizes — a modern, dull black model "45" with a picture frame window — brand new clear plastic 4½-inch square meter priced for the volume user — the distinctive Medalist series and the contemporary "MS" series, each in 3 standard sizes. Auto-Torque meters give you the widest selection of band-type meters available today.

More Reliable!

Auto-Torque's simplified design has 50% fewer parts.

And since Auto-Torque meters are machine made, they

give you uniform quality and precision never

before possible

in conventional

meters. You can

just about say

good-bye

to service

problems!

Revolutionary and fast selling



You save money!

Quantity-order prices for volume buyers are below comparable pivot and jewel meters!

Self-shielded mechanism

Auto-Torque meters can be mounted on any panel without special calibration; accuracy is unaffected by external fields!

Outlasts conventional meters!

Auto-Torque's moving system is suspended on metal bands under tension. As a result, there's no friction and wear.

For more information on the revolutionary Auto-Torque meters, write Honeywell Precision Meter Division, Manchester, N. H. 03105.

Because *one* data sheet — representing Motorola's new MR1120-30 series 12-ampere, 7/16" stud rectifiers — now gives you the chance to replace any of more than 65 older EIA 3 to 12-ampere devices . . . *all* priced considerably higher than this new series (the lowest-cost counterpart to a \$1.00,* 400-volt MR1124 unit is \$3.05*)! And Motorola 12-ampere capability in lower-current sockets gives you an extra cost-saving bonus in lessened heat sinking needs.

But don't let the low price tags obscure the topnotch performance and efficiency advantages of these rectifiers:

- highest obtainable current/temperature capability — handles a 12-ampere load up to 150°C . . . superior to more than 4 out of 5 other 7/16" stud devices
- greatest surge-current handling ability — 300-amperes (1/2-cycle) @ 150°C . . . at least 20% more protection than other 12-ampere units
- low forward voltage drop — 0.55 V_{F(AV)} @ T_r = 150°C . . . less power loss in your circuit — minimizes thermal excursions and early device failure

*100-up

Contact your franchised Motorola semiconductor distributor now for evaluation units. For the latest word in comprehensive, low-to-medium-current-rectifier data sheets, write Dept. TIC, Box 955, Phoenix, Arizona 85008.

TYPE	V _{RM(rep)} Volts
MR1120	50
MR1121	100
MR1122	200
MR1123	300
MR1124	400
MR1125	500
MR1126	600
MR1128	800
MR1130	1000
Reverse polarities available	



MOTOROLA
Semiconductors



Design in DC for 2/3 Less

(and throw out 27 data sheets)

Washington Newsletter

April 4, 1966

**Congress likely
to expand NSF's
scope, not power**

Congress is expected to approve a bill this year greatly expanding the scope but not the power of the National Science Foundation.

Because of strong White House opposition, the House Science and Astronautics Committee has decided not to push to have the foundation take over as chief scientific adviser to the President and as coordinator of all federal research activities. The drive to overhaul the foundation was initiated last February by Emilio Q. Daddario (D., Conn.), chairman of the committee's Science, Research and Development subcommittee.

Under the Daddario plan that Congress is expected to approve, the foundation's area of interest would be expanded into such fields as engineering, scientific manpower and resources and scientific information. Hearings are scheduled for April 19 to 21.

The science foundation once had much broader power but never fully exercised it. With the rapid growth of the military and space research programs, power was concentrated within the agencies involved, such as the Pentagon and the National Aeronautics and Space Administration. When President Kennedy took office, he created the Office of Science and Technology and conferred on it the responsibilities that the foundation never assumed [Electronics, July 12, 1965, p. 121]. Since this placed the Office of Science and Technology directly under the President's wing, the White House saw the recent effort to change this line of command as a drive to usurp a power of the President.

**Pentagon to rate
off-the-shelf dealers**

Apparently satisfied with results of evaluating contractors' performance on major weapons systems, the Pentagon is extending the report-card system to vendors of off-the-shelf electronic equipment. The evaluations of past performance will help determine who will get future contracts. The program will cover military equipment supplied under contracts totaling \$100,000 or more.

As a test, the Defense Supply Agency is evaluating producers of selected supplies and equipment. Starting June 1, the Defense Electronic Supply Center, the Defense Construction Supply Center and the Defense General Supply Center will begin using the evaluations for new contracts. By Jan. 1, 1967, the Defense Department will refine the evaluation program and put it on a permanent basis.

Contractors will be judged on the basis of how well they fulfill their contracts with respect to technical performance, milestones and cost levels. They will be allowed to see the evaluations and comment on them. In case of bad marks, they can advise the Pentagon immediately of corrective steps or make them evident in subsequent contract proposals.

**Supreme court
again tightens
rules on patents**

The Supreme Court is continuing to tighten the rules regulating patent applications by inventors. Setting a precedent that the Patent Office and lower courts will have to follow, the High Court has ruled that commercial usefulness must underlie a patent request. The court turned down the inventor of a process to turn out steroid chemicals. The process has no known usefulness—but could prove helpful to scientists doing further research.

Washington Newsletter

Immigration eased for skilled workers

Immigration of skilled workers has been eased by a Labor Department certification that there is a critical nationwide shortage of technicians, draftsmen, engineers and machinists. Under the certification, companies in all regions will no longer have to document their own local shortages before going abroad for wholesale hiring.

June 1 a deadline on accelerator site

The Atomic Energy Commission is trying to pick a winner in the "200-bev sweepstakes" by June 1. The AEC has been given a list of seven locales in six states as best bets for location of the proposed 200-billion-electron-volt particle accelerator.

Sites still in the running are Ann Arbor, Mich.; Madison, Wis.; South Barrington or Weston, Ill., near Chicago; Brookhaven National Laboratory, near Upton, N. Y.; Sierra Foothills, near Sacramento, Calif.; and Denver.

Unless the AEC meets the June 1 deadline for final selection, it may lose its chance to get about \$7 million in a supplemental appropriation for fiscal 1967 to start engineering and design.

All-U. S. Early Bird proposed by AT&T

The American Telephone & Telegraph Corp. has asked the Communications Satellite Corp. to consider launching a satellite for domestic communications. The request may open a battle over who owns the ground stations—Comsat or the common carriers.

AT&T says there is a need to supplement its continental cable and microwave network with a large-capacity satellite.

Comsat is interested in the plan; earlier it had invited industry proposals on a multipurpose satellite for domestic use. AT&T has suggested that ground stations for the system be owned by the carriers. But the Federal Communications Commission ruled earlier that domestic ground stations for Comsat's international network should be owned by Comsat—at least at first. However, this decision is not likely to be binding on an entirely domestic network.

Defense priority briefings scheduled

The Business and Defense Services Administration will begin a series of briefings April 11 to prepare industry for the speeded-up demand for priority deliveries of all defense goods at the expense of civilian orders. A series of 20 or more sessions for defense contractors will be held by the Commerce Department agency to make sure contractors know what to expect and how to comply with the regulations under the Defense Production Act. Firm dates for future briefings now include Dallas, April 11; Atlanta, April 18; Birmingham, April 20; Orlando, Fla., April 22; Cleveland, April 25, and Philadelphia, May 10. The briefings are in response to an increasing flow of requests from contractors for guidance on how to handle the priority requirements.

Addendum

By the end of April, the Federal Communications Commission is expected to propose rules governing the use of long-distance communications lines by time-shared computer-service operations. Any FCC action will influence the rates charged on the communications lines and the growth of the industry.

**What increased
chemical cleaning
production 20%
and cut solvent
costs in half?**

**ITT says:
FREON® solvents
and Branson
Ultrasonics.**

At ITT's Electron Tube Plant in Easton, Pa., components are now cleaned in a Branson ultrasonic system using FREON TF solvent. Standard degreasing just couldn't do the job as efficiently. Time and money were lost through re-cleaning.

Now, FREON leaves components microscopically clean—the first time through. With its low surface tension it reaches into the smallest pores and crevices. With its high density, FREON carries off all traces of dirt, cutting oils and other contaminants. It dries quickly, leaving no residue.

The result: chemical cleaning production up 20% . . . solvent costs down 52% from \$100 to \$48 per week.

And, because FREON is nonexplosive and relatively nontoxic, no special exhaust system is needed. Its high stability permits recovery and reuse after simple distillation.

FREON solvents could be the answer to your cleaning problems. For more information, write Du Pont Co., Room 3679, Wil-

ilmington, Delaware 19898. (In Europe, write: Du Pont de Nemours International S.A., "FREON" Products Div., 81 Route de l'Aire, CH 1211 Geneva 24, Switzerland.)



Better Things for Better Living
... through Chemistry

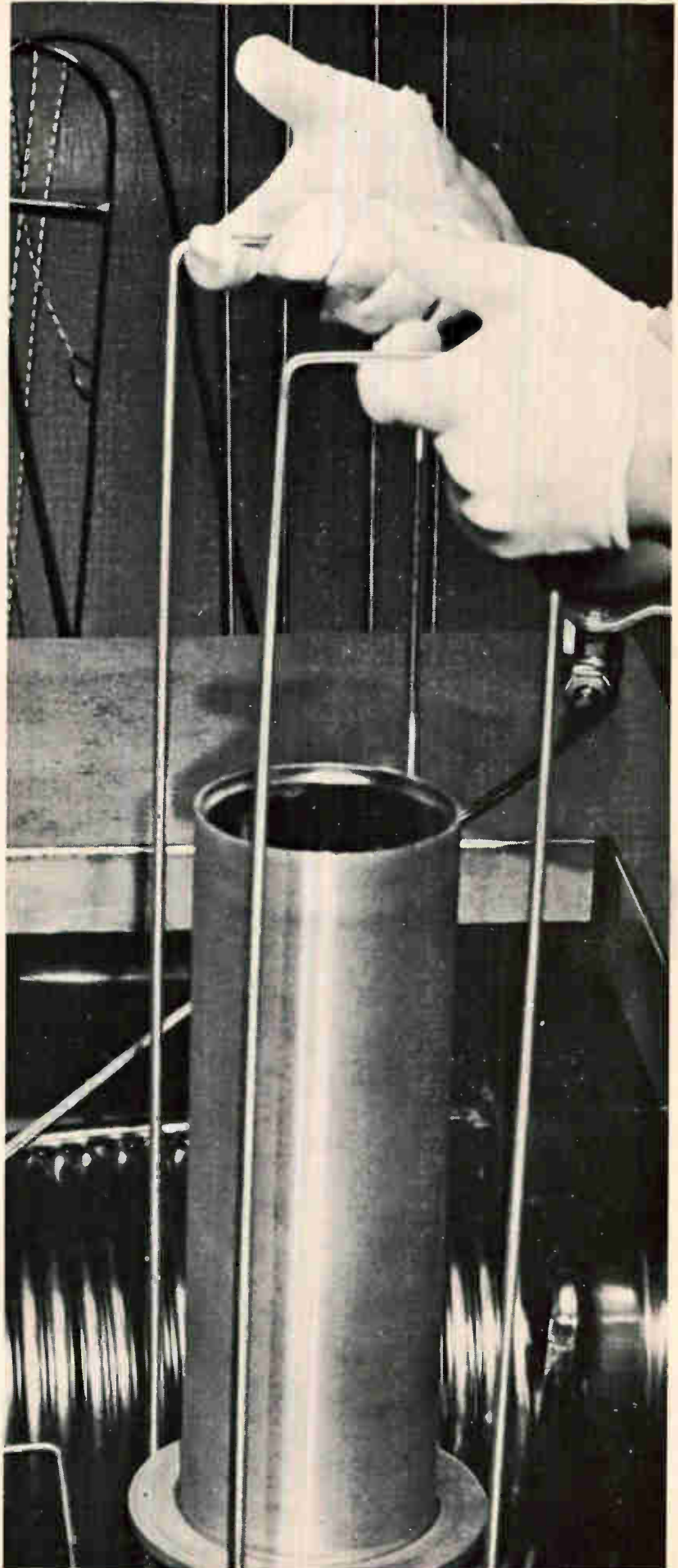

Amelco's New TTL Logic With 8 Elements Really Flies!



INITIAL LOGIC ELEMENTS

Five/Three Nand/Nor Gate
Dual Three Input Gate
RST Flip Flop
Dual Shift Register
Gated Buffer
Flip Flop Driving Buffer
Output Interface Circuit
Input Interface Circuit

TTL LOGIC — TYPICAL SPEC'S

Power Dissipation 1.3 mw/node
Propagation Delay 50 ns/node
Noise Immunity 800 mV
(2.5 v with Interface Circuits)
Fan Out 9
Single Power Supply 4 v

Designed specifically for advanced avionics systems, AMELCO TTL permits exceptionally high packaging density because power dissipation is limited to 1.3 mw per node. In addition, the range of logic circuits available facilitates system design. ■ The low power dissipation has not been obtained by sacrificing other parameters. Propagation delay is only 50 nsec and fan out is 9. Noise immunity is 800 mV and is increased to 2.5v when interface circuits are used. ■ A group of 8 elements is presently available, and more are being designed. The initial group of 8 elements has been in production for several months and are now in stock at Amelco Distributors in both TO-5 and flat packages.

AMELCO SEMICONDUCTOR

DIVISION OF TELEDYNE, INC.

1300 TERRA BELLA AVENUE • MOUNTAIN VIEW, CALIFORNIA
Mail Address: P. O. Box 1030, Mountain View, California
Phone: (415) 968-9241 / TWX: (415) 969-9112 / Telex: 34-8416

REGIONAL OFFICES

Southwest—Suite 213, 9621 Bellanca Ave., Los Angeles, California 90045, (213) 678-3146 • Northwest—1300 Terra Bella Avenue, Mountain View, California, (415) 968-9241 • East—P. O. Box 2091, Paterson, New Jersey 07509, (516) 334-7997 • Northeast—543 High Street, Westwood, Massachusetts, (617) 326-6600 • Midwest—650 West Algonquin Road, Des Plaines, Illinois, (312) 439-3250; 3020 Woodlark Lane, St. Paul, Minnesota (612) 646-1161.



LASERS IN THE COMPLETE COMMUNICATIONS SPECTRUM

Optical missile tracking and laser — TV systems

Now in development at Sylvania Electronic Systems

■ An optical radar system that will measure missile position to within a fraction of an inch during launch phase, yielding position and velocity data an order of magnitude better than now possible.

■ A laser television system that has already produced excellent picture transmission over a 6000-foot link, and is being considered for use in an optical communications system to interconnect an 11-building complex over a six-mile radius.

Although stable CW gas lasers are the heart of both these systems, a much wider variety of electronics hardware is necessary to make the systems successful. And behind the hardware are the men and women of Sylvania Electronic Systems who bring to-

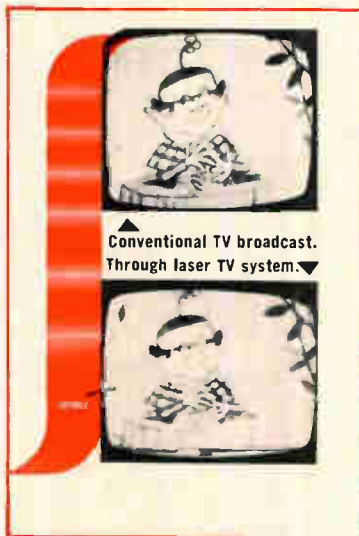

morrow's dreams into today's engineering reality.

There's a place for you in the complete communications spectrum at Sylvania Electronic Systems if you have an engineering degree — BS/MS/PhD plus a high level of technical competence — and are keenly interested in advancing the state-of-the-art together with your career. Enjoy excellent working conditions, security, advancement and educational opportunities in a scientific environment. Location — at the firm's major complexes in Suburban Boston, Buffalo, and San Francisco, near world-renowned educational institutions.

If you are a candidate send your resume today to: Manager, Professional Staffing, Sylvania Electronic Systems, Division of Sylvania Electric Products Inc., 56 Sylvan Road, Waltham, Mass. 02154.

The complete spectrum of opportunity — work range, location, professional satisfaction is awaiting you at Sylvania Electronic Systems
An equal opportunity employer m/f

GTE

GENERAL TELEPHONE & ELECTRONICS
Total Communications from a single source through

SYLVANIA ELECTRONIC SYSTEMS

RESEARCH • PRODUCT DEVELOPMENT • MANUFACTURING • FIELD ENGINEERING

A. King McCord,
President, Westinghouse Air Brake Company, says,

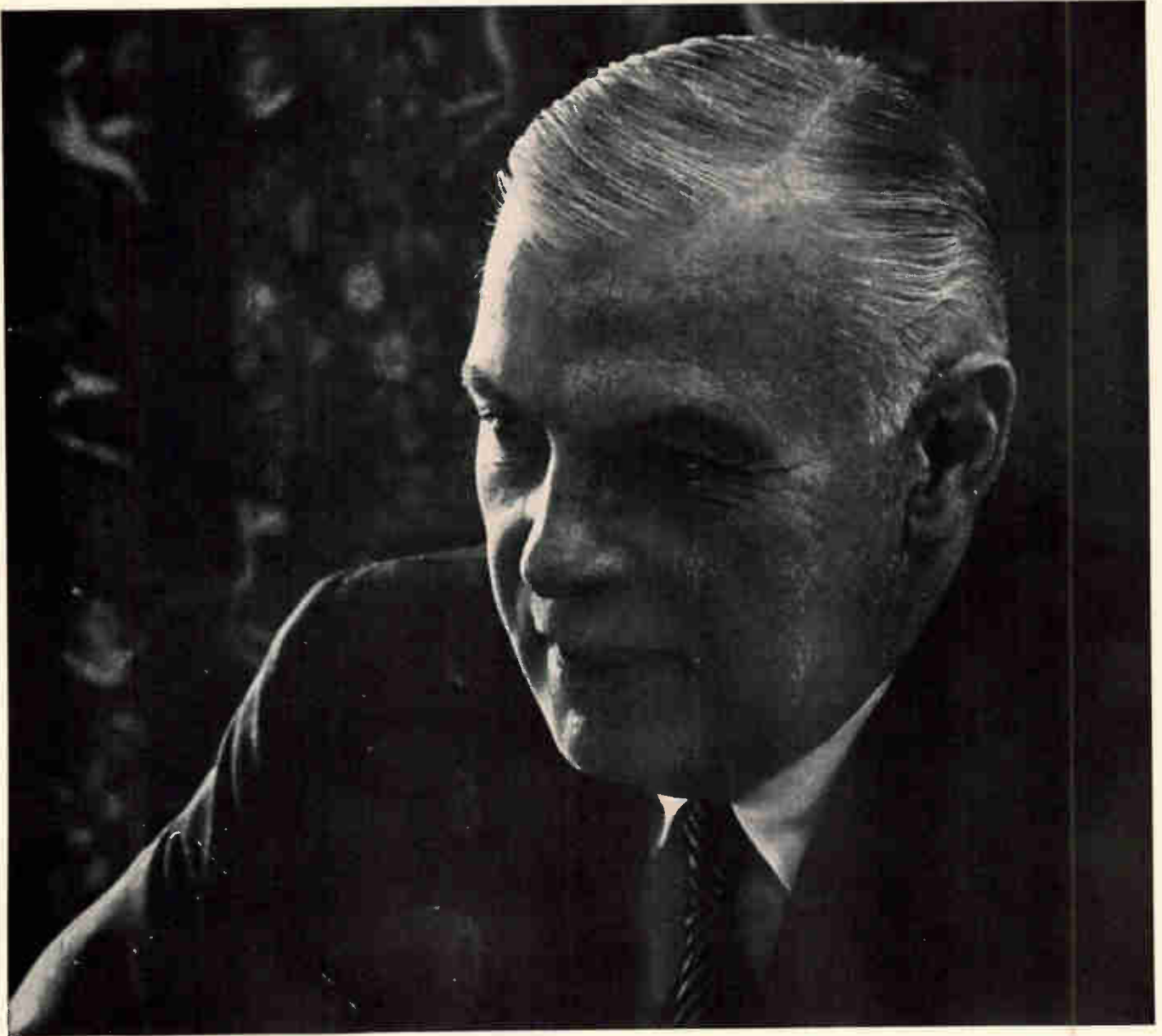

“We’ve introduced the world to WABCO with Industrial Advertising.”

“We gave *seven* individual companies a single corporate identity—virtually overnight. We let customers in thirty major markets know that Westinghouse Air Brake now ranks among the world’s most skilled and diversified suppliers—of earthmovers, drilling equipment, compressors,

automatic signal and control systems, electronic guidance detection and communications equipment, control valves, hydraulic and pneumatic cylinders, and—that’s right—air brakes. We told the story fast and inexpensively to hundreds of thousands of purchasing influences, with Industrial Advertising.”

Advertising cuts the cost of selling . . .

ASSOCIATION OF INDUSTRIAL ADVERTISERS



271 Madison Ave., New York, N. Y. 10016

MORE AIRCRAFT UP TIME—LESS DOWN TIME

With **NEW** Automatic Wiring Analyzer

Keeping today's complex aircraft ready for action is a major challenge. Dalmo Victor is helping meet the challenge with the AN/USM-185*, a mobile, versatile wiring analyzer that checks electrical integrity of oft-neglected aircraft wiring by automatically making error-free resistance, leakage and continuity tests. Though developed specifically for the F-105 and F4C, this analyzer can be used for **depot or field** maintenance to check out all present and future aircraft in all commands... all services.

Results of Air Force Project CAST and earlier related studies plus current operational command field tests that compare automatic and manual methods of checking aircraft wiring integrity indicate the true significance of automatic wiring analyzers. For example, automatic equipment revealed marginal and faulty wiring normally not detected by manual means... test accuracy was significantly increased... and reduction in test times consistently averaged **minutes** (vs. **hours**).

These studies also indicated that wiring age equals marginal wiring. Translated into more dramatic—but valid—terms, automatic wiring analyzers can contribute heavily to more aircraft up time, improved mission success and **saved aircraft**.

The USM-185 will make maximum contributions in these areas. With the simplest tape programming yet devised, the USM-185 is designed to automatically make go/no-go tests on a 5,000 point harness in only 36 minutes. Maximum test capacity is 40,000 points. Operational versatility is provided with automatic, semi-automatic, "manual" and self-programming operating modes. The central data processor is expandable for **functional versatility**. Self-test features ensure dependability and maintainability. When required, the USM-185 is readily adapted to card programming.

For more information, contact Dalmo Victor's Automatic Test Equipment Product Manager today.

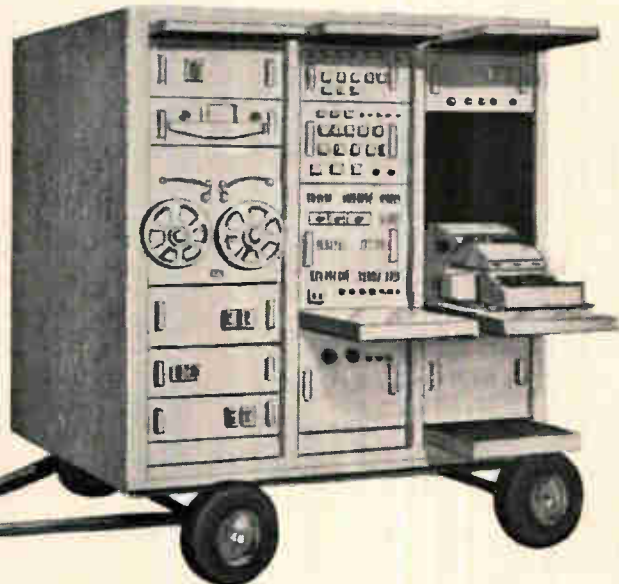
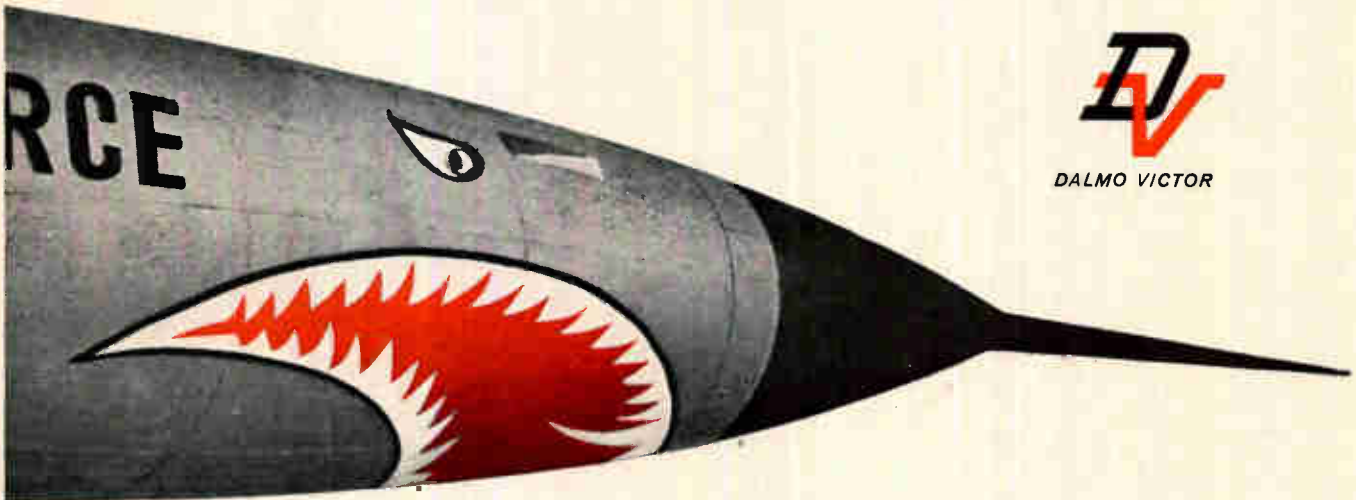

*AN/USM-185, completely militarized automatic wiring analyzer being developed by Dalmo Victor under contract to the Aeronautical Systems Division, Air Force Systems Command, USAF, Wright-Patterson AFB, Ohio. This analyzer meets or exceeds requirements of MIL-T-38218A, MIL-T-21200 and MIL-R-26667. Contract terms call for delivery of the first unit early this summer.

DALMO VICTOR 1515 INDUSTRIAL WAY • BELMONT, CALIFORNIA 94002
TELEPHONE: 415/591-1414 TWX: 910/376-4400

A **textron** DIVISION

10 gram guard



Reverse-voltage defense is just one more reason for G-E tantalum foil

Forget about a surprise reverse with G-E tantalum foil capacitors. They're designed to take it. And reverse-voltage defense is just one reason for using G-E tantalum foil. Here are three others:

PROVED IN-CIRCUIT RELIABILITY: They've been proved—and improved—for over 17 years. More than 20 million have been successfully applied. G-E tantalum foil earned a 0.00023 reliability record (per 1000 hours) on Minuteman reliability tests,

based on the Minuteman acceleration factor.

NO CATASTROPHIC FAILURES: Low impedance circuits and catastrophic failures are no problem with G-E tantalum foils. They're self healing. **LONG SHELF LIFE:** We're up to the 14 year mark . . . with less than a 5% capacitance change at 25C. That's shelf life!

G-E tantalum foil capacitors are available in ratings up to 450VDC, 0.15 to 3500uf, —55 to 85 or 125C. They're

virtually risk-proof. And may cost more. But isn't a proved line your best defense?

For all the facts on G-E tantalum foil reliability, write for Reliability Report, Section 430-25, General Electric Co., Schenectady, N. Y. 12305.

ELECTRONIC COMPONENTS DIVISION
GENERAL  ELECTRIC



**then add
this complete,
low cost
data system!**

(only \$4,300, including DVM!)

**Start with the EI-620
DVM with *autoject* ...**

Whether your signal levels are single ended or floating above ground, fool proof operation is provided by the 620's isolated-guarded differential input (140 db of CMR). Ground loops, offset or error due to noise are eliminated. The 620's constant high input impedance of greater than 1000 megohms eliminates errors due to source of loading. Fluctuating DC signals are accurately measured with the 620's integrating logic, the value being integrated over the sampling time base of 100 msec.

The exclusive autoject circuitry provides greater than 60 db of normal mode rejection to superimposed noise of any frequency above 30 Hz, without the delay required by filters. (See graph.) *All this at ±.01% accuracy!*

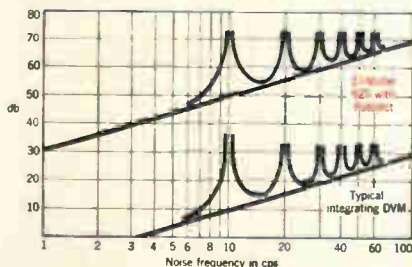

620 features — • ±.01% accuracy • 4 full digits plus 5th for 20% overrange • Automatic ranging and polarity • 4 readings per second • DC and Ratio • Differential inputs • Isolated electrical outputs • Remote control • Completely solid state circuitry including logic • From \$995.00

* 620 Data System — Now, a low cost portable measuring and recording system utilizing as its heart, the EI-620 DVM with *autoject*. Plug in your EI-620 and the system is complete.

Whether your application is for in house or field use, the 620 system provides a portable package everyone can use, anywhere!

System features — • 40 points of guarded scanning • High-Low limit channel selection • Automatic or manual channel selection • Single or continuous cycle operation • Printed record on

4 inch wide paper tape • Printed record includes channel ID, polarity, 5 digits of measured value and range • New, bold printed numerals • Automatic or single print operation • From \$4300.00 (including DVM)

Additional systems extensions — are also available to provide additional signal conditioning and printout capability. Write for systems brochure No. S25.512.

Your choice of system or portable DVM use. When systems operation is not required, the EI-620 is unplugged and used with its portable case with convenient carrying handle and bench stand. All features and specifications are identical in either instance.

Explore the benefits of a superior, low cost, fully solid state digital voltmeter or system with Autoject ... the Series 620!



Electro Instruments, Inc. 

8611 BALBOA AVENUE, SAN DIEGO, CALIFORNIA 92112

41 EMMASTRAAT, VELDHOVEN, HOLLAND

TYPE FT-201A IF-TAPE CONVERTER

Designed to accept 21.4-mc IF output from CEI (and other) receivers, translating it to a signal which can be recorded on a wide-band tape recorder.



Data bandwidth is 100 kc to 1.4 mc, with response varying less than 2 db. Output center frequency of 750 kc can easily be adjusted to any frequency within data bandwidth by changing a plug-in crystal. Special techniques insure minimum signal degradation; spurious outputs are a minimum of 50 db below 1 volt. When used as part of a complete predetection record/playback system, less than 1 db S/N impairment will be experienced as compared to direct demodulation of incoming signal. (In full-rack 19" configuration, this is designated the Type FT-101A.)

TYPE TF-201 TAPE-IF CONVERTER

Translates output signals from a tape recorder up to 21.4 mc. Provides a data bandwidth of 1.3 mc



when the input center frequency is 750 kc, although any input center frequency between 100 kc and 1.4 mc may be used with a corresponding reduction in bandwidth. Response over the data bandwidth varies less than 2 db, input signals up to 10 v rms can be accepted, and output level (continuously variable) is up to 10 mv into a 50-ohm load. (In full-rack 19" configuration, this is designated the Type TF-101.)

TYPE TF-202 TAPE-IF CONVERTER

Identical to TF-201 except that additional front-panel control tunes the second local oscillator to permit maintaining the 21.4 mc output frequency for input center frequencies between 100 kc and 1.4 mc. (In full-rack 19" configuration, this is designated the Type TF-102.)

TYPE IFD-201 IF DEMODULATOR

Provides AM and FM detection of 21.4 mc input signals (companion unit to TF-201 or TF-202 above and,



when used with one of them, comprises a tape demodulator system) and offers four selectable IF bandwidths: 10 kc, 50 kc, 300 kc and 1 mc. Both the AM detector and FM discriminator in the selected IF strip operate simultaneously, and separate video amplifiers for the discriminator and detector outputs are provided. Front panel controls include IF bandwidth, IF gain, AM video gain and FM video gain. (In full-rack 19" configuration, this is designated the Type IFD-101.)

NOTE: Half-rack versions of these four units are 8" wide and 3.25" high, and designed to be used in CEI's EF-201 dual equipment frames. All full-rack versions are 3.5" high.

NEW from CEI WIDEBAND PREDETECTION RECORDING CONVERTERS AND DEMODULATORS

- IF-to-Tape Converters
- Tape-to-IF Converters
- IF Demodulators

Introducing an unusual new line of solid state converters and demodulators designed to facilitate predetection recording of 21.4 mc and 455 kc center frequencies.

TYPE FT-4557 FREQUENCY TRANSLATOR

For Recording Multiple 455-kc IF Signals Simultaneously

By using the new FT-4557 frequency translator, recording and tape requirements can be dramatically reduced in any instance where a large number of predetected 455-kc IF signals must be recorded. The unit will simultaneously accept IF outputs from as many as six communications receivers, converting 455-kc signals to six staggered output frequencies between 580 kc and 1.33 mc. Each input channel has a data bandwidth of 50 kc; a seventh (video) input is provided which is not translated and can be used to record timing signals, demodulated video signals from an additional receiver, or voice announcements.



The seven inputs are combined in a summing network into a single output signal for recording on a wideband tape recorder; thus a single seven-track recorder can accept inputs from up to 42 receivers (plus seven video signals) when used with seven FT-4557's.



COMMUNICATION ELECTRONICS INCORPORATED

For further information about any CEI product, please contact:

6006 Executive Blvd., Rockville, Md. 20852 Phone: (301) 933-2800

“ACTIVE”...

ERIE Definition of Advanced Component Capability



SUBMINIATURE MONOBLOC CERAMIC CAPACITORS

High capacitance to volume ratio. Hermetically sealed in glass; precision molded; and phenolic dipped types.



MINIATURE HERMETICALLY SEALED BUTTON MICA CAPACITORS

For -55°C. to +200°C. applications.



SUBMINIATURE BROAD BAND R. F. I. FILTERS

Eliminate RF noise in 10 KC to 10 KMC frequency range.



HIGH RELIABILITY TUBULAR and DISC CERAMIC CAPACITORS

General Purpose; Temperature Compensating; and High Stability types.



MINIATURE CERAMIC and GLASS TRIMMERS

Precision trimmers with capacitance and terminal arrangements to suit need.



MINIATURE FILM CAPACITORS

Designed for filter, bypass, coupling and blocking applications.

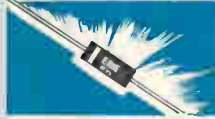

SUBMINIATURE DIFFUSED SILICON RECTIFIERS

High forward conductance, low-leakage currents and reliable performance.



MINIATURE BYPASS CAPACITOR SYSTEMS FOR TRANSMITTING TUBES

Effective capacitive bypassing and coupling or filtering of all signals in 10 to 3000 megacycle range and beyond.



SUBMINIATURE INTEGRATED NETWORKS

Compact modules of resistor-capacitor networks with 2, 4, 6 or 8 leads... with or without semiconductor elements.

THE term “ACTIVE” in the Erie organization identifies a total program encompassing the research, development and production of Advanced Components Through Increased Volumetric Efficiency for aerospace, military and commercial equipment.

Project “ACTIVE” now brings to electronics and avionics a series of high performance, subminiature components designed for applications where every cubic inch of space and every ounce of weight is critical to successful equipment performance.

These Erie components have been and are being designed into the circuitry of such demanding systems as Gemini, Apollo, Minuteman, Nike X, Telstar, Polaris... commercial computers, oscilloscopes... and many other applications where size, weight and dependable performance are vital. While the advanced products illustrated at left are in quantity production, a number of components are still in the concept stage, while others are at final evaluation ready for production.

Consider the problem-solving advantages Erie ACTIVE components can offer you in your quest for reliable, subminiature components. We suggest ERIE as your quality source. A collect call or letter to your nearby representative... or to Erie headquarters is all that is needed as the “first step.”

Erie's Project “ACTIVE”
Advanced Components through Increased Volumetric Efficiency



Formerly
Erie Resistor
Corporation

644 West 12th Street
Erie, Pennsylvania



Great editorial is something he takes to work

What a climate for selling! Today's busy engineer has to make good use of the time he spends on the 8:05. His is a business of lightning change, where a single "space shot" can breed a new technology overnight.

That's why more than 68,000 engineers turn to Electronics to keep abreast of what's important in the technical field of their

complex industry. Last year alone, Electronics ran 2,167 editorial pages (almost 25% more than any other industry publication.) Where the busy engineer seeks editorial, he finds ads that keep him abreast of products and services. Be there!

Electronics A McGraw-Hill *Market-Directed* Publication, 330 West 42nd Street, New York 10036

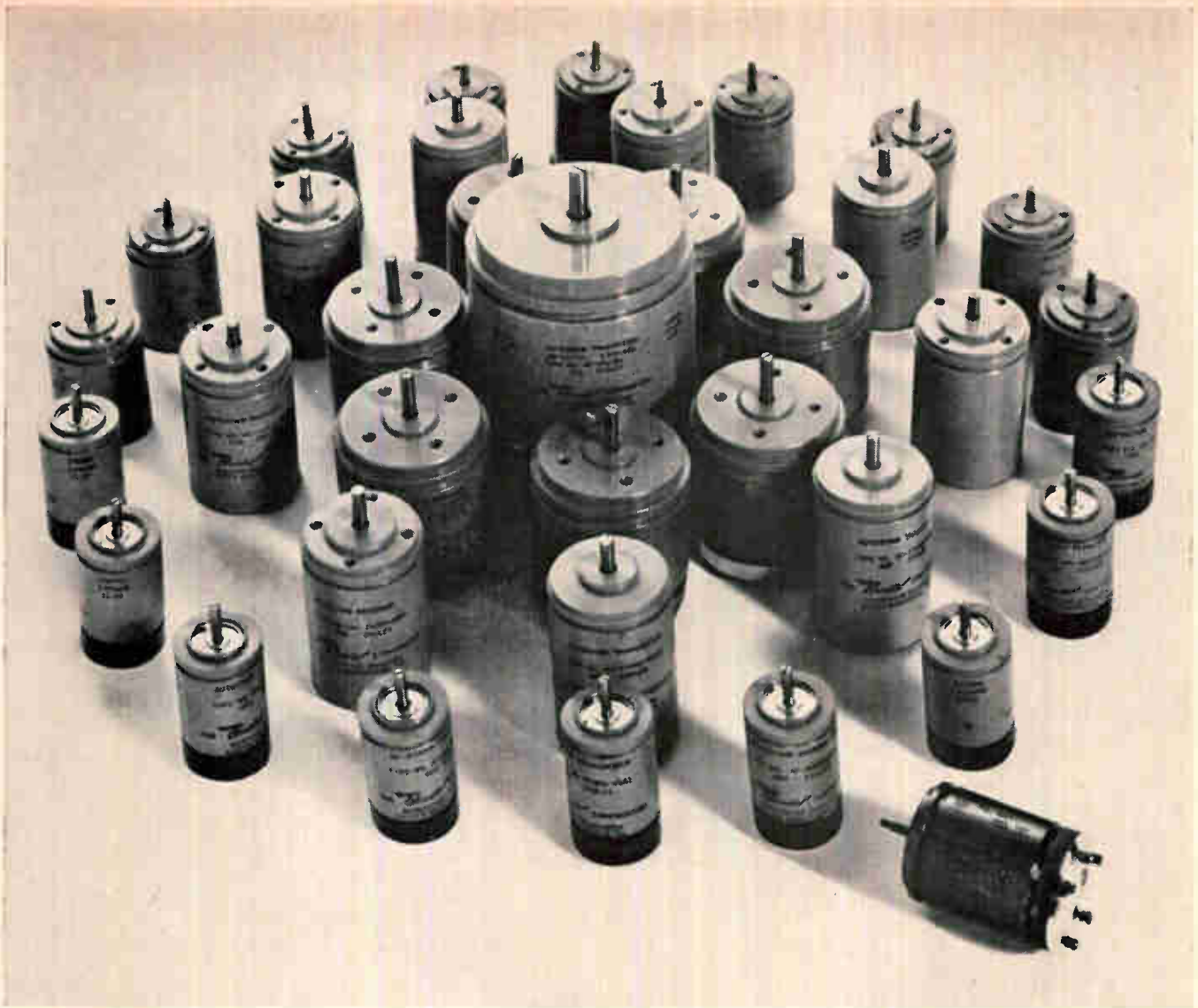

Just when we've solved your synchro problem, somebody comes up with a new one.

Designing and producing Autosyn[®] Synchronizers to fill the everyday needs of our customers isn't enough. We also specialize in meeting the unique need and solving your specific requirements.

Fact: engineers needed smaller, lighter-weight synchronizers for space-critical designs. Solution: the new series of 16 Size 08 Autosyn Synchronizers.

Fact: supersonic aircraft applications demanded synchronizers that could consistently operate at ultra-high

temperatures. Solution: eleven different Autosyn Synchronizers will perform accurately at temperatures up to 800°F.

Fact: we've built many of them to be corrosion- and radiation-resistant.

AUTOSYN[®] SYNCHROS

Size	Max. Diameter (In.)	Typical Weight (Oz.)	No. of Models
08	0.750	1.3	16
10	0.937	1.7	25
11	1.062	3.2	29
15	1.437	4.7	24
22	2.161	18	5

And we're able to provide synchronizers with tolerances as close as 50 millionths of an inch.

Meeting all needs has been our way of business since we began business in the 1920's. That's why the Bendix line of Autosyn Synchronizers (and Mil-Spec synchronizers) is the most extensive you can find. And it's why we're ready to solve your synchro problem. Try us. Phone (717) 278-1161, Montrose, Pennsylvania. Or write for our new 42-page catalog.

Montrose Division



we don't just make memories . . .

we solve storage systems problems

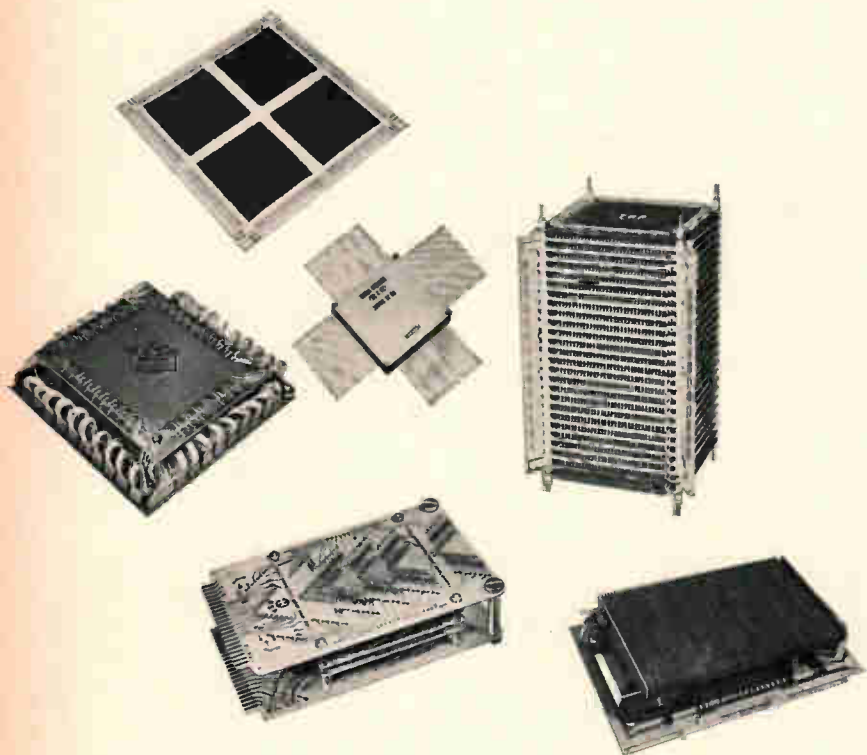
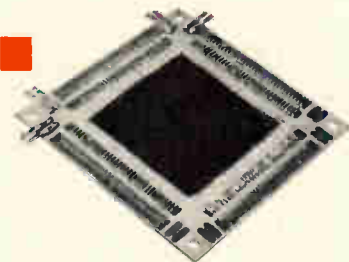

You get more than mere ferrite-memory manufacturing capability when you talk to Burroughs.

You get *experience*.

Experience in understanding what a systems designer's most exacting requirements are, and then meeting them. Experience in manufacturing that has made our facility *the best in the business, bar none*. Experience that goes well beyond just having a line of products for sale.

Here's what we make as *standard* products in our ferrite memory line:

Ferrite Cores: 20, 30, 50 and 80 mils: They're manufactured to the most rigid MIL and industrial specifications. They provide those very desirable qualities of low cost, high speed, and extreme uniformity—core after core after core.

Standard Memory Planes: They employ 20 or 30 mil cores on a 30 mil center. Two types are available:

- A quad-frame configuration providing a word capacity up to 16,384 words.
- A double-matted configuration providing a word capacity up to 4,096 words per side.

Both types employ either conventional cores or wide-temperature types. The latter provide operational reliability over a broad temperature range minimizing the need for costly temperature compensation.

Using these standard memory planes, we can then make Burroughs Stacks for virtually any coincident-current application you have in mind.

And if you can't find something in our *standard* line to fill your needs, we can probably help with a special order. Write or phone your nearest Burroughs Sales Representative, or use the inquiry card for complete information.



Burroughs Corporation

ELECTRONIC COMPONENTS DIVISION

PLAINFIELD, NEW JERSEY 07061

Technical Articles

Selecting the right digital voltmeter: page 84

Three types of digital voltmeter—ramp, integrating, and potentiometric—are widely used, but each has its limitations. Now a fourth type has been developed combining potentiometric and integrating techniques. It measures d-c voltages with high resolution, even with noisy inputs.

Automatic celestial guidance, part II: page 94

Although the principles of the electro-optical system have been worked out in detail, much must be done to develop hardware to implement them. Chief necessities are more versatile and accurate sensors and ultimately an optical computer to eliminate interface problems.

Using transistors to multiply and divide: page 109

Because a pn junction exhibits a logarithmic relationship between current and voltage, it can be exploited to perform multiplication and division just like a slide rule. These transistor circuits are simpler, more accurate and faster than other electronic means to compute analog functions. They are intended for equipment designs that require analog computation.

Integrated scratch pads sire new generation of computers: page 118

Electronics

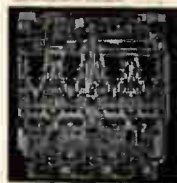

Scratch-pad memories for computers have been talked about for years, but used sparingly because they have tended to be expensive. Now a microelectronic scratch pad, containing eight bits of memory and their decoding networks on a single silicon chip, makes widespread use of such memories economically feasible. If many of the high-speed microelectronic memories are used, time-sharing becomes more economical. For the cover, art director Saul Sussman took negatives of the masks used to produce the IC's and created this stained-glass window effect of Signetics Corp.'s new eight-bit scratch pad microelectronic memory.

Coming April 18

- Some experiments with nonlinear optics
- Solid state circuits for color tv
- Protecting against surge voltages
- Power supplies for d-c converters

Selecting the right digital voltmeter

Three types of dvm's—ramp, integrating and potentiometric—are widely used, but each has its limitations. Now a fourth provides d-c measurements with high resolution, even when inputs are noisy

By Bill G. Kay

Loveland division, Hewlett-Packard Co., Loveland, Colo.

The ideal digital voltmeter—one that combines the lowest cost with high accuracy, resolution, sensitivity, stability, reading rate, superimposed and common mode noise rejection—just doesn't exist. Three basic techniques that enable a digital voltmeter to convert analog measurements to digital displays—ramp or slope, integrating, and the potentiometric or successive approximation—are widely used, but each has limited applications.

For example, the ramp type voltmeter is a relatively low-cost instrument, but is usually only accurate within 0.05%. If higher accuracy within 0.005% coupled with good stability is sought, the potentiometric technique is probably the most desirable—but its reading rate is low. And if a good reading rate combined with relatively high accuracy and good superimposed noise rejection is needed, then an instrument based on the integrating technique is the best but the most expensive.

Approaching the ideal is a new, relatively low-cost instrument that provides d-c measurements with high resolution, accuracy, stability, and reading rate even with noisy input signals. The instrument combines the potentiometric and integrating methods. This technique employs a voltage-to-frequency converter to achieve noise rejection, while its accuracy depends on the potentiometric method with its precision d-c power supply and resistive divider. Still, not everybody wants

this new type and the problem is which of the four kinds of digital voltmeter to use.

The ramp method

Digital voltmeters that utilize the ramp technique are in what can be considered the economy class of dvm's. These voltmeters measure the length of time it takes an internally generated ramp voltage with a precisely known slope, starting from a known level, to become equal to the unknown input voltage.

In a typical dvm of this type, the ramp voltage—shown in the diagram on page 85—is compared with two voltage levels: ground and the unknown voltage E_x to be measured. When the ramp voltage equals ground potential, the first comparator generates a coincidence pulse that opens the gate at time t_1 . The second comparator closes the gate when the ramp and unknown voltage coincide at time t_2 . The time $T = t_2 - t_1$ is proportional to E_x .

While the gate is open, a train of pulses from the fixed oscillator passes to decimal counters and the number of pulses counted during the gating interval is also proportional to E_x .

The relationship between the number of counts, N , entered into the counters and the gating time, T , with respect to the oscillator's fixed rate, R , is simply $N = RT$. Thus, the appropriate choice of ramp slope and oscillator frequency provides a direct readout in volts of the totalizing circuit. For example, a four-digit voltmeter might have a ramp slope $R = 60$ volts per second and an oscillator frequency of 600 kilocycles per second. With the dvm set on the one-volt range, if $E_x = 0.75$ volt, then $T = 0.75/60$ second, and the number of gated oscillator cycles— $N = RT$ —is 7,500.

Integrating dvm technique

Ramp type meters are usually limited in accuracy to within 0.05% by the accuracy of the com-

The author



Bill G. Kay has designed digital voltmeters since joining the Hewlett-Packard Co. in 1962. He is currently a digital-voltmeter project leader in H-P's Loveland research and development laboratory.

parators and the linearity of the ramp, and are subject to false triggering by input noise. The outstanding feature of an integrating dvm is its inherent capability to reject superimposed noise signals without an input filter. Generally a filter is undesirable because its response time tends to degrade the instrument's maximum reading rate; and in instruments of high resolution, the filter capacitors can act as high impedance voltage generators after removal of an input voltage as a result of dielectric polarization, degrading the voltmeter's accuracy by adding a small d-c component to the next input signal to be measured.

The integrating voltmeter measures the true average of an unknown voltage over a specific time interval. The ramp type instrument measures the voltage itself at the end of a time interval. In most integrating meters, the unknown voltage, E_x , is first converted to a frequency—as shown in the diagram on page 86—then the frequency is counted over a fixed time interval. The simple relationship, $N = RT$, is still valid except that now the rate R , rather than the time T , is proportional to the unknown voltage E_x .

Eliminating noise

How the voltmeter integrates an input signal and thereby averages out noise signals, can be demonstrated with the aid of the graphs on page 86. Consider the case where the unknown voltage E is a sine wave with a period equal to the fixed gate time T .

The choice of starting time t_0 relative to $E_x(t)$ is inconsequential. The frequency generated by the voltage-to-frequency converter is proportional to the instantaneous input voltage. Thus at t_0 , the frequency of the converter output is zero, and at t_1 and t_3 , the frequency is highest. A graph of N , the total count stored in reversible decade counters, is shown in the lower figure on page 86. Between t_0 and t_1 the instantaneous output frequency increases as $E_x(t)$ becomes larger. Hence, the slope of N as a function of time continually increases. Between t_1 and t_2 , the rate of increase of the converter frequency declines until it is zero at time t_2 [$E_x(t_2) = 0$]. During this period N continues to increase, but its slope decreases until it reaches zero at t_2 . At t_2 , N is proportional to the average value of $E_x(t)$ over the first half of its period; thus $E_x(t)$ has been integrated over the period t_0 to t_2 . If the instrument is capable of observing the polarity change at the time t_2 , and is equipped with reversible counters, then the integration may continue from time t_2 to t_4 . With reversible counters, N at t_4 will be exactly equal to zero since the above steps are repeated with N now being decreased over the interval t_2 to t_4 .

The attenuation versus frequency characteristic of the integrating type digital voltmeter is shown in the upper figure on page 87. Note that infinite input attenuation exists for the frequencies $= \frac{m}{T}$ where $m = 1, 2, 3, \dots \infty$. The previous example, in which

$m = 1$, can be extended to the case of $m = 2$. Here, two cycles of the input signal will be completed during gate time T and the net count will again be zero. This can be used to reject a specific a-c input signal by properly choosing T .

Usually the largest noise component present at the input terminals of the voltmeter will be at the line frequency. If the gate time T is chosen to be $n/60$ seconds ($n = 1, 2, \dots \infty$), the instrument will reject signal components which contain the 60-cps line frequency and its higher harmonics.

Increased sensitivity

The inherent noise rejection of the integrating voltmeter has one other very good use. Note in the graph on page 87 that as T is increased, the lower frequencies are attenuated by a larger amount. The net result is that the effective noise bandwidth of the voltmeter is smaller for longer T . Thus, at low frequencies down to d-c, the noise always present in the input circuitry is effectively reduced, making it possible to increase the sensitivity of the instrument.

For example, a voltmeter might have $T = 1/60$ second and an inherent amplifier noise of 10 microvolts over the resulting effective noise bandwidth. The ultimate lower limit on the instrument's sensitivity is therefore 10 microvolts. If T were increased to $1/6$ second, the amplifier noise over the reduced effective noise bandwidth might reasonably be expected to decrease to four microvolts.

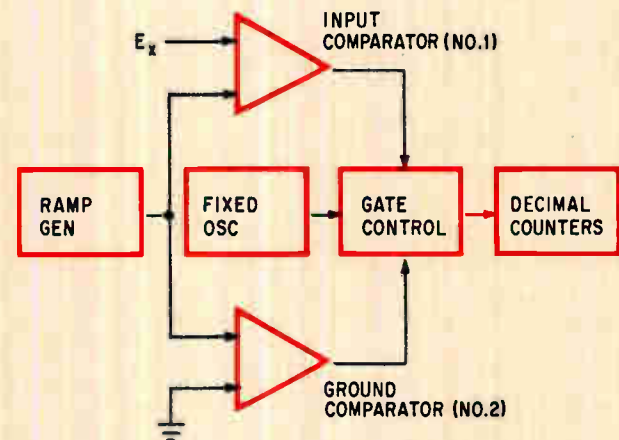

D-c voltage is measured with ramp technique by counting the number of cycles allowed through the gate during the time ($T = t_2 - t_1$) the ramp voltage requires to increase from ground to the unknown voltage E_x .

This is the technique used in integrating digital voltmeters to resolve low-level signals in the microvolt region, at the sacrifice of reading rate.

The ramp technique has an attenuation versus frequency curve similar to that shown on page 87. However, since T is proportional to the unknown input signal, the cusps of infinite rejection are not fixed with respect to frequency. Thus the ramp technique cannot easily be used to integrate out, or reject a specific a-c input signal.

Although the integrating technique itself places no limit on reading rate, the limitations of the voltage-to-frequency converter and the selection of the cusps of infinite rejection do.

To reject noise signals at line frequency, T is chosen to be at least $1/60$ second. This means that if no dwell time is required between readings for such operations as resetting the range, the maximum possible reading rate is 60 per second. Some three- and four-digit integrating voltmeters approach this rate, but in a five-digit instrument the reading rate is usually considerably slower because of the voltage-to-frequency converter's limitations. The outputs of typical voltage-to-frequency converters are 500 kc or less because of cost and linearity problems.

The maximum reading rate of a given instrument can be determined from the basic formula, $N = RT$. For a 5-digit instrument, a full-scale indication is equivalent to $N = 10^5$ counts. Thus if $R_{max} = 500$ kc, then $T = 10^5/5(10^5) = 1/5$ second. This implies that the maximum reading rate for the 5-digit instrument is 5 readings per second.

From the equation $N = RT$, the accuracy of the integrating instrument is obviously dependent upon the accuracy of both T and R . T may be controlled with great precision by using a crystal time base; essentially then, the accuracy of the instrument depends on R .

The ideal and realizable transfer curves for a typical voltage-to-frequency converter are shown on page 87. A detailed discussion of why the curves differ is beyond the scope of this article, but the linearity of a voltage-to-frequency converter becomes more difficult to control as frequency is increased, and the cost of building a converter rises rapidly as the maximum frequency output increases. Converter nonlinearity and stability are formidable design problems.

Successive approximation

The potentiometric or successive approximation technique is quite different in concept and implementation from the two methods already described.

Digital voltmeters of this type use a precision d-c power supply with a resistive divider to null out the unknown input voltage. As shown in the diagram on page 88, the resistor divider is controlled by a logical programmer to quantize the output of the power supply. The discrete increments of voltage thus created are applied to a comparator amplifier whose other input is the unknown voltage, E_x . The amplifier output serves as the input for the

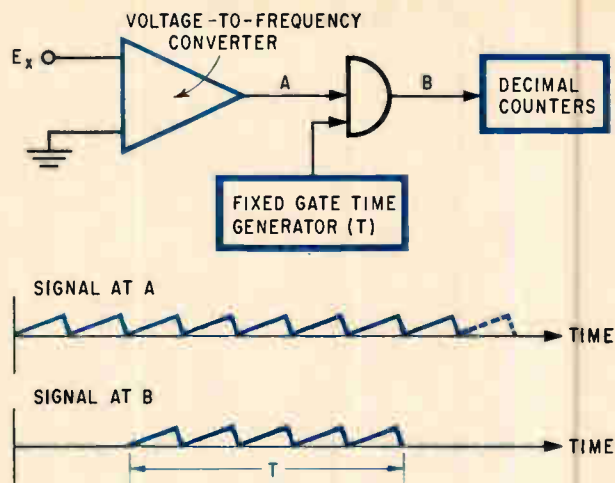

In an integrating dvm the time interval, rather than the frequency, is fixed. The unknown input voltage is converted to a proportional frequency, which is counted for a fixed period.

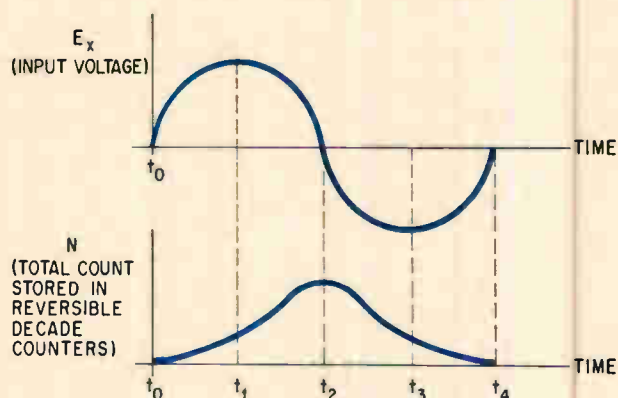

Integrating dvm has high immunity to noise since a-c signals are averaged out by reversible decade counters in the instrument. The number of counts builds up during one-half the sine wave. But during the second half of the cycle, the counts are subtracted. The net count is zero.

logical programmer, which drives the resistor divider in a prescribed sequence, adding or subtracting more voltage increments to null out the unknown input signal. The final setting of the divider can be sensed logically by determining whether the individual resistors are connected to ground or the reference supply. This simple code is then converted to decimal information that can be displayed.

Both the accuracy and stability of a potentiometric instrument depend upon the d-c reference supply and the resistive divider. Both the stability and temperature coefficient of the reference diodes or standard cell contribute to inaccuracies in the reference supply. As a result, the critical components associated with the supply are usually placed in an oven whose temperature is accurately controlled. The divider is generally constructed of precision wire-wound resistors. The linearity of the quantized output from the divider and the stability of this system are much more easily controlled than the linearity and stability of the voltage-to-fre-

quency converters used in integrating dvm's.

Design compromises

Certain compromises must be made in the design of the potentiometric digital voltmeter. The primary compromise involves a trade-off between reading rate and superimposed noise rejection. The reading rate is limited by the rate at which the reference voltage may be quantized and compared to the unknown. It is not unrealistic to effect reading rates of 10,000 readings per second. However, without an input filter, the potentiometric instrument has no noise immunity at all because only the unknown d-c signal is nulled out by the resistive divider output. Thus, as soon as the total superimposed noise is greater than the minimum voltage increment generated by the divider, the sensitivity, resolution, and hence the accuracy of the instrument are degraded. Since very few unknown signals are noise free, an input filter is almost always used in a five-digit potentiometric instrument. The response time of the filter then lowers the reading rate considerably.

A potentiometric voltmeter with a five-digit display accurate within 0.01% of reading, has a reading rate of five per second with a filter on its input. How well does the instrument reject superimposed noise, particularly at line frequency, and how much superimposed noise can be tolerated before the accuracy of the instrument is significantly degraded?

In a five-digit instrument, the least significant digit represents a resolution of 10 parts per million. Thus, a signal with superimposed noise equal to 0.001% of full scale that reaches the input of the comparator amplifier will cause a one-count deviation in that digit.

Even so, jitter in the least significant digit is not the major limitation since the instrument's accuracy is not degraded significantly. The most important criterion is when an abrupt change or step in the d-c voltage occurs, the filter's response time must be fast enough so that within the time allotted for one reading, the error due to the filter is less than the rated instrument error of 0.01%. This is a rather idealized situation since the entire 200 milliseconds is not available to the filter because of the digitizing time in the instrument.

Most potentiometric dvm's use RC filters with up to three poles—frequencies at which the filter impedance is infinite. For example, an RC filter with three identical poles results in the maximum rejection of noise signals at the line frequency. Analysis of such a filter's performance with a step input, using Laplace transform analysis, shows that the filter must have a pole frequency of about 11.2 cycles per second to meet the basic accuracy requirement of a reading rate of 5 per second. Attenuation of the superimposed noise at 60 cps is calculated to be 44 decibels. This attenuation can be increased slightly more, without changing the other response characteristics, with a more sophisticated filter, one that has more poles.

Glossary of terms

Resolution—The smallest increment of a variable that can be read without ambiguity.

Sensitivity—The minimum signal to which an instrument will respond. For example, a dvm set for a full-scale range of 1.00000 has a sensitivity of 10 microvolts.

Stability—The ability of an instrument to maintain a constant error as a function of time and/or environment.

Reading rate—The rate at which an instrument is capable of performing continuous independent measurements and display them.

Superimposed noise rejection—The degree to which an instrument rejects unwanted signals in series with the unknown input voltage.

Common mode noise rejection—The ability of an instrument to reject unwanted signals caused by unbalanced voltages between input terminals and ground.

The amount of superimposed line-frequency noise that can be tolerated without significantly degrading the instrument's accuracy is more difficult to ascertain. Because the error is specified as 0.01% of reading, for a full-scale reading of 100,000, 0.01% error is equivalent to 10 counts in the least significant digits. However, for a reading that is one-tenth of full scale—for example, 10,000—0.01% error is equivalent to one count in the least significant digit.

For ease of calculation, assume the line fre-

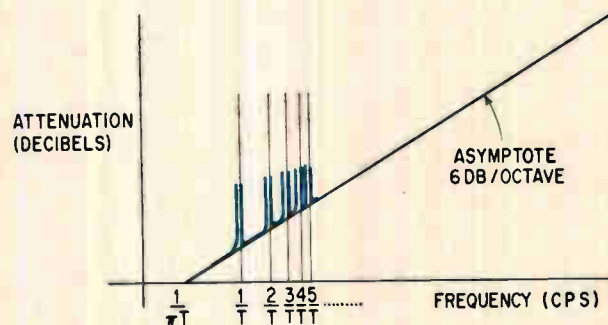

Infinite attenuation exists for those frequencies that are multiples of the integrating dvm's period, 1/gate time. The gate time is therefore chosen to give the greatest possible rejection of the 60-cps line frequency.

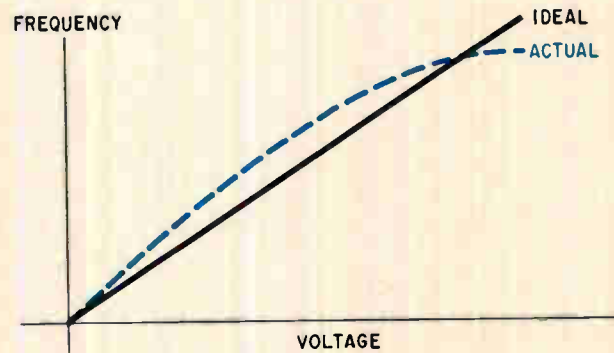

Large source of error in integrating dvm's occurs because voltage-to-frequency converter characteristic curve is not perfectly linear.

quency is attenuated by 46 db. In this case, if the peak value of the superimposed 60-cps noise signal is 2% of full scale it will yield a jitter of 10 counts in the display. The magnitude of the 60 cps signal must be less than 0.2% of full scale to prevent more than one count of jitter in the display. This can be overcome if the reading rate is reduced and a large filter is used. What is left is a technique that allows d-c voltages to be measured accurately and has excellent long-term and environmental stability. But a technique in which the speed of operation must be greatly sacrificed to maintain accuracy and resolution in the presence of superimposed noise.

Best of two methods

A new method, the potentiometric/integrating technique, combines many of the advantages of its two namesakes while eliminating some of the more objectionable weaknesses, and at a cost competitive with either system.

The potentiometric/integrating technique combines integration with successive approximation to achieve a fast, highly accurate, stable system that is capable of rejecting superimposed noise signals. The new approach to voltage measurements is employed in the Hewlett-Packard Co.'s 3460A digital voltmeter. A simplified block diagram is shown on the next page. Each reading consists of two approximations or samples of the unknown voltage and two transfer periods.

At the beginning of the reading, a one-millisecond delay is introduced during which all the timing circuits are set and the reversible decade counters set to zero. Thus when the first sample is initiated, the stored count in the decade counters is zero and the output voltage of the programable resistive divider-precision d-c supply is zero. Initially, the unknown voltage E_x is applied directly across the terminals of the voltage-to-frequency converter. The converter's output frequency which is proportional to E_x , is transformer coupled through the

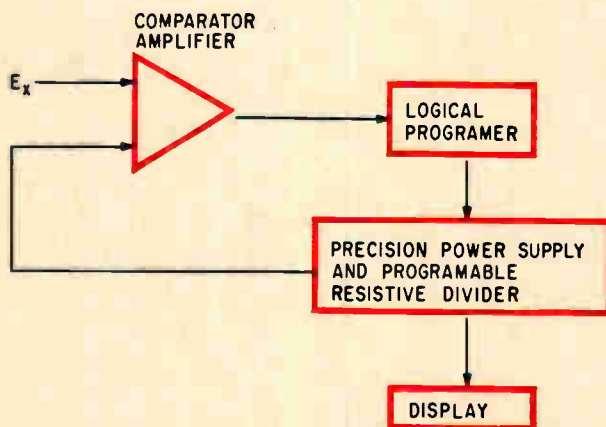

Potentiometric dvm uses comparator amplifier to drive a logical programmer. The programmer in turn adjusts a precision power supply and resistive divider to null out the unknown voltage at the comparator's input. The final setting of the divider in code form provides a readout of the input voltage.

guard to the logic section of the instrument. No counts are entered into the decimal counters until the gate time generator and the sample 1 timing signal coincide, opening gate 1 and allowing the transformer-coupled pulses to pass through the gate into the fourth decade counter. The counts are entered into the decades until the fixed gate time T has passed.

The count in the four most significant decade counters at the end of the first sample period represents a measurement of the unknown voltage within 0.3%, or three counts of error in the fourth digit. This error consists of a possible logic error of ± 1 count, and the combined error of the voltage-to-frequency converter and gate generator, on the order of 0.1% or one count in the fourth digit. The count stored in the four decades is retained during the remainder of the reading cycle but is not displayed until after the second sample period during which it will be corrected.

The transfer period occurs immediately after the first sample period is completed. During the transfer time, the counts stored in the four decades are used to quantize the reference supply voltage inside the guard. The information is relayed from the counters to the resistive divider through the guarded reed-relay switches. The conversion accuracy of the resistive divider-reference supply is typically within 0.0015%, and its quantized output opposes the unknown voltage applied to the terminals of the voltage-to-frequency converter.

At the beginning of the second sample period, the output frequency of the voltage-to-frequency converter is proportional to the difference voltage across its input terminals. The gate generator and the sample 2 timing signals allow the transformer-coupled pulses to enter the more significant decades. The count is allowed to overflow from the fifth into the fourth decade to correct the error of the first sample as necessary. Because the error of the first sample reading may be either positive or negative, logic circuitry determines the polarity of the difference voltage relative to the unknown voltage. The circuitry also determines whether the pulses from the voltage-to-frequency converter during the second sample period are to be added to or subtracted from the original approximation of the unknown voltage.

The second transfer period takes place at the end of the second sample. Its duration is adjustable from the front or rear panels of the instrument. During this time, the final count in the five decades—plus six digit overrange—is transferred to the in-line digital display tubes on the front panel, and a print command is issued to permit accumulation of the stored count by an external digital recorder. The instrument has now completed one reading.

Still not perfect

An analogy may be drawn between the system just described and a measurement scheme that uses an inaccurate voltmeter and an errorless pro-

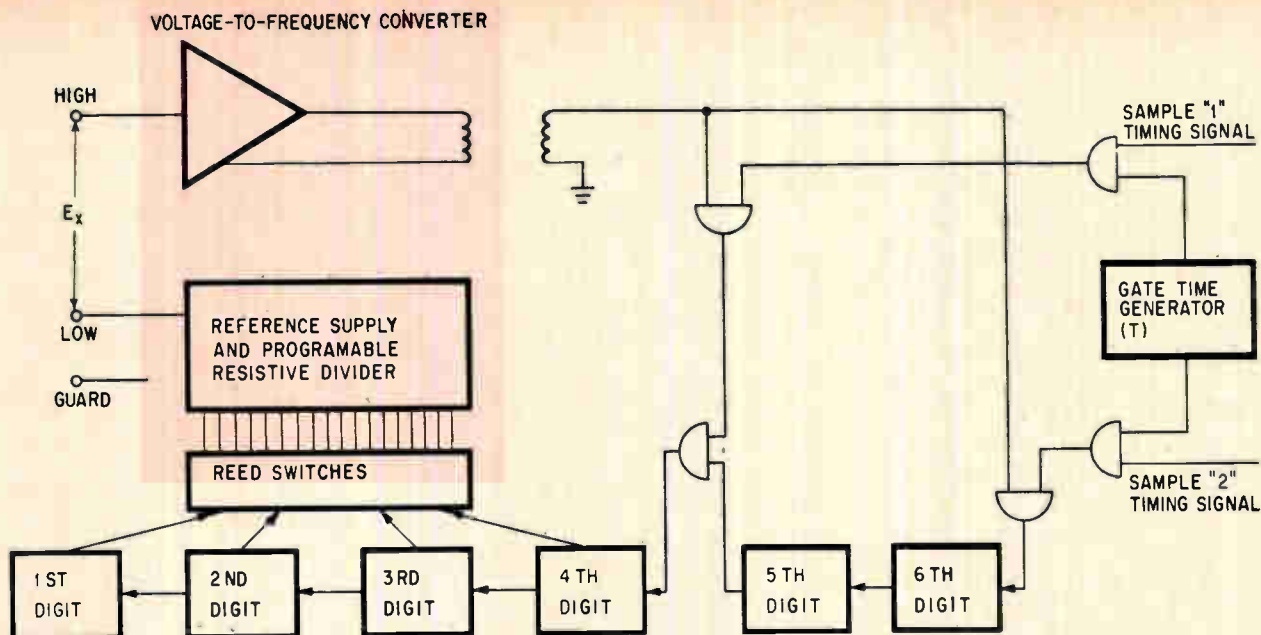

Potentiometric/integrating digital voltmeter combines the noise immunity of the integrating technique and the accuracy and stability of the potentiometric method. Two samples of the unknown voltage are made: the first results in a measurement accurate to approximately 0.3% and sets the programmable reference supply to this reading. The second sample measures the difference between the unknown and the first sample. The two measurements are then added and displayed on decimal counters.

gramable power supply.

For example: a voltmeter that reads low by 1% and a perfect programmable power supply are to be used to determine an unknown voltage E_x to within 0.01%. At the first measurement, the voltmeter reads low by 1%; this initial measurement is equal to $0.99 E_x$, which is not within the desired accuracy. The programmable power supply is then set to $0.99 E_x$, and the output of the supply is used to "buck" E_x . The difference is $0.01 E_x$. Since the voltmeter is still 1% low, the second measurement equals $0.01 E_x - (0.01)0.01 E_x$, or $0.0099 E_x$. By adding the two approximations, the final reading, $0.9999 E_x$ is obtained and is accurate within the desired 0.01%.

While this technique may, in a broad sense, be called successive approximation, it differs from the technique used by successive approximation voltmeters in that the power supply in the example was programmed to exactly the voltmeter reading. In the successive approximation voltmeter, E_x is approached by quantizing the power supply voltage and then by deciding logically whether E_x was large or smaller than the bucking voltage.

In the HP 3460A, the voltage-to-frequency converter and time base, which alone constitute a truly integrating voltmeter, are analogous to the inaccurate voltmeter of the previous example; the reference supply-resistive divider combination is the equivalent of the ideal power supply. In the example, the error contributed by the voltmeter to the final reading was simply the voltmeter error squared—the 1% voltmeter with two samples yielded E_x to within 0.01%. Similarly, if the

voltage-to-frequency converter and time base are accurate to within 0.1%, then with a two-sample technique, the error of the final reading due to the voltage-to-frequency converter and time base is only 0.001^2 or 0.0001%. This represents one-tenth of one count in the least significant digit of the instrument. Thus the accuracy of the voltage-to-frequency converter and the time base need not be as closely controlled as in the basic integrating technique.

The instrument's accuracy is determined primarily by the reference d-c power supply and the resistive divider which has a typical conversion error of 0.0015% of reading. This error is not reduced by the multiple sample technique as in the basic potentiometric technique. As a result, its error and the possible logic error in the sixth digit represent the accuracy limit of the instrument.

The voltage-to-frequency converter achieves superimposed noise rejection, but its performance requirements have been drastically reduced by the new techniques involved. First, its accuracy is now of secondary importance. Secondly, the maximum frequency output of the converter may be quite low without appreciably affecting the instrument's reading rate. As shown previously, a voltage-to-frequency converter capability of 500 kc with a gate time of 1/60 second enabled a five-digit integrating voltmeter to read at a rate of five readings per second. With the new technique, the voltage-to-frequency converter is never asked to fill more than three decades—plus a 20% overrange—during a given sample period. Thus the converter needs only to operate linearly up to 72 kc with a gate

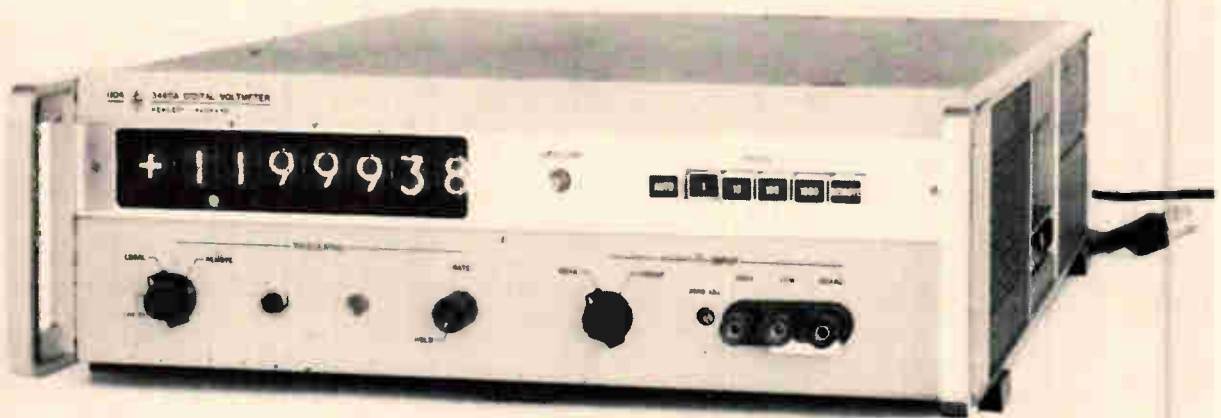

Latest in H-P line of digital voltmeters is model HO4-3460A. The meter extends basic potentiometric/integrating technique and results in instrument with a resolution of one part per million and a sensitivity of one microvolt.

time of 1/60 second to achieve an instrument reading rate of 15 readings per second. Because of the reduced requirements of the converter, its cost is considerably lower than a similar instrument employing the basic integrating technique.

Limit on superimposed noise

The only compromise concerning the voltage-to-frequency converter pertains to the magnitude of superimposed noise that may be applied to its terminals. Even though a 60-cps noise signal may be completely rejected by the converter, the magnitude of that signal could not be increased indefinitely. The limit on the magnitude of superimposed noise is established as follows: during the second sample period, the voltage-to-frequency converter has the d-c difference voltage between the unknown input and the reference supply's output applied to its terminals. However, the unattenuated superimposed noise signal also is applied to it. Unlike the basic potentiometric digital voltmeter, the difference voltage may be smaller than the noise without a loss of instrument accuracy as long as the noise is properly integrated. If the noise signal becomes too large, however, the required frequency out of the converter exceeds the maximum design frequency and the converter becomes non-linear. The compromise that must be made is a trade-off between the cost of the converter and its maximum frequency output with respect to the noise handling ability of the instrument. In the HP 3460A, the maximum allowable magnitude of the superimposed noise has been chosen to be 6% of full scale.

Just how much superimposed noise a voltmeter should be capable of handling cannot be stated with certainty. Application may range from the measurement of a noise-free standard cell voltage

to an aircraft engine test measurement where noise may exceed 100% of full scale. In addition to the basic problem of how much superimposed noise may exist, there is always the possibility of large common mode signals being present. Although a fully guarded instrument is able to reject common mode noise signals of up to 500 volts, a great deal of confusion exists about how to properly use the guarding capability. Consequently, what often appears to be superimposed noise in a test set up is, in reality, a common mode signal that could be eliminated by the proper use of the guard.

New breed emerges

The new potentiometric/integrating technique lends itself to the development of a new breed of digital voltmeter—the full six-digit instrument, with seventh digit overrange, that is capable of making highly accurate measurements with a resolution of one part per million at a relatively fast reading rate.

One more significant digit is added and the gate time T for the second sample period is increased. By increasing T , the maximum rate of the voltage-to-frequency converter need not be increased since the time required to fill the seventh decade can automatically be accounted for. Also, by increasing T , it is possible to take advantage of the resulting effective noise bandwidth reduction that occurs in integrating voltmeters as the gating time is increased. Thus, it is quite possible to measure and read one volt with a resolution of one part per million and a sensitivity of one microvolt.

This extension of the basic technique has been incorporated into the Hewlett-Packard HO4-3460A voltmeter shown above. In addition to having high resolution, the new meter is accurate within 0.002% of reading. It is a fully guarded instrument with high common mode noise rejection—160 decibels.

Designer's casebook

Designer's casebook is a regular feature in Electronics. Readers are invited to submit novel circuit ideas, packaging schemes, or other unusual solutions to design problems. Descriptions should be short. We'll pay \$50 for each item published.

Overload protection for d-c amplifier

By Leander Payerl,
Visolux-Electronic GmbH, Berlin

In spite of the loss which occurs, a high series resistance is often included in a d-c amplifier to protect it in the event of an overload. In the d-c amplifier circuit at the right however, an electronic fuse switches the high series resistance R_3 into the circuit only when an overload or short circuit actually occurs. This circuit restores the full output voltage immediately after the short circuit or overload is removed.

During normal operation, there is only a small resistance in the load, formed by R_2 and the collector-emitter resistance of Q_2 . In this state the voltage drop across R_2 is less than the turn-on base-emitter voltage of Q_1 . Hence, Q_1 and Q_4 are off, and Q_2 is on, shunting R_3 .

If I_{out} increases beyond a certain level because of short circuit or overload, the voltage drop across R_2 increases and Q_1 turns on. Simultaneously, transistor Q_4 turns on and zero-biases the base of Q_2 . This cuts off Q_2 so that R_3 limits the current.

Switching will occur when $I_{out}R_2 \geq V_{BE1}$. In this

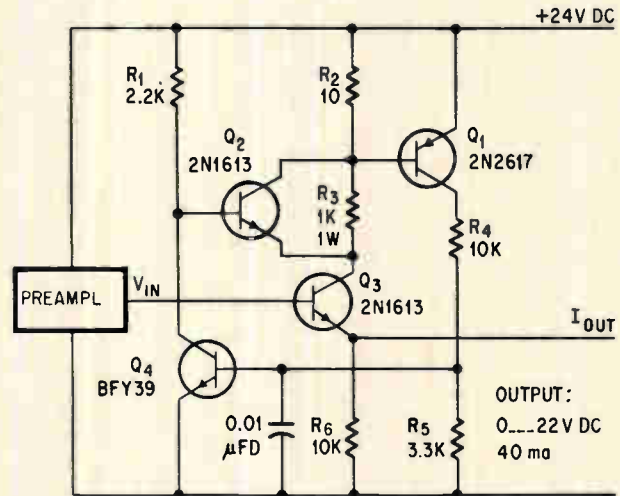

Electronic fuse in d-c amplifier cuts in high series resistance R_3 when there is an overload or short circuit and bypasses R_3 instantly when they are removed. All resistors 0.5 w unless otherwise specified.

circuit, maximum output current is 40 milliamperes.

When Q_2 turns off, voltage R_2 may decrease enough to turn off Q_1 . This circuit will thus oscillate at an amplitude and frequency determined by R_3 until the fault is removed. In the circuit shown, the amplitude of the oscillation is 1.5 volts peak to peak; its frequency is about 250 kc. The base of Q_4 is shunted by a small capacitor to prevent oscillations that might be excited by fast load changes.

Latching gate removes counter ambiguity

By Roy A. Wilson
Hycon Manufacturing Co. Monrovia, Calif.

Clock pulses being gated into a register require positive gating action to avoid putting an extra count into the register. The ordinary diode gate provides this positive gating action with the addition of a silicon controlled rectifier.

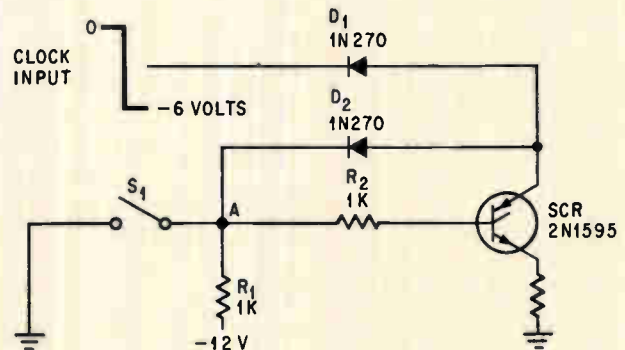

Adding latching feature to diode gate allows output to follow clock input when S_1 is closed. When S_1 is opened, output will be fixed at existing clock level.

The latching gate on page 91 allows the output to follow the clock input when S_1 is closed and, after S_1 is opened, the output remains indefinitely at the level of the clock input at the time the switch opened.

Closing of switch S_1 grounds point A; this forward-biases the gate-to-cathode terminals of the scr every time the clock input is at -6 volts. When the clock returns to zero, the scr has no voltage across it and thus turns off.

If S_1 is opened during the time the scr is off the

output will remain at zero as long as S_1 remains open. This is because point A is now at -12 volts, precluding any possibility of the gate becoming forward-biased.

If S_1 is opened when the scr is conducting, the output will remain at -6 volts. Opening of the switch applies -12 volts to the scr cathode through R_1 and D_2 . This reverse-biases D_1 , maintaining the voltage across the scr. The scr will continue to conduct and maintain the output at -6 volts until S_1 is again closed.

Delay circuit varies turn-on, turn-off

By Cruz R. Mora

North American Aviation, Inc., Downey, Calif.

Turn-on and turn-off delays, independently and continuously variable, are achieved with the four-stage circuit shown below. Both input and output delays are variable from 1.5 to 1500 milliseconds; a limitation on the maximum turn-on delay is the duration

of the input pulse, which it can never exceed.

An input voltage of 28 volts d-c is applied to the turn-on delay circuit, a relaxation oscillator. The turn-on time for the unijunction transistor Q_1 is set by adjusting R_1 , which controls the charging rate of C_1 . As C_1 is charging, the emitter voltage of Q_1 rises exponentially towards the supply voltage. When the emitter voltage reaches its peak, the emitter becomes forward biased, providing a discharge path for C_1 and briefly turning on Q_1 . The resulting voltage pulse across R_4 is coupled through D_3 , to the gate of SCR_1 . This turns on SCR_1 , resulting in a voltage drop across R_{11} which provides forward bias to Q_4 . In turn, Q_4 provides forward bias to Q_5 turning it on. The resultant output volt-

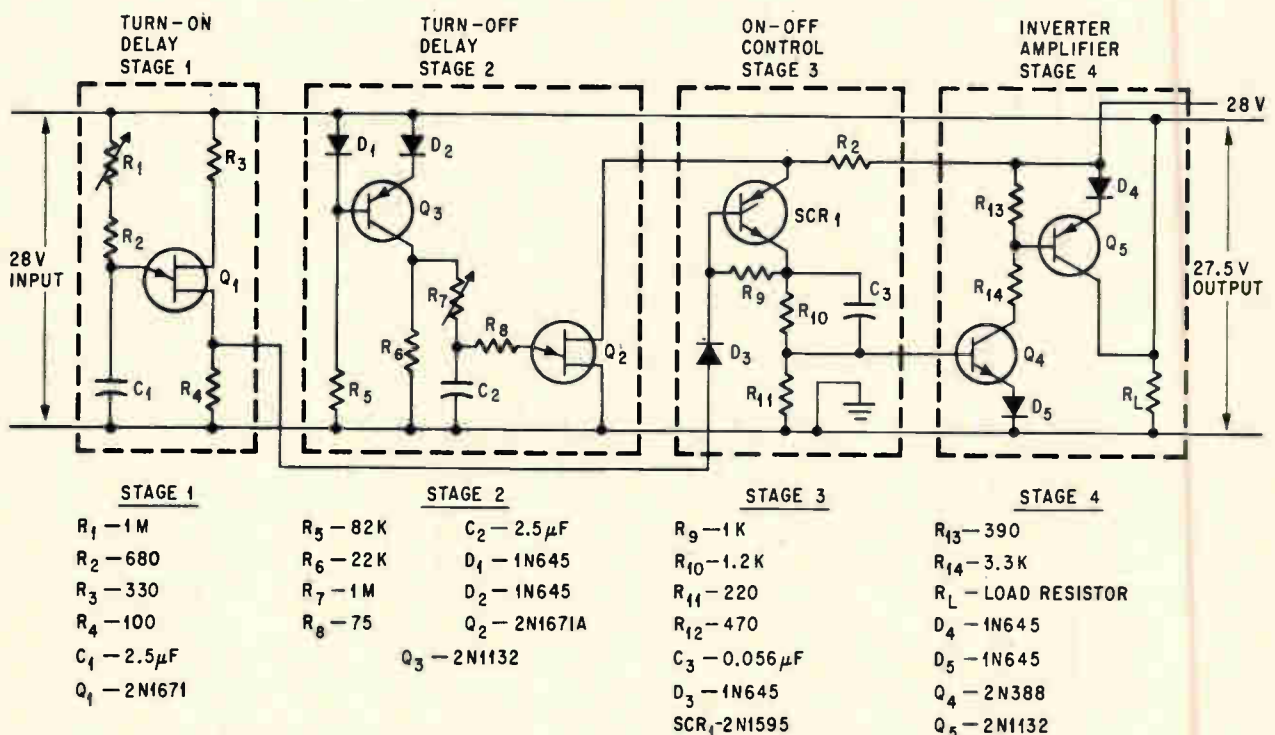

Increasing time constants R_1C_1 and R_2C_2 , in conjunction with unijunction transistors having higher intrinsic stand-off ratios, increases possible time delays up to four minutes. See pulses at top of page 93.

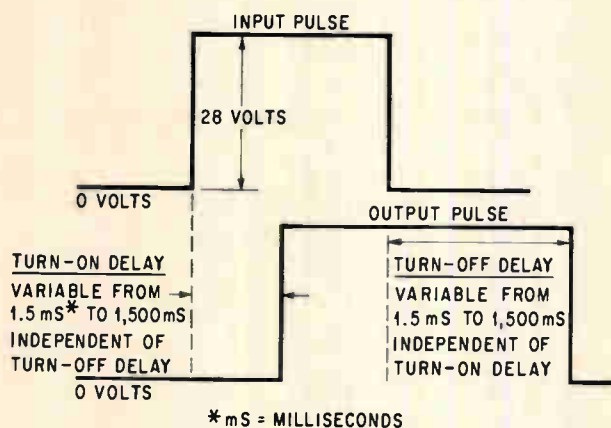

Time delay capabilities of the circuit are represented by the pulses. The maximum input delay is limited by the width of the original pulse.

age across R_1 , is slightly less than 28 volts because of voltage drops across D_1 and Q_3 .

The turn-off operation is started by transistor Q_3 . While the input voltage is present, the collector of Q_3 is at nearly zero volts and almost all the input voltage appears across R_5 . When the input voltage drops to zero, Q_3 turns on and a voltage of about 25.5 volts appears across R_6 . The turn-off delay time is controlled by the setting of R_7 which governs the charging rate of C_2 . When the peak emitter voltage of Q_2 is reached, C_2 discharges, turning Q_2 on. The conduction of Q_2 connects the anode of SCR_1 to nearly ground potential; at the same instant, the cathode of SCR_1 is above ground potential because of the charge on C_3 . The reverse bias on SCR_1 simultaneously turns it off and also Q_3 and Q_4 off.

Transistors control small d-c motor

By James B. Tiedemann

University of Kansas, Lawrence, Kan.

A versatile transistor servo-control circuit combines the functions of a rectifier and a power amplifier while providing directional control of a small direct-current motor.

The direction of the motor's rotation B is determined by the polarity of the input signal. This input, or error signal, provides the base current to turn on Q_3 or Q_4 . These transistors in turn supply the base drive for either Q_1 or Q_2 . Current from the six-volt transformer will drive the motor in either direction, depending on which of the p-n-p power transistors, Q_1 or Q_2 is conducting.

Input impedance and sensitivity are determined by resistors R_1 and R_2 . They must be large enough to prevent excessive base current in Q_3 and Q_4 at the highest input-signal level anticipated. A value of 1,000 ohms will cause a typical six-volt motor to start with a one-volt signal. If the source is not limited by current, Q_3 and Q_4 can be protected without sensitivity loss with zeners at D_3 and D_4 .

A six-volt, d-c motor, such as a Pittman DC85A-6, requires several hundred milliamperes for reasonable power output. Rectifiers D_1 and D_2 and transistors Q_1 and Q_2 should therefore be capable of handling at least 750 milliamperes. Because the

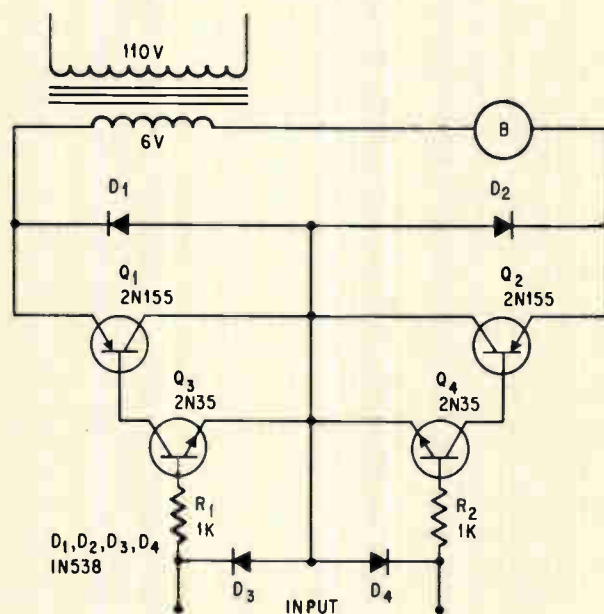

Six volt d-c motor B is energized by rectified voltage from filament transformer T_1 . Motor's direction of rotation is controlled by the polarity of the input signal which determines whether Q_1 or Q_2 is conducting.

grounded collector configuration of Q_1 and Q_2 provides a high base impedance, control transistors Q_3 and Q_4 and rectifiers D_3 and D_4 need only handle a few milliwatts of power. An ordinary filament transformer, with a secondary current rating of one ampere, is satisfactory for T_1 . Heat sinks are not required unless sustained operation at full power is required. A center-tapped battery and potentiometer can be used as the signal source.

Automatic celestial guidance, part 2: new challenge to designers' ingenuity

An electro-optical system for space flight has been proven out in principle. Still needed are further advances in microelectronics, and computers that work directly with optical data

By Robert L. Lillestrand, Joseph E. Carroll and James S. Newcomb

Control Data Corp., Minneapolis, Minn.

Early on the bitter-cold morning of Dec. 1, two busy silhouettes could be seen on the roof of the Control Data Corp.'s Government Systems laboratory near Minneapolis. Below, in a warm and comfortable computer room, three men were watching data coming through, culminating five years' work.

The five researchers were demonstrating a new

concept for space systems: celestial, in place of inertial, guidance. Randomly pointing a sensor at the sky, they succeeded in obtaining position and attitude measurements accurately from the stars, without the need for an external reference or any previous assumptions about orientation. The men on the roof were George Zenk and Robert Willey, electronics specialists.

The experiment showed further that the system could provide its accurate measurements rapidly, on-line, eliminating the need for gyroscopes in travel beyond the earth's atmosphere. By adding a strapped-down gyro to the already strapped-down celestial sensor, the range of applications to guiding a vehicle's ascent and descent can undoubtedly be extended.

The principles of this system, described in the first part of this article [Electronics, March 21, p. 115], are now well established. Results of the rooftop experiment are described in detail on page 103. Still needed, however, are final versions of the hardware that can implement these principles. The hardware consists chiefly of two pieces of equipment: a three-axis attitude sensor (TAAS) that can perform many measurement and control tasks in space, and a small but fast computer.

The electro-optical sensor

Celestial guidance, the ultimate successor to inertial guidance for space applications, is achieved in four steps: attitude detection, attitude control, navigation and guidance. For the most general problem, the system operates with 24 unknowns—12 for measurement and 12 for control—as shown in the table below the chart on page 95; the chart gives more detailed descriptions of various applica-

The authors



Robert L. Lillestrand is CDC's staff specialist for aerospace research. He is a member of the Committee on Guidance and Control of the American Astronautical Society.



Joseph E. Carroll specializes in mathematical studies of satellite and interplanetary navigation systems. He holds a master's degree in physics from the University of Minnesota. He is a senior research scientist.



James S. Newcomb was responsible for the mechanical design and construction of the three-axis attitude sensor. He has a master's degree in physics from Brown University, and is a senior research scientist.



Celestial guidance for various space operations. For attitude control, top left sector, TAAS controls local vertical without horizon sensors if its orbit is known; upon completion of maneuver, realignment will carry optical axis of disk-shaped vehicle to local vertical. TAAS can also control yaw orientation relative to the orbit plane. Surveillance of the earth or another planet can be achieved by driving the optical axis relative to the stars so that sensors pointed at the planet are stabilized on a specified target area. For attitude detection, in top right sector, when spacecraft is spinning, TAAS provides star-transit data; this permits computer to determine vehicle's time-dependent orientation, including processional and nutational motions. When spacecraft is not spinning, sensor provides celestial orientation. For navigation, at lower right, TAAS can either sense the position of another body relative to the stars, or, with the help of a periscope, lock a ground tracker onto a point on the surface while the TAAS sweeps across the sky. For guidance, at lower left, TAAS with hyperhemispheric field of view senses position of another spacecraft and controls its own vehicle's propulsion system to accomplish rendezvous. Note that the two bright upper sectors represent attitude measurement and control, while the bright lower sectors represent navigation and guidance; also that the two sectors at the right represent measurement functions while those at the left represent spacecraft control functions. Table below shows classes of problems entailed in performing various operations in space.

UNKNOWNNS	FUNCTIONS		
	MEASUREMENT	COMPUTATION	CONTROL
ORIENTATION $\psi_i, \dot{\psi}_i$ $i = 1, 2, 3$	ATTITUDE DETECTION	NO. OF UNKNOWNNS 6 6	ATTITUDE CONTROL
POSITION q_i, \dot{q}_i $i = 1, 2, 3$	NAVIGATION	6 6 24	GUIDANCE

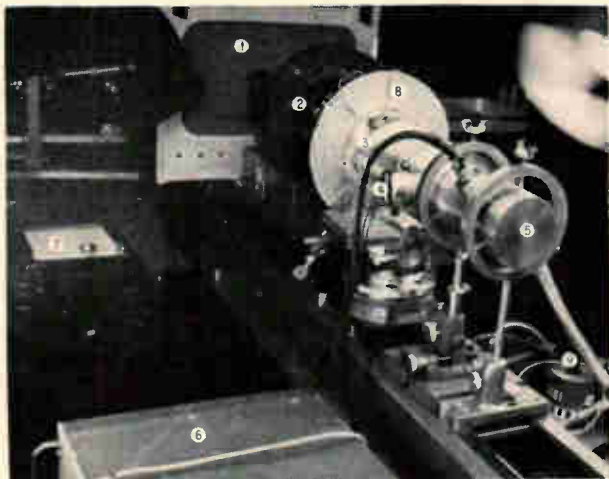

Experimental three-axis attitude sensor. Parts are: 1, simulated star field; 2, collimating lens; 3, mounting tube for lens and angle encoder; 4, synchronous drive motor; 5, photomultiplier housing; 6, variable filter; 7, strip-chart recorder; 8, plate for gimbaling; 9, battery.

tions. The system's computer must process varying amounts of information on-line. Attitude sensing and navigation involve only 6 unknowns; attitude control, a maximum of 12; for guidance, at least 18 parameters are necessary to describe the state of the system.

An experimental TAAS is shown above. The system consists of a lens, a rotating disk with three slits, a photomultiplier, a drive motor, and a 16-bit angle encoder. When one slit passes under the image of a star on the focal surface of the objective lens, the starlight is transmitted to the photocathode of the multiplier, and the resultant electrical pulse gates the angle encoder's output to the digital computer. Each detectable star generates three pulses. The computer also receives noise pulses produced by the stellar background and the photomultiplier's dark current.

Measurement and control

One objective of the TAAS design is to provide a single sensor for many applications. Studies are being conducted to determine whether one TAAS design can be used both for measurement and as part of a control loop. This dual capability would be particularly valuable in electro-optical designs without moving parts, in which accuracy can be traded for scanning rate when switching from measurement functions to control functions. Versatility is essential for a high degree of standardization.

To circumvent the blocking effect of the earth or to avoid exposure to the intense light of the sun, two TAAS sensors may be necessary in a space vehicle. As an alternative, the computer's attitude program can be arranged to cause the spacecraft to turn about an axis perpendicular to the sensor's optical axis until an acceptable pointing direction is found.

Computer subroutines also can be standardized because most applications for the sensor pose certain common problems: pattern recognition, manipulation of trigonometric functions, matrix inversions and orbit computations. By tying these subroutines together with additional logic, various operating modes can be added.

To accomplish these functions, it is necessary first for the system to recognize patterns of stars; this task, like that of determining the spacecraft's attitude and later of guiding the vehicle, requires a general-purpose digital computer that can fulfill a variety of input-output requirements. Such a computer is being developed. If present advances in microminiaturization continue, an operating computer may be built in five years that occupies only five cubic inches.

Whenever the sun, earth or moon lies in the field of view, a shutter can protect the photodetector. The shutter design varies from one application to another, but generally the type required follows the pattern shown on page 117 of the March 21 issue. For optical and mechanical shutters, sensing and actuation would be accomplished with a small photocell. Self-actuating photochromic shutters have been described by G. H. Brown and W. G. Shaw.⁶ The Kerr cell and Pockels cell require a separate photosensor to drive them; this system has been described by Bruce H. Billings and Robert O'B. Carpenter.⁷ The electrical shutter would be actuated when the signal output from the photomultiplier exceeds a preestablished level. The circuitry is described in detail on page 103.

Looking ahead, the next step should be a TAAS which is purely electro-optical, with no moving parts for any mode of application. Later, optical computers will be necessary, to which information will be transferred directly from an optical sensor. These prospects are discussed on page 104.

In recognition of guiding stars

Man identifies the stars from three characteristics: their relative positions in the sky, their intensities and apparent colors. Researchers at CDC studied all of these approaches before deciding to rely entirely on geometry for pattern recognition. The decision was based on the fact that most applications for TAAS require highly accurate measurements of star position if the vehicle's attitude is to be determined accurately; since these measurements are available, the researchers reasoned, they might as well be used also for pattern recognition. Furthermore, the problem of obtaining absolute intensity measurements accurate to about 1% would be extremely difficult, requiring periodic calibration, more sophisticated detection electronics, and an additional analog-to-digital converter.

If the TAAS's approximate orientation is known, it is possible to solve the three-axis problem with only θ measurements, in which case the scanner disk needs only one radial slit. For random orientation, however, each star's polar coordinates (ρ , θ) must be determined.

But is the geometric approach to pattern recognition feasible? Given a minimum of stars for all fields of view, how accurate must be the measurements of their relative positions if the pattern is to be recognized without ambiguity?

The problem was simulated on a Control Data 1604 computer for an optical system with a 46° field of view, "pointed" at 2,580 positions across a "sky" studded with 789 simulated stars.

When only two stars were used, the angular separation had to be measured to an accuracy of about one second of arc, as shown below in the graph of results. With a third star, the allowable error was increased to about 100 seconds of arc. As more stars are added, the allowable error increases, but at a diminishing rate.

For celestial guidance, a typical field of view—in this case 46° —requires the detection of at least three stars for all pointing directions, with root mean square errors in angular separations held to 30 arc-seconds.

The seven steps in pattern recognition are shown in the figure on page 98, and may be summarized as follows:

1. Angle storage. The computer memory receives angle data generated by pulses from stars, background noise, dark current, planets, airplanes, satellites and other sources.

2. Slit matching. A star which is detected at each of the three slits produces pulses at two equally spaced intervals, designated Δ_{ij} and Δ_{jk} . The computer logic then searches through a list of angular measurements which have the property that $\Delta_{ij} = \Delta_{jk} \pm \epsilon_0$, where $\epsilon_0 \ll \Delta_{ij}, \Delta_{jk}$. Whenever this condition is met, three angles are stored in the memory. This technique eliminates most noise pulses, false targets and inaccurate data about stars. It has been shown experimentally that nine signal pulses (from three stars) can be readily identified by this method from as many as 30 associated noise pulses.

3. Target positions. For each set of three angles, the computer finds the polar coordinates of the hypothetical target. At this point, it is not known whether any of these targets are stars. In fact, it would be possible—though highly unlikely—for a "target" to be indicated by three noise pulses accidentally spaced in accordance with the criteria of step 2.

4. Angular separations. The angular separations between all of the targets are computed and stored in memory. The number of these separations is the combinatorial $\frac{n!}{(n-2)! 2!}$ where n is the number of targets. The process cannot begin unless $n = 2$; however, because of possible ambiguities in the angular separations, it is preferable that $n \geq 3$.

5. Matching of angular separations. The next step is to search through the computer memory for stars whose angular separations are similar within $\pm \epsilon_p$ of each of the angular separations computed in step 4. Usually, more than one pair of stars will meet this criterion; this potential

ambiguity is removed in step 6.

6. Linking of pairs. If S_1, S_2 and S_3 represent the star numbers for three detected stars, then when the pair numbers are written out they must have the following cyclic property: first pair, S_1, S_2 ; second pair, S_2, S_3 ; third pair, S_3, S_1 . When this requirement is met, the ambiguities in step 5 are removed.

7. Computing sensor's orientation. When the stars have been identified, their positions can be determined from star lists stored in the computer's memory and the three axes of orientation of the sensor can be determined.

If a pattern has not been recognized, the values of the parameters ϵ_0 and ϵ_p must be enlarged. During the rooftop experiments, values for ϵ_0 and ϵ_p were determined empirically, and done frequently; the process always converged on the correct answer when enough stars were detected. However, each time ϵ_0 and ϵ_p are increased, the danger of an erroneous pattern recognition is enhanced. Another approach which has been success-

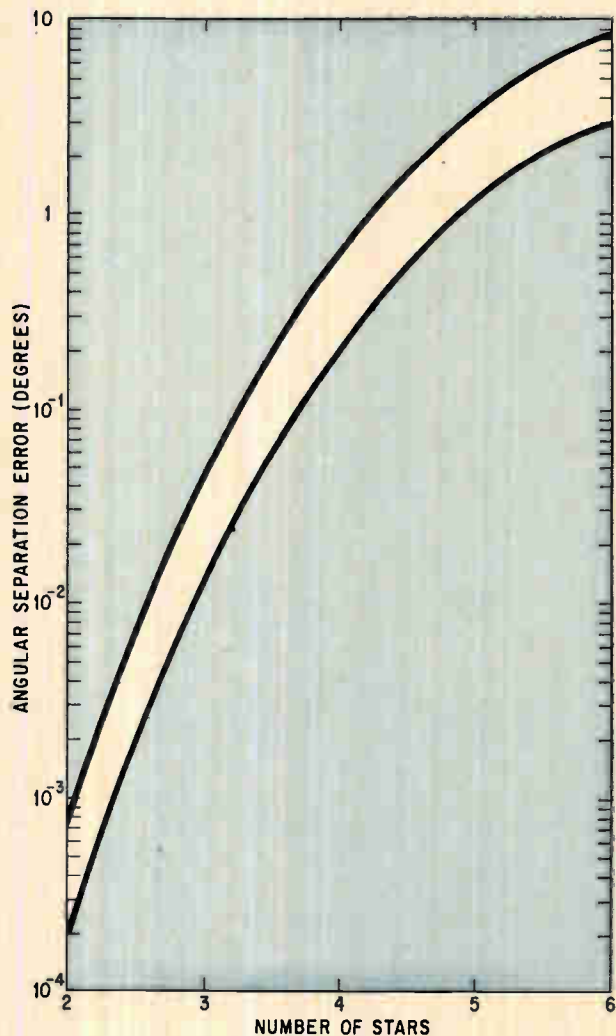

When more stars are used in pattern recognition, larger errors are permissible in measurements of angular separations between the stars. Shaded area gives approximate values for a 46° field of view and a 99% probability of unambiguous pattern recognition.

Seven steps in pattern recognition

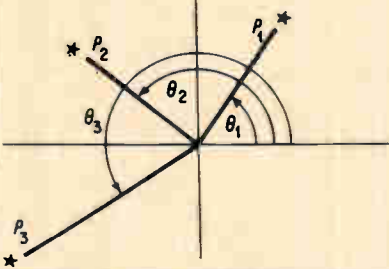
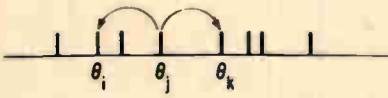
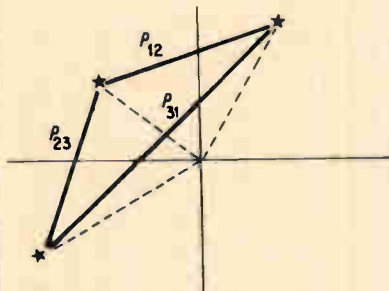
<p>1. Angle storage. Photomultiplier transmits to computer pulses from stars, also false targets and noise.</p> 	<p>3. Target positions. The three pulses from a given target define the polar coordinates of its position.</p> 	<p>5. Matching angular separations. From a stored catalog, selecting star pairs which have similar angular separations.</p> <table border="1" data-bbox="1024 334 1409 474"> <thead> <tr> <th>ρ_{12}</th> <th>ρ_{23}</th> <th>ρ_{31}</th> </tr> </thead> <tbody> <tr> <td>29 - 43</td> <td>13 - 19</td> <td>92 - 29</td> </tr> <tr> <td>71 - 62</td> <td>24 - 60</td> <td></td> </tr> <tr> <td></td> <td>35 - 80</td> <td></td> </tr> <tr> <td></td> <td>43 - 92</td> <td></td> </tr> </tbody> </table>	ρ_{12}	ρ_{23}	ρ_{31}	29 - 43	13 - 19	92 - 29	71 - 62	24 - 60			35 - 80			43 - 92	
ρ_{12}	ρ_{23}	ρ_{31}															
29 - 43	13 - 19	92 - 29															
71 - 62	24 - 60																
	35 - 80																
	43 - 92																
<p>2. Slit matching. Finding the three pulses from a given star</p> $\Delta_{ij} = \theta_j - \theta_i$ $\Delta_{jk} = \theta_k - \theta_j$ <p>Test condition: is $\Delta_{ij} = \Delta_{jk} \pm \epsilon\theta$?</p> 	<p>4. Angular separations. Computing the separations of the stars based on TAAS measurements.</p> 	<p>6. Linking angular separations. Searching for a linked triad among the lists in step 5</p> <table border="1" data-bbox="1024 636 1409 679"> <tbody> <tr> <td>29 - 43</td> <td>43 - 92</td> <td>92 - 29</td> </tr> </tbody> </table>	29 - 43	43 - 92	92 - 29												
29 - 43	43 - 92	92 - 29															
		<p>7. Computing sensor's orientation. α=right ascension, δ=declination, β=azimuth relative to north celestial pole.</p>															

ful, especially when scintillation problems are severe, is to discard the data and scan again.

Pattern recognition for a randomly oriented TAAS requires detection of at least three stars. If only two targets result from step 2, then ϵ_p might be increased to see whether a third target can be found. In certain cases, where the pointing direction of TAAS is known to within about 5° , two stars are sufficient. When ϵ_p is too large and an ambiguity remains after performing step 6, ϵ_p can be reduced and the recognition program returned to step 5.

A problem in star-pattern recognition is size of the computer memory necessary to contain the star data. At the minimum, the right ascension and declination of each star must be stored. For a typical system with 100 stars, about 4,200 bits of memory are required, including star-identification numbers. Ultimately, angular separations are required; the system may carry a list of these separations, or they may be generated from the data in the basic star list. If the list of angular separations is carried, the size of the computer's memory is enlarged but the solution time is reduced; if the list is not available, the converse is true. Experience indicates that a minimum list of angular separations is usually desirable; the list may include up to 3,000 separations, depending on the size of the optical system's field of view.

The computer memory can be reduced by about one-half if the star pairs are listed in order of increasing angular separation, even if the separation values are not included. An interpolation scheme

then helps to approximate the location of the correct star pairs and to start a process of angular-separation calculation, which becomes the basis for more refined interpolation. This process is similar to that of opening a book to a certain page. It is not necessary to start at page 1. The list of angular separations corresponds to the number of pages; if the total is known, four or five attempts will usually be sufficient to find the correct page.

Processing the sensors' outputs

The pattern-recognition and navigation techniques are complex enough to require the help of a general-purpose electronic computer for data reduction. The digital nature of the TAAS outputs makes them ideally suited to digital processing.

The computer's size, weight, power and reliability depend chiefly on the speed and memory needed. To estimate these, it is necessary to count the elementary operations which the computer is likely to perform while executing a particular task, and to calculate the amount of data and number of instructions to be stored.

But what operations should be elementary, requiring complex hardware? And which should be synthesized by programming, increasing the size of the computer's memory? This trade-off is illustrated in the chart below.

The practice is to synthesize with subroutines all operations at the "sine" level of complexity and above. Whether this should be done for more basic operations, such as multiply/divide, requires further consideration of machine organization and

the complexity of the problem to be solved.

Complex programs, such as recognizing patterns of stars and determining a space vehicle's orbit, require a large computer memory, but can tolerate slow solution. In contrast, controlling attitude and position requires a high-speed computer. In practice, this can be accomplished only by selecting a starting point such that the computer needs to process only the incremental changes in the state of the entire system. Such computers can be relatively simple.

Two examples of very simple organizations (one serial, one parallel) are shown on page 100. The serial design is effected using only 14% as many gates as required of the simple parallel design. However, the serial machine is a bit-by-bit device with only eight fundamental instructions. Thus, even such simple operations as the addition of two 24-bit numbers must be constructed as subroutines out of these bit-oriented instructions. In effect, a set of such subroutines simulates a machine of higher basic capability on the minimal machine. Then the programing need only be accomplished using the more sophisticated simulated machine. Programing the original device for problems of the complexity of those discussed here would be almost impossible.

In contrast, the parallel computer shown is more powerful, containing even a multiply (but not a divide) instruction. This increased capability to perform more complex operations is achieved in slightly over 500 gates, by two techniques: the 24-bit arithmetic is performed in 12-bit bytes, and a "register file" is used. The register file eliminates as many as four full-length (12-bit) registers from the hardware by assigning them to specific locations in the memory. The resulting reduction in complexity is achieved in exchange for an increase in running time, caused by the need to refer to memory several times during each instruction.

The two designs thus form an interesting contrast: the serial operations are so fundamental that it was deemed too complicated to execute an add

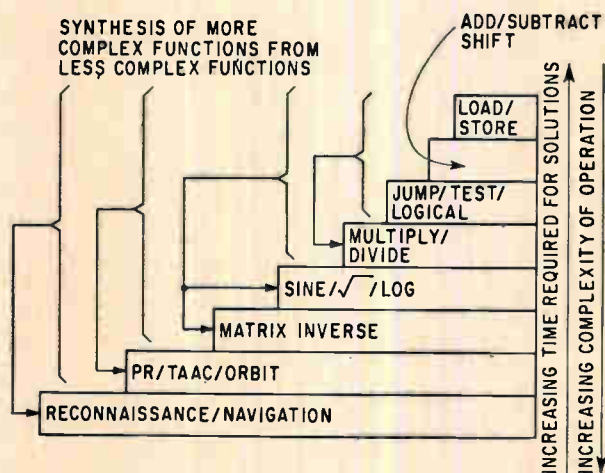

Hardware vs. software. As machine's logical complexity increases, computation time is reduced at the expense of additional computer hardware.

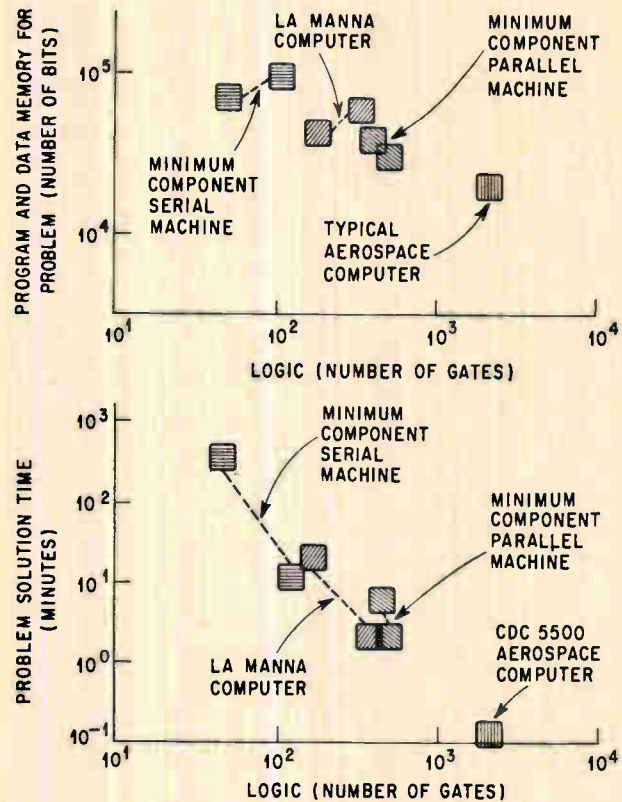

Computer trade-offs for navigating along the moon's surface with TAAS. Increasing each computer's complexity reduces solution time considerably; surprisingly, this tends to make the computer smaller because the reduction of memory size is greater than the increase in logic volume. This is true because most aerospace computers require memories that occupy 60% to 80% of the design volume. In bottom graph, as complexity of computer logic is increased, memory requirement is gradually reduced. Problem solution times refer to initial pattern recognition and to three-axis attitude determination.

with hardware; in the parallel design, a multiply could be included easily from existing, complex functions. In the parallel organization, a little extra hardware buys much more power than in the serial organization.

An illustration of the data-processing problem is provided by the TAAS's potential use in navigating on the surface of the moon, as described in the panel on page 101. If several computer schemes are compared as to logic complexity, memory size and solution time, results of the type shown in the diagram above will be obtained.

The block diagrams of the computers labeled "minimum component" are on page 100. The La Manna machine is a serial computer with 16 instructions designed according to principles laid down by T. J. LaManna.⁴ The fourth machine is the CDC 5500—a high-capability space computer for general-purpose data processing.

There are two boxes for each type of computer, representing two versions; they indicate the range of parameters for each type.

The class of digital computers discussed here is simpler than the typical aerospace computer under development. This is principally because the

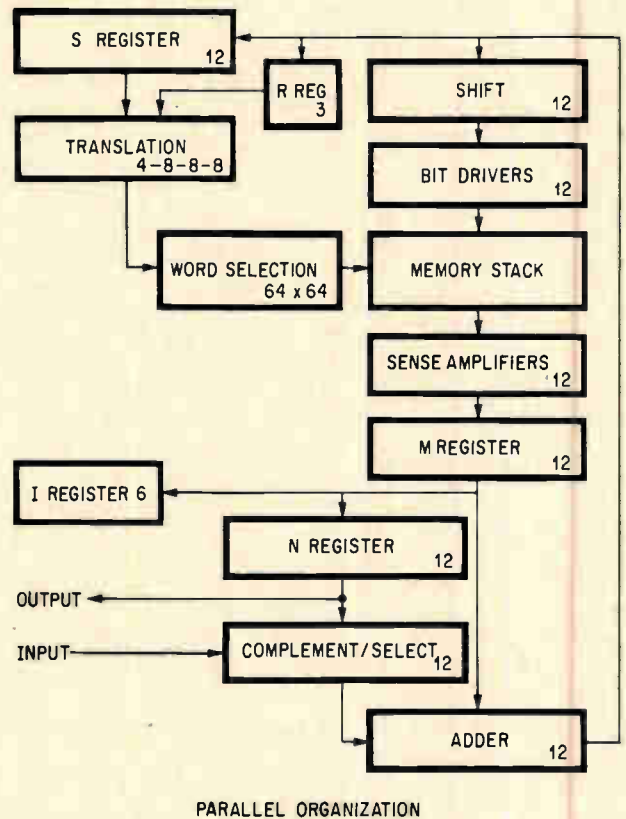
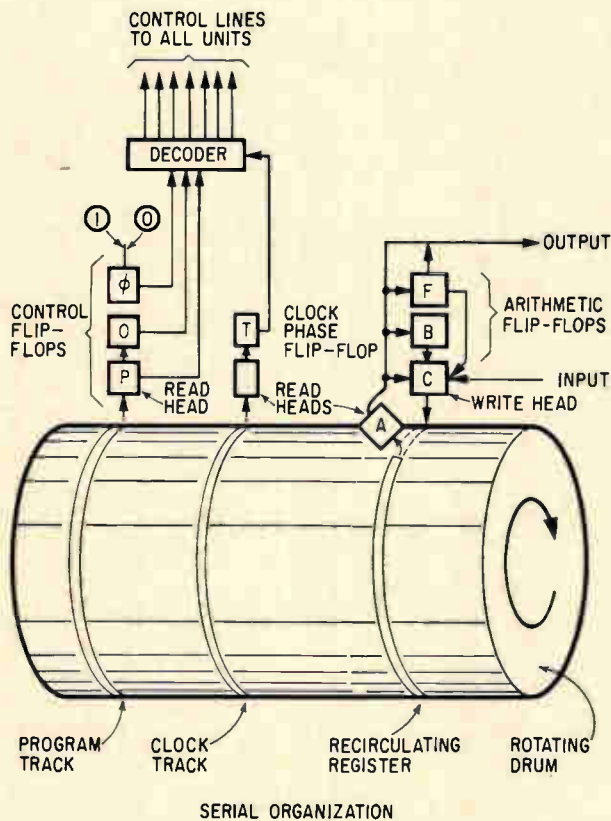

Serial vs. parallel organization of computer. Serial design is simpler but slower and more difficult to program for problems of the complexity encountered in celestial guidance.

TAAS is a versatile instrument whose outputs are readily convertible to meaningful attitude and navigational information. This permits fewer subprograms and fewer input-output channels, and results in significant reductions in size, weight and power. The type of computer required to process the outputs of a TAAS can be fabricated in less than 20 cubic inches, and will require no more than three to four watts. Technological advances over the next two to five years are expected to reduce these numbers by about one-half.

Filtering signals from the sky

The electro-optical detection system is basically a series of filters. As outlined in the first part of the article, the optical system and photodetector constitute a spectral filter for incoming electromagnetic radiation, and the scanner disk with its slits is a mechanical filter. There are also two types of electrical filters: digital and analog; the pattern-recognition logic in the computer constitutes a digital filter, and the filters immediately behind the photodetector are analog.

The optical test bench for scanning the stars is shown on page 96. The major design characteristics of the sensor are summarized in the table at the left.

In the rooftop experiment, the signal from the photomultiplier contained two kinds of noise: shot noise from the instrument itself, and optical "noise" from the sky. The sky noise was mostly reflection of lights from Minneapolis and St. Paul. The shot

noise consisted of short pulses of random amplitude; the sky noise produced a relatively continuous signal that changed somewhat as the pointing direction was altered, also changing slowly even when the pointing direction remained constant.

Unwanted short pulses were removed by an active low-pass filter with a constant phase shift over the pass range. An active filter, rather than passive, was chosen to avoid bulky inductors and impedance-matching problems. The filter was a modified sixth-order Bessel type, called a Paynter filter; such a device has been described by P. J. Hansen.⁷ The filter's characteristics and operation

Sensor-design summary

1. Optical system	
Objective diameter (inches).....	1.8
f-number.....	1.1
On-axis blur circle (seconds of arc)....	20
2. Scanner system	
Number of slits.....	3
Shape of slits.....	pie-section
Field of view (min. and max.).....	16, 38
3. Detection system	
Photomultiplier.....	EMI 9514S
quantum efficiency.....	0.075
dark current (pulses per second)...	300
Filter.....	Paynter
Bias level.....	floating
	(on noise)

Exploring the moon

After a landing on the moon or on a remote planet, a three-axis attitude sensor can be used for surface navigation. Supported pendulously on a roving lunar vehicle, the TAAS might quickly check position and heading each time the vehicle stops. Early exploration of the far side of the moon will almost certainly require such celestial measurements.

For these measurements, the position fix is based on astronomic coordinates represented by 1 on the drawing. This type of measurement is subject to local deflections of the gravity vertical, caused by the irregular distribution of the moon's mass, and by physical librations which are on the order of 10^2 seconds of arc. On earth, specifically in the United States, average rms deflections of the vertical are approximately five seconds of arc; deflections on the moon are unknown.

An alternate method of navigating on the moon is to sense the position of a satellite of known orbit, perhaps the vehicle's mother ship as it moves overhead, as represented by 2. These measurements can be used to provide the lunar vehicle's selenocentric coordinates—based on the center of the moon—and would not suffer detectably from errors associated with local deflections of the vertical.

For another application, a pendulously supported TAAS could be mounted on a lunar excursion module for computing its coordinates relative to the orbiting command-and-service module; these computations would be vital in planning a reunion in space.

A scientific application of TAAS is for comparing astronomic coordinates with selenocentric coordinates as a means of investigating geologic processes on the moon. Comparative position fixes, made by a roving vehicle, could be used to obtain a grid-type measure of the deflections of the vertical in any region of the moon's surface. By comparing these deflections with the topography, subsurface variations in density could be studied; this principle is already followed in geologic studies of the earth. These measurements would aid considerably in attempts to understand the relative role of meteoric and volcanic action in creating the visible features of the lunar surface.

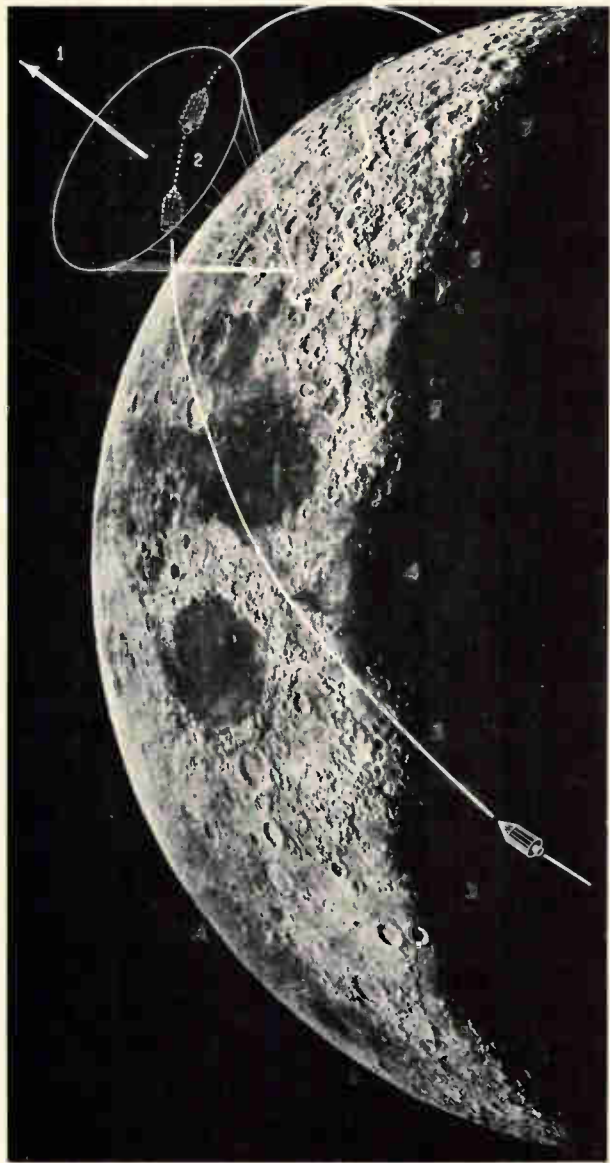

Photo courtesy of University of Chicago Press

are shown in the drawings and photos on page 102.

Background noise from the sky was controlled by a threshold-detection system. Unwanted signals were kept out by manually setting the detector's threshold higher than the level of background signals but lower than the level of star signals.

In various pointing directions, particularly near a bright target such as the moon or the planet Jupiter, the background signal was found to be much stronger than in other regions included in the same scan. Therefore a fixed-threshold setting high enough to reject background signals in the vicinity of the bright targets would also reject faint but valid star signals in other parts of the scan. The circuit provides a varying threshold-control voltage that causes the detection threshold to operate at a level slightly higher than that of the background signal. The input of the variable threshold control is the output of the Paynter filter.

The operation of the circuit can be understood

from the block diagram on page 103. The signal enters an amplifier, which clips any signal that is more than a few tenths of a volt stronger than the long-term average signal. Thus any fast-rise pulse, such as the signal from a star, is clipped and, in effect, removed from the threshold circuit.

This signal is passed to the threshold-shaping unit, which operates as a fast-rise, slow-fall automatic gain control. A constant of 2.3 milliseconds was chosen for the rise time; this is about 10 times the star signal's pulse width and fast enough to follow changes in background, but too slow to respond to the clipped star pulses. The discharge time constant was chosen to be about one-tenth the speed of the attack time constant.

An isolator, shown in the block diagram between the threshold-shaping circuit and the gain-control circuit eliminates any positive feedback to the signal amplifier from the reference return.

The gain-control circuit allows manual adjust-

Two key circuits of celestial sensor are low-pass filter . . .

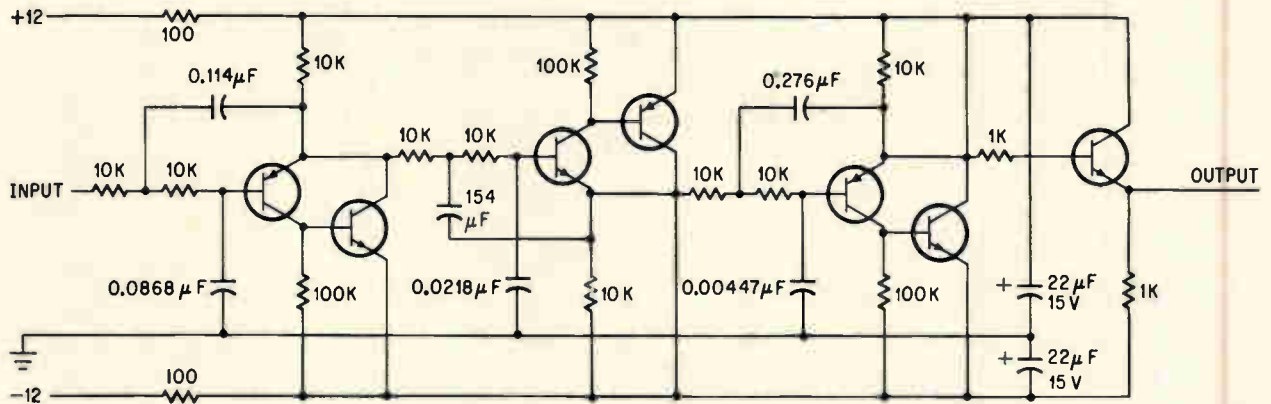

Active low-pass filter with constant phase shift

TRANSISTORS: NPN 2N-3405
PNP 2N-3702

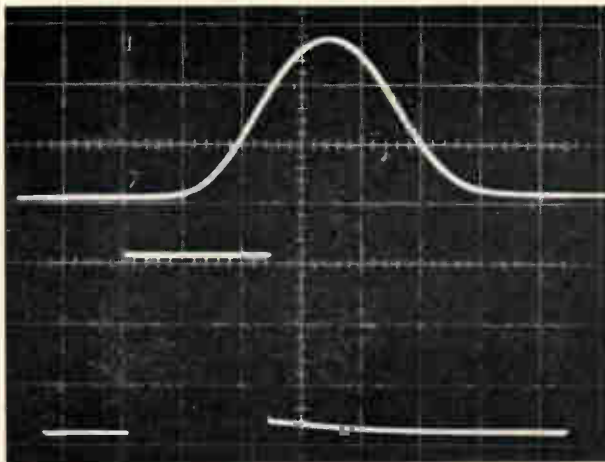

Response to 2.5-millisecond pulse

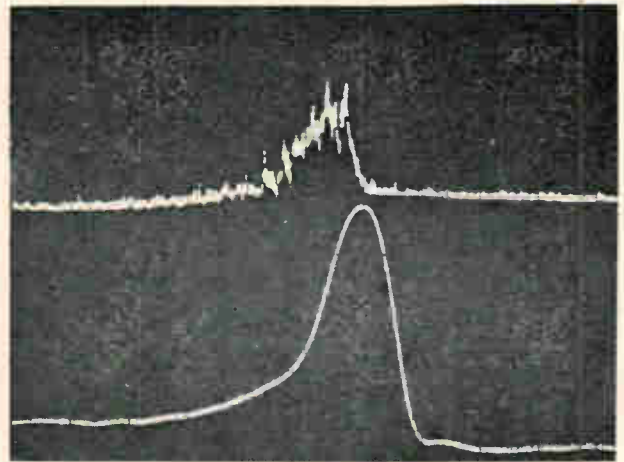

Star signal noise (bottom) and filtered (top)

Low-pass filter for celestial sensor with 15-second scan period and 2.3-millisecond delay between input and output signals. Graph at right shows frequency response and phase shift. Oscilloscope at left above shows filter's response to a 2.5-millisecond pulse; upper trace is filter output, lower is input. Oscilloscope at right above shows circuit's pulse-shaping and delay properties; top trace is a noisy star signal, bottom one is the amplified and filtered pulse with a constant time delay.

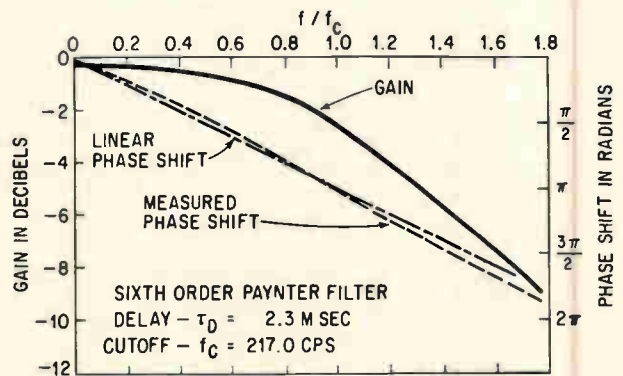

Frequency response vs phase shift

ment of the range of variable threshold control.

The manual bias control sets the direct-current level from which the automatic control operates. The d-c bias voltage and the threshold-control voltage are added in the operational amplifier labeled "mixer."

A detailed circuit diagram of the system is shown at the top of page 103; below it at the right is an oscilloscope showing the effect of the auto-

matic threshold control.

The relationships of the various members of the analog detection system are shown in the diagram on page 105. Typical oscilloscope traces for test points A, B and C are included.

This analog system sends three classes of information to the computer:

- The encoder reading at the time each star entered the slit.

. . and automatic threshold control to reject background noise

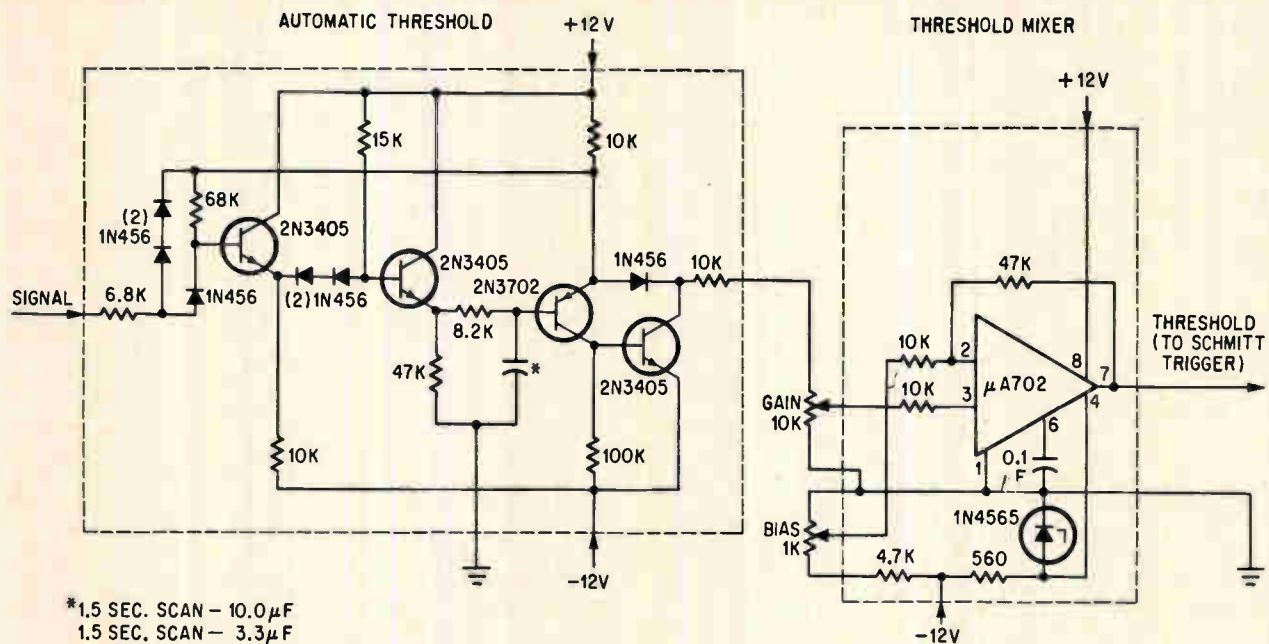

Threshold control's input is output of Paynter filter

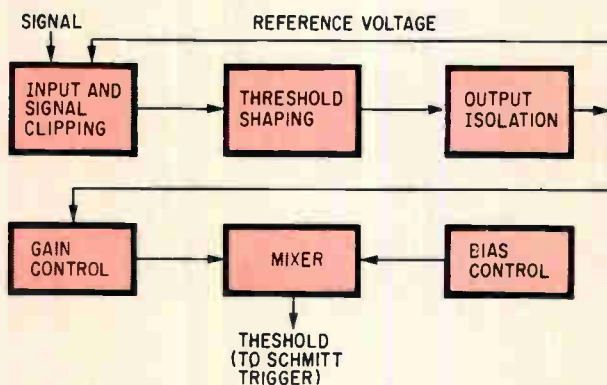

Six steps in automatic threshold control

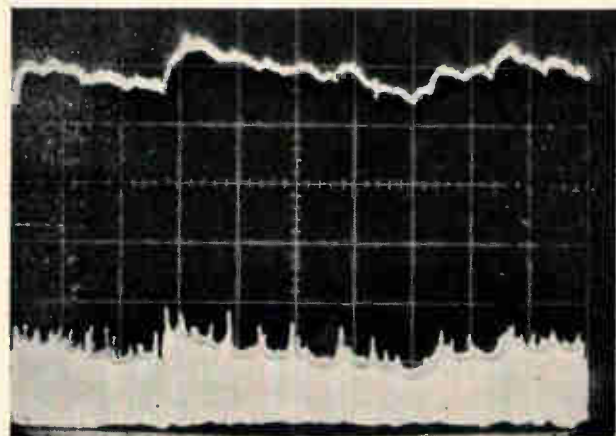

Star signal (top) detected through noise (bottom)

Automatic threshold control keeps detection threshold slightly above the level of background signal. Oscilloscope shows how circuit detects star signals through noisy sky background; upper trace is threshold-control voltage, lower is sky background plus star-signal spikes. Note that threshold-control voltage "follows" the background, not the signal spikes. For clarity, static position of automatic threshold trace has been displaced from its position relative to background signal.

- The number of encoder counts that occurred while the star was in the slit.
- A digital indication of the relative height of the star pulse; this is obtained from a peak detector and an analog-to-digital converter.

Experimental results

To evaluate the results of the rooftop experiments, the output of a TAAS sensor was processed on-line on a Control Data 160-G computer installed about 100 feet from the observatory. Pattern-recognition tests, based on random pointing, were performed with real stars. To evaluate the system's potential accuracy in space, free from the degradational effects of the earth's atmosphere, tests were performed with an artificial star field.

A computer printout, resulting from a single scan of the sky from the roof of the Government Systems building, is shown at the top of page 104.

The sensor was pointed at both artificial and real stars, with various accuracies. Typical values are shown in the table at the bottom of page 104.

Errors (σ) in azimuth are significantly greater than errors in latitude or longitude, as might be expected with a sensor whose field of view was only 36° . With a larger field of view, the value of σ_θ would have been smaller.

When a satellite or aircraft crossed the field of view, the pattern-recognition technique discriminated successfully against these false targets.

Another class of problems was caused by the earth's atmosphere, particularly background radia-

1. DATA ACQUISITION		2. SLIT MATCHING		5. ANGULAR SEPARATION MATCHING				
DATA POINT NO.	ANGLE ENCODER MEASUREMENT	$(\epsilon_{\odot} = \pm 30 \text{ counts})$		$(\epsilon_p = \pm 6 \text{ minutes of arc})$				
1	9596	a.	2 - 3 - 6	a - b	b - c	c - d	d - a	
2	35071	b.	5 - 7 - 8	18971-18458	8833-6937	8302-8969	8302-4633	
3	38900	c.	11 - 13 - 17	6681-6029	8302-7078	19728-18971	5605-6937	
4	40059	d.	12 - 15 - 16	22558-21332	10438-9947	10120-10438	10438-7543	
5	41359			7543-7557	17374-14842	16942-16724	18144-19033	
6	42725			23693-22677	10120-8633	9443-9886	1117-4427	
7	44438			8969-8675	7557-10120	16953-16724	11105-9307	
8	47523			17029-16618	16952-18809		20029-16268	
9	49442				6960-8223		1400-3664	
10	51446				6681-4688		18458-14842	
11	57005				4041-2572		19656-22845	
12	58548				16953-18809		27354-28295	
13	60502				127-32149		23693-26386	
14	61077				17262-17179		20128-23708	
15	61141				18133-19607		8969-9307	
16	63738				25024-22677		8969-13506	
17	63997				6029-4427		25024-21982	
18	64792				17179-21332		19975-20926	
					20926-22845		13443-15340	
					9307-10040			
					4633-8941			
		3. TARGET POSITIONS (Radians)		6. ANGULAR SEPARATION LINKING				
		ρ Θ		a - b	b - c	c - d	d - a	
		a.	0.21973 3.73095	7543-7557	7557-10120	10120-10438	10438-7543	
		b.	0.26843 4.26115	7. COMPUTED POINTING DIRECTION				
		c.	0.23902 5.80209	Right ascension: $\alpha = 106^{\circ} 26.490'$				
		d.	0.31530 5.86282	Declination: $\delta = 44^{\circ} 50.907'$				
				Azimuth: $\beta = 319^{\circ} 27.240'$				
				8. IDENTIFIED STARS				
				G. C. No.	Constellation	Name	m_b	m_v
				a.	β Auriga	Menkalinan	1.92	1.90
				b.	Θ Auriga	—	2.55	2.63
				c.	α Gemini	Castor	1.61	1.58
				d.	β Gemini	Pollux	2.13	1.13

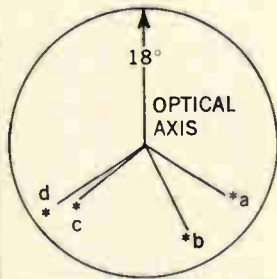

POINTING DIRECTION ASSUMPTION: α =NONE
 δ =NONE

Computer printout from a single scan of the sky made Dec. 1, 1965, at 2:37 a.m. Step 1 shows raw data from 16-bit angle encoder ($360^{\circ} = 65,536$ parts). Steps 7 and 8 show the stars which were recognized and the completed three-axis attitude determination. In step 8, m_b and m_v refer to the blue and visual magnitudes of the stars detected. Note in step 8 that the sensor detected Castor and Pollux, the twin stars that constitute the Gemini constellation.

tion caused by scattering of radiation from city lights and by atmospheric turbulence causing scintillation or twinkle.

The future of celestial guidance

What is the next step in the evolution of celestial sensors? What effects will the TAAS and its as-

Type of error	Type of star field	
	Artificial	Real
σ_{α} (longitude).....	3.8	26
σ_{δ} (latitude).....	3.7	38
σ_{β} (azimuth).....	13.8	97
Pointing errors:		
Single-scan.....	5.3	46
Ten-scan.....	1.7	15

Pointing accuracy with artificial stars was 5 to 10 times greater than with real stars; the main reason is the error introduced by atmospheric effects which would be absent in space. Errors are measured in arc seconds. Artificial stars were matched with real stars in intensity.

sociated computer have on future space systems? Is the present state of computer technology adequate to cope with the high information rates of optical sensors operating close to their theoretical limits? Some of these questions can be answered accurately today; others must wait.

Certainly a next step in the development of strapped-down celestial systems will be the fabrication of a TAAS which is purely electro-optical, containing no moving parts for any mode of application. In the next few years small sensors without moving parts are likely to achieve accuracies to within one second of arc with apertures of approximately one inch and with sampling periods of one second. With a single optical element whose field of view is 40° , these sensors will be able to recognize star patterns anywhere in the sky, and provide a complete three-axis attitude capability.

Once approximate attitude control is achieved with TAAS, improved systems will attain pointing accuracies to 10^{-2} second of arc with one-inch apertures in a few seconds of integration time.

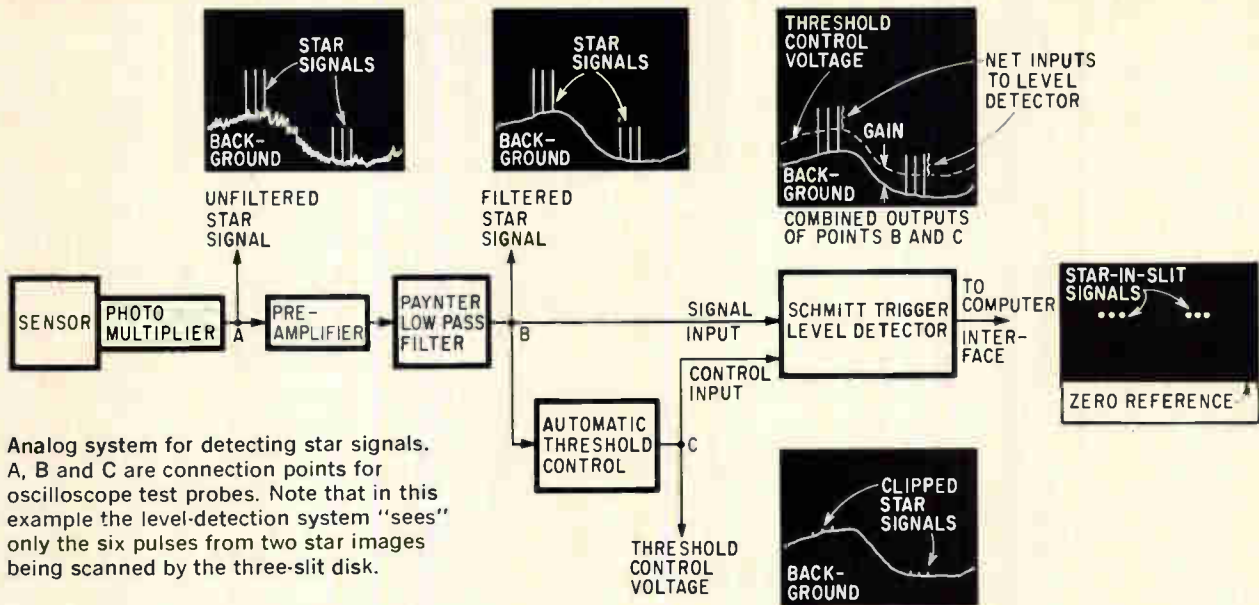

Analog system for detecting star signals. A, B and C are connection points for oscilloscope test probes. Note that in this example the level-detection system "sees" only the six pulses from two star images being scanned by the three-slit disk.

This will be accomplished by information-limited angle interpolation of optical images. Most passive electro-optical sensors—such as star trackers—now fall short of their information limit by several orders of magnitude.

A great deal of progress can be expected in the next few years in reducing the number of sensors and the number of kinds of devices required for space systems. The TAAS sensor already provides solutions applicable to all 24 variables in the general guidance problems. For example, a system based on a strapped-down TAAS functions without gimbaledd star trackers or gyros. TAAS replaces the star tracker because of its ability to solve the pattern-recognition problem; it replaces the gyros because of its high potential sampling rate when using multiple-slit autocorrelation techniques.

Other sensors can also be eliminated. If the orbit is known, the system can control a spacecraft's orientation relative to local vertical better than horizon sensors can—and TAAS also controls yaw. By using TAAS to sense the position of a released test probe relative to the stars, autonomous satellite navigation systems accurate to within 500 feet can be achieved. These would do away with the need for ground-tracking or horizon-sensing equipment.

Present electrical analog filters unavoidably degrade the observational data from stellar sources. As the computer's data-processing capacity is increased, designers will be able to use purely digital filters. Thus, each measurement of angle or time, corresponding to a quantum event at the photocathode, can be transmitted to the computer. Because of the intrinsic complexity of the statistical hypotheses to be tested, digital data-processing techniques can be used to improve the ability to extract useful information from the radiation environment.

One of the greatest needs is for optical computers to which information can be transferred directly from an optical sensor with no intermediate electronic elements. The information at the lens's focal surface will then directly actuate an alterable memory matrix in the computer. In this way the boundary between the computer and the sensor of electromagnetic radiation will begin to vanish and one of the major bottlenecks in the input section can be eliminated.

The evolution of guidance techniques has progressed from instinct to dead reckoning to inertial guidance. The logical next step for space systems is celestial guidance. The mechanical simplicity and versatility resulting from application of modern electro-optical technology makes the approach particularly attractive.

References

1. R.L. Lillestrand, and J.E. Carroll, "Horizon-Based Satellite Navigation System," IEEE Transactions on Aerospace and Navigational Electronics, Vol. ANE-10, No. 3, September, 1963, p. 266.
2. D. Wille, "Star Identification by Optical Radiation Analysis," Air Force Avionics Laboratory, Wright-Patterson Air Force Base, Ohio. Report No. AL TDR 64-13, January, 1964.
3. M.E. Campbell, "A Celestial Orientation System Based on Star Pattern Recognition," AIAA Paper No. 64-652.
4. R.J. LaManna, et al, "Simple General Purpose Computer," U. S. Patent No. 3, 116, 410.
5. P.J. Hansen, "New Approaches to Active Filters," The Lightning Empiricist, Vol. 12, No. 1 and 2, p. 3, January-July, 1965.
6. Glenn H. Brown and Wilfred G. Shaw, "Phototropism (Photochromism)," Review of Pure and Applied Chemistry, Vol. 11, No. 1 (1961), p. 2.
7. Bruce H. Billings, "The Electro-Optical Effect in Uniaxial Crystals of the Type XH₂PO₄," Parts I and II, Journal of the Optical Society, October, 1949, pp. 797 and 802; Robert O'B. Carpenter, Part III, "Measurement of Coefficients," *ibid*, April, 1950, p. 225.

Acknowledgment

Much of the work described has resulted from company-sponsored programs over the past five years. The experimental program was sponsored in part by the Avionics Laboratory at Wright-Patterson Air Force Base, Ohio. Various analytical programs were sponsored by NASA laboratories—mainly the Goddard Space Flight Center, Md., and Langley Research Center, Va.

What Kind of Panel Meter Do You Need ?



crisp, classic Horizon Line?

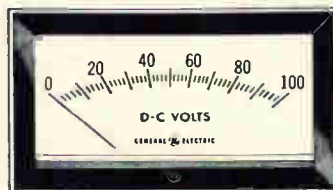

trim, built-in Horizon Line?

Built-in or front-mounted, General Electric HORIZON LINE® panel meters add quiet sophistication that accents, never dominates your electronic equipment. Check these distinctive HORIZON LINE features: smart, low-profile; clean, soft line; fine-precision markings. All ratings are available in 2½", 3½", and 4½".

distinctive Big Look?



Add bold, exciting, truly distinctive styling to your electronic equipment with General Electric BIG LOOK® panel meters. Panelboards take on added flair with such BIG LOOK features as . . . big, bold numerals, uncluttered display, tapered pointer, stylish shape, plus many others. All ratings are available in 1½", 2½", 3½", 4½".

Besides saving you valuable panel space, General Electric slim-line Type 185 EDGEWISE panel meters add exceptional styling and readability to your electronic equipment. These 2¼" Type 185 EDGEWISE panel meters can be mounted individually or in space-saving clusters of two, three, or more. All ratings are available for vertical or horizontal mounting, with or without bezels.

smart, slim edgewise?

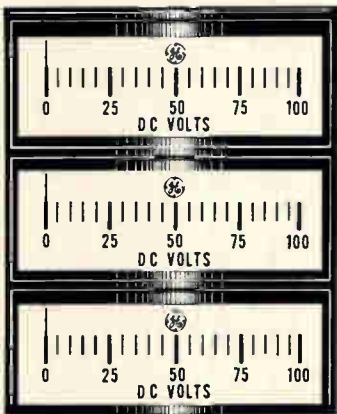

style-matched time meters?



Distinctive BIG LOOK styling is yours with General Electric BIG LOOK elapsed time meters. These "look-alike" time meters combine to give your equipment uniformity and beauty. G-E elapsed time meters measure either hours or minutes with or without a reset knob. All ratings are available in 2½" and 3½".

bright, bold meter relay?



Add years ahead BIG LOOK styling to your equipment with General Electric Type 195 contactless meter relays, featuring a totally new, solid-state, light-sensitive switch for the ultimate in control simplicity and readability. "Piggyback" control modules make for faster, easier installation. Companion pyrometers are also offered. All ratings are available in three sizes (2½", 3½", 4½") with single or double setpoints.

You can get it...from General Electric's full line

And, of course, General Electric's full line of panel meters is unmatched for accuracy and reliability. They're as near as your dependable G-E electronic distributor or sales office. You get fast delivery, too. For free descriptive bulletins describing G.E.'s full line of panel meters, write General Electric Co., Section 592-25A, Schenectady, New York 12305.

GENERAL  ELECTRIC



This little sample will help explain some...

New ideas for multi-layer circuitry

Formica's MLC system permits accurate registration of circuits, maximum packaging density, high-temperature stability, plus!

Many common multi-layer circuitry problems can be solved. Just ask your Formica rep to bring in his kit (with samples) detailing Formica's new MLC system. System's base laminate is FORMICA® brand copper clad laminated plastic, FR-45—documented reliability. Pre-preg has resin specifically developed for use with FR-45 . . . has inorganic additives which increase thermal conductivity of laminate; OKs use of thin

circuit lines, thin copper foil, dense packaging. And circuit pads hold tight for accurate registration . . . no slippage. Go ahead and weld or solder: bond holds. Reliable circuits . . . resin stays viscous (but not watery) to fill around all elements. Many tiny, closely-spaced holes to drill? Your Formica rep can tell you how. Also how you can use one laminate (instead of 4) for G-10, G-11, FR-4, FR-5 requirements. Write, Dept. ID-5.



Leadership through innovation • FORMICA CORPORATION • Cincinnati, Ohio 45232 subsidiary of

FORMICA® is our trademark for various products, including our brand of laminated plastic.

CYANAMID

Using transistor circuits to multiply and divide

They effectively employ the transistor's current-voltage characteristics to raise numbers exponentially and extract roots

By George E. Platzer Jr.

Chrysler Corp., Detroit

Because a pn semiconductor junction exhibits a logarithmic relationship between current and voltage, it can be exploited to perform calculations such as multiplication, just as a slide rule does. Since the junctions may be used to take antilogarithms as well as logarithms, it is possible to multiply, divide and raise to exponents in the logarithmic domain by simple addition and subtraction. Thus, in instrumentation and control systems, transistor circuits can perform the same function as a slide rule, but with the advantage that the mathematical operation is performed continuously and rapidly as the input quantities change.

Although there are other electronic ways of performing analog operations, these transistor circuits^{1,2} generally have advantages of simplicity, accuracy and faster response time. For example, conventional servomultipliers, which use ganged potentiometers to perform multiplication, operate more accurately but the frequency response is generally poor. Other devices require complex circuits. Analog circuits most closely equivalent to transistor circuits in performance utilize Hall effect devices and magnetoresistors. Compared with these, the transistor circuits are generally more accurate and less sensitive to temperature.

The author



George E. Platzer Jr. heads the physics group of Chrysler Corp.'s physics-instrumentation research laboratory, where he directs the development of solid state circuitry for automobiles. His background includes degrees in physics and in electrical and automotive engineering.

Engineers at the Chrysler Corp. use the transistorized computers for controlling the input energy of a resistance welder, for calculating the average of squared values and root mean square values, and for direct computation of efficiency and slip in mechanical systems. In the welding application, a multiplier computes the instantaneous power delivered to the weld area. The frequency response of the multiplier is high enough to respond to the transients caused by the welder's phase controlled transformer. Within limits, the circuit is able to compensate for line voltage variations, electrode wear, and dimensional variations of the workpiece.

Log and antilog

The basic principle of the electronic slide rule is that for low-level input signals, the current and voltage in an ideal diode junction are related by

$$I = I_R \left(e^{\frac{qV}{kT}} - 1 \right) \approx I_R e^{\frac{qV}{kT}} \quad (1)$$

- where I = the diode current in amperes
- I_R = the diode reverse-saturation current in amperes
- V = the voltage across the diode in volts
- q = electron charge in coulombs
- k = Boltzmann's constant
- T = temperature in degrees Kelvin

At the current levels used for logarithmic computations, the approximation in equation 1 is in error by less than 1 part in 10 million.

The diode's saturation reverse current, I_R , is temperature sensitive and is given by³

$$I_R = I_{R0} \left(\frac{T}{T_0} \right)^{1.4} e^{-\frac{E_G}{k} \left(\frac{1}{T_0} - \frac{1}{T} \right)} \quad (2)$$

where I_{R0} is the reverse saturation current at temperature T_0 in amperes and E_G is the energy gap

of the material at 0° Kelvin in electron volts.

Taking the logarithm to the base e of both sides of equation 1, and rearranging terms results in

$$\log_e \frac{I}{I_R} = \frac{qV}{kT} \quad (3)$$

From equation 3 are derived the two fundamental statements expressing the characteristics of an ideal diode junction:

- The voltage across the diode is proportional to the logarithm of the current through the diode. The corollary to this statement is:

- The current through the diode is proportional to the antilogarithm of the voltage. For an ideal transistor, the foregoing is reworded to read:

The base-to-emitter voltage of a transistor is proportional to the logarithm of the emitter current. As a corollary statement:

The emitter current is proportional to the antilogarithm of the base-to-emitter voltage.

Simple multiplier

The multiplier circuit on this page won't work well in practice, but it clearly shows the principle of the slide rule. Input currents I_1 and I_2 flow through diodes D_1 and D_2 . The voltage across each diode is proportional to the logarithm of the current. Because the diodes are in series, the voltage at the emitter-to-base junction of the transistor Q_1 is proportional to the sum of the logs or equivalently to $\log I_1 I_2$. By the corollary statement already given, the emitter current is proportional to the antilogarithm of $\log I_1 I_2$ or simply to $I_1 I_2$. If the junction characteristics are ideal and the transistor has infinite current gain, the multiplication is exact and the collector and emitter current are proportional to the product of the diode currents.

With a bit more complexity, the circuit can be made practical with excellent accuracy. As a multiplier operating over an output range of 500 microamperes to 5 μ a, maximum error is about 0.5% full scale, while the maximum absolute error at any point is about 2% of the reading. In other words, accuracy is maintained even at the low end of the current range.

Transistors and diodes

Characteristics of transistors and diodes must be more closely examined to select devices that will function properly in practical circuits; diodes are not suitable in this application.

In these computing circuits, the junction device must exhibit an exponential characteristic over an extensive range of input voltages or currents. Since equation 1 is for an ideal junction, it does not indicate any bound on the exponential region. However, series resistance within the junction modifies the exponent in equation 1, preventing the device from operating ideally. In addition, the value of the exponent also varies with current density and temperature. All these factors limit

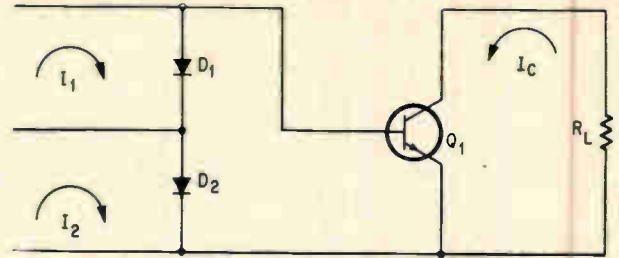

In simple multiplier, the voltage across D_1 and D_2 is proportional to $\log I_1 I_2$. Collector current I_C is proportional to $I_1 I_2$.

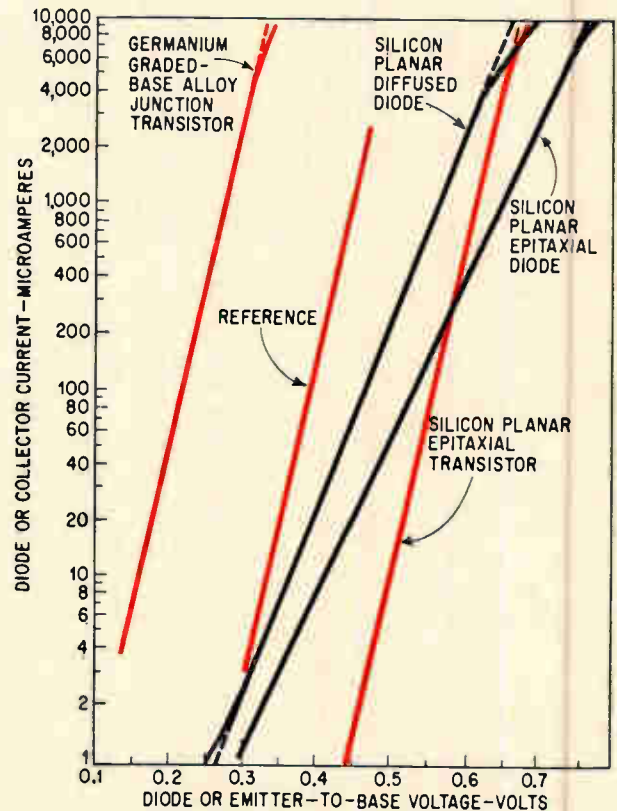

Diodes and transistors exhibit exponential characteristics represented by linear section of this semilog plot. Transistor curves, in color, have a slope equal to qV/kT . Reference line parallel to transistor curves is computed from equation 1 for an ideal junction at 298°K.

the range over which practical junction devices will exhibit an exponential characteristic.

The departure from ideal operation is illustrated above in the graph, which plots the voltage current characteristics measured in several commercial diodes and transistors. In this semilogarithmic plot, the exponential regions are represented by the linear segments of the curves. Since the silicon planar epitaxial transistor is linear over three decades of current, it is used in the output of the multiplier circuits.

In a transistor, a linear semilogarithmic relationship is possible only at relatively low-power levels. This happens because a few milliwatts of collector dissipation are sufficient to increase the junction temperature and to make the emitter-base voltage a significantly strong function of collector dissipa-

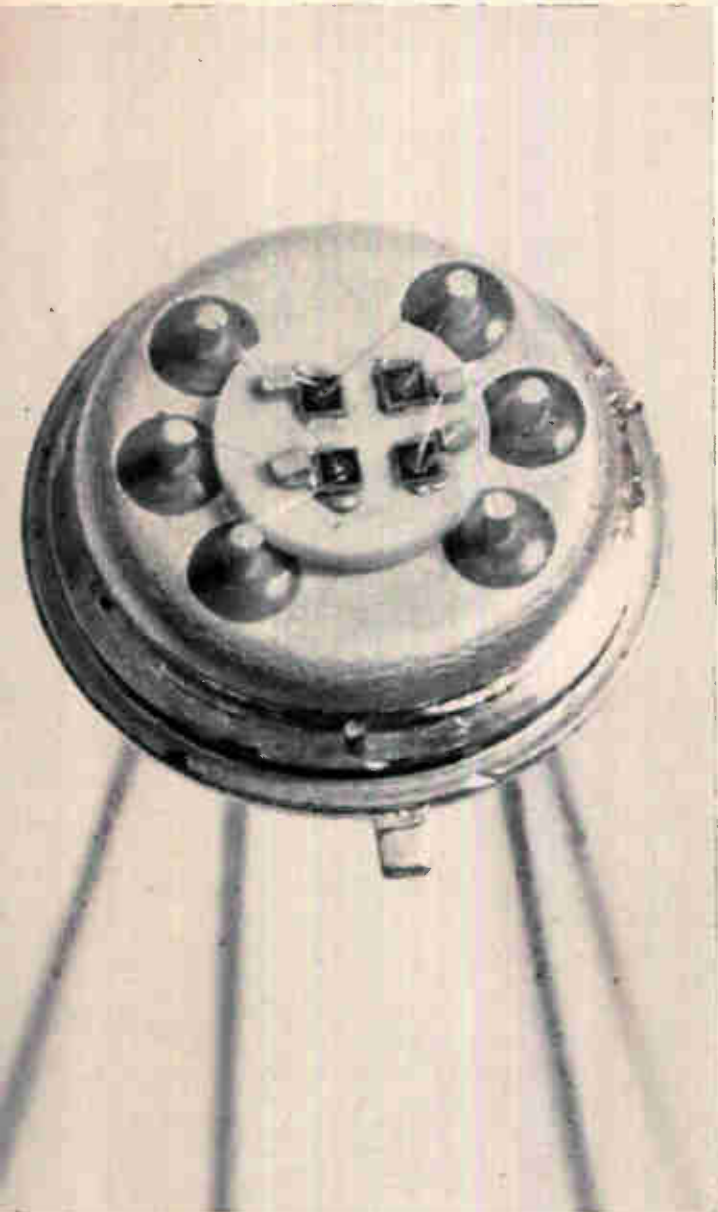

Multichip transistor multiplier contains four silicon planar epitaxial, npn transistors in a TO-5 case.

tion, as well as current. However, using a transistor to take the antilogarithm of a voltage presents no problems as long as the base-to-emitter voltage is scaled to the capabilities of the transistor.

Though they may have a large exponential region, commercial diodes are not suitable for an application in these analog circuits. The primary reason is that the value of the exponent in equation 1 is smaller than the value for transistors. A difference in exponents is represented as a change in slope in the graph on page 110. In a multiplier circuit, this would mean that the output would be proportional to some power of the input, rather than to the product.

Therefore it is necessary to find a device that has an exponent that matches that of the tran-

sistor. Although conventional diodes do not qualify, the emitter-base junction of the transistors might qualify, but the exponential characteristics are satisfactory only at extremely low-current levels.

The solution is to operate a transistor as a diode with the collector connected to the base, so that $V_{CE} = V_{BE}$. Operated in this manner, the current-voltage characteristics is substantially the same as the amplifier connection. This occurs because the collector-base barrier potential is still large enough to collect the charge carriers that diffuse across the base to the collector. Although the collector-to-emitter voltage is lower than usual, currents and voltages at the terminals have the same range of values found in normal amplifier operation.

Transistors that have been tested and found satisfactory for this application include silicon planar epitaxial types 2N3053, 2N1711, 2N2904 and 2N2905A. In the multiplier circuits, only the output transistor must have high current gain. One multiplier has been constructed in the multichip transistor in the photograph at the left. Called the SC-286 it is manufactured by Motorola Inc.

Multiplier theory

A more exact multiplier circuit at the top of page 112 is similar to the simple multiplier, except that transistors are used in place of diodes. The output current I_C , proportional to the product $I_1 I_2$, is determined using the basic equations.

From equation 2, the sum of the voltages across the diode-connected input transistors

$$V_1 + V_2 = \frac{kT}{q} \log_e \frac{I_1 I_2}{I_{R1} I_{R2}} \quad (4)$$

where I_{R1} and I_{R2} are the reverse saturation currents of Q_1 and Q_2

Taking the antilogarithm

$$I_1 I_2 = I_{R1} I_{R2} e^{\frac{q(V_1 + V_2)}{kT}} \quad (5)$$

For the output transistor Q_3 ,

$$I_E = I_{RE} e^{\frac{qV_{BE}}{kT}} \quad (6)$$

where I_E is the emitter current and I_{RE} is the reverse saturation current of the output transistor Q_3 .

From the diagram on page 112

$$V_{BE} = V_1 + V_2 \quad (7)$$

Substituting equation 7 into equation 6, and the subsequent result into equation 5

$$I_E = \frac{I_{RE}}{I_{R1} I_{R2}} I_1 I_2 \quad (8)$$

$$\text{Because } I_E = I_C / \alpha \quad (9)$$

$$I_C = \frac{\alpha I_{RE}}{I_{R1} I_{R2}} I_1 I_2 \quad (10)$$

where $\alpha =$ common-base current gain

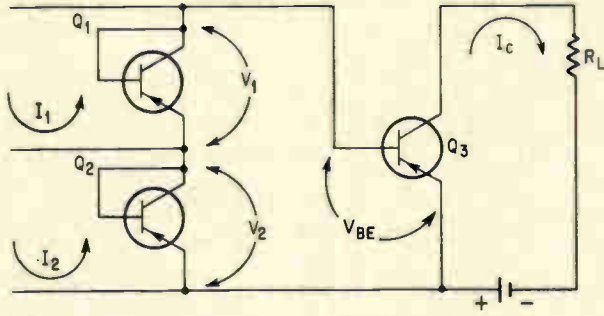

In improved multiplier circuit, Q_1 and Q_2 are connected as diodes to match exponential characteristics of Q_3 .

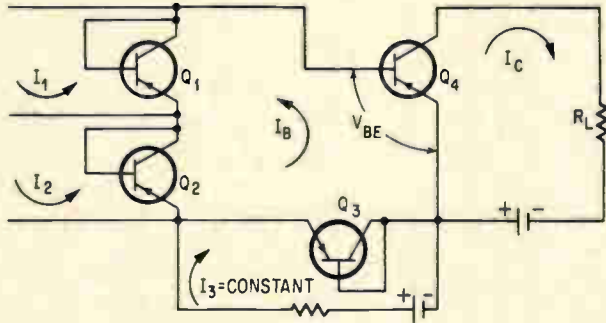

Practical multiplier adds circuit consisting of Q_3 and its current supply to permit increased input levels and to provide thermal compensation.

For equation 10 to define a useful multiplier, signal currents I_1 and I_2 must be independent of the output circuit. This occurs if the current gain, β , of the output transistor, Q_3 , is high so that its base current is much smaller than the signal currents, I_1 and I_2 . Ideally, I_B should be zero.

Even this multiplier circuit may not be entirely satisfactory. First, all the transistors may not operate in the same current range. This occurs when the same type of transistor is used for generating both the logarithm and the antilogarithm values. Secondly, to operate with reasonable current levels in the logarithmic region of the transistors requires input and output currents of the same order of magnitude. This requirement cannot be met with this configuration. For example, if 1 ma is set as the upper limit of output current, the circuit at the top of the page would allow maximum input currents of only $0.01 \mu\text{a}$ in each of the input transistors. This is easily seen on the graph on page 110, which shows that V_{BE} must be approximately 0.6 volt at 1 ma.

For equal voltage across each of the input transistors, V_{BE} would only be 0.3 volt. The current at this voltage is about $0.01 \mu\text{a}$. This is not only an unreasonably low signal current to work with, but it is also comparable to the base current of the output transistor. This difficulty may be avoided by increasing V_1 and V_2 and using a constant series voltage in the circuit to subtract from $V_1 + V_2$. If each of the input currents is 1 ma, V_1 and V_2 each will be about 0.6 volt. For V_{BE} to be 0.6 volt, a bucking voltage of 0.6 volts must be provided.

Another difficulty—indicated by equation 10—is that the highly temperature-dependent reverse-saturation currents are unbalanced since they appear once in the numerator and twice in the denominator. This will make the multiplier temperature sensitive. Using a transistor for the bucking voltage source compensates for the temperature dependence.

In the lower circuit, left, which incorporates these improvements, current I_3 is maintained constant. Following a procedure similar to that used to develop equations 4 to 10 results in

$$I_C = \frac{\alpha I_{RE} I_{R3}}{I_{R1} I_{R2} I_3} I_1 I_2 \quad (11)$$

where I_{R3} is the reverse saturation current in the diode-connected compensating transistor Q_3 .

Now the saturation currents are balanced, and I_C is reduced as compared to equation 10 for given values of I_1 and I_2 .

This multiplier will be stable and accurate over a wide range of currents and temperature.

Equation 11 indicates that if I_1 or I_2 are constant, and I_3 is a variable signal current, the multiplier may operate as a ratio or dividing circuit, in which the output current is given by

$$I_C = \left[\frac{\alpha I_{RE} I_{R3}}{I_{R1} I_{R2}} I_2 \right] \frac{I_1}{I_3} \quad (12)$$

As a divider, the output current, I_C , decreases as the signal current, I_3 , increases. As a result, both range and accuracy are reduced because the base current may become a significant part of the input transistor current. However, good accuracy can still be maintained over a 20-to-1 range.

Another valuable operation is extracting roots. The circuit at the bottom of page 113 will produce the square root of an input signal, I_X . Diode-connected transistor Q_1 is placed in series with the emitter of Q_3 to make the output circuit perform the square root operation. Current I_2 is constant. Transistor Q_2 provides thermal equalization and balances the voltages in the input and output circuit. The input circuit acts as a multiplier so that

$$V_1 + V_2 \propto \log_e I_X I_2 \quad (13)$$

where V_1 and V_2 are the voltages across Q_1 and Q_2 and \propto is the proportionality symbol. $V_1 + V_2$ equals the sum of the base-to-emitter voltage drops across Q_3 and Q_4 . The voltage drops across each of these transistors is proportional to the log of the collector current developed by Q_3 . Therefore

$$V_1 + V_2 \propto 2 \log_e I_C = \log_e (I_C)^2 \quad (14)$$

Since I_2 is constant, combining equations 13 and 14 results in

$$(I_C)^2 \propto I_X \quad (15)$$

More exactly, the collector current is

$$I_C = \alpha \left[\frac{I_{RE} I_{R1} I_2}{I_{R1} I_{R2}} \right]^{1/2} \sqrt{I_X} \quad (16)$$

where I_{R4} is the reverse saturation current of Q_4 .

Generalized logarithmic computer

A valuable feature of this transistorized slide rule lies in its ability to perform combined operations of the basic functions. For example, the circuit shown below will perform the computation $\sqrt{XY/Z}$, which is useful in computing mass flow of a compressible fluid. In this circuit, Q_1 and Q_2 form the log of the product $I_X I_Y$; Q_3 subtracts the term $\log_e I_Z$; and Q_4 and Q_5 perform the antilog and square root operation.

A generalized statement of the operations that these circuits can perform is

$$Z = \left(\frac{X_1 X_2 \dots X_m}{Y_1 Y_2 \dots Y_n} \right)^{1/r} \quad (17)$$

If m is the number of multiplying factors, there must be m transistors connected in such a way as to increase conduction in the output transistor when the signal current increases. If n is the number of dividing factors, there must be n transistors connected in such a way as to decrease conduction in the output transistor when the signal current increases. If r is the order of the root to be taken, there must be $(r-1)$ transistors in the emitter circuit of the output transistor connected so that the emitter current flows in the forward direction for that element.

The number of diode-connected transistors re-

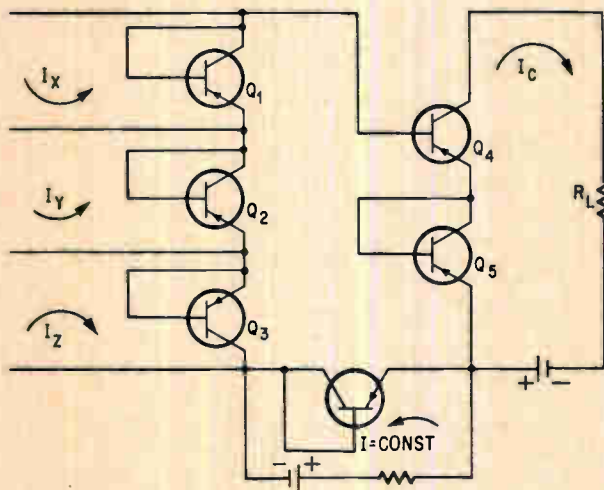

Functions of the form $\sqrt{XY/Z}$ are computed by combining the multiplying circuit Q_1 and Q_2 , the dividing circuit Q_3 , and the square root circuit, Q_4 and Q_5 .

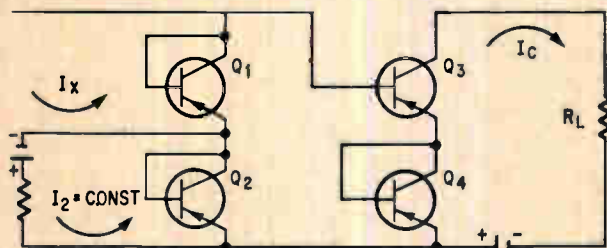

Square root of the input I_X is produced by transistor Q_2 in series with diode-connected transistor Q_1 .

quired for temperature stabilization will be equal to $n + r - m$. If this sum is positive, the compensating transistors are connected as multipliers; if the sum is negative, they are connected as dividers. The constant current through the compensators is made large enough to assure that all the transistors are working in their logarithmic range.

A four-quadrant multiplier.

All of the circuits shown so far have been one-quadrant types in which only positive signals are accepted and only a positive output is available. With the multiplier circuit on page 114, four-quadrant operation can be obtained. The circuit consists of two basic multiplier units connected together. A bias current I_{B1} must be supplied to each of the input transistors and inverted signal currents to one side of the unit. Summing the individual output currents in the load resistor yields

$$I_L = I_{C1} + I_{C2} = [2 (I_{B1})^2 + 2 I_1 I_2] K_1$$

where K_1 is a function of the saturation currents that are assumed equal for both sides of the circuit and I_L is the load current. The product may, of course, be easily separated from the constant term $2(I_{B1})^2$.

Sources of error

The capabilities and limitations of the circuits depend on the simplifying assumptions that were made. In the development of equations 4 to 10 it was assumed that:

- Transistors are accurately described by equations 1 and 2;
- Transistors are all operating at the same temperature;
- The base current of the output transistor is very small compared with the input currents; and
- The current gain, β , of the output transistor is constant.

In addition to these assumptions, system capacitance and its effect on frequency response have been ignored.

Silicon planar transistors, have been proved best for these applications. Equation 1 is accurate in the forward conduction region if a saturation current is calculated from some point in the linear semilog portion in the graph on page 110. At 27°C , the slope of the exponential region is approximately 59.5 millivolts per decade of current and is nearly the value predicted by equations 1 and 2. As the temperature increases, the slope decreases, as indicated by the graph on page 114.

There are also slight slope variations at a fixed temperature and from one unit to another. For instance, at 25°C , variations in excess of a millivolt per decade of current have been observed among several units. In addition, the change in slope with temperature is not always uniform.

At a fixed temperature, a difference in slope of 1 millivolt per decade of current between a multiplier's input and output transistor causes an absolute error of 4% over a decade of current. To

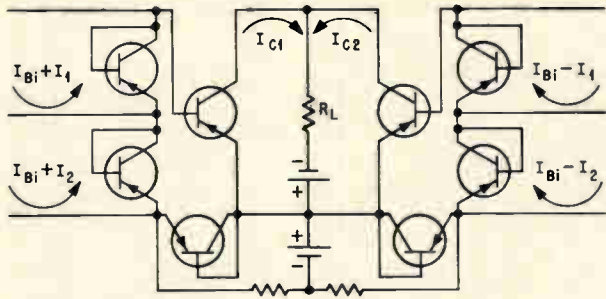

Four-quadrant multiplier performs multiplications for any combination of negative and positive inputs. Circuit consists of two multipliers connected in parallel. I_{B1} is a bias current.

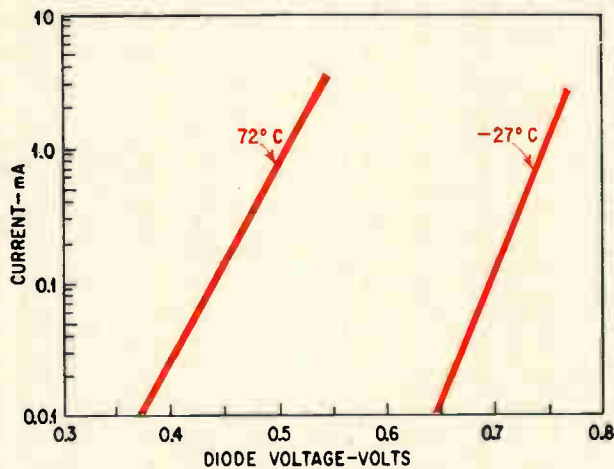

Increasing temperature shifts the transistor's exponential characteristics and also reduces the slope.

minimize this kind of error, it is necessary to carefully match the transistor's slope.

Furthermore, if the device is to work over an extended temperature range, matching will also be necessary at the lower temperatures, where slope variations are particularly accentuated. However, from 0°C to 100°C, slope variations in the absence of any special matching results in a 0.02% change in the output current per °C.

Reference shift

Another effect arises from the different transistor temperatures in a given circuit. At a constant current, the diode voltage shifts approximately -2 millivolts/°C as indicated by the graph directly above. If a one-degree difference exists between an input and output transistor, the reference point will shift by about 8% resulting in an error in the calibration of the readout.

To prevent a reference shift, all transistors are placed on an isothermal mounting pad. This pad is either an anodized aluminum-block, drilled to accept individually packaged transistors, or it is an alumina disk with the transistor dice mounted on it and interconnected by multichip integrated circuit techniques. For individually packaged transistors the aluminum pad must be anodized for electrical isolation.

Some temperature variation among transistors is unavoidable because of the differences in power dissipation. A low collector supply of 1.5 volts with a 1,000-ohm load keeps the output transistor's dissipation sufficiently low to avoid difficulty.

Base current

If it is not valid to assume that the base current I_B of the output transistor is small, then an error, ϵ_r , will be developed at the output even if all the junctions are ideal. An expression for the error that can occur in a multiplier will be determined. For analysis, the base current in the circuit on page 112 is assumed to be small, but not negligible compared with I_1 , I_2 and I_3 .

With this new assumption, equation 11 becomes

$$I_C = \frac{\alpha I_{RE} I_{R3}}{I_{R1} I_{R2}} \left\{ \frac{(I_1 - I_C/\beta)(I_2 - I_C/\beta)}{(I_3 + I_C/\beta)} \right\} \quad (18)$$

where $I_B = I_C/\beta$.

Because I_C/β is small,

$$I_C \approx \delta \frac{I_1 I_2}{I_3} \times \left\{ 1 - \frac{\delta}{\beta} \left[\left(1 + \frac{I_1}{I_3} \right) \left(1 + \frac{I_2}{I_3} \right) - 1 \right] \right\} \quad (19)$$

where

$$\delta = (\alpha I_{RE} I_{R3}) / (I_{R1} I_{R2})$$

Assuming that the output collector current is at some reference current I_{CC} , determined by the input reference currents I_{11} , I_{22} and I_{33} , then from (19)

$$I_{CC} \approx \delta \frac{I_{11} I_{22}}{I_{33}} \times \left\{ 1 - \frac{\delta}{\beta} \left[\left(1 + \frac{I_{11}}{I_{33}} \right) \left(1 + \frac{I_{22}}{I_{33}} \right) - 1 \right] \right\} \quad (20)$$

Now the operating currents are written

$$I_1 = x I_{11} \quad (21)$$

$$I_2 = y I_{22} \quad (22)$$

$$I_3 = z I_{33} \quad (23)$$

In these equations, x , y , and z are the factors by which I_1 , I_2 and I_3 are related to I_{11} , I_{22} , and I_{33} , respectively. These factors may be either greater or less than unity.

Substituting equations 21, 22 and 23 into 19

$$I_C = \delta \frac{xy}{z} \frac{I_{11} I_{22}}{I_{33}} \times \left\{ 1 - \frac{\delta}{\beta} \left[\left(1 + \frac{x I_{11}}{z I_{33}} \right) \left(1 + \frac{y I_{22}}{z I_{33}} \right) - 1 \right] \right\} \quad (24)$$

The relative error of any point referred to the reference currents is defined as

$$\epsilon_r = \frac{I_{CC} \frac{xy}{z} - I_C}{I_{CC} \frac{xy}{z}} = 1 - \frac{I_C}{I_{CC} \frac{xy}{z}} \quad (25)$$

where the term $I_{CC} xy/z$, represents the output

current for the values x , y , and z when it is valid to assume that the base current is negligible.

Substituting equations 20 and 24 into 25 and ignoring second order terms

$$\epsilon_r \approx \frac{\delta}{\beta} \left[\frac{I_{11}I_{22}}{(I_{33})^2} \left(1 - \frac{xy}{z^2} \right) + \frac{I_{11}}{I_{33}} \left(1 - \frac{x}{z} \right) + \frac{I_{22}}{I_{33}} \left(1 - \frac{y}{z} \right) \right] \quad (26)$$

Circuit performance

The table on the right shows the results obtained from a multiplier constructed with Motorola's SC-286 multichip integrated circuit. Input signals I_1 and I_2 both have full-scale values of 500 μa . I_3 is adjusted to give 500 μa of collector current in the output transistor. The output signal varies over a 100-to-1 range in response to a 10-to-1 input variation. In this table, the calculated value of I_c is 1/500 of the product I_1I_2 .

For this unit δ was 1.1 and β was 275. The small discrepancy between the observed and calculated errors is attributable to variations in parameters between the transistors, the approximation previously discussed, and instrument errors.

Measurements were made at room temperature and at -50°C and at 100°C with equally good results. At the temperature extremes, the only observed variation was in the value of I_3 required to produce 500 μa of output current with I_1 and I_2 at 500 μa . At 0°C , the value of I_3 was approximately 510 microamperes. It increased at a rate of 0.19 $\mu\text{a}/^\circ\text{C}$. The required I_3 varies not only with temperature, but also from unit to unit because of the difficulty in selecting perfectly matched devices.

Two calculations involving division are tabulated on the right. In the first calculation, the reference input current I_{33} was 300 μa and I_{11} and I_{22} were adjusted to 290 μa to give a reference output current I_{c0} of 300 μa . I_3 was then varied above and below the reference current. In the second calculation, I_{33} was 100 μa and I_{11} and I_{22} were adjustable to 96.5 μa for a reference output current of 100 μa .

If the data in the table were plotted, the absolute error of any point would be within 2% of the correct value over nearly a 10-to-1 range for the first case and nearly a 20-to-1 range for the second case. The improvement in the second case occurs because the output transistor's base current is a small fraction of I_3 . While the second example exhibits a greater range, it is achieved at the expense of output current.

Frequency response

The frequency response of these circuits is limited by both junction and external capacitances. In the case of medium-power, individually packaged transistors that have their collectors bonded directly to the header, considerable external capacitance is introduced by mounting these transistors on an anodized aluminum heat sink. The mounting

I_1 (μA)	I_2 (μA)	I_c (μA) Calculated	I_c (μA) Measured	% Error Measured	% Error Calculated
500	500	500	500.0		
400	500	400	401.57	.39	.14
500	400	400	401.33	.33	.14
300	500	300	301.91	.64	.27
500	300	300	302.65	.88	.27
200	500	200	202.03	1.01	.40
100	500	100	101.45	1.45	.54
50	500	50	51.01	2.02	.60
100	100	20	20.33	1.65	.87
50	50	5	5.06	1.36	.95

Calculated and measured errors in a multiplier circuit indicate an error of about 2% over a 100-to-1 range in output current.

I_3 (μA)	I_c (μA) Calculated	I_c (μA) Measured	% Error Measured	% Error Calculated
I 1500	60.0	59.5	-.8	+.8
900	100.0	100.6	+.6	+.7
600	150.0	151.1	+.7	+.6
300	300.0	300.0	0	0
200	450.0	443.7	-1.4	-.7
150	600.0	582.4	-2.9	-1.5
100	900.0	843.1	-6.3	-3.8
II 1500	6.66	6.50	-2.4	+.9
800	12.50	12.40	-.8	+.9
400	25.00	25.05	+.4	+.8
200	50.00	50.30	+.6	+.6
100	100.00	100.00	0	0
50	200.0	195.8	-2.1	-1.6
25	400.0	370.3	-7.5	-6.7

Error in a divider network is approximately 2% over at least a 10-to-1 range in output current. Values are for two experimental conditions.

used in the multichip version is the best way to reduce external capacitance.

The frequency response of only one multiplier was checked. The test was performed on a circuit that used individually packaged transistors mounted on an anodized aluminum heat sink. Its response was essentially flat out to one megacycle, falling off 3 db at 20 megacycles. The response of the multichip version should be considerably better.

References

- G.E. Platzer Jr., "Circuitry, for the Extraction of Roots, Multiplication and Division," U.S. Patent No. 3,152,250, Oct. 6, 1964, (Assigned to the Chrysler Corporation).
- G.E. Platzer Jr., "Logarithmic Multiplication and Division," U.S. Patent No. 3,197,626, Oct. 27, 1965. (Assigned to the Chrysler Corporation).
- A.B. Phillips, "Transistor Engineering," McGraw-Hill Series in Solid State Engineering, 1962, p. 131.
- J.L. Moll, "The Evolution of the Theory for the Current-Voltage Characteristics of PN Junctions," Proceedings of the IRE, 1958, p. 1076.

From the expanding line of Sigma relays . . .

Now there are 3 low-cost relays for switching up to 2 amps.

Order them off-the-shelf.

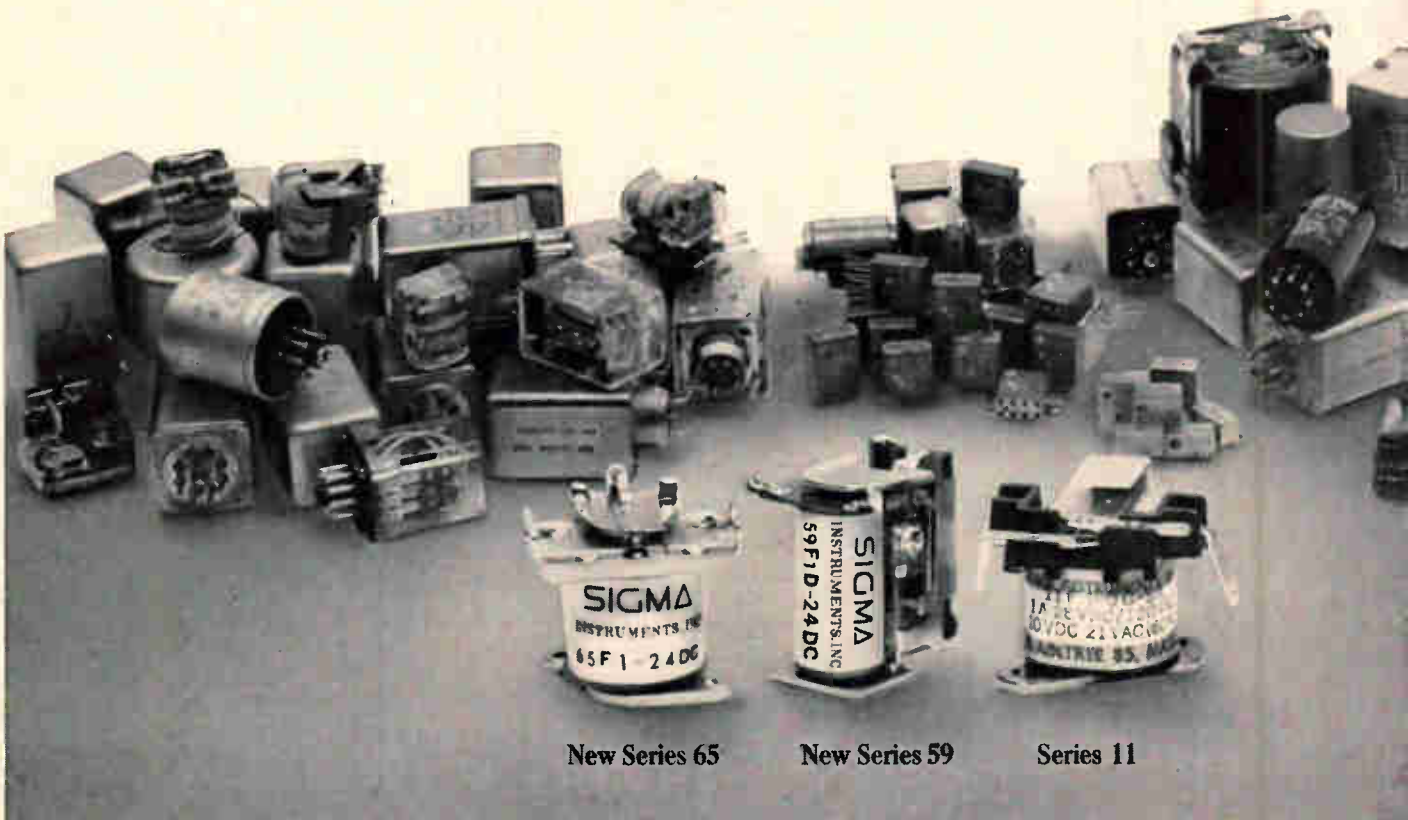

New Series 65

New Series 59

Series 11

**Match these specifications against your requirements.
Then contact Sigma or your distributor.**

Series 11:	Contact rating 1 ampere. Unenclosed, screw mounted, solder or printed-circuit terminals, all UL-listed (E28610 Yellow Card). Choice of 3 physical types, 11 coil resistances, 2 adjustments, 3 DC or 2 AC coil voltages.
Series 59:	Contact rating 2 amperes. Unenclosed, screw mounted, solder terminals; or metal dust cover, 8-pin plug. Choice of 3 DC coil voltages.
Series 65:	Contact rating 1 ampere. Unenclosed, screw mounted, solder terminals, or terminals for printed circuit mounting. Choice of 3 DC coil voltages.

New Sigma Series 59 and 65 relays now join the popular Series 11 to provide a broader range of low-cost SPDT relays for general purpose switching. Each of these small, one-ounce relays provides optimum operation for controlling light industrial and commercial loads. All are immediately available from stock at low prices.

How low in cost? Take the new Series 65. These DC relays are available in quantity at less than a dollar. They are specifically designed for simple, reliable on-off switching.

New Sigma Series 59 relays are built for gradually changing signals as well as on-off operation. This is made possible by the unique construction of these DC relays which use a snap-switch instead of conventional contacts.

Sigma Series 11 relays are available in both AC and DC versions. They are UL-listed and combine low price and high sensitivity with the ability to respond to gradually changing and on-off DC.

The new Sigma Series 59 and 65 relays and the Series 11 are suitable for applications ranging from vending machines and alarm systems to industrial controls. Use them wherever there is need for small, low-cost, highly dependable relays.

FREE CATALOG: Send today for the new Sigma Preferred Standard and Stock Relay Catalog and up-to-date stock list. They will help you select the relay types immediately available in quantity from your distributor or Sigma direct.

SIGMA DIVISION  **SIGMA INSTRUMENTS INC**
Assured Reliability With Advanced Design / Braintree, Mass. 02185

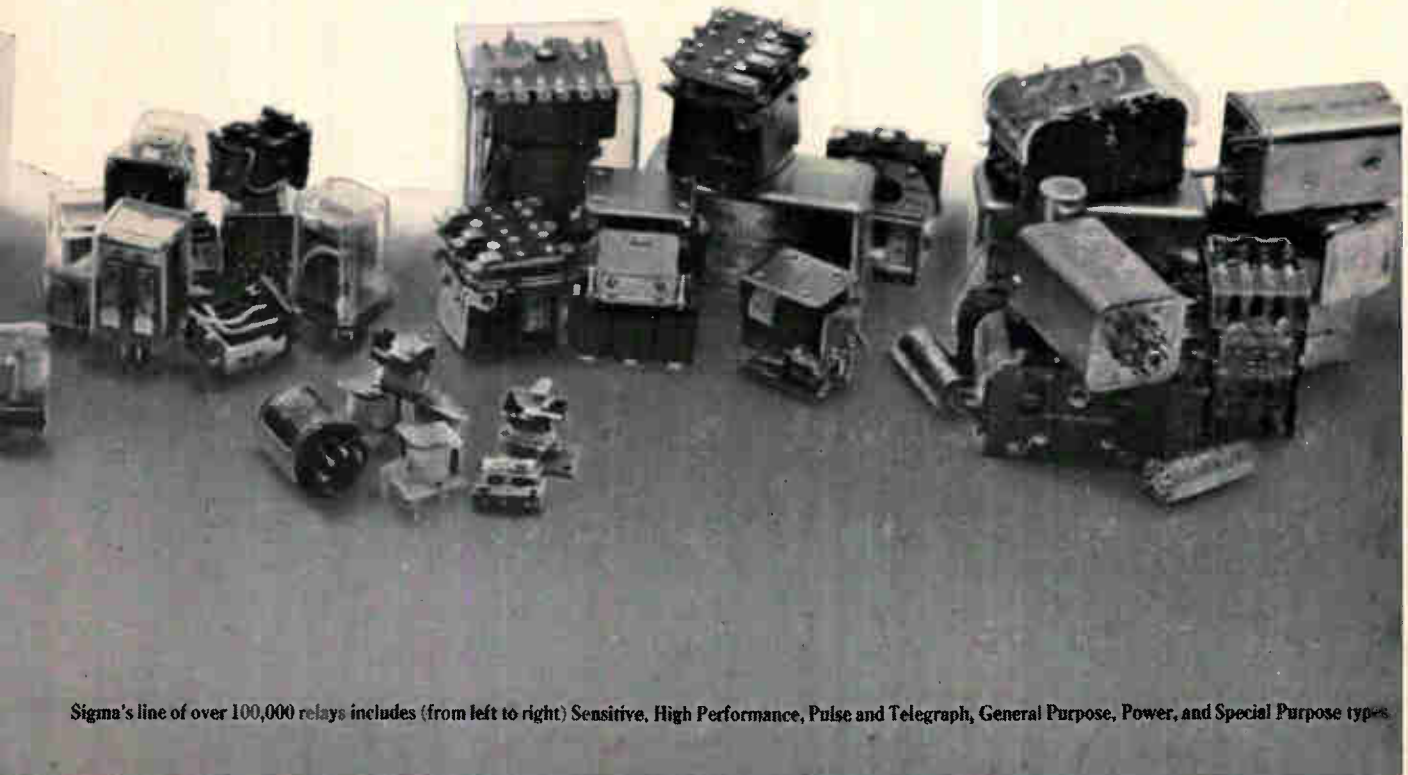

Sigma's line of over 100,000 relays includes (from left to right) Sensitive, High Performance, Pulse and Telegraph, General Purpose, Power, and Special Purpose types.

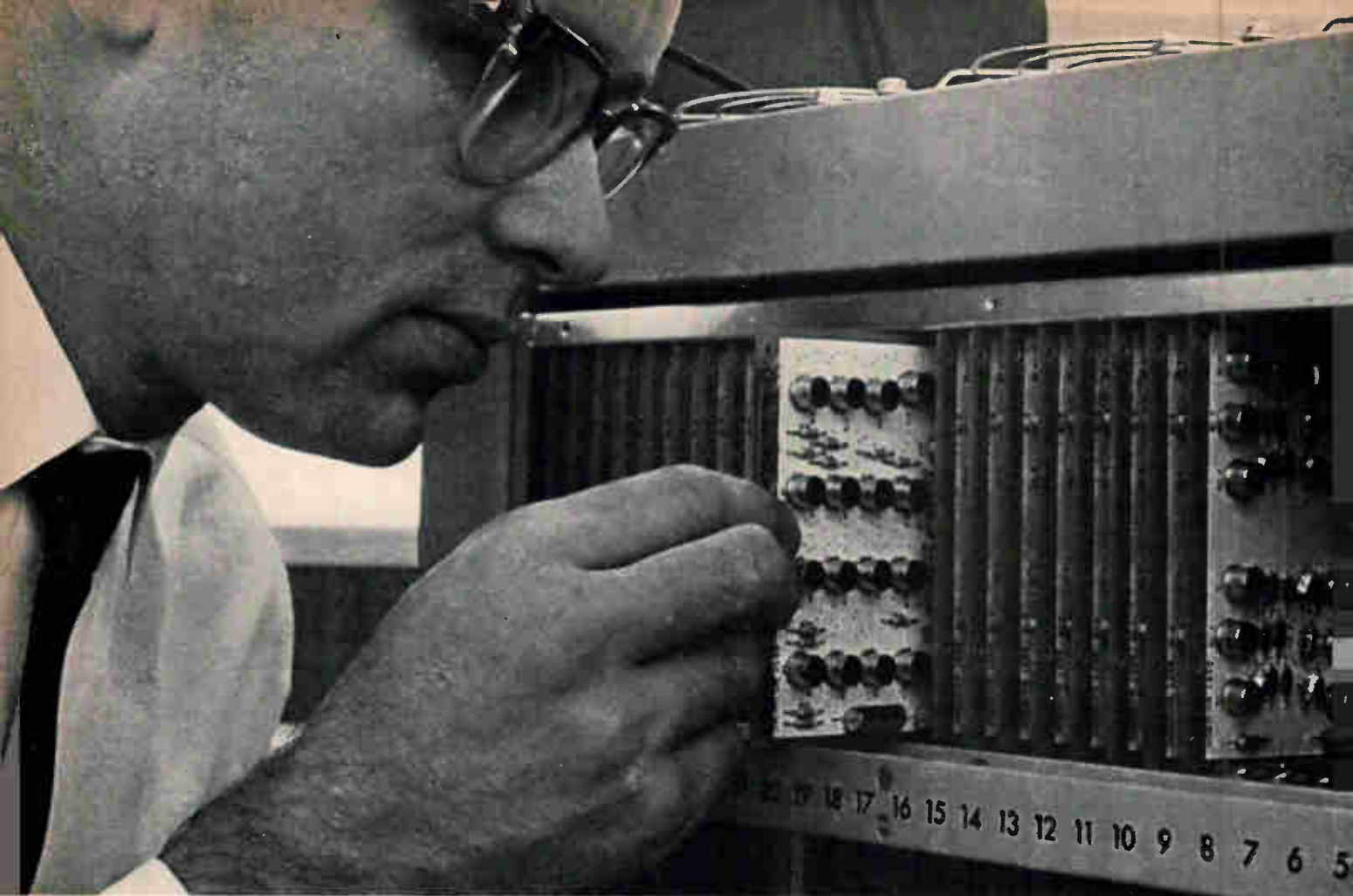

Gene Potter plugs a 16-byte memory module into one of the standard logic-module cages of a computer. Each cage can contain 128 words, each 32 bits (4 bytes), of scratch pad memory.

Computers

Integrated scratch pads sire new generation of computers

When a single chip of silicon carries eight bits of memory and their buffered decoding network, numerous high-speed memories go into a computer and time sharing becomes economical

By Gene B. Potter and Jerry Mendelson, Scientific Data Systems, Inc., Santa Monica, Calif.
Sam Sirkin, Signetics Corp., Sunnyvale, Calif., a division of Corning Glass Works

The mass production of integrated circuits containing several bits of memory—complete with decoding and output circuitry—makes practical a new generation of computers. With the IC's, many small memories, called scratch pads, operating at the speed of the logic circuitry, can be built economically into workaday data-processing systems.

The scratch pads enable moderately priced computers to provide the speed, capacity and versatility once available only in huge, expensive systems. As a result, the cost of processing large amounts of data can be halved.

An example of the efficiency that can be obtained when scratch pads are the keystone of the computer organization is in the Sigma 7 family of computers, which Scientific Data Systems, Inc. (SDS) introduced March 15 [Electronics, March 21, 1966, p. 37]. A typical Sigma 7, costing about \$500,000, has an input-output rate of some 160 million bits a second.

The high efficiency results from a new control memory and an arithmetic organization based upon the use of from two to a dozen scratch pads. The scratch pads are modular plug-in units, ranging in size from 16 to 512 words. The memories are made with the monolithic integrated circuits pictured on the cover and on page 122. The IC's were developed in a cooperative effort of SDS and the Signetics Corp. and are being produced by Signetics for SDS. Each circuit contains eight flip-flop storage bits and their encoding, decoding, control and buffer circuits.

A printed circuit card, carrying 16 IC's plus the drive circuitry pictured on page 121, forms a 16-byte module (8 bits per byte) that is the basic building block for all Sigma 7 scratch pads. For example, four such modules make up a 16-word scratch pad. If more capacity is needed, more boards are plugged into the computer's address and data buses. The modules are self-contained, having address-decoding circuits for up to 128 words.

The main job of the scratch pads is to quicken the response of the system to multiple inputs by reducing its dependence on the main memories for many operations and by allowing it to react instantly to priority requests. The Sigma 7 can service up to 200 users at remote consoles while simultaneously performing several routine chores such as inventory control and while operating peripheral equipments. The functions of the scratch pads are outlined in the block diagram on page 125.

The multiple-register architecture of the system, with its indexing, mapping (program relocation) and memory-write protection, requires multiple accesses to scratch pads within the main memory cycle. Therefore, to be effective, scratch pads must operate at least five times as fast as the main memory. Otherwise their operation would not mesh effectively with logic and control circuitry.

The Sigma 7 scratch pads typically have a writing speed of about 90 nanoseconds and a reading speed of 60 nanoseconds. The main memories, built

of ferrite cores, have a cycle time of 1.2 microseconds and an effective cycle time of 700 nanoseconds when the operation of the main-memory modules is overlapped.

The cost problem

The costs of scratch pads appeared to be a crucial problem when development of the system began two years ago. Designers of time-sharing machines have long known that unrestricted use of scratch pads would immeasurably improve system performance, but the expense limited their use in commercial systems.

Except for a few systems, new at the time, which had scratch pad-like registers composed of logic IC's, scratch pads were made of magnetic storage elements and transistor circuitry. In contrast to large, ferrite-core memories, scratch pads were inefficient in space used, power consumed and access time per bit. The cost was more than 50 cents per bit compared to a few pennies per bit for mass memories.

At that time, these problems were being attacked through the development of batch-fabrication methods, among them monolithic circuits, various forms of thin-film matrices, the weaving of magnetic wires and the molding of multibit ferrite elements.

IC's were the most attractive solution. Production processes were established. Functional density was high and could be made higher. Power and voltage requirements were compatible with the other IC's planned for the system. The ability of the IC's to operate at normal logic levels and provide useful logic drive simplified application. The eight-bit design selected provided the best trade-offs among power, packaging and system-design constraints and semiconductor-manufacturing capabilities.

Today, IC's containing 16 bits of storage with internal decoding, or 32 bits without it, probably can be made. If the system constraints on power dissipation and packaging can be eased, they may be used. One advantage of the present IC design is that it can be packaged in a 10-lead, TO-5 can, which is low in cost, easily assembled and reliable.

The design selected has 178 components on a silicon die measuring 104 by 95 mils. The components are bipolar transistors and diodes, and diffused resistors. Considerably higher functional density could have been obtained with circuits composed of field effect transistors made by the metal-oxide-silicon technology. But MOS circuitry was less developed at the time of design selection and is still too slow for scratch pads in the Sigma 7.

How big a scratch pad?

As the system design took shape, it became apparent that scratch pad modules could be used with significant gains in several places in the system, most of which are discussed on pages 124 to 126. To take full advantage of the savings possible with high-volume production of IC's, all the scratch

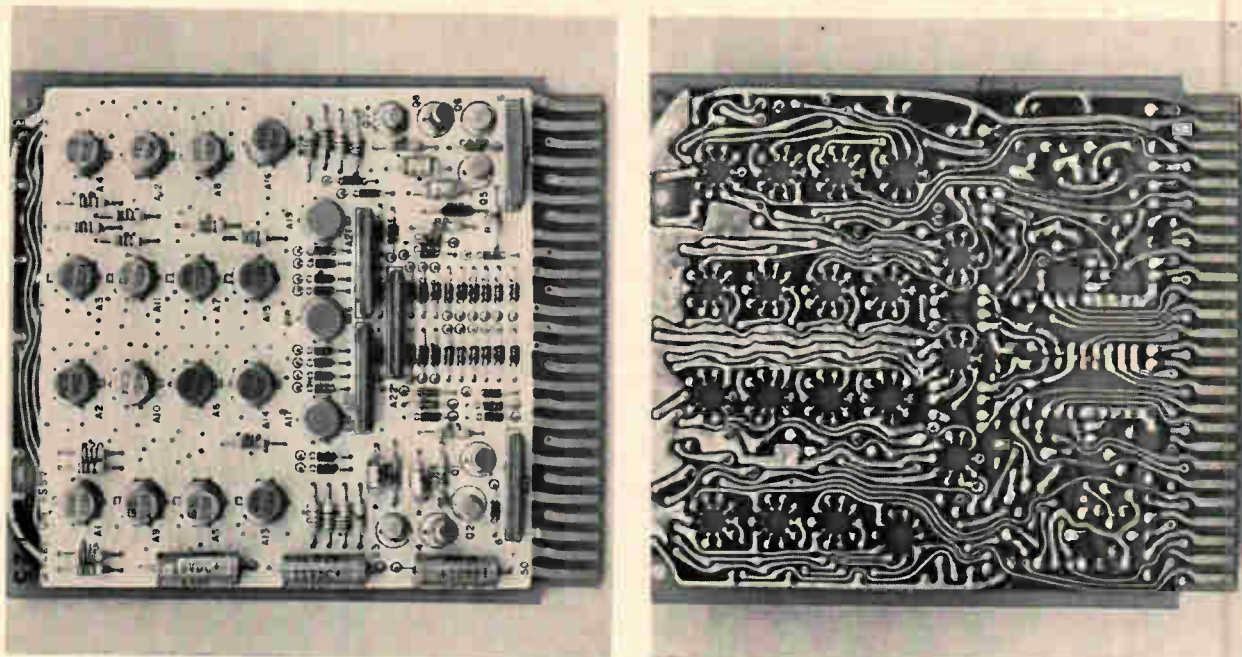

Scratch-pad module, front and back. On the front (left), the wiring—coated with an insulation—runs in a direction generally vertical to plug-in position. On the back, wiring is generally horizontal. The design avoids the need for expensive multilayer printed circuits. The bar-shaped objects are thick-film resistors.

pads should use the same IC and be assembled in similar configurations.

Since even large machines need only a few one-word registers, a scratch-pad size of 16 bytes appeared ideal. This number meshed with system word lengths, nominally 32 bits composed of four 8-bit bytes. It also meshed with the main memory, which can be addressed in bytes, half words, words, and 64-bit double words.

A linear-select (word-organized) form of memory was required. This is an advantageous form for IC storage because bits are positioned within a regular, two-dimensional wiring network. The coincident

(bit-organized) form requires three wiring planes.

The two-dimensional matrix is easily provided by printed circuit cards, as illustrated above and below. The wiring runs in the X direction on one side of a card and in the Y direction on the other side. In a register memory, four 16-byte cards are placed side-by-side to form a 16-word block. These are organized so that a single set of control lines are shared by each row of IC's. Without that sharing, packaging would be expensive.

The memory module operates in a parallel manner, obtaining one bit from each of eight separate IC's, as part of a linear-select memory scheme.

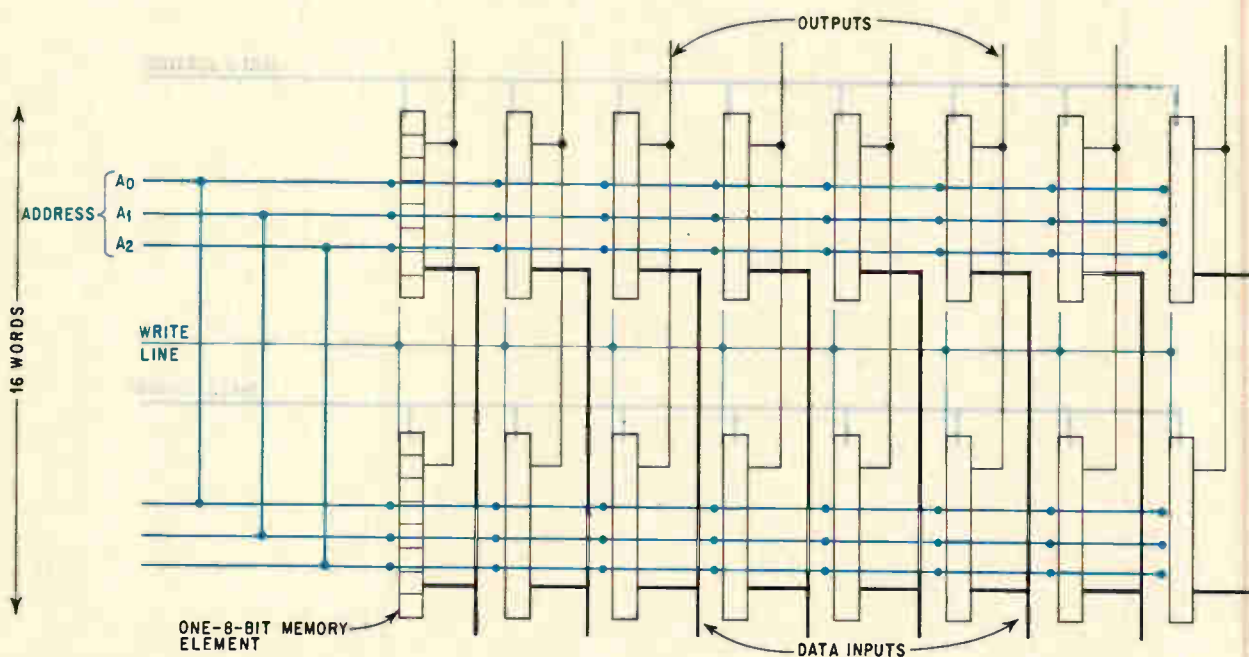

Module wiring configuration that is one byte wide by 16 words high. Ground and voltage lines are not shown.

The monolithic choices

IC-processing and scratch pad design constraints pointed toward an eight-bit or 16-bit IC design. For economy and reliability, the circuits had to fit into the 10-lead, TO-5 cans, which had also been chosen for the other IC's in the system. Four-bit IC's were rejected as too small and not economical; they would require a doubling up of the number of circuits and the amount of processing and assembly.

If 16 bits were used, the buffered decoding network and the group of storage flip-flops would have to be made as two types of IC's, costing some of the mass-production advantages of one type. With external decoding, the individual flip-flops would present a heavy current load, requiring more and higher-current drive circuits. Also, the bits would be sensitive to the noisy environment they would create, due to the fast switching of heavy current and capacitive loads. Since these and other design factors would increase over-all cost, eight bits appeared optimum.

Volatility and compatibility

In a large IC scratch pad, power consumption tends to be high and heat dissipation becomes a problem. Unfortunately, IC scratch pads are volatile, so that power cannot be removed from those portions not in use. A unique circuit design minimized the difficulty. Standby power is provided to only the actual storage flip-flops of an IC when that IC is not in use.

This was accomplished by using one of the required address lines as a control line. It switches a transistor, in the IC, which in turn gates power to all internal logic except the elementary storage flip-flops. The technique saves 60% of the power

that would ordinarily be consumed.

IC scratch pads are extremely convenient to use in a computer because they can be matched electrically to the rest of the system. The machine's normal logic-voltage and current levels can interface directly with the inputs and outputs of the memory IC's. The nondestructive readout (NDRO) operation of the scratch pad makes character regeneration unnecessary, producing highest system speed. Writing is simple since the memory need not be cleared or reset; when the voltage on the write-enable line rises, the address lines steer the data to the proper locations and force the storage flip-flop to the proper state.

Electrical specifications for the IC's are given on page 124 and the schematic is on page 122. The circuitry is transistor-transistor logic, which is the fastest type for the logic-voltage levels employed.

Note that the tenth lead of each IC is not used; this allows addition of a mass-reset function. The other nine leads are for an address-control line, three address-decoding lines, write-enable line, input, output, supply-voltage and ground lines.

Power-saving circuit

A data bit pulse enters a given IC, is gated by the write line and directed to the selected bit by the three address circuits (three variables will identify any location). The control line deprives the decoding and write circuitry of power, when they are not in use, suppressing noise and saving up to 60% of the power. It also provides the option—essential, since the outputs of a column of IC's are tied together—of not altering or looking at the state of any flip-flop.

The address-control line switches a transistor Q_1 (in the IC schematic), which feeds supply cur-

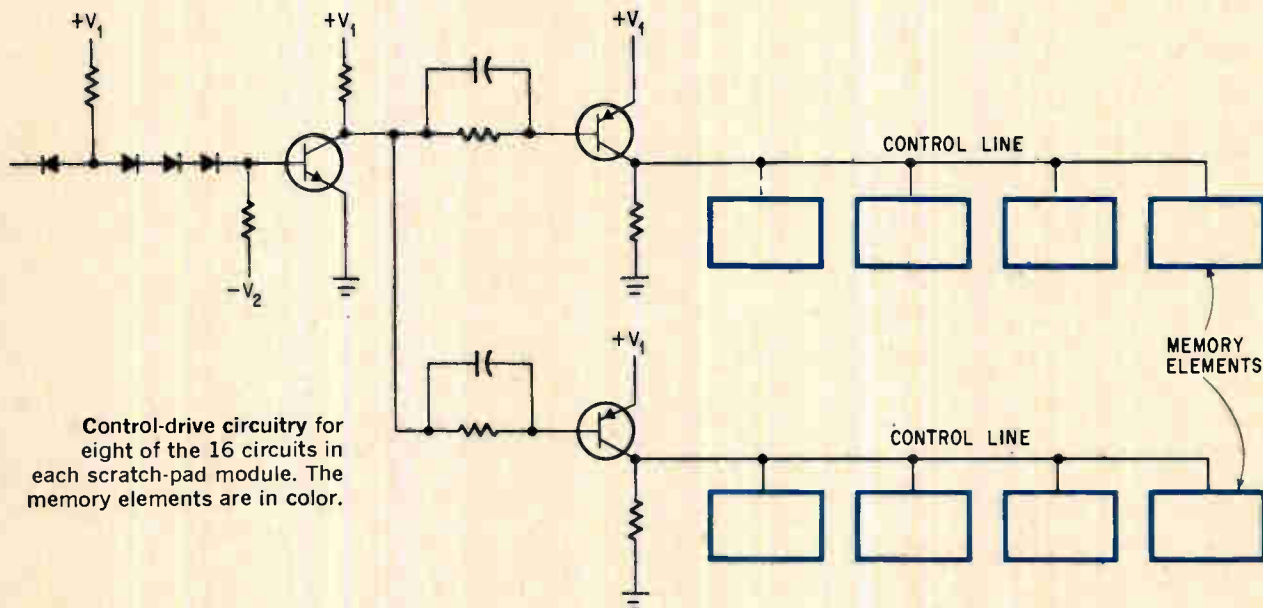

Control-drive circuitry for eight of the 16 circuits in each scratch-pad module. The memory elements are in color.

Reading, writing and eight bits on a chip

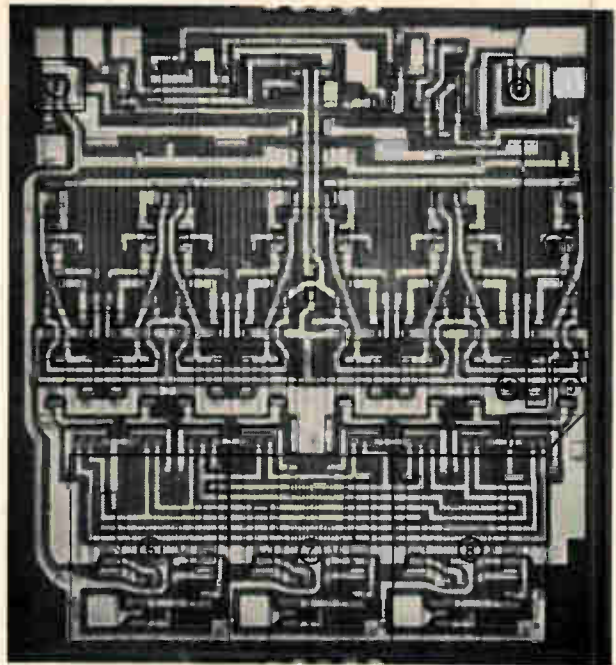
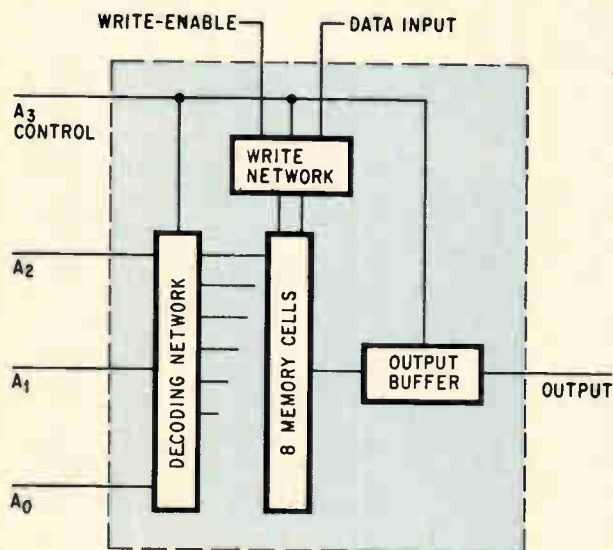

Layout of memory circuit, shown schematically at the left, is rearranged to pack the 178 components compactly on a single chip measuring 104 by 95 mils. The circuitry is transistor-transistor logic.

- Key areas of the chip, outlined on the photograph, are:
- 1, 2. Control and output transistors
 3. One of the eight flip-flop storage cells in a band across the center of the chip
 - 4, 5. Cell's clamp diodes and three-input AND gate
 - 6, 7, 8. Address-decoding circuits.

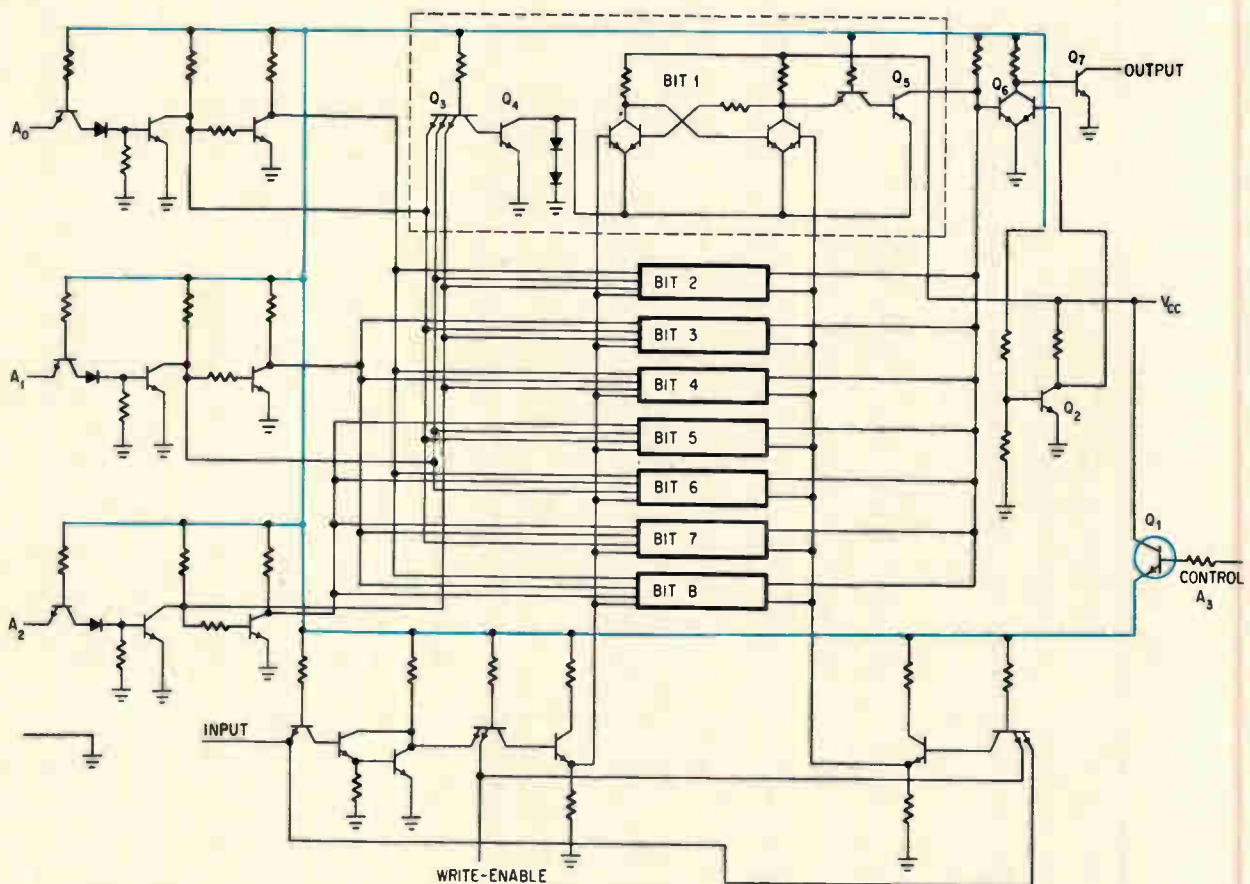

Power consumption of the memory elements is sharply reduced by control transistor Q_1 , which shuts down the power line (color) to deprive unused circuits of power, and by the flip-flop design. When one bit is on line, it prevents the others from receiving power they can't use.

Evolution of a memory circuit

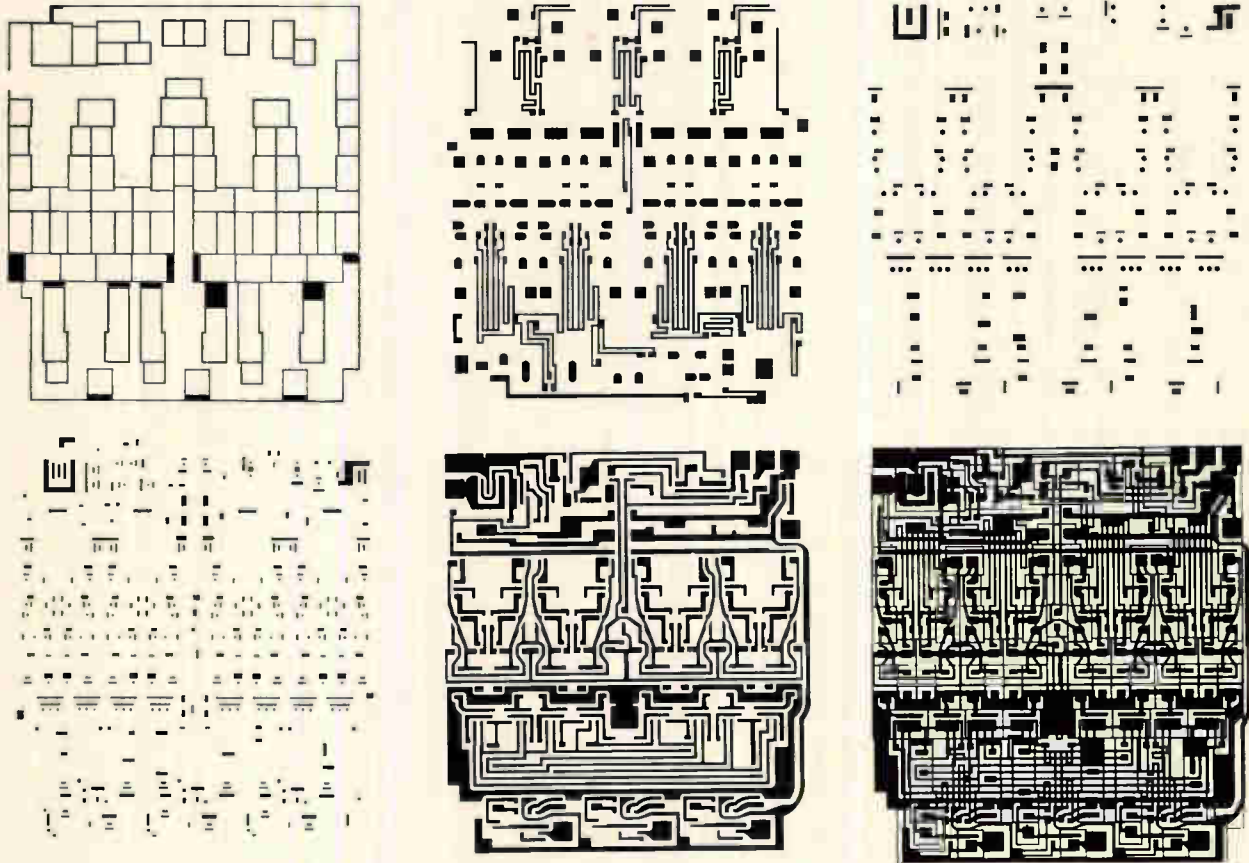

Processing stages that produce the monolithic memory circuits can be traced in these patterns. They are a series of masks for etching the oxide passivation coating of the silicon crystal and the thin-film metal layer. The patterns etched in the oxide bare the silicon for diffusion of isolation moats and the resistors, diodes and transistors. The next to last pattern produces the thin-film interconnections. These patterns were superimposed to create the composite pattern at the lower right and the color illustration on the cover.

rent to 20 other transistors. When Q_1 is on, current flows to the decoding and write logic and to the output buffer. When Q_1 is off, these circuits are deprived of power. The flip-flops draw power directly from the supply-voltage lead V_{cc} . Signals on the data-input line cannot be inserted by the write circuitry, since that is not functioning.

The output buffer is also deprived of power. When the control line is down, Q_2 is deactivated. This holds the buffer off because the right-hand side of transistor pair Q_6 , which feeds Q_7 , is turned on. The voltage swing for the control line is between 6.6 volts and ground.

Q_1 and Q_7 are the biggest and most powerful transistors in the IC. They are oversized so they can carry large currents without excessive loss and overheating of the IC.

Low-power flip-flops

So that decoding can be done on the chip, the address circuitry subjects only the selected bit to a write-line input. Likewise, only that bit controls the output of the memory. The decoding design also reduces the unselected bits' power consumption about 30%. The power saved is used to speed

up the address and write circuitry.

If it is assumed that a diode drop equals approximately 0.75 volt, a transistor's $V_{be(sat)}$ equals 0.70 volt and $V_{ce(sat)}$ equals 0.20 volt, the operation of the circuit can be described as follows:

The base reference of a selected bit is only $V_{ce(sat)}$ above ground, while that of all the unselected bits is equal to two diode drops above ground, thus reducing their apparent supply voltage 1.5 volts. The selected bit clamps the write lines at $V_{be(sat)} + V_{ce(sat)}$, or 0.9 volt. The other bits cannot be written into because a write pulse has to be at least three times the diode voltage drop or 2.25 volts, to get into a flip-flop.

For example, if bit 1 in the schematic on page 122 is not selected, its base reference will be about +1.5 volts. That is the voltage drop across the two clamp diodes that are connected in series from the collector of Q_4 to ground. However, if bit 1 is selected, the base reference is only about +0.2 volt, the collector-to-emitter saturation voltage of Q_4 . All the emitters of Q_3 are high.

The state (on or off) of the selected flip-flop is reflected by Q_5 and detected by Q_6 . Q_5 can turn Q_6 off only if Q_5 's emitter has been grounded

through Q_4 . Q_6 is normally on. It can be switched off by Q_5 only if bit 1 has been selected and bit 1 is in the off state. Since the system already knows which bit it is looking at, the presence or absence of an output from the IC (through Q_7) tells the state of the bit.

If bit 1 has not been selected, the collector of Q_5 will be at a high enough level in either state to tend to keep Q_6 on. With Q_4 shut off, the emitter of Q_5 is at 1.5 volts and Q_6 is on regardless of the state of Q_5 . Thus, Q_6 has to look elsewhere for a turn-off signal.

Third generation

The IC's qualify Sigma 7 as a third-generation computer since the design goes beyond that of tube and transistor systems. In another sense, it is a "third-and-a-half-generation" system because the scratch pads represent a move toward the ex-

pected organization of future generations. Many computer designers feel that when huge arrays of circuits can be batch-fabricated cheaply, it will be practical to make self-programming and self-organizing systems, or systems composed of many small computers working in parallel, or even machines composed of thousands of cells in which the system's control, logic and memory functions are combined.

There are strong resemblances between Sigma 7 and the "fourth generation." It can do any combination of time-sharing, multiprogramming and multiprocessing [Electronics, Nov. 29, 1965, p. 71]. It can operate in real time, run several programs asynchronously, correct errors when programs are being run and automatically adjust its internal operation to changing user demands.

The scratch pads helped make this possible by avoiding the need to build a large quantity of fixed-capability hardware into the system. In each of their four major applications, described below and outlined in the block diagram on the facing page, the scratch pads have various optional applications and sizes.

Scratch pad I

The first application of the scratch pads is as general register blocks that implement the Sigma

IC specifications

V_{cc}	4.0 volts \pm 10%
I_{cc}	50 ma maximum
A_3 "1"	6.6 volts maximum
Output current	60 ma at 0.5-volt maximum
Operating temperature	5° to 70° C

Other scratch pads, other systems

The integrated circuits of today do not end the search for the ultimate component for scratch-pad memories. As the authors of the Sigma 7 article point out, it should be possible soon to double or quadruple the storage content of each IC. Furthermore, competing forms of high-speed memories are being sought by researchers.

The breadth of the development effort was indicated in February at the Solid State Circuits Conference when four companies gave reports on four distinctly different scratch-pad designs. A common theme—high-speed memories produced by low-cost techniques—emerged:

- Bell Telephone Laboratories, Inc. is developing a diode-selection matrix, with performance comparable to that of a transistor matrix, for a 1,024-word magnetic memory. The magnetic-storage elements are wires plated with magnetic alloy.

- Univac division of the Sperry Rand Corp. and Motorola, Inc.

described a 64-word memory built by vacuum-depositing magnetic films and interconnections on a small glass plate and then attaching to the plate integrated circuits and other semiconductor components. An earlier report described the fabrication techniques [Electronics, Oct. 4, 1965, p. 102].

- Nippon Electric Co., Ltd. of Japan, is preparing an associative memory of integrated circuits made by the metal-oxide-semiconductor technique (MOS). The active elements in the storage cells are p-channel MOS transistors. With p-n-p transistor sense amplifiers, the cycle time is 150 nanoseconds, unusually fast for MOS circuitry.

- The Radio Corp. of America is also developing a high-speed MOS memory. The storage cells, constructed of complementary n-channel and p-channel MOS transistors, operate in 20 nanoseconds. A 16-word array containing 1,080 MOS transistors, including decode and drive circuitry, is expected to read in 50 nanoseconds and write in 75 nanoseconds.

Bipolar IC's. Several companies, in addition to Signetics Corp., are making scratch pad IC's with bi-

polar transistors. An IC containing 16 bits of storage and their associated circuitry will soon be introduced commercially by Texas Instruments Incorporated [Electronics, March 21, 1966, p. 144]. Sylvania Electric Products, Inc., a subsidiary of the General Telephone & Electronics Corp., will soon offer a 16-bit chip. Transatron Electronic Corp. is making them on custom order. Signetics also has a 16-bit project. Motorola, Inc. is developing storage arrays.

General Micro-electronics, Inc., is making large-capacity MOS IC's on custom order and GME and other companies are also making off-the-shelf circuits, such as shift registers [Electronics, Oct. 4, 1965, pp. 84 and 96]. One GME custom circuit stores 64 bits in a flatpack. One of its main features is low standby power, typically 10 microwatts per bit; the read-write cycle time is 500 nanoseconds.

For future use in its own computers, the International Business Machines Corp. is readying monolithic memory circuits that are compatible with the hybrid IC's now used in its System 360 computers. One research IC, described

7's instruction set. Each set of registers, termed a register block, has 16 registers and is made up of four 16-byte modules. One such 16-word scratch pad is standard; there can be as many as 32 blocks, or 512 words.

A five-bit block-pointer register designates which of the 32 blocks is active: that is, which block is to be employed in the execution of an instruction.

These registers greatly improve the speed with which the computer responds to interrupts. Interrupt requests can be honored instantly by aborting long instructions in midexecution without loss of information, because operands come from storage into active circuit registers for instruction execution. Moderately long instructions (10 to 30 microseconds) are aborted and restarted upon return from an interrupt. Instructions longer than 30 microseconds are designed so they may be aborted almost instantly and then resumed from the point of interrupt upon return from the interrupt routine. Even though some instructions take 500 microseconds, it takes only 2 to 20 microseconds to initiate an interrupt response. The total response time is never more than 25 microseconds and it may be as short as 6 microseconds.

In conventional systems, interrupt processing requires the content of the general registers to be stored in core memory to preserve the operating

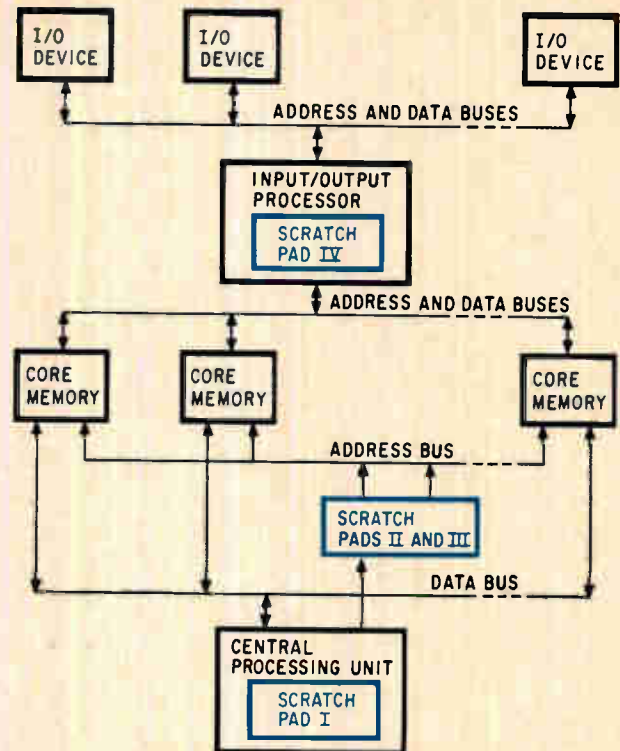

Main applications of scratch pads: I, as registers; II and III, memory mapping and protection; IV, addressing and local storage.

last fall, contains 16 storage cells and their control circuitry on 0.07-inch-square chip of silicon [Electronics, Nov. 1, 1965, p. 31].

The Fairchild Semiconductor division of the Fairchild Camera & Instrument Corp. has been working for more than a year on IC scratch pads [Electronics, March 8, 1965, p. 46]. Its latest model, a test bed for circuit, system and packaging design, is a mix of the company's standard logic circuits and special 36-bit storage cells. Four printed circuit cards, each carrying 160 IC packages, form a memory that stores 256 words that are 72 bits long.

Other systems. Scratch pads have been employed in small quantities in computers for years. Some small airborne computers make do with simple delay-line storages. Others have high-speed magnetic storage assemblies. Univac and the Burroughs Corp., for example, have been putting high-speed thin-film memories into their computers. The plated-wire type of thin-film memory is also in commercial use. Woven-wire scratch pads, resembling a piece of cloth, are built into France's newest computers,

the Bull-General Electric Gamma 140 and 141 [Electronics, March 7, 1966, p. 304].

Computer manufacturers began using conventional logic IC's as scratch-pad elements about two years ago. One of the earliest applications was in Electronic Associates Inc.'s EAI 8400. The central processing and input-output control sections are made with discrete components, but built into the circuitry are stacks of IC registers that also handle several scratch-pad functions.

The EAI 8400's central processor has eight 32-bit registers, split into 16-bit halves. Four of these are "save" registers that act as bookmarks in computer programs. They permit interruptions and store intermediate results of programs. Another register stack in the input-output section aids in memory control and buffers variations in data-transfer speeds.

To improve the speed of the larger models of the IBM 360 computers, the register and scratch-pad circuitry is scattered throughout the logic circuitry. Instead of making separate plug-in modules, IBM puts storage circuits a few at

a time onto the logic-circuit cards to shorten lead lengths and control wiring delays. The arrangements are designed by computers [IBM's design-automation techniques and the organization of the System 360 are described in the April, 1964, issue of the "IBM Journal of Research and Development"; the wiring techniques are detailed in Electronics, Nov. 1, 1965, p. 90].

The Models 65 and 75 of the System 360 have 25 registers that are each 36 bits long (four bytes of eight bits plus a parity bit for each byte). Among the functions which qualify the registers as scratch pads are working storage and local provision of instructions. In the larger Model 90, there are 76 one-word registers. Scratch pads in three smaller models are separate ferrite-core arrays. Twenty-four of the registers in each can be manipulated by the computer users.

IBM has been using hybrid integrated circuits. It is expected to use monolithic circuits, such as the 16-bit memory chip, as these emerge from the IBM labs and go into production.

George Sideris

environment of the interrupted program. The registers must also be loaded from the core memory to establish the operating environment of the interrupt process. Later, the interrupted program has to be returned to the registers.

The Sigma 7's multiple-register blocks preserve the status of the interrupted program in register by simply changing the content of the block-pointer register. The change takes place within the six-microsecond execution time of a single instruction that stores in memory the control state of the interrupted program and obtains from memory the corresponding control states for the interrupting program. In effect, the program-switching instruction causes the system to walk away from one block of registers and step into another with no additional time cost.

Scratch pad II

Scratch pad II stores constants, assigned by the supervisory program, for program relocation (main-memory mapping) and memory protection.

Mapping is essential for time-shared or multiprogrammed operation. It allows programs to flow continuously in and out of the main memory, occupying different fragments of the memory each time it is entered. The user's instructions generally call for a contiguous block of memory at one location, but honoring such reservations for room wouldn't be efficient. Instead, the system files the program parts as though it had a loose-leaf notebook. At one time a word may appear on page 8, word 9, and at another time at page 88, word 9. A memory of 131,072 words will have room for 512 words on each of 256 pages.

The system keeps track of the program's actual addresses in core by storing address-change constants in the scratch pad. The system refers to these each time it initiates an access to memory. The validity of each reference is controlled by 2-bit access-protection codes stored in the scratch pad.

The access-protection codes prevent one program from interfering with another. They also prevent snooping. One user can't get at another's proprietary information, such as the pay rates for key personnel, since the codes can be set to prevent it.

The memory-mapping scratch pad is provided by 16 cards, each carrying 16 bytes' worth of IC's. That works out to one byte per page for the 131,072-word addressing range. Core memory size is expandable to eight 16,384-word modules. If main memories faster than those now used become available, they can be plugged into the system.

The 512-bit scratch pad for 256 pairs of access protection bits is provided by four 16-byte modules. The map scratch pad and these modules are addressed concurrently.

Scratch pad III

Another 512-bit scratch pad stores 256 2-bit "locks" that provide write-protection control for a main memory of the maximum size, 256 pages. Each program is given a 2-bit "key" when it is given

control of the computer. Write access is permitted a program when its key opens the lock assigned to a page (512 words). The key and lock codes must have values of 00 or some nonzero value.

The speed of the scratch pads allow the access-protection and the write-protection techniques to be performed sequentially without slowing down system operation.

Scratch pad IV

In the multiplexing input-output processor (IOP), the scratch pad speeds up I/O processing and avoids idling of the central processor unit (CPU) while data is read into or out of relatively slow peripheral equipment. Each IOP can handle 32 peripherals and there can be eight IOP's in a system.

The IOP gets its initiating instructions from the CPU, but operates independently thereafter. The CPU specifies the peripheral, the direction of data transfer and where transfer should begin in memory, and the number of words to be transferred. The CPU proceeds with the program, while the input-output control information remains in the IOP scratch pad until the data arrives.

The basic IOP scratch pad provides for eight channels. It is built with five cards, providing 16 words of 40 bits. Generally, 10 bytes control a channel. The scratch pad can be expanded in sets of sixteen 40-bit words to a maximum size of 64 words. That size will control concurrent operations on 32 channels.

The authors



Gene B. Potter is responsible for semiconductor applications, including custom integrated circuits, at Scientific Data Systems, Inc. He is an honor graduate of the University of California and joined SDS in 1964.



Jerry Mendelson, another University of California honor graduate, directs the planning and design of all SDS products, including the Sigma 7 computer. Until 1964, he was manager of the advanced programs staff at Litton Industries, Inc. He has eight computer patents.



Sam Sirkin, a naval aviator from 1957 to 1962, joined Signetics, Inc., in 1964 after graduation from the University of California. He was responsible for the design of the SDS memory circuit and is now working on ultrahigh-speed designs for digital integrated circuits.

MONOLITHIC VOLTAGE COMPARATOR: \$5.00

The Fairchild μ A710C linear integrated circuit offers performance characteristics better than most discrete circuits — at discrete circuit prices. This fast precision comparator is highly versatile and can be used in a wide variety of applications including A-D conversion, process control, machine control, analog computers, power supplies, DVMs etc. Use them as GO/NO GO detectors, voltage comparators, sense amplifiers, precision monostable multivibrators, voltage controlled oscillators, video amplifiers, and phase discriminators. In stock at Fairchild Distributors, or write for complete specifications.

FAIRCHILD
SEMICONDUCTOR

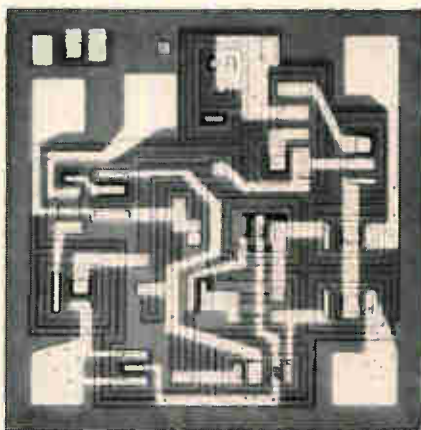

Typical characteristics:

Resolution 1mV
Low input offset 2mV
Fast response time 40nsec.
Temperature coefficient of input offset voltage 7.5 μ V/ $^{\circ}$ C
Output compatible with all integrated logic forms +4V to -0.5V
Large input voltage range \pm 5V

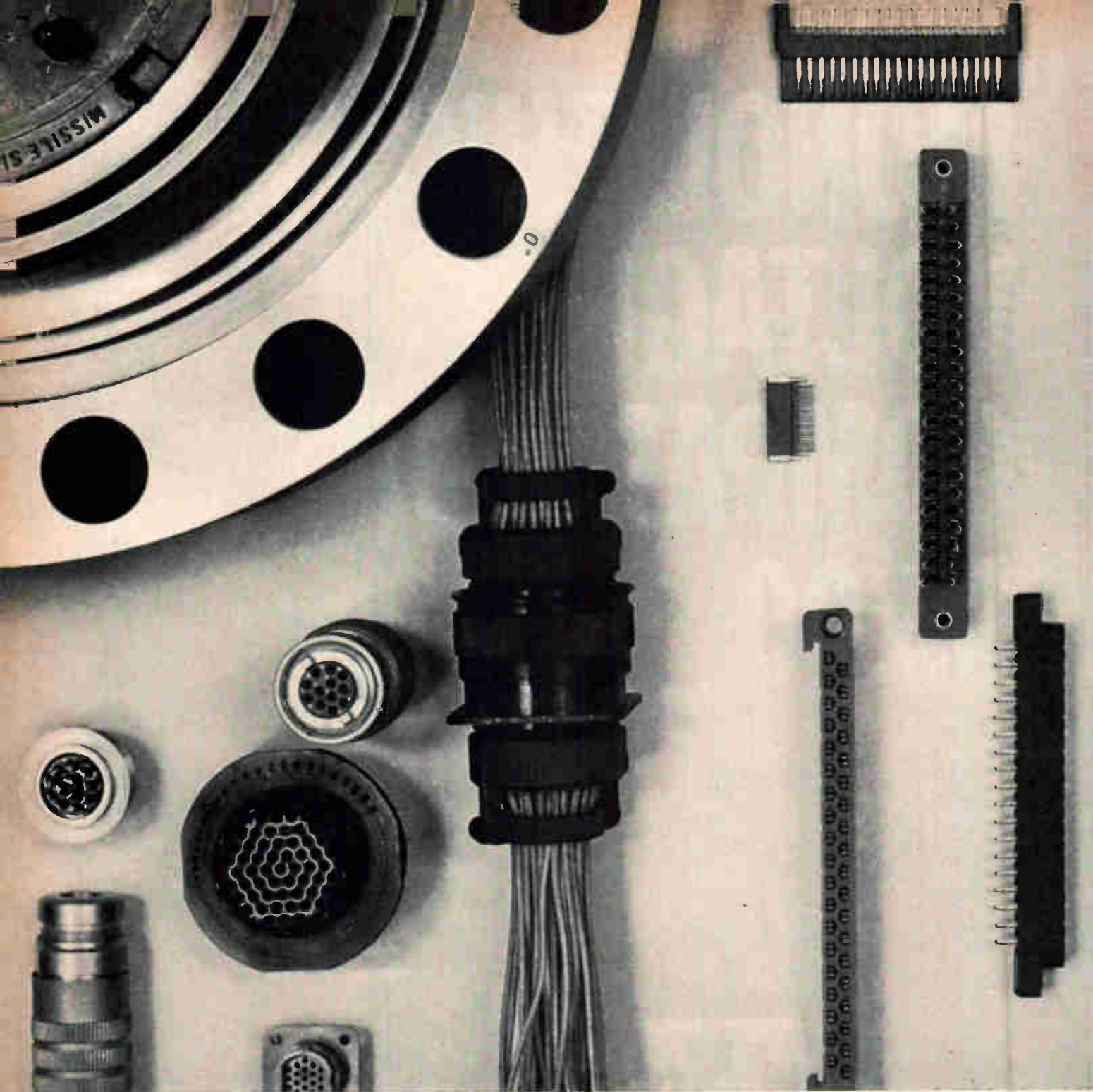

***Here are just 36
of the 36,000
Amphenol connectors***

Why so many? Because interconnection jobs have become so diverse and complex. On a Polaris, you may need a big aft umbilical connector that withstands 5000°F for 2½ minutes. But if you're miniaturizing a strip chart recorder, you can pack 50 contacts into a 1" connector. What else? **MILITARY CONNECTORS.** (Far left) We make all the standard AN/MS and other Mil-spec types, including

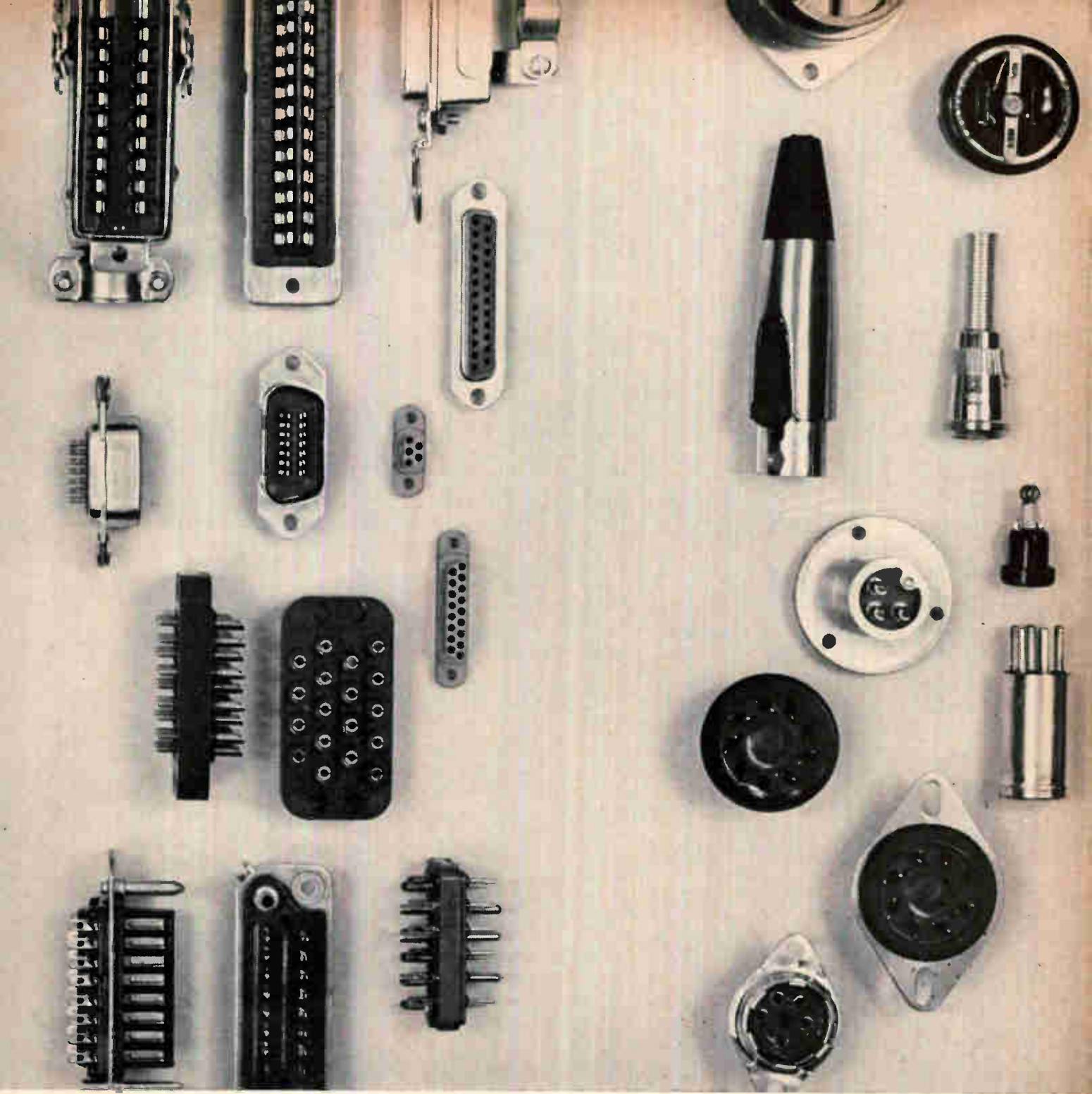

MIL-C-26500 and MIL-C-38300 circular environmental connectors. (Incidentally, we have a Space and Missile Systems facility just for specials.)

PRINTED CIRCUIT CONNECTORS. (Middle left) There are actually thousands. Everything from the micro-miniature 64 Series to the bellows-contact type 225 Series to the new Amphenol Flex-1 connector that welds directly to unstripped flat cable.

RACK AND PANEL CONNECTORS. (Middle right) There's the Min-Rac 17, with its extremely uniform body contacts. For the ultimate in mating reliability, consider our new Series 217. It is 99.99% reliable with three positive seals: around the contacts, at the rim, and at the lip. Or for easy blind mating, choose the Amphenol Blue Ribbon connector with sturdy, wedgelike contacts.

COMMERCIAL PLUGS AND SOCKETS. (Far right) Pick from a long list of tube sockets, microphone plugs, cable jacks, tip jacks, heavy duty industrial sockets—all you'll ever need.

Delivery? The fastest in the business. Ask your nearest distributor or Amphenol Sales Engineer. (Or write to us.) *Amphenol Connector Division, 1830 South 54th Avenue, Chicago 50, Illinois.*



AMPHENOL CONNECTOR DIVISION
AMPHENOL CORPORATION

Specify Amphenol . . . the leading name in cable, connectors, assemblies, RF switches, potentiometers, motors, microelectronics



***I'm an
engineer.***

***I'm a
marketing
man.***

*Let me tell you,
it's the most stimulating work
I've ever done.*

How about your job? It's been only a year or two now since you got your degree. Do you still enjoy straight engineering assignments? Or do you want something more?

Jack Pietri wanted more. So, he became an IBM Marketing Rep. His job combines the challenge of engineering with the excitement of selling. And he thinks it's the most stimulating work in the world.

You might think so, too. You'd still apply your engineering know-how. To solve critical management problems. To get the right information to the right place at the right time in the right form. To give your customers maximum control, maximum output or maximum economy.

We'll teach you how to work with real-time control of industrial processes. Communications-based information systems. Time-shared computer systems. Graphic data processing. Computer-controlled manufacturing systems. Management operating systems. Or engineering design automation.

When you finish our Computer Systems Science Program you're ready for the most absorbing, stimulating assignments you've ever had. And for the opportunities that go with them at IBM. Growth, advancement, responsibility.

With branch offices in over 150 major cities coast to coast, we'll try to match your assignment with your preferences.

You can get a better idea of the Marketing Rep's job at the nearest IBM

office. Talk it over with the branch manager. Or write to Dr. E. S. Savas, IBM Data Processing Division, Dept. 015, 112 East Post Road, White Plains, New York 10601. IBM is an Equal Opportunity Employer (M/F).

IBM Marketing Representative John H. Pietri is assigned to a manufacturing territory in Houston. He received his B.S.M.E. degree from Rice University.

IBM®

Helipot's side-adjust
Helitrim® cermet
trimmer—world's
smallest—costs as little
as \$1.50 in quantity.



Helipot's side-adjust
Helitrim® cermet
trimmer—world's
smallest—costs as little
as \$1.50 in quantity.



Helipot's side-adjust
Helitrim® cermet
trimmer—world's
smallest—costs as little
as \$1.50 in quantity.



Helipot's side-adjust
Helitrim® cermet
trimmer—world's
smallest—costs as little
as \$1.50 in quantity.



The Model 62PA side-adjust is a new easy-access cermet trimmer with these quality features: virtually infinite resolution; excellent high frequency characteristics; and standard resistance from 10 ohms to 1 megohm. Its rugged cermet resistance element gives you long, trouble-free life and freedom from sudden failure. Inside its plastic case is a sealed metal housing identical to the popular 1/4" top-adjust Model 62P.

Focus in on delivery advantages, too... immediate stock availability. Call your Helipot sales rep for full specs.

Beckman

INSTRUMENTS, INC.
HELIPOT DIVISION
FULLERTON, CALIFORNIA • 92634

INTERNATIONAL SUBSIDIARIES: GENEVA; MUNICH; GLENROTHES, SCOTLAND; TOKYO; PARIS; CAPE TOWN; LONDON

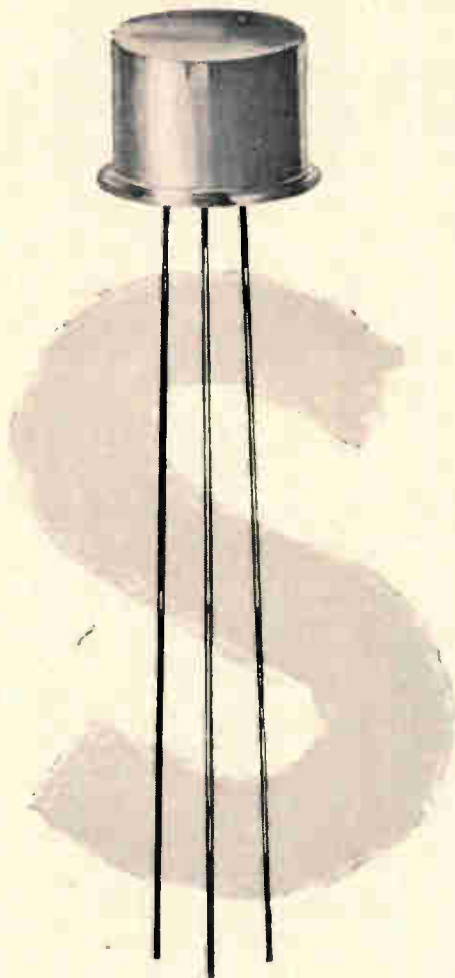

Prejudice can be a costly luxury!

Take device packages for example. Devices in metal packages are reliable, but costly. Plastic packages afford economies in production and are low in cost. But earlier molding plastics would distort, burn . . . some would contaminate device junctions . . . destroying device characteristics and reliability. Thermal limitations restricted device capability.

Result: the opinion that *all* molded devices are of questionable quality—not to be considered where long term reliability is required.

Fact? . . . opinion? . . . or prejudice? Facts lead to opinions . . . opinions that can be costly prejudice with the recent

development of devices packaged in silicone molding compound!

Unlike all other plastics, silicone molding compound is inherently non-burning, will not contaminate devices. Fact is, silicone resins have long been used on device junctions!

Molded devices packaged in silicone molding compound are now available from several leading manufacturers. Generally, these devices are lower in cost . . . lighter in weight . . . unaffected by heat aging . . . offer long term reliability . . . are non-burning . . . don't deform during soldering . . . pass moisture resistance tests.

Don't you owe it to yourself to evaluate these devices . . . and this new silicone packaging material?



Write for complete performance data on Dow Corning® molding compound. Value analysis will convince you that prejudice can truly be a costly luxury. Address Department 3904, Electronic Materials Department, Dow Corning Corporation, Midland, Michigan 48640.

DOW CORNING

**A
10 Hz
to
10 MHz
AC Voltmeter
with
DC Output**

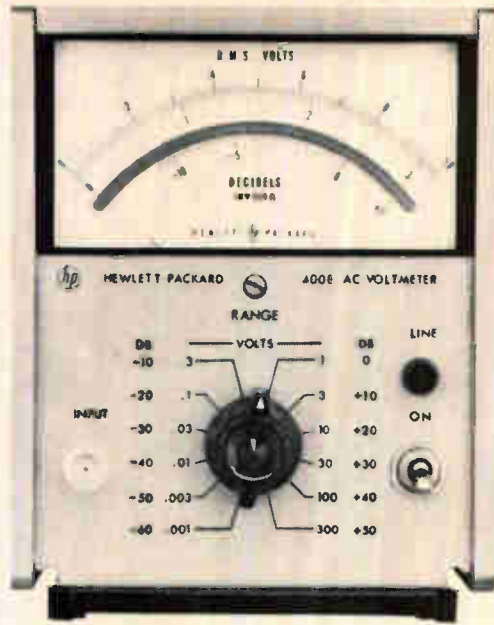

**With
1 mV
to
300 V
Linear/Log
Ranges**



for \$285



THAT'S WHAT HAPPENS WHEN THE HEWLETT-PACKARD 400 SERIES GOES SOLID-STATE! Here's the world's first averaging ac voltmeter with a 0.5% of reading dc output... something you've never been able to get before. Offers a broad ac range, 10 Hz (cps) to 10 MHz (mc), 1 mV to 300 V, plus a log model, -72 to +52 dBm.

Highest available input impedance, too, (10 MΩ) with shunt capacity at a low value (8pf) unequalled by other instruments.

WHAT'S EVEN BETTER: Price... only \$285 for the 400E, only \$295 for the 400EL log model!

If you have any of the following responsibilities, you should consider these points:

Design and production: 1 mV-300 V range, adjustable meter setting

Systems: 0.5% of reading dc out (1 V) for ac/dc conversion

Communications: 10 Hz-10 MHz, dB scales, external battery operation

Sciences: ac amplifier output (150 mV), long-term stability

Military: More rugged than the reliability-proven tube versions

University: budget price

The brief specs here tell the story. Compare them with any others... and then call your Hewlett-Packard field engineer (you probably won't even need a demonstration). Or write for complete specs to Hewlett-Packard, Palo Alto, Calif. 94304, Tel. (415) 326-7000; Europe: 54 Route des Acacias, Geneva.

SPECIFICATIONS

Voltage range: 1 mV to 300 V full scale, 12 ranges

Frequency range: 10 Hz to 10 MHz

hp 400E/EL								
Accuracy % of reading, 3 mV to 300 V ranges								
Frequency	10 Hz	20 Hz	40 Hz	2 MHz 4 MHz 10 MHz				
At full scale	±4	±2	±1	±2	±2	±4	±4	
Accuracy % of reading, 1 mV range								
Frequency	10 Hz	20 Hz	40 Hz	500 kHz	1 MHz	4 MHz	6 MHz	
At full scale	+4 -10	±2	±1	±2	±4	±4	-10	
hp 400E/EL								
AC-to-DC Converter Output								
Accuracy % of reading, 3 mV to 300 V ranges								
Frequency	10 Hz	20 Hz	40 Hz	100 Hz	500 kHz	2 MHz	4 MHz	10 MHz
At full scale	±4	±2	±1	±0.5*	±1	±2	±2	±4

*For 15°C-40°C on 1 mV-1 V ranges only.

Input impedance: 10 megohms shunted by 21 pf on the 1 mV-1 V ranges, 10 megohms shunted by 8 pf on the 3 V-300 V ranges

Amplifier ac output: 150 mV rms for full-scale meter indication; output impedance 50 ohms, 10 Hz to 10 MHz (105 mV on the 1 mV range)

AC-DC converter output: 1 V dc output for full-scale meter deflection; output is linear for both 400E and 400EL

External battery operation: terminals provided on rear panel

Price: 400E, \$285 (replaces 400H-\$325)
400 EL, \$295 (replaces 400L-\$325)

Data subject to change without notice. Prices f.o.b. factory.

HEWLETT  **PACKARD**
An extra measure of quality

Cherry

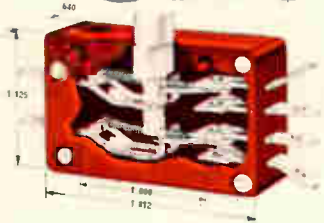

**E19-00A
DOUBLE POLE**
15 amp. 125-250 VAC
¾ H.P. 125 VAC
1½ H.P. 250 VAC

LONG-LIFE

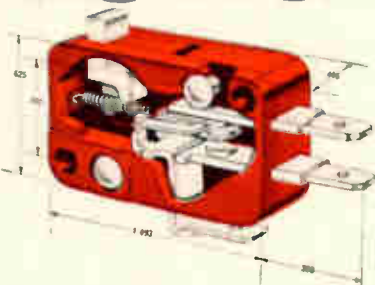

**E34-00A
MINIATURE**
15 amp. ½ H.P.
125-250 VAC

**E13-00E
GENERAL PURPOSE**
15 amp. 125-250 VAC
¾ H.P. 125 VAC
1½ H.P. 250 VAC



switches



**E62-10A
SUBMINIATURE**
10.1 amp. 125-250 VAC
¾ H.P. 125 VAC

The more than 80,000,000 Cherry precision switches now in use prove every day that their exclusive coil spring construction lasts millions of cycles longer. Prove it to yourself. Tell us what you need in long-life switches and ask for a sample.

CHERRY

**ELECTRICAL
PRODUCTS CORP.**

1656 Old Deerfield Rd., Highland Park, Ill. 60035



Great editorial is something he takes home

(What a climate for selling!)

Electronics

A McGraw-Hill Market-Directed Publication
330 West 42nd Street, New York, N.Y. 10036



A whole litter of them, in fact. In the form of technical bulletins covering the most complete line of ferrite materials and shapes in the world. Included are core sizes and shapes not available as standard from any other manufacturer and ferrite materials made only by Indiana General.

Take flyback transformers, for example. In color-TV our 05 ferrite is the leading core material because of its high-voltage per-

formance. Where ferrites for filters are concerned, our TC-7 combines extremely high "Q" and low loss with the most linear temperature coefficient of inductance found anywhere.

In all, we list 11 ferrite materials in 315 standard shapes and sizes including: cup cores; toroids; transformer C cores; rods and strips; E, I, U, and C cores; the international series of cup cores, and cross cores.

Whether you are designing circuits or purchasing components, you can have our Ferramic® Materials Bulletins Nos. 100 thru 105 on your desk. Write Mr. K. S. Talbot, Manager of Sales, Indiana General Corporation, Electronics Division/Ferrites, Keasbey, New Jersey.

INDIANA GENERAL 

COPYRIGHT 1966. INDIANA GENERAL CORPORATION.

We're ready to let the cat out on our 315 standard ferrite core shapes and 11 different materials.

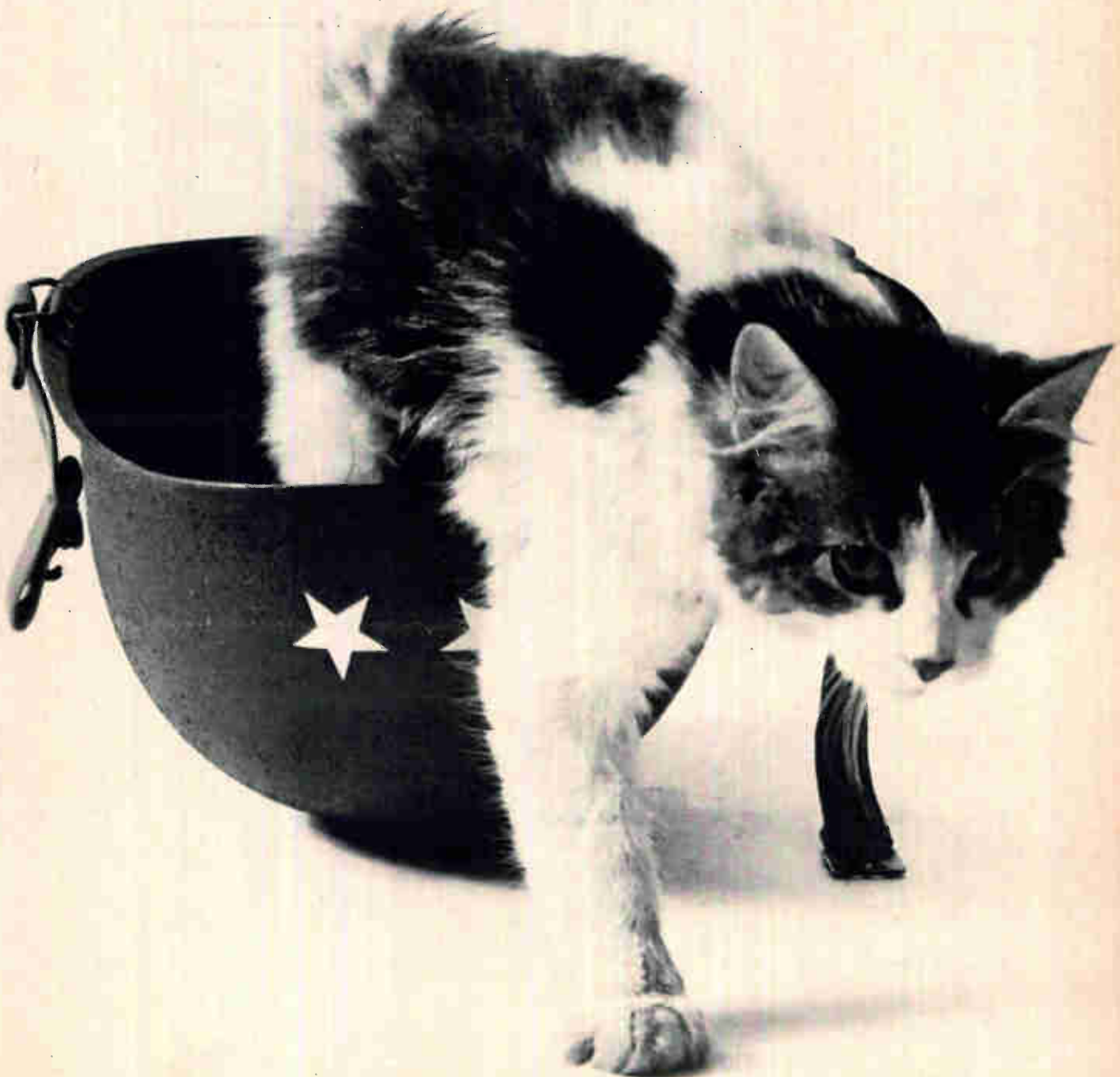

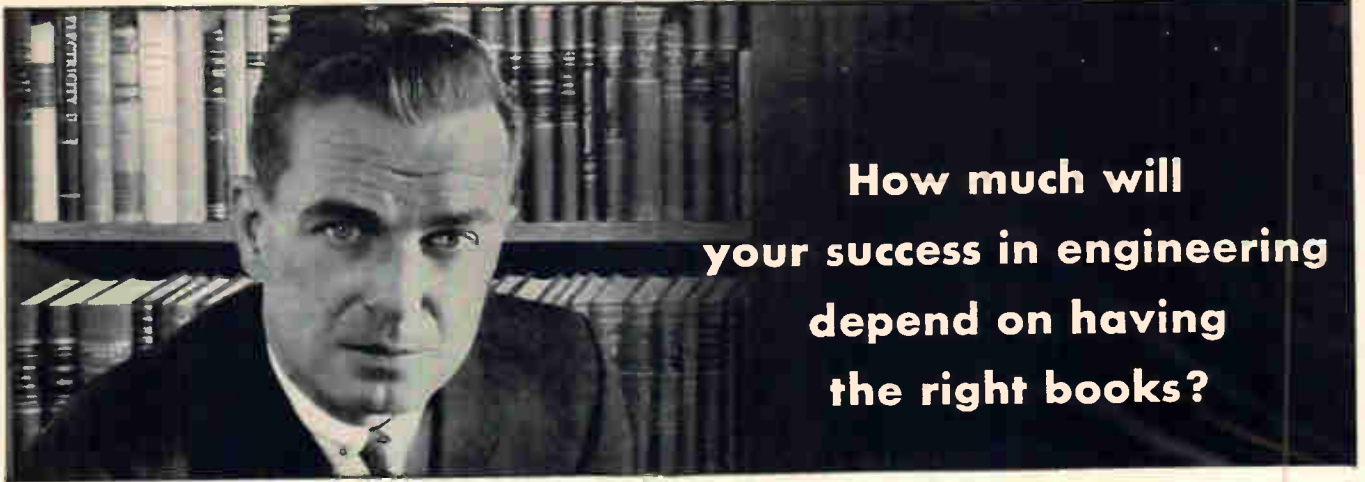

How much will
your success in engineering
depend on having
the right books?

The Electronics and Control Engineers' Book Club helps you keep ahead in your field . . . at a savings

Start your membership with any of these selections:



Introduction to Radar Systems by M. Skolnik. Covers everything from the prediction of radar range performance to applications.

Publisher's Price, \$14.50
Club Price, \$12.35



Mathematics for Electronics with Applications by H. M. Nodelman and F. W. Smith, Jr. Methods for solving practical problems.

Publisher's Price, \$7.00
Club Price, \$5.95



Transistor Circuit Design, prepared by the Engineering Staff of Texas Instruments Inc. Reduces theory to actual practice.

Publisher's Price, \$15.00
Club Price, \$12.75



Electronic Amplifier Circuits by J. M. Pettit and M. M. McWhorter. Gives reliable guidance on electronic amplifier circuit design.

Publisher's Price, \$10.50
Club Price, \$8.95



Modern Digital Circuits by Samuel Weber. A practical reference on design aspects of digital-type circuits.

Publisher's Price, \$9.50
Club Price, \$8.10



Electronic and Radio Engineering by F. E. Terman, 4th Ed. Helps solve modern problems in the electronic and radio engineering fields.

Publisher's Price, \$16.00
Club Price, \$13.60



Electronic Measuring Instruments by H. Soisson. Covers electronic equipment used for precise measurements and control.

Publisher's Price, \$7.50
Club Price, \$6.40

Your engineering career owes a great deal to books. Why not take advantage of this convenient, economical way to have the best professional books available when you need them? THE ELECTRONICS AND CONTROL ENGINEERS' BOOK CLUB brings you the essential technical literature in your field. It also helps you overcome today's high cost of building a professional library by saving you an average of 15% from publisher's prices.

How the Club Operates. You regularly receive free of charge *The Electronics and Control Engineers' Book Bulletin*, as issued. This gives complete advance notice of the next selection-of-the-month, as well as many alternate selections. If you want the main selection you do nothing; the book will be mailed to you. If you want an alternate selection—or no book at all—you can notify the Club by returning the convenient card enclosed with each *Bulletin*.

Saves You Time and Money. You agree only to the purchase of four books over a two-year period. Certainly out of the large number of books offered in your field there are at least four you would buy anyway. By joining the Club you save both money and the trouble of searching.

Send No Money Now. Just check the book you want as your first selection on the coupon below. With it you will be sent *Handbook of Semiconductor Electronics* for only one dollar. Take advantage of this offer and receive two books for less than the regular price of one. (If coupon is detached, write to The Electronics and Control Engineers' Book Club, Dept. LX0418, 330 W. 42nd St., New York 36, N. Y.)



ACCEPT THIS
\$19.50 BOOK

FOR ONLY \$1.00

with membership in
The Electronics and
Control Engineers'
Book Club

HANDBOOK OF SEMICONDUCTOR
ELECTRONICS

Prepared by a Staff of 18 Specialists

Edited by LLOYD P. HUNTER

Here is a wealth of reliable information to assist you in understanding the basic physical action of transistors, diodes, and photocells—for assembling necessary equipment, and fabricating typical semiconductor—and, above all, for designing a large variety of transistor circuits for use in various frequency ranges.

Handbook of Semiconductor Electronics is typical of the selections of THE ELECTRONICS AND CONTROL ENGINEERS' BOOK CLUB. All books are chosen by qualified editors and consultants. Their thoroughgoing understanding of the standards and values of the literature in your field guarantees the authoritative nature of the selections.

(NOTE: If you already own this volume, you may substitute any other book on this page as your DOLLAR book. Check two books below and you will receive the higher priced selection for only \$1.00.)

CLIP AND MAIL THIS COUPON TODAY

The Electronics and Control Engineers' Book Club, Dept. LX0418
330 West 42nd Street, New York, N.Y. 10036

Please enroll me as a member of the Electronics and Control Engineers' Book Club. You will bill me for my first selection indicated at right at the special club price and \$1 for *Handbook of Semiconductor Electronics* (or alternate choice), plus local tax where applicable, and a few cents delivery costs. (The Club assumes delivery costs on prepaid orders.) Forthcoming selections will be described in advance and I may decline any book. I need take only 4 selections or alternates in 2 years of membership. (This offer good in U. S. only.)

PLEASE PRINT

Name
Address
City State Zip
Company

Send as my first selection: (If more than one book is checked we will send the higher priced selection as your \$1.00 book.)

- Introduction to Radar Systems, \$12.35
- Mathematics for Electronics with Applications, \$5.95
- Transistor Circuit Design, \$12.75
- Electronic Amplifier Circuits, \$8.95
- Modern Digital Circuits, \$8.10
- Electronic and Radio Engineering, \$13.60
- Electronic Measuring Instruments, \$6.40

NO RISK GUARANTEE: If not completely satisfied, you may return your first shipment within 10 days and your membership will be canceled.

L-324xx



AUTHORIZED DISTRIBUTORS

- ALABAMA**
Argo & Company
Birmingham
- ARIZONA**
Electrical Specialty Co.
Phoenix
- CALIFORNIA**
Electrical Specialty Co.
Los Angeles
Electrical Specialty Co.
South San Francisco
R. V. Weatherford Co.
Glendale
- COLORADO**
Electrical Specialty Co.
Denver
- CONNECTICUT**
R. H. Carlson Co., Inc.
Greenwich
- D. C.**
Read Plastics, Inc.
Washington
- FLORIDA**
Gulf Semiconductors, Inc.
Coral Gables
Gulf Semiconductors, Inc.
Winter Park
- ILLINOIS**
Allied Radio Corp.
Chicago
Federal Insulation Corp.
Chicago
J. J. Glenn and Co., Inc.
Chicago
- INDIANA**
Hyaline Plastics Corp.
Indianapolis
- IOWA**
Plastic Supply, Inc.
Des Moines
- KENTUCKY**
General Rubber &
Supply Co.
Louisville
- MASSACHUSETTS**
Northeast Chemical Co.
Boston
- MICHIGAN**
F. B. Wright Co., Inc.
Dearborn
Ren Plastics Inc.
Lansing
- MINNESOTA**
D. A. Schultz Company
Minneapolis
- MISSOURI**
D. A. James Company
St. Louis
Regal Plastic Supply Co.
Kansas City
- NEBRASKA**
Regal Plastic Supply Co.
Omaha
- NEW JERSEY**
Smooth-on Mfg. Co.
Jersey City
- NEW YORK**
Punt, Inc.
Floral Park
Queen City Rubber Co.
Buffalo
Adhesive Products Corp.
New York
Chamberlin Rubber Co.
Rochester
Syracuse
- OHIO**
Philpott Rubber Co.
Cleveland
Parkway Products, Inc.
Cincinnati
- OREGON**
Electrical Specialty Co.
Portland
- PENNSYLVANIA**
Smith of Philadelphia, Inc.
Philadelphia
Speck-Marshall Co.
McKees Rocks
- TEXAS**
Lawrence Electronic Co.
Dallas
Houston Industrial
Supply Co., Inc.
Houston
- WASHINGTON**
Electrical Specialty Co.
Seattle
- WISCONSIN**
R. J. Wittenburg Co.
Milwaukee

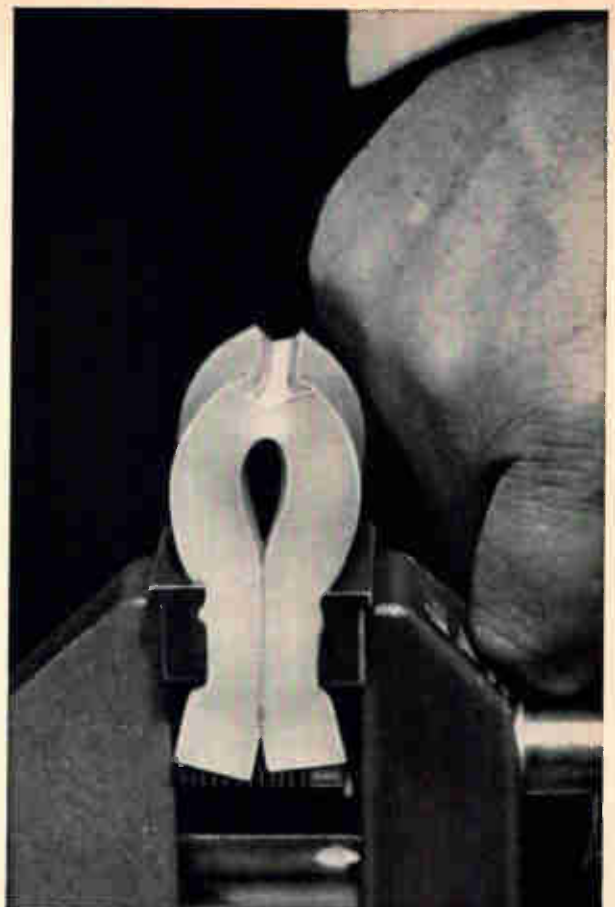
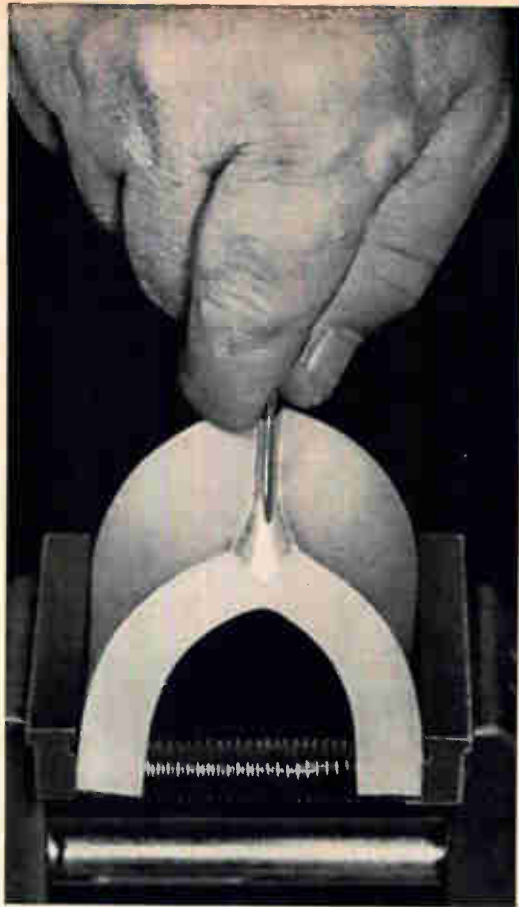

G-E ultra high strength RTV-630: slash it, flex it double...it never tears

General Electric RTV-630 silicone rubber has a tear strength of 100 psi-die B. That's more than twice the tear resistance of any other RTV. It also has a hardness of 55-70 durometer, tensile strength up to 850 psi and elongation of up to 400%.

Because of its great strength, RTV-630 can be used in thinner conformal coatings and improved

production line potting. RTV-630 is designed to protect against the worst environments of thermal shock, vibration, moisture, ozone and temperatures from -65°F to 500°F .

Experience shows RTV-630 molds for electronic parts last up to twice as long as conventional RTV. As a punch die, it has performed more than six times as long.

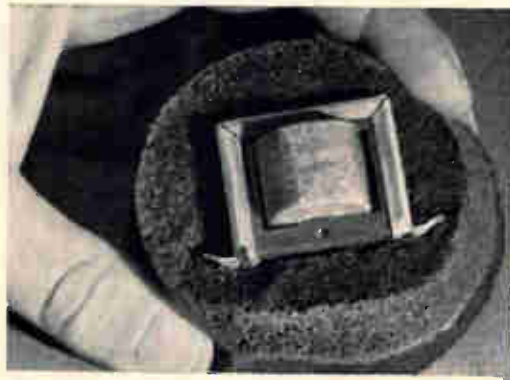

RTV-7 foam for shock and vibration damping. Foams to 5 times original size and cures in 10 minutes. Density can be varied. Extremely resilient.



Ready-to-use RTV-102 cartridge speeds production line sealing. No catalyst, no priming needed. Tough, flexible. UL recognition.

For more data, ask your nearest distributor as listed or write Section N4193R, Silicone Products Dept., General Electric Co., Waterford, N. Y.

GENERAL  ELECTRIC

No matter what we start discussing at Xerox... sooner or later we're talking about more new jobs.

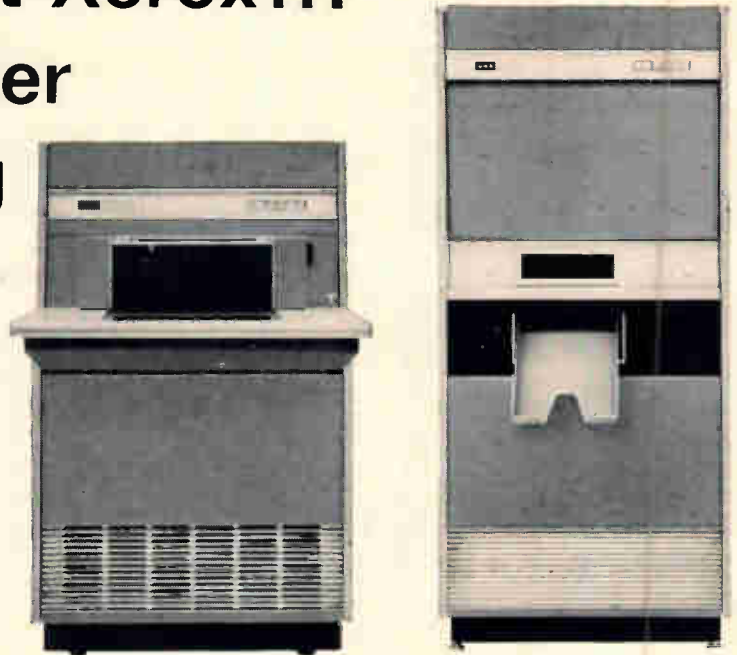

Sometimes people are puzzled when we say that Xerox is in the business of graphic communications. Let's try to clarify. (It could be important, especially if you're intrigued with Xerox, but not perfectly sure why.)

We define graphic communications as the entire spectrum of communications in a graphic sense — the formulation, reception, transmission, recording, storing, retrieving, processing, copying, or presentation of any meaningful images. As you can imagine, graphic communications transcends copying equipment, no matter how advanced. LDX (Long Distance Xerography) suggests some-

thing of our future. The current system recently sent an 8½" x 11" xerographic image 3,450 miles over broadband telephone lines in 7 seconds. For what LDX implies, re-read the definition of graphic communications above. You'll get the picture.

The openings outlined below are abstracts from our current list of immediate vacancies. In most cases they are new, expansion-created spots. In others, the man has been promoted. Isn't this the best way to come on board in any organization?

ELECTRICAL DEVELOPMENT ENGINEERS

To work in the areas of electrical development and design of new commercial electro-magnetic products. BSEE required with at least three years' experience in one of the following areas: Illumination, electro-statics, electro-magnetics, electronic circuitry design, controls for automatic photographic equipment, component evaluation and control circuitry.

COMPUTER PERIPHERAL SYSTEMS ENGINEERS

Electrical or mechanical engineers, with experience in the peripheral equipment area for data systems or computer systems including development work on magnetic tape, magnetic drums, punched card equipment, electro-mechanical printers. Should also have been involved with systems planning and/or systems integration of computer peripherals with computer systems.

ELECTRONIC DEVELOPMENT ENGINEER

Will assist in the development of new techniques and in the design of electrolytical circuits and devices for government contract and development projects. Three years' experience in two or more of the following areas is required: automatic test equipment design, servo systems, analog-digital circuits, electro-optical sub-systems, display technology, information theory, signal processing, sensors, light modulation, imaging and laser devices. BSEE required (MS in EE or Engineering Physics preferred).

Positions are in Rochester, N. Y. Send resume, including salary history, to Mr. L. B. Sundsted, Dept. ZDD-116, Xerox Corporation, P.O. Box 1540, Rochester, New York 14603.

XEROX

An Equal Opportunity Employer (M & F)

XEROX AND LDX ARE TRADEMARKS OF XEROX CORPORATION



New microelectronic package for semiconductors permits mechanized production of hybrid integrated circuits

From the very first days of microelectronics, designers and manufacturers of hybrid film circuits have sought a semiconductor package truly suited for the new technology.

The ideal package would be of microminiature dimensions; it should be capable of mounting on the substrate by mass production, jiggling techniques; capable of being completely characterized for both AC and DC measurements and readily pre-selected (for noise, gain, etc.,) for critical applications.

LIDS (leadless inverted devices) developed by Amperex fulfill all of these requirements... and more.

As a start, Amperex is offering two high-performance silicon planar epitaxial transistor families in the new Amperex LIDS: high-speed switches similar to the 2N2369 and low-noise, high gain amplifiers similar to the 2N930. Dual-diodes will

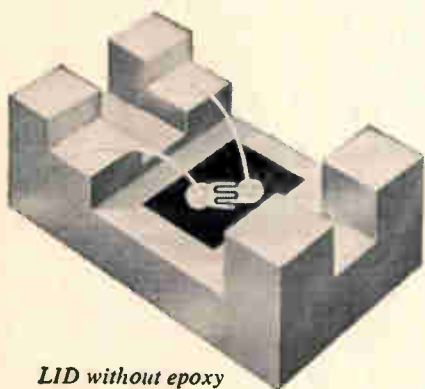

LID without epoxy

be available next, followed by the entire Amperex line of small signal RF, AF and switching types.

The Amperex LID is an all-ceramic package that is smaller (0.075" x 0.045" x 0.032") and less costly than any existing metal package. Its smaller size permits the manufacturer to reduce costs by reducing the substrate size.

Having no external wiring, expensive wire-bonding machinery and the skilled labor to operate it are no longer needed; handling is simpler, breakage is eliminated and production yields of the integrated circuits will be higher.

For complete protection before, during and after assembly, the transistor chip is coated with epoxy after it is mounted in the LID.



*Completed LID
with protective coating*

In place of delicate, external wire leads, LIDS have four contact legs that are an integral part of the ceramic package. Their surfaces are coated with metallized solderable gold. This construction permits the LIDS to be positioned on the substrate by automatic jigs, without the need for micro-optics for orientation.

Any number of LIDS can be mounted simultaneously for true mass production volume and cost savings. LIDS are bonded to the substrate by low-temperature soldering, which, unlike the usual high temperature techniques does not alter the transistor characteristics.

Unlike chips, LIDS can be characterized, and pre-selected for critical circuits; and unlike chips, they can be color-coded or similarly marked and so identified for easy and efficient production.

To learn more about Amperex LIDS, write: Amperex Electronic Corporation, Semiconductor and Receiving Tube Division, Dept. 371, Slatersville, Rhode Island 02876.

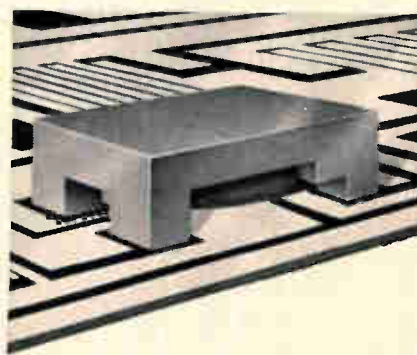

LID mounted on circuit

Amperex®

1

HIGHEST QUALITY

Quality and reliability demonstrated by a proven 4½ million hours MTBF

2

GREATEST VERSATILITY

Complete families of rugged potted germanium and silicon modules

3

LOWEST COST

For example, 100 Kcps S-R flip-flop module \$3.95 each in quantities of 100

Practical reasons why so many engineers choose EMC digital logic modules



potted in *TIMONIUM*

Complete families of digital logic modules operate over an ambient temperature range of -55°C to $+125^{\circ}\text{C}$

ELECTRONIC
MODULES
CORPORATION

Electronic Modules Corporation • COMPONENTS DIVISION

1949 GREENSPRING DRIVE • TIMONIUM, MARYLAND • TEL. (301) 252-2900 • TWX-301-252-0723

#66-4

Westinghouse announces epoxy diodes with guaranteed hermeticity

Westinghouse Semiconductor Lifetime Guarantee

Westinghouse warrants to the original purchaser that it will correct any defect or defects in workmanship, by repair or replacement f.o.b. factory, for any JEDEC-type silicon power semiconductor during the life of the equipment in which it is originally installed, provided said device is used within manufacturer's published ratings and applied in accordance with good engineering practice. This warranty is applicable to devices of the stated types shipped after March 9, 1964, until further notice. This warranty shall constitute a fulfillment of all Westinghouse liabilities in respect to said products. This warranty is in lieu of all other warranties expressed or implied. Westinghouse shall not be liable for any consequential damages.

Now what have glass or metal types got besides high price?

The new Westinghouse 1N4816 series diodes feature glass-to-metal reliability at epoxy prices. Hermeticity is assured by humidity tests per MIL-S-750, method 1021. With a current rating of 1.5 amps, voltages to 1000 V, and a 50 amp surge rating, this new series replaces hundreds of conventional types.

And they save you money. Prices range from 16¢ at 50 volts to 75¢ for 1000 volts, in lots of 5,000 to 9,999. Call your Westinghouse distributor for samples and details now. Or write to Westinghouse Semiconductor Division, Youngwood, Pennsylvania.

SC-2058

You can be sure if it's Westinghouse



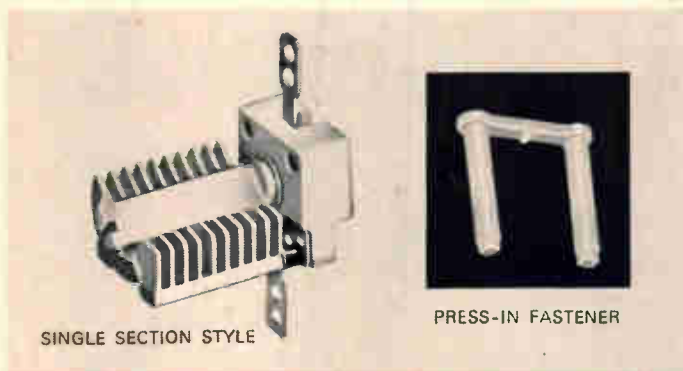

Unique Machined Design..



means Best Performance here!

Now larger plate area permits a 28 per cent increase in capacitance with no size increase in Johnson's new Type "U" single section capacitors. Mounting dimensions and overall length remain the same. Require less than .2 square inch for mounting on printed board or chassis. Precision milling technique enables rotor and stator to be machined from one piece of solid brass, providing exceptional uniformity and stability. New acetal fastener for chassis mounting permits rapid, low-cost, press-in mounting. Breakdown ratings to 1,100 volts DC.

- 28% more capacitance—up to 24.5 pf max.
- High Q—greater than 1,500 at 1MC
- Electrically Stable—temperature coefficient plus 45 ± 15 PPM/°C
- New Convenient Fastener

PICK THE APPLICATION. JOHNSON HAS THE CAPACITOR

Write Today for Complete Information on Johnson Capacitors and Other Electronic Components.



E. F. JOHNSON COMPANY

3029 Tenth Avenue S.W.
Waseca, Minnesota

Troubled by TRANSIENTS?

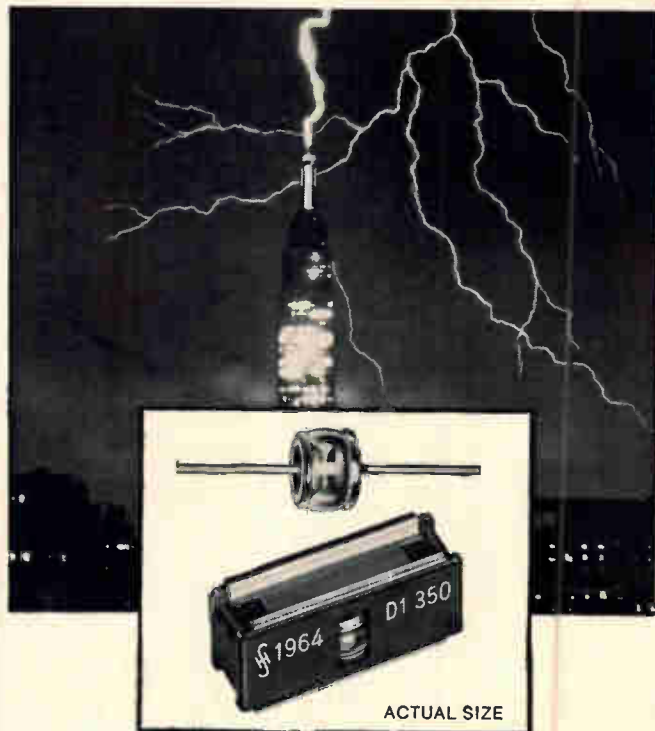

use SIEMENS gas-filled surge voltage protectors

- Protect communications systems and other delicate solid state equipment
- Ensure higher reliability
- Economically reduce maintenance costs, cut outage time
- Can be used in existing hardware with illustrated adapter
- Delivery from New York stock

Rated DC arc over voltage: 230, 350, 470 or 800 volts
Under specified test conditions:
response time: appr. 250 nsec. (230 V-type)
rated discharge current: 5,000 amps
insulation resistance: $> 10^{10}$ ohms
Larger types available

SIEMENS AMERICA INCORPORATED
350 Fifth Avenue, New York, N. Y. 10001

A Corporation of THE SIEMENS GROUP IN GERMANY
Berlin • Munich • Erlangen

In Canada:
SIEMENS CANADA LIMITED
407 McGill Street, Montreal 1, P.Q.

Circle 468 on readers service card
Circle 143 on readers service card →



Upset? Power contactor deliveries rescheduled again? Next time call Leach!

We've got hundreds of power contactors in stock throughout the country. Contactors like the models 9324 (20 amp), 9123 (25 amp), and the 9124 (50 amp).

These new units are the smallest, lightest power contactors meeting MIL-R-6106E. True balanced armature construction lets them take up to 50g shock and 25g vibration with a contact opening of less than 10 microseconds.

The Model 9324 (MS27418) is a 20 amp, 3PST/NO contactor. Under motor load, its rating is 15 amp break and 75 amp make at 115 VAC, 3 phase. Operate time 20 milliseconds, with release at 10 milliseconds.

The 25 amp model 9123 (MS27997) and 50 amp 9124

(MS27222) meet the latest requirement of the aircraft and aerospace industries. Basic models are 3PST/NO and 3PST/NO with 5 amp auxiliary contacts. Industry standard mounting makes them interchangeable with older, larger, top-hat type MS24143 and MS24376.

Interested? Then ask for our new Power Contactor Brochure, or better still, send us your purchase order. You'll have your power contactors by return mail. Leach Corporation, Relay Division, 5915 Avalon Bl. Los Angeles, California; 90003
Phone (Area code 213) 232-8221
Export: LEACH INTERNATIONAL S. A.



LEACH

Engineers and Scientists:

*The Hughes Aircraft Company
is proud to announce the establishment of*

THE HUGHES PROFESSIONAL CAREER DEVELOPMENT PROGRAM

This new Program emphasizes individual career growth through a sequence of selected work assignments for graduate engineers who have acquired between two and eight years of professional experience. It is designed primarily for two types of development:

1. Specialized, in-depth assignments to develop unusual proficiency in a specific area of interest.

2. Broad, systems-types of assignments to prepare for system and project engineering responsibilities.

There will be a maximum of three assignments which will be determined jointly by the participant and the Professional Development Section. The assignments, which are flexible in length would normally extend for one year each. They may be selected from a broad spectrum of aerospace electronics hardware and systems-oriented programs and will be designed to provide optimum backgrounds in specialized areas of interest.

The Program will be limited to 50 participants in 1966. These will be selected from candidates who are graduates in E.E., M.E. or Physics from fully-accredit-

ed universities and who have acquired from two to eight years of professional-level technical experience. U.S. citizenship is required.

Those in the Program will receive salaries commensurate with levels established by their overall experience and qualifications.

We invite interested Engineers and Physicists to submit their qualifications for consideration.

Please forward your resume including details of your educational and experience background to:

Mr. Robert A. Martin
Head of Employment
HUGHES Aerospace Divisions
11940 W. Jefferson Blvd.
Culver City 10, California

HUGHES

HUGHES AIRCRAFT COMPANY
AEROSPACE DIVISIONS

An equal opportunity employer

a little...

Hoffman provides semiconductors of inherent reliability completely compatible with the manufacturer's needs.

The Hoffman "N" series solar cell, an N/P, shallow diffused, photovoltaic device is optimized for operation in the spectrum of space. These cells are tested and qualified for radiation resistance in accordance with GSFC (NASA) Specification No. 63-106. An electrically conducting grid has been sintered to the active surface to reduce sheet resistance and thus increase conversion efficiency.

These physical characteristics are manufacturing tolerances for all Hoffman Semiconductor Solar Cell Types.

1. OHMIC CONTACT: (A) Electrically continuous and mechanically bonded. (B) Extends to .032 inches from the edge of the cell.
2. GRID LINES: Guaranteed to .100 inch tolerance. Hoffman's photo masking technique assures complete mechanical tolerances.
3. EDGE CHIPS: .010" wide, .100" long not to exceed one such chip per top and one per bottom edge of cell.
4. CORNER CHIPS: .030" on the hypotenuse of the chip.
5. WEIGHT: N120CG .18 Gr. Avg. N220CG .36 Gr. Avg.
 N210CG .18 Gr. Avg. N230CG .54 Gr. Avg.

Typical Electrical Specifications

2 x 2cm cell.....	.430 mV @ 135 mA
1 x 2cm cell.....	.430 mV @ 65 mA

Test Temperature: 28°C ± 2°C.

Hoffman solar cells are coated with silicon monoxide to render the active area anti-reflective to obtain maximum use of solar energy. These cells withstand temperature excursions from -196°C to +200°C.

STANDARD ENVIRONMENTAL TEST: Each lot of cells is immersed in boiling DI water for periods to one hour followed by a live steam test for a comparable period.

All of these advantages insure complete compatibility of products for industrial uses.

or a lot



Hoffman solid state photo-sensing devices are now being used for measuring, cloth cutting, sequence counting, liquid level gauging, data processing and other manufacturing functions requiring absolute accuracy.

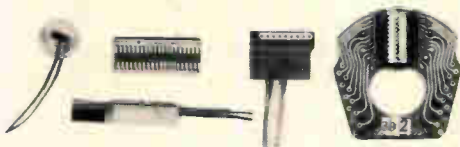

TYPICAL INDUSTRIAL COMPATIBLE PRODUCTS: A shaft encoder is currently being produced to mechanical tolerances of ±.0005" and electrical parameters matched within 2%. Data processing readouts are being produced with an I_a of 3 μA max. at 1.5 volts reverse bias. Other sensing elements are being made with active areas as small as .002" x .023" and as large as 2.5" x 1.0".

For additional information regarding these products write: Hoffman Electronics, Dept. A, El Monte, Calif.



SEMICONDUCTORS

Why do the world's leading electronic firms come to HULL?

For superior systems to encapsulate electronic components,* small or large . . . that's why



There's more to "The HULL Story" than simply building better machines for superior encapsulation. It starts back in 1956 when we helped Western Electric package their varistors in the then "short-cure" resins. The resultant process proved ideal.

In the decade that followed, we worked in strict confidence with many electronic firms . . . helping them solve their encapsulation problems . . . adapting methods and materials to

the needs of new components.*

Today, several hundred installations later, we're proud to claim unquestioned leadership in the field of encapsulation, offering a *complete system capability*. Our list of customers reads like a "Who's Who" in electronics: Texas Instruments, General Electric, IBM, Motorola, Philips, Fairchild Semiconductor—to name a few.

Get "The HULL Story" on a pack-

*Such as transistors, integrated circuits, capacitors, resistors, modules, transformers, and coils.

aged system . . . including molds, loading frames, and controls . . . for rapid and economical encapsulation of your component or circuit. Write or phone today! **HULL CORPORATION**, 6033 Davisville Rd., Hatboro, Pa. 19040 Tel.: (215) 675-5000 Export: 1505 Race St., Phila., Pa. 19102



H-32

Circle 146 on reader service card



Great editorial is something he takes on a business trip

(What a climate for selling!)

Electronics

A McGraw-Hill Market-Directed Publication
330 West 42nd Street, New York, N.Y. 10036



THESE REPLACE SERVO-SET POTENTIOMETERS IN A COMPUTER?



THAT'S RIGHT!

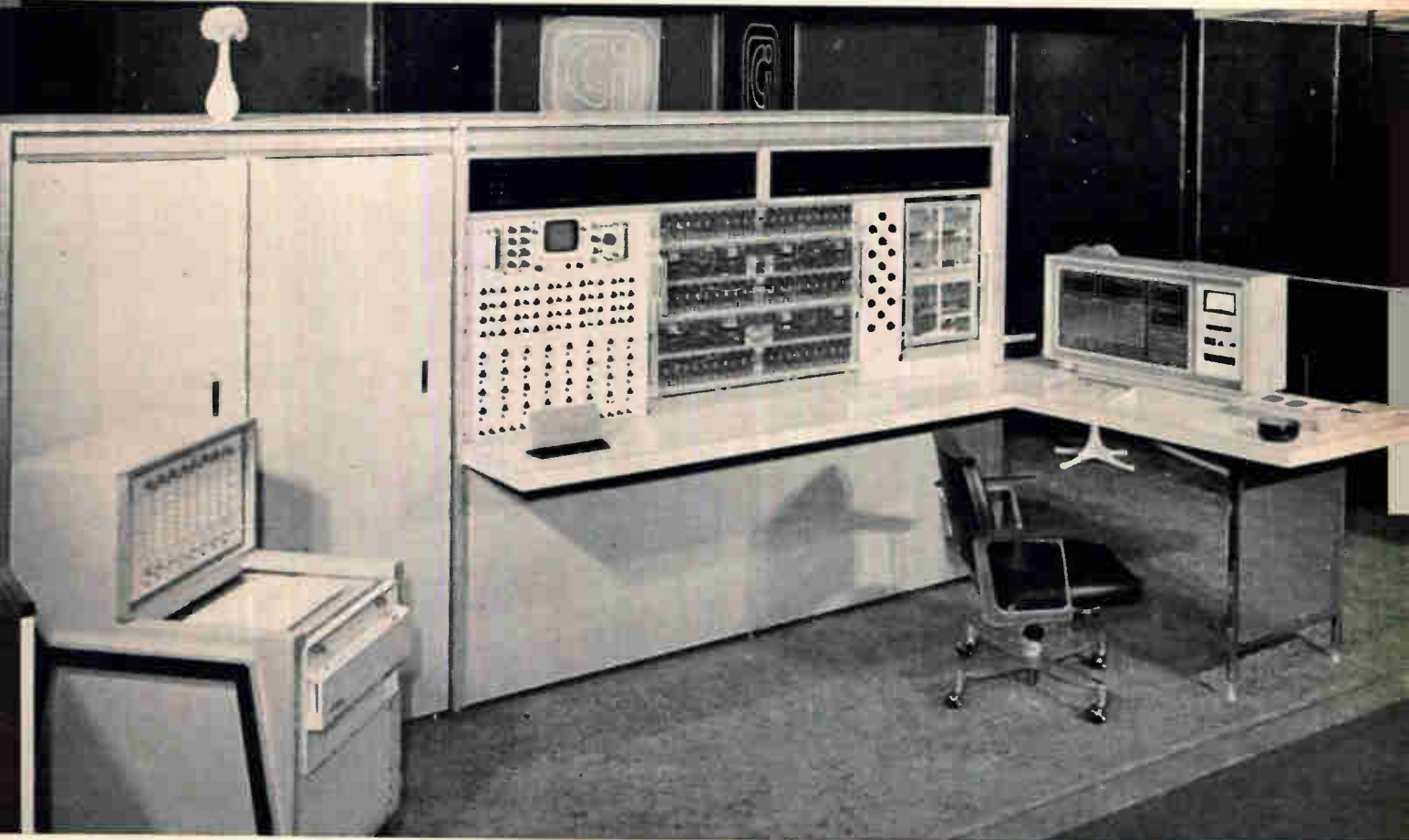

1965 Fall Joint Computer Conference

IT MUST REDUCE SET-UP TIME?

CONSIDERABLY!



AN INDUSTRY FIRST... THE COMCOR Ci-196 DIGITAL ATTENUATOR... ONE HUNDRED CAN BE SET UP IN LESS THAN 2 SECONDS! Completely solid-state in design, it replaces the servo-set



potentiometers in a computer system. In COMCOR's Ci-5000 Analog/Hybrid Computer (shown above) in which it was initially installed, the Ci-196 drastically reduced set-up time—previously *each* potentiometer setting took one second plus. Learn more about this amazing subsystem; *contact your COMCOR representative or phone, wire or write COMCOR direct.*



COMCOR

A SUBSIDIARY OF ASTRODATA, INC.

1335 SOUTH CLAUDINA STREET / ANAHEIM, CALIFORNIA 92803

Circle 147 on reader service card

Widest variety of laminated plastic tubes



We are able to offer you the widest variety of laminated plastic tube shapes and sizes in the industry. We make tubes from $\frac{3}{16}$ " ID up to $26\frac{1}{4}$ " OD. We make them round, square, oval, rectangular or you name it.

Call Synthane *first* for your tubing requirements. Many popular sizes, shapes and grades available immediately from our Instant Stock. Synthane Corporation, 36 River Road, Oaks, Pa. 666-5011 (Area Code 215).

SYNTHANE
CORPORATION  OAKS, PENNA.

Laminated Plastic Sheets, Rods,
Tubes and Fabricated Parts

Circle 469 on readers service card

Do you need a hard-to-make laminated plastic part?

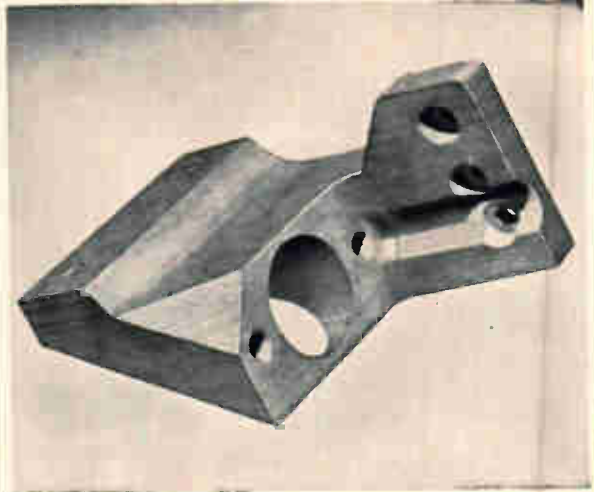

Do you need a laminated plastic part that is hard to make? Then call us in. We are specially equipped to fabricate them from Synthane sheets, rods and tubes. This includes intricate or one-of-a-kind parts. Be sure you contact Synthane first. Synthane Corporation 36 River Road, Oaks, Pa. 666-5011 (Area Code 215).

SYNTHANE
CORPORATION  OAKS, PENNA.

Laminated Plastic Sheets, Rods,
Tubes and Fabricated Parts

Circle 470 on reader service card

Highest-quality copper-clad laminates for multi-layer printed circuits



Laminated plastics for multi-layer printed circuits have to be a special breed—very thin, made to exacting tolerances, uniform, free of voids and pinholes, suitable for etching and all soldering operations.

Synthane Thin Laminated grades G-10 and FR-4 are highest-quality fabric epoxy laminates. All produced under exacting clean room conditions. Write for leaflet. Synthane Corporation 36 River Road, 666-5011 (Area Code 215).

SYNTHANE
CORPORATION  OAKS, PENNA.

Laminated Plastic Sheets, Rods,
Tubes and Fabricated Parts

148 Circle 148 on readers service card

Synthane copper-clad laminates in stock for fast delivery!



First quality Synthane copper-clad laminates, made under clean room conditions, are now stocked in many grades, and in many sheet laminate and foil thicknesses for quick delivery. If your specific requirements are not in stock they can be pressed quickly from our huge stock of semi-finished materials. Write for folder on Synthane copper-clad laminates and for a quotation on your needs. Synthane Corporation, 36 River Road, Oaks, Pa.

SYNTHANE
CORPORATION  OAKS, PENNA.

Laminated Plastic Sheets, Rods,
Tubes and Fabricated Parts

Circle 471 on readers service card

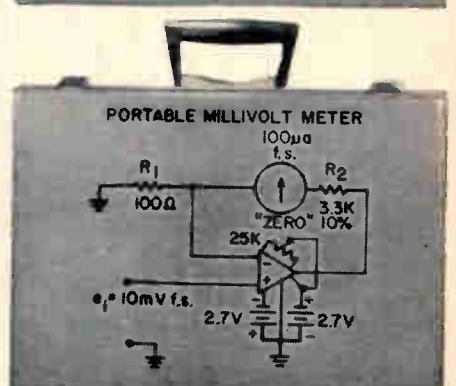
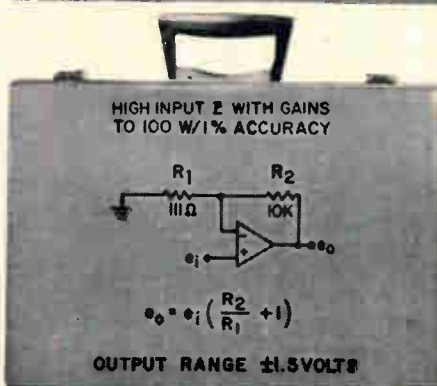
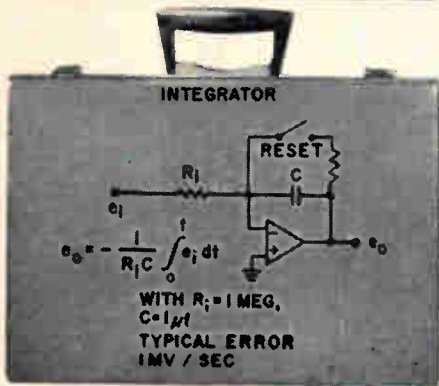
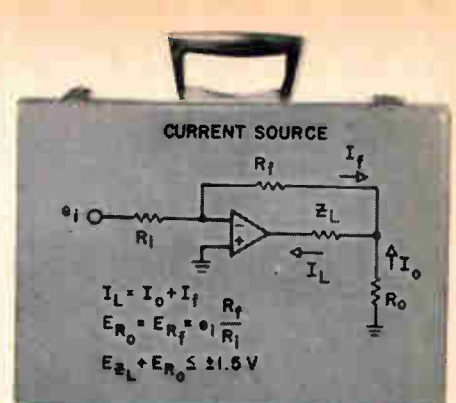
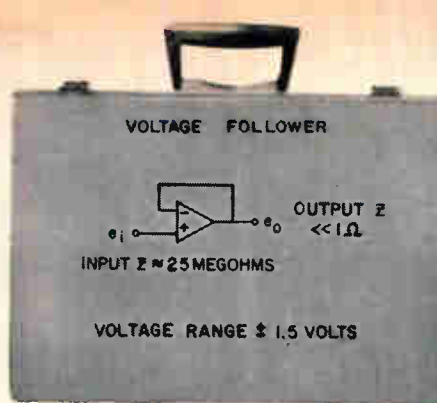
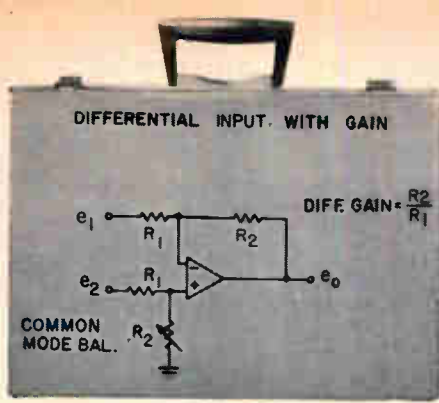

The new Nexus 2LV-1 2.7 volt operational amplifier is VERY PORTABLE

Developed specifically for use in a wide range of remote and portable, battery-powered electronic equipment, the new 2LV-1 operational amplifier combines high reliability, excellent performance, and economical low-power operation.

The miniature, encapsulated unit operates on a supply voltage of ± 2.7 volts ... has a low standby power drain of approximately 4 milliwatts.

Employing all-silicon semiconductors, the 2LV-1 operates over the range from -25° to $+85^\circ C$. It is particularly well-suited to use in geophysical, medical, oceanographic and aerospace instrumentation where low power consumption is a critical requirement. The unit offers a d.c. open-loop gain of 10,000, with an output capability of ± 1.5 v at ± 1.5 ma.

Reliable and economical operation are important advantages of the 2LV-1. Two Mallory TR132R mercury batteries provide approximately 1000 hours of operation. For longer life, four RM-12R mercury cells will provide approximately 4000 hours, or four RM-42R cells may be employed for approximately 15,000 hours of operation. Price, 1-9 \$35.

NEXUS
 RESEARCH LABORATORY, INC.
 480 NEPONSET STREET, CANTON, MASS. 02021
 TEL: (617) 828-9000 TWX (617) 828-1022

TYPICAL ELECTRICAL CHARACTERISTICS
 (@ 25°C unless noted)

Supply voltage	± 2.7 volts (nom.)
Supply current (quiescent)	≈ 0.75 ma
Output voltage range ($R_L = 1K$)	± 1.5 v @ 1.5 ma
E_{cm}	± 1.5 v
$\Delta E_{os} / \Delta T$ ($-25^\circ C$ to $+85^\circ C$)	$\approx 5 \mu v / ^\circ C$
I_{os}	≈ 1.0 na
$\Delta I_{os} / \Delta T$ ($-25^\circ C$ to $+85^\circ C$)	≈ 0.5 na / $^\circ C$
A_o ($R_L = 1K$)	$\approx 10K$
Input Z differential	0.2 megohms
Input Z common-mode	25 megohms

Prices FOB Canton, Massachusetts — Prices Slightly Higher Outside North America

Circle 149 on reader service card



When you need a curve tracer for transistors, get it from someone who knows transistors.

The Fairchild 6200 curve tracer is newly designed to display important characteristics of the latest solid



state devices. It has the features you need when you want to display low current-high gain transistors, FET, unijunction, SCR, or diode curves. It has unique capabilities, such as a 1000 volt, 40mA collector sweep. The

portable and rugged 6200 has variable base drive over a wide range and pulsed base operation for high current tests. Its programmable option makes this curve tracer ideal for volume production testing. It has all the controls and accuracy of a lab instrument, yet is simple enough to use on the production line.

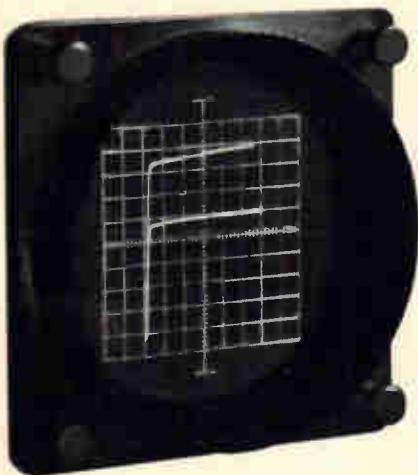

FAIRCHILD
INSTRUMENTATION

Send for complete technical details.

Probing the News

Military electronics

Avionics for a more mobile army

Vietnam has shown the need for more improved airborne surveillance and communications systems. New aircraft will have these built-in

By W. J. Evezia

Avionics Editor

Army helicopters in Vietnam have carried almost two million passengers and 84 million pounds of cargo. Fire support helicopters have made over a million sorties. Surveillance airplanes — fixed-wing Mohawks—have brought back vital intelligence that couldn't have been obtained in any other way. And forward air-control planes, directing ground battles, have often meant the difference between victory and defeat.

Although many officials were skeptical when the Defense Department decided to let the Army support the foot soldier with its own aircraft, they have now been won over to the concept of air mobility. And the Army is hard at work to improve its airborne operations. Having determined that six kinds of aircraft will do the job, the Army plans to build and equip its new aircraft with advanced avionics systems.

Observation. Already well along in development is the light observation helicopter, a small chopper that will fly over enemy territory, spot artillery and troops, and transmit this information to combat forces on the ground and in the air. The first production order is for 714 of these aircraft. The LOH will replace the aging L-19 and O-1F fixed-wing planes now used in Vietnam. The Hughes Tool Co. is building a prototype which has been designated UH-6A; the Sylvania



Station-keeping system, developed by the Sierra division of the Philco Corp. The scope in the control panel is the system's plan position indicator.

Electronic Systems division of the General Telephone & Electronics Corp. is working on the avionics package.

Fire-support missions. The advanced airborne fire support system will be the Army's first helicopter specifically designed for fire-support missions. Scheduled to be in the field in 1969, it will replace the UH-1B armed escort helicopter, which was hurriedly outfitted with machine guns and 2.75-mm rocket guns for combat in Vietnam. The Lockheed Aircraft Corp. is developing the prototype airframe. The new helicopter will have the integrated helicopter avionics system (IHAS). Although it is being developed by the Navy, the Army is funding 40% of the production contract for IHAS avionics.

Surveillance. In the development phase is a surveillance and target acquisition system (Stass) that will replace the hardworking Mohawk which is equipped with side-looking radar, infrared, ultraviolet and other detection devices. Stass will be equipped with advanced versions of Mohawk's equipment.

Transport. The Army is not planning to replace its present transport aircraft, but as new avionic systems are developed, planes built within the same time period will utilize them. The Army has divided its rotary-winged transport aircraft into three categories: utility tactical transport, typified by the Bell Helicopter Co.'s UH-1D Huey; light tactical transport, such as the Vertol division's CH-47A Chinook; and heavy-lift transport helicopters, like the Sikorsky Aircraft division's CH-54 Flying Crane. Sikorsky is a subsidiary of the United Aircraft Corp. and Vertol is a division of the Boeing Co.

I. Light observation helicopter

The prime purpose of the LOH is to provide company commanders with more information. In addition to artillery and troop spotting, the helicopter will be used for radio relays, psychological warfare missions, target marking, flare dropping and supply hauling. Although human eyes, rather than electronic sensors, will do the observing, the helicopter's communications system will be able to communicate with other supporting aircraft as

well as ground troops.

Radio links. Frequency-modulated radio equipment will link the flying observer with infantry, armored and artillery forces; very high frequency and ultrahigh frequency amplitude-modulated sets will mesh with supporting Air Force, Navy and Marine aircraft. The helicopter's communications system will also work with radio equipment used by terminal air traffic controllers and ground-based forward air controllers.

LOH avionics will not be available for installation until about the third procurement year of the airframe, when the Army will decide how many of the operating LOH aircraft will be retrofitted. Until that time, conventional avionic subsystems will be used.

The new equipment is much smaller. In many instances, all of the electronics for the new sets fits into the same space as the old unit's control box. This eliminates the need for bulky cabling and reduces the failure rate.

One set that typifies the new aircraft's avionics is the AN/ARC-114, a multichannel vhf/f-m transceiver. It weighs only 8 pounds, takes up 150 cubic inches of space and has a power output of 10 watts. The transceiver operates over a frequency range of 30 to 75.95 megacycles with 920 channels spaced every 50 kcs. Because solid state circuitry is used, the mean time between failures is about 1,000 hours. This set is designed to replace the AN/ARC-54 radio, which weighs about 26.5 pounds, is less reliable and takes up about three times the space.

The homing capability of the ARC-115 will enable the LOH to operate efficiently out of jungle air

fields. It uses keyed tactical ground transmitters for orientation.

Smaller transceivers. The AN/ARC-115, a lightweight vhf/a-m multichannel set with retransmission and homing capability, will replace the 30-pound AN/ARC-73. This new transceiver, about one-fourth the size of the old one, weighs 10 pounds and has an effective transmitted power output of 10 watts. It covers a frequency band of 116 to 150 Mc in 1,360 distinct channels (channel spacing is 25 kc).

LOH's will also carry the AN/ARC-116, a lightweight uhf/a-m transceiver. Slightly smaller than the ARC-114, it will replace the 36-pound AN/ARC-51 radio and will cover a frequency range of 225 to 399.95 Mc in 3,500 channels (50 kc channel spacing). Army engineers are designing a flush-mounted integrated antenna for it.

The helicopter will also carry a five-pound radio receiver—R-1297/ARC—an auxiliary vhf/f-m radio receiver for voice communications that covers a frequency range of 30 to 75.95 Mc. In addition, the aircraft will have automatic low-frequency, medium-frequency airborne direction finders. Two models are being produced, one covers a frequency range of 190 to 1,750 kcs in three bands: 190 to 412 kc, 410 to 850 kc, and 850 to 1,750 kc. The second model will cover the range from 100 kc to 3,000 kc in four bands. This equipment will be a functional replacement for the present-generation AN/ARN-59 and AN/ARN-83 directional finders.

Although the helicopter will not carry long-range communications systems, a high-frequency, single sideband system will be installed

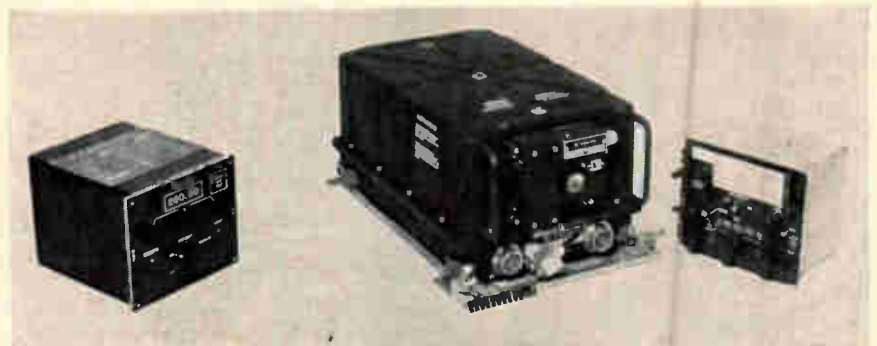

One multichannel ultrahigh-frequency a-m transceiver the ARC 116, left, replaces LOH's two-part ARC 51 which had a transceiver and a control unit.



Light observation helicopter, packed with new communications equipment, will spot enemy artillery and troop movements. It will replace the fixed-wing planes now in use.

if one can be made that meets the Army's requirements.

II. Airborne weapons platform

Army engineers consider the LOH avionic subsystems a transition between transistor technology and complete integrated circuit implementation. But the IHAS avionics in AAFSS will be the first Army system to take advantage of advanced microelectronics and integrated circuit component development. The Army will receive two experimental IHAS systems from Teledyne Inc., in early November for evaluation in the Army's tactical avionics system simulator. The systems will be flight tested this fall aboard Sikorsky CH-53A helicopters. Teledyne is about midway through the two-year IHAS avionics development program.

A roll-stabilized doppler radar navigator made by the Canadian Marconi Co., will be IHAS's primary navigation subsystem. It will use both digital and analog microcircuits and weigh about 37 pounds. Backing up the doppler radar will be a modified ASN-50 inertial platform, to be built by Lear Siegler, Inc. High accuracy synchros and low drift gyros will replace the ASN-50's standard components,

and a Sperry SYT 110 transfer alignment system will be used to set up heading references. A digital converter will convert synchro analog output to digital for computer use.

The IHAS system, like the Navy's integrated light attack avionics system (ILAAS), being built by the Sperry Gyroscope Co., a division of the Sperry Rand Corp., uses a functional modularity approach. This has resulted in some similarity of subsystems. Therefore the Army will probably use the Sperry display subsystem designed for the light attack system in its version of IHAS.

Three displays. The Sperry subsystem, which is scheduled to be delivered to Teledyne in early spring, will have three displays. The vertical situation display, with individual monitors for pilot and co-pilot, operates in four modes; it functions as a flight instrument command display, a shades-of-grey display for terrain avoidance, E-scan, and as a display for low light level television system.

The horizontal tactical display also works in two modes: one for navigation and a second for radar. In the navigation mode, a map is superimposed over the cathode-ray

tube and the display shows heading, ground track, and command heading. In the radar mode a plan position indicator scan is obtained from the terrain radar.

The advanced airborne fire support system is also expected to use the same computer subsystem as IHAS, because the computer has modular construction and used microcircuits, it can be physically expanded or contracted to meet most of the fire control requirements. The computer also will use various pressure, temperature and other air data inputs for dead reckoning navigation. A tactical air navigation system will employ ground or sea-based beacons to update both the computer and ASN-50 platform.

IHAS will have a terrain-avoidance radar system made by Norden, a division of the United Aircraft Corp. This radar system meets the Navy requirements but the Army has not yet decided whether it will use the system for AAFSS. IHAS is expected to be ready before the airframe.

Problem for AAFSS. Both terrain-avoidance and station-keeping radar were in the original list of specifications for the Army's airborne fire-support system. Both of



Great editorial is something he takes home

(What a climate for selling!)

Electronics 

A McGraw-Hill Market-Directed Publication
330 West 42nd Street, New York, N.Y. 10036

these control radar systems have advanced rapidly enough to be included in the prototype aircraft. The Army expects to have operational terrain-avoidance and station-keeping radars in the late 1960's.

According to the Army, the need for terrain avoidance radar had not been acute until now. But the change in military tactics brought about by Vietnam has made the radar mandatory. Therefore, the Army is investigating terrain-avoidance radar systems for both rotary and fixed-wing aircraft.

The Army is evaluating the AN/APN-165 on the Mohawk. But the radar developed by the Air Force for its drone aircraft has thus far failed to meet requirements. So the Army is taking a close look at other systems being developed for its sister services.

The Army wants station-keeping radars to help huge flotillas of helicopters to maintain their relative positions throughout an operation. This would result in greater safety and a more effective concentration of firepower, say Army tacticians. The Army is interested in both manual and automatic station-keeping systems. Four firms are working on developing them: Teledyne, Inc.; the Sierra division of the Philco Corp.; the Lockheed Electronics Co., a division of the Lockheed Aircraft Corp.; and TRG Inc.

The Army has bought four systems from Sierra for evaluation. Engineers at the Avionics Laboratory are using Sierra's systems to determine the station-keeping requirements for the fire-support system.

The Sierra SN-64/2A provides manual and automatic station-keeping at ranges from 75 feet to 3 miles (with an expansion capability to 10 miles). It has a range accuracy of $\pm 10\%$ and a bearing of accuracy of $\pm 2^\circ$.

But the system does not have the operational capability needed for fire support. Only range and bearing are presented on a position indicator scope, which the Army says is too hard to read. Equally as important as range and bearing, is relative altitude. The Army wants to be able to resolve altitude differences of less than 20 feet.

The Army will also evaluate two Teledyne station-keeping systems. The Navy is now testing early models of the IHAS subsystem at the Naval Air Development Center in Johnsville, Pa., but the Navy's problem is different from the Army's. The Navy can make do with a 500-foot separation between aircraft instead of the Army's 20-foot requirement. Also, the IHAS station-keeper weighs about 85 pounds; the Army's weight limit is about 30 pounds.

The Air Force is evaluating a manual station-keeping system for its C-130 transport aircraft. The C-130's must maintain station at ranges from 2,500 feet to 10 miles.

In the cockpit. The Army has under way a program designed to develop cockpit instrumentation to display the information generated by advanced avionics systems such as IHAS. The goal of the program, called the advanced Army aircraft instrumentation system, is to provide equipment that will take over time-consuming cockpit operations such as continuous instrument scan, navigation computation and fuel management.

An analog system will be used to determine the physical and psychological stresses faced by a pilot. The primary displays in the system are a 14-inch vertical situation display which gives the pilot the view below him, and a horizontal display which presents the side, front and rear view—all in real time. Inputs into the system could be from television, infrared or other types of scanners.

Transports. The CH-47 Chinooks have become the mainstay of the 1st Air Cavalry Division. They fly an average of 850 missions per day carrying 550 tons of equipment and 1,500 passengers. Avionics for transports like these need not be as sophisticated as those in the fire-support system or as compact as those on the LOH. It is therefore unlikely that the Army will retrofit any of its transport family with advanced systems. However, as the systems become generally available, certain subsystems will be included in new aircraft.

III. Surveillance program

The surveillance and target acquisition system is about two years behind the advanced airborne fire-

support system in the Army's timetable. The Army has not chosen either the airframe or the avionic subsystems, although one Army official has said that the avionics will probably be an optimized mix of the subsystems for the light observation helicopter, the integrated helicopter avionics system and the integrated light attack avionics system. However, the surveillance and target acquisition system will have some requirements that the three other systems cannot now fulfill. Several types of airframes—vertical short take-off and land (V/STOL), STOL, tilt wing, tilt prop and jet aircraft—are all prime candidates for the system.

The Research Analysis Corp. in McLean, Va., is now completing a study of the surveillance concept, including techniques of acquiring surveillance data, the optimum location of the aircraft to the front lines, types of aircraft—VTOL versus conventional or short take-off types—runways and the time required to get collected surveillance data to Division or Corps headquarters.

Quite apart from the Research Analysis study is a request for a surveillance program sent in February to the Pentagon by the Combat Surveillance and Target Acquisition Laboratory of the Army Electronics Command at Fort Monmouth. The Army's Chief of research and development is scheduled to take action on this request soon.

Whatever form the system takes, its surveillance and data collection equipment will be very different from that which the Mohawk OV-1's now carry. Lasers and optoelectronics will be used extensively and its electronics subsystems will be almost exclusively microminaturized and/or molecularized. Side-looking and forward-looking radar antennas will have low silhouettes; some systems will use the aircraft's skin as a radar reflector. Night vision systems—low-light level television and infrared sensors—will be standard equipment. The surveillance aircraft of the 1970's also will have new high-speed panchromatic cameras and have on-board photo-processing, recording, pattern recognition and reconnaissance analysis equipment.

Glass-Epoxy

Copper-clad

through TAYLOR'S TOTAL RELIABILITY PLAN:

Raw materials, panels or punched blanks to your reliability requirements. You get what you order from a fully integrated source.

FAST DELIVERY from two fully equipped plants—one at Valley Forge, Pa., the other at La Verne, Calif. Or from warehouses in Chicago, Ill. and other key locations.

... **FULL SIZE SHEETS, CUT-TO-SIZE PANELS or PUNCHED BLANKS** to satisfy fabricating and processing requirements. Ease of fabrication is a plus value in printed circuit production.

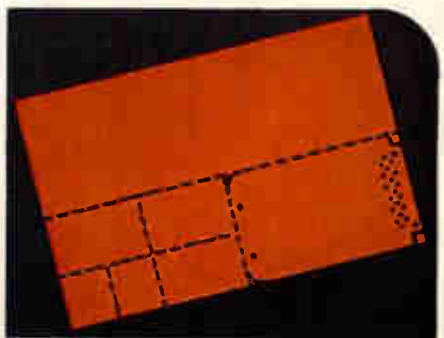
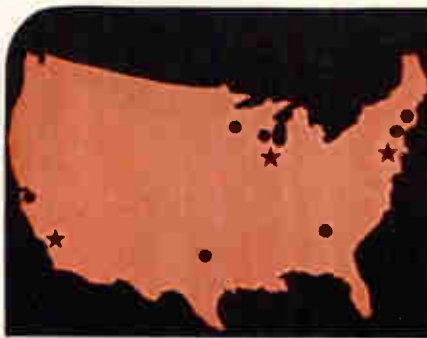

... **STANDARD AND ULTRA-THIN FORMS.** Standard sheets in all grades. Ultra-thin sheets and multilayer preregs in GEC 500 (G-10) and Fireban 600 (G-10, FR-4).

... **WHITE GLOVE HANDLING** in atmosphere-controlled white rooms, careful processing, extremely tight quality control and special packaging assure top performance.

Taylor's copper-clad has proven total reliability demonstrated by an ever increasing number of major OEM's and commercial etchers. This acceptance substantiates our claim for unsurpassed quality, ease of fabrication and delivery to your scheduled requirements. Let us demonstrate this reliability to you. Ask for a sample (give grade designation and copper combination) and a copy of Bulletin GB-2.



Taylor copper-clad

TAYLOR CORPORATION • Valley Forge, Pa. 19481

Phone: 215-666-0300 TWX: 215-666-0659

West Coast Plant: La Verne, Calif.

Also manufacturer of Taylor laminated plastics, Taylorite® vulcanized fibre and Tayloron® preregs

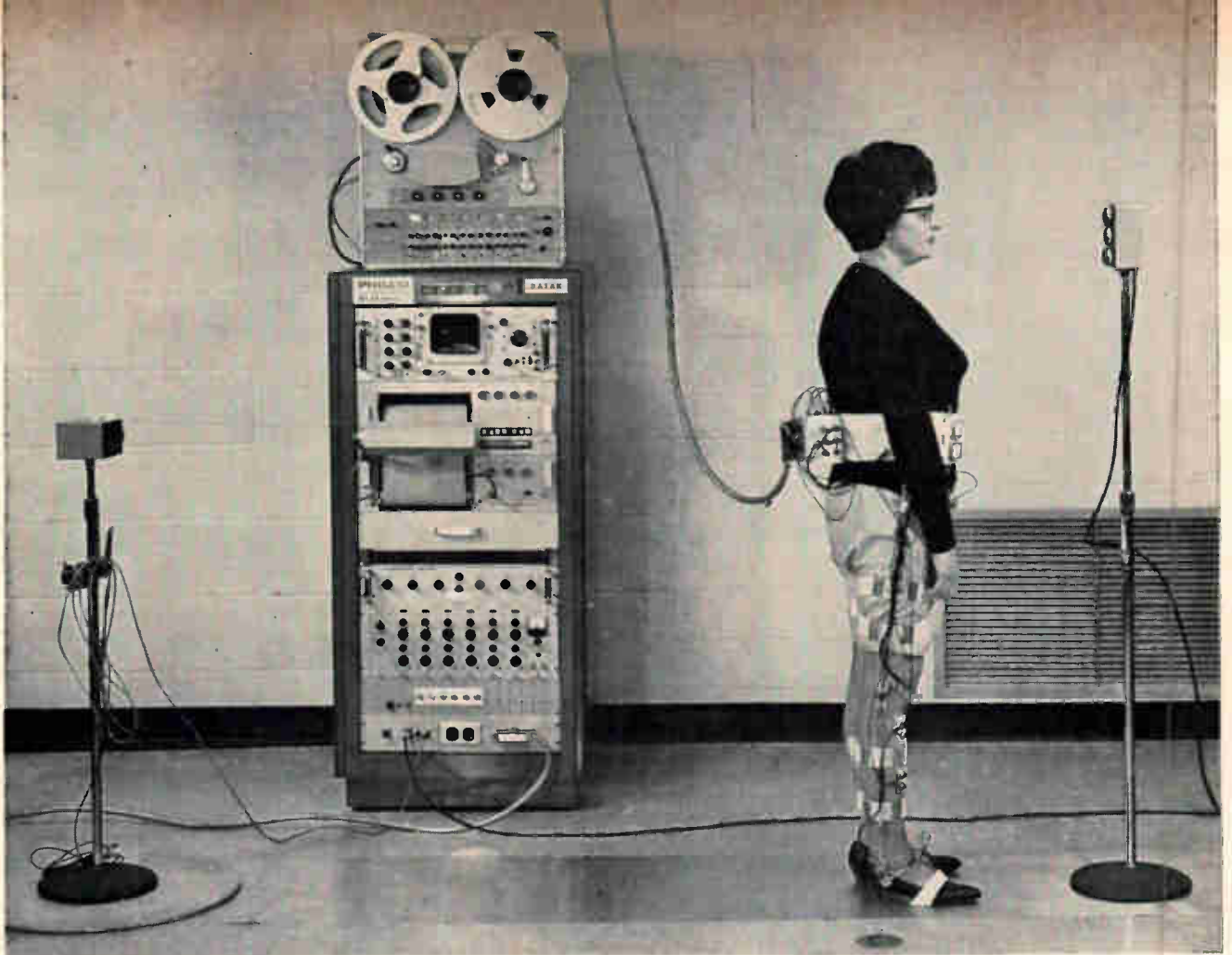

Gait-study subject. When she walks, she will create velocity signals and timing signals for comparison with EMG. Tachometer in housing at left generates the velocity signal as she walks. Lights at right tell her when to walk.

Medical electronics

Why some people fall often: EMG signals studied for clues

Muscle signals already control experimental prosthetic devices. Soon they may help researchers learn why older women fall down more often than young ones, and how these accidents can be reduced

By Carl Moskowitz

Instrumentation Editor

For centuries, the male of the species has observed intriguing differences in the ways various women walk. Analyses of these differences have been largely subjective; now scientific study is being made with the help of computer analysis of the tiny electrical signals associated with muscle contraction. The work

at the Moss Rehabilitation Hospital in Philadelphia is designed to learn why women fall more often when they get older. If falls are a result of changes in gait, as some researchers suspect, teaching older women how to walk differently might prevent painful injuries.

Until now, these signals—called

electromyographic or EMG—have found many applications in controlling damaged or artificial limbs. Two years ago the Philco Corp. demonstrated a way to use the signals, which are measured in microvolts, to control an artificial arm or leg [Electronics, Nov. 30, 1964, p. 74]. Last year Case Institute of



half the picture

When you look at electronic components are you seeing only half the picture?

We're the last people to argue with component purchasers who put performance, price and delivery first — meeting these three basic requirements is what keeps us in business. But most engineers are also on the lookout for something more, and many of them find it at Mullard.

Take research and development for instance. Out of Mullard R&D have come outstanding devices such as the travelling wave tubes for the New York—San Francisco and Montreal—Vancouver microwave links. Production resources? Mullard

plants are among the most efficient anywhere, with a reputation for the production of tight-tolerance devices to proved standards of reliability. As for circuit know-how, Mullard has the best equipped applications laboratories in Britain. And when it comes to technical services, you will find that Mullard provides the kind of comprehensive performance specs, survey documents and application reports that are just that much more useful.

If you want to get the *whole* picture, why not ask us to help you with some of your component problems?

DIODES · TRANSISTORS · PHOTO-DEVICES AND RADIATION DETECTORS · RECTIFIER DIODES AND STACKS · THYRISTORS AND STACKS · INTEGRATED CIRCUITS · CATHODE RAY TUBES · RECEIVING TUBES · ELECTRON OPTICAL DEVICES · PHOTSENSITIVE DEVICES · COLD CATHODE DEVICES · POWER DEVICES · TRANSMITTING TUBES · MICROWAVE DEVICES · CAPACITORS · FERRITE MATERIALS AND ASSEMBLIES · COMPUTER COMPONENTS AND ASSEMBLIES · MAGNETIC MATERIALS · SPECIAL PURPOSE MAGNETS · VACUUM DEVICES · WOUND COMPONENTS.

Mullard

where the product is only part of the deal

MULLARD LIMITED · TORRINGTON PLACE · LONDON WC1 · ENGLAND

Circle 157 on reader service card

MU6

feeling the pinch

{ for qualified
electronics
technicians? }

New electronics equipment demands technicians with a wide range of specialized skills. Men who understand the "why" of electronics... can install, maintain, troubleshoot and repair the electronics gear you're using today and will be using in years ahead.

Qualified electronics technicians are scarce. But with a Cleveland Institute of Electronics Training Program you can soon develop an ample supply by up-grading your present staff of technical personnel. CIE "AUTO-PROGRAMMED" Courses are fast, economical, effective. What's more, they can be readily "tailored" to your specific training needs. Hundreds of companies use them... thousands of men are enrolled. Get free details fast. Mail coupon today. Cleveland Institute of Electronics, Dept. E-21, 1776 E. 17th St., Cleveland, Ohio 44114.

SEND COUPON TODAY

Cleveland Institute of Electronics

Dept. E-21, 1776 E. 17th St., Cleveland, Ohio

Gentlemen: I am interested in learning more about your Electronics Home Study Programs. Please send complete information.

Name _____

Title _____

Company _____

Address _____

City _____ State _____ Zip _____

Accredited Member, National Home Study Council.

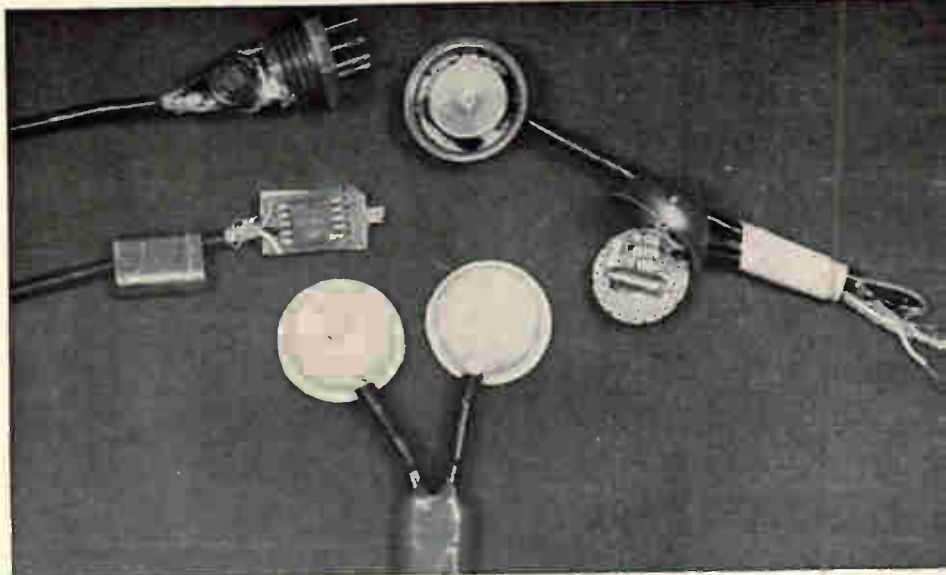

Differential electrodes, top and bottom views. Blocking capacitors behind each electrode prevent any d-c component from appearing at the signal processor.

Technology found a way in which EMG signals from a shoulder muscle can help to restore the use of a disabled muscle in an arm [Electronics, Sept. 20, 1965, p. 110].

I. Starting gait

When the subject begins to walk along a 30-foot copper sheet backed with mylar, small electrodes on her heel and toe make contact with the sheet. Each time the heel or toe touches this ground plate, a reference is created from d-c potentials on the electrodes, for timing with EMG, kinematic and velocity data gathered by more delicate methods.

The Philco Corp., which is conducting the study for the Public Health Service, collects EMG information from six muscles by means of electrodes on the skin and a data-collection system called a Datak, which consists of an oscilloscope, signal conditioners, a graphic recorder and a tape recorder. The data is fed to the tape recorder, then played back through a signal analyzer-processor for digitizing. Kinematic data also is collected by an electrogoniometer, an angle-measuring instrument strapped to the leg. The instrument, which resembles a leg brace, has five potentiometers which are positioned at the foot, ankle, knee and side and frontal hip joints. Readings from the potentiometers give the angular displacements of these joints. Velocity is measured by a tachometer.

Sorting the signals. It is the analyzer-processor, called a Myocoder, which permits EMG signals to be separated from the tens of thousands of others generated in the body. Recently, Philco improved the two-year-old system so that the Myocoder not only detects the signals that accompany muscle movement, but also reduces the data to a digital format automatically and punches it onto cards. This advance has made the gait studies possible, says Miss Rona Finizie, a senior scientist in Philco's bio-cybernetics group. "Otherwise it would be impossible to process all the data that will be accumulated during the test," she explains.

At present, the computer receives the values of EMG signals at only four stages of a stride: when the heel makes or breaks contact with the ground plate, and when the toe makes or breaks contact. Philco is working on equipment which it hopes will be able to analyze, automatically, velocity and the position of various leg joints; at present this information is read directly from the recorder charts and punched manually onto the computer cards.

Wiring the subject. To obtain a signal, Philco uses pairs of electrodes to detect changes in potential on the surface of the subject's skin. By removing the ground reference, these electrodes minimize the effect of line noise.

To overcome resistance changes

between skin and electrode, caused by shifting of the contact as the subject walks, electrodes had to be designed with input impedance high enough to overcome the effect of the changes on the signals. To solve the impedance problem, Philco chose a microminiature amplifier with an emitter-follower first stage. Besides providing the necessary high-input impedance, this amplifier boosts the EMG signal to a level that overcomes the attenuation caused by the long cable that connects the subject to the data-collection system. Another network on each electrode prevents any d-c portion of the EMG signal from passing through to the processing equipment.

II. Before the countdown

The time required to get a subject ready for a test still has to be reduced. She must stand on a raised platform for about an hour; first the electrogoniometer is strapped in place, with each potentiometer adjusted to make sure it is at exactly the right spot. When all the instruments are in place, they are checked out; while the subject walks about 10 feet, the instruments indicate the level of her EMG signals, and the Datak operator sets the attenuation levels of the 12 data channels accordingly.

For the study, data from 200 women over 65 years of age will be compared with data from a control group of 35 women of 18 to 25.

Beyond the Philadelphia project, broader applications are envisioned for Philco's approach to the study of electromyographic signals. Walter Wasserman, director of the company's biomedical development laboratory, sees it helping in the design of automobile seats by studying driver fatigue. He notes that some researchers believe that tired muscles may exhibit differences in their EMG patterns. If this is true, changes in the levels of an individual's EMG signals may provide a measure of his fatigue as he sits behind the steering wheel hour after hour.

EMG is also the subject of another Philco study whose goal is to learn whether electromechanical machinery for automobile assembly plants could be designed more efficiently if their motions followed those of human limbs more closely.

There is a single source for all oscillographic paper and chemical needs



The place is CEC

Today, the broad spectrum of oscillography covers twelve different papers and chemicals. You are probably using some of these CEC products now. However, since there are important differences between them, we'd like you to meet the entire family.

DATACOLOR 88. A two-color red and cyan emulsion paper which produces oscillograph records in distinctly different hues for *rapid* and *positive* trace identification.

DATAFLASH 55. The extreme sensitivity of this paper now makes it possible to obtain *perfect* oscillograph records at writing speeds in excess of 75,000 ips.

DATAFLASH 56. A high writing speed product which produces superb traces, timing, and grid lines where Xenon lamps are used.

DATAFLASH 57. High writing speed Dataflash 57 features a "develop-out" option for oscillograms of archival quality.

DATATRACE 11 & 31. Heat sensitive recording papers for use with CEC's DG-5511 Portable Two-Channel Thermal Writing Recorder. High contrast or reproducible types are available.

DATARITE 33. DATARITE refers to CEC's Datarite Magazine in which oscillograms are automatically developed and dried as quickly as data is recorded. DATARITE 33 is ideal for high writing speed applications.

DATARITE 22. Type 22 has less sensitive emulsion than Type 33. At low writing speeds, it will give excellent oscillograms.

Type 49943-3 Datarite Developer Solution is a non-ammonia, general purpose formula which provides exceptionally high trace contrast and high writing speed capability.

Type 49943-4 Datarite Developer Solution is an ammonia-type formula which combines high writing speeds with reduced paper staining in high humidity environments.

Hi-Speed Chemical Kit — No. 217050. Designed for use in CEC's new 23-109B and 23-109A Processors. Easily capable of processing more than 1500 square feet of oscillographic paper without replenishment, it's the logical choice where numerous rolls of recorded material must be processed.

Liquid Concentrate Chemical Kit — No. 145455. The "economy" package for use with the 23-109A. Processes up to 500 square feet of paper, on an intermittent basis, thereby avoiding costly waste of solutions.

For further information about CEC oscillographic papers and chemicals, call or write for CEC Bulletin Kit 9053-X2.

CEC

Data Instruments Division

CONSOLIDATED ELECTRODYNAMICS
A SUBSIDIARY OF BELL & HOWELL/PASADENA, CALIF. 91109
INTERNATIONAL SUBSIDIARIES: WOKING, SURREY, ENGLAND
AND FRIEDBERG (HESSON), W. GERMANY

How many MATCHED radar channels?

Build all you need with



LEL Gain and Phase Matched Amplifiers and Mating Mixer-Preamplifiers

LEL 2- or 3-Channel matched post amplifier units offer superior performance over the widest range of gain control. They're ideal for use in monopulse radar applications. In such an application you can

also build with LEL's monopulse comparators, matched mixer-preamplifiers and appropriate LEL-LINE strip components now available up through Ku Band. Send for LEL's new catalog now.



Mixer-Preamplifiers

Signal Input	3.95 to 5.85 Ghz†
IF Center Frequency	30, 60 or 70 Mhz
Bandwidth (3 db)	25 Mhz
Gain (RF to IF)	20 db
Gain Reduction	20 db
Maximum RF Input Signal for Linear Output	-20 dbm
Output Impedance	50 ohms
Noise Figure	as low as 7.5 db
Power Required	-20 VDC
Phase Tracking (as compared to another similar unit operated off a common AGC bias)	2° (max)
Gain Tracking (as compared to another similar unit operated off a common AGC bias)	1 db (max)
Chassis Adjustments	Phase Trim and Gain Trim

†36 ranges available between 0.1 and 40 Ghz.



Dual Channel Amplifier

Center Frequency	30, 60 or 70 Mhz
Bandwidth (3 db)	10 Mhz
Gain (IF)	65 db
Gain Reduction	40 db (min)
Max. Output Signal for Linear Operation	+10 dbm
Max. Input Signal for Linear Operation	-15 dbm
Input Impedance	50 ohms
Output Impedance	50 ohms
Power Required	160 ma @ -20 VDC AGC: 0 to +10 VDC
Phase Match	2.5° (max)*
Gain Match	1.0 db (max)*
Dimensions	7" L x 1½" H x 2½" W
Weight	1½ lb. max
Chassis Adjustments	Gain and Phase Trim

*These data are maximum variations within temperature range of -50°C to +75°C and over the full specified gain control range, for a signal spectrum greater than 60% of the IF bandwidth.

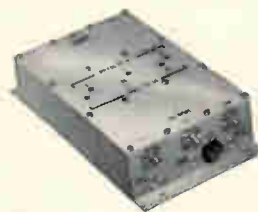

Triple Channel Amplifier

Center Frequency	30, 60 or 70 Mhz
Bandwidth (3 db)	10 Mhz
Gain (IF)	65 db
Gain Reduction	40 db (min)
Max. Output Signal for Linear Operation	+10 dbm
Max. Input Signal for Linear Operation	-15 dbm
Input Impedance	50 ohms
Output Impedance	50 ohms
Power Required	240 ma @ -20 VDC AGC: 0 to +10 VDC
Phase Match	3.5° (max)*
Gain Match	1.5 db (max)*
Dimensions	7" L x 1½" H x 3¾" W
Weight	2 lb. max
Chassis Adjustments	Gain and Phase Trim



AKRON STREET, COPIAGUE, L.I., NEW YORK 11726

(516) AMityville 4-2200 / (516) PYramid 9-8200 / TWX Code 516-691-5085



Broadcast equipment like these studio television monitors has helped the East Germans move into world markets. Gear rates high for quality but it's bulky.

Markets

Electronics booming in East Germany

Production of hardware continues to rise with emphasis shifting from consumer goods to industrial and commercial products, but lack of access to Western technological advances is still a major drawback

East Germany's communist boss Walter Ulbricht traditionally opens the Leipzig Spring Industrial Fair with a whirlwind trip through the pavilions. This year, though, Ulbricht and his official party slowed down when they reached the Hall of Electronics. Ulbricht even

stopped to chat at the stand of Siemens & Halske AG; usually he stares straight ahead as he strides past the displays of West German companies.

Ulbricht's change of pace illustrates the ruling hierarchy's growing awareness of the need to de-

velop the country's electronics industry. Up against a labor shortage, East German economic planners are pressing hard to step up productivity, under the circumstances about the only way to keep the output of goods climbing. Strengthened electronics capabil-

LOW MICROWAVE NOISE?

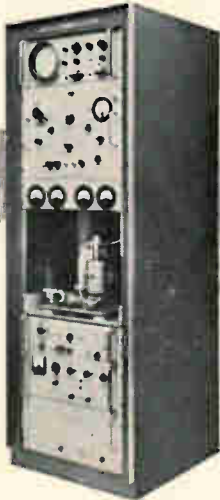

Model SE-200

WHY NOT PROVE IT?

SPECTRA Microwave Noise Measuring Instruments are the only equipments yet devised that can give you the FM and AM noise content of conventional and solid state microwave sources — to accuracies as high as ± 1 DB. Proof? Maybe not, but close to it.

SPECTRA-EXCLUSIVES:

- RF Frequency Ranges: 1.0 Gc/s to 32 Gc/s
- Self-Calibrating for both AM & FM noise measurements
- Broad Video Frequency Coverage: 1 Kc/s to 150 Kc/s
- Residual FM Monitor: 10 cps to 1 Kc/s
- Dual Bandwidth Spectrum Analyzer: 100 cps and 1 Kc/s
- High Sensitivity: AM 135 DB below carrier level; FM .0032 cps rms deviation
- Minimum RF Input Power: 1.5 milliwatts
- Self-Contained Microwave Spectrum Analyzer
- Phase-Locked Local Oscillator

NEW MEASUREMENT SERVICE

A custom Noise Measurement Service is now operated by Spectra to provide accurate noise measurements of X-band sources in the frequency range from 8.5 Gc/s to 10.5 Gc/s. Readout: X-Y recordings of FM or AM noise vs. video frequency. Write today for technical data and complete details.

SPECTRA  ELECTRONICS

P.O. Box 85
Los Altos, Calif. 94023 • (415) 948-4998

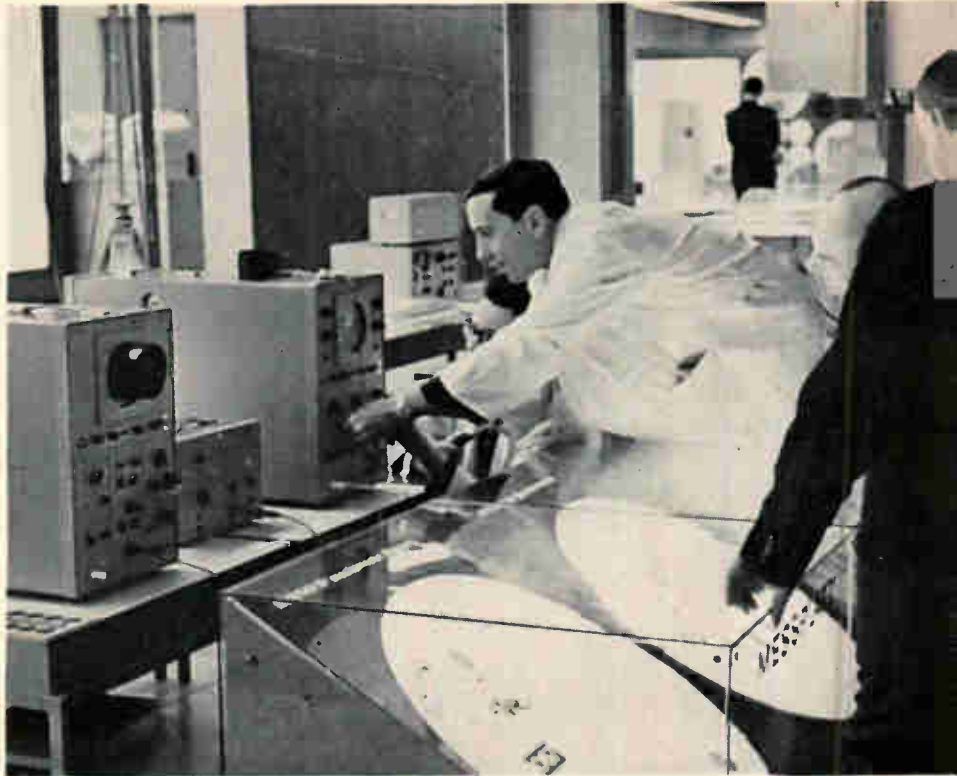

One-shot waveforms persist up to a week on the tube of a new oscilloscope developed by a "people's own" instrument maker in East Berlin.

ity, especially in industrial equipment, is crucial to this effort.

What's more, the planners count heavily on electronics exports to earn sorely needed foreign exchange. About one-fourth of the industry's output now goes to other countries.

Little wonder, then, that in the rigidly planned East German economy the fastest growing sector is electronics. Production of electronics hardware has bounced up 10% annually in recent years. Industry officials say they can maintain that rate during the next few years, especially since technical support from Russia seems likely.

All the same, they're itching for access to Western electronics know-how. But there's small prospect of that in the offing; the best they can hope for is a slight easing in the North Atlantic Treaty Organization's embargo list that keeps advanced Western hardware out of countries that belong to the Council of Mutual Economic Assistance—the Eastern equivalent to the Common Market in Western Europe.

Number 2. By Comecon standards, however, East Germany has progressed swimmingly in electronics. Over-all, she ranks second

only to Russia. East German planners don't disclose figures that pin down the size of the industry, but Western experts estimate it's now running at a level of \$600 million yearly. That, of course, is a far cry from the \$2.257 billion worth of business the West German industry expects to do this year.

Inevitably, the concern over electronics development has shifted the emphasis from consumer goods to industrial and commercial products. A former television manufacturing facility, for example, now turns out data-processing equipment. In fact, only one plant produces television sets. East German planners hold the view that with three million sets in service for a total population of 17 million, the country is saturated by socialist standards; so a single plant can handle replacements and exports.

East meets West. At Leipzig, communists meet capitalists at spring and fall fairs and out of the encounters comes a profile of the East German electronics industry. The East German stands bristle with equipment the industry thinks it can peddle to its Comecon partners and in world markets as well. This pinpoints the industry's strong sectors.

Western manufacturers, on the other hand, make capital of East Germany's weak spots. They show equipment—within the range permitted by the NATO embargo—that the East Germans can't produce for themselves.

I. The positive side

Visitors to last month's spring fair came away with a strong impression that the industry is doing best with communications equipment and instrumentation. In these two sectors, the East Germans have made big strides. Some 29 factories, backed up by the research efforts of university institutes and government science centers, turn out more than a thousand different items of equipment. Over the past five years, output of measuring and control equipment has tripled, industrial officials boast.

The "people's own" companies sell instruments such as sweep generators, oscilloscopes, high- and low-frequency signal generators and transistor-characteristic curve tracers to more than 50 countries, many of them in the West. The East Germans also have moved into world markets with radio and television broadcast equipment. They are now delivering to Indonesia, for example, a short-wave facility worth several million dollars.

High marks. Western observers give the East Germans high marks for the quality of their equipment. Some items, in fact, can stand comparison both in price and performance with instruments made in the United States. A case in point is a recently developed oscilloscope that can store signals up to one week (see photo). It's designed for work with single, nonrecurring waveforms like those encountered in mechanical, electrical and acoustical engineering problems. With this oscilloscope engineers can analyze a waveform long after it has vanished, without photographing it.

To be sure, items like the long-store oscilloscope—sophisticated enough to have a potential market in technically advanced Western countries—are few and far between. But the East Germans have spotted some gaps in the lineup of production equipment made in the West and moved to fill them. They've developed, for example,

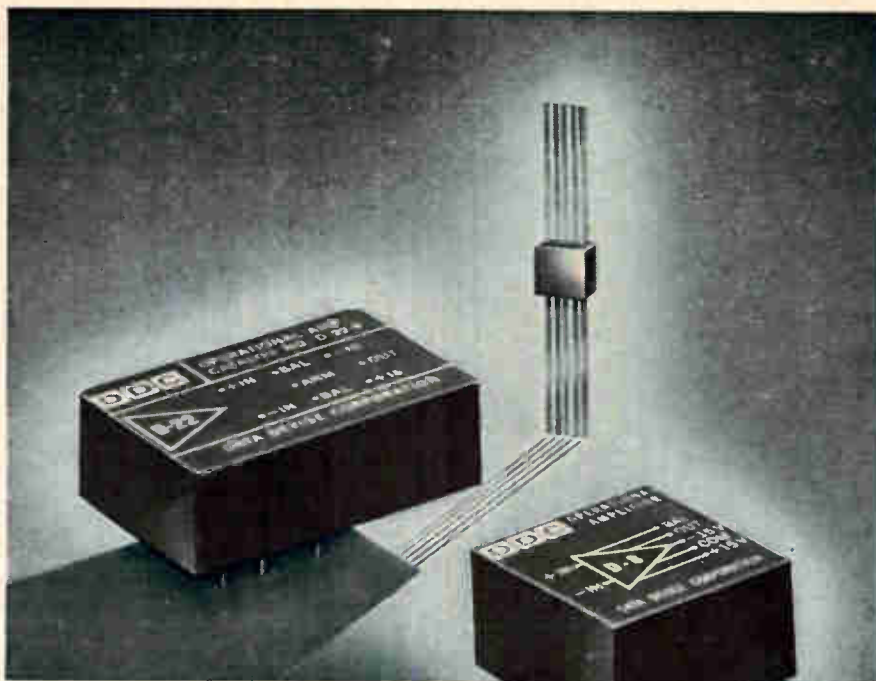

The new Op Amps up front are bigger. And better.

There's no comparison between DDC's new *Assured Reliability* Operational Amplifiers and that flat pack—unless you *must* trade off size for far inferior offset current. And stability. And output current. And voltage swing. And ease of installation. And price. And so on.

But don't just limit your comparison to IC amplifiers—check DDC's parameters and prices with *whatever* you're using.

Check the specs of our new economical D-8. And our new high-current, high-stability D-22. And their costs. Optional configurations let you drop a DDC amplifier right into your present PC board or connector.

Both amplifiers are all silicon. They're virtually indestructible, and need no external components to make them stable. And delivery, happily, is usually from stock.

OPERATIONAL AMPLIFIERS

CHARACTERISTICS @ 25° C

	D-8	D-22-9
V _{OUT} (P-P).....	±11 V (min).....	±10 V (min)
I _{OUT}	±2.2 ma (min).....	±20 ma (min)
V _{GAIN}	90 db (typ).....	103 db (typ)
I _{OFFSET}	20 nA (max).....	10 nA (max)
V _{DRIFT/TEMP}	20 μV/°C (max).....	15 μV/°C (max)
Freq. for Full Output.....	18 Kc (min).....	10 Kc (min)
Price (1-9)	\$29	\$85
Standard Packages	5/8" H x 1 1/8" x 1 1/8".....	D-22: 5/8" H x 1 1/8" x 1 1/8"*
(Optional Configurations) 0.4" H x 1 1/8" x 1 1/8".....		D-22-9: .6" H x 1.2" x 1.8"***

*(.1" grid) ** (.3" grid)

Check? Now check the reply card, or check us direct—
call or write for complete information, free Applications Booklet.



DATA DEVICE CORPORATION

240 Old Country Road, Hicksville, L. I., N. Y. 11801
516-433-5330 TWX 516-433-5779

When Motor Specifications *demand*

- HIGH INITIAL TORQUE
- FLEXIBLE SPEEDS
- CONTINUOUS USE
- RESISTANCE TO HEAT OR COLD



turn the job over to SYNCHRON® MOTORS!

No matter whether you need a motor that can "do tricks" or handle simple routine work, think of a SYNCHRON Motor first. Here at Hansen Manufacturing Co., we've helped designers and production people solve problems ranging from unusual cycling patterns, to meeting swiftly varying temperatures, and a hundred other special applications. And of course we've supplied industry with literally millions of motors for uncomplicated designs. We can help you, too; write or phone us!

HANSEN

MANUFACTURING COMPANY, INC.



PRINCETON,
INDIANA

HANSEN REPRESENTATIVES: CAREY & ASSOCIATES, Houston, Tex., R. S. HOPKINS CO., Sherman Oaks, Calif., MELCHIOR & MACPHERSON, INC., San Carlos, Calif., THE FROMM CO., Chicago, Ill., H. C. JOHNSON AGENCY, INC., Rochester, N. Y., WINSLOW ELECTRIC CO., Essex, Conn., Narberth, Pa., and New York, N. Y. EXPORT DEPARTMENT, 64-14 Woodside Ave., Woodside, N. Y.

automatic stator-winding machines, program-controlled equipment for forming wiring harnesses, and computer-controlled resistor-making machines.

Another sector where the industry is going full steam ahead is shipboard equipment. Despite a dearth of advanced devices, East German engineers have managed to develop complete navigational radar systems, automatic ship-control equipment, cargo handling equipment, ultrasonic fish spotters, and communications gear. The thriving East-German shipbuilding industry supplies completely equipped vessels to both Western and Eastern countries.

Office equipment, too, is a mainstay of East German electronics. The annual output is estimated at close to \$100 million. Soemtron, Ascota and Optima electronic calculating and invoicing machines are exported to some 80 countries including the United States.

The Soemtron 220 shows how far along the East Germans are with small electronic desk-top calculators. This machine can add, subtract, multiply, divide or raise to powers 15-digit numbers at an average speed of 0.5 second. VEB Büromaschinenwerke Soemmerda, the largest office-machine manufacturer in the country, sells the calculator for about \$2,250. The VEB in the firm's name is the acronym for "people's own factory" in German.

II. Where they lag

Although it has done well with small office machines, the East German industry has a lot of catching up to do in computers. It has developed a small computer and made much of it last spring at the Leipzig fair. But mass production won't start until later this year.

This state of affairs leaves the industry far behind neighboring Poland and hopelessly outdistanced by West Germany and the United States. Along with high-quality solid state components, medium and large computers at the moment are a leading market for outsiders in the country. Reiner Staehr, deputy director of the industry association for data-processing equipment, says East Germany needs at least 10 complete installations in the large-machine category. All will

have to be imported.

The need for medium computers is even greater. Hundreds, planners say, are required to push industrialization of the country. But Staehr hopes much of the demand can be met in the future by the industry.

Kingpin. To that end, the East Germans have developed the Robotron 300. The machine presumably will be a kingpin attraction at next fall's Leipzig fair. Officials hint it will be unveiled then. They say it will be three times as fast as its predecessor, the Robotron 100, which has serial addition and subtraction time of 0.5 millisecond.

The Robotron 300, then, will be comparable to the Siemens 3003 computer, made by Siemens & Halske of West Germany. Until the Robotrons start coming off the production line, though, Siemens can almost surely count on more orders for its 3003 model; one already is installed in a warehouse in Leipzig.

One computer East Germany will have in production later this year is a small machine for scientific problems and statistical applications. It's called the Cellatron SER 2c and sells in the \$16,000 to \$20,000 range. Büromaschinenwerke AG of Zella-Mehlis makes it.

For their money, buyers get a punched-tape controlled machine with addition and subtraction time—without address—of 2.5 milliseconds. With an address, the same operations take 50 milliseconds. Speeds for multiplication and division, with or without address, are 140 and 180 seconds, respectively. The memory is a magnetic drum with access time of 11 seconds.

On the heels of the Cellatron SER 2c will come the Cellatron D4a intended for administration, industrial, and scientific applications. It has a maximum computing speed of 2,400 operations per second. This machine sells for \$22,500 to \$30,000, depending on peripheral equipment.

Semiconductor woes. The East Germans can make the conventional components and the memory devices for these small computers, but they have to buy high-quality transistors and diodes outside the country. Chief suppliers are Russia, West Germany and Japan.

This dependence on foreign imports points up one of the sore

Dc.
 nts from 50 cps
 ns from 100 ohms
 rejection of all
 measurements.
 minimizes
 re, 200 3-wire
 its for group



Data Acquisition Requirements?

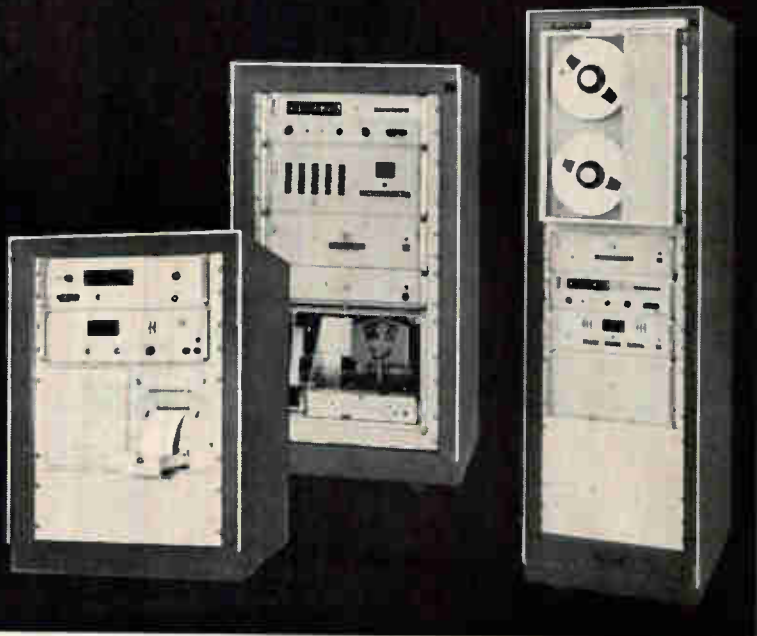

APPLICATION

Dymec Data Acquisition Systems are designed to measure analog data derived from a number of sources, and to display and record this information in digital form. To present the information available with a choice of output recording systems. For direct reading by the operator, output on paper tape is provided. On the other hand, if the data is to be entered into a computer, it may be recorded on punched paper tape, perforated cards, or digital magnetic tape, as appropriate.

...Just turn to an hp Data Sheet!

Feature	2013 Series (economy)	2010 Series (noise rejection)	2015 Series (speed, accuracy)	2017 Series (readout in engr. units)
Number of Input Channels	25 (2-wire) or 50 (1-wire) 2013 A-D	25 (3-wire) expandable to 100 2010A, B, E, H	25 (3-wire) expandable to 100 2015A, B, E, H	25 (3-wire) expandable to 100 2017A, B, E, H
	25 (3-wire) expandable to 100 2013 J-M	200 (3-wire) or 100 (6-wire) 2010C, D, F, J	200 (3-wire) or 100 (6-wire) 2015C, D, F, J	200 (3-wire) or 100 (6-wire) 2017C, D, F, J
Noise Rejection	NMR 90 dB at 60 c/s (filter)	inf. at 60 c/s (integrating)	inf. at 60 c/s	20 db min. all freq. (integrating)
	ECMR	At least 105 dB, all frequencies (floating)		
DC Voltage Range	10, 100, 1000 V. fs	0.1, 1, 10, 100, 1000 V. fs	1, 10, 100, 1000 V. fs	0.1, 1, 10, 100, 1000 V. fs
Resolution (mV/digit)	100 μ V 10 μ V with amplifier	1 μ V standard 0.1 μ V with amplifier	10 μ V	1 μ V standard 0.1 μ V with amplifier
Accuracy (% rdg.)	.05%	.015%	.005%	.015%
Max. Speed, Readings/Sec, DC Volts	1.7 (4 digits)	18 (3 digits) 7 (4 digits) 1 (5 digits)	12 (5 digits)	18 (3 digits) 7 (4 digits) 1 (5 digits)
Optional Measurement Capability	AC voltage, resistance, dc current	AC voltage, resistance (frequency is standard)	AC voltage, resistance	AC voltage, resistance (frequency is standard)
Programming		standard with DY-2901A; add DY-2911C or DY-2560A with DY-2911		
Types of Output Recording	Printed strip, typewriter, punched tape, cards	Printed paper strip, perforated tape, punched card (IBM 526) magnetic tape		
Price Range (Basic System)	\$4495 - \$6000	\$8310 - \$18,550	\$8160 - \$18,400	\$10,960 - \$21,200

If you have a data acquisition application, just call your Hewlett-Packard field engineer for a solution... from a data sheet. Dymec Division offers 32 basic configurations of standard medium-speed systems, one of which is sure to solve the problem. They're completely spec'd, field proved, right off a production line (without special engineering)—and the economy of "off-the-shelf" delivery is passed along to you.

The four basic lines of systems are briefly specified in the chart. They differ primarily in the basic measuring instrument, and each series offers a wide variety of measuring parameters and an equally wide assortment of recorded outputs, including printed paper tape, perforated tape, punched card, magnetic tape and typewritten record.

For accurate measurement of low-level signals, especially in the presence of noise problems, look at the 2010 Series. For economical systems, offering a wide variety of voltmeter plug-in capabilities, the 2013 Series. High-speed, high-accuracy data acquisition can be solved by the 2015 Series, while data acquisition from transducers with readout in engineering units (i.e., psi, rpm, °C or F) at the time of measurement is possible with the 2017 Series.

Complete information is available (on data sheets) from your Hewlett-Packard field engineer. Or write Hewlett-Packard, Dymec Division, 395 Page Mill Road, Palo Alto, California 94306, Tel. (415) 326-1755; Europe: 54 Route des Acacias, Geneva.

Data subject to change without notice. Prices f.o.b. factory.



NEW! The only bench type pantograph with 1:1 RATIO

Drills PRINTED CIRCUITS pneumatically
Engraves up to 100:1

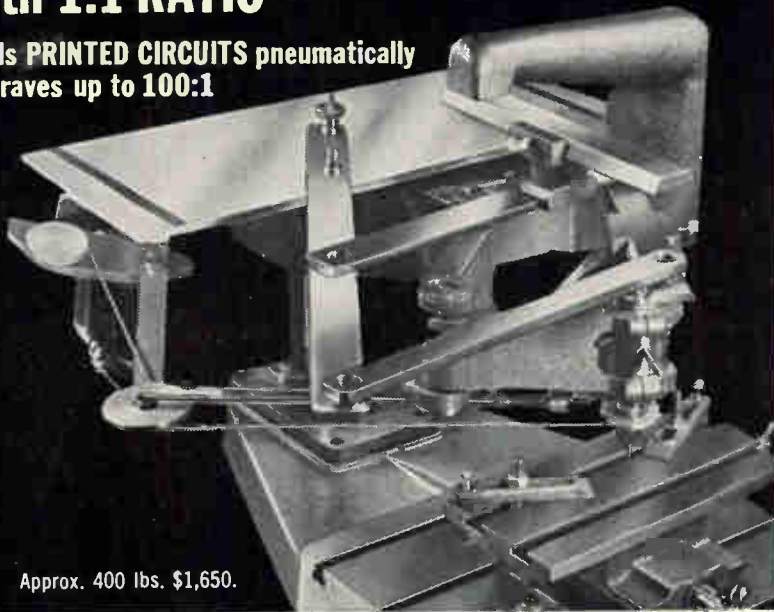

Approx. 400 lbs. \$1,650.

The most versatile machine tool for pantographic production drilling and routing. Reproduces your printed circuit prototype in full scale or in any ratio to 100:1. Ideal for unskilled labor. No changing of tools. One tool for all diameter holes and profiles. Close tolerances. Send for catalog # 139

new hermes engraving machine corp.

154 WEST 14th STREET, NEW YORK 11. N. Y. Chicago. Atlanta, Dallas. Los Angeles. Dayton, Detroit, Mexico City, Montreal

Circle 479 on reader service card

NOW, Micro-Miniature

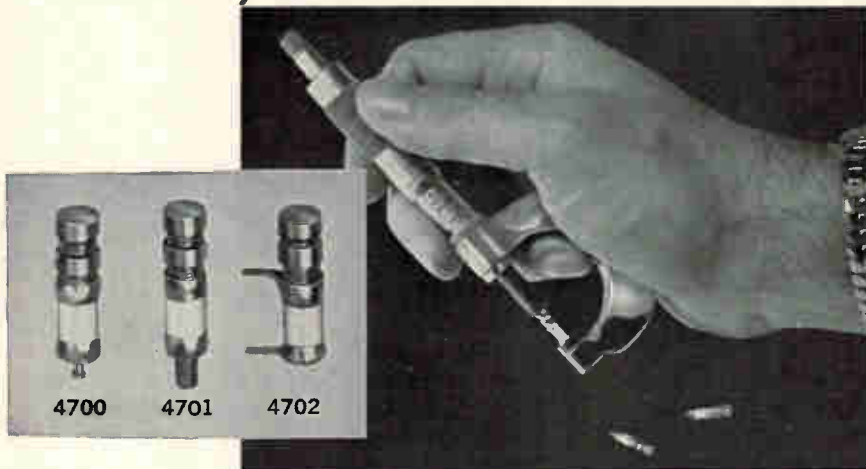

Highest Q Air Capacitors

- .140 in Diameter, 1/2" length
- Q @ 250 mc > 2000
- Q @ 100 mc > 5000
- Capacitance Range 0.35 pF to 3.5 pF
- Finest Materials
- Finest Workmanship

Write for full data

Johanson MANUFACTURING CORPORATION
400 Rockaway Valley Road, Boonton, N. J. Phone (201) DEerfield 4-2676

spots in East Germany's electronics industry. Production of semiconductor devices lags well behind advanced Western countries' capability. Devices like photodiodes, tunnel diodes and some types of high-frequency transistors still are in the development stage.

East German officials frankly admit there's a lack of adequate transistor-making equipment and a shortage of semiconductor materials. But they're hopeful. Says one, "With Russian help, these problems will be overcome."

III. Barriers are still up

But it isn't Russian help alone the East Germans want. They're aching—without much hope for relief—for licenses to produce equipment developed in the United States and other Western countries. Licensing deals would bring a double benefit. For one thing, they'd help immensely in the effort to catch up with the West in electronics and generally stimulate the industry. For another, they'd save foreign exchange, in tight supply in Comecon countries, which otherwise would have to be spent to buy Western hardware.

To be sure, the NATO embargo and other Western-government restrictions aren't air-tight. A lot of restricted items wind up in East Germany by circuitous routes [Electronics, Jan. 10, 1966, p. 242]. But contraband components and hardware are costly.

Minority view. A few East German engineers say the embargo policies have stimulated rather than deterred the industry. "You have been helping us rather than hurting us," says Hansgeorg Laporte, a physicist. He points out that the industry built a special type of sampling oscilloscope after a much-needed model couldn't be had from the West.

But Laporte is one of a small minority. Time and time again U. S. visitors to the Leipzig fair heard East German engineers single out as the industry's major drawback its lack of access to Western electronics advances. "We can't get to know the true state of the art by going to the Soviet pavilion," moaned one East German. That statement sums up the feeling that prevailed throughout the industry generally.



Here's the right integrated circuit if you want very stable switching voltage

We call it the Silicon Bilateral Switch. You'll find it just about eliminates power output fluctuations caused by temperature effects on the triggering voltage. The switching voltage of this new device is virtually unaffected by temperature. What's more, G.E.'s new SBS has extremely low switching voltage—a mere 10 volts. Use G-E SBS's to trigger SCR's and bi-directional thyristors (Triac's). They're available in unilateral form as well as bilateral form. Circle **Number 90** for more details.

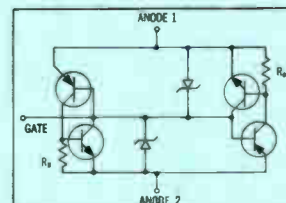

Silicon Bilateral Switch Equivalent Circuit

G-E thermistor probes solve many design problems



Here's the answer if thermistor probes are your problem:

- G-E H-series probes give you trigger-fast response in a truly rugged, hermetically sealed unit . . . operate up to 400C in air, gas and non-conductive liquids.
- G-E 1/4" diameter probes range from 50 to 100,000 ohms resistance, Grade 1 through 4 materials.
- G-E bead probes are designed to fit into nearly any circuit package. Easy-to-mount and operable up to 400C, you can even use them in liquid media. Circle magazine inquiry card **Number 91**.

New bonded heater-cathodes for planar ceramic triodes

Now you can meet all these design goals: ■ faster warmup . . . 3 to 5 seconds without heater over-voltage ■ tolerance to extreme mechanical environments . . . up to 50 g's RMS ■ extremely low microphonic output . . . quietest of any known tube design ■ improved life, reliability . . . heater temperature is sharply reduced ■ predictable thermal transfer between heater and cathode . . . permits precise control of cathode temperature through heater-voltage control ■ circuit simplicity . . . indirectly-heated cathode needs no special heater circuitry or voltage. This new heater-cathode technique can be applied to all recent tube designs. Circle **Number 92** on the magazine inquiry card.

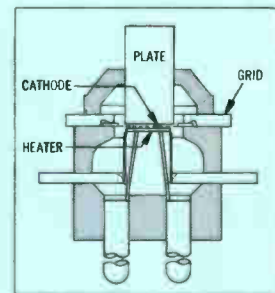

More and still more G-E economy transistors

Switch to the low-cost way to solid state. Try the famous planar passivated economy line. Try new G-E 2N3973-76 transistors for example. They're tops for medium speed industrial switching and large signal RF amplifiers. And they feature excellent h_{FE} holdup at collector currents between 0.1mA and 500mA. Or try our new 2N3858A and 2N3859A transistors . . . excellent as high voltage, high gain amplifiers. Circle inquiry card **Number 93**.

Want high-level color demodulation?



The 6AG10 compactron

This little G-E 6AG10 compactron gives full color fidelity . . . actually does the work of 2 miniature demodulators, or of 2 pentodes and 3 triodes. The 6AG10 puts out 3 "color-difference" signals directly to 3 cathode-ray-tube guns. Here, unquestionably, is your lowest-cost way to full-color-fidelity demodulation. And best of all, it's a COMPACTRON. Ask your G-E engineer/salesman for our new "Compactrons for Color TV" Brochure or circle **Number 94** on the magazine inquiry card.

MORE



Solid-state
light-sensitive switch
controls G.E.'s
meter relays



GE-Type 195 meter relay
with single setpoint

Contactless pass-through control action—that's the advantage you get with these solid-state meter relays. Completely self-contained control action is initiated by a light-sensitive switch directly controlling the load relay. No troublesome pointer contacts. No external amplifiers, power supplies or load relays. No mechanical interference with meter movement. Pointer travel is unrestricted across the entire scale. You get continuous indication above and below the setpoints. And you get all this in a distinctive, easy-to-read BIG LOOK meter package. Ask for Publication GEA-8014 or circle magazine inquiry card **Number 95**.

PREDICTION:
Crystal-can relays out.
150-grid
relay family in.

G-E low-profile 150 Grid-space relays set the trend for things to come in relay applications. Available now in 2-pole and 4-pole arrangements (and a latching version's due this year, too) these small devices have 150-mil terminal spacing, are only 0.32" high. This growing family of new relays offers you the best in space-saving ability with all the performance required from a mil-spec relay. Circle **Number 96**.



Family will soon include
new latching version

Give critical components
the protection
they deserve



Triggered Vacuum Gap

Divert system and component faults through a General Electric triggered vacuum gap. Nothing else will do the job as well. TVG's trigger remarkably easily, just as low pressure gas gaps do. Yet TVG's are gas-free. Their voltage holdoff capabilities won't degenerate. They are also free from adverse atmosphere damage, adaptable to any environment, and will protect against faults ranging from 10 to 100% of their rated voltage. Circle **Number 97** for more information on all 5 available models.

Try this new
ramp-and-pedestal
precision temperature
regulator

At maximum gain setting, this low cost circuit controls load power over its entire range by a mere 3°C change in thermistor temperature. What's more its feedback control network is stabilized by the circuit's adjustable gain. How's it work? Ask your G-E engineer/salesman for Application Information Publication 671.1 and cost details. Or circle magazine inquiry card **Number 98**.

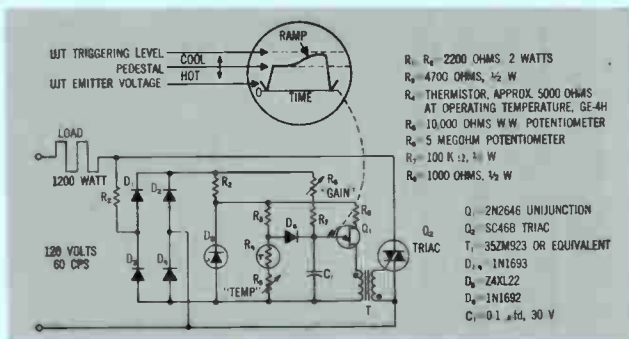

8 different case sizes
now for
Black Hawk capacitors

And each capacitor size has 5 different voltages to choose from—50, 100, 200, 400 or 600 VDC. Black Hawk capacitors are molded to give you a hard, moisture-resistant shell around the capacitor roll. Each one you use has strong welded leads, extended foil construction, and very precise dimensions (± 0.005). Circle **Number 99** on the magazine inquiry card for all the facts.



Featuring
molded
encapsulation

WE MAY NOT OFFER EVERYTHING YOU WANT FROM ONE COMPONENTS SUPPLIER. BUT WE DO COME A LITTLE CLOSER THAN ANYONE ELSE.

285-12

GENERAL  ELECTRIC

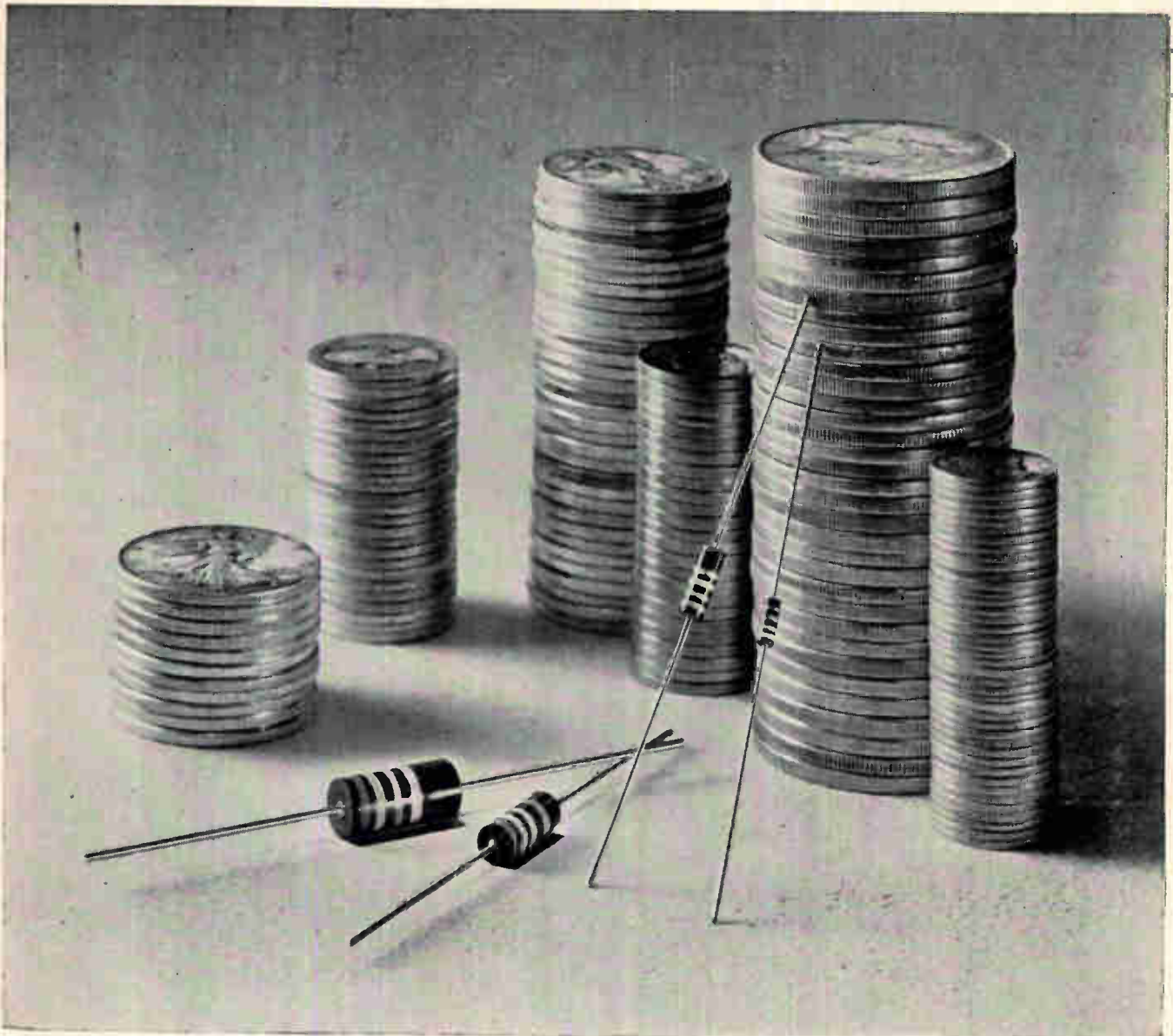

Quality Need Not Be Expensive

Some people would have you believe that to buy the best, you must pay the most. This is not necessarily true. Price is only a measure of value—never a substitute for it.

At Stackpole, the real value of any resistor is determined by a combination of its performance record and its price. Perhaps this is why so many of our customers continue to specify Stackpole resistors year after year to maintain top performance for established products and for their new ones, too. Such confidence and loyalty cannot be based on price alone.

Uniformity has become the accepted characteristic of Stackpole resistors. Unique production methods, coupled with in-depth experience in manufacturing and testing are your assurance that Stackpole resistors will give you absolute performance. The resistors you order today will be identical in every way to your last order.

Most leading manufacturers of electronic equipment have long recognized Stackpole resistors for reliability.

Whether it be the rugged demands of portable television or the critical tolerances of space age communication and tracking equipment, Stackpole resistors deliver the performance you expect—the kind of dependability that builds a reputation for your products.

Why continue to pay a premium for quality? Let us prove that you get value from Stackpole. Quality resistors, economically priced, are delivered promptly and backed up by our complete corporate facility. Next time, specify Stackpole. There's a family of fine resistors available in sizes of 2, 1, ½ and ¼ watts. For samples and additional information, write: Stackpole Carbon Company, Electronic Components Division, Kane, Pa. Phone: 814-837-7000 — TWX: 510-695-8404.



WHERE CAN MAN GO...IN ELECTRONICS?

Electronics is a discipline unlike any other. For whatever name we give to these fast paced times in which we live—the Age of Space, the Age of Mass Communications, the Age of Transportation—electronics plays a vital role. Through advances in this single key technology, advances in all others are brought nearer to reality. And nowhere is this truth more evident than at Lockheed, where to all programs, electronics is essential. Research. Development. Systems. At Lockheed, those knowledgeable in the nuances of electronics help to further man's achievement upon this planet. They bring practicality to investigative ocean vehicles such as Lockheed's Deep Quest, a two-place research submarine. They permit land vehicles of the future to achieve reality. And they extend the reach of mankind heavenward through spacecraft systems such as Agena. Undersea, on land, and in space environments, Lockheed electronic systems control and guide, communicate and compute. Now, generalists and specialists, experienced and interested in a broad spectrum of electronics assignments, are invited to write Mr. K. R. Kiddoo, Professional Placement Manager, Sunnyvale, California. Lockheed is an equal opportunity employer.

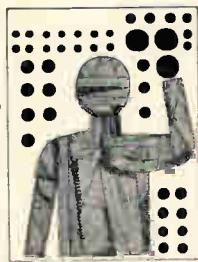

LOCKHEED
MISSILES & SPACE COMPANY
A GROUP DIVISION OF LOCKHEED AIRCRAFT CORPORATION

We hate the numbers game

because we fall for it ourselves, sometimes. Sure, a volt is a thousand millivolts, and your gigacycle has the same thousand megacycles in it that ours has. Numbers **are** necessary, and we sell many of our instruments **simply because** our numbers are better; but **numbers alone** can't possibly describe the many reasons why one instrument design is superior to all the rest. Take our **2-Gc-Dispersion Modular Spectrum Analyzer** series, for example. When you sit down and compare the numbers, the POLARAD design wins by a tidy margin, in just about every department . . . but the numerical specifications can't tell you that **only the POLARAD design** is completely image-free . . . that **only the POLARAD design** has the foolproof harmonic-identifier push button . . . that the Model 2992-A is really a three-piece "starter set", from which, by adding only four more modules, from "open stock", you can build **up the most complete**

spectrum analyzer capability ever offered . . . that with those seven, you can assemble 17 different spectrum analyzers! Check the features listed here—there's not a number in them, but they constitute a powerful set of reasons for **going the POLARAD route**. Call 212-EX 2-4500. One demonstration is worth 10,000 numbers.



This module alone is a complete Spectrum Analyzer with 100 Mc Dispersion.

Add Continuous Phase-Lock Frequency Stabilization with this Module . . . permits narrow-dispersion analysis of signals down to 1 Kc resolution!

Add this "Swept Front End" module for 2-Gc dispersion over 10 Mc—91 Gc.

MODEL 2992-A 2-Gc-DISPERSION SPECTRUM ANALYZER

- **TRULY QUANTITATIVE.** Built-in crystal markers. Choice of LIN-LOG-POWER display modes, all with excellent level-resolution, for optimum signal-amplitude accuracy.
- **WIDEST RESOLUTION RANGE**
- **WIDEST DISPERSION RANGE.** In calibrated steps or variable in a pair of continuous ranges.
- **ERROR-FREE.** Push-button Harmonic Identifier—foolproof, fast, positive! Image-free presentation over full rated dispersion on all bands—without exception!
- **LOWEST NOISE, HIGHEST STABILITY.** Obtainable at present state of the art . . . orders of magnitude better, due to phase-lock stabilization of front-end L.O., which eliminates spurious FM/jitter.

By the way, those rumors you hear are true. We can't give you better than about 60-day delivery, despite nearly tripled production on the 2992. We are shipping and manufacturing like mad, though, to try to catch up. (No manufacturer *enjoys* having instruments on the shelf. Backlogs are better.)



World Leader in
Microwave
Instrumentation

POLARAD

ELECTRONIC INSTRUMENTS

A Division of Polarad Electronics Corporation
34-02 QUEENS BOULEVARD
LONG ISLAND CITY, NEW YORK 11101

Measuring Frequency?

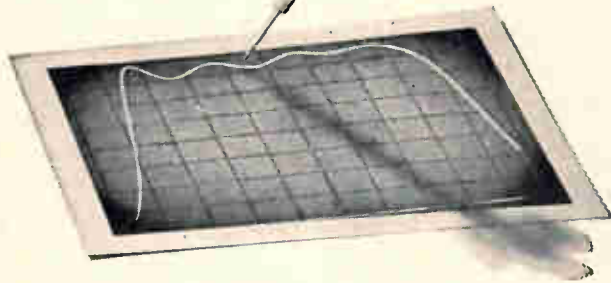

Quit Guessing...

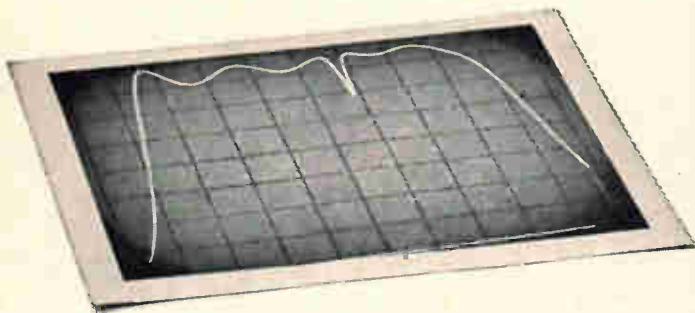

... for only \$195⁰⁰!

Now, for the first time, a Wavemeter capable of indicating frequency to 0.2% accuracy on a direct-reading dial is available at a price under \$200. It's the new Telonic Model TWM.

50 Mhz to 4 Ghz

An absorption type meter, the instrument has a tuning range of 1 full octave covering all frequencies from 50 Mhz to 4 Ghz. Insertion loss is held to 0.5 db and VSWR at 1.5/1. The TWM passes signals through a matched transmission line, the sample being absorbed by the cavity at resonance and causing a 2 ± 1 db power dip in the line.

Pre-Calibrated

Simple to use, the TWM has a pre-calibrated 5:1 vernier dial that needs no interpolation or extrapolation. The setting you make is the frequency you read. Considering convenience, accuracy, range and price, the TWM Wavemeter is a natural for every engineer who wants to be frequency-sure. Full specifications available on request.



Telonic ENGINEERING CO.
A DIVISION OF TELONIC INDUSTRIES, INC.
480 Mermaid St., Laguna Beach, California 92651
Tel: (714) HY 4-7581 TWX: 714 673-1120

MODEL	6 db BANDWIDTH
TL-2D5A	2 kc
TL-4D8A	4 kc
TL-6D11A	6 kc
TL-8D14A	8 kc
TL-10D16A	10 kc
TL-16D25A	16 kc
TL-20D32A	20 kc
TL-30D45A	30 kc
TL-40D55A	40 kc
TL-45D65A	45 kc
TL-32E48C	32 kc
TL-50D75C	50 kc

Clevite Ceramic Ladder Filters 80 db rejection in 0.1 cu. in.

- 50% lower insertion loss
- Increased skirt selectivity
- Less insertion loss change with temperature

Clevite ceramic ladder filters provide more selectivity for their size than any conventional i-f filter. They are fixed tuned and need no alignment—are non-magnetic and non-microphonic. Leading manufacturers now specify Clevite ladder filters for their modern communications equipment. Improve your newest design with these unique filters. Write now for complete specifications—Bulletin 94017 or request selectivity curves for each stock model. ■ Dimensions: 5-1/6" diameter x 1-1/2" long ■ Selectivity: 60 db/6db shape factor from 1.4:1 to 2.5:1 ■ Center Frequency Stability: within 0.2% for 5 years, and within 0.2% from -40°C to +85°C ■ Impedance: 1200-2500 ohms ■ Designed for military and space environment. ■ Clevite Corp., Piezoelectric Division, 232 Forbes Road, Bedford, Ohio 44014.

CLEVITE

LATCH on to the EXCITEMENT in MICROELECTRONICS and SILICON DEVICE DEVELOPMENT at DELCO RADIO

Enthusiasm is running high at General Motor's Delco Radio Division.

Exciting developments in microelectronics and silicon devices have spawned a rapidly expanding research effort. New buildings . . . new equipment . . . and most importantly, new people!

The dynamic pace of accomplishment at Delco is pushing the state of the art clear out of sight. The opportunity is here for those who choose to capitalize on it.

Microelectronics

Circuit oriented EE's—0 to 5 years experience. Here's a chance to get in on the excitement in microelectronics. Research programs in both linear and digital circuitry embrace monolithic . . . thick film . . . thin film . . . and hybrid microcircuits.

Silicon Device Development

Lots of room here for the BS, MS, PhD in Physics, Chemistry, Physical Chemistry, or related fields. Development programs are underway in these areas:

Low power and very high power monolithic and hybrid circuits.

Silicon Transistors—from very high

frequency 10 milliamper through 25 ampere, 1000 volts.

Thyristors—from 50 milliamper through 500 ampere, 2000 volts.

Zener Diodes.

Silicon Rectifiers—from milliamper through 250 ampere, 3000 volts.

Continuing R&D efforts already have led to Delco's leadership in high power, high voltage silicon transistors. Delco rectifiers—rated at 250 amps, 2000 volts—are going into alternators designed to handle the full power generated by the latest Diesel-electric locomotives.

Full-size, fully-transistorized TV sets now are in production, thanks to a Delco high powered transistor in the horizontal and vertical deflection circuits.

A tremendous momentum is building at Delco. The time is ripe—now—to join this outstanding research group.

If you'd like more information immediately, pick up the phone and call us collect, Area Code 317/459-2808. Ask for C. D. Longshore. Or, send your resume to Mr. Longshore, Salaried Employment, Dept. 102, Delco Radio Division, General Motors, Kokomo, Indiana.

An equal opportunity employer

PART 8 of a series on THE STATE OF THE CHOPPER ART

INPUT CIRCUIT IMPEDANCE ABOVE 1000 MEGOHMS

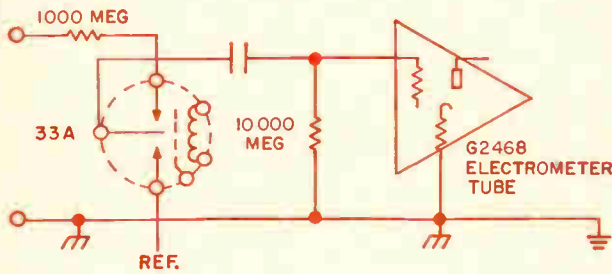

AT 1000 MEGOHMS USE A 33A

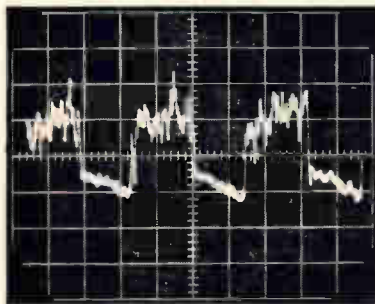

150 MICROVOLT SIGNAL, 10,000 MEGOHMS



33A

We do feel awfully apologetic about using a tube. Maybe if we just kept at it we could get a MOS FET with INSULATED GATE working, and we do know how much better SOLID STATE is. But our Chief Engineer has a mighty small appreciation for creative art. He said meet the budget. So we're sorry, but a G2468 electrometer tube works at 10,000 megohms but only costs a couple bucks. Same reason we used a 33A chopper. No romance. No fun developing new circuits. It just works. Noise and offset? Down around $\frac{1}{4}$ uv.

OFFSET VALUES BELOW 10 NANOVOLTS

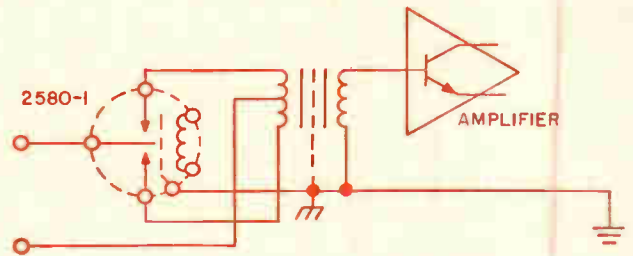

AT 10 NANOVOLTS USE A 2580-1

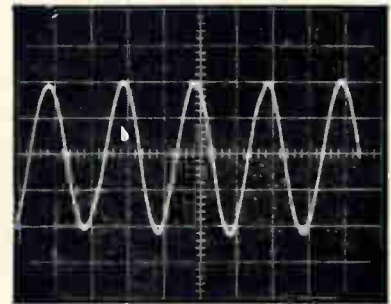

$\frac{1}{2}$ MICROVOLT SIGNAL, 10,000 OHMS



2580-1

We have been deluding our faithful readers. The Airpax choppers we have foisted off all these years were **not** completely free of noise. In fact some of them, like the 33A next door, were loaded. They run upwards of 200 or 300 nanovolts—0.2 of a microvolt. But perhaps we can make it up to you with the 2580-1. It doesn't seem to have any hum pickup or fixed offset or variable offset. A most rash and unscientific statement. Interpreted, means we don't know how to measure below 10 nanovolts.

Should you use the same chopper at 10,000 ohms or 10,000 megohms? You can. It might be more expensive. Mechanical choppers perform for three reasons. The open contact approaches infinite resistance. The closed contact approaches zero resistance. And the transit between zero and infinity approaches zero time. Reliability? We have photo choppers and transistor choppers to sell you, when you need not save money. Or when you need over 25,000 hours life.

2½-D memory operates in nanoseconds

Computer memory's unusual wiring scheme permits high-speed operation at low cost

The world's fastest large-scale commercially available ferrite-core memory will make its debut at the Spring Joint Computer Conference in Boston, April 26 to 28. The Nanomemory 650, made by Electronic Memories, Inc., has a cycle time of 650 nanoseconds and an access time of 300 nanoseconds, for any of up to 16,384 words each of which may be as long as 84 bits.

This speed is attained with a 2½-dimensional organization, which combines the speed of a linear-select, or 2-D, design with the economy of a coincident-current, or 3-D, design. The cores are toroidal, similar to those in most conventional ferrite-core memories, with an outside diameter of 0.02 inch. The memory is faster than other big ferrite-core memories, some of which are experimental only. [See p. 118; and Electronics, Dec. 28, 1965, p. 36, for example.]

The sketch below illustrates how the 2½-D combines the advantages of its 2-D and 3-D cousins.

A 2-D memory is organized as a single plane. It is expensive because, for high speed, a capacity of 2^n words requires decoding of n address bits.

Because a 3-D organization re-

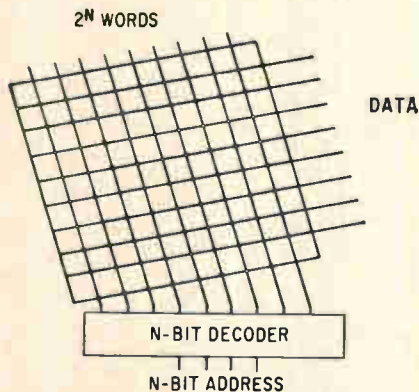

Two-dimensional organization is fast but quite expensive for large memories.

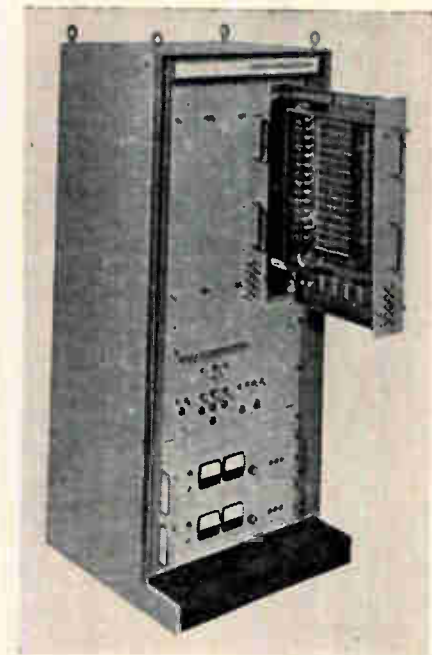

quires substantially less address decoding it is cheaper, but it is substantially slower. It is organized as a series of stacked planes; each plane contains one bit in each word contained in the memory.

In the 2½-D organization, the plane array resembles the 2-D; but the x-winding is doubled around to pass through two rows of cores. Current in the x-winding may pass in one direction or the other, depending on which of the two rows

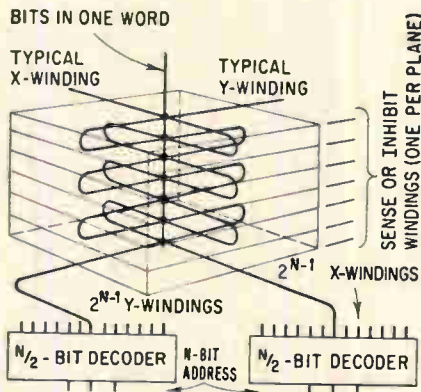

Three-dimensional organization is less expensive, but limited in speed.

of cores is being addressed.

The Nanomemory 650 is complete with all electronic circuits in one package. However, only one side of the data register is available as output; if the user requires both 0 and 1 outputs, he must provide his own inverters in his own circuit package.

A price range of 6 to 8 cents per bit is quoted for the N-650. This comes to about \$100,000 for the largest available size, 16,384 words by 84 bits.

Specifications

Capacity	4,096, 8,192, or 16,384 words
Word length	8 to 84 bits
Operations	Read and restore Clear and write Read, modify and write (split cycle)
Cycle time	650 nanoseconds (read, write) 775 nanoseconds (minimum split)
Access time	300 nanoseconds
Input power	115 ±10 vac, 60 cps, single phase, 3 wire 700 watts normal, 1700 peak, typical (varies with word length)
Operating environment	+10° to +40° C., 90% relative humidity
Interface	Twisted-pair, either voltage or current. Either positive or negative voltage output (not both)
Weight	350 pounds
Delivery	4½ to 5 months

Electronic Memories, Inc., 12621 Chadron Ave., Hawthorne, Calif. 90250
Circle 350 on reader service card.

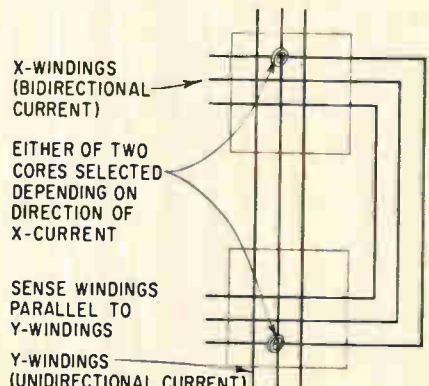

Bidirectional current is part of address decoding in 2½-dimensional scheme.

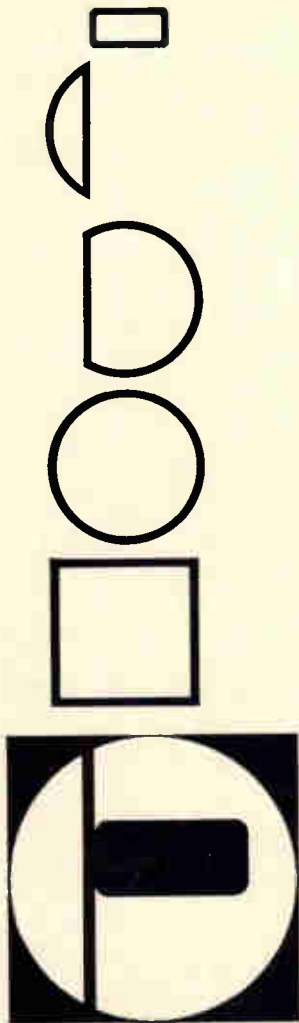

PRECISION

This new corporate mark of Precision identifies the world's most dependable source for nonferrous metal tubing, Bourdon and pointer tubing, custom-fabricated tubular parts, "Coaxitube" semirigid coaxial cables. And it symbolizes the precision for which these products are known throughout the industrial and scientific world. May we send you our catalog?



PRECISION TUBE COMPANY, INC.
 Tube Mill Division • Special Products Division
North Wales, Pennsylvania 19454

New Components and Hardware

Power switch without r-f interference

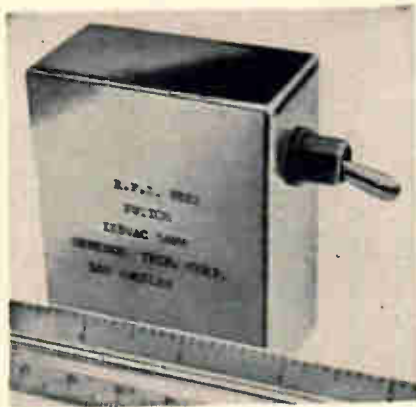

A switch for alternating-current power circuits, which can be opened and closed without generating excessively large interference transients, has been developed by the Genistron division of Genisco Technology Corp.

The device senses when the a-c line voltage is zero, switches the control circuit on and allows current to flow to the load thereafter. If the switch is closed at any other time in the a-c cycle, the sensing circuit waits until zero voltage is reached before it energizes the load.

When the switch is opened, the

device waits until the load current is zero before turning the circuit off. This eliminates the abrupt discontinuity in voltage and current that causes high-frequency portions of conducted noise to be generated. The action of the switch also assures long life, since no damaging current surges occur. It also protects sensitive equipment, such as power semiconductors, from high-level switching transients.

The switch is of solid state design and uses long-life, silicon semiconductor devices that are conservatively rated. The mechanical section of the switch only handles milliamperes of current at low voltage.

Specifications

Voltage	110-125 a-c, at 60 hz or 400 hz (cps)
Current	
Model no.	
RFS 115-5	5 amps
RFS 115-10	10 amps
Dimensions	1.5 x 2.8 x 2.5 in.
Weight	11 ounces
Mounting	Panel, 3/8 in. dia., hole
Noise	Meets Mil-I-26600
Delivery	4-6 weeks

Genisco Technology Corp., 6320 W. Arizona Circle, Los Angeles 45, Calif. [351]

Cores and toroids use soft ferrite ceramics

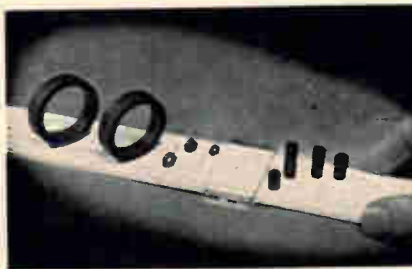

Safe ferrite magnetic material is available for commercial, military, and industrial electronic applications. The first shapes being produced are in the form of threaded cores and toroids.

The new materials are used in

r-f coils for f-m radio and tv receiver circuits, discriminator circuits, telemetry, multiplex receivers, and i-f band circuitry. These applications require controlled permeability, Q and temperature stability.

Two basic grades of the company's soft ferrite ceramic magnetic materials have been developed, and will also be available in three or four sub-grades.

One of the two grades has an operating frequency range of approximately 1 kc to 1 Mc. The other grade operates in the megacycle frequency range.

Current production of the toroids and threaded cores is confined to several standard sizes from the manufacturer's tooling. These sizes

include $\frac{1}{4}$ -28 pitch and $\frac{1}{2}$ pitch threaded cores with hexagonal holes, ranging from $\frac{1}{4}$ in. to $\frac{3}{4}$ in. in length. The toroid sizes range from a $\frac{1}{8}$ in. outside diameter to a 1.1 in. outside diameter.

Delivery from available tooling is three to four weeks. Present threaded core prices range from \$15 per thousand to \$25 per thousand and toroids from \$50 per thousand. Custom-made parts will also be manufactured.

The Arnold Engineering Co., Box G, Marengo, Ill., 60152. [352]

Readout-out integrator with infinite memory

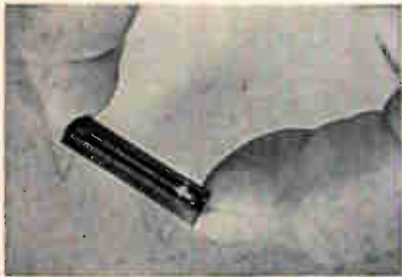

An electrochemical integrator offers both visual and electrical readouts and infinite memory capabilities. Model 304 integrator uses the manufacturer's ampere hour meter and differential capacitance read-out techniques to provide extremely accurate and symmetrically reversible long- and short-term integrations. Size, complexity, weight, power consumption and cost are substantially reduced compared to electromechanical devices performing similar integration functions.

Model 304 measures 1.1 in. long by 0.18 in. wide and may be used with any input signal between -2 ma and $+2$ ma. The input threshold is zero. The stored integral is retained indefinitely, regardless of power or other external factors. Total capacity is a 4-inch stored integral.

The integrating element consists of a capillary tube filled with two columns of mercury separated by a gap of aqueous electrolyte. The input signal electroplates mercury across the gap at a rate that is a direct function of the input signal's amplitude, which causes the gap to move. The outside of the capillary tube is covered by a vapor-

Choice — not chance!

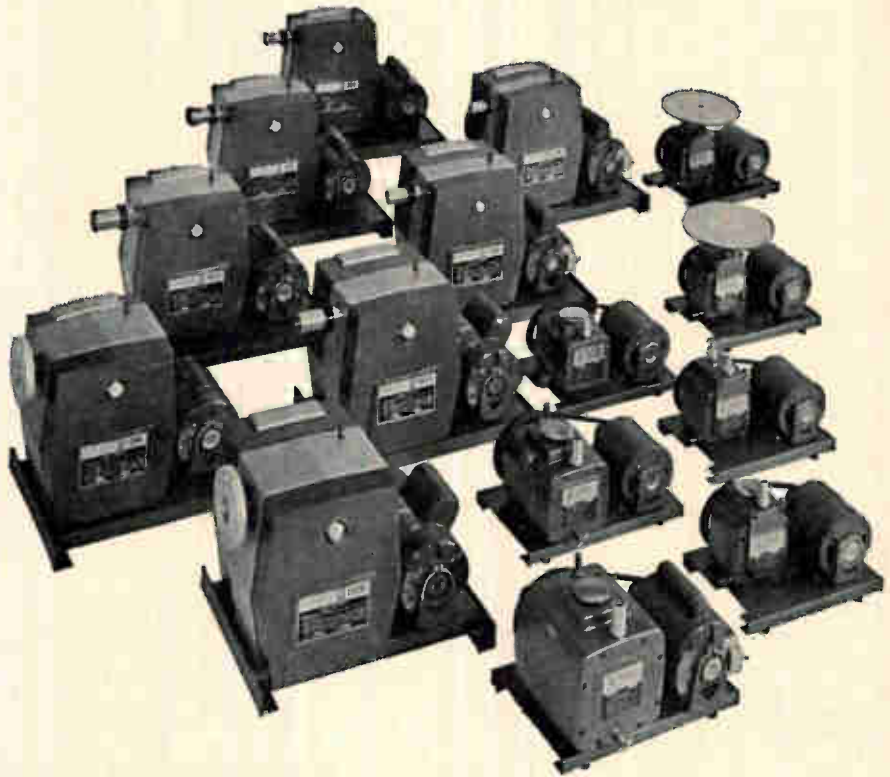

New Precision High Vacuum Pumps are job-rated to meet your needs!

Now you can eliminate the guesswork—and save money, too! From this newest, most complete line of internal vane mechanical vacuum pumps on the market today you can select a model performance matched to your job. Take your choice of both single and two stage models in capacity ranges from 25 to 1500 liters/minute, at prices ranging from \$100 to \$1500. Guaranteed ultimate vacuum runs to 0.1 or 15 microns of mercury depending on model. And because Precision Pumps are more efficient at actual working pressures—up to a remarkable 79% at 1 micron—you not only get the job done faster, but can frequently use a smaller pump. Add handsome design, smaller size, quiet, vibration-free operation and you see why Precision is your best buy. Consult your Precision Scientific Distributor or write today for Bulletin 650.

Since 1920 • The finest in Quality Laboratory Apparatus



**PRECISION
SCIENTIFIC CO.**

SUBSIDIARY OF
**GCA
CORPORATION**

3737 W. Cortland Street, Chicago, Illinois 60647
Local Offices in New York • Chicago • Los Angeles



Meet the DC voltage standard with:

STABILITY WITHIN 15 PPM

... for 7 days, 25 ppm for 6 months.
Recorded stability history available.

0.003% ACCURACY

... ensured by temperature-controlled precision
Zener reference.

IMMEDIATE DELIVERY

... the COHU Model 326 is off-the-shelf... like the
entire family of COHU DC voltage standards.

... and voltages from 0 to 1222.2221 in 3 ranges;
steps as small as 1 μ v.

Price: \$2490.00 F.O.B. San Diego,
additional export charge.



Box 623
San Diego, Calif. 92112
Phone 714-277-6700

INTEGRATED CIRCUIT



TIME CODE GENERATOR EECO 911

- All silicon semiconductors
- Integrated-circuit logic
- 5 simultaneous time codes
- Change code by inserting new circuit card
- Automatic time presetting
- with thumbwheel switches
- 5¼ inch panel height
- Battery backup



- Push panel for triggering horizontal sweep on scan
- Thumbwheel switches preset generator to desired start time
- Pushbutton sets generator to base selected by thumbwheel switches
- Pushbutton advances time in sub-second increments for course correction
- Switch starts and stops manual measurement
- Switches control advance or retard rate
- Manually set control advances or retards time at selected rate for fine correction

EECO 911
... from \$4,000



Electronic Engineering Company
of California
1601 East Chestnut Avenue (Box 58)
Santa Ana, California 92702
Phone: Kimberly 7-5501 (714) • TWX: 714-531-5711



CRAMER LIFT-LOK Stools

adjust to every worker like fine tools!

Because Cramer Lift-Lok is infinitely adjustable! Just lift the seat and stop at the most comfortable height. It takes less time than to read this sentence. Since fatigue is a critical factor in efficiency of seated workers, it makes good sense to provide tools that minimize fatigue. With Lift-Lok every worker can seek exactly his own efficient level. Available in four base types, steel, wood or plastic seats, contoured or flat, adjustable or flexible backs. To find out about the stools that qualify as production tools, write: V.P. Sales, Cramer, 625 Adams, Kansas City, Kan. 66105.

Industrial supplier inquiries invited.

CRAMER
CRAMER INDUSTRIES INC. - KANSAS CITY, KANSAS

Fine seating—safety ladders—stands and related products for office, industry and institutions.

Circle 181 on reader service card

New DC Scope! ... the Heathkit® 10-14

- Sets New Standard for Performance & Value . . . \$299.00 Kit . . . \$399.00 Assembled
- DC to 8 mc Bandwidth—0.04 usec. rise time • Calibrated Vertical Attenuator — .05 v/cm to 600 v. (max.) Input • Triggered Sweep — 18 calibrated rates • Delay-Line Vertical Amplifiers for Fast Rise Signal Analysis • Electronically Regulated Power Supplies — Forced Air Cooling • Built for Continuous-Duty Industrial & Lab Use



A 5" DC scope with calibrated time base & 5X sweep magnifier. For 115/230 volt, 50-60 cycle operation.
Kit 10-14, 45 lbs. . . . \$299.00
Assembled 10W-14,
45 lbs. . . . \$399.00

FREE CATALOG!



Fully Describes Over 250 Heathkit Electronic Products

Heath Company, Dept. 520-28
Benton Harbor, Michigan 49022

Please send FREE Heathkit Catalog & Information describing the New Heathkit 10-14 Oscilloscope

Enclosed is \$_____, plus shipping.
Please send model_____

Name _____
Address _____
City _____ State _____ Zip _____

Prices & specifications subject to change without notice.

TE-141

New Components

is guaranteed as 500 minimum at 1 Mc. Working voltage is 1,000 v. LRC Electronics, Inc., Horseheads, N.Y. [354]

Shielded inductors for printed circuits

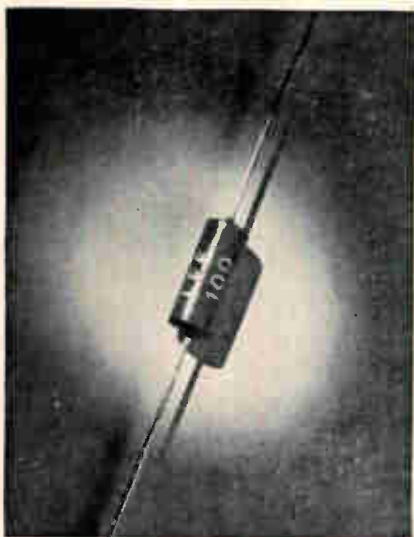

The Micro-Red subminiature shielded inductors offer an inductance range of 0.10 μ h to 10,000 μ h in an envelope size 0.335 in. long by 0.125 in. diameter. They are specifically designed for density circuitry.

The manufacturer claims they set a new industry standard with exceptional Q values, ranging from 40 to 85 over the inductance range. These inductors are offered in 61 predesigned values for stock delivery and are designed to meet Mil-C-15305, Class 1, Grade B. Lenox-Fugle Electronics Inc., 475 Watchung Ave., Watchung, N.J. [355]

Multiconductor cables offer size reductions



Miniaturized round multiconductor cables are now being marketed. Using MIL-ENE polyester laminate



When low-amp circuit breakers make slow-blow fuses obsolete... ... TI DELIVERS!

Designed to fit most fuse holder panel openings, new KLIXON® 7277 Series Circuit Breakers are now protecting circuits in data processing and communications equipment, power supplies, transformers, battery chargers and other industrial electronic equipment.

Equipment downtime reduced! The indicating reset buttons on these inexpensive push-pull devices signal location of circuit failure... eliminate the time-wasting search for blown fuses... prevent the possibility of incorrect fuse replacement. A built-in thermal element provides fast tripping response under overload conditions, while permitting harmless voltage surges to pass without tripping the breaker.

Check the specs! Ampere ratings from 1/2 to 10 amp 28V-dc, from 1/2 to 10 amp 120 V-ac. Dielectric strength 1500 volts. Insulation resistance 100 megohms. Calibration at 25°C, hold 110% and trip 150% rating, trip in 2 to 35 seconds at 200% rating. Endurance: 1000 cycles, 30 V-dc, 2500 cycles 120 V-dc.

Bulletin CIRB-29 contains complete data on KLIXON 7277 Series Circuit Breakers. Write for your copy today.



METALS & CONTROLS INC.
5004 FOREST ST., ATTLEBORO, MASS.
A CORPORATE DIVISION OF
TEXAS INSTRUMENTS
INCORPORATED

analysis in depth!

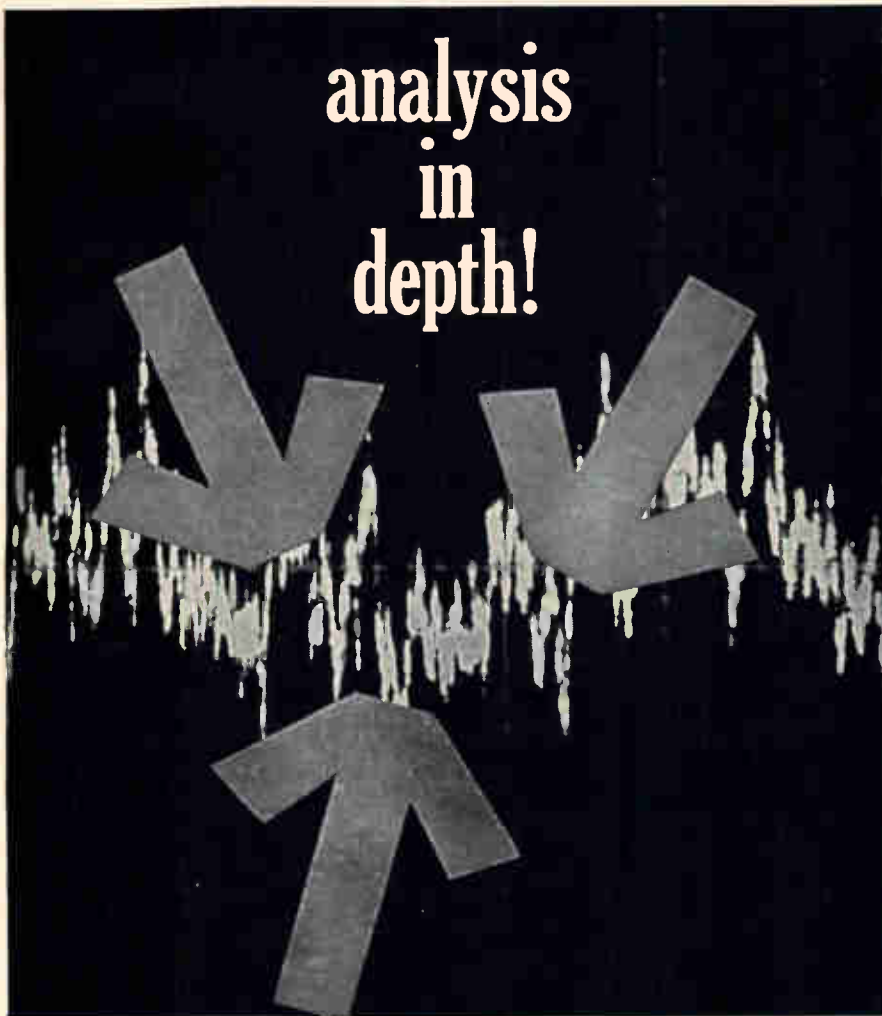

new center provides fast, low-cost analysis of dynamic test data

WAC — Weston's Waveform Analysis Center — offers complete facilities to provide time-to-frequency conversion of transient and random tape recordings. The Center is equipped to detect and evaluate random signals in dynamic systems, processes or environments, and to determine signal content, power spectra and transfer function.

In addition, WAC can provide detailed analyses of short test runs performed under adverse signal/noise conditions. Results approach the ultimate which theory indicates possible in signal and transfer function determination.

WAC equipment operates in real time from 0.01 to 1,000 cps or higher. Bandwidths as low as .01 cps in real time are available. Significance of coherence and phase data be-

tween two channels can easily be evaluated. Sine waves are identified in amplitude down to 40 db, and frequency to 1 part in 500.

WAC service is fast . . . cost is low . . . typically only \$350 for a preliminary tape analysis with written report and visual presentations. And, technical assistance is always available from Weston-Boonshaft & Fuchs engineers. Their unique experience includes nuclear reactor, space vehicle, oil exploration, earth magnetic field, star mapping, meteorological, medical, automotive, and seismological measurements for major industrial, military and aerospace projects. *Address:*

**Weston Instruments, Inc.,
Boonshaft and Fuchs Division,
Hatboro, Penna. 19040**

WESTON® prime source for precision...since 1888

New Components

insulations, the cable shown at right offers size reductions as great as 50% over cables in which individual conductors are insulated with more conventional PVC. Only four mils of MIL-ENE insulation provide the electrical and mechanical properties of ten mils of PVC.

Combining the MIL-ENE primary insulation with jackets of polyurethane, finished cables are stronger, more flexible and substantially smaller than those previously available. A wide range of specially designed cables are available incorporating twisted triads, pairs and quads along with co-axes, shielded and unshielded leads.

Cables are produced to customer specifications with deliveries running six to eight weeks. Prices vary with constructions.

W.L. Gore & Associates, Inc., 555 Paper Mill Road, Newark, Del., 19711. [356]

Hermetically sealed aerospace relays

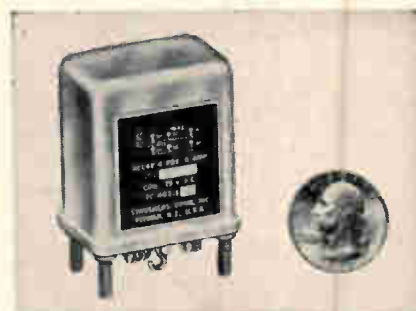

Hermetically sealed relays with two-pole, double-throw contacts are rated for 10-ampere resistive loads at 28 v d-c or 115 v, 400 cps. Designed to MIL-R-6106E specifications, drawing MS25273, the units are for aircraft, missile, ground support, and other aerospace applications. Bifurcated movable contacts are used on both types to insure contact reliability under extreme vibration and shock.

Two models with solder hook terminals are currently available. Both measure 1.531 in. wide by 1.1 in. deep by 1.781 in. above the mounting surface. Type FC-402-1 has a d-c coil nominally rated at

**If you ever
wished for a versatile,
easy-to-work-with
dielectric FILM,
with all the
electrical properties,
environmental resistance
and unsurpassed reliability
of Du Pont TEFLON®—**

**What are you waiting for?
Mail this coupon!**



BETTER THINGS FOR BETTER LIVING
... THROUGH CHEMISTRY

TEFLON® FEP fluorocarbon film

Du Pont Company, Room 3871
Wilmington, Delaware 19898

Please send me complete information
on Du Pont TEFLON FEP fluorocar-
bon film. I am particularly interested
in evaluating this film for the follow-
ing area(s) of application:

- flexible, single and multilayer
printed circuits
- laminated, flexible, flat cable
insulation
- high-temperature, high-dielectric-
strength insulation

Other application _____

Name _____

Title _____

Company _____

Address _____

City _____

State _____ Zip _____

Business Phone _____

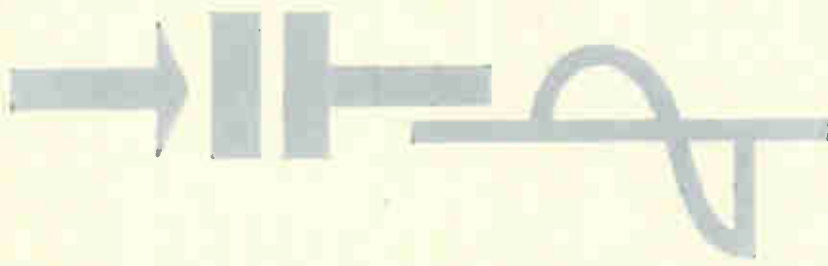

NEW-UNEXCELLED VARACTOR POWER OUTPUT...

MOTOROLA POWER VARACTORS AT THESE DISTRIBUTORS... NOW!

EASTERN

ALABAMA, Huntsville • 2310 Bob Wallace Ave., S.W.	Electronic Wholesalers • 534-2461
ALABAMA, Huntsville • 8100 Memorial Parkway, S.W.	Gulf Semiconductors • 881-7737
CONNECTICUT, Hamden • 60 Connolly Parkway	Cramer Electronics • 288-7771
O.C., Washington • 2345 Sherman Ave., N.W.	Electronic Wholesalers • HU 3-5200
FLORIDA, Miami • 7495 N.W. 48th St.	Gulf Semiconductors • 887-6541
FLORIDA, Orlando • 2049 W. Central Blvd.	Powell/Crescent Electronics • 423-8586
GEORGIA, Atlanta • 1135 Chattahoochee Ave., N.W.	Jackson Electronic • 355-2223
MARYLAND, Baltimore • 3004 Wilkens Ave.	Electronic Wholesalers • WI 5-3400
MASSACHUSETTS, Cambridge • 71 Pearl St.	R&D Electronics Supply • 864-0400
MASSACHUSETTS, Newton • 320 Needham St.	Cramer Electronics • WO 9-7700
NEW JERSEY, Moorestown • Pleasant Valley Ave.	Angus, Inc. • 235-1900
NEW YORK, Buffalo • 916 Main St.	Summit Distributors • TT 4-3450
NEW YORK, Elmhurst, Queens • 80-02 51st Ave.	Cramer/Esco • GR 8-4000
NEW YORK, New York • 160 Varick St.	Milgray Electronics • YU 9-1600
NEW YORK, Syracuse • The Pickard Bldg., E. Motloy Rd.	Eastern Semiconductor Sales • 454-9247
NEW YORK, Westbury, L.I.	Schweber Electronics • EO 4-7474
NORTH CAROLINA, Winston-Salem • 938 Burke St.	Electronic Wholesalers • PA 5-8711
PENNSYLVANIA, Philadelphia • 701 Arch St.	Radio Electric Service Co. • WA 5-6900

CENTRAL

ILLINOIS, Chicago • 100 N. Western Ave.	Allied Electronics • HA 1-6800
ILLINOIS, Chicago • 223 W. Madison St.	Newark Electronics • ST 2-2944
ILLINOIS, Chicago • 5700 W. North Ave.	Semiconductor Specialists • NA 2-8860
IOWA, Cedar Rapids • 618 First St., N.W.	Deeco • 365-7551
KANSAS, Kansas City • 2707 West 43rd St.	Precision Electronic Devices Co. • AO 6-4343
MICHIGAN, Dearborn Heights • 20203 Ann Arbor Trail	Semiconductor Specialists • LU 4-5901
MICHIGAN, Detroit • 12775 Lyndon Ave.	Radio Specialists Co. • BR 2-4212
MINNESOTA, Minneapolis • 730 East 38th St.	Allied Electronics • TA 7-5401
MINNESOTA, Minneapolis • 601 West 66th St.	Semiconductor Specialists • UN 6-3435
MISSOURI, St. Louis • 6154 Jefferson Ave.	Semiconductor Specialists, Inc. • JA 1-8866
OHIO, Cincinnati • 10 Knollcrest Dr.	Sheridan Sales • 761-5432
OHIO, Cleveland • 5403 Prospect Ave.	Pioneer-Standard Electronics • 432-0010
OHIO, Dayton • 2975 Far Hills Ave.	Allied Electronics • 298-9831
TEXAS, Dallas • 2642 Andron Dr.	Sterling Electronics • FL 1-9921
TEXAS, Garland • 326 Kirby St.	Hall-Mark Electronics • BR 6-8501
TEXAS, Houston • 8000 Westglen	Hall-Mark Electronics • SU 1-0011
TEXAS, Houston • 1420 Hutchins	Lenert Co. • CA 4-2663

WESTERN

ARIZONA, Phoenix • 1741 No. 28th Ave.	Hamilton Electro of Ariz. • 272-2601
CALIFORNIA, Inglewood • 399 S. Isis Ave.	Liberly Electronics • OR 8-8111
CALIFORNIA, Los Angeles • 10912 W. Washington Blvd.	Hamilton Electro Sales • UP 0-3300
CALIFORNIA, Los Angeles • 5645 E. Washington Blvd.	K-Tronics • OV 5-5888
CALIFORNIA, Mountain View • 2288 Charleston Road	Elmar Electronics • 961-3611
CALIFORNIA, Mountain View • 340 Middlefield Rd.	Hamilton Electro Sales-North • 961-7000
CALIFORNIA, Oakland • 140 11th St.	Elmar Electronics • TE 4-3311
CALIFORNIA, San Diego • 8137 Engineer Rd.	Kierulff Electronics • BR 8-2112
CALIFORNIA, San Diego • 4618 Santa Fe	San Deitor • 274-3131
COLORADO, Denver • 1200 Stout St.	Kierulff Electronics • TA 5-7033
NEW MEXICO, Alamo • 811 First St., S.E.	Kierulff Electronics • 437-0370
NEW MEXICO, Albuquerque • 6405 Acadia Rd., S.E.	Kierulff Electronics • 268-3901
UTAH, Salt Lake City • 433 W. Third So.	W. H. Bintz Co. • 363-5821
WASHINGTON, Seattle • 516 First Ave., No.	Hamilton Electro • AT 2-3836

New Components

28 v., 0.25 amp. The FC-402-2 has a self-contained rectifier for a-c coil operation at 115 v, 400 cps, 0.07 ampere.

Both relays are available on an approximate six-week delivery basis. Prices are in the \$14 range for types with d-c coils, \$20 for a-c operated types.

Struthers-Dunn, Inc., Pitman, N.J., 08071. [357]

Military quality glass capacitors

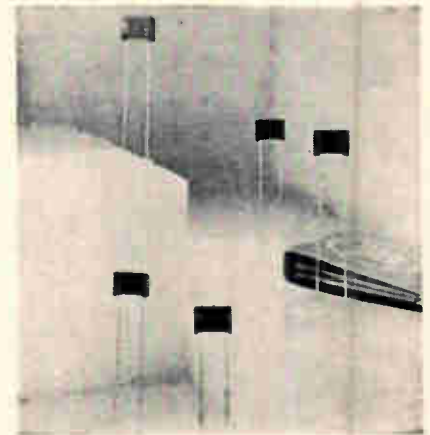

Low-cost glass capacitors meet or exceed all the performance requirements of military specification MIL-C-11272. Type CYW-6 capacitors are designed for tuned r-f and analog circuits; for signal generating, shaping, and handling; and for critical applications requiring exceptional stability and repeatability in addition to low drift and losses.

Capacitance range of the CYW-6 is from one through 560 pf at a voltage rating of 300 v d-c, permitting the capacitors to be used in either transistor or vacuum tube circuits. The injection-molded plastic case, which houses the same kind of glass capacitor element used in higher priced military-type CY units features tiny feet that raise the body of the case off the circuit board to effect more reliable soldering and facilitate cleaning of the board surface. The upright mounting also contributes to higher efficiency in circuit packaging. Standard lead material is gold-plated dumet, which is both solder-

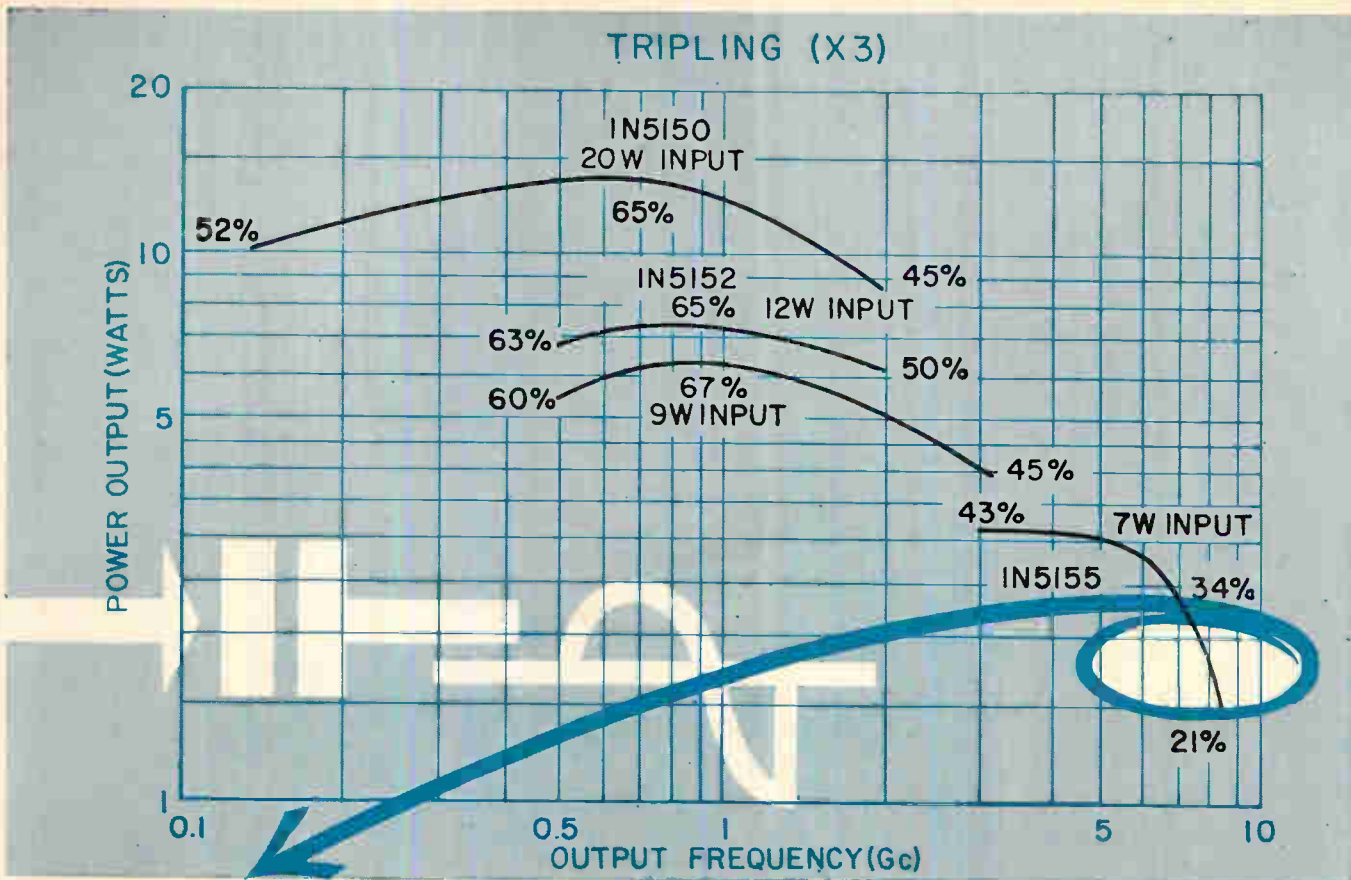

1.8 WATTS at 8000 MHz

... typical microwave performance of Motorola's NEW
1N5154/5 High-Power, Step-Recovery Varactor.

If unmatched power and efficiency at microwave frequencies up to 8000 MHz is one of your specific design goals, you'll want to check the specifications on the high-powered performance of the four new Motorola large-area, step-recovery varactors shown here.

You'll find each unit an ideal frequency-multiplier for high power at microwave frequencies for transmitters, local oscillators, one-step high-order multipliers, reference frequencies, broadband circuits, parametric amplifier pumps, and other UHF and microwave applications.

Another pleasant surprise is the price—as low as \$18.00 each (100-up)!

Call your franchised Motorola distributor for immediate delivery on the types you'll want to try right now! For data sheets and application notes, write to: Dept. 031, Motorola Semiconductor Products Inc., Box 955, Phoenix, Arizona 85001.

Three Space-Saving Packages ...



1N5154
1N5151



1N5155
1N5152



1N5153
1N5150
1N5149

(Packages shown approximately 2½ times actual size.)

GUARANTEED TEST PERFORMANCE						
Product Type	INPUT		OUTPUT			Price Each (100-Up)
	Frequency	Power	Frequency	Min. Power	Min. Efficiency	
1N5154/5	2 GHz	5 Watts	6 GHz	2 Watts	40%	\$28.00
1N5151/2/3	1 GHz	12 Watts	2 GHz	6 Watts	50%	28.00
1N5150	.5 GHz	37 Watts	1 GHz	24 Watts	65%	28.00
1N5149	.5 GHz	20 Watts	1 GHz	11 Watts	55%	18.00

*We guarantee minimum tripler 2-watts output at 6 GHz with 40% efficiency.

MOTOROLA
Semiconductors



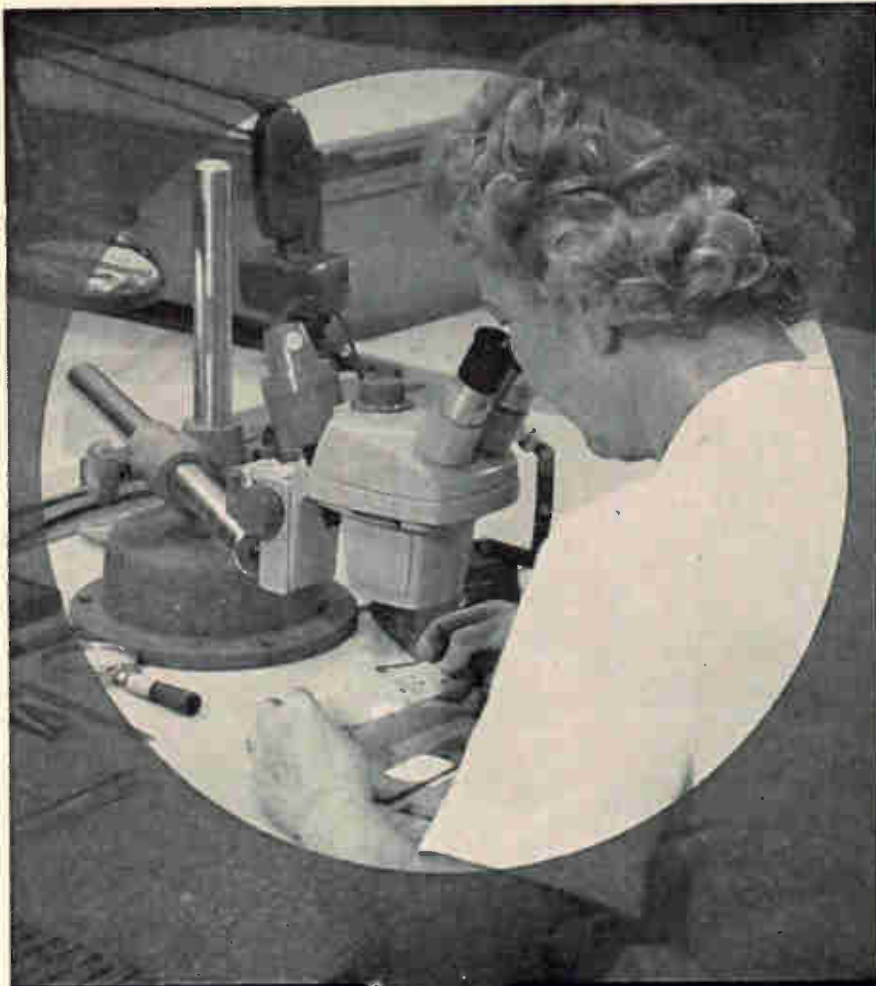

*To find micro-size voids, pits,
porosity and nodulation...*

**WESTINGHOUSE DEPENDS ON
BAUSCH & LOMB STEREOZOOM®**

The Aerospace Division of Westinghouse found StereoZoom ideally suited for spotting defects in Printed Circuit Boards with plated-through holes. The three-dimensional viewing it offers is the only way these holes can be checked properly. The bright, clear, magnified detail simplifies the inspector's work. With StereoZoom, breaks in circuit and shorts between layers can be clearly seen. Pinholes, dents and scratches can be found. To do this, many changes of magnification are required. StereoZoom adjusts its continuously variable magnification quickly and easily. The flexibility of the mounting parts and stand of StereoZoom allows complete freedom of movement of the parts under visual inspection.

For your quality assurance, choose a StereoZoom. There are 24 complete models as well as selected components. Call your dealer or write for Catalog 31-15, Bausch & Lomb, 61428 Bausch Street, Rochester, New York 14602.

BAUSCH & LOMB 

New Components

able and weldable.

Prices of the CYW-6 glass capacitors range from 27 cents to \$1.44 each in quantities above 1,000. Delivery is from 4 to 8 weeks after receipt of order.

Westinghouse Electronic Capacitor Department, Box 130, Irwin, Pa. [358]

Low loss co-ax-relay uses reed switch



A coaxial relay using a special high-frequency, Form A contact miniature reed switch as the switching element has been developed for use in low level r-f switching for communications and instrumentation applications.

The proportions of the reed switch, and its associated insulation and shielding, have resulted in a unit whose characteristics closely match those of coaxial cable. The relay's excellent impedance match and minimal line disturbance are apparent by a vswr of 1.05 and an insertion loss of appreciably less than 0.1 db. Line isolation is 44 db at 100 Mc with switch open.

Known as the Duncoaxial relay, the unit is housed in a steel enclosure measuring approximately $1\frac{5}{16}$ in. long x $\frac{1}{2}$ in. square, less connectors. Coaxial connectors are mounted at each end. Subminiature r-f connectors of 50 ohms and 75 ohms impedance are standard.

Coil power requirement is approximately 0.4 w with nominal voltages of 6, 12, and 24 v d-c. Contacts are rated for continuous currents of 10 ma or less and open

?

**Should you buy Signetics
new SP600 series dual in-line plug-in packages
just because they're low-priced**



**No, there are better reasons.
They contain multi-function DTL circuits, for one.**

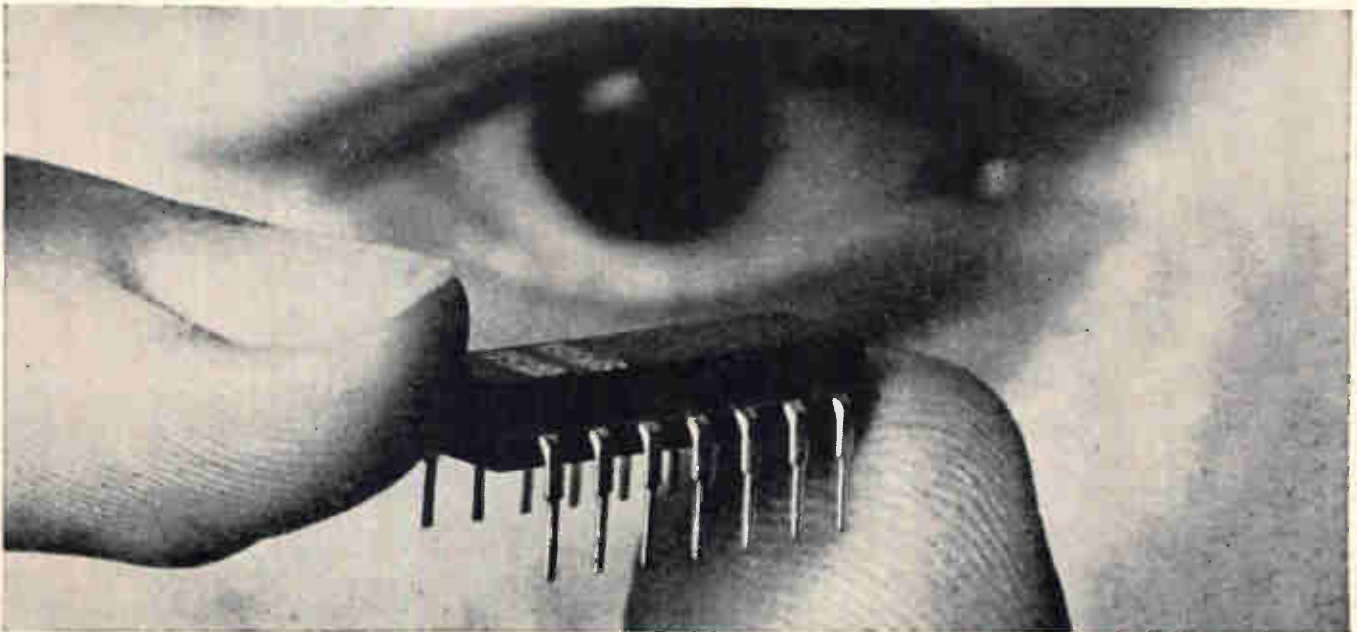

For another, the SP600 package is monolithic. A solid epoxy block encapsulates both the circuit chip and the leads connecting it to the external plug-in pins. Result: mechanical ruggedness and built-in vapor barrier protection for the circuit. The new SP600 series package has been tested and stressed to levels far in excess of those required by MIL-S-19500D and MIL-STD-750, even though it is intended for

commercial applications. Handling and insertion ease are guaranteed by 100 mil center-to-center pin spacing and 300 mils between rows conforming to widely accepted circuit board drill patterns. Mechanical or hand insertion and high-volume flow soldering techniques can be used on all Signetics SP600 series circuits. For the other umpteen reasons, write for your free copy of our SP600A brochure.

SIGNETICS INTEGRATED CIRCUITS

A subsidiary of Corning Glass Works,
811 East Arques Avenue, Sunnyvale, California
Tel.: (408) 739-7700 TWX: (910) 737-9965



Signetics SP600 series includes a J-K flip-flop, three multiple DTL gate packages (dual, triple and quadruple NAND/NOR), a quadruple gate-input expander, and a dual DTL line driver/buffer element.

YES, WE SAID 5 NANOSECOND RISE TIME

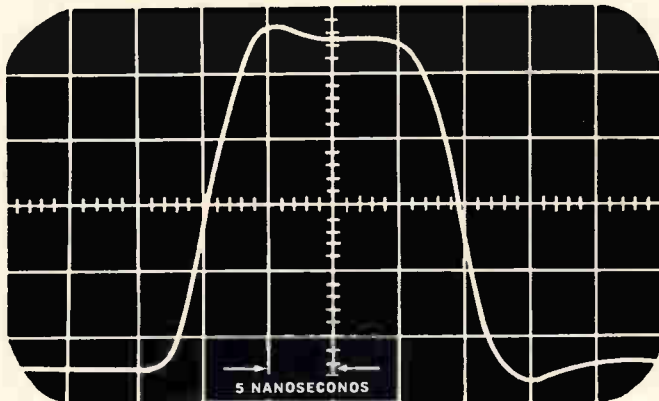

and 100:1
SLOPE CONTROL

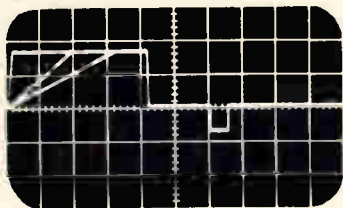

and DOUBLE PULSES
SEPARATELY VARIABLE

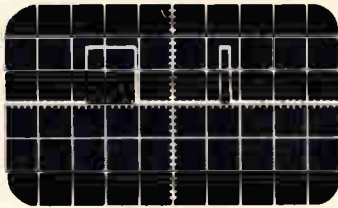

THEY'RE JUST A FEW OF THE GREAT FEATURES OF THE NEW DOUBLE PULSER

For example, the PG-33 Double Pulse Generator provides repetition rates from 0.1 c/s to 20 mc/s. It has positive and negative current outputs up to 200 ma, or voltage outputs up to 10 volts, with independent slope control of each output. Outputs can be first pulse, double pulse, second pulse or square wave. Each channel can provide up to 200 ma of offset for the other. And both channels can be combined for bipolar output.

The PG-33 is yours for \$1200. A demonstration costs nothing at all. Just call or write.

The PG-33 takes only 3½" of rack space, uses silicon semiconductors throughout. Snaplock top and bottom covers give complete access to plug-in circuitry. Supplied with rack adapter.



INTERCONTINENTAL INSTRUMENTS INC.

500 Nuber Avenue, Mount Vernon, N. Y. 10550
(914) 699-4400

New Components

circuit voltages of 10 v d-c or less.

The relay is priced in the \$20 to \$40 range, depending upon quantity. Delivery is approximately six weeks.

Struthers-Dunn, Inc., Pitman, N.J., 08071. [359]

Miniature capacitors are air-variable

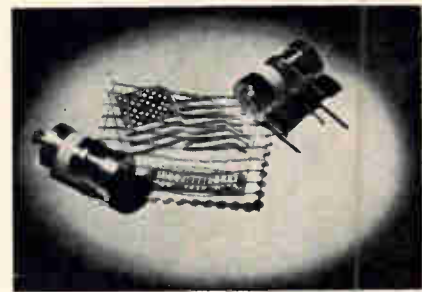

Extremely high Q and greater capacitance values are featured in the VAM series miniature air-variable capacitors. The small, rugged units have a Q factor of greater than 2,000, measured at 100 Mc and 10 pf. They offer very low losses at higher frequencies. Capacitance range is from 0.8 to 10.0 pf measured at 1 Mc. Designated VAM 010 and VAM 101W, they are designed for panel mounting or printed circuit use, respectively.

Insulation resistance is 10⁴ megohms at 100 v d-c and 25°C. Units are gold plated to prevent corrosion damage and for high surface conductivity. A high-density insulator between rotor and stator provides excellent structural strength as well as electrical characteristics. Rubber-gasketed threaded end caps effectively seal the units against contamination after tuning.

The new capacitors measure approximately ½ in. long and ¼ in. in diameter. They have a working voltage of 250 v d-c and a test voltage of 500 v d-c. Measured through an operating temperature range of -55° to +125°C, their temperature coefficient of capacitance is 0 ± 20 ppm/°C.

JFD Electronics Corp., 15th Ave. at 62nd St., Brooklyn, N.Y., 11219. [360]

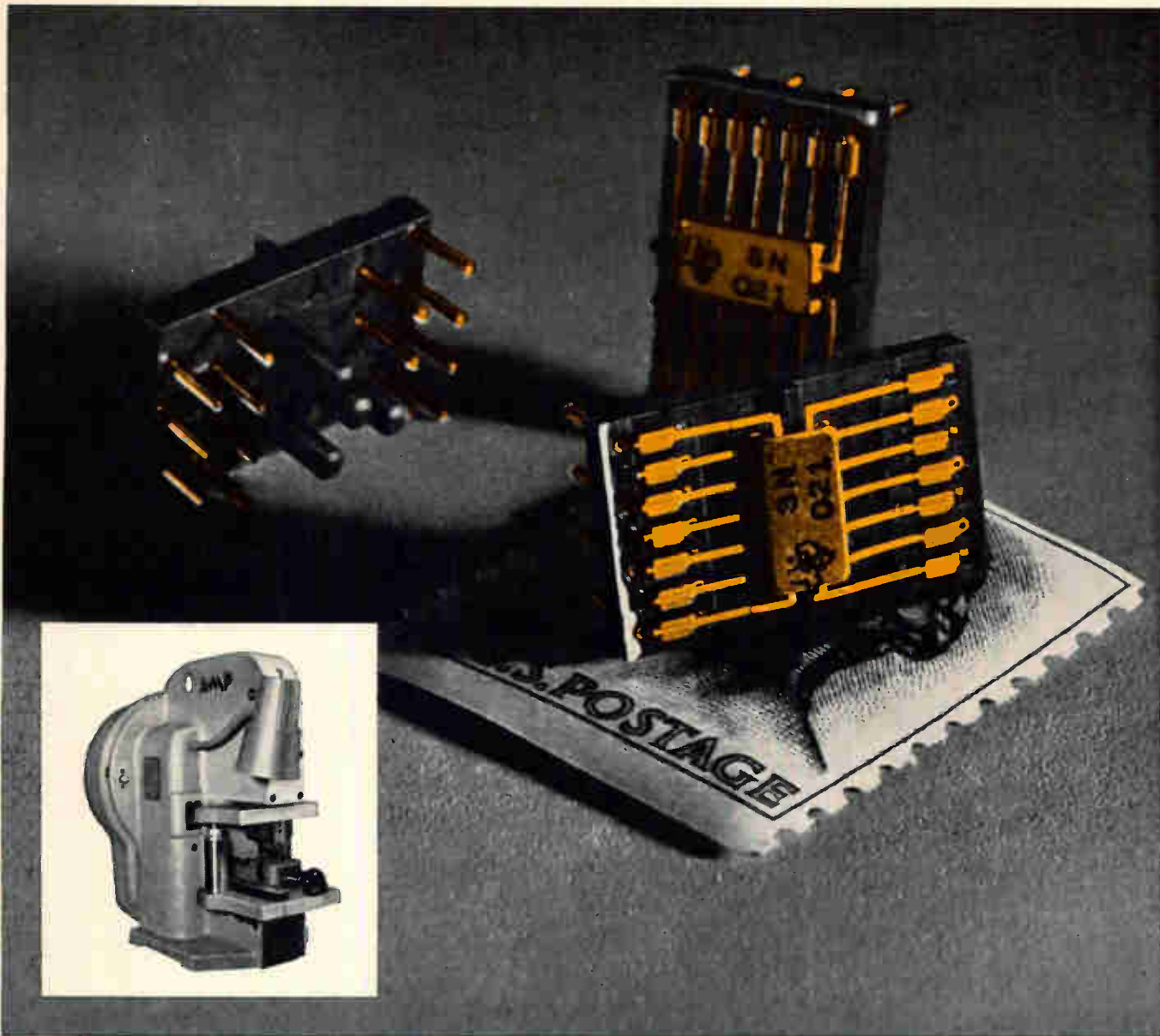

GANG CRIMPING

A new breakthrough in integrated circuits

All 14 ribbon leads of the flat pack above were crimped simultaneously to pins on our new AMP-CRIMPAC* Header . . . a feat of engineering that only a leader in crimping techniques would attempt.

Frankly, it wasn't easy—even for us.

For one thing, we had to use plastic as the anvil for the crimping dies. Nobody had ever done that before. Then, we had to make the pack's .050" mounting centers compatible with existing wiring techniques. And, to top it off, the whole system had to be completely trouble-free and uniformly reliable.

Here's how we did it. We made the AMP-CRIMPAC Header of sturdy phenolic and molded in 14 pins, staggered so that they come through on .100" centers. We designed a precision automatic machine to gang crimp all 14 of the pack's leads at once. After encapsulation, the pack assembly is as rugged as a transistor can or other plug-in component. It can either be plugged and soldered directly onto printed circuit boards, or plugged into an AMP-CRIMPAC Receptacle.

The receptacle attaches to the system panel and is provided with posts that accept AMP's TERMI-POINT* clips for automatic or manual back-panel wiring. Both the header and its mating receptacle are color-coded,

polarized, and keyed for optimum control during production and in field maintenance.

Why go to crimping in integrated circuits? Consider the evidence:

- Reliability is controllable and repeatable
- No heat damage to the circuit function
- No need for bending or pre-forming pack leads
- Exceptionally fast assembly
- Less capital outlay for equipment
- Available for all 1/4" x 1/4" or 1/4" x 1/8" flat pack applications

Now you can enjoy system maintainability right down to the single flat pack circuit. Write for more information on AMP-CRIMPAC Headers and Receptacles today.

*Trademark of AMP INCORPORATED



A-MP★ products and engineering assistance available through subsidiary companies in: Australia • Canada • England • France • Holland • Italy • Japan • Mexico • Spain • West Germany

LC Filters?

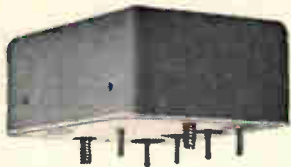

You'll pay for a Bulova—why not get one?

You can't beat Bulova for LC Filters. No better quality made, no faster delivery anywhere, and—thanks to Bulova's technical capabilities—the price is the same as you'd pay elsewhere, or less!

Bulova's use of computer techniques in designing filters reduces the number of components to the minimum number possible. As a result, reliability is greater, initial cost is less. Delivery can start in as little as 4 weeks, faster if necessary.

What's more, all Bulova LC Filters can be manufactured to meet NASA requirements and latest revisions of Mil F-18327. "They" include lowpass, highpass, bandpass and bandreject filters as well as amplitude and phase equalizers, discriminators, tuned circuits and lumped constant delay lines.

In addition, Bulova's engineering staff is always available to consult with you on problems or design special filters to meet your requirements.

Bulova components have proven successful on such projects as Apollo, TFX, Sparrow, Bull Pup and LEM among others. Next



time, why don't you try Bulova? You may as well get the high quality you're paying for!

BULOVA FREQUENCY CONTROL PRODUCTS

ELECTRONICS DIVISION
OF BULOVA WATCH COMPANY, INC.

61-20 WOODSIDE AVENUE
WOODSIDE, N.Y. 11377, (212) DE 5-6000

New Instruments

D-c dvm measures a-c within 0.02%

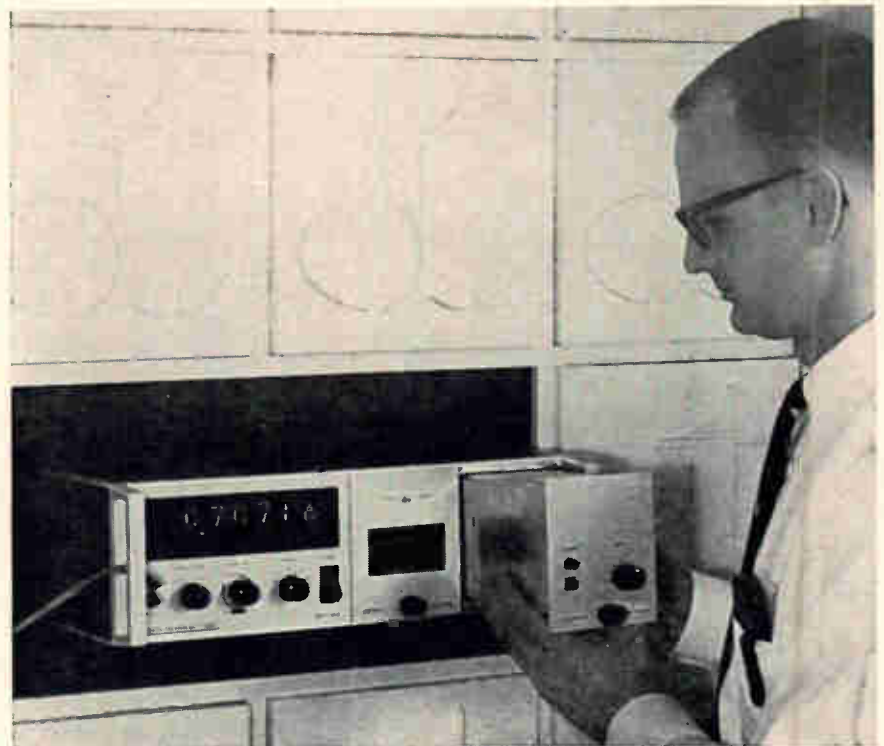

A plug-in a-c to d-c converter now makes it possible to measure a-c voltages with an integrating type digital voltmeter and achieve an accuracy within 0.02% of full scale. The DT-1404 plug-in, developed by the Data Technology Corp., can be used with the company's six-digit d-c voltmeter and also provides common-mode noise rejection of 140 decibels at 60 cycles per second.

The plug-in is essentially a rectifier and filter that convert the a-c input signal to a d-c signal proportional to the rms value of the a-c input. This signal is accurately measured and displayed by the d-c dvm. Although conceptually simple, the converter is a complex device, which the company claims overcomes many problems of a-c measurement with a digital voltmeter.

The a-c input, which can range from 1 volt to 1,000 volts, is applied to an attenuator circuit. The attenuator output is summed at the junction of a high-gain operational amplifier with feedback from diodes at the amplifier's output. Two feed-

back paths are needed so that both the positive and negative half cycles of the rectified output appear at the summing junction. The rectifier output is also applied to the filter which smoothes the half-wave rectified signal before it is applied to the digital voltmeter.

To compensate for the effects of stray capacitance, the resistors in the attenuator are paralleled with trimmer capacitors. Glass dielectric capacitors are used throughout the DT-1404 to minimize any nonuniform capacitance changes that may occur over the instrument's operating frequency range from 50 cps to 10 kc.

Leakage resistance in the attenuator as high as 10^{10} ohms causes a 0.01% error in an instrument of this type, so engineers at Data Technology mounted the attenuator resistors on terminals over a grounded plate. This established the leakage path from the terminal to ground, rather than across the resistor itself.

All the measuring circuits are contained in an isolated guard

shield, which is the third wire of the input circuit. This provides the instrument with high common-mode noise rejection. A multiple-pole output filter provides sufficient ripple attenuation for stable readings.

Although the plug-in is packaged to fit the company's DVX-315 digital voltmeter, it can be used separately wherever a a-c to d-c conversion is required because it contains its own power supply and shielding.

Specifications

Input impedance	Greater than one megohm shunted by less than 20 picofarads
Input voltage range	1 v rms full scale to 1,000 v rms full scale in four ranges
Input frequency	50 cps to 10 kc
Linearity	$\pm 0.01\%$ of reading $\pm 0.01\%$ of full scale relative to best zero-based straight line
Overall accuracy	$\pm 0.02\%$ of full scale
Output	Push-pull, d-c output proportional to full wave average value of pure sine wave input, calibrated to indicate rms
Power	115 v, 60 cps, less than 5 va

Data Technology Corp., 2370 Charleston Rd., Mountain View, Calif. 94040 [361]

Coulometer presents data in digital form



An electronic measuring instrument has been developed that displays directly in coulombs. (A coulomb is one ampere-second.) The instrument is a refinement of an ampere-hour recorder and process controller made by the company for several years for the electroplating industry.

The coulometer (or coulomb meter) is a semiconductor device that

Ballantine High Voltage AC/DC Calibrator

Model 421A

Price: \$650

Portable

0-111 V dc

0-1110 V ac

400 or 1000 Hz,
RMS or Peak-to-Peak

May be used with
Optional Error
Computer



NEW,

Improved!

Accurately Calibrates to 0.15% Vm's, 'Scopes, Recorders...

(and other ac and dc voltage-sensing devices)

Ballantine's new Model 421A is an accurate source of dc or ac voltage that can be set precisely to any value desired up to 111 volts on dc or up to 1110 volts on ac. It's small, rugged, portable... enabling you to check with ease a wide range of instruments without loss of down time. You'll find it useful, too, as an accurate, stable source for measurements of gain or loss, and as a stable source for bridges or strain gauges.

The selected voltage is indicated digitally to four significant figures on each of six decade ranges. The voltage indicated may be dc, or it may be ac at 400 Hz or 1000 Hz, RMS or Peak-to-Peak.

Note, for example, the settings in the photo — 42.35 volts RMS at 1000 Hz output. And with an accuracy that you can be sure is better than 0.15%. The receptacle on the lower right of the instrument is for high voltage outputs from 100 volts to 1110 volts at 400 Hz, RMS or Peak-to-Peak.

In addition to its greater voltage range on ac, the Model 421A has a lower source impedance on ac than the Model 421 it replaces. It also features a connection for an optional Model 2421 Error Computer that enables you to read calibration errors directly in percentages, speeding up your calibrations considerably.

Line voltage effects on the instrument are negligible. A $\pm 10\%$ line voltage change, for instance, causes less than a 0.05% change in output voltage.

Write for brochure giving many more details

— Since 1932 —



BALLANTINE LABORATORIES INC.
Boonton, New Jersey

CHECK WITH BALLANTINE FIRST FOR DC AND AC ELECTRONIC VOLTMETERS AMMETERS OHMMETERS, REGARDLESS OF YOUR REQUIREMENTS. WE HAVE A LARGE LINE, WITH ADDITIONS EACH YEAR ALSO AC/DC LINEAR CONVERTERS, AC/DC CALIBRATORS, WIDE BAND AMPLIFIERS, DIRECT-READING CAPACITANCE METERS, AND A LINE OF LABORATORY VOLTAGE STANDARDS FOR 0 TO 1,000 MHZ.

SMART CIRCUITS know the difference!

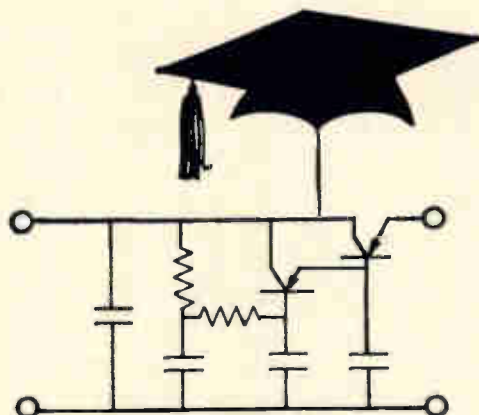

That's why Hopkins Capacitors come in such a wide selection of parameters.



Some capacitors may be rejected by circuits as being incompatible with other components although they may seem to fit at first glance. As the circuit requirements become increasingly more stringent, smart designers often take a second look for capacitors with compatible characteristics to specify. To make your job easier, Hopkins makes a wide family of metallized dielectric capacitors—METALLIZED PAPER, METALLIZED MYLAR, HERMETICS, DUREZ COATED and WRAP & FILL—in hundreds of values, styles and sizes.

Whether you specify capacitors by capacitance, voltage, space, case style, price, polarity, temperature, tolerance, stability, resistance, or dissipation factor, check your HOPKINS catalog first—your circuit knows the difference.

Write for catalog.

HOPKINS
Engineering Company

Telephone: (213) 361-8691 • TWX 213-7645998 • Cable: HOP
12900 Foothill Blvd., P. O. Box 191, San Fernando, Calif. 91341
A Subsidiary of Maxson Electronics Corporation

New Instruments

integrates the voltage developed across a current shunt with time for presentation in digital form to an accuracy of better than $1\% \pm$ one digit. A front panel switch selects internal shunts for full-scale ranges of 0.01, 0.1, 1.0 and 10.0 amperes. Decimal point position to the digital presentation is directly identified by each switch position.

The electromechanical counter is equipped with a manual reset. Electrical connections are provided on the rear of the instrument to connect the pulse output to external equipment for automatic printout, data accumulation, separate count accumulation or special process control. The instrument operates from 115 v 60 cps single phase.

The instrument is expected to have many applications in research and quality control. Special variations of the unit for time integration with voltage, current or temperature will be furnished on special order. Model VT-1176 coulometer is available from stock at \$350.

Vari-Tech Co., 546 W. Leonard, Grand Rapids, Mich. [362]

Temperature recorders are 0.02% accurate



Expanded scale recording of temperature and absolute accuracy of 0.02% are features of a new line of temperature recorders. The CR-207 series recorders do away with the necessity of cold junction compensation or ice bath reference junctions in temperature measurement. Temperature sensing is by means of wire resistance thermometers. Any platinum, nickel iron, or nickel unit in patch type, tubular type, air sensing type, immersion

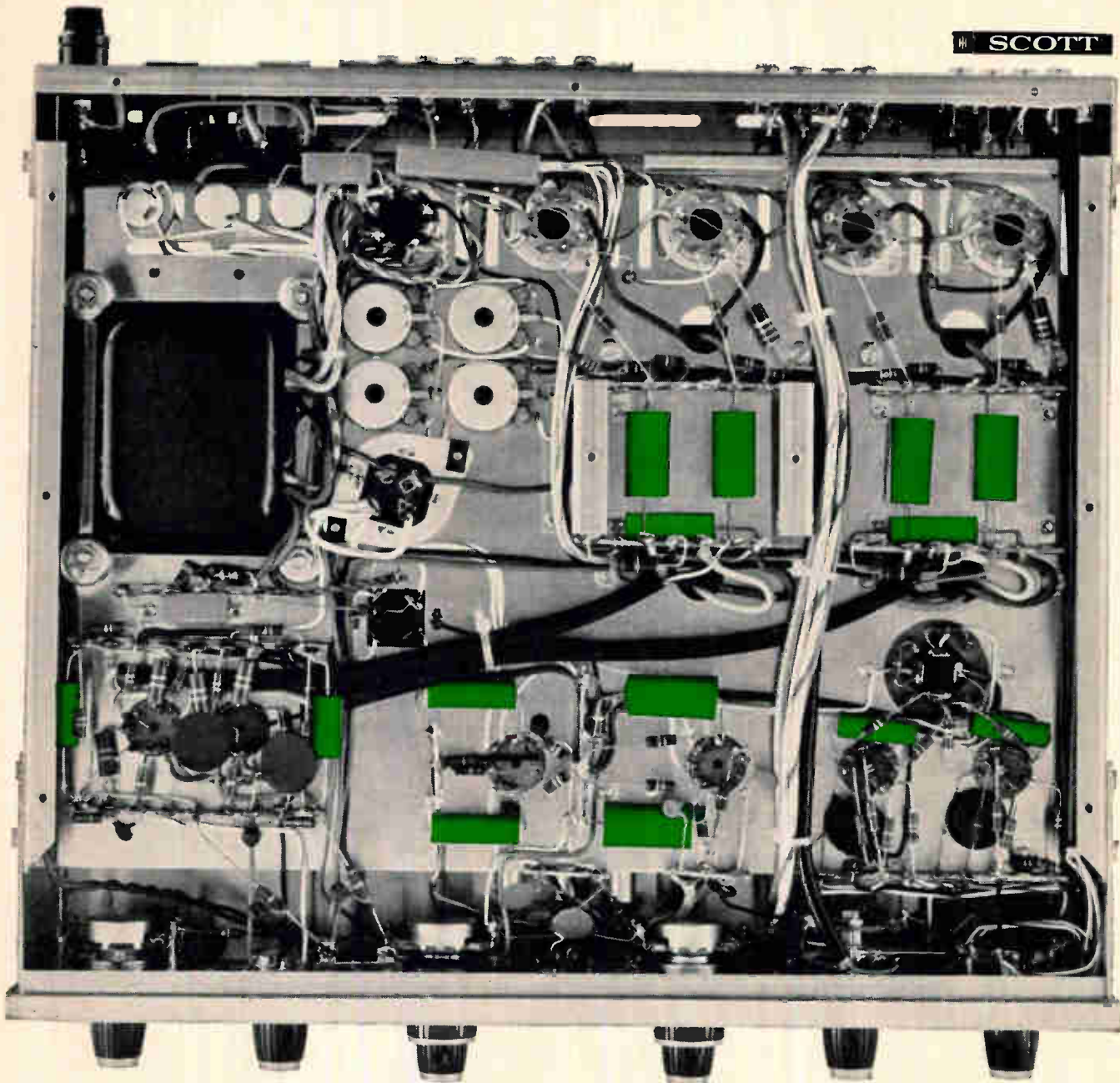

Capacitor reliability? Take Scott's word for it: MYLAR®

H. H. Scott manufactures some of the world's most widely used stereo amplifiers. They are recommended by many leading independent testing organizations. Because this kind of reputation depends on capacitor reliability, engineers at Scott use capacitors of MYLAR* exclusively for audio circuits from .047 to .47 microfarads:

"We don't have to worry about performance with capacitors of MYLAR in our components and consoles," says Chief Engineer Dan von Recklinghausen. "We use capacitors of MYLAR because of their low leakage, extremely long life, excellent capacitance stability and ability to withstand the wide temperature and humidity

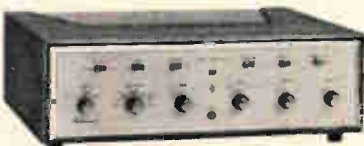

ranges encountered in high-power hi-fi amplifiers." MYLAR also offers high dielectric strength in thin gauges, so capacitors can be made smaller, leaving space for more circuitry. And, in many cases, capacitors of MYLAR cost less than paper.

Scott components and consoles are known for excellence in quality, performance and reliability. So are capacitors of MYLAR. For complete information write Du Pont Co., Room 3370A, Wilmington, Delaware 19898. (In Canada, write Du Pont of Canada Ltd., P.O. Box 660, Montreal 3, Quebec.)



Better Things for Better Living
... through Chemistry



*DUPONT'S REGISTERED TRADEMARK FOR ITS POLYESTER FILM.

WHY PAY THE PRICE OF A SAGE PREMIUM PERFORMANCE POWER RESISTOR?

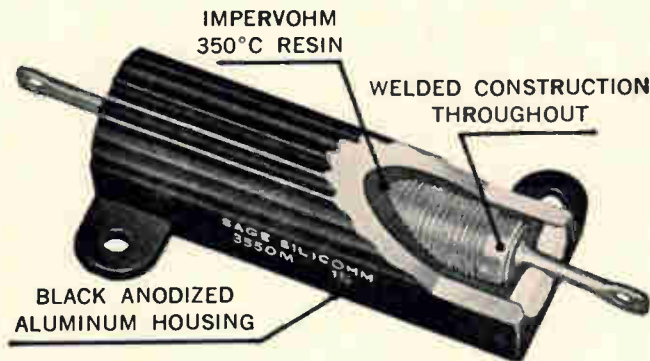

Here are 5 convincing reasons:

- ① **MINIATURIZATION** Ounce for ounce, square inch for square inch, no other type resistor comes close in matching these power ratings—8, 14, 25, 50 watts.
- ② **PRECISION & STABILITY** 1% tolerance, paced by MIL-R-18546C usage, and 20 ppm/°C T.C. are standard everyday features. Specials are available to .5%, .25%, .1% and .05% accuracy; and fractional values can be made well below .1 ohm.
- ③ **ENVIRONMENTAL SUPERIORITY** Type M chassis mount resistors are strides ahead of other components in surviving today's space oriented requirements such as temperature extremes, shock, vibration, salt water immersion and humidity. For example, tens of cycles of moisture resistance testing (voltage polarized) typically cause no more than slight fractional percent resistance change.
- ④ **ESTABLISHED RELIABILITY** Inquire about special screening test methods developed for Titan and Polaris programs.
- ⑤ **PRICE** Yes, all said and done, you'll find price is the one exception to all this talk about premium features.



STYLE	RATED WATTAGE	
	Heat Sunked	Free Air
3105M	8	4
3010M	14	6
3225M	25	12
3550M	50	16

SAGE

SAGE ELECTRONICS CORP.
BOX 3926 • ROCHESTER, N. Y. 14610

New Instruments

style, etc., may be used. The instrument uses a precision Wheatstone bridge with high sensitivity magnetic amplifier null detector to determine the resistance of the sensor, and hence its temperature. Read-out is on a front panel digital dial. Absolute accuracy is to 0.02%.

The temperature indicator and recorder of the CR-207 are of the expanded scale type which is capable of monitoring extremely small deviations in temperature. With typical resistance sensors, a span of as low as 0.3°C can be spread across the full scale of the indicator and recorder making 0.01°C easily observable. Larger spans may, of course, also be selected by adjustment of the front panel span switch, which has seven pre-calibrated positions.

The recorder on the CR-207 is synchronously driven, so chart times are exact. The total time may be changed by a gear change lever to 1, 7, or 30 hours for one model, or 1, 7, or 30 days for the second. The recording is inkless and is done from behind the chart, so no part of the trace is obstructed from view. Any desired notation may be made on the chart paper in either ink or pencil.

Harrel, Inc., 16 Fitch St., E. Norwalk, Conn., 06855. [363]

Wave analyzer with digital display

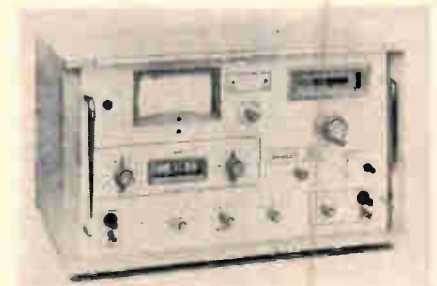

Model 301A wave analyzer permits the user to examine fundamental frequencies, harmonics, and other components of any signal in the range of 20 cps to 100 kc. Frequency resolution is specified as $\pm(1\% + 10 \text{ cps})$ from 20 cps to 10 kc, and $\pm 100 \text{ cps}$ for 10 kc to 100 kc.

The instrument contains a digital frequency display that is direct-reading in kilocycles. The five-digit display provides numerical values in 10-cps increments, with 2-cps interpolation marks. A tuner motor drives the instrument across the full range of 20 cps to 100 kc in approximately 35 seconds.

The 301A also contains provisions for operation as a tracking signal generator or as a selective voltmeter with restored signal output. In the signal generator mode, the frequency of the output is the same as that to which the voltmeter is tuned.

Frequency-response measurements can be made by turning only one knob. Both voltmeter and signal generator are automatically tuned to the same frequency. The output level of the generator is held constant within ± 0.5 db across the full frequency range.

As a voltmeter with restored signal at the output (identical in frequency with the input signal), the 301A provides a filter effect to isolate one signal out of a group, or a signal partly masked by noise, and amplifies it for greater resolution and measurement accuracy.

Full-scale voltage ranges cover from $30 \mu\text{v}$ to 300 v. The instrument also reads dbm directly on 600-ohm circuits at full-scale levels from +50 to -90 dbm, with ± 0.5 -db accuracy. Price is \$1,995.

Sierra/Philco, 3885 Bohannon Drive, Menlo Park, Calif., 94025. [364]

Pressure transducers rated to 3,000 psi

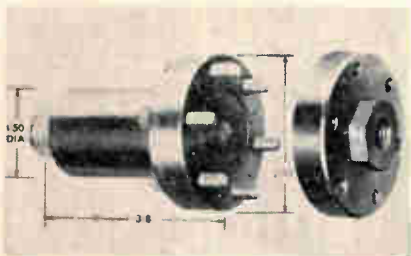

A series of pressure transducers consists of five units with capabilities of 15, 100, 300, 1000 and 3000 psi. The 1281 series is designed for use in industries such as aerospace, petroleum, chemical, hydraulics and others. The pressure sensors operate on a variable inductance

Now, You Have the Smallest Rear-Projection Readout in the World!

It Displays Characters This Big.



All the versatility, readability, and reliability of our patented rear-projection readouts are now available in the world's tiniest theatre: the $\frac{3}{4}$ " H x $\frac{1}{2}$ " W IEE Series 340. We've managed to fit everything but a projectionist in there to give you a choice and clarity of message that no other type of readout can match—regardless of size!

The tiny 340 uses *film* to project any message: numbers, letters, words, symbols, colors. *Anything* you can put on film! You're not limited to crudely formed characters that look strange to the eye. Choose type styles that human-factors tests prove to be most readable!

Your message appears clearly and sharply on a single-plane screen. There's no visual hash or camouflage-netting effect from unlit filaments. The 340 may be tiny, but your message appears *big*, up to an easily read $\frac{3}{8}$ " in height!



HERE'S HOW IT WORKS:

All IEE readouts are passive, nonmechanical devices built for long life. An input signal through the proper contact illuminates the desired lamp, projecting only the selected message through the lenses onto a non-glare viewing screen. This one-lamp-per-message concept eliminates character misreadings caused by partial failures.



**CLICK, IT'S IN
CLICK, IT'S OUT!**

For quick, easy lamp replacement or change of message, just press the front of the 340, pull the whole unit out! Permanently wired base remains in assembly!



SEND TODAY FOR COMPLETE INFORMATION

INDUSTRIAL ELECTRONICS ENGINEERS, INC.

7720 LEMONA AVE. • VAN NUYS, CALIFORNIA • PHONE: (213) 787-0311 • TWX (213) 781-8115
REPRESENTATIVES IN PRINCIPAL CITIES

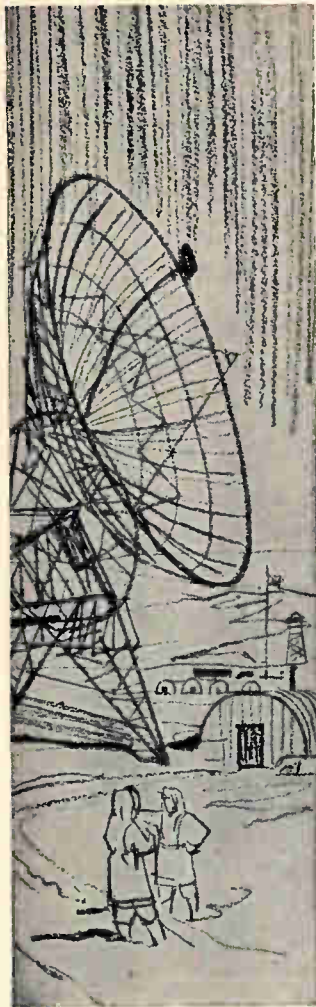

KLIXON
PRECISION CONTROLS

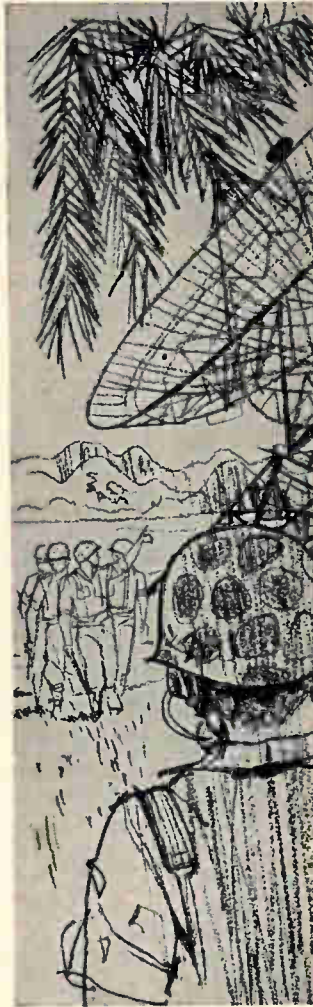

ACTUAL SIZE



For superior thermal stability of semiconductor components in ambients from -55°C to 100°C . . .

RELY ON T_I FOR TEMPERATURE CONTROL

NEW KLIXON Component Ovens provide for the first time accurate temperature control for DO-7 and TO-5 type semiconductor components without the use of conventional heaters, thermostats or controllers. Result? Improved performance with substantial cost reductions.

A breakthrough in semiconductor technology! These miniature ovens utilize the self-regulating characteristics of a polycrystalline semiconductor material to assure uniform component temperature over a wide range of ambient temperatures.

Two ovens now . . . more later! The 3ST oven reduces the temperature coefficient of voltage regulator diodes (DO-7). The 4ST oven stabilizes the temperature of transistors (TO-5) in dc and differential amplifiers, unijunction and voltage controlled oscillators, pulse-counting discriminators, infrared sensing equipment and high frequency crystals. Power requirements are 24v-ac or v-dc, 3.4 watts max (3ST), 6.5 watts max (4ST). Control temperature is 115°C . Warm-up time from -55°C is less than 2.5 minutes. Ovens for other component configurations and temperatures are being developed.

TIXD746 — 759 series temperature compensated diodes, offering improved temperature coefficients, greater voltage range, are available from TI distributors. Write for bulletins giving complete details.

KLIXON
CONTROL PLANTS IN
Attleboro, Mass. - Versailles, Ky.
Central Lake, Mich. - Richmond Hill,
Ontario - Holland - Italy - Australia
Argentina - Brazil - Mexico



METALS & CONTROLS INC.
5004 FOREST ST. ATTLEBORO, MASS.
A CORPORATE DIVISION OF
TEXAS INSTRUMENTS
INCORPORATED

New Instruments

bridge principle in conjunction with carrier amplifiers and are for use with such recording systems as Sanborn models 31, 321, 350 series, 7700 series, and 950 series.

Contact material is 17-4 stainless steel and the transducer housing is of nickel plated steel. The temperature range of -40°F to 250°F allows accurate operation with a thermal zero shift of 0.01% per degree. The 1281 series pressure transducers exhibit a 0.5% linearity, and 8 mv per volt of excitation sensitivity, and have high overload protection. The units measure 2.50 in. in diameter by 3.8 in. high, and weigh 24 oz. They can be flush-mounted or with threaded adapters. Sanborn Division, Hewlett-Packard Co., 175 Wyman St., Waltham, Mass., 02154. [365]

Portable bridge spans wide values



A versatile, portable bridge (model 4959) provides accurate, sensitive and convenient measurements over wide spans of conductance and resistance values. When used with appropriate conductivity cells, it is ideally suited for measuring electrolytic conductivity or resistivity of grounded or ungrounded solutions extending from ultrapure demineralized water to strong acids, bases or salts.

A dual range permits operation from 0.5 to 105,000 microhms or 9.5 to 2 million ohms, based on the

use of a 1.0 cm^{-1} cell. An adjustable dial permits compensation for a wide range of cell constants and solution temperatures.

When properly adjusted using the compensation-factor calculator supplied with the bridge, the instrument reads out directly in specific conductance and specific resistance.

Leeds & Northrup Co., 4901 Stenton Ave., Philadelphia, Pa. [366]

Modular, solid state servo analyzer

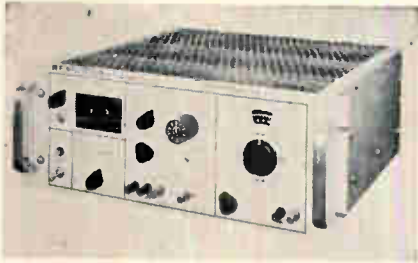

A general-purpose servo analyzer, model 910 Servodyne finds broad application in servo system testing and transfer function analysis. The unit incorporates a precision electronic function generator and high-accuracy variable phase reference. The function generator provides sine, triangle, square and \pm peak reference output signals (unmodulated or modulated) whose amplitude is accurately presettable. These signals serve as the drive, or forcing function, to the servo or network under test.

A signal from any desired point in the test unit is compared via an external oscilloscope (not supplied) with the drive signal to obtain a measure of amplitude ratio between drive and test signal. A separate variable-phase signal from the Servodyne enables the operator to determine phase of the test signal. Frequency of the forcing function is preset, in three decades, from 0.01 to 99 cps using panel-mounted thumbwheel switches. Frequency is accurate to $\pm 2\%$ of setting. Amplitude is continuously adjustable over three ranges: 0 to 100 mv, 0 to 1.0 v, and 0 to 10.0 v; and may be preset to an accuracy of $\pm 2\%$ of setting, $\pm 5 \text{ mv}$ ($\pm 0.5 \text{ mv}$ on the lowest range). The variable-phase reference is continuously adjustable from 0 to $\pm 180^\circ$ and can be

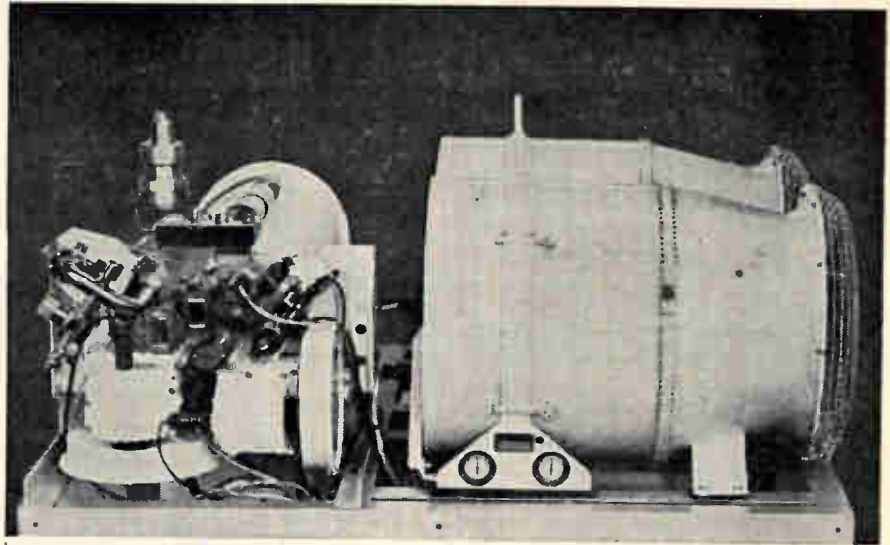

3.9°K CRYO-REFRIGERATOR

Air Products introduces its new Model R-311 Cryo-Refrigerator for cooling masers, superconducting magnets, and parametric amplifiers. This critical-performance Cryo-Refrigerator operates continuously for up to 5,000 hours.

The inherent high reliability of the new R-311 system can be further enhanced by redundant compressors and expanders. Other key features include:

- **Continuous operation** at temperatures down to 3.9°K .
- **Low installation cost** made possible by system compactness. Compressors and cryostat both operate in any orientation and can be easily mounted on the antenna.
- **Dry-Lubricated Compressors**, of exclusive Air Products design, that eliminate contamination problems from oil carryover.
- **No liquid refrigeration** or other cryogenics required for clean-up or cool down.
- **Automatic pushbutton control** starts up and shuts down the refrigeration system. Redundant compressor and expander provide automatic back-up for high reliability.

All system components have been fully tested and proven in five years of actual field operation. Now, the new R-311 provides the advanced state-of-the-art answer for installations requiring maximum refrigeration availability with minimum operator attention.

If your plans call for helium cryo-refrigerators, phone or write today:



Air Products and Chemicals
INC.

ADVANCED PRODUCTS DEPARTMENT
ALLENTOWN, PENNSYLVANIA

it brings in
telemetry signals
you never
received before!



THE NEW



SERIES AFM-8-BB
VHF-UHF

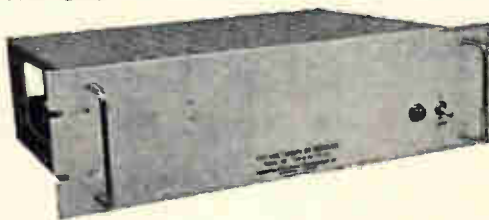

MULTICOUPLER

Now in use in America's aerospace programs

Only AEL offers multicouplers with the necessary low intermodulation characteristics to bring in crystal clear signals on range telemetry systems . . . even from 'way out space. HERE'S WHY . . .

■ DYNAMIC RANGE

. . . ± 10 db for any inband signal.

■ INTERMODULATION PRODUCTS

. . . are better than 45 db below inband signals of 0 db or less.

These active filter devices receive an RF input signal, and power amplify and divide the signal equally to 2, 4, or 8 outputs. The design features broad band, high isolation hybrid couplers and high level RF amplifiers . . . and the resultant low noise figure. 60 to 70 db isolation between outputs is typically achieved. Another AEL first!

For complete AEL MULTICOUPLER specifications . . . plus information on ■ COMMAND RECEIVERS ■ TRANSMITTERS ■ DECODERS ■ PREAMPLIFIERS ■ and other CUSTOM TELEMETRY PRODUCTS . . .

SEND FOR DETAILED TECHNICAL BULLETIN



**American Electronic
Laboratories, Inc.**

P. O. BOX 552, LANSDALE, PENNA. 19446 • (215) 822-2929



New Instruments

set with $\pm 1^\circ$ accuracy.

All input and output signal returns are electrically isolated from chassis. Instrument construction is modular solid state with all circuits packaged as plug-in printed circuit boards.

Canoga Electronics Corp., 1805 Colorado Ave., Santa Monica, Calif. [367]

Power supply offers 0.02% regulation



Model PS-3A d-c power supply offers 0 to 25 v d-c at 0 to 200 ma; and 0.02% line or load regulation. Maximum ripple is 0.5 mv. The unit also offers a 12-to-1 ratio for output voltage adjustment.

The supply provides dependable performance for designing transistor circuits, and for development, testing and equipment-operation applications. It also serves as a bias supply for vacuum-tube circuitry.

D-c voltages remain constant regardless of load, within ratings, at any output voltage; and regardless of a-c input supply voltage fluctuations between 105 and 125 v a-c, 60 cps.

Other features include: special internal reference and stabilization circuitry, floating output terminals with separate chassis ground terminal, and 2% accuracy D'Arsonval meter for monitoring voltage and current. Size is 6¼ in. high x 5 in. wide x 6 in. deep. Weight is 3½ lbs. Price is \$99.95.

Electro Products Laboratories, 6123 W. Howard St., Chicago, Ill., 60648. [368]

If you want to capture signals from way way out,

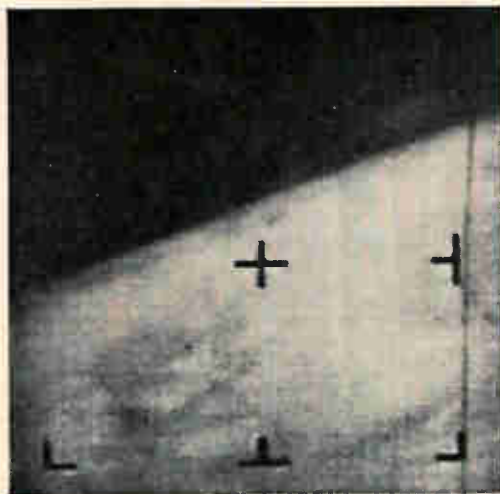

record them on the tape with total recall

MEMOREX

PRECISION MAGNETIC TAPE

VISIT BOOTHS 420 & 430
NATIONAL TELEMTRY SHOW

When you put a reel of Memorex instrumentation tape on your transport, you can expect the most reliable performance, both from the tape and from your recorder. Because Memorex coating formulations are highly uniform, you'll find fewer dropouts; because they are extremely durable, you'll find significantly less oxide shedding, and freedom from head build-up or gap smear. The result is multi-pass

stability of performance unequalled by any other tape.

If you write Memorex Corporation at 410 Memorex Park, Santa Clara, California 95052, we will send you instrumentation tape specification data and a bibliography of technical information available without obligation from the Memorex library of reprints.

Memorex Branch Offices in New York, Philadelphia, Washington, Atlanta, Orlando, Dayton, Chicago, Detroit, Dallas, Los Angeles, San Francisco; Offices and Affiliates in London, Cologne, and Paris

TRYLON CONICAL MONOPOLE ANTENNA
Vertically-polarized, omnidirectional, for any
4:1 range from 2 to 30 mc. 4 db/iso gain.
50-ohm input. Power to 50 kw PEP

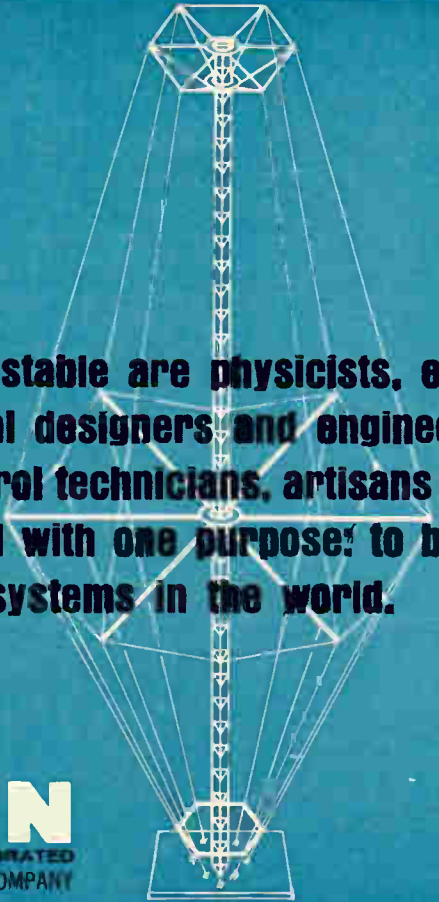

Here in one stable are physicists, electrical and structural designers and engineers, production and control technicians, artisans and expeditors—all fired with one purpose: to build the finest antenna systems in the world.



Circle 457 on Reader Service Card

NOT A NEW ISSUE

400,000 Shares
Bourns, Inc.
Capital Stock
(Par Value 50c Per Share)

Price \$15.75 Per Share

Upon request, a copy of the Prospectus describing these securities and the business of the Company may be obtained within any State from any Underwriter who may regularly distribute it within such State. The securities are offered only by means of the Prospectus, and this announcement is neither an offer to sell nor a solicitation of any offer to buy.

Goldman, Sachs & Co.

Blyth & Co., Inc.

Eastman Dillon, Union Securities & Co.

Glore Forgan, Wm. R. Staats Inc.

Hornblower & Weeks-Hemphill, Noyes

Lazard Frères & Co.

Lehman Brothers

Merrill Lynch, Pierce, Fenner & Smith
Incorporated

Smith, Barney & Co.
Incorporated

Wertheim & Co.

Dean Witter & Co.

March 16, 1966.

New Semiconductors

Power transistors have 50-Mc response



A line of high voltage silicon power transistors is announced. These 10 amp planar n-p-n units feature collector to emitter breakdown voltages from 200 v to 325 v. They are offered in the TO-3 package and have a frequency response of 50 Mc and a base capacitance of 150 pf.

The transistors are suited for use in high voltage inverters and switching regulators, tv deflection circuits, as well as all line voltage switching and amplifier applications.

The series is MHT 7201 through MHT 7205; prices in 100 quantity are from \$52 to \$100.

Solitron Devices, Inc., 1177 Blue Heron Blvd., Riviera Beach, Fla. [371]

High reliability silicon diodes



A line of high reliability, silicon planar epitaxial diodes is designed for high speed switching and computer applications. Types 1N914, 1N914A, 1N916, 1N916A and 1N3064 miniature glass silicon diodes are packaged in a standard DO-7 case. Application of advanced

epitaxial technology provides greater reliability, increased yield, and reduced cost. It offers extremely low forward voltage drop at higher forward current.

The chip, prior to final hermetic seal, receives a surface passivation which provides a hermetic seal in itself, eliminates photo effects and improves stability. Operating over a temperature range of -65° to $+175^{\circ}\text{C}$, these high performance diodes have a peak reverse voltage of -100 v for types 1N914 through 1N916A, and -75 v for type 1N3064.

Maximum reverse current is $-50\text{ }\mu\text{a}$ for types 1N914 through 1N916A at a reverse voltage of -20 v and ambient temperature of 150°C , and $-100\text{ }\mu\text{a}$ for type 1N3064 at a reverse voltage of -50 v and ambient temperature of 150°C . Maximum reverse recovery time is 4 nsec at $25\text{ }^{\circ}\text{C}$.

Nucleonic Products Co., Inc., 3133 E. 12th St., Los Angeles, Calif., 90023. [372]

Solid state isolator is photon-coupled

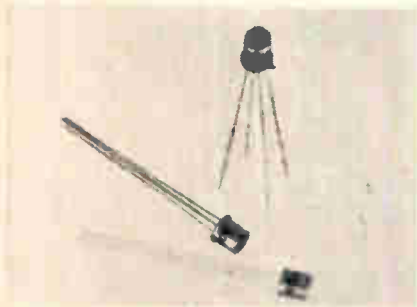

Model 4310 is a solid state photon-coupled isolator with an injection luminescent photon source and an improved silicon p-i-n diode photo-detector. The photon source is an improved gallium arsenide diode. The isolator, packaged in a 4-lead JEDEC TO-18 hermetically sealed case, can be used on printed circuit boards as a conventional semiconductor component. The anode of the input diode is connected to the case.

The non-photon coupling between the input and output is 2 pf and 10^{11} ohms. The working voltage rating between input/output is 200 v peak maximum; and the photon-coupled current transfer ratio is on the order of 0.001 from

THIS is frequency response?

Critical measurement of frequency response with point-by-point plotting leaves much to be desired. It is time consuming and often misses pertinent data if the frequency intervals are large.

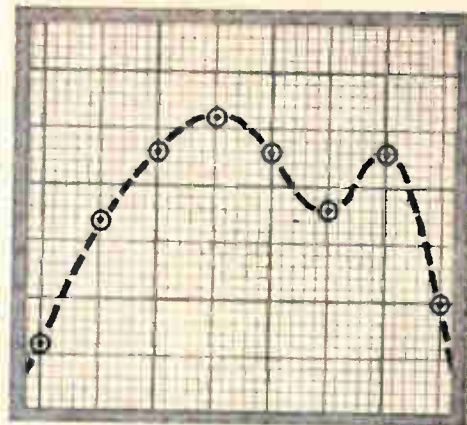

Point-by-point plotting with a signal generator

THIS IS frequency response!

The use of swept frequency techniques, on the other hand, provides an instantaneous display of the response over a large area of the spectrum, at all frequencies. There is no lost time—no lost data.

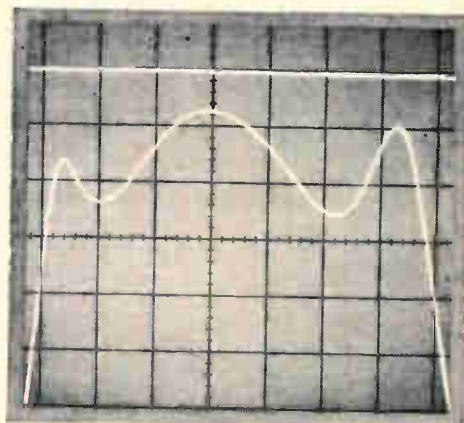

Display of same response using a Telonic Sweep Generator

Applications—

Telonic Industries, the major producer of Swept Frequency Instrumentation, has compiled an extensive application file covering many uses of the sweep generator in testing, aligning and adjusting circuits, sub-assemblies and components. Your copy is available on request. You will also then automatically receive future additions to this application file.

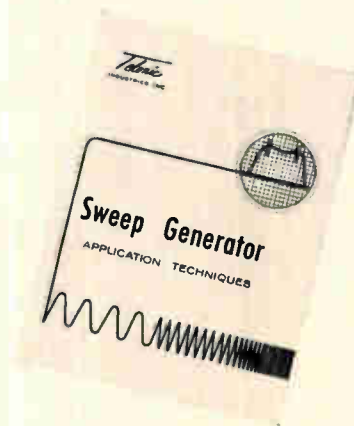

INDUSTRIES, INC.

60 North First Avenue, Beech Grove, Indiana 46107 Tel. (317) 787-3231 TWX: 810-341-3202



Telonic[®] INDUSTRIES, INC.
Beech Grove, Indiana

Please forward Sweep Generator Application Notes, and place me on your mailing list.

Name _____

Firm _____

Address _____

City _____ State _____

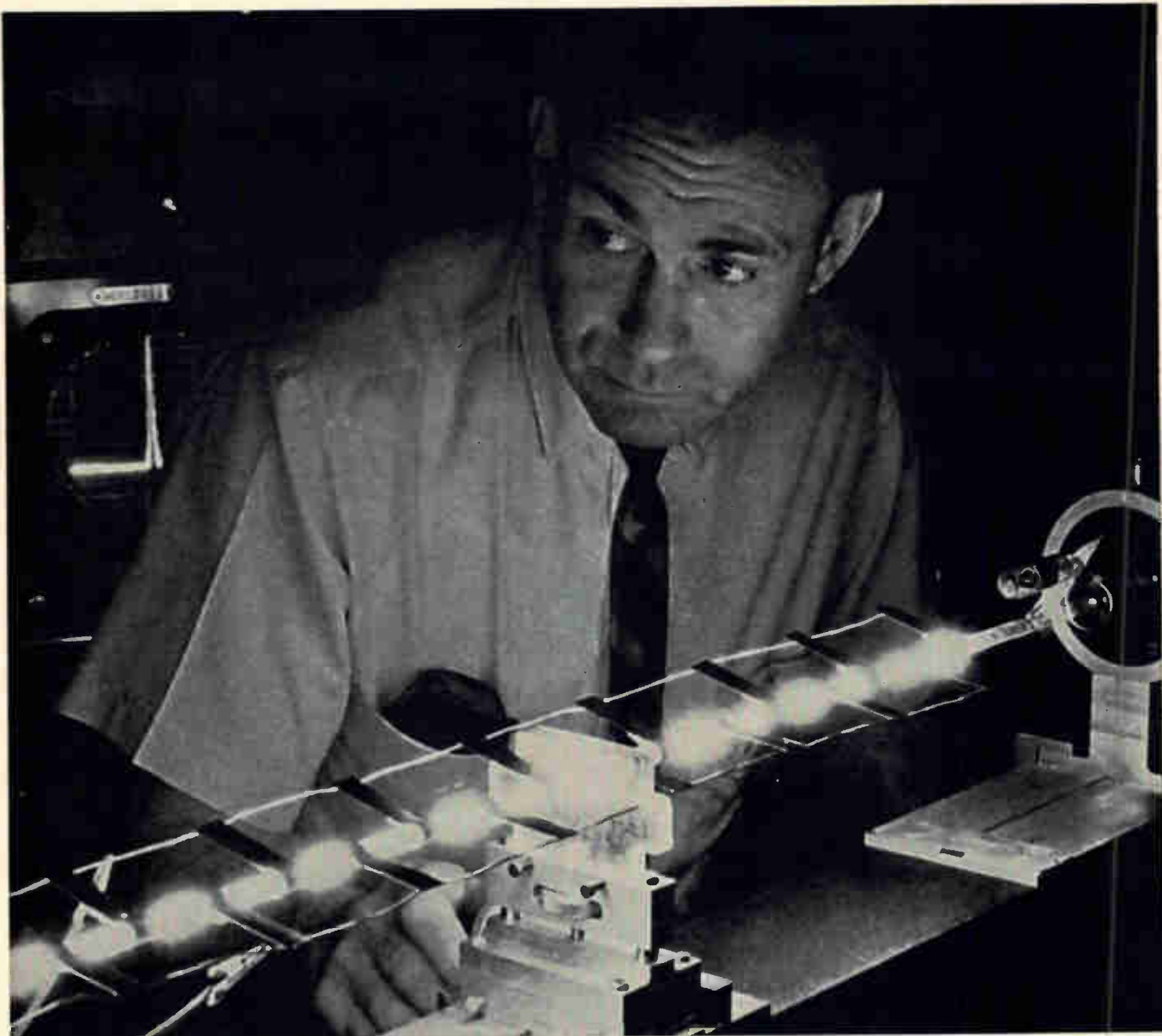

ENGELHARD fused quartz tube used in Martin laser research

A practical demonstration of the potential of lasers in space navigation has been made with a doppler laser simulator by Martin-Orlando scientists. Shown publicly for the first time at the American Institute of Aeronautics and Astronautics meeting, the doppler device uses a CW gas laser operating in the visible spectrum. The laboratory model shows precise resolution of target speed, either fast or slow, over a wide range.

The capability of detecting velocities as low as one millimeter per second makes the device particularly applicable for space rendezvous maneuvering systems.

The optical doppler frequencies, being much higher than those of microwave (radar) systems, permit the measurement of lower velocities, higher resolution in velocity measurement and, therefore, significantly greater accuracy. In addition, the narrow beamwidth of the laser provides maximum interception of the emitted energy by the target. This means that trans-

mission losses are small and longer ranges possible with less power.

Engelhard's Amersil Quartz Division pioneers the road

Martin-Orlando scientists forge ahead, and Engelhard paves the way for them. Amersil Quartz Division's fused quartz tube was built to the most exacting specifications for use in the Martin laser.

The research facilities and extensive technical know-how of the Amersil Division are often called upon in such situations. In meeting the needs of industry for high-purity fused quartz, Engelhard scientists have transformed many experimental items into useful implements for sophisticated research. At their disposal are the finest casting, molding and drawing facilities in the industry. Write our technical services department today for further information on Amersil Fused Quartz.

339



Some other **ENGELHARD** products

SILVER PLATING with Silva-Brite® Solution protects components, increases conductivity. Plating is quick, easy and non-critical at current densities from 10 to 40 amps. Operation at normal room temperature minimizes fumes and bath decomposition.

LAMINATED CONTACT MATERIALS are produced in virtually any combination of precious metals and alloys with base metals and alloys. Types include edge, strip, inlay, spot, single or double-face laminations. Supplied in flat lengths, in strip, coil or fabricated forms.

THIN WIRE AND FOIL are produced by Engelhard's Baker Platinum Division to meet rigid electronic design requirements. Both extruded and Taylor Process thin wire are available in diameters as small as .001". Thin-gauge foil is supplied in sheets up to 8" x 18".

LIQUID GOLD produces an excellent heat barrier when applied to metals and other surfaces. Solutions are easy to use. Resulting metallic films are highly efficient reflectors of infra-red, often permit important weight reduction of substrate materials.

RHODIUM PLATING is simple with Engelhard electroplating solutions. Rhodium deposits provide outstanding protection against surface corrosion, reduce electrical noise in moving parts. Efficiency is improved wherever long-wearing, oxide-free components are required.



New Semiconductors

d-c to the cutoff frequency of 10 Mc.

The 4310 is for circuits requiring economical input/output common mode isolation of moderate levels. The 10-Mc bandwidth makes possible isolation of video bandwidth signals; pulse rise time capability is typically 50 nsec.

One important application is the interruption of common ground currents in various digital and analog circuits. The 4310 isolator is also useful in transferring signals through floated and guarded interfaces. Price in quantities from 1 to 99 is \$55.

HP Associates, 620 Page Mill Road, Palo Alto, Calif., 94304. [373]

Stud-base rectifiers operate at 6 amps



A series of 6-ampere, stud-base silicon rectifiers have peak inverse voltage ratings from 15 to 1,200 v. At room temperature the series withstands an 8-msec nonrecurrent surge of 300 amps; maximum reverse current is 25 μ a; maximum d-c forward drop at 6 v is 1.2 v. The rectifiers may be operated at 6 amps to a temperature of 50°C when mounted to a suitable heat sink. They then derate linearly to 0 at 175°C.

The hermetically sealed devices meet or exceed all MIL-S-19500 environmental specifications. They are direct replacements for the manufacturer's SOD stud base series, and are available in high voltage stacks to customer's specifications. Price is 35 cents to \$8.40 each, depending on type and quantity. Availability is stock to 2 weeks.

Solitron Devices, Inc., 256 Oak Tree Road, Tappan, N.Y., 10983. [374]

No amplifier needed with Vernistat® a.c. pots

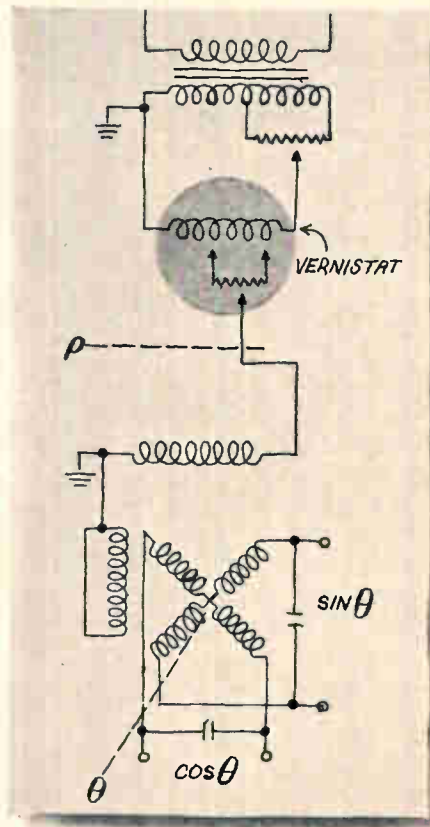

You don't need a buffer amplifier to drive a servomechanism—if you use a Vernistat a-c potentiometer. It has an output impedance low enough to drive a resolver or other low input impedance device directly. Use an a-c potentiometer to simplify circuits, improve reliability, gain greater accuracy and reduce circuit costs. For full information and data sheets, write to Electronic Products Division, Perkin-Elmer Corporation, 751 Main Avenue, Norwalk, Connecticut.

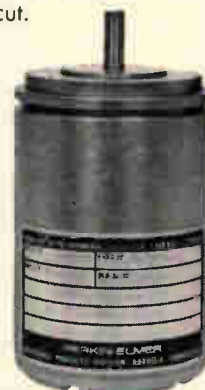

PERKIN-ELMER

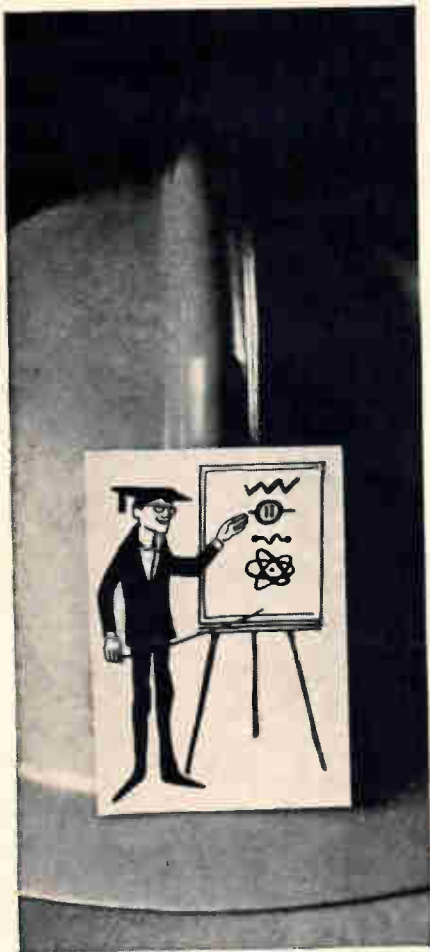

workability

(pre-production training)

WESTern PENNSylvania has a proved-in-use plan by which adaptable, productive people with a variety of industrial aptitudes will be trained in advance for YOUR operation, usually at no cost to you. You can also save on labor-turnover costs in WESTern PENNSylvania where the "Voluntary Quit rate" is only one-third the national average. This workability and training program . . . plus 100% financing at low, low interest rates . . . fair



tax climate . . . four-season livability . . . give WESTern PENNSylvania a top combination of plant-location values.

WEST PENN POWER

an operating unit of ALLEGHENY POWER SYSTEM

Area Development Department, Room 663
WEST PENN POWER—Greensburg, Pa. 15602
Phone: 412—837-3000

In strict confidence, I'd like to know more about WESTern PENNSylvania's: Pre-Production Training Financing Plans Fair Tax Climate Industrial Properties and Shell Buildings
 Please have your Plant Location Specialist call.

Name _____
Title _____
Company _____
Address _____
City _____ State _____
Code _____ Phone _____

New Subassemblies and Systems

System power supplies with fixed output

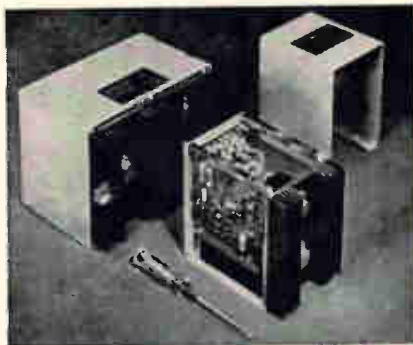

A series of fixed-output, d-c system power supplies, called Systematics, feature Mil-Spec construction, a completely field-repairable design, and integrated heat exchangers that eliminate the need for additional external heat sinks.

Open, easy-access design is based on all-silicon solid state circuitry, with 90% of the components incorporated on one plug-in printed-circuit board that can be easily and quickly removed and replaced by an identical unit in the event of damage to the power supply. This feature permits field repair, eliminating high cost of complete replacement required when sealed or encapsulated units are damaged and must be discarded.

Completely self-contained and self-cooled, Systematics do not require additional, space-consuming external heat sinks that add costs and labor to installation and often result in an inefficient thermal path that limits the life and efficiency of a sealed unit. All heat-sensitive components are mounted directly on high-efficiency heat sinks in the power supply for optimum heat transfer.

Systematics are available in 84 standard off-the-shelf models with fixed outputs spanning the output voltage range of 1 to 100 v at current ratings from 0.3 to 12 amps. All-silicon, transistor-regulated circuitry maintains regulation at 0.025%, holds ripple and noise to 1 mv rms maximum. Class F high-reliability, epoxy-encapsulated, low-loss transformers with elec-

trostatic shields are included in the circuitry which has been conservatively designed for optimum reliability without resorting to critically matched or selected semi-conductors.

All models feature special control circuits to permit finite voltage adjustment within $\pm 10\%$ of the rated fixed output by means of locking type potentiometers accessible from the outside for screwdriver adjustment. Each model includes remote sensing capability and automatic electronic current limiting for protection against overloads and short circuits. Cover enclosures that permit removal of the power supply without demounting the enclosure from its installed position are optional.

Prices start at \$89.50. Delivery is from stock.

Perkin Electronics Corp., 345 Kansas St., El Segundo, Calif. [380]

Deflection amplifier in modular package

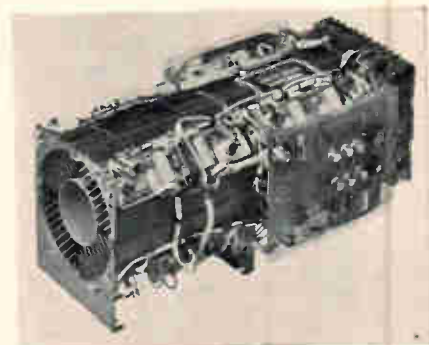

Model DA 105 deflection amplifier is an all silicon, solid state modular package featuring high deflection performance characteristics at low cost. It is designed for application in any crt or storage tube display system employing magnetic deflection.

The amplifier is capable of supplying up to 12 amps of deflection current to a directly-coupled deflection coil. The module comprises two identical channels of power amplification, one for X deflection and one for Y deflection.

The new unit is a d-c coupled operational-type difference ampli-

fier. It features excellent linearity, wide bandwidth and stable operation. Since the amplifier is d-c coupled throughout, it may be utilized in random point plotting or alphanumeric deflection applications as well as for raster or other periodic scan formats. Centering, off-set, geometry correcting and other inputs may be introduced with ease at the summing point of the difference amplifier stage.

The input of the model DA105 deflection amplifier is designed to be compatibly coupled to the output of the model SG415 sawtooth generator. The amplifier is also fully compatible with all other modular display systems components manufactured by the company.

Beta Instrument Corp., 377 Elliot St.,
Newton Upper Falls, Mass., 02164.
[381]

Transducer modules work with wattmeters

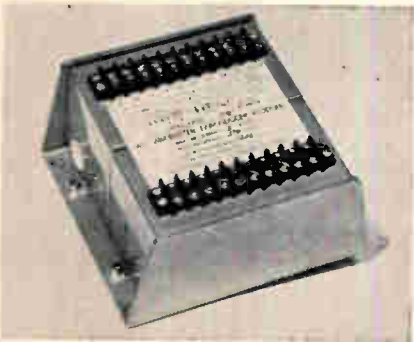

Prepackaged modules have been developed that enable panel meters or meter-relays to function as indicating or controlling wattmeters. The new wattmeter transducer modules are available in three basic types: single-phase; three-phase, three-wire; and three-phase, four-wire.

The manufacturer furnishes special panel meters and optical meter-relays for operation with the transducer modules. Meters and transducers are calibrated together. Meter movements are rated at 50 to 100 mv d-c.

Standard ranges for 60-cycle measurement begin with 0 to 500-w full scale for single-phase transducers, with a top range of 0 to 4,000 w. For three-phase, three-wire transducers, ranges go from

extflex*



*An absolutely fictional word we dreamed up to drive home the extreme flexibility of Phelps Dodge Electronics Miniature Coaxial Cable. While the best competitive cable lasted only 55 minutes on flexing test, ours was vibrated at resonance for 7 hours before the sheath cracked.

Construction consists of a silver plated Copper-weld inner conductor, a Teflon TFE dielectric and solid, flexible copper sheath. Available, from stock, in diameters of .070", .085" and .141", in lengths up to 200', special diameters can be built for your special needs.

Here's the answer for small cable requirements in low noise amplifiers, microwave transmission, high-speed computers and a wide range of instrument sheath applications. For very low attenuation across Gc band, ease of stripping and joining, low VSWR, no radiation, and high performance in environmental extremes, think PDE Miniature Coaxial Cable.

Write for fully descriptive Bulletin Mc, Issue 1.

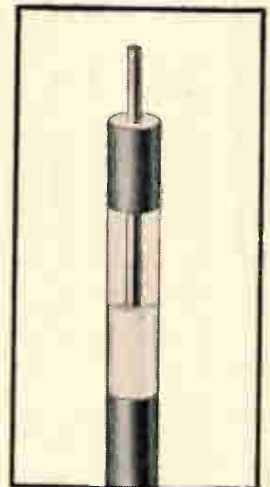

PHELPS DODGE ELECTRONIC PRODUCTS
NORTH HAVEN, CONNECTICUT



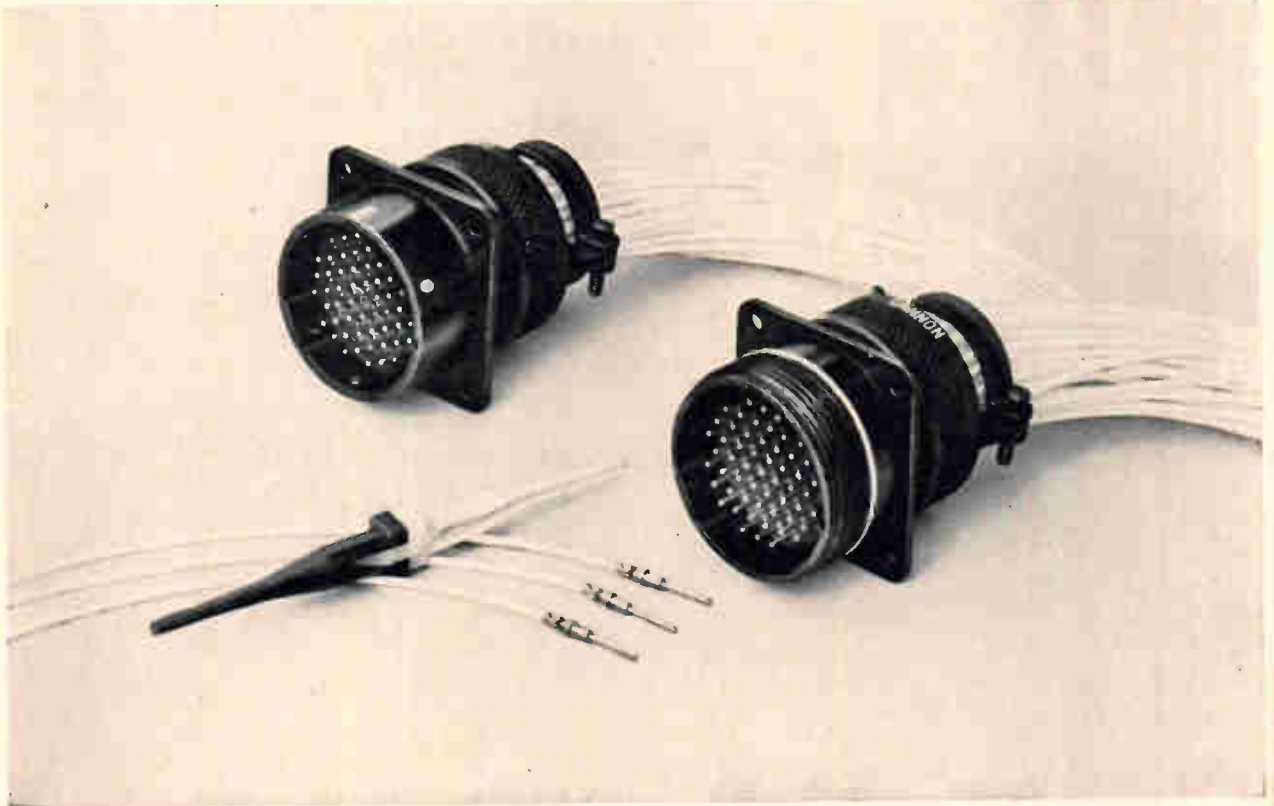

KV/PV series qualified to NAS 1599 for critical environmental applications

- KV/PV intermates with MIL-C-26500 and MIL-C-26482 type connectors offering improved design, reliability and performance characteristics.
- Upgrades systems to higher performance standards without costly investment or complete circuit design changes.
- Now in use throughout the industry in critical applications on such vital programs as Apollo and Minuteman.
- Features the universally-accepted "LITTLE CAESAR"™ rear release contact assembly.
- Significant inventory cost savings accomplished through connector standardization.

NAS 1599 combines into one industry specification the best features of two existing military specifications. The KV/PV Series provides superior reliability where it counts most . . .

POSITIVE CONTACT MATEABILITY
IMPROVED CONTACT STABILITY
STRONGER, SIMPLIFIED CONTACTS

Utilizing the same contacts, backshells, accessories, military crimping tool and free expendable insertion/extraction tool, both the KV and PV reduce costly inventories and lessen user assembly training time. The feature of intermateability supports military and industry design needs and the economy aims of all government agencies.

For information on complete 1599 line, including hermetics and test plugs, write to: ITT Cannon Electric, 3208 Humboldt St., Los Angeles, Calif. A division of International Telephone and Telegraph Corp.



ITT CANNON

Take a look at our family...



We've got lots of daughters and they're looking for dates. We can arrange a "wedding" to your specifications . . . quickly and with only a small dowry on your part. If you see a member of our family you'd like to know better . . . call one of our "kinfolk" in your neighborhood (see column at right) or get in touch with our "home" in Wheeling (Ill.).

*Registered trademark—DuPont Co.
 **Registered trademark—Precision Paper Tube Co.



Precision

Paper Tube Company

Divisions: Resinite • Buckeye Bobbin • Automation Devices

1033 S. Noel Ave., Wheeling, Ill. Phones: Chicago: 631-1445 • Long Distance: 312-537-4250, TWX: 312-537-5202

our "kinfolk" are
spread far and wide
to serve you . . .

EASTERN STATES

(N.Y. City—South)
H. Wm. Bauer,
234 Terrace Ave.,
Jersey City, N.J. 07307
201-795-2480

E. MICHIGAN, OHIO, W. NEW YORK

John F. Kirby, Jr.,
11120 Riveredge Dr.,
Parma, Ohio 44080
216-886-1221

NEW ENGLAND N.E. NEW YORK

Walter S. Peterson,
Box 17, Station 1,
E. Natick, Mass. 01760
617-653-3855

S. ILLINOIS, MISSOURI

Tanler and Company
7720 E. Big Bend Blvd.,
St. Louis, Mo. 63119
314-645-0590

KENTUCKY

Packaging Service Corp.,
3001 W. Madison St.,
Louisville, Ky.
502-778-5565

MEXICO

Industrias Comerciales,
S.A.,
Medellin No. 184,
Mexico 7, D.F.,
14-65-58, 14-65-66

ENGLAND

Langley London Ltd.,
Kelvin Way
Crawley, Sussex
Crawley 25955

CANADA

The Glendon Company Ltd.
—Suite No. 4—603 Evans Ave.,
Toronto 14, Ontario, Canada,
416-255-5001
—P.O. Box 101
Ile Perrot Sud, Quebec
514-453-6375

MOUNTAIN & WEST COAST

Electrical Specialty Co.
with offices in: Denver,
Phoenix, Los Angeles,
San Francisco, Portland,
Seattle.

No. ILL., WISC., IOWA,
MINN., W. MICH., INDIANA
(AND BALANCE OF U.S.)

PRECISION PAPER TUBE CO.

1033 S. Noel Ave.,
Wheeling, Illinois 60090
Chicago: 631-1445, Long Dist.:
312-537-4250, TWX: 312-537-5202

Electronics | April 4, 1966

New Subassemblies

strobe time. Therefore, effective playback signal is twice the amplitude of that produced by other recording methods.

The model 52 system comprises two separate items: the magnetic drum, measuring 11 x 11 x 15 in., and mounted on four shock mounts; and associated circuits, mounted on a standard module chassis.

Vermont Research Corp., Precision Park, North Springfield, Vt., 05150. [383]

Digitally programed d-c power supply

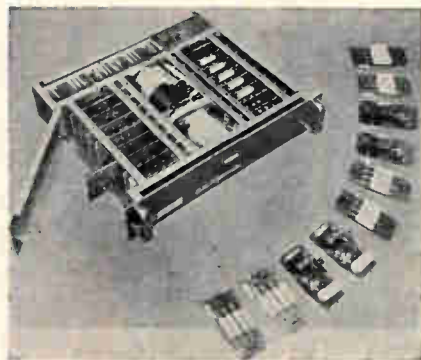

The DCP 800 is a high performance, solid state d-c power supply with exceptional versatility. It is a digitally programed unit suitable for automatic test equipment. It provides automatic changeover from regulated voltage to regulated current. Power supply and load may be spaced widely apart. Ranges are from 0.001 v to 100 v d-c in 1-mv increments, and current from 1 μ a to 1 amp in 1- μ a steps. Individual plug-in cards are available for reference supplies, amplifiers and voltage and current decades. Standard input is a 1-2-4-8 binary code for both current and voltage.

Flexibility of the design permits making the DCP800 a constant current/constant voltage unit, or altering it to be a constant voltage with current limiting or a constant current with voltage limiting supply. A multifunction power supply, the DCP800 can be programed in any number of voltage current combinations and is adaptable to other configurations of current or voltage

Number ONE Choice PERMACOR® for Every Electronic Powdered Iron Core Need...

There are many reasons why Permacor ranks as number one producer of iron cores. Experience, facilities and dedication to quality, are but a few of them. Whether your iron core needs are standard stock, or custom crafted, look into Permacor capabilities today.

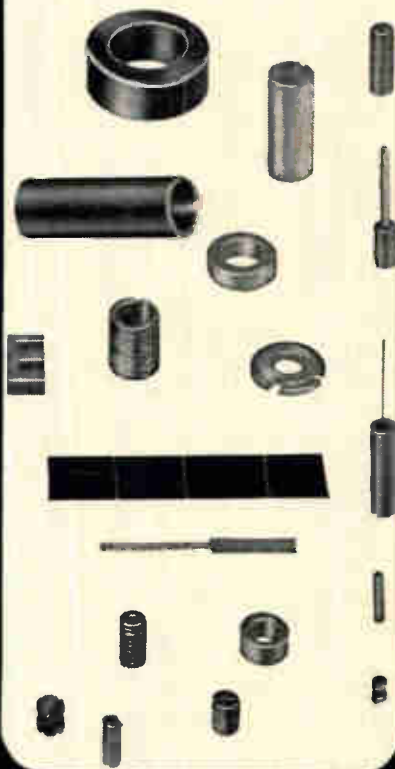

PERMACOR®

A Division of Radio Cores, Inc.

9540 Tulley Ave., Oak Lawn, Ill.

Phone: 312 — HI 5-5733

MAGNETIC TAPE DEGRADATION CAN BE PREVENTED DURING STORAGE OR SHIPPING . . .

with **NETIC CONTAINERS**



Widely adopted for military and industrial use since 1956, Netic Containers protect your valuable tapes from unpredictable, distortion-producing magnetic environments. Long life rugged containers withstand the rigors of repeated shipment. Available in a variety of shapes and sizes to solve your shipping or storage problems . . . they're non-retentive, impervious to shock or vibration, and require no periodic annealing.

A low cost form of insurance . . . the loss and inconvenience avoided are incalculable. Request Manual 106.

MAGNETIC SHIELD DIVISION

Perfection Mica Company

1322 N. ELSTON AVE., CHICAGO, ILLINOIS 60622

ORIGINATORS OF PERMANENTLY EFFECTIVE NETIC CONTAINER MAGNETIC SHIELDING

Circle 459 on reader service card

Metronix

**REGULATED
DC
POWER
SUPPLIES**

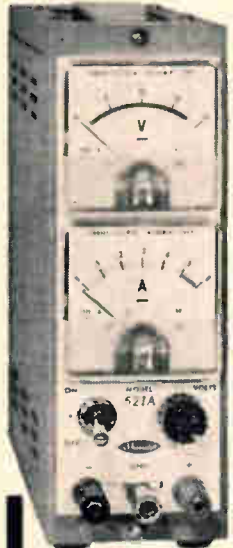

MODEL
521A

RIPPLE: 3mVp-p

MODEL	VOLTS	AMPS	REGULATION (line or load)
521A	1~18V	0.5A	± 20mV
541A	1~35V	0.25A	± 20mV
543	1~35V	0.5A	± 20mV
531B	0~35V	1A	± 10mV
535C	0~35V	5A	± 3mV

Metronix **Metronix corp.**

76, CHOFU-CHIDORI-CHO, OTA-KU, TOKYO, JAPAN



Revolutionary electronic calculator

- Unmatched speed, versatility
- Simple to operate
- Single keystrokes provide all these functions

+ - ÷ x x² √x e^x log_ex

- Two independent accumulators for random data entry and retrieval
 - **LOW PRICE — FROM \$1690 to \$2095**
- Additional keyboard units from \$450
- Time sharing units also available
- Write for complete details



WANG
LABORATORIES, INC.

Dept. HH-4, 836 North St., Tewksbury, Mass. 01876
Tel. (617) 851-7311

Circle 460 on reader service card

New Subassemblies

limiting. Down time, maintenance time and obsolete power requirements are cut to a minimum—all being corrected by the simple, easy plug-in boards.

The Rowan Controller Co., Eatontown, N.J., 07724. [384]

Silicon solid state power amplifiers

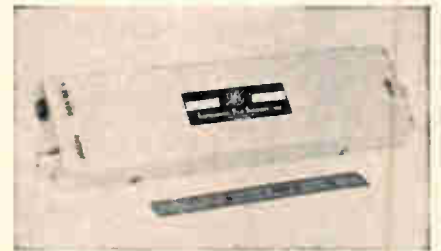

A series of low-noise, silicon solid state, wideband power amplifiers provide a minimum of 1 watt c-w into 50 ohms over 10 kc to 100 Mc without tuning. Power gain of the model 2100 is 50 db minimum. Frequency response is ±1 db at full power output. Input impedance is 50 ohms nominal.

Variations in the model 2100 series allow for higher power output, power gain to 60 db and input impedances to 1 megohm. Price of the basic model 2100 is approximately \$1,500; availability, 45 days.

Instruments for Industry, Inc., 101 New South Road, Hicksville, N.Y. [385]

Electromechanical time code generators



Two series of low-cost electromechanical time code generators have been announced. Both are of modular construction and fit in a standard 19-in. rack and panel mount. The K42601 series supplies time information in straight dec-

inal switch patterns, and the K42602 series provides binary coded decimal.

These units can supply digital time inputs to data handling systems, digital computers, illuminated time displays, telemetering systems, tape punchout devices, checkout equipment, and direct printout devices.

Seven standard models with various combinations of readouts in seconds, minutes, hours, and days are available in either series. Visual display is obtained from counters with $\frac{3}{16}$ -in. white characters on a black background. Settings are made by wheels with knurled o-d's for easy rotation.

All units operate from a standard 115-v, 60-cps supply. Time base is an integral, synchronous motor-driven repeat cycle timer. Up to 50-ma loads can be handled. Minimum life is one year at rated load.

Units can be modified to provide special code outputs, if required. The A.W. Haydon Co., 232 N. Elm St., Waterbury, Conn., 06720. [386]

Pulsed laser system is solid state

Model 1401 is a complete pulsed-gallium-arsenide-laser system, including power supply. The laser operates at room temperature and radiates at least one watt peak power when pulsed between 0.1 and 1.0 kc.

All solid state electronics for pulsing the diode is self-contained. Current pulses of 100 amps for 100 nsec are generated.

Output light is at a wavelength of approximately 9,000 angstroms and the bandwidth is approximately 150 angstroms. The beam is collimated (or may be focused) by means of a lens at the end of the package. A standard $\frac{3}{8}$ -in. rod is provided for optical bench mounting. Price of the model 1401 is \$750.

Austin Electronics Corp., P.O. Box 9312, Austin, Texas, 78756. [387]

Precision frequency power supply

Model 6B precision frequency power supply is ruggedly built, and

Leading cable makers coast-to-coast demand

tough



If **Scotchpar**[®] polyester film is tough enough for cable... how about your needs?

From Anaconda Wire & Cable Co. in New York, to Western Insulated Wire Company in Los Angeles, cable makers across the country pick tough "SCOTCHPAR" polyester film. It serves as a barrier, separator, insulator and manufacturing aid. Think how well "SCOTCHPAR" film could serve your needs. It combines outstanding dielectric properties with physical strength and resistance to moisture and solvents. It stays stable over a wide range of temperatures. It won't get brittle with age. Resistant to oils, impregnants, varnish, refrigerants. It's inert to fungus. Won't corrode copper. There is a thickness and type of "SCOTCHPAR" film to meet your exact requirements. Call or write: Film & Allied Products Division, 3M Co., 2501 Hudson Rd., St. Paul, Minn. 55119, Dept. ICL-46.

3M
COMPANY

BUSS SHIELDED FUSEHOLDERS

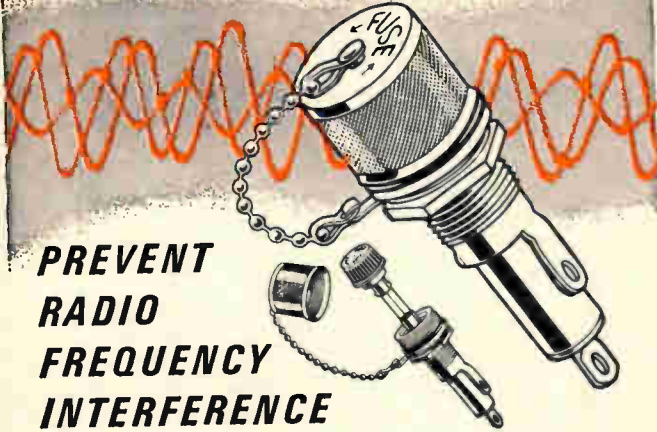

**PREVENT
RADIO
FREQUENCY
INTERFERENCE**

For use where fuse and fuseholder could pick up radio frequency radiation which interferes with circuit containing fuseholder—or other nearby circuits.

Fuseholder accomplishes both shielding and grounding.

Available to take two sizes of fuses— $\frac{1}{4} \times 1\frac{1}{4}$ " and $\frac{1}{4} \times 1$ " fuses. Meet all requirements of both MIL-I-6181D and MIL-F-19207A.

Write for BUSS Bulletin SFH-12

INSIST ON **BUSS**
QUALITY

BUSSMANN MFG. DIVISION, McGraw-Edison Co., ST. LOUIS, MO. 63107

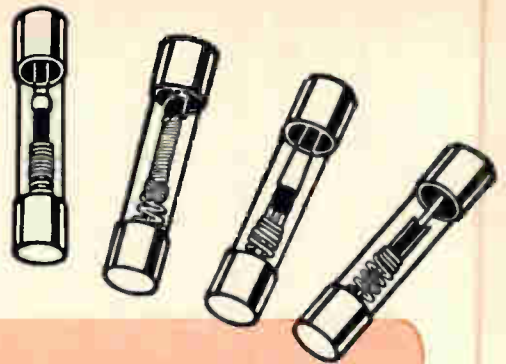

FUSETRON
dual-element Fuses
slow blowing

Write for
BUSS
Bulletin SF3

"Slow blowing" fuses prevent needless outages by not opening on harmless overloads—yet provide safe, protection against short-circuits or dangerous overloads.

INSIST ON **BUSS**
QUALITY

BUSSMANN MFG. DIVISION, McGraw-Edison Co., ST. LOUIS, MO. 63107

BUSS: The Complete Line of Fuses and . . .

Circle 212 on reader service card

Circle 212 on reader service card

**COOL
LIQUIDS
TO -23°C
ANYWHERE**



BLUE M *Constant Flow*
(Patented)

PORTABLE COOLING UNITS

Compact, convenient, efficient method of obtaining cooled liquids at exact temperature for direct testing or recirculation to auxiliary equipment. New patented principle permits rapid cycling . . . control to within $\pm 0.15^\circ\text{C}$. Compressor runs constantly . . . lasts longer. Exclusive no-load starting avoids overload stopping and manual reset. Four models . . . two capacities.

SEND FOR FULL INFORMATION

Clip ad to your signed letterhead for full details and low prices.



BLUE M *Electric Company*

138th & Chatham Streets

Blue Island, Illinois

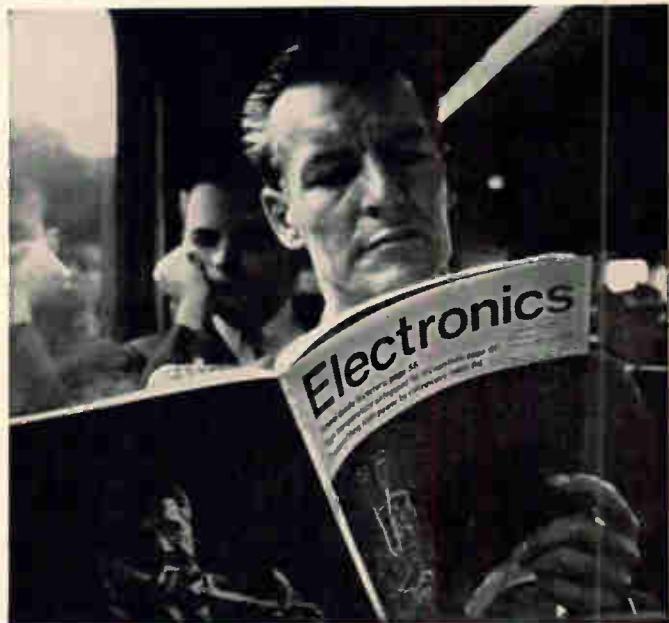

**Great editorial is
something he takes to work**
(What a climate for selling!)

Electronics

A McGraw-Hill Market-Directed Publication
220 West 52nd Street, New York, N.Y. 10019



New Subassemblies

can provide tens of thousands of hours of trouble-free, dependable 115 v a-c power at 60 cps. It can be used to power many 115 v a-c devices, up to 250 w, where the frequency of the power is critical and requires extremely accurate regulation. Its rugged design plus modern techniques in use of solid state regenerative divider chains along with the precision built crystal control oscillator, maintain a frequency accuracy of 1 part in 10^{-9} per day.

One of the prime functions of the 6B is to provide and maintain an accurate a-c power source to power the manufacturer's time-of-day announcement equipment. The 6B is equipped with an output frequency correction feature so that minor adjustments in time can be easily made. With this unit, it is no longer necessary to rely on local station or

utility power for operation of the time-of-day equipment.

The Audichron Co., 721 Miami Circle, N.E., Atlanta, Ga., 30324. [388]

IC core memory offers easy cabinet access

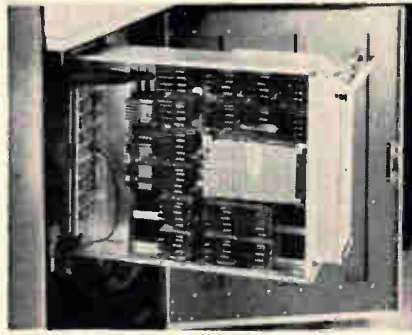

One- μ sec cycle time, 500- μ sec access time, plus availability in capacities from 4,096 x 6 bits to 16,384 x 84 bits are some of the

features of the ICM-40 core memory. The 5¼ in. high ICM-40, originally designed to mount horizontally, is now available with new hardware for vertical mounting in a standard 24 in. deep x 19 in. wide cabinet. In the vertical configuration, the memory module swings out, tilts and locks for easy access to the module side or the wire wrap side for testing, module replacement or inspection.

Because of its 5¼-in. dimension, the ICM-40, which provides ¼ million bits of storage, can be interleaved with other vertical modules for more efficient packaging density without sacrificing accessibility at the front of the cabinet. For example, three vertical mounted ICM-40 units provide 4K x 84, 8K x 84 or 16K x 42 bit size memory capacity and at the same 1- μ sec cycle time as the horizontal unit.

Computer Control Co., Inc., Old Connecticut Path, Framingham, Mass., 01702. [389]

Fuseholders of Unquestioned High Quality

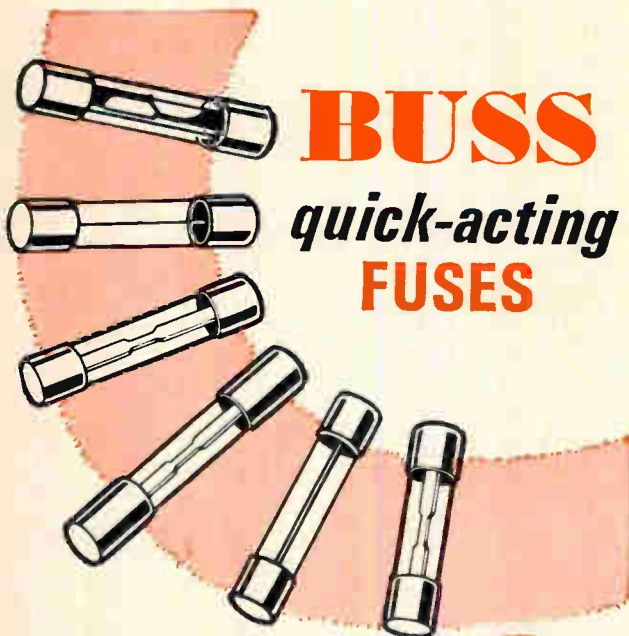

BUSS quick-acting FUSES

"Quick-Acting" fuses for protection of sensitive instruments or delicate apparatus;—or normal acting fuses for protection where circuit is not subject to current transients or surges.

Write for
BUSS
Bulletin SFB

INSIST ON **BUSS**
QUALITY

BUSSMANN MFG. DIVISION, McGraw-Edison Co., ST. LOUIS, MO. 63107

Circle 213 on reader service card

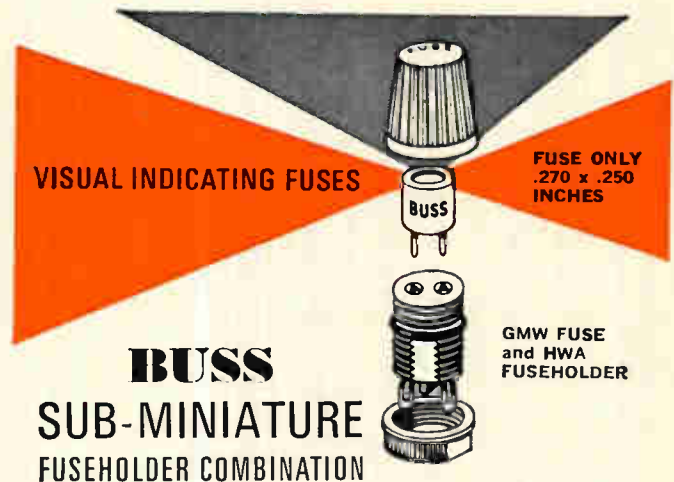

VISUAL INDICATING FUSES

FUSE ONLY
.270 x .250
INCHES

BUSS SUB-MINIATURE FUSEHOLDER COMBINATION

GMW FUSE
and HWA
FUSEHOLDER

For space-tight applications. Fuse has window for inspection of element. Fuse may be used with or without holder.

Fuse held tight in holder by beryllium copper contacts assuring low resistance.

Holder can be used with or without knob. Knob makes holder water-proof from front of panel.

Military type fuse FM01 meets all requirements of MIL-F-23419. Military type holder FHN42W meets all military requirements of MIL-F-19207A.

Write for **BUSS** Bulletin SFB

INSIST ON **BUSS**
QUALITY

BUSSMANN MFG. DIVISION, McGraw-Edison Co., ST. LOUIS, MO. 63107

Circle 213 on reader service card 213

Distinctively Styled



1½ in. AM-1 (actual size)

high torque, self-shielded panel meters

Clean, modern styling... easy scale readability... sizes 1½ to 4½". High torque mechanism gives 1% linearity, 2% accuracy and sensitivity to 20 μ a. Magnetic system completely shields external field influences, permitting bezel-to-bezel mounting on any material without interaction or effect on calibration. Choice of colors or finishes, custom dials—ASA/MIL 4-stud mtg.

AMMON

AMMON INSTRUMENTS, INC.
345 Kelley Street, Manchester, N. H. 03105

Circle 462 on reader service card



FREE!

44-PAGE CATALOG ON BLOWERS, FANS PACKAGED COOLING

Here's the largest and best line of cooling equipment: Venturi fans • Propeller fans • Centrifugal blowers • Packaged blowers • RFI-shielded Mil-Spec • Commercial • Long-life, High-quality • Low-cost.

McLean Engineering Laboratories,
P. O. Box 228, Princeton, N. J. 08540
Phone 609-799-0100,
TWX 609-799-0245, TELEX 083-4345.

214 Circle 214 on reader service card

New Microwave

Single knob tunes low-noise klystron

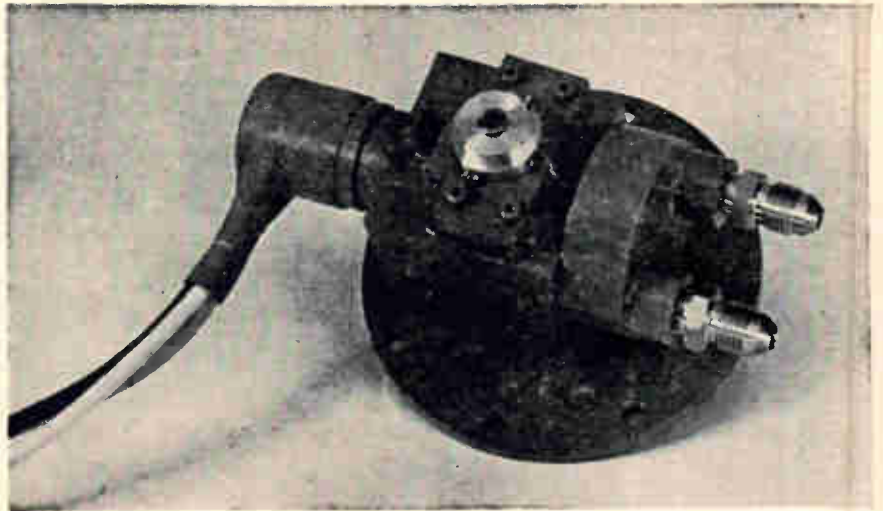

Low noise, single-knob tuning and high power output are features of a family of two-cavity klystron oscillators introduced by Varian Associates of Palo Alto, Calif. Varian claims that its VA-521 series has the lowest noise output of any klystrons in this power range—2 to 10 watts. Designed for doppler radar applications, the tubes have the added advantage of simple tuning. They operate in C band at center frequencies of 5.5 to 7.0 gigacycles per second.

In doppler radar systems, for example a side-looking radar for ground mapping, tube noise modulates the frequency of the oscillators, thus reducing the resolution capabilities and sensitivity of the system.

To generate a signal without frequency modulation, the VA-521 is designed to minimize sources of noise within the tube. A low-current electron beam is used to reduce shot noise. In some klystrons, grids are used in the gaps of the cavities to increase the coupling between the beam and the cavity. The VA-521 series operates without these grids, eliminating the noise caused by the interception of electrons by the grid. Ion traps, which are required to prevent a space charge around the grid, are also eliminated, avoiding another

source of noise.

The noise output of the VA-521 is equivalent to a frequency deviation of 0.3 cps. By comparison, a gridded two-cavity oscillator has a noise output equivalent to a 1 to 2 cps deviation. These noise measurements are equivalent to the root mean square voltage measured in a 1-kilocycle bandwidth at the output of a frequency discriminator. The measurement is made at a frequency separated 30 kc from the carrier.

A single knob controls a diaphragm that simultaneously tunes both cavities over a ± 50 Mc minimum range. Strongly overcoupled cavities prevent small errors in the tracking of the resonant frequency of each cavity from appreciably affecting the r-f output. In tubes with critically or weakly coupled cavities a tracking error between cavities can cause the tube to drop out of oscillation.

Although low-noise tubes generally have low power outputs, the VA-521 series can provide at least 2 watts and as much as 10 watts of stable radio-frequency power. This relatively high power output requires that the klystrons be liquid cooled. A typical tube, the VA-521A, operates at 5.5 Gc and delivers 2 watts output at 4 kilovolts d-c beam voltage and 33 milliam-

peres d-c beam current.

Each VA-521 is warranted for a life of 1,000 hours. Standard models can be delivered in 60 to 90 days.

Specifications

Series	VA-521
Frequency range	5.5-7.0 Gc
Tuning range	±50 Mc
Power output	
Minimum	2 watts
Maximum	10 watts
Tuning	Mechanical

Varian Associates, 611 Hansen Way, Palo Alto, Calif. 94303 [391]

Dual-frequency microwave antenna

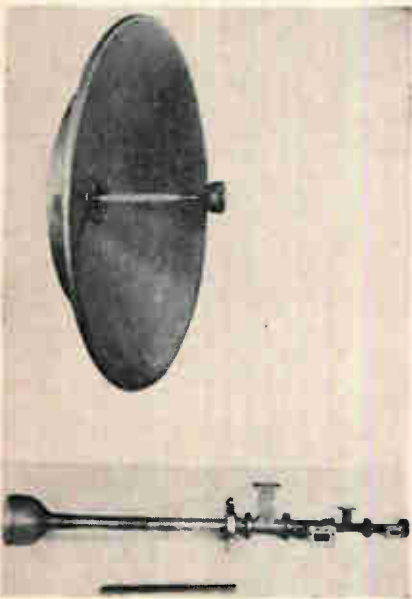

A four-port rear-fed microwave antenna is available with mechanical features and electrical characteristics as good or better than the manufacturer's front-fed design. The dual-frequency antenna allows simultaneous dual polarized operation in both the 6 Gc and 11 Gc bands with the use of a single parabola.

The antenna consists of a slender cylindrical feed equipped with a small fiberglass cap to protect the feed aperture and splash plate. An external full radome enclosure is not required in direct radiator applications. The feed is easily insertable from the rear of the antenna dish. It will meet all wind-loading and environmental specifications required of ordinary front fed commercial and public utility antennas.

While vswr at both bands is

MEC's pioneering efforts in high power TWT technology produced the first practical 100-watt traveling wave tubes. Now MEC has doubled power output! This C-band TWT delivers a healthy 200 watts across its full octave frequency, 4-8 GHz. It's a dependable 200 watts, too, because MEC's unique method of mounting the helix provides adequate heat dissipation. Like all MEC high power TWTs, the new 200-watt tube features PPM-focusing, rugged metal ceramic construction, depressed collector operation, low cathode loading and use of a dispenser cathode to assure long operating life. Applications? ECM, communications, troposcatter systems.

MEC is now delivering TWTs which provide from 20 to 200 watts of CW power over octave frequency ranges at S, C and X-bands. Many will meet military system requirements. For details, please contact your MEC engineering representative (listed in EEM) or write to us. Internationally, contact Frazar and Hansen, Bern, Switzerland.

Exceptional opportunities on our technical staff for qualified engineers and scientists. An equal opportunity employer.

ANOTHER HIGH POWER FIRST: 200 WATTS CW BROADBAND

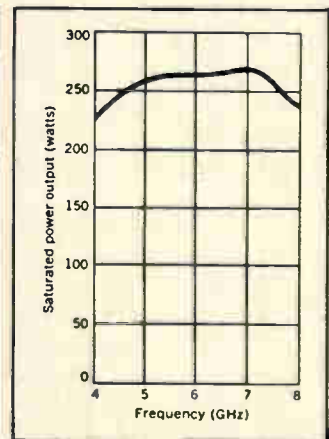
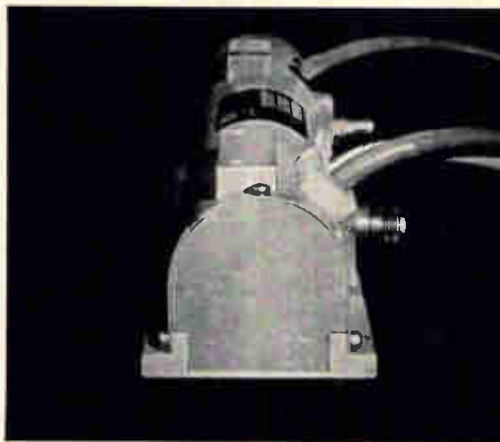

Microwave Electronics

3165 Porter Drive
Palo Alto, California

a division of Teledyne, Inc.

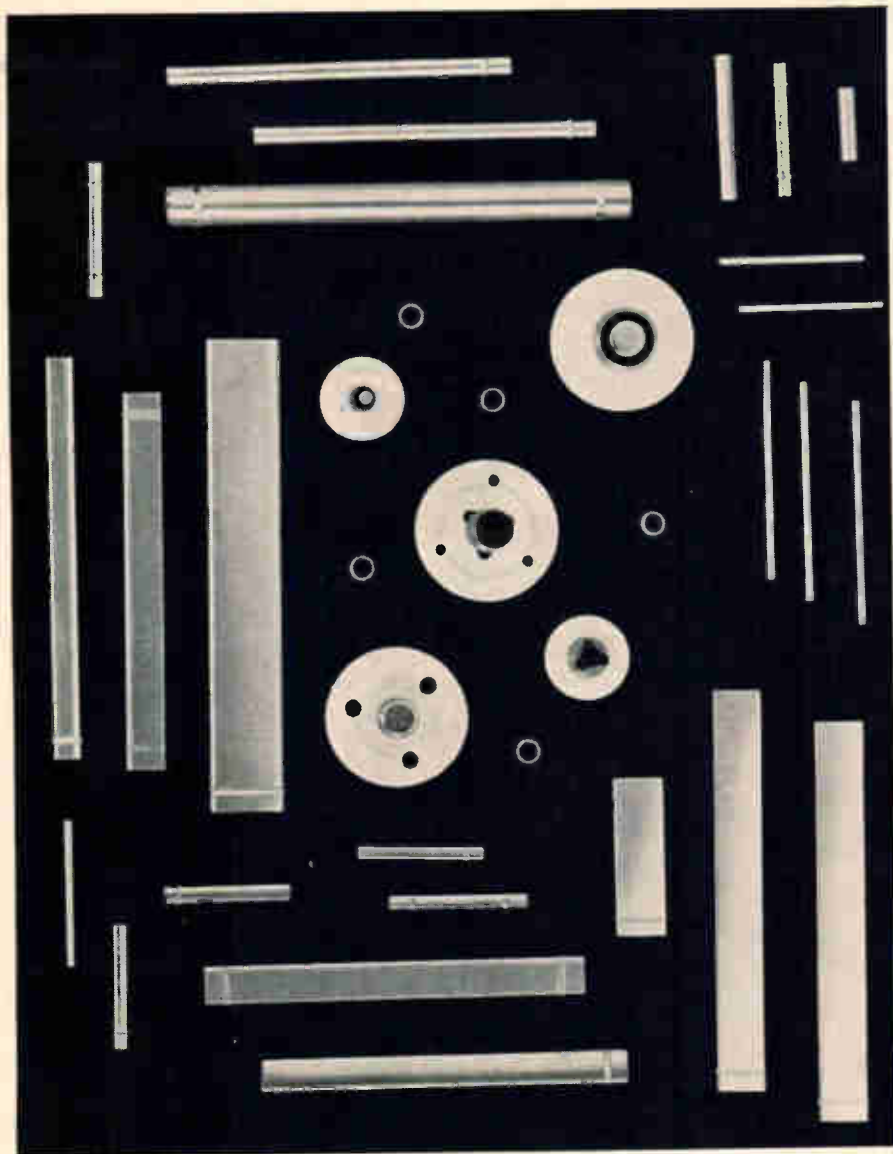

YES, WE ARE INDEPENDENT!

We Are The World's Leading Independent Maker of Nickel Cathodes.

Every cathode that we fabricate is for our customers. And we have two large plants that are producing a variety of cathodes including seamless, Weldrawn, disc, lockseam and lapseam.

Superior offers you cathodes in a wide choice of materials for your most exacting requirement. We are pioneers in creating new designs and in developing and using new materials for improved performance.

Do you have a copy of Superior Catalog No. 51? Send for it today. Dept. 2500.

Superior Tube 

The big name in small tubing

NORRISTOWN, PA. 19404

West Coast: Pacific Tube Company, Los Angeles, California

Johnson & Hoffman Mfg. Corp., Carle Place, N. Y.—an affiliated company making precision metal stampings and deep-drawn parts

New Microwave

consistently being measured at 1.13, the manufacturer expects production units to run in the order of 1.15.

Gabriel Electronics, division Maremont Corp., North St., Saco, Me. [392]

Uhf circulators cover broad band

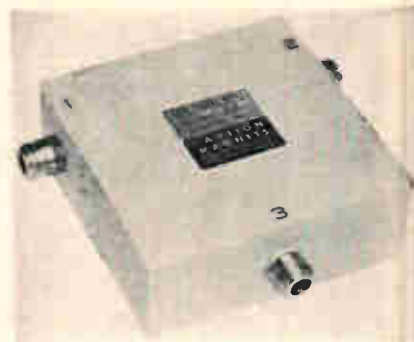

Uhf coaxial circulators cover a two-octave range from 250 Mc to 1 Gc with four units. The units provide excellent electrical characteristics over a minimum bandwidth of 33 1/3%.

Typically, the model V25T has isolation of 17 db minimum, insertion loss of 0.6 db maximum, and vswr of 1.30 maximum over the frequency range of 250 to 350 Mc.

Price is available on request; delivery, 30 days after receipt of order.

E & M Laboratories, 7419 Greenbush Ave., North Hollywood, Calif. [393]

Transmission-type noise generator

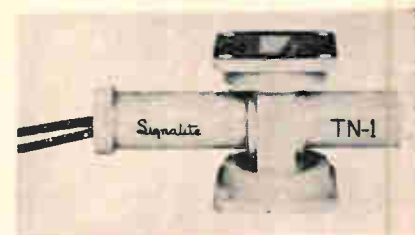

A miniature transmission-type, 90° E-plane noise generator, type TN-1, is designed for use from 8.5 to 9.6 Gc in systems where space and weight are at a premium. With low non-operating insertion loss and

vswr, it is intended for system use directly in the receiver line of X-band systems.

The unit is especially suitable for airborne and shipborne systems that have limitations on available drive power and which require rugged components with long operating life. The thermionic, but still single-ended, cathode in the tube permits a two-lead construction for the complete noise generator while simultaneously providing a low tube drop with subsequent low operating power requirements.

Typical specifications include 900-v starting spike, nominal operating voltage of 55 v at 100 ma current, excess noise ratio of 14.5 \pm 0.5 db with an operating vswr of 2.1 max, and a cold vswr of 1.25 max. Length along the waveguide axis is less than 2 in. and height of the tube holder section, perpendicular to the waveguide axis, is 4 in. The entire unit weighs only 4 oz.

Signalite Inc., 1933 Heck Ave., Neptune, N.J. [394]

Pump tubes available for masers, paramps



Reflex klystron oscillators, designated the VA-254 series, serve as pump tubes for masers and parametric amplifiers. Well-suited for airborne use, this durable reflex klystron delivers at least 150 mw into a matched load over its entire 1,000-Mc tuning range. Tubes are available for any specific center frequency between 18 and 26.5 Gc. Tuning is mechanical.

Hermetically sealed, the VA-254 oscillator not only operates at high altitude without pressurization, but it can also be cooled by liquid im-

SEE TOMORROW'S TECHNOLOGY-TODAY!

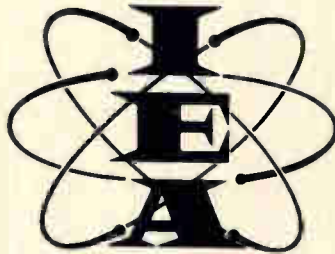

SIXTH INTERNATIONAL INSTRUMENTS ELECTRONICS AUTOMATION EXHIBITION

OLYMPIA LONDON
ENGLAND

23-28 MAY 1966

The International Instruments, Electronics and Automation Exhibition is the technological show of the future—today. The most significant exhibition of the year, IEA focuses at Olympia the achievements of 800 international firms in the vanguard of scientific industrialisation. Catholic in scope, IEA ranges the whole field of instrumentation, electronics and automation.

For your free Official Invitation Card and further details contact:



INDUSTRIAL EXHIBITIONS LIMITED 9 ARGYLL STREET LONDON W1 ENGLAND

NEW WANLASS R-3200 VOLTAGE REGULATORS

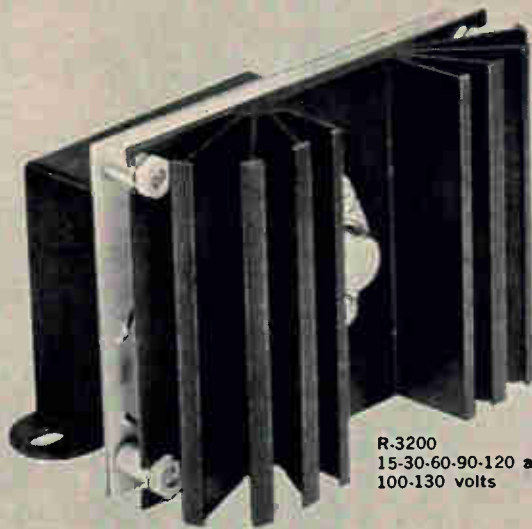

R-3200/60
REGULATOR
PATENTS PENDING

R-3200
15-30-60-90-120 and 250 va
100-130 volts

**NOW . . . A 1% LINE AND LOAD REGULATOR
WITH MICROSECOND RESPONSE
and 47-63 CYCLE OPERATION**

- Economy* • *Small size* • *Light Weight*
- Power factor insensitive* • *Current overload protection*
- No phase shift* • *All solid state* • *Optional 400 cycle operation*
- *Efficiency—up 10% more in rated tests*

PRODUCT COMPARISON CHART		
	R-3200/60 60 va Unit	Typical 60 va Ferroresonant Transformer
Price	\$20.00*	\$21.00
Line Regulation	±1%	±1%
Load Regulation	±1%	—
Frequency	47-63 cps	60 cps
Power Factor	Insensitive up to ±0.7	1.0
Phase Shift	No	Yes
Response	50 μ-sec	25,000 μ-sec
Weight	2.5 lbs.	8 lbs.
Size	3x3¼ x 4 in.	3x4x5 in.**
Units to be mounted	1	2

*F.O.B. Santa Ana. Subject to change.
**Dimensions do not include separate capacitor.

The new Wanlass R-3200 Series voltage regulators are designed specifically for a wide variety of electronic instruments and equipments. Compare cost, performance, economy of operation with other competitively priced units (see table). Wanlass R-3200 voltage regulators are the ideal choice for all original equipment applications now using constant voltage ferroresonant transformers. Write today for complete technical data. Wanlass Electric Co., 2189 S. Grand Ave., Santa Ana, Calif. 92705. (714) 546-8990.

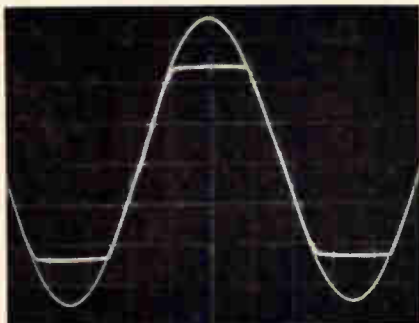

Unretouched photo shows output waveform superimposed over input. Regulation is achieved by "peak clipping."

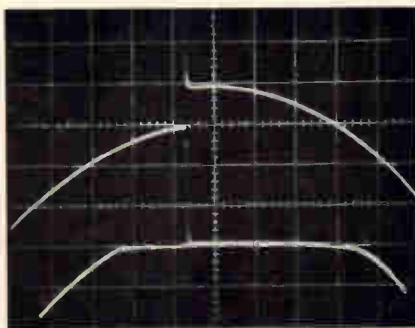

R-3200 has significant line noise suppression. Note 25-volt input change (upper) and 50 μ-second response in output (lower).

WANLASS ELECTRIC CO.



New Microwave

mersion, conduction, or forced air. Weighing only 3.5 oz, it mounts in any position.

Varian Associates, 611 Hansen Way, Palo Alto, Calif., 94303. [395]

Crystal controlled local oscillator

Model MA-8730 is a solid state, crystal controlled local oscillator that features high frequency, stability, compactness, and light weight. This 1.5-pound source operates in the 14 to 16 Gc frequency range, giving 4 mw power output with low input power drain on a single 28-v d-c supply.

Short term frequency stability is $\pm 5 \times 10^{-9}$ per 100 msec and spurious response is -30 db. The device is designed for applications in high resolution mapping radars, data link, doppler navigators, and landing navigation systems.

Microwave Associates, Inc., Burlington, Mass. [396]

Reflex klystrons feature long life

Every model in a new series of eight reflex klystrons (types YK-1070-YK1077) has a guaranteed life expectancy of 5,000 hours. All are designed for use in the output stages of microwave communications links and are mechanically and electrically similar to the international VA222 series, for which they are suitable alternatives.

They cover a frequency range of 5.925 to 8.1 Gc. Each type has a power output of 1 watt, and tuning is by screw adjustment of the external cavity. The klystrons are contact-cooled, eliminating the need for a blower and thus reducing the cost and improving the reliability of a microwave communications link. Output connections are in WR137 waveguide (British size 14).

Mullard Overseas Ltd., Torrington Pl., London, W.C1, England. [397]

Noisy components? Reject them

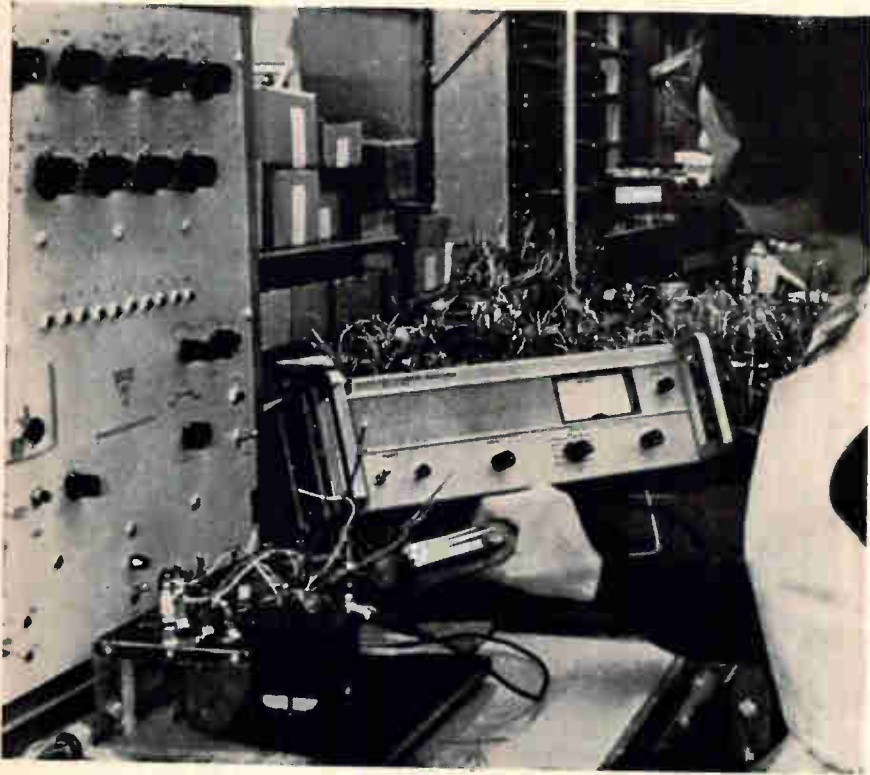

A good ear is no longer needed to tell whether an electronic component has passed the ultrasonic noise test. An improved ultrasonic detector can be set up on the production line to inspect the components and automatically accept and reject them.

Designated the Delcon 4950A Ultrasonic Translator, the tester is an outgrowth of the battery-powered detectors which the Delcon division of the Hewlett-Packard Co. makes for such applications as field-testing for leaks in pressurized telephone cables. Those detectors give an audible indication of noise intensity, requiring the operator to make a qualitative judgment of whether a fault exists.

The go-no-go tester can, for example, test the transformers of television receivers. It listens for the noise that is produced by corona discharge and high-voltage breakdown. In the photograph above, the instrument is making a corona test on a filament high-voltage transformer during a breakdown test at 3.5 kilovolts. The mid-point

on the meter indicates the rejection noise level.

The instrument will also announce detection of a fault with an indicator light, display the noise on an oscilloscope, feed the results to a recorder, or trigger relays that actuate rejection mechanisms on automatic inspection lines. It can make measurements as rapidly as 150 a minute. Also, it can be set up to ignore spurious signals resulting from harmonics of, for example, a sweep transformer's 15.75-kilocycles-per-second frequency.

Although the new model makes operator judgments unnecessary in routine use, it does have a loudspeaker for personnel training, noise identification and test setup. It is also the first Delcon model to operate on alternating current.

Two methods can be used to set up the instrument for go-no-go tests. A noise level above the ambient factory and system noise can be selected arbitrarily. This method is recommended for detecting electrical noise in transformers, capacitors and insulators, and for finding

DUAL OUTPUT POWER SUPPLIES

Guaranteed
3-DAY
Shipment!

Dual output power supplies are housed in one case 3-5/16" x 4-5/32" x 4-11/16" high. Identical or different output voltages from 1.5 to 75 are available in 1 volt increments for each of the DC outputs. The graph below furnishes maximum current corresponding to output voltage. Select the two outputs needed and telephone Acopian for all the details — plus guaranteed 3-day shipment after receipt of your order.

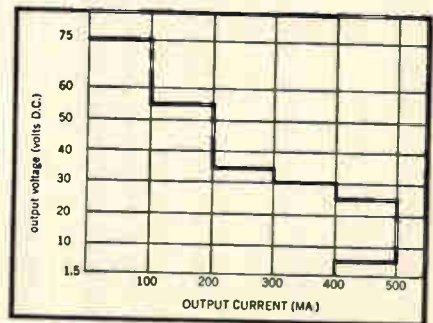

TYPICAL SPECIFICATIONS

Input Voltage: 105 to 125 VAC
Line Regulation: ± 0.5 to $\pm 0.05\%$
(depending on model)
Load Regulation: ± 1.0 to $\pm 0.05\%$
(depending on model)
Ripple: 5 to 1 mv (depending on model)
No additional external heat sinking required.

Write for Acopian's 16-page catalog and price list to: Acopian Corp., Easton, Penna., or call collect (215) 258-5441.



WHAT LIMITS
YOUR ACCURACY
IN ANALOG COMPUTATION?

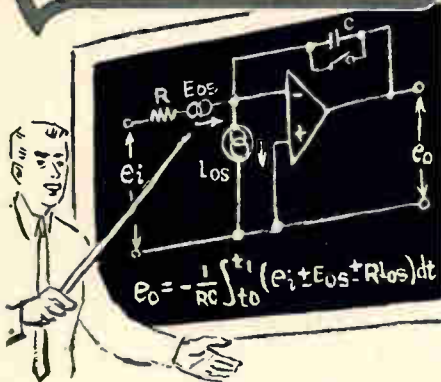

In the typical operational amplifier application shown, the output errors are a function of E_{os} , (the input offset voltage) and I_{os} , (the input offset current).

If input errors are your problem MELCOR has reliable DC operational amplifiers with extremely low E_{os} and I_{os} . Our high output ($\pm 100V$) units further help to reduce the effects of these input errors.



DC OPERATIONAL AMPLIFIER Model 1509

DC OPERATIONAL AMPLIFIER Model 1527

DC OPERATIONAL AMPLIFIER Model 1528 (Chopper Stabilized)

Worst case data on three standard models over a temperature range of -25° to $+85^{\circ}C$ and an elapsed time of four weeks

MODEL	1509	1527	1528
Saturation Output	$\pm 10V$	$\pm 100V$	$\pm 100V$
Input Offset Voltage	$\pm 250\mu V$	± 2.5 mv	$\pm 120\mu V$
Change			
Input Offset Current	± 3 na	± 200 na	± 50 pa
Change			
Maximum Output Error in % of Saturation Output Due to E_{os} , for $\frac{t}{RC} = 10$	$\pm 0.25\%$	$\pm 0.25\%$	$\pm 0.012\%$
Maximum Output Error in % of Saturation Output Due to I_{os} , for $\frac{t}{RC} = 10$ and $R = 100$ K Ω	$\pm 0.030\%$	$\pm 0.2\%$	$\pm 0.0005\%$

MELCOR's complete line of DC Operational Amplifiers range from the very inexpensive to the best State-of-the-Art Models.

MELCOR specifications are clear, unambiguous and unequivocal. We invite your inquiries and will provide clear, unambiguous and unequivocal answers. Ask for application notes TN 1001.



MELCOR ELECTRONICS CORPORATION

1750 NEW HIGHWAY
FARMINGDALE, NEW YORK
TEL: 516-694-5570

AMPLIFIERS FOR INDUSTRY

Production Equipment

leaks in pressurized or vacuum components. The other method, determining the unacceptable noise level by preliminary sample testing, is preferred for such tests as detecting excessive friction in bearings and other moving parts.

Specifications

Frequency range	36 to 44 kilocycles
Noise intensity	Zero to 90 decibels
Test probe	22° directional microphone
Sampling intervals	0.1, 0.3, 1 and 3 seconds
Recorder output	1 volt d-c full scale
Oscilloscope output	1 volt a-c full scale
Power input	115 or 230 volts, 50 or 60 cps
Price	\$1,475, immediate delivery

Delcon division of the Hewlett-Packard Co., 943 Industrial Avenue, Palo Alto, Calif. [401]

Laser welding unit for high production



A production laser welder, model 355, is announced for use in microelectronics and other high production microwelding applications. A prototype of the first generation has logged 2 million operations over the past 13 months. Model 355's repetition rate is beyond the 1 pulse per second range.

Closed cycle, liquid medium cooling of the laser cavity allows for close control of the ruby rod temperature to produce consistent laser power and flash tube life expectancy as high as 100,000 flashes. Stereo microscope or projection optics are available and an output laser beam power meter is standard. Pulse forming networks allow pulse variation over a 1 to 4 millisecond range.

Electro Powerpacs, Inc., 253 Norfolk St., Cambridge, Mass., 02139. [402]

20 to 100 μa —
no charge for
1% tracking
or taut-band



Offered only by **api**

API is the only manufacturer who offers $\pm 1\%$ tracking and frictionless taut-band construction as standard specifications for production-quantity meters, at no extra cost.

Precise tracking is the most useful attribute of a panel meter in modern electronic applications. Taut-band meters give truer readings, respond to smaller signals, resist damage from shock or vibration and do not deteriorate in operation.

Order from Stock

Best of all, API also offers quick delivery from stock of DC panel meters with the double-header bonus of taut-band plus 1% tracking.

You get all this in the most popular ranges of nine models in API's economically priced Stylist and Panelist lines (illustrated). Take your pick of these full-scale DC ranges:

Microamperes	Millivolts
0—20	0—5
0—50	0—10
0—100	

(You also get the double header in the 0-25 millivolt range, but it isn't stocked.)

If precise tracking is a real fetish with you, don't forget that API can give you 0.5% tracking at reasonable extra cost. No other manufacturer features this "super-calibration" and backs it up with catalog prices.

Bulletin 47-A describes all
API panel meters and pyrometers

api

INSTRUMENTS CO.

Formerly Assembly Products, Inc.
CHESTERLAND OHIO · PHONE 216-423-3131



give...so more will live
HEART FUND

NCC to be Sure

POLYESTER FILM CAPACITORS

Type MXT.



In Plastic Tube.
Capacitance

Range : .001 MFD to .22 MFD.
Voltages : 100v, 200v, 400v, 600v DC.

Type MFL.

dipped Flat Shape.
Capacitance

Range : .001 MFD to .47 MFD.
Voltages : 35v, 50v, 100v, 200v DC.

Type MFK.

dipped Flat Shape.
Non-Inductive Construction.
Capacitance

Range : .01 MFD to .22 MFD.
Voltages : 100v, 200v, 400v, 600v DC.

METALLIZED POLYESTER FILM CAPACITORS

Type FNX-H



Mylar Wrapped Semioval
With Epoxy End Seal.
Capacitance

Range : 1 MFD to 10 MFD.
Voltages : 50v DC.

SOLID TANTALUM CAPACITORS

Type TAS.

Sealed with Epoxy Resin.



Capacitance

Range : 1 MFD to 220 MFD.
Voltages : 3v, 6v, 10v, 15v, 20v, 25v, 35v DC.

Type TAX.

MIL-C-26655A Hermetically Sealed.

MATSUO ELECTRIC CO., LTD.

HEAD OFFICE: 3-chome, Sennari-cho, Toyonaka-shi, Osaka, Japan.
Cable Address "NCC MATSUO" OSAKA

Circle 475 on reader service card

5 of a series

TRANSICOIL SOLVES SERVO PROBLEMS

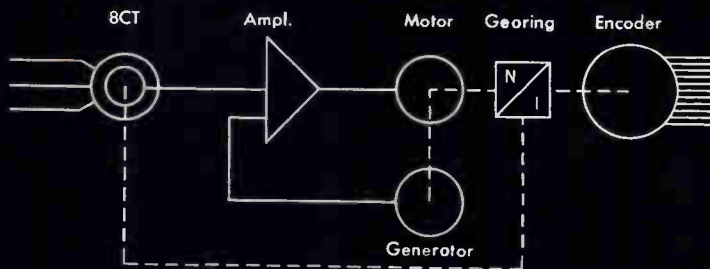

New Transicoil synchro-to-digital converter

This particular servo package provides synchro-to-digital conversion of airborne test data for telemetering to a ground station. Synchro input is fed to a size 8 control transformer which is nulled by an 11 motor generator driven from a transistorized servo amplifier. An 11-bit V-scan encoder is precision geared to the synchro and provides output in natural binary form. Careful packaging design facilitates side-by-side stacking for multi-channel applications in a confined space. Let Weston-Transicoil convert your system requirements into a sophisticated assembly... test our response time!

PERFORMANCE: Input: 11.8V, 400 CPS, 3 wire synchro ■ Output: 11 bit natural binary from V-Scan encoder ■ Static Accuracy: ±2 bits at encoder ■ Dynamic Accuracy: 1° at 16 RPM ■ Slew Speed: 16 RPM ■ Power Required: 115V, 400 CPS, 15 watts; 28V d.c., 250 ma. ■ Weight: 30 oz. ■ Size: 1.8 x 4.75 x 5.0"

Weston Instruments, Inc. Transicoil Division, Worcester, Pa. 19490.

WESTON® prime source for precision . . . since 1888



Cramped for space?

Use Couch 1/7-size Relays

Space/weight problem? The new Couch 2X 1/7-size crystal can relay gives you tremendous savings in space and weight. 0.1" grid — plus many outstanding specs — all in micro-miniature. Thoroughly field-proven in electronics and space applications.



	2X (DPDT)	1X (SPDT)
Size	0.2" x 0.4" x 0.5"	same
Contacts	0.5 amp @ 30 VDC	same
Coil Operating Power	100 mw 150 mw	70 mw 100 mw
Coil Resistance	60 to 4000 ohms	125 to 4000 ohms
Temperature	-65°C to 125°C	same
Vibration	20 G	same
Shock	75 G	same

Broad choice of terminals, coil resistances, mounting styles. Write for detailed data sheets.

RUGGED ROTARY RELAYS Dynamically and Statically Balanced

COUCH ORDNANCE INC.

3 Arlington St., North Quincy, Mass. 02171, Area Code 617, CYPress 8-4147 • A subsidiary of S. H. COUCH COMPANY, INC.

New Books

Communications

Basic Theory of Space Communications
Frederick J. Tischer
D. Van Nostrand Co., 463 pp., \$11.75

Four disciplines make up the field of space communications: antennas and electromagnetics, plasma dynamics, wave propagation, and communication techniques. The book is divided into these disciplines.

The author sets out to present the basic theory of each of the disciplines with special emphasis on high-frequency relationships. His discussion and analysis of the theory concerned with each discipline is generally clear. And yet the book has many failings.

In each of the four parts, entirely too much space is devoted to elementary material which is readily available in previously published books. Many books have been written on antennas, electromagnetic theory, plasmas, propagation and communication theory that cover the subjects more extensively than Tischer does. Tischer's book would have been a much more valuable contribution if it had picked up where these texts left off.

In each part, only the last one or two chapters truly concerns the field of space communications. The rest is foundation material. Nevertheless the book does cover some important new areas in its discussion of space vehicle antennas (for example, low-noise antennas) and reentry communications.

One serious fault is the lack of simplified practical problems and their solutions. A book of this nature would be considerably more useful if it included design examples. For example, the author might have presented the performance goals for a particular spacecraft antenna, discussed the various problems, patterns, impedance considerations, etc., and then illustrated the design procedure with a step-by-step solution. A few problems, without solutions, are at the end of each chapter.

The book is poorly edited and has some errors in equations that are serious enough to raise questions concerning the accuracy of



Portable SOLID STATE PHASE METER

MODEL PM-720

Provides exacting accuracy with compact portability at low price. Advantages: Light weight (5 lbs.) ...3 1/8" height...Absolute panel meter accuracy of $\pm 1^\circ$ or 2%... External output relative accuracy of $\pm 0.20\%$...Equal accuracy for symmetrical waveforms of any shape...Two inputs can have amplitude differences of 1,000 to 1 without affecting phase reading... Direct phase angle readings between 0° and 360° without adjustments or phase shift insertion instruments. Price: \$950.



For complete specifications write to:
R. H. DOW, MGR., AEROMETRICS,
AEROJET-GENERAL CORPORATION,
P. O. Box 216-F5, SAN RAMON, CALIF.

AEROMETRICS



many of the mathematical expressions. Some of the notation used is not standard; in some cases it is apt to cause confusion.

The author's reasoning in portions of the discussion, such as the treatment of charged particle motion in a nonuniform magnetic field, is not easy to follow. This is because many steps are left out in derivations of formulas although the results are correct. The discussion on equivalent black body radio noise is incomplete in that the very important aspects of the polarization are not included.

The book could serve as a quick reference for some of the mathematical expressions. It could also be useful to someone with knowledge of one of the disciplines who wants to know something about the analytical bases of the other disciplines.

Stanley H. Gross

Airborne Instruments Laboratory
Deer Park, N. Y.

Recently published

European Miniature Electronic Components and Assemblies Data, Part II: France, Netherlands, Scandinavia and Switzerland 1965-66, edited by G.W.A. Dummer, J. MacKenzie Robertson, Pergamon Press, 1,123 pp., \$35

American Ultraminiature Component Parts Data 1965-66, edited by G.W.A. Dummer, J. MacKenzie Robertson, Pergamon Press, 486 pp., \$21.50

Fluidics, edited by E.F. Humphrey, D.H. Tarumoto, Fluid Amplifier Associates, Inc., 268 pp., \$28

On-Line Computation and Simulation, Martin Greenberger, M.M. Jones, J.H. Morris, Jr., D.N. Ness, the Massachusetts Institute of Technology Press, 126 pp., \$4.95

Transistors: Principles and Applications, R.G. Hibberd, Hart Publishing Co., 304 pp., \$5.95

Digest of the International Solid State Circuits Conference, edited by J.A.A. Raper, Institute of Electrical and Electronics Engineers, Inc., copies available from H.G. Sparks, the Moore School of Electrical Engineering, University of Pennsylvania, 132 pp., \$6

Crystals: Perfect and Imperfect, Allan Bennett, Robert Miller, Donald Hamilton, Joseph Murphy, Alexei Maradudin, Westinghouse Research Laboratories, and Walker and Company, 237 pp., \$5.95

David Sarnoff, a biography by Eugene Lyons, Harper & Row Publishers, Inc., 372 pp., \$6.95

Fields and Waves in Communication Electronics, Simon Ramo, J.R. Whinnery, Theodore VanDuzer, John Wiley & Sons, Inc., 754 pp., \$13.50

Pulsed Neutron Research, Proceedings of the Symposium on Pulsed Neutron Research, Karlsruhe, Germany, May 10-14, 1965, Vol. 1, International Atomic Energy Agency, 698 pp., \$14; Vol. 2, 917 pp., \$18

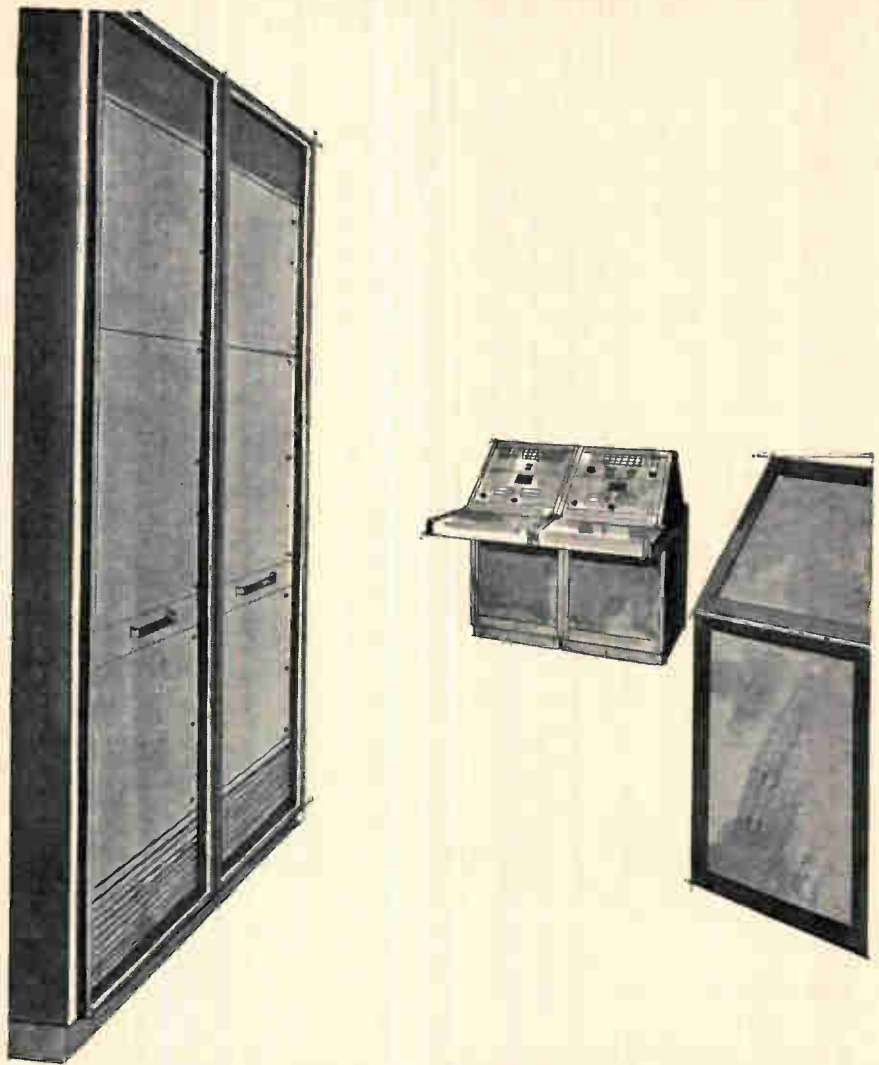

Crafted with the care you'd use

EMCOR cabinetry makes you as proud of the exterior look as you are of the equipment's capabilities. Every unit of the EMCOR Modular Enclosure Systems receives as much care and attention as you give your instrumentation.

With EMCOR cabinets, you won't see the usual little imperfections; blisters, paint runs, or flexible tolerances. You will find cabinetry that looks like fine furniture, with every piece crafted for beauty and structural strength.

See and touch EMCOR cabinets. You'll agree they're exceptional. Call your local EMCOR Sales and Service Engineer and let him tell you what makes them that way.

Albany 436-9649; Albuquerque: 265-7766; Alexandria: 836-1800; Binghamton, N. Y.: 723-9661; Bridgeport: 368-4582; Buffalo: 632-2727; Chicago: 676-1100; Cleveland: 442-8080; Dallas: 631-7450; Dayton: 298-7573; Del Mar: 454-2191; Denver: 934-5505; Fort Lauderdale: 564-8000; Fort Lee, N. J.: 944-1600; Houston: 526-2959; Huntsville: 539-6886; Indianapolis: 356-4249; Kansas City: 444-9494; Los Angeles: 938-2073; Minneapolis: 545-4481; New Hartford, N.Y.: 732-3775; New Orleans: 242-5575; Orlando: 425-5505; Palo Alto: 968-8304; Pittsburgh: 884-5515; Phoenix: 273-1673; St. Louis: 647-4350; Seattle: 722-7800; Southfield, Mich.: 357-3700; Tulsa: 742-4657; Valley Forge, Pa.: 265-5800; Wilmington, Mass.: 944-3930; Winston-Salem: 725-5384;

EMCOR / distinguished cabinetry

Ingersoll Products 1242 W. 120th St., Chicago, Ill. 60643

DIVISION OF BORG-WARNER CORPORATION

electronic
equipment



Technical Abstracts

Complex integrated circuits

A systematic engineering approach to complex arrays

L. Vadasz, R. Nevala, W. Sander, R. Seeds

Fairchild Semiconductor division, Fairchild Camera & Instrument Corp. Palo Alto, Calif.

The evaluation of silicon digital integrated circuits has been more rapid than expected. Semiconductor-device manufacturers have already started to develop very complex logic arrays. These arrays will be the equivalent of hundreds of logic gates.

By putting hundreds of gates on a single monolithic silicon chip reliability is greatly improved, making complex logic arrays highly attractive to the military. However, to interest commercial and industrial users of integrated circuits, the semiconductor-device manufacturer must add other inducements.

Two potential advantages are reduced engineering time and low cost.

A metal - oxide - semiconductor chip having groups of a particular component pattern known as cells can provide both advantages. With the chip, a variety of complex logic circuits, such as memory systems, can be obtained by using various cell connection schemes.

A few different combinations could probably be used to form a cell. One such cell family which has been investigated includes six sections. These are a quad nand gate, a quad nor gate, a dual gated latch, a master slave flip flop, a dual exclusive-nor gate and a quad output driver.

To minimize the over-all system-design time the user should study the manufacturer's specifications for the integrated circuit and then supply the manufacturer with the logic specification for the subsystem in accordance with the manufacturer's design limits. The manufacturer will then design the

masks and build, test and deliver the circuits. The work of the user is kept to a minimum and the over-all engineering time is reduced because of the manufacturer's familiarity with the integrated circuit.

Presented at the 1966 International Solid State Circuits Conference, Philadelphia, Feb. 9 to 11.

Fixed memory with E cores

Development of an E-core read-only memory

P.S. Sidhu

Ampex Corp., Culver City, Calif.

A read-only memory to hold control information in a computer can be built of E cores. Inexpensive to build, fast and reliable, the memory's manufacture can be easily automated and the design appears to impose no limit on its size.

An E core is a piece of ferrite material with three legs perpendicular to its main body, making it resemble the letter "E". If two E cores are placed leg to leg, the result is a two-aperture ferrite core. A wire passing through one of the



the latest in Heat Sink Extrusions

WAKEFIELD DISTRIBUTOR PRODUCTS CATALOG

Your authorized WAKEFIELD Electronic Distributor stocks a wide variety of Heat Sink Extrusions in 3 ft. \pm 1/4" lengths. This catalog will give you the name of your nearest distributor and full product information: milliwatt to high power coolers, circuit board heat sinks, extrusions, thermal joint compound DELTA BOND 152 Thermally Conductive Adhesive.

FOR YOUR COPY, WRITE

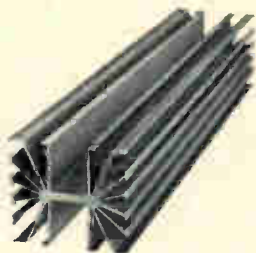

WAKEFIELD
ENGINEERING, INC.



139 FOUNDRY ST. / WAKEFIELD, MASS. (617) 245-5900 • TWX 617-245-9213

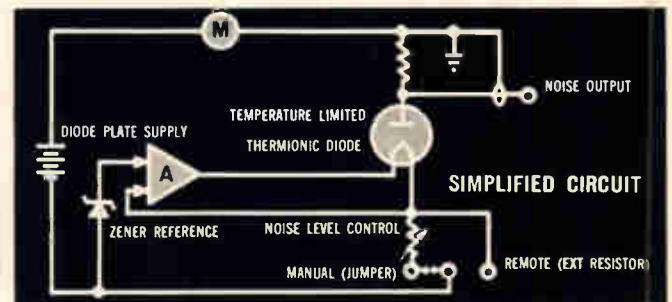

PRECISION RANDOM NOISE VLF-UHF

- **SERVO-STABILIZED OUTPUT:** compensated for drift over temperature, line voltage, noise tube aging.
- **STABILITY:** 0.05 db after 11 msec warmup.
- **ACCURACY:** \pm 0.1 db to 200 MHz.
- **Model NS-LB:** 100 Hz - 500 MHz. Output absolutely free of line noise harmonic contamination at VLF. Only generator on the market with precision VLF capability.
- **Model NS-C:** 1 MHz - 500 MHz.
- **Model NS-H:** 1 MHz - 2000 MHz.

Other products by ARI: Laboratory RF Measurements Equipment, Precision Frequency and Timing Instrumentation.



AEROSPACE RESEARCH, INC.

130 Lincoln St., Boston, Mass. 02135

(617) 254-7200

STUCK for MAGNETS?



CALL PERMAG

We stock all sizes, all shapes, all grades, for all uses . . . all ready for 24-HOUR DELIVERY. Including soft magnetic materials — now available for the first time in small, less-than-mill-run quantities. Also, magnets engineered and fabricated to your needs. Write for catalog and data sheets.

PERMAG PACIFIC CORP. 5441 W. 104th St. Los Angeles, Calif. 90045 / Phones: Area Code 213 776-5656, 213 670-7060 / TWX: 213 670-0408

PERMAG CENTRAL CORP. 5301 D. Otto Ave. Rosemont, Des Plaines, Illinois 60018 / Phone: Area Code 312 678-1120

PERMAG CORP. 88-06 Van Wyck Expressway Jamaica, New York 11418 / Phone: Area Code 212 OLYMPIA 7-1818 / TWX: 212 479-3654

Circle 473 on Readers Service Card

Reprint order form

Send to: Electronics Reprint Dept.
330 West 42nd Street
New York, N. Y. 10036

For listing of reprints available see the reader service card.

To help expedite mailing of your reprints please send cash, check or money order with your order.

For reprints of the latest special report:

Computer Time Sharing Part II

Send me _____ reprints of key no R-86 at 50¢ each.

For reprints of previous special reports fill in below:

Send me _____ reprints of key no.(s) _____ at _____ ¢ each.

For prices see the reader service card.

Name _____

Number & Street _____

City, State _____

Zip code _____

apertures permanently stores a 0; a wire through the other stores a 1. The sense wire is wound around the center leg of the E-core, two-aperture structure.

The E-core memory operates in the linear range of the ferrite material, so that no magnetic switching takes place. Between the drive wires (word lines) and the sense winding is an a-c coupling; stored 0's and 1's produce negative and positive pulses, respectively, in the sense wire.

An experimental E-core read-only memory was assembled containing 1,024 words of 24 bits each; the core array was in the form of two rows of 48 cores, with 256 wires threaded through each row. A current pulse on one wire then read out the contents of two words, one of which was placed in the output register. The addressing logic selected the drive wire and one of the two output words. Linear selection was used for reliability and low cost; other techniques of addressing, such as series-parallel or coincident-current, could be used on larger arrays. Because the output pulses are bipolar, the sense amplifier circuits can be simple. But the output pulses must be strobed to distinguish between a pulse and the overshoot, or ringing, that may follow it. Cycle time of the experimental memory is 250 nanoseconds; access time is 150 nanoseconds.

The outlook for further development of an E-core memory is good. In production, for instance, the cores could be wired on a board, as they were in this experimental memory, and then transferred to one or more printed-circuit cards for pluggable insertion in a computer. The assembly is easily automated. Loose or pre-formed wires, or printed circuit wires, can be dropped into the openings in the single E-core, and the wired array capped with another set of E-cores to produce the two-aperture array. The drive and sense circuits can easily be made of integrated circuits, although they were not in this model. Faster operation can be obtained with high-frequency ferrite materials, particularly since there is no magnetic switching.

Presented at the Fall Joint Computer Conference, Las Vegas, Nev., Nov. 30 to Dec. 2, 1965.

ACCURACY

To $\pm 1/2$ the least significant bit



212 A/D Converter

If your conversion problem requires speed and accuracy with repeatability, take a look at the new 212 A/D Converter by Control Data. Total conversion time is 15 microseconds, and maximum sample rate is 50 KC. In actual systems use, the 212 is producing a conversion accuracy of $\pm 1/2$ the least significant bit. Precision construction and components eliminate the need for conventional "tweaking" or daily calibration.

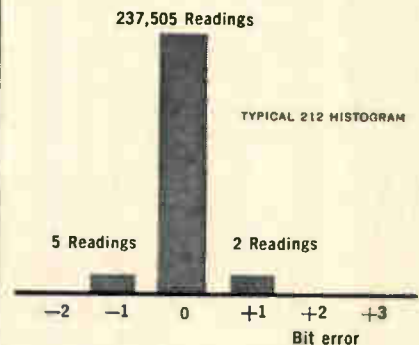

The histogram shown here is typical of that produced by 212's for inflection points over the total input range. Inputs are offered up to ± 100 volts.

Control Data produces a complete line of data converters and multiplexers for applications where performance and reliability are paramount.

Control Data, building complete data acquisition systems, offers a full line of converters and multiplexers. For information concerning these "systems proven" instruments, contact: La Jolla Division, Dept. 307, Control Data Corporation, 4455 Miramar Road, La Jolla, California. (Phone 714, 453-2500).

CONTROL DATA

CORPORATION

4455 Miramar Road, La Jolla, Calif.

QUALIFICATION FORM FOR POSITIONS AVAILABLE

ATTENTION: ENGINEERS, SCIENTISTS, PHYSICISTS

This Qualification Form is designed to help you advance in the electronics industry. It is unique and compact. Designed with the assistance of professional personnel management, it isolates specific experience in electronics and deals only in essential background information. The advertisers listed here are seeking professional experience. Fill in the Qualification Form below. **STRICTLY CONFIDENTIAL:** Your Qualification form will be handled as "Strictly Confidential" by Electronics. Our processing system is such that your form will be forwarded within 24 hours to the proper executives in the companies you select. You will be contacted at your home by the interested companies.

WHAT TO DO. (1.) Review the positions in the advertisements. (2.) Select those for which you qualify. (3.) Notice the key numbers. (4.) Circle the corresponding key number below the Qualification Form. (5.) Fill out the form completely. Please print clearly. (6.) Mail to: Classified Advtg. Div., Electronics, Box 12, N. Y. 10036.

COMPANY	Page #	Key #
ATOMIC PERSONNEL INC. Phila., Pa.	228	1
BAUSCH & LOMB Rochester, N. Y.	226	2
ELECTRONIC COMMUNICATIONS INC. St. Petersburg, Fla.	228	3
DEPARTMENT OF THE NAVY U. S. Navy Bureau of Ships Washington, D. C.	227	4
GENERAL DYNAMICS Fort Worth Division Fort Worth, Texas	130*	5
GENERAL DYNAMICS General Atomic Division San Diego, Calif. 92112	213*	6

COMPANY	Page #	Key #
GENERAL ELECTRIC CO. Syracuse, N. Y.	216*	7
GENERAL MOTORS CORP. Defense Research Laboratories Santa Barbara, Calif.	227	8
GENERAL MOTORS CORP. Delco Radio Division Kokomo, Indiana	138	9
INTERNATIONAL BUSINESS MACHINES Bethesda, Maryland	164*	10
INTERNATIONAL BUSINESS MACHINES Data Processing Division White Plains, N. Y.	173	11
KAISER ENGINEERS Oakland, Calif.	214*	12
LOCKHEED CALIFORNIA CO. Burbank, Calif.	126*	13
LOCKHEED MISSILES & SPACE CO. Sunnyvale, Calif.	170	14
TELEDYNE INDUSTRIES Geotech Div. Garland, Texas 75040	218*	15
UNITED CONTROL Redmond, Washington 98052	286*	16
U. S. NAVY Navy Overseas Employment Office San Francisco, Calif. 94102	218*	17
XEROX CORP. Rochester, N. Y.	130	18

* These advertisements appeared in the March 21st issue.

PERSONAL BACKGROUND

Name
Home Address
City Zone State.....
Home Telephone

EDUCATION

Professional Degree(s)
Major(s)
University
Date(s)

FIELDS OF EXPERIENCE (Please Check) 4/4/66

- | | |
|--|---|
| <input type="checkbox"/> Aerospace | <input type="checkbox"/> Medicine |
| <input type="checkbox"/> Antennas | <input type="checkbox"/> Microwave |
| <input type="checkbox"/> ASW | <input type="checkbox"/> Navigation |
| <input type="checkbox"/> Circuits | <input type="checkbox"/> Operation Research |
| <input type="checkbox"/> Communications | <input type="checkbox"/> Optics |
| <input type="checkbox"/> Components | <input type="checkbox"/> Packaging |
| <input type="checkbox"/> Computers | <input type="checkbox"/> Radar |
| <input type="checkbox"/> ECM | <input type="checkbox"/> Radio-TV |
| <input type="checkbox"/> Electron Tubes | <input type="checkbox"/> Simulators |
| <input type="checkbox"/> Engineering Writing | <input type="checkbox"/> Solid State |
| <input type="checkbox"/> Fire Control | <input type="checkbox"/> Telemetry |
| <input type="checkbox"/> Human Factors | <input type="checkbox"/> Transformers |
| <input type="checkbox"/> Infrared | <input type="checkbox"/> Other |
| <input type="checkbox"/> Instrumentation | <input type="checkbox"/> |

CATEGORY OF SPECIALIZATION

Please indicate number of months experience on proper lines.

	Technical Experience (Months)	Supervisory Experience (Months)
RESEARCH (pure, fundamental, basic)
RESEARCH (Applied)
SYSTEMS (New Concepts)
DEVELOPMENT (Model)
DESIGN (Products)
MANUFACTURING (Product)
FIELD (Service)
SALES (Proposals & Products)

CIRCLE KEY NUMBERS OF ABOVE COMPANIES'

POSITIONS THAT INTEREST YOU 1 2 3
4 5 6 7 8 9 10 11 12 13 14 15
16 17 18

Bausch & Lomb has openings for

ELECTRONIC ENGINEERS

B.S. or M.S. with one to five years experience in the design of analog and digital circuits and systems. Good theoretical background in math, physics and network analyses desirable. Experience in control systems and low signal level circuit techniques helpful. Projects involve development of sophisticated instruments in bio-medical, chemical, optical and electronic fields at the applied research stage.

Please send resume in confidence, including salary requirements to: E. J. Walter, Employment Specialist, Bausch & Lomb, 620 St. Paul St., Rochester, N.Y. 14602.

BAUSCH & LOMB 

An Equal Opportunity Employer

The Scientists and Engineers served by Corcoran in the last year have found the difference between "a job" and "the job."

● Whether your search for a new working environment is based on a desire for larger responsibility, wider scope of action, broader technical interests, or for financial gain, the individual attention offered by Corcoran assures a greater chance of success.

● Nationwide, we serve large and small clients on a fee paid basis. Please airmail background to:

JOSEPH P. CORCORAN
Personnel Consultants

505 B Germantown Pike
Lafayette Hill, Pa. 19444
Member IEEE

GM DEFENSE RESEARCH LABORATORIES

**In Beautiful
Santa Barbara, Calif.**

Electrical Engineers

Expanding activities in the field of Electrical power and propulsion for advanced Land, Ocean, and Lunar vehicles have created immediate openings for electrical engineers interested in the design, analysis and fabrication of:

Logic and Electronic Circuits

**Power Inverters and
Frequency Converters**

**Electrical Machines and
Electro-Mechanical Devices**

Feed Back Control Systems

Openings exist for recent BS, MS and Ph.D. Graduates as well as senior personnel with several years experience. These positions offer an excellent opportunity to participate and advance in a rapidly growing technology in a stable corporate environment.

GM Defense Research Laboratories is currently engaged in research programs encompassing Sea, Land, Aerospace, and Lunar activities and can offer the advantage of a small laboratory (800 people), a fine professional staff, and the backing of a large corporation.

Please send resume to W. E. Wells and upon review, interviews will be arranged for qualified candidates.

**GM DEFENSE RESEARCH
LABORATORIES**

GENERAL MOTORS CORP.

Box T

Santa Barbara, Calif.

An Equal Opportunity Employer M/F

engineering management opportunities with

U.S. NAVY-BUREAU OF SHIPS

in:

ANTI-SUBMARINE WARFARE

The Navy's high-priority anti-submarine warfare program, involving multi-million dollar contracts with industry, needs qualified engineers for program management involving research, development, testing, evaluation, procurement planning, production, installation and maintenance in these fields:

- SURFACE SHIP, VARIABLE DEPTH AND SUBMARINE SONAR SYSTEMS
- UNDERWATER ACOUSTIC COMMUNICATIONS AND IFF SYSTEMS
- OCEANOGRAPHY ● DIGITAL SIGNAL PROCESSING
 - Transportable Underwater Ocean Area Surveillance Systems
- Acoustic Navigation And Mine Avoidance Equipments
 - Inshore Undersea Warfare Equipment
 - Mine And Torpedo Detection Sonar
- ASW Target Classification ● Transducer Design
- Non-Acoustic Detection of Submerged Submarines
- Display Engineering ● Systems Analysis

AND OTHER FIELDS: NAVAL ARCHITECTURE; MARINE, ELECTRICAL, ELECTRONIC, MECHANICAL ENGINEERING IN—SHIPS DESIGN, CONSTRUCTION AND MAINTENANCE; MACHINERY DESIGN; RADAR, COMMUNICATIONS, TEST EQUIPMENT, QUALITY ASSURANCE & RELIABILITY.

These positions, which are in Washington, D.C., involve travel and considerable contact with industrial organizations. Degree in mechanical or electro/electrical engineering and related experience desirable. Starting salaries range from \$7,987 to \$14,680 depending on experience. Most positions are at \$10,619 and \$12,510. Relocation expenses paid. These are career Civil Service positions with full benefits, regular salary increases.

Send resume or SF-57 to:

**Civilian Personnel Division
Bureau of Ships, Code 263R-07
Department of the Navy, Room 2435
Washington, D.C. 20360**

An Equal Opportunity Employer

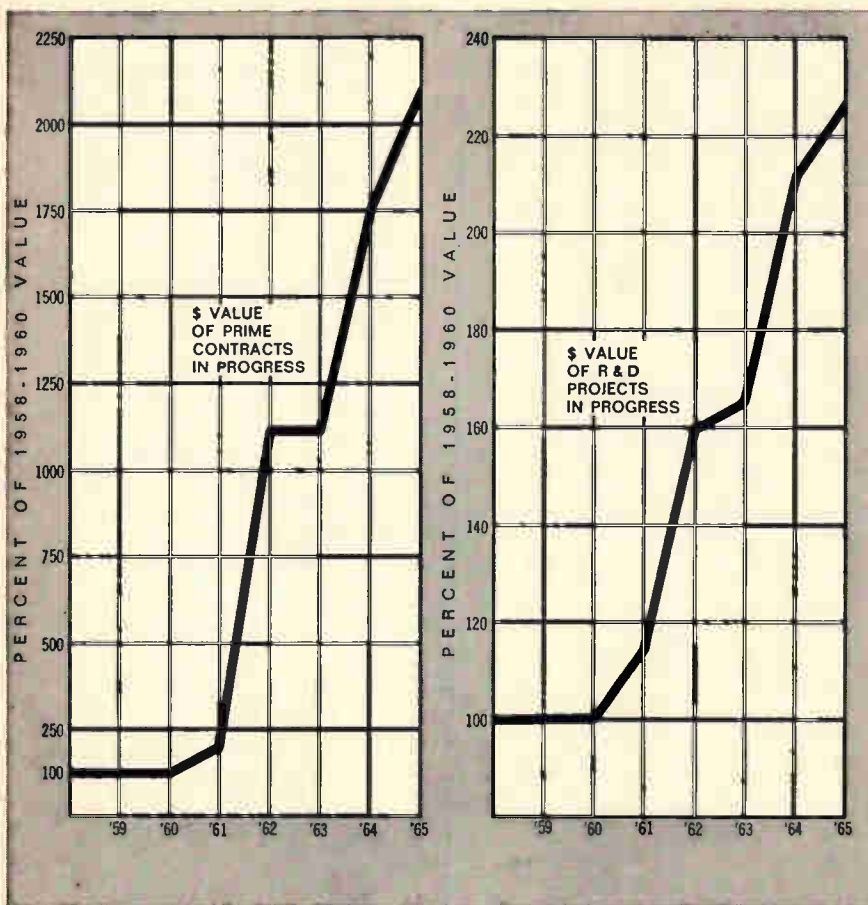

2 REASONS WHY THERE'S MORE ENGINEERING OPPORTUNITY AT ECI

Where there's engineering excitement there's engineering opportunity. Two key indicators — prime contracts in progress and R&D work in progress — prove that exciting things are happening at Electronic Communications, Inc. ECI has generated these remarkable activity increases by building a solid, successful reputation in airborne systems, multiplexing, space instrumentation and other areas of military and aerospace communication. You can get aboard this upward trend immediately if you are qualified in:

RF ENGINEERING — aggressive new programs are now under way in the design and development of microminiature transmitters and receivers. Positions require at least a BS degree, with a minimum of three years experience, and sound knowledge of transmitter and/or receiver design theory.

SPACE INSTRUMENTATION PROJECT ENGINEERING — you'll need in-depth technical ability, plus six years experience in data handling, control, or analog instrumentation.

THIN-FILM CIRCUIT DESIGN — involving theory and application of thermodynamics, mechanics of materials and electronic component design in the development of microelectronic circuitry. BS or MS in EE or physics required.

SYSTEMS INTEGRATION — you must be thoroughly grounded in aircraft electrical systems and be familiar with interface problems involved in installation of airborne communications equipment. Prior systems integration or field installation experience is most desirable.

If you are qualified, send your resume, in confidence, to Duane Meyer, ECI, Box 12248E, St. Petersburg, Fla., or call him collect at (813) 347-1121. (An equal opportunity employer.)

ELECTRONIC COMMUNICATIONS, INC.

ST. PETERSBURG, FLORIDA



EMPLOYMENT OPPORTUNITIES

THE MARKET-PLACE FOR ALL EMPLOYMENT NEEDS

Send new ads or inquiries to:

ELECTRONICS

Class. Adv. Div., P.O. Box 12, N.Y. 10036



E. E.'S WRITE US FIRST for FEE-PAID positions

Use our confidential application for professional, individualized service. A complete national technical employment agency. We are "Experienced Engineers Working Full Time... For You!"

ATOMIC PERSONNEL, INC.
Suite L, 1518 Walnut St., Phila., Pa.

ADDRESS BOX NO. REPLIES TO: Box No. Classified Adv. Div. of this publication. Send to office nearest you.
NEW YORK, N. Y. 10036; P. O. Box 12 CHICAGO, Ill. 60611; 645 N. Michigan Ave. SAN FRANCISCO, Cal. 94111; 255 California St.

POSITIONS VACANT

Do you want high grade sales representation in the growing French industrial electronic, nuclear and aerospace market? Write to: S. P. I. A., 11, Rue de Provence, Paris 9e—France.

Instructors wanted in the field of Electronics and Radio-Television servicing. Age open—salary open—must possess a college degree or equivalent. Preference will be given to individuals with an EE Degree with Electronics option. Year round employment in Southeastern United States—excellent opportunity in growing institution. Send complete resume of education, personal data, and experience to Robert E. Paap, President, Catawba Valley Technical Institute, Hickory, North Carolina.

YOU'RE H!RED

Do you need electronics engineers or technical management men? Electronics magazine is the way to recruit them. Electronics is designed specifically for the working engineer. 68,000 subscribers and an additional 133,000 pass-along readers turn to it to keep up with their industry. You can find the man that meets your qualifications with an advertisement in the Employment Opportunities Section.

For rates & information write: Electronics, a McGraw-Hill Publication. Classified Advertising Division, Post Office Box 12, New York 10036.

MITSUMI COMPONENTS

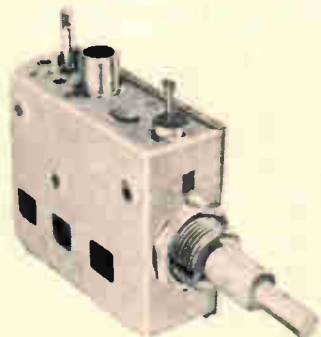

UHF U-AS11



VHF V-AS11

NEW TRANSISTOR TV TUNER

The characteristics of Mitsumi transistor TV tuner are high sensitivity, small spurious radiation and high durability.

The tuner is available for both VHF and UHF. It has a unique fine adjustment mechanism and is superior in humidity characteristics and temperature characteristics.

Main Products

Polyvaricon · IFT · Oscillator coil · Antenna coil · Composite coil · Special coil · Micro motor · Synchronous motor · Variable resistor · Trimming potentiometer · FM tuner TV tuner · Various sockets · CdS photoconductive cell.



MITSUMI ELECTRIC CO., LTD.

New York office: 11 Broadway, New York, N.Y. 10004.
U.S.A. Phone: HA-5-3085, 3086.
Main office: 1056, Koadachi, Komae-machi, Kitatama-gun, Tokyo, Japan.
Phone: Tokyo 415-6211/23

New Literature

Resistance thermometer elements. Electric Thermometers, Inc., 615 Schuyler Ave., Kearny, N.J., 07032. Bulletin 120 is a six-page brochure describing platinum resistance thermometer elements for industrial and laboratory use between -250° and $+850^{\circ}$ C. Circle 420 on reader service card.

Switching module. James Electronics, Inc., 4050 N. Rockwell St., Chicago, Ill., 60618. A two-page data sheet provides specifications for the Micro-scanner relay/p-c board module for high-speed, low to medium level signal switching. [421]

Ultrasonic cleaner. Multisonic Corp., 1100 Shames Drive, Westbury, N.Y. Bulletin 300 offers a description and specifications of a bench model ultrasonic cleaner, model 66. [422]

Microsheet glass for substrates. Electronic Products Division of Corning Glass Works, Raleigh, N.C. Properties for Code 0211 microsheet glass for substrates are tabulated in Reference File CE-10.10, a one-page data sheet. [423]

Digital voltmeter. Dana Laboratories, Inc., Irvine, Calif., 92664, has published an eight-page catalog describing its function-expandable 4-digit model 5400 digital voltmeter for millisecond measurements. [424]

Vacuum contactors. Jennings Radio Mfg. Corp., P.O. Box 1278, San Jose, Calif., 95108, presents a catalog on vacuum contactors that are designed for controlling d-c, r-f, and 50, 60, and 400 cycle circuits at all voltage levels. [425]

Relay assemblies. Chicago Dynamic Industries, Inc., 1725 Diversey Blvd., Chicago, Ill., 60614, has published a catalog page on the series 271-2500 fast-acting, electrical trip latch switch assemblies that can accommodate 2 to 20 slide switches with a maximum of 8 spdt contacts available per slide switch. [426]

Programmable power modules. Electronic Research Associates, Inc., 67 Factory Place, Cedar Grove, N.J., 07009. Fully programmable, all-silicon Transpac d-c power modules are described in catalog supplement No. 136. [427]

Oscillographs. Midwestern Instruments Inc., division of Telex Corp., 41st & Sheridan Road, Tulsa, Okla. Brochures describing models 621 and 1200 oscillographs contain specifications, features, operating principles and applications for the new instruments. [428]

Accelerometer. B&K Instruments, Inc., 5111 W. 164th St., Cleveland, Ohio, 44142, announces a specification sheet

on the model 4333 low-cost measurement standard accelerometer. [429]

Compactrons. General Electric Co., Schenectady, N.Y., 12305. A condensed 20-page "Catalog of Compactrons" is now available for use by designers of tv and audio communications products. [430]

Rfi filters. The Gudeman Co., 340 W. Huron St., Chicago, Ill., 60610, offers a six-page brochure describing a wide range of tubular and bathtub style rfi filters. [431]

Coil forms. J.W. Miller Co., 5917 S. Main St., Los Angeles, Calif., 90003, has released a 32-page catalog describing ceramic, resinite and Velvetork coil forms. [432]

Custom circuit modules. Engineered Electronics Co., 1441 E. Chestnut Ave., Santa Clara, Calif., 92702, has published a four-page illustrated brochure on its facilities and capabilities in resistance welding, dip soldering, and reflow soldering of all types of circuit modules. [433]

Programed current pulse generator. Computer Test Corp., 12 Fellowship Road, Cherry Hill, N.J. A technical brochure describes the model 1700 programed current pulse generator for analysis of fast switching magnetic memory devices. [434]

Frequency and time standards. Hewlett-Packard, 1501 Page Mill Road, Palo Alto, Calif., 94304. Application Note No. 52 is a 108-page booklet not only covering the fundamentals of frequency and timekeeping, but also containing the latest schedules on U.S. and international time signal broadcasts. [435]

Heat sinks. Astrodyne, Inc., 207 Cambridge St., Burlington, Mass., 01803. A complete series of natural convection heat sinks (2500 Series) is described in a four-page catalog. [436]

Coaxial circulators. Raytheon Co., 130 Second Ave., Waltham, Mass., 02154, has available a catalog presenting a wide selection of high-power coaxial circulators in all frequency ranges from uhf to X-band. [437]

Relay and timing devices. Allied Control Co., Inc., 2 East End Ave., New York, N.Y., 10021. A 64-page manual describes full operating characteristics, electrical characteristics and mounting information for over 40 different types of relays and timing devices. Copies may be obtained by letterhead inquiry.

Noise rejection. Dana Laboratories, Inc., Irvine, Calif., 92664. A 24-page technical paper, DL-521, is entitled "Tech-

1
PUNCH

20
HOLES

Or 37 holes! Or 2—
or 86! With press
brake or punch
press, Di-Acro Ad-
justable Punches
and Dies are quickly
arranged to fit your
layout exactly. Easy
to repeat a setup.
Use over and over.
Ask for 12-page
folder . . . Tells
about starter-set
too. See your dis-
tributor or write us.

20
HOLES

COUNT
'EM

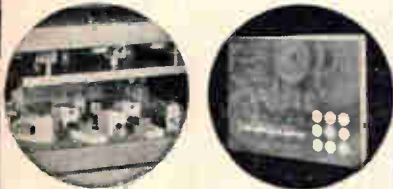

DI-ACRO

A Division of Houdaille Industries, Inc.
459 Eighth Ave., Lake City, Minn. 55041

NOTCHES
COUNT.
TOO

niques to Analyze and Optimize Noise Rejection Ratio of Low Level Differential Data Systems". [438]

Power supplies. Deltron, Inc., Wissahickon Ave., North Wales, Pa., 19454. Bulletin 203A describes a series of power supplies that features ultrafast programming speed in either voltage or current mode with instantaneous crossover to either mode. [439]

Printed circuit connectors. Continental Connector Corp., 34-63 56th St., Woodside, N.Y., 11377. Form RTA-1065 is a 14-page technical catalog covering an expanded group of right-angle plug and socket connectors for printed circuit applications. [440]

Magnetic components. Pulse Engineering Inc., 560 Robert Ave., Santa Clara, Calif. The 1966 magnetic component catalog is said to contain the most complete listing of pulse and high-frequency transformers ever offered. Copies are available by request on company letterhead.

Voltage tunable magnetrons. General Electric Co., Schenectady, N.Y. Voltage tunable magnetron brochure ETD-4374 outlines recent breakthroughs in protecting the devices against radio-frequency interference and in magnetic shielding. [441]

Numerical control. The Bendix Corp., Industrial Controls division, 8880 Hubbell Ave., Detroit, Mich., 48228. A 12-page, 2-color brochure (BICD-267) describes the new DirectaPath numerical control system. [442]

Miniature terminal block. Buchanan Electrical Products Corp., 1065 Floral Ave., Union, N.J., offers a four-page brochure outlining the benefits and applications of its new miniature terminal block, the 300V, which allows 48 circuits per foot and ends the need for lugging. [443]

Toroidal cores. MicroMetals, 72 E. Montecito Ave., Sierra Madre, Calif., 91024, has available new data sheets describing a wide variety of iron powder toroidal cores, primarily for high-frequency applications. Information on Q vs frequency for typical inductances is included. [444]

Frequency converters. Brooks Instrument division, Emerson Electric Co., Hatfield, Pa., has issued a technical bulletin on series 4300 and 4700 frequency converters, which convert a variable frequency input into a precisely proportional d-c voltage or current. [445]

Diode reliability report. Unitrode Corp., 580 Pleasant St., Watertown, Mass. A 60-page report summarizes 15,700,000 diode hours of 100°C life test at rated conditions. The tests discussed were conducted over a period of three years, during which 7,885 units were life-tested without a failure. [446]



New

5 1/2"

SHADED-POLE Model 6500 PAMOTOR Axial Fans

- Free air delivery in excess of 300 cfm at 3000 rpm
- Over 20,000 operational hours without maintenance
- Outstanding performance at moderate cost (under \$30.00 for single units)
- Only 2" deep
- 110 v or 220 v operation
- Stocked for immediate delivery

Write for technical data on the Model 6500 and other PAMOTOR axial fans to:

PAMOTOR, INC.
312 SEVENTH STREET • SAN FRANCISCO, CALIF.

Precision you can trust, because it's built in.

**±50 ppm TC.
1/2% and 1% tolerances.
<0.5% load-life ΔR guaranteed.
Mil-R-10509E, Char. C.**

New CORNING® NC-style Resistors.

NC4—1/10 watt at 125° C., 49.9 ohms to 150K

NC5—1/8 watt at 125° C., 49.9 ohms to 499K

NC6—1/4 watt at 125° C., 49.9 ohms to 1 Meg.

True precision resistors with all the long-term reliability you've come to expect from CORNING glass-tin oxide film. And not just tested into some. Nor sorted out of many.

But precision that's built in . . . in a continuous manufacturing process that provides the highest inherent reliability of any resistor made today. Here's how:

The tin oxide film is bonded *molecularly* to a glass cane substrate at red heat . . . it isn't plastered on, or sputtered on.

Temperature coefficient of film and substrate match perfectly.

The substrate is chemically inert to the film.

Once cooled, the film compares in hardness to high-carbon tool steel . . . you can't scrape it off.

We make CORNING NC-styles with these materials and this technique to guarantee you constant resistivity, constant quality . . . precision that's built in.

Call your CORNING distributor for technical data and samples or send the coupon today. Evaluate the new NC-styles, and see how their built-in precision gives you new design confidence.

CORNING GLASS WORKS, 3913 Electronics Dr., Raleigh, N.C.

Please send me new NC-style Resistors data and samples.

Name..... Title.....

Company.....

Address.....

City..... State..... Zip.....

CORNING
ELECTRONICS

Electronics Abroad

The Netherlands

Spot check

Toward the end of the year, Hollanders with especially acute hearing will notice, off and on, that strange, barely perceptible sounds are coming from their television and radio sets.

At that time, the government-run broadcasting stations will begin to air advertising spots. When a spot is broadcast, stations will identify it during the first five seconds with code signals—at the low end of the audio frequency range—mixed with the regular sound of the spot. Recorded on tape in a sample of receivers that matches the makeup of the Dutch population, these code signals will provide the basic data for a rating system that will tell advertisers whose message is getting through to the most listeners.

Electrologica NV, a small computer manufacturer based in The Hague, developed the system for a Dutch market research organization called Intomart. Intomart plans to install the recorders, dubbed Intometers, in a 1,000-household sample before yearend.

Coded. The system is designed so that the recorder attached to a receiver runs only during periods when the tuned-in station broadcasts a code signal. The code begins with a half-second pulse of three audio frequencies that starts the tape drive. This is followed by a half-second blank interval as a safety margin. Then come five half-second periods with single-frequency pulses or blanks; the combination identifies the spot being broadcast. Finally, there is a half-second pulse destined to identify the beginning of a block of data when the tape is run backwards to feed its contents into a computer.

For the prototype versions, Electrologica used frequencies of 70



Tape cartridge removed from Intometer recorder later is run through high-speed reader that feeds data from tape directly into a computer.

and 90 cycles per second for the code signals. The production Intometers, however, will use frequencies of 57, 75 and 93 cycles per second.

Selective. Input to the recorder is picked off the loudspeaker leads of the receiver. The audio signal first passes through a diode clipper (see block diagram). The clipper is followed by an automatic gain control amplifier so that a signal with a fairly constant amplitude is applied to the selective amplifiers, each of which is tuned to one of the code frequencies. These are two-stage amplifiers with feedback over a twin-T filter and an emitter follower.

Output of the tuned amplifiers passes to both an AND gate and a

summing amplifier. When a start pulse is received, the code frequencies appear simultaneously at the AND gate. This triggers a monovibrator circuit that powers the tape drive motor for five seconds. As the motor runs, the tape records the identification pulses fed to the recording head through the summing amplifier. Circuitry throughout is transistorized. The prototype version has two code-frequency channels; production models will have three.

Different. Operating as it does, the Intometer differs in many ways from the Audimeter used by the A. C. Neilson Co. to gather and store data for program ratings in the United States.

For one thing, the Audimeter runs 24 hours a day. The Intometer turns itself on for five-second recording sessions only when code signals are broadcast to identify advertising spots.

For another, data on the tape cartridges of the Dutch device can be transferred on-line into a computer. Electrologica has developed a high-speed reader that transcribes the tape data into computer language and passes it directly into a working memory of the computer. By contrast, the basic store in the Nielsen unit is a photographic film. It takes several time-consuming steps to convert the optical data on the film into magnetic pulses on a computer tape.

Nielsen has under development an Audimeter using magnetic tape that will be tried out in the Los

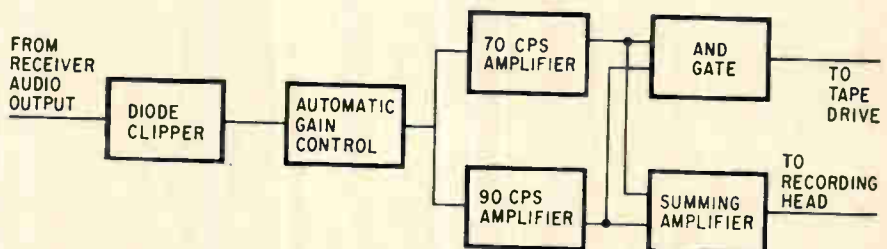

Dutch tape recorder runs for five seconds after frequencies from both selective amplifiers appear simultaneously at AND gate to trigger monovibrator circuit that powers tape drive motor. Prototype version shown above has two channels; production model will have three.

Angeles area about 18 months from now. Both the Audimeter and Intometer systems process the basic data on high-speed computers.

The Intometer hooks up to a receiving set simply by connecting it across the loudspeaker leads, something any technician can do in a few minutes, but the Audimeter has to be wired into the channel selector switch by a specially trained technician and it takes about an hour to do the job.

Finally, the Intometer is much the smaller of the two, about the size of a paperback book. In a household installation, this is no particular advantage since both the U.S. and Dutch units can be located off the set, down in the basement if need be. But the Intometer's small size gives it an added potential application—marketing data on use of audio radios. Philips Gloeilampenfabrieken NV, which has a 40% shareholding in Electrológica, may use the Intometer for that purpose.

West Germany

X-rays on tape

Waiting time for results on extensive X-ray examinations has been slashed to practically nothing in some German medical centers where doctors are testing recording equipment that puts X-ray images on television tape.

Until now, physicians or researchers concerned with body functions in the chest, heart, digestive tract and the like relied on a cinematic recording of fluoroscope or serial X-ray images. But it meant waiting for the films to be developed before any detailed analysis could be made.

With the video tape equipment, however, the recording can be played back immediately. Although doctors can get instant viewing on a fluoroscope, the television tape equipment has an important advantage. The tape can be replayed over and over so doctors can spot anomalies visible only for a brief



Doctors get immediate playback of X-ray images recorded on television tape.

moment that might be missed in a fluoroscope examination.

The recorder also is a valuable aid for teaching over closed-circuit tv systems in university hospitals and may well become standard equipment in many hospitals.

West Germany's Siemens-Reiniger-Werke AG developed the equipment, which is called the Siemens VR 1550. Basically, video signals derived from a tv pick-up unit coupled to the X-ray stereoscope are fed to the tape recorder and stored on 2-inch magnetic tape.

Whirling heads. Helical scanning techniques are used to record the X-ray images for television. The tape travels around a stationary scanning assembly. Inside it, a pair of recording heads whirls at 1,550 revolutions per minute. Because the tape describes a helix as it runs around the scanner, the recorded tracks slope across the tape. In the first half-revolution of the head drum, one head records a single field—312.5 lines of 625-line frame. In the second half-revolution the other head records the second 312.5-line field for the frame on the following track with interlacing.

The tape travels at about 4 inches per second around the scanning assembly; scanning speed of the rotating heads is 60 feet per second. At this speed the equip-

ment can record video frequencies up to 5 megacycles.

Slow motion, too. For playback, a control system makes sure that each track on the tape stays synchronized with the head that recorded it. The system also provides for varying the tape speed to get slow-motion effects as in conventional motion pictures.

In addition to the video signals, the equipment can record audio signals from 90 cycles per second to 8 kilocycles in two independent channels. This allows doctors to record at the same time body sounds on one channel and their diagnoses or other data pertaining to the examination on the other channel. The audio tracks can be erased if a second playback without sound is desired.

Scandinavia

Down with defects

A third-harmonic testing technique pioneered in Scandinavia promises sweet music to engineers who want to speed up reliability checks on batches of linear components like resistors and capacitors.

The third-harmonic technique measures nonlinearity in components at rates up to 20 per second. This compares to integration times of as much as half a second per component when resistors are tested in the conventional way using wide-band noise sources.

Swedish idea. L.M. Ericsson Telephone Co. of Stockholm first hit upon the technique. Like manufacturers of telephone exchange equipment everywhere, Ericsson runs stringent reliability tests on the components it uses. Looking for something faster than wide-band noise testing, the company found that there's a close correlation between the noise in a linear component and the harmonic distortion the component causes when a pure sine wave is applied.

In resistors, defects like poor connections between leads and caps, bad spots in the carbon film, traces of carbon in grooves or poor contact between the cap and film show up as harmonic distortions in the test. So do small movements caused by electrostatic forces in capacitors and faulty contacts on capacitors. High-reliability equipment makers can't put components with faults like these into their gear.

Danish machine. Ericsson has been testing components with the third-harmonic technique for some years using made-in-the-house instrumentation. Now Radiometer A/S of Copenhagen has put on the market a tester based on Ericsson's experience. The Radiometer instrument soon will be introduced in the United States.

The instrument measures the third harmonic generated in components under test when a pure sinusoidal 10-kilocycle wave is applied. Although the concept is simple, some tricky circuitry is necessary to make the idea work since the third harmonic must be measured 160 decibels below the level of the 10-ke test signal. To achieve this, Radiometer developed special air core matching transformers, filter circuits, and highly stable automatic gain controls.

The third-harmonic output is displayed on a meter with sensitivity

of 1 microvolt and an accuracy of 5%. For testing in production quantities, a logarithmic amplifier is switched in to prevent overload. This allows a dynamic output variation of 60 decibels, a range that can easily be encountered in production testing when components are faulty.

A component sorting device can be coupled directly to Radiometer's tester. When this is done, over-all reliability of a batch of components can be increased by sorting out components whose nonlinearity exceeds the average range for the batch.

France

Competition for Comsat?

Charles de Gaulle's determination to free France—and for that matter all Western Europe—from dependence on the United States may give the Communications Satellite Corp. some competition.

De Gaulle wants his communications satellite to link France with a dozen countries in Africa and the Mideast. A decision on the \$50-mil-



Charles de Gaulle's insistence on a French communications satellite has produced plans for the \$50-million Safran project. Safran is the acronym for satellite francais.

lion dollar project may come soon. With top-ranking space and communications officials scheduled to confer with de Gaulle and his cabinet late this month or early in May, the go-ahead could come then.

By the dozen. Safran is the name the French have given their communications satellite project. The 400-pound satellite would have 144 telephone channels assigned a dozen each to a dozen ground stations. The main transmission station would be at Pleumeur-Bodou in Finistere, the existing French facility for space communications.

Preliminary estimates peg the cost for building the satellite, the launch vehicle, and the 12 ground stations at about \$35 million. A launching pad for Safran at the French Guiana space complex [Electronics, Nov. 1, 1965, p. 159] would cost another \$14 million. The tentative launch date is 1970.

For their outlay, the French would get only a part-time system. Plans are for a single satellite in an equatorial orbit. That means the satellite would be in range of the ground stations only six hours a day. For round-the-clock service, six satellites would be needed. The price presumably would be more than the French are willing to pay.

With the system they plan, it's obvious that the French don't intend to drop out of Comsat. But from de Gaulle on down, French officials refuse to consider space communications satellites as the exclusive preserve of the United States and Russia.

Side effect. De Gaulle's projected communications satellite may be a tonic for the ailing European Launcher Development Organization. Great Britain, which makes the biggest contribution to the seven-nation joint rocket effort, wants to pull out of ELDO or at least have her share of costs reduced. Cost of the three-stage ELDO-A rocket has doubled to \$400 million from the \$200 million originally estimated and the first one still hasn't been launched.

To launch Safran, the French are considering a modified ELDO-A rocket with an added fourth stage to boost the payload to slightly

1

SOURCE...

YOUR ELECTRONIC CRYSTALS
& MATERIALS HEADQUARTERS

LASER CRYSTALS and SYSTEMS

- Gas Laser Systems & Components
- Solid State Laser Systems & Components
- Injection Laser Systems & Components

SEMI-CONDUCTOR SINGLE CRYSTALS and MATERIALS

- Germanium
- Silicon
- III-V Compounds
Gallium Arsenide, Antimonide
Indium Phosphide, Arsenide, Antimonide
Custom Compounds of III-Vs
- II-VI Compounds
Cadmium Sulfide, Selenide, Telluride
Zinc Sulfide, Selenide, Telluride
Custom Compounds of II-VIs

THERMAL ELECTRIC and MAGNETOTHERMOELECTRIC SINGLE CRYSTALS & MATERIALS

- Bismuth, Antimony, Other Bismuth Alloys
- Lead Telluride
- Cuprous Sulfide, Other Exotics

THIN FILM CHEMICALS and SUBSTRATES FOR CONTROLLED VACUUM DEPOSITION

- SEVAC* Grade Chemicals and Compounds
- Single Crystal Substrates of
Metals Bromides
Oxides Iodides
Chlorides Vacuum Exotic Compounds

*Trademark for vacuum deposition chemicals

For literature write Dept. EL-3



semi-elements, inc.

Saxonburg Blvd., Saxonburg, Pa., 16056

Phone: 412-352-1548

Electronics Abroad

over 400 pounds. So there's a good chance France would agree to ease the British burden. The ELDO countries will meet next month to hash over future plans.

If ELDO fizzles, the French have in reserve a project to boost the lifting power of their own Diamant satellite launcher [Electronics, March 7, 1966, p. 302].

Great Britain

Uncoiled

For the upcoming generation of receivers built around integrated circuits, set makers want to do away with bulky coils, Gullivers in the Lilliputian world of thin films and silicon chips.

Researchers at Standard Telecommunications Laboratories Ltd. of Harlow, England, have come up with a thin-film IC filter design that points to the demise of coils in frequency-selective circuits for intermediate frequency amplifiers. Already they've pushed their filters to frequencies as high as 10 megacycles and obtained response factors (Q) of 20.

H. T. Roettgers and P. Lemke, who spearheaded the research work at STL, admit the Q is still too low for consumer receivers. But the pair thinks further design refinements would make their thin-film filter a practical component for receivers. First applications, though, will most likely come in professional equipment to back up mechanical filters and selective stages of noise suppression circuits.

Old hat. Filters without coils are old hat at audio frequencies. The most commonly used circuit is the twin-T, six lumped resistance and capacitance components arranged in a bridge network. Above audio frequencies, however, twin-T filters start having troubles. Their response factors are not predictable. In feedback networks, the center frequency of the filter-amplifier combination shifts away from the center frequency of the filter itself,

cutting down its effectiveness. Roettgers and Lemke say their thin-film three-component filter with distributed resistance and capacity overcomes these drawbacks.

Actually, the theory of tapered distributed filters is not new. Researchers at several American companies have demonstrated the possibility. But so far there's been little success at translating the theory into a device. The theory was verified by simulating distributed resistance with impregnated paper paired with foil for the capacitive elements. Diffused R-C networks were tried but they failed because values of the diffused components couldn't be controlled closely enough.

Bell Telephone Laboratories, however, has a process—sputtered tantalum—that shows promise for high-frequency distributed filters. Already Bell Labs has designed a sputtered tantalum network for the audio-frequency notch filter in a telephone data set.

Armed. The thin-film filter developed by STL has a series arm and a parallel arm. To make it, STL first deposits a distributed series-arm resistance and the parallel-arm resistance on a glass substrate. Then follows a silicon monoxide layer to form the dielectric for the capacitor. Finally, a tapered metal top plate for the capacitor is deposited along with a connection between the plate and the parallel-arm resistor.

In a network like this, output voltage is a combination of the voltages across the two arms. Voltage across the series arm varies with frequency. At the center frequency, real and imaginary components of the voltage vector in each arm are equal and opposite; this attenuates the center frequency.

For the filters, STL has plotted standard design curves to calculate the values of resistances and capacitance needed to obtain the required center frequency. It is inversely proportional to the product of the RC values; the component tolerances determine the center-frequency accuracy.

The amount of taper on the series-arm resistance controls the Q

of the filter. Theoretically, infinite Q is possible but the maximum value obtained so far is about 20. Over-all Q value of the filter-amplifier combination also depends on the gain of the amplifier. To hold Q within 5%, for example, an amplifier with a gain of 35 decibels would have to be stabilized to plus or minus one decibel.

Around the world

Japan. A laser radar—Japan's first—has been built at the Institute of Industrial Science of the University of Tokyo. Scientists there think it could be the forerunner of collision-preventing equipment for high-speed trains and aircraft. Effective range of the laser is six miles and its beam width less than 1 milliradian. The ruby laser develops an output of 20 megawatts at a one-second repetition rate.

Denmark. Storno, a Copenhagen-based maker of mobile communications equipment, plans to tackle the United States market with a taxi-alarm system. The equipment automatically transmits five tones in sequence when the driver pushes an "emergency" button. The tone sequence rings an alarm at the base station and displays the taxi's identification number on a panel.

Switzerland. Wild-Heerbrugg, Ltd., has teamed up with the Raytheon Co. to produce an automatic mapping system that scans a pair of stereo photographs and extracts profiles, contours and digital data. The equipment may find its way into applications for numerically controlled machine tool. It could translate the shape of an industrial model into digital data for NC milling machines.

Kuwait. The Marconi Co. of Great Britain has won a \$2.8-million contract to build one of the world's most powerful broadcasting stations for the Kuwait government. The station will have three 750-kilowatt transmitters and cover the entire Middle East.

You just discovered how to build a 3.9 volt power supply from any DC source in minutes.

By using a super/reg[®] synthesized zener diode, you make simple and quick the design of precision DC power supplies having .01% regulation and .5mv ripple.

Because typical super/reg impedances are 2 to 8 milliohms, lowest ever yet achieved.

Its unique "third" terminal lets you trim the output voltage a full $\pm 10\%$ from nominal, with no derating or degradation.

.01%/°C temperature compensation at high power levels; thermal stability 100-times greater than that of the standard zener.

Zener voltages from 3.9 to 56V.

Full 3-ampere steady-state rating up to 75 watts.

A super/reg diode breaks the zener barrier by means of its "syn-

thesized" construction: embodies a sensing bridge, operational amplifier, thermally compensated zener diode, in standard TO-36 case.

Looks, mounts like any other diode. Performance-proven reliability; patent pending design. Designed for MIL applications.

Write or call for complete data and application bulletins.

Semi-conductor Division, Trio Laboratories, Inc., Plainview, L.I., N.Y. (516) OV-1-0400.

TWX: (510) 221-1861.



© 1966, TRIO LABORATORIES, INC. • ORIGINAL CONCEPTS IN INSTRUMENTATION



This is the super/reg[®] synthesized zener diode.

Electronics advertisers

April 4, 1966



■ AMP Incorporated Garceau, Hargrave & McCullough Inc.	189	Consolidated Electrodynamics Corp. Hixson & Jorgensen Inc.	159	■ Hughes Aircraft Corp. Foote, Cone & Belding	144
API Instruments Company George Z. Griswold	220	Control Data Instruments Barnes-Champ Advertising	225	■ Hull Corporation The Michener Company	146
Acopian Corporation Mort Barish Associates Inc.	219	Corning Glass Works, Electronic Division The Rumrill Company	232	■ Ichizuka Optical Co., Ltd. Matsushita Inc.	240
Aerojet-General Corporation D'Arcy Advertising Company	222	Couch Ordnance Inc. Culver Advertising Inc.	222	IBM Benton & Bowles	130
Aerospace Research Sales Promotion Services	224	Cramer Industries Potts Woodbury Inc.	180	Indiana General Corporation Griswold & Eshleman Company	135
Airpax Electronics Inc. Welch, Mirabile & Company Inc.	174	■ CTS Corporation Burton Browne Advertising	33	Industrial Electronic Engineers, Inc. Gumpertz, Bentley & Dolan	195
■ Air Products & Chemical Inc. Arthur Falconer Associates Corporation	197	Dalmo Victor Company Pierce & Strain Advertising	75	Industrial Exhibitions Ltd. Walkley Hodgson Ltd.	217
Allen-Bradley Company The Fensholt Advertising Agency	27, 28	■ Delco Radio Division, General Motors Corporation Campbell-Ewald Company	20, 21	■ Ingersoll Products, Div. of Borg-Warner Corp. Connor-Sager Associates, Inc.	223
Amelco Semiconductor Sturges & Associates	72	■ Data Device Corporation Conti Advertising	163	Inland Controls, Inc., Sub. of Kollmorgen Corporation S. Gunnar Myrbeck & Co.	45
■ American Electronic Laboratories Inc. Benn Associates	198	■ Di-Acro Corporation Charles E. Brown Advertising Agency	231	Intercontinental Instruments Inc. Murray Heyert Associates	188
■ Ammon Instruments Inc. Culver Advertising Inc.	214	Dow Corning Corporation Church and Guisewrite Adv. Inc.	132	IRC, Inc. Gray & Rogers, Inc.	53
■ Amperex Electronic Corporation Sam Groden Incorporated	139	■ DuPont de Nemours & Company Inc. E. I. Batten, Barton, Durstine & Osborn Inc.	71, 183, 193	■ I T & T, Cannon West, Weir & Bartel, Inc.	206, 207
Amphenol Borg Electronics Corporation Marsteller Inc.	128, 129	Electro Instruments Inc. Van Der Boom, McCarron Inc.	77	Johanson Manufacturing Corporation Josephson, Cuffari & Company	166
■ Astrodata Inc. Bonfield Associates Inc.	15	■ Electronic Engineering Co. of California Jansen Associates Inc.	180	Johnson Company, E.F. Midland Associates, Inc.	142
■ Automatic Electric Company Tatham-Laird & Kudner Inc.	58	Electronic Modules Corporation Ray Thompson & Associates	140	Kay Electric Company Josephson, Cuffari & Co.	60
■ Ballantine Laboratories Lang-Lawrence Advertising Inc.	191	Emerson & Cuming Inc. Edwin F. Hall	240	■ Kepco, Inc. Weiss Advertising	22
■ Bausch & Lomb Wolff Associates Inc.	186	Engelhard Industries Inc. Keyes Martin & Company	202, 203	■ Leach Corporation Jay Chiat and Associates	143
Beckman Instruments Inc. Electronic Instruments Division Hixson & Jorgensen Inc.	41	Erie Technological Products Inc. Altman Hall Associates Adv.	79	■ LEL, Inc. Snow & Depew, Incorporated	160
Beckman Instruments Inc. Helipot Division Hixson & Jorgensen Inc.	131	■ Fairchild Instrumentation Faust/Day Inc.	150	Lockheed Missiles & Space Co. McCann-Erickson, Inc.	170
Beckman Instruments Inc. Offner Division Hixson & Jorgensen Inc.	54	■ Fairchild Semiconductor Faust/Day Inc.	127		
Bendix Corporation Montrose Division MacManus, John & Adams Inc.	81	The Formica Corporation Perry Brown Inc.	108		
■ Biley Electric Co. Barber & Drullard Inc.	239	■ Fork Standards Inc. K & A Incorporated	46		
■ Blue M Electric Company South Suburban Advertising	212	■ General Electric Company George R. Nelson Inc.	167, 168		
The Borden Chemical Company, Mystik Tape Division Robert Conahay Incorporated	50	■ General Electric Company George R. Nelson Inc.	14, 106, 107, 76		
■ Brush Instruments Div. of Clevite Corporation Carr Liggett Advertising Inc.	2nd Cover	■ General Electric Company Ross Roy Inc. Advertising	137		
Bulova Electronics Division Frank Best & Company Inc.	190	■ General Motor Corporation, Delco Radio Div. H.L. Ross Advertising Inc.	173		
Burroughs Corporation Conti Advertising Agency Inc.	82	General Radio Company K.E. Morang Company	6		
■ Bussmann Mfg. Co. Div. of McGraw-Edison Co. Henderson Advertising Company	212, 213	Goldman Sachs & Company Doremus & Company	200		
■ Carpenter Steel Company Beaumont, Heller & Sperling Inc.	56	Gudebrod Bros. Silk & Co. Inc. Ramsdell Buckley & Company Inc.	66		
Cherry Electrical Products Corp. K & A Incorporated	134	Hansen Mfg. Co. Inc. Keller Crescent Company	164		
Chuo Denki Standard Advertising Inc.	44	■ Heath Company Advance Advertising Service Inc.	180		
■ Cinch Mfg. Company Stral Advertising Company Inc.	55	■ Hewlett Packard Company Lennen & Newell Inc.	1, 43, 51, 133, 165		
■ Clevite Corporation Piezoelectric Div. Carr Liggett Advertising Inc.	172	■ Hewlett Packard, Sanborn Division Culver Advertising Inc.	2		
Cleveland Institute of Electronics Rapp & Collins Div. of Foote, Cone & Belding	158	Hoffman Electronics Corporation Honeywell PMD	145, 67		
Cohu Electronics Inc. Erwin Wasey, Ruthrauff & Ryan Inc.	179	Batten, Barton, Durstine & Osborn Inc.			
Comcor Sub. of Astrodata Inc. Marketing Directions	147	Hopkins Engineering Co. Philip J. Meany Company	192		
Communication Electronics Incorporated	78				
Computer Control Company Franklin P. Folts Incorporated	61				
Consolidated Vacuum Corporation Wolf Associates Inc.	17				
				Classified advertising	
				F. J. Eberle, Business Mgr.	
				EMPLOYMENT OPPORTUNITIES	226-228
				Equipment	
				(Used or Surplus New)	
				For Sale	229
				ADVERTISERS INDEX	
				A & A Electronics Corp.	229
				Atomic Personnel Inc.	228
				Bausch & Lomb	226
				Candee Co., J.J.	229
				Corcoran, Joseph P.	226
				Easy-Up Inc.	229
				Electronic Communications Inc.	228
				Fishman Co., P.	229
				General Motors Research Laboratories	227
				Goodheart Co., Inc., R.E.	229
				Norman Electronic Sales	229
				Radio Research Instrument Co.	229
				Rex Industrial Electronics	229
				Surplus Saving Center	229
				U.S. Navy Bureau of Ships	227
				■ For more information on complete product line see advertisement in the latest Elec- tronics Buyers' Guide	
				□ Advertisers in Overseas Advertising Section	

Executive, editorial, circulation and advertising offices: McGraw-Hill Building, 330 West 42nd Street, New York, N.Y., 10036. Telephone (212) 971-3333. Teletype TWX N.Y. 212 640-4646. Cable: McGrawHill, N.Y. Officers of the McGraw-Hill Publications: Joseph H. Allen, President; Vice Presidents: J. Eiton Tuohij, Operations; John R. Callahan, Editorial; Ervin E. DeGraff, Circulation; Donald C. McGraw, Jr., Advertising Sales; Angelo R. Venezian, Marketing. Officers of the Corporation: Donald C. McGraw, Chairman of the Board; Shelton Fisher, President; L. Keith Goodrich, Hugh J. Kelly and Robert E. Slaughter, Executive Vice Presidents; John J. Cooke, Vice President and Secretary; John L. McGraw, Treasurer. Title R registered U.S. Patent Office; © copyright 1966 by McGraw-Hill, Inc. All rights reserved, including the right to reproduce the contents of this publication, in whole or in part.

Electronics advertisers

April 4, 1966

■ Mallory and Co., P.R. Aitkin-Kynett Co., Inc.	47	Sigma Instruments Inc.	116, 117
■ Machlett Laboratories Fuller & Smith & Ross Inc.	9	The Marschalk Company Inc.	
■ Markem Machine Company Culver Advertising, Inc.	48	Signetics Corporation Cunningham & Walsh Inc.	187
■ Matsuo Electric Co., Ltd. Fuji Agency	221	Simpson Electric Company The Fensholt Advertising Agency	65
■ McCoy Electronics Company Buchen Advertising, Inc.	52	□ Souriau & Cie Ariane Publicite	OAS 4
■ McGraw-Hill Book Co.	136	■ Spectra Electronics Marketing Services	162
■ McLean Engineering Laboratories Healy Advertising Agency	214	Sperry Electronic Tube Division Neals & Hickok Inc.	57
■ Memorex Corporation Hal Lawrence Inc.	199	Sprague Electric Company The Harry P. Bridge Company	5, 10
■ Melcor Electronics Corporation Samuel H. Goldstein	220	Stackpole Carbon Company Meek & Thomas Inc.	169
■ Metals & Controls, Div. of Texas Instruments, Inc.	181, 196	■ Superior Tube Company Gray & Rogers Inc.	216
■ Horton, Church & Goff, Inc.		Sylvania Electric Products Inc. Briant Advertising	73
■ Metronix Standard Adv. Inc.	210	Synthane Corporation Arndt, Preston, Chapin & Lamb, Keen Inc.	148
■ Micro Kits, Inc.	240		
■ Micro Switch Batten, Barton, Durstine & Osborn, Inc.	30, 31	Taylor Corporation Gray & Rogers Inc.	155
■ Microwave Electronics Bonfield Associates	215	■ Tektronix Inc. Hugh Dwight Advertising Inc.	18, 19
■ Minnesota Mining & Mfg. Co. Klau-Van Pietersom-Dunlap, Inc.	211	■ Telonic Engineering Company Jansen Associates Inc.	172
■ Mitsumi Electric Co., Ltd. Dentsu Advertising Ltd.	230	■ Telonic Industries Inc. Jansen Associates Inc.	201
■ Motorola Semiconductor Products Inc.	68, 184, 185	Tempress Research Co. Hal Lawrence Inc.	49
■ Lane and Bird Advertising		■ Texas Instruments Incorporated Robinson-Gerrard Inc.	64
■ Mullard Ltd. Stuarts Adv. Agency Ltd.	157	Topaz Inc. Teawell Inc.	207
		Trio Laboratories Zam & Kirshner	237
■ New Hermes Engraving Machine Corp. Lester Harrison Advertising, Inc.	166	Transitron Electronic Corporation Larcom Randall Advertising Inc.	7
■ Nexus Research Labs. Larcom Randall Advertising, Inc.	149	TRW Semiconductors Fuller & Smith & Ross Inc.	39
■ North Atlantic Industries, Inc. Murray Heyert Associates	11	■ Tylon Incorporated George Moll Advertising Inc.	200
■ Pamator, Incorporated Harry P. Bridge Company	231		
■ Penta Laboratories, Inc. Fuller & Smith & Ross Inc.	8	Ultra Carbon Corporation Church and Guisewite Adv. Inc.	42
■ Perkin-Elmer Corporation Gaynor & Ducas, Inc.	203	■ United Transformer Corporation Philip Stogel Company Inc.	2nd Cover
■ Permag Corporation Schneider, Allen, Walsh, Inc.	225		
■ Perfection Mica Company Burton Browne Advertising	210	■ Vitro Electronics Buchen Advertising Inc.	178
■ Phelps Dodge Electronic Products Corp. Smith, Dorian & Burman, Inc.	205		
□ Plessey Roles & Barker Ltd.	OAS 2 & 3	Wakefield Engineering, Inc. Sales Promotion Services	224
■ Polarad Electronic Instruments Keys, Martin & Co.	171	Wang Laboratories Larcom Randall Advertising, Inc.	210
■ Polaroid Corporation Doyle, Dane, Bernbach, Inc.	59	Wanlass Electric Co. Leland Oliver Co., Inc.	218
■ Potter & Brumfield Grant, Schwenck & Baker, Inc.	24	Watkins-Johnson Company William C. Estler	16
■ Precision Paper Tube Company T.W. Blakeslee Advertising	208, 209	Wavetek Chapman, McQuiston Suzuki & Wright	29
■ Precision Scientific Company Tri-State Advertising Co.	177	□ Weinschel Engineering Geo. T. Petsche Adv.	OAS 1
■ Precision Tube Company, Inc. George Moll Advertising, Inc.	176	West Penn Power Fuller & Smith & Ross Inc.	204
■ Princeton Applied Research Corporation Mort Barish Associates, Inc.	34	Westinghouse Electric Corp., Semiconductor Div. ITSM Div. of McCann-Erickson, Inc.	141
		Weston Instruments, Boonshaft & Fuchs Div. Arndt, Preston, Chapin, Lamb & Keen, Inc.	182
■ Radiation, Inc. Basford Inc.	12, 13	■ Weston Instruments, Transicoil Div. Arndt, Preston, Chapin, Lamb & Keen, Inc.	221
■ Radio Cores, Inc. Sander Rodkin Advertising Agency, Ltd.	209		
■ Radio Corporation of America Al Paul Lefton Company	4th Cover	Xerox Corporation Deutsch & Shea	138
■ Raytheon Company Fuller & Smith & Ross Inc.	32		
■ Rohde & Schwarz Sales Frank Best & Co., Inc.	62, 63		
■ Sage Electronics Corp. Scrivener & Company	194		
■ Semi-Elements, Inc. Cavanaugh Morris Adv.	236		
■ Siemens America Incorporated Wesley Advertising Inc.	142		

New Member of the QUALITY QUORUM



Bliley TYPE BK2 CRYSTALS

Type BK2 was designed primarily for compact precision at 1 mc in high stability applications. A Koldweld sealed holder eliminates contamination due to heat and flux to assure optimum crystal performance. Typical parameters include:

- ▶ Maximum aging 3×10^{-8} per week
- ▶ Short term stability 1×10^{-8} per day
- ▶ Average Q 500,000

Type BK2 is also available on special order in range 900-1000 kc.

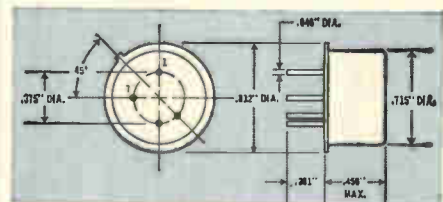

Request Bulletin 527B-S for complete information.

Bliley If you buy quality

BLILEY ELECTRIC COMPANY
Union Station Bldg.
Erie, Pennsylvania

90% of all Japanese ITV cameras use COSMICAR lenses.

COSMICAR
INDUSTRIAL TV LENSES



For your vidicon, image orthicon and professional movie cameras, Cosmicar lenses are available in focal lengths from 12.5mm up to 1000mm.

New zoom lenses are now available.



ICHIZUKA OPTICAL CO., LTD.

2-568, SHIMOOCHIAI, SHINJUKU-KU, TOKYO

CABLE ADDRESS "MOVIEKINO TOKYO"

Circle 516 on reader service card

NEW! SCR CAPACITIVE DISCHARGE
FURY XII
ELECTRONIC AUTO IGNITION SYSTEM



Kit or Assembled!
SATISFACTION
GUARANTEED!

You've read all the ads - Heard all the claims - Now buy the VERY BEST. FURY XII costs a little more but we ADD QUALITY rather than CUT COST !!!!
FURY XII Kit..... \$ 39.95
FURY XII Assembled..... \$ 59.95

MICRO-KITS, INC.
1900 Crest Drive, Eugene, Ore.

I ENCLOSE \$39.95 for kit.

I ENCLOSE \$59.95 ASSBLD

NAME ADDRESS
CITY STATE

DIELECTRIC MATERIALS SUPPLEMENT



This brand new chart in full color for wall mounting or notebook contains data on all important materials developed since the original DIELECTRIC MATERIALS chart. The original is shown in the background.

This valuable chart is yours.

Write or use the Reader Service Card.

EMERSON & CUMING, INC.



CANTON, MASS.

604 W. 182nd St.

Gordena, Calif.

9667 Allen Ave.

Rosemont, Illinois

Emerson & Cuming Europe N.V.
Oevel, Belgium

Circle 515 on reader service card



Advertising sales staff

Gordon Jones [212] 971-2210
Advertising sales manager

Atlanta, Ga. 30309: Gus H. Krimsier,
Michael H. Miller, 1375 Peachtree St. N.E.,
[404] TR 5-0523

Boston, Mass. 02116: William S. Hodgkinson
McGraw-Hill Building, Copley Square,
[617] CO 2-1160

Chicago, Ill. 60611: Robert M. Denmead,
J. Bradley MacKimm
645 North Michigan Avenue,
[312] MO 4-5800

Cleveland, Ohio 44113: Paul T. Fegley, 55
Public Square, [216] SU 1-7000

Dallas, Texas 75201: Richard P. Poole, The
Vaughn Building, 1712 Commerce Street,
[214] RI 7-9721

Denver, Colo. 80202: Joseph C. Page, David
M. Watson, Tower Bldg., 1700 Broadway,
[303] 255-5484

Detroit, Michigan 48226: Paul T. Fegley
856 Penobscot Building
[313] 962-1793

Houston, Texas 77002: Kenneth George,
2270 Humble Bldg.,
[713] CA 4-8381

Los Angeles, Calif. 90017: Ian C. Hill,
John G. Zisch, 1125 W. 6th St.,
[213] HU 2-5450

Minneapolis, Minn. 55402: J. Bradley
MacKimm, 1104 Northstar Center
[612] 332-7425

New York, N. Y. 10036:
Donald R. Furth [212] 971-3615
Frank LeBeau [212] 971-3615
George F. Werner [212] 971-3615
500 Fifth Avenue

Philadelphia, Pa. 19103: William J. Boyle,
Warren H. Gardner, 6 Penn Center Plaza,
[215] LO 8-6161

Pittsburgh, Pa. 15222: Paul T. Fegley,
4 Gateway Center, [412] 391-1314

Portland, Ore. 97204: James T. Hauptli,
Pacific Building, Yamhill Street,
[503] CA3-5118

St. Louis, Mo. 63105: Robert M. Denmead
The Clayton Tower, 7751 Carondelet Ave.
[314] PA5-7285

San Francisco, Calif. 94111:
James T. Hauptli, 255 California Street,
[415] DO 2-4600

London W1: John W. Patten, Edwin S.
Murphy Jr., 34 Dover Street,
Hyde Park 1451

Milan: 1, via
Baracchini Phone: 86-90-617
86-90-656

Frankfurt/Main: Gerd Hinske, Joseph
Wuensch, 85 Westendstrasse
Phone: 77 26 65 and 77 30 59

Geneva: Michael R. Zeyne,
1, rue du Temple
Phone: 31 95 60

Paris VIII: Denis Jacob, 17 Avenue
Matignon ALMA-0452

Tokyo: Nobuyuki Sato, 1, Kotohiracho
Shiba, Minato-Ku [502] 0656

Osaka: Ryosi Kobayashi, 163, Umegee-cho,
Kita-ku [362] 8771

Wallace C. Carmichael [212] 971-3191
Manager Electronics Buyers' Guide

David M. Tempest [212] 971-3139
Promotion manager

Milton Drake [212] 971-3485
Market research manager

Wallace C. Carmichael [212] 971-3191
Business manager

Stephen R. Weiss [212] 971-2044
Production manager

Electronics reader service

Use these handy post cards for more detailed information on: products advertised, new products, new literature.

Circle the number on the Reader Service post card that corresponds to the number at the bottom of the advertisement, new product item, or new literature in which you are interested.

Please print clearly. All written information must be legible to be efficiently processed.

If someone has beaten you to the post cards, you may obtain the needed information by writing directly to the manufacturer, or by sending your name and address, plus the Reader Service number, to Electronics Reader Service department.

All inquiries from outside the U.S. that cannot reach Electronics before the expiration dates noted on the Reader Service post card, must be mailed directly to the manufacturer. The manufacturer assumes all responsibilities for responding to inquiries. Electronics merely provides and clears requests for information from inquirer to manufacturer.

Correct amount of postage must be affixed for all mailings from outside the U.S.

To subscribe to or to renew Electronics

Fill in the "For Subscriptions" area on the card if you desire to subscribe to or renew your present subscription to Electronics. Send no money. Electronics will bill you at the address indicated on the Reader Service post card.

Multi-product advertisements

For information on specific items in multi-product advertisements which do not have a specific Reader Service number indicated write directly to manufacturer for information on precise product in which you are interested.

7 April 4, 1966 Card Expires June 4, 1966 14

Name _____ title _____

Company _____

Address _____

For Subscriptions
 new renewal
 3 years \$12.00
 1 year \$6.00

1 20 39 58 77 96 115 134 153 172 191 210 229 248 267 286 305 324 343 362 381 400 419 438 457 476 495 514 962
 2 21 40 59 78 97 116 135 154 173 192 211 230 249 268 287 306 325 344 363 382 401 420 439 458 477 496 515 963
 3 22 41 60 79 98 117 136 155 174 193 212 231 250 269 288 307 326 345 364 383 402 421 440 459 478 497 516 964
 4 23 42 61 80 99 118 137 156 175 194 213 232 251 270 289 308 327 346 365 384 403 422 441 460 479 498 517 965
 5 24 43 62 81 100 119 138 157 176 195 214 233 252 271 290 309 328 347 366 385 404 423 442 461 480 499 518 966
 6 25 44 63 82 101 120 139 158 177 196 215 234 253 272 291 310 329 348 367 386 405 424 443 462 481 500 900 967
 7 26 45 64 83 102 121 140 159 178 197 216 235 254 273 292 311 330 349 368 387 406 425 444 463 482 501 901 968
 8 27 46 65 84 103 122 141 160 179 198 217 236 255 274 293 312 331 350 369 388 407 426 445 464 483 502 902 969
 9 28 47 66 85 104 123 142 161 180 199 218 237 256 275 294 313 332 351 370 389 408 427 446 465 484 503 951 970
 10 29 48 67 86 105 124 143 162 181 200 219 238 257 276 295 314 333 352 371 390 409 428 447 466 485 504 952 971
 11 30 49 68 87 106 125 144 163 182 201 220 239 258 277 296 315 334 353 372 391 410 429 448 467 486 505 953 972
 12 31 50 69 88 107 126 145 164 183 202 221 240 259 278 297 316 335 354 373 392 411 430 449 468 487 506 954 973
 13 32 51 70 89 108 127 146 165 184 203 222 241 260 279 298 317 336 355 374 393 412 431 450 469 488 507 955 974
 14 33 52 71 90 109 128 147 166 185 204 223 242 261 280 299 318 337 356 375 394 413 432 451 470 489 508 956 975
 15 34 53 72 91 110 129 148 167 186 205 224 243 262 281 300 319 338 357 376 395 414 433 452 471 490 509 957 976
 16 35 54 73 92 111 130 149 168 187 206 225 244 263 282 301 320 339 358 377 396 415 434 453 472 491 510 958 977
 17 36 55 74 93 112 131 150 169 188 207 226 245 264 283 302 321 340 359 378 397 416 435 454 473 492 511 959 978
 18 37 56 75 94 113 132 151 170 189 208 227 246 265 284 303 322 341 360 379 398 417 436 455 474 493 512 960 979
 19 38 57 76 95 114 133 152 171 190 209 228 247 266 285 304 323 342 361 380 399 418 437 456 475 494 513 961 980

2

Business reply mail
 No postage stamp necessary if mailed in the United States

Postage will be paid by

Electronics
Reader service department
Box 444
Hightstown, N.J. 08520

First class
Permit no. 42
Hightstown, N. J.



7 April 4, 1966 Card Expires June 4, 1966 14

Name _____ title _____

Company _____

Address _____

For Subscriptions
 new renewal
 3 years \$12.00
 1 year \$6.00

1 20 39 58 77 96 115 134 153 172 191 210 229 248 267 286 305 324 343 362 381 400 419 438 457 476 495 514 962
 2 21 40 59 78 97 116 135 154 173 192 211 230 249 268 287 306 325 344 363 382 401 420 439 458 477 496 515 963
 3 22 41 60 79 98 117 136 155 174 193 212 231 250 269 288 307 326 345 364 383 402 421 440 459 478 497 516 964
 4 23 42 61 80 99 118 137 156 175 194 213 232 251 270 289 308 327 346 365 384 403 422 441 460 479 498 517 965
 5 24 43 62 81 100 119 138 157 176 195 214 233 252 271 290 309 328 347 366 385 404 423 442 461 480 499 518 966
 6 25 44 63 82 101 120 139 158 177 196 215 234 253 272 291 310 329 348 367 386 405 424 443 462 481 500 900 967
 7 26 45 64 83 102 121 140 159 178 197 216 235 254 273 292 311 330 349 368 387 406 425 444 463 482 501 901 968
 8 27 46 65 84 103 122 141 160 179 198 217 236 255 274 293 312 331 350 369 388 407 426 445 464 483 502 902 969
 9 28 47 66 85 104 123 142 161 180 199 218 237 256 275 294 313 332 351 370 389 408 427 446 465 484 503 951 970
 10 29 48 67 86 105 124 143 162 181 200 219 238 257 276 295 314 333 352 371 390 409 428 447 466 485 504 952 971
 11 30 49 68 87 106 125 144 163 182 201 220 239 258 277 296 315 334 353 372 391 410 429 448 467 486 505 953 972
 12 31 50 69 88 107 126 145 164 183 202 221 240 259 278 297 316 335 354 373 392 411 430 449 468 487 506 954 973
 13 32 51 70 89 108 127 146 165 184 203 222 241 260 279 298 317 336 355 374 393 412 431 450 469 488 507 955 974
 14 33 52 71 90 109 128 147 166 185 204 223 242 261 280 299 318 337 356 375 394 413 432 451 470 489 508 956 975
 15 34 53 72 91 110 129 148 167 186 205 224 243 262 281 300 319 338 357 376 395 414 433 452 471 490 509 957 976
 16 35 54 73 92 111 130 149 168 187 206 225 244 263 282 301 320 339 358 377 396 415 434 453 472 491 510 958 977
 17 36 55 74 93 112 131 150 169 188 207 226 245 264 283 302 321 340 359 378 397 416 435 454 473 492 511 959 978
 18 37 56 75 94 113 132 151 170 189 208 227 246 265 284 303 322 341 360 379 398 417 436 455 474 493 512 960 979
 19 38 57 76 95 114 133 152 171 190 209 228 247 266 285 304 323 342 361 380 399 418 437 456 475 494 513 961 980

Reprint service

All Electronics editorial matter available in reprint form:

For reprints of special reports and feature articles see list on right side of this page. Send your order to Electronics Reprint Department at the address indicated. To expedite mailing of your order for single reprints please send cash, check or money order with your order.

Bulk reprints of editorial matter can be ordered from current or past issues. The minimum quantity is 100 copies. The higher the quantity ordered, the more economical the cost per copy. Prices quoted on request.

To order reprints or for further information, please write to: Electronics Reprint Department, 330 West 42nd Street, New York, N.Y. 10036. Telephone: Area code 212 971-3140.

Prices for the below listed reprints unless otherwise specified are 1-10 copies 50¢ each; 11-24 copies 35¢ each; 25-99 copies 25¢ each; price for 100 or more is 20¢ each.

You may order any of the below listed reprints by key number.

Key no. R-87 The Packaging Revolution In Microelectronics (Parts IV, V and VI. 32 pages). \$1.00

Key no. R-86 Computer Time Sharing Part II 12 pages.

Key no. R-85 U.S. Electronics Markets 1966 24 page forecast report with 6 page foldout chart.

Key no. R-84 European Electronics Markets 1966. 16 pages with 4 page foldout chart.

Key no. R-83 A Look At Japanese Electronics Technology 36 pages.

Key no. R-82 Computer Time Sharing Part I 20 pages

Key no. R-80 The Packaging Revolution In Microelectronics (Parts I, II, and III. 32 pages). \$1.00

Key no. R-79 MOS Integrated Circuits 12 pages.

Key no. R-78 The Overlay Transistor 15 pages.

Key no. R-77 Cold Cathode Tubes (3 part series, 28 pages).

Key no. R-76 Automated Trains: Who's On The Right Track? 16 pages.

Key no. R-75 Biotelemetry [2 Part series 16 pages].

Key no. R-74 Unijunction Transistors, 24 pages.

Key no. R-68 Designing Against Space Radiation, 18 pages:

Key no. R-66 Field Effect Transistors, Part III 16 pages.

Key no. R-65 Field Effect Transistors, Part II 24 pages

Key no. R-64 Field Effect Transistors, Part I 24 pages.

Key no. R-63 Silicon Power Transistors 8 pages. 25¢

Key no. R-61 Direct Digital Control in Industry, 24 pages.

Key no. R-60 Transistor Heat Dissipators, 32 pages.

Key no. R-31 1962 Electromagnetic Spectrum Chart, [22" x 30" foldout chart]. \$1.00

3

Business reply mail

No postage stamp necessary if mailed in the United States

Postage will be paid by

First class
Permit no. 42
Hightstown, N. J.



Electronics
Reader service department
Box 444
Hightstown, N. J. 08520

7

April 4, 1966 Card Expires June 4, 1966

14

Name _____	title _____	For Subscriptions <input type="checkbox"/> new <input type="checkbox"/> renewal <input type="checkbox"/> 3 years \$12.00 <input type="checkbox"/> 1 year \$6.00
Company _____	_____	
Address _____	_____	

1 20 39 58 77 96 115 134 153 172 191 210 229 248 267 286 305 324 343 362 381 400 419 438 457 476 495 514 962
 2 21 40 59 78 97 116 135 154 173 192 211 230 249 268 287 306 325 344 363 382 401 420 439 458 477 496 515 963
 3 22 41 60 79 98 117 136 155 174 193 212 231 250 269 288 307 326 345 364 383 402 421 440 459 478 497 516 964
 4 23 42 61 80 99 118 137 156 175 194 213 232 251 270 289 308 327 346 365 384 403 422 441 460 479 498 517 965
 5 24 43 62 81 100 119 138 157 176 195 214 233 252 271 290 309 328 347 366 385 404 423 442 461 480 499 518 966
 6 25 44 63 82 101 120 139 158 177 196 215 234 253 272 291 310 329 348 367 386 405 424 443 462 481 500 900 967
 7 26 45 64 83 102 121 140 159 178 197 216 235 254 273 292 311 330 349 368 387 406 425 444 463 482 501 901 968
 8 27 46 65 84 103 122 141 160 179 198 217 236 255 274 293 312 331 350 369 388 407 426 445 464 483 502 902 969
 9 28 47 66 85 104 123 142 161 180 199 218 237 256 275 294 313 332 351 370 389 408 427 446 465 484 503 951 970
 10 29 48 67 86 105 124 143 162 181 200 219 238 257 276 295 314 333 352 371 390 409 428 447 466 485 504 952 971
 11 30 49 68 87 106 125 144 163 182 201 220 239 258 277 296 315 334 353 372 391 410 429 448 467 486 505 953 972
 12 31 50 69 88 107 126 145 164 183 202 221 240 259 278 297 316 335 354 373 392 411 430 449 468 487 506 954 973
 13 32 51 70 89 108 127 146 165 184 203 222 241 260 279 298 317 336 355 374 393 412 431 450 469 488 507 955 974
 14 33 52 71 90 109 128 147 166 185 204 223 242 261 280 299 318 337 356 375 394 413 432 451 470 489 508 956 975
 15 34 53 72 91 110 129 148 167 186 205 224 243 262 281 300 319 338 357 376 395 414 433 452 471 490 509 957 976
 16 35 54 73 92 111 130 149 168 187 206 225 244 263 282 301 320 339 358 377 396 415 434 453 472 491 510 958 977
 17 36 55 74 93 112 131 150 169 188 207 226 245 264 283 302 321 340 359 378 397 416 435 454 473 492 511 959 978
 18 37 56 75 94 113 132 151 170 189 208 227 246 265 284 303 322 341 360 379 398 417 436 455 474 493 512 960 979
 19 38 57 76 95 114 133 152 171 190 209 228 247 266 285 304 323 342 361 380 399 418 437 456 475 494 513 961 980

1

Business reply mail

No postage stamp necessary if mailed in the United States

Postage will be paid by

First class
Permit no. 42
Hightstown, N. J.

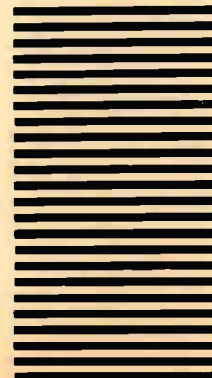

Electronics
Reader service department
Box 444
Hightstown, N.J. 08520

For research labs and rolling mills and everything in between...

The Incomparable Brush Mark 200.

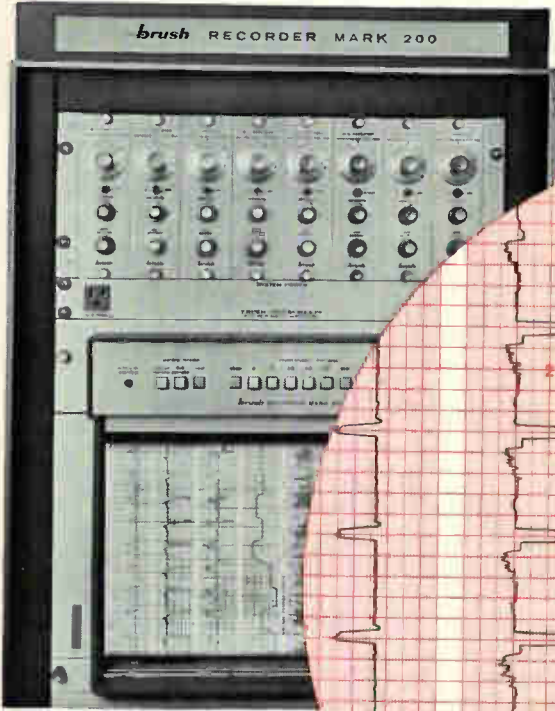

The record
speaks
for itself!

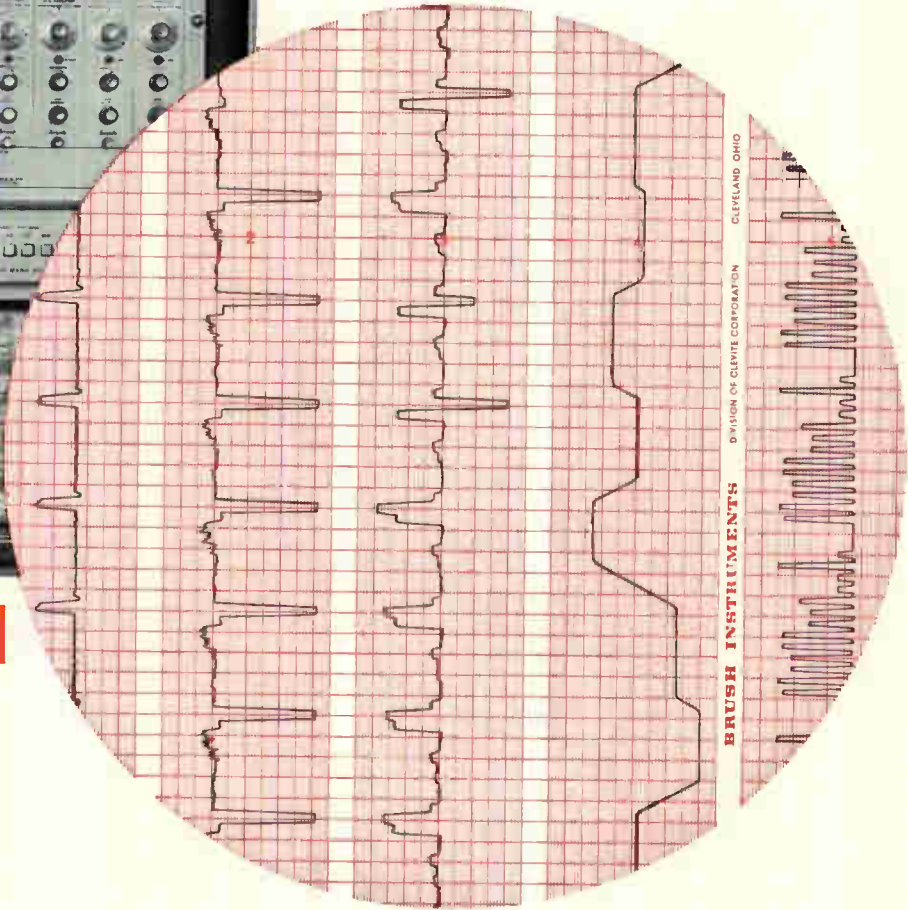

Look again.

Only one direct writing recording system in the world will give you such incredibly crisp traces: the Brush Mark 200. No wonder people call it "the finest ever built!"

That's what we had in mind when we designed it.

That's why Mark 200 Systems have a patented Hydrostatic Inking System that puts the trace *into* the paper . . . not just on it. And a unique, reliable pen position feed-

back system that delivers *total* system accuracy of better than ½%! Plus a totally new pen linkage that assures *true* rectilinear writing.

But that's not all. Thanks to modular sub-systems, we can match a Mark 200 to your specific requirements *without* special engineering time and costs. Choice of three different penmotors . . . thirty-two pre-amplifiers . . . vertical or horizontal oscillographs. Any combination you want for any recording job

that comes along.

But words alone don't do the Mark 200 justice.

The only way to *really* appreciate a Mark 200 is to see one perform. And with well over 20,000 channels now operating across the country, a demonstration under actual field conditions is easy. Ask your Brush representative. Or write for our free booklet. Brush Instruments Division, Clevite Corporation, 37th and Perkins, Cleveland, Ohio 44114.

brush INSTRUMENTS DIVISION
CLEVITE

Circle 901 on reader service card

Simplify Circuits and Reduce Costs in New Microwave Equipment with RCA "overlay" Transistors

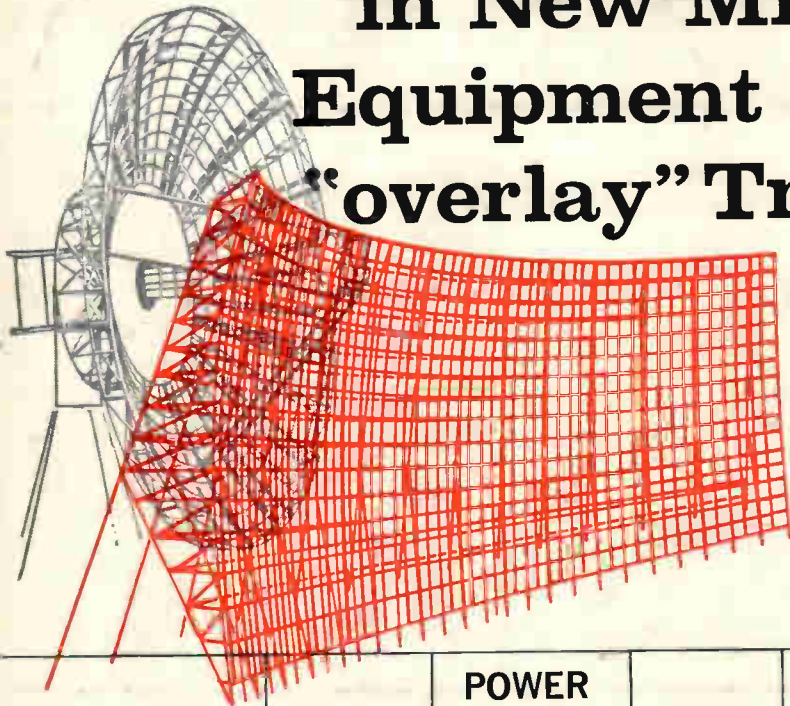

TYPE	FREQ. Mc/s	POWER OUTPUT WATTS (Min)	GAIN dB	V _{CC} VOLTS	C _{ob} pF (Max.)	EFF. %	PKG.
2N3375	400	3	5	28	8	40	TO-60
2N3733	400	10	4	28	15	45	TO-60
2N3866	400	1	10	28	3	45	TO-39
2N4012	1050	2.5	4	28	10	25	TO-60

As Much as 2.5 W Power Output With Power Gain at 1 Gc/s. RCA "overlay" technology extends transistor performance into the microwave region with greater power, gain, efficiency, and frequency capability. This solid performance means you can design doubler, tripler, and quadrupler microwave stages with fewer solid-state devices and less complex circuitry, reducing the cost of your equipment design while increasing total circuit reliability.

At microwave frequencies, RCA "overlay" transistors are your best choice for functions such as frequency multiplication. Not only do you get exceptional power gain, you also cut circuit costs by reducing the number of components needed. In the "overlay" design, the non-linear capacitance of the collector-to-base junction acts as a built-in varactor diode, thereby eliminating the diode as

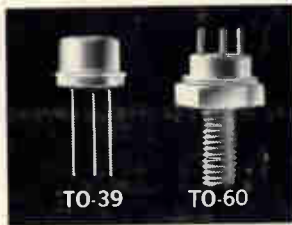

well as the transistor amplifier previously needed.

Combine this inherent frequency multiplication capability with the frequency performance of "overlay" and you have all the ingredients needed for an efficient oscillator frequency multiplier. RCA "overlay" transistors operated in oscillator-quadrupler circuits have achieved outputs as high as 300 mW at 1.7 Gc/s. And "overlay" offers comparable design benefits for straight-through amplifiers and oscillators.

For more information on RCA "overlay" transistors at microwave frequencies, consult your RCA Representative. For technical data and a copy of a new application note "Frequency Multiplication Using 'overlay' Transistors" (SMA-40), write: RCA Commercial Engineering, Section I-N-4-1, Harrison, N. J.

Also Available From Your RCA Distributor

RCA Electronic Components and Devices



The Most Trusted Name in Electronics

See "THE OVERLAY TRANSISTOR—The Challenge and The Answer," on a new 16-mm color film. Available through your local RCA representative.

Circle 902 on reader service card