

Electronics[®]

Designing linear microcircuits: page 84

Pacemaker powered by the body: page 105

Integrated circuits for tv: page 137

March 21, 1966

75 cents

A McGraw-Hill Publication

Below: Navigation system of the future
will have no gyros or gimbals: page 115

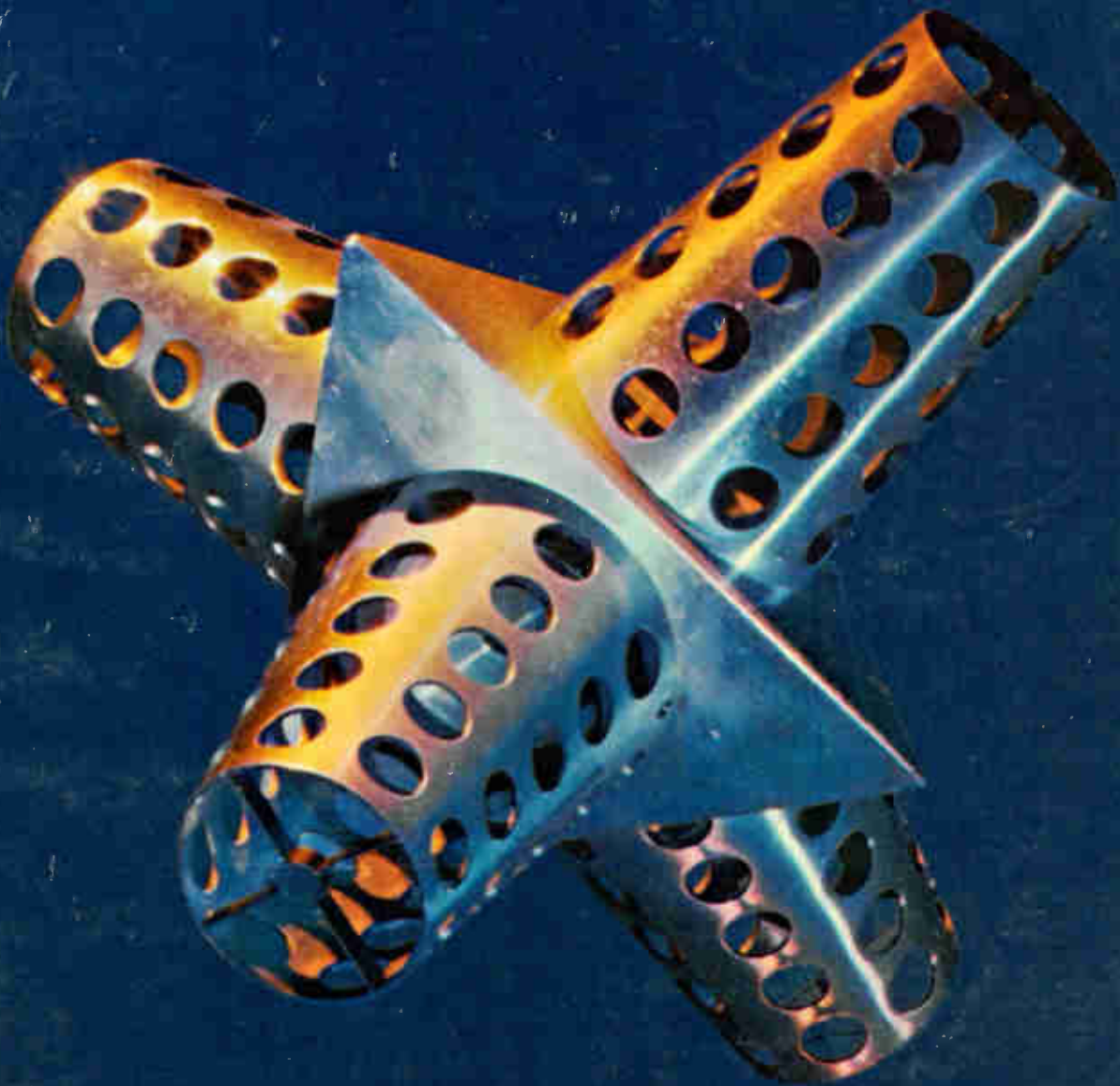



PULSE INSTRUMENTS



Type 1217-C



Type 1398-A



Type 1397-A



Type 1395-A

High Performance at Minimum Cost

Type 1217-C Unit Pulse Generator is a new model whose applications are many and varied, ranging all the way from testing high-speed computing circuits to physiological pulse simulation.

Pulse Repetition Frequency: controllable internally from 2.5 c/s to 1.2 Mc/s or externally from dc to 2.4 Mc/s.

Rise and Fall Times: 12 ns.

Pulse Duration: adjustable from 100 ns to 1.1 s.

Output: positive and negative 40-mA current pulses available simultaneously; adjustable to 40 V, peak. Positive and negative sync pulses and a delayed synchronizing pulse are also provided. Single pulses obtainable with the accessory Type 1217-P2 Single-Pulse Trigger (\$25).

Price: \$275 in U.S.A.

This generator requires an external power supply, such as GR's Type 1203 Unit Power Supply, \$65 in U.S.A.

Fast Rise and Fall Times

Type 1398-A Pulse Generator is basically a Type 1217-C Unit Pulse Generator (see above) with a self-contained power supply, higher output, and improved output-pulse characteristics. Rise and fall times are less than 5 ns, and the output consists of positive and negative 60-mA current pulses, providing 60 V across the 1-k Ω internal load impedance.

Price: \$535 in U.S.A.

Linear Amplifier with 1.2-Ampere Output

Type 1397-A Pulse Amplifier output pulses have typical rise and fall times of 50 ns when used with Types 1217-C or 1398-A Pulse Generators. Can also be used as a pulse shaper with rise and fall times continuously adjustable from 0.1 to 100 μ s.

Price: \$495 in U.S.A.

Produce Any Pulse You May Want

With the Type 1395-A Modular Pulse Generator, you can order only the pulse-generating capability you require. Five different modules are available, and as many as seven modules can be inserted in the main frame. Modules can be arranged in 38,400 different combinations.

Buy a main frame and as many modules as you need to custom-build your own pulse generator.

PRF Unit: provides internally generated repetition rates from 2.5 c/s to 1.2 Mc/s, from dc to 2 Mc/s when driven externally. Can use 7 per frame. Price: \$160 in U.S.A.

Pulse/Delay Unit: delays input pulses from 100 ns to 1 s and adjusts amplitude, polarity, and duration. Can use 7 per frame. Price: \$190 in U.S.A.

Pulse Shaper: adjusts rise and fall times from 100 ns to 10 ms, either individually or simultaneously. Limit of 3 per frame. Price: \$375 in U.S.A.

Power Amplifier: delivers 20-V pulses of either polarity into a 50-ohm load. Limit of one per frame. Price: \$270 in U.S.A.

Word Generator: produces binary words up to 16 bits long; as many as seven modules can be cascaded to provide 112-bit capability. Can use 7 per frame. Price: \$400 in U.S.A.

Main Frame: contains power supply and other circuits that are common to all modules. Price: \$575 in U.S.A. (without modules).

See Them at the IEEE Show, Booths 3B46-3B51

GENERAL RADIO COMPANY

WEST CONCORD, MASSACHUSETTS

BOSTON • NEW YORK • CHICAGO • PHILADELPHIA • WASHINGTON, D.C. • SYRACUSE • DALLAS • SAN FRANCISCO • LOS ANGELES • ORLANDO • CLEVELAND — TORONTO • MONTREAL
GENERAL RADIO COMPANY (Overseas), ZURICH
GENERAL RADIO COMPANY (U.K.) Ltd., BOURNE END, ENGLAND

Circle 900 on reader service card

NEW



VERSATILITY

FOR FREQUENCY MEASUREMENTS TO 15 GHz WITH COUNTER ACCURACY

The improved Hewlett-Packard 2590B Microwave Frequency Converter, used with the hp 5245L Counter (with the 5253B or 5252A Plug-in) measures cw frequencies 0.5 Hz to 15 GHz with the accuracy of the counter time base... even on drifting signals. A 12.4-18 GHz range is optional. The 5252A Counter Plug-in with a modification to the counter itself permits direct readout of the frequency.

The 2590B phase-locks an internal transfer oscillator to the signal frequency. When used with the 5245L, accuracy is 5 parts in 10^9 short term, 3 parts in 10^9 /day. Using an external quartz frequency standard for the counter reference provides even higher accuracy.

The 2590B provides pushbutton mode and range selection, front-panel indication of lock, agc to accommodate variations in signal level. The transfer oscillator can be externally modulated for dynamic measurements of signal generator modula-

tion linearity. Direct access to the transfer oscillator and harmonic mixer allow the 2590B to be used as a variable microwave frequency reference, for applications such as wave-meter calibration and frequency marker generation. Yet another way the 2590B can be used is as a 30 MHz receiver with AM and FM demodulating capability.

Here's an instrument that lets you make measurements never before possible... and improves on measurement capabilities previously available. Model 2590B, \$1900. Complete specifications, indicating the versatility of this microwave converter, are available with a call to your Hewlett-Packard field engineer or by writing Hewlett-Packard's Dymec Division, 395 Page Mill Road, Palo Alto, Calif. 94306, Tel. (415) 326-1755, TWX 910-373-1296. Europe: 54 Route des Acacias, Geneva.

Data subject to change without notice. Price f.o.b. factory.

Here are some of the advantages offered by the 2590B

- Wide phase-lock range for easy monitoring of drifting signals
- Automatic search oscillator for easy synchronization to the signal
- Continuous observation of jitter, FM and AM on drifting signal, with low-frequency scope
- Accurate FM measurements at deviation rates to 1 MHz, using internal precision FM discriminator
- Measurement of the carrier frequency of pulses as short as 0.5 μ sec
- Sensitivity better than -30 dbm at 0.5 GHz, -10 dbm at 14 GHz

**HEWLETT
PACKARD**  **DYMEC
DIVISION**

See it at IEEE, 3rd Floor New York Coliseum, March 21-24

1191

Circle 1 on reader service card

new measure of scope performance:

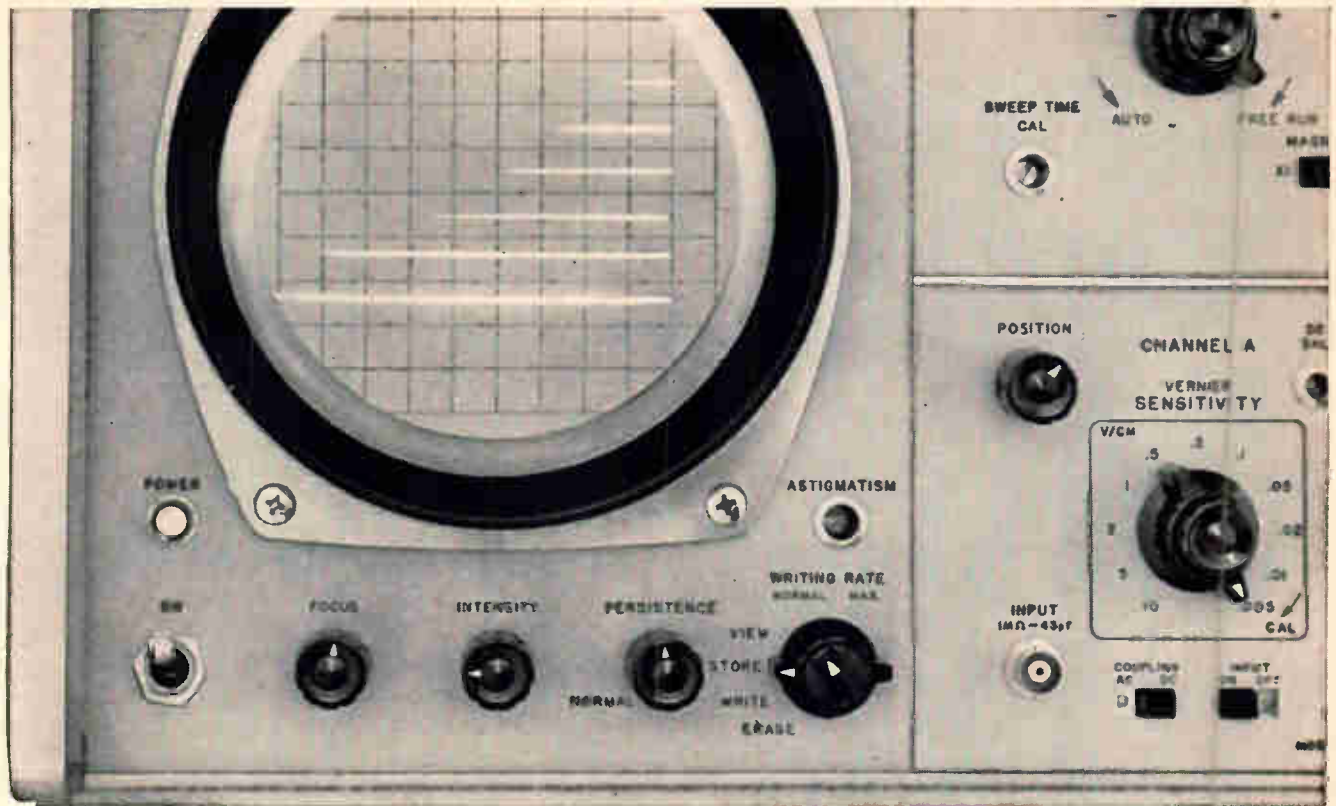

New Variable Persistence for Easy, Flicker-Free Viewing of all Waveforms

HEWLETT-PACKARD 141A STORAGE SCOPE: three in one!

1. VARIABLE PERSISTENCE with front-panel control, 1/5 sec. to 1 min. (continuously variable). Eliminates flicker on slow sweeps or fast signals with low rep rates. Easy viewing of slowly moving waveforms. See the complete picture on the screen at all times yet avoid any overlapping traces. Display several succeeding traces at once for direct comparison. Get clear pictures of jittery signals, persistence adjusted so that repetitive signal builds up, random signal doesn't.

2. STORAGE SCOPE holds trace for up to an hour, for days with scope turned off. Study waveforms at your convenience without a camera. Capture fast single-shot

events with writing rate $>1 \text{ cm}/\mu\text{sec}$. Automatically integrate dim repetitive signals until bright enough to view, photograph conveniently. Store several single-shot signals on a single crt, photograph.

3. CONVENTIONAL PLUG-IN SCOPE accepts same plug-ins as the popular hp 140A Scope. Maximum versatility with five vertical, two time base plug-ins. Plug-ins provide sensitivities to $10 \mu\text{V}/\text{cm}$, bandwidths to 20 MHz. Special double-size plug-ins for TDR testing of cables, connectors and strip lines, and for microwave measurements made with swept-frequency oscillators.

A special cathode-ray tube, plus Hewlett-Packard circuitry, combines all these advantages into a single instrument. Besides the unprecedented performance, you get storage with a high contrast, full 10 cm x 10 cm viewing area, no-parallax internal graticule, a 7.5 kV post-accelerator crt for high brightness... and a *full year's warranty on the crt at full specification!*

The 141A mainframe costs \$1275. And 141A dual-channel performance with 20 MHz bandwidth and time base with sweep delay costs only \$2450. A $100 \mu\text{V}/\text{cm}$ 400 kHz system costs only \$1810.

Every combination of scope and plug-ins gives you Hewlett-Packard design and manufacturing quality.

See it at IEEE, 3rd Floor New York Coliseum, March 21-24

Backed up, too, by your Hewlett-Packard field engineer, who can help solve your measurement problem with a scope or with other tools from the broad line of high-quality instrumentation he offers. Give him a call for complete data on the 141A. Or write Hewlett-Packard, Palo Alto, California 94304, Tel. (415) 326-7000; Europe: 54 Route des Acacias, Geneva.

Prices f.o.b. factory.

HEWLETT  **PACKARD**
An extra measure of quality

1047

Electronics

March 21, 1966
Volume 39, Number 6

Page	4	Readers Comment
	8	People
	14	Meetings
	16	Meeting Preview
	23	Editorial
	25	Electronics Newsletter
	71	Washington Newsletter
	171	New Products
	210	Technical Abstracts
	219	New Literature

Electronics Review

Page	37	Jotting in real time	40	Cold flame spray
	37	Star gazer	42	Technicolor hologram
	38	0.2-nsec IC's?	42	Backlogs pile up
	38	Navy reorganizes	44	Semiconductors
	39	In touch with Saigon		sound off
	39	Wired IC's	46	Electronics notes

Probing the News

137	It's a television first . . . receivers with IC's
144	Which way to monolithic systems?
157	For Saturn stages, a stop in Mississippi

Electronics Abroad

221	Thin-film, color-tv camera	223	Making millimeter waves
222	Color them happy	223	Touch of Venus
222	Place in space	224	Barge control

Technical articles

I. Design

Integrated circuits	84	Reducing analog IC cost with multipurpose chips Standard chips replace custom-made ones to reduce costs Grover Kennett, Motorola
Integrated circuits	88	General-purpose IC chips speed analog design Breadboarding with multipurpose chips bypasses the usual step needed using discrete components Jerome Eimbinder, solid state editor
Solid state	93	Overlay transistors move into microwave region Now they outperform varactor diodes in the gigacycle region H.C. Lee and G.J. Gilbert, RCA
Circuit design	96	Designer's casebook <ul style="list-style-type: none">■ Voltage splitter balances floating power supply■ D-c converter circuit eliminates transformer■ High-voltage and current in electro-optic modulator■ Linear amplifier uses no transformers

II. Applications

Reference sheet	101	Nomograph simplifies design of f-m/f-m telemetry systems This chart takes the place of separate calculations for nonstandard data channels J.K. Pulfer, A.C. Hudson, National Research Council of Canada
Medical electronics	105	Keeping the heart alive with a biological battery Body fluid is the electrode in a new battery to power pacemakers O.Z. Roy and R.W. Wehnert, National Research Council of Canada
Consumer electronics	109	For a good mixer add one FET The field effect transistor simplifies uhf tuners S.M. Weaver, Texas Instruments Incorporated
Space electronics	115	Celestial successor to inertial guidance (cover) Electro-optics is updating the ancient art of navigation E.J. Farrell and R.I. Lillestrand, Control Data Corp.

Title R registered
U.S. Patent Office;
© copyright 1966
by McGraw-Hill, Inc.
All rights reserved,
including the right to
reproduce the contents
of this publication,
in whole or in part.

Electronics

Editor: Lewis H. Young

Senior editors

Technical: Samuel Weber

News: Kemp Anderson Jr.

Senior associate editors: John F. Mason, George Sideris

Department editors

Advanced technology: Joan Blum

Avionics: W.J. Evanzia

Computers: Wallace B. Riley

Consumer electronics: Richard Lipkin

Electronics abroad: Arthur Erikson

Electronics review: Stanley Zarowin

Instrumentation: Carl Moskowitz

Manufacturing: George Sideris

Military electronics: John F. Mason

New products: William P. O'Brien

Solid state: Jerome Eimbinder

Space electronics: Robert Henkel

Regional editors

Domestic

Boston: Thomas Maguire, editor; Robin Carlson

Los Angeles: William B. Wallace, Walter Barney, editors; June Ranill

San Francisco: Laurence D. Shergalis, Edmond G. Addeo, editors; Mary Jo Jadin

Foreign

European: Derek Barlow, (London)

Bonn: John Gosch

Tokyo: Charles Cohen

Copy editors

Howard Rausch, Sally Powell, Kenneth Munn, James J. Moran

Graphic design

Art director: Saul Sussman

Assistant art directors: Donna M. Griffiths, Ann Mella

Production editor: Arthur C. Miller

Editorial secretaries: Claire Benell, Mary D'Angelo, Lynn Emery, Lorraine Fabry, Kay Fontana, Lorraine Longo, Carolyn Michnowicz

McGraw-Hill News Service

Director: John Wilhelm; **Atlanta:** Fran Ridgway; **Chicago:** Reck Johnson;

Cleveland: Arthur Zimmerman; **Dallas:** Marvin Reid;

Detroit: N. Hunter; **Houston:** Ron Lovell; **Los Angeles:** Michael Murphy, Gerald Parkinson;

San Francisco: Margaret Ralston;

Seattle: Ray Bloomberg; **Washington:** Arthur L. Moore, Charles Gardner,

Herbert W. Cheshire, Seth Payne, Warren Burkett, Warren Kornberg

McGraw-Hill World News Service

Bonn: John Johnsrud; **London:** John Shinn;

Mexico City: Bruce Cross; **Milan:** Ronald Taggiasco;

Moscow: Donald Winston; **Paris:** Peter Kilborn;

Rio de Janeiro: Wes Perry; **Tokyo:** Marvin Petal

Circulation manager: Hugh J. Quinn

Reprints: T.M. Egan

Publisher: C.C. Randolph

Electronics: March 21, 1966, Vol. 39, No. 6

Printed at 99 North Broadway, Albany, N.Y., 12207
Second class postage paid at Albany, N.Y.

Subscriptions are solicited only from those actively engaged in the field of the publication. Position and company connection must be indicated on orders. Subscription prices: United States and Possessions and Canada, \$6.00 one year, \$9.00 two years, \$12.00 three years. All other countries \$20.00 one year. Single copies, United States and Possessions and Canada 75¢. Single copies all other countries \$1.50.

Published every other Monday by McGraw-Hill Inc., 330 West 42nd Street, New York, N.Y. 10036. Founder: James H. McGraw, 1860-1948. Corporate officers: Shelton Fisher, President; John J. Cooke, Secretary; John L. McGraw, Treasurer.

Subscribers: The Publisher, upon written request to our New York office from any subscriber, agrees to refund that part of the subscription price applying to copies not yet mailed. Please send change of address notices, subscription orders or complaints to Fulfillment Manager, Electronics, at the address below. Change of address notices should provide old as well as new address, including postal zone number if any. If possible, attach address label from recent issue. Allow one month for change to become effective.

Postmaster: Please send Form 3579 to Fulfillment Manager, Electronics, P.O. Box 430, Hightstown, New Jersey 08520

Readers Comment

This letter was received in March, 1965 but the writer asked Electronics not to publish it then because the IEEE management had been very upset by the copy it had received. We held off because the society told us it was going to upgrade the quality of the technical sessions at the annual meeting in New York. Now that the society has dropped its plans to improve the sessions—[Editorial, p. 23]—we are running this letter as an example of what one technical group is doing to improve its role in the annual meeting. We've withheld the name of the writer and the technical group.

Raising the standards

To the Editor:

There are indications that your editorial "IEEE's technical sessions" [March 8, 1965, p. 15] has been widely noticed. Electronics deserves credit for stating what many responsible members of the IEEE had already recognized as a problem. Let me assure you that forces have been at work within the Institute to reverse the trend you detect, and to restore the traditional level of the technical sessions.

I can speak for the Group on ——— which, through merger last year, inherited the features of its two parent societies, the IRE (Institute of Radio Engineers) and the AIEE (American Institute of Electrical Engineers). At the forthcoming New York Convention [1965] this group has sponsored many sessions, and it is hoped that the tone set by it will be noticeable to the convention visitor.

This group has adopted as a policy to review, to the greatest extent possible, the full manuscript of any paper offered or solicited for presentation at any major convention. There are seven technical committees which assign each paper submitted to a board of three reviewers. In this manner, and only in this manner, is it possible to separate early enough, papers of real technical value from those which do not measure up to our standards.

The group is also certain that one

New from Sprague!

1966
SPRAGUE
METFILM 'A'
CAPACITORS



1963
ULTRA-THIN
METALLIZED
POLYESTER FILM
CAPACITORS



1956
METALLIZED
POLYESTER FILM
CAPACITORS



1947
METALLIZED PAPER
CAPACITORS



1944
OIL-IMPREGNATED
PAPER
CAPACITORS

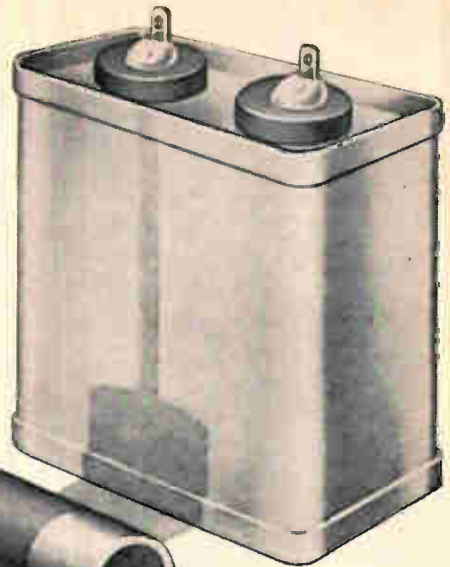

METFILM* 'A' CAPACITORS ... dramatically smaller in size, yet more reliable than military-grade capacitors of the past!

Just a few years ago, the only 10 μ F capacitor considered dependable enough for military applications was Type CP70 (to JAN-C-25), and was a block-busting 3 $\frac{3}{4}$ " wide x 1 $\frac{3}{4}$ " thick x 4" high. Today, you can get a military-quality 10 μ F tubular capacitor measuring only $\frac{1}{2}$ " in diameter x 2 $\frac{1}{4}$ " long. And it's more reliable than any capacitor of the past!

Sprague Type 680P Metfilm 'A' Metallized Capacitors meet all environmental requirements of MIL-C-18312, yet they occupy only one-third the volume of conventional metallized film capacitors of equivalent capacitance and voltage rating. Employing a new thin organic film dielectric system, Type 680P capacitors use a dual film totalling only 0.00008" thick, as compared to conventional polyester-film capacitors with a single film measuring 0.00015".

*Trademark

Another distinct advantage of the Metfilm 'A' dielectric system is minimum degradation of electrical properties during life.

Hermetically sealed in corrosion-resistant metal cases, capacitor sections are effectively of non-inductive construction, resulting in capacitors with performance characteristics superior to those of comparably-sized capacitors.

Type 680P Metfilm 'A' Capacitors are available with capacitance values to 10 μ F in both 50 and 100 volt ratings.



For complete technical data, write for Engineering Bulletin 2650 to Technical Literature Service, Sprague Electric Company, 35 Marshall St., North Adams, Mass. 01247.

SPRAGUE COMPONENTS

CAPACITORS
TRANSISTORS

RESISTORS
INTEGRATED CIRCUITS
THIN-FILM MICROCIRCUITS

PULSE TRANSFORMERS
INTERFERENCE FILTERS
PULSE-FORMING NETWORKS
TOROIDAL INDUCTORS
ELECTRIC WAVE FILTERS

CERAMIC-BASE PRINTED NETWORKS
PACKAGED COMPONENT ASSEMBLIES
BOBBIN and TAPE WOUND MAGNETIC CORES
SILICON RECTIFIER GATE CONTROLS
FUNCTIONAL DIGITAL CIRCUITS

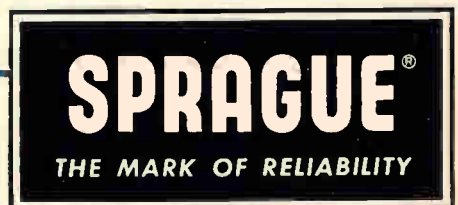

*Sprague' and '®' are registered trademarks of the Sprague Electric Co.

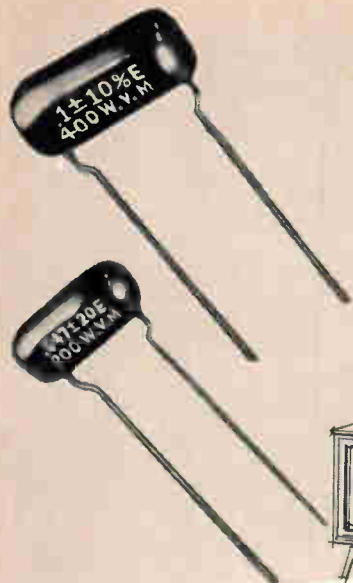

Proof Positive of High Reliability of EL-MENCO *MYLAR-PAPER DIPPED Capacitors

OVER 330,000,000 OF THESE HIGH QUALITY UNITS USED IN TV SETS SINCE 1959!

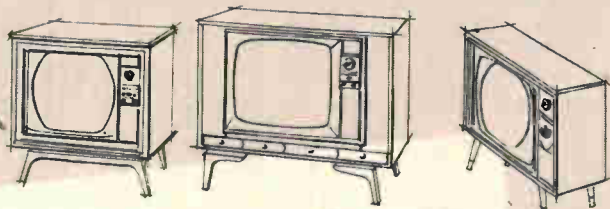

Imagine! Over 330 million EL-MENCO Mylar* Paper Dipped Capacitors have been used in black and white and in color TV sets since 1959! These capacitors of the highest quality and reliability help bring programs to millions of people who have invested in TV sets . . . and 330 million is just a drop in the bucket! For the demand for EL-MENCO capacitors still far exceeds the supply!

The number of EL-MENCO capacitors in TV sets is truly amazing. This figure of 330,000,000 represents more than the total population of the following countries:

- United States and Possessions
- United Kingdom and Canada
- Argentina Belgium
- Denmark Ecuador Chile

299,813,929 people (1960 Census)

Even with this tremendous mass production the quality of EL-MENCO capacitors has not suffered. Here's a fine tribute of the high reliability of EL-MENCO capacitors from a leading TV manufacturer:

"... I am certain that you are aware of the enthusiasm our Engineering and Quality people have displayed for this unit, for to us it represents the virtual elimination of capacitor field problems in the future ..."



Write dept. AE for descriptive bulletin #MPD

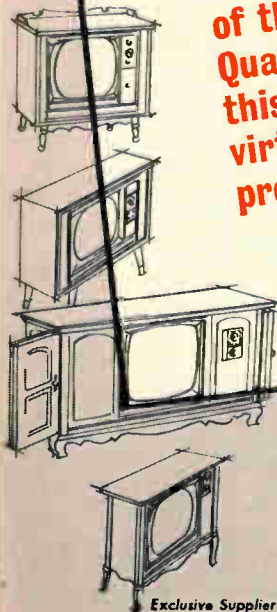

EL-Menco
Capacitors

DIPPED MICA
MOLDED MICA
SILVERED MICA FILMS
MICA TRIMMERS & PADDERS
MYLAR* PAPER DIPPED
PAPER DIPPED
MYLAR* DIPPED
TUBULAR PAPER

*Registered Trade Mark of DuPont Co.

THE ELECTRO MOTIVE MFG. CO., INC.
WILLIMANTIC, CONNECTICUT

Exclusive Supplier to Jobbers and Distributors in the U. S. and Canada
ARCO ELECTRONICS, INC., COMMUNITY DRIVE,
GREAT NECK, L. I. NEW YORK

West Coast Manufacturers Contact:
COLLINS & HYDE CO., 1020 CORPORATION WAY, PALO ALTO, CALIFORNIA
5380 WHITTIER BOULEVARD, LOS ANGELES, CALIFORNIA

of the most effective ways to further the "dialogue" between the author of an important paper and his audience is to have preprinted copies of the papers available well in advance of presentation. Anyone who has witnessed the presentation of a paper so prepared will agree that this is the way to put the spark into the discussion. Other groups have also had favorable experience along these lines.

Because this method, which was considered one of the strong features in the AIEE, is slightly more expensive, it has become less attractive to those who must worry about the financial aspects of meetings. There are proposals before the IEEE Executive Committee to marshal the Institute's Headquarters resources to this end.

Name withheld

Chairman _____ Group
IEEE

▪ Though many technical groups of the IEEE employ such a review procedure, not all of them take the review so seriously nor apply very stiff criteria. Some groups pass off all responsibility to the general program committee of the annual meeting.

Intelligent reaction

To the Editor:

"Electronic quiz" [Dec. 13, p. 238] should have been reviewed by a competent psychologist before publication.

The article said, "... the speed with which these information-processing signals follow the stimulus is proportional to that vague attribute called intelligence." Few variables in this business are more

poorly correlated than reaction time and intelligence. Statements such as "the neurological efficiency on which all intelligence depends" betray a lack of appreciation of the complexity and subtlety of the concept of intelligence.

No simple-minded average measurement of a one-dimensional elementary, temporal feature of sensory information processing can be expected to have practical relevance to the prediction of general intelligence.

Michael G. Saslow

Department of Psychology
University of Washington
Seattle

▪ The story reporting an electronics approach to intelligence testing carried out by Canadian psychologist John P. Ertl in Ottawa was in fact reviewed by the Toronto Mental Health Foundation. Psychologist Saslow's argument is really with psychologist Ertl's interpretation of intelligence, a controversy best left to the psychologists to thrash out.

Self-criticism

In my article "Getting the most out of feedback" [Jan. 24, p. 66], the text states erroneously on page 67, that from equations 7 and 8 it can be shown that ΔG is approximately equal to $\Delta A/\mu b$. The statement at the bottom of the first column should read: "As μb is usually much larger than $(1 + R_o/R_L)$,

$$\Delta G \approx \Delta A \left(1 + \frac{R_o}{R_L} \right) (\mu b)^2$$

N. A. Zellmer

Lenkurt Electric Co.
San Carlos, Calif.

TRANSFORMER ELECTRONICS COMPANY

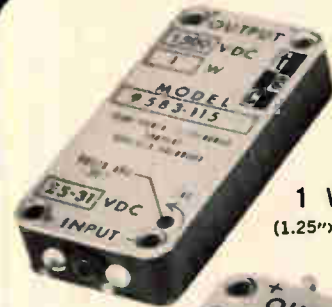

1 WATT
(1.25"x2.5"x.5")

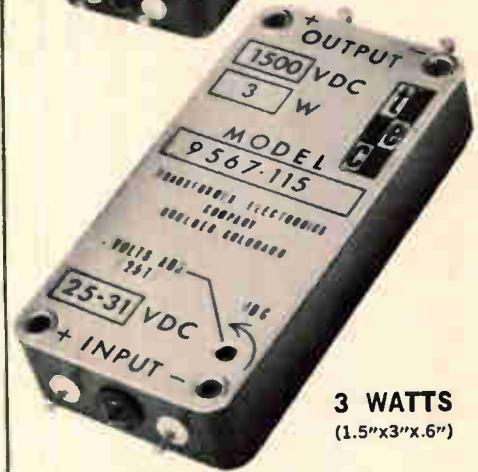

3 WATTS
(1.5"x3"x.6")

MINIATURE REGULATED POWER SUPPLIES

Cost-Performance Optimized
Reduces System Design Effort
Meets Extreme Environments

9583 SERIES

1 Watt output power capability
18 models—3 vdc to 3000 vdc
25-31 vdc input

9567 SERIES

3 watt output power capability
24 models—3 vdc to 5000 vdc
25-31 vdc input

SUBSCRIPTION SERVICE

Please include an Electronics Magazine address label to insure prompt service whenever you write us about your subscription.

Mail to: Fulfillment Manager
Electronics
P.O. Box 430
Hightstown, N.J. 08520

To subscribe mail this form with your payment and check new subscription renew my present subscription

Subscription rates: in the U.S.: 1 year, \$6; two years, \$9; three years, \$12. Subscription rates for foreign countries available on request

CHANGE OF ADDRESS

ATTACH
LABEL
HERE

If you are moving, please let us know five weeks before changing your address. Place magazine address label here, print your new address below.

name _____

address _____

city _____

state _____

zip code _____



TRANSFORMER
ELECTRONICS
COMPANY

BOULDER INDUSTRIAL PARK
BOULDER, COLORADO
TWX 303 443-2561 PHONE (303) 442-3837

POWER SUPPLIES • INVERTERS
CONVERTERS • TRANSFORMERS

What's the safe, efficient way to bring transmitter power to an HF antenna?

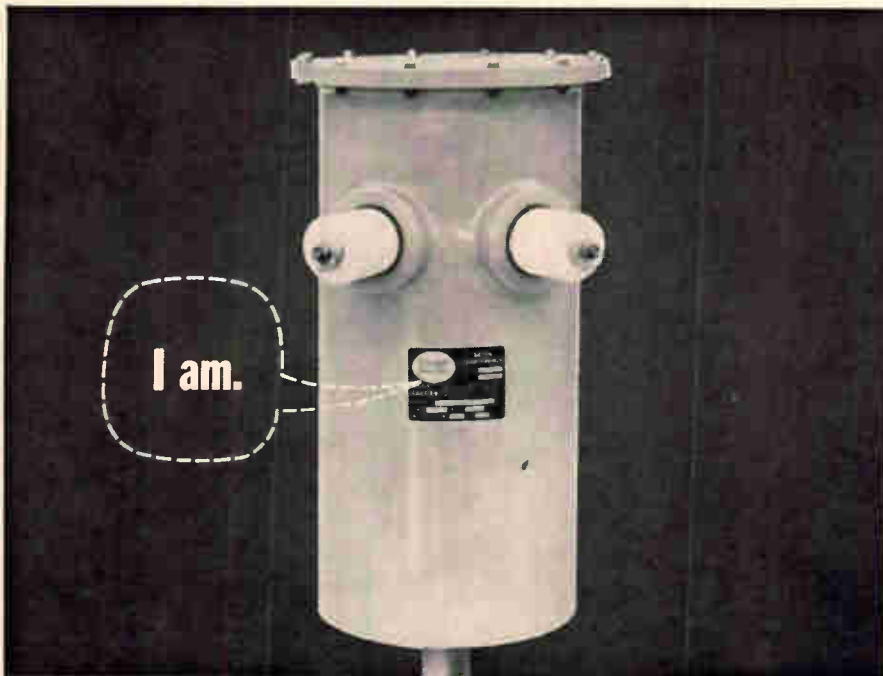

Granger Associates has the answer

now This Granger Associates balun transformer is the critical link in the safest, most efficient way to bring power to an HF antenna. For safety, you lead power out of the transmitter building on shielded co-ax. Then to obtain high efficiency at low cost, you couple the co-ax through a G/A balun to simple open wire lines for the long run to the antenna.

Unlike other balun transformers, G/A baluns do not restrict the transmitter's frequency or limit the power it can transfer to the antenna. All G/A baluns transfer power with more than 97% efficiency at any HF frequency. The largest will handle 50 kw average power and 200 kw PEP. They will operate into a load VSWR as high as 2.5:1. Moreover, insertion VSWR never rises above 1.2:1— which means that the transmitter can operate at full rated power without danger of creating excessive voltages or currents.

G/A baluns are sealed within a weather-proof container, need never be opened for maintenance, and have an expected operating life of 20 years in most environments.

Send for complete technical data on Models 543, 545 and 555.

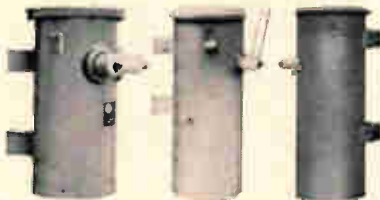

Model 545 7½ kw average (30 kw PEP) 2 to 32 MHz	Model 555 25 kw average (100 kw PEP) 2 to 32 MHz	Model 543 50 kw average (200 kw PEP) 3 to 30 MHz
--	---	---



CAREER OPPORTUNITIES FOR ENGINEERS IN ANTENNAS AND TRANSMISSION PRODUCTS

1601 California Ave., Palo Alto, California / Telephone: 321-4175 / TWX: 910-373-1291
Granger Associates Ltd.
Russell Hse., Molesey Rd., Walton-on-Thames, Surrey, England / Walton-on-Thames 29913

People

"An astronaut can't very well spend a year in space with a thermometer stuck in his mouth," observes physiologist **Philip F. Mulvey**. But since space scientists must be able to take physiological measurements, the National Aeronautics and Space Administration is working on ways to keep tabs on an astronaut's physical condition without placing sensors on or inside his body. In his new job as senior physiologist at the agency's Electronic Research Center in Cambridge, Mass., Mulvey will work with instrumentation engineers on new ways to measure man's temperature, blood pressure and heart rate.



It's hoped, he says, that the techniques developed by NASA will also lead to improved monitoring of patients in hospitals.

A key to extended space missions is improvement in microelectronics. The space agency has given a contract to the Case Institute of Technology of Cleveland for micro-miniaturization of devices for physiological measurement and data processing.

"We are counting on electronic techniques that will provide on-board processing and immediate readout for the astronaut, as well as sensing," says the 34-year-old Mulvey. "It is important for the astronaut to know his condition, as well as having it telemetered back to earth."

One group working under Mulvey is exploring biodata analysis, a mathematical technique aimed at predicting an astronaut's future performance on the basis of physiological measurements. If a hazard to the astronaut is recognized early, says Mulvey, it may be possible to prescribe corrective action.

Also under study is a method of monitoring body temperature by infrared sensors. "What we want is the core temperature," says Mulvey. The body emits infrared radiation from deep inside itself.

"It looks like the eardrum is

200 kW power output with .7 kW drive from magnetically beamed Machlett triode

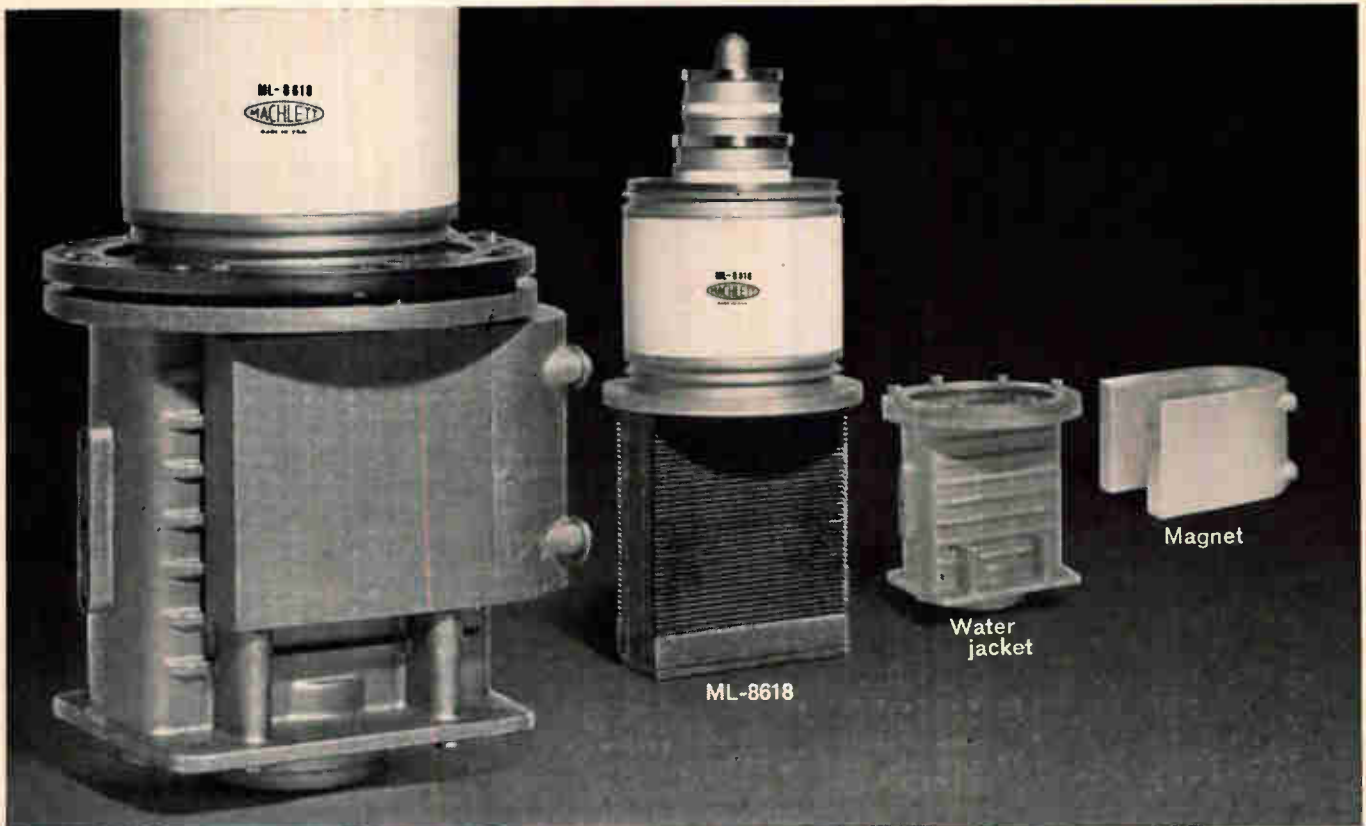

ML-8618, Machlett's new magnetically beamed water-cooled triode, provides high power gain, high plate efficiency and maximum cathode utilization. Electron trajectory from cathode to plate is magnetically controlled to greatly reduce electron interception by the grid . . . and therefore decrease grid current and heating and allow significantly higher performance levels.

Result: the ML-8618 delivers a typical 200 kW power output with .7 kW drive as a Class C rf amplifier or oscillator. As a switch tube in pulse modulators, it is capable of a maximum 8 Mw high duty pulse. For full operating details, write to The Machlett Laboratories, Inc., Springdale, Conn. 06879.



A SUBSIDIARY OF RAYTHEON COMPANY

New from Sprague!

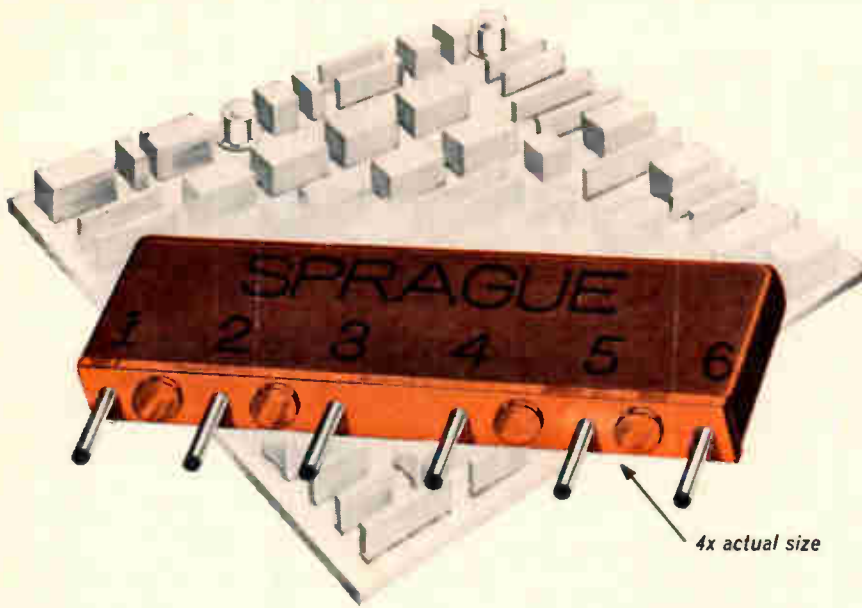

METANET[®]

TRUE METAL-FILM PRECISION RESISTOR

NETWORKS

Save Space, Time, and Money

- High packaging density—4 to 8 times that of individual components.
- Fewer components to stock, handle, inspect, install. Entire module can be hand-inserted faster than one axial-lead component.
- Permit substantial savings over equipment assembled with individual components.
- Epoxy terminal board keeps pin terminals free of resin coating, unlike conventional dipped components, and provides uniform lead spacing.
- Stand-off bosses permit effi-

cient flux removal after soldering. Also prevent dirt and moisture traps around leads.

- Extremely stable and reliable. Meet performance requirements of MIL-R-10509E. Resistance tolerances to $\pm 1\%$.
- Ceramic capacitors can be incorporated for further savings and size advantages over individual components.

For complete information write to Integrated Circuit Application Engineering Department, Sprague Electric Company, 35 Marshall Street, North Adams, Mass. 01248

SPRAGUE COMPONENTS

RESISTORS
CAPACITORS
TRANSISTORS
INTEGRATED CIRCUITS
THIN-FILM MICROCIRCUITS
INTERFERENCE FILTERS

PACKAGED COMPONENT ASSEMBLIES
FUNCTIONAL DIGITAL CIRCUITS
MAGNETIC COMPONENTS
PULSE TRANSFORMERS
CERAMIC-BASE PRINTED NETWORKS
PULSE-FORMING NETWORKS



"Sprague" and "®" are registered trademarks of the Sprague Electric Co.

People

going to be the best source for getting the temperature of the body through infrared measurements," says Mulvey. Under a contract with NASA, Block Engineering, Inc., of Cambridge is investigating the infrared emissivity of the ear without attaching or implanting any sensors.

The instrumentation group is also investigating ultrasonics as a way to continuously monitor the flow of blood.

In the years following World War II, Robert A. Averitt was a member of the team that directed the General Electric Co.'s move to broaden its basically military avionics production into the commercial market. Now, he will be doing the same job for the Autonetics division of North American Aviation, Inc., of Anaheim, Calif., where he has been named director of a new commercial avionics organization.



Averitt spent more than 25 years with GE, most of them in aviation systems engineering. He joined Autonetics two years ago, after the division formed a commercial development office. He was assistant to the vice president for commercial development until his recent appointment.

At the moment, Autonetics' avionics business is based entirely on government contracts.

"Commercial airlines' business," he forecasts, "will double by 1970 and will probably double again in the following five years." Because of this, Averitt predicts an increasing need for more sophisticated avionics systems that are "safe, reliable and economical."

For instance, he believes there is a commercial market for about 1,000 inertial navigation systems over the next five years. The division is now developing such a system.

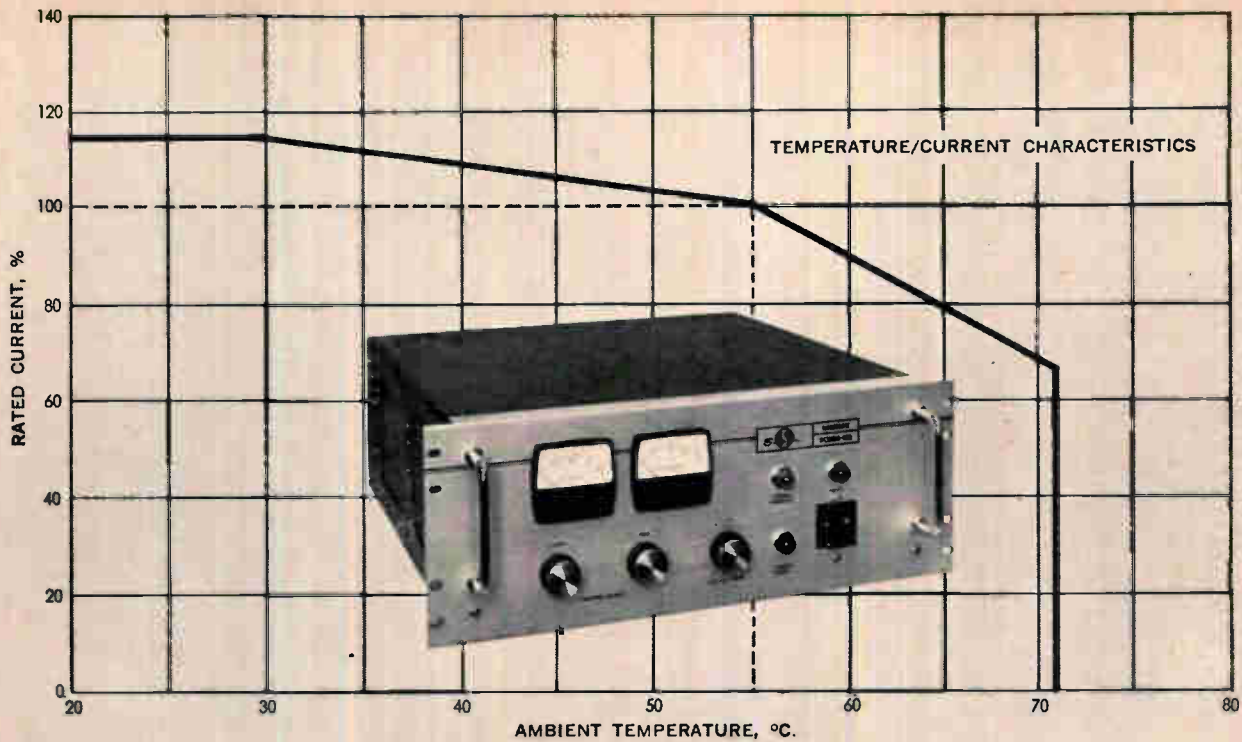

Sorensen DCR Series now with temperature capability to 71°C.

All-Silicon Power Supplies to 20 kW.

Sorensen's wide range DCR Series has been up-dated and improved. What's new about the DCR's? They are now 100% silicon; ambient temperature capability is now to 71°C. • Four 3-phase models have been added extending power capability to 20 kW; 24 models are now available with ranges up to 300 volts. • Multiple mode programming—voltage/current/resistance. • Voltage regulation, line and load combined, is $\pm 0.075\%$ for most models • Constant current range 0 to rated current. • DCR's meet MIL-I-26600 and MIL-I-6181

specifications and conform to proposed NEMA standards. • Front panel indicator for voltage/current crossover. These features of the improved DCR (model numbers will have an "A" suffix) are offered at no increase in price.

For DCR details, or for data on other standard/custom power supplies, voltage regulators or frequency changers, call your local Sorensen representative, or write: Sorensen, A Unit of Raytheon Company, South Norwalk, Connecticut 06856.

MODEL SELECTION CHART

Voltage	Amps.	Model	Price	Amps.	Model	Price	Amps.	Model	Price	Amps.	Model	Price
0-20	125	DCR 20-125A	\$1055	250	DCR 20-250A	\$1495	—	—	—	—	—	—
0-40	10	DCR 40-10A	325	20	DCR 40-20A	525	35	DCR 40-35A	\$ 710	60	DCR 40-60A	\$925
0-40	125	DCR 40-125A	1350	250	DCR 40-125A	1995	500	DCR 40-500A	2950	—	—	—
0-60	13	DCR 60-13A	525	25	DCR 60-25A	710	40	DCR 60-40A	900	—	—	—
0-80	5	DCR 80-5A	325	10	DCR 80-10A	525	18	DCR 80-18A	710	30	DCR 80-30A	875
0-150	2.5	DCR 150-2.5A	325	5	DCR 150-5A	525	10	DCR 150-10A	710	15	DCR 150-15A	825
0-300	1.25	DCR 300-1.25A	325	2.5	DCR 300-2.5A	525	5	DCR 300-5A	710	8	DCR 300-8A	825



A UNIT OF RAYTHEON COMPANY

Circle 11 on reader service card

**How many integrated circuit manufacturers shipped more units last December than all others combined?
One.**

FEAR

PROCI

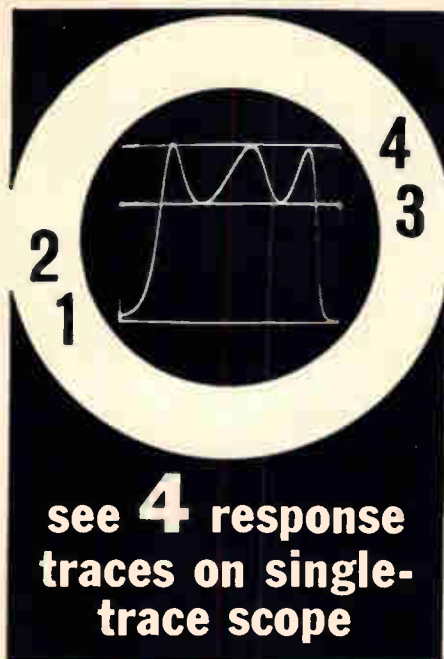

see **4** response
traces on single-
trace scope

measurement by comparison
up to 1,200 mc



NEW
JERROLD
SOLID-STATE
3-POSITION
COAXIAL SWITCHER

Model TC-3 \$295⁰⁰

Turn any single-trace oscilloscope into a 4-trace scope; insert two reference traces automatically in addition to test trace and baseline. These references have advantage of permanent relative accuracy over scribed or painted lines.

Results are repeatable, as accurate as your reference attenuators. Generator and scope drift do not affect accuracy of measurements. Frequency from dc to 1,200 mc extends usefulness of comparison technique well into the UHF band. The TC-3 Coaxial Switcher can save you thousands of dollars in speed and accuracy. Write for literature.

JERROLD
ELECTRONICS

Industrial Products Division,
Philadelphia, Pa. 19132
In Canada: Jerrold Electronics,
60 Wingold Ave., Toronto 19, Ont.
Export: Rocke International,
13 E. 40th St., New York, N.Y. 10016

SWEEP GENERATORS • AMPLIFIERS
PRECISION ATTENUATORS • COMPARATORS

Meetings

National Association of Broadcasters Convention, NAB; Conrad Hilton Hotel, Chicago, March 27-30.

International Conference on Electronic Switching, Union of International Technical Associations, Societe Francaise des Electroniciens et des Radioelectriciens; UNESCO Conference Hall, Paris, France, March 28-31.

Digital Electronics Seminar, RCA Institutes, Inc.; Hotel New Yorker, New York, March 28-April 1.

Physics Exhibition, Institute of Physics; Alexandra Palace, London, March 28-31.

Automatic Control in Electricity Supply Meeting, IEE; Renold Building, Manchester College, England, March 29-31.

Conference on Analysis and Synthesis of Networks, IEEE-NTG; Stuttgart, West Germany, March 31-April 1.

Industrial Engineering Conference, AIIE; Hotel Pontchartrain, Detroit, March 31-April 1.

Symposium on Computer Graphics, University of California; Los Angeles, April 4-6.

Advanced Planning Briefing for Industry, AEC, AFCEA; Fort Monmouth, N.J., April 5-6.

Advanced Seminar for Automatic Data Processing, International Computation Center; International Computation Center, Rome, April 6.

Symposium on Electron and Laser Beam Technology, IEEE, University of Michigan; Ann Arbor, Mich., April 6-8.

Conference on Ground-Based Aeronomic Studies of the Lower Ionosphere, AFCL, DRTE; Defense Research Telecommunications Establishment, Ottawa, Canada, April 11-15.

IEEE Region III Convention, IEEE; Mariotta Motor Inn, Atlanta, April 11-13.

Cleveland Electronics Conference, Cleveland section of IEEE; Engineering and Scientific Center, Cleveland, April 12-14.

Symposium on Electronics Measurement and Controls in Ships and Shipbuilding, IEE, IERE; University of Strathclyde, Scotland, April 12-15.

Symposium on Remote Sensing of Environment, Office of Naval Research; University of Michigan, Ann Arbor, April 12-14.

Quantum Electronics Conference, IEEE Groups on Electron Devices and Microwave Techniques; Towne House, Phoenix, April 12-14.*

International Symposium on Generalized Networks, Polytechnic Institute of Brooklyn, AFOSR; Hotel Commodore, New York, April 12-14.

Technical Meeting and Equipment Exposition, Institute of Environmental Sciences; El Cortez Hotel, San Diego, April 13-15.

Symposium on Process Automation, Beckman Instruments, Inc., Consolidated Electrodynamics Corp., Control Data Corp., et al; Newporter Inn, Newport Beach, Calif., April 18-20.

International Scientific Radio Union Meeting (URSI), National Academy of Sciences, National Research Council; Washington, D.C., April 18-21.

International Seminar on Automatic Control in Production and Distribution of Electrical Power, Institut Belge de Regulation et D'Automatisme; Brussels, Belgium, April 18-22.

Call for papers

Wire and Cable Symposium, U.S. Army Electronics Command; Atlantic City, N. J., Dec. 7-9. April 15 is deadline for submission of 500-word summary on cable design and applications, cable materials, manufacturing techniques, connective devices, and requirements for advanced equipment to J. Spergel, Co-chairman, Wire and Cable Symposium, U.S. Army Electronics Command, Fort Monmouth, N. J. 07703, Attn: AMSEL-KL-EE.

Symposium on Switching and Automata Theory, University of California, IEEE Computer Group; University of California, Berkeley, Oct. 26-28. May 2 is deadline for submission of six copies of abstracts on switching theory, logical design, and automata theory to Prof. David E. Muller, Mathematics Dept., University of Illinois, Urbana, Ill. 61803.

* Meeting preview on page 16

Each Fluke all-solid-state voltage calibrator gives you more for your instrumentation dollar! Things like 0.0005% line and load regulation in every model. Compact and lightweight construction for portability. Heatfree, fanfree operation for long life and best stability. High speed remote programming in two models. Calibration accuracy to 0.003%. Price range \$1,295 to \$2,490.

Model	Voltage	Current	Stability	Readout	Calibration Accuracy	Panel Height and Weight	Price
313A	0 to 50 vdc 0 to 5 vdc	0 to 2 amps	±0.002%	6 digit inline	±0.01%	5¼"–50 lbs.	\$1,295
315A*	0 to 50 vdc	0 to 1 amp	±0.005%		±0.025%	5¼"–50 lbs.	\$1,895
332A	0 to 1111 vdc	0 to 50 ma	±0.0015%	7 digit inline	±0.003%	7" –60 lbs.	\$2,490
382A	0 to 50 vdc 0 to 5 vdc	0 to 2 amps	±0.002%	6 digit inline	±0.01%	5¼"–50 lbs.	\$1,595
383B*	0 to 50 vdc	0 to 2 amps	±0.005%		±0.025%	5¼"–50 lbs.	\$1,950

*Remotely Programmed



FLUKE • Box 7428, Seattle, Washington 98133 • Phone: (206) 776-1171 • TWX: (910) 449-2850

Model 332A
Voltage Calibrator

Model 383B
Remotely
Programmed
Voltage/Current
Calibrator

Model 315A High-Speed
Remotely Programmed Voltage Calibrator

Model 382A Voltage/Current Calibrator

Model 313A
Voltage Calibrator

See us at The IEEE #3K19, 3K20

Now from Sprague!

DIFFERENTIAL AMPLIFIERS IN FLAT PACKS!

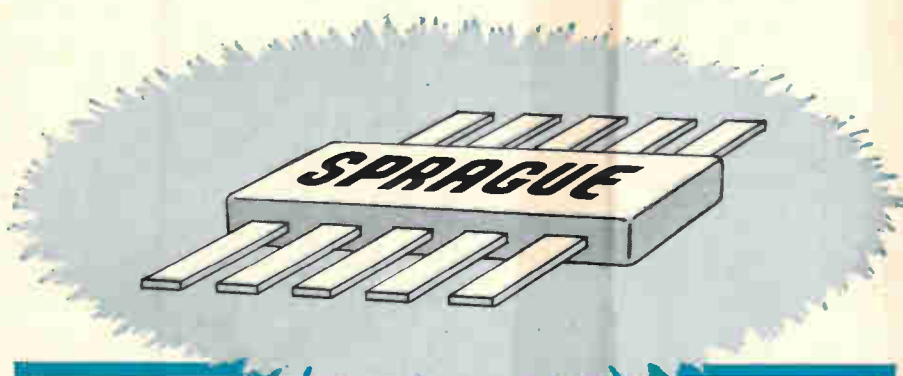

2N3043 2N3044 2N3046
2N3047 2N3049 2N3050 2N3051
2N3052 2N3520 2N3524

PNP or NPN • BETA MATCHING to 10%

V_{BE} MATCHING to 3mV

VOLTAGE CAPABILITY to 60 VOLTS

TEMPERATURE COEFFICIENTS to $5\mu\text{V}/^\circ\text{C}$

ALSO AVAILABLE IN 6-LEAD TO-5 OUTLINE PACKAGES!

For complete information, write to Technical Literature Service, Sprague Electric Company, 35 Marshall Street, North Adams, Mass. 01248

SPRAGUE COMPONENTS

TRANSISTORS	PACKAGED COMPONENT ASSEMBLIES
CAPACITORS	FUNCTIONAL DIGITAL CIRCUITS
RESISTORS	MAGNETIC COMPONENTS
THIN-FILM MICROCIRCUITS	PULSE TRANSFORMERS
INTEGRATED CIRCUITS	CERAMIC-BASE PRINTED NETWORKS
INTERFERENCE FILTERS	PULSE-FORMING NETWORKS



*Sprague and ® are registered trademarks of the Sprague Electric Co.

Meeting preview

Quantum electronics meeting

Laser researchers will discuss everything from laser materials to biomedical applications of the laser at the 1966 International Quantum Electronics Conference in Phoenix, Ariz., April 12-14.

There are 191 papers scheduled for delivery at the conference, which is sponsored by the Electron Devices and Microwave Theory and Techniques Groups of the Institute of Electrical and Electronic Engineers, and the American Institute of Physics with the cooperation of the American Physical Society and the Optical Society of America.

The keynote session will include a description by Kumar Patel, Bell Telephone Laboratories, Inc., of his work in producing phase-matched second harmonic generation from an elemental crystal, and the possibility of making a continuous-wave tunable oscillator in the 15- to 25-micron range with tellurium as the nonlinear medium and a 10.6-micron carbon-dioxide laser as the pump.

Charles H. Townes, provost of the Massachusetts Institute of Technology, and A. M. Prokhorov and N. G. Basov of the Lebedev Institute in Moscow will deliver the opening remarks at the keynote session.

In the session on the measurement of laser fluctuations, Henri Hodara of the National Engineering Science Co., Pasadena, Calif., will discuss signal-to-noise ratios, using a statistical approach, in amplitude stabilized lasers. Other papers on allied topics deal with noise in gas, solid crystal, and semiconductor lasers: statistical properties of laser radiation; and the analysis of spectral linewidths of laser radiation.

The second session, on ion lasers, will include a report by a French researcher, M. Armand, on the effect of a longitudinal magnetic field on an argon laser. L. I. Gudzenko of the Lebedev Institute will discuss temperatures and electron densities necessary to produce laser oscillation. Millimeter wave gas amplifiers also will be discussed.

COMPANY
CONFIDENTIAL

COMPETITIVE INFORMATION

OKAY CARL, YOU ASKED ME TO DO A LITTLE SNOOP-
ING ON SPECTROL FOR IEEE, and I managed to dig
up some advance information and sneak a few
snapshots of their products. Here they are, so
"read 'em and weep"...

I guess this is enough bad news for one spying
venture. But if we can't scoop Spectrol, I'm sure
that the other big "B" can't either. Just the
same, I think I'll hop right over and see what
they're doing, too.

Bill



MINIATURE ROTARY SELECTOR SWITCHES:

Look out for this line of half-inch
switches for PCB applications.
Their single-pole, ten-position
Model 88 got a lot of attention at
WESCON, but now they've come up with
a whole new line of three-, five-,
and ten-position switches with
stops, available in single-pole,
double-pole and three-pole versions.
This Model 87 line is going to be
a hard one to beat. No one else in
the industry has anything like it!



TURNS-COUNTING DIALS: And we can't
afford to overlook their Dial line
either. This Model 25 turns-
counting dial is available in both
a three-wheel and four-wheel
version. It is only 1-13/16 of an
inch in diameter and is easier
to read, set, lock, and mount than
anything anyone else is offering.

P.S. You'll find
spectrol
at IEEE Booth 2E03-2E05.



TRIMMERS: They're going to be right
in there with trimmers, too. The
Models 84 and 85 half-inch, single-
turn wirewound jobs have been giving
us plenty of trouble in the market-
place. These round trimmers are
rated at 1-1/2 watts at 70°C. and
have a standard resistance tolerance
of $\pm 4\%$. They've been popular enough
to push our stuff into the back-
ground wherever they've been tried!



PRECISION POTS Of course, they've always
been hard guys to catch up with in
precision pots. When they brought out
their low-cost, ten-turn, half-inch
Model 162, it shook us up because it
looked like a military pot at commercial
prices. Well, now they're broadening
this line with two companion models—
the 163 with a rugged 1/4-inch shaft and
3/8-32 thread bushing for panel
mounting; and the 164, which is a servo
mount version of the standard 162.
And they're also going to be pushing
their Model 140—which is a lot of pot
for the money in a half-inch,
single-turn version.

From the expanding line of Sigma relays . . .

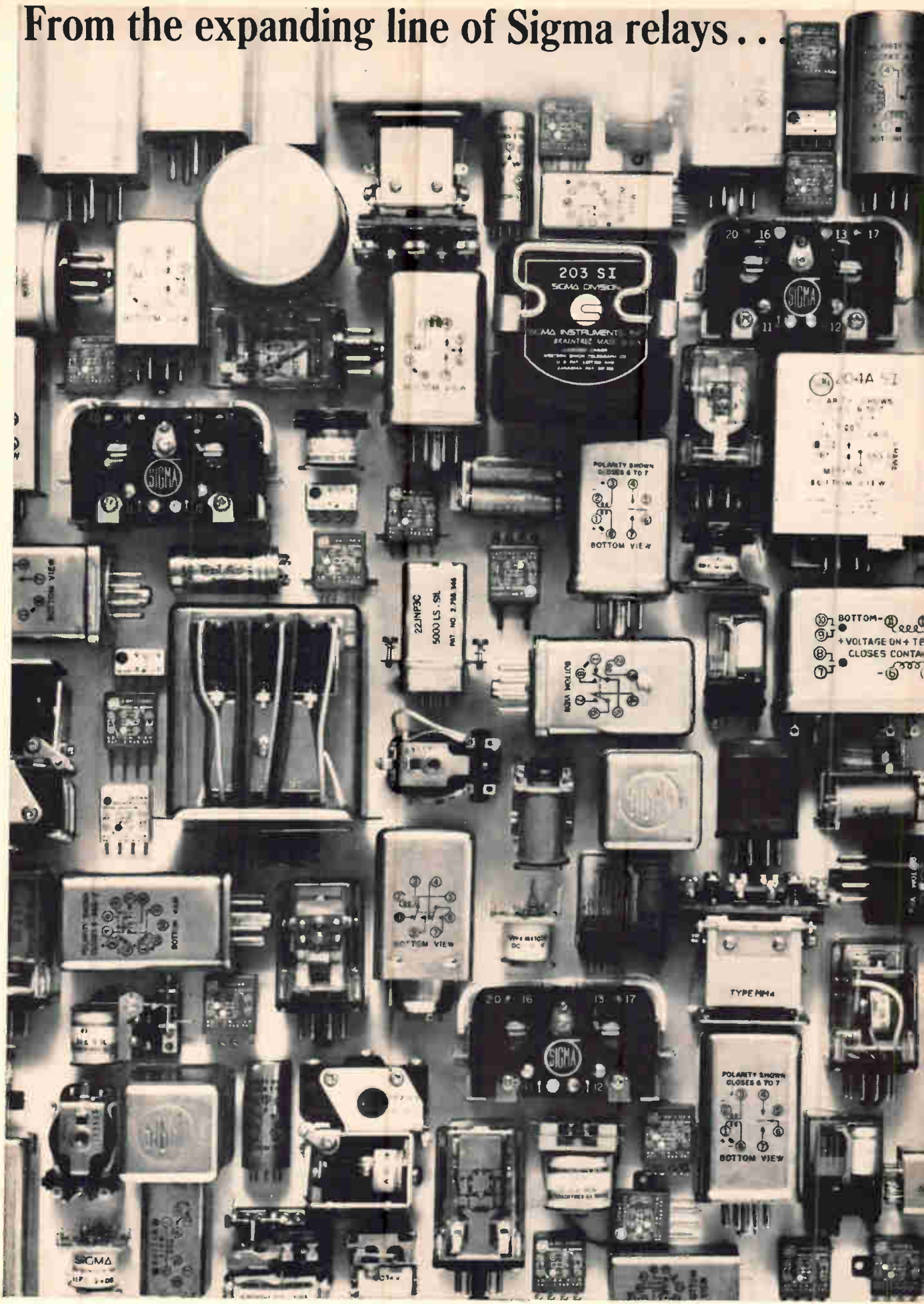

New 1, 2 and 3 pole relays for nearly every application in the 5 and 10 amp range.



New Series 50 3-pole

New Series 50 1-pole

New Series 50 2-pole

Order them off-the-shelf.

You name the general-purpose industrial application you're working on and chances are new Sigma Series 50 relays will meet your requirement. This new series is designed to be versatile and it is—12 versions cover every combination of its 1, 2 or 3 poles, 5 or 10 amp AC or DC power ratings, enclosed and open types, plug-in and soldered connections.

And they're available at the lowest prices Sigma has ever offered for relays of this type.

Along with their versatility and low-cost, Series 50 relays include such quality features as: Adjustable armature hinge for precise contact alignment. Heavy-duty contact base material for improved dielectric strength and insulation resistance. Single molded plug assembly with high temperature resistant polycarbonate housing.

Series 50 relays are designed for the broadest variety of general purpose industrial applications ranging from output relays in sensing controls to photocopiers and vending machines.

They are immediately available from your local Sigma distributor at factory-low prices—or from Sigma direct.

Want more information? Write for the new 16 page Sigma Preferred Standard and Stock Relay Catalog and an up-to-date stock listing. It will help you select the relays immediately available in quantity.

SIGMA DIVISION  SIGMA INSTRUMENTS INC
Assured Reliability With Advanced Design / Brantree, Mass. 02185

Sigma's line of over 100,000 relays includes Sensitive, High Performance, Pulse and Telegraph, General Purpose, Power, and Special Purpose types.



DC-to-50 MHz Bandwidth

Advanced Dual-Beam Performance

10 ns/cm Sweep Rates and Sweep-Delay

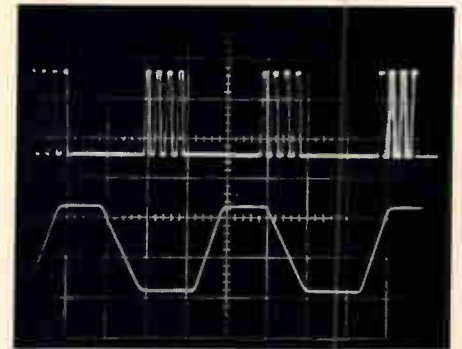
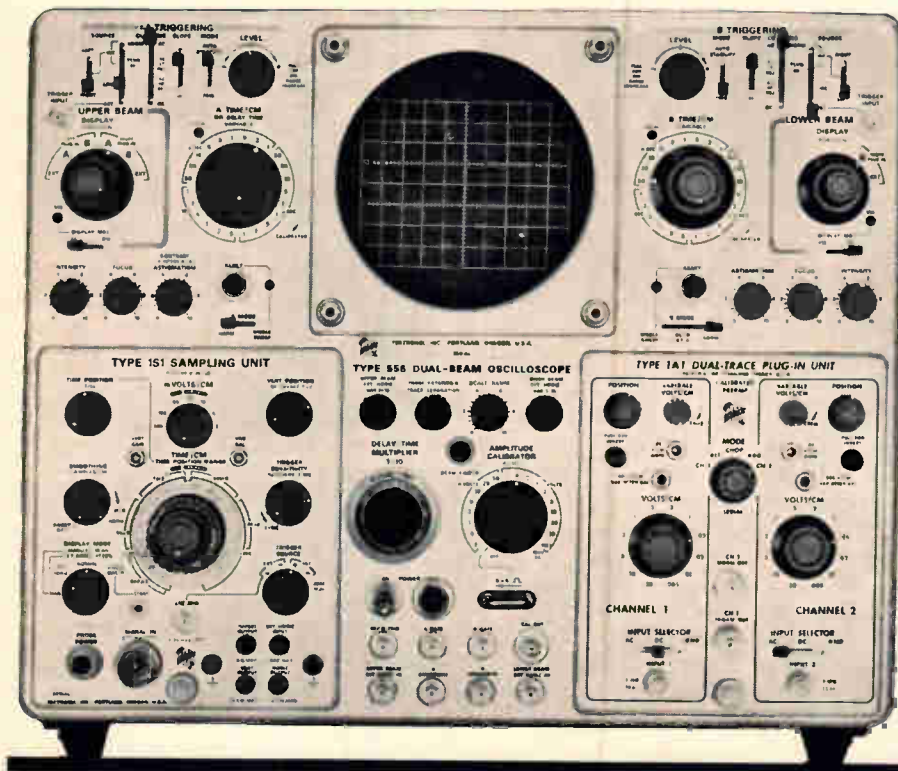

Single-Input Dual-Beam Displays. The upper beam shows bursts of 2.5 MHz pulses on Time Base A with time variation between bursts. This shows up as increasing time-jitter between the first and successive bursts. The lower beam shows B Sweep ($0.1 \mu\text{s}/\text{cm}$) delayed by A Sweep and triggered on the second pulse of the last burst to provide a jitter-free expanded display of the A Sweep intensified zone. The use of only one probe and one plug-in input simplifies signal connection and provides minimum loading on the source.

Here's a new Tektronix Oscilloscope that will tackle virtually every measurement job in your laboratory. The Type 556 and its rack-mount counterpart, the Type R556, have an ability for simultaneous information display that makes complex measurements simple and routine. They accept any Tektronix letter and 1-series plug-ins, including spectrum analyzer and sampling units.

This new Tektronix dual-beam oscilloscope offers these features:

for performance

- 50 MHz bandwidth • 10 ns/cm sweep rates • 6 cm vertical scan each beam • zero-parallax displays
- X10 sweep magnifier • AC HF Reject trigger coupling • 2% calibrator with current loop • front-panel variable contrast for A INTENS by B • short-safe solid state supplies
- EMI (RFI) suppression.

for convenience

- both beams can display signals from 1 plug-in (on same or different time bases) • fixed delay cable requires no adjustment • lever switch trigger controls • two-range TRIGGER LEVEL control • front panel ASTIGMATISM control • front panel EXT HORIZ IN and EXT HORIZ VAR 1-10 • beam finder • color coordinated indicator lights • rack-mount model available.

The Type 556 uses any combination of over 25 plug-ins —provides over 30 display modes.

The UPPER BEAM can display a signal from either *left* or *right* plug-in; with either Time Base A, Time Base B, or external signals; triggered from a composite vertical signal, plug-in single channel signal (with 1A1 or 1A2), external, or line.

The LOWER BEAM can display a signal from the *right* plug-in; with either Time Base B or external signals; triggered from a composite vertical signal, plug-in single channel signal (with 1A1 or 1A2), external, or line.

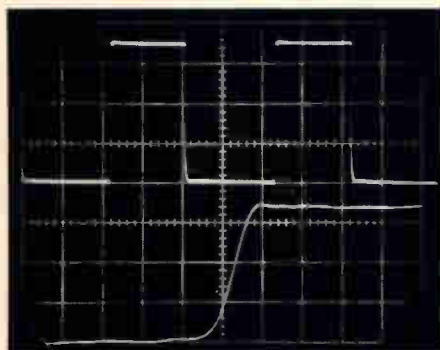

Sampling and Real-Time Displays. Upper beam shows a square wave at 1 $\mu\text{s}/\text{cm}$ as applied to a Type 1A2 Plug-In. The lower beam shows the risetime of the same pulse at 1 ns/cm as provided by a Type 1S1 Sampling Plug-in.

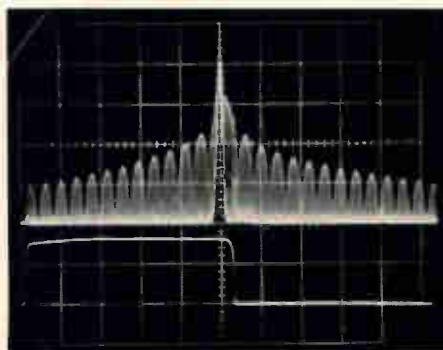

Time and Frequency Displays. The upper beam shows the spectral output of a 200 MHz gated oscillator applied as IF feedthrough to a Type 1L20 Spectrum Analyzer; the calibrated dispersion is 1 MHz/cm. The lower beam shows a real time display of the 10 kHz gating pulse; sweep rate is 0.5 $\mu\text{s}/\text{cm}$.

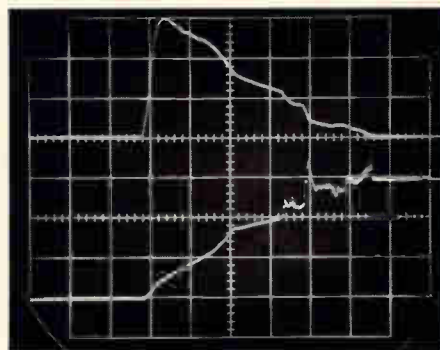

Simultaneous Single-Shot Displays. Current versus voltage display of a .75 ampere, fast-blow fuse during destructive overload. Both beams are driven by B Time-Base at 50 $\mu\text{s}/\text{cm}$ which is delayed by pre-triggered A Time-Base to provide base reference lines before and after the event. The upper beam shows the current waveform at 30 A/cm while the lower beam shows the corresponding voltage across the fuse at 100 V/cm.

Characteristics

New Dual-Beam CRT (with illuminated internal graticule)—provides "zero-parallax" viewing of small spot size and uniform focus over the 8 cm by 10 cm display area.

Calibrated Sweep Delay—extends continuously from 0.1 microsecond to 50 seconds, to permit expansion of a selected portion of the delayed sweep.

Independent Sweep Systems—provide 24 calibrated steps from 0.1 $\mu\text{s}/\text{cm}$ to 5 s/cm; the X10 Magnifier extends the fastest sweep rates to 10 ns/cm.

Single-Sweep Operation—enables one-shot displays for photography of either normal or *delayed* sweeps.

2 Independent Triggering Systems—provide stable displays over the full bandwidth, and to beyond 50 MHz. Both vertical amplifiers supply trigger signals to both of the time-base triggering systems.

Meets interference specifications of MIL-I-6181D over the following frequency ranges—Radiated (with CRT mesh filter installed): 150 kHz to 1 GHz; Conducted (power line): 150 kHz to 25 MHz.

Other Specifications—size is 15" by 17" by 24"; weight is \approx 80 pounds without plug-in units; power requirement is 100-130 V or 200-260 V, 50-60 Hz, \approx 850 watts.

Type 556 Dual-Beam Oscilloscope \$3150
Rack Mount Type R556 Oscilloscope \$3250

U.S. Sales Prices f.o.b. Beaverton, Oregon

Plug-ins illustrated

Type 1A1 Dual-Trace Unit \$600
(Dual-Trace: 50 mV/cm at DC-to-50 MHz, 5 mV/cm at DC-to-28 MHz. Single-Trace: 500 $\mu\text{V}/\text{cm}$ at 2 Hz-to-15 MHz. 5 Display Modes: Channel 1, Channel 2, Alternate, Chopped, Added Algebraically. Front-panel signal output.)

Type 1S1 Sampling Unit \$1100
(DC-to-1 GHz, internal triggering, built-in delay line. Sweep Rates: 100 ps/cm to 50 $\mu\text{s}/\text{cm}$, with \pm 3% accuracy, normal or magnified (up to X100). DC Offset Range: greater than \pm 1 V. 4 Display Modes: repetitive, single sweep, manual scan, or external scan.)

If you've been waiting for an oscilloscope that will handle your present requirements and that has the versatility to take care of future needs, investigate the new Type 556. Call your nearby Tektronix field engineer for complete information, or write Tektronix, Inc., P.O. Box 500, Beaverton, Oregon 97005.

Tektronix, Inc.

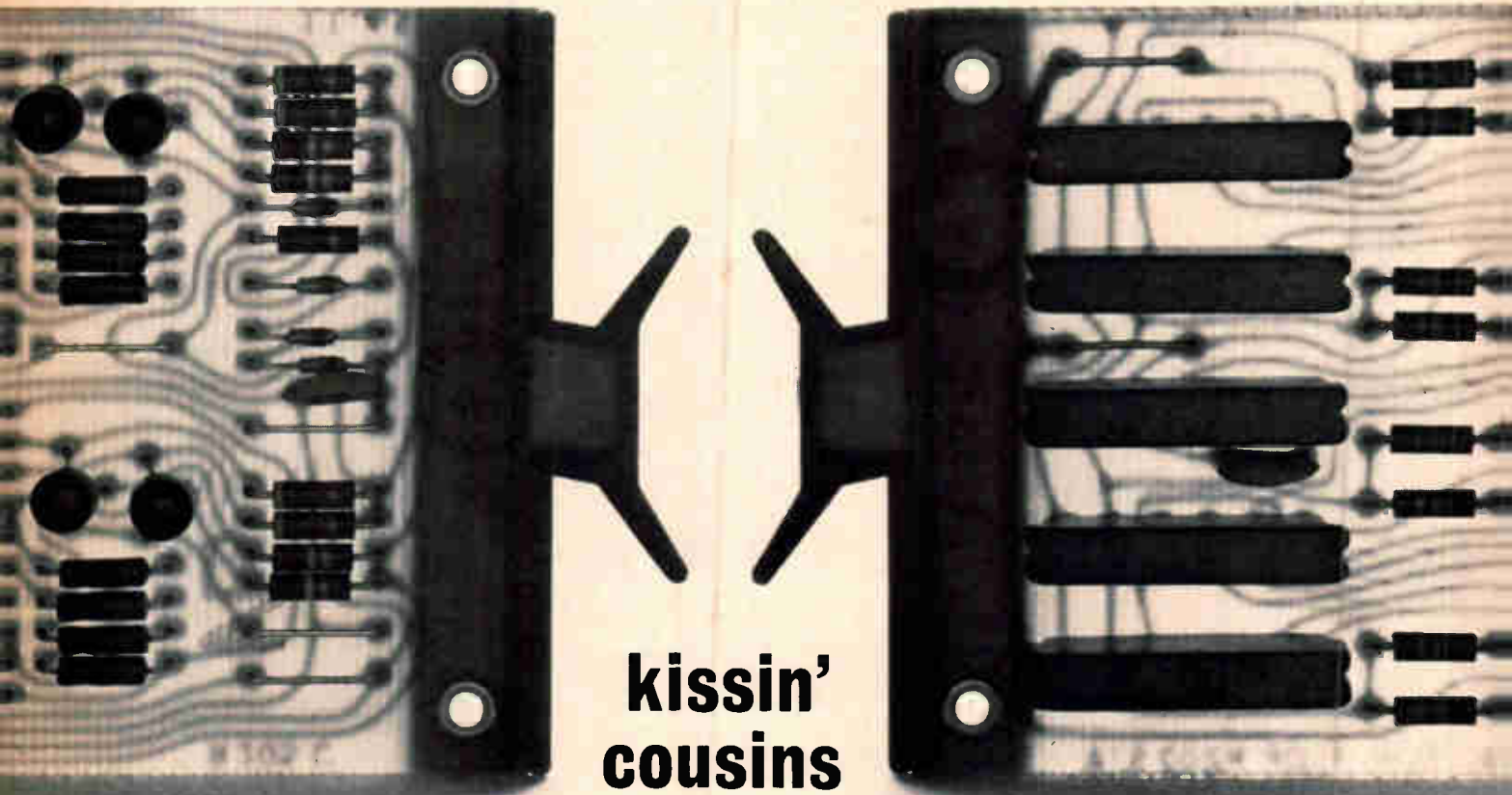

kissin' cousins

These two digital modules are directly related to 99 other standard Flip Chip™ modules. They are related electrically, physically, and logically, and they all carry the same 10-year guarantee.

Together with their kinfolk, they can be arranged to make an up counter, a down counter, a shift register, a jam transfer buffer, a high speed parallel adder, an analog to digital converter, or a vice versa.

Or a signal multiplexer, a typewriter driver, a Gray to binary converter, a vice versa, a paper tape punch control, a reader control, a pseudo random sequence generator, a data acquisition system, or an interface between peripherals and a real time computer.

Sometimes it pays to have a big family.

Write for a catalog.

DIGITAL

MOOULES • COMPUTERS

DIGITAL EQUIPMENT CORPORATION, Maynard, Massachusetts 01754. Telephone: (617) 897-8821 • Cambridge, Mass. • Washington, D. C. • Parsippany, N. J. • Rochester, N.Y. • Philadelphia • Huntsville • Orlando • Pittsburgh • Chicago • Denver • Ann Arbor • Los Angeles • Palo Alto • Seattle • Carleton Place and Toronto, Ont. • Reading, England • Paris, France • Munich and Cologne, Germany • Sydney and West Perth, Australia • Modules distributed also through Allied Radio

Editorial

IEEE settles for second rate sessions

The technical program at the annual meeting of the Institute of Electrical and Electronics Engineers from March 21 to 24 is maintaining its usual standard of mediocrity.

This will not astonish many engineers who have learned, after many disappointments, to skip the annual technical sessions. But it may frustrate a few die-hard optimists who believed the rosy promises made last March by the incoming leadership of the society.

After the very poor program of 1965—during the question period of one session, a visitor asked an author how he dared present such a bad paper at an IEEE meeting—incoming president Bernard Oliver promised to upgrade the quality of the technical sessions. Partly to answer an editorial which appeared on this page [March 8, 1965, p. 15], and partly to stem growing dissatisfaction among a segment of the membership, the newly elected president pledged sweeping reform.

One year later, retiring president Oliver says it would be too difficult to improve the technical program at this time. The newly elected president of the society, W. G. Shepherd, hadn't even looked at the program two weeks before the sessions were to start. This is a good clue to what's in store for visitors.

We disagree vehemently with Bernard Oliver. The technical sessions at IEEE's annual meeting can be improved. And we are aware that it will not be easy.

But first the society management—both elected and paid—has to decide that it wants to improve the technical program. The fundamental weakness, it appears, is that in importance in the eyes of the people at IEEE headquarters, the income produced at the show each year far outranks any contribution that might be made by technical sessions. As long as visitors stream into the Coliseum to look at exhibits, and the exhibitors buy plenty of booth space, the IEEE will not lift a finger to improve the technical sessions. Only if attendance falls and exhibitors scream, will the society's leaders act.

Because the job will be difficult, a more energetic effort must be made than the one that just

fizzled. Last spring, Oliver appointed an ad hoc committee to study how the annual meeting could be turned into a first-class technical session. Although it met only infrequently, the committee did discover that each of the technical groups of the IEEE holds back the best presentations on major technical advances for its own special symposiums or conferences. Thus the annual meeting is deprived of anything that is very good.

At one time during its sporadic deliberations, the committee thought the annual meeting might be turned into a congress of symposiums with each group presenting the best of its technical material—certainly an effort worthy of serious consideration. But, for reasons that escape us, the group came up with the decision that the time was not right for such a move. This means there will be no shift in policy for the technical sessions at the annual meeting.

What discouraged the committee most was that persuading each of the technical groups to contribute their best material looked like a Herculean job. They were right. Too many of the society's technical groups have a sovereignty mania, a phobia that they must be independent of IEEE headquarters. Then too, a few of the leaders of such groups are jealous of their political power in the society and are reluctant to compromise on anything that might be considered a diminution of their authority.

Though the job is tough, the IEEE ought to be able to produce an executive diplomatic enough to persuade technical group leaders that putting on sorry technical sessions does credit to no one—the society, the technical group or the group leader—and tough enough to enforce some criterion for quality.

Improvement can be made within the structure of the technical groups that are so sacred to the IEEE. An example of one group's effort is reported in the letter on page 4.

Some needed program changes are obvious. For example, it's doubtful whether all the groups combined can produce 300 to 500 top-notch technical papers every year, the number generally on the program. The number of papers presented should be reduced sharply. A technical group should be limited by the number of outstanding papers it can present, not by some quota it fills by drawing on papers already presented at earlier technical meetings, or sales promotion pitches for specific products, or nothing position papers prepared by egocentric members ambitious for political power in the society.

Every year, the IEEE meeting moves closer to being purely a trade show rather than a society meeting. If something is not done very soon to reverse this trend, it will be too late.

✓ Check CLIFTON for Servo Packages



**ELECTRONIC COMPONENTS FOR COMPUTER USE
F-111 AIRCRAFT**



**BOOSTER AMPLIFIERS, COMPONENTS OF
THE NAVIGATION AND BOMBING COMPUTERS
F-111 AIRCRAFT**



**SERVO ASSEMBLY
F-111 AIRCRAFT**



**AUTO-PILOT SYNCHRONIZER
A7A AIRCRAFT**



**SERVO AMPLIFIERS USED
ON VARIOUS AIRCRAFT**

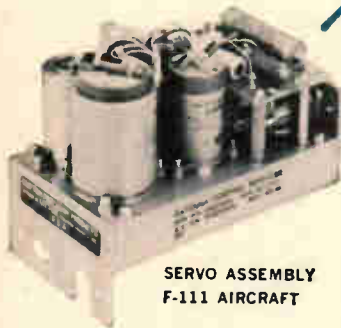

**SERVO ASSEMBLY
F-111 AIRCRAFT**

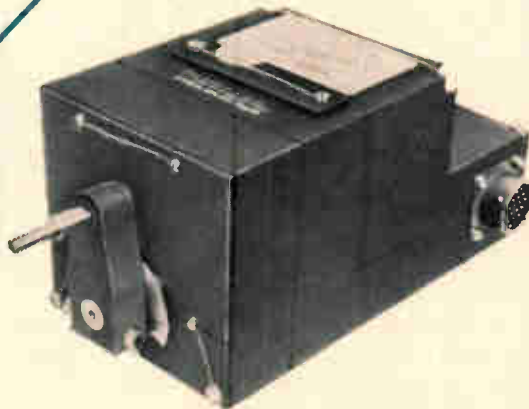

**AUTOMATIC STABILIZATION ACTUATOR
CH47A HELICOPTER (SEA KNIGHT)**



**TACAN RANGE AND BEARING COUPLERS
NAVIGATIONAL USE ON VARIOUS AIRCRAFT**

All units shown $\frac{1}{3}$ actual size.



We have been designers and manufacturers of flight controls and special aircraft devices for the past 10 years. A great many engineers and purchasing people think of Clifton only as a leader-manufacturer of rotating components, synchros, servo motors and resolvers. We would like to point out that we also develop, design and produce servo sub-assemblies, to the most exacting requirements. These precision-engineered modules are now flying, or will soon fly, in our coun-

try's most important aircraft.

These packages are built to Clifton synchro standards of reliability and accuracy . . . and in production quantities. While we can hand build models for you, we excel in "in-line" quantity and quality production.

Give us the opportunity to discuss your next servo package need! Do it now, today!

Call 215 622-1000 and ask for Mr. E. Fisher, or TWX 215 623-1183.

cppe

CLIFTON PRECISION
PRODUCTS

DIVISION OF LITTON INDUSTRIES

Clifton Heights, Pa.

Colorado Springs, Colorado



Flash! Clifton has just opened a new synchro plant in Fall River, Mass.

Electronics Newsletter

March 21, 1966

GE plans to build computer systems for hospitals

The General Electric Co. plans to enter the hospital time-sharing computer field, according to reliable sources. Last week GE announced an agreement with Bolt Beranek and Newman, Inc., a consulting and research concern in Cambridge, Mass., "to expand the utilization of computer-based information systems."

Bolt Beranek helped develop a time-shared computer system for the Massachusetts General Hospital in Boston [Electronics, Jan. 24, p. 93].

Jordan Baruch, a vice president of the research company, has been granted a leave of absence to work with GE in a "management capacity," no other details were provided. GE also declined further comment. Baruch played an important role in developing the Boston hospital's computer system.

Pentagon official cites laser danger

A new warning has been sounded on the hazards resulting from the use of high-powered lasers [Electronics, March 22, 1965, p. 128]. "The increasing power and diversification of lasers is outrunning the ability of the medical sciences to define the hazard limits," Daniel J. Fink, the Pentagon deputy director of research and engineering, said in Boston. "With such developments as the invisible carbon dioxide laser, someone is going to be badly hurt unless we establish reasonable precautions," Fink says. Carbon dioxide laser output is at 10 microns, in the infrared region, where the output can't be seen.

The laser danger is not limited to the laboratory. Increasingly, lasers are being applied in the field by engineers as measuring instruments and by the military as range finders for weapons.

IBM diode produces color without n material

A team of researchers at the International Business Machines Corp. has found a novel way to fabricate light-emitting diodes. The technique may open the door to the development of highly efficient diodes that produce color from the infrared to the ultraviolet.

Junction diodes capable of producing red, green, blue and yellow light are currently available, but the IBM researchers say a wider range of colors can be produced more efficiently from a group of materials called the II-VI compounds. Examples of such materials are zinc selenide, zinc oxide and zinc and cadmium sulfide. The problem, however, is getting both p and n material in this class of compounds to form the light-emitting junction. Researchers Billy Crowder, Frederick Morehead and Peter Wagner have sidestepped the problem by eliminating the need for the n-type material.

In the IBM method, a layer of metal, a layer of insulating zinc telluride and a p-type layer of zinc telluride are used. Conduction in the structure is by impact ionization in the insulating layer; light is produced by a recombination of holes and electrons in the p-type layer. The diodes developed so far emit green light and have an over-all power-conversion efficiency of 0.6% at 77°K—the temperature of liquid nitrogen.

The IBM team hopes to be able to improve performance and to get the diodes to operate at room temperature.

Applications include color displays for computers or other electronic equipment and, possibly, a solid state display that could replace a color television tube.

Electronics Newsletter

Red Chinese show, but don't sell electronics gear

After a four-year absence, the Red Chinese turned up at the recent Leipzig industrial fair with equipment that shows evidence of great leaps forward in electronics technology. The fair in East Germany is an industrial showcase for the entire Eastern bloc. The Chinese displayed an analog computer, an electron-beam tracer accurate to within 0.5%, transistorized closed-circuit television, noise generators, oscilloscopes with frequency capability up to 100 kilocycles and much more.

The Red Chinese apparently showed their new equipment at Leipzig more for prestige than for commercial reasons; dial markings were in Chinese, detailed data sheets weren't available and people manning the stand didn't know much about what was shown.

Low-cost, reliable IC chip assembly sought by Navy

The Navy is funding a study to find out the cheapest, most reliable approach for interconnecting integrated circuits chips without a common package and bonding them to thin-film interconnections. Under a \$100,000 contract, the Computer Control Co. of Framingham, Mass., is evaluating the major contenders: straight ultrasonic bonding, solder bonding with and without thick bonding pads, called balls, and beam-lead techniques [Electronics, June 28, 1965, pp. 66 and 68; Oct. 4, 1965, p. 102]. The goal of the Navy-sponsored evaluation: to develop techniques for producing modules with 10,000 hours mean-time-between-failures per dollar of production cost.

The over-all study of face-down bonding technology is being done by the company's techniques laboratory and will include a critical appraisal of the two principal types of bonding: ultrasonic and thermal.

One of the methods that has already been ruled out is laser welding through the glass substrate because it is difficult to control and lasers powerful enough for the job operate only in the pulse mode, says Colin Knight, manager of microelectronics at Computer Control's techniques laboratory.

Ford, GM plan '67 car radios with hybrid IC's

The Ford Motor Co. and the General Motors Corp. are expected to use hybrid integrated circuits in their 1967 car radios.

The Philco Corp., a subsidiary of Ford, disclosed that its circuit is an audio preamplifier with two transistors, two capacitors and 12 thick-film resistors. Philco is also building passive-component networks on ceramic substrates.

General Motors' electronics division, Delco Radio, won't comment on rumors that it has been field testing a radio containing hybrid IC's. Currently, car radios made by Delco use thick-film passive-component circuits on ceramic substrates; the circuits are bought from vendors.

Now, however, Delco is said to be tooling up to produce two to three million thick-film hybrid IC's a year in time for production of radios for the 1967 car models.

Computer printer bypasses storage

An experimental computer printer that operates at 120 characters per second will be shown this week by the International Business Machines Corp. at the Institute of Electrical and Electronics Engineers meeting in New York. The printer works so fast that it can accept most information serially, without the use of a buffer storage unit. IBM says the machine can plot three graphs simultaneously.

IDEAS

from SYLVANIA Electronic Components Group

READOUTS

Improve readability by 2:1 with newest EL high-contrast panels

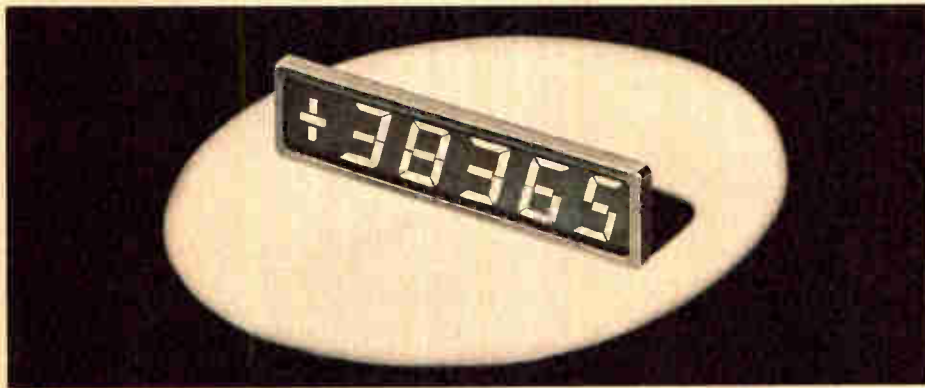

It's not enough to say that brightness is the all-important consideration in making readout devices truly readable. (In fact, beyond a practical limit, brightness can induce a halo effect.) Scientists and engineers have now clearly established that readability is the result of the interrelationship of many factors, including brightness, ambient lighting and contrast. Contrast is the most important of these.

In attaining a new high level of Electroluminescent character readability, Sylvania has increased contrast by more than one and one-half times. The result is a two-to-one improvement in the readability of EL under

high ambient light conditions.

This newest EL capability is the direct result of a requirement for solid-state readout panels for eventual aerospace use. Sylvania design engineers developed high-contrast EL after lengthy study of the three principal types of light in spacecraft cabins—ambient light, emitted light (from readout characters) and reflected light (from panel surfaces).

With a new neutral density filter that reduces reflected light in the panels, some 80% of the reflected light is now absorbed. Because a higher degree of contrast is the result, all characters are well defined and highly readable in conditions where they were previously "washed out."

High-contrast EL is now available (on special order) at no sacrifice to any feature in the long list of standard EL advantages. For instance, all EL readouts have the same wide viewing angle, almost 180°. Besides consuming very little power, they are light in weight. Other features of EL include its soft blue-green color that's always pleasing to the human eye. Information can be displayed as fast

HIGH-CONTRAST EL, P-SERIES

Operating Characteristics, typical

Brightness (Initial) FL	9 min
Contrast Ratio (300 FC ambient).....	0.13
Reflectance (300 FC ambient).....	15%
Wavelength Angstroms	5100
V-AC RMS	115
F Cps	400
I Ma	1.1 max
P Mw55 max
PF80 max

Maximum Ratings

Peak Voltage	300
RMS Voltage	130
Peak Transient Voltage	400
Operating Temp. Range	-55 to 71°C

as it may be needed.

EL readout panels are available hermetically sealed to provide maximum reliability for the demanding conditions of space travel. Rigid inspection both during and after assembly of each panel is assurance of continued high-quality performance.

CIRCLE NUMBER 300

This issue in capsule

CRTs — how spiral accelerator types can improve brightness and precision in your display.

Microwave Diodes — new silicon mixer diode operates over the 50 to 90 GHz range.

Photoconductors—how PC matrices can save time, space and trouble in logic arrays.

Integrated Circuits—now there's a plug-in package that can solve design problems faster.

Diodes—specify from a full line of multiple diodes with variety in arrays and packages.

Television—15" color bright 85™ tube brightens picture for set manufacturers.

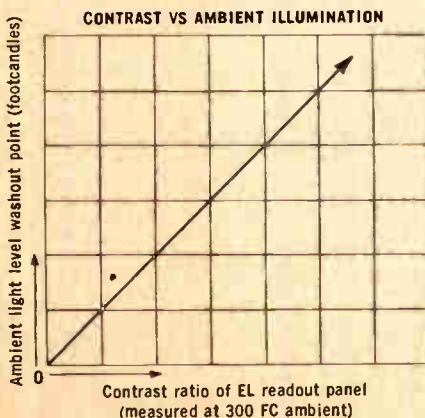

Now specify discrete or monolithic arrays in six package styles

Today a diode manufacturer who only makes standard "warhorse" units isn't worth his weight in salt to the majority of users. Sylvania came to that conclusion years ago based on projections that specialty types would become important to manufacturer and users alike. So-called "complete" lines must now be as complete as possible to offer users state-of-the-art diodes for today's and tomorrow's applications. For example, Sylvania applied this philosophy to multiple diodes. Here's the result:

It's well known that Sylvania puts diodes together in a wide variety of combinations. From the partial selection described here, the design engineer finds a genuine freedom of choice in multiple diodes—from a variety of special and standard packages as well as the variety in discrete and monolithic arrays. With this

choice he also gets inherent superior electrical characteristics and the highest reliability standards.

Two basic styles of multiple diode arrays are included in Sylvania's standard line. Molded discrete arrays are made up of two or more individual diodes hermetically sealed in all-glass packages and then molded together in one epoxy package. Monolithic arrays of multiple diodes can be supplied in a variety of packages such as 3-, 4-, or 5-lead TO-46 cans and multi-lead flat packs. This twin approach offers great flexibility in supplying exactly the right device for circuit designers' needs. The diodes in all units are passivated epitaxial types made of silicon for high performance reliability.

Experience in working with OEM customers who used standard diodes and rectifiers lead Sylvania into de-

veloping more advanced devices and arrays. Now, with an established capability in advanced diodes, Sylvania supplies a variety of array functions including the bridges and ring modulators shown on this page. In addition to the standard molded and TO-46 packages, on special order Sylvania will package these arrays into 14-lead flat packs, plug-in packages and specialty molded packages.

Sylvania's series of molded matched pairs and matched quads can save the engineer much costly confusion. The units are especially rugged and eliminate handling problems by pre-packaging the diodes to maintain proper polarity and type identification. Epoxy-molded matched pairs and quads can also be supplied with common cathode, common anode, and series circuit configurations.

CIRCLE NUMBER 301

TO-46 PACKAGES

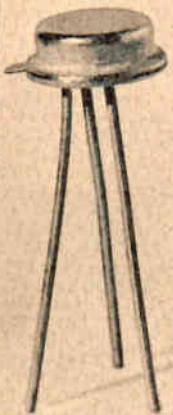

Type	No. of Diodes	Circuit	
S1D2A-1	2	Common cathode	
S1D2A-2	2	Common cathode	
S1D2A-3	2	Common cathode	
S1D2A-4	2	Common cathode	
Type	No. of Diodes	Circuit	
S1D2B-1	2	Common anode	
S1D2B-2	2	Common anode	
S1D2B-3	2	Common anode	
Type	No. of Diodes	Circuit	
S1D3A-1	3	Common cathode	
S1D3A-2	3	Common cathode	
S1D3A-3	3	Common cathode	
S1D3A-4	3	Common cathode	
S1D3A-6	3	Common cathode	
Type	No. of Diodes	Circuit	
S1D3B-1	3	Common anode	
S1D3B-2	3	Common anode	
S1D3B-3	3	Common anode	

MOLDED EPOXY PACKAGES—matched pairs and quads



Type	No. of Diodes	PRV	Fwd Current @ 10 V	
M9311-9314	2	150 volt	200ma	
M9731-9734	2	100 volt	50ma	
M9741-9744	2	50 volt	100ma	
M9751-9754	2	50 volt	50ma	
Type	No. of Diodes	PRV	Fwd Current @ 10 V	
M9316-9319	4	150 volt	200ma	
M9736-9739	4	100 volt	50ma	
M9746-9749	4	50 volt	100ma	
M9756-9759	4	50 volt	50ma	

BRIDGES AND RING MODULATORS

BRIDGES				
TO-46	Fwd Current at 1.0 volt	PRV	Matching Fwd Voltage @ 2ma	
S1D-4C-2	30ma	50 volt	20mv	
S1D-4C-3	50ma	75 volt	20mv	
Molded Epoxy				
M-9328	30ma	50 volt	20mv	
M-9329	50ma	75 volt	20mv	
RING MODULATORS				
TO-46	Fwd Current @ 1.0 volt	Matching Fwd Voltage @ 2ma		
S1D4D-1	50ma	20mv		
Molded Epoxy				
M-9330	50ma	20mv		

MULTI-DIODE EPOXY PACKAGES

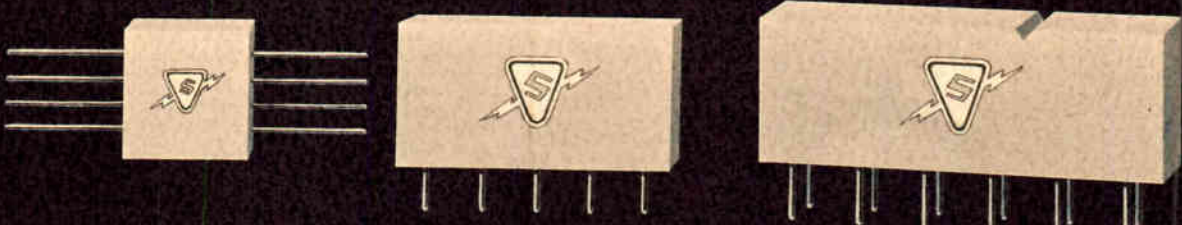

MATCHED DIODE QUAD 5-PIN PLUG-IN 12-PIN PLUG-IN



Sylvania's SC-4448 (with SC-3802 in foreground)

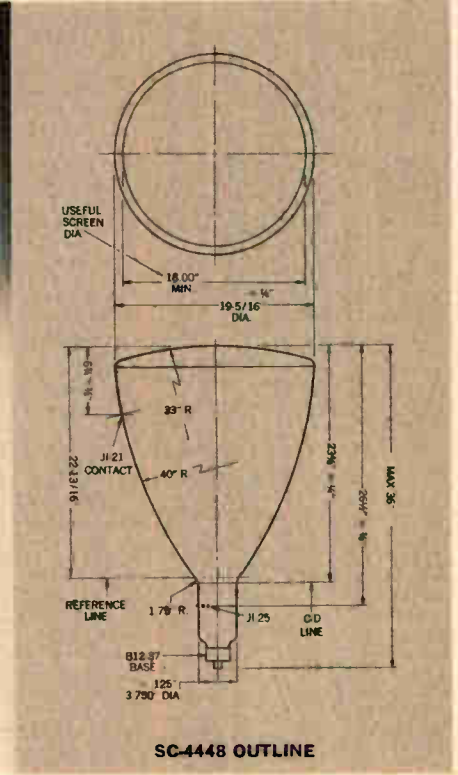

SC-4448 OUTLINE

How spiral accelerator tubes can improve display brightness and precision

We're always surprised to hear of engineers using older methods to solve electronic problems. A case in point: How can spiral post deflection accelerator cathode ray tubes be bypassed where their inherent advantages can save time and money while bringing better results? Sylvania is a major supplier of standard post deflection accelerator tubes also, but we recognize that there are situations where conventional coatings can cause less than optimum results.

If the oscillography problem is to achieve maximum brightness with controlled spot size, a spiral accelerator is the answer. That's because the spiral approach brings about superior display *with* minimum pattern distortion, but *without* either complicated circuitry or materially affected costs.

The helical resistance coating inside the spiral tube allows accelerating voltage to be uniformly increased along the length of the bulb between deflection plates and screen. This permits a higher ratio of final anode voltage to second anode voltage without excessive pattern distortion.

The electrostatic deflection guns are assembled on special mounting

jigs that are accurate to .001". These are magnified ten times actual size on optical comparators and carefully checked for spacings, dimensions and alignments.

The newest CRT in the series is a specially developed 19-inch round console display tube for visual read-out of character and vector information. The SC-4448's advanced design allows high resolution and brightness, even at exceptionally high writing rates.

Design features of the SC-4448 include a direct-viewed aluminized

screen and spiral post deflection acceleration. Its deflection plate leads are brought out through the neck to minimize deflection plate lead capacitance. Deflection and focus are electrostatic. The tube incorporates a special geometry control electrode to achieve maximum pattern linearity.

In the area of smaller screens, Sylvania's SC-3377 was developed for transistor drive requirements. Its features include low heater power, a 3½-inch square face for full use of display space and high deflection sensitivity.

CIRCLE NUMBER 302

SC-4448P31 TYPICAL OPERATING CONDITIONS

Anode No. 3 (Post Accelerator) Voltage	25,000 Volts dc
Anode No. 2 Voltage	10,000 Volts dc
Grid No. 2 Voltage	1,000 Volts dc
Anode No. 1 Voltage for Focus	3,400 to 3,800 Volts dc
Grid No. 1 Voltage Required for Cutoff	-100 to -200 Volts dc
Deflection Factors	
Deflecting Plates 1-2	200 Volts dc/Inch Max.
Deflecting Plates 3-4	200 Volts dc/Inch Max.
Modulation	50 Volts Max.
Trace Brightness	75 FTL Min.
Trace Width	
Center015 Inch
Corners of 12.6" square025 Inch
Spot Position	1.0 Inch
Spot Displacement	0.4 Inch
Focus Correction	0 to 3000 Volts Max.
Astigmatism Correction	±500 Volts Max.
Geometry Control	±500 Volts Max.

How Sylvania's plug-in package can solve your design problems faster and better

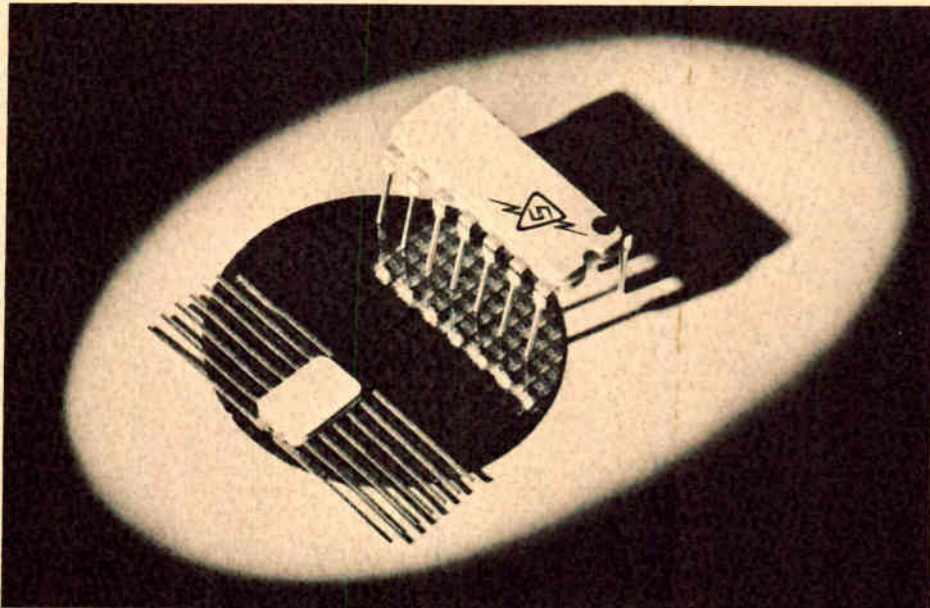

It is a truism to say that package design is an essential art in the electronics industry. To a large extent, the component package can effect the design of an entire system. At times, component packaging can even be as important as performance itself. When the two are successfully combined, a manufacturer has something to shout about. Now, in integrated circuitry, the physical features of one package and the performance of one product line combine to outshine all the others.

Predictions: (1) Sylvania's highly versatile dual-in-line plug-in package will be the most widely used enclosure in the monolithic integrated circuit industry. (2) It will replace the

TO-5 for industrial applications. Here's why.

To the logic designer and device engineer, the SUHL I and II lines of high level TTL represent the furthest advance yet in the state of IC performance and packaging art. Sylvania's plug-in package itself offers the advantages of the preferred lead styling, and an extremely effective hermetically sealed ceramic IC package.

The Sylvania plug-in package has fourteen pins, more than enough for the vast majority of applications. Lead spacing of 100 mils, with another 300 mils between the two rows, allows printed circuit leads to be brought under the package, an important space economy on the board surface.

Leads on the Sylvania package are 5 mils thick, compared with the 10 mil leads of another popular flat pack design. Also, the Sylvania plug-in package design allows leads to be flexed close to the body without cracking the seal. When a Sylvania plug-in lead is clipped to a 0.170" length, the result is an extremely rigid lead that has great strength in its rolled portion (see cross-section diagram).

Sylvania's rolled lead provides great stiffness in the area where the lead is inserted in the board. Thus the possibility of lead collapse during automatic insertion is virtually eliminated. In addition, the rolled tubular lead design is an ideal configuration for capillary solder flow and uniform solder joints. With soldering, a large mass of metal results,

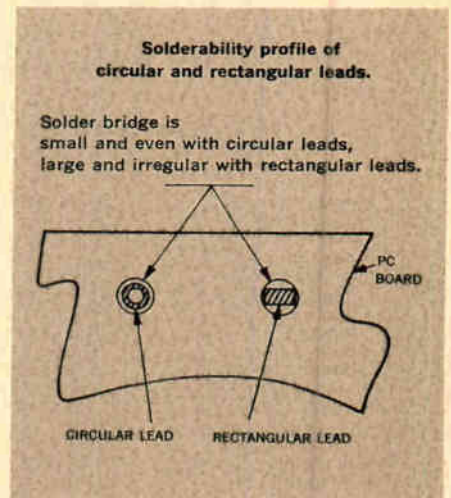

which allows for good heat conduction during the assembly process. Thus, where the lead should be flexible, it is. Yet it retains a rigidity similar to that of the leads of a TO-5 and TO-18 package.

The rolled lead design is also clearly superior to that of rectangular types which don't lend themselves to good solderability.

Most important to design engineers is the Sylvania lead's tapered shoulder, an advantage over square-shouldered types. With tapering, the lead tends to wedge in the holes of the circuit board. The chance that the lead may fall out when the board is moved to a solder bath is virtually eliminated because of the wedge-type contact.

Comparison of Sylvania's plug-in package with leading competitive types.

	NO. PINS	A	B	C	D	E	F	G	H	Q_{JA}^C /MW
SYLVANIA	14	0.70	0.25	0.30	0.10	0.09	0.13	0.17	20 Mil Dia.	0.2
LEADING BRAND "A"	14	0.775	0.28	0.30	0.10	0.18	0.20	0.17	10Mil X 20 Rect.	0.2
LEADING BRAND "B"	16	0.89	0.39	0.20	0.10	0.145	0.175	0.125	20 Mil Dia.	0.2

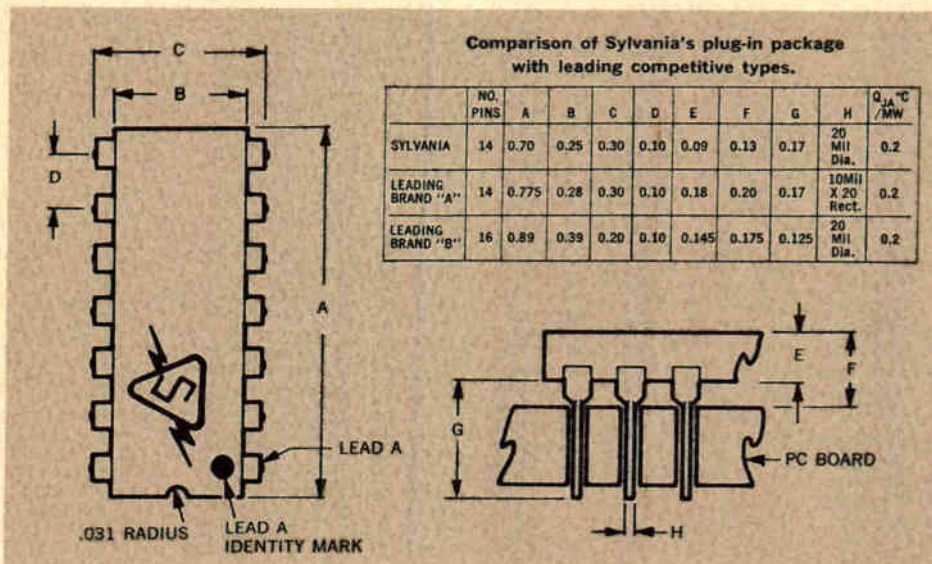

When the Sylvania unit is mounted, packages are high enough off the board to allow the designer to run other leads underneath. Yet packages are close enough to the board to permit true compactness. Compact stacking of multiple packages is still

another result of the Sylvania design.

The diagram on this page graphically shows how package height relates to hole size in printed circuit boards. Circuit designers can use this to determine necessary lead lengths with respect to standoff heights from the board.

An extremely effective hermetic package seal is another feature of the Sylvania plug-in unit. The package, a ceramic-filled glass body with a Kovar base plate and a glass-to-glass sealed ceramic cover, is capable of meeting hermeticity specifications as high as 10^{-8} cc/sec. Sylvania's methods result in seals that are clearly superior to other types which depend either on flowing large masses of frit or on welding a large Kovar plate to a formed Kovar sidewall.

In a comparative sense, the compact Sylvania package is one-half the volume of one principal manufacturer's unit and one-third the volume of the other major competitor. In addition to its superior hermetic seal, the Sylvania package also offers the advantage of leads extending from the sidewall, permitting both easy re-

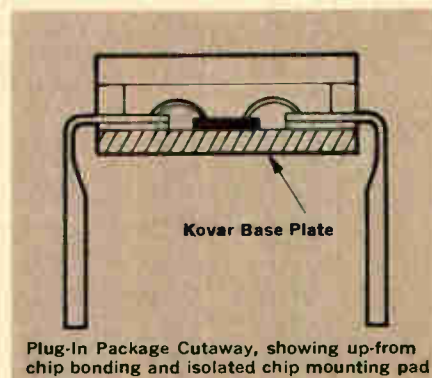

Plug-In Package Cutaway, showing up-from chip bonding and isolated chip mounting pad

moval from the board as well as in-place testing. Moreover, the Sylvania package does not require a special spread when it is used with standard hole spacing of 300 mils between rows.

Sylvania foresees its plug-in unit becoming an industry standard. It is already replacing the TO-5 integrated circuit packaging for several reasons. Because of its configuration, TO-5 testing is costly. Logic cannot exceed that of its 12-pin capacity. The TO-5 is also expensive to assemble and requires expensive board layouts, because leads cannot be brought under the package.

CIRCLE NUMBER 303

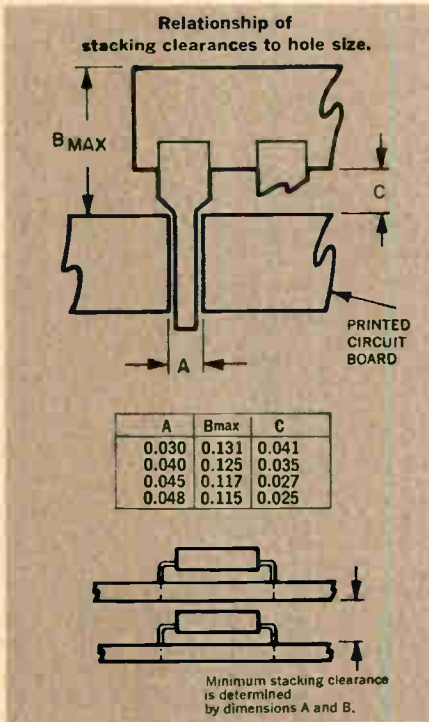

INTEGRATED CIRCUITS

Select the IC for your needs from two complete TTL lines

Here's your guide to an entire new generation of monolithic integrated circuits, the SUHL I and SUHL II lines. These are the transistor-transistor-logic families with the industry's outstanding combination of high noise margin, fast speed, high logic swing, high fan-out, low power and capacitance drive capability.

Each of the 28 circuits is available in prime and standard fan-outs for Military and Industrial applications. And each unit displays the fastest saturated logic available to date for applications down to five nanoseconds.

Speaking of speed, SUHL II is the line that scored the breakthrough for extreme speed requirements, while allowing all other important performance characteristics to be maintained at their full efficiency levels. Combine these advantages with low cost, high reliability and reduced can counts, and you'll see why SUHL circuits are now considered the industry's foremost problem-solving lines.

SUHL I	Function	SUHL TYPICAL CHARACTERISTICS (+25°C, +5.0 volts)						Military (-55°C to +125°C)		Industrial (0°C to +75°C)	
		series	tpd (nsec)	Avg. Power (mw)	Noise Immunity (volts)	Prime FO	Std. FO	Prime FO	Std. FO		
Dual 4-Input NAND/NOR Gate		SG-40	10	15	1.1 1.5	15	7	12	6		
Expandable Quad 2-Input OR Gate		SG-50	12	30	1.1 1.5	15	7	12	6		
Single 8-Input NAND NOR Gate		SG-60	12	15	1.1 1.5	15	7	12	6		
Exclusive-OR with Complement		SG-90	11	35	1.1 1.5	15	7	12	6		
Expandable Triple 3-Input OR Gate		SG-100	12	25	1.1 1.5	15	7	12	6		
Expandable Dual 4-Input OR Gate		SG-110	12	20	1.1 1.5	15	7	12	6		
Expandable Single 8-Input NAND/NOR Gate		SG-120	18	15	1.1 1.5	15	7	12	6		
Dual 4-Input Line Driver		SG-130	25	30	1.1 1.5	30	15	24	12		
Quad 2-Input NAND/NOR Gate		SG-140	10	15	1.1 1.5	15	7	12	6		
Quad 2-Input OR Expander		SG-150	4	20	1.1 1.5						
Triple 2-Input Bus Driver		SG-160	15	15	1.1 1.5	15	7	12	6		
Dual 4-Input OR Expander		SG-170	3	5	1.1 1.5						
Dual 4-Input AND Expander		SG-180			1.1 1.5						
Triple 3-Input NAND/NOR Gate		SG-190	10	15	1.1 1.5	15	7	12	6		
Set-Reset Flip-Flop		SF-10	20mc	30	1.1 1.5	15	7	12	6		
Two-Phase SR Clocked Flip-Flop		SF-20	20mc	30	1.1 1.5	15	7	12	6		
Single-Phase SRT Flip-Flop		SF-30	12mc	30	1.1 1.5	15	7	12	6		
J-K Flip-Flop (AND Inputs)		SF-50	20mc	50	1.1 1.5	15	7	12	6		
J-K Flip-Flop (OR Inputs)		SF-60	20mc	55	1.1 1.5	15	7	12	6		
SUHL II											
Expandable Dual 4-Input OR Gate		SG-210	7	30	1.0 1.5	12	6	10	5		
Quad 2-Input NAND/NOR Gate		SG-220	6	22	1.0 1.5	12	6	10	5		
Quad 2-Input OR Expander		SG-230	2	28	1.0 1.5						
Dual 4-Input NAND/NOR Gate		SG-240	6	22	1.0 1.5	12	6	10	5		
Expandable Quad 2-Input OR Gate		SG-250	7.5	43	1.0 1.5	12	6	10	5		
Single 8-Input NAND/NOR Gate		SG-260	8	22	1.0 1.5	12	6	10	5		
Dual 4-Input OR Expander		SG-270	2	6.7	1.0 1.5						
J-K Flip-Flop (AND Inputs)		SF-250	30mc	55	1.0 1.5	12	6	10	5		
J-K Flip-Flop (OR Inputs)		SF-260	30mc	55	1.0 1.5	12	6	10	5		

CIRCLE NUMBER 304

How PC matrices can save time, space and trouble in logic arrays

Thirty-two photocells, each one individually mounted, were principal components of a teaching machine's logic array. Efficient? Yes, a large advance over mechanical approaches to logic arrays. But 32 cells also meant space-consuming bulk and complicated circuitry. Here's how Sylvania answered the problem.

A matrix composed of 32 photoconductive wafers, precision-mounted on a printed circuit board, saved a manufacturer considerable assembly time and headaches. It also provided valuable space economies in the design of his teaching machines. Similar matrices can offer the same economies in many other types of automated systems where logic can be based on visual detection.

Sylvania's 32-wafer SRP-4210 photoconductor matrix was designed especially for use as a part of the control in a teaching machine. The unit enabled the manufacturer to replace an older array consisting of 32 individual photocells with the single matrix.

This machine presents information to the student with a projection system through the 35mm film. Information for the student is contained in every other frame along the film, with alternate frames containing control information for the machine in the form of clear areas in an otherwise blackened film. The clear areas allow light to be transmitted to specific photoconductors on the matrix board which in turn control gate circuits with instructions for advancing the film.

After reading information contained in one frame of the film, the

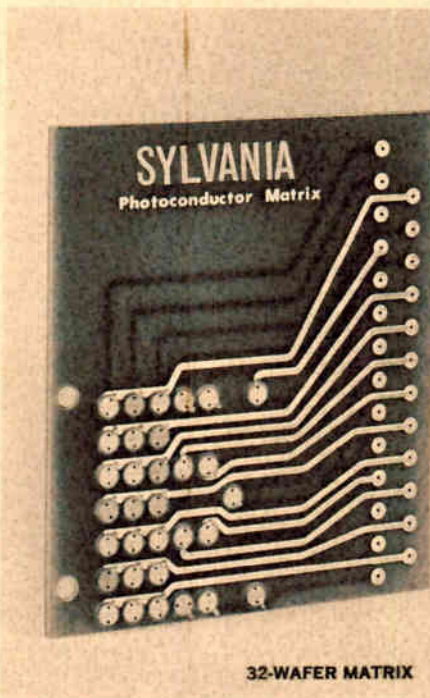

student is asked a question and given a choice of three answers. He indicates his choice by closing a switch identified with the answer. This applies voltage to one of three groups of seven photoconductors and, according to their lighted condition, instructs the machine to look for another coded frame on the film. It also determines whether the film must proceed forward or be reversed.

The correct frame is recognized by a fourth group of photoconductors and, through their gates, stops the film. This frame is then centered properly from instructions by a pair of photoconductors which control the drive motors. The student then reads the information in the film, selects an answer and proceeds as before.

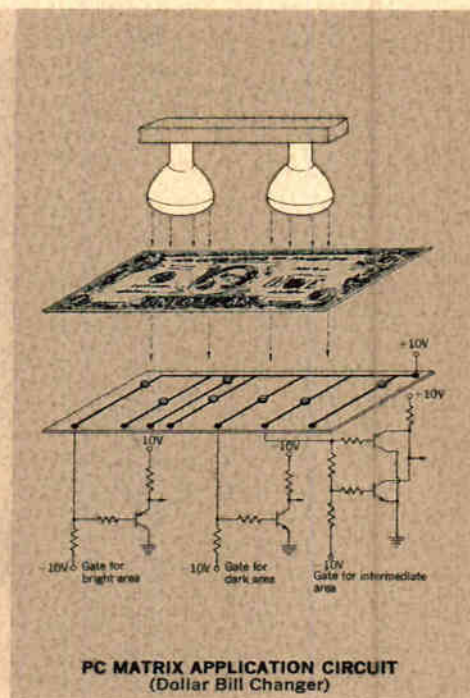

Among other possible applications for similar matrix boards are card readers, tape readers, dollar bill changers or in any equipment presently using a quantity of photoconductors in a distinct pattern.

The resistance of the individual photoconductors may be controlled at a wide variety of levels, depending upon the area and illumination available for each cell. Dissipation also varies with space requirements. With large active areas ($\frac{1}{2}$ " diameter) the cells are capable of operating relays directly. With small active areas (as in the SRP-4210) a switching transistor is operated by the photoconductor which in turn operates a relay or similar power device.

CIRCLE NUMBER 305

TELEVISION

15" Color bright 85TM tube brightens 1966 picture for set makers

"Sylvania, a subsidiary of General Telephone & Electronics, has stolen a march on the rest of the industry with a new rare-earth phosphor that makes colors glow '40 percent brighter,'" says a story in Fortune's January, 1966 issue. The fuller story began a year and a half earlier when the company

announced a new concept in color picture tubes. The effect was a mild revolution: in the months that followed, old methods of making color tubes were modified or discarded throughout the industry in an attempt to equal the brighter, more realistic Sylvania product. In the meantime,

Sylvania did not sit on its laurels but applied the same advanced technology to newer picture tubes.

The newest in the line of color bright 85 picture tubes will shortly be sampled by color television set manufacturers. A 15-inch rectangular, three-gun aperture mask tube is in final stages of development now.

The special significance of this new color picture tube is that it will hasten the availability of smaller-sized, more portable color sets to meet in-

creasing consumer demands. Now the second largest producer of color picture tubes, Sylvania supplies them to most of the nation's color set makers.

Sylvania is continuing production of rectangular *color bright 85* tubes in 19- and 25-inch models, as well as the round 21-inch type. A 22-inch rectangular tube will also be produced in 1966.

What were the major factors that changed color picture tube standards in mid-1964? One of the prime reasons was that *color bright 85* tubes featured a new red-emitting phosphor containing the rare-earth element Europium. The new phosphor, actually a Europium-activated Yttrium vanadate YV04:Eu, brought out red tones that were truer and substantially brighter than standard industry sulfides.

While other picture tube manufacturers were able in time to develop comparable rare-earth phosphors, Sylvania's own screening techniques still remained the differentiating factor that keeps the *color bright 85* tube ahead of others.

Fidelity in color values was one more of the tube's major accomplishments. Red shades held their true colors over wider ranges of brightness. The new Sylvania tubes also kept their natural hues without taking on orange-reds in the highlights of the picture.

Now, with a 15-inch *color bright 85* tube on the horizon, all the tube's advantages can be brought to smaller, lighter-weight, solid-state color television models.

CIRCLE NUMBER 306

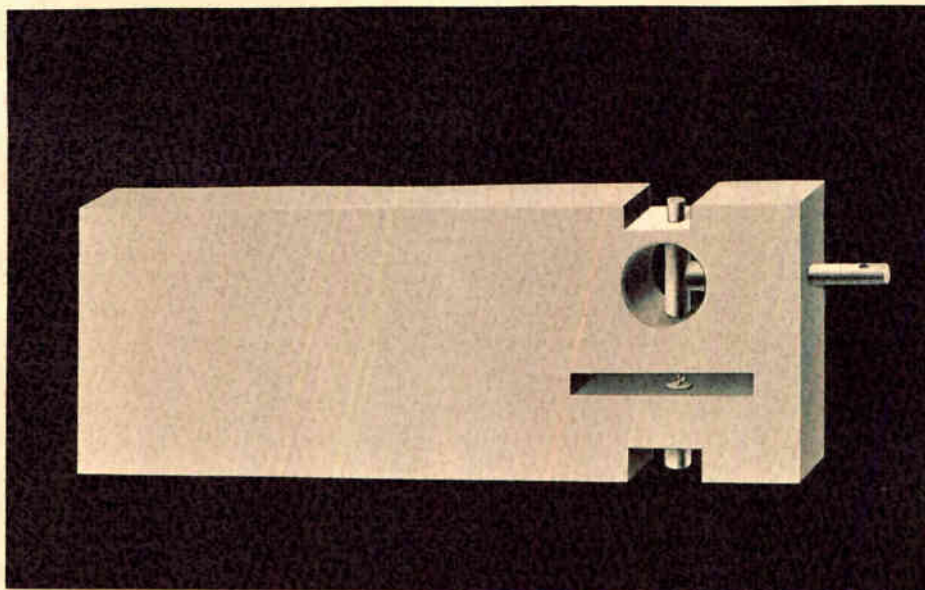

Newest point contact mixer excels at millimeter wavelengths

Finding a suitable mixer diode to span the millimeter frequency spectrum has long been a problem for the microwave engineer. Until now he has had to design with individual devices that are effective only in limited segments of the 50 to 90 GHz range. Here's a new mixer diode from Sylvania that fills a recognized void.

Now there's a versatile new silicon diode that can operate over this 50 to 90 GHz frequency range and which can also be used as a highly sensitive video detector. Sylvania's D-5252 point contact device was designed as a mixer capable of spanning the operating frequency range of RG98 and RG99 wave guide.

The new unit has maximum over-

all noise figure of 18 db (with $NF_{if} = 1.5$ db) and a typical conversion loss of 12 db at 70 GHz. Below this frequency these values tend to improve slightly. However, at higher frequencies, these values may increase by about 1 db.

The D-5252 is gold-plated to minimize RF losses and is supplied in Sylvania package 100, as shown here. Commercial holders are available in RG98/U and RG99/U wave guide sizes.

ELECTRICAL CHARACTERISTICS (25°C):

Overall Noise Figure, NF_0 18.0 db max.
IF Impedance, Z_{if} 300-700 ohms
Test Conditions:

$F = 70$ GHz; $P_{i0} = 1.0$ mw
 $Z_m = 400$ ohms; $R_L = 100$ ohms

CIRCLE NUMBER 307



HOT LINE INQUIRY SERVICE

Use Sylvania's "Hot Line" inquiry service, especially if you require full particulars on any item in a hurry. It's easy and it's free. Circle the reader service number(s) you're most interested in; then fill in your name, title, company and address. We'll do the rest and see you get further information almost by return mail.

BUSINESS REPLY MAIL

No Postage Stamp Necessary if Mailed in the United States

POSTAGE WILL BE PAID BY

SYLVANIA ELECTRONIC COMPONENTS GROUP

Sylvania Electric Products Inc.
1100 Main Street
Buffalo, New York 14209

Dept. A33

FIRST
Permit
Buf

"Trade shows are a waste of time!"

"...and a waste of money too." How often have you heard this? You may have said it yourself. For a great many people it's true, shows are wasted efforts.

After all, too many exhibits are little more than 3-dimensional catalogs. Nothing's exciting in seeing cold lifeless products tacked to a back wall. We at Sylvania shudder to think of the dull repetition (and, possibly, repulsion) of 100 receiving tubes in a row.

And what if you just happen to see one product that interests you? Ask a reasonable question at the booth about it, and you usually find that the expert on the subject is out to lunch. (Would you believe this at 9:30 AM?)

But exhibitors are only partners in the crime of trade shows. Attendees share a large portion of the blame. Engineers are in New York during the IEEE show often for three or four days. But during that time they're seen in the Coliseum for as much as four hours! Ask them if they saw the show. Why, certainly they did! To have seen every exhibit in that period of time, they would have had to be Olympic track stars if only to go through all of the aisles.

After our sprinter does complete

his exhaustive survey, general comments run from "same old stuff" to "nothing really new." Anything less than the discovery of a new energy source seems to be a disappointment. Well, we could go on and on, but essentially our point of view is that, like most things, trade shows are valueless *unless* all exhibitors and attendees work at it.

Sylvania has made some innovations in presentation techniques—live presentations, information booth and telephone hot line. We hold no licenses on these methods and wish (in fact, strongly urge) other exhibitors would liven up their booths in a similar manner.

A better show benefits everyone. In fifteen minutes at the Sylvania booths, 2C25-2C36, we feel an engineer can be initially exposed to the full scope of Sylvania's manufacturing and engineering efforts. Included, of course, are new product developments, particularly those that are pertinent to today's designs and requirements. A few more minutes and we'll give detailed information on specific product types from our microfilm data file right at the booth.

Visitors also have the option of talking directly to our plant and engi-

neering locations anywhere in the country. Further, they can request that specific information be sent to them at the completion of the show on any product which we manufacture. It isn't necessary to ask ten people in order to receive this information. Our purpose at a trade show is not to take orders there on the floor, but rather to disseminate the maximum amount of information on our overall company capabilities.

We want people to know more of what Sylvania can do today and in the years to come.

For your company, trade shows can be a waste of time, but there is also the opportunity to learn a great deal at a relatively small cost. We sincerely hope you share our thoughts for maximizing the time and money devoted to the trade show concept. Sylvania wants to make good use of the time you give us.



Bill Dixon
W. R. DIXON

This information in Sylvania Ideas is furnished without assuming any obligations.

SYLVANIA

SUBSIDIARY OF
GENERAL TELEPHONE & ELECTRONICS GTE

NEW CAPABILITIES IN: ELECTRONIC TUBES • SEMICONDUCTORS • MICROWAVE DEVICES • SPECIAL COMPONENTS • DISPLAY DEVICES

STATE _____

Corresponding to Product Item

302	303	304
307		

have a Sales Engineer call



HOT LINE INQUIRY SERVICE

Need information in a hurry? Clip the card and mail it. Be sure to fill in all information requested. We'll rush you full particulars on any item indicated.

You can also get information using the publication's card elsewhere in this issue. Use of the card shown here will simplify handling and save time.

Monolithic Differential Amplifier by Amelco provides excellent tracking

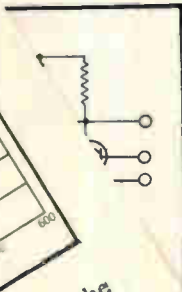
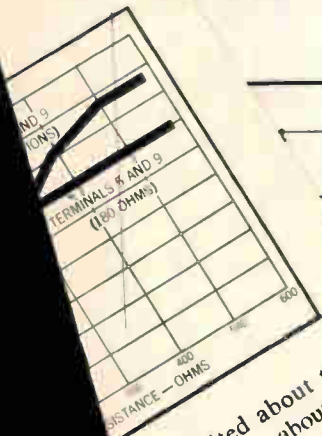

DESIGNED for low level differential input applications, type D13-001 provides excellent tracking and great stability. It is manufactured in a single silicon chip using diffused resistors and transistors. Because of this, beta and V_{BE} are closely matched and thermal coupling is extremely tight. The result is shown by the specifications below. Type D13-001 is available from stock at \$35.00 for 1-99 and \$28.00 for hundred quantities.

quickly, excited about the new device—about the possibilities it opens for you in broadband video amplifiers, amplifiers through VHF, oscillators, and more like the like. Look upon it as yet another Philco—extending the frontiers of electronic technology. For additional information on the type D13-001, write, wire or call Philco Electronics Marketing Department (855-4681).

AMELCO MICONDUCTOR

DIVISION OF TELEDYNE, INC.
TERRA BELLA AVENUE • MOUNTAIN VIEW, CALIFORNIA
Address: P. O. Box 1030, Mountain View, California
(415) 968-9241 / TWX: (415) 969-9112 / Telex: 033-914

REGIONAL OFFICES

West—8621 Bellanca Ave., Los Angeles, California 90045,
Northwest—1300 Terra Bella Avenue, Mountain View,
East—P. O. Box 1927, Paterson, New Jersey
Northeast—543 High Street, Westwood, Massa-
chusetts
Midwest—650 West Algonquin Road, Des Plaines,
Southwest—West #2nd Street, Minneapolis, Minnesota,

OPERATION
CO
Philco
Company
LANSDALE, PA.
Mills, Ontario, Canada

Electronics | March 21, 1961

45 db at 60 Mc
25 db at 160 Mc
2.5mw power output

Philco Microelectronics announces the PA7600 broadband amplifier!

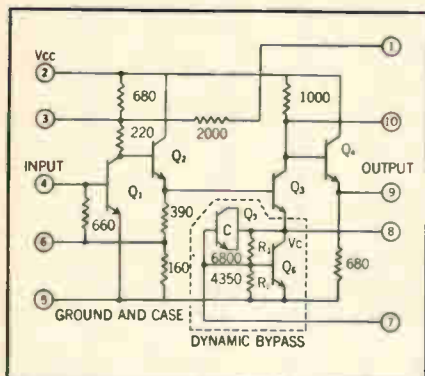

This is a new planar epitaxial monolithic silicon integrated microcircuit—a broadband amplifier that represents a significant advance in gain-bandwidth coupled with useful power output. Developed by Philco Microelectronics the PA7600 amplifier offers you externally adjustable gain and bandwidth combinations—such as 45 db gain out to 60 Mc or 25 db gain to 160 Mc.

An examination of the gain vs. frequency curves (measured with 50 ohm source and load) also suggests the desirable bandpass flatness (± 1 db). And

the Voltage vs. Load Resistance curve reveals a 2.5 mw power output—more than adequate to drive, say, a detector.

In addition to this remarkable set of parameters—the Philco PA7600 maintains its operating point and gain characteristics stable over the full military temperature range (-55° to 125° C).

It operates with a single power supply.

It is AGC-able.

It requires a minimum of external components.

And the Philco PA7600 is available in

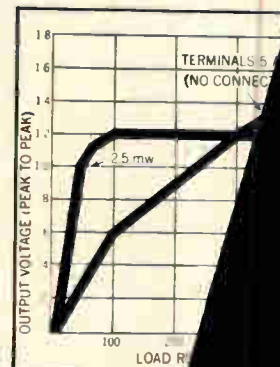
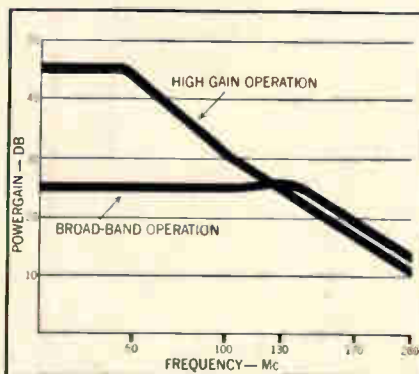

a TO5 package.

We are, frankly, realizing the potential of the design possibilities in such fields as RF and IF amplifiers and detectors.

And we

from

micro

or

Philco

Micro

(215

"SEE THIS AND 16 OTHER NEW MICROELECTRONIC PRODUCTS AT IEEE—BOOTH 1C04-1C10"

PHILCO MICROELECTRONICS
 A SUBSIDIARY OF Ford Motor
 LANSDALE DIVISION
 In Canada, Don Mills Road, Don

Monolithic Differential Amplifier by Amelco provides excellent tracking

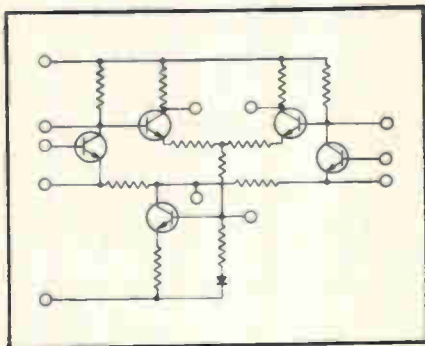

SPECIFICATIONS:

TRACKING = $5 \mu\text{V}/^\circ\text{C}$ (-55°C to $+125^\circ\text{C}$)

OFFSET = 8 mV (untrimmed)

COMMON MODE REJECTION = 90 db

GAIN = 400

BANDWIDTH = 400 Kc

DESIGNED for low level differential input applications, type D13-001 provides excellent tracking and great stability. It is manufactured in a single silicon chip using diffused resistors and transistors. Because of this, beta and V_{BE} are closely matched and thermal coupling is extremely tight. The result is shown by the specifications below. Type D13-001 is available from stock at \$35.00 for 1-99 and \$28.00 for hundred quantities.

AMELCO SEMICONDUCTOR

DIVISION OF TELEDYNE, INC.

1300 TERRA BELLA AVENUE • MOUNTAIN VIEW, CALIFORNIA
Mail Address: P. O. Box 1030, Mountain View, California
Phone: (415) 968-9241 / TWX: (415) 969-9112 / Telex: 033-914

REGIONAL OFFICES

Southwest—Suite 213, 8621 Bellanca Ave., Los Angeles, California 90045, (213) 678-3146 • Northwest—1300 Terra Bella Avenue, Mountain View, California, (415) 968-9241 • East—P. O. Box 1927, Paterson, New Jersey 07509, (516) 334-7997 • Northeast—543 High Street, Westwood, Massachusetts, (617) 326-6600 • Midwest—650 West Algonquin Road, Des Plaines, Illinois, (312) 439-3250; 2428 West 22nd Street, Minneapolis, Minnesota, (612) 374-1969.

45 db at 60 Mc 25 db at 160 Mc 2.5mw power output

Philco Microelectronics announces the PA7600 broadband amplifier!

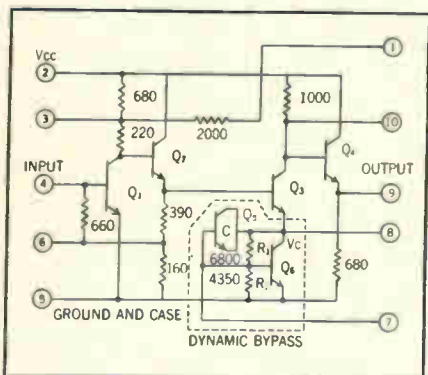

This is a new planar epitaxial monolithic silicon integrated microcircuit—a broadband amplifier that represents a significant advance in gain-bandwidth coupled with useful power output. Developed by Philco Microelectronics the PA7600 amplifier offers you externally adjustable gain and bandwidth combinations—such as 45 db gain out to 60 Mc or 25 db gain to 160 Mc.

An examination of the gain vs. frequency curves (measured with 50 ohm source and load) also suggests the desirable bandpass flatness (± 1 db). And

the Voltage vs. Load Resistance curve reveals a 2.5 mw power output—more than adequate to drive, say, a detector.

In addition to this remarkable set of parameters—the Philco PA7600 maintains its operating point and gain characteristics stable over the full military temperature range (-55° to 125° C).

It operates with a single power supply. It is AGC-able.

It requires a minimum of external components.

And the Philco PA7600 is available in

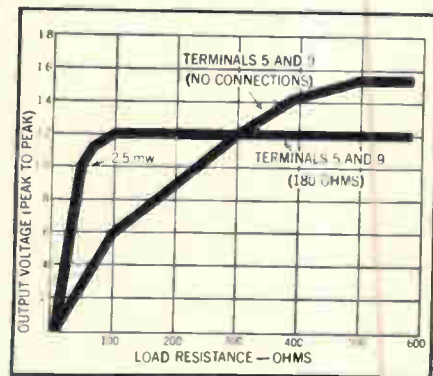
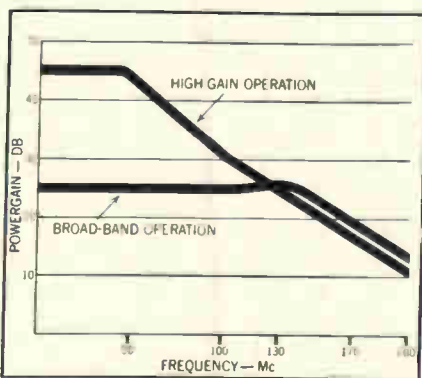

a TO5 package.

We are, frankly, excited about the potential of this new device—about the design possibilities it opens for you in such fields as broadband video amplifiers, RF and IF amplifiers through VHF, oscillators and the like.

And we look upon it as yet another product from Philco—extending the frontiers of microelectronic technology.

For additional information on the Philco PA7600, write, wire or call Philco Microelectronics Marketing Department (215-855-4681).

"SEE THIS AND 16 OTHER NEW MICROELECTRONIC PRODUCTS AT IEEE—BOOTH 1C04-1C10"

MICROELECTRONICS OPERATION
PHILCO
A SUBSIDIARY OF *Ford Motor Company*
LANSDALE DIVISION • LANSDALE, PA.
In Canada, Don Mills Road, Don Mills, Ontario, Canada

Computers

Jotting in real time

Scratch pads—those small, fast memories that work inside a computer's logic and control subsystems—have been used only sparingly in commercial models. Now, Scientific Data Systems, Inc., has introduced a computer, the Sigma 7, that uses many groups of 16-word scratch pads, built with monolithic integrated circuits.

Scratch pads have seen limited use because they are expensive. However, the company and its supplier, the Signetics Corp., say they have come up with an integrated circuit that is inexpensive and reduces power consumption.

Scratch pads, SDS says, allow the computer to process more data for less money. Relying less on the main memories, the computer can act in real time in many applications. For example, it can service up to 256 peripheral equipments and input-output consoles at remote locations by operating as a time-sharing system [Electronics, Nov. 29, 1965, p. 71].

The accelerators. The scratch pads read in 60 nanoseconds and write in 90 nanoseconds, five times as fast as the main memory. Depending on how many options a customer selects—at system prices from \$200,000 to \$1 million—a Sigma 7 will contain two to a dozen scratch pads ranging in size from 16 to 512 words.

The building block for the scratch pads is a printed circuit card containing 16 bytes (eight bits, or a quarter of a word to a byte). The cards plug into subsystems. There are 16 IC's on each card. Each IC contains eight bits, complete with their addressing, writing, reading and output-drive circuits.

In the Sigma 7, scratch pads perform four basic functions:

- They store information that



Programmer operates a keyboard to control time-sharing computer system of the Sigma 7.

controls the amount of data and its position in the main memory for the 32 input-output devices connected to each input-output processor. Several processors, each with its own scratch pad, can operate independently and in parallel.

- They contain information for dynamic program relocation and four modes of memory-access protection, in time-sharing, multiprogramming and multiprocessing applications.

- They can contain 256 "locks" for a memory-write protection. To open a lock at any memory location, a program must have the right key.

- They allow up to 224 priority users to immediately interrupt instructions that are being processed. Without the scratch pads, a priority user would have to wait until operations on the previous instruction were completed. The Sigma 7 can handle new instructions in as little as six microseconds.

Priority treatment. As an instruction is processed, the data is stored in one scratch-pad register. When an interrupt comes in, that register holds the data while a new register takes over. After the priority request is handled, processing of the interrupted instruction is resumed.

The computer can have as many as 32 blocks of 16 one-word registers. Up to 224 priority requests can be handled in their priority.

As index registers, the scratch pads are used in a new way that enables one index register to refer to data units of different lengths. A single register can index instructions operating on bytes, two-byte half words, words or double words.

Main memory sizes range from 4,096 words to 131,072 and can be expanded by modules containing increments of 4,096 words. The basic memory cycle time is 1.2 microseconds, but overlapping of the reading and writing operations of different modules makes the effective cycle time as short as 700 nanoseconds. The Sigma 7 is compatible in program and communications languages with the International Business Machines Corp.'s System 360 computers.

Space electronics

Star gazer

The National Aeronautics and Space Administration this week is

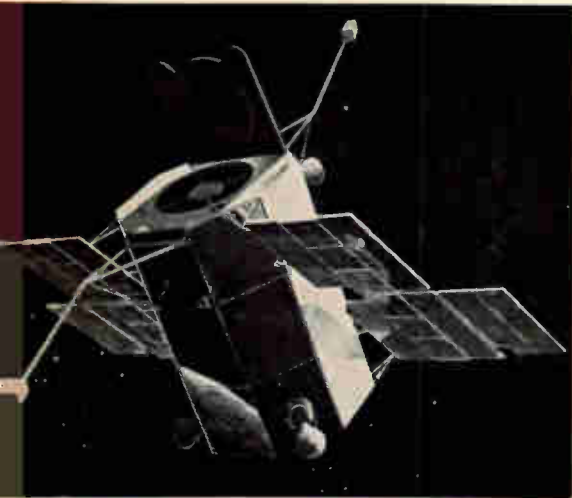

Monitoring the stars. First full-time space observatory will be launched this week.

putting the first full-time astronomical observatory on the track of stars. The Orbiting Astronomical Observatory (OAO) will aim its telescopes and sensors with an accuracy of ± 1 arc minute at stars to study their ultraviolet, gamma and x rays before the earth's atmosphere absorbs, scatters, reflects or bends them.

After being placed in a 500-mile circular orbit by an Atlas-Agena rocket, the satellite will be aligned with the sun. Then, using six gimballed star trackers and computer controls, it will acquire six stars to steer by and establish a predetermined orientation. Controlled from the ground, the OAO will slew from one region of the sky to another until a specific star is chosen for study. The trackers can be reset and locked on new stars if ground control wants to change the observatory's position. A composite spectral picture will be built up and relayed to a ground station.

Second magnitude. The satellite weighs 4,000 pounds and carries one 16-inch and four 8-inch ultraviolet telescopes, one high-energy and one low-energy gamma-ray telescope, a soft x-ray telescope and two ultraviolet spectrometers. The star trackers, developed by the Kollsman Instrument Corp. of Elmhurst, N. Y., will be sensitive enough to respond to stars with an apparent brightness of the second magnitude, 31 of which have been

chosen for use as navigation fixes for the satellite.

Three more Orbiting Astronomical Observatories are scheduled by NASA. Two are to be launched next year. The fourth, to be launched in 1968, will have improved aiming accuracy—to within ± 0.1 arc second. It will carry a 32-inch telescope, which is being developed to make high-resolution studies of stars [Electronics, Feb. 28, 1964, p. 28]. After the fourth is launched, NASA hopes to continue the program and launch one observatory a year. The agency has spent \$150 million on the program so far and expects to spend \$100 million more to get the first five OAO's in orbit.

Solid state

0.2-nsec IC's?

The Philco Corp. says it has refined its photoengraving and shallow-diffusion techniques to the point where it should be possible soon to build silicon monolithic integrated circuits that are more than twice as fast as the fastest experimental IC's developed thus far. According to Robert L. Luce, manager of the advanced development device group at the company's Lansdale division, Philco expects to build logic integrated circuits with propagation delay times of less than 0.2 nanosecond by December. The fastest experimental digital integrated circuit reported previously was Philco's nonsaturated emitter-coupled logic circuit with a propagation delay time of 0.5 nanosecond [Electronics, Nov. 1, 1965, p. 25].

Uses a chip. The fastest propagation delay time available from an integrated circuit in computers today is about 1.5 nanoseconds; however, this circuit, used by the International Business Machines Corp., is a hybrid IC having several transistor chips. The fastest logic IC's, used in the Spectra 70 computers of the Radio Corp. of America, are emitter-coupled current-steered circuits with propagation delay times of 3.6 nanoseconds.

These circuits are monolithic.

Last year, Philco developed silicon n-p-n transistors with gain bandwidth products of 6 to 4 Gc—a record for this kind of device. Theoretically, these transistors—if employed in monolithic integrated circuits—make it possible to build 0.2-nanosecond IC's. But Philco engineers designing the devices into IC's ran into trouble: more diffusions were required than needed for the discrete transistors, and compromises and trade-offs had to be made to achieve the desired circuit performance. As a result, the gain bandwidth products for the six transistors in the circuit fell off to about 2 Gc.

Luce expects that Philco will be able to be put transistors with a gain bandwidth of about 5 Gc in the ultrafast IC's being planned.

In addition, Philco engineers are developing transistors with emitter widths of only one micron. Widths of 2.5 microns were used for the 6-Gc transistors built by Philco. The eventual use of these new transistors is expected to further increase the speed capabilities of IC's. Luce thinks that delay times as fast as 0.1 nanosecond will be obtained within two years by using IC's built with 1-micron emitter-width transistors. Average power dissipators under 10 mw are likely.

Not all of Luce's problems deal with fabrication of the IC's. "One problem we still face," says Luce, "is figuring a way to accurately measure the propagation delay time as the circuits get faster." Currently, Philco extrapolates the delay time for a single IC from the total delay time for a number of IC's connected in a ring.

Funds are being provided for the work by the Air Force through a subcontract awarded by the Lincoln Laboratory of the Massachusetts Institute of Technology.

Military electronics

Navy reorganizes

Throwing overboard more than a century of tradition, the Navy is

abolishing its familiar four bureaus—the Bureau of Ships, the Bureau of Naval Weapons, the Bureau of Yards and Docks and the Bureau of Supplies and Accounts.

In their stead, it is creating six systems commands—including an electronic systems command—in line with the management techniques favored by Defense Secretary Robert S. McNamara. The reorganization copies much of the same pattern followed earlier by the Army and Air Force.

For decades, the four bureaus operated almost autonomously, reporting directly to the Secretary of the Navy. Little coordination was exercised below the secretarial level with the result that planes, ships and weapons were designed and developed without achieving fully effective systems integration.

Now the bureaus are being ditched in favor of functional commands—a ship systems command, air systems command, electronic systems command, ordnance systems command, supply systems command and facilities engineering command.

Compatibility. The commander of the electronics systems command will set standards for electronic equipment that all the commands must follow and will make sure equipment is compatible. The command falls to Rear Adm. Joseph E. Rice, presently assistant chief of shore electronics of the Bureau of Ships.

The ship and air commands will exercise systems control over electronic equipment that is part of vessels and aircraft. But the electronics and ordnance commands will be the black box developers in most cases.

The electronics command, for example, will handle shipboard communications, navigation aids, air traffic control and electronic countermeasures. The ordnance command will handle shipboard weapons systems, including fire control radar and other equipment, as well as the technical characteristics and configuration of ship-mounted sonar.

In the air. In the field of aviation equipment, the electronics command will handle air navigation

aids and air traffic control. But all other airborne electronics and most space electronics will be the responsibility of the air command.

The ordnance command will oversee development of air-launched underwater weapons, working under the system control of the air command.

The electronics command will exercise primary jurisdiction over these other areas: all shore (ground) electronics; the sonar sound surveillance underwater system, satellite communications; shore-based strategic data systems; data link systems external to ships and aircraft; and general purpose electronic test equipment.

Rear Adm. Edward J. Fahy, presently chief of the Bureau of Ships, will head the ship command; Rear Adm. Allen M. Shinn, now chief of the Bureau of Weapons, the air command; and Rear Adm. Arthur R. Gralla, present deputy chief of the Bureau of Weapons, the ordnance command.

The office of antisubmarine warfare programs, which is a special branch of the Chief of Naval Operations' office, will not be affected by the reorganization. It will continue to draw upon the Naval services.

In touch with Saigon

The weakest links in the communications between Saigon and Washington are the hastily constructed, sometimes unreliable relay stations installed early in the war by the military in Vietnam. The buildup of forces and the increasing number of messages between Saigon and Washington has now prompted the Pentagon to order permanent relay stations and other communication facilities.

A letter contract for \$26 million has gone out to the Philco Corp. and for \$34 million to Page Communications Engineers, a subsidiary of the Northrop Corp., for the project's first stage. The system will eventually cost \$200 million.

Much of the information is classified, but this much is known:

- About a dozen billboard-size troposcatter antennas, about 120



Billboard-size antenna of the kind being built in Vietnam.

by 60 foot square, will be built at strategic points. They will replace dish antennas, the MRC-98's and 85's, that the military brought in by air at the start of the war.

- An 1,100-mile underwater cable will probably be strung between Vietnam and Formosa. One cable was built early in 1964 as part of Project Wet Wash-Alpha.

- A host of microwave towers, land lines, satellite-communications stations (for use with Syncom 3) and combat communications gear will be installed.

The system will be able to handle both telegraph and voice-grade signals and would provide a link to other stations in Southeast Asia. The military also plans to use the network for command-and-control functions.

The system will be able to handle up to 72 voice channels simultaneously; 12 teletype channels can be substituted for each voice channel. It can be expanded for military or civilian needs.

Manufacturing

Wired IC's

A new package for integrated circuits allows the IC's to be inter-

connected with wrapped-joint wiring. No mounts, no headers, no subassembly operations are needed. The package makes each IC a plug-in module.

The package is being manufactured by the Western Electric Co., the manufacturing arm of the American Telephone & Telegraph Co. It was designed at the Bell Telephone Laboratories, where the wrapped-joint wiring technique was invented about 10 years ago.

Resembling large transistor cans, each package is about 650 mils in diameter and 100 mils high. Instead of the conventional flexible leads, there are 11 stiff, straight leads that are 490 mils long and 25 mils square. The spacing between pins is 100 mils.

Laminated motherboard. The packages are being made for a research and development program. At present, Western Electric's Allentown (Pa.) Works is using the package to house some 15 types of logic and switching circuits, operating at speeds as fast as a few nanoseconds. The circuits are shipped to other Western Electric plants for assembly into systems.

At the assembly plants, the packages are plugged into a standardized form of multilayer printed-circuit board. The board is not used for signal wiring—that wiring is added later with automatic wire-wrapping machines. The board is prefabricated with three layers of copper: a heat-sink layer, a power-distribution plane and a ground plane. These are continuous sheets except for etched and drilled clearance holes for the package pins.

At each package location is a cluster of five pins soldered to the ground plane as part of the prefabricated board, one pin soldered to the power plane, and 11 holes for the package pins. The pins in the board are also spaced 100 mils apart. The pin-and-hole clusters are repeated in a regular pattern, maintaining equal spacing when the packages are plugged in. Up to 300 packages fit on a board.

Automatic wiring. After the packages are inserted, the board is turned over and placed in a wiring machine that interconnects the pins

with each other and with the power and ground pins at a rate of about 500 wires an hour. A board with 300 IC's requires about 3,000 wires. The machine, a type used in many plants making large electronic systems, makes the wire-to-pin joints by removing the insulation at the ends of the wires and tightly wrapping the bare wire around the pins.

After wiring, an automatic test set makes contact with the ends of the pins and checks out the wiring and the circuits. If replacement is required, packages and wiring can be replaced with hand tools.

Higher reliability. Western Electric engineers say the technique makes IC systems highly reliable and flexible. They expect sharply reduced costs for design, fabrication and tests. The wiring and testing machines can be programed by instructions generated by computers used to design the systems.

The reliability is credited to three factors: wrapped-joint wiring is a tried-and-true interconnection method; directly connecting the pins with wires introduces no extra series joints in any signal path; and the package has a low thermal impedance, making it possible to keep the temperature of the semiconductor-device junctions low without expensive cooling devices.

Cold flame spray

For years, Solitron Devices, Inc., of Tappan, N. Y., has been spraying printed circuits on odd-shaped parts with a process that is an amalgamation of a couple of older techniques. But their process, according to the company, can make circuit boards do new tricks.

Next week, at the exhibit of the Institute of Electrical and Electronics Engineers in New York, Solitron will put its boards on the market. It also plans to license the technique outside of the electronics industry.

As in the fluid-bed process, the company coats sheet-metal blanks with an insulating coating. But instead of putting on a smooth coating of epoxy resins, Solitron applies a coating of an inorganic material, such as silicon carbide,

plus an organic binder. At this stage the surface is rough.

Next, as in the Schoop process, copper is flame-sprayed onto the board. But the particles of copper are dry, not molten. Unlike the pressed or sintered powder techniques, the sticking force is not pressure or heat, but the high velocity the flame gun imparts to the particles. They splatter into the rough surface of the board, producing a peel strength of 50 pounds, the company says.

Rigid boards. Solitron has been using the process to print wiring on structural members and chassis in airborne and other types of military electronics equipment, according to Sanford Sussman, vice president of the company. Solitron also makes rigid circuit boards, with aluminum cores.

One demonstration board shows the full range of circuit-board application. In various areas are shielding strips, ground lines deposited into holes in the insulation, signal wiring, multilayer boards (four layers—one on each side of the base board, two more on top of additional coatings of insulation) and the tiny wiring patterns employed for surface welding of integrated-circuit flatpack leads. The copper patterns are sprayed through masks.

Cold welding. The IC wiring is about 25 mils wide on the sample. Sussman says that with suitable masks, lines as small as 10 mils wide and 10 mils apart can be made. The IC leads can be welded or soldered to the copper, he says, but the best way is to flame spray the lead joints.

The spraying mask is modified to mask the flatpacks but leave their leads exposed atop the printed wiring. More copper is sprayed on to encase the leads and weld them to the lower layer. It isn't hot welding, but cold welding, because the binding force is velocity. Thus, Sussman says, there is no heat damage to the integrated circuits.

The conductivity of the sprayed wiring is at least 80% that of copper-foil wiring. The difference is made up by making the wiring thicker than etched foil. Other metals can also be sprayed. One

A PROBLEM SOLVER RECTIFIER... FOR FREQUENCIES TO 100 KC

INTERESTED?

Read on and learn how fast recovery rectifiers helped one designer

CASE HISTORY

George had a problem--the bridge rectifiers in a 30 KC static inverter power supply were running much too hot. This perplexed him since the bridge output current of 1 Amp was within the rating of these rectifiers, 1N3189s. Although crowded for space, George decided to try larger stud mounted 1N1124As. No help! They also ran hot and in addition reduced output voltage and operating efficiency.

What George needed was a fast recovery rectifier to eliminate the severe reverse recovery losses at this frequency. Such losses cause conventional diodes to overheat and drop their output voltage. The solution ... UNITRODE UTR22s which have recovery times of 100 nanoseconds in the standard 1 Amp to 30 volt test circuit. In contrast the 1N3189 has a typical recovery time of 2 microseconds; a stud mounted 1N1124A is even slower.

In addition, George picked up some other bonuses--much smaller size, lighter weight, higher thermal efficiency and increased reliability because of the unique Unitrode monolithic construction.

P. S. Note the Unitrode 50 watt surge zeners (the same small size as the UTR 22) used to protect the expensive power transistors from burnout due to voltage spikes.

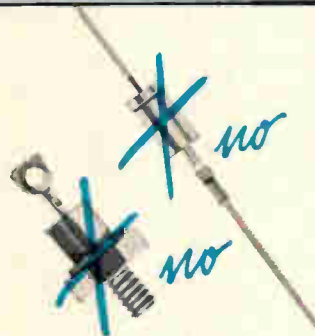

WAVE FORM

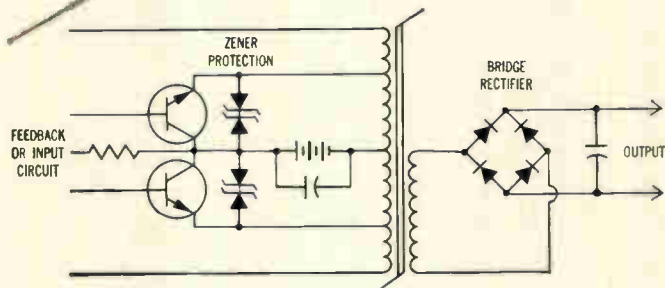
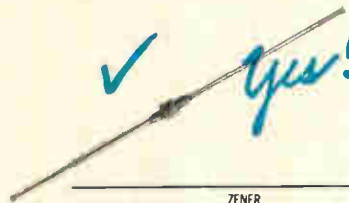

YOU CAN HELP YOUR DESIGNS TOO.

Contact the factory, call your local COMPAR office, or circle the reader service number on this magazine's reply card. All will insure your receiving data sheets and samples of Unitrode Fast Recovery Rectifiers (including the new 50 nanosecond UTX series) plus information on other Unitrode devices immediately.

REPRESENTATIVES IN PRINCIPAL CITIES THROUGHOUT THE WORLD

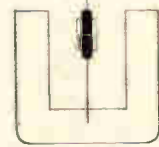

UNITRODE®
"better always/by design"

UNITRODE CORPORATION
580 Pleasant Street, Watertown,
Mass. 02172 Telephone (617) 926-0404
TWX (710) 327-1296

See us at IEEE Booth No. 2J30

nonelectronic use Solitron envisions is spraying nickel-chrome on steel to form resistance heating elements in irons; another is spraying wiring on automobile dashboards.

Advanced technology

Technicolor hologram

Holography made two tremendous advances this month. First, two researchers at the University of Michigan reconstructed a three-dimensional holographic image with ordinary white light instead of a laser. Then, the same men, working with two researchers at the Bell Telephone Laboratories, used the basic technique to produce a multi-colored 3-D image.

At a Physics Club conference earlier this month in Chicago, George Stroke, a professor of electrical engineering at the University of Michigan, demonstrated the white-light reflection technique that he developed with his research assistant, Antoine Labeyrie.

Stroke showed how a photographic plate could be illuminated, for example, with red laser light that had been reflected from an object, and then reilluminated with ordinary white light. A clear image of the object was created in red—the color that had been used to illuminate it originally.

Beam splitting. Conventional holograms are recorded by splitting a laser beam into two parts: one part illuminates the subject and is reflected onto the front of a holograph plate; the other part is aimed by mirrors directly at the front of the same plate where it interferes with the subject beam. An interference pattern, resembling the pattern of raindrops on a pond, is recorded on the plate as disturbances in the photographic emulsion set up by the interfering wavefronts. To reconstruct an image of the subject, conventional transmission holography requires that another laser beam be transmitted through the hologram. The wavefronts of the subject are reconstructed behind the plate, in space,

as a three-dimensional image exhibiting parallax and perspective just as solid object would. An observer can see around the image by moving his head as he peers through the plate.

Deft Stroke. Stroke's reflection technique differs from the conventional one in that the reference beam is incident on the back rather than the front of the plate. The subject beam, however, falls on the front of the plate. The two sets of waves travel in opposite directions through the photographic emulsion. Thus, standing waves are created and stored in the emulsion along the direction of propagation of the two sets of waves, or perpendicular to the surface of the plate. A series of stratifications are formed in the thick emulsion, parallel to the plate's surface.

The stratifications act as a color filter similar to the antireflection coating on a camera lens. When ordinary white light illuminates the plate, these stratifications filter all colors other than the one with which the holographic image was recorded.

Wrong way. The trick doesn't work for conventional holograms because the stratifications are formed in the wrong direction—at right angles to the plate, not parallel to it.

Teaming up with Keith Pennington and Lawrence Lin, the two researchers from Bell Labs, Stroke and Labeyrie are using their reflection technique for technicolor holograms. Two gas lasers—one emitting in the blue and the other in the red—are now being used to produce multicolor holograms with white light. In this case, the reference beams from both lasers are made to impinge on the back of the photographic plate, and the same color-filter stratifications are set up in the emulsion.

According to Edwin Land, president of the Polaroid Corp., all colors can be reproduced by selectively combining two colors. In this case, it is not certain whether it is the Land effect that accounts for the production of the additional colors.

Production

Backlogs pile up

A combination of factors—booming production for the military and civilian markets—is stretching delivery times for electronic components.

Electronic companies maintain that their production schedules have not been affected so far, but are growing increasingly concerned over delays in getting components. Additionally, there is worry that under high demand, reliability will slip. The Guidance and Control Systems division of Litton Industries, Inc., for instance, is intensifying incoming inspection and quality control of vendor components. The division is also searching for additional sources on almost all components they buy. And a spokesman says that if the present market trends continue, the company's own production schedules could be interrupted.

List growing. The range of components in short demand is broad. George Larson, purchasing manager for the Raytheon Co., cites silicon transistors as a serious trouble spot and says that germanium diodes, sought principally as replacement units for devices used in Vietnam, are scarce.

John J. Davin, procurement manager for Sylvania Electric Products, Inc.'s Electronic Systems division, says that delivery delinquencies have doubled in the past six months. Delays for special-purpose connectors, he says, have slipped from 12 to 14 weeks to 20 to 40 weeks; capacitors from 10 to 12 weeks to 22 weeks plus and high-reliability integrated circuits from 10 weeks to 12 to 20 weeks.

And users report the delays are growing longer and longer for an expanding list of electronic components. A spokesman for the Autonetics division of North American Aviation, Inc., says the wait has grown on relays, connectors, non-standard electrical filters, printed-circuit boards, motors, transformers and electrical wire. The Systems division of Beckman In-

COMPONENT COMMENTS

From Speer

Are our new custom resistor networks the missing link your precision circuits have been waiting for?

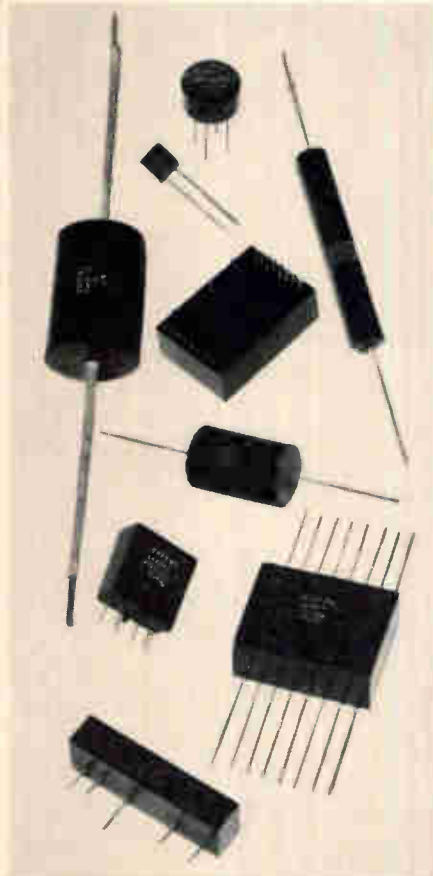

We suspect that they are—since they're a direct descendant of our Jeffers Electronics Division's *standard* JXP resistor.

What we did first was to recognize that the advantages (price, delivery, and performance) of the highly stable

JXP metal film resistive elements used in the standard line were also applicable to custom network and packaging assemblies. Therefore, we established an engineering staff and production facilities to handle design and manufacture of complex resistive element combinations and to package them according to your custom requirements.

In the meantime, the state of the art of producing the JXP type of metal film resistive element advanced. Specifically, we developed the ability to calibrate resistive elements to tolerances as low as 0.01% with characteristics of very low temperature coefficient of resistance and compatible stability.

What's more, we can design these packages to meet any network application—ladder, analog-digital, voltage divider, function generation, summing amplifier, pulse sampling—you name it.

Our custom packaged networks and assemblies offer broad environmental capabilities. And thanks to the marvels of modern technology performance, they will meet all your requirements at the lowest possible cost on the shortest delivery schedule known for this type of product.

Doesn't this indicate that our new custom packaged resistor networks are worth investigating further? You can do this at the IEEE Show. Or you can get more information by merely mailing us the coupon.

Explore our new custom resistor networks at the IEEE Show

Come to the Jeffers/Speer Booth (4M32) at the Coliseum. You'll see

both our new networks and our standard JXP. (Not to mention that work horse of the electronics industry—the Speer carbon composition resistor.) If you can't make it to the Show, send us the coupon and we'll tell you more about our new networks. You'll find that they make quite a package!

Visit with our Technical Service Engineers

Take a little time out to visit our Technical Service Engineers at Booth 4M32 at the Coliseum. They are well acquainted with networks, especially in regard to resistors (as they should be), because of contributions made by them and other members of our technical staff to specifications during development of our networks.

SPEER® Carbon Co.

JEFFERS ELECTRONICS DIVISION
SPEER CARBON COMPANY
DuBois, Pennsylvania 15801

Speer Carbon Co. is a Division of
Air Reduction Company, Inc.

Rush more information on your new custom resistor networks.

Name _____

Title _____

Company _____

Address _____

City _____ State _____ Zip _____

NEW... FREE...



VITREOSIL® PURE FUSED QUARTZ CATALOG

From Thermal American Fused Quartz Company . . . A comprehensive 48 page catalog describing the latest in VITREOSIL pure fused quartz laboratory ware, industrial ware, tubing, fabrication and special quartz products.

Also included are informative sections giving technical and application data.

Price information is included with each catalog — see separate price list.

Ask for your copy today. 46



Electronics Review

struments, Inc., says lead time is stretching as far as 18 to 20 weeks on such items as metal film resistors, connectors and capacitors.

Litton reports that its Electron Tube division is facing an increasing demand for power tubes as replacement units. Also, that its system group has a backlog for inertial navigation equipment, primarily because of Vietnam, while its Utrac division plans to triple production of color-tv deflection yokes to meet the needs of the tv industry.

More contact. One of the results of the stretch-outs has been stepped-up personal contact to prod vendors to cut down lead times. Hal Cooperman, manager of customer service at the Continental Device Corp., says that as lead times lengthen, handling orders can "get painful." Customer visits, he explains, have changed from social calls to strictly business.

Consumer electronics

Semiconductors sound off

Swedish jet fighters built by Saab Aktiebolag use semiconductor strain gauges to measure aircraft acceleration. In some United States missiles, semiconductor strain gauges initiate the arming sequence for the warhead. And now the Sonotone Corp. has found a down-to-earth application for them—phonograph cartridges.

Sonotone, a major supplier of cartridges to record-player manufacturers, introduced four stereophonic solid state cartridges a fortnight ago. List prices range from \$19.50 to \$23.50. The company also has a line of monaural cartridges, but hasn't set prices yet. Sonotone says its new semiconductor units will cost phonograph makers about \$1 more each than the ceramic and crystal types commonly used in lower-cost record players.

What's the difference? For the \$1 difference, manufacturers will get advantages that more than offset the slight added cost, according to Richard J. Mahler, manager

of Sonotone's electronic applications division. He cites these:

- Wider frequency response. Distortion, particularly at the high and low ends of the audible frequency range, is reduced.

- Greater reliability. In many cases, the total number of circuit components is reduced, eliminating many interconnections and simplifying manufacturing.

- Steadier performance. Humidity and temperature changes don't introduce distortions.

Tested phonos. To demonstrate the performance of their cartridges, Sonotone first tested four different phonographs with the manufacturers' original cartridges. Then they modified the circuits, equipped the phonographs with the solid state cartridges and retested them. The phonographs ranged in price from \$19.95 for the Columbia Masterpiece model M1901, a monaural record player, to \$119.95 for the stereo model DP694 made by Decca.

Frequency response of the Columbia model was increased from 150-6,500 cycles per second to 80-20,000 cps by the conversion. The number of components required was reduced from 13 to 9 with the number of transistors needed being cut from three to one.

To convert the Decca unit to take a solid state cartridge, the number of components had to be increased slightly, but the frequency response range was improved from 190-3,500 to 40-10,000 cps. The frequency-response ranges for the two other converted phonographs also were considerably improved. In one unit the undistorted power output was nearly doubled as the number of components used was reduced from 29 to 23.

In the monaural solid state cartridge a tiny silicon chip is mounted on a copper-clad substrate. The diamond or sapphire record needle is attached to the silicon. The stylus motion produces strains in the semiconductor material, which change the material's resistance. This, in turn, causes a predictable change in the current flowing through the semiconductor material. The stereo cartridge works on the same principle except

ALLOYS CUSTOM BLENDED TO YOUR SPECS

through powder metallurgy

Need a nickel alloy that will perform exactly as you want? No tramp elements, low carbon and gas content, exact performance reproducibility, uniform etching properties, excellent surface and mechanical characteristics?

Here at Magnetics Inc. we call such metals Blendalloy®. With more than 10 years' experience in powder metallurgy, we are now prepared to formulate and produce custom blended alloys to your specs—and to guarantee performance under the conditions you name.

Example: Blendalloy 52. We developed this 52% nickel controlled expansion alloy for dry reed switches and mercury wetted relays. Blendalloy 52 is made to match with precision the expansion characteristics of Corning O120 glass. When used with other types of glass, Blendalloy 52 is modified to match any change in expansion characteristics. Dilatometry and polarimetry tests on both laboratory and production runs assure this match for both standard and modified alloys.

Magnetics Inc. produces Blendalloy metals in bar, rod, strip and wire, in lots from one pound to 50 tons or more. For information, write for our Blendalloy 52 technical data sheet. For general information, ask for our new metals capabilities brochure: *Metals From Magnetics*, Magnetics Inc., Dept. M-92, Butler, Pa. 16001

**METALS
FROM
MAGNETICS**

Guaranteed Performance
Reproducibility through
Powder Metallurgy
Techniques

MAGNETICS inc.

Circle 45 on reader service card

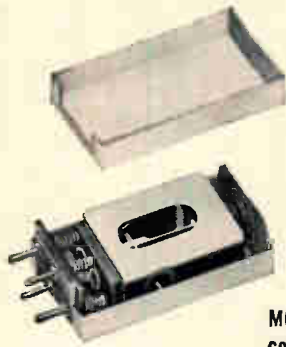

MODEL RF20
contactless resonant
reed encoder/decoder
1½ x ¾ x 1½

REMOTE CONTROL SWITCHING WITH AUDIO SIGNALS

An audio tone can be generated by an electronic oscillator or resonant reed encoder circuit, then transmitted by wire or radio. The tone activates a resonant reed relay to perform a control function.

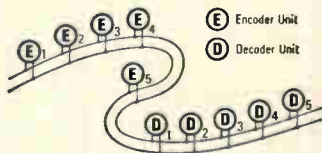

A single pair of wires, or a leased telephone line, can carry the audio signals for a complete control system.

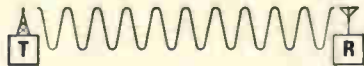

For inaccessible areas or mobile installations, a radio transmitter and receiver system can carry the signals.

Bramco reeds permit over 50 selective control frequencies within the 67 to 1600 cps spectrum. This is assured by: (1) the narrow response bandwidth of about 1% for decoders and (2) the high accuracy of Bramco reed encoders (1/10 of 1% of design frequency).

A big advantage of reeds in control switching is that they are ideally suited for simultaneous and sequential coded tone systems. The actual number of control functions possible in such a system is virtually unlimited. For example, over 3300 individual control functions are possible with only 16 frequencies coded sequentially in groups of three.

Compared to other types of tone filters, resonant reeds are small and inexpensive. They give more control functions per spectrum, per size, per dollar.

If you work with controls that select, command, regulate, or indicate, you should know about how it can be done with audio signals. We custom design and stock a broad line of encoder/decoder components and modules.

For literature write Bramco Controls Division, Ledex Inc., College and South Streets, Piqua, Ohio, or call 513-773-8271.



BRAMCO CONTROLS DIVISION, LEDEX INC.
College and South Streets, Piqua, Ohio 45356

See these control products plus others at IEEE booths 4A39, 4A40, 4A41

that two separate transducers, one for each channel, are used.

In the groove. The silicon strain gage used in the Sonotone cartridge is a chip of bulk-doped semiconductor material. The Raytheon Co. investigated the use of a silicon monolithic circuit as an ultrasensitive transducer element in a cartridge. It was looking for a way to put several hours of sound on a standard-size record. The grooves would have been about one-tenth as wide as the microgroove tracks used in today's 33⅓ revolutions per minute long-playing records.

Raytheon dropped this development three months ago. But Cary Darling, formerly the project engineer, has formed Stow Laboratories to produce and market needle-tipped semiconductor transducers primarily for industrial applications. Stow's transducers are based on the Raytheon patents.

Electronics notes

▪ **Air traffic control.** The Communications Satellite Corp., in response to a request from the Federal Aviation Agency, has offered the agency the use of a synchronous-orbit satellite that will provide air-traffic control over the Atlantic. Comsat estimates that the service will cost the FAA about \$6 million a year. The communications company contemplates building special ground stations in the United States and in England. As soon as the FAA approves the proposal, Comsat will put the satellite and ground stations out for bids. The satellite will be the predecessor of a much larger family of satellites that Comsat is planning, each of which will have more than 1,200 voice channels and will be orbited in 1968.

▪ **RCA enters publishing.** The acquisition of Random House, Inc., by the Radio Corp. of America has been approved by the directors of both companies. Stockholders of Random House will vote on the proposal at a special meeting next month. The publishing company would become a wholly owned subsidiary of RCA but would function as a separate entity with complete

editorial autonomy. This is RCA's first entry into the publishing field.

▪ **Food preservation.** The Food and Drug Administration is prepared to authorize the first purely civilian use of electron beam accelerators for preservation of food by irradiation. The irradiation method has been used by the military for the past several years. A regulation approving a petition by the High Voltage Engineering Corp., of Burlington, Mass., has already been proposed and is expected to become final by the end of April. The FDA will approve the process, not the manufacturers, thus opening the door to other manufacturers as well. The FDA approves irradiation on a food-by-food basis. High Voltage's petition was for application of up to 5-million electron volts (mev) to eliminate insects from wheat. Under consideration, in addition, is a regulation increasing authorized power to 10 mev—the range of other manufacturers' machines—and increasing the allowed dose of electron radiation so that approval of food sterilization also will be possible. High Voltage estimates that a dozen \$400,000 accelerators could blanket the wheat infestation market; 500 such machines might handle all food irradiation needs. The Department of Commerce has estimated the demand for food irradiating accelerators will reach 300 by 1980.

▪ **Geodetic surveying satellite.** The Federal Laboratories division of the International Telephone & Telegraph Corp. will build for the Army a solid state transponder satellite to help map the exact size and shape of the earth. The new satellite is expected to outperform earlier geodetic satellites. Its transponder will achieve a higher order of sensitivity and ranging accuracy by using a technique of frequency compressive feed back and phase-locked loop demodulation. Special telemetry circuits will maintain a check of the satellite's condition and report to a ground station. The satellite weighs less than 12 pounds; it will last at least a year. Federal Laboratories also has produced six 40-pound geodetic positioning satellites for the Army.

basic measuring tools from

**HEWLETT
PACKARD**

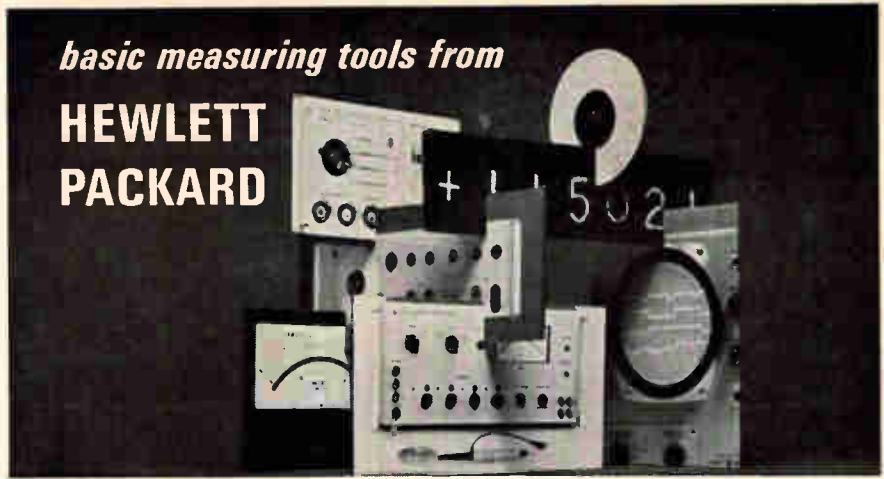

Field-proven hp 200CD Wide-range Oscillator

Accurate test signals, 5 Hz to 600 kHz
Balanced output, better than 1% over entire range
10 volts output into 600 ohms, 20 volts open circuit
Distortion less than 0.2% below 200 kHz

Use it for:

Lab work, subsonic to radio frequencies
Source for testing servo, vibration systems
Testing medical and geophysical equipment
Checking audio amplifiers, circuits and transducers
Testing sonar and ultrasonic apparatus
Checking carrier telephone systems, video frequency circuits,
low radio frequency equipment

Here is a true standard of the industry. Small and compact, the 200CD was designed for extreme ease of use. Waveform purity is retained even with loads of a few ohms. Output balance is better than 0.1% at lower frequencies and approximately 1% at high frequencies. A nominal source impedance of 600 ohms makes it suitable for both audio and carrier applications. Price: 200CD (cabinet), \$195; 200CDR (rack mount), \$200.

A special low-distortion model, the H20-200CD, also is available. Distortion

is 0.06% or less, 60 Hz to 50 kHz; 0.1% or less, 50 kHz to 400 kHz; 0.5%, 5 Hz to 600 kHz. Output is 7.5 volts into 600 ohms. Price: H20-200 CD (cabinet), \$245; H20-200 CDR (rack mount), \$250.

Ask your Hewlett-Packard field engineer for a demonstration of these oscillators or write for complete information: Hewlett-Packard, Palo Alto, Calif. 94304, Tel. (415) 326-7000; Europe: 54 Route des Acacias, Geneva.

*Data subject to change without notice.
Prices f.o.b. factory.*

HEWLETT  **PACKARD**
An extra measure of quality

1042



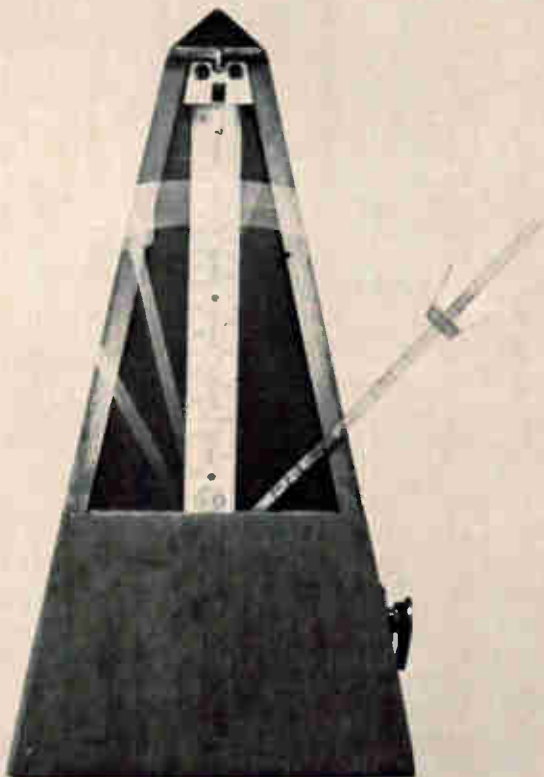

there are ordinary oscillators

...and then there's McCoy

McCoy manufactures the most complete line of high and low frequency oscillators for precise control of output signals. New TCXO's (Temperature Compensated Crystal Oscillators) offer reduced size, weight and input power advantages while eliminating the need for temperature control. Stabilities of 0.5 PPM over -40°C to $+70^{\circ}\text{C}$ are typical results without an oven. Regular crystal oscillators, oven controlled crystal oscillators and



TCXO's are available in the 10 kc to 125 mc range. With frequency dividing circuitry, low frequency outputs can be provided with the stability of high frequency oscillators. Tuning fork oscillators provide control in the 1 cps to 20,000 cps audio and power range. McCoy's line of oscillators is too broad to be covered here—write for our new oscillator catalog giving full details on types for every purpose.



MCCOY ELECTRONICS COMPANY

A Division of OAK ELECTRO/NETICS CORP.
Mt. Holly Springs, Pa. 17065

SEE US AT THE IEEE SHOW—BOOTH 2B17—MARCH 21-24

NOW—One Source

for Militarized Printers and Perforated Tape Readers Potter Instrument Company

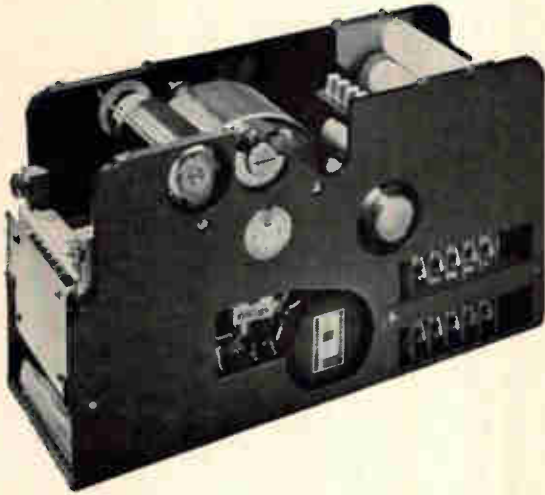

HSP-3604 High Speed Printer

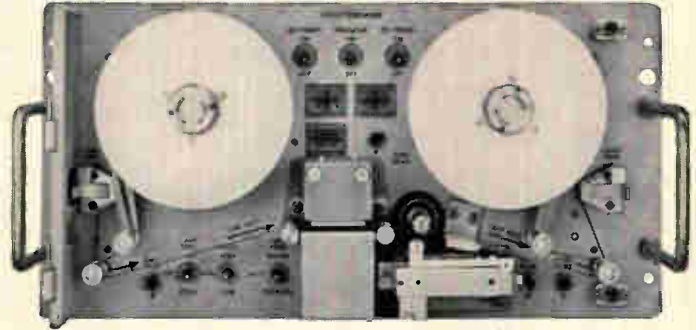

PT-5000 Perforated Tape Reader

MINIATURIZED, LIGHTWEIGHT, RELIABLE, AND MAINTAINABLE For Telemetry, Ground Support, Automatic Testing, Computer Readout on airborne, shipboard or ground systems

Potter's all-new HSP-3604 high-speed serial printer operates at an average print speed of 25 ch/sec. It has a self-contained paper supply, take-up spool and solid-state silicon electronics.

The drum is easily replaced for format interchangeability. The unit, only 5.4 W. x 15.8 D. x 8.8 H. provides three copy printout.

It uses Potter's unique patented double hammers in a system that reduces parts and makes for easy maintenance and speedy repair. It also features immediate visibility of the last printed line.

Potter's all-new PT-5000 perforated tape reader operates at dual speed, 250 and 500 characters per second. Its sub-assemblies are completely adjustment-free and include a network of built-in diagnostic test exercises and indicators.

Designed with standard hardware, the tape reader can be completely dismantled and assembled with only a screwdriver by operator personnel.

Measuring 18 W. x 8 D. x 9 H. this compact unit weighs 45 pounds and features modular construction throughout.

Both these high reliability units have a mean-time-between-failure in excess of 2,500 hours. They can be repaired in less than 15 minutes by operator personnel. Complete support documentation is available. Both printer and tape reader satisfy the specifications of MIL-T-21200, MIL-E-16400, MIL-Q-9858, MIL-I-16910 and MIL-I-6181. They operate within a temperature range of -25°F to $+135^{\circ}\text{F}$.

Contact Military Products Manager
or fill in the coupon for full details.

 **POTTER**
INSTRUMENT CO., INC.

151 Sunnyside Boulevard • Plainview, N.Y. 11803
(516) CH 9-0790 • TWX (510) 221-1852 • Cable-PICO

Send details on perf tape
readers and printers

Name _____

Company _____

Address _____

City _____ State _____

Soliton

*announces a family
of NPN Silicon Planar
Power Transistors
featuring*

TO-46 Package

*2 Amps I_C max
4 watts at
100°C!*

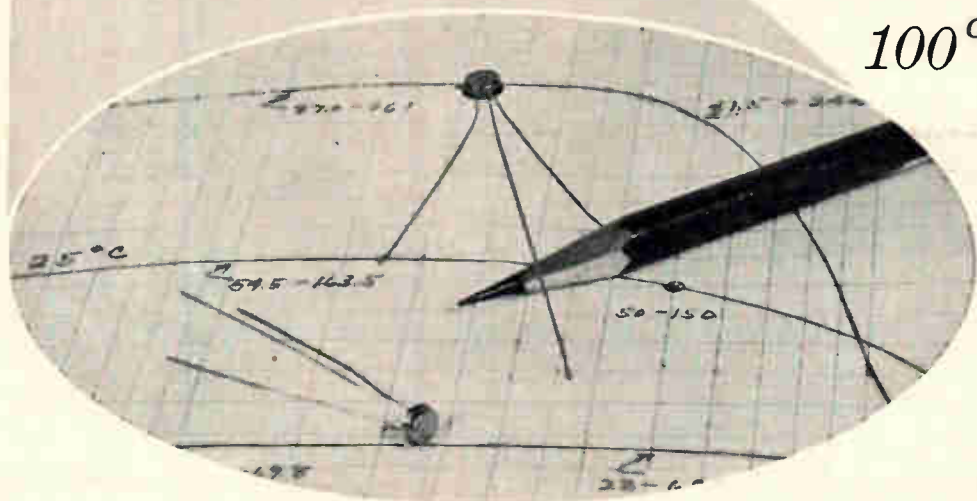

Type Number	Pkg. Size	DESIGN LIMITS							PERFORMANCE SPECIFICATIONS					
		T_J	θ	P_T	BV_{CBO}	V_{CE0} (BUS)	BV_{EBO}	h_{FE}	V_{BE} (sat)	V_{CE} (sat)	I_{CBO}		f_T	
		°C	°C/W	Watts	Volts	Volts	Volts	Min. Max.	Volts	Volts	μA		mc	
		Max.	Max.	Max.	Min.	Min.	Min.	Min. Max.	Max.	Max.	Max.	Max.	Min.	
MHT5001	TO-46	200	25	4	60	40	8	50	150	1.2	0.35	0.1		50
MHT5002	TO-46	200	25	4	80	60	8	50	150	1.2	0.35	0.1		50
MHT5003	TO-46	200	25	4	100	80	8	50	150	1.2	0.35		0.1	50
MHT5004	TO-46	200	25	4	140	100	8	50	150	1.2	0.35		0.1	50
MHT5005	TO-46	200	25	4	180	120	8	50	150	1.2	0.35		0.1	50

Soliton TRANSISTOR DIVISION
DEVICES, INC.

1177 BLUE HERON BLVD. / RIVIERA BEACH, FLORIDA / (305) 848-4311

Leader in Germanium and Silicon Power Transistors, Cryogenic Thermometers, High Voltage Rectifiers, Temperature Compensated Zeners, Voltage Variable Capacitors, Random/White Noise Components and Microelectronic Components.

SIGNETICS



INTEGRATED CIRCUIT NEWS AND APPLICATIONS

NEW INSTRUMENTATION PACKAGE TO MEASURE FLIGHT STRESS DATA INCLUDES SIGNETICS LOW-POWER IC SERIES

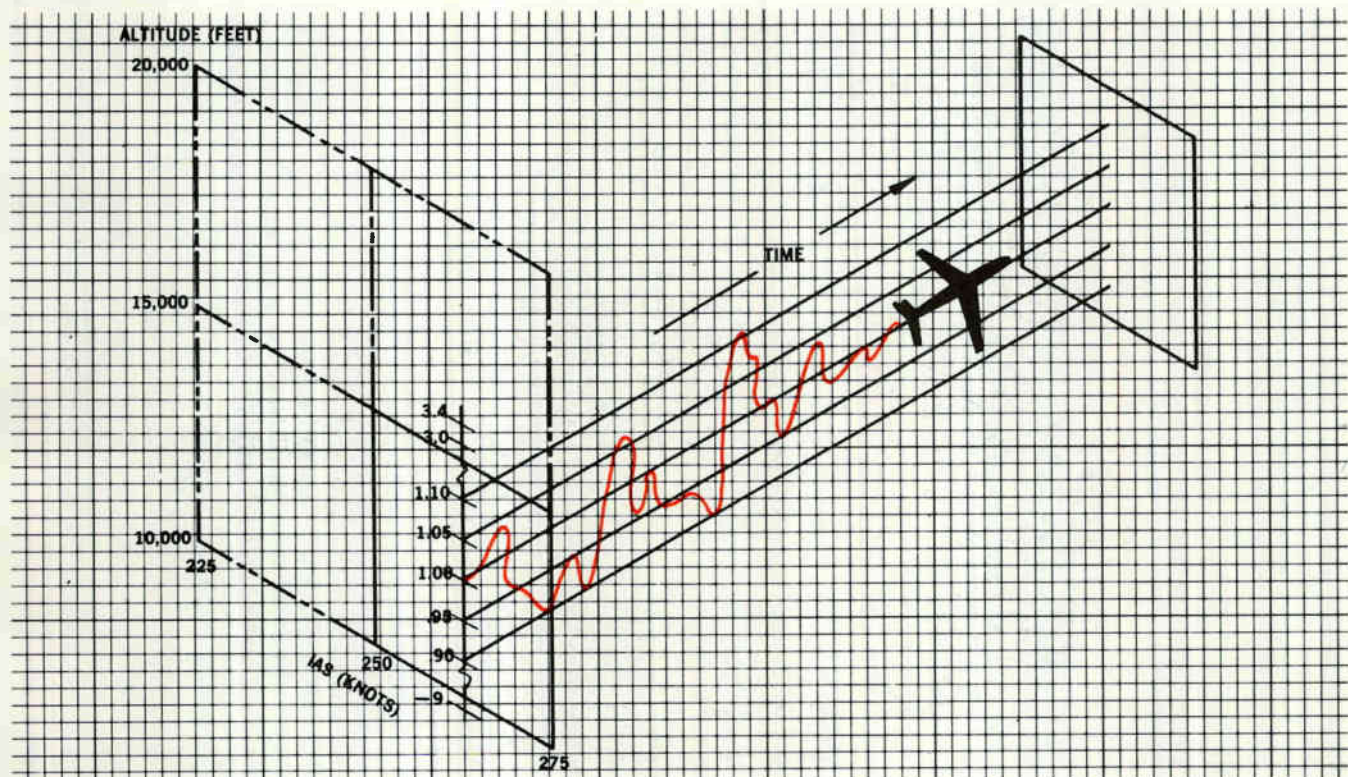

The need for an accurate, reliable statistical recorder was established by USAF's Aircraft Structural Integrity Program which began about seven years ago.

The answer comes in a new instrumentation package developed by Giannini Controls Corporation. Called DASR (Data Acquisition and Statistical Recorder), it defines accurately the G-load history of an aircraft:

1. It counts the number of times an airframe encounters a pre-selected value of G-load.
2. It correlates and records these events only at pre-selected levels of altitude, speed, time and acceleration as shown in the illustration.
3. It produces a tape record that can cover 50 hours of G-history in a 5-minute playback.

The DASR records data in digital form on magnetic tape compatible with IBM data processing equipment.

An important part of the Giannini package is the computer built with Signetics SE400 integrated circuits. These Signetics circuits were selected because they provide high speed at very low power. The feature element in the series is the SE424 five-megacycle dual binary element which operates on less than 9mW per flip flop. The entire SE400 Series operates on 20% to 40% less power than comparable elements while providing equal or better speed and noise immunity. Other elements in the series are:

SE480 — a quadruple 2-input NAND gate, each gate having the

fan-out capability of the flip flop, 7 DC or 2 AC loads.

SE416 — a dual 4-input expandable NAND gate with active output pull-up for fast rise times.

SE455 — a dual 4-input driver/buffer for driving high capacitance loads and for high DC fan-out requirements.

Circle No. 250 on Reader Service Card.



Data Acquisition and Statistical Recorder (DASR).



**SIGNETICS
INTEGRATED
CIRCUITS**

LATEST COMMERCIAL HIGH-SPEED DATA ACQUISITION SYSTEM USES SIGNETICS UTILOGIC

The increasing application of large computers as central processors in industrial operations is making accurate, high-speed data acquisition systems more important than ever before. One of the most recent of these systems to become commercially available is the SOLAR System (Serialized On-Line Automatic Recording), designed and produced by Data Pathing Inc. of Palo Alto, California.

The basic system consists of a programmed receiver incorporating a magnetic recorder and fifteen transmitters which may be located at widely separated points and interconnected by a single pair of wires. Up-to-the-minute reports on material movement, work-in-process, machine and operator utilization, order location, inventory, etc., can be magnetically recorded at the receiver for later processing, or routed from the receiver to a central processor for immediate analysis.

The system logic is implemented with Signetics LU-Series Utilogic elements, selected for their high noise immunity, capacitive drive capability, and the ease with which they interface. The low cost per function and the very high functional density provided by Utilogic have made it economically and physically feasible to incorporate system design features that would otherwise be prohibitive. Among the self-checking features incorporated in DPI's SOLAR system:

- (1) An active visual display at each transmitter which tells the operator exactly what data is wanted and the order in which to enter it via a simple ten-key board.
- (2) An immediate check on transmission accuracy.
- (3) A continuing check on transmitter condition which automatically removes a defective transmitter from the line and signals for the maintenance man.

To date, no Utilogic element failures have been reported in either the earliest prototypes or the first production models of the SOLAR System. One particular feature of Utilogic elements which has won DPI's unqualified approval has been a number of practical demonstrations that they are, indeed, immune to damage by accidental shorts. The type of "probe accident" or "debugging error" that commonly causes a continual loss of discrete semiconductor devices in new systems development has no effect on Utilogic.

Circle No. 251 on Reader Service Card.



SOLAR System transmitter. (18" high, 22" wide, 16" deep).



SOLAR System receiver.

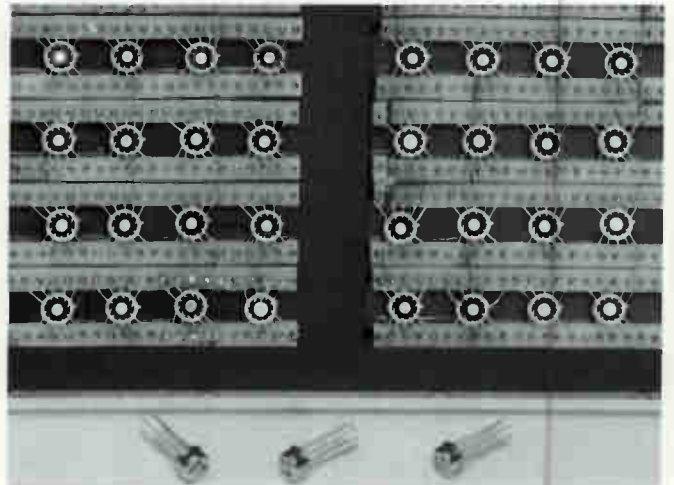

Signetics LU-Series Utilogic elements in SOLAR System logic boards. Note novel upside-down mounting technique of TO-5 cans.

**See the Signetics
showcase of new products at
the IEEE show
"INNOVATION"
March 21-24, 1966**

**Signetics booths 2J40 and 2J42
on the second floor
of the New York Coliseum**



**SIGNETICS
INTEGRATED
CIRCUITS**

NEW DUAL IN-LINE PLUG-IN PACKAGE FEATURES DTL IC'S

Signetics' new SP600 series comes in a unique monolithic package. A solid epoxy block encapsulates both the circuit chip and the leads connecting it to the external plug-in pins. The new package contains two rows of pins 300 mils apart and spaced on 100 mil centers, conforming to widely accepted circuit board drill patterns.

Although designed for commercial use, the low-cost package has been subjected to mechanical and environmental stresses at levels far in excess of those required by MIL-S-19500D and MIL-STD-750.

Signetics SP600 series includes a J-K flip-flop, three multiple DTL gate packages (dual, triple and quadruple NAND/NOR), a quadruple gate-input expander, and a dual DTL line driver/buffer element.

The SP600 series circuits are now in stock at Signetics distributors.

Circle No. 254 on Reader Service Card.

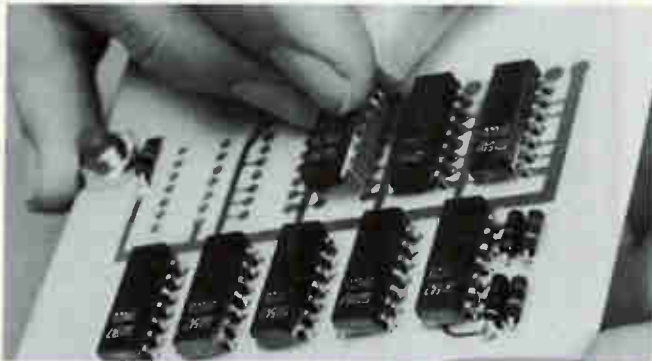

Manual Insertion of SP600 packages in circuit board.



SP600 plug-in package.

NEW HIGH-SPEED TTL FAMILY FROM SIGNETICS

In early March Signetics will market a new high-level TTL family of integrated circuits: the SE800 series.

While consuming generally more power than DTL circuits, the most widely used integrated logic form at present, the new family represents a very useful design trade-off in some situations in which the speed performance of DTL may be considered marginal.

The SE800 series consists of six different gate configurations, a gate expander, and a J-K flip flop. They're interchangeable in both function and pin layout with Texas Instrument's Series 54 elements.

All elements are made in Signetics glass-Kovar 14-lead TO-88 flat package.

Circle No. 255 on Reader Service Card.

CALL A HELPFUL SIGNETICS DISTRIBUTOR—THE ONE NEAREST YOU:

AUTHORIZED SIGNETICS REPRESENTATIVES AND DISTRIBUTORS: **ALA.** Compar Southern, Huntsville, 539-8476; **ARIZ.** Compar Rocky Mountain, Scottsdale, 947-4336; **CALIF.** Compar Los Angeles, Glendale, 245-1172; Compar San Francisco, Burlingame, 697-6244; Jack Pyle Company, San Mateo, 349-1266; Wesco Electronics, Pasadena, 684-0880; **COLO.** Compar Rocky Mountain, Denver (Englewood), 781-0912; **CONN.** Compar New England, Hamden, 288-9276; **DISTRICT OF COLUMBIA** (see Hyattsville, Md.); **FLA.** Compar Florida, Orlando, 855-3964; **ILL.** Compar Chicagoland, Chicago 46, 775-5300; **MD.** Compar Chesapeake, Baltimore 15, 484-5400; Compar Hyattsville, Md., 927-7222; **MASS.** Compar New England, Newtonville 60, 969-7140; **MICH.** Compar Chicagoland, Livonia, 476-5758; **MINN.** Compar Twin Cities, Minneapolis, 922-7011; **MO.** Compar Ozark, St. Louis 2, 428-5313; **N. J.** Compar Philadelphia, Haddonfield, 429-1526; **N. M.** Compar Rocky Mountain, Albuquerque, 265-1020; **N. Y.** Compar Albany, Albany, 436-8536; Compar Albany, Endwell, 723-8743; Compare Albany, Depew, 684-5731; Compare New York, Clifton, N.J., 471-6090; Terminal Hudson Electronics (Distributors), New York, 243-5200; **N. C.** Compare Southern, Winston Salem, 724-0750; **OHIO** Compare Ohio, Rocky River, 333-4120; Compare Ohio, Fairborn, 878-2631; **PENN.** Philadelphia (see Haddonfield, N.J.); Western Pennsylvania (see Compare Ohio, Fairborn); **TEXAS** Compare Southwest, Dallas 18, 327-3944; Compare Southwest, Houston, 645-2135; **WASH. and ORE.** Compare Northwest, Seattle, 622-0622; **CANADA** Aero Sales Engineering Company, Rexdale, Ontario, 249-9139; Aero Sales Engineering Company, Ottawa, Ontario, 828-8560.

SIGNETICS SALES OFFICES: Eastern Regional Sales Office, 591 North Avenue, Wakefield, Mass., (617) 245-8200; TWX (617) 245-8367. Mid-Western Regional Sales Office, 212 Skyline Drive, Barrington, Ill., (312) 463-5105. Western Regional Sales Office, 8820 Sepulveda Blvd., Los Angeles 45, Cal., (213) 776-2295/2296; TWX (213) 670-4303. Metropolitan NYC Sales Office, 129 W. Mount Pleasant Ave., Livingston, N.J. (201) 992-3980.

SIGNETICS INTERNATIONAL SALES REPRESENTATIVES: **FRANCE** Technique et Produits, 63 Bis Rue D'Aguesseau, Boulogne Sur Seine, France. **GERMANY, ITALY, BELGIUM, HOLLAND, LUXEMBOURG, SPAIN** Sovcor Electronique, 11, Chemin de Ronde, Le Vesinet S.-&O., France. **UNITED KINGDOM, IRELAND, SWEDEN, DENMARK, NORWAY, SWITZERLAND, AUSTRIA, PORTUGAL** Electrosil Ltd., Lakeside Estate, Coinbrook By Pass, Slough, Buckinghamshire, Great Britain. **AUSTRALIA** Corning Australia, 1202 Plaza Building, Australia Square, Sydney N.S.W. TWX: "Cornglas" Sydney, 27-3692.

SEND US THE COUPON.

WE'LL SEND YOU ALL THE INFORMATION YOU'LL NEED. FAST.

TO: SIGNETICS, 811 E. Arques Ave., Sunnyvale, California

Please send me information on the following:

- SE400 Series Giannini DASR System
 LU-Series Utilogic DPI SOLAR System
 Advanced Automatic Integrated Circuit Tester
 J-Series Data Sheet
 DTL circuit plug-in package
 SE800 Series

NAME _____

ADDRESS _____

CITY _____

STATE _____

ZIP _____



half the picture

*When you look at electronic components
are you seeing only half the picture?*

We're the last people to argue with component purchasers who put performance, price and delivery first — meeting these three basic requirements is what keeps us in business. But most engineers are also on the lookout for something more, and many of them find it at Mullard.

Take research and development for instance. Out of Mullard R&D have come outstanding devices such as the travelling wave tubes for the New York—San Francisco and Montreal—Vancouver microwave links. Production resources? Mullard

plants are among the most efficient anywhere, with a reputation for the production of tight-tolerance devices to proved standards of reliability. As for circuit know-how, Mullard has the best equipped applications laboratories in Britain. And when it comes to technical services, you will find that Mullard provides the kind of comprehensive performance specs, survey documents and application reports that are just that much more useful. If you want to get the *whole* picture, why not ask us to help you with some of your component problems?

DIODES · TRANSISTORS · PHOTO-DEVICES AND RADIATION DETECTORS · RECTIFIER DIODES AND STACKS · THYRISTORS AND STACKS · INTEGRATED CIRCUITS · CATHODE RAY TUBES · RECEIVING TUBES · ELECTRON OPTICAL DEVICES · PHOTSENSITIVE DEVICES · COLD CATHODE DEVICES · POWER DEVICES · TRANSMITTING TUBES · MICROWAVE DEVICES · CAPACITORS · FERRITE MATERIALS AND ASSEMBLIES · COMPUTER COMPONENTS AND ASSEMBLIES · MAGNETIC MATERIALS · SPECIAL PURPOSE MAGNETS · VACUUM DEVICES · WOUND COMPONENTS.

Mullard

where the product is only part of the deal
MULLARD LIMITED · TORRINGTON PLACE · LONDON WC1 · ENGLAND

Circle 55 on reader service card

FROM TRANSISTORS TO TRIGGERS...

NEW MOTOROLA TYPES TO FIT YOUR TOUGHEST DESIGN JOBS

all new... all oriented to your needs!
in this handy "applications
brochure... yours for the



all described
"unlimited"
asking!

SILICON BILATERAL TRIGGER...MT-32 (32V±4V)

... For an economical, highly reliable device for use in Thyristor and other triggering circuits

- Symmetrical V-I characteristics
- High pulse-current — 2 Amps
- Packaged in miniature DO-7 "glass" hermetic encapsulation — $P_D = 150$ mW

VOLT/AMP. CHARACTERISTICS

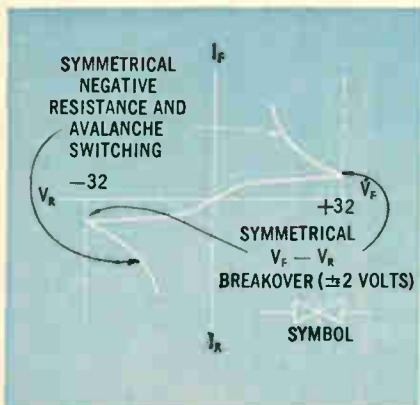

LOW-VOLTAGE, FAST SWITCHING, EPITAXIAL 4-LAYER DIODES

Series M4L3052, 53, 54

- Low breakover voltages: 8-12 volts
- Low junction capacitance: typically 35 pf @ 8-12 V_F
- Fast switching speeds: typically $t_{ON} = 50$ nsec, $t_{OFF} = 100$ nsec
- Packaged in DO-7 "glass" case ($P_D = 150$ mW)

All this at new low prices!

TYPICAL CHARACTERISTICS

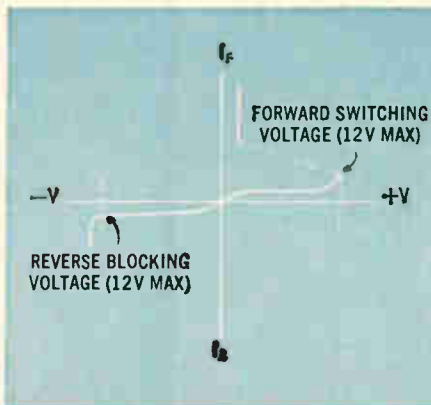

"NO COMPROMISE" LOW-COST PLASTIC SILICON TRANSISTORS

... with UNIBLOC* Performance and Reliability Features!

- NPN /PNP for complementary circuit design
- Complete "h" parameters specified
- Gain specified from 100 μ A to 100 mA
- High voltage — 40 volts (min)

*Trademark of Motorola Inc.

PNP — 2N3905-6 NPN — 2N3903-4



"Unibloc" unit package eliminates use of separate preformed header and poured cap (which can be separated under thermal cycling due to incompatibility at the interface).

CHOOSE FROM 3 NEW RTL INTEGRATED CIRCUIT LOGIC COMPLEMENT LINES

... to best fit your particular performance/cost requirements!



- Fan-out capability up to 5
- 12 nsec — typical propagation delay
- 15 mW/NODE Dissipation
- MC900G series — designed for MILITARY extreme environmental applications. Operating Temp. Range: -55°C to $+125^{\circ}\text{C}$
- MC800G series — for reliable operation in INDUSTRIAL logic applications. Operating Temp. Range: 0 to $+100^{\circ}\text{C}$
- MC700G series — value priced for broad INDUSTRIAL COMMERCIAL applications. Operating Temp. Range: -15°C to $+55^{\circ}\text{C}$ — choice of 19 circuit functions.

✓ (New, comprehensive technical brochures are available describing the complete MC900G, MC800G, and MC700G series ... check coupon below for your copies.)

... for saturated switching OPTIMIZED "FOUR-H" GEOMETRY — FOR MEMORY DRIVER DESIGNS TO 1½ AMPS!

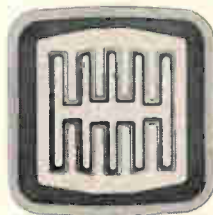

Optimized "Four-H" Geometry

PNP 2N3762 Series



NPN 2N3734-37 Series

Featuring:

- High speeds — $f_T = 330$ mc (NPN), 220 mc (PNP)
- High current — to 1.5 A
- $C_{ob} = 7$ pf (NPN), 12 pf (PNP)
- h_{FE} — specified from 10 mA to 1.5 A
- Low $V_{CE(sat)} = 0.7$ V @ 1.0 A

... for non-saturated switching

1800 MC CURRENT-MODE SWITCHES NPN-2N3959 & 2N3960

CURRENT-GAIN — BANDWIDTH PRODUCT

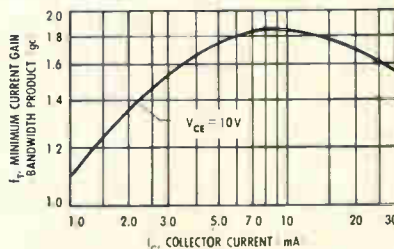

TYPICAL PERFORMANCE FOR THE 2N3960

Featuring:

- 1800 mc — frequency response
- Specified 12 volt (min) BV_{CEO}
- Low $C_{ob} = 2.5$ pf (max)
- Low $r'_b C_c = 20$ psec (typ) TO-18 Pkg.

12-AMP SILICON RECTIFIERS (50-1000V) MR1120-MR1130

... filling your needs for high-performance, medium-current rectification at an economical price!

- 12 amps @ 150°C
- High surge-current @ elevated temperatures — 300 amps @ 150°C
- Low forward voltage drop — 0.55 V (average)
- Available in standard or reverse polarity

CURRENT VS. TEMPERATURE DERATING CURVE

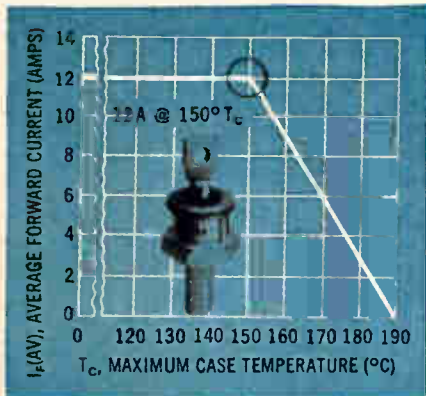

To receive your copy of APPLICATIONS UNLIMITED and the following design aids, just fill out coupon below and drop it in the mail to us.



MOTOROLA
Semiconductor
Products Inc.

5005 EAST McDOWELL ROAD, PHOENIX, ARIZONA 85008



Please print

NAME _____ TITLE _____

JOB FUNCTION _____

COMPANY _____ DEPT. NO. _____

ADDRESS HOME WORK _____ PHONE _____

CITY _____ STATE _____ ZIP _____

Send to:

MOTOROLA SEMICONDUCTOR PRODUCTS, INC.
BOX 955, PHOENIX, ARIZONA 85001

- RTL Integrated Circuit Brochures Zener Selection Guide Silicon Rectifier Selection Guide Silicon Annular Transistor Selection Guide
- Germanium Power Transistor Selection Guide

GET SET...



Kay 121-C
500 KHz to 1700 MHz

This solid-state instrument is an electronically swept VHF-UHF wide-sweep and marker generator which accepts a variety of UHF plug-ins to provide extended frequency ranges and sweep widths. With its plug-ins, the 121-C covers a range of 500 KHz to 1700 MHz, offers octave-wide sweeps at low UHF frequencies where most generators in this range are limited to narrow widths. Narrow sweep and wide sweep plug-ins cover special applications such as UHF-TV — full 440 to 920 MHz in a single wide sweep. A digital frequency dial provides smooth center frequency control and remarkable vernier adjustment for narrow sweep operation.

Performance characteristics include line-lock, cw, manual and variable sweep rates, and external input.

External modulation from dc up to more than 15 KHz, a built-in detector and switched attenuator are standard features.

Wide-Sweep

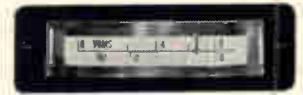

RF OUTPUT... *Set*

0.5 volt rms into 50 ohms
Flat: $\pm .25$ db to 800 MHz
 $\pm .5$ db to 1700 MHz



FREQUENCY... *Set*

digital frequency dial;
vernier control at all frequencies



SWEEP WIDTH... *Set*

5 KHz to 500 MHz
VHF: 50 KHz to 300 MHz
UHF: *P-121 — 124 Plug-ins

Marker Generator



harmonic (picket) birdie markers



single-freq. type birdie markers



*P-121: 200 MHz to 1050 MHz
Sweep: 35 KHz to 350 MHz @ 800 MHz
5 KHz to 50 MHz @ 220 MHz



*P-122: 900 to 1300 MHz
Sweep: 200 KHz to 400 MHz



*P-123: 100 to 1000 MHz
Sweep: 5 KHz to any octave

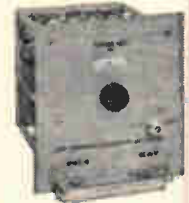

*P-124: 1300 to 1700 MHz
Sweep: 500 KHz to 400 MHz

KAY ELECTRIC COMPANY

Pine Brook, Morris County, New Jersey • (201) 227-2000

Visit Kay at the IEEE Show, Booths 3C11 - 3C17

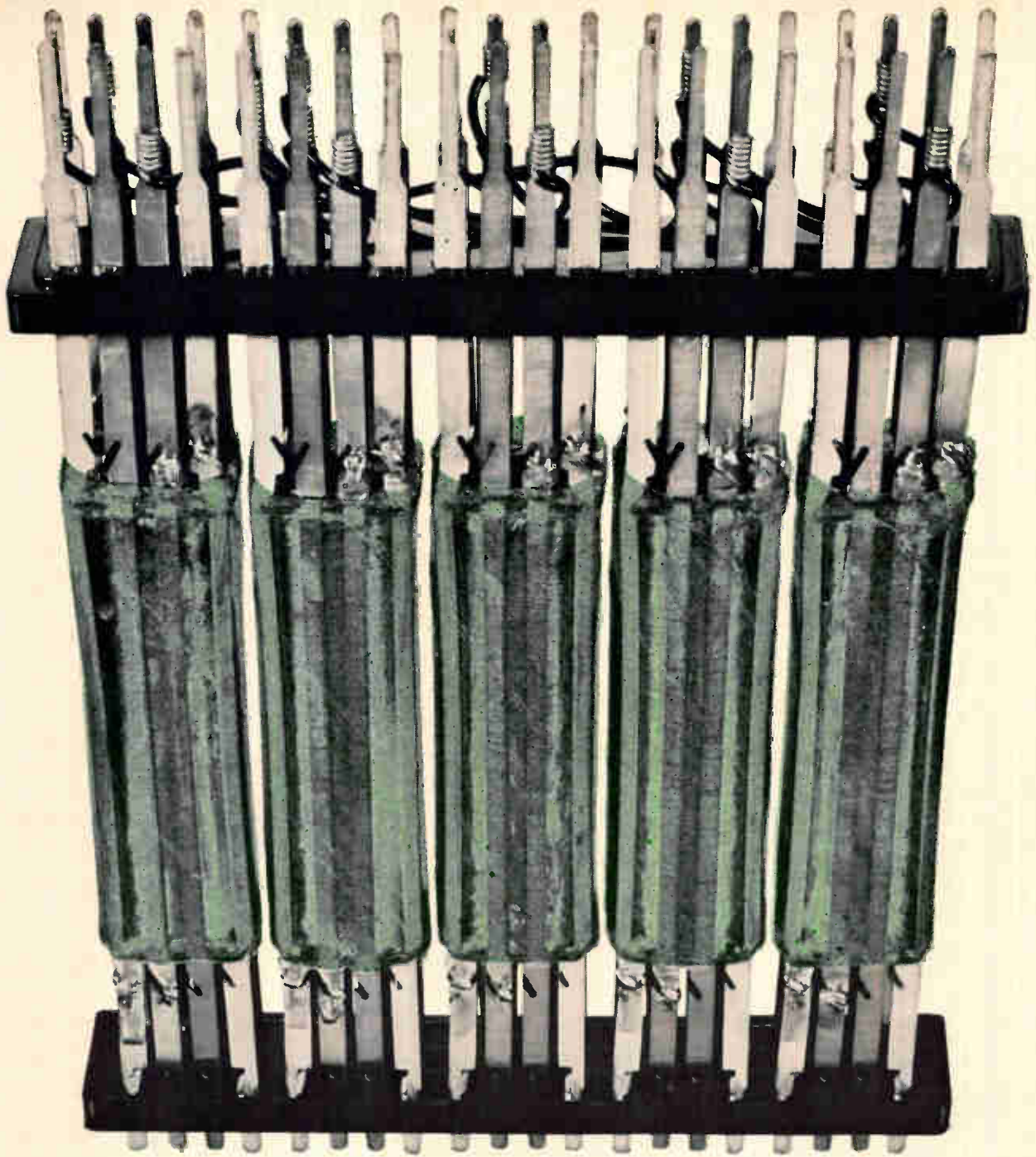

A switch to insulation of MYLAR[®] gave Western Electric a more reliable relay

Greater performance reliability with substantial cost savings—that's why Western Electric has switched from cellulose acetate to insulation of MYLAR* polyester film in the manufacture of relays. MYLAR gives not only superior dielectric strength for better insulation, but also greater physical strength. During assembly, it actually holds the relay terminals parallel without additional tools or supports. Over all, this has permitted Western Electric to reduce costs.

Relays are just one type of compo-

nent where MYLAR improves performance and saves money. Chances are you could take advantage of its unique balance of properties: exceptional strength in thin, weight-saving gauges . . . thermal stability from -60° up to +130 C° . . . high moisture and chemical resistance . . . long-lasting flexibility.

Why not investigate? For your free



Better Things for Better Living
... through Chemistry

only DU PONT makes

MYLAR[®]
POLYESTER FILM

copy of the complete "Fact File" on insulation of MYLAR—mail coupon.

DU PONT REGISTERED TRADEMARK
Du Pont Company, Room 3666C
Wilmington, Delaware 19898
Please send me a copy of the
"Fact File" on insulation of MYLAR[®]

Name

Title

Company

Street

City State Zip

In Canada: Du Pont of Canada, Ltd., P.O. Box 660, Montreal



these connectors aren't just accessories!

Andrew is one of the world's largest manufacturers of RF connectors. Our engineers develop connectors not just as accessories but as part of complete antenna, cable and transmission line systems. Be sure of proved performance and reliability. Contact your regional Andrew sales engineer or write Andrew Corporation, P. O. Box 807, Chicago, Illinois, U.S.A. 60642.

10-66

Andrew
CORPORATION
29 YEARS OF ENGINEERING INTEGRITY

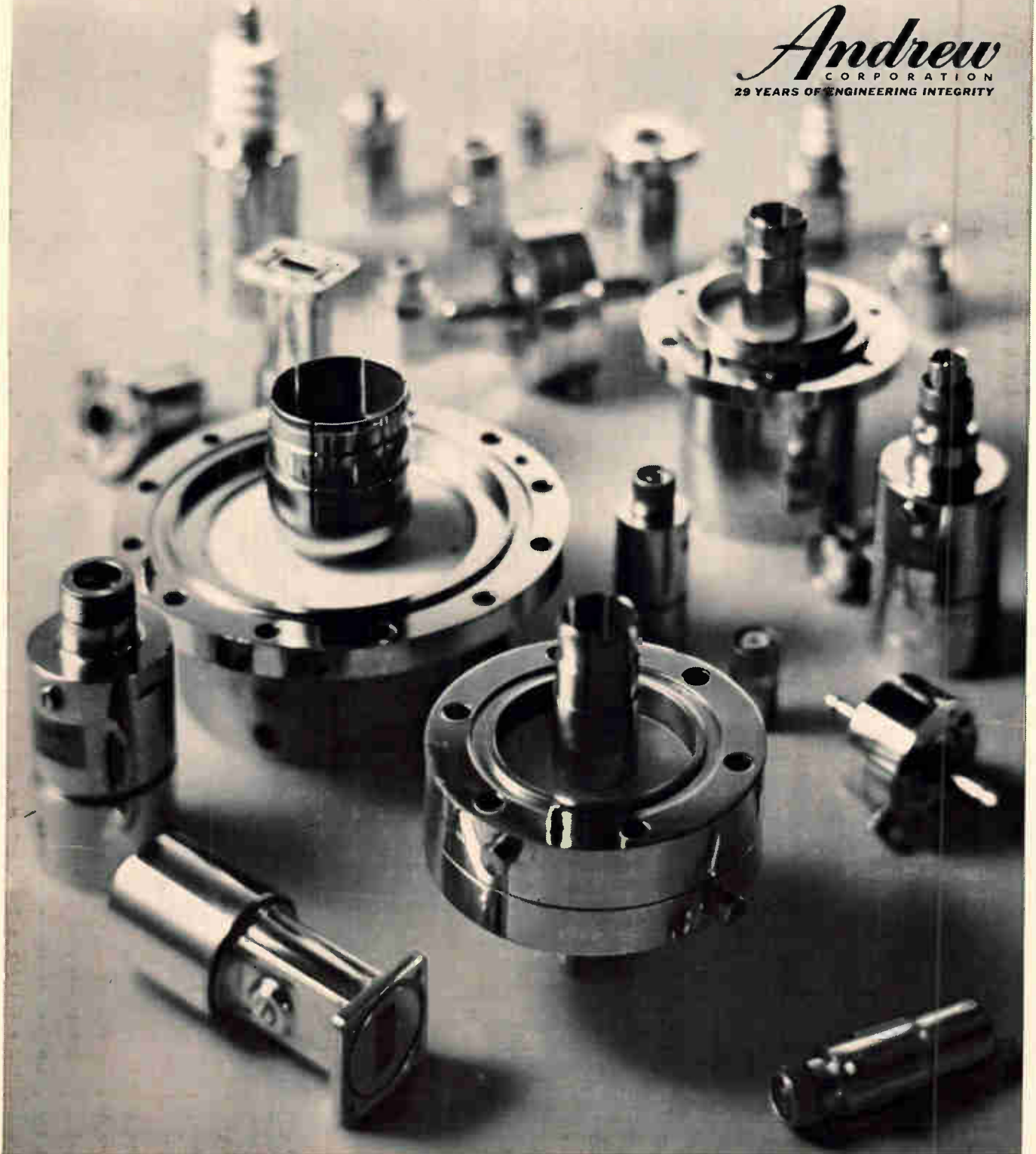

RECORD

Visit The Moseley Division of Hewlett-Packard at IEEE 3rd Floor New York Coliseum, March 21-24

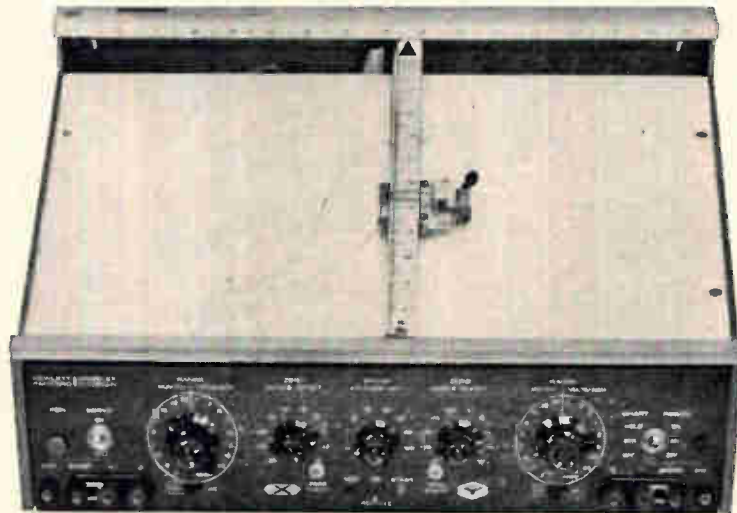

low-level ac low-level dc

ON THIS SOLID-STATE 11" x 17" X-Y RECORDER

100 μV /inch dc sensitivity
5 mv/inch ac sensitivity
1-megohm input resistance
high common mode rejection

The Moseley Division 7000A Recorder accepts dc or ac signals on either or both axes, offers dc cmr of 140 db, ac cmr of 120 db. Potentiometric input available on six most sensitive ranges; accepts roll chart and other accessories for maximum versatility. Internal time base switchable to either axis, featuring automatic reset, adjustable sweep length, automatic recycling.

Other features of the 7000A include extended zero offset with calibrated steps,

maintenance-free AUTOGRIP* electric paper holddown, sturdy, compact construction. Also available from current production is the Model 7001A, identical to the 7000A except for the omission of ac input ranges. Metric and rack mount models available, as well. Price, 7000A, \$2495; 7001A, \$2175.

*Trade Mark Pat. pend.

Data subject to change without notice.
Prices f.o.b. factory.

948

**HEWLETT
PACKARD**  **MOSELEY
DIVISION**

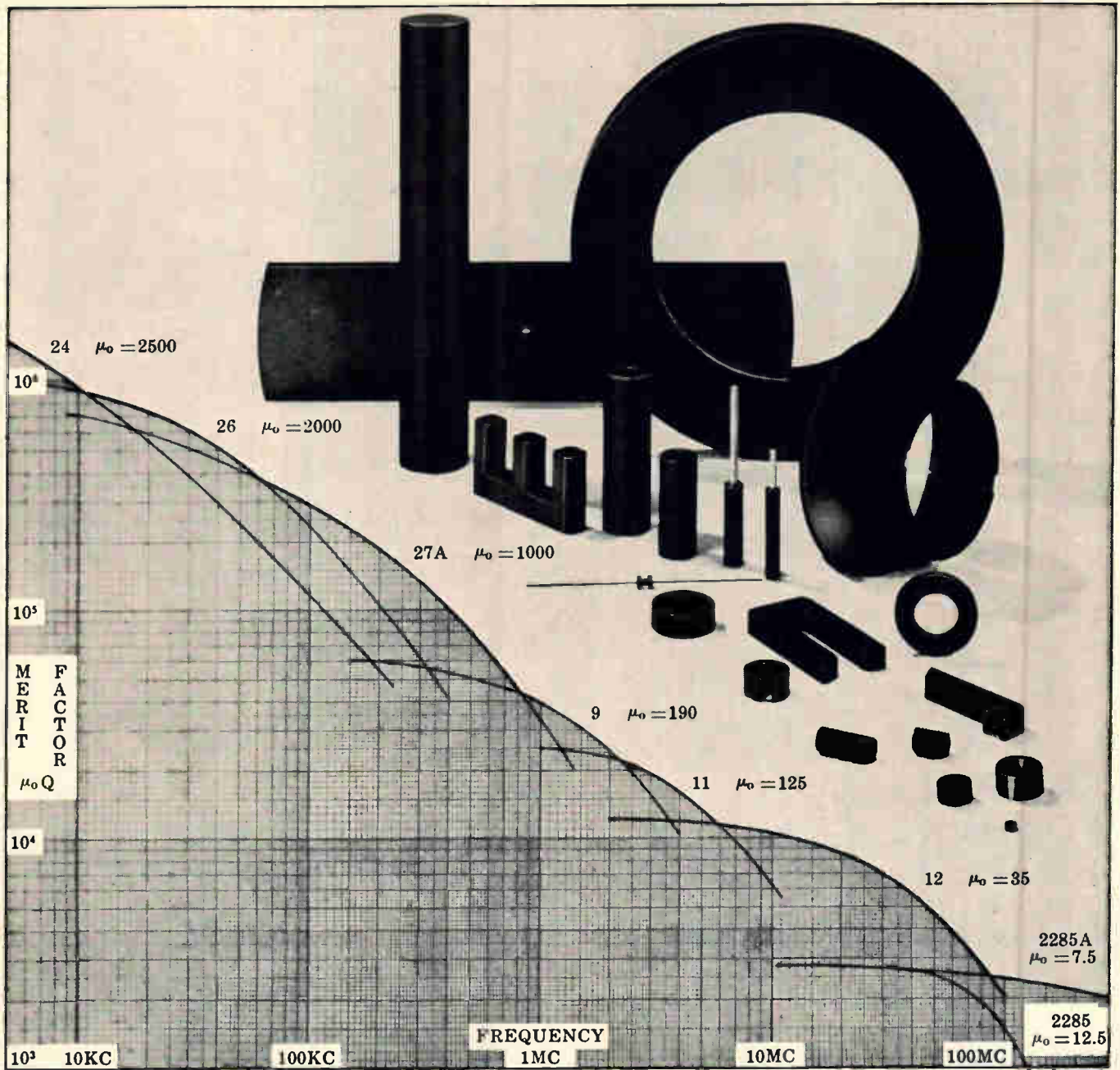

CERAMAG® FERRITE PARTS ARE CONSISTENT

Stackpole offers over 30 grades of Ceramag® material. More are being developed continually. Such up-to-the-minute technology permits you to specify Ceramag® on every new application. Discover the unique advantages of the versatile Ceramag® ferrites: complete moldability to virtually any shape, and the important savings over steel alloys for low frequency applications. When high permeability is an important factor, Ceramag® is the answer.

Hundreds of Ceramag® parts are already tooled as toroids, cup cores, insert cores, transformer cores, deflection yokes and rectangular solids. Special tooling is also available.

Stackpole is a name long associated with quality components in the electronic field. Only the closest attention to every production detail can result in the kind of product uniformity available with Ceramag® ferrites. As one of our customers

put it, "Your ferrite cores are more consistent from order to order than any of your competitors."

If you are about to select a ferromagnetic material for a new application, or if you are dissatisfied with the performance and service of your present ferrite supplier, why not investigate Stackpole's Ceramag®? To discover how you can save and still insure superior performance, write for our Bulletin 1-A, Stackpole Carbon Company, Electronic Components Division, St. Marys, Pennsylvania 15857. Phone: 814-781-8521 — TWX: 510-693-4511.



**Been looking at all those OTHER oscillators?
Now—take a long, hard look
at the completely different
SD-104 LINEAR/LOG SWEEP OSCILLATOR**



Tired of the continuous monitoring of output normally necessary when making frequency-response tests? Work in the range of .005 cps to 50 kc? Then here's why—point by point—you will find the SD-104 Linear/Log Sweep Oscillator superior to every other instrument on the market today . . .

- Continuously variable, completely electronic linear and log sweep rates
- Unequaled accuracy in frequency indication and resolution through automatic range switching of the front panel meter
- Exceptionally flat frequency response
- Uninterrupted and automatic sweeps over a full three-decade range
- Eight simultaneous outputs, including extremely accurate DC analog output voltages, permitting DIRECT plotting of data on X-Y recorders without frequency or log converters

Plus

special capabilities and options, including . . .

- Continuously variable phase output, 0-360°
- Fixed-phase outputs of 0°, 90°, 180°, 270°
- Phase locking and frequency tracking
- Combined linear-log sweep
- External programming (analog or digital)
- Stepped-frequency operation

DEMONSTRATIONS? YOU BET! Every one of our Reps—from coast to coast—has a demo unit ready to set up at your convenience. Just call or write.



SPECTRAL DYNAMICS CORPORATION OF SAN DIEGO

POST OFFICE BOX 671 SAN DIEGO, CALIFORNIA 92112, TELEPHONE 714-278-2501

Why the CEC Electrolytic Cell has revolutionized moisture measurement

CEC Electrolytic Moisture Monitors have proved to be the most precise and reliable instruments now available for the tracing and measurement of ppm amounts of water in gases, liquids and solids.

The reason is primarily due to the exclusive brain of these instruments—the CEC Electrolytic Cell. This unique cell has greater accuracy at low levels than any other, twice the life, and cannot become shorted by prolonged storage or disuse. Furthermore, the CEC cell uses glass-supported electrodes, and it is potted for impact resistance, and replaceable in seconds without tools.

Should the electrolytic cell need attention at any time, CEC also offers prompt cleaning and recoating for a minimal charge.

Additional advantages

- ☐ CEC Moisture Monitors assure the fastest usable readings. From 15 minutes to one hour after initial sample stream hookup, accurate readings can be made from 1-1000 ppm. After that, a 63% response to moisture change occurs in 30 seconds or less.
- ☐ CEC Moisture Monitors are advanced throughout. A specially manufactured flow controller, plus ingenious circuitry, assure more accurate and dependable performance at the lowest cost.
- ☐ CEC Moisture Monitors are backed by greater experience. As the pioneer and leader in the field of moisture monitoring, CEC can guarantee users the right answers to application needs as well as the best instruments.

A moisture monitor for every purpose

The following instruments are representative of the full range of moisture monitors currently available from CEC.

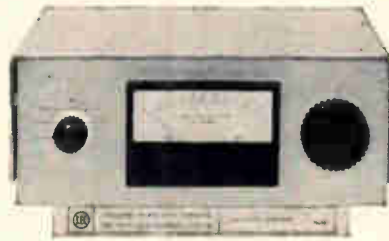

26-303 Portable Laboratory Moisture Monitor. This is the finest laboratory-quality moisture monitor designed for industry—yet it sells for less than any other coulometric-electrolytic moisture measuring instrument. *Performance:* Continuously measures 1-1000 ppm water in gas • Fast response—immediate recovery • Accuracy better than 5%.



26-301 Hydrogen Moisture Monitor. Especially designed for the continuous measurement of water in hydrogen- or oxygen-rich gas streams, it uses the error-proof CEC Delta Flow principle. *Performance:* Range 1-1000 ppm with a gas flow rate of 20 cc/min. • Accuracy 5% of full scale for any attenuator setting.



26-350 High Pressure Moisture Monitor. The 26-350 provides a rapid, accurate

and continuous means of measuring trace quantities of moisture in high pressure gases, gaseous mixtures and vapors up to 6000 psig pressures. *Performance:* Dynamic range 1-1000 ppm by volume, equivalent to a dew point of from -101°F to -5°F • Accuracy $\pm 5\%$ of full scale on any range.



26-321A Solids Moisture Analyzer. This unit delivers the most conclusive results, and is the most trouble-free, easy-to-use instrument made for measuring water in solids. *Performance:* Dynamic range 0.1 μg to 99,999.9 μg • Accuracy $\pm 20 \mu\text{g}$ of water or $\pm 2\%$ of final reading, whichever is larger.

For all the facts about the complete moisture monitor line, call or write for CEC Bulletin Kit 9041-X1.

Also available upon request—the booklet, "Moisture Monitor Hints," which covers moisture detection problems and how to solve them.

CEC

Analytical & Control Division

CONSOLIDATED ELECTRODYNAMICS

A SUBSIDIARY OF BELL & HOWELL/PASADENA, CALIF. 91109
INTERNATIONAL SUBSIDIARIES: WOKING, SURREY, ENGLAND
AND FRIEDBERG (HESSSEN), W. GERMANY

Series 53M Potentiometer for quieter performance, long life, zero backlash!

100% CARBON-TO-CARBON wiper-element contact construction completely eliminates metal-carried carbon wiper and results in an extremely long, noise and backlash free, life. One piece molded construction is the Clarostat secret . . . and for even greater reliability and stability, each unit is completely sealed against moisture, dust and other environmental hazards.



BRIEF SPECIFICATIONS

- Power Rating — 2 Watts
- Working Voltage—500VDC
- Resistance Range — 50 ohms to 10 megohms linear, 250 ohms to 5 megohms tapered
- Available with shaft seals, mounting seals, switches, high torque, ganging, non-metallic shafts, L & T Pads, concentric shafts, high-voltage standoffs, backlash assemblies, and locking bushings.
- Meets specifications per MIL-R-94 — Style RV-4.

WRITE FOR COMPLETE SPECIFICATIONS

CLAROSTAT

CLAROSTAT MFG. CO., INC. DOVER, NEW HAMPSHIRE
Visit Clarostat IEEE Booth 4M14

now..... a fully militarized primary cesium beam frequency standard

BY NATIONAL 

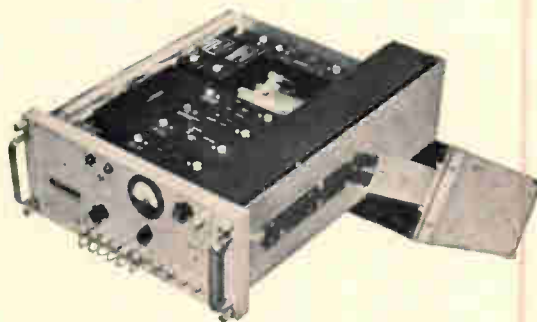

NC 3501 SPECIFICATIONS

ACCURACY: $\pm 2 \times 10^{-11}$
 LONG TERM STABILITY: $\pm 2 \times 10^{-12}$ TYPICAL,
 $\pm 4 \times 10^{-12}$ WORST CASE
 SHORT TERM STABILITY: $\pm 1 \times 10^{-11}$ TYPICAL 5×10^{-11} WORST CASE
 for 1 SEC AVERAGES
 OUTPUTS: 10MHz, 5MHz, 1MHz, 0.1MHz,
 14.591479MHz (UTZ OR A.1)
 TIME SCALE
 INPUT POWER: 115V/230V $\pm 10\%$
 50 cps to 400 cps or 28VDC ± 4 VDC
 CESIUM BEAM RESONATOR LIFE:
 10,000 hrs GUARANTEED
 SIZE: . . . 7" HIGH x 17" WIDE x 20" DEEP
 STANDARD 19" RELAY RACK MOUNTING

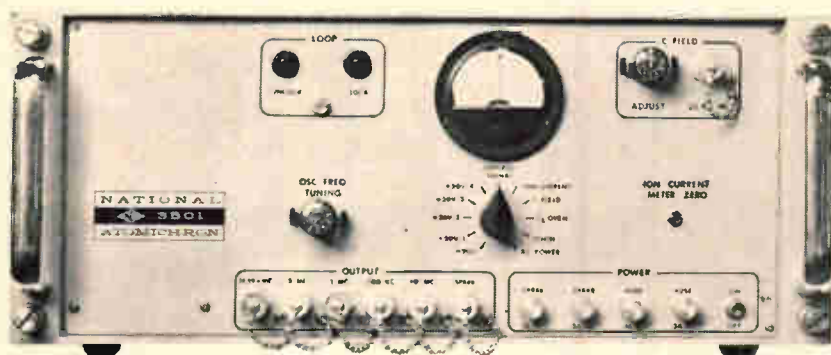

THE ATOMICHRON

SEND NOW FOR COMPLETE DATA FILE ON NATIONAL'S ATOMICHRONS



NATIONAL COMPANY INC.  MELROSE, MASSACHUSETTS



new

RF Sputtering of Insulators with PlasmaVac[®]... First Production System for the deposition of Insulators

Now, the microelectronics manufacturer can deposit the dielectric in thin-film capacitors, encapsulate thin film and integrated circuits, or carry on surface passivation of semi-conductors.

CVC's new RF Sputtering Unit is a versatile addition to the PlasmaVac low-energy sputtering system, so successful in the controlled deposition of metals,

alloys, and semi-conductors. This first commercially available system utilizing RF Sputtering expands PlasmaVac's capability to include materials like quartz, barium titanate, magnesium oxide, aluminum oxide, synthetic mica, pyrex and other commercial glasses. Sequential deposition of metals and insulators using both dc and RF sputtering to fabricate capacitors can be

done without breaking vacuum.

PlasmaVac with RF Sputtering can deposit more materials with better control than any other deposition equipment available today. And, PlasmaVac adapts easily to your production line or laboratory.

Write us today for full details. Consolidated Vacuum Corporation, 1775 Mt. Read Boulevard, Rochester, N. Y. 14603.



Consolidated Vacuum Corporation

ROCHESTER, N. Y. 14603 • A SUBSIDIARY OF BELL & HOWELL
International Subsidiaries: Woking, Surrey, England
& Friedberg, West Germany

A science fiction story that's not all fiction

"THE MYSTERY OF THE MISSING PEAKS"



Dick Whittington, ace space scientist, was baffled by an over-modulated data signal while testing the 7-litre rockets of his supersport moon machine. The signal looked like a stock-market cycle:

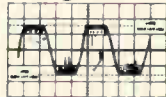

Naturally, our resourceful hero thought of A.G.C. But he knew that wouldn't work.



Suddenly, he had an inspiration! With the speed of light, he contacted Sangamo Electric Company via his two-way 17-jewel wrist TV. From Springfield, Illinois, came the comforting voice of Philo Faraday, a crack Sangamo engineer, saying, "Why, that's easy as π . What you need is our Type AR-2L two-level automatic solid state Attenuator/Restorer with integrated circuits.

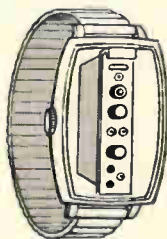

"It attenuates your data signal so that it looks like

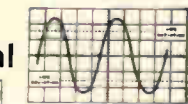

as stored on

magnetic tape, and like  when reconstituted by the restorer."

"Eureka!" Dick exclaimed. "And you say it's inexpensive, too?" Excitedly, Mr. Faraday replied, "Right! And the Type AR-2L substantially broadens the effective dynamic range of your recorder, and allows for transients without sacrificing low-level data... no need for costly channel sharing, either."

"Zounds, I must have one posthaste!" allowed Dick. "Now my peaks won't look so peaked, and Sangamo's two-level automatic Attenuator/Restorer will put my missing data back on the band."

THE MORAL: No need to lose expensive data. If you don't have a wrist TV, write, wire, or phone for complete description to



ES66-1

SANGAMO ELECTRIC COMPANY / Electronic Systems Division / Springfield, Illinois

**Last week,
you needed
a
switchlite.**



**Today,
you need a
pushbutton
switch.**



**Tomorrow, a
subminiature
toggle
switch.**



**Next Tuesday, a
hermetically-
sealed
switch.**



Good thing Control Switch is around to help.

We're unique among switch suppliers. No other manufacturer makes all the kinds of switches we make. And some don't make any of them.

When we're around to help, you can have your choice of:

3,150 toggle switches
4,200 pushbutton switches
1,240 hermetically-sealed switches
1,800 lighted pushbutton panel switches
460 basic precision switches
1,180 indicator lights.

Plus countless more standard variations. Get any or all of the catalogs listed at the right and see our line-up for yourself.

These are quality switches and switchlites. For computers, aircraft, missiles, equipment and controls that demand reliable components.

Keep your Control Switch distributor . . . or us . . . in mind. Today. Tomorrow. Next Tuesday.



CONTROL SWITCH DIVISION
1420 Delmar Drive, Folcroft, Pennsylvania 19032.

Build a reference file! Check numbers on the Reader Service Card corresponding to those below for any or all catalogs you want.

- #450 Condensed Switch Catalog 100
- #451 Basic Snap-Action Switch Catalog 110
- #452 Toggle Catalog 181
- #453 Indicator Light Catalog 120
- #454 Hermetic Switch Catalog 130
- #455 Switchlite Catalog 220
- #456 Pushbutton Catalog 190



DALE

**3-in-1 T-pot design
gives you more
for your money!**



**One simple, rugged design adds reliability
to all three rectilinear Mil wirewound styles**

RT-10, RT-11, RT-12 – Dale meets all three with a single design. You benefit from this simplification through increased reliability, faster delivery, better price. Call us today!

- ① **ALL-MOLDED HOUSING** design eliminates seal problems. Meets MIL-STD-202 and MIL-R-27208A.
- ② **RUGGED COLLECTOR SYSTEM** assures you of noise levels well below mil requirements.
- ③ **FULL LENGTH WINDING** allows increased power handling capability. Permits use of large diameter thermoconductive mandrel which eliminates "hot spots" by acting as high mass heat sink.
- ④ **1-PIECE WIPER ASSEMBLY** of precious metal insures setting stability under all environmental conditions.
- ⑤ **STAINLESS STEEL ADJUSTMENT SCREW** has metal-to-metal clutching – prevents over-travel damage.
- ⑥ **CONSTANT LEAD SCREW SEAL** is assured by shaft-retaining spring which maintains unvarying pressure against high temperature silicone rubber "O" ring.

DALE MIL-R-27208A MODELS

RT-10

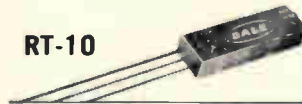

Model 691 P.C. Pin
Model 697 Flex. Leads

RT-11



Model 1287 P.C. Pin
Model 1288 Flex. Leads

RT-12



Model 1680 P.C. Pin
Model 1697 Flex. Leads

RT-22



5000 Series – 1/2" square-trim models meet RT-22, made with same basic design considerations shown here.

**WRITE FOR CATALOG B – containing specifications on
57 Dale T-Pots including many special models.**



DALE ELECTRONICS, INC.
1300 28th Avenue, Columbus, Nebraska



Washington Newsletter

March 21, 1966

Military spending tops Korea peak

The war in Vietnam is pushing the volume of military contracting to the highest levels since Korea. Defense officials now forecast that by June 30, when the current fiscal year ends, orders will total \$36 billion. This will represent a 32% jump over awards in fiscal 1965; it will reverse a two-year decline and will substantially exceed the fiscal 1963 total of \$29.4 billion, the previous peak contracting year for the military buildup begun during the Kennedy Administration.

Of the fiscal 1966 total, \$19.1 billion—up from \$13 billion a year before—represents spending for major military hardware such as weapons, vehicles and ordnance. Research-and-development spending, put at \$5 billion, is up from \$4.8 billion in 1965.

The biggest part of the \$36 billion will be parceled out between now and June 30. During the first half of the fiscal year—from July through December, 1965—awards amounted to \$15.6 billion. This means another \$20.4 billion in contracts is yet to be let.

The contract flow will slacken somewhat in fiscal 1967, but will remain at a level higher than the 1963 peak. The projection for the coming fiscal year is \$34 billion, but this is an admittedly conservative forecast because it assumes the war in Vietnam will not intensify greatly.

McNamara expected to approve Nike X

Defense Secretary Robert S. McNamara, with fresh warnings of Red China's nuclear capability, indicated he will eventually approve production and deployment of a limited version of the Nike X antimissile system [Electronics, Feb. 7, p. 51].

In congressional testimony, McNamara for the first time predicted that China will be able to launch nuclear weapons 500 to 700 miles beyond her borders within three years. He repeated his belief that by the middle or late 1970's, China will possess a nuclear striking force capable of reaching the United States.

McNamara leaves little doubt he will order an anti-Chinese version of the Nike X system, though he still feels a year can safely pass before work must begin. He flatly says a system costing \$8 billion to \$10 billion, which emphasizes interceptors beyond the atmosphere, "offers promise of a highly effective defense" against the Chinese threat.

McNamara reports "a number of significant improvements" have been made to Nike X radars, including the use of a modular-design concept that permits a variety of defense combinations against a broad range of threats. He is still not indicating whether he favors another small-scale Nike X system to provide so-called "hard point" defense around U.S. intercontinental missile launch sites.

Stennis presses for disclosures on arms readiness

The Senate Preparedness subcommittee is threatening a showdown with Defense Secretary Robert S. McNamara over what it claims are his attempts to stymie an investigation into the state of the nation's military readiness. Critics are claiming that the sudden military buildup for the Vietnam war has left the armed forces short of many supplies, including a considerable amount of much needed electronic equipment. The

Washington Newsletter

subcommittee is part of the Armed Services Committee.

Sen. John Stennis (D., Miss.), subcommittee chairman, objects to the Pentagon's insistence on having documents and reports relating to the readiness of military manpower and equipment "cleared" by Defense Department officials before they are turned over to the subcommittee.

The clearance procedures are being used as a delaying tactic and as a cover-up by McNamara to hide deficiencies in the armed forces, subcommittee members charge.

Stennis is threatening to take "other steps" if the clearance procedures aren't halted or at least speeded up appreciably. The subcommittee is said to be considering public hearings to force McNamara to answer charges about the alleged cutoff of information to Congress. It could also subpoena documents it wants to see, though this undoubtedly would touch off a dispute with the White House.

The present impasse followed the Pentagon's refusal to give a security clearance to an interim subcommittee report to Congress alleging serious deficiencies in the Army's manpower, equipment and training. While bottling up this report, McNamara has issued a long public statement and called a press conference to deny charges that equipment is in short supply.

NASA data-relay satellites proposed

The National Aeronautics and Space Administration will select a company within the next few weeks to do a four-to-six-month detailed study on the feasibility of using two or three synchronous satellites for data relay from earth-orbiting satellites. An initial call to industry drew response from eight concerns. NASA believes that a system of relay satellites could collect data from other orbiting satellites, then transmit it back to three to six ground stations. The result would be continuous and better data readout from satellites.

Army is purchasing interim helicopters

Pending development of a heavier, more sophisticated armed helicopter by the Lockheed Aviation Corp., the Army plans to purchase a new high-speed, heavily armed version of the Bell Helicopter Co.'s UH-1B. The new Bell aircraft, called the HueyCobra, is a two-man ship specifically designed for attack missions. Present armed helicopters in Vietnam are transports to which weapons were rigged as an afterthought. Bell Helicopter is part of the Textron, Inc., complex.

In another procurement action, the Army has awarded an initial \$485,000 contract to the McDonnell Aircraft Corp. for development of a shoulder-fired, medium antitank assault weapon (MAW). MAW is a wire-guided missile that follows the line-of-sight aim of a gunner using a telescopic sight.

The Army also plans to select a second producer for the gun-launched, microwave beam-guided Shillelagh missile. The Aeronutronic division of the Philco Corp. is now the sole contractor. Future procurement, beginning in mid-1967, will be put on a competitive basis.

Other likely candidates for future competition include MAW; a tube-launched, wire-guided heavy antitank missile now produced by Hughes Aircraft Co.; and the Chapparral, an antiaircraft version of Philco's air-to-air Sidewinder missile.

Why specify Mallory MTP wet slug tantalum capacitors?

- they're much smaller than solid tantalum types and
- they don't need voltage de-rating!

Suppose you need a high-reliability capacitor for a miniaturized circuit. You know working DC voltage, required capacitance, ambient temperature. What capacitor will meet these parameters in minimum size?

Our answer—the Mallory MTP wet slug tantalum capacitor. C x V "density" of the MTP goes up to 172,000 mfd-volts per cubic inch—about 5 times as much rating per unit size as solid electrolyte tantalum types.

Next step—pick the exact rating you need. The circuit says 30 volts. So you decide to specify a 50 volt unit. Right?

Wrong. You *don't* need to de-rate the MTP. Contrary to long-standing belief, operating at reduced voltage neither improves nor impairs performance. Not for this capacitor. We've made tests to prove it. Here is typical data:

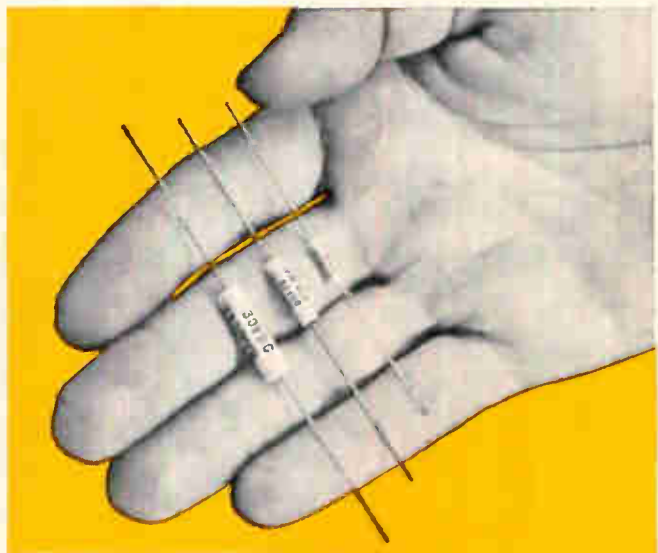

Rating	% change in Capacitance after 1000 hours								
	at 26°C			at 65°C			at 85°C		
	0% RV*	50% RV	100% RV	0% RV	50% RV	100% RV	0% RV	50% RV	100% RV
6.8 mfd, 50V	-1	-1	-1	-0.1	-0.1	0	-1.3	-0.7	-0.9
30 mfd, 50V	0	0	0	0	0	0	-1.0	-2.5	-5.2
78 mfd, 50V	0	0	0	-0.1	-0.2	-0.3	-1.2	-1.2	-1.2
450 mfd, 6V	0	0	0	-0.2	-0.7	-3.0	-1.0	-2.2	-8.0

*RV: Rated DC Voltage

Running the MTP at rated voltage can often help you make further savings in size. 33 mfd at 60 volts, for instance, goes in a "C" case, .225" in diameter and .775" long. But a 33 mfd 50 volt rating fits in the "B" case, which is only .145" in diameter and .590" long. And the cost is about 13% lower.

And that's not all. The MTP is made in the same facility as similar capacitors for Minuteman II. And like all

Mallory wet slug tantalum capacitors, it has lower DC leakage and greater freedom from catastrophic failure than solid tantalum types.

Write today for our latest engineering report on voltage rating tests on MTP capacitors, for bulletin giving complete specifications. Mallory Capacitor Company, a division of P. R. Mallory & Co. Inc., Indianapolis, Indiana 46206.

50th
ANNIVERSARY

MALLORY



Data Display Devices from Raytheon

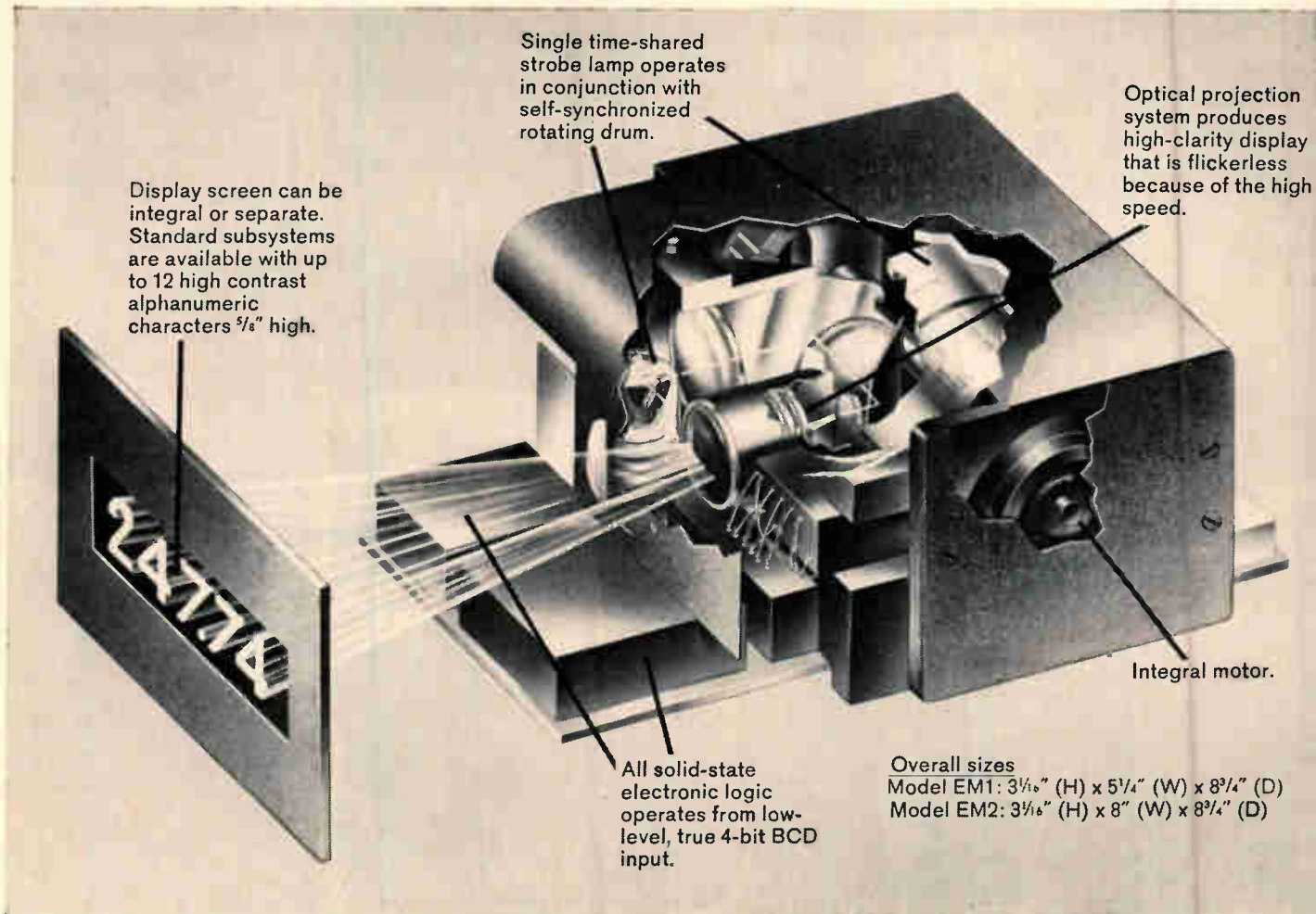

New Raytheon Datastrobe* subsystem offers you reliable readouts at very low cost

The Datastrobe subsystem employs a new concept of data display that offers you precisely registered, reliable readouts and simple, flexible installations—at very low cost.

To produce high-clarity displays of precise registration, the Datastrobe subsystem utilizes (1) a single rotating, self-synchronized drum operating in conjunction with a single time-shared, high-speed strobe lamp, (2) time-shared, all solid-state circuits, and (3) an optical projection system to produce multi-digit, in-line, single-plane displays.

Reduced number of components increases reliability. The time-shar-

ing feature reduces the number of components. Self-contained Datastrobe subsystem wires directly to logic without buffers or drivers. There are no signal amplifiers, mechanical switches or relays. One 6-digit Datastrobe subsystem can replace as many as 66 incandescent bulbs or 6 electromechanical readouts! No complementary input or 8-line to 4-line converter is required.

Self-decoding eliminates wrong readouts. A self-decoding feature incorporated into the Datastrobe subsystem uses direct logic comparison to eliminate erroneous or ambiguous readouts. The conventional white-on-black displays are

bright, steady, and provide high contrast and easy recognition.

Wide range of design options. Datastrobe subsystem display screens can be integral or separate. Standard models are available with up to 12 digits; floating decimal point is optional. Models with more digits and combinations of alphanumeric characters or symbols are available. Additional readout locations are accommodated with simplified wiring. Codes other than BCD, such as 2-out-of-5 code, are available as options.

For a Datastrobe demonstration, contact your Raytheon regional sales office.

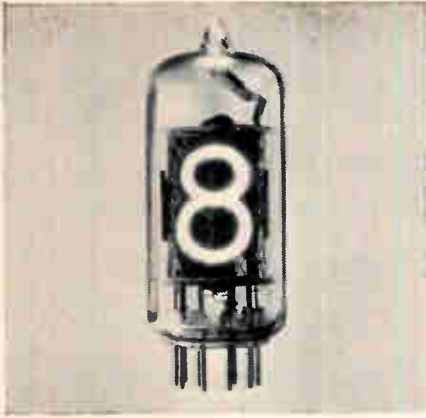

Datavue* Numerical Indicator Tubes in side-view configurations. These side-view in-line visual readout tubes display singly numerals 0 through 9 or pre-selected symbols such as + and - signs. Gas-filled cold-cathode tubes, they employ the principle of the neon-glow lamp. And their life expectancies range upward of 200,000 hours in dynamic operation.

The $\frac{5}{8}$ " high characters are easily read from a distance of thirty feet. They're also easily read in high ambient light—where other displays tend to wash out. Erroneous readouts due to segment failure do **not** occur because the characters are fully formed.

Side-view Datavue tubes cost less because their engineering design provides manufacturing economies. They're also economical to install because the bezel and filter assembly can be eliminated, and their mating 11-pin sockets are less expensive than for end-view types.



Datavue* End-View Tubes. Raytheon end-view Datavue tubes have essentially the same characteristics as side-view types. They fit into standard-size receptacles and conform to EIA ratings. Models include round (CK8421) and rectangular (CK8422). Both models are designed for ultra-long life, with an expectancy of 200,000 hours or more in dynamic operation.

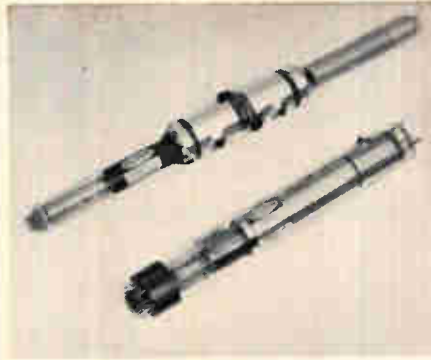

Recording Storage Tubes. Raytheon recording storage tubes are electronic input/output cathode ray storage devices. Applications include radar scan-conversion, slow-down video, signal processing, signal enhancement, time delay, and stop motion. Types include single gun and dual gun—standard and miniature sizes. Shown above are miniature single-gun (CK1516) and dual-gun (CK1519) storage tubes, which provide high resolution and erase capability of 1.2 seconds.

Recording storage tubes feature fast writing, long storage, fast erase and immediate readout capabilities. Information can be written and stored by sequential techniques or by random writing. Complete, partial, or selective erasure is possible. Many other types of recording storage tubes are available, covering a wide range of requirements and applications.

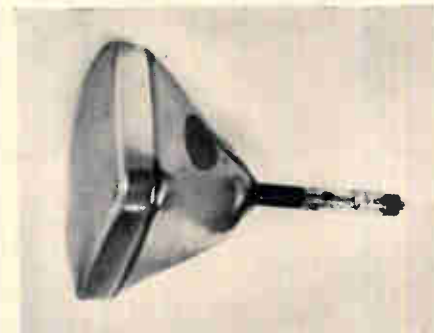

Dataray* Cathode Ray Tubes. Raytheon makes a wide range of industrial CRTs—including special types—in screen sizes from 7" to 24". Electrostatic, magnetic, and combination deflection types are available for writing alphanumeric characters while raster scanning. All standard phosphors are available and specific design requirements can be met. Combination deflection or "diddle plate" types include CK1395P (24" rectangular tube), CK1400P (21" rectangular), and CK1406P (17" rectangular).



Symbolray* CRT Tube. The new Raytheon CK1414 Symbolray tube provides alphanumeric inputs for computer read-out devices. The tube's 2" target can be scanned electronically to select symbols, characters, and punctuation marks in sequence to form the readout on a display tube. This type has applications with data processing equipment as an economical method for generating characters for hard copy print-out or for cathode ray display. Design with 64 and 100 characters are available.



Send the Reader Service Card for Literature Kit containing these data sheets and catalogs—

- Datastrobe Data Sheet
- Datavue Numerical Indicator Tube Catalog
- Cathode Ray Tubes Data Sheets
- Recording Storage Tube Brochure

Or call your nearest Raytheon regional sales office, or write to *Raytheon Company, Components Division, 141 Spring Street, Lexington, Mass. 02173.*

*Trademark of Raytheon Company



Raytheon Components Division—A single source for Transistors/Diodes/Integrated Circuits/Industrial Tubes/Control Knobs/Panel Hardware/Circuit Modules/Display Devices

DESIGNER'S

P. R. MALLORY & CO. INC., INDIANAPOLIS, INDIANA 46206

Molded Zener Diodes give high reliability at low prices

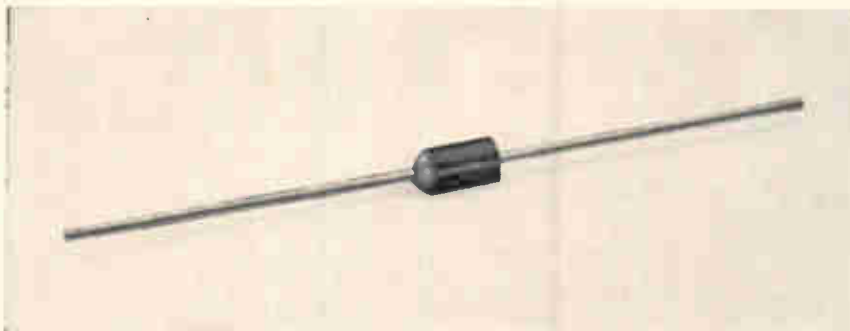

The Mallory Type ZA zeners are molded units which give performance and reliability equal to that required by military specifications—at about half the price of hermetically sealed zeners.

One reason for this unusual quality is that Mallory uses the same silicon cell in the Type ZA as in the zener diodes we make for military requirements. Another is the unique Mallory production technique, in which complete classification, screening and

pre-testing can be done on silicon cells before packaging. And finally, there's the economy of the molded case—moisture-proof, electrically cold, and so compact that high-density circuit packages are readily accommodated.

The 1-watt Type ZA and 3-watt type ZAC are available in zener ratings from 6.8 to 200 volts. Hermetically sealed and high wattage ratings are also available.

CIRCLE 240 ON READER SERVICE CARD

Wire-Wound Controls with special Temperature Coefficients

When exceptional stability of resistance is needed over the normal operating temperature range, Mallory can supply custom-made wire-wound controls with special values of temperature coefficient. Selected types of resistance wire are used for the winding.

The minimum TC available is 20 parts per million per degree C . . . also stated as .002% or $\pm .00002$ ohm/ohm/°C. All styles of Mallory wire-wound controls—2, 3, 4, 5, 7 and $12\frac{1}{2}$ watts—can be supplied with special TC.

CIRCLE 241 ON READER SERVICE CARD



New Hermetic Seal Tantalum Capacitors—Style CL55 of MIL-C-3965C

The new Mallory Type TL wet slug tantalum capacitor is a compact rectangular package designed for ability to withstand extreme environmental conditions. It has glass-to-metal terminal seals in a hermetic sealed outer case. Microfarad-volt ratings per unit volume are exceptionally high for this class of construction.



The TL offers the superior performance which is characteristic of Mallory wet slug capacitors. It has exceptional stability of capacitance and power factor, both over a broad temperature range from -55°C to $+125^{\circ}\text{C}$, and throughout extended operating life and shelf tests. DC leakage is low; maximum values at top mfd-volt ratings are in the order of 10 microamps, with actual test values typically around 1 to 2 microamps.

Ratings available: 2400 mfd, 15 volts to 180 mfd, 150 volts. Temperature rating: -55°C to $+125^{\circ}\text{C}$. The TL is designed to meet performance criteria of style CL55, per MIL-C-3965C and MIL-C-3965/21B.

CIRCLE 242 ON READER SERVICE CARD



No voltage de-rating needed on MTP wet slug tantalum capacitors

Many designers add their own "safety factor" by specifying a considerably higher voltage rating than actually needed for surge or steady state conditions in the circuit. With Mallory MTP miniature wet slug tantalum capacitors, you don't need to de-rate. And you can often save space and money by *not* de-rating.

How come? In the first place, we've already built in a generous safety factor in the stated rating on the capacitor. And second, we've found out by tests that operating at reduced voltage neither improves nor impairs performance of the MTP. We have extensive data in a recent engineering report, which we'll be glad to send on request.

As an example of the size savings possible, a 33 mfd, 60 volt MTP measures .225" in diameter by .775" long. But the same 33 mfd at 50 volts fits into the next smaller case size: .145" in diameter by .590" long. And the cost is about 13% lower. The MTP, incidentally, has the most capacity per unit size of any tantalum capacitor—up to 178,000 mfd-volts/cubic inch, or about five times what you can get in any solid electrolyte type. And it's made in the same high-reliability facility as similar Mallory capacitors for Minuteman II.

CIRCLE 243 ON READER SERVICE CARD

Heavy-duty alkaline batteries now available in flat cell design

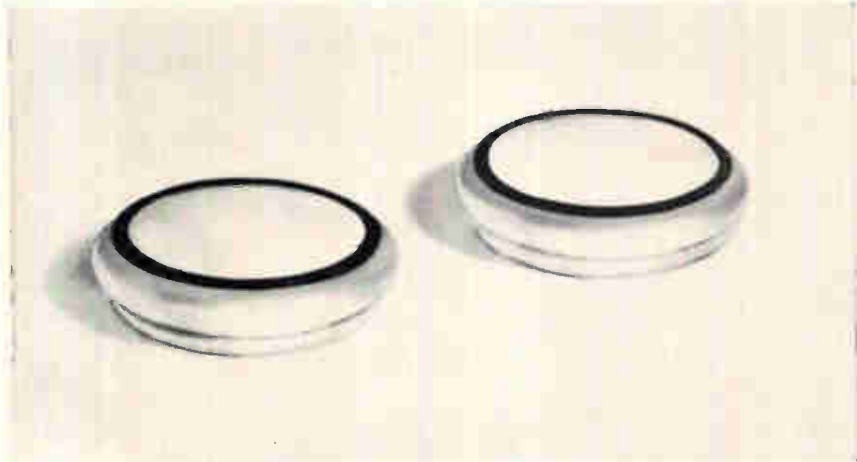

The alkaline primary battery system which Mallory has been making in standard flashlight cell sizes can now be obtained in a flat configuration similar to that used for certain mercury batteries. Currently available is a cell 0.9" in diameter, 1/4" high. Its capacity is 450 milliamper-hours. Nominal output is 1.5 volts. The case is made with flanged construction which fits into a matched receptacle in the end product to prevent insertion with reverse polarity. The case is gold

plated for minimum contact resistance.

This configuration often presents opportunities for miniaturization of equipment not practical with usual long cylindrical shaped cells.

The chemical system used in the flat cells has the same superior life qualities under heavy drains as other Mallory Alkaline Batteries. Other flat cell configurations can be made on special order.

CIRCLE 244 ON READER SERVICE CARD

Flat style resistors stack up to save space

Mallory Type F vitreous enamel fixed resistors have a flat configuration that can save space by stacked mounting. They are available in 30 to 75 watt ratings, equivalent to MIL-R-26 Styles RW20 through RW24. Their construction is similar to Mallory tubular vitreous enamel resistors. A strong ceramic core is uniformly wound to prevent hot spots, and coated with a moisture-resistant vitreous enamel.

Nominal wattage ratings are calculated with the resistor mounted on a 3/4" steel plate. Ratings should be



reduced 15% for non-metallic mounting surfaces. Resistance values are from 1 to 100K ohms.

CIRCLE 245 ON READER SERVICE CARD

Sometimes we worry about Jim becoming a Narcissist.

It all started with Celanar Polyester Film. We go to extremes to make it the cleanest, strongest, smoothest film available. Then challenge Jim, and our quality control experts, to find a flaw in it. But stare as he may, it's a rare day when Jim finds a wrinkle, a cross-buckle or other visual defect to mar his own reflection on a roll of Celanar. Which is enough to turn anyone into a narcissist.

The cleanliness of Celanar starts in our "White Room" production area at Greer, S.C., where air filtration systems trap dirt specks as tiny as 0.3 micron. But *clean* just begins to describe Celanar. It's stronger than the other polyester film. Retains its strength at elevated temperatures. Its gauge thickness is more uniform. We assure its



uniformity by radioactively inspecting every foot of every roll before it's shipped. And Celanar film has excellent aging characteristics, resists embrittlement.

What's more, we go a long way to supply Celanar in the roll lengths, widths, and gauges most convenient to you. Even guard it during shipment with temperature recording flags. Or impact recorders, when necessary.

Send for complete details about Celanar Polyester Film—and how we can help you make the best use of it. Celanese Plastics Company, Dept. 133-C, 744 Broad Street, Newark, N. J.

Celanese Plastics Company is a division of Celanese Corporation of America. Celanese® Celanar®



What's Bendix doing with over 250,000 different connector engineering drawings?

Offering you new connector innovations almost daily.

High on our ever-growing list of impressive newcomers is the new line of Bendix® JT "Pancake" connectors. These featherweights offer up to 128 contacts, yet reduce connector weight and length almost 60% to win hands down as the industry's smallest, lightest, off-the-shelf connectors now available. All are available with crimp or solder terminations, in nine shell sizes, eight shell styles, temperature range to 392° F

and 34 different insert patterns with 16-, 20-, 22-, and 24-contact sizes that will accept a wire range of 16 through 28 gage.

Keeping pace with developments like this are our other types of connectors. Included are series for pressurized and environmental-resistant requirements. Also Heavy-Duty and Waterproof types for power and control circuits in ground support equipment. Even Fireproof, High Voltage, Ordnance, Radio Shielded,

Potted, Dwarf, Pygmy®, Rack & Panel, Micro-Packaging and Printed Circuit models . . . for a grand total of 250,000 basic drawings covering 8 million different connectors all told. Every last one of them boasts design concepts and test procedures developed by Bendix which, more often than not, go on to become industry standards.

For complete information, contact us in Sidney, N.Y. Phone: (607) 563-9511.



Scintilla Division



Circle 79 on reader service card

THE ONLY SOLID-STATE AM/FM MODULATION METER

MODEL 2300

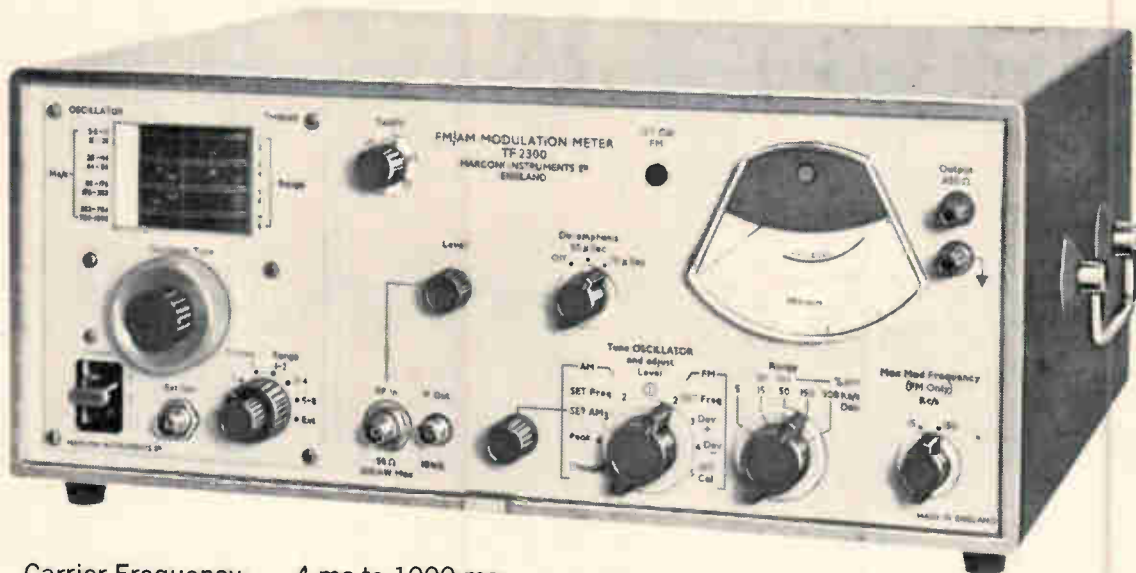

Carrier Frequency: 4 mc to 1000 mc

Sensitivity: 20 mV to 250 mc
50 mV to 500 mc
100 mV to 1000 mc

need we say more?

	<p>FM MEASUREMENT Peak deviation in five ranges of 5, 15, 50, 150 and 500 kc. Modulating frequencies 30 cps to 150 kc. Suitable for AM or FM broadcast (mono or stereo) TV Sound, telemetry and communications.</p>		<p>AM REJECTION. Less than ± 1 kc additional deviation error with 80% amplitude modulation superimposed at 1 kc using a 15 kc audio bandwidth.</p>
	<p>AM MEASUREMENT for carriers to 500 Mc. Two ranges of 30% and 100% (usable to 95%). Peaks or troughs switch selected. Modulating frequencies 30 cps to 15 kc.</p>		<p>L. F. OUTPUT Low distortion, low noise demodulated signal derived from FM or AM carrier. Switchable de-emphasis 50 μsec and 75 μsec. Level 0dB into 600Ω feeds distortion or wave analyser.</p>

WRITE FOR DETAILED CATALOG SHEET

MARCONI INSTRUMENTS

DIVISION OF ENGLISH ELECTRIC CORPORATION

111 CEDAR LANE

• ENGLEWOOD, NEW JERSEY •

(201) 567-0706

"SEE US AT IEEE—BOOTH 3601-3605"

SCIENCE/SCOPE

Air Watch. Hughes air defense systems will probe hundreds of miles of sky space, detect and follow even supersonic aircraft. Japan, Belgium, The Netherlands, West Germany and Switzerland will use them to size up threats and take instant protective measures.

Falcons for the F-4 Fighter. Now being delivered to the Air Force, Hughes new AIM-4D Falcon Missile combines advantages of two earlier models. Result is more effective, reliable, costs less. Infrared-guided, the AIM-4D is the latest of many types of Falcon air-to-air guided missiles built by Hughes for U.S. Air Defense.

Earth-Facing Satellites. A new breed of satellite equipped with weighted booms will constantly "look" earthward. Purpose of booms: to interact with the earth's gravitational field, keeping the satellite stable. Built by Hughes for NASA, the new ATS satellite family will conduct scientific studies in communications, weather, ion engines, solar radiation.

Wanted: Sharp Engineering Brains. In 1965, Hughes hired a record number of engineers to meet challenging demands in programs like BADGE, EARLY BIRD, PHOENIX and CORDS. Personnel people say 1966 will see even more engineers and scientists added to our West Coast laboratories and production plants. (For information on current openings, address D. A. Bowdoin, Hughes Aircraft Co., Culver City, California. An equal opportunity employer.)

Zero Defects Award to Hughes. In recognition of outstanding contributions to national defense through reduction in errors, Hughes recently won the coveted Air Force Zero Defects Achievement Award. Accomplishments like a 98% reduction in welding errors, an 85% improvement in accuracy of missile calibration, added up to a saving equivalent to 250,000 man hours in one year.

Planet Recognizer. A machine that would automatically categorize a planet's surface from a speeding space vehicle is being studied by Hughes Research Laboratories. Multivac Mark II, which recognizes patterns electronically, would "see" a planet via television and identify its surface by comparing it with a "landscape library".

New Technical Papers Offered. Recent available titles include: RR 341 "Linearization Based Upon Differential Approximation", RR 347 "Improvement of the Cluster Variation", "Electron and Ion Emission from Cesium Refractory Compounds", "Voltage Dependence of the Al-Al₂O₃ Barrier Height". For reprints please write: Technical Information Dept., Hughes Research Labs, 3011 Malibu Canyon Road, Malibu, California.

Creating a new world with electronics

HUGHES

HUGHES AIRCRAFT COMPANY

Circle 81 on reader service card

2/10 second
recorder response
over 10" span?

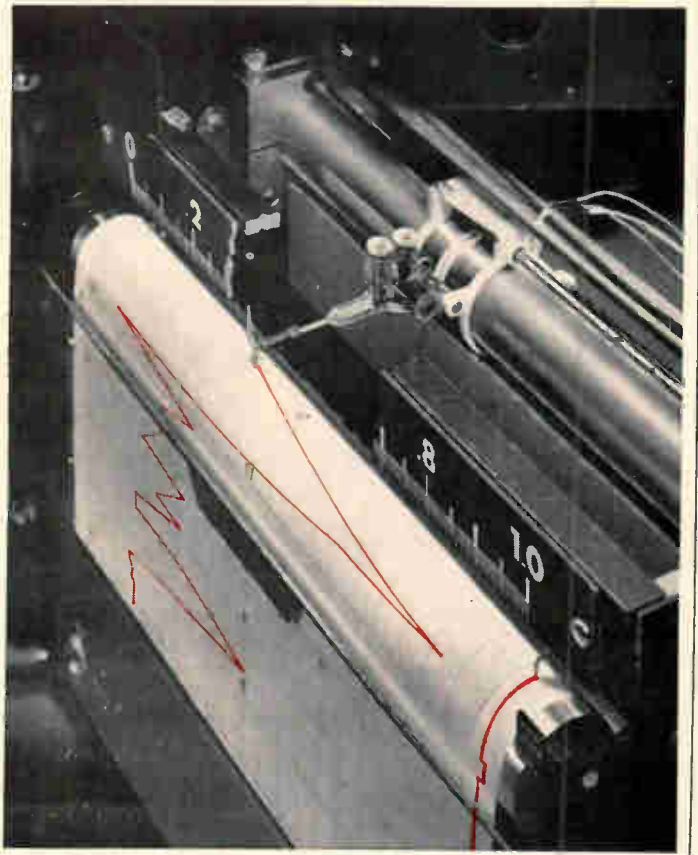

Only the pen moves. No pulleys. No drive cords. No gears.

Easy with Esterline Angus Speed Servo®

SPEED SERVO® FEATURES:

Response

2/10 second over full 10" span.

Speed Line Writing

Breaks state-of-the-art barrier with exclusive inertial ink pump. Writes legible record at any speed, even at speeds above 100 inches per second.

Input Impedance

500,000 ohms off-balance.

Accuracy

± 0.4% of span for any range.

Source Impedance

Meets all specifications to 50,000 ohms, maintains rated accuracy to 100,000 ohms.

Feedback Potentiometer

Effectively infinite resolution conductive plastic feedback potentiometer. Lasts thousands of hours longer than any wirewound potentiometer.

Adjustable Zero Adjustable Span (AZAS)

Zero elevation or suppression continuously adjustable from 0 to 100 MV for any span setting. Span continuously adjustable from 1 to 100 MV.

Solid State Amplifier

Has all silicon transistors. Has high input impedance because field-effect transistor is used.

Widest Chart Drive Selection

Choose from 15, 10 or 5 speed automatic drives. Dial speeds from 1/2" per hour to 8" per second.

■ Learn more about this exciting breakthrough in servo recording. Write for new Series "E" catalog.

Esterline Angus Instrument Company, Inc.
Box 24000E • Indianapolis, Indiana 46224

*Excellence in
instrumentation for
over 60 years*



ESTERLINE ANGUS

Technical Articles

**Designing microcircuits
with multipurpose chips:
page 84**

Two articles deal with building low-cost analog microcircuits. In the first, which describes Motorola's approach, the author proposes using a few versatile chips that can be produced in volume. The engineer can base his designs on them instead of developing specialized custom chips. The second article describes how breadboarding with general-purpose chips can speed design work.

**Keeping the heart alive
with a biological battery:
page 105**

Many people with heart trouble can lead normal lives with a cardiac pacemaker—but they live with the fear that the pacemaker battery may fail. Two scientists propose a system in which the body supplies its own lifesaving power: body fluids act as an electrolyte of a biological battery.

**For a good mixer, add
one FET:
page 109**

By using field effect transistors instead of point-contact diodes, an engineer can produce a simplified mixer for ulf television tuners. A mixer with an FET is less subject to cross-modulation and causes less intermediate-frequency skewing.

**Celestial successor to
inertial guidance:
page 115**

Electronics



The ancient art of navigating by the stars is being updated with modern optoelectronics. The big advantage is that space-ships can be guided and controlled without many of the mechanical products—such as gyros, gimbals and stable platforms—that can go awry. New electronic systems have been built to make stellar observations from earth with pointing errors of 30 seconds of arc; in space, free of atmospheric disturbance, the errors should be less than five seconds of arc. For the cover, Vincent Pollizzotto photographed a model of an electronic star tracker against a blue background that simulates the space environment it will operate in.

**Coming
April 4**

- Four kinds of digital voltmeters
- An electronic slide rule
- Celestial navigation system: part II
- Microcircuits reshape the scratch-pad memory

Reducing analog IC cost with multipurpose chips

A selection of standard chips with a number of components on each enables a designer to meet his circuit needs without resorting to custom design

By Grover Kennett

Motorola, Inc., Scottsdale, Ariz.

Volume production of a few versatile integrated circuit chips could propel IC's into the analog equipment field, where their progress has been hindered by high cost. In digital equipment, because of volume production, the impact of IC's has been profound and widespread.

Though IC's offer the same advantage in analog circuits as in digital—small size, light weight, reliability and low operating power—analogue system designers have been reluctant about them because they are a poor value. Digital IC's, on the other hand, usually are priced much lower than the total cost of the discrete components they replace. Add to this the valid savings provided by the reduction in interconnections and it's obvious why integrated circuits have been rushed into digital applications.

Why haven't the prices of analog integrated circuits dropped as did the prices for digital IC's shortly after introduction? The answer lies in the manner in which the market for digital IC's was developed.

Early in the game, many of the semiconductor-device manufacturers and government agencies accurately foresaw the need for a large volume of digital IC's and seized the initiative in develop-

ing them. Several IC families emerged; the manufacturers were able to achieve production capacity that enabled them to cut the IC price enough to compete with discrete-component circuitry.

Nonrepetitive functions

Unlike a digital system, even a relatively simple analog subsystem often requires a variety of nonrepetitive circuit functions. The need for large numbers of a specific functional circuit simply does not arise in analog circuits. Often, the needed circuits are not available commercially and must be custom-designed for the subsystem.

Versatility needed

Is there a solution? There could be with several versatile, multipurpose chips and a new approach to system design.

The idea is to have a selection of chips available to meet the designer's needs. If none approaches what he has in mind, the designer can still design around a few multipurpose chips rather than develop a full complement of specialized custom chips.

There are several ways to achieve chip versatility. One is to manufacture chips with a number of components on them and later arrange circuit configurations by using different masks.

Another is to design chips in which special circuits can be created by connecting or bypassing leads. A combination of approaches is also feasible.

If these techniques should lead to volume production, multipurpose chips could be reasonably priced. And they could offer the designer a large number of diffused components and, in some cases, thin-film resistors and capacitors. Depending on the interconnection pattern used, the same chip

The author



Grover Kennett is a senior engineer in the radar transponder section at the Western Center of Motorola's Military Electronics division. He has been designing radar equipment since he joined Motorola in 1956. He began investigating IC's for use in transponders in 1960.

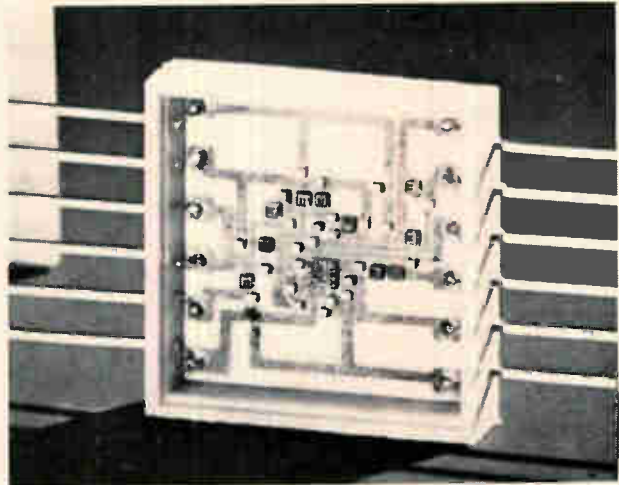
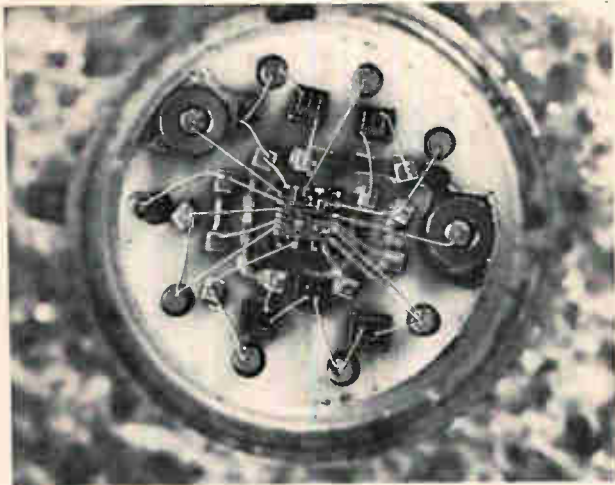

These two hybrid integrated circuits illustrate the partial integration concept. For example, the use of one multipurpose chip in the round package makes possible the housing of all the components in a JeDEC TO-5 package.

could be a small-signal intermediate-frequency amplifier, a video pulse amplifier, or a monostable multivibrator. Better still, by the appropriate choice of masks, two or more stages might be obtained from the same chip to cut down on the number of packages required.

Analog chips designed to be little more than a collection of components can be economical and practical, provided some careful thought is given to the selection of the components, their layout, and their values.

The general-purpose chip

Choosing appropriate transistors for a general-purpose (multifunction) chip is not a serious problem. Many transistors have been used widely. The 2N404, for example, developed originally for medium-speed switching, was the only transistor type used by one enterprising manufacturer in a six-transistor radio receiver. The 2N404's served as radio-frequency amplifiers, converters, intermediate-frequency amplifiers, and audio amplifiers.

A high-performance silicon planar transistor designed for general-purpose applications is the 2N708. It has been used in video amplifiers, multivibrators, switching circuits and even in small-

signal d-c amplifiers. Transistors similar to the 2N708 are a good choice for inclusion in a multipurpose monolithic chip.

More difficult to decide is the size of the chip and the number of components that it should contain. The chip should be large enough to hold a considerable number of components but small enough to ensure a very high yield when mass produced. At present, a chip area no smaller than 45 mils by 45 mils seems desirable because it can provide area for an adequate number of components with good yields. The number of components is limited not only by the chip area, but also

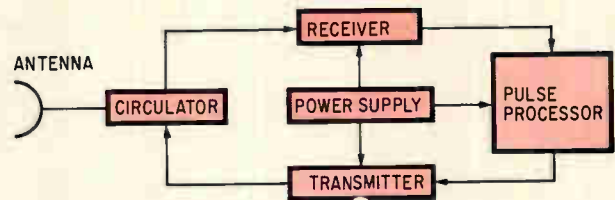

Simplified block diagram for a radar transponder. Pulse-processing portion of transponder consists of 11 sections, 8 of which can use the same multipurpose integrated circuit.

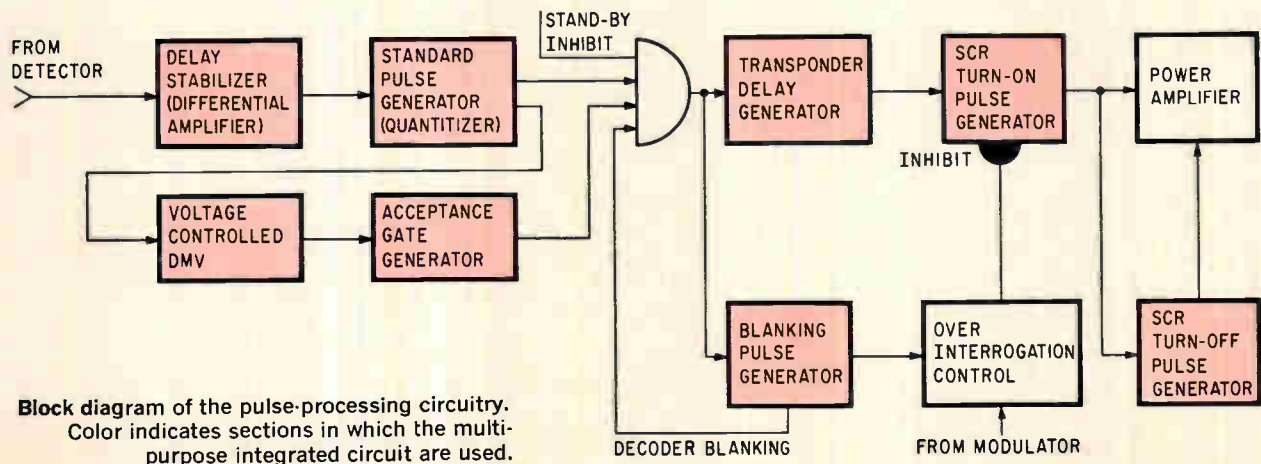

Block diagram of the pulse-processing circuitry. Color indicates sections in which the multipurpose integrated circuit are used.

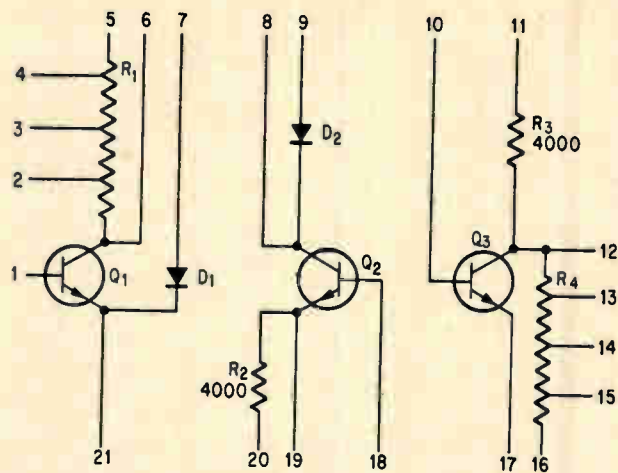

Multipurpose integrated circuit. Numbered are points at which connections may be made either by the metallization pattern or by use of external leads.

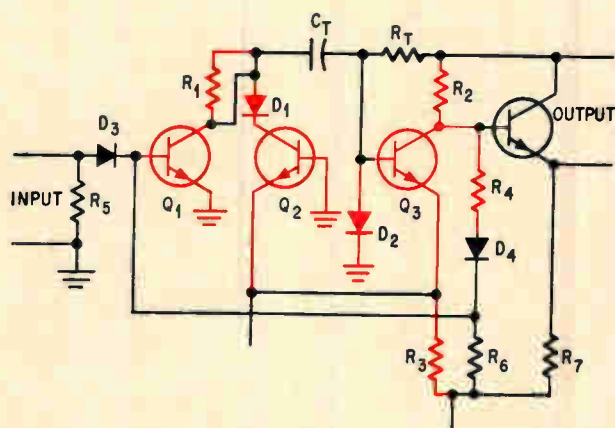

Delay generator uses nine components from the multipurpose chip plus eight others. Color indicates the multipurpose chip elements.

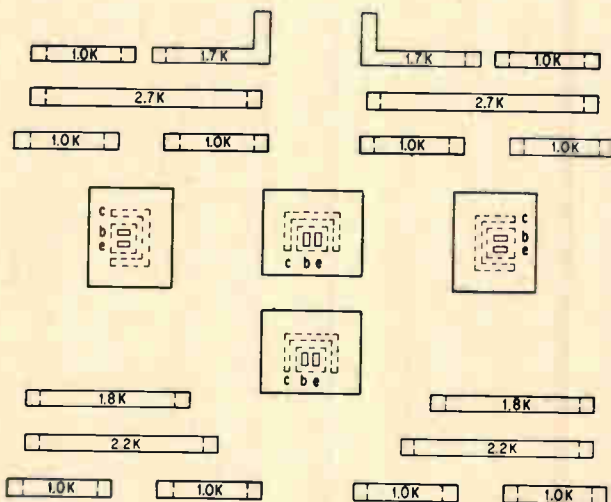

Typical layout for radio-frequency chip. Chip contains four diffused transistors and 18 Nichrome resistors. Applications are in radio-frequency amplifiers, intermediate-frequency amplifiers, broadband video amplifiers, oscillators, and mixers for the 10-Mc to 150-Mc range.

by the layout for applying metallization patterns.

Many amplifiers, multivibrators, and other basic circuits require less than six junctions (two for transistors and one for diodes). Studies indicate that three to six resistors per junction will usually give the designer adequate flexibility to design a circuit to meet his needs. Sometimes, the designer may find that he cannot get along with the selection of components. However, it may still pay him to use the multipurpose chip with another different one to get the component values he needs. Or he may find it economical to use a multipurpose chip in conjunction with a few individual-component chips—separate transistors or passive components—on a single substrate.

A few applications will help to demonstrate the feasibility of using multipurpose analog chips. As a test vehicle the concept was first considered for portions of a radar transponder.

Used in missiles

Radar transponders are used extensively in missile and aircraft tracking systems, and in navigational equipment.

It's important to keep them as small and light as possible. This leaves more room for the battery that often powers them.

The radar transponder is a microwave receiver that receives pulses from tracking radar, amplifies them, and feeds them to a microwave transmitter. The basic mission of the transponder is to amplify these pulses greatly to extend the radar tracking range or improve accuracy.

Often the transponder includes pulse-processing circuitry between the receiver and the transmitter. One function of this circuitry is to identify the particular transponder handling the signal through the coding contained in the radar signal. For example, the transponder may be designed to reply to a particular repetition frequency. If the radar is capable of transmitting groups of pulses, the identification code may be contained in the separation between pulses within the group.

Virtually all the transponder's receiver circuitry, its pulse-processing circuitry and the low-signal level portions of its transmitter, normally built with discrete transistor circuitry, can be constructed with integrated circuits. This includes intermediate-frequency amplifiers, video amplifiers, pulse-timing and gating circuits. Integrated circuits can also be used in the power supply regulator and the pulse drivers for the modulator circuit. Portions of the transponder that require transformers, such as the d-c to d-c voltage converter, the power supply and the high-power pulse modulator in the transmitter have not yet yielded to integration techniques.

Pulse-processing circuitry

A typical diagram for a transponder's pulse-processing section is shown on page 85. To establish the design of a multipurpose analog IC for use throughout the system, each block must be

analyzed and compared with the others to determine common components or circuit functions.

It has been found that the same basic circuit could be utilized in 8 of the 11 transponder pulse-processing blocks. This was possible even though the over-all functions of the blocks vary considerably.

The circuit is a delay monostable multivibrator consisting of three transistors, two diodes, and four resistors. The required resistor values vary from block to block, complicating the design.

A circuit diagram for the delay monostable multivibrator is shown on page 86. Twenty-one possible tie points are available. Thus with the appropriate mask, the circuit interconnections can be made to produce the desired block function.

In the circuit, resistors R_1 and R_4 are each 8,000 ohms, with taps at 2,200, 4,400, and 6,600 ohms, for flexibility in choosing collector loads. The chip actually contains five transistors but the base-to-emitter junctions of two of the devices are used for diodes D_1 and D_2 . The collectors and bases of these two transistors are tied together to remove the possibility that transistor action will occur.

Besides being used in eight of the blocks of the pulse-processing circuitry, the same multipurpose chip was evaluated for several other circuit jobs. It performed satisfactorily in video amplifiers, Schmitt triggers and d-c amplifiers.

Delay generator

A means of converting the multipurpose circuit to a particular circuit is illustrated by the diagram on page 86. Here nine components from the multipurpose circuit are combined with eight additional components to form a delay generator. The timing is easily controlled by adjusting external components C_T and R_T .

With slight changes in the external circuitry and by choosing appropriate values for C_T and R_T , the basic circuit can be changed to a standard pulse generator, a blanking pulse generator, a silicon-controlled-rectifier trigger or an acceptance-gate generator.

Radio-frequency chip

A suggested layout for a multipurpose r-f chip is shown on page 86. The chip contains four transistors with characteristics similar to the 2N918 (a gain-bandwidth-product of 750 megacycles per second) and 18 Nichrome resistors.

These 22 components may be used to form a large variety of video amplifiers, radio-frequency amplifiers, intermediate-frequency amplifiers, oscillators and mixers in many types of equipment. Typical applications would be radar transponders, pulse-radar equipment, continuous-wave radar systems, amplitude-modulation broadcast receivers, and frequency-modulation receivers.

Three possible configurations from the components on the multipurpose radio-frequency chip are shown on this page. These are a two-transistor cascode circuit for intermediate-frequency ampli-

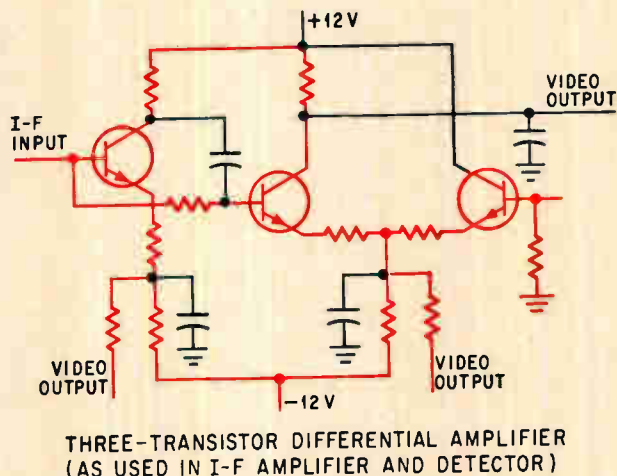
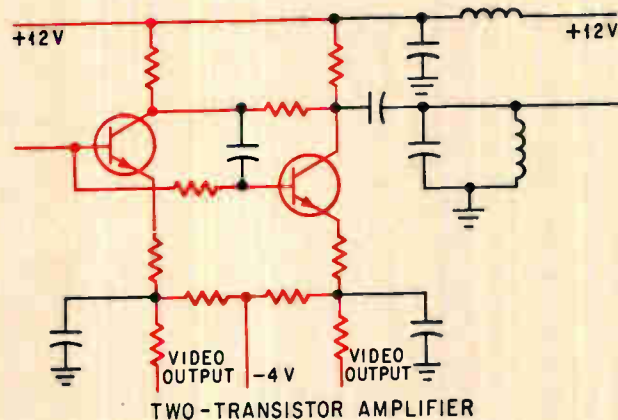
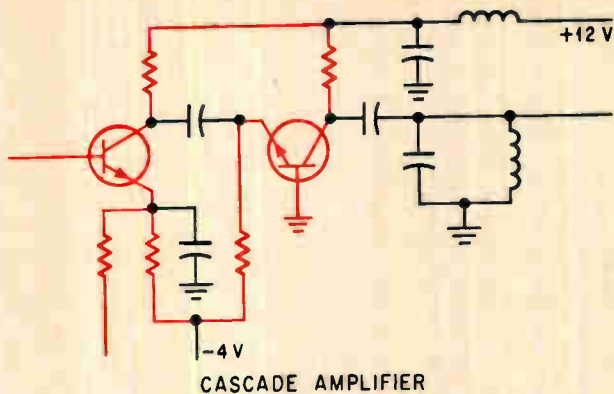

Three basic circuit configurations obtained with radio-frequency chip. Circuits are a cascode intermediate-frequency amplifier (top), a two-transistor, intermediate-frequency amplifier (center) and a three-transistor differential amplifier. Color shows multipurpose-chip portions of circuits.

fication; a two-transistor, common-emitter amplifier; and a three-transistor differential amplifier.

Logarithmic amplifier

All three can be combined to form a logarithmic intermediate-frequency amplifier. The gain supplied by the amplifier is linear for small signals. However, for input signals in the order of 10 to 20 decibels above the receiver noise level or larger, the output signals are compressed. For a 20- to 70-decibel range of input levels, the output will

increase by no more than 6 to 10 decibels. This compression is the only significant distortion imposed on the signal.

To form the linear logarithmic amplifier, the cascode circuit would be used at the input, followed by two common-emitter amplifiers and a video amplifier-detector. The last stage would include the differential-amplifier configuration shown in the figure on page 87. The anticipated over-all performance would be center frequency, 60 Mc; bandwidth, 12 Mc; small-signal power gain, 85 db.

Multipurpose advantages

Advantages of the multipurpose chip concept are:

- **Cost.** In many cases, the production cost of equipment built with multipurpose chips will be lower than if built completely with custom monolithic integrated circuits or completely with discrete components.

- **Size.** Space will be saved, although not as much as if only monolithic circuits were used.

- **Performance and reliability data.** A wealth of information concerning the multipurpose chip will be at the designer's fingertips.

- **Reliability.** A gain in reliability will result from using chips known to be dependable, from reduction in handmade interconnections and from elimination of particularly critical bonds by integration at critical points.

The multipurpose delay multivibrator has been built and successfully demonstrated in a radar transponder. As shown on page 85, the use of the multipurpose IC concept sometimes merely cuts down on the number of discrete chips used. Nevertheless this chip reduction pays off in increased reliability and reduced cost and design time. The multipurpose radio-frequency chip is still being evaluated and may be altered before final design.

General-purpose IC chips speed analog design work

Breadboarding with multipurpose IC's can bypass use of discrete components, cut costs, save time and more accurately represent the final circuits

By Jerome Eimbinder

Solid state editor

Systems designers at the Westinghouse Electric Corp. believe, as does Motorola, Inc.'s engineer Grover Kennett (see page 84), that multipurpose integrated circuits provide the best hope for successful analog system design. But Westinghouse engineers differ from Kennett in application of the chips—using them not in the final system but as a breadboard component. Once they've built a working system with the multipurpose chips, they optimize the design, combine functions and then redesign the IC's to reduce the number of chips and connections in the system. This usually eliminates the multipurpose IC's.

Recently, Westinghouse delivered two entirely different pieces of prototype equipment, each built with a number of the same type of analog (linear) integrated circuit. One was a helmet transceiver built for the Air Force; the other was a television

camera developed for the National Aeronautics and Space Administration.

Westinghouse believes the deliveries strengthen its contention that the fastest and cheapest way to build analog integrated systems is by using a general-purpose monolithic chip as a building block during the prototype phase.

With general-purpose IC's as breadboarding devices, Westinghouse says it is sometimes able to bypass working with discrete components entirely. In other cases, their use is reduced to a minimum.

Prototype of television camera designed for first Apollo lunar exploration mission. The camera's circuitry was based on more than 20 general-purpose Clem integrated circuits. It has a primary scanning rate of 10 frames per second with 320 scan lines.

Some companies begin system design by breadboarding circuits entirely with discrete components. After evaluating performance, they usually breadboard a second circuit capable of equivalent performance, but built with components believed compatible with monolithic IC design.

Besides savings in time and cost, Westinghouse engineers like breadboarding with general-purpose IC's because they get a better indication of the interactions and parasitics involved. They point out only one flaw in this approach, which they say is negligible and can be ignored: jumper wires are used to make connections. As a result, the capacitive interaction that occurs between deposited interconnections and the substrate in the final version of the IC will not be produced.

At the company's Defense and Space Center in

Baltimore, an engineer can pull a handful of general-purpose IC's out of a closet, and in a matter of hours or days, build a breadboard IC system. With other design methods, Westinghouse engineers say, it would take several months and cost \$10,000 or more for each monolithic chip needed.

The deliveries of the helmet transceiver and camera indicate that a decision made over five years ago by Westinghouse is paying off.

In 1961, two Westinghouse engineers, Michael Guiliano and Charles Hoffman, decided to test the feasibility of developing a general-purpose analog chip. Aided by other Westinghouse engineers, they designed a monolithic structure containing a transistor, three diodes, and a selection of resistors. They then used five of these chips, together with discrete components, to build an amplifier for use



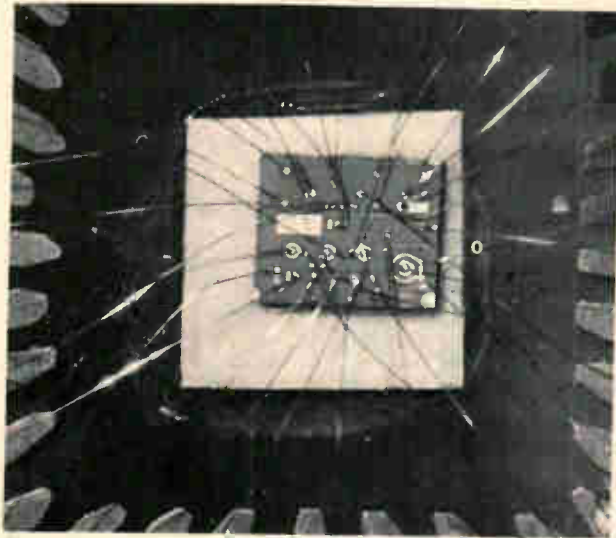

Mirt chip was the first general-purpose linear integrated circuit developed by Westinghouse. In 1961 it was used to build a prototype infrared search-track system and the IC is still being used.

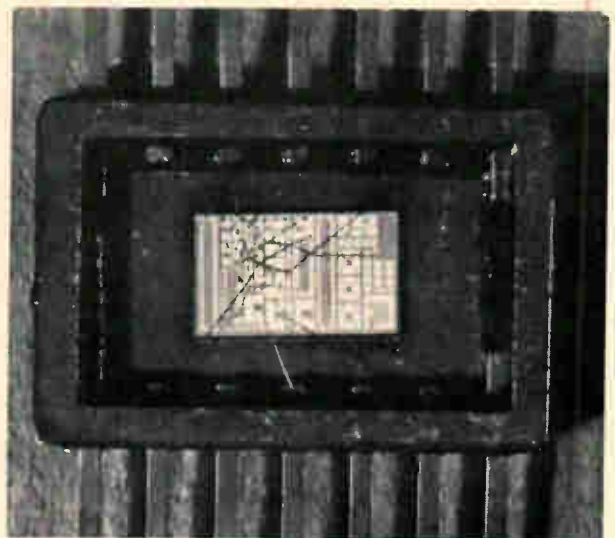

Newest of the Westinghouse general-purpose linear integrated circuits is Clem. Clem chips have 10 transistors, 6 pairs of diodes and 18 diffused resistors, which can be subdivided.

in an infrared search-track system. Once the basic circuit had been established, Westinghouse engineers refined and improved it, eventually winding up with a five-stage amplifier built on only two monolithic chips.

Since that time, Westinghouse has generally followed this pattern in building prototypes for analog systems. The final version of the camera will probably not use any general-purpose analog IC's. Once Westinghouse has created a working system with the general-purpose IC's, the engineers set out to redesign the system for optimum performance. The redesign is simplified by the choice

of resistors on the chip.

The Westinghouse arsenal of general-purpose analog IC's consists of four chips known as Mirt, Lava, Gem and Clem. More than one kind of chip can be used to breadboard an integrated circuit system. For example, the prototype of an integrated doppler radar system built by Westinghouse in 1964 contained both Mirt and Lava integrated circuits.

Mirt and Lava came first

Mirt stands for Molecular Infrared Track, the name of a Westinghouse system that uses the Mirt chip.

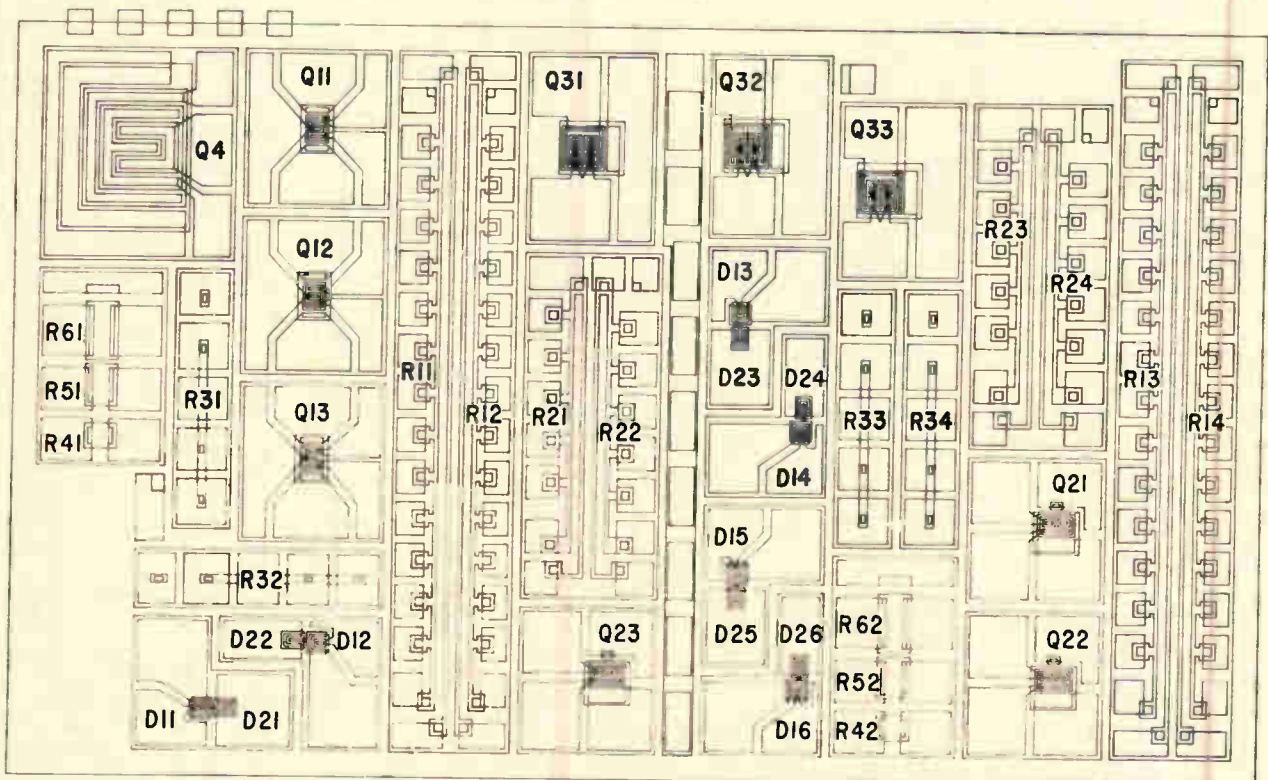

Breadboarding a circuit with a Clem block is simplified by sketching the connections on a diagram of the chip.

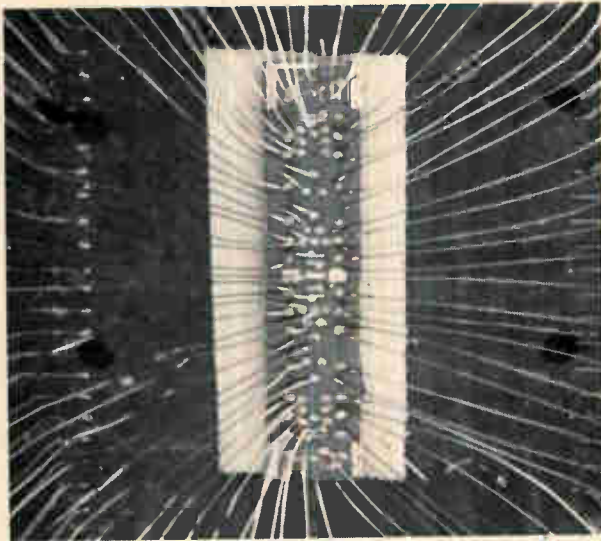

Gem chip has 5 pairs of transistors, 17 diodes and 92 resistors. A wide variety of linear circuit configurations may be obtained by varying the connections of its 88 leads.

Mirt is designed so that by bonding wires to large metal islands on top of the chip, the designer can select any of the components or tap off the desired amount of resistance.

The transistor in the Mirt IC has a small-signal current gain of 100 at a collector current of 100 microamperes, a collector-to-emitter breakdown voltage of 15 volts and a gain-bandwidth product of 50 megacycles per second. Resistance values from 2,000 to 200,000 ohms are available from the four resistors. Amplifiers built with Mirt chips have operated stably over a temperature range of -40° to $+85^{\circ}$ C.

At five years of age, the 32-lead Mirt IC is quite old in the swift-moving solid state technology, but continues in good use for breadboarding.

Lava has 88 leads

Lava is an acronym for Linear Amplifier for Various Applications. The Lava chip dates back to 1961 when it was developed by J. R. Cricchi and Wesley Jones. It has six transistors, four diodes, and 16 separate resistors. Ten of the resistors have several taps, effectively increasing the number of resistors available to 46.

The Lava transistors have a small-signal current gain of 20 at a collector current of 10 milliamperes, a collector-to-emitter breakdown voltage of 100 volts, and a gain-bandwidth product of 150 Mc. The diffused resistors can supply resistances from 10 ohms to 10,000 ohms. Chips with either p-n-p or n-p-n transistors are available.

If the leads are bonded to all of the connection points on the Lava chip, 88 leads are required. For ease in making connections, the device can be mounted on a block with connection strips sufficiently spaced for breadboarding use.

Gem was next

Gem stands for General Epitaxial Monolith. The Gem IC, developed in 1963, has five pairs of transistors, 17 diodes and 92 resistors.

A diagram revealing the components on the Gem chip is shown below.

The transistors have a small-signal current gain of 100 at 1 milliamperes, a collector-to-emitter breakdown voltage of 25 volts, and a gain-bandwidth product of 200 Mc at a collector current of 1 milliamperes. Resistor values from 50 ohms to 50,000

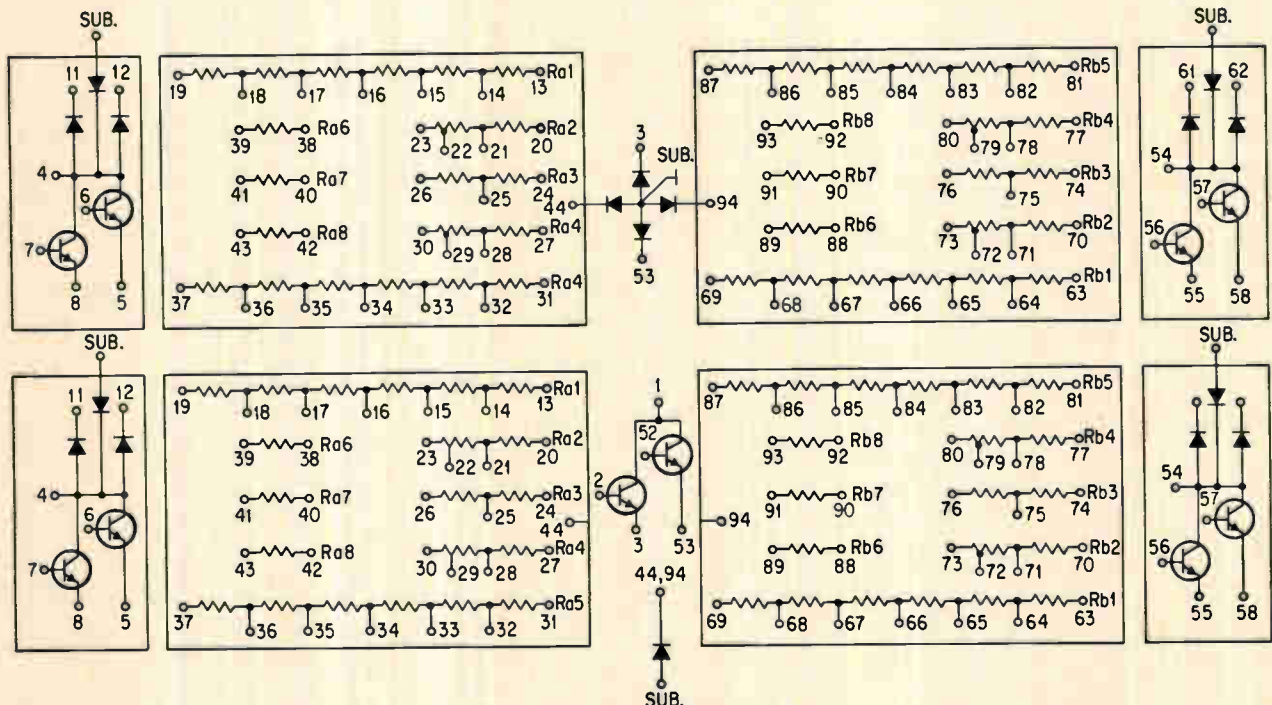

Gem chip offers more than twice the selection of components provided by the Lava chip. The Lava chip resembles the lower half of the Gem chip, but lacks the three diodes connected to the substrate.



Doppler radar system, built for the Air Force, demonstrated that it was practical to mix Mirt and Lava chips in breadboarding prototype equipment. Breadboarded system is in background. Bill List holds actual-size model of final equipment.

Molecular Infrared Track built by Westinghouse for airborne use. The system demonstrated the feasibility of using general-purpose chips to build prototypes.

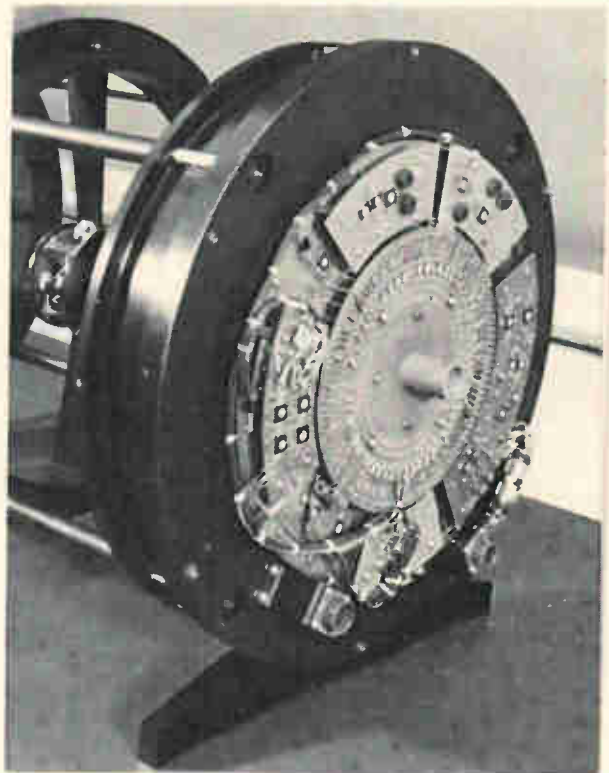

ohms can be obtained. Two versions of the Gem chip have been built: one with thin-film resistors deposited on top of the silicon dioxide insulation, the other with diffused resistors. Mirt, Lava and Clem are built only with diffused resistors.

And finally Clem

The acronym, Clem, is derived from Composite for the Lunar Excursion Module. The Clem circuit was developed in 1964 for the Apollo lunar television camera being built by Westinghouse. Work on Clem was conducted by the Aerospace division's solid state technology department, headed by Gene Strull. In the prototype camera delivered to NASA last month, more than 20 of the camera's 50 different internal functions were carried out by Clem IC's. These included saw-tooth generation, mixing, amplification, regulation, switching, driving and de-

tection. All linear functions were handled by Clem's.

The Clem chip has 10 transistors of four different types; six pairs of diodes; and 18 isolated tapped diffused resistors, which can be divided into more than 100 resistors. The resistors range in value from 50 ohms to 110,000 ohms. The transistors range in current-handling capability from 50 to over 200 milliamperes. One of the transistors has a gain-bandwidth product in excess of 500 Mc at a collector current of 10 milliamperes.

The helmet transceiver built with Clem IC's will enable astronauts to communicate with each other and with a spacecraft. The unit has six regular communications channels plus a guard channel.

Master slice

The Westinghouse general-purpose chips should not be confused with the master-slice series of integrated circuits introduced in 1961 by Texas Instruments Incorporated. Master-slice is a technique now used by several manufacturers to cut their IC production cost by using the same basic chip for several different circuits.

As do the Westinghouse chips, master-slice IC's contain a large number of components. However, in manufacturing master-slice IC's the metallization pattern is placed on the wafer before it is sliced into chips. As a result, it is the semiconductor manufacturer, not the system designer who chooses the particular circuit to be fabricated. The system designer cannot bond from component to component on the chip, as he can with the Westinghouse chips.

Examples of master-slice linear (analog) IC's are the Series 52 (operational amplifiers) and the Series 55 (video and sense amplifiers) circuits manufactured by Texas Instruments.

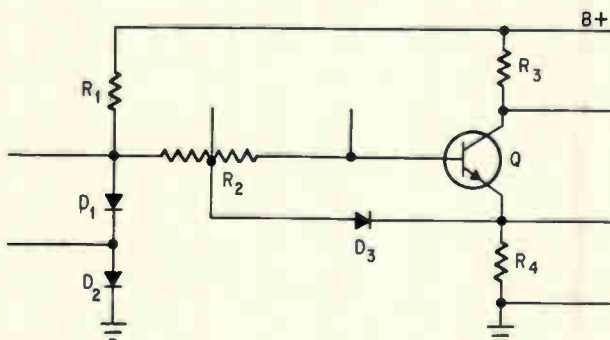

Typical single-stage amplifier configuration that may be obtained from a Mirt chip. A voltage gain of 50 over a temperature range of -40°C to $+80^{\circ}\text{C}$ is provided. The input impedance is 30,000 ohms. The average power dissipation is 200 microwatts when the stage is operated from a 3-volt supply.

Overlay transistors move into microwave region

At low-gigacycle frequencies, they outperform varactors and conventional transistor amplifiers

By Hon C. Lee and George J. Gilbert

Radio Corp. of America, Somerville, N.J.

Continued development of the overlay transistor has extended its high-power capability into the microwave region. An overlay transistor, the 2N4012, can now provide more than 2.5 watts as a frequency tripler at an output frequency of 1 gigacycle per second and has a collector efficiency of 25% or higher.

Thus, a single transistor can replace both the varactor multiplier and the power amplifier now used at L-band frequencies (0.39 to 1.55 Gc) for military and industrial microwave equipment. In telemetry systems and radio relay, a varactor diode usually performs frequency multiplication. Now, by replacing two devices—the varactor and a conventional amplifier transistor—one overlay transistor will simplify circuit design, reduce the over-

all space requirement and lower cost.

This is only the beginning. Within two years, overlay transistors with four times the power capability of the 2N4012 at L-band frequencies and the same capability at S-band (1.55 to 5.2 Gc) should be available.

High power

Meanwhile, the power levels achieved are already considerable. The 2N4012 can be operated as a doubler, tripler or quadrupler with outputs of one to three watts at frequencies in the low-Gc range.

The power output of the 2N4012 as a doubler, triple and quadrupler is plotted on page 94 as a function of frequency. In a common-emitter doubler circuit, the transistor typically delivers 3 watts of output power at 800 megacycles per second with a conversion power gain of 4.8 db. As a tripler, the 2N4012 supplies 2.7 watts of output power at 1 Gc with a conversion gain of 4.3 db; as a quadrupler, it delivers 1.7 watts at 1.2 Gc with a conversion gain of 2.3 db.

Double threat

The way overlay transistors operate to achieve amplification and frequency multiplication can be considered as two separate mechanisms. First, the transistor must be capable of delivering high power with gain at the fundamental or drive frequency. Second, the device must efficiently convert the power at the fundamental frequency to a harmonic frequency.

An overlay transistor can perform frequency multiplication because the capacitance of its collector-to-base junction varies nonlinearly with collector voltage, much as varactor junction capacitance varies with the diode junction voltage. This

The authors



Physicist George J. Gilbert has participated in the design and development of high-frequency transistors since joining RCA's semiconductor operation in 1958. He was a member of the team that developed RCA's first overlay transistor, the 2N3375.



Hon C. Lee also joined RCA in 1958. He has designed circuits for low-power and high-power high-frequency transistors and for varactor diodes. He is currently developing new amplifier and frequency-multiplier circuits using overlay transistors at microwave frequencies.

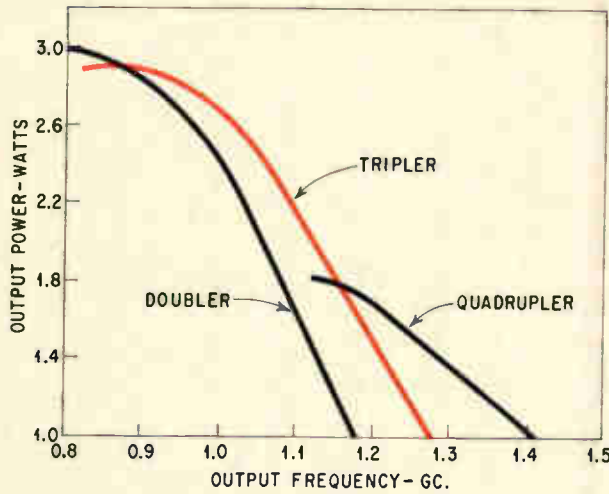

Output power levels obtained for the 2N4012 in doubler, tripler and quadrupler applications for one watt of input power. Measurements were made in common-emitter circuits.

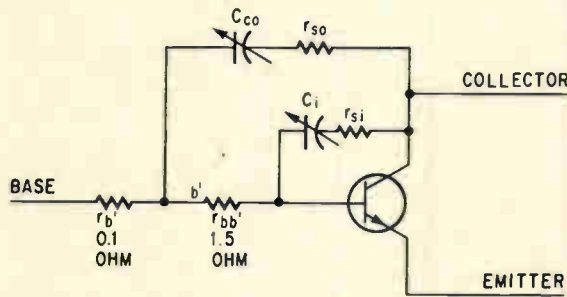

Equivalent circuit for the varactor portion of the overlay transistor. Varactor action results from nonlinear variation in collector-to-base junction capacitance with collector voltage.

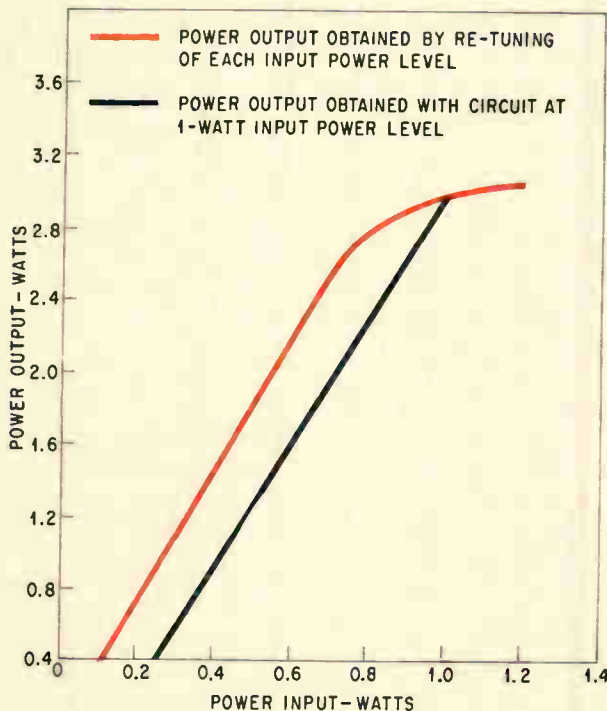

Output power from amplifier-tripler circuit using the 2N4012. Collector supply voltage is 28 volts.

nonlinear collector-to-base capacitance characteristic provides the rapidly varying function needed for harmonic generation.

How successfully the device performs each of its two roles can be measured by the figure of merit f_{max} , which is the frequency at which the power gain becomes unity, and the cutoff frequency f_{VCB} , which is the frequency at which the Q of the varactor is equal to unity.

The figure of merit f_{max} is also known as the maximum frequency of oscillation. It is given by:

$$f_{max} = (PG)^{1/2}f = \frac{1}{4\pi} \left[\frac{1}{r_{bb}'C_c\tau_{ec}} \right]^{1/2} \quad (1)$$

where PG is the power gain, f is the frequency of operation, r_{bb}' is the intrinsic base-spreading resistance, C_c is the collector capacitance, and τ_{ec} is the emitter-to-collector transit or signal-delay time. The value of C_c is directly dependent on the size of the collector area; r_{bb}' varies inversely with area; and τ_{ec} is a function of the emitter and collector resistances and capacitances.

Cutoff frequency

The cutoff frequency for a collector-to-base junction functioning as a varactor is given by:

$$f_{VCB} = \frac{1}{2\pi C_{min}(r_b' + r_s)} \quad (2)$$

where f_{VCB} is the varactor cutoff frequency; C_{min} is the minimum collector-to-base capacitance; r_b' is the extrinsic base spreading resistance; and r_s is the collector series resistance.

Most of C_{min} is contributed by the collector-to-base junction area which is not located opposite the emitter sites. This area is called the active portion of the varactor and the capacitance it contributes is known as the outer collector capacitance, C_o . The remainder of C_{min} is the capacitance of that part of the collector-to-base junction which is opposite the emitter-to-base junction. This is called the inner capacitance, C_i .

The collector series resistances associated with C_i and C_o are designated r_{si} and r_{so} . The locations of C_i , C_o , r_{si} and r_{so} are shown in the equivalent circuit for the overlay transistor at the left.

C_o is a much more efficient varactor than C_i , because C_i has to charge and discharge through r_{bb}' and r_b' , as well as through r_{si} , whereas C_o has to charge and discharge only through r_b' and r_{so} . Because the intrinsic base spreading resistance, r_{bb}' , is much greater than the extrinsic base spreading resistance, r_b' , there is a larger difference in the cutoff frequency, f_{VCB} , for the two parts of C_{min} . The large difference in r_b' and r_{bb}' arises from the difference in sheet resistance in the two areas. The sheet resistance under the emitter, which forms r_{bb}' , is several thousand ohms per square; the sheet resistance between the emitter and base contacts varies from 5 to 100 ohms per square.

If the emitter area is made a small fraction of the base area, C_o is kept much smaller than C_i .

In the 2N4012, the emitter area is made about one-tenth the base area and, hence, $C_i \cong 0.1 C_o$. As a result, the effect of C_i on the conversion efficiency is almost negligible.

The microwave overlay 2N4012 has 156 small square emitters which are tied together by a metalization pattern. Carley, McGeough and O'Brien have described how this construction can be used to produce large currents at high frequencies.

The transistor's n-material epitaxial layer dominates the collector series resistance. The thickness of this layer is kept to the minimum required to withstand collector-to-bias breakdown. Lowering the resistivity of the epitaxial layer might lower the series resistance but it would also increase C_{min} and f_{VCB} would remain constant.

Recently measured characteristics of the 2N4012 are: collector-to-base voltage, 65 volts; $r_{bb}' = 1.5$ ohms; $r_b' = 0.1$ ohm; $r_{so} = 1.8$ ohms; and $C_o = 3.5$ picofarads. From these values, calculations show that f_{max} is 800 Mc and f_{VCB} is 24 Gc for the 2N4012.

A frequency tripler circuit designed with a 2N4012 is shown at the right. It produces from

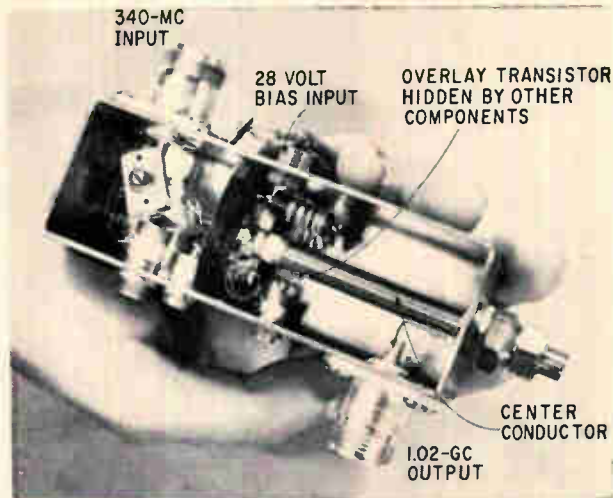

Combination amplifier-tripler uses one overlay transistor as both amplifier and frequency multiplier. The unit measures approximately 4 by 1 1/4 by 1 1/4 inches.

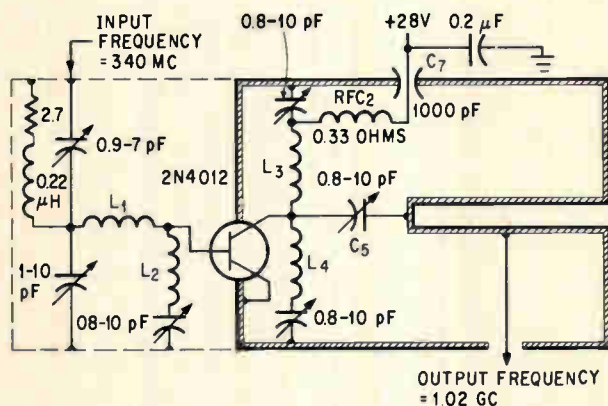

Amplifier-tripler circuit provides 2.9 watts of output power with a 1-watt, 340-Mc input and a collector supply of 28 volts. One overlay transistor can eliminate conventional transistor amplifier and chain of varactor frequency multipliers.

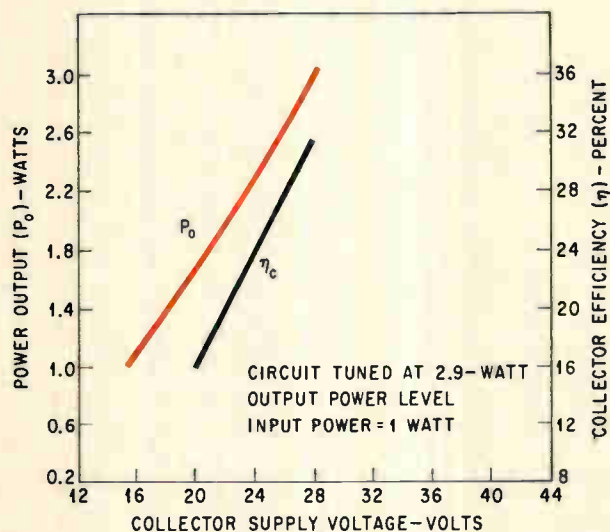

Tripler power output and collector efficiency rise linearly as voltage is increased. Curves are for a 340-Mc amplifier-tripler using the 2N4012.

2.5 to 3.5 watts at 1.02 Gc with 1 watt of drive power at 340 Mc.

The circuit uses lumped-element input and idler circuits and a coaxial-cavity output circuit. A pi-section input circuit consisting of C_1 , C_2 , L_1 , L_2 and C_3 matches the impedance of the 340-Mc driving source to the impedance of the base-to-emitter junction of the transistors. Inductor L_2 and capacitor C_3 return the collector-to-base junction (the junction acting as a varactor diode) to ground.

The 340-Mc idler loop is formed by L_3 , C_4 and the transistor. The second-harmonic (680 Mc) idler circuit consists of L_4 , C_6 and the transistor.

The output circuit is a foreshortened cavity 1 1/4 inches square. To permit adjustment of the electrical length of the cavity, lumped capacitance C_5 , Johanson type JMC 2954, is placed in series with the 1/4-inch diameter hollow-center conductor near the open end of the cavity. Output power at 1.02 Gc is obtained by direct coupling to a point near the shorted end of the cavity.

The output power of the tripler at 1.02 Gc as a function of the input power is shown on page 94. The collector supply voltage is 28 volts. The color curve is obtained when the circuit is retuned for maximum output at each increase in input level. The black curve is obtained when the circuit is tuned to an output level of 2.9 watts with 1 watt of drive at 340 Mc.

Output power and collector efficiency with the collector supply voltage at an input drive level of 1 watt is shown at the left. These curves are obtained with a collector voltage of 28 volts with the circuit tuned for an output power of 2.9 watts.

Several 2N4012's were tested both in a conventional 340-Mc amplifier circuit and in the circuit shown on this page. The power delivered by this circuit ranged from 60% to 75% of the power supplied by the straight-through amplifier. This is comparable to the efficiency that would be obtained with a good varactor in this frequency range.

Designer's casebook

Designer's casebook is a regular feature in Electronics. Readers are invited to submit novel circuit ideas, packaging schemes, or other unusual solutions to design problems. Descriptions should be short. We'll pay \$50 for each item published.

Voltage splitter balances floating power supply

By James M. Kasson

Santa Rita Technology, Inc., Menlo Park, Calif.

An ungrounded, or floating, power supply of V_0 volts can be converted to produce an output with a reference anywhere between zero and V_0 . While not as versatile as when two separate power supplies are used, this approach is considerably less expensive.

In the circuit below, a 24-volt d-c power supply is converted to an output of +12 volts d-c and -12 volts d-c. The 24-volt source used was a Harrison Labs 6202A.

With small heat sinks, the voltage splitter delivers unbalanced currents up to 700 milliamperes in either direction with a change in output voltage of less than 10 mv.

A balanced voltage divider R_1R_2 establishes a 12-volt reference voltage at the base of Q_1 . Q_1 and Q_2 form a differential amplifier, where the base of Q_2 is in the negative feedback path from the emitters

of transistors Q_5 and Q_6 .

When an unbalanced load is applied, the ground point tries to move up or down with respect to the plus and minus 12-volt lines. As a result, an error voltage, generated between the bases of Q_1 and Q_2 , is amplified by the common-emitter d-c amplifier Q_3 and appears at the base of the emitter-follower Q_4 . The error voltage from Q_4 acts to turn on either Q_5 or Q_6 , returning the ground reference to its proper position. Both output transistors cannot be on simultaneously; all unbalanced current flows through either Q_5 or Q_6 . When an unbalanced load is connected at the output, the impedance from ground to either the +12 or -12-volt line acts as the load for the emitter follower.

Resistors R_9 and R_{10} are used when the power supply is not current limited.

If only small unbalanced currents are required, the components to the right of the dotted line may be omitted. In this case, the emitter of Q_4 is grounded and a small protective resistor added in series with the base of Q_4 . When the circuit is operated this way, the permissible unbalanced current is determined by the quiescent current of Q_4 . The parts in the circuit shown below cost approximately \$6 in very small quantities. In lots of 100, the cost would be approximately \$4.

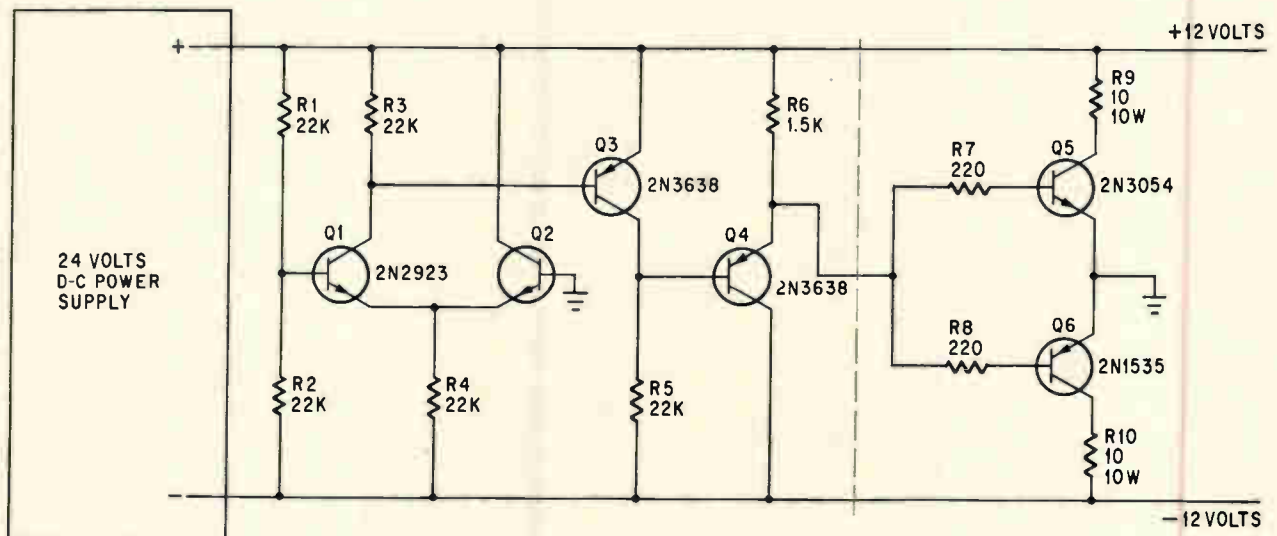

A 24-volt power supply is split into a ± 12 -volt output. Negative feedback loop permits unit to deliver unbalanced currents up to 700 milliamperes in either direction.

Bistable multivibrator immune to noise

By R. Wayne Simister

University of Utah, Radio-Television Services, Salt Lake City

When speed of switching is not an important factor, a bistable multivibrator can be made free from accidental triggering because of noise by adding a capacitor, shown as C_2 in the diagram, right. Such an arrangement makes it possible to use the circuit in a high-noise environment with high reliability and without special shielding or layout precautions.

This circuit has proved valuable in operating closed-circuit television and in controlling videotape and audio-tape recorders.

Capacitor C_2 bridges the collectors of Q_1 and Q_2 to eliminate the most stubborn case of noise triggering. If Q_1 is conducting, a negative noise pulse at its base could cause it to cease conduction. The resulting positive pulse from the collector of Q_1 through resistor R_2 to the base of Q_2 would normally allow Q_2 to go into full conduction. However, the decreasing voltage at Q_2 's collector is immediately fed back through C_2 to Q_1 's collector, thus suppressing the pulse and breaking the feedback path.

When Q_1 is cut off and a positive noise pulse arrives at the base of Q_1 , the negative-going pulse at the collector of Q_1 is shunted to ground through C_2 and transistor Q_2 , which is conducting. This

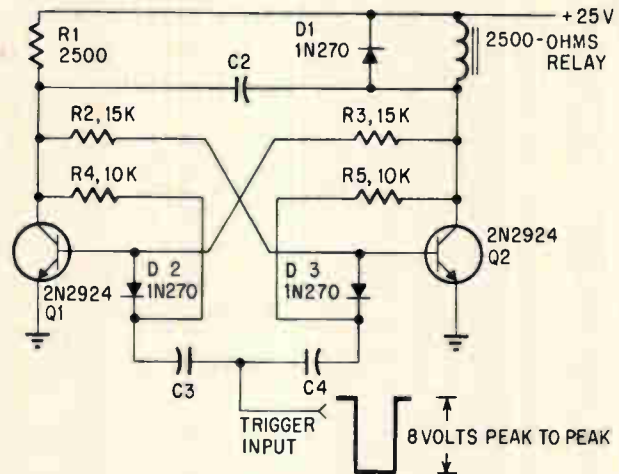

Addition of capacitor C_2 prevents accidental triggering of bistable multivibrator because of noise.

again breaks the feedback path for noise.

The larger the value of C_2 , the less susceptible to noise the circuit becomes, keeping in mind that the larger values reduce the frequency response proportionally. With C_2 equal to 0.1 microfarad in the circuit shown, the upper frequency limit accepted by the input is about 400 cycles per second. With C_2 at 0.47 μf , the limit is about 100 cycles per second. C_3 and C_4 should be half the value of C_2 to insure proper triggering and maximum speed.

In this circuit, a relay is used as Q_2 's collector load for alternately controlling other electronic circuits. D_1 , which normally protects Q_2 from the inductance of the relay when it is de-energized, can usually be eliminated because small inductive loads are bypassed to ground through C_2 and conducting transistor Q_1 .

D-c converter circuit uses capacitors

By J.M. Marzolf

U.S. Naval Research Laboratory, Washington

D-c to d-c converters usually employ transistors for switching elements, a transformer to change the voltage level and a rectifier to provide the d-c output. The circuit shown to the right eliminates the transformer and accomplishes conversion by alternately charging and discharging capacitors. Relative simplicity of design and the use of low-voltage components make this circuit useful in

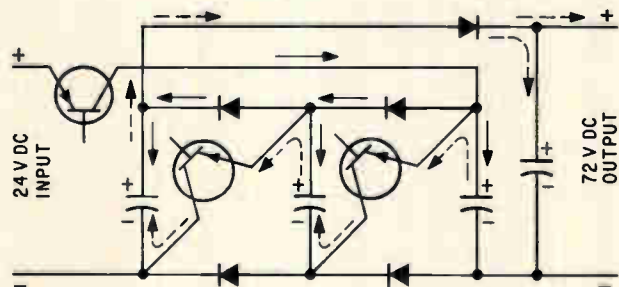

ALL TRANSISTORS 2N174 ALL CAPACITORS 1,000 μf ALL DIODES 1N250

Three-stage d-c to d-c converter. Solid arrows show the charge cycle; dotted arrows show the discharge cycle.

low-power, high-voltage battery applications. It might also be used for applications requiring low-magnetic fields such as magnetometer instrumenta-

tion circuits.

For voltage step-up, as shown in the diagram, the capacitors are charged in parallel and discharged in series. To step down the voltage, the capacitors are charged in series and discharged in parallel. The transistors, rectifier diodes and capacitors, with the exception of the output rectifier and filter capacitor, need only be rated at the input voltage level. Any number of stages can be connected to obtain an output at that multiple of the input voltage.

The transistors function as switches and are all driven simultaneously by phased square-wave pulses. A small static inverter generates the square-wave pulses. Other sources might be used, provided the pulses are electrically isolated from each other. The driving circuits are phased so that when the input transistor is turned on, the interstage transistors are turned off. The current flow will simultaneously charge all the capacitors in parallel, as shown by the small solid arrows.

During the discharge cycle, the input transistor is turned off and the interstage transistors are simultaneously turned on. This connects the interstage transistors in series and the capacitors discharge through the output circuit, as shown by the small dotted arrows. During the discharge cycle, current does not flow through the interstage rectifiers because they are all reverse-biased. The capacitor across the load, acting as an energy storage device, continues to supply power to the load during the portion of the cycle when the other capacitors are being charged.

The circuit was operated at approximately 2,500 cycles per second with 1,000- μ f capacitors. At a higher frequency, lower values of capacitors may

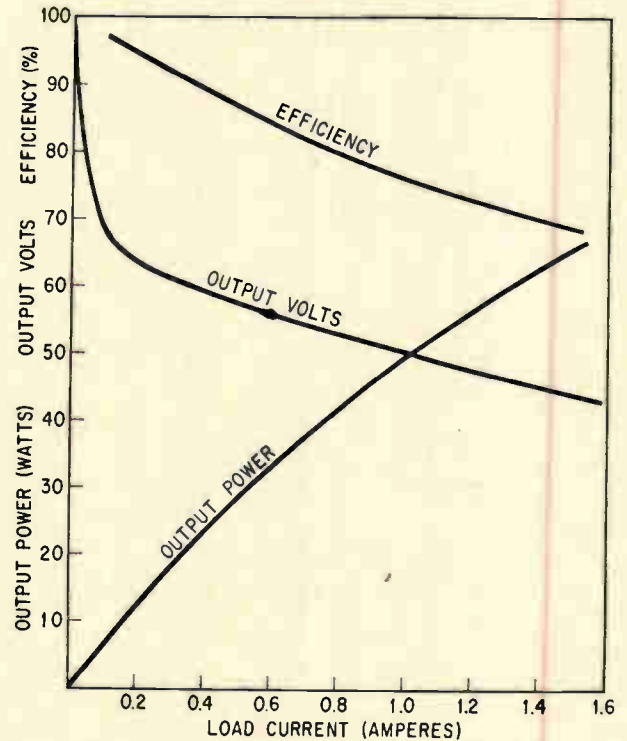

Output characteristics of the three-stage converter.

be used for the same output power. The output characteristics of this circuit are shown in the curves for output volts, power and efficiency as a function of output current. The driving power for the transistors was excluded in the derivation of these curves; however, it is relatively constant for all loads. The curves indicate a no-load voltage more than three times the input voltage. The switching spikes caused the higher output voltage, which led to poor regulation at very light loads.

High voltage, high current in electro-optic modulator

By Carl F. Johnson

International Business Machines Corp., Lexington, Ky.

Generation of high electric fields, usually required for light modulation, can impose severe current requirements on the high-voltage power supply. The arrangement above right uses switching tubes to minimize this current drain.

Light modulation employing the electro-optic, or Pockels effect, depends on applying an electric field to electro-optic crystals such as potassium dihydrogen phosphate (KDP), cuprous chloride (CuCl) and

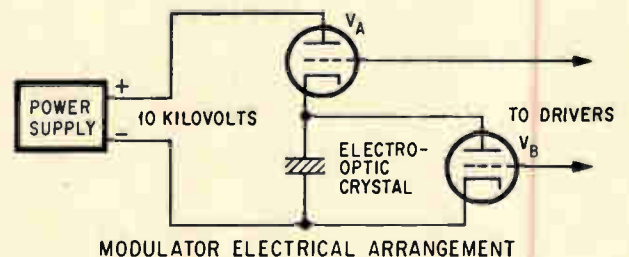

MODULATOR ELECTRICAL ARRANGEMENT

Electro-optic light modulator circuit. The high-voltage power supply is required to supply the electric field for the electro-optic crystal. Switching tubes V_A and V_B charge and discharge the crystal voltage.

others. Characteristics of these materials are given in reference 1. Under the influence of the electric field, the crystals become birefringent, changing the index of refraction and the velocity of light. This effect on the index of refraction also changes the

polarization of light passing through the crystal. The polarization change, which is a function of the applied electric field, results in an intensity change in the output light—if the output is viewed through a polarizer.

Relatively high fields across the electro-optic crystals are required to produce a polarization shift sufficient to vary the light intensity from full on to off.

Position of the crystal in a typical optical arrangement is shown at the right.

Pulse tubes V_A and V_B act as the switching elements. A 4PR65A is a typical tube to use as V_A and V_B . The operation is explained by assuming that initially both tubes are off and that the voltage across the crystal is zero.

To turn the light on, V_A is turned on with an input pulse, and the power supply voltage appears across the crystal. Because the crystal acts as a low-loss capacitor, V_A can then be turned off and the voltage will remain across the crystal. The crystal rapidly charges to the potential of the high voltage supply since tube V_A can conduct high peak currents for short periods of time.

Tube V_B is then pulsed on briefly to discharge the crystal voltage and turn the light off.

Short bursts of current through V_A and V_B control the state of the crystal so that the average current requirements from the power supply are low.

Light modulation by electro-optic materials is applicable in light-beam communication systems, facimile systems and in light-beam deflection for displays.

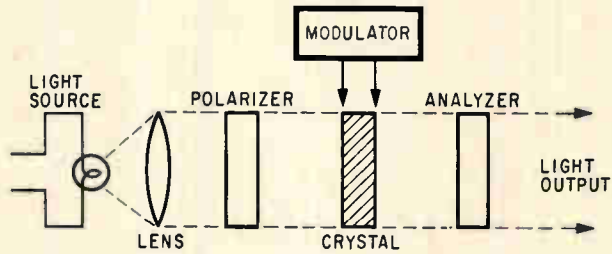

Optical arrangement shows position of the electro-optic crystal relative to the light source and modulator.

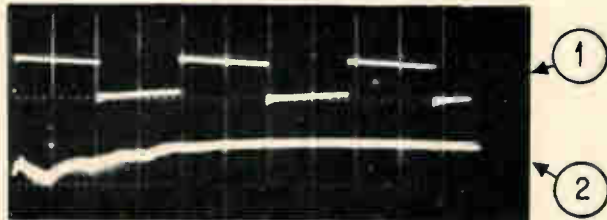

Detected light output in trace 1 shows the light being gated on for approximately one millisecond and off for one ms. The horizontal time base is 0.5 ms/cm. Trace 2 shows the leading edge of the detected light output. Approximately six microseconds (μ s) are required to gate the light on or off. Horizontal time base is 2 μ s/cm.

Reference

1. Richard A. Soref and Donald H. McMahon "Bright hopes for display systems: flat panels and light deflectors," *Electronics*, Nov. 29, 1965, p. 56.

Linear amplifier circuit eliminates transformers

By John Althouse

Escondido, Calif.

Modulation transformers at audio and ultrasonic carrier frequencies are bulky and expensive. They can be eliminated with the circuit shown in the schematic at right.

The linear modulator comprises an integrated-circuit operational amplifier and a field effect transistor. Since the circuit is linear and single ended, neither a filter nor transformer is needed.

If the input circuit of the operational amplifier at right is assumed to be a resistor, and if this resistance is varied to control the amplifier gain, then the resistance versus output voltage characteristic is hyperbolic. The drain source resistance versus

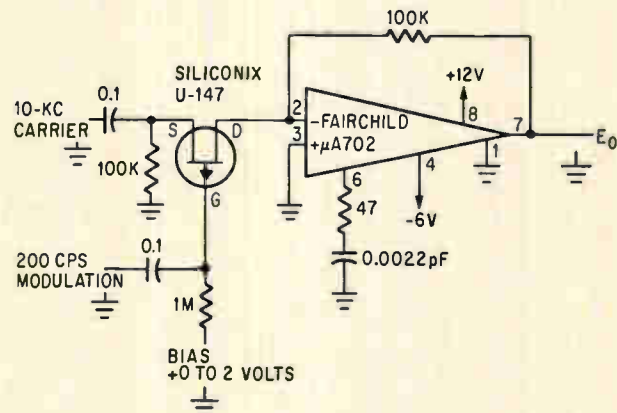

Siliconix field effect transistor replaces the modulation transformer in this linear amplifier circuit.

gate source voltage characteristic for a typical field effect transistor is markedly similar. Thus, the resistor may be replaced by an FET, and by applying the modulating signal to the gate, linear modulation of the audio signal may be obtained.

Carrier level is adjusted by d-c bias that sets the gate midway between zero bias and pinchoff.



This little latching relay



does everything this full size crystal can
latching relay does.

When size and weight are important considerations in specifying relays, take a look at Electronic Specialty Co.'s 55R series of half-size latching relays. These 2 PDT, 2 amp relays are electrically and mechanically interchangeable with full-size crystal can relays yet only half the weight and height (.4 in. x .4 in. x .8 in.). And, there are no higher quality relays made. The 55R series'

all-welded sealing insures cleanliness, eliminating fluxing and increasing efficiency. They meet or exceed MIL-R-5757D and withstand vibrations of 30G, 3000 cycles. A qualification test report is available.

That's the 55R series of relays by Electronic Specialty Co. (formerly from Iron Fireman Mfg. Co.). Send for a data sheet.



ELECTRONIC SPECIALTY CO. 18900 N.E. Sandy Boulevard, Portland, Oregon

In Europe contact Elektro-Metall, Dusseldorf, Germany

Nomograph simplifies design of f-m/f-m telemetry systems

Chart eliminates need for separate calculations for nonstandard data channels—reducing design time

By J.K. Pulfer and A.C. Hudson
National Research Council, Ottawa, Canada

When nonstandard data channels are required for an f-m/f-m telemetry system, the nomograph on page 103 permits rapid calculation of the channel parameters, and indicates the tradeoffs that result in the best system design.

In f-m/f-m telemetry, data is transmitted by frequency modulation of an audio subcarrier oscillator, which in turn frequency modulates an r-f carrier.

The flexibility of this telemetry system makes it attractive for many applications. A wide range of data formats, bandwidths and accuracy requirements may be met with a single f-m/f-m system.

However, data channels often require parameters that do not conform to the standard format specifications of IRIG (Interrange Instrumentation Group). For these, a separate design optimization must be made.

The authors



J.K. Pulfer, a research officer with the Council's space electronics section, is engaged in rocket telemetry and data processing. He was graduated from the University of Manitoba in 1953.



A.C. Hudson, who works on radar receivers and ultrasonics at the Council's Laboratories, was formerly employed by Research Enterprises, Ltd. He was graduated from the University of Toronto in 1941.

The relevant parts of a typical f-m/f-m system are shown by the block diagram on page 102. The parameters that specify each channel are listed on page 103, and these are interrelated by the nomograph. Quite often the carrier modulation index and the subcarrier signal-to-noise ratio (S/N), are unknown, but can be rapidly determined by the nomograph as shown by the examples in this article. At other times, these two parameters must be fixed; then with the help of the nomograph, the designer can determine other parameters, such as the input and output bandwidths that will suit the two fixed parameters.

Nomograph shows system limitations

The cross-hatched region on the input S/N ratio scale indicates a limitation imposed by the discriminator input threshold. The threshold may occur at any S/N ratio below about +12 decibels, depending on the design of the discriminator in use¹. If the input S/N ratio is below threshold, the discriminator output noise will contain an impulsive noise component as well as the inevitable Gaussian component. The user wanting to operate a system in this region must consider the effects of impulsive noise on his particular signal format, and interpret the output S/N accordingly.

The large cross-hatched region, shown in the center of the charts, represents a zone in which a significant portion of the signal spectrum will fall outside the discriminator input filter bandwidth.

The dotted boundary is based on an ideal rectangular filter. The solid boundary is based on a filter having a simple 6 db/octave roll-off. Most filters fall between these two extremes.

The complete nomograph is reproduced at the bottom of page 102 to illustrate the use of the chart in some practical examples. For each channel the nomograph is used twice, once for the first dis-

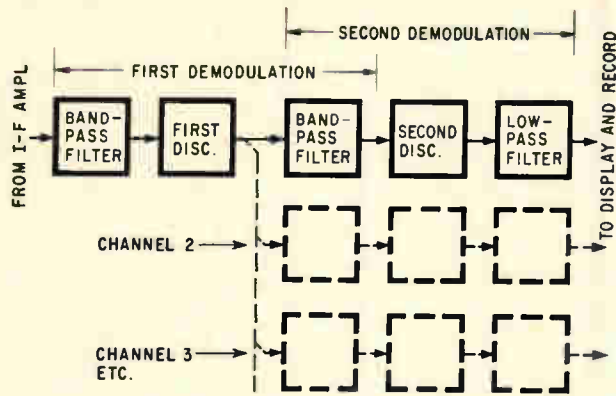

Parts of the f-m/f-m system to which the nomograph applies. The nomograph is used for calculations applying to the first discriminator and again, for the second discriminator.

criminator and once for the second discriminator. If the lines drawn across the nomograph enter either of the two cross-hatched regions, difficulties will occur as described above.

Example 1. Consider a 70 kilocycle-per-second subcarrier channel in a standard IRIG f-m/f-m system. Conditions at the second discriminator are:

- Second discriminator output low-pass filter bandwidth = 1.05 kc
- Second discriminator input filter bandwidth = 10.5 kc
- Deviation ratio = 5:1
- Desired output S/N = 40 db

The first step is to consider the second demodulator stage. The S/N input to the second discriminator can be determined with the aid of the nomograph.

Step 1

Draw a line from 1.05 on the low-pass scale at the left side of the nomograph through 10.5 on the input-filter bandwidth scale to intersection C_1 .

Step 2

Draw a second line from C_1 through 5 on the deviation scale to intersection C_2 . This line intersects the cross-hatched region, based on an ideal rectangular filter, but falls outside the area based on a filter with a roll-off of 6 db per octave. Because the discriminator input filter used with most IRIG f-m/f-m telemetry systems has a skirt slope greater than 6 db per octave, the error introduced by using the nomograph is small.

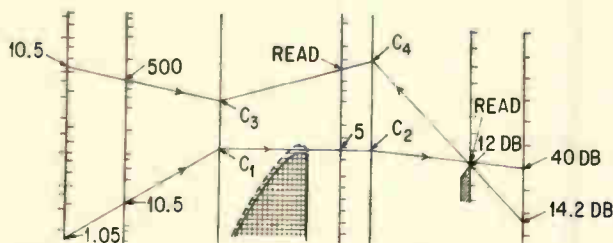

Reproduction of nomograph indicates the steps outlined in example 1. The effect of entering either cross-hatched region is described in the text.

Step 3

Draw a third line from C_2 to 40 db on the output S/N scale, and read its intersection with the input S/N scale as 14.2 db.

Having established that the input S/N ratio for the second discriminator must be at least 14.2 db, the nomograph is used again with values relevant to the first demodulator.

- Intermediate frequency band pass = 500 kc
- First discriminator output bandpass = second discriminator input bandpass = 10.5 kc
- The desired output S/N calculated above = 14.2 db
- A minimum input S/N = 12 db.

Step 4

Draw a line from 10.5 on the output bandpass scale through 500 on the input filter scale to intersect C_3 .

Step 5

Draw a line from the output S/N of 14.2 db through the input S/N of 12 db to intersection C_4 .

Step 6

Join C_4 and C_3 , intersecting the modulation index scale at 0.27.

Thus, the necessary modulation index for the 70-kc subcarrier is 0.27. This means that the carrier peak deviation caused by the 70-kc subcarrier is 0.27 by 70, or 18.9 kc.

The line joining C_3 to C_4 is well above the cross-hatched region, indicating that the i-f bandwidth will not be fully used. There are two reasons for this: first, the remainder of the subcarriers and the resulting increased overall carrier deviation has not been taken into account; second, a small factor of safety has been inserted in the standard IRIG format to allow for transmitter frequency drift.

Example 2. Consider a situation in which the output bandwidth and S/N ratio, required by the data to be telemetered, cannot be met by any of the standard IRIG channels:

- Second discriminator output low-pass filter bandwidth = 1.5 kc
- Required output S/N = 45 db

This channel is to be interleaved with a standard system, so that all other parameters—such as a subcarrier deviation of $\pm 7.5\%$ —must remain unchanged. If the data bandwidth is increased to 1.5 kc, while maintaining the deviation of $\pm 7.5\%$, then the deviation ratio will be decreased to 5 by $1.05/1.5 = 3.5$.

Proceeding as before, the required S/N ratio at the output of the first discriminator this time is 24 db. Using this result, a second pass through the nomograph shows that a carrier deviation of ± 57.4 kc is needed for this channel.

Reference

1. Kenneth M. Uglow, "Noise and Bandwidth in F-m/F-m Radio Telemetry," IRE Transactions on Telemetry and Remote Control, May 1957, p 19.

Nomograph for design of f-m/f-m telemetry system

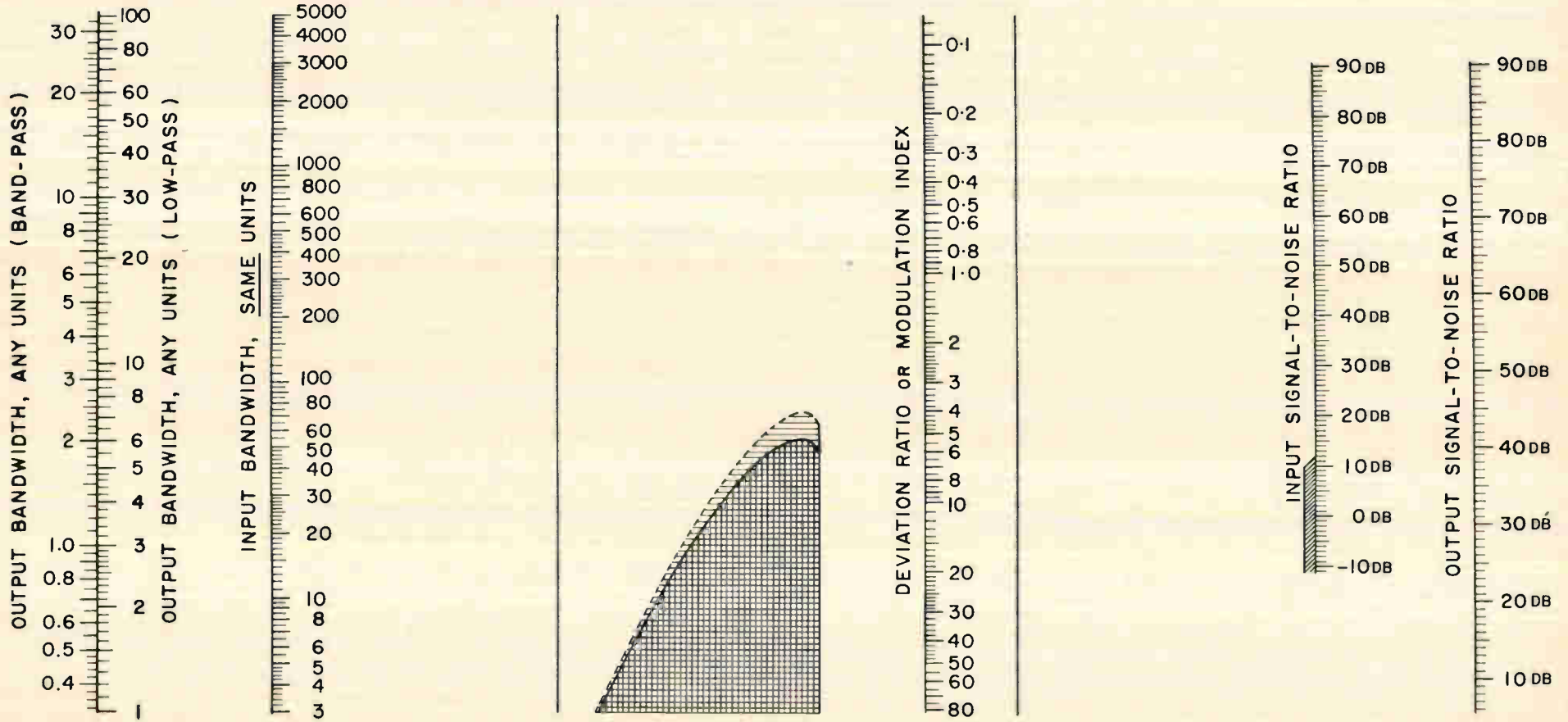

Data channel parameters

- | | |
|-----------------------------------|------------------------------------|
| Input filter bandwidth | Subcarrier deviation ratio |
| Subcarrier input filter bandwidth | Carrier signal-to-noise ratio |
| Data channel (low-pass) bandwidth | Subcarrier signal-to-noise ratio |
| Carrier modulation index | Data channel signal-to-noise ratio |

THESE CON AVIONICS POWER SUPPLIES COSTS \$200 LESS THAN THE GOING RATE. WHAT DO YOU TRADE OFF WHEN YOU BUY THEM?

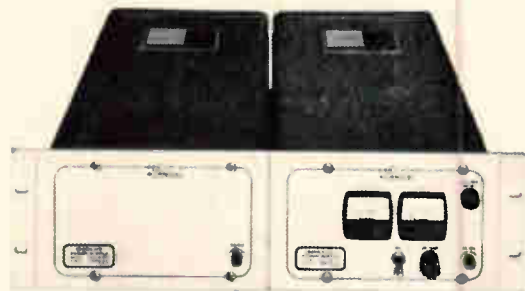

This rack holds two HS power supplies. Each power supply is rated at 12 volts, 20.5 amps.

NOTHING.

You certainly don't trade off quality. Our power supplies are guaranteed unconditionally for five years. They have an M.T.B.F. of 35,000 hours, calculated according to Mil Handbook 217. Silicon transistors are used exclusively.

The secret in manufacturing these units for \$200 less than the going rate is designing systems power supplies right from the start. (Most other manufacturers just warm over their designs for lab supplies.) So our way, with a lot of value analysis and some new techniques, we're able to pack a lot of value into just 5¼" of panel height.

If you buy systems power supplies it could very well be worth \$200 to you to have Con Avionics' data available.

PARTIAL SPECIFICATIONS

INPUT: 105-125 VAC, 47-63 cps
REGULATION: (Line and load combined) $\pm 0.05\%$
RIPPLE: 1 mv RMS max
RESPONSE TIME: 25 microseconds
TEMPERATURE COEFFICIENT: 0.015%/°C or 18 mv/°C., whichever is higher
TEMPERATURE: 75°C max.
M.T.B.F.: 35,000 hours
GUARANTEE: 5 years, unconditional

The entire voltage range between 0 vdc and 51.0 vdc is covered in 42 models. Currents range from 5.5 amps to 46.0 amps. Wattages from 55 to 816.

A DIVISION OF



CORPORATION

CONSOLIDATED AVIONICS

800 SHAMES DRIVE WESTBURY, L.I., NEW YORK / (516) ED 4-8400 TWX: 510-222-6151

See us at IEEE Booth 1A26

Keeping the heart alive with a biological battery

Body fluids, acting as an electrolyte, may enable implanted electrodes to provide longer-lasting battery for pacemakers that keep faltering hearts beating

By O.Z. Roy and R.W. Wehnert

National Research Council, Ottawa, Canada

With cardiac pacemakers, many people with heart trouble are able to lead lives that are normal in many respects except one—fear that the pacemaker battery may fail. This concern has led to experiments in making the body a partner in supplying its own lifesaving power.

Although body fluids can act as an electrolyte in generating enough power for a pacemaker, researchers still must find the most suitable metals for the electrodes and the best sites for implanting them. It is conceivable that the stimulator and power source can be implanted right in the heart.

When it first came into common use, the pacemaker—which stimulates the beat of faltering hearts electronically—was considered to have a life

expectancy of four to five years. Subsequently, this figure was reduced to 15 months. Improvements in lead construction, component selection and impregnation techniques have reduced failures considerably, but the pacemaker's life is still limited by the life of the power source.

Heart stimulant

To stimulate the heart with electrodes sewn on its muscular tissue, 16 to 20 microjoules are required. This energy is usually transferred to the heart in the form of a pulse with a duration of two milliseconds. The stimulus rate is usually set to produce 60 to 70 heartbeats per minute. The average current then drawn from the battery is about 50 microamperes. This includes the current required to overcome all losses in the pulse circuitry. To operate 10 years, the battery should have a capacity of 4.5 ampere-hours.

Many cathode and anode materials have been tested for use with a body fluid. Over the past two years at the University of Toronto's Banting Institute, such work has been directed by Dr. W.G. Bigelow, an assistant professor of surgery at the university and chief cardiovascular surgeon at Toronto General Hospital. For cathodes, platinum black, silver and silver chloride have proved most consistent in potential developed and capacity. Materials of pure zinc, iron, and carbon or mild steel have also been tried for anodes. Zinc appears superior to the others, but results are inconclusive.

When platinum black or silver is used with any of the anodic materials tested, the body fluid supplies not only the electrolyte, which provides ionic conduction between the electrodes, but sufficient

The authors



O.Z. Roy has been an engineer at the instrument section of the Radio and Electrical Engineering division of the National Research Council since 1956. He is a member of the International Federation for Medical Electronics and Biological Engineering.



R.W. Wehnert has been designing medical electronic equipment since joining the National Research Council upon graduation from the Ryerson Institute of Technology in 1961.

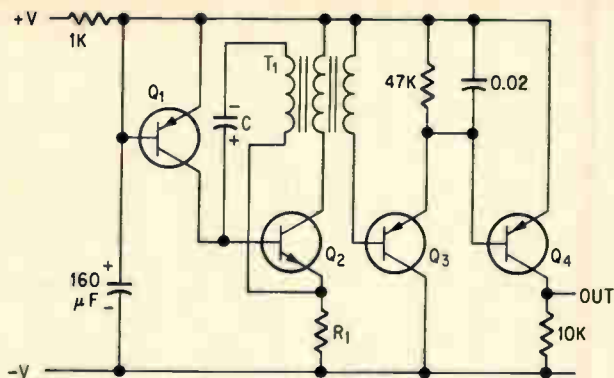

Early body-fluid pacemaker used rectifying action of base-emitter junction of transistor Q_2 to enable oscillations from ringing-choke oscillator to charge C_1 . Voltage on capacitor C_1 is raised by charging to a level that cuts Q_2 off. Then C_1 is discharged to create output pulse.

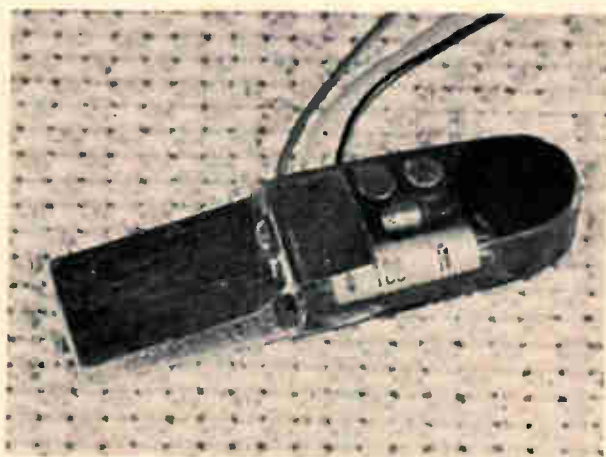

Pacemaker is encapsulated in epoxy for rigidity and protection. Extending outward at the left are flat plates which form the electrodes. Electrodes and pacemaker were separated by leads in later designs.

oxygen to serve as the depolarizer at the cathode. With a 50-microampere drain, such a battery needs oxygen at the rate of 0.01 cubic centimeter an hour for depolarization. Some typical measurements made on a galvanic cell with a 50-microampere load are in the table at the right. These measurements were made over a period of several weeks at room temperature with the electrodes immersed in a normal saline solution.

When platinum black and carbon or mild steels are used as electrodes, the steel behaves galvanically like iron. It even corrodes at the same rate. Steels with higher chromium content, however, make poor cathodes, since the chromium retards corrosion and the amount of energy produced is insufficient. A battery with silver chloride and zinc electrodes operates well within the body and produces a potential difference of 1 volt at currents up to 10 milliamperes. This power source has its own depolarizer, chloride, and the body fluids behave as the electrolyte.

Of anodic materials tested, it seems that zinc is superior in potentials developed and capacity. Silver

Old technique

When Alessandro Volta immersed silver and zinc in jars of salt water in the early 1800's, he caused electric current to flow, forming the first galvanic cell.

The principle he discovered remains in use. All galvanic cells consist of an anode, a cathode and an electrolyte. The cathodes are characterized by the ease with which they accept electrons; in so doing they are reduced to a lower state of oxidation. Usually noble metals, such as platinum, gold and silver serve as cathodes. However, lead oxide, silver chloride, nickel oxide and other compounds can be used.

Anodic materials are metals such as lead, iron, cadmium, magnesium or zinc. These metals part readily with electrons, dissolving to form positively charged ions in the electrolyte. This is an oxidation process.

Oxidation and reduction processes are both accompanied by chemical changes and all of these changes take place in accordance with Faraday's law of electrolysis. This law states in effect that to produce a battery of 26.8 ampere-hour capacity, one equivalent weight of material is liberated at each electrode, where the equivalent weight is the atomic weight divided by element's valence. This then gives an index as to how much material will be used to convert chemical energy to electrical energy for any given battery capacity.

chloride-zinc and platinum black-zinc batteries have been implanted in dogs and rabbits for periods of up to nine months without ill effects. Other studies also confirm that large quantities of zinc can be tolerated by animals with no apparent ill effects.^{1, 2, 3, 4, 5}

Pacemakers in animals

The circuit diagram of the first series of body-fluids pacemakers tested in animals is shown above. The circuit consists of a ringing-choke oscillator with feedback supplied to the base of transistor Q_2 by the secondary winding of the transformer T_1 . The rectifying action of the base-to-emitter-junction of Q_2 lets the oscillations charge the capacitor C_1 until Q_2 is cut off. The transistor Q_2 remains off until C_1 has been discharged through the resistor R_1 and the constant current source Q_1 to sufficiently lower the base bias to its original value. The current source serves to stabilize the output rate of the stimulator against variations in the battery voltage. With a resistor in the base

Galvanic cell measurements

Cathode material	Anode material	Voltage (volts d-c)	Anodic material loss
Platinum black	Zinc	0.9 to 1.0	550
Platinum black	Iron	0.5 to 0.6	468
Platinum black	Mild steel	0.5 to 0.6	468
Silver	Zinc	0.8 to 0.9	550
Silver chloride	Zinc	1.0 to 1.1	550

Typical measurements of batteries with different electrode materials immersed in a saline solution. The anodic material used as fuel is calculated in milligrams per year.

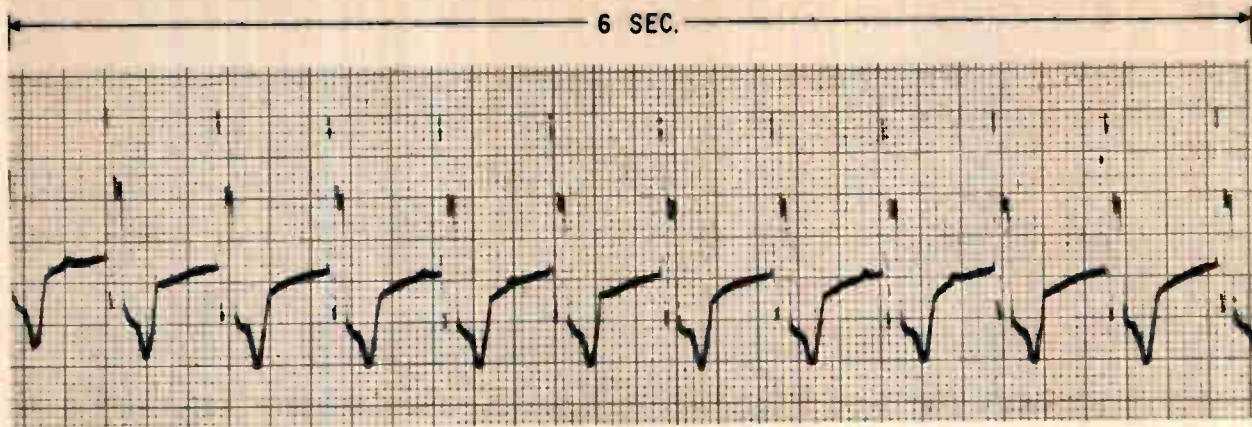

Electrocardiogram of dog's heart stimulated for a month by pacemaker powered by body-fluid energy. The stimulator has maintained the dog's heart rate—120 beats per minute—for 13 weeks now with no ill effects.

biasing circuit, the rate of the pacemaker output varied from approximately 30 beats to 180 beats per minute for battery voltage changes from 0.5 to 1.5 volts.

The remaining circuitry acts as an impedance transformer that matches the heart to the pulse circuit. At a battery voltage of 1 volt, the stimulator produces a 0.9-volt pulse of 8 milliseconds duration into a 500-ohm load at an average current drain of 50 microamperes.

Stimulators of the type shown in the photograph on page 106 were implanted into a series of dogs in whom a heart block had been induced. The battery electrodes used were either platinum black-zinc or silver-zinc. The cathodic material was either implanted just beneath the skin or beneath the skin near well oxygenated tissue such as muscle. The anodic material was separated from this cathode by 1 to 20 centimeters: for example, the platinum-black electrode near the muscle of the right flank and the zinc electrode in the abdomen. Separation, it was found, had very little to do with performance of the pacer. The stimulating leads were attached to the heart on the surface of the right ventricle.

It was found that this stimulator did capture and control the heart's beats and worked well for a period of 48 hours. After this time, the heart muscle ceased to respond to the stimulus. Upon investigation it was found that the resistance of the heart had risen, either through fibrosis around the leads or chemical changes in the tissue beneath the stimulating electrodes. And a one-volt pulse was now insufficient to transfer enough energy into the heart to maintain pacing.

As a result, a new pacemaker, using a ringing-choke converter was designed.⁶ Here a step-up transformer T_1 is used with transistor Q_1 to form an oscillator which converts the galvanic potentials to a-c. The stepped-up voltage is then rectified and used to drive a stimulator similar to the one previously described. This pacemaker with the converter produces a 1-millisecond pulse of 6 volts across a 500-ohm load. The efficiency of the converter is approximately 30%. These stimulators

are now being implanted and their long-term effect being studied. The electrocardiograph tracings shown above were taken from a dog with heart block a month after pacemaker implantation; the stimulation rate is 120 beats per minute.

Nuclear-powered pacemaker

The Atomic Energy Commission is working with the National Heart Institute on the possible use of nuclear power as a long-term source of energy for pacemakers.

Plutonium-238 would operate a thermoelectric static converter to produce the several hundred microwatts needed to drive the device. The entire pacemaker and 10-year power supply would fit in a container the size of a cigarette pack.

Radioactivity raises two problems. What if the person wearing the pacemaker has an accident? The AEC feels it has enough experience to provide safeguards to protect both the user and those nearby from radiation.

Keeping the day-to-day radiation exposure to the pacemaker user at a medically safe level is more difficult. The reactor's efficiency will have to reach a point where the amount of fuel is small enough to pose no hazards.—Carl Moskowitz

References

1. P.K. Thompson et al, "The Effect of Zinc Administration upon Reproduction and Growth in the Albino Rat, together with a Demonstration of the Constant Concentration of Zinc in a Given Species, Regardless of Age," *Am.J. Physiol.* Vol. 80, 1927, pp. 65-74.
2. K.R. Drinker, "The Normal Excretion of Zinc in the Urine and Feces of Man," *J.Biol. Chem.* Vol. 72, 1927, pp. 375-383.
3. W. Salant, "Pharmacology of Heavy Metals," *J.Ind. Chem.* Vol. 2, 1920, pp. 72-78.
4. V.G. Heller and A.B. Burke, "Toxicity of Zinc," *J.Biol. Chem.* Vol. 74, 1927, pp. 85-93.
5. K.R. Drinker, "The Effect of Long-Continued Ingestion of Zinc, in the Form of Zinc Oxide, by Cats and Dogs, together with Observations upon the Excretion and Storage of Zinc," *Am.J. Physiol.* Vol. 80, 1927, pp. 31-64.
6. L.H. Little, "Principles of the Transistor D.C. Converter," *Mullard Technical Communication* Vol. 17, February 1956, pp. 159-204.

Acknowledgements

The authors acknowledge the assistance of Dr. W.G. Bigelow, Dr. W. Firor, Dr. D. McGregor and Dr. D. Armour in assessing the pacemakers and power sources.



**AUTHORIZED
DISTRIBUTORS**

ALABAMA

Argo & Company
Birmingham

ARIZONA

Electrical Specialty Co.
Phoenix

CALIFORNIA

Electrical Specialty Co.
Los Angeles
Electrical Specialty Co.
South San Francisco
R. V. Weatherford Co.
Glendale

COLORADO

Electrical Specialty Co.
Denver

CONNECTICUT

R. H. Carlson Co., Inc.
Greenwich

D. C.

Read Plastics, Inc.
Washington

FLORIDA

Gulf Semiconductors, Inc.
Coral Gables
Gulf Semiconductors, Inc.
Winter Park

ILLINOIS

Allied Radio Corp.
Chicago
Federal Insulation Corp.
Chicago
J. J. Glenn and Co., Inc.
Chicago

INDIANA

Hyaline Plastics Corp.
Indianapolis

IOWA

Plastic Supply, Inc.
Des Moines

KENTUCKY

General Rubber &
Supply Co.
Louisville

MASSACHUSETTS

Northeast Chemical Co.
Boston

MICHIGAN

F. B. Wright Co., Inc.
Dearborn
Ren Plastics Inc.
Lansing

MINNESOTA

D. A. Schultz Company
Minneapolis

MISSOURI

D. A. James Company
St. Louis
Regal Plastic Supply Co.
Kansas City

NEBRASKA

Regal Plastic Supply Co.
Omaha

NEW JERSEY

Smooth-on Mfg. Co.
Jersey City

NEW YORK

Punt, Inc.
Floral Park
Queen City Rubber Co.
Buffalo
Adhesive Products Corp.
New York
Chamberlin Rubber Co.
Rochester
Syracuse

OHIO

Philpott Rubber Co.
Cleveland
Parkway Products, Inc.
Cincinnati

OREGON

Electrical Specialty Co.
Portland

PENNSYLVANIA

Smith of Philadelphia, Inc.
Philadelphia
Speck-Marshall Co.
McKees Rocks

TEXAS

Lawrence Electronic Co.
Dallas
Houston Industrial
Supply Co., Inc.
Houston

WASHINGTON

Electrical Specialty Co.
Seattle

WISCONSIN

R. J. Wittenburg Co.
Milwaukee



G-E ultra high strength RTV-630: slash it, flex it double...it never tears

General Electric RTV-630 silicone rubber has a tear strength of 100 psi-die B. That's more than twice the tear resistance of any other RTV. It also has a hardness of 55-70 durometer, tensile strength up to 850 psi and elongation of up to 400%.

Because of its great strength, RTV-630 can be used in thinner conformal coatings and improved

production line potting. RTV-630 is designed to protect against the worst environments of thermal shock, vibration, moisture, ozone and temperatures from -65°F to 500°F .

Experience shows RTV-630 molds for electronic parts last up to twice as long as conventional RTV. As a punch die, it has performed more than six times as long.

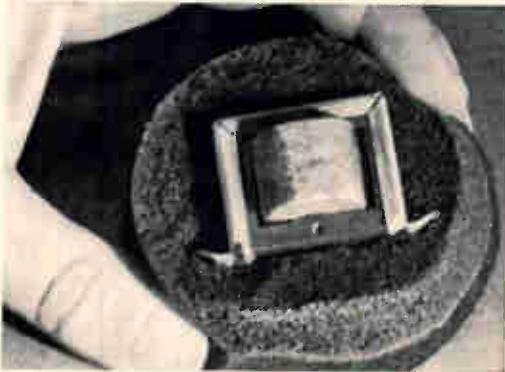

RTV-7 foam for shock and vibration damping.
Foams to 5 times original size and cures in 10 minutes. Density can be varied. Extremely resilient.



Ready-to-use RTV-102 cartridge speeds production line sealing. No catalyst, no priming needed. Tough, flexible. UL recognition.

For more data, ask your nearest distributor as listed or write Section N3193R, Silicone Products Dept., General Electric Co., Waterford, N. Y.

GENERAL  ELECTRIC

For a good mixer, add one FET

Field effect transistors, rather than point-contact diodes, in mixers simplify ultrahigh-frequency television tuners

By Sam M. Weaver

Texas Instruments Incorporated, Dallas.

Ultrahigh-frequency tuners can be significantly improved and simplified by using field effect transistors rather than the usual point-contact diodes in mixers. FET's produce gain—diodes don't. FET's are also less subject to cross-modulation and cause less intermediate-frequency skewing.

Certain FET's, like those in the 2N3821 and 2N3824 series, can operate as a mixer with gain, eliminating expensive low-noise amplifiers in the following stage to achieve an acceptable signal level. Also, the FET produces a negligible third-order component so its transfer characteristic follows a square law almost perfectly—keeping cross-modulation to a minimum.

Point-contact diodes, such as the 1N82A and 1N23B, have a conversion gain less than unity and thus the mixer must be followed by a low-noise intermediate-frequency amplifier. The diode mixer also has excessive cross-modulation—the transfer of the modulation component of a large undesired signal to a weak desired signal.

As the frequency of the diode tuner is varied, the impedance of the i-f tuned circuit changes as a result of changing input impedance. This change affects amplitude and phase relationships of the signal components. This distortion, for example in a color television receiver, causes erroneous color reproduction.

The author



Sam M. Weaver, senior engineer at Texas Instruments Incorporated, designs tv-signal processing circuitry. For the past 5 of his 12 years with the company, he has designed and evaluated semiconductors for tv.

Testing the circuit

An FET test mixer was constructed with strip transmission lines, as presently found in several tv-tuner designs. No attempt was made to provide tuning over the tv band. Strip transmission line consists of a conductor midway between two larger rectangular ground-plane conductors.

This strip line construction is easily seen in the photograph of the FET mixer on page 110. A schematic, which corresponds to the circuit layout, is also shown on page 110. The heavy black lines in the schematic represent the ground-plane conductors of the two strip transmission lines, which are shown side by side in the photograph. The heavy lines in color are the smaller center conductors of the strip line. The ground-plane conductors form a case for the circuit and separate it into three cubicles, so the r-f input, the local oscillator output and the i-f output are shielded from each other.

The two center strip conductors are shorted to the case at one end and terminated at the other end with ceramic tubular trimmer capacitors—variable from 1 to 8 picofarads—so the r-f and local-oscillator tanks can be tuned. The r-f input, the FET input and the local-oscillator input are tapped to a center conductor at points near the shorted end, which provides the best impedance match.

The r-f input and FET taps in the r-f tank are spaced to provide an approximate impedance match and to give an input bandwidth of a little more than 20 Mc. Such a broad bandwidth is desirable in a test circuit to simplify cross-modulation measurements. In a receiver, the bandwidth would be narrowed to correspond to the frequency spectrum of the signal by simply tapping nearer the shorted end of the center strip conductor. The bandwidth should be such that no component of the desired signal is attenuated, while all other frequencies are discriminated against. Otherwise, image frequencies and spurious responses generated by internod-

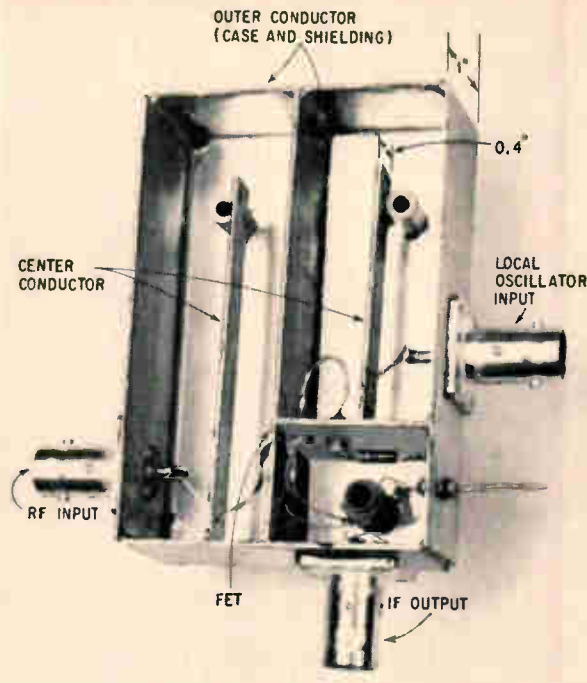

Strip transmission line construction of the uhf mixer. Two outer ground plane conductors, 1.0-inch high, form the case and the internal shielding for the circuit. Center conductors are 0.4-inch high.

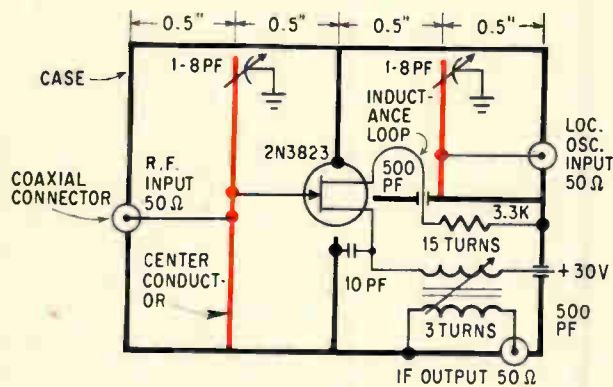

Schematic of FET mixer corresponds to actual layout of circuit. Heavy lines represent outer conductors of strip transmission lines. Lines in color represent the strip line's smaller center conductors.

ulation will appear in the output.

The local oscillator signal is injected into the FET source by low-inductance loop coupling. The low-potential end of the loop is bypassed with a feedthrough capacitor. To provide less than 1 ma FET drain current for proper mixing, a value of 3,300 ohms was chosen for the source resistor. Larger values would increase the local-oscillator power requirement.

Skewing of the i-f bandpass could occur with changes in local-oscillator injection because of the changing output impedance of the FET. However, in this circuit with a 10-pf collector capacitor, the reactance change is sufficiently swamped so skewing is negligible.

The mixer gain can be controlled by varying the local-oscillator injection. If fixed gain is desired, the i-f transformer can be tuned to the output capacitance of the FET, eliminating the collector capacitor and providing an additional 9 decibels or more of gain.

The 50-ohm load was transformed to approximately 1,250 ohms by the i-f transformer to provide the proper i-f bandwidth. Although the supply voltage was +30 volts, the circuit's performance was not significantly affected by reducing the voltage. The gain began to drop rapidly, however, below +15 volts. The local-oscillator injection was adjusted to give an FET drain current of 3 ma, which was also the supply current.

The r-f in the test circuit is single-tuned to provide a realistic noise figure measurement and to provide matching. If this were a commercial tuner, however, double-tuning would be required to give much higher image rejection and much lower radiation than the test circuit provided. Performance parameters for the FET mixer are listed in the table on page 112.

Designing the mixer

Designing a mixer is almost entirely empirical because measuring large-signal parameters meaningfully is difficult.

For this UHF application, the 2N3823 was chosen for its low-noise and high-frequency characteristics.

In designing the i-f output transformer, the proper primary reactance is found by resonating it at the intermediate frequency with both the output capacitance of the FET and whatever swamping capacitance is desired. To tune the circuit, the inductance is varied with a metal slug while the point of resonance is noted on a grid-dip meter.

Next, the turns ratio is chosen to provide the proper bandwidth. Because the real part of the output impedance of the FET is very high, the bandwidth is determined by the load. Then,

$$Q_L = \frac{f_o}{\Delta f}, R_L' = \frac{Q_L}{\omega C}$$

where R_L' is the reflected load and C is the sum of FET output capacitance and swamping capacitance. For a first approximation, assume unity coupling so that

$$\frac{N_1}{N_2} = \frac{R_L'}{R_L}$$

N_1 is the number of turns in the primary of the i-f output transformer; N_2 is the number of turns in the secondary; and R_L is the mixer load.

The theoretical voltage gain of a single-stage FET amplifier is $A = g_m R_L'$, where g_m is the transconductance. The actual gain, however, depends on the conversion loss in the mixing action and g_m , which is a function of bias.

With the preliminary i-f transformer designed, the next step is choosing the bias, which involves a compromise between noise and gain. Noise in the

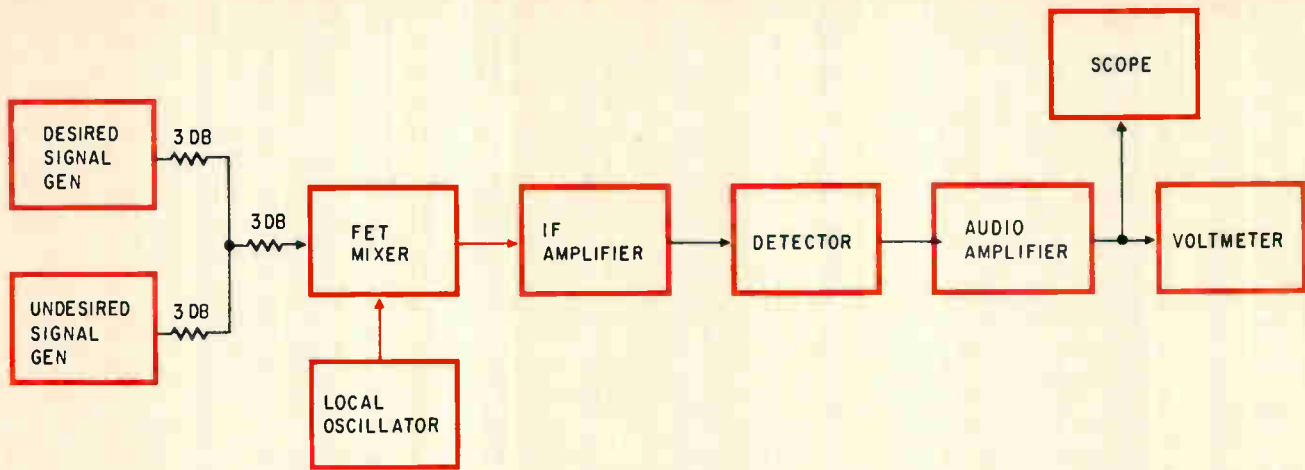

Cross-modulation—the transfer of modulation components from one signal to the other—is measured in the FET mixer with this equipment. Unmodulated desired signal and 30% a-m undesired signal used as a reference are separated by a network of 3-db pads.

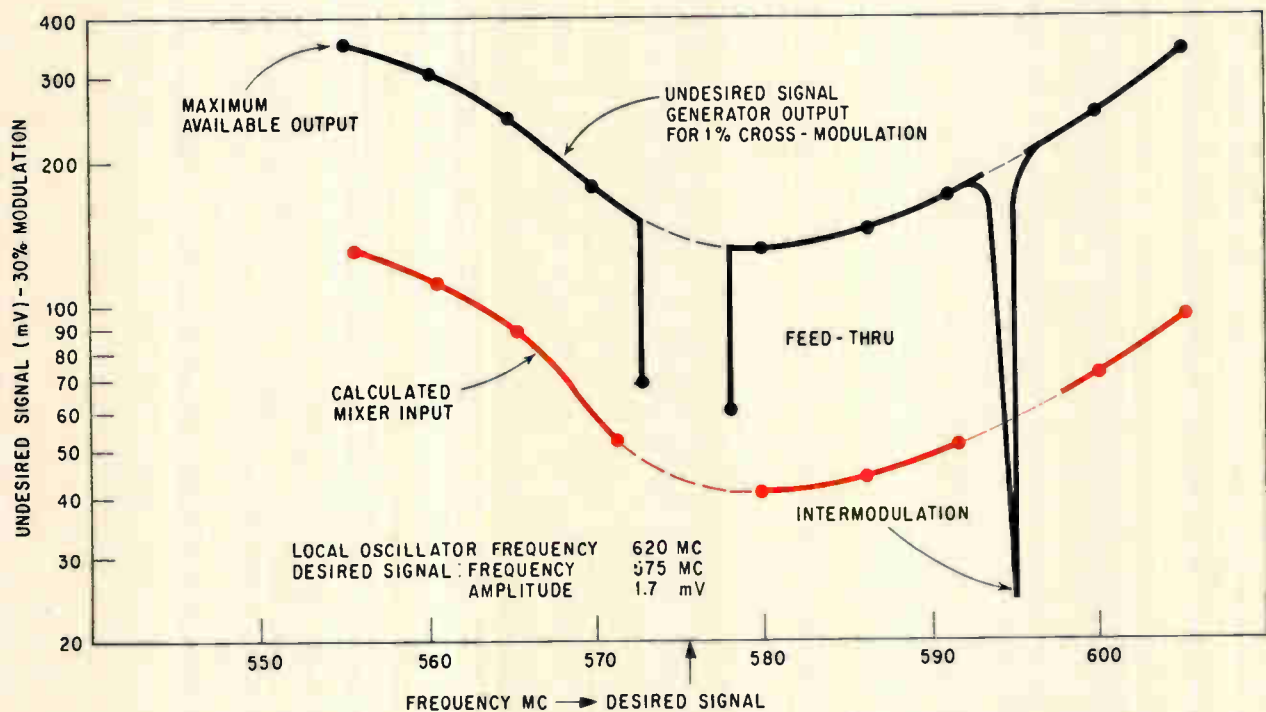

Frequency response of the input circuit is shown in black curve as the output of the undesired signal generator needed to produce 1% cross-modulation. Bottom curve in color—calculated as 9 db down from the top curve—represents actual input to the mixer.

mixing process depends on conversion loss because each decibel of this loss adds a decibel to the noise figure. The device achieves low noise when its transfer characteristic is most nearly square law. This occurs near the FET's pinch-off bias, where drain current I_d is zero. Unfortunately, minimum drain current also results in minimum amplifier gain, since g_m increases as the drain current increases.

This dilemma, however, can be resolved by self-biasing the FET so that I_d is well below 1 ma, with a suitable source resistor, and then applying a large local oscillator signal to drive the FET on during positive half cycles. In this way, an average I_d of 3 ma or more can be achieved. Noise is kept

low, yet effective g_m is sufficient to provide gain. The next step is the design of the two input circuits. Using transmission lines as tuned circuit becomes almost imperative at uhf to control circuit parameters. The simplest construction, which is least critical regarding radiation and tuning, was strip transmission line.^{1,2,3} Mixing at vhf and lower frequencies may be done with lumped components, but to prevent oscillation the two inputs and the output must be shielded from interaction.

Maximum gain results by applying the r-f signal to the gate and the local-oscillator signal to the source. Isolation between the r-f and oscillator inputs—necessary because of oscillator radiation—is provided by a low-inductance loop at the source.

FET mixer performance

Radio frequency input	575 Mc
Local oscillator input	620 Mc
Intermediate frequency output	45 Mc
Conversion gain	9 db
Bandwidth	9 Mc
Noise figure	6.5 db (with 12.8-db image rejection)
1% cross-modulation	Undesired signal level—45 mv Desired signal level—1.7 mv

Impedance matching of the two inputs is done mostly by a cut-and-try method. The input impedances of the mixer vary with levels of local oscillator injection. These impedances are difficult to measure, but with sufficient oscillator injection into the source, gate impedance is well below 100 ohms; source impedance is well below gate impedance.

Though impedance matching provides maximum gain, the lowest noise figure does not necessarily result. If no r-f amplifier precedes the mixer, then noise is the first consideration. The coupling loops are then adjusted for minimum noise. If gain is more important than noise in a particular application, then the loops are adjusted for maximum gain.

As the loading is changed, the bandwidth of the r-f tank is affected. To retain the desired r-f bandwidth, the input loading must be changed. Adjusting the local oscillator will also affect the r-f bandwidth, so that several attempts may be required to get the proper combination of bandwidth and impedance matching.

If double tuning is required, the second circuit should be added after determining the parameters of the local oscillator; this decreases the number of cut-and-try operations.

The final design step requires a readjustment at the i-f transformer. Because the adjustment of the local oscillator changes the FET's output impedance and the i-f transformer design was an approximation, the turns ratio will probably have to be readjusted to provide the desired bandwidth, especially if the collector swamping capacitance is low.

Cross-modulation

Cross-modulation is an important criterion for measuring the performance of a mixer. Two procedures for measuring cross-modulation will be described; a diagram of the equipment for these measurements is shown on page 111.

The first method is to apply both an undesired signal, which is 30% amplitude-modulated, and an unmodulated desired signal to the mixer. The cross-modulation is measured at the output as the amount of modulation in the desired signal. The FET circuit discussed here had in its output a 1% amplitude-modulated desired signal as a result of the 30%-modulated undesired signal reference.

The desired and undesired signal sources are isolated by a network of 3-db pads. The output of the test circuit is measured by a system with

approximately 30 db of linear dynamic range. A single receiver with this capability could be substituted for the system shown.

Because the percentage of cross-modulation is independent of desired signal voltage, any convenient signal level can be used. In this setup, 1.7 mv provided a signal that is well above the noise level, and yet well below the overload point.

To set up a reference level on the voltmeter for calibration, the undesired signal is completely attenuated, and the desired signal is modulated at 20%. This reading is then divided into 20 parts, each representing 1% modulation. This can be done because the measuring system is linear.

To plot the response of the mixer input's tuned circuit over its frequency range as on page 111, the 1.7-mv, unmodulated desired signal is applied to the FET with the 30% modulated undesired signal at a particular frequency. The undesired signal is increased in amplitude until the voltmeter indicates 1% modulation. The undesired signal level is then recorded, and the procedure repeated for several other frequencies in the range of the mixer.

The top curve represents the output of the undesired signal generator needed to produce 1% cross-modulation in the mixer. The actual input to the mixer, shown in the bottom curve, is 9 db down from the signal generator output because of the isolation network losses.

The lowest point on the bottom curve represents the undesired signal level required to produce 1% cross-modulation in the FET if it were independent of the tuned circuit.

The points marked feed through indicate that the frequency of the undesired signal is within the amplifier bandpass, and is being received in the same manner as the desired signal.

The point marked intermodulation is a result of mixing action. When mixed with the local oscillator signal, the undesired signal produces a signal which is half the i-f frequency. The second harmonic of this signal—also produced in mixing—appears as the i-f and is detected. This shows the necessity for input preselection.

The second method of characterizing a circuit's susceptibility to cross-modulation is to specify the 30%-modulated, undesired-signal level required to produce cross-modulation a certain number of decibels down from full 30% modulation of the desired signal. In this method, a reference level for the desired signal is set up as in the last method: a 30%-modulated desired signal is applied to the FET and the voltmeter reading is set at 0 db. The modulation of the desired signal is then removed, and the undesired signal, with 30% modulation, is increased in amplitude until the voltmeter reads a value the specified number of decibels below 0 db.

References

1. "Reference Data for Radio Engineers," fourth edition, International Telephone and Telegraph Corp., pp. 598-600.
2. J.R. Dangi and K.P. Steele, "Using strip transmission line to design microwave circuits, Part I," *Electronics*, Feb. 7, 1966, p. 72.
3. J.R. Dangi and K.P. Steele, "Using strip transmission line to design microwave circuits, Part II," *Electronics*, Feb. 21, 1966, p. 90.

ENGINEERS . . . DESIGNERS . . . RESEARCHERS

WIN A COLOR TV

other outstanding prizes . . . in the
FENWAL ELECTRONICS

"MR. THERMISTOR" CONTEST

ATTENTION . . . THERMISTOR USERS

If you have ever employed *thermistors* for temperature measurement, temperature compensation, industrial control, or any one of the dozens of other applications for which they are ideally suited, here is a chance to cash in on your experience. All you have to do is describe the applications briefly, in

accordance with the contest rules below, and send it to Fenwal Electronics, Inc. before April 30, 1966. Just for entering, you will receive an F. E. I. Experimenters Thermistor Kit (valued at \$9.95). And you will be eligible to win one of the three valuable grand prizes described below.

1ST PRIZE



23" COLOR TV . . . A handsome 23" Motorola table-model color set (valued at \$500) goes to "Mr. Thermistor". This prize, guaranteed to please the whole family, will be delivered to the winner's home, installed, with a full ninety-day warranty.

2ND PRIZE



ACCUTRON® TIMEPIECE . . .

The winner of the second "Mr. Thermistor" prize will receive this striking timepiece . . . said to be the world's most accurate. Electronically-driven by pulses from a tuned oscillator, it is a real engineer's watch, guaranteed to make you the envy of the whole department. Retail value \$125.

3RD PRIZE



SPANISH TREASURE PEN

This unique Parker 75 pen (which lists for \$75) is a conversation piece you will treasure for years. The beautifully-wrought barrel is genuine antique silver, recently salvaged from the remains of a Spanish plate fleet which foundered in a hurricane off the East coast of Florida in 1715. With the pen you get documentary proof of its authentic origin. It is also a fine writing instrument.

EVERYBODY WINS

Everyone who submits an entry in the April Fenwal Electronics "Mr. Thermistor" Contest will receive one of F.E.I.'s large G-701 Experimenter's Thermistor Kits (which sell for \$9.95) containing 10 assorted precision thermistors with complete specifications and application data.



"MISTER THERMISTOR" CONTEST RULES

1. F.E.I.'s "Mr. Thermistor" Contest is open to all qualified engineers and researchers residing within the United States, with the exception of employees of Fenwal Electronics, Inc., Fenwal, Inc., and their advertising agencies.
2. Each entry should describe in as many words as necessary:
 - a. The product, system or application in which the thermistor was used.
 - b. The specific function of the thermistor, (or thermistors), operating parameters, and the type used.
 - c. Why a thermistor was used, instead of some alternative approach, and how well the application achieved objectives.A sketch or schematic (pencil is OK) must be included to illustrate the application.
3. More than one entry may be submitted by a contestant.
4. Entries should be typed, or written clearly, on 8½ x 11 paper. Sender's name, title, company affiliation, and home or company address should be clearly indicated. Each entry must

be signed in ink. More than one individual may sign, but only one prize will be awarded per entry.

5. Entries will be judged on: ingenuity of thermistor utilization, sophistication of probe design or thermistor circuitry, and or effectiveness of the thermistor approach in solving a specific design problem.

6. Decision of the judges will be final. All entries become the property of Fenwal Electronics, Inc.

7. Entries for this "Mr. Thermistor" Contest must be postmarked no later than midnight, April 30. Winners will be advised directly.

8. First Prize winner (1) will receive a 23" Motorola Color Television Set. Second Prize winner will receive an ACCUTRON® Timepiece. Third Prize winner will receive a Parker 75 Treasure Pen. Every contestant will receive a G-701 Thermistor Kit.

9. Entries should be addressed to:
Thermistor Contest
Fenwal Electronics, Inc.
63 Fountain Street
Framingham, Massachusetts



63 Fountain Street
Framingham, Mass.

GET YOUR ENTRY IN NOW BEFORE THE APRIL 30, DEADLINE

NEW WANLASS R-3200 VOLTAGE REGULATORS

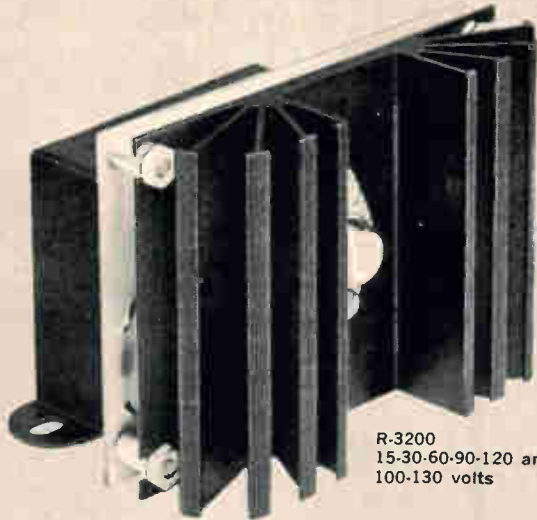

R-3200/60
REGULATOR
PATENTS PENDING

R-3200
15-30-60-90-120 and 250 va
100-130 volts

NOW . . . A 1% LINE AND LOAD REGULATOR
WITH MICROSECOND RESPONSE
and 47-63 CYCLE OPERATION

- Economy* • *Small size* • *Light Weight*
Power factor insensitive • *Current overload protection*
No phase shift • *All solid state* • *Optional 400 cycle operation*
• *Efficiency—up 10% more in rated tests*

PRODUCT COMPARISON CHART		
	R-3200/60 60 va Unit	Typical 60 va Ferroresonant Transformer
Price	\$20.00*	\$21.00
Line Regulation	±1%	±1%
Load Regulation	±1%	—
Frequency	47-63 cps	60 cps
Power Factor	Insensitive up to ±0.7	1.0
Phase Shift	No	Yes
Response	50 μ-sec	25,000 μ-sec
Weight	2.5 lbs.	8 lbs.
Size	3x3¼ x4 in.	3x4x5 in.**
Units to be mounted	1	2

*F.O.B. Santa Ana. Subject to change.
**Dimensions do not include separate capacitor.

The new Wanlass R-3200 Series voltage regulators are designed specifically for a wide variety of electronic instruments and equipments. Compare cost, performance, economy of operation with other competitively priced units (see table). Wanlass R-3200 voltage regulators are the ideal choice for all original equipment applications now using constant voltage ferroresonant transformers. Write today for complete technical data. Wanlass Electric Co., 2189 S. Grand Ave., Santa Ana, Calif. 92705. (714) 546-8990.

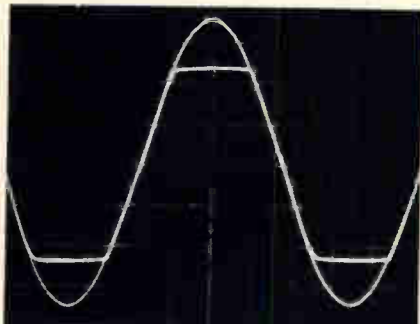

Unretouched photo shows output waveform superimposed over input. Regulation is achieved by "peak clipping."

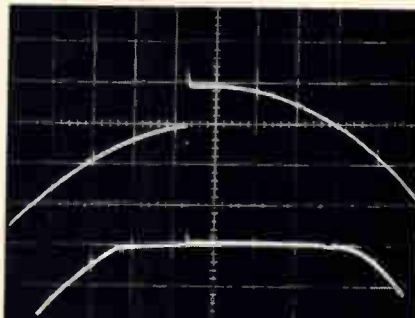

R-3200 has significant line noise suppression. Note 25-volt input change (upper) and 50 μ-second response in output (lower).

WANLASS ELECTRIC CO.

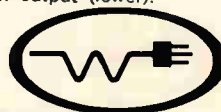

See Wanlass Regulators Booth 4M09—IEEE SHOW NEW YORK CITY

WANLASS

REPRESENTATIVES AND SALES OFFICES

ALBUQUERQUE
Hyde Electronics Co., Inc.
5206 Constitution N.E.
Albuquerque, N.M. 265-8895

ATLANTA
Gentry and Assoc., Inc.
P.O. Box 13513, Stn. K
Atlanta, Ga. 233-3816

BENTON HARBOR
Robert O. Whitesell & Assoc.
303 Fidelity Building
Benton Harbor, Mich. 927-2041

BURLINGTON
Gentry and Assoc., Inc.
2714 Eldermont St.
Burlington, N.C. 227-7916

CHICAGO
Wanlass Electric Co.
P.O. Box 7814
Chicago, Ill. 478-5499

CINCINNATI
Robert O. Whitesell & Assoc.
1172 W. Galbraith
Cincinnati, Ohio 511-2290

CLEVELAND
Robert O. Whitesell & Assoc.
21139 Lorain Ave.
Cleveland, Ohio 333-2585

COLUMBUS
Robert O. Whitesell & Assoc.
1350 W. 5th Ave.
Columbus, Ohio 488-9731

DALLAS
Parvin Sales Co.
P.O. Box 307
Addison, Texas 363-8596

DAYTON
Robert O. Whitesell & Assoc.
4129 S. Dixie Ave.
Dayton, Ohio 298-9546

DENVER
Hyde Electronics Co.
888 S. Lipan St.
Denver, Colo. 936-3456

DETROIT
Robert O. Whitesell & Assoc.
16801 Wyoming Ave.
Detroit, Mich. 862-2225

FORT WAYNE
Robert O. Whitesell & Assoc.
Central Bldg., Rm. 272
Fort Wayne, Ind. 743-4411

HUNTSVILLE
Gentry & Assoc., Inc.
Rm. 418, Clinton Bldg.
2109 W. Clinton Ave.
Huntsville, Ala. 534-9771

INDIANAPOLIS
Robert O. Whitesell & Assoc.
6620 E. Washington St.
Indianapolis, Ind. 635-9766

KANSAS CITY
Harris-Hanson
7916 Paseo St.
Kansas City, Mo. 444-9494

LOUISVILLE
Robert O. Whitesell & Assoc.
3620 Lexington Rd.
Louisville, Ky. 893-7303

MINNEAPOLIS
Lloyd F. Murphy & Assoc., Inc.
730 Chicago Ave.
Minneapolis, Minn. 333-4511

ORLANDO
Gentry & Assoc., Inc.
P.O. Box 11096
Orlando, Fla. 424-0730

PHOENIX
Hyde Electronics Co., Inc.
4710 N. 16th St.
Phoenix, Ariz. 264-5609

PITTSBURGH
Robert O. Whitesell & Assoc.
201 Penn Center Blvd.
Pittsburgh, Pa. 242-0100

ST. LOUIS
Harris-Hanson Co.
2814 S. Brentwood Blvd.
St. Louis, Mo. 647-4350

SALT LAKE CITY
Hyde Electronics Co., Inc.
3801 Delsa Dr.
Salt Lake City, Utah 278-4465

Celestial successor to inertial guidance

The ancient art of navigating by the stars is being updated with modern electro-optics. It promises to measure and control spaceships' positions without moving parts such as gyroscopes, gimbals and platforms

By E.J. Farrell and R.L. Lillestrand

Control Data Corp., Minneapolis, Minn.

Spaceships will soon be guided across the sky in much the same way that mariners once directed sailing ships across the dark seas, relying entirely on celestial rather than inertial measurements.

An electro-optical system, without moving parts such as gyroscopes, will perform the navigator's role of searching the sky for recognizable star patterns, measuring their direction, and then determining the craft's orientation—as well as its position and velocity. The same system, acting on the same celestial information, will then become the helmsman, controlling the craft's direction by means of flywheels or gas jets,

Electro-optical systems which achieve automatic

celestial pattern recognition for a randomly oriented sensor have already been built. One, designed by the Control Data Corp., has made stellar observations from the earth with pointing errors of 30 seconds of arc. When the system is used in space, free from atmospheric disturbances that cause the stars to appear to twinkle, the errors are expected to decrease to less than 5 seconds of arc.

For flight tests, CDC is designing smaller sensors rugged enough to withstand such rigors of space travel as strong vibration and extreme temperatures.

Celestial-guidance should be smaller, simpler and more reliable than inertial-guidance equipment.

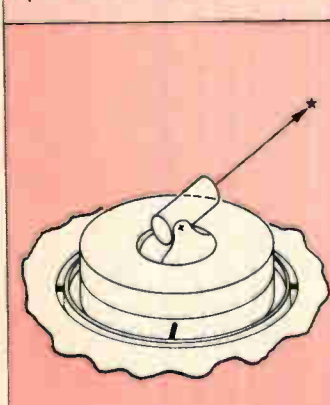
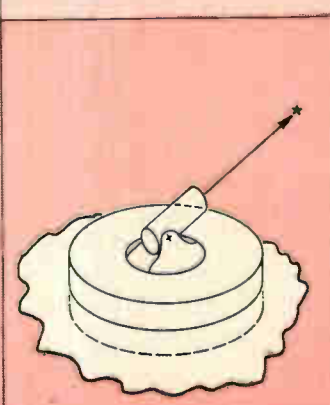
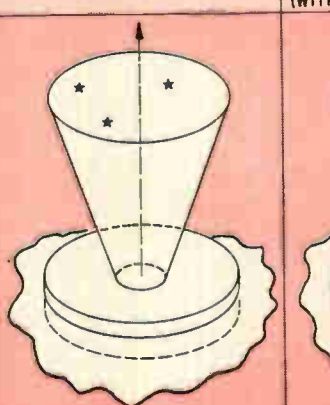
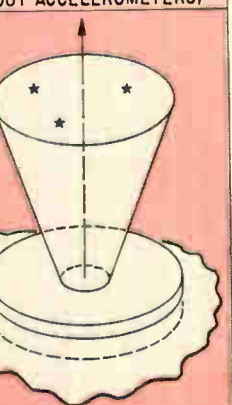
CONVENTIONAL INERTIAL REFERENCE SYSTEM	STRAPPED-DOWN INERTIAL REFERENCE SYSTEM	STRAPPED-DOWN CELESTIAL REFERENCE SYSTEM	STRAPPED-DOWN CELESTIAL REFERENCE SYSTEM (WITHOUT ACCELEROMETERS)
			
CELESTIAL SENSORS 1	1	1	1
COMPUTERS 1	1	1	1
ACCELEROMETERS 3	3	3	0
GYROS 3	3	0	0
GIMBALS 5	2	0	0
TORQUERS 5	2	0	0
ANGLE ENCODERS 5	5	1	1

Scanning reference systems rely increasingly on computers and other electronic equipment, less on mechanical devices.

A three-axis attitude sensor, called TAAS, can be strapped down on a spacecraft, often eliminating all moving parts. In place of the hardware required on a conventional inertial-reference system—a celestial sensor, computer, three accelerometers, three gyroscopes, five gimbals with platform, five torquers and five angle encoders—the CDC system requires only a coffee-cup-size computer and a sensor; the two components together will be only 3 inches in diameter and about 10 inches long.

The evolution of scanning reference systems is shown in the drawings on page 115 and that of hardware requirements in the drawing below.

TAAS achieves precise attitude measurements—accurate to between one-twentieth and one-tenth the size of the image of a star—with electrical filtering, both analog and digital; this permits the use of a relatively inexpensive optical system.

Working with a digital computer and reaction wheels—motor-operated flywheels that control the spacecraft's movements in three directions—the strapped-down sensors also can control the spacecraft's attitude. For these and other space applica-

tions, a miniaturized computer is being built.

TAAS has potential applications beyond attitude control. It could make accurate calculations of one spacecraft's position with respect to another's during rendezvous. For travel beyond Mars, it could monitor asteroids' positions near the spacecraft to avoid collisions, or to make scientific studies. It could precisely aim a laser beam for communication with a ground station during a deep-space probe. For less-exotic applications, a flier who bails out over unknown terrain could set up a five-pound system that would tell him exactly where on earth—or elsewhere—he is.

Star gazing

The stars are examined by a single optical system capable of providing three-axis attitude data. Various operational configurations are shown in the drawings on page 117. After passing through a lens, starlight is transmitted through a narrow optical slit in a disk mounted at the lens's focal surface; the transmitted light is converted into a cluster of 10 to 1,000 pulses by a photomultiplier.

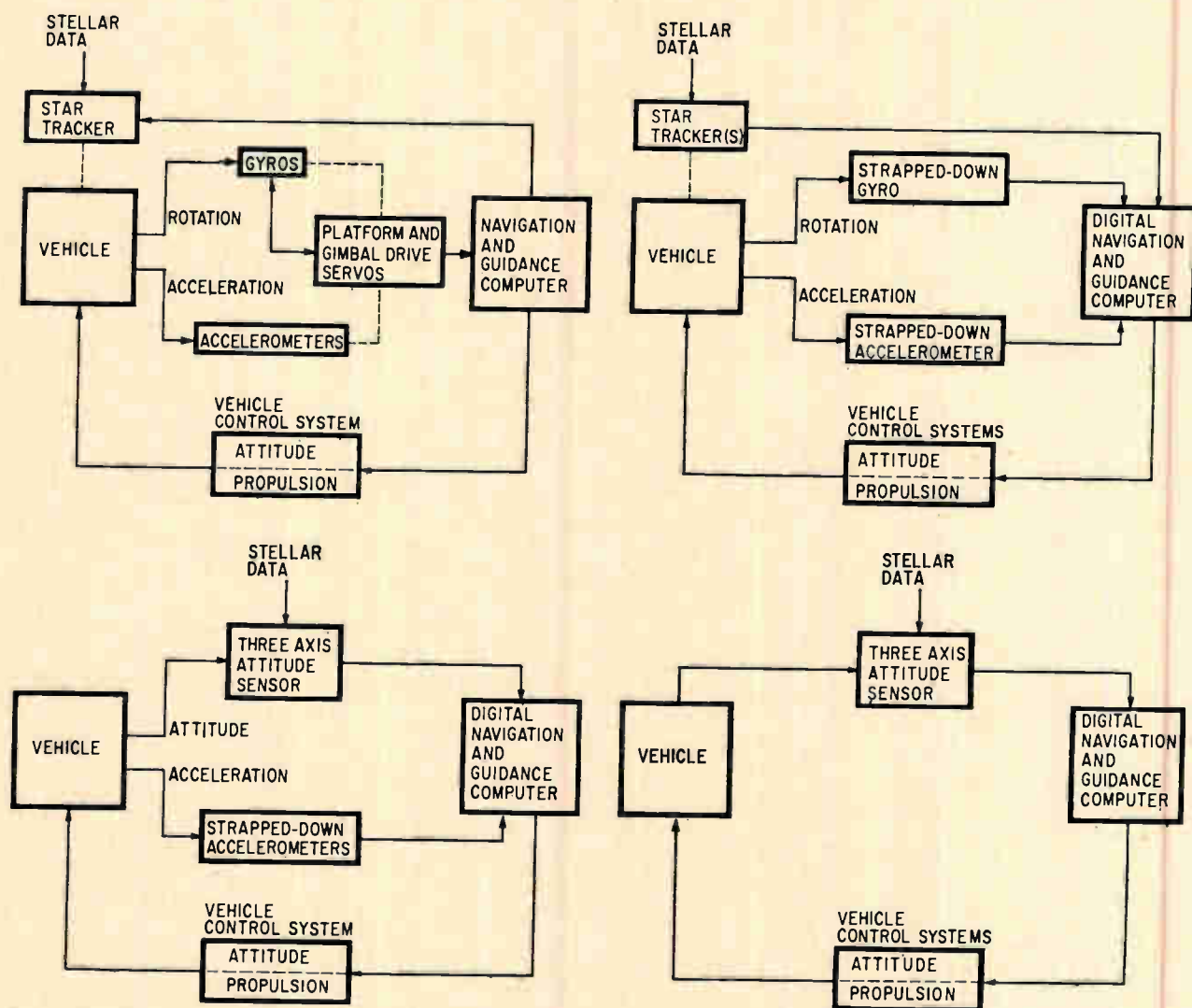

Four guidance systems. At top left, gimbals, gyroscopes and accelerometers are required. System at top right performs gimbal functions with a digital computer. At bottom left, TAAS does away with gimbals, gyros and trackers; only one angle encoder is required. Attitude-control system at bottom right does not require accelerometers.

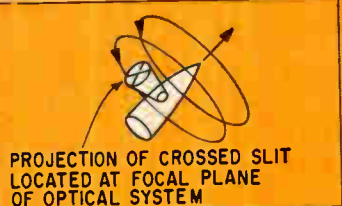
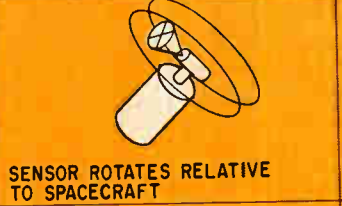
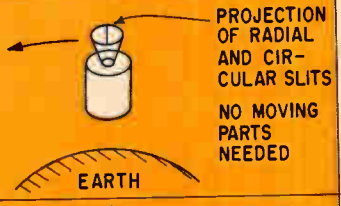
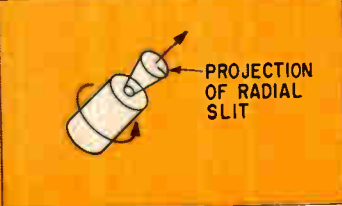
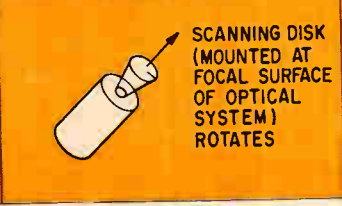
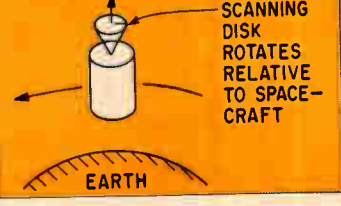
TYPE OF SCAN FIELD (RELATIVE TO CELESTIAL SPHERE)	SPACECRAFT MOTION		
	SPINNING	INERTIALLY STABILIZED	STABILIZED RELATIVE TO LOCAL VERTICAL
STRIP	 <p>PROJECTION OF CROSSED SLIT LOCATED AT FOCAL PLANE OF OPTICAL SYSTEM</p>	 <p>SENSOR ROTATES RELATIVE TO SPACECRAFT</p>	 <p>PROJECTION OF RADIAL AND CIR- CULAR SLITS NO MOVING PARTS NEEDED</p> <p>EARTH</p>
CONICAL	 <p>PROJECTION OF RADIAL SLIT</p>	 <p>SCANNING DISK (MOUNTED AT FOCAL SURFACE OF OPTICAL SYSTEM) ROTATES</p>	 <p>SCANNING DISK ROTATES RELATIVE TO SPACE- CRAFT</p> <p>EARTH</p>

Measuring spacecraft's attitude in three different operating conditions, with three-axis sensors. For a spinning vehicle, sensor requires no moving parts relative to spacecraft. When vehicle is inertially stabilized, one degree of rotation freedom enables sensor to determine all three attitude axes. When vehicle's motion is stabilized relative to local vertical, a "running" attitude fix by conical scan provides time-varying orientation of spacecraft.

The peak pulse rate is 10^5 to 10^7 pulses per second, depending on the star's size and brightness and on the slit's width and speed.

From the angular position of the rotating slit, measured from the pulse clusters emitted by the photomultiplier, the computer calculates the positions of stars that lie within the field of view. The position of celestial bodies can be measured to an accuracy greater than one twenty-thousandth of the diameter of the field of view. From the angular separations between three stars, the computer recognizes the star pattern and computes the spacecraft's pointing direction by triangulation, much as a navigator performs measurements with a transit and sextant. To help identify the stars, their brightness is sometimes measured.

When the spacecraft is spinning, its motion provides the scan, and no moving parts are necessary. When the craft is stabilized, however, a motor is needed to rotate the slotted disk.

The relation of scan period and optical aperture to accuracy is shown in the graph at the right. The optical axis is assumed to be perpendicular to the spin axis. For a given degree of accuracy, a slower scan permits the aperture to be smaller.

With the lens, slotted disk, photomultiplier and detection electronics, the celestial scanning system can be pointed anywhere in the sky at random, recognize the pattern of stars, and solve the problem of three-axis determination. Such a system will be described in detail in the concluding part of this article, to be published April 4.

Sorting signals from noise

The input to the detection circuits consists not only of the desired star signals, but also of a variety of noise. This includes stellar background radiation, photon noise from the star and from the background, and internally generated noise such as photomultiplier dark current. Noise sources

can be classified by their power spectra.

All types of incident radiation, as well as the photomultiplier dark current, have high-frequency noise components of 100 kilocycles to 10 megacycles per second. Since the signal does not exceed one millisecond in duration, a significant improvement in the signal-to-noise ratio can be obtained by using a low-pass filter at the output of the photomultiplier. Nominally, the cutoff frequency is between 500 cycles and 2 kilocycles per second. The resulting reduction in noise is achieved without distorting the signal.

The stellar background also has a noise component whose power spectrum coincides with the signal spectrum. This is a scanning noise that results from scanning the galactic background of weak stars. This noise cannot be eliminated by filtering, but it can be reduced if the detection threshold is selected carefully. In this way, the photomultiplier's output is processed only when its amplitude exceeds a preassigned threshold. When this happens, the location of the star pulse is estimated by differentiating the pulse and detecting its zero crossing. An alternate method is to average two crossings of the detection threshold.

A low-frequency noise component results from

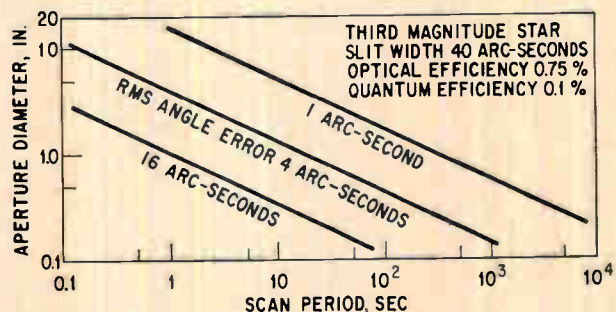

Relation of minimum aperture to scan period in information-limited scanning system. Longer scan permits the aperture, and therefore the sensor, to be smaller.

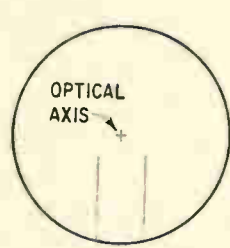
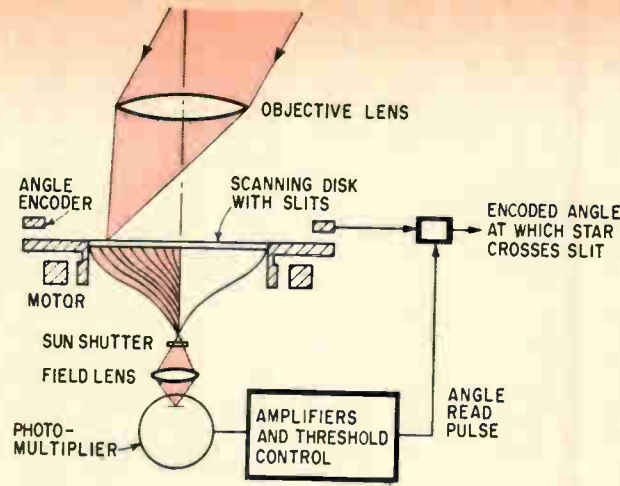

SCANNING DISK WITH TWO NONRADIAL SLITS

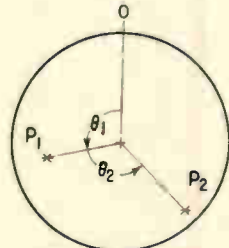

POLAR COORDINATES OF STARS AS MEASURED BY SCANNER DISK

Three-axis attitude sensor consists of a lens, scanning disk and photomultiplier. Slit configuration shown can provide, through mathematical transformation, the polar coordinates of each detected star.

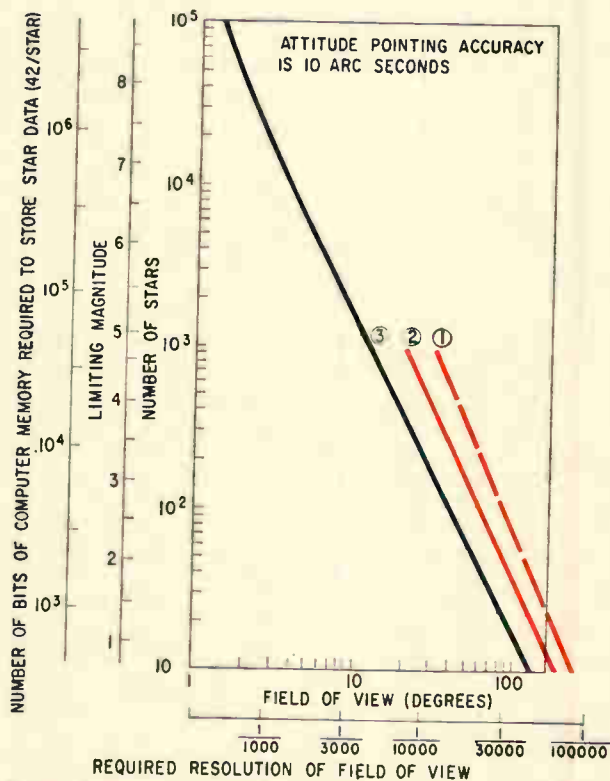

Design tradeoffs for three-axis attitude system. With wide field of view, the computer can operate with data on relatively few stars stored in its memory, and the detection system needs to consider only the brightest stars. However, this advantage requires high resolution in the field of view. Line 1 indicates conditions resulting in a 1.0 probability of finding three or more stars in field of view; line 2, probability of 0.9; line 3, an average of three stars.

variations in ambient background radiation over the sky; this can change by as much as an order of magnitude. Consequently, the photomultiplier output has a low-frequency component whose period equals the scan period, 1 to 20 seconds. Since detection is based on threshold crossings, this low-frequency component can be eliminated with a floating detection threshold.

Detection based on a threshold crossing, as shown in the block diagram on page 119, permits the greatest probability of detecting any bright star for a given risk of incorrect detection. Also, the time of the peak value of the detected star pulse is the time when the star is most likely to be centered in the slit. The system is capable of achieving an angle interpolation of one-tenth to one-twentieth of the star image in the focal plane. This permits the system to achieve the required accuracy, even with relatively inexpensive optics.

The internal and external noise sources introduce limitations on the accuracy of determining a star's position and on the detectability of the images. These limitations, which are independent of signal-processing techniques, have been described by E. J. Farrell and C. D. Zimmerman.¹

Angle accuracy is directly related to the width of the slit. However, a narrowing of the slit must be accompanied by either a widening of the aperture or an increase in scan period, to assure that enough photons pass through the lens-slit system.

An alternate way to increase angle accuracy is with multiple slits and a correlation technique. This method permits the aperture and scan period, and therefore the sensor, to be small enough for practical use. The photodetector's output is correlated with an electrical replica of the multiple-slit pattern. If the correlator's peak output exceeds a preassigned detection threshold, a star is present at the time of the peak output.

The number of slits in a multiple-slit pattern is determined by the signal requirements; slit widths depend on the angle accuracy required. A slit pattern is selected so that the waveform generated by the correlator is relatively simple. As the star transits the slit, the correlator's output should rise and decay monotonically, without intermediate dips; multiple-peaked output would complicate the task of star-pattern recognition. Also, the central peak should be as narrow as possible consistent with the length of a code pattern.

In designing the system for operation at the lowest possible signal level, it is necessary to keep the expression mD^2T constant, where m is the number of slits, D the optical aperture, and T the scan period. For example, for a system with 10 slits instead of one, it is possible to reduce the optical aperture to about one-third, or the scan period could be reduced by a factor of 10—an important advantage for guidance systems which require high sampling rates. These improvements which result from the use of multiple slits are achieved without the loss in angle accuracy that would occur if a single slit were widened by a

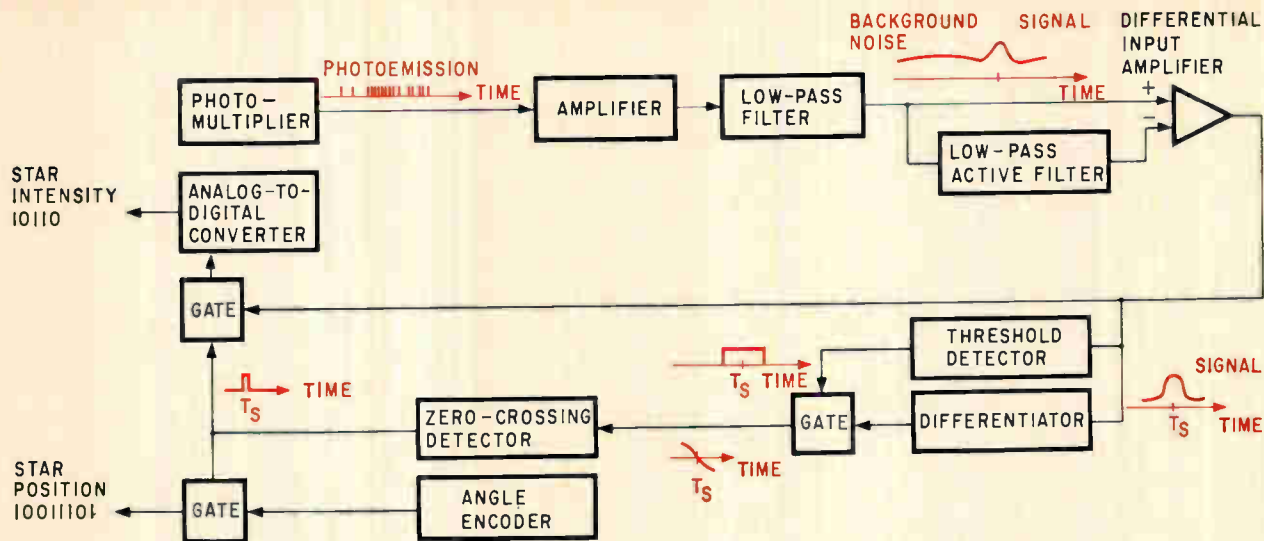

One approach to detection electronics. The first low-pass filter eliminates high-frequency noise. The differential input amplifier and low-pass active filter eliminates the low-frequency noise produced by the ambient background radiation. Bright stars are detected with a threshold-type detector. The time at which the star is centered in the slit is determined by measuring the peak-time of the detected star pulse. The corresponding position is obtained from an angle encoder. The star intensity is proportional to the amplitude of the detected star pulse.

factor of 10 to attain the required signal level.

Designing the scanning sensor

The basic elements of the scanner are a lens, a scanning disk and a photodetector with its associated electronics. Depending upon the application, other components may be added, such as an angle encoder, drive motor, fiber optics and field lens assembly. For a spinning satellite with strip scanning, as shown in the drawing on page 117, an angle encoder is not required. Such a system is shown in the drawing on page 122. When the spacecraft is inertially stabilized, however, the slit and fibers must be rotated by an angle encoder and motor, as shown at the top of page 118. At the top of this page are shown all the elements required in a sensor for such a stabilized vehicle.

In selecting an arrangement of scanning slits, the minimum requirement is that measurements of three star transits are made, from a minimum of two stars. These transits must generate an independent system of equations in the three attitude unknowns. The designer usually seeks a slit configuration which gives an error-propagation characteristic that is largely independent of the geometry of the stars lying within the field of view. This requirement is satisfied by systems with two non-radial slits.

To obtain a complete three-axis description of a spacecraft's attitude when pointed randomly at the sky, the designer has several reasons for making the field of view as wide as possible. Although pointing direction might be measured with a narrow field of view, the third axis can be established accurately with a single optical system only if the field of view is large. There are other advantages to large field of view: dimmer stars can be eliminated from consideration, permitting the use of a smaller objective lens; the fewer the stars to be considered, the smaller can be the star catalog

stored in the computer's memory; also pattern-recognition becomes easier.

However, there is an upper limit to the width of the viewing field. A field of view greater than 60° presents insurmountable problems in optical design if high-quality imaging is to be achieved. Further, to keep the sensor small, it is desirable to have a small f-number and a lens whose physical size is small compared with its effective aperture. Shielding will always be necessary to protect the photomultiplier from radiation from the sun; however, when the field of view is too large, it would frequently encompass the sun, and at those times the system could not operate. The experimental system operated even when bright bodies such as the moon were in the field of view.

These factors encourage the designer to consider fields of view of 40° to 60° . Such breadth, however, would require the scanning system to be able to measure the positions of celestial targets accurately to about one part in 20,000 in the field of view if it is to maintain the necessary accuracy—to within 10 seconds of arc. Such accuracy is not achievable with image orthicons, electroluminescent panels or mosaics; precision optical scanners are required. Electron filtering permits the required accuracy without inordinately expensive optics. One sensor, which will be described in the second part of this article, has achieved root-mean-square pointing accuracies better than $1/50,000$ of the field of view of the optical system.

The graph at the bottom of page 118 shows the results of a simulation on a CDC 1604. In this case the computer was programed to "point" at 2,580 directions uniformly spaced across the sky. The computer then calculated the field of view necessary to provide three or more stars for all pointing directions and for various limiting magnitudes. Because of statistical fluctuations in star densities, it was

found that only half of the stars down to a given intensity need be stored in the computer memory if the sensor is to be pointed randomly.

In designing a scanning sensor, the engineer is usually confronted with a set of required system-performance characteristics. These three or four requirements may narrow his choices from 50 variables to between 20 and 30 that characterize the equipment. Even after these restrictions, however, the problem of system synthesis still may offer more degrees of freedom than most designers can handle. In practice, this problem is often solved by arbitrarily assigning values to certain design parameters, placing bounds on others, and then solving for those remaining. A computer program, which implements this concept and designs optical scanning systems, is shown in the chart below. As a result of this program, near-optimum designs can be achieved in a few days; previously, four to six months were required.

As a starting point in this program, values are specified for eight variables; the number of photoelectrons from a limiting-magnitude star during the slit transit; scan period and scanning geometry; quantum efficiency; optical efficiency; ratio of image diameter to slit width; number of star detections required per scan; probability of detecting the required number of stars; and number of scans which are correlated. In addition, upper

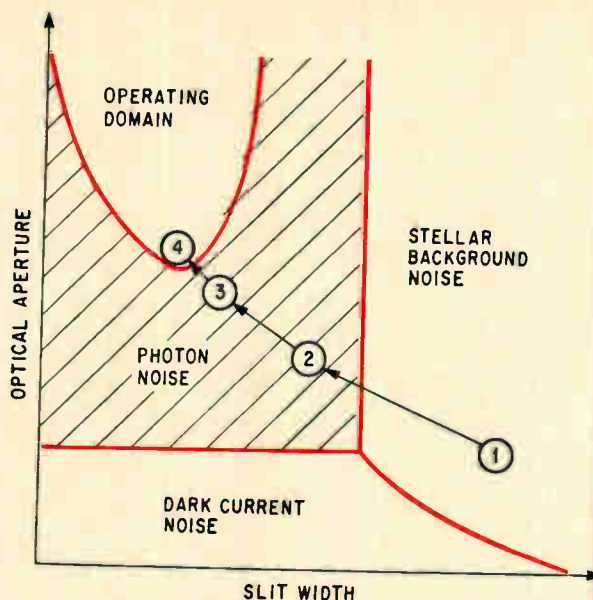

Different kinds of noise are dominant for each combination of slit width and aperture size. Numerals refer to iterative steps in the automatic design program to reach point in operating domain at which aperture is minimal.

bounds are placed on the expected number of false star detections and the rms star-transit error. With these constraints, the optical aperture is minimized, as are the volume and weight of the sensor.

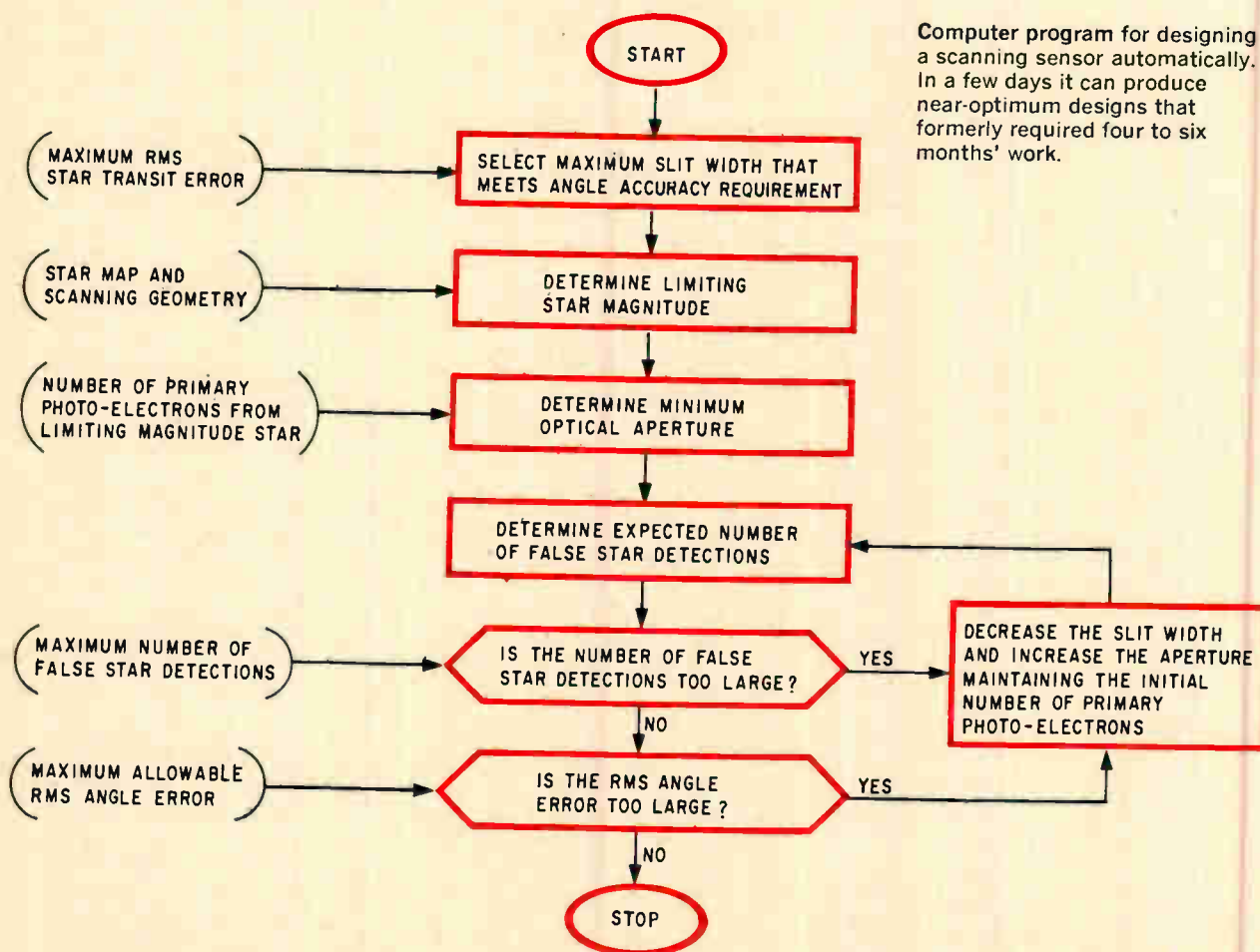

The basic relationships between signal and noise, relative to slit width and optical aperture, are illustrated in the graph on page 120. All of the sensor parameters are fixed except slit width and optical aperture; the image diameter is always equal to the slit width. Initially in the automatic design program, the system is noise-limited. Then the slit width is decreased and the aperture increased, maintaining a constant signal level. The iteration stops when the operating domain is reached and the aperture is a minimum size.

Of special interest to engineers is the method for choosing a photomultiplier. This involves three primary parameters: peak quantum efficiency, spectral response, and level of dark-current noise. There are also three secondary parameters: active photocathode area, over-all dimensions, and environmental requirements such as tolerance to vibration, shock and extremes of temperature.

The primary parameters influence the optical de-

sign in a complex way. To compare photomultipliers, it is necessary to design a separate sensor for each tube under consideration, then select a tube based on the operation of the sensor of which it is a part. With the automatic program discussed on page 120, it is easy to analyze many photomultipliers.

The principal consideration is the sensor's weight, which varies approximately as the cube of the optical aperture. In general, the most satisfactory photomultiplier is one which fits into a sensor design requiring the smallest aperture. In designing one system, nine photomultipliers were considered; the heaviest resultant sensor weighed 200 times as much as the lightest.

However, the best photomultiplier at one scan rate may not be the best at another. The designer must determine which scan rates are likely to be used the most.

The secondary parameters influence the optical

History of celestial sensing with electro-optics

Prior to the 1960's, work on celestial sensing devices centered on star-tracking systems that contained photomultipliers; the possibilities of celestial sensing without closed-loop tracking were not extensively considered. Furthermore, no work was done on the more general problem of attitude-tracking an arbitrary continuum of points across the sky as might be needed for search, surveillance or reconnaissance. The principal exception was the work done with the image orthicon; in this approach a gimbaled optical system was pointed approximately at the target and the final measurement was made by the image tube.

Since image tubes are accurate only to about 1/1000 of the field of view, it was necessary to restrict fields of view to 3.6° to achieve an accuracy of 10 seconds of arc. Hence, such crude pointing was necessary, even though the final determination of star position was made on an open-loop basis requiring only position sensing.

Subsequently, several investigators considered combining image tubes with wide-angle optical systems. With this type of detection system, a sufficient number of bright stars could be detected to achieve automatic pattern recognition for a randomly oriented system. A system of this type, suggested by A. Rosenfeld,² with a field of view about 10° achieved an accuracy down to a few minutes of arc, and detected stars down to the sixth magnitude. Another system, described by N.S. Potter,³ had a field of view about 30° , achieving an accuracy of approximately seven minutes of arc and detecting stars down to the third magnitude. Both systems succeeded in operating without closed-loop tracking, but had other defects: to achieve adequate accuracy, they had to detect very faint stars.

More recently, efforts have been made to develop mosaic or grid-type celestial sensors that would avoid the need for an image tube or for moving parts. Thus far, systems of this type have not provided resolution high enough to be competitive with star trackers. An interesting system described by E. F. Lally⁴ uses a mosaic of solid state detectors. The accuracy expected from a 10-by-10 detector of this type is seven seconds of arc, with a scanning

resolution of 1/50 of each detector and with optics providing a 1° field of view. A related grid-type system is the electroluminescent panel⁵ in which a solid state cross-grid of wires produces a light source which is projected onto a beam-coincidence detector. When the star image and the beam from the panel coincide, the detector's conductance increases sharply. Another mosaic-type system, described by S.S. Viglione and H.F. Wolf,⁶ considered 400 photovoltaic cells. With a field of view of 25° , a limiting magnitude of 4.5 and two lines of sight orthogonal to one another and to the sun, an accuracy of 0.2° was predicted.

A partial solution to the problem of achieving high resolution has been achieved by a novel device described by L. Snowman,⁷ in which a highly accurate attitude sensitivity (30 seconds of arc) was achieved for all three axes with an optical system that provided a 46° field of view. In this case, various reference star fields were mechanically fabricated and mounted at the optical system's focal plane. However, this device must be pointed to within 10° of the center of the reference field.

A panoramic camera can be adapted to carry a 360° slit, as has been demonstrated by R.L. Lillestrand and J.E. Carroll. A study of system tradeoffs led Lillestrand and Carroll⁸ to become interested in wide-field-of-view systems, particularly for the problem of achieving sufficiently high resolution. This is the basis for the strapped-down celestial reference system described in this article.

By employing a narrow optical slit, and conveying the light to a photomultiplier by means of fibers mounted immediately behind the slit, the position of celestial targets can be found to an accuracy of at least 1/10,000th of the optical system's field of view. This means that optical systems of the order of 30° in field of view can provide accuracy down to 10 seconds of arc, as described by D.C. Harrington.⁹ In the case of spinning spacecraft, systems of this type can be fabricated with no moving parts as described by R.L. Kenimer and T.M. Walsh.¹⁰ In the case of inertially stabilized spacecraft, however, provision must be made for rotating the slit.

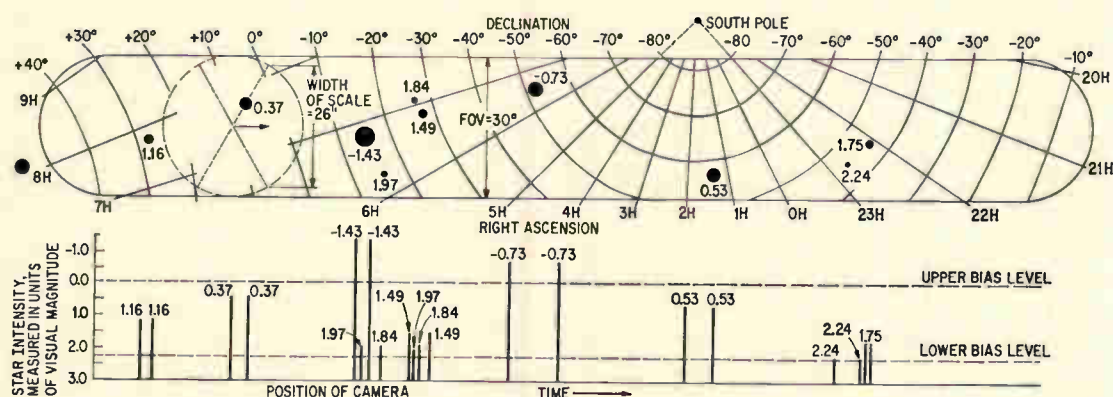
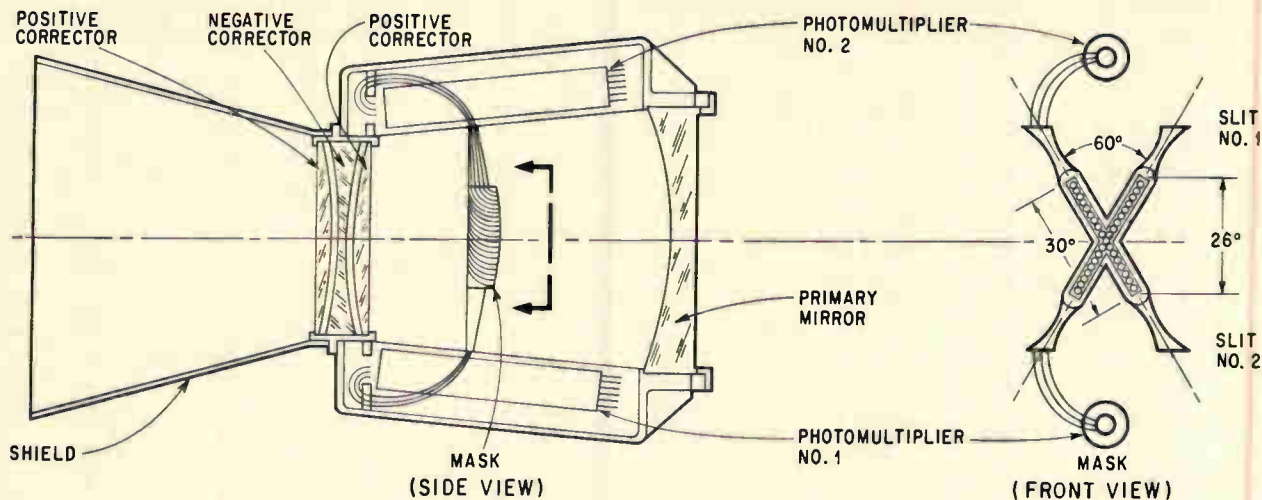

Scanner and its output. As camera sweeps across the sky, it generates pulse pattern similar to that shown in bottom diagram. In this case, only pulses between upper and lower bias levels are transmitted to the computer for identification. Separation between pulses from any star is a function of star's distance from the scan plane; average position of pulses is a measure of star's angular position in the scan plane. Typical scan field might be 26° wide. If a nearby planet obscures one-half of the 360°-long strip of sky, the limiting magnitude must be reduced to about 2.5 if three or more stars are to be available for all fields of view.

design indirectly. If the active photocathode area is small, additional optical elements are needed to obtain the field of view on the active area. In addition, for satellite applications, small sensors are required which can tolerate vibration and extreme temperatures.

There are two major photocathode configurations: the end window and the internal type. In the end-window type, the photoemissive surface is a thin coating on the underside of the optically flat end of the glass tube. The availability of the photocathode surface allows great freedom of optical design in coupling the tube to the rest of the sensor; however, the end-window design results in a relatively large tube. A tube with an internal photocathode is smaller, but places severe restrictions on the design of the light-collecting system; these restrictions on design of the optical system are outweighed by the reduction in volume; therefore, internal photocathodes are preferred.

In light of recent advances in solid state detectors, the question arises, why not use these instead of a photomultiplier? There are three basic reasons:

- The response time of solid state detectors is prohibitively long, except for silicon diodes.

- Unlike photomultipliers, solid state detectors cannot incorporate almost-noiseless amplification internally. They require external amplification, which adds noise.

- The optical system transmits light in a particular spectral range. The photomultiplier's spectral response is compatible with this range, but solid state detectors would require special optics.

Attitude control

Strapped-down scanning sensors can be applied directly to attitude control in space if they are combined with a digital computer and reaction wheels. Such a control system is described in the chart on page 123. In most control situations the sensor-computer system must solve the pattern-recognition problem and compute the spacecraft's orientation. In situations requiring inertial lock-on control, general pattern recognition is not required.

Consider the problem of measuring the orientation and drift rate of a tumbling spacecraft. If the system's angular momentum is constant, long-term smoothing may be employed to solve for two unknowns: attitude and rate. The orientation relative to the desired celestial coordinates may be repre-

Spacecraft gets the point—from the stars

Operational mode

1. Tumbling: Sensor provides measurement of inertial orientation and rate. Operation in this mode is open-loop.

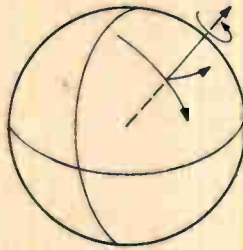

Applications

When vehicle is spinning or tumbling. Where sensor is used to drift-trim gyros in vehicles with low inertial rates. Sensor is used in place of gyro down to 10^{-3} degree per hour.

2. Inertial lock-on: For stability control, system holds orientation relative to inertial space; orientation may be that at t_0 and may be unknown. For pointing control, system holds orientation relative to preassigned attitude.

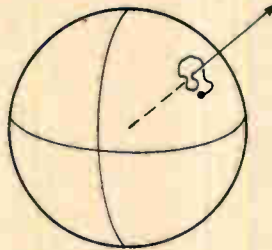

Whenever inertial stabilization or inertial pointing control is required, as in astronomical investigations.

3. Reorientation: Starting at one orientation, system is shifted to any selected new orientation.

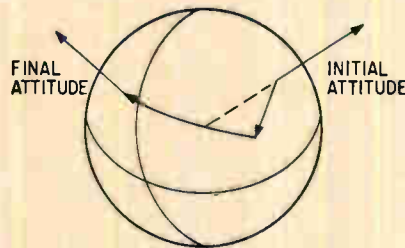

When specific pointing directions must be achieved, either sequentially or at discrete times.

4. Reference-path tracking: Following a designated path across the sky.

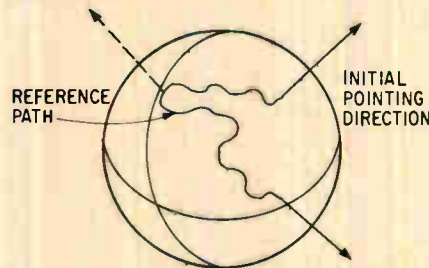

When searching for other spacecraft or for celestial targets of interest in astronomy.

5. Reference-point tracking: Following a designated path across the sky with the restriction that the spacecraft's orientation must be at a certain point along the "attitude path" at a certain time.

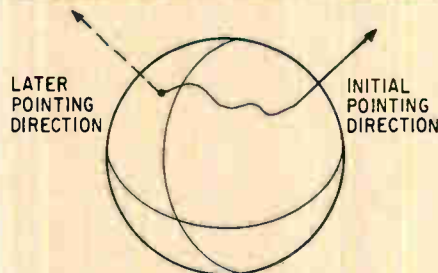

As substitute for horizontal sensors, for stabilization relative to instantaneous local vertical. For stabilization relative to specific points on the ground over which satellite passes. For stabilization relative to other nearby spacecraft.

6. Reference-attitude tracking: Besides following designated path across the sky, system controls azimuth to follow a prescribed continuum of values, and maintains all three parameters of spacecraft position at designated values as a function of time.

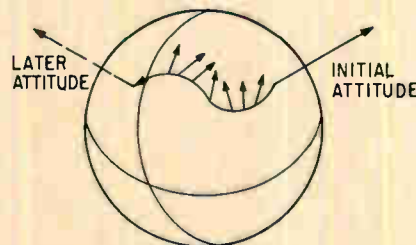

For stabilization relative to plane consisting of spacecraft, a planet and a natural satellite, with pointing axis toward planet or natural satellite. Examples: earth and moon or Mars and one of its satellites, Phobos or Deimos.

Six steps in attitude control performed by strapped-down celestial reference system. Mode 1 requires sensing of spacecraft's orientation and drift rate. In mode 2, spacecraft is stabilized relative to celestial coordinate frame; in mode 3 it is reoriented to new angular position. In mode 4 it follows a prescribed path relative to the stars. Mode 5 brings the spacecraft to a continuum of points along this path at predetermined times. Mode 6 adds the capability of controlling yaw of spacecraft at each point. Complexity of control problem increases from mode 2 to mode 6.

sented by an equation of the form $\psi_i = a_0 + a_1 t$, with $i = 1, 2$ or 3 . The rms error in the computed orientation and rate of change are

$$\sigma(a_1) \approx \frac{2}{\sqrt{n}} \sigma(\psi_i) \quad (1)$$

$$\sigma(a_0) \approx \frac{2}{T} \sqrt{\frac{3}{n}} \sigma(\psi_i) \quad (2)$$

where n = number of scans averaged, $T = nt_0$, where t_0 is the scan period in seconds, and $\sigma(\psi_i)$ = rms error per scan in the orientation i^{th} axis.

Experimental results show that a value of $\sigma(\psi_i) \approx 10 t_0^{-1}$ arc seconds can reasonably be expected when an optical system with a two-inch aperture is used. When this expression for $\sigma(\psi_i)$ is substituted into equations 1 and 2 and a total sampling interval of one hour is used $\sigma(a_0) \sim 20 T^{-1/2} = 0.3$ arc second and $\sigma(a_1) \approx 20\sqrt{3} T^{-3/2} = 1.6 \times 10^{-4}$ degrees per hour. Because the rms error in the drift-rate determination is proportional to $T^{-3/2}$, this error becomes very small if scan periods as long as one hour are used. For this reason, in certain applications such as those involving astronomical observations, the celestial sensor can be used as a substitute for precision rate gyros.

Should corrective action be taken with flywheels whose angular positions are controlled, attitude control of the spacecraft can be achieved without destroying the information in prior sensor measurements. This is inertial lock-on, mode 2 in the chart. With a system which can provide three-axis attitude control, the problem arises of reorienting the vehicle to a completely new pointing direction. By moving the flywheels through known angles and measuring the changes in attitude of the spacecraft, the ratio of the spacecraft's moment of inertia to that of the flywheel can be calculated for each axis. Then an open-loop maneuver to the new orientation can be made by turning the flywheels through a prescribed number of revolutions. In this case, the control loop involves only the computer and reaction elements, and the TAAS is outside the control loop.

To avoid the problems of flywheel speed control and cross-coupling, the three flywheels are rotated sequentially.

Next in order of complexity among the computer programs is the problem of reference-path tracking. This mode might be used in searching for distant spacecraft or for faint targets of astronomical interest. If one adds the requirement of pointing in a certain direction at a specified time, reference-point tracking is achieved. This capability might be used to point sensors for planetary surveillance. Finally, if the spacecraft is to move along a certain path relative to the stars while the yaw axis is being controlled, this poses the most general time-dependent three-axis problem of attitude control: reference-attitude tracking. If computer programs are available for this latter mode, all prior modes of operation become special cases.

For stability control and pointing control, pattern recognition is not required; also the computation

of the attitude error is relatively simple. Consequently, in these applications, the computer is available for other computations during most of the scan period. A single sensor can be used for both measuring and controlling attitude; only the data-processing method needs to be changed.

Control systems with scanning optical sensors have the advantage of being self-calibrating; this capability is required for satellites where masses are periodically ejected, or moved about, thereby changing the vehicle's moment of inertia and invalidating ground-based calibrations. The moment of inertia can be measured to one part in 10^4 while a spacecraft is in orbit.

The second part of this article will discuss experimental results from a TAAS system, and explain how patterns of stars are recognized, relying only on relative star positions. It will also analyze requirements for a TAAS computer and look into the future of celestial guidance in space operation.

References

1. E.J. Farrell and C.D. Zimmerman, "Information Limits of Scanning Optical Systems," *Optical and Electro-Optical Information Processing*, J.T. Tippett et al. eds., MIT Press, Cambridge, 1965.
2. A. Rosenfeld, "Stellar Navigation Without Star Tracking," East Coast Conference on Aeronautical and Navigational Electronics, 1960.
3. N.S. Potter, "Orientation Sensing in Inertial Space by Celestial Pattern Recognition Techniques," ARS 15th Annual Meeting, Washington, D.C., Dec., 1960.
4. E.F. Lally, "Mosaic Guidance for Interplanetary Travel," ARS Space Flight Report to the Nation, Oct., 1961.
5. W.L. Harmon, G.J. Shroyer and K.J. Gilkey, "Optical Trackers in Space," *ISA Journal*, Nov., 1962, pp. 70-73.
6. S.S. Viglione and H.F. Wolf, "Star Field Recognition for Space Vehicle Orientation," Paper 1.2.5, 9th Annual East Coast Conference on Aerospace and Navigational Electronics, Baltimore, Oct., 1962.
7. L. Snowman, "Star-Field Tracker Gives Attitude Data," *Aviation Week and Space Technology*, June 18, 1962.
8. R.L. Lillestrand and J.E. Carroll, "Self-Contained System for Interplanetary Navigation," American Astronautical Society, San Francisco, Aug., 1961.
9. D.C. Harrington, "Noise Error Analysis of an Optical Star and Planet Scanner," NAECON, Institute of Electrical and Electronic Engineers, Dayton, May, 1963.
10. R.L. Kenimer and T.M. Walsh, "A Star Field Mapping System for Determining the Attitude of a Spinning Probe," International Conference on Aerospace Electro-Technology, Phoenix, Apr., 1964.

The authors



This is Edward J. Farrell's tenth published article. He received a bachelor's degree in physics in 1958 and has completed course work for a doctorate in mathematical statistics, both at the University of Minnesota. He joined Control Data as a senior research scientist in 1964.



Robert L. Lillestrand is the staff specialist for aerospace research at Control Data which he joined in 1961. Since then he has contributed to the development of a variety of autonomous space navigation systems. He holds a master's degree in physics from the University of Minnesota.

Ruby, sapphire, YAG— you know our single crystals.

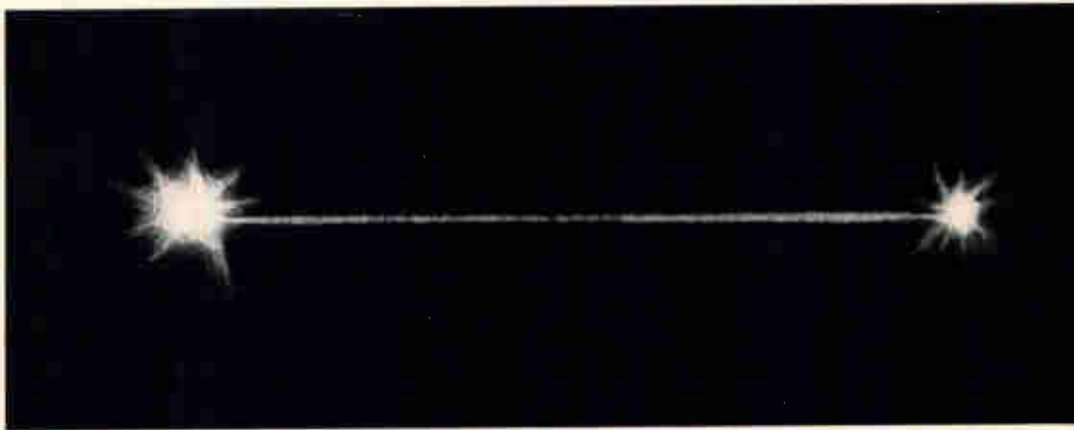

Now see what you think of our bright new laser.

It's the brightest laser in the world — 25×10^{10} times brighter than the sun...nearly triple the brightness of any previous commercial laser. It's the new K-1500 laser, now available from KORAD Corporation, a subsidiary of Union Carbide.

We are committed to leadership not only in crystals and laser products...but also in such fields as special transistors, integrated and modular circuitry, and solid tantalum



and foil-film capacitors. What sort of company innovates such important new products and backs them with multi-disciplined technology? Union Carbide—dedicated to growth through research.

For specific data on single crystals or laser systems — or if you'd like more information on our electronics activities — please write Union Carbide Corporation, Dept. E-33, Linde Division, 270 Park Ave., N.Y. 10017.

KORAD is a registered trade mark of Union Carbide Corporation.

WHERE CAN MAN GO...IN SYSTEMS



In space, on land, in the ocean depths...if his company is exploring those environments. Lockheed's systems activities encompass journeys to near and distant space, automated hospitals and unique land vehicles, and deep submersibles. And indispensable to this broad effort are men able to contribute to systems management. To analyze. Design. Test. To integrate subsystems into entities reaching thousands of miles — or thousands of fathoms — beyond the limits binding men today. Engineers and scientists with a systems flair are invited to write Mr. K. R. Kiddoo, Professional Placement Manager, Sunnyvale, California. Lockheed is an equal opportunity employer.

LOCKHEED
MISSILES & SPACE COMPANY
A GROUP DIVISION OF LOCKHEED AIRCRAFT CORPORATION

Coors Strate-Breaks™



Speed Circuit Manufacturing

High quantity production of integrated circuits with uniform quality, increased precision tolerances, greater economy in the production of micro-ceramic components—all these are yours by gang printing your circuits on Coors *Strate-Breaks*. No cutting apart, no multiple handling before assembly. Just SNAP! . . . and there are your individual components with a straight, smooth, precision edge.

Coors *Strate-Breaks* are made to your specifications in sizes from 1/2" x 1/2" to 4" x 4". They are available unglazed for thick-film circuits, and glazed or unglazed for thin-film circuits. For on-the-spot answers to your questions, dial the Coors "hot line"—303/279-4533, Ext. 351. For full details on Coors *Strate-Breaks*, write for Coors *Strate-Break* Data Sheet 7011.

Patent
Pending

*consider
Coors
ceramics*

Coors
CERAMICS

ALUMINAS • BERYLLIAS • MAGNESIAS • SPECIAL OXIDES
Coors Porcelain Co., Golden, Colo.

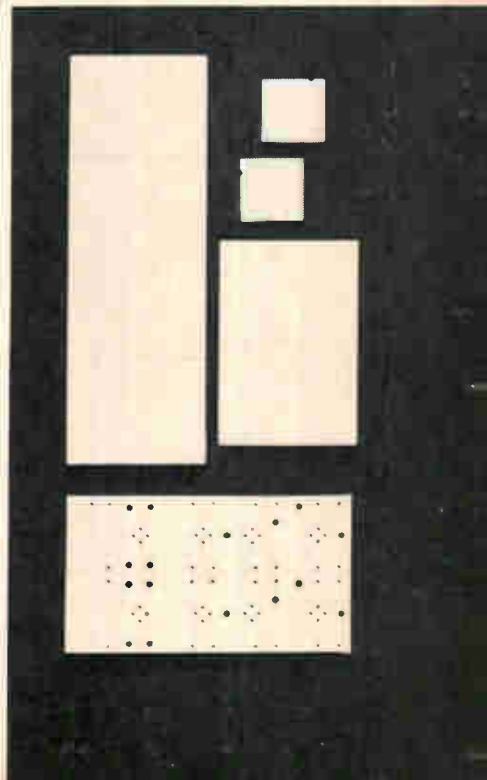

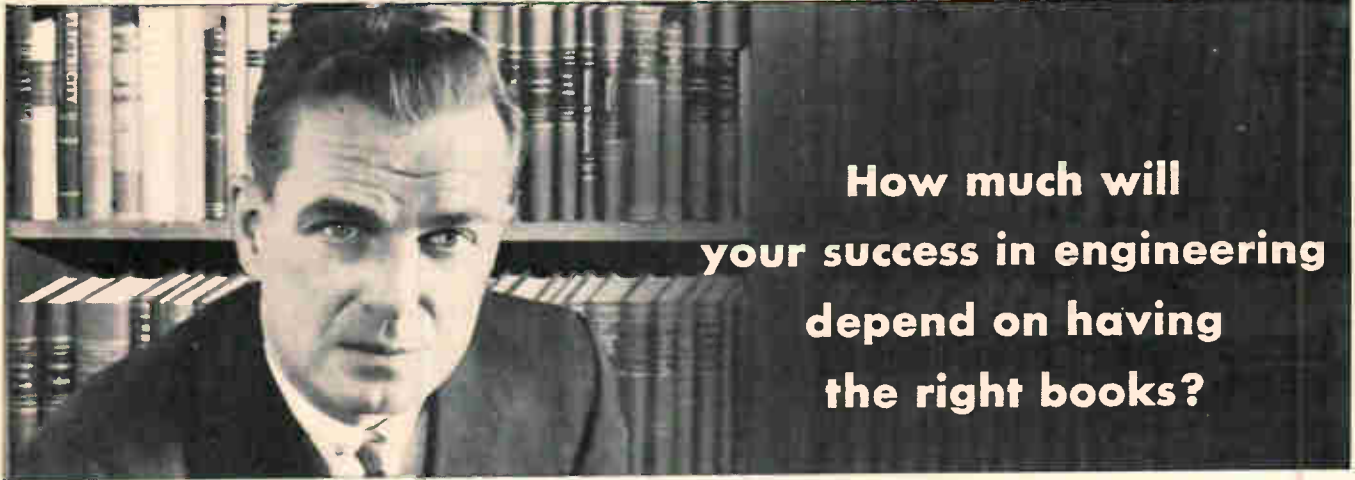

How much will
your success in engineering
depend on having
the right books?

The Electronics and Control Engineers' Book Club helps you keep ahead in your field . . . at a savings

Start your membership with any of these selections:



Introduction to Radar Systems by M. Skolnik. Covers everything from the prediction of radar range performance to applications.

Publisher's Price, \$14.50
Club Price, \$12.35



Mathematics for Electronics with Applications by H. M. Nodelman and F. W. Smith, Jr. Methods for solving practical problems.

Publisher's Price, \$7.00
Club Price, \$5.95



Transistor Circuit Design, prepared by the Engineering Staff of Texas Instruments Inc. Reduces theory to actual practice.

Publisher's Price, \$15.00
Club Price, \$12.75



Electronic Amplifier Circuits by J. M. Pettit and M. M. McWhorter. Gives reliable guidance on electronic amplifier circuit design.

Publisher's Price, \$10.50
Club Price, \$8.95



Modern Digital Circuits by Samuel Weber. A practical reference on design aspects of digital-type circuits.

Publisher's Price, \$9.50
Club Price, \$8.10



Electronic and Radio Engineering by F. E. Terman, 4th Ed. Helps solve modern problems in the electronic and radio engineering fields.

Publisher's Price, \$16.00
Club Price, \$13.60



Electronic Measuring Instruments by H. Soisson. Covers electronic equipment used for precise measurements and control.

Publisher's Price, \$7.50
Club Price, \$6.40

Your engineering career owes a great deal to books. Why not take advantage of this convenient, economical way to have the best professional books available when you need them? THE ELECTRONICS AND CONTROL ENGINEERS' BOOK CLUB brings you the essential technical literature in your field. It also helps you overcome today's high cost of building a professional library by saving you an average of 15% from publisher's prices.

How the Club Operates. You regularly receive free of charge *The Electronics and Control Engineers' Book Bulletin*, as issued. This gives complete advance notice of the next selection-of-the-month, as well as many alternate selections. If you want the main selection you do nothing; the book will be mailed to you. If you want an alternate selection—or no book at all—you can notify the Club by returning the convenient card enclosed with each *Bulletin*.

Saves You Time and Money. You agree only to the purchase of four books over a two-year period. Certainly out of the large number of books offered in your field there are at least four you would buy anyway. By joining the Club you save both money and the trouble of searching.

Send No Money Now. Just check the book you want as your first selection on the coupon below. With it you will be sent *Handbook of Semiconductor Electronics* for only one dollar. Take advantage of this offer and receive two books for less than the regular price of one. (If coupon is detached, write to The Electronics and Control Engineers' Book Club, Dept. L-324xx, 330 W. 42nd St., New York 36, N. Y.)



ACCEPT THIS
\$19.50 BOOK

FOR ONLY \$1.00

with membership in
The Electronics and
Control Engineers'
Book Club

HANDBOOK OF SEMICONDUCTOR
ELECTRONICS

Prepared by a Staff of 18 Specialists
Edited by LLOYD P. HUNTER

Here is a wealth of reliable information to assist you in understanding the basic physical action of transistors, diodes, and photocells — for assembling necessary equipment, and fabricating typical semiconductor—and, above all, for designing a large variety of transistor circuits for use in various frequency ranges.

Handbook of Semiconductor Electronics is typical of the selections of THE ELECTRONICS AND CONTROL ENGINEERS' BOOK CLUB. All books are chosen by qualified editors and consultants. Their thoroughgoing understanding of the standards and values of the literature in your field guarantees the authoritativeness of the selections.

(NOTE: If you already own this volume, you may substitute any other book on this page as your DOLLAR book. Check two books below and you will receive the higher priced selection for only \$1.00.)

CLIP AND MAIL THIS COUPON TODAY

The Electronics and Control Engineers' Book Club, Dept. L324xx
330 West 42nd Street, New York, N.Y. 10036

Please enroll me as a member of the Electronics and Control Engineers' Book Club. You will bill me for my first selection indicated at right at the special club price and \$1 for Handbook of Semiconductor Electronics (or alternate choice), plus local tax where applicable, and a few cents delivery costs. (The Club assumes delivery costs on prepaid orders.) Forthcoming selections will be described in advance and I may decline any book. I need take only 4 selections or alternates in 2 years of membership. (This offer good in U. S. only.)

PLEASE PRINT

Name
Address
City State Zip
Company

Send as my first selection: (If more than one book is checked we will send the higher priced selection as your \$1.00 book.)

- Introduction to Radar Systems, \$12.35
- Mathematics for Electronics with Applications, \$5.95
- Transistor Circuit Design, \$12.75
- Electronic Amplifier Circuits, \$8.95
- Modern Digital Circuits, \$8.10
- Electronic and Radio Engineering, \$13.60
- Electronic Measuring Instruments, \$6.40

NO RISK GUARANTEE: If not completely satisfied, you may return your first shipment within 10 days and your membership will be canceled. L-324xx

60 db

Treasured recipes we know for cooking up bones, hides, silver, nitric acid, cotton lint, and numerous less familiar ingredients yield an admirably uniform and miraculously sensitive quantum device that comes in long strips 16mm, 35mm, or 70mm wide under the name KODAK

PLUS-X Pan Film. You may be startled to learn that this familiar and widely obtainable film, when developed 10 minutes at 68°F in the equally familiar KODAK Developer D-76, can record a luminance range of 1,000,000:1. Naturally, those who want a 60 db dynamic range must be prepared for the conse-

quences. The heavy end of the exposure scale is represented by some pretty heavy density, like 4.5. A strong light is required to get the good out of it.

If more encouragement is desired before acting on this hint, please communicate with Eastman Kodak Company, Special Applications, Rochester, N. Y. 14650.

Shall we sharpen up the cool world?

At this particular juncture in technological history something ought probably to be done to sharpen up the infrared images that lenses can form from temperature differences they see in the world, even the pretty cool world. If you think this is desirable and have strong enough reasons to participate, we suggest you arrange for the necessary talent in geo-

metrical optical design, with or without accompanying computer software, and we'll furnish the refractive index data about the KODAK ITRAN Optical Materials that now permit realistic planning along these lines. These polycrystalline media all have mechanical, thermal, and solubility properties that allow them to be worked with little or no modification of the very familiar optical shop prac-

tices. By comparison with other infrared-transmitting media, heat of their own dims them less.

Our own lens designers are too busy at the moment to do any designing for you, but their chief would doubtless enjoy dictating a letter of broad, general counsel on what to read to get going. To make contact, write Eastman Kodak Company, Special Products, Apparatus and Optical Division, Rochester, N. Y. 14650.

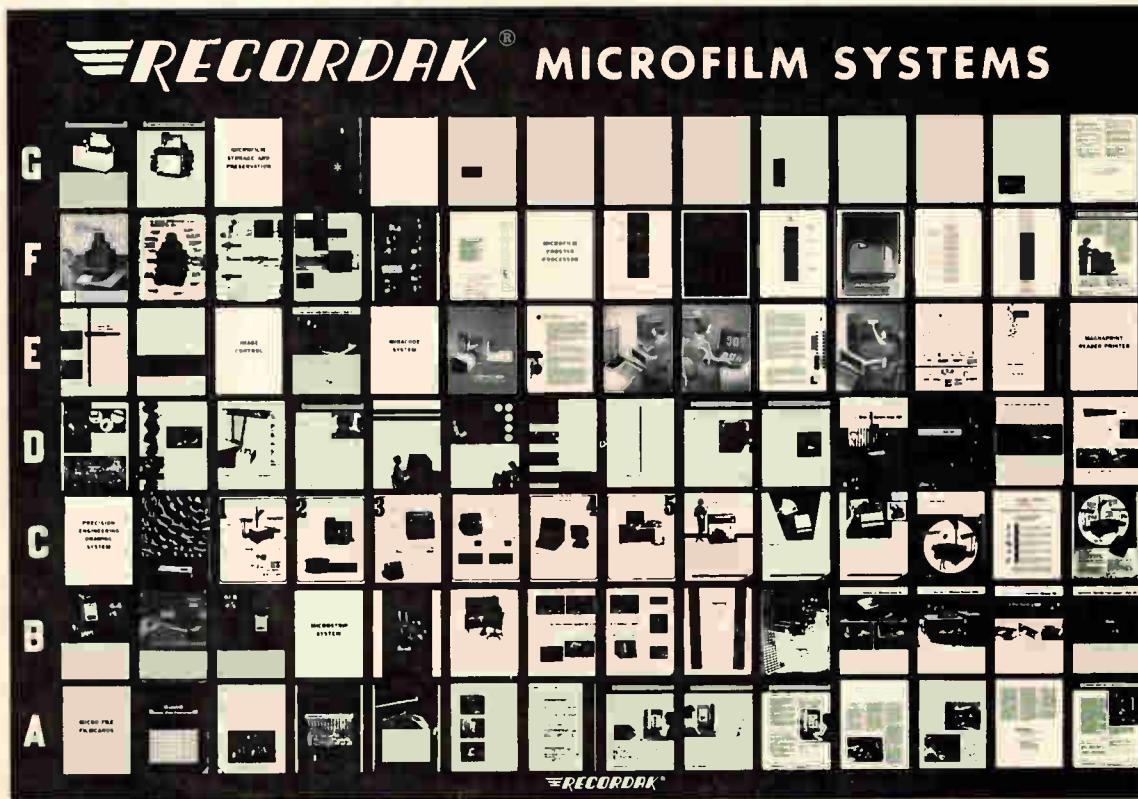

If the press that printed this magazine could pack information as tightly as photography can, the microfiche crudely reproduced here actual size would convey all the facts not only about the microfiche system itself but also about all the other RECORDAK systems for information storage and retrieval that

might be better for your purposes than microfiche. Certain prominent aircraft manufacturers and certain airlines they serve would argue, however, that for handling something like maintenance information there is no better system than microfiche, or, as we call it, the RECORDAK MICRO-FILE Filmcard.

We can even go so far as to send the 98 pages full size upon indication of interest to Recordak Co (770 Broadway, New York City 10003), Business Systems Markets Division of Eastman Kodak Company, which company attempts to serve many different fields of interest as sensibly as possible

Kodak

**RESPONSIBLE ASSIGNMENTS FOR CREATIVE,
ENERGETIC ENGINEERS AND SCIENTISTS IN:**

F-111 AND OTHER ADVANCED AIRCRAFT PROJECTS

MISSILE PROJECTS

SPACE SYSTEMS & MISSION ANALYSIS PROJECTS

OTHER R&D ASSIGNMENTS

INFORMATION TECHNOLOGY

- Mission Simulation, Display Technology

NAVIGATION, STABILITY, GUIDANCE & CONTROL

- Stability and Control, Computer Design, Servo Analysis

ELECTRONIC SYSTEMS

- ECM, Penetration Aids

ELECTRONIC AGE

- Microwave and Computer Design

ELECTRONICS LABORATORIES

- Circuit Design, Flight Test Instrumentation

Highly qualified engineers and scientists of virtually every discipline are needed to fill important openings in our highly diversified Research and Engineering Departments — now.

Live in or near Fort Worth, 1965's All American City — Uncongested, easy living where your dollar buys more — Superior housing, public schools and recreation — Graduate studies at local universities and colleges.

CALL COLLECT — 817 - PE 2-4811

or send a complete resume of your education and experience to J. B. Ellis, Industrial Relations Administrator, Engineering, General Dynamics, Fort Worth Division, P. O. Box 748 E Fort Worth, Texas. An equal opportunity employer.

GENERAL DYNAMICS
Fort Worth Division

Vintage 1952

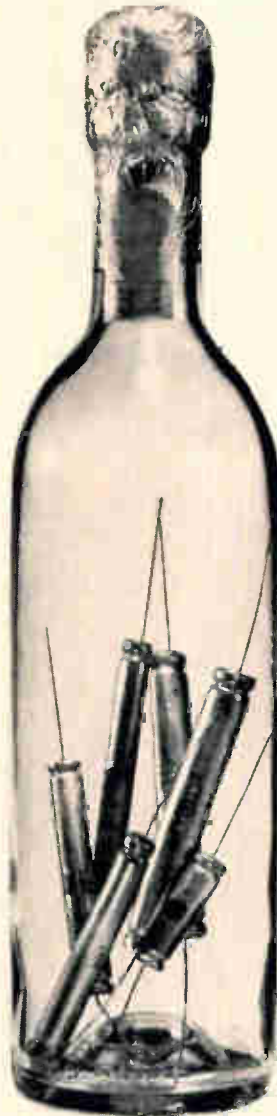

That's 14 years at 25C . . . with capacitance change less than 5%. The bouquet's still there! And long shelf life is only one reason for using G-E tantalum foil capacitors. Here are 3 others:

PROVED OPERATING LIFE: Our 85C tantalum foil has been on continuous test for over 50,000 hours, our 125C for more than 40,000 hours . . . with no capacitance change significant enough to affect performance. And with General Electric's Minuteman-proved true hermetic seal (now offered on most foil units for a small additional charge), life can be extended indefinitely.

REVERSE VOLTAGE STRENGTH: G-E tantalum foil capacitors are designed

to withstand unsuspected reversals.

SELF HEALING: Forget about low impedance circuit problems and catastrophic failures. G-E tantalum foil capacitors are self-healing.

G-E tantalum foil capacitors are available in ratings up to 450VDC, 0.15 to 3500uf, —55 to 85 or 125C.

We've been proving—and improving—them for 17 years. They're virtually risk-proof. And may cost a bit more. But don't the best grapes make the best vintage?

For all the facts on G-E tantalum foil reliability, write for Reliability Report, Section 430-27, General Electric Co., Schenectady, N. Y. 12305

14 years proved shelf life is just one more reason for G-E tantalum foil

ELECTRONIC COMPONENTS DIVISION

GENERAL  ELECTRIC

EIMAC

announces next-generation TWT/power packages for radar augmentation

Here's a new family of miniaturized lightweight traveling wave tubes and power packages from Eimac. They're designed to answer your needs for radar augmenters. These next-generation packages provide power from 2 to 20 watts, and instantaneously amplify any frequency from S through X bands. All incorporate PPM-focused high performance TWT's providing high gain consistent with minimum size and weight. Tubes are available with depressed collectors for increased efficiency, and meet environmental specs for missile applications. No temperature compensation is required for operation at -54° to $+74^{\circ}$ C. Write for complete technical and applications information.

CHARACTERISTICS (MINIMUM)

Package type	EM-1184	EM-1186	EM-1193
Frequency (Gc)	5-11	8-12	2-4
Power output (watts)	2	20	5
Small signal gain (db)	60	60	50
Tube type	X-1044	X-1056	X-1061
Dimensions (in) (Tube/Package)	6x3x10	6x3x12	6x3x10
Weight (lbs)	7	8	7

EIMAC

San Carlos, California 94070
A Division of Varian Associates

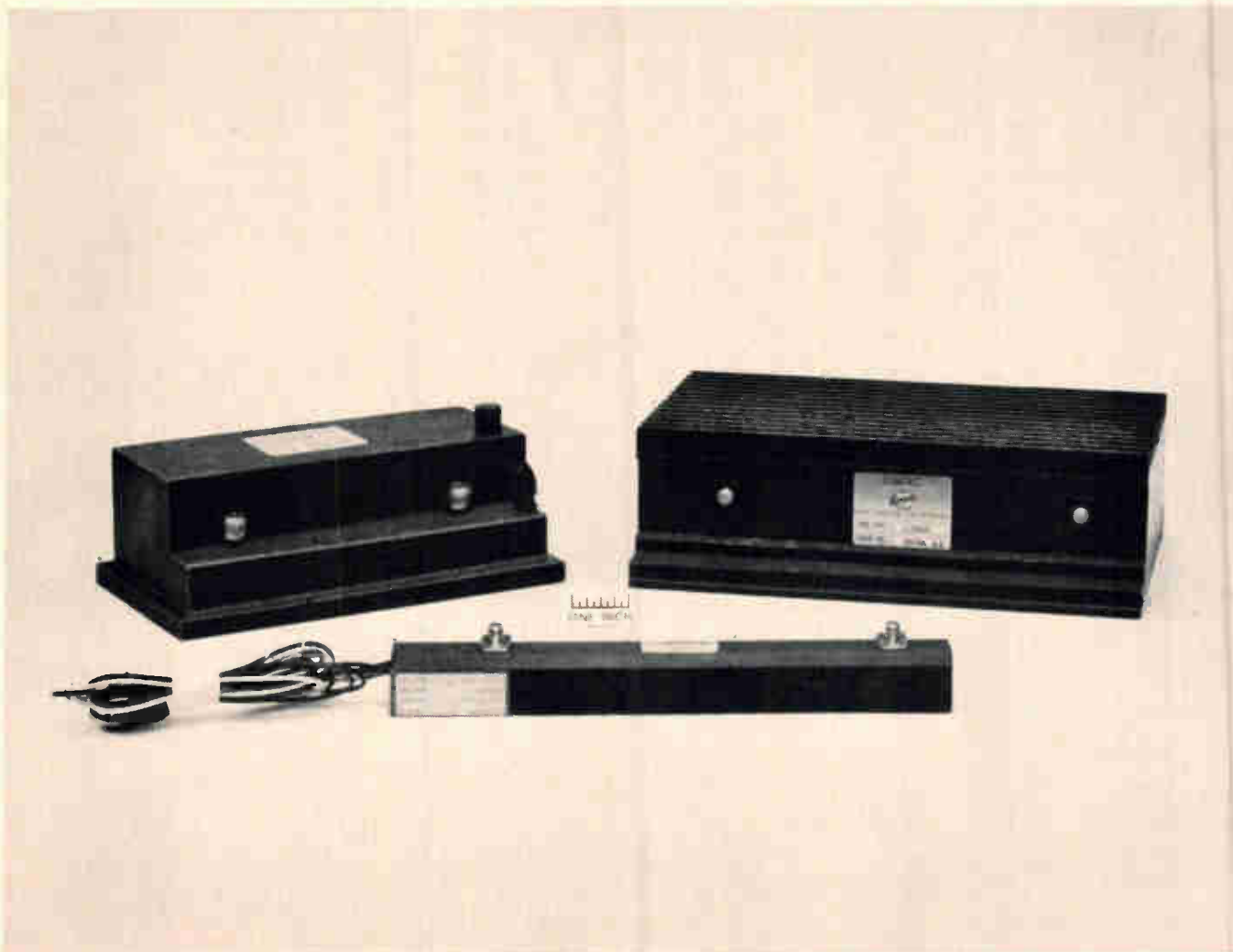

Now Vector can supply you with a full range of microelectronic subcarrier oscillators for your FM telemetry systems: The Low Level MMO-30, for inputs from 0 to 20mV or $\pm 10\text{mV}$, has complete input to output isolation and a truly differential floating input, measures 0.271 cubic inch and weighs 15.0 grams. The High Level MMO-11, for inputs from 0 to 5V or $\pm 2.5\text{V}$, measures 0.108 cubic inch and weighs only 3.8 grams.

You can order both from Vector today.

The world's smallest microelectronic voltage-controlled subcarrier oscillators are part of Vector's full line of FM, Digital, and RF telemetry equipment. For more information, write or call Vector, (215) 355-2700.

Vector DIVISION OF UNITED AIRCRAFT CORPORATION
SOUTHAMPTON, PENNSYLVANIA

U
A



LATCH on to the EXCITEMENT in MICROELECTRONICS and SILICON DEVICE DEVELOPMENT at DELCO RADIO

Enthusiasm is running high at General Motor's Delco Radio Division.

Exciting developments in microelectronics and silicon devices have spawned a rapidly expanding research effort. New buildings . . . new equipment . . . and most importantly, new people!

The dynamic pace of accomplishment at Delco is pushing the state of the art clear out of sight. The opportunity is here for those who choose to capitalize on it.

Microelectronics

Circuit oriented EE's—0 to 5 years experience. Here's a chance to get in on the excitement in microelectronics. Research programs in both linear and digital circuitry embrace monolithic . . . thick film . . . thin film . . . and hybrid microcircuits.

Silicon Device Development

Lots of room here for the BS, MS, PhD in Physics, Chemistry, Physical Chemistry, or related fields. Development programs are underway in these areas:

Low power and very high power monolithic and hybrid circuits.

Silicon Transistors—from very high

frequency 10 milliamperere through 25 ampere, 1000 volts.

Thyristors—from 50 milliamperere through 500 ampere, 2000 volts.

Zener Diodes.

Silicon Rectifiers—from milliamperere through 250 ampere, 3000 volts.

Continuing R&D efforts already have led to Delco's leadership in high power, high voltage silicon transistors. Delco rectifiers—rated at 250 amps, 2000 volts—are going into alternators designed to handle the full power generated by the latest Diesel-electric locomotives.

Full-size, fully-transistorized TV sets now are in production, thanks to a Delco high powered transistor in the horizontal and vertical deflection circuits.

A tremendous momentum is building at Delco. The time is ripe—now—to join this outstanding research group.

If you'd like more information immediately, pick up the phone and call us collect, Area Code 317/459-2808. Ask for C. D. Longshore. Or, send your resume to Mr. Longshore, Salaried Employment, Dept. 102, Delco Radio Division, General Motors, Kokomo, Indiana.

An equal opportunity employer

We call them Microstacks®. They are being used in the lunar excursion module of the Apollo program, the Agena satellite, and the Minuteman missile.

They take tough temperature requirements in stride. Memory cores remain stable over a wide temperature range.

They can take a beating too. They're not built like conventional memory stacks. The "X" and "Y" axis of all the memory planes are continuously wired, then assembled in a folded array. This

design, which we originated, eliminates more than 80% of the solder joints and reduces size and weight. Stacks are ultra-reliable when packaged to meet Mil Spec shock, vibration, humidity, and other extreme-environment conditions.

When specifications call for a new core, or stack configuration, nobody can match Indiana General's design, development, and production capabilities. We make and sell more ferrite memory cores than anyone in the world. In fact,

we invented them. Many of our competitors are licensees.

If you have a military application for a high-reliability, low-power, miniaturized memory stack we'd like to send you our new Microstack Bulletin. Write to Mr. Thomas Loucas, Manager of Sales, Indiana General Corporation, Electronics Division/Memory Products, Keasbey, New Jersey.

INDIANA GENERAL 

**Our memory stacks play it cool
when Mil Specs make things hot.**



HIGH-GAIN, LINEAR PNP TRANSISTORS

Two new series of Planar II PNP transistors are now available from Fairchild for use in circuits requiring high gain and linearity.

2N3962, 2N3963, 2N3964, 2N3965 — This series features high current gain, low noise figure, and excellent beta linearity. The devices can be used over a wide range of current ratings, from less than $1\mu\text{A}$ to 50mA. Typical applications include low-noise audio pre-amps, DC amplifiers, micro-power flip-flops, linear amplifiers in sub-audio to HF frequencies, and IF amplifiers in the 20Kc to 500Kc range.

2N4030, 2N4031, 2N4032, 2N4033 — This series has high voltage capability, low saturation, and excellent beta linearity. Use these transistors in amplifier driver and output circuits, up to 300mA and 1 watt for Class A, up to 800mA and 5 watts for Class B. Use them also in TV vertical sweep circuits, operating from 60-70V B^+ lines, or as medium-frequency linear amplifiers, or as complementary devices for use with supply voltages up to 80V.

These new PNP devices are available under the FACT program. Currently at Fairchild Distributors. Sample specifications shown below. Write for complete data sheets.



2N3965

NF 2db Max. @ 1Kc, $I_c=20\mu\text{A}$
 4db Max. @ 100cps, $I_c=20\mu\text{A}$
 8db Max. @ 10cps, $I_c=20\mu\text{A}$
 h_{FE} 180 Min. @ $I_c=1\mu\text{A}$
 250-500 @ $I_c=10\mu\text{A}$
 180 Min. @ $I_c=50\text{mA}$
 LV_{CEO} 60V Min.
 f_T 50Mc Min.
 C_{ob} 6pf Max.



2N4033

h_{FE} 75 Min. @ $I_c=100\mu\text{A}$
 100-300 @ $I_c=100\text{mA}$
 70 Min. @ $I_c=500\text{mA}$
 25 Min. @ $I_c=1000\text{mA}$
 LV_{CEO} 80V Min.
 $V_{CE(SAT)}$ 0.5V Max. @ $I_c=500\text{mA}$
 f_T 150Mc Min.

Planar is a patented Fairchild process.

FAIRCHILD SEMICONDUCTOR/A Division of Fairchild Camera and Instrument Corporation ■ 313 Fairchild Drive, Mountain View, California (415) 962-5011 ■ TWX: 910-379-6435

Probing the News

Consumer electronics

It's a television first . . . receivers with integrated circuits

RCA's new line of television sets will be the first to use monolithic IC's in color and black-and-white tv sets

By Jack Avins

Home Instruments Division, Radio Corp. of America, Indianapolis, Ind.

When the Radio Corp. of America introduced its new line of television sets in San Francisco last week, industry attention focused on one 12-inch black-and-white model. It made news because, with it, a long-awaited step had been taken. RCA was marking a television industry first by putting a monolithic integrated circuit into the sound channel of a tv receiver.

RCA's Electronic Components and Devices division in Somerville, N.J. is manufacturing the IC's and they are going into the receivers at the company's Home Instruments division in Bloomington, Ind. [What's more, the division is gearing up to sell its integrated circuits to other manufacturers. See box, p. 140].

Four functions. The integrated circuit performs amplification, limiting, balanced frequency-modulation detection, and audio preamplification in the 4.5-megacycle inter-carrier sound channel.

The basic techniques used in the design of RCA's IC have potential application for industrial and military equipment. In effect, a systems approach was followed so that a large functional block could be developed on a single silicon chip. This is analogous to the current trend in digital integrated circuits — building large arrays with a minimum number of external circuit connections. No attempt was made by RCA to replace the discrete ele-

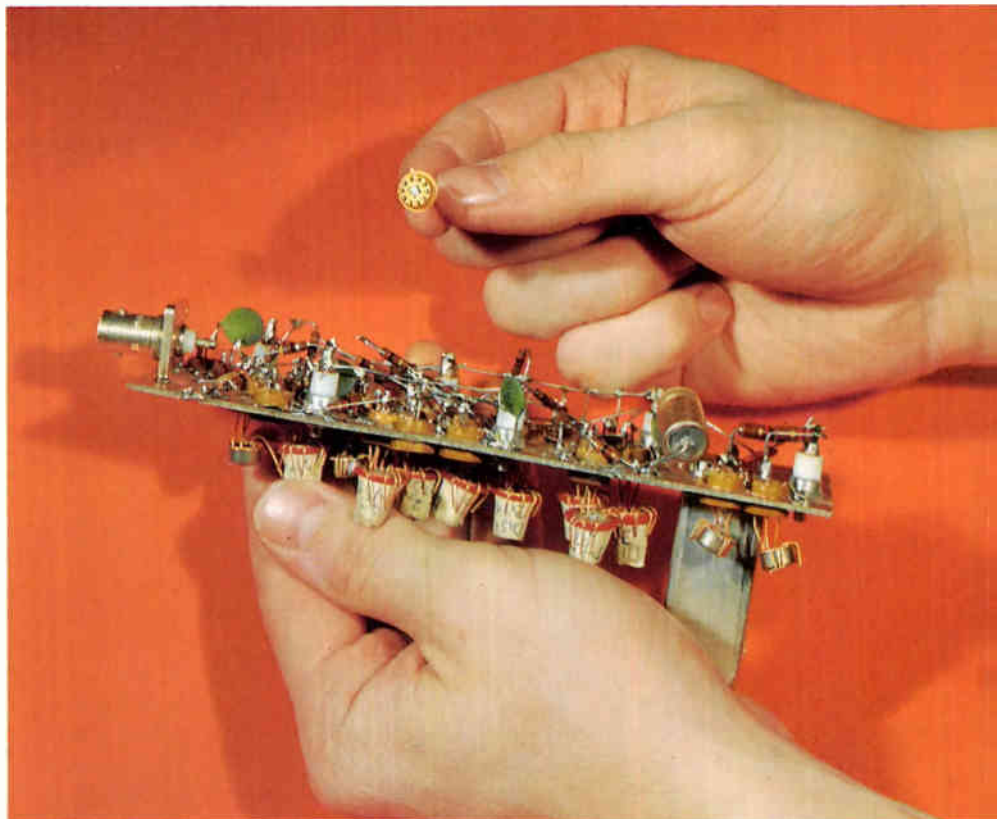

Breadboard version of the integrated circuit compared with the actual integrated circuit. Breadboard was built first to establish the IC's performance goals.

ments on a component-by-component basis.

The right place. With the decision made to develop an integrated circuit that would perform enough functions to make it competitive with discrete-component circuits, the next question was where to use

it in the television receiver.

The choice was limited; several areas were eliminated as possibilities because they offered neither technical nor commercial advantages. For example, since it isn't possible to integrate inductive elements, coils must be added extern-

ally. The same objection applies where values of capacitance in excess of 50 picofarads — total per chip — are needed. Resistor values above 30,000 ohms must also be external at this stage of IC development. And, because of the operating stresses that would be placed on an IC, the high-voltage and high-power sections of the tv receiver were ruled out.

I. Frequency-modulation detection

Finally, the choice settled on the frequency-modulation-detection portion of the receiver. It was the most promising area for an integrated circuit because:

- Four complex functions could be combined on a single chip.
- Cost savings could be realized by replacing nearly 30 discrete transistors and components with a single device.

- Better performance could result. Conventional f-m limiter-detector circuits are limited by cost from using enough devices to do an ideal job, but integrated circuits do not have this limitation and can be expected to perform better, particularly under fringe-area receiving conditions.

- The same circuitry could be used in radio receivers.

Counter counted out. Initially, attempts were made to use a digital detector IC. Theoretically, f-m detection with a cycle-counting circuit offered the possibility of eliminating the tuned circuits used in f-m detectors. Practically, however, it was found that a tuned circuit was still needed to insure the continuous presence of the 4.5-Mc intercarrier frequency. Otherwise, during channel switching, both the signal and noise could be lost momentarily because of the automatic-gain-control constant. Moreover, the resistor and capacitor tolerances required for the multivibrator were difficult to control.

As a result of these constraints, the digital detector was rejected in favor of an integrated discriminator network driven from an external tuned transformer.

II. F-m intercarrier chip

The four-function circuit which is going into RCA's new television sets is shown in the photograph and the schematic on these pages.

The input voltage e_1 is the 4.5-

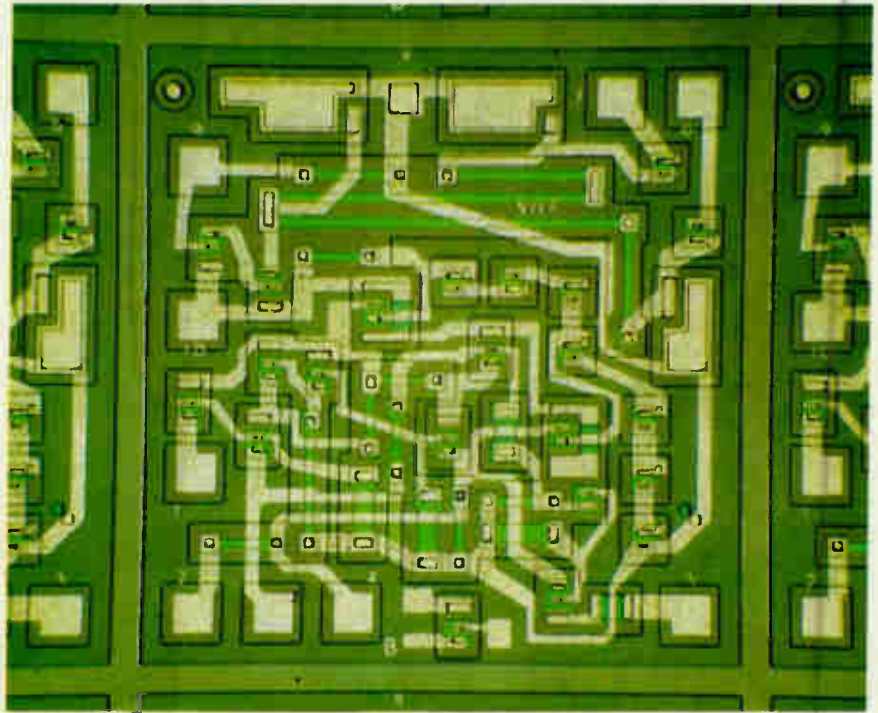

Close-up view of the integrated circuit. One-inch diameter wafers are used to make the IC's. Each IC replaces 26 discrete components.

Mc f-m intercarrier (beat) signal produced by mixing the 45.75-Mc picture carrier frequency and the 41.25-Mc f-m sound carrier frequency produced at the video detector. The high-Q transformer input circuit defines the passband at 4.5 Mc, eliminates spurious beat components and improves the threshold sensitivity of the f-m system by limiting the effective noise bandwidth before the signal reaches a limiter stage. The output at the secondary of the phase-shift transformer is normally in quadrature with the primary voltage. Drive from the third emitter-coupled limiter stage shifts the phase of the secondary voltage so that the phase shift follows the frequency modulation of the signal.

The balanced detector network is followed by an emitter follower that provides the desired audio output signal at a low impedance level. A single-polarity internally regulated voltage supply furnishes the voltages for the limiter, detector, and amplifier functions. The overall gain at 4.5-Mc is 75 decibels.

III. Amplifier-limiter

The amplifier circuit (above, right) consists of three direct-coupled cascaded stages. Each of the first two stages includes a two-transistor emitter-coupled amplifier and an emitter follower. The operat-

ing conditions are selected so that the d-c potential at the output of each triad (three transistor configuration) is identical with the d-c potential at the input to the triad. This is accomplished by operating the bases at one-half the supply voltage ($E/2$) and selecting the common-emitter load resistor to be one-half of the collector load resistor. For this condition the voltage drops across the emitter and collector load resistors are equal. Moreover, the collector of the emitter-coupled stage operates at a voltage which is higher than the base potential $E/2$ by an amount equal to V_{BE} , so that the potential at the output of the emitter follower is also $E/2$. Accordingly the triads can be iterated.

The operating conditions are such that the potential at the output of each triad is equal to the input potential despite temperature changes in the diffused transistors and resistors. In particular, changes in V_{BE} are compensated because a reduction in the common-mode gain of the emitter-coupled stage is accompanied by an increase in the gain of the emitter-follower circuit.

Independent gain. The amplifier gain is independent of the absolute values of the load resistors. This is particularly desirable because the absolute values of the integrated load resistors cannot be held to

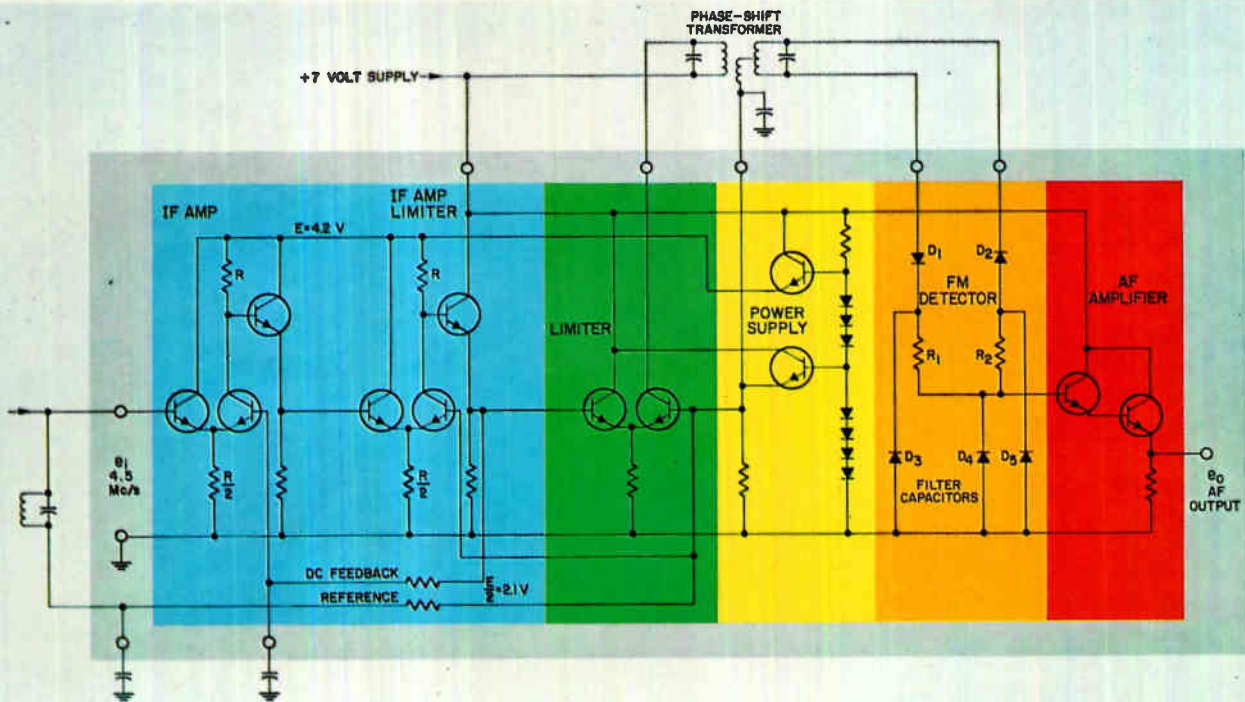

Functions provided by the chip are: blue, i-f amplification; green, limiting; orange, f-m detection; red, audio-amplification frequency. External components associated with the IC are shown outside of the color blocks.

tolerance better than $\pm 20\%$. The amplifier operation depends on maintaining the ratio between the values of the emitter and collector load resistors. Fortunately, integrated circuit technology permits fabrication of IC's with resistor ratios held to within approximately 3% and variations in the resistivity of the integrated resistors result only in a negligible effect on the over-all high-frequency cutoff of the amplifier. Since the cutoff frequency lies beyond the operating frequency it does not affect performance.

Good limiters. The emitter-coupled stages, which can be seen in the circuit above function particularly well as limiters because each half of the differential amplifier is alternately cut off on the positive and negative half-cycles of the input signal. Looking at it in a somewhat different way, the total emitter current I_0 tends to stay constant, and the current is equally divided between the two transistors. On the positive half-cycle, the current is steered so that the first transistor carries the full current I_0 while the second transistor is cut off. Similarly, on the negative half-cycle, the current is steered so that the first transistor is cut off and the second transistor carries the full emitter current I_0 . If the collector

voltage supply is maintained at 4.2 volts ($6V_{BE}$), the output voltage collector swing can be shown to be symmetrical about the zero-signal axis so that symmetrical limiting is attained without spurious phase modulation.

The d-c operating point is maintained by using d-c feedback around the first two stages. The third stage is then held automatically at the proper operating point because the feedback around the first two stages holds the voltage at the base of the third stage at $E/2$ volts. The third stage is thus balanced without being in the feedback loop. This is desirable because the tendency toward oscillation within the feedback loop is reduced by keeping the number of stages as low as possible. Because resistors of equal value are used in the base return circuit of the first stage, proper bias for the third stage is essentially independent of transistor current gain.

Regulation network. An internal regulated power supply feeds both the amplifier and the discriminator circuits. Two emitter-follower circuits provide $E=4.2$ volts, and $E/2=2.1$ volts, at low impedance, the circuits being driven by the voltages across the series diode network. This network provides regulation which keeps the gain relatively con-

stant with changes in power supply voltage. The system characteristics are essentially independent of supply voltage over the range from less than 6 volts to more than 10 volts.

The first two amplifier stages within the feedback loop are operated from the regulated low-voltage 4.2-volt, center-tapped supply. The second-stage emitter-follower circuit, however, is driven from the unregulated 7-volt supply, to prevent a degenerative signal voltage from being developed across the output impedance of the 4.2-volt supply. The collectors of the balanced output stage are driven from the unregulated supply.

IV. Detector network

All of the components in the f-m detector network, except the tuned phase-shift transformer, are integrated on the monolithic chip along with the amplifier-limited stages. The design eliminates the nonintegrable large diode load capacitors conventionally used to obtain peak rectification. Detection is accomplished with a substantially resistive load; filtering of the signal frequency and its harmonics is provided by the distributed capacitance of the load resistors and is further augmented by the capacitance of the small reverse-biased diode junctions D_3 , D_4 , and D_5 .

Operating the detector into a substantially resistive load has the advantage of reducing the loading effect of the discriminator diode network on the secondary and primary windings of the tuned phase-shift transformer. In conventional f-m discriminator circuits, a $\pm 20\%$ variation in the resistors substantially alters the peak-to-peak separation and linearity of the detector. However, the loading reflected by the diffused load resistors can be reduced to so low a level that it plays a negligible role in determining the discriminator characteristics; linearity and peak-to-peak separation are maintained over the full range of resistance values. In addition, amplitude modulation suppression and balance are maintained over this full range because the circuit is balanced and the diffused resistors will be substantially matched in value, although their values may vary widely from wafer to wafer.

Eliminating spikes. In addition to reducing the load variations, the integrated detector eliminates the high-frequency spikes of radio-frequency interference, characteristic of conventional f-m detectors. These



Integrated circuit replaces the discrete components shown. Eliminated are 2 transistors, 2 diodes, an interstage transformer, 14 resistors and 7 capacitors.

pulses contain harmonics which can be picked up by the internal antenna circuits or the i-f amplifier input and cause undesirable interference with the incoming signal.

In the integrated detector, this interference is greatly reduced because the detector load circuit is essentially resistive and the currents are confined to a small area.

IC's on the threshold of a new era

While RCA's Home Instruments division was proudly unveiling the black-and-white television set which is the industry's first with integrated circuitry, the company's Electronics Components and Devices division was readying an announcement of its own.

On March 15 it announced that RCA was offering the potentially huge market represented by original equipment manufacturers of home-enter-

tainment systems four integrated circuits designed for the f-m sound channel of television receivers and radios.

To the consumer products industry, already troubled by rumors of plans to incorporate microcircuits in upcoming products [Electronics, Dec. 27, 1965, p. 103] the news was unsettling. Experts have been saying that installing IC's in entertainment equipment was three to five years away. The reason most often expressed was the probable high cost of such circuits. One chief engineer of a Chicago-based firm has been saying all along that "suppliers would have to get the price below \$5 a circuit to win acceptance."

What increases the impact of RCA's news is the announced prices ranging from \$3.15 for an amplifier-discriminator in small quantities to \$1.25 for a less complex amplifier in quantities over 1,000. Clearly, RCA has crashed the arbitrary price barrier that had been set up by engineers in the consumer products business.

Though it is still too early to evaluate completely the effect of RCA's announcement, consumer products companies have been forced to take notice, some reluctantly. The announcement added to pressure started last autumn when word leaked out that the Admiral Corp., was hard at work trying to develop an integrated circuit de-



Integrated circuit in a production-line tv receiver manufactured by the Radio Corp. of America. Circle denotes the IC. Large cans are transformers.

The frequency modulation can be analyzed in terms of a switching action in that the junction of resistors R_1 and R_2 is periodically connected to the tertiary signal voltage

at the centertap of the transformer secondary.

If E_1 = peak value of the tertiary voltage, E_2 = peak value of the secondary voltage, 2ϕ = angle during

which rectifiers D_1 and D_2 are conducting, θ = phase shift with frequency deviation from the center frequency (that is, the resonant frequency of the secondary tuned circuit),

$$E_{AF} = \frac{1}{2\phi} \int_{-\phi}^{+\phi} E_1 \sin(\omega t + \theta) d(\omega t) \\ = E_1 \left(\frac{\sin \phi}{\phi} \right) \sin \theta$$

If the secondary voltage is large enough with respect to the diode "contact" potential to switch over 180° ,

$\phi = \frac{\pi}{2}$ and $\frac{\sin \phi}{\phi} = \frac{2}{\pi}$, so that the demodulated output signal

$$E_{AF} = \frac{2}{\pi} E_1 \sin \theta$$

Under these conditions, the demodulated output signal is independent of the amplitude of the secondary voltage.

The 2.1-volt supply voltage applied through the tertiary winding effectively biases the input and output diode network as well as the direct-coupled emitter-follower output amplifier. Operating the discriminator network at a positive potential with respect to the ground-

modulator for its 1967 color television models.

Then the Zenith Corp. started an in-house experimental program even though last December its vice president for engineering, J. E. Brown was saying that IC's in consumer entertainment products were three to five years away.

Because the consumer products business is so competitive it's safe to predict that once one company starts using IC's, few companies will be able to withstand the pressure, particularly when microcircuits mean better performance. Today, engineers of such equipment have to restrict the number of active elements they use because adding diodes and transistors to circuits raises their cost too much. But active elements come cheap in microcircuits. One of RCA's new circuits, which displaces 26 discrete components, has 39 components of which 24 are active elements.

In its research laboratory, RCA has been developing IC's for consumer products for about three years. Last year it introduced nine linear circuits [Electronics, Nov. 15, 1965] intended for a wide variety of applications. These general-purpose, highly versatile circuits were one way to break into the consumer-product market but RCA had another plan in mind: to apply the systems engineering approach which its military divisions had mastered to consumer products. In

its new circuits, the company has put complete functions on single chips instead of trying to replace discrete components by integrated elements.

Of the four new circuits, two are wideband amplifiers and two are wideband amplifier-discriminators — all are packaged in TO-5 cans. The amplifiers perform in the range from 100 kilocycles to 20 megacycles, a fact which makes RCA see potential applications in communications outside the television and radio field. Power gain is 75 db at 4.5 megacycles.

In addition to realizing some economies by saving components and wiring on the production line, users of the new circuits should enjoy the added benefit of easier servicing. RCA engineers predict that diagnosis and repair will be easier with IC's. That's because most service calls are to replace components whose performance has degraded and the ailing parts are sometimes hard to locate. Integrated circuits, on the other hand, fail catastrophically so a failure is easy to detect.

Lewis H. Young

ed substrate in this manner also makes it possible for the isolation junctions of signal diodes D_1 and D_2 to stay reverse-biased with respect to the substrate even when signal voltage is applied to the circuit.

The 2.1-volt bias voltage applied to the secondary winding results in the junction of the detector load resistors R_1 and R_2 being clamped at this voltage when a signal (or noise) is being received. Thus, diodes D_3 , D_4 , and D_5 receive the correct reverse-bias potential to function as small capacitors of approximately 7 picofarads each.

At the center frequency, the potential at the junction of R_1 and R_2 is substantially equal to the 2.1-volt bias voltage at the secondary winding and this supplies the necessary positive bias voltage for the emitter-follower output stage. On either side of center frequency the voltage swings positively and negatively about the bias voltage in accordance with the frequency modulation.

V. F-m radio receivers

The integrated circuit approach for the intercarrier sound channel of television receivers is directly applicable to broadcast f-m receivers. The chip can be used directly at 10.7 Mc, the intermediate frequency of broadcast f-m receivers, to replace an i-f amplifier, the limiter and the f-m detector stages.

Flat and free. Similarly, this integrated circuit can be used in communications receivers requiring a wideband limiter characteristic of exceptional flatness and freedom from incidental phase modulation. The f-m detector network, being substantially resistive, can be used not only at 4.5 Mc and 10.7 Mc but also at low frequencies such as 455 kc. The IC can also operate as high as 50 Mc although the gain of the wideband amplifier falls off in the vicinity of 50 Mc.

One IC=26 components. The intercarrier sound section of the RCA KCS-153 television receiver on page 141 shows the sound-takeoff transformer, which provides the 4.5-Mc selectivity, the integrated circuit, and the phase-shift discriminator transformer. Formerly, the ratio-detector circuit used a total of 26 discrete components. Now a single integrated circuit replaces them.

The performance of the integrated circuit is at least equal in every characteristic, and superior in most. For input signals between 500 and 200,000 microvolts, the output signal is constant to within better than ± 0.5 db. For signals between 1,000 and 200,000 microvolts, the output variation is less than ± 0.1 db. Because of the direct coupling in the three-stage amplifier-limiter and the absence of time constants which could charge on impulse noise, this steady state performance is accompanied by comparably high amplitude-modulation suppression under dynamic conditions of impulse noise interference.

VI. Meeting the test

RCA has a d-c test program that evaluates the essential characteristics of the amplifier, limiter, detector, output amplifier, and power-supply sections in a matter of seconds. Units which pass this automated d-c test are almost certain to pass the dynamic signal test in which operation in the receiver is simulated by applying an f-m signal and observing the flatness of limiting and the demodulated output. The ability to test the integrated circuit as a complete subsystem is of considerable advantage in simplifying the testing and lowering the cost.

Running the gamut. In discrete transistor technology, the total yield of a given generic type usually is subdivided by parameter to permit use of the entire output. That practice is not feasible in IC production. Instead, the designer of integrated circuits has to devise circuits that will work for substantially the full gamut of parameter variations characteristic of the IC process.

A good example of such design ingenuity is the circuit which has been described. It performs acceptably for a beta (current gain) range between less than 30 and more than 200. Because the output of each stage is isolated from the input through the common-emitter connection, feedback capacitance variations are of no importance.

VII. Assessing the impact

An extensive test and evaluation program satisfied RCA that its IC for television receivers had already attained the goals of improved performance and reliability. In addition,

yields have been high because of the circuit's ability to tolerate wide variations in the absolute values of the integrated components. Thus, every integrated circuit chip which does not have a catastrophic failure can be expected to provide entirely satisfactory performance.

Potentially, a number of the low-level signal-processing sections of a radio or television receiver can be replaced with integrated circuits. However, such a replacement on a stage-by-stage basis would not be economic, nor would it improve performance or reliability.

Design ingenuity. Selecting functional blocks and designing "integrable" circuits to do the job of the discrete components they replace—not necessarily in the same way—seems the best approach so far. The future of IC's in other areas of tv and radio receivers depends, largely, on the ingenuity of the circuit designer in devising integrated circuits that can compete with efficient low-cost transistor circuits using discrete components.

His job won't be easy—the circuits must work with a limited range of resistance values, essentially without capacitors, preferably without inductors, and with a minimum number of connections external to the chip. On the other hand, he can use transistors and diodes freely with the assurance that transistor, diode, and resistor parameters will match to a high degree.

Integrated circuits will doubtless move into other sections of television and radio receivers, particularly in the low-level signal processing area. In the higher-voltage, higher-power areas, and in the r-f amplifier input circuits, discrete transistors and components probably will continue to retain their economic advantage for some time.

The author

Jack Avins, who has been active in radio and television receiver circuit development since 1946, is a staff engineer with the RCA Home Instruments division. He is a Fellow of the IEEE and a past chairman of the IEEE Receivers Committee.

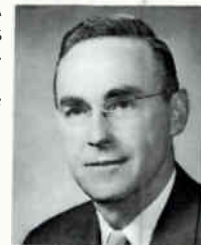

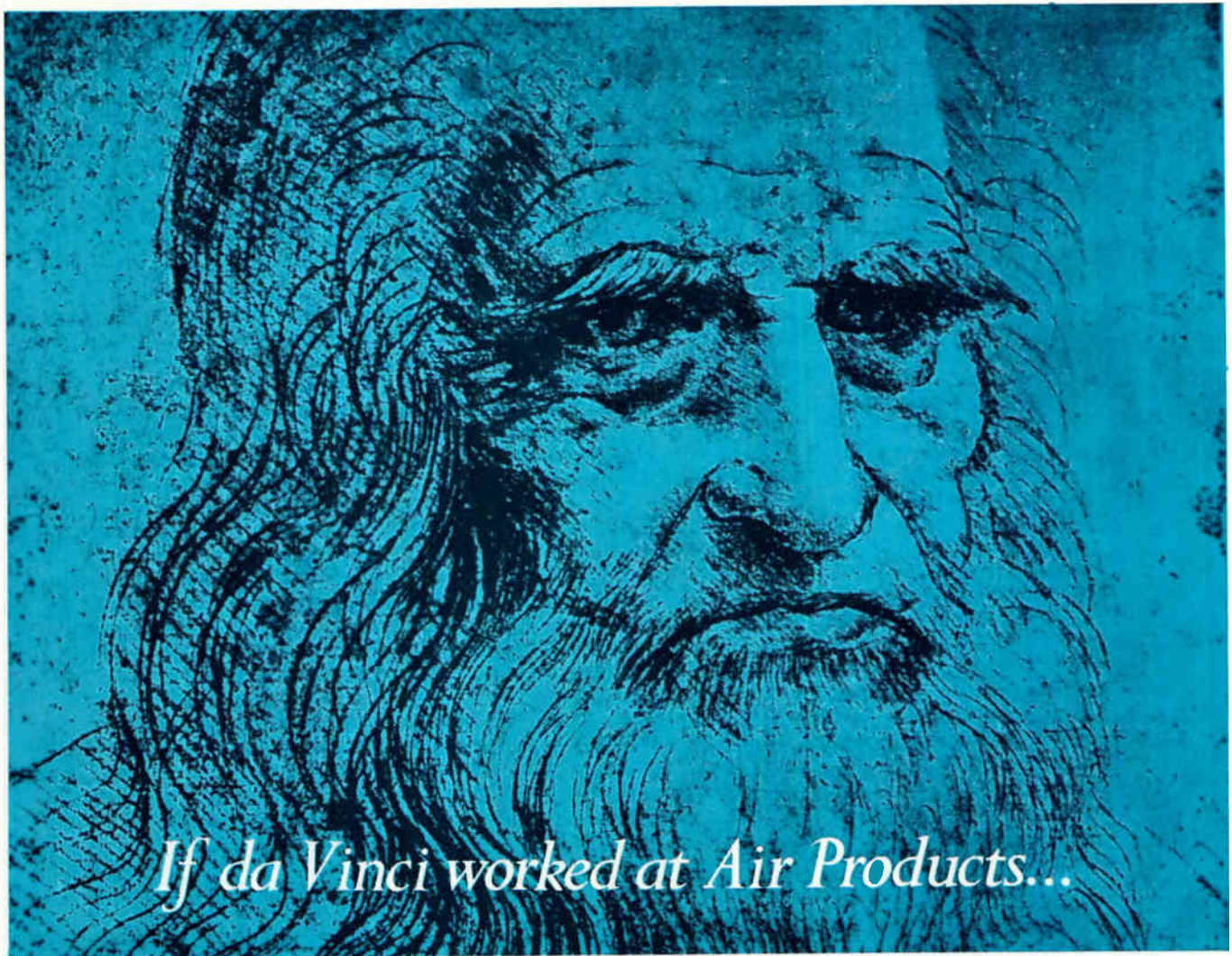

If da Vinci worked at Air Products...

If Leonardo da Vinci worked at Air Products, he would have at his command the necessary support capability in skilled personnel and complete facilities to translate his great pioneering inventions into practical realities.

At Air Products innovation is everyone's responsibility. Supported by in-depth capabilities, this spirit has propelled the Company to a position of leadership in chemicals and cryogenics sales and profits.

Even da Vinci would have admired the challenges that Air Products has met in servicing its customers. They include helping melt steel faster... freeze-sealing flavor in foods... propelling man into space... keeping water resources clean... fusing or cutting any metal... improving agricultural yields... saving heat for the winter... producing safer tires.

Like da Vinci, Air Products people have had to dream, design, and develop things that didn't exist before. Unlike da Vinci, Air Products has the total support capability to carry its innovations to the market place.

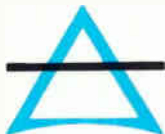

Air Products and Chemicals

ALLENTOWN, PENNSYLVANIA

INC.

Did you know? Air Products operates worldwide, with over 75,000 customers, and has shown record sales and profits every year for the past seven years.

Which way to monolithic systems?

Researchers scout one trail, arrays of hundreds of simple integrated circuits, while production crews take complex single circuits to the marketplace

By George Sideris

Manufacturing Editor

"We think we will have 200 circuits on a chip this year and perhaps 500 in a year or two." In his usual laconic fashion, Jack S. Kilby, the driving force behind Texas Instruments Incorporated's program to develop monolithic subsystems, was saying that the era of large-scale integrated circuits has arrived.

Arrays like the one at the right, with 1,000 components in a $\frac{1}{8}$ -inch-square chip, will soon be sold by the Fairchild Semiconductor division of Fairchild Camera & Instrument Corp.

TI is already making arrays of 100 digital-gate circuits and has put 120 on some chips. The goal of TI and the other major IC makers who are working on arrays is to drive production costs below the plummeting prices of IC's. Eventually, says Kilby, "the array cost per gate will be one-third to one-fourth the cost per gate in a conventional IC package." The customer saves far more, because he doesn't have to assemble the circuits.

Roughly, that means the cost for a large logic function, all wired up and ready to plug in, would be about \$1 a circuit. Kilby is talking, however, about arrays with bipolar transistors. The going price for mass-produced, multifunction circuits made with metal-oxide-semiconductor (MOS) field effect transistors which are smaller and easier to make, is often below 50 cents per gate.

Systems in 1968. When will large, bipolar arrays go into operational equipment? "I think we will see some by 1968," Kilby answers, "but I am not sure what they will be." TI has designed five small computers for the terrain-following radar it is developing under an Air Force contract [Electronics, Feb. 21, 1966, p. 135], plus a simple pragramer

and a large digital integrator.

"The development of really large scale, very high-speed computers should certainly boost array use," adds a spokesman for Motorola Semiconductor Products Inc., a division of Motorola, Inc. "Not only can these large machines take advantage of arrays, their demands are such that they provide a market for developmental arrays." One type of array Motorola is developing is a high-speed memory composed of groups of cells like the one pictured on page 152.

Almost all the present array work concerns digital circuitry. Engineers have only begun to define the design requirements for analog arrays and they expect test problems to be severe. It takes a computer to design the wiring of a large digital array and to control the testing, even though digital circuits are generally simpler than analog circuits.

I. Complex shortcuts

If a computer isn't used to design an interconnection pattern that detours around the unusable circuits on a slice, the array manufacturer has to try to make nearly every circuit perfect. That rarely happens with bipolar circuits, although MOS manufacturers claim better luck.

A more direct route to large functions is to design them as single, complex circuits. During the past year, IC plants have been turning these out on custom orders. Bipolar types containing a couple of hundred components are being mass-produced. MOS circuits are up into the range of 1,000 components a chip [Electronics, Oct. 4, 1965, p. 84, 96].

Complex, bipolar circuits, produced for off-the-shelf sale this year will shake up the IC market. Designed for functions that are stand-

ard in most computers, they'll sell for as little as half the total cost of conventional IC's that have to be assembled to do the same job.

So far, the biggest of these complex circuits is a decade frequency divider—the equivalent of about 40 gates—on a chip about 0.05 by 0.08 inch. The circuit, pictured on page 148, was introduced last week by Sylvania Electric Products Inc., a subsidiary of the General Telephone & Electronics Corp. Sylvania made it available in engineering quantities, along with a family of registers that are the equivalent of 20 gates and adders with nine gates.

BaTTL. Alvin B. Phillips, Sylvania's general manager for IC's, doesn't see a profit at present in arrays. "The machine to be built in a year is in design now," he argues. "Somewhere along the line, you stop blue-skying and design. This development is here, and we'll make our mark with it." The new circuits will join Sylvania's family of transistor-transistor logic (TTL) circuits, a line that has been battling (Phillips says it should be spelled baTTL) the Texas Instruments TTL line in the computer market.

However, TI doesn't have all its eggs in the array basket. It, too, has been preparing complex circuits, one of which is shown on page 147. The circuit schematics are on page 151. It is a 16-bit memory element, designed for computer scratch pads—small, high-speed memories built into the logic circuitry. This circuit will be formally introduced shortly after TI unveils three other complex

Experimental array of integrated circuits contains approximately 1,000 bipolar devices in a $\frac{1}{8}$ -inch square.

Called "micromatrix" by Fairchild Semiconductor, it combines the array and complex-IC techniques.

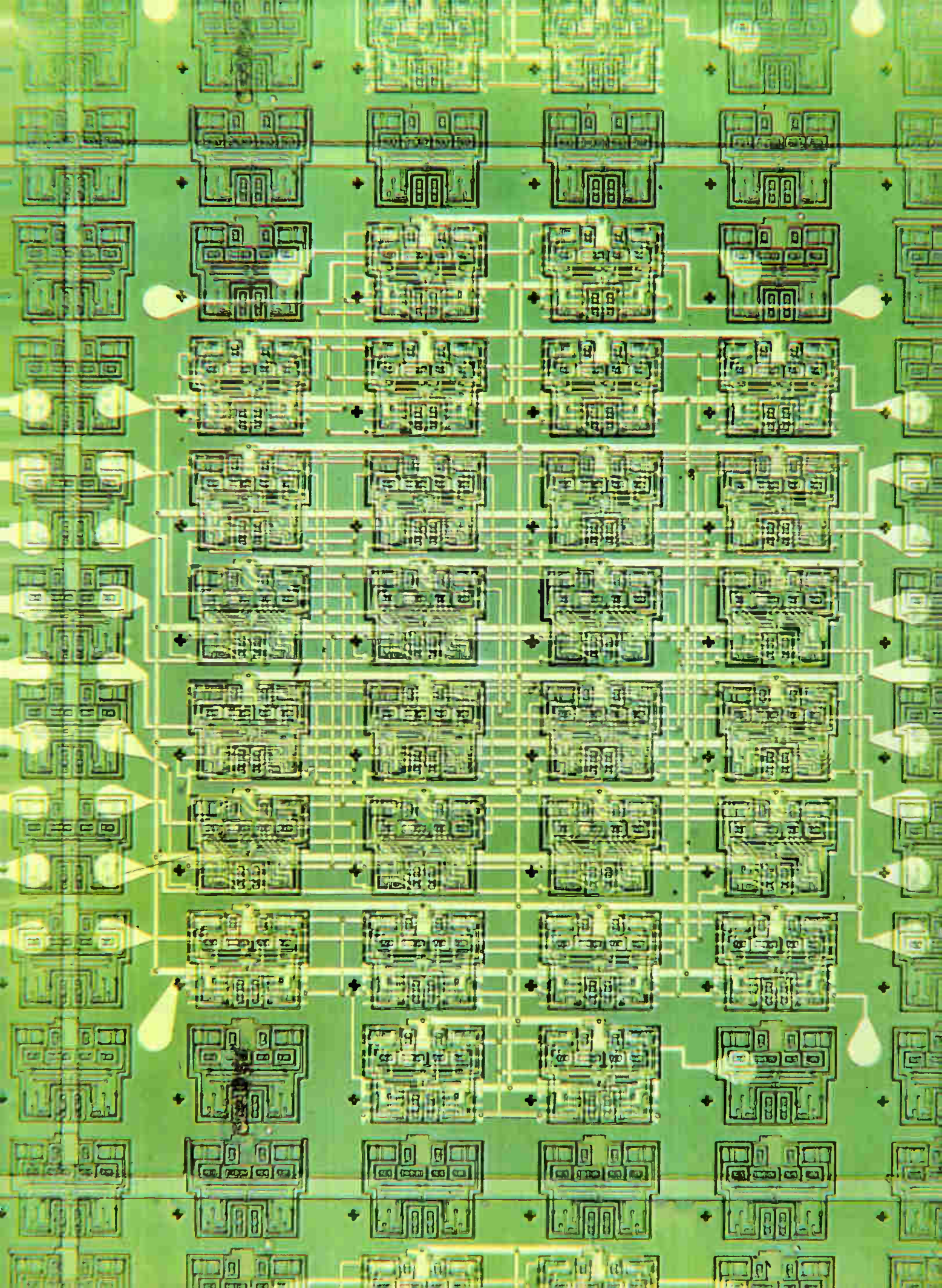

IF YOUR COMPUTER SYSTEM REQUIRES A-D or D-A Conversion

where:

A=resolver or
synchro

D=10 to 16 bits

JUST PICK UP THE PHONE.

North Atlantic
offers a complete line of
resolver/synchro interfaces
for computer systems,
aircraft/space vehicle simulation,
antenna position/programming,
and airborne use.

All silicon solid-state, 10 to 16 bits,
multi-speed, multiplexed inputs/outputs,
60 cps to 10KC.

As we said, just pick up the phone.



NORTH ATLANTIC
industries, inc.
TERMINAL DRIVE, PLAINVIEW, NEW YORK • (516) 601-0600
See us at IEEE—Booths 3A40—3A41

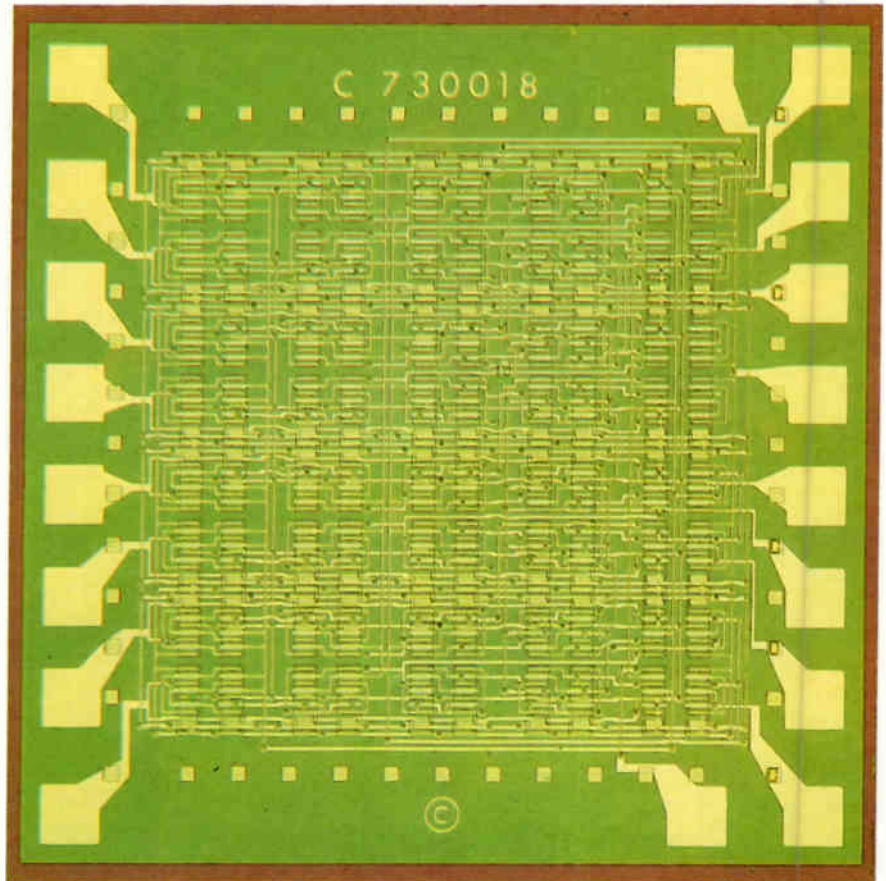

Twenty cells, each with 20 metal-oxide-silicon devices, make up this Fairchild Semiconductor array. Four logic gates or two flip-flops can be made in a cell.

circuits this week at the annual exhibit of the Institute of Electrical and Electronics Engineers. One is a gated full adder that will replace a \$44 group of five IC packages and cost half as much, or perhaps less.

Micromatrixes. Meanwhile, still a third route to large-scale integration is being developed by Fairchild Semiconductor. A blend of the array and complex-chip approach, it results in bipolar arrays.

Fairchild covers a slice of silicon with tiny cells composed of elemental logic gates. These devices are interconnected by etching wiring out of thin metallic films. The patterns are defined by photographic masks, as in the conventional process. However, the lines and line spacings can be as small as 0.0001 inch instead of the usual 0.001 inch.

Different groups of masks are applied to the cells to convert them into logic functions, such as flip-flops. Then, the array is coated with an inorganic insulation and a second layer of interconnections is fabricated to connect the groups of cells. Fairchild calls it a "micromatrix."

Basically the same technique

made the MOS array shown above. Each of the 20 cells in that array contains enough MOS transistors and resistors for four gates. Fairchild Semiconductor has also made arrays, it reports, containing both bipolar and MOS devices. The method is suitable for functions such as full adders.

Serial computers. The arrays are being developed in cooperation with two other firms. The company expects that custom orders will become the pattern for array sales. It plans to try out the market for standardized arrays with circuits suitable for the small, serial computers called digital differential analyzers (DDA's).

The Raytheon Co. is also investigating MOS arrays for DDA's. Fred Plemenos, head of a group that recently designed a DDA for missile applications [Electronics, Feb. 21, 1966, p. 103], says that one 50-bit, MOS shift register could probably replace 50 IC flip-flops and eliminate most of the input-output leads such systems now need. However, he isn't sure that the arrays will stand up under the harsh environ-

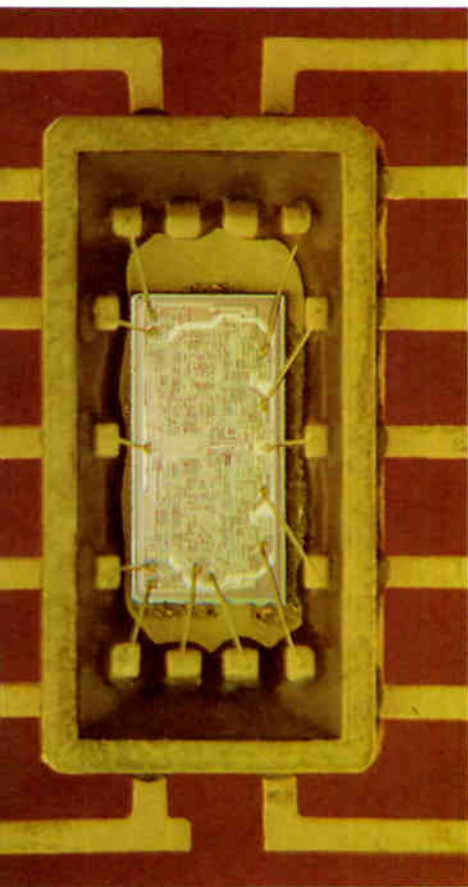

Sixteen bits of memory are packed into a chip by Texas Instruments.

mental conditions military systems face.

II. Arrays spell economy

Although MOS developers have been talking confidently about making 1,000-gate arrays, Kilby isn't sure whether Texas Instruments will push the bipolar arrays beyond 500 gates. It hasn't been determined whether extremely large arrays will be practical or useful, he says.

He does have firm ideas on the processing and design savings obtainable with computer-designed arrays. Processing yield—the percentage of usable circuits on a slice—is raised about 50%, he says. Packaging costs are cut. Only a few pins are needed for functions like shift registers and even when the wiring is complex, such as in control logic for a computer, one pin can service two gates. It shortens design time. An array can be designed in a week, while a complex circuit takes 12 to 16 weeks.

Higher yields. The main reason that array yields are higher is that the circuits don't have to meet worst-case operating conditions and

MAP © 1966 JEPPESEN & CO. ALL RIGHTS RESERVED



Recording Session

Not for the pleasure of the audiophile—but for precise and rapid reproduction of all events related to a weapon system, including acquisition and destruction of a target. The equipment used? Interstate Electronics Corporation's Model 1060 Synchro Data System.

Interstate Electronics Corporation, the prime contractor for the test instrumentation system of the Polaris program, has specialized capability in the development of sophisticated systems for the FBM program. The 1060, developed from this experience, provides real-time and after-the-fact information in the form of computer-compatible tape and display or printed outputs. This portable system accepts coarse and fine synchro, ac analog, dc analog, and event data. It also converts these data to digital form in computer format for permanent recording or to engineering units for immediate evaluation.

Every significant signal existing at the interface between major components of a weapon system may be recorded permanently for future total weapon system analysis, system validation and statistical performance prediction.

For complete information, send for the new 6-page brochure on the Model 1060. Write to Dept. SB-3.

INTERSTATE ELECTRONICS CORPORATION SYSTEMS DEVELOPMENT DIVISION

707 E. VERMONT AVE., ANAHEIM, CALIFORNIA 92803
Regional Offices: Atlanta, Georgia • Washington, D. C.
Subsidiary of
INTERSTATE ENGINEERING CORPORATION



Your local
**ELECTRONIC
DISTRIBUTOR**
has it!
SHIELDFLEX®

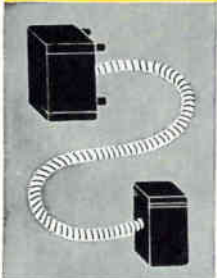

flexible
tubing

**STOPS
ELECTROMAGNETIC
INTERFERENCE**

SHIELDFLEX is especially designed to: isolate conductors from external magnetic fields; contain the magnetic field generated by current carrying conductors; provide electrostatic shielding.

BENEFITS:

- production economy—cable can be run through a length of Shieldflex for both magnetic and mechanical protection
- optimum shielding efficiency equivalent to that expected from high permeability shield structures
- typically 39 db attenuation in a 1 oersted, 60 cps field
- space economy since conductors can be routed very close to components or other conductors

AND:

- it is now available at your local electronic distributors
- packaged, ready for use in random lengths

Distributed nationally through local electronic distributors by:

Russell Industries, Inc.

Write, wire or call 96 Station Plaza, Lynbrook, N. Y. 11563. Phone: (516) 887-9000.

Products of **MAGNETIC METALS COMPANY**; also manufacturers of: • Transformer Laminations • Motor Laminations • Tape Wound Cores • Powdered Molybdenum Permalloy Cores • Electromagnetic Shielding • Metallurgical Services • Custom Heat Treating • Photo Etched Precision Parts

therefore tolerances can be looser. Individually packaged circuits, for example, would be subject to variations in supply voltage. The arrays, Kilby points out, have all the circuits operating at the same voltage level and the interconnections between circuits on a chip don't have to contend with heavy external loads.

It is almost impossible, Kilby contends, to make large arrays by applying standard wiring patterns to groups of circuits. About 15- or 20-gate circuits is the best that can be done now, he says, and a reasonable goal for the future would be 100 gates. To get a 10% circuit yield requires a 95% yield of gates on the slice, which cannot be reached as yet. The computer-designed, random wiring drops the requirement to a modest 80%.

Custom computers. One of the side benefits of computer-generated wiring patterns is that it takes no longer to design a custom logic function than a standard one, according to Harlow Freitag, who has been developing the computer procedures used in the International Business Machines Corp.'s array program [Electronics, Feb. 7, 1966, p. 148]. In time, he thinks, it will be possible to custom-design entire computers. Few computers are standard systems today; the buyer generally is offered variations composed of standard subsystems.

Freitag and his associates at the IBM Watson Research Center, are experimenting with two ways of modifying MOS arrays. One is

changing the characteristics of the gates by varying the length of the MOS-FET electrodes and the cell wiring patterns. The other is, as in other labs, reorganizing the wiring patterns. The latter chore takes an IBM 7094 computer about half a minute—10 cents a gate in a 48-gate array. With a special, small computer, the cost would be less.

Ingested gates. While the IBM wiring program is elaborate—15,000 to 20,000 instructions—the principle is a simple one. The input-output pins are considered good circuits, in fixed positions, that the computer must use so that all similar functions will plug in the same way. The computer first wires up several good cells that are bunched near the center of the slice. Then, like an amoeba, it extends the skin of the good group until it has enveloped enough good cells and has linked them with wiring of the right length.

MOS arrays are being used for the experiments for two reasons: yields are high, sometimes 100%, and MOS research won't duplicate bipolar research being done at other IBM labs. The techniques are applicable to either type of circuit. MOS has one big drawback in logic circuits—its speeds are 2 to 5 Mc, while bipolar can clip along at a clock rate around 25 Mc. IBM rates its circuits at a conservative 500 kilocycles.

III. Speedier MOS arrays

An Air Force program to build digital systems with chips contain-

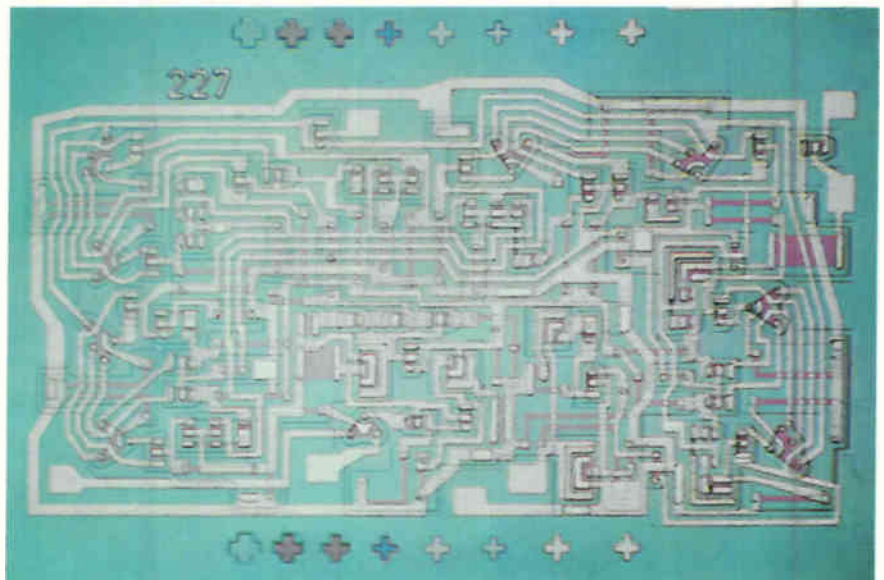

Equivalent to 40 conventional logic gates, this complex circuit is being made by Sylvania Electric Products Inc. It is a decade frequency divider.

ing 100 to 1,000 bipolar or MOS circuits is expected to accelerate the development of arrays and the speed of MOS arrays [Electronics, Aug. 23, 1965, p. 40].

The contracts are expected to be awarded to Texas Instruments, for a system with bipolar logic and memory; General Micro-electronics, Inc., recently acquired by the Philco Corp. a system with MOS memory and logic, and the Radio Corp. of America, one in which the logic is bipolar and the memory MOS. Neither the companies nor the Air Force will disclose design details until contracts are signed.

The Air Force wants the MOS arrays to be complementary—that is, made with N-channel types of MOS-FET's as well as the usual P-channel. This could boost speed to 10 Mc. Another of the Air Force's goals is that the memories, whether bipolar or MOS, retain data if the memory power fails. Semiconductor memory elements, such as flip-flop circuits, generally require power.

Quick solution? Last month at the International Solid State Circuits Conference, RCA speakers headed by J. R. Burns, of the RCA Laboratories, reported on an MOS scratch-pad memory design that appears to meet the Air Force requirements, except that it stores few words. While the memory has not yet been built, the storage cells have been tested at an operating speed below 20 nanoseconds. Usually, any speed of 25 nanoseconds or better is considered in the bipolar province. Data is permanently stored in the RCA cells by grounding the write line. The cells are flip-flops that are made of 11 N-type and five P-type MOS transistors.

The memory will store 16 words, each four bits long. The read access time is expected to be 50 nanoseconds and the write time, 75 nanoseconds. All the circuitry, including decoding and drive circuits, will be made up of 1,080 MOS-FET's. The package will have only 17 pins. Another MOS memory, already built, by RCA, is a four-word, eight-bit, content-addressable memory.

One big circuit. MOS arrays are generally made with fixed, rather than random wiring patterns, and can be considered very complex circuits. The reason, explains Donald Farina, GMe's subsystems manager, is that it is better to arrange the MOS-FET's so that wiring is

LOOK WHAT YOU CAN DO WITH THIS

Acme ACME Electric

POWER SUPPLY

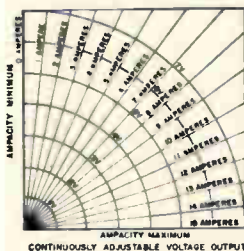

Here is a power supply designed to be a laboratory or production line work horse. Circuitry is simple, components are rugged—it is unsophisticated in design—no flashing lights, bells or buzzers. It will provide a dependable D.C. output continuously variable over a range from 0 to 7 volts with maximum ampacity of 15. Ripple less than 2%. Priced right.

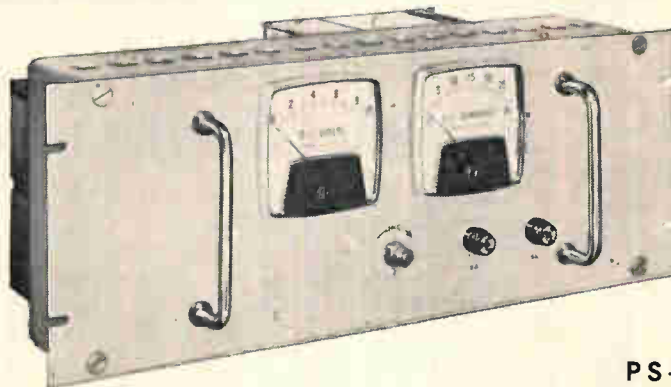

PS-57350

CONSTRUCTION AND COMPONENT FEATURES OF THE PS-57350 POWER SUPPLY

Input voltage range 100 to 130 volts: constant voltage transformer provides $\pm 1\%$ line regulation: continuously adjustable autotransformer regulates input voltage to isolated stepdown transformer: continuous duty solid state rectifier: computer grade, electrolytic filter capacitors: easy reading D.C. voltmeter: easy reading D.C. ammeter: two external input line fuse holders: size of panel 19" x 7" x 10"

OR CHOOSE FROM THESE STOCK MODELS

Catalog Number	D. C. OUTPUT			Max. Ripple	Max. Line	Reguln. Load
	Volts	Amps	Watts			
PS-57360	23-28	2	56	1%	$\pm 1\%$	2%
PS-57361	23-28	3	84	1%	$\pm 1\%$	2%
PS-57362	48-54	4	216	1%	$\pm 1\%$	2%
PS-57363	24, 24	15/2	360/48	1%	$\pm 1\%$	2%
PS-57364	24, 125	2/0.5	48/62.5	1%	$\pm 1\%$	2%
PS-57365	24, 125	1/3	24/375	1%	$\pm 1\%$	2%
PS-1-6757	0-45	0/2.5	112.5	-1%	$\pm 1\%$	5%
PS-39600	0-50	0/5	250	-1%	$\pm 1\%$	3%

Catalog 175 illustrates and gives specifications on 42 other stock model Power Supplies. Write for a copy.

Acme ACME Electric

Engineers and Builders of...

313 WATER STREET, CUBA, NEW YORK

Canadian Representative: Polygon Services, Ltd.
50 Northline Rd., Toronto 16, Ont.

SA-3932-3221

REGULATED POWER SUPPLIES
STATIC POWER RECTIFIERS
VOLTAGE STABILIZERS
VOLTAGE REGULATORS

Report from

**BELL
LABORATORIES**

R. C. Miller (left) and J. A. Giordmaine check the alignment of the crystal in which variable-frequency, laser-type light is generated.

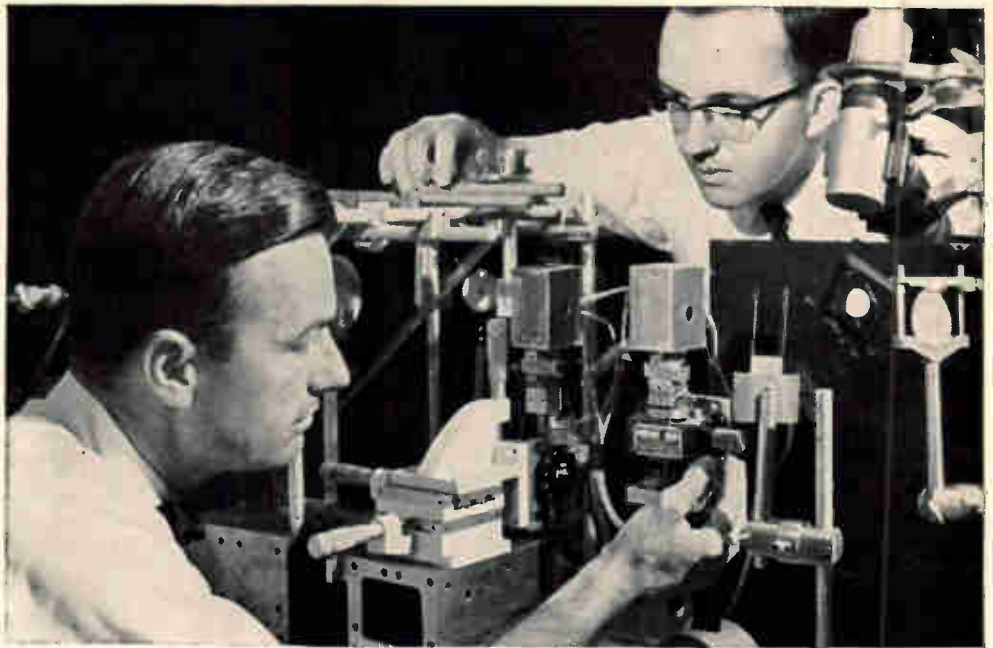

A Tunable Source of "Laser" Light

A narrow beam of light, as generated by a laser, appears to offer many desirable qualities as a possible medium of communication. Individual lasers, however, operate at separate, discrete frequencies. For communications, tunable sources of light comparable to the variable-frequency oscillators used in radio work are useful.

Recently, Bell Telephone Labora-

tories scientists J. A. Giordmaine and R. C. Miller demonstrated an experimental tunable source of this type. Operating on parametric oscillation principles at optical frequencies (see illustration below), the device uses a crystal of lithium metaniobate, which is "pumped" by a laser beam. The device emits two beams, each of which is tuned by changing the temperature

of the crystal. With the present model an 11° C temperature change produces a 6 percent change in output wavelength of each of the beams.

Tunable, coherent sources represent a versatile scientific tool of importance for optical spectroscopy. In other applications, they could function as local oscillators in optical-frequency super-heterodyne receivers.

Operating features of tunable source based on parametric oscillation at optical frequencies: "pump" light from laser enters lithium metaniobate crystal at left, and, as a consequence of parametric oscillation, two additional beams are produced in the crystal. End surfaces of crystal, to which dielectric coatings have been applied, are partially reflecting. From right end emerge the two beams, plus the pump light, which is blocked by the filter.

The principles governing parametric oscillation include the conservation of the energy and momentum of the interacting photons. As a consequence of energy conservation, the sum of the two output frequencies equals that of the pump. These output frequencies vary with temperature since the crystal's temperature-dependent index of refraction controls photon momentum in the beams.

In current work, the second harmonic of a pulsed calcium tungstate/neodymium-doped laser provides the required 7 kilowatts of pump power. Pump frequency of 5.7×10^6 gigacycles (5290A wavelength) produces output frequencies ranging from about 2.6×10^6 gigacycles (11,500A) to 3.1×10^6 gigacycles (9700A), depending on temperature.

Lithium metaniobate, whose unique optical properties are essential to this effect, was first investigated in detail at Bell Laboratories where, also, large optical-quality crystals for this experiment were grown.

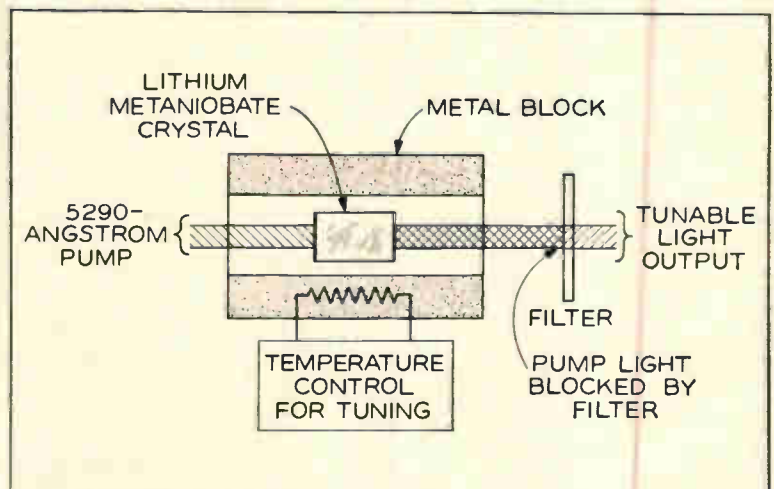

Bell Telephone Laboratories

Research and Development Unit of the Bell System

simple. The circuits, he points out, are designed in a manner suitable for computer layout. Scaling of the electrodes determines device function, whereas diffusion geometries are the determinant in bipolar devices.

Farina's comment on the MOS speed question was: 5 Mc with current-mode switching today, 20 Mc with improved processing in two years.

IV. Millions of tests

Testing conventional and complex IC's is child's play compared with the tests that must be performed on large arrays. The complex circuits can be given functional tests similar to conventional IC's. In fact, Sylvania tests both types with the same automatic test systems, once before packaging and once after packaging.

An array of 100 circuits can take up to eight hours to test, according to Joseph Logue, manager of advanced logic technology at IBM's East Fishkill, N.Y., facility. To excite every possible combination of the 38 inputs, he points out, would take 2^{38} tests—not including alternating-current tests. To test an array that contains sequential logic requires a test system with a memory, because the tests must be made in an exact order and each result depends on the results preceding it.

It's still a module. Logue's solution is essentially one that computer manufacturers have adopted. His suggestion—don't attempt to make all possible tests. Define the essential tests and perform them by exercising the array in a computer. The computer can run through several programs that will check out the array, or can choose the states that will excite the array in almost every combination it will encounter in use. The customers, according to Logue, have to be educated to accept this.

Other companies agree. Motorola finds that an array can be tested much like a conventional logic assembly, with several hundred tests made by a stored-program computer. The tests are more extensive than for an ordinary IC because the storage capability of the array requires sequential testing. TI expects 200 to 300 tests to check out a 100-gate array. GME also exer-

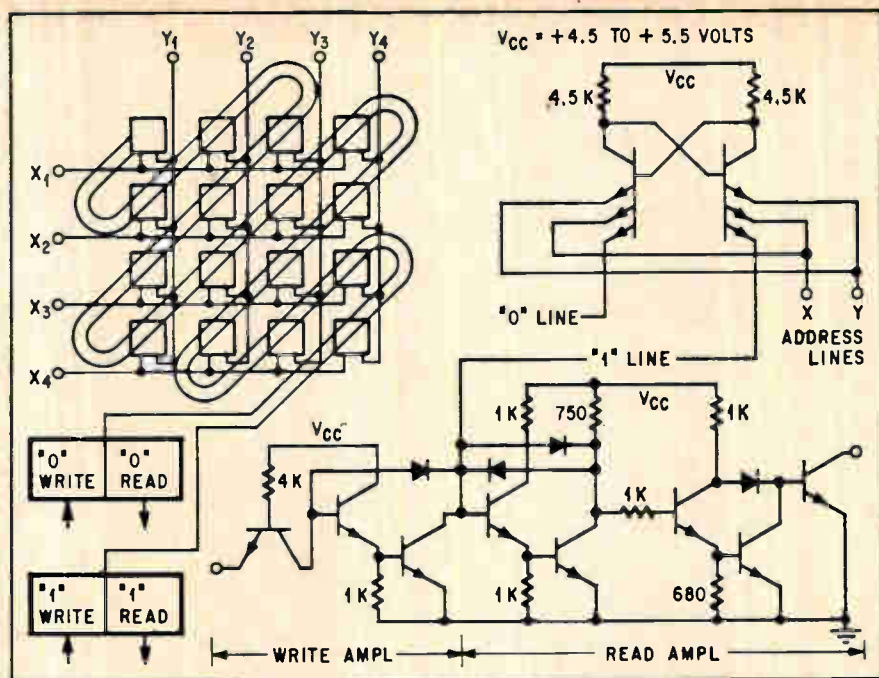

Active memory element, with 16 flip-flop storage circuits, is made on a single chip by Texas Instruments Incorporated. Block diagram is below.

cises each gate as though it were testing a conventional printed circuit assembly.

No tests at the cell level were made on the Fairchild MOS array on page 146 before the wiring was fabricated. It was tested functionally, however. Fairchild hopes to convince its customers that testing all the components of the array is not necessary. Otherwise, some circuits would require five million tests.

Cell by cell. The computer-programmed wiring method requires tests of each cell on the slice before the wiring pattern is fabricated. Testers similar to those which test conventional IC's are generally employed.

IBM's researchers, who are attempting to define essential tests, have been making an elaborate se-

ries of 31 kinds of tests on every cell in the MOS arrays. With the aid of a test wiring pattern that is later removed, they test not only the electrical characteristics of the MOS devices, but the oxide and other materials as well. Then they test again to make sure that the test currents didn't cause any damage to the materials.

After wiring, each of the 80 cells is tested again and the entire array is given a series of functional tests. The entire process takes several hours with the laboratory test equipment. If IBM decides to produce arrays, it will build high-speed testing systems.

Beam or masks? IBM fabricates the wiring by a method that avoids the preparation of etching contact masks. Photoresist on the metallized slice is exposed to a beam of

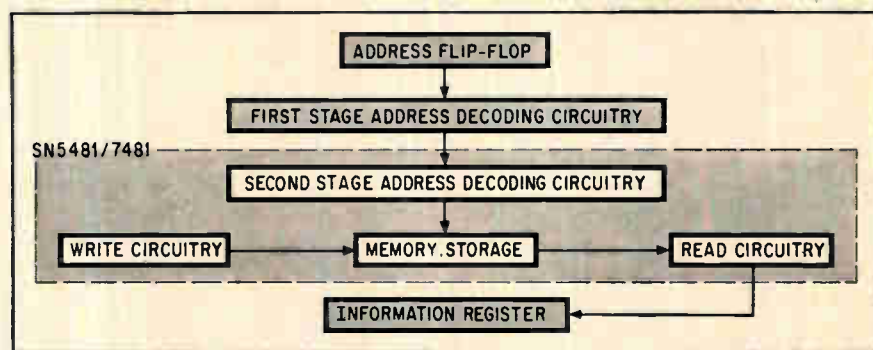

Memory circuit, shown above and on page 147, can be connected with the circuits outside the dotted lines to form computer scratch pads.



The shape of tomorrow, today

For more than 20 years, Ultra Carbon consistently has provided industry with advanced graphite technology. "F" purity graphite for the AEC ... semiconductor crystal crucibles, boats, headers and fixtures made from *Ultra purity* graphite—these are typical of our past contributions to the electronic industries.

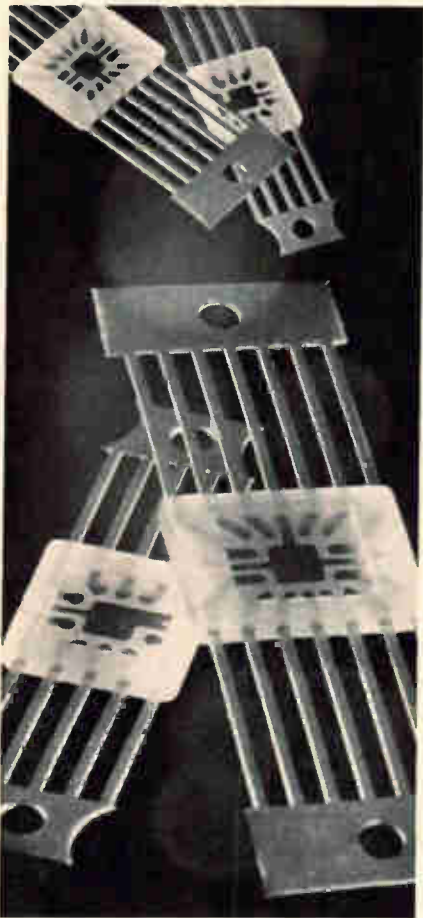

ULTRA/FGP® flat glass packs for integrated circuits in 14 lead $\frac{1}{4} \times \frac{3}{8}$ inch and 10 lead $\frac{1}{4} \times \frac{1}{4}$ inch are now in production. Write Ultra Carbon Corporation, Box 747, Bay City, Michigan 48709.

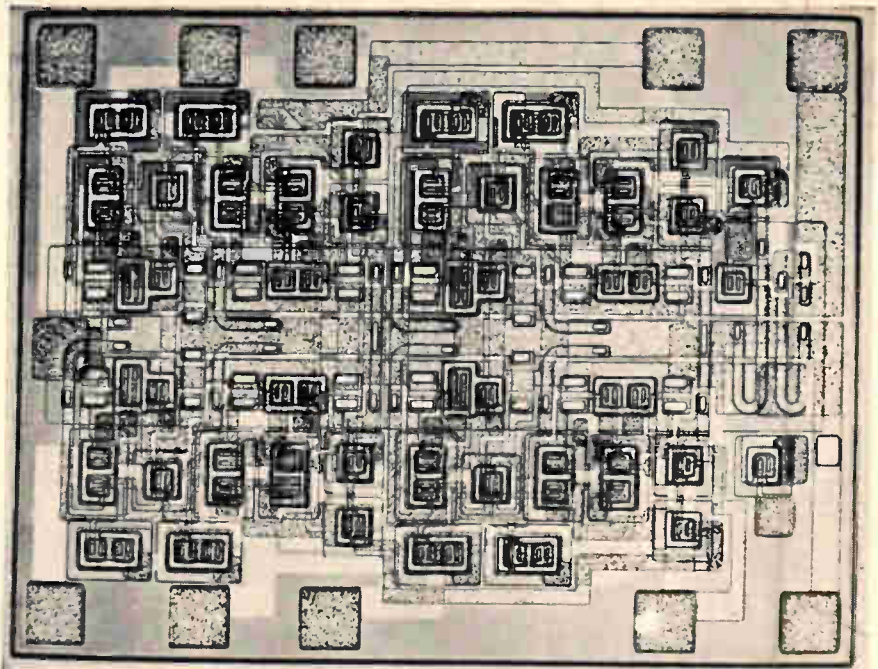

Array structure being developed by Motorola for fast memories. Second layer of wiring will connect this four-bit group to adjoining cell groups.

light that is programed by the design computer.

The beam is 0.002-inch square and can be brought down to 0.0005 inch. The slice is placed on a tiny, motor-driven table that jitters back and forth under the beam at a rate of 0.2 inch per second. A shutter interrupts the light at the end of each line traced by the motion of the table.

Texas Instruments uses its design computer's output to run an automatic drafting machine that prepares the artwork for conventional etching masks. TI's arrays require up to three layers of wiring and as many masks. To speed up the process, TI plans to prepare actual size masks with a flying-spot scanner controlled by the computer. That would cut the mask-making time to a few minutes.

Motorola says that it is using and developing the drafting machine method and also a method of directly forming the patterns on slices coated with metal and photoresist.

Extremely minute patterns can be formed on the slice with scanning electron beams. The Westinghouse Electric Corp. has been experimenting with this method for three years [Electronics, Nov. 16, 1964, p. 82]. Researchers hoped to be making programed interconnections with an electron beam in 1966. Westinghouse had been mak-

ing production arrays with contact masks. It's silence on its masking methods are an indication that it is changing its process.

V. Long-run circuits

Last fall, one IBM laboratory made news with a complex circuit that had 148 components and did the job of a 16-bit shift register [Electronics, Nov. 1, 1965, p. 31]. Off-the-shelf circuits were considered big if they contained 6 or 8 gates.

Phillips, of Sylvania, is convinced that the time is ripe to sell king-sized circuits off the shelf. "Regardless of whose computer it is, it performs certain standard functions or operations." Those are the functions Sylvania is selling.

His 40-in-1 circuit, the decade divider, has six stages. It divides analog and digital signals with frequencies from 5 cycles per second to 30 Mc. The first stage shapes the pulse, the next three divide by five, the next divides by two and the final stage is a buffer that gives a-c and d-c fanouts of 6 to 15. The systems can have a clock rate of 25 Mc.

Something for everybody. "We are aiming at a high-volume industrial and military market," Phillips continues. "We picked what we consider the optimum size for now, a four-bit building block. We will probably go to eight or 16 bits later,

Hi-Q capacitors for critical lunar shots

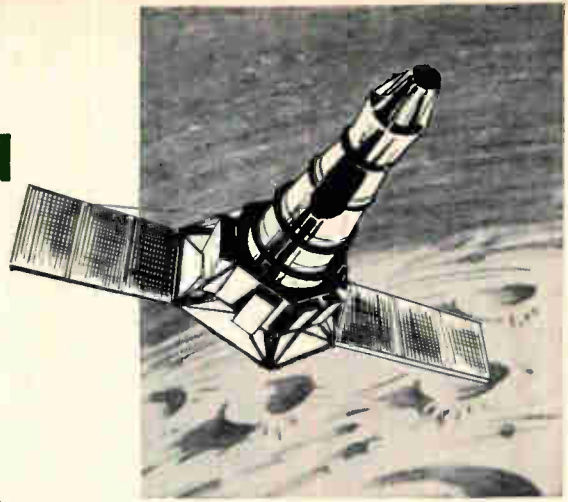

and TV tuner trouble spots

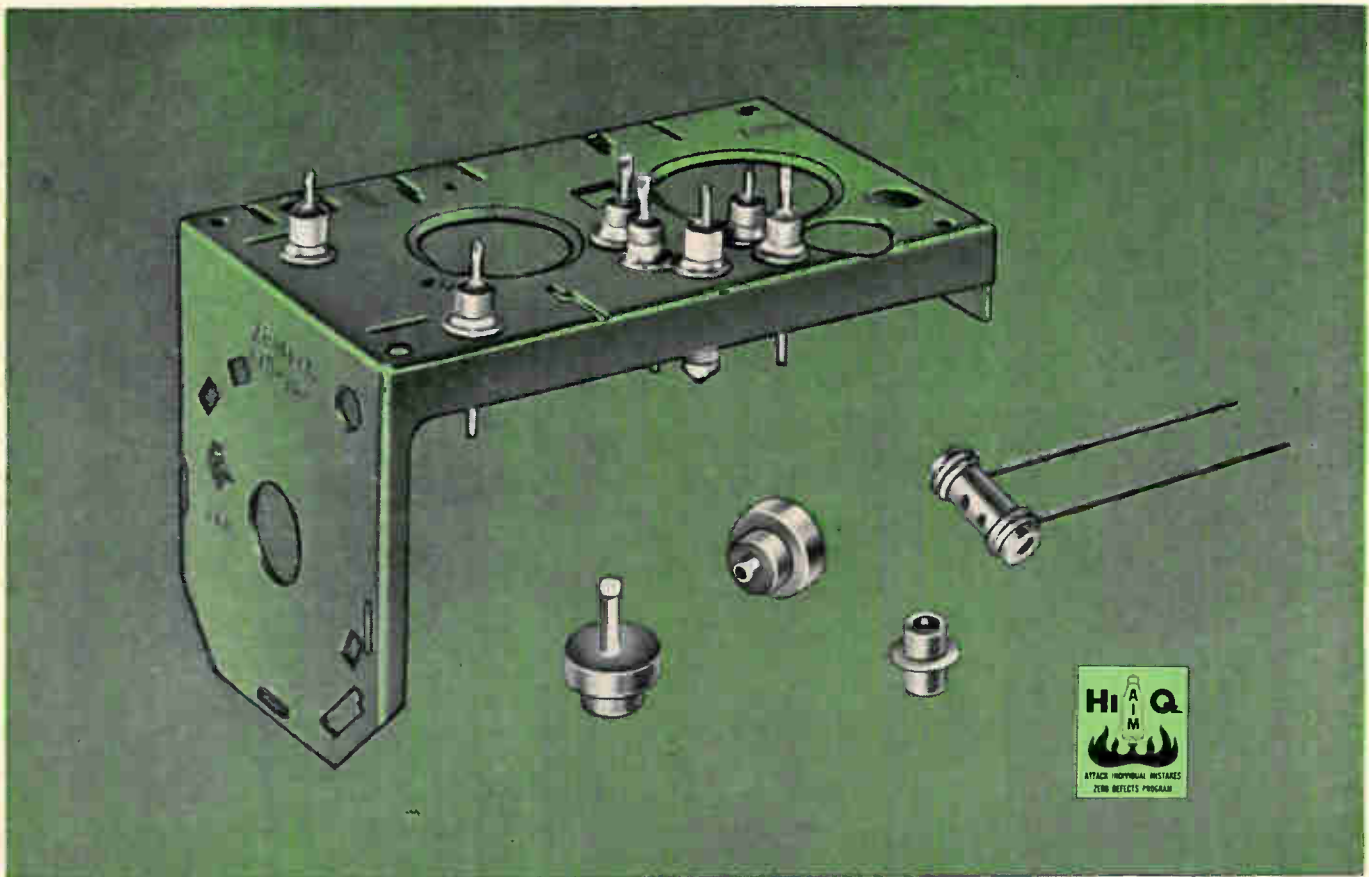

We once received a letter that said, in part, "... Ranger 6... slammed into the moon on one of the most phenomenally accurate shots ever achieved... your company has helped to achieve an enviable record in space activities. Even greater challenges await us in space... your company will help meet (them) with the same enthusiasm and dedication to quality and reliability you have exhibited in the past." But it didn't change our ideas one bit about the importance of quality in "ordinary" capacitors for TV tuners too. That's why Hi-Q capacitors are selected and specified most often for any kind of application—moon shot or mundane.

Of course, our greatest challenges are usually generated

in the more exotic developments of electronics for space. But the things we learn in meeting these requirements are also reflected in the increasing performance and reliability of our "everyday" capacitors for less demanding uses.

So whatever your capacitor needs, check with a Hi-Q catalog... or check with a Hi-Q engineer. You'll find an answer with one or the other.



AEROVOX
CORPORATION
MYRTLE BEACH
SOUTH CAROLINA

Visit HI-Q IEEE Booths 2J48-50

Circle 153 on reader service card

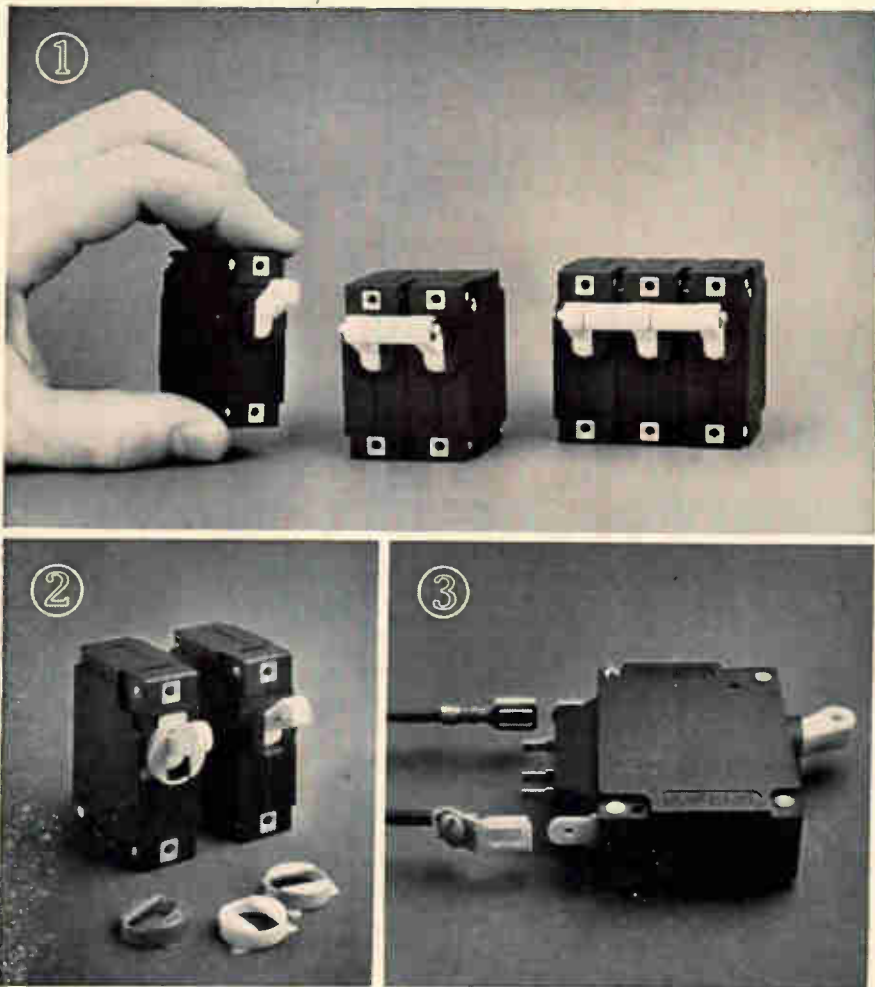

**Three nice features
and a surprise
in Heinemann's new
Series JA circuit breakers:**

1. Natural shoulder packaging. The slim, Ivy League JA weighs in at just 2.5 ounces per pole, including hydraulic-magnetic actuating element, silver-alloy contacts and an uncommonly efficient arc-quenching device.
2. Pizazz—The JA is the first breaker with snap-on color-coding caps that you can mix or match for functional or decorative purposes. Also included: a very dressy white handle.
3. Convenience. The JA's 'universal' terminals are made to accept soldered, crimped-type, or screw-type connections; you can use whichever you're tooled for—or overstocked with.
4. Economy. This is the surprise. The JA actually costs less, model for model, than our Series AM12 breakers, which it can replace to your advantage. The JA is available in current ratings from 0.100 to 20 amps, at up to 250V AC or 50V DC. With a choice of time-delay or non-time-delay response. Special-function internal circuits, too. Bulletin 3350 will give you full technical data. Write, wire or shout for a copy.

Heinemann Electric Company

2600 Brunswick Pike, Trenton, N. J. 08602

**"We're taking away some
designer's prerogatives . . ."**

but nothing will be custom-made.

"The big question facing everyone is how much can we integrate the integrated," he says. "The more you put in one package, the more you move toward custom-made." Mass-production with standardized interconnection patterns, not several layers of computerized wiring, is the way to cut costs and increase sales, he contends.

"We're taking away some of the designer's prerogatives and we're taking over some of the user's work," admits Joseph T. Nola, Sylvania's IC marketing specialist. "You can't expect progress toward low cost and high reliability if the logician and designer won't standardize."

VI. Delicate subject

The array scene has one foggy bottom—the relationship between the vendors and the buyers when the vendors are making subsystems.

Ling-Temco-Vought, Inc., is leery about working too closely with vendors. "We've been burned before," says George H. Cramer, corporate director of electronics for the systems company. "We try to do business with those semiconductor manufacturers who are not in the systems business. The trouble is, most of them are."

LTV plans to buy complex circuits, such as 50-bit MOS shift registers, and use them in hybrid memory systems. It will share some engineering with its vendors, but plans to keep the critical design work in-house. Cramer is hoping the arrays will improve the reliability of electronic systems in deep-space probes.

The Fairchild Semiconductor spokesman thinks that arrays will give small but "supremely technical" companies the opportunity to graduate into big-time systems companies. On the other hand, subsystem manufacturers may find their business taken over by components companies.

But, there's time to prepare. Fairchild doesn't expect large arrays to be a way of life until at least 1970.

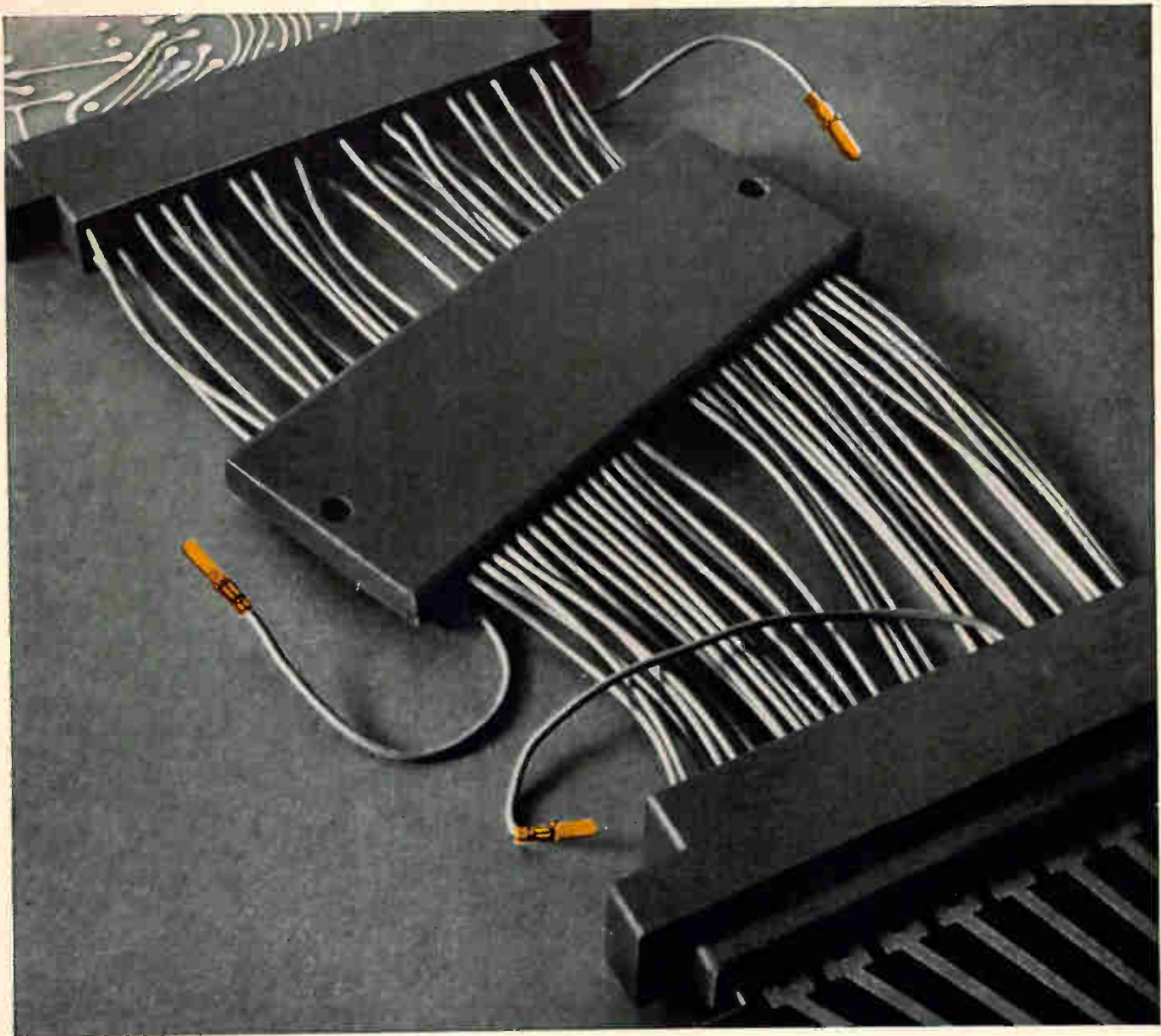

Where can you go from here?

We've gone about as far as you can go toward simplifying inter-rack harnesses and printed circuit board wiring.

Now all you need to do is crimp a tab onto both ends of your lead; then it's a simple matter to put one end into an AMP-TAB* Printed Circuit board connector, the other end into an AMP-TAB Feed-thru Block. Wiring's done! And without solder, heat, or awkward combinations of wiring techniques.

You stock only tabs, so right away your inventory is reduced. One tool crimps #26 thru #18 AWG wire, so you save valuable assembly time. Savings in space and applied costs are about three to one compared to other interconnection methods. It's easy to see how your installation costs come down with these AMP-TAB terminals and connectors.

But you don't save by sacrificing quality. All AMP-TAB terminals and contacts have AMP's famous corrosion-proof gold over nickel plating for better conductivity and long wear. Special attention to design—redundant wiping surfaces, insulation support "F" crimp, diallyl phthalate housings, closed entry—for high performance and reliability.

An important feature allows you to change wiring from

the rear of the printed circuit connector without removing the board. And there's no need for post-insulation because of the egg-crating design of both the AMP-TAB connector and feed-thru block.

Look what else you have to gain:

- Terminals available in strip form for high-speed automachine production
- Contact spacing of .100", .125" or .156" available
- Dual or Quad printed circuit connectors; easy keying
- Contrasting cavity identification
- Low installed costs

Write today and find out all the plus features of AMP-TAB printed circuit board connectors and Feed-thru blocks.

*Trademark of AMP INCORPORATED



AMP products and engineering assistance available through subsidiary companies in: Australia • Canada • England • France • Holland • Italy • Japan • Mexico • Spain • West Germany

THE ONLY FIELD PROVEN 2MC PORTABLE

RECORDER/REPRODUCER

P-5000 field history has established Fairchild/Winston as the leader in wideband portable instrumentation recorder/reproducers. Results of extensive field applications have proven the P-5000's ability to consistently provide unparalleled performance. A combination of compactness and laboratory-quality performance, the P-5000 offers the most advanced instrumentation tape recorder/reproducer in a truly portable package — designed for predetection, telemetry and general instrumentation — applicable to airborne, shipboard and mobile use. Bi-directional operation provides 50 minutes of 2.0 mc recording. Qualified to military environmental and RFI specifications.

- 2.0 mc at 120 ips
- Flutter — 0.3% peak-to-peak, DC to 10 kc at 60 ips
- Bi-directional operation
- Five electrically selectable speeds
- 7 or 14 track, IRIG configuration
- 140 pounds
- 17 $\frac{1}{2}$ x 24 $\frac{1}{2}$ x 11 inches



FOR ADDITIONAL INFORMATION CONTACT:

FAIRCHILD

**WINSTON RESEARCH
CORPORATION**

A DIVISION OF FAIRCHILD CAMERA AND INSTRUMENTATION CORPORATION

6711 So. Sepulveda Blvd., Los Angeles,
Calif. 90045 Telephone: 213-670-3305
TWX: 910-328-6128

1625 "I" Street, NW, Washington,
D.C. 20006 Telephone: 202-628-2588
TWX: 710-822-9558

Hyer Electronics Company
Englewood, Colorado
Telephone: 303-771-5285

Hyer Electronics Company
Albuquerque, New Mexico
Telephone: 505-268-6744

Wild & Associates, Inc.
Syosset, Long Island, N.Y.
Telephone: 516-921-7100

For Saturn stages, a stop in Mississippi

NASA will test its lunar rockets with stationary firing at a 220-square-mile facility nearing completion in Mississippi

By Robert Henkel

Space Electronics Editor

A giant space proving ground, the Mississippi Test Facility, prepares this month for its first mission—the static firing in April of a Saturn V booster stage. Its sound will boom over a 220-square-mile complex in a lonesome marshland near the Gulf Coast.

After a few more Saturn tests at Huntsville, Ala., the National Aeronautics and Space Administration will depend entirely on the Mississippi facility as a proving ground for the first and second stages of Saturn V—the big rocket that will propel United States astronauts toward the moon.

The facility is also a proving ground for an experiment in private industry. For the first time, one company—the General Electric Co.—will operate a major facility owned by the space agency; GE will supply all the electronic support for stationary rocket testing.

Clearing job. NASA has spent \$265 million, so far, in spading the proving ground from miles of cypress swamps and piney forests. Electronic equipment accounts for more than \$30 million of the spending. Though the agency stressed reliability in designing and selecting equipment, some electronic “firsts” did develop:

- Telemetry test data will be collected and reduced in real time.
- More than 2,500 channels of data may be taken and recorded from one static firing.

William M. Barrentine, who heads the data handling center, boasts this is the “only system like it in the country. Everything from the output of the data receiver back is computer controlled.”

The computer takes the measurement data from a firing, samples and converts it to parallel digital

form. This data is formatted and recorded, then played back, scaled and converted into usable engineering units.

The data acquisition facility receives data signals from the vehicle and rocket stand by means of hard wiring through a concrete tunnel.

Up to 2,540 channels of instrumentation will be acquired during a test. This makes the facility the biggest in terms of channels of data received from a single rocket test, says Robert Young, acquisition facility manager.

Much work remains at the space

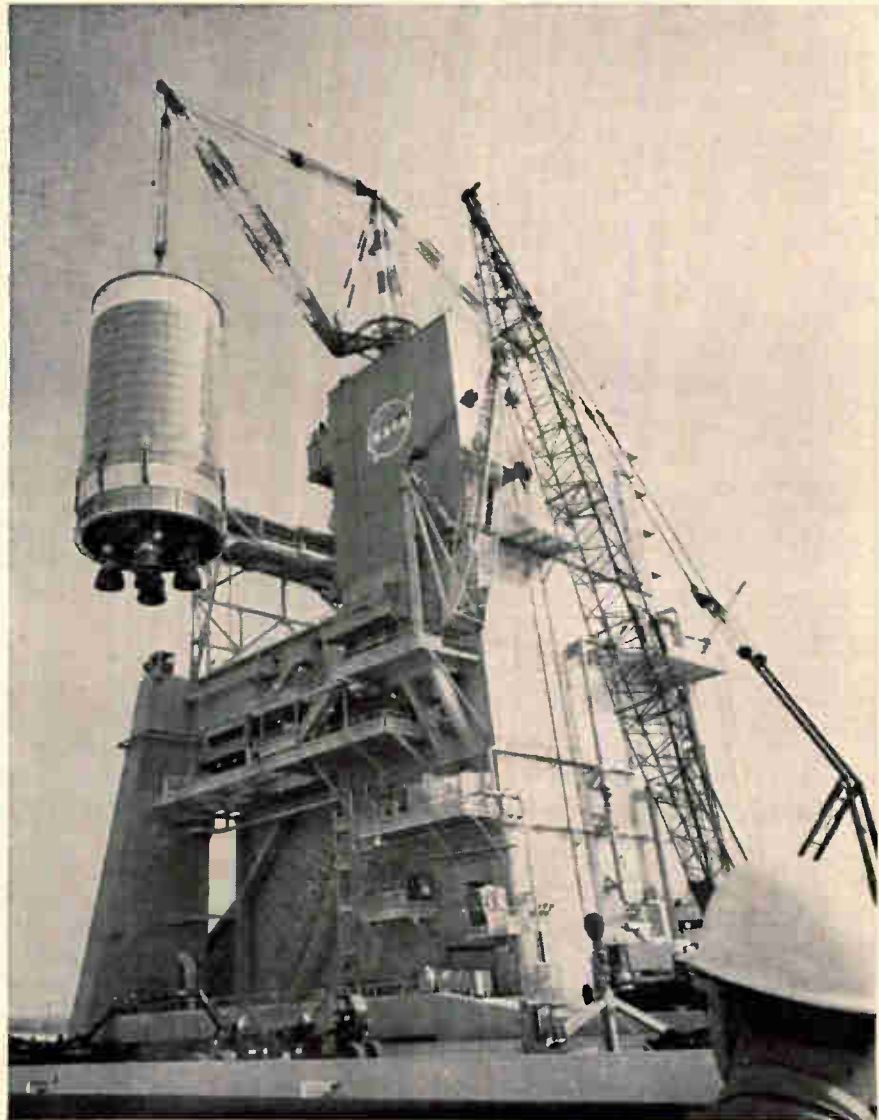

Saturn moon rocket second stages will soon be locked into this huge test stand in Mississippi and test fired for NASA.

collage

A random collection of fact, opinion and miscellany... some of it a blatant attempt to peddle the products and capabilities of Motorola's Military Electronics Division.

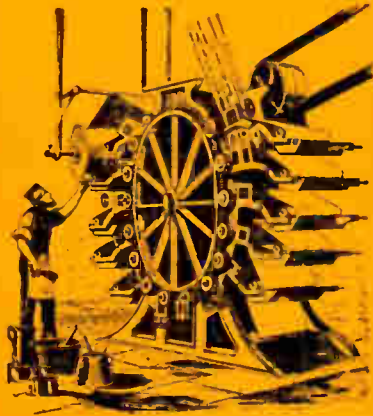

UNAMBIGUOUS METEOROLOGICAL RADIOSONDES

... or, the frightening prospect of a big-business giveaway program

Someone at our Western Center must be kidding. Can you imagine anyone designing an "unambiguous ranging system with a CPE (circular probable error) of 150 feet maximum at 300 miles and a multi-channel telemetry link with 0.1% accuracy" and then wanting to sell it rather than placing it on exhibit at the Smithsonian Institution or someplace?

Incredible, but they say it's true. And it's all part of an advanced Meteorological Sounding System we designed for the Air Force Cambridge Research Lab. One of our brighter engineers claims we can bring it off using a radiosonde design which, in large enough quantities, could be sold at the ridiculously low price of several for a hundred dollars. Since this is a paid ad, our legal buffs say that we must back up any claim made hereon. So, better order a carload quickly before we go out of business. For details, write our Western Center.

Continued on page 172

facility, which is 45 miles from New Orleans. Construction of 4 test stands, 20 buildings, and a canal and railroad network began in May, 1963, and NASA hopes to have construction wrapped up by the end of this year. Only NASA's Merrit Island complex at Cape Kennedy is a larger construction job in the United States right now.

GE signed a five-year contract in June 1963, with the space agency, to run the facility as an extension of its Apollo-support contract.

I. Site chosen in 1961

The space agency had selected the location in 1961 because of natural water entries, for floating in hardware; the cheap land that was available; sparse population (2,600 residents moved out, five villages pulled down); and because the area is only 38 miles from the Michoud Assembly Facility where the Boeing Co. is building the Saturn IC first-stage booster.

General Electric will control everything except the actual static tests, which will be done by Boeing and North American Aviation, Inc., second-stage builder.

Quick switch. With luck, early in April, North American will conduct the first hot firing, a quick switching on and off of an engine of the Saturn V second stage, the S-II, a million-pound thrust, liquid-hydrogen booster.

Early in 1967 Boeing will test fire the S-IC, the 138-foot Saturn first stage, which delivers 7.5-million pounds of thrust.

II. Companies cooperate

Paul W. Sage, who guides GE's 650 support personnel, calls the project a genuine cooperative effort. He has been spending a good deal of time on interface problems: "Does GE do it, or Boeing?" Though he foresees no major difficulties among companies, Sage acknowledges that GE hasn't yet worked in a pressure situation with the Saturn contractors.

So far, both GE and the space agency appear satisfied with their unique relationship, with GE confiding it is realizing a good return on its investment.

The reduced role of the space agency is reflected in the fact that the agency expects to have only 130 of its people in the permanent

support force of 3,000.

The first of the big first-stage S-IC's to be ground tested will be the fourth flight booster now being assembled at nearby Michoud. It will be fired early in 1967, which will put the facility "well within schedule," a spokesman said. The first three S-IC flight models will be tested at Huntsville, Ala.

III. Agency expects 15 rockets

Acceptance tests on the seven S-IC boosters that are coming through will continue into 1969. Ten Saturn V's are under contract, but an agency official said: "We are reasonably sure of 15 vehicles," which pushes tests into the 1970's at the Mississippi grounds.

The central recording facility for all test stands is the data acquisition facility, which is a windowless, reinforced-concrete structure located in the center of the four test-stand complex. The test stands, into which the rockets are locked for stationary firing, are designated A-1, A-2, A-3 and A-4.

Data acquisition cable lengths range from 1,575 feet to A-2 stand to 3,600 feet to the A-1 stand—described as the "longest cable lengths ever"—through concrete tunnels. These distances caused problems in procurement; cable producers doubted that cable that long could be manufactured. General Electric finally consented to splicing at the factory, but prohibited any splicing in the field.

Took hard line. A hard line (wire) system was required rather than a telemetry system because hard line is accurate to 1% or less and because one wire carries the signal from one transducer. A single radio-frequency telemetry failure could knock out 200 channels.

A typical test of a flight model will use 1,100 to 1,200 channels, but the acquisition facility, expandable to 4,000 channels, will record 1,700 channels from the first S-II, because it is a test model.

The present capacity includes 792 analog-to-digital channels for recording quasi-static data from 0 to 10 cycles per second, 760 channels with the digital-event recorder for test events, 600 oscillographs for medium-frequency signals from 10 cycles per second to 5 kc, 200 constant bandwidth (redundant multiplexed channels) for 0 to 500

MEMORY
TEST
SYSTEMS



Memory cores. Over five billion of them this year. Every one 100% tested. Expensive necessity. But one bad core can cost you plenty. So can inferior test equipment—in errors, in machine downtime, in idled people, in late deliveries and lost business. The real cost of testing cores isn't the first cost—it's the final cost. And that's where CTC memory test equipment pays off. We collect bad cores—at the lowest overall cost.

COMPUTER TEST CORPORATION
CHERRY HILL, NEW JERSEY



**we
collect
bad
cores**



If you use wire, you need a Eubanks

Eubanks automatic wire strippers will help you boost your profits by cutting your costs — whether you are stripping leads for half a dozen black boxes or mass producing appliance harnesses. Let us send you complete information. Eubanks Engineering Company, P.O. Box 563, Monrovia, California.

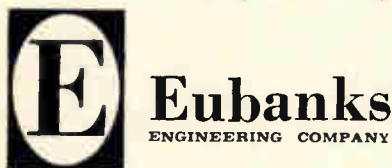

Circle 256 on reader service card

NOW GET
72 HOUR DELIVERY



Size F Size G Size H Size J Size H (Open)
On sizes F, G, H & J (D Series) Regulated
DC Power Supplies

FEATURES

- Fully Repairable
- Large Quality Discounts
- Low Cost
- 0.5 to 60 vdc Coverage By Model Selection
- 0.05% or 0.5% Combined Regulation
- Temperature coefficient from $\pm 0.01\%/^{\circ}\text{C}$
- See 1965-66 EEM, page 1538 (Prices are obsolete)

Contact our representative or the factory for details

IEEE Booth 3B37



DYNAGE, INC.
390 CAPITOL AVENUE, HARTFORD, CONN. 06108
TELEPHONE (203) 249-5654

NORTON Magnetic Tape Heads



SERIES 7500
• CROSSTALK—40DB
• +75°C Temperature Operation

Send now for complete technical literature.

NORTON
ASSOCIATES, INC.
240 Old Country Road, Hicksville, N. Y.

Circle 257 on reader service card

cps analog data, 140 magnetic tape channels for high frequency in the 5 to 20 kc area, and 48 strip chart recorders channels for quasi-static data.

The facility has a four analog-to-digital data acquisition system, including four Beckman Instruments, Inc. 210 systems and four Beckman 420 digital computers.

Its manager Young said: "We have had to install a large amount of equipment which was never tied together except on paper. Debugging has gone relatively smoothly. For example, a complete diagnostic program was being run on the Beckman systems two hours after the power was wired in."

IV. For quick look

The primary function of the data handling center is to provide the facility with a capability of reducing digital and analog data—both hard line and telemetry—to "quick-look" formats. The backup, for more detailed data reductions, is an agency computer center 12 miles southwest, at Slidell, La.

A little late. The data handling center is not on schedule.

There have been "quite a few problems in interfacing" its various components and subsystems, a GE official said.

One major component of the space center which has been accepted is the telemetry ground station. For receiving r-f telemetry from stage equipment, the station will handle up to 12 f-m carriers in the 215 to 260 megacycle band, demodulate them and output the data in the 0 to 2 Mc spectrum.

A second part of the center is an analog analysis system, divided into computer-controlled "quick look and detailed analysis subsystems." The system does all vibration data analysis, receiving data from single-sideband telemetry or constant bandwidth units in the acquisition facility.

The center's digital-data-handling system is built around two medium scale Scientific Data Systems, Inc. 930 computers and peripheral equipment. This system handles data reduction on a priority (interrupt) basis. To increase data-reduction runs during test firings, the integrated system automatically sets up and checks out its own equipment.



Great editorial is something he takes to work

(What a climate for selling!)

Electronics

A McGraw-Hill *Market-Directed* Publication
330 West 42nd Street, New York, N.Y. 10036

MEMBER: AUDIT BUREAU OF CIRCULATIONS, AMERICAN BUSINESS PRESS

Work at your own speed at Lockheed.



Subsonic. Supersonic. Hypersonic.

Where do you feel the greatest potential in developmental aviation lies today? Which type of craft, which speed regime, is personally most stimulating to you? Subsonic? Supersonic? Hypersonic? No matter what your answer, you will find a breadth of opportunity at Lockheed that is unmatched in the aerospace industry today.

The Army's Advanced Aerial Fire Support System—AAFSS—is the first major compound helicopter award in history to enter development. It is at Lockheed. Revolutionary composite vehicles able to stop, fold, or start blades in forward flight are another current Lockheed project. From heavy-lift helicopters for large cargo operations to STOL and V/STOL short-haul

passenger transports, Lockheed is active in virtually every aspect of developmental aviation.

Lockheed is also hard at work on a new generation of high performance aircraft in the upper supersonic speed range. At the same time, other remarkable aircraft, for Mach 3 flight, are currently in development at Lockheed. Additional work is continuing on supersonic V/STOL fighters, extremely advanced versions of the famed F-104 Starfighter, and America's fixed-wing SST.

Lockheed is using the SCRAMJET approach in manned hypersonic test and cruise vehicles. Designed to fly many times the speed of sound, they will help man achieve the capability of

landing at earth bases after maneuvers in space. And also, they will lead to high priority passenger and cargo transport at hypersonic speeds.

A large number of significant positions are now open for engineers on sub, super, and hypersonic programs. For information concerning specific opportunities, please write: Mr. E. W. Des Lauriers, Professional Placement Manager, Dept. 1503, 2404 North Hollywood Way, Burbank, California. Lockheed is an equal opportunity employer.

LOCKHEED-CALIFORNIA CO.

A DIVISION OF LOCKHEED AIRCRAFT CORPORATION

Boston Technical Publishers, Inc. . . . announces an unprecedented offer of . . .

10 FREE HARDCOVER BOOKS

. . . of your own choice on prepaid orders of any 15 or more assorted titles of equal or higher prices. You will receive 25 books for the price of 15 (on orders of only 5 or more assorted titles you will receive 2 FREE BOOKS). You may order single or multiple copies of any titles at our reduced prices, individually or jointly with your colleagues. Please send all orders with checks marked "ELECTRONICS March 1966 Offer." If you prefer, you may pay in three or six equal monthly installments. We even pay all postage/handling expenses. FREE BOOKS OFFER EXPIRES APRIL 30, 1966.

Choose from the list of outstanding technical books reprinted and clothbound in USA 1964-66.

These were originally published by America's leading publishers at 55% to 140% higher prices, and are currently among the most widely used and best known elec. engineering books.

Beam and Wave Electronics in Microwave Tubes. By R. G. E. Hutter, Chief Engineer, Special Tube Operations, Sylvania Electric Products, Inc. (1960) Pp. 378, illus. Catalog No. EM1. . . . Orig. Price: \$10.75. . . . Our Price: \$6.50

Measurements at Centimeter Wavelength. By D. D. King, Vice President and Director Research Division, Electronic Communications, Inc. Pp. 327, illus. Catalog No. EM2. . . . Orig. Price: \$7.50. . . . Our Price: \$4.50

Transient Circuit Analysis. By Y. H. Ku, Prof. of Electrical Engineering Moore School of Elec. Engineering, Univ. of Pennsylvania. (1961) Pp. 441, illus. Catalog No. EM3. . . . Orig. Price: \$13.00. . . . Our Price: \$7.75

Foundations of Electrodynamics. By P. Moon, Assoc. Prof. of Elec. Engineering, Massachusetts Institute of Technology; and D. E. Spencer, Assoc. Prof. of Mathematics, Univ. of Connecticut. (1960) Pp. 314, illus. Catalog No. EM4. . . . Orig. Price: \$9.75. . . . Our Price: \$5.75

Control Engineering By G. J. Murphy. (1959) Pp. 385, illus. Catalog No. EM5. . . . Orig. Price: \$7.50. . . . Our Price: \$4.75

Transient and Steady-State Analysis of Electric Networks. By E. Peskin, Prof. of Elec. Engineering, Stevens Inst. of Technology. (1961) Pp. 423, illus. Catalog No. EM6. . . . Orig. Price: \$13.00. . . . Our Price: \$7.50

Functional Circuits and Oscillators. By H. J. Reich, Prof. of Electrical Engineering and Applied Science, Yale Univ. (1961) Pp. 466, illus. Catalog No. EM7. . . . Orig. Price: \$12.50. . . . Our Price: \$7.75

Microwave Theory and Techniques. By H. J. Reich, P. F. Ordung, Head, Dept. of Elec. Engineering, Univ. of California (Santa Barbara); H. L. Kraus, Assoc. Prof. of Elec. Engineering, Yale Univ.; and J. G. Skalnik, Assoc. Prof. Elec. Engineering Yale Univ. Pp. 902, illus. Catalog No. EM8. . . . Orig. Price: \$14.25. . . . Our Price: \$8.75

Fundamentals of Radio Communication. By A. Sheingold, Assoc. Prof. of Electronics and Physics, U. S. Naval Post Graduate School, Monterey, Calif. Pp. 442, illus. Catalog No. EM9. . . . Orig. Price: \$7.95. . . . Our Price: \$5.50

Very High Frequency Techniques. Prepared by the Staff of the Radio Research Laboratory, Harvard University, N.D.R.C., under the editorship of H. J. Reich, Yale Univ., and developed under the sponsorship of the Office of Scientific Research and Development, Foreword by Prof. P. E. Terman Pp. 1047, illus. Two Volume Set—Combined in One. Catalog No. EM10. . . . Orig. Price: \$19.00. . . . Our Price: \$9.75

Ultra High Frequency Propagation. By H. R. Reed, Prof. of Elec. Engineering, Univ. of Maryland, Consultant N.A.T.C.; C. M. Russell, Chief, Traffic Control Research, Systems Research and Development Service; (1964). Pp. 582, illus. Catalog No. EM12. . . . Revised 1964 Edition. . . . Our Price: \$6.75

The Metallurgy of Semiconductors. By Yu. M. Shashikov, Authorized Translation from the Russian by J. E. S. Bradley, Ph.D. (1961). Pp. 183, illus. Catalog No. EM14. . . . Orig. Price: \$9.50. . . . Our Price: \$5.75

Ferrites at Microwave Frequencies. By A. G. Gurevich, Authorized translation from the Russian by A. Tybulewicz, B.Sc., M.I. Int.Sc. (1963). Pp. 329, illus. Catalog No. EM15. . . . Orig. Price: \$17.50. . . . Our Price: \$8.75

Magnetic Transitions. By K. P. Belov, Authorized translation from the Russian by W. H. Furry (1961). Pp. 242, illus. Catalog No. EM16. . . . Orig. Price: \$12.50. . . . Our Price: \$6.75

Introduction To Neutron Physics. By L. P. Curtiss, Consultant to the Director of Standards. (1959). Pp. 380, illus. Catalog No. NS9. . . . Orig. Price: \$10.75. . . . Our Price \$5.75

Engineering Data Processing System Design. By A. D. Even, Management Consultant and Pilot Project Officer, U. S. Army Ordnance Corps. (1960) Pp. 282, illus. Catalog No. MS1. . . . Orig. Price: \$8.50. . . . Our Price: \$4.75

Principles of Modern Acoustics. By G. W. Swenson, Prof. of Elec. Engineering, Univ. of Illinois. Pp. 222, illus. Catalog No. MS3. . . . Orig. Price: \$6.00. . . . Our Price: \$4.50

Airborne Radar. By D. J. Powell, Director, New Product Service; R. S. Raven, Advisory Engineer, Weapons Systems Development, both at Westinghouse Electric Corp.; and P. Wateman, Head, Equipment Research, U. S. Naval Research Lab. (1961). Pp. 823, illus. Catalog No. AS2. . . . Orig. Price: \$20.00. . . . Our Price: \$9.75

"Expense on books is an investment in knowledge—
—in professional and financial advancement!"

If your employer does not reimburse you it is a tax deductible expense.

Now you can have your own **HARDCOVER BOOKS** at almost **PAPERCOVER PRICES** especially when you receive **FREE BOOKS** on large individual or group orders as offered above.

BOSTON TECHNICAL PUBLISHERS, INC.
Central Sq Box 111 E, Cambridge Massachusetts 02139
Phone (617) 491-0443

MASSACHUSETTS INSTITUTE OF TECHNOLOGY RADIATION LABORATORY SERIES

Radar System Engineering—Hidenour
Cat #RL1 Orig. Price: \$12.50 Our Price: \$5.50

Radar Aids to Navigation—Hall
Cat #RL2 Orig. Price: \$10.00 Our Price: \$5.50

Radar Beacons—Roberts Cat #RL3
Orig. Price: \$9.50 Our Price: \$4.25

Loran—Pierce, McKenzie, and Woodward
Cat #RL4 Orig. Price: \$10.00 Our Price: \$4.50

Pulse Generators—Glasoe and Lobaqq
Cat #RL5 Orig. Price: \$12.50 Our Price: \$5.50

Microwave Magnetrons—Collins Cat
#RL6 Orig. Price: \$13.50 Our Price: \$5.75

Klystrons and Microwave Triodes—Hamilton, Knippe and Kuper Cat
#RL7 Orig. Price: \$11.00 Our Price: \$5.00

Principles of Microwave Circuits—Montgomery, Dicke, and Purcell
Cat #RL8 Orig. Price: \$10.00 Our Price: \$4.50

Microwave Transmission Circuits—Hagan Cat #RL9 Orig. Price: \$12.00 Our Price: \$5.25

Waveguide Handbook—Marcuvitz Cat
#RL10 Orig. Price: \$11.00 Our Price: \$5.00

Technique of Microwave Measurements—Montgomery Cat #RL11 Orig. Price: \$14.50 Our Price: \$6.00

Microwave Antenna Theory and Design—Silver Cat #RL12 Orig. Price: \$12.50 Our Price: \$5.50

Propagation of Short Radio Waves—Kerr Cat #RL13 Orig. Price: \$13.00 Our Price: \$5.50

Microwave Duplexers—Smullin and Montgomery Cat #RL14 Orig. Price: \$9.50 Our Price: \$4.25

Crystal Rectifiers—Torrey and Whitmore Cat #RL15 Orig. Price: \$8.50 Our Price: \$4.00

Microwave Mixers—Pound Cat
#RL16 Orig. Price: \$8.75 Our Price: \$4.00

Components Handbook—Blackburn
Cat #RL17 Orig. Price: \$11.50 Our Price: \$5.00



Vacuum Tube Amplifiers—Valley and Wallman Cat #RL18 Orig. Price: \$13.50 Our Price: \$5.75

Waveforms—Chance, Hughes, MacNicol, Sayre, and Williams Cat
#RL19 Orig. Price: \$13.50 Our Price: \$5.75

Electronic Time Measurements—Chance, Hulsizer, MacNicol, and Williams Cat #RL20 Orig. Price: \$11.00 Our Price: \$5.00

Electronic Instruments—Greenwood, Holdam, and MacIae Cat #RL21 Orig. Price: \$13.50 Our Price: \$5.75

Cathode Ray Tube Displays—Soller, Starr, and Valley Cat #RL22 Orig. Price: \$13.50 Our Price: \$5.75

Microwave Receivers—Van Voorhis Cat #RL23 Orig. Price: \$11.50 Our Price: \$5.00

Threshold Signals—Lawson and Uhlendorf Cat #RL24 Orig. Price: \$9.50 Our Price: \$4.25

Theory of Servomechanisms—James, Nichols, and Phillips Cat #RL25 Orig. Price: \$9.50 Our Price: \$4.25

Radar Scanners and Radomes—Cady, Karelitz, and Turner Cat #RL26 Orig. Price: \$10.00 Our Price: \$4.50

Spinning Mechanisms and Linkages—Svoboda Cat #RL27 Orig. Price: \$8.50 Our Price: \$4.25

Index—Henney Cat #RL28 Orig. Price: \$4.50 Our Price: \$3.25

New 1966 EDITION, coming off the press Mid April 1966

Integrated Circuit Engineering—Basic Technology by G. R. Madland, R. L. Pritchard, H. K. Dicken, D. B. Kret, R. D. Richardson and F. H. Bower of Integrated Circuit Engineering Corp., Phoenix, Arizona. A major reference work embodying the findings and experience of a team of recognized integrated circuit specialists—20 sections including 6 on processing, 7 on design, 4 on reliability and testing and 2 on management—406 pages, over 400 illustrations 8 1/2" x 11", clothbound POSTPUBLICATION PRICE \$22.50 Cat #ICI. . . . Prepaid, PRE-PUBLICATION PRICE \$18.50 thru April 30, 1966.

Order Form:
Fill in and send to:
Boston Technical Publishers, Inc.
Central Sq. Box 111 E,
Cambridge, Mass. 02139

I/We wish to pay for books Catalog # RL1 RL2 RL3 RL4 RL5
RL6 RL7 RL8 RL9 RL10 RL11 RL12 RL13 RL14 RL15 RL16
RL17 RL18 RL19 RL20 RL21 RL22 RL23 RL24 RL25 RL26 RL27
RL28 EM1 EM2 EM3 EM4 EM5 EM6 EM7 EM8 EM9 EM10 EM12
EM14 EM15 EM16 NS9 MS1 MS3 AS2 ICI

and receive as FREE BOOKS Cat. #.....

Check enclosed \$..... Balance will be paid in equal
monthly installments.

Name Date

Address

City State Zip Code

30 DAYS UNCONDITIONAL REFUND PRIVILEGE ON ALL BOOKS



George Washington couldn't sleep here.

There's too much going on.

"Here" is IBM's Federal Systems Center in Bethesda, Maryland.

What's going on? Plenty!

Our principal mission is to develop and build special information processing equipment to solve individual and unique problems for command/intelligence, marine, tactical and communications systems.

As a member of our creative Federal Systems Center team, you'll work on some of the most advanced, sophisticated systems development problems we believe you've ever seen.

If your discipline is listed below, we may have an immediate opening for you. Look and see if your talent and training are needed.

It's kind of great to get to the job when you know you're needed, important, and growing.

Sonar systems design • Advanced communications systems design • Systems engineering • Digital and analog circuit design • Digital systems logic design • Mechanical

packaging design • Electrical systems design • Optical mechanical design.

IBM is an Equal Opportunity Employer
Direct your resume in complete confidence to:

Mr. J. B. Farrington, Dept. 554P1,
IBM Federal Systems Center,
Federal Systems Division, **IBM**[®]
7220 Wisconsin Avenue,
Bethesda, Maryland.

WANTED

People interested in recording:

Applicants desired from industry, hospitals, schools, laboratories; with almost any type of data acquisition problem. Special benefits available for people who once thought magnetic tape recording was too expensive or complicated.

Successful applicants need only know how to pick up data and turn simple knobs. Need own source of power (110 volts; or 220; 48 to 400 cycles; or 12 volts DC). Will be allowed to operate in plant or lab, and have complete freedom to record in the field, in car, aircraft, submarine, or Land Rover.

Can have any number from 1 to 8 data channels on a quarter inch of tape; will not be required to buy any more channels than needed. Will be able to change from Direct to FM recording, select one of three recording speeds in unique and highly useful speed ratios of 1:10:100 . . . all at the flip of a switch without changing electronic modules. Must be prepared to record and play back in both directions, and be able to compress a whole night's operations into a 10-minute playback next morning, or expand a critical 3-minute event into 5 hours of detailed analysis.

VELOCITY
TEMPERATURE
WEIGHT
VIBRATION
FREQUENCY
PRESSURE
FLOW
R. P. M.
ACCELERATION
BRAINWAVES
TIME INTERVAL
DISTANCE
PULSEBEATS
HUMIDITY
pH
POWER
TIDES
SOUNDS
MOTION
SALINITY
FILM THICKNESS
LIGHT INTENSITY
VISCOSITY
EARTHQUAKES
You name it!

All usual fringe benefits available, plus significant advantage in dealing with largest, oldest exclusive manufacturer of instrumentation tape recorders; designer of first solid-state recorder (1958), first portable instrumentation recorder (1958), first concentric reel recorder (1958), first satellite recorder (1960), first portable television recorder (1962), first incremental recorder (1962).

Send only name and present affiliation; PI-6200 brochure containing complete specifications will be mailed immediately.

Contact PI-6200 Application Dept., 3170 Porter Drive Stanford Industrial Park, Palo Alto, California 94304 or call nearest representative for local interview.

We're world wide.

PRECISION
INSTRUMENT



PI-6200 is an equal opportunity recorder, available to anyone regardless of sex, race, color, creed, or national origin.

No engineering degree required!



PI-6200 magnetic tape recorder, easiest-to-use tape recorder ever designed; will help applicant fill any data acquisition job requirements.



One way to check for power loss

Visual inspection may sometimes reveal the source of a power loss. Most transmitters, however, require more sophisticated test equipment. Fortunately, the cost of wide-range power meters like Sierra's new Series 401A r-f termination wattmeters need not sound a sour note in your budget.

At prices you can appreciate (see below), Series 401A wattmeters make precise measurements of power on four selectable ranges up to 1,000 watts, with frequency coverage of 2 to 1000 Mc. Single-knob switching lets you read down to two watts on the 1,000-watt model. Sierra's "Twist-Off" connectors permit quick field changes of eight connector types. Permanent sealing eliminates coolant leakage.

You can bring on a full range of data concerning Sierra Series 401A r-f wattmeters with a note to Sierra/Philco, 3885 Bohannon Drive, Menlo Park, California 94025.

Sierra 401A R-F Termination Wattmeters

401A (120 w)	\$195.00	401A (500 w)	\$275.00
401A (250 w)	\$225.00	401A (1,000 w)	\$365.00

A better way from Sierra

SIERRA ELECTRONIC DIV.
OF
PHILCO
A SUBSIDIARY OF *Ford Motor Company*

YOU DON'T ALWAYS GET WHAT YOU PAY FOR FROM AN ELECTRONICS DISTRIBUTOR

APPLICATIONS ASSISTANCE to help you solve your semiconductor design problems is available

from our own full-time staff of electronics engineers. **EMERGENCY DELIVERIES** are

speeded by special emergency telephone numbers. Through either private listing or answering service, Weatherford's key personnel are on

24-hour call. **PRODUCT DATA** comes to you in many forms . . .

Weatherford Technical Seminars, the monthly Weatherford Report newsmagazine, and a full library of product literature. Weatherford **TESTING LABORATORY** provides pretesting, sorting services and many facilities extras (even a wind

tunnel). **ENGINEERING SERVICES** such as calibration and

SOMETIMES

YOU

GET

MORE!

equipment modification are offered by JSD Engineering, a

division of R. V. Weatherford. A computer-**CONTROLLED INVENTORY** assures complete

and accurate stocks, with fast information and order service coordinated by the **INSTANT COMMUNICATIONS** of a private telephone network

linking all Weatherford locations. These service "plusses" — and Weatherford's traditional

accuracy and fast delivery — are your guarantee of full-

value electronics distribution. And don't overlook the biggest plus of all — Weatherford has the largest stocks in the

West . . . of the broadest semiconductor line in the industry . . . from **TEXAS INSTRUMENTS**.



R. V. WEATHERFORD CO.

DISTRIBUTORS OF ELECTRONIC COMPONENTS AND EQUIPMENT

GLENDALE I, CALIFORNIA: 6921 San Fernando Road, VI 9-3451
ANAHEIM, CALIFORNIA: 1651 State College Blvd., KI 7-7521
PALO ALTO, CALIFORNIA: 3240 Hillview Drive, Stanford Industrial Park, DA 1-5373

**WEATHERFORD
SERVICE
PLUS**



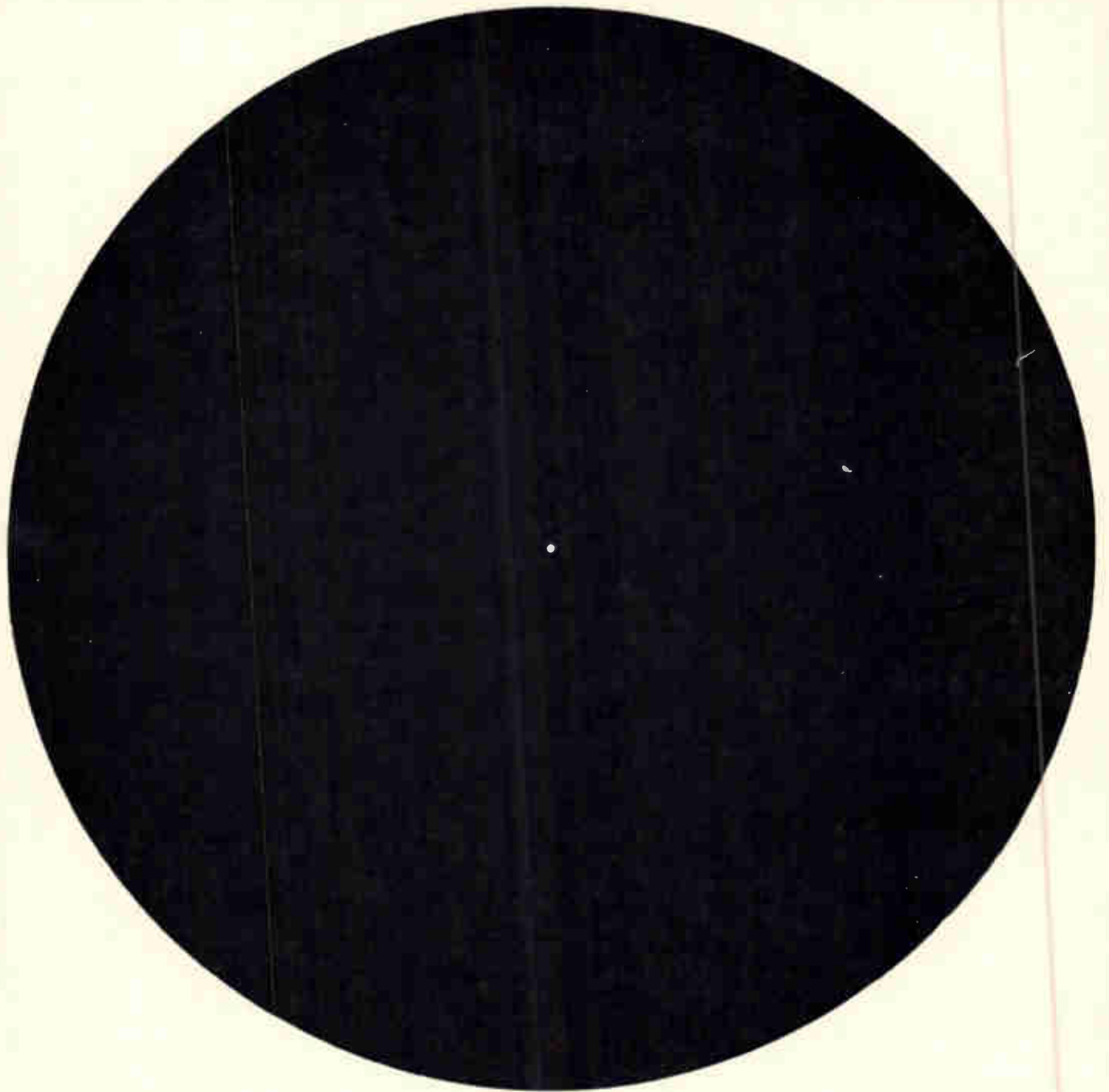

The small pin hole in the center of this circle is more than enough light for MTI Image Orthicon Television Cameras.

MTI is the world's largest manufacturer of low light level TV systems. This simply means that low light levels are our specialty. Specifically, at 1×10^{-5} foot candles of ambient light (approaching total darkness) MTI image Orthicon TV cameras will produce high resolution pictures. So the amount of light illustrated by the pin hole is more than enough.

There are hundreds of applications for MTI low light level equipment. Here are just a few: viewing nocturnal animals performing tasks, observing stars, examining small components such as transistors, diodes, capacitors and relays for minute flaws, and so on. In any application where low light levels are of prime importance, MTI can solve your problems.

Seven different line scan frequencies are available "off the shelf". Specific details available on request. If you have an application problem, call us. We can help.

mti MARYLAND TELECOMMUNICATIONS, INC.

York & Video Roads, Cockeysville, Maryland / Area code 301, 666-2727

WORLD'S LARGEST MANUFACTURER of low light level image Orthicon cameras





Topic 5:

Paper tape, magnetic tape or punched cards,

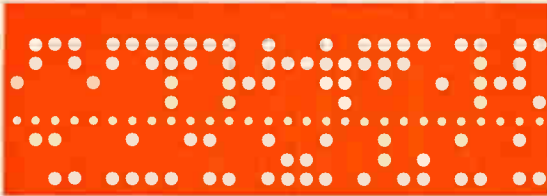

which media should you use?

Choosing the right medium for a given EDP application is primary to optimum data system performance. As the maker of the world's most complete line of perforated tape processing equipment, we wish we could tell you paper tape is the only way to go. However, the problem doesn't lend itself to such a ready solution. In truth, paper tape, magnetic tape, and punched cards all have their place in collecting, storing, and processing data.

Paper tape is the least costly medium, per se. Information is recorded in a non-volatile machine language form on paper, foil, or plastic tape. The message can be of any length. It's visible and will withstand rough handling. Code and formats are compatible with modern computers. Speed range is between cards and mag tape. Cost of equipment for recording, reading, and storage is the lowest of the three media.

Magnetic tape mounted on ordinary reels will handle up to 90,000 characters per second. Information stored on magnetic tape is delicate, volatile, and invisible. Cost of magnetic tape digital data handling equipment is far higher than either paper tape or punched cards. Speed is the big advantage.

Punched cards are the oldest and most widely understood of the three media. Cards have a fixed format which imposes a valuable preparation discipline. Further, they are sortable. These advantages, however, turn out to be a mixed blessing. Sortability is of no advantage in modern computers. Fixed format requires the whole card to be repunched whenever an error occurs.

Fixed record length causes waste in both short and long messages. Short messages fail to use up the card's capacity. Long messages, exceeding 80

character columns, require duplication of indicator information again and again. Cards have a low data density (i.e., they use a lot of space to put the message down). Cards have a low mechanical efficiency in terms of the speed at which they can be processed and the amount of equipment necessary for the task.

Summing up, if your problem is reading data at less than 1,000 characters per second or recording both long and short messages at up to 300 characters per second, paper tape will undoubtedly serve your needs better. If your problem is reading data serially above 1,000 characters per second or writing data serially above 300 characters per second, you should be looking at magnetic tape equipment. If your problem is handling units of recorded data with message lengths less than the capacity of the punched card and you must reorganize data blocks prior to processing, you should consider punched cards.

If you would like to know more about Tally products, we would be pleased to send you complete information. Please address Mr. Ken Crawford, Tally Corporation, 1310 Mercer Street, Seattle, Washington 98109. Phone: (206) MA 4-0760. TWX: (910) 444-2039. In the U.K. and Europe, write our man in London, H. Ulijohn, Manager, Tally Europe Limited, Radnor House, 1272 London Road, London S.W. 16, England. Phone: POLlards 9199.

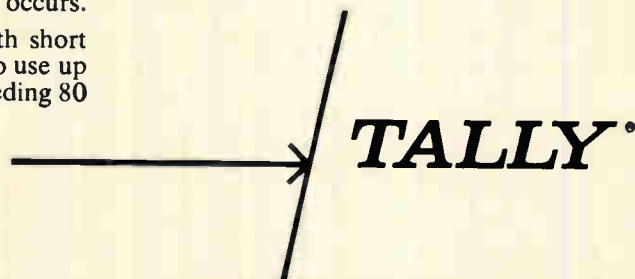

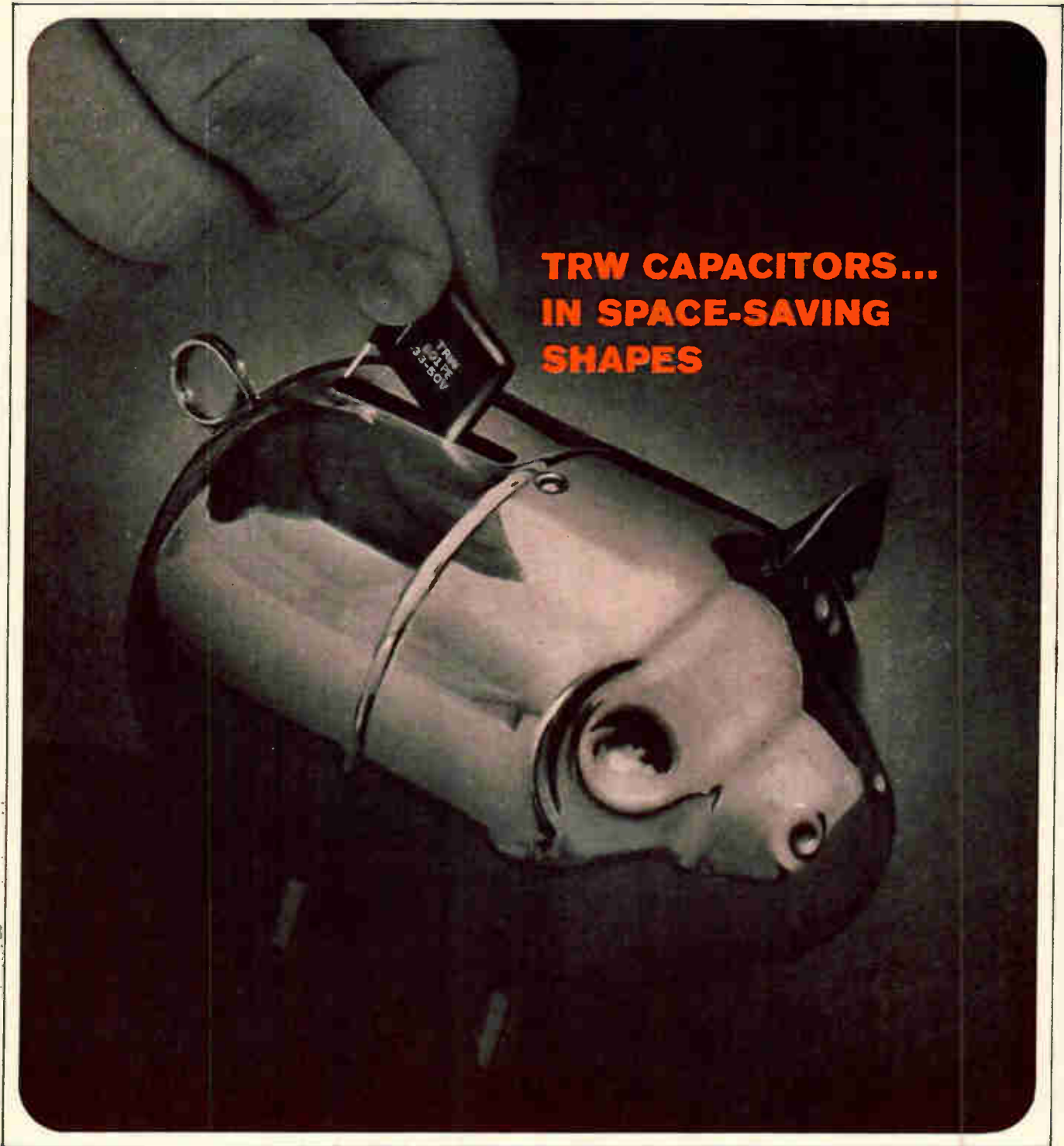

**TRW CAPACITORS...
IN SPACE-SAVING
SHAPES**

The 601 PE... a particular shape for a particular need.

Design with Mylar reliability in the size and shape of a disc! The slim, compact type 601 PE is tailored for printed circuits in military or industrial applications.

In all you will find more than 200 design variations of reliable TRW Capacitors. Round or oval cross-sections. Axial

or radial leads. Dipped, tape-wrapped, or metal enclosed cases. Essentially all these constructions are available in film-foil, in metalized Mylar* and polycarbonate dielectric.

In a tight spot? There's a TRW Capacitor to help you. Contact TRW Capacitors, Box 1000, Ogallala, Nebraska.

*Du Pont Trademark

TRW CAPACITORS

Multipurpose operational amplifier

Unit can operate as a linear or logarithmic amplifier for signals from 10^{-14} to 10^{-2} ampere

An operational amplifier, using electrometer input tubes, is claimed by the manufacturer to have the highest input impedance and the lowest current offset of any operational amplifier. Electrometer input tubes have less noise, better stability and are less sensitive to voltage transients than other high-impedance devices now available.

Primarily a current amplifier, the model 300 has more current sensitivity than any other operational amplifier—says the manufacturer, Keithley Instruments of Cleveland, Ohio. It can operate as a linear or logarithmic amplifier, integrator or other current modifier for signals from 10^{-14} to 10^{-2} ampere. The amplifier's high input impedance permits its operation as a linear current amplifier with resistors as high as 10^{13} ohms in the feedback loop. This increases sensitivity, reduces drift and improves signal-to-noise ratio. Because of its low-current offset, noise and drift, the model 300 can amplify signals as low as 10^{-13} ampere without using a special circuit to compensate for offset.

With high megohm resistors in the model 300 feedback loop, large voltage signals may be developed from very small currents. The model 300 operates with a 1-volt signal, since it can use a 10^{12} ohm feedback resistor. Therefore, drift is very small compared to its output while other operational amplifiers will suffer from severe voltage drift problems as well as from current offset difficulties.

Current offset of the model 300 is less than 5×10^{-14} ampere. This allows amplification without compensating circuits, even for currents as low as 10^{-13} ampere. Drift due to current offset is less than 10^{-15} ampere per day.

For applications requiring a wide dynamic current range, the model 300 can be easily connected to give

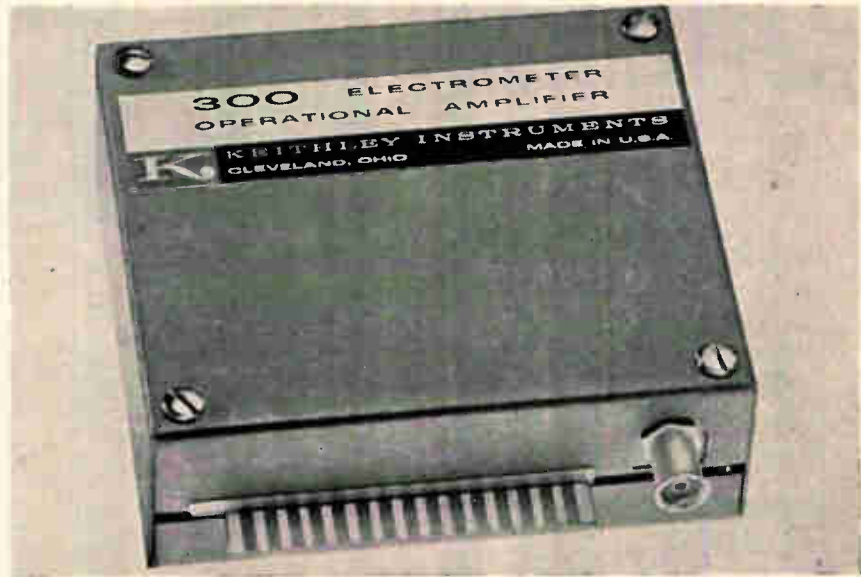

a logarithmic response. As a logarithmic current amplifier, the model 300 is very useful in nuclear reactor monitoring systems, health physics dosimetry, amplifying mass spectrometer currents and optical density measurements.

As a logarithmic amplifier, high input impedance, low current offset and noise enable the model 300 to operate in more sensitive ranges with more stability than other current amplifiers. Seven to nine decades between about 10^{-12} to 10^{-2} ampere can be covered without range switching using silicon diodes.

The model 300 is an excellent impedance matching amplifier when used with a floating power supply for signals from 10 millivolts to 10 volts. The high input impedance of the model 300 allows it to be used with high source resistances with minimum circuit loading. It is capable of withstanding 400-volt overloads without damage. Output impedance is less than 0.05 ohm at d-c unity gain. Voltage drift is less than 500 microvolts per hour averaged over any 24-hour period after a 2-hour

warm-up. With 100% feedback, this drift is less than 0.005% of full output per hour.

Specifications

D-c voltage gains (at 25°C) open loop	
Unloaded	Greater than 20,000
1000-ohm load	Greater than 12,000
Input characteristics	
Resistance	Greater than 10^{14} ohms
Capacitance	Less than 10 picofarads
Current offset	Less than 5×10^{-14} ampere
Drift	Less than 10^{-15} ampere/24 hours
Voltage offset	
Drift	Adjustable to zero Less than 500 microvolts/hour averaged over any 24-hour period after two hour warm-up
Temperature coefficient	
	Less than 500 microvolts/°C
Voltage noise (0.1-10 cps) (10 cps-100 kc)	
	Less than 5 microvolts rms Less than 5 millivolts rms
Power requirements	
	± 16 to ± 25 volts unregulated
Overload limit	
	± 400 volts
Frequency characteristics	
Closed loop unity gain	
Operating temperature	D-c to 100 kc (-3 db)
Dimensions	0 to 50°C 3½" high x 4" wide x 1½" deep;
Weight	13 ounces
Price	\$200

Keithley Instruments, Cleveland, Ohio.

Circle 350 on reader service card

collage

More Motorola mishmash,
continued from page 158

Breaking the ANALOG JAM with multi-purpose chips

One sure way to get so-called integrated circuit specialists wishing they were back doing wiring lists is to toss them a job having analog functions. Transponders fall into this category, but our die-hards weren't discouraged by the fact that off-the-shelf integrated linear circuits are quite rare. So they upped and developed a family of flexible multi-purpose monolithic chips that do right well used with thin film and semiconductor components for quick fabrication of many different types of linear circuits for transponders and such. This eliminates the time and high cost usually required for customized circuits, and everyone is tickled. Our Western Center people are frothing to give you the details.

WHO NEEDS IT

DEPARTMENT

Can there possibly be a use for a handsomely styled small box that does little else than silently disgorge great quantities of printed paper? Well, Sperry-Rand and NASA seem to think there is because they've ordered a slew of them as readout devices for the UNIVAC 1230 command and telemetry computers used in the Apollo program. The box in question is our TP-4000 high-speed, non-impact teleprinter. It spews out 3000 wpm, is all solid state. AND incorporates I/C design of such reliability you wouldn't believe it. And it's so quiet you can't tell it's working except for the paper flying out. Our Chicago Center has the spew for you. Write them.

Continued on page 226

New Components and Hardware

Capacitor adjusts thermal coefficient

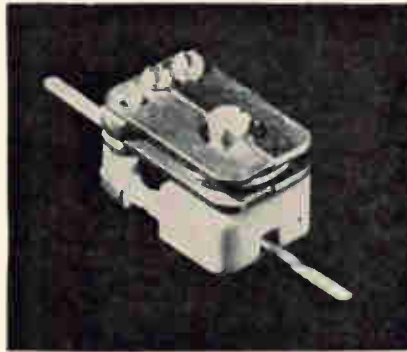

An adjustable temperature coefficient is the unique feature of a 2.3 picofarad capacitor according to British Radio Electronics, Ltd., developers of the device.

Although the component, called a Thermotrimmer, looks like a differential air-spaced trimmer with a ceramic base, adjustment of the rotor alters only the temperature coefficient, to any desired value from +1700 ppm through zero to -1700 ppm; the capacitance changes linearly with temperature.

The variation in capacitance when the device is adjusted for maximum positive coefficient is from 2.3 picofarads at 20°C to 3.3 picofarads at 80°C. A similar negative coefficient is produced simply by turning the rotor through 180°.

Thermal compensation of an uhf oscillator which incorporates a Thermotrimmer is quickly achieved, the supplier claims. The frequency is noted when the oscillator is switched on. After warm-up, the oscillator is returned to its original "cold" frequency by positioning of the Thermotrimmer's rotor, thereby providing compensation for the oscillator's temperature range. This eliminates the need for tedious capacitor substitution. Frequency drift of the oscillator at an intermediate temperature is automatically corrected by the Thermotrimmer.

The Thermotrimmer may find application in drift compensation of high-quality telemetry systems or military communications receivers.

The unit measures 0.6 in. x 0.4 in. x 0.4 in. All metal parts are gold plated. Single units are priced at \$4.00; quantity prices are lower. Delivery is immediate.

Specifications

Capacitance	2.3 pf at 20°C
Voltage	500 vdcw
Dimensions	0.6 in x 0.4 in. x 0.4 in.
Temperature range	-40°C to +80°C
Range of temperature coeff.	+1700 ppm/°C through zero to -1700 ppm/°C
Blade resonance	3,000—4,000 cps

British Radio Electronics Ltd., 1742 Wisconsin Ave., N.W., Washington, D.C. 20007. [351]

Fuse extractor posts stop stray signals

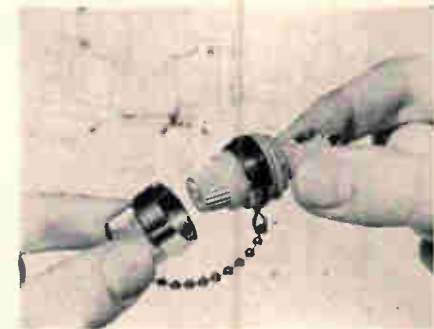

Two waterproof, radio-frequency shielded fuse extractor posts eliminate possible transmission or reception of stray r-f signals through the hole in the chassis used for the fuse post mounting. With 3A6 and 8A6 size fuses, the rest are designed for military ground-support test equipment and for computers.

The fuse extractor post that accommodates 3AG fuses—1¼ in. by ¼ in. diameter—is part No. 340225. The fuse post for 8AG fuses—1 in. by ¼ in.—is part No. 370011. The shielded fuse posts are made to meet qualified product listings, with the FHN26G holder for 3 AG-fuses and the FHN31G for 8AG-fuses. They are ruggedly constructed to withstand environmental conditions such as salt spray, vibration, shock and water immersion.

Mechanically, each of the two r-f

fuse posts has a metal collar that fits over the molded fuse holder body and acts as a ground for the unit as well as a metal-to-metal shielding, preventing radio frequency interference. The metal collar is threaded to accommodate a 7/8-in. diameter brass-nickel plated cap that protects and tamper-proofs the fuse holder and a neoprene water seal "O" ring that waterproofs the unit.

A metal keep chain, connected to the diamond knurled finish cap and the metal collar, prevents the cap from being misplaced when checking the fuse. Two wire mesh embedded silicon gaskets insure complete r-f shielding and waterproofing. The gaskets are mounted in front of the panel. A hexagonal mounting nut that fits on the threaded molded fuse holder body holds the entire assembly to the chassis panel.

Price range for the two r-f shielded fuse extractor posts is from \$2 to \$5, depending upon quantity. Delivery is from stock. Littelfuse, Inc., 800 E. Northwest Highway, Des Plaines, Ill. [352]

There are about 140 companies marketing potentiometers in the U.S.A. Of these, only 72 claim to make precision pots. Of these, only 6 make conductive plastic and wirewound precision pots. Of these, only 1 has six or more years experience in both conductive plastic and wirewound; has equal capability in both, and can objectively recommend either. That one is



new england instrument company

Kendall Lane, Natick, Massachusetts Tel. 617-655-1411, TWX. 617-875-4261
MEMBER OF PRECISION POTENTIOMETER MANUFACTURERS ASSOCIATION

10-turn potentiometer rated 2.5 w at 40°C

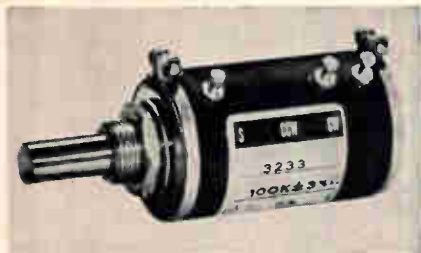

A 10-turn, wirewound precision potentiometer has been announced. Designated model 3233, the 7/8-in., bushing-mount unit is for instrument and control applications.

Model 3233 has a resistance range of 10 ohms to 200,000 ohms ($\pm 3\%$), $\pm 0.25\%$ linearity, and an operating temperature range of -55° to $+105^\circ\text{C}$. Mechanical life is 2 million revolutions, with a power rating of 2.5 w at 40°C . Other operating features include uniform torque with zero backlash, and 100 oz.-in. stop strength.

The unit is enclosed in a high-impact plastic housing secured by rugged clamp bands. Up to 46 taps can be accommodated. Construc-

<p>World's leading line of Precision Single-Turn Pots</p>	<p>Thousands of Custom Designs</p>
<p>Standard Conductive Plastic</p>	<p>Standard Wirewound</p>
<p>WAFERPOTs™ (industry's slimmest)</p>	<p>Resistive Elements</p>
<p>Also, NEI's ECONOPOTs™ are the world's only stock line of long life, infinite resolution, precision pots priced from \$11.55!</p> <p>Disassembled ECONOPOT, showing 3 basic assemblies ▶</p>	<p>ENVIRONMENTAL ECONOPOT TEST</p> <p>MECHANICAL STRENGTH SHOCK VIBRATION HUMIDITY SOLDER HEATING HIGH SPEED LIFE TEMPERATURE SHOCK</p> <p>FREE ON REQUEST</p>

WITH FAIRCON® TRIMMERS

The Only Difference is Quality & Price



AND WHAT A DIFFERENCE! FAIRCON square and rectangular trimmers are engineered and manufactured to provide quality and reliability exceeding MIL-R-27208. What's more, they're designed to meet most portions of MIL-R-39015—the new high reliability specification. That's QUALITY. You'll be pleasantly surprised at our PRICES too. Write today for complete specifications. And for immediate delivery from stock...see ARCO.

FAIRCHILD

CONTROLS

A DIVISION OF FAIRCHILD CAMERA AND INSTRUMENT CORPORATION
225 PARK AVENUE, HICKSVILLE, L. I., NEW YORK
TELEPHONE: (516) 938-5600 • TWX: (510) 231-1854
CABLE: FAIRCON-HICKSVILLE, NEW YORK, U. S. A.

See Them at IEEE Show—Booth 2605

New Components

tion features include welded lead terminations, gold-plated terminals and non-corrosive brass front lid and bushing. Price is \$7.13 in lots of 250 to 499 pieces.

Duncan Electronics, Inc., 2865 Fairview Road, Costa Mesa, Calif. [353]

High-impedance choppers, switches

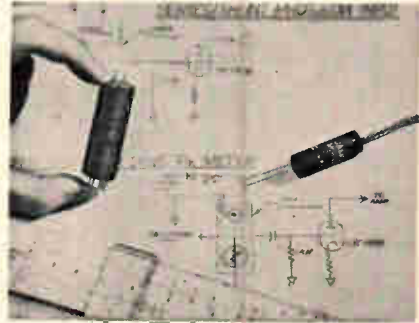

A series of three solid state Photocom choppers and switches has been developed with on-resistances greater than 1 megohm, and off-resistances greater than 10^{11} for applications with source impedances up to 1,000 megohms. Typical uses include: Ph meters, electrometer instruments, integrating amplifiers, logarithm and high impedance servocontrol instruments, and other ultrahigh source impedance, low-signal input applications. They can also be used as series or shunt modulators, or solid state relays.

Model C-4812 Photocom chopper is a complete 7-pin miniature socket-plug-in modulator package, series shunt single-pole double-throw. It has standard chopper contact arrangement. The high-speed photocell switching action provides break-before-make operation at modulating speeds up to 1 kc. Contact-to-case insulation resistance is maintained at 100,000 megohms minimum. The drive network has electrostatic isolation from the contacts of better than 10^{-4} pf. The chopper operates from 120 v a-c drive at frequencies up to 3 kc and is capable of chopping signal levels in the 1- μ v range. Chopping efficiencies are greater than 85% in high-impedance systems. No external associated drive circuitry is needed. The grey metal

113 STANDARD MODELS . . .

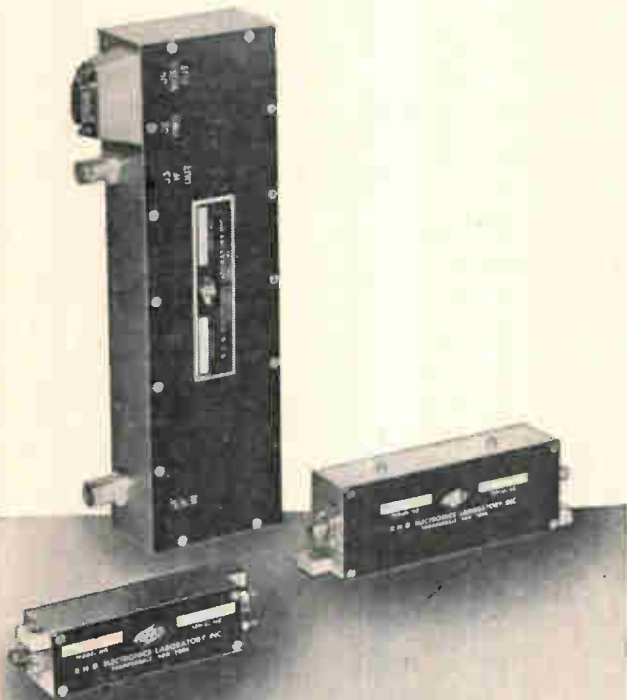

RHG IF AMPLIFIERS

FEATURING

- Linear or Log response
- Solid State, Tube, and Ultra-miniature
- RFI Protected
- IF and Video Outputs
- MIL Grade
- Matched Units

RANGE OF SPECIFICATIONS

Center Frequency:	5 to 160 MHz
Bandwidth:	.25 to 100 MHz
Gain:	to 100 db
Noise Figure:	to 1.4 db
Price:	From \$185

In addition to offering the widest line of off-the-shelf units in the Industry, an additional 268 CUSTOM DESIGNS have been produced. The solution to your problem may be on file in our library now.

For specials, test our ONE-DAY-QUOTE Service. For standards, see complete listing in EEM Section 3400.

RHG

RHG ELECTRONICS LABORATORY, INC.

94 Milbar Blvd., Farmingdale, N.Y. 11735
(516) 694-3100

MICROWAVE FM and AM RECEIVERS ■ MICROWAVE MIXER PREAMPS
LINEAR and LOG IF AMPLIFIERS ■ RF and OCTAVE AMPLIFIERS

NOW! NAVCOR 1050 CUSTOMIZED KEYBOARDS



Tired of searching for the right keyboard to fit your requirements? 1050 Keyboards solve that problem with unsurpassed flexibility.

Need numeric or alphanumeric layout, special key arrangements, rack mounting or table top housing? They're all available in the 1050 Series, along with a choice of switch closure or pulse outputs, diode matrix plug-ins that provide any coded output up to 15 bits, and a variety of special output options.

So stop searching! Send the coupon—we'll tell you all about the 1050 Series and KM Keys.

NAVCOR®

Valley Forge Industrial Park
Norristown, Pennsylvania



I'M INTERESTED! Please send me technical data and prices on your 1050 Keyboards and KM Keys.

Name _____
Title _____
Company _____
Address _____
City _____
State _____ Zip _____

Dept. EL-023

Reader Service #515

NEW! magnetic keys for your keyboard



Here's the key that outdates ordinary switches. Magnetically actuated, with minimum bounce, these switches are sealed in glass for environmental immunity. Life expectancy? Up to 100 million operations. And the magnetic hysteresis band prevents make/break microphonics.

They're available with switch closure or pulse outputs, standard or special letters, numerals and symbols, and require no special installation tools. You'll save time, cost and headaches with KM Keys. Send coupon for details.

NAVIGATION COMPUTER CORPORATION

Valley Forge Industrial Park • Norristown, Pennsylvania
Dept. EL-023 • TWX 215-666-0729 • Phone 215-666-6531

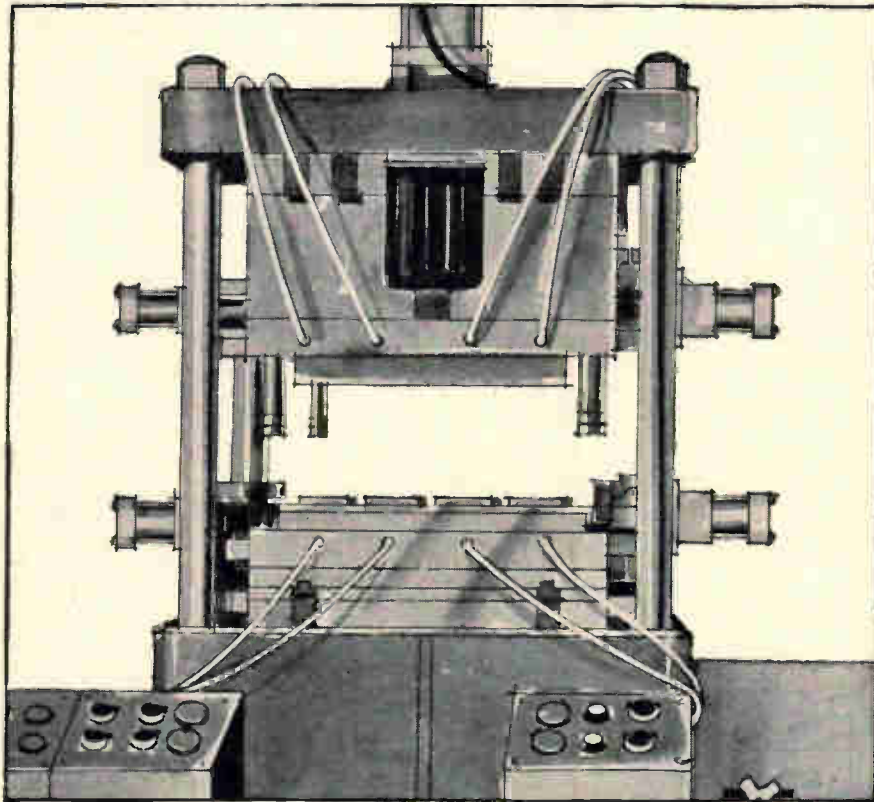

NEW HYFLO® EPOXY MOLDING POWDERS AUTOMATE ENCAPSULATION

Encapsulate electrical-electronic components the new automated way with HYFLO® Epoxy Molding Powders. Built-in automation eliminates weighing, mixing, liquid mess, ovens, long cure cycle, shelf life and pot life problems at no increase in material costs. Economical, low pressure HYFLO® Epoxy Transfer Molding Powders feature extreme toughness, low coefficient of expansion, high dielectric properties, excellent moisture protection, flame-out properties and outstanding thermal shock resistance.

SAVE TIME AND MONEY. Write, wire or call for application engineering assistance today.

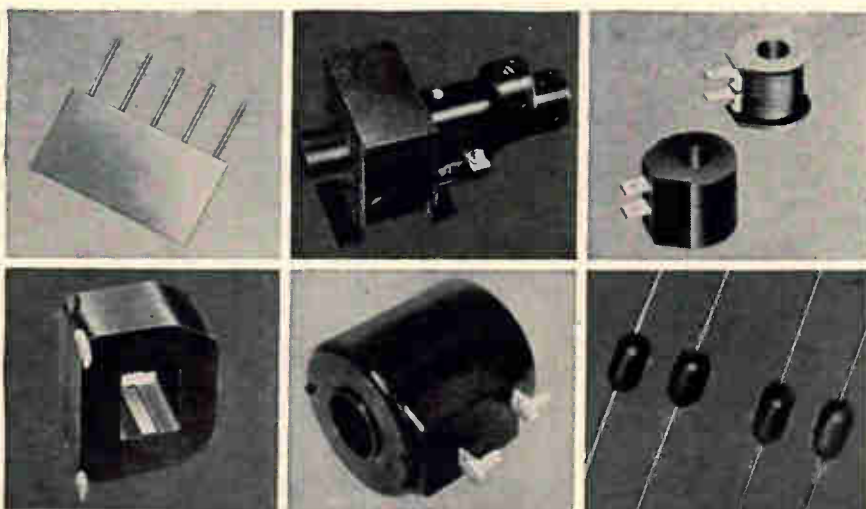

PROGRESSIVE PRODUCTS

HYSOL HYSOL CORPORATION • CLEAN, NEW YORK
THRU CHEMICAL RESEARCH Los Angeles, California/Hysol (Canada) Ltd., Ontario/London, England

New Components

cylindrical package "W" is $2\frac{1}{4}$ in. high, with $\frac{1}{4}$ -in. long pins, and has a 0.760-in. diameter. The unit weighs 1.3 oz.

Photocom models C-4840 and C-4841 are single-pole single-throw high-speed switches. Turn-on time is 750 μ sec nominal. Turn-off time is 3 msec. Driven from 120 v a-c, they can be modulated synchronously or asynchronously. Isolation is better than 10^{-4} pf. Signal levels are in the 1- μ v range. Model C-4840, in the "A" package, is supplied with printed-circuit board, gold-plated drive lead connections and a p-c board shielding lead. The cylindrical case has a $\frac{1}{2}$ -in. diameter and is $1\frac{1}{2}$ in. long. The C-4840 weighs less than $\frac{1}{2}$ oz.

Model C-4841 is made with a shielded pair drive cable for guarded-shield applications for the ultimate in common mode rejection and electrostatic noise isolation. The cylindrical body is $\frac{1}{2}$ in. in diameter with gold-plated leads extending $1\frac{1}{4}$ in. from mounting surface and shielded drive leads 6 in. long. It also weighs less than $\frac{1}{2}$ oz.

Sample quantities of the choppers and switches (up to 25 units) are available from stock. Production quantities are available in 4 to 5 weeks from receipt of order. Price range of the C-4812 chopper is \$39 to \$15. Price range of the C-4840 high-speed switch is from \$6 to \$4 in production lots. Prices of the C-4841 range from \$7 to \$5 in production lots.

James Electronics, Inc., 4050 N. Rockwell St., Chicago, Ill., 60618 [354]

Tiny power rheostat handles $7\frac{1}{2}$ watts



Considerably smaller than most $\frac{1}{2}$ -watt composition potentiometers, the unenclosed model C rheostat is rated $7\frac{1}{2}$ watts at 40° C ambient (104°F). The ceramic and metal



Reeves New 20IG (C40D) P. M. Torquer rate-integrating Gyro.

Our **C40D GYRO** keeps your plans strictly on the level

Reeves stands ready to help you with many types of gyros, plus precision resolvers and synchros to 128 speed—in any type you need, in any configuration you require. Over one million Reeves components are in use today. Typical is the new C40D Gyro—whose permanent-magnet torquer rate-integrating characteristics are another prime example of Reeves ability to bring you top engineering developments at maximum economy. Low-cost is built-in (under \$3000). Design improvements permit us to pass production savings on to you. Fact is, all of the C40D Gyro is a triumph of Reeves engineering. Its D'arsonval torquer eliminates all

error parameters. It has no magnetic restraints. No hysteresis, no non-linearities due to saturation. And the C40D's construction completely eliminates the power drain associated with reference field excitation. Its two-pole, high-speed wheel operation, with NYSORB bearings, increases functional performance, over-all reliability and dynamic life. (Reeves guarantees 5,000 hours as the dynamic

wearout wheel-bearing life.) Moreover, the C40D's over-heat protection is equal to anything on the market, by using volume sampling as a criteria for safety.

All this, and a new low price, too! What more is there? Except knowing more about our C40D and our other useful components. Discover them today. Write for Gyro Literature package, or just call us: 516-746-8100, Ext. 510.

Reeves[®]

INSTRUMENT COMPANY

Garden City, New York / Division Dynamics Corporation of America **DCA**

high-voltage workhorse VICTOREEN DIODES

Regulator
Pulse Coupler
High-Impedance
Voltage Divider
High-Voltage
Reference



Victoreen GV1A Corotron diode actual size; other types available.

You probably think of Victoreen Corotron diodes as high-performance thoroughbreds for exotic uses. And they are. But this is only part of the Corotron pedigree. They're also real workhorse diodes for everyday uses. As regulators and H-V references... H-V pulse couplers... high-impedance voltage dividers. And still we haven't run out of Corotron applications. So put your imagination to work. Savings in cost, complexity and weight can put you on velvet. Right away, write away for latest dope on Corotron diodes — high-voltage workhorse. Address Applications Engineering Department.

Write for free copy of illustrated 40-page catalog of Victoreen diodes.

THE VICTOREEN INSTRUMENT COMPANY
10101 WOODLAND AVENUE • CLEVELAND, OHIO 44104
EUROPEAN SALES OFFICE: GROVE HOUSE, LONDON RD., ISLEWORTH, MIDDLESEX, ENGLAND



6471-A

New Components

rheostat measures $\frac{1}{2}$ in. in diameter and $\frac{15}{32}$ in. in depth behind the panel.

Model C will be available in values ranging from 10 ohms to 5,000 ohms in both the standard and locking bushing types. In addition, a high torque version will be available that will hold its setting under extreme conditions of vibration and shock.

Enclosed versions of the model C rheostat are also available in standard and locking bushings. Ohmite Mfg. Co., 3670 Howard St., Skokie, Ill., 60076. [355]

Flat construction miniature inductors

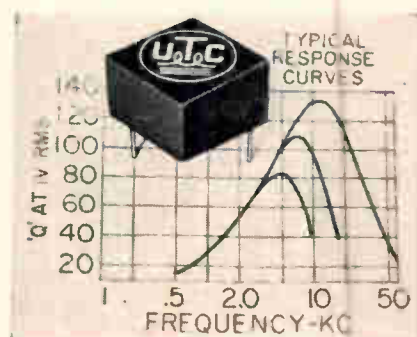

Miniature inductors with flat construction, designated FE, are considered ideal for transistor and printed-circuit applications. They have pin terminals and a maximum height of only $\frac{1}{2}$ inch.

The FE's are symmetrical toroids, providing maximum Q in minimum size. These inductors are guaranteed to be designed, manufactured, and successfully tested to all MIL-T-27B environmental requirements. They are designated MIL type TF5RX20ZZ.

Specifications of stock items are: size, $\frac{15}{16}$ by $\frac{15}{16}$ by $\frac{1}{2}$ in. maximum; weight, 0.7 oz.; inductance range, from 0.02 to 2 henries; maximum d-c, from 50 to 2 ma; maximum d-c resistance, from 5.1 to 500 ohms.

FE inductors are adjusted at 1 v, 1 kc. Temperature stability is said to be unequalled from -55° to $+100^{\circ}$ C. For specific inductance values, the manufacturer should be told the exact level, frequency and

WHAT'S SO NEW ABOUT IT?



EVERYTHING!

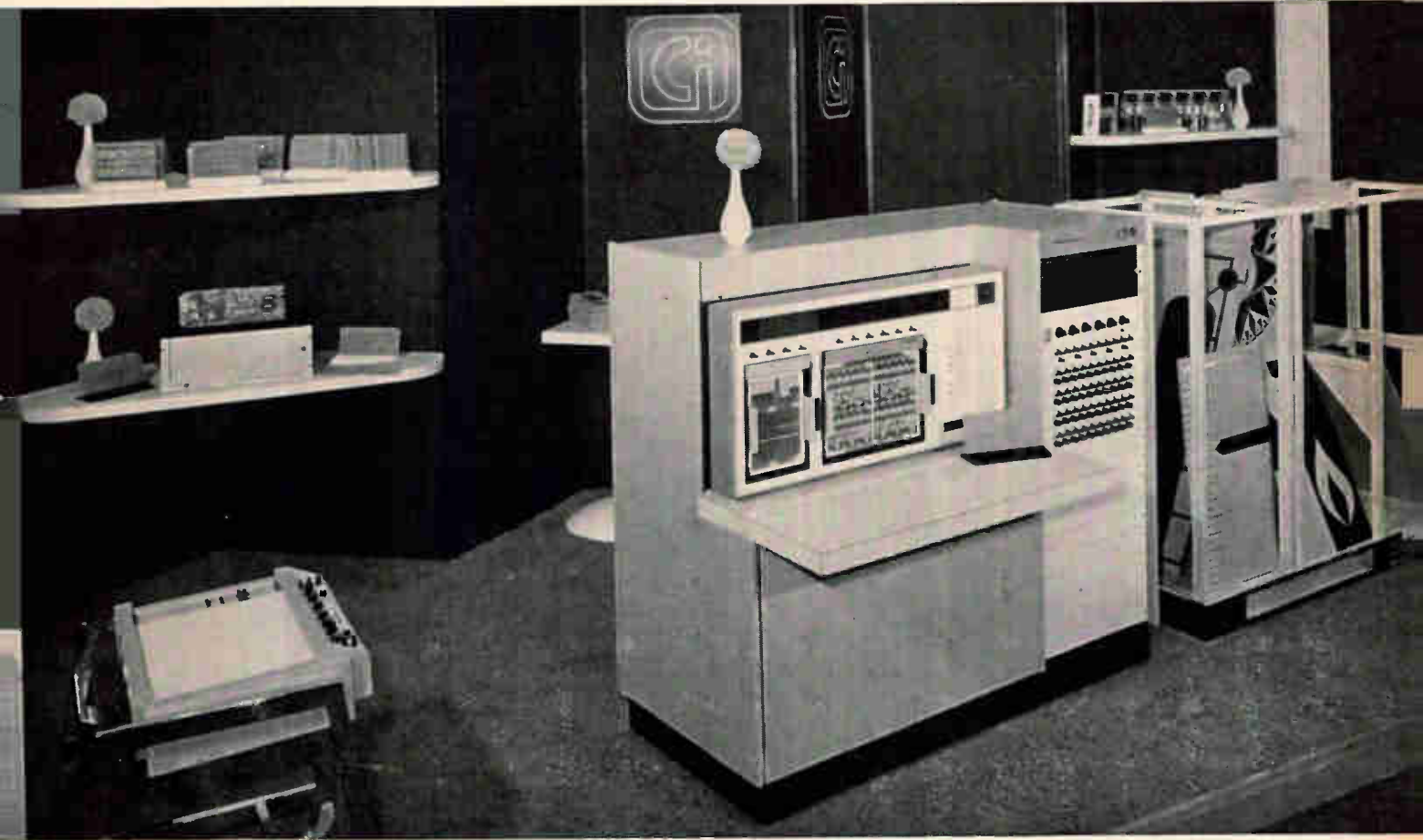

1965 Fall Joint Computer Conference

HOW IS IT FOR INDUSTRIAL APPLICATIONS?



THAT'S WHAT IT WAS DESIGNED FOR!

ANOTHER COMCOR FIRST... AN ECONOMICAL, SMALL-SCALE 100-VOLT ANALOG/HYBRID COMPUTER! Introduced at the Fall Joint Computer Conference, the all new COMCOR Ci-175 is designed for industrial firms that require a small, economical computer for research, development, production and processing. Fast and accurate, the Ci-175 is solid-state

throughout and will accommodate up to seventy-five 100-volt, 50-ma operational amplifiers. Ideal for "building block" expansion, units can be joined for multiple system requirements. If

you missed it at the show see your COMCOR representative for full information or contact COMCOR direct. Telephone (714) 772-4510 • TWX 714-776-2060.



COMCOR

A SUBSIDIARY OF ASTRODATA, INC.

3335 SOUTH CLAUDINA STREET / ANAHEIM, CALIFORNIA 92803

Circle 179 on reader service card

MEPCO

mass-produced film hybrid

MICROCIRCUITS

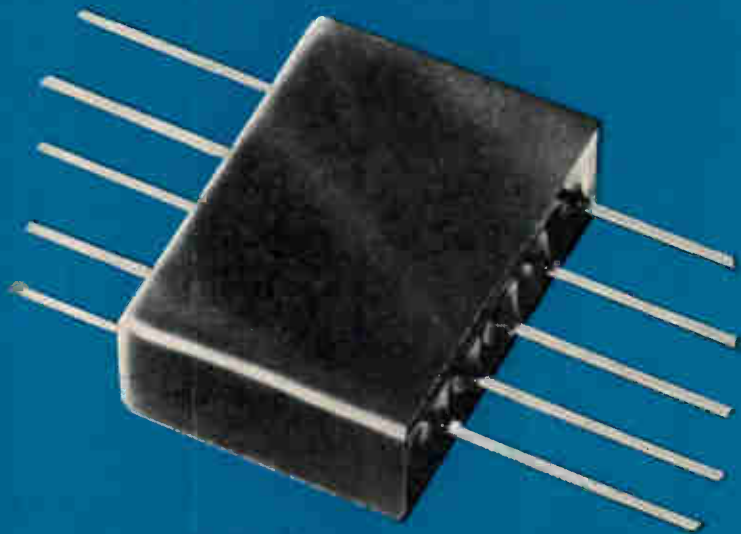

can shrink your
existing circuits to
micro-packages...from
gates to video amplifiers.

FEATURES

- Increased reliability with 10^{-3} or greater size reductions.
- Low set-up and production costs.
- Precision circuit parameters applicable to linear or digital circuits.
- Switching time of 10 nano-seconds.
- Clock rates of 10 megacycles.
- Tracking temperature coefficient characteristics of 10 PPM for a typical resistance ratio of 3 to 1.

MEPCO's prototype processes permit rapid delivery of initial evaluation modules. Our high-volume production line can meet your most stringent delivery requirements.

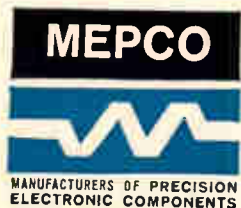

Write or call today for complete details

MEPCO, INC.

Columbia Road, Morristown, New Jersey
07960 (201) 539-2000

New Components

Q requirements to determine the suitability of the part in application. These units are equally well suited for vacuum-tube application. United Transformer Corp., 150 Varick St., New York, N.Y., 10013. [356]

Time delay relay is easily adjustable

A compact time delay relay features convenient screw terminal connections. The time delay period is adjusted by a single knob. Specifications for standard units include: double-pole, double-throw and switching of 10 amps; operating voltage 85 to 130 v a-c or 20 to 32 v d-c; repeat accuracy, 10% or better over temperature and voltage range, or 2% at nominal voltage and room temperature; temperature range, -40° to $+150^{\circ}$ F; timing ranges, 0.1 sec to 300 sec.

Special order specifications include other operating voltages, longer timing ranges, and increased temperature ranges. Units feature quality construction using tantalum capacitors and an scr in timing circuits. Price range is approximately \$25.

AEMCO Division of Midtex Inc., 10 State St., Mankato, Minn. [357]

Polycarbonate-film miniature capacitors

A series of miniature polycarbonate-film capacitors is rated at 50 v d-c. The Dimie series of hermetically sealed capacitors is intended specifically for critical miniaturized electronic packaging. Typical of the volume efficiency: a 1.0- μ f capacitor in a volume of less than 0.07 cu in.

The units are rated for operation at 50 v d-c up to a temperature of 125° C or 30 v a-c at 400 cps at 105° C. Standard capacitance values range from 0.047 μ f in a case with a 0.174 in. diameter by 0.531 in. long to 5.6 μ f in a case with a 0.500 in. diameter by 1.125 in. long. Dearborn Electronics, Inc., P.O. Box 530, Orlando, Fla. [358]



*Look
closely:*

*These are true subminiature switches
from a family of 274 different types.
That's a lot of switches.*

And that's a lot more than most subminiature switch producers can say. **Reason:** Most subminiature switches are just scaled-down big switches. Arrow-Hart subminiature switches are different. They're **true** subminiatures from the drawing board up. For one thing, they use subminiature-rated components. For another, they're much more versatile, more thrifty with space.

Best of all, there are 274 different pushbutton and toggle types. All varieties of contact arrangements. All designed to deliver maximum performance, dependability, and ruggedness — in minimum envelope and weight.

If you need a special subminiature switch, Arrow-Hart's Innovators in Switch Design can create it for you . . . and produce it quickly, efficiently, and economically.

This broad line of subminiature switches and the specialists who can innovate creatively for you and your products . . . are two of many reasons why you **buy better electrically** at Arrow-Hart. Write today for free folder. The Arrow-Hart & Hegeman Electric Co., 103 Hawthorn Street, Hartford, Conn.



QUALITY SINCE 1890

ARROW-HART

The Arrow-Hart & Hegeman Electric Company, Hartford, Connecticut 06106

BUY BETTER ELECTRICALLY • BUY BETTER ELECTRICALLY • BUY BETTER ELECTRICALLY • BUY BETTER ELECTRICALLY

New Semiconductors

Annular transistors in dual packages

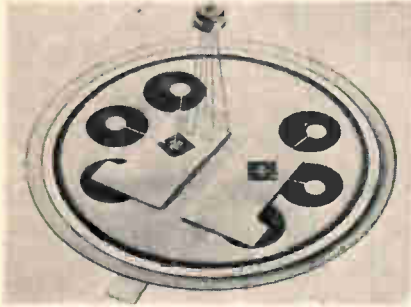

Silicon annular transistors are now available in space saving, dual-device packages. The packages are being used to market three multiple device transistor series: MD-2218, MD2904, and MD3250.

The MD22 series—18, 18A, 19, and 19A—offers n-p-n transistors designed for high-speed switching circuits, d-c to vhf amplifier applications, and circuitry complementary with the MD2904 series. The transistors have a current gain specified from 0.1 ma to 300 ma d-c. The series offers a high-current gain-bandwidth product with f_T being equal to 300 Mc minimum for the MD2219A. The leads of all devices in the series are electrically isolated from the low profile 6-lead TO-5 case for design flexibility.

The MD29 series—04, 4A, 5 and 5A—is made up of dual-device p-n-p types designed for applications similar to those of the first series and circuitry complementary with the MD2218 series. The second series, featuring a high-voltage rating with a collector-emitter breakdown voltage as high as 60 v d-c minimum on the MD2904A and MD2905A, offers a high uniform beta over a current range from 0.1 ma to 300 ma, and has a high-current gain-bandwidth product with a minimum f_T of 200 Mc. Saturation voltage is low: 0.4 maximum at 150 ma.

The MD32 series includes the 50, 50A, 51, and 51A. The A versions are available with a beta match as tight as 0.9 to 1, and are especially designed for low-level, differential amplifier applications. The base-voltage differential for the A versions is as low as 3 mv maximum

with a collector current of 100 μ a d-c. The collector-emitter breakdown voltage for the MD3250 series is typically 70 v d-c. The maximum wideband noise figure limit for the series is 3 db, and current gain is guaranteed from 10 μ a to 50 ma.

Motorola Semiconductor Products Inc.,
Box 955, Phoenix, Ariz., 85001. [361]

Ultralow-noise silicon photodiode

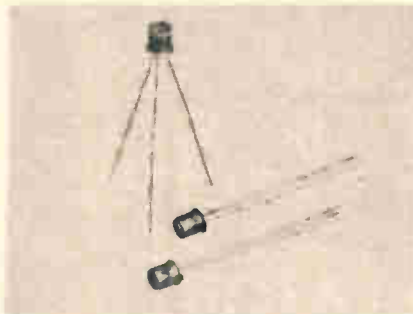

Model 4204 is an ultralow-noise silicon photodiode that combines wide spectral response, high speed, and low capacitance with extremely low dark or leakage current. The ultralow-noise property is a direct result of the low dark current; in applications where the load resistance is less than 100 megohms, the noise contribution of the diode is negligible. Noise equivalent power as a result of shot noise from dark current is less than 1.2×10^{-14} watts per root cycle; excess noise appears only at frequencies below 100 cps, and varies approximately $1/f$.

The device has a maximum dark current of 100 picoamps at -10 v reverse bias at 25°C , a typical junction capacitance of 2 pf at -10 v reverse bias, a maximum series resistance of 50 ohms, and a typical diode to case capacitance of 2 pf. Typical response at 0.77 micron at -10 v reverse bias and 1 megohm load resistance is 0.5 $\mu\text{a}/\mu\text{w}$. Typical speed of response is 1 nsec or less at -10 v reverse bias and 50 ohm load resistance.

The 4204 is packaged in a 3-lead TO-18 size case with a glass window. The two diode leads are iso-

**AUTHORIZED
ERIE
DISTRIBUTOR**



For Erie Components In-Stock Call . . .

ARIZONA
Phoenix
Kierruff Electronics Corp.—273-7331
CALIFORNIA
Glendale
R. V. Weatherford Co.—849-3451
Inglewood
Newark Electronics Corp.—OR4-8441
Oakland
Elmar Electronics, Inc.—TE4-3311
Palo Alto
R. V. Weatherford Co.—DA1-5373
San Diego
R. V. Weatherford Co.—BR8-7400
South Pasadena-Capacitors, Inc.—MU2-3541
COLORADO
Denver
Newark-Denver Elect. Supply—757-3351
DISTRICT OF COLUMBIA
Hyattsville, Maryland
Milgray/Washington, Inc.—UN4-6330
FLORIDA
Orlando
Crescent Elect. Sales Co.—423-8586
ILLINOIS
Chicago
Newark Electronics Corp.—ST2-2944
INDIANA
Indianapolis
Graham Elect. Supply, Inc.—ME4-8486
MARYLAND
Baltimore
Whise. Radio Pts. Co., Inc.—MU5-2134
MASSACHUSETTS
Boston
DeMambro Electronics—783-1200
Cramer Electronics, Inc.—WO9-7700
MICHIGAN
Detroit
Newark-Ferguson Elect., Inc.—548-0250
MINNESOTA
Minneapolis 1
Stark Electronics Supply Co.—FE2-1325
MISSOURI
St. Louis
Electronic Components for Industry
Kansas City Co.—647-5505
ECI Semiconductor, Inc.—931-0829
NEW MEXICO
Alamogordo
Kierruff Electronics Corp.—437-0370
Albuquerque
Kierruff Electronics Corp.—268-3901
NEW YORK
Buffalo
Summit Distributors Inc.—884-3450
New York
Arrow Electronics—MY4-6800
Newark Electronics Center—255-4600
Milgray Electronics, Inc.—YU9-1600
Rochester
Rochester Radio Supply Co.—454-7800
NORTH CAROLINA
Winston-Salem
Electronic Wholesalers, Inc.—PA5-8711
OHIO
Cincinnati
Newark-Herrlinger Elect. Corp.—
Columbus 421-5282
Electronics Marketing Corp.—299-4161
OKLAHOMA
Tulsa
Texas Instruments Supply Co.—
PENNSYLVANIA LU3-8121
Philadelphia
Radio Elect. Serv. Co. of Pa., Inc.—
Pittsburgh WA5-5840
Cameradio Company—391-4000
TENNESSEE
Nashville
Electra Distributing Co.—AL5-8444
TEXAS
Dallas
Texas Instruments Supply—FL7-6121
Houston
Texas Instruments Supply—MO6-2175
WASHINGTON
Seattle
Universal Electronics Co.—MA3-2783
CANADA
Montreal 12, Quebec
Preco Electronics Ltd
389-8051
Toronto, Ontario
Alpha Arcon Radio
Elect. Ltd.—635-6181
Vancouver 2, B. C.
Western Agencies Ltd.
685-7221



IMPORTANT ANNOUNCEMENT TO
COMPONENT ENGINEERS AND BUYERS

FIRST TIME!... ERIE'S FULL LINE OF HIGH PERFORMANCE

DISC CERAMIC CAPACITORS



available through your ---
in Quantities to ---

AUTHORIZED
ERIE
DISTRIBUTOR

5000

Directly from Stock!

133 POPULAR VALUES

STOCKED IN-DEPTH FOR IMMEDIATE DELIVERY

CHARACTERISTIC	CAPACITANCE RANGE AVAILABLE
<ul style="list-style-type: none"> ● High Stability Types: NPO..... 5 to 100 pf. 	5 to 100 pf.
<ul style="list-style-type: none"> ● Temperature Compensating Types: N750 10 to 100 pf. 	10 to 100 pf.
<ul style="list-style-type: none"> ● Hi-K (General Purpose) Types: X5F..... 47 to 3300 pf. X5R..... 4700 to 5000 pf. Z5U 10,000 to 20,000 pf. 	47 to 3300 pf. 4700 to 5000 pf. 10,000 to 20,000 pf.
<ul style="list-style-type: none"> ● High Capacitance — Low Voltage Types: 12 VOLTS..... .05 to .47 mf. 25 VOLTS..... .01 to .47 mf. 100 VOLTS..... .005 to .1 mf. 	.05 to .47 mf. .01 to .47 mf. .005 to .1 mf.
<ul style="list-style-type: none"> ● MIL-C-11015C 	



Call your authorized ERIE Distributor TODAY!



Advanced Components Through Increased Volumetric Efficiency

Erie, Pennsylvania

Control Products at IEEE

Rotary Switches Broad new line of manual rotary switches, from 1" to 2 $\frac{5}{16}$ " diameter; 12, 18, 20 & 24 positions. Ceramic, epoxy glass, kel-F, mycalex and phenolic insulation.



WILMINGTON CONTROLS DIV., LEDEX INC.
360 South Nelson Road, Wilmington, Ohio 45177
Phone 513/382-3767

Circle 506 on reader service card



New Contactless Reed for Audio Tone Control Systems

New Bramco resonant reed works as audio tone filter with sharp selectivity or as frequency source for stable audio tone generator. It has four terminals with isolated input and output. Frequency range is 80 to 3000 cps, accuracy $\pm .15\%$. A major state-of-the-art advance, the device has no mechanical contacts. Its life and reliability approach that of solid state circuitry. Sugar cubed size, plug-in package shown measures 1 $\frac{1}{32}$ x $\frac{5}{8}$ x 1 $\frac{1}{32}$.



BRAMCO CONTROLS DIV., LEDEX INC.
College and South Streets, Piqua, Ohio
Phone 513/773-8271

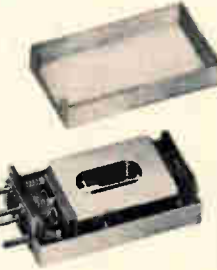

RF20 Resonant Reed

Circle 507 on reader service card

LEDEX
FLAT-FACE PLUNGER
(Short Stroke)

Push/Pull Solenoids Precision built for rapid response, high force. Flat-face plunger for strokes to .030, conical for strokes from .030 to .250. Force beyond output beyond 350 pounds. Now 10 basic models to choose from.



LEDEX
CONICAL PLUNGER
(Medium Stroke)



Rotary Solenoids Our latest solution for space squeezed actuating application problems, this disc-shaped rotary solenoid has a 1 $\frac{5}{16}$ " diameter and is only $\frac{7}{16}$ " thick. Torque is 20 ounce-inches at intermittent duty. Other rotary solenoids with torque to 98 pound-inches, strokes from 20 to 95 degrees. Ledex endurance engineered solenoids have life of 100,000,000 actuations and are now available from the shelf.



Packaged Control Solutions Here we put our disc-shaped solenoid to work as a driver for a miniaturized (4.5" x 1.3" x .550) 12-position stepping switch. Model shown is an armament control (intervalometer). It is used to fire 19 rockets in pairs sequentially, at 10 ms intervals. We can tailor one like it for your stepping or sequentially timed switch application.



LEDEX INC., 123 WEBSTER STREET, DAYTON, OHIO 45402
Designers & Manufacturers Electronic & Electro-Mechanical Components
& Remote Control Switching Systems Phone 513/224-9891

See these control products plus others at IEEE booths 4A39, 4A40 and 4A41.

New Semiconductors

lated from the case and the third lead, connected to the case, is provided for maximum circuit flexibility. The sensitive area of the unit is 0.020 in. in diameter. Spectral response—25% points—extends from 0.4 to 1.0 micron.

Applications for which the 4204 is particularly suitable include monitoring of low- and high-level laser output, tachometers or position encoders, spectrophotometers, and high-speed, light-activated switches. The 4204 has a noise equivalent power two orders of magnitude less than a typical photomultiplier tube.

Price in quantities of 1 to 99 units is \$90. Availability is from stock.

HP Associates, 620 Page Mill Road, Palo Alto, Calif., 94304. [362]

Schottky-barrier mixer diodes

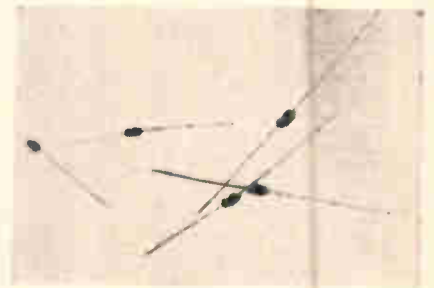

A series of high reliability, Schottky-barrier junction mixer diodes is designed for series mounting in strip transmission line circuits. The manufacturer says these diodes give improved reliability, burnout protection, and bandwidth in microwave mixers and detectors and are r-f characterized to assure premium circuit performance.

Mounted in low-loss microwave packages, the diodes will withstand the mechanical and temperature requirements of MIL-S-19500 and are capable of storage to 250°C. Both axial wire leads and ribbon leads are available. Typical performance of the new series is demonstrated by the MA-4855, which features a 0.5-w, c-w burn-out rating, a 6.5-db noise figure at L (1.1-1.7 Gc) and S (2.6-3.95 Gc)

bands, and an 8.5-db noise figure at X (8.2-12.4 Gc) band.

Microwave Associates, Inc., Burlington, Mass. [363]

H-v rectifier diode withstands radiation

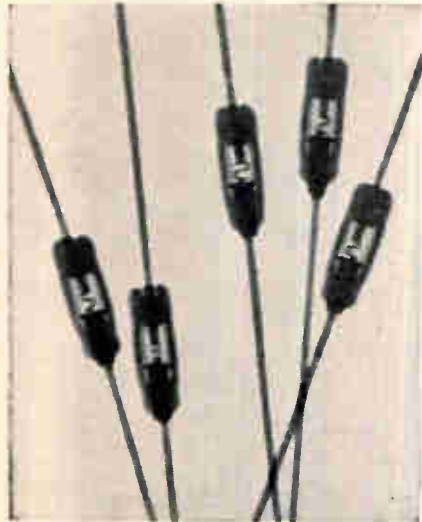

A planar-passivated, high-voltage rectifier diode has a guaranteed forward voltage after fast neutron radiation. The FRR-300's design provides that the forward conductance will not fall below the specified guaranteed value, even after exposure to radiation environments. It is the only 350 v to 450 v radiation tolerant diode using planar process technology, according to the manufacturer.

Intended primarily for high radiation environments requiring high stability, the FRR-300 is available as a single unit, or in any of the standard diode assemblies—series arrays for extremely high voltage, matched pairs, quads, bridges, and other groupings.

Guaranteed forward voltage is up to 1 v at 100 ma forward current after exposure to fast neutron radiation of 5×10^{14} neutron velocity \times time (nvt); and up to 1.1 v at 100 ma forward current after exposure to fast neutron radiation of 1×10^{15} nvt. Reverse current is no greater than 100 na at a reverse voltage of 250 v.

Price is \$5 each in lots of 1 to 99, and \$3.30 each in lots of 100 and more.

Fairchild Semiconductor, a division of Fairchild Camera & Instrument Corp., 313 Fairchild Dr., Mountain View, Calif. [364]

Glass-Epoxy Copper-clad

through TAYLOR'S TOTAL RELIABILITY PLAN:

Raw materials, panels or punched blanks to your reliability requirements. You get what you order from a fully integrated source.

FAST DELIVERY from two fully equipped plants—one at Valley Forge, Pa., the other at La Verne, Calif. Or from warehouses in Chicago, Ill. and other key locations.

FULL SIZE SHEETS, CUT-TO-SIZE PANELS or PUNCHED BLANKS to satisfy fabricating and processing requirements. Ease of fabrication is a plus value in printed circuit production.

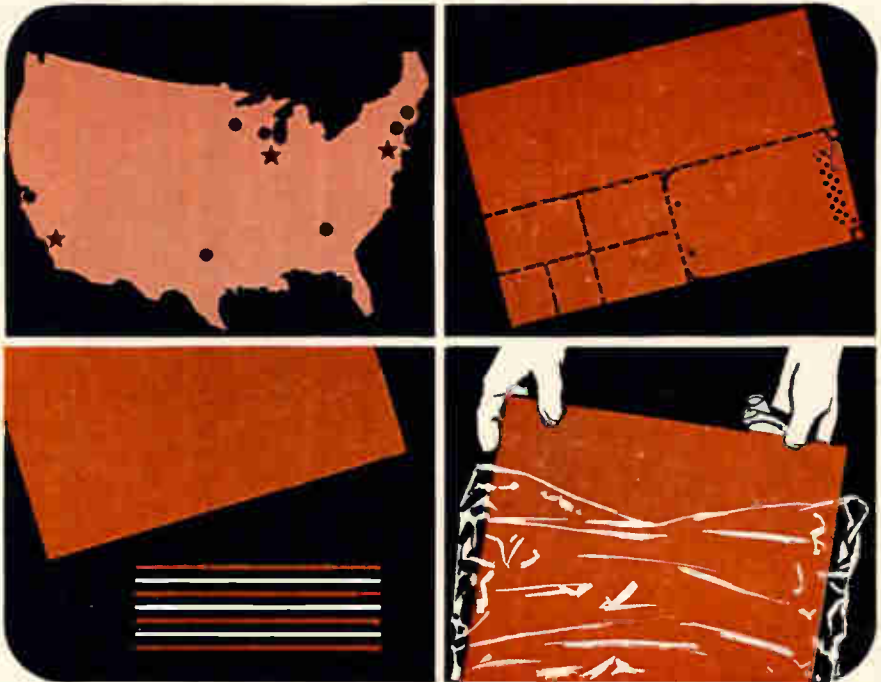

STANDARD AND ULTRA-THIN FORMS. Standard sheets in all grades. Ultra-thin sheets and multilayer prepregs in GEC 500 (G-10) and Fireban 600 (G-10, FR-4).

WHITE GLOVE HANDLING in atmosphere-controlled white rooms, careful processing, extremely tight quality control and special packaging assure top performance.

Taylor's copper-clad has proven total reliability demonstrated by an ever increasing number of major OEM's and commercial etchers. This acceptance substantiates our claim for unsurpassed quality, ease of fabrication and delivery to your scheduled requirements. Let us demonstrate this reliability to you. Ask for a sample (give grade designation and copper combination) and a copy of Bulletin GB-2.



Taylor copper-clad

TAYLOR CORPORATION • Valley Forge, Pa. 19481

Phone: 215-666-0300 TWX: 215-666-0659

West Coast Plant: La Verne, Calif.

...your assurance
of quality

Also manufacturer of Taylor laminated plastics, Taylorite® vulcanized fibre and Tayloron® prepregs

CALL ON
hurst-POWER
 FOR *YOUR* APPLICATION

NEW **hurst** 600 IN. OZ.
 HYSTERESIS REVERSIBLE SYNCHRONOUS
**INSTRUMENT
 MOTOR**



- HEAVY DUTY GEARING
- NO LUBRICATION REQUIRED
- CAN BE STALLED WITHOUT OVERHEATING

For long life and higher torque applications. Offers instrument manufacturers high performance and economy. Starting torque is uniform; smoothly, rapidly accelerates into synchronization. Capacitor included.



150 IN. OZ. OF TORQUE
 AT 1 RPM (Unidirectional) (EA)
 Open frame, shaded pole, extremely cool running. Bronze bearings, brass gears, hardened steel pinions and wheel shafts, stainless steel output shaft. For dependable, low-cost timing applications. Wide range of speeds.



120 IN. OZ. OF TORQUE
 AT 1 RPM (Reversible) (DA)
 Timing accuracy both clockwise and counterclockwise. SPDT switching. Case 2 1/2" diam., 1 3/4" long. Will not overheat. Capacitor included.

100 IN. OZ. OF TORQUE
 AT 1 RPM (Reversible) (CA)
 Features 1200 rpm rotor speed for quiet performance. Extremely versatile (animated displays, program instruments, outdoor advertising, etc.) Wide range of output speeds. Will not overheat. Capacitor included.



RATED 40 IN. OZ. OF TORQUE
 AT 1 RPM (Unidirectional) (SM)
 For tough jobs demanding accurate timing. Excellent shock and vibration resistance. Starts instantly at full torque. Will not overheat. Wide range of output speeds.

40 IN. OZ. OF TORQUE
 AT 1 RPM (Unidirectional) (PC-SM)
120 IN. OZ. OF TORQUE
 AT 1 RPM (Reversible) (PC-DA)
 Both are positive clutch and instantaneous brake motors. For extremely fast starts and stops. Motor runs continuously with clutch and brake controlled by switching actuator only. Clutch starts output shaft within 20 milliseconds; brake stops output shaft within 1/5° at 1 rpm; with 12° at 60 rpm. Motor on AC voltage; actuator AC or DC. Either can be supplied in any voltage combination when motor is AC. Will not overheat.



100 IN. OZ. OF TORQUE
 AT 1 RPM (Reversible) (AR-DA)
40 IN. OZ. OF TORQUE
 AT 1 RPM (Unidirectional) (AR-SM)
 Automatic reset. Planetary-type clutch operates directly upon output shaft. When de-energized, shaft is manual or automatic reset. Addition of external return spring to output shaft provides automatic reset on either model. Motor on AC voltage; actuator on AC or DC. Either can be supplied in any voltage combination when motor is AC. Will not overheat. Capacitor included.

STANDARD SPEEDS STOCKED BY
 YOUR HURST DISTRIBUTOR

hurst

MFG. CORP. • PRINCETON, INDIANA

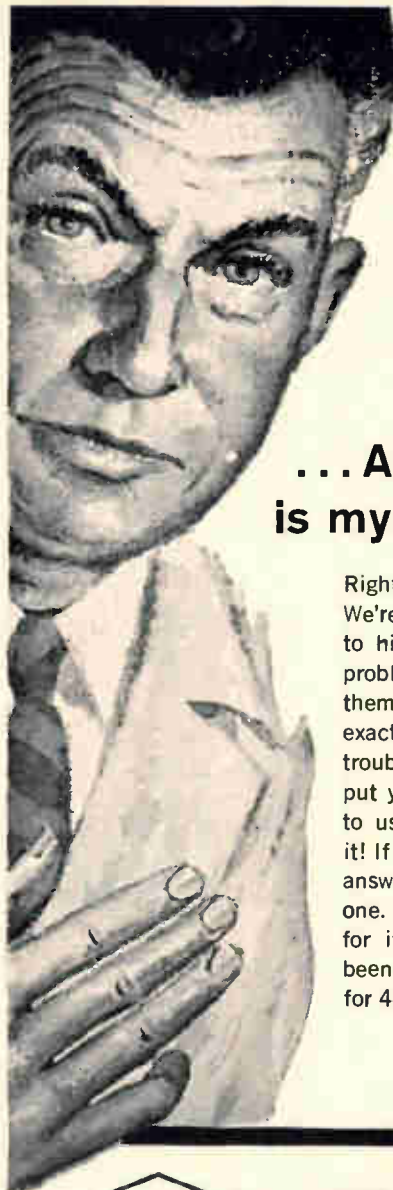

... All you want
 is my **PROBLEM?**

Right . . . just the problem! We're loaded with *solutions* to high temperature wiring problems. Quite likely one of them matches your problem exactly. So save yourself the trouble we've already had . . . put your wiring problem up to us the minute you spot it! If we don't have the right answer on tap, we'll find one. You can take our word for it . . . because we've been insulation specialists for 44 years.



**HIGH TEMPERATURE
 WIRE AND CABLE**

A wide variety of standard leadwire constructions, insulated with Teflon (TFE and FEP) or silicone rubber, are available for applications up to 1000 V. and 200°C. FLEXLEAD can also be supplied in many special wire and cable constructions to meet your specific requirements. These may combine insulations (Teflon, silicone rubber, fiberglass, nylon-shielding, fillers, liners, and jacket materials), and provide single, twisted pair or multiple conductors . . . for any temperature from -90°C to 260°C. The line also includes both standard and special RG/U coaxial cables, fused twisted pair, and MB bondable Teflon wire. Ask for a FLEXLEAD Selector. Write . . .

L. FRANK **MARKEL** & SONS

Norristown, Pa.

215-272-8960

INSULATING TUBINGS & SLEEVINGS • HIGH TEMPERATURE WIRE & CABLE

Self-adjusting oscilloscope



Although that engineer on the ladder can't reach the front panel of the oscilloscope, he isn't worried about the setting of the scope's vertical sensitivity and time base, despite the fact that he's analyzing a lot of different signal amplitudes and frequencies.

Equipped with a pair of plug-in units just made available by Tektronix, Inc., the oscilloscope automatically seeks and selects the appropriate vertical sensitivity and time base for any input signal on command actuated by a switch on the test probe, or optionally on the front panel. The type 3A5 automatic amplifier and 3B5 automatic time base fit most of the company's series 560 scopes.

The seeking feature is not only useful when the scope is located out of the operator's reach but also for tests where both hands are otherwise occupied and in repetitive production tests.

The type 3A5 automatic/programmable amplifier operates over 12 calibrated ranges from 10 millivolts to 50 volts per division with a frequency response of d-c to 15 megacycles per second. Also, there are

two additional ranges of one and two millivolts per division when the unit is used in the manual mode, at reduced frequency response.

Automatic seeking in the 3A5 is accomplished with a pair of pick-off diodes in a voltage comparator circuit. The number of divisions on the oscilloscope screen that the display will occupy is preset with a front-panel display size adjustment. This establishes a reference voltage in the comparator amplifier. If the peak signal voltage sensed by either of the diodes is greater than the reference, it will cause a blocking oscillator to fire. The resulting advance pulse activates a ring counter and switches the attenuator to a less sensitive setting. When the signal is attenuated to the point where neither diode is turned on, switching stops.

Operating on a similar principle, the 3B5 time base seeks the appropriate sweep rate for the frequency of the input signal. The number of cycles of any input frequency the operator desires displayed is set with a front-panel control—a cycles per sweep adjustment. When activated, the time base plug-in starts seeking at the slowest sweep rate and switches to faster rates until it finds the setting falling within the preset limits. In the automatic mode, sweep rates from 0.1 microsecond per division to 5 seconds per division can be obtained. Other sweep rates, from 10 to 50 nanoseconds per division, may be selected manually.

On both units, readout windows tell the operator which settings he is working with and whether the unit is in the manual or seeking mode. In addition, a display on the automatic amplifier shows if the amplifier is a-c or d-c coupled and if the variable volts per division adjustment used during manual operation is not in its calibrated position. Also, if the company's special P6030 probe is being used, the 3A5 compensates for the probe multiplying factor of ten and lights up the words "with probe" in the

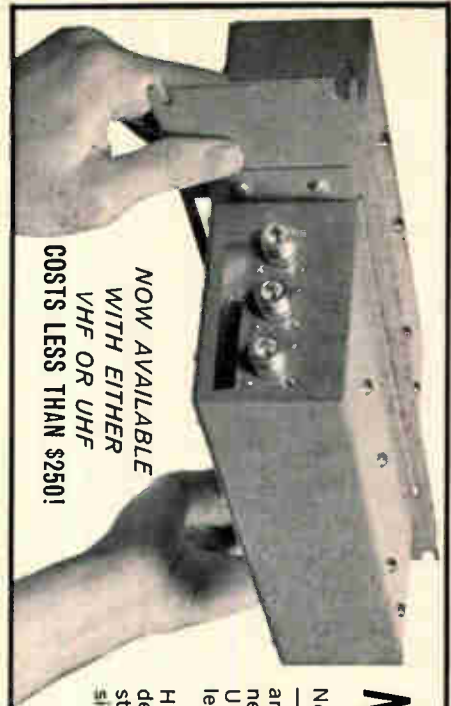

**NOW AVAILABLE
WITH EITHER
VHF OR UHF
COSTS LESS THAN \$250!**

NEW... SMALLEST BASE STATION DUPLER (ONLY 2" HIGH)

Now—in a fourth or less of the space formerly required—you can stack a duplexer right with your transmitter and receiver... all at eye level. Only 3" of rack space needed for Sinclair's new VHF Duplexer... 3" for the UHF model. And these surprisingly compact units cost less than \$250!

Don't let the low price throw you! These new Model H-150 and H-450 duplexers are packed with all the dependable quality features of larger Sinclair base station duplexers. They allow simultaneous transmission and reception from a common antenna with separation between frequencies as low as 3 Mc at 150 Mc and 5 Mc at 450 Mc. Returning to a new frequency—if desired—is easily done by returning the cavities. Neither cable nor harness need be changed. Though small in size, these new duplexers have standard power rates of 100 watts (optional ratings up to 200 watts are available). The temperature range of from -20°F to 150°F makes them exceptionally versatile in either base station or repeater station applications. Investigate today! Write for complete FREE information on all Sinclair duplexers, antennas and multicouplers.

SINCLAIR RADIO LABORATORIES, INC.

523 FILLMORE AVENUE, DEPT. 101, TONAWANDA, NEW YORK

Can an engineer flunk Fortran and still find happiness?

Happiness is
finding a digital computer with a simple keyboard,
whose language is algebra.

Happiness is
having 48 to 88 individually addressable storage registers
plus 5 separate registers for arithmetic manipulations,
480 steps of program memory,
and/or 18 optional prewired programs of 48 steps each,
right in your own department.

Happiness is
not spending a million dollars for a digital computer,
or \$50,000, or \$20,000, or even \$10,000.

Happiness is
getting 8 to 9 significant digit accuracy
with a 2 digit power of ten exponent,
automatic decimal placement,
paper tape readout,
100 column number capacity.

Happiness is
getting intelligent accessories,
like a paper tape punch and reader,
or a page printer.

Happiness is
a Mathatron 8-48 plus the new
Auxiliary Program Storage.

MATHATRONICS, INC.

257 Crescent Street
Waltham, Mass. 02154
(617) 894-0835



New Instruments

plug-in's window.

In addition to the automatic seek mode, the plug-ins may be operated manually or programmed through a 37-pin connector on the front panel with an optional accessory, the company's type 263 programmer.

Specifications

Type 3A5	
Bandwidth	D-c to 15 Mc from 10 mv/div. to 50 v/div. D-c to 5 Mc at 1 mv/div.
Programmable function	Volts/div. settings, input coupling, positioning, x 10 probe attenuation, a-c trace stabilization.
Price	\$760
Type 3B5	
Sweep rates	10 ns/div. to 5 sec./div.
Programmable functions	Time/div. settings, triggering, positioning, delay time.
Price	\$890

Tektronix, Inc., P.O. Box 500, Beaverton, Ore. 97005. [371]

Low-cost multimeter measures E, I and R



This solid state instrument measures differentially both d-c voltage and current. A special Wheatstone bridge circuit allows a wide range of resistors to be measured also. The limits of error are $\pm(0.05\%$ of reading + $10 \mu\text{v}$) for all d-c voltages from 1 mv to 1,000 v. The current ranges extend from $0.1 \mu\text{a}$ to 11 amps and the limit of error is $\pm 0.1\%$ of reading or 0.3 na for all ranges except the 1.1 and 11-amp ranges, where the error increases to $\pm 0.25\%$. The resistance ranges are

from 1.1 ohms to 11 megohms full scale. The maximum limit of error on this function is $\pm 0.1\%$ of reading or 1 milliohm. The resolution on all three functions is normally better than 0.01% of reading.

The compact unit is fully transistorized and can be operated either from the power line or from internal rechargeable batteries. Automatically positioned decimal lights provide for error-free readout of the many functions. Accessories available for the unit include an a-c voltage adapter, a high voltage d-c adapter, and a temperature measuring adapter. The latter device covers the range from 0 to 100°C with four-place direct readout. The accuracy is better than $\pm 0.3^\circ\text{C}$ and the resolution is $\pm 0.005^\circ\text{C}$.

Model A-50 differential multimeter is priced at \$550 and is available in 30 days after receipt of order. Medistor Instrument Co., 1443 N. Northlake Way, Seattle, Wash., [372]

Capacitance tester with digital display

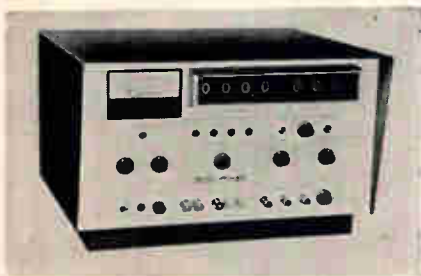

An instrument is announced for measuring capacitance and displaying the results in easy-to-read digital format. Model 5340 measures and provides in-line readout of capacitance, dissipation factor, equivalent series resistance and d-c leakage current over a dual frequency range of 120 cps or 1 kc. Capacitance is measured to an accuracy of $\frac{1}{4}\%$ of full scale, dissipation factor to $\pm 0.2\%$, equivalent series resistance to $\pm 2\%$, and d-c leakage current to $\pm 1\%$.

The solid state instrument utilizes an internal 0 to 100 v d-c bias supply with electronic current limiting for measurement of leakage current. An external supply to 300 v d-c may also be used.

The 5340 provides constant amplitude test signals, has a 25%

LANTHANUM
CERIUM
PRASEODYMIUM
SAMARIUM
GADOLINIUM
TERBIUM
DYSPROSIUM
HOLMIUM
ERBIUM
THULIUM
LUTETIUM
NEODYMIUM
EUROPIUM
YTTORIUM
THORIUM

THINKING AHEAD WITH RARE EARTHS



gets your laser research on the beam!

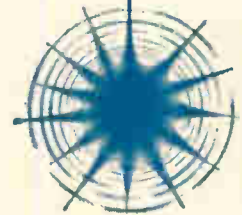

AS LASER DOPANTS, NO OTHER MATERIALS DO THE JOB QUITE AS WELL AS ULTRA-HIGH PURITY RARE EARTHS.

Rare earths have electronic properties as yet undiscovered, unexplored, unapplied. If you have interests in such areas as lasers, capacitors, semiconductors, garnets or phosphors, take a look at what rare earths can do for you. As the world's leading producer of high-purity and ultra-high purity rare earths, we have these materials available now, off-the-shelf, at relatively low prices. Our Special Products Department can work with you on a confidential basis, translating your research theories into actual working materials and accelerating your new product development from laboratory, to pilot plant, to production line. We're ready to send you the facts. ■ Write, wire, or call for detailed literature today! RARE EARTH DIVISION, West Chicago, Illinois 60185. Phone 231-0760 (Area code 312).



American Potash & Chemical Corporation

want
oscillograph
flexibility?

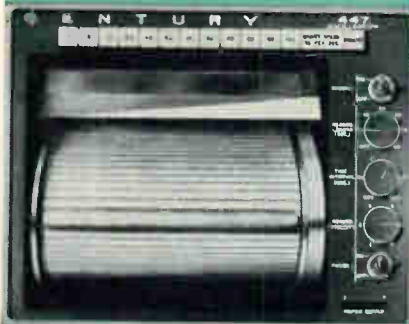

the new
Century 447
has 1,000
chart speeds!

- specify any 12 speeds
(.1"/sec. to 100"/sec.)
- change to any 12 speeds of a
possible 1,000 anytime you
wish—as often as you wish!

The new CENTURY 447 has a highly precise electronic drive which permits a wide range of speeds. Specify the speeds you require—you can quickly change to other speeds at any time.

The new CENTURY 447 also features:

- AUTOMATIC RECORD LENGTH based on time—the common base for all measurement
- CONTINUOUSLY VARIABLE REMOTE SPEED CONTROL for optimum record analysis.

Remote control options include START, STOP, and CHART SPEED DRIVE.



Send for the
Century 447
brochure
containing
detailed
specifications.

CENTURY
ELECTRONICS & INSTRUMENTS

Subsidiary of Century Geophysical Corp.
6540 E. Apache St., Tulsa, Oklahoma 74115

New Instruments

over-range on capacitance and leakage current measurements and gives true series capacitance and leakage current measurements independent of dissipation factor. It is fast and simple to use, ideally suited to production installations. Price is \$4,500; delivery, stock to 30 days.

Micro Instrument Co., 13100 Crenshaw Blvd., Gardena, Calif. [373]

Modulation meter covers 4 to 1,000 Mc

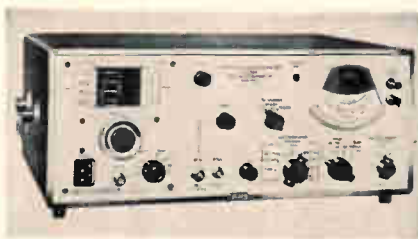

A transistorized f-m/a-m modulation meter covers a frequency range from 4 Mc to 1,000 Mc. Model 2300 measures deviation in five ranges— ± 5 , ± 15 , ± 50 , ± 150 and ± 500 kc—at modulating frequencies up to 150 kc and is relatively unaffected by the presence of spurious a-m up to 80%. The local oscillator may be locked to harmonics of internal crystals anywhere in the range from 20 Mc to 1,000 Mc and provision is made for driving with an external local oscillator (for example, a programed synthesizer).

De-emphasis circuits are provided and a 15-kc low pass filter may be switched in to limit the demodulated signal bandwidth. Deviation due to f-m noise is less than 15 cps using 15-kc bandwidth and a crystal controlled local oscillator. A-m measurement is provided in two ranges of 30% and 95%; peaks and troughs selected by a switch.

Applications include broadcast signal measurement, tv sound, f-m stereo and narrow band and wide-band modulation systems used in communications and telemetry. Price is \$1,735; delivery, mid-1966. Marconi Instruments, division of English Electric Corp., 111 Cedar Lane, Greenwood, N.J., 07631. [374]

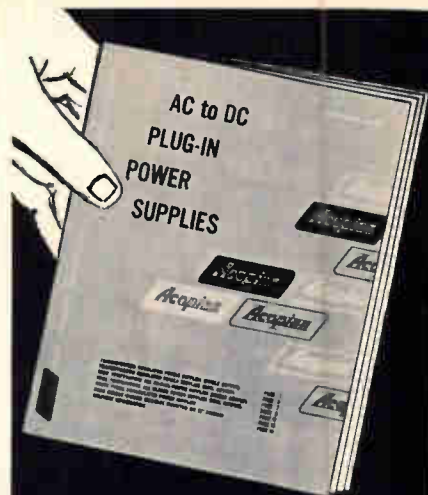

with this catalog
you can
choose
from
62,000
different
power supplies...

all available
for shipment
in
3 DAYS!



Write for
your copy today to
Acopian Corp.
Easton, Pennsylvania
or telephone
(215) 258-6149.



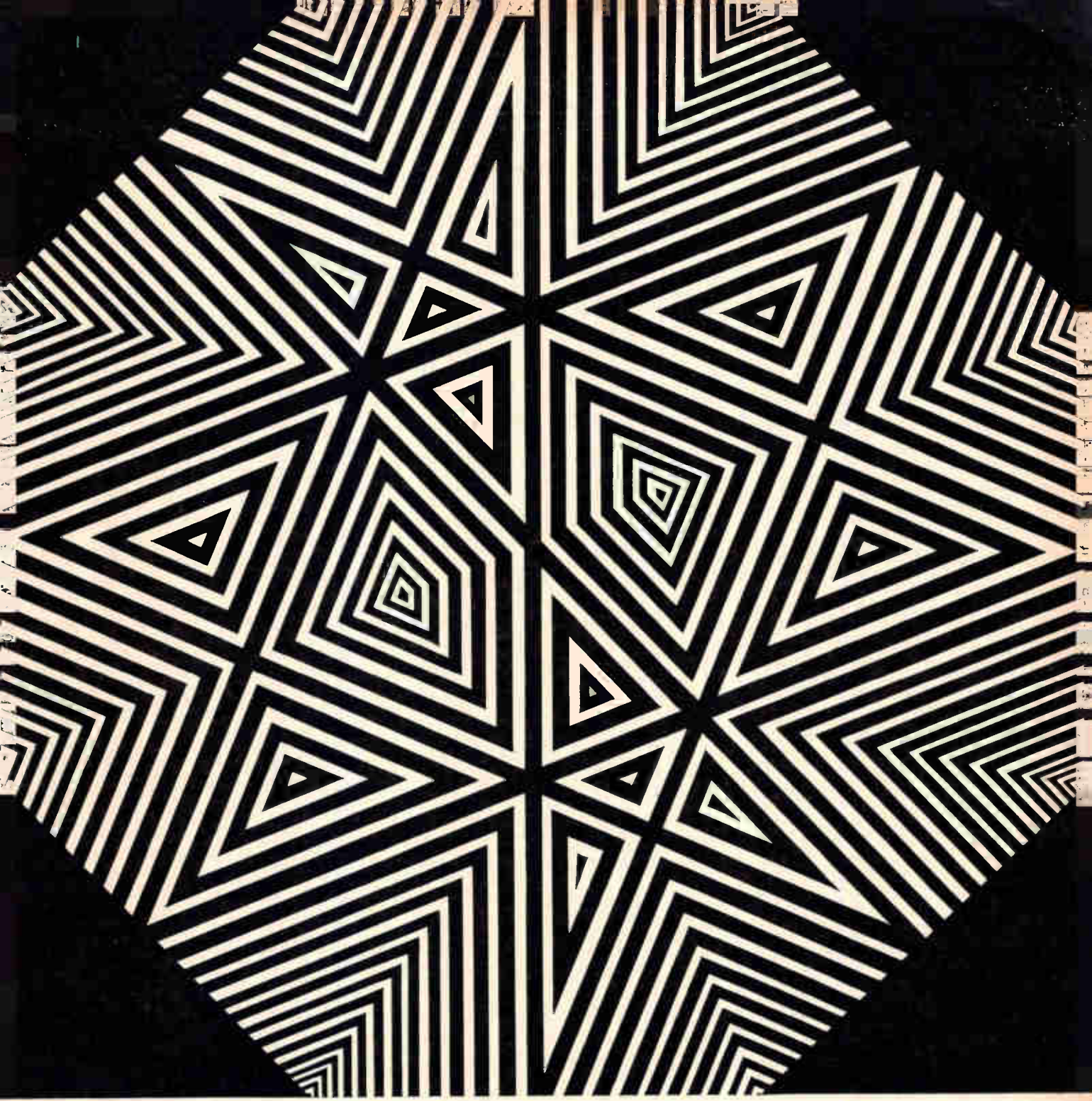

Optimizing the art... in delay lines

Typical problems we've made look easy: 32-module isothermal multidelay package (0.01°C temperature stability) — 150 microsecond digital delays with 20-80 db attenuation. We can do even better to meet your special needs — 60 modules? 100? 0.001°C thermal stability? 300-microsecond Zero T. C. (Temperature Coefficient) Memory System? So come to us for unusual requirements in glass, quartz, electromagnetic and magnetostrictive delay lines, or in associated electronics — transformers, amplifiers, temper-

ature controllers, serial ultrasonic memories, and other advanced components.

In the microwave field, we've done tricky things in phase-locked and other oscillators, frequency and pulse stability testers, noise measurements, and other advanced instrumentation. Oh, yes, since LFE "wrote the book" on delay lines, we'll be happy to send you copies of our brochures defining common terms and basic measurement techniques. To OPTimize your design, OPT LFE.



LFE ELECTRONICS

A DIVISION OF LABORATORY FOR ELECTRONICS, INC.
WALTHAM, MASSACHUSETTS 02154

Delay Lines • Filters • Transformers • Amplifiers, and Associated Electronics
Microwave Measurement & Signal Generation Equipment

Circle 191 on reader service card

Problem Solvers

For precision clean manufacturing and research

White-Bench



Mobile Down-Flow Module



Convertible Laminar Flow Work Station



All our PROBLEM SOLVERS provide FED STD No. 209 Class 100 Absolute Filtered Air

For further information on these and other products contact:

MATTHEWS mri
RESEARCH, INC.

4306 Wheeler Avenue
Alexandria, Virginia (703) 548-1600

New Subassemblies and Systems

Scr's used in xenon power supply



High-current xenon power supply, half the size of other welder power supplies, uses silicon controlled rectifiers for greater efficiency.

With the introduction of new xenon lamps in the 20-kilowatt range at last year's IEEE show in New York, a need for stable, high-power supplies was created. Adding to their existing line of xenon power supplies, the Christie Electric Corp., of Los Angeles will introduce at this year's IEEE show two units to satisfy the new demand. Christie power supply model CX12000-24S will operate xenon lamps from 5 to 12 kw; model ICX25000-4S is designed for lamps between 5 and 25 kw.

High-power xenon lamps now in use are usually energized by arc welding power supplies. These power supplies have certain disadvantages such as current ripple, which shortens the life of the xenon tube's electrodes. Christie engineers say that a 5% current ripple is typical in a welder power supply. Another characteristic harmful to the electrodes is excessive overshoot in the starting current. The two new Christie power supplies guarantee a current ripple of less than 1% and a starting overshoot of less than three times running current.

The new power supplies represent more than just a beefing-up of the standard Christie line. Silicon controlled rectifiers replace the magnetic control previously used, resulting in greater efficiency with a size only half that of the average welder power supply.

Taken from their standard line, but unique to the Christie Electric Corp., is the power slope control. The unit can be adjusted to maintain a constant power level—that is, to automatically reduce voltage proportionately as current flow increases. Alternatively, a constant current flow can be maintained despite voltage fluctuations, or the control can be set to increase power proportionately to input voltage. The constant power feature is desirable when minor changes in lamp impedance occur because of aging. Constant current control is useful when the lamp is new, to maintain a desired light intensity.

No units of the new models have been subjected to field operations yet, but Christie engineers, on the basis of calculations and laboratory tests, estimate that lamp life will be increased about 50%. With lamps costing about \$1,000 apiece, a 50% increase in life will completely pay for the power supply with every dozen or so lamps it is used on, they say.

Specifications

Model CX12000-24S	
Power	5,000 to 12,000 watts
Voltage	25 to 45 volts
Current adjustment	100 to 300 amperes
Price	About \$4,000
Model ICX25000-4S	
Power	5,000 to 25,000 watts
Voltage	25 to 55 volts
Current adjustment	100 to 600 amperes
Price	About \$5,000
Maximum current ripple	1%
Delivery	60 to 90 days
Christie Electric Corp., 3410 West 67 Street, Los Angeles, Calif. [381]	

Small power modules are solid state units

A family of small-size power modules is designed for 60-cycle input power. The VO5/HA05 series

converts 115 v a-c to any required output voltage from 5 to 2,080 v d-c at 5 w. Latest modular design techniques are employed in these converters to provide a package as small as 2¾ in. x 4¾ in. x 3½ in., weighing less than 4 lbs.

These solid state devices utilize components that assure the high reliability and long service life required in missiles and space ground-support installations, as well as in industrial and shipboard applications. Hermetically sealed and encapsulated, the units meet or exceed the environmental specifications of MIL-E-5272C. Operating temperature range is from -4° to +160°F.

Short-circuit protection is built in on all HAO5 units, and special fail-safe short-circuit protection is available on the VO5 models. Design characteristics insure close regulation (0.2%) for line variations of 105 to 125 v a-c. Output ripple is less than 0.2% rms. Other features include complete isolation of outputs and inputs, and an adjustment range of 12% from the nominal output voltage.

Price is as low as \$145 each; delivery, 3 to 4 weeks.

Abbott Transistor Laboratories, Inc.,
3055 Buckingham Road, Los Angeles,
Calif., 90016. [382]

Hybrid, flexible scr bridge assembly

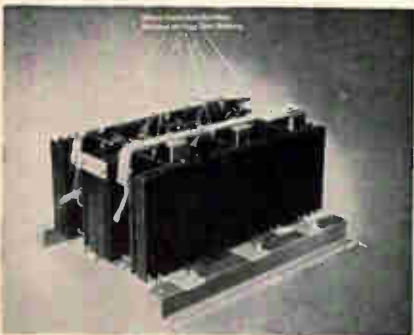

A hybrid, silicon controlled rectifier bridge assembly now available was designed especially for maximum cooling and optimum performance under adverse conditions such as heat and dust. Valuable design features include simplified terminal attachment, accessible gate terminal blocks, and insulated rail mounting for utmost flexibility.

Applications range from motor

now! ZERO t.c. and 500 vdc

... integrated reliably in these
monolithic, space-saving capacitors

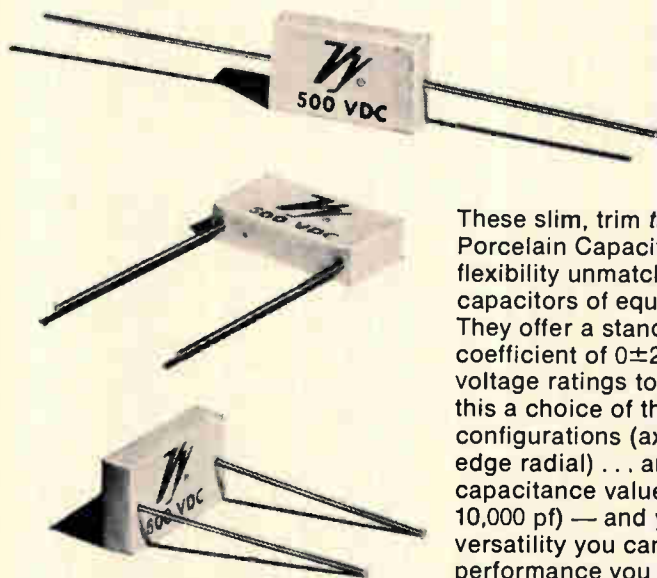

These slim, trim *thin line* VY® Porcelain Capacitors offer design flexibility unmatched by any capacitors of equivalent rating! They offer a standard temperature coefficient of 0 ± 25 ppm/°C and voltage ratings to 500 vdc. Add to this a choice of three lead configurations (axial, face radial, edge radial) . . . and a wide range of capacitance values (0.5 pf to 10,000 pf) — and you have versatility you can work with . . . performance you can depend on.

Send for Data Sheet P10
for the complete story.

- Capacitance Range: 0.5 pf to 10,000 pf
- Temperature Range: -55°C to 125°C
- Voltage Ratings: 50 to 500 VDC

Booth Nos. 2D06-2D08 IEEE

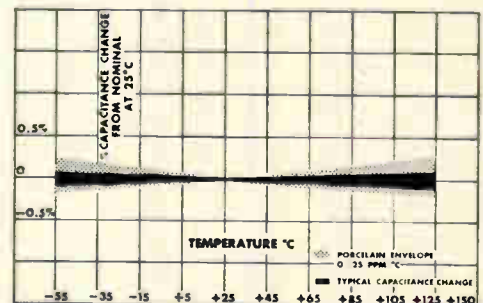

© Vitramon, Inc. 1966

Vitramon®

VITRAMON, INCORPORATED
BOX 544
BRIDGEPORT, CONN. 06601

In Greater Europe contact:
VITRAMON EUROPE
Bourne End, Bucks, England

CEI's NEW 900 SERIES VHF RECEIVERS



NOW RE-DESIGNED FOR EVEN FINER PERFORMANCE

State-of-the-art circuitry advances—plus improvements in readability and re-setability—mark CEI's new and outstanding 900 Series VHF receivers. A 26" metal tape dial provides increased precision and readability in tuning, and a local oscillator output to drive a digital counter (such as CEI Type DRO-300) has been added. Additional new features include all solid state circuitry except in the front end, where nuvistors are employed for superior signal handling performance and to assure low intermodulation products.

Types 901B, 904A, 905A and 906A all receive AM, FM and CW from 30 to 300 mc, are identical except that the 904A includes a crystal marker oscillator (CMO), the 905A contains a carrier operated relay (COR) and the 906A contains both.

Covering their range in two bands (30-90 and 60-300 mc), they offer selectable IF bandwidths of 300 kc and 20 kc, with a built-in BFO activated automatically in CW mode and operable in either bandwidth.

For full information about these feature-packed receivers, please contact:

COMMUNICATION ELECTRONICS INCORPORATED

6006 Executive Blvd., Rockville, Md. 20852 Phone: (301) 633-2800 TWX: 710-824-9603

Circle 509 on reader service card

RCL 1/2" ROTARY SWITCHES

ESTABLISHING A NEW SET OF PERFORMANCE STANDARDS!

- Up to 12 positions per deck with stops.
- As many as 6 poles per deck.
- Shorting and non-shorting poles may be grouped on one deck in any combination.
- All individual deck parts are self-contained, and are permanently molded into place.
- Wiring to switches possible "in the flat".
- Easily assembled and disassembled with WireEasy construction.

"Off-The-Shelf" Delivery



RCL

Write for complete engineering information

ELECTRONICS, INC.

General Sales Office: One Hixon Place,
Maplewood, New Jersey 07040

New Subassemblies

controls, electric furnace and oven supplies, to a-c regulator power supplies and motor and generator excitation.

The assembly is now available in single-phase or three-phase configurations, with outputs up to 140 amps and prv ratings reaching 1,300 volts.

International Rectifier Corp., 233 Kansas St., El Segundo, Calif. 90246. [383]

Lightweight camera for closed-circuit tv



A fully transistorized, closed-circuit television camera, said to be the most compact, lightweight camera ever to be offered for nonmilitary professional use, the T1-105 features low-power consumption and stable operation. It will not overheat even after hours of continuous use.

The well stabilized circuitry produces very sharp pictures, without interference; nor is there need to keep adjusting the focus once it has been satisfactorily set. The camera remains stable even in situations where there may be a sudden change in power voltage or a change in climate. Incorporated in the camera is an "electronic eye" which adjusts automatically to changes in object illuminations, thereby producing signals of constant output.

Specifications include: number of scanning lines, 525 or 630; number of pictures per second, 30 or 25; interlacing, random; object illumination required, 9.29 to 9,290 lumens per sq ft; resolutions, 300 or 420 lines; power-supply requirement, 100 v a-c, 60/50 cps, at 10 v-a to 12 v-a; ambient temperature, 45°C maximum; picture-tube used,

NEC Vidicon 7735A; outer dimensions, 3 in. wide x 5 in. high x 9½ in. deep; weight, 4¾ lbs.
Nippon Electric Co., Ltd., Fuchu City, Tokyo, Japan. [384]

Sample and hold for data control

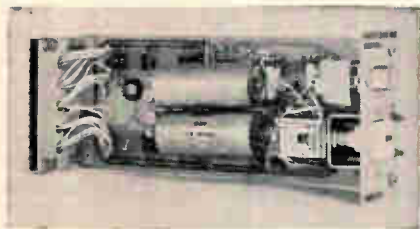

Sample-and-hold amplifier model 101 memorizes analog input values for hours after input is removed, allowing manual control to take over or preventing loss of data until service is restored. The electronic device holds values to better than 1%, yet it uses no unwieldy and expensive electromechanical arrangements. A capacitance-feedback amplifier arrangement performs the required memory function yet reduces cost at least 20% over the nearest competing device on the market, according to the manufacturer.

Two modes of operation are offered: low-level, floating, hold amplifier adjustable from 2.5 v down to 50 mv inputs full scale using a preamplifier; and single-ended sample and hold with 2.5 v full scale. Higher line voltages are handled with voltage divider networks. Provision is made for either manual or automatic operation with transfer being bumpless (no discontinuity in signal level). Up/down push button switches and output meter allow level to be set manually to any point. Output current ranges are 1 to 5 ma into 3,000-ohm loads (floating) and 4 to 20 ma into 750-ohm loads (floating). Stability is $\pm 0.5\%$ full scale or 15°F temperature change, up to 1 month time, and power variations of 10%.

Applications of the model 101 include a data transmission system where loss of signal would cause dangerous or costly conditions. Microwave links and long lines to remotely controlled operations for power dam control, stream flow,

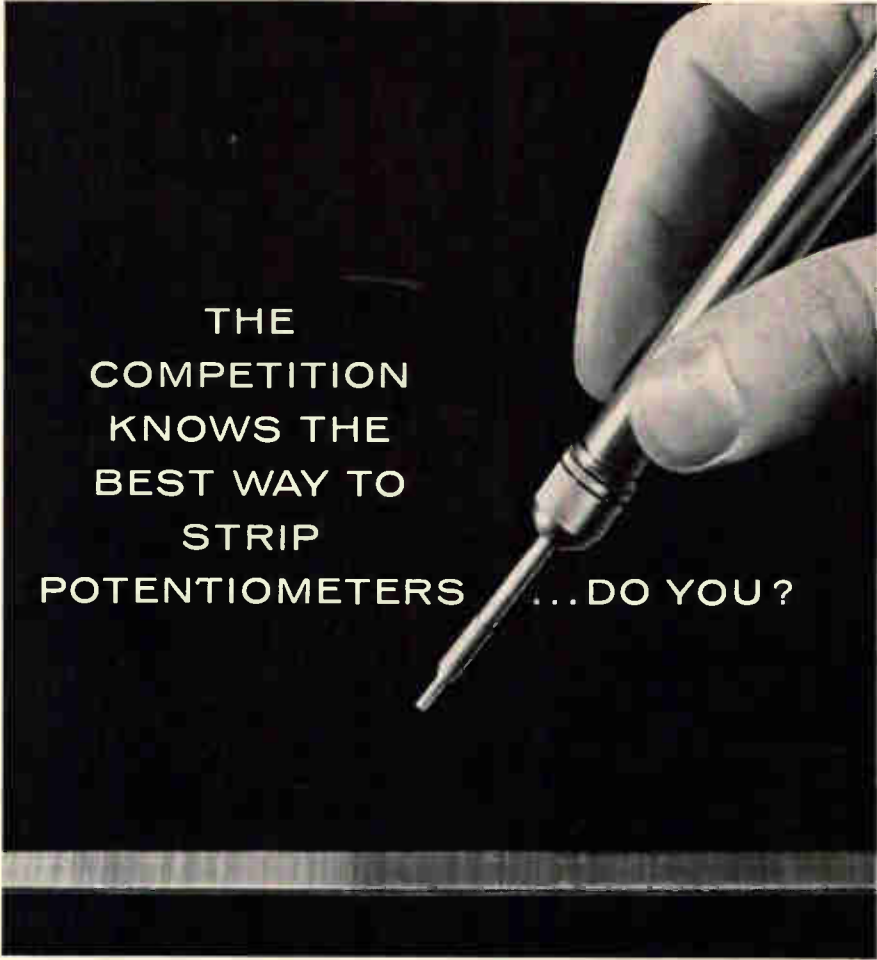

THE COMPETITION KNOWS THE BEST WAY TO STRIP POTENTIOMETERS ...DO YOU?

If you're still trying to strip potentiometers without an S. S. White Airbrasive unit, you're a victim of unfair competition. For 90% of your competitors know how to do it the easy, cheap, fast, and uniform way—the Airbrasive way. Airbrasive directs a precisely-controlled jet of graded abrasive particles at supersonic speeds for cool, shockless, non-distorting abrasion. Cuts away varnish without altering the electrical properties of substrate winding wire. Result: Faster stripping; fewer rejects; more uniform product.

One company cut rejects by 65%; time from 30 minutes to 2 minutes. This has been the typical experience of the industry.

Other Airbrasive applications include: adjusting microresistors; lead cleaning; micromodule fabrication; dicing germanium; shaping semiconductor materials, all flashing and deburring operations. Airbrasive is easily automated, adapts to use with jigs, lathes, templates. It can cut, abrade, machine, drill, deburr any hard, brittle refractory material.

Investment is low—less than \$1,000 sets you up.

If you're still skeptical, call us collect for an Airbrasive demonstration or send us samples of your problem-child for a free evaluation. All your competitors can't be wrong.

S. S. WHITE INDUSTRIAL DIVISION
Dept. EU, 201 East 42nd Street, N. Y., N. Y. 10017
Telephone 212-661-3320

SEND FOR
BULLETIN 6407A
Complete
information



S.S. WHITE COMPANY
Industrial Division

SWITCH TO THE BEST

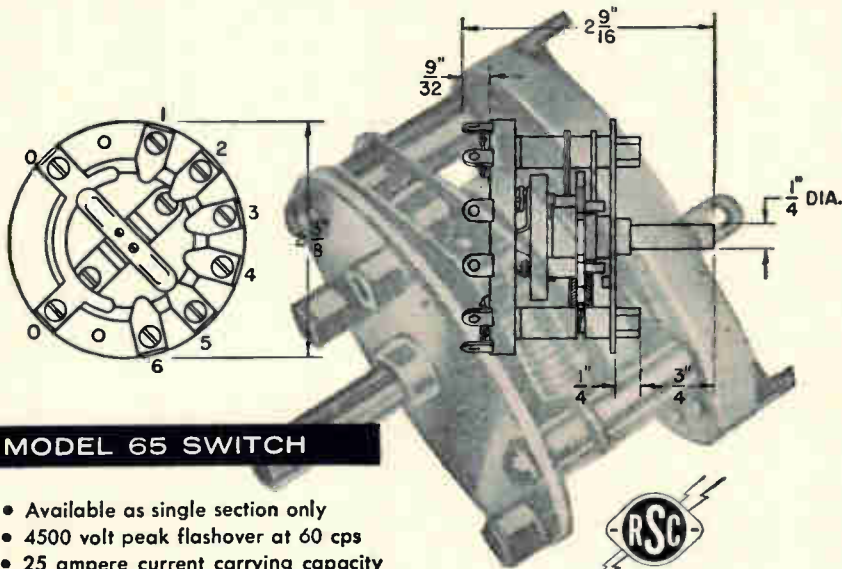

MODEL 65 SWITCH

- Available as single section only
- 4500 volt peak flashover at 60 cps
- 25 ampere current carrying capacity
- Current carrying members heavily silver plated
- Low loss silicone impregnated steatite stator and rotor
- Nylon detent wheel
- Sleeve bearing



RADIO SWITCH CORPORATION

MARLBORO, NEW JERSEY
Tel. 462-6100 (Area Code 201)

Circle 510 on reader service card

GRAPHIC VISUAL CONTROL

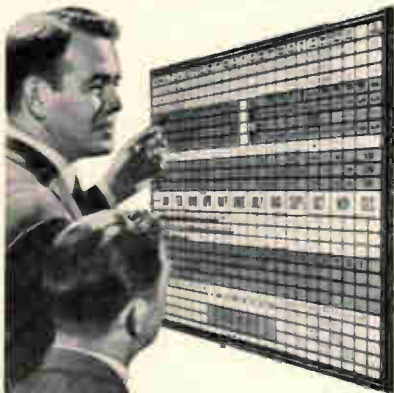

You SEE How To Get Things Done With The BOARDMASTER System

You see a Graphic Picture of your operations, spotlighted in color. You have facts at Eye Level. Saves time, cuts costs and prevents errors.

Ideal for Production, Maintenance, Scheduling, Inventory, Sales, Traffic, Personnel and many other uses.

Simple and flexible tool. You write or type on cards and post on board. All cards are interchangeable.

Compact and Attractive. Made of Aluminum. Over 1,000,000 in use.

Complete Price \$49⁵⁰ Including Cords

FREE 24-Page BOOKLET No. C-10
Mailed Without Obligation

Write Today for Your Copy

GRAPHIC SYSTEMS
925 Danville Road • Yanceyville, N.C.

As a prime source...

WE HAVE

INDIUM

WE ARE THE PIONEERS IN PROCESSING

INDIUM

WE ARE THE ORIGINAL FABRICATORS OF

INDIUM

WE KNOW HOW TO USE

INDIUM

- Indium metal and alloys—standard and high purity grades
- Indium pellets
- Indium wire
- Indium foil
- Indium oxide all purities
- Indium plating solutions
- Indium salts
- Indium powders
- Indium ribbon
- Indium spheres
- Gallium



SOLDER KIT 13 Indalloy solders and 5 fluxes plus full instructions and an Indium test chart. \$16.50. Write Dept. E1.

We welcome your inquiries

INDIUM Corporation of America
1676 Lincoln Avenue
Dept. E1 • Utica, New York

Since 1934... pioneers in the Development and Applications of Indium for Industry

Circle 511 on reader service card

New Subassemblies

gas and oil pumping are typical examples. A binary number can be converted to an analog value in conjunction with model 4010 D/A converter to extend the reliability of digital systems in the least expensive manner.

The sample-and-hold amplifier sells for \$300 in small quantities and below \$200 at 500 or better quantities.

Pacific Data & Controls, 6406 Foster Road, Portland, Ore. [385]

Static inverters offer high stability

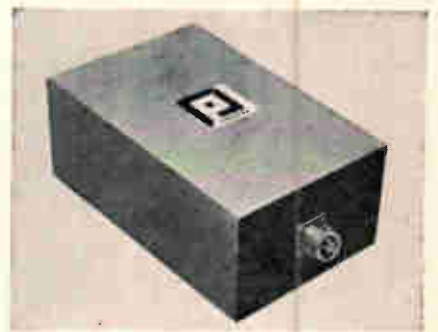

The PD series represents a complete line of static inverters now in full production. A 115-v a-c output voltage with power levels of 125, 250 or 500 v-a at 60 cps, and 125, 250, 500 or 1,000 v-a at 400 cps are standard. Frequency stability is $\pm 1\%$ over an ambient temperature range of -40° to $+60^\circ\text{C}$. The output voltage regulation is $\pm 2\%$ for load changes from no load to full rated load and with the d-c input voltage changing from 24 v to 30 v. The output wave shape is a sine-wave having a nominal distortion of 3% total rms.

The output frequency is controlled by a temperature-stabilized oscillator. To insure high conversion efficiency at all input voltages, output voltage regulation is achieved by pulse-width control techniques. A high Q, half-section constant K filter provides a low-distortion sinewave, even into switching loads. The inverter is protected against external shorts or overloads by self-resetting electronic circuitry. To insure long-term reliability under all possible operating conditions, no scr's are

used. All semiconductors are silicon. The PD series of static inverters has been designed to meet the environmental conditions of MIL-E-5272C.

Protran Co., Inc., 7 Commercial St., Hicksville, L.I., N.Y. [386]

Power control module eliminates relays



Power and logic control modules known as CoZmo units are miniaturized solid state devices that contain multiple control circuits. They eliminate the need for bulky relay control boxes. Many installations of power control and limit switching are compact enough to be packaged in the operator control box on the machine.

The series is designed for 117 v a-c operation at 500 w and includes: power control modules PCM-1 normally open, PCM-2 normally closed, PCM-3 for single-pole double-throw applications, and logic circuit module LCM multiple switching unit and TCM timer control module for zero to one-second delay switching. All CoZmo modules are designed with visual indication of switching positions and with a base plug for standard octal sockets. They require a power supply of any simple bell transformer. As many as 50 modules can be operated from one transformer.

Applications covered are: logic memory units for lock on, lock off or momentary switching, isolated turn-on against ground and multiple combinations of these operations. Each module measures 1 3/4 in. x 1 3/4 in. x 4 in. high and is hermetically sealed for operation in any type of environment. Prices range from \$17.50 to \$45. Techrand Corp. of America, Muskegon, Mich. [387]

phystable *

*A word we have coined to dramatize exactly how unique physically stable Phelps Electronics Styroflex coaxial cable actually is. Essentially an air dielectric cable, Styroflex inherently exhibits lower attenuation and higher propagation than solid dielectric types. The effect of temperature cycling on attenuation is minute and results from changes in metal resistivities amounting to less than 1% per 5°C temperature change. Continuous support assures perfect centering of the conductor during the load cycling.

If you are concerned with circuit design in AM, FM, VHF and UHF transmission, CATV, microwave communications, radar, forward scatter systems and telemetering, multichannel long line telephone networks or general pulse work, here is a coaxial cable worth knowing more about. Available, from stock, in 3/8", 1/2", 7/8", 1 1/8", 3 1/8" diameters in 50 ohm impedance, on 1000' reels, custom cut lengths or specially fabricated assemblies.

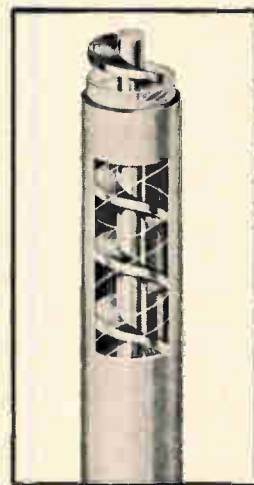

PHELPS DODGE ELECTRONIC PRODUCTS
NORTH HAVEN, CONNECTICUT



New Microwave

Common supply cuts amplifier cost

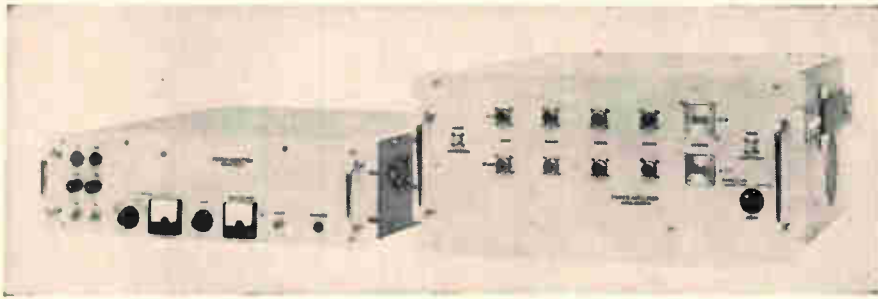

By using a common power supply to operate five different traveling-wave tubes, a multiband, microwave amplifier operating from 1 to 18 gigacycles per second frequency may be purchased at a substantial savings. Its manufacturer, the Alto Scientific Co. Inc. of Palo Alto, Calif., claims that eliminating additional power supplies permits five

amplifiers to be purchased for the price that three amplifiers would usually cost. It further claims that it is the least expensive multiband amplifier offering medium power output over such an extended frequency range.

Alto's model 135 consists of a power supply section that provides all operating voltages, metering and

gain control and a radio-frequency section that houses the twt's and has provisions for cooling as well as for optional inputs to modulate the amplified signal. Both amplitude and serrodyne-modulation inputs are available. Serrodyne modulation is a form of phase modulation in which a linear sawtooth voltage is applied to the twt's helix to vary the output phase over a 360° range.

The amplifier has a small signal gain of 35 decibels and a noise figure of less than 35 db in each of the five bands included in the 1 to 18 Gc frequency range. Three twt's, each capable of an octave bandwidth and 18 watts of power output, provide amplification in the 1 to 8 Gc region. Two other twt's—one operating from 8 to 12.4 Gc and the other from 12.4 to 18 Gc—have an 8-watt power output. An option offers 50 db of small signal gain at all frequencies except the 12.4 to 18 Gc band.

To switch bands, a plug from the power supply is connected to the

FORWARD MARCH TO

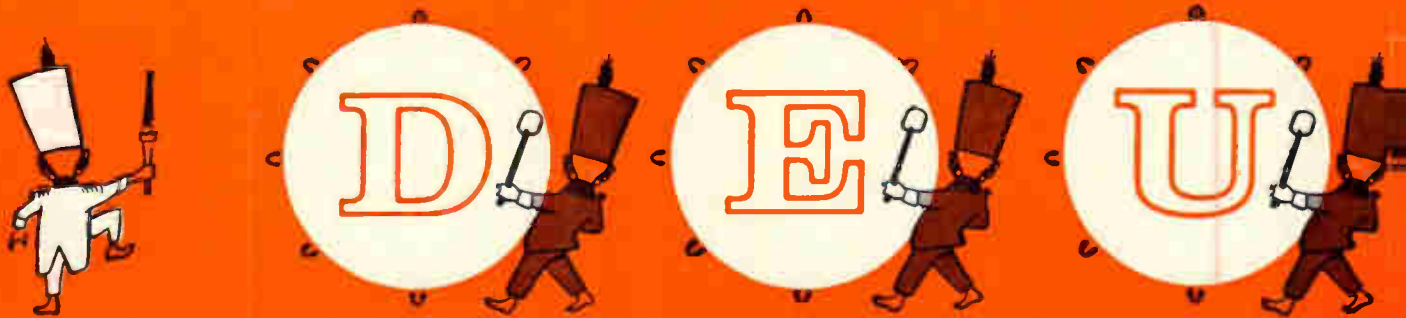

The Totally Integrated Termination System! The

central element in this system concept is the rear release contact which makes it possible to maintain uniform application standards throughout an entire interconnection system. The Deutsch Rear-Release Terminal Junction Series replaces terminal strips with lightweight, low-cost modules which operate even in the harshest environments, are a perfect termination interface between any type of electrical connector and the advanced Deutsch Rear-Release connectors. For even more integration, the Deutsch NAS 1599/1600 Series Bayonet-lock and the DBA 70 Series Push-Pull Coupling intermate and interchange with existing MIL-C-26500 and MIL-C-26482 connectors. The Deutsch 460 Series Bayonet coupling MIL-C-26482 type is interchangeable and intermateable with all MS 3120 through 26 bayonet styles; including the Deutsch NAS 1599/1600 Series. Find a crowded corner and upgrade your system with the Deutsch RE Series of rectangular subminiatures or the RTK and RSM Series of cylindrical subminiatures, environmental and non-environmental.

REAR-RELEASE ADVANCED TERMINAL JUNCTIONS

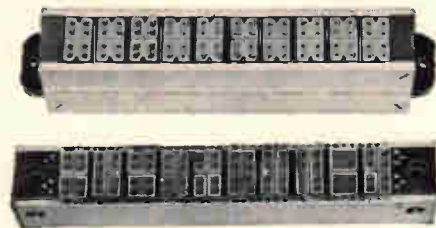

Terminal Junction Multi-Module Units



For complete information on Deutsch devices that make up the Deutsch Total Integration Termination System, contact the Deutsch Company, or call for your local Deutschman.

Watch for the Deutschman at IEEE show
at the Barbizon Plaza March 21-23

Prices reduced on all
Radiation digital equipment



NOW 12-BIT 50KC

A/D converter: \$3,025!

12 CHANNEL 8-BIT D/A CONVERTER: \$3,050

Increased reliability and accuracy offered by digital data acquisition and processing is now practical for all your requirements. Prices on industry's finest line of digital equipment have been substantially reduced. That's because of increased production, and lower cost of Radiation plug-in logic modules used in the design of these units.

For example, Radiation's Model 5516 A/D Converter is priced at only \$3,025, and Model 5610 D/A Converter at only \$3,050. In addition: Model 5710 Multiplexer Programmer is now \$1,225, Model 5416 16-Channel Unity Gain Multiplexer is \$1,350. Model 5817 Read/Write Electronics (for 7-track requirements) has been reduced to \$3,350, and Model 5819 (for 9-track) to \$3,790.

Write for data sheets on Radiation digital equipment, or phone for detailed information.



RADIATION
INCORPORATED

CONTROL AND COMMUNICATION DIVISION • DEPT. EL-03 • P.O. BOX 430 • MELBOURNE, FLORIDA 32902. PHONE: (305) 727-3711

Circle 508 on reader service card

THE REAR WITH DEUTSCH REAR-RELEASE HIGH PERFORMANCE CONNECTORS

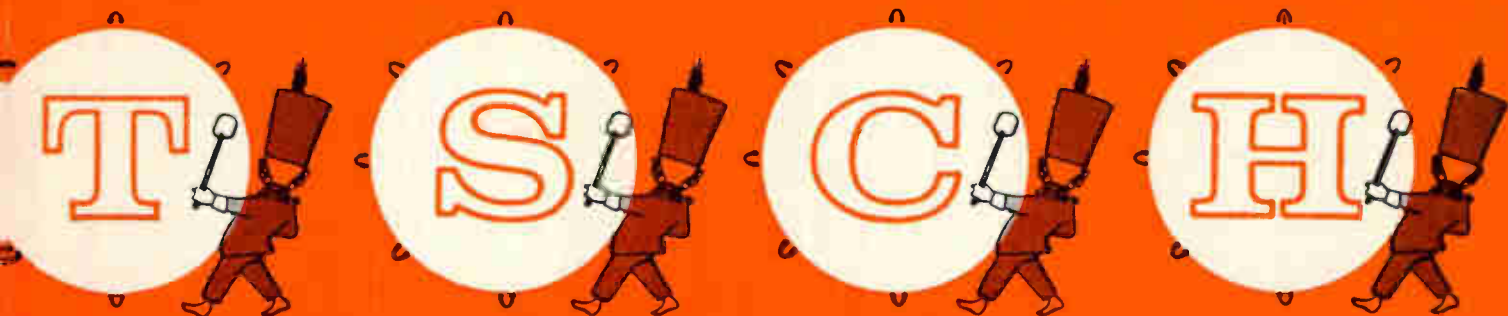

REAR-RELEASE
CYLINDRICAL MINIATURES



IAS 1599/1600 Bayonet Coupling



DBA 70 Push-Pull Coupling



460 Bayonet Coupling

REAR-RELEASE
RECTANGULAR SUBMINIATURES



RE Jackscrew Coupling

REAR-RELEASE
CYLINDRICAL SUBMINIATURES



RTK Bayonet Coupling
Environmental/Non-environmental



RSM Push-Pull Coupling
Environmental/Non-environmental

ONE FOR ALL
ALL FOR ONE



One standard hand crimp tool
and one assembly procedure.



One plastic, expendable "fail-safe" insertion/removal tool. Can't harm connector interfaces because contacts are inserted and removed from the rear — even in a mated condition.

DEUTSCH

ELECTRONIC COMPONENTS DIVISION
Municipal Airport Banning, California

Circle 199 on reader service card

COMBINED MULTIPLEXER AND A/D CONVERTER



EECO 762

- From 5 to 100 analog inputs
- Up to 14-bit binary or 4 BCD + sign
- Gated display of output for any input channel
- Up to 44,000 conversions per second
- F.E.T. switches--100 megohm input impedance
- Optional simultaneous binary and BCD outputs
- 100 nanosecond aperture on sample and hold
- Only 7 inches of panel height

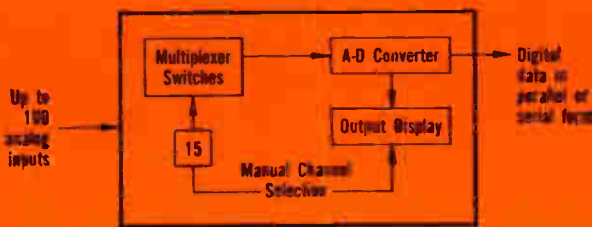

EECO 762

... less than \$4,000
for most models



Electronic Engineering Company

in California
1601 East Chestnut Avenue (Box 58)
Santa Ana, California 92702
Phone: Kimberly 7 5501 (714) • TWX: 714-531-5713

Widest variety of laminated plastic tubes



We are able to offer you the widest variety of laminated plastic tube shapes and sizes in the industry. We make tubes from $\frac{3}{32}$ " ID up to 26 $\frac{1}{4}$ " OD. We make them round, square, oval, rectangular or you name it.

Call Synthane first for your tubing requirements. Many popular sizes, shapes and grades available immediately from our Instant Stock. Synthane Corporation, 36 River Road, Oaks, Pa. 666-5011 (Area Code 215).

SYNTHANE
CORPORATION  OAKS, PENNA.

Laminated Plastic Sheets, Rods,
Tubes and Fabricated Parts

Circle 503 on reader service card

Synthane copper-clad laminates in stock for fast delivery!



First quality Synthane copper-clad laminates, made under clean room conditions, are now stocked in many grades, and in many sheet laminate and foil thicknesses for quick delivery. If your specific requirements are not in stock they can be pressed quickly from our huge stock of semi-finished materials. Write for folder on Synthane copper-clad laminates and for a quotation on your needs. Synthane Corporation, 36 River Road, Oaks, Pa.

SYNTHANE
CORPORATION  OAKS, PENNA.

Laminated Plastic Sheets, Rods,
Tubes and Fabricated Parts

Circle 504 on reader service card

New Microwave

appropriate tube and the voltage levels are adjusted for that tube.

The amplifier is intended mainly for applications that utilize the entire available frequency band. Although the tubes may be purchased separately, price savings are realized only with four or more tubes.

The model 135 may be mounted on a standard 19-inch rack or may be purchased as bench unit. Prices start at \$6,600. A unit with five tubes costs \$22,300.

Specifications

Frequency ranges	A. 1—2 Gc @ 18 watts B. 2—4 Gc @ 18 watts C. 4—8 Gc @ 18 watts D. 8—12.4 Gc @ 18 watts E. 12.4—18 Gc @ 8 watts
Tubes	Periodic permanent magnet (PPM) focused twt's
Small signal gain	35 db nominal
Saturated gain	Typically 3 to 6 db below small signal gain
Noise figure	30 db nominal, 35 db maximum
Gain control range	6 db minimum
Impedance	50 ohms input and output
Connectors	1 through 12.4 Gc, type N female 12.4 through 18, UG-419/U waveguide
Metering	Helix, beam, and collector current and beam voltage
Over-all size (inches)	R-f section 17h x 19w x 21d Power section 8 3/4h x 19w x 21d
Input power	105 to 125 vac, 60 cps, single phase
Price (with 5 tubes)	\$22,300

Alto Scientific Co., 4083 Transport St., Palo Alto, Calif. [391]

Tiny rotary joint covers d-c to 18 Gc

Model 345 is a d-c to 18 Gc, contacting-junction rotary joint featuring maximum vswr of 1.30, maximum insertion loss of 0.2 db, and maximum wow of 0.1 db/360°. Unlike round rotary joints, which require special mounting flanges, the joint's body is square in cross-section and is drilled and tapped for direct mounting.

The unit is 1.06 in. long by 0.50 in. square and weighs 1 oz. Connections mate with all standard miniature types. Unit price is \$175 in small quantities.

Sage Laboratories, Inc., 3 Huron Drive, Natick, Mass., 01762. [392]

Moving Electronic Equipment?



HAD SHAMROCK BEEN IN THE PICTURE... "OUR MEN IN GREEN WOULD HAVE MADE BIG THINGS HAPPEN"

Emotional strain while millions of dollars of electronic equipment needs to be delivered and installed in some distant city. The customer is calling and everyone from engineering to top management is looking to the traffic manager for a solution. What's more, this delicate equipment must be moved under rigid temperature controls or it could be seriously damaged. If the traffic manager had known about Shamrock's revolutionary Climatic Control



Vans there would have been no loss of time in talking to other carriers. Shamrock is the pioneer in this field. After Shamrock's efficient Men in Green gently load and secure the equipment in the unique Climatic Control Van, it will be transported to its destination under regulated temperatures at any degree, regardless of season. Add Shamrock's rapid centralized dispatch system and the traffic manager would have been the man of the hour. For the best move you've ever made, put your electronic equipment in the careful hands of Shamrock's Men in Green.



Inc. P. O. Box 5447, Dallas, Texas 214-253-3671

Circle 201 on reader service card

To order reprints: Fill in, cut out coupon below, insert in envelope and mail to: Electronics Reprint Dept., 330 W. 42nd Street, New York, N.Y. 10036

Reprint order form

For listing of reprints available see the Reader Service Card.

The Overlay Transistor

Send me _____ reprints of Key no. R-78 at 75¢ each.

For reprints of previous special reports fill in below:

Send me _____ reprints of Key No.(s) _____ @ _____ ¢ each.

(For prices, see Reader Service Card)

Name _____

Number of street _____

City, State, Zip code _____

LOW-INDUCTANCE triggered discharge SWITCH

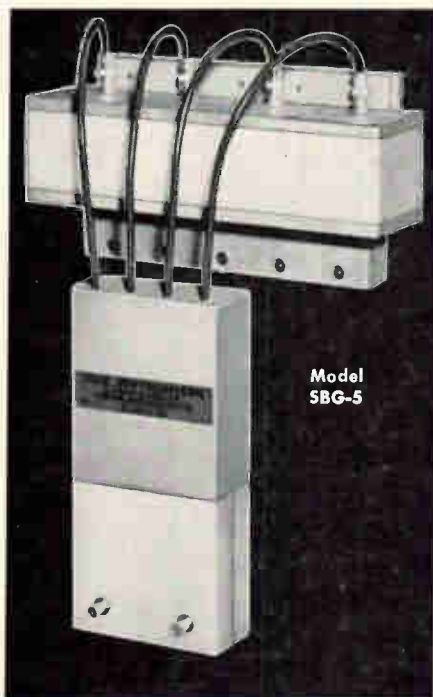

- Operating voltage: 20 kilovolts
- Peak current: 750 kiloamperes
- Energy transfer: 3000 joules
- Self-inductance: 5 nanohenries
- Life: 10,000 discharges

The TOBE Model SBG-5 Switch is of multi-channel spark-gap configuration, with a unique method of simultaneous gap-firing that achieves a 50-nanosecond delay, with total system-jitter below 5 nanoseconds.

The high-voltage trigger-system furnished with the switch fires on a 250-volt positive pulse. The necessary charge of 10 kv at 1 ma. can easily be taken from the 20-kv capacitor-charging supply, through a suitable dropping resistor.

Detailed information about dimensions, acceptance tests, and mountings is given in Bulletin EB365-60 available, on request.

And write or call us
whenever you have special or
unusual requirements.

TOBE DEUTSCHMANN

LABORATORIES

CANTON, MASSACHUSETTS 02021

Telephone (617) 828-3366



New Production Equipment

Converging air blocks dirt

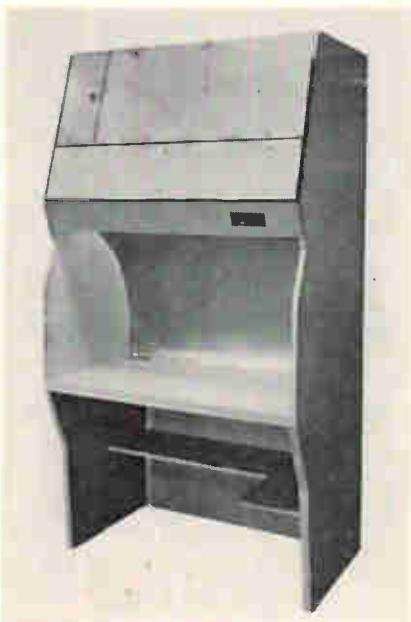

The cleanest of clean benches, claims Air Control, Inc., is a new model that directs converging streams of filtered air toward the outer edge of the work area. The company considers the converging flow a major improvement over the laminar type of flow which is now generally used in clean-air work stations for semiconductor production.

In laminar-flow work stations, filtered air is forced through a perforated, vertical wall at the back of the work bench. If bulky objects, such as test or bonding equipment, are placed in the air stream, says the company, the resulting turbulence may draw unfiltered air into the work area.

In the converging-flow work station, the filtered air goes through a curving wall, so that the breeze surrounds the equipment on the bench. The air pattern is more stable, the company says, preventing aspiration of dirty air. A cleanliness of less than 100 particles of 0.3 micron size per cubic foot can be maintained.

The shape of the perforated wall can be made to suit the shape of the equipment on the bench. The bench illustrated is suitable for operations like mask alignment and

welding. For bell-jar deposition, the back wall can be a vertical half-cylinder wrapped around the bell jar.

The bench will be displayed for the first time at the IEEE Show in New York this week.

Specifications

Width	4 or 6 feet
Cleanliness	Exceeds Class 100, Federal Standard 209
Price	Approximately \$1,500 (depending on choice of lights, sinks, etc.)
Delivery	6 weeks

Air Control, Inc., 125 Noble St., Norristown, Pa. [401]

Nozzle tips improve air-abrasive tool

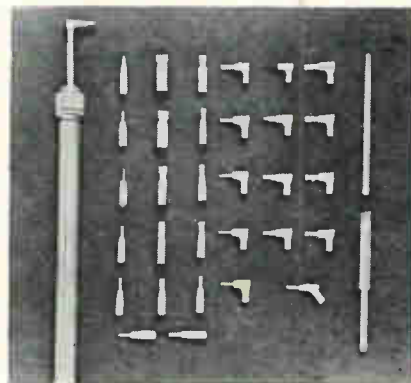

The increased use of microminature devices for the electronics field has resulted in the need for development of a broad line of tough tungsten carbide nozzle tips for the manufacturer's Airbrasive tool. The Airbrasive is a cutting instrument that uses a controlled, gas-propelled, high-speed stream of abrasive particles that quickly cut, clean, etch, abrade, and debur hard, brittle materials.

A prime example is in resistor trimming, an application that is precisely accomplished by means of computerized automatic machines equipped with clusters of Airbrasive nozzles which can trim as many as six resistors simultaneously. Rectangular nozzle tips for this operation, ranging in size from

Who designed and constructed the world's highest power RF feed-through bushing? **Lapp Insulator Company**

Lapp? Yes, Lapp Insulator of LeRoy, N. Y. Matter of fact Lapp has been designing and producing Feed-Through Bushings for 42 years. They get bigger, *and* more intricate, all the time. Demanding, unusual specifications don't bother us. Why? Because when it comes to radio frequency insulating components we've got plenty of "know-how" . . . and ingenuity . . . and *ability* to produce the finished product.

Getting back to that "world's highest power" bushing, we designed and made three of these for Continental Electronics Manufacturing Company. They are a vital part of the U. S. Navy VLF transmitter at Northwest Cape, Australia. Each one is rated for 2545 amperes continuous duty at 140 kv RMS at 15.5 kc and is both internally and externally graded to assure uniform voltage distribution. These bushings are approximately 16 feet tall and weigh about 7000 pounds each.

Two other Feed-Through Bushings we've made are shown here. But there have been hundreds of others. Write or call us with *any* radio frequency insulating problem. Radio Specialties Division, Lapp Insulator Co., Inc., Dept. E, LeRoy, N.Y. 14482.

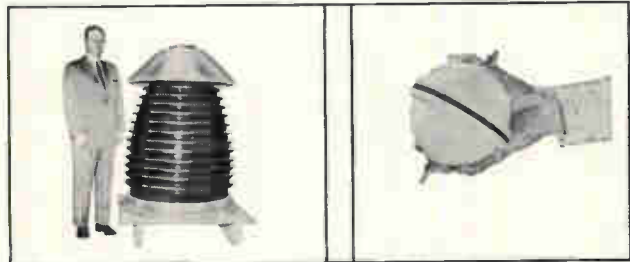
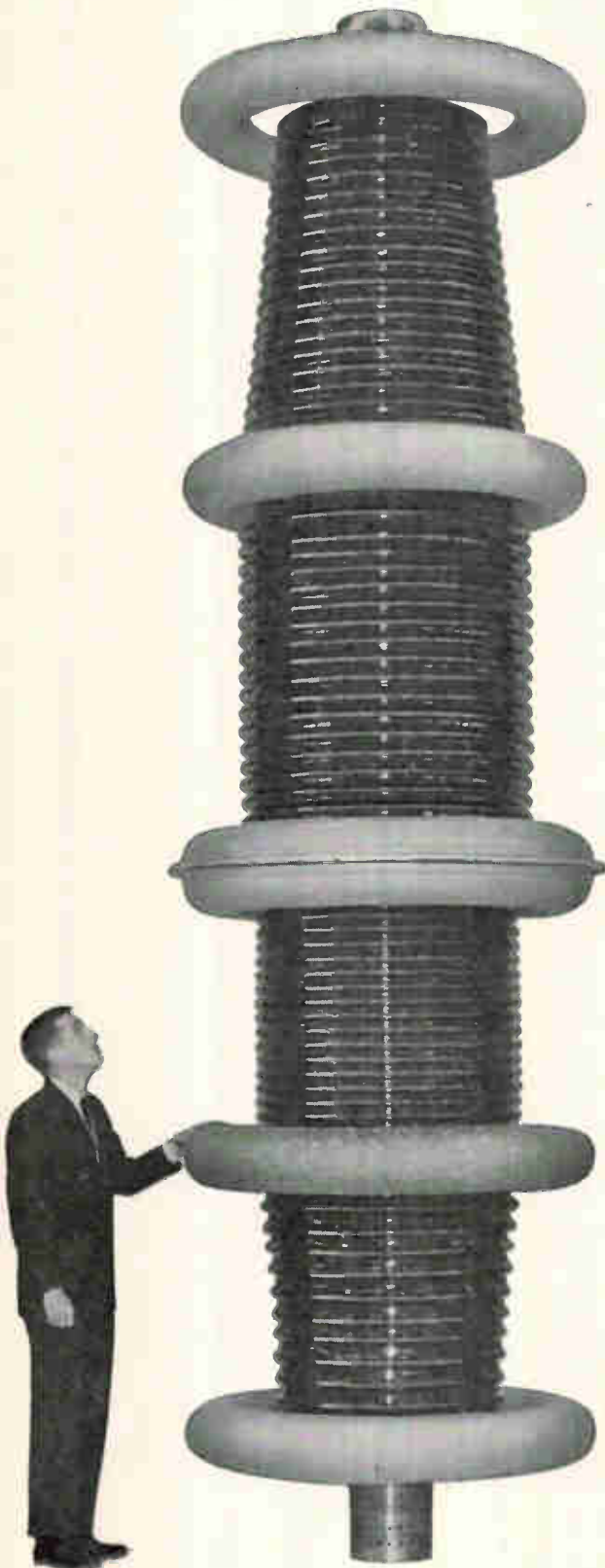

Lapp



99.999% pure wire (how do you handle it?)

The wire which Secon supplies to the Semiconductor industry is generally contamination free and can be spectrographically 99.999% pure. It is produced and spooled in "white rooms" under extreme care and controlled conditions.

In order to maintain this standard at your facility — here's what our Engineers recommend:

1. Use extreme care when removing spools from shipping containers.
2. Do not remove spool from package for visual inspection — new transparent blister package was designed to permit visual inspection without removal.
3. Store spooled wire with barrel of spool in a horizontal position.
4. Inspection spools should never be used for production. Be careful not to mar or stretch wire during de-spooling.
5. When you de-spool always start from end marked "START THIS END" on the label.
6. Be extremely careful when placing the wire in bonders.
7. Do not under any circumstances place fingers on wire. Hold the spool by the flanges—not only will the fingers introduce contaminants, they may bruise or damage the fine wire.

If your requirements are for very high quality, fine electronic wire or ribbon, you should have a copy of our comprehensive 48 page brochure Wire Products For The Semiconductor Industry. It lists the physical and electrical properties of available materials. Please write on your letterhead; no obligation of course.



7 INTERVALE STREET, WHITE PLAINS, N. Y. ■ (914) WH 9-4757

Circle 204 on reader service card

To order reprints: Fill in, cut out coupon below, insert in envelope and mail to: **Electronics Reprint Dept., 330 W. 42nd Street, New York, N.Y. 10036**

Reprint order form

For listing of reprints available see the Reader Service Card.

Computer Time Sharing Part II

Send me reprints of Key no. R-86 at 50¢ each.

For reprints of previous special reports fill in below:

Send me reprints of Key No.(s) @ ¢ each.

(For prices, see Reader Service Card)

Name

Number of street

City, State, Zip code

Production Equipment

0.006 in. x 0.020 in. to 0.007 in. x 0.150 in., with many sizes in between, are used for this highly sophisticated procedure. Variations in length of nozzle tip orifice correspond to the path of abrasive necessary to trim various width resistors.

For resistors too tiny for even the smallest rectangular tips, the manufacturer has developed a round orifice with a diameter of only 0.005 in. Abrading larger areas of work led to the need for a very large rectangular tip of 0.007 in. x 0.150 in.

The smallest nozzle available at present is 0.003 in. x 0.020 in., but the company points out that the technology of extruding tungsten carbide nozzle tips has advanced to the point where any size nozzle tip can be produced to meet any demand or application. There is even a square nozzle tip available (0.026 in. x 0.026 in.).

The average life of the carbide tips under bombardment by the abrasive particles is approximately 30 hours. However, the manufacturer also supplies a nozzle with a synthetic sapphire tip, which outwears carbide tips by a considerable margin. These tips are available with a round orifice only, and are considerably more expensive than the carbide-tipped nozzle.

S.S. White Industrial Division, 201 E. 42nd St., New York, N.Y., 10017. [402]

Cleaning tool for component leads



A low-cost component lead cleaner, designated as catalog No. W-14, is designed to comply with the requirements of NASA NPC 200-4 soldering techniques. This tool cleans the oxide layer off pretinned component leads to assure better quality of solder joints. List price

is \$1.49 each with substantial quantity discounts.

Consolidated Instrument Corp., Box 1030, Stamford, Conn. [403]

Ultrasonic bonder welds power devices



Using ultrasonics, the model WU-100 wire bonder welds a wide range of power transistors such as TO-3's, TO-66's, stud packs and other large devices. It bonds wire from 5 to 40 mils.

Automatic wire feed and cut-off are included. The unit's Micropositioner has a 10-to-1 reduction with a 1-in. motion and 360° rotation. The chuck is a strong, spring-loaded clamp, adaptable to a wide variety of headers, stud packs and special shapes.

Optics are Bausch and Lomb, 7X-30X magnification; Nicholas illuminator; 100-watt ultrasonic generator. Bonder dimensions are 24 in. wide x 20 in. deep. The generator is 24 in. wide x 15 in. deep.

The Axion Corp., 6 Commerce Park, Danbury, Conn., 06810. [404]

Automatic console solders microcircuits

A micro-soldering console has been designed for hands-off soldering of integrated circuits and other micro-circuitry devices. Using the prin-

NEW CAPACITOR TESTER SAYS EXACTLY WHAT IT MEANS



MODEL 5340 DIGITAL CAPACITOR TESTER

- Measures true series capacitance
- Direct digital display with long-life Nixie® tubes
- Tests capacitance, leakage, DF, and ESR
- Test frequencies of 120 cps and 1 kc
- Internal dc bias supply with electronic current limiting

The dual-frequency 5340 provides an exceptionally flexible instrument for accurately measuring a wide range of capacitance, leakage, dissipation factor and equivalent series resistance values. Results (in picofarads, nanofarads, microfarads) are displayed immediately on a 4-digit Nixie® readout, with a separate 3-digit readout of DF or ESR. Five terminal guarded measurements prevent stray capacitance and lead resistance errors. A 25% over-range capability facilitates test operation procedures. Since capacitors are always specified in terms of series capacitance by the manufacturer, direct series capacitance measurements on the Model 5340 DCT are therefore much faster and easier. No need for conversion formulae. No table look-ups. Reduced operator error. Priced at \$4500.00. Single frequency capacitor testers from \$1995.00.

For complete information, including a new 4-page technical paper entitled "Theory and Application of Capacitance Measurements", contact the Micro Instrument representative near you or write directly to us.



13100 CRENSHAW BLVD., GARDENA, CALIFORNIA 90249

PHONES: (213) 323-2700 & 321-5704 / TWX (213) 327-1312

ON DEMONSTRATION AT IEEE SHOW IN BOOTH 4 M 31



Model 886-101

SIX REASONS YOU'LL GET BETTER PERFORMANCE WITH ASTRODATA'S NEW WIDEBAND DIFFERENTIAL DC AMPLIFIER

Here's a solid-state amplifier for superior performance in numerous signal conditioning applications, low-level multiplexed data gathering, high-level multiplexed data gathering, and one-amplifier-per-channel systems where fast transients must be faithfully amplified to high levels for recording.

1. Because it offers wide bandwidth, fast settling time, low output impedance, and fast recovery from large input overloads.
2. Because chopper stabilization achieves drift rates, temperature coefficients, and low input current unequalled by any other techniques.
3. Because solid-state FET switching in chopper stabilizing circuit assures high reliability and long mean-time-between-failures.
4. Because high common mode rejection is achieved with up to 1000 ohms source unbalance in either input leg.
5. Because the input circuit is floating, guarded and isolated from the output and power ground circuits.
6. Because the output is compatible with both a-to-d data systems and galvanometer recorders.

SPECIFICATIONS

BANDWIDTH: dc to 50 kc.

SETTLING TIME: Less than 100 μ secs to within $\pm 0.05\%$ of final value (either polarity).

OVERLOAD RECOVERY: Recovers from overloads up to ± 10 times full scale to within $\pm 0.05\%$ of final value in 200 μ secs or less at any gain.

OUTPUT IMPEDANCE: Less than 0.1 ohm in series with 50 μ h.

Complete specifications and technical data available upon request.



ASTRODATA

P. O. Box 3008 ■ 240 E. Palms Road, Anaheim, California ■ 92808

Production Equipment

principle of precision controlled resistance heating, the unit permits pin-point soldering with absolute repeatability. Operator error and inconsistency are eliminated.

Faster production, fewer rejects, and superior quality standards are said to be the hallmark of this console. All operations are foot-controlled, leaving the operator's hands free for other operations. The Microbond II console has integrated into its design precision 10X binocular optics and a high-intensity light source.

Precision-ground, high-temperature stainless steel electrodes permit solder temperatures to 1,000°. Resistance probes are of a unique parallel gap design featuring independent flexing and controlled work pressure. Price is \$590, including 10X optics.

Browne Engineering Co., 2003 State St., Santa Barbara, Calif., 93105. [405]

Cutter and former for transistor leads

The Leadmaster, model H-132, automatically cuts transistor lead wires or forms dimples for stand-off insertion into printed-circuit boards or does both. Stand-off dimpling improves ventilation and eliminates the need for transistor pads. Savings in costs enable the machine to pay for itself in less than 20 hours of operation, the manufacturer says.

The unit handles case sizes in the order of TO-5 and TO-18, with three leads. Processing is strain-free and impact-free. The input of the machine demonstrates a high tolerance for bent leads.

Separate, continuously variable controls are included for the length of leads, positioning of dimples and height of case. Top-side indicators traverse engraved scales for positive, eye-level locating of cutting and forming dies.

Standard Leadmaster models operate on 110 v, 50-60 cps a-c, with 220-v models available. Processing rate is up to 2,500 transistors per hour.

Heller Industries Inc., 30 N. 15th St., East Orange, N.J., 07017. [406]

CR* batteries

* CHARGE RETAINING

**Dependable Power
for a Year
Without Recharging
or Maintenance**



- Typical applications are instruments, buoys, deep sea devices and systems requiring uniform voltage characteristics over prolonged, unattended operating periods.
- Permit continuous or intermittent discharge at high or low rates. 85% of capacity available after one-year idle stand at 80° F — more at lower temperatures.
- May be charged and discharged repeatedly with little change in characteristics. Voltage practically linear between 2.12 and 1.95 per cell.
- All the proven dependability and cost advantages of the lead-acid battery plus charge retention. Five sizes available: 26 to 600 ampere hours.

FOR COMPLETE INFORMATION WRITE:

**WISCO
DIVISION**

The Electric Storage Battery Co. 
1222 — 18th Street, Racine, Wis. 53403

Circle 512 on reader service card

INTRODUCING DELTA BOND 152 THERMALLY CONDUCTIVE ADHESIVE

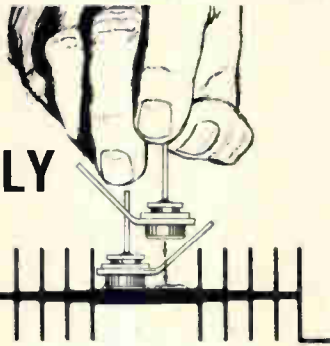

... To be used:

- For bonding thermally, yet isolating electrically, semiconductors to anodized or hard-coated chassis heat sinks.
- As a general adhesive, i.e. fabricating thermal links.
- For bonding when a thermally conductive interface is required.

Being 100% solid adhesive, it is effective on porous and non-porous surfaces. Features . . . high thermal conductivity, excellent dielectric strength, a coefficient of thermal expansion similar to Al and Cu, and produces a rigid high strength bond to most materials when cured.

Available in 4 oz. kits or 15 lb. cans . . . from authorized WAKEFIELD Electronic Distributors.

Write for BULLETIN 152.

**WAKEFIELD
ENGINEERING, INC.**



139 FOUNDRY ST / WAKEFIELD, MASS (617) 245 5900 • TWX 617 245 9213

Now! a NEW HIGH STABILITY CERAMIC CAPACITOR

Typical NYTcap Stability

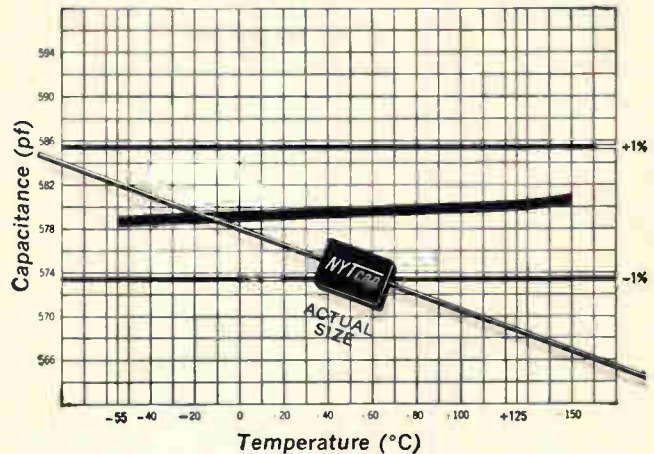

The NEW NYTcap

Temperature Coefficient: Within 1% envelope over temperature range of -55°C to $+125^{\circ}\text{C}$.

The new NYTcap now offers the design engineer these important advantages: Package size 0.350 x 0.250 x 0.1; Capacitance range 100pf. to 1000pf.; Capacitance tolerance $\pm 10\%$; Standard E.I.A. values; Loss (at 1 kc) less than 0.001 at 25°C, less than 0.002 at 125°C; Voltage rating 200 Volts dc; and Insulation resistance at 25°C 1,000,000 megohms, and 125°C 10,000 megohms. 24 hour delivery.

The NYTcap is the newest product to join the Nytronics subminiature family of inductors, ceramic capacitors, precision wire wound resistors, thin film resistors, crystal filters, L-C filters, transformers, and delay lines. Use coupon for engineering data!

NYTRONICS

Design Leaders — STANDARD Components to Meet CUSTOM Requirements
550 Springfield Ave., Berkeley Heights, N. J.

MAIL COUPON TODAY FOR COMPLETE DATA!

TO: NYTRONICS, INC.

550 Springfield Avenue, Berkeley Heights, N. J.

Dept. E

Please send complete engineering data on the NYTcap

NAME/TITLE _____

FIRM _____

ADDRESS _____

CITY/STATE/ZIP _____

New Parameters In Pulse Expansion/ Compression DELECON

DELECON is a new concept which has extended the current state-of-the-art. Devices using this new concept extend performance, lower cost, reduce physical size and improve reliability. DELECON is available in custom configurations as well as a variety of off-the-shelf packages.

Typical of a standard unit is DELECON Model P451, priced at \$42,000 f.o.b. Hartford, Connecticut, with delivery quoted at 120 days.

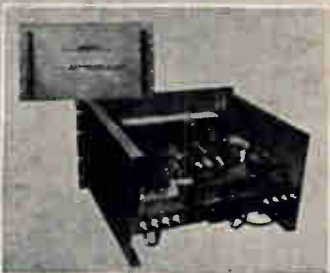

Model P451 DELECON Pulse Expansion/Compression System

compression ratio:	400:1
frequency:	45 Mc
bandwidth:	20 Mc
delay dispersion:	20 μ sec.
sidelobes:	-35 db
volume:	1.5 cu. ft.
weight:	25 lbs.

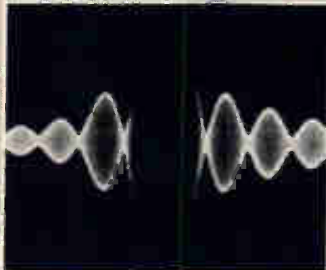

Ask Andersen Labs about DELECON and other advanced signal and data processing systems for radar, sonar, communication, telemetry, simulation, navigation and analysis.

ANDERSEN LABORATORIES, INC.
NEW PARK AVENUE, WEST HARTFORD,
CONNECTICUT 06110

New Materials

Metals and alloys for thin-film devices

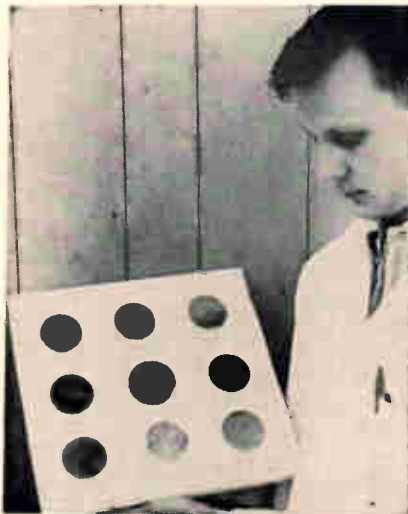

A line of vapor deposition and sputtering materials is offered in purity levels heretofore unavailable commercially according to the manufacturer. Improved metal purification and alloying techniques have made these high-purity materials available at prices that are competitive in electronic circuit and device production applications. The materials offer four advantages to producers of thin-film circuits: 1) a decrease in the number of production variables; 2) more uniform electrical characteristics of deposited films; 3) higher integrity of thin-film circuits and devices; and 4) reduced rejection rates of finished circuits and devices, with resultant cost reductions.

Both pure metals and alloys are available in rod, wire, sheet and foil form. Purity levels of elemental metals are up to 99.999%. Significant in the purity statement is that the figure includes gas impurities which many suppliers of materials do not include in their claims of purity, according to the manufacturer. Alloys are provided with a compositional tolerance of $\pm 0.1\%$.

The materials are prepared from high-purity starting stock which has been electron-beam zone refined or vacuum out-gassed to minimize both interstitial and substitutional impurities. Alloying is

done in vacuum or under inert gas to preserve these purities. Materials Research Corp., Orangeburg, N.Y., 10962. [407]

Flexible epoxy copper clad laminate

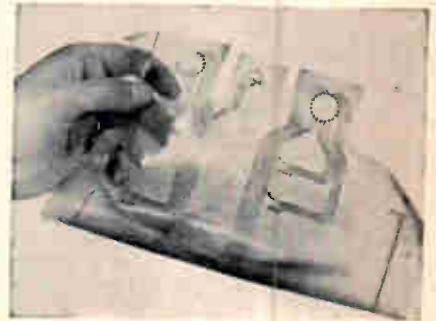

GT-8500, a thin glass epoxy type copper clad, is being offered as part of a series of flexible electrical laminates used in printed circuitry, etched flat cable, flexible-to-rigid combination circuits, and printed components such as fuses and capacitor and resistor arrays. Single or double clads of 1-oz or 2-oz copper are offered on the 3-mil continuous filament glass epoxy substrate.

With excellent resistance to deformation at elevated temperatures, GT-8500 offers superior solderability in addition to high bond strength, unique flexibility, and high dimensional stability. The material is available as a standard item in rolls and sheets up to 17 inches in width.

Electrical Products division, G.T. Schjeldahl Co., Northfield, Minn. [408]

One-component solder resist

A fast-drying, one-component masking material resists soldering temperatures and strips off easily after drying. Called Stripcoat No. 931, this product was developed to act as a temporary solder stop-off during dip or wave soldering. The versatile coating can be used over gold-plated contact surfaces on

p-c boards; component contact surfaces; for temporarily masking board holes to prevent plugging with solder; for partial, selective soldering of metallic surfaces and leads and for similar applications.

Stripcoat No. 931 may be applied by brushing, dipping or flowing over any smooth metallic or nonmetallic surface. A 5-10 mil film is suitable for most applications. For best results, the Stripcoat should air dry at room temperature for 10 to 20 minutes, then cure in a low-temperature oven at 150° to 200°F for 10 to 15 minutes. Repeated dipping after drying is feasible. After curing, the coating is ready for use.

The dry Stripcoat, before and after soldering, can easily be removed. It is simply lifted in one corner and peeled off in one motion.

Alpha Metals, Inc., 56 Water St., Jersey City, N.J., 07304. [409]

Vacuum-stable solid lubricant

Niobium diselenide is a solid lubricant that possesses the combination of electrical conductivity and high vacuum/high temperature stability.

The powdered lubricant demonstrates greater electrical conductivity than graphite. Volume resistivity is 0.535×10^{-3} ohm-cm, while graphite's resistivity measures 2.64×10^{-3} ohm-cm.

Niobium diselenide has shown excellent resistance to outgassing in vacuums as high as 10^{-12} torr and in this respect has greater vacuum stability than molybdenum and tungsten disulfides (non-conductors). Graphite is not stable in vacuum or in air under low moisture conditions. The new lubricant is vacuum stable from -430°F to over 2400°F , and in air commences oxidation at 650°F , at which temperature graphite and molybdenum disulfide commence oxidation.

The combination of properties described makes niobium diselenide an attractive lubricant for many aerospace, electromechanical, and instrumentation applications.

Bemol Inc., P.O. Box 11, Newton, Mass., 02164 [410]

Zenith demands

thin

"SCOTCHPAR" IS A REG. T.M. OF 3M CO.

Zenith power transformer for color TV.

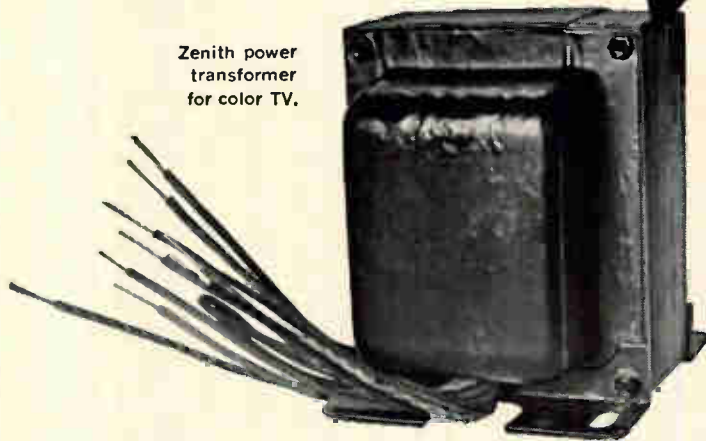

If Scotchpar[®] polyester film is thin enough for transformers . . . how about your needs?

Zenith Radio Corporation demanded a thin .001" insulation for transformer coils that had outstanding dielectric properties...plus physical strength...plus resistance to moisture and solvents. "Scotchpar" polyester film answered all their requirements. Now think how well this thin, tough, dielectric film can give you more volts per mil per insulation dollar. Besides its strength and thinness, it offers stability over a wide range of temperatures. It's nonhygroscopic. It won't get brittle with age. Resistant to oils, impregnants, varnish, refrigerants. It's inert to fungus and won't corrode copper. There is a thickness and type of "Scotchpar" polyester film to match your exact needs. Call or write: Film & Allied Products Div., 3M Co., 2501 Hudson Rd., St. Paul, Minn. 55119. Dept. ICL-36.

3M
COMPANY

WHAT WORKS IN ANY ENVIRONMENT?



The **RUGGED** S-I Digital Magnetic Tape Drive

**ARCTIC COLD — DESERT HEAT
STEAMING JUNGLE**

**AIRBORNE • SHIPBOARD • UNDERSEAS
IN THE FIELD • VEHICULAR**

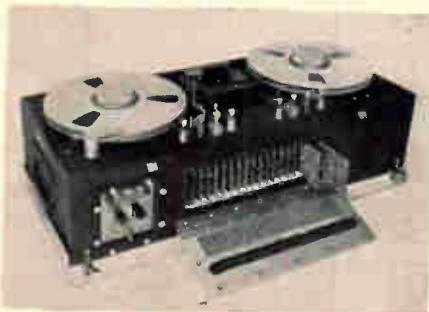

Compare this high-performance, fast stop-start S-I tape drive with anything you've ever owned or heard of. Compatible with IBM and other standard computers, this transistorized DT-03 series is qualified under MIL E-5400 and MIL I-26600.

Write for fully illustrated catalog No. 3



103 PARK AVE., NUTLEY, N. J. 07110
(201) 667-0055 TWX 710-483-4454

Technical Abstracts

Microwave amplifier

An integrated 4-GHz balanced transistor amplifier
T.E. Saunders and P.D. Stark
Bell Telephone Laboratories, Inc.
Murray Hill, N.J.

A broadband 4-megacycle balanced transistor amplifier has been built using tantalum thin films on a glazed alumina substrate.

The single-stage amplifier consists of two electrically similar transistors, two 3-db directional couplers, and bias and decoupling circuits. The incoming signal is split equally between the transistors by the input coupler, and the amplifier outputs of the transistors are recombined in the output coupler. If the transistors are similar, but not necessarily well-matched to the 50-ohm circuit impedance, the amplifier will have a low vswr at its terminals because most of the reflected signal from the transistors is absorbed in the 50-ohm coupler terminations. The vswr is low, so that several units can be cascaded for high gain with little interaction.

The amplifier uses 50-ohm shielded stripline circuitry deposited on a 0.024-in. thick, 1.5-in. square ceramic substrate supported between ground planes spaced 0.125 in. apart. The thin-film components include two 50-ohm microwave terminations, four bypass capacitors, and four distributed RC components. The quarter wave line in the base circuit, collector inductor, and all conductors are copper-plated for low loss. One conductor of each coupler is on a separate smaller ceramic which is applied to the amplifier board during final assembly. Holes are provided in the substrate to position the transistors, which are soldered to the circuit. The transistors and coupler ceramics are epoxy-bonded to the main substrate. Gold-plated beryllium copper springs and bellows provide bias and grounding connections and also support the amplifier in its enclosure.

A significant feature of the design is that no tuning adjustments are required. The base capacitor and collector inductor were chosen to match the average transistor to the circuit.

One side of the 1.5-in. square amplifier substrate is glazed to provide a smooth surface, which is necessary for high-quality film components. The board is first covered with reactively sputtered tantalum nitride film with a resistivity of 15 ohms per square and thin layers of chromium and gold. The conductor pattern and resistor and capacitor areas are then defined by photoresist techniques and selective etching.

Electrolytic anodization is employed to trim the resistors to their final value and to form a thin layer of Ta₂O₅ dielectric on the capacitor electrodes. The conductor areas are then electroplated with copper to a thickness of 0.4 mil, which is equivalent to several skin depths at 4 Gc. Vapor deposition of one SiO dielectric and the gold counter-electrodes of the capacitors completes the thin-film process. Final assembly includes the attachment of transistors, coupler ceramics, and grounding springs.

The single-stage amplifiers typically have gains of 2.5 db to 3.5 db at 4 Gc with a variation of about 0.5 db over the 3.7-Gc to 4.2-Gc band. The input and output vswr values are typically less than 1.25 over this band.

Four single-stage units were assembled into a four-stage amplifier that gave 12 db of gain at 4 Gc and was flat to within ± 0.5 db over the 3.7 to 4.2 Gc band. The reverse loss was greater than 45 db over this band. No gain compression was evident at an output power level of 0 dbm. Increasing the output level to +10 dbm resulted in a decrease in gain of 0.5 db.

The best measured noise figure of a single-stage amplifier was below 6 db, with a gain of 3 db. This implies that multistage high-gain amplifiers with noise figures of about 8 db are possible with this design.

The transistors are experimental germanium planar devices mounted in an "inverted R" package. The maximum available gain is typically 4 db at 4 Gc with an emitter current of 5 to 10 milliamperes and a collector-to-emitter voltage of 6 volts.

The amplifier represents the first practical transistor amplifier developed for use above 3 Gc and also represents the first application of

Precision you can trust, because it's built in.

**±50 ppm TC.
1/2% and 1% tolerances.
<0.5% load-life ΔR guaranteed.
Mil-R-10509E, Char. C.**

New CORNING® NC-style Resistors.

NC4—1/10 watt at 125° C., 49.9 ohms to 150K

NC5—1/8 watt at 125° C., 49.9 ohms to 499K

NC6—1/4 watt at 125° C., 49.9 ohms to 1 Meg.

True precision resistors with all the long-term reliability you've come to expect from CORNING glass-tin oxide film. And not just tested into some. Nor sorted out of many.

But precision that's built in... in a continuous manufacturing process that provides the highest inherent reliability of any resistor made today. Here's how:

The tin oxide film is bonded *molecularly* to a glass cane substrate at red heat... it isn't plastered on, or sputtered on.

Temperature coefficient of film and substrate match perfectly.

The substrate is chemically inert to the film. Once cooled, the film compares in hardness to high-carbon tool steel... you can't scrape it off.

We make CORNING NC-styles with these materials and this technique to guarantee you constant resistivity, constant quality... precision that's built in.

Call your CORNING distributor for technical data and samples or send the coupon today. Evaluate the new NC-styles, and see how their built-in precision gives you new design confidence.

CORNING GLASS WORKS, 3913 Electronics Dr., Raleigh, N.C.

Please send me new NC-style Resistors data and samples.

Name..... Title.....

Company.....

Address.....

City..... State..... Zip.....

CORNING
ELECTRONICS

"bugged" BY A PRINTED CIRCUIT PRODUCTION PROBLEM?

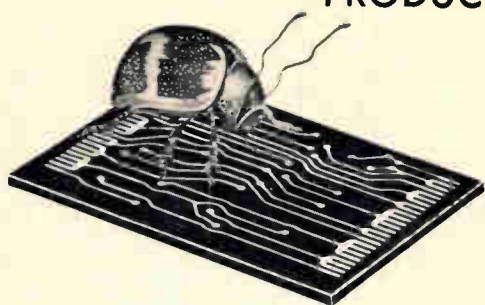

BRING IT TO CHEMCUT

Whether it's a microminiature or mammoth board, Chemcut has the spray etcher to produce it for you—accurately and economically. Chemcut, the pioneer and leader in the spray etching field, has units ranging in size from laboratory models to fully automatic, conveyorized systems for high volume production. (Model 502 horizontal, conveyorized etcher is shown at left.) Also available is a complete line of Chemcut equipment for printing, developing, resist removal and other auxiliary functions. There are over 1800 units in use throughout the world. One that will fill your production needs is available through your nearby Chemcut distributor.



HOW ABOUT PART PRODUCTION?

With continued emphasis on miniaturization, manufacturers of electronic devices are finding spray etchers ideally suited to the production of a variety of parts. We welcome the opportunity of exploring your part production problems with you.

CHEMCUT Corporation

500 Science Park,
State College, Pennsylvania 16801.

Circle 212 on reader service card

To order reprints: Fill in, cut out coupon below, insert in envelope and mail to: **Electronics Reprint Dept., 330 W. 42nd Street, New York, N.Y. 10036**

Reprint order form

For listing of reprints available see the **Reader Service Card**.

Computer Time Sharing

Send me reprints of Key no. R-86 at 50¢ each.

For reprints of previous special reports fill in below:

Send me reprints of Key No.(s) @¢ each.

(For prices, see Reader Service Card)

Name

Number of street

City, State, Zip Code

Technical Abstracts

tantalum thin-film integrated circuitry for use above 1.5 Gc.

Presented at the 1966 International Solid State Circuits Conference, Philadelphia, Feb. 9 to 11.

Avalanche-diode noise

Potential applications and the noise problem in the Read avalanche diode
Marion Hines
Microwave Associates, Inc.
Burlington, Mass.

Noise in Read and other avalanche transit-time (ATT) microwave generators is very large compared with that of klystrons, crystal-controlled harmonic generators, or tunnel diode oscillators. Noise of about 40 db has been measured in low-level, ATT amplifiers with about a 10-db gain. The noise problem is important because it will limit the number of possible applications of ATT diodes. A partial solution to this problem is the use of a high-Q—2,000 to 3,000—transmission cavity. For example, at a frequency of 10 Gc, a power output of 10 mw, and a Q of 100, noise should be 90 db and the linewidth 35 cps. F-m noise deviation would be 3,360 cps (rms). Under similar conditions, with Q increased to 1,000, noise should be 99.6 db and linewidth 0.35 cps. F-m noise deviation would be 336 cps (rms). Thus, increasing the Q from 100 to 1,000 improves amplitude noise by 9.6 db, f-m deviation by 20 db and linewidth by 40 db.

By carefully choosing device parameters, improved performance and reduced noise are possible, but the use of stable local oscillator (stalo) techniques is expected to be most effective for reducing noise. However, such techniques will severely limit the electronic tuning range of ATT devices.

The author indicates potential applications for Read and related structures as receiver local oscillators in pulsed and doppler radar, and in f-m communications. They might also be suitable for sweep frequency sources and bench oscillators, but as low-noise amplifiers, ATT diodes cannot be used.

Presented at the 1966 International Solid State Circuits Conference, Philadelphia, Feb. 9-11.

DIRECT LINE

to classified
advertising results.
Call the McGraw-Hill
office nearest you.

404-875-0523
1375 Peachtree St., N.E.
Atlanta 30309

617-262-1160
607 Boylston St.
Boston 02116

312-664-5800
645 N. Michigan Ave.
Chicago 60611

216-781-7000
55 Public Square
Cleveland 44113

214-747-9721
1800 Republic
Nat'l Bank Tower
Dallas 75201

303-255-2981
1700 Broadway
Denver 80202

313-962-1793
856 Penobscot Bldg.
Detroit 48226

713-224-8381
2270 Humble Bldg.
Houston 77002

213-482-5450
1125 W. 6th St.
Los Angeles 90017

212-971-3594
500 Fifth Ave.
New York 10036

215-568-6161
Six Penn Center Plaza
Philadelphia 19103

412-391-1314
4 Gateway Center
Pittsburgh 15222

314-725-7285
Clayton Tower
7751 Carondelet Ave.
St. Louis 63105

415-362-4600
255 California St.
San Francisco 94111



Career Opportunities for Engineers, Physicists

Rapid progress in advanced nuclear reactor, linear accelerator and electromagnetic pulse technology at General Atomic Division of General Dynamics has created several career opportunities for electrical and electronic engineers and physicists. Here you will work in a creative atmosphere conducive to maximum development of your capabilities. The San Diego climate is one of the best in the world. Nearby academic facilities provide opportunity for graduate work. Immediate requirements include the following:

SENIOR ELECTRICAL ENGINEER

Lead development programs to advance state-of-the-art in MAGNEFORM® electromagnetic pulse forming technology. General Atomic Division is developing and marketing the revolutionary MAGNEFORM commercial manufacturing machines for the assembly and forming of metal parts using electro-magnetic pulses. Advanced studies and technical project planning. MS/PhD EE, Physics, and at least 8 years' experience, including creative application of basic EM theory in the design or development of machinery and components.

ELECTRICAL ENGINEERS

Design of control and other circuitry in field of electromagnetic pulse technology — MAGNEFORM. BS/MS EE, 2-3 years' product-oriented experience.

EXPERIMENTAL PHYSICIST

Determine radiation vulnerability and develop hardening techniques for solid state circuits and systems. MS/PhD with sound foundation and experience in solid state circuitry design and analysis.

EXPERIMENTAL PHYSICIST

Perform research in solid state physics and radiation effects. MS/PhD.

ELECTRICAL ENGINEER

For linear accelerator operations. Will be responsible for maintenance and new development at LINAC. Intensive development experience in high power pulse modulators, control systems, high voltage power supplies or high power radar transmitter.

ELECTRONIC ENGINEERS

For analysis and experiments leading toward development of radiation-hardened circuits and systems. Should be experienced either in radiation effects analysis, experiments or design of military electronic systems. EE or Physics degree.

CONTROL AND INSTRUMENTATION ENGINEER

Apply commercial instruments to the measurement and control of turbo-machinery and/or nuclear power plants, conceive control and safety systems, sketch P/I and logic diagrams and prepare instrument procurement specifications. BS ME, ChE, or EE and 2-5 years' experience.

If these kinds of challenging assignments appeal to you, apply for a career position with General Atomic Division. Send your resume in confidence to Manager of Employment, Dept. 43 — P. O. Box 608, San Diego, California 92112. An Equal Opportunity Employer M/F

GENERAL DYNAMICS
General Atomic Division

QUALIFICATION FORM FOR POSITIONS AVAILABLE

ATTENTION: ENGINEERS, SCIENTISTS, PHYSICISTS

This Qualification Form is designed to help you advance in the electronics industry. It is unique and compact. Designed with the assistance of professional personnel management, it isolates specific experience in electronics and deals only in essential background information. The advertisers listed here are seeking professional experience. Fill in the Qualification Form below. **STRICTLY CONFIDENTIAL:** Your Qualification form will be handled as "Strictly Confidential" by Electronics. Our processing system is such that your form will be forwarded within 24 hours to the proper executives in the companies you select. You will be contacted at your home by the interested companies.

WHAT TO DO. (1.) Review the positions in the advertisements. (2.) Select those for which you qualify. (3.) Notice the key numbers. (4.) Circle the corresponding key number below the Qualification Form. (5.) Fill out the form completely. Please print clearly. (6.) Mail to: Classified Advtg. Div., Electronics, Box 12, N. Y. 10036.

COMPANY	Page #	KEY #
ABBOTT'S OF BOSTON	282*	1
AMPEX CORP.	292*	2
ATOMIC PERSONNEL INC.	288*	3
BAUSCH & LOMB	290*	4
BOOZ ALLEN APPLIED RESEARCH INC.	290*	5
DEPARTMENT OF THE NAVY U.S. Navy Bureau of Ships	217	6
DOUGLAS AIRCRAFT Missiles & Space Div.	310*	7
ELECTRO-MECHANICAL RESEARCH INC.	291*	8
GENERAL DYNAMICS Electronics Division	215	9
GENERAL DYNAMICS Fort Worth Division	130	10

GENERAL DYNAMICS General Atomic Division	213	11
GENERAL ELECTRIC CO.	216	12
GENERAL MOTORS CORP. Delco Radio Div.	134	13
INTERNATIONAL BUSINESS MACHINES	164	14
KAISER ENGINEERS	214	15
KING WHITNEY, JR.	288*	16
KOLLSMAN INSTRUMENT CORP.	287*	17
LAWRENCE RADIATION LABORATORY	288*	18
LOCKHEED CALIFORNIA CO.	126	19
LOCKHEED MISSILES & SPACE CO.	162	20
MITRE CORP.	309*	21
PHILADELPHIA NAVAL SHIPYARD	288*	22
SANDERS ASSOCIATES INC.	289*	23
TELEDYNE INDUSTRIES Geotech Div.	218*	24
UNITED CONTROL	286	25
U.S. NAVY Navy Overseas Employment Office		29
XEROX CORP.	272-273*	26
P 8687	291*	27
P 8692	288*	28

*These advertisements appeared in the March 7th issue.

PERSONAL BACKGROUND

Name
 Home Address
 City Zone State
 Home Telephone

EDUCATION

Professional Degree(s)
 Major(s)
 University
 Date(s)

FIELDS OF EXPERIENCE (Please Check) 3/21/66

- | | |
|--|---|
| <input type="checkbox"/> Aerospace | <input type="checkbox"/> Medicine |
| <input type="checkbox"/> Antennas | <input type="checkbox"/> Microwave |
| <input type="checkbox"/> ASW | <input type="checkbox"/> Navigation |
| <input type="checkbox"/> Circuits | <input type="checkbox"/> Operation Research |
| <input type="checkbox"/> Communications | <input type="checkbox"/> Optics |
| <input type="checkbox"/> Components | <input type="checkbox"/> Packaging |
| <input type="checkbox"/> Computers | <input type="checkbox"/> Radar |
| <input type="checkbox"/> ECM | <input type="checkbox"/> Radio-TV |
| <input type="checkbox"/> Electron Tubes | <input type="checkbox"/> Simulators |
| <input type="checkbox"/> Engineering Writing | <input type="checkbox"/> Solid State |
| <input type="checkbox"/> Fire Control | <input type="checkbox"/> Telemetry |
| <input type="checkbox"/> Human Factors | <input type="checkbox"/> Transformers |
| <input type="checkbox"/> Infrared | <input type="checkbox"/> Other |
| <input type="checkbox"/> Instrumentation | <input type="checkbox"/> |

CATEGORY OF SPECIALIZATION

Please Indicate number of months experience on proper lines.

	Technical Experience (Months)	Supervisory Experience (Months)
RESEARCH (pure, fundamental, basic)
RESEARCH (Applied)
SYSTEMS (New Concepts)
DEVELOPMENT (Model)
DESIGN (Products)
MANUFACTURING (Product)
FIELD (Service)
SALES (Proposals & Products)

CIRCLE KEY NUMBERS OF ABOVE COMPANIES' POSITIONS THAT INTEREST YOU

1	2	3	4	5	6	7	8	9	10	11	12	13	14	15	16	17	18	19	20	21	22	23	24	25	26	27	28	29
---	---	---	---	---	---	---	---	---	----	----	----	----	----	----	----	----	----	----	----	----	----	----	----	----	----	----	----	----

COMPUTER ENGINEERS

Graduate engineers familiar with computers to develop and implement computer applications in mechanical, civil, electrical and other design disciplines. 2-3 years design experience desirable.

LIBERAL BENEFITS INCLUDE:

- MEDICAL PROGRAM
- LIFE INSURANCE
- RETIREMENT PROGRAM
- SICK LEAVE
- PAID VACATION

Please send detailed resume including salary requirements to:

KAISER ENGINEERS

300 Lakeside Drive, Oakland, California

An Equal Opportunity Employer

YOU'RE H!RED

Do you need electronics engineers or technical management men? Electronics magazine is the way to recruit them. Electronics is designed specifically for the working engineer. 68,000 subscribers and an additional 133,000 pass-along readers turn to it to keep up with their industry. You can find the man that meets your qualifications with an advertisement in the Employment Opportunities Section.

For rates & information write: Electronics, a McGraw-Hill Publication. Classified Advertising Division, Post Office Box 12, New York 10036.

When it comes to talking down to misguided submarines, our systems engineers speak with unprecedented authority.

(Are you reading us?)

When it comes to the proliferating activities of our ASW Laboratory, the systems engineers concerned not only have a great deal that's unique to say, they have a great deal of say so!

Coming up with the authoritative answer is bound to be easier when, like our ASW systems people, you enjoy the services of three separate transducer departments—Hydroacoustics, Electroacoustics and Special Development—each with its own technical facilities and staff. This is particularly true when your facilities include items like a half-million gallon test tank 48 feet in diameter and instrumented to the hilt, on the premises. And on a nearby lake—600 feet deep and ice free—a completely instrumented, self-propelled, 165-foot barge capable of testing transducers that weigh up to 35 tons.

Among the newest and most intriguing programs you might find yourself working on are: an advanced marker/launcher system for USW; an advanced integrated sonar system for surface ships; and the use of special hydroacoustic sources for deep submergence sonar.

With all this, if you get the impression that we are profoundly and permanently committed to an ever expanding ASW program, you are 100% right.

This is *not* to say we aren't also expanding our other activities—study and development programs in AGE, radio communications, data equipment, reconnaissance & countermeasures, space communications & navigation aids, and tracking systems—we are.

Briefly our roster of openings includes opportunities in sonar systems analysis and integration, signal processing, digital logic, acoustic systems, transducer/amplifiers, TACAN, electrical design for receivers, transmitters & displays, high power linear amplifier design, SSB equipment, input-output devices, MODEMS and equipment packaging.

Direct your resume, in confidence, to Mr. L.A. Corwin, Dept. 113.

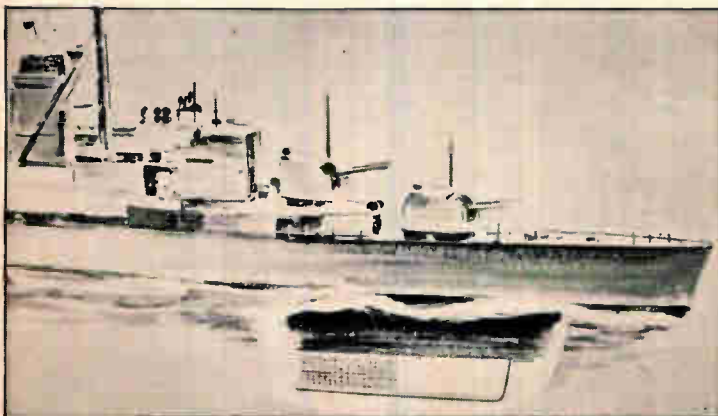

GENERAL DYNAMICS *Electronics Division*

1400 N. Goodman St. Rochester, New York 14601
An Equal Opportunity Employer, M&F



**CONSUMER
ELECTRONICS
OPPORTUNITIES**

TV / CRT ENGINEERING AND MANUFACTURING

G.E.'S TELEVISION RECEIVER DEPARTMENT OFFERS YOU:

- **A variety of career openings in professional engineering**
- **A chance to couple your personal progress with our long-range business growth**
- **Full G.E. benefits — including advanced education and stock/savings plan**
- **A good place to live and work in Syracuse, N. Y. or Portsmouth, Va.**

■ **At Television Receiver Department, you'll be part of General Electric's broadly diversified consumer electronics business—contributing professionally to a growth curve that's on a steep upswing. We've always tried to encourage innovation, and it's paying off in new designs like our new Porta-color TV; our battery portable; the 12" personal portable, (plus a lot of other things due soon or a long way out that you'll be in the thick of). G.E. benefits are liberal—up to four weeks vacation, pension, insurance, and include a Savings and Security plan where the Company matches half your savings. TVR is headquartered at beautiful Electronics Park in Syracuse—a campus-like electronics center near one of Upstate New York's most progressive cities. And a positive indication of growth: our new plant in Portsmouth, Va. (right on the seashore ½ hour from Virginia Beach.)**

■ **REVIEW THIS PARTIAL LIST OF OPENINGS.** ■ **Signal Circuit Design:** conceive, develop and apply signal processing circuits to development of monochrome and color TV. ■ **Deflection Circuit Design:** develop deflection and convergence circuits for TV receivers. Requires experience in design of deflection yokes and related magnetic deflection components. ■ **Mechanical Product Design:** requires 2-4 years experience in consumer electro-mechanical product design and packaging. ■ **Component Design and/or Application:** conceive, design and apply electronic components for monochrome and color TV receivers. Needs 2-4 years component design or application experience. ■ **TV QC, Process Control and Mfg. Engineering:** establish, plan and attain QC programs. Apply QC principles to engineering design; develop plan; determine quality capabilities methods, testing, evaluating; analyze failure data; recommend action. BSEE plus QC or TV production ■ **CRT Design, Mfg, Process and Quality Control Engineering:** Design and develop cathode ray tube products for both monochrome and color, including element, materials application, mfg. techniques, and QC. 2-10 years related experience needed.

■ **FOR MORE INFORMATION, OR TO ARRANGE A PERSONAL INTERVIEW,** send a resume in confidence to Mr. M. H. FitzGibbons, Television Receiver Dept., Box 119, General Electric Co., Electronics Park, Syracuse, N. Y. 13201. An Equal Opportunity Employer (M/F)

231-12

GENERAL  ELECTRIC

In electronics it's Electronics magazine to sell used equipment!

Your advertisement will produce Results in Electronics. Engineers turn to Electronics magazine for the latest technical developments — and for the latest buying information. You can reach them inexpensively in Electronics Searchlight Section.

For information:
Searchlight Section
Classified Advertising Division
Post Office Box 12
New York 10036



POSITION VACANT

Instructors wanted in the field of Electronics and Radio-Television servicing. Age open—salary open—must possess a college degree or equivalent. Preference will be given to individuals with an EE Degree with Electronics option. Year round employment in South-eastern United States—excellent opportunity in growing institution. Send complete resume of education, personal data, and experience to Robert E. Paap, President, Catawba Valley Technical Institute, Hickory, North Carolina.

CLASSIFIED ADVERTISING
 **SEARCHLIGHT SECTION**
 BUSINESS OPPORTUNITIES
 USED OR SURPLUS EQUIPMENT

free catalog
POTTING APPLICATORS
MANUAL AND DISPOSABLE
 6cc 12cc 30cc
 FOR POTTING, ENCAPSULATING, AND
 SEALING OF MINIATURE COMPONENTS
 PHILIP FISHMAN COMPANY
 7 CAMERON ST., WELLESLEY 01, MASSACHUSETTS

CIRCLE 951 ON READER SERVICE CARD

SURPLUS
 Field Telephone Set Two-Way Telephone communication or signaling to multiple stations. Range, 2 miles. Utilizes standard connecting telephone line—Features: Local or remote control. Battery powered. AN/GRA-6
MONMOUTH ELECTRIC CO., INC.
 1805 Corliss Ave. Neptune, N. J.
 Phone—201-776-5300

CIRCLE 952 ON READER SERVICE CARD

SEMICONDUCTORS
MAJOR BRANDS
 INTEGRATED CIRCUITS • DIF. AMPS DARLINGTONS • POWER DIODES & TRANSISTORS
 • SPECIAL DEVICES
 Write for Catalog S-1
SEMICONDUCTOR SALES OF CALIF.
 1063 Perry Annex Whittier, Calif.
 (213) 696-7544

CIRCLE 953 ON READER SERVICE CARD

FREE M.I.T. Radiation Series Index Vol. 28—Hard covers—orig. Price \$4.50. Send only 50¢ handling/postage expense. Also, FREE Catalog of outstanding hard cover physics/electronics books at greatly reduced prices.
BOSTON TECHNICAL PUBLISHERS, INC.
 Box 111E, Central Sq. Cambridge, Mass. 02139

CIRCLE 954 ON READER SERVICE CARD

RADAR AUTO-TRACK & TELEMETRY ANTENNA PEDESTALS 3 & 10 CM. SCR 584 AUTOTRACK RADARS. M-33 RADAR TPS-1D SEARCH. APS-45 TPS-100 HT. FINDERS. WX RADARS. FPN-32GCA. APS-10 APS-15B APS-27 (AMT) SEARCH. ■ ■ ■ APN-102 DOPPLER. DOZENS MORE. CARCINOTRONS. PPN'S. 25.5-1-23-6 MEGAWATT PULSE MODULATORS. CAVITIES. PULSE TRANSFORMERS. IF STRIPS. WAVEGUIDE. BENDS 200 MC. 1 KMC. 3 KMC. 6 KMC. 9 KMC. 24 KMC. RF PKGS.
RADIO RESEARCH INSTRUMENT CO.
 550 5TH AVE., NEW YORK 36, N. Y. JU 6-4691

CIRCLE 955 ON READER SERVICE CARD



Advertise in
Electronics Searchlight Section
 for fast results!

engineering management opportunities with U.S. NAVY-BUREAU OF SHIPS in: **ANTI-SUBMARINE WARFARE**

The Navy's high-priority anti-submarine warfare program, involving multi-million dollar contracts with industry, needs qualified engineers for program management involving research, development, testing, evaluation, procurement planning, production, installation and maintenance in these fields:

- SURFACE SHIP, VARIABLE DEPTH AND SUBMARINE SONAR SYSTEMS
- UNDERWATER ACOUSTIC COMMUNICATIONS AND IFF SYSTEMS
- OCEANOGRAPHY ● DIGITAL SIGNAL PROCESSING
 - Transportable Underwater Ocean Area Surveillance Systems
- Acoustic Navigation And Mine Avoidance Equipments
 - Inshore Undersea Warfare Equipment
 - Mine And Torpedo Detection Sonar
- ASW Target Classification ● Transducer Design
- Non-Acoustic Detection of Submerged Submarines
 - Display Engineering ● Systems Analysis

AND OTHER FIELDS: NAVAL ARCHITECTURE; MARINE, ELECTRICAL, ELECTRONIC, MECHANICAL ENGINEERING IN-SHIPS DESIGN, CONSTRUCTION AND MAINTENANCE; MACHINERY DESIGN; RADAR, COMMUNICATIONS, TEST EQUIPMENT, QUALITY ASSURANCE & RELIABILITY.

These positions, which are in Washington, D.C., involve travel and considerable contact with industrial organizations. Degree in mechanical or electro/electrical engineering and related experience desirable. Starting salaries range from \$7,987 to \$14,680 depending on experience. Most positions are at \$10,619 and \$12,510. Relocation expenses paid. These are career Civil Service positions with full benefits, regular salary increases.

Send resume or SF-57 to:

Civilian Personnel Division
 Bureau of Ships, Code 263R-07
 Department of the Navy, Room 2435
 Washington, D.C. 20360

An Equal Opportunity Employer

ENGINEERING OPPORTUNITIES IN HAWAII

"THE PARADISE OF THE PACIFIC"

Electronic, Electrical, Marine,
Mechanical, General, Nuclear Power
Engineers and Naval Architects

STARTING SALARIES \$7,987, \$9,267 or \$10,619

Depending on Experience

Plus 15% Tax-Free Cost-of-Living Allowance

Opportunities for professional growth and for exceptionally pleasant living for you and your family are offered by the expansion of the Pearl Harbor Naval Shipyard, the largest industrial organization in the Pacific. The Pearl Harbor Naval Shipyard plays, and will continue to play, a vital role in today's nuclear Navy. The activities of the Yard in ship modification and construction create a broad range of assignments for engineers and naval architects.

Hawaii boasts world-famous beaches, a sub-tropical climate free from unpleasant extremes, and sunshine virtually every day of the year. Shopping facilities, schools, hospitals and other services compare favorably with those on the mainland.

Transportation to Hawaii and back provided for employees and their dependents.

A generous amount of household effects will be shipped at government expense. Transportation for home leave provided if employment agreement is renewed after three years.

These are career Civil Service positions with regular salary increases, generous benefits, liberal retirement plan, and will be filled on an Equal Opportunity basis.

Send resume of professional experience or Standard Form 57 to:

Navy Overseas Employment Office (Pacific)

Federal Office Building, 50 Fulton Street

San Francisco, California 94102



We are expanding our capability to provide analog and digital data acquisition and processing systems in all areas of applied geophysics, marine science, and industrial instrumentation. This growth requires the addition of a number of professional personnel to our staff. We need engineers and scientists with experience in:

GEOPHYSICS

•
STATISTICS

•
OPTICS

•
**MAGNETIC TAPE
RECORDING**

•
**SMALL MECHANISM
DESIGN**

If you think you can become as enthusiastic as we are about the chances for an outstanding future, please send me your qualifications.

Jack H. Hamilton

Vice President, General Manager

**TELEDYNE INDUSTRIES
GEOTECH DIVISION**
DEPT 100, 3401 SHILOH RD,
GARLAND, TEXAS 75040

"Geotech Serves the Sciences"

New Literature

Germanium diodes. Nucleonic Products Co., 3133 E. 12th St., Los Angeles, Calif., 90023. A catalog specification sheet describes miniature glass germanium gold bond diodes and germanium point contact diodes. Circle 420 on reader service card.

Synthesized power zeners. Semiconductor Division of Trio Laboratories, Inc., Dupont St., Plainview, N.Y., offers a two-page technical bulletin illustrating and describing its line of Super/reg synthesized power zener diodes in the very low voltage region. [421]

Coil-winding machine. Associated American Winding Machinery, Inc., 750 St. Ann's Ave., Bronx, N.Y., 10456, has available a two-page bulletin on the Rotawinder Mark IV, a coil-winding machine that employs the automatic transfer principle to reduce winding costs by as much as 80% to 90%. [422]

Precision temperature controls. Metals & Controls Inc., a corporate division of Texas Instruments Incorporated, 34 Forest St., Attleboro, Mass., 02703. The complete line of Klixon electro-mechanical thermal switches and solid state temperature controllers and component ovens is described in bulletin PRET-100. [423]

Telemetry equipment. General Electronic Laboratories, Inc., 1085 Commonwealth Ave., Boston, Mass., 02215. has published a catalog on telemetry receivers, ancillary and accessory equipment for the military, industrial and scientific markets. [424]

Curve resolver. Instrument Products Division, DuPont Co., Wilmington, Del., 19898. An instrument that resolves spectra, chromatograms and other complex analytical data into component peaks is described in bulletin CRB. [425]

Encapsulated batteries. Gulton Industries, Inc., 212 Durham Ave., Metuchen, N.J., 08840, has issued a four-page illustrated brochure on the VO series of encapsulated alkaline batteries. [426]

Glass capacitor test data. Westinghouse Electronic Capacitor Department, Box 130, Irwin, Pa. An eight-page booklet lists a wealth of technical data resulting from various tests on the type CY glass capacitors. [427]

Pressure transducers. Taber Instrument Corp., 107 Goundry St., North Tonawanda, N.Y., has published an illustrated bulletin presenting the latest addition to its Teledyne line of pressure transducers. [428]

Varistors. The Carborundum Co., P.O. Box 339, Niagara Falls, N.Y. A brochure on varistors includes characteristics,

applications, and complete physical and electrical specifications. [429]

Component testing. Teradyne, Inc., 87 Summer St., Boston, Mass., 02110, has available a 32-page, illustrated booklet entitled "Automatic Test Instruments for Electronic Components." [430]

Ferrite core memories. Electronic Engineering Co. of California, 1601 E. Chestnut Ave., Santa Ana, Calif., 92702. Random access, sequential access, and sequential interlace ferrite core memories are described in a four-page, technical data sheet. [431]

Plug-in power supply. Acopian Corp., Easton, Pa. A four-page brochure discusses the Pow-A-Meter, an adjustable plug-in power supply with its own voltmeter. [432]

Quartz crystal units. Reeves-Hoffman Division of Dynamics Corp. of America, 400 W. North St., Carlisle, Pa., 17013. Bulletin QX65 describes and illustrates steps in manufacturing from raw quartz to finished crystal units for filters and oscillators. [433]

Magnetic tape heads. Michigan Magnetics, Inc., Vermontville, Mich., 49096, has issued a 10-page catalog covering a complete line of its mass-produced tape recording heads. [434]

Traveling-wave-tube amplifier. Watkins-Johnson Co., 3333 Hillview Ave., Stanford Industrial Park, Palo Alto, Calif., 94304, has available a technical bulletin on a 2.2 to 2.3 Gc, low-noise, permanent-magnet twt amplifier with integral power supply. [435]

Advanced communications systems. Fairchild Hiller Corp., 5006 Jackson St., Bladensburg, Md., 20710, offers an eight-page brochure entitled "Advanced Communications Systems." [436]

I-f amplifier microcircuit. Microtek-Electronics Inc., 138 Alewife Brook Parkway, Cambridge, Mass., has published a data sheet on a thick-film hybrid microcircuit that contains all of the non-selective elements of a linear i-f amplifier stage with provision for agc. [437]

Medium-power transmitting capacitors. Electronic Products Division of Corning Glass Works, Raleigh, N.C. Reference file CE-1.03 illustrates and describes glass-dielectric, medium-power transmitting capacitors. [438]

Portable instrumentation recorder. KRS Instruments, division of Datapulse Inc., 780 S. Arroyo Parkway, Pasadena, Calif., 91105. Complete specifications for a programable, multicartridge portable data recorder are provided in technical bulletin DR-2. [439]

What's in it for you when
you order **SILICON
SLICES** and **EPITAXIAL
SLICES** from the nation's
Number 1 specialist?



**CONSISTENT
QUALITY,
CONSISTENT
ECONOMY,
FASTEST
DELIVERY**

And the most complete line in Crystals and Slices...as sliced, lapped, etched, polished, diced and epitaxial in N/N+, P/P+, multilayer, oxidized. Top source for Germanium, too.

You can safely (and profitably) lower your own inventory when you order from Semimetals.

Try us and see for yourself.



SEMIMETALS, INC.
172 Spruce Street

Westbury, L.I., N.Y. 516-333-8400

CIRCUIT CONTROL AND PROTECTION BY AIRPAX

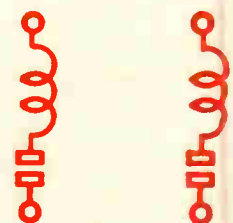
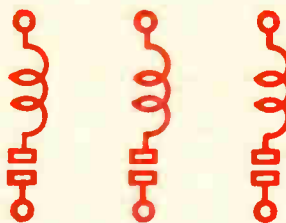
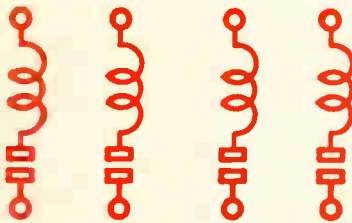
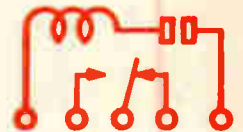
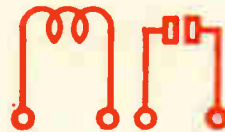
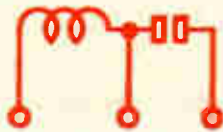
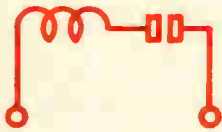
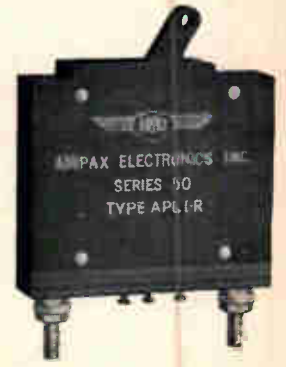

TYPE APL1 IS UNDERWRITERS' LABORATORY RECOGNIZED FOR APPLIANCE PROTECTION. 20A, 50V 15A, 115V 7.5A, 240V

COMPLETELY MAGNETIC TIME DELAY AND TRIP. CONTAINS NO HEATING ELEMENTS.

AVAILABLE 50 MA TO 50 AMPERES AC OR DC. 50, 60 AND 400 CYCLES.

TRIP TIME IN SECONDS vs. PERCENT OF RATED CURRENT

	100%	125%	200%	400%	800%	1000%
Delay 60	No Trip	.120 max.	.035 max.	.030 max.	.020 max.	.018 max.
Delay 61	No Trip	1.0 - 6.0	.240 - .800	.040 - .180	.012 - .050	.010 - .040
Delay 62	No Trip	15.0 - 70.0	3.0 - 9.0	.30 - 1.50	.018 - .080	.010 - .040

AIRPAX ELECTRONICS incorporated
Cambridge, Maryland
(301) 228-4600

AIRPAX ELECTRONICS incorporated
Ft. Lauderdale, Fla.
(305) 587-1100

AIRPAX ELECTRONICS incorporated
Van Nuys, Calif.
(213) 781-2821

AIRPAX ELECTRONICS incorporated Cambridge Division, Cambridge, Maryland

Great Britain

Thin-film, color-tv camera

Thin films almost certainly will mean a thick slice of the U. S. color television camera market for the Marconi Co., Ltd., of England.

Marconi will demonstrate its four-tube camera with thin-film circuits for the first time in the United States next week at the National Association of Broadcasters' convention in Chicago. But enough broadcasters have seen—and liked—the camera in Britain over the past few months that the company already has a fat backlog of more than 180 orders, more than half from the U. S.

For Marconi, there's no mystery about why the sheaf of orders has grown so thick so fast. Sixty-five thin-film modules make the camera so stable that engineering adjustments are needed only once a day even though there are four channels to keep matched. That amounts to "hands off" operation except for studio artistic controls like iris opening, black level, and gain.

Registered colors. The four-tube approach makes color registration less critical because the black-and-white luminance signal doesn't have to be pulled out of the color signals as in three-tube cameras. Incoming light is split up by a prism behind the field lens. The prism beams part of the light onto the luminance tube; the remainder is split into red, green and blue components by dichroic surfaces on the prism and each component is transmitted to the associated tube. For monochrome operations, the prism can be set so all the light passes to the luminance tube.

What's more, the tubes used in the camera are Plumbicons, notable for their ability to work with relatively little light. With an iris aperture of $f/4$, good color images can be picked up at light levels down to 30 foot-candles. This is well be-

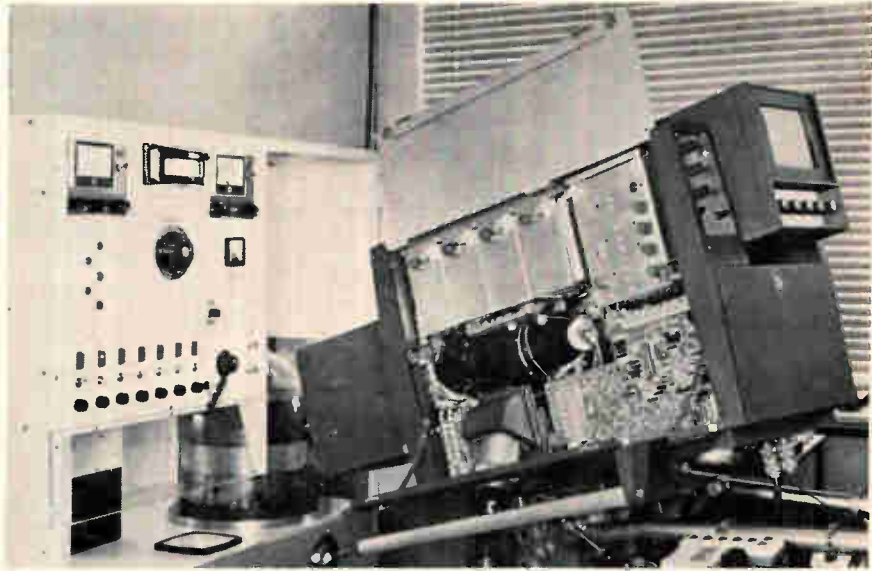

Thin-film circuits produced by Marconi Co., Ltd., of England are key to high stability of the company's new color-tv camera.

low the acceptable level for image-orthicon tubes.

The Plumbicon tube was developed by Philips Gloeilampenfabrieken N.V. of the Netherlands. It uses a photoconductive layer of lead monoxide instead of the antimony sulfide or selenium normally found in a vidicon tube. The North American Philips Co., an affiliate, was first on the market with a camera using Plumbicons, and Radio Corp. of America has a four-tube camera [Electronics, April 5, 1965, p. 29]; but Marconi is the first to combine a four-tube camera and Plumbicons.

Inside job. In its design studies for the "hands off" color-tv camera, Marconi found it would need resistors and capacitors with temperature coefficients in the order of 15 parts per million per degree centigrade to obtain high enough camera stability. Thin-film components were the answer. But in a shopping tour around British components makers, Marconi turned up no one who could meet its tight specifications in production quantities. So Marconi makes its own.

The company developed a once-through process to turn out the

eight different types of thin-film circuit modules used in the camera. The circuits are built up three at a time in five stages of deposition without breaking the vacuum. This rules out contamination during fabrication and largely because of this, Marconi gets yields better than 70%.

The process starts with a chemical cleaning of the glass substrate, followed by ionic cleaning under vacuum. Then nichrome resistor patterns are deposited on the substrate through masks carried by a turret. After this stage, the turret moves a new mask over the substrates and nichrome gold connections are put down.

After the resistors come the capacitors. First aluminum is deposited to form the lower electrodes. A silicon oxide deposit follows; it forms the capacitor dielectric and at the same time gives the resistors a protective covering. Then the upper capacitor electrodes are deposited. Finally, the whole thin-film circuit is covered with a protective layer before the vacuum is released.

The circuits are made into modules by adding active components

and then potting the units.

Using this once-through process, Marconi turns out resistors with values from 50 ohms to 50 kilohms. Range for capacitors is 10 picofarads to 0.01 microfarad. Both resistance and capacitor values are monitored during depositing, which stops when the right value is reached. The tolerances on value run around 5%, but 2.5% is possible for key components. Above all, temperature coefficients are well within the 15 ppm/C° Marconi needs for camera stability.

Color them happy

Television set and component makers dropped their traditional British reserve this month after Postmaster General Anthony Wedgewood Benn set a late-1967 date for starting color television broadcasts in Great Britain. The industry, its black and white market saturated, waxed jubilant even though the date is more than 18 months off and live color programming at the outset will be a scant four hours a week. Said one executive, "It's the first bit of reasonable news the industry has had for a year."

According to government estimates, the number of color sets in operation at the end of the first two years of broadcasting should run close to 150,000. Over the first four years, the market estimate is a total of \$280 million. The sets will cost about \$700 each initially.

As expected, Wedgewood Benn confirmed that Britain planned to adopt the PAL system and a 625-line standard for its color broadcasts. PAL is a West German development, an offshoot of the National Television Standards Committee (NTSC) system used for color broadcasting in the United States and Japan.

There is, however, one slight string attached to the British decision to go ahead with PAL. The International Radio Consultative Committee (CCIR) will meet next June in Oslo in a last try for an agreement on a common color-tv system for Europe. Along with PAL, the other serious contender is the French Secam system.

With Britain and West Germany solidly in the PAL camp and the French—backed by the Eastern bloc countries—holding out steadfastly for Secam, a deadlock seems inevitable. If Secam, contrary to expectations, does get the nod, Britain of course would use that system.

This slight hitch doesn't particularly trouble the industry. The firm decision to start color broadcasts already has caused tube and receiver makers to revise their plans.

Mullard Ltd., for example, has had a pilot shadow mask tube production line for some time. But earlier this year the company turned down a \$5.6 million order from U. S. set makers for color tubes. With no home market to count on at the time, Mullard couldn't see its way clear to a major investment in a production plant. With color tv now around the corner in Britain, the company is moving ahead with plans for production capacity of 100,000 tubes a year.

West Germany

Place in space

The Apollo project to put a man on the moon by the end of the decade may turn out to be a boon for the fledgling West German aerospace industry. Because of heavy spending for Apollo, the National Aeronautics and Space Administration has less funds for other programs. To stretch them out, NASA is encouraging jointly financed space efforts with European countries and the industry sees a strong possibility of United States-German deep-space missions.

Already the West Germans have singled out what might be their place in deep space—probes at Jupiter. In fact, preliminary work on Jupiter probes financed by the ministry for scientific research has been completed.

Boelkow GmbH of Munich checked into three types of probes ranging from 770 pounds to several

tons. Along with calculations on flying time and the fly-by program near the planet, Boelkow assessed the requirements for power supplies and control systems as well as radio communication and data transmission systems.

The company hopes that with U. S. help a German-built probe could be launched by 1973. According to the Boelkow timetable, flight analysis and spacecraft design would take about two years. Development work could begin in 1968.

Another candidate for Jupiter probes is Development Group North, a joint venture of Verinigte Flugtechnische Werke GmbH and Hamburger Flugzeugbau GmbH. The group wants to develop a 1,430-pound probe with a scientific payload of 220 pounds. The experiment package for a fly-by mission would include a television camera. Flight time along a 720-billion-mile path would be about 850 days.

Satellite first. If a Jupiter project jells, it will be the second joint space effort by the U. S. and West Germany. For the next peak period of solar flare activity in 1968 the Germans have scheduled a launching of a small scientific satellite with a NASA Scout Booster at the U. S. Air Force Western Test Range.

Boelkow looks like the leading contender for the prime contract, but much of the work will be farmed out to other companies to spread space know-how as widely as possible through the industry.

Boelkow's latest version of the satellite, the 625-A1, calls for a lighter overall weight and payload than the first design [Electronics, Mar. 22, 1965, p. 185] although the mission remains the same—measure concentration and energy spectra of protons and electrons within the earth's inner radiation belts. The 625-A1 design specifies a 132-pound vehicle 30 inches in diameter and 46 inches high. Its scientific payload would weigh 26.4 pounds.

The satellite would have two transmitters, one for tracking and direct data transmission, the other for transmitting stored data. Data flow would be 40 bits per second.

Japan

Making waves

In their bid for world leadership in solid state microwave hardware, the Japanese have diodes as trumps. Already Esaki diodes and Kita diodes are at work in Japan's microwave link network—the densest anywhere. Now the Mizuno diode [Electronics, Feb. 21, 1966, p. 25] seems likely to strengthen the Japanese hand in years to come.

The diode, made of germanium, generates millimeter waves when biased in the reverse-breakdown region. In experiments so far, it has been operated in a pulsed mode at frequencies up to 90 gigacycles, with outputs close to 10 milliwatts in the 10 to 20 Gc range. Key to the oscillation is a highly doped pn junction with impurity concentration well above the 10^{15} atoms per cubic centimeter found in commercial germanium diodes.

The mechanism by which it oscillates has yet to be fully explained, but the new diode can't be classed as a lucky accident. Hiroyuki Mizuno, who spearheaded the development, believed that a millimeter-wave oscillator could be obtained with a semiconductor equivalent of a klystron, where high-frequency operation is made possible through velocity modulation of the electron stream. Mizuno leads a research group working in the laboratories of the Matsushita Electronics Corp. Matsushita is a joint venture of Matsushita Electric Industrial Co. of Japan and Philips Gloeilampenfabrieken N.V. of the Netherlands.

But Mizuno reasoned it couldn't be done with a transistor. Interaction between the semiconductor lattice and the current carriers is far greater than the interaction among the carriers themselves in a transistor. For velocity modulation effects, hot electrons are necessary; their temperature, or speed, is high enough for carrier-carrier interaction to predominate over carrier-lattice interaction.

Hot carriers. In the Mizuno diode, the highly doped pn junction

injects hot carriers into the bulk semiconductor, where they interact. When an input pulse biases the diode, the carriers tunnel and the diode breaks down, triggering the oscillation. The output pulse lags the input pulse by about one microsecond. For the higher frequencies Mizuno has obtained, breakdown voltage was well below 20 volts, the level where avalanche breakdown begins. In avalanche breakdown, the current carriers col-



Hiroyuki Mizuno leads research group that developed a millimeter-wave germanium diode.

lide with lattice electrons and the ionization that results multiplies the number of carriers.

Mizuno's tunneling germanium diode differs in two major respects from Bell Telephone Laboratories' microwave diode [Electronics, Nov. 1, 1965, p. 24]. Bell's is silicon and it operates by avalanche breakdown.

These differences, Mizuno thinks, may give his diode the edge over silicon microwave diodes. Theoretically, tunneling is less noisy than avalanche breakdown so the signal-to-noise ratio should be inherently higher. Based on experience with transistors, the germanium diodes probably can be pushed to higher frequencies than silicon diodes. The 90-Gc top frequency recorded by Mizuno's group was the upper limit of its test gear and not necessarily the diode's.

But with germanium there is a major obstacle—heat dissipation—to overcome before Mizuno's group can achieve continuous wave oscillation. Silicon has better heat conductivity and this makes heat dissipation easier. The Nippon Electric Co., another entrant in the international race to develop a commercial solid state oscillator, already has solved a heat-removal problem with a special cartridge mount for its gallium-arsenide Gunn-effect oscillator [Electronics, Nov. 1, 1965, p. 157].

Soviet Union

Touch of Venus

Soviet scientists still haven't written off Venus 2, the spacecraft that went dead last month as it sped past its namesake planet at a distance of 15,000 miles.

Although they haven't revealed how, the Russians say they hope to get Venus 2 back on the air again. They want to retrieve close-up television pictures and scientific data stored on board.

So far, no one has managed to revive a blacked-out interplanetary spacecraft. If the Soviets can turn the trick, they'll have another impressive first in space electronics, especially if they "repair" Venus 2 by bypassing a faulty command circuit. The American Telephone and Telegraph Co. did this with its Telstar 1 communications satellite, but with Venus 2 the difference in distance would be astronomical.

Like its sister spacecraft, Venus 3, Venus 2 stopped transmitting as it entered Venus' atmosphere. Just before it went silent, temperature started to rise well above predicted levels. Then when the command signal to switch to automatic research regime was sent, the ship didn't acknowledge. But the Soviets assume that the command signal reached the spacecraft.

Probing. The main experiment in Venus 2 was designed to obtain close-up tv pictures of the planet. The camera was paired with a

special transmitter operating at centimeter wavelength. Venus 3, the probe that steered right onto the planet, also had an experiment package. Its purpose was to take readings like temperature and density on Venus' atmosphere. This package was a 36-inch sphere designed for ejection from the spacecraft. Russian space officials say it had a parachute and a thermal shield.

With the tv pictures and the atmospheric data, the Soviets hoped to unravel part of the mystery surrounding the high temperatures of Venus. They have a hunch the surface is considerably cooler than the 800°F recorded by Mariner 2 as it passed by the planet at a distance of 22,000 miles. Mariner, they believe, picked up the temperature of the outer region of the atmosphere.

Along with the planet experiments, the two Russian Venus probes measured interplanetary magnetic fields and cosmic radiation as they sped through space.

Super steering. Many U. S. spacecraft can perform the same sort of experiments, but they've never been steered with the same precision that put Venus 3 down on the planet about 300 miles from its planned impact point. The landing's timing was just 4 minutes off schedule. Timing was important because the Soviets wanted to have their ground stations facing the planet when the probe hit.

Toughest phase of the inflight steering was the midcourse correction that put Venus 3 on target. Unlike Venus 2, which moved out of its parking orbit headed for the near-miss the Russians aimed at, Venus 3 was on a course that would have missed by 40,000 miles. To put it back on target, a trajectory change accurate to a few minutes of arc was made.

Venus 3 locked on the star Canopus for the correction maneuver. Speed and distance data developed by an onboard Doppler-effect transceiver was fed to several ground computing centers that calculated the angle for the correction jets and the required thrust. Soviet ground stations held 16 radio com-

munications sessions—out of a total of 31 with Venus 3—to pick up the data needed to plan the correction maneuver. More than 1,300 readings of distance, 5,000 of speed, and 7,000 of angle-to-earth were taken before the signal to start the correction was sent.

Pointed. The spacecraft telemetered these and other data to the ground stations through a highly directional parabolic antenna that transmitted at both decimeter and centimeter wavelengths. This antenna locked onto the Earth only during data-sending sessions. To aim it, the spacecraft swung around its sun axis on command from a ground station. For the swing, the orientation system overrode the solar lock that kept the solar-cell panels pointed toward the sun except when the spacecraft transmitted data.

A semidirectional receiving antenna picked up command signals. However, this antenna was designed as a backup transmitting antenna for decimeter wavelengths. The idea was to keep the spacecraft on the air if the orientation system failed and the parabolic antenna thus couldn't be aimed at the earth. The Russians may be counting on the backup antenna as they attempt to reactivate Venus 2.

Belgium

Long haul

Toward the end of the year, barges plying the canal between Brussels and Charleroi will start getting a strange lift. Instead of passing through a series of locks, they'll ride in tanks hauled along an inclined plane nearly a mile long. The vertical lift is 220 feet.

The hand at the throttle of the tanks, so to speak, will be an electronic control system designed by Ateliers de Constructions Electriques de Charleroi. ACEC engineers say it was one of the trickiest jobs they've yet handled.

At first glance the problem looks simple, not much more than an

elevator drive system—cables, a powered drum and counterweight—tilted over on its sides. Trouble is, the massive loads of the 6,000-ton tanks and the 5700-ton counterweights make the cables act like springs.

No dawdling. Tanks, counterweights and cables form an oscillating system that can develop cable-snapping forces if acceleration isn't closely controlled. At the same time, the tanks can't dawdle at startup since the operating schedule calls for them to accelerate from zero to a constant running speed of 3.9 feet per second in 2½ minutes.

ACEC's system automatically controls the speed characteristic of the six 170-horsepower motor-generator sets that drive each tank. The key signal is developed in a special two-stage slope generator. It consists essentially of two transistor amplifier modules originally designed for an ACEC analog computer. The two amplifiers are arranged as integrators and connected in series.

The first amplifier produces a trapezoidal waveform that imposes an acceleration limit on the overall speed control system. To obtain the required accuracy, the reference voltage used for the integration is stabilized to $\pm 0.1\%$.

Output of the first stage is not applied directly to the regulation circuits. Instead, the trapezoidal waveform is integrated in the second stage of the slope generator to obtain a voltage analog of the speed characteristic. This signal is applied to the regulation circuits where it is compared to the output of a tachometer to obtain a common control signal for the six motor-generator sets.

Because the two-stage slope generator is so crucial to the speed control system, ACEC designed the system with three of them in parallel. Outputs of all three are compared in a resistance network. If the slope generator switched onto the regulation circuits deviates from the average more than the other two, it is cut out automatically and the output of one of the other two is applied.

Versatility



ANYTHING YOU CAN PUT ON FILM
YOU CAN DISPLAY ON IEE READOUTS
(EVEN COLORS!)

NUMBERS, LETTERS, WORDS, SYMBOLS, COLORS!
There is literally no limit to the display versatility of IEE readouts. As rear-projectors, they operate by back-lighting display symbols arranged on film and projecting the selected message on a non-glare viewing screen. VERSATILITY OF SIZES, TOO! Five sizes with maximum character heights of $\frac{3}{8}$ ", $\frac{1}{2}$ ", 1", 2", 3 $\frac{1}{2}$ ".

SEND TODAY FOR COMPLETE INFORMATION!

INDUSTRIAL ELECTRONIC ENGINEERS, INC.

7720 Leona Avenue • Van Nuys, California
Phone: (213) 787-0311 • TWX (213) 781-8115



Representatives in Principal Cities

SEE IEE AT IEEE BOOTH IF-ew

Circle 229 on reader service card

ALCOSWITCH

MINIATURE MOMENTARY PUSH BUTTON SPDT & DPDT SWITCH



Exceptionally high current: 5 amps @ 115VAC. Positive snap-action with fast make and break contacts. SPDT & DPDT, useable as either a Normally Open or Normally Closed switch. Silver contacts and terminals.

FREE
PRODUCT
PLANNING
SAMPLES

IMMEDIATE DELIVERY FROM
ALCOSWITCH

By ALCO ELECTRONIC PRODUCTS, INC., LAWRENCE, MASS.

ALCOSWITCH

WORLD'S FIRST

MINIATURE $\frac{1}{2}$ " DIA. ADJUSTABLE-STOP ROTARY SWITCH



ALSO WATER PROOF MODELS IN STOCK

SHAFT: $\frac{1}{8}$ " DIAMETER — $11\frac{1}{16}$ " LENGTH
First ultra-miniature, multiple-stop switch. Useable 2 to 10 positions. Also available 2 Pole, 3 Pole and 4 Pole adjustable, 500MA @ 125VAC. Long life cycle. $\frac{1}{2}$ " diameter. 36° spacing. Fully enclosed. Ideal for aircraft, computers, electronic equipment.

WITH OR WITHOUT KNOBS

ALCOSWITCH

By ALCO ELECTRONIC PRODUCTS, INC., LAWRENCE, MASS.

Circle 246 on reader service card

EECoLogIC

INTEGRATED CIRCUIT LOGIC CARDS

OVER 50
BASIC LOGIC
and
LOGIC FUNCTION CARDS
OFF-THE-SHELF
OR
YOUR OWN
CIRCUIT DESIGNS

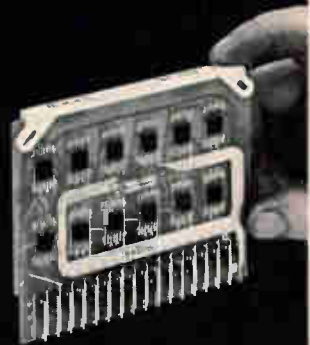

... and for HIGH-DENSITY, combine
EECoLogIC and **MicroSystem**[®]
on the same card.

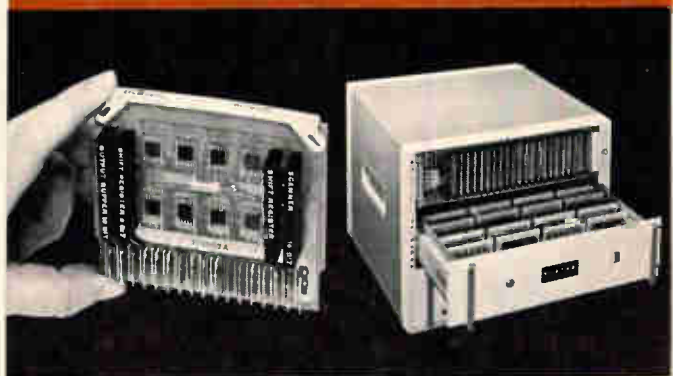

MicroSystem is a new, simplified method of interconnecting flat pack integrated circuits in "sticks," each containing as many as 10 I.C. flat packs with standard, multilayer, interconnecting matrices.

Complete hardware for EECo-Logic consists of: swing-out card files, card drawers, power supplies and all necessary accessories.

EECoLogIC
catalog on request.



ENGINEERED ELECTRONICS Company

1441 East Chestnut Avenue, Santa Ana, Calif. 92702
Phone: (714) 547-5651 TWX: 714-531-5522
Cable ENGELEX

Circle 225 on reader service card

225

collage

More Motorola mishmash,
continued from page 172



(and leave on your beard)

This seems to be our month for pushing Motorola's integrated circuit capabilities. Don't be offended. If you could apply I/C like we do, you'd brag too. And if you *can*, our employment office has assured us you won't have to shave off your beard or even take a Rorschach. Anyway, now we want to speak of RIC, or Radar Interceptor Calculator for the Rome Air Development Center. What's so elegant (to use PhD talk) about RIC is that it uses 3,000 integrated circuits to do the work of 12,000 conventional circuits. Unless you happen to be in the conventional circuit biz, you'd have to admit this is great. The calculator works with a PPI scope to furnish a semi-automatic target tracking and intercept prediction capability. It's only 1/2 cu. foot small. If we sold them by the pound we'd go broke. Write Chicago Center for details.

Get off the dime!

And send it to us: we can use the business. Matter of fact, if we get your business — you get your dime (the one you got off of) — back. You would make our marketing-type people very happy if you would write for some of the beautiful brochures they produce. They cover everything we've pitched on these pages, not to mention digital and microwave communications, command receivers and so forth.



MOTOROLA
Military Electronics Division

CHICAGO CENTER

1450 N. Cicero Ave. Dept. 2, Chicago, Illinois

WESTERN CENTER

8201 E. McDowell Rd., Dept. 2, Scottsdale, Arizona

Electronics advertisers

March 21, 1966

■ AMP Incorporated Garceau, Hargrave & McCullough Inc.	155	Mylar Division Batten, Barton, Durstine & Osborn Inc.	59
■ Acme Electric Corporation Scheel Advertising Agency Acopian Corporation Mort Barish Associates Inc.	149	Dynage Incorporated The F. W. Prella Company	160
Aerovox Corporation Lescarboursa Advertising Inc.	153	E-Z Hook Test Products	228
Airpax Electronics, Inc. Welch, Mirabile & Company Inc.	220	Eastman Kodak Company The Rumrill Company	129
■ Air Products & Chemicals Inc. Arthur Falconer Associates Corp.	143	EIMAC Hoefler, Dieterich & Brown Inc.	132
Alco Electronics Marketronics adv.	225	Electro Motive Mfg. Co. Inc. Cory Snow Inc.	6
Amelco Semiconductor Corp. Sturges Associates	35	Electronic Engineering Company of California Jansen Associates Inc.	200
American Potash & Chemical Corpora- tion Walker Brooks & Associates Inc.	189	Electronic Specialty Company Gaynor & Ducas Inc.	100
Andersen Laboratories Inc. Smith, Dorian & Burman Inc.	208	Engineered Electronics Jansen Associates Inc.	225
■ Andrew Corporation The Fensholt Advertising Agency	60	Erie Technological Products, Inc. Altman-Hall Associates	182, 183
The Arrow-Hart & Hegeman Electric Company Chirurg & Cairns Inc.	181	Esterline Angus Instrument Co. Inc. Caldwell Larkin & Sidener Van Riper Inc.	82
■ Astrodata Bonfield Associates Inc.	206	Eubanks Engineering Company Moore-Bergstrom Company	160
Bell Telephone Laboratories N.W. Ayer & Son Incorporated	150	■ Fairchild Controls Dunwoodie Associates Inc.	174
Bendix Corporation, Scintilla Division McManus, John Adams Inc.	79	■ Fairchild Semiconductor Corporation Faust/Day Inc. Advertising	12, 13, 136
Boston Technical Publishers Inc. Boston Technical Consultants Inc.	163	Fenwal Electronics Larcom Randall Advertising Inc.	113
Brush Instruments, Div. of Clevite Corporation Carr Liggett Advertising Inc.	3rd Cover	Fluke Mfg. Co. Inc. John Bonfield Associates Inc.	15
■ CSF Celanese Corporation of America West, Weir & Bartel Inc.	OAS 1 78	General Dynamics Electronics, Fort Worth Division Glenn Adv. Inc.	130
■ Centralab Div. of Globe Union Inc. Stral Advertising Company Inc.	OAS 4	■ General Electric Electronic Components Division George R. Nelson Inc.	131
Century Electronics & Instruments Inc. Writing and Advertising Inc.	190	General Electric Co. Silicone Products Dept. Ross Roy Inc. Advertising	108
Chemcut Corporation Adams Associates Inc.	212	General Radio Company K. E. Morang Company	2nd Cover
Clarostat Mfg. Co. Inc. Lescarboursa Advertising Inc.	65	Granger Associates West Associates	8
■ Clifton Precision Products Co. Inc. Ivey Advertising Inc.	24	Graphic Systems Inc. Caswell Advertising Agency	196
Comcor Inc. Marketing Directions Inc.	194	Heinemann Electric Company Thomas R. Sundheim Incorporated	154
Communications Elect-onics Inc. S. G. Stackig Inc.	194	■ Hewlett Packard Lennen & Newell Inc.	1, 2, 47
Computer Test Corporation James Lees Advertising	159	■ Hewlett Packard, Moseley Division Lennen & Newell Inc.	61
Consolidated Avionics Corporation The Stanley Schwartz Company	104	■ Hughes Aircraft Company Foote, Cone & Belding Inc.	81
Consolidated Electrodynamics Corp. Hixson & Jorgensen Inc.	64	Hurst Mfg. Corporation Hathaway and Associates Inc.	186
Consolidated Vacuum Corporation Wolff Associates Inc.	67	Hysol Corporation Barber & Drullard Inc.	176
Controls Company of America The Harry P. Bridge Company	69	Industrial Electronic Engineers Inc. Gumpertz, Bentley & Dolan Advertising	225
Corning Glass Works, Electronics Division The Rumrill Company	211	Indiana General Corporation The Griswold & Eshleman Company	135
Coors Porcelain Company Tallant Yates Advertising Inc.	127	Indium Corporation Darvoe, Breck & MacFarland Inc.	196
H. Cross Company Milchar Advertising Inc.	228		
Delco Radio Division of General Motors Corp. H. L. Ross Adv. Inc.	134		
Dale Electronics Inc. Swanson, Sinkey, Ellis Inc. Advertising	70		
Deutsch Company, The Jordan Farrell Incorporated	198, 199		
Digital Equipment Corporation Kalb & Schneider Inc.	22		
DuPont de Nemours & Company Inc.			

■ For more information on complete product line see advertisement in the latest Electronics Buyers' Guide.

□ Advertiser in Overseas Edition

Electronics advertisers

March 21, 1966



IBM Corporation	164	Philco Corporation, Lansdale Div.	36	Tobe Deutschmann Laboratories	202
Benton Bowles Inc.		Batten, Barton, Durstine & Osborn Inc.		Engineered Advertising	
Interstate Electronics Corporation	147	Philco Corporation, Sierra Div.	166	Transformer Electronics Company	7
Hixson & Jergensen Inc.		Hal Lawrence Incorporated		Dacey, Wolff Associates Inc.	
		☐ Plessey	Oas 2 & 3		
		Potter Instrument Company	49		
		Michel Cather Inc.			
Jerrold Electronics Corporation	14	Precision Instrument Company	165	Ultra Carbon Corporation	152
Lescarboursa Advertising Inc.		Hal Lawrence Incorporated		Church and Guisewite Advertising Inc.	
		Radiation Inc.	199	Union Carbide Corporation Linde	125
		Basford Incorporated		Division	
Kay Electric Company	58	Radio Switch Corporation	196	J. M. Mathes Incorporation	41
Josephson, Cuffari & Company		George Homer Martin Associates		Unitrode Corporation	41
		Radio Corporation of America	4th Cover	Electronic Marketing Assistance	
		Al Paul Lefton Company		United Aircraft Corporation,	133
		Raytheon Company	74, 75	Vector Division	
		Fuller & Smith & Ross Inc.		Cunningham & Walsh Inc.	
Lapp Insulator Company Inc.	203	RCL Electronics Inc.	194		
Wolff Associates Inc.		Morvay Advertising Agency			
Ledex Inc.	184	Reeves Instrument Corp.	177		
Yeck and Yeck		Duncan Brooks Inc.			
Ledex Inc. Bramco Control Division	46	☐ Ribet-DesJardins	OAS 7	Victoreen Instrument Company	178
Yeck & Yeck		RHG Electronics Lab.	175	Palm & Patterson Inc.	
LFE	191	S. M. Sachs & Associates Inc.		Vitramon	193
Hepler & Gibney Inc.				Ted Sommers Inc.	
Lockheed California Co.	126				
McCann-Erickson Inc.					
Lockheed Missiles & Space Co.	162				
McCann-Erickson Inc.					
		Sangamo Electric Company	68	Wakefield Engineering Inc.	207
		Winius-Brandon Company		Sales Promotion Services	
Machlett Laboratories Inc.	9	Secon Metals Corporation	204	Wanlass Electric Company	114
Fuller & Smith & Ross Inc.		Walter J. Zimmerman Associates Inc.		Leland Oliver Company Inc.	
☐ Magnetics Inc.	45	Semimetals Inc.	219	White Company, S. S.	195
Lando Advertising Inc.		Duncan Brooks Inc.		W. L. Towne Company Inc.	
Magnetics Metals Company	148	Shamrock Van Lines Inc.	201	Winston Research Corporation	156
John B. Ferguson Jr. Advertising		Western Brands Inc.		Jordan Farrell Adv.	
Mallory & Company Inc. P.R.	73, 76, 77	S-I Electronics	210	Wisco Division, The Electric Storage	207
Aitkin-Kynett Company Inc.		Healy Advertising Agency		Battery Co.	
Marconi Instrument Ltd.	80	Sigma Instruments Inc.	19, 20	E. L. Speer Advertising Agency	
Armand Richards Advertising Agency		The Marschalk Company Inc.			
Markel & Sons, L. Frank	186	Signetics Corporation	51 to 54		
George Moll Advertising Inc.		Cunningham & Walsh Inc.			
Maryland Telecommunication	168	☐ Siliconix	OAS 5		
Incorporated		Phd Mactagart Adv.			
Raymond E. Finn Advertising		Sinclair Radio Laboratories Inc.	187		
Mathatronics Inc.	188	John E. Hayes Company Inc.			
Kalb & Schneider Inc.		Solotron Devices Inc.	50		
Matthews Research Inc.	192	Haselmire Pearson Advertising			
Compton Jones Associates		Sorensen A Unit of Raytheon Company	11		
McCoy Electronics Company	48	James Advertising Inc.			
Buchen Advertising Inc.		☐ Souriau & Cie	OAS 6		
McGraw Hill Book Company	128	Ariane Publicite			
Mepco Inc.	180	Spectral Dynamics Corporation	63		
Ray Ellis Advertising Corporation		Teawell Inc. Advertising			
Micro Instrument Company	205	Spectral Electronics Corporation	17		
Bonfield Associates Inc.		Jones, Maher, Roberts Adv.			
Minnesota Mining & Mfg. Company,	209	Speer Carbon Company	43		
Scotchpar Electrical		Hazard Advertising Company Inc.			
Klau-Van Pietersom-Dunlap Inc.		Sprague Electric Company	5, 10, 16		
Motorola Inc.	158, 172, 226	Harry P. Bridge Company			
Charles Bowes Advertising Inc.		Stackpole Carbon Company	62		
Mullard Ltd.	55	Meek and Thomas Inc.			
Roles & Parker Ltd.		Sylvania Electric Products Inc.	27 to 34		
		Tatham-Laird & Kudner Inc.			
		Synthane Corporation	200		
		Arndt Preston Chapin Lamb & Keen Inc.			
National Company	66				
J. J. Joslin Advertising		TRW Electronics	170		
Navigation Computer Corporation	175	Fuller & Smith & Ross Inc.			
Industrial Public Relations Inc.		Tally Corporation	169		
New England Instrument Company	173	Bonfield Associates Inc.			
Impact Advertising		Taylor Corporation	185		
North Atlantic Industries Inc.	146	Gray & Rogers Inc.			
Murray Heyert Advertising		☐ Tektronix Inc.	20, 21		
Norton Company	160	Hugh Dwight Adv. Inc.			
J. J. Coppo Company		Texas Instruments Incorporated			
Nytronics Inc.	207	Semiconductor Division	167		
The Stukalin Advertising Agency Inc.		Don L. Baxter Inc.			
		Thermal American Fused Quartz Co. Inc.	44		
		Kniep Associates Inc.			
Phelps Dodge Electronic Products	197				
Corp.					
Smith, Dorian & Burman Inc.					

Classified advertising

F. J. Eberle, Business Mgr.	
EMPLOYMENT OPPORTUNITIES	213-218
Equipment	
(Used or Surplus New)	
For Sale	217
ADVERTISERS INDEX	
Boston Technical Consultants Inc.	217
Department of the Navy	
U.S. Navy Bureau of Ships	217
Fishman Co., P.	217
General Dynamics	
Electronics Division	215
General Dynamics	
General Atomic Division	213
General Electric Co.	216
Geotechnical Corp.	218
Kaiser Engineers	214
Monmouth Electric Co., Inc.	217
Radio Research Instrument Co.	217
Semiconductor Sales of Calif.	217
U.S. Navy	
Navy Overseas Employment Office	218

☐ For more information on complete product line see advertisement in the latest Electronics Buyers' Guide

☐ Advertisers in Overseas Edition

Executive, editorial, circulation and advertising offices: McGraw-Hill Building, 330 West 42nd Street, New York, N.Y., 10036. Telephone (212) 971-3333. Teletype TWX N.Y. 212 640-4646. Cable: McGrawhill, N.Y. Officers of the McGraw-Hill Publications: Joseph H. Allen, President; Vice Presidents: J. Elton Tuohig, Operations; John R. Callahan, Editorial; Ervin E. DeGraff, Circulation; Donald C. McGraw, Jr., Advertising Sales; Angelo R. Venezian, Marketing. Officers of the Corporation: Donald C. McGraw, Chairman of the Board; Shelton Fisher, President; L. Keith Goodrich, Hugh J. Kelly and Robert E. Slaughter, Executive Vice Presidents; John J. Cooke, Vice President and Secretary; John L. McGraw, Treasurer. Title R registered U.S. Patent Office; © copyright 1966 by McGraw-Hill, Inc. All rights reserved, including the right to reproduce the contents of this publication, in whole or in part.

Rolled Metal Ribbon & Strips



(THINK OF CROSS FIRST)

MAJOR MICROWAVE MANUFACTURERS DO!

Top manufacturers like Microwave Associates, Watkins-Johnson, Varian Associates and Raytheon use CROSS-rolled ribbons for their most finicky chores. That's because CROSS rolls molybdenum and tungsten down to tolerances of $\pm .0001$. CROSS is the only company to do so on a production basis.

CROSS rolls tantalum, columbium, zirconium, rhenium moly, titanium, vanadium, copper, nickel, alloys and standard metals. CROSS will roll strips to precise order, meet any demand for precision metals.

There's a good reason why top companies think of CROSS first—because if CROSS does it—it's right the first time! Join the top manufacturers who've found out how perfectly CROSS meets your most exacting metal requirements.

Phone or write today.

H. CROSS CO.

363 Park Ave.
Weehawken, N. J.
201-UNION 3-1134



Advertising sales staff

Gordon Jones [212] 971-2210
Advertising sales manager

Atlanta, Ga. 30309: Gus H. Krimsier, Michael H. Miller, 1375 Peachtree St. N.E., [404] TR 5-0523

Boston, Mass. 02116: William S. Hodgkinson McGraw-Hill Building, Copley Square, [617] CO 2-1160

Chicago, Ill. 60611: Robert M. Denmead, J. Bradley MacKimm 645 North Michigan Avenue, [312] MO 4-5800

Cleveland, Ohio 44113: Paul T. Fegley, 55 Public Square, [216] SU 1-7000

Dallas, Texas 75201: Richard P. Poole, The Vaughn Building, 1712 Commerce Street, [214] RI 7-9721

Denver, Colo. 80202: Joseph C. Page, David M. Watson, Tower Bldg., 1700 Broadway, [303] 255-5484

Detroit, Michigan 48226: Paul T. Fegley 856 Penobscot Building [313] 962-1793

Houston, Texas 77002: Kenneth George, 2270 Humble Bldg., [713] CA 4-8381

Los Angeles, Calif. 90017: Ian C. Hill, John G. Zisch, 1125 W. 6th St., [213] HU 2-5450

Minneapolis, Minn. 55402: J. Bradley MacKimm 1104 Northstar Center [612] 332-7425

New York, N. Y. 10036: Donald R. Furth [212] 971-3615 Frank LeBeau [212] 971-3615 George F. Werner [212] 971-3615 500 Fifth Avenue

Philadelphia, Pa. 19103: William J. Boyle, Warren H. Gardner, 6 Penn Center Plaza, [215] LO 8-6161

Pittsburgh, Pa. 15222: Paul T. Fegley, 4 Gateway Center, (412) 391-1314

Portland, Ore. 97204: James T. Hauptli, Pacific Building, Yamhill Street, (503) CA3-5118

St. Louis, Mo. 63105: Robert M. Denmead The Clayton Tower, 7751 Carondelet Ave. [314] PA5-7285

San Francisco, Calif. 94111: James T. Hauptli, 255 California Street, [415] DO 2-4600

London W1: John W. Patten, Edwin S. Murphy Jr., 34 Dover Street, Hyde Park 1451

Milan: 1, via Baracchini Phone: 86-90-617 86-90-656

Frankfurt/Main: Gerd Hinske, Joseph Wuensch, 85 Westendstrasse Phone: 77 26 65 and 77 30 59

Geneva: Michael R. Zeyne, 1, rue du Temple Phone: 31 95 60

Paris VIII: Denis Jacob, 17 Avenue Matignon ALMA-0452

Tokyo: Nobuyuki Sato, 1, Kotohiracho Shiba, Minato-Ku (502) 0656

Osaka: Ryosi Kobayashi, 163, Umegee-cho, Kilita-ku [362] 8771

Hugh J. Quinn: [212] 971-2335 Manager Electronics Buyers' Guide

David M. Tempest: [212] 971-3139 Promotion manager

Milton Drake: [212] 971-3485 Market research manager

Wallace C. Carmichael: [212] 971-3191 Business manager

Stephen R. Weiss: [212] 971-2044 Production manager

MINIATURE CLIP and LEADS

Make "Impossible" Connections



Make test connections never before possible with world's smallest connector . . . actually reach $1\frac{3}{8}$ " through $\frac{1}{8}$ " hole . . . reach $\frac{1}{4}$ " through .080 slot. Insures positive hook-up . . . won't jump off. Fully insulated to prevent shorting out. Ideal for printed circuits, transistor sets, CB transceivers, computer units, and for temporary muscle and nerve connections in (Heart) surgery.

No. X100 E-Z-Mini-HOOK "Q" Ball Clip only, 49¢
No. AX-1 Test Lead (.080 tip), 89¢ ea. No. BX-1 Lead (banana tip) 94¢ ea.

Unique Design HARNESS BOARD CLIP

Saves on board construction. Saves on cable assembly . . . increases production, improves quality.

Write for reprint telling how a firm estimates savings at \$20,000 annually with this clip. Only 14¢ each in 250 quantity.

Both items cataloged in EEM. Radio Master VSMF. Satisfaction guaranteed. Order from distributor or direct.

No. 81-1 E-Z-HOOK "Nail" Clip (Use T-20 Tool) 24¢ ea. — 10 for 1.98
No. K8150T-1 "Nail" Clip Kit (50 Clips Tool & Instr.) Wt. 2 oz. — ea. 8.95
No. T-20 E-Z-HOOK "Nail" Clip Driving Tool Wt. $\frac{1}{3}$ oz. — ea. .35

E-Z-HOOK®
BOX 105, COVINGTON, KY. 41012

Circle 230 on reader service card

Reprint order form

Send to: Electronics Reprint Dept.
330 West 42nd Street
New York, N. Y. 10036

For listing of reprints available see the reader service card.

To help expedite mailing of your reprints please send cash, check or money order with your order.

For reprints of the latest special report:

U. S. Electronics Markets 1966

Send me reprints of key no R-85 at 50¢ each.

For reprints of previous special reports fill in below:

Send me reprints of key no.(s) at ¢ each.

For prices see the reader service card.

Name

Number & Street

City, State

Zip code

Electronics reader service

Use these handy post cards for more detailed information on: products advertised, new products, new literature.

Circle the number on the Reader Service post card that corresponds to the number at the bottom of the advertisement, new product item, or new literature in which you are interested.

Please print clearly. All written information must be legible to be efficiently processed.

If someone has beaten you to the post cards, you may obtain the needed information by writing directly to the manufacturer, or by sending your name and address, plus the Reader Service number, to Electronics Reader Service department.

All inquiries from outside the U.S. that cannot reach Electronics before the expiration dates noted on the Reader Service post card, must be mailed directly to the manufacturer. The manufacturer assumes all responsibilities for responding to inquiries. Electronics merely provides and clears requests for information from inquirer to manufacturer.

Correct amount of postage must be affixed for all mailings from outside the U.S.

To subscribe to or to renew Electronics

Fill in the "For Subscriptions" area on the card if you desire to subscribe to or renew your present subscription to Electronics. Send no money. Electronics will bill you at the address indicated on the Reader Service post card.

Multi-product advertisements

For information on specific items in multi-product advertisements which do not have a specific Reader Service number indicated write directly to manufacturer for information on precise product in which you are interested.

6	March 21, 1966 Card Expires May 21, 1966	14
Name _____ title _____		For Subscriptions <input type="checkbox"/> new <input type="checkbox"/> renewal <input type="checkbox"/> 3 years \$12.00 <input type="checkbox"/> 1 year \$6.00
Company _____		
Address _____		
1 20 39 58 77 96 115 134 153 172 191 210 229 248 267 288 305 324 343 362 381 400 419 438 457 476 495 514 962 2 21 40 59 78 97 116 135 154 173 192 211 230 249 268 287 306 325 344 363 382 401 420 439 458 477 496 515 963 3 22 41 60 79 98 117 136 155 174 193 212 231 250 269 288 307 326 345 364 383 402 421 440 459 478 497 516 964 4 23 42 61 80 99 118 137 156 175 194 213 232 251 270 289 308 327 346 365 384 403 422 441 460 479 498 517 965 5 24 43 62 81 100 119 138 157 176 195 214 233 252 271 290 309 328 347 366 385 404 423 442 461 480 499 518 966 6 25 44 63 82 101 120 139 158 177 196 215 234 253 272 291 310 329 348 367 386 405 424 443 462 481 500 900 967 7 26 45 64 83 102 121 140 159 178 197 216 235 254 273 292 311 330 349 368 387 406 425 444 463 482 501 901 968 8 27 46 65 84 103 122 141 160 179 198 217 236 255 274 293 312 331 350 369 388 407 426 445 464 483 502 902 969 9 28 47 66 85 104 123 142 161 180 199 218 237 256 275 294 313 332 351 370 389 408 427 446 465 484 503 951 970 10 29 48 67 86 105 124 143 162 181 200 219 238 257 276 295 314 333 352 371 390 409 428 447 466 485 504 952 971 11 30 49 68 87 106 125 144 163 182 201 220 239 258 277 296 315 334 353 372 391 410 429 448 467 486 505 953 972 12 31 50 69 88 107 126 145 164 183 202 221 240 259 278 297 316 335 354 373 392 411 430 449 468 487 506 954 973 13 32 51 70 89 108 127 146 165 184 203 222 241 260 279 298 317 336 355 374 393 412 431 450 469 488 507 955 974 14 33 52 71 90 109 128 147 166 185 204 223 242 261 280 299 318 337 356 375 394 413 432 451 470 489 508 956 975 15 34 53 72 91 110 129 148 167 186 205 224 243 262 281 300 319 338 357 376 395 414 433 452 471 490 509 957 976 16 35 54 73 92 111 130 149 168 187 206 225 244 263 282 301 320 339 358 377 396 415 434 453 472 491 510 958 977 17 36 55 74 93 112 131 150 169 188 207 226 245 264 283 302 321 340 359 378 397 416 435 454 473 492 511 959 978 18 37 56 75 94 113 132 151 170 189 208 227 246 265 284 303 322 341 360 379 398 417 436 455 474 493 512 960 979 19 38 57 76 95 114 133 152 171 190 209 228 247 266 285 304 323 342 361 380 399 418 437 456 475 494 513 961 980		

2

Business reply mail
No postage stamp necessary if mailed in the United States

Postage will be paid by

**Electronics
Reader service department
Box 444
Hightstown, N.J. 08520**

First class
Permit no. 42
Hightstown, N. J.



6	March 21, 1966 Card Expires May 21, 1966	14
Name _____ title _____		For Subscriptions <input type="checkbox"/> new <input type="checkbox"/> renewal <input type="checkbox"/> 3 years \$12.00 <input type="checkbox"/> 1 year \$6.00
Company _____		
Address _____		
1 20 39 58 77 96 115 134 153 172 191 210 229 248 267 286 305 324 343 362 381 400 419 438 457 476 495 514 962 2 21 40 59 78 97 116 135 154 173 192 211 230 249 268 287 306 325 344 363 382 401 420 439 458 477 496 515 963 3 22 41 60 79 98 117 136 155 174 193 212 231 250 269 288 307 326 345 364 383 402 421 440 459 478 497 516 964 4 23 42 61 80 99 118 137 156 175 194 213 232 251 270 289 308 327 346 365 384 403 422 441 460 479 498 517 965 5 24 43 62 81 100 119 138 157 176 195 214 233 252 271 290 309 328 347 366 385 404 423 442 461 480 499 518 966 6 25 44 63 82 101 120 139 158 177 196 215 234 253 272 291 310 329 348 367 386 405 424 443 462 481 500 900 967 7 26 45 64 83 102 121 140 159 178 197 216 235 254 273 292 311 330 349 368 387 406 425 444 463 482 501 901 968 8 27 46 65 84 103 122 141 160 179 198 217 236 255 274 293 312 331 350 369 388 407 426 445 464 483 502 902 969 9 28 47 66 85 104 123 142 161 180 199 218 237 256 275 294 313 332 351 370 389 408 427 446 465 484 503 951 970 10 29 48 67 86 105 124 143 162 181 200 219 238 257 276 295 314 333 352 371 390 409 428 447 466 485 504 952 971 11 30 49 68 87 106 125 144 163 182 201 220 239 258 277 296 315 334 353 372 391 410 429 448 467 486 505 953 972 12 31 50 69 88 107 126 145 164 183 202 221 240 259 278 297 316 335 354 373 392 411 430 449 468 487 506 954 973 13 32 51 70 89 108 127 146 165 184 203 222 241 260 279 298 317 336 355 374 393 412 431 450 469 488 507 955 974 14 33 52 71 90 109 128 147 166 185 204 223 242 261 280 299 318 337 356 375 394 413 432 451 470 489 508 956 975 15 34 53 72 91 110 129 148 167 186 205 224 243 262 281 300 319 338 357 376 395 414 433 452 471 490 509 957 976 16 35 54 73 92 111 130 149 168 187 206 225 244 263 282 301 320 339 358 377 396 415 434 453 472 491 510 958 977 17 36 55 74 93 112 131 150 169 188 207 226 245 264 283 302 321 340 359 378 397 416 435 454 473 492 511 959 978 18 37 56 75 94 113 132 151 170 189 208 227 246 265 284 303 322 341 360 379 398 417 436 455 474 493 512 960 979 19 38 57 76 95 114 133 152 171 190 209 228 247 266 285 304 323 342 361 380 399 418 437 456 475 494 513 961 980		

Reprint service

All Electronics editorial matter available in reprint form:

For reprints of special reports and feature articles see list on right side of this page. Send your order to Electronics Reprint Department at the address indicated. To expedite mailing of your order for single reprints please send cash, check or money order with your order.

Bulk reprints of editorial matter can be ordered from current or past issues. The minimum quantity is 100 copies. The higher the quantity ordered, the more economical the cost per copy. Prices quoted on request.

3

Business reply mail

No postage stamp necessary if mailed in the United States

Postage will be paid by

Electronics
Reader service department
Box 444
Hightstown, N. J. 08520

First class
 Permit no. 42
 Hightstown, N. J.



To order reprints or for further information, please write to: **Electronics Reprint Department, 330 West 42nd Street, New York, N.Y. 10036.** Telephone: Area code 212 971-3140.

Prices for the below listed reprints unless otherwise specified are 1-10 copies 50¢ each; 11-24 copies 35¢ each; 25-99 copies 25¢ each; price for 100 or more is 20¢ each.

You may order any of the below listed reprints by key number.

Key no. R-87 The Packaging Revolution In Microelectronics (Parts IV, V and VI. 32 pages). \$1.00

Key no. R-86 Computer Time Sharing Part II 12 pages.

Key no. R-85 U.S. Electronics Markets 1966 24 page forecast report with 6 page foldout chart.

Key no. R-84 European Electronics Markets 1966. 16 pages with 4 page foldout chart.

Key no. R-83 A Look At Japanese Electronics Technology 36 pages.

Key no. R-82 Computer Time Sharing Part I 20 pages

Key no. R-80 The Packaging Revolution In Microelectronics (Parts I, II, and III. 32 pages). \$1.00

Key no. R-79 MOS Integrated Circuits 12 pages.

Key no. R-78 The Overlay Transistor 15 pages.

Key no. R-77 Cold Cathode Tubes (3 part series, 28 pages).

Key no. R-76 Automated Trains: Who's On The Right Track? 16 pages.

Key no. R-75 Biotelemetry [2 Part series 16 pages].

Key no. R-74 Unijunction Transistors, 24 pages.

Key no. R-68 Designing Against Space Radiation, 18 pages.

Key no. R-66 Field Effect Transistors, Part III 16 pages.

Key no. R-65 Field Effect Transistors, Part II 24 pages

Key no. R-64 Field Effect Transistors, Part I 24 pages.

Key no. R-63 Silicon Power Transistors 8 pages. 25¢

Key no. R-61 Direct Digital Control in Industry, 24 pages.

Key no. R-60 Transistor Heat Dissipators, 32 pages.

Key no. R-31 1962 Electromagnetic Spectrum Chart, [22" x 30" foldout chart]. \$1.00

6

March 21, 1966 Card Expires May 21, 1966

14

Name _____ title _____
 Company _____
 Address _____

For Subscriptions
 new renewal
 3 years \$12.00
 1 year \$6.00

1	20	39	58	77	96	115	134	153	172	191	210	229	248	267	286	305	324	343	362	381	400	419	438	457	476	495	514	962
2	21	40	59	78	97	116	135	154	173	192	211	230	249	268	287	306	325	344	363	382	401	420	439	458	477	496	515	963
3	22	41	60	79	98	117	136	155	174	193	212	231	250	269	288	307	326	345	364	383	402	421	440	459	478	497	516	964
4	23	42	61	80	99	118	137	156	175	194	213	232	251	270	289	308	327	346	365	384	403	422	441	460	479	498	517	965
5	24	43	62	81	100	119	138	157	176	195	214	233	252	271	290	309	328	347	366	385	404	423	442	461	480	499	518	966
6	25	44	63	82	101	120	139	158	177	196	215	234	253	272	291	310	329	348	367	386	405	424	443	462	481	500	900	967
7	26	45	64	83	102	121	140	159	178	197	216	235	254	273	292	311	330	349	368	387	406	425	444	463	482	501	901	968
8	27	46	65	84	103	122	141	160	179	198	217	236	255	274	293	312	331	350	369	388	407	426	445	464	483	502	902	969
9	28	47	66	85	104	123	142	161	180	199	218	237	256	275	294	313	332	351	370	389	408	427	446	465	484	503	951	970
10	29	48	67	86	105	124	143	162	181	200	219	238	257	276	295	314	333	352	371	390	409	428	447	466	485	504	952	971
11	30	49	68	87	106	125	144	163	182	201	220	239	258	277	296	315	334	353	372	391	410	429	448	467	486	505	953	972
12	31	50	69	88	107	126	145	164	183	202	221	240	259	278	297	316	335	354	373	392	411	430	449	468	487	506	954	973
13	32	51	70	89	108	127	146	165	184	203	222	241	260	279	298	317	336	355	374	393	412	431	450	469	488	507	955	974
14	33	52	71	90	109	128	147	166	185	204	223	242	261	280	299	318	337	356	375	394	413	432	451	470	489	508	956	975
15	34	53	72	91	110	129	148	167	186	205	224	243	262	281	300	319	338	357	376	395	414	433	452	471	490	509	957	976
16	35	54	73	92	111	130	149	168	187	206	225	244	263	282	301	320	339	358	377	396	415	434	453	472	491	510	958	977
17	36	55	74	93	112	131	150	169	188	207	226	245	264	283	302	321	340	359	378	397	416	435	454	473	492	511	959	978
18	37	56	75	94	113	132	151	170	189	208	227	246	265	284	303	322	341	360	379	398	417	436	455	474	493	512	960	979
19	38	57	76	95	114	133	152	171	190	209	228	247	266	285	304	323	342	361	380	399	418	437	456	475	494	513	961	980

1

Business reply mail

No postage stamp necessary if mailed in the United States

Postage will be paid by

Electronics
Reader service department
Box 444
Hightstown, N.J. 08520

First class
 Permit no. 42
 Hightstown, N. J.

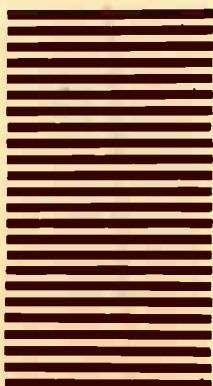

Another Brush Innovation in Recording:

The Brush Mark 280.
Once you've seen
it work,
the chain makes
a lot of sense.



People who use the Brush Mark 280 can get pretty possessive.

No wonder.

True rectilinear traces so crisp and clear you'll never miss the message. Dual recording channels a full 80 millimeters wide. Resolution the likes of which you've never seen. A pressurized inking system. Metri-site pen positioning. Low cost chart

paper. Pushbutton choice of 12 chart speeds. Solid state electronics. Response as high as 200 cps at useable amplitude and better than 30 cps full scale. System accuracy of 1/2%!

And now get set for the big surprise: the performance-packed Brush Mark 280 measures just 10 1/2" x 18 3/8" x 11 1/2"!

Search no more for a full perform-

ance portable. No one *but no one* has anything to compare with the amazing Mark 280. Ask your Brush representative for a demonstration. Or write today for our free booklet. Brush Instruments Division, Clevite Corporation, 37th and Perkins, Cleveland, Ohio 44114.



brush **CLEVITE**
INSTRUMENTS DIVISION

NOW **RCA** ASSURES AEROSPACE/MILITARY RELIABILITY IN AN "OFF-THE-SHELF" UHF TRANSISTOR

RCA 40294 low-noise UHF AMPLIFIER—only 4 dB typical noise figure at 450 Mc/s—tested to meet your most exacting high reliability requirements for critical aerospace and military applications.

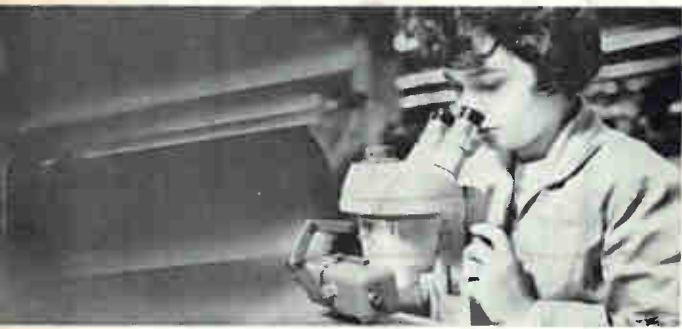

100% inspection of all components, and assemblies before sealing

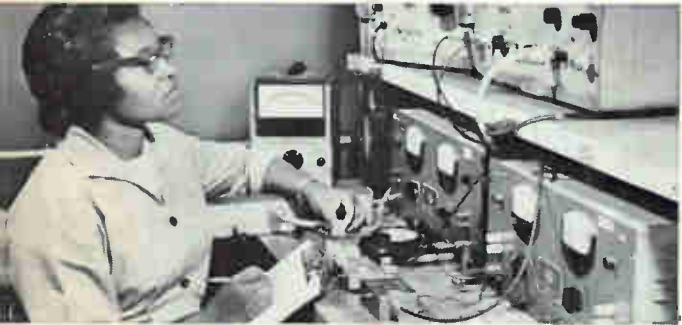

100% testing for 450 Mc/s gain and noise figure



100% power burn-in for reliability assurance

Gone is that long costly wait for delivery on transistors to meet aerospace/military reliability standards.

At least on the RCA 40294. It's available right now—as a stock item—either directly from RCA or from your RCA Distributor. It's electrically equivalent to our familiar and popular 2N2857 low-noise silicon UHF amplifier. But the RCA 40294 is specially controlled, processed, and tested to assure *ultra-high* reliability. RCA 40294's get all these extra tests...

EXTRA! RIGOROUS CONTROLS AND INSPECTIONS of all components and assemblies before sealing.

EXTRA! 100% PRECONDITIONING AFTER SEALING AND BEFORE TESTS. Includes stabilization bake (50 hours min. at 200° C), temperature cycling from -65° C to +200° C, helium leak and bubble tests...plus sample constant-acceleration (centrifuge).

EXTRA! 100% RELIABILITY ASSURANCE TEST. Each 40294 transistor undergoes "power burn-in"—running at full power rating for 340 hours—then is *retested* to assure that I_{CBO} and h_{FE} have not deviated beyond prescribed limits.

EXTRA! 100% PERFORMANCE REQUIREMENTS TESTS. All electrical characteristics including 450 Mc/s gain and noise are then *RE-TESTED* as per MIL-STD 750 requirements.

...PLUS—A 100% MICROSCOPIC EXAMINATION FOR THE FINAL MECHANICAL INSPECTION.

For the performance assurances you need for critical aerospace/military applications, specify the RCA 40294 (or a special version to meet your particular requirements).

For complete electrical characteristics of the 40294, information on custom versions, or any other technical information, call your RCA Field Representative, or write: RCA Commercial Engineering, Section C-N-3-3, Harrison, N. J.

AVAILABLE THROUGH YOUR RCA DISTRIBUTOR

RCA ELECTRONIC COMPONENTS AND DEVICES

MAXIMUM RATINGS, Absolute-Maximum Values:

COLLECTOR-TO-BASE VOLTAGE, V_{CBO}	30 max. volts
COLLECTOR-TO-EMITTER VOLTAGE, V_{CEO}	15 max. volts
EMITTER-TO-BASE VOLTAGE, V_{EBO}	2.5 max. volts
COLLECTOR CURRENT, I_C	40 max. mA
TRANSISTOR DISSIPATION, P_T	200 max. mW (25° C T_{FA})

TEMPERATURE RANGE:

Storage and Operating (Junction)

-65 to +200° C



The Most Trusted Name in Electronics