

Electronics®

Switching with light: page 58

Now, tv with photographic quality: page 70

Packaging integrated circuits: page 75

November 1, 1965

75 cents

A McGraw-Hill Publication

Below: Tracing wiring patterns automatically in safe light: page 90



J H JAKES
L 9
3838 MONTEVISTA RD
CLEVELAND HEIGHTS 21 OHIO
R



A Self-Contained 0.1% C, R, L, G Measurements Laboratory

If you want to measure R, L, or C components or impedances accurately without resorting to separate bridges for each parameter, here is the bridge you need. Six internal ac bridges cover all possible phase angles so that any network can be measured, even such "black boxes" as filters, transducers, and equalizers.

- Digital in-line readout; unit of measurement and decimal point automatically indicated.
- Appropriate D and Q scales illuminated automatically . . . no multiplying factors to remember.
- 6 bridges in one. Lets you measure components having any value of Q. Measures series or parallel parameters.
- Self-contained 1-kc oscillator and selective null detector. Plug-in modules available for other frequencies. External generator and detector can also be used from 20 c/s to 20 kc/s.
- $\pm 0.1\%$ basic accuracy for C, R, L, and G at 1 kc ($\pm 0.2\%$ to 10 kc/s); high phase accuracy at 1 kc/s permits determinations of D as low as 0.0005 or Q as high as 2000.
- Rapid balancing — coaxial balance controls for coarse and fine adjustments.
- Standard EIA dc voltages supplied internally for resistance measurements; external dc bias can be applied to components under measurement.
- Internal standards are precision elements: the standard capacitor is a combination silver mica and polystyrene unit with a low temperature coefficient. The wire-wound resistors are similar to those used in GR decade resistance boxes.

RANGES:

Resistance:

0.05 m Ω to 1.1 M Ω in 7 ranges
(ac or dc)

Conductance:

0.05 n Ω to 1.1 Ω in 7 ranges
(ac or dc)

Capacitance:

0.05 pF to 1100 μ F in 7 ranges
(series or parallel)

Inductance:

0.05 μ H to 1100 H in 7 ranges
(series or parallel)

At 1 kc/s:

D (series C): 0.0005 to 1
Q (series L): 0.5 to 50
Q (series R): 0.0005 to
1.2 Inductive

D (parallel C): 0.02 to 2
Q (parallel L): 1 to 2000
Q (parallel G): 0.0005 to
1.2 Capacitive

Accuracy (at 1 kc): $\pm 0.1\%$ of reading $\pm 0.005\%$ of full scale except on lowest R and L ranges and highest G and C ranges where it is $\pm 0.2\%$ of reading $\pm 0.005\%$ of full scale. D and 1/Q accuracy are $\pm 0.0005 \pm 5\%$ at kc/s for L and C; Q accuracy $\pm 0.0005 \pm 2\%$ for R and G. At 10 kc/s L and C accuracy is $\pm 0.2\%$; R and G, $\pm 0.3\%$

Power Requirements: 105-125 or 210-250 V, 50-60 c/s; 10W.



Type 1608-A Impedance Bridge,
\$1300 in U.S.A.

*Write or call your nearest GR sales engineering office
for further information or for an on-the-spot evaluation.*

IN CANADA: Toronto 247-2171, Montreal (Mt. Royal) 737-3673
IN EUROPE: Zurich, Switzerland — London, England



GENERAL RADIO COMPANY

WEST CONCORD, MASSACHUSETTS

BOSTON NEW YORK, N. Y., 964-2722 CHICAGO PHILADELPHIA WASHINGTON, D.C. SYRACUSE DALLAS SAN FRANCISCO LOS ANGELES ORLANDO, FLA. CLEVELAND
(W. Concord) 646-0550 (Ridgefield, N. J.) 943-3140 (Oak Park) 848-9400 (Ft. Washington) 646-8030 (Rockville, Md.) 946-1600 454-9323 ME 7-2240 (Los Altos) 948-8233 469-6201 425-4671 886-0150

Circle 900 on reader service card

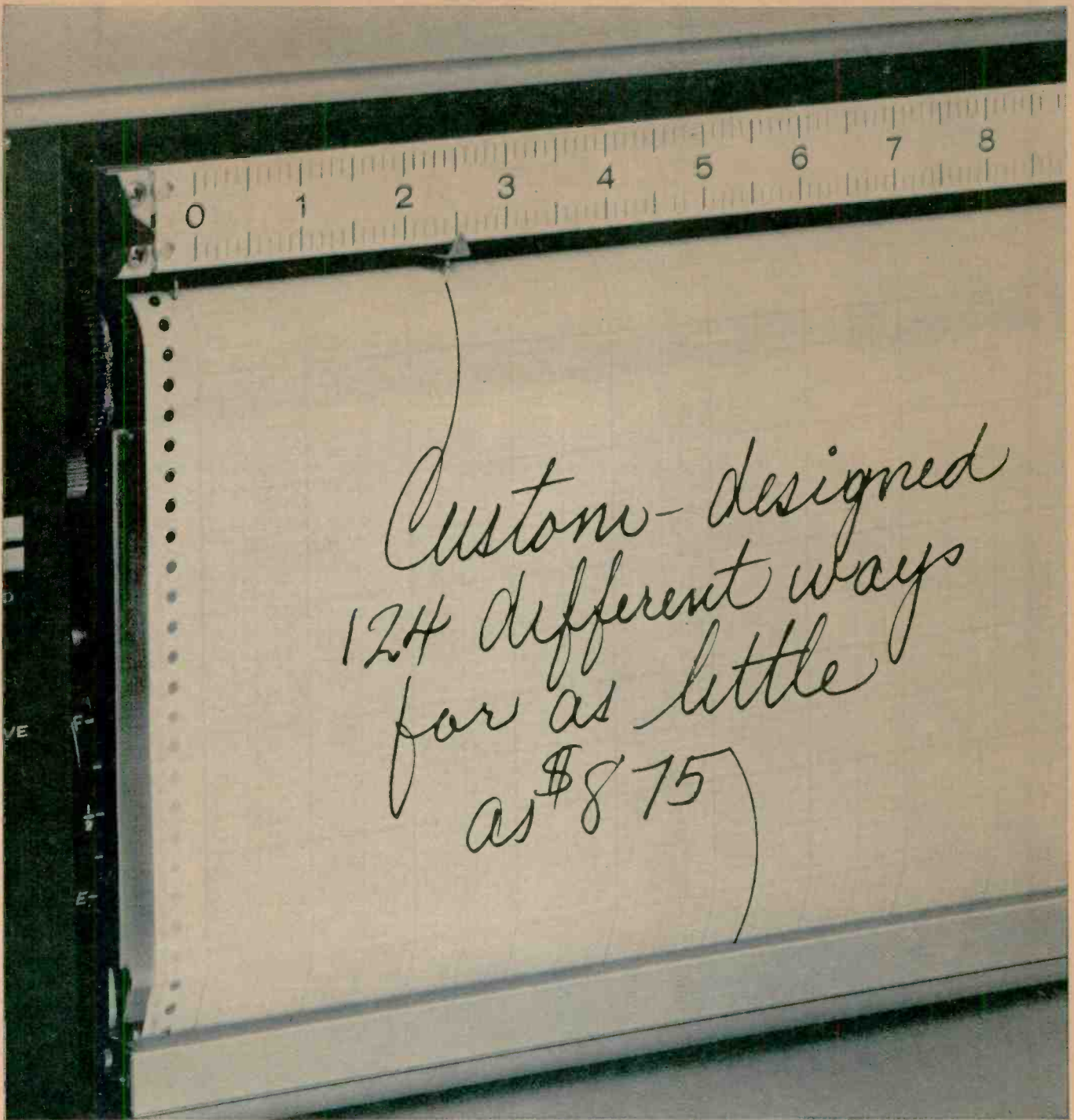

New freedom of choice in wide-chart recorder operation is now yours, at no extra cost, with the new Moseley Models 7102A and 7103A. Standard two- and one-channel versions are available with a 5-millivolt full scale span and 4 inches per minute chart speed. In addition, models with customer-selected spans and chart speeds are available in 124 different combinations from 1 millivolt to 1 volt, full scale, and 1 inch per hour to 4 inches per minute.

The new instruments provide high accuracy (better than 0.2% of full scale with 0.1% linearity); fast slewing speed (0.5 second full scale); one megohm input resistance at null; and a continuous Zener-controlled electronic reference.

Mechanical features include tilting recording platen, cartridge ink supply, and manual pen lift. Options at extra cost include event markers, retransmitting potentiometers, remote electric pen lift, on-off remote chart control, high-low limit switches, and latching glass door.

Bench, rack, or metric models are available, at the low price of \$1100 for the two-channel 7102A, and \$875 for the one-channel 7103A, including wide choice of span and chart speed.

Call your Moseley/Hewlett-Packard field engineer or write: Moseley Division, Hewlett-Packard, 433 N. Fair Oaks Ave., Pasadena, California 91102.

New Moseley 10" Strip-Chart Recorders

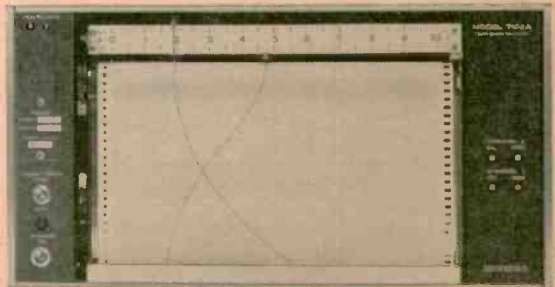

**HEWLETT
PACKARD**  **MOSELEY
DIVISION**

New pulser!

10 MC REP RATE!

4 NS RISE TIME!

10 VOLTS OUT!

...AND ONLY \$690!

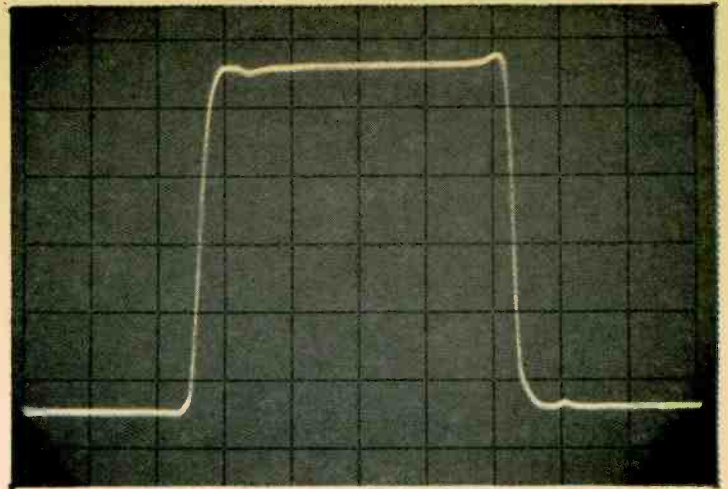

10 v pulse at 10 mc rep rate; sweep speed 10 ns/cm.

Test the range and performance of your circuits and components economically with the Hewlett-Packard 222A Pulse Generator. Priced at just \$690, the 222A provides 10-volt, 4 ns rise time pulses at rep rates to 10 mc, for full-range testing of your switching circuits, components and amplifiers.

Pulse rep rate, amplitude and width are continuously adjustable to match your particular test requirement. Select positive or negative pulses with amplitudes from 0.05 to 10 v, rep rates from 10 cps to 10 mc and widths from 30 ns to 5 ms. Square waves are available from 100 cps to 10 mc.

You can trigger the 222A externally to provide pulses synchronized with auxiliary equipment. In addition, the 222A generates a pulse for triggering other equipment. With the pulse delay control you can delay the output pulse from 100 ns to 5 ms with respect to the trigger pulse—permitting advance triggering of external circuitry.

Pulse shape is carefully controlled and specified to insure accurate, easy-to-interpret measurements. The quality of the pulse is shown on the oscillogram and in the brief specifications below. The pulse circuitry has a 50-ohm source impedance which insures clean pulses when driving non-50-ohm loads, and it is dc coupled to maintain the dc level with changes of amplitude or duty cycle.

Your Hewlett-Packard field engineer is ready to demonstrate the 222A on your bench. Give him a call. Or write for complete data to Hewlett-Packard, Palo Alto, Calif. 94304, Tel. (415) 326-7000; Europe: 54 Route des Acacias, Geneva; Canada: 8270 Mayrand St., Montreal.

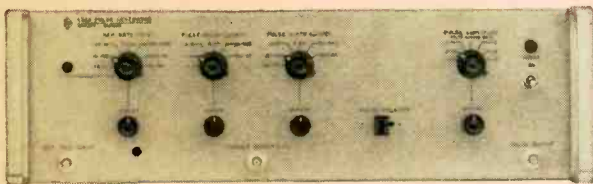

SPECIFICATIONS, output pulse

Source impedance: 50 ohms \pm 3%, approx. 15 pf shunt

Pulse shape

Rise and fall time: <4 ns

Overshoot and ringing: <4% peak of pulse amplitude

Corner rounding: occurs no sooner than 95% of pulse amplitude

Time to settle within 3% of flat top: <20 ns

Preshoot: <2% on leading edge, <4% on trailing edge

Perturbations on flat top: <3% of pulse amplitude

Pulse voltage: positive or negative, 1, 2, 5 step attenuator, with vernier, provides continuous adjustment from 0.05 to 10 v (into 50 ohms)

Pulse width: continuously adjustable from 30 ns to 5 ms in 6 ranges

Max. duty cycle: at least 50%, 100 cps to 10 mc

Price: \$690

Data subject to change without notice. Price f. o. b. factory.

HEWLETT  **PACKARD**
An extra measure of quality

Electronics

November 1, 1965
Volume 38, Number 22

| | |
|--------|------------------------|
| Page 4 | Readers Comment |
| 8 | People |
| 14 | Meetings |
| 16 | Meeting Preview |
| 23 | Editorial |
| 25 | Electronics Newsletter |
| 43 | Washington Newsletter |
| 125 | New Products |
| 143 | New Books |
| 144 | Technical Abstracts |
| 155 | New Literature |

| | | | | |
|------|----|---------------------------|----|-----------------------|
| | | Electronics Review | | |
| Page | 31 | Hybrids hold on | 35 | Airborne recorder |
| | 32 | Desk-top computer | 37 | Landing without help |
| | 33 | Electron-beam welding | 38 | First, aid for lasers |
| | 34 | The Pentagon shuffle | 40 | New field for scr's |

Probing the News

| | |
|-----|------------------------------|
| 109 | Space tracking in the 1970's |
| 114 | Transformation in Taiwan |
| 118 | A tiger in Voyager's tank |

Electronics Abroad

| | | | |
|-----|------------------------|-----|----------------------|
| 157 | Gunn-effect oscillator | 159 | Trade with China |
| 157 | Industrial computers | 159 | A time for decisions |
| 158 | Hospital computers | 160 | New IC industry |
| 158 | Another Lightning | 160 | Around the world |
| 159 | Latin launch-site | | |

Technical Articles

I. Design

| | | |
|------------------------|----|--|
| Optoelectronics | 58 | Switching with light Three types of circuits use optical signals for faster, less expensive switching T.E. Bray, General Electric Co. |
| Circuit design | 66 | Designer's casebook <ul style="list-style-type: none">● FET circuit stores light measurement● Chopper adapts voltmeter to d-c● R-f switching matrix cuts out crosstalk● Short-circuit protection consumes little power |

II. Application

| | | |
|-------------------------------|----|---|
| Industrial electronics | 70 | The picture looks better for closed circuit tv High-resolution systems produce photographic quality for industrial applications F. Dan Meadows, Granger Associates |
|-------------------------------|----|---|

III. Manufacturing

| | | |
|-----------------------|----|--|
| Special report | 75 | The packaging revolution, part II: design and manufacturing overlap How manufacturing and design engineering work together when integrated circuits are used J.J. Staller, Sylvania Electric Products Inc. and George Sideris, manufacturing editor |
| | 80 | The system designer's role Through the steps of a packaging problem Matthew Abbott, Sylvania Electric Products Inc. |
| | 88 | Computers design the layout By analyzing all possible configurations, a computer can reduce crosstalk and delays Edmund U. Cohler, Sylvania Electric Products Inc. |

| | | |
|-------------------|----|---|
| Production | 90 | Designing transmission lines into multilayer circuit boards (Cover) With the proper compromises, transmission lines of complex systems can be produced automatically William K. Springfield, IBM Corp. |
|-------------------|----|---|

Title R registered
U.S. Patent Office;
© copyright 1965
by McGraw-Hill, Inc.
All rights reserved,
including the right to
reproduce the contents
of this publication,
in whole or in part.

Electronics

Editor: Lewis H. Young

Senior editors

Technical: Samuel Weber
News: Kemp Anderson Jr.

Senior associate editors: John F. Mason, George Sideris

Department editors

Advanced technology: Joan Blum
Avionics: W.J. Evanzia
Circuit design: Michael Elia
Computers: Wallace B. Riley
Consumer electronics: Richard Lipkin
Electronics review: Stanley Zarowin
Instrumentation: Carl Moskowitz
Manufacturing: George Sideris
Military electronics: John F. Mason
New products: William P. O'Brien
Solid state: Jerome Eimbinder
Space electronics: Peter R. Sigmund
Special projects: Richard M. Machol

Regional editors

Boston: Thomas Maguire, editor; Robin Carlson
Los Angeles: William B. Wallace, Walter Barney, editors; June Ranlin
San Francisco: Laurence D. Shergalis, Edmond G. Addeo, editors; Mary Jo Jadin

Copy editors

Howard Rausch, Sally Powell

Graphic design

Art director: Saul Sussman
Assistant art director: Donna M. Marchyn
Editorial production: Ann Mella
Production editor: Arthur C. Miller

Editorial secretaries: Claire Benell, Mary D'Angelo, Lynn Emery, Kay Fontana, Carolyn Michnowicz, Lorraine Longo, Lorraine Werner

McGraw-Hill News Service

Director: John Wilhelm; **Atlanta:** Fran Ridgway; **Chicago:** Bruce Cross, Louis S. Gomolak; **Cleveland:** Arthur Zimmerman; **Dallas:** Marvin Reid;
Detroit: N. Hunter; **Los Angeles:** Michael Murphy, Ron Lovell;
San Francisco: Margaret Ralston;
Seattle: Ray Bloomberg; **Washington:** Arthur L. Moore, Charles Gardner, Herbert W. Cheshire, Seth Payne, Warren Burkett, Warren Kornberg

McGraw-Hill World News Service

Bonn: John Johnsrud, John Gosch; **Brussels:** Arthur Erikson; **London:** John Shinn;
Mexico City: Wesley Perry; **Milan:** Bruce Bendow;
Moscow: Donald Winston; **Paris:** Dan Smith;
Rio de Janeiro: Leslie Warren; **Tokyo:** Marvin Petal, Charles Cohen

Circulation manager: Hugh J. Quinn

Reprints: T.M. Egan

Publisher: C.C. Randolph

Electronics: November 1, 1965, Vol. 38, No. 22

Printed at 99 North Broadway, Albany, N.Y.
Second class postage paid at Albany, N.Y.

Subscriptions are solicited only from those actively engaged in the field of the publication. Position and company connection must be indicated on orders. Subscription prices: United States and Possessions and Canada, \$6.00 one year, \$9.00 two years, \$12.00 three years. All other countries \$20.00 one year. Single copies, United States and Possessions and Canada 75¢. Single copies all other countries \$1.50.

Published every other Monday by McGraw-Hill Inc. 330 West 42nd Street, New York, N.Y. 10036. Founder: James H. McGraw, 1860-1948.

Subscribers: The Publisher, upon written request to our New York office from any subscriber, agrees to refund that part of the subscription price applying to copies not yet mailed. Please send change of address notices, subscription orders or complaints to Fulfillment Manager, Electronics, at the address below. Change of address notices should provide old as well as new address, including postal zone number if any. If possible, attach address label from recent issue. Allow one month for change to become effective.

Postmaster: Please send Form 3579 to Fulfillment Manager, Electronics, P.O. Box 430, Hightstown New Jersey 08520

Readers Comment

Straightening out resistor string

To the Editor:

It appears to me that Robert P. Owen is in error in the article "Forming accurate dividers with nonprecise resistors," [Electronics, Oct. 4, p. 100]. Since any single resistor error (in such a divider as proposed by the author) is averaged out over the total number of resistors included up to that point, then the least accurate resistors should be at the top of the string, and the most accurate at the bottom, with the plus and minus errors staggered.

Taking his values of resistance and arranging them according to this principle, rather than as he has suggested, I get the following results:

| Divider Resistors | Divider Steps | % Error |
|-------------------|---------------|---------|
| 91 | 100% | 0.00 |
| 110 | 90.87% | +0.97 |
| 94 | 79.85% | -0.19 |
| 105 | 70.44% | +0.63 |
| 97 | 59.92% | -0.13 |
| 102 | 50.20% | +0.40 |
| 98 | 39.98% | -0.05 |
| 101 | 30.16% | +0.53 |
| 100 | 20.04% | +0.20 |
| 100 | 10.02% | +0.20 |

The author's worst-case and average error are -1.04% and 0.46%, respectively. The above results display comparative figures of +0.97% and 0.33%, respectively.

Although either configuration of the divider string is quite usable as a 1% string the point, nevertheless, is that the principle of placing the least accurate resistors in the middle of the string is incorrect if the author truly intended to have a voltage divider as described.

Alfonso Angelone
Chief, Research Section
Biomedical Engineering Branch
USAF School of Aerospace
Medicine
Brooks Air Force Base, Texas

Revolutionary scr's

To the Editor:

I have just finished reading "Powerful scr's control industry's

Sprague has what it takes to cope with any problem in electromagnetic interference or susceptibility control

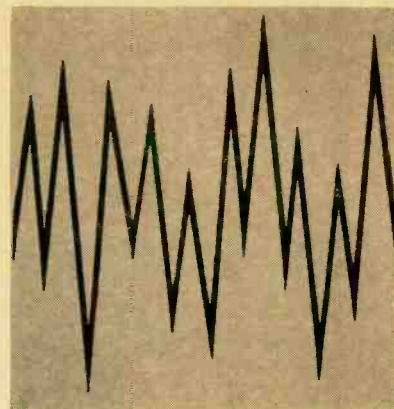

And we mean any problem . . . arising at any point in the development of any equipment or system!

Sprague's interference control facilities provide one of the most complete, fully integrated capabilities you can call on . . . embracing every aspect of interference and susceptibility control.

Design Assistance: Black boxes . . . subsystems . . . complete systems. Using advanced interference prediction techniques, Sprague engineers replace design by "hunch" with precise analysis of electrical schematics. Suppression and shielding can be designed into pre-prototype plans so accurately that little or no modification is required upon evaluation of the model. With today's more complex equipment and increasingly stringent EMI requirements, Sprague assistance in initial design can pay for itself in a dozen different ways by helping you be right the *first* time!

Measurement, Evaluation: Sprague can help you measure interference and susceptibility characteristics of your breadboard, prototype, or production equipment to the applicable interference specification. You know where you stand before investing in further development. We can also research such areas as shielding effectiveness, screen room integrity, transient susceptibility of digital equipment, and cable cross coupling.

Component Design: Sprague Filter Engineering Specialists can design, evaluate, and sample interference control devices to your particular requirements. These range from standard feed-thru capacitors and radio interference filters to the more sophisticated packages, such as frequency-controlling electric wave filters.

Component Production: Each of four Filter Development Centers maintains a well stocked model shop for the rapid fabrication of special

components in prototype quantities. Full scale production facilities are maintained in Visalia, Calif.; North Adams, Mass.; and Vandalia, Ohio.

Compliance Testing: Sprague can test your equipment or system and report on its compliance to the applicable specification: MIL-I-6181, MIL-I-26600, MIL-I-16910, MIL-E-6051 or to such other specialized interference documents as GM07-59-2617A, AFBSD Exhibit 62-87 (Minuteman WS133B), LSMC Specification ERS11897 (Polaris A3) or MIL-STD-449. If compliance is not indicated, a Sprague engineer will make concise recommendations and will, if you desire, give you every assistance in achieving that compliance.

Regional Service: Wherever you may be, this integrated EMI capability is readily available to you from strategically located Filter Development Centers in North Adams, Mass.; Annapolis Junction, Md.; Vandalia, Ohio; and Los Angeles, Calif. Each is fully equipped and staffed to evaluate, modify, or qualify your equipment.

In-plant Service: Sprague can put competent Interference Control Specialists at your service in your plant for consultation on, or supervision of, special projects.

Whether your work involves military or industrial electronic equipment or systems, Sprague Filter Development Center personnel can help assure substantial savings in dollars and hours at many points during development. Get complete information from the development center nearest you or by writing for a comprehensive brochure (FD-101) to Technical Literature Service, Sprague Electric Company, 35 Marshall Street, North Adams, Massachusetts.

FILTER DIVISION PRODUCTS AND SERVICES

INTERFERENCE FILTERS AND CAPACITORS
PRECISION TOROIDAL INDUCTORS
FREQUENCY SPECTRUM SIGNATURES
COMPONENT ENVIRONMENTAL TEST FACILITIES

ELECTRIC WAVE FILTERS
TELEMETRY FILTERS
EMI TEST FACILITIES
EMI SYSTEMS ENGINEERING



*Sprague' and '®' are registered trademarks of the Sprague Electric Co.

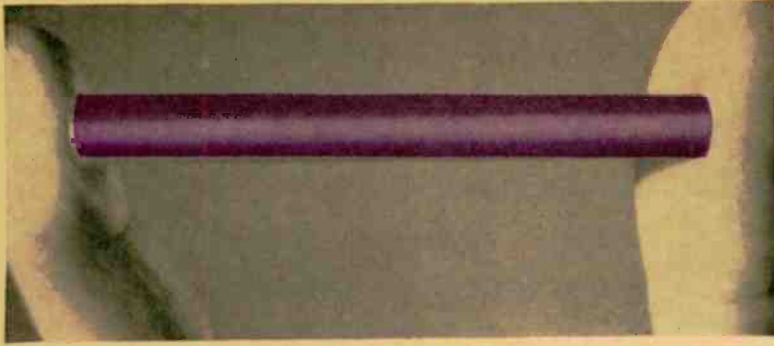

This American Optical AOLux laser rod will increase energy output of most laser systems using your existing power supply. Think of the gain with an AOLux rod this big . . .

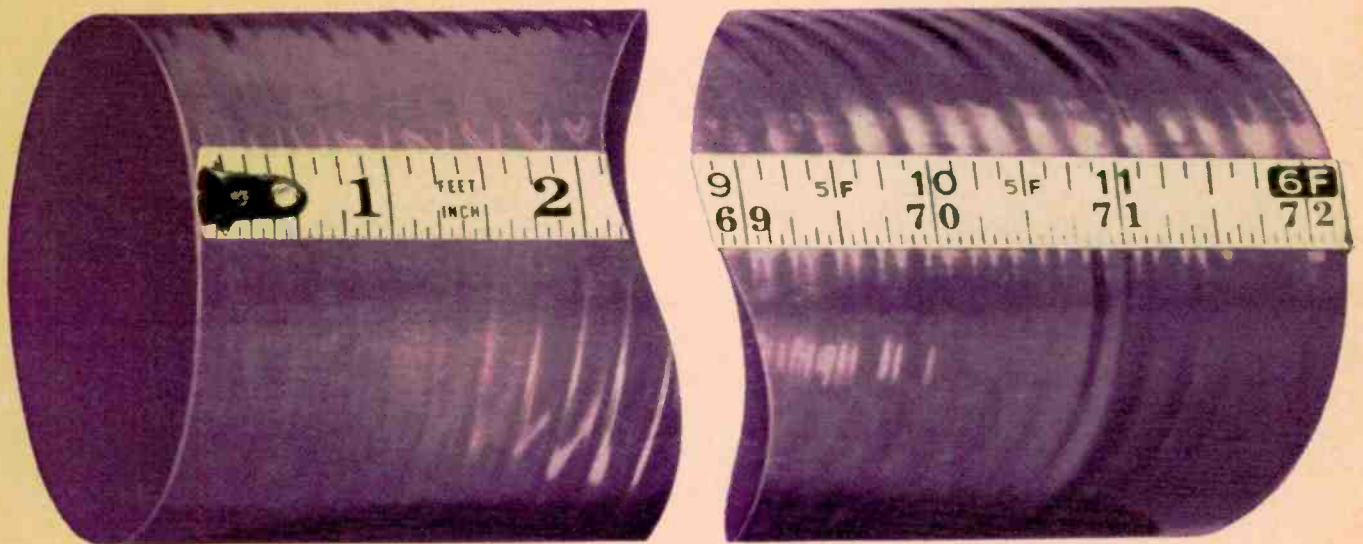

and no cryogenic cooling required.

DESCRIBE, ON YOUR LETTERHEAD, the particulars of your laser system so we may recommend the proper AOLux rod geometry for you. With our advances in AOLux rod size, durability and efficiency, we can improve the performance of your laser device. After all, we invented the neodymium-doped glass laser. Write American Optical Company, Space-Defense Division, Dept. E-1, Southbridge, Massachusetts 01551.

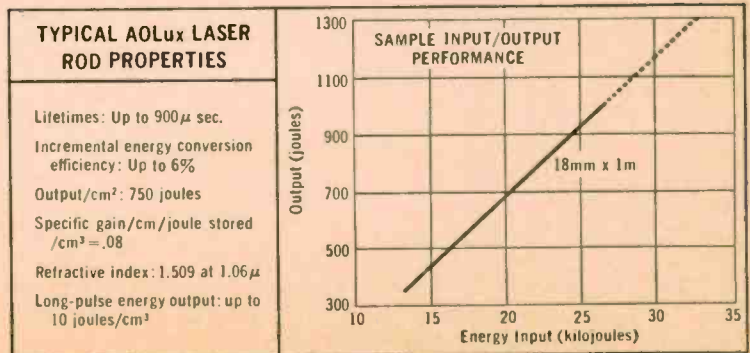

AMERICAN OPTICAL COMPANY
SPACE-DEFENSE DIVISION—SOUTHBRIDGE, MASSACHUSETTS

biggest machinery" [Oct. 4, p. 110], and I was especially interested in section three describing the use of the scr with a-c motors.

I am interested in the type of scr and variable speed drive that is now becoming widely used for driving centrifugal devices such as pumps and fans. This device uses a standard Nema D squirrel-cage motor and, by varying the voltage only, controls the slip of the motor, providing a variable speed drive for devices that absorb horsepower in proportion to the cube of the speed.

I believe that the scr will revolutionize the variable speed drive industry as we know it now.

Lester D. Teachout
Twin Disc Clutch Company
Racine, Wis.

Reader, read on

To the Editor:

I wish you would stop using those ultrashort, cryptic, clever titles in your table of contents. I cannot afford the time to scan the whole magazine and must rely on the table of contents in deciding what I want to look at. At present, it is not very helpful.

Examples of titles with near-zero information content in the Oct. 18 issue are: "Sensing danger," "In deep water," "Sound effects," "Color by cholesterol," "Gambling against transistors," "Triple-deckers," and "Come on in! The water's fine."

Peter W. Tappan
Bolt Beranek and Newman Inc.
Downers Grove, Ill.

▪ Clever, we hope. Cryptic, no. The content of any story in Electronics is indicated by the department title which precedes it. Reader Tappan is urged to go beyond the contents page; he will find

that the first sentences of each story will tell him what he wants to know.

Unerring detector

To the Editor:

Trying to follow reader Norman A. Forbes' problem in his comment [Oct. 18, p. 7] was very difficult because his equation for peak values of current and voltage ($I\frac{1}{2}I$) and ($V\frac{1}{2}V$) made no sense to me. Do I detect the work of a gremlin here?

Jack Skilowitz
Scarsdale, N. Y.

▪ Jack Skilowitz's gremlin detector is unerring. The expressions should have been $\sqrt{2} I$ and $\sqrt{2} V$, respectively.

Not constantly constant

To the Editor:

Tsk! Tsk! What would Dr. Einstein say about Messrs. Harris, Massey, Oshman and Targ?

In their article, "Controlling laser modulation," [Electronics, Sept. 20, p. 101], these gentlemen state that "... the velocity of light is different in different parts of the cavity" (in which oscillation builds up as light makes multiple passes through it).

Don't they remember Einstein's postulate: The velocity of light is a universal constant, the same for all observers in all inertial systems?

Howard S. Balsam
East Greenwich, R. I.

▪ Reader Balsam forgets that the phase velocity of light, like any coherent electromagnetic radiation, is slowed down by the presence of dielectric at the ends of the cavity. In addition the phase velocity of the various modes differ.

SPRAGUE®

MODEL 500 INTERFERENCE LOCATOR

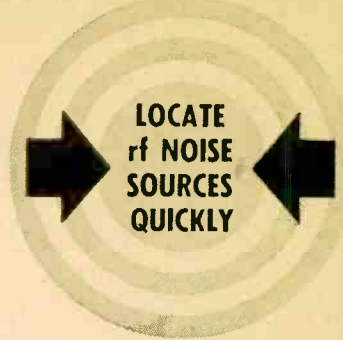

This versatile instrument is a highly sensitive interference locator—with the widest frequency range of any standard available unit! Model 500 tunes across the entire standard and FM broadcast, shortwave, and UHF-TV spectrums from 550 kc. to 220 mc. in 6 bands.

It's a compact, portable, rugged, versatile instrument—engineered and designed for most efficient operation in practical field use. It features a transistorized power supply, meter indications proportional to carrier strength as well as sensitivity of 5 microvolts minimum for 5% meter deflection over entire tuning range.

Send for brochure IL-106.

SPRAGUE ELECTRIC COMPANY
35 Marshall Street, North Adams, Mass.



"Sprague" and "®" are registered trademarks of the Sprague Electric Co.

SUBSCRIPTION SERVICE

Please include an Electronics Magazine address label to insure prompt service whenever you write us about your subscription.

Mail to: Fulfillment Manager
Electronics
P.O. Box 430
Hightstown, N.J. 08520

To subscribe mail this form with your payment and check new subscription renew my present subscription

Subscription rates: in the U.S.: 1 year, \$6; two years, \$9; three years, \$12. Subscription rates for foreign countries available on request

CHANGE OF ADDRESS

ATTACH LABEL HERE

If you are moving, please let us know five weeks before changing your address. Place magazine address label here, print your new address below.

name

address

city

state

zip code



how to measure resolver or synchro position with 30 second repeatability

In both production test and ground checkout systems, North Atlantic's high performance Angle Position Indicators provide exceptional operator ease and precision in the measurement of synchro and resolver position. Features include digital readout in degrees and minutes, 30 second resolution, continuous rotation, plug-in solid-state amplifier and power supply modules. Due to the design flexibility of these units, they can be readily provided with a variety of features for specific requirements. Typical units in this line incorporate combinations of the following features:

- Single Synchro or Resolver Input
- Dual Synchro or Resolver Inputs
- Retransmit Synchro, Resolver, Potentiometer, or Encoder
- 2-Speed Synchro Input
- Multi-frequency Inputs
- DC Input
- 0-999 Counter

BASIC SPECIFICATIONS

| | |
|--------------------|--------------------------------|
| Range..... | 0°-360° continuous rotation |
| Accuracy..... | 6 minutes (standard) |
| Repeatability..... | 30 seconds |
| Slew Speed..... | 25°/second |
| Power..... | 115 volts, 400 cps |
| Size..... | API-8025 1¾" h x 9½" w x 9" d |
| | API-8027 3½" h x 4¼" w x 9¾" d |



Your local North Atlantic representative has complete data on the API line. Call him today or write direct for technical literature.

NORTH ATLANTIC industries, inc.
TERMINAL DRIVE, PLAINVIEW, L. I., NEW YORK • QVerbrook 1-8600

People

James McCormack, a retired Air Force general and vice president of the Massachusetts Institute of Technology, will become chief executive officer of the Communications Satellite Corp. on Dec. 1, succeeding Leo D. Welch. His annual salary will be \$125,000.



McCormack, 54 years old, known to colleagues as "Gentleman Jim," has a reputation as a persuasive organizer and an articulate manager of large-scale research, educational and systems engineering projects. At MIT, he supervised the institute's two largest research divisions, Lincoln Laboratory and the Instrumentation Laboratory. He also helped organize the nonprofit Mitre Corp. and Aerospace Corp.

Alec Harley Reeves, winner of the Stuart Ballantine Medal for outstanding achievement in communications, has managed to remain a scientist by fighting off all efforts to expand his administrative duties.



In 1960 the genial engineer found himself helping to run a 120-man group at the Standard Telecommunications Laboratory in Harlow, England. Today, the advanced circuit-research section, of which he is assistant manager, has only 15 scientists and engineers; the others are working on problems that are more immediate to STL, an affiliate of the International Telephone and Telegraph Corp. "When I retire in two years," he says, his eyes sparkling, "the number will be down to two and my work will be nearly entirely scientific."

The portly, 63-year-old Englishman modestly omits the fact that while his department shrinks in size, its work moves further and

Power Tube Breakthrough Permits Nearly 100 to 1 Grid to Plate Current Division

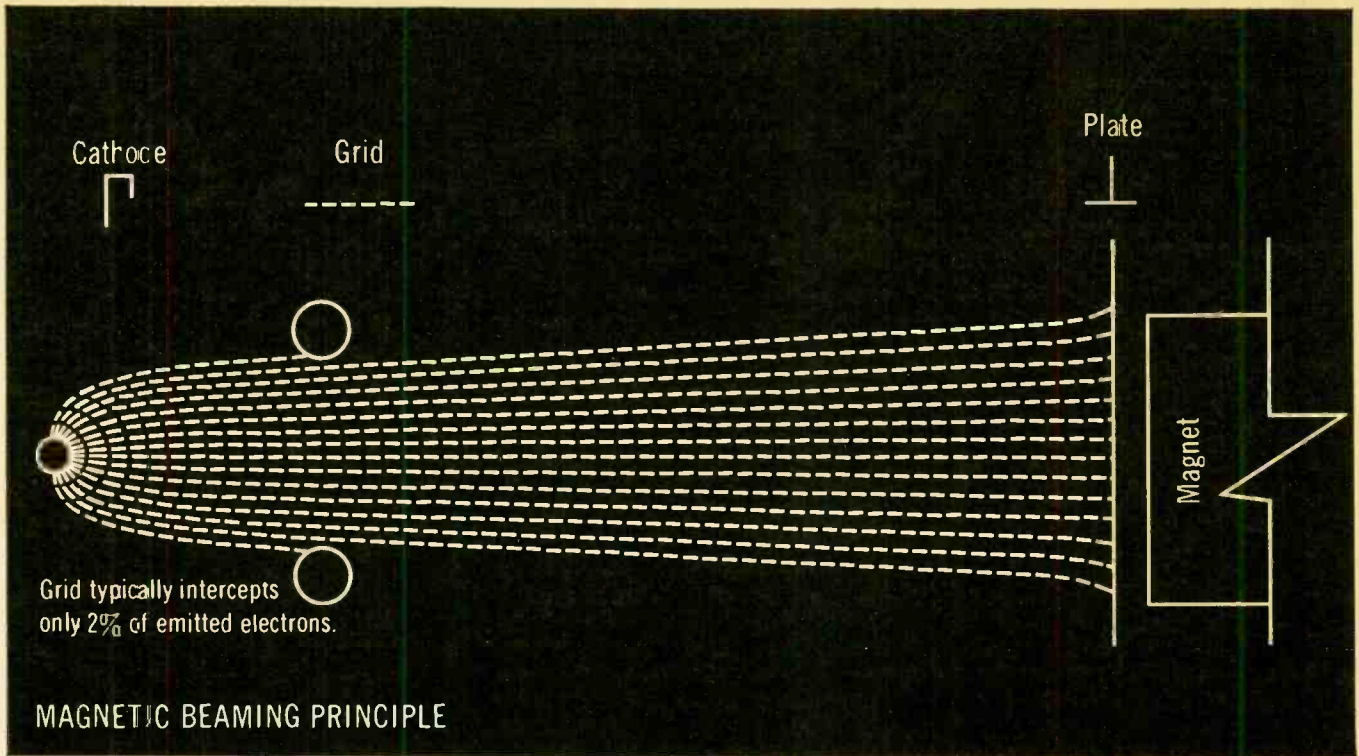

Machlett research has led to a new magnetic beaming principle for use in grided power tubes. This breakthrough in power tube design results in higher power gain, increased tube efficiency, and maximum double-sided cathode utilization. As shown above (in simplified single-sided form), a permanent magnet, placed external to the active tube elements, controls the electron trajectory from cathode to plate so that only a negligible amount of electrons are intercepted by the grid—typically 2% as opposed to 20% in conventional tubes. Grid dissipation is no longer the limiting factor in tube operation. Magnetic beaming is being applied to an expanding line of Machlett triodes and tetrodes. Whether you require high power/high voltage triodes or tetrodes, UHF planar triodes, X-ray tubes or vidicons, or if you need assistance in research or design development, write The Machlett Laboratories, Inc., Springdale, Conn. 06879. An affiliate of Raytheon Company.

MACHLETT

ELECTRON TUBE SPECIALIST

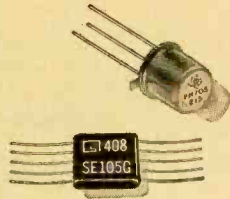

Need to say a lot
in a little space?

(or make markings
more **durable**...or
more **economical**...
or at **higher rates**?)

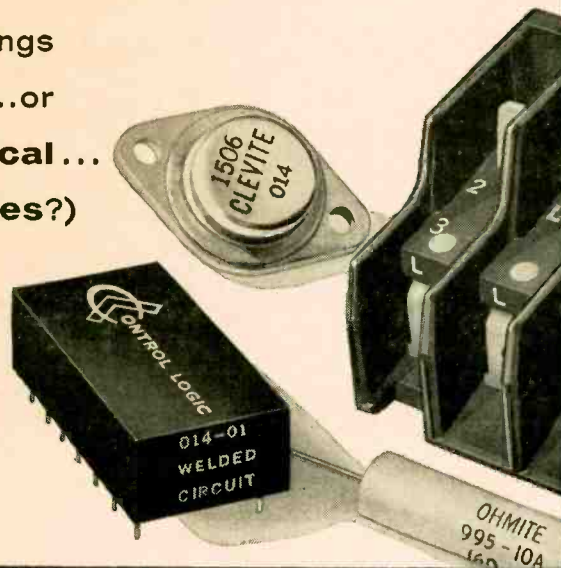

We can show you how

We can show you how to identify products so they will resist extreme amounts of handling, abrasion, many solvents and other atmospheric conditions . . . or how to sequentially number and identify components with savings of more than \$50 per 1000 . . . or how to print trademark, type number, value and date code on 90 units a minute . . . or how to produce an imprint that remains readable after 1000 hours at 200°C. . . or get 10 digits and 2 letters in a micro-circuit area of 0.090" — or 21 characters on a TO-5 case with interchangeable type number and date code . . . or save 75 cents of every dollar you now spend on buying, applying, inventorying and discarding obsolete preprinted labels.

The answers are in proven Markem machines, type and specialty inks, which daily produce better product or package identification by reducing costs, smoothing production control and increasing customer acceptance. And while Markem machines, type and inks are helping to produce better products through more complete and lasting identification, they frequently pay for themselves in the savings they make possible. Tell us what *you* make, what it must say, and for how long: we'll give you a specific recommendation and cost estimate right away. Write Electrical Division, Markem Machine Co., 305 Congress St., Keene, New Hampshire 03431.

MARKEM

further into the future of communications. Few of Reeves's latest developments—in optical communications, for example—are likely to come into common use soon. But neither did the 1937 invention for which he received the Ballantine Medal on Oct. 20. That invention was pulse-code modulation, the technique for slicing electronic information—such as voice signals or television pictures—into digital bits.

Only with the advent of semiconductor devices in the past decade has it become economically feasible to use pulse-code modulation for sending telephone messages across the United States. The technique scored a dramatic triumph last summer when it was used to transmit tv pictures 134 million miles from the spacecraft Mariner 4, near Mars.

Reeves expects optical techniques, employing pulse-code modulation, to revolutionize communications by the year 2000. He envisions scientific conferences that bring together not men, but ideas. "There will be no need for people to crisscross the Atlantic," he explains. "You'll be able to attend a conference with British and French engineers without leaving your office, and without them leaving theirs, simply by turning on a video screen."

Coaxial cables and communications satellites can cope with some of the need, he concedes, but by 2000 A.D., if present techniques are relied upon for future communications needs, "the sky would have to be black with satellites."

The basic technology for optical communications is already available, Reeves says, but it's not yet economical. "It's entirely a matter of demand," he explains. All that remains to be solved are physics problems connected with handling this data fast enough and efficiently enough. "Optics will be by far the cheapest way to do it," he declares. But he does not expect the first optical submarine cable to span the Atlantic much before the turn of the century.

The Ballantine Award, made by the Franklin Institute of Philadelphia, is named for Stuart Ballantine, an American research engineer in acoustics and electrophysics, who died in 1944.



Get $\pm 0.2\%$ regulation with high voltage DC power

Unique combination of Sorensen's 1000 Series high voltage power supplies and ACR Series (SCR) line voltage regulators gives you $\pm 0.2\%$ output voltage regulation for $\pm 10\%$ line voltage variation.

This is just one of the customer-oriented benefits you get with the versatile 1000 Series...plus these other important features:

- 1 SELECTION OF 9 MODELS...cover range of 0 to 150KV and up to 750 W. (Other Series up to 400KV and 15,000 W.)
- 2 LINE REGULATION $\pm 1.5\%$ OR $\pm 0.2\%$ (optional)
- 3 LOW RIPPLE...0.01% (optional)
- 4 EASILY REVERSIBLE POLARITY
- 5 CONTINUOUSLY VARIABLE OUTPUT...coarse and fine controls
- 6 SOLID STATE HIGH VOLTAGE RECTIFIERS
- 7 FULLY METERED

THESE SAFETY DEVICES STANDARD ON ALL MODELS:

- On loss of input power, output power is automatically shorted.
- Meters and relays are protected against shorts by zener diodes.
- Series output resistor limits short circuit surges.
- Zero-Start Interlock assures zero output voltage at turn-on. Bypass is provided for special surge-on applications.
- Overcurrent cutoff adjustable from 20% to 120% of rated current.
- Overvoltage cutoff adjustable from 10% to 110% of rated output voltage.

For data on the 1000 Series and other Sorensen products, send for the "Controlled Power Catalog and Handbook." Write: Sorensen, A Unit of Raytheon Co., Richards Ave., South Norwalk, Conn. 06856. Or use Reader Service Card Number 200.

1000 SERIES DC POWER OUTPUT SPECIFICATIONS

| MODEL | 1151* | 1121* | 1101* | 1061* | 1030-20 | 1020-30 | 1012-50 | 1006-100 | 1003-200 |
|---------|---------|---------|---------|--------|---------|---------|---------|----------|----------|
| VOLTAGE | 0-150KV | 0-120KV | 0-100KV | 0-60KV | 0-30KV | 0-20KV | 0-12KV | 0-6KV | 0-3KV |
| CURRENT | 5 MA | 5 MA | 1.5 MA | 10 MA | 20 MA | 30 MA | 50 MA | 100 MA | 200 MA |

*Furnished with separate high voltage section



Circle 11 on reader service card

**If you read this ad you may have
to redesign your next computer.**

(you may have to anyway.)

Fairchild Complementary Transistor Micrologic (CT μ L) is drastically changing all existing speed/cost ratios in the computer industry. If you are not already using CT μ L (many computer manufacturers are) here are 10 reasons why you should:

1. Complementary Transistor Micrologic combines PNP and NPN transistors in a single monolithic circuit. As you know from your experience with discrete components this form of logic provides very fast propagation rates but isn't very stable.

2. We added a resistive network to the CT μ L elements to arrive at a circuit which is as stable as DTL logic—and at least twice as fast.

3. In our newer circuits we substitute an input voltage clamp for the resistive network. This damps out ringing, eliminates additive harmonic effects, and stabilizes the circuit to a point where you can drive a 15-foot line instead of a 1-foot maximum.

4. We then turned to the package and designed it for your particular needs: highly reliable, but with less concern for space than is necessary for military applications.

5. As a result you can use CT μ L elements just like discrete components: use standard boards instead of multi-layer; insert by hand or machine instead of using expensive carriers; flow solder instead of precision weld; use standard wiring on your back-panel instead of twisted pair or coaxial.

6. We make a complete line of CT μ L (see listing below) consisting of all the elements you need to design virtually every standard logic function in the book.

7. CT μ L is a field-proven line, in production, available for immediate delivery from distributors.

8. Last, but by no means least, CT μ L costs less per decision than any other logic form on the market today—and that includes the one in your back room.

9. If you don't want to design a computer which is either slower or more expensive than the competition, we suggest that you get some CT μ L circuits now. Or write us for complete information.

10.

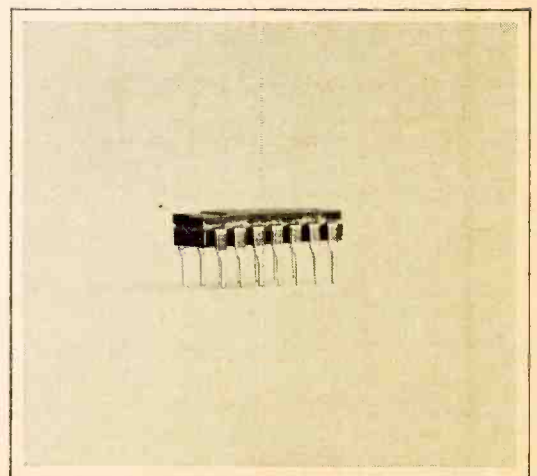

CT μ L Elements: CT μ L952 Dual 2-input inverter/NOR gate CT μ L953 2,2,3-input AND gate CT μ L954 Dual 4-input AND gate CT μ L955 Single 8-input AND gate CT μ L956 Dual 2-input buffer CT μ L957 Dual-rank flip-flop CT μ L964 3,3,1-input AND gate CT μ L965 Quad one-input AND gate CT μ L967 J-K flip-flop CT μ L968 Dual latch. Micrologic and CT μ L are FAIRCHILD Trademarks. Micrologic: FAIRCHILD SEMICONDUCTOR'S Trade Name for Analog and Digital Monolithic Circuits.

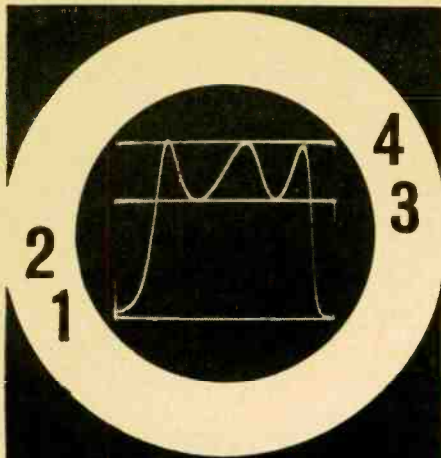

see **4** response traces on single-trace scope

measurement by comparison up to 1,200 mc



NEW

JERROLD SOLID-STATE 3-POSITION COAXIAL SWITCHER

Model TC-3 \$295.00

Turn any single-trace oscilloscope into a 4-trace scope; insert two reference traces automatically in addition to test trace and baseline. These references have advantage of permanent relative accuracy over scribed or painted lines.

Results are repeatable, as accurate as your reference attenuators. Generator and scope drift do not affect accuracy of measurements. Frequency from dc to 1,200 mc extends usefulness of comparison technique well into the UHF band. The TC-3 Coaxial Switcher can save you thousands of dollars in speed and accuracy. Write for literature.

JERROLD ELECTRONICS
Industrial Products Division,
Philadelphia, Pa. 19132
In Canada: Jerrold Electronics,
60 Wingold Ave., Toronto 19, Ont.
Export: Rocke International,
13 E. 40th St., New York, N.Y. 10016

**SWEEP GENERATORS • AMPLIFIERS
PRECISION ATTENUATORS • COMPARATORS**

Meetings

Conference on Men, Machines and Automation, Institution of Production Engineers; Eastbourne, England, Nov. 7-10.

Conference on Hall Effect Applications, Electron Devices Group of IEEE; Kresge Little Theatre, MIT, Cambridge, Nov. 8-9.

Materials for Electron Devices and Microelectronics Meeting, ASTM; ASTM Headquarters, Philadelphia, Nov. 9-10.

Research and Development Meeting, New Jersey Council for Research and Development; Princeton Inn, Princeton, N. J., Nov. 10.

Engineering in Medicine and Biology Conference, ISA, IEEE; Sheraton Hotel, Philadelphia, Nov. 10-12.

International Meeting of the Society of Exploration Geophysicists, Society of Exploration Geophysicists; Statler-Hilton, Dallas, Nov. 14-18.

Oceanography Conference, Institute of Marine Science; Miami, Nov. 17-24.

Mid-America Electronics Conference (MAECON), Kansas City section of IEEE; Hotel Continental, Kansas City, Missouri, Nov. 18-19.

Electromagnetic Sensing Symposium, University of Miami, American Geophysical Union Univ. of Miami, Coral Gables, Fla., Nov. 22-24.

International Conference on UHF Television, IEEE; London, England, Nov. 22-23.

Nuclear Electronics Conference, International Atomic Energy Agency; Bombay, India, Nov. 22-26.

Symposium on the Interaction of Space Vehicles with an Ionized Atmosphere, AAS, School of Environmental and Planetary Sciences, University of Miami, Deauville Hotel, Miami Beach, Nov. 26-27.

Ultrasonics in Medicine Conference, AIUM; Lima, Peru, Nov. 26-27.

Digital Equipment Computer Symposium, DECUS; Stanford Univ., Stanford, Calif. Nov. 29.

Joint Computer Conference, AFIPS, Las Vegas, Nov. 30-Dec. 2.*

Sonics and Ultrasonics Symposium, IEEE; Hotel Sheraton, Boston, Dec. 1-3.

Vehicular Communication Conference, G-VC/IEEE; Sheraton-Park Hotel, Washington, D.C., Dec. 2-3.

Integrated Circuit Design Seminar, Integrated Circuit Engineering Corp; Marriott Motor Inn, Philadelphia, Dec. 6-10.

Analytical and Measuring Instruments and Laboratory Apparatus Show, Bureau of International Commerce; U.S. Trade Center, London, England, Dec. 7-17.

International Conference on Radiological Protection in the Industrial use of Radioisotopes, Societe Francaise de Radioprotection; Centre de Conferences Internationales, Paris 16, Dec. 13-15.

ASSET/Advanced Lifting Re-entry Technology Symposium, Flight Dynamics Lab; Wright-Patterson Air Force Base, Dayton, Dec. 14-16.

American Association for the Advancement of Science, AAAS; Univ. of Calif., Berkeley, Dec. 26-31.

International Symposium on Differential Equations and Theory of Systems, AFOSR, Brown Univ. and the Univ. of Puerto Rico; Univ. of Puerto Rico, Dec. 27-30.

Call for papers

Region 111 Convention, IEEE; Marriott Motor Inn, Atlanta, Ga., Apr. 11-13. **Nov. 1** is deadline for submission of 200-word abstract on real-time information, communication, and control processes to M. D. Prince, Dept. 72-14, Zone 400, Lockheed-Georgia Co., Marietta, Ga. 30061.

National Telemetry Conference, ISA, AIAA, IEEE; Prudential Center, Boston, May 10-12. **Dec. 15** is deadline for submission of completed papers and a 200-word abstract, in duplicate, on telemetry technology or its applications to other fields, to Dr. Fred Nieman, NTC-66 Program Committee, NASA Electronics Research Center, 575 Technology Square, Cambridge, Mass. 02139.

* Meeting preview on page 16

Value equals performance divided by price. Our new Null Detector/Microvoltmeter satisfies the equation. The parameters:

- 100 & 10 megohm input impedances
- 1 microvolt to 1000 vdc ranges with $\pm 2\%$ accuracy
- Input isolation 10^{12} ohms
- takes up to 1200 vdc on any range
- grounded recorder output isolated from input
- rechargeable battery operation
- price: \$350, or \$395 with batteries.

Applications for the Fluke 845 Null Detector/Microvoltmeter include standardization of voltage dividers, intercomparison of standard cells, ratio measurements, voltage measurements with a dc calibrator, isolation amplifier and as a general purpose transistorized voltmeter. Other specifications include DC common mode rejection of better than 180 db; AC common mode rejection, 120 db; milspec shock and vibration requirements; size, 7" high x 8½" wide; two units fit a 19" rack. For details and a demonstration, call your Fluke engineering representative or write.



FLUKE • Box 7428 • Seattle, Washington 98133 • Phone: (206) PR 6-1171 • TWX: (910) 449-2850

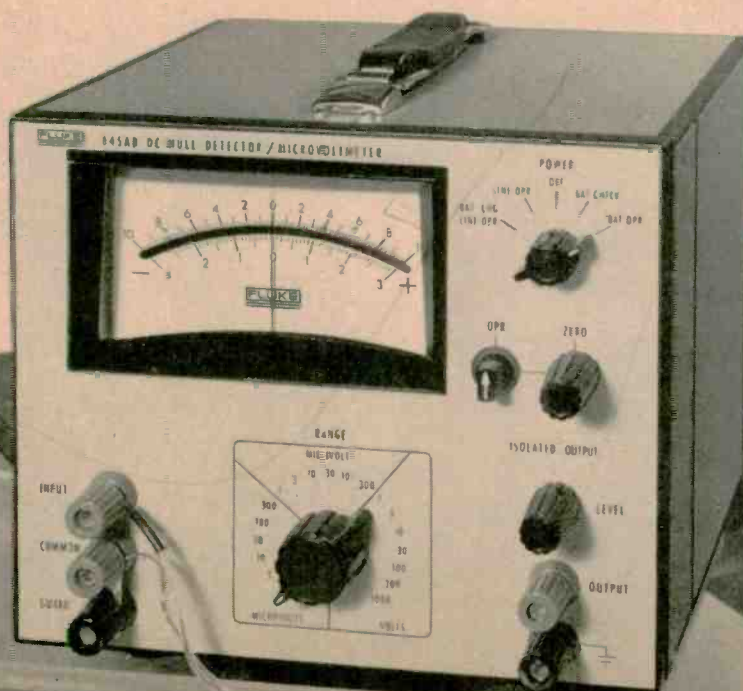

New Fluke Model 845AB checking out Rosa type resistors in oil bath.



Beckman solves space age problems in DeKalb-Atlanta

Where can a company get a good deal on warehouse space—close to the booming space age projects of the Southeast? Beckman Instruments, a leader in the field of producing instruments for industry, science and biochemical research, found the industrial site and technical talent it needed in DeKalb-Atlanta's Peachtree Industrial Blvd. District. From DeKalb, Beckman markets direct—developing an increasingly productive relationship with Southeast customers. If you have a space—or space age—problem, DeKalb-Atlanta may be your launching site, too. Write today for more details.

Reid Williamson, Jr., Manager, Industrial Committee of 100, or B. H. Manning, Jr., Chairman, DeKalb County Commission, P.O. Drawer 15059, Atlanta, Georgia 30333

NAME _____
 TITLE _____
 COMPANY _____
 ADDRESS _____
 CITY & STATE _____

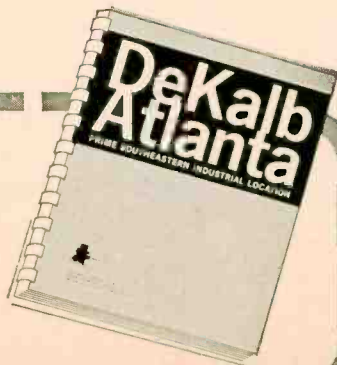

Meeting preview

FJCC at Las Vegas

Four categories of computer technology—hardware, software, management and applications—will be examined at the 1965 Fall Joint Computer Conference. The conference, sponsored by the American Federation of Information Processing Societies, will be held in Las Vegas, Nev., from Nov. 30 through Dec. 2.

Technical meetings at the conference will include tutorial sessions for attendees who wish to explore beyond their own specialties. Although sessions are scheduled on a variety of topics, interest is focused on memory technology and time-sharing.

One of the tutorial sessions, entitled "Time-Sharing in the Real World," consists of papers by Arthur Rosenberg of Scientific Data Systems, Inc., Richard Kaylor of Informatics, Inc., and Ed Bryan of the Rand Corp. The session is intended for nonprogrammers—engineers and management people.

Rosenberg will describe the impact of a time-shared computer system on an organization and will discuss the economics of time-sharing.

Kaylor will give a general description of time-sharing and talk about scheduling, program-swapping, and other mechanical considerations.

Finally, Bryan will emphasize the importance of communications in a time-shared system, and the effect of long-distance telephone tolls and technical difficulties on time-sharing installations.

Discuss-only sessions. An unusual feature of this year's conference is a number of discuss-only sessions, at which attendees will talk with the authors of the papers presented. Attendees are expected to have read the papers in advance of the sessions.

Discuss-only sessions will be held on five topics, three involving hardware and two, software. From three to seven papers will be discussed at each session; their authors will be present, and in two cases a panel of other experts will also be on hand.

at Air Products



chemicals

In chemicals, specialized processes created by our Houdry Division serve world-wide needs of the gasoline, petrochemical, and chemicals industries. Chemical products include oxo-alcohols used as key ingredients in plastics and detergents . . . catalysts that control speed of reactions in hundreds of processes and applications . . . fertilizer chemicals, such as ammonia needed to help feed the world's burgeoning population.

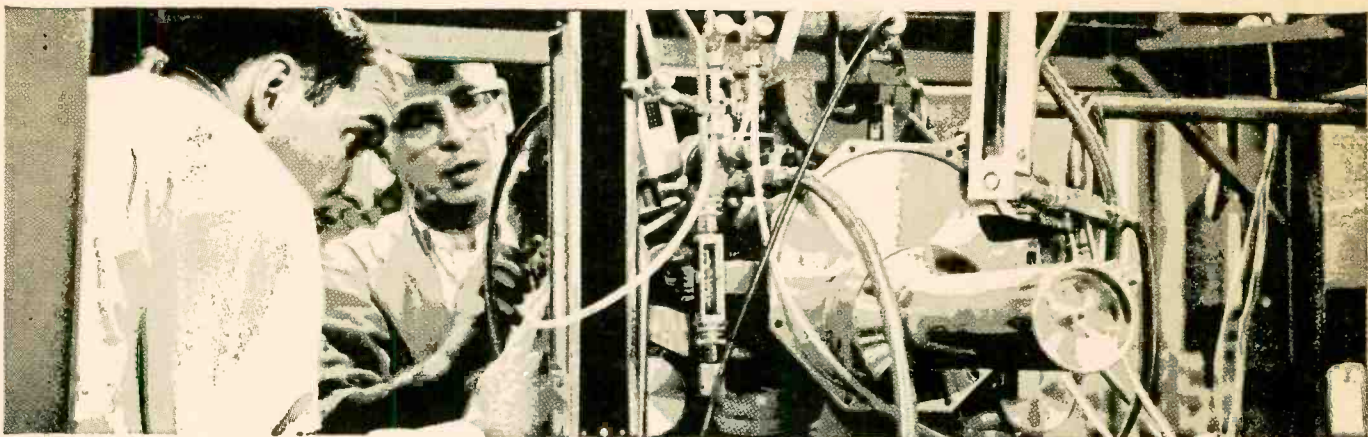

and cryogenics

In cryogenics, Air Products with its nationwide network of on-site plants produces and markets oxygen, nitrogen, argon, hydrogen and other vital industrial, medical and research gases . . . as well as powerful space propulsion and missile fuels. Cryogenic products include miniature to massive ultralow-temperature equipment . . . compact, highly automated on-site plants . . . food freezing systems . . . in-transit food refrigeration units . . . cutting and welding apparatus. Today, Air Products research in chemicals and cryogenics is continually providing improved products and processes at lower costs.

are a team



Air Products and Chemicals
INC.

ALLENTOWN, PENNSYLVANIA

Did you know? Air Products has just completed a \$30-million chemicals and cryogenics complex at New Orleans—including a major industrial gas plant, a liquid hydrogen plant to meet NASA's space fuel requirement and a 600-ton per day fertilizer chemical facility.

We're into electronics

that's why Bausch & Lomb V.O.M.
ASSURE YOU

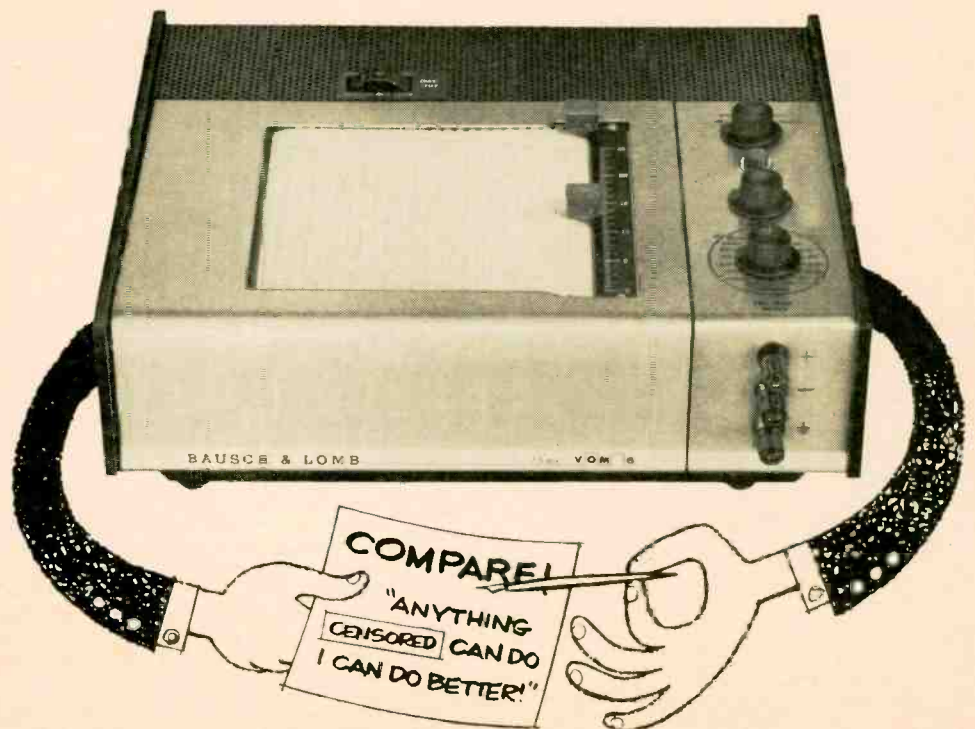

up to our ears...

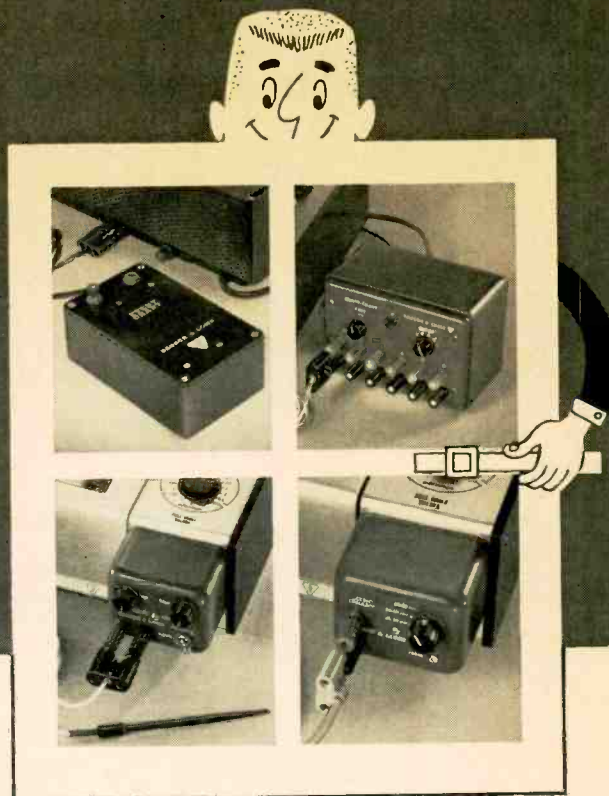

Recorders outstanding performance!

V.O.M. Recorders are backed by years of experience in engineering the most sophisticated electronic circuitry for a wide variety of precision scientific instruments. An entire division is devoted exclusively to the development and production of electronic products. Result? Outstanding performance and reliability... with exclusive important advantages for you at surprisingly low cost. Like recording multiple inputs... volts, ohms, milliamps... directly, without extra converters. Or the 5 chart speeds, and many more. People who buy them, like them and buy more. The V.O.M. Recorder in use is its own best salesman!

| | V.O.M.-5 | V.O.M.-6 | V.O.M.-7 | V.O.M.-8 |
|-----------------------------|-------------------|---------------------|------------------|--|
| Voltage range: | 10 mv—500 v DC | 2.5 mv—125 v DC | 0.5 mv—10 v DC | Absorbance/ Transmittance Measurement (voltage, current, resistance ranges same as V.O.M.-5) \$900 COMPLETE |
| Current range: | 10 μ a—100 ma | 2.5 μ a—25 ma | 1 μ a—10 ma | |
| Resistance range: | 1 ohm—100 K ohms | 0.25 ohms—25 K ohms | 1 ohm—100 K ohms | |
| Prices: (suggested list) | \$595 COMPLETE | \$700 COMPLETE | \$885 COMPLETE | |

We also have the capability of designing special recorders... modified to handle whatever applications you wish. For complete information on our standard recorders and the many time-saving accessories available for them, write for Catalog 37-2068. Let us know if you are interested in modification for special needs. Bausch & Lomb, 61423 Bausch Street, Rochester, New York 14602.

BAUSCH & LOMB

ELECTRONICS DIVISION

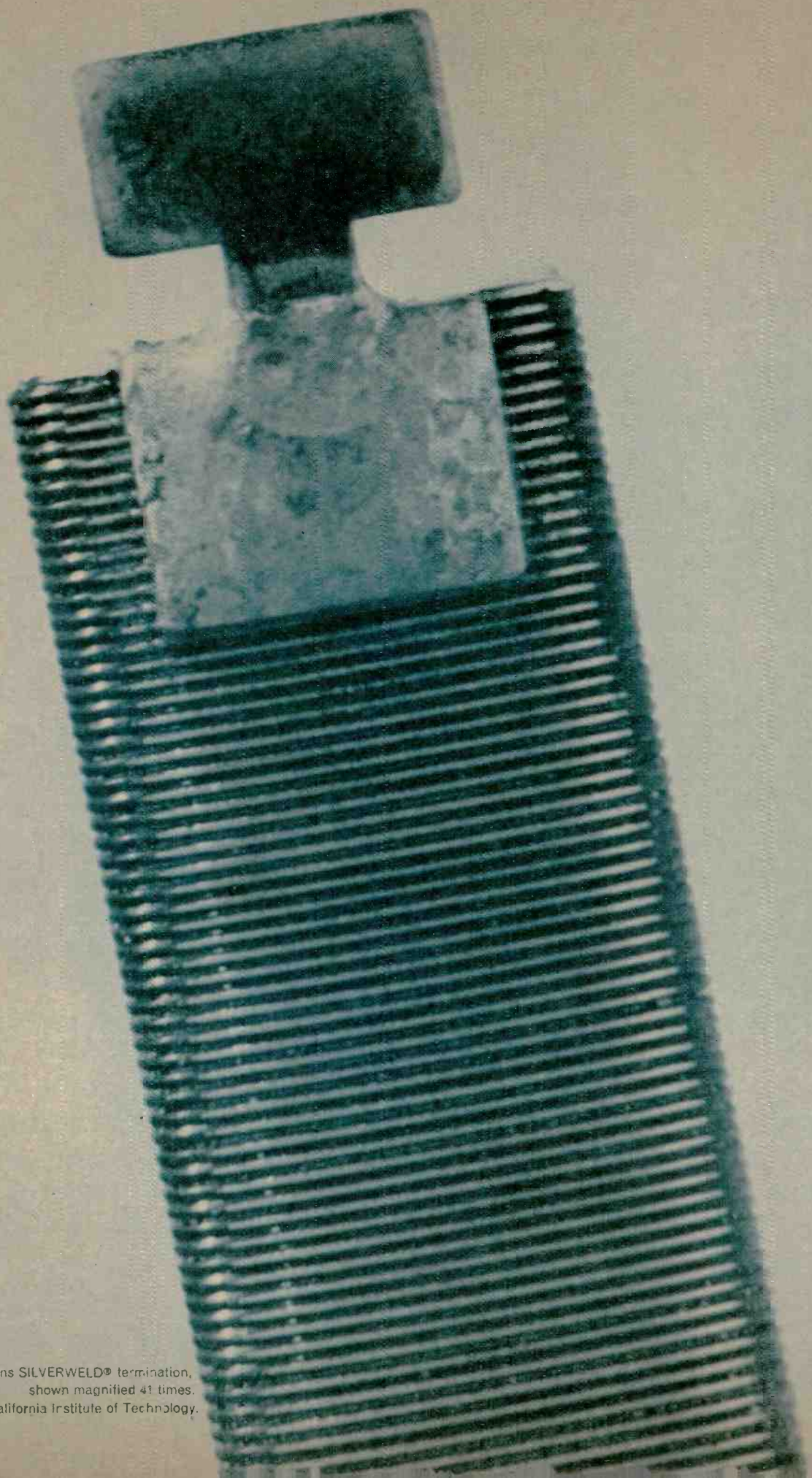

Exclusive Bourns SILVERWELD[®] termination,
shown magnified 41 times.
Photo by California Institute of Technology.

The termination that ended the chief cause of potentiometer failure...a typical example of

BOURNS TOTAL VALUE

Probably ninety per cent of potentiometer failures were once the result of fragile terminations. If the connection between the end of the resistance element and the terminal couldn't take the slam and shake of a missile ride or hold up reliably under years of use in industrial instrumentation, the potentiometer and its dependent functions became casualties.

With the creation of its exclusive SILVERWELD® termination in 1959, Bourns ended the fragility problem. The new termination proved virtually indestructible. To create it, Bourns fused a broad band of metal to many turns of the resistance element, and fused the external

terminals to the band. A continuous electrical circuit from one external terminal to the other. *No solder, no rivets, no spot welds, no tabs, no pigtailed, no weak spots, no hot spots.* The bond could not be broken without the destruction of the element itself. Used with ceramic-card elements, SILVERWELD termination has been tested to 1000°F and cycled from room temperature to 450°F without failure. Problem-solving innovations of this caliber mean extra reliability in the potentiometer—and receipt of total value for your potentiometer dollar. When the performance *must* match the promise, remember . . . TRIMPOT means Bourns—Bourns means quality.

THIS IS BOURNS TOTAL VALUE / Always your best value in potentiometers

EXCLUSIVE RELIABILITY PROGRAM

The Bourns Reliability Assurance Program is the only one of its kind in the potentiometer industry. Its primary goal is reliability! It frequently requalifies *all* standard models to insure conformance with published specifications. It also makes available free test data, saving you the time and expense of quality verification. Conducted in *addition* to quality control, it makes Bourns potentiometers the most thoroughly inspected and tested units available.

SUPERIOR QUALITY CONTROL

One-fifth of all Bourns employees work in quality control or reliability monitoring. This is one of the highest personnel ratios of QC employees and inspectors in the electronics industry. In addition, all standard Bourns products undergo extensive in-process and 100% final inspection. These facts help account for the company's return rate of only 0.2% (2 units returned of each 1000 shipped!), one of the lowest on record.

MOST ADVANCED PRODUCTS

As the pioneer in adjustment potentiometers, Bourns has set the standards for an entire industry—in new products, in product improvements, in materials, in processes. Innovations such as the RESISTON® carbon and PALIRIUM® film

elements and the virtually indestructible SILVERWELD® termination demonstrate that Bourns is constantly pushing the standards higher.

LARGEST SELECTION

Bourns offers the world's largest selection of potentiometers and an extensive line of precision potentiometers, relays and micro-components. This single-source capability means less shopping around, avoidance of costly specials.

BEST AVAILABILITY

The factory maintains a constant reserve of more than 500,000 units. In addition, more than sixty distributors across the nation carry complete stocks of Bourns adjustment potentiometers. Whatever you need in potentiometers, you can depend on Bourns for an off-the-shelf answer.

OUTSTANDING APPLICATIONS HELP

Bourns maintains a staff of ten professional Application Engineers whose sole job is to give you technical assistance. Each of these specialists serves a specific geographic area. All are extremely able and anxious to help you cut time, corners and costs.

LONGEST EXPERIENCE, RELIABILITY

Bourns—originator of the TRIMPOT® lead-screw-actuated potentiometer—has

been making adjustment potentiometers longer than any other manufacturer. Bourns products have the longest reliability record, too, having performed successfully in every major U.S. missile and space program. And the record continues: in today's world-wide markets, far more adjustment potentiometers bear the Bourns label than any other.

COMPETITIVE PRICES

Depth of product line and high production efficiency allow Bourns to meet or beat the prices of competitors—despite its heavy extra expenditure for product reliability. Furthermore, Bourns "holds the line" on prices while continually upgrading its products. In those cases where a Bourns unit is slightly more expensive, you can be sure that the small extra cost means considerable extra value. It is a firm Bourns policy *never* to compromise quality for price.



BOURNS

BOURNS, INC., RIVERSIDE, CALIFORNIA
Manufacturing Facilities
RIVERSIDE, CALIFORNIA; AMES, IOWA
Subsidiaries
TORONTO, CANADA; ZUG, SWITZERLAND

TRIMPOT is a registered trademark of Bourns, Inc.

MANUFACTURER: TRIMPOT® & PRECISION POTENTIOMETERS, RELAYS; TRANSDUCERS FOR PRESSURE, POSITION, ACCELERATION

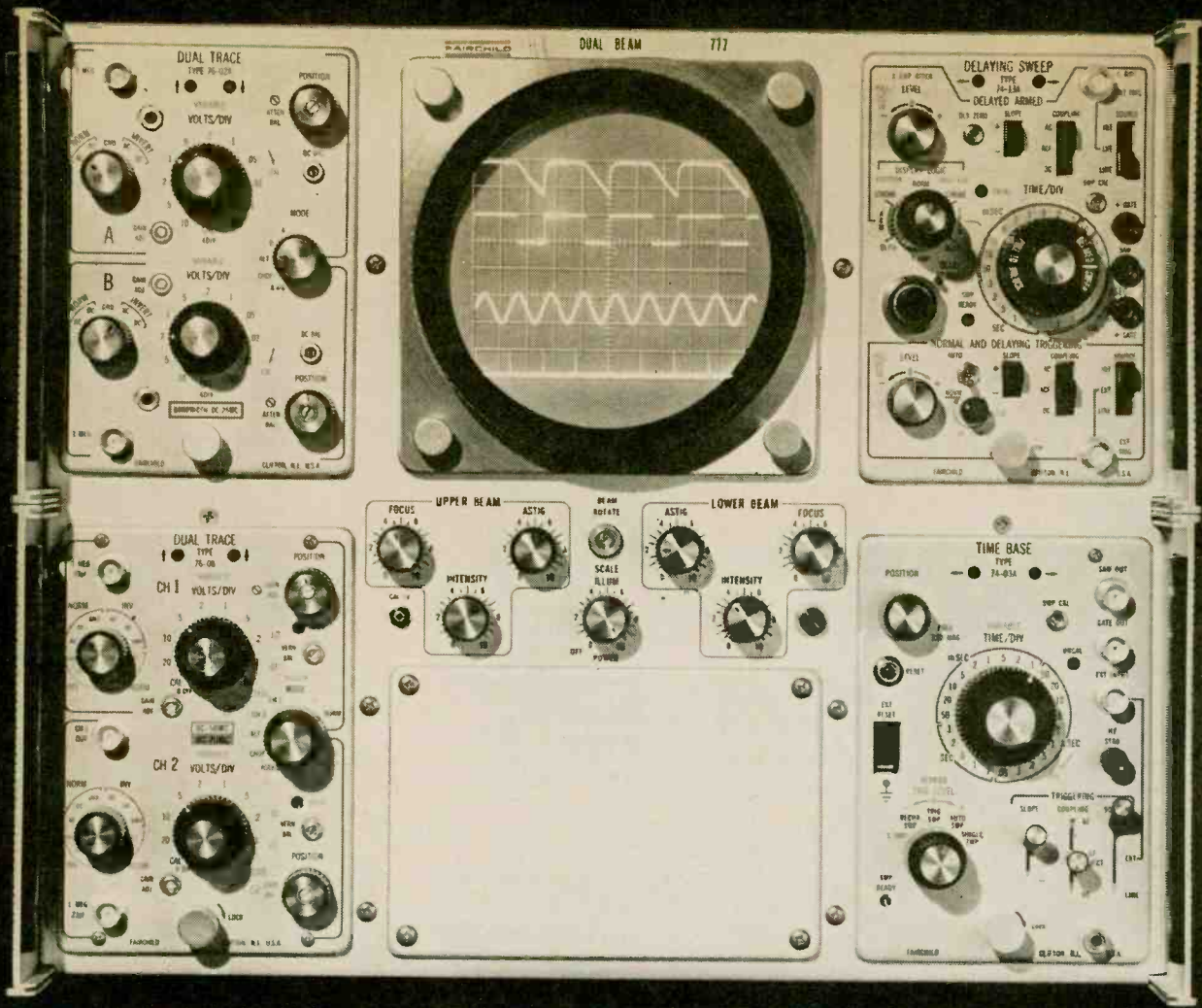

HOW MANY SCOPES CAN THIS ONE REPLACE?

A sizable number, depending upon the range of applications. For this is the Fairchild 777—the most versatile of all industrial scopes. The 777 is a dual beam, dual trace scope in which any four of 22 plug-ins are completely interchangeable in both X and Y cavities. These same plug-ins fit all Fairchild 765H Series scopes. They include DC-100 mc bandwidth, spectrum analyzer and raster display capabilities, sensitivity to 500 $\mu\text{v}/\text{cm}$, risetime to 3.5 ns.

Other features of the 777 include 6 x 10 cm display area for each beam with 5 cm overlap between beams for optimum resolution... unique 13 kv CRT with four independent deflection structures... solid state circuitry (with all deflection circuitry in the plug-ins)...light weight (44 lbs.)... environmentalized for rugged applications. Price (main frame): \$1,600 f.o.b. Clifton, N.J.



The 777 illustrates the Fairchild concept of value through versatility. One scope doing many tasks is only part of it. Future state-of-the-art capability is equally important because it helps you curb the high cost of Technological

Obsolescence. And finally, service. Fairchild has more service centers than any other scope manufacturer.

Ask your Fairchild Field Engineer for details on this and other new generation Fairchild scopes. Or write to Fairchild Instrumentation, 750 Bloomfield Ave., Clifton, N.J.

FAIRCHILD

INSTRUMENTATION
A DIVISION OF FAIRCHILD CAMERA
AND INSTRUMENT CORPORATION

*Technological Obsolescence

Circle 22 on reader service card

Editorial

Asian musical chairs

In the Far East, the electronics industry has grown and flourished on cheap labor, mainly supplied by the deft, nimble fingers of young girls under the age of 22. Yet cheap labor threatens to be a transitory advantage. In Japan, Hong Kong and Taiwan, the leaders of Asian electronics, companies are striving desperately to build a future on something more permanent. On every side you hear of ambitious projects to improve product development, enlarge research capabilities and enhance engineering.

In 1958, Japanese companies set the mold which is now cracking. In its search for world markets Japan found its cheap labor could produce consumer electronics products like radios, television and tape recorders far more cheaply than the higher paid wage earners in the United States. In three years, Japan cornered the cheap radio market, and garnered a majority share of the small-screen, black-and-white television business and a respectable percentage of the inexpensive tape-recorder field. Other Asian countries watched jealously.

Hong Kong started assembling radios about 1961 and its cheaper labor stole a big share of the market away from Japanese companies. Now assemblers in Taiwan are making inroads on Hong Kong's traditional markets with still lower-priced labor (see page 114).

That kind of musical chairs makes Asian suppliers nervous. In addition they see the labor rates in Japan, Hong Kong and Taiwan rising rapidly and at least three countries close by—India, Korea and Thailand—have lower pay scales today. In Japan, for example, labor rates have risen nearly 10% a year from 1960 to 1964; this year, rates rose nearly 13%. As if this were not enough, Asian firms nervously watch U. S. companies, fearing the introduction of automation that can outproduce their cheap labor.

By American standards, labor rates in Asia are still shockingly low. In Japan, which worries about pricing itself out of markets, a production worker starts at a salary of about 18,000 yen a month, about \$50, and a bonus of four months pay—so monthly earnings over the first year average about \$67. But one Japanese executive points out that fringe benefits fatten cash wages by 2½ times, putting the average monthly wage up to \$168.

In Hong Kong, there are no fringe benefits (except work jackets supplied free by a few plants) and monthly wages start as low as 125 Hong Kong dollars; roughly \$22 in U. S. money. Companies now starting up are offering beginning wages as high as 300 Hong Kong dollars a month—or about \$53. In Taiwan, a production worker will start at 600 New Taiwan dollars a month, or \$15.

In 1965, for the first time, Taiwan made an appreciable dent in the radio market; the country's assemblers will turn out 800,000 radios if production continues at its present pace. Taiwan's impact on Asian electronics can best be seen by what has happened to radio prices which had been stabilized until this year. They fell 25% in Hong Kong in the past nine months, from \$3.20 to \$2.42, delivered in the U. S., for a 6-transistor a-m set. In Hong Kong the lowest price being quoted was \$2.42; in Taiwan it was \$2.20.

Japan's answer has been to step up its product development and research effort [Electronics, Oct. 18, p. 23], to create new ideas that will give it an edge in technology.

Hong Kong is moving into more complex and more sophisticated products, items that require some engineering. With production for Christmas sales in Europe and the U. S. completed, Hong Kong radio companies are now developing some specialties for the 1966 season. Some typical examples: a low-priced waterproof radio for boating and beach enthusiasts, and a high quality audio amplifier for radios and hi-fi phonographs that permits excellent tonal quality in a radio that costs only \$4. The addition of engineering is a big change from the days when an entrepreneur with \$1,000 and a customer could go into the radio business, building a set from circuits supplied by a transistor manufacturer.

Taiwan too is anxious to improve its engineering and increase the sophistication of its prod-

Continued on page 148

CLIFTON

steps in to the Stepper Motor field



CLIFTON STEPPER MOTORS

| SIZE | 8 | 8 | 10 | 10 | 11 | 11 | 8 | 8 | 8 | 11 |
|---------------------------------|------------|------------|------------|------------|------------|------------|------------|------------|---------------|---------------|
| LENGTH (M.F.) | 0.770 | 0.770 | 0.770 | 0.770 | 1.215 | 1.215 | 1.062 | 1.112 | 0.770 | 1.215 |
| WEIGHT (OZ.) | 1.0 | 1.0 | 1.6 | 1.6 | 3.2 | 3.2 | 1.5 | 1.5 | 1.0 | 3.2 |
| INERTIA (GM-CM ²) | 0.19 | 0.19 | 0.19 | 0.19 | 0.77 | 0.37 | 0.18 | 0.45 | 0.19 | 0.77 |
| INDEX ANGLE | 90° ±3° | 90° ±3° | 90° ±3° | 90° ±3° | 90° ±3° | 15° ±1° | 90° ±3° | 90° ±3° | 45° ±2° | 45° ±2° |
| TYPE | PM 2Ø | PM 2Ø | PM 2Ø | PM 2Ø | PM 2Ø | VR 3Ø | PM 2Ø | PM 2Ø | PM 2Ø | PM 2Ø |
| RATED D.C. VOLT. | 28V | 28V | 28V | 28V | 28V | 28V | 28V | 28V | 28V | 28V |
| RESISTANCE (OHMS/PHASE) | 460 | 300 | 300 | 300 | 300 | 150 | 300 | 300 | 135 per PHASE | 130 per PHASE |
| NO LOAD RESPONSE RATE PULSE/SEC | 250 | 320 | 350 | 330 | 220 | 500 | 350 | 280 | 600 | 440 |
| NO LOAD SLEW RATE PULSE/SEC | 510 | 930 | 700 | 610 | 265 | 1600 | 375 | 650 | 2700 | 1200 |
| HOLDING TORQUE OZ-IN ONE PHASE | 0.37 | 0.35 | 0.50 | 0.53 | 1.1 | 0.60 | 0.80 | 0.58 | 0.60 | 1.5 |
| DETENT, OZ-IN ZERO INPUT | 0.12 | 0.05 | 0.05 | 0.13 | 0.24 | — | 0.17 | 0.10 | 0.05 | 0.12 |
| TYPE NUMBER | MSA-8-A-1 | MSA-8-A-2 | MSA-10-A-1 | MSA-10-A-2 | MSA-11-A-1 | MSA-11-A-2 | MSA-8-B-1 | MSL-8-A-1 | MSA-8-A-3 | MSA-11-A-2 |

EXCITATION MODE: TWO PHASES PARALLELED ALTERNATELY.

After careful testing and having already had units in end-use equipment in the field, we are now ready to announce a full line of size 8, 10 & 11 stepper motors and the controllers that go with them.

Steppers are gaining popularity rapidly in digital systems because of their quick response, high resolution, and many other distinct advantages over the con-

ventional servo motor.

We'd like to step in to your stepper motor picture with Clifton Precision quality, reliability and application knowledge.

Clifton Precision Products, Division of Litton Industries, Clifton Heights, Pa., Colorado Springs, Colo. Area 215 622-1000; TWX 215 623-6068.

eppe **CLIFTON** PRECISION PRODUCTS
DIVISION OF LITTON INDUSTRIES



Electronics Newsletter

November 1, 1965

Admiral to use IC in color tv

The first color television set to use an integrated circuit will be introduced by the Admiral Corp. early next year.

All but the high-voltage deflection and video-demodulator circuits will be transistorized. An integrated circuit will be used in the video-demodulator stage and a vacuum tube in the high-voltage deflection stage. The Philco Corp. recently announced it will introduce a color-tv set that uses both tubes and transistors.

The complete electronic signal-processing package, when complete, will be used as a standard for all Admiral color sets up to 25-inches. It will allow smaller packaging designs.

Speed record for a Philco IC

Nonsaturated monolithic integrated circuits with propagation delay times of less than a half nanosecond—about four times faster than the speediest now available—have been developed by the Philco Corp. Saturated IC's with delay times of 1.3 to 1.6 nanoseconds also have been claimed by Philco. Details on the new circuits were disclosed at last month's International Electron Devices Conference in Washington.

Techniques for producing the fast IC's were developed while Philco was designing n-p-n silicon transistors with gain-bandwidth products in the four- to five-gigacycles-per-second range, at collector currents above one to two milliamperes. Base resistance was below 15 ohms. This know-how, combined with a new technique for producing very shallow diffusions, was employed in the fabrication of transistors with a low base resistance, with gain-bandwidth products of six gigacycles per second.

The nonsaturated IC contains 11 components, including six transistors. The diffusion regions occupy about 50 square mils of silicon chip. Average propagation delay times of less than 0.4 nanosecond were recorded for this circuit.

The saturated circuit is a three-input transistor-transistor logic gate, which consists of a three-emitter transistor (each emitter is 0.1 by 1.5 mil), an inverter transistor and three resistors. Average propagation delay times of 1.3 to 1.6 nanoseconds are obtained when the circuit is pulsed by 10 to 20 milliwatts. The circuit had a fan-in and fan-out of 1, with approximately 5 to 10 picofarads of load resistance. Gold doping is used in producing the circuit. The noise figure is from three to four decibels over the 60- to 400-megacycle range.

High c-w output from Gunn device

The highest continuous-wave power yet achieved with a Gunn-effect device was reported last week at the International Electron Devices Meeting in Washington.

Cyril Hilsum and Paul Butcher of Great Britain's Royal Radar Establishment told of achieving 35 milliwatts at 7 gigacycles per second and 20 mw at 9 Gc. Hilsum predicted that efficiencies of 20% to 40% would be achieved using the exceptionally pure gallium arsenide he produced by an epitaxial process developed at the Royal Radar Establishment. Obtaining high-purity GaAs has been the problem in developing practical Gunn effect oscillators.

While advances in Gunn-effect oscillators were reported at the meeting, interest focused on amplification achieved in bulk semiconductors and junction devices. Bell Telephone Laboratories' Hartwig Thim and

Electronics Newsletter

the Massachusetts Institute of Technology's Alan McWhorter both achieved amplification in GaAs bulk semiconductors. McWhorter reported a maximum gain of 10 decibels at 3.3 Gc, using a 100 ohm-cm sample 50 microns long. The applied bias field was 7,200 volts per centimeter.

B. C. De Loach told of oscillation and amplification achieved in silicon pn junction diodes. He also achieved oscillation with a Read diode (formed of p and n material separated by avalanching and drift regions). Oscillations from the device occurred at 5.2 Gc at a c-w power of 19 milliwatts and 1.5% efficiency. Theoretically, such diodes are capable of 20 watts c-w at frequencies up to 50 Gc.

Unlike Gemini, Ogo did go —but briefly

The spectacular failure of the Gemini 6 Agena rocket nearly overshadowed the fate of Ogo 2, the orbiting geophysical observatory launched Oct. 14. Ogo immediately developed trouble with the infrared horizon scanner that was supposed to keep the bird in level flight, and eventually ran out of argon gas trying to correct nonexistent errors. It is now tumbling through space.

Spotting CAT early with ions and radar

A technique for detecting clear air turbulence (CAT)—the phenomenon that has caused at least a dozen airplane crashes or near-crashes in the last five years—has been proposed by researchers at the Argonne National Laboratory.

In a paper delivered at the National Electronics Conference in Chicago last week, the Argonne scientists reported that conventional radar can detect CAT if the air that's undergoing upheaval is ionized. Columns of air several miles ahead of a plane can be ionized with high-intensity bursts from x-ray tubes or lasers, the scientists said. Doppler radar can tell the pilot the velocity of the wind currents.

Solid state display varies persistence

A solid state display panel, with variable persistence to prevent fading and smudging of the image, has been developed by the General Telephone & Electronics Corp. The system has been delivered to the Navy, which plans to use it for displaying readings from continuous-transmission, frequency-modulated sonar.

Automatic controls for Montreal metro

A partially automated rapid-transit system to serve the Montreal World's Fair in 1967 is being built by the Union Switch and Signal division of the Westinghouse Air Brake Co. (Wabco). Wabco is one of four contractors taking part in the tests of automatic rapid transit for San Francisco's Bay Area Rapid Transit District [Electronics, July 26, p. 71]; the West Coast system will not be in operation until late in 1968.

Addenda

The first tests of voice communications between airplanes and ground stations via satellites are planned for next year, using the National Aeronautics and Space Administration's first applications technology satellite. Digital data was relayed in January over the Pacific, via Syncom 3, from a plane to a ground station in California. . . . About 60 of the nation's leading experts on solid state technology are scheduled to meet Nov. 15-16 in Las Vegas to exchange information about semiconductor-oxide physics. Attendance is by invitation only.

ANDREW



... Factory attached fittings

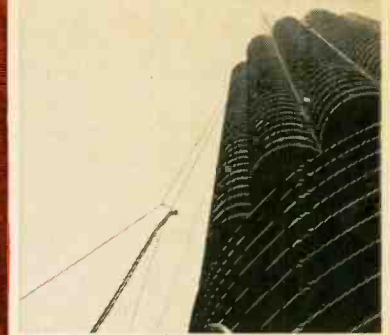

... Long lengths

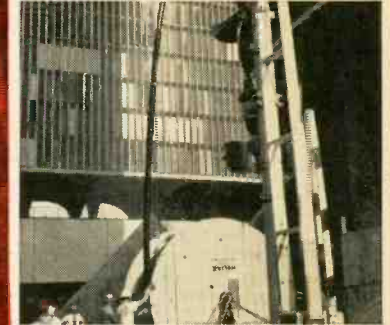

... No splices

HELIAX 5" air dielectric coaxial cable hoisted from street to Marina Tower rooftop in one continuous length for ABC-TV, Chicago

HELIAX® FLEXIBLE COAXIAL CABLE

guaranteed reliability for high power RF transmission

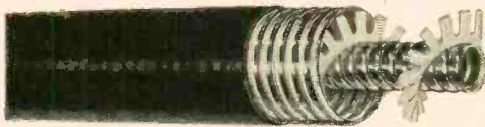

Actual measured VSWR for installed 742 foot length of 5" HELIAX

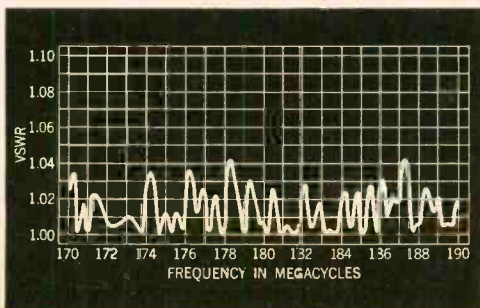

Long continuous lengths, and flexibility of Andrew HELIAX cable made this critical transmission line system possible. Installation required less than six hours. Cost was dramatically reduced.

Type H9-50 HELIAX cable insures long term reliability in high power RF transmission*. Corrugated copper inner and outer conductors absorb stress and cable retains superior electrical qualities after repeated flexing. Andrew end connectors firmly anchor inner to outer conductor and eliminate any RF noise from vibration or temperature changes.

Contact your Andrew sales engineer, or write for information on this superior transmission line.

*Handles average power of 250 kw @ 10 Mc or over 50 kw @ 200 Mc

28 YEARS OF ENGINEERING INTEGRITY

4-65

Andrew
CORPORATION
P. O. BOX 807 • CHICAGO, ILLINOIS U.S.A. • 60642

**Today,
a general-purpose resistor,
a semi-precision resistor,
and a precision resistor
just became the same thing.**



New C Styles from CORNING.®

New CORNING[®] C Style Resistors give you precision stability, reliability, 1, 2 and 5% tolerances, 100 ppm T.C.



All of which boils down to this. Only one component to specify, buy and stock. One component you can use for general-purpose, semi-precision and precision use alike. One component that satisfies two military specs, as a look at the table quickly reveals. And you still get all the performance advantages of CORNING Glass-Tin-Oxide film resistor construction. Now for your tests. At our expense. Return coupon for samples.

PERFORMANCE CHARACTERISTICS

| Characteristics | New CORNING C-Style Resistors | | | Mil-R-226848 | Mil-R-10509E Characteristic D* |
|--|-------------------------------|-------------|-------------|--------------|-----------------------------------|
| | 70°C | 70°C | 125°C | 70°C | 70°C |
| Temperature Rating | 70°C | 70°C | 125°C | 70°C | 70°C |
| Wattage C 4 (RL075) Resistors, 51 ohms to 150K | ¼ | ¼ | 1/10 | ¼ | ¼ |
| Wattage C 5 (RL205) Resistors, 10 ohms to 499K | ½ | ¼ | ¼ | ½ | ¼ |
| Load Life Δ R | 1.0% | 0.5% | 0.5% | 2% | 1% |
| Design Tolerance Δ R | -2 to +4% | -1 to +2.5% | -1.5 to +3% | | |
| Temperature Coefficient from -55°C to +175°C | ±100 ppm | | | ±200 ppm | +200 -500 ppm |
| Dielectric Withstanding Voltage Δ R | ±0.10% | | | ±0.50% | ±0.5% |
| Moisture Resistance Δ R | ±0.50% | | | ±1.50% | ±1.5% |
| Short Time Overload Δ R | ±0.25% | | | ±0.50% | ±0.5% |
| Temperature Cycling Δ R | ±0.25% | | | ±1.00% | ±0.5% |
| Effect of Soldering Δ R | ±0.10% | | | ±0.50% | ±0.5% |
| Low Temperature Operation Δ R | ±0.50% | | | ±0.50% | ±0.5% |
| Shock Δ R | ±0.10% | | | ±0.50% | ±0.5% |
| Vibration Δ R | ±0.10% | | | ±0.50% | ±0.5% |
| Terminal Strength Δ R | ±0.10% | | | 0.50% | |
| Voltage Coefficient | ±0.001%/Volt | | | | |
| Shelf Life Δ R | +0.10%/Year | | | | ±1.0% |

*For Type-marked, military lead Mil-R-10509 E Characteristic D Resistors, specify CORNING NA Style Resistors

CORNING GLASS WORKS, 3913 Electronics Dr., Raleigh, N. C. 27604.
Send complete data, test samples of new CORNING[®] C Style Resistors.

Name _____

Title _____

Company _____

Address _____

City _____ State _____ ZIP _____

CORNING
ELECTRONICS

This is PlasmaVac

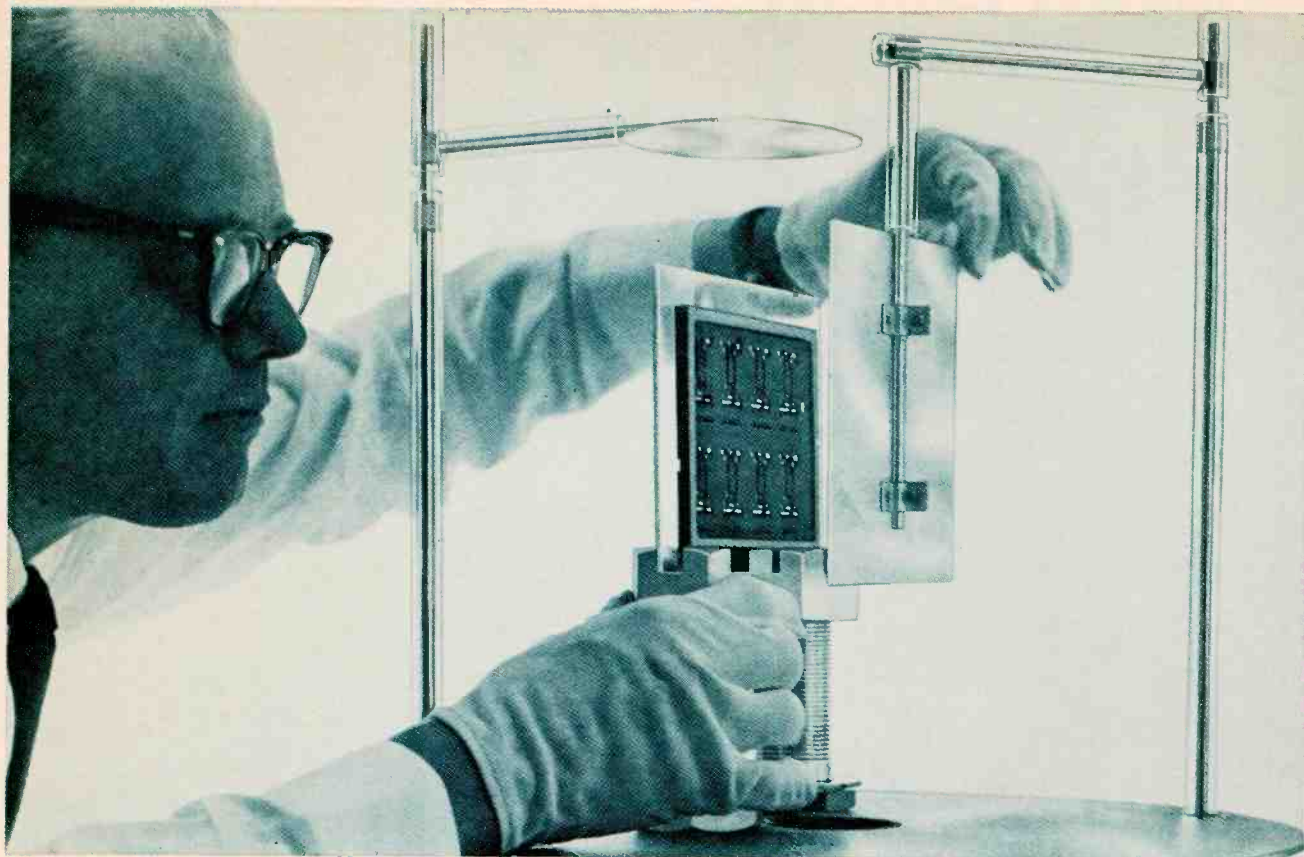

It can increase yields.

It can make commercial microcircuitry possible.

It will allow you to utilize a broader range of circuit materials.

■ CVC's PlasmaVac low-energy sputtering unit is ready for your production line. This controlled ion bombardment technique promises yields far greater than conventional techniques in the *production* of thin-film and SIC microcircuits—*economy enough to make micro-miniature circuitry a commercial reality.* ■ PlasmaVac works at pressures of 1×10^{-3} torr and eliminates many of the drawbacks of conventional sputtering. You can sputter through a mask, films are purer, adhere better, and film uniformity is within 2% over a 2" x 2" substrate. Two or more materials can be deposited simultaneously. Films deposited

simultaneously on both sides of a substrate may be connected through a hole during deposition.

■ PlasmaVac will deposit a wider range of materials than conventional evaporation techniques. Deposition rate can be preset and held constant, or varied, giving you easy control over film thickness. Materials can be deposited sequentially. And, PlasmaVac fits most existing evaporators or pumping systems . . . CVC or other. ■ Does all this give you any ideas about commercial applications? It should. Contact us NOW for the full PlasmaVac story.



Consolidated Vacuum Corporation

ROCHESTER, N. Y. 14603 • A SUBSIDIARY OF BELL & HOWELL
International Subsidiaries: Woking, Surrey, England
& Friedberg, West Germany

Electronics Review

Computers

Hybrids hold on

The speculation about when the International Business Machines Corp. would switch to monolithic circuits in its System 360 computers is all but over. In the last few weeks, IBM officials have made it clear that the company will continue to use the hybrid IC form it calls solid logic technology (SLT), but will phase monolithic circuits into the basic hybrid modules.

strates used in the SLT modules from other manufacturers.

Scratchpad circuits. One of the first IBM monolithics will be a new, multicircuit memory device described at the International Electron Devices Conference in Washington by Benjamin Augusta, advisory engineer at IBM's System Development division in East Fishkill, N. Y., where the main SLT plant is also situated.

The new device, which IBM says is still experimental, has 16 circuits—representing 16 bits of memory with control circuits—on a 0.07-

IBM says the chips are to be used in experimental scratchpad memories. These are high-speed memories, usually employed in the central processor of a computer. IBM had previously disclosed that the large models of the System 360 would employ several scratchpads.

The other shoe. The week before, IBM officials at the East Fishkill plant pointed out that System 360 computers, whose design is based on the SLT, are being produced at a 1,000-a-year clip. Each requires 20,000 to 30,000 SLT modules, and production of those has

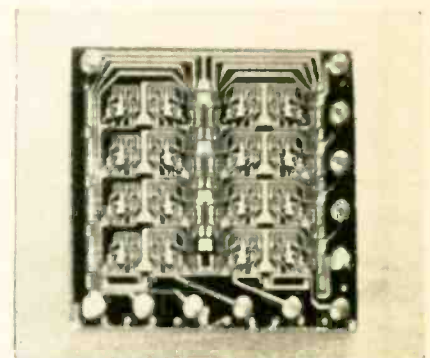
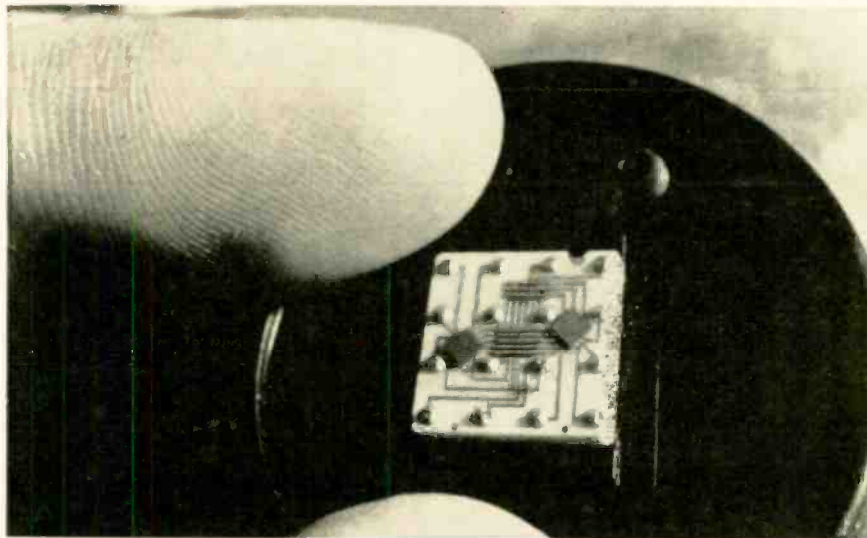

Two 16-circuit memory chips fit on the same type of substrate now used to make hybrid circuits (left). Each chip (above) is 0.07 inch square.

The company is doubling its module-production plant capacity while developing monolithic circuits that can be produced and assembled into SLT modules by the same basic processes and automatic assembly machinery that are used now to make the SLT modules.

In addition, Texas Instruments Incorporated will become a major supplier of the SLT to the computer maker. Texas Instruments is understood to be reserving a major portion of its facilities for producing the modules. IBM has been buying some of the hybrid sub-

inch-square silicon chip. Like the transistors and diodes now used in SLT circuits, the chips can be bonded face down to a ceramic substrate. Each chip contains 148 components—80 transistors, 64 resistors and four clamp diodes in a planar, n-p-n diffused structure.

Each circuit contains a storage cell that performs the function of a ferrite memory core; also a read-write interrogation network and a selector network that steers the interrogation pulses. The array can be read nondestructively with an 8-nanosecond pulse. Writing takes 20 nanoseconds.

risen to millions a year, IBM said.

Ever since the SLT and the System 360 were announced early in 1964 [Electronics, April 20, 1964, p. 101], there have been persistent rumors that IBM would change to monolithics and was negotiating multimillion-dollar contracts with manufacturers.

Two weeks ago, IBM dropped the other shoe: it announced it was producing an advanced form of the SLT, called ASLT, and the opening of a new plant in Burlington, Vt., to build modules. IBM now has three SLT factories—two in the United States and one in

France—and is reported to be negotiating now for a supplier in Japan.

Bigger, but faster. ASLT modules contain an average of 3 to 4 circuits per plug-in module, compared with one circuit in the SLT; some ASLT modules have six circuits. The basic unloaded delay time of an ASLT is about 1.5 nanoseconds; the minimum in the SLT is 5 nanoseconds.

Three improvements account for the ASLT's high speed:

- Two ceramic substrates are piggybacked in each module and both sides of each substrate are used for circuitry. The tight packaging minimizes wiring delay.

- The diode-transistor logic of the SLT has been changed to transistor current-steering (emitter-follower) logic, stabilized by capacitors. Each ASLT module has about 19 transistors—double and triple types made by IBM—compared with two transistors and five diodes in an average SLT module.

- Circuit power has been multiplied to 80 milliwatts for an ASLT circuit from 15 to 20 milliwatts for an SLT circuit.

The ASLT will be used in special high-performance machines, unidentified by IBM, but reportedly a king-size System 360, the model 95. The ASLT approach had been previewed at a research conference last fall [Electronics, Dec. 28, 1964, p. 26].

Monolithics later. IBM spokesmen have been countering the monolithics rumors by stating that they would use monolithics when the time was ripe, but not now.

E. J. Garvey, general manager of the East Fishkill plant, calls the ASLT computer-circuit family contains "the fastest in the world." Monolithics will be used "when they can equal SLT in cost and performance," he adds.

One often-cited reason for the rumor that IBM would switch soon to monolithics is that SLT reject rates were too high. IBM says that good modules coming off the production line two years ago constituted only 2% or 3% of the total, but that it is now closer to 50% and that IBM is on schedule in plans to raise the figure to 80%.

Business machines

Desk-top computer

The first desk-top calculator was the abacus; next came a hand-cranked machine; then the hand crank was removed and an electric motor was added to turn the small registers; the next step was getting rid of the mechanical parts and making the machine electronic. But basically, they all did the same things: add, subtract, multiply and divide when told, step by step. Now comes a new breed: the Programma 101, the first desk-top calculator



Programma 101 resembles a small computer.

calculator that has some characteristics of a computer.

The 101 is the first member of a family of computer-calculator machines that its producer, Ing. C. Olivetti & Co., S.p.A., of Italy, hopes to introduce.

Two out of three. The programma 101 exhibits two of the three characteristics that distinguish a general-purpose digital computer from a desk calculator: it can operate on a stored program, and one of its instructions is a conditional branch—that is, an instruction to itself can depend upon the results of a previous instruction. What the Programma 101 lacks is the ability to operate on instructions in the same way as on data; for example, the calculator cannot alter its own program as it goes along.

The stored program can be entered from the keyboard; it can be

recorded on a card much the same as on magnetic tape. Later, it can be reentered into the machine from the card.

A card contains two programs, one at either end, each with as many as 120 instructions. This machine lacks another ability of a large computer: the capacity to store up data in advance. Data must be entered manually through the keyboard.

Rat-tat-tat. The Programma contains 10 registers, each with a capacity of 22 digits, plus sign and decimal point. Its printed output is produced by a flying-drum printer. The drum rotates continuously; a hammer, sliding across it, prints a character for each print position as it goes by. This and the card feed are the only nonelectronic parts of the machine, and the printer is the only noisy part—the hammer makes a rat-tat-tat as it bangs out the characters at a 30-per-second rate. The noise is made by the paper; without paper, the printer is almost noiseless.

The company is secretive about how the machine works and about details of its electronics. A spokesman says, however, that it contains discrete components. Company officials say they are keeping close watch on progress in integrated circuits and will consider IC's in future models if the circuits are priced low enough.

There is speculation that the registers are made of some kind of ultrasonic delay line, because flip-flop would be expensive and bulky and it would not be economical to build a ferrite-core memory of only 1,000 bits or so. The magnetic cards for recording programs are 2¾ by 9½ inches and can hold one 120-step program at each end. The recording format or method of encoding are not disclosed, but this much program would fit on less than an inch of magnetic tape; Olivetti says the program occupies only 15% of the space on the magnetic card.

The Programma 101 is 7½ inches high, 19 inches wide, and 24 inches deep. It weighs 65 pounds and sells for \$3,200. Full-scale production started Oct. 1, officials say, and deliveries are ex-

pected to begin in January or February.

By contrast, most electronic desk calculators, including the new Victor 3900 [Electronics, Oct. 18, p. 26], do no more than what desk calculators have always done—except possibly to store a few more numbers internally. Those with cathode-ray tube outputs, as the Victor has, are quiet and fast. The longest possible division problem that the Victor 3900 can perform, $99,999,999,999,999,999,999 \div 1$, takes about half a second; but it does only what the user tells it to do—and only when he tells it. The Olivetti takes about two seconds for a similar calculation. The Victor 3900 is about the size of a pair of In and Out office baskets, weighs 25 pounds, and sells for \$1,825.

Manufacturing

Electron beam tops laser

Lasers have lost one round in the continuing fight with electron beams for a share of the micro-welding market. The Autonetics division of North American Aviation, Inc., has shelved development of an automatic laser welder to try out a \$125,000 electron-beam welder.

The intended application is welding leads of integrated-circuit flatpacks to circuit boards, considered a promising job for laser welding [Electronics, Oct. 19, 1964, p. 96]. Autonetics' decision is significant because the company has been a bellwether of high-reliability IC-assembly techniques (see related article on p. 75).

Vote for scanning. Autonetics set aside its lasers because of difficulties with spot control—that is, control of beam focusing, positioning and energy at the point where a lead is fused to a welding pad on a circuit board. Laser beams are focused optically; usually the spot is positioned by moving the board.

The electron-beam welder is fully automated; the operator only monitors the process. The spot is controlled electronically, improving

precision, and can travel a half-inch in the X and Y axes, which will probably allow all of a flatpack's leads to be welded before the board must be moved. Flatpack leads are spaced 20 to the inch.

Autonetics bought the welder from the Hamilton Standard division of the United Aircraft Corp., which has been using a similar system to make welds in integrated-circuit modules [Electronics, Sept. 7, 1964, p. 73]. Welding speed is $1\frac{1}{2}$ seconds per joint, comparable to high-speed resistance welding and four times as fast as soldering. Unlike soldering, beam welding causes virtually no temperature rise in the IC, adds an Autonetics spokesman.

Burning question. Another of Autonetics' objections to laser welding was the difficulty of attenuating the beam so that the heat would not damage the board under the weld spot, "although new lasers may be more satisfactory," said an Autonetics spokesman.

Laser proponents are somewhat puzzled by the statement because pulse-lengthening techniques and improved weld configurations avoid that problem. The Linde division of the Union Carbide Corp., for example, is recommending two alternatives to having the beam melt through the lead to the pad—a chief cause of the difficulty. The heat transfer can be kept low by having the beam hit the lead and pad simultaneously, either by pre-drilling a hole in the lead or by lap-welding the lead end to the pad.

At the Westinghouse Electric Corp.'s Aerospace division, the pads are etched in the form of U-channels, into which the flatpack leads are fitted. Each lead is welded at each side to the raised edges of the channel. This keeps the spot away from the board and the double joints are also more reliable than single-spot joints.

By using lasers to weld small lots of special assemblies, Westinghouse eliminates the cost of production tooling. In addition to flatpack welding, its lasers have been used in such applications as welding leads to etched-foil antennas.

Westinghouse had hoped to be making routine production use of lasers by now, but that has been put off until next year.

Substitute for scanning. Westinghouse is using an automatically controlled work table to move the assemblies under the beam at a rate of about 600 joints an hour. A similar system was shown this summer at the Western Electronic Show and Conference (Wescon) by Lear-Siegler, Inc. Such setups cost \$40,000 to \$50,000.

A number of optical methods of getting the same effect as scanning and improving spot control are be-

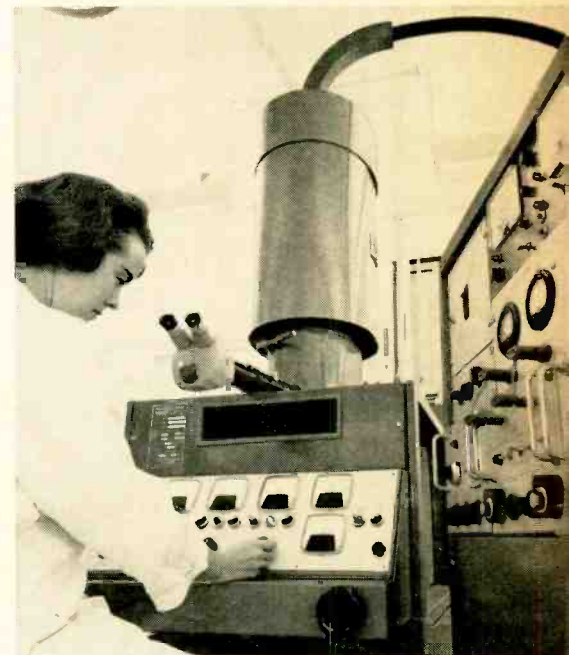

Electron-beam welder used by Autonetics for experimental production. The welds are made in the vacuum chamber, left.

ing tried by laser suppliers and their customers interested in welding—all of whom are apparently still using lasers only for manufacturing research, not routine welding.

One technique which Lear-Siegler proposes is optically hollowing and masking the beam so that the beam pattern looks like a dotted, circular line. Such a pattern could be used to weld all of a flatpack's leads simultaneously, without burning the board between the leads. The board would only have to be moved once for each flatpack. The mask would also reduce the spot

size and keep the weld edges even. When an unmasked beam is used, weld edges can be sloppy if there are variations in pulse energy.

Military

The Pentagon shuffle

Changes in leadership, organization and programs are giving a new look to the Office of Defense Research and Engineering, the biggest single dispenser of funds for the nation's \$22-billion research and development effort.

Command of the office and control over its \$7-billion annual R&D outlay has shifted to John S. Foster Jr., 43-year-old nuclear specialist and former head of the Lawrence Radiation Laboratory [Electronics, Sept. 20, p. 71]. Foster succeeds Harold Brown as the man who decides go or no-go on the vast Pentagon efforts to expand new technologies and, from this, to develop and put into operation new military weapons and equipment.

In addition, the office's staff has been realigned to reflect a changing emphasis in military R&D efforts and a shift in assignments caused by the departure of two of Brown's key aides—Eugene Fubini, formerly the top deputy and number two man in the office, and Albert C. Hall, deputy director for space. Brown is remaining in the Pentagon as Secretary of the Air Force.

The realignment puts a new man in charge of electronics R&D programs, increases emphasis on space and tactical-warfare systems, and by organizational changes, acknowledges the decline in the development of strategic weapons.

New job. Thomas Rogers has been promoted from assistant director of electronics and communications to a new and broader post of deputy director for electronics and information systems. In addition to retaining his former duties, Rogers is taking over many of the electronics programs that were supervised by Fubini or scattered through the research and engineering office.

Fubini, now a vice president of the International Business Machines Corp., not only was Brown's alter ego in running the Pentagon's R&D, but also passed on major electronic projects in communications, avionics, intelligence, reconnaissance and command-and-control. Foster has not yet selected his

chief deputy, but the staff realignment makes it clear that the new man will play a smaller role in electronics matters than Fubini did. As a consequence, Rogers becomes a key decision-maker on military electronics developments.

Rogers is a former chief of the communications division of the Lincoln Laboratory of the Massachusetts Institute of Technology.

New responsibility. In another staff change, Daniel Fink gets broader responsibilities as deputy for strategic and space systems. Fink, who already was in charge of strategic systems, is taking over the space work formerly performed by Hall, who has returned to the Martin Co. The combination of the two jobs offsets the rising emphasis on space with a smaller work load in strategic weaponry.

Thomas Cheatham continues as deputy director for tactical-warfare programs, but greater emphasis is being put in this field, partly as a result of lessons learned in Vietnam. Cheatham is specifically charged with making sure that a systems approach is taken in tactical-weapon development.

Chalmers W. Sherwin continues as deputy for research and technology. His office is largely unchanged except for the shift of the electronics and communications work formerly done by Rogers under his supervision. A new office of laboratory management, headed by Edward M. Glass, also is being set up in Sherwin's domain. Glass will concentrate on overhauling and strengthening military in-



John S. Foster
Director of Defense
Research & Engineering



Thomas F. Rogers
Electronics & Information
Systems



Chalmers W. Sherwin
Research & Technology



Daniel J. Fink
Strategic & Space Programs



Thomas P. Cheatham
Tactical Warfare Program

...READ ALL ABOUT IT!



EXTRA — All New 16 Page High Voltage Assembly Catalog

EXTRA — New Stacks and Bridges — Standard and Fast Recovery

EXTRA — Complete Applications Information

To get your copy, circle reader service No. 35

UNITRODE CORPORATION

580 PLEASANT STREET • WATERTOWN, MASSACHUSETTS 02172 • TELEPHONE (617) 926-0404 • TWX (710) 327-1296

Electronics | November 1, 1965

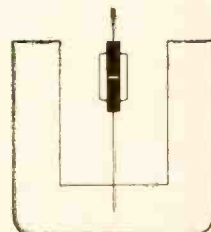

Export: Dage Corporation

Who needs a dual-output, dual-range power supply?

You might—if you want to step up to the most versatile, sophisticated laboratory power supply available today!

Consider the advantages.

The new DL40-700 Silicon Dual-Lab supply gives you TWO independent outputs from one half-rack chassis—simultaneously!

Flexibility? Each of these outputs has TWO independently selectable ranges—40V at 350ma, or 20V at 700ma.

Convenience? Each output is controlled by a concentric vernier voltage control and has its own switchable volt/ammeter.

Versatility? Series or parallel the two outputs at will!

Consider, too—at only \$249, the DL40-700 costs only slightly more than a single output power supply with comparable features. Who needs it?

If you want a power supply with real versatility and flexibility, two power supplies in one for your dual voltage laboratory needs . . .

you do!



For all the exciting features, write

TRYGON
POWER SUPPLIES

Roosevelt, New York

TEL (516) 378-2800 · TWX (516) 868-7508

house laboratories as a result of the Pentagon's decision to lessen its reliance on nonprofit companies.

Strong man. Both Brown and Defense Secretary Robert S. McNamara agreed when they moved into the Defense Department in 1961 that not enough useful results were being obtained from R&D expenditures, which had been mounting steadily over the years. They leveled off the R&D budget and made it clear that the Pentagon was no longer interested in supporting what McNamara called "the intellectually challenging, but militarily useless, engineering 'tour de force.'"

They canceled numerous programs and required that proposed new programs meet rigid tests before they are approved. In particular, they insisted that the military build on technological advances within its grasp rather than strain for new advances. Brown came to be known derisively by his critics as Dr. No.

Foster's selection surprised political figures in Washington and the scientific community, even though it fit in with a tradition of giving the research-and-engineering post to a nuclear specialist and specifically to the head of the Lawrence Lab. Both Brown and his predecessor, Herbert York, had headed the laboratory, a branch of the University of California that works largely for the Atomic Energy Commission.

The surprise stemmed from the fact that Foster, with another colleague at the Lawrence Lab, Edward Teller, was one of the few scientists to oppose the nuclear test-ban treaty. The treaty, a key proposal of the Kennedy Administration, had McNamara's vigorous support.

Avionics

Airborne recorder

A digital recorder small enough to be airborne, yet precise enough in its stops and starts so that it can feed directly into a computer, has

been developed by the Ampex Corp. It should eliminate the need for time-consuming processing by costly auxiliary equipment on the ground.

During the decade in which it has dominated the computer market, the International Business Machines Corp. has set many standards: design standards for its competitors' computers, and interface standards for producers of auxiliary equipment. One interface standard that, up till now, hadn't been met by airborne magnetic tape recorders, is the requirement that no more than $\frac{3}{4}$ inch of space appear between blocks of data stored on the tape. To make up for the deficiency, users of airborne recorders have to feed the tape through data-reforming equipment to produce the proper $\frac{3}{4}$ -inch interblock gap.

Stopping on a dime. Ampex's ATM-13, which will be introduced soon, closes the gap between data blocks by stopping and starting within milliseconds. Development of a large, costly recorder that meets the $\frac{3}{4}$ -inch requirement is no trick; many companies produce them, including Ampex. But it's another matter when the aim is a suitcase-size recorder that weighs about 100 pounds.

To solve the problem, the Ampex engineers turned their attention to the tape drive. They set out to develop a drive that can halt a tape within six milliseconds, from an operating speed of 75 inches per second, then resume full speed just as quickly. If the gap between the information is more than $\frac{3}{4}$ inch, or if it takes more than $\frac{3}{4}$ inch of tape to bring the machine up to full speed, parts of the data block could be lost by the computers, since most of them are programmed to receive tape data with a gap of no more than $\frac{3}{4}$ inch.

No arms. The designers started by throwing away the 16 to 18 heavy, friction-producing, spring-loaded arms that guide the tape around conventional recorders. In their place, Ampex designed a vacuum chamber. Tape is unreeled from the unloading spindle and guided into the vacuum chamber, where it is neatly folded into

a loop. As needed, the tape is drawn out of the chamber by the capstans and rolled over the recording head. When the lightweight capstans start from a standstill, they face little resistance in drawing the tape out of the vacuum chamber; the tape is maintained in the chamber with sufficient slack to avoid any stretch of the tape during rapid starts.

To maintain a proper tape supply inside the vacuum chamber, Ampex added real-time photo sensors inside the chamber; when the sensors detect too little tape in the chamber, the supply reel is speeded up; when there is too much tape, the reel is slowed down.

Landing without help

In warfare, where temporary airfields must be set up quickly, there is no time to install landing aids to guide planes in during bad weather. The Air Force, with the cooperation of the Federal Aviation Agency, hopes to overcome this weakness shortly; studies are under way by the Lockheed Aircraft Corp.'s Lockheed-Georgia division to develop an automatic landing system for the giant C-141 Starlifter so it will be able to land during pea-soup weather on makeshift airfields without the help of ground-based landing aids. But if electronic landing aids are available, the system would be versatile enough to make use of them.

Fully automatic landings of planes in zero-zero weather is clearly feasible: the Navy is almost ready to make an operational all-weather landing system for aircraft-carrier planes [Electronics, Sept. 6, p. 120] and the Federal Aviation Agency is expected to approve a system for commercial airliners in the 1970's. In all the systems under study, an assortment of sophisticated ground-based equipment is necessary to guide the craft to a landing.

Finding the field. The most important part of the Lockheed landing system is the vertical navigation unit, which provides steering commands to the electronic flight detector and autopilot; at the beginning of letdown it can maintain

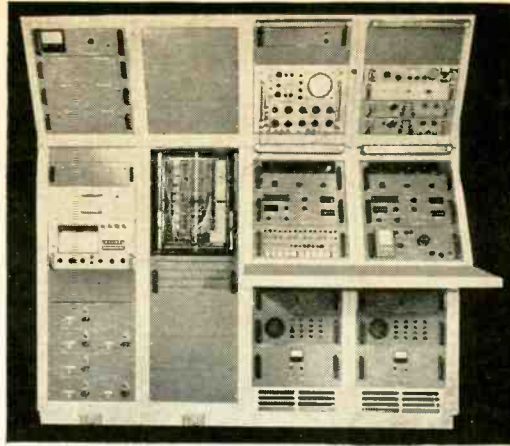

U. S. Navy
(AUTEC)
Master Timing
System

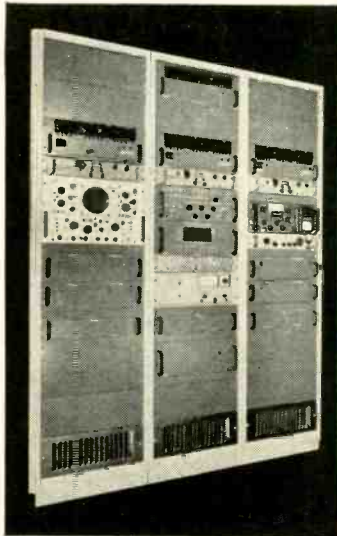

NASA
Mississippi
Test Facility
(MTF) Master
Timing System



NASA Wallops Island
Terminal Time Systems

Hyperion

the name for Precision Time Indexing and Automatic Search Equipment and Systems

Hyperion's Timing Equipments are being used on many major Range Facilities including NASA, Mississippi Test Facility (MTF), U. S. Navy Underwater Range (AUTEC), NASA, Wallops Island, etc.

Hyperion's Technical Staff represents 100-man years of technical experience in the field of Precision Timing and a broad background in the field of Ultra-Stable Oscillators, Automatic Time Synchronization with LORAN-C, VLF, and WWV Time Transmission Equipment, Precision Time Equipment includes Precision Time Code Generators and Countdown Clocks, and Fully Automatic Tape Search Equipments for Ground and Airborne environments.

Write or call Hyperion for your precision range time indexing and search requirements

Hyperion

 INDUSTRIES CORPORATION

• DIGITAL PRODUCTS DIVISION

134 COOLIDGE AVENUE, WATERTOWN, MASSACHUSETTS 02172
TWXN: 617-924-9272 TEL: 617-WA6-0140

FOR PRECIOUS METAL POWDERS BE SURE TO CHECK BISHOP

Here's Why

- Bishop offers variety in metals and their characteristics
- Bishop is willing to "tailor" to your specs and Bishop's prices are amazingly low

Look into Bishop's wide variety of powders which differ in particle size, surface area, bulk density, shape (powder or flake) to meet exacting requirements. No matter how you use powders—for fuel cells, metalizing preparations, resistors, printed circuits, circuit decals, capacitors, or in other ways, you will find Bishop has, or will make, precious metal powders to meet your particular specifications. By all means, contact us when you need a precious metal powder for making inks or pastes or for your own special application.

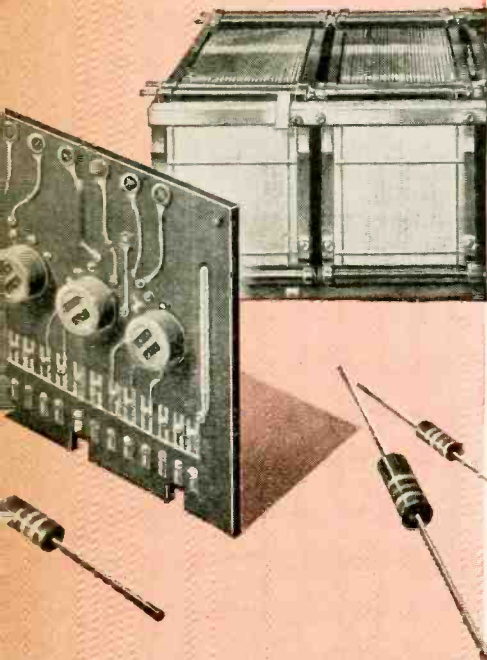

BISHOP

**J. BISHOP & CO.
PLATINUM WORKS**

MALVERN, PENNSYLVANIA 19355
PHONE: (215) 644-3100

Electronics Review

vertical angles of between 2° and 15° , and at the moment before let-down it can control the plane to a descent angle of between 2° and 5° .

The approach angle can be set ahead of time by the pilot. If the air base is under enemy fire, the pilot will probably select a steep approach angle so the plane spends as little time as possible at low altitudes; a slow, normal approach can be selected when the area around the air base is militarily secure.

The job of locating the field in dense fog is left to a digital navigational computer; coordinates of a predetermined landing point are manually programed into the computer, while altitude data is automatically fed into it via on-board air-data computer.

Many components of the landing equipment are similar to an all-weather system developed by the Bendix Corp. and the Boeing Co. and currently being installed on many Boeing 720 jetliners. The autopilot that's being used is a Bendix model, the Eclipse-Pioneer PB-60; the flight-director computer is a Bendix CPU-65.

The landing computer will be a new dual system. It will contain both a flare computer, which controls the rate of descent to within $2\frac{1}{2}$ feet per second at the moment before touchdown, and a decrab computer, which controls the horizontal angle at which the craft approaches the field.

The pilot will always have the option of overriding the automatic landing system.

Medical electronics

First, aid for lasers

"Laser surgery has proven its value in the early treatment of accessible cancer," says a Cincinnati physician who heads the first medical laboratory in the country at which high-energy laser radiation has been used to treat cancer.

Dr. Leon Goldman of the Children's Hospital Research Foundation will ask laser manufacturers to

turn their attention to medical laser instrumentation and cooperate in a program where engineers, physicists, biologists and physicians would supervise the laser treatment of skin malignancies at specially equipped medical centers. These programs, says Dr. Goldman, are needed to establish uniform radiation techniques and for accurate measurements of laser energy densities.

"Work is needed especially on ruby lasers," says Dr. Goldman. "The outputs are unreliable and our efforts must be judged often by actual effects on tissue."

Appeal at Nerem. Dr. Goldman will make his appeal to the laser equipment industry and to electronics engineers this week (Nov. 4) in Boston at Nerem-65, the Northeast Electronics Research and Engineering Meeting.

"With few exceptions" says Dr. Goldman, "laser manufacturers are not interested in the production of equipment for medical purposes. This has thrown a great deal of responsibility on the laser laboratory to develop equipment suitable for the treatment of patients."

His medical laser laboratory in Cincinnati and the one just getting under way at the National Cancer Institute are believed to be the only ones in the world organized for treatment of cancer with high-energy lasers.

Dr. Goldman will report at Nerem on 80 patients—the largest group yet treated with high-energy ruby and neodymium lasers. Patients afflicted with some types of cancer showed definite improvement after treatment, says Dr. Goldman. Most had surface malignancies in accessible parts of the body, though some deep cancers were bombarded.

Tumors were hit with ruby laser radiation of up to 600 joules exit energy, and densities up to 20,000 joules per square centimeter. A neodymium laser used in the program put out 1,160 joules.

Lack of power. The results, says the skin specialist, "emphasize the limitations of laser radiation in terms of low-energy densities, inadequate impact areas, and lack of prolonged follow-up studies."

One of the real problems, he says, is getting at a tumor in an inaccessible area and hitting it with sufficient energy density. Instrumentation developed at the Cincinnati laboratory can direct high energies at accessible malignancies where adjacent tissues can be protected. But for lesions about the mouth and face, for example, more studies are needed.

Special crown-clad quartz rods are being tested at the laboratory as transmitters of laser beams. To date, says Dr. Goldman, the rods have taken a 70-joule output from a laser and delivered 539 joules per square centimeter to a target without splitting. Gold mirrors are also used, and the laboratory is experimenting with plastic and epoxy materials as laser beam carriers. According to Dr. Goldman, optical fibers have not been able to transmit sufficient energy.

Impact area. The size of the area hit by a narrow laser beam also poses problems. If relatively high-energy densities become available, says Goldman, repetitive pulses can widen the impact area. Increasing the size of laser crystals will give larger target areas, but this increases the expense of what is already an expensive and highly sophisticated piece of equipment.

While concave lenses can enlarge the area, spreading the laser beam reduces energy density—and higher energy densities are needed.

Integrated circuits

New field for scr's

In the past few months, silicon controlled rectifiers have been showing up in surprising places: small power tools, high-current switches and variable-control light switches. Now, they're appearing in monolithic integrated circuits.

The first industrial IC to use scr's is being produced by Sylvania Electric Products, Inc., a subsidiary of the General Telephone and Electronics Corp.

Sylvania says the IC is a four-bit memory device with less than one-

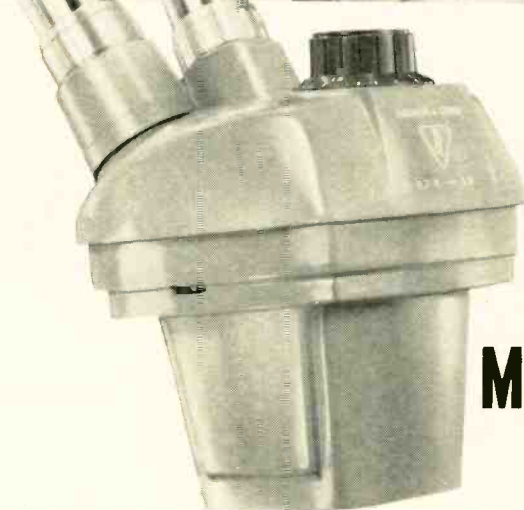

For ALL 8 Leading Micro-Welders

BECAUSE BAUSCH & LOMB STEREOZOOM adds product value, benefits users. That's why StereoZoom outsells all other stereomicroscopes combined. Why your choice should be StereoZoom whether for your own product... for your production lines... for quality control and inspection.

With StereoZoom you get the brightest, sharpest 3-D images, plus continuously variable magnification. It saves operators' time, increases production, minimizes fatigue. It's built to withstand hard industrial usage, is dust-proof, shock-proof, trouble-free.

Besides, the StereoZoom line lets you pick a complete microscope or selected components... to make sure your job is done right.

Call your dealer or write for Catalog 31-15, Bausch & Lomb, 62323 Bausch Street, Rochester, New York 14602.

BAUSCH & LOMB 

TRYLON CONICAL MONOPOLE ANTENNA
Vertically-polarized, omnidirectional, for any
4:1 range from 2 to 30 mc. 4 db/° so gain.
50-ohm input. Power to 50 kw PEP

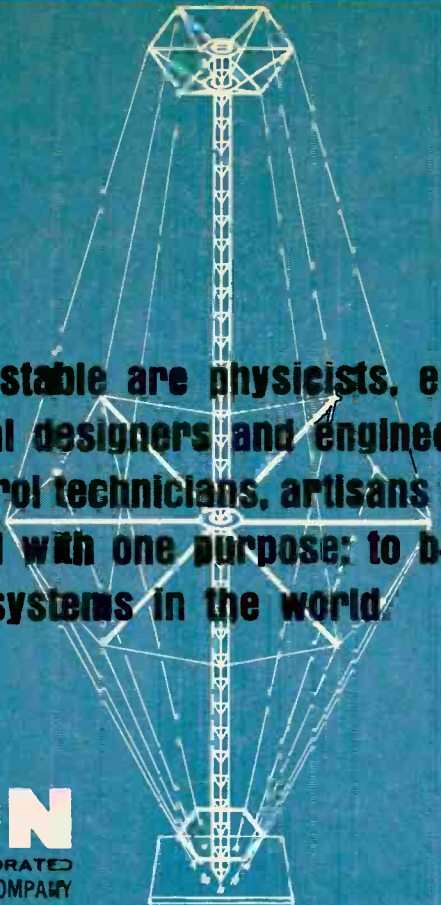

Here in one stable are physicists, electrical and structural designers and engineers, production and control technicians, artisans and expeditors—all fired with one purpose: to build the finest antenna systems in the world.



Elverson, Pa. 19520 (215) 942-2931 — International Division, 750 Third Ave., New York, N.Y. 10017, U.S.A.

Circle 203 on reader service card

Electronics Review

microsecond cycle time. However, the company does not disclose the name of the customer or the device's actual application. Deliveries of the scr-IC's began about a month ago.

Interest grows. Sylvania is not the only electronics company that is showing interest in such a combination circuit. The Westinghouse Electric Corp.'s Molecular Electronics division is not far behind Sylvania in scr-IC research. Westinghouse is working on an integrated circuit that has a logic gate and an scr capable of handling one ampere on the same chip.

In addition, Westinghouse is building, for an unidentified customer, an integrated circuit that contains only scr's—six of them.

According to Westinghouse, the use of scr's in integrated circuits becomes advantageous in microcircuit applications when high-current pulse outputs are required for the design.

TI's research. Research into the scr-on-a-chip concept is also being conducted by Texas Instruments Incorporated. That company is putting six scr's on a chip in an experimental lamp-driver integrated circuit; the circuit is being compared with another IC built with transistors, to see which is more economical for one customer's purposes.

The idea of depositing several scr's on a single silicon chip goes back almost two years. At that time Honeywell, Inc., at its Riviera Beach, Fla., facilities—which have since been sold—developed a 20-scr decade-counter integrated circuit and then, in 1964, produced a small quantity for in-house use. Each of the 20 scr's controlled up to 20 milliamperes.

Production problem. One factor that has held back the development of multiple-scr integrated circuits is the difficulty of production. For example, engineers have found they could not build the circuits with good isolation between components and still maintain high current-handling capability. But now, apparently, these difficulties are being solved, although no company is willing to explain its solutions in detail.

WITH THIS HEAT SINK...

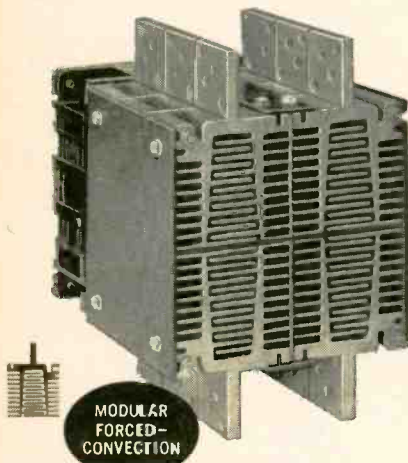

**2 to 3 times
previously
achievable
ratings**

for power transistors
and power diodes

FLEXIBILITY permits easy design of custom packages using side panels as terminal boards or for component mounting.

ACCESSIBILITY of mounted components for installation, maintenance, or replacement on easy-to-get-at transistor shelves. (Specify any mounting pattern)

CIRCUIT EFFICIENCY with reduction of number of transistors needed and decrease of compensating capacitors and resistors.

LIGHT WEIGHT and high strength/weight ratio of aluminum permits use of combined unit as an integral part of component design.

COMPACT BLOWER is standard, commercial unit providing forced convection for banks of 4, 8, 12, 16 or more individual heat sinks.

One of over 80 Astrodyne standards, this "building block" design provides more heat transfer surface in less space than most other devices.

Astrodyne (successor to Astro Dynamics Heat Sink Div.) Representatives and Distributors throughout the USA and Europe are prepared to assist with immediate price and delivery information. Call, wire or write for detailed information.



astrodyne, inc.

SUBSIDIARY OF ROANWELL CORP. 207 CAMBRIDGE ST.
BURLINGTON, MASS. (617) 272-3850

HIGH VALUE

DTL INTEGRATED CIRCUITS

- GMe's Epitaxial DTL Family provides optimum performance at low cost per function.
- High noise immunity: Typ. 1 volt at 25°C.
- High speed: Typ. 17 nsec.
- Low Power Dissipation: Typ. 18 mw per gate function.
- Fan-out: 8 minimum.
- Single and double power supply operation available.
- Dual source availability: Interchangeable on a pin for pin basis with Signetics parts.



General Micro-electronics Inc.
Subsidiary of The Pyle-National Company

2920 SAN YSIDRO WAY • SANTA CLARA, CALIF. 95051
TWX: (408) 737-9961 PHONE: (408) 245-2966

GENERAL MICRO-ELECTRONICS, INC./DTL CROSS REFERENCE CHART

| GME CATALOG NUMBER | COMPETITIVE EQUIVALENT | DESCRIPTION |
|--------------------|------------------------|--|
| 254G4 | SE101 | 4-Input NAND/NOR GATE* |
| 254G3 | SE102 | 3-Input NAND/NOR GATE* |
| 254G6 | SE105 | 6-Input Gate Expander |
| 254DA | SE106 | Dual 5-Input Gate Expander |
| 264P | SE110 | 3-Input Power Gate* |
| 264D4 | SE111 | Dual 4-Input Power Gate |
| 264E3 | SE112 | Dual 3-Input Power Gate* |
| 264D3 | SE113 | Dual 3-Input Power Gate |
| 264D2 | SE115 | Dual 2-Input NAND/NOR Gate |
| 263DG | SE116 | Dual 4-Input NAND/NOR Gate* |
| 264B | SE124 | RST Binary Element |
| 264L | SE150 | 2-Input CLOCK/CAPACITIVE Line Driver |
| 264B4 | SE155 | Dual 4-Input CLOCK/CAPACITIVE Line Driver |
| 264E4 | SE156 | Dual 4-Input CLOCK/CAPACITIVE Line Driver* |
| 264B3 | SE157 | Dual 3-Input CLOCK/CAPACITIVE Line Driver |
| 264SS | SE160 | One-Shot Multivibrator |
| 264G9 | SE170 | Triple 3-Input NAND/NOR Gate |
| 264Q2 | SE180 | Quadruple 2-Input NAND/NOR Gate |
| 263Q | SE181 | Quadruple Inverter |
| 254D5 | CS700 | Dual 3-2-Input NAND/NOR Gate |
| 254DR | CS701 | Dual 3-2-Input NAND/NOR Gate |
| 264MB | CS704 | RST Binary Element |
| 254D3 | CS705 | Dual 3-Input AND Gate |
| 254DD | CS709 | Dual 3-Input Gate Expander |
| 264T2 | CS727 | Triple 2-Input NAND/NOR Gate* *Expandable |

30-gage computer wire for miniaturization of circuits has tough new insulation. The material: KYNAR* — Pennsalt vinylidene fluoride plastic. Even in 5-mil wall thickness, KYNAR affords exceptional mechanical strength and cut-through resistance. Wire insulated with KYNAR is available in long lengths... goes smoothly through automatic wire-wrap machines... cuts and strips cleanly, bends readily, doesn't stretch, stays put when formed.

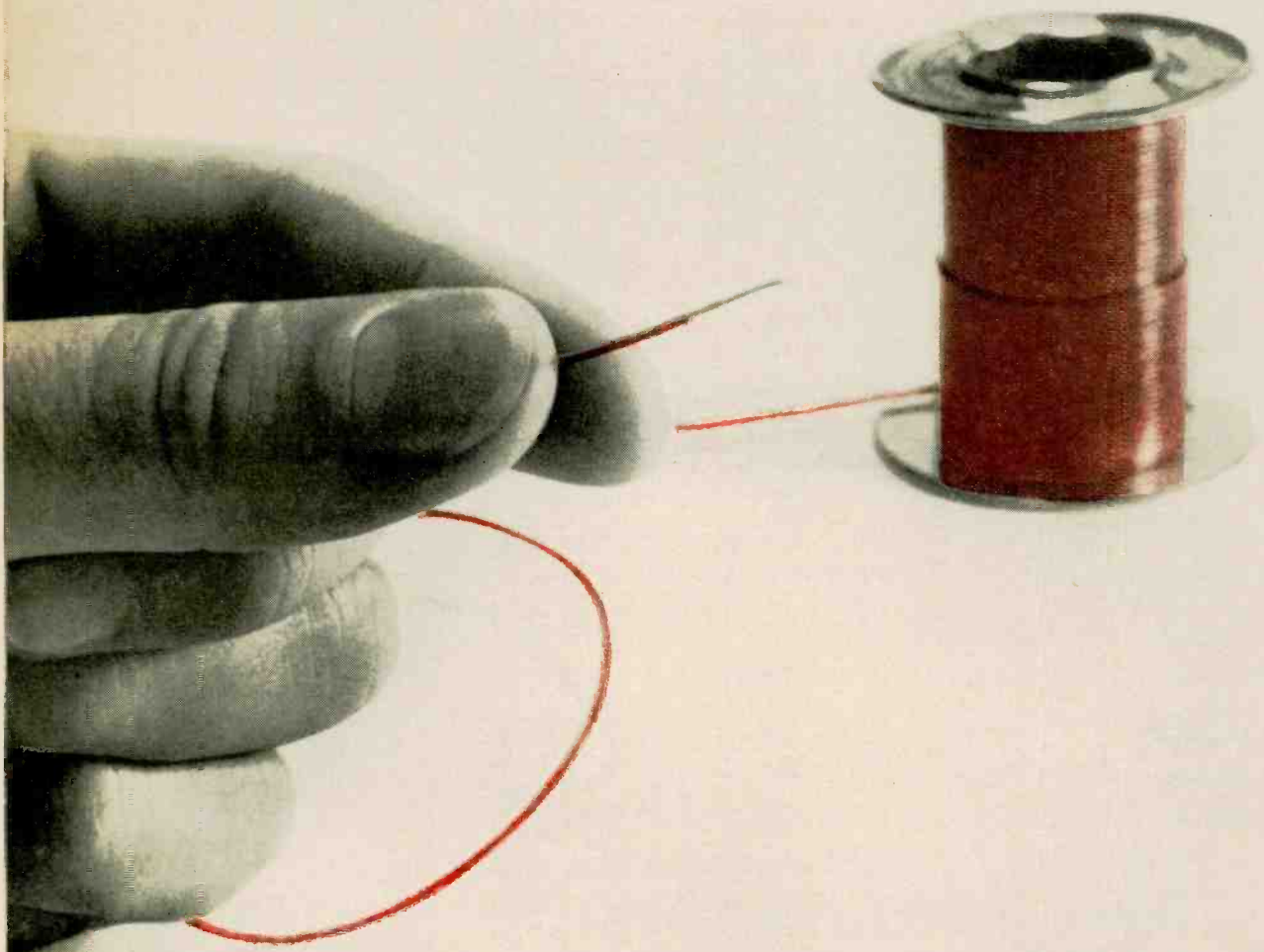

Write for information and the names of leading manufacturers who supply wire insulated with KYNAR. Plastics Department, Pennsalt Chemicals Corporation, 3 Penn Center, Philadelphia, Pa. 19102.

Kynar... a fluoroplastic that's tough!

*KYNAR is a registered trademark of Pennsalt Chemicals Corporation.



Washington Newsletter

November 1, 1965

**Europe may widen
output of weapons
designed in U. S. . . .**

The Defense Department plans to broaden cooperative production of American-developed weapons by members of the North Atlantic Treaty Organization. Leading candidates for new European production programs are the shoulder-fired Redeye anti-aircraft missile and Mark 12 IFF (identification friend or foe) equipment for aircraft.

The F-104 fighter, the Hawk anti-aircraft missile, the Sidewinder air-to-air missile, the Bullpup air-to-ground missile and the Mark 44 torpedo already are part of the NATO coproduction program. And to this was added recently the Sparrow air-to-air missile for the Italian version of the F-104. This will mark the first time the Sparrow has ever been mated with the F-104.

Coproduction and joint research-and-development efforts are now being broadened into a wider defense "common market" concept, which will enable European companies to compete with American firms for some weapons to be purchased by the U. S.

Henry J. Kuss, deputy assistant defense secretary specializing in weapons sales, believes the common market approach will eventually require a new breed of engineer-diplomat, whose job will be to work out "the thousands of details" involved in qualifying foreign companies to bid in the U. S. and in supervising competition between foreign and American companies.

**. . . while receiving
more subcontracts**

Meanwhile, the Pentagon's effort to stimulate foreign electronics companies to produce parts of major weapons systems that United States companies sell abroad is meeting with moderate success.

The aim is to encourage the allies to step up purchasing of U. S. military systems by giving them a share of the equipment business [Electronics, Oct. 4, p. 38].

In the first major test of this program, the McDonnell Aircraft Corp., which has a contract to supply 300 F-4 Phantom jet fighters to the Royal Air Force, is understood to have invited British bids on 199 items valued at a total of about \$150 million. So far, British companies have bid on 60% of the items and contracts have been awarded for about a dozen of them.

The dual-country procurement program creates headaches for the American prime contractor. For example, it means that McDonnell has to put the foreign-made electronic equipment through more extensive testing.

**Comsat contract
goes to Page**

Page Communications Engineers, a division of the Northrop Corp., has won a \$4.5-million contract to build three portable ground stations for a satellite communications system for Apollo. The International Telephone and Telegraph Corp. was the only other bidder.

The stations will be operated by the Communications Satellite Corp., which last month was authorized to provide satellite communications service for the Apollo program [Electronics, Oct. 18, p. 25].

Each station, costing \$1.5 million, will be the equivalent of a dish 42 feet in diameter. Comsat will install stations in Maine, Washington and

Washington Newsletter

Hawaii. Page hopes to sell two portable stations to Spain and Australia. These countries, members of the Comsat consortium, would use the portable stations both for the Apollo program and commercial operation.

Private studies of public problems?

Should the federal government follow California's example and award contracts to the aerospace industry to study such fields as transportation, crime prevention and pollution control? A month after a presidential panel said "no," Sen. Gaylord Nelson said "yes." The Wisconsin Democrat has introduced legislation to authorize a \$125-million, five-year program. In September, Gardner Ackley, chairman of the President's Council of Economic Advisers, recommended against such a program [Electronics, Sept. 20, p. 47].

Lunar lab gear sought by NASA

As they begin planning for post-Apollo projects, space agency and industry officials are putting together a shopping list of equipment for lunar laboratories. Apollo is a mission to land men on the moon before 1970. The over-all need is for compact, lightweight, ready-to-operate equipment.

Directing the planning are C. William Henderson for the National Aeronautics and Space Administration and Grady L. Mitcham of the Boeing Co. These are the major items on the list:

- At least two vehicles for lunar surface research.
- Optical telescopes, including electronic-control equipment.
- Radioastronomy equipment, ranging from simple wire antennas and beacons to a large steerable dish.
- Heat and light sensors to conduct meteorological studies of the earth from the lunar base.
- Ranging devices, perhaps lasers, to take measurements of the earth.
- High-power telemetry and television equipment to transmit data back to the earth.

Three small manned lunar labs are contemplated, including at least one that can be expanded into a large permanent base for two dozen or more scientists.

Congress supports change of policy on research funds

Congressional impetus is building up behind recent Administration decisions to alter the distribution of federal research support to universities [Electronics, Oct. 4, p. 65]. The House Committee on Government Operations has endorsed a report of its subcommittee on research and technical programs that supports Administration efforts to increase the spread of federal research support to new geographical areas by favoring smaller universities where possible. The report also urges shifting the emphasis to institutions; at present, contracts go almost exclusively to promising research projects and their designers.

"The \$16-billion annual federal research and development program," the committee concludes, "while it has achieved many breakthroughs in such fields as atomic energy, space and health, has actually harmed higher education in this country." Federal research funds, it is felt, have distorted university programs because researchers, rather than educators, control the uses to which federal funds are put.

PCM GROUND CHECK-OUT EQUIPMENT

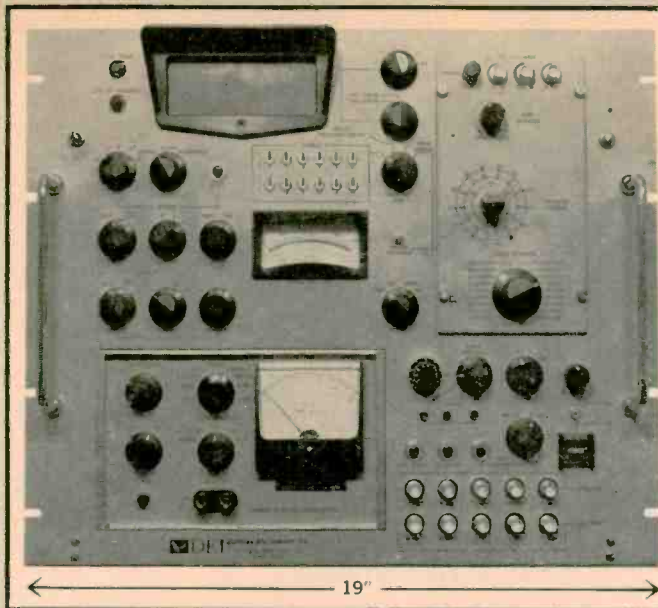

new

BIT SYNCHRONIZER ANALYZER

Self-Contained—No External Test Equipment Required
 Special Analytic PCM Test Simulator
 Wide Range of Bit Rates: 1.2 bps to 1.2 mb
 Measures and Displays Bit Error Rate and Sync Acquisition Time
 Built-In Gaussian Noise Source, S/N Ratio: -10 db to +20 db

DEI's model BA-101 Bit Synchronizer Analyzer provides a means of evaluating operation of a PCM Bit Synchronizer (Signal Conditioner) for pre-flight confidence checks, electrical interference detection, or other analytical purposes. Design of the analyzer is such that a synchronizer may be tested for performance using accepted test conditions or using conditions which normally prevail in actual operation. This device will allow convenient measurement of the following performance characteristics: (1) Minimum signal/noise at which synchronization is acquired, (2) Sync acquisition time, (3) Minimum signal/noise at which sync is maintained, (4) Transition density to acquire and maintain sync, (5) Data error rate. A decimal counter display plus overrange indicator serve as visual output. Printer outputs for an external recorder are optional. The Bit Synchronizer Analyzer contains output terminals to monitor the results. For further information write for DEI product bulletin BA-101.

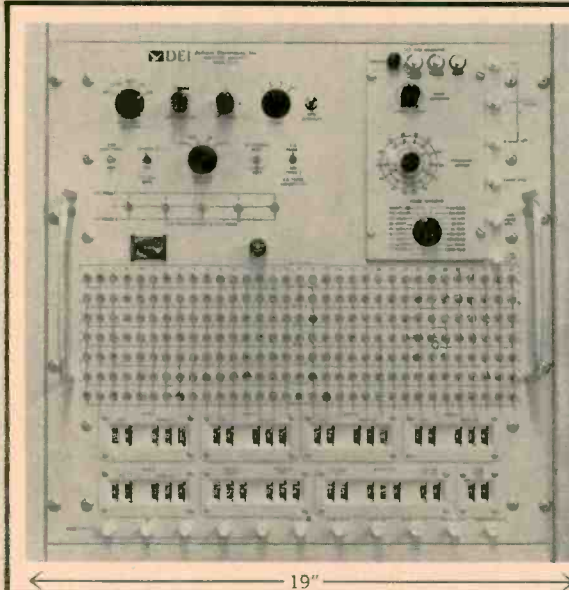

new

PCM SIGNAL SIMULATOR

7 Independently Variable Word Lengths
 Wide Range of Bit Rates: 1.2 bps to 1.2 mb
 Complementary Sync Patterns Selectable
 Complete Error Simulation Capabilities
 Pre-Transmission Filter Simulation
 Alternate Complement Common Word

DEI's model DS-101 is a general purpose PCM Simulator designed to generate PCM formats currently in use as well as formats developed for the future by means of simple front panel programming. Formats such as the Gemini, Titan, Saturn, and general purpose wave trains are easily generated and controlled. Up to seven words can be generated with independently variable format and word lengths within the same data train. Sub commutation synchronization of both the recycling code and the counting address (1D) types is provided. Low Z output of variable amplitude and DC offset are standard. Amplitude adjustable to ± 10 volts zero centered (20 v p-p maximum) across 50 ohms. For further information write for DEI product bulletin DS-101.

Defense Electronics, Inc.
 Rockville, Maryland



DEI
 RESEARCH
 DEVELOPMENT
 MANUFACTURING

ROCKVILLE, MD. (301) 762-5700, TWX: 302-427-4660; SHERMAN OAKS, CALIF. (213) 872-2870, TWX: 213-783-2742; COCOA, FLA. (305) 632-5400; TWX: 305-632-5442; HUNTSVILLE, ALA. (205) 881-5139; WILLOW GROVE, PA. (215) 659-5051; DALLAS, TEXAS (214) EM 3-7263; INT'L, ROCKVILLE, MD.; CABLE: DEIUSA; EXPORT (212) Circle 6-2133, TELEX: TRIL 224326, N.Y., N.Y.; OTTAWA, ONT. EMISCO Ltd. (613) Central 6-0811, Cable: EMISCO

Searching for quality electronic components delivered on time?

Stop.

Let Northern's Facilities Register* search for you.

*It's sort of an electronic yellow pages that can tell you who makes what in electronics. A unique find-it-in-a-hurry service of the Northern Natural Gas Company that can instantly locate reliable suppliers, sub-contractors and sources for parts, components and sub-assemblies made to your specifications. ■ In technical terms, Northern's Facilities Register is a computerized compilation of all industrial fabricators in the Northern Plains area - Iowa, Minnesota, Nebraska and South Dakota. It's the one source of

information that can tell you where to buy wisely, profitably and quickly. And it's free. ■ To use it, whether you're interested in electronic components, plastics, short run stampings, motors, precision machined parts, instruments, die castings, or whatever, just fill out the coupon. You'll receive complete information. And if you attach a sketch or specifications of your required components, the Facilities Register will start working for you the day your inquiry is received.

| | |
|---|--|
| FACILITIES REGISTER | |
| Area Development Dept. E | Northern Natural Gas Co., Omaha, Nebr. 68101 |
|  | Dear Sirs: Please send Sources of Supply information on: _____ |
| | _____ <input type="checkbox"/> Drawings enclosed. |
| Name _____ | Title _____ |
| Company _____ | |
| Address _____ | |
| City _____ | State _____ |

i/c's and modules tested...

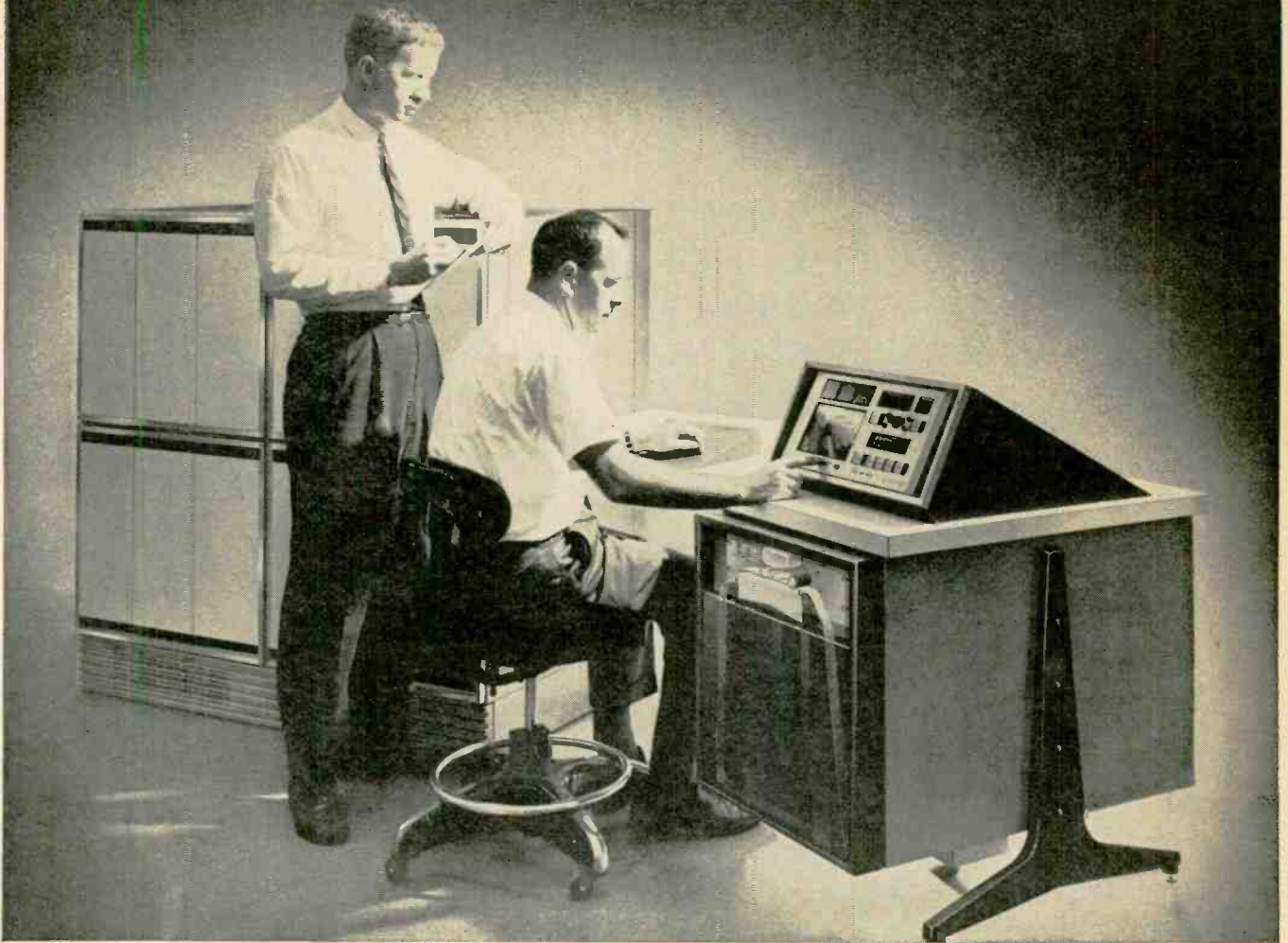

DYNAMICALLY!

Now you can perform important *dynamic* tests in addition to ordinary static (dc) tests with TI's Model 553 *Dynamic Test System*. Measure propagation delay and noise feed-through; *dynamically* determine "fan-in"/"fan-out" ratios, and noise immunity; assess the effects of transients. Now, measure switching times in terms of percentage or absolute values. You save money by performing more tests at high speed with handling reduced by single-socket testing.

The 553 *Dynamic Test System* is designed for integrated circuits, transistors, diodes, thin films, logic cards, other circuit elements with 10, 20, 50, or more active leads. Testing can be done from dc to 50 mc, thereby simu-

lating actual operating speeds. Time or voltage is measured anywhere *on* or *between* pulses (widths from 10 ns to 1 ms) with a resolution of .000001%. Jitter is less than 50 ps; accuracies better than 2%.

Modular design and variable word-length program logic provide for infinite system expansion. Simplified programming language allows operators to learn to program in 45 minutes. Data as well as double-ended hi-lo limits can be produced at test rates faster than go/no-go systems with a wide variety of output recording techniques available.

For detailed information about the 553, contact your TI Field Office or the Test Equipment department, Houston.

INDUSTRIAL
PRODUCTS
GROUP



TEXAS INSTRUMENTS
INCORPORATED
P. O. BOX 66027 HOUSTON, TEXAS 77006
118 RUE du RHONE GENEVA, SWITZERLAND

740B

all five have these features—

bright 6 x 10-cm displays

illuminated, no-parallax graticule



1234FIVE

Vers

small spot size, uniform focus

full-passband triggering

plug-in unit adaptability

Here are **five** oscilloscopes of the same family—but each with a distinct personality. All five oscilloscopes use the new Tektronix 1-A series plug-in units or any of the 17 different "letter-series" units for extraordinarily broad coverage of application needs.

Most versatile is the Type 547, a single-beam instrument that provides dual-beam performance in most applications—and at an economical price. With automatic display switching between its two time bases, the Type 547 permits alternate presentation of the same signal at two different sweep speeds, or two different signals at two different sweep speeds and sensitivities.

With a new Type 1A1 or 1A2 Plug-In Unit, the Type 547 has all the performance characteristics needed for demanding applications:

Wide Band Response—dc-to-50 MHz dual-trace displays at sensitivities to 50 mV/cm.

High Sensitivity—500 μ V/cm (uncalibrated) single-trace displays at 2 Hz-to-15 MHz; 5 mV/cm dual-trace displays at dc-to-28 MHz (with Type 1A1).

Calibrated Sweep Delay—for precise time measurements.

Fixed-Tuned Delay Line—for uniform transient response.

The Type 546 has all the features of the Type 547 less automatic display switching.

The Type 544 has one time base and six steps of sweep magnification from 2X to 100X.

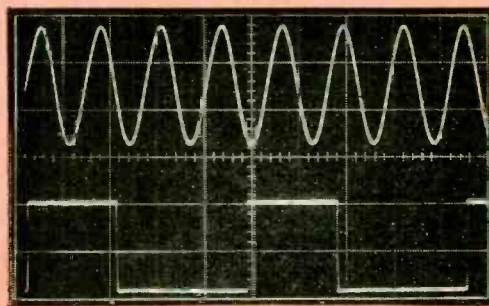

Single-exposure photograph.

2 signals—different sweeps (with Type 547 and 1A1 unit)

Upper trace is Channel 1/A sweep, 1 μ sec/cm.
Lower trace is Channel 2/B sweep, 10 μ sec/cm.

atile Tektronix Oscilloscopes

The Type 545B is an improved version of the Type 545A, which has proved itself of great service to a multitude of laboratories and industries throughout the years and has been considered a standard by which other oscilloscopes can be judged.

With the new Type 1A1 Plug-In Unit, the Type 545B provides dc-to-33 MHz operation at sensitivities to 50 mV/cm—dc-to-23 MHz at 5 mV/cm dual-trace and 2 Hz-to-14 MHz at approximately 500 μ V/cm single-trace—sweep speeds to 20 nsec/cm, calibrated sweep delay, plus these new and improved features:

- New crt—for high resolution, uniform-focus traces.

- New 6 x 10-cm display area—for greater viewing ease.
- New vertical amplifier—for greater stability and reliability.
- New fixed-tuned delay line—for uniform transient response.
- New internal illuminated graticule—for no-parallax viewing.
- New trigger circuits—for triggering beyond 30 MHz.

The Type 543B is similar to the Type 545B but has one time base and wide-range sweep magnification of 2X to 100X.

Major Characteristics

| | PASSBAND ^① | SWEEP RANGE | SWEEP DELAY | SWEEP MAGNIFIER | PRICE |
|-----------|-----------------------|---|-------------------------|-----------------------------|--------|
| Type 543B | DC to 33 MHz | 0.1 μ sec/cm to 5 sec/cm in 24 calibrated steps, variable uncalibrated from 0.1 μ sec to 12 sec/cm. | None | 2X, 5X, 10X, 20X, 50X, 100X | \$1300 |
| Type 545B | | | 1 μ sec to 10 sec | 5X | \$1550 |
| Type 544 | DC to 50 MHz | Same characteristics as Type 546 plus Automatic Display Switching, which provides equivalent dual-beam performance for most applications. | None | 2X, 5X, 10X, 20X, 50X, 100X | \$1550 |
| Type 546 | | | 0.1 μ sec to 50 sec | 2X, 5X, 10X | \$1750 |
| Type 547 | | | | | \$1875 |

Type 1A1 Plug-In Unit is priced at \$600.

Type 1A2 Plug-In Unit is priced at \$325.

^① Passband is with one of the new amplifier plug-ins, Type 1A1 or 1A2, at 50 mV/cm. Each of these dual-trace units provides maximum passband for all Tektronix Oscilloscopes that accept Letter-Series Plug-Ins.

Rack Mount Models also available. U.S. Sales Prices f.o.b. Beaverton, Oregon.

Tektronix, Inc. ————— throughout the world





AE is your supermarket for relays and switches. Over 200 types...for off-the-shelf delivery within 7 days!

Get 'em fast—direct from us—at no extra charge. That's the AE Stock Program.

Under this growing program, we keep about 205 types of relays, switches and accessories on hand at all times. In quantities large enough to fill your ordinary requirements within one week.

*U. S. Patent Pending

You get this fast delivery on many of the most popular types from AE's broad line: EIN (integral socket) relays with power contacts; mercury-wetted contact relays; PC Correeds*; rotary stepping switches with Gold Levels for dry circuits; ERM (magnetic latching) relays; Class E relays with four dif-

ferent terminal designs, and many more.

Send for your free copy of Circular 1053, "AE Relays and Switches in Stock." It's the latest listing of items available for quick delivery. Just write to the Director, Relay Control Equipment Sales, Automatic Electric, Northlake, Ill. 60164.

AUTOMATIC ELECTRIC

SUBSIDIARY OF

GENERAL TELEPHONE & ELECTRONICS

GTE

Another New High Order of Reliability!

EI-Menco

* MYLAR-PAPER DIPPED CAPACITORS

TYPE
MPD

ASSURE A LOW FAILURE RATE OF
Only 1 Failure in 7,168,000 Unit-Hours for 0.1 MFD Capacitors*

14,336,000

Setting A New High Standard Of Performance!

★ Life tests have proved that EI-Menco Mylar-Paper Dipped Capacitors — tested at 105°C with rated voltage applied — have yielded a failure rate of only 1 per 1,433,600 unit-hours for 1.0 MFD. Since the number of unit-hours of these capacitors is inversely proportional to the capacitance, 0.1 MFD EI-Menco Mylar-Paper Dipped Capacitors will yield ONLY 1 FAILURE IN 14,336,000 UNIT-HOURS.

CAPACITANCE AND VOLTAGE CHART
• Five case sizes in working voltages and ranges:

| | |
|-------------|------------------|
| 200 WVDC — | .018 to .5 MFD |
| 400 WVDC — | .0082 to .33 MFD |
| 600 WVDC — | .0018 to .25 MFD |
| 1000 WVDC — | .001 to .1 MFD |
| 1600 WVDC — | .001 to .05 MFD |

SPECIFICATIONS

- **TOLERANCES:** 10% and 20%. Closer tolerances available on request.
- **INSULATION:** Durez phenolic, epoxy vacuum impregnated.
- **LEADS:** No. 20 B & S (.032") annealed copper clad steel wire crimped leads for printed circuit application.
- **DIELECTRIC STRENGTH:** 2 or 2½ times rated voltage, depending upon working voltage.
- **INSULATION RESISTANCE AT 25°C:** For .05MFD or less, 100,000 megohms minimum. Greater than .05MFD, 5000 megohm-microfarads.
- **INSULATION RESISTANCE AT 105°C:** For .05MFD or less, 1400 megohms minimum. Greater than .05MFD, 70 megohm-microfarads.
- **POWER FACTOR AT 25°C:** 1.0% maximum at 1 KC

These capacitors will exceed all the electrical requirements of E. I. A. specification RS-164 and Military specifications MIL-C-91B and MIL-C-25C.

Write for Technical Brochure

MINIMUM LIFE EXPECTANCY FOR ** 1.0 MFD * MYLAR-PAPER DIPPED CAPACITORS AS A FUNCTION OF VOLTAGE & TEMPERATURE

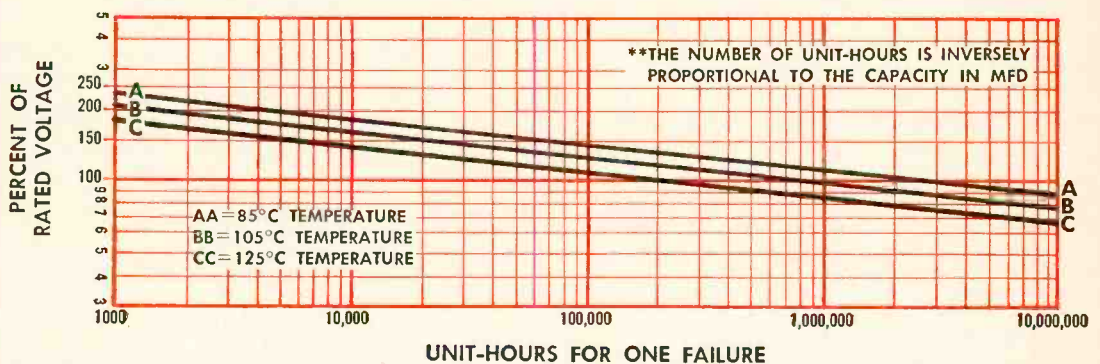

*Registered Trade Mark of DuPont Co.

THE ELECTRO MOTIVE MFG. CO., INC.
WILLIMANTIC, CONNECTICUT

Dipped Mica • Molded Mica • Silvered Mica Films • Mica Trimmers & Padders
Mylar-Paper Dipped • Paper Dipped • Mylar Dipped • Tubular Paper

ARCO ELECTRONICS, INC., Community Drive,
Great Neck, L. I., New York
Exclusive Supplier to Jobbers and Distributors
in the U. S. and Canada

West Coast Manufacturers Contact:
COLLINS & HYDE CO. 1020 Corporation Way
Palo Alto, California
5380 Whittier Boulevard, Los Angeles, California

MANUFACTURERS OF
EI-Menco
Capacitors

COMPONENT COMMENTS *From Speer*

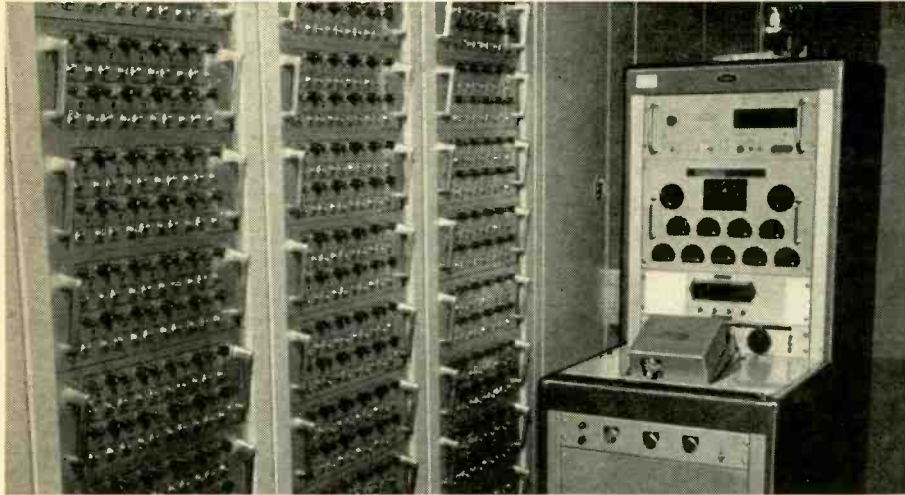

In order to accommodate the 10,000-hour failure-rate level determination load life test (shown above) as well as the other special tests required by MIL-R-39008, Speer recently added 28,000 square feet of quality control and inspection facilities to its Bradford, Pennsylvania, resistor plant.

How to be sure that a resistor will shape up to MIL-R-39008

The problem, as we see it, is twofold. First: how can the resistor manufacturer be sure? And second: how can you, the purchaser, be sure?

First things first. The new MIL-R-39008 "Established Reliability" specification is a challenge to the manufacturer to achieve higher standards of accuracy and reliability than were required by the earlier MIL-R-11 military specs. Not only are the MIL-R-39008 tests more extensive and more exacting; they're also decidedly more time-consuming. (Example? Up to 630 million unit test hours are required to extend qualification to the lowest of the new failure-rate levels. With MIL-R-11, failure-rate level determination was not even required.)

We at Speer had a sneaking suspicion that we possessed the broad background and the resistor know-how to achieve these new standards of accuracy and reliability. And now, at last, we've completed sufficient long-term life testing to determine that our 5-stripe resistors *can* indeed "shape up" to MIL-R-39008's rugged military standards.

So far, so good. But how do we now assure *you* of our resistors' Established Reliability? Five colorful stripes aren't adequate assurance. Neither are glowing adjectives.

So we've decided to do more—and that's why each shipment of our 5-stripe resistors comes to you with a lot of quality certificate to document its performance. Automatically generated data from each test group is maintained for detailed reference.

If you'd like to pursue this subject of Established Reliability still further, we invite you to send for our technical article entitled "How the New 'Tri-Service' Specification MIL-R-39008 Applies to Resistors." To get a copy, use the coupon.

SPEER CARBON COMPANY

St. Marys, Pennsylvania

Speer Carbon Co. is a Division of Air Reduction Company, Inc.

- Rush "How the New 'Tri-Service' Specification MIL-R-39008 Applies to Resistors."
- Rush "The Jeffers Inductor Handbook."
- Arrange for me to receive reprints of "Component Comments."

Name _____

Title _____

Company _____

Address _____

City _____

State _____ Zip _____

Our inductor capabilities are an open book

We have just discovered that our Jeffers Electronics Division is not a group to be trifled with.

In a recent issue of "Component Comments," we presented a feature on "The Speer Resistor Handbook." When our Jeffers associates got wind of this, they reminded us, a trifle tartly, that "The Jeffers Inductor Handbook" is equally fascinating.



Interior view of our free, 16-page, lavishly illustrated "Inductor Handbook."

And so it is. This colorful 16-page brochure takes you through the entire Jeffers inductor plant—from the automated manufacturing operation and the application engineering services to the Established Reliability Program and the comprehensive Quality Control & Inspection Program. (Did you know, for example, that there are continuous patrol checks at every manufacturing step?) You'll also learn how our standard catalog inductors have performed under MIL-C-15305 test conditions.

As you can see, our Jeffers Division's inductor capabilities are an open book. If you'd like a copy, just mail us the coupon.

“We demand minimum size plus maximum reliability. That’s why we use capacitors of Mylar®”

says Worthington C. Lent, Vice President,
Telephone Development & Operations,
Lear Siegler, Inc.

Central telephone office equipment must be designed as compactly as possible. At the same time, this equipment must be reliable for a service life of many years. So Lear Siegler uses capacitors of MYLAR*. And nothing but capacitors of MYLAR in the R-635 Voice-Frequency Repeater. The extremely high dielectric strength of MYLAR means smaller capacitors. The extremely high stability of MYLAR means long-term reliability.

Other dielectric materials could have been used but anything else that would meet specifications would cost much more than capacitors of MYLAR, according to Lear-Siegler, Inc.

If size, reliability and price are important to you, check the ways capacitors of MYLAR could help you improve your designs. For some interesting technical data, write Du Pont Co., Room 3241-A, Wilmington, Delaware 19898. (In Canada, write Du Pont of Canada Ltd., P. O. Box 660, Montreal, Quebec.)

only DU PONT makes
MYLAR®
POLYESTER FILM

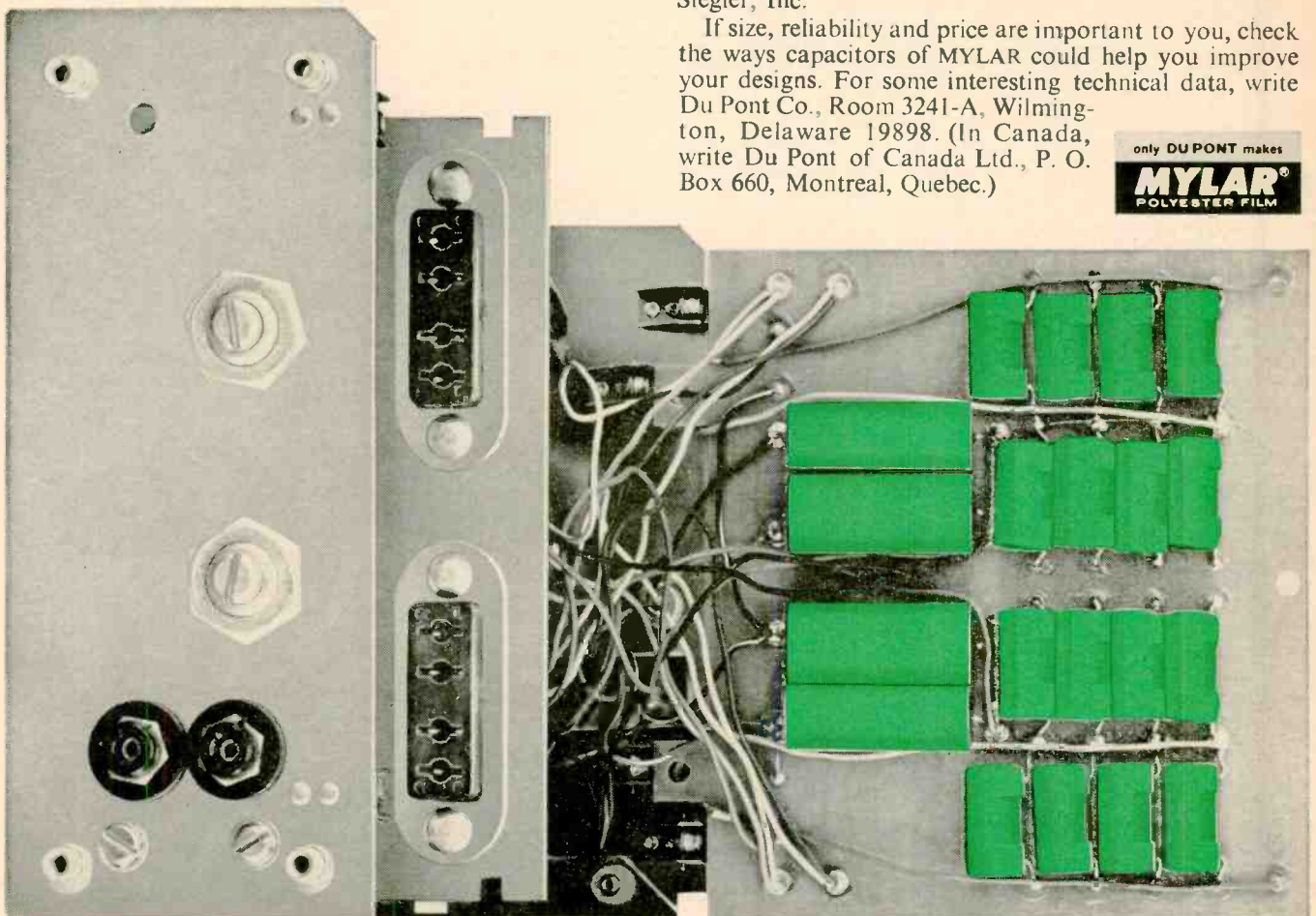

20 capacitors of MYLAR* polyester film are used in the R-635 Voice-Frequency Repeater manufactured by the Electronic Instrumentation Division of Lear Siegler, Anaheim, California.

*Du Pont's registered trademark for its polyester film.



BETTER THINGS FOR BETTER LIVING... THROUGH CHEMISTRY



DIVISION OF THOMAS A. EDISON INDUSTRIES

precision wire wound

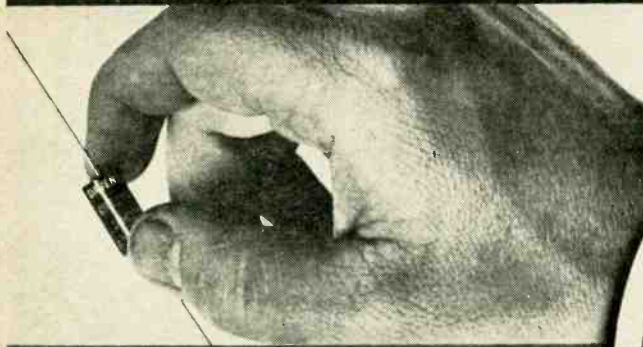

resistors & networks

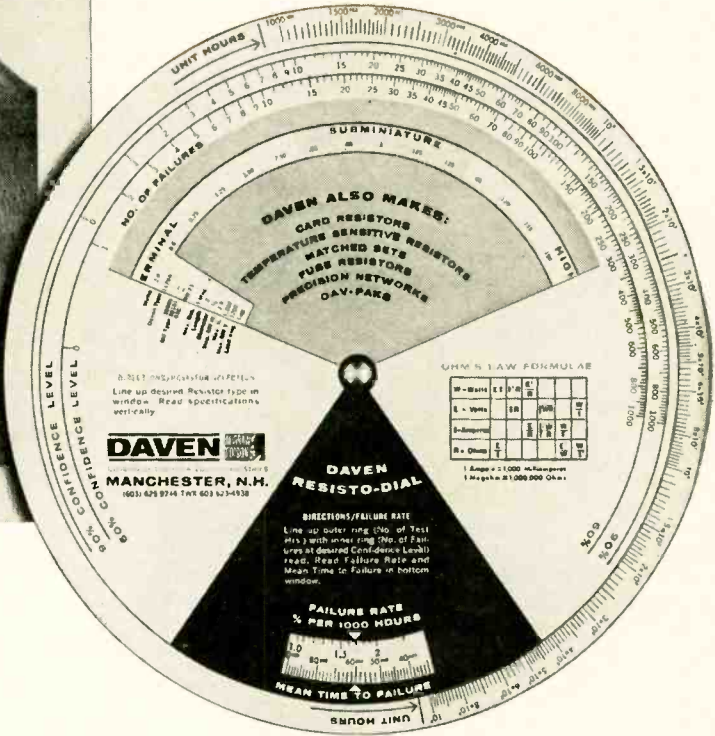

What this brand new catalog won't tell you...

this brand new calculator will.

BOTH FREE

Between the new Daven catalog on precision wire wound resistors and networks... and the new Resisto-Dial... you've got the most complete, concise, *usable* data published today. Both are designed to provide just the information you want, just the way you want it—fast!

The 16-page catalog is the "Bible" on precision resistors... high reliability, encapsulated, subminiature, printed circuit, fuse, power, instrument grade, high frequency, and unencapsulated resistors. Also covered: DAV-Pak Prepackaged Networks.

The Resisto-Dial *instantly* calculates resistor styles based on requirements; calculates failure rate based on unit hours at a given confidence level; and many other computations. Both are yours free, just for the writing.

DAVEN 
 MANCHESTER, NEW HAMPSHIRE
 (603) 625-9746 • TWX 603 623-4938 • Cable: Daven Manchester N H

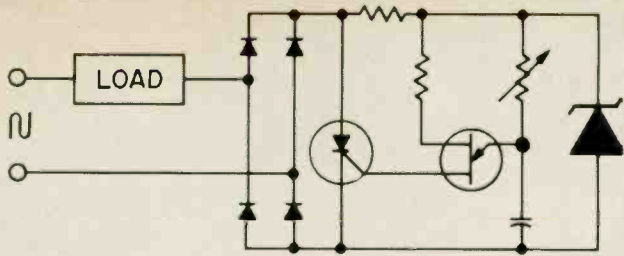

Clipper Zener Diode generating constant amplitude trapezoidal wave form for trigger pulse synchronization — used in SCR circuitry.

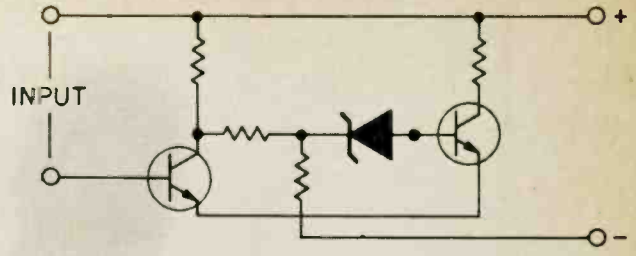

Noise Immunity Zener Diode provides voltage threshold which must be exceeded before transistor will conduct thereby eliminating false triggering.

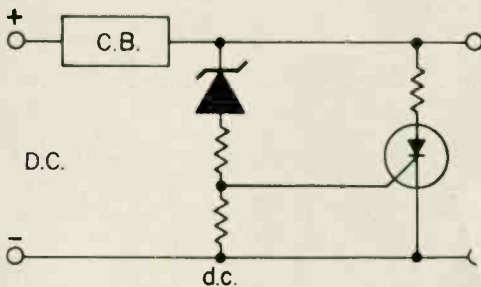

Over-voltage protection using a Zener Diode with an SCR and a circuit breaker will clear over-voltage faults. Both AC and DC circuits can be protected.

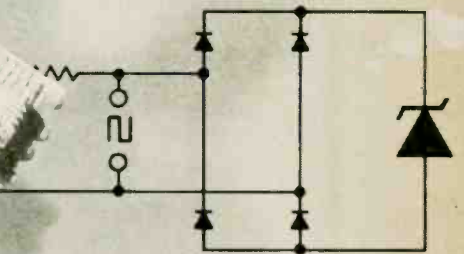

AC regulation Zener Diode used in symmetrical clipper circuit for square wave generation or surge protection where regulated AC output is desired.



Don't avoid zener diode applications like these ...because of price!

Now you can get a low-cost zener diode for virtually *all* those commercial/industrial applications you never before considered economical — Motorola's new Surmetic® Zener Diode! Priced at only 95¢†, it offers these significant design advantages:

- 1 watt at 50°C, ambient — provides high thermal efficiency
- passivated junctions — seals against leakage and contamination... assures long-term stability
- completely defined zener breakdown region — 100% oscilloscope-tested and characterized at

4 critical points for sharp "knees"

- small size — no larger than a "glass" diode

Your franchised Motorola distributor has an in-depth stock of 3.3 to 100-volt Surmetic Zener Diodes — contact him about evaluation units today!

Quality Leader in Zener Diode Technology ...

MOTOROLA  **Semiconductor Products Inc.**

BOX 955 • PHOENIX, ARIZONA 85001

® Trademark of Motorola Inc.

†100¢ price for all ±10% tolerance units from 3.3 to 100-volts; lower in larger quantities.



A Zener Diode Assortment at Your Fingertips
... Order a Surmetic "Handylab" from your distributor... includes 100 ±5% tolerance units in a convenient, divided-by-voltage storage cabinet for only \$79! (Value=\$148; Save \$69!)

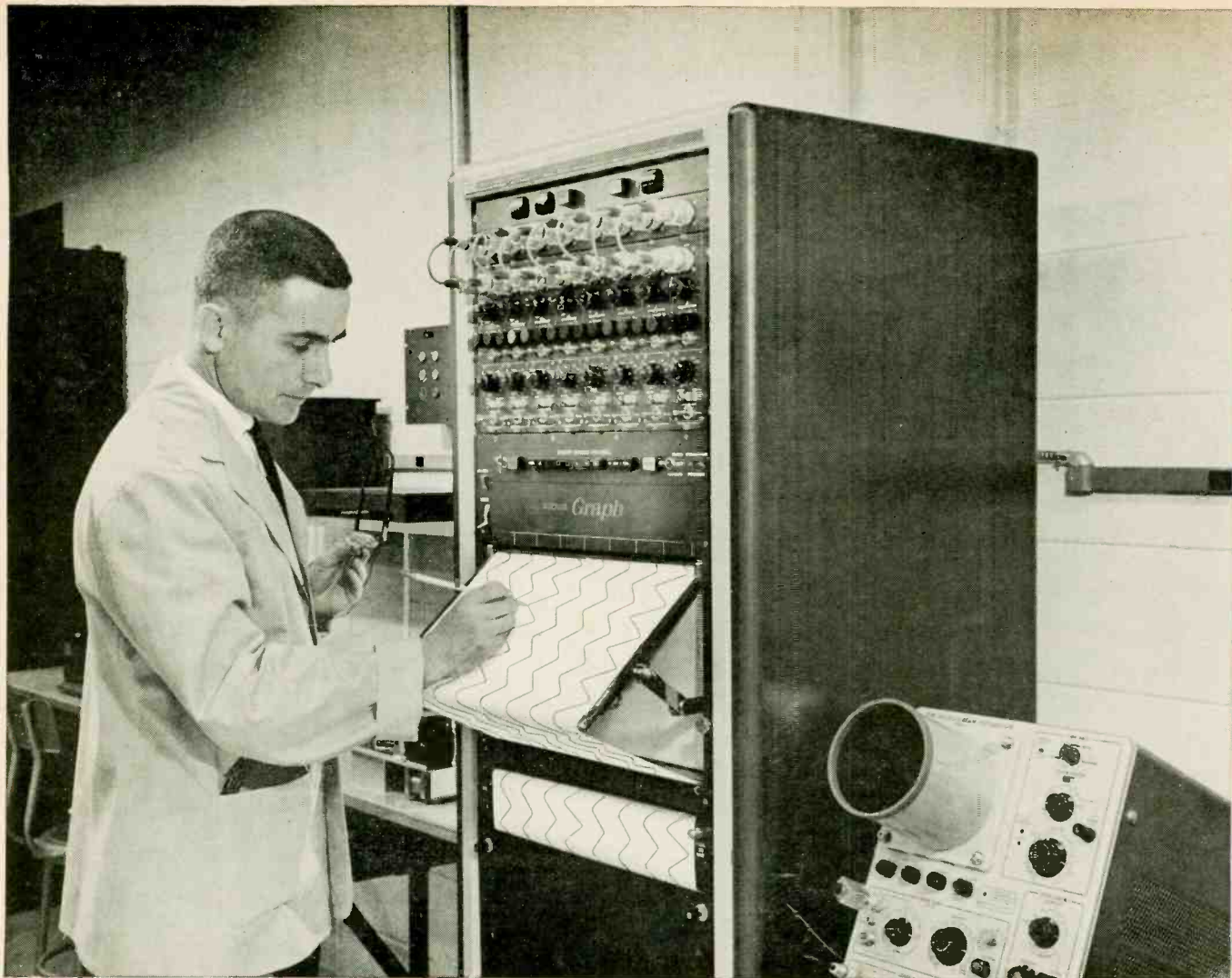

110 cps full scale response
+
greatest resolution } = your best Oscillo Graph buy

No other oscillograph recorder can match the frequency response of Esterline Angus . . . flat to 110 cps ($\pm 1\%$) at 40 mm peak-to-peak deflection.

At 140 cps, frequency response of these four, six and eight channel recorders is down only 3 db from full scale. Even at 200 cps, stylus excursion is 8 to 10 mm.

Resolution? Esterline Angus combines highest chart speeds (to 500 mm per second) with highest frequency response.

Exceptional resolution is further assured because of the exclusive Direct-Carbon-Transfer writing method. Even the one, two and three channel portables feature this inkless and heatless writing method. Advantages of D-C-T?

- 0.005 inch wide trace occupies only $\frac{1}{2}\%$ of full scale. Traces of competitive oscillographs are three times wider.
- Chart paper at half the cost of heat sensitive paper. Charts can be easily, economically reproduced.

- No start-up problems because there are no pens to clog or ink to splatter.
- No stylus temperature adjustments to bother with.

Interchangeable, plug-in amplifiers and couplers provide a multitude of signal channels to record signals from a few microvolts to hundreds of volts.

The stylus motor uses no permanent magnets. This eliminates the clutter of brushes, slip rings, armature leads and linkages normally found in stylus drive mechanisms.

For highest resolution, unequalled response and trouble-free writing, investigate Esterline Angus Oscillo Graph Recorders.

Write for informative Series "O" Catalog.

ESTERLINE ANGUS INSTRUMENT COMPANY, INC.
Box 24000 E • Indianapolis, Indiana 46224

ESTERLINE ANGUS

Excellence in instrumentation for over 50 years



Technical Articles

**Switching with light:
page 58**

Optoelectronics, once limited to research laboratories, is becoming a tool of development engineers. As more devices become available commercially, engineers can consider using them in product design. One major application is switching, where optoelectronic devices have many advantages—from isolation of signals to higher speed. This article considers the problems of switching with optical signals and the kinds of devices that can be used. In the next issue, we will examine some of the optoelectronic devices available for switching and other applications.

**The picture looks better
for closed-circuit tv:
page 70**

Television is finding more uses in industry, but new requirements demand photographic quality that cannot be supplied by the equipment used for home entertainment. New high-resolution equipment reduces the effect of noise, hum and other deleterious ingredients in tv pictures.

**The packaging revolution
part 2: decisions on
manufacture start early:
page 75**

Microelectronic systems are dissolving the time-honored division between engineering and manufacturing. The manufacturing department can no longer wait for the engineers to finish designing before plans for fabrication begin. The reason is that so many design decisions affect assembly methods. This article examines the role of designers and manufacturing engineers, the variety of connections that can be used, and how some large-scale systems have been packaged.

**Designing transmission lines
into multilayer
circuit boards:
page 90**



Transmission lines made as multilayer printed circuit boards are a reliable means of transmitting high-frequency signals among the active circuits of high-performance microelectronic computers. The technique has been polished to a high degree of efficiency in IBM's System 360. In the cover photograph, the wiring patterns are drawn automatically on photoresist in a red-lighted environment which is photographically safe.

**Coming
November 15**

- A survey of optoelectronic devices
- Tuning integrated circuits
- A magnetoresistive servo potentiometer
- The fundamentals of error coding

Switching with light

Three types of circuits use optical signals for faster, less expensive logic and switching. Here are the relative merits of each, also a preview of a fourth type that is still in the laboratory stage

By T.E. Bray

General Electric Co., Syracuse, N. Y.

Recent developments in solid state materials and devices are bringing about the practical realization of circuits and systems that use light to perform the functions normally achieved by current, voltage or electron beams.

The development of efficient electroluminescent p-n-junction devices in particular has given a marked impetus to the field of optoelectronics. Lasers also have added to the capabilities and focused interest in the technology.

The four-part series that begins with this article is designed to show some of the vast potential and the still-modest achievements of solid state optoelectronics. The next article will describe some new materials being developed, and the light emitters and detectors being made from them. Subsequent articles will discuss new concepts in optoelectronic displays and in computer memories.—S. Weber

For switching circuits, such as those used in computers, optical signals have three major advantages over their electrical counterparts: higher carrier frequencies with potentially higher speed, parallelism to enable each channel to carry more signals, and isolation to prevent interference between channels. Generally, they also require smaller components; even the large components, such as lenses, have capabilities in switching circuits that far outweigh the increase in size.

These advantages are exploited in three basic kinds of optoelectronic circuits:

The author



T. E. Bray is manager of optoelectronics and solid state devices at GE's Electronics Laboratory. He holds several patents in optoelectronics.

- Polycrystalline optoelectronic devices, such as electroluminescent-photoconductor (EL-PC) circuits. Photoconductor switches, which are already in commercial use, are slower but less costly than their electronic counterparts.

- Noncoherent single-crystal devices, such as gallium-arsenide light sources and silicon-based detectors. Although they suffer from low quantum gain, these circuits operate over a range of 100 kilocycles to 10 megacycles per second.

- Coherent devices. Even faster than the single-crystal type, these circuits still require technical advances before they can become practical.

In addition to these three basic types, a fourth—optical beam deflection—seems likely to become feasible for such applications as memory readout. But technical improvements are necessary.

Some principles of optoelectronics

Optical signals, which have wavelengths of 3,000 to 12,000 Angstroms or more, differ from electrical signals in four major ways.¹ Optical signals consist of photons, which are electrically neutral, contrasted with the electron's negative charge; optical radiation consists of two-dimensional waves; it is absorbed by many common materials; and its scattering can be detected by the eye or by some device.

Because photons are electrically neutral, optical signals can be decoupled and isolated without special hardware. This permits large fan-in—the number of signals that can be brought into a single switching circuit at once.

The two-dimensional nature of optical radiation permits many independent signals to be propagated through simple channels without interfering with one another. Small components can be placed close together, allowing higher operating speeds. Also, high carrier frequencies are possible on the order of 100,000 gigacycles. It is even possible to transmit

two-dimensional digital signals, viewed as parallel propagation of one-dimensional digital signals; that is, a light beam traveling in the z direction may vary in the x and y directions as a function of two independent quantities. Two-dimensional propagation is also a powerful technique in analog systems [Electronics, Sept. 6, 1965, p. 72].

Because materials such as cardboard are opaque to optical radiation, optoelectronic devices can be applied readily to the reading of data stored on paper tape or punched cards. Punched cards are also convenient for reprogramming an optoelectronic switching network.

Stray or intentionally scattered optical radiation can indicate the state of an optoelectronic switch. Development engineers can check on the state of an EL-PC logic network by looking at it; this is easier than using an oscilloscope and, unlike the scope, properly connected electroluminescent devices introduce no stray electrical effects into the network. At high speeds, however, and for wavelengths other than the visible, a suitable optical sensor is required.

The high speed possible with optoelectronics is a result not of the velocity of light, as is commonly believed, but of its high frequency. All electrical and optical signals travel at speeds approaching that of light, falling short only by an amount that depends on the circuit's inductance and capacitance, or the medium's index of refraction.

The advantages of isolation and parallelism are illustrated above. The optical sources may be neon bulbs, gallium-arsenide infrared sources, or clear and opaque areas in a photographic plate. Each source produces a corresponding image at an optical receiver. Although all of the light rays are mixed in the lens they form separate images in the image plane. Since each optical channel is independent of the others, parallel transmission of a large amount of data is simple. Many other optical transmission techniques—for instance optical fibers—are also available.

Only light will do

But why choose the optical range? Would not most of these techniques work at other wavelengths? Unfortunately they would not, for several reasons.

First, for wavelengths approaching the far ultraviolet region, the photon's energy increases and most materials become highly absorptive—attenuating transmission. With even shorter wavelengths, approaching the x-ray region, materials again become more transparent—reducing their efficiency as receivers. Yet at any wavelength a good transmitter should be transparent and a good receiver should be absorbent. It is difficult to satisfy both conditions at any wavelength other than those near the visible region.

A second drawback with very short wavelengths is that they are more difficult to generate than are those in the visible and near-infrared spectral regions.

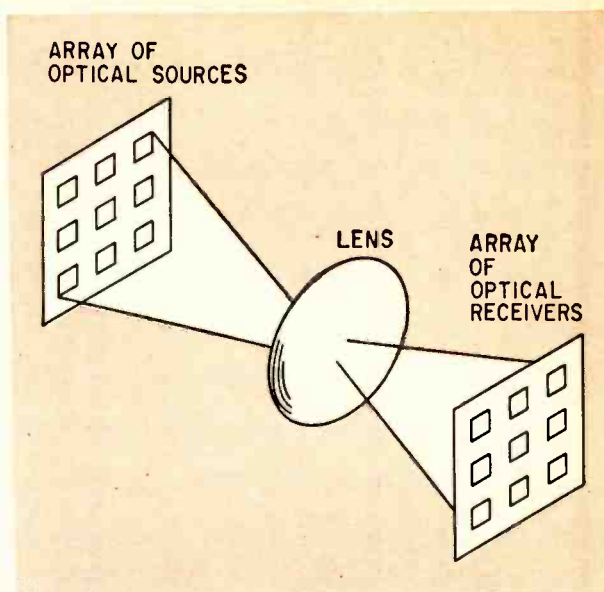

Many independent parallel channels may transmit data through a lens. The sources at the left may be any type of modulated light sources. Although the signals are mixed as they pass through the lens, they separate again and focus cleanly on the receiver.

Thirdly, ultraviolet radiation, with more energy per photon, requires more power to produce a given photon flux or current.

With wavelengths substantially longer than optical—those in the far infrared region—receivers require cooling, and black-body radiation gives rise to spurious signals that must be suppressed at the receiver.

Quantum gain

The gain of a logic device is one of its most important parameters. The most general definition of gain is:

$$\text{Quantum gain} = \frac{\text{Number of particles per second output}}{\text{Number of particles per second input}}$$

In optics the particles are photons. In transistor circuits the particles are electrons, and the gain is simply the ratio of the output current to input current. In a phototransistor, the input particles are photons and the output particles are electrons.

In a switching device the gain must be greater than unity, otherwise the signal will diminish as it passes through successive stages. Logic circuits usually drive two or more similar circuits, and must therefore have a gain of two or more.

The over-all quantum gain is the product of two gains: the optical source's and the photo-detector's. If the emitter's gain is less than unity, as it usually is, then the detector gain must be correspondingly large; this often poses a serious problem for over-all quantum gain.

Coherent vs. noncoherent switching

Three types of optoelectronic switching are available. They can be classified, by the components employed, into noncoherent and coherent types.

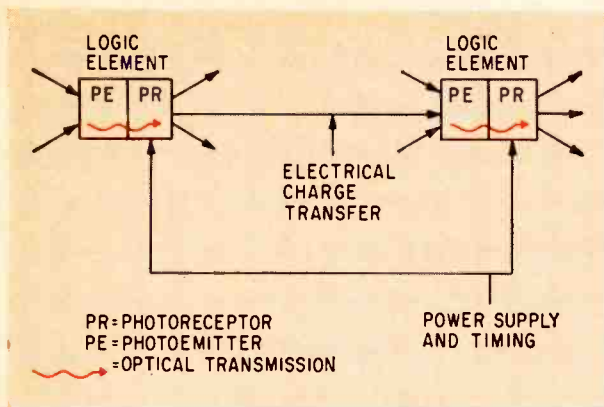

Local optical coupling with electrical transmission among logic elements. The logic elements may be EL-PC devices.

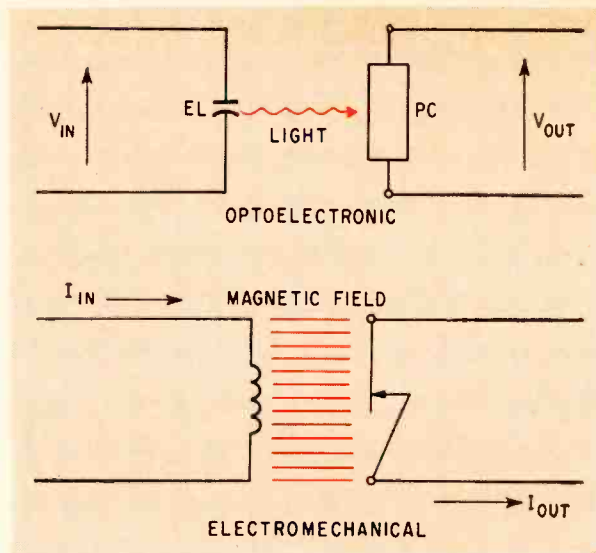
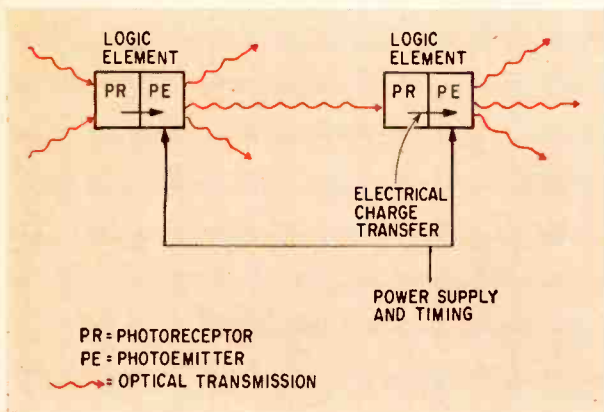

Optoelectronic device compared with a relay. A voltage across an electroluminescent cell corresponds to a current through a relay coil, light generated by the cell corresponds to the coil's magnetic field and the photoconductor cell is analogous to the relay contacts. Unlike a relay, however, a photoconductor can have a continuous change in resistance.

Local electrical coupling with optical transmission among logical elements.

Noncoherent optoelectronic systems require both an optical source and an optical detector. In the source, electrical energy is converted to light energy; the detector converts light back to electrical energy. Charge must move through conductors or semiconductors at some point in the system.

Coherent systems are fastest. They do not usually require internal detectors, because the photons can be amplified directly by laser action. Electrical detectors are usually needed at the output. Electrical charge need not necessarily move through a coherent device; the only requirement is a change in the energy state of electrons or molecules. This lack of particle motion gives a coherent system a big advantage in speed; charge transfer takes time, if only a few nanoseconds.

On the other hand, charge transfer has an advantage in noncoherent systems: it assures directionality, because the detector cannot affect the source. In a coherent system, it is necessary either to have directional couplers or to have the input and output paths at right angles; otherwise the two paths cannot be distinguished and may interfere with each other.

Noncoherent logic circuits can be divided into two classes: low-speed, or polycrystalline types, and high-speed or semiconductor types of circuits. They can also be classified according to whether it is the electrical or the optical signals that are transmitted from stage to stage. With one approach,

the optical transmission paths are localized and the electrical signals transmitted from stage-to-stage, as in electroluminescent-photoconductor circuits; with the other, the transfer of electrical charge is local and optical signals are transmitted; no such device is known to be in use, but research is in progress. Optical isolation is possible in both classes of noncoherent circuits.

The arrangement in the sketch at the upper left shows local optical coupling with electrical transmission between logic elements. This approach permits potentially high efficiency of optical coupling, but does not eliminate the problems of conventional computer transmission problems such as reflection, limited fan-in and fan-out.

The arrangement in the sketch at the lower left above consists of logic elements with electrical internal coupling. Optical paths link these elements. The advantages of this method are the short distance through which the charge must move, the relative simplicity of the transmission, and the high fan-in ratio. The major disadvantage is the difficulty of obtaining an efficient optical coupling over paths that are long and sometimes complex.

Low-speed circuits

One type of logic circuit is the low-speed electroluminescent-photoconductor (EL-PC) or neon-photoconductor (Ne-PC) device. An EL-PC³ or Ne-PC⁴ device consists of a neon or thin electro-

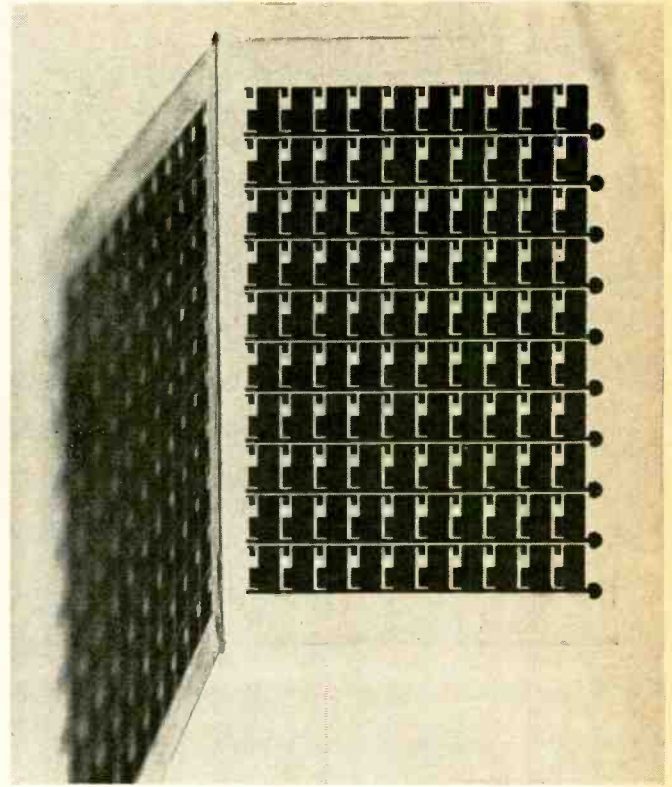
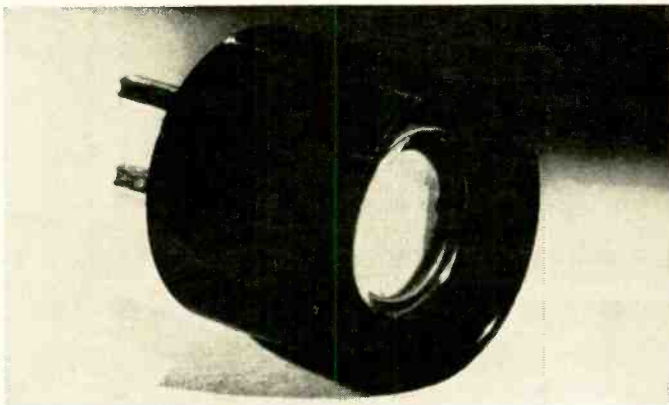
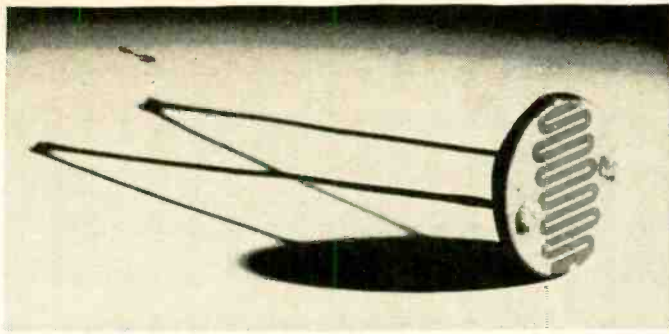

Three types of photoconductor devices. At top left is the General Electric Co.'s new plastic-encapsulated cell which is as sensitive as more expensive units. It is less than one-half inch in diameter and 1/16 inch thick. The photo at lower left shows a similar device mounted in a plug-in base for rapid installation. At right is a developmental array of 100 polycrystalline cadmium-selenide photoconductors on a glass substrate.

luminescent lamp next to a highly sensitive photoconductor such as cadmium selenide or cadmium sulfide. For switching purposes, this assembly is analogous to a relay, with light in the EL-PC device doing the job of a magnetic field in a relay (see sketch at the upper right, opposite page).

Most photoconductors are polycrystalline, and are usually applied by spray or evaporation techniques on a ceramic or glass substrate. The photoconductor electrodes may be deposited before or after the photoconductor itself is deposited. Individual cells or relatively complex arrays can be made in this way (see photos above).

The electroluminescent lamp for an EL-PC device consists of a thin layer of powdered zinc-sulfide dielectric sandwiched between two electrodes; usually at least one electrode is transparent. Either single lamps or multiple arrays of individually controllable cells can be fabricated in essentially the same manner. Because of the dielectric, alternating voltages must be used to excite commercial electroluminescent lamps.

Neon bulbs for Ne-PC devices are similar to those often used as indicators. They can be used to excite photoconductors, or they can be controlled by photoconductors. Efforts to make arrays of neon lamps have generally been unsuccessful; however, multielement neon lamps in a single envelope are well known.

EL-PC and Ne-PC elements are inexpensive and

easy to use in fabricating switching circuits. These elements are relatively slow; their frequency limit is about 10 to 10³ cycles per second in a switching mode. Speed is limited, partly by the photoconductor and partly by the low quantum gain of neon or electroluminescent light sources. Low quantum gain restricts speed because the over-all quantum gain must exceed unity in most applications. The photoconductor must compensate for the light source's low gain; its high gain is attained at the expense of response time.

Although switching speeds of EL-PC and Ne-PC devices are low by most electronic standards, they are adequate for many industrial applications such as process control, or for situations where human response times are a factor, such as those using numerical indicators and displays. The ratio of a photoconductor's resistance in the dark to its resistance at modest light levels (a few footcandles) falls within the range of 10⁵ to 10⁸. However, a PC's resistance in the light is generally higher than 100 ohms, except at high light intensities or in very large cells; sometimes resistance in the light is as high as several thousand ohms. Electrically, the photoconductor and electroluminescent elements may be classed as high-voltage, high-impedance devices. Low-impedance neon lamps are generally connected in series with high resistances, to limit the current and prolong the lamp's life.

Low-cost, low-speed optoelectronic relay ele-

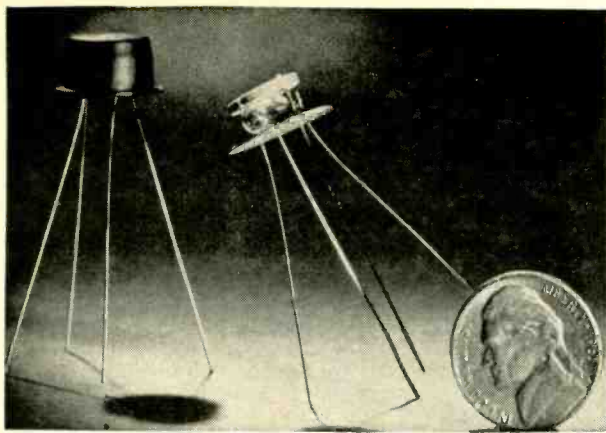

Photocell with sealed-in light source, made by General Electric. High-reliability lamp permits cell to operate as a resistor whose resistance changes with the voltage across the lamp.

ments are not yet in wide use, in spite of their many potential applications. One reason is that the light output of an electroluminescent cell decays with time and usage. This light change can affect switching-circuit operation. But significant increases in life expectancy have been made, and continued progress is expected. EL-PC arrays can be made acceptably uniform but there are yield problems in manufacturing that could eliminate all of the potential cost savings of the devices.

As integrated circuits increase in popularity and economy, it is reasonable to ask whether a polycrystalline optoelectronic device is really less expensive. The answer depends upon the ultimate cost of fabrication techniques for photo-masked single-crystal and thin-film devices compared with the cost of larger polycrystalline or thick-film devices made by processes in air, such as spraying or silk-screening.

Photoconductor switching has found applications in commerce and in laboratories. One application is switching or chopping low-level analog signals.⁵ Alternating light pulses, generated by neon lamps, illuminate photoconductor elements that convert the low-level input signal to an a-c signal. This light signal can be boosted in a stable a-c amplifier, then rectified if necessary. This eliminates any need for d-c amplifiers, which tend to drift. Because the photoconductor's resistance characteristic is linear at any light level, small-signal distortion—which occurs outside the linear region of almost all p-n junction devices—is prevented.

A novel and effective use of photoconductor arrays has been found by the Hewlett-Packard Co. for converting binary counter codes to a visual decimal display.⁶ In the Hewlett-Packard system the photoconductor converter is driven by neon lamps in the counters. The photoconductor array, in turn, directly controls the neon display elements. Although the counters operate electronically, slow photoconductor elements are satisfactory because the display is viewed only after the converter stops.

Several companies sell neon-photoconductor or

incandescent photoconductor packages that may be used as relays. A commercially available unit, shown in the photograph at the left, consists of a photoconductor and lamp, sealed in the container with four leads—two for the signal and two for control.

Laboratory EL-PC circuits include counters, shift registers, shaft-position encoders, logic circuits and memory-display modules.

High-speed circuits

Another class of optoelectronic switching and logic devices is based on recent advances in injection electroluminescent and single-crystal photodetector technology. It is important to distinguish between noncoherent injection luminescent diodes, to be described in this section, and laser diodes, which will be discussed later. Typical optical emitters are made with the compound semiconductors—gallium arsenide and gallium phosphide—which emit at approximately 840 to 900 millimicrons (near infrared) and 540 to 650 millimicrons (green to orange) millimicrons, respectively. In general, shorter wavelengths are emitted and higher quantum efficiencies obtained at lower temperatures.

Single-crystal photodetectors include photodiodes, solar cells, phototransistors and photoconductors. These are usually based on silicon and germanium, although many other semiconductors can also be used.

These single-crystal devices are much faster than their polycrystalline optoelectronic counterparts, with lower impedance. However, the basic single-crystal devices are generally more expensive because they are manufactured with techniques similar to those used in diode and transistor manufacture—techniques such as diffusion, alloying, etching, and lead bonding. The optical emitters have good stability superior to that of polycrystalline electroluminescent cells.

Although few visible-light injection diodes have been made, several materials and their emission colors have been reported or are being studied: gallium phosphide (orange or green, depending on the doping); gallium phosphide-arsenide combinations in various proportions (red or orange); boron nitride (white); aluminum phosphide (blue) and silicon (white-plasma). Neither large individual lamps nor complex arrays have yet been made, but the methods of manufacture are in many respects compatible with microelectronic and silicon integrated-circuit techniques, and therefore pose no new manufacturing problems.

At present, the available quantum efficiency—or gain—of optical emitters is low, typically 0.001 to 0.01 at room temperature. The semiconductor surface is shaped in such a way as to reduce losses due to internal reflection; reflection, in turn, is caused by the material's high index of refraction. The quantum efficiency is much higher at very low temperatures. The low efficiency of such optical emitters requires a high gain in the detector, just

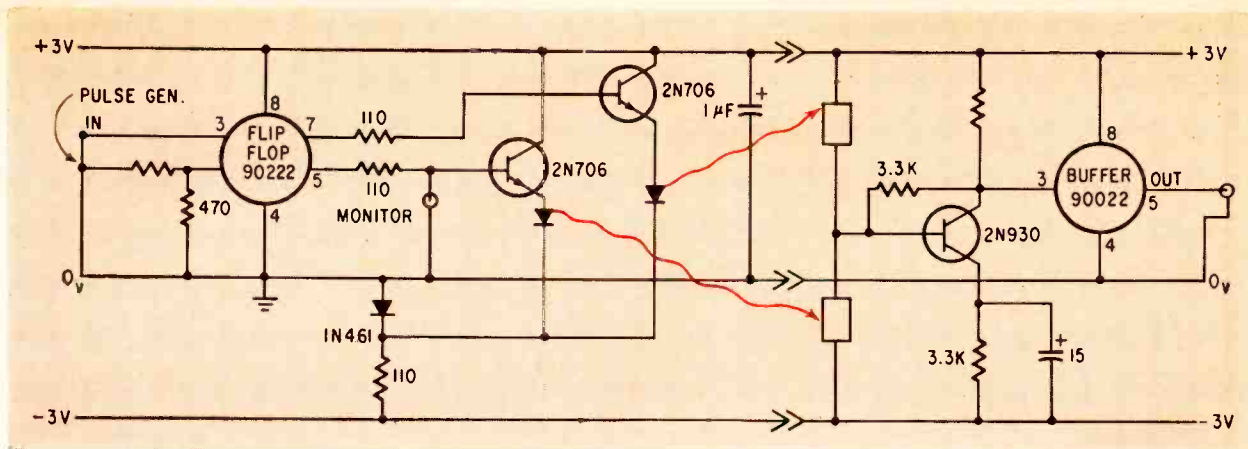

Optical coupling as used in a push-pull amplifier circuit. Circuit diagram shows gallium-arsenide injection diodes and high-speed silicon photo-conductors with a single stage of transistor gain.

as it did for the EL-PC logic devices. This requirement leads to lower speeds; nevertheless, switching frequencies exceeding one megacycle have been achieved.

The optical interconnection of integrated circuits with single-crystal optoelectronic techniques has been investigated. Two interesting techniques were reported. In one,⁷ a transistor and photoconductor overcome loss incurred with optical coupling as shown in the diagram above; the optical devices, furthermore, may be decoupled merely by moving the two parts of the circuit package out of line. In the other method,⁸ the experimenter used a phototransistor instead of a photoconductor, and achieved better optical coupling when he bonded the emitter and detector together with a high-index medium. However, he lost the ability to decouple the circuit easily, and found undesirable coupling in the phototransistor, caused by a deep penetration of near-infrared radiation—wavelength of 900 millimicrons—into the silicon.

Optoelectronic coupling at high speeds, with excellent electrical isolation, is available in Hewlett-Packard coupling devices.⁹ The high speed is attained in exchange for quantum loss in the structures.

Slower-speed devices with gain can be assembled from light-sensitive, negative-resistance elements such as light-activated silicon controlled rectifiers.¹⁰ These devices can be used as solid state relays. The input or triggering energy of an scr is generally small, particularly for the light-activated variety; yet, when the device turns on, its impedance decreases by several orders of magnitude, so that the output energy is large.

The voltage decreases from its triggering value to its steady-state "on" value, but the current increases from an almost negligible value to a value limited principally by external circuitry. The negative voltage change and the positive current change represent a negative resistance. The gain, represented by the ratio of output to input energy, is therefore a result of the device's negative-resistance characteristic. This gain is accompanied by response time of 10 to 100 microseconds. These de-

vices have a very high power control capability.

One intriguing development is an optical transistor.¹¹ The signal coupling from emitter to collector would occur by means of photons instead of electrical charge carriers. A typical structure is shown in the sketch below. In a conventional transistor, the switching speed is determined by the length of time it takes carriers to cross the base and by the extent to which the carriers diffuse in the base; therefore the thinner the base, the faster the transistor. In an optical transistor, the speed would be determined by optical emission and absorption times, rather than by carrier mobility and diffusion; theoretically, therefore, the base need not be nearly as thin as in a conventional transistor. By keeping the radiation within the semiconductor, internal reflection losses would be minimized. The devices reported so far are relatively fast (10 to 100 nanoseconds) but the current transfer, or alpha, is very low, on the order of 0.1 at room temperature.

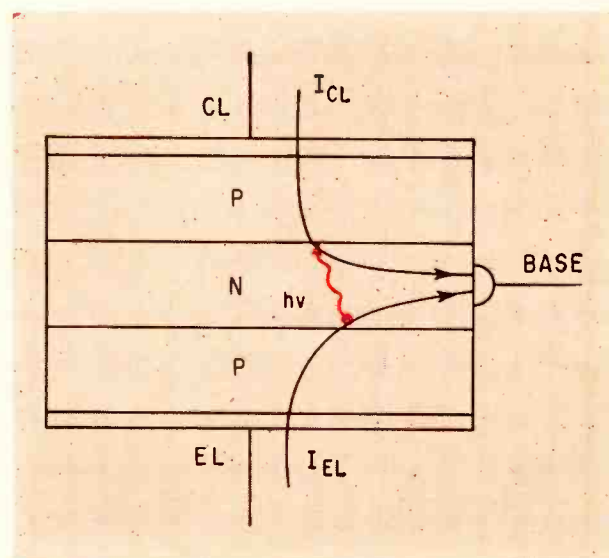

Optically coupled transistor-like device. Symbols EL and CL refer to the light-emitting and -collecting junctions. Wavy line represents light emission from emitter junction.

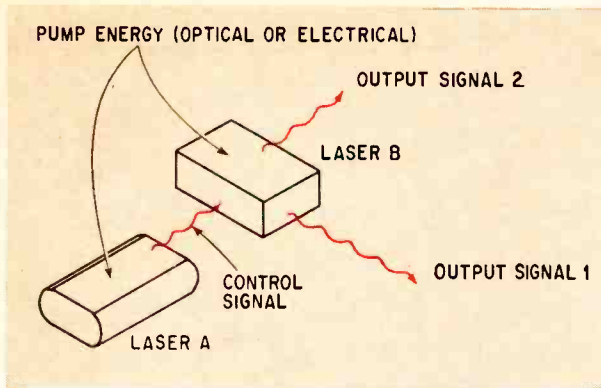

Setup for coherent optical switching experiment. Laser A produces control signal that excites laser B, which will not lase without this external excitation.

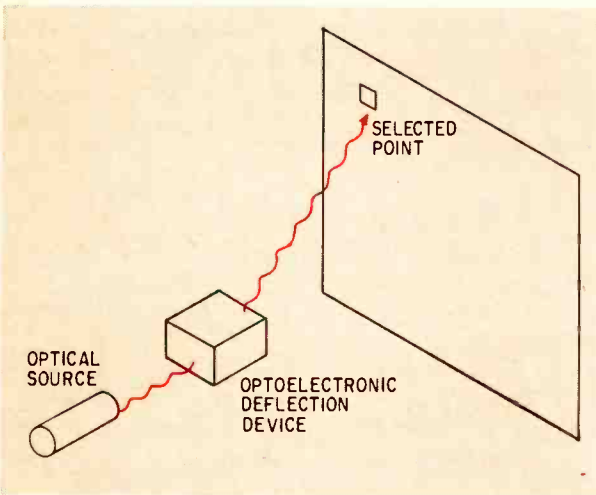

Optical beam-steering in simplified form. Source and deflection device may be separate, or may be parts of a multimode laser.

An integrally coupled negative-resistance device, shown in the upper diagram on the opposite page, has been demonstrated.¹² A current through the light-emitting diode shown at the top of the figure produces radiation within the semiinsulating bulk material. This radiation changes the threshold voltage at which switching occurs. All the radiation remains within the gallium-arsenide structure, so there is little loss from refraction and reflection. The gain at room temperature is about unity.

A heterojunction optical transistor (lower diagram on opposite page) also has been proposed,¹³ but unfortunately it does not work experimentally. The proposal calls for a gallium-arsenide p-n junction, integrally fabricated with a reverse-biased gallium-arsenide-germanium heterojunction. The heterojunction was intended to absorb photons efficiently near the junction, and thus to produce a quantum gain near unity.

The technique does not work¹⁴ because there is a difference in the energy gaps of gallium arsenide and germanium. Gallium-arsenide emitters have good quantum efficiency only at low temperatures; at these temperatures, the photocurrent through

the entire device is limited and the alpha is low.

A combined electron beam-semiconductor junction device has been proposed¹⁵ to obtain high detector gain, for use with an array of gallium-arsenide optical emitters for logic purposes. The gain would be obtained by accelerating an electron beam in a vacuum. The beam would produce many electron-hole pairs when it impinged upon a reverse-biased p-n junction. The electrons would be produced by a photocathode. Unfortunately, the best photocathodes have low quantum efficiencies at wavelengths beyond 700 millimicrons. Therefore additional gain, on the order of 10^3 , must be introduced so that the photocathode loss can be overcome.

Coherent optical logic devices

Coherent optical devices have been found to be capable of high speed in logic functions, but experiments indicate a limited duty cycle, limited repetition rate and high power requirement; also, cooling is often required.^{16, 17, 18, 19} These drawbacks are expected to remain until basic improvements are made in low-power, continuous, efficient lasers. When such lasers are developed for use at room temperature, additional work in optical circulators or rectifiers may achieve the unidirectional characteristic required in present logic systems.

Experiments have been performed with lasers and with laser-like structures, modified so they would not oscillate (lase) except when additional optical signals are supplied. Other experiments have been made using optically pumped crystal and fiber lasers, also electrically pumped junction lasers. In general, these systems employ one coherent device, or laser, to control other coherent devices.

A generalized experiment is shown in the diagram at the top left. Laser A produces the coherent optical control signal that impinges on laser B. Laser B must be excited externally.

Two methods have been used for exciting laser B. In the first, the pump power applied to B is insufficient to yield a coherent optical output from B. However, the additional energy supplied optically from A allows a coherent energy output (2) from A.

In the second method, the lasing action of B is quenched by prestimulation by means of optical emission from A. Therefore, if A impinges on B during the pumping cycle, it stimulates emission into output (2) and prevents (or quenches) output (1).

Experiments have been reported using gallium-arsenide junction laser devices.^{20, 21} Digital control could be exercised with rise times of 1 to 10 nanoseconds. However, the repetition rates are severely limited by the large pumping-energy density required. Also, the junction devices must be cooled to at least 77° and usually below 10°K , to obtain a suitable quantum gain. Experiments on interacting optical fiber lasers placed in optical

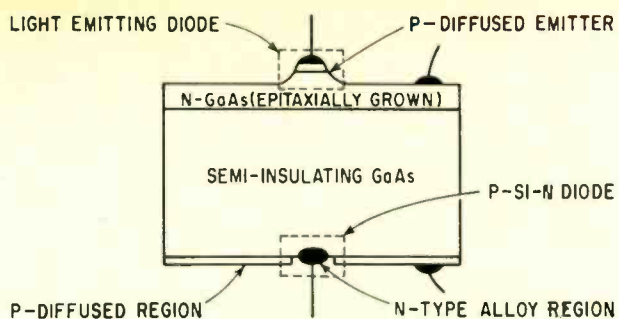

Light-coupled negative resistance device with quantum gain of about unity. Refraction and reflection losses are small because all radiation remains within the structure.

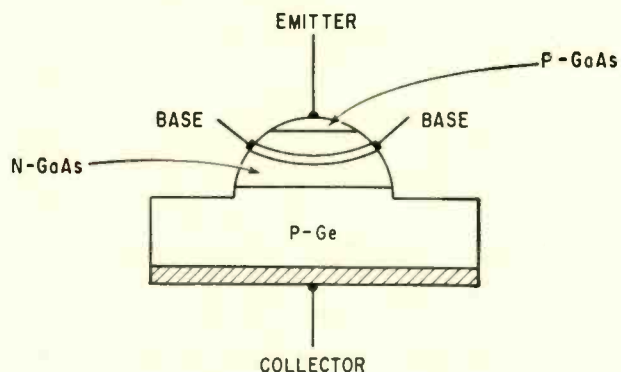

Heterojunction optical transistor with gain near unity has been proposed. The hemispherical mesa has a reflecting coating that reflects the infrared radiation to the collector junction.

contact have been reported;²² switching is fast—rise times of several microseconds are propagated—but the repetition rate is limited by the heat generated by optical pumping.

Optical beam-switching

A system of steering an optical beam to selected points in space, as shown in the diagram at the lower left on the opposite page, could be used to read a permanent optical memory such as a photographic matrix of clear and opaque zones, or to control an array of optical logic devices.

Two basic configurations have been proposed. The most common has a source of optical radiation—usually coherent—followed by a beam-steering mechanism.²³ Most steering methods modify a medium's index of refraction, either electrically, magnetically or acoustically. A particular gradient of index of refraction, or a grating structure, can alter the direction of a coherent light beam. Two deflectors, each deflecting along one axis, can be placed at right angles to produce a two-dimensional scan in the same way in which deflection plates and yokes in a cathode-ray tube scan the face of the tube.

Another steering method uses a laser cavity that oscillates in several spatial modes,²⁴ each of which causes emission in a different direction. By proper control methods, all modes except one can be

blocked, thereby directing the beam. Mode selection with electro-optically active crystals and controlled reflectivity has been proposed.

Beam-switching and steering devices operate at relatively narrow angles; the scan dimension is 50 to 100 times the diameter of the beam spot. A deflection rate in the gigacycle range has been attained, but at the cost of high power consumption. Furthermore, most suitable materials have high absorption losses, which require care in designing the complete optical system. When optical beam-steering is improved, the technique will take its place in optical switching device technology.

Optoelectronics is not limited to switching; it has applications in optical image processing, infrared sensing and linear signal amplification. Its use in memories for digital computers will be described in a future issue of Electronics.

References

1. T.E. Bray and G. Jacobs, "State of the Art of the Optical Logic Element," Proceedings, Optical and Electro-Optical Information Processing Symposium; MIT Press, 1965.
2. I. Wunderman, "Performance Limits of Photon Coupled Logic," Proceedings, 1963 Pacific Computer Conference, IEEE, Pasadena, Calif., p. 63.
3. Samuel Weber, "Optoelectronic Devices and Circuits," McGraw-Hill, 1964, p. 174.
4. Samuel Weber, op. cit. p. 256.
5. Hewlett-Packard, Inc., Instruction Manual for Hewlett-Packard 412-A Vacuum Tube Voltmeter.
6. Samuel Weber, op. cit., p. 246.
7. J.R. Barrett, G.C. Gerhard and G.E. Claflin, "Radiative Interconnections of Solid State Circuit Arrays," Digest of Technical Papers, 1965 International Solid-State Circuits Conference of the IEEE and University of Pennsylvania, p. 60.
8. J.D. Merryman, "An Optically-Coupled Digital Integrated Circuit," Digest of Technical Papers, 1965 International Solid-State Circuits Conference of the IEEE and University of Pennsylvania, p. 58.
9. Hewlett-Packard, Inc., Tentative Data Sheet, "Wideband Photon-Coupled Isolator No. 4301."
10. AMC Staff, "The Photran, a New Bistable Switch," Automatic Control, June 1962.
11. R.F. Rutz, "Transistor-like Device Using Optical Coupling Between Diffused P-N Junctions in GaAs," Proceedings of the IEEE, March, 1963, p. 470.
12. S.W. Ing, Jr. and H.A. Jensen, "Light-Coupled Negative-Resistance Device in GaAs," Proceedings of the IEEE, May, 1963, p. 852.
13. R.H. Rediker, T.M. Quist and B. Lax, "High Speed Heterojunction Photodiodes and Beam-of-Light Transistors," Proceedings of the IEEE, January, 1963, p. 218.
14. B. Augusta and L.R. Anderson, "Opto-Electric Effects in Ge-GaAs p-n Heterojunctions," Journal of Applied Physics, January, 1965, p. 206.
15. E.H. Cooke-Yarborough, P.E. Gibbons and P. Iredale, "Proposed Optoelectronic Method of Achieving Very Fast Digital Logic," Proceedings of the Institution of Electrical Engineers (London), October, 1964, p. 1641.
16. J.T. Tippett and H.E. Puthoff, "The Status of Optical Logic Elements for Nanosecond Computer Systems," Proceedings, 1963 Pacific Computer Conference, IEEE, Pasadena, Calif., p. 47.
17. G.J. Lasher and A.B. Fowler, "Mutually Quenched Injection Lasers as Bistable Devices," IBM Journal of Research and Development, September, 1964, p. 471.
18. G.J. Lasher, "Analysis of a Proposed Bistable Injection Laser," Solid State Electronics, October, 1964, p. 707.
19. C.E. Kelly, "Interactions Between Closely Coupled GaAs Injection Lasers," Transactions of the IEEE on Electron Devices, January, 1965, p. 1.
20. M.I. Nathan, J.C. Marinace, R.F. Rutz, A.E. Michel and G.J. Lasher, "A GaAs Injection Laser with Novel Mode Control and Switching Properties," Journal of Applied Physics, February, 1965, p. 473.
21. O.A. Reimann and W.F. Kosonocky, "Progress in Optical Computer Research," IEEE Spectrum, March, 1965, p. 181.
22. C.J. Koester, "Possible Uses of Lasers in Optical Logic Functions," Proceedings 1963 Pacific Computer Conference, IEEE, Pasadena, Calif., p. 54.
23. V.J. Fowler, C.F. Bührer and L.R. Bloom, "Electro-Optic Light Beam Deflector," Proceedings of the IEEE, February, 1964, p. 193.
24. R. Pole, R. Meyers, H. Wiedner and E. Barrekette, "Laser Deflection and Scanning by Internally Lifting Degeneracy of Multimode Cavities," Proceedings, Optical and Electro-Optical Information Processing Symposium; MIT Press, 1965.

Designer's casebook

Designer's casebook is a regular feature in Electronics. Readers are invited to submit novel circuit ideas, packaging schemes, or other unusual solutions to design problems. Descriptions should be short. We'll pay \$50 for each item published.

FET circuit stores light measurement

By Cordon R. Kerns

Lawrence Radiation Laboratory
University of California, Berkeley

The output from a pulsed light source can be measured and the measurement "held" by the circuit shown at the right. The circuit can give the value of a single flash of light or the total value of a series of flashes.

Photodiode P_1 drops to a low impedance when light is incident upon it, permitting C to charge up through D_1 to a voltage that is proportional to the total incident light output.

At the end of the light flash, P_1 returns to its high impedance state and the voltage across C back-biases D_1 , which prevents leakage from C by that path. Field effect transistors Q_1 and Q_2 have high gate impedances, which permit the voltage across C to be read on the meter without appreciably discharging C .

The capacitor should be a low-leakage type, with no hysteresis, such as Mylar. The choice of value depends on the light levels to be measured and

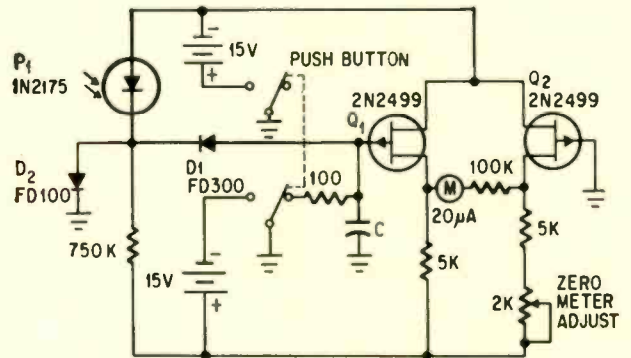

Field effect transistors Q_1 and Q_2 have high gate impedance, permitting readout of voltage across C without appreciable discharge.

on the duration of the pulses; and for good linearity, the capacitor should charge to a voltage of only two or three volts.

The push button connects the batteries into the circuit when pushed. It disconnects them when released, simultaneously discharging C through the 100-ohm resistor and resetting the circuit for the next light flash.

The meter is initially set to zero by adjusting the balance potentiometer with voltage applied to Q_1 and Q_2 , and when C is externally shorted.

The circuit can be packaged as a small handheld, battery-operated light meter.

Chopper adapts voltmeter to d-c

By I. Queen, Brooklyn, N. Y.

An inexpensive photocell chopper may be built to allow d-c voltages to be accurately measured with a conventional average-reading vacuum-tube voltmeter. The NE-2H neon lamps are alternately fired by the rectified 60-cycle line voltage, causing the Clairex CL-703-CL photocells to alternate between high and low resistance states. Conductive glass,

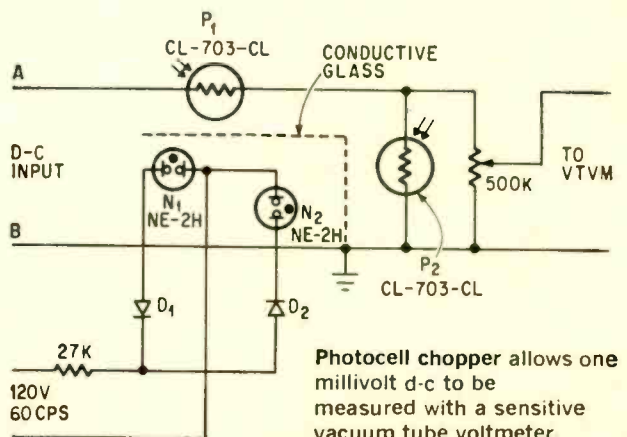

Photocell chopper allows one millivolt d-c to be measured with a sensitive vacuum tube voltmeter.

represented by dashed lines in the diagram on page 66, is mounted between the lamps and the photocells, and is grounded to the d-c circuit through a spring-loaded carbon brush. The conductive glass is used to filter out noise from the neon lamps.

Photocell P_1 acts as an on-off switch while photocell P_2 short-circuits the meter when P_2 is off. The resulting input to the meter is a 60-cps square wave. One volt d-c input will be read as about one-half volt on the vtvm. The 500,000 ohm potentiometer is adjusted to make the meter read exactly one-half

the calibration input, and all subsequent readings are multiplied by two to obtain the true value. A check with a Ballantine model 300H voltmeter indicated that the circuit was accurate to within 2% from 50 volts down to less than one millivolt.

The photocell circuit may be packaged in a $2 \times 2 \times 1\frac{1}{2}$ inch metal box, to eliminate ambient light and to shield against electrical noise. The neon lamps are mounted outside the box. Thin slots, cut into the box, allow the lamps to illuminate the photocells.

R-f switching matrix cuts out crosstalk

By W. Mergner

RCA Communications System Div., Camden, N.J.

Many electronically tuned frequency synthesizers of various types—mixer, divide-by-N, and others—used for test apparatus and in communications systems require any one of a given number of frequencies as an input to one of several mixers. To switch and maintain high spectral purity, the radio-frequency switching matrices should be free from crosstalk and have a high on-to-off ratio.

The circuit shown below, right, is part of a switching matrix designed for a 4-to-5-megacycle single sideband transceiver. The synthesizer's signal-to-noise ratio had to be greater than 140 decibels and the measured interfrequency crosstalk had to be more than 140 db down. Each of the solid-state switches are controlled by a single line.

Originally, the circuit consisted of three diodes and a resistor connected as shown below, left. Ideally, the generator and receiver supply d-c paths

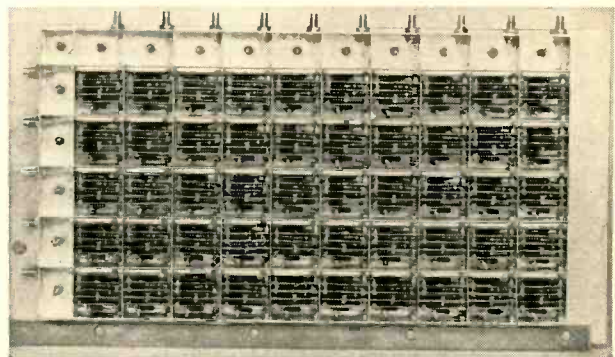

Typical frequency synthesizer matrix with 50 crosspoint switches, 15 r-f connectors, and 50 control lines.

for the bias current. With a positive voltage applied to R_1 , diodes D_1 and D_2 conduct, and the switch turns on.

The resistance of a forward-biased diode in the proximity of the knee of their characteristic I-V curves is given by

$$R = \frac{KT}{eI} = \frac{0.025}{I}$$

where

K = Boltzman's constant

T = absolute temperature in degrees Kelvin

e = charge on an electron

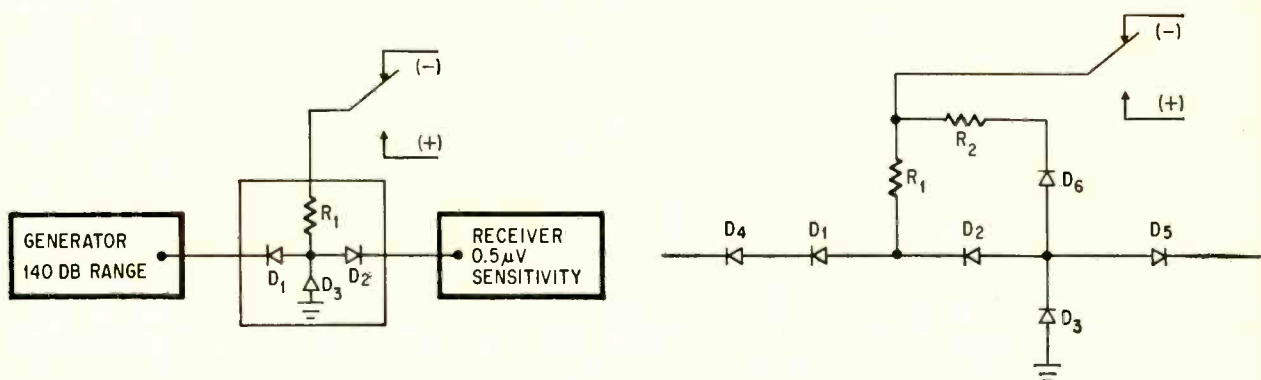

Equivalent circuit of the diode switch, right. Impedances shown for the diodes are calculated at 5 Mc. The original circuit, left, did not provide enough attenuation.

I = diode current in amperes

If voltage V_2 and resistance R_1 allow at least 5 milliamperes to flow through D_1 and D_2 , the diode resistances are approximately 5 ohms each.

When a small input signal (less than 0.1 volt rms) is applied to the circuit, the insertion loss of the switch is

$$20 \log \frac{R_o + R_s}{R_L} = \frac{20 \log 50 + 5 + 5}{50}$$

$$= 20 \log \frac{60}{50} = 1.6 \text{ db}$$

where

- R_o = generator output impedance
- R_s = diode conduction resistance
- R_L = receiver input impedance

With a negative voltage applied to R_1 , D_3 conducts, D_1 and D_2 are reverse-biased by approxi-

mately 0.7 volt, and the switch is turned off. The attenuation of the 5-Mc signal was calculated to be about 124 db.

To get the desired increase in isolation, three series diodes were added to the original circuit. Since there is no path to ground through R_1 with bias applied, D_4 and D_1 are back-biased by the full amount of negative voltage V_1 . Not only are the input diodes prevented from being forward-biased by large input signals, but the effective capacitance of D_4 , D_1 and D_2 is reduced. A-c signal ground is through D_3 . The capacitance of the 1N3064 diodes D_4 , D_1 and D_2 is one picofarad; that of D_3 is 1.5 pf.

Since 3,000 ohms is a conservative estimate of the impedance of the reverse-biased diode, additional attenuation can be expected, although the calculated attenuation is only 137 db.

Short-circuit protection consumes little power

By Garry A. Chunn and Garry D. Norton

Chrysler Corp., Huntsville, Ala.

The circuit which protects a space vehicle's voltage regulator from damage caused by an accidental short circuit must be constructed to consume a negligible amount of the craft's limited power while the regulator is operating normally. The voltage-sensing short-circuit switch shown below, dissipates only about 100 milliwatts when coupled to a con-

ventional series regulator circuit.

When input power is applied to the regulator circuit, Q_4 saturates, turning off Q_5 . When the load resistor R_L is short-circuited, Q_4 turns off. As the collector voltage of Q_4 rises toward the unregulated supply voltage through R_2 , Q_5 saturates, and effectively grounds the base of Q_2 . This causes the series-regulating transistor Q_1 to turn off. In the short-circuit mode, the output current is limited to approximately 33 milliamperes by R_8 .

After the short circuit is removed, the output voltage, $V_{in}R_L/(R_L + R_S)$ is sufficient to saturate Q_4 , causing the regulator to return to normal operation. In the normal mode, the circuit's output with a 300 ma load, is $+28v \pm 0.5v$ as the input lines varies between +31 and +41 volts.

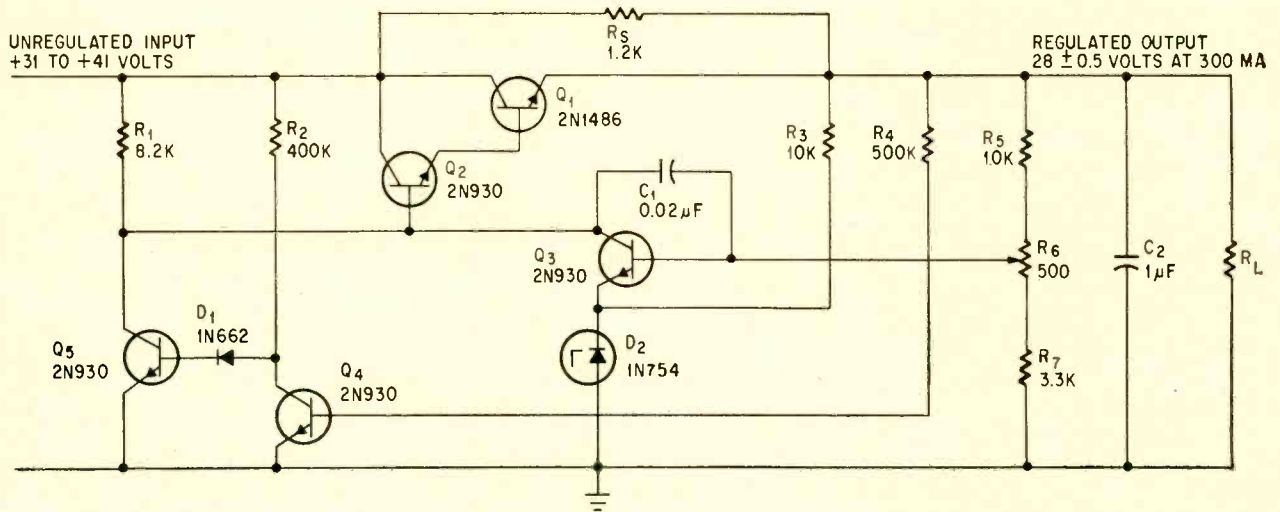

Voltage regulator is open-circuited by Q_5 when Q_4 senses an overcurrent condition in the load.

Simple circuit increases measurement accuracy

By Donald S. Belanger

Semiconductor Circuits, North Reading, Mass.

With an expanded scale voltmeter and the simple circuit at the right, an a-c voltage between 95 and 135 volts can be measured almost as accurately as with a precision thermocouple voltmeter.

A single rectifier, D_1 , converts the a-c line voltage to be measured to a d-c reference and a d-c sample voltage. Since the accuracy of the measurement is dependent upon the stability of the reference voltage, a preregulator zener diode, D_2 , stabilizes the current for the voltage regulator diodes D_3 and D_4 . This keeps changes in the reference voltage to a few hundred microvolts as the line changes from 95 to 135 volts.

Reference diodes D_3 and D_4 have a low temperature coefficient of zener voltage. The dynamic impedance of the reference source is less than 30 ohms. Since the meter requires 200 microamperes for full-scale deflection, the change in reference voltage is 6 millivolts, maximum. This is a change of only 0.005% of the 12.4-volt reference.

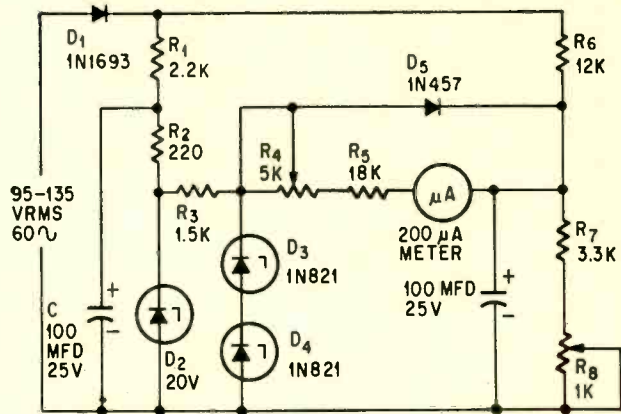

Circuit reduces error of an expanded scale voltmeter from 2.0% to 0.6%. Meter scale is from 95 to 135 volts. For voltages less than 95 volts, diode D_5 bypasses the meter.

When the input voltage is below 95 volts, diode D_5 bypasses the meter, shunting the current from the reference source.

The 95-volt rms point on the meter (zero meter current) is adjusted by R_8 . Resistor R_4 is adjusted for full-scale deflection at 135 volts rms.

If the meter movement has 2% accuracy, the error can only occur within the 40-volt range of the voltage being measured. Therefore 2% accuracy can only result in an 0.8-volt error, which is approximately 0.6% of 135 volts.

Darlington maintains constant unity gain

By Ingemar Ingemarsson

Chalmers University of Technology
Goteborg, Sweden

The Darlington circuit with a pnp and an npn transistor, at the right, is a broadband impedance transformer having unity gain from several megacycles down to d-c.

The +5 volt and -5 volt supplies are adjusted to provide identical base-emitter voltages for each transistor. This maintains less than one millivolt difference between the input and output, and hence unity gain.

The circuit's a-c gain is somewhat higher than 0.98 and falls off to -3 decibels at 20 megacycles.

With ordinary transistors, the measured input resistance is about 65,000 ohms and the output re-

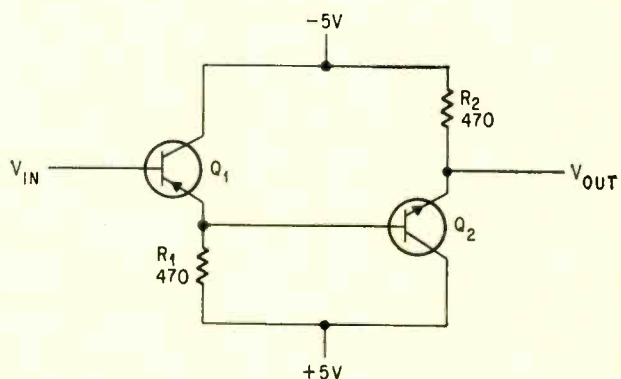

Darlington circuit is an impedance transformer with unity gain from d-c to several megacycles.

sistance is 3 ohms, both measured at 50 kilocycles. If the emitter resistors in the circuit are increased to 4,700 ohms, the input impedance is about 500,000 ohms.

Any complementary pair of transistors having sufficiently high gain and cutoff frequency can be used for Q_1 and Q_2 .

The picture looks better for closed-circuit television

High-resolution systems can be designed to transmit a wide range of data when engineers make the right tradeoffs

By F. Dan Meadows

Granger Associates, Palo Alto, Calif.

Inside a shut-down atomic reactor, a television camera moves slowly over every inch of the surface, searching for signs of deterioration. At a remote point, observers watch a monitor. As tiny cracks, fissures or other warning signs appear in sharp detail on the screen, they halt the camera and carefully examine the damage; then the search resumes.

Television systems are being used increasingly to transmit this kind of sensitive data. Such systems demand high-resolution capabilities that conventional television, adequate for home entertainment, cannot supply. Subjectively, a high-resolution tv image is defined as one that has photographic quality. Quality is further defined by three parameters: signal-to-noise ratio, tonal scale and picture sharpness. These factors, often mutually antagonistic, must be understood if the designer of a high-resolution tv system is to make intelligent tradeoffs.

Signal-to-noise ratio

Television noise is generated in several ways. Usually, random circuit noise is generated in the initial circuit stages and the noise power is proportional to the equivalent resistance, the video bandwidth, and the absolute temperature, following

the general formula $E^2 = KTR(f_2 - f_1)$ where E represents the noise voltage, K is Boltzmann's constant, T the absolute temperature, R the source resistance, and f_1 and f_2 the lower and upper frequency limits in cycles per second, of the bandpass being considered.

This type of noise appears as "snow" or graininess in the picture. In a typical vidicon camera system, the vidicon load resistor determines the value of the initial signal and also makes a major contribution to the noise. The shunt capacitance of the vidicon circuitry and the input amplifier limit the high-frequency response. High-peaking circuits, added to compensate for the high-frequency rolloff at the vidicon output, will also boost high-frequency noise. It can be seen that the greater the signal current from the vidicon the lower the load resistor need be and the less high peaking is required. Thus, the signal-to-noise ratio is improved and wider bandwidths are more readily attained.

Hum pickup produces horizontal dark bars in the picture and often causes an "S" distortion along the vertical edges of the image. Most electrical interference shows up as horizontal streaks in the picture.

Noise may obscure picture information when its level approaches that of the signal. Fortunately, the eye integrates coherent (nonchanging) information in the picture and averages out much of the noncoherent noise. Signal-to-noise ratios which are discouragingly inadequate when measured on an oscilloscope, are often acceptable when viewed on the video monitor.

Dark current

Inadequate illumination of a scene forces the use of higher operating voltages on the camera tube

The author



F. Dan Meadows is manager of video products at Granger Associates. He has worked on video systems for over 20 years, with the Radio Corp. of America, Dage Electronics Corp., and the Ampex Corp. Meadows lists his spare-time interests as flying, golf, tennis, hi-fi and experimental electronics.

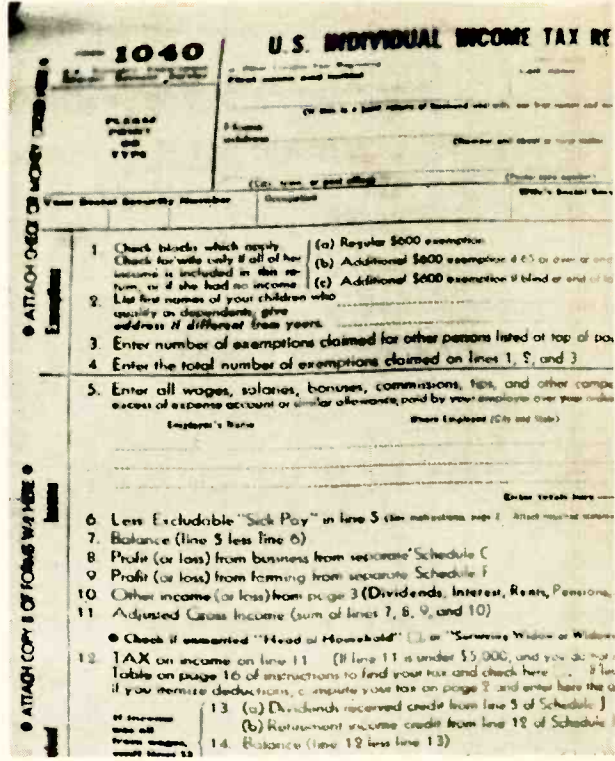
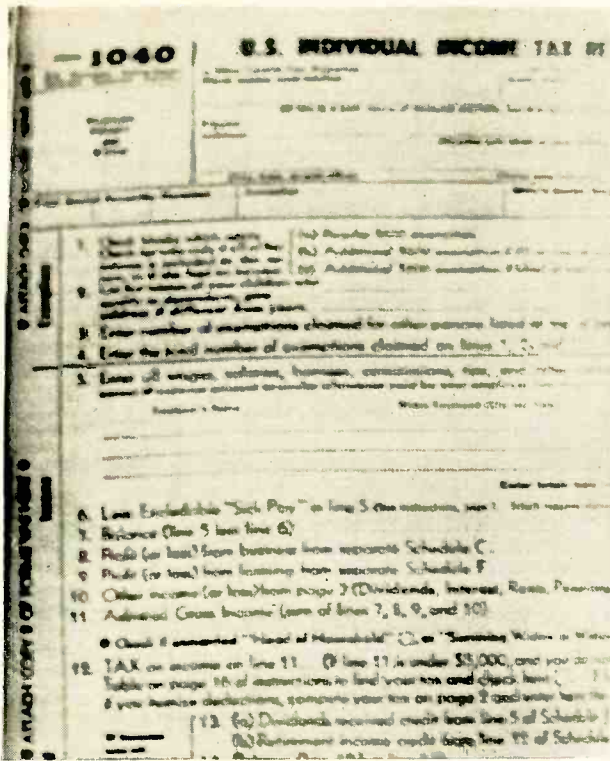

Blurred image of income tax form at the left is the way it's viewed on standard 525-line monitor—and by many taxpayers. Image at the right shows clarity possible with high-resolution 945-line television monitor.

to provide more sensitivity. This, in turn, boosts the visible level of camera-tube anomalies such as nonuniform dark current and target surface irregularities. Dark current is the background current that flows through the camera tube even in the absence of light.

If the dark current is constant it does not affect the signal-to-noise ratio because the following amplifier is a-c coupled. However, nonuniformities during horizontal and vertical sweeps are transmitted through the system. Often these are repro-

duced as a dark ring around the outer edge of the picture, and are known as a "porthole" effect. Portholing can be caused by nonuniform deposition of the photosensitive material on the tube or by the scanning electron beam when it strikes the outer edges of the tube at an angle other than perpendicular. The signal output is proportional to the perpendicular component of the scanning beam, and because of the larger deflection angle, is smaller at the outer edges.

New vidicon types such as the 8507 have a sepa-

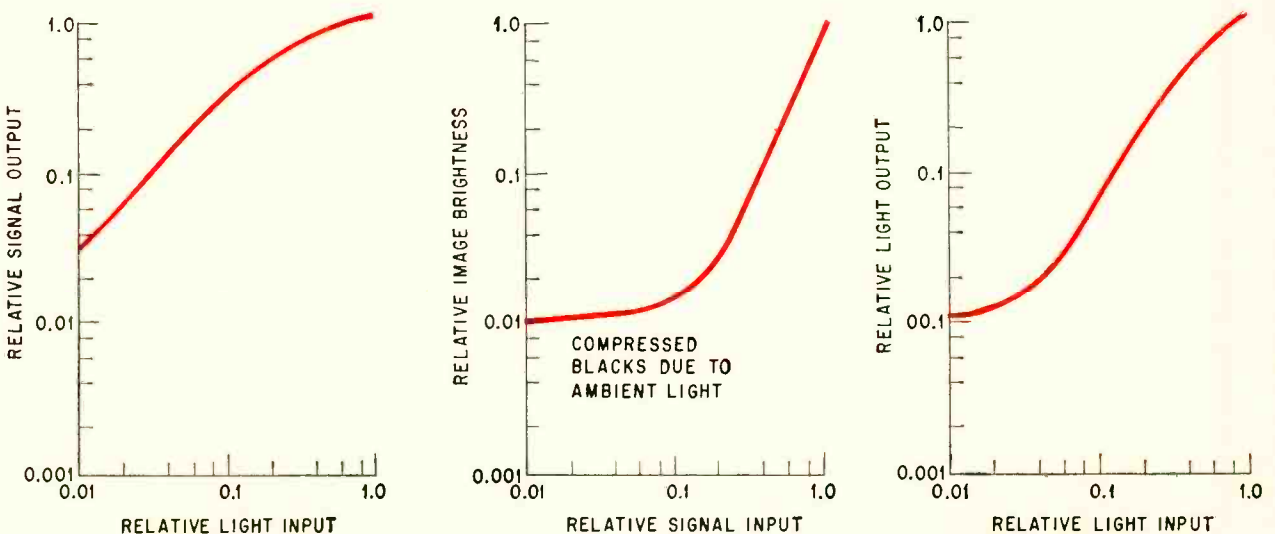

Linear system transfer characteristic (right), desirable for high resolution, is achieved by combining the individual characteristics of camera tube (left), in this case an image orthicon and kinescope tube (center).

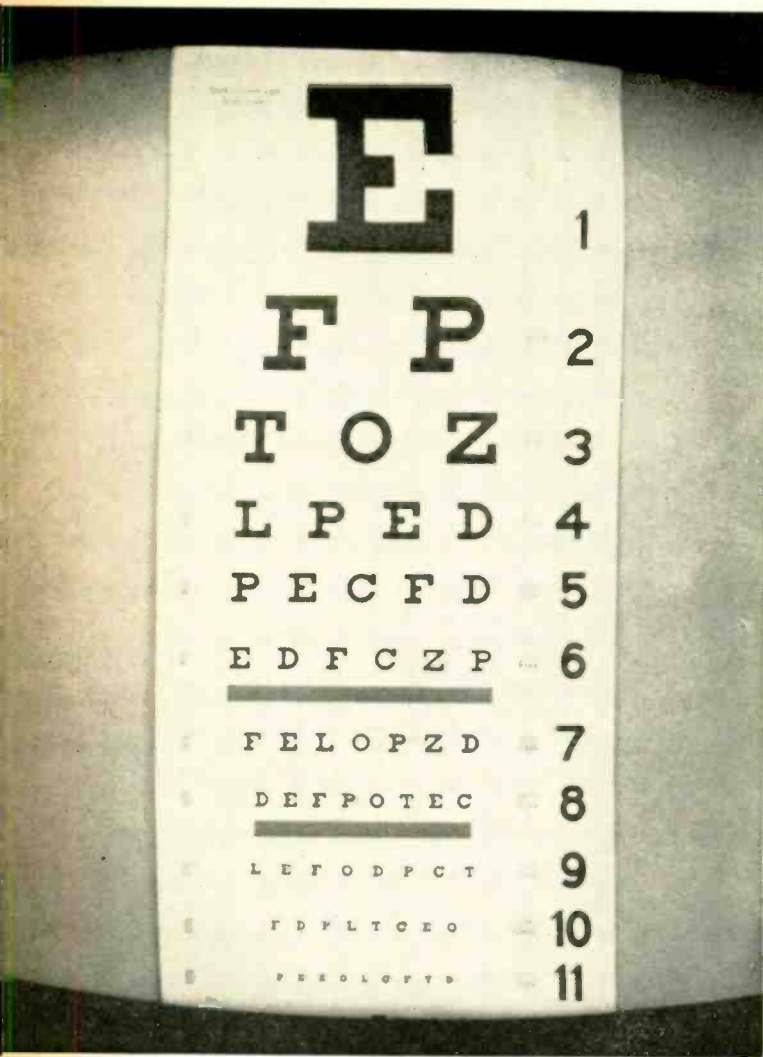

Eye chart is displayed with almost photographic quality by a high-line-rate system with a 30-megacycle video bandwidth. Such systems are being used in banks, businesses and hospitals to transmit printed data.

rate mesh electrode which reduces the beam-landing error. In the case of the vidicon, the dark current increases more rapidly than the signal level (as the operating voltages are increased) and this ultimately limits the useful sensitivity of the tube.

A new vidicon tube, the Plumbicon, recently introduced by Philips Gloeilampenfabrieken, N.V., has a lead monoxide (PbO) surface instead of the usual antimony trisulfide (Sb₂S₃). Because of its very small dark current it can be used at low light levels that previously were more suited for the image orthicon than the vidicon.

A study of camera tube characteristics will indicate the minimum light level required for good signal-to-noise ratio and resolution.

Tonal scale

Tonal scale is the ability of the television system to reproduce faithfully varying shades of gray, from black to white, in the original scene. A good system can display 10 shades of gray over a brightness range of at least 30 to 1. "Black compression"

or "white clipping" can occur when the camera pickup tube is not properly adjusted, if there's poor video circuit design, or as the result of maladjustment of the contrast control on the viewing screen. Another source of trouble is external illumination that hits the face of the picture tube and washes out the blacks in the picture. High-resolution viewing requires low ambient light levels because fine detail with low contrast may be lost in the ambient light reflections and scattering.

The transfer characteristic of a television system is the plot of light output versus light input. The "gamma" is the slope of the curve when plotted on log-log paper. The gamma of a typical camera tube compensates for the inverse characteristics of the kinescope display tube so that the net result is nearly a linear curve (gamma = 1). Adjustable gamma "correction" circuits are often added to the video chain to permit the tv system to reproduce film inputs with varying gamma characteristics. Gamma correction is also used to emphasize contrast when viewing x-ray images or transmitting printed data.

The illustration on page 71 shows that the transfer functions of camera and kinescope tubes can be combined to obtain a nearly linear curve.

Picture sharpness

Although it is a subjective parameter, picture sharpness is customarily measured by viewing a standard resolution "wedge" chart. But this is only part of the story; the eye is also sensitive to the contrast between images and even if a picture has relatively poor limiting resolution, high contrast will make it seem sharp.

The concept of detail response is important to the proper evaluation of tv systems. A typical detail response curve is similar to the response curve of a high-fidelity audio system. As the electron beam in the camera pickup tube scans the optical image it generates video signals with frequencies proportional to the number of picture elements. The more detail in the picture, the higher are the generated frequencies. The amplitude of the signal decreases with the output frequency for many reasons. Among them are:

- The finite size of the scanning beam (aperture) of both the camera tube and the kinescope display tube.
- Bandwidth limitations which tend to round off what should be square waves
- Limitations of the camera lens
- Limitations of the human eye which cannot distinguish between separate images less than approximately one minute of arc (1/60°) apart.

A detail response curve shows the relative signal output resulting from scanning vertical black and white lines on a test chart. The horizontal line number is the number of vertical black and white lines in a horizontal dimension equal to the picture height. The 100% reference level is the signal resulting from a half black-half white pattern. As more lines are scanned, the generated video fre-

quency increases and the signal output level rolls off ultimately to the point where the signal is lost in the noise. The 10% response point is usually considered the limit of useful resolution. The graph at the right shows the detail response curves of the various elements of a tv system and the response curve of the combined system.

Surprisingly, even a good lens has substantial fall-off at the higher line numbers and contributes substantially to the loss in resolution in a high resolution tv system.

The effect of "aperture" or cross-section of the scanning electron beam in the camera tube is shown in the lower graph at the right. The curve demonstrates the improvement due to increases in the focus field surrounding the tube. An increase from a 40-gauss to a 70-gauss focus field increases the signal output from 40% to 55% at 1,500 lines. This results from the tighter packing of the electron beam and the subsequent smaller scanning spot. In order to maintain one spiral loop as the beam travels down the vidicon tube, the accelerating voltage must be increased as the focus field is increased.

It has been shown that subjective sharpness can be specified by the term N_e which is the equivalent passband of the system element being evaluated.¹ N_e is simply a rectangle whose area is the same as that under the squared detail response curve. In other words, regardless of the limiting resolution as viewed from the test pattern, systems with the same area under the squared response curve have the same subjective sharpness. Even the eye has an N_e whose value varies with illumination and distance from the kinescope.

The over-all system response at any line number is the product of the individual component responses at that line number and the system. N_e can be found by the following formula:

$$N_e = \sqrt{\frac{1}{\left(\frac{1}{N_{e1}}\right)^2 + \left(\frac{1}{N_{e2}}\right)^2 + \dots}}$$

The N_e for typical components and the total system is:

| | |
|--------------------|-----|
| Camera lens | 940 |
| Camera tube | 200 |
| Kinescope | 350 |
| Total system | 170 |

Substantial improvement in system sharpness can be obtained by introducing a compensating high-frequency boost (aperture correction) in the video amplifier. The boost must be at the frequencies and magnitude that will not boost objectionable noise levels along the signal.

Scan lines

The discussion thus far applies primarily to sharpness in the horizontal direction. Vertical resolution is determined largely by the number of scanning lines. Vertical resolution can be measured by viewing the horizontal wedges on a test pattern. The point where they merge indicates the

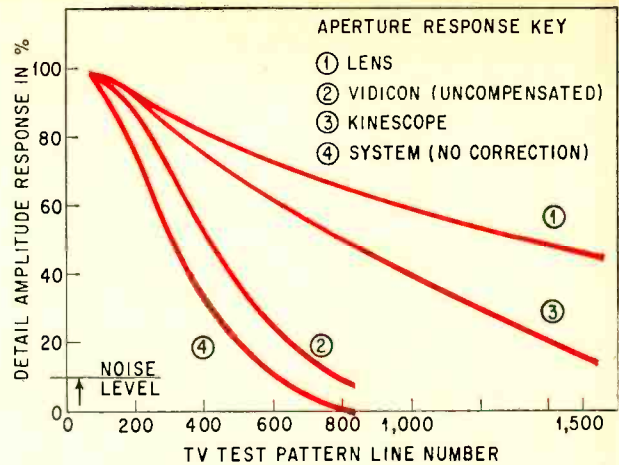

Response to detail of the components of a television system, measured in terms of test pattern lines. Unless compensated, each component contributes to system degradation as resolution capability is increasingly taxed.

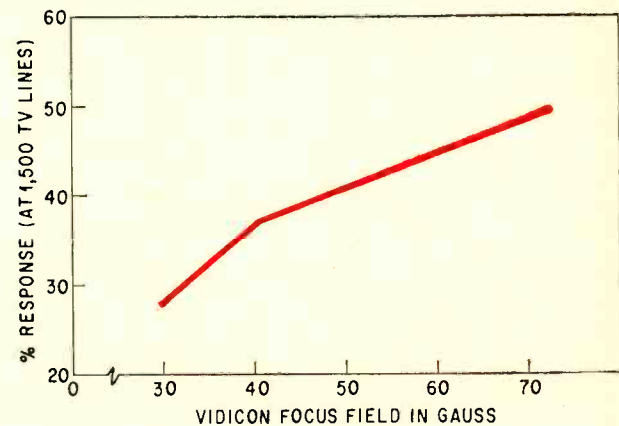

Reducing the beam cross-section in a vidicon tube by increasing the tube's magnetic focusing field can improve the camera's resolution significantly.

line number of limiting vertical resolution. This number is approximately 0.7 of the number of scanning lines. The 0.7-figure is known as the Kell factor.

All of the video signal is generated along the scan lines and no information is produced from the space between the lines. To increase the amount of detail in the vertical dimension, more scan lines are needed.

For commercial broadcast tv service the number of scanning lines is fixed by the governments of the various countries. The United States standard is 525; in England it is 405; for France the number is 819, and so on. Since closed-circuit tv is not government regulated, the scan rate becomes a matter of design choice. Systems with scanning rates up to 1,225 lines are available off the shelf. For good video transmission of alphanumeric data at least 7, and preferably 10, scan lines should pass through each character. Thus a 525-line system would require character sizes 2% of the picture

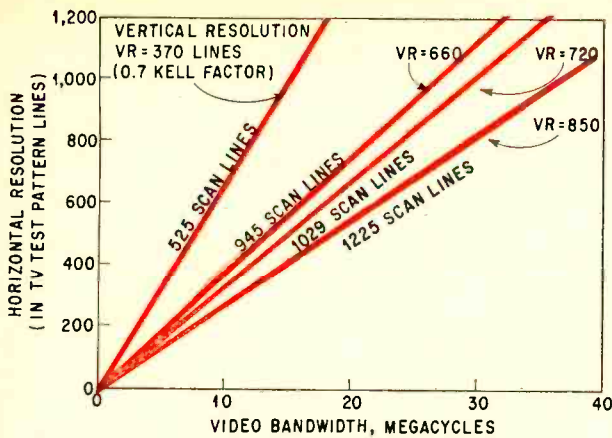

For a given number of lines in the display raster, video bandwidth must be increased to achieve higher horizontal resolution. The Kell factor referred to relates the number of scan lines to vertical resolution of the system.

height. A 1,029-line system can reproduce characters whose size is only 1% of the picture height, making it possible to view twice as much data with a 1,029-line system as with a 525 line system.

Unfortunately, the designer's job means more than just doubling the sweep frequency in order to get twice as many scan lines. Doubling of the number of lines in the same frame time (usually 1/30 second) requires doubling the linear velocity of the scanning beam. The available signal pulse rise time is now halved and unless the bandwidth of the system is increased in proportion to the increase in number of scan lines, the horizontal resolution suffers in exact proportion to the increase in vertical resolution.

A good 525-line tv system with a 10-megacycle bandwidth can reproduce one-half a typewritten page, $8\frac{1}{2} \times 11$ inches, with satisfactory results. However, it cannot reproduce a full page satisfactorily. The task becomes even more difficult if the data is of random nature, such as alphanumeric output from a computer, because the mind cannot fill in missing information. On the other hand, a high-line-rate system with a 30-Mc video bandwidth can produce an image of almost photographic clarity.

Broader use

Some typical applications of high-resolution tv capabilities include its use in commercial establishments to transmit printed data from floor to floor using a very simple transmitting console and a camera suspended above an illuminated table. The copy is placed on the table in a predetermined position and the image is sent to various viewing locations throughout the building, eliminating the need for messengers to deliver copy from file locations to the user.

Large hospitals file patient's medical records in a basement area and transmit the data via closed-circuit television to various viewing areas throughout the hospital.

Very sophisticated television display systems are in use at the Manned Spacecraft Center in Hous-

ton, at the North American Air Defense Command in Colorado Springs, at the Satellite Test Center in Sunnyvale, Calif., and at the Jet Propulsion Laboratory in Pasadena, Calif. Multiple camera and viewing positions permit personnel to have immediate access to information posted on situation display boards in other areas; to switch to selected Teletype images; to view maps of geographical areas and weather conditions; and to view the printed output of computers. Fingertip controls permit the selection of as many as 200 sources of data at one viewing console in a fraction of a second.

High-resolution tv equipment is being used to investigate matter through high-powered microscopes. One system at the University of California Radiation Laboratories views tracks left by the disintegration of atomic particles through a film emulsion. The video output is processed and fed into a computer which analyzes six different sets of data for each track. Track information, less than one micron in size, is analyzed by the tv system through a microscope with a magnification of 2500X. A similar technique is used by a British manufacturer in metallurgical applications to measure inclusions, volume fraction, grain size, and size distribution.

The Picker X-Ray Corp. of Cleveland offers a very-high-resolution tv system that uses an x-ray-sensitive vidicon tube to examine small components such as transistors, diodes, capacitors, relays, for minute flaws. A solder ball only 0.006 inch in diameter has been detected inside a TO-5 transistor housing.

Another company, the Rucker Manufacturing Co. of Oakland, Calif., is constructing a large centrifuge which will mount a high-resolution tv camera to observe the effects of 100-g acceleration on sample objects. The photographic quality of the image will permit the discovery of very small distortions which would be undetectable with tv systems of conventional design.

The Federal Aviation Agency has tested systems for use at airports to observe taxiing aircraft that are out of view of the controller in the tower. High-resolution tv systems permit the reading of identification numbers on aircraft at distances that are twice the capability of conventional tv systems. A tradeoff for such an application would be the use of a wide-angle lens that would permit four times the area of view with the same resolution as could be obtained by a conventional system with one-fourth of that field of view.

In one military application, the use of high-resolution tv cameras on radar dishes permits visual observation of missiles at limiting ranges more than twice that possible through the use of conventional television designs.

Reference

1. "Image Gradation, Graininess and Sharpness in Television and Motion Picture Systems," *Journal S.M.P.T.E.*, August, 1953.

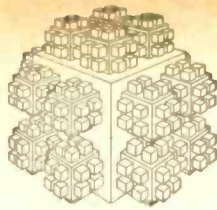

The packaging revolution, part II: design and manufacturing overlap

Assembly of integrated-circuit systems requires special fabrication processes. At an early stage, designers and the manufacturing department must make important decisions such as what package form and lead-joining method to use

By Jack J. Staller, Sylvania Electric Products, Inc.
and George Sideris, Manufacturing Editor

The time-honored divisions of responsibility between engineering and manufacturing departments must be altered when a company begins producing microelectronic systems. It is no longer possible for the designers to develop and document the system and slip the specifications under the factory door. The manufacturing department must be brought into the design picture as the system is developed and given time to learn and experiment with the special processes that will be required.

Each basic packaging decision, starting with selection of the IC package form and running through modular size, form of wiring and method of cooling (see p. 84), has its impact on the assembly methods. Likewise, the packaging decisions are heavily influenced by manufacturing capabilities.

I. Package selection

Established assembly techniques can be used if the integrated-circuit package is one of the modified transistor cans used for monolithic IC's or hybrid IC's, the new in-line package for MIC's, or a large hybrid IC package. The MIC flatpack with radial leads requires more exotic methods.

If uncased monolithic chips are to be used, many of the techniques of the semiconductor industry are necessary—thin-film vacuum deposition or the firing of conductive and resistive inks in controlled fur-

naces, masking and thermocompression bonding, hermetic sealing, and leak testing.

Transistor cans

The inexpensive TO packages are familiar and have excellent hermetic seals (versions for industrial use that are plastic-encapsulated rather than hermetically sealed are even cheaper).

However, the positions of the 8, 10 or 12 flexible leads are relatively uncontrolled and the style is not suited to automatic assembly. Once the leads are fanned out and inserted in circuit boards, conventional mass soldering methods can be used.

Radial-lead flatpacks

The strong points of radial-lead flatpacks (also called flat packs and flat packages) are: the reduced height reduces system volume; the form factor is efficient for 3-D packaging; leads are not limited to the 12 on TO-5 cans; the heat-transfer surface is accessible for conductive cooling; and there is greater choice of lead-joining methods.

But flatpacks are harder to assemble due to their small size, close spacing of leads and inadequate standardization.

One illustration on page 76 gives the form factors registered by the Electronic Industries Association as TO-84 to TO-91. The EIA's Micro-miniature Circuit Applications Committee, which represents the users, recommends only two types, as shown, and wants tolerances tightened to permit mechanical interchangeability of types made by different circuit manufacturers.

Flatpackaged MIC's are also shipped to the user in carriers which differ radically in shape, and in

The first part of this article, on Oct. 18, page 72, surveyed the impact of integrated circuits on systems packaging and discussed modular packaging designs. The third part of the report is on page 88.

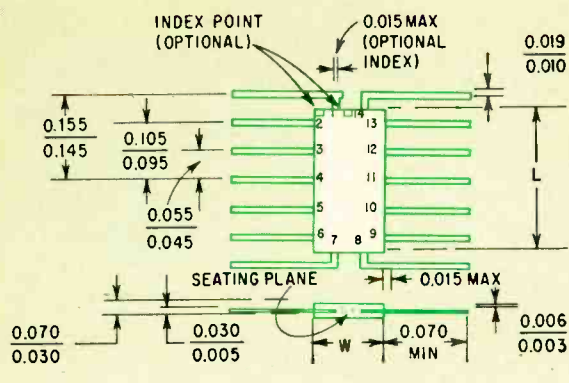

| Out-line no. | No. of leads | L | | W | | Remarks |
|--------------|--------------|------|------|------|------|---------------|
| | | min | max | min | max | |
| TO-84 | 14 | .240 | .260 | .120 | .150 | A, 1/4 x 1/8 |
| TO-85 | 14 | .240 | .275 | .160 | .185 | A, 1/4 x 3/16 |
| TO-86 | 14 | .240 | .275 | .240 | .260 | A, 1/4 x 1/4 |
| TO-87 | 14 | .360 | .410 | .240 | .275 | B, 3/8 x 1/4 |
| TO-88 | 14 | .330 | .350 | .240 | .260 | B, 3/8 x 1/4 |
| TO-89 | 10 | .240 | .290 | .120 | .150 | B, 1/4 x 1/8 |
| TO-90 | 10 | .240 | .290 | .160 | .185 | B, 1/4 x 3/16 |
| TO-91 | 10 | .240 | .290 | .240 | .260 | B, 1/4 x 1/4 |

A: elbow end leads; B: no leads at end

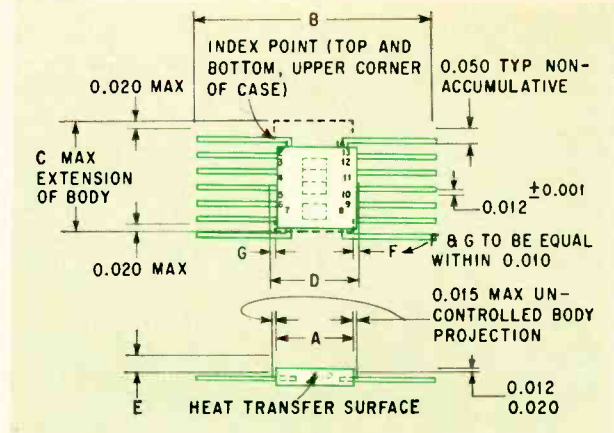

| Case type | Max. leads | A max | B = .015 | C max | D = .010 | E max |
|-----------|------------|-------|----------|-------|----------|-------|
| 1 | 14 | .185 | .800 | .345 | .260 | .050 |
| 2 | 14 | .260 | .800 | .345 | .335 | .065 |

A variety of flatpack sizes have been accepted by the Electronic Industries Association's circuit-manufacturers' committee (left chart). The circuit-users' committee recommends only the two styles shown above.

lead access and removal. This lack of standardization requires special handling and test-probing fixtures for each type, especially when the user wants to employ automatic equipment. Removing the flatpacks from some types of carriers requires cutting the leads. Once removed, the package must be handled with tweezers and the leads carefully protected.

If the packages are to be mounted on metal heat-transfer strips, the ticklish job of forming and cutting the leads is introduced. The lead may have to be bent so it can be bonded to a pad below the package. This requires a die that will grip the leads near the package, to protect the hermetic seal, and bend the outboard portions of the leads.

The Sylvania MSP-24 computer boards (see p. 81) call for flatpacks with two leads depressed below the others so they can be joined directly to the subsurface ground and voltage planes. In the Univac 1824 computer, the leads on one side of the package are bent back over the package body, so the flatpacks can be mounted vertically, making the assembly more compact.

In-line packages

The new in-line packages solve many production problems. Sylvania's package is shown on page 77; other manufacturers make similar packages. Texas Instruments Incorporated's plug-in style has the two rows of pins spaced 0.2 inch apart. Packages with up to 40 pins are planned.

The rigid leads (rectangular, round or rolled round) can be inserted readily in standard printed circuits or multilayer boards. The 0.1-inch lead

spacing permits looser tolerances on etched wiring, insertion-hole drilling and solder pads. The standoff formed in the leads prevents solder bridging and flux entrapment. The large size facilitates manual or automatic assembly.

Etched conductors can run under the package. This, and the larger board area used, can eliminate the need for multilayer boards in many cases. However, assemblies must be larger to accommodate the packages and the longer signal-lead paths may pose problems in high-speed systems.

II. Lead joints and connections

There is more dispute about lead-joining methods than any other phase of microelectronic packaging. One of the authors (Staller), for example, has moderated two of the many debates on welding versus soldering and has ruled them ties. There are no clear-cut conclusions; it depends on the applications. The pros and cons change continuously, as new materials and methods appear, and quantitative data on the merits of different methods is scarce.

To meet the high-reliability goals of joints in military systems (0.00001% of failures per thousand hours) many designers favor the welding of flatpack leads.¹ Yet one report states that missile systems containing 50,000 solder joints per system had shown no joint failures after 200 billion joint-hours of performance.²

Classes of joints

- There are three general classes of joints:
 - Permanent, in which one or both lead ends

must be destroyed to separate them. An example is a welded joint.

- Semipermanent, such as solder joints which require special tools or processes to separate the two leads. The leads can be rejoined at the same point.

- Temporary, or quick-disconnect, such as plug-in, friction connectors.

Joints can be made by many techniques: soldering with hand irons, dip or flow machines, resistance or induction heating, ultrasonic or optical energy, and hot-gas jets; welding with opposed-electrode, parallel-gap or series resistance, or a percussive arc; welding with laser or electron beams; ultrasonic and thermocompression bonding; metal-to-metal diffusion; mechanically joining by wrapped-wire methods, spring clips, clamp screws and crimps; friction connection; films deposited by plating, vacuum evaporation, pyrolysis, sputtering and metal spraying; and conductive adhesives. New variations and new ways are being tried almost daily.

Flatpack-lead joining

Dip soldering was an obvious first choice for flatpack-lead bonding en masse, but the attempts were usually unsuccessful. There were difficulties with lead forming; joints in printed circuit boards became solder-starved because a ribbon in a round hole leaves a large void which the capillary action of the molten solder often could not fill; temperature shock often damaged the MIC or the package seal; and multilayer boards could not be used unless they had plated-through holes.

Consequently, when the design calls for soldering flatpack leads into printed circuit boards, the lead forming, insertion and soldering are often done by hand. Successfully mechanizing these tricky operations requires a heavy investment in tooling.

Most flatpack-interconnection designs provide for lap soldering or welding, in which the lead ends are placed on a flat contact surface, such as the end of a printed-wiring run, a projecting tab or a mounting post in a multilayer board. But whether the lap-joining is done with a hand iron, a mechanized resistance-soldering machine, or a parallel-gap welder such as the one illustrated on page 78, the joints are made one at a time. (An exception is a "branding iron" soldering technique used by the Computer Control Co. The iron heats all 14 joints of a flatpack simultaneously.) Variables, especially such welding variables as the differences in lead and plating thicknesses in flatpacks from different manufacturers, must be carefully watched for and process adjustments made and monitored.

Lap soldering with a hand iron requires a skilled operator. Since the iron-tip temperature must be about 550° F to melt 60-40 solder, great care must be taken to prevent board delamination or heat damage to the MIC.

Reflow soldering alleviates the problem; just the

right amount of solder is preplaced at the joint by use of preforms or solder cream, or by tinning the conductors. The heat that is applied to reflow the solder, thus forming the joint, can be controlled. For example, resistance soldering time and current can be regulated. Reflow soldering of flatpack leads has been successfully mechanized.

Ways of focusing heating energy on reflow-type joints also lend themselves to control and automation. Tests were made of optical soldering with infrared beams concentrated to the spot size of the joints; the joints were smoother than those made by hand and joint temperatures were only 425 to 450° F. The beam can also reach places a soldering iron can't.

The Sperry Gyroscope Co., a division of the Sperry Rand Corp., estimates that it can safely make 500 joints a minute with a machine that reflows solder with eight tiny jets of hydrogen heated to 700° F. The company says trial runs, on joints in plated-through holes, showed that a four-jet

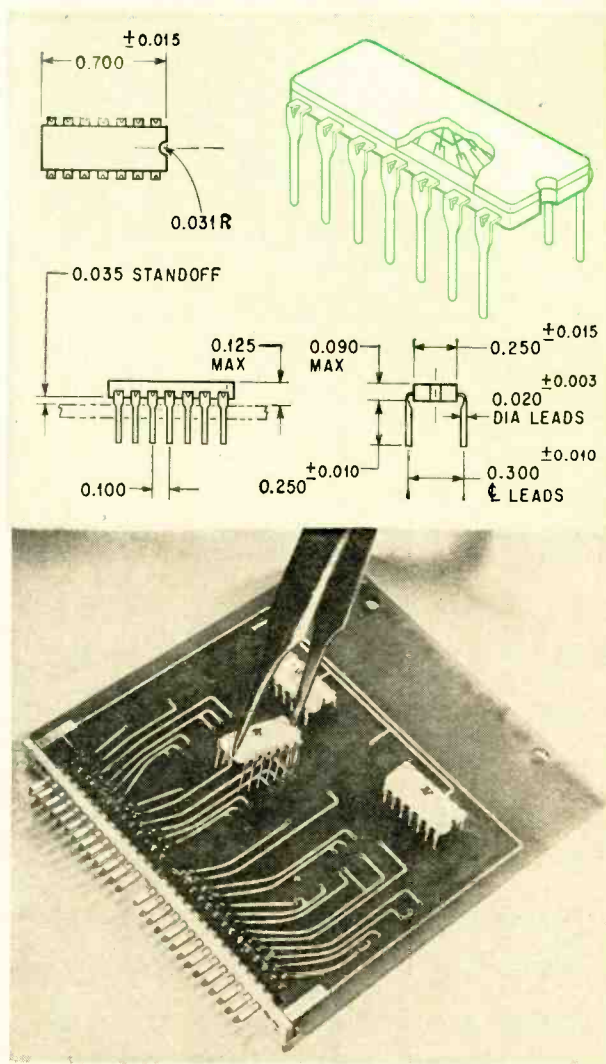

In-line packages for MIC's make assembly easier. This one, made by Sylvania, is one of several designs that are available. They can be plugged into circuit boards and solder joints made by dip or flow soldering.

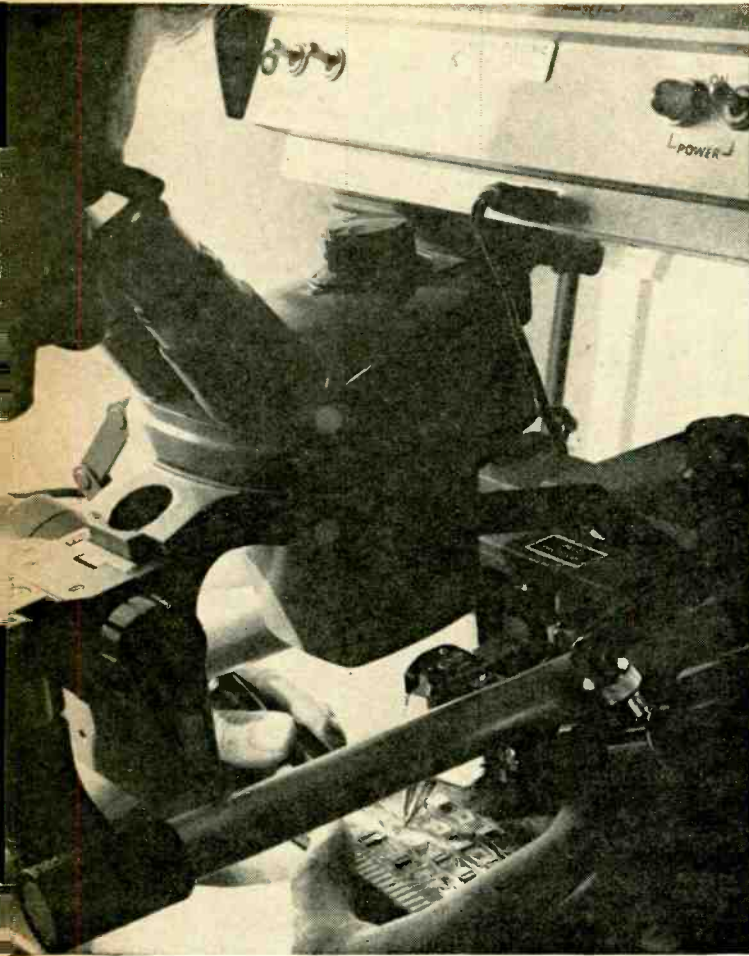

Tweezers, stereoscopic microscopes and precision welders are tools of the flatpack-assembly trade. This picture was taken at Sylvania Electronic Systems' Buffalo plant. The leads of the flatpacks are welded to etched conductors on the surface of a printed circuit board.

machine could solder 20,000 joints (250 assemblies) in a day.

The packaging design must accommodate these techniques if they are to be mechanized efficiently. The lead ends should be lined up in rows so the resistance-soldering-iron tip or the energy beam can step down the line or sweep along it. Such packaging can be highly efficient; a cordwood package which Johns Hopkins University designed for optical soldering offers a density of 120,000 circuits per cubic foot.³

Soldering and welding

One often-used resistance soldering technique is known as the controlled-energy-profile method. A controlled amount of a-c or d-c energy is dissipated within the joint, as the electrodes press the lead on the soldering pad. Parallel-gap welders can be used for this type of soldering; their precise controls, including dynamic-feedback voltage regulation, make for consistency in the properties of the soldered joints. However, the energy source must be adjusted for joints of different mass; this may be a problem when multilayer boards are used

because the heat-absorption properties of the joints varies with the number of internal joints tied to each solder pad.

To overcome that problem, temperature-seeking resistance-soldering machines were developed. The machine goes into a predetermined cooling cycle when a thermocouple in the soldering tip senses that the proper joint temperature is reached.

For welded joints, opposed electrode welders have been used for many years. The electrodes are placed on opposite faces of the two wires or ribbons to be joined and the weld energy causes the wires to fuse at their interface. This method is used for cordwood and foil-tab types of integrated-circuit modules, but is difficult to use for lap joints on printed circuit boards since both sides of the joints are not available. Parallel-gap welders overcome this difficulty; both electrodes are placed on the flatpack lead and the passage of energy through the lead fuses the lead to the surface of the printed conductor. Successful parallel-gap welding requires careful control of lead materials and welder adjustment, and inspection of all the joints made.

Film conductors

Packaged or unpackaged IC's can be interconnected with conductors deposited on a substrate. The concept is much like that of hybrid integrated circuits; several hybrid IC's made with flatpackaged MIC's were illustrated in Part I of this report.

The interconnection cost is low when the conductors are inks that are screen-printed and fired on a ceramic plate. Moreover, ceramic is a good heat conductor. The amount of wiring can approximate that of a two-sided printed circuit if a layer of glass insulates conductors at crossover points. Multilayer forms are being developed.

The reverse of this approach has also been used for a number of years to connect the leads of devices in an encapsulated assembly. Conductors are formed on the outside surface of the encapsulant, usually by plating and etching, to connect the exposed ends of the device leads.

Electronic joints

Electrical engineers are making progress on electronic forms of interconnection. Optoelectronic coupling can link a photogenerating component in one circuit with a photoreceptor in an adjacent, electrically isolated circuit. Light pipes may become a substitute for multiconductor cables and shielded transmission lines. Another possibility is using controlled forms of capacitive and inductive coupling, usually the cause of the crosstalk so difficult to eradicate from high-density wiring structures.

Multilayer interconnection boards

Multilayer boards are, at present, the most popular way of putting many circuit-to-circuit wires in a small space. The chief design problem is communication between layers.

Plated-through holes are the most common method of electrically connecting the layers of mul-

tilayer boards. Holes are etched or drilled through the laminated assembly and the interior of the holes plated to join the conductors on different layers. Such holes are essential in master-interconnection boards which require wires or pins soldered through the board.

A major problem, the reliability of the plated joints at the narrow edges of the internal layers, can be relieved by etching and abrasion to enlarge the joint area. Packaging limitations are the difficulty of mounting devices on both sides of the board and the severe reduction of mounting area because of holes at every interconnection point.

Sequential fabrication techniques eliminate most through holes. Autonetics starts with a two-sided laminated core board and builds up each side, layer by layer. Layer-to-layer connections are made by chemically drilling holes in each epoxy-glass layer, then filling the hole with a conductor (shown on p. 81). The printed wiring is etched, the next layer laminated in place and the process repeated. Through holes are made only where required.

Sequential fabrication raises the wiring density, and can reduce the number of layers required or raise the surface-mounting efficiency. Layout and fabrication generally cost more and processing time is longer.⁴

Plated-up-post methods of sequential fabrication are used by several companies, including Sanders Associates, Inc., Intellux, Inc., and Litton Industries, Inc. Generally, short posts are plated on a starting layer. Depressions between the posts are filled with plastic to make a plane surface. The next layer's wiring is plated and etched on this surface and the process repeated. This method gives continuous metal posts and eliminates expensive hole drilling.

A combination method is to make subassemblies by a sequential or plated-through process, laminate these subassemblies, and connect the layers by a plated-through process. This gives both designer and fabricator greater flexibility and provides trade-offs between the high interconnection density of the sequential process and the moderate processing time and cost of the through-hole boards. It is possible to change the design of a combination board without halting production of all the subassemblies.

Prefabricated multilayers

Partially prefabricated boards are a more direct solution to the need for shorter engineering and fabrication cycles.

Buried layers are used for interconnection patterns that are normally fixed, such as ground, voltage and sometimes clock and reset signal wiring. These are made in advance as core boards and stocked. The variable signal wiring is placed on external surfaces, or on layers readily added to the core boards.

The core of the board used in Sylvania's MSP-24 computer is a central ground plane, made of sheet metal, with voltage planes on either side (see photo, p. 81). Rectangular lead pads are bonded at regular



Parallel-gap soldering machine is similar in operation to the parallel-gap welder shown on the facing page. The electrodes of both are placed atop the flatpack leads. However, the joints are made by reflow of solder rather than by fusion of flatpack lead and printed-circuit metals.

intervals to each plane and corresponding clearance holes are punched in the voltage layer and in the insulation between layers.

The signal planes are two-sided boards, laminated to each side of the prefabricated assembly. Signal boards are stocked with punched, rectangular lead-clearance holes and plated-through holes at all the pads for flatpack lead bonding. They can be quickly etched and laminated to the core board. The ground and voltage leads of the flatpacks are formed so that they reach through the clearance holes to the pads on the voltage and ground planes. This is a unique feature of the Sylvania board.

Another alterable form is in a computer which the Bunker-Ramo Corp. uses to prove out concepts for commercial IC computers.⁵ The additional signal layers are etched on thin, insulating stock. Etched fingers, which hang over the edge of the stock, are soldered to mating pads on a signal-voltage core. The overlay can be unsoldered and a new pattern applied.

Point-to-point wiring

It is difficult to use multilayer boards for Level

The system designer's role

By Matthew Abbott, Sylvania Electronic Systems division

Before the packaging engineer can prepare the physical design of a new computer, the system's foundations must be laid by the systems engineer and the logic and circuit designers. They establish the instruction repertoire, processing rates and functional size the computer must have.

But they must also be ready to prepare alternative circuit or logic structures to help the package designer out of a corner, particularly in the Level II wiring which interconnects the Level I functional assemblies. Level II wiring may have 5,000 to 20,000 interconnections, with little or no recognizable regularity in the pattern of wiring routes in the initial layout. Power and ground pin positions are standardized, but they are few in number.

(Level I is a module of interconnected circuits, Level II a subsystem of interconnected Level I modules, and Level III a system of Level II modules.)

One precaution that can be taken to alleviate Level II wiring problems is to make some of the Level I pin positions interchangeable, so that the packager can choose the straighter of two wiring paths between modules. Another is to make the circuitry and wiring in the modules more flexible and design the Level II wiring before the Level I wiring. However, it would be very difficult for the designer to devise Level II wiring rules in terms of Level I layout capability before Level I layout is established.

A more practical solution is to plan on Level III—a master interconnection level—so that the Level II wiring can be fabricated in modular form once the wiring routes are known. The Level II wiring modules could not be identical, but they could all have a standard form, such as multilayer boards of equal size and pin numbers, interconnected with relatively few wires in Level III.

There are also ways of simplifying the wiring functionally. Logic functions can be performed, for example, by interconnecting certain circuits with a common wire or bus instead of individual wires and pins, as shown at the right by the contrasting uses of cascode and bus drivers.

Cascodes are high-speed, high-power, high-efficiency drive circuits. They are desirable output-circuit logic devices, but they cannot be operated independently if they are connected in parallel with a bus. They require individual interconnections.

A solution is to add to the cascode family of circuits a bus driver—an inverter circuit that is operated with an external inverter load resistor. Such circuits can perform the AND-OR logic functions when they are connected in parallel with a bus. The functions performed by paralleled circuits depend on the nature of the inputs to the drivers. The driver circuits can be scattered along a single wiring run.

Steps in system design

Such key decisions are the responsibility of the systems engineer, who arbitrates between the competing demands of logic, circuit and package designers. If he doesn't make the right decision at the right time, the design flow could become a series of iterative loops that would make project costs excessively high. At each step of the design flow,

some of which are done in parallel, the efforts of the different design groups must mesh.

The first step, after performance goals are set, is to block-diagram the system, identifying the functions and data paths and the logic structures which govern processing rates. Algorithms for execution of each instruction are prepared.

Next, the system and circuit designers jointly determine machine timing—the clock system, cycle time and the number of cycles needed to implement the algorithms. They also prepare the rules for detailed logic design, based on circuit characteristics. These include flip-flop data entry, circuit fan-in and fan-out, and the allowable number of circuits in a wiring path.

The logic required by the algorithms is detailed. This step, called mechanization, produces the set of Boolean statements that cover every machine instruction and function. The logic is then reduced to the minimum number of terms, to reduce the number of circuits required, and the logic list converted to a list of the circuits and a list of the interconnections between unit-circuit terminals.

Now, the packaging ground rules can be made firm. Allowable electrical characteristics of the signal and power wiring are expressed in mechanical parameters, such as length and size. Module size and accessibility are selected to best suit the conflicting requirements of malfunction detection and maintenance and repair. Cooling-design data—device characteristics and estimated power dissipation—is determined.

The packaging rules are analyzed to reveal how many internal connections and external interconnections each functional module would require. Tradeoffs may be required [Electronics, Oct. 18, 1965, p. 72]. Fabrication instructions and test procedures are prepared.

Finally, the entire interconnection and physical packaging design is reviewed and the mechanization rewritten. The rewritten lists incorporate the results of circuit layout procedures [see article by Edmund U. Cohler on page 88] and any revisions in logic. The combined data becomes the documents for system test and maintenance.

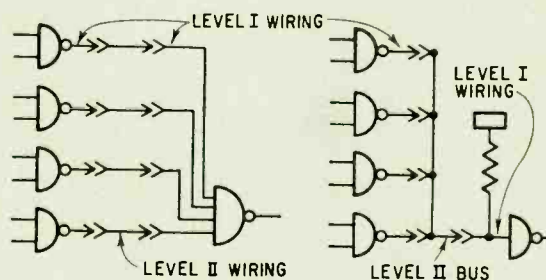

Multiple AND-OR logic can be driven from a common bus with paralleled inverter circuits. The usual logic configuration (left) requires four wiring paths and eight connections, while the use of drivers and a bus (right) reduces this to five connections and the bus. The bus performs the OR function.

II wiring, in engineering models or in systems produced in small quantities. Point-to-point wiring is changed more readily. The type of wiring usually depends on the wire terminating methods, which include:

- **Poke-home connectors.** These are miniature connectors whose pins lock into place when they are inserted in the connector body. The wire can be staked to the pin in advance, or two wires can be staked into each pin, so that long, daisy-chain wiring assemblies can be tied together in advance. Surprisingly high wiring density can be achieved. One photo on page 82 is Level II wiring for the MSP-24 engineering model.

- **Wire-Wrap.** Wrapped wire connections were pioneered by the Bell Telephone Laboratories, Inc. The wiring routes can be programmed during design and the wiring done automatically with Wire-Wrap machines made by the Gardner-Denver Co. The miniaturized form, with wire wrapped around 25-mil-square pins that are 100 mils apart, is becoming popular in microelectronic systems. In some systems in high-volume production, including the IBM System 360, random and variable signal wires are wrapped to multilayer boards.

- **Termi-Point.** This product of AMP Incorporated is a small spring clip that forces the wire into intimate contact with a post. The properties of the joint are similar to Wire-Wrap's. Its advantages are: the wire can be stranded; a clip at the bottom of a post can be snapped off and a new one added at the top of the post, forcing the higher pins down the post; the terminations can be made more quickly; and changes in engineering models can be accommodated by leaving a loop of wire at each post.

The ease of replacing wires warrants consideration of using Termi-Point, instead of friction connectors, to interconnect the input-output pins of Level I modules, and even those of highly reliable Level II assemblies.

Welded wiring

If nickel pins are molded into a planar, plastic structure, flatpack leads can be welded to the pins on one side and fine, insulated wire (magnet wire) routed on the other. The wire can be welded to one post after another without cutting and stripping it, as illustrated on the next page.

Sylvania does this when engineering models of a Level I assembly are needed quickly. The wire is nickel, coated with a special polyethylene. Pincer-like welding electrodes force the wire against the side of the pin, mechanically breaking down the insulation. As the nickel-to-nickel resistance weld is made, the heated polyethylene flows slightly, sealing the joint. To reduce the number of wires, an etched, two-sided, printed circuit can be bonded to the pins. Flatpack leads are welded to the pins by opposed-electrode welding. Flatpacks can be removed and new ones welded or soldered in place many times.

Similar assemblies can be made by soldering, but

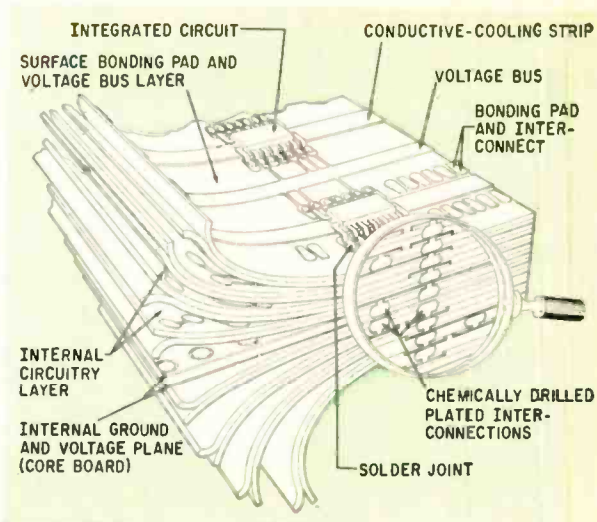

Sequentially fabricated multilayer board made by the Autonetics division of North American Aviation, Inc. The drawing, taken from reference 4, also illustrates other packaging techniques, including lap-soldered flatpack leads, conductive cooling and the use of voltage buses.

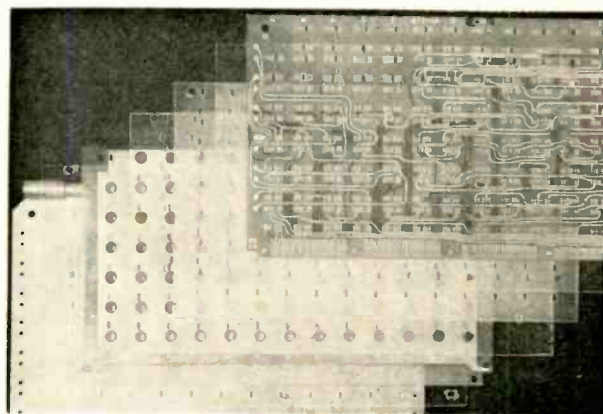

Partially prefabricated multilayer boards are used in Sylvania's MSP-24 computer. This shows the layers on one side. The opaque layers are, left to right: ground plane, voltage plane and signal plane. The transparent layers are binders, insulators and spacers.

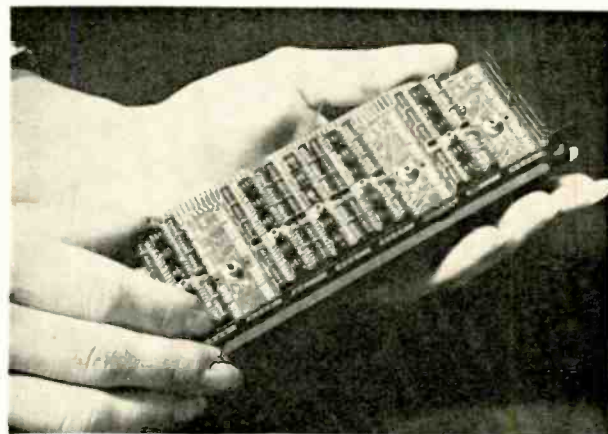

Flatpack leads are mounted on carriers and flatpack-lead joints made by friction-clamp contacts, in this assembly of the Sperry Loran-C navigation system. A level II motherboard with five Level I modules in place is shown.

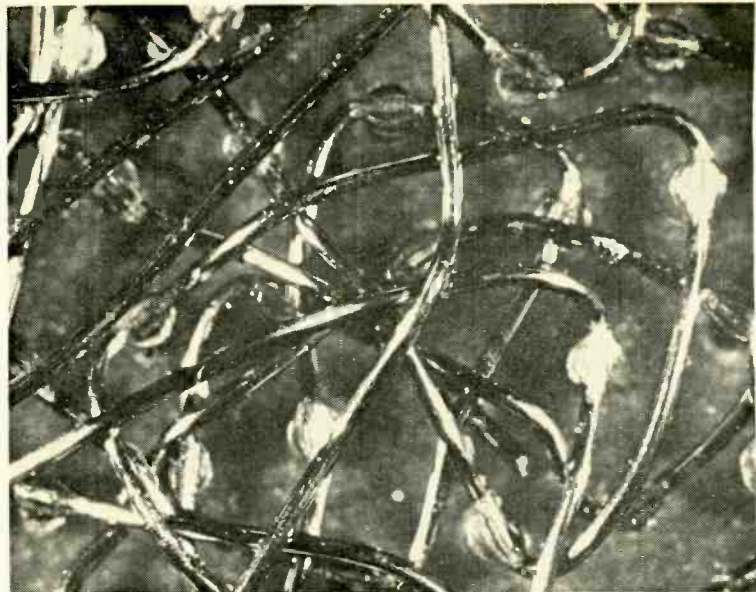
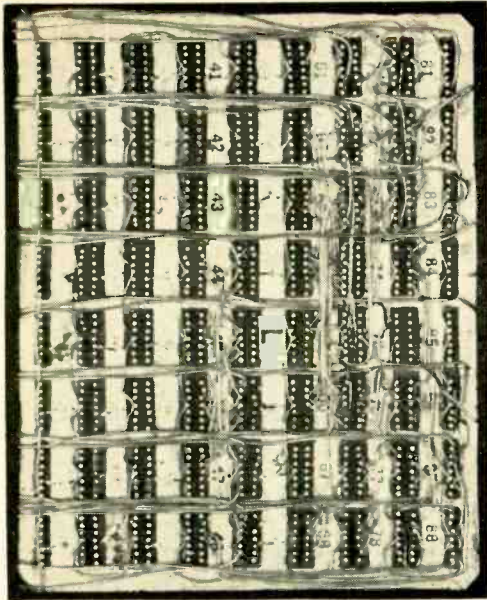

A very compact form of point-to-point wiring is welded magnet wire. The joints in the Sylvania wiring plane (left) correspond to flatpack lead positions. The posts in the Jet Propulsion Laboratory matrix (right) are 50 mils apart.

Another way of making interconnections that are compact, yet easily modified, is with wires terminated in poke-home connectors.

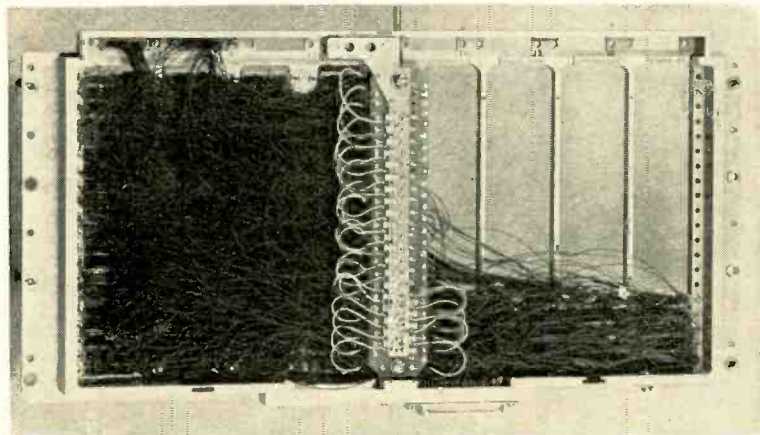

the tight quarters make soldering difficult and wiring density is lower.

Welded matrices

Versatile simulations of two-sided printed circuits can be made by bonding nickel ribbon to each side of a thin sheet of Mylar or other insulation, and welding the ribbons through holes in the sheet at intraconnection points. Many of the properties of a multilayer board can be achieved by stacking such assemblies and connecting the layers with riser ribbons welded at the edge of the stack. The Sippican Corp. has applied this technique to several systems. The assemblies are simple to design, make and change, but are larger and heavier than regular multilayer boards, and costs in quantity production may be higher.

Small, functional modules can be made by mounting flatpacks on strips of multilayer sandwiches similar to those described above. The package leads are joined to tabs extending from the edges of the conductor layers, which are punched from nickel foil.

Welding flatpacks leads to the tabs with opposed electrode welders provides highly reliable, easily

inspected lead joints. Punching each layer of conductors from a foil eliminates internal joints. The strips can be prefabricated and stocked; unwanted tabs can be removed at the time the module is assembled.

Apparently, the first use was in a spacecraft application at the California Institute of Technology's Jet Propulsion Laboratory. The packaging philosophy is this: when conventional modules are placed on a motherboard, the functional lead positions are random, so the board wiring is complex. However, if the modules are strips across one dimension of the motherboard, and the leads are organized so that inputs and outputs always appear at the same location on each strip, the motherboard wiring becomes extremely simple. For example, all clock and reset signal pins would be in straight rows connected by a single printed-circuit line.

The Engineered Electronics Co.'s Micro System and the Elco Corp.'s Omni-Comb are commercially available versions of this approach.

The Military Electronics division of Motorola, Inc., uses an etched-circuit version.⁶ Each layer is a single-sided printed circuit; the tabs are formed by etching away the insulation at each side. Wir-

Packaging the big commercial computers

Prefabricated multilayer boards, supplemented by point-to-point wiring, will be the packaging base of most of the big commercial computers to be built with monolithic integrated circuits.

The Radio Corp. of America is using them in the larger models of the Spectra 70. Honeywell, Inc. plans to use them in the H4200 and H8200. Most other companies indicate they'll go along.

The International Business Machines Corp. used this form of board first in the System 360 (see article on page 90). IBM's computers are built with hybrid IC's, but the speed and packaging density of the hybrids rivals that of monolithic IC's [Electronics, Oct. 18, 1965, p. 25, and Dec. 28, 1964, p. 26].

Are IBM's competitors copycats? No; there are significant differences between the IBM, RCA and Honeywell styles of packaging, although the key decision to use multilayer boards was based on similar packaging and production needs: short signal paths, wiring-design flexibility, and low cost through automation of design and production.

RCA Spectra 70

RCA's packaging starts in the central processor, with three types of logic gates in flatpacks: two types of twin four-input gates and an eight-input gate. These are flow-soldered into 4×5 -inch cards which carry up to 16 flatpacks. The cards are double-sided, with plated-through holes and signal wiring lines spaced 100 mils apart. Since the flat-pack leads are only 50 mils apart, alternate leads are soldered to lines on top of the board; the other leads are bent closer to the package body and soldered to lines on the bottom. The male contacts on the board are etched and gold-plated extensions of the lines.

The motherboard is bigger than IBM's—17 inches square. This reduces the need for discrete wiring and allows plenty of room to mount memory planes with all their associated circuitry. Each board carries up to 130 female connectors, whose contact numbers are variable up to 48. The pins extend through the board and are used for wire wrapping.

The external signal wiring is arranged as two orthogonal planes. There is a standard pattern of 10-mil-wide lines, 25 mils apart, over the board. Instead of generating the lines to produce the interconnection patterns, RCA alters the master pattern by interrupting lines and running extensions to the lands around feedthrough holes. This is done, as part of the photoetching process, by using a master line and land pattern which is modified by a programmed drafting machine.

The voltage planes in the standardized buried layers are orthogonally striped. The lines in neighboring planes always cross at right angles to make impedance uniform and to minimize crosstalk.

The main-frame assembly is three pairs of doors, with three boards on each door. One pair of doors swings open to the front, another pair opens to the rear, revealing the center pair. The "pin forest"—the discrete wiring side of the boards—is the board side exposed when the doors are opened.

Honeywell H200 series

Honeywell is taking an entirely different approach. One of the prototype multilayer-board assemblies for the H4200 and H8200 is shown above. It isn't a Level II motherboard, but a Level I 5×6 -inch plug-in card.

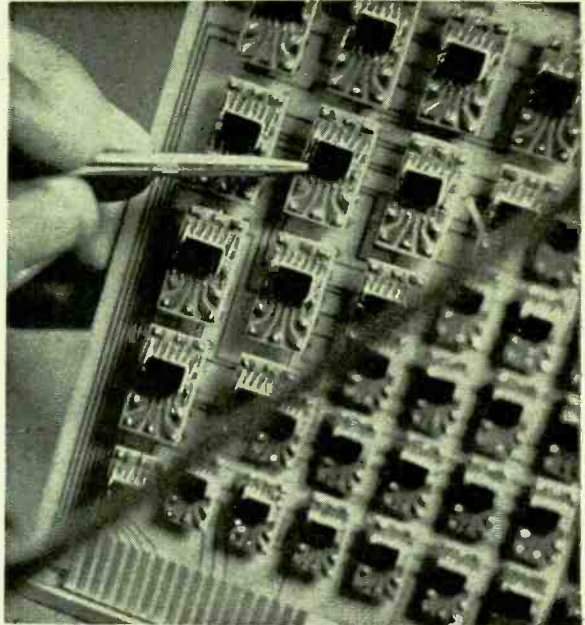

Functional assemblies of up to 50 IC packages are formed on Honeywell, Inc.'s multilayer plug-in cards.

The Level II wiring will be wires wrapped on pins, supplemented by etched wiring for clock and other high-speed signals. Honeywell figures the wiring will be so short in most cases that transmission lines won't be needed; the exceptions are being taken care of by twisted-pair wires connecting the backplane pins. The pins will be spaced 125 mils apart. One two-foot-square motherboard will be used in each major subassembly of the H4200 and two in the larger H8200.

Each plug-in card will be a functional assembly of related circuits, reducing the number of pins needed, and shortening wiring. Each edge connector will have only 80 contacts for up to 50 MIC packages. The logic circuits are the Honeywell-designed High-Level Transistor-Transistor Logic. To improve card repeatability, large functions can be divided; for example, each bit of a 48-bit shift register can be assigned to each of 48 boards.

The internal voltage and ground planes of the boards are copper sheets that are continuous except for openings around plated-through holes which connect the signal wiring on the surfaces. The signal wiring is etched on a mechanized, precision spray-etching line now used to make conventional circuit cards. A programmed drafting machine will prepare the photoetching artwork.

In the prototype assemblies, the flatpacks are soldered to plug-in carriers. Plans are to use the new in-line packages in production models. Meanwhile, the carriers offer assembly and design advantages like those of the in-line packages and have their own advantages as an interim technique for using flatpacks. The flatpacks can be mounted and tested as a subassembly operation, the carriers open up the flatpack lead spacing to 100 mils, and the pin leads can be flow-soldered into the plated-through holes of the board and desoldered for circuit changes. The pins are preformed to raise the carrier off the board.—George Sideris

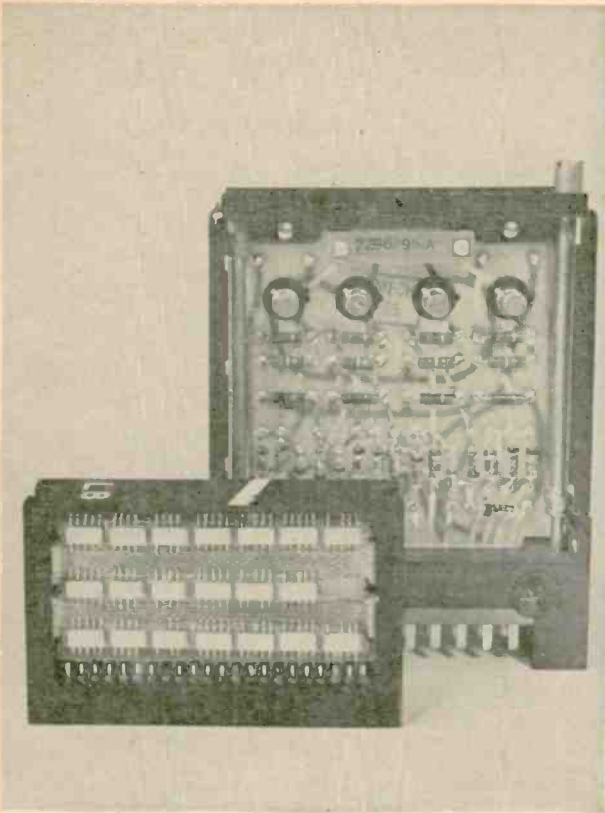

The small module above is made with MIC's and welded-foil interconnections. It is used in the computer below.

ing and isolation-design flexibility is greater.

The Sperry Gyroscope Co. makes its wiring matrix by winding nickel ribbon at a 0.50-inch pitch on anodized aluminum channels.⁷ The windings are bonded and cut to form two rows of short tabs, to which device leads are joined, and two rows of long tabs, which are welded and insulated to provide all interconnections.

The Raytheon Co. has developed machinery to punch ladder-like configurations in foil strips automatically. The location of the ladder runs and the projecting tabs determine the interconnection pattern in the strip assembly. The tape which programs the machine can be prepared as the modules are designed. Raytheon has been developing this packaging method, in cooperation with the Instrumentation Laboratory of the Massachusetts Institute of Technology, for use in the Apollo space program, and to build the microelectronic computer shown below.

III. Thermal management

It has been proved time and again that the hotter a semiconductor-device junction gets, the quicker the device fails. And when monolithic integrated circuits, rather than discrete components or hybrid IC's are used, thermal concentrations rise because of the compactness of the circuits and the system.

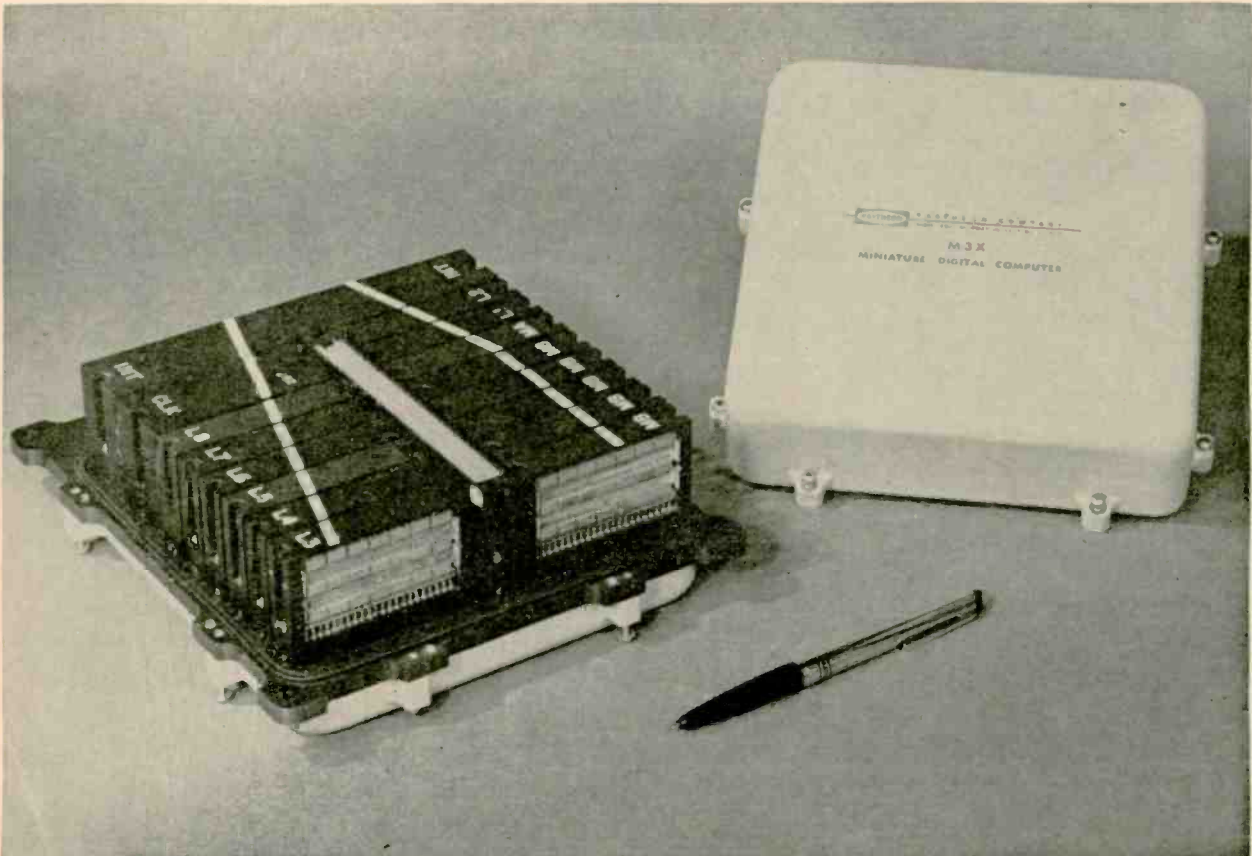

Intended for high-reliability applications, this computer, built by the Raytheon Co., can be held in one hand.

Great gains in system reliability can be made through careful thermal management—the art of limiting temperature rises and differentials by controlling the generation, extraction and removal of unwanted heat.

Since heat generation depends on power dissipation, it obviously is important for the circuit designers not to use excessive amounts of power and to organize circuit placement to distribute power-dissipating elements as evenly as possible. Heat extraction and removal are generally handled by the packaging engineers in two ways: passive, such as conducting the heat along metallic paths to an external heat exchanger; and active, by moving gases or liquids.

As MIC power dissipation rises with increased speed and circuit complexity, and as packaging densities rise, more efficient heat-removal methods will be needed. Likely methods include thermoelectric cooling at heat-concentration points, and direct liquid cooling by immersion or forced flow. MIC packages with better heat-transfer characteristics can also be designed.

Conductive cooling

Conductive cooling has been stimulated by missiles and spacecraft, which operate where there is no air for forced air cooling. It also has positive attractions for systems operating in air:

- It eliminates air-moving equipment. Rotating

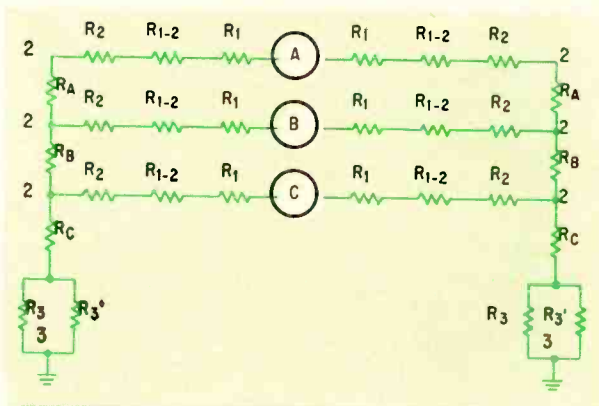
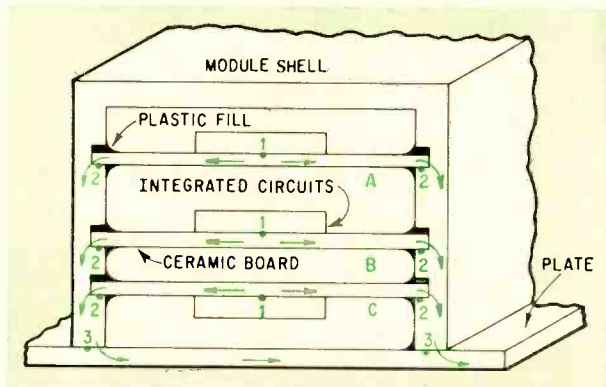

Thermal resistances of heat-flow paths in a module can be calculated by determining resistances at interfaces 1, 2 and 3 (in color) and in thermal conductors (arrows) and preparing an equivalent circuit.

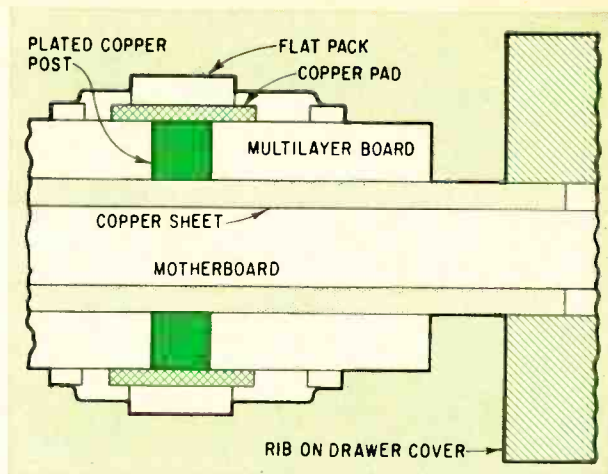

Thermal path in Litton Industries, Inc.'s prototype computer [see Part I of this report] Electronics, for the L-300 series. Since Part I was printed, Litton has revealed that the Level I boards in production models will not be small modules, but boards carrying 270 flatpacks. Two boards will be mounted back-to-back, and use a similar form of conductive cooling.

blowers introduce acoustical and electrical noise and they can fail, reducing reliability.

- Cases can be sealed, to simplify radio-frequency-interference protection, avoid the airborne moisture and dirt, and end the changing of air filters.

- Circuits won't overheat because of shortages of cooling air at particular locations in the system.

MIC flatpacks are excellent for conductive cooling. The silicon chip is generally bonded to a thermally conductive base. Useful figures of merit are the thermal gradients between the junction and the case or the air in degrees centigrade per milliwatt of power dissipated. For example, Sylvania Semiconductor division defines the thermal gradients of its flatpack as 0.3°C per mw junction-to-air and 0.1°C per mw junction-to-case.

The TO-5 and in-line packages are less suited to conductive cooling. It is difficult to put their heat transfer surface in thermal contact with a heat sink. Their larger profiles, however, make them more adaptable to air cooling than flatpacks.

The main design objective in conductive cooling is to make the thermal resistance as low as possible in the path from the heat producer to the heat removal point. Major resistances are the bulk resistance of the conductors and the interfaces and joints in the path.

In modular systems, a prime concern is good thermal contact at module connection points. This can be done if the voids between the heat-transfer surfaces of the modules are filled with silicone grease, thermally conductive rubber, or spring membranes. The surfaces can also be wedged or clamped. If the system is to operate in a vacuum, a void filler at all interfaces is essential because even smooth-looking surfaces have peaks and valleys that cause high thermal resistance.

Once the heat is brought to the system case,

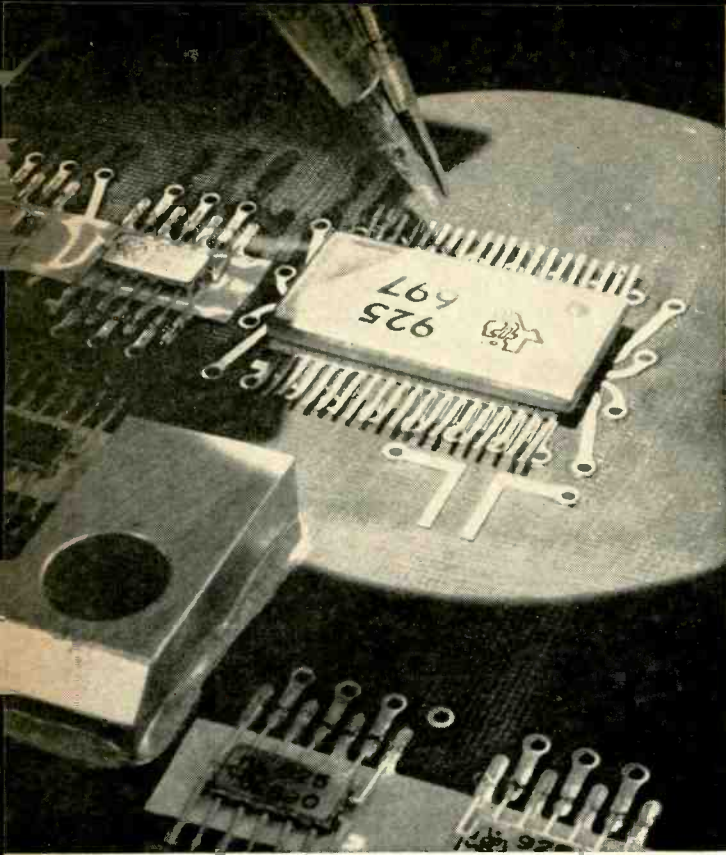

Flatpacks are getting bigger and lead-spacing tighter. There are 10 logic circuits in the king-sized flatpack.

it will be dissipated in the air by natural surface emission, convection and some radiation, if the ambient air temperature is low enough and the case surface area large enough. Clamps are often used in missiles and satellites to transfer heat to a supporting structure or cold plate. An adjoining heat exchanger can be fabricated on the outside of the sealed case and gas or liquid coolant passed through it.

Thermal-resistance analysis

The many heat sources in a system, and the many thermal interrelationships, make it difficult to calculate heat-transfer factors precisely. In most cases, simplified worst-case analysis is used; in severe cases, rigorous analysis, frequently supported by a computer, has been used.

A typical simplified analysis is pictured on page 85. In this case, the interfaces are:

1. Where the flatpacks are mounted to ceramic interconnection plates (R_1 is the contact resistance and $R_{1,2}$ is the resistance of the ceramic board).

2. Where the board is joined to the aluminum housing (R_2 is the contact resistance and R_a , R_b and R_c are the resistances of the module shell).

3. Where the aluminum shell is clamped to an aluminum heat transfer plate (R_3 is contact resistance and R_3' is the gap resistance).

The equivalent circuit assumes that all the heat is transferred from the MIC's to the plate by conduction alone. This reduces the problem to a one-dimensional heat-transfer study, and heat flow can be calculated from known properties of the materials and tests of interface resistances.

IV. Other systems

Packaging designs conceived for computers are being applied to other systems that are digital or switching in nature and require large numbers of low-powered circuits. A navigation system has already been cited. Other applications include communications switching centers in which MIC's replace hundreds of thousands of relays, digital transmission systems, large instrumentation systems and the like.

One unusual example is a bistable electroluminescent (EL) display that Sylvania is studying [Electronics, Jan. 11, 1965, p. 36]. The objective is to illuminate, with control signals, selected spots on a large EL display panel. The spots are to remain lit until a turn-off signal is received. Each spot is driven by an MIC drive and memory circuit, which requires relatively high voltages, from 100 to 200 volts a-c.

The spots are to be on $\frac{1}{8}$ or $\frac{1}{10}$ -inch centers in the initial designs. That requires mounting 64 to 100 MIC's per square inch. One solution being tested is to put three memory-drive circuits in each flatpack, $\frac{1}{4}$ inch long by $\frac{3}{16}$ inch wide. If the flatpacks are stacked back to front, allowing $\frac{1}{10}$ inch height or spacing for each flatpack, the output terminals can be arranged on $\frac{1}{10}$ -inch centers and the desired packaging density achieved.

V. A look at the future

A year ago, Sylvania Electronic Systems studied the trends in integrated-circuit technology as part of a program to evaluate military computer techniques for the next decade. Some of the highlights of the IC predictions are summarized below as development timetables for two forms of IC's:

- Film technology (thin and thick-film hybrid circuits with discrete components). Uncased semiconductor devices will be used in 1965 and in 1966 glass will be used to protect circuit surfaces. In 1968, final decisions on the use of active thin-film elements will be made and in 1969 thin-film and semiconductor technologies will merge. Also in 1969, photon techniques will interconnect circuits. In 1970, circuit topology, construction and assembly will be automatically programed.

- Semiconductor technology (monolithic IC's and semiconductor-thin film IC's). The number of MIC's in a multicircuit chip will grow from five in 1965, to 10 in 1966, 50 in 1967 and 100 in 1970. Meanwhile, multichip concepts will provide complex functions. Reliability will reach 0.001% per thousand hours per circuit in 1968. Cost will drop below \$1 per circuit function in 1970 (military circuits). Propagation delays per circuit will drop to 1 nanosecond or less in 1967 and down to 0.5 ns in 1970. Film and semiconductor technologies will merge in 1969.

One year later, the trends are still in the same general direction, but the rate of progress is often quicker than anticipated and there have been shifts in the emphasis given competing techniques.

For example, multicircuit chips with 12 to 20 logic gates per chips are now available, up to 150 gates per chips are promised by special techniques, and MOS-FET devices (metal-oxide-silicon field-effect transistor) are providing large functions on a single chip.⁸ Electroformed chip leads and other ways of eliminating discrete wiring will probably accelerate the development of multichip functions.⁹ Improvements in isolation methods indicate that circuit speeds will rise faster than had been predictable a year ago.

In film technology, the emphasis seems to have shifted from deposited thin films to screen-printed and fired thick and thin films. Uncased MIC's are becoming widely used in hybrid circuits. The work on active thin-film elements appears to be concentrating on MOS-FET devices.

Uncased chips

Glass-protected transistors and other active devices are now being used in hybrid IC's and glass will soon be used to protect MIC's in multichip arrays. However, whether such uncased circuits equal hermetically sealed MIC's in environmental performance is still questionable. Another question is the best way to interconnect uncased circuits.

The most promising joining method still is to turn the chip upside-down and bond the terminals on the chip to film-wiring terminals on a substrate of glass or ceramic. While it is difficult to inspect joints buried under the chip, film wiring is ideal for interconnecting terminals that are $\frac{1}{100}$ inch, or less, apart. The requirements for multilayer film interconnections may lead to fabrication of special thin-film circuit functions along with the wiring.

Larger and larger functions

Increasing the functional content of integrated circuits creates the same problems as increasing the size of modular assemblies; repeatability drops so that functions become more unique and more costly; the number of pins per function drops, but the number of pins per package rises; the possibility of a faulty circuit in the functional assembly rises. The latter is a severe problem in complex MIC's because process problems depend heavily on chip area—the yield of good MIC's drops almost exponentially as chip size increases.

The problems of repeatability and yield of multicircuit arrays are being attacked through process and interconnection improvements. One advanced method is to program a computer to design unique interconnection patterns for each array; the wiring bypasses inoperative circuits, but can include marginal circuits whose performance is adequate for the intended function.

Packages with 40 or more leads are coming into use for MIC arrays and MOS circuits. On some, the leads are only 25 mils apart. System packaging will have to change to use these packages efficiently. Replacement at the package level will probably be required and modularity and maintenance philosophies will be affected. Improved wiring

geometries will be needed as well, since the functions interconnected will be larger, closer together and higher in speed.

The larger functions may generate new logical structures for computers. For example, multiprocessor types of systems may be composed of numerous processor-memory functional units. Such systems could be designed so they automatically bypass defective units and reorganize the remaining units so system operation will continue without repairs.

Reliability and maintainability

During system tests, the failure rates of packaged MIC's have been as high as 25 times the failure rate of the MIC's alone. This is due to stresses during handling, testing and assembly. The main sources of failure are wire bonds in the package and damage to the package's hermetic seals. The techniques outlined above avoid these failures.

The expected improvement in reliability of larger functional circuits, plus the anticipated reductions in cost, will make it possible to consider the fabrication of throw-away systems. From the military point of view, such systems are economical if the mean time between failure (MTBF) equals the expected life of the system. They could pay large dividends in eliminating the need for highly trained maintenance personnel, complex fault-isolation and test equipment, and expensive maintenance manuals and maintenance bases.

In Part I of this report [Electronics, Oct. 18, 1965, p. 72], a proposed \$1/10,000 hours cost formula for modules was discussed. That figure is obviously too arbitrary, and should be revised in favor of functional complexity to permit throw-away systems or subsystems. A \$100,000 cost for a throw-away module containing 5,000 MIC's should be reasonable if the module's mean time between failures is about 10 years or 80,000 operating hours.

References

1. Proceedings of the Welded Electronic Packaging Conference, Society of Automotive Engineers, New York, 1964.
2. G.V. Browning, "Advances in Electronic Systems Through Use of Microelectronics," Pub. X4-1456/3111, Autonetics division of North American Aviation, Inc.
3. G.J. Veth, "Optical Soldering Promotes Automated Packaging," Electronics, March 22, 1963, p. 90.
4. Elsie F. Harmon, "Fabrication of Multilayer Boards at Autonetics for Minuteman II Program," Pub. X5-562/33, Autonetics.
5. R. Lawrence, "Mechanical Design Considerations for a Commercial Integrated-Circuit Computer," Sixth International Electronic Circuit Packaging Symposium, San Francisco, 1965.
6. J.S. Walker, "Micro-Harness: a New Concept in Interconnection for Integrated Circuits," San Francisco Symposium, op. cit.
7. C.W. Johnson, "All Welded Automated Multilayer Integrated Circuit Packaging Innovations," San Francisco Symposium, op. cit.
8. D.E. Farina and D. Trotter, "MOS integrated circuits save space and money," Electronics, Oct. 4, 1965, p. 84.
9. J.G. Curtis, "Crossbred technology automates production of hybrid microcircuits," and G. Sideris, "Bumps and balls, pillars and beams: a survey of face-bonding methods," Electronics, June 28, 1965, p. 66 and p. 68.

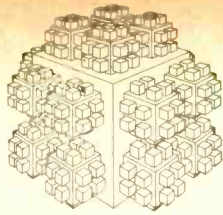

Part III: Computers design the layout

As logic circuits become faster, their location and connection in complex systems becomes increasingly important. By analyzing all possible configurations, a computer can reduce wiring delay and crosstalk

By Edmund U. Cohler

Sylvania Electronic Systems Division, Sylvania Electric Products, Inc., Waltham, Mass.

The increases in the speed of integrated circuits make their placement and interconnection in complex systems so critical that the designer must call on a computer for help in obtaining optimum speed and performance. The earliest IC's did not pose serious layout difficulties because they were slow. Now, delays per stage are 2 to 15 nanoseconds and wiring delay and crosstalk are again major concerns.

Electrical layout is important because of logical and electrical constraints: clock timing fixes the delay allowed between events, states must change simultaneously throughout the machine, and the circuits in one signal path must not be activated falsely by signals picked up from another path.

Logical delay

Logical delay is the sum of the inherent IC delays and the wiring delays. The effect is most prominent in critical propagating circuits, such as the carry or parity chains. The simplest carry chain has as many stages as there are bits in a computer word. For 36 bits, the chain will use some 72 to 540 nanoseconds. This time often determines the computer's clock period, so it is desirable not to make it longer by adding wiring delay.

The basic parameters of wiring delay are ap-

parent in the familiar transmission-line formulas:

$$\tau = \sqrt{LC} = \tau_0 \sqrt{\epsilon\mu}$$

where τ is the delay per unit length, L and C are inductance and capacitance per unit length, τ_0 is the delay in free space (about 1 nsec per foot), ϵ is the dielectric constant of the propagating medium and μ is the medium's permeability.

Since most wave-propagation materials are non-magnetic (except in magnetic memories), the propagation speed depends mostly upon the effective dielectric constant of the signal path. The ϵ for typical encapsulants, such as epoxy, is about 4, so propagation speeds of about 2 ns per foot can be expected. Capacitance loads tapped along the path will cause additional delays, and it may take several delay times for reflected signals to disappear from improperly terminated lines.

There is little to be gained from the use of different dielectrics, since the range of ϵ is only about 2 to 6. The length of the wiring generally controls the amount of delay.

Clock skew and crosstalk

Trouble is usually caused in the clock section by variations in delay times rather than absolute times. The variations are the cause of clock skew.

In most computers, flip-flops activate the logic gates. After flip-flop and gate transients disappear, clock pulses strobe the gates to cause a change in the state of certain flip-flops. If strobing is not simultaneous, the logic associated with these flip-flops will not operate properly. Timing variations become troublesome when they approach or exceed the clock-pulse width, some 50 nanoseconds in high-speed systems. Such a delay would cause a flip-flop to operate out of step.

Here again, the problem can best be solved by controlling circuit location and wiring length.

The more compact the wiring, the more likely

The author



Edmund U. Cohler is a senior engineering specialist at the Sylvania Applied Research Laboratory. He has supervised circuit and memory design for many computers and digital communications systems. He got his Ph.D. at Northwestern University in 1952 and joined Sylvania, a subsidiary of the General Telephone & Electronics Corp., in 1956.

that one wire will pick up another's signals. Crosstalk is mainly due to the mutual inductance of two lines. This inductance is linearly proportional to the distance of each line from the ground plane. It increases logarithmically as the distance between the wires decreases.

These approximations hold as long as the wire cross-sections are smaller than the spacings. Therefore, proportionally decreasing wire-to-wire and wire-to-ground spacing will help control crosstalk as the wiring packaging becomes tighter.

Crosstalk per unit length can also be reduced by careful design, such as minimizing circuit cross-section by adequate bypassing of signal leads, isolating heavy di/dt leads (those carrying large transient currents) from sensitive circuits, and making sure that ground currents are carried along with corresponding signals.

Little can be gained by further improvements in wiring material and geometry. The ability to pack more wires into less space is already hitting the constraint of wire conductivity. The practical thickness of insulating layers in multilayer boards limits spacing.

Modification of physical design also has its limits as a way to obtain shorter wiring paths. The shortest path from a circuit at one corner of a cube to a circuit at the opposite corner is the diagonal of the cube; but this path is only shorter than the "long way around," via the three edges, by the square root of 3. The longest edge path on a one-inch cube is three inches, and the diagonal about $1\frac{3}{4}$ inches.

Computer-designed layouts

Optimum layout of circuits and wiring offers the most significant improvements in delay and crosstalk. It can separate noisy paths and sensitive circuits, reduce distances between critical elements many times, make clock-signal delays uniform and also alleviate thermal design problems.

Computer techniques are available to accomplish optimum layout. One of the first routines was developed to minimize wiring length.¹ The gains from clever wiring in a given package may be limited, but correct placement of the packages themselves can provide substantial reductions in length. The routines start with an initial package placement, a description of allowable wiring paths and a list of required connections. The computer examines the possible wiring configurations and chooses the minimum-length configuration.^{2, 3, 5-9} One program refinement reduces crosstalk by investigating the minimum-length pattern to see if small changes will reduce common paths of signal wires. Wires longer than a maximum are shielded.

There are also algorithms and programs which enable a computer to calculate the best arrangement of circuit packages.^{3, 4, 6, 7, 8} Iterative techniques are used, since the problem is complex; although the solutions are only approximate, the layouts are better than a technician can prepare.

At first, these routines minimized total wire

length. Later attempts sought a near-minimum total with longest wires as short as possible. Some of the most sophisticated recent work has concerned the placement of IC's on circuit boards.⁶

Critical delays

More refined layout programs will give special attention to critical delay and timing points.

The program can trace through the logical networks from a pulse gate to the controlling flip-flops to determine how much ahead of the pulse the logic level will show up. This is the delay margin. The computer then seeks a layout which will reduce the delay in minimum-margin paths, even at the expense of increasing total delay or wire length.

This reduces delay where it is critical, because the maximum speed of the logical system is constrained by these minimum-margin cases. Once the computer identifies them, further changes in system design may be considered to increase speed.

To best control delay variations in clock-pulse circuitry, the layout routine should assign locations to clock-source circuits so that pulse gates cluster symmetrically around a clock-pulse center.

Thermal balancing

Power density rises appreciably as circuits become faster. Balancing the heat in the system can also be done by computers, using programs which optimize power-density distribution while nearly optimizing timing and cross talk. In an optimum layout, the engineer will find many "don't care" delay conditions. Since the power dissipation in each integrated circuit is usually well-defined, one can employ the freedom given by the don't-care cases to adjust package placement further and reduce temperature gradients in the system.

Finally, computer design can ease the costly and onerous job of fabricating the wiring. The problem of wiring crossovers is much less when the printed circuit boards are multilayered, so they can be laid out by fairly simple computer routines. If the layouts are recorded on magnetic tape, the tape can directly control drafting or milling machines.

References

1. H. Loberman and A. Weinberger, "Formal Procedures for Connecting Terminals with a Minimum Total Wire Length," *JACM*, Oct., 1957, p. 428.
2. G.W. Altman, L.A. DeCampe, and C.R. Warburton, "Automation of Computer Panel Wiring," *Comm. Electronics*, May, 1960, p. 118.
3. D.B. Kirby, and C.W. Rosenthal, "Computer Program for Preparing Wiring Diagrams," *Comm. Electronics*, Nov., 1961, p. 509.
4. Leon Steinberg, "The Backboard Wiring Problem: A Placement Algorithm," *SIAM, Rev.*, Jan., 1961, p. 37.
5. A.I. Leiner, A. Weinberger, C. Coleman, and H. Loberman, "Using Digital Computers in the Design and Maintenance of New Computers," *IRE Trans. EC-10*, Dec., 1961, p. 680.
6. R.A. Rutman, "An Algorithm for Placement of Interconnected Elements Based on Minimum Wire Length," *AFIPS Conf. Proc.*, (1964 SJCC), p. 477.
7. O.R. Kodres, "Geometrical Positioning of Circuit Elements in a Computer," *AIEE Fall General Meeting*, Oct., 1959.
8. R.H. Glaser, "A Quasi Simplex Method for Designing Sub-Optimum Packages of Electronic Building Blocks," 1959 Computer Application Symposium, Armour Research Foundation, (IITRI), Chicago, p. 100.
9. M. Klopmok, P.W. Case, and H.H. Graff, "The Recording, Checking and Printing of Logic Diagrams," *Proc. EJCC*, Dec., 1958, p. 108, *AIEE*, New York, July, 1959.

Designing transmission lines into multilayer circuit boards

Electrical characteristics vary with the thicknesses of the dielectric and the width of the conductor lines. The circuit designer must temper his requirements to accommodate manufacturing limitations on tolerances

By William K. Springfield, International Business Machines Corp., Endicott, N.Y.

Transmission lines made by multilayer printed circuit techniques are a reliable means of transmitting high-frequency signals and distributing high-current power among the active circuits of high-performance microelectronic computers. They are used extensively in solid logic technology (SLT), the form of microelectronics employed in the System 360 computers.

SLT is the International Business Machines Corp.'s first large-scale production use of multilayer boards. Besides pointing up the advantages of printed transmission lines, the experience has reemphasized the need for a scientific approach to packaging development and for an understanding of the impact which manufacturing limitations may have on significant properties of the transmission lines.

Packaging based on single-sided cards and long, randomly routed, discrete (yellow-wire) interconnections would have been inadequate; the higher speeds, smaller size and greater information-handling capabilities resulting from advances in semiconductor and computer technology would have been sacrificed.

Printing the transmission lines provides a regularity in wiring geometry that allows the circuit designer to choose a specific impedance range for circuit-to-circuit communication. He can also predict with assurance the capacitance loading, signal-propagation delay and line-to-line coupling per unit length of line. The smaller size and shorter length of the lines help reduce signal delays, losses and crosstalk, and give the designer freedom to manipulate line spacing and the number of lines

Definitions of terms

| | |
|----------|--|
| C_{wg} | Capacitance between a conductor line and its ground plane (wire-to-ground capacitance) |
| C_{ww} | Mutual capacitive line coupling (wire-to-wire capacitance) |
| D_o | Effective wire diameter (found, in practice, to be equal to $0.567W$ plus $0.67T$) |
| di/dt | Rise rate of a transient current |
| dv/dt | Rise rate of a transient voltage |
| gap | Distance between lines, edge to edge |
| H | Spacing between a conductor and its ground plane (thickness of the dielectric layer) |
| L_{wg} | Inductance of the transmission line |
| M_{ww} | Mutual inductive line coupling (wire-to-wire inductance) |
| R_{dc} | D-c resistance |
| R_{of} | Active-line termination, far end |
| R_{of} | Quiet-line termination, far end |

| | |
|---------------|---|
| R_{qn} | Quiet-line termination, near end |
| S | Spacing of conductor lines, center-to-center |
| T | Thickness of line conductor |
| t_d | Propagation delay |
| V_f | Voltage of coupled far-end noise |
| V_n | Voltage of coupled near-end noise |
| W | Average width of a conductor line |
| Z_o | Characteristic impedance |
| Z_{oa} | Characteristic impedance of an active line |
| Z_{oq} | Characteristic impedance of a quiet line |
| α_c | Skin-effect attenuation by the printed line |
| α_d | Dielectric loss of the laminate material |
| α_T | Attenuation of a printed line |
| ϵ_o | Dielectric constant of air |
| ϵ_r | Dielectric constant of the board laminate |
| ϵ_r' | Apparent dielectric constant of the printed line with respect to its ground plane, a composite of ϵ_o and ϵ_r |

per channel to further control those characteristics.

Solid logic technology

The System 360 boards are the third level of the basic SLT package in the photos at the right.

The smallest units are the hybrid modules.¹ These contain half-inch-square hybrid integrated circuits made by screen-printing conductive and resistive inks on a ceramic substrate and attaching chip transistors and diodes. The modules have up to 16 pins—as many as four rows of four pins—located on a 0.125-inch (125-mil) grid.

Plug-in cards form the next packaging level. There are four card sizes: for 6 modules and 24 modules, and two for 12 modules. The 6-module card is 1½ inches high by 1⅝ inches wide; the dimensions of the other cards are multiples of this unit card. Discrete components, such as decoupling capacitors, can be soldered to the cards.

Card wiring consists of two external wiring planes and one internal plane. Plated-through holes, on a 9 by 12 matrix in the unit size, connect the modules and the wiring planes. Two standard line widths are used, 8 mils for signal lines and 24 mils for voltage lines. These cards must be produced in large volume; transmission-line characteristics are of secondary importance because the cards are small and line lengths less than 2½ inches.

The plug-in connectors on each card also follow the 125-mil spacing. Rows of 12 contact springs are soldered to tabs on each side of the card, forming the female part of a 24-pin connector.

Up to 66 cards can be plugged onto each 12½-by-8¾-inch multilayer board. The wiring layers are connected by 6,800 “vias”—plated-through holes spaced 125 mils apart in a 100 by 68 matrix. Pins which mate with the card contact springs are mounted in the holes at the card-socket locations. There are also 20 sockets for flat, multiple-conductor, high-frequency cables for board-to-board and subsystem connections. The cables terminate on cards similar to the module cards.

A typical board cross-section is shown on the next page. The boards are fabricated by the techniques pictured on the next two pages.

The signal lines are typically 8 mils wide and are spaced 20 mils apart. On one side of the board, the lines run vertically and on the other horizontally. This orthogonal arrangement, plus the vias, allows a maximum amount of signal-wiring crossovers and facilitates the use of computers to design the wiring and control its fabrication. Supplemental discrete wiring is added to provide the small amount of interconnection that can't be fitted into the printed pattern. These wires are wrapped to pins under the board. The pins are extensions of the male contact pins on the top of the board.

The internal voltage plane is segmented and can deliver three voltages. Voltages are supplied to the cards through four of the contact pins in each 24-pin set. Bus bars plugged into the board edge supply the voltages to the internal plane.

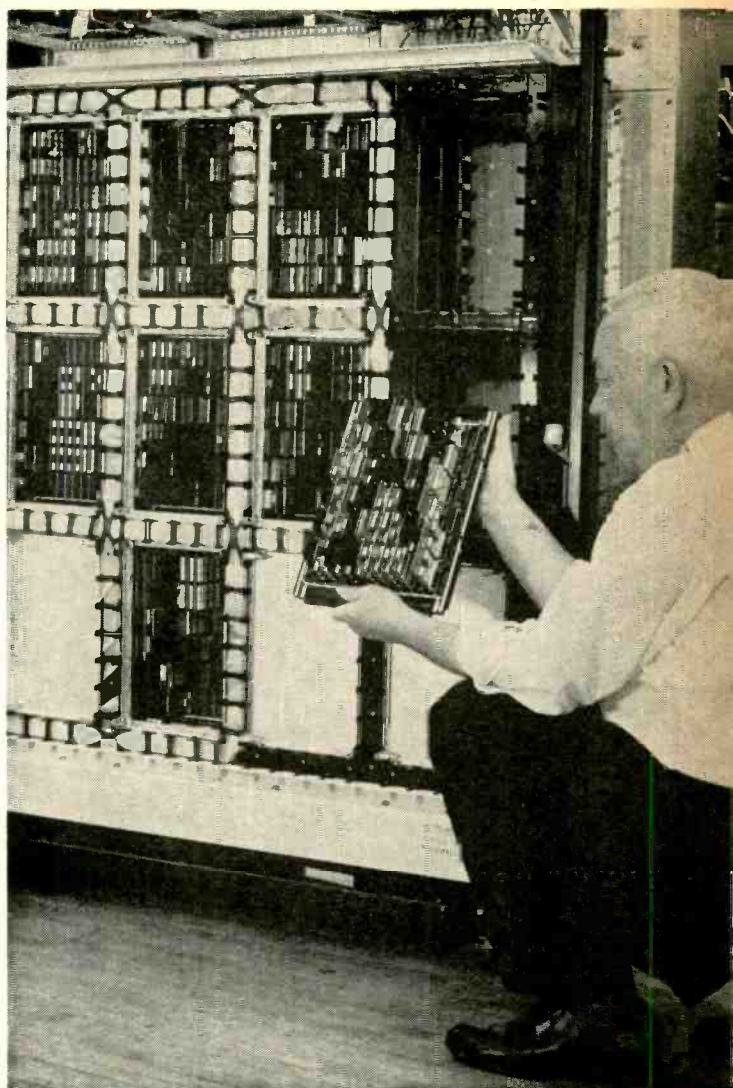

System 360 computers are built up with varying numbers of logic assemblies like the one held by the engineer. That assembly is part of a central processing unit, seen in the background, of a Model 30 computer.

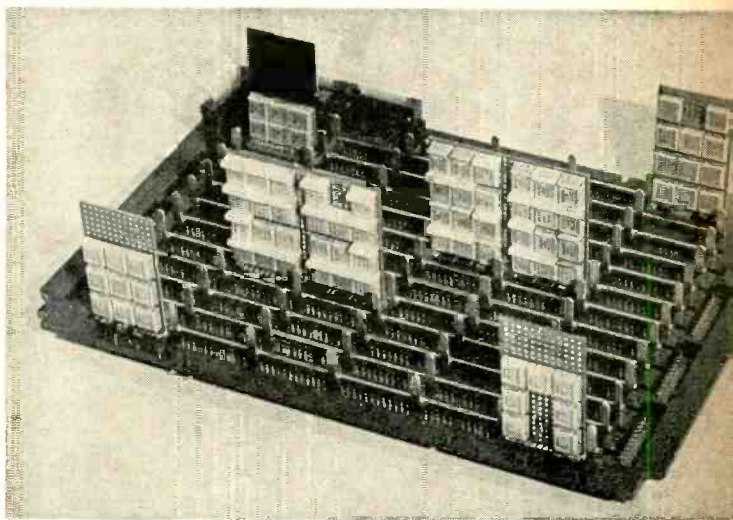

Basic package of the System 360 computers is this assembly of logic modules soldered into logic cards that plug into multilayer printed circuit boards. Flat cabling to other boards terminates in cards.

Computers control board fabrication

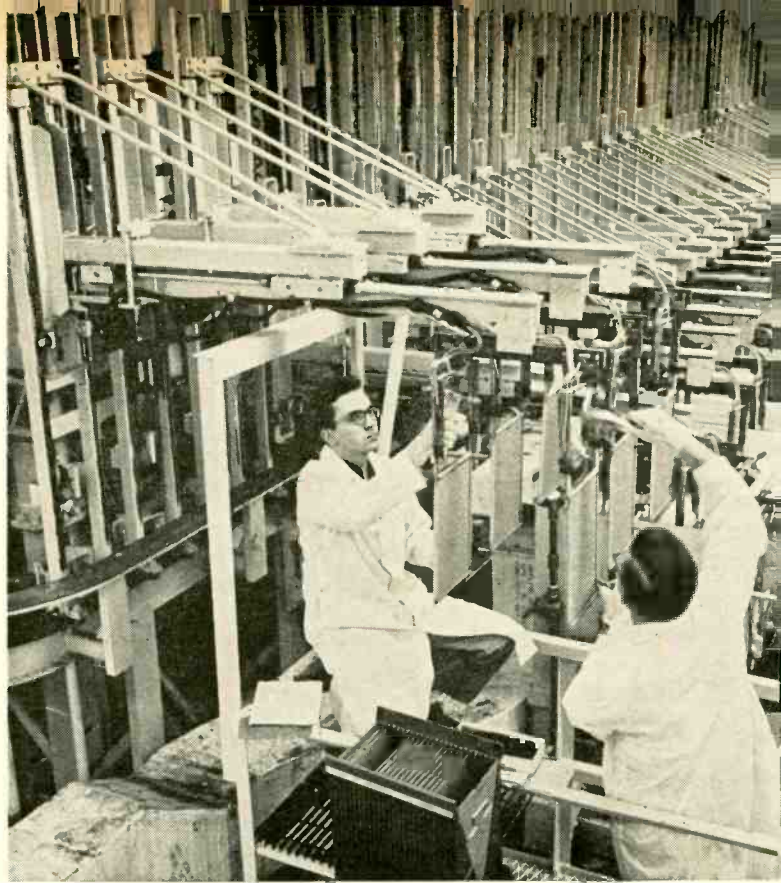
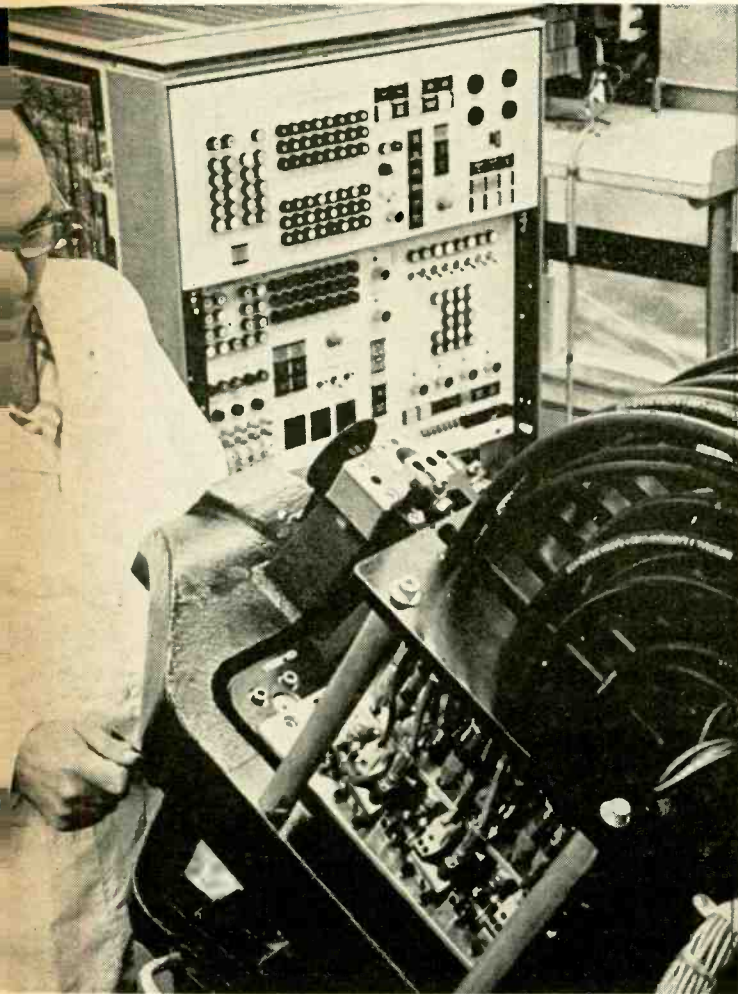

Copper for the signal wiring and holes is plated on the laminates with this mechanized system. In all, there are 200 boards moving through the 60 processes at one time. The line is run and monitored by a computer.

Holes are drilled in circuit-board laminates with this machine, run by an IBM 1710 control system. Its 24 numerically controlled drilling spindles can put 6,000 holes a minute in a 10 × 15-inch logic-card panel.

Electrical-design ground rules

Naturally, the circuit requirements dictate the electrical design of the boards, but this must be tempered by the variable relationship between electrical properties and board producibility. The important electrical parameters are the character-

istic impedance Z_0 , mutual inductive line coupling M_{ww} and mutual capacitive coupling C_{ww} , direct-current resistance R_{dc} , the dielectric constant ϵ_r of the laminate material, and line attenuation α .

The system 360 is an 80-ohm system; that is, Z_0 has a nominal value of 80 ohms and can range between 70 and 92 ohms. This range is a com-

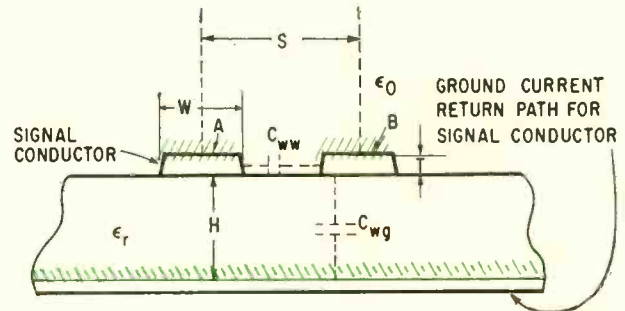
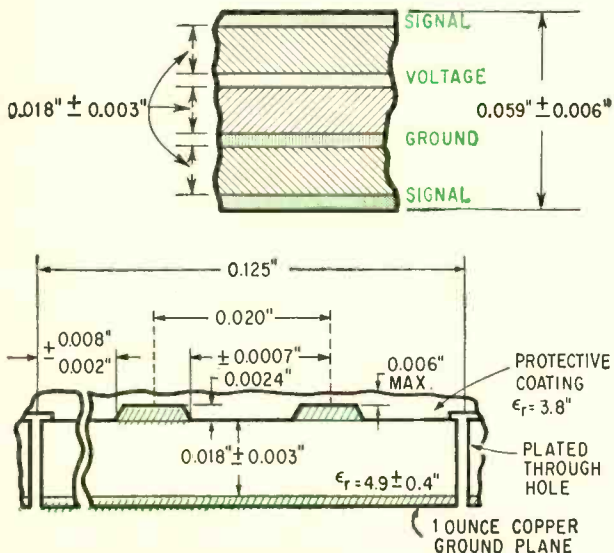

Cross-sections of typical SLT boards. At top left are the dimensions of a complete board. At lower left, the dimensions for a transmission line (signal wiring and ground) are given. Above is a schematic of the relationship between dimensions and dielectric properties.

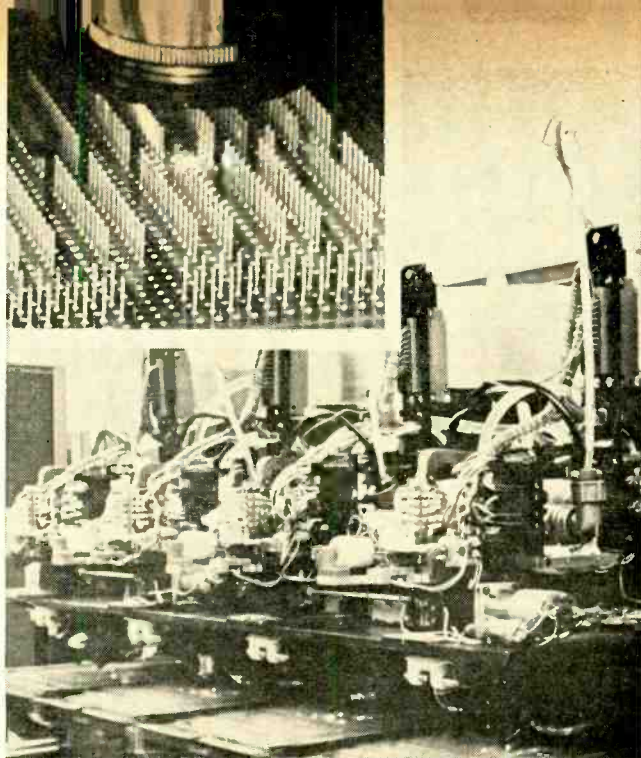

▲ After standard wiring patterns are etched, and pins inserted in the large multilayer boards, this machine (also shown on the cover) develops special wiring patterns with a computer-controlled beam of light.

Photoetching of the small, plug-in logic cards is done after the resist on the laminate is exposed to light shining through a glass negative (upper right). It carries the computer-generated wiring patterns for 48 cards.

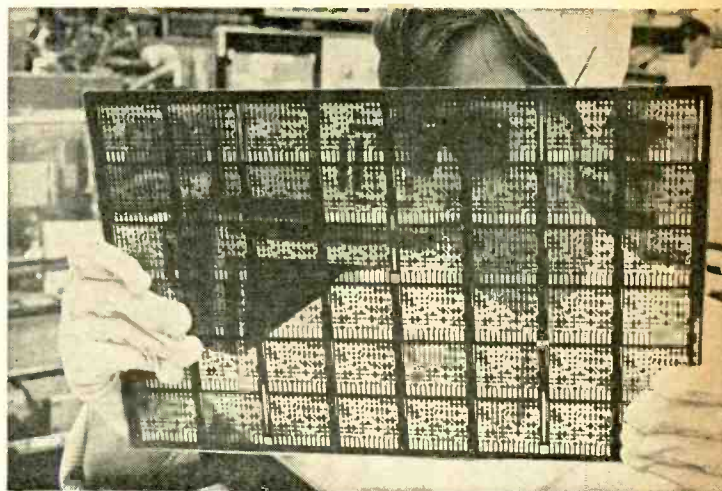

After a computer-controlled assembly machine plugs logic circuits into the cards, more than 2,000 wiring and logic tests are made on each card by this machine, whose control computer is programmed by the logic-design computer.

promise among the following factors, with most of the weight placed on the first four:

- Power dissipation of terminating networks and load resistors.
- Load capacitance that unterminated lines could drive.
- Limitations on line-to-line coupling.
- Manufacturing limitations on line width and dielectric spacing.
- Compatibility with other transmission-line systems.

Since IBM had not previously attempted to mass-produce multilayer boards, it was essential to investigate the geometrical tolerances which could be maintained during etching, laminating and other fabrication steps.

The procedure used to analyze the effect on Z_0 of manufacturing tolerances can serve as a guide to the analysis of other parameters.

Holding impedance limits

The first step in the analysis is stating the relationship between the characteristic impedance, the conductor dimensions, and the dielectric properties of the materials (see illustrations at the left and on p. 94). The conductors are plated copper and the dielectric laminate is epoxy-glass, which has a

dielectric constant of 4.9 ± 0.4 . The approximate equation is:

$$Z_0 = \frac{60}{\sqrt{\epsilon_r}} \ln \frac{4H}{D_0}$$

D_0 represents the effective wire diameter;

$$D_0 = 0.567W + 0.67T.$$

The equation is accurate to within $\pm 10\%$ for the ratios of T and W/H used in this application. Restated, the limits are $W \cong \frac{1}{2}H$, $W \cong 4T$, and the width of the ground plane $\gg W$. Inadequacies have been found in these equations as the ratio W/H approaches unity or less. But the accuracy of the first equation has been verified by a more exact solution to the problem.²

Keeping impedances within the specified range (70-92 ohms) is of greater importance on the board than on the cards, because the lines on the board are longer. Lengths usually run up to 10 inches.

The first equation can be solved to determine how much Z_0 is affected by manufacturing variations. The equations below are the partial derivatives of Z_0 with respect to each of its independent variables. The percentage change in Z_0 for a percentage change of the variable in question, while holding the other variables at a constant value, is shown by graphs on page 94. Values chosen are

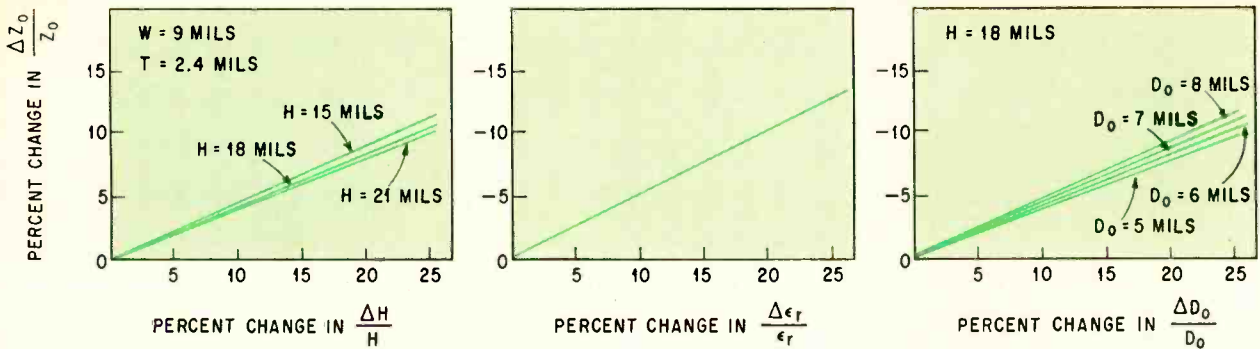

Characteristic impedance Z_0 changes with changes in dielectric thickness (left), dielectric constant of the laminate material (center) and effective wire diameter of the printed-line conductor (right).

those for a nominal SLT transmission line.

$$\frac{\Delta Z_0}{Z_0} = -0.5 \left(\frac{\Delta \epsilon_r}{\epsilon_r} \right)$$

$$\frac{\Delta Z_0}{Z_0} = -\frac{1}{\ln \frac{4H}{D_0}} \left(\frac{\Delta H}{H} \right)$$

$$\frac{\Delta Z_0}{Z_0} = -\frac{1}{\ln \frac{4H}{D_0}} \left(\frac{\Delta D_0}{D_0} \right)$$

$$\frac{\Delta Z_0}{Z_0} = -\frac{1}{\ln \frac{4H}{0.536W+0.67T}} \left(\frac{\Delta W}{W+1.25T} \right)$$

$$\frac{\Delta Z_0}{Z_0} = -\frac{1}{\ln \frac{4H}{0.536W+0.67T}} \left(\frac{\Delta T}{0.8W+T} \right)$$

Once the variation of Z_0 with laminating, etching and conductor plating is known, tradeoffs in

the electrical and manufacturing specifications can be made. For example, if the electrical design required a maximum variation in Z_0 of 10%, but this was almost entirely used up by the tolerances originally specified for H , then tighter specifications could be placed on H to give the circuit designer the required impedance.

Such analyses have revealed needed improvements in fabrication processes and are useful for instructing manufacturing personnel on the impact of their processes on the electrical design of the boards.

The investigation was carried further so that circuit designers could learn the statistical nature of Z_0 . The distributions of each variable such as line width W —that is, the extent and the frequency of the variations from nominal width—were obtained from the quality control department.

A Monte Carlo statistical analysis program was then used to solve for Z_0 , 10,000 times on a computer, using the equations for Z_0 and D_0 (the first two on page 93) and an approximation for the effec-

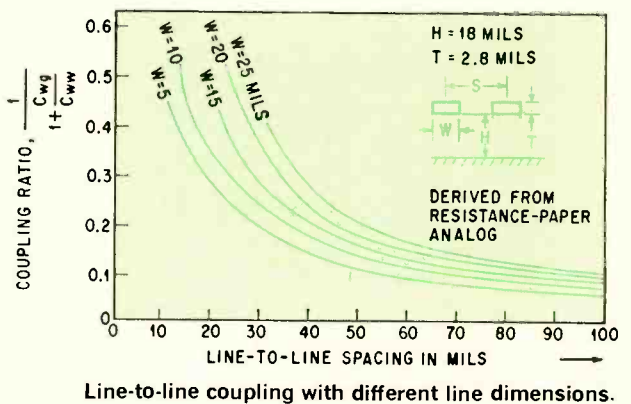
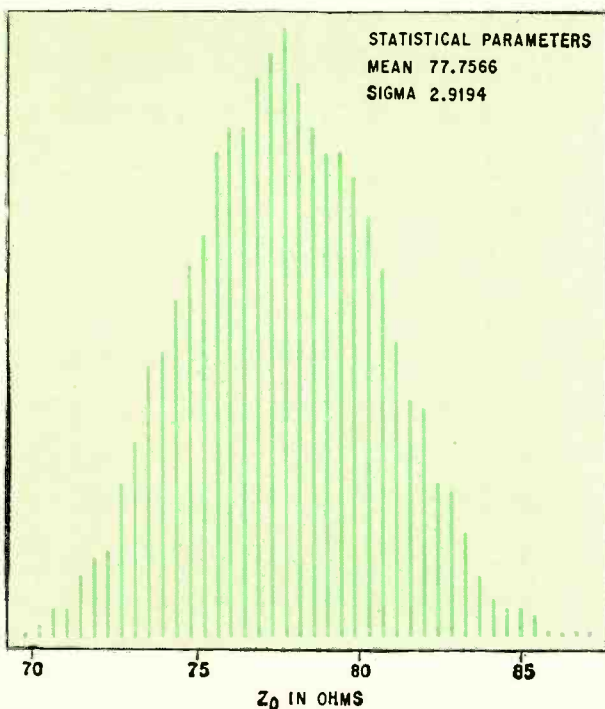

Line-to-line coupling with different line dimensions.

Distribution of characteristic impedances of 10,000 lines.

tive dielectric constant of the epoxy-glass laminate material and air. The input data was the distribution of each variable.

An example of the statistical output is given in the form of a bar chart on page 94. It can readily be used to set specification limits. In this case, the following assumptions were made:

- Distributions for T , W and ϵ_r are normal, with the nominal and ± 3 sigma limits as

$$T = 0.002 \pm 0.0007 \text{ inch}$$

$$W = 0.008 \pm 0.002 \text{ inch}$$

$$\epsilon_r = 4.9 \pm 0.4$$

- The distribution of H is rectangular, with the limits 0.017 inch and 0.021 inch.

Line-to-line coupling

Tightly spaced parallel lines (8-mil lines on 20-mil centers in SLT), do an excellent job of coupling signals with fast rise times. However, unless the amount of coupling is restricted, noise will degrade the operation of the circuits.

The amount of coupling depends strongly on the spacing between lines and their height above the ground plane. The relationship is complicated by the protective coating material on the board surface.

The mutual-inductance to inductance-ground ratio M_{ww}/L_{wg} can be determined for the given conductor geometry by measuring the open-circuit ratio C_{ww}/C_{wg} when the lines are entirely covered with the dielectric material of the base laminate. The lines are then considered to be in a homogeneous medium. Now, M_{ww}/L_{wg} is equal to C_{ww}/C_{wg} with capacitances measured in a homogeneous medium. For noise analysis, the mutual capacitance coupling must be determined with the actual thickness of the protective coating used on the boards.

The coupling ratios for lines of several widths, in a homogeneous medium, are plotted as a function of line spacing at left.

Circuit noise can be calculated, but the calculations are rigorous and beyond the scope of this article. The amount of noise depends upon the line lengths that are parallel, line-termination impedances, the magnitude and rise rate di/dt of transient currents and the rise rate dv/dt of transient voltages.

It is easier to determine actual circuit noise by experimentation, employing lines of the specific geometry to be used in the package. Maximum coupled noise for given lengths of parallel active and quiet lines can be determined. The impedances of the lines and the maximum di/dt and dv/dt are obtained from the circuit designers.

Two types of noise are possible, "far end" and "near end" (see schematic above). Usually, the designer is more concerned about the noise at the far end, since noise from various coupling sources adds up along the length of the line. The graph accompanying the schematic shows a typical plot of quiet-line noise versus parallel line length.

A line is called active when it is carrying a signal—in this case, a switching signal—from a source to

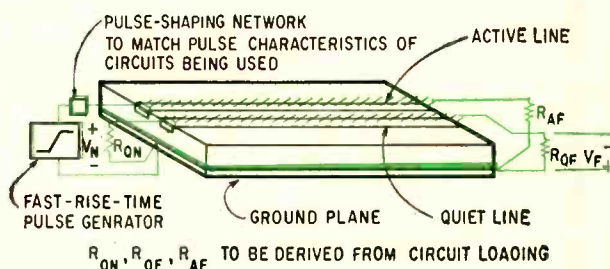
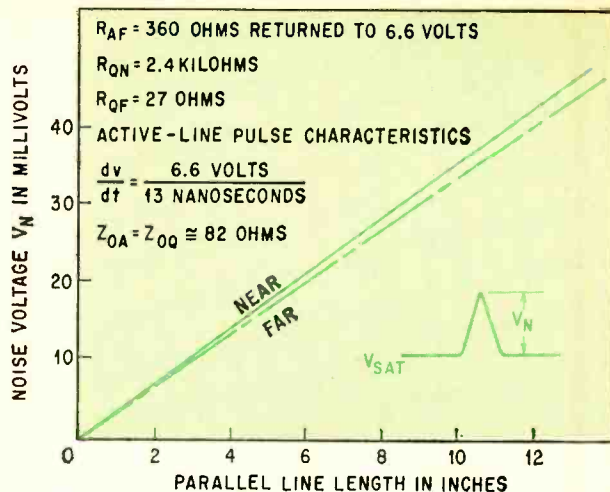

Noise schematic for parallel active and quiet lines
The graph shows the maximum positive-going (turn-on) noise for two adjacent lines on an SLT board.

a load. A quiet line is one on which no switching is taking place. A pulse picked up from an adjacent active line could make the quiet line spuriously active. When a channel contains active lines on either side of a quiet line, simultaneous switching on the active lines doubles quiet-line noise.

These analyses, when used with data on the noise-gain tolerances of the circuits on the lines, help the designer prepare wiring rules.

Line resistance and attenuation

The d-c resistance R_{dc} of a line becomes important in three instances:

- When long lengths of printed wire are used to drive logic circuits and the IR drop across the line becomes a factor in the noise-sensitivity of the circuits—that is, when the signal becomes weak compared to noise.

- When a high-power transistor is used to drive high current (0.1 to 1 ampere) to electromagnetic devices.

- When steady-state values of current cause the temperature of the line to rise above safe limits for the board materials. Such a condition could occur when signal lines are used as power distribution lines.

The lines of an SLT board, in the nominal width of 0.008 inch (8 mils), have an R_{dc} of less than 0.8 ohms per foot. The temperature of similar lines is given as a function of current in one set of curves on page 96. The other set gives temperature rises

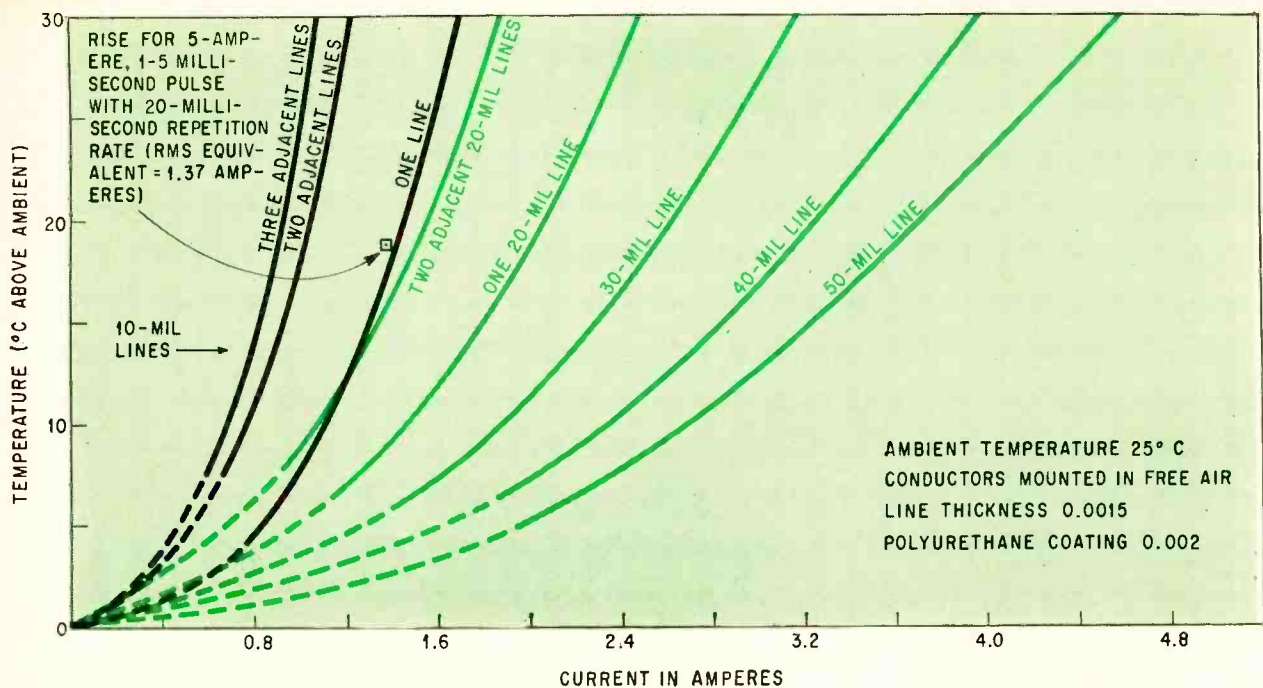

Transmission lines can distribute power, provided their temperature rise does not exceed the board-material limits. Temperature rises for lines 10 mils wide with 10-mil gaps are in black and the curves for wider lines are in color.

for wider lines. The data was obtained, under steady-state temperature conditions, with an infrared detector.

The attenuation of a printed line, α_T , is a function of frequency. It is equal to the sum of α_c , the conductor attenuation known as skin effect, and α_d , the dielectric loss of the laminate material, which is given by the loss tangent or dissipation factor.

Dielectric loss did not pose a severe problem in the SLT package because total line lengths through the system are less than three feet. A maximum dissipation factor of 0.04 was adequate for the board laminate. The measured attenuation of SLT printed lines is 0.25 decibels per foot at 60 megacycles and 0.35 db/ft at 200 Mc.

Propagation delay

Critical timing paths in a computer require consideration of propagation delay t_d . The delay can be considered in three parts: the delay of the logic block (input to output transition), the printed-line delay independent of loading, and the line delay with loading.

The packaging engineer controls the amount of delay in unloaded lines. It can be measured conveniently in nanoseconds per foot by considering

$$t_d = Z_0 C_{wg}$$

where C_{wg} is the wire-to-ground capacitance in picofarads per foot.

The average propagation time for SLT wiring is 2.1 nanoseconds per foot. Protective coating on the board increases this, however. The effect of the coating is minimal when it is thicker than 0.006 inch over the line. Up to 6-mil thicknesses, delay and Z_0 are quite dependent on thickness. The

amount of dependency is a function of the ratio of W/H and ϵ_r of the laminate.

Printed lines are not necessarily faster than discrete wiring, as shown by the following typical propagation times:

- 1.015 ns/ft in free space (the speed of light)
- 1.3 ns/ft in yellow wire with a fluorocarbon-plastic (PTFE) coating
- 1.8 ns/ft in printed lines on an uncoated, epoxy-glass board (dielectric constant of 4.9)
- 2.3 ns/ft in printed lines coated with polyurethane 6 mils thick (dielectric constant of 4.9).

However, the net effect of using printed transmission lines is that system efficiency at higher frequencies can be assured and the system can be packaged more compactly for an over-all reduction in wiring delays.

References

1. E.M. Davis, W.E. Harding, P.S. Schwartz and J.J. Corning, "Solid Logic Technology; Versatile, High Performance Microelectronics," IBM Journal of Research and Development, April, 1964.
2. V.A. Cordi, S. Kingsley and A.M. Shah, "Predicting Transmission-Line Properties of Printed-Circuit Conductor Geometry," National Electronic Packaging and Production Conference, June, 1965.

The author



In his nine years with IBM, William K. Springfield has designed test equipment, power supplies, miniaturization techniques and high-frequency packaging. Now he specifies and evaluates the electrical design of packages for high-speed digital IC's.

Signal conditioning is a push-in with these input couplers

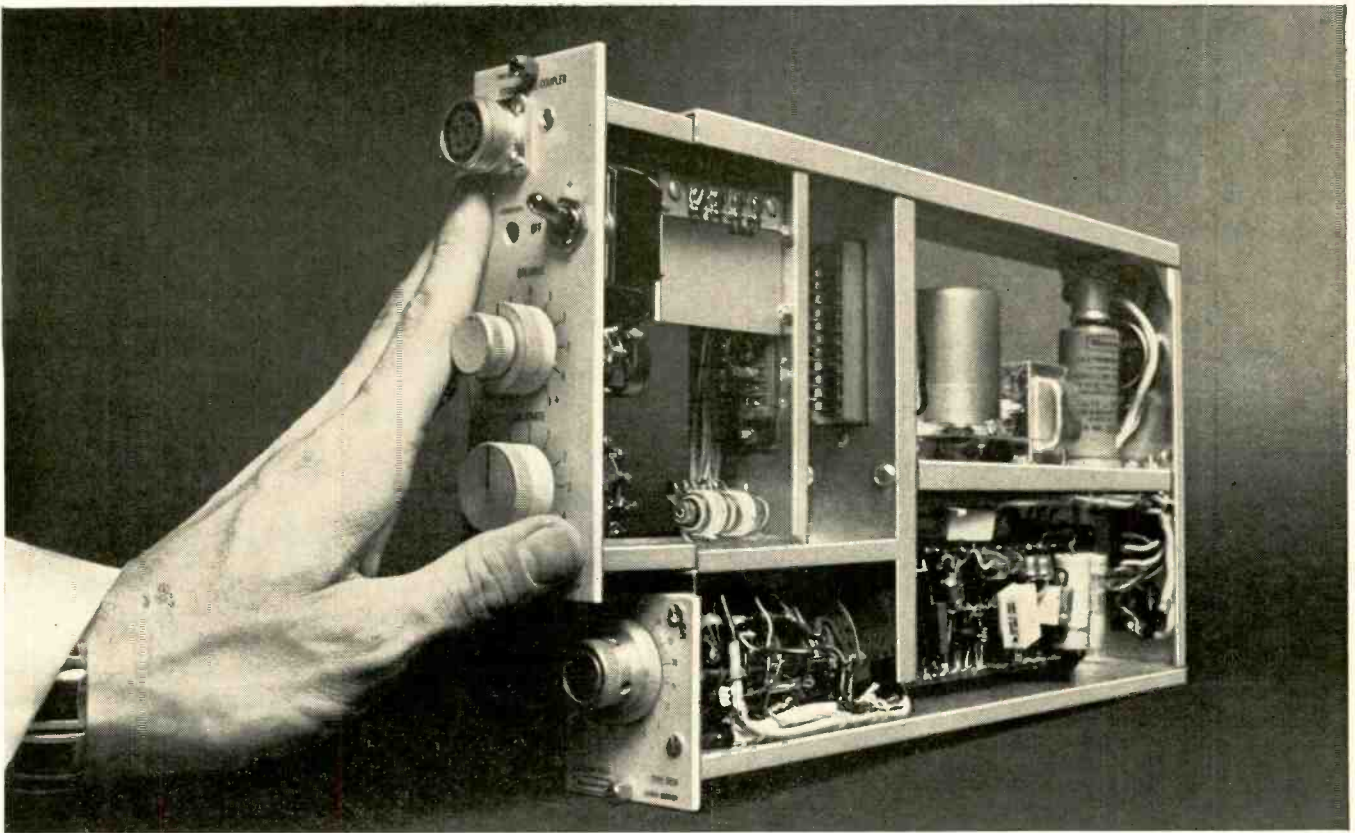
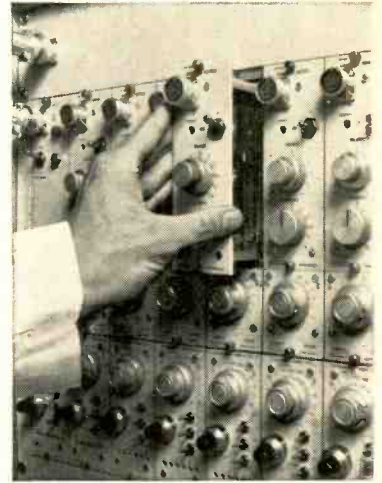

Record directly . . . strain . . . pressure . . . displacement . . . temperature . . . or any other phenomena that can be transduced into an electrical signal. The Beckman 9800 Series Input Couplers (over 30 of them) plug directly into the preamplifier in the Dynograph® Recorder, averting heavy expenditures for specialized amplifier systems when your application needs change.

Low-cost versatility . . . a simple change of couplers adapts the recorder to your particular requirement. They provide all the signal conditioning required for recording, including computation, demodulation, rectification, etc. Additionally, they supply the excitation and calibration signals necessary for many types of transducers . . . such as strain gage and reluctance gage.

Your Dynograph Recorder, with no complicated and expensive amplifier system changes, can readily meet your recording requirements today . . . and tomorrow.

For further information, including application, price and delivery, contact your local Offner Division Sales Engineering Representative . . . or write direct.

Beckman®

INSTRUMENTS, INC.

OFFNER DIVISION

SCHILLER PARK, ILLINOIS 60176

INTERNATIONAL SUBSIDIARIES: GENEVA; MUNICH; GLENROTHES, SCOTLAND; TOKYO;
PARIS; CAPE TOWN; LONDON

FOR UNLIMITED LIFE AND SUPERIOR PERFORMANCE

General Magnetiques'

"MAG MOD"[®] Micro, Miniaturized and Standard Magnetic Modulators

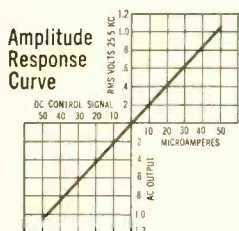

Typical Performance Data for Model 748-3

- Electrical zero point and gain, repeatability and stability over entire service life
- Extremely broad bandwidth
- Carrier frequencies as high as 1 megacycle
- Input signal current resolution better than 0.01 μ a
- Absolute reliability—unlimited life
- Repeatable data over years of continuous, unattended operation
- High shock and vibration proof
- Low milliwatt power consumption

"MAG MODS" PROVIDE FOUR QUADRANT OPERATION, extreme stability with negligible change of phase, gain and zero position over a wide temperature range. Design is simple, featherweight and rugged—with no vacuum tubes, semiconductors or moving parts to limit life.

THESE MODULATORS ARE AVAILABLE in micro, miniaturized and standard sizes depending on requirements. The micro modulators shown below are typical; for specifications on other models request catalog.

MICRO MAGNETIC MODULATORS FEATURE an essentially drift-free circuit with superior phase and gain stability over wide environmental ranges. All the ruggedness, dependability, wide dynamic range and stability that are characteristic of the larger magnetic modulators are engineered into this new magnetic circuit. MICRO "MAG MODS" are shock and vibration proof, provide infinite standby and service life.



| TYPE NUMBER | IMM 818-1 | IMM 821-1 | IMM 748-3 | IMM 800-4 |
|---|---|---|---|--|
| Reference Carrier Voltage and Frequency | 3.0 V RMS @ 63 KC | 3 V RMS @ 96 KC | 10 V RMS @ 25.5 KC | 8 V RMS @ 400 cps. |
| Input Control Signal Range | 0 to $\pm 100 \mu$ a | 0 to $\pm 100 \mu$ a (DC to 1000 Cps.) | 0 to $\pm 50 \mu$ a (DC to 2000 cps.) | 0 to $\pm 100 \mu$ a DC |
| DC Resistance of Input DC Signal Winding | 130 ohms | 150 ohms | 175 ohms | 3 Signal Windings, 5.5 K, 6.5 K, 7.5 K ohms |
| AM Phase Reversing AC Output Range | 0 to 1 V RMS | 0 to 0.6 V RMS | 0 to 1.0 V RMS | 0 to 1.0 V RMS (1% Linearity) |
| Differential Gain RMS mv. AC Output/ μ a DC Sig. Input | 10 MV RMS/ μ a | 6 MV RMS/ μ a | 20 MV RMS/ μ a | 7 MV/ μ a each winding, 21 MV RMS/ μ a all series |
| AC Output Null (Noise Level) RMS | 10 MV RMS Max. | 20 MV RMS Max. | 10 MV RMS Max. | 10 MV RMS Max. |
| Output Impedance | 5.5 K ohms | 7.5 K ohms | 28 K ohms | 21 K ohms |
| External Load | 100 K ohms | 100 K ohms | 50 K ohms | 100 K ohms |
| Excitation (Carrier Winding) Impedance | 500 ohms | 115 ohms | 500 ohms | 6 K to 8 K ohms |
| Zero Point Drift over Temp. Range Referred to DC Input Terminals | 0.2% | 0.2% | 0.2% | 0.2% |
| Hysteresis in Percent of Max. Input DC Signal | 0.2% | 0.2% | 0.2% | 0.1% |
| % Harmonic Distortion in Output Wave | 5% | 5% | 3% | 5% |
| Temperature Range | 0°C to +100°C | 0°C to +100°C | 0°C to +85°C | -55°C to +86°C |
| Frequency Response | 1000 cps. with source impedance of 1000 ohms | 1000 Cps. | 2000 cps. | 50 cps. |
| Overall Dimensions (in inches) | 0.562 x 0.40 x 0.5 | 0.562 x 0.40 x 0.5 | $2\frac{1}{2} \times 1\frac{3}{16} \times \frac{9}{16}$ | 0.5 x 0.575 x 1.175 |
| Type of Mounting | Printed Circuit Board | Printed Circuit Board | Printed Circuit Board 1/10 inch grids | Printed Circuit Board 1/10 inch grids |
| Approximate Weight (in ounces) | 0.12 ounces | 0.12 ounces | 0.3 ounces | 0.4 ounces |

The Circuit and Fundamental Principles of these Magnetic Modulators are covered by U.S. Patent No. 2758162



THERE IS NO SUBSTITUTE FOR RELIABILITY

All "MAG MODS" conform to MIL-T-27A and MIL-E 5400 Specifications

Prime Components in Solid State Design—The "MAG MOD" family of Magnetic Modulators has proven to be the most reliable module circuit block in aircraft and space vehicle flight control systems developed to date. They are universally accepted and in use in many military and commercial products where reliability is a prime factor. Request literature.

GENERAL MAGNETICS • INC
135 BLOOMFIELD AVENUE, BLOOMFIELD, NEW JERSEY 07003

RESISTOR PROVING GROUND

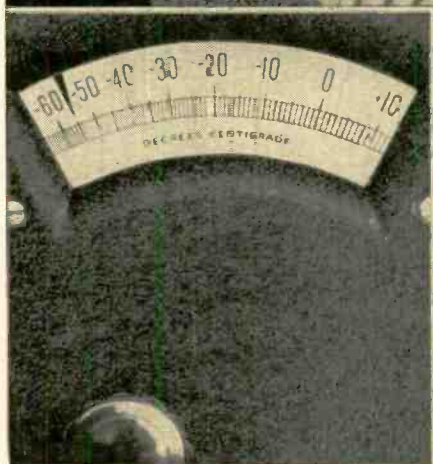

TEMPERATURE/RESISTANCE CHARACTERISTICS

Resistors are tested in accordance with the procedures of MIL-R-11. The amount of characteristic change falls well within the limits of the specifications. This test is one of many conducted in Stackpole's continual program of resistor development. Other characteristics subjected to similar testing are load life and

moisture resistance. If you have a question on some part of Stackpole's resistor development program, why not discuss it with Don Kirkpatrick, Manager-Engineering, Electronic Components Division, Stackpole Carbon Company, St. Marys, Pa. Phone 814 834-1521. TWX: 510-693-4511.



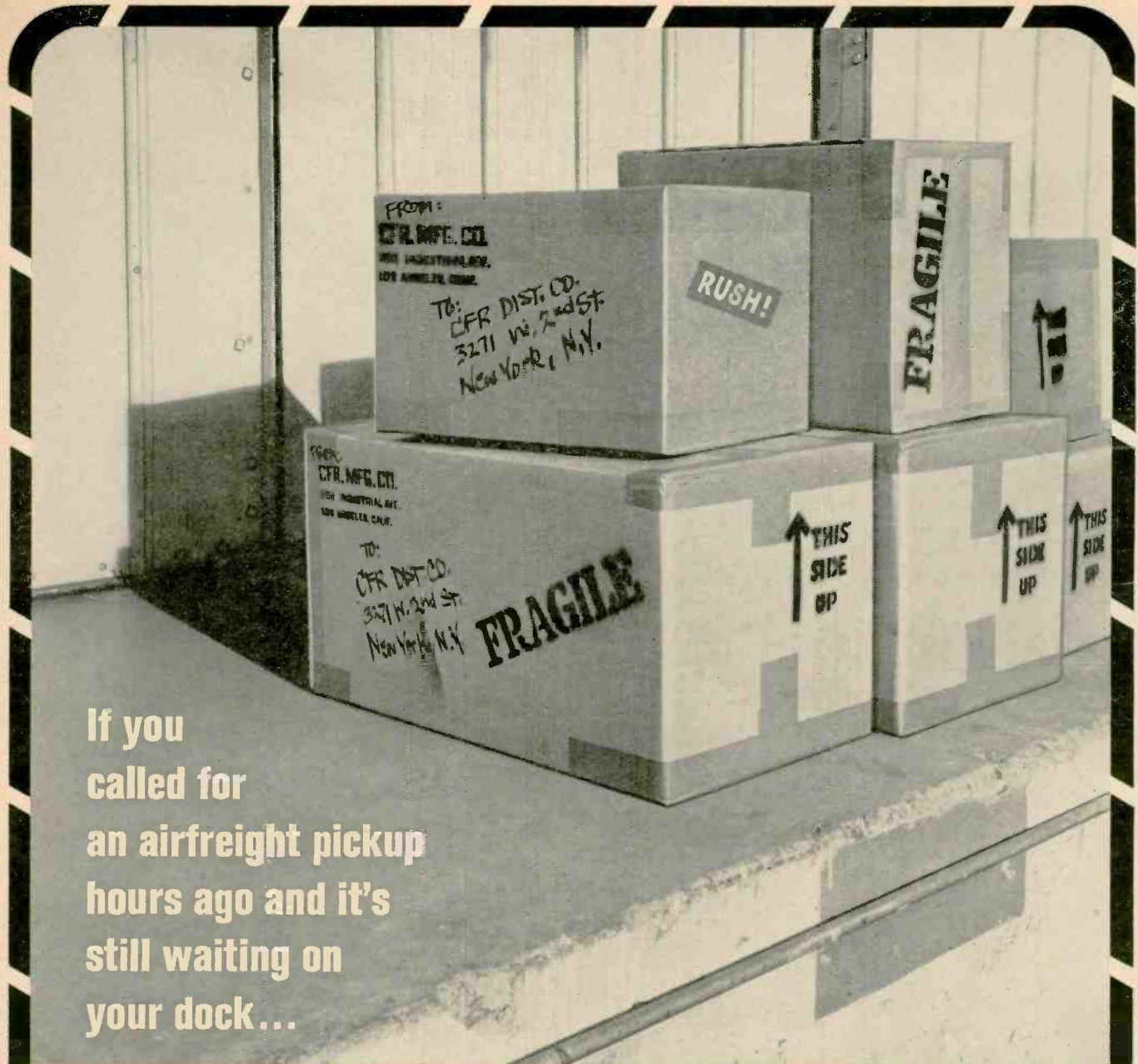

If you called for an airfreight pickup hours ago and it's still waiting on your dock...

BETTER CALL A MAN ABOUT A TIGER!

What use is fast air service if pickup and delivery on the ground bog down? Tigertrucks make *prompt* pickups—many are radio-controlled for even faster service. And Tigertrucks are on hand to speed shipments from planes to their destinations *immediately*.

Airfreight is our business. So every Tigerservice is geared to save you time, money, effort and worry. Put an end to unreliable pickup and delivery today. Call us for proof: you can't afford not to ship Tigers!

Get These Tiger Extras!

Exclusive Advance Manifest System—lets you know where your shipment is at any time and when it will be delivered ■ Only Coast-to-Coast All-Cargo Flights with Nonstop Service Both Ways ■ Swingtail CL-44s—only airfreighter that can carry single shipments up to 84 feet long.

FLYING TIGER LINE

THE AIRFREIGHT SPECIALIST



**Available Now...
A Microcircuit
Computer
for under
\$35,000**



In production. Sperry has firm orders to deliver more than 200 microcircuit computers. Worldwide acceptance of these computers insures immediate availability of replacement parts and service. A MIL-spec, stored-program advance design digital reality, the Mark XIV affords 55,500 operations per second...is light (32 lbs.), small (0.66 cu. ft.)...offers 21 bit word length, 500 kc clock rate, numerous input-output modes, 4,096-word memory core, 16,700 multiplies per second...draws less than 250 w. MTBF is 6,000 hours. Mark XIV meets environmental requirements for MIL-E-5400, MIL-E-16400. Options include increased memory sizes, test and control panel, tape reader input, and special input/output. For details, contact Marketing Mgr. (T-214) INFORMATION & COMMUNICATIONS DIVISION, Sperry Gyroscope Company, Great Neck, New York.

SPERRY
DIVISION OF
SPERRY RAND
CORPORATION



MICRO SWITCH Precision Switches



"ISX," Smallest Subminiature Switches available: Long-life, high electrical capacity. Size: .35" x .50" x .20". Variety of auxiliary actuators. SPDT. Rating: 7 amps, 115 or 230 vac; 4 amps ind. and 7 amps res., 28 vdc. Available with gold contacts for dry circuits.



"SM" Subminiature Switches: Small, light weight. 5 or 10 amp versions. Auxiliary actuators available. Size: .78" x .52" x .25". SPDT. Ratings: 5 amp "SM"—5 amps, 125 or 250 vac; 3 amps ind. and 5 amps res., 28 vdc. 10 amp "41SM"—10 amps, 125 or 250 vac; 1/4 hp, 125 or 250 vac. 5 amp version available with gold contacts.



"HM" Hermetically-sealed, Subminiature Switches: Sealed metal-to-metal and glass-to-metal. Interchangeable with other subminiature switches. High-temperature and corrosion resistant. Temperature range, -300° to +500° F. SPDT. .49" x .79" x .25". Rating: 3 amps ind. and 5 amps res., 28 vdc.



"SE" Environment-proof Subminiature Switches: Small, sealed. Temperature range, -65° to +212° F. Size: .81" x .88" x .34". Auxiliary actuators available. SPDT. Rating: 5 amps, 125 or 250 vac; 3 amps ind. and 5 amps res., 28 vdc.



1CS1 Reed Switch: For dry circuit applications requiring long life, low power actuation. Consists of low reluctance metal reeds, hermetically sealed in inert gas filled glass tube. Actuated by permanent magnet or magnetic coil. Size: .105" diameter x 1.5". Rating: .100 amp, 120 vac; .125 amp, 32 vdc.



"V3" Miniature Switches: Small, high capacity. Screw, solder or quick connect terminals. Can be gang-mounted. Integral actuators (shown) or auxiliary actuators. SPDT or SPST. Size: .74" x 1.09" x .40" (without terminals or actuator). Rating: 15 amp, 125 or 250 vac; 1/2 amp, 125 vdc; 1/4 amp, 250 vdc. Gold contact versions available.



"Z" General Purpose Basic Switches: Rigid lever ideal for slow cams and slides having low operating force. Size: 1.33" x 1.94" x .69". Variety of terminals and actuators. Rating: 15 amps, 125, 250 or 480 vac; 1/2 amp, 125 vdc; 1/4 amp, 250 vdc.



"BZ-2RDS" Basic Switches: Elastomer boot and cover seal protect against dust and moisture. Large diameter plunger and 1/16 inch over-travel. Variety of circuitry and terminals. Size: 1.94" x 1.64" x .69". Rating: 15 amps, 125, 250 or 480 vac; 1/2 amp, 125 vdc; 1/4 amp, 250 vdc.



12 MA Actuators: Fit on pin-plunger switches for pushbutton applications. Attractive black, red, and green plastic buttons in 1/2" and 1" sizes. Anodized mounting hardware.



"AC" Interlock Switches: Used on electrical or electronic equipment to cut power safely when doors or drawers are opened for servicing. Automatic reset. Size: 1.18" x 1.10" x .34".



"DM" Pushbutton Switches: Attractive, rugged snap-in panel mount. SPDT or DPDT circuitry. Three button styles, 1/2" to 1" diameter, red or black. Rating: 10 amps, 125 or 250 vac; 1/2 hp, 125 or 250 vac. Size shown: 1.85" x 1.25" x .68".



"PB" Pushbutton Switches: Snap-action button mechanism with subminiature basic switches. 2, 3 or 4 poles. SPDT. Compact. Size shown: 1.54" x .78" x .91".



"302PB" Miniature Lighted Pushbutton Switches: Occupies less than one cubic inch of space. Alternate action, momentary action, or indicator units. Long lamp life. 15 screen color combinations. Size: 1.3" x .99" x .81".



3MN Basic Switches: Two-circuit double-break for limit or control functions. Integral terminals permit gang-mounting without separate insulating barriers. Combined width of three switches, only 2.03". Rating: 15 amps, 120, 240, 480 or 600 vac; 0.8 amp, 115 vdc; 0.4 amp, 230 vdc. Size: 2.50" x 1.20" x .68".

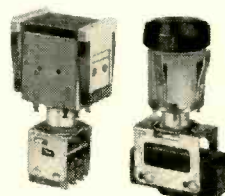

"Series 2" Modular Lighted Pushbutton Switches: Round or rectangular operator units. Maintained, momentary or magnetic pull-in action. Variety of color screens. 20 switch modules. Size: 3" x 1 1/4" x 1".



Coordinated Manual Control: Combines lighted legend display and heavy duty or electronic duty contact blocks in compact, sealed assembly. Units available—pushbutton, rotary selector, selector-push, and indicator only. Variety of color-coded displays, up to seven lines of legend. Requires only 2 1/16" x 2 1/16" panel front space.



"TS" Bushing-mounted Toggle Switches: Sealed lever and keyed bushing. Multi-circuit switching. 1 and 2 pole. Size: 2.24" x 1.13" x .63". Rating: 15 amps ind., 25 amps res., 30 vdc; 10 amps ind. and 15 amps res., 125 vac.



"1RM" Multi-pole Rotary Switches: 15 amp. capacity, up to eight switching units. Two-position switches are standard—up to eight positions available. Gold-contact and hermetically-sealed assemblies available. Size: shown: 2.5" x 1.6" x 1.5".



Mercury Switches: Offer reliability in contaminated atmospheres. Many sizes, capacities, and operating characteristics. Hermetically sealed glass tube. Enclosed switch shown: 1.88" x .53" diameter.



Pre-engineered Electronic Switch-circuit Packages: Eliminate need for custom circuits. Size shown: 3.22" x 1.04" x .75".

Variety gives you the best chance to avoid compromise

A quick glance into the MICRO SWITCH line helps you find an economical off-the-shelf answer to most any switch problem—whether it involves space or weight limitations, circuitry, actuation, environment, indication, reliability, or any of the other countless switch requirements. Most every time you avoid the special you may have thought necessary. The MICRO SWITCH line is that extensive and is continually expanding with new developments. A few of the hundreds available are shown above.

For information on the switches shown or any others, call a MICRO SWITCH Distributor or a Branch Office (See Yellow Pages). Or, write for catalogs.



MICRO SWITCH
FREEPORT, ILLINOIS 61033
A DIVISION OF HONEYWELL
IN CANADA: HONEYWELL CONTROLS LIMITED, TORONTO 17, ONTARIO

GAF introduces the answer to cardboard...

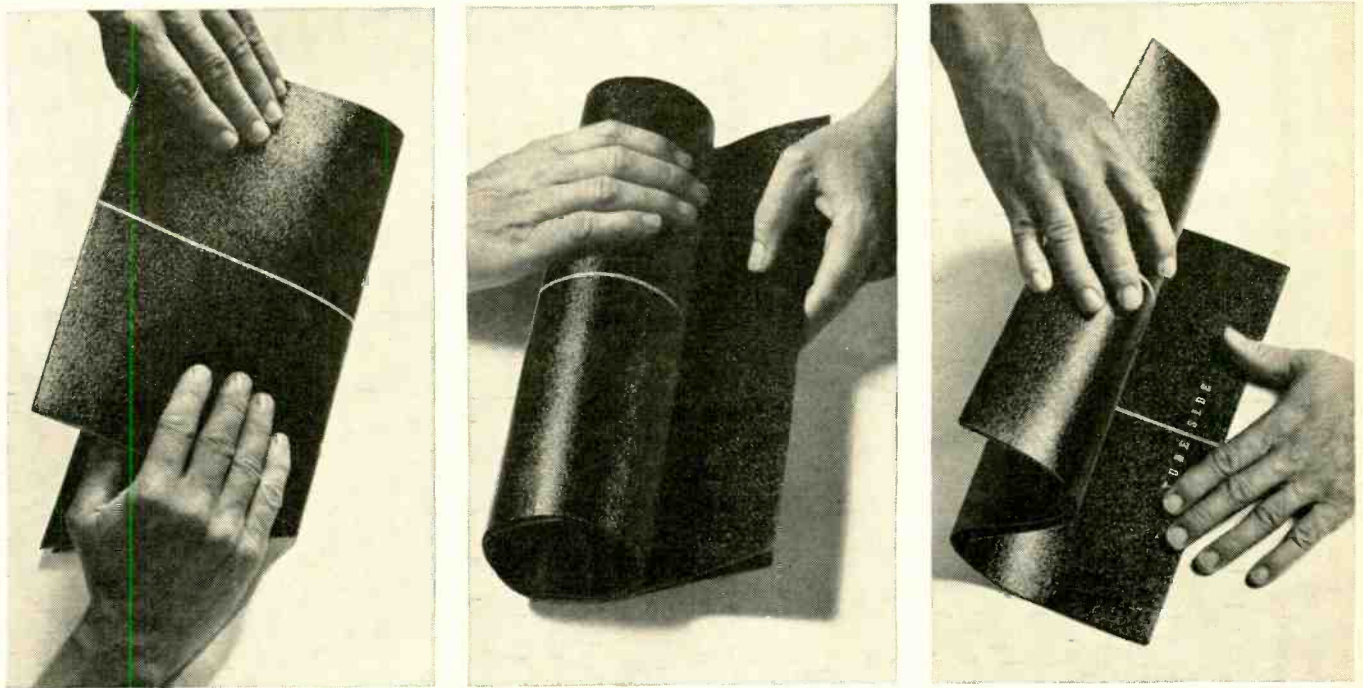

the new vinyl-impregnated ANSCOFLEX* x-ray film holder

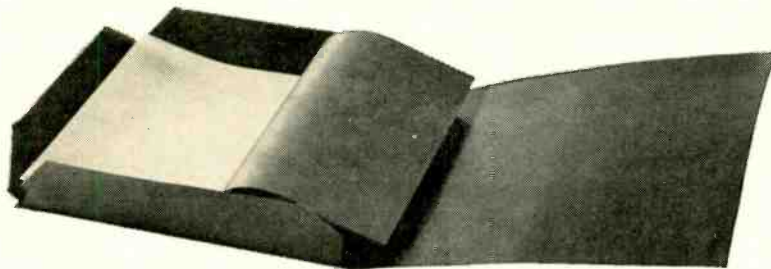

Bend it. Roll it. Twist it. ANSCOFLEX x-ray film holders are flexible enough to wrap around the smallest diameter without damage to the film or holder.

ANSCOFLEX holders are vinyl-impregnated. That means they're durable and moisture proof. Resistant to stains, scratches and abrasions. Dust particles cannot be imbedded to obscure the detection of flaws. Easily cleaned with a damp cloth.

ANSCOFLEX holders stand up under severe lab or field conditions. Last considerably longer than cardboard holders, with substantial savings to you. They are available in ten standard sizes, from 4 x 5 to 14 x 17 inches. For complete information about new ANSCOFLEX holders for industrial radiography, send the coupon.

*Trademark of General Aniline & Film Corporation.

gaf

GENERAL ANILINE & FILM CORPORATION

140 WEST 51 STREET · NEW YORK 10020

Customer Services
Industrial X-ray Department E-111

Please send me additional information about your new ANSCOFLEX x-ray Film Holder,

Name _____

Title _____

Firm _____

Address _____

City _____ State _____ ZIP _____



GENERAL ELECTRIC

Who put the "Cad" on TV?



New Cerro Cadmium Bell Anodes — more "throwing" power — better, faster plating.

Leading television and stereo set manufacturers did it!

They use cadmium plating on chassis and vital components for superior corrosion resistance and sales-stimulating eye appeal. Cadmium plating is also specified on military-grade gear which must operate reliably in environments that would humble other platings.

Leading fastener manufacturers, too, feature cadmium plating — both they and their customers know its intrinsic value.

Cerro produces quality cadmium high in the Peruvian Andes . . . and availability is excellent. To find out more about Cerro cadmium or the other high-purity, nonferrous metals we produce, contact us.

CERRO SALES CORPORATION

SUBSIDIARY OF CERRO CORPORATION

300 Park Avenue, New York, N.Y. 10022

CERRO

Report from

**BELL
LABORATORIES**

New circuits for communications

The success of a modern large-scale communications system depends importantly on the circuits of which it is built. For this reason Bell Telephone Laboratories places great emphasis on exploring new approaches to high-performance, economical circuit design. The circuits illustrated below are but a few examples of recent Bell Laboratories developments that are helping to advance the techniques of communications.

Bell Telephone Laboratories
Research and Development Unit of the Bell System

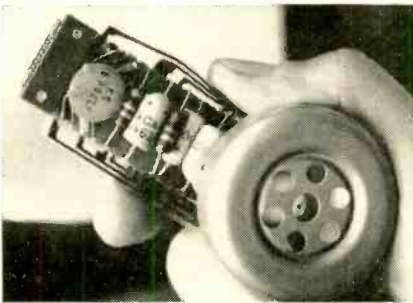

Circuit for mounting inside telephone handset for use by people with impaired hearing. Circuit includes one PNP transistor, provides up to 25 db gain, and has negative feedback for stability and to compensate for variations in component characteristics. Power is derived by taking a small part of direct current supplied to the telephone transmitter. Circuit board is flexible to permit part of conducting path to be bent and entire unit to fit snugly in narrow handset.

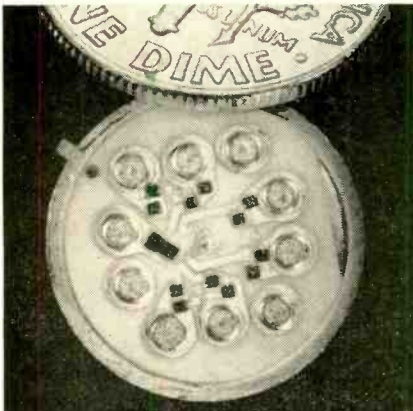

High-speed integrated logic package consists of 3 separate flip-flop circuits assembled together on a single header. On the 11-lead ceramic header, all circuit interconnections are made using gold thermo-compression bond wires. This device contains 6 transistors (2 are required for each flip-flop) and 12 resistors. The individual flip-flops perform their switching functions with typical operating times of approximately 6 nanoseconds.

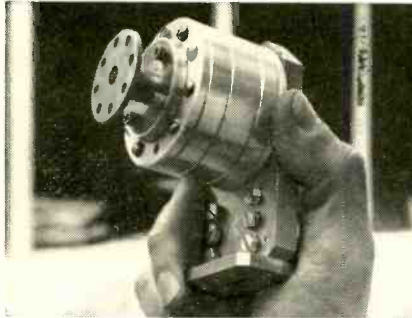

Parametric amplifier used in new microwave radio system will provide low-noise amplification to a radio frequency signal which is frequency-modulated by 1200 telephone conversations. It is a reflection type parametric amplifier operating in the 4-gigacycle range, providing approximately 13 db of gain using a varactor diode pumped at approximately 12 gigacycles. Its very low noise figure, typically 3.5 db, permits increased systems capabilities which are used to increase the number of telephone channels per radio channel.

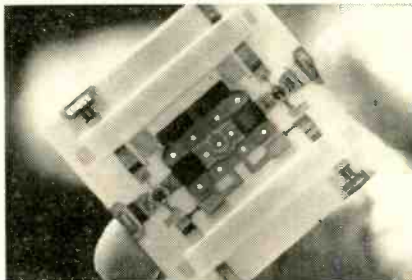

Integrated balanced microwave amplifier makes use of high-frequency germanium transistors for precise wideband applications. Each stage of amplifier (one stage shown) consists of a pair of electrically similar transistors whose inputs and outputs are combined by 3-db couplers. This arrangement eliminates tuning adjustments and provides excellent gain flatness and impedance matching. Multistage amplifiers of this type have been designed to operate with bandwidths of 1000 mc in the 0.5- to 3-gigacycle range, with noise figures of about 6 db.

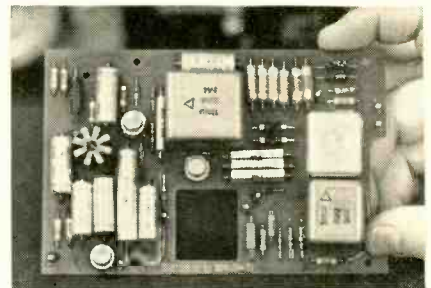

Compressor circuit used in several telephone carrier systems raises volume of soft voice sounds and lowers volume of loud voice sounds. This new circuit effects a 2-to-1 reduction in dynamic range of a telephone signal, which is then transmitted with an improved signal-to-noise ratio. Nearly perfect compression is achieved over greater than the normal voice range, as a result of circuitry that varies the impedance of two precise silicon diodes. A 3-stage feedback transistor amplifier maintains desired stability and provides the required transmission characteristics.

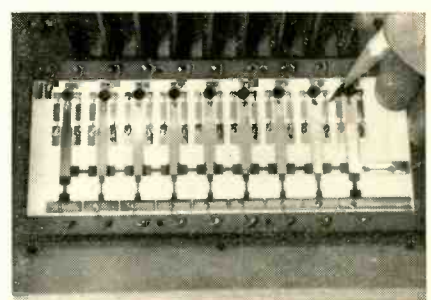

Thin-film decoder for high-speed pulse code modulation systems converts binary pulse sequences into analog signals. Circuit consists of precision resistor network and multiply-encapsulated control diodes. Precision resistors (pointer) generate reference currents that are switched into resistive ladder network (I-shaped elements at bottom of unit). Output voltage is proportional to binary code applied to diodes. Precision sufficient for decoding 9-digit binary codes is obtained, at code rates up to 12 mc (108 mb/s pulse rates).

New low-cost Daystrom Model 333 commercial trimmer has knurled finger-tip adjustment knob. It also has an Allenhead for fine adjustment . . . 4 to 1 ratio, nominal. Designed for PC board use, it requires approximately 1/2 cubic inch of space. Price is another unusual feature — only \$1.45 in 100 lot quantities!

Model 333's unique resistance element is the same as used in MIL-type Squaretrim® pots. Thus, it provides high resolution, linearity, and low noise. In addition, it is vibration and shock resistant.

This is just one of the special-purpose Daystrom units—from industry's broadest line of subminiature square-trimming potentiometers. Chances are that we can fill your most exacting requirements with a standard, off-the-shelf model.

Weston, originator of the Squaretrim pot, celebrates its tenth year of experience in this field. See your Weston distributor for catalog, prices and evaluation units. Weston Instruments, Inc., Archibald, Pennsylvania 18403. Phone: (717) 876-1500. In Canada: Daystrom Ltd., Cooksville, Ont.

From Weston's broad trimmer line



Model 333 — 1/2" by 3/16" by 3/16". Dual adjustment: knurled finger-tip knob and Allenhead. For PC board mounting. Resistance: 50Ω to 10k, up to 50k on special order. Rating: 0.2w @ 40°C in still air.

actual size



Series 200 — 3/8" Squaretrim, 0.150" thick, slotted or Allenhead adjustment screws. This is only one of a full line of 3/8" pots. Operation: from -55 to 150°C. Resistance: 10Ω to 50k. Rating: 1w @ 50°C in still air.

Only Weston's exclusive wire-in-the-groove offers **LOCKED-IN LINEARITY**

**let your
fingers
do the
trimming**

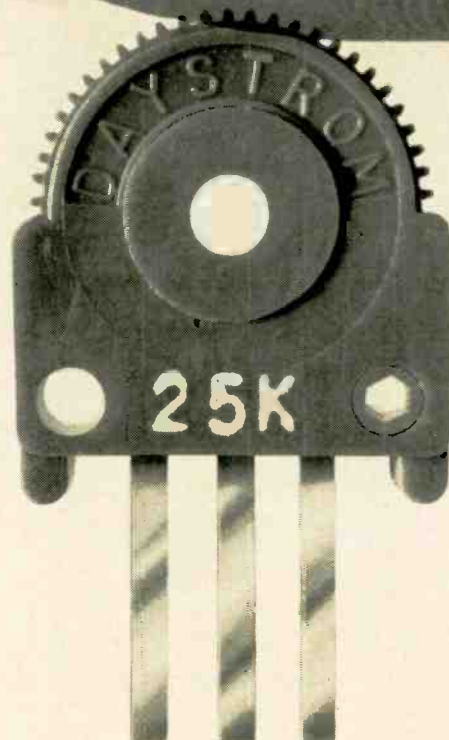

QUALITY BY DESIGN
 **WESTON INSTRUMENTS, INC.**
 Archibald, Pennsylvania 18403

30-DAY FREE TRIAL

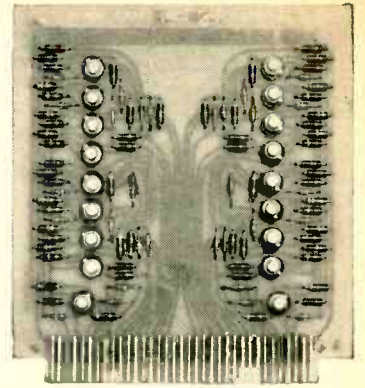

EVALUATE SPACE CRAFT'S 1Mc LOGIC CARDS

Gentlemen:

I hear you've had remarkable success in producing competitively priced logic cards with optimum function groupings that minimize system wiring. I'd like to have the following card(s) for a 30-day free shakedown in my lab:

- | | | |
|---|--|---|
| <input type="checkbox"/> NAND-2Z: 6 two-input NANDS 3 three-input NANDS | <input type="checkbox"/> OR-2Z: 6 three-diode clusters 2 two-diode clusters | <input type="checkbox"/> ULC-2Z: 6 Schmitt trigger / buffer amplifier circuits for universal level control |
| <input type="checkbox"/> NOR-2Z: 5 two-input NORs 3 three-input NORs | <input type="checkbox"/> UFF-2Z: 4 universal Flip-Flops | <input type="checkbox"/> ND-2Z: Nixie Driver, 4-line input, 10-line output |
| <input type="checkbox"/> ADD-2Z: 4 half-adders 2 two-input NANDS | <input type="checkbox"/> SFF-2Z: 3 shift register Flip-Flops | |
| <input type="checkbox"/> AND-2Z: 6 three-diode clusters 2 two-diode clusters | <input type="checkbox"/> OS-2Z: 4 one-shot multivibrators | COMMON SPECIFICATIONS: Temperature, 0 to +50° C Power supply, +6, -6, -15 VDC Connector, 35-pin Elco Varicon Operating freq., DC to 1 Mc |
| <input type="checkbox"/> RD-2Z: 8 relay drivers | <input type="checkbox"/> MV-2Z: 2 multivibrators | |
| | <input type="checkbox"/> CD-2Z: 8 capacity drivers | |

Name _____ Title _____
 Company _____
 Address _____
 City _____ State _____ Zip _____

SPACE CRAFT, INC.

8620 SOUTH MEMORIAL PARKWAY • HUNTSVILLE, ALABAMA 35802



CEC Announces the VR-3800

**A modestly priced six-speed
switchable tape transport...with
six-speed switchable electronics**

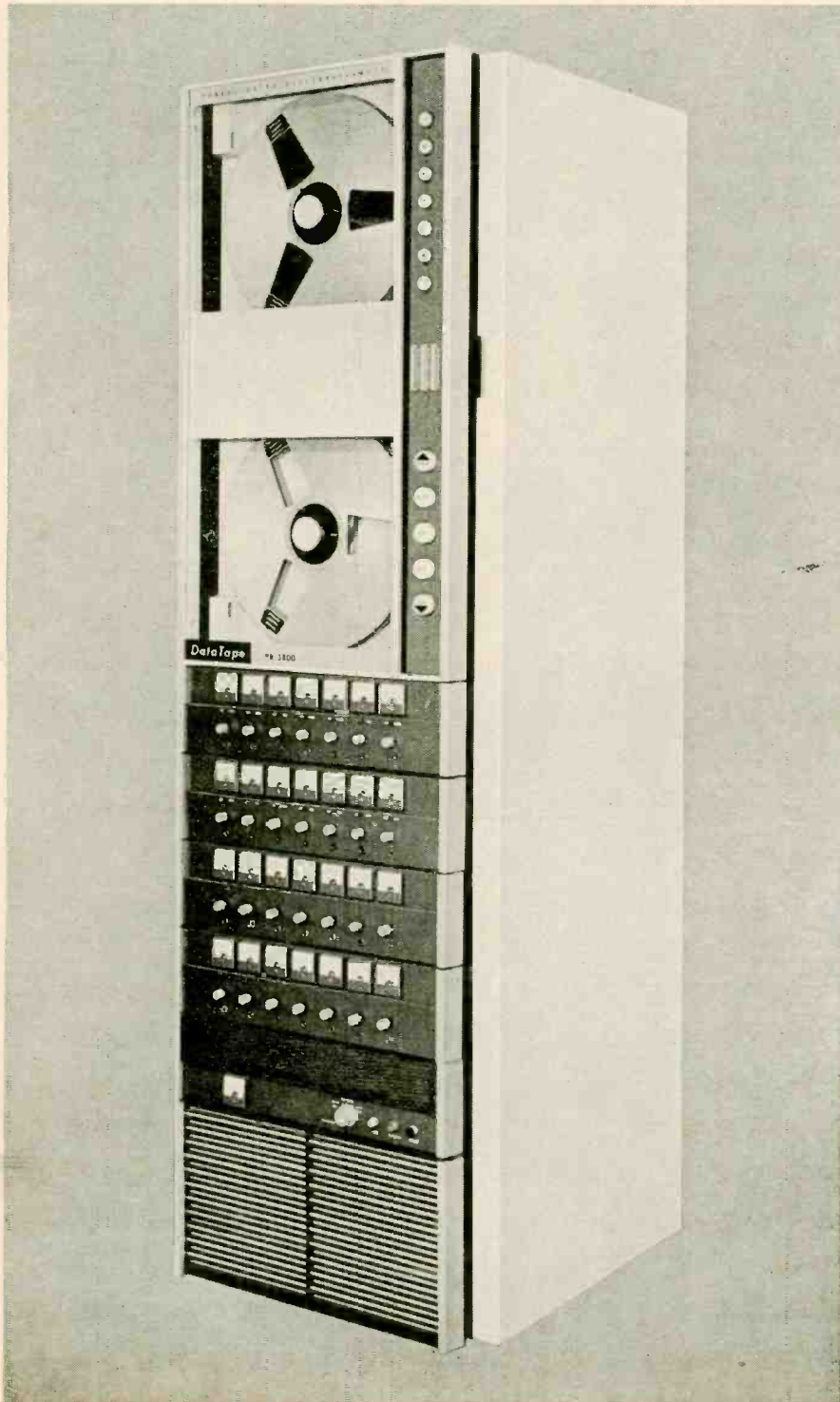

CEC's VR-3800 is the precise answer to a long-felt need. Namely, a magnetic tape recorder/reproducer that offers the basic advantages of CEC's top-rated systems at a *modest price*.

To users in most lab environments, this adds up to one important fact. The new VR-3800 is destined to become the work horse of midband recorders. For here is a recorder that is competitive in price with 100 kc class instruments, yet records up to 300 kc at 60 ips with unsurpassed reliability.

The VR-3800's outstanding features include:

- Six speeds to 60 ips; both transport and electronics electrically switchable. Speed sensitive plug-ins available for any number of transport speeds required. Buy only those you need, and save!
- Seven or fourteen channels may be used for data storage in the d-c to 300 kc frequency range.
- Extended wideband FM offers d-c to 40 kc at 60 ips. Standard FM from d-c to 20 kc at 60 ips.
- Longer lasting recording heads — smooth all-metal-front-surface design lasts up to 6 times longer than conventional heads, and reduces cleaning to a minimum.
- Record and reproduce amplifiers are solid-state, and the direct system is fully amplitude- and phase-equalized at all speeds, providing optimum square wave response.
- Signal-to-noise ratio is the highest; distortion the lowest.
- Tape tension constantly controlled by closed-loop servo control.
- Easy handling dynamic braking used exclusively. Fail-safe mechanical brakes used only when tape motion is stopped or power fails.

And—since all components are designed and manufactured by CEC, users realize the additional advantage of single-source responsibility.

For complete information about the VR-3800, call CEC or write for Bulletin 3800-X8.

CEC

Data Recorders Division

CONSOLIDATED ELECTRODYNAMICS

A SUBSIDIARY OF BELL & HOWELL/PASADENA, CALIF. 91109
INTERNATIONAL SUBSIDIARIES: WOKING, SURREY, ENGLAND
AND FRIEDBERG (HESSSEN), W. GERMANY

Probing the News

Space electronics

Space tracking in the 1970's

As traffic in outer space gets heavier, automation is inevitable; ground station operators and their manual equipment are already beginning to feel the strain of keeping up with mountains of data

By Warren Burkett

Washington News Bureau

Every 104 minutes, the small crew on duty at the National Aeronautics and Space Administration's satellite tracking station near Rosman, N. C. turns one of the station's two 85-foot parabolic antennas and one of the two yagi arrays to the northern horizon to wait for the appearance of Pogo, the Polar Orbiting Geophysical Observatory.

For the first five of the 30 minutes Pogo will be within "view" of the station, the yagi array follows the satellite, getting warmed up to issue it commands. Besides ordering Pogo to begin dumping its stored data—at the rate of 128,000 bits per second—to the waiting 85-foot receiving dish, the yagi has 297 other commands it can make. It tells Pogo what to turn on and what to turn off; it activates or deactivates certain of the 20 experiments aboard, which are measuring such phenomena as the geomagnetic field, solar ultraviolet and x-ray emissions, charged particles dumped from the radiation belts into the auroral zones, and the earth's airglow.

Meanwhile, another crew is working the other 85-foot dish. It may be tracking the Orbiting Solar Observatory (OSO) or the SN-39, a Defense Department satellite.

At a console in another building, a third team may be using the second yagi array as a telemetry receiver to monitor and record signals from satellites such as NASA's two

Relay communications satellites, Canada's Alouette, Britain's Ariel, and the host of NASA's scientific Explorer satellites.

Now, NASA's scientific ground stations called Stadan, for space tracking and data acquisition network, are handling two and three, or sometimes four, satellites at once, 50% of the time. At present the 16 Stadan ground stations are supporting 23 NASA satellites and six put up by the Department of Defense.

Besides the 16 Stadan stations that support scientific and applications satellites—those for weather, communications and navigation—there are four Deep Space Instrumentation Facility stations, and 19 for manned flights.

1. More and better facilities

Over the next ten to 15 years, all these stations must be upgraded. According to Robert Stephens, chief of advanced tracking systems in NASA's program support and advanced systems division, there will be more missions, the spacecraft will be bigger and more elaborate, requiring more exchange of data, and the functions of each station will be broadened. Facilities for unmanned deep space probes, for example, will also have to work with the manned Apollo mission to the moon. Apollo S-band stations will, in turn, have to support unmanned moon missions and pos-

sibly interplanetary probes. Data from scientific experiments on manned orbiting laboratories might be fed to stations in the Stadan network.

With present facilities, one big mission ties up the whole network. "You might say we turn off the rest of the world when a big mission is on," Paul Barritt, staff scientist in the advanced program support division, said. One manned flight strains men and machines on the entire manned network and one Ranger flight to the moon monopolizes all the deep space stations.

Even a not-so-spectacular project like the Eccentric Geophysical Observatory uses a lot of telemetry equipment. EGO ties up five receivers, two data processing computers, three recorders, and two data transmission links.

Traffic in outer space. In time, the luxury of being able to turn off the world won't exist. There will be too many important missions going at the same time. By 1980, NASA may be flying Apollo applications ships around earth or in synchronous orbits, ferrying men and machinery to laboratories on the moon, supplying the manned orbiting laboratory, and sending men to Mars and beyond.

Unmanned probes will orbit the moon, Voyager will explore Mars (see page 118) and other space vehicles will go to Jupiter and Saturn. Advanced orbiting solar observa-

No amplifier needed with Vernistat[®] a.c. pots

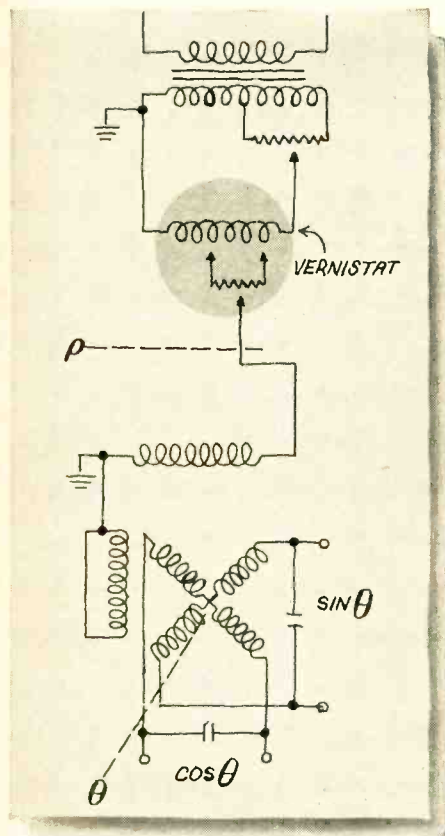

You don't need a buffer amplifier to drive a servomechanism—if you use a Vernistat a.c. potentiometer. It has an output impedance low enough to drive a resolver or other low input impedance device directly. Use an a.c. potentiometer to simplify circuits, improve reliability, gain greater accuracy and reduce circuit costs. For full information and data sheets, write to Electronic Products Division, Perkin-Elmer Corporation, 751 Main Avenue, Norwalk, Connecticut.



PERKIN-ELMER

tories and a synchronous solar observatory will watch for the beginning of solar storms. And for other government agencies, a number of applications satellites will make geological resource surveys, maps for the Coast and Geodetic Survey, and forecast the outcome of crops for the Department of Agriculture.

Tracking facilities for all these missions will have to be built and upgraded.

Improvement is needed in four areas, Stephens said: station turnaround time, the quality of target acquisition and telemetry, faster data reduction, and more programmed command and control.

II. Station turnaround

The time needed after one satellite has passed over to get ready for the next one—manned or unmanned—is far too long. If one hour could be trimmed off the pre-flight and postflight checkout time, it would be a great help, operations personnel say.

Stadan is already beginning to feel the pinch. Its stations have only minutes to switch telemetry receiving frequencies, recorders, and other equipment after supporting an American satellite, for example, to monitor an Italian, Canadian or another American one. One time there were 35 satellites transmitting to Stadan stations simultaneously.

Harold L. Hoff, chief of network engineering and operations at the Goddard Space Flight Tracking Center, Greenbelt, Md., says Stadan is managing to keep up, but probably will be saturated in a few years.

Pressure on the manned spaceflight network is also increasing.

Technicians at Stadan station in Santiago, Chile, are now beginning to get more satellite data than they and their present equipment can handle. The answer is automation.

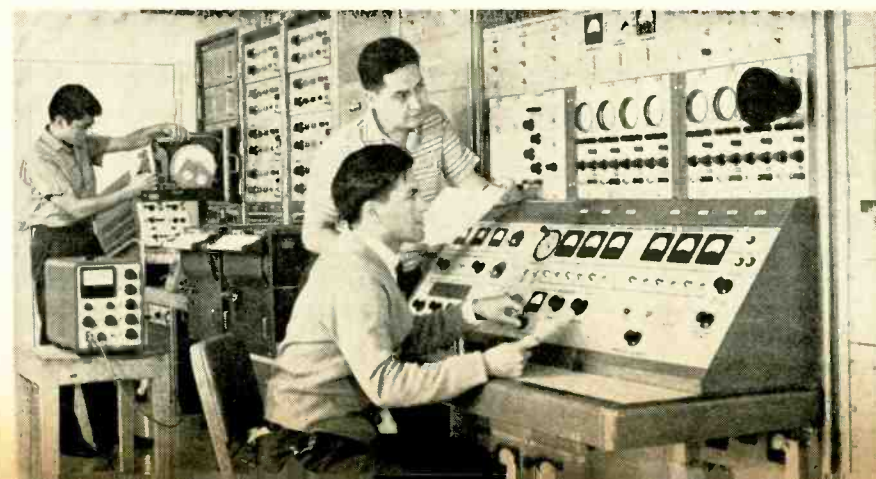

The rapid launching of Gemini spacecraft now leaves a minimum of time to make repairs and tune the stations from one Gemini shot to the next.

Automation. The answer, Stephens says, may be automation. Automatic checkout equipment might do the job, or at least warn station operators that there isn't time to complete changeover.

Goddard has a system it uses for the manned network that will automatically check out the status of each subsystem in a station. Readings on each subsystem are fed into a 7094 computer where they are matched against the correct readings. But this is as far as it goes. Stephens would like a system that would go beyond Goddard's; one that would first reorient a station for the next satellite, changing the frequencies and setting up the other equipment; check the status of subsystems; then isolate the malfunctioning components and indicate needed repairs.

III. Tracking

Automation is needed for the basic business of tracking the spacecraft, too Stephens said. Present systems require the operator to point the antennas manually to positions indicated by predicted flight paths or to use autotrack systems, which sense a weakening telemetry signal and jerk the antenna forward. With autotrack, however, data may suffer from signal impairment, Stephens said, and operators must search manually for the satellite.

A tumbling satellite or one that is poorly stabilized in the horizontal and vertical direction presents another tracking problem. The horizontal and vertical components



Cinch improvements in .045" square tail hermaproditic contact design

PROVIDE THE TAIL STABILITY
YOU NEED FOR AUTOMATIC
WIRE WRAPPING

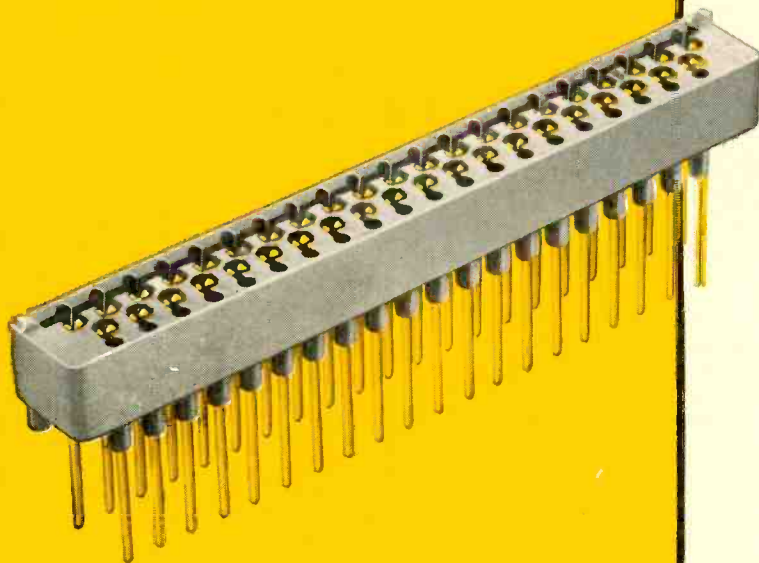

INTERMATEABLE WITH ELCO'S PRODUCTS
SOLD UNDER ELCO'S TRADEMARK "VARICON"

The outstanding reliability and popularity of Cinch's hermaproditic printed circuit connectors* has stemmed from the fork-like design of the engaging or mating section of the contact. Now CINCH has improved on the terminating section, to assure the rigidity and stability required for programmed wire wrapping. The entire contact provides a single one-piece thickness construction for optimum durability and performance.

The contacts are available individually in bulk for mounting in P.C. boards or in molded insulator as shown.

Complete technical and application data on these new Cinch connectors is given in our Bulletin PBM-66, available from your local Cinch sales office or by writing to Cinch Manufacturing Company, 1026 South Homan Avenue, Chicago, Illinois 60624.

*Manufactured under license agreement with Elco Corporation.

CM-6513



CINCH

DIVISION OF UNITED-CARR

NCR is moving fast in worldwide business automation.

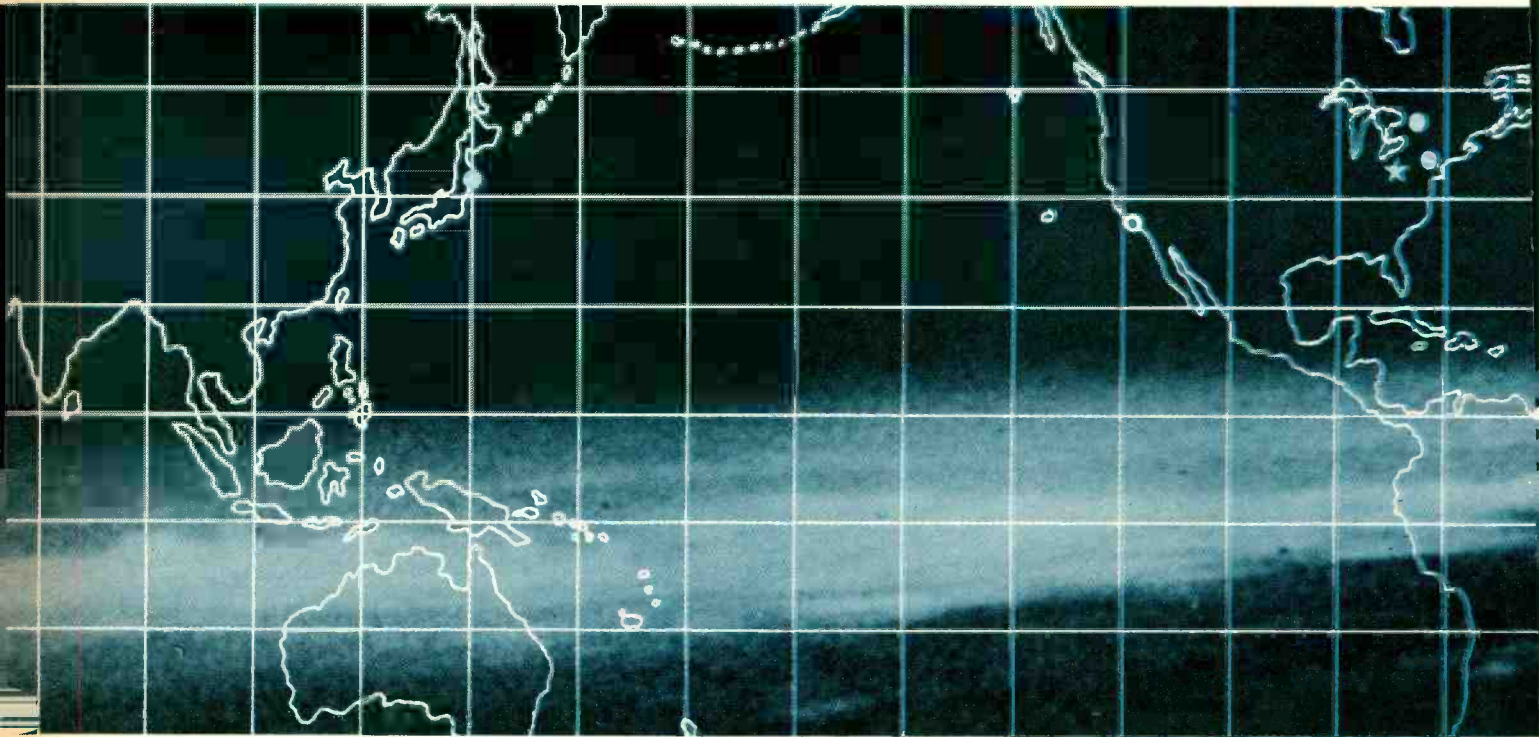

How about you?

Does your future in digital systems look distant or uncertain? At NCR Electronics Division in Los Angeles—one of 12 major NCR facilities throughout the world—the Computer Era is a reality *now*. NCR sales of advanced EDP hardware in more than 120 countries tell you that this Division is as successful as it is creative. Join the men who developed CRAM, the NCR 315 RMC Rod Memory Computer and the 420 Optical Journal Reader—and share in their next success. Your future can start *today* at NCR.

ADVANCED PRODUCT PLANNING SPECIALISTS

To work in advanced product planning group responsible for determining and analyzing requirements of new product markets, recommending product development programs needed to promote new ideas, formulating and specifying new products based on state-of-the-art and beyond-the-state-of-the-art hardware, software, and application concepts.

Ability to deal with "total systems" concept in a business data processing environment is essential. Specific experience in such areas as time sharing systems, multi-processing, data transmission technique, programming language design, list processing, and information retrieval is desirable.

Requires a broad background in business data

processing systems with a minimum of eight years of hardware and software systems design experience. Advanced engineering or science degree desirable.

ADVANCED MECHANISMS SPECIALIST

For analysis and design of complex computer mechanisms. Must have knowledge of applied mechanics and high-level mathematical ability. PhD required.

MAGNETIC RECORDING SPECIALISTS

Senior and intermediate positions for men with experience in advanced magnetic recording techniques. Knowledge of media, circuitry and magnetic head design necessary. Requires BS in engineering or physics.

ADVANCED MEMORY-RESEARCH SPECIALISTS

Positions require MS in EE or physics and previous experience with nanosecond pulse technique and high-speed applications of magnetic cores or thin films to memories with computer systems logic and hardware.

ADVANCED SYSTEMS SPECIALISTS

Senior-level positions in advanced logic, circuitry, and memory development and preliminary design of beyond-the-state-of-the-art data processing equipment. Considerable experience

required in the over-all system design and integration of commercial computing equipment. BSEE required with advanced degree highly desirable.

ELECTRONIC PRODUCT ENGINEERING

Positions require a BSEE degree with experience in designing digital computer equipment and in maintaining liaison with manufacturing.

PACKAGING

Positions entail layout and design of packaging for computer systems. Applicants must have previous experience with electronic computers or electro-mechanical devices. Background in miniaturization utilizing thin films and integrated circuits is desirable. BSEE required.

SOFTWARE PROGRAMMING

Positions entail development of software for various computer input/output routines, operating systems and monitors. Applicants must have previous programming experience with machine language on a large file computer.

DESIGN AUTOMATION PROGRAMMING

Positions require previous experience in programming for design automation, good understanding of engineering and hardware problems, and BS degree in math, engineering or related field.

SYSTEMS FORMULATION

Positions available at all levels to study and formulate systems for commercial and industrial on-line computer applications, with emphasis on communications interface. Requires a minimum of two years' experience in specifying or programming real-time systems for banks, airlines or industry. A degree in engineering, business administration or related field is required.

LOGIC DESIGN

For design of advanced integrated-circuit computers. Requires BSEE and 2 to 5 years in logic design with emphasis on processor and floating-point design.

POWER SUPPLY DESIGN

Power supply specification and design, including determination of power-sequencing requirements. Requires BSEE and 3 to 5 years' experience in worst-case circuit design, with emphasis on design of solid-state power supplies.

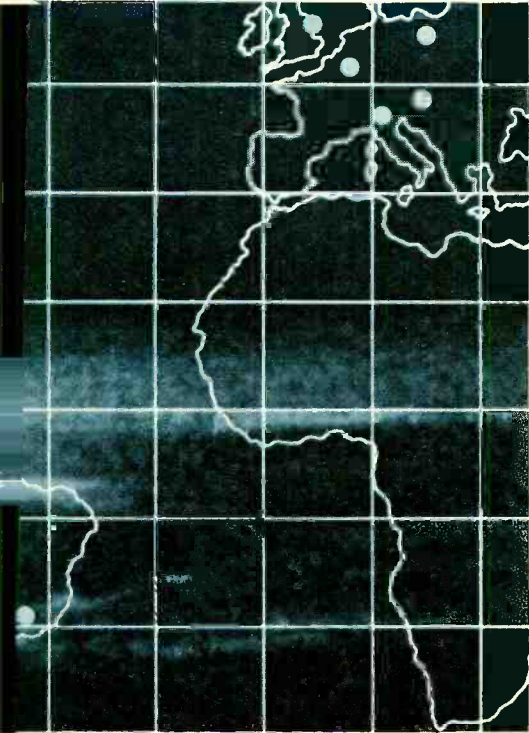

MECHANISMS DESIGN

These senior-level positions entail working with new techniques for development of advanced high-speed random-access memories. Work requires five years' experience in servomechanisms and BSEE or BS in physics; or considerable experience in high-speed mechanisms and BSME and MSEE or BSEE and MSME.

TEST ENGINEERS AND TEST TECHNICIANS

Openings in checking out, de-bugging and testing solid-state digital computers. Engineering applicants must have at least two years' experience in computers. An EE degree is desirable. Technician applicants must have a minimum of one year's experience in testing digital computers and associated peripheral equipment.

ARRANGE NOW FOR AN INTERVIEW IN YOUR AREA

Confidential interviews will be held soon in various parts of the country. Openings above are in Los Angeles. Additional openings in Dayton, Ohio, for mechanical, electrical and chemical engineers, physicists, chemists (MS or PhD level). Send resume immediately to Bill Holloway, Technical Placement, or call collect.

The National Cash Register Company



ELECTRONICS DIVISION
2816 W. El Segundo Blvd., Hawthorne, Calif.
Telephone: Area Code (213) 757-5111
An equal-opportunity employer

of the radio-frequency wavefronts containing the telemetry data will not exactly match the polarization of the antenna. When this happens, no signal—or at best a weak one—comes through. To find the spacecraft the operator must start searching manually to line up his antenna with the spacecraft's polarization, thus losing time and data.

Apdar. Equipment to do this automatically has been developed by the General Dynamics Corp.'s Electronics division, tested at Goddard, and will be installed this month at the Stadan station at Wallops Island, Va. Goddard describes the system, called Apdar, for advanced polarization diversity autotrack receiver, as consisting essentially of two complete autotrack channels, operating with outputs in parallel. Each channel receives vertically or horizontally polarized satellite signals, and relies upon the principle that polarization fading does not occur simultaneously on both channels. The autotrack capability is therefore as good as the better of the two signals.

Apdar also uses a diversity pre-detection combining feature, not used in conventional autotrack systems, that aligns the ground antenna polarization with that of the received radio frequency energy.

In the future, Stephens says a satellite should be able to trigger ground equipment to issue a command. And ground equipment should be automatically adaptive enough to command the satellite to switch to another beacon with a different frequency when the one it is using gets weak. The station's command circuits could, in fact, be programmed to examine a number of possible causes for a degraded signal, choose the right one, and issue a command to remedy it.

IV. On-site data processing

Automatic data processing at each individual station may help solve two future problems that Stephens envisions. Real-time command will require that a certain amount of the telemetry data be processed automatically as it comes in to a station.

Now there is a delay of days and even weeks before telemetry is converted into usable data. The Stadan

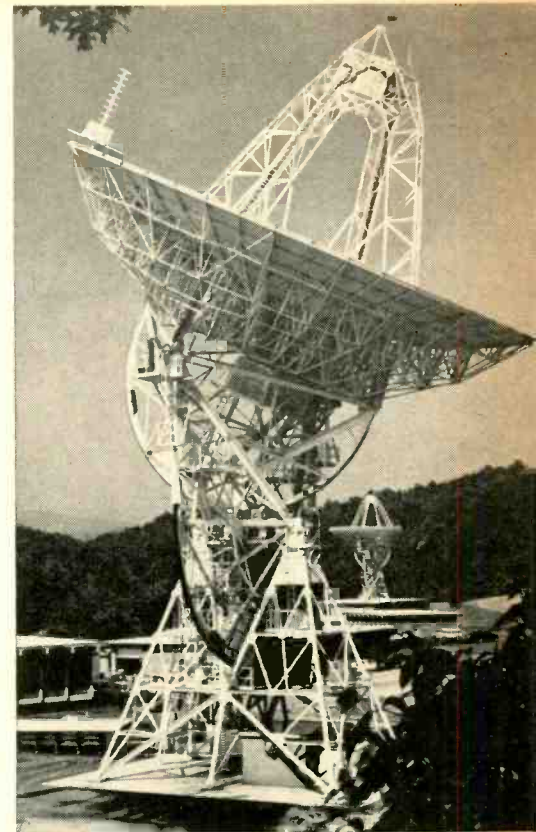

This 85-ft dish at Rosman, N.C. receives video signals from the Nimbus weather satellite. Later they go through a rapid photo-processing system to produce 70-mm negatives showing the earth's cloud cover.

stations record telemetry on paper or magnetic tape which must be processed and upgraded at Goddard before reaching the scientist. "It would help, too, if a station's computers could flag a whole set of data as useless. Then we'd avoid the processing costs," Stephens said.

Computers adaptive enough to recognize degraded data and bring the received information up to acceptable thresholds before recording it is another promising area for automation. Eventually, says Stephens, the computers in the tracking stations should have multiple-processing capability, maintaining constant operation but using a priority system to select data to be worked on at any given time, weighing this function against the time and requirements for automatic checkout, station readiness reports, active tracking, and control and command. The Gemini stations have some capacity for this now. But they, and all the other stations, now and those to come, need more.

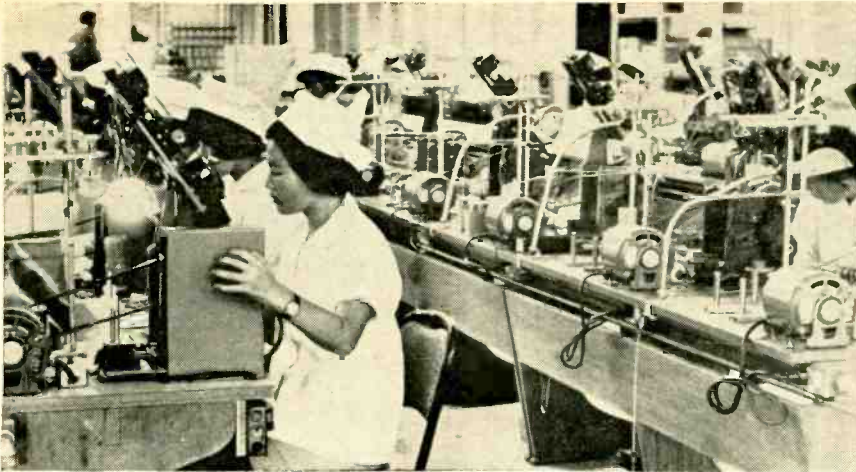

Young Chinese girls assemble selenium rectifiers at Taiwan Electronics Corp. plant. Because the girls are smaller than their occidental counterparts, each station on the line is only 30 inches wide instead of the 36 inches in a U.S. plant. That means more workers can fit into the same length production line and that assembly lines take less space.

Regions

Transformation in Taiwan

Cheap island labor is attracting foreign companies and lowering prices of Asian electronic goods, much to the concern of producers in Japan and Hong Kong.

By Lewis H. Young

Editor

The electronics industry in the United States has long worried about low-cost labor in Japan, which in turn has fretted about cheap labor in Hong Kong. Now, Hong Kong has a worry—one that works back up the line to Japan, and will eventually reach back to the U.S.—the incredibly low cost of producing electronic goods in Taiwan.

At first glance, Taiwan is an unlikely spot for an electronics industry. A small, mountainous island, 100 miles from Communist China, Taiwan has, for centuries, based its economy on the land. Rice, sugar, fruit and tea are raised on the plains; timber and camphor in the mountains. There is no pool of experienced engineers nor sophisticated technology. It has few natural resources for producing electronics. And it is 9,000 miles from its prime

markets in the United States and Europe. In addition, its government is at war with the communist People's Republic of China and martial law restricts the operation of people and companies.

Still an electronics industry is blooming there, growing alongside pineapple farms, sugar cane plantations and rice paddies. Already, the low cost of Tawian-produced transistor radios has forced a 25% drop in the prices of cheap sets made in Hong Kong and Japan. With this initial small success to its credit, Taiwan is about to see a buildup of electronics activity.

The big attractions are a large, low-cost, willing work force and a government that is bending over backwards to encourage electronics companies to set up shop. As producers in Hong Kong and Japan worry about Taiwan's low costs,

U.S. companies are showing increasing interest in the twin lures of the island.

Last month, for example, Taiwan planners scored their biggest coup to date. The Philco Corp., a subsidiary of the Ford Motor Co., was granted approval to build a \$2½-million plant to assemble radios and television sets for export.

Signs of success. Almost at the same time, the Taiwan Electronics Corp., a subsidiary of the General Instrument Co. and the first U.S. electronics firm on the island, completed a plant expansion that tripled its manufacturing capacity in Taiwan. Clearly, GI executives consider their Taiwan experiment, launched in 1963, a success. The plant builds ultrahigh-frequency tuners, deflection yokes for television, selenium rectifiers, intermediate-frequency transformers, and mica capacitors—all of which are exported to the U.S. Later this year, on part of the newly added floor space, Taiwan Electronics will start producing semiconductor devices for U.S. markets in face-to-face competition with the Fairchild Semiconductor division facility in Hong Kong.

As more U.S. companies come to the island, Taiwanese-based companies are stepping up their activity. The Tatung Engineering Co. of Taiwan whose 1964 sales of steel, electrical equipment and home appliances totaled nearly \$75 million, entered the electronics business for the first time in 1963 producing a few television sets and radios for the domestic market. Now, Tatung is building a six-floor factory to produce electronic components as well as radios and television sets for domestic consumption and export. This year, electronics will account for 10% of Tatung's total sales and the percentage is rising rapidly.

I. Ties with Japan

On Taiwan, there are a thousand small shops and plants turning out radios and electronic parts, some with as few as one or two employees. But the bulk of the industry's activity is carried on by about 30 companies.

Examining the major producers uncovers some familiar Japanese names. Japan's Matsushita Electric Industrial Co. owns 60% of the

Taiwan Matsushita Electric Co.; the Sanyo Electric Co., another Japanese firm, owns a minority interest in the Taiwan Sanyo Electric Co.; and the Tokyo Shibaura Electric Co. owns over 9% of Tatung Engineering.

Even the companies with Chinese-sounding names have close bonds with Japanese firms. Shen Po builds Sharp television sets, the brand and design of the Hayakawa Electric Co. in Osaka. The Haing Yung Industry Co. has a technical agreement with the Yaou Electric Co. in Tokyo; the Taiwan Television Broadcasting Corp. builds Hitachi tv sets; Hsia Fah has a technical pact with the Fuji Electric Co. and Dah Kuang Victor has a similar pact with the Japanese Victor Co.

Most of these agreements cover domestic production only and prohibit export into markets served by the Japanese companies.

Occupied. Japan's ties to Taiwan go back to 1895 when the Japanese army occupied the island to capture another rice bowl. Formosa, as the Japanese called it, was an agricultural colony and, with a few exceptions, was still mainly agricultural when the Japanese surrendered and left the island in 1945.

In October, 1962, the Japanese began to move back. U. S. military and economic aid was doing good things for the Taiwan economy; the Chinese Republic's president, Chiang Kai-shek, was beginning to push industrial expansion; television broadcasting was starting up in Taipei, the island's capital, creating a demand for tv sets, and Japanese firms wanted to build them.

Because import duties on tv sets were high—up to 100% on small quantities—and later the government banned large-quantity imports, Japanese companies had to move to Taiwan; they had to set up shop, enter joint ventures, or sign technical agreements.

Producing tv sets, however, has not yet become a big business. Despite the fact that 11 companies were making them, only 19,600 sets were sold last year—most of them 23-inch sets which the Chinese regard as a status symbol. This year, they hope to sell 50,000 receivers. And now that a tv relay transmitter has been installed to carry televi-

sion reception beyond the mountains that surrounds Taipei, tv men expect domestic demand to climb to 100,000 sets a year by 1967.

Radio boom. Japanese radio manufacturers also went to Taiwan. Labor rates in Japan had been going up like an elevator—10% a year since 1960 and 13% this year. Hong Kong was hiring workers to assemble radios at low wages, according to Japanese standards. And the Japanese were scared.

To compete, they took complete sets of components and parts for radios to Taiwan, paid a Taiwan firm to assemble them—frequently as little as 30 cents a set—and then sold them in the U. S. and Europe.

Taiwan radio production jumped tremendously because of this practice—from about 100,000 sets a year in 1961 and 1962 to 550,000 in 1964 (of which 450,000 were exported) and an estimated 925,000 in 1965 (with 800,000 marked for export). The biggest radio producer in Taiwan, the Tasung Trading Co. assembles radio sets solely for a Japanese company.

Though Taiwan's radio business is growing sharply—up nearly 86% this year—nobody is really proud of it because the products are not very good. One executive of a radio assembler confided, "A Taiwan radio is almost a toy. You

can sell them if they sound all right and the price is right. We sell a lot of them to U. S. teenagers who keep them for a couple of weeks and when they stop working, throw them away and buy more."

A few radio producers are trying to upgrade their products. The China Electric Manufacturing Co., the second largest radio producer in Taiwan, with ten engineers, is designing more expensive radios. China Electric makes ten radio models, some components like loudspeakers, printed circuit boards, capacitors, and transformers. The company sells primarily to mass marketing retailers in the U. S.

II. Government roadblock

Though the Japanese clearly started and nurtured Taiwanese electronics, the government has withdrawn its welcome mat for further Japanese participation. In fact, obstacles mysteriously appear these days to impede the operations of Japanese companies.

At Sanyo's Taiwan joint venture, vice general manager Tadatoshi Kato sees the change. "The Taiwan government wants U. S. money in first today. Japanese companies have trouble doing business."

There are two reasons for the turnabout. First, more and more officials in Taiwan see the Japanese as arch competitors in world electronics markets. And the evidence is clear. Even Sanyo's Kato admits that his own parent firm in Japan does not allow the Taiwan branch to export tv and radios because they would compete with those made by the Sanyo plants in Japan and Hong Kong.

But the second reason swings more weight with officials: Japan wants to trade with Red China. To the Chinese on Taiwan, trading with the communists is unforgivable and they are punishing Japanese firms for their country's expressed intent.

III. Encouraging Yankee dollars

Explaining the goal Taiwan has set for itself, K. T. Li, Minister of Economic Affairs told Electronics, "There is not much foreign industrial capital in Taiwan now, only \$25 million to \$30 million. We want companies to use Taiwan as a base for world markets. You can't come here anymore to build for domestic

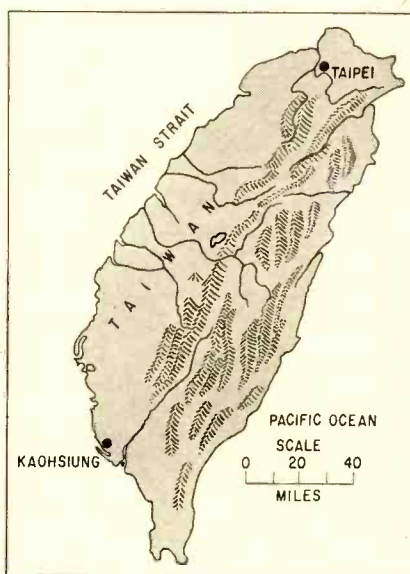

Most industry in Taiwan is in the North, in and near the capital city of Taipei. But officials expect bigger growth in the South in Kaohsiung where a free export area and free port is being established.

Vector Radiation Hardened NPN Silicon Transistors



Vector Model V-120RH
(TO-18)
(TO-46)
(TO-51)

- Performance Tested: 10^{15} nvt dosage fission spectrum $>10\text{KEV} < 3.2\text{MEV}$ (avg. 1.5MEV)
- Meets requirements for high level radiation environments
- For low level-high gain amplifier and high speed switching circuits
- Immediate delivery in production quantities

MAXIMUM VOLTAGES

| | |
|-----------|-----|
| V_{cbo} | 20V |
| V_{ceo} | 10V |
| V_{ebo} | 4V |

ELECTRICAL CHARACTERISTICS POST IRRADIATION*

| Symbol | Min. | Typ. | Max. | Units | TEST CONDITION |
|---------------|------|------|------|---------------|--|
| h_{FE} | 7.0 | 9.0 | | | $I_C = 0.1\text{mA}, V_{CE} = 5\text{Volts}$ |
| h_{FE} | 11.0 | 14.0 | | | $I_C = 1.0\text{mA}, V_{CE} = 5\text{Volts}$ |
| h_{FE} | 12.5 | 14.5 | | | $I_C = 10\text{mA}, V_{CE} = 5\text{Volts}$ |
| $V_{CE(sat)}$ | .17 | .25 | | V | $I_C = 1.0\text{mA}, I_B = 0.2\text{mA}$ |
| h_{FE} | 9.5 | 11 | | | $I_C = 8\text{mA}, V_{CE} = 5\text{Volts}$ |
| I_{CBO} | .45 | 40 | | μA | $I_E = 0, V_{CB} = 5\text{Volts}$ |
| t_s | 3 | 6 | | nsec | $I_C = I_{B1} = I_{B2} = 5.0\text{mA}$ $V_{CE} = +3.0\text{V}$ |
| t_{off} | 3 | 6 | | nsec | $I_C = 10\text{mA}, I_{B1} = I_{B2} = 1.0\text{mA}$ $V_{CE} = -1.0\text{V}$ |

* 10^{15} nvt, $>10\text{KEV} < 3.2\text{MEV}$ (avg. 1.5MEV)

Tempistors®
Silicon Dioxide Capacitors
RF Transistors—Types 2N3866, 2N3375,
2N3632, 2N3733, 2N3553

For more data call
Vector Solid State Laboratories,
(215) EL7-7600, or write:

Vector
U
DIVISION OF UNITED AIRCRAFT CORPORATION
A
SOUTHAMPTON, PENNSYLVANIA

markets. Companies have to change their ideas; they'll come here to export, not to squeeze the domestic market."

To encourage investment, particularly from the U. S., the government makes capital equipment free of import duty (normally 25%) under certain circumstances. One condition is if the investment in a new product totals more than \$2½ million. Philco's new plant will qualify under this term. Or, if the industry is a desirable one—like electronics—the government will grant a duty exemption for a period of time. Thus, the Taiwan Electronics Corp., whose initial investment was over \$1 million, but under the \$2½ million limit, received an exemption for five years.

Last summer, the government announced plans for a free port and manufacturing area in Kaohsiung on the southern side of the island. Companies who operate in the 150-acre zone will pay no import duties on materials or equipment. Their products must be exported.

Taiwan is encouraging 17 different kinds of industry in the duty free zone, and electronics has the second highest priority, behind precision machinery and instruments. So far the government has approved seven application for facilities in the zone; two are local electronics firms.

IV. Risks are high

Though Taiwan is flashing a big green light for U. S. electronics companies, almost everybody on the island admits there are more than normal risks to doing business there. The biggest complaint is government bureaucracy. Taiwan officials, foreign manufacturers say, have a fondness for paperwork that approaches a phobia. Moses Shapiro, president of General Instrument complains, "The foreign investment application, a document as thick as a book, had to be filed in 39 copies. And that's when they wanted us badly."

Impatient Americans. M. T. Wu, director of the industrial development and investment center of the Council for International Economic Cooperation and Development, a government agency that tries to help foreign companies, blames American impatience for many of the complaints.

Frustrated by bureaucracy, executives have charged the government with everything from nepotism to downright dishonesty. One executive put it bluntly. "You must have connections, particularly to get components in through customs and finished products out."

Engineer shortage. Probably the second most serious problem in Taiwan is the shortage of good technical help. As a result, the Taiwan Electronics Corp. does no design engineering on the island at present, and production lines are set up abroad and moved in. Only production engineering for day-to-day operations is carried out in Taiwan. Managing director David Jones explains why. "To set up a production line, a production engineer needs a lot of experience and that's what most Taiwan engineers lack. I think it would be a mistake to take a new product and try to put it into production for the first time in Taiwan."

The future? Two other uncertainties hang over the budding electronics industry. A question for private conversations is "Can the Chinese communists end Taiwan's independent status?" And equally touchy: "What will happen in Taiwan when Chiang Kai-shek dies?"

As more U. S. industries move to Taiwan, the natives breathe easier. A bank manager in Taipei analyzed the situation this way: "Every U. S. company that sets up shop here is another lobbyist in Washington working to preserve Taiwan's independence."

What will happen when Chiang goes is a muddier problem. Most people agree now that a power struggle is likely to result and it could damage Taiwan's industrial program.

Ignoring such debates, the Ministry of Economic Affairs continues to solicit industry. This year for the first time, industrial activity in Taiwan will pass agricultural in dollar volume.

Taiwan government officials cite the Taiwan Electronics Corp. as a model success story. It fits almost exactly Taiwan's ideal specifications which according to M. T. Wu are for "a labor-based industry. We want companies that produce parts and raw materials."

Now it seems that Taiwan is getting them.

Tests prove it... Mallory MTA capacitors deliver big performance for small cost

Results of performance testing of the new Mallory MTA molded aluminum electrolytic capacitors may change your ideas about how much quality you can now buy in a miniature capacitor at low cost.

Good low temperature stability

The MTA has good capacity retention for a miniature electrolytic—even at -30°C . Take a look at the chart.

Good life and reliability at high temperature

Capacitance, DC leakage and dissipation factor show good stability on life test at 65°C —and at 85°C . The chart shows the first 500 hours' data on a production lot of 100 mfd, 10 VDC units. At 85°C , there hasn't been a single failure of any kind during 1 million piece-hours of life test. And at 65°C , we've had only *one* failure in $2\frac{1}{2}$ million piece-hours of testing.

Both our tests and those by customers indicate that the MTA has reliability superior to many miniature aluminum types, including many metal case models. DC leakage of polar models is less than 0.03 microamps per mfd-volt. We invite you to evaluate the MTA. We believe you'll find its performance applicable to a broad range of entertainment and industrial uses. And we know you'll like its price. For data, write or call Mallory Capacitor Company, a division of P. R. Mallory & Co. Inc., Indianapolis, Indiana 46206.

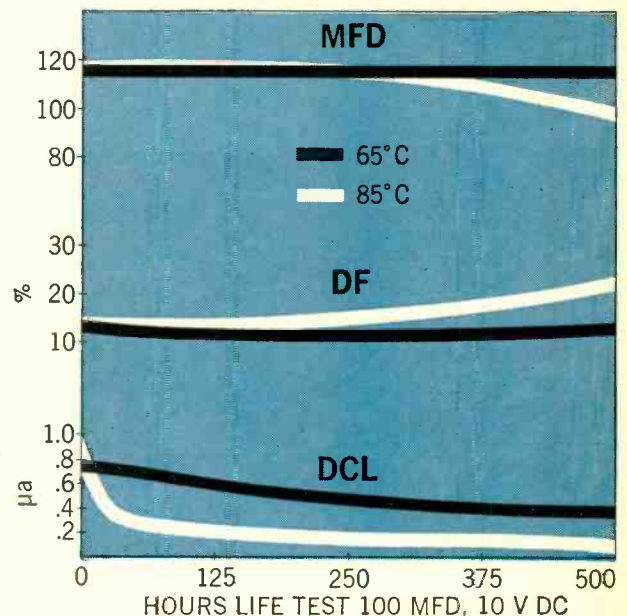
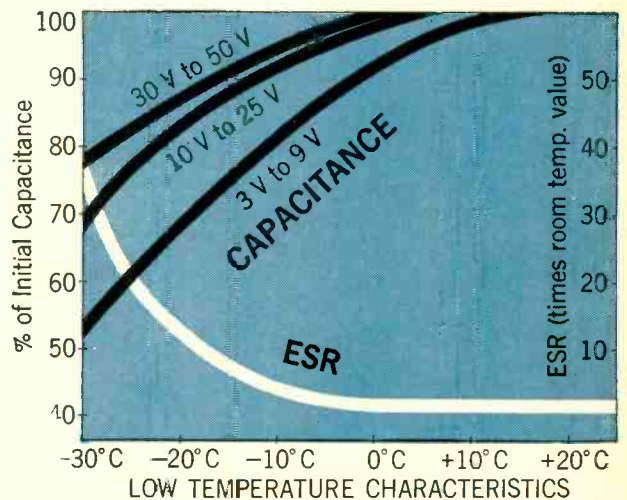

| Maximum Ratings—MTA | | | |
|---------------------------------------|------------|---------------------------------|---------------|
| Case size | Volts WVDC | Maximum capacity—mfd. polarized | non-polarized |
| $\frac{5}{16}'' \times \frac{7}{8}''$ | 3 to 50 | 75-8 | 65-4 |
| $\frac{3}{8}'' \times 1\frac{1}{8}''$ | 3 to 50 | 210-20 | 135-10 |
| $\frac{1}{2}'' \times 1\frac{1}{2}''$ | 3 to 50 | 800-85 | 525-40 |

MALLORY

A tiger in Voyager's tank

Shift to Saturn V launcher would permit spacecraft to be fired two at a time, with capsules that would orbit Mars before landing. Still needed are better S-band tubes and solid state transmitters

By Peter R. Sigmund

Space Electronics Editor

Besides the technical problems inherent in placing an instrument package on Mars undamaged, Project Voyager has encountered two other obstacles: a reduced budget in Washington and a reduced estimate of the density of the atmosphere around Mars.

The National Aeronautics and Space Administration seems about to overcome both with a single move—switching from the Saturn 1B-Centaur rocket, which has a 1.8-million-pound thrust, to the Saturn V, which has a thrust of 8.7 million pounds. Saturn V's development costs are being paid under Project Apollo, the program to land men on the moon by the end of the decade.

Such a decision by NASA would cause no major change in electronic subsystems for the \$1.3-billion Voyager program. It might even hasten development by diverting funds that would have been allocated for the Saturn 1B-Centaur.

The financial difficulty stems from the rising cost of Apollo, which will lead to cuts in Voyager's budget.

The scarcity of atmosphere around Mars was detected by the Mariner IV space probe last summer; the planet's atmospheric pressure was found to be only 6 to 10 millibars instead of the 14 millibars previously supposed. This caused two changes for Voyager's landing capsule: its size and probably its route to Mars.

The lander will be made larger to increase drag as it descends onto Mars; also, it may be put into orbit around Mars so it can spiral to the planet's surface, thereby tak-

ing advantage of whatever atmosphere exists around the planet. Originally the lander was to have been cut loose from the spacecraft ten days out and allowed to complete its journey alone.

Saturn V is powerful enough to put the lander as well as the spacecraft into orbit around Mars; in fact it will be able to launch into orbit two spacecraft with landers at the same time.

I. Changing the timetable

The first mission to Mars, in 1971, will be more modest than had been planned. If a lander is carried, it will be instrumented to study the journey's effect on the capsule itself, rather than the nature of the Martian environment. If no lander is carried, the spacecraft probably will send probes toward Mars that will send back information about the atmosphere close to the planet's surface. The Avco Corp. recently delivered the first such probe to NASA.

The contractors. The changes will bring immediate pressure on contenders for a contract to build the spacecraft. The three companies—the Boeing Co., General Electric Co. and TRW, Inc.—will have to revamp the preliminary design proposals they submitted in August. When these studies are completed, probably early next year, NASA will request firm proposals for the spacecraft. One of these companies will then be chosen as the prime contractor.

Because of uncertainty about Mars's atmosphere, development of the landing capsule has lagged behind that of the spacecraft. NASA

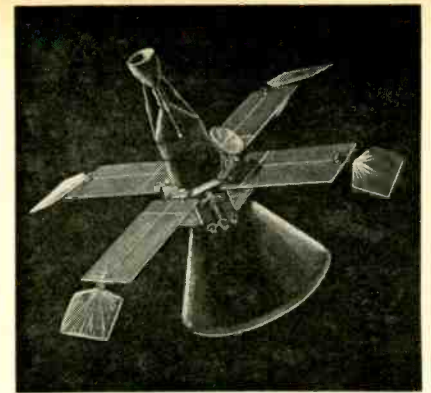

still hopes to call for proposals on the lander early in 1967, and to choose a contractor before 1968. Avco's Research and Advanced Development division and the General Electric Co.'s Missile and Space division have made studies on landers for NASA.

The experiments. Nov. 19 is NASA's deadline for proposals on experiments to be conducted when landings begin in 1973. The equipment probably will include a mass spectrometer, a gas chromatograph, or a combination of the two, for detecting any life that may exist on Mars.

Instruments also may be carried for measuring temperature, pressures, wind velocity, radiation and seismic activity.

Telemetry data and television pictures from Mars will be digitized and sent over the same transmitters. The signals will be received by one or more of NASA's deep-space-network stations; which will include a 210-foot receiver at Goldstone, Calif., and 85-foot receivers in South Africa, Australia and Spain. By 1973, NASA hopes to install 210-foot receivers at the stations in Australia and Spain.

II. Keeping in touch with the earth

For communications with bases at home, each spacecraft may be equipped with two 50-watt S-band transmitters, one as a backup. It will also carry four antennas. For the powerful S-band units, a vacuum tube will have to be developed that is more powerful than the present 25-watt limit.

The transmitter's antenna will probably be a 10-foot, high-gain

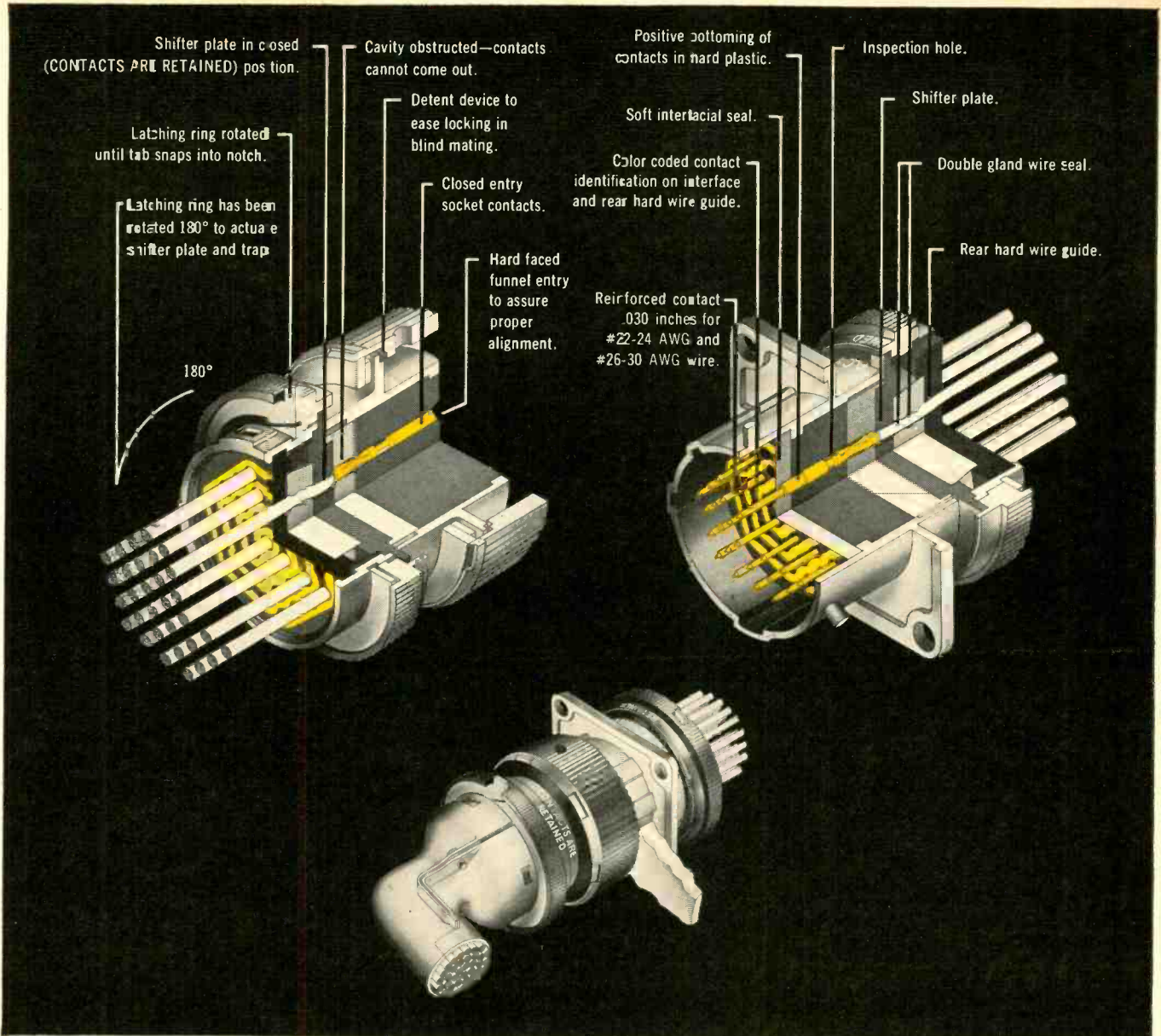

This connector begins where others leave off

Take the best subminiature pin and socket connector on the market. Eliminate its inherent failure modes. Give it twice the contact density of other connectors. Then add the very latest innovations in design and materials. This was our objective in developing the new CH-AMP★ Subminiature Circular Connector.

The result shown here is in many ways even more spectacular than the objective. Here is a bayonet-coupled connector with a unique twist-to-lock contact retention mechanism that eliminates the need for retention clips and extraction tools—an environmentally sealed connector designed in a stainless steel housing that provides continuous grounding from mounting flange to cable clamp.

The contacts are a special reinforced spring design with closed entry for probe protection and a four-indent crimp for maximum electrical conductivity. A resilient wafer grips them in the proper position prior to locking. Color-coded interfaces and positive visual checks top off the many precision engineered features that give the CH-AMP Connector a positive GO for all high grade military and industrial applications.

- Meets or exceeds the requirements of MIL-C-26500 and MIL-C-26482
- Available in 85, 58, 37, 26, and 14 contact configurations
- Contact retention force: 2 lbs. unlocked, 15 lbs. locked
- Positive depth-controlled contact insertion
- Moisture-proof, double gland wire seal
- 90° or 180° cable clamp can be applied *after* connector is wired

Available in five shell configurations for wire sizes AWG 22-30. For full details, write today for the new A-MP★ Subminiature Circular Connector brochure.

★Trademark of AMP Incorporated



A-MP★ products and engineering assistance are available through subsidiary companies in: Australia • Canada • England • France • Holland • Italy • Japan • Mexico • Spain • West Germany

Measure Transients of less than 1 μ s



Model 440A PEAK LOK Transient Reading Voltmeter reads and holds the largest signal received over any selected period of time. Pulses shorter than 1 μ s are measured and the reading accurately held until reset.

DC coupling is provided and input ranges from 0.1 volt to 1000 volts may be selected manually. Polarity may also be selected with a front panel switch.

The PEAK LOK Model 440A can be manually or electronically reset. Visual output is on taut-band mirror-backed meter. Output for logging—low impedance 0 to +5 volts with 1% absolute accuracy. Portable or rack mounted versions are available. The Model 440A utilizes Control Data's unique ANALOK* Analog Memory technique. Silicon semiconductors are used throughout to insure reliability in operating temperatures from 0° to +50°C.

*Trademark

FOR INFORMATION on the Model 440A PEAK LOK contact:

ADCOMP Corporation, Dept. 105
20945 Plummer St.
Chatsworth, Calif.

(Area code 213, 341-4635)

ADCOMP CORPORATION

SUBSIDIARY OF

CONTROL DATA

CORPORATION

paraboloid. Plans call for it to be gimballed so that its narrow beam can be pointed toward earth stations accurately to within 1°. One of its pointing systems will be based on a computer whose memory would be kept up to date with tracking data from earth; the other pointing systems will use the star Canopus as the reference for on-board sensors.

The spacecraft's other three antennas will probably be an omnidirectional low-gain unit to receive command signals from earth, a medium-gain antenna—either an ellipsoid or a three-foot dish—for telemetry and tracking during the major portion of the flight before the high-gain antenna takes over close to Mars, and a very-high frequency fixed antenna with relatively low gain and wide beam to receive signals from the landing capsule. The vhf antenna may be either a dipole or turnstile type.

Data will be stored on magnetic tape and transmitted to earth at 5,000 to 10,000 bits per second. A data-automation system on the spacecraft will sort out and label the data and send it in proper sequence.

Spacecraft power will be provided by four or more solar panels, each occupying about 85 square feet—also silver-zinc batteries.

On the lander. Two transmitters and two antennas will be carried on the lander. The transmitters will have to be solid state because a vacuum tube might not survive the impact. A more powerful transmitter than NASA's present 3-watt unit may have to be developed. Paul Tarver, systems engineer for the capsule at NASA headquarters, says NASA would like a transmitter that could reach 20 watts.

A low-gain, S-band (between 2,100 and 2,300 megacycles), fixed antenna with relatively wide beam will be mounted in the first lander to communicate directly with the earth. Later, NASA hopes to develop a steerable antenna to compensate for changes in the position of Mars relative to the earth.

Data from the lander will be sent to the spacecraft by a low-gain, fixed, very-high-frequency antenna identical to that carried on the spacecraft. Vhf signals from the lander will be converted to S band and relayed from the spacecraft to

ground stations on the earth.

During its descent, the lander will store data on tape as well as transmit to the spacecraft at rates of 30 to 120 bits per minute. After landing, it will transmit at the same rate to earth or at 100 bits per second to the spacecraft orbiting Mars. The tape recorder may be replaced by a more-durable, core-storage system or by plated wire storage.

Power. The lander probably will get its power from silver-zinc batteries. Designers are also considering nickel-cadmium batteries, but these are heavier and won't be used unless development of silver-zinc batteries runs into trouble.

The first operational lander, in 1973, will have a lifetime of a few days at most. Landers on later mission, may last as long as two years, especially if nuclear power is available.

Television. The spacecraft will be equipped with television cameras—probably two—and the lander will probably carry optical devices to scan the Martian surface in the visible, infrared and ultraviolet regions.

Voyager's tv—like Mariner IV's—will scan images on a vidicon tube, convert the video signals to digital form, and store them on magnetic tape for transmission to earth. The amount of digital data transmitted by Voyager, however, will far exceed Mariner IV's because of an increase in transmitting power, the high-gain antenna on the spacecraft and the 210-foot antennas on the ground that will be ready to receive Voyager's messages.

Each picture from Voyager is expected to consist of one million bits: Mariner IV sent 250,000-bit pictures. Voyager will transmit pictures at about 10,000 bits per second; Mariner IV transmitted at 8½ bits per second.

On the ground, NASA will convert the digital data into 800-line pictures, providing quality equal to that of Ranger IX's pictures of the moon last spring.

Transmission techniques. To avoid losing important data, NASA may use a signal-redundancy technique, called bi-orthogonal block coding, which will take a seven-bit word, for example, and convert it into many more bits. Then, even

DPDT TRIMPOT® Relay: 160 mw Sensitivity, Microminiature Size

This new DPDT is more than just small—it's reliable! Subject it to 150 G shock or 40 G, 3000 cps vibration, and you still get the performance that's on the published data sheet. Model 3101 has single-coil design, rotary balanced armature, hermetically sealed case, and self-cleaning contacts. It's designed to meet or exceed all environmental requirements of MIL-R-5757D.

Every relay goes through a 5000-operation run-in and 100% final inspection, including mass-spectrometer leak testing, for all important characteristics. In addition, monthly samples undergo the punishment of the Bourns Reliability Assurance Program. This program, originally developed for TRIMPOT potentiometers, is one of the most extensive series of electrical and environmental tests in the electronics industry. It underscores the trustworthiness of the name TRIMPOT in relays, too.

Model 3101 relays and their SPDT companion, Model 3100, are available immediately from the factory in a full range of coil-resistances and with voltage or current adjustment. Three terminal types, two mounting-bracket styles. Write for complete technical data.

Size: .2" x .4" x .6"
 Maximum operating temperature: 125°C
 Contacts: DPDT; Rating: 1.0 amp resistive, 26.5 VDC
 Coil resistances: 65Ω to 2000Ω
 Pick-up sensitivity: 160 milliwatts
 Vibration: 40G, 5-3000 cps
 Shock: 150 G

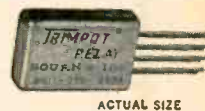

ACTUAL SIZE

**IF it's TRIMPOT,
it's BOURNS**

Compare its space requirements with those of the usual crystal-can or half-crystal-can types.

TRIMPOT is a registered trademark of Bourns, Inc.

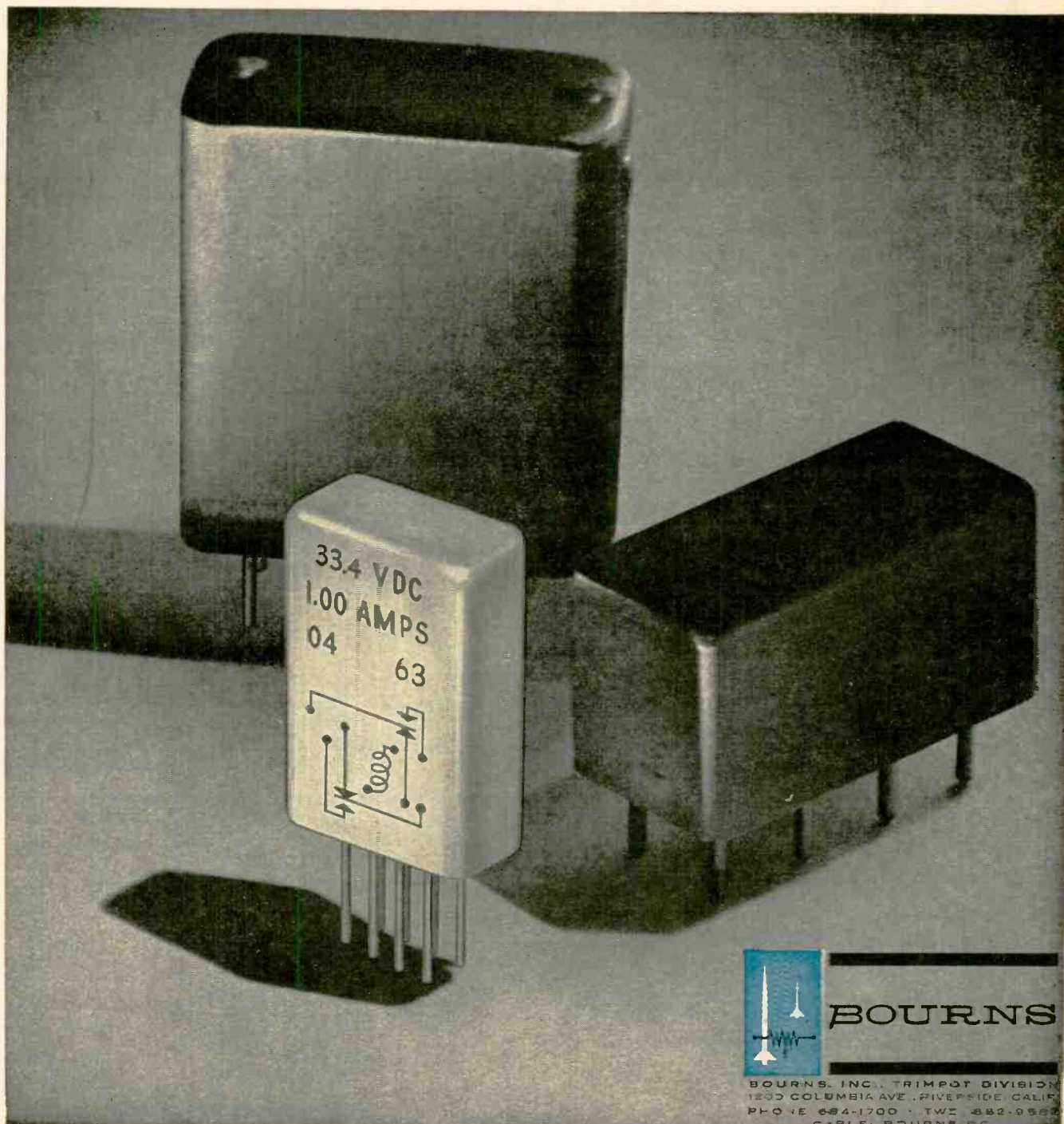

BOURNS

BOURNS, INC., TRIMPOT DIVISION
 1200 COLUMBIA AVE., RIVERSIDE, CALIF.
 PHONE 694-1700 • TWX 382-9582
 CABLE: BOURNS INC.

Manufacturer: Trimpot® & Precision Potentiometers, Relays; Transducers for Pressure, Position, Acceleration. Plants: Riverside, California; Ames, Iowa; Toronto, Canada

DO-IT-YOURSELF MAGNETIC SHIELDS

*Cut Quickly—
Wrap Easily*

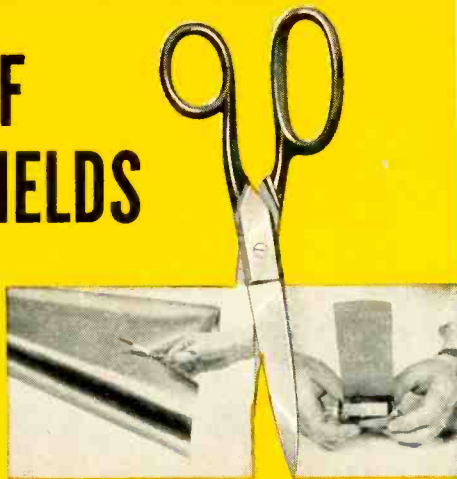

With ordinary scissors, cut flexible Co-Netic and Netic foil to any size or outline. Your component is quickly wrapped and protected—within seconds. Component performance is dramatically enhanced. Co-Netic and Netic foils stop degradation from unpredictable magnetic fields. When grounded, they also shield electrostatically. Foils are not significantly affected by dropping, vibration or shock, and do not require periodic annealing. Available in thicknesses from .002" in rolls 4", 15", and 19-3/8" wide. High attenuation to weight ratio possibilities. Widely used in experimental evaluation and production line operations for military, commercial and industrial applications.

MAGNETIC SHIELD DIVISION

Perfection Mica Company

1322 N. ELSTON AVENUE, CHICAGO 22, ILLINOIS

ORIGINATORS OF PERMANENTLY EFFECTIVE NETIC CO-NETIC MAGNETIC SHIELDING

Circle 204 on reader service card

24 HOUR DELIVERY

MINIATURE
TRANSFORMERS

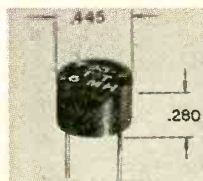
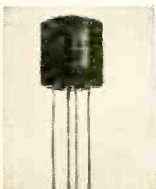

TOROIDAL COILS



Manufactured to Mil-T-27

SEND FOR COMPLETE CATALOG OF
24 HOUR ITEMS

*Call or
Write*

TOROTEL
INC.

Page 662
EBG

13402 South 71 Highway
Grandview, Missouri 64030
Phone: SO 1-6314 — Code 816, TWX SPDA 816 — 763-3432

with low-strength signals, enough bits will get through to carry the message. NASA believes that the technique—which has never been used in a spacecraft before—will result in an increase in data equivalent to 3-db gain in the receiving antenna.

Data compression will also probably be used. With this technique, only new information is transmitted. Dots in a tv picture will only be transmitted if they differ from those that precede them.

NASA may decide to use both data compression and block coding. It would, in effect, reduce data to the essentials and then send it in coded form.

III. The Martian surface

The climatic conditions on Mars are brutal for man and are not going to be easy for electronic components. Temperatures are believed to range from -60°F to $+60^{\circ}\text{F}$, and the thin atmosphere sweeps across the planet's surface at velocities up to several hundred miles an hour.

To help the electronic gear to survive, NASA has taken a number of steps. During entry into the Martian atmosphere, which begins at about 800,000 feet, the instruments in the lander will be protected by a heat shield which will ablate, or char away, in the frictional heat, as well as help hold the vehicle together. Although the atmosphere is thin it is believed to contain carbon-dioxide bands, which will increase radiative heating.

To soften the impact—which is expected to be 1,000 to 1,500 g's anyway—the instrumentation in the lander will be protected inside a balsa wood or aluminum honeycomb container. Also, NASA is still considering the use of retrorockets to slow the lander's descent.

NASA is sponsoring considerable research and development on methods of packaging components. Special pottings will protect them against temperature changes, and parts that could cold-weld in the near-vacuum will be given protective coatings. To avoid contaminating Mars, the lander will be sterilized in dry heat before launch. The spacecraft won't be sterilized, but it will orbit Mars for at least 50 years before touching the planet.

When a capacitor failure means the failure of an entire system, you can't afford to take chances!

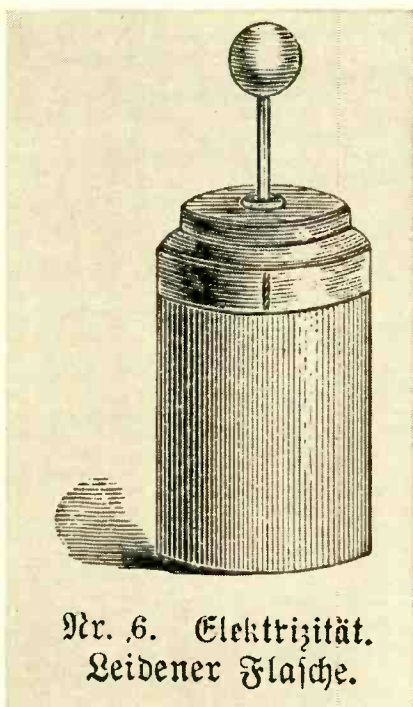

The Bettmann Archive

Why the first thing you learned about capacitors is still the most important thing you can know about them.

You remember the Leyden jar, the classic capacitor. Made of glass.

The Leyden jar is two centuries old. So is man's recognition of glass as the ideal dielectric.

You can boil glass, freeze glass, bury glass, drown glass, irradiate glass—and its dielectric properties won't change measurably.

You know how a glass capacitor will behave. Classically. According to the book.

In 1965, CORNING® glass capacitors give you this classically predictable performance, backed up by

stability and reliability data that is unequalled.

Why settle for less than the predictable performance that's your with CORNING glass capacitors. Millions have performed without failure on Titan, Surveyor, Syncom, Apollo, Mariner, Gemini, and Minuteman.

Specify CORNING glass capacitors and tuned circuits stay tuned, RC time constants stay constant, coupled circuits stay coupled, decoupled circuits stay decoupled, phase shifters stay fixed. There's none better for high-frequency applications.

Send to Corning Glass Works, 3913 Electronics Dr., Raleigh, N.C., for complete technical data on CORNING glass capacitors, or ask your Corning distributor.



CORNING
ELECTRONICS

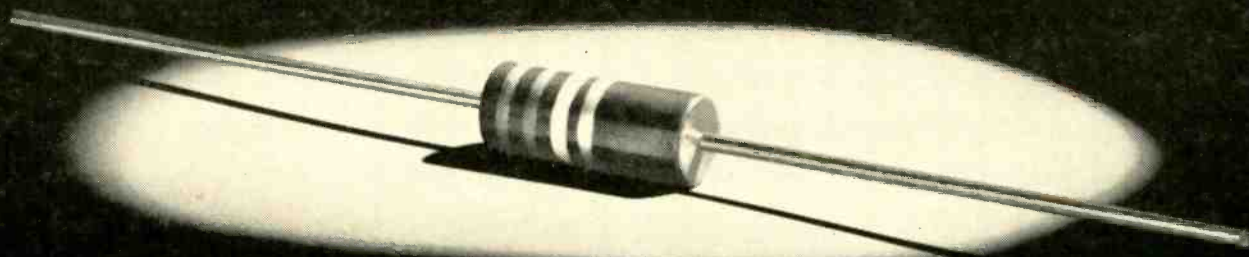









If you can find one **GENERAL PURPOSE** resistor versatile enough for all your applications

... specify it

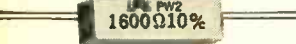
We don't think you will.

Only IRC makes all these different types . . . can recommend without bias.

| | | | |
|--|---|--|--|
|  <p>COMMERCIAL/INDUSTRIAL FIXED COMPOSITION Most popular, it combines superior performance with economy. $\frac{1}{4}$, $\frac{1}{2}$ and 1 watt.</p> |  <p>MILITARY FIXED COMPOSITION For MIL-R-11 applications. Controlled carbon composition element. $\frac{1}{4}$, $\frac{1}{2}$ and 1 watt. 5%, 10% and 20% tolerances.</p> |  <p>ESTABLISHED RELIABILITY FIXED COMPOSITION $\frac{1}{4}$ watt RCR07 and $\frac{1}{2}$ watt RCR20 styles for MIL-R-39008, levels M, P and R. 5% tolerance.</p> |  <p>MOLDED WIREWOUND Low cost approach to wirewound stability for low range needs. RC 20 and RC 32 sizes. $\frac{1}{2}$, 1 and 2 watts.</p> |
|  <p>CERAMIC CASE WIREWOUND Fireproof inorganic construction. Excellent high temperature and overload capability. 2 watts.</p> |  <p>METAL GLAZE FILM For MIL-R-22684. Rugged thick-film element. $\frac{1}{4}$, $\frac{1}{2}$, 1 and 2 watts. 2% and 5% tolerances.</p> |  <p>POWER METAL FILM Better performance and lower cost than 2 watt carbon composition. Glass hard element.</p> |  <p>UNINSULATED WIREWOUND Least expensive for automotive and appliance needs. Wide variety of terminal configurations.</p> |

Write for General Purpose Resistor Catalog . . . complete data in handy form.



INTERNATIONAL RESISTANCE COMPANY

PHILADELPHIA, PA. 19108

Circle 124 on reader service card

A modular voltage-controlled oscillator

Series 300, a solid-state device, is said to be the first to offer a catalog of different specs in one basic model

Raw analog data must often be converted from one form to another. Generally the reason for making this conversion is the difficulty of processing some signals in their original form. For example, slowly-varying d-c voltages cannot be recorded directly onto magnetic tape, but must first be changed to a form compatible with the recording process.

One successful conversion technique has been the use of a voltage-controlled oscillator whose absolute output frequency is a function of the input voltage level. The series 300 solid state voltage-controlled oscillator being manufactured by the MF Electronics Corp. in New York City is claimed to be the first of this type that offers a user a catalog of many different specifications in one basic model.

Such oscillators are applicable in communications and telemetry systems, and in many industrial measurement and control systems. In communications they are used in frequency synthesizers, automatic frequency control systems, and



Series 300 voltage-controlled oscillator is assembled from reliable, dice-size electronic building blocks to give versatility in performance (left). Test point and potentiometer adjustments for output, deviation and center frequency are accessible through the cover (right).

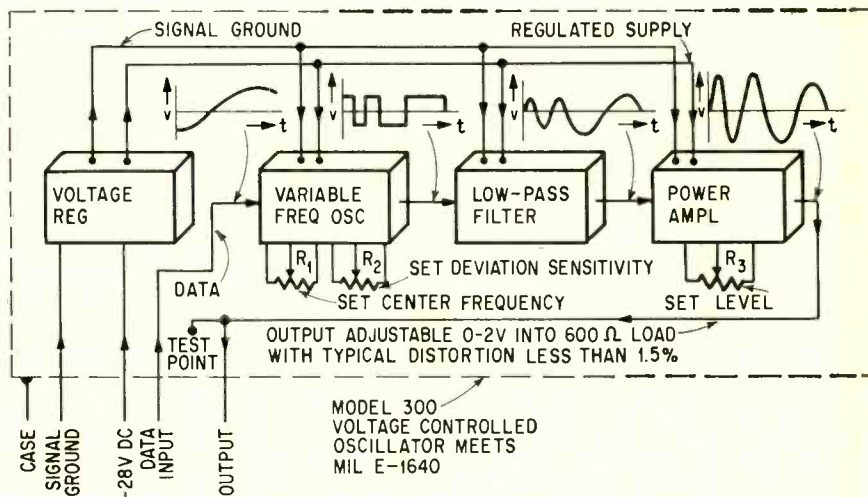

Modular construction provides wide performance range and simplifies field repairs of the oscillator.

phase-locked loops. In telemetry applications, the oscillator converts the outputs of strain gages, thermistor probes, pressure monitors and many other transducers onto proportional changes in frequency. In industry the oscillator can be used for remote monitoring of motor speed regulator systems.

Four dice-size modules, or building blocks, make up the model 300: voltage regulator, variable-frequency oscillator, low-pass filter and power amplifier. Any one of the latter three modules may be switched to give the particular output parameters that the user requires. For example, the variable-frequency oscillator and the filter are changed to provide a desired center frequency between 1 kc and 20 kc; if square waves instead of sinusoids are desired, the filter and power amplifier are replaced; if tighter tolerances must be held, any or all of the modules can be changed. Because of the oscillator's modular construction, the user can make these changes himself.

A linear d-c voltage, varying from plus to minus four volts, produces a frequency change of 20% in the oscillator's output. Output

deviation from the center frequency is linear to within 0.025% up to $\pm 5\%$ of the frequency change, and rises to 0.10% at $\pm 20\%$ of the frequency deviation.

The output voltage, which is set by the a-c operational amplifier module's gain-setting potentiometer, can be adjusted for output of 0 to 2 volts into load impedances as low as 600 ohms. The output level remains constant to within two decibels at any voltage setting, with frequency changes up to 20%.

Specifications

| | |
|-----------------------|---|
| Frequency | 400 to 200,000 cps, specials to 60 cps |
| Deviation | To $\pm 20\%$ |
| Linearity | Better than 0.25% of deviation band |
| Stability (0 to 60°C) | Better than 0.16% at low frequency, and better than 0.3% for high frequency at full 20% deviation |
| Distortion | Less than 3% at $\pm 20\%$ bandwidth |
| Output | Adjustable 0 to 2 volts into 600-ohm loads |
| Output level | Stabilized within ± 2 db at 0° to 60°C for any output-voltage setting and full $\pm 20\%$ deviation |
| Price | \$175 to \$265, depending upon specifications (module mix) and quantity ordered |

MF Electronics Corp., 118 E. 25 St., New York, N. Y. 10010
Circle 350 on reader service card



SILICONE LUBRICANTS WORK LONGER WHERE OTHERS FAIL...

In precision electrical gear

Plagued with failures caused by short-life lubes, a manufacturer of precision electrical timers switched to G-E Versilube® grease. Failures dropped to zero.

In space vehicle recorders

Tape recorders in the Mercury spacecraft required a lube that operated consistently in a vacuum and at varying, extreme temperatures. Versilube did the job.

In jet hydraulic systems

Mach 3 systems function at bulk temperatures exceeding 500°F and hot spots as high as 700°F. Of all the lubes tested, Versilube F-50 rated best.

General Electric's Versilube lubricants outperform all others at high and low temperature extremes... from -100°F to above 500°F. Viscosity remains relatively constant over a wide temperature range; oxidation and thermal breakdown are minimal.

FREE NEW DATA BOOKS

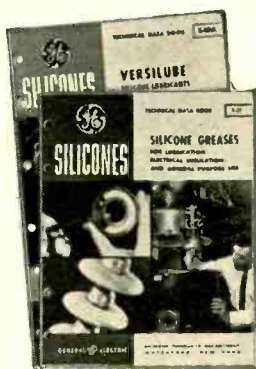

For more proof, get Technical Data Book S-10. It's packed with comparison tests, applications and design considerations on silicone lubricating fluids. So is S-21, the book on silicone greases.

®Registered trademark of General Electric.

Write to Section N11174, **Silicone Products Dept., General Electric Co., Waterford, New York.**

GENERAL  ELECTRIC

New Components and Hardware

Pulse transformers for high voltages

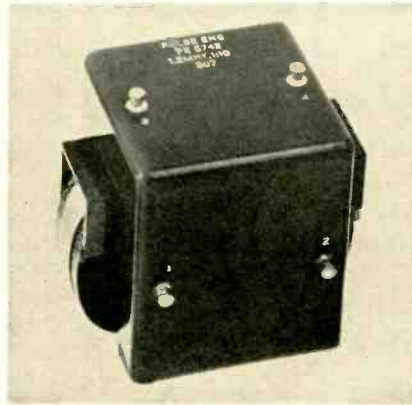

The M-12 series of pulse transformers is designed for pulse levels ranging between 500 and 4,500 volts. The rugged transfer molded units are an extension of the M-10 series, which is designed for intermediate pulse levels of 100 to 2,000 volts. The average power rating of the M-12 series is 75 w.

The M-12 has been designed for optimum pulse performance in coupling applications, impedance matching, and pulse modulation of light-house tubes, magnetrons, and other uhf oscillators.

Pulse Engineering, Inc., 560 Robert Ave., Santa Clara, Calif. [351]

±10%; higher values and closer tolerances are under development. All resistors are color-coded.

The resistors have several new design features. The carbon deposit, applied by pyrolysis to the ceramic substrate, is extended to cover cavities at the ends of the rod. The leads are soldered to nickel plating overlying the carbon in these cavities. This assures stable electrical contact and a strong mechanical bond, and provides the longest possible resistance path.

The risk of heat damage during soldering has been greatly reduced by use of copper-nickel leads, which combine high strength with low thermal conductivity. The leads are gold-plated for instant solderability.

Quantity prices are as low as 18 cents each.

British Radio Electronics, Ltd., 1742 Wisconsin Ave., N.W., Washington, D.C. [352]

Thumbwheel switch has 16 positions

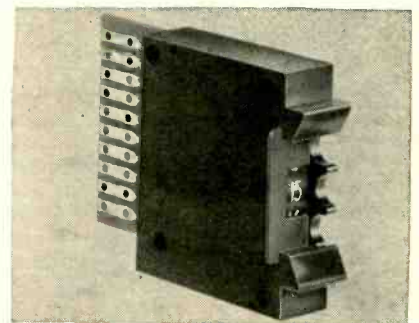

A quick-setting, 16-position thumbwheel switch is offered with letter, decimal or coded electrical output. For example, a standard 0-15 dial converts directly to binary-coded-hexidecimal output, plus complement with two commons. Provisions have been made for mounting diodes in the output terminals.

The new switch module is only ½ in. wide. Individual modules may be ganged into a single unitized assembly for simplicity of mounting. They are available for

Tiny resistors offer high stability



High-stability resistors, approaching the ultimate in miniaturization of discrete components, are designed for use in hybrid and cordwood circuits. Type RKL2 resistors are 0.102 in. long and 0.035 in. in diameter, and are rated at 30 mw. Resistance values of 47 ohms to 100,000 ohms can be supplied in tolerances of 2 ±20% or

front or back mounting. No separate escutcheon plate, secondary brackets or other special hardware is needed—only four screws.

The Digitran Co., 855 S. Arroyo Parkway, Pasadena, Calif. [353]

Wirewound resistors are silicone-coated



The HLW series is a new line of silicone-coated, commercial power wirewound resistors. The resistors, currently being produced in six models ranging from 5 to 20 w, have lug-attached terminal wires to allow easy direct electrical connection in high-speed assembly operations. All are also available with noninductive winding.

The resistors are designed to be a direct replacement for vitreous enamel types and are similar in construction to the company's HL series. Their use of a silicone coating in place of vitreous enamel provides a chip- and craze-resistant covering which can be applied without affecting the characteristics of the resistance element. The result is higher resistance values, lower tolerances and temperature coefficients, and more long-term stability than is normally associated with vitreous enamel resistors. Over 1.8 million unit-hours of testing has established a maximum failure rate of 0.05% per 1,000 hours for the HLW type. This testing is based on full-rated power at 25°C with failure defined as 3% change in resistance and 60% confidence level. The HLW series meets the electrical and environmental requirements of MIL-R-26C. However, its lug-attached leads are not covered in the specification.

Resistance range is 0.1 to 100,000 ohms; operating temperature range, -55° to +350°C; tolerance, 5%

Complete line of faster, field-proven

MULTIPLEXERS A/D-D/A CONVERTERS BY CONTROL DATA

When you require speed and performance, don't settle for less than your long-range needs. The broad line of products developed by Adcomp, a subsidiary of Control Data, now makes it possible to select the instrument for your *specific* application. Here are typical models:

HIGH SPEED MULTIPLEXERS



Silicon solid-state switches are used in multiplexers to obtain high speed and low offset voltage. The Model 402 32-channel Multiplexer offers a speed of 500,000 samples per second with a maximum offset voltage of 250 μ V max. Linearity is better than 0.001% and input impedance is 100 megohms min. Input ranges from ± 1 to ± 100 volts are available.

ANALOG TO DIGITAL CONVERTERS



Analog to Digital Converters are available with resolutions from 8 to 14 bits, and 50 to 250,000 conversions per second. A number of inputs are offered up to ± 100 volts. Digital output is binary. Integral sample and holds and extremely stable reference supplies provide exceptional accuracy and stability.

DIGITAL TO ANALOG CONVERTERS

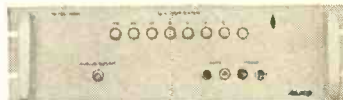

These instruments incorporate the finest components obtainable. For example, high accuracy and temperature stability are obtained with a precision resistance ladder immersed in oil. Various models offer resolutions from 8 to 14 bits, absolute accuracy to $\pm .015\%$ and an update rate up to 300 kc. Buffer amplifiers are available for various output voltages and drive capabilities.

FOR INFORMATION concerning these and other ADCOMP instruments, contact: ADCOMP CORPORATION, Dept. 304, 20945 Plummer St., Chatsworth, California 91311 (Area code 213, 341-4635)

ADCOMP CORPORATION
SUBSIDIARY OF

CONTROL DATA
CORPORATION

You get better results with high speed integrated monolithic circuits that are packaged right

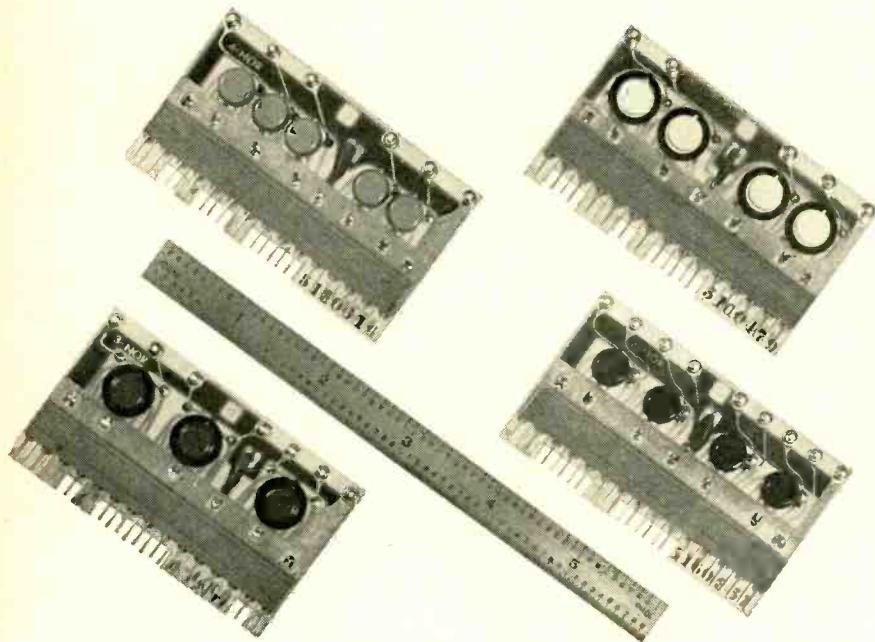

SEL 8500 Series Micrologic Modules

Here is the answer to your digital logic design and assembly problems. Whether your requirements are for an entire system or a single demonstration unit, you will appreciate these operational and packaging advantages: Easily accessible test points, ELCO connectors for quick and reliable wire-wrap inter-connecting. Card shape and size minimize flexing. One power supply voltage is required, and operation speeds are in excess of 5 mc. Noise immunity is excellent. A full line of SEL trays and files is available for compatible packaging.

Write for SEL Bulletin 9031

SEL SYSTEMS ENGINEERING LABORATORIES, INCORPORATED
P.O. BOX 9148 • FORT LAUDERDALE, FLA. 33310

Telephone 305-587-2900

TWX 305-587-1079

Immediate openings for logic design engineers • An equal opportunity employer

New Components

(10% on 1 ohm and lower values); temperature coefficient, ± 30 ppm. Typical price is 23 cents each in quantities of 100—depending on size, value and tolerance required. Dale Electronics, Inc., P.O. Box 488, Columbus, Nebr. [354]

Push-button switch for long-life control

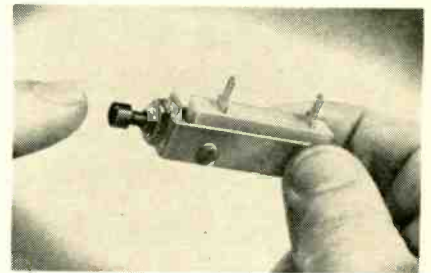

A push-button Seal-X switch now available uses a permanent magnet to actuate a reed capsule. The spst Form A switch can be used for any push-button-control application, including control panels, r-f band switching, instruments, encoders, and communications equipment.

The miniature device is designed for convenient front-panel mounting and is available with either red or black push buttons. The $\frac{5}{16}$ -in.-wide switches may be gang-mounted, taking very little panel space. The designer has a choice of either normally closed or normally open configurations.

The Seal-X requires only 3 to 7 oz of force over a distance of $\frac{3}{32}$ in to operate. Spring loading returns the switch to normal position after each operation.

The switch has a life expectancy of over 100 million operations. It is packaged in a high-impact-resistant nylon fiberglass case. Contacts are gold alloy for low resistance. Open switch capacitance is 0.2 pf, maximum. Operating speed is up to 100 cps. Switching voltage is up to 150 v, with power-carrying capacity up to 10 v-a in d-c operation and 12 v-a in a-c circuits.

The Seal-X measures, behind panel, $1\frac{9}{16}$ in. long x $\frac{5}{16}$ in. wide x 0.613 in. high, including terminals. James Electronics, Inc., 4050 North Rockwell St., Chicago, Ill., 60618. [355]

A Message From the Manufacturer:

**We know perfectly well that these
nine and twelve pin receiving tubes
are as good as anybody else's.**

**We wouldn't advertise them
if they weren't. Nor would
we pack the full range
of them in our own
color TV sets. Or
sell as many as we
do to other
manufacturers. After
all, we're just as interested
in showing a profit as the next
person. But not at his expense.
And the goods are what count.**

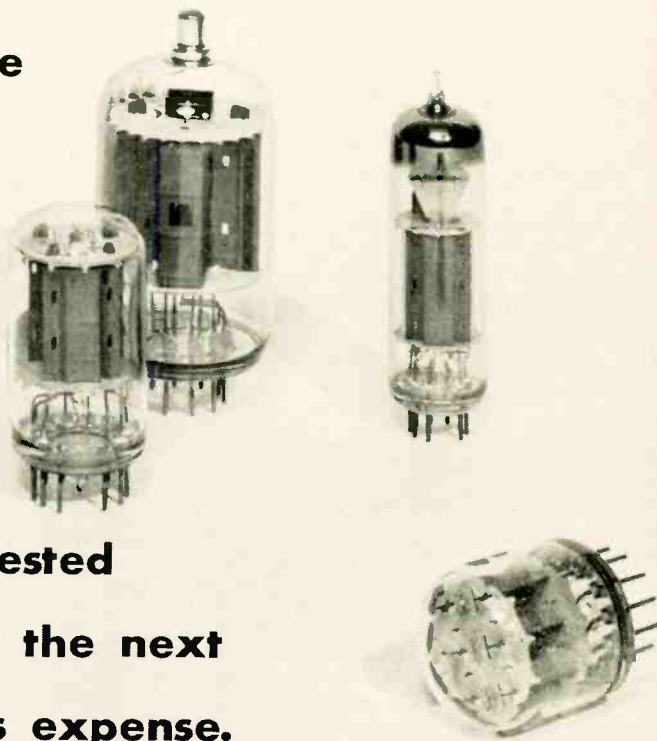

 **HITACHI**
Tokyo Japan

HITACHI SALES CORPORATION 333, N. Michigan Avenue, Chicago 1, Ill., U.S.A. 666, 5th Avenue, New York, N.Y. 10019, U.S.A. 12715, S. Daphne Avenue, Hawthorne, Calif., U.S.A. HITACHI, LTD. DUESSELDORF OFFICE Graf Adolf Strasse 37, Duesseldorf, West Germany BUENOS AIRES OFFICE Avenida de Mayo 666 Piso 12, Buenos Aires, Argentina SAO PAULO OFFICE Rua Direita, 250-23 Andar S/5, Sao Paulo, Brazil INTERNATIONAL IMPORTERS, INC. (Agent in U.S.A.) 2242, S. Western Avenue, Chicago, Ill., U.S.A.

Quick Reaction Capability that Counts



HERE'S WHY:

These 1-mc Forward-Backward Decade Counters may be applied quickly and easily to systems and products requiring reliable high-speed bi-directional counting.

JANUS Model B100-80 Series Forward-Backward Counters Provide:

SPEED: Accept pulses to 1-mc in either direction.

QUICK REVERSING TIME: Less than two microseconds.

RELIABILITY: All transistorized, silicon circuitry throughout.

LOW COST:* \$115.00 (or less) for units with display. \$46.50 (or less) for units without display. Less costly than making them yourself.

FAST DELIVERY: From stock.

Available (with or without display) individually or in quantity for use in high speed counter applications where quality, low-cost and reliability are important.

Write for Technical Literature.

The Next Time You Need Counters
Count on JANUS

*Price (FOB Newton, Mass.)
even lower in large quantity.

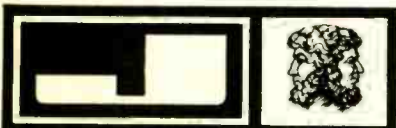

JANUS CONTROL CORPORATION
HUNT ST., NEWTON, MASS. TEL. 926-1037

New Semiconductors

Reference diodes in 14 voltage ratings

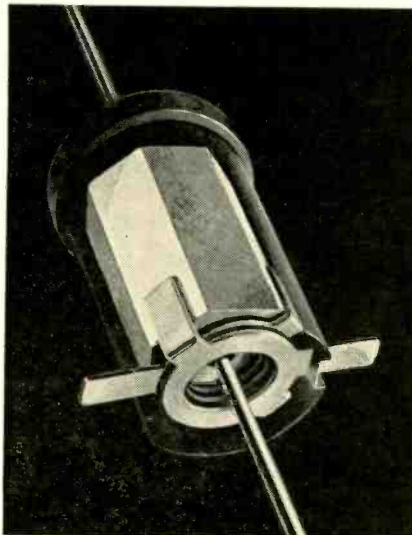

A line of temperature-compensated reference diodes comprise a glass-encapsulated hermetically sealed Moly/G diode within a self-regulating polycrystalline semiconductor oven. A nonconductive outer jacket of compression-molded high-temperature Nylon provides protection against moisture and physical damage.

The TIXD746-759 series is available in 14 standard ratings from 3.3 to 12 v (and up to 33 v on special order). The devices offer increased design flexibility in circuits requiring temperature-compensated diodes. These, until now, have largely been limited to 6- and 9-volt devices.

Current to the self-regulating oven varies inversely with temperature to provide stabilization over a wide temperature range. Maximum temperature coefficient ratings are 0.005%/°C from -55° to 100°C and 0.003%/°C from 0° to 75°C. Temperature coefficients as low as 0.001%/°C are available depending on voltage range.

Typical applications include voltage-regulated power supplies, digital voltmeters, high-frequency crystals, differential amplifiers, and instrumentation requiring voltage reference.

The TIXD746 series is priced at \$2.70 in 100 to 999 quantities. Texas Instruments, Inc., 13500 North Central Expressway, Dallas, Tex. [371]

Rectifier diode rated at 2 amps

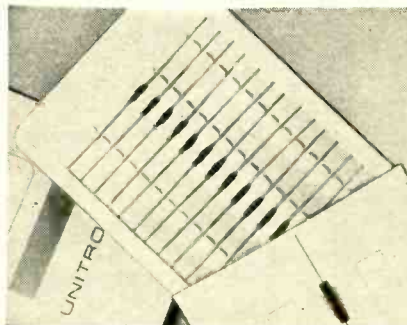

Ultrafast-recovery rectifiers now in production can operate at frequencies of 100 kc square wave, or 350 kc sine wave. The 2-amp-rated devices have typical recovery times of 50 to 60 nsec. They can withstand surges up to 40 amps and have leakages under 1 μ a at 25°C.

The units are less than 1/4 in. long, with a maximum diameter of 0.085 in., and feature the manufacturer's unique construction. Refractory metal pins are metallurgically bonded across full face to a silicon die of identical diameter. The resultant structure is then fused in hard glass, which forms a void-free hermetic seal around the junction.

Prices of the UTX series vary from \$1.90 to \$4.95, depending on voltage rating and quantity. Unitrode Corp., 580 Pleasant St., Watertown, Mass. [372]

Silicon rectifiers offer fast recovery

EIA registration is announced for a series of lead-mounted, fast-recovery silicon rectifiers. The units are designed for use in circuits re-

quiring up to 1 amp average rectified d-c output current at frequencies up to and beyond 100 kc and temperature ranges of -55° to $+150^{\circ}\text{C}$.

Series 1N4993 through 1N4937 are rated from 50 to 600 v piv with a maximum surge current rating of 30 amps at 75°C and maximum reverse current recovery time of 200 nsec specified for all types. The rectifiers are supplied in a new axial lead package, with 0.030-in. leads and over-all package length of 0.205 in.

Of special interest is the very low d-c reverse leakage current at 100°C of $100\ \mu\text{a}$ and a maximum reverse current at 25°C of $5\ \mu\text{a}$.

Dickson Electronics Corp., 310 Wells Fargo Ave., Scottsdale, Ariz. [373]

Zener diodes are hermetically sealed

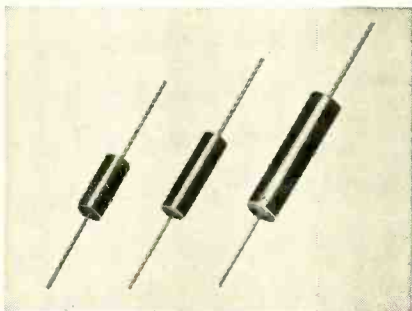

Temperature-compensated zener diodes are available covering a 1.5- to 2.5-w range, with zener voltages ranging from 12.4 to 200 v. Their JEDEC numbers are 1N4057A through 1N4085A. Temperature coefficients of 0.002% or 0.005% per $^{\circ}\text{C}$ may be selected. Maximum dynamic impedance of the units is 25 ohms for the 12.4-v diode, up to 1,350 ohms for the 200-v diode.

The diodes are hermetically sealed in molded packages, and conform to all applicable MIL standards. Their small size, light weight and insulated bodies make them particularly suitable for regulated airborne power supplies, amplifiers, etc.

Because their voltage drop is independent of current over a wide current range, they are very effective in regulating d-c voltages, low-impedance d-c level changing, clamping, clipping, and surge protection within their rating.

Solitron Devices, Inc., 256 Oak Tree Road, Tappan, N.Y., 10983. [374]

For Printed Circuits to meet any requirement...

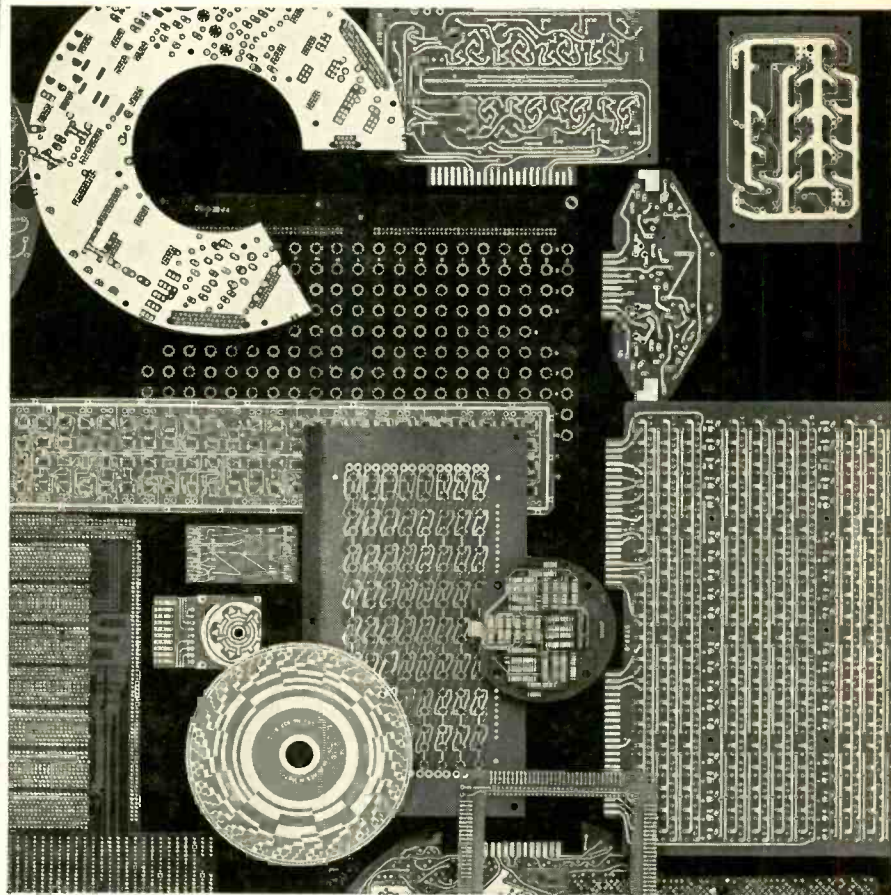

...Specify Cinch-Graphik

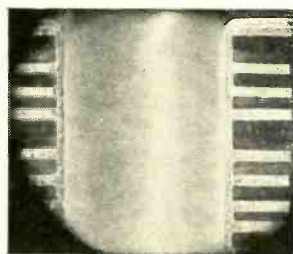

You name it... big as a card table or tiny as this:  ...one of a kind or millions... single or multilayer (30 layers or more!)... Cinch-Graphik can do! The multilayer cross-section photo shows some of the details of Cinch-Graphik's precision production techniques: Uniform thickness of the plated thru-hole and the complete interface bond between the individual circuit layers and the plated wall. This type of matchless craftsmanship is found in all Cinch-Graphik circuits regardless of type or application. For satellites or stereo, computers or communications, there are no finer printed circuits than Cinch-Graphik. To learn more about our unique capabilities, write for our new brochure.

precision production techniques: Uniform thickness of the plated thru-hole and the complete interface bond between the individual circuit layers and the plated wall. This type of matchless craftsmanship is found in all Cinch-Graphik circuits regardless of type or application. For satellites or stereo, computers or communications, there are no finer printed circuits than Cinch-Graphik. To learn more about our unique capabilities, write for our new brochure.

CINCH-GRAPHIK
DIVISION OF UNITED-CARR

200 South Turnbull Canyon Road, City of Industry (Los Angeles), Calif. 91744 • Phone (213) ED 3-1201. Offices in 22 Principal Cities throughout United States, Canada, England and Australia listed under Cinch Mfg. Co. or United-Carr Incorporated • Cinch • Cinch-Monadnock • Howard B. Jones • Ucinite • Palnut

meeting the high reliability and performance requirements of

150

MISSILE AND AEROSPACE COMPANIES

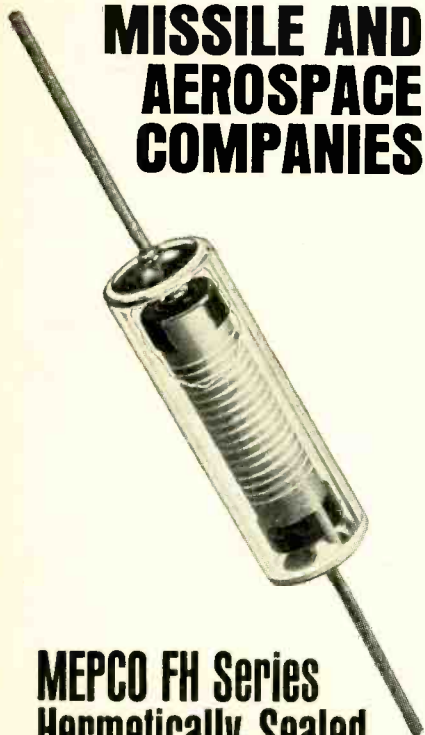

**MEPCO FH Series
Hermetically Sealed,
Glass Enclosed
METAL FILM
RESISTORS**

High reliability resistors for demanding requirements of aerospace and military electronics fields. Conform to MIL-R-55182.

For complete information and detailed specifications, write:

MEPCO, INC.

Morristown, New Jersey 07960
Phone (201) 539-2000
TWX (201) 538-6709

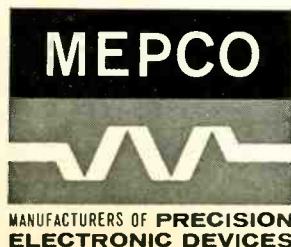

New Instruments

Power supply for automatic testers

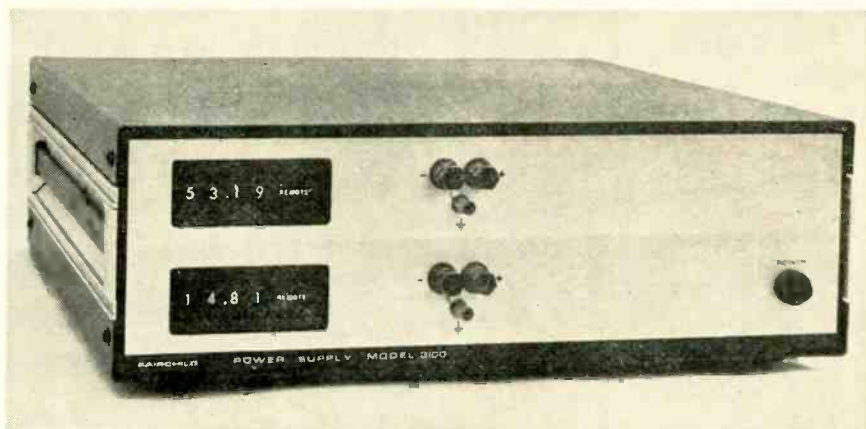

Many testing applications require the use of a prescribed sequence of different test voltages or current levels. To achieve this with conventional power sources, it is necessary either to combine a fixed power supply with a precision resistor bank and stepping switches, or to use a continuously variable power supply whose setting must be changed manually.

A precision power source that is externally programmable simplifies this automatic testing procedure. The new model 3100 power supply, developed by the instrumentation division of the Fairchild Camera & Instrument Corp., consists of two independently programmed power supplies. Each can be used as a constant current source or a precise voltage source. The output values are selected either by a remote program or manually by front-panel switching. The desired series of voltage or current levels is generated in response to binary-coded control signals.

Both outputs are floating and can be operated in parallel for additional current capability, or in series for voltages higher than 100. In either mode of operation, the output can be controlled either by front-panel thumb switches or by external contact closure. At the rear, there is a corresponding 1-2-4-8 binary-coded-decimal program input for each digit of the front-panel control. There is no need for external programming resistors. The

mode of operation and the programmed output voltage are indicated on the digit switches.

Either of the two inputs provides 00.00 to 99.99 volts in 0.01-volt steps, or 00.00 to 99.99 milliamperes in 0.01-ma steps. Accuracy of voltage or current output is 0.01% ± 1 digit. The model 3100 changes voltage in less than five milliseconds. Short-circuit protection in the voltage mode and open-circuit protection in the current mode have been built into the instrument. If the external programming is accidentally disabled, the output falls to zero automatically.

The model 3100 power supply was designed for high stability and fast transient response. Fairchild

Specifications

| | |
|--|--|
| Output characteristics (voltage mode) | |
| voltage | 00.00 to 99.99 volts in 0.01-volt steps |
| accuracy | 0.01% ± 1 digit |
| output resistance | less than 1 milliohm |
| load current | 100 ma maximum |
| hum and noise | less than 1.0 mv peak-to-peak |
| (current mode) | |
| current | 00.00 to 99.99 milliamperes in 0.01-ma steps |
| accuracy | 0.01% ± 1 digit |
| output conductance | less than 10 ⁻⁷ mho |
| hum and noise | less than 1 microampere peak-to-peak |
| General | |
| temperature coefficient | 0.002% per degree centigrade |
| transient response | less than 50 μsec for 100% load change |
| line regulation | less than 0.01% for ± 10% line change |
| input voltage | 115 ± 10% volts, 50/60 cps, 40 watts maximum |
| temperature | 10° to 50°C |

says it is an ideal component for automatic test systems, including semiconductor and integrated-circuit testers. The new instrument can also be used as a precise power source in a laboratory.

The price of the model 3100 is \$1,500; delivery is from stock.

Fairchild Instrumentation, division of Fairchild Camera & Instrument Corp., 844 Charleston Rd., Palo Alto, Calif. 94303 [381]

Recorder prints out digital data

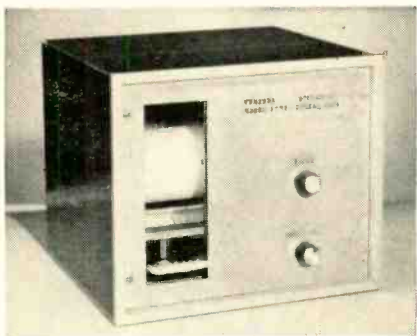

Model 1001 digital printing recorder prints out digital data in response to an analog d-c voltage input. It may be used with a variety of scientific laboratory and medical instruments to produce a digital printed record. In many instruments it may be connected directly in parallel with an existing panel meter.

The recorder incorporates a 4-digit data printer and a 2-digit cycle printer to identify the data. Pressure-sensitive recording paper is used, so no ink ribbon is required. Multiple-ply paper rolls may be used if duplicate copies of data are desired. Data is immediately visible after it is printed. Balance servo system is fully transistorized and chopper stabilized, and has potentiometric input and a zener reference.

Span is 2,900 digits. Any fraction of the total span may be utilized, and the data printer may be set to print any 2,900 digits from 0000 through 9999. Sensitivity is 100 mv per 1,000 digits. Accuracy is $\pm 0.15\%$ full scale. Balance time is 3 seconds per 1,000 digits. Print-out is on command (push "print" switch). Size is 8.7 in. high, 10.3 in. wide, 10 in. deep. Price is



Trompeter Electronics' STANDARDIZED coaxial patching panels and accessories are designed for installation in 19" cabinets for 50, 75, or 93 ohm systems using RG-8, 9, 11, 58, 59, and 62 cables. Where maximum patching density is required, our MINIATURIZED patching system provides twice the number of jacks in a standard 19" panel. The miniature system is for utilization with small cable systems of RG-122 (50 ohm), Amphenol 21-597 (75 ohm), RG-180 and RG-195 (95 ohm), as well as standard RG-58, 59 and 62 cables. Our new TWINAX patching system is for telephone systems (124 ohm), high frequency data and checkout circuitry (78 ohm), low frequency, low level analog and digital balanced lines. Unlike other methods which require two jacks to accommodate each pair, this new twinax jack accommodates the two conductors and the shield within the same shell. Electrical matching is maintained and substantial savings in both space and cost is achieved.

COAX / TWINAX PATCHING

(BNC, TNC, type N and type C)

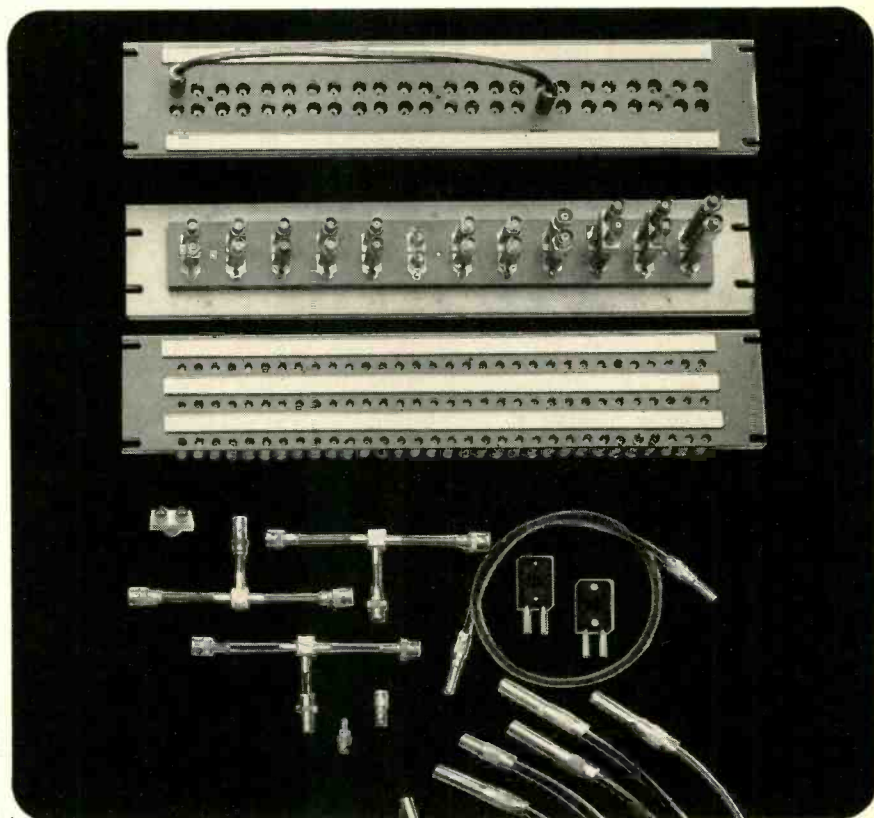

TROMPETER ELECTRONICS

8936 Comanche Ave., ■ Chatsworth, Calif. 91311 ■ (213) 882-1020

MOLD THERMOSETS in 14 SECONDS!

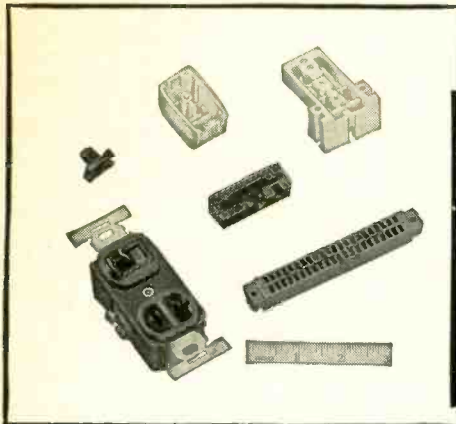

Yes, automatic overall cycles of 14 seconds or less with the "99C"

Now used for high-speed production of:

- MOLDED CONNECTOR BODIES
- WIRING DEVICES
- OTHER ELECTRICAL or ELECTRONIC PARTS

CONNECTOR PRODUCTION in one plant became fully automatic, at five times previous rates, with a "99C" transfer molding machine. Molding costs, exclusive of materials, dropped from 22¢ to 2¢ per piece! Yet precise tolerances were maintained.

In connector cavities with 0.160-in. thick sections, the 99C cures standard glass fiber-reinforced DAP's in as low as 10 sec. —with overall cycles of 15 seconds. Electronic preheat to curing temperatures provides such fast cycles.

FOR WIRING DEVICES, the 99C cures phenolics and ureas in as low as 5 seconds! Automatic, horizontal press action permits easier part ejection and

operation of automatic degating molds.

FOR PARTS MOLDING, the 99C handles any preformable material... in short runs as well as long. The machine truly represents a new concept in high-speed, reliable molding of thermosets. For a demonstration in our plant, or literature, write or phone: **HULL CORPORATION**, 5037 Davisville Road, Hatboro, Pa. 19040. Phone (215) 675-5000.



H-24

▶▶▶ SEE THE 99C IN ACTION TO BELIEVE IT! ◀◀◀

Circle 210 on reader service card

Distinctively Styled



1½ in. AM-1 (actual size)

high torque, self-shielded panel meters

Clean, modern styling... easy scale readability... sizes 1½ to 4½". High torque mechanism gives 1% linearity, 2% accuracy and sensitivity to 20 ua. Magnetic system completely shields external field influences, permitting bezel-to-bezel mounting on any material without interaction or effect on calibration. Choice of colors or finishes, custom dials—ASA/MIL 4-stud mtg.

AMMON

AMMON INSTRUMENTS, INC.
345 Kelley Street, Manchester, N. H. 03105

GRAPHIC VISUAL CONTROL

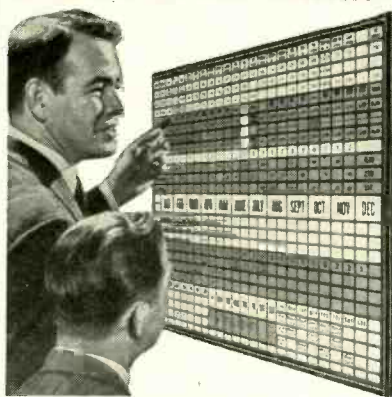

You SEE How To Get Things Done With The BOARDMASTER System

You see a Graphic Picture of your operations, spotlighted in color. You have facts at Eye Level. Saves time, cuts costs and prevents errors.

Ideal for Production, Maintenance, Scheduling, Inventory, Sales, Traffic, Personnel and many other uses.

Simple and flexible tool. You write or type on cards and post on board. All cards are interchangeable.

Compact and Attractive. Made of Aluminum. Over 1,000,000 in use.

Complete Price \$49⁵⁰ Including Cards

FREE 24-Page BOOKLET No. C-10 Mailed Without Obligation

Write Today for Your Copy

GRAPHIC SYSTEMS
925 Danville Road • Yanceyville, N.C.

Circle 211 on reader service card

New Instruments

\$595 including recorder, instruction manual, and two rolls of paper. Ventura Scientific, P.O. Box 1202, Thousand Oaks, Calif. 91360. [382]

F-m signal generator has drift under 50 ppm



An f-m signal generator, covering 470 to 960 Mc in one continuous band, has been designed for communications. Model 1060/3 has drift of less than 50 parts per million per 10 minutes and delivers an output of 0 dbm into 50 ohms with accurate attenuation to -130 dbm.

The tuned-line oscillator operates on fundamentals with complete freedom from subharmonics. Carrier harmonics are less than 2% distortion factor.

Three ranges of f-m deviation are provided, with full-scale values of ±30, ±100 and ±300 kc. Internal modulation is at 1 kc and the external modulation bandwidth extends from 30 cps to 100 kc; 5 v provides 300 kc deviation.

Price is \$1,650.

Marconi Instruments, 111 Cedar Lane, Engelwood, N.J. [383]

Recording photometer is accurate, stable



High-current recording photometer, model 16, uses a solid-state opera-

tional amplifier for measurement of photomultiplier tube currents from 100 milliamps to 10 picoamps. The maximum error is 0.2%. The instrument offers dark-current cancellation and four recorder drives—10 v at 100 ma, 1 ma, 100 mv, and 10 mv.

The unit may be coupled to a wide variety of recorders (potentiometric as well as galvo), oscilloscopes, and digital voltmeters. Its accuracy and stability make it a useful laboratory instrument for a wide variety of current-measuring applications.

Model 16 is packaged for rack or bench-top use. Prices vary from \$945 to \$1,063 with choice of options. Delivery is 30 to 45 days. Pacific Photometric Instruments, 3022 Ashby Ave., Berkeley, Calif. [384]

Reflectometer covers 30 to 1,000 Mc

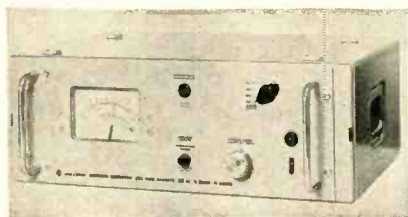

A broadband, direct-reading reflectometer measures reflection coefficients from 0.5% to 100% and attenuations from 0.05 db to 5 db. The type ZRZ reflectometer operates over a frequency range from 30 to 1,000 Mc. Its reflection range is divided into ranges of 0.5 to 3%, 10%, 30% and 100%, with standard characteristic impedances of 50 ohms and 60 ohms, depending on model. Type ZRZ gives direct reflection indication by a nearly linear meter calibrated in percent.

Since this unit supplies only low voltages to the test item, it is applicable for semiconductor circuits. The voltage is controlled automatically, so the frequency response of the signal generator need not necessarily be flat.

The fully transistorized model ZRZ is equipped with outputs for both a slave meter for remote measurements and a recorder for plotting sweep measurements.

The unit is priced at \$2,960. Rohde & Schwarz, Passaic, N.J. [385]

ASTRODATA



NEW MODULARIZED EQUIPMENT AND SYSTEMS FOR UNIVERSAL DC SIGNAL CONDITIONING

Here at last is a trouble-free, practical solution for every DC signal conditioning need: stable excitation, circuit completion, biasing, balancing, calibration, filtering, attenuation and amplification precisely matched to your transducer type and full scale range. *Trouble-free* and *practical*, because the Series 1155 accommodates virtually all classes of DC transducers and impedances from an integrated family of modularized plug-in circuits and components. Total isolation between channels, input-output, power line, cabinet ground, etc. And you can calibrate in any mode, manual or automatic, remote or local, in tandem or channel by channel.

PROVEN: Over 1000 channels in daily use in the Apollo space program.

UNIVERSAL CONDITIONING:

- 1-, 2-, and 4-arm (full bridge) strain gages
- Single element resistance temperature sensors
- Thermistors
- Potentiometers
- Thermocouples
- Voltage taps
- ±5 volt transducer signals

VERSATILE CALIBRATION MODES:

1. Local calibration of individual channels from a front panel calibration switch on each conditioner unit.
2. Local or remote calibration of all channels in tandem, with each calibration step manually selected.
3. Local or remote calibration of all channels in tandem, with each calibration step advancing automatically at intervals of approximately 2.5 seconds.

DIFFERENTIAL AMPLIFICATION:

Series 1155 Signal Conditioner mounts side-by-side with Astrodata Series 885 or 886 Differential Amplifiers to provide complete, isolated, self-contained conditioning, calibration and amplification functions.



ASTRODATA

P. O. Box 3003 ■ 240 E. Palais Road, Anaheim, California ■ 92803

Now twice as many



Couch 0.1 oz. rotary relays

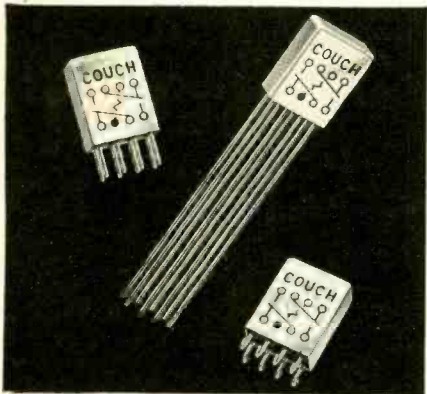

each available in
3 terminal styles . . .

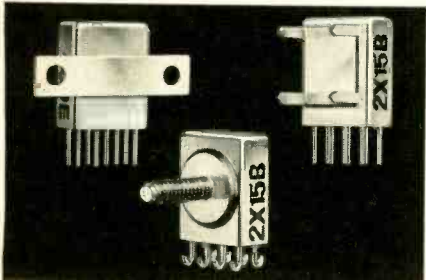

and in many mounting styles

We now offer a full line of SPDT relays, type 1X, to match our DPDT, type 2X, relay line. Except for coil data, specifications are identical for both types:

| | 2X | 1X |
|----------------------|------------------|------------------|
| Size | 0.2" x .4" x .5" | same |
| Terminal Spacing | 1/10" grid | same |
| Rating | 0.5 amp @ 30 VDC | same |
| Coil Operating Power | 150 mw | 70 mw |
| Coil Resistance | 60 to 4000 ohms | 125 to 4000 ohms |
| Temperature | -65°C to +125°C | same |
| Vibration | 20 G | same |
| Shock | 75 G | same |

Write for Data Sheets No. 9 and 10

RUGGED ROTARY RELAYS  Dynamically and Statically Balanced

COUCH ORDNANCE INC.

3 Arlington Street, North Quincy 71, Mass., Area Code 617,
CYpress 8-4147 A subsidiary of S. H. COUCH COMPANY, INC

New Subassemblies and Systems

Control uses master and slave computers

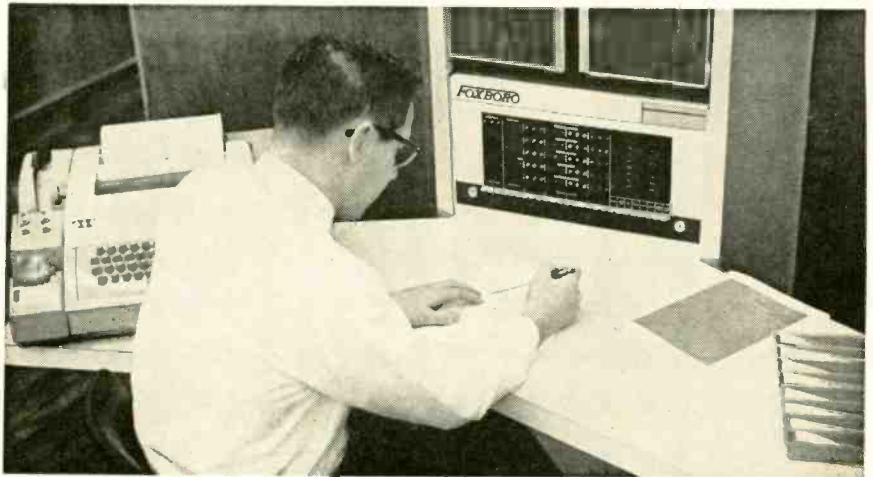

More and more, industrial computer control systems are being made up of several small computers arranged in a master-slave configuration. Usually, such multiple-computer systems are assembled from standard computers, and the master-slave relationship comes about because of the way the system is interconnected. But now the Foxboro Co. is formally offering a multiple-computer system as a complete product. The PCP 88 is assembled from two or more Model 97400A digital computers.

The master and slave computers are practically identical in structure. It is the programming and the nature of the memories that makes them able to perform differently in the system. Foxboro points out that this basic similarity between the computers allows each to take over the other's functions in case of a failure. The company claims that because of this redundancy, the PCP 88 system will have 30-year mean time between failures.

The slave is used for continuous, on-line direct digital control (DDC) of a process. It can simultaneously handle 250 process control loops, updating each loop once each second. The slave repetitively cycles through the loops, taking in digitized readings from the loop sensors, cranking these into the equations (which are stored in the slave's memory), and delivering new commands to the loop's actual

ators. It is assumed that the loop's state has not changed more than 10% since the previous cycle, a conservative assumption for most industrial processes. The slave is programmed in machine language and uses a random-access magnetic-core memory.

The master is designed to be easy for the customer to use in monitoring and improving the overall control system behavior, rather than as an efficient DDC computer. To this end, Foxboro has made it possible to program the master with on-line Fortran language. This makes it easy for most customers to learn quickly to converse with the master, the company says.

But at the same time, Foxboro has made the master serve as a buffer between the slave and the user. The PCP 88 system is arranged so that an inexperienced user cannot, as he works with the master, inadvertently upset the vital continuous control action of the slave. Thus, while it is possible for the user to request the master to fetch information about the state of the process loops from the slave's memory, the master only has access to the slave's memory at such a time and in such a manner that there will be no interference with the slave's higher-priority control computations.

The master serves as an on-line backup for the slave. If the slave computer fails for any reason, the

continuous monitoring routines in the master will immediately detect the failure, and the take-over procedure will automatically begin. The master will cause all the loop control equations in the slave's memory to be transferred to its own memory, and the master will then perform the control. However, when the master is standing in for the slave, it will not be able to continue all of its "master-level" functions.

To enable it to carry out its wider functions, the master computer has a large-capacity disc-file memory. It also can be provided with more elaborate operator consoles.

Specifications

| | |
|------------------|---|
| Type of computer | M/97400A |
| Slave's memory | Random access core 4,096-32,768 words high-speed disc |
| Master's memory | high-speed disc |
| Word length | 12 bits |
| Add time | 3.0 microseconds |
| Multiply time | 21.2 microseconds |
| Divide time | 37.2 microseconds |

The Foxboro Co., Foxboro, Mass. [401]

Command and control a-m/f-m receiver



An a-m/f-m receiver has been developed for simplified, low-cost application to command and control systems. The receiver is all-silicon, crystal controlled, and is available for any frequency from 3 to 60 Mc.

Specifications include less than 3.5 cu in. volume, 5 μ V sensitivity, 80 db dynamic range, 50 mw standby power, and 270 ohms audio output impedance.

The series, designated RC2000A 010, can supply on-off commands or proportional controls when applied with a-m or f-m tone, pdm or pcm decoders. Application notes showing an example of system design are available on request.





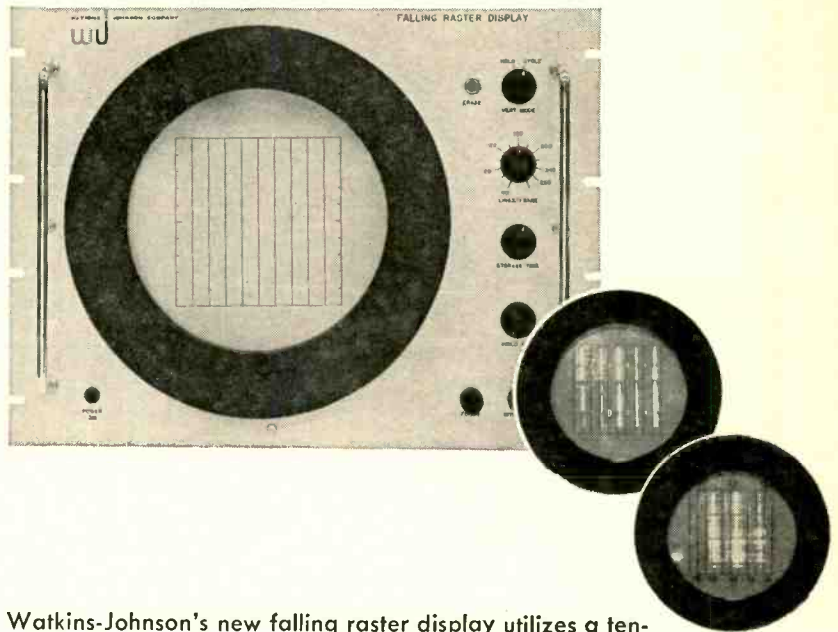

Receivers at 27.255 Mc are available from stock. Price is \$38.75. Novatec Corp., 3930 Walnut St., Fairfax, Va., 22030. [402]

FALLING RASTER DISPLAY



Watkins-Johnson's new falling raster display utilizes a ten-inch controlled-persistence cathode ray tube to create a "three-dimensional" presentation of receiver signals: signal frequency, time, amplitude. When operated in conjunction with a sweeping receiver, it provides a large raster on a 5.25-inch field. The internally generated raster delivers 256 scans of time information and the receiver video produces intensity modulation corresponding to signal amplitudes. The time information may be stored up to ten minutes. All functional units, excepting the display tube, are solid state. Silicon transistors are used throughout with conservative derating.

Again, the advantages —

-  Large presentation
-  Real-time display
-  Improves receivers by integrating signal out of noise
-  All internal voltages digitally controlled for accuracy
-  High reliability — all solid state components
-  Up to ten minutes information storage

Information in more detail available from representative in your area, or from Applications Engineering.

WATKINS — JOHNSON COMPANY

wj

3333 HILLVIEW AVENUE
STANFORD INDUSTRIAL PARK
PALO ALTO, CALIFORNIA 94304

NEW FET OPERATIONAL AMPLIFIERS from BURR-BROWN

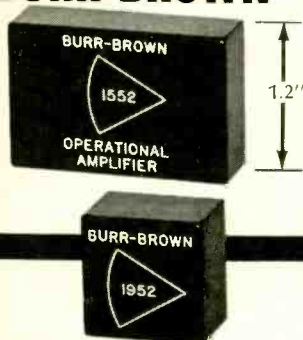

These new general purpose dc operational amplifiers employ matched junction FETs in the balanced input stage to achieve high input resistance and unusually low drift. Designed for ± 10 volt service, units have an operating temperature range of -40 to $+85^\circ\text{C}$. Model 1552 is supplied in a modular $1.8'' \times 1.2'' \times 0.6''$ package. Model 1952, designed for high density applications, is $1.0'' \times 1.0'' \times 0.7''$. Units are priced at \$145 and \$165.

| | 1552 | 1952 |
|--|---|------|
| Input Impedance | | |
| Differential | $10^{10}\Omega$ | |
| Common Mode | $10^{10}\Omega$ | |
| Voltage Gain | 106 db | |
| Bandwidth @ 0 db | 1.5 Mc/s | |
| Maximum Frequency for rated output | 100 Kc/s | |
| Input Voltage Drift | $\pm 5 \mu\text{v}/^\circ\text{C}$ | |
| Input Current Offset @ 25°C typical | $\pm 0.1 \text{ nA}$ | |
| Input Current Drift | (offset doubles every 10°C) | |

Two additional new FET amplifiers (Models 1553 & 1953) are also offered by Burr-Brown. Performance is similar to above except isolated-gate FETs are used to achieve $10^{12}\Omega$ input impedance with corresponding changes in offset and drift characteristics.

FOR COMPLETE TECHNICAL INFORMATION write, wire, or phone Burr-Brown, today.

BURR-BROWN

RESEARCH CORPORATION
INTERNATIONAL AIRPORT INDUSTRIAL PARK
BOX 11400, TUCSON, ARIZONA 85706
PHONE: 602-294-1431 • TWX: 910-952-1111

New Microwave

Solid state switching in less than 1 nsec

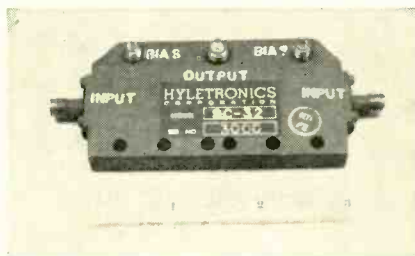

A solid state microwave switch that can be turned off or on in less than one nanosecond has been announced by the Hyletronics Corp. The company says the single-pole, double-throw switch is smaller and faster, and requires less bias power, than conventional switches rated for the same frequency and power.

The switching element is a gallium-arsenide diode, controlled by a bias network, formed from microwave printed circuitry, which has a cut-off frequency approaching 1,000 megacycles per second. Bias networks composed of discrete components have a much lower cut-off frequency, hence they turn on slower. The microwave printed circuits also allow the switch to be made only about one-half the size of switches with equivalent ratings. Only five milliwatts are required to hold it in the off state.

The model SC-32 switch (photo at left) has an insertion loss of approximately 0.7 decibel, representing an improvement of several tenths of a decibel over comparable switches—a significant gain at low power levels. The SC-32, a C-band switch, has a 10% bandwidth and can handle about 100 milliwatts. Hyletronics offers similar 1-nano-second switches at other frequencies, from 100 to 12,000 megacycles. Connectors are miniature type BRM or OSM, which are equivalent types.

The switch, which was developed on contract for application in missiles, can withstand severe environmental conditions, including ambient temperature up to 125°C , the company says.

Specifications

| | |
|--------------------|-----------------------------------|
| Model SC-32 | |
| Isolation | 30 decibels |
| Insertion loss | 0.7 decibel |
| Frequency | C band |
| Bandwidth | 10% |
| Power | 100 milliwatts |
| Bias voltages | |
| ON state | -5 volts, 0 milliamperes |
| OFF state | +1 volt, 5 milliamperes |
| Price and delivery | depend on customer specifications |

Hyletronics Corp., 183 Cambridge St., Burlington, Mass. [421]

Rotary coupler is used with C-band systems

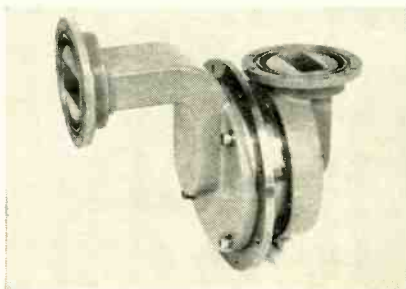

The D26C1 rotary coupler is designed for C-band-system applications requiring operation at megawatt power levels with low loss. Operating frequency range is 5.4 to 5.9 Gc.

The unit operates at a 1-Mw peak power level, $1\text{-}\mu\text{sec}$ pulse width, 0.001 duty cycle. It is capable of continuous operation at 100% power overload. Normal operation is with 30 psig pressurization, but the D26C1 will withstand 45 psig. Maximum insertion loss is 0.3 db, including a 0.1 db maximum variation for a 360° rotation. Maximum vswr is 1.25 including a 0.07 rotation variation.

The D26C1 has a 5-foot-pound maximum break-away (starting) torque and an exceptionally low running torque of 7 inch-pounds maximum.

Major applications of this rotary coupler are in tracking and surveillance radars requiring minimum extraneous modulation of received

or transmitted signals. Price is \$950; delivery, 90 to 120 days. Sperry Microwave Electronics Co., P.O. Box 1828, Clearwater, Fla. [422]

S-band amplifier uses tunnel diodes

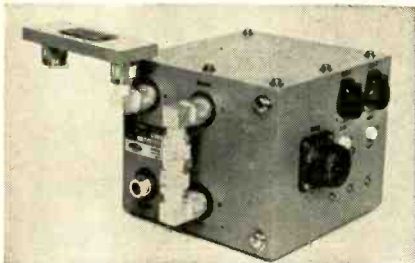

An S-band tunnel-diode amplifier features 25-db gain. The solid-state device operates over a frequency range of 2.9 to 3.1 Gc, with a typical noise figure of 3.9 db. The high-gain amplifier can be supplied with a protective, specially designed passive limiter.

The Micro State Electronics Corp., a subsidiary of Raytheon Co., 152 Floral Ave., Murray Hill, N.J. [423]

Tunable, wide-range frequency multiplier

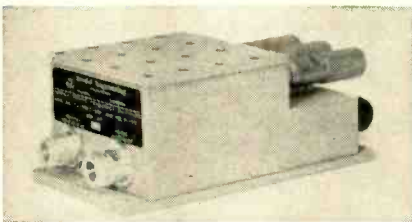

A tunable, solid state frequency multiplier is useful in both L-band and S-band applications. The passive unit accepts input signals from 150 to 300 Mc and delivers, typically, 1/2 to 1 w output power between 900 Mc and 2.4 Gc.

Multiplication is adjusted by micrometer tuning. Input and output impedance are 50 ohms nominal.

A multiplier diode type of unit, the model 90600 is compact and weighs less than 3 lb. Output filtering holds undesired harmonics and spurious frequency oscillations down more than 30 db, typically 50 db or more.

Resdel Engineering Corp., 990 South Fair Oaks Ave., Pasadena, Calif., 91105. [424]

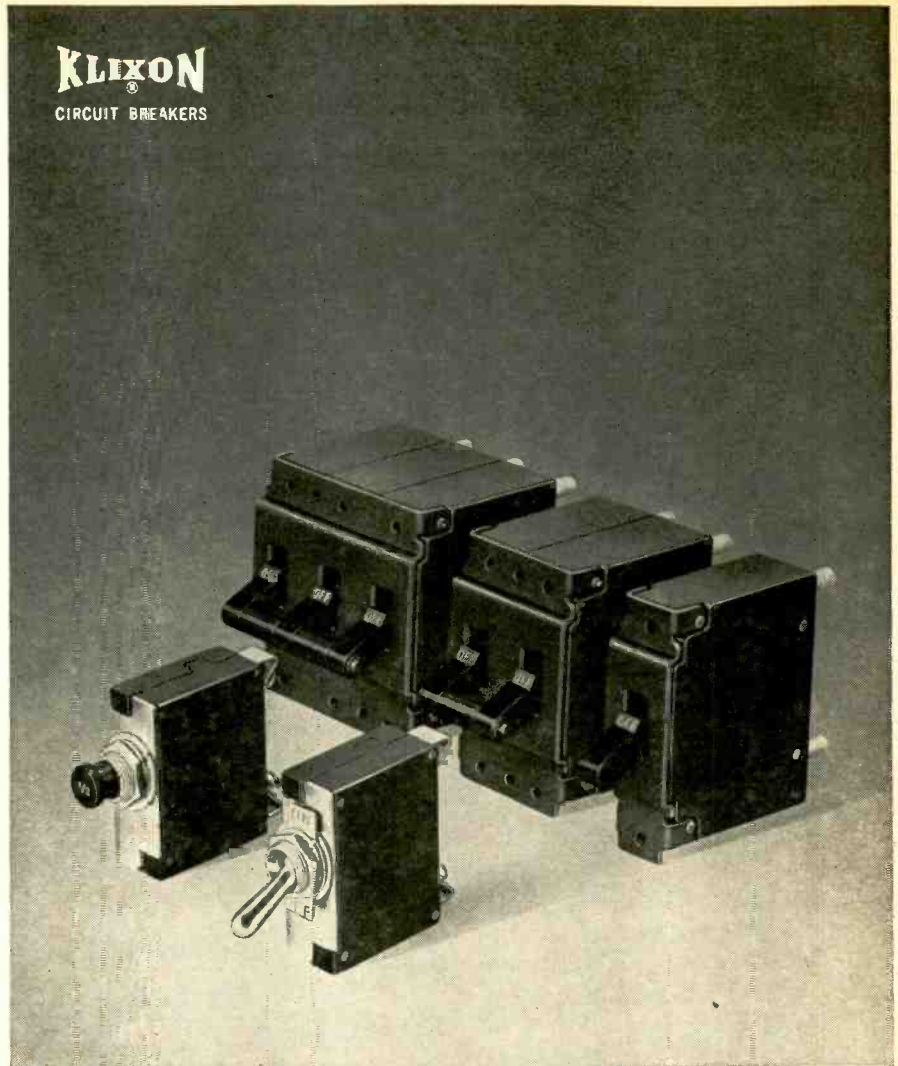

When magnetic circuit breakers are needed for high-reliability protection

...TI DELIVERS!

Name your specifications! Ratings from 0.050 to 50 amp. 2, 3 or 4 terminals. Internal circuits for series, shunt, calibrating tap or relay trip. Remote indication or control. Toggle or push-pull actuation. One, two or three poles. 20% lower voltage drop. 50% higher rupture capacity. All these options are included among the 202 standard types of KLIXON® brand Magnetic Circuit Breakers. All available for off-the-shelf delivery from stock.

Bulletin CIRB-1 contains complete technical information on TI magnetic circuit breakers. Write for your free copy today.



METALS & CONTROLS INC.
5011 FOREST ST., ATTLEBORO, MASS.
A CORPORATE DIVISION OF
TEXAS INSTRUMENTS
INCORPORATED



CUT BLANKS—Shear your blanks accurate within thousandths of an inch on a Di-Acro Shear. Jam-free inclined ram, micrometer gauging, four-edged blade. Widths to 48".

NOTCH BOXES—Cut any size notch up to 6" x 6". Now a new Di-Acro Tab Notcher cuts a special tab for a stronger box that's self-aligning.

FORM WITH THIS 6-IN-1 BRAKE—Here's the most versatile machine in your "Die-less Duplicating" production setup.

1. **Standard Brake**—to 135° angle across 24" width.
2. **Bar Folder**—angles up 150°—makes hemming easier.
3. **Box and Pan Brake**—box fingers form to 24" in ¼" widths.
4. **Open End Former**—forms angular closed shapes.
5. **Tab Former**—raise from center of material.
6. **Radius Former**—accurate ways to form radii.

Get full information in Di-Acro's newest catalog. See your distributor or write us.



DI-ACRO

A Division of Houdaille Industries, Inc.
4511 Eighth Ave., Lake City, Minn. 55041

New Production Equipment

Lightweight, precision rotary wire-stripper

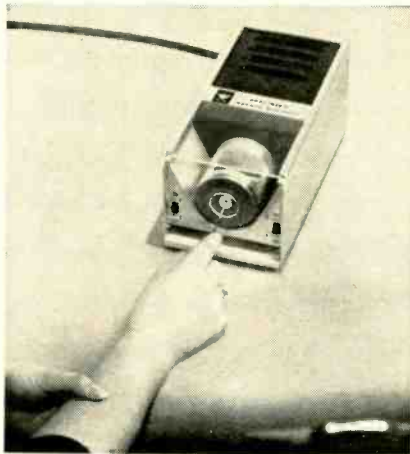

Consistent nick-free wire stripping on a production basis is achieved with this precision rotary wire stripper. The device handles solid or stranded conductors with single-layer insulation in sizes from Awg No. 16 through No. 26. It will precision-strip slick insulation such as Teflon or PVC with thicknesses up to 3/32 in. and over-all wire diameters up to 1/4 in.

The unit is lightweight (11¼ lbs), comes completely assembled, and requires no installation.

The stripping head contains a removable anodized aluminum wire guide which is available in 23 sizes from 0.040 in. through 0.250 in. Hole diameter is marked on the exposed face. Behind the wire guide is the stripping blade assembly. It consists of a blade guide and a leaf-spring, to which a reversible, double-edge carbide blade is attached.

The blade's stripping depth is adjusted with a calibrated tool. Each revolution of this tool moves the blade 0.006 in. giving the operator precise control over the adjustment.

Farther back in the stripping head is an adjustable wire stop, marked in 1/8-in. increments. It allows the operator to adjust stripping length from 1/8 in. to 1 in. The stripping head is powered by a direct-connected 1725-rpm, 115-v, 60-cycle shaded-pole reversible motor. A switch on the front panel reverses motor rotation to accom-

modate the lay of stranded conductors. The panel also has an on-off switch.

Ideal Industries, Inc., Sycamore, Ill., 60178. [451]

Infrared ovens for p-c boards

A line of infrared ovens now available heat fast and offer close temperature control in the drying and curing of acid-resistant inks, photo resists, solder resists, fluxes, and adhesives on printed-circuit boards. Ovens are supplied in various capacities depending on the coating used by the customer and the production requirement. Circuit boards are fed from the coater onto the oven conveyor, which transports them first through the heating section and then through the cooling section.

Typical time cycles for etch resists and protective coatings on circuit boards are: heating time, 30 seconds; cooling time, 90 seconds. Typical time cycles for solder resists on circuit boards are: heating time, 60 seconds; cooling time, 90 to 120 seconds.

Because of the simple construction and the advantages of infrared heat, these ovens are said to give lower first cost and savings in floor space compared to other types of heating. They also offer ±5°F temperature control because of their thermocouple-heating element mounting; clean heat; and quick setup and changeover. The modular heating panels give uniform heat across their face, which allows them to be set close to the work for highest efficiency. Pyrometric controls provide for an automatic feedback system. The conveyor is a screen-type belt, self-tracking, with a speed from 1 fpm to 8 fpm, driven by a 1/4-hp motor. Typical oven size is 15 ft long, 3 ft wide, and 7½ ft high.

Infra Red Systems, Inc., Route 23, Riverdale, N.J. [452]

"ROOM AT THE TOP"



Growth opportunities in Communications with **TRW SYSTEMS** in Los Angeles and Houston

There is "room at the top" for your special talents on America's major missile and space programs with TRW Systems' Communication Laboratory in either Los Angeles or Houston. From the beginning of communications via space, this group has played a preeminent role in developing communications systems for the nation's major missile and space programs. Major achievements include the first unified carrier tracking, telemetry and command system and the first PCM telemetry system for space. Now is the time for you to investigate these opportunities with this outstanding professional organization.

MAJOR PROGRAMS . . .

- Apollo spacecraft systems
- Advanced Minuteman systems
- Mars mission and spacecraft studies
- Nuclear Detection (Vela) Satellites
- Pioneer interplanetary spacecraft
- Weather satellite systems
- Standardized tracking, telemetry and command system (SGLS)
- Advanced space probes
- Lunar telemetry systems
- Communication satellite systems

Senior Communication Engineers

For design, analysis and management of communication systems and evaluation of scientific and military applica-

tions of communication techniques for aircraft, spacecraft and underwater craft use. BSEE, MSEE or PhD.

Communication Equipment Design Engineers

Several years' experience in design and analysis in the following fields: RF filters, duplexers, antennas, phased arrays, feeds, solid-state transmitters, receivers, phase-lock loop techniques, cavity techniques, strip line, very wide and very narrow band circuits, circuit engineering, and modulation techniques. BSEE or MSEE.

Communication System Analysis Engineers

Conceptual design, analysis and synthesis of wide variety of digital and analog communication systems, employing coding, modulation, and statistical communication theory. Systems include integrated coherent-carrier systems, phase lock demodulation (restrictive/non-restrictive), communication satellites and deep space probes. MSEE or PhD.

Signal Processing Engineers

Design and development of sophisticated communication systems and components. Signal conditioners, analog and digital encoding and decoding, modulation tracking and carrier track-

ing phase lock loops, and multiphase modulation are involved in tracking, telemetry and command equipment which includes but is not limited to space applications. BSEE or MSEE.

Telemetry Circuit Design Engineers

To design a wide variety of analog and digital signal processing circuits for spacecraft digital telemetry equipment. Experience should relate to the design of analog-to-digital converters, analog and digital multiplexers, logic and data storage. Familiarity with microelectronics desirable. BSEE or MSEE.

Telemetry System Engineers

Experienced in the functional and logical design of analog and digital telemetry systems. Familiarity with design, development, application and evaluation of spacecraft instrumentation systems. Experienced in the design of data systems to interface with a wide variety of data sources including scientific experiments, and engineering measurements.

Please submit resume and salary history in confidence to R. J. Brown, TRW Professional Placement, Dept. E-11, One Space Park, Redondo Beach, California 90278. TRW is an equal opportunity employer.

TRW SYSTEMS

ONE SPACE PARK, REDONDO BEACH, CALIFORNIA
Formerly TRW Space Technology Laboratories — STL

HERE'S AN OPPORTUNITY

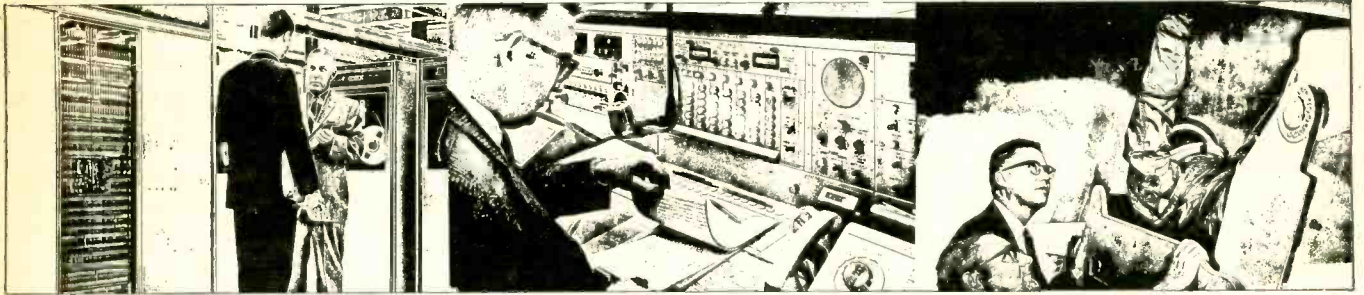

TO IMPROVE YOUR FUTURE

... Both professionally and personally. Every project at Collins is the most demanding in its area of industry, and we need professionals to continue the growth this level of qual-

ity has created. Living and working conditions—and compensation—are commensurate with these standards. These listings are current.

SEND RESUME FOR PROMPT INFORMATION

MICROWAVE SYSTEMS ENGINEERS — Positions involve proposal effort and design of basic communication systems, including support and accessory equipment such as facsimile, Teletype, remote control and carrier. Background in microwave and carrier communications with working knowledge of frequency division multiplex systems is required. (Dallas)

RF SYSTEMS ENGINEERS — B.S.E.E. with experience in RF Systems including receivers, transmitters, and antennas in the VHF-UHF frequency range. Of specific interest is experience in phase locked loop receivers, high power transmitters, tracking (monopulse) antenna systems, and tracking system analysis. (Dallas)

RELIABILITY ENGINEERS — E.E.'s with experience in design and component application to handle qualification and acceptance test analysis and component engineering on high reliability electronic

equipment programs. B.S.E.E. required. (Cedar Rapids)

INDUSTRIAL ENGINEERS — B.S.I.E. or B.S.M.E. with industrial option. Should have experience in manufacturing methods and procedures, work station analysis, facilities planning or material handling. MTM application and training highly desirable. (Cedar Rapids and Dallas)

FIELD SUPPORT ENGINEERS — Permanent positions for field engineers with installation and check-out experience in any of the following areas: tropospheric scatter, SSB or microwave. Most openings are single status in Southeast Asia with minimum of one year at location. (Dallas)

CIRCUIT DESIGN ENGINEERS — For design of general communications equipment. Prefer solid state and/or digital experience. Project assignments will involve HF through M/W frequency ranges in military, commercial or space programs.

B.S.E.E. or M.S.E.E. required. Also solid state circuit design for airborne applications. Knowledge of operational amplifiers in consulting techniques desirable. (Cedar Rapids and Dallas)

MECHANICAL ENGINEERS — B.S.M.E. for equipment and systems design. Duties will include machine design, hydraulic circuit design, stress and dynamic analysis, hydraulic and pneumatic design, electronic packaging and production processes. (Dallas)

FLIGHT CONTROL ENGINEERS — B.S.E.E. with experience in Avionics Systems application for design work in family of flight control equipment. Solid state experience desirable. (Cedar Rapids)

CRYSTAL FILTER ENGINEERS — To work in the challenging field of crystal filter development and/or crystal development. Minimum requirement B.S. degree but prefer M.S. or Ph.D. Two to four years minimum experience. (Newport Beach)

COMMUNICATION / COMPUTATION / CONTROL



COLLINS RADIO COMPANY
An equal opportunity employer

New Books

Control Systems

Control System Design
Stanley M. Shinnars
John Wiley and Sons, Inc.
525 pp., \$11.75

The time has long since passed when a single book can cover all the many facets of automatic control with sufficient detail. The principal fault of this book is that it attempts to do just that: About three-quarters of the material is devoted to classical, linear, lumped-parameter control theory, including statistical and sampled-data concepts; the remainder touches lightly on nonlinear, optimal and adaptive systems.

This attempt to be all-inclusive reflects a classroom orientation: the desire to provide in a single book all the material that might be covered by a course on the subject. As a result, while the coverage of the topics is adequate for introductory purposes, the usefulness of the book as a reference tool for practicing engineers is very limited.

The organization of the material is somewhat unusual. After a brief review of most of the required mathematical tools, such as Laplace transforms, block diagrams and signal flow charts, the reader is confronted with a discussion, with examples, of performance criteria, and a lengthy comparison of the methods of determining the stability of linear systems. Placing the discussions of performance and stability criteria ahead of the details of feedback theory correctly emphasizes the importance of these two concepts. The details of linear and nonlinear feedback, followed by statistical considerations, complete the material on continuous single-variable systems. A discussion of sampled-data techniques precedes the treatment of multi-variable and multidimensional problems of optimal and adaptive control.

The author's technique of discussing several formulations of linear stability criteria simultaneously with presentation of the graphical methods of Nyquist, Bode and Nichols, and the root locus, makes the reader conscious of the importance of stability. Ex-

tensive as the coverage of stability is, however, it suffers from a serious deficiency: It lacks an explicit statement defining the manner of closing the Nyquist polar plot from $0-$ to $0+$. Only a specialist could easily verify, via the Nyquist, Bode and Nichols techniques, the stability of a system described by:

$$G(s) = \frac{K(s+1)}{s(s-1)}$$

The author's lack of appreciation of the importance of an explicit closure statement is further evidenced when he writes: "For example, no matter what order the system is, we would not use the Bode diagram-Nichols chart approach if the system had nonminimum-phase-shift characteristics." There is no inherent reason why these techniques cannot be applied to nonminimum-phase networks. Had the body of examples included an investigation of the stability of a loop characterized by

$$K \left(\frac{s}{s+1} \right)^3$$

it would have provided a more complete understanding of stability representation in the Bode and Nichols charts.

Though the author may justifiably assume the reader's familiarity with the calculus, it is presumptuous of him to assume equal familiarity with the concepts of the differential operator d/dt , the frequency-response variable $j\omega$, and the Laplace variable, s . His tabulation of the important properties of the Laplace transform does not include statements of convolution and multiplication in both time and frequency domains. Omission of these concepts is evident in his equation 3-57, repeated below:

$$T_D(s) = K_T' I_f(s) I_a(s)$$

Torque in the time domain is proportional to the product of field and armature currents. Its representation in the frequency domain involves the transform of the product of the two time functions $I_f(t)$ and $I_a(t)$. What the author means by equation 3-57 is not clear.

Richard E. Lang

Raytheon Co.
Wayland, Mass.

"Get Acquainted" Offer

If you'll tell us more about yourself through the confidential resume below, we'll know where to send you this booklet telling more about ourselves.



Send resume to Manager,
Professional Employment,
Collins Radio Company

Cedar Rapids, Iowa
Dallas, Texas
Newport Beach, California

CHECK LISTINGS

Name _____ Home Address _____
City & State _____ Phone _____
Present Position, Company _____
Primary Experience Area _____ No. of years _____
Education: EE _____ ME _____ Math _____ Physics _____ Chemistry _____
Bus. Adm. _____ Other _____
Degree: BS _____ MS _____ PhD _____ school, date _____
school, date _____
Please attach any pertinent information

3

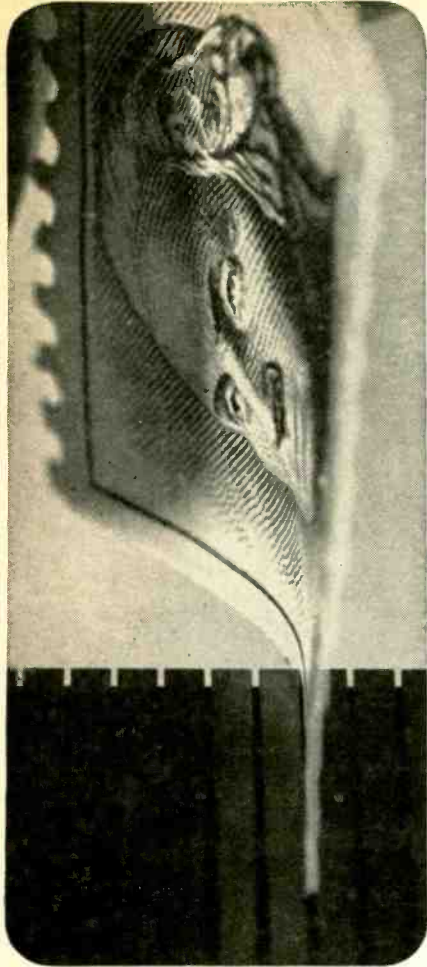

Need graphite with 0.003" slots?

Call on Ultra Carbon. Typical capability: graphite machined with 0.003" slots. Shown, six times actual size, 0.006" slots.

Your most exacting specifications in graphite parts can be met by the microprecision machining capabilities of Ultra. Complex and precise broaching, milling, slotting and drilling of graphite is achieved with the newest and best in machine tools. The Ultra emphasis is on service to meet your tomorrow's demands. An engineering staff of specialists in graphite is always ready to help you. Why not submit your drawings or sketches and an outline of your application to us? Write P. O. Box 747, Bay City, Mich. 48709.



Technical Abstracts

Lightweight vhf filter

Miniature vhf filter with sharp selectivity
Solomon I. Hecht and Jesse J. Taub
Airborne Instruments Laboratory, a
division of Cutler-Hammer, Inc.,
Deer Park, N.Y.

Selective very-high-frequency filters that are smaller, lighter, easier to assemble, and cheaper to build have been made using helical resonators in a coaxial configuration.

A helical resonator consists of a single-layer solenoid surrounded by a highly conductive shield, which may either be circular or square. In previous designs, the resonators were separately enclosed in cavities bored into a block of metal, coupled by an external capacitor. In the new design, the helices are arranged coaxially on a dielectric rod, such as polyurethane, and are shielded by a common outer conductor. In this arrangement, closely spaced coils are coupled by mutual inductance, and more widely spaced coils by external capacitors. The coaxial structure permits reductions of 40% in size and weight without affecting the electrical characteristics.

The resonators are used in the 30-to 400-megacycle band to obtain high-Q circuits for filters with 3-decibel bandwidths in the order of one-half percent or greater. This is wider than the bandwidth provided by crystal filters but narrower than that of lumped-constant circuits of practical size.

The design procedure is straightforward, even though the helical resonator is described in terms of its distributed capacitance, inductance, and resistance. These parameters, as well as the design of the coil, may be calculated from formulas provided by specifying the unloaded Q necessary to realize the desired filter response. The spacing between coils is a function of both the required coefficient of coupling and of the dielectric constant of the support rod. In general, the capacitance introduced by high dielectric constant materials requires closer spacing to obtain the specified inductive coupling. A formula based on uniform current distribution in the coils can be used to determine the approxi-

mate distance between two coils. However the simplest procedure is to build a simple two-resonator structure and measure the coupling as a function of resonator spacing.

A four-section 60-Mc filter with a 1-Mc bandwidth using inductive coupling was constructed using this procedure and exhibited a maximum deviation of $\frac{3}{4}$ db from its predicted frequency response. The 22-cubic-inch filter represented a 40% reduction in size over an equivalent conventional version. Another 60-Mc filter employing the coaxial structure with external capacitors for coupling was in excellent agreement with calculated results in the passband, but its response was 13% wider than expected at the 30-db rejection points. This 14-ounce filter provided a 56% reduction in weight over the conventional design, and was used to replace an older design in an airborne application.

Presented at the National Electronics Conference, Chicago, Oct. 25-27.

Reflectometer standards

Coaxial line standards for measurement of reflections with a time-domain reflectometer system

J. E. Cruz and R. L. Brooke, National Bureau of Standards, Boulder, Colo.

Time-domain reflectometry has made the measurement of transmission-line characteristics relatively simple. Fixed circular and variable rectangular standards with calculable reflection coefficients have been developed to calibrate a TDR system and eliminate the need to know the actual voltage amplitudes of the TDR display on an oscilloscope.

Several short lengths of precision coaxial transmission line with differing characteristic impedances are used with matched loads as one reflection coefficient standard for the TDR system. These are made with a single precision outer conductor and several interchangeable inner conductors. The characteristic impedance of each coaxial combination is calculated from the standard equation for the impedance of a coaxial transmission line. The reflection coefficient of each

NEW ELGENCO 3 BAND 20 cps to 5 mc RANDOM NOISE GENERATOR



MODEL 602A

- Symmetrical wave form
- Non-clipped wave form
- Constant output Z
- All Solid State
- \$290

SPECIFICATIONS: MODEL 602A — GAUSSIAN DISTRIBUTION: Symmetrical non-clipped wave form all ranges. **FREQUENCY RANGES:** 20 cps to 20 kc, 20 cps to 500 kc, and 20 cps to 5 mc. **OUTPUT SPECTRUM:** Uniform from 20 cps to 20 kc within ± 1 db, 20 cps to 500 kc within ± 3 db, 500 kc to 5 mc within ± 8 db. **OUTPUT VOLTAGE:** Maximum open circuit at least 3 volts for 20 kc range, 2 volts 500 kc range, and 1 volt 5 mc range. **TYPICAL SPECTRAL DENSITY** (with 1 volt rms output): 5 mv/ $\sqrt{\text{cps}}$ for 20 kc range, 1.2 mv/ $\sqrt{\text{cps}}$ 500 kc range, and 0.4 mv/ $\sqrt{\text{cps}}$ 5 mc range. **CONTINUOUS AMPLITUDE CONTROL — FIVE POSITION OUTPUT ATTENUATOR:** X1.0, X0.1, X.01, X.001, and X.0001; Accuracy $\pm 3\%$ to 100 kc, $\pm 10\%$ to 5 mc. **OUTPUT IMPEDANCE:** Constant 900 ohms on direct output; 200 ohms on step attenuated output. **OUTPUT VOLTMETER:** 0-5 volt, calibrated to read rms value of Gaussian noise. **Operating Temperature:** 0 to 50 degrees C. **POWER REQUIREMENTS:** 115/230 volts $\pm 10/20$ volts, 50 to 1,000 cps, approx. 5 watts; rechargeable battery option available. **DIMENSIONS:** 5 1/4" high x 8 3/4" wide x 11" deep. Panel height for 19" relay-rack mounting is 5 1/4". **PRICE:** \$290. **DELIVERY:** Stock to 30 days.

OTHER MODELS: 610A 10 cps to 5 mc — \$1175; 603A 20 cps to 5 mc — \$495; 301A - DC to 40 cps — \$1995; 321A DC to 120 cps — \$2095; 311A DC to 40 cps and 10 cps to 20 kc — \$2395; 312A DC to 120 cps and 10 cps to 20 kc — \$2495; 311A 10 cps to 20 kc — \$1295.



ELGENCO INCORPORATED

1550 EUCLID ST. • SANTA MONICA, CALIF. • (213) 451-1635

For more than 10 years Noise Generators have been our major endeavor.

Circle 212 on reader service card

**NEW
FOR 1966**

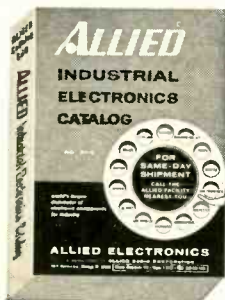

FREE INDUSTRIAL ELECTRONICS CATALOG

Here's the standard of the industry from Allied, the world's largest stocking distributor of electronic components and equipment. 552 pages. 64,000 items, 6,000 new products. Factory OEM prices. Same-day shipment. Get your personal copy now.



FULL CHOICE • FAST DELIVERY • OEM PRICES
Best selection of IRC resistors, including: high reliability, metal film and wirewound precision, metal glaze semi-precision, fixed composition and power wirewound. Metal glaze and wirewound precision trimmers in rectangular, square, round and cube styles. Complete line of multi-turn pots.

For FREE catalog, check reader service card or write direct to:

ALLIED ELECTRONICS

subsidiary of ALLIED RADIO CORPORATION

100 N. Western Ave., Dept. 224, Chicago, Illinois 60680

Circle 213 on reader service card

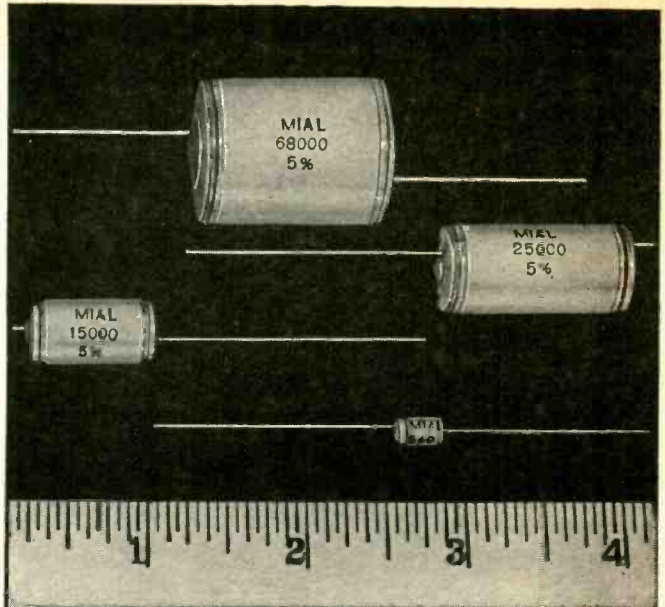

NEW MIAL general purpose polystyrene capacitor with more than 500,000 megs insulation resistance

The MIAL Style 611 general purpose polystyrene capacitor outperforms all other film capacitor or mica units—yet costs less! Ideally suited for TV, radio, stereo and instrumentation applications requiring long life, high reliability, and complete freedom from drift.

- Capacitance Range: 20 to 100,000 pF
- Temperature Coefficient: N150 ± 50 ppm/ $^{\circ}\text{C}$
- Capacity Tolerance: from $\pm 1\text{pF}$ to $\pm 20\%$
- Voltage Range: 33VDCW to 1000 VDCW
- Q Factor: Over 2,000 at 100 KC $+25^{\circ}\text{C}$

Polystyrene
Capacitors

Write today for new complete catalog. Gives environmental, electrical and mechanical characteristics, charts and dimensions.



MIAL
U. S. A., I N C.

165J FRANKLIN AVENUE, NUTLEY, N.J. 07110 • (201) 667-1600-1601

Circle 145 on reader service card

145

Moving Electronic Equipment?

Technical Abstracts

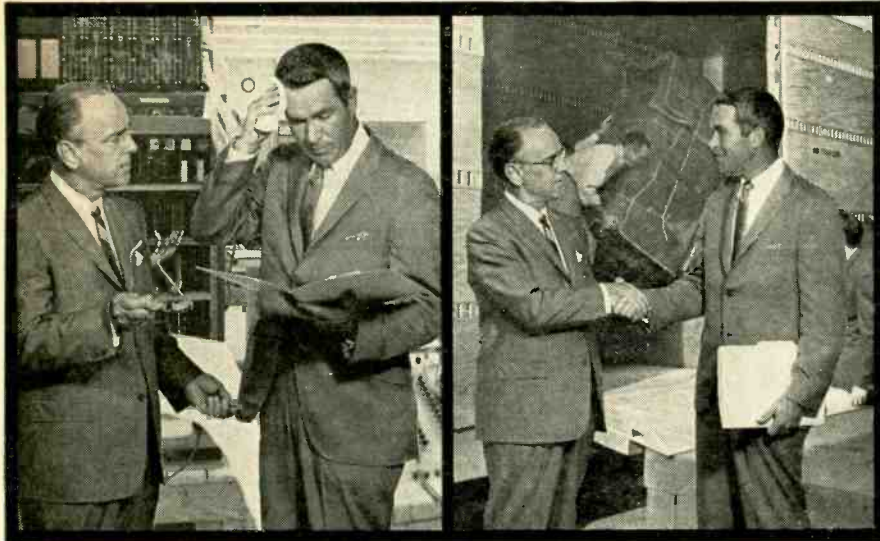

**HAD SHAMROCK BEEN IN THE PICTURE...
"OUR MEN IN GREEN WOULD HAVE MADE BIG THINGS HAPPEN"**

Emotional strain while millions of dollars of electronic equipment needs to be delivered and installed in some distant city. The customer is calling and everyone from engineering to top management is looking to the traffic manager for a solution. What's more, this delicate equipment must be moved under rigid temperature controls or it could be seriously damaged. If the traffic manager had known about Shamrock's revolutionary Climatic Control

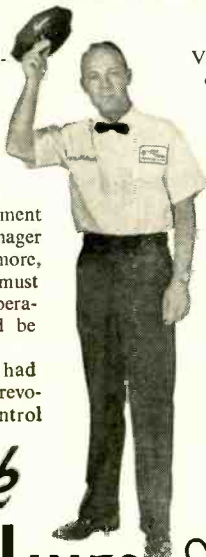

Vans there would have been no loss of time in talking to other carriers. Shamrock is the pioneer in this field. After Shamrock's efficient Men in Green gently load and secure the equipment in the unique Climatic Control Van, it will be transported to its destination under regulated temperatures at any degree, regardless of season. Add Shamrock's rapid centralized dispatch system and the traffic manager would have been the man of the hour. For the best move you've ever made, put your electronic equipment in the careful hands of Shamrock's Men in Green.



Inc. P. O. Box 5447, Dallas, Texas 214-253-3671

Circle 146 on reader service card

To order reprints: Fill in, cut out coupon below, insert in envelope and mail to: **Electronics Reprint Dept.,
330 W. 42nd Street, New York, N.Y. 10036**

Reprint order form

For listing of reprints available see the Reader Service Card.

The Overlay Transistor

Send me reprints of Key no. R-78 at 75¢ each.

For reprints of previous special reports fill in below:

Send me reprints of Key No.(s) @ ¢ each.
(For prices, see Reader Service Card)

Name

Number of street

City, State, Zip code

coaxial standard can then be found in terms of the characteristic impedance and some reference impedance, Z_0 , not necessarily the characteristic impedance of the line under test.

The variable standard, in the form of a rectangular coaxial line with a rotating outer conductor, has a sinusoidal characteristic impedance with respect to the angle of rotation. Its reflection coefficient is found and calibrated with the fixed standards.

There are three ways to establish an impedance reference level to determine reflection coefficients of transmission lines with unknown discontinuities. One method uses a high-quality circular coaxial transmission line of known impedance. In another, a reference level that is the basis for calculating the ratio of the reflected voltage amplitudes of the two fixed coaxial standards is extrapolated from their superimposed traces on an x-y recorder. Comparing this ratio to the calculated ratio of their two reflection coefficients confirms the accuracy of the original reference level.

A third method uses the variable standard; with it, the TDR system is calibrated by first rotating the standard to a 50-ohm reference position and recording the trace. The variable is again rotated, this time to a convenient impedance deviation from the 50-ohm level, and a second trace is superimposed on the first. The time-domain reflectometer is then calibrated.

Unknown reflections can now be measured and their reflection coefficients determined by a standard equation.

The accuracy of the fixed coaxial line standards of circular cross section for the calibration of the TDR system and for the determination of the unknown reflection coefficients is considered better than that of the rectangular variable-impedance line. The variable standard, however, is tunable and allows for transmission-line matching and comparison without having to remove it from the system.

Presented at Wescon
1965, San Francisco, Aug. 24-27.

1 of a series

TRANSCOIL SOLVES SERVO PROBLEMS

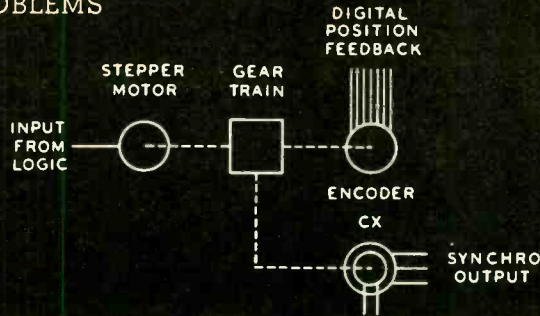

Transcoil digital-to-analog converter

This unit is one of Transcoil's broad line of specially-designed servos. It employs a 13-bit V-scan shaft encoder as position sensing element. Information is fed back to an external network which generates a pulse train from position error. ■ The stepper motor receives a series of logically-switched field excitations to provide the driving force of the servo. When the encoder has been driven to a position of agreement with the desired digital command, the pulse train is shut off and the servo stops at its last step—held by the magnetic detent of the motor. Analog output is provided by a synchro driven directly from the encoder. ■ By re-arranging components, the package can be used in the analog-to-digital mode. In this configuration, input is 3-wire synchro data, and the driving member is a conventional 2-phase servomotor. Digital output is provided by the encoder. ■ Transcoil offers an unusual capability for combining servo components into operating servo systems. We would like the opportunity to help solve your problems. Write for our 16-page brochure, SERVO ASSEMBLIES.

QUALITY BY DESIGN

 WESTON INSTRUMENTS, INC.

WESTON TRANSCOIL
Worcester, Pennsylvania 19490

Circle 214 on reader service card

Ω

7

W

+9

8

GO

NEW FROM IEE

μ

+

A

4

1 VOLT

3

WORLD'S SMALLEST REAR-PROJECTION READOUT GIVES YOU CHARACTERS THIS BIG!

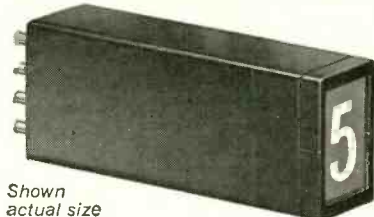

Shown actual size

The new Series 340 is the smallest rear-projection readout in the world! It's just 3/4" x 1/2" x 2"—yet its 3/8" characters are clear, sharp, and easily read.

Only IEE's patented rear-projection readouts give you your choice of any type face, symbol, color. Anything you can put on film! Use the single-plane Series 340 anywhere you need maximum clarity in minimum space.

Send for complete technical information.



INDUSTRIAL ELECTRONIC ENGINEERS, INC.
7720 Lemona Avenue • Van Nuys, California
Phone: (213) 787-0311 • TWX (213) 781-8115

Representatives in Principal Cities

KNOW with an AEROCOM MODULATION MONITOR

AEROCOM's Model 906 Modulation Monitor is used for continuous monitoring of percentage of modulation of an AM transmitter operating on Low, Medium, High, and Very High frequencies.



This AEROCOM unit

- Measures percentage of Modulation on either positive or negative peaks.
- Monitors modulation level. Covers carrier frequency range from 200 kc. to 160 mc.
- Handles transmitter power up to one kilowatt. Adjustment provided to meet different carrier powers.
- No power supply required (passive).

Detector unit is installed and left in transmission line and connected to meter panel with RG 58/U coaxial cable. This monitor is available for rack mounting (Model 906-R) and as a portable unit (Model 906-C) in self-contained case.

Additional data on request

WORLD WIDE



SINCE 1946

3090 S.W. 37th Avenue

Miami, Florida 33133

Circle 215 on reader service card

Circle 147 on reader service card

147

Engineers interested in developmental aviation have 3 ways to go at Lockheed-California.

Subsonic.



Supersonic.



Hypersonic.

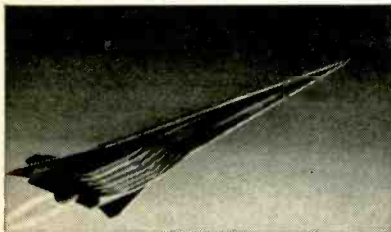

Lockheed's company speedometer spans speed regimes from 0 mph through Mach 12.

In subsonic airborne systems, Lockheed is deeply involved in STOL and V/STOL short-haul transports for mass travel between major cities. Under development — many helicopter projects including advanced rotary-wing craft able to stop, fold, or start blades in forward flight.

Lockheed's supersonic efforts are also expanding. Its SST program alone is a major and growing endeavor.

Manned hypersonic test and cruise vehicles, using the SCRAMJET approach, are under development at Lockheed. They point to the day of Mach 12 travel.

Engineering positions are now open in all technical disciplines. For information: Write Mr. E. W. Des Lauriers, Professional Placement Manager, Dept. 1511, 2404 N. Hollywood Way, Burbank, Calif. An equal opportunity employer.

LOCKHEED-CALIFORNIA CO.

A DIVISION OF LOCKHEED AIRCRAFT CORPORATION

Asian musical chairs

Continued from page 23

ucts. Minister of Economic Affairs K. T. Li has announced a government project to institute an electronic research program at Chiao Tung University, a new college just completed in Hsin Chu, 75 kilometers from the capital city of Taipei. Li also hopes that an influx of U. S. companies to Taiwan will lure many Chinese engineers now working in the U. S. back to the Republic of China and strengthen the country's technical know-how. So far the General Instruments Corp. has established a subsidiary to build television tuners, deflection yokes, capacitors, rectifiers, and semiconductors, and the Philco Corp. won investment approval last month for a \$2.5 million plant to assemble television sets.

Each of these three electronic areas face big obstacles in their drive for less dependence on low labor rates. In Japan, the biggest problem is a shortage of capital to finance the desired research and development. A domestic recession also hurt investment. Last month, Japan urged the formation of an Asian Bank to make loans that might alleviate the tight capital situation.

In Hong Kong, where capital is plentiful, the need is for technology. The radio assemblers are seeking foreign companies for joint ventures which might supply them with established engineering departments.

Taiwan, however, faces the hardest road. Capital is in short supply and interest rates on the island are so high that bank borrowing is prohibitive. In addition, the Chinese have built a bureaucracy and a screen of red tape that makes doing business in Taiwan irritating and frustrating. For example, customs officials are so capricious that there is no pattern to the way shipments of parts are processed. Some are held up for days while others pass through swiftly.

In the meantime, products from these areas of low labor costs pose the most severe competition for U. S. manufacturers. And the best weapons to fight it are low-cost mechanized production and new, useful products.

GRC



die cast
ZINC ALLOY

DIE CAST ZINC ALLOY GEAR KIT FOR SMALL GEAR USERS

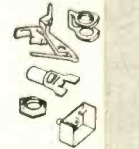

molded
PLASTICS



Coil Bobbins
Gears & Pinions

Get this useful assortment for your design work. Die cast by GRC's exclusive automatic techniques, these one-piece gear and pinion combinations offer unique assembly and cost advantages. Many combinations from stock. **SMALL GEARS TO SPECS:** Send prints for quotes on gears and other small parts, die-cast or plastic molded. **NO MINIMUM SIZE!**

Write for Gear Kit, Gear Stock List and Designers' Aids on Your Letterhead.

GRIES

GRIES REPRODUCER CO.

Division of Coats & Clark Inc. World's Foremost Producer of Small Die Castings and Plastic Moldings

151 Beechwood Ave., New Rochelle, N.Y. • (914) NE 3-8600

Circle 216 on reader service card

we are your best bet for electronic materials

"What did you say?"
"WE SAID, WE ARE YOUR BEST BET FOR ELECTRONIC MATERIALS!"

We are a primary fabricator and supplier of high purity metals and alloys, compound semiconductors and thermoelectric cooling materials.

PHONE AREA CODE 509 747-6111
TWX 509-328-1464 Telex 032 610

IMMEDIATE SHIPMENT BY AIR PRE-PAID

COMINCO PRODUCTS, INC.

electronic materials division

818 West Riverside Ave.,
Spokane, Washington 99201

6803

ELECTRONICS

Qualification Form
for Positions Available

ATTENTION: ENGINEERS, SCIENTISTS, PHYSICISTS

This Qualification Form is designed to help you advance in the electronics industry. It is unique and compact. Designed with the assistance of professional personnel management, it isolates specific experience in electronics and deals only in essential background information. The advertisers listed here are seeking professional experience. Fill in the Qualification Form below. **STRICTLY CONFIDENTIAL:** Your Qualification form will be handled as "Strictly Confidential" by Electronics. Our processing system is such that your form will be forwarded within 24 hours to the proper executives in the companies you select. You will be contacted at your home by the interested companies.

WHAT TO DO. (1.) Review the positions in the advertisements. (2.) Select those for which you qualify. (3.) Notice the key numbers. (4.) Circle the corresponding key number below the Qualification Form. (5.) Fill out the form completely. Please print clearly. (6.) Mail to: Classified Advtg. Div., Electronics, Box 12, N. Y. 10036.

| COMPANY | PAGE | KEY # |
|------------------------------------|---------|-------|
| ATOMIC PERSONNEL INC. | 150 | 1 |
| BAUSCH & LOMB | 190* | 2 |
| COLLINS RADIO CO. | 142-143 | 3 |
| THE DOW CHEMICAL | 150 | 4 |
| ELECTRONIC COMMUNICATIONS CO. | 150 | 5 |
| GENERAL DYNAMICS | 149 | 6 |
| GENERAL DYNAMICS | 153 | 7 |
| GENERAL ELECTRIC CO. | 188* | 8 |
| GENERAL TELEPHONE & ELECTRONICS | 189* | 9 |
| GRUMMAN AIRCRAFT ENGINEERING CORP. | 151-152 | 10 |
| LOCKHEED CALIFORNIA CO. | 148 | 11 |
| LOCKHEED MISSILE & SPACE CO. | 162* | 12 |
| NATIONAL CASH REGISTER | 112-113 | 13 |
| TRW SYSTEMS | 141 | 14 |
| VARIAN ASSOCIATES | 187* | 15 |

*These advertisements appeared in the Oct. 18 issue.

PERSONAL BACKGROUND

Name
Home Address
City Zone State
Home Telephone

EDUCATION

Professional Degree(s)
Major(s)
University
Date(s)

FIELDS OF EXPERIENCE (Please Check) 11/1/65

| | |
|--|--|
| <input type="checkbox"/> Aerospace | <input type="checkbox"/> Medicine |
| <input type="checkbox"/> Antennas | <input type="checkbox"/> Microwave |
| <input type="checkbox"/> ASW | <input type="checkbox"/> Navigation |
| <input type="checkbox"/> Circuits | <input type="checkbox"/> Operations Research |
| <input type="checkbox"/> Communications | <input type="checkbox"/> Optics |
| <input type="checkbox"/> Components | <input type="checkbox"/> Packaging |
| <input type="checkbox"/> Computers | <input type="checkbox"/> Radar |
| <input type="checkbox"/> ECM | <input type="checkbox"/> Radio-TV |
| <input type="checkbox"/> Electron Tubes | <input type="checkbox"/> Simulators |
| <input type="checkbox"/> Engineering Writing | <input type="checkbox"/> Solid State |
| <input type="checkbox"/> Fire Control | <input type="checkbox"/> Telemetry |
| <input type="checkbox"/> Human Factors | <input type="checkbox"/> Transformers |
| <input type="checkbox"/> Infrared | <input type="checkbox"/> Other |
| <input type="checkbox"/> Instrumentation | |

CATEGORY OF SPECIALIZATION

Please indicate number of months experience on proper lines.

| | Technical Experience (Months) | Supervisory Experience (Months) |
|-------------------------------------|-------------------------------|---------------------------------|
| RESEARCH (pure, fundamental, basic) | | |
| RESEARCH (Applied) | | |
| SYSTEMS (New Concepts) | | |
| DEVELOPMENT (Model) | | |
| DESIGN (Product) | | |
| MANUFACTURING (Product) | | |
| FIELD (Service) | | |
| SALES (Proposals & Products) | | |

CIRCLE KEY NUMBERS OF ABOVE COMPANIES' POSITIONS THAT INTEREST YOU 1 2 3 4 5 6 7 8 9 10 11 12 13 14 15

ELECTRICAL & ELECTRONIC ENGINEERS

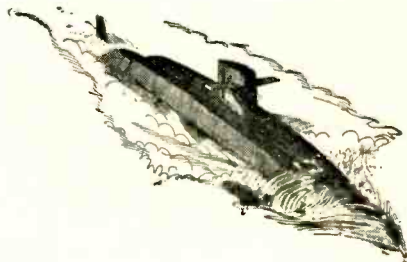

A small electric motor started it all.

When William Woodnut Grissom patented his electric motor way back in 1880, the theory of electronics was many years away from discovery, and the submarine was yet an inventor's frustrated dream. Today electric motors are still in use, and electronics applications abound, on America's nuclear powered submarines, the first man-made miniature worlds deployed in inner space.

At Electric Boat, where the U.S. Navy's first submarine was built in 1900, and the free world's first atomic submarine designed and launched in 1955, Electrical and Electronic Engineers are still facing new challenges. Not only on submarines, which carry all of the electrical equipment necessary to generate light, heat and power 24 hours every day for months, and the electronic equipment associated with communications, navigation, fire control, ECM and ASW—but on the Company's recently broadened product line of surface ships.

Electrical and Electronic Engineers interested in variety—and an opportunity to work ahead of most fields—are invited to consider a position in one of the following areas:

Power Distribution & Control Systems
Electrical Propulsion Systems
Nuclear Power Plant Electrical Instrumentation & Control Systems
Process Control Instrumentation
Digital Control Systems
Communications & Signal Data Processing
Test Instrumentation
Sound & Vibration
Weapons Systems Test

Resumes should be addressed to Mr. Peter Carpenter.

GENERAL DYNAMICS

Electric Boat Division

128 Eastern Point Road, Groton, Connecticut

An Equal Opportunity Employer

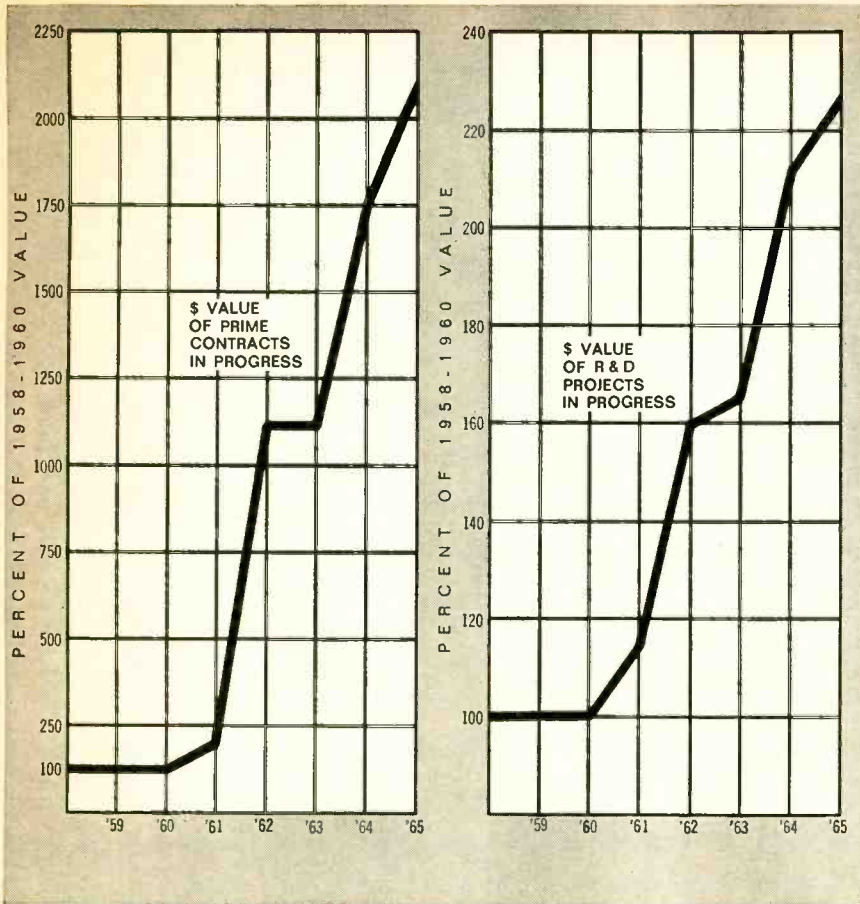

2 REASONS WHY THERE'S MORE ENGINEERING OPPORTUNITY AT ECI

Where there's engineering excitement there's engineering opportunity. Two key indicators — prime contracts in progress and R&D work in progress — prove that exciting things are happening at Electronic Communications, Inc. ECI has generated these remarkable activity increases by building a solid, successful reputation in airborne systems, multiplexing, space instrumentation and other areas of military and aerospace communication. You can get aboard this upward trend immediately if you are qualified in:

RF ENGINEERING — aggressive new programs are now under way in the design and development of microminiature transmitters and receivers. Positions require at least a BS degree, with a minimum of three years experience, and sound knowledge of transmitter and/or receiver design theory.

SPACE INSTRUMENTATION PROJECT ENGINEERING — you'll need in-depth technical ability, plus six years experience in data handling, control, or analog instrumentation.

THIN-FILM CIRCUIT DESIGN — involving theory and application of thermodynamics, mechanics of materials and electronic component design in the development of microelectronic circuitry. BS or MS in EE or physics required.

SYSTEMS INTEGRATION — you must be thoroughly grounded in aircraft electrical systems and be familiar with interface problems involved in installation of airborne communications equipment. Prior systems integration or field installation experience is most desirable.

If you are qualified, send your resume, in confidence, to Duane Meyer, ECI, Box 12248E, St. Petersburg, Fla., or call him collect at (813) 347-1121. (An equal opportunity employer.)

ELECTRONIC COMMUNICATIONS, INC.

ST. PETERSBURG, FLORIDA



INSTRUMENT ENGINEER

Should have experience and interest in General Electronics Instrumentation. Must have a B.S. or M.S. in Electrical Engineering, Physics or Chemical Engineering. Prefer 0-5 years experience in the Design, Development and Application of Instrument systems; i.e., Transducers, numerical machine tool controls, and automatic controls.

Position will be in a research and production facility at The Rocky Flats Division of The Dow Chemical Company, located approximately fifteen miles northwest of Denver, Colorado.

Please send resume, including salary requirements to:

THE DOW CHEMICAL COMPANY

Rocky Flats Division

Technical Employment

P. O. Box 888, Golden, Colorado 80402

(Operating Contractor for the Atomic Energy Commission)

An Equal Opportunity Employer

Can Consider Only U.S. Citizens



E. E.'s

for FEE-PAID Positions
WRITE US FIRST!

Use our confidential application for professional, individualized service . . . a complete national technical employment agency.

ATOMIC PERSONNEL, INC.

Suite 1207L, 1518 Walnut St., Phila. 2, Pa.

SELLING OPPORTUNITY WANTED

Electronic Sales Corporation interested exclusive agency of advanced European components or instruments, Pacific Coast only. Itonra, P.O. Box 1412 Beverly Hills, California.

Do you want high grade sales representation in the growing French industrial electronic, nuclear and aerospace market? Write to: A. P. I. A., 11, rue de Provence Paris 9e—France.

FOR SALE

Noise Field Intensity Meter Model NF-105 MFG Empire Devices Products Corporation. For details, write Lawtronics, P O Box 4052, Baltimore, Maryland, 21222.

Your Inquiries to Advertisers Will Have Special Value . . .

—for you—the advertiser—and the publisher, if you mention this publication. Advertisers value highly this evidence of the publication you read. Satisfied advertisers enable the publishers to secure more advertisers and—more advertisers mean more information and more products or better service —more value—to YOU.



time & space

...The time is short, if the U.S. is to achieve its goal of landing the astronauts on the lunar surface in the late sixties. Grumman Engineers, working in the space sciences, are pressing forward on the LEM (Lunar Excursion Module) program to meet this schedule.

No amount of enthusiasm 'cranked-in' to a program could explain the personal enthusiasm that our engineer-scientists have for it, nor the motivation that makes them our best recruiters. A large part of the LEM group has been brought in from the outside by these engineers as they 'buttonhole' friends, college classmates and association brothers to join LEM, designated by many as the greatest technical challenge of our times. Space takes on a deeper dimension for all concerned, since LEM is the first manned vehicle being developed to operate *solely* in outer-space.

Further U.S. commitments to manned space travel will undoubtedly hinge on the success of this endeavor. When this happens, those responsible for it will stand poised for the next rung up the ladder of space technology. The LEM program is young. If you're qualified, we have the space for you. The time is now!

Space Dynamicists—BS or MS in Physics, Aerospace Engineering, Applied Math or Applied Mechanics, with a minimum of 2 years experience in the analysis of flight dynamics. Experience in space dynamics, e.g. disturbance torques, orbital mechanics, lunar trajectory analysis, and separation system dynamics is desirable.

Guidance Dynamicists—BS or MS in AE, EE, or Applied Mechanics with a minimum of 2 years experience in the analysis of guidance systems for spacecraft. To analyze and evaluate functional configurations and dynamic characteristics of radar, IR, optical and inertial guidance loops; signal processing and error analysis. Background in sampled data & nonlinear controls systems.

Control Dynamicists—BS or MS in AE, EE or ME with a minimum of 2 years experience in analysis of control systems. Will evaluate automatic flight control system stability and performance. Familiarity with nonlinear techniques, digital control techniques is desirable.

Guidance & Control Integration Engineers—BS or advanced degree with experience in design, analysis and integration of vehicle guidance & control systems. Applicants should possess a working knowledge of both analog & digital feedback system & design techniques. System test or hardware design experience desirable. Position entails conceptual work in defining guidance & control systems, establishing subsystem and component requirements, system development and verification.

Computer System Engineers—Engineers & Mathematicians with 1-5 years experience in the analysis, design and development of digital computer systems.

Programmers—Experienced in both general purpose and special purpose programming techniques, to work on complex systems for aerospace vehicles.

Electronic Design Engineers—B.S. in E.E. or M.E. with 3 to 5 years experience in electronic circuit product design to military specifications.

Electro-Mechanical Designers—Designers with experience in aircraft electrical/electronic circuit design, installation, liaison, packaging to military specifications.

Electronics Standards Engineers—B.S. in E.E. or Physics with 3 to 5 years experience in Electronics Standards & components to military specifications.

Specifications Engineers—BS (EEE preferred) with a minimum of 2 years experience in Preparation of Performance and Test Specifications for systems, sub-systems and associated equipment. Knowledge of AFSCM 375 series documents and configuration management desired.

Manufacturing Electronic Development Engineers—Process oriented Engineer with the ability to plan & monitor future Manufacturing Engineering advanced development programs. Experienced in etching vacuum deposition & packaging for all phases of electronic assembly required. Degree in electronics desirable.

Quality Control Engineers—BSEE or proven experience in writing & approving test procedures for airborne electronic instruments & systems, &/or acceptance testing of electronic components (synchros, resolvers, digital modules, etc.) Knowledge of electronic test equipment is required.

BSEE with 3-10 years extensive experience with military specifications & requirements for electronic systems testing. Must be capable of establishing & implementing inspection & test procedures as well as experienced in dealing with production, inspection & other engineering groups.

(Additional opportunities in space as well as aircraft & ASW programs, on following page)



GRUMMAN
AIRCRAFT ENGINEERING CORPORATION
Bethpage • Long Island • New York
An Equal Opportunity Employer

(Continued from previous page)

R F Engineers—Graduate Engineers with a minimum of 4 years experience in Radar, Electronic counter measures, Electronic counter counter measures, or Communications. Circuit Analysis or support design experience required.

Servo Engineers—Graduate Engineer with a minimum of 4 years experience in one or more of the following: Circuit Analysis, Servo Design, Inertial Navigation Displays, and Flight Instruments.

Senior Circuit Design Engineers—BSEE with 5 to 10 years experience in solid-state circuit design to military specifications. Experience with broad band amplifiers, A/D or D/A converters or high speed (10 mc) switching circuits desirable. Knowledge of packaging techniques for cordwood construction and integrated circuits helpful.

Logic & Switching Engineers—BSEE with 3 to 5 years experience in digital logic, timing & control, arithmetic elements and time sharing systems. Must be capable of developing a detailed logic design from system specification. Should be able to perform detailed system analysis to minimize hardware, eliminate hazards and timing problems and specify testing requirements.

Digital Support Systems Engineers—BSEE with 3 to 5 years experience in military digital and data processing equipment. Must be capable of performing a comprehensive analysis of digital equipment to establish support concepts and define support requirements.

Electrical Power Systems Support Engineers—Graduate Engineers with a minimum of 4 years experience in one or more of the following areas: Aircraft & Space Vehicle Electrical Power Systems; Ground Support Equipment Power & Control Circuits; and Environmental Test Installations.

Support Site Activation Engineers—Graduate engineer (ME, AE or EE) with 5 or more years experience in Support Equipment installations. In any of the following GSE disciplines: fluids, electrical-electronics, handling and transportation, and instrumentation. Duties include system engineering, interface documentation, specifications and liaison associated with the manufacture, installation, and maintenance of GSE at new spacecraft test and/or launch complexes. Assignments available at Long Island, White Sands, Texas and Florida.

Systems Test Engineers — BSEE or BSME with experience in all phases of testing, to analyze systems/subsystems parameters. Will apply latest testing techniques to test equipment design concepts & determine production test requirements for aircraft, spacecraft, "innerspace" & ground support equipment.

Automatic Circuit Analysts — Adapter Cable Designers & Test Programmers with 3-5 years experience in wiring breakdown for machine analyzed testing programs. Experience required on DITMCO MODEL 610, HUGHES FACT or comparable machines. Positions available at Bethpage & Peconic facilities.

Electronic Designers — (Printed Circuit Boards) — Requires 3 to 7 years experience in the design of Printed Circuit Boards to MIL-STD 275 and MIL-P-55110, capable of laying out printed circuit Boards from Engineering Schematics and/or Logic Diagrams. Must be familiar with the application & selection of Electrical components.

Configuration Control Engineers—BS in EE or ME or equivalent with 3-5 years experience in Configuration Management. Must be familiar with AFSC-375-1, ANA-445 & NPC-500-documents.

Systems & Procedures Engineers—Graduate Engineer or equivalent with 3-5 years recent experience in Engineering Systems & Procedures writing. Ability to work alone, to investigate & provide solutions to problems of a procedural nature required.

Radar Reliability Test Engineers — BSEE with 5 years experience in design and/or test of radar equipment (antennas and electronics). Will monitor development and qualification test programs for Reliability including specifying environmental tests, negotiating requirements with subcontractors, reviewing test plans, monitoring tests, reviewing and assessing test results. Reliability experience is desirable although not mandatory.

R&D Electronic Flight Test Engineers—B.S. in E.E. or Physics plus test experience in Electronic Airborne Systems including Radar, computer, navigation & guidance, stabilization & control & communications equipments for application to space programs.

Liaison Systems Test Engineers—BS in EE or Physics plus 4 or more years of relevant systems test experience. Will perform early test planning, evaluation testing & debugging of new systems in addition to performing any sustaining engineering support required during subsequent program phases. Assignments involve hands-on trouble shooting & remedial design requiring exceptional technical proficiency.

NOTE: Positions also available in the above areas to February or June '65 Engineering Graduates

Use the attached inquiry form to arrange a mutually convenient interview.



GRUMMAN
AIRCRAFT ENGINEERING CORPORATION
Bethpage · Long Island · New York
An Equal Opportunity Employer

PROFESSIONAL PLACEMENT INQUIRY

For your convenience and to facilitate your inquiry, please use this form. It will enable the professional staff at Grumman Aircraft to evaluate your background and experience and arrange for a mutually convenient personal interview. All inquiries will be held in strictest confidence. Enclose in an envelope and send to Mr. P. E. Van Putten, Manager, Engineering Employment, Dept. GR 76, Grumman Aircraft Engineering Corp., Bethpage, L.I., N.Y.

Background and experience (Brief resume of experience, recent history of employment. If available, attach prepared resume.)

NAME _____

STREET ADDRESS _____

CITY & STATE _____ TELEPHONE _____

NEAREST MAJOR CITY (IF APPLICABLE) _____

COLLEGE GRADUATE: YES ___ NO ___ Degree _____ Subject _____ Year _____

Major Specialty _____ Yrs. _____ Other Specialty _____ Yrs. _____

Applying for position(in)(of) _____

Background and experience (Brief resume of experience, recent history of employment. If available, attach prepared resume.)

There's nothing soft about our hardware programs. (That, we can promise you.)

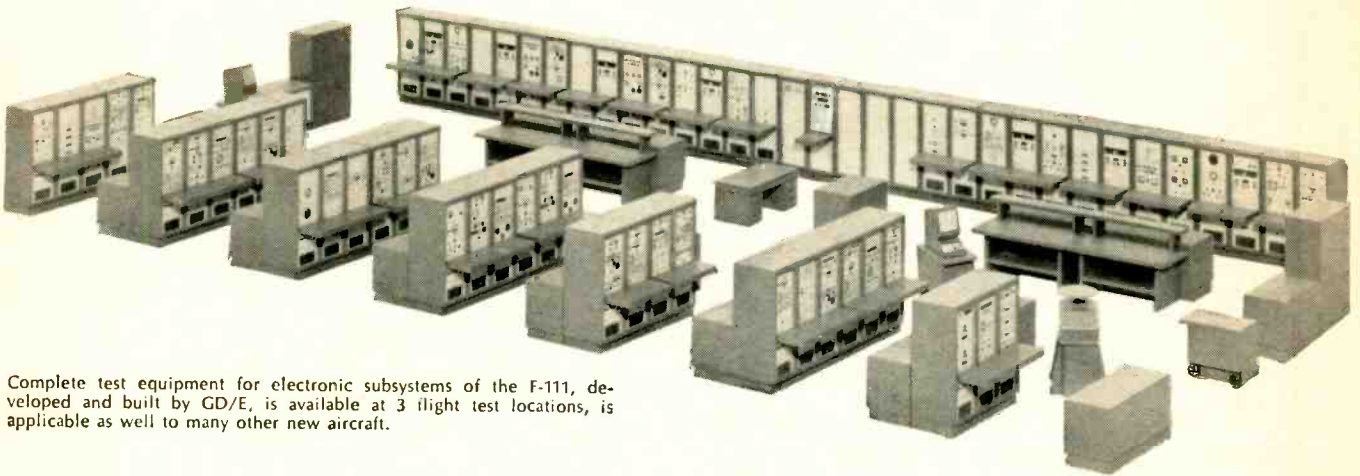

Complete test equipment for electronic subsystems of the F-111, developed and built by GD/E, is available at 3 flight test locations, is applicable as well to many other new aircraft.

In a world where all too often promises made with the best intentions cannot be kept, more and more career-oriented engineers are filtering out the glow of unsubstantiated anticipation, and fixating on the successful track record of an organization they may be interested in joining.

Fine with us.

We're fast becoming known as one of the few places in the country that persists in *keeping* promises we never made.

AUTODIN is a good example.

Wouldn't we have enjoyed dangling the prospect of working on a program as huge and complex as AUTODIN before the eyes of the experienced systems and circuit design engineers who were considering us as recently as a year ago? All we could promise was a chance to become part of a lean, hard-hitting, aggressive and competitive professional team with a pretty respectable batting average. Yet they came on board and helped us win

AUTODIN. And a remotely tuned, automatically controlled HF communications receiving set for the Navy's most far-reaching project, Southern Cross; advanced communications countermeasures equipment for the intelligence community; an advanced acoustic marker/launcher system for undersea warfare; an improved Diversity Autotrack Receiver for satellite antenna positioning used on the TOS (Tiros Operational Satellite) program...and a variety of other contracts. All within a 12-month period.

Can we make you a richer promise? It's up to you.

Tell us which of these areas seem to match your interests: Radio Communications ● Data Communications ● Antisubmarine Warfare ● Reconnaissance/Countermeasures ● Radio Frequency Interference ● Space Tracking ● Navigation Aids ● Signal Processing ● Hydroacoustics ● Reliability & Maintainability ● Total Systems or Subsystems.

Write to John F. Miller, Dept. 22.

GENERAL DYNAMICS

Electronics Division

1400 N. GOODMAN ST., ROCHESTER, NEW YORK 14601
An Equal Opportunity Employer

AUTOTRACK ANTENNA MOUNT

360 degree azimuth, 210 degree elevation sweep with better than 1 mil. accuracy. Missile velocity acceleration and slowing rates. Amplidyne and servo control. Will handle up to 20 ft. dish. Supplied complete with control chassis. In stock—immediate delivery. Used world over by NASA, USAF. TYPE MP-61 B. SCR-584. NIKE AJAX mounts also in stock plus several airborne trackers.

SCR 584 AUTOMATIC TRACKING RADARS

Our 584s in like new condition, ready to go, and in stock for immediate delivery. Ideal for telemetry research and development, missile tracking, satellite tracking, balloon tracking. Used on Atlantic Missile Range, Pacific Missile Range, N.A.S.A., Wallops Island, A.R.M.A. Write us. Fully Desc. MIT Rad. Lab. Series. Vol. 1, pps. 207-210, 228, 284-286. Compl. inst. Bk. avail. \$25.00 each.

AN/GPG-1

SKYSWEEP TRACKER

3 cm. automatic tracking radar system. Complete package with indicator system. Full target acquisition and automatic tracking. Input 115 volts 60 cycle New. In stock for immediate delivery. Entire System 6' long, 3' wide, 10' high. Ideal for infrared Tracker, Drone Tracker, Missile Tracker. R. & D.

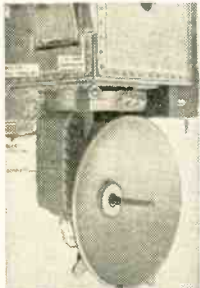

PULSE MODULATORS

MIT MODEL 9 PULSER

1 MEGAWATT—HARD TUBE

Output 25 kv 40 amp. Duty cycle .002. Pulse lengths .25 to 2 microsec. Also .5 to 5 microsec. and 1 to .5 microsec. Uses 6C21. Input 115v 60 cycle AC. Mfr. GE. Complete with driver and high voltage power supply. Ref: MIT Rad. Lab. Series. Vol. 5, pps. 152-160.

2 MEGAWATT PULSER

Output 30 kv at 70 amp. Duty cycle .001. Rep rates: 1 microsec 600 pps, 1 or 2 msec 300 pps. Uses 5948 hydrogen thyratron. Input 120/208 VAC 60 cycle. Mfr. GE. Complete with high voltage power supply.

MIT MODEL 3 PULSER

Output: 144 kw (12 kv at 12 amp.) Duty ratio: .001 max. Pulse duration: .5, 1 and 2 microsec. Input: 115 v 400 to 2000 cps and 24 vdc. \$325 ea. Full desc. Vol. 5. MIT Rad. Lab. series, pg. 140.

250KW HARD TUBE PULSER

Output 16 kv 16 amp. duty cycle .002. Pulses can be coded. Uses 5D21, 715C or 4PR60A. Input 115 v 60 cycle ac. incl. H.V. pwr supply \$1200 ea.

5949 THYRATRON AGING RACK

Compl. Chatham Electronics Console incl. 15 kv power supply & PFN's. \$1800.

MICROWAVE SYSTEMS

E-4 FIRE CONTROL SYSTEM

Hughes Aircraft X Band. Complete. In stock.

C-BAND RADAR

250 KW output. C-band. PPI indicator, 5C22 thyratron modulator. Antenna hi gain parabolic section. Input 115 volts 60 cycle AC. complete \$2750.00.

300 TO 2400MC RF PKG.

300 to 2400 MC CW. Tuneable. Transmitter 10 to 30 Watts. Output. As new \$475.

500KW "L" BAND RADAR

500 kw 1220-1359 mcs. 160 nautical mile search range P.P.I. and A Scopes. MTI thyratron mod. 5J26 magnetron. Complete system.

PHILCO MICROWAVE LINKS

C Band Microwave Link terminal bays and repeater bays in stock. New \$1500 each or \$2500 per pr.

100-800MC. CW SOURCE

150 watts CW nominal output 115 V 60 Cy AC Input. \$1600.

100KW 3CM. RADAR

Complete 100 kw output airborne system with AMTI. 5C22 thyr. mod. 4J52 magnetron. PPI. 360 deg az sweep. 60 deg. elev. sweep. gyro stabilizer. hi-gain revr. Complete with all plugs and cables.

M-33 AUTO-TRACK RADAR SYSTEM

X band with plotting board, automatic range tracking, etc. Complete with 1 megawatt acq. radar.

INFRARED SOURCES

Collimated radiation simulator and transistorized temp. controller. Temp. range. 200-600 degree C. Absolute Accuracy ± 3 degree C. Type AN/USM. \$1975 New.

3KW RCA PHONE & TELEG XMTR

2-30 MC. 10 Autotone channels plus MO. Input 220 vac. 50/60 cycles.

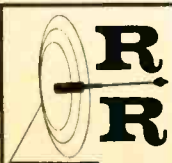

Radio-Research Instrument Co.

560 6th Ave. New York 36, N.Y.
Tel. Judson 6-4691

CIRCLE 955 ON READER SERVICE CARD

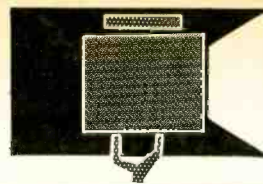

SEARCHLIGHT SECTION

• CLASSIFIED ADVERTISING • BUSINESS OPPORTUNITIES
• USED OR SURPLUS EQUIPMENT

ELECTRON TUBES

KLYSTRONS • ATR & TR • MAGNETRONS
SUBMINIATURES • C.R.T. • T.W.T. • 5000-
6000 SERIES

• SEND FOR NEW CATALOG A2 •

A & A ELECTRONICS CORP.

1063 PERRY ANNEX
WHITTIER, CALIF.
696-7544

CIRCLE 951 ON READER SERVICE CARD

TEST EQUIPMENT

For over 20 years specializing in top brands only. Write for our latest listing. We buy complete inventories.



ELECTRONIC SALES

1413 Howard Street, Chicago, Illinois 60626
Telephone ROgers Park 4-0600

CIRCLE 952 ON READER SERVICE CARD

New

VACUUM PENCIL



PHILIP FISMAN CO.

7 CAMERON ST., WELLESLEY, MASSACHUSETTS

CIRCLE 953 ON READER SERVICE CARD

SMALL AD but BIG STOCK

of choice test equipment
and surplus electronics

Higher Quality—Lower Costs
Get our advice on your problem

ENGINEERING ASSOCIATES

434 Patterson Road — Dayton 19, Ohio

CIRCLE 954 ON READER SERVICE CARD

WANTED

Coil Winder for winding universal type coils. Also Tektronix type "S" plug-in. Send full details to:

3329 Doris Ave.

WANAMASSA, NEW JERSEY 07712

Phone: 201-775-4221

CIRCLE 956 ON READER SERVICE CARD

Your Used, Surplus and Rebuilt Equipment

Advertising here in the

Searchlight Section

will impress key buyers

Buyers regularly turn to these pages for their used equipment needs . . .

You can reach these buyers quickly and economically with your advertising in this "meeting place" of used electronics equipment buyers and sellors.

For more information, please contact:

ELECTRONICS

Classified Advertising Division

POST OFFICE BOX 12

NEW YORK, NEW YORK 10036

Area Code 212, 971-2557

FREE CATALOG!
NEARLY 4,000 BUYS
FOR INDUSTRY

OPTICS! SCIENCE! MATH!
GIANT 148 PAGES

Many on-the-job helps . . . Quality Control Aids! Write for this completely new, 1965 Catalog. New items, new categories, new illustrations. 148 easy-to-read pages packed with hundreds of charts, diagrams, illustrations. A treasure-house of optical and scientific information . . . unusual bargains galore. Optics for industry, research labs, design engineers, experimenters, hobbyists! Instruments for checking, measuring—to speed work, improve quality, cut production costs. We give you facts: what it is—how it works—where it's used!

COMPARATORS, MAGNIFIERS, MICROSCOPES

Hard-to-get war surplus bargains—ingenious scientific tools—imported—domestic. Thousands of components: lenses, prisms, wedges, mirrors, mounts—accessories of all descriptions. Dozens of instruments: magnifiers, stereo microscopes, telescopes, binoculars, infra-red equipment, photo attachments. Shop by mail. No salesman will call. Use the Catalog of America's greatest Optics—Science—Math Mart. Known for reliability. Mail coupon below for catalog "EX". No obligation.

EDMUND SCIENTIFIC CO.
Barrington, N. J.

MAIL COUPON FOR FREE CATALOG 'EX'

EDMUND SCIENTIFIC CO., Barrington, N. J.

Please send FREE Giant 148-page Catalog 'EX'

NAME

ADDRESS

CITYZONE.....STATE.....

CIRCLE 958 ON READER SERVICE CARD

New Literature

Microwave facilities. Weinschel Engineering, Gaithersburg, Md. A 16-page brochure, "The Pursuit of Precision," gives a profile of the company and its personnel, predicts growth, and explains capabilities and facilities for the design and manufacture of precision microwave equipment.

Circle 461 on reader service card

Space batteries. Gulton Industries, 212 Durham Ave., Metuchen, N.J. The VO-HS series of hermetically sealed nickel-cadmium space batteries is described in bulletin VO114d. [462]

Motors and gear motors. The Singer Co., Diehl Division, 2221 Barry Ave., Los Angeles, 90064. An illustrated catalog now available is entitled "DC Motors/DC Gear Motors." [463]

Pulse and digital instrumentation. Data-pulse, Inc., 509 Hindry Ave., Inglewood, Calif., 90306, offers its 1965-66 condensed catalog furnishing major specifications, general descriptions and prices for over 25 pulse generators, including programmable models, digital data generators, and plug-in output units. [464]

Low-loss ferrite. Indiana General Corp., Electronics Division/Ferrites, Keasbey, N.J., has available an engineering data bulletin on Ferramic "O-5," a high-initial-permeability, low-power-loss ferrite material. [465]

High-purity materials. United Mineral & Chemical Corp., 129 Hudson St., New York, N.Y., 10013, has released a brochure containing description and prices of high-purity materials for the semiconductor, missile and nuclear industries. [466]

Electrolytic capacitors. Sprague Electric Co., 35 Marshall St., North Adams, Mass. Engineering bulletin 3060B describes type 89D Verti-lytic aluminum electrolytic capacitors designed for upright mounting on printed wiring boards. [467]

High-power circulators. Raytheon Co., 130 Second Ave., Waltham, Mass., offers a short form catalog describing more than 60 high-power differential phase shift circulators. [468]

Traveling-wave tubes. Microwave Associates, Inc., Burlington, Mass. Catalog SF-1800 contains complete descriptions of and specifications for six of the firm's standard traveling-wave tubes, as well as three others that are in the late stages of development. [469]

D-c motor. Globe Industries, Inc., 2275 Stanley Ave., Dayton, Ohio, 45404. Two-page bulletin A-1904 provides design data on the type JM permanent magnet d-c motor, rated at 1/65 hp. [470]

Electronic choppers. Solid State Electronics Corp., 15321 Rayen St., Sepulveda, Calif., has published a bulletin on the models 40 and 40P microminiature silicon-transistor electronic choppers. [471]

Mobile power supply. Chatham Electronics, division of Tung-Sol Electric, Inc., 630 W. Mt. Pleasant Ave., Livingston, N.J., has a technical data sheet listing physical and electrical specifications for a 45-amp, scr-regulated, mobile power supply. [472]

H-v power packs. Wabash Magnetics, Inc., 1375 Swan St., Huntington, Ind., 46750. Six high-voltage power pack series are pictured and described in a new four-page folder. [473]

Epoxy powders. The Polymer Corp., Reading, Pa., 19603, offers a brochure describing its Corvel epoxy coating powders for insulation by spray or fluidized-bed heat-fusion coating techniques. [474]

Programming switches. Seaelectro Corp., Mamaroneck, N.Y., 10544. A four-page catalog describes the features and operating principles of ACTAN drum programming switches. [475]

Microcircuit synchronizing generators. Cohu Electronics, Inc., Box 623, San Diego, Calif., 92112. Microcircuit synchronizing generators for monochrome or color tv cameras are detailed in bulletin 6-378. [476]

Proportional control oven. CTS Knights, Inc., Sandwich, Ill. Catalog sheet 952-5 illustrates and describes four new low-cost proportional-control ovens for crystals, oscillators and other electronic components. [477]

Laser system. Applied Lasers, Inc., 72 Maple St., Stoneham, Mass., 02180. A technical specification bulletin describes a high-repetition, high-energy laser system. [478]

Silicon rectifier circuits. Edal Industries, Inc., 4 Short Beach Road, East Haven 12, Conn., has issued a bulletin on the series P miniature silicon rectifier circuits. [479]

Operational amplifiers. Melcor Electronics Corp., 1750 New Highway, Farmingdale, L.I., N.Y. A line of solid-state differential operational amplifiers is described in catalog C1001. [480]

Compound semiconductor materials. Ohio Semitronics, Inc., 1205 Chesapeake Ave., Columbus, Ohio, 43212. A five-page catalog describes high-purity elements III-V and other semiconducting materials supplied with electrically characterized properties. [481]

FREE! NEW!

NEWARK 1966 INDUSTRIAL ELECTRONICS CATALOG LISTING

over 1000

TEXAS INSTRUMENTS



Semiconductors

including the new

"SILECT"™ TRANSISTORS



These economically-priced silicon transistors are designed for consumer and industrial applications.

They are packaged in silicone plastic that will not burn or deform at soldering temperatures and is naturally opaque. Sample lots have been tested to the moisture resistance requirements of MIL-STD-202B, method 106A, with no failures.

"SILECT" Transistor series currently available include high frequency (NPN), medium-power (NPN), low-noise, low-level (NPN), unijunctions and PNP transistors.

- Immediate Delivery from Stock
- Factory OEM Prices

NEWARK CATALOG 85

- Industry's Most Complete Catalog
- 660 Pages • Over 70,000 items
- Over 600 Standard Brand Lines
- Seven Stocking Warehouses
- Over \$6,000,000 Industrial Electronics Inventory

NEWARK ELECTRONICS CORPORATION

Main office and warehouse • Dept. EL
223 West Madison • Chicago, Ill. 60606

Authorized Texas Instruments
Warehouses in:

CHICAGO, ILL.
(312) ST 2-2944

CINCINNATI, OHIO
(513) 421-5282

DENVER, COLORADO
(303) 757-3351

DETROIT, MICHIGAN
(313) 548-0250

GRAND RAPIDS, MICHIGAN
(616) 452-1411

LOS ANGELES AREA
(213) OR 8-0441

Other Newark Warehouses in:
NEW YORK CITY
(212) 255-4600

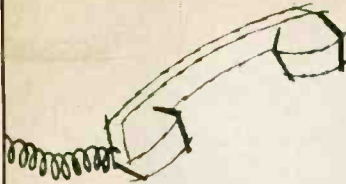

CALL **m**
MILGRAY



ERIE MINIATURIZED CERAMIC TRIMMERS

FOR COMMERCIAL and MILITARY APPLICATIONS

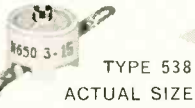

TYPE 538
ACTUAL SIZE

**IDEAL FOR PRINTED CIRCUIT BOARD
APPLICATIONS . . . OR POINT-TO-POINT WIRING**

Engineers demanding quality and reliability in miniaturized Ceramic, Glass, Quartz and Plastic Trimmers look to Erie for their total trimmer requirements. Erie variable capacitors, long acknowledged as the industries' finest, are available in a complete range of types, sizes and values right off-the-shelf for immediate delivery.

Take the 538 Type illustrated above. This subminiature Ceramic Trimmer Capacitor is made of excellent all-ceramic material with fired electrodes and non-ferrous silver plated terminals. The 538's rugged construction and reliable performance make it ideal for Aerospace, Military and Commercial circuit applications. It is available in a variety of terminal arrangements and capacitance ranges to suit particular applications. Of course the 538 is available directly from stock.

We maintain a complete inventory of all miniaturized Erie Trimmers . . . a few of which are shown at right. In addition, complete stocks are maintained on other subminiature Erie components . . . Monobloc high capacitance capacitors, tubular and disc units, stand-offs, feed-thrus, micas, films, tantalums, R.F.I. filters and semiconductors.

Remember, your Erie distributor is your one-stop Trimmer source. Call or write for your supply . . . now.



Formerly
Erie Resistor
Corporation

OTHER ERIE TRIMMERS IN STOCK



● CERAMIC . . .

-  503 SERIES
-  538 SERIES
-  557 SERIES
-  519 SERIES

● GLASS and QUARTZ

-  PANEL MOUNT
-  PRINTED CIRCUIT MOUNT

● PLASTIC

-  531-532 SERIES
-  535 SERIES

ERIE

TECHNOLOGICAL

PRODUCTS, INC.



MILGRAY / NEW YORK
160 VARICK ST. / N. Y., N. Y. 10013 / 212-YU 9-1600
NEW JERSEY 201-HE 2-4300 / TWX 212-640-5638 / TELEFAX FQF

MILGRAY / WASHINGTON
5133 LAWRENCE PLACE / HYATTSVILLE, MARYLAND 20781
202-864-6330 / BALT. 301-727-1870 / TWX 301-422-1211
ENTERPRISE AND ZENITH NUMBERS IN LEADING INDUSTRIAL AREAS



644 West 12th Street
Erie, Pennsylvania

Advanced Components Through Increased Volumetric Efficiency

Electronics Abroad

Volume 38

Number 22

Japan

Gunn-effect oscillator

The Nippon Electric Co. has qualified in the international race for a commercial solid state oscillator. The Japanese company announced last month that it has attained continuous-wave operation of Gunn-effect diodes.

With this achievement, Nippon Electric is only a few months behind two American companies—the International Business Machines Corp. and Bell Telephone Laboratories—and a British concern, Standard Telecommunications Laboratories, an affiliate of the International Telephone and Telegraph Corp.

The Gunn effect is the emission of coherent microwave oscillations from a bulk semiconductor when an electrical field of a specific magnitude is applied.

Output in gigawatts. The diodes at Nippon Electric have a center frequency of about three gigacycles with a power output of several milliwatts. The frequency spectrum is less than one megacycle. Hiromi Murakami, head of the group that developed them, says the frequency can be varied between 2 and 4 Gc, a range of one octave, by adjusting a built-in cavity in the diode mount.

This is higher than the 1 Gc delivered by the British experimental oscillator. IBM has predicted it will achieve 9 Gc with about 10 milliwatts of continuous-wave power in the next few months.

A solid state oscillator is a particularly attractive goal in Japan, which has the world's heaviest concentration of microwave lines. Nippon Electric supplies 95% of Japan's microwave carrier equipment.

Solving the heat problem. Murakami says the key development was a cartridge mount with a built-in cavity and improved heat-transfer characteristics. The package allows the dissipation of five watts of in-

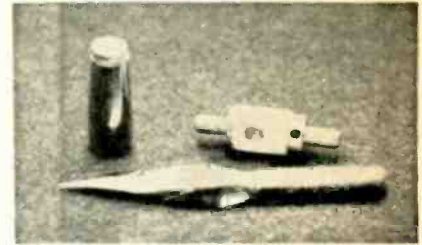
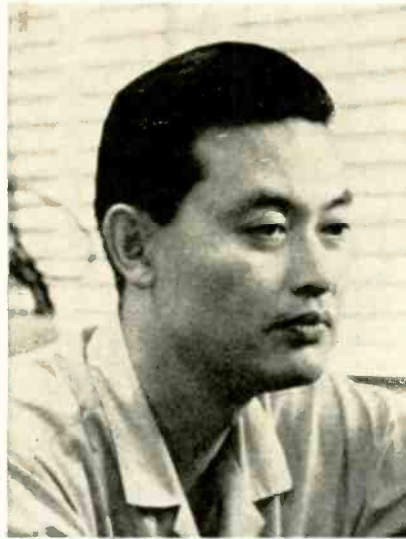

Gunn-effect oscillators, c-w type left and pulse type at right, are both dwarfed by the penpoint in foreground.

Hiromi Murakami leads research group that developed Nippon Electric's Gunn-effect diode.

put, corresponding to 50 applied volts; in experiments, about 30 volts are supplied, resulting in inputs of slightly more than two watts.

Heat is a problem because the gallium-arsenide crystals imported from the United States have lower resistivity—by one or two orders of magnitudes—than that of the material with which Bell Labs is working. Because the Gunn effect is a voltage-controlled negative resistance with precise threshold voltage, low resistivity results in high current and the device must be able to dissipate high power without burning up.

Nippon Electric says it has achieved pulses at frequencies of more than 10 Gc.

Dies are cast. The Japanese 3-Gc diodes use semiconductor dies 40 microns thick and about 100 microns square. Ohmic contacts are made by evaporating a nickel-tin alloy onto the semiconductor's upper and lower surfaces.

The British oscillator, an epitaxial Gunn-effect device, is built of a substrate of semi-insulating gallium arsenide about 100 microns thick, on which is grown a layer of pure gallium arsenide 15 microns thick.

Murakami's immediate goals are amplification and continuous-wave

outputs of 100 milliwatts and pulses of 100 watts. At these powers, the Japanese believe that Gunn-effect diodes could replace low-power reflex klystrons; the diodes would even be superior to varactor multipliers for this purpose for two reasons: varactors often suffer from spurious responses, and they tend to become unwieldy when large multiplication ratios are required.

Many other Japanese companies, in addition to Nippon Electric, are working on Gunn-effect oscillators. Several, including the Tokyo Shibaura Electric Co. (Toshiba), Fujitsu, Ltd. and Hitachi, Ltd., have achieved pulse oscillations.

West Germany

Industrial computers

Computers, which have been working their way into West German factories via accounting offices, now seem ready to take charge of the production lines as well. This was dramatically evident at Interkama, the international automation and instrumentation show that closed Oct. 19 at Duesseldorf.

One organizer of the quinquen-

nial exhibition put it this way: "At our last show you could count the computers on the fingers of one hand. Now it almost takes a computer to count them."

A continuing shortage of skilled labor, coupled with an economic boom that shows no sign of let-down, has made German industry acutely aware of automatic controls. One advantage of electronic controls was described by an exhibitor of pneumatically driven valves: "We have a strong product line, but electronic goods have the glamour."

Spare time. Siemens & Halske AG showed its 303p, a small process-control computer that can be used by itself or as a satellite in a bigger system. The 303p is no sloth; when it has free time in its process-monitoring duties, it does problem-solving and other tasks.

Ferranti, Ltd., of Britain, drew favorable comments about its microminiature Argus computers. Designed to fit into a plane, the Argus 400's central processor is made with silicon integrated circuits that permits fewer than 600 elements to do the work of 1,000 elements in other machines with similar capacity. At Duesseldorf, Ferranti had an Argus 400 hooked up as a process simulator, with set-point controls open so that visitors could vary them. The setup duplicated the method by which a similar Argus has controlled the operations of an alkali plant of Imperial Chemical Industries, Ltd., with 100 loops.

Another British company, Elliott-Automation, Ltd., showed a small version of an Arch 1000 computer to demonstrate the optimization of a catalytic process and of a traffic-control program.

A German concern, AEG, exhibited a model of a sintering oven operating under digital control.

Expanding market. These exhibitors—and others from the United States, France, Belgium and the Netherlands—are seeking a share of an economy whose strength is second only to America's. Production of industrial controls in West Germany is expected to total \$1 billion this year, a hefty climb from the \$550-million level of 1960,

when the last Interkama was held.

And the growth pace should continue. Automated plants in Germany still constitute a small proportion of the country's industry and the number is expected to double every five years. Pricing has been fairly stable, as has an order backlog of about six months.

Sweden

Hospital computers

The biggest advances in computerization of hospital records are likely to be made in Sweden. That prediction was made in Stockholm by James Sweeney, head of the Tulane University Data Center. He spoke Sept. 30 near the end of a three-day symposium on medical record systems, believed to be the first meeting of its type.

Sweeney explained that computerization is easiest in Sweden and other countries whose hospital services are nationalized; another reason is Sweden's severe shortage of hospital personnel.

Data delivery. Delegates generally agreed that medical monitoring is a relatively small problem compared with the complexities of keeping hospital records. Hospital administrators in Sweden estimate that only 5% of all patients require intensive care; complex monitoring systems for these few patients is not as vital as the need for keeping track of such records as diagnoses, prognoses and treatment.

Plans for mass medical examinations—for as many as one million people at a time—are giving added impetus to computerization in Sweden.

Dr. Paul Hall, head of a data-processing group at Seraphimer Hospital in Sweden, said: "The goal . . . is to build a total medical records system to handle all information on a patient with a computer, plus building a communications system that can put information in and take information out immediately." For this task, Hall said, the largest computers in existence are probably too small.

Soviet Union

Another Lightning

With the launching of a second communications satellite, the Soviet Union has made clear its intention to blanket its 85 million square miles with a system of relay stations in space.

The fact that the new satellite is being called the second Molnya 1, not Molnya 2, indicates that a second generation of communications satellites may be in the works. There has been speculation in Moscow that the second generation would be capable of transmitting to various points on earth simultaneously; Molnya 1 can handle messages to only two points at a time in the Soviet Union.

Tandem in space. A Russian engineer says the second satellite will be used in conjunction with the first "to check out cosmic communications systems using more than one sputnik." The second Molnya (the Russian word for lightning) seems to be a carbon copy of the first. Its initial orbital period was 11 hours and 59 minutes; presumably it would be kicked up to a slightly higher perigee to put it into a synchronous orbit of one revolution every 12 hours.

Molnya's big advantage over the United States' Early Bird satellite, according to the Russians, is its radiation power—40 watts, or six times the strength of Early Bird. Prof. M. Kaplanov, a communications specialist writing in *Izvestia*, the government newspaper, said that the greater power permits a significant reduction in the size of ground stations.

Soviet engineers say sputniks eventually should be able to broadcast directly to simple ground equipment or even to home receivers. There is also a growing feeling in favor of international controls lest satellites, broadcasting on conventional television wavelengths, clutter up the world's frequency spectrums.

The first Molnya has transmitted color tv between Moscow and Vladivostok, 4,000 miles to the east, using the French Secam system.

France

Latin launch-site

Twenty-five hundred miles southeast of Cape Kennedy, France is building a satellite-launching site that she expects to rival any in the world. By 1969 the space city on South America's northeast shoulder will comprise 23 buildings, 25,000 employees and the latest in equipment. It will be built on the coast of French Guiana, an overseas department of France.

French officials expect the 15-mile-long site to become the center for their civilian space activities, perhaps for all of Europe's and even for some American projects. The Guiana site, they explain, has one big advantage over Cape Kennedy: at a latitude of 5.3° north, it practically straddles the equator, where the earth's rotational speed is highest and therefore makes it easiest for a spacecraft to attain enough speed to break away from the earth's gravitational pull.

First satellites. France is anxious to establish launch facilities on her own territory. Her first two satellites are scheduled for launch late in December or early in 1966; but one firing will take place at a site in the Sahara which the French have agreed to vacate in July, 1967, at the request of the Algerian government, and the other will be launched in California by the United States' National Aeronautics and Space Administration, on contracts with the French.

Paris is not saying whether any satellites are to be launched between 1967, when the Algerian site is vacated, and 1969, when the Guiana site is ready. The first stage of construction in Guiana, which began in September, will cost about \$60 million, with total costs expected to reach triple that amount before the first satellite is launched from South America.

The National Center for Space Studies, the French equivalent of NASA, has ordered two big tracking radars. Before 1966, the French also plan to buy two digital computers and two telemetry stations. And some time next year a weather

station is scheduled to be installed.

Tracking. The two main tracking radars, ordered from the Compagnie Française Thomson-Houston, are described as equivalent to the AN-PF 16 in the United States. One will be placed nine



miles from the launch site, the other 40 miles away. Each will have a range of about 1,400 miles.

Both radars will feed into a buffer computer; a second computer will calculate impact point, visualize the trajectory, and point the antennas for the optical and telemetering systems. A smaller radar at the missile site will point the main tracking radars' antennas.

Alain Rocroi, equipment chief of the French space agency, says each computer will have a 32,000-word memory capacity and a basic cycle time of 1.5 microseconds. He says the costs of the computers and the three radars will total about \$10 million.

The stations. One telemetry station will be established at Cayenne, one of Guiana's three ports; the other will be at Kourou, 25 miles up the coast. These stations will operate at 215,260 megacycles per second. If other European countries decide to use the base, the stations' scope will be extended with pulse-code modulation equipment, Rocroi says.

The weather station's first task will be to study Guiana's climate; it will be equipped to receive reports from Tiros and Nimbus, the U.S. weather satellites. For the optics, the French are considering infrared systems because they may be better able to penetrate the humid atmosphere of Guiana than can signals in the microwave spectrum.

Trade with China

Communist China has placed her first big order for French electronics equipment: two broadcast transmitters that will operate at between 3 and 26 megacycles. The manufacturer, Compagnie Française Thomson-Houston, declines to disclose the contract price, but such transmitters in the United States, broadcasting at 350 kilowatts, cost \$300,000 to \$450,000, according to one American specialist.

Whatever its size, the contract is the largest received in France from China. Until now, Chinese orders have been confined to a few measuring instruments.

Exhibition in Peking. Half a dozen French electronics companies will take part next month in a Peking exhibition sponsored by the French electrical-construction industry. Besides Thomson-Houston, France's second-largest electronics producer, the exhibitors will include Compagnie Générale de Télégraphie Sans Fils (CSF), France's biggest, and Compagnie Générale d'Electricité (CGE), the third-ranking electronics concern.

Says one French executive: "There's a wide gap in China that was left when the Russians departed in 1960, and we want to fill it. A group of French engineers who vacationed in China last August saw a very modern components plant in Shanghai. The Chinese evidently are making good progress in routine electronics, but so far they haven't much in the way of advanced equipment."

Great Britain

A time for decisions

When Parliament begins its new session on Nov. 9, Britain's electronics industry will be watching three men most closely:

- Prime Minister Harold Wilson, who seems to have weathered economic and political storms and will now try to put into effect new programs to implement the five-year plan announced in September—one

of whose implied goals is a 7% to 8% annual growth in the electronics industry.

▪ Opposition leader Edward Heath, who will stir up new criticism of the government's economic policies, particularly assailing the Technology Ministry as a do-nothing agency.

▪ Technology Minister Frank Cousins, still the Labor government's storm center, who is expected to counter criticism by disclosing some specific plans for improving the technological level of all British industry.

Wilson. When the Queen gives her "speech from the throne," setting out the government's legislative program, the Prime Minister will be comfortable in the knowledge that the pound sterling seems safe again and that polls indicate his popularity is higher than at any time since he took office.

But he also knows that at this session of Parliament he will have to produce. No longer can he argue that the new day he has promised has not yet dawned because his programs need time to mature and because the government is constantly harried by a sterling crisis not of its own making.

Heath. The new Conservative leader, a parliamentary in-fighter, has criticized Labor's cancellation of military planes, particularly the TSR-2 tactical - strike - reconnaissance aircraft. More important than loss of sales, the Conservatives say, is the damage to British technology.

With Wilson's majority in the House of Commons down to one vote, Heath will be ready to take advantage of any defections in the Labor-Liberal coalition to scuttle the government's program.

Cousins. If Britain's five-year plan is to be realized, the Technology Minister will have to come up with many more specific programs than he initiated in the past year. So far his office has made many studies, begun a program designed to strengthen the computer industry.

Last month, for example, it awarded a three-year grant of up to \$126,000 to meet half the cost of creating an organization to develop computer techniques for

planning and controlling all aspects of the manufacture of shoes.

The industry. Consumer electronics have been in the doldrums all year, but that is not blamed on the government's deflationary measures. Domestic radio production is suffering from competition by low-priced sets from abroad, chiefly from Hong Kong and Japan. The television industry overproduced last year in anticipation of high demand for sets capable of receiving ultrahigh frequencies; that demand has not materialized because the British Broadcasting Co.'s second channel—on uhf—has been a flop with most viewers.

Norway

New IC industry

Norway's electronics industry, always dependent on imported components, will have its first domestic commercial supplier of integrated circuits late this year.

The birthplace of the IC industry will be Horten (population 13,500), near the Oslofjord. Here a new company, Akers Electronics A/S, plans to produce highly specialized integrated circuits and semiconductors such as piezoresistors and field effect transistors. Akers Electronics is a member of the Akers Group, which is composed of companies engaged principally in building ships, machinery and electronic equipment.

The Norwegians do not expect to end their dependence on foreign components. "We will emphasize quality, not quantity," says an Akers official, "and the immediate goal is a capability for producing highly specialized products in areas of electronics that are not served by foreign countries." The long-range goal is the creation of a group of experts in semiconductor and IC technology. At present, electronics companies in Norway specialize in quality, high-priced radios, tv sets and tape recorders.

Three-year study. Work on integrated circuits is not new in Norway. The Central Institute for In-

dustrial Research in Oslo spends \$250,000 a year for research on semiconductors. Most of the work is on instrumentation, especially for medical electronics, industrial and scientific measurements, and digital control systems; but for three years, researchers have been studying integrated circuits. Many of the IC workers were trained at plants in the United States and Canada.

The institute's semiconductor group also operates a pilot plant, which produces special types of planar and field effect transistors. Monolithic logic circuits also have been made in small quantities.

Around the world

Sweden. Check-out procedures for avionics on the Viggen supersonic fighter-attack bomber and reconnaissance plane will be automated. The winner of the \$9-million equipment contract, the Ericsson Telecommunications and Electronics Co., says Sweden will be the first country to use all automatic techniques. Ericsson's equipment is designed specifically for the Viggen; the United States Army, in contrast, insists on general-purpose checkout gear.

France. GE-Bull has boosted sales but is still operating in the red, according to officials of the company owned jointly by the General Electric Co. of the United States and Compagnie des Machines Bull of France. GE-Bull has begun to manufacture the GE 400 line of computers, and says it will be buying 70% of the components in Europe in about a month.

Yugoslavia. A total of 113 companies, including a dozen from the United States, participated in the 12th International Exhibition of Electronics, Automation and Nuclearics at Ljubljana last month. The most important innovation was the marked shift away from consumer products such as radios, and toward such equipment as computers, signaling systems, telecommunications gear and research instruments.

NOW! PCM GROUND DATA ACQUISITION SYSTEMS



TYPICAL TYPE 775 PCM SYSTEM
FROM DYNAPLEX CORPORATION
STANDARD FEATURES

- FET Analog Input Gates
- Fully Programmable Frame Sync Words
- Programmable High & Low Level Input Channels
- Three Different Input Levels
- Offsets Below ± 10 microvolts
- Adjustable Internal Clock for Changing Sampling Rate
- NRZ-M or NRZ-C 9 Bit Word Serial Outputs
- Up to 160 Input Channels
- Backcurrents Below ± 0.05 Microamperes

REQUEST INFORMATION ON TYPE 775 PCM DATA SYSTEMS

DYNAPLEX
CORPORATION

P.O. BOX 341

PRINCETON, NEW JERSEY

08540

Circle 218 on reader service card

Interdepartmental
MEMO

TO: COUNTING GROUP

How can our counter be more costly yet less expensive?

Answer: By outlasting others five to one!

Signed: *Electromechanical Group*

Send for your copy of new HSI catalog.

HSI
HAYDON SWITCH & INSTRUMENT, INC.

1500 MERIDEN ROAD, WATERBURY, CONN. 06720

Circle 219 on reader service card

NEW

**CROSS BAR TYPE
SELECTOR SWITCH**

10 Sliders

20 Contacts

200 Switching
Combinations

- PROGRAMMING
- CIRCUIT DESIGNING
- TESTING
- COMMUNICATIONS

Each module
1 3/4" x 3 1/2" x 5 3/4"

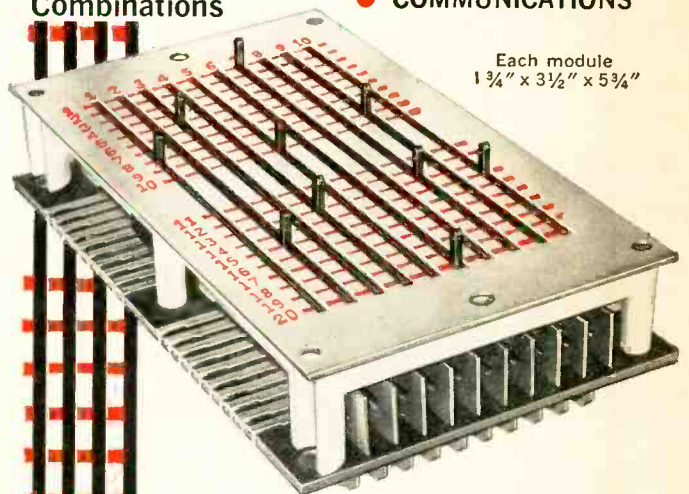

- Expendable modules—up to 1000 crosspoints
- Positive detent positioning
- QC terminal connections
- Rapid circuit selection

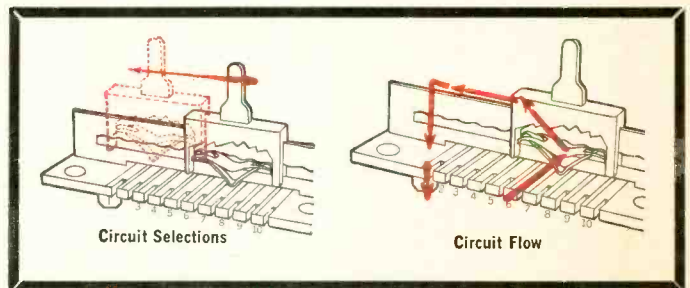

Electrical capacity:

1. Current carrying only (no make or break)
3 amp 125 V AC or DC
2. Make or break
1 amp 15 V DC, 150 m.a. 125 V AC



The complete snap-action switch line
Cherry Electrical Products Corporation

P.O. Box 437-12 Highland Park, Ill.
IN CANADA: BARRY ELECTRIC LTD., REXDALE, ONTARIO

Circle 161 on reader service card

161

Specialist



IN WIRE & CABLE CONSTRUCTIONS

Wiring problems can't always be answered by standard materials, even from the broad range of wire products available today. Markel's capacity for engineering high temperature wire and cable constructions to meet particular needs has grown steadily with the demand. The toughest requirements in temperature, corrosive atmospheres, flexing, corona effect, etc., can be solved—with long range economy and reliability — by specially designed products from our FLEXLEAD Division.

Teflon, Silicone Rubber, Fiberglass, Nylon

Any combinations of insulations, shielding, fillers, liners, and jacket materials—for temperatures from -90° to 260°C —with single, twisted pair, or multiple conductors. May we help you solve your wiring problems?

Norristown, Pa. L. FRANK **MARKEL** & SONS

FLEXLEAD

HIGH TEMPERATURE WIRE AND CABLE

Get more facts. Write or call for a FLEXLEAD Wire and Cable Selector

Order your copy now, of the Complete 1964 Electronics Index to Volume 37



This new, easy to use Index is 40 pages long, and is available for \$1.00.

The Complete Electronics Index for 1964 contains 4 helpful, informative sections:

Subject index—catalogs all articles; technical features, news letter items, Electronics Review, Electronics Abroad and Probing the News stories, also key new product items. They're grouped in more than 250 categories and cross-indexed for easy reference.

Authors index—lists alphabetically all authors of articles which appeared in 1964, so articles may be found when authors are known.

Manufacturers index—This corporate reference gives the page and issue for each mention of an electronics company in the editorial pages of Electronics. It also references government and military organizations.

Advertisers Index: Every advertiser in the 1964 issues of Electronics is listed in this section alphabetically with the issue dates and page numbers of their ads.

This index is a valuable, year round reference tool for your home, office or company library. Use the coupon below to order your copy today. Price is \$1.00.

Send your order to:

Electronics Reprint Dept.
330 West 42nd Street
New York, N.Y. 10036

Enclosed is my check for \$1.00.

Please send me a copy of the Complete 1964 Index.

Name

Number & Street

City, State

Zip Code



| | | | | | |
|--|-------------|---|-----------|--|-----------|
| ■ AMP Incorporated Garceau, Hargrave & McCullough Inc. | 119 | Esterline Angus Instrument Company Inc. Caldwell, Larkin & Sidener-Van Riper Inc. | 56 | Perkin Elmer Corporation Gaynor & Ducas Inc. | 110 |
| ■ Adams-Russell Company Inc. Tech/Reps | 164 | ■ Fairchild Instrumentation The Wexton Company Inc. | 22 | Radio Corporation of America Al Paul Lefton Company | 4th Cover |
| ■ Aerocom Grant Advertising Inc. | 147 | ■ Fairchild Semiconductor Corp. Faust/Day Inc. Advertising | 12, 13 | Shamrock Van Lines Inc. Western Brands Inc. | 146 |
| ■ Air Products & Chemicals Inc. Arthur Falconer Associates Corp. | 17 | ■ Fluke Mfg. Co. Inc. John Bonfield Associates Inc. | 15 | ■ Sorensen Inc. Fuller & Smith & Ross Inc. | 11 |
| ■ Allied Electronics Sub. of Allied Radio Co. Winius-Brandon Company Adv. | 145 | ■ Flying Tiger Line Cole Fischer Rogow Inc. | 100 | ■ Space Craft Inc. Neals & Hickok Incorporated | 107 |
| ■ American Optical Company Fuller & Smith & Ross Inc. | 6 | ■ General Aniline & Film Corporation Hazard Advertising Company Inc. | 103 | ■ Speer Carbon Company Hazard Advertising Company | 52 |
| ■ Ammon Instruments Inc. Culver Advertising Inc. | 134 | ■ General Electric Co., Silicone Products Dept. Ross Roy Inc. | 126 | ■ Sperry Gyroscope Company, Div. of Sperry Rand Corp. Reach, McClinton & Company | 101 |
| ■ Andrew Corporation The Fensholt Advertising Agency | 27 | ■ General Magnetics Inc. George Homer Martin Associates | 98 | ■ Sprague Electric Company The Harry P. Bridge Company | 5, 7 |
| ■ Astrodata Inc. Bonfield Associates Inc. | 135 | ■ General Micro-Electronics Jack Herrick Advertising Inc. | 41 | ■ Stackpole Carbon Company Meek and Thomas Inc. | 99 |
| ■ Astrodyne Inc. Tech/Reps | 40 | ■ General Radio Company K.E. Morang Company | 2nd Cover | ■ Systems Engineering Laboratories Tech-Ad Service | 128 |
| ■ Automatic Electric Company Tatham-Laird & Kudner Inc. | 50 | ■ Graphic Systems Inc. Caswell Adv. Agency | 134 | TRW Systems Fuller & Smith & Ross Inc. | 141 |
| ■ Bausch & Lomb Inc. Wolff Associates Inc. | 18, 19, 39 | ■ Gries Reproducer Corporation Harold Marshall Advertising Co. Inc. | 148 | ■ Tektronix Inc. Hugh Dwight Adv. Inc. | 48, 49 |
| ■ Beckman Instruments Inc. Offner Division Hixson & Jorgensen Inc. | 97 | ■ Haydon Switch & Instrument Inc. Cory Snow Inc. | 161 | ■ Texas Instruments Incorporated Industrial Products Group Robinson-Gerrard Inc. | 47 |
| ■ Bell Telephone Laboratories N.W. Ayer & Son Incorporated | 105 | ■ Hewlett-Packard Company Lennen & Newell Inc. | 2 | ■ Texas Instruments Incorporated Metals & Controls Division Horton, Church & Goff Inc. | 139 |
| ■ Bishop & Company, J. Richardson, Thomas & Bushman Inc. | 38 | ■ Hewlett-Packard Company, Moseley Division Lennen & Newell Incorporated | 1 | ■ Torotel Inc. Spangler Advertising | 122 |
| ■ Bourns Inc. Allen, Dorsey & Hatfield Inc. | 20, 21, 121 | ■ Hitachi Ltd. Dentsu Advertising Ltd. | 129 | ■ Trompeter Electronics Writing and Advertising Inc. | 153 |
| ■ Brush Instruments Div. of Clevite Corp. Carr Liggett Adv. Inc. | 3rd Cover | ■ Hull Corporation The Michener Company | 134 | ■ Trygon Electronics The Wexton Company Inc. | 36 |
| ■ Burr Brown Research Corporation N.A. Winter Adv. Agency | 138 | ■ Hyperion Industries Inc. S. Gunnar Myrbeck & Company | 37 | ■ Trylon Inc. George Moll Adv. Inc. | 40 |
| ■ Cerro Corporation Feeley Advertising Agency | 104 | ■ Industrial Electronic Engineers Inc. Gumpertz, Bentley & Dolan Adv. | 147 | ■ Ultra Carbon Corporation Church & Guisewite Advertising Inc. | 144 |
| ■ Cherry Electrical Products Corp. Jd culea Advertising Inc. | 161 | ■ International Resistance Company Gray & Rogers Inc. | 124 | ■ Unitrode Corporation Electronic Marketing Assistance | 35 |
| ■ Cinch Manufacturing Company Stral Advertising Company Inc. | 111 | ■ Janus Control Corporation L.K. Frank Co. Inc. | 130 | ■ Vector Department of Norden Div. of United Aircraft Corporation Cunningham & Walsh Inc. | 116 |
| ■ Cinch-Graphik Div. of United Carr Reach, McClinton & Company | 131 | ■ Jerrold Electronics Corporation Irving Gould Advertising Inc. | 14 | ■ Watkins-Johnson Company William C. Estler Public Relations | 137 |
| ■ Clifton Precision Products Co. Div. of Litton Industries Ivey Advertising Inc. | 24 | ■ Lockheed-California Company McCann-Erickson Company | 148 | ■ Weston Instruments Incorporated Arndt, Preston, Chapin, Lamb & Keen Inc. | 106, 147 |
| ■ Collins Radio Company Tracy-Locke Company Inc. | 142, 143 | ■ Machlett Laboratories Inc., The Fuller & Smith & Ross Inc. | 9 | | |
| ■ Cominco Products Inc. McKim Productions Limited | 148 | ■ Mallory & Company Inc. P.R. The Aitkin-Kynnett Company | 117 | | |
| ■ Consolidated Electrodynamics Corporation Hixson & Jorgensen Inc. | 108 | ■ Markel & Sons, L. Frank George Moll Advertising Inc. | 162 | | |
| ■ Consolidated Vacuum Corporation Wolff Associates Inc. | 30 | ■ Markem Machine Company Culver Advertising Inc. | 10 | | |
| ■ Control Data/Adcomp Division Barnes Champ Advertising | 120, 127 | ■ Mepco Inc. Ray Ellis Advertising Corp. | 152 | | |
| ■ Corning Glass Works The Rumrill Company Inc. | 28, 29, 123 | ■ M.I.A.L., U.S.A., Inc. Keyes Martin Company | 145 | | |
| ■ Couch Ordnance Inc. Culver Advertising Inc. | 136 | ■ Micro Switch Division of Honeywell Batten, Barton, Durstine & Osborn Inc. | 102 | | |
| ■ Daven Div. of McGraw-Edison Inc. Keys, Martin Company | 54 | ■ Motorola Semiconductor Products Inc. Lane and Bird Advertising Inc. | 55 | | |
| ■ Defense Electronics Inc. H. Durand Associates | 45 | ■ National Cash Register Company Allen, Dorsey, & Hatfield Inc. | 112, 113 | | |
| ■ Dekalb County Chamber of Commerce Burke Dowling Adams Inc. | 16 | ■ Newark Electronics Corporation Stral Advertising Company Inc. | 155 | | |
| ■ Di-Acro Corporation Charles E. Brown Adv. | 140 | ■ North Atlantic Industries Inc. Murray Heyert Associates | 8 | | |
| ■ DuPont de Nemours & Company Inc. E.I. Batten, Barton, Durstine & Osborn Inc. | 53 | ■ Northern Natural Gas Company Bozell & Jacobs Inc. | 46 | | |
| ■ Dynaplex Corporation | 161 | ■ Pennsalt Chemicals Corporation The Aitkin-Kynnett Company | 42 | | |
| ■ Electro Motive Mfg. Co. Inc., The Cory Snow Inc. | 51 | ■ Perfection Mica Company, Magnetic Shield Division Burton Browne Advertising | 122 | | |
| ■ Elgenco Incorporated Wesco Advertising | 145 | | | | |
| ■ Erie Technological Products Co. Inc. Altman-Hall Associates | 156 | | | | |

Classified Advertising

F.J. Eberle, Business Mgr.

| | |
|---|---------|
| EMPLOYMENT OPPORTUNITIES | 149-153 |
| EQUIPMENT (Used or Surplus New) | |
| For Sale | 154 |
| WANTED | 154 |

Advertisers Index

| | |
|-------------------------------------|---------|
| A & A Electronics Corp. | 154 |
| Atomic Personnel Inc. | 150 |
| Dow Chemical Company The | 150 |
| Edmund Scientific Co. | 154 |
| Engineering Associates | 154 |
| Electronic Communications Co. | 150 |
| Fishman Co., Philip | 154 |
| General Dynamics Electric Boat Div. | 149 |
| General Dynamics Electronics Div. | 153 |
| Grumman Aircraft Engineering Corp. | 151-152 |
| Norman Electronic Sales | 154 |
| Radio Research Instrument Co. | 154 |

■ For more information on complete product line see advertisement in the latest Electronics Buyers' Guide



HAPPINESS

is going
from 40 to 400 Mc
in a single
subminiature
hybrid



There's not much depth to our new hybrid product line . . . only 11/32" in fact. Weighing less than 10 grams, these new devices permit significant size reduction and highly reliable circuits.

Our new subminiature hybrids, Iso-T's and Null-T's are available with miniature OSSM connectors or optional feed-through types for integration into printed circuits.

Designed to meet NASA-200-3 specs, these devices are being successfully incorporated into printed circuitry. They meet published specifications with conservative margin.

At Adams-Russell, happiness is receiving orders for these deliverable-from-stock components.

| | |
|--------------------|---------------|
| Frequency | 40 - 400 Mc |
| Insertion Loss | 0.5 db (max.) |
| Isolation | 30 db (min.) |
| Phase Balance* | 1.0° (max.) |
| Amplitude Balance* | 0.2 db (max.) |
| VSWR | 1.3 (max.) |

*Differences measured between isolated ports.

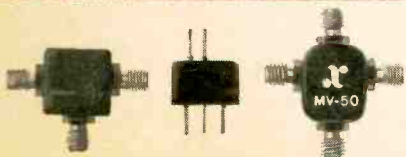
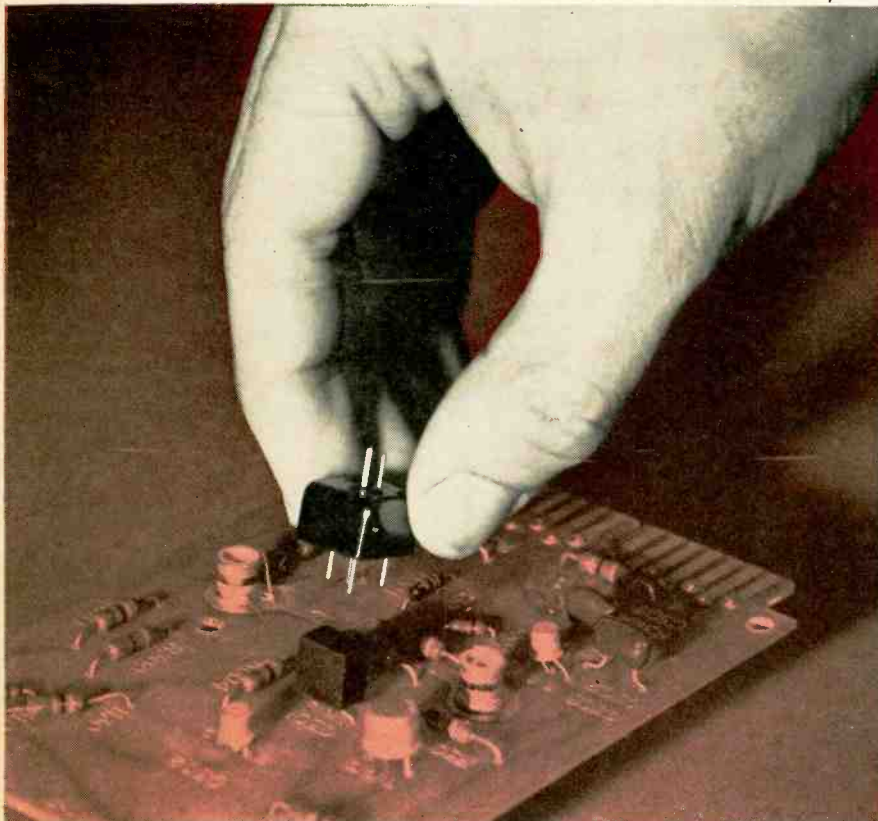

Subminiature Iso-T's, Null-T's, Hybrids



ADAMS-RUSSELL COMPANY, INC.

280 BEAR HILL ROAD
WALTHAM, MASS. 02154
(617)-899-3145



Advertising sales staff

Gordon Jones [212] 971-2210
Advertising sales manager

Atlanta, Ga. 30309: Gus H. Krimsier,
Michael H. Miller, 1375 Peachtree St. N.E.,
[404] TR 5-0523

Boston, Mass. 02116: William S. Hodgkinson
McGraw-Hill Building, Copley Square,
[617] CO 2-1160

Chicago, Ill. 60611: Robert M. Denmead,
J. Bradley MacKimm
645 North Michigan Avenue,
[312] MO 4-5800

Cleveland, Ohio 44113: Paul T. Fegley, 55
Public Square, [216] SU 1-7000

Dallas, Texas 75201: Richard P. Poole, The
Vaughn Building, 1712 Commerce Street,
[214] RI 7-9721

Denver, Colo. 80202: Joseph C. Page, David
M. Watson, Tower Bldg., 1700 Broadway,
[303] AL 5-2981

Detroit, Michigan 48226: Paul T. Fegley
856 Penobscot Building
[313] 962-1793

Houston, Texas 77025: Kenneth George,
2270 Humble Bldg.,
[713] CA 4-8381

Los Angeles, Calif. 90017: Ashley P.
Hartman, John G. Zisch, 1125 W. 6th St.,
[213] HU 2-5450

Minneapolis, Minn. 55402: J. Bradley
MacKimm 1104 Northstar Center
[612] 332-7425

New York, N. Y. 10036:
Donald R. Furth [212] 971-3615
Frank LeBeau [212] 571-3615
George F. Werner [212] 971-3615
500 Fifth Avenue

Philadelphia, Pa. 19103: William J. Boyle,
Warren H. Gardner, 6 Penn Center Plaza,
[215] LO 8-6161

Pittsburgh, Pa. 15222: Paul T. Fegley,
4 Gateway Center, (412) 391-1314

Portland, Ore. 97204: James T. Hauptli,
Pacific Building, Yamhill Street,
(503) CA3-5118

St. Louis, Mo. 63105: Robert M. Denmead
The Clayton Tower, 7751 Carondelet Ave.
[314] PA5-7285

San Francisco, Calif. 94111:
James T. Hauptli, 255 California Street,
[415] DO 2-4600

London W1: John W. Patten, Edwin S.
Murphy Jr., 34 Dover Street,
Hyde Park 1451

Milan: 1, via
Baracchini Phone: 86-90-617

Frankfurt/Main: Gerd Hinske, 85
Westendstrasse Phone: 77 26 65 and
77 30 59

Geneva: Michael R. Zeynel, Joseph Wuensch,
2 Place du Port 244275

Paris VIII: Denis Jacob, 17 Avenue
Matignon ALMA-0452

Tokyo: Nobuyuki Sato, 1, Kotohiracho
Shiba, Minato-Ku (502) 0656

Osaka: Kazutaka, Miura, 163, Umegee-cho,
Kilta-ku [362] 8771

Nagoya: International Media Representatives,
Yamagishi Bldg., 13, 2-Chome,
Oike-cho Naka-ku

Hugh J. Quinn: [212] 971-2335
Manager Electronics Buyers' Guide

David M. Tempest: [212] 971-3139
Promotion manager

Milton Drake: [212] 971-3485
Market research manager

Wallace C. Carmichael: [212] 971-3191
Business manager

Theodore R. Geipel: [212] 971-2044
Production manager

Electronics reader service

Use these handy post cards for more detailed information on: products advertised, new products, new literature.

Circle the number on the Reader Service post card that corresponds to the number at the bottom of the advertisement, new product item, or new literature in which you are interested.

Please print clearly. All written information must be legible to be efficiently processed.

If someone has beaten you to the post cards, you may obtain the needed information by writing directly to the manufacturer, or by sending your name and address, plus the Reader Service number, to Electronics Reader Service department.

All inquiries from outside the U.S. that cannot reach Electronics before the expiration dates noted on the Reader Service post card, must be mailed directly to the manufacturer. The manufacturer assumes all responsibilities for responding to inquiries. Electronics merely provides and clears requests for information from inquirer to manufacturer.

Correct amount of postage must be affixed for all mailings from outside the U.S.

To subscribe to or to renew Electronics

Fill in the "For Subscriptions" area on the card if you desire to subscribe to or renew your present subscription to Electronics. Send no money. Electronics will bill you at the address indicated on the Reader Service post card.

Multi-product advertisements

For information on specific items in multi-product advertisements which do not have a specific Reader Service number indicated write directly to manufacturer for information on precise product in which you are interested.

| | | | | | | | | | | | | | | | | | | | | | | | | | | | | |
|---------------|----|---|----|--|-----|-----|-----|-----|-----|-----|-----|-----|-----|-----|-----|-----|-----|-----|-----|-----|-----|-----|-----|-----|-----|-----|-----|-----|
| 22 | | November 1, 1965 Card Expires December 31, 1965 | | 14 | | | | | | | | | | | | | | | | | | | | | | | | |
| Name _____ | | title _____ | | For Subscriptions <input type="checkbox"/> new <input type="checkbox"/> renewal <input type="checkbox"/> 3 years \$12.00 <input type="checkbox"/> 1 year \$6.00 | | | | | | | | | | | | | | | | | | | | | | | | |
| Company _____ | | | | | | | | | | | | | | | | | | | | | | | | | | | | |
| Address _____ | | | | | | | | | | | | | | | | | | | | | | | | | | | | |
| 1 | 20 | 39 | 58 | 77 | 96 | 115 | 134 | 153 | 172 | 191 | 210 | 229 | 248 | 267 | 286 | 305 | 324 | 343 | 362 | 381 | 400 | 419 | 438 | 457 | 476 | 495 | 514 | 962 |
| 2 | 21 | 40 | 59 | 78 | 97 | 116 | 135 | 154 | 173 | 192 | 211 | 230 | 249 | 268 | 287 | 306 | 325 | 344 | 363 | 382 | 401 | 420 | 439 | 458 | 477 | 496 | 515 | 963 |
| 3 | 22 | 41 | 60 | 79 | 98 | 117 | 136 | 155 | 174 | 193 | 212 | 231 | 250 | 269 | 288 | 307 | 326 | 345 | 364 | 383 | 402 | 421 | 440 | 459 | 478 | 497 | 516 | 964 |
| 4 | 23 | 42 | 61 | 80 | 99 | 118 | 137 | 156 | 175 | 194 | 213 | 232 | 251 | 270 | 289 | 308 | 327 | 346 | 365 | 384 | 403 | 422 | 441 | 460 | 479 | 498 | 517 | 965 |
| 5 | 24 | 43 | 62 | 81 | 100 | 119 | 138 | 157 | 176 | 195 | 214 | 233 | 252 | 271 | 290 | 309 | 328 | 347 | 366 | 385 | 404 | 423 | 442 | 461 | 480 | 499 | 518 | 966 |
| 6 | 25 | 44 | 63 | 82 | 101 | 120 | 139 | 158 | 177 | 196 | 215 | 234 | 253 | 272 | 291 | 310 | 329 | 348 | 367 | 386 | 405 | 424 | 443 | 462 | 481 | 500 | 900 | 967 |
| 7 | 26 | 45 | 64 | 83 | 102 | 121 | 140 | 159 | 178 | 197 | 216 | 235 | 254 | 273 | 292 | 311 | 330 | 349 | 368 | 387 | 406 | 425 | 444 | 463 | 482 | 501 | 901 | 968 |
| 8 | 27 | 46 | 65 | 84 | 103 | 122 | 141 | 160 | 179 | 198 | 217 | 236 | 255 | 274 | 293 | 312 | 331 | 350 | 369 | 388 | 407 | 426 | 445 | 464 | 483 | 502 | 902 | 969 |
| 9 | 28 | 47 | 66 | 85 | 104 | 123 | 142 | 161 | 180 | 199 | 218 | 237 | 256 | 275 | 294 | 313 | 332 | 351 | 370 | 389 | 408 | 427 | 446 | 465 | 484 | 503 | 951 | 970 |
| 10 | 29 | 48 | 67 | 86 | 105 | 124 | 143 | 162 | 181 | 200 | 219 | 238 | 257 | 276 | 295 | 314 | 333 | 352 | 371 | 390 | 409 | 428 | 447 | 466 | 485 | 504 | 952 | 971 |
| 11 | 30 | 49 | 68 | 87 | 106 | 125 | 144 | 163 | 182 | 201 | 220 | 239 | 258 | 277 | 296 | 315 | 334 | 353 | 372 | 391 | 410 | 429 | 448 | 467 | 486 | 505 | 953 | 972 |
| 12 | 31 | 50 | 69 | 88 | 107 | 126 | 145 | 164 | 183 | 202 | 221 | 240 | 259 | 278 | 297 | 316 | 335 | 354 | 373 | 392 | 411 | 430 | 449 | 468 | 487 | 506 | 954 | 973 |
| 13 | 32 | 51 | 70 | 89 | 108 | 127 | 146 | 165 | 184 | 203 | 222 | 241 | 260 | 279 | 298 | 317 | 336 | 355 | 374 | 393 | 412 | 431 | 450 | 469 | 488 | 507 | 955 | 974 |
| 14 | 33 | 52 | 71 | 90 | 109 | 128 | 147 | 166 | 185 | 204 | 223 | 242 | 261 | 280 | 299 | 318 | 337 | 356 | 375 | 394 | 413 | 432 | 451 | 470 | 489 | 508 | 956 | 975 |
| 15 | 34 | 53 | 72 | 91 | 110 | 129 | 148 | 167 | 186 | 205 | 224 | 243 | 262 | 281 | 300 | 319 | 338 | 357 | 376 | 395 | 414 | 433 | 452 | 471 | 490 | 509 | 957 | 976 |
| 16 | 35 | 54 | 73 | 92 | 111 | 130 | 149 | 168 | 187 | 206 | 225 | 244 | 263 | 282 | 301 | 320 | 339 | 358 | 377 | 396 | 415 | 434 | 453 | 472 | 491 | 510 | 958 | 977 |
| 17 | 36 | 55 | 74 | 93 | 112 | 131 | 150 | 169 | 188 | 207 | 226 | 245 | 264 | 283 | 302 | 321 | 340 | 359 | 378 | 397 | 416 | 435 | 454 | 473 | 492 | 511 | 959 | 978 |
| 18 | 37 | 56 | 75 | 94 | 113 | 132 | 151 | 170 | 189 | 208 | 227 | 246 | 265 | 284 | 303 | 322 | 341 | 360 | 379 | 398 | 417 | 436 | 455 | 474 | 493 | 512 | 960 | 979 |
| 19 | 38 | 57 | 76 | 95 | 114 | 133 | 152 | 171 | 190 | 209 | 228 | 247 | 266 | 285 | 304 | 323 | 342 | 361 | 380 | 399 | 418 | 437 | 456 | 475 | 494 | 513 | 961 | 980 |

First class
Permit no. 42
Hightstown, N. J.

Business reply mail
No postage stamp necessary if mailed in the United States

Postage will be paid by

Electronics
Reader service department
Box 444
Hightstown, N.J. 08520



| | | | | | | | | | | | | | | | | | | | | | | | | | | | | |
|---------------|----|---|----|--|-----|-----|-----|-----|-----|-----|-----|-----|-----|-----|-----|-----|-----|-----|-----|-----|-----|-----|-----|-----|-----|-----|-----|-----|
| 22 | | November 1, 1965 Card Expires December 31, 1965 | | 14 | | | | | | | | | | | | | | | | | | | | | | | | |
| Name _____ | | title _____ | | For Subscriptions <input type="checkbox"/> new <input type="checkbox"/> renewal <input type="checkbox"/> 3 years \$12.00 <input type="checkbox"/> 1 year \$6.00 | | | | | | | | | | | | | | | | | | | | | | | | |
| Company _____ | | | | | | | | | | | | | | | | | | | | | | | | | | | | |
| Address _____ | | | | | | | | | | | | | | | | | | | | | | | | | | | | |
| 1 | 20 | 39 | 58 | 77 | 96 | 115 | 134 | 153 | 172 | 191 | 210 | 229 | 248 | 267 | 286 | 305 | 324 | 343 | 362 | 381 | 400 | 419 | 438 | 457 | 476 | 495 | 514 | 962 |
| 2 | 21 | 40 | 59 | 78 | 97 | 116 | 135 | 154 | 173 | 192 | 211 | 230 | 249 | 268 | 287 | 306 | 325 | 344 | 363 | 382 | 401 | 420 | 439 | 458 | 477 | 496 | 515 | 963 |
| 3 | 22 | 41 | 60 | 79 | 98 | 117 | 136 | 155 | 174 | 193 | 212 | 231 | 250 | 269 | 288 | 307 | 326 | 345 | 364 | 383 | 402 | 421 | 440 | 459 | 478 | 497 | 516 | 964 |
| 4 | 23 | 42 | 61 | 80 | 99 | 118 | 137 | 156 | 175 | 194 | 213 | 232 | 251 | 270 | 289 | 308 | 327 | 346 | 365 | 384 | 403 | 422 | 441 | 460 | 479 | 498 | 517 | 965 |
| 5 | 24 | 43 | 62 | 81 | 100 | 119 | 138 | 157 | 176 | 195 | 214 | 233 | 252 | 271 | 290 | 309 | 328 | 347 | 366 | 385 | 404 | 423 | 442 | 461 | 480 | 499 | 518 | 966 |
| 6 | 25 | 44 | 63 | 82 | 101 | 120 | 139 | 158 | 177 | 196 | 215 | 234 | 253 | 272 | 291 | 310 | 329 | 348 | 367 | 386 | 405 | 424 | 443 | 462 | 481 | 500 | 900 | 967 |
| 7 | 26 | 45 | 64 | 83 | 102 | 121 | 140 | 159 | 178 | 197 | 216 | 235 | 254 | 273 | 292 | 311 | 330 | 349 | 368 | 387 | 406 | 425 | 444 | 463 | 482 | 501 | 901 | 968 |
| 8 | 27 | 46 | 65 | 84 | 103 | 122 | 141 | 160 | 179 | 198 | 217 | 236 | 255 | 274 | 293 | 312 | 331 | 350 | 369 | 388 | 407 | 426 | 445 | 464 | 483 | 502 | 902 | 969 |
| 9 | 28 | 47 | 66 | 85 | 104 | 123 | 142 | 161 | 180 | 199 | 218 | 237 | 256 | 275 | 294 | 313 | 332 | 351 | 370 | 389 | 408 | 427 | 446 | 465 | 484 | 503 | 951 | 970 |
| 10 | 29 | 48 | 67 | 86 | 105 | 124 | 143 | 162 | 181 | 200 | 219 | 238 | 257 | 276 | 295 | 314 | 333 | 352 | 371 | 390 | 409 | 428 | 447 | 466 | 485 | 504 | 952 | 971 |
| 11 | 30 | 49 | 68 | 87 | 106 | 125 | 144 | 163 | 182 | 201 | 220 | 239 | 258 | 277 | 296 | 315 | 334 | 353 | 372 | 391 | 410 | 429 | 448 | 467 | 486 | 505 | 953 | 972 |
| 12 | 31 | 50 | 69 | 88 | 107 | 126 | 145 | 164 | 183 | 202 | 221 | 240 | 259 | 278 | 297 | 316 | 335 | 354 | 373 | 392 | 411 | 430 | 449 | 468 | 487 | 506 | 954 | 973 |
| 13 | 32 | 51 | 70 | 89 | 108 | 127 | 146 | 165 | 184 | 203 | 222 | 241 | 260 | 279 | 298 | 317 | 336 | 355 | 374 | 393 | 412 | 431 | 450 | 469 | 488 | 507 | 955 | 974 |
| 14 | 33 | 52 | 71 | 90 | 109 | 128 | 147 | 166 | 185 | 204 | 223 | 242 | 261 | 280 | 299 | 318 | 337 | 356 | 375 | 394 | 413 | 432 | 451 | 470 | 489 | 508 | 956 | 975 |
| 15 | 34 | 53 | 72 | 91 | 110 | 129 | 148 | 167 | 186 | 205 | 224 | 243 | 262 | 281 | 300 | 319 | 338 | 357 | 376 | 395 | 414 | 433 | 452 | 471 | 490 | 509 | 957 | 976 |
| 16 | 35 | 54 | 73 | 92 | 111 | 130 | 149 | 168 | 187 | 206 | 225 | 244 | 263 | 282 | 301 | 320 | 339 | 358 | 377 | 396 | 415 | 434 | 453 | 472 | 491 | 510 | 958 | 977 |
| 17 | 36 | 55 | 74 | 93 | 112 | 131 | 150 | 169 | 188 | 207 | 226 | 245 | 264 | 283 | 302 | 321 | 340 | 359 | 378 | 397 | 416 | 435 | 454 | 473 | 492 | 511 | 959 | 978 |
| 18 | 37 | 56 | 75 | 94 | 113 | 132 | 151 | 170 | 189 | 208 | 227 | 246 | 265 | 284 | 303 | 322 | 341 | 360 | 379 | 398 | 417 | 436 | 455 | 474 | 493 | 512 | 960 | 979 |
| 19 | 38 | 57 | 76 | 95 | 114 | 133 | 152 | 171 | 190 | 209 | 228 | 247 | 266 | 285 | 304 | 323 | 342 | 361 | 380 | 399 | 418 | 437 | 456 | 475 | 494 | 513 | 961 | 980 |

Reprint service

All Electronics editorial matter available in reprint form:

For reprints of special reports and feature articles see list on right side of this page. Send your order to Electronics Reprint Department at the address indicated. To expedite mailing of your order for single reprints please send cash, check or money order with your order.

Bulk reprints of editorial matter can be ordered from current or past issues. The minimum quantity is 100 copies. The higher the quantity ordered, the more economical the cost per copy. Prices quoted on request.

To order reprints or for further information, please write to: **Electronics Reprint Department, 330 West 42nd Street, New York, N.Y. 10036.** Telephone: Area code 212 971-3140.

Prices for the below listed reprints unless otherwise specified are 1-10 copies 50¢ each; 11-24 copies 35¢ each; 25-99 copies 25¢ each; price for 100 or more is 20¢ each.

- Key no. **R-79** MOS Integrated Circuits 12 pages.
- Key no. **R-78** The Overlay Transistor 15 pages. 75¢
- Key no. **R-77** Cold Cathode Tubes (3 part series, 28 pages).
- Key no. **R-76** Automated Trains: Who's On The Right Track? 16 pages.
- Key no. **R-75** Biotelemetry [2 Part series 16 pages].
- Key no. **R-74** Unijunction Transistors, 24 pages.
- Key no. **R-73** Communications on Gemini 24 pages.
- Key no. **R-72** Electronics 35th Special Anniversary Section 28 pages.
- Key no. **R-71** Experiments On Gemini 28 pages.
- Key no. **R-69** 1964 Complete Electronics Index 40 pages. \$1.00
- Key no. **R-68** Designing Against Space Radiation, 18 pages.
- Key no. **R-67** Electronics Markets 1965. 24 page forecast report with 6 page foldout chart.
- Key no. **R-66** Field Effect Transistors, Part I 16 pages.
- Key no. **R-65** Field Effect Transistors, Part II 24 pages
- Key no. **R-64** Field Effect Transistors, Part I 24 pages.
- Key no. **R-63** Silicon Power Transistors 8 pages. 25¢
- Key no. **R-62** Electronic Telephone Switching, 16 pages.
- Key no. **R-61** Direct Digital Control in Industry, 24 pages.
- Key no. **R-60** Transistor Heat Dissipators, 32 pages.
- Key no. **R-58** Oceanography, 15 pages.
- Key no. **R-31** 1962 Electromagnetic Spectrum Chart, [22" x 30" foldout chart]. \$1.00
- Key no. **R-30** Graphical Symbols For Electronic Diagrams, [29" x 11" foldout chart].

First class
Permit no. 42
Hightstown, N. J.



Business reply mail

No postage stamp necessary if mailed in the United States

Postage will be paid by

Electronics
Reader service department
Box 444
Hightstown, N. J. 08520

22 November 1, 1965 Card Expires December 31, 1965 14

Name _____ title _____

Company _____

Address _____

For Subscriptions
 new renewal
 3 years \$12.00
 1 year \$6.00

| | | | | | | | | | | | | | | | | | | | | | | | | | | | | |
|----|----|----|----|----|-----|-----|-----|-----|-----|-----|-----|-----|-----|-----|-----|-----|-----|-----|-----|-----|-----|-----|-----|-----|-----|-----|-----|-----|
| 1 | 20 | 39 | 58 | 77 | 96 | 115 | 134 | 153 | 172 | 191 | 210 | 229 | 248 | 267 | 286 | 305 | 324 | 343 | 362 | 381 | 400 | 419 | 438 | 457 | 476 | 495 | 514 | 962 |
| 2 | 21 | 40 | 59 | 78 | 97 | 116 | 135 | 154 | 173 | 192 | 211 | 230 | 249 | 268 | 287 | 306 | 325 | 344 | 363 | 382 | 401 | 420 | 439 | 458 | 477 | 496 | 515 | 963 |
| 3 | 22 | 41 | 60 | 79 | 98 | 117 | 136 | 155 | 174 | 193 | 212 | 231 | 250 | 269 | 288 | 307 | 326 | 345 | 364 | 383 | 402 | 421 | 440 | 459 | 478 | 497 | 516 | 964 |
| 4 | 23 | 42 | 61 | 80 | 99 | 118 | 137 | 156 | 175 | 194 | 213 | 232 | 251 | 270 | 289 | 308 | 327 | 346 | 365 | 384 | 403 | 422 | 441 | 460 | 479 | 498 | 517 | 965 |
| 5 | 24 | 43 | 62 | 81 | 100 | 119 | 138 | 157 | 176 | 195 | 214 | 233 | 252 | 271 | 290 | 309 | 328 | 347 | 366 | 385 | 404 | 423 | 442 | 461 | 480 | 499 | 518 | 966 |
| 6 | 25 | 44 | 63 | 82 | 101 | 120 | 139 | 158 | 177 | 196 | 215 | 234 | 253 | 272 | 291 | 310 | 329 | 348 | 367 | 386 | 405 | 424 | 443 | 462 | 481 | 500 | 900 | 967 |
| 7 | 26 | 45 | 64 | 83 | 102 | 121 | 140 | 159 | 178 | 197 | 216 | 235 | 254 | 273 | 292 | 311 | 330 | 349 | 368 | 387 | 406 | 425 | 444 | 463 | 482 | 501 | 901 | 968 |
| 8 | 27 | 46 | 65 | 84 | 103 | 122 | 141 | 160 | 179 | 198 | 217 | 236 | 255 | 274 | 293 | 312 | 331 | 350 | 369 | 388 | 407 | 426 | 445 | 464 | 483 | 502 | 902 | 969 |
| 9 | 28 | 47 | 66 | 85 | 104 | 123 | 142 | 161 | 180 | 199 | 218 | 237 | 256 | 275 | 294 | 313 | 332 | 351 | 370 | 389 | 408 | 427 | 446 | 465 | 484 | 503 | 951 | 970 |
| 10 | 29 | 48 | 67 | 86 | 105 | 124 | 143 | 162 | 181 | 200 | 219 | 238 | 257 | 276 | 295 | 314 | 333 | 352 | 371 | 390 | 409 | 428 | 447 | 466 | 485 | 504 | 952 | 971 |
| 11 | 30 | 49 | 68 | 87 | 106 | 125 | 144 | 163 | 182 | 201 | 220 | 239 | 258 | 277 | 296 | 315 | 334 | 353 | 372 | 391 | 410 | 429 | 448 | 467 | 486 | 505 | 953 | 972 |
| 12 | 31 | 50 | 69 | 88 | 107 | 126 | 145 | 164 | 183 | 202 | 221 | 240 | 259 | 278 | 297 | 316 | 335 | 354 | 373 | 392 | 411 | 430 | 449 | 468 | 487 | 506 | 954 | 973 |
| 13 | 32 | 51 | 70 | 89 | 108 | 127 | 146 | 165 | 184 | 203 | 222 | 241 | 260 | 279 | 298 | 317 | 336 | 355 | 374 | 393 | 412 | 431 | 450 | 469 | 488 | 507 | 955 | 974 |
| 14 | 33 | 52 | 71 | 90 | 109 | 128 | 147 | 166 | 185 | 204 | 223 | 242 | 261 | 280 | 299 | 318 | 337 | 356 | 375 | 394 | 413 | 432 | 451 | 470 | 489 | 508 | 956 | 975 |
| 15 | 34 | 53 | 72 | 91 | 110 | 129 | 148 | 167 | 186 | 205 | 224 | 243 | 262 | 281 | 300 | 319 | 338 | 357 | 376 | 395 | 414 | 433 | 452 | 471 | 490 | 509 | 957 | 976 |
| 16 | 35 | 54 | 73 | 92 | 111 | 130 | 149 | 168 | 187 | 206 | 225 | 244 | 263 | 282 | 301 | 320 | 339 | 358 | 377 | 396 | 415 | 434 | 453 | 472 | 491 | 510 | 958 | 977 |
| 17 | 36 | 55 | 74 | 93 | 112 | 131 | 150 | 169 | 188 | 207 | 226 | 245 | 264 | 283 | 302 | 321 | 340 | 359 | 378 | 397 | 416 | 435 | 454 | 473 | 492 | 511 | 959 | 978 |
| 18 | 37 | 56 | 75 | 94 | 113 | 132 | 151 | 170 | 189 | 208 | 227 | 246 | 265 | 284 | 303 | 322 | 341 | 360 | 379 | 398 | 417 | 436 | 455 | 474 | 493 | 512 | 960 | 979 |
| 19 | 38 | 57 | 76 | 95 | 114 | 133 | 152 | 171 | 190 | 209 | 228 | 247 | 266 | 285 | 304 | 323 | 342 | 361 | 380 | 399 | 418 | 437 | 456 | 475 | 494 | 513 | 961 | 980 |

First class
Permit no. 42
Hightstown, N. J.

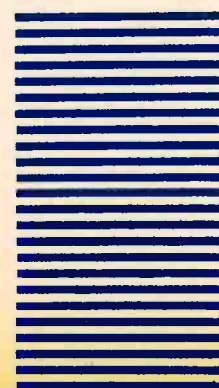

Business reply mail

No postage stamp necessary if mailed in the United States

Postage will be paid by

Electronics
Reader service department
Box 444
Hightstown, N.J. 08520

Another Brush Innovation in Recording:

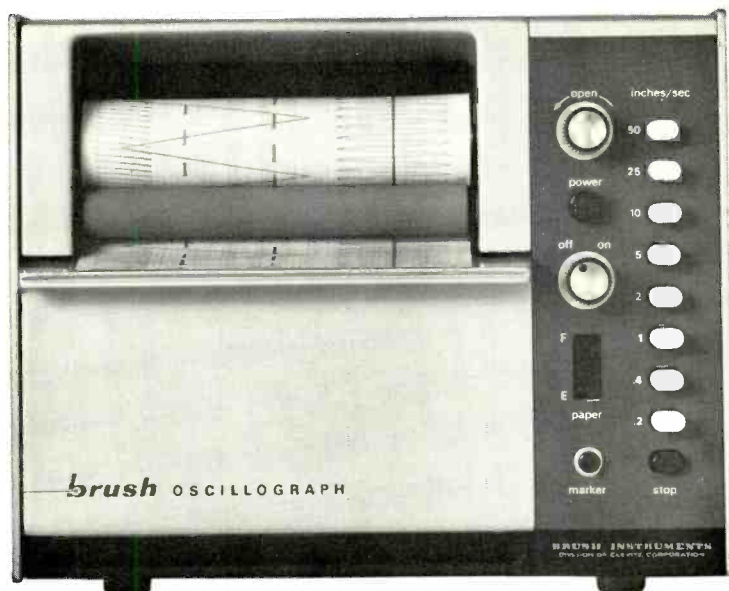

The Brush 2300. Best recorder around for getting lots of data down on one piece of paper.

No wonder the Brush 2300 light beam recorder can handle just about any industrial recording job you can name.

It's available with 1 to 16 analog channels. Writing speeds from 0 to 30,000 inches per second. Push-button choice of eight different chart speeds—or sixteen if you like. And all the frequency response you'll ever need.

Power requirements? Next to nothing . . . even operates off a car battery. One model operates off flashlight batteries!

And here's the topper. *Anyone, anywhere* can operate a 2300. The controls are logically grouped, chart paper loads from the front and the

galvos can be switched and adjusted in seconds. Simple. Rugged. Lightweight. Low cost per channel. That's the 2300. The common-sense selection for almost every industrial recording requirement.

A demonstration will prove it.

Get in touch with your local Brush Sales Engineer. Or, call us collect . . . 216—EN 1-3315. An illustrated brochure is yours for the asking. Brush Instruments Division, Cleveland Corporation, 37th & Perkins, Cleveland, Ohio 44114.

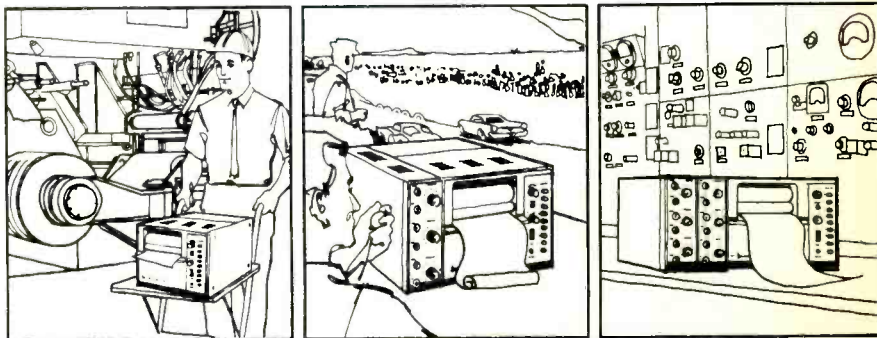

brush **CLEVITE**
INSTRUMENTS DIVISION

Circle 901 on reader service card

No other RF transistor can offer this performance

- ✓ 5 dB NF typ. at 450 Mc/s
- ✓ 11.5 dB gain min. at 200 Mc/s
- ✓ High temperature capability and low-leakage silicon construction

at this price... \$1.25

2N3932 in quantities of 1,000 and up.

RCA's new 2N3932 and 2N3933 low-noise, low-capacitance devices let you simplify VHF receiver circuitry and get more gain, less noise at the same time.

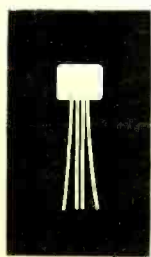

ACTUAL SIZE

RCA 2N3932 and 2N3933 low-noise silicon transistors are hermetically sealed in a 4-lead metal case. Grounding the metal case with the 4th lead:

- reduces internal capacitances, to provide higher usable gain;
- reduces spurious signal pickup and device radiation;
- permits the devices to be operated at full gain because of the internal shielding, even at high frequencies.

These top-value transistors are made possible by RCA's skills in silicon technology and mass-production economy techniques.

For full price and delivery information, phone your RCA Field Representative. Or write: RCA Commercial Engineering, Section E-N-11-1, Harrison, N. J.

AVAILABLE THROUGH YOUR RCA DISTRIBUTOR

RCA ELECTRONIC COMPONENTS AND DEVICES



The Most Trusted Name in Electronics

SUGGESTED APPLICATIONS: Commercial, industrial and military communications equipment, such as: Mobile and aircraft radio. Expendable military equipment, Ham Gear, Citizens' Band radio. Wide-band amplifiers in industrial, military and nuclear applications.

Check the specifications and see how these RCA devices can help you build better VHF/UHF circuits:

- High Gain-Bandwidth Product (f_T): 750 Mc/s min., both types
- Low System Noise Figure†

| | | | |
|---------------|---------------|---------------|---|
| | 2N3932 | 2N3933 | |
| NF @ 450 Mc/s | 5.0 dB typ. | 5.0 dB typ. | †As measured in noise-test circuit shown in Technical Bulletin for RCA 2N3932 and 2N3933. |
| NF @ 60 Mc/s | 2.5 dB typ. | 3.0 dB max. | |
| NF @ 200 Mc/s | 4.5 dB max. | 4.0 dB max. | |
- Low Collector-to-Base Time Constant ($r_b'c_c$):
2N3932—8 ps max. 2N3933—6 ps max.
- High Unneutralized Power Gain (G_{pu}):
2N3932—11.5 dB min., at 200 Mc/s 2N3933—14 dB min., at 200 Mc/s
- Low Output Capacitance (C_{ob}):
2N3932—0.55 pF max. 2N3933—0.55 pF max.
- Hermetically Sealed, Isolated Collector with one lead connected to case.

| Maximum Ratings, Absolute-Maximum Values | | 2N3932 | 2N3933 |
|---|-------|------------------------|----------------|
| V_{CBO} , COLLECTOR-TO-BASE VOLTAGE | | 30 | 40 max. volts |
| V_{CEO} , COLLECTOR-TO-EMITTER VOLTAGE | | 20 | 30 max. volts |
| V_{EBO} , EMITTER-TO-BASE VOLTAGE | | 2.5 | 2.5 max. volts |
| I_C , COLLECTOR CURRENT | | limited by dissipation | |
| P_T , TRANSISTOR DISSIPATION at free-air (up to 25°C) | | 175 | 175 max. mW |
| TEMPERATURE RANGE: Storage and Operation (Junction) | | -65 to +175°C | |